

Architectural Door Accessories

Rockwood Door Pull Catalog

ASSA ABLOY

The global leader in
door opening solutions

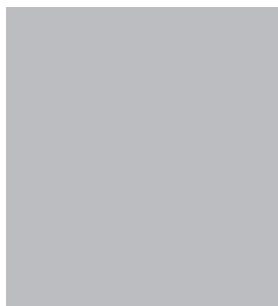
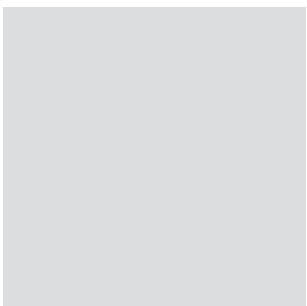
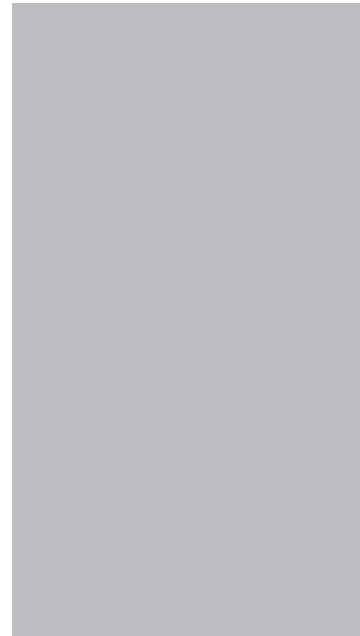

Table of Contents



The global leader in
door opening solutions

Copyright ©2018, ASSA ABLOY Accessories and Door Controls Group, Inc. All rights reserved. Reproduction in whole or
in part without the express written permission of ASSA ABLOY Accessories and Door Controls Group, Inc. is prohibited.

Rockwood Company History	4	Square Grip	66
.....	Leather	69
Custom Manufacturing	5	GeoMetek™	69
.....	Accents	70
Architectural Finishes	6	AccenTek™	70
.....	Diamond	71
Leather Craftsmanship	10	GeoMetek™	71
.....	Smooth	73
Round Grip	12	PlanTek™	73
Leather	15	GeoMetek™	75
English Bridle	15
Upholstery	17	Sculpted Pulls	76
Flush	19	Non-Traditional	78
.....	MariTek™	78
Wood	21	SculpTrex™	79
ArborMet™	21	MegaCurve™	81
ArborTek™	23	CenTrex™	82
ArborTek™ with Collars	25
.....	Traditional	85
Santoprene	27	Classic	85
SoftMet™	27	Traditional	87
SoftTek™	29
.....	Locking Pull System	88
Black Anodized	31	Locking Door Pull System Options	91
NoirMet™	31
NoirTek™	33	Locking Door Pull Configurations	92
.....
Grooved	34	Horizontal Push/Pull Bar Configurations	93
LineaMax™	34
Groove	37	Sliding and Closet Pulls	94
.....	Sliding	97
Smooth	38	AccenTek	97
MegaTek™	38	Closet	98
NeoMax™	41	Closet Pulls	98
NeoMetrix™	43	Edge Pulls	99
NeoMitre™	45
NeoCylinder™	47	Accessories	100
.....	Coat Hooks	102
Accents	49	Door Stops	104
SkewTek™	49	Push Plates, Pull Plates, and Signage	107
MezzoTek™	51
BandWidth™	53	Custom Door Pulls	108
.....
Essential	55	The Good Design Studio	111
RightAngles	55
Tubular	57	Technical Information	112
Standard	59
.....	Finishes	114
Oval Grip	60
Leather	62
Leather Oval	62
.....
Smooth	63
OvalTek™ with Flat Oval Grip	63
OvalTek™ with True Oval Grip	65

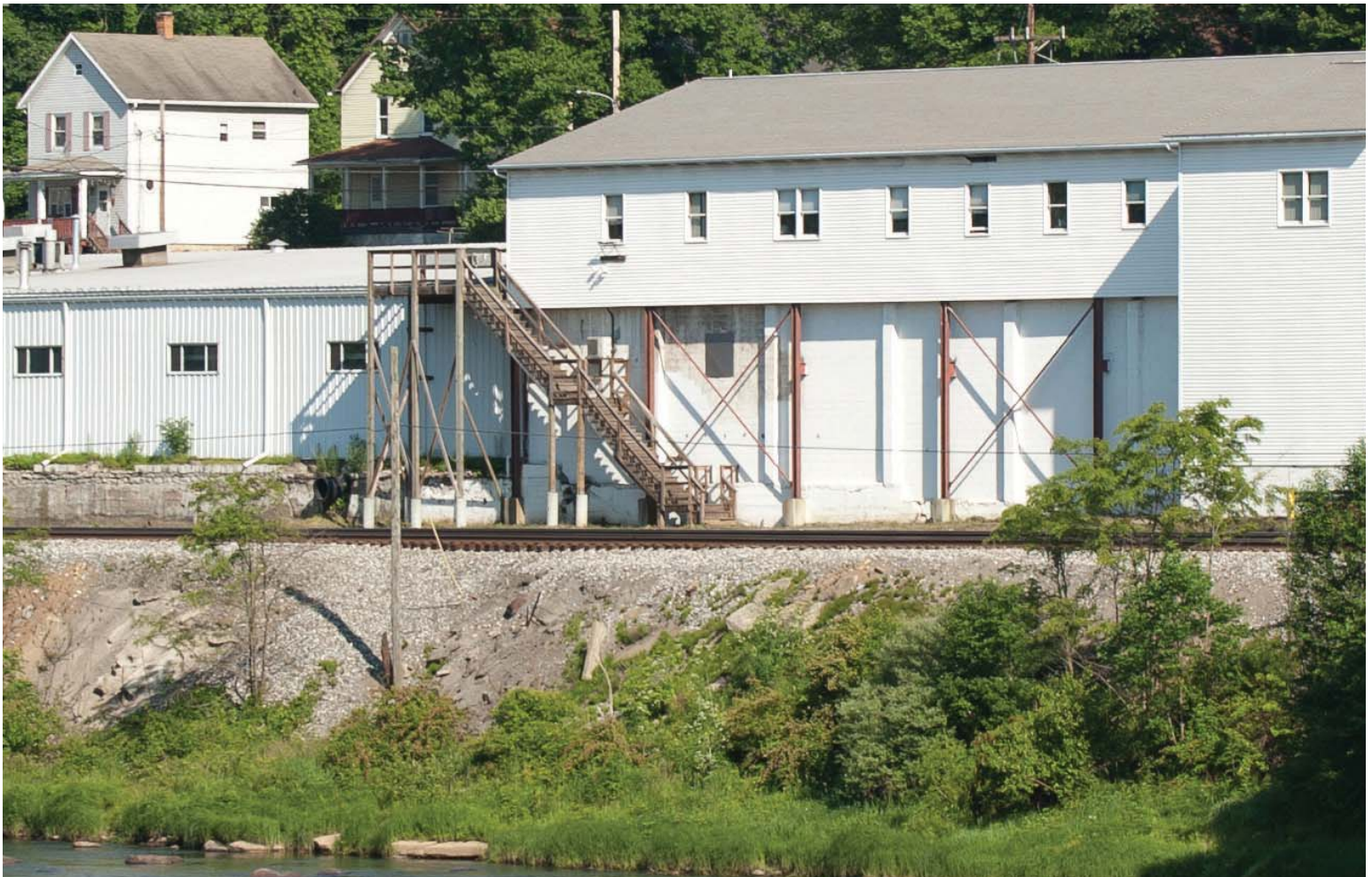

Rockwood Company History

Rockwood Manufacturing Company, founded in 1946 by the Gurzenda Family in rural southwestern Pennsylvania, focuses on the design and manufacture of quality builders' hardware for commercial, institutional, and finer residential buildings.

Now in our third generation of skilled craftsman, we continue to develop new products and processes that improve our offering. Our strict attention to detail, from the selection of top-grade materials to the application of the finest finishes, results in a tough and handsome product of the highest caliber.

ASSA ABLOY

In 2008 Rockwood Manufacturing Company joined ASSA ABLOY, the global leader in door opening solutions. This partnership significantly increased Rockwood's design and development capabilities and greatly expanded ASSA ABLOY's product offering to our customers. The expansion included the addition of many coordinating products between Rockwood and other ASSA ABLOY Group brands through The Good Design Studio.

When you select a Rockwood stainless steel door pull for your LEED certified building project, you are using a product that is made from a minimum 75% post industrial waste and is 100% recyclable. Additionally, these pulls usually can be refinished to their original appearance any time during the life of the building, eliminating the need for replacement when a renovation is conducted. Because of this, ASSA ABLOY can help to achieve prerequisites and accumulate points in several categories and credit areas of LEED.



ASSA ABLOY is a member of the USGBC and CaGBC

U.S. Green Building Council logo is a trademark owned by the U.S. Green Building Council and is used with permission.

The global leader in
door opening solutions

Copyright ©2018, ASSA ABLOY Accessories and Door Controls Group, Inc. All rights reserved. Reproduction in whole or in part without the express written permission of ASSA ABLOY Accessories and Door Controls Group, Inc. is prohibited.



Custom Manufacturing

Design your own hardware! Whether it is a modification of a standard product, a completely unique design, or a custom finish, we will quote your design and offer suggestions for the best mounting applications. We take special pride in our custom products. For more information, please see page 109.









ASSA ABLOY

Architectural Finishes

With several architectural finishes to choose from, Rockwood products are finished to the highest quality standards.



Aluminum Finishes

Swatch	Description	US Code	ANSI/BHMA
	Satin	US27	627
	Clear Anodized	US28	628
	Light Bronze Anodized	311	—
	Medium Bronze Anodized	312	—
	Dark Bronze Anodized	313	710
	Extra Dark Bronze Anodized	314	—
	Black Anodized	315	711







Brass Finishes

Swatch	Description	US Code	ANSI/BHMA
	Polished Clear Coated	US3	605
	Polished No Coating	US3NL	—
	Satin Clear Coated	US4	606
	Satin No Coating	US4NL	—
	Satin Oxidized Relieved	US5	609
	Polished Nickel Plated Clear Coated	US14	618
	Satin Nickel Plated Clear Coated	US15	619
	Satin Nickel Blackened Relieved Clear Coated	US15A	620
	Polished Chrome Plated	US26	625
	Satin Chrome Plated	US26D	626

Bronze Finishes

Swatch	Description	US Code	ANSI/BHMA
	Polished Clear Coated	US9	611
	Satin Clear Coated	US10	612
	Satin Black Oxidized Oil Rubbed	US10A	—
	Satin Oxidized Oil Rubbed	US10B	613
	Satin Oxidized Clear Coated	US10BL	614
	Dark Oxidized Statuary Clear Coated	US20A	624

Powder Coat Finishes

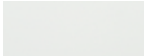
Swatch	Description	US Code	ANSI/BHMA
	Flat Black Powder Coat	US19 (FBPC)	622
	Dark Oxidized Satin Bronze, Equivalent	10BE	(613E)
	Black Powder Coat (gloss)	BPC	—
	Red Powder Coat	RPC	—
	White Powder Coat (gloss)	WPC	—
	Black Suede Powder Coat (matte)	BSP	—
	White Suede Powder Coat (matte)	WSP	—

Stainless Steel Finishes

Swatch	Description	US Code	ANSI/BHMA
	Polished Stainless Steel	US32	629
	Polished MicroShield® Coated	US32MS*	—
	Polished 316 Alloy	US32316*	—
	Satin Stainless Steel	US32D	630
	Satin MicroShield® Coated	US32DMS*	—
	Satin 316 Alloy	US32D316*	—

* Available on select items.

For finish availability by product series, see the Finish Matrix on pages 114-115.

The global leader in door opening solutions

Copyright ©2018, ASSA ABLOY Accessories and Door Controls Group, Inc. All rights reserved. Reproduction in whole or in part without the express written permission of ASSA ABLOY Accessories and Door Controls Group, Inc. is prohibited.

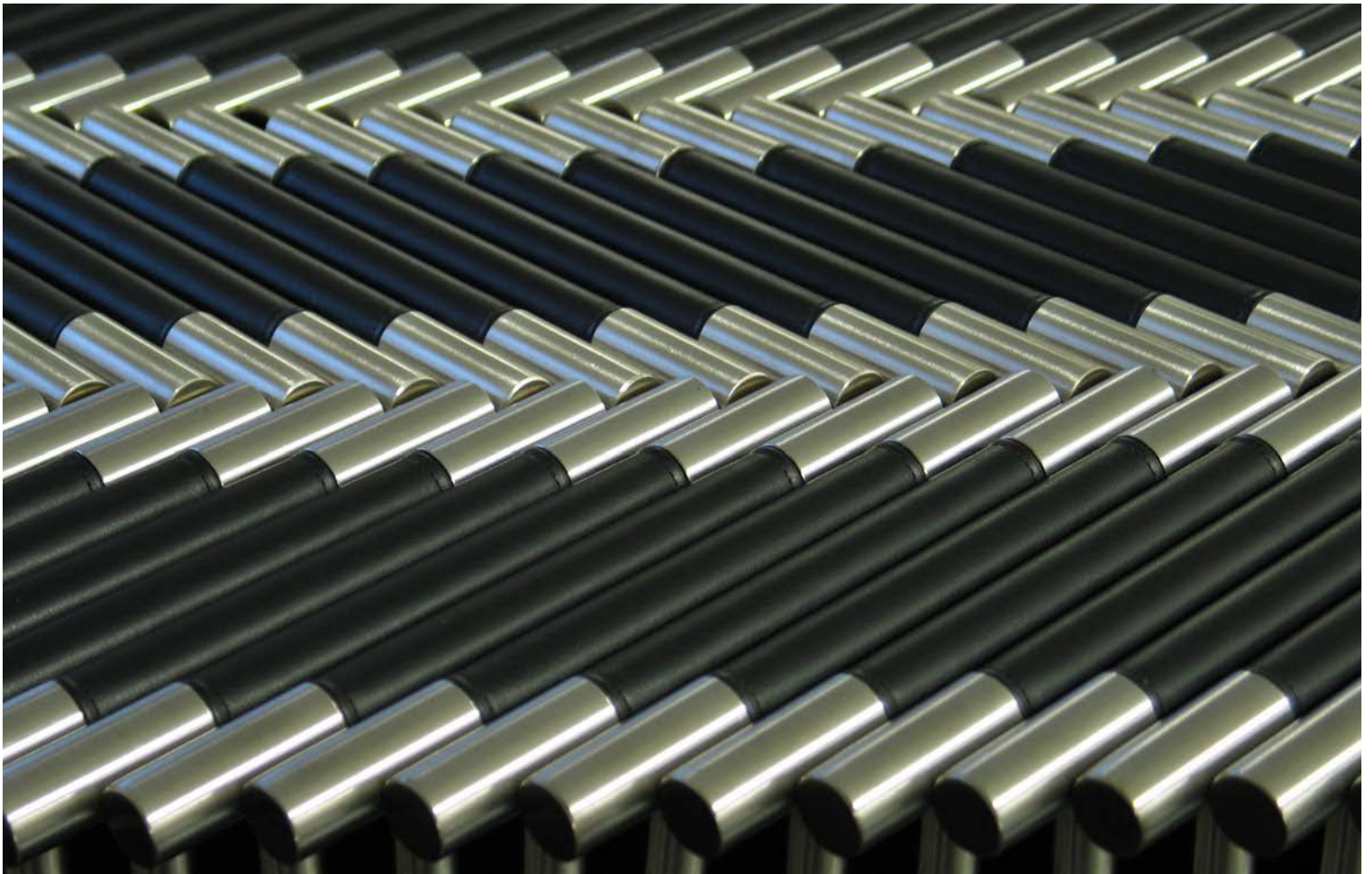

Special Finishes Descriptions

US32DMS (MicroShield®): As part of our promise to provide innovative solutions to our customers, ASSA ABLOY Group companies offer the MicroShield® technology, a silver-based antimicrobial coating designed to inhibit the spread of germs and bacteria.



MicroShield® is a registered trademark of Yale Security Inc., an ASSA ABLOY Group company.

US32316 and US32D316 are made from alloy 316 stainless steel containing molybdenum and extra nickel giving it substantially higher corrosion resistance than the standard stainless steels typically used in door hardware. This finish is ideal for use in coastal, urban, and industrial areas that have harsh environmental conditions.

Special Powder Coat Finish Description

10BE Dark Oxidized Satin Bronze equivalent: This finish provides the richness and warmth of the 10B/613 "living" finish, but maintains its original color and appearance and will not fade or wear over time. The 10BE finish is offered by Corbin Russwin, McKinney Products, Norton, RIXSON, Rockwood Products, SARGENT and Yale, providing visual consistency between ASSA ABLOY Group brands.

Black Suede (BSP) is a permanent matte finish that conveys sophisticated elegance. Tested to ANSI/BHMA A156.18 standards, BSP delivers a "suede-like" feel.

Finish Tips

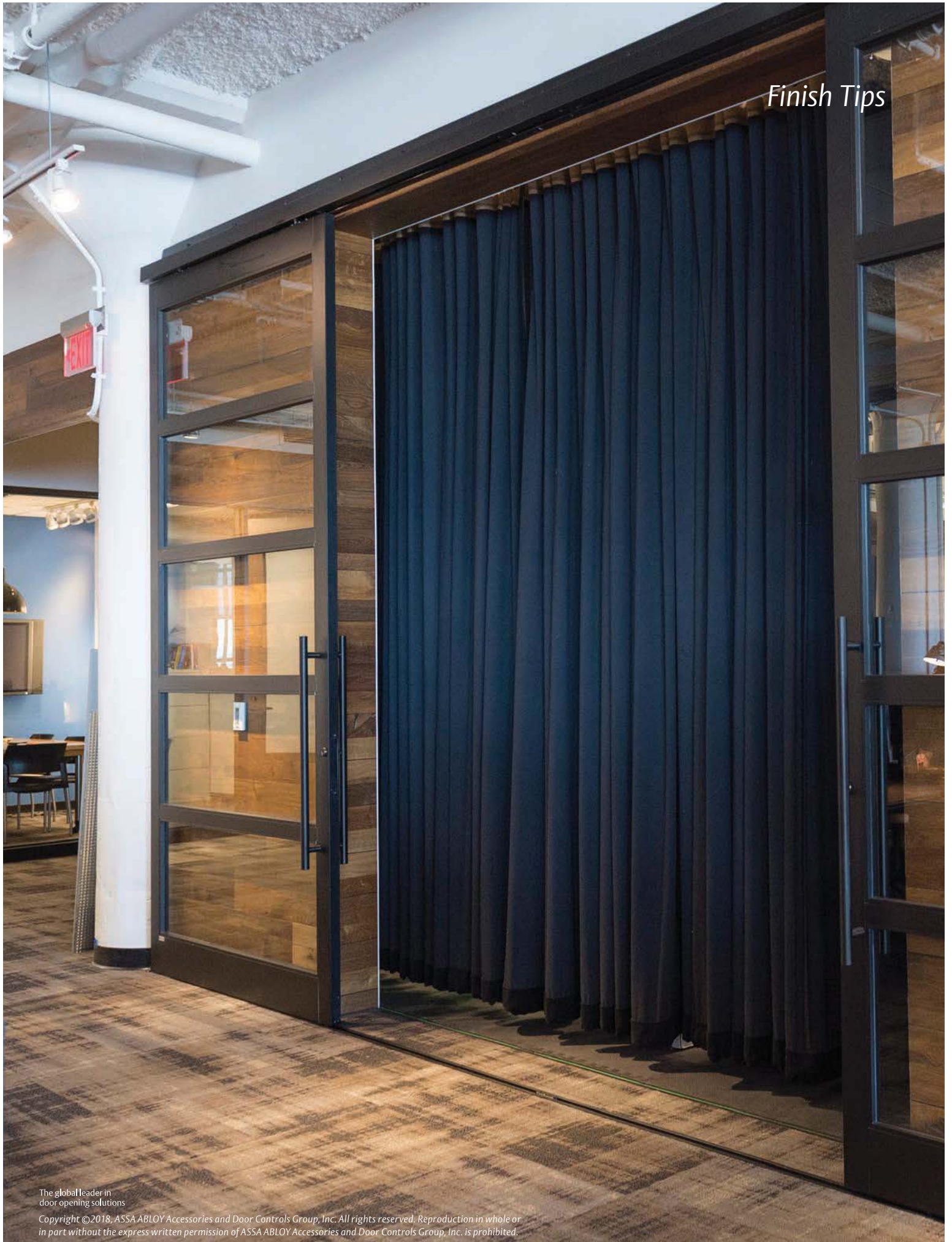

The global leader in
door opening solutions

Copyright ©2018, ASSA ABLOY Accessories and Door Controls Group, Inc. All rights reserved. Reproduction in whole or
in part without the express written permission of ASSA ABLOY Accessories and Door Controls Group, Inc. is prohibited.

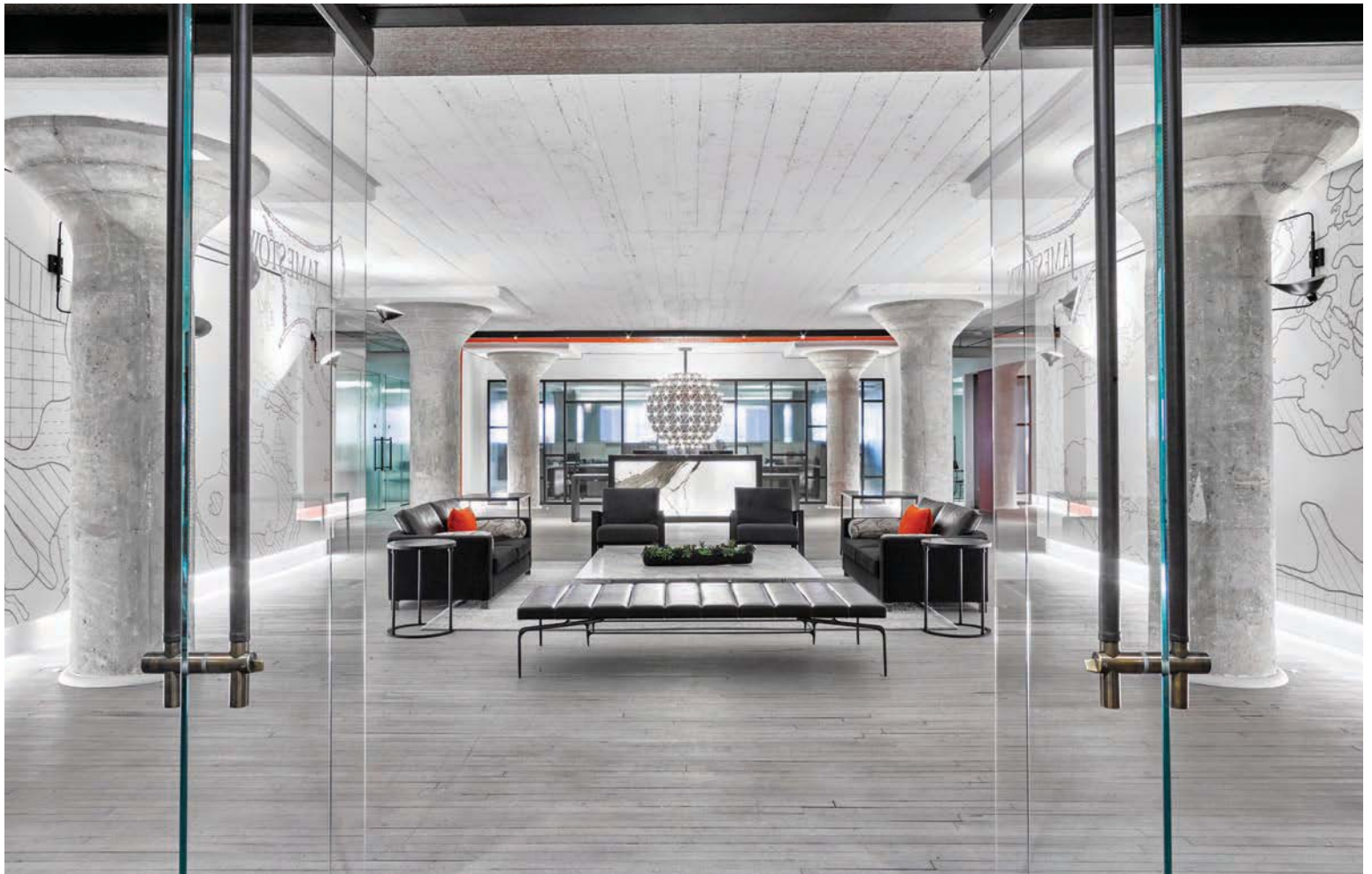

Stainless Steel

Stainless steel is one of the most dependable materials used in architecture. There are many types, each with different properties and different levels of corrosion resistance. For most indoor (except chlorine and other harsh chemical exposure) and many outdoor (mildly corrosive) environments, our standard stainless steel performs exceeding well and is best maintained with periodic water washing. If your job site has road salt, marine salt air, industrial, or urban pollution, we recommend the use of molybdenum bearing alloy 316 stainless steel. Specify US32316 or US32D316.

To enhance the corrosion resistance of stainless steel, use the polished finish (US32) in place of the satin finish (US32D). The mirror smooth surface of the polished finish has no rough surface to retain the microscopic dirt or debris that promotes corrosion.

Heat Resistant

Exterior hot and sunny climates call for a finish that is resistant to heat. We recommend our white powder coat finish. This durable exterior finish reflects many of the heat rays and is substantially cooler to the touch than stainless steel or other finishes.

Bacterial Protection

MicroShield® (US32DMS) is the ideal finish for hospitals, schools, laboratories, assisted living facilities, public restroom areas, and anywhere there are concerns about controlling bacteria growth and meeting demanding standards of cleanliness. Contact our customer service department for more detailed information.

Finish Sample Displays

Educational and informative displays are available showing our most popular finishes.



Leather Craftsmanship

Rockwood products use the finest bridle and upholstery leathers, hand-sewn by a talented craftsman. A selection of standard leather colors is available, as well as a plethora of custom colors and threading options. The custom leather covering options are endless. From minor design changes or unique custom creations, we are dedicated to making the door pull of your dreams.

Maintenance

All leather pulls leave our factory with an initial coating of leather dressing. Upholstery Leather has a breathable protective finish that is best cleaned by wiping with a cool damp cloth. For tougher soiling, use a pH balanced soap on a cloth and rinse; always use cool water. Repeat if necessary. Do not use wax, mink oil, saddle soap, or polishes on upholstery leather. Occasional use of a finished leather cleaner, conditioner, and protector is recommended. Clean English Bridle Leather as necessary with a damp cloth and allow to dry. Apply a light coat of leather care product, allow to dry and buff with a soft cloth.

Finishes

Leather wrapped door pulls are offered in brass, bronze, and stainless steel base materials in a wide variety of architectural finishes.



Leather

Rockwood products use 8–10 ounces of hand-colored, vegetable-tanned English Bridle leather, the finest leather in the world, so you can be assured of a beautiful and durable leather door pull.

In addition to our selection of fine English Bridle and Upholstery leathers, you may specify a custom leather application, including color, thread, and stitching. Minimum charges apply for special order leather.

Standard Color Selections

English Bridle Leather



B-LBRN
(Light Brown)



B-BUR
(Burgundy)



B-MBRN
(Medium Brown)



B-DBRN
(Dark Brown)



B-BLK
(Black)

Upholstery Leather



U-DBRN
(Dark Brown)



U-BLK
(Black)



ROUND GRIP Discover the clean, smooth simplicity of our round grip design, infused with eye-catching elements for added interest. Select the collection that makes your vision a reality. From contrasting, contemporary effects to subtle-toned natural warmth, a variety of size and finish options are available to compliment any door concept.

The global leader in
door opening solutions

Copyright ©2018, ASSA ABLOY Accessories and Door Controls Group, Inc. All rights reserved. Reproduction in whole or in part without the express written permission of ASSA ABLOY Accessories and Door Controls Group, Inc. is prohibited.



Leather

Expansive selection of high-quality, durable, leather door pulls

Wood

Naturally unique markings and tones with exotic elegance and alluring warmth

Santoprene™

Pure comfort in high-performance engineered thermoplastic elastomer grips

Black Anodized

Durability with the high-visibility contrast of satin-black, hard-coat anodized aluminum

Grooved

Unmatched contemporary fashion in the smooth transition of precision-fitted joints amid solid ends and expertly grooved tubing

Smooth

Simple, attractive, with contemporary design elements

Accents

Interesting design elements move beyond the commonplace and into the extraordinary

Essential

Industry-standard, uncomplicated forms for a basic composition

RM6060-RM6092
RM6700-RM6730



English Bridle Leather

B-LBRN
(Light Brown)

B-BUR
(Burgundy)

B-MBRN
(Medium Brown)

B-DBRN
(Dark Brown)

B-BLK
(Black)

The global leader in
door opening solutions

Copyright ©2018, ASSA ABLOY Accessories and Door Controls Group, Inc. All rights reserved. Reproduction in whole or
in part without the express written permission of ASSA ABLOY Accessories and Door Controls Group, Inc. is prohibited.

English Bridle

Vegetable-tanned, English Bridle leather is hand-colored in one of many beautiful shade selections. These pulls are tightly-wrapped and sewn with detail on the ends and back of the pull, for a truly tailored look.



Straight Pulls - Flat Ends

Part	Dia.	Proj.
RM6060	1"	2 ³ / ₄ "
RM6061†	1 ¹ / ₄ "	3"
RM6062	1 ¹ / ₂ "	3 ¹ / ₄ "

† For locking pull options, see page 91.

* Black leather is shown.



Offset Pulls - Flat Ends

Part	Dia.	Proj.
RM6070	1"	2 ¹ / ₂ "
RM6071	1 ¹ / ₄ "	2 ³ / ₄ "
RM6072	1 ¹ / ₂ "	3"

* Black leather is shown.



Straight Pulls - Round Ends

Part	Dia.	Proj.
RM6080	1"	2 ³ / ₄ "
RM6081	1 ¹ / ₄ "	3"
RM6082	1 ¹ / ₂ "	3 ¹ / ₄ "

* Black leather is shown.



Offset Pulls - Round Ends

Part	Dia.	Proj.
RM6090	1"	2 ¹ / ₂ "
RM6091	1 ¹ / ₄ "	2 ³ / ₄ "
RM6092	1 ¹ / ₂ "	3"

* Black leather is shown.



Small Full Wrapped Straight Pulls - Flat Ends

Part	Dia.	Proj.
RM6700	1/2"	1 ³ / ₈ "
RM6710	5/8"	1 ¹ / ₂ "

* Burgundy leather is shown.



Small Full Wrapped Offset Pulls - Flat Ends

Part	Dia.	Proj.
RM6730	5/8"	1 ⁷ / ₈ "

* Burgundy leather is shown.

Contact factory for custom color options.

Projection shown excludes leather thickness.

RM6160-RM6192
RM6500-RM6570



Upholstery Leather

U-DBRN
(Dark Brown)

U-BLK
(Black)

The global leader in
door opening solutions

Copyright ©2018, ASSA ABLOY Accessories and Door Controls Group, Inc. All rights reserved. Reproduction in whole or
in part without the express written permission of ASSA ABLOY Accessories and Door Controls Group, Inc. is prohibited.

Upholstery

Add a glove-soft leather feel to any interior door. Available in both standard and custom colors, these tanned leather pulls are tightly-wrapped stitching, for a beautifully detailed look.



Straight Pulls - Flat Ends

Part	Dia.	Proj.
RM6160	1"	2 ³ / ₄ "
RM6161†	1 ¹ / ₄ "	3"
RM6162	1 ¹ / ₂ "	3 ¹ / ₄ "

† For locking pull options, see page 91.

* Dark Brown leather is shown.



Offset Pulls - Flat Ends

Part	Dia.	Proj.
RM6170	1"	2 ¹ / ₂ "
RM6171	1 ¹ / ₄ "	2 ³ / ₄ "
RM6172	1 ¹ / ₂ "	3"

* Dark Brown leather is shown.



Straight Pulls - Round Ends

Part	Dia.	Proj.
RM6180	1"	2 ³ / ₄ "
RM6181	1 ¹ / ₄ "	3"
RM6182	1 ¹ / ₂ "	3 ¹ / ₄ "

* Dark Brown leather is shown.



Offset Pulls - Round Ends

Part	Dia.	Proj.
RM6190	1"	2 ¹ / ₂ "
RM6191	1 ¹ / ₄ "	2 ³ / ₄ "
RM6192	1 ¹ / ₂ "	3"

* Dark Brown leather is shown.



Small Straight Pulls - Flat Ends

Part	Dia.	Proj.
RM6500	1 ¹ / ₂ "	1 ³ / ₈ "
RM6510	5 ⁵ / ₈ "	1 ¹ / ₂ "

* Burgundy leather is shown.

* Also available in English Bridle.



Small Offset Pulls - Flat Ends

Part	Dia.	Proj.
RM6530	5 ⁵ / ₈ "	1 ⁷ / ₈ "

* Burgundy leather is shown.

* Also available in English Bridle.



Small Straight Pulls - Round Ends

Part	Dia.	Proj.
RM6540	1 ¹ / ₂ "	1 ³ / ₈ "
RM6550	5 ⁵ / ₈ "	1 ¹ / ₂ "

* Burgundy leather is shown.

* Also available in English Bridle.



Small Offset Pulls - Round Ends

Part	Dia.	Proj.
RM6570	5 ⁵ / ₈ "	1 ⁷ / ₈ "

* Burgundy leather is shown.

* Also available in English Bridle.

Contact factory for custom color options.

Projection shown excludes leather thickness.

RM6300-RM6354
RM6610-RM6670



English Bridle Leather

B-LBRN
(Light Brown)

B-BUR
(Burgundy)

B-MBRN
(Medium Brown)

B-DBRN
(Dark Brown)

B-BLK
(Black)

Upholstery Leather

U-DBRN
(Dark Brown)

U-BLK
(Black)

The global leader in
door opening solutions

Copyright ©2018, ASSA ABLOY Accessories and Door Controls Group, Inc. All rights reserved. Reproduction in whole or in part without the express written permission of ASSA ABLOY Accessories and Door Controls Group, Inc. is prohibited.

Flush

Classic pulls that unite a welcoming leather style with clean, contemporary lines. These wrapped leather pulls highlight the smooth, fitted transition between solid metal ends and a detailed leather grip.



Straight Pulls - Flat Ends

Part	Dia.	Proj.
RM6300	1"	2 ³ / ₄ "
RM6310	1 ¹ / ₄ "	3"
RM6320	1 ¹ / ₂ "	3 ¹ / ₄ "

* Medium Brown leather is shown.



Offset Pulls - Flat Ends

Part	Dia.	Proj.
RM6330	1"	2 ¹ / ₂ "
RM6340	1 ¹ / ₄ "	2 ³ / ₄ "
RM6350	1 ¹ / ₂ "	3"

* Medium Brown leather is shown.



Straight Pulls - Round Ends

Part	Dia.	Proj.
RM6304	1"	2 ³ / ₄ "
RM6314	1 ¹ / ₄ "	3"
RM6324	1 ¹ / ₂ "	3 ¹ / ₄ "

* Medium Brown leather is shown.



Offset Pulls - Round Ends

Part	Dia.	Proj.
RM6334	1"	2 ¹ / ₂ "
RM6344	1 ¹ / ₄ "	2 ³ / ₄ "
RM6354	1 ¹ / ₂ "	3"

* Medium Brown leather is shown.



Small Straight Pulls - Flat Ends

Part	Dia.	Proj.
RM6610	5/8"	1 ¹ / ₂ "

* Burgundy leather is shown.



Small Offset Pulls - Flat Ends

Part	Dia.	Proj.
RM6630	5/8"	1 ⁷ / ₈ "

* Burgundy leather is shown.



Small Straight Pulls - Round Ends

Part	Dia.	Proj.
RM6650	5/8"	1 ¹ / ₂ "

* Burgundy leather is shown.



Small Offset Pulls - Round Ends

Part	Dia.	Proj.
RM6670	5/8"	1 ⁷ / ₈ "

* Burgundy leather is shown.

RM4000-RM4054
RM1510-RM1570



The global leader in
door opening solutions

Copyright ©2018, ASSA ABLOY Accessories and Door Controls Group, Inc. All rights reserved. Reproduction in whole or
in part without the express written permission of ASSA ABLOY Accessories and Door Controls Group, Inc. is prohibited.

ArborMet™

Combining the strength of solid brass and stainless steel with the warm feel and varied tones of wood, these pulls add ambiance to any entrance.



Straight Pulls - Flat Ends

Part	Dia.	Proj.
RM4000	1"	2 ³ / ₄ "
RM4010	1 ¹ / ₄ "	3"
RM4020	1 ¹ / ₂ "	3 ¹ / ₄ "



Straight Pulls - Round Ends

Part	Dia.	Proj.
RM4004	1"	2 ³ / ₄ "
RM4014	1 ¹ / ₄ "	3"
RM4024	1 ¹ / ₂ "	3 ¹ / ₄ "



Small Straight Pulls - Various Ends

Part	Dia.	Proj.
RM1510 (Flat)	5/8"	1 ¹ / ₂ "
RM1550 (Round)	5/8"	1 ¹ / ₂ "

RM1510

RM1550



Push Bars - Flat Ends

Part	Dia.	Proj.
RM4002	1"	2 ³ / ₄ "
RM4012	1 ¹ / ₄ "	3"
RM4022	1 ¹ / ₂ "	3 ¹ / ₄ "



Offset Pulls - Flat Ends

Part	Dia.	Proj.
RM4030	1"	2 ¹ / ₂ "
RM4040	1 ¹ / ₄ "	2 ³ / ₄ "
RM4050	1 ¹ / ₂ "	3"



Offset Pulls - Round Ends

Part	Dia.	Proj.
RM4034	1"	2 ¹ / ₂ "
RM4044	1 ¹ / ₄ "	2 ³ / ₄ "
RM4054	1 ¹ / ₂ "	3"



Small Offset Pulls - Various Ends

Part	Dia.	Proj.
RM1530 (Flat)	5/8"	1 ⁷ / ₈ "
RM1570 (Round)	5/8"	1 ⁷ / ₈ "

RM1530

RM1570



Push Bars - Round Ends

Part	Dia.	Proj.
RM4006	1"	2 ³ / ₄ "
RM4016	1 ¹ / ₄ "	3"
RM4026	1 ¹ / ₂ "	3 ¹ / ₄ "

Standard wood finish shown: Hickory, Sanded - Unfinished.
For additional species, see page 25.

RM4100- RM4154



The global leader in
door opening solutions

Copyright ©2018, ASSA ABLOY Accessories and Door Controls Group, Inc. All rights reserved. Reproduction in whole or in part without the express written permission of ASSA ABLOY Accessories and Door Controls Group, Inc. is prohibited.

ArborTek™

Full-length wood pulls and push bars pair with solid brass and stainless-steel mounting posts to create an expression of pure elegance.



Straight Pulls - Flat Ends

Part	Dia.	Proj.
RM4100	1"	2 ³ / ₄ "
RM4110	1 ¹ / ₄ "	3"
RM4120	1 ¹ / ₂ "	3 ¹ / ₄ "



Offset Pulls - Flat Ends

Part	Dia.	Proj.
RM4130	1"	2 ¹ / ₂ "
RM4140	1 ¹ / ₄ "	2 ³ / ₄ "
RM4150	1 ¹ / ₂ "	3"



Straight Pulls - Round Ends

Part	Dia.	Proj.
RM4104	1"	2 ³ / ₄ "
RM4114	1 ¹ / ₄ "	3"
RM4124	1 ¹ / ₂ "	3 ¹ / ₄ "



Offset Pulls - Round Ends

Part	Dia.	Proj.
RM4134	1"	2 ¹ / ₂ "
RM4144	1 ¹ / ₄ "	2 ³ / ₄ "
RM4154	1 ¹ / ₂ "	3"



Push Bars - Flat Ends

Part	Dia.	Proj.
RM4112	1 ¹ / ₄ "	3"
RM4122	1 ¹ / ₂ "	3 ¹ / ₄ "



Push Bars - Round Ends

Part	Dia.	Proj.
RM4116	1 ¹ / ₄ "	3"
RM4126	1 ¹ / ₂ "	3 ¹ / ₄ "

Standard wood finish shown: Hickory, Sanded - Unfinished.
For additional species, see page 25.

RM4160- RM4190



The global leader in door opening solutions

Copyright ©2018, ASSA ABLOY Accessories and Door Controls Group, Inc. All rights reserved. Reproduction in whole or in part without the express written permission of ASSA ABLOY Accessories and Door Controls Group, Inc. is prohibited.

ArborTek™ with Collars

Add contrasting metal collars to your ArborTek pull to create a distinctive, unique look.



Straight Pulls - Flat Ends











Part	Dia.	Proj.
RM4160	1"	2 ³ / ₄ "
RM4170	1 ¹ / ₄ "	3"



Offset Pulls - Flat Ends

Part	Dia.	Proj.
RM4180	1"	2 ¹ / ₂ "
RM4190	1 ¹ / ₄ "	2 ⁷ / ₈ "

Wood Species

Standard Domestic		Premium		Super Premium	
Hickory		Beech		Mahogany	
White Oak		Cherry		Jatoba (Brazilian Cherry)	
Red Oak		Birch		Canary Wood	
Maple				Walnut	

RM2510-RM2544



The global leader in
door opening solutions

Copyright ©2018, ASSA ABLOY Accessories and Door Controls Group, Inc. All rights reserved. Reproduction in whole or
in part without the express written permission of ASSA ABLOY Accessories and Door Controls Group, Inc. is prohibited.

SoftMet™

Durable, weather-resistant, Santoprene™ grips locked between solid metal, offer comfort and durability in a variety of architectural finishes and styles.



Straight Pulls - Flat Ends

Part	Dia.	Proj.
RM2510	1 1/4"	3"



Offset Pulls - Flat Ends

Part	Dia.	Proj.
RM2540	1 1/4"	2 3/4"



Straight Pulls - Round Ends

Part	Dia.	Proj.
RM2514	1 1/4"	3"



Offset Pulls - Round Ends

Part	Dia.	Proj.
RM2544	1 1/4"	2 3/4"



Push Bars - Flat Ends

Part	Dia.	Proj.
RM2512	1 1/4"	3"



Push Bars - Round Ends

Part	Dia.	Proj.
RM2516	1 1/4"	3"

RM2610-RM2640

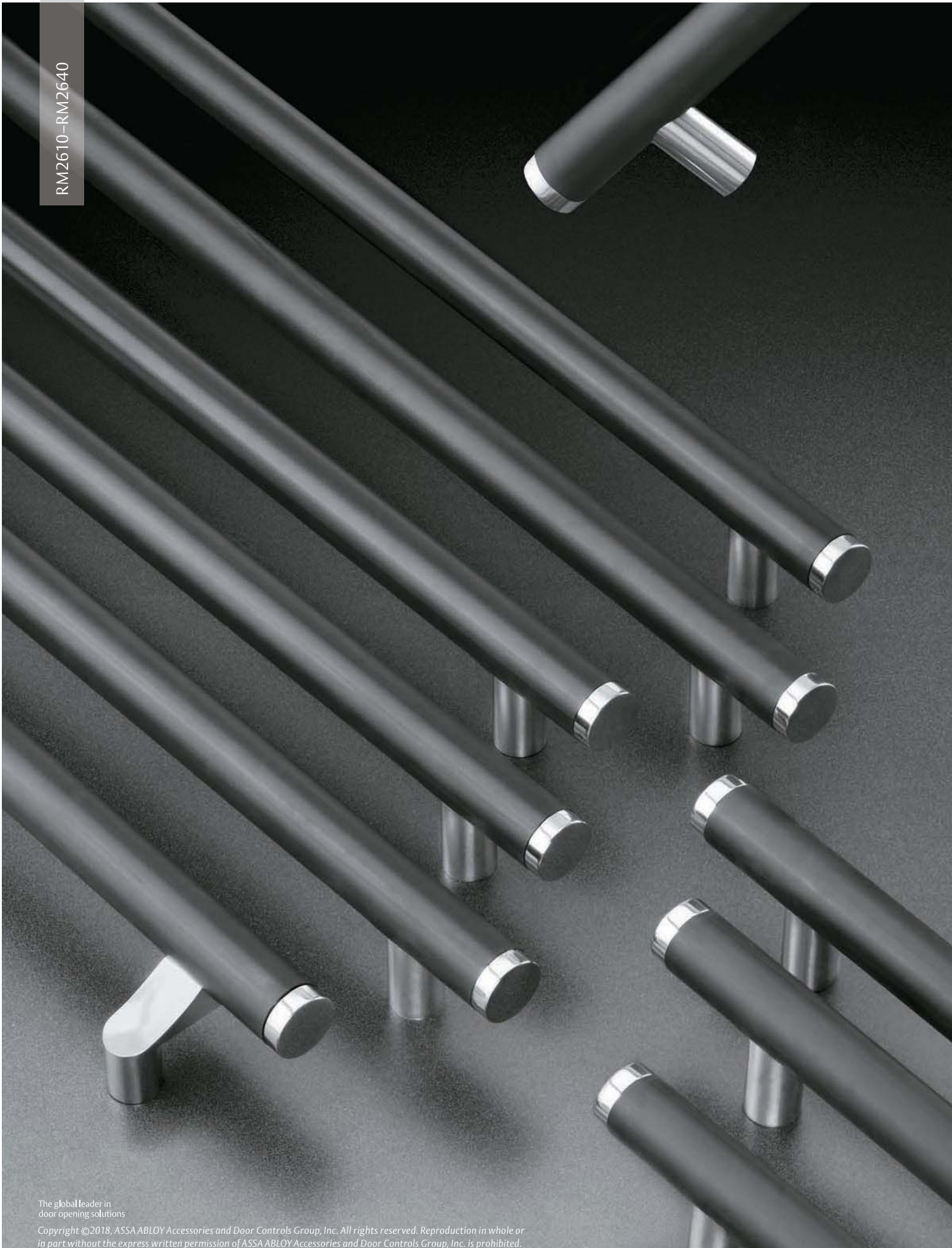

The global leader in
door opening solutions

Copyright ©2018, ASSA ABLOY Accessories and Door Controls Group, Inc. All rights reserved. Reproduction in whole or
in part without the express written permission of ASSA ABLOY Accessories and Door Controls Group, Inc. is prohibited.

SoftTek™

Extend your grip with a full-length application of Santoprene™. These pulls provide the ultimate in durable, weather-resistant gripping surfaces.



Straight Pulls - Flat Ends

Part	Dia.	Proj.
RM2610	1 1/4"	3"



Offset Pulls - Flat Ends

Part	Dia.	Proj.
RM2640	1 1/4"	2 3/4"



Push Bars - Flat Ends

Part	Dia.	Proj.
RM2612	1 1/4"	3"

RM3800-RM3854
RM1410-RM1470



The global leader in
door opening solutions

Copyright ©2018, ASSA ABLOY Accessories and Door Controls Group, Inc. All rights reserved. Reproduction in whole or in part without the express written permission of ASSA ABLOY Accessories and Door Controls Group, Inc. is prohibited.

NoirMet™

Make a bold statement with the subtlety of black, hard-coat anodized grips contrasted with a compelling selection of end and mounting post finishes.



Straight Pulls - Flat Ends

Part	Dia.	Proj.
RM3800	1"	2 ³ / ₄ "
RM3810	1 ¹ / ₄ "	3"
RM3820	1 ¹ / ₂ "	3 ¹ / ₄ "



Straight Pulls - Round Ends

Part	Dia.	Proj.
RM3804	1"	2 ³ / ₄ "
RM3814	1 ¹ / ₄ "	3"
RM3824	1 ¹ / ₂ "	3 ¹ / ₄ "



RM1410



RM1450

Small Straight Pulls - Various Ends

Part	Dia.	Proj.
RM1410 (Flat)	5/8"	1 ¹ / ₂ "
RM1450 (Round)	5/8"	1 ¹ / ₂ "



Offset Pulls - Flat Ends

Part	Dia.	Proj.
RM3830	1"	2 ¹ / ₂ "
RM3840	1 ¹ / ₄ "	2 ³ / ₄ "
RM3850	1 ¹ / ₂ "	3"



Offset Pulls - Round Ends

Part	Dia.	Proj.
RM3834	1"	2 ¹ / ₂ "
RM3844	1 ¹ / ₄ "	2 ³ / ₄ "
RM3854	1 ¹ / ₂ "	3"



RM1430



RM1470

Small Offset Pulls - Various Ends

Part	Dia.	Proj.
RM1430 (Flat)	5/8"	1 ⁷ / ₈ "
RM1470 (Round)	5/8"	1 ⁷ / ₈ "



Push Bars - Flat Ends

Part	Dia.	Proj.
RM3802	1"	2 ³ / ₄ "
RM3812	1 ¹ / ₄ "	3"
RM3822	1 ¹ / ₂ "	3 ¹ / ₄ "



Push Bars - Round Ends

Part	Dia.	Proj.
RM3806	1"	2 ³ / ₄ "
RM3816	1 ¹ / ₄ "	3"
RM3826	1 ¹ / ₂ "	3 ¹ / ₄ "

RM3900-RM3954



The global leader in
door opening solutions

Copyright ©2018, ASSA ABLOY Accessories and Door Controls Group, Inc. All rights reserved. Reproduction in whole or
in part without the express written permission of ASSA ABLOY Accessories and Door Controls Group, Inc. is prohibited.

NoirTek™

These full-length, black, hard-coat anodized grip pulls make an appealing statement of their own. The muted luster of black satin complements any setting and provides an atmosphere of relaxed sophistication.



Straight Pulls - Flat Ends

Part	Dia.	Proj.
RM3900	1"	2 ³ / ₄ "
RM3910	1 ¹ / ₄ "	3"
RM3920	1 ¹ / ₂ "	3 ¹ / ₄ "



Offset Pulls - Flat Ends

Part	Dia.	Proj.
RM3930	1"	2 ¹ / ₂ "
RM3940	1 ¹ / ₄ "	2 ³ / ₄ "
RM3950	1 ¹ / ₂ "	3"



Straight Pulls - Round Ends

Part	Dia.	Proj.
RM3904	1"	2 ³ / ₄ "
RM3914	1 ¹ / ₄ "	3"
RM3924	1 ¹ / ₂ "	3 ¹ / ₄ "



Offset Pulls - Round Ends

Part	Dia.	Proj.
RM3934	1"	2 ¹ / ₂ "
RM3944	1 ¹ / ₄ "	2 ³ / ₄ "
RM3954	1 ¹ / ₂ "	3"



Push Bars - Flat Ends

Part	Dia.	Proj.
RM3902	1"	2 ³ / ₄ "
RM3912	1 ¹ / ₄ "	3"
RM3922	1 ¹ / ₂ "	3 ¹ / ₄ "



Push Bars - Round Ends

Part	Dia.	Proj.
RM3906	1"	2 ³ / ₄ "
RM3916	1 ¹ / ₄ "	3"
RM3926	1 ¹ / ₂ "	3 ¹ / ₄ "

RM3701-RM3782
RM3512-RM3626

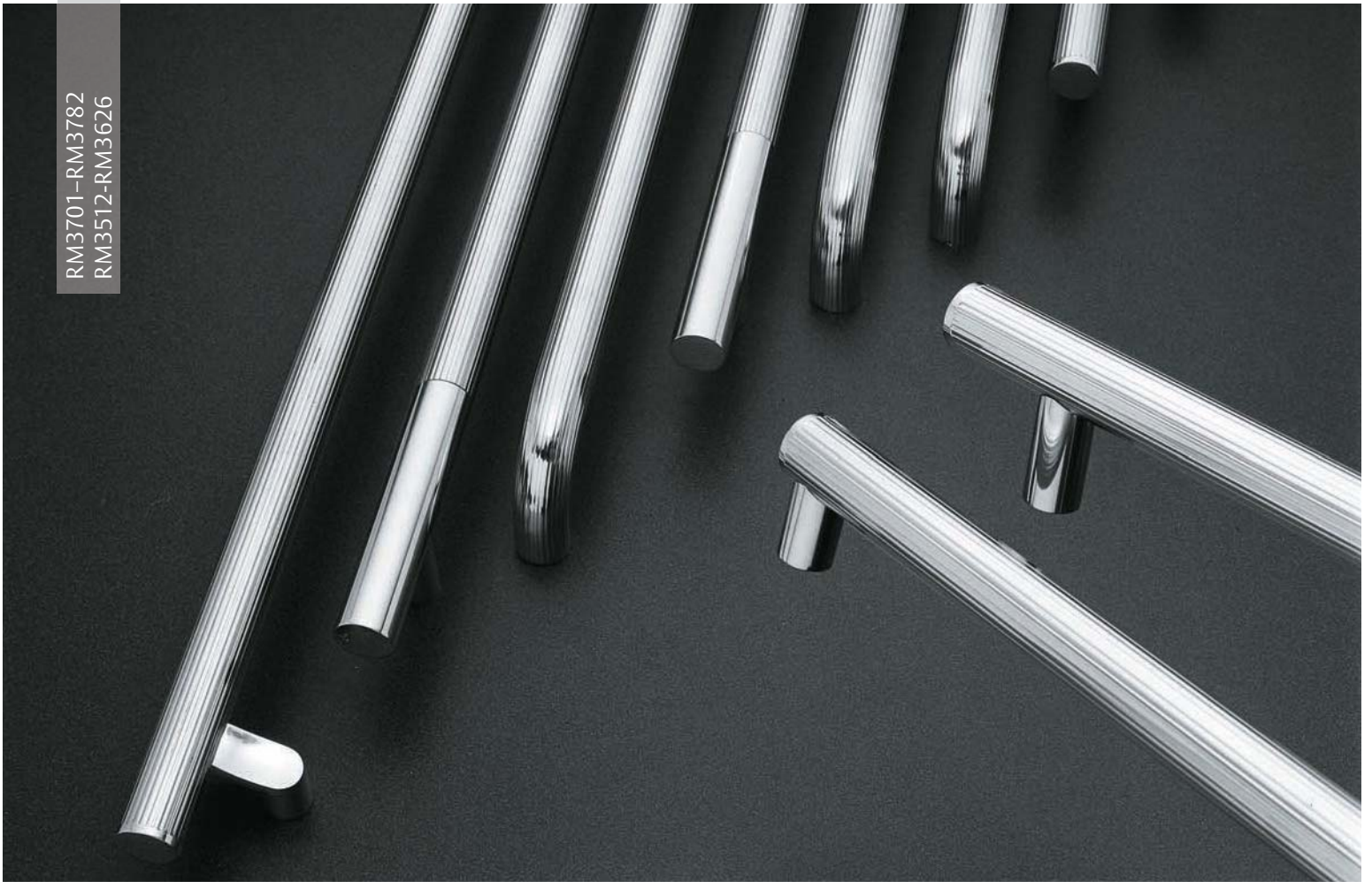

LineaMax™

Create a beautiful, fully-grooved, long door pull or add an element of interest using solid, smooth ends.



Push Bars - Solid Flat Ends

Part	Dia.	Proj.
RM3512	1 1/4"	3"
RM3522	1 1/2"	3 1/4"



Push Bars - Solid Round Ends

Part	Dia.	Proj.
RM3516	1 1/4"	3"
RM3526	1 1/2"	3 1/4"



Push Bars - Fully Grooved Flat Ends

Part	Dia.	Proj.
RM3612	1 1/4"	3"
RM3622	1 1/2"	3 1/4"



Push Bars - Fully Grooved Round Ends

Part	Dia.	Proj.
RM3616	1 1/4"	3"
RM3626	1 1/2"	3 1/4"

The global leader in
door opening solutions

Copyright ©2018, ASSA ABLOY Accessories and Door Controls Group, Inc. All rights reserved. Reproduction in whole or in part without the express written permission of ASSA ABLOY Accessories and Door Controls Group, Inc. is prohibited.

LineaMax™ (continued)



Straight Pulls - Solid Flat Ends

Part	Dia.	Proj.
RM3701	1 1/4"	3"
RM3702	1 1/2"	3 1/4"



Straight Pulls - Fully Grooved Flat Ends

Part	Dia.	Proj.
RM3721	1 1/4"	3"
RM3722	1 1/2"	3 1/4"



Straight Pulls - Solid Round Ends

Part	Dia.	Proj.
RM3751	1 1/4"	3"
RM3752	1 1/2"	3 1/4"



Straight Pulls - Fully Grooved Round Ends

Part	Dia.	Proj.
RM3771	1 1/4"	3"
RM3772	1 1/2"	3 1/4"



Straight Pulls - Fully Grooved Bent Ends

Part	Dia.	Proj.
RM3741	1 1/4"	3"
RM3742	1 1/2"	3 1/2"



Offset Pulls - Solid Flat Ends

Part	Dia.	Proj.
RM3711	1 1/4"	2 3/4"
RM3712	1 1/2"	3"



Offset Pulls - Fully Grooved Flat Ends

Part	Dia.	Proj.
RM3731	1 1/4"	2 3/4"
RM3732	1 1/2"	3"



Offset Pulls - Solid Round Ends

Part	Dia.	Proj.
RM3761	1 1/4"	2 3/4"
RM3762	1 1/2"	3"



Offset Pulls - Fully Grooved Round Ends

Part	Dia.	Proj.
RM3781	1 1/4"	2 1/2"
RM3782	1 1/2"	3"

RM3101, RM3131
RM1211



The global leader in
door opening solutions

Copyright ©2018, ASSA ABLOY Accessories and Door Controls Group, Inc. All rights reserved. Reproduction in whole or in part without the express written permission of ASSA ABLOY Accessories and Door Controls Group, Inc. is prohibited.

Groove

Get your groove on. The machined bands at both ends of these post mount pulls provide an added level of sophistication.



Straight Pulls - Flat End

Part	Dia.	Proj.
RM3101	1"	2 ³ / ₄ "



Offset Pulls - Flat End

Part	Dia.	Proj.
RM3131	1"	2 ¹ / ₂ "



Small Straight Pulls - Flat End

Part	Dia.	Proj.
RM1211	⁵ / ₈ "	1 ¹ / ₂ "

RM3102-RM3126, RM3300-RM3342,
RM1200-RM1270

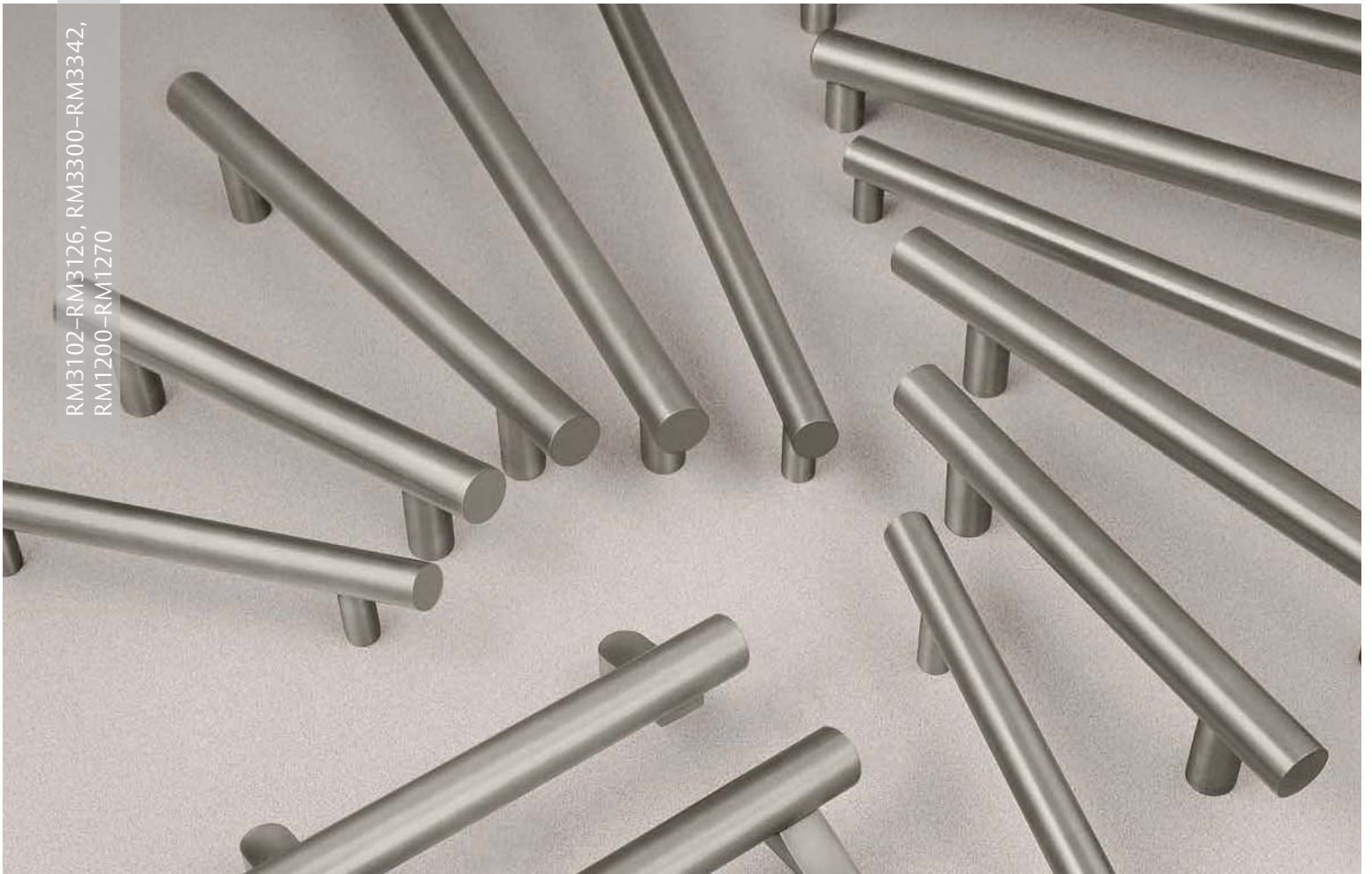

Smooth

MegaTek™

Effortless style in a simple design allow these pulls to offer a pleasing, functional, modern solution to any entry door.



Straight Pulls - Flat Ends

Part	Dia.	Proj.
RM3300	1"	2 ³ / ₄ "
RM3301*	1 ¹ / ₄ "	3"
RM3302	1 ¹ / ₂ "	3 ¹ / ₄ "

* For locking pull options, see page 91.



Straight Pulls - Round Ends

Part	Dia.	Proj.
RM3320	1"	2 ³ / ₄ "
RM3321	1 ¹ / ₄ "	3"
RM3322	1 ¹ / ₂ "	3 ¹ / ₄ "



Offset Pulls - Flat Ends

Part	Dia.	Proj.
RM3310	1"	2 ¹ / ₂ "
RM3311	1 ¹ / ₄ "	2 ³ / ₄ "
RM3312	1 ¹ / ₂ "	3"



Offset Pulls - Round Ends

Part	Dia.	Proj.
RM3330	1"	2 ¹ / ₂ "
RM3331	1 ¹ / ₄ "	2 ³ / ₄ "
RM3332	1 ¹ / ₂ "	3"

The global leader in door opening solutions

Copyright ©2018, ASSA ABLOY Accessories and Door Controls Group, Inc. All rights reserved. Reproduction in whole or in part without the express written permission of ASSA ABLOY Accessories and Door Controls Group, Inc. is prohibited.

MegaTek™ (continued)



Small Straight Pulls - Flat Ends

Part	Dia	Proj.
RM1200	1/2"	1 3/8"
RM1210	5/8"	1 1/2"



Small Straight Pulls - Round Ends

Part	Dia.	Proj.
RM1240	1/2"	1 3/8"
RM1250	5/8"	1 1/2"



Straight Pulls - Bent Ends

Part	Dia	Proj.
RM3340	1"	3"
RM3341	1 1/4"	3"
RM3342	1 1/2"	3 1/2"



Push Bars - Flat Ends

Part	Dia	Proj.
RM3102	1"	2 3/4"
RM3112	1 1/4"	3"
RM3122	1 1/2"	3 1/4"



Small Offset Pulls - Flat Ends

Part	Dia	Proj.
RM1230	5/8"	1 7/8"



Small Offset Pulls - Round Ends

Part	Dia.	Proj.
RM1270	5/8"	1 7/8"



Push Bars - Round Ends

Part	Dia	Proj.
RM3106	1"	2 3/4"
RM3116	1 1/4"	3"
RM3126	1 1/2"	3 1/4"

RM3400-RM3442
RM3202-RM3226
RM1300-RM1370

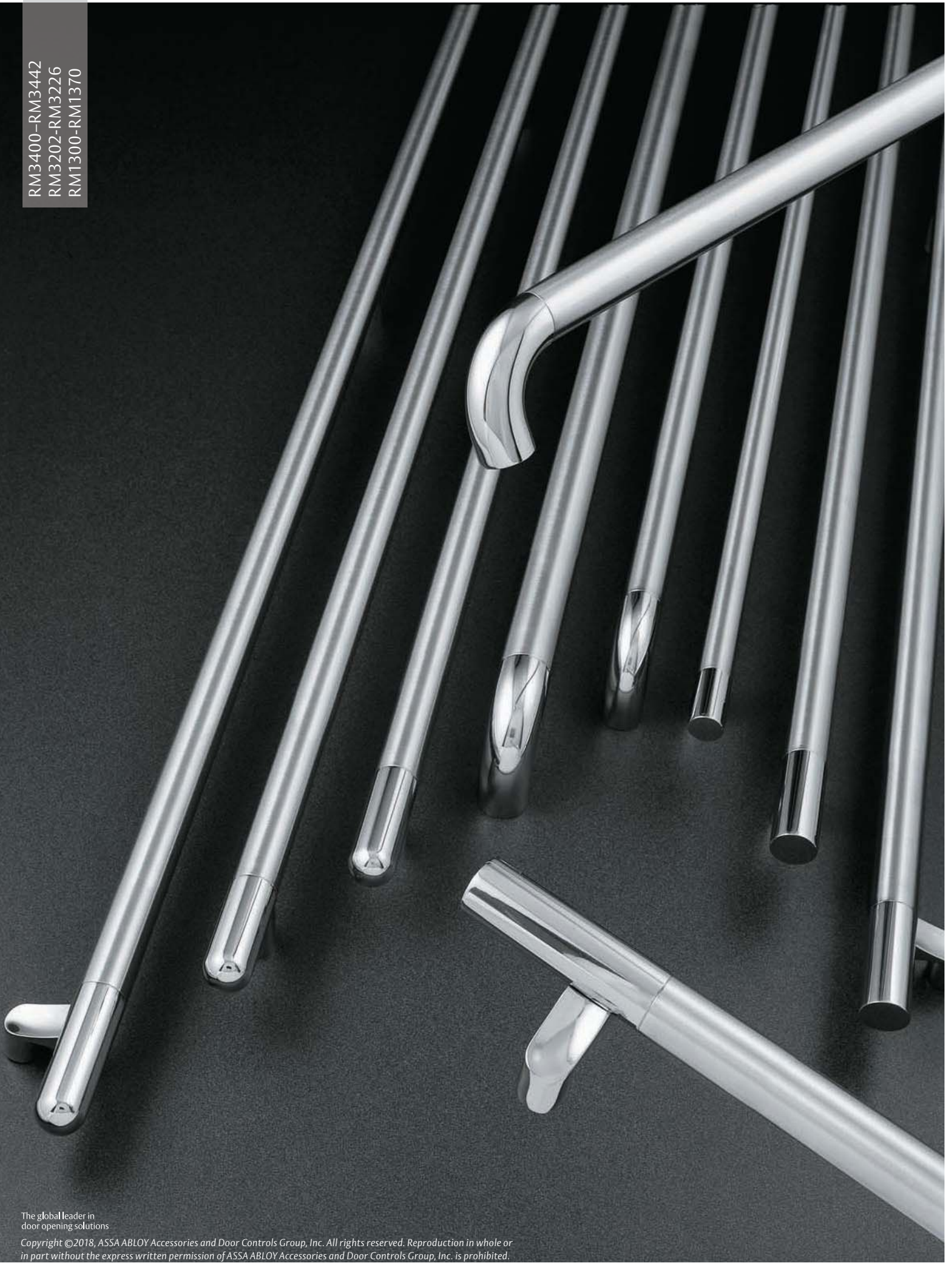

The global leader in
door opening solutions

Copyright ©2018, ASSA ABLOY Accessories and Door Controls Group, Inc. All rights reserved. Reproduction in whole or
in part without the express written permission of ASSA ABLOY Accessories and Door Controls Group, Inc. is prohibited.

NeoMax™

These post-mounted pulls feature a durable and attractive GripZone finish over a smooth, contemporary base style.



Straight Pulls - Flat Ends

Part	Dia.	Proj.
RM3400	1"	2 ³ / ₄ "
RM3401*	1 ¹ / ₄ "	3"
RM3402	1 ¹ / ₂ "	3 ¹ / ₄ "

* For locking pull options, see page 97.



Straight Pulls - Round Ends

Part	Dia.	Proj.
RM3420	1"	2 ³ / ₄ "
RM3421	1 ¹ / ₄ "	3"
RM3422	1 ¹ / ₂ "	3 ¹ / ₄ "



Straight Pulls - Bent Ends

Part	Dia.	Proj.
RM3440	1"	3"
RM3441	1 ¹ / ₄ "	3"
RM3442	1 ¹ / ₂ "	3 ¹ / ₂ "



Push Bars with 7" GripZone - Flat Ends

Part	Dia.	Proj.
RM3202	1"	2 ³ / ₄ "
RM3212	1 ¹ / ₄ "	3"
RM3222	1 ¹ / ₂ "	3 ¹ / ₄ "



Offset Pulls - Flat Ends

Part	Dia.	Proj.
RM3410	1"	2 ¹ / ₂ "
RM3411	1 ¹ / ₄ "	2 ³ / ₄ "
RM3412	1 ¹ / ₂ "	3"



Offset Pulls - Round Ends

Part	Dia.	Proj.
RM3430	1"	2 ¹ / ₂ "
RM3431	1 ¹ / ₄ "	2 ³ / ₄ "
RM3432	1 ¹ / ₂ "	3"



Push Bars with 7" GripZone - Round Ends

Part	Dia.	Proj.
RM3206	1"	2 ³ / ₄ "
RM3216	1 ¹ / ₄ "	3"
RM3226	1 ¹ / ₂ "	3 ¹ / ₄ "



RM1300



RM1340

Small Straight Pulls - Various Ends

Part	Dia.	Proj.
RM1300 (Flat)	1/2"	1 ³ / ₈ "
RM1310 (Flat)	5/8"	1 ¹ / ₂ "
RM1340 (Round)	1/2"	1 ³ / ₈ "
RM1350 (Round)	5/8"	1 ¹ / ₂ "



RM1330



RM1370

Small Offset Pulls - Various Ends

Part	Dia.	Proj.
RM1330 (Flat)	5/8"	1 ⁷ / ₈ "
RM1370 (Round)	5/8"	1 ⁷ / ₈ "

RM3010-RM3060



The global leader in
door opening solutions

Copyright ©2018, ASSA ABLOY Accessories and Door Controls Group, Inc. All rights reserved. Reproduction in whole or
in part without the express written permission of ASSA ABLOY Accessories and Door Controls Group, Inc. is prohibited.

Smooth

NeoMetrix™

The satin finish of the GripZone area against a bright finish provides a practical solution to extending the life of your door pull or push bar by concealing the minor marks and scratches of everyday use.



Straight Pulls - Bent Ends

Part	Dia.	Proj.
RM3010	1"	3 1/2"
RM3020	1 1/4"	3"
RM3030	1 1/2"	3 1/2"



Offset Pulls - Bent Ends

Part	Dia.	Proj.
RM3040	1"	3 1/2"
RM3050	1 1/4"	3"
RM3060	1 1/2"	3 1/2"



Push Bars with 7" GripZone - Bent Ends

Part	Dia.	Proj.
RM3012	1"	2 1/2"
RM3022	1 1/4"	3"
RM3032	1 1/2"	3 1/2"

RM7300-RM7450



The global leader in door opening solutions.
Copyright © 2014 ASSA ABLOY Accessories and Door Controls Group, Inc. All rights reserved. Reproduction in whole or in part without the express written permission of ASSA ABLOY Accessories and Door Controls Group, Inc. is prohibited.

NeoMitre™

Combine the attractive, concealing aspects of the GripZone finish with a precise fabrication process that smooths the joints of this mitre pull.



Straight Pulls without GripZone

Part	Dia.	Proj.
RM7300	1"	2 ³ / ₄ "
RM7310	1 ¹ / ₄ "	3"
RM7320	1 ¹ / ₂ "	3 ¹ / ₄ "



Offset Pulls without GripZone

Part	Dia.	Proj.
RM7330	1"	2 ³ / ₄ "
RM7340	1 ¹ / ₄ "	3"
RM7350	1 ¹ / ₂ "	3 ¹ / ₄ "



Straight Pulls with GripZone

Part	Dia.	Proj.
RM7400	1"	2 ³ / ₄ "
RM7410	1 ¹ / ₄ "	3"
RM7420	1 ¹ / ₂ "	3 ¹ / ₄ "



Offset Pulls with GripZone

Part	Dia.	Proj.
RM7430	1"	2 ³ / ₄ "
RM7440	1 ¹ / ₄ "	3"
RM7450	1 ¹ / ₂ "	3 ¹ / ₄ "



Push Bars without GripZone

Part	Dia.	Proj.
RM7302	1"	2 ¹ / ₂ "
RM7312	1 ¹ / ₄ "	3"
RM7322	1 ¹ / ₂ "	3"



Push Bars with 7" GripZone

Part	Dia.	Proj.
RM7402	1"	2 ¹ / ₂ "
RM7412	1 ¹ / ₄ "	3"
RM7422	1 ¹ / ₂ "	3"

RM7210-RM7240

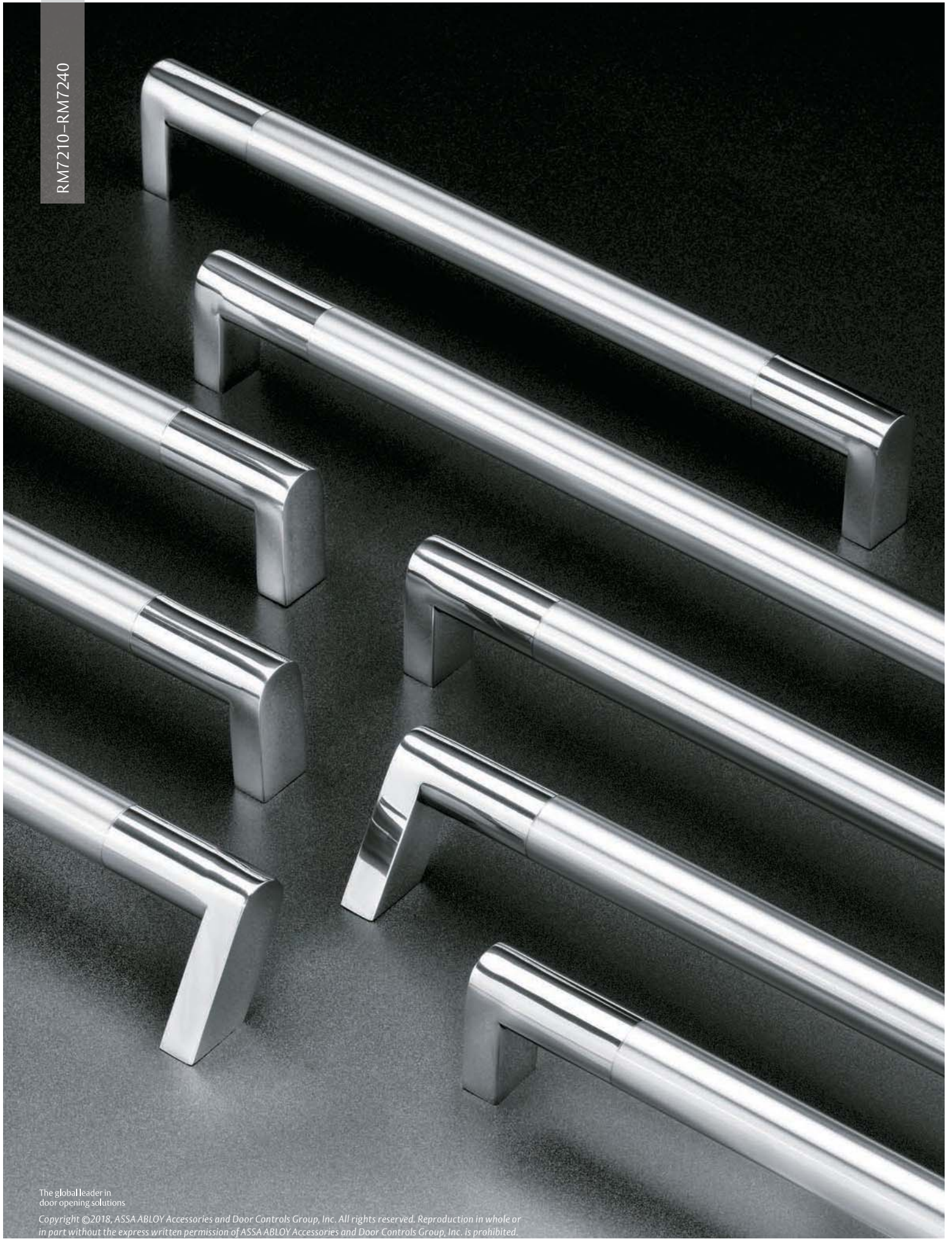

The global leader in
door opening solutions

Copyright ©2018, ASSA ABLOY Accessories and Door Controls Group, Inc. All rights reserved. Reproduction in whole or
in part without the express written permission of ASSA ABLOY Accessories and Door Controls Group, Inc. is prohibited.

NeoCylinder™

Mesmerizing style fashioned from the seamless blending of a cylinder pull combined with flat end posts. Achieve pure captivation with the addition of the GripZone finish as contrast.



Straight Pull without GripZone

Part	Dia.	Proj.
RM7210	1 1/4"	2 3/4"



Offset Pull without GripZone

Part	Dia.	Proj.
RM7220	1 1/4"	2 3/4"



Straight Pull with GripZone

Part	Dia.	Proj.
RM7230	1 1/4"	2 3/4"



Offset Pull with GripZone

Part	Dia.	Proj.
RM7240	1 1/4"	2 3/4"



Push Bar without GripZone

Part	Dia.	Proj.
RM7212	1 1/4"	2 3/4"



Push Bar with 7" GripZone

Part	Dia.	Proj.
RM7232	1 1/4"	2 3/4"

RM4200-RM4274

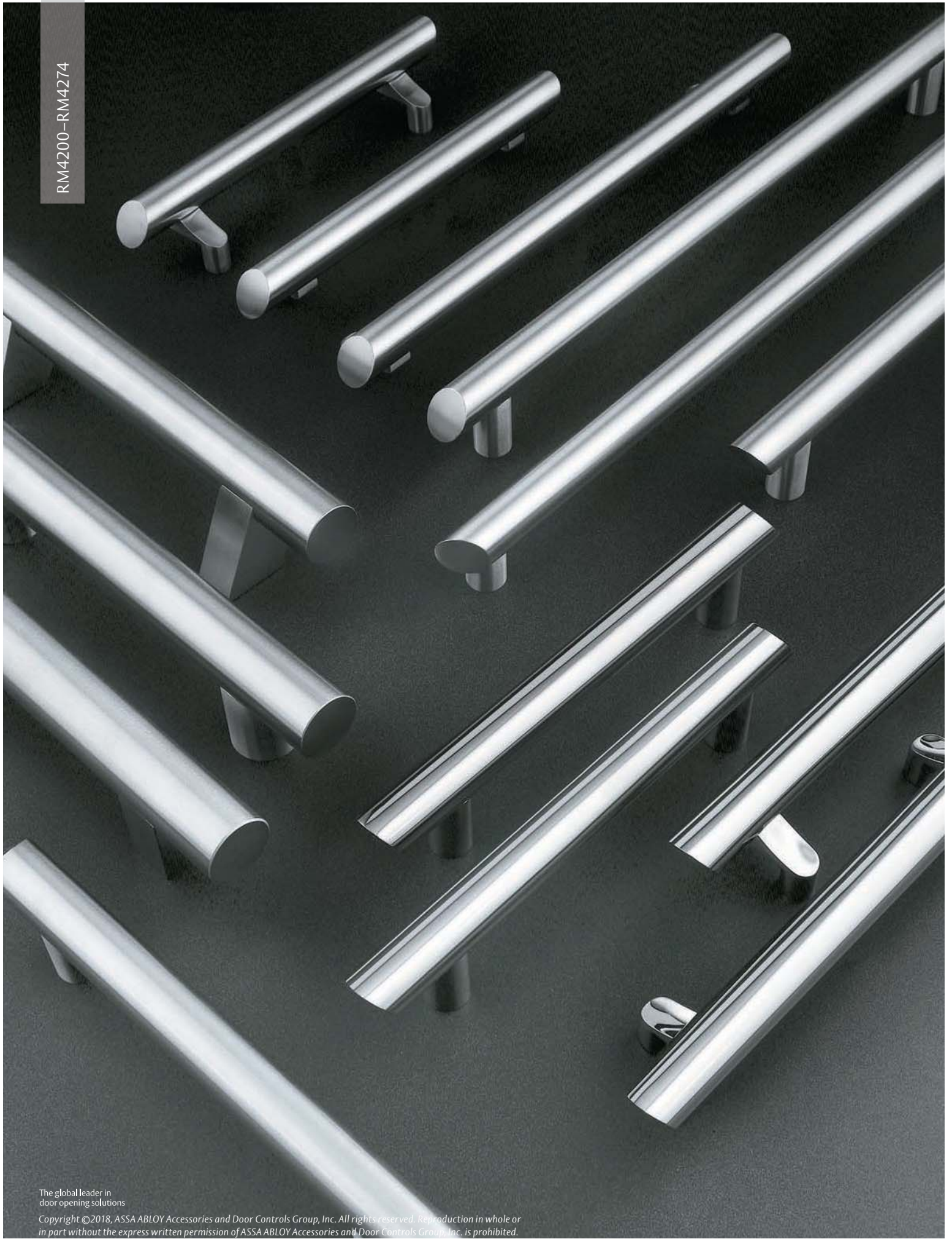

The global leader in
door opening solutions

Copyright ©2018, ASSA ABLOY Accessories and Door Controls Group, Inc. All rights reserved. Reproduction in whole or
in part without the express written permission of ASSA ABLOY Accessories and Door Controls Group, Inc. is prohibited.

SkewTek™

Angled ends coupled with a tubular design allow this made-to-order pull to be as unique and distinctive as your entrance.



Straight Pulls - Forward Segment

Part	Dia.	Proj.
RM4200	1½"	3¼"



Offset Pulls - Forward Segment

Part	Dia.	Proj.
RM4210LH	1½"	3"
RM4210RH	1½"	3"



Straight Pulls - Rectangular Posts

Part	Dia.	Proj.
RM4270	2"	3¾"



Offset Pulls - Rectangular Posts

Part	Dia.	Proj.
RM4272	2"	3¾"



Straight Pulls - Round Posts

Part	Dia.	Proj.
RM4274	2"	3¾"

RM2110-RM2150



The global leader in
door opening solutions

Copyright ©2018, ASSA ABLOY Accessories and Door Controls Group, Inc. All rights reserved. Reproduction in whole or
in part without the express written permission of ASSA ABLOY Accessories and Door Controls Group, Inc. is prohibited.

MezzoTek™

Mounted on sturdy, necked posts, these pulls appear to float across your door. Choose a contrasting finish to bring an extra element of interest to an already unique style.



Straight Pulls without GripZone

Part	Dia.	Proj.
RM2110	1 1/4"	3"
RM2120	1 1/2"	3 1/4"



Straight Pull with Double Stepped Post

Part	Dia.	Proj.
RM2150	1"	2 3/4"



Straight Pulls with GripZone

Part	Dia.	Proj.
RM2130	1 1/4"	3"
RM2140	1 1/2"	3 1/4"



Push Bars without GripZone

Part	Dia.	Proj.
RM2112	1 1/4"	3"
RM2122	1 1/2"	3 1/4"



Push Bars with 7" GripZone

Part	Dia.	Proj.
RM2132	1 1/4"	3"
RM2142	1 1/2"	3 1/4"

RM2200-RM2244



The global leader in
door opening solutions

Copyright ©2018, ASSA ABLOY Accessories and Door Controls Group, Inc. All rights reserved. Reproduction in whole or in part without the express written permission of ASSA ABLOY Accessories and Door Controls Group, Inc. is prohibited.

BandWidth™

Select from a variety of finishes, base metals, grip options, and end styles to find the perfect combination of color, contrast, and design.



Straight Pulls - Flat Ends

Part	Dia.	Proj.
RM2200	1"	2 ³ / ₄ "
RM2210	1 ¹ / ₄ "	3"



Offset Pulls - Flat Ends

Part	Dia.	Proj.
RM2230	1"	2 ¹ / ₂ "
RM2240	1 ¹ / ₄ "	2 ⁷ / ₈ "



Straight Pulls - Round Ends

Part	Dia.	Proj.
RM2204	1"	2 ³ / ₄ "
RM2214	1 ¹ / ₄ "	3"



Offset Pulls - Round Ends

Part	Dia.	Proj.
RM2234	1"	2 ¹ / ₂ "
RM2244	1 ¹ / ₄ "	2 ⁷ / ₈ "



Push Bars - Flat Ends

Part	Dia.	Proj.
RM2202	1"	2 ³ / ₄ "
RM2212	1 ¹ / ₄ "	3"



Push Bars - Round Ends

Part	Dia.	Proj.
RM2206	1"	2 ³ / ₄ "
RM2216	1 ¹ / ₄ "	3"

Projection shown excludes collar thickness.

RM405 - RM423

The global leader in
door opening solutions

Copyright ©2018, ASSA ABLOY Accessories and Door Controls Group, Inc. All rights reserved. Reproduction in whole or
in part without the express written permission of ASSA ABLOY Accessories and Door Controls Group, Inc. is prohibited.

RightAngles

Add symmetry to matching glass door exit devices with the usable, visually-appealing style of the horizontal and vertical sections found in these right-angle pulls and push bars.



Angled Pull

Part	Dia.	Proj.
RM405-15	1 1/4"	3"



Angled Pull with GripZone

Part	Dia.	Proj.
RM415-15	1 1/4"	3"



Short Angled Push Pulls*

Part	Dia.	Proj.
RM410 (Leg Up)	1 1/4"	3"
RM411 (Leg Down)	1 1/4"	3"



Short Angled Push Pulls with GripZone*

Part	Dia.	Proj.
RM420 (Leg Up)	1 1/4"	3"
RM421 (Leg Down)	1 1/4"	3"



Long Angled Push Pulls*

Part	Dia.	Proj.
RM412 (Leg Up)	1 1/4"	3"
RM413 (Leg Down)	1 1/4"	3"



Long Angled Push Pulls with GripZone*

Part	Dia.	Proj.
RM422 (Leg Up)	1 1/4"	3"
RM423 (Leg Down)	1 1/4"	3"

* RM410–RM423 specify height X width.

RM201-RM372



The global leader in
door opening solutions

Copyright ©2018, ASSA ABLOY Accessories and Door Controls Group, Inc. All rights reserved. Reproduction in whole or
in part without the express written permission of ASSA ABLOY Accessories and Door Controls Group, Inc. is prohibited.

Tubular

Rugged beauty describes these functional tubular pulls.



Straight Pulls - Bent Ends

Part	Dia	CTC	Proj.
RM301	1 1/4"	12"	3"
RM302	1 1/4"	18"	3"
RM303	1 1/4"	24"	3"
RM304	1 1/4"	36"	3"
RM321	1 1/2"	12"	3 1/2"
RM322	1 1/2"	18"	3 1/2"
RM323	1 1/2"	24"	3 1/2"
RM324	1 1/2"	36"	3 1/2"



90° Offset Pulls - Bent Ends

Part	Dia	CTC	Proj.
RM201	1 1/4"	12"	3"
RM202	1 1/4"	18"	3"
RM203	1 1/4"	24"	3"
RM204	1 1/4"	36"	3"
RM221	1 1/2"	12"	3 1/2"
RM222	1 1/2"	18"	3 1/2"
RM223	1 1/2"	24"	3 1/2"
RM224	1 1/2"	36"	3 1/2"

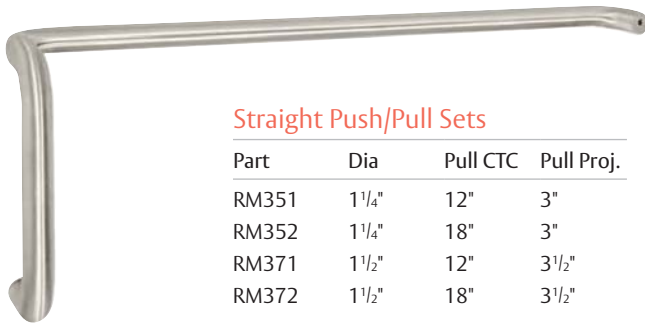

Straight Push/Pull Sets

Part	Dia	Pull CTC	Pull Proj.
RM351	1 1/4"	12"	3"
RM352	1 1/4"	18"	3"
RM371	1 1/2"	12"	3 1/2"
RM372	1 1/2"	18"	3 1/2"



Heavy Duty 30° Offset Pulls

Part	Dia	CTC	Proj.
RM257	1 1/4"	10"	3 3/4"
RM258	1 1/4"	12"	3 3/4"
RM259	1 1/4"	18"	3 3/4"



Push Bars

Part	Dia	Proj.
RM350	1 1/4"	3"
RM370	1 1/2"	3 1/2"

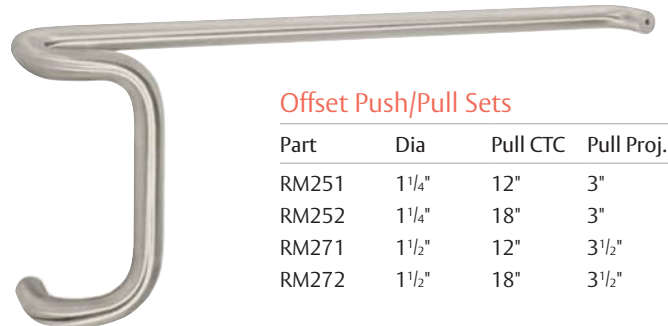

Offset Push/Pull Sets

Part	Dia	Pull CTC	Pull Proj.
RM251	1 1/4"	12"	3"
RM252	1 1/4"	18"	3"
RM271	1 1/2"	12"	3 1/2"
RM272	1 1/2"	18"	3 1/2"

110-BF169, 11047-BF15847,
47-PB-SP47

KOHLER ENVIRONMENTAL CENTER



The global leader in
door opening solutions

Copyright ©2018, ASSA ABLOY Accessories and Door Controls Group, Inc. All rights reserved. Reproduction in whole or in part without the express written permission of ASSA ABLOY Accessories and Door Controls Group, Inc. is prohibited.

Standard

When the project requires the benefit and beauty of a classic pull or push bar, these standard products fit the bill.



Straight Pulls

Part	CTC	Proj.
110-RKW	8"	3½"
111A	9"	3½"
111	10"	3½"
112	12"	3½"
118	18"	3½"

NOTE: Pull projection is 3½" for stainless steel and 3" for aluminum, brass, and bronze.



90° Offset Pulls

Part	CTC	Proj.
BF156	8"	3½"
BF157A	9"	3½"
BF157	10"	3½"
BF158	12"	3½"
BF159	18"	3½"

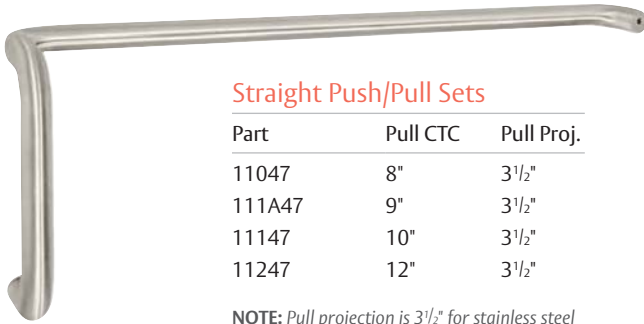

Straight Push/Pull Sets

Part	Pull CTC	Pull Proj.
11047	8"	3½"
111A47	9"	3½"
11147	10"	3½"
11247	12"	3½"

NOTE: Pull projection is 3½" for stainless steel and 3" for aluminum, brass, and bronze.



45° Offset Pulls

Part	CTC	Proj.
BF166	8"	3½"
BF167A	9"	3½"
BF167	10"	3½"
BF168	12"	3½"
BF169	18"	3½"



Push Bars

Part	Base Plate	Proj.
47-PB	No	2¾"
BP47	Yes	2⅞"



Single Projection Push Bar

Part	Proj.
SP47	2¾"

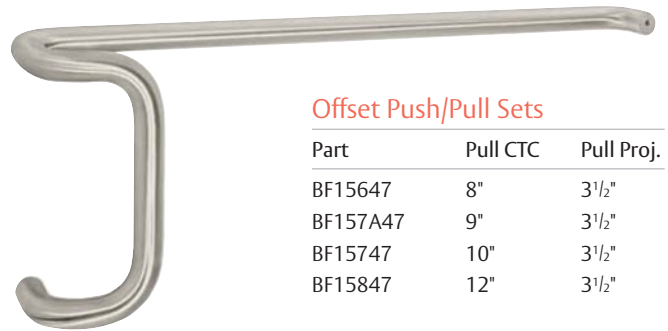

Offset Push/Pull Sets

Part	Pull CTC	Pull Proj.
BF15647	8"	3½"
BF157A47	9"	3½"
BF15747	10"	3½"
BF15847	12"	3½"

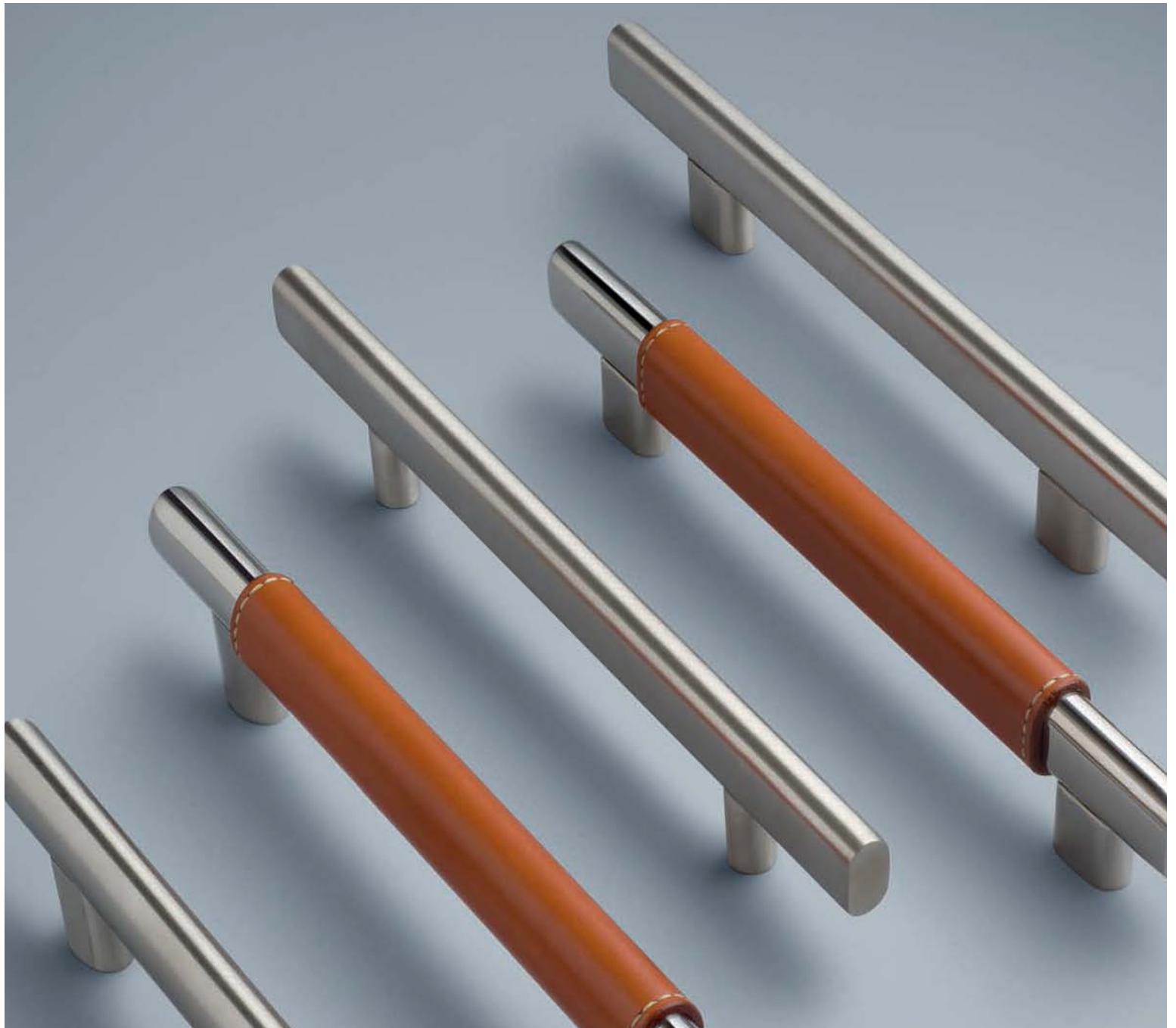

OVAL GRIP Sturdy, sleek, and ergonomic, these collections offer the perfect combination of strength, style, and practicality. Available in flat or standard oval shapes, these attractive groupings provide the most ergonomic comfort for a door pull while still preserving a flair for elegance.

The global leader in
door opening solutions

Copyright ©2018, ASSA ABLOY Accessories and Door Controls Group, Inc. All rights reserved. Reproduction in whole or in part without the express written permission of ASSA ABLOY Accessories and Door Controls Group, Inc. is prohibited.



Leather

Expansive selection of high-quality, durable, leather door pulls

Smooth

Defining standards of comfort, conforming to the natural contours of the hand



Leather

Leather Oval

This collection mixes the smooth, durable sophistication of English Bridle or Upholstery leather with the ergonomic flair of an oval pull.



True Oval - 7/8" x 1 1/16" Posts

Part	Grip Size	Proj.
RM6200	1" x 1 1/2"	3"

* Light Brown leather is shown.



Flat Oval - 3/4" Diameter Posts

Part	Grip Size	Proj.
RM6220	3/4" x 1 1/2"	2 3/4"

* Light Brown leather is shown.



Flat Oval - 1" Diameter Posts

Part	Grip Size	Proj.
RM6230	3/4" x 1 1/2"	3 1/4"

* Light Brown leather is shown.



Flat Oval - 3/4" x 1 1/2" Posts

Part	Grip Size	Proj.
RM6240	3/4" x 1 1/2"	2 3/4"

* Light Brown leather is shown.

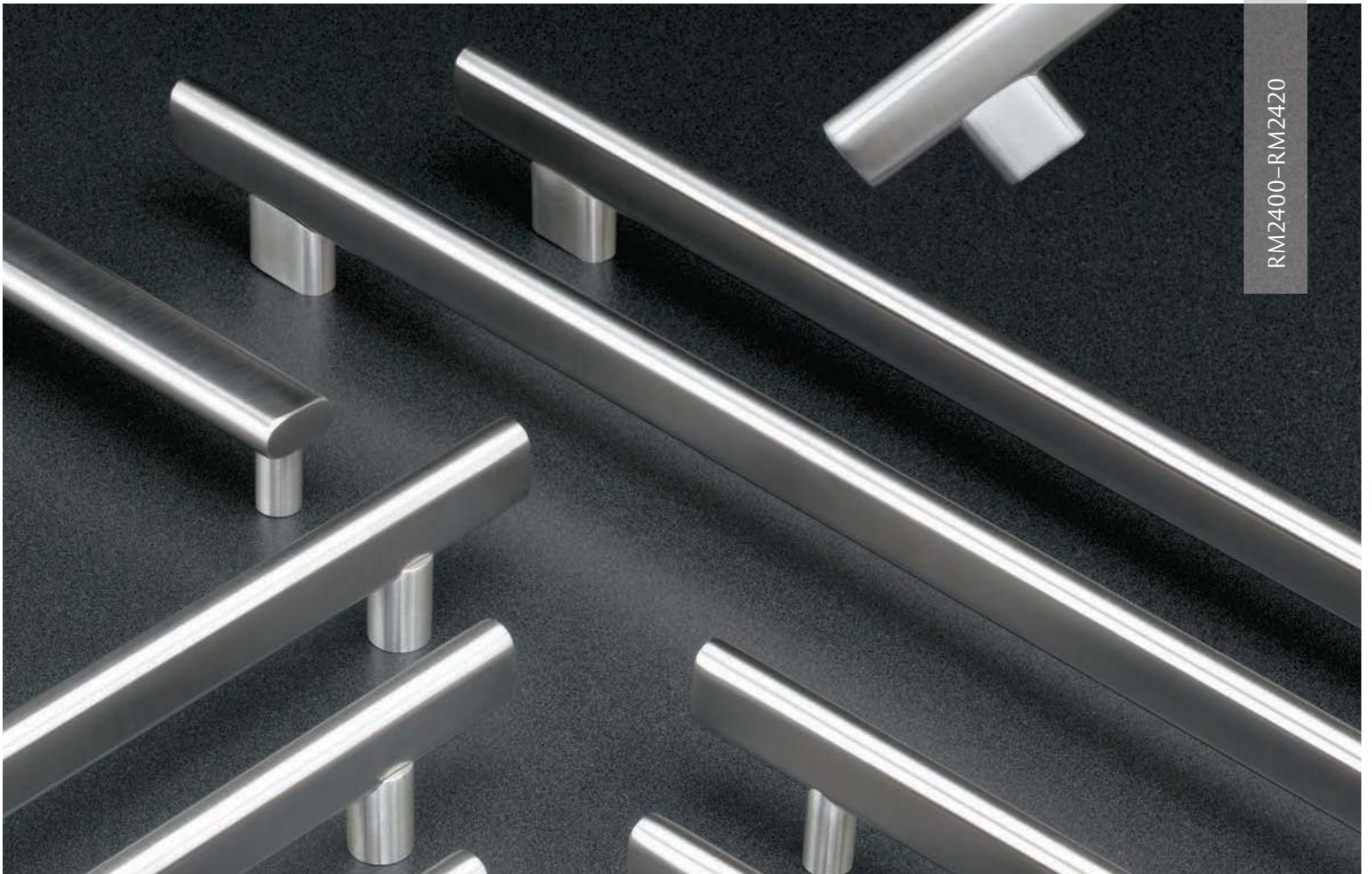

Smooth

OvalTek™ with Flat Oval Grip

Trim lines and a sleek oval shape enhance these beautiful ergonomic pulls available in standard and full-height sizes with leather wrapping options.



Straight Pull - Small Round Post

Part	Grip Size	Proj.
RM2400	3/4" x 1 1/2"	2 3/4"



Straight Pull - Large Round Post

Part	Grip Size	Proj.
RM2410	3/4" x 1 1/2"	3 1/4"



Straight Pull - Oblong Post

Part	Grip Size	Proj.
RM2420	3/4" x 1 1/2"	2 3/4"



Push Bar - Large Round Post

Part	Grip Size	Proj.
RM2402	3/4" x 1 1/2"	2"

RM2300-RM2330

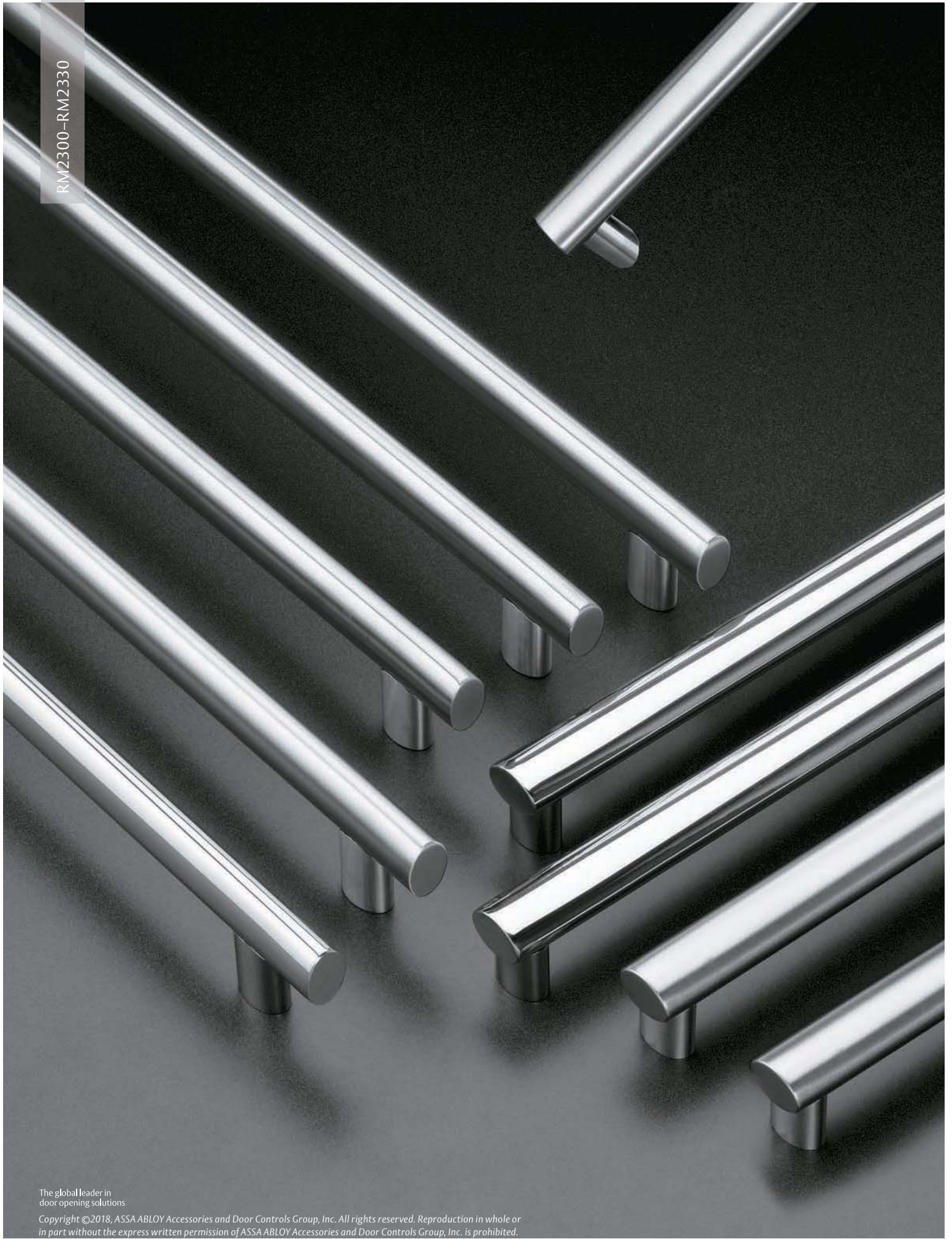

The global leader in
door opening solutions

Copyright ©2018, ASSA ABLOY Accessories and Door Controls Group, Inc. All rights reserved. Reproduction in whole or
in part without the express written permission of ASSA ABLOY Accessories and Door Controls Group, Inc. is prohibited.

Smooth

OvalTek™ with True Oval Grip

With a naturally contoured grip, these post-mounted pulls set the standard for user comfort.



Straight Oval Pulls

Part	Grip Size	Proj.
RM2300	1" x 1 1/2"	3"
RM2310	1 1/8" x 1 7/8"	3 3/8"



Offset Oval Pulls

Part	Grip Size	Proj.
RM2320	1" x 1 1/2"	2 7/8"
RM2330	1 1/8" x 1 7/8"	3 1/4"



Push Bars

Part	Grip Size	Proj.
RM2302	1" x 1 1/2"	2 1/4"
RM2312	1 1/8" x 1 7/8"	2 1/4"



SQUARE GRIP Clean lines and bold styling fuse to create these sturdy pulls. Available in a range of sizes and casting options, these daring pulls include features ranging from a contoured, comfort-focused grip to elegant monochrome accents. Choose your options to enhance any door.

The global leader in
door opening solutions

Copyright ©2018, ASSA ABLOY Accessories and Door Controls Group, Inc. All rights reserved. Reproduction in whole or in part without the express written permission of ASSA ABLOY Accessories and Door Controls Group, Inc. is prohibited.



Leather

Multiple color options, detailed stitching, and glove-soft leather

Accents

Beautiful, angular design with intimations of white, black, or parting lines

Diamond

Distinct brilliance made complete with square or diamond ends and posts

Smooth

Narrow profile and clean lines in scalable style

RM6400 - RM6440



Upholstery Leather

U-DBRN
(Dark Brown)

U-BLK
(Black)

The global leader in
door opening solutions

Copyright ©2018, ASSA ABLOY Accessories and Door Controls Group, Inc. All rights reserved. Reproduction in whole or in part without the express written permission of ASSA ABLOY Accessories and Door Controls Group, Inc. is prohibited.

GeoMetek™

Add contemporary flair to your door with these chic leather wrapped square and rectangular door pulls.



Straight Pulls - Square Ends

Part	Grip Size	Proj.
RM6400	$\frac{3}{4}$ " x $\frac{3}{4}$ "	2 $\frac{1}{4}$ "
RM6440†	1 $\frac{1}{4}$ " x 1 $\frac{1}{4}$ "	3"

† For locking pull options, see page 91.

* Black leather is shown.



Offset Pulls - Square Ends

Part	Grip Size	Proj.
RM6420	$\frac{3}{4}$ " x $\frac{3}{4}$ "	2 $\frac{1}{4}$ "

* Black leather is shown.



Straight Pulls - Rectangular End

Part	Grip Size	Proj.
RM6410	$\frac{3}{4}$ " x 1 $\frac{1}{2}$ "	3"

* Black leather is shown.



Offset Pulls - Rectangular Ends

Part	Grip Size	Proj.
RM6430	$\frac{3}{4}$ " x 1 $\frac{1}{2}$ "	3 $\frac{1}{4}$ "

* Black leather is shown.

Outside stitching must be specified when ordering.

Projection shown excludes leather thickness.



Accents

AccenTek™

These pulls exude elegance using accents of white, black, or delicately parting lines.



Cast Pulls

Part	Grip Size	Proj.
RM4720	1 1/2" x 1/2" x 12 1/2"	2"
RM4700B	1 1/4" x 5/8" x 14"	2"
RM4700W	1 1/4" x 5/8" x 14"	2"



Solid Grooved Pulls

Part	Grip Size	Proj.
RM4750	1/2" x 1 1/4"	2"
RM4755	3/4" x 1 1/4"	2 1/4"



Diamond

GeoMetek™

These pulls feature a beautifully angled diamond shape integrated into the posts or ends of the pull to create an unparalleled, distinctive look.



Flat End - Square Post

Part	Grip Size	Proj.
RM7800	3/4" x 3/4"	2 7/8"



Flat End - Diamond Post

Part	Grip Size	Proj.
RM7805	3/4" x 3/4"	2 7/8"



Diamond End - Square Post

Part	Grip Size	Proj.
RM7810	3/4" x 3/4"	2 7/8"



Diamond End - Diamond Post

Part	Grip Size	Proj.
RM7815	3/4" x 3/4"	2 7/8"

RM5200-RM5280

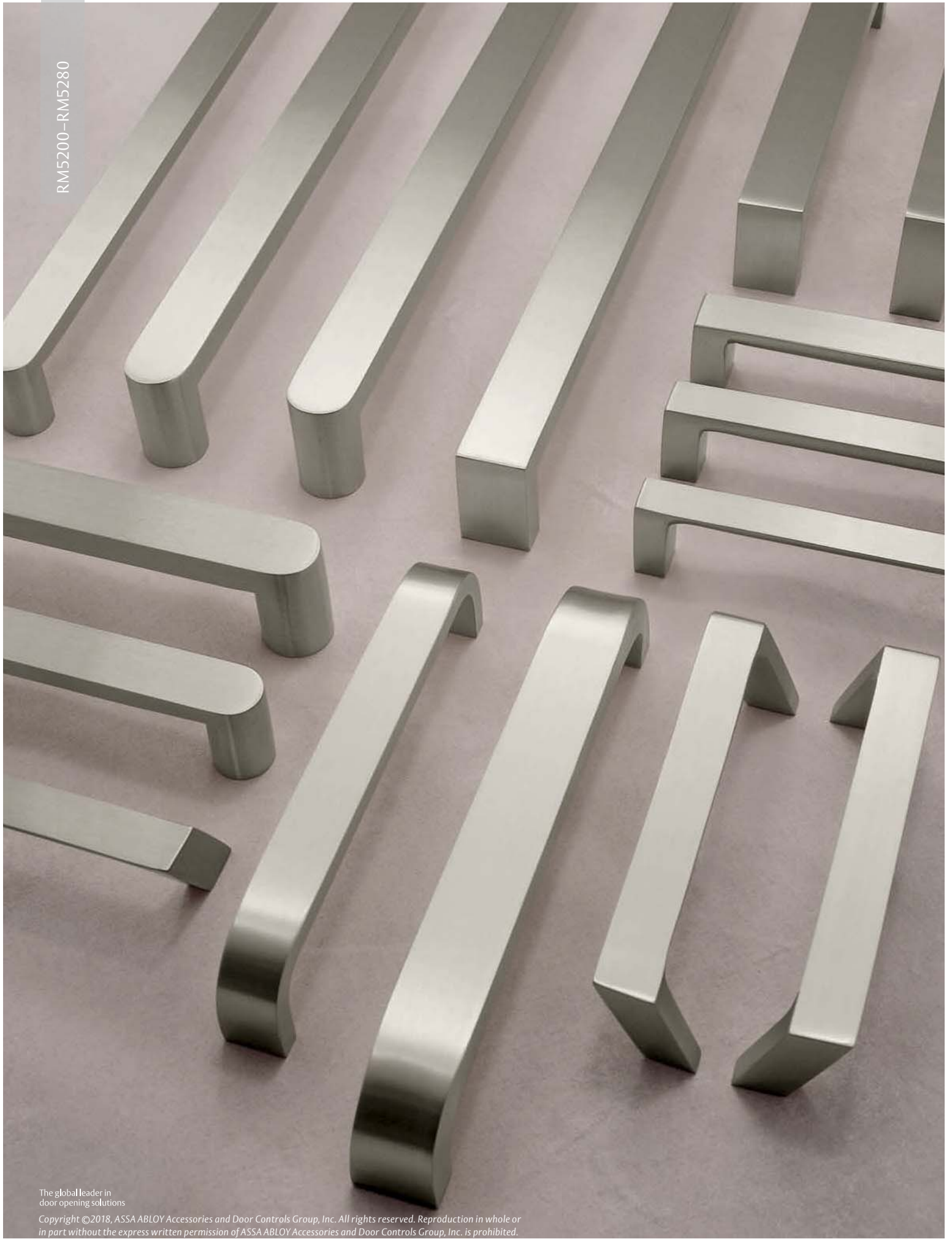

The global leader in
door opening solutions

Copyright ©2018, ASSA ABLOY Accessories and Door Controls Group, Inc. All rights reserved. Reproduction in whole or
in part without the express written permission of ASSA ABLOY Accessories and Door Controls Group, Inc. is prohibited.

PlanTek™

The options are endless. These cast pulls, with a contoured-back grip, are available in a range of sizes and stocks for a distinctive and alternative form.



Straight Cast Pulls

Part	Grip Size	CTC	Proj.
RM5200	1"	7", 12"	2"
RM5202	1 1/4"	12"	2"



Straight Cast Pulls

Part	Grip Size	CTC	Proj.
RM5280	1/2" x 1 1/2"	9"	1 1/2"



Flat End Pulls

Part	Grip Size	Proj.
RM5230	1/2" x 1 1/4"	2 1/2"
RM5240	3/4" x 1 1/2"	2 1/2"



Radius End Pulls

Part	Grip Size	Proj.
RM5270	1/2" x 3/4"	2 1/2"



Flat End Push Bars

Part	Grip Size	Proj.
RM5232	1/2" x 1 1/4"	2"
RM5242	3/4" x 1 1/2"	2"



Offset Cast Pulls

Part	Grip Size	CTC	Proj.
RM5204	1"	8", 12"	2"



Bent End Pulls

Part	Grip Size	Proj.
RM5250	1/2" x 1 1/4"	2 1/4"
RM5260	3/4" x 1 1/2"	2 1/4"



Radius End Pulls

Part	Grip Size	Proj.
RM5210	1/2" x 1 1/4"	2 1/2"
RM5220	3/4" x 1 1/2"	2 1/2"



Radius End Push Bars

Part	Grip Size	Proj.
RM5212	1/2" x 1 1/4"	2"
RM5222	3/4" x 1 1/2"	2"

RM7900-RM7960



The global leader in
door opening solutions

Copyright ©2018, ASSA ABLOY Accessories and Door Controls Group, Inc. All rights reserved. Reproduction in whole or
in part without the express written permission of ASSA ABLOY Accessories and Door Controls Group, Inc. is prohibited.

Smooth

GeoMetek™

The square and rectangular pulls offer clean lines and a slim profile.



Straight Pulls - Square Ends

Part	Grip Size	Proj.
RM7900†	3/4" x 3/4"	2 1/4"
RM7940	1 1/4" x 1 1/4"	3"

† For locking pull options, see page 91.



Offset Pulls - Square/Rectangular Ends

Part	Grip Size	Proj.
RM7920 (Square)	3/4" x 3/4"	2 1/4"
RM7930 (Rectangular)	3/4" x 1 1/2"	3 1/4"



Straight Square Bridge Pulls

Part	Grip Size	Proj.
RM7902	3/4" x 3/4"	2 1/4"



Straight Rectangular End Stepped Post Pulls

Part	Grip Size	Proj.
RM7960	3/4" x 3/4"	2 1/2"



Straight Pulls - Rectangular Ends

Part	Grip Size	Proj.
RM7910	3/4" x 1 1/2"	3"



Straight Rectangular Bridge Pulls

Part	Grip Size	Proj.
RM7912	3/4" x 1 1/2"	3"



SCULPTED PULLS Add a sleek and graceful element to any door. Our collections offer symmetry, flowing shapes, the pleasing aspects of an ergonomic design, and custom options that provide the flexibility to blend with any environment using noticeable style that is delightful to behold and engage.

The global leader in
door opening solutions

Copyright ©2018, ASSA ABLOY Accessories and Door Controls Group, Inc. All rights reserved. Reproduction in whole or in part without the express written permission of ASSA ABLOY Accessories and Door Controls Group, Inc. is prohibited.

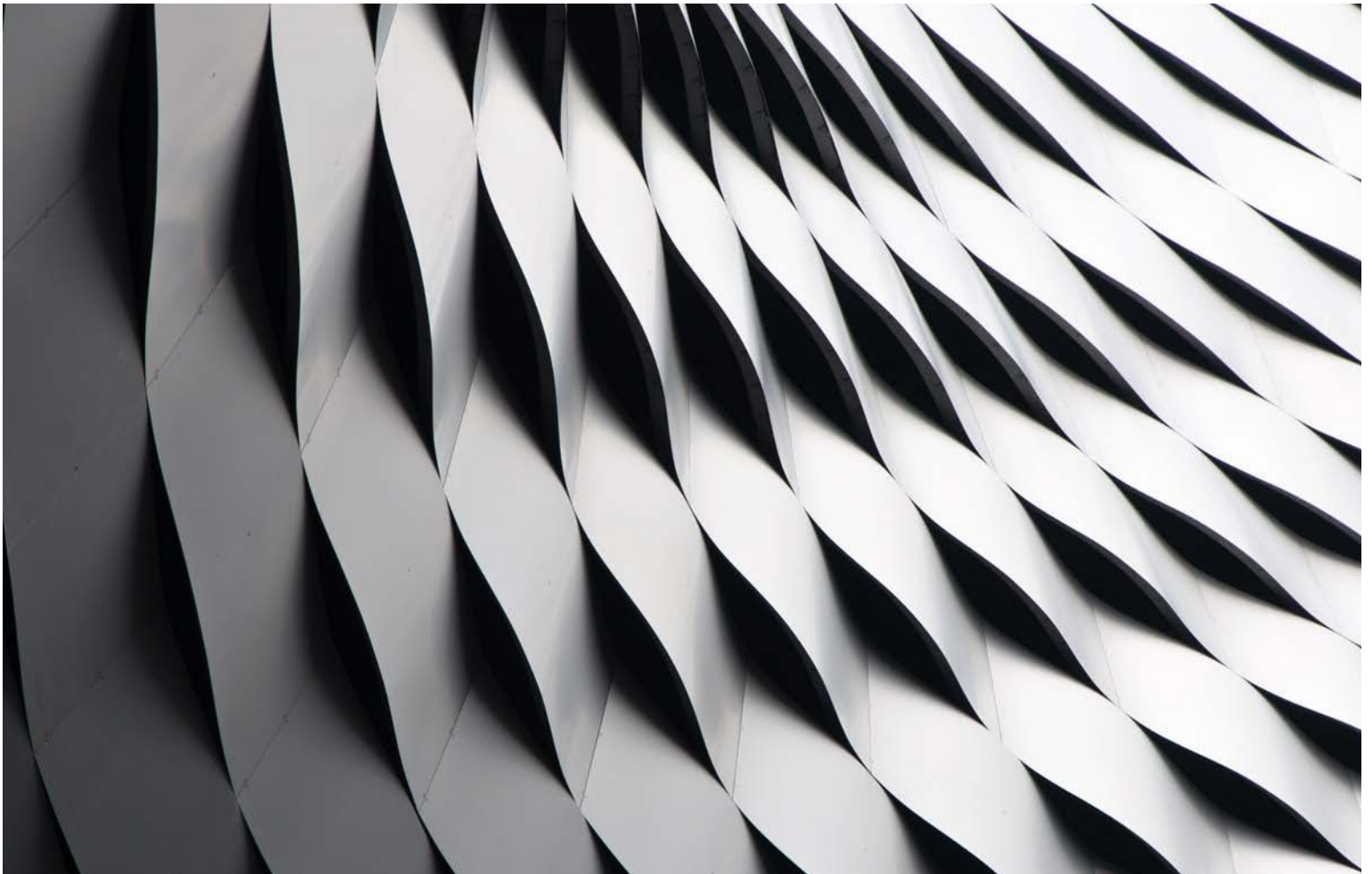

Non-Traditional

Precision curves, flowing design, sophisticated elegance

Traditional

Commercial, high-quality castings with enduring style



Non-Traditional

MariTek™

These versatile, solid-cast, post-mount pulls enhance any door location with character and appeal.



RM5700



RM5702

Straight Door Pulls

Part	Proj.	CTC	Grip Size
RM5700	2 ¹¹ / ₁₆ "	6"	1"
RM5702	2 ³ / ₄ "	12"	1"



Non-Traditional

SculpTrex™

Consistent with the name, these pulls offer the sophisticated, appealing quality of a sculpture with the graceful, comfortable feel of a curved pull.



RM5032



RM5042

Shaped Cast Pulls

Part	CTC	Grip Size	Proj.
RM5032	20"	1 ⁷ / ₁₆ "	3 ¹ / ₄ "
RM5042	20"	1 ¹ / ₄ "	2 ⁷ / ₈ "

RM2000-RM2034



The global leader in
door opening solutions

Copyright ©2018, ASSA ABLOY Accessories and Door Controls Group, Inc. All rights reserved. Reproduction in whole or
in part without the express written permission of ASSA ABLOY Accessories and Door Controls Group, Inc. is prohibited.

MegaCurve™

Make your door a point of conversation. These long, precision-curved pulls, in standard or custom shapes, add enchantment and fascination to any entrance.



Mid Bow

Part	Dia.	Proj.
RM2000	1 1/4"	3"
RM2004	1 1/4"	3"



Long Bow Pulls

Part	Dia.	Proj.
RM2010	1 1/4"	3"
RM2014	1 1/4"	3"

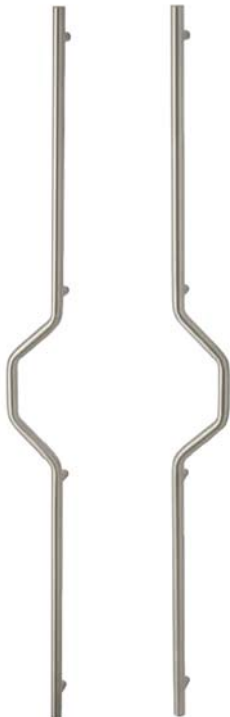

45° Pulls

Part	Dia.	Proj.
RM2020	1 1/4"	3"
RM2024	1 1/4"	3"



Triangle Pulls

Part	Dia.	Proj.
RM2030	1 1/4"	3"
RM2034	1 1/4"	3"



Non-Traditional

CenTrex™

Graceful and elegant, these smoothly curved pulls offer comfort in a sleek design. Use individually or mix with a push bar to create a unique and distinctive look.



Side Radius Pull

Part	Dia.	Proj.
RM4510	1 1/4"	3"



Projecting Radius Pulls

Part	Dia.	Proj.
RM4512	1 1/4"	3 1/8"



Straight Radius Pulls

Part	Dia.	Proj.
RM4410	1"	3"



Offset Radius Pulls

Part	Dia.	Proj.
RM4412	1"	2 1/2"

CenTrex™ (continued)



Semi-Circular Pulls - Flat Ends

Part	Dia.	Proj.
RM4502	1 1/4"	3"
RM4506	1 1/4"	3"



Semi-Circular Pulls - Round Ends

Part	Dia.	Proj.
RM4500	1 1/4"	3"



Radius Push Bar

Part	Dia.	Proj.
RM4516LH	1 1/4"	2 3/4"
RM4516RH	1 1/4"	2 3/4"



Radius Push Bars - Bent Ends

Part	Dia.	Proj.
RM4440LH	1"	2 1/2"
RM4440RH	1"	2 1/2"



Curved Pulls - Bent Ends

Part	Dia.	Proj.
RM4400	1"	3"



Double Curved Pulls - Bent Ends

Part	Dia.	Proj.
RM4402LH	1"	3"
RM4402RH	1"	3"



Semi-Circular Pulls - Bent Ends

Part	Dia.	CTC	Proj.
RM4420	1"	9"	3"
RM4422	1"	12"	3"



Compound Radius Push Bars - Bent Ends

Part	Dia.	Proj.
RM4450LH	1"	2 1/2"
RM4450RH	1"	2 1/2"

RM5650-RM5670

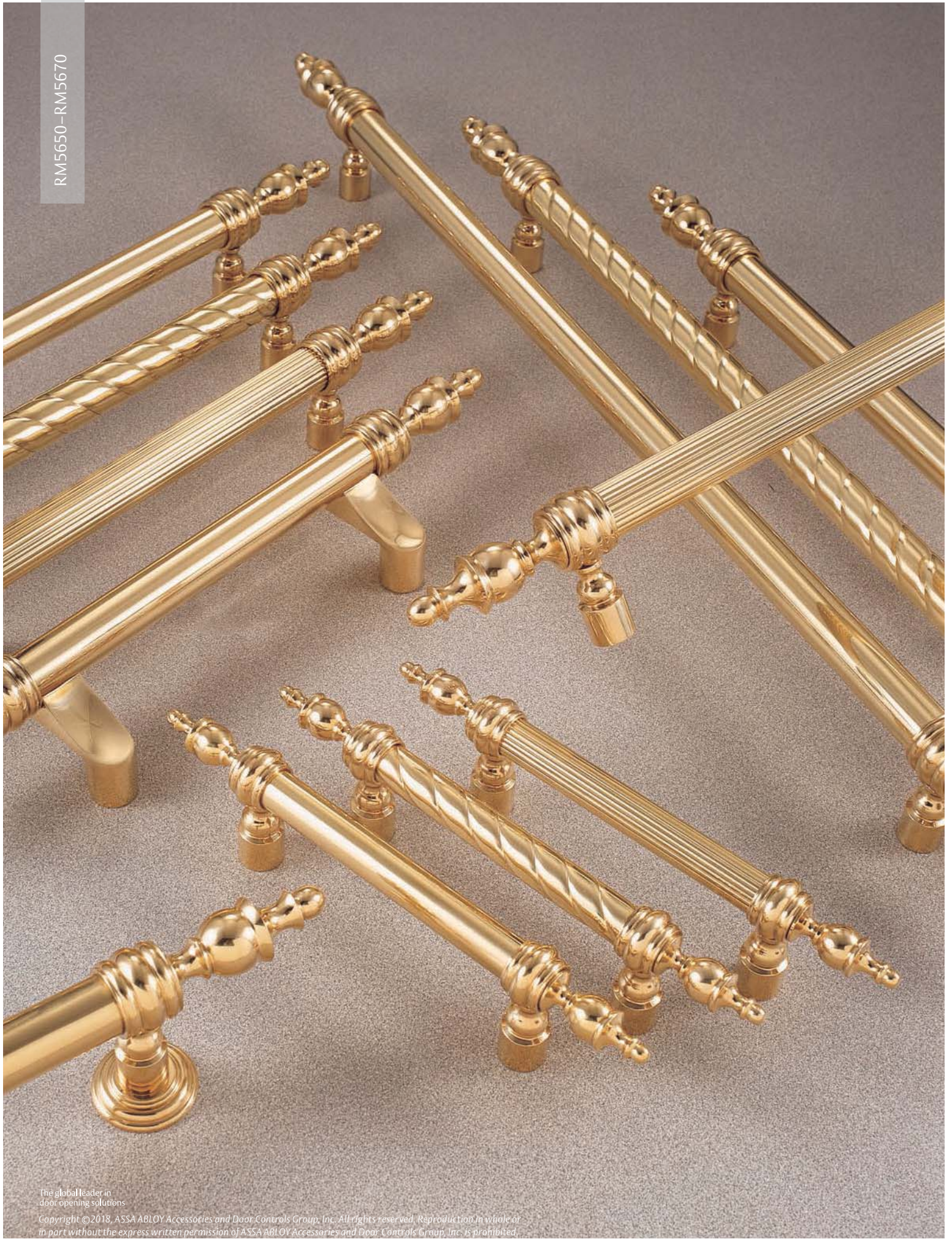

The global leader in
door opening solutions

Copyright ©2018, ASSA ABLOY Accessories and Door Controls Group, Inc. All rights reserved. Reproduction in whole or
in part without the express written permission of ASSA ABLOY Accessories and Door Controls Group, Inc. is prohibited.

Classic

Traditional, decorative, and enduring, these pulls use finials, variable lengths, and optional base plates as custom elements to complement and enrich a classic style.



RM5650-3

Plain Grip

Part	Dia.	Base Plate	Proj.
RM5650	1"	No	2 ¹¹ / ₁₆ "
RM5660	1"	Yes	3 ¹ / ₁₆ "



RM5652-4

Rope Grip

Part	Dia.	Base Plate	Proj.
RM5652	1"	No	2 ¹¹ / ₁₆ "
RM5662	1"	Yes	3 ¹ / ₁₆ "



RM5664-2

Fluted Grip

Part	Dia.	Base Plate	Proj.
RM5654	1"	No	2 ¹¹ / ₁₆ "
RM5664	1"	Yes	3 ¹ / ₁₆ "

* Shown with base plate



RM5670-1

Plain Offset

Part	Dia.	Base Plate	Proj.
RM5670	1"	No	2 ¹¹ / ₁₆ "



Finial Style Number (example: RM5650-4)

Suffix	Finial Style
1	Plain
2	Urn
3	Berry
4	Pinecone



Optional Base Plate

Dia.	Proj.
1 ³ / ₄ "	³ / ₈ "

RM5500-RM5598



The global leader in
door opening solutions

Copyright ©2018, ASSA ABLOY Accessories and Door Controls Group, Inc. All rights reserved. Reproduction in whole or
in part without the express written permission of ASSA ABLOY Accessories and Door Controls Group, Inc. is prohibited.

Traditional

Solid, commercial-quality, decorative pulls and plates that offer durability with a tasteful flair.



RM5500



RM5512



RM5520



RM5522



RM5530

Cast Pulls

Part	Base Plate	CTC	Proj.
RM5500	No	6"	2½"
RM5502	Yes	6 ⁷ / ₈ "	2 ⁷ / ₈ "
RM5510	No	12"	2½"
RM5512	Yes	12 ⁷ / ₈ "	2 ⁷ / ₈ "
RM5520	No	8"	2¼"
RM5522	Yes	8"	2 ⁵ / ₈ "
RM5530	No	5½"	1 ⁷ / ₈ "
RM5532	No	7½"	1 ⁷ / ₈ "
RM5534	No	12"	1 ⁷ / ₈ "



RM5598B



RM5596B

Cast Plates

Part	Size
RM5598B	3½" x 15"
RM5596A	3" x 12"
RM5596B	3½" x 15"



RM5590A



RM5592A



RM5594B

Heavy Plates - .090" Thick

Part	Size
RM5590A	3" x 12"
RM5590B	3½" x 15"
RM5590C	4" x 16"
RM5592A	3" x 12"
RM5592B	3½" x 15"
RM5592C	4" x 16"
RM5594B	3½" x 15"



LOCKING PULL SYSTEM add beauty and convenience to your locking application. Flawlessly integrate the contemporary style of rockwood's postmount or geometek door pulls with an easy-to-install deadbolt locking system. Manufactured for strength and durability and designed with clean and appealing lines, these systems offer perfectly simple, elegantly flexible solutions.





Features

- Key operated from outside; turn piece on inside
- Multiple cylinder options
- Door types: Glass, Wood, and Metal
- Multiple locking options: down, up, or both
- Bolt location: 2" from face of door to centerline of bolt
- Bolt has $1\frac{3}{16}$ " travel with fine adjustment
- Horizontal push/pull bar option
- Available in brass, bronze and stainless steel

Benefits

- Cylinder and thumbturn location eliminates physical strain when locking and unlocking
- Bolt concealed inside pull provides a clean, streamlined look
- Simple door preparation allows for faster installation
 - Requires only 2 holes for half height pulls, 3 holes for full height
- Suites with popular Rockwood door pulls, Corbin Russwin and Sargent lever handles, creating a continuum of design
- Offers flexibility in custom sizes for a variety of applications

LP3301-LP7901



The global leader in
door opening solutions

Copyright ©2018, ASSA ABLOY Accessories and Door Controls Group, Inc. All rights reserved. Reproduction in whole or
in part without the express written permission of ASSA ABLOY Accessories and Door Controls Group, Inc. is prohibited.

LP3301 Series
Post Mount - Round

This basic post mounted pull is a clean and simple design. The simplicity adds contemporary beauty to standard entrance doors.



LP6161 Series
Upholstery Leather Wrapped - Round

Supple yet durable leather makes a discriminating statement. Available in two standard colors and a palette of others on special order.



LP3401 Series
NeoMax with GripZone - Round

This beautiful bright and brushed two-tone finish provides a “wear” area for gripping the pull. This minimizes the appearance of small scratches caused by rings and keys.



LP6440 Series
GeoMetek Upholstery Leather Wrapped - Square

Beautifully crafted, the GeoMetek and Upholstery Leather combination produces an elegant composition. The leather is tightly wrapped and neatly sewn on the back and is offered in a plethora of custom colors.



LP6061 Series
English Bridle Leather - Round

Authentic J & E Sedgwick & Co. Ltd. bridle leather imported from Walsall, England is hand sewn by a talented craftsman. Typically used for saddles and equestrian products, this smooth durable leather is suitable for both interior and exterior applications.



LP7901 Series
GeoMetek Smooth - Square

This series offers a streamlined profile and crisp lines. The square pull complements the shape of the opening creating symmetrically balanced design.





Locking Door Pull Configurations

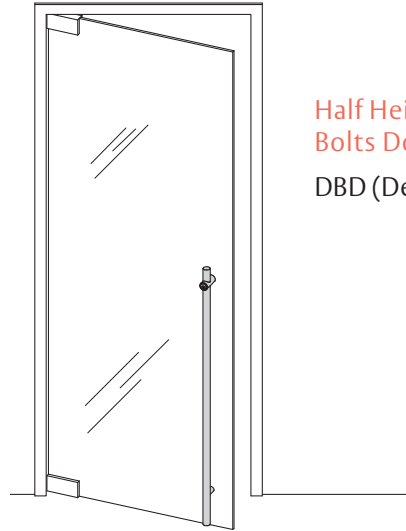

Half Height Pull -
Bolts Down
DBD (Dead Bolt Down)

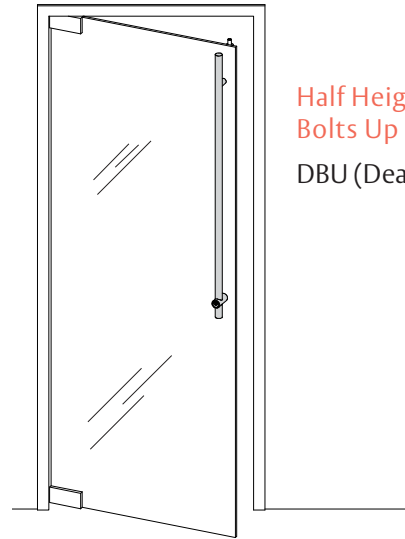

Half Height Pull -
Bolts Up
DBU (Dead Bolt Up)

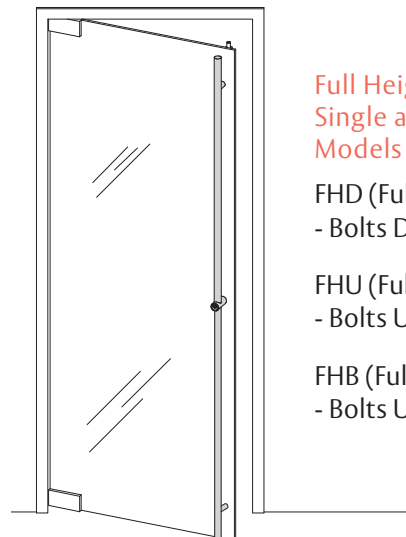

Full Height Pull -
Single and Dual Bolt
Models
FHD (Full Height Down)
- Bolts Down
FHU (Full Height Up)
- Bolts Up
FHB (Full Height Both)
- Bolts Up and Down



Horizontal Push/Pull Bar Configurations

Designation	Description
BEPB	Bent End Both Sides
BEPT	Bent End Thumbturn Side - Mating Side Vertical
BEPC	Bent End Cylinder Side - Mating Side Vertical



Designation	Description
PMPB	Post Mount Both Sides
PMPT	Post Mount Thumbturn Side - Mating Side Vertical
PMPC	Post Mount Cylinder Side - Mating Side Vertical

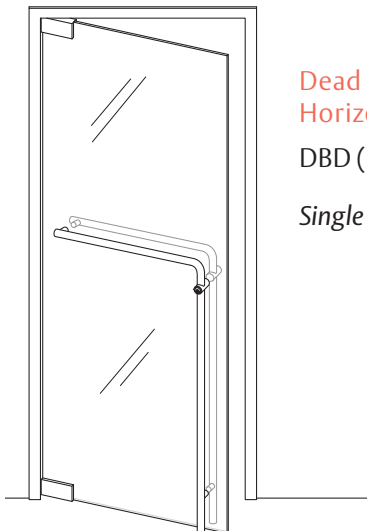

**Dead Bolt Down -
Horizontal Bar**
DBD (Dead Bolt Down)
Single or Double Sided

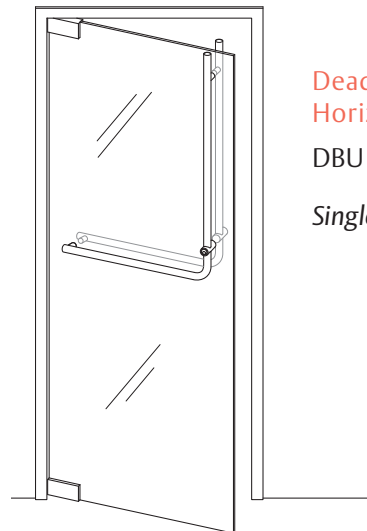

**Dead Bolt Up -
Horizontal Bar**
DBU (Dead Bolt Up)
Single or Double Sided



SLIDING AND CLOSET PULLS Practical and modern style applications for sliding and closet doors. Our collections inspire visions of industrial sensibility, rustic charm, or seamless beauty. These pulls come in a variety of custom sizes and finishes to meet any application need.



The global leader in door opening solutions

Copyright ©2018, ASSA ABLOY Accessories and Door Controls Group, Inc. All rights reserved. Reproduction in whole or in part without the express written permission of ASSA ABLOY Accessories and Door Controls Group, Inc. is prohibited.

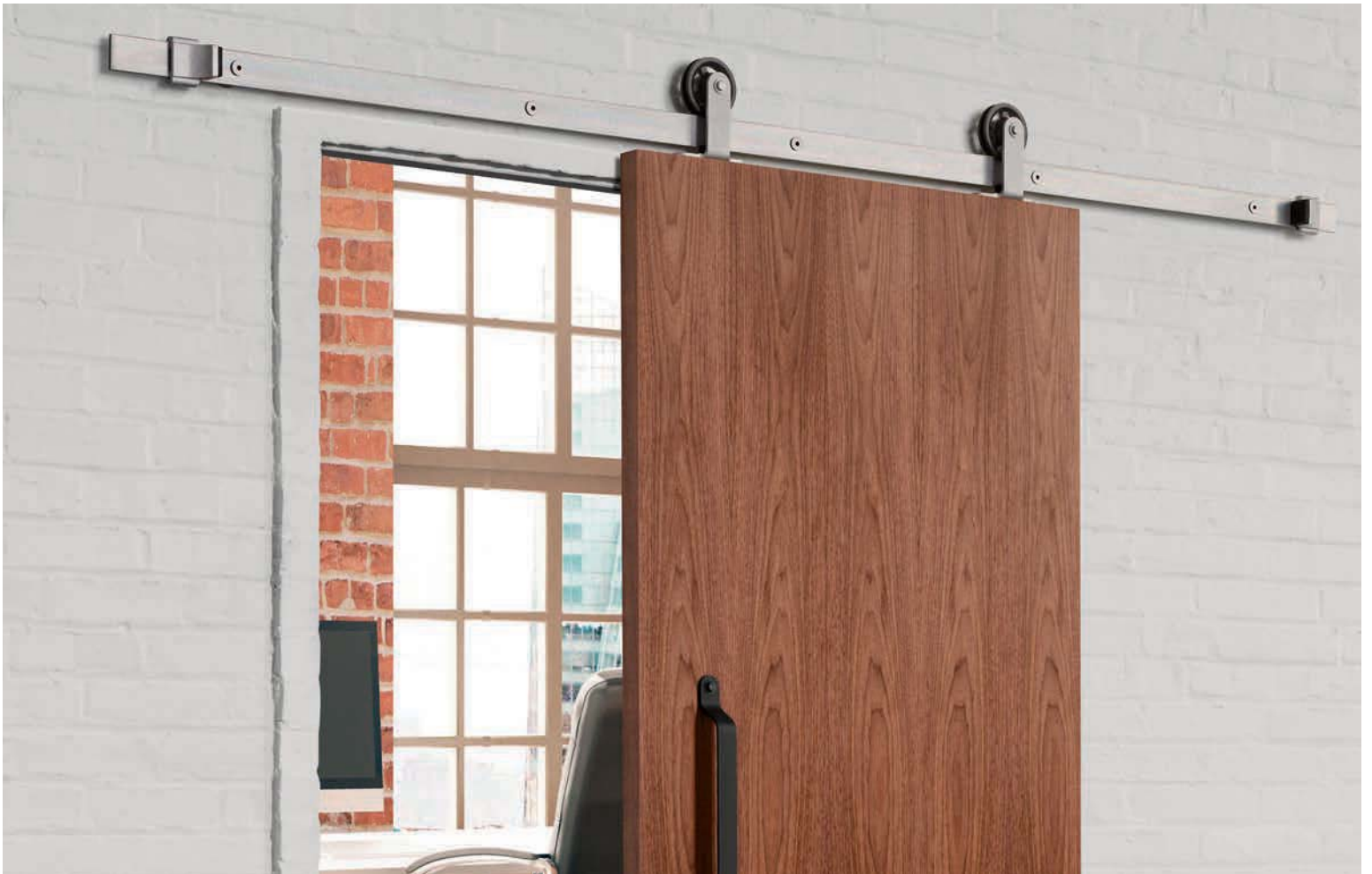

Sliding

Industrial style with decorative, rustic finishes

Closet

Simple closet door solutions in a variety of attractive designs and finishes

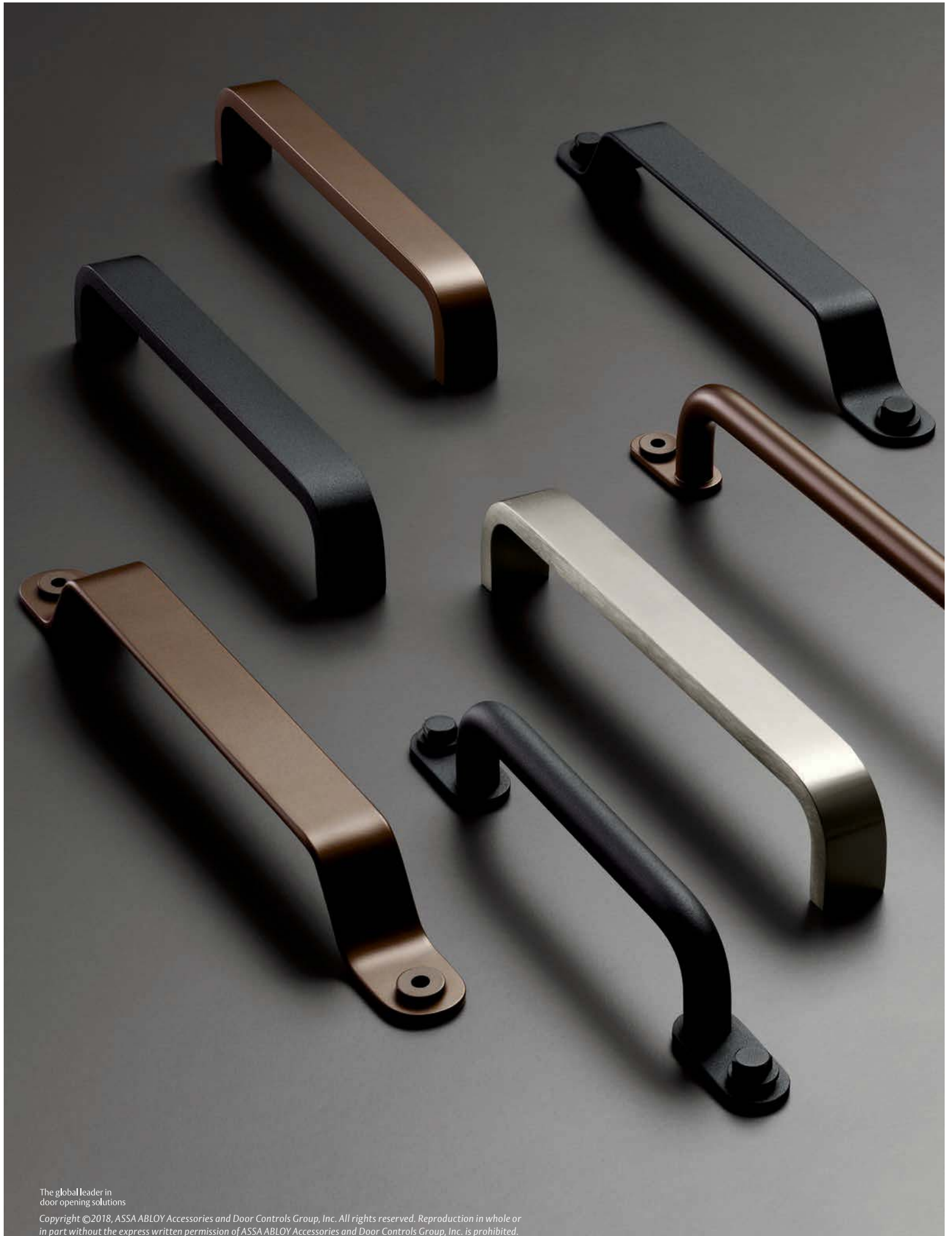

The global leader in
door opening solutions

Copyright ©2018, ASSA ABLOY Accessories and Door Controls Group, Inc. All rights reserved. Reproduction in whole or
in part without the express written permission of ASSA ABLOY Accessories and Door Controls Group, Inc. is prohibited.



Sliding

AccenTek

These pulls offer a modern, industrial look with exposed fasteners and rustic finishes.



RM4800



RM4810



RM4820



RM780



RM782



RM785

Formed Pulls with Distinguished Fastener Heads

Part	Grip Size	Proj.
RM4800	3/4" dia	2 1/2"
RM4810	1 1/2" x 1/4"	1/4"
RM4820	1 1/2" x 3/16"	1 5/16"

Flush Pulls

Part	Size	Opening	Depth
RM780	2 3/16" x 3 1/4"	7/8" x 2 3/8"	3/4"
RM782	2 11/16" x 4 3/16"	1 7/16" x 3 7/16"	3/4"
RM785	3 1/2" dia	2 5/8" x 1 5/8"	7/8"

RM5250 PlanTek Pull also shown on left image.



Closet

Closet Pulls

Simplicity and practicality combined into a pull that is fabricated to your specifications.



RM715

Closet Door Pulls

Part	Dia.	Base Plate	Proj.
RM710	3/8"	No	1 1/2"
RM715	3/8"	Yes	1 1/2"
RM720	1/2"	No	1 3/4"
RM725	1/2"	Yes	1 7/8"
RM730	5/8"	No	2"
RM735	5/8"	Yes	2 1/8"



Closet

Edge Pulls

A variety of finishes, sizes, and solutions to handle any door application.



RM752

Flat Edge Door

Part	Return	Rolled Size
RM751	No	7/16"
RM752	Yes	7/16"



RM753

Bevel Edge Door

Part	Return	Rolled Size
RM753	No	7/16"
RM754	Yes	7/16"



Double Edge Pull

Part	Rolled Size
RM755	7/16"



Concealed Edge Pull

Part	Size
RM760	1" x 4 1/4"



ACCESSORIES Enhance your setting. Our collections of coat hooks, door stops, push/pull plates, and signage provide an added element of interest to your door area. Precision-manufactured and durable, these accessories can be customized to match specific door pull selections with resilient beauty.



Coat Hooks

Solid brass, bronze, or stainless steel materials with tasteful finish options

Door Stops

Durable, long-lasting style

Push Plates, Pull Plates, and Signage

Detailed and available with design options to match our pulls

Coat Hooks

Available in most architectural finishes, our collection of coat hooks add an element of convenience to enhance any environment.



RM801



RM802



RM803



RM804



RM805
RM807



RM806
RM808



RM811



RM812



RM820



RM821



RM822



RM823



RM828



RM829

Essential Coat Hooks

Part	Size
RM801	1 1/4" x 1 3/4"
RM802	1 1/4" x 2 3/4"
RM803	1" x 2"
RM804	1" x 3"
RM805	1" x 1 3/4"
RM806	1" x 3"
RM807	1 1/4" x 2 1/8"
RM808	1 1/4" x 3 1/2"

Part	Size
RM811	3/4" x 1 5/8"
RM812	1 1/4" x 2 1/4"
RM820	1/2" x 1 5/8"
RM821	5/8" x 2 1/8"
RM822	1/2" x 1 1/2"
RM823	5/8" x 2"
RM828	3/4" x 2 7/8"
RM829	3/4" x 1 7/8"



RM830



RM831



RM835



RM836

LineaMet Coat Hooks

Part	Base Plate	Size
RM830	Yes	1 1/4" x 2 1/8"
RM831	Yes	7/8" x 2 1/8"

ArborMet Coat Hooks

Part	Base Plate	Size
RM835	Yes	1 1/4" x 2 1/8"
RM836	Yes	7/8" x 2 1/8"



RM838



RM839



RM840
RM841



RM842
RM843

SoftMet Coat Hooks

Part	Base Plate	Size
RM838	Yes	1 1/4" x 2 1/8"
RM839	Yes	7/8" x 2 1/8"

Groove Coat Hooks

Part	Base Plate	Size
RM840	Yes	1/2" x 1 5/8"
RM841	Yes	5/8" x 2 1/8"
RM842	No	1/2" x 1 1/2"
RM843	No	5/8" x 2"



GeoMetek Coat Hooks

Part	Size	Proj.
RM817	1 1/8" x 1 3/4"	2 1/16"

Door Stops

Complete your look with these durable rubber door stops for walls, doors, and baseboards.



RM850



RM851



RM855



RM856



RM857

Floor Mounted

Part	Description	Base	Proj.
RM850	Short - Flat Top	1 1/4"	1 3/4"
RM851	Tall - Flat Top	1 1/4"	2 1/2"
RM855	Short - Round Top	1 1/4"	1 3/4"
RM856	Tall - Round Top	1 1/4"	2 3/4"
RM857*	Tall - Square	1"	2 3/4"

* Can be used as a base board mounted stop.



RM860



RM861



RM867

Wall Mounted

Part	Bumper	Base	Proj.
RM860	Convex	1 5/8"	1 3/32"
RM861	Concave	1 5/8"	1 3/32"
RM867	Flat Square	1 3/4"	3/4"



RM870



RM875



RM871



RM876



RM872



RM877

Baseboard Mounted

Part	Base Plate	Base	Proj.
RM870	No	5/8"	1 1/2"
RM871	No	5/8"	3 1/4"
RM872	No	5/8"	3 3/4"
RM875	Yes	1"	1 5/8"
RM876	Yes	1"	3 3/8"
RM877	Yes	1"	3 7/8"

RM1010-RM1160

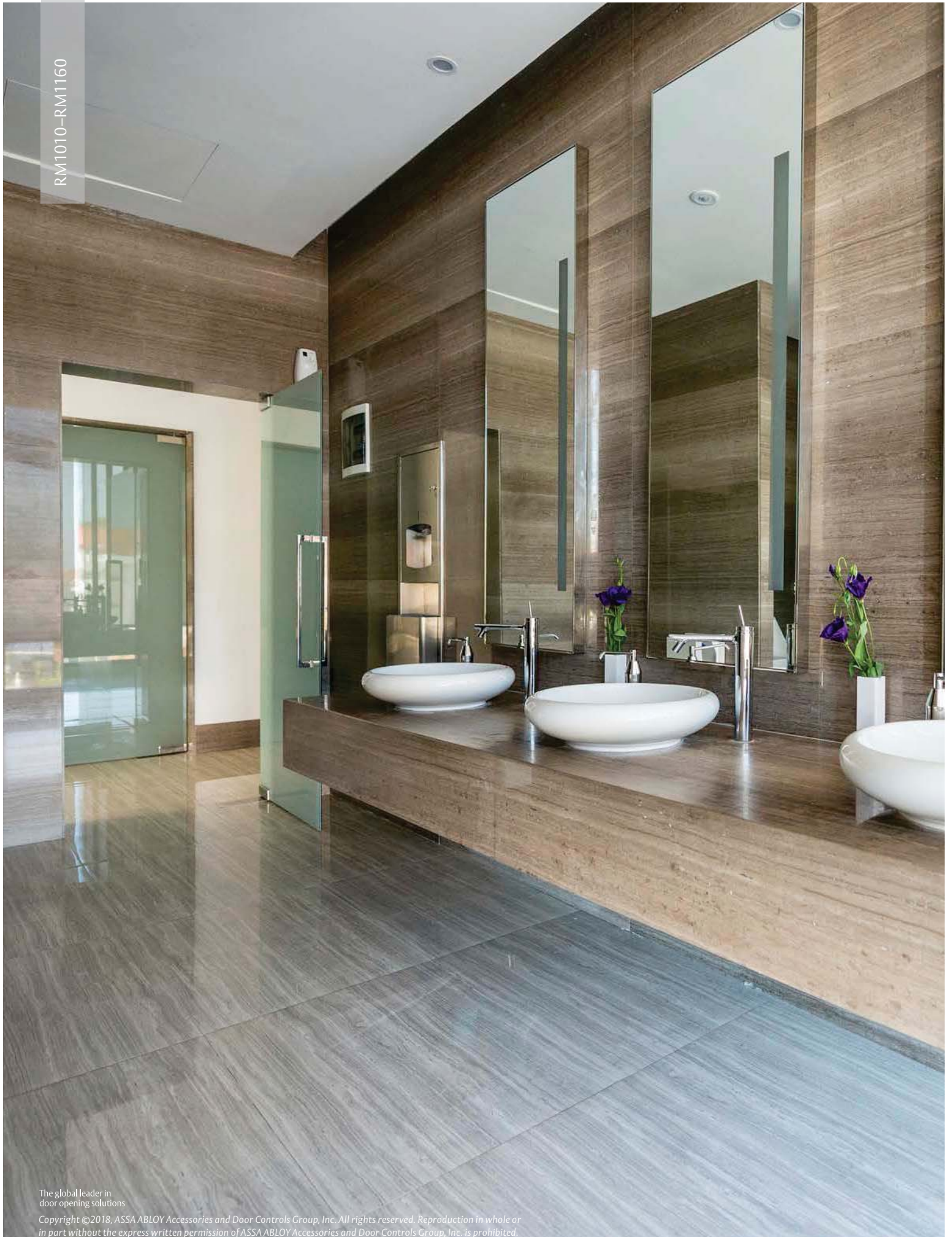

The global leader in
door opening solutions

Copyright ©2018, ASSA ABLOY Accessories and Door Controls Group, Inc. All rights reserved. Reproduction in whole or
in part without the express written permission of ASSA ABLOY Accessories and Door Controls Group, Inc. is prohibited.

Push Plates, Pull Plates, and Signage

Standard and custom-engraved options are available for these push and pull plates.



Square Corners - Adhesive Mount

Part	Engraved	Size
RM1010	Blank	4" x 22"
RM1010H	PUSH	4" x 22"
RM1010L	PULL	4" x 22"



Square Corners - Screw Mount

Part	Engraved	Size
RM1020	Blank	4" x 22"
RM1020H	PUSH	4" x 22"
RM1020L	PULL	4" x 22"



Radius End Corners - Adhesive Mount

Part	Engraved	Size
RM1030	Blank	4" x 22"
RM1030H	PUSH	4" x 22"
RM1030L	PULL	4" x 22"



Radius End Corners - Screw Mount

Part	Engraved	Size
RM1040	Blank	4" x 22"
RM1040H	PUSH	4" x 22"
RM1040L	PULL	4" x 22"



Indicator Plates - PUSH/PULL

Part	Engraved	Dia.	Mounting
RM1110H	PUSH	1"	Adhesive
RM1110L	PULL	1"	Adhesive
RM1120H	PUSH	2 1/2"	Adhesive
RM1120L	PULL	2 1/2"	Adhesive



Indicator Plates - MEN/WOMEN

Part	Engraved	Size	Mounting
RM1150M	MEN	2" x 4"	Adhesive
RM1150W	WOMEN	2" x 5 3/4"	Adhesive
RM1160M	MEN	2" x 4"	Screw
RM1160W	WOMEN	2" x 5 3/4"	Screw



CUSTOM DOOR PULLS Are you looking for door hardware that is different, funky, or suites with other components in your facility and is not shown in our current offering? The ASSA ABLOY custom hardware program offers a myriad of options to turn your dreams into beautiful reality.

The global leader in
door opening solutions

Copyright ©2018, ASSA ABLOY Accessories and Door Controls Group, Inc. All rights reserved. Reproduction in whole or in part without the express written permission of ASSA ABLOY Accessories and Door Controls Group, Inc. is prohibited.

First impressions are everything

Door pulls are the gateway into a building. Whether you're looking for drama or elegance, ASSA ABLOY Rockwood door pulls can be highly customized, making your ideas come to life. Made with top-notch quality materials including various metals, leather, and wood, we use a selection of manufacturing processes to produce your custom design.

Custom Machining

Computer controlled machining techniques including water jet cutting and milling enable precision fabrication and the efficient production of designs.

Corporate Identity

Incorporate your company logo on a door opening through computer aided etching or engraving. These durable marking techniques are readily available to add that finishing touch.

Custom Casting

Working with a variety of pattern makers, we can produce the exact design you compose. Castings provide a unique surface texture and can be economical when you have more than a few to make.

Custom Bending

A variety of bent shapes are displayed in our standard product line, however, we can bend a radius of your choice on any material you select.

Custom Materials

Our leather craftsmanship expresses our attention to detail as each leather door pull is hand stitched. We apply equal expertise to our door pull fabrication by using the finest bridle or upholstery leather, in any custom color you desire.

Wood adds an element of warmth to your opening. We offer a selection of premium species including Mahogany, Canary and Walnut. Paired with numerous metal finishes, including custom colors, the options are endless.





The global leader in
door opening solutions

Copyright ©2018, ASSA ABLOY Accessories and Door Controls Group, Inc. All rights reserved. Reproduction in whole or
in part without the express written permission of ASSA ABLOY Accessories and Door Controls Group, Inc. is prohibited.

Collection 3



Corbin Russwin 21L and SARGENT RAL Lever

**Dark Brown leather is shown.*



Rockwood Flush Leather Door Pull



McKinney Two Knuckle Hinge with Flat Tips



Rockwood RM850 Door Stop



Rockwood RM801 Coat Hook

Collection 6



Corbin Russwin 21S and SARGENT RAS Lever



Rockwood SoftMet Door Pull



Rockwood SoftTek Door Pull



McKinney Five Knuckle Split Finish Hinge



Rockwood RM850 Door Stop



Rockwood RM839 Coat Hook



Rockwood RM838 Coat Hook

Collection 14



Corbin Russwin 135 and SARGENT H003 Lever



Corbin Russwin 137 and SARGENT H005 Lever



Rockwood AccenTek Door Pull



McKinney Two Knuckle Square Barrel Hinge



Rockwood RM867 Wall Stop



Rockwood RM857 Floor Stop



Rockwood RM817 Coat Hook



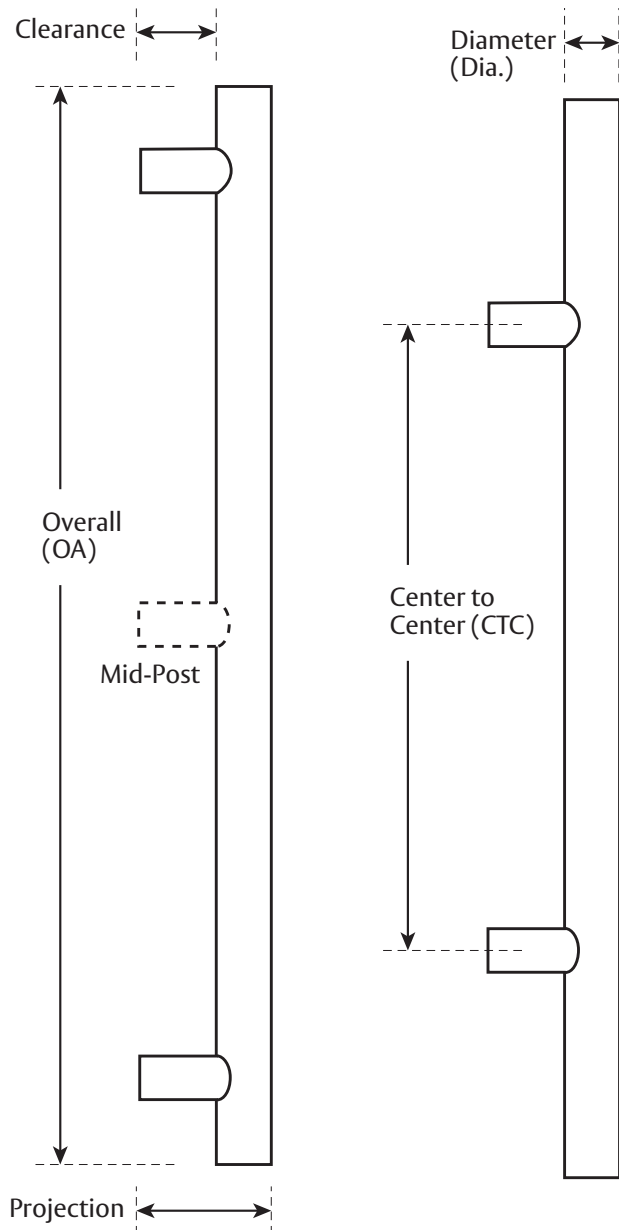

Technical Information

Long door pulls naturally have a small amount of flexing between mounting points that are spaced far apart. The following guidelines will help determine when a mid-post is required, or when altering the location of the mounting posts (by moving them closer together) should be considered to minimize flexing of the grip. A rigid grip is ideal for long door pulls and is particularly important on all glass doors which inherently flex. The mid-post will keep the mechanical joints and fasteners in a sturdy position.

The recommendation for adding a mid-post to long door pulls is based on a theoretical pull load of 30 foot pounds maximum, to open the door. This is a greater than the typical force required to open an average door. The maximum amount of deflection of the grip that might be encountered, is $\frac{3}{8}$ ". The conditions on your job site can vary due to door weight, wind loading, closer settings, locked doors being aggressively pulled, and other circumstances. ASSA ABLOY proposes adding a mid-post to heavy or hard-to-open doors, which will create a more stable and durable installation.

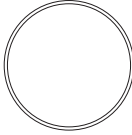

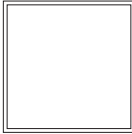
Post Mounted Pulls, Shapes, and Sizes

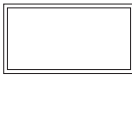
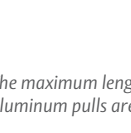
Shape	Material	Material Size	Maximum CTC
 Round	Stainless Steel	1"	70"
		1 $\frac{1}{4}$ "	90"
		1 $\frac{1}{2}$ "	110"
	Brass/Bronze	1"	57"
		1 $\frac{1}{4}$ "	73"
		1 $\frac{1}{2}$ "	87"
 Oval	Stainless Steel	1" x 1 $\frac{1}{2}$ "	100"
		1" x 1 $\frac{7}{8}$ "	119"
		1" x 1 $\frac{1}{8}$ "	119"
 Flat Oval	Stainless Steel	3 $\frac{3}{4}$ " x 1 $\frac{1}{2}$ "	93"
		3 $\frac{3}{4}$ " x 1 $\frac{1}{2}$ "	93"
 Square	Stainless Steel	3 $\frac{3}{4}$ " x 3 $\frac{3}{4}$ "	62"
		3 $\frac{3}{4}$ " x 3 $\frac{3}{4}$ "	62"
 Rectangular	Stainless Steel	1 $\frac{1}{2}$ " x 1 $\frac{1}{4}$ "	86"
		3 $\frac{3}{4}$ " x 1 $\frac{1}{2}$ "	110"
		3 $\frac{3}{4}$ " x 1 $\frac{1}{2}$ "	89"
 Rectangular	Stainless Steel	1 $\frac{1}{2}$ " x 1 $\frac{1}{4}$ "	52"
		3 $\frac{3}{4}$ " x 1 $\frac{1}{2}$ "	75"
		3 $\frac{3}{4}$ " x 1 $\frac{1}{2}$ "	60"
 Rectangular	Brass/Bronze	3 $\frac{3}{4}$ " x 1 $\frac{1}{2}$ "	60"
		3 $\frac{3}{4}$ " x 1 $\frac{1}{2}$ "	60"

On long pulls, post can be positioned closer to each other and farther away from ends as a strategy to avoid mid-post if door condition permits.

*The maximum length of anodized aluminum pulls is 87" due to our tank size. Longer aluminum pulls are available in satin finish and clear coated or powder coat paint.



Fastening Systems

Rockwood pulls attach using three basic fastening systems. These mounting systems firmly secure the pull to the door.

Optional base plates can be added for aesthetic or functional purposes. The larger diameter base plates add stability to the fastening system, which is beneficial for glass or wood door applications.

Standard Mounting Details

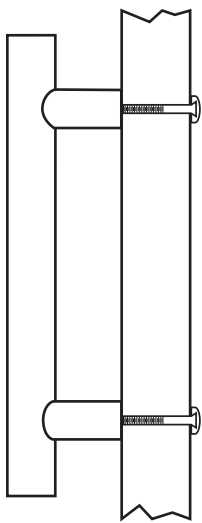

Single Thru Bolt

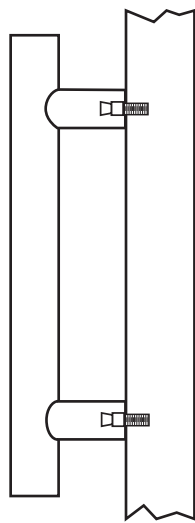

Single Concealed

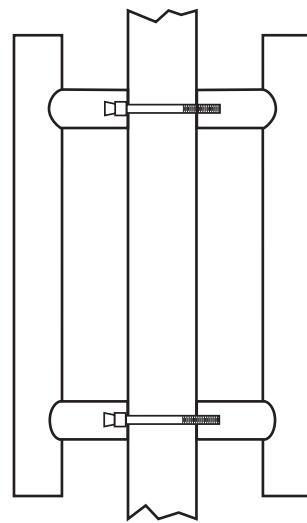

Pair Back to Back

Finishes

Base Material	Aluminum			Bronze						Brass							Stainless Steel						PC		
	US27	US28	311-315	US9	US10	US10B	US10A	US10BL	US20A	US3	US4	US5	US14	US15	US15A	US26	US26D	US32	US32D	US32DMS	US32MS	US32316		US32D316	Stock PC/ 10BE
Part #																									
Tubular (RM201-RM372)	•	•	•	•	•	•	•	•	•	•	•	•	•	•	•	•	•	•	•	•	•	•	•	•	•
Right Angles (RM405-RM413)	•	•	•	•	•	•	•	•	•	•	•	•	•	•	•	•	•	•	•	•	•	•	•	•	•
Right Angles (RM415-RM423)				•																					
Closet Pulls (RM710-RM735)																									
Flush Pulls(RM780-RM785)																									
Edge Pulls(RM751-RM755)				•																					
Edge Pulls(RM760)																									
Coat Hooks (RM801-RM804)																									
Coat Hooks(RM805-RM817)																									
Coat Hooks (RM820-RM823)	•	•	•																						
Coat Hooks (RM828-RM829)	•	•	•																						
Coat Hooks (RM830-RM843)																									
Door Stops (RM850-RM877)																									
Push Plates Pull Plates & Signange (RM1010-RM1160W)	•	•	•	•	•	•	•	•	•	•	•	•	•	•	•	•	•	•	•	•	•	•	•	•	•
MegaTek Small Pulls (RM1200-RM1270)																									
Groove Small Pulls (RM1211)																									
GripZone - Small Pulls (RM1300-RM1370)																									
NoirMet and ArborMet Small Pulls(RM1410-RM1470)(RM1510-RM1570)																									
MegaCurve (RM2000-RM2034)				•																					
MezzoTek(RM2110-RM2150)	•	•	•																						
BandWidth (RM2200-RM2244)																									
OvalTek (RM2300-RM2420)																									
SoftMet and SoftTek (RM2510-RM2640)				•	•	•	•	•	•	•	•	•	•	•	•	•	•	•	•	•	•	•	•	•	•
NeoMatrix (RM3010-RM3060)				•																					
Groove (RM3101 & RM3131)	•	•	•	•	•	•	•	•	•	•	•	•	•	•	•	•	•	•	•	•	•	•	•	•	•

The global leader in door opening solutions

Copyright ©2018, ASSA ABLOY Accessories and Door Controls Group, Inc. All rights reserved. Reproduction in whole or in part without the express written permission of ASSA ABLOY Accessories and Door Controls Group, Inc. is prohibited.



ASSA ABLOY is the global leader in door opening solutions, dedicated to satisfying end-user needs for security, safety and convenience

ASSA ABLOY



ASSA ABLOY
300 Main Street
Rockwood, Pennsylvania 15557
Phone: (800) 458-2424 • Fax: (800) 922-9212
www.assaabloydooraccessories.us • orders.rockwood@assaabloy.com

Rockwood is a product line of ASSA ABLOY Accessories and Door Controls Group, Inc., an ASSA ABLOY Group company. Copyright © 2018, ASSA ABLOY Accessories and Door Controls Group, Inc. All rights reserved. Reproduction in whole or in part without the express written permission of ASSA ABLOY Accessories and Door Controls Group, Inc. is prohibited.

Effective 12/1/2018
RM120 Rev D 11/18