

STILE & RAIL DOOR ELEVATION - 1011

JOB NUMBER: _____ PAGE: _____ / _____

JOB NAME: _____

STANDARDS:* Top Rail: 6" Stile: 6"
 Bottom Rail: 10"

* Standard component dimensions may vary on fire rated doors. Refer to the Stile & Rail Brochure.

Heritage

SS1011 **SA1011** **SC1011** **SR1011** **AA1011** **RR1011**

Dimensions

- Standard - see above
- Custom - fill in below

Top Rail: _____

Bottom Rail: _____

Hinge and Lock Stiles: _____

Sticking

Heritage Collection

- Ovolo
- Square
- Ogee
- Mission
- Classic
- Other – Supply Drawing

Panels[#]

- Raised Step
- Flat

[#]Panel dimensions will vary depending on prefit door size.

Dimensions are to cutout (do not include sticking height). Panel dimensions will vary depending on prefit door size.

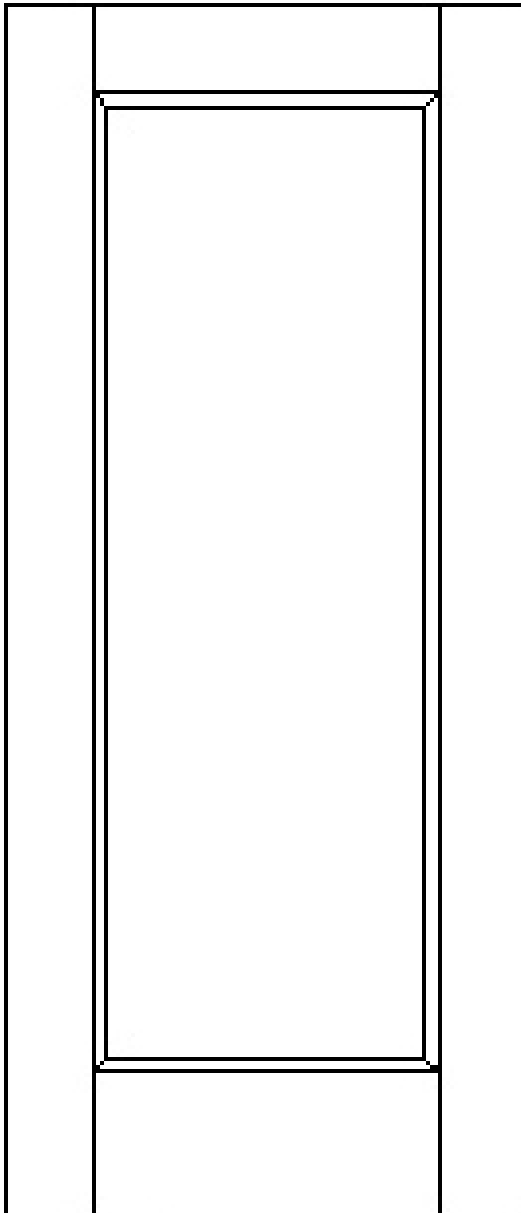



STILE & RAIL DOOR ELEVATIONS -1021

JOB NUMBER: _____ PAGE: _____ / _____

JOB NAME: _____

STANDARDS:*
 Top Rail: 6" Stile: 6"
 Bottom Rail: 10" Lock Rail: 8 3/4"

* Standard component dimensions may vary on fire rated doors. Refer to the Stile & Rail Brochure.
 (C/L of Lock Rail location will match frame manufacturer standard C/L of strike location unless otherwise noted)

Heritage

SS1021 **SA1021** **SC1021** **SR1021** **AA1021** **RR1021**

Dimensions

- Standard - see above
 Custom - fill in below

Top Rail: _____

Bottom Rail: _____

Hinge and Lock Stiles: _____

Lock Rail: _____

C/L of Lock Rail from TOD: _____

Sticking

Heritage Collection

- Ovolo
 Square
 Ogee
 Mission
 Classic
 Other – Supply Drawing

Panels*

- Raised Step
 Flat

*Panel dimensions will vary depending on prefit door size

Dimensions are to cutout (do not include sticking height). Panel dimensions will vary depending on prefit door size.

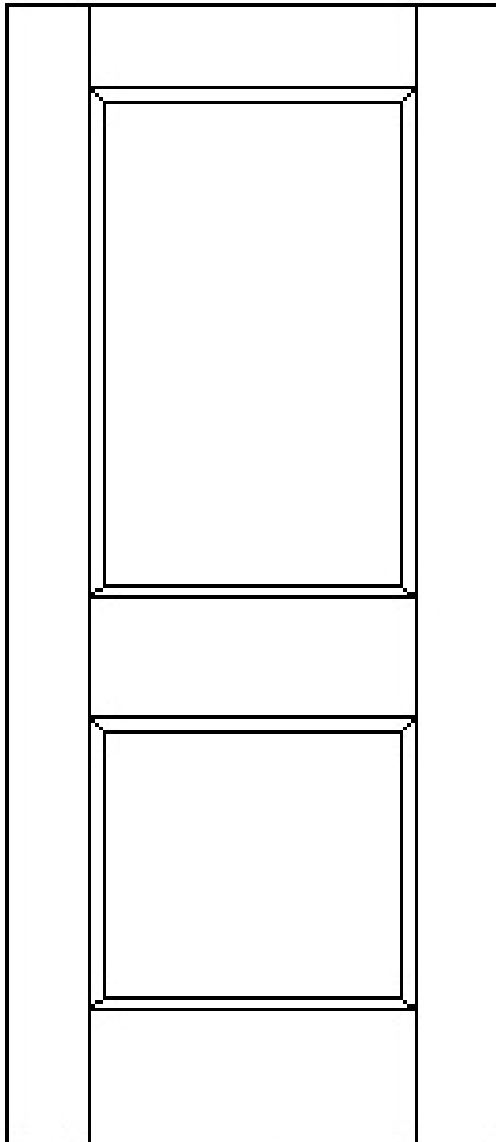



STILE & RAIL DOOR ELEVATIONS -1031

JOB NUMBER: _____ PAGE: _____ / _____

JOB NAME: _____

STANDARDS:* Top Rail: 6" Stile: 6"
Bottom Rail: 10" Mid Rail: 3-5/8"

* Standard component dimensions may vary on fire rated doors. Refer to the Stile & Rail Brochure.
 (C/L of Lock Rail Assembly will match frame manufacturer standard C/L of strike location unless otherwise noted)

Heritage

- SS1031**
 SA1031
 SC1031+
 SR1031
 AA1031
 RR1031

Dimensions

- Standard - see above
 Custom - fill in below

Top Rail: _____ Bottom Rail: _____

Hinge and Lock Stiles: _____ Mid Rail: _____

C/L of Lock Rail Assembly from TOD: _____

Lock Rail Panel Height: _____
 (Standard Lock Rail Panel Height is 8")

Sticking

Heritage Collection

- Ovolo
 Square
 Ogee
 Mission
 Classic
 Other- Supply Drawing

Panels**

- Raised Step
 Flat

Glass** (Advise which panels are glass)

Supplied By:	Thickness/Type	
<input type="checkbox"/> VT	<input type="checkbox"/> 1/4" Tempered***	<input type="checkbox"/> 3/16" Clear Firelight®
<input type="checkbox"/> Other	<input type="checkbox"/> 1/4" Wire	
<input type="checkbox"/> N/A	<input type="checkbox"/> Other: _____	

**Glass opening dimensions will vary depending on prefit door size

***If diagonal dimension of tempered glass is less than 13", glass will be substituted with laminated safety glass

**Panel dimensions not specified will vary depending on prefit door size
 Dimensions are to cutout (do not include sticking height). Panel and glass dimensions will vary depending on prefit door size

+Not available with glass panels

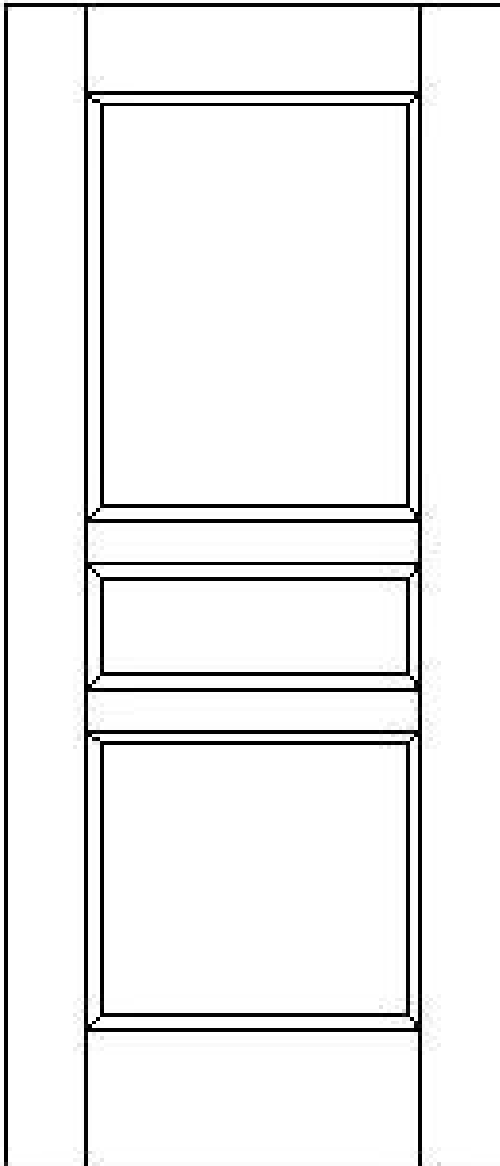

Lock Rail Panel Height

C/L Lock Rail Assembly



STILE & RAIL DOOR ELEVATIONS -1032

JOB NUMBER: _____ PAGE: _____ / _____

JOB NAME: _____

STANDARDS:* Top Rail: 6" Stile: 6"
Bottom Rail: 10" Mid Rail: 3-5/8"

* Standard component dimensions may vary on fire rated doors. Refer to the Stile & Rail Brochure.

Heritage

SS1032 **SA1032** **SC1032*** **SR1032** **AA1032**

Dimensions

- Standard - see above
- Custom - fill in below

Top Rail: _____ Bottom Rail: _____

Hinge and Lock Stiles: _____ Mid Rail: _____

Mid Rail: _____

Panel Dimensions are Equal

Sticking

Heritage Collection

- Ovolo
- Square
- Ogee
- Mission
- Classic
- Other- Supply Drawing

Panels*

- Raised Step
- Flat

Glass (Advise which panels are glass)**

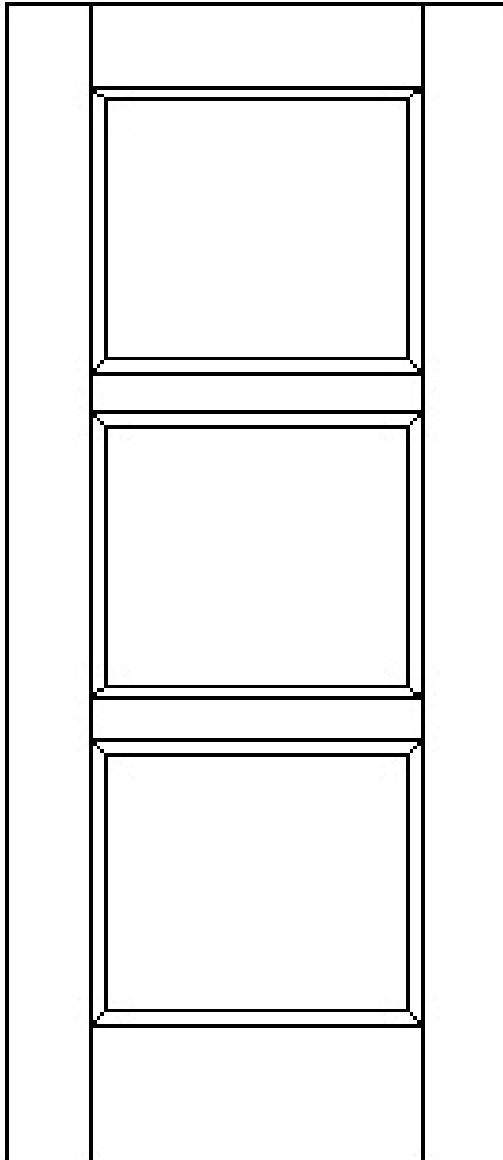

Supplied By:	Thickness/Type
<input type="checkbox"/> VT <input type="checkbox"/> Other <input type="checkbox"/> N/A	<input type="checkbox"/> 1/4" Tempered*** <input type="checkbox"/> 3/16" Clear Firelight® <input type="checkbox"/> 1/4" Wire <input type="checkbox"/> Other: _____

**Glass opening dimensions will vary depending on prefit door size

***If diagonal dimension of tempered glass is less than 13", glass will be substituted with laminated safety glass

*Panel dimensions will vary depending on prefit door size
 Dimensions are to cutout (do not include sticking height). Panel and glass dimensions will vary depending on prefit door size

+Not available with glass panels



STILE & RAIL DOOR ELEVATIONS -1033

JOB NUMBER: _____ PAGE: _____ / _____

JOB NAME: _____

STANDARDS:* Top Rail: 6" Stile: 6" Mullion: 3-5/8"
 Bottom Rail: 10" Lock Rail: 8 3/4"

(C/L of Lock Rail location will match frame manufacturer standard C/L of strike location unless otherwise noted)

Heritage

SS1033 **SA1033** **SC1033⁺** **SR1033** **AA1033** **RR1033**

Dimensions

- Standard - see above
- Custom - fill in below

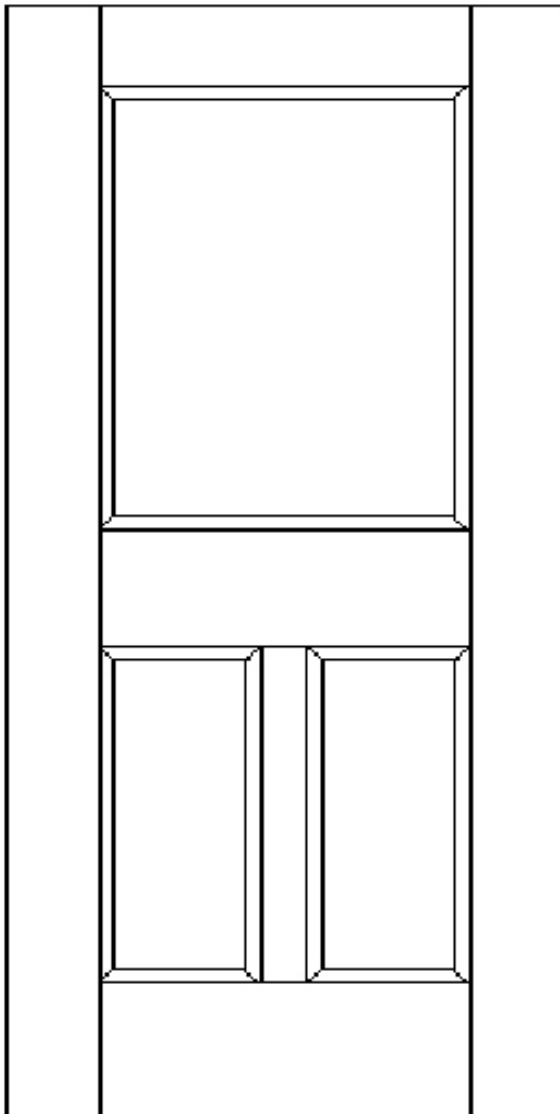

Top Rail: _____ Bottom Rail: _____

Hinge and Lock Stiles: _____ Mullion: _____

C/L of Lock Rail from TOD: _____ Lock Rail: _____

Sticking

Heritage Collection

- Ovolo
- Square
- Ogee
- Mission
- Classic
- Other- Supply Drawing

Panels[†]

- Raised Step
- Flat

Glass (Advise which panels are glass)**

Supplied By:	Thickness/Type
<input type="checkbox"/> VT <input type="checkbox"/> Other	<input type="checkbox"/> 1/4" Tempered*** <input type="checkbox"/> 1/4" Wire <input type="checkbox"/> Other: _____

**Glass opening dimensions will vary depending on prefit door size
 ***If diagonal dimension of tempered glass is less than 13", glass will be substituted with laminated safety glass
 #Panel dimensions will vary depending on prefit door size
 Dimensions are to cutout (do not include sticking height). Panel and glass dimensions will vary depending on prefit door size
 +Not available with glass panels



STILE & RAIL DOOR ELEVATIONS -1041

JOB NUMBER: _____ PAGE: _____ / _____

JOB NAME: _____

STANDARDS:* Top Rail: 6" Stile: 6" Mid Rail: 3-5/8"
 Bottom Rail: 10" Mullion: 3" Lock Rail: 8 3/4"

* Standard component dimensions may vary on fire rated doors. Refer to the Stile & Rail Brochure.
 (C/L of Lock Rail location will match frame manufacturer standard C/L of strike location unless otherwise noted)

Heritage

SS1041

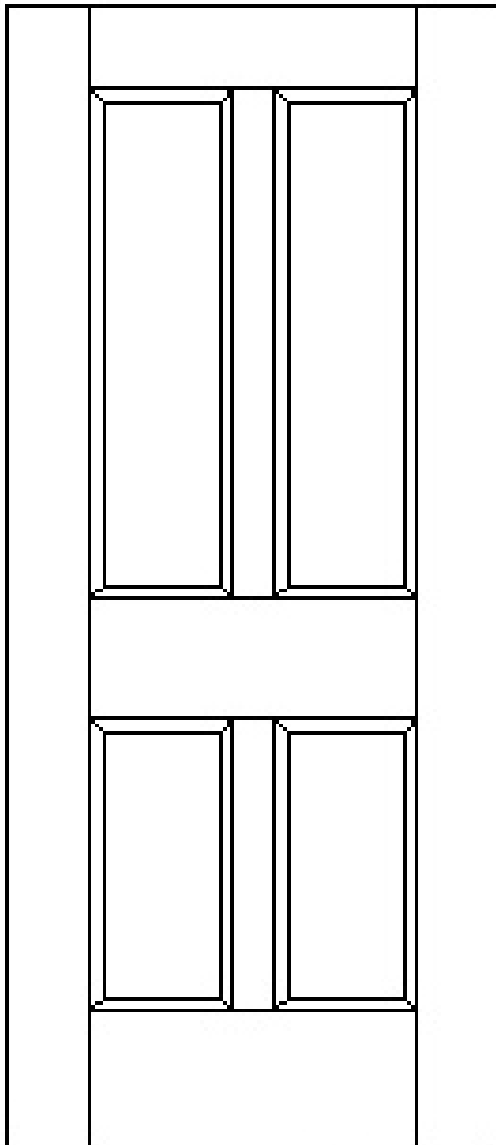

Dimensions

- Standard - see above
- Custom - fill in below

Top Rail: _____ Bottom Rail: _____

Hinge and Lock Stiles: _____ Mullion: _____

C/L of Lock Rail from TOD: _____ Lock Rail: _____

Sticking

Heritage Collection

- Ovolo
- Square
- Ogee
- Mission
- Classic
- Other – Supply Drawing

Panels[#]

- Raised Step
- Flat

Glass (Advise which panels are glass)**

Supplied By:		Thickness/Type	
<input type="checkbox"/> VT	<input type="checkbox"/> Other <input type="checkbox"/> N/A	<input type="checkbox"/> 1/4" Tempered***	<input type="checkbox"/> 3/16" Clear Firelight [®]
<input type="checkbox"/> Other		<input type="checkbox"/> 1/4" Wire	
<input type="checkbox"/> N/A		<input type="checkbox"/> Other: _____	

**Glass opening dimensions will vary depending on prefit door size

***If diagonal dimension of tempered glass is less than 13", glass will be substituted with laminated safety glass

*Panel dimensions will vary depending on prefit door size
 Dimensions are to cutout (do not include sticking height). Panel and glass dimensions will vary depending on prefit door size



STILE & RAIL DOOR ELEVATIONS -1042

JOB NUMBER: _____ PAGE: _____ / _____

JOB NAME: _____

STANDARDS:* Top Rail: 6" Stile: 6"
 Bottom Rail: 10" Mid Rail: 3-5/8"

* Standard component dimensions may vary on fire rated doors. Refer to the Stile & Rail Brochure.

Heritage

SS1042 **SA1042** **SR1042⁺**

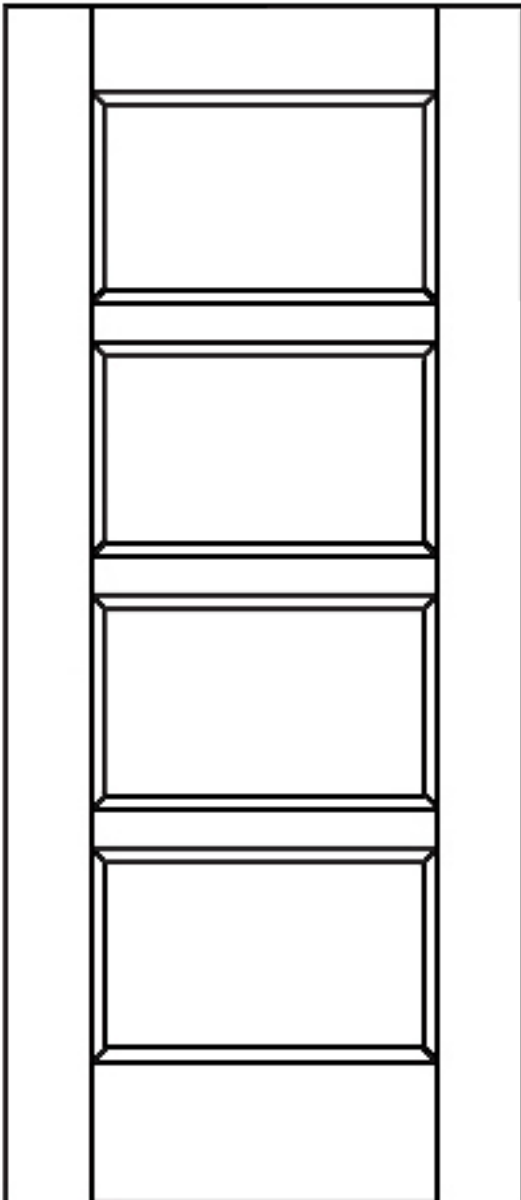

Dimensions

- Standard - see above
- Custom - fill in below

Top Rail: _____ Bottom Rail: _____

Hinge and Lock Stiles: _____ Mid Rail: _____

Panel Dimensions are Equal

Sticking

Heritage Collection

- Ovolo
- Square
- Ogee
- Mission
- Classic
- Other – Supply Drawing

Panels[#]

- Raised Step
- Flat

Glass ** (Advise which panels are glass)

Supplied By:	Thickness/Type
<input type="checkbox"/> VT	<input type="checkbox"/> 1/4" Tempered*** <input type="checkbox"/> 3/16" Clear Firelight®
<input type="checkbox"/> Other	<input type="checkbox"/> 1/4" Wire
<input type="checkbox"/> N/A	<input type="checkbox"/> Other: _____

**Glass opening dimensions will vary depending on prefit door size

***If diagonal dimension of tempered glass is less than 13", glass will be substituted with laminated safety glass

[#]Panel dimensions will vary depending on prefit door size
Dimensions are to cutout (do not include sticking height). Panel and glass dimensions will vary depending on prefit door size

+ Not available with top glass panel.



STILE & RAIL DOOR ELEVATIONS -1051

JOB NUMBER: _____ PAGE: _____ / _____

JOB NAME: _____

STANDARDS:* Top Rail: 6" Stile: 6" Mid Rail: 3-5/8"
 Bottom Rail: 10" Mullion: 3-5/8"

* Standard component dimensions may vary on fire rated doors. Refer to the Stile & Rail Brochure.
(C/L of Lock Rail Assembly will match frame manufacturer standard C/L of strike location unless otherwise noted)

Heritage

SS1051

Dimensions

- Standard - see above
- Custom - fill in below

Top Rail: _____ Bottom Rail: _____

Hinge and Lock Stiles: _____ Mid Rail: _____

Mullion: _____

C/L of Lock Rail Assembly from TOD: _____

Lock Rail Panel Height: _____
(Standard Lock Rail Panel Height is 8")

Sticking

Heritage Collection

- Ovolo
- Square
- Ogee
- Mission
- Classic
- Other- supply Drawing

Panels##

- Raised Step
- Flat

Glass** (Advise which panels are glass)

Supplied By:	Thickness/Type
<input type="checkbox"/> VT	<input type="checkbox"/> 1/4" Tempered*** <input type="checkbox"/> 3/16" Clear Firelight®
<input type="checkbox"/> Other	<input type="checkbox"/> 1/4" Wire
<input type="checkbox"/> N/A	<input type="checkbox"/> Other: _____

**Glass opening dimensions will vary depending on prefit door size

***If diagonal dimension of tempered glass is less than 13", glass will be substituted with laminated safety glass

##Panel dimensions not specified will vary depending on prefit door size
Dimensions are to cutout (do not include sticking height). Panel and glass dimensions will vary depending on prefit door size

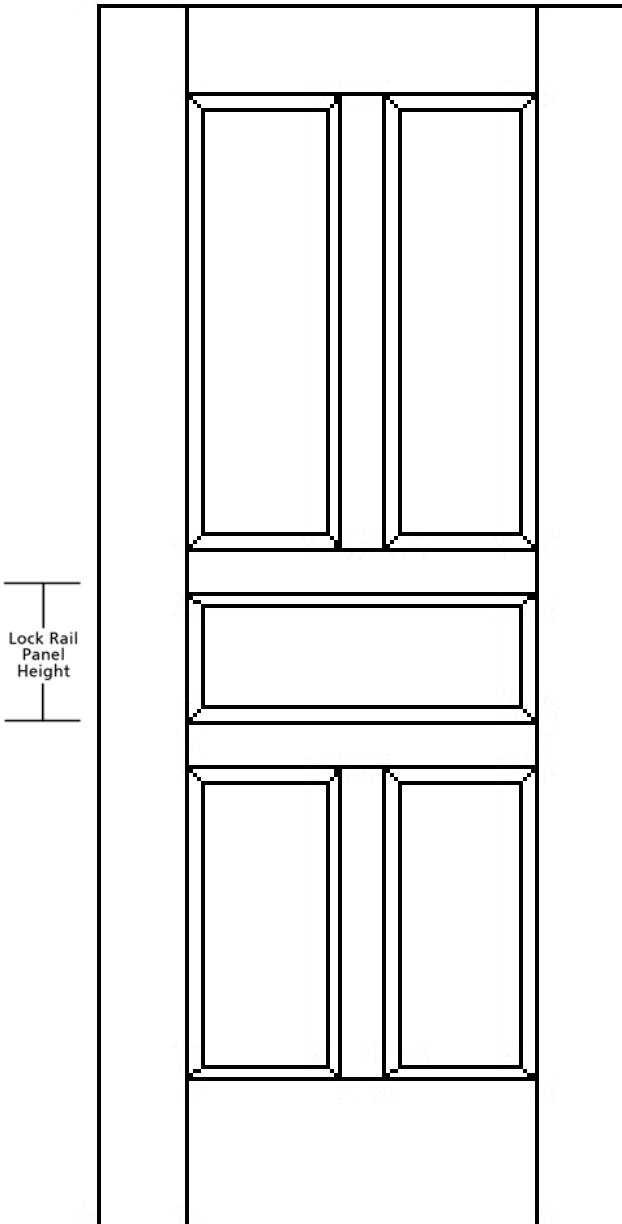



STILE & RAIL DOOR ELEVATIONS -1052

JOB NUMBER: _____ PAGE: _____ / _____

JOB NAME: _____

STANDARDS:* Top Rail: 6" Stile: 6"
 Bottom Rail: 10" Mullion: 3-5/8"

* Standard component dimensions may vary on fire rated doors. Refer to the Stile & Rail Brochure.

Heritage

SS1052 **SA1052** **SC1052**

Heritage Only Heritage Only

Dimensions

- Standard – see above
- Custom – fill in below

Top Rail: _____ Bottom Rail: _____

Hinge and Lock Stiles: _____ Mid Rail: _____

Panel Dimensions are Equal: _____

Sticking

Heritage Collection

- Ovolo
- Square
- Ogee
- Mission
- Classic
- Other- Supply Drawing

Panels[#]

- Raised Step
- Flat

[†]Panel veneer grain will run vertical unless otherwise noted

Glass** (Advise which panels are glass)

Supplied By:	Thickness/Type
<input type="checkbox"/> VT	<input type="checkbox"/> 1/4" Tempered*** <input type="checkbox"/> 3/16" Clear Firelight®
<input type="checkbox"/> Other	<input type="checkbox"/> 1/4" Wire
<input type="checkbox"/> N/A	<input type="checkbox"/> Other: _____

**Glass opening dimensions will vary depending on prefit door size

***If diagonal dimension of tempered glass is less than 13", glass will be substituted with laminated safety glass

[#]Panel dimensions will vary depending on prefit door size
Dimensions are to cutout (do not include sticking height). Panel and glass dimensions will vary depending on prefit door size

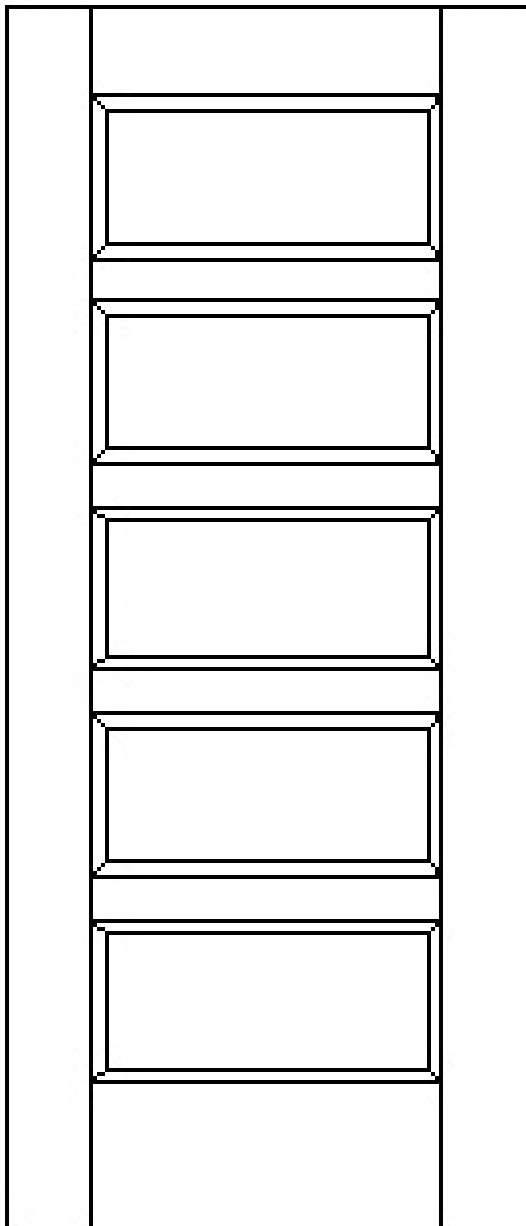



STILE & RAIL DOOR ELEVATIONS -1061

JOB NUMBER: _____ PAGE: _____ / _____

JOB NAME: _____

STANDARDS:* Top Rail: 6" Stile: 6" Mid Rail: 3-5/8"
 Bottom Rail: 10" Mullion: 3-5/8"

* Standard component dimensions may vary on fire rated doors. Refer to the Stile & Rail Brochure.
 (C/L of Lock Rail Assembly will match frame manufacturer standard C/L of strike location unless otherwise noted)

Heritage

SS1061

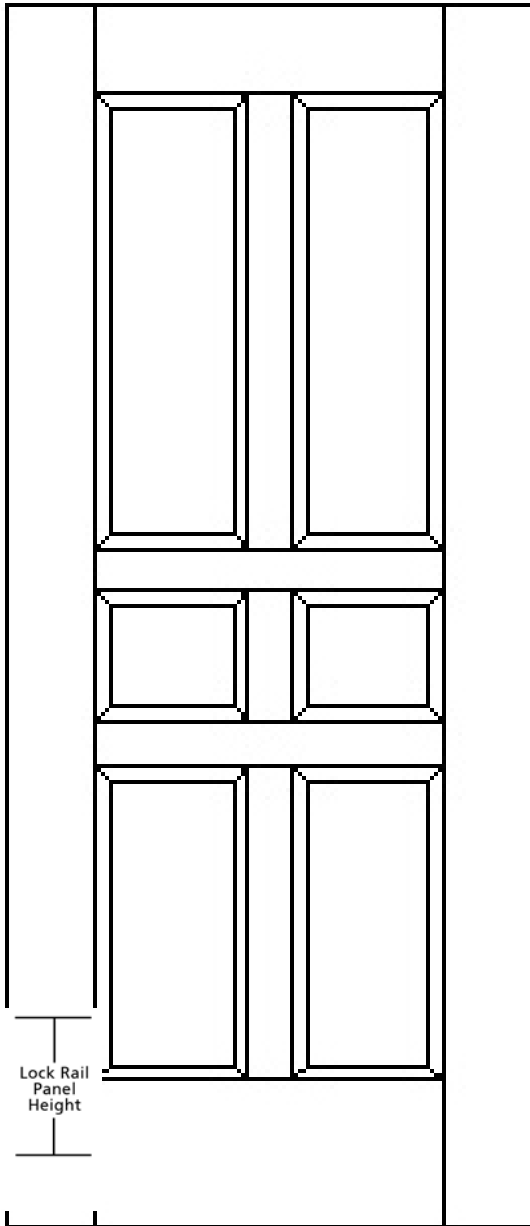

Dimensions

Standard – see above

Custom – fill in below

Top Rail: _____ Bottom Rail: _____

Hinge and Lock Stiles: _____ Mullion: _____

Mid Rail: _____

C/L of Lock Rail Assembly from TOD: _____

Lock Rail Panel Height: _____
 (Standard Lock Rail Panel Height is 8")

Sticking

Heritage Collection

- Ovolo
- Square
- Ogee
- Mission
- Classic
- Other- Supply Drawing

Panels[#]

- Raised Step
- Flat

Glass** (Advise which panels are glass)

Supplied By:	Thickness/Type
<input type="checkbox"/> VT	<input type="checkbox"/> 1/4" Tempered***
<input type="checkbox"/> Other	<input type="checkbox"/> 1/4" Wire <input type="checkbox"/> 3/16" Clear Firelight®
	<input type="checkbox"/> Other: _____

Lock Rail Assembly

C/L _____

Opening dimensions will vary depending on prefit door size
 Panel dimension of tempered glass is less than 13", glass will be
 supplied with laminated safety glass
 Panel dimensions not specified will vary depending on prefit door size
 Panel dimensions are to cutout (do not include sticking height). Panel and glass
 dimensions will vary depending on prefit door size



STILE & RAIL DOOR ELEVATIONS - 1062

JOB NUMBER: _____ PAGE: _____ / _____

JOB NAME: _____

STANDARDS:* Top Rail: 6" Stile: 6" Mid Rail: 3-5/8"
 Bottom Rail: 10" Mullion: 3-5/8" Lock Rail: 8 3/4"

* Standard component dimensions may vary on fire rated doors. Refer to the Stile & Rail Brochure.
 (C/L of Lock Rail location will match frame manufacturer standard C/L of strike location unless otherwise noted)

Heritage

SS1062

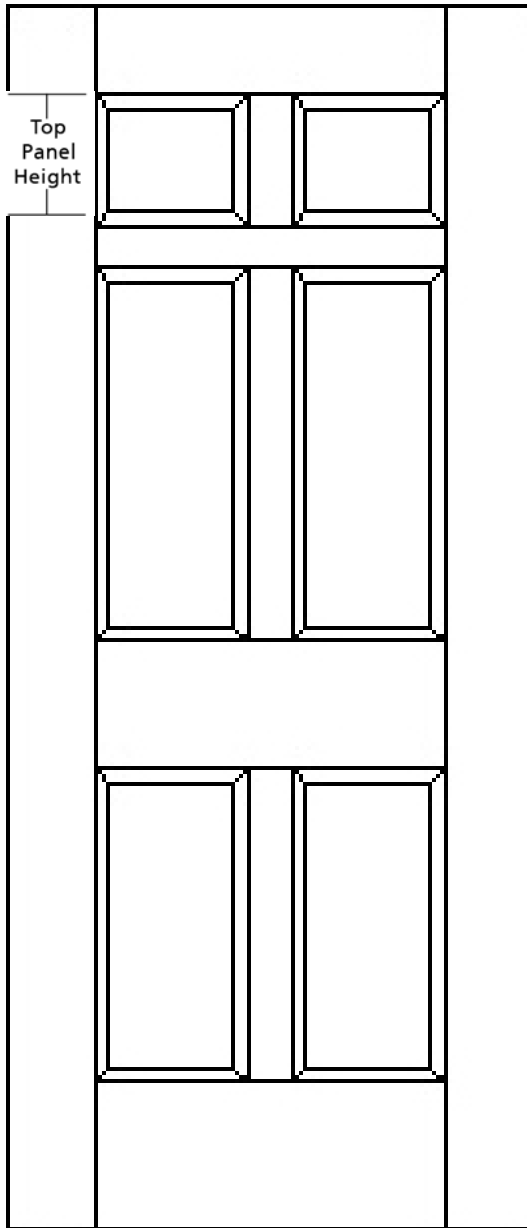

Dimensions

- Standard - see above
- Custom - fill in below

Top Rail: _____ Bottom Rail: _____

Hinge and Lock Stiles: _____

Mullion: _____ Mid Rail: _____

Top Panel Height: _____ Lock Rail: _____
 (Standard Top Panel Height is 8")

C/L of Lock Rail from TOD: _____

Sticking

Heritage Collection

- Ovolo
- Square
- Ogee
- Mission
- Classic
- Other- Supply Drawing

Panels**

- Raised Step
- Flat

Glass ** (Advise which panels are glass)

Supplied By:	Thickness/Type	
<input type="checkbox"/> VT <input type="checkbox"/> Other <input type="checkbox"/> N/A	<input type="checkbox"/> 1/4" Tempered*** <input type="checkbox"/> 1/4" Wire <input type="checkbox"/> Other: _____	<input type="checkbox"/> 3/16" Clear Firelight®

**Glass opening dimensions will vary depending on prefit door size

***If diagonal dimension of tempered glass is less than 13", glass will be substituted with laminated safety glass

**Panel dimensions not specified will vary depending on prefit door size
 Dimensions are to cutout (do not include sticking height). Panel and glass dimensions will vary depending on prefit door size



STILE & RAIL DOOR ELEVATIONS -1063

JOB NUMBER: _____ PAGE: _____ / _____

JOB NAME: _____

STANDARDS:* Top Rail: 6" Stile: 6" Lock Rail: 8 3/4"
 Bottom Rail: 10" Mullion: 3-5/8"

* Standard component dimensions may vary on fire rated doors. Refer to the Stile & Rail Brochure.
 (C/L of Lock Rail location will match frame manufacturer standard C/L of strike location unless otherwise noted)

- Heritage **SS1063**

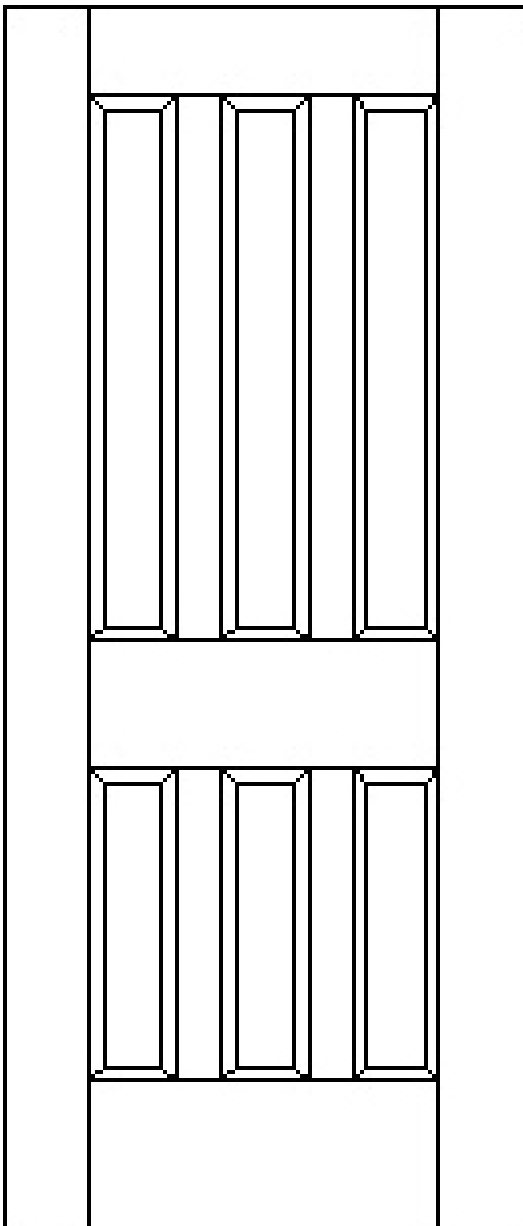

- Standard - see above
 Custom- fill in below

Top Rail: _____

Dimensions

Bottom Rail: _____

Hinge and Lock Stiles: _____

Mullion: _____

Lock Rail: _____

C/L of Lock Rail from TOD: _____

Sticking

Heritage Collection

- Ovolo
 Square
 Ogee
 Mission
 Classic
 Other- Supply Drawing

Panels#

- Raised Step
 Flat

Glass** (Advise which panels are glass)

Supplied By:	Thickness/Type	
<input type="checkbox"/> VT	<input type="checkbox"/> 1/4" Tempered***	<input type="checkbox"/> 3/16" Clear Firelight®
<input type="checkbox"/> Other	<input type="checkbox"/> 1/4" Wire	
<input type="checkbox"/> N/A	<input type="checkbox"/> Other: _____	

**Glass opening dimensions will vary depending on prefit door size

***If diagonal dimension of tempered glass is less than 13", glass will be substituted with laminated safety glass

#Panel dimensions will vary depending on prefit door size

Dimensions are to cutout (do not include sticking height). Panel and glass dimensions will vary depending on prefit door size



STILE & RAIL DOOR ELEVATIONS – 1081

JOB NUMBER: _____ PAGE: _____ / _____

JOB NAME: _____

STANDARDS:* Top Rail: 6" Stile: 6" Mid Rail: 3-5/8"
 Bottom Rail: 10" Mullion: 3-5/8"

* Standard component dimensions may vary on fire rated doors. Refer to the Stile & Rail Brochure.

Heritage

SS1081

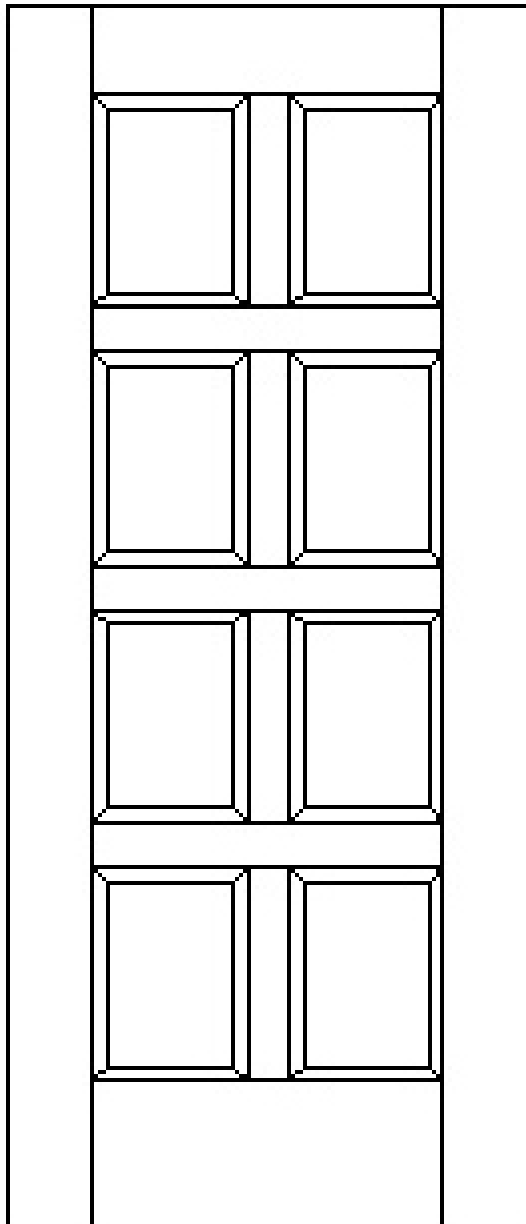

Dimensions

- Standard - see above
- Custom - fill in below

Top Rail: _____ Bottom Rail: _____
 Hinge and Lock Stiles: _____ Mullion: _____
 Mid Rail: _____
 Panel Dimensions are Equal

Sticking

Heritage Collection

- Ovolo
- Square
- Ogee
- Mission
- Classic
- Other- Supply Drawing

Panels[#]

- Raised Step
- Flat

Glass** (Advise which panels are glass)

Supplied By:	Thickness/Type	
<input type="checkbox"/> VT <input type="checkbox"/> Other <input type="checkbox"/> N/A	<input type="checkbox"/> 1/4" Tempered***	<input type="checkbox"/> 3/16" Clear Firelight®
	<input type="checkbox"/> 1/4" Wire	
	<input type="checkbox"/> Other: _____	

**Glass opening dimensions will vary depending on prefit door size
 ***If diagonal dimension of tempered glass is less than 13", glass will be substituted with laminated safety glass

[#]Panel dimensions will vary depending on prefit door size
 Dimensions are to cutout (do not include sticking height). Panel and glass dimensions will vary depending on prefit door size



STILE & RAIL DOOR ELEVATIONS -1091

JOB NUMBER: _____ PAGE: _____ / _____

JOB NAME: _____

STANDARDS:* Top Rail: 6" Stile: 6" Mid Rail: 3-5/8"
Bottom Rail: 10" Mullion: 3-5/8"

* Standard component dimensions may vary on fire rated doors. Refer to the Stile & Rail Brochure.

Heritage

SS1091

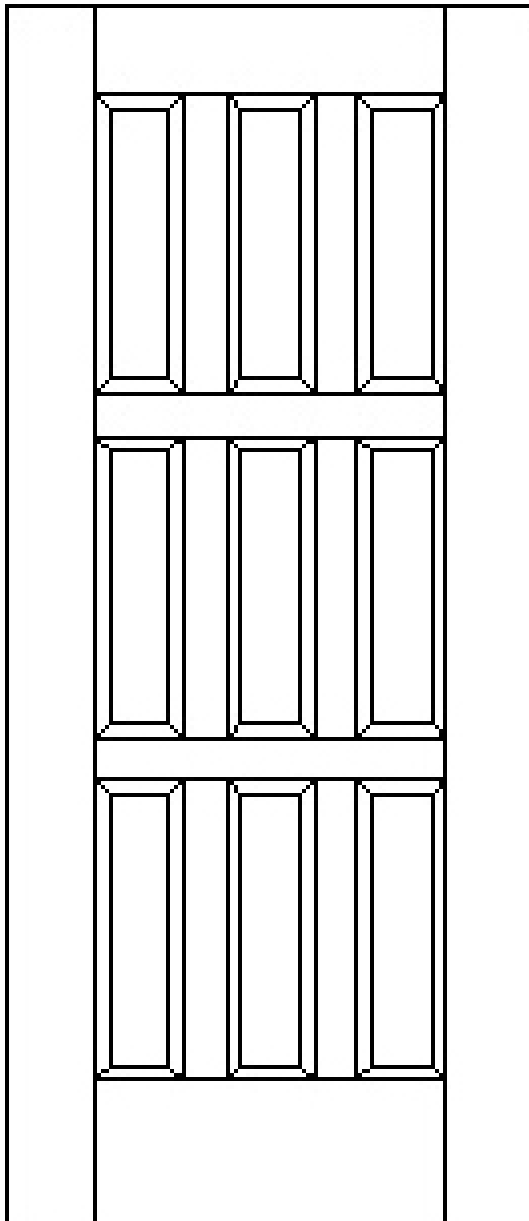

Dimensions

- Standard - see above
- Custom - fill in below

Top Rail: _____ Bottom Rail: _____

Hinge and Lock Stiles: _____ Mullion: _____

Mid Rail: _____
 Panel Dimensions are Equal

Sticking

Heritage Collection

- Ovolo
- Square
- Ogee
- Mission
- Classic
- Other Supply Drawing

Panels[#]

- Raised Step
- Flat

Glass ** (Advise which panels are glass)

Supplied By:	Thickness/Type	
<input type="checkbox"/> VT <input type="checkbox"/> Other <input type="checkbox"/> N/A	<input type="checkbox"/> 1/4" Tempered*** <input type="checkbox"/> 1/4" Wire <input type="checkbox"/> Other: _____	<input type="checkbox"/> 3/16" Clear Firelight [®]

**Glass opening dimensions will vary depending on prefit door size

***If diagonal dimension of tempered glass is less than 13", glass will be substituted with laminated safety glass

[#]Panel dimensions will vary depending on prefit door size
 Dimensions are to cutout (do not include sticking height). Panel and glass dimensions will vary depending on prefit door size



STILE & RAIL DOOR ELEVATIONS -3011

JOB NUMBER: _____ PAGE: _____ / _____

JOB NAME: _____

STANDARDS:* Top Rail: 6" Stile: 6"
 Bottom Rail: 10" Glass Thickness: 1/4"

* Standard component dimensions may vary on fire rated doors. Refer to the Stile & Rail Brochure.

- Heritage
- SS3011**
- SA3011**
- SR3011**

Dimensions

- Standard - see above
- Custom - fill in below

Top Rail: _____

Bottom Rail: _____

Hinge and Lock Stiles: _____

Sticking

Heritage Collection

- Ovolo
- Square
- Ogee
- Mission
- Classic
- Other- Supply Drawing

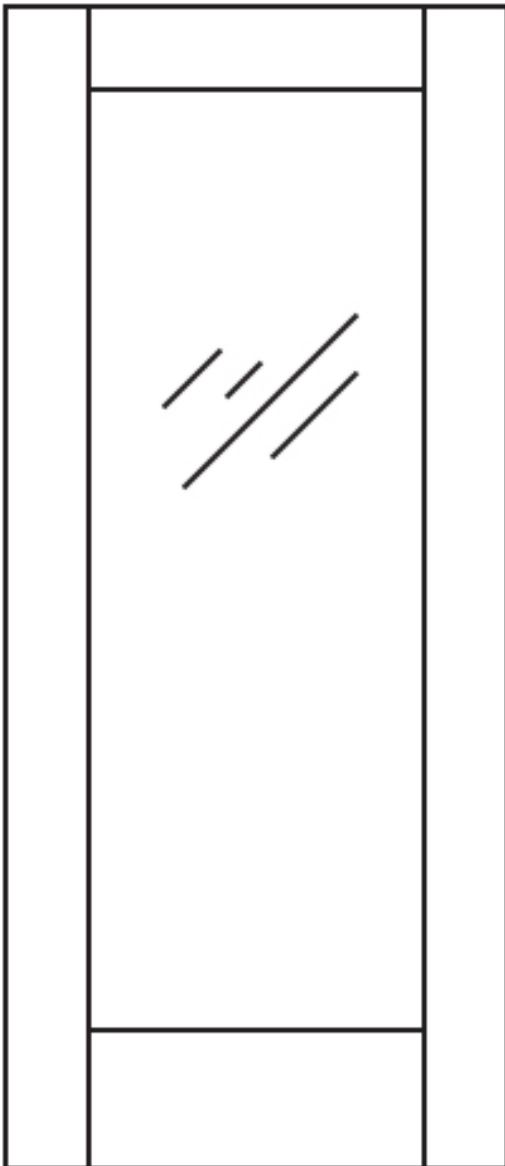

Glass**

Supplied By:	Thickness/Type	
<input type="checkbox"/> VT	<input type="checkbox"/> 1/4" Tempered***	<input type="checkbox"/> 3/16" Clear Firelight®
<input type="checkbox"/> Other	<input type="checkbox"/> 1/4" Wire	<input type="checkbox"/> Other: _____

**Glass opening dimensions will vary depending on prefit door size

***If diagonal dimension of tempered glass is less than 13", glass will be substituted with laminated safety glass

Dimensions are to cutout (do not include sticking height). Glass dimensions will vary depending on prefit door size



STILE & RAIL DOOR ELEVATIONS - 3091

JOB NUMBER: _____ PAGE: _____ / _____

JOB NAME: _____

STANDARDS:* Top Rail: 6" Stile: 6" Glass Thickness: 1/4"
Bottom Rail: 10" Muntin: 1/2"

*Non-Rated Only

Heritage

SS3091

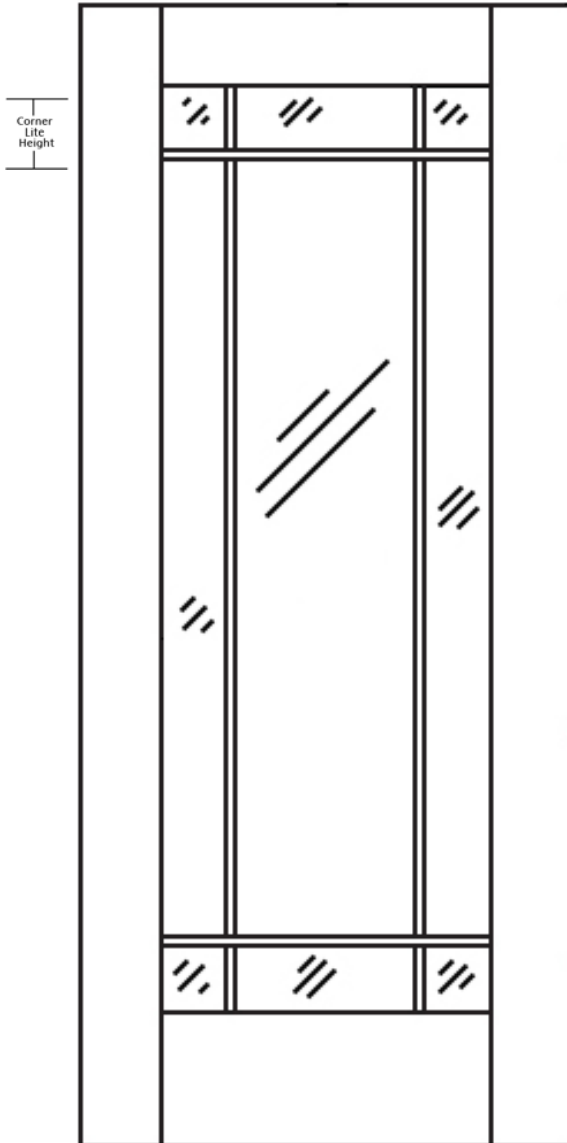

Dimensions

- Standard - see above
- Custom - fill in below

Top Rail: _____

Bottom Rail: _____

Hinge and Lock Stiles: _____

Corner Lite Height: _____
(4" Minimum)

Corner Lite Width: _____
(4" Minimum)

Sticking

Heritage Collection

- Ovolo
- Square
- Ogee
- Mission
- Classic
- Other- Supply Drawing

Glass**

Supplied By:	Thickness/Type	
<input type="checkbox"/> VT	<input type="checkbox"/> 1/4" Tempered***	<input type="checkbox"/> 1/4" Wire
<input type="checkbox"/> Other	<input type="checkbox"/> Other: _____	

**Glass opening dimensions will vary depending on prefit door size

***If diagonal dimension of tempered glass is less than 13", glass will be substituted with laminated safety glass

Dimensions are to cutout (do not include sticking height). Glass dimensions will vary depending on prefit door size



Rev. 12/17



STILE & RAIL DOOR ELEVATIONS - 3101

JOB NUMBER: _____ PAGE: _____ / _____

JOB NAME: _____

STANDARDS:* Top Rail: 6" Stile: 6" Glass Thickness: 1/4"
Bottom Rail: 10" Muntin: 1/2"

*Non-Rated Only

Heritage

SS3101

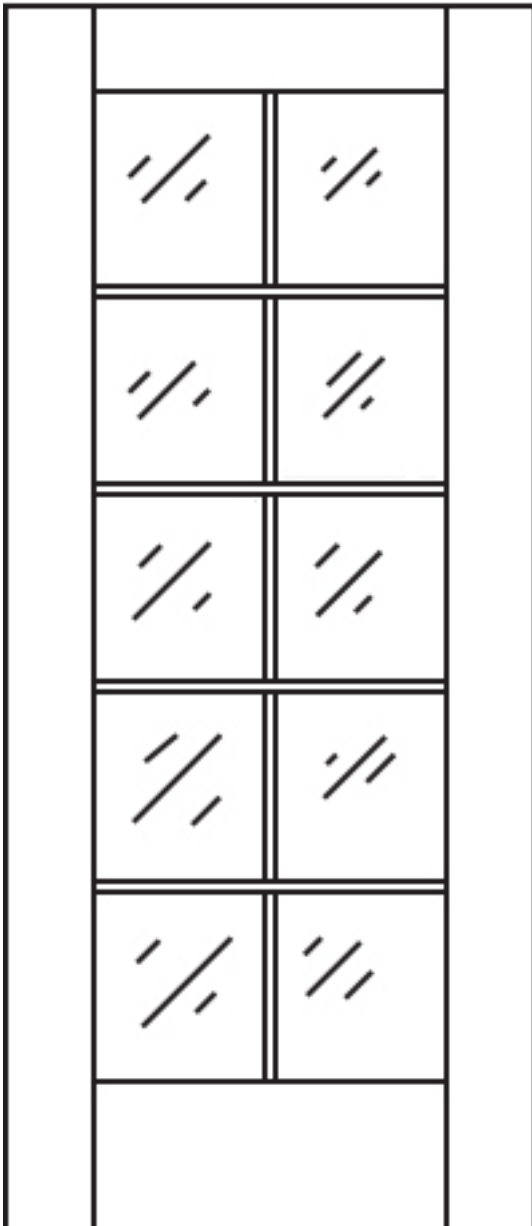

Dimensions

- Standard - see above
- Custom - fill in below

Top Rail: _____

Bottom Rail: _____

Hinge and Lock Stiles: _____

Glass Opening Dimensions are Equal

Sticking

Heritage Collection

- Ovolo
- Square
- Ogee
- Mission
- Classic
- Other- Supply Drawing

Glass**

Supplied By:	Thickness/Type	
<input type="checkbox"/> VT <input type="checkbox"/> Other	<input type="checkbox"/> 1/4" Tempered***	<input type="checkbox"/> 1/4" Wire <input type="checkbox"/> Other: _____

**Glass opening dimensions will vary depending on prefit door size

***If diagonal dimension of tempered glass is less than 13", glass will be substituted with laminated safety glass

Dimensions are to cutout (do not include sticking height). Glass dimensions will vary depending on prefit door size



STILE & RAIL DOOR ELEVATIONS -3151

JOB NUMBER: _____ PAGE: _____ / _____

JOB NAME: _____

STANDARDS:* Top Rail: 6" Stile: 6" Glass Thickness: 1/4"
Bottom Rail: 10" Muntin: 1/2"

*Non-Rated Only

Heritage

SS3151

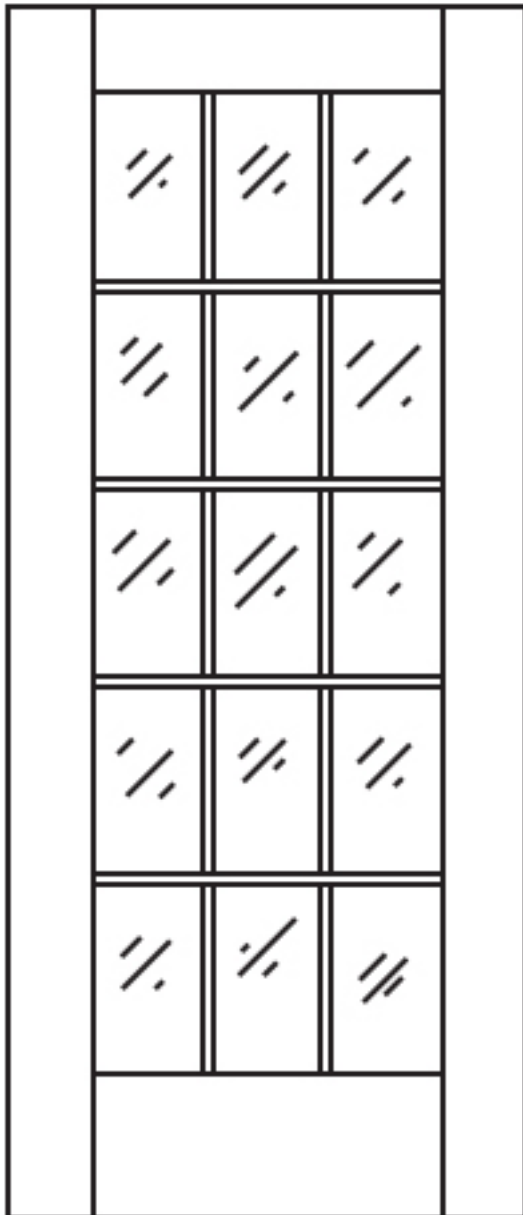

Dimensions

- Standard - see above
- Custom - fill in below

Top Rail: _____

Bottom Rail: _____

Hinge and Lock Stiles: _____

Glass Opening Dimensions are Equal

Sticking

Heritage Collection

- Ovolo
- Square
- Ogee
- Mission
- Classic
- Other- Supply Drawing

Glass**

Supplied By:	Thickness/Type	
<input type="checkbox"/> VT <input type="checkbox"/> Other	<input type="checkbox"/> 1/4" Tempered***	<input type="checkbox"/> 1/4" Wire <input type="checkbox"/> Other: _____

**Glass opening dimensions will vary depending on prefit door size

***If diagonal dimension of tempered glass is less than 13", glass will be substituted with laminated safety glass

Dimensions are to cutout (do not include sticking height). Glass dimensions will vary depending on prefit door size



STILE & RAIL DOOR ELEVATIONS - 5021

JOB NUMBER: _____ PAGE: _____ / _____

JOB NAME: _____

STANDARDS:* Top Rail: 6" Stile: 6" Glass Thickness: 1/4"
 Bottom Rail: 10" Lock Rail: 8 3/4"

* Standard component dimensions may vary on fire rated doors. Refer to the Stile & Rail Brochure.
 (C/L of Lock Rail location will match frame manufacturer standard C/L of strike location unless otherwise noted)

Heritage

SS5021 SA5021 SR5021

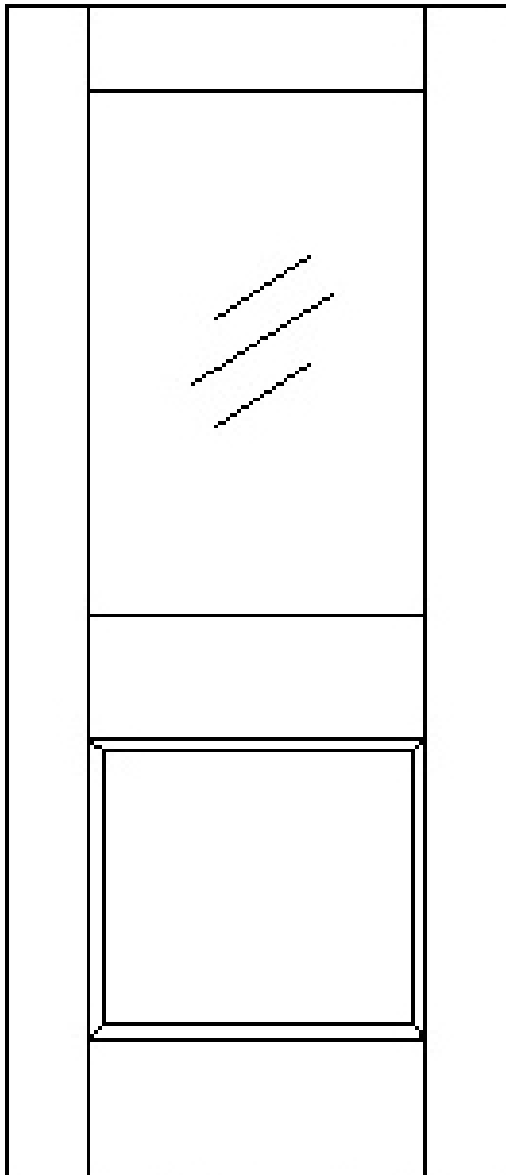

Dimensions

- Standard - see above
- Custom - fill in below

Top Rail: _____ Bottom Rail: _____

Hinge and Lock Stiles: _____ Lock Rail: _____

C/L of Lock Rail from TOD: _____

Sticking

Heritage Collection

- Ovolo
- Square
- Ogee
- Mission
- Classic
- Other- Supply Drawing

Panels[#]

- Raised Step
- Flat

Glass**

Supplied By:	Thickness/Type
<input type="checkbox"/> VT	<input type="checkbox"/> 1/4" Tempered*** <input type="checkbox"/> 3/16" Clear Firelight [®]
<input type="checkbox"/> Other	<input type="checkbox"/> 1/4" Wire <input type="checkbox"/> Other: _____

**Glass opening dimensions will vary depending on prefit door size

***If diagonal dimension of tempered glass is less than 13", glass will be substituted with laminated safety glass

[#]Panel dimensions will vary depending on prefit door size
 Dimensions are to cutout (do not include sticking height). Panel and glass dimensions will vary depending on prefit door size



STILE & RAIL DOOR ELEVATIONS -5031

JOB NUMBER: _____ PAGE: _____ / _____

JOB NAME: _____

STANDARDS:* Top Rail: 6" Stile: 6" Mullion: 3-5/8"
 Bottom Rail: 10" Lock Rail: 8 3/4" Glass Thickness: 1/4"

* Standard component dimensions may vary on fire rated doors. Refer to the Stile & Rail Brochure.
 (C/L of Lock Rail location will match frame manufacturer standard C/L of strike location unless otherwise noted)

- Heritage SS5031 SA5031 SR5031

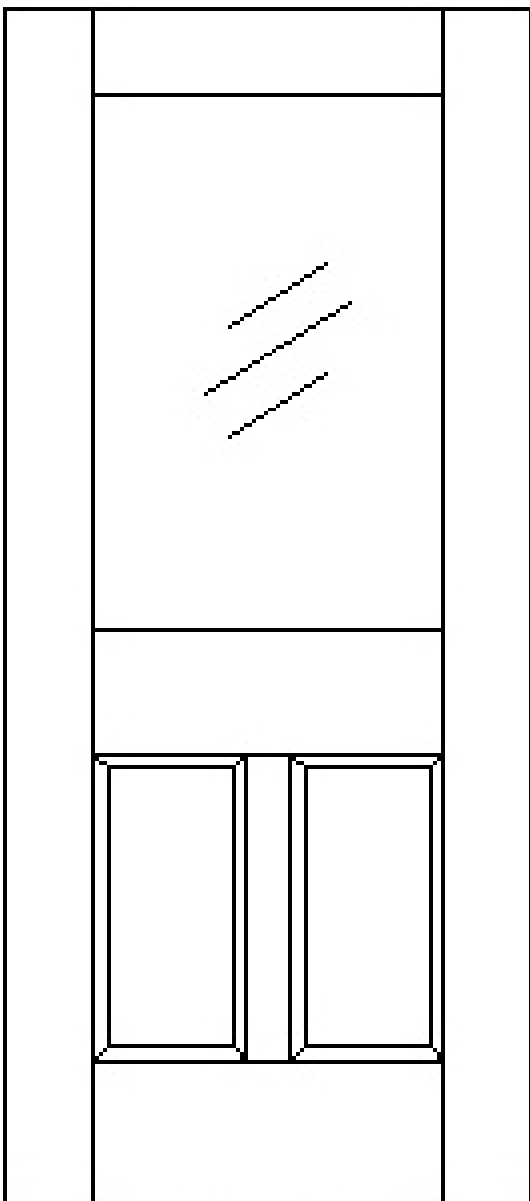

Dimensions

- Standard – see above
 Custom – fill in below
- Top Rail: _____ Bottom Rail: _____
- Hinge and Lock Stiles: _____ Mullion: _____
- C/L of Lock Rail from TOD: _____ Lock Rail: _____
- Panel dimensions are equal

Sticking

Heritage Collection

- Ovolo
 Square
 Ogee
 Mission
 Classic
 Other – Supply Drawing

Panels[#]

- Raised Step
 Flat

Glass**

Supplied By:	Thickness/Type
<input type="checkbox"/> VT	<input type="checkbox"/> 1/4" Tempered*** <input type="checkbox"/> 3/16" Clear Firelight [*]
<input type="checkbox"/> Other	<input type="checkbox"/> 1/4" Wire <input type="checkbox"/> Other: _____

**Glass opening dimensions will vary depending on prefit door size
 ***If diagonal dimension of tempered glass is less than 13", glass will be substituted with laminated safety glass
[#]Panel dimensions will vary depending on prefit door size
 Dimensions are to cutout (do not include sticking height). Panel and glass dimensions will vary depending on prefit door size



STILE & RAIL DOOR ELEVATIONS – 5041

JOB NUMBER: _____ PAGE: _____ / _____

JOB NAME: _____

STANDARDS:* Top Rail: 6" Stile: 6" Glass Thickness: 1/4"
Bottom Rail: 10" Mullion: 3-5/8"

* Standard component dimensions may vary on fire rated doors. Refer to the Stile & Rail Brochure.
 (C/L of Lock Rail Assembly will match frame manufacturer standard C/L of strike location unless otherwise noted)

Heritage

SS5041 SA5041 SR5041

Dimensions

- Standard - see above
- Custom - fill in below

Top Rail: _____ Bottom Rail: _____

Hinge and Lock Stiles: _____ Mullion: _____

C/L of Lock Rail Assembly from TOD: _____ Mid Rail: _____

Lock Rail Panel Height: _____

(Standard Lock Rail Panel Height is 8")

Bottom Panel dimensions are equal

Sticking

- Ovolo
- Square
- Ogee
- Mission
- Classic
- Other- Supply Drawing

Panels

- Raised
- Flat
- Step

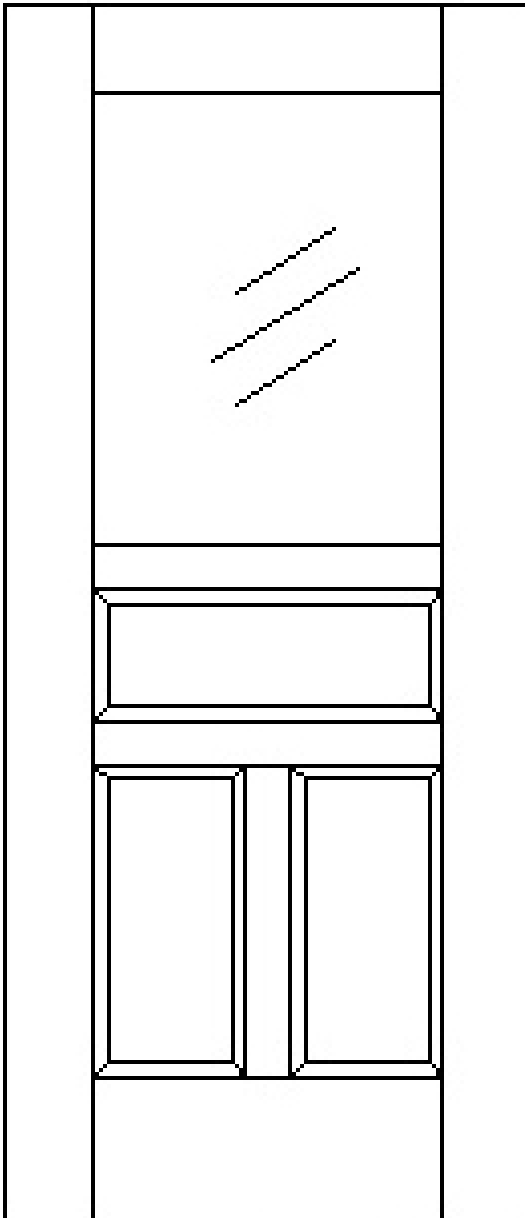

C/L Lock Rail Assembly

Lock Rail Panel Height

Glass**

Supplied By:	Thickness/Type
<input type="checkbox"/> VT	<input type="checkbox"/> 1/4" Tempered*** <input type="checkbox"/> 3/16" Clear Firelight®
<input type="checkbox"/> Other	<input type="checkbox"/> 1/4" Wire <input type="checkbox"/> Other:

**Glass opening dimensions will vary depending on prefit door size

***If diagonal dimension of tempered glass is less than 13", glass will be substituted with laminated safety glass

Panel dimensions not specified will vary depending on prefit door size
 Dimensions are to cutout (do not include sticking height). Panel and glass dimensions will vary depending on prefit door size



STILE & RAIL DOOR ELEVATIONS -5071

JOB NUMBER: _____ PAGE: _____ / _____

JOB NAME: _____

STANDARDS:* Top Rail: 6" Stile: 6" Lock Rail: 8 3/4"
Bottom Rail: 10" Muntin: 1/2" Glass Thickness: 1/4"

* Non-Rated Only
 (C/L of Lock Rail location will match frame manufacturer standard C/L of strike location unless otherwise noted)

Heritage **SS5071**

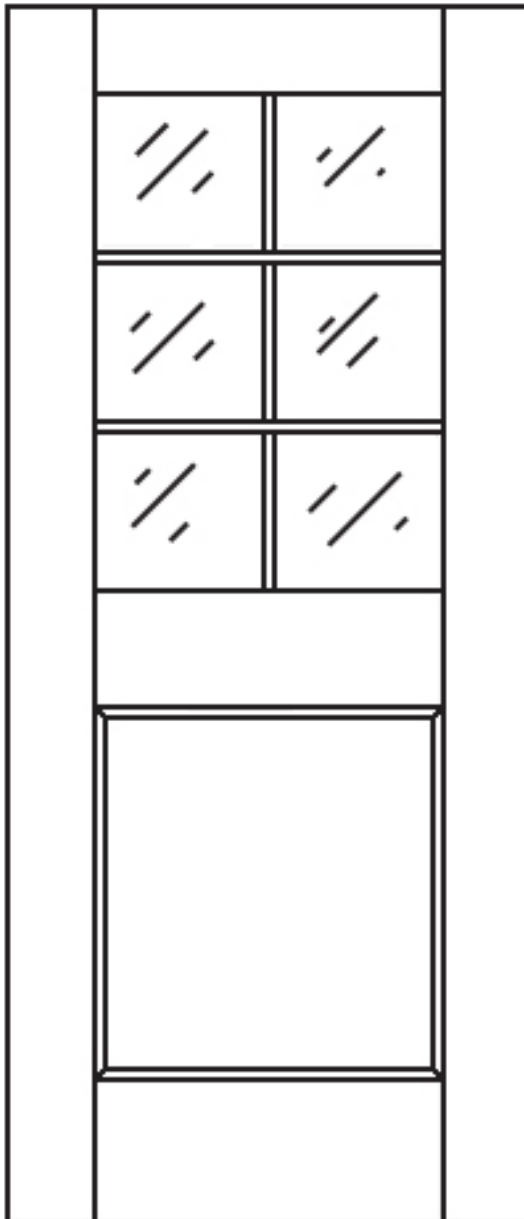

Standard - see above
 Custom - fill in below

Dimensions

Top Rail: _____
 Bottom Rail: _____
 Hinge and Lock Stiles: _____
 Mullion: _____
 Mid Rail: _____
 Lock Rail: _____

C/L of Lock Rail from TOD: _____
 Glass Opening Dimensions are Equal

Sticking

Heritage Collection

- Ovolo
- Square
- Ogee
- Mission
- Classic
- Other- Supply Drawing

Panels#

- Raised Step
- Flat

Glass**

Supplied By:	Thickness/Type	
<input type="checkbox"/> VT	<input type="checkbox"/> 1/4" Tempered***	<input type="checkbox"/> 1/4" Wire
<input type="checkbox"/> Other	<input type="checkbox"/> Other: _____	

**Glass opening dimensions will vary depending on prefit door size
 ***If diagonal dimension of tempered glass is less than 13", glass will be substituted with laminated safety glass
 #Panel dimensions will vary depending on prefit door size
 Dimensions are to cutout (do not include sticking height). Panel and glass dimensions will vary depending on prefit door size



STILE & RAIL DOOR ELEVATIONS -5101

JOB NUMBER: _____ PAGE: _____ / _____

JOB NAME: _____

STANDARDS:* Top Rail: 6" Stile: 6" Muntin: 1/2"
 Bottom Rail: 10" Lock Rail: 8 3/4" Glass Thickness: 1/4"

*Non-Rated Only
 (C/L of Lock Rail location will match frame manufacturer standard C/L of strike location unless otherwise noted)

Heritage

SS5101

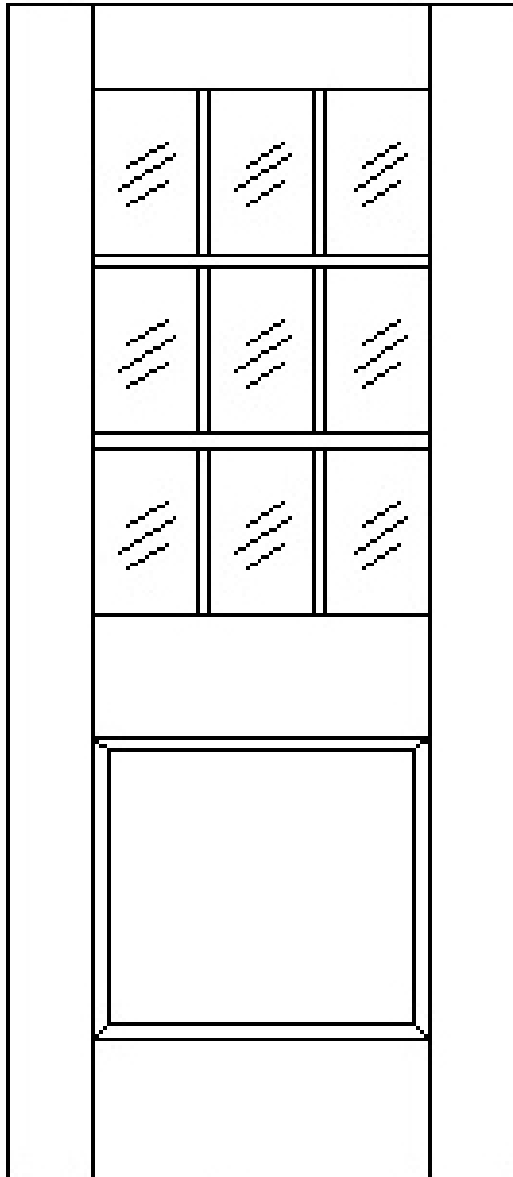

Dimensions

- Standard - see above
- Custom - fill in below

Top Rail: _____

Bottom Rail: _____

Hinge and Lock Stiles: _____

Lock Rail: _____

C/L of Lock Rail from TOD: _____

Glass Opening Dimensions are Equal

Sticking

Panels[#]

- Ovolo
- Square
- Ogee
- Mission
- Classic
- Other – Supply Drawing

- Raised
- Flat
- Step

Glass**

Supplied By:	Thickness/Type
<input type="checkbox"/> VT	<input type="checkbox"/> 1/4" Tempered*** <input type="checkbox"/> 1/4" Wire
<input type="checkbox"/> Other	<input type="checkbox"/> Other: _____

**Glass opening dimensions will vary depending on prefit door size
 ***If diagonal dimension of tempered glass is less than 13", glass will be substituted with laminated safety glass
 #Panel dimensions will vary depending on prefit door size Dimensions are to cutout (do not include sticking height). Panel and glass dimensions will vary depending on prefit door size



STILE & RAIL DOOR ELEVATIONS - 5111

JOB NUMBER: _____ PAGE: _____ / _____

JOB NAME: _____

STANDARDS:* Top Rail: 6" Stile: 6" Muntin: 1/2"
Bottom Rail: 10" Mullion: 3-5/8" Lock Rail: 8 3/4"
Glass Thickness: 1/4"

*Non-Rated Only
 (C/L of Lock Rail location will match frame manufacturer standard C/L of strike location unless otherwise noted)

Heritage SS5111

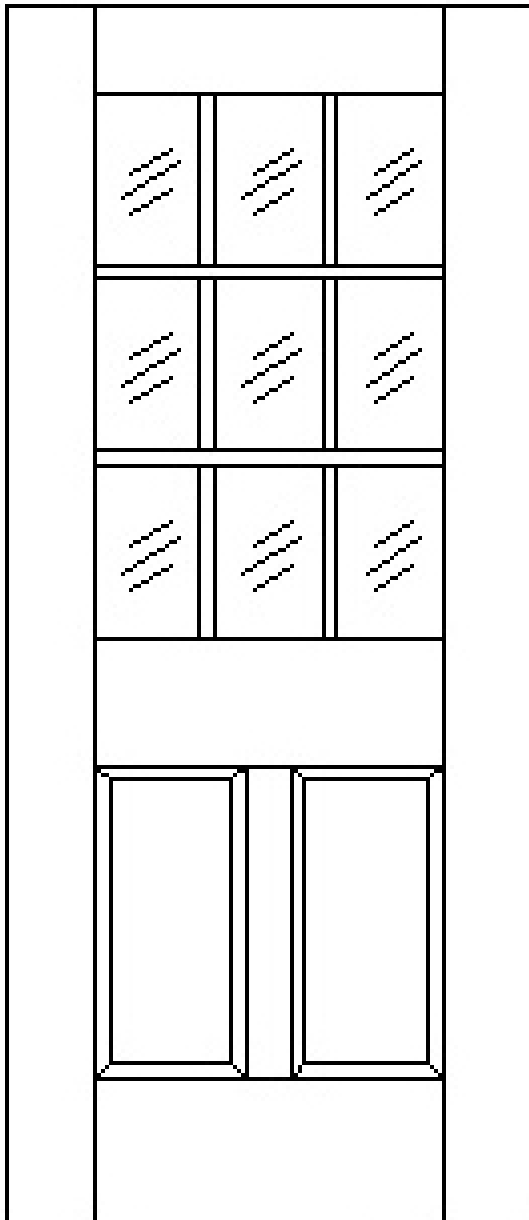

Dimensions

- Standard - see above
- Custom - fill in below

Top Rail: _____

Bottom Rail: _____

Hinge and Lock Stiles: _____

Mullion: _____

Lock Rail: _____

C/L of Lock Rail from TOD: _____

Panel Dimensions are Equal
 Glass Opening Dimensions are Equal

Sticking

Heritage Collection

- Ovolo
- Square
- Ogee
- Mission
- Classic
- Other- Supply Drawing

Panels

- Raised
- Flat
- Step

Glass**

Supplier By:	Thickness/Type	
<input type="checkbox"/> VT	<input type="checkbox"/> 1/4" Tempered***	<input type="checkbox"/> 1/4" Wire
<input type="checkbox"/> Other	<input type="checkbox"/> Other: _____	

**Glass opening dimensions will vary depending on prefit door size

***If diagonal dimension of tempered glass is less than 13", glass will be substituted with laminated safety glass

#Panel dimensions will vary depending on prefit door size. Dimensions are to cutout (do not include sticking height). Panel and glass dimensions will vary depending on prefit door size



STILE & RAIL DOOR ELEVATIONS- 7011

JOB NUMBER: _____ PAGE: _____ / _____

JOB NAME: _____

STANDARDS:* Top Rail: 6" Stile: 6"
Bottom Rail: 10"

*Non-Rated Only

[] Heritage

[] SS7011

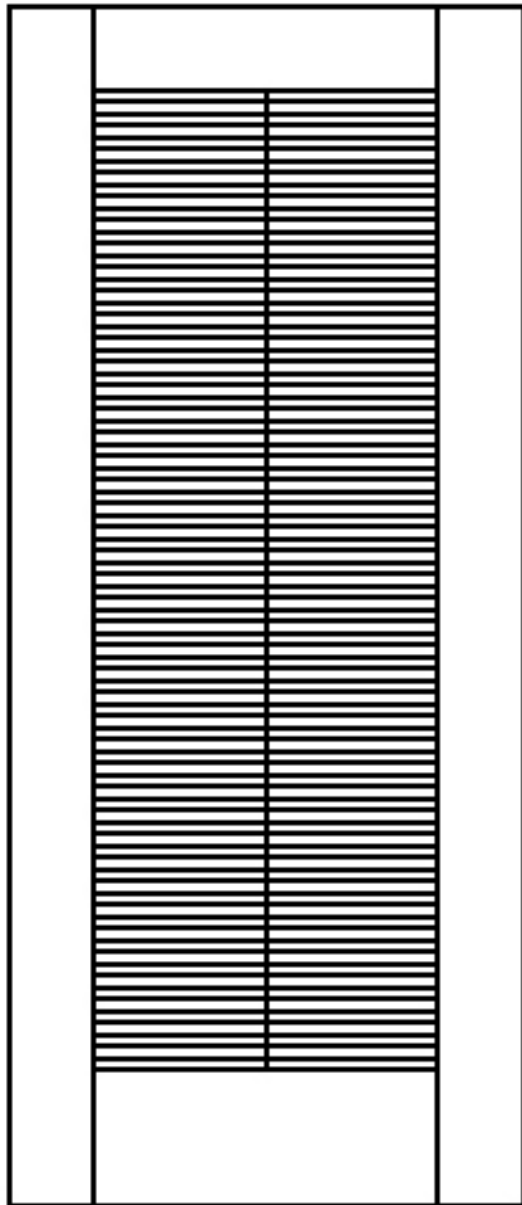

Dimensions

- [] Standard - see above
[] Custom - fill in below

Top Rail: _____

Bottom Rail: _____

Hinge and Lock Stiles: _____

Sticking

Heritage Collection

- [] Ovolo
[] Square
[] Ogee - 1-3/4" only
[] Mission - 1-3/4" only
[] Classic - 1-3/4" only
[] Other- Supply Drawing

Panels

- [] Raised
[] Flat
[] Step

Louver

- [] Chevron (Inverted V) - Standard#
[] Round Slat (Flat Slat)** - Blind side outside
[] Round Slat (Flat Slat)** - Blind side inside
[] Louver by Other - Cutout only

#Center vertical muntin required if prefit width of louver is greater than 16"

Dimensions are to cutout (do not include sticking height). Louver dimensions will vary depending on prefit door size



STILE & RAIL DOOR ELEVATIONS -7021

JOB NUMBER: _____ PAGE: _____ / _____

JOB NAME: _____

STANDARDS:* Top Rail: 6" Stile: 6"
 Bottom Rail: 10" Lock Rail: 8 3/4"

*Non-Rated Only
 (C/L of Lock Rail location will match frame manufacturer standard C/L of strike location unless otherwise noted)

Heritage **SS7021**

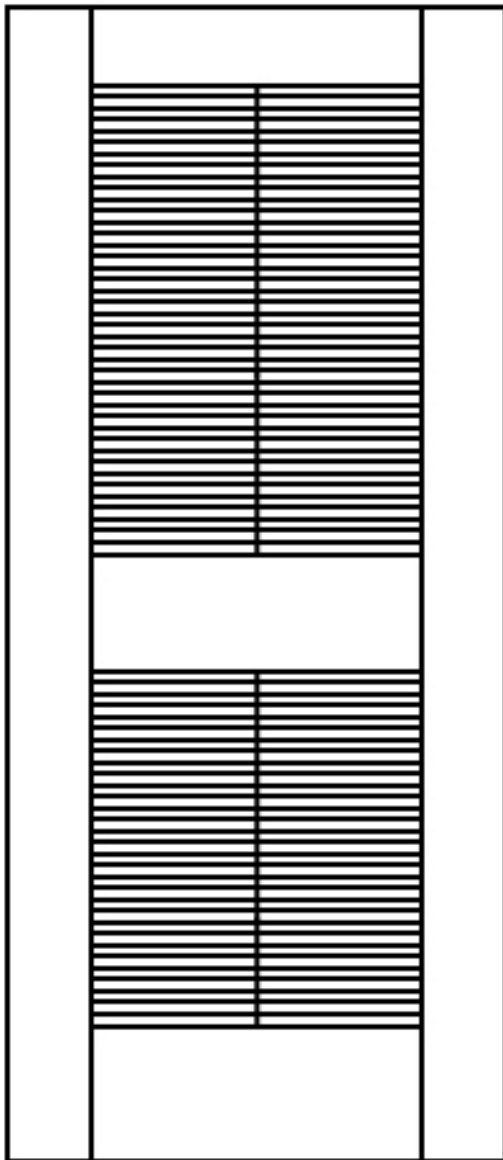

Dimensions

- Standard - see above
- Custom - fill in below

Top Rail: _____

Bottom Rail: _____

Hinge and Lock Stiles: _____

Lock Rail: _____

C/L of Lock Rail from TOD: _____

Sticking

Heritage Collection

- Ovolo
- Square
- Ogee – 1-3/4" only
- Mission 1-3/4" only
- Classic – 1-3/4" only
- Other- Supply Drawing

Louver

- Chevron (Inverted V) – Standard[#] (no air flow)
- Flat Slat
- Louver by Other – Cutout only

[#]Center vertical muntin required if prefit width of louver is greater than 16"
 Dimensions are to cutout (do not include sticking height). Louver dimensions will vary depending on prefit door size



VT INDUSTRIES, INC.
1000 INDUSTRIAL PARK
HOLSTEIN, IA 51025

P 1.800.827.1615
F 1.712.368.4111
WWW.VTINDUSTRIES.COM



WOOD FRAME ELEVATION FE01-A

Date:	Page # /
Wood Frame Elevation:	
Job PO Number:	
Job Name:	

Jamb Profile:			
Door Thickness (C)	Wall Depth (V)	Door Stop Height (D)	Fire Rating
			<input type="checkbox"/> No Door Stop

Opening Type	
<input type="checkbox"/> Single	<input type="checkbox"/> Bifold/Slider
<input type="checkbox"/> Single Egress Pair	<input type="checkbox"/> Double Egress
<input type="checkbox"/> Communicating	<input type="checkbox"/> Cased (no door in opening)

- Provide Jamb legs 2" over length
- Casing by other

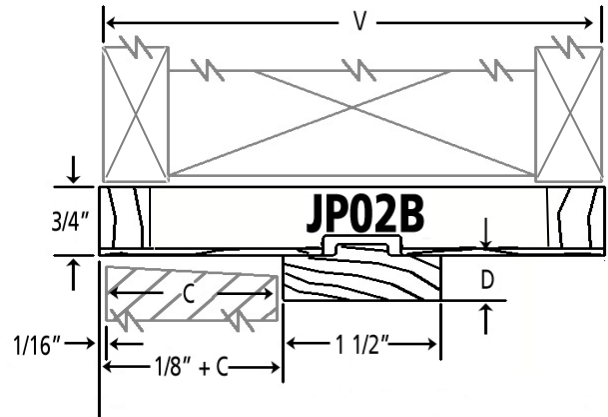

MINIMUM WALL WIDTH 4-5/8"
NON-RATED, 20 MIN, 45 MIN, 60 MIN, 90 MIN
1/2" stop height standard for non-rated
5/8" stop height required for rated

