

# TurboShip

**SARGENT**  
ASSA ABLOY



ASSA ABLOY, the global leader  
in door opening solutions

# Table of Contents

TurboShip

**SARGENT**  
**ASSA ABLOY**

www.sargentlock.com



General Information.....	3	8800 Series with Trim.....	34
TurboKey Information.....	4	8800 Series Trim Only.....	35
Cylinders/Keys.....	5-10	8700 Series.....	36
Parts.....	6-8	8600 Series.....	37
Keyblanks.....	9	8500 Series.....	38
Degree Keyblanks.....	10	8400 Series.....	39
Bored Locks.....	11-20	30 Series.....	40-41
11 Line.....	11	90 Series.....	42
10 Line.....	12	7000 Series Multipoint Lock.....	43
7 Line.....	13	Mullions.....	44
6500 Line.....	14	550 Series & 5800 Series Alarm Hardware.....	45
8X Line.....	15	Parts.....	46-52
6 Line.....	16	Auxiliary Locks.....	53-56
HP ALP Trim.....	17	4870 Series Mortise Deadbolt.....	53
DL Series.....	18	470 & 480 Series Cylindrical Deadbolt.....	54
Parts.....	19-20	758 & 858 Series Padlock.....	55
Mortise Locks.....	21-27	Parts.....	56
8200 Series.....	21	Access Control.....	57-60
8200 Series with ALP Trim.....	22	Keypad Operated Products.....	57
8200 Series Lockbody Only.....	23	KP Technology.....	57
Parts and Accessories.....	24	Profile Series.....	58-59
Door Control.....	25-31	LK Technology.....	58
281 Series / 351 Series / 1431 Series.....	25	v.G1.5 Series.....	59
1331 Series.....	26	Electromechanical Parts and Accessories.....	60
1131 Series.....	27	Order Forms.....	61-67
422 Series.....	28	Cylinders/Keys.....	61
Overhead Holders & Stops.....	29	Bored Locks.....	62
Parts.....	30-31	Door Closers.....	63
Exit Devices.....	32-52	Mortise Locks.....	64
80 Series.....	32-39	Exit Devices.....	65
8900 Series with Trim.....	32	Auxiliary Locks.....	66
8800 Series Device Only.....	33	Access Control.....	67

# General Information

## TurboShip

### Program Guidelines

- Only products listed in this brochure are available on Turbo. Products not listed in this brochure will automatically be entered at standard factory production lead times
- Please refer to the SARGENT Price Book for product pricing information
- Cylinders are packed separately within the product box
- The TurboKeyway is LA, furnished with nickel silver keys, for all products requiring a keyed function
- Standard Keying - 1-BITTED (111111) keying with LA Keyway. If Keyed Different is desired, specify KD(LA)
- Electrified products offered are available in 12VDC or 24VDC
- The #34 rim and #41, #42, #47-41-101 mortise cylinders are available in LA keyway only

### 24-Hour

- Orders received prior to 1pm EST will ship within 24 hours
- Standard Buying Program discount less 10 points is automatically applied
- Electrified products have a total maximum quantity of 50 locks per order
- Orders cannot be changed or cancelled

### 1-Week

- Orders received prior to 3pm EST will ship within 5 working days
- Standard Buying Program discount is automatically applied. Project Quote discounts less 5 points may also be applied
- Orders cannot be changed or cancelled

### 2-Week

- Orders received prior to 3pm EST will ship within 10 working days
- Standard Buying Program discounts or project quote discounts are applicable
- Limited to \$50,000 net/net orders
- Orders changed or cancelled 3 days after receipt of order will affect the shipping date and will result in a charge of costs for materials and labor expenses that have been incurred prior to notifications from Customer. If products have been made and/or are located in the shipping room, the 45% restocking fee will apply. Handling charges are billed on Customer's original order.

### Shipments

- All shipments are made F.O.B. factory. Shipments may be subject to small parcel handling charges and fuel surcharges as part of the freight.
- Shipping charges are prepaid and will be added to your invoice
- Prepaid freight limit of \$7,000
- UPS Ground is the standard freight carrier

### How To Order

1. Please use a separate Order Form for each Turbo Program used, Turbo - 24 -hour, 1-Week, 2-Week, or TurboKey.
2. This catalog contains one Order Form. Copy Order Forms from this catalog as needed.  
*Note: The Order Form is your Purchase Order – Do not send a cover sheet. If your order is duplicated, it cannot be returned.*
3. You may fax the preprinted SARGENT Turbo Program to 1-800-906-6606 or email to usnew.orderentry@assaabloy.com.
4. If you use your own purchase order forms instead of the pre-printed SARGENT form, please supply the information in the proper SARGENT nomenclature so your order can be processed without delay:

### Ordering Example

Quantity	Options	Product	Trim	Finish	Hand	Rail Size
5	12	8813	ETJ	32D	RHR	G

*\*All orders must have complete information for processing.  
Please reference the SARGENT price book for specifics about freight and special shipping requests.*

### General Information

1. TurboKey orders for simple Masterkeyed jobs & existing conventional cylinder systems that were developed after 1997, received prior to 3 PM EST will be scheduled to ship 8 working days after receipt of order.
2. TurboKey orders for simple Masterkeyed jobs are available in SARGENT LA Keyway only.
3. TurboKey orders are available in conventional 6 pin cylinders only, Prefixes are not available.
4. Buying Program discount is automatically applied. No additional discount may be applied.
5. TurboKey orders cannot be changed or cancelled.

### Program Guidelines

- All products available on 1 week Turbo are available on TurboKey. Products not listed in this brochure will be entered at standard factory lead times.
- TurboKey orders for existing conventional cylinder systems that were developed after 1997 are available in all SARGENT keyways except single keyway sections R, S, U and CR, along with C Keyway
- Orders must be received on the provided TurboKey forms
- NO changes or cancellations will be allowed
- Stamping of keysets on keys (only) available. Key stamping...DO NOT duplicate etc., NOT available.
- 2 keys per cylinder will be provided. NO Exceptions
- One Masterkey system per order
- 6 masterkeys will be provided with each order
- NO door schedules or key schedules will be accepted as orders
- NO cross-keying
- No Degree, Keso F1, KESO, XC, Signature, 5100/6300 LFIC (Removable) Cores, or Best I.C.
- Additions to existing TurboKey generated systems. Please note that these orders DO NOT go through keying review. Keysets will be furnished as ordered. Please refer to the bitting list that was provided with the original order for keyset information
- Key Registration number must be furnished with order number

### Simple Masterkey System Guidelines

- All General Guidelines apply as noted above
- LA Keyway ONLY
- Simple level 2 Masterkey systems only
- Construction keying 21 option (lost ball) available (22-NOT available)
- Maximum of 150 keyed cylinders per order; Maximum of 50 keyed cylinders per order for existing systems
- 3 construction keys will be provided on 21 option construction key systems
- For new Masterkey systems or additions to TurboKey generated systems only. Expanded bitting lists will be provided to the distributor on every order. Orders with less than 40 changes, expansion will be 60 total. Orders with greater than 40 changes, expansion will be 256 changes.
- For NEW masterkey systems or TurboKey generated systems or TurboKey generated systems ONLY.
- TurboKey system numbers begin with LT

### How to Order

1. Orders must be received on the Order Forms provided and specified as a TurboKey Program Order.
2. Please do not combine with any other orders.
3. Order Forms are your Purchase Orders – Do not send a cover sheet. If your order is duplicated, it cannot be returned.
4. You may fax the preprinted SARGENT Turbo Program order forms to 1-800-906-6606 or email to [usnew.orderentry@assaabloy.com](mailto:usnew.orderentry@assaabloy.com).

# Cylinders

## Bored Lock & Mortise Lock Cylinders

Cylinders and keys provide the right level of control with a full range of options.

Cylinders /  
Keys



### Bored Lock Cylinders

Program	Options	Cylinder Type	Finishes
1-Week & 2-Week	KD	C10-1	04, 15

### Mortise Cylinders

Program	Options	Cylinder Type	Finishes
24-Hour	KD, SC*, 60	34 41	32D
1-Week & 2-Week		34 41 42 41-101	03, 04, 10, 10B, 10BE, 32, & 32D

#### Options

- KD Keyed Different
- SC Schlage "C" Keyway
- 60 Disposable Construction Core

#### Finishes

- 03 Bright Brass
- 04 Dull Brass
- 10 Satin Bronze
- 10B Oxidized Satin Bronze
- 10BE Dark Oxidized Satin Bronze - Equivalent
- 15 Satin Nickel
- 32 Bright Stainless Steel
- 32D Satin Stainless Steel

#### Cylinder Types

- 34 Rim Cylinder
- 41 Mortise Cylinder (1-1/8")
- 42 Mortise Cylinder (1-1/4")
- 41-101 Mortise Cylinder with 101 Cam (13-0512) - (Adams Rite 1850 & 4700)
- 42-101 Mortise Cylinder with 101 Cam (13-0512) - (Adams Rite 1850 & 4700)
- C10-1 10, 7, 6500 Line Cylinder

\* Not available with 41 or 42 cylinders

# Cylinders

## Parts

Cylinders /  
Keys

Program	Part #	Description	Cylinder/ Product	Finish	Keyways	Restricted Keyways			
1-Week & 2-Week	13-2005	Body & Slide Assembly	34 & 41	N/A	N/A	N/A			
	13-0664	Standard Cam	41						
	01-1121	Cam Screws							
	13-0512 (101)	Adams Rite Cam							
	13-1341	Slide*	34 & 41, 480 Line, 6 Line, 6500 Line, 7 Line, 10 Line, 11 Line						
	13-0086	Cylinder Back Plate	34						
	13-0085	Rim Tail Piece							
	13-0074	Standard Connecting Screws							
	13-0080	Plug Retainer							
	13-3257	Body & Slide Assembly	6 Line, 6500 Line, 7 Line, 10 Line, 11 Line						
	13-0908	Tail Piece	6 Line						
	13-0205	Plug Retainer	6 Line, 6500 Line, 7 Line, 10 Line, 11 Line						
	13-0401	Plug	41				04, 15	LA, LB, LC, LE, LF, LG, LJ, LK, LL, RA, RB, RC, RE, RF, RG, RJ, RK, RL	AA, AB, AC, AE, AF, AG, AJ, AK, AL, BA, BB, BC, -GA, GB, GC, GE, GF, GG, GJ, GK, GL, KA, KB, KC, KE, KF, KG, KJ, KK, KL, VA, VB, VC, VE, VF, VG, VJ, VK, VL, NA, NB, NC, NE, NF, NG, NJ, NK, NL
	13-0090		34						
6251 CMK	Unassembled Core	10, 7, & 6500 Line	N/A	N/A	N/A				
6251 CTL									
6400						04, 15			
65-6300						LA, LB, LC, LE, LF, LG, LJ, LK, LL, HA, HB, HC, HE, HF, HG, HJ, HK, HL RA, RB, RC, RE, RF, RG, RJ, RK, RL			

\* Used for cylinders manufactured after June 2009 (Sold in sets of 100 units)

# Cylinders

## Parts

Program	Part #	Description	Cylinder/ Product	Finish	Keyways	Restricted Keyways
1-Week & 2-Week	13-3142	Plug w/ Retainer	6,6500, 7, 8, 10, 11	04, 15	LA, LB, LC, LE, LF, LG, LJ, LK, LL, RA, RB, RC, RE, RF, RG, RJ, RK, RL	AA, AB, AC, AE, AF, AG, AJ, AK, AL, BA, BB, BC, GA, GB, GC, GE, GF, GG, GJ, GK, GL, KA, KB, KC, KE, KF, KG, KJ, KK, KL, VA, VB, VC, VE, VG, VJ, VK, VL, NA, NB, NC, NE, NF, NG, NJ, NK, NL
	13-3425	Plug	7, 8 Line			
	13-0874		470, 480 7500			
	13-0895	Tail Piece	6500 Line, 7 Line, 10 Line	N/A	N/A	N/A
	13-1385		11 Line			
	13-0680	Tail Piece Retainer	6500 Line, 7 Line, 10 Line, 11 Line			
	13-3493	Body & Slide Assembly	460 Line, 470 Line, 480 Line			
	13-0875	Cap	480 Line			
	13-1554	Cap Pin	480 Line - Effective 6/03			
	13-0691					
	13-1555	Cap Spring				
	13-0693		480 Line - Prior to 6/03			
	13-0882	Tail Washer	484			
	13-0883		464, 465, 485, 486, 487			
	13-0884	Blocking Piece	460, 470, 480			
	13-0878	Tail Piece	464, 474,484			
	13-0880		465, 485, 487			
	13-0881		475, 486			
	13-2048	Body & Slide Assembly	8 and 9 knobs			
	06-0166	Plug w/ Retainer	7,8,9 knobs (prior to March 2005)			

\* Discontinued product

\*\* Used for Cylinders manufactured after June 2008 (sold in sets of 100 units)

Program	Tool #	Description
1-Week & 2-Week	436-1	Slide Block Kit
	432RC	LFIC Installation Tool
	432IC	SFIC Installation Tool
	13-0064 Size 1 13-0065 Size 2 13-0066 Size 3 13-0067 Size 4 13-0068 Size 5 13-0069 Size 6 13-0070 Size 7 13-0071 Size 8 13-0072 Size 9 13-0073 Size 10 13-0061 Size 12 13-0062 Size 13 13-0063 Size 14	Bottom Pins
	13-0051 Size 2 13-0052 Size 3 13-0053 Size 4 13-0054 Size 5 13-0055 Size 6 13-0056 Size 7 13-0057 Size 8 13-0058 Size 9 13-0059 Size 10 13-0060 Size 11 13-0061 Size 12 13-0062 Size 13 13-0063 Size 14	Master Pins (Splits)
	13-0265 13-1769	Springs
	437S 437RC/UL 437 DG1 437 DGM	Keying Kits
	13-1341	Slide



Program	Tools	Description	Keyways	Restricted Keyways
1-Week & 2-Week	6275	6 Pin Change/Day Keyblanks	L-Series: LA, LB, LC, LE, LF, LG, LJ, LK, LL H-Series: HA, HB, HC, HE, HF, HG, HJ, HK, HL R-Series: RA, RB, RC, RE, RE, RG, RJ, RK, RL	A-Series: AA, AB, AC, AE, AF, AG, AJ, AK, AL B-Series: BA, BB, BC, BE, BF, BG, BJ, BK, BL G-Series: GA, GB, GC, GE, GF, GG, GJ, GK, GL K-Series: KA, KB, KC, KE, KF, KG, KJ, KK, KL N-Series: NA, NB, NC, NE, NF, NG, NJ, NK, NL V-Series: VA, VB, VC, VE, VF, VG, VJ, VK, VL
	11-6275	6 Pin Change/Day Keyblanks	L-Series: LA, LB, LC, LE, LF, LG, LI, LK, LL R-Series: RA, RB, RC, RE, RF, RG, RJ, RK, RL	N/A
	6 Pin Keyblanks (6285B)	Small Format 6 or 7 Pin Keyblanks	4A	4B
	7 Pin Keyblanks (7285B & 11-X7285B)			
	6270	6 Pin Master Keyblanks	L-Series: LD, LH, LM, LN, LDH, LDM, LHM H-Series: HD, HH, HM, HN, HDH, HDM, HHM R-Series: RD, RH, RM, RN, RDH, RDM, RHM	A-Series: AD, AH, AM, AN, ADH, ADM, AHM B-Series: BD, BH, BM, BDH, BDM, BN G-Series: GD, GH, GM, GN, GHD, GMD, GHM K-Series: KD, KH, KM, KN, KDH, KDM, KHM N-Series: ND, NH, NM, NN, NDH, NDM, NHM V-Series: VD, VH, VM, VN, VDH, VDM, VHM
11-6270	6 Pin Master Keyblanks (XC Cylinders)	L-Series: LD, LH, LM, LN, LDH, LDM, LHM R-Series: RD, RH, RM, RN, RDH, RDM, RHM	L Series: LD, LH, LM, LN, LDH, LDM, LHM R Series: RD, RH, RM, RN, RDH, RDM, RHM	

**Note:**

Restricted Keyblanks require a copy of end users Purchase Order or letter of authorization w/purchase order.

Program	6 Pin Change/Day Keyblanks	Patented Keyways
1 Week & 2 Week	DG6275	DG1: TA, TB, TC, TE, TF, TG, TJ, TK, TL
	DS6275	DG2, DG3: TA, TB, TC, TE, TF, TG, TJ, TK, TL
	DG6270	DG1: TD, TH, TM, TDH, THM, TN
	DS6270	DG2, DG3: TD, TH, TM, TDH, THM, TN

**Degree DG1 Required Administrative Documents**

All Degree DG1 Keyblank turbo ship orders require a system registration number and a letter of authorization if the product is shipped to an address other than what's recorded on the System Information Document and/or if the address on the purchase order is different than what is listed on the System Information Document.

**Degree DG2 & DG3 Required Administrative Documents**

A specific randomized security code will be required for each order unless "Opt-Out" has been authorized by the system administrator.

If the "Opt-Out" option is NOT selected

- A correct system specific (randomized) security code must be included with each subsequent order.
- \*Security codes are specific to each order.
- If the shipping address is other than the one listed on the System Information Document, a Letter of Authorization signed by one of the recorded authorized representative of the facility must accompany the order.
- Letter of Authorization must contain the same shipping address that appears on the customer's purchase order.
- Letter of Authorization will not be kept on file at factory
- Without the proper security code, Letter of Authorization, or if the shipping address is other than what is listed on the System Information Document, the order cannot be processed.

If the "Opt Out" option WAS selected

- If the shipping address is other than the one listed on the System Information Document, a Letter of Authorization signed by one of the recorded authorized representative of the facility must accompany the order.
- Letter of Authorization must be signed by one of the facility's authorized representatives.
- Letter of Authorization must contain the same shipping address that appears on the customer's purchase order.
- Letter of Authorization will not be kept on file at factory

# Bored Locks

## 11 Line

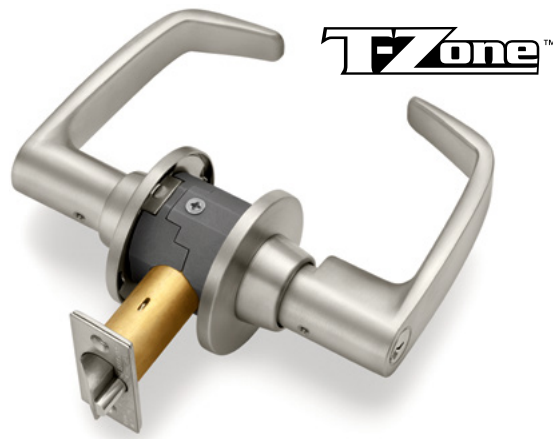

The SARGENT® 11 Line sets a higher standard for Grade 1 bored-in locks. The unique T-Zone® construction provides unequalled strength and durability for the most demanding applications such as schools and hospitals. This is accomplished by true interlocking between the lockbody and the latch far exceeding the ANSI/BHMA 156.2 Series 4000 Grade 1 standards like no other lock can.

Bored  
Locks

Program	Options	Functions	Rose	Lever	Finishes
1-Week	30, 60, 70, KD, LC, SC	28-11G04, 28-11G05, 28-11U15*, 28-11G16, 28-11G24, 28-11G37, 28-11G38, 28-11G54, 28-11U65*	L, O	B, L	10BE, 26D
2-Week			B, L,		

### Cylinder Options

- 30 Lever to accept Schlage cylinders - no cylinder provided
- 60 Disposable Construction Core
- 70 Interchangeable Core Disposable Plug
- KD Keyed Different
- LC Less Cylinder
- SC Schlage "C" Keyway

### Functions

- 28-11G04 Storeroom
- 28-11G05 Office
- 28-11U15\* Passage
- 28-11G16 Classroom/Security
- 28-11G24 Entrance/Office
- 28-11G37 Classroom
- 28-11G38 Security Classroom
- 28-11G54 Corridor
- 28-11U65\* Bathroom/Privacy

### Finishes

- 10BE Dark Oxidized Satin Bronze - Equivalent
- 26D Satin Chrome

\* Cylinder options are not available

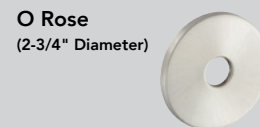
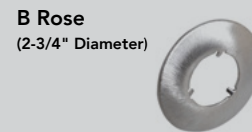

# Bored Locks

## 10 Line

Bored  
Locks

The SARGENT® 10 Line is a heavy duty cylindrical key-in-lever handle lockset that far exceeds the ANSI/BHMA 156.2 Series 4000 Grade 1 standards. At over 10 million cycles, the 10 Line withstands more than ten times the standard without allowing entry, and is designed to conform to national and state fire and handicapped requirements.



### B Lever



### J Lever



### L Lever



### P Lever



### G Rose

(3-1/2" Diameter)



### L Rose

(3-1/2" Diameter)



Program	Options	Functions	Rose	Lever	Finishes
24-Hour	KD	28-10G04, 28-10G05, 28-10U15*, 28-10G37, 28-10U65*	G, L	B, L	26D
1-Week	30, 60, 70, FW, KD, LC, RX, SC	28-10G04, 28-10G05, 28-10U15*, 28-10G15-3*, 28-10G16, 28-10G24, 28-10G37, 28-10U65*, 28-10G70**, 28-10G71**, 10U93*, 10U94*		B, J, L, P	10B, 10BE, 26, 26D
2-Week					03, 04, 10, 10B, 10BE, 26, 26D

### Cylinder Options

- 30 Lever to accept Schlage cylinders - no cylinder provided
- 60 Disposable Construction Core
- 70 Interchangeable Core Disposable Plug
- KD Keyed Different
- LC Less Cylinder
- SC Schlage "C" Keyway

### Mechanical Options

- FW Freewheeling (not available with J lever)
- RX Available on 10G70 and 10G71 only

### Finishes

- 03 Bright Brass
- 04 Dull Brass
- 10 Dull Bronze
- 10B Oxidized Dull Bronze
- 10BE Dark Oxidized Satin Bronze - Equivalent
- 26 Bright Chrome
- 26D Satin Chrome

### Functions

- 28-10G04 Storeroom
- 28-10G05 Office
- 28-10U15\* Passage
- 28-10G15-3\* Exit or Twin Communicating
- 28-10G16 Classroom Security Apartment/Exit/ Privacy
- 28-10G24 Entrance/Office
- 28-10G37 Classroom
- 28-10U65\* Bathroom/Privacy
- 28-10G70 Fail/Safe
- 28-10G71 Fail/Secure
- 10U93\* Single Lever Pulls
- 10U94\* Double Lever Pulls

### Voltage (Available on 10G70 and 10G71 only)

- 12V
- 24V

\* Cylinder options are not available

\*\* Electrified products have a total maximum quantity of 50 locks per order

# Bored Locks

## 7 Line



The SARGENT 7 Line is a key-in-lever lock designed for standard duty commercial interior and exterior applications in public buildings, medical offices, hotels/motels and government facilities. Exceeds ANSI/BHMA A156.2 Grade 2 standards for cycling and durability.

Bored  
Locks

Program	Options	Functions	Rose	Lever	Finishes
24-Hour	KD	28-7G04, 28-7G05, 28-7U15*, 28-7G37, 28-7U65*	L	L	26D
1-Week	1, 20, 30, 60, 70, KD, LC, SC	28-7G04, 28-7G05, 28-7U15*, 28-7G15-3*, 28-7G37, 28-7U65*, 7U93*, 7U94*		B, L, P	10B, 10BE, 26, 26D
2-Week					03, 04, 10, 10B, 10BE, 26, 26D

### Cylinder Options

- 30 Lever to accept Schlage cylinders - no cylinder provided
- 60 Disposable Construction Core
- 70 Interchangeable Core Disposable Plug
- KD Keyed Different
- LC Less Cylinder
- SC Schlage "C" Keyway

### Mechanical Options

- 1 for 1-3/8" thick door
- 20 for 2-3/8" Backset

### Functions

- 28-7G04 Storeroom
- 28-7G05 Office
- 28-7U15\* Passage
- 28-7G15-3\* Exit or Twin Communicating
- 28-7G37 Classroom
- 28-7U65\* Bathroom/Privacy
- 7U93\* Single Lever Pulls
- 7U94\* Double Lever Pulls

### Finishes

- 03 Bright Brass
- 04 Dull Brass
- 10 Dull Bronze
- 10B Oxidized Dull Bronze
- 10BE Dark Oxidized Satin Bronze - Equivalent
- 26 Bright Chrome
- 26D Satin Chrome

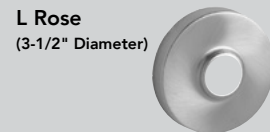

\* Cylinder options are not available

# Bored Locks

## 6500 Line

A standard duty key-in-lever lock designed to exceed the requirements of ANSI/BHMA A156.2 Series 4000 Grade 2.

Bored  
Locks

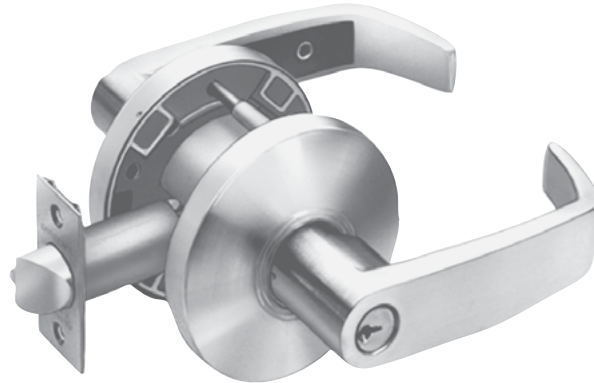

L Lever



K Rose



Program	Options	28-6500 Line x Functions	Rose	Lever	Finishes
1-Week & 2-Week	KD, SC, 20, LC	28-65G04, 28-65G05, 28-65U15*, 28-65G37, 28-65U65*, 65U93*, 65U94*	K	L	03, 04, 10B, 26, 26D

### Cylinder Options

KD Keyed Different (LA Keyway Only)  
SC Schlage "C" Keyway  
LC Less Cylinder

### Mechanical Options

20 for 2-3/8" Backset  
(160 prep)

### Functions

28-65G04 Storeroom  
28-65G05 Office  
28-65U15\* Passage  
28-65G37 Classroom  
28-65U65\* Bathroom/Privacy  
65U93\* Single Lever Pulls  
65U94\* Double Lever Pulls

### Finishes

03 Bright Brass  
04 Dull Brass  
10B Oxidized Dull Bronze  
26 Bright Chrome  
26D Satin Chrome

\* Cylinder options are not available

# Bored Locks

## 8X Line



The SARGENT 8X Line is designed and tested for robust applications. The Grade 1 bored-in lock is a worry free solution.

Bored  
Locks

Program	Functions	Rose	Knob	Finishes
24-Hour	28-8XG04, 28-8XG05, 28-8XU15, 28-8XG17, 28-8XG37, 28-8XU65, 28-8XU93	L	B	32D
1-Week				10BE, 32D
2-Week				03, 10BE, 32D

### Finishes

- 03 Bright Brass
- 10BE Dark Oxidized Satin Bronze - Equivalent
- 32D Satin Stainless Steel

### Functions

- 28-8XG04 Storeroom
- 28-8XG05 Office
- 28-8XU15 Passage
- 28-8XG17 Utility
- 28-8XG37 Classroom
- 28-8XU65 Bathroom/Privacy
- 28-8XU93 Single Knob Pulls

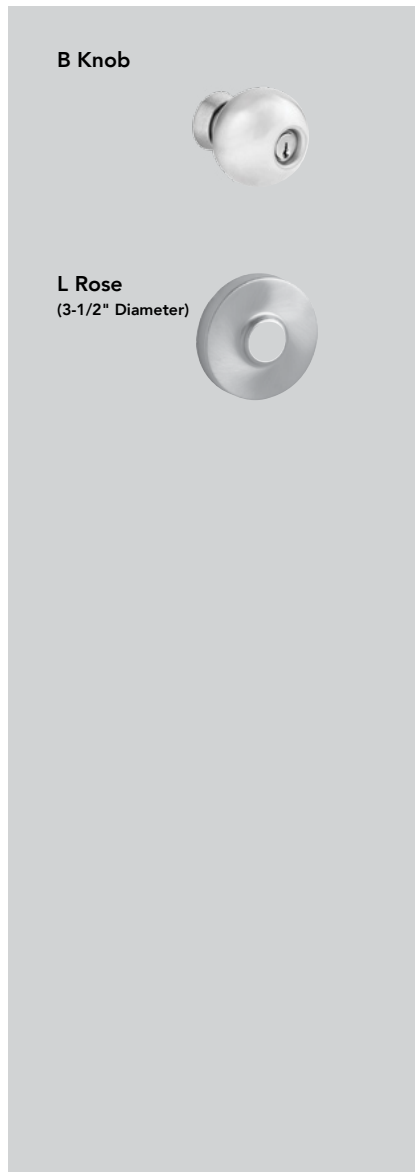

**B Knob**



**L Rose**  
(3-1/2" Diameter)



# Bored Locks

## 6 Line

The 6 Line is a standard duty knob lock line. This ANSI/BHMA Grade 2 bored lock is suited for apartments, hotels and commercial buildings.

Bored  
Locks



**B Knob**



**O Rose**



Program	Options	Functions	Rose	Knob	Finishes
1-Week & 2-Week	24, 28	6G04, 6G05, 6U15, 6G37, 6U65	O	B	26D

### Mechanical Options

- 24- 2-3/4" (70mm) backset
- 28- 4-7/8" (124mm) ANSI curved lip strike # 808

### Functions

- 6G04 Storeroom
- 6G05 Office
- 6U15 Passage
- 6G37 Classroom
- 6U65 Bathroom/Privacy

### Finishes

- 26D Satin Chrome



# Bored Locks

## HP ALP Trim



The HP Series Bored Lock with ALP push/pull trim provides an aesthetically pleasing alternative to standard push/pull products. Ease of operation allows its use in many environments, including healthcare and education. The paddle shape and location create a comfortable target for door activation without using hands.

Bored  
Locks

Program	Options	Functions	Trim	Finishes
1-Week & 2-Week	14, 24, 28, WBS	HPU15, HPU65*	ALP	32D

### Mechanical Options

- 14- 505 Full Lip Strike
- 24- 2-3/4" (70mm) backset
- 28- 4-7/8" (124mm) ANSI curved lip strike # 808
- WBS Wrought Box Strike

### Finishes

- 32D Satin Stainless Steel

### Hand

- LH Left Hand
- RH Right Hand

### Functions

- HPU15 Passage
- HPU65 Privacy\*

### Passage



### Privacy



Note: Maximum quantity of 15 units per order

\* Handed

# Bored Locks

## DL Series

Bored  
Locks

The DL Series tubular lock is designed for ease of installation with the quality you expect from the SARGENT name. The DL Series exceeds the expectations of the most demanding architects and design professionals. All Studio Collection and Coastal Series levers, as well as standard levers, can be used with the DL Series.



### MD Lever



### ME Lever



### MG Lever



### MI Lever



### MJ Lever



### MV Lever



### ND Lever



### NJ Lever



### REM Lever



### LN Rose

(2-1/8" Diameter)



### O Rose

(2-3/4" Diameter)



Program	Options	Functions	Rose	Lever	Finishes
24-Hour	28-	DLU15, DLU15-3,	LN*, O	MD, MI	26D
1-Week	12-, 14-, 20-, 28-, WBS-	DLU65, DLU93, DLU94		MD, ME, MG, MI, MJ, MV, ND, NJ, REM (32D only)	10B, 10BE, 15, 26, 26D, 32D
2-Week					03, 10, 10B, 10BE, 15, 26, 26D, 32D

### Cylinder Options

- 12 UL Listed for 3 hour fire rated doors
- 14 505 Full lip strike
- 20 2-3/8" backset latch with square corner front 2-1/4" x 1" front
- 28 Strike #808. Lip length 1-1/4"
- WBS Wrought box strike

### Finishes

- 03 Bright Brass
- 10 Satin Bronze
- 10B Oxidized Satin Bronze
- 10BE Dark Oxidized Satin Bronze - Equivalent
- 15 Satin Nickel
- 26 Bright Chrome
- 26D Satin Chrome
- 32D Satin Stainless Steel  
(Available with REM only)

### Functions

- DLU15 Passage
- DLU15-3 Communicating set
- DLU65 Privacy set
- DLU93 Single lever pull
- DLU94 Double lever pull

### Hand

- LH Left Hand
- RH Right Hand

\* Available with DLU93 and DLU94 functions only

Note: Maximum quantity of 100 units per order

# Bored Locks

## 7 Line & 10 Line Parts

### 10 Line Parts

Program	Part #	Description	Finishes
1-Week, 2-Week	10-3192	Latches - Guarded - 2-3/4" BS	03, 04, 10, 10B, 32D
	10-2022	Latches - Unguarded - 2-3/4" BS	
	10-0798	Inside and Outside Rose Scalp - L	26D
	10-0790	Inside and Outside Rose Scalp - G	
	10-3048	Inside Rose Assembly	Standard
	10-3049	Outside Rose Assembly	

### 7 Line & 10 Line Parts

Program	Part #	Description	Finishes
1-Week, 2-Week	10-0501	Levers - I/S or O/S "L" design, Passage	26D
	10-0502	Levers - I/S or O/S "L" design, Cylinder, Emerg.	
	10-0503	Levers - I/S or O/S "L" design, Turn, 30 option	
	10-0523	Levers - I/S or O/S "B" design, Passage	
	10-0524	Levers - I/S or O/S "B" design, Cylinder, Emerg.	
	10-0525	Levers - I/S or O/S "B" design, Turn, 30 option	
	10-0545	Levers - I/S or O/S "P" design, Passage	
	10-0546	Levers - I/S or O/S "P" design, Cylinder, Emerg.	
	10-0547	Levers - I/S or O/S "P" design, Turn, 30 option	
	10-2070	Screw Packs (28-)	
	10-2052	Screw Packs (Standard)	

### 7 Line Parts

Program	Part #	Description	Finishes
1-Week, 2-Week	07-2430	Latches - Guarded - 2-3/4" BS	03, 04, 10, 10B, 32D
	07-2432	Latches - Unguarded - 2-3/4" BS	
	07-0111	Rose Scalp (All functions)	03, 04, 10, 10B, 26D
	07-2425	Inside Rose Body (all except 94, 94-2)	
	07-2426	Outside Rose Body (all except 93, 94, 94-2, 15-3)	Standard
	07-2648	1-3/8" Door Mounting Kit	
	07-2446	Through-bolt Mounting Pack	
	07-2431	7 Line Latch (2-3/8" Guarded)	03, 10, 10B, 32D
	07-2433	7 Line Latch (2-3/8" Unguarded)	

# Bored Locks

## 6 Line Parts

### 6 Line Parts

Program	Part #	Description	Finishes
1-Week, 2-Week	600	Strikes	03, 04, 10, 10B, 32D
	06-5083	Latches - Guarded	
	06-5225	Latches - Unguarded	
	06-2675	Screw Packs	Standard
	06-5056	Screw Packs	
	06-5057	Screw Packs	

# Mortise Locks

## 8200 Series with Trim

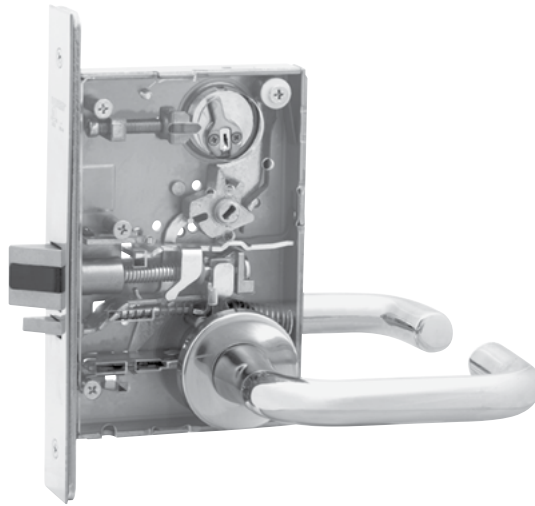

The 8200 Series far surpasses ANSI/BHMA A156.13 Series 1000 Grade 1 standards, making it the strongest and most durable mortise lock in the industry.

Program	Options	Functions	Rose	Lever	Finishes
24-Hour	KD, RX, WBS	8204, 8205, 8215, 8225, 8237, 8265, 8270*, 8271*	LN	B, J, L, P, MD, MI	26D
1-Week	60, 70, KD, LC, LX, RX, SC, WBS	8204, 8205, 8215, 8225, 8237, 8238, 8239, 8240, 8241, 8243, 8245, 8255, 8265, 8270*, 8271*, 8272*, 8273*, 8293, 8294	LN, LW1, O, WT	B, J, L, P, MD**, ME**, MG**, MI**, MJ**, MV**, ND**, NJ**, REM (32D Only)	10B, 10BE, 15, 26, 26D, 32D
2-Week					03, 10, 10B, 10BE, 15, 26, 26D, 32D

### Options

- 60 Disposable Construction Core
- 70 Interchangeable Core Disposable Plug
- KD Keyed Different
- LC Less Cylinder
- RX Request to Exit
- SC Schlage "C" Keyway
- WBS Wrought Box Strike
- LX Latchbolt Monitor

### Finishes

- 03 Bright Brass
- 10 Dull Bronze
- 10B Oxidized Dull Bronze
- 10BE Dark Oxidized Satin Bronze - Equivalent
- 15 Satin Nickel
- 26 Bright Chrome
- 26D Satin Chrome
- 32D Stainless Steel

### Voltage (Available on 8270, 8271, 8272, 8273 only)

- 12V
- 24V

\* Electrified products have a total maximum quantity of 50 locks per order

\*\* Maximum quantity of 100 units per order

### Functions

- 8204 Night Latch or Storeroom
- 8205 Office or Entry
- 8215 Passage
- 8225 Dormitory or Exit
- 8237 Classroom
- 8238 Classroom Security
- 8239 Classroom Security with Deadbolt
- 8240 Classroom Security with Deadbolt
- 8241 Classroom Security
- 8243 Apartment
- 8245 Dormitory
- 8255 Office w/Toggle
- 8265 Bathroom
- 8270 Fail Safe
- 8271 Fail Secure
- 8272 Fail Safe
- 8273 Fail Secure
- 8293 Single Dummy
- 8294 Trim Dummy

### Hand

- LH Left Hand
- RH Right Hand

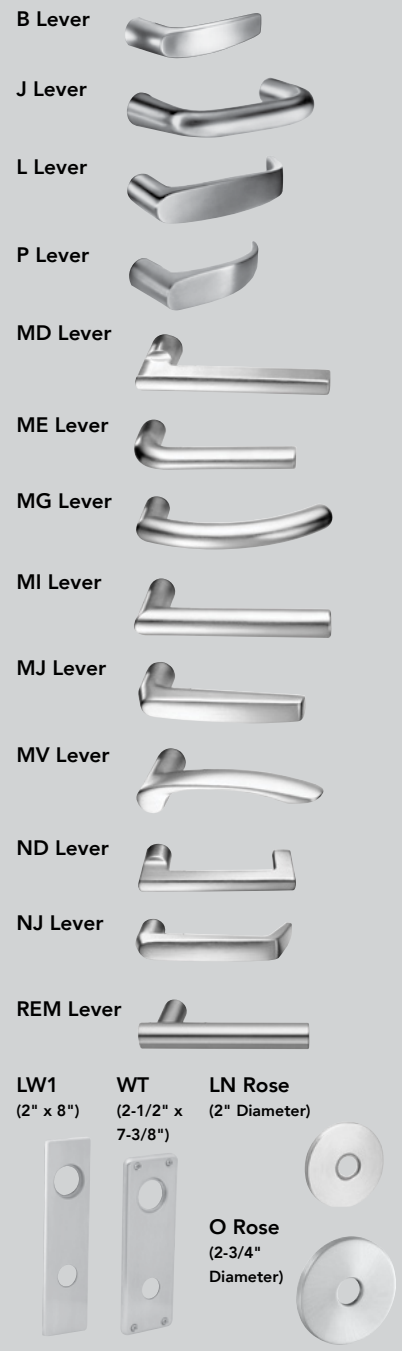

Mortise Locks

# Mortise Locks

## 8200 Series with ALP Trim

Heavy-duty push/pull hardware that is flexible, easy to use and aesthetically pleasing; it's appropriate for healthcare settings and beautiful enough for healing environments. This trim offers multiple mounting options and easy operation, even when your hands aren't free.



Mortise  
Locks

Program	Options	Functions	Trim	Finishes
1-Week & 2-Week	KD, LC, SC, WBS, 60, 70	8204, 8205, 8215, 8237, 8265, 8270, 8271	ALP	32D

### Options

- 60 Disposable Construction Core
- 70 Interchangeable Core Disposable Plug
- KD Keyed Different
- LC Less Cylinder
- SC Schlage "C" Keyway
- WBS Wrought Box Strike

### Finishes

- 32D Stainless Steel

### Functions

- 8204 Night Latch or Storeroom
- 8205 Office or Entry
- 8215 Passage
- 8237 Classroom
- 8265 Bathroom
- 8270 Fail Safe
- 8271 Fail Secure

### Hand

- LH Left Hand
- RH Right Hand

Note: Maximum quantity of 15 units per order

# Mortise Locks

## 8200 Series Lockbody Only



The 8200 Series mortise lock far surpasses ANSI/BHMA A156.13 Series 1000 Grade 1 standards, making it the strongest and most durable mortise lock in the industry.

Mortise  
Locks

Program	Options	Functions	Finishes
24-Hour	WBS	8204, 8205, 8215, 8225, 8237, 8265	26D, 32D
1-Week & 2 Week		8204, 8205, 8215, 8225, 8237, 8238, 8239, 8240, 8241, 8243, 8245, 8255, 8265, 8293, 8294	10B, 10BE, 15, 26, 26D, 32D

### Options

WBS Wrought Box Strike

### Finishes

03 Bright Brass  
 10 Dull Bronze  
 10B Oxidized Dull Bronze  
 10BE Dark Oxidized Satin Bronze - Equivalent  
 15 Satin Nickel  
 26 Bright Chrome  
 26D Satin Chrome  
 32D Stainless Steel

### Functions

8204 Night Latch or Storeroom  
 8205 Office or Entry  
 8215 Passage  
 8225 Dormitory or Exit  
 8237 Classroom  
 8238 Classroom Security  
 8239 Classroom Security with Deadbolt  
 8240 Classroom Security with Deadbolt  
 8241 Classroom Security  
 8243 Apartment  
 8245 Dormitory  
 8255 Office w/Toggle  
 8265 Bathroom  
 8293 Single Dummy  
 8294 Trim Dummy

### Hand

LH Left Hand  
 RH Right Hand  
 LHR Left Hand Reverse  
 RHR Right Hand Reverse

# Mortise Locks

## Mechanical Parts & Accessories

Program	Part #	Description
1-Week, 2-Week	01-1028	#8-32 x 1/4" Mortise Outside Front Screws
	01-5002	#12 Combination Latch Screw (mortise lock mounting screw)
	578-2	Spindle Kit (Dimpled - 1-3/4" door) (Available on 8100 Series only)
	579-2	Spindle Kit (Threaded - 1-3/4" door) (Available on 8100 Series only)
	01-0079	Washer
	01-1174	Lever Set Screw (B, J, L, P, W Levers)
	01-1472	Lever Set Screw (A, E, F Levers)
	01-1495	Machine Screw #8-32 x 5/8"
	130KB	Thumbturn (Specify 03, 10, 10B, 26, 26D, 32D)
	130W	Thumbturn (Specify 03, 10, 10B, 26, 26D, 32D)
	184KB	Emergency Release (Specify 03, 10, 10B, 26, 26D, 32D)
	184W	Emergency Release (Specify 03, 10, 10B, 26, 26D, 32D)
	77-3468	Screw Pack 1-3/4" Dr (KE2/LE2 Trim)
	77-1141	Strike Box (for 8200 & 808 strikes)
	77-4236	Lockbody Screw Pack (All trim, specify 03, 04, 10, 10B, 32, 32D)
	81-0723	Mounting Post
	82-0110	Standard Curve Lip Strike (03, 04, 10, 10B, 10BE, 32, 32D)
	82-0184	Cap Nut (Std O/S Lever)
	82-0612	Wave Spring for Rose
	82-2136	Trim Pack Kits - E, O, KW, L (7894) LN, LW - 94 Function
	82-2137	Trim Pack Kits - KE1, KE2, LE1, LE2, KS, LS - 94 Function
	82-2138	Trim Pack Kits - L (8294), WT - 94 Function
	82-2135	Trim Pack Kits - L (8293), WT - 93 Function
	82-3211	Trim Pack Kits - E, O, KW, L (7800), LN, LW
	82-3212	Trim Pack Kits - KE1/LE1, KE2/LE2, KE3/LE3, KE4/LE4
	82-3213	Trim Pack Kits - L (8200), WT - All
	82-3341	Screw Pack - 1-3/4" Dr. (KE1/LE1, KE3/LE3, KW/LW Trim)
	82-3654	Screw Pack - All Door Thickness (WT Trim)
	82-3675	Screw Pack - 1-3/4" Dr (FE trim)



# Door Control

## Powerglide 281, 351 & 1431 Series

Surface door closers for interior and exterior doors with flexibility to meet virtually every application. A full complement of arm types and front-facing valves make installation and maintenance easy.



**281 Door Closer**



**351 Door Closer**



**1431 Door Closer**

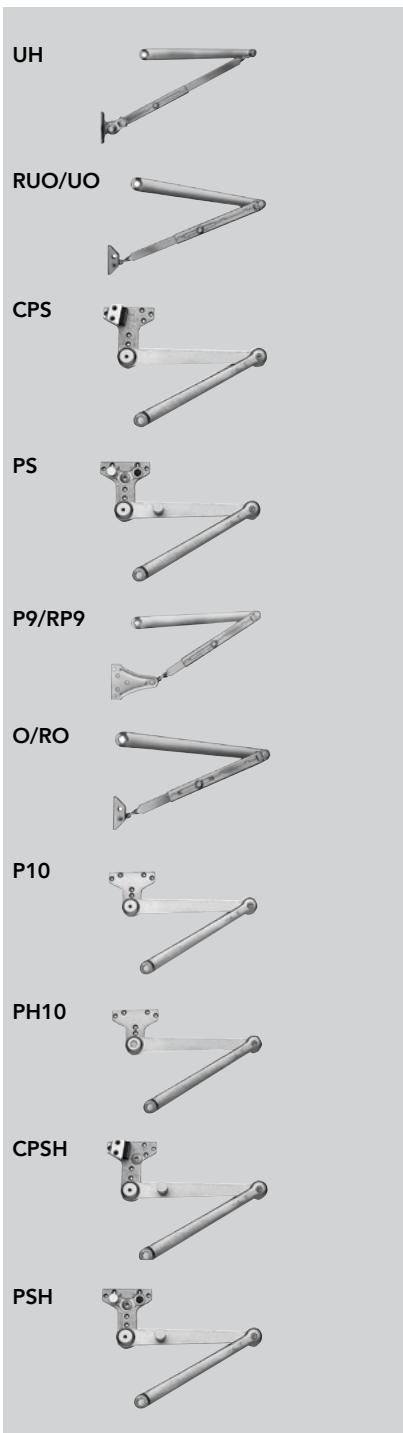

Program	Options	Arm Types	Finishes
24-Hour	-	O, UO, RO*, RUO*	EB, EN
1-Week & 2-Week	DA, TB	O, CPS, PS, P10, PH10, CPSH, PSH, P9, UH, UO, RO*, RP9*, RUO*	EAB, EB, EN, EP, 10BE

### Arm Types

- UH Universal Hold Open STD, Parallel, Top Jamb
- RUO Universal Arm STD, Parallel, Top Jamb RUO
- UO Universal Arm STD, Parallel, Top Jamb RUO
- CPS Heavy Duty Parallel Arm with Compression Stop
- PS Heavy Duty Parallel Arm with Positive Stop
- P9 Standard Parallel Arm RP9
- RP9 Standard Parallel Arm RP9
- RO Standard Arm Standard & Top Jamb RO
- O Standard Arm Standard & Top Jamb RO
- P10 Heavy Duty Parallel Arm
- PH10 Heavy Duty Friction Hold Open Parallel Arm
- CPSH Heavy Duty Hold Open Parallel Arm with Compression Stop
- PSH Heavy Duty Hold Open Parallel Arm with Positive Stop

### Finishes

- EB Bronze Enamel to match 10B
- EN Aluminum Enamel
- EP Bronze Enamel to match US10
- EAB Brass Enamel to be used with brass finishes
- 10BE Dark Oxidized Satin Bronze - Equivalent

\* Available with 1431 Series door closer only

Door Control

# Door Control

## 1331 Series

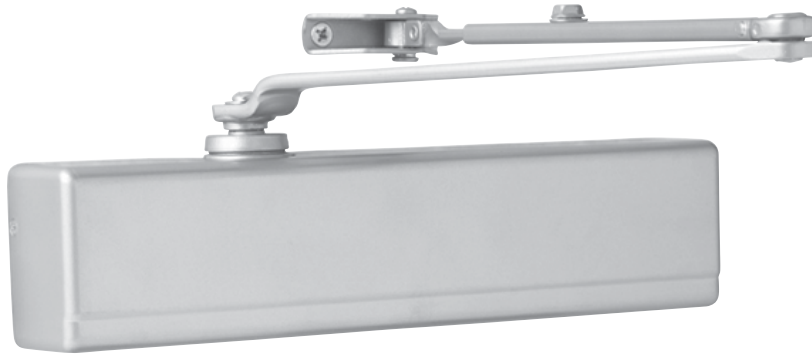

The SARGENT 1331 Series door closer can be used for the most common applications and is a Grade 1 fully adjustable closer. Available with a selection of arms and accessories, the 1331 Series door closer can be used for most common applications and is ideal for standard duty installations.

Door  
Control

Program	Options	Arm Types	Finishes
24-Hour	-	JH, JO, JP9, JPH9, JUH, JUO	EB, EN
1-Week & 2-Week	DA, TB		10BE, EAB, EB, EN, EP

### Arm Types

JO	Arm Standard/Top Jamb
JH	Hold Open Arm Standard
JP9	Arm Parallel
JPH9	Hold Open Arm Parallel
JUO	Tri Pack or "Universal Packed"
JUH	Hold Open Tri Pack or "Universal Packed"

### Finishes

EB	Bronze Enamel to match 10B
EN	Aluminum Enamel
EP	Bronze Enamel to match US10
EAB	Brass Enamel to be used with brass finishes
10BE	Dark Oxidized Satin Bronze - Equivalent

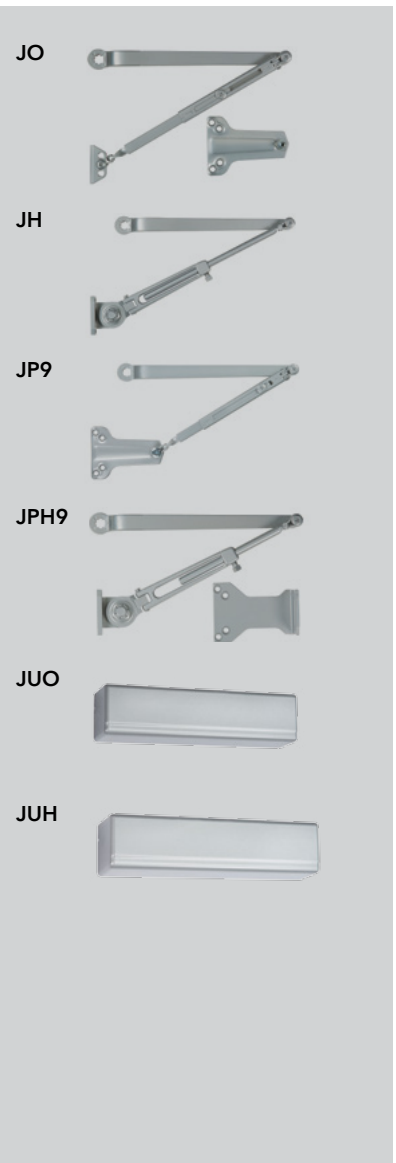

# Door Control

## 1131 Series

A reversible "Non-handed" economy aluminum door closer.

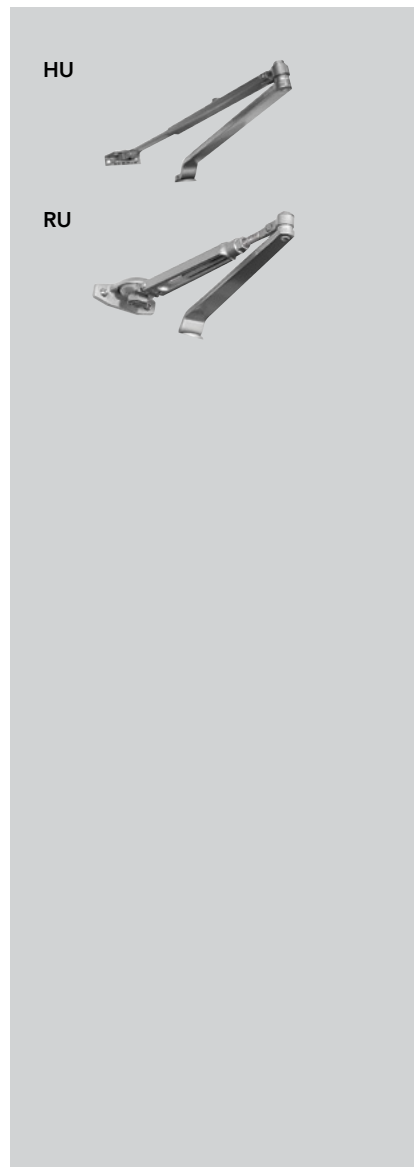
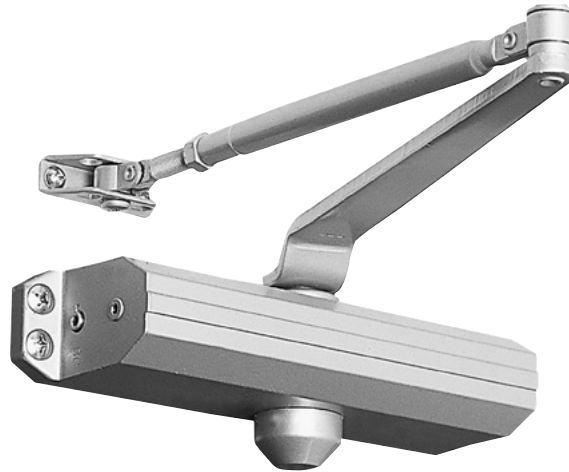

Program	Options	Arm Types	Finishes
24-Hour	-	HU, RU	EB, EN
1-Week & 2-Week	DA, TB		

### Product Designation Based on Application

1131 Adjustable for sizes 1 through 6. Ideal for use on aluminum storefronts and other medium traffic, commercial applications. Complies with opening force requirements outlined in the Americans with Disabilities Act (A.D.A.) and ANSI A117.1 for interior doors.

### Finishes

- EB Bronze Enamel to match 10B
- EN Aluminum Enamel

### Options

- DA Bronze Enamel to match 10B
- TB Aluminum Enamel

### Arm Types

- HU Hold-Open Arm Bracket
- RU Regular Parallel Arm Bracket

Door Control

# Door Control

## 422 Series



The high performance design of the 422 Cam Action Closer ensures doors that are light to open for ADA compliance, with the right amount of closing force to handle a wide range of environments. The closer's non-hold open track and internal spring are specifically built to protect the door and frame in abusive, high-traffic conditions.

Door  
Control

Program	Options	Arm Types	Finishes
1-Week & 2-Week	TB	CTB2, CTHB2, PCTB2*, PCHTB2*	EB, EN, 10BE

### Arm Types

CTB2	Pull with Bumper
CTHB2	Pull with Holder and Bumper
PCTB2	Push with Bumper
PCHTB2	Push with Holder and Bumper

### Hand

LH	Left Hand
RH	Right Hand

### Finishes

EB	Bronze Enamel to match 10B
EN	Aluminum Enamel
10BE	Dark Oxidized Satin Bronze - Equivalent

Note: Maximum quantity of 40 units per order

\* Handed

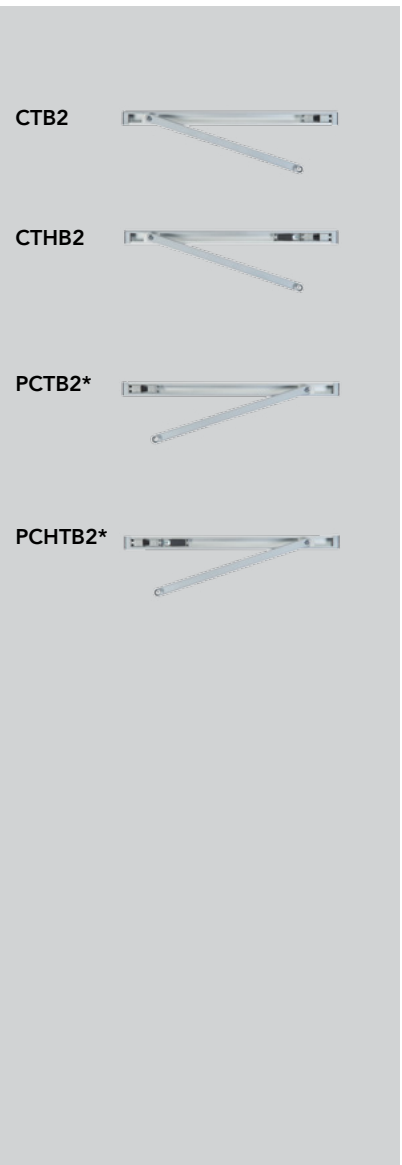

# Door Control

## Overhead Holders & Stops

Overhead holders and stops are used to extend the life of the door, frame and door closing devices on an opening. SARGENT offers both concealed and surface mount types, with various functions and degree of opening.

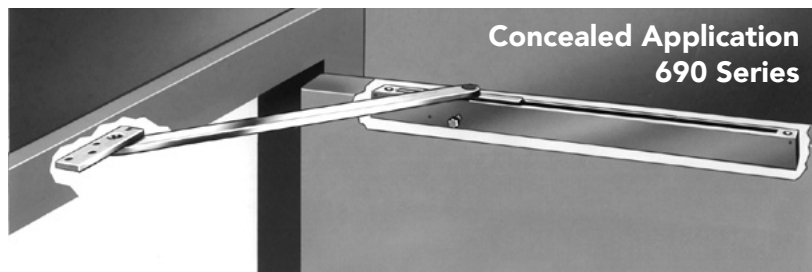
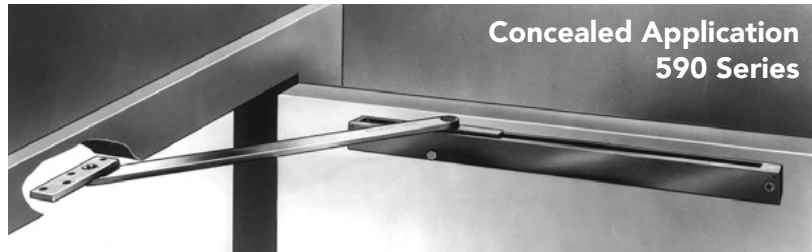

Door  
Control

Program	Product Designation	Options	Finish
1-Week, 2-Week	597,598,599 697, 698, 699 1546,1547,1548, 1549	H, S	26D

### Product Designation

#### 590 Series

- 597 24" - 32-1/2" Door Width
- 598 32-5/8" - 39-1/8" Door Width
- 599 39-1/4" or Greater Door Width

#### 690 Series

- 697 24" - 32-1/2" Door Width
- 698 32-5/8" - 39-1/8" Door Width
- 699 39-1/4" or Greater Door Width

#### 1540 Series

- 1546 18-1/2" - 25" Door Width
- 1547 25-1/8" - 32-1/2" Door Width
- 1548 32-5/8" - 40" Door Width
- 1549 40-1/8" - 48" Door Width

### Finishes

26D Satin Chrome

### Options

- H Hold Open with Stop
- S Stop Only

Note: Maximum quantity of 15 units per order

# Door Control

## Door Closer Parts

Door  
Control

Program	Part #	Description	Finishes	
24-Hour 1-Week & 2-Week	25 O	Standard Arm – Complete Arm assy.	10BE, EN, EB, EP, EAB	
	25 H	Holder Arm – Complete Arm assy.		
	25 P9	Parallel Arm – Complete Arm assy.		
	25 PH9	Parallel Holder Arm – Complete Arm assy.		
	25 P10	Parallel Heavy Duty Arm – Complete Arm assy.		
	25PH10	Parallel Holder Heavy Duty Arm (Left Hand)		
	25PH10	Parallel Holder Heavy Duty Arm (Right Hand)		
	25 PS	Parallel Stop Arm – Complete Arm assy.		
	25 PSH	Parallel Stop/Holder Arm – Complete Arm assy.		
	25 CPS	Compression Stop Arm – Complete Arm assy.		
	25 CPSH	Compression Holder Arm – Complete Arm assy.		
	581-1	Blade Stop Spacer Kit		
	581-2	Blade Stop Spacer Kit		
	61-2303	61-2303		Foot assy. - (H, HZ, HZA, PH4, PH9, UH-Arms)
63-0516		Bumper holder - (CPS, CPSH - Arms)		
63-2216		Foot assy. - (O, OLC, RO, UO, RUO - Arms)		
63-2217		Foot assy. - (OZ - Arm)		
63-2218		Foot assy. - (OZA, FZA - Arm)		
63-3070		Main arm & swivel assy. (H, H8, PH4, PH9, PF9, UH - Arms)		
63-2230		Main arm & link assy. - (HZ - Arm)		
63-2231		Main arm & link assy. - (HZA - Arm)		
63-2271		Foot assy- (P9, PR9 Arms)	10BE, EN, EB, EP, EAB	
63-0641		Arm & bearing assy. (P10, CPS, PS, CPSH, PSH - Arms)	10BE, EN, EB, EAB	
63-2607		Main arm & link assy. (O, O8, OZ, OZA, P3, P3A, P4A, P9, RP9-Arms)		
63-3493		Bumper only - (CPS, CPSH - Arm) - use w/63-0516	Standard	
63-3727		Arm and bracket assy. (P10 arm)	10BE, EN, EB, EAB	
63-3830		Arm and bracket assy. (CPS arm)		
63-3833	Arm and bracket assy. (PSH arm)			
63-3836	Arm and bracket assy. (CPSH arm)			
63-3837	Arm and bracket assy. (PS arm)			

Program	Part #	Description	Finish
1-Week, 2-Week	21-0198	1540 Jamb Bracket Shim	26D
	01-3436	Machine Screw	
	21-0104	590 Jamb Bracket Shim	
	01-3454	Machine Screw	32D

# Door Control

## Door Closer and Overhead Holders & Stops Parts

Program	Part #	Description	Finishes
24-Hour	125 P3	Arm Conversion Unit	EB, EN
	125 P3A	Arm Conversion Unit	
	125 P4A	Arm Conversion Unit	
	351A	Mounting Plate	
	351B	Mounting Plate	
	351D	Drop Bracket	
	1431D	Drop Bracket	
	4TB	Through-bolt Pack	
1-Week & 2-Week	125P9	Parallel Arm Foot	EB, EN, EAB
	125PH9	Parallel Arm Foot	
	125 P3	Arm Conversion Unit	EB, EN, EAB, EP
	125 P3A	Arm Conversion Unit	
	125P4	Arm Conversion	
	125 P4A	Arm Conversion Unit	
	281C	Closer Cover	EB, EN, EP, EAB
	351A	Mounting Plate	EB, EN, EAB, EP
	351B	Mounting Plate	
	351C	Closer Cover	B, EN, EP, EAB
	351D	Drop Bracket	EB, EN, EAB, EP
	1431D	Drop Bracket	
	281D	Mounting Plate	
	581-1	Blade Stop Spacer Kit (P9, PH9, PF9)	
	581-2	Blade Stop Spacer Kit (P10, PS, PSH, CPS, CPSH, PH10)	
	1431C	Closer Cover	EB, EN, EP, EAB
	4TB	Through-bolt Pack	EB, EN, EAB, EP
	Paint	Paint (One Color per 12 Unit Case)	EB, EN, EAB, ED, EP

Door Control

### Electromagnetic Door Holders & Locks

Program	Part #	Description	Finish
1-Week, 2-Week	1560	Electromagnetic Door Holder - Wall Mount, Surface Applied	EN
	1561	Electromagnetic Door Holder - Concealed Wiring	
	1584	Electromagnetic Lock - Push Single door	32D

# Exit Devices

## 8900 Series Device with Trim



8900 Series mortise lock exit device has concealed single point guarded latching for additional security and is designed for standard width stile applications on wood and metal doors.

Program	Options	Functions	Rails	Escutcheon	Lever	Finishes
1-Week	12, 16, 43, 55, 56, 60, 70, AL, KD, LC, SC, WS**	8910, 8913, 8915, 8963, 8973*, 8974*, 8975*, 8976*	F, G, J	ET, PTB, No Trim***	B, J, L, P, MD, ME, MG, MI, MJ, MV, ND, NJ, REM (32D Only)	10B, 10BE, 32D
2-Week						10, 10B, 10BE, 32D

### Cylinder Options

- 60 Disposable Construction Core
- 70 Interchangeable Core Disposable Plug
- KD Keyed Different
- LC Less Cylinder
- SC Schlage "C" Keyway

### Mechanical Options

- 12 Fire Rated
- 16 Cylinder Dogging
- 43 Flush End Cap
- 55 Request-to-Exit
- 56 Electric Latch Retraction (ELR)
- AL Alarmed Exit
- WS\*\* Windstorm

### Rail

- F 33" - 36" (84cm - 91cm)  
(No cutting required for 36" (91 cm) door)
- G 43" - 48" (110cm - 122cm)  
(No cutting required for 48" (122 cm) door)
- J 37" - 42" (94cm - 107cm)  
(No cutting required for 42" (107cm) door)

### Functions

- 8910 (ANSI 01) Exit Only No Outside Trim
- 8910 (ANSI 02) Exit Only with PTB or ET Trim
- 8913 (ANSI 08) Key Locks/Unlocks with ET Trim
- 8915 (ANSI 14) Passage Only with ET Trim
- 8963 (ANSI 05) Key Locks/ Unlocks with PTB Trim
- 8973 Electrified ET Trim - Fail Safe, Power off, Unlocks Lever (No Cylinder)
- 8974 Electrified ET Trim - Fail Secure, Power off, Unlocks Lever (No Cylinder)
- 8975 Electrified ET Trim - Fail Safe. Power off, Unlocks Lever, Key retracts Latch
- 8976 Electrified ET Trim - Fail Secure. Power off, Unlocks Lever, Key retracts Latch

### Finishes

- 10 Dull Bronze
- 10B Oxidized Dull Bronze
- 10BE Dark Oxidized Satin Bronze - Equivalent
- 32D Dull Stainless

### Hand

- LHR Left Hand Reverse
- RHR Right Hand Reverse

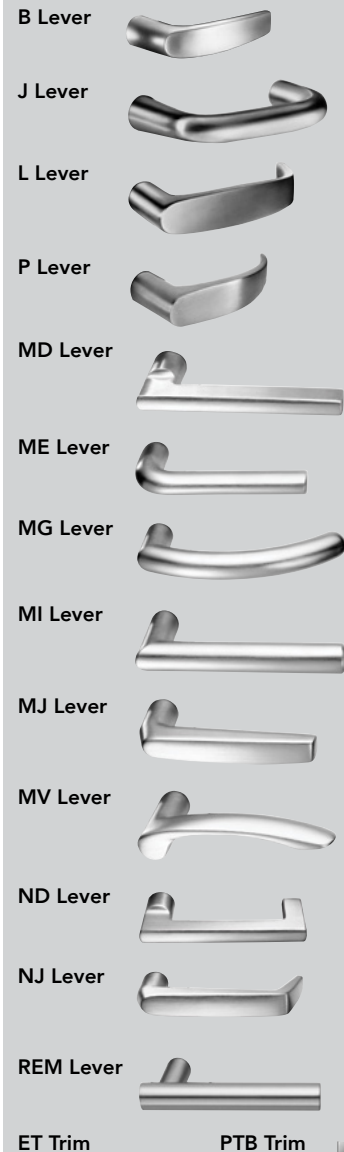

Note: LA is the standard SARGENT keyway and all cylinders will be 1-bitted unless KD is specified. Cylinder dogging (16- option) is available with the 13 and 63 function devices only. 12- & 16- are not available together.

ET trims are supplied in 26D in lieu of 32D.  
\* Specify 12V or 24V when ordering solenoid operated ET Trim  
\*\* WS is available for single hollow metal door applications for 1-3/4" thick doors, 3'0" x 7'0" max doors.  
\*\*\* Available on 8910 only



# Exit Devices

## 8800 Series Device Only

The 8800 Series rim exit device is designed for standard width stile applications on wood and metal doors. This reversible rim exit device sets the industry standard for durability and reliability.



Program	Options	Functions	Rail Sizes	Finishes
24-Hour	12, 21, 43	8888/8810	F	32D
1-Week	12, 16, 43, 60, 70, KD, LC, SC		F, G, J	10B, 10BE, 32D
2-Week				03, 10, 10B, 10BE, 32D

### Cylinder Options

- 60 Disposable Construction Core
- 70 Interchangeable Core Disposable Plug
- KD Keyed Different
- LC Less Cylinder
- SC Schlage "C" Keyway

### Finishes

- 03 Bright Brass
- 10 Dull Bronze
- 10B Oxidized Dull Bronze
- 10BE Dark Oxidized Satin Bronze - Equivalent
- 32D Dull Stainless

### Mechanical Options

- 12 Fire Rated
- 16 Cylinder Dogging
- 43 Flush End Cap

### Rail

- F 33" - 36" (84cm - 91cm)  
(No cutting required for 36" (91 cm) door)
- G 43" - 48" (110cm - 122cm)  
(No cutting required for 48" (122 cm) door)
- J 37" - 42" (94cm - 107cm)  
(No cutting required for 42" (107cm) door)

### Functions

8888/8810 Multifunction

### Hand

- LHR Left Hand Reverse
- RHR Right Hand Reverse

Note: LA is the standard SARGENT keyway and all cylinders will be 1-bitted unless KD is specified.

12 & 16 options are not available together

Cylinder options are available with 16 option devices only

# Exit Devices

## 8800 Series Device with Trim



Program	Options	Functions	Rails	Escutcheon	Lever	Finishes
24-Hour	12, 43, 55, 56, KD	8813	F	ET, PSB, PTB	B, J, L, P, MD, ME, MG, MI, MJ, MV, ND, NJ, REM, 88CLL	32D
1-Week	12, 16, 43, 55, 56, 60, 70, HC, KD, LC, SC, WS*	8804, 8810, 8813, 8815, 8863, 8873*, 8874*, 8875*, 8876*	F, G, J			10B, 10BE, 32D
2-Week						03, 10, 10B, 10BE, 32D

### Cylinder Options

- 60 Disposable Construction Core
- 70 Interchangeable Core Disposable Plug
- KD Keyed Different
- LC Less Cylinder
- SC Schlage "C" Keyway

### Mechanical Options

- 12 Fire Rated
- 16 Cylinder Dogging
- 43 Flush End Cap
- 55 Request-to-Exit
- 56 Electric Latch Retraction (ELR)
- HC Hurricane Code
- WS\*\* Windstorm

### Finishes

- 03 Bright Brass
- 10 Dull Bronze
- 10B Oxidized Dull Bronze
- 10BE Dark Oxidized Satin Bronze - Equivalent
- 32D Dull Stainless

### Functions

- 8804 (ANSI 03) Key Retracts Latch with PSB or ET Trim
- 8810 (ANSI 01) Exit Only, No Outside Trim
- 8810 (ANSI 02) Exit Only, with PTB or ET Trim
- 8813 (ANSI 08) Key Locks/Unlocks ET Trim
- 8815 (ANSI 14) Passage Only with ET Trim
- 8863 (ANSI 05) Key Locks/Unlocks PTB Thumb Piece
- 8973 Electrified ET Trim - Fail Safe, Power off, Unlocks Lever (No Cylinder)
- 8974 Electrified ET Trim - Fail Secure, Power off, Unlocks Lever (No Cylinder)
- 8975 Electrified ET Trim - Fail Safe. Power off, Unlocks Lever, Key retracts Latch
- 8976 Electrified ET Trim - Fail Secure. Power off, Unlocks Lever, Key retracts Latch

### Rail

- F 33" - 36" (84cm - 91cm)  
(No cutting required for 36" (91 cm) door)
- G 43" - 48" (110cm - 122cm)  
(No cutting required for 48" (122 cm) door)
- J 37" - 42" (94cm - 107cm)  
(No cutting required for 42" (107cm) door)

### Hand

- LHR Left Hand Reverse
- RHR Right Hand Reverse

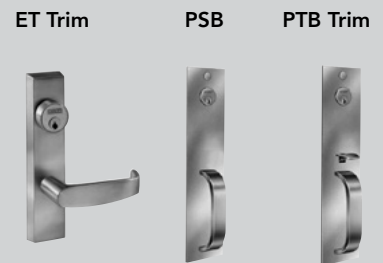
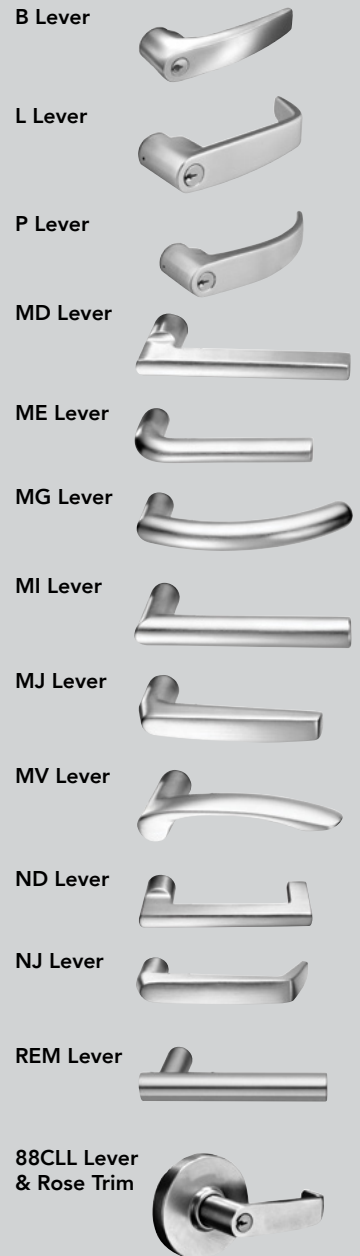

Exit Devices

\* Specify 12V or 24V when ordering solenoid operated ET Trim

\*\* WS is available for single hollow metal door applications for 1-3/4" thick doors, 3'0" x 7'0" max doors.

# Exit Devices

## 8800 Series Device - Trim Only

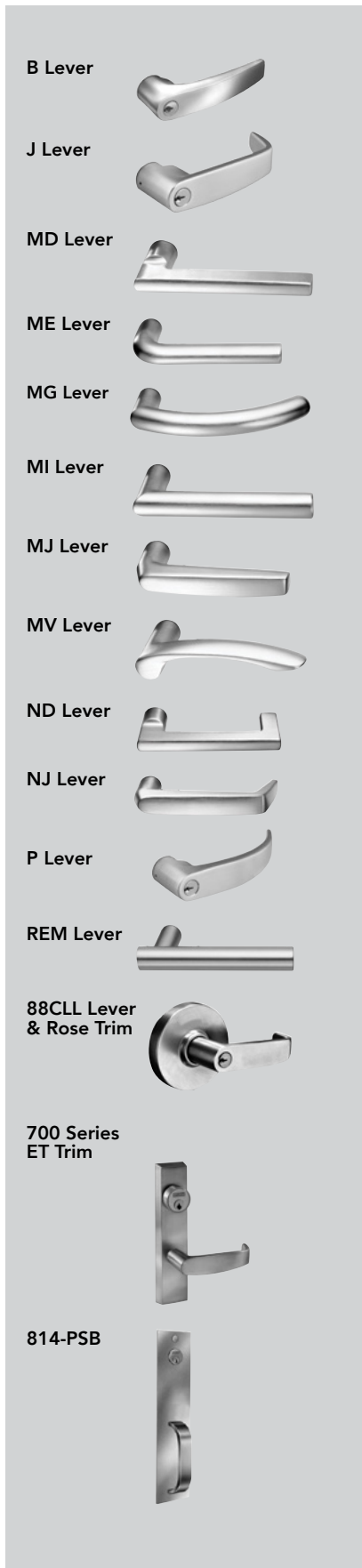

Program	Options	Trim Functions	Levers	Finishes
24-Hour	KD	713-8 ET	L	26D
1-Week	60, 70, KD, LC, SC,	704 ET, 710 ET, 713-8 ET, 715-8 ET, 773-8 ET, 774-8 ET, 775-8 ET, 776-8 ET	B, J, L, P	10B, 10BE, 26D
2-Week	-	814-PSB, 88CLL	-	03, 10, 10B, 10BE, 26D

### Cylinder Options

- 60 Disposable Construction Core
- 70 Interchangeable Core Disposable Plug
- KD Keyed Different
- LC Less Cylinder
- SC Schlage "C" Keyway

### Finishes

- 03 Bright Brass
- 10 Dull Bronze
- 10B Oxidized Dull Bronze
- 10BE Dark Oxidized Satin Bronze - Equivalent
- 32D Dull Stainless

### Functions

- 704ET Key Retracts Latch
- 710ET Pull Only No Cylinder
- 713-8ET Key Locks/Unlocks Lever
- 715-8ET Passage Only
- 773-8 ET Fail Safe Power Off, Unlocks Lever (No Cylinder)
- 774-8 ET Fail Secure Power Off, Locks Lever (No Cylinder)
- 775-8 ET Fail Safe Power Off, Unlocks Lever, Key Retracts Latched
- 776-8 ET Fail Secure Power Off, Locks Lever, Key Retracts Latch
- 88CLL Key Locks/Unlocks Trim
- 814-PSB Key Retracts Latchbolt (04 Function)

### Hand

- LHR Left Hand Reverse
- RHR Right Hand Reverse

### Voltage

- 12V
- 24V

*Note: Electrified products have a total maximum quantity of 50 locks per order  
LA is the standard SARGENT keyway and all cylinders will be 1-bitted unless KD is specified.*

*710ET and 715-8ET are non cylinder functions*

# Exit Devices

## 8700 Series



**8700 Surface Vertical Rod**



**NB8700 Top Latch Surface Vertical Rod**

The SARGENT 8700 Series Surface Vertical Rod Exit Device has two point latching (top and bottom of the door) and is adjustable through the center case.

Program	Options	Functions	Rail	Escutcheon	Lever	Finishes
1-Week	12, 14, 16, 43, 55, 56, 60, 70, KD, LC, NB, SC	8706, 8710, 8713, 8715, 8763, 8773, 8774	F, G, J	ET, PTB, No Trim*	B, J, L, P, MD, ME, MG, MI, MJ, MV, ND, NJ, REM (32D only)	10B, 10BE, 32D
2-Week						03, 10, 10B, 10BE, 32D

### Cylinder Options

- 60 Disposable Construction Core
- 70 Interchangeable Core Disposable Plug
- KD Keyed Different
- LC Less Cylinder
- SC Schlage "C" Keyway

### Options

- 12 Fire Rated
- 14 Solid Brass Bottom Bolt
- 16 Cylinder Dogging
- 43 Flush End Cap
- NB Less Bottom Bolt (Not available with PTB Trim)
- 55 Request to Exit
- 56 Electric Latch Retraction

### Opening Height

(Center Line of Exit Device is 41" AFF)

- 84"
- 96"

Note: Electrified products have a total maximum quantity of 50 locks per order

LA is the standard SARGENT keyway and all cylinders will be 1-bitted unless KD is specified.

Cylinder options are available with 16- option; 06, 13, or 63 function only

12 and 16 options are not available together

14 option is not available with 12- or NB options

12-NB applications require thermal pin. Thermal pin supplied when ordered as a 12-NB device.

ET trims are supplied in 26D, in lieu of 32D

\* Available on 8710 only

### Hand

- LHR Left Hand Reverse
- RHR Right Hand Reverse

### Function

- 8706 (ANSI 09) Key allows Lever to Retract Bolts With ET Trim
- 8710 (ANSI 01) Exit Only No Outside Trim
- 8710 (ANSI 02) Exit Only with PTB or ET Trim
- 8713 (ANSI 08) Key Locks/Unlocks Trim with ET Trim
- 8715 (ANSI 14) Passage Only with ET Trim
- 8763 (ANSI 05) Key Locks/Unlocks PTB Trim
- 8773 Fail Safe
- 8774 Fail Secure

### Finishes

- 03 Bright Brass
- 10 Dull Bronze
- 10B Oxidized Dull Bronze
- 10BE Dark Oxidized Satin Bronze - Equivalent
- 32D Dull Stainless

### Rail

- F 33" - 36" (84cm - 91cm)  
(No cutting required for 36" (91 cm) door)
- G 43" - 48" (110cm - 122cm)  
(No cutting required for 48" (122 cm) door)
- J 37" - 42" (94cm - 107cm)  
(No cutting required for 42" (107cm) door)

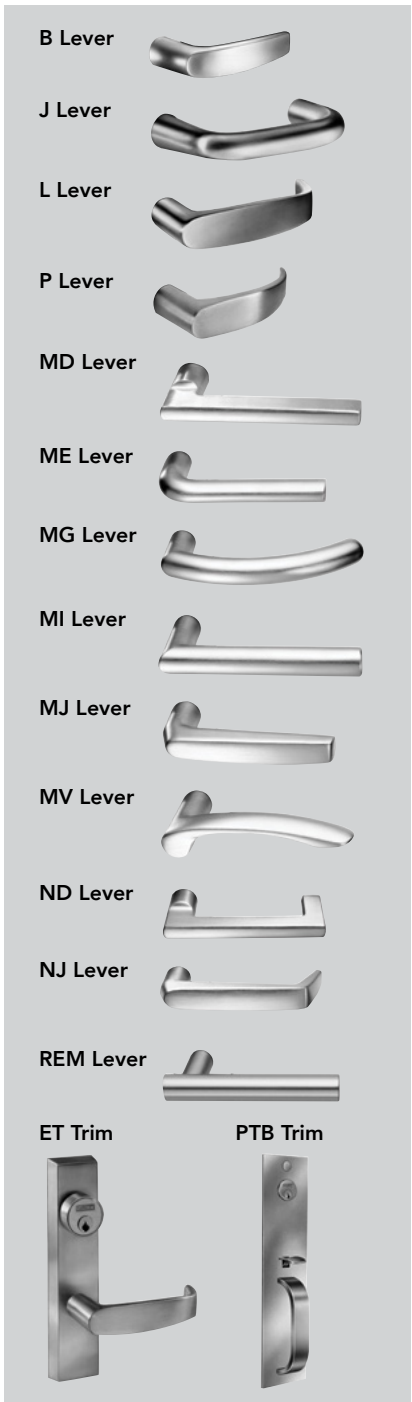

Exit Devices

# Exit Devices

## AD8600 & MD8600 Series

The AD8600/NB-AD8600 and MD8600 Series are designed for standard width single or double aluminum or metal doors. The AD Series and the MD Series Concealed Rod Exit Devices meet ANSI/BHMA Grade 1 standards.

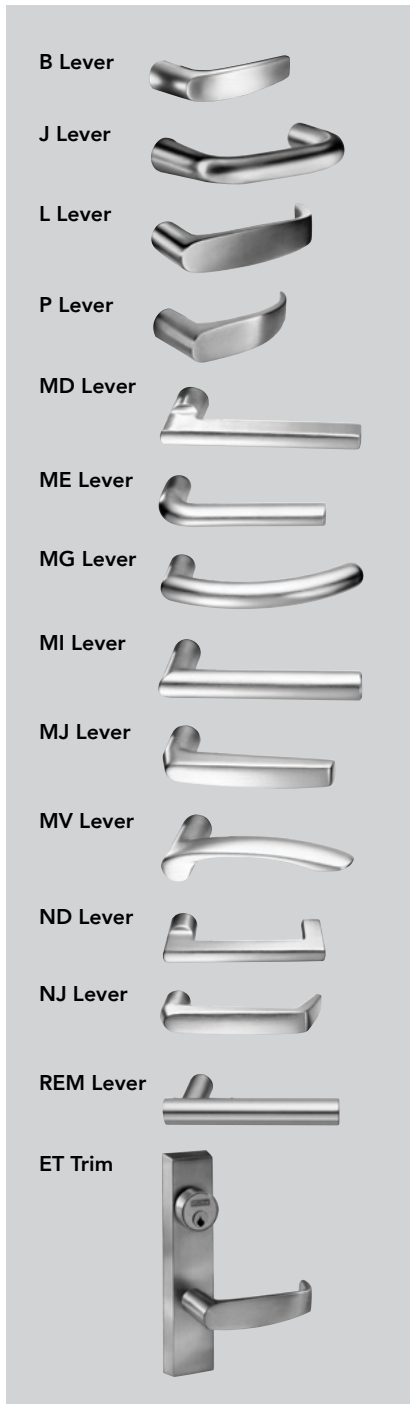

### AD8600

Program	Options	Functions	Rail	Escutcheon	Lever	Finishes
1-Week	16, 43, 60, 70, KD, LC, NB, SC, AL, 55, 56	AD8606, AD8610, AD8613, AD8615	F, G, J	ET, No Trim*	B, J, L, P, MD, ME, MG, MI, MJ, MV, ND, NJ, REM (32D only)	10B, 10BE, 32D
2-Week						03, 10, 10B, 10BE, 32D

### MD8600

Program	Options	Functions	Rail	Escutcheon	Trims	Finishes
1-Week	12, 16, 43, 60, 70, KD, LC, NB, SC, AL, 55, 56	MD8606, MD8610, MD8613, MD8615, MD8673, MD8674	F, G, J	ET, No Trim*	B, J, L, P, MD, ME, MG, MI, MJ, MV, ND, NJ, REM (32D only)	10B, 10BE, 32D
2-Week						03, 10, 10B, 10BE, 32D

#### Cylinder Options

- 60 Disposable Construction Core
- 70 Interchangeable Core Disposable Plug
- KD Keyed Different
- LC Less Cylinder
- SC Schlage "C" Keyway

#### Options

- 12 Fire Rated
- 14 Solid Brass Bottom Bolt
- 16 Cylinder Dogging
- 43 Flush End Cap
- NB Less Bottom Bolt
- AL Alarmed Exit
- 55 Request to Exit
- 56 Electric Latch Retraction

#### Rail

- F 33" - 36" (84cm - 91cm)  
(No cutting required for 36" (91 cm) door)
- G 43" - 48" (110cm - 122cm)  
(No cutting required for 48" (122 cm) door)
- J 37" - 42" (94cm - 107cm)  
(No cutting required for 42" (107cm) door)

#### Opening Height

(Center Line of Exit Device is 41" AFF)

- 84"
- 96"

#### Hand

- LHR Left Hand Reverse
- RHR Right Hand Reverse

#### Function

- AD/MD8606 (ANSI 09) Key allows Lever to Retract Bolts with ET Trim
- AD/MD8610 (ANSI 01) Exit Only, No Outside Trim
- AD/MD8610 (ANSI 02) Exit Only with ET Trim
- AD/MD8613 (ANSI 08) Key Locks/Unlocks Trim with ET Trim
- AD/MD8615 (ANSI 14) Passage Only with ET Trim
- MD8673 Electrified ET Trim - Fail Safe Power Off, Unlocks Lever (No Cylinder)
- MD8674 Electrified ET Trim - Fail Secure Power Off, Locks Lever (No Cylinder)

#### Finishes

- 03 Bright Brass
- 10 Dull Bronze
- 10B Oxidized Dull Bronze
- 10BE Dark Oxidized Satin Bronze - Equivalent
- 32D Dull Stainless

Note: Electrified products have a total maximum quantity of 50 locks per order  
LA is the standard SARGENT keyway and all cylinders will be 1-bitted unless KD is specified.

Cylinder options are available with 16- option; 06 or 13 function only

12 and 16 options are not available together

12-NB applications require thermal pin. Thermal pin supplied when ordered as a 12-NB device.

ET trims are supplied in 26D, in lieu of 32D

\* Available on AD8610 & MD8610 only

# Exit Devices

## 8500 & AD8500 Series



The 8500 Series Narrow Design Rim Exit Device is designed for narrow stile applications and features a rim bolt for quiet operation and security.

Program	Options	Functions	Rail	Escutcheon	Lever	Finishes
1-Week	12, 16, 43, 60, 70, KD, LC,	8504, 8510, 8513, 8573, 8574, AD8504,	F, G, J	ET, No Trim*	B, J, L, P, MD, ME, MG, MI, MJ, MV, ND, NJ, REM (32D only)	10B, 10BE, 32D
2-Week	SC, AL, 55, 56	AD8510, AD8513				03, 10, 10B, 10BE, 32D

### Cylinder Options

- 60 Disposable Construction Core
- 70 Interchangeable Core Disposable Plug
- KD Keyed Different
- LC Less Cylinder
- SC Schlage "C" Keyway

### Mechanical Options

- 12 Fire Rated
- 16 Cylinder Dogging
- 43 Flush End Cap
- AL Alarmed Exit
- 55 Request to Exit
- 56 Electric Latch Retraction

### Hand

- LHR Left Hand Reverse
- RHR Right Hand Reverse

### Rail

- F 33" - 36" (84cm - 91cm)  
(No cutting required for 36" (91 cm) door)
- G 43" - 48" (110cm - 122cm)  
(No cutting required for 48" (122 cm) door)
- J 37" - 42" (94cm - 107cm)  
(No cutting required for 42" (107cm) door)

### Exit x Function

- 8504 (ANSI 03) Key allows Lever to Retract Bolts With ET Trim
- 8510 (ANSI 01) Exit Only No Outside Trim
- 8510 (ANSI 02) Exit Only with ET Trim
- 8513 (ANSI 08) Key Locks/Unlocks Trim with ET Trim
- 8573 Electrified ET Trim - Fail Safe Power Off, Unlocks Lever (No Cylinder)
- 8574 Electrified ET Trim - Fail Secure Power Off, Locks Lever (No Cylinder)

### Finishes

- 03 Bright Brass
- 10 Dull Bronze
- 10B Oxidized Dull Bronze
- 10BE Dark Oxidized Satin Bronze - Equivalent
- 32D Dull Stainless

*Note: Electrified products have a total maximum quantity of 50 locks per order*

*LA is the standard SARGENT keyway and all cylinders will be 1-bitted unless KD is specified.*

*Cylinder options are available with 16- option; 04 or 13 function only*

*ET trims are supplied in 26D, in lieu of 32D*

*\* Available on 8510 and AD8510 only*

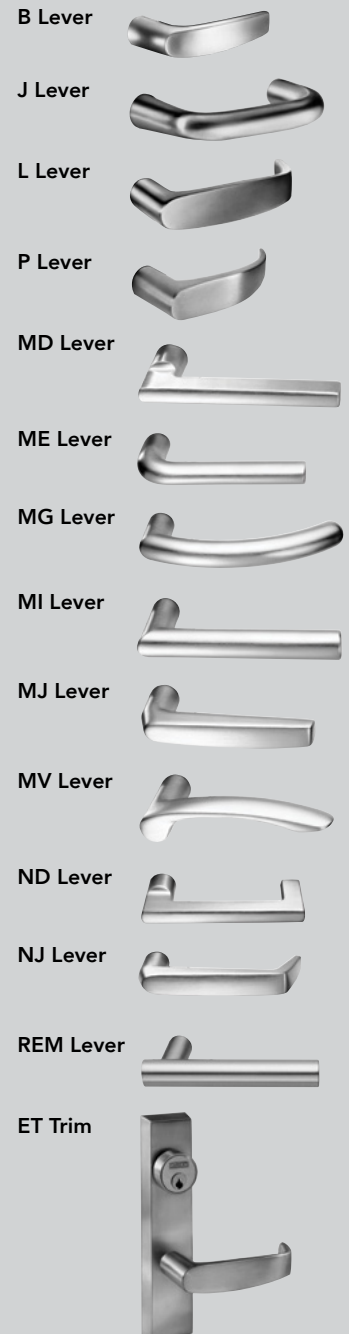

# Exit Devices

## AD8400/MD8400 Series

The AD8400 and MD8400 Series are designed for narrow width single or double aluminum or metal doors. The AD Series and the MD Series Concealed Rod Exit Devices meet ANSI/BHMA Grade 1 standards.



### 106 Auxiliary Control



### 862 Pull

Program	Options	Exit Device	Rail	Trims	Finishes
1-Week	16, 43, 60, 70, KD, LC, NB, SC, AL, 12-MD, 55, 56	AD8410, MD8410	F, G, J	106 x 862 Pull, 862 Pull, No Trim	10BE, 10B, 32D
2-Week					03, 10 10B, 10BE, 32D

#### Cylinder Options

- 60 Disposable Construction Core
- 70 Interchangeable Core Disposable Plug
- KD Keyed Different
- LC Less Cylinder
- SC Schlage "C" Keyway

#### Mechanical Options

- 16 Cylinder Dogging
- 43 Flush End Cap
- NB Less Bottom Bolt
- AL Alarmed Exit
- 55 Request to Exit
- 56 Electric Latch Retraction

#### Hand

- LHR Left Hand Reverse
- RHR Right Hand Reverse

#### Opening Height

(Center Line of Exit Device is 41" AFF)

- 84"
- 96"

#### Trims

- 106 Aux Control x 862 Pull (ANSI 12) Key allows Turn to Retract Bolts
- 862 Pull (ANSI 02) Pull Only, No O/S Operation
- No Trim Exit Only (ANSI 01)

#### Finishes

- 03 Bright Brass
- 10 Dull Bronze
- 10B Oxidized Bronze, Oil-Rubbed
- 10BE Dark Oxidized Satin Bronze - Equivalent
- 32D Satin Stainless Steel

#### Rail

- F 33" - 36" (84cm - 91cm) (No cutting required for 36" (91 cm) door)
- G 43" - 48" (110cm - 122cm) (No cutting required for 48" (122 cm) door)
- J 37" - 42" (94cm - 107cm) (No cutting required for 42" (107cm) door)

Note: Electrified products have a total maximum quantity of 50 locks per order

LA is the standard SARGENT keyway and all cylinders will be 1-bitted unless KD is specified.

Cylinder options are available with 16- option or 106 Aux Control only

12-NB applications require thermal pin. Thermal pin supplied when ordered as a 12-NB device.

# Exit Devices

## 30 Series Exit Device

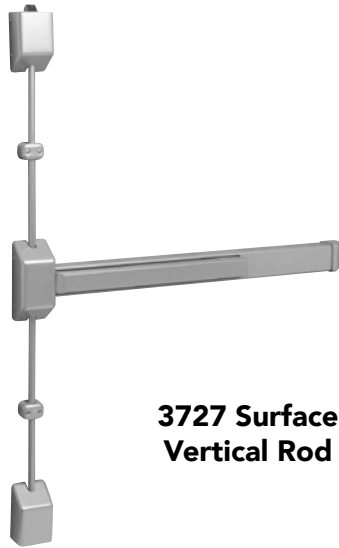

**3727 Surface Vertical Rod**



**3828 Rim Exit Device**

The 3727 and 3828 Series are rugged exit devices in a surface vertical rod and rim design with 4 available trims and is easy to mix and match the device and trim.

Program	Options	Exit Device	Rail	Finishes
24-Hour	-	3828	F	EN
1-Week	12-	3828, 3727	F, G, J	EB, EN

### Cylinder Options

- 12 Fire Rated
- 21 Construction Keying (Lost Ball)
- KD Keyed Different
- LC Less Cylinder
- SC Schlage "C" Keyway

### Finishes

- EB Bronze Enamel to match 10B (814HTB Only)
- EN Aluminum Enamel (814HTB Only)

### Opening Height

(Center Line of Exit Device is 41" AFF)

- 84"
- 96"

### Rail

- F 33" - 36" (84cm - 91cm)  
(No cutting required for 36" (91 cm) door)
- G 43" - 48" (110cm - 122cm)  
(No cutting required for 48" (122 cm) door)
- J 37" - 42" (94cm - 107cm)  
(No cutting required for 42" (107cm) door)

### Function

- 3828 Rim
- 3827 Surface Vertical Rod

### Hand

- LHR Left Hand Reverse
- RHR Right Hand Reverse

Note:

12 and 16 options are not available together

LA is the standard SARGENT keyway and all cylinders will be 1-bitted unless KD is specified



# Exit Devices

## 30 Series Trim

The 3727 and 3828 Series are rugged exit devices in a surface vertical rod and rim design with 4 available trims and is easy to mix and match the device and trim.



Program	Options	Trim	Finishes
24-Hour	KD	28CLL, 28COB, 814HTB	26D
1-Week	KD, LC, SC		10B, 10BE, 26D

### Cylinder Options

- KD Keyed Different
- LC Less Cylinder
- SC Schlage "C" Keyway

### Function

- 28CLL 13 Function
- 28COB 13 Function (Key locks/unlocks knob)
- 814HTB 04 Function (Key retracts latch)

### Finishes

- 10B Oxidized Dull Bronze
- 10BE Dark Oxidized Satin Bronze - Equivalent
- 26D Satin Chrome
- EB Bronze Enamel to match 10B (814 HTB only)
- EN Aluminum Enamel (814HTB only)

Note:

814HTB (EB & EN only) for 3828 only

Exit Devices

# Exit Devices

## 90 Series



The 90 Series cross bar exit device is for single door and pairs of doors where a narrow stile application is required.

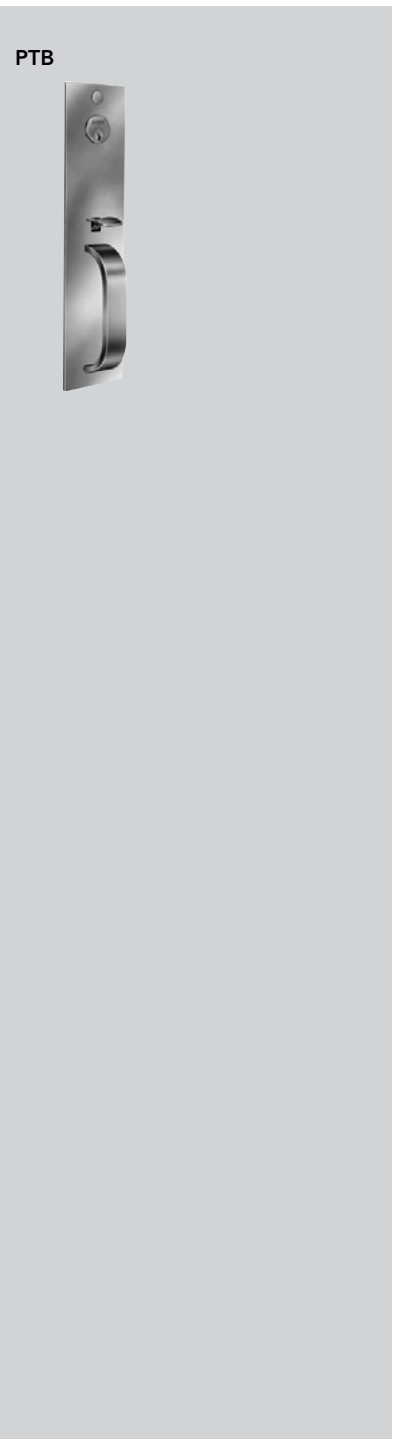

Program	Options	Trim/Function	Finishes
24-Hour	KD	814-PTB, 810-PTB, 866-PTB	26D
1-Week	KD, SC, 60, 70, LC		
2-Week			10, 26D

Program	Function	Finishes
24-Hour	9898	32D
1-Week		
2-Week		10, 32D

Exit  
Devices

### Cylinder Options

- 60 Disposable Construction Core
- 70 Interchangeable Core Disposable Plug
- KD Keyed Different
- LC Less Cylinder
- SC Schlage "C" Keyway

### Finishes

- 10 Dull Bronze
- 26D Satin Chrome

### Hand

- LHR Left Hand Reverse
- RHR Right Hand Reverse

### Device

9898 Multifunction Rim Crossbar\*

### Trim Function

- 814-PTB Trim 04 (ANSI 03) Night Latch Key Retracts Latch
- 810-PTB Pull 10 (ANSI 02) Dummy Trim No O/S Operation Pull Only
- 866-PTB Trim 63 (ANSI 05) Entry Lock Key Locks/Unlocks Thumb Piece

Note: LA is the standard SARGENT keyway and all cylinders will be 1-bitted unless KD is specified

\* Device supplied for up to 44" wide doors

# Exit Devices

## 7000 Series

The 7000 is perfect for a wide variety of applications including conference rooms, commercial office buildings, convention centers, upscale condominiums, medical and educational institutions where exit devices are not required.

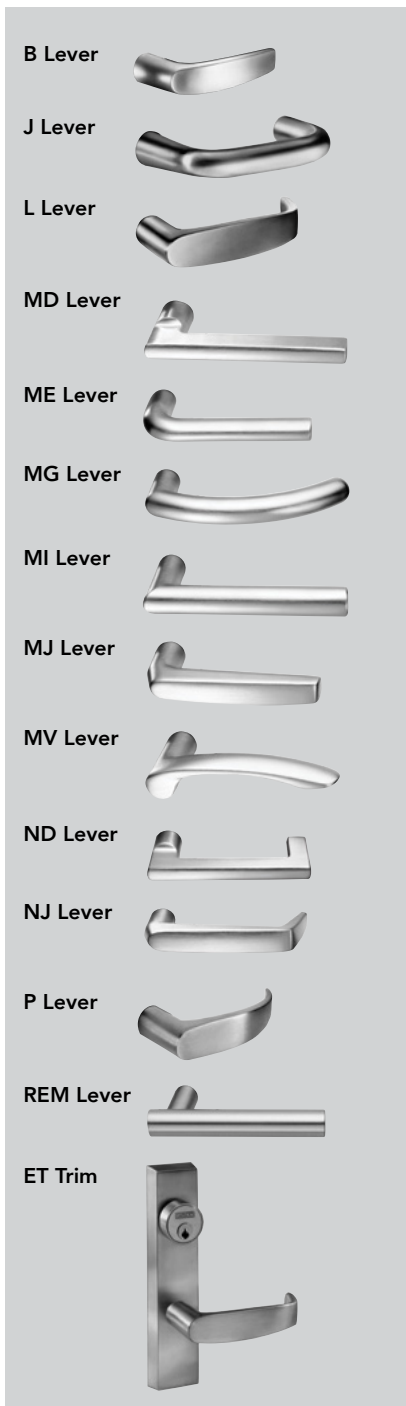

Program	Options	Exit Device	Escutcheon	Lever	Finishes
1-Week & 2-Week	60, 70, KD, LC	700615, 701015, 701313, 701315, 701515, 707415	ET	B, J, L, P, MD, ME, MG, MI, MJ, MV, ND, NJ, REM (32D only)	26D

### Options

- 60 Disposable Construction Core
- 70 Interchangeable Core Disposable Plug
- KD Keyed Different
- LC Less Cylinder

### Finishes

- 26D Satin Chrome

### Opening Height

(Center Line of Exit Device is 41" AFF)

- 84"
- 96"

Note: Maximum quantity of 25 units per order

### Functions

- 700615 Key unlocks Trim; Trim retracts latch; Trim relocks when key is removed
- 701015 No outside Operation (No Cylinder); Pull Only
- 701313 Class Room Key Outside Unlocks/locks Trim; #41 Cylinder Supplied
- 701315 Class Room Key Outside Unlocks/locks Trim; #41 Cylinder Supplied
- 701515 Passage only (No cylinder)
- 707415 Electrified Trim - Fail Secure

### Hand

- RHR Right Hand Reverse
- LHR Left Hand Reverse

Exit Devices

# Exit Devices

## Mullions

Program	Mullion
24-Hour	980, 12-980
1-Week	650A, 980, L980, 980S, 12-980, L980S, 12-L980, HC980, 12-HC980, HCL980, 12-HCL980
2-Week	650A, 980, L980, 980S, 12-980, L980S, 12-L980, L980S, 12-L980, HC980, 12-HC980, HCL980, 12-HCL980

Note: 12 option refers to fire rated

### Aluminum Mullions

Product	650A	980	L980
Description	Removable	Removable	Removable
Material	Aluminum	Aluminum	Aluminum
Standard Finish	US28/Satin Anodized Aluminum	Prime Coat	Prime Coat
Size	96"	96"	96"
Preprepped	658 Strikes Included	No	No
Cylinder kit	Not Required	Not Required	980C1
Shape	1-1/2" x 2-1/2"	T Shaped 2-1/2" x 3"	T Shaped 2-1/2" x 3"
Misc Info & Accessories	Includes 651 Stabilizers and imbedded Weather Stripping Top Retainer 94-2050 Bottom Retainer 94-2051	Top Retainer - 511 Bottom Retainer - 502	Cylinder options: KD, LC, SC, 60, 70 Wall Mount Kit 98-2578 Top Ret Pack 98-2526 Bottom Ret Pack 98-2525

SARGENT offers aluminum, steel and electrified mullions for use in a multitude of applications.

#### 650A Mullion

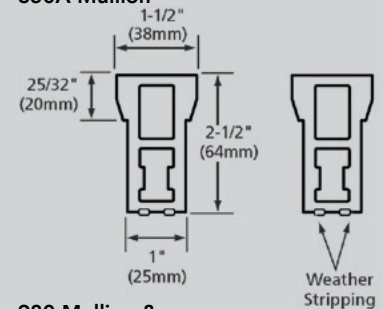

#### 980 Mullion & L980 Lockable Mullion

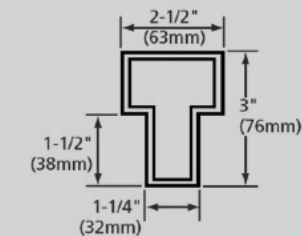

#### 980S/HC980/12-HC980 Mullion Application

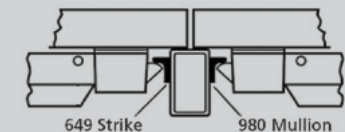

#### L980S, HCL980, 12-HCL980 Lockable Mullions

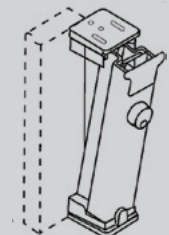

Exit Devices

### Steel Mullions

Product	HC980	980S	12-HC980	L980S	HCL980	12-HCL980
Description	Hurricane Code	Standard Mullion	Fire Rated Hurricane Code	Lockable	Lockable Hurricane Code	Fire Rated - Lockable Hurricane Code
Material	Steel	Steel	Steel	Steel	Steel	Steel
Std Finish	Gray Paint	Gray Paint	Gray Paint	Gray Paint	Gray Paint	Gray Paint
Size	96"	96"	96"	96"	96"	96"
Preprepped	No	No	No	No	No	No
Cylinder kit	Not Required	Not Required	Not Required	980C1	980C1	980C1
Shape	Rectangular 2' x 3"	Rectangular 2' x 3"	Rectangular 2' x 3"	Rectangular 2' x 3"	Rectangular 2' x 3"	Rectangular 2' x 3"
Misc Info	Designed for severe wind load conditions due to hurricanes or windstorms. Tested to Dade County Protocols & ASTM Standards	For 12-8800 - Channel Iron & Malleable iron top & bottom retainers.	Designed or severe wind load conditions due to hurricanes or tornadoes. Tested to Dade County protocols and ANSI 250.13 ASTM Standards and FEMA 361	Fire rated for 8'0" x 8'0" paired openings	See Notes Below	12-HD980 is for pair of doors over 8'0" to 10'0" for use with 12-8800 Rim Exits includes two piece strikes
Accessories	Top Ret Pack - 98-2599 Bottom Ret Pack - 98-2600 Top Retainer Shim Kit - 601	Top Ret Pack - 98-2190 Bottom Ret Pack - 98-2191 Top Retainer Shim Kit - 601	Top Ret Pack - 98-2599 Bottom Ret Pack - 98-2600 Top Retainer Shim Kit - 601	Wall Mounting Kit - 98-2579 Top Ret Pack - 98-2559 Bottom Ret Pack - 98-2556 Top Retainer Shim Kit - 601 Cylinder Kit - 980C1*	Bottom Ret Pack - 98-2594 Top Retainer Shim Kit - 601 Cylinder Kit - 980C1*	Top Ret Pack - 98-2599 Bottom Ret Pack - 98-2600 Top Retainer Shim Kit - 601

# Exit Devices

## 550 Series & 5800 Series

SARGENT's line of exit alarms is designed to signal a violation when a door is misused for authorized exit or passage. The 550 Series provides alarm indication with no locking function.

SARGENT's 5800 Series Alarmed Exit Devices are designed for areas requiring a stand-alone alarm on outward swinging doors. This device has an integrated alarm to discourage the unauthorized use of emergency exit doors.



**550 Series Alarm**



**5800 Alarmed Exit**

28CLL



28COB



28KOB



28KGTB



### 550 Series Alarm

Program	Option	Exit Device/ Exit Alarm	Rail Size	Exit Finish
1-Week & 2-Week	-	550	-	EB & EN

### 5800 Series Exit Device

Program	Option	Exit Device/ Exit Alarm	Rail Size	Exit Finish
1-Week & 2-Week	12-	5804, 5810 & 5813	F, J & G	EB & EN

### Trim for 5800 Series Exit Alarm

Program	Options	Function	Trim	Trim Finish
24-Hour	KD	04, 10, 13	28KGTB (EN Only), 28COB	26D
1-Week, 2-Week	KD, *SC, LC		28KOB, 28COB & 28DLL	10B, 26D
			28KGTB, 28DGTB	EN

#### Options

12	Fire Rated
KD	Keyed Different
SC	Schlage "C" Keyway
LC	Less Cylinder

#### Functions (5800 Series Only)

04	(ANSI 03) Night Latch Key Retracts Latch
10	(ANSI 02) Dummy Trim No Outside Operation
13	(ANSI 08) Entrance Lock Key Locks/Unlocks Trim

#### Finishes

EN	Aluminum Enamel to Match US28
EB	Bronze Enamel to Match US10B
10B	Oxidized Dull Bronze
26D	Satin Chrome

#### Hand

RHR	Right Hand Reverse
LHR	Left Hand Reverse

#### Rail

F	33" - 36" (84cm - 91cm)
G	43" - 48" (110cm - 122cm)
J	37" - 42" (94cm - 107cm)

Note: Electrified products have a total maximum quantity of 50 locks per order

# Exit Devices

## 80 Series Parts

Program	Part #	Description	Finishes
24-Hour	01-0098	Retaining Clip	Standard
	01-0610	Wave Spring Washer Standard	
	68-0405	8700 Chassis Cover	3, 10, 10B, 32D
	68-0406	8800 Chassis Cover	
	68-0407	8600 & 8900 Chassis Cover	
	68-0561	Plastic End Cap	Black
	68-2279	Through-bolt Pack - Rail & Chassis (86,87,88,89)	3, 10, 10B, 26D
	68-2282	Through-bolt Pack - Cases & Guides (87)	
	68-2288	Through-bolt Pack - 12-8700	
	68-2596	Hex Key Dogging Kit	Standard
	68-2695	F Rail Assembly - Wide	32D
	68-2696	G Rail Assembly - Wide	
	68-2697	J Rail Assembly - Wide	
	68-2703	12- F Rail Assembly - Wide	
	68-2704	12-G Rail Assembly - Wide	
	68-2705	12-J Rail Assembly - Wide	
	68-3023	Screw Pack 12-8700	26D
	68-3671	ET Spindle Adapters (Square spindle to cross shaped -8)	Standard
	97-0001	Hex Dogging Key	
	97-0020	Rod Guides	3, 10, 10B, 32D
	97-0052	End Cap Screws (Cover)	Standard
	97-0349	16-Collar (for rail Lockdown)	26D
	565	Metal End Cap Kit	32D
	571-12	12" Rod Ext . Kit for 9700/2700/8700 (mfg prior 11/02)	3, 10, 10B, 32D
	571-18	18" Rod Ext . Kit for 9700/2727/8700 (mfg prior 11/02)	
	571-6	6" Rod Ext . Kit for 9700/2700/8700 (mfg prior 11/02)	
	644	Strike - Surface or Double door strike for 2828 & 8800	Black Nylon
	649	Strike - Standard for 12-2828, 12-5800, 12-8800, 12-9800	
	650	Top Strike	
	665	Flush End Cap	32D
	687-12	Top Rod for 8700 41" AFF - 96" Door (new style 8700's), PP/PR/SP8700	03, 10, 10B, 32D
	687-18	Top Rod for 8700 41" AFF - 102" Door (new style 8700's), PP/PR/SP8700	
	687-6	Top Rod for 8700 41" AFF - 90" Door (new style 8700's), PP/PR/SP8700	
	809	Lexan Touchpad Kit	Black
	815	Open Back Strike - LHR	Black Nylon
	815	Open Back Strike - RHR	

Program	Part #	Description	Finishes
1-Week & 2-Week	01-0098	Retaining Clip	Standard
	01-0610	Wave Spring Washer Standard	
	68-0405	8700 Chassis Cover	3, 10, 10B, 32D
	68-0406	8800 Chassis Cover	
	68-0407	8600 & 8900 Chassis Cover	
	68-0561	Plastic End Cap	Black
	68-2279	Through-bolt Pack - Rail & Chassis (86,87,88,89)	3, 10, 10B, 26D
	68-2282	Through-bolt Pack - Cases & Guides (87)	
	68-2288	Through-bolt Pack - 12-8700	
	68-2596	Hex Key Dogging Kit	Standard
	68-2695	F Rail Assembly - Wide	3, 10, 10B, 32D
	68-2696	G Rail Assembly - Wide	
	68-2697	J Rail Assembly - Wide	
	68-2703	12- F Rail Assembly - Wide	
	68-2704	12-G Rail Assembly - Wide	
	68-2705	12-J Rail Assembly - Wide	
	68-3023	Screw Pack 12-8700	3, 10, 10B, 26D
	68-3671	ET Spindle Adapters (Square spindle to cross shaped -8)	Standard
	97-0001	Hex Dogging Key	
	97-0020	Rod Guides	3, 10, 10B, 32D
	97-0052	End Cap Screws (Cover)	Standard
	97-0349	16-Collar (for rail Lockdown)	26D
	97-0579	Holdback Spring for Top Case	Standard
	565	Metal End Cap Kit	3, 10, 10B, 32D
	571-12	12" Rod Ext . Kit for 9700/2700/8700 (mfg prior 11/02)	
	571-18	18" Rod Ext . Kit for 9700/2727/8700 (mfg prior 11/02)	
	571-6	6" Rod Ext . Kit for 9700/2700/8700 (mfg prior 11/02)	
	576	12-Bottom Pullman Bolt Conversion Kit (8700)	Standard
	587	Shim Kit (8700)	EN
	589	Shim Kit (8800, 12-8800, 8910 & 12-8910 Function)	
	644	Strike - Surface or Double door strike for 2828 & 8800	Black Nylon
	649	Strike - Standard for 12-2828, 12-5800, 12-8800, 12-9800	
	650	Top Strike	
	665	Flush End Cap	
	809	Lexan Touchpad Kit	Black

# Exit Devices

## 80 Series Parts

Program	Part #	Description	Finishes
1-Week & 2-Week	687-12	Top Rod for 8700 41" AFF - 96" Door (new style 8700's), PP/PR/SP8700	03, 10, 10B, 32D
	687-18	Top Rod for 8700 41" AFF - 102" Door (new style 8700's), PP/PR/SP8700	
	687-6	Top Rod for 8700 41" AFF - 90" Door (new style 8700's), PP/PR/SP8700	
	730-1	700 Series Spindle Kit - 1-3/4" Door	Standard
	730-2	700 Series Spindle Kit - 2" Door	
	730-3	700 Series Spindle Kit - 2-1/4" Door	
	730-7	700-8 Series Spindle Kit - 1-3/4" Door	
	730-8	700-8 Series Spindle Kit - 2" Door	
	730-9	700-8 Series Spindle Kit - 2-1/4" Door	
	815	Open Back Strike - LHR	
	815	Open Back Strike - RHR	
	816-1	Cylinder Dogging Kits - w/ Wide Stile F size rail	3, 10, 10B, 32D
	816-2	Cylinder Dogging Kits - w/ Narrow Stile E, F size rail	
	816-3	Cylinder Dogging Kits - w/ Wide Stile G size rail	



# Exit Devices

## 90 Series Parts

Program	Part #	Description	Finishes
24-Hour	01-0098	Retaining Clip	Standard
	01-0610	Wave Spring Washer	
	68-0561	Plastic End Cap	Black
	68-2279	Through-bolt Pack - Rail & Chassis (86,87,88,89)	26D
	68-2282	Through-bolt Pack - Cases & Guides (87)	
	68-2288	Through-bolt Pack - 12-8700	
	68-2596	Hex Key Dogging Kit	Standard
	68-2695	F Rail Assembly - Wide	32D
	68-2696	G Rail Assembly - Wide	
	68-2697	J Rail Assembly - Wide	
	68-2703	12- F Rail Assembly - Wide	
	68-2704	12-G Rail Assembly - Wide	
	68-2705	12-J Rail Assembly - Wide	
	68-3023	Screw Pack 12-8700	26D
	68-3671	ET Spindle Adapters (Square spindle to cross shaped -8)	Standard
	97-0001	Hex Dogging Key	
	97-0020	Rod Guides	3, 10, 10B, 32D
	97-0052	End Cap Screws (Cover)	Standard
	97-0349	16-Collar (for rail Lockdown)	26D
	98-2159	Bolt Spring & Bracket Assembly	Standard

# Exit Devices

## 90 Series & 30 Series Parts

Exit  
Devices

Program	Part #	Description	Finishes
1-Week & 2-Week	01-0098	Retaining Clip	Standard
	01-0610	Wave Spring Washer	
	68-0405	8700 Chassis Cover	3, 10, 10B, 32D
	68-0406	8800 Chassis Cover	
	68-0407	8600 & 8900 Chassis Cover	
	68-0561	Plastic End Cap	Black
	68-2279	Through-bolt Pack - Rail & Chassis (86,87,88,89)	3, 10, 10B, 26D
	68-2282	Through-bolt Pack - Cases & Guides (87)	
	68-2288	Through-bolt Pack - 12-8700	
	68-2596	Hex Key Dogging Kit	Standard
	68-2695	F Rail Assembly - Wide	3, 10, 10B, 32D
	68-2696	G Rail Assembly - Wide	
	68-2697	J Rail Assembly - Wide	
	68-2703	12- F Rail Assembly - Wide	
	68-2704	12-G Rail Assembly - Wide	
	68-2705	12-J Rail Assembly - Wide	
	68-3023	Screw Pack 12-8700	3, 10, 10B, 26D
	68-3671	ET Spindle Adapters (Square spindle to cross shaped -8)	Standard
	97-0001	Hex Dogging Key	
	97-0020	Rod Guides	3, 10, 10B, 32D
	97-0052	End Cap Screws (Cover)	Standard
	97-0349	16-Collar (for rail Lockdown)	26D
	97-0579	Holdback Spring for Top Case	Standard
	98-2159	Bolt Spring & Bracket Assembly	
	543	ANSI 161 Adapter Kit	
	544	ANSI 86 Adapter Kit	
	587	Shim Kit (8700)	EN
	589	Shim Kit (8800, 12-8800, 8910 & 12-8910 Function)	

Program	Part #	Description	Finishes
24-Hour, 1-Week & 2-Week	28-2024	3828 TB Pack	10B or 26D
1-Week & 2-Week	28-2031	3727 TB Pack	

# Exit Devices

## Electromechanical Parts & Accessories

### Miscellaneous Accessories

Program	Part #	Description	Finish
24-Hour, 1-Week, 2-Week	807	TL- SARGuide Lamp Repl. Kit	N/A
	32-7044	Tamper Switch & Bracket Assembly for 5100/5800	
	3287	Door Position SPDT Switch (Concealed)	
	547	Retrofit Kit to cover Unican Prep (10L)	26D

### 12 & 24 Volt Power Supplies

Program	Part #	Description
24-Hour, 1-Week, 2-Week	3540	Power Supply 24VDC - 2 AMP
	3541	Power Supply 12VDC - 2 AMP
	737	12VDC-5 Amp Hour Battery Backup
	738	24VDC-5 Amp Hour Battery Backup
	TMR2	Multi-Function Timer 12 or 24 VDC/VAC
	TMR9	Release Hold Timer
1-Week & 2-Week	3520	Power Supply 24VDC - 1 AMP
	3521	Power Supply 12VDC - 1 AMP
	3570	Power Supply 24VDC - 6 AMP
	3571	Power Supply 12VDC - 6 AMP

### 55- Request to Exit Insert Kits

Program	Part #	Description	Finish
24-Hour, 1-Week, 2-Week	855-1	F Wide Insert & Switch Assembly	32D
	855-2	F & E Narrow Insert & Switch Assembly	
	855-4	G Narrow & 8895F Insert Switch Assembly	
1-Week, 2-Week	855-3	G Wide & 8895E Insert Switch Assembly	
	855-5	E Wide Insert Switch Assembly	
	855-6	J Narrow Insert Switch Assembly	
	855-7	J Wide Insert Switch Assembly	
	855-8	8895J & 8895G Wide Insert Switch Assembly	

### 59- Delayed Egress Accessories

Program	Part #	Description	Finish
1-Week, 2-Week	52-2994	59- Circuit Board & Harness Replacement Kit F Rail	N/A
	52-2995	59- Circuit Board & Harness Replacement Kit J Rail	
	52-2996	59- Circuit Board & Harness Replacement Kit G Rail	
	52-2204	Latchbolt Switch Assembly for 59-8500/59-8800	
	52-5052	Electroguard Circuit Board Replacement Kit (59-)	
	68-3784	Rail Assembly for wide stile 12-59-80 Series (F)	

# Exit Devices

## Electromechanical Parts & Accessories

### 56-Electric Latch Retraction Rails & Accessories

Program	Part #	Description	Finish
24-Hour, 1-Week, 2-Week	68-0807	56-80 Series ELR Lift Lever for Devices mfg prior to 2007	N/A
	68-3211	56- Rail Assembly for 80 Series - Wide Stile - 43"-48" (G)	32D
	68-3212	56- Rail Assembly for 80 Series - Wide Stile - 33"-36" (F)	
	68-3213	56- Rail Assembly for 80 Series - Wide Stile - 37"-42" (J)	
	68-3216	56- Rail Assembly for 80 Series - Narrow Stile 43"-48" (G)	
	68-3217	56- Rail Assembly for 80 Series - Narrow Stile 33"-36" (F)	
	68-3218	56- Rail Assembly for 80 Series - Narrow Stile 37"-42" (J)	

### Solenoid for 700 Series ET Trim

Program	Part #	Description
1-Week, 2-Week	52-3287	Solenoid for ET Trim 774 & 776 24VDC (Secure)
	52-3288	Solenoid for ET Trim 774 & 776 12VDC (Secure)
	52-3289	Solenoid for ET Trim 773 & 775 24VDC (Safe)
	52-3290	Solenoid for ET Trim 773 & 775 12VDC (Safe)

### Availability: 56-Electric Latch Retract Push Kits

Program	Options	Push Kit	Rail Size	Finishes
24-Hour	-	M56A, R56A	F	32D
1-Week & 2-Week	19-, 55-, HK-	M56A, M56B, R56A, R56B	F, J & G	03, 10, 10B, 32D

# Auxiliary Locks

## 4870 Series Mortise Deadbolt



The SARGENT 4870 Series Deadbolt is a heavy duty deadbolt that assures safety and security.

### 4870 Series

Program	Options	Functions	Finishes
24-Hour	KD	4875	26D
1-Week 2-Week	KD, SC, 60, 70, LC	4874, 4875, 4877	03, 10, 10B, 10BE, 26, 26D

#### Functions

- 4874 Cylinder O/S & I/S
- 4875 Cylinder O/S & Thumb Turn I/S
- 4877 Cylinder O/S & Thumb Turn I/S;  
Thumb Turn retracts Deadbolt only

#### Cylinder Options

- KD Keyed Different
- SC Schlage "C" Keyway
- 60 Disposable Construction Core
- 70 Interchangeable Core Disposable Plug
- LC Less Cylinder

#### Finishes

- 03 Bright Brass
- 10 Dull Bronze
- 10B Oxidized Dull Bronze
- 26 Bright Chrome
- 26D Satin Chrome
- 10BE Dark Oxidized Satin Bronze -  
Equivalent

# Auxiliary Locks

## 470 & 480 Series Cylindrical Deadbolt

The 470 Series is a medium grade cylindrical deadbolt which meets Grade 2 ANSI 156.5 1000 Series specifications.

The 480 Series is a high grade cylindrical deadbolt which meets ANSI A156.5 Grade 1 requirements.

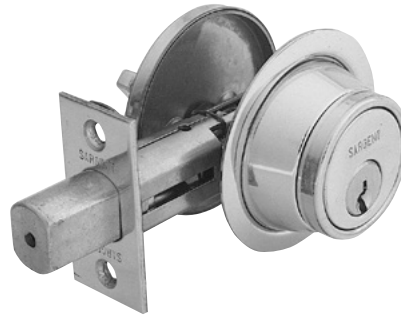

**470 Line**



**480 Line**

### 470 Line

Program	Options	Functions	Finishes
24-Hour	KD	474, 475	26D
1-Week, 2-Week	KD, SC		03, 10, 10B, 10BE, 26D

### 480 Line

Program	Options	Functions	Finishes
1-Week, 2-Week	KD, SC, 20, 60, 70, LC	484, 485, 487, 489	03, 10, 10B, 10BE, 26D

#### Cylinder Options

- KD Keyed Different
- SC Schlage "C" Keyway
- 60 Disposable Construction Core
- 70 Interchangeable Core Disposable Plug
- LC Less Cylinder

#### Options

- 20 for 2-3/8" 160 prep

#### Functions

- 474 Single Cylinder
- 475 Double Cylinder
- 484 Cylinders O/S & I/S
- 485 Cylinder O/S & Thumb Turn I/S
- 487 Cylinder O/S & Thumb Turn I/S; Thumb Turn retracts Deadbolt only
- 489 Turn Lever I/S & Blank Plate O/S

#### Finishes

- 03 Bright Brass
- 10 Dull Bronze
- 10B Oxidized Dull Bronze
- 10BE Dark Oxidized Satin Bronze Equivalent
- 26D Satin Chrome

# Auxiliary Locks

## 758 & 858 Series Padlocks



The 758 padlock is manufactured to the highest quality standard and is available with multiple keyways, allowing use into master keyed systems (6 pin cylinder standard).

### 758, 858 Series

Program	Options	Functions
1-Week, 2-Week	KD, 60	758, 858

#### Functions

- 758 Key retaining. Key removable in locked position only
- 858 Non key retaining. Key can be removed while unlocked and relocked without key

#### Cylinder Options

- KD Keyed Different
- SC Schlage "C" Keyway

# Auxiliary Locks

## Auxiliary Parts

### 480 Line Parts

Program	Part #	Description	Finishes
1-Week, 2-Week	16-2153	Deadbolt Assembly - 2-3/8" BS	03, 04, 10, 10B, 32D
	16-2149	Deadbolt Assembly - 2-3/4" BS	
	16-2201	Screw Packs - 484	03, 04, 10, 10B, 26D
	16-2202	Screw Packs - 485, 486, 487	03, 10, 10B, 26D
	16-2203	Screw Packs - 489	
	16-2039	T-Turns-Inside - 485, 489	03, 26D
	16-2179	T-Turns-Inside - 487	
	16-2460	Dummy Plates-Outside - 489	03, 10, 10B, 26D



# Access Control Keypad Operated Products

## KP Technology



The KP Series Keypad locks are designed for openings that require standalone, basic authorized entry capabilities. They are battery powered, motor driven, self contained locks that use a microprocessor based controller with non-volatile memory. All programming is done at the door using the keypad with functions selected by the user according to opening requirements.

Program	Options	Functions	Trim	Lever	Finishes
1-Week, 2-Week	60, 70, KD, LC	28-KP-10G77	G, L	B, J, L, P	26D

Program	Options	Functions	Trim	Lever	Finishes
1-Week, 2-Week	60, 70, KD, LC	KP-8276, KP-8278	LN	B, J, L, P	26D

Program	Options	Functions	Trim	Lever	Finishes
1-Week, 2-Week	60, 70, KD, LC	KP-8877	ET	B, J, L, P	32D

### Cylinder Options

KD	Keyed Different
60	Disposable Construction Core
70	Interchangeable Core Disposable Plug
LC	Less Cylinder

### Finishes

26D	Satin Chrome
32D	Satin Stainless Steel

Note: Electrified products have a total maximum quantity of 50 locks per order

### Functions

28-KP-10G77	Cylinder override
KP-8276	Cylinder override and deadbolt
KP-8278	Cylinder override and no deadbolt
KP-8877	Deadbolt and no cylinder override

B Lever



J Lever



L Lever



P Lever



G Rose  
(10 Line Only)



L Rose  
(10 Line Only)



LN Rose  
(10 Line Only)



ET Trim



# Access Control Keypad Operated Products

## LK Technology

The SARGENT Profile Series with LK technology are stand-alone access control products that offer a high level of security and flexibility. These products need to be programmed via keypad to gain entry.



B Lever



J Lever



L Lever



P Lever



ET Trim



Program	Options	Functions	Lever	Finishes
1-Week, 2-Week	60, 70, KD, LC	28-LK-10G77	B, J, L, P	26D

Program	Options	Functions	Lever	Finishes
1-Week, 2-Week	60, 70, KD, LC	LK-8276	B, J, L, P	26D

Program	Options	Functions	Escutcheon	Lever	Finishes
1-Week, 2-Week	60, 70, KD, LC	LK-8877	ET	B, J, L, P	32D

### Cylinder Options

KD	Keyed Different
60	Disposable Construction Core
70	Interchangeable Core Disposable Plug
LC	Less Cylinder

### Functions

28-LK-10G77	Cylinder override
LK-8276	Cylinder override and deadbolt
LK-8278	Cylinder override and no deadbolt
LK-8877	Deadbolt and no cylinder override

### Finishes

26D	Satin Chrome
32D	Satin Stainless Steel

Note: Electrified products have a total maximum quantity of 50 locks per order

# Access Control Keypad Operated Products

## v.G1.5 Profile Series Lock



This version of stand-alone access control products offers the highest level of security and flexibility. These products can be programmed via keypad or SoloPlus requiring both a code (1-6 digits) and proximity card/fob/tag presentation to gain entry. It can also be programmed for keypad or proximity presentation only.

Program	Options	Functions	Escutcheon	Lever	Finishes
1-Week, 2-Week	60, 70, KD, LC	28-G1-10G77	PK	B, J, L, P	26D

Program	Options	Functions	Escutcheon	Lever	Finishes
1-Week, 2-Week	60, 70, KD, LC	G1-8276	PK	B, J, L, P	26D

Program	Options	Functions	Escutcheon	Lever	Finishes
1-Week, 2-Week	60, 70, KD, LC	G1-8877	ET	B, J, L, P	32D

### Cylinder Options

- KD Keyed Different
- 60 Disposable Construction Core
- 70 Interchangeable Core Disposable Plug
- LC Less Cylinder

### Finishes

- 26D Satin Chrome
- 32D Satin Stainless Steel

Note: Electrified products have a total maximum quantity of 50 locks per order

### Functions

- 28-G1-10G77 Cylinder override
- G1-8276 Cylinder override and deadbolt
- G1-8278 Cylinder override and no deadbolt
- G1-8877 Deadbolt and no cylinder override

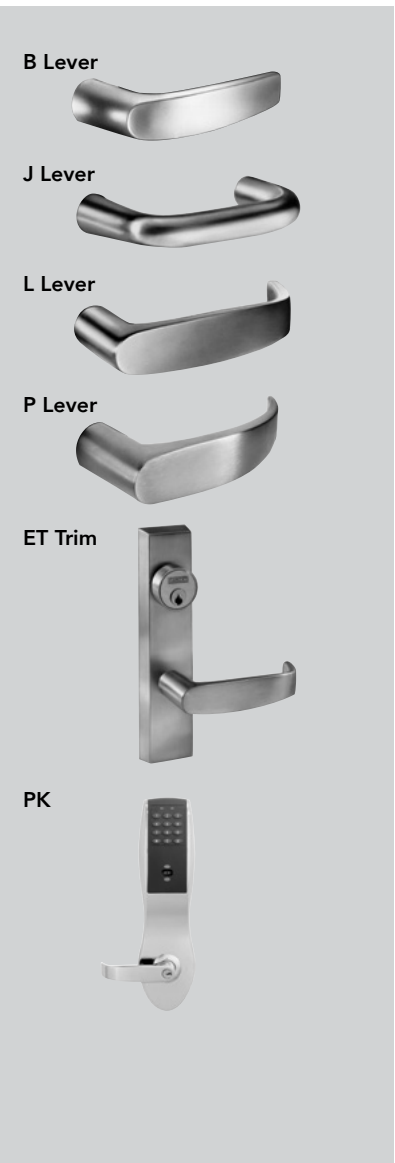

Access  
Control

## Electromechanical Parts and Accessories

### Switches, Keypads, Key Switches & Readers

Program	Part #	Description	Finish
1-Week, 2-Week	4341	Momentary Push Button	32D
	4291	Keypad - Indoor	
	4292	Keypad - Outdoor	
	4301	Card Reader	N/A
	4370	One SPDT Maintain Key Switch	32D
	4371LT	One SPDT, w/2 LED's & Adjustable Time, Momentary Key Switch	
	4375LH	Two SPDT, 2 LED'S, 1 Horn, Momentary Key Switch	

### Keypad Assemblies & Controllers

Program	Part #	Description	Finish
24-Hour, 1-Week, 2-Week	52-2299	Keypad Assembly for KP10G77, KP8200, KP8800, KP8900	N/A
	52-2400	Controller for KP10G77	
	52-2401	Controller for KP8200	
	52-2561	Controller for KP8800/8900 (may need to order ET-consult factory)	

# Order Form - Turboship Cylinders/Keys

**SARGENT**  
**ASSA ABLOY**

THIS FORM IS THE PURCHASE ORDER. DO NOT SEND A COVER P.O.  
DUPLICATED ORDERS CANNOT BE RETURNED.

www.sargentlock.com

## ORDER FAX (800) 906-6606

CUSTOMER P.O. NO. \_\_\_\_\_ DATE \_\_\_\_\_

CUSTOMER \_\_\_\_\_

CUSTOMER ACCT. NO. \_\_\_\_\_

ADDRESS \_\_\_\_\_

CITY \_\_\_\_\_ STATE \_\_\_\_\_ ZIP \_\_\_\_\_

BUYER \_\_\_\_\_ TITLE \_\_\_\_\_

SHIP GOODS TO \_\_\_\_\_

ADDRESS \_\_\_\_\_

ATTN TO \_\_\_\_\_

CITY \_\_\_\_\_ STATE \_\_\_\_\_ ZIP \_\_\_\_\_

SHIP VIA \_\_\_\_\_ STD. SARGENT CARRIER \_\_\_\_\_ (OTHER) \_\_\_\_\_

**24-Hour**

**1-Week**

**2-Week**

FOR EDITING, DO NOT WRITE

**ORD NO.**

Quote # \_\_\_\_\_

Quote # \_\_\_\_\_

- Standard buying program % or quoted discount less 5 points
- Orders shipped within 5 business days
- \$50k net/net maximum order

- Standard buying program % or quoted discount
- Orders ship within 10 business days
- \$50k net/net maximum order

Qty	Cylinder Option	Cylinder Type	Finish

Order  
Forms

# Order Form - Turboship Bored Locks

THIS FORM IS THE PURCHASE ORDER. DO NOT SEND A COVER P.O.  
DUPLICATED ORDERS CANNOT BE RETURNED.

www.sargentlock.com

## ORDER FAX (800) 906-6606

CUSTOMER P.O. NO. \_\_\_\_\_ DATE \_\_\_\_\_

CUSTOMER \_\_\_\_\_

CUSTOMER ACCT. NO. \_\_\_\_\_

ADDRESS \_\_\_\_\_

CITY \_\_\_\_\_ STATE \_\_\_\_\_ ZIP \_\_\_\_\_

BUYER \_\_\_\_\_ TITLE \_\_\_\_\_

SHIP GOODS TO \_\_\_\_\_

ADDRESS \_\_\_\_\_

ATTN TO \_\_\_\_\_

CITY \_\_\_\_\_ STATE \_\_\_\_\_ ZIP \_\_\_\_\_

SHIP VIA \_\_\_\_\_ STD. SARGENT CARRIER \_\_\_\_\_ (OTHER) \_\_\_\_\_

**24-Hour**

**1-Week**

**2-Week**

FOR EDITING, DO NOT WRITE

**ORD NO.**

Quote # \_\_\_\_\_

Quote # \_\_\_\_\_

- Standard buying program % or quoted discount less 5 points
- Orders shipped within 5 business days
- \$50k net/net maximum order

- Standard buying program % or quoted discount
- Orders ship within 10 business days
- \$50k net/net maximum order

Qty	Options	Function	Rose	Lever	Finish	Hand	Voltage

# Order Form - Turboship Door Closers

**SARGENT  
ASSA ABLOY**

THIS FORM IS THE PURCHASE ORDER. DO NOT SEND A COVER P.O.  
DUPLICATED ORDERS CANNOT BE RETURNED.

www.sargentlock.com

**ORDER FAX (800) 906-6606**

CUSTOMER P.O. NO. \_\_\_\_\_ DATE \_\_\_\_\_

CUSTOMER \_\_\_\_\_

CUSTOMER ACCT. NO. \_\_\_\_\_

ADDRESS \_\_\_\_\_

CITY \_\_\_\_\_ STATE \_\_\_\_\_ ZIP \_\_\_\_\_

BUYER \_\_\_\_\_ TITLE \_\_\_\_\_

SHIP GOODS TO \_\_\_\_\_

ADDRESS \_\_\_\_\_

ATTN TO \_\_\_\_\_

CITY \_\_\_\_\_ STATE \_\_\_\_\_ ZIP \_\_\_\_\_

SHIP VIA \_\_\_\_\_ STD. SARGENT CARRIER \_\_\_\_\_ (OTHER) \_\_\_\_\_

**24-Hour**

**1-Week**

**2-Week**

FOR EDITING, DO NOT WRITE

**ORD NO.**

Quote # \_\_\_\_\_

Quote # \_\_\_\_\_

- Standard buying program % or quoted discount less 5 points
- Orders shipped within 5 business days
- \$50k net/net maximum order

- Standard buying program % or quoted discount
- Orders ship within 10 business days
- \$50k net/net maximum order

Qty	Options	Door Closer Type	Arm Type	Finish

# Order Form - Turboship 8200 Mortise Locks

THIS FORM IS THE PURCHASE ORDER. DO NOT SEND A COVER P.O.  
DUPLICATED ORDERS CANNOT BE RETURNED.

**SARGENT**  
**ASSA ABLOY**

www.sargentlock.com

## ORDER FAX (800) 906-6606

CUSTOMER P.O. NO. \_\_\_\_\_ DATE \_\_\_\_\_

CUSTOMER \_\_\_\_\_

CUSTOMER ACCT. NO. \_\_\_\_\_

ADDRESS \_\_\_\_\_

CITY \_\_\_\_\_ STATE \_\_\_\_\_ ZIP \_\_\_\_\_

BUYER \_\_\_\_\_ TITLE \_\_\_\_\_

SHIP GOODS TO \_\_\_\_\_

ADDRESS \_\_\_\_\_

ATTN TO \_\_\_\_\_

CITY \_\_\_\_\_ STATE \_\_\_\_\_ ZIP \_\_\_\_\_

SHIP VIA \_\_\_\_\_ STD. SARGENT CARRIER \_\_\_\_\_ (OTHER) \_\_\_\_\_

**24-Hour**

**1-Week**

**2-Week**

FOR EDITING, DO NOT WRITE

**ORD NO.**

Quote # \_\_\_\_\_

Quote # \_\_\_\_\_

- Standard buying program % or quoted discount less 5 points
- Orders shipped within 5 business days
- \$50k net/net maximum order

- Standard buying program % or quoted discount
- Orders ship within 10 business days
- \$50k net/net maximum order

Qty	Options	Function	Trim	Lever	Finish	Hand	Voltage

Order Forms



# Order Form - Turboship Exit Devices

**SARGENT**  
**ASSA ABLOY**

THIS FORM IS THE PURCHASE ORDER. DO NOT SEND A COVER P.O.  
DUPLICATED ORDERS CANNOT BE RETURNED.

www.sargentlock.com

**ORDER FAX (800) 906-6606**

CUSTOMER P.O. NO. \_\_\_\_\_ DATE \_\_\_\_\_

CUSTOMER \_\_\_\_\_

CUSTOMER ACCT. NO. \_\_\_\_\_

ADDRESS \_\_\_\_\_

CITY \_\_\_\_\_ STATE \_\_\_\_\_ ZIP \_\_\_\_\_

BUYER \_\_\_\_\_ TITLE \_\_\_\_\_

SHIP GOODS TO \_\_\_\_\_

ADDRESS \_\_\_\_\_

ATTN TO \_\_\_\_\_

CITY \_\_\_\_\_ STATE \_\_\_\_\_ ZIP \_\_\_\_\_

SHIP VIA \_\_\_\_\_ STD. SARGENT CARRIER \_\_\_\_\_ (OTHER) \_\_\_\_\_

**24-Hour**

**1-Week**

**2-Week**

FOR EDITING, DO NOT WRITE

**ORD NO.**

Quote # \_\_\_\_\_

Quote # \_\_\_\_\_

- Standard buying program % or quoted discount less 5 points  
- Orders shipped within 5 business days  
- \$50k net/net maximum order

- Standard buying program % or quoted discount  
- Orders ship within 10 business days  
- \$50k net/net maximum order

Qty	Options	Exit Device x Function	Rail Size	Trim	Finish	Hand

Order  
Forms

# Order Form - Turboship Auxiliary Locks

**SARGENT**  
**ASSA ABLOY**

THIS FORM IS THE PURCHASE ORDER. DO NOT SEND A COVER P.O.  
DUPLICATED ORDERS CANNOT BE RETURNED.

www.sargentlock.com

**ORDER FAX (800) 906-6606**

CUSTOMER P.O. NO. \_\_\_\_\_ DATE \_\_\_\_\_

CUSTOMER \_\_\_\_\_

CUSTOMER ACCT. NO. \_\_\_\_\_

ADDRESS \_\_\_\_\_

CITY \_\_\_\_\_ STATE \_\_\_\_\_ ZIP \_\_\_\_\_

BUYER \_\_\_\_\_ TITLE \_\_\_\_\_

SHIP GOODS TO \_\_\_\_\_

ADDRESS \_\_\_\_\_

ATTN TO \_\_\_\_\_

CITY \_\_\_\_\_ STATE \_\_\_\_\_ ZIP \_\_\_\_\_

SHIP VIA \_\_\_\_\_ STD. SARGENT CARRIER \_\_\_\_\_ (OTHER) \_\_\_\_\_

**24-Hour**

**1-Week**

**2-Week**

FOR EDITING, DO NOT WRITE

**ORD NO.**

Quote # \_\_\_\_\_

Quote # \_\_\_\_\_

- Standard buying program % or quoted discount less 5 points
- Orders shipped within 5 business days
- \$50k net/net maximum order

- Standard buying program % or quoted discount
- Orders ship within 10 business days
- \$50k net/net maximum order

Qty	Cylinder Option	Auxiliary Lock Function	Finish

Order Forms



SARGENT Manufacturing Company  
100 Sargent Drive  
New Haven, CT 06511 USA  
800-727-5477  
[www.sargentlock.com](http://www.sargentlock.com)

ASSA ABLOY is the global  
leader in door opening solutions,  
dedicated to satisfying  
end-user needs for security,  
safety and convenience