

Owner's Maintenance

RIXSON[®]
ASSA ABLOY

ASSA ABLOY, the global leader
in door opening solutions



Heavy-Duty Floor Closers

1. Arm Loosening p 3

2. Weather Changes & Closing Speed Adjustments..... p 5

3. Door Out of Plumb – Offset..... p 7

4. Door Out of Plumb – Center Hung p 8

5. Door Sagging – Vertical Height Adjustment p 9

6. Removing a Door..... p 10

Overhead Concealed Closers

1. Arm Loosening p 11

Pivots & Pivot Sets

1. Door Sagging p 12

2. Removing a Door..... p 13

Other Rixson products require no product maintenance.

Maintenance Tips

1) Make sure ARM LOCKING SCREW is tight.

Symptoms of Loose Arm Locking Screw

Door will not fully close.

Door will slam just before closing.

Door will have little or no control in latch speed range.

Door will "bounce" back after closing against frame.

On hold open models, door will wiggle when in hold open.

Door will make a loud popping noise when taken out of hold open.

This is one of the most common causes of door control problems and it is very easy to cure. The installation instructions show the method that ensures that the screw is properly tightened.

Offset Floor Closers (Triangular Spindle)

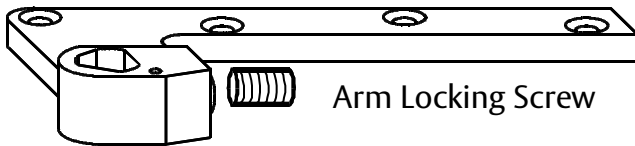

To properly tighten the arm locking screw, remove the arm cover cap and open the door slightly. While wiggling the door back and forth, tighten the screw with the correct size wrench until it is fully seated on the closer spindle. This allows the arm locking screw to firmly connect the arm to the spindle.

Center Hung Floor Closers (Tapered Spindle)

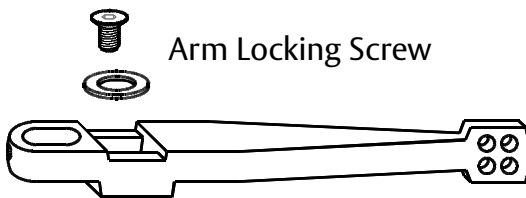

For center hung applications, the door must be removed to access the arm locking screw. Once the door has been removed, tighten the screw securely down through the washer and onto the closer spindle. Once door is rehung, install/tighten arm alignment screws and washers.

Maintenance Tips

Center Hung Floor Closer (Tapered Spindle)

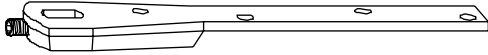

Center Hung Floor Closer (Square Spindle)

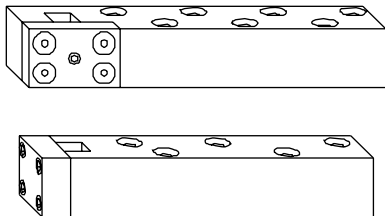

For these less common arm applications, the door need not be removed to access the arm locking screws. These arms are firmly affixed to the underside of the door. The door is then banked or slid onto the spindle.

With the square block arms, it is important that the screws be tightened at the same time, not one and then another. This will cause the arm to wobble on the spindle, shortening the life of the installation and the arm.

Maintenance Tips

2) Adjust closing speed valve(s) to proper speed

Check door and frame for conflicts and correct them

Does anything interfere with door that may prevent it from closing?

- Door and frame alignment/building settlement
- Misaligned latch/strike
- Weatherstrip
- Threshold or carpeting
- Severe wind or air pressure conditions

Identify and locate valves

The door may need to be opened slightly to access the valves. Use proper size screwdriver – do not remove valves.

Determine proper closing and latch speed

- Any door's speed should be adjusted to suit conditions.
- Exterior doors and doors with latching hardware - faster latch speed.
- Interior doors and doors with push-pull hardware - slower latch speed.
- Location and usage of the door are primary factors - some codes identify minimum closing times for accessibility requirements.
- Floor closers on EXTERIOR DOORS may require seasonal adjustments.
Cold weather - increase closing speed (CCW).
Hot weather - decrease closing speed (CW).



Closing or Latch speed valves
(or optional Delayed Action)

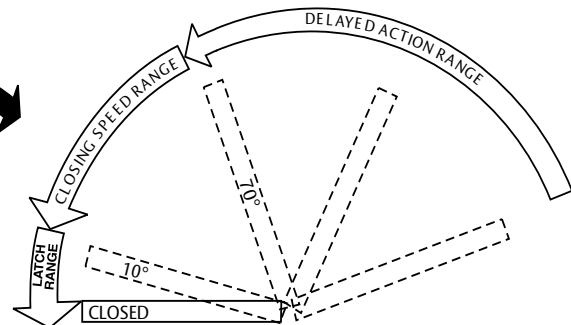

Backcheck valve

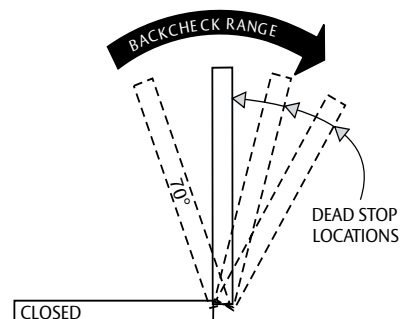

Valve Location Diagrams

Models 27 and 28 (3, 4 or 5 valves)

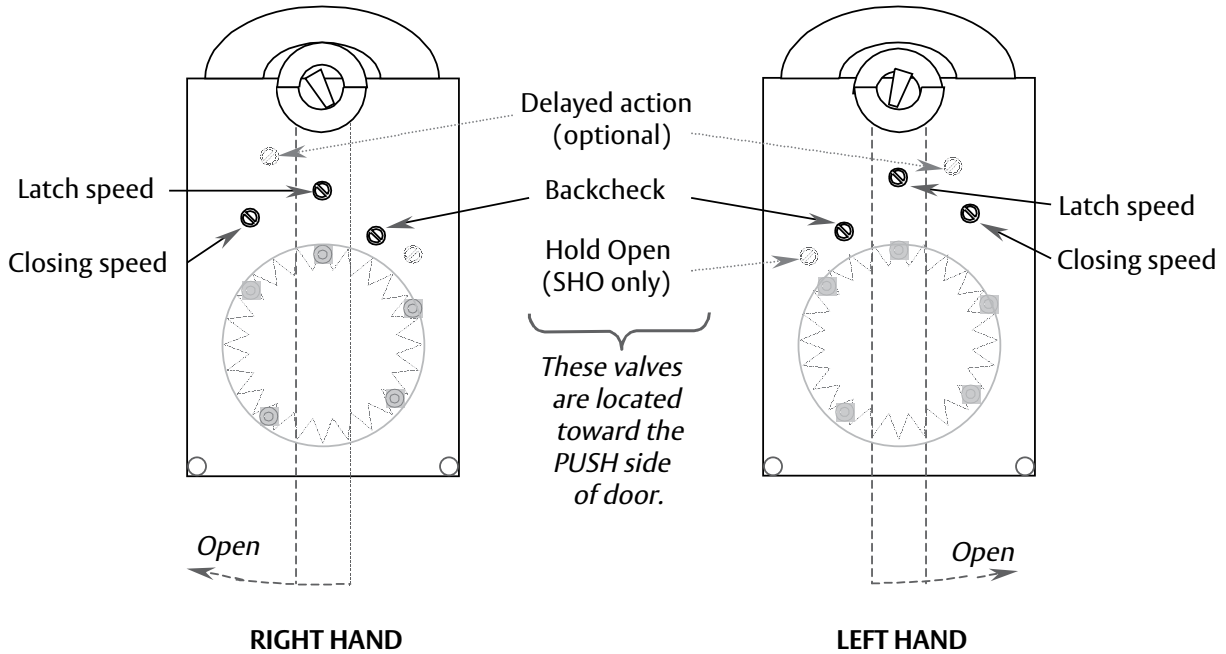

Models 30 and 40 (2 valves)

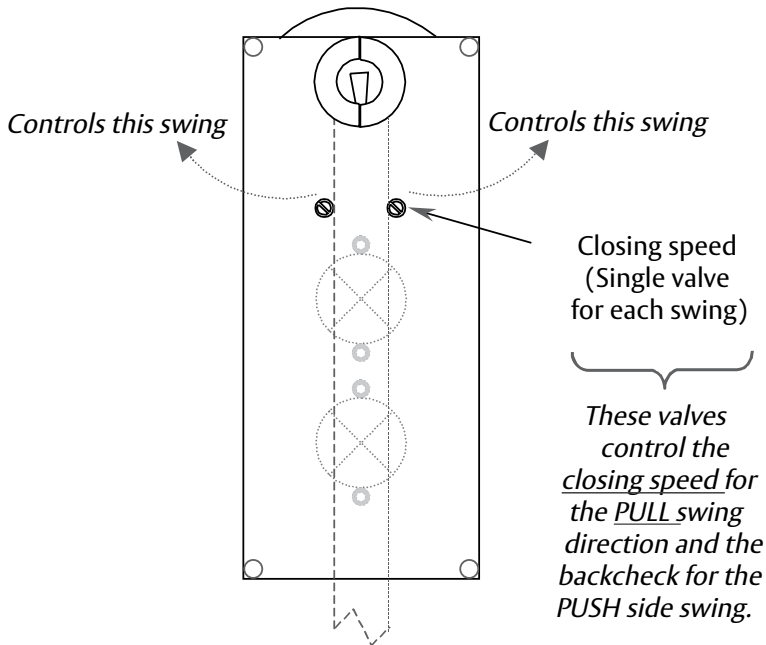

Models 20, 21, 25 and 26 (1 valve)

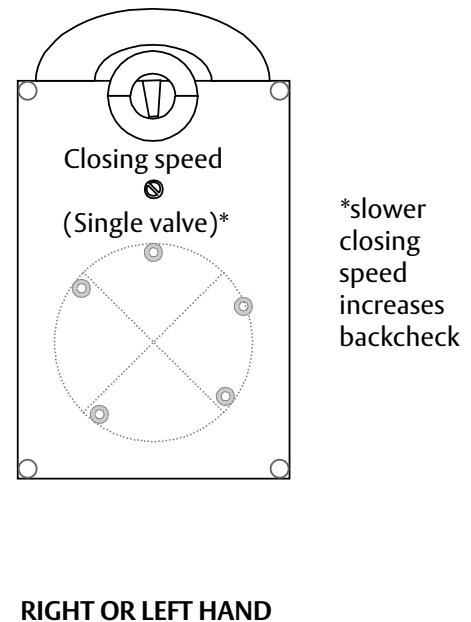

Maintenance Tips

3) Check clearance between door and frame

Is the door hitting the frame before it is completely closed and latched?
Check for wear spots or grooves worn into edge of door.

There should be uniform clearance between the vertical edges of the door and frame (1/8" is ideal). The top of the door should also clear the frame.

The frame should be firmly anchored to prevent movement.

Reinforcing at intermediate and/or top pivot must be attached securely and fasteners tightened.

Center hung applications allow horizontal door adjustment at the bottom arm through the heel edge of the door.

Does the door require an extra "push" to fully latch?
(This causes extra wear on the pivot bearings)

Open door slightly to check for excess movement at the top pivot. If the pivot is securely fastened and still allows "slop," the pivot may need to be replaced.

The door may be "out of plumb." Check alignment with a plumb bob. Centerline of top pivot must be in line with centerline of closer spindle.

Make sure there are no obstructions such as weatherstrip or a misaligned latch and strike.

Correct any obstructions before attempting to adjust closer.

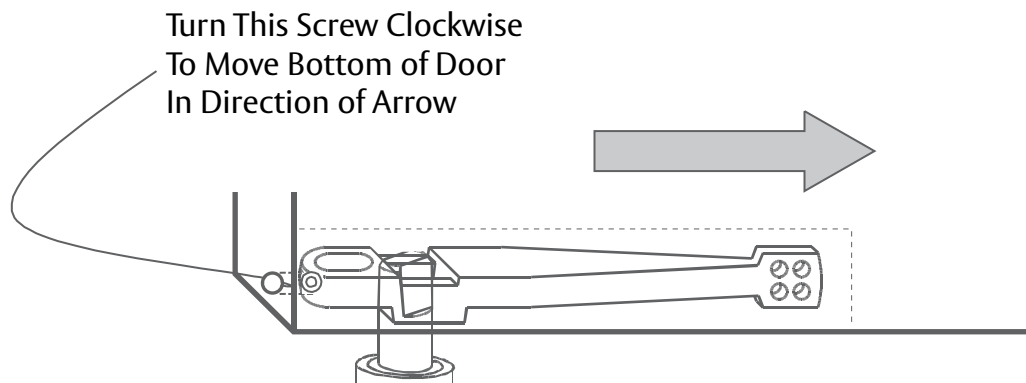

Maintenance Tips

4) Special adjustments for CENTER HUNG FLOOR CLOSERS

For most center hung applications, the bottom arm is attached to the closer spindle and the door is resting on top of the arm. This application can be identified by the presence of the door centering screws.

Door centering screws are located on the face of the door near the lower edge where the bottom arm is attached. There should be a large countersunk finished washer between this screw and the door face.

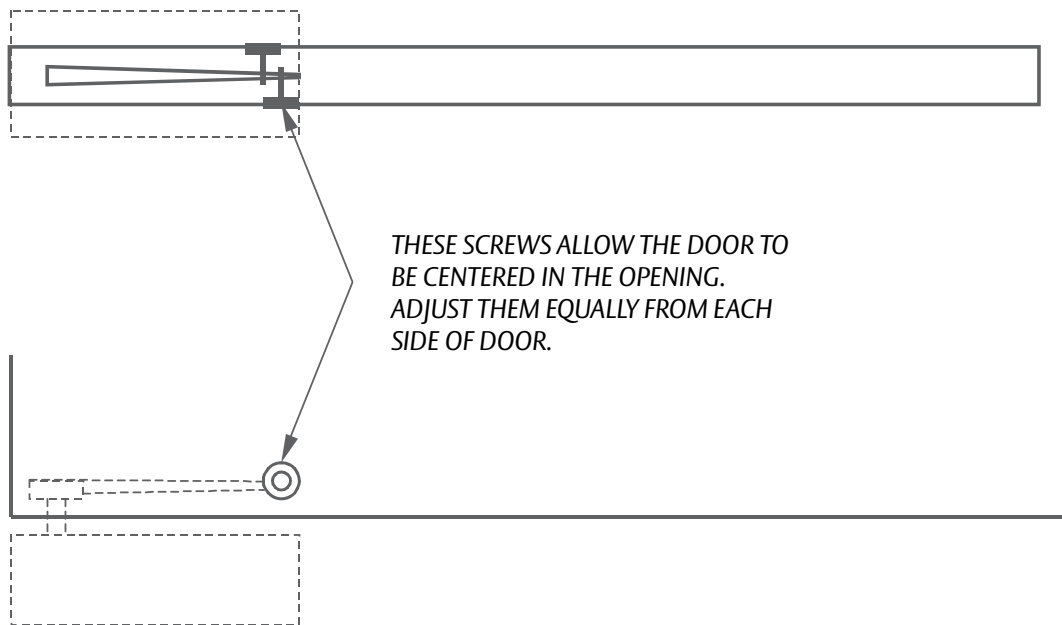

The centering adjustment is more critical for pairs of doors to get the meeting stiles to align when the doors are in the closed position. This is especially the case with DOUBLE ACTING DOORS, single or pairs.

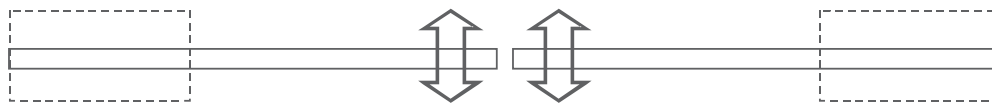

ADJUST ARM CENTERING SCREWS TO ALIGN EDGE OF DOOR WITHIN OPENING OR ALIGN MEETING STILES ON PAIRS OF DOORS.

Maintenance Tips

5) Vertical height adjustment

Check the clearance between bottom of the door and the floor. The door should not be dragging on the floor. If the door needs to be raised to provide clearance, shims can be inserted at the bottom to accomplish this.

For CENTER HUNG applications, shims must be inserted between the ARM PLATE "H" and the bottom of the cutout. The door needs to be removed for shims to be added. See installation instructions.

For most OFFSET applications, 1/16" shims can be added without removing the door. Remember that the weight of the door must bear on the bottom arm, not on the intermediate pivot (if used).

- 1) Loosen the ARM LOCKING SCREW on the offset bottom arm.
- 2) Raise the door by lifting the bottom of the door with a crowbar (or by removing the cover cap on the intermediate pivot and turning the pivot pin screw clockwise).
- 3) While the door is held in the raised position, insert the required quantity of shims (P/N 275065) directly beneath the bottom arm.
- 4) Relieve the tension on the crowbar (or intermediate pivot) and allow the bottom arm to carry the entire weight of the door.
- 5) Re-tighten the ARM LOCKING SCREW.

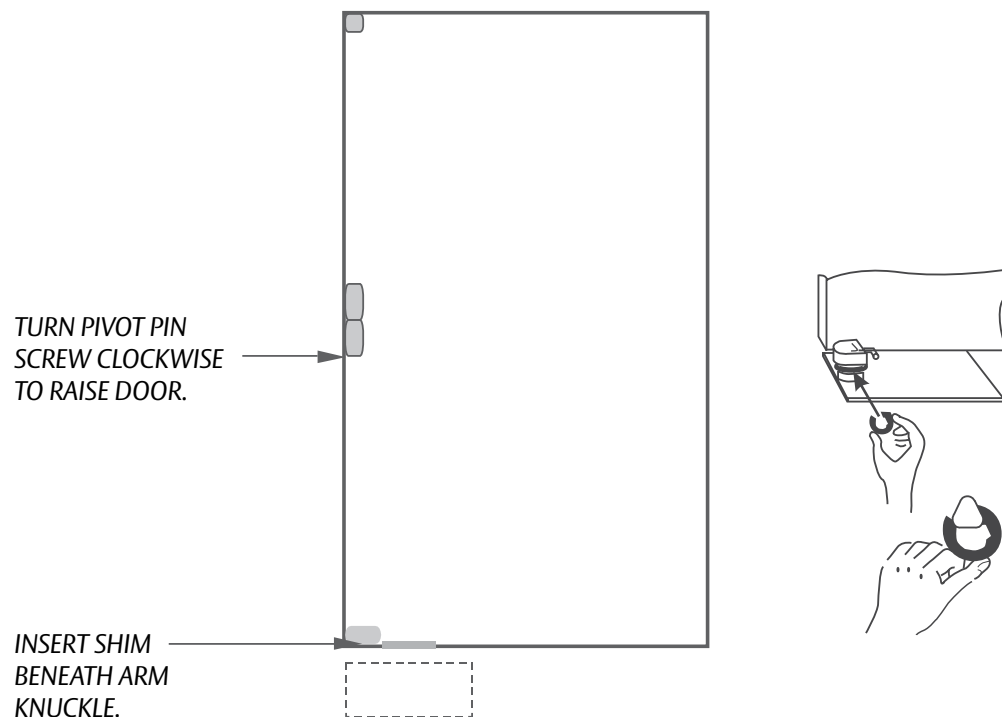

Maintenance Tips

6) Removing a door from a floor closer

Before demounting the door, it is helpful to turn the closing speed valve down to its slowest setting (do not force). This will prevent the closer spindle from turning too quickly while the door is being removed.

CENTER HUNG APPLICATIONS

The frame above a center hung door usually prevents the door from being simply "lifted" out of the opening. The top pivot is specially designed to allow the pin that holds the top of the door in place to be retracted to facilitate installation and removal of the door.

Most center hung floor closers use the "standard" bottom arm arrangement. For special applications or extra heavy doors, please consult the factory.

- 1) Remove door centering screws (if used) from bottom door face.
- 2) Loosen arm adjustment screw from heel edge of door.
- 3) Open door slightly (about 30°) to access top pivot. While door is being held, retract top pivot pin by turning screw counterclockwise.
- 4) When pin is fully retracted, lean the door toward you until the top of the door clears the frame.
- 5) Lift door off arm/closer assembly.

OFFSET HUNG APPLICATIONS

Offset hung doors will usually allow the door to be lifted off the closer spindle without interference from the frame.

- 1) Open the door slightly.
- 2) Remove the screws from the FRAME PORTION of the intermediate pivot(s).
- 3) Remove the cover cap(s) from the knuckle of the TOP PIVOT to access the top pivot pin. (If the pin is held in place by a set screw, loosen the set screw.)
- 4) While the door is being held, remove top pivot pin and allow door to lean toward you until the door can be lifted straight up. (Intermediate pivot frame portion should fall out at this point.)
- 5) Lift door (with bottom arm and door portions of intermediate and/or top pivot still attached to door) off closer spindle.

Maintenance Tips

1) Make sure Arm is tight on Spindle

Symptoms of Loose Arm

Door will not fully close.
Door will slam just before closing.
Door will have little or no control in latch speed range.
Door will “bounce” back after closing against frame.

Offset Application

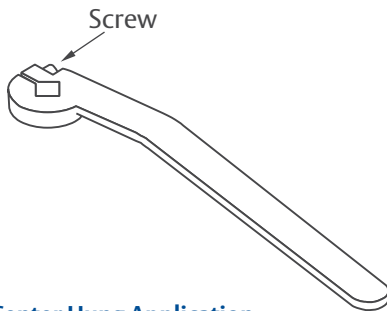

Center Hung Application

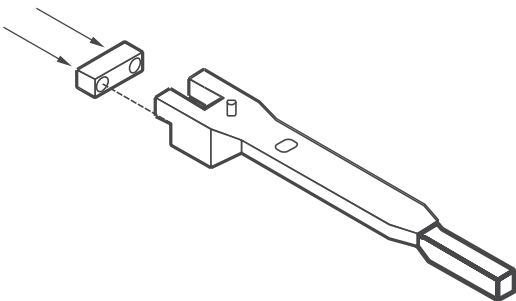

It is important that the screws be tightened at the same time; not one fully and then the other. This will cause the arm to wobble on the spindle shortening the life of the installation and the arm.

Also – Insure arm alignment screws are secure on the end load application.

Maintenance Tips

1) Vertical height adjustment

Check the clearance between bottom of the door and the floor. The door should not be dragging on the floor. If the door needs to be raised to provide clearance, shims can be inserted at the bottom to accomplish this.

For most OFFSET applications, 1/16" shims can be added without removing the door. Remember that the weight of the door must bear on the bottom arm, not on the intermediate pivot (if used).

- 1) Loosen the ARM LOCKING SCREW on the offset bottom arm.
- 2) Raise the door by lifting the bottom of the door with a crowbar (or by removing the cover cap on the intermediate pivot and turning the pivot pin screw clockwise).
- 3) While the door is held in the raised position, insert the required quantity of shims (P/N 275065) directly beneath the bottom arm.
- 4) Relieve the tension on the crowbar (or intermediate pivot) and allow the bottom arm to carry the entire weight of the door.
- 5) Re-tighten the ARM LOCKING SCREW.

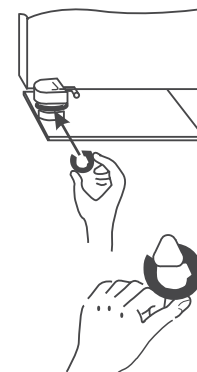
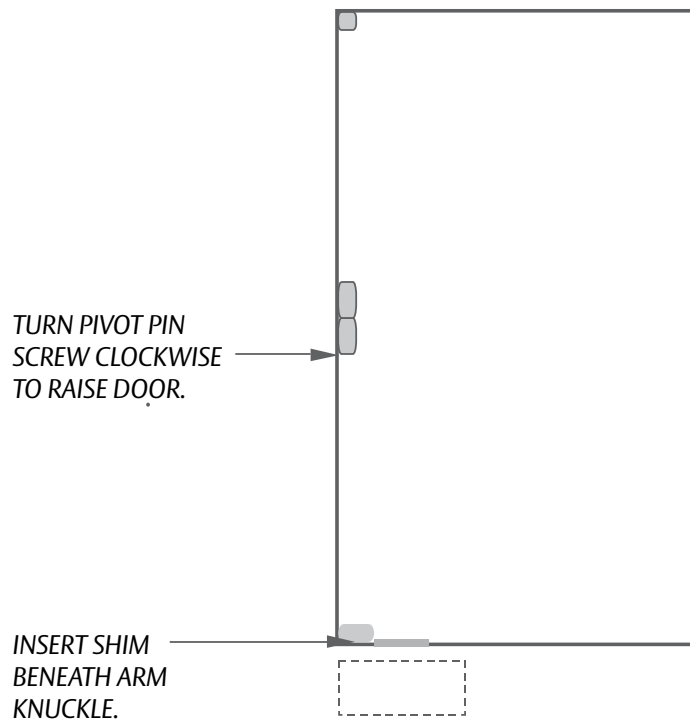

Maintenance Tips

2) Removing a door from a pivot

Before demounting the door, it is helpful to turn the closing speed valve down to its slowest setting (do not force). This will prevent the closer spindle from turning too quickly while the door is being removed.

OFFSET HUNG APPLICATIONS

Offset hung doors will usually allow the door to be lifted off the closer spindle without interference from the frame.

- 1) Open the door slightly.
- 2) Remove the screws from the FRAME PORTION of the intermediate pivot(s).
- 3) Remove the cover cap(s) from the knuckle of the TOP PIVOT to access the top pivot pin. (If the pin is held in place by a set screw, loosen the set screw.)
- 4) While the door is being held, remove top pivot pin and allow door to lean toward you until the door can be lifted straight up. (Intermediate pivot frame portion should fall out at this point.)
- 5) Lift door (with bottom arm and door portions of intermediate and/or top pivot still attached to door) off closer spindle.

Notes

Notes

RIXSON

ASSA ABLOY

For a complete listing of products and applications please visit our website:
www.rixson.com

Rixson Specialty Door Controls

3000 Highway 74 East
Monroe, NC 28112 USA
Tel: 800.457.5670 • Fax: 800.221.0489
www.rixson.com

ASSA ABLOY Door Security Solutions - Canada

Address: 160 Four Valley Drive, Vaughan, Ontario L4K4T9 Canada
Tel: 800.461.3007 • Fax: 905.738.2478
www.assaabloy.ca

ASSA ABLOY NA International

www.aanai.com

Rixson®, Rixson and Design®, Duo-Chek®, Uni-Check®, Checkmate® and Smok-Chek® are registered trademarks of Yale Security Inc., an ASSA ABLOY Group company. RollerMate™ is a trademark of Yale Security Inc., an ASSA ABLOY Group company. Other products' brand names may be trademarks or registered trademarks of their respective owners and are mentioned for reference purposes only. These materials are protected under U.S. copyright laws. All contents current at time of publication. Yale Security Inc. reserves the right to change availability of any item in this catalog, its design, construction, and/or its materials. Copyright © 2010, Yale Security Inc., an ASSA ABLOY Group company. All rights reserved. Reproduction in whole or in part without the express written permission of the Yale Security Inc., an ASSA ABLOY Group company, is prohibited.

ASSA ABLOY is the global leader in door opening solutions, dedicated to satisfying end-user needs for security, safety and convenience.