

PRIME-LINE[®]

Introduces...

Child Safe[®]

A complete line of safety products designed to help protect your children

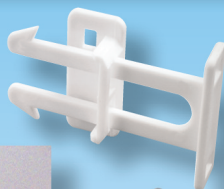

S-4437 (White)

Ball Cabinet Catches

Contents: 2 ball catches; 2 keepers and installation screws.

Description: Plastic catch for use on cabinets and drawers to deter small children's access.

Standard Pack: 6/box

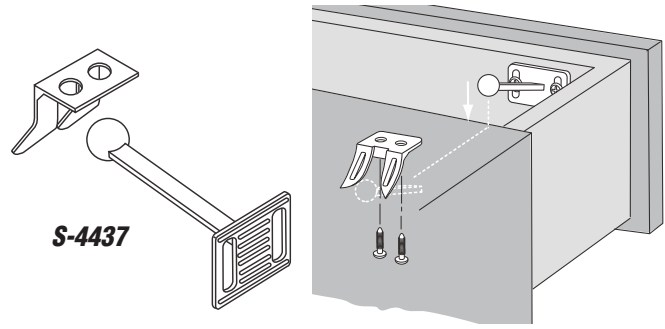

S-4438 (White - 3 pack)

S-4462 (White - 6 piece "Value" pack)

Cabinet Catches

Contents: hook catches; keepers and installation screws.

Description: Plastic catch for use on cabinets and drawers to deter small children's access.

Standard Pack: 6/box

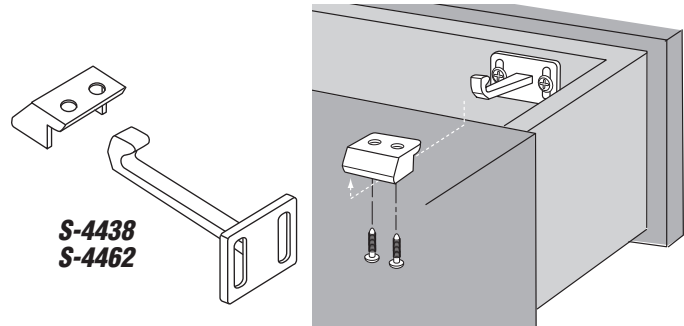

S-4439 (White)

Drawer Catches

Contents: 3 double hook catches; 3 keepers and installation screws.

Description: Plastic catch allows drawer or cabinet door to open about 1-1/2"; hooks must be compressed to open.

Standard Pack: 6/box

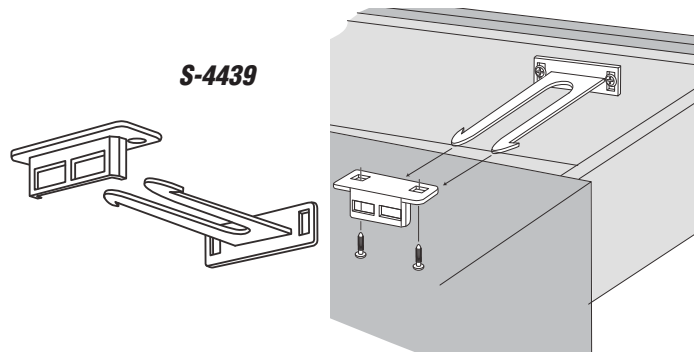

S-4444 (White)

Drawer Catch

Contents: 3 safety latches; 3 keepers and installation screws.

Description: Plastic catch offers double protection to toddlers; when engaged, this catch limits accessibility and also protects tiny fingers from being pinched if unit is closed accidentally.

Standard Pack: 6/box

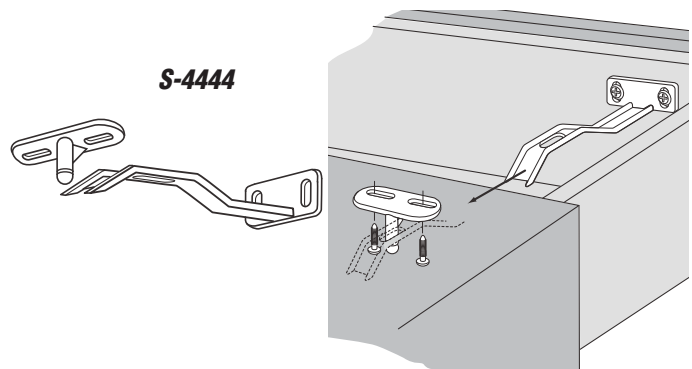

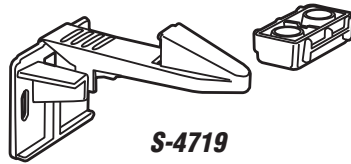
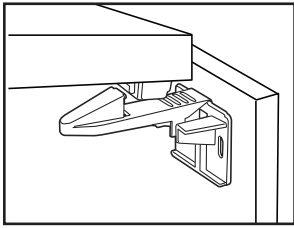

S-4719

S-4719 (White)

Cabinet Catches

Contents: 3 hook catches; 3 keepers and installation screws.

Description: Plastic catch for use on cabinets and drawers to deter small children's access.

Standard Pack: 6/box

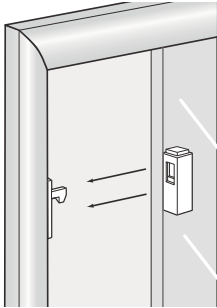

S-4440

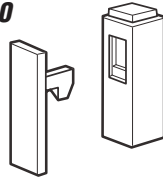

S-4440 (Ivory)

Cabinet Locks

Contents: 2 locks; 2 keepers.

Description: No tools required; plastic lock and keeper have self-adhesive backers; use on sliding cabinet doors.

Standard Pack: 6/box

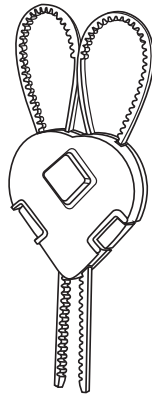
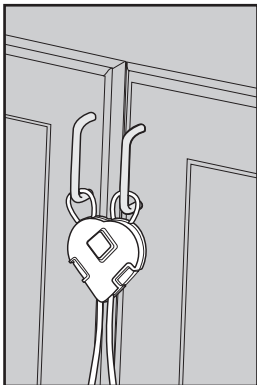

S-4624

S-4624 (White)

Cabinet Knob Strap Lock

Contents: 1 loop lock and 1 locking mechanism.

Description: No tools required; plastic lock attaches over knobs or thru pulls on a pair of cabinet doors; ratcheting action holds doors closed; easy removal.

Standard Pack: 6/box

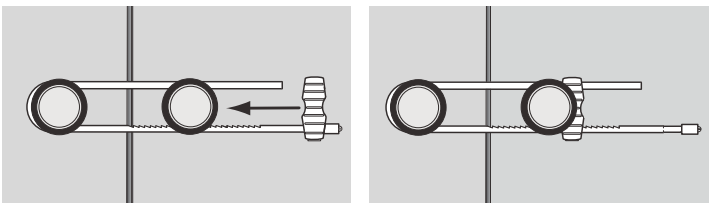

S-4442

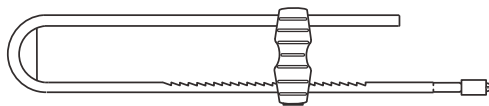

S-4442 (White)

Cabinet Slide Lock

Contents: 2 loop locks and 2 locking mechanisms.

Description: No tools required; plastic lock attaches over knobs or thru pulls on a pair of cabinet doors; ratcheting action holds doors closed; easy removal.

Standard Pack: 6/box

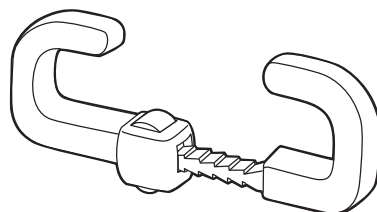
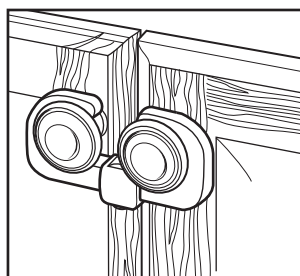

S-4717

S-4717 (White)

Cabinet Slide Lock

Contents: 1 loop lock.

Description: No tools required; plastic lock attaches over knobs or thru pulls on a pair of cabinet doors; ratcheting action holds doors closed; easy removal.

Standard Pack: 6/box

Child Safety

S-4441 (White)

Door Knob Covers

Contents: 2 knob covers.

Description: Plastic covers may be applied over most door knobs to keep toddlers from gaining entry to off-limit areas.

Standard Pack: 6/box

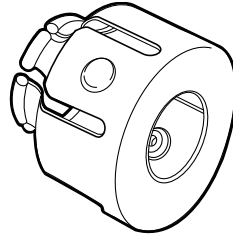

S-4441

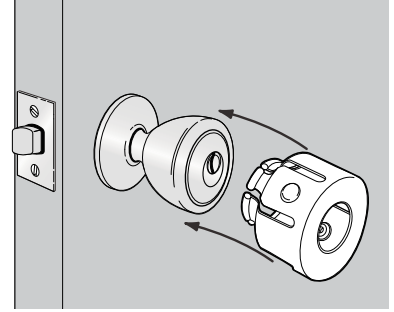

S-4560 (White)

Door Blocker

Contents: 1 door blocker.

Description: Soft foam shape fits 1-3/8" thick doors; prevents door from closing on little fingers; white color.

Standard Pack: 6/box

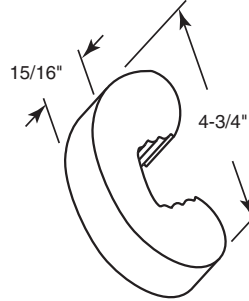

S-4560

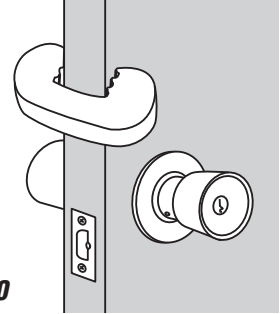

S-4448 (Ivory)

Super Grip Door Holder

Contents: 1 clasp; 1 door stop and installation screws.

Description: Plastic door clasp and stop holds door firmly to wall and eliminates unwanted door movement.

Standard Pack: 6/box

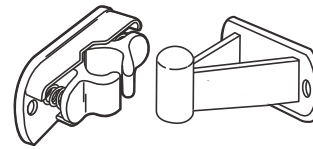

S-4448

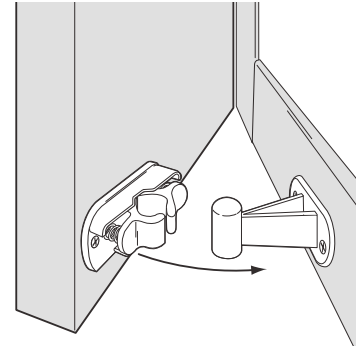

S-4445 (Clear)

Corner Cushion

Contents: 4 corner cushions.

Description: Plastic cushions, when applied to sharp corners on furniture, can assist in deterring serious injury to small children; NO TOOLS REQUIRED; self adhesive pads facilitate easy installation.

Standard Pack: 6/box

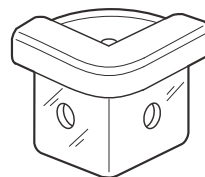

S-4445

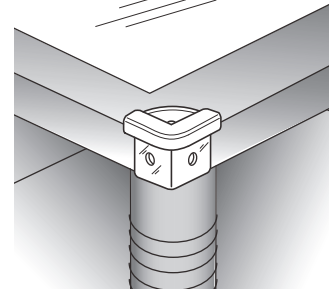

S-4447 (Ivory)

S-4461 (White)

Swivel Outlet Cover

Contents: 1 cover.

Description: Plastic cover assembly protects tiny fingers or prying objects from causing electrical shock; replaces existing outlet cover and spring loaded plug covers do the rest.

Standard Pack: 6/box

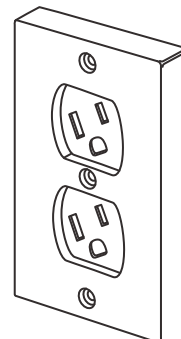

**S-4447
S-4461**

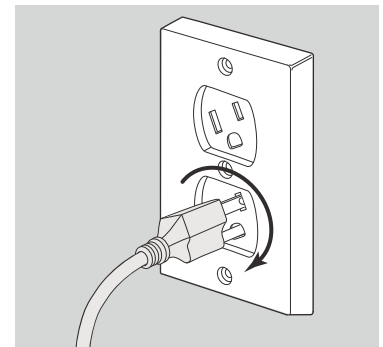

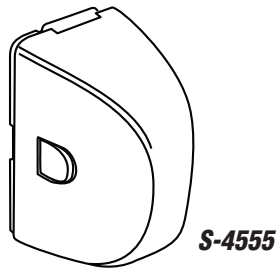
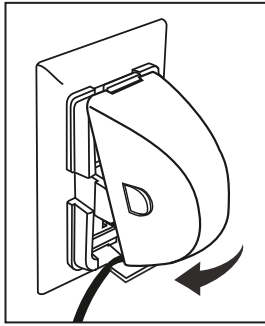

S-4555 (White)

In-Use Plug & Outlet Cover

Contents: 2 covers.

Description: Plastic cover assembly protects tiny fingers or prying objects from causing electrical shock.

Standard Pack: 6/box

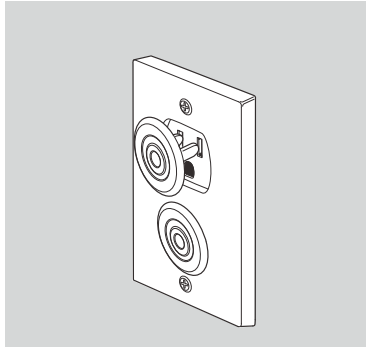

S-4443
S-4460
S-4551

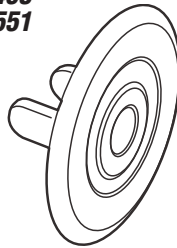

S-4443 (White - 12 Pack)

S-4551 (White - 24 Pack)

S-4460 (Clear - 12 Pack)

Shock Guard

Contents: Guards.

Description: No tools required; plastic guards protect tiny fingers or prying objects from causing electrical shock.

Standard Pack: 6/box

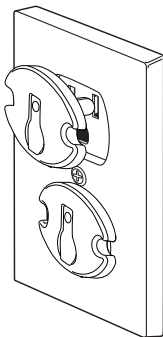

S-4724
S-4725

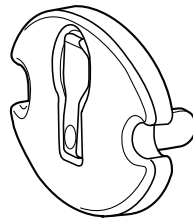

S-4724 (White)

S-4725 (Ivory)

Shock Guard

Contents: 30 Guards.

Description: No tools required; plastic guards protect tiny fingers or prying objects from causing electrical shock; push and pull lever for extra security.

Standard Pack: 6/box

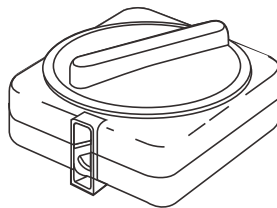
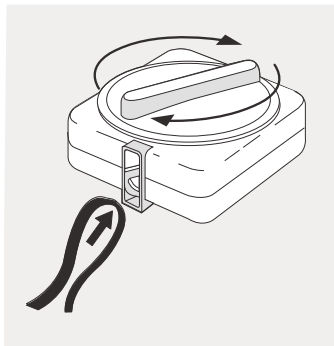

S-4446

S-4446 (Ivory)

Electrical Cord Shortener

Contents: 1 cord shortener.

Description: Plastic mechanism aids in reducing the chance of tripping over cords by reeling-in excess length.

Standard Pack: 6/box

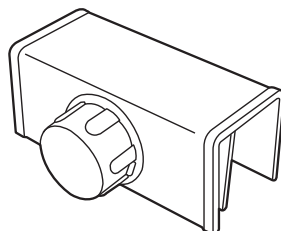
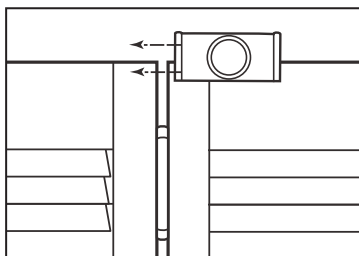

S-4553

S-4553 (White)

Bi-Fold Door Safety Catch

Contents: 1 catch.

Description: Fits up to a 1-3/8" thick door, slides over split in doors to stop doors from opening; protects against child access, white plastic.

Standard Pack: 6/box

Child Safety

S-4557 (White)

Window Blind Cord Winder

Contents: 2 cord wraps.

Description: The cord winder conceals potentially dangerous excess cord and keeps it out of child's reach.

Standard Pack: 6/box

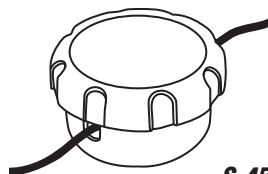

S-4557

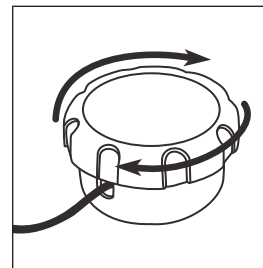

S-4623 (Clear)

Drapery Cord Safety Cleat

Contents: 4 cord cleats.

Description: Helps keep window blind cords out of reach; **clear plastic**; mounts with 2 screws.

Standard Pack: 6/box

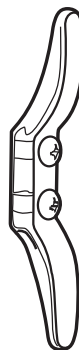

S-4623

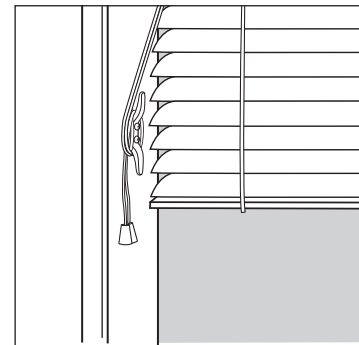

S-4554 (Clear)

Stove Knob Covers

Contents: 4 knob covers.

Description: **Plastic** covers help prevent children from turning stove knobs; cover hinges back for normal use; hinged design for ease of use.

Standard Pack: 6/box

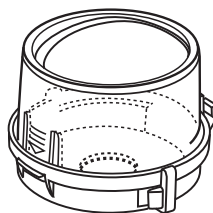

S-4554

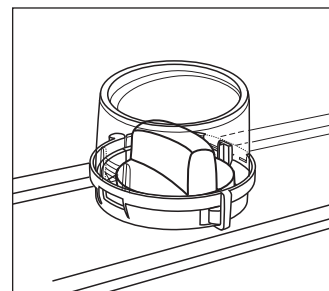

S-4556 (White)

Appliance Lock

Contents: 1 lock.

Description: Snap lock for any hinged door; helps keep children out; fits refrigerators, microwaves, cabinet doors; adhesive mounted.

Standard Pack: 6/box

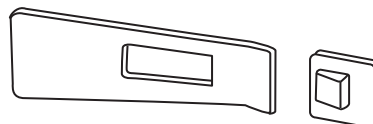

S-4556

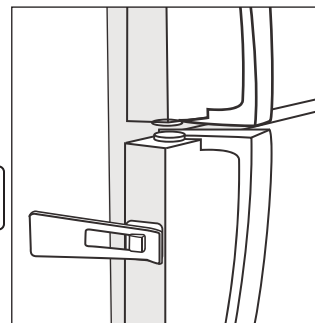

S-4552 (White)

Oven & Microwave Lock

Contents: 1 lock.

Description: Hinged lock helps keep children out of oven or microwave; adhesive mounted.

Standard Pack: 6/box

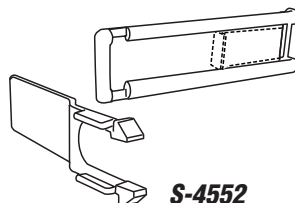

S-4552

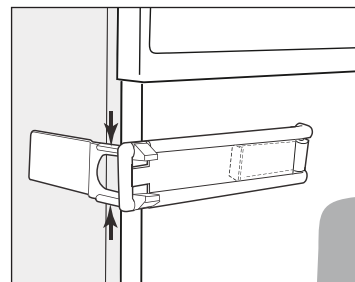

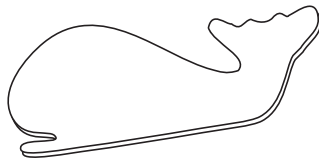
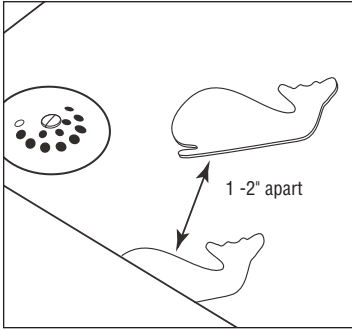

S-4630

S-4630 (White)

Bathtub Non-Slip Pads

Contents: 12 pads.

Description: Non-slip surface helps prevent slips in tub; adhesive backed; whale pattern.

Standard Pack: 6/box

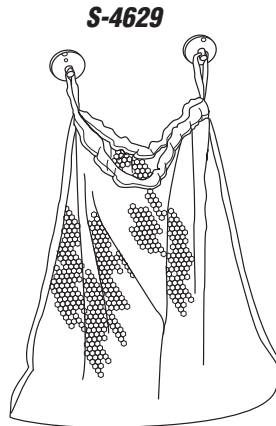
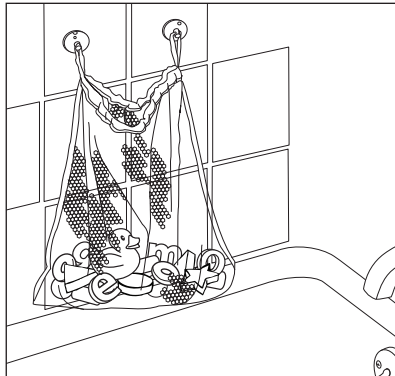

S-4629

S-4629 (White)

Bathtub Toy Storage Net

Contents: 1 lock.

Description: Storage net keeps children's toys dry and out of the way; suction cup mounting to any smooth surface.

Standard Pack: 6/box

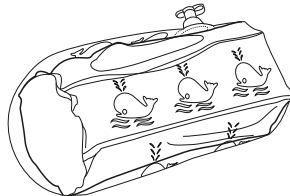
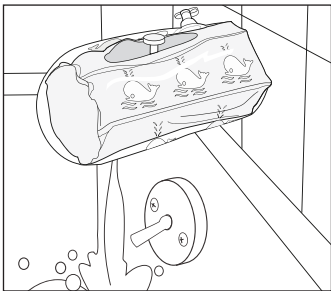

S-4628

S-4628 (Inflatable)

Bathtub Spout Cover

Contents: 1 cover.

Description: The spout cover guards the bath tub faucet and protects children from bumps; inflatable; blue color.

Standard Pack: 6/box

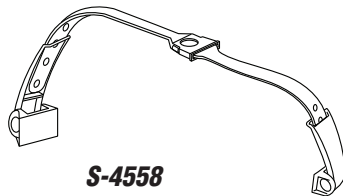
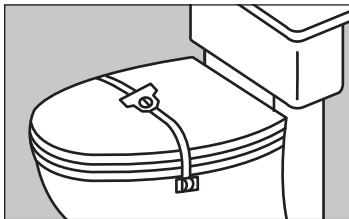

S-4558

S-4558 (White)

Toilet Lid Safety Lock

Contents: 1 lock.

Description: Toilet lid lock; adhesive mounts to side of toilet; prevents lid from opening.

Standard Pack: 6/box

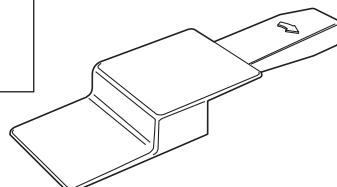
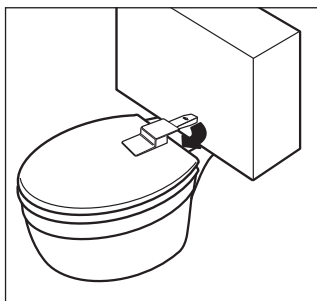

S-4715

S-4715 (White)

Toilet Lid Flip Lock

Contents: 1 lock.

Description: Toilet lid flip lock; adhesive mounts to top of toilet lid; spring loaded arm prevents lid from opening.

Standard Pack: 6/box

Child Safety

S-4627 (Black)

Baby Seat Mirror

Contents: 1 mirror.

Description: Car mirror suction cup mounts to windshield; allows driver to see child safely.

Standard Pack: 6/box

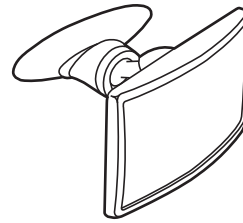

S-4627

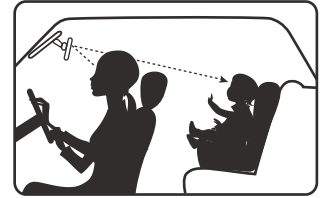

S-4625 (Black)

Seatbelt Adjuster Pads

Contents: 1 adjuster.

Description: For use with children over 50 lbs.; aligns seat belt and shoulder strap across chest; helps prevent unsafe strap position on smaller bodies.

Standard Pack: 6/box

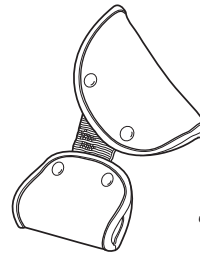

S-4625

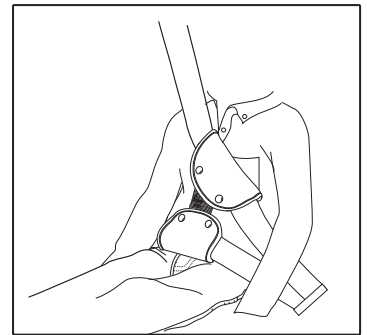

S-4626 (Black)

Child Car Sun Shield

Contents: 1 shield.

Description: Suction cup mounts to any window; roll-up feature blocks UV rays; protects child from prolonged sun exposure; 14" wide x 19-1/2" long.

Standard Pack: 6/box

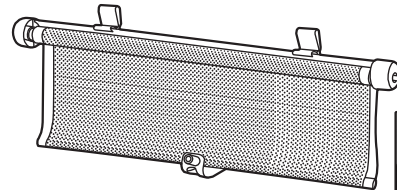

S-4626



S-4729

Baby On Board Sign

Contents: 1 shield.

Description: 5"; yellow 'Baby On Board' car window sign; suction cup mounts to any window;

Standard Pack: 6/box



S-4729

