



2012-2013



— WINDOW & DOOR — *North America's MOST POPULAR*

Replacement Hardware

Dear Valued Customer:

As you look through this catalog, we would like to take a minute to thank you for your patronage, and share some information about our company. We are proud to be 100% employee owned, and consider this to be an important part of our core workings. Our employees supply the innovative ideas and solutions necessary to meet your needs every day, and this catalog reflects their hard work over the past 60 years.

As we continue to grow and evolve as a company, our goals remain constant:

**Deliver outstanding customer service
Offer an unmatched assortment of high-quality products
Industry best fill rates**

We hope this catalog will be indispensable to you, and inspire improvements to your own surroundings, or help you offer innovative solutions to your customers. Your needs drive our company, and we appreciate feedback. If you do not find what you are looking for in these pages, please visit primeline.net, where we have thousands of items available and ready to ship. For special orders, please call 1-800-255-3505.

Thank you,

Prime-Line

4-5	Sliding screen door
6-7	Patio door
8-9	Sliding window
10-11	Casement / jalousie window
12-13	Window screen / storm window
14-15	Tub & shower
16-17	Sliding closet door
18-19	Bi-passing closet door
20-21	Pocket door
22-23	Drawer
24-25	Household
26-27	Window security
28-29	Patio door security
30-31	Entry door security
32	Vintage door
33	Utility
34	Segal
35	Strikes
36	Latch shields
37	Reinforcers
38-39	Child safety
40	Mailbox locks
41	Handyman springs
42-43	Garage door
44-45	Screen & storm door
46-47	Make-To-Fit
48	Gibcloser
49	Re-key a lock
50	Flag pole holders
51	Commercial door
52-53	Toilet partition
54	Wall shields
55	Hang-ups
56	Shutter repair

6
Patio door



10
Casement window



26
Window security

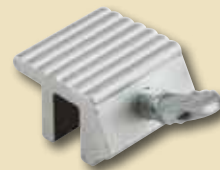

42
Garage door



52
Toilet partition

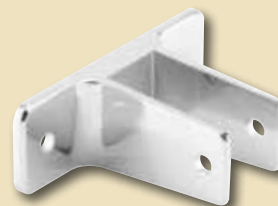

WHO WE ARE...

Prime-Line Products has been supplying repair and replacement parts for windows and doors since 1978. Over 30 years of business acumen has led Prime-Line to the top of its trade. The worldwide need for residential maintenance has motivated our company to develop over 18,000 unique items for our customers. We service the professional trades with repair solutions throughout North America and abroad.

We also provide products to the Do-It-Yourself industry through home centers, hardware stores and lumber yards, with a wide variety of specialized repair parts that fit various individual and regional demands. We currently supply many manufacturers with OEM components that are in wide demand.

PRIME-LINE®



Sentry SUPPLY LLC

Sentry Supply LLC was originally established in 1975. Providing toilet partition hardware for over 30 years, Sentry has expanded its production capabilities to offer one of the most comprehensive inventory listings for all makes of partition hardware. Sentry proudly boasts its quick response time to customer needs and provides timely shipment, fast quotes and diligent sourcing for those "hard-to-find" items. A local distribution center allows us to dramatically improve service and lower costs to West coast locations. Committed to customer satisfaction, Sentry will provide you with the item you need, when you need it.



The Prime-Line facilities are ready to fulfill any large capacity order. With over 600,000 sq. ft. of warehouse and office space, we can take your order from inception to completion in stride.

PRECISION® Screen & Security Products A Division of Prime-Line

Precision Screen and Security Products offers a selection of door and window products that answers our customer's demands for innovative, high quality designs that combines the convenience of global accessibility with a local neighborhood attitude. We pride ourselves on outstanding customer service that covers all aspects of our products.



WHAT WE OFFER...

- » Automated parts counting
- » E-business capability
- » In-house creative services available
- » Shipping nationwide or international
- » In-house printing capability
- » Engineering capability with 3-D rendering
- » 3-D printer model making capability
- » QC department and cycle testing
- » PVC and aluminum extrusion capability
- » Multiple roll-forming capabilities
- » Metal fabrication shop
- » Custom steel door and aluminum door fabrication
- » Product packaging capabilities



HOW WE CAN HELP...

- » Order fulfillment services include pick, pack and ship
- » Order assembly and palletization
- » EDI, ASN generation
- » Prepacking & promotional packing
- » Product storage & warehousing
- » Inventory and labeling
- » Cross-dock capabilities



From selection, to fabrication and production, to final shipment and fulfillment, Prime-Line has you covered.

Let us help you with all your bulk product and special orders. Prime-Line is a full service company that will gladly find the method that best suits your needs. From everyday needs to one-time orders, Prime-Line is your "go to" company.



- » Is there anything else you need? Prime-Line offers THOUSANDS of unique replacement parts online...

Scan here to search online!! primeline.net



Regardless of which of our companies you may deal with, there will always be the same personable service and dedication awaiting your call.

With customer service available from 6 A.M. to 5 P.M. PST every weekday, you'll get the answers you want, when you want them.

For further information, please contact us directly:

26950 San Bernardino Ave.,
Redlands, CA 92374

800.255.3505
primeline.net



A-111 | Latch

- » Black plastic pull
- » Non-handed
- » Surface mount

A-108 | Latch & Pull

- » Black plastic pull
- » Non-handed
- » With security lock

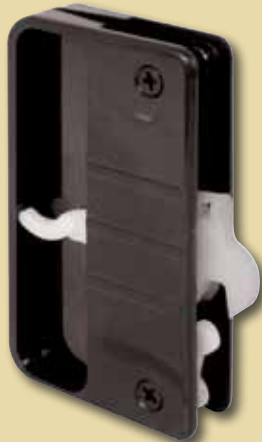

A-142 | Latch & Pull

- » Black plastic pull with steel latch
- » Non-handed
- » Mortise installation

A-150 | Latch & Pull

- » Black plastic pull with steel latch
- » Non-handed
- » Mortise installation



A-236 | Strike & Guide Kit

- » 2 strikes, top guides and bushings to repair most screen doors



B-702 | Roller Assembly

- » Spring loaded
- » 1" O.D. steel ball bearing wheel with center groove



B-551 | Roller Assembly

- » 1" O.D. plastic wheel with center groove
- » 8-32 x 3/8" machine screw & binder post nut





B-639 | Tension Roller

- » 1" O.D. steel ball bearing roller with center groove
- » Heat treated, high tension steel spring



B-513 | Tension Roller

- » 1" O.D. steel ball bearing roller with center groove
- » Heat treated, high tension steel spring



B-649 | Tension Roller

- » 1" O.D. plastic roller with center groove
- » Heat treated, high tension steel spring



SCREEN DOOR Hardware

Sliding patio screen doors can be maintained and repaired easily using Prime-Line's patio screen door hardware. With nearly 500 separate items available, finding the right part is assured. Components such as top and bottom rollers, latches, keepers, and top guides work to keep your door rolling smoothly. Our packaging identifies key item dimensions, other related parts that might be needed, and includes installation instructions.





C-1204 | Mortise Handle Set

- » Diecast inside and outside handles
- » 3-15/16" Hole centers



C-1032 | Flush Mount Handle Set

- » Diecast construction
- » Reversible
- » 6-5/8" Hole centers



C-1018 | Internal Lock Handle Set

- » Diecast aluminum
- » Reversible
- » 3-15/16" Hole centers



E-2082 | Keeper

- » Diecast
- » Adjustable



E-2000 | Cylinder Lock

- » 5-pin tumbler
- » Weiser, Kwikset & Weslock compatible



E-2164 | Mortise Lock with Faceplate

- » Steel housing and hook
- » Round end faceplate
- » Adjustable hook projection



E-2014 | Mortise Lock

- » Steel housing and hook
- » Round end faceplate
- » Adjustable hook projection



D-1688 | Roller Assembly

- » Adjustable steel housing
- » 1-1/4" O.D. steel ball bearing roller

D-1563 | Roller Assembly

- » Adjustable steel housing
- » 1-1/2" O.D. steel ball bearing roller



D-1551 | Tandem Roller Assembly

- » Adjustable steel housing
- » 1-1/8" O.D. steel ball bearing rollers

D-1796 | Roller & Axle Kit

- » 1-1/4" O.D. steel ball bearing roller
- » Assorted axles used to repair roller assemblies



PATIO DOOR Hardware

Sliding patio doors are one of the most neglected entry points for most homes. Prime-Line has developed over 1600 repair and maintenance items to ensure these doors function safely and securely. We carry over 350 different patio door handles, and over 550 roller assemblies. We manufacture the largest selection of patio door roller assemblies in the world using top quality, precision ground, sealed bearing assemblies.



F-2533 | Sash Lock

- » Diecast
- » Cam action lock design holds window securely closed

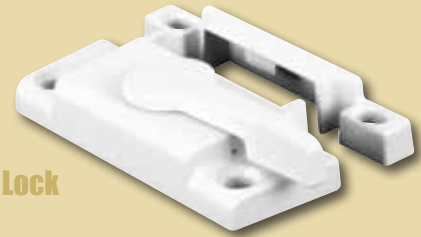

F-2554 | Sash Lock

- » Diecast
- » Cam action lock design holds window securely closed
- » Latch body has alignment lugs



F-2588 | Sash Lock

- » Diecast
- » Cam action lock design holds window securely closed



F-2535 | Sash Lock

- » Stamped steel
- » Used on double hung wood windows

F-2537 | Sash Spring

- » Spring steel construction
- » Corner mounted
- » Installs in seconds



F-2598 | Tilt Latch

- » White vinyl
- » Spring loaded
- » Used on single or double hung windows



F-2642 | Tilt Latch

- » White plastic
- » Spring loaded
- » Used on single or double hung windows





Horizontal
SLIDING WINDOWS

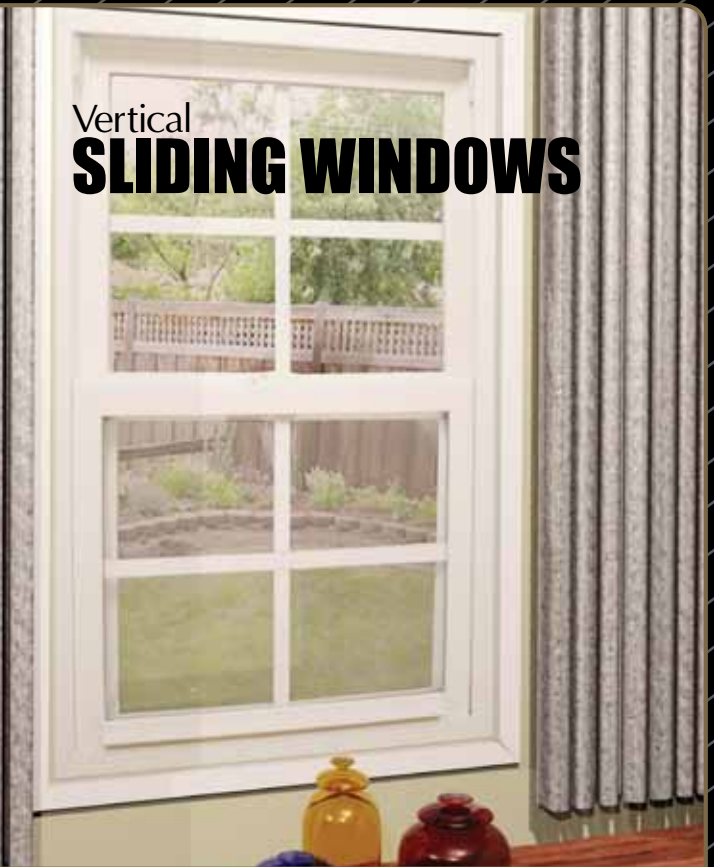

Vertical
SLIDING WINDOWS

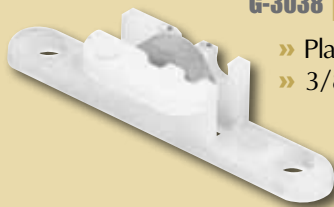

G-3038 | Roller Assembly

- » Plastic housing
- » 3/8" O.D. flat edge steel roller

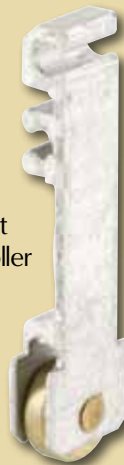

G-3102 | Roller Assembly

- » Extruded aluminum bracket
- » 1/2" O.D. flat edge steel roller

G-3078 | Corner Guide Set

- » Black plastic guides

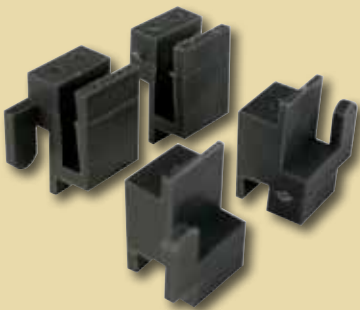

G-3077 | Roller Assembly

- » Stamped aluminum bracket
- » 1/2" O.D. flat edge plastic roller

**WINDOW
Hardware**

There are over 1 billion windows in active use today in the United States. Window maintenance is one of the fastest growing categories with the explosion of vinyl windows over the last 15 years. Prime-Line can supply thousands of components to keep your windows functioning safely, including sash balances, latches and rollers.



H-3966 | Crank Handle



- » Used on Andersen casement operators
- » 3/8" spindle

H-3531 | Crank Handle

- » Diecast handle
- » 5/16" spindle



H-3892 | Universal Tee Handle

- » Diecast handle
- » Universal spindle size

H-3962 | Folding Crank Handle

- » Handle folds down to eliminate window blind interference
- » Universal spindle size



H-3553 | Casement Lock

- » Brass plated
- » 3 different keepers
- » Used on old style wood casement windows



H-3539 | Locking Handle

- » Diecast lock for steel or aluminum windows
- » Accepts 1/8" security pin

H-3546 | Louvre Operator

- » Diecast
- » Reversible
- » Universal break-off link

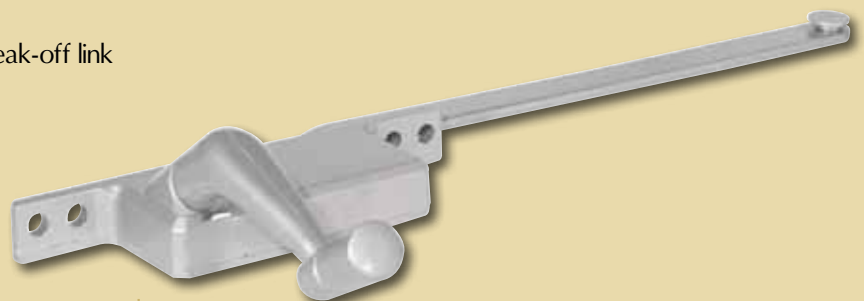

H-3514 | Operator

- » Steel arm
- » Used on steel framed windows
- » 3/8" spindle





TH-23076 | Dual Arm Operator

- » Diecast zinc base with steel arm
- » Dual arm action pushes the sash open while pulling the hinge side of sash to the open position
- » 11/32" spindle



TH-21931 | Operator Cover

- » High impact plastic
- » Snaps on



TH-21998 | Crank Handle

- » Diecast handle
- » 11/32" spindle



TH-24186 | Operator

- » Diecast zinc base with steel arm
- » Provides a full 90° window opening
- » 11/32" spindle



CASEMENT & JALOUSIE WINDOW Hardware

We offer a large selection of casement & jalousie window hardware, including operators, handles, pulls, and locks. Multiple styles and finishes available. We have over 700 items available to service all types of windows.

Truth Hardware designs and manufactures a complete line of hinges, locks, and operators, for use on wood, vinyl, metal and fiberglass windows. For over 50 years Truth Hardware has been recognized as the industry leader in the design and manufacture of quality operating hardware. We maintain over 300 items packaged with access to thousands more via special order.





L-5506 | Screen Clip

- » White nylon
- » For flush mounting screens

L-5507 | Screen Clip

- » Gray plastic
- » 1/16" offset

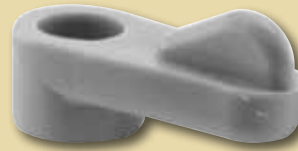

L-5566 | Lift Tab

- » Black plastic
- » Installs in the spline channel and aids in the removal of window screens



L-5505 | Screen Clip

- » Zinc diecast
- » 7/16" offset



L-5529 | Hanger & Latch

- » Stamped aluminum
- » Used to install 7/16" window screens to wood framed windows



L-5540 | Plunger Latch

- » Black plastic
- » Snap-on style, spring loaded
- » For 3/8" & 7/16" x 3/4" aluminum framed screens

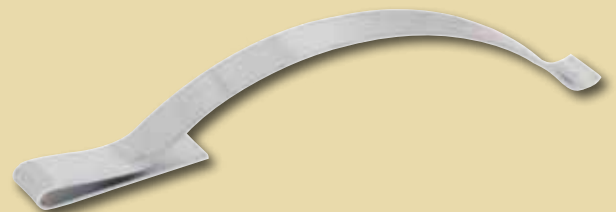

L-5577 | Tension Spring

- » Corner mounted
- » Heat-treated steel



T-8677 | Flush Panel Clip

» Clear acrylic



T-8666 | Flush Panel Clip

» White nylon

T-8502 | Panel Clip

» Aluminum clip & thumbscrew



T-8506 | Panel Clip

» Aluminum clip & thumbscrew

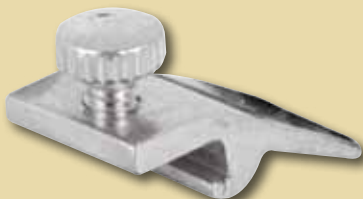

T-8662 | Panel Clip

» Aluminum clip & thumbscrew

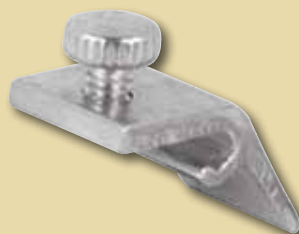

WINDOW SCREEN & STORM WINDOW Hardware

We offer a large variety of types and sizes to ensure that you can find the perfect piece to secure your screen frame. We offer clips, lift tabs, plunger latches, retainer clips, hangers & latches and springs in multiple finishes and materials. Over 360 items are available.

Storm door hardware includes glass panel retainer clips, fasteners and door threshold replacement inserts. These hard to find items help maintain your storm door and window panels to maintain energy efficiency.



M-6000 | Roller

- » 3/4" O.D. round edge plastic ball bearing
- » Threaded hex hub



M-6001 | Roller

- » 3/4" O.D. flat edge plastic ball bearing
- » Threaded hex hub



M-6145 | Roller Bracket

- » Extruded aluminum bracket
- » 3/4" O.D. plastic ball bearing roller
- » For use on up to 3/16" thick glass

M-6119 | Bumper

- » Clear vinyl
- » 3/4" O.D.



M-6158 | Handle

- » Chrome plated
- » 2" hole spacings

M-6023 | Bottom Seal

- » Star shaped gray vinyl sweep
- » Prevents water from leaking onto floor



M-6040 | Bottom Seal

- » T-shaped gray vinyl sweep
- » Prevents water from leaking onto floor





M-6014 | Catch

- » Stainless steel
- » Spring loaded plastic tip
- » Adjustable

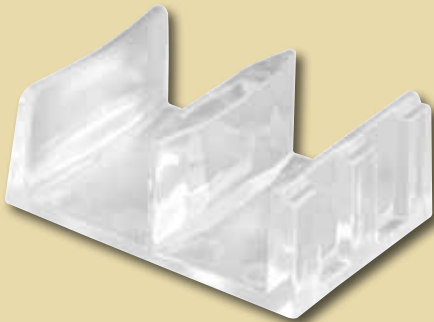

M-6058 | Bottom Guide

- » Clear plastic
- » Fits 7/16" thick door panels



M-6067 | Bottom Guide

- » Clear plastic
- » Fits 7/16" thick door panels

TUB & SHOWER Hardware

Your tub & shower is one of the most used items in your home. When it's time to repair your tub or shower door, Prime-Line's large selection of rollers, seals and guides can help with your repair project. We have over 270 different items to fix most door systems.

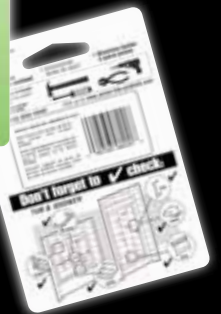

N-6563 | Guide

- » Molded white plastic
- » For 1-3/8" thick doors

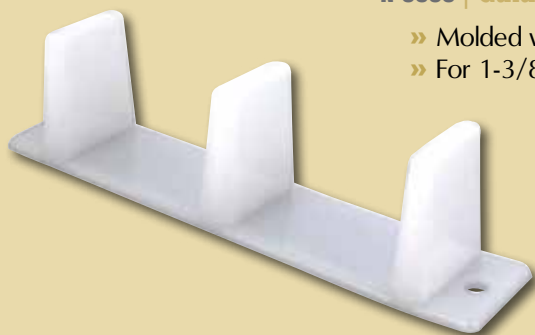

N-6661 | Guide

- » For 3/4" to 1-3/8" thick doors
- » 1/8" thick plastic shim plates raise guide up to 5/8" above carpet

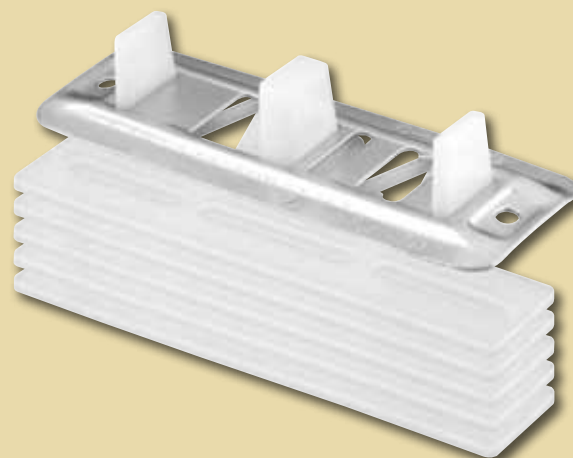

N-6513 | Roller

- » 3/4" offset adjustable bracket
- » 1" O.D. round edge plastic wheel
- » Fits 3/4" to 1-3/8" thick doors



N-6761 | Guide

- » For 3/4" to 1-3/8" thick doors
- » 1-1/4" high legs helps clear carpet pile



N-6501 | Roller

- » 1/2" offset adjustable bracket
- » 7/8" O.D. round edge plastic wheel
- » Fits 3/4" to 1-3/8" thick doors



N-7297 | Pull

- » Satin nickel finish
- » Fits a 2-1/8" diameter hole



N-6517 | Roller

- » 1/2" offset adjustable bracket
- » 3/4" O.D. round edge plastic ball bearing wheel
- » Fits 3/4" to 1-3/8" thick doors



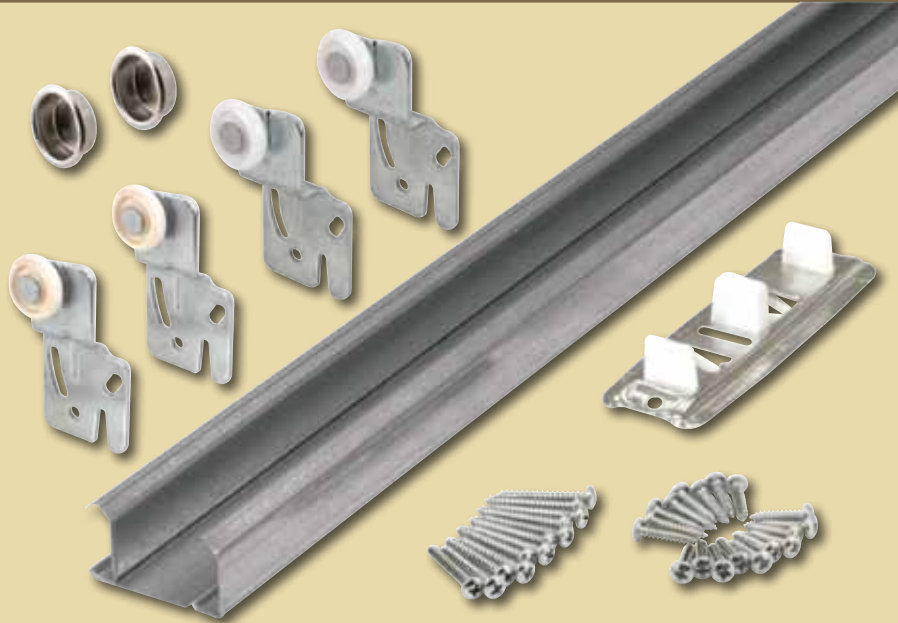

161791 | Sliding Door Track & Hardware Kit - 48"

- » Galvanized steel track
- » Used with wood door panels 3/4" to 1-3/8" thick
- » For use on doors weighing up to 60 lbs. each
- » Complete with rollers, bottom guide and finger pulls

SLIDING DOOR
Closet Hardware

Maintaining the look and operation of your sliding closet doors is a simple project. When it's time replace your worn out rollers, guides and pulls, we maintain nearly 1000 unique items in this category that will meet your project requirements.





N-7283 | Repair Kit

- » Repair kit for 3/8" dia. holes
- » Fits 7/8" wide top track
- » Includes most parts needed to repair one (1) two door set



N-6703 | Guide Wheel

- » Spring loaded
- » 7/8" O.D. plastic wheel, 3/8" O.D. nylon base
- » Top mount

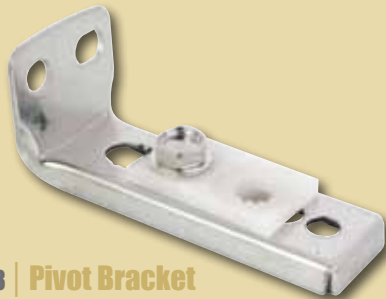

N-6543 | Pivot Bracket

- » Adjustable steel bracket
- » For 1" to 1-3/8" thick doors up to 50 lbs. each



N-6700 | Pivot

- » Spring loaded
- » 1/4" O.D. pin, 3/8" O.D. nylon base
- » Top mount



N-6704 | Guide Wheel

- » Spring loaded
- » 3/4" O.D. plastic wheel, 3/8" O.D. nylon base
- » Top mount

N-6606 | Pivot Bracket

- » Adjustable steel bracket
- » Mounts into top track



N-6701 | Pivot & Guide

- » Spring loaded
- » 7/16" O.D. plastic cap, 7/16" O.D. plastic base
- » Top mount

N-6656 | Hinge

- » Brass plated steel hinge
- » Non-mortise installation

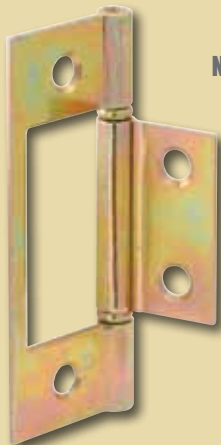

N-7372 | Knob

- » 1-11/16" O.D.
- » Satin nickel





161794 | Bi-Passing Door Track & Hardware Kit - 36"

- » Steel track
- » Used with wood door panels 1" to 1-3/8" thick
- » For use on doors weighing up to 30 lbs. each
- » Complete with pivots, pivot brackets, hinges, snugger & knobs
- » 2 different track systems available

BI-FOLDING DOOR Closet Hardware

A standard bi-fold closet door allows for easy access to ones closet. In general, bi-fold doors can last a lifetime if you properly maintain the door hardware. Prime-Line can help with maintaining your door with a large selection of pin's, pivots and accessories.





N-7239 | Lock & Pull

- » Pull-out edge tab with privacy lock
- » For 1-3/8" thick doors
- » Reversible

N-6768 | Pull

- » Brass plated
- » Used on interior flush mounted doors



N-7238 | Pull

- » Pull-out edge tab
- » For 1-3/8" thick doors
- » Reversible



N-7015 | Bottom Guide

- » Adjustable
- » Will accommodate any door thickness

N-6566 | Bottom Guide

- » Steel bracket with nylon tips
- » For 1-3/8" thick doors



N-7065 | Roller

- » Round edge 13/16" O.D. plastic ball bearing wheels
- » For doors weighing up to 100 lbs.

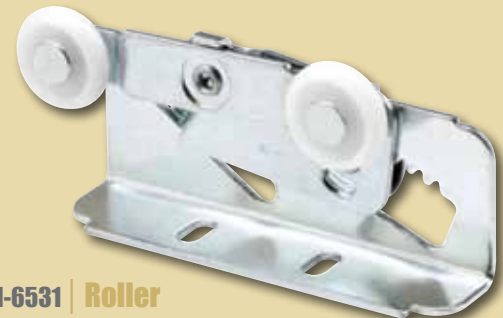

N-6531 | Roller

- » Top mount adjustable bracket
- » Round edge 7/8" O.D. plastic wheels
- » For doors weighing up to 75 lbs.

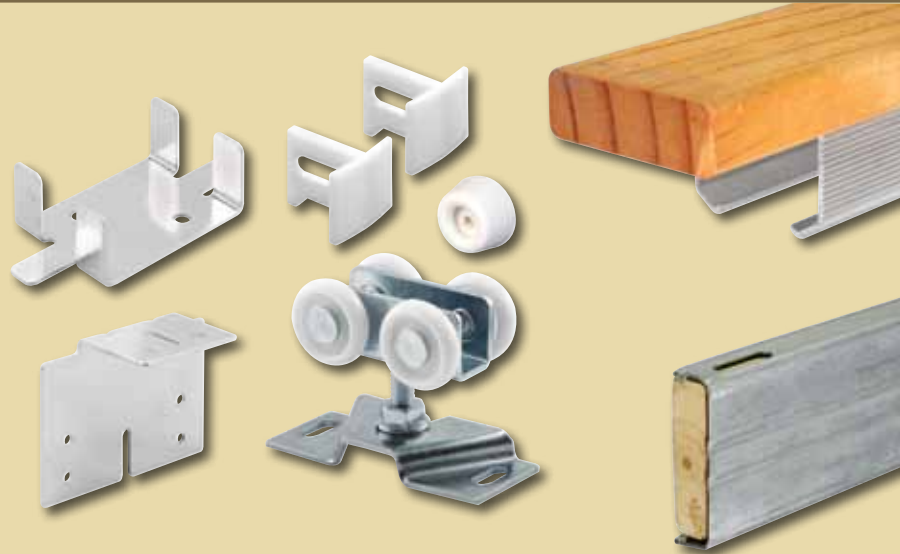

164553 | Pocket Door Track & Hardware Kit - 72"

- » Extruded aluminum track
- » Used with wood door panels 1-3/8" to 1-3/4" thick
- » For use on doors weighing up to 150 lbs. each
- » Complete with guides, rollers, brackets & bumper

POCKET DOOR
Closet Hardware

Pocket doors are popular because they are more space efficient than a sliding or bi-folding door. When the time comes to update or repair your pocket door hardware, we have a selection of rollers, guides and pulls to help complete your project.



R-7154 | Guide Kit

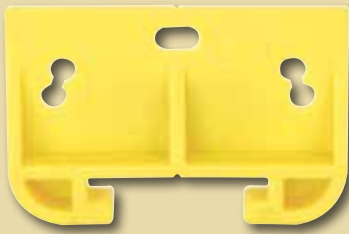

- » Plastic guide & side saddle
- » For 3/32" x 1-9/32" track

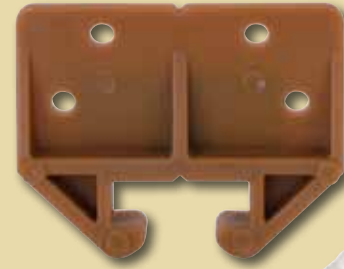

R-7084 | Guide Kit

- » Plastic guide & side saddle
- » For 1/4" x 7/8" track

R-7085 | Guide Kit

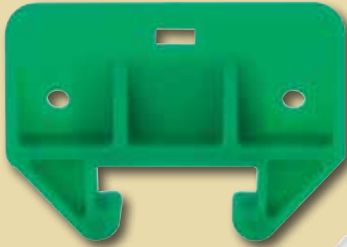

- » Plastic guide & side saddle
- » For 9/32" x 1-1/8" track



R-7133 | Back plate

- » Used on rolled edge and other center mounted tracks

R-7082 | Guide Kit



- » Plastic guide & side saddle
- » For 9/32" x 3/4" track



R-7153 | Side Saddle

- » White plastic
- » Allows for smooth operation of drawer



R-7144 | Track Repair Kit

- » Complete kit replaces most wood track systems
- » Wood track, plastic guides & side saddles, steel angle brackets



R-7147 | Roller

- » Adjustable steel bracket with plastic wheel
- » Provides alignment for track mounted drawers

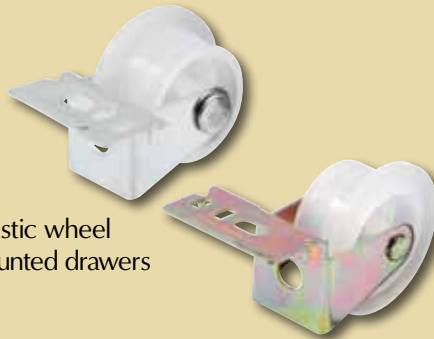

DRAWER Hardware

Drawer guides and rollers allow drawers to function smoothly. Over time, they can become worn or broken. Replacement is easy and we have a large selection of plastic guides and rollers.

R-7141 | Roller (Left hand)

- » Steel bracket with 13/16" O.D. plastic roller
- » Mounts on rear of drawer



R-7148 | Roller (Right hand)

- » Steel bracket with 13/16" O.D. plastic roller
- » Mounts on rear of drawer





U-9005 | Bed Frame Rail Clamp

- » Heavy gauge steel bracket
- » Used to secure bed frame meeting rails



U-9047 | Roller Catch

- » Brass plated steel catch & strike
- » Spring loaded plastic roller
- » Used on interior closet & utility doors



U-9132 | Bullet Catch

- » Brass plated diecast catch & steel strike
- » Used on interior closet & utility doors



U-9187 | Shelf Peg

- » White plastic with steel peg
- » Fits 5 mm diameter hole



U-9131 | Picture Hanger

- » Adjustable from 2-7/8" to 3-11/16"
- » Steel hanger



U-9360 | Shelf Peg

- » Clear plastic
- » Fits 5 mm diameter hole



U-9000 | Door Stop

- » Brass plated steel
- » Rubber tip
- » Flexible

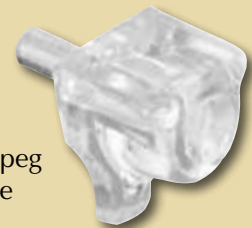

U-9302 | Shelf Peg

- » Clear plastic with steel peg
- » Fits 3 mm diameter hole



U-9001 | Shelf Peg

- » Brown plastic
- » Fits 1/4" diameter hole



U-10089 | Shelf Peg

- » Brass plated with vinyl tip
- » Fits 1/4" diameter hole



U-9054 | Shelf Peg

- » Brass plated
- » Fits 1/4" diameter hole



U-9337 | Shelf Peg

- » Nickel finish
- » Fits 5 mm diameter hole



HOUSEHOLD Hardware

Prime-Line offers a large selection of shelf pegs that are suitable for kitchen cabinets, entertainment centers, bookcases, curio cabinets and more. We also have door catches, mirror clips, bed frame rail clamps and more. Over 1000 items are available in this category.



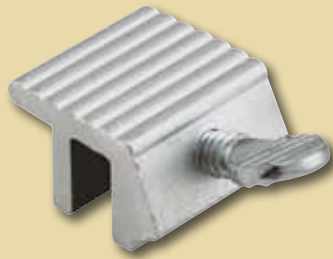

U-9800 | Thumbscrew Lock

- » Extruded aluminum housing
- » No tools needed to install
- » Securely locks window in closed or ventilating position



U-9820 | No-Mar Lock

- » Extruded aluminum housing with no-mar vinyl insert
- » No tools needed to install
- » Securely locks window in closed or ventilating position

U-9819 | Thumbscrew Lock

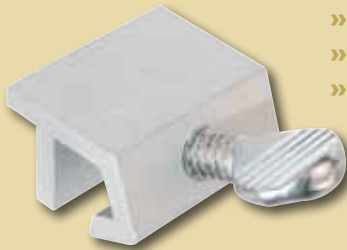

- » Extruded aluminum housing
- » No tools needed to install
- » Securely locks window in closed or ventilating position

U-9823 | Vinyl Window Lock

- » Cast zinc construction
- » Fits rail thicknesses from 1/16" to 1/2"
- » Ergonomic locking lever
- » Locks in 3 positions



U-9925 | Sash Lock

- » Stamped steel
- » Cam action



U-9824 | Cam Action Lock

- » Extruded aluminum housing
- » No tools needed to install
- » Securely locks window in closed or ventilating position

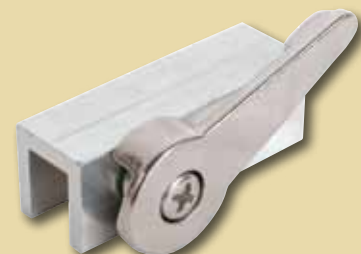



U-9938 | Wood Window Flip Lock

- » Brass plated steel
- » Mounts on vertical track
- » Stops window in vented position



U-9857 | Pin Lock

- » Plated steel pin
- » Prevents sliding & lifting of window
- » Securely locks window in closed or ventilating position

WINDOW SECURITY Hardware

Most windows can easily be forced open by prying or lifting the sash. Secondary security locks can allow for ventilation, help prevent unwanted access and offer child safety benefits. A wide variety of styles offer the homeowner everything from tamper-resistant window locks to keyed locks, assuring solid, safe child protection as well.



**Defender[®]
Security**

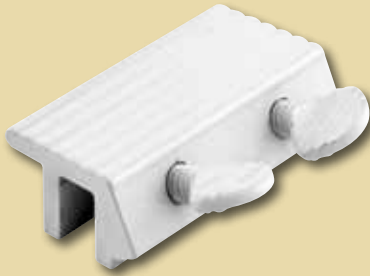

U-9807 | Thumbscrew Lock

- » Extruded aluminum housing
- » No tools needed to install
- » Securely locks window in closed or ventilating position

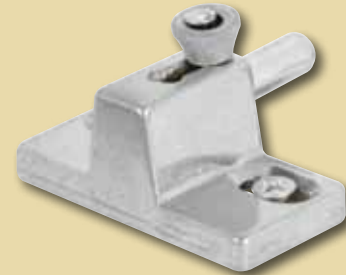

U-9866 | Slide Bolt Lock

- » Diecast housing with steel bolt
- » Securely locks door in closed or ventilating position



U-9882 | Step-On Keyed Lock

- » Diecast housing with hardened steel bolt
- » Convenient foot operation of bolt
- » Securely locks door in closed or ventilating position



U-9920 | Security Bar Lock

- » Clear anodized aluminum
- » Accommodates 28" to 48" wide inside & outside sliding patio doors



U-9848 | Twist-In Lock

- » Zinc plated housing
- » Aluminum bolt
- » Securely locks door in closed or ventilating position

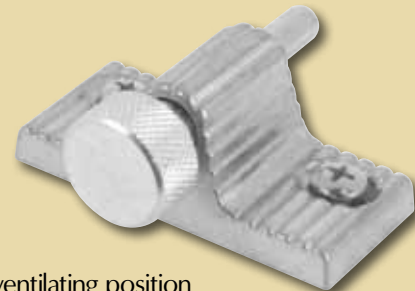

U-9842 | Glass Surface Lock

- » Clear lucite
- » Clear adhesive backing
- » Two piece hinged assembly with spring loaded plunger lock



U-9847 | Loop Lock

- » Hardened steel locking rod with diecast bracket & keeper
- » Secures door to jamb



U-9858 | Pin Lock

- » Plated steel pin
- » Prevents sliding & lifting of door
- » Securely locks door in closed or ventilating position

PATIO DOOR SECURITY
Hardware

Patio doors are a favorite entry point for many burglars. Many door systems can be lifted or pried open easily. Adding a security bar or secondary locking bolt provides another layer of protection for your family that will help secure your home.



Defender[®] Security



U-9907 | Chain Door Guard

- » Solid brass keepers with steel chain
- » Secures door while allowing viewing and ventilation

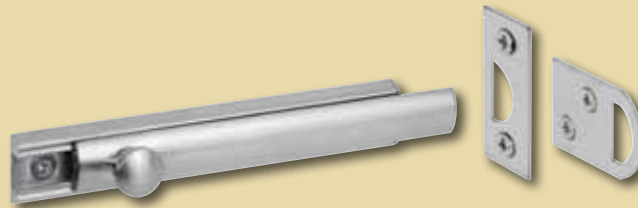

U-10306 | Surface Bolt

- » Solid brass
- » 2 keepers allow for surface or mortise frame installation

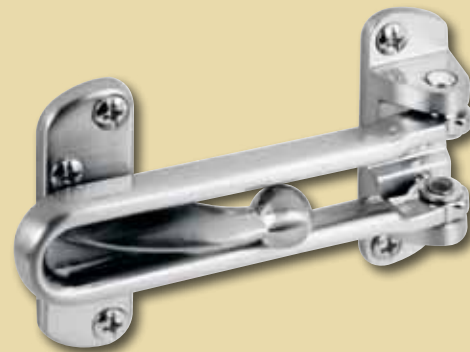

U-10308 | Swing Bar Lock

- » Plated heavy metal casting
- » Secures door while allowing viewing and ventilation



U-9887 | Flip Door Lock

- » Brass plated steel
- » Flip action to lock or unlock



U-10827 | Door Reinforcement Lock

- » Prevents lock bumping or lock picking in the locked position
- » Designed to withstand 8000 lbs. of force
- » Meets Texas building code requirements



U-9891 | Viewer

- » 200°
- » Solid brass housing
- » Glass lens
- » Fits 1-3/8" to 2-1/8" thick doors
- » U.L. Listed

U-10314 | Viewer

- » 130°
- » Solid brass end caps with diecast threaded housing
- » Glass lens
- » Fits 1-3/4" to 2-3/8" thick doors

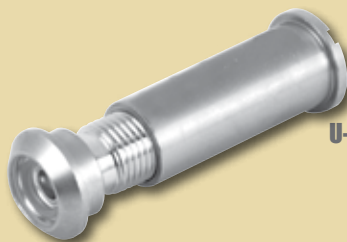

U-9880 | Viewer

- » 160°
- » Solid brass housing
- » Glass lens
- » Fits 1-5/16" to 2-1/8" thick doors
- » U.L. Listed

ENTRY DOOR SECURITY Hardware

Over half of all burglaries are initiated by forced entry. A majority of these are accomplished by kicking in a door. Door viewers, chain door guards and bar door guards help keep you safe from strangers when answering your door.



Defender Security



E-2279 | Knob

- » Glass knobs
- » Brass finish base



E-2293 | Mortise Lock Set

- » Brass plated steel trim plates
- » Keyed
- » Lock bolt is key activated both inside and outside

**VINTAGE DOOR
Hardware**

Prime-Line offers a selection of over 60 vintage door hardware items. Choose from multiple backplates, lock sets & door knob styles. Available in multiple finishes.



E-2294 | Mortise Lock Assembly

- » Steel case with brass plated faceplate
- » For 2-3/8" backset
- » Keyed

E-2282 | Door Knob Rosette

- » 2-1/4" O.D.
- » Brass plated



**Defender
Security**

U-9951 | Keyed Hasp

- » Plated steel
- » Twist key knob to lock, use key to unlock
- » ILCO keyway



U-9949 | Showcase Window Key Lock

- » Chrome plated steel
- » Fits up to 5/16" thick glass
- » Adjustable



U-9947 | Drawer & Cabinet Lock

- » Brass plated diecast housing
- » Fits 7/8" hole
- » Yale keyway

U-9942 | Drawer & Cabinet Lock

- » Brass plated face, brass plated diecast housing
- » For drawers up to 5/16" thick
- » Yale keyway



UTILITY Hardware

Keep dangerous chemicals and important items locked up for safety and peace of mind. Cam locks, panel locks and mailbox locks can provide security in these overlooked areas. Useful in the home or garage, these devices are also easily installed.



**Defender[®]
Security**



SEGAL Hardware

The original SEGAL lock was developed in 1912 by Samuel Segal, a New York police officer, who saw the need to protect residents from thieves "jimmying" or spreading the door frame to gain entry. Improvements over the years have changed the original design and made the Segal Vertical Deadbolt one of the strongest locking devices available through the retail channels.

Made from cast bronze material and equipped with a drop forged bolt and solid brass cylinder with a 5-pin tumbler, Segal Locks are some of the strongest locking devices on the market today.



SE-70007 | Cylinder

- » Solid brass with brushed brass finish
- » 5-pin tumbler cylinder

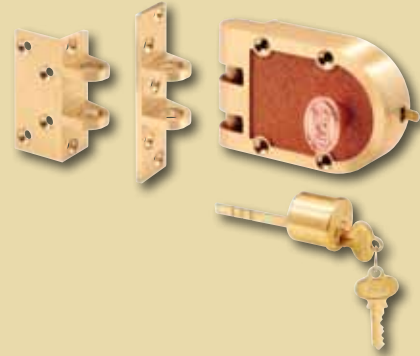

SE-15361 | Jimmy-resistant Deadlock

- » Includes tamper resistant shutter guard
- » 5-pin tumbler cylinder

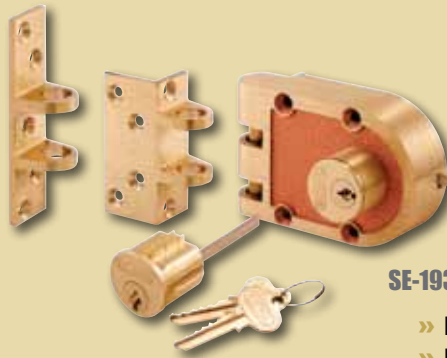

SE-19361 | Jimmy-resistant Deadlock

- » Double cylinder
- » Includes tamper resistant shutter guard
- » 5-pin tumbler cylinder

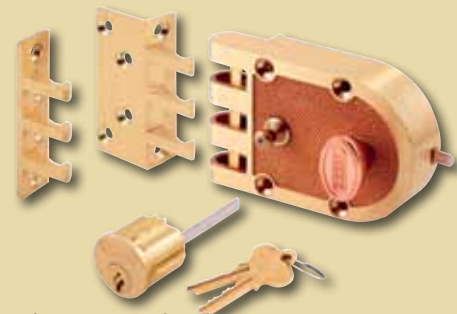

SE-14326 | Slam Lock

- » Includes tamper resistant shutter guard
- » 5-pin tumbler cylinder



E-2232 | Latch Strike

- » Brass plated steel strike with adjustable tab
- » Replaces most residential interior & exterior strikes



E-2299 | "T" Strike

- » Solid brass, stainless steel finish
- » Used on wood or metal jambs with most grade 2 locksets



U-9426 | Security Latch Strike

- » Brass plated steel
- » Strengthens or repairs wood jambs

E-2235 | Deadbolt Strike

- » Brass plated steel
- » Replaces most deadbolt strikes for increased security



SECURITY STRIKES

Over half of all burglaries are initiated by forced entry. A majority of these are accomplished by kicking in a door. High security strikes help prevent door kick in attacks. A secure metal barrier prevents jimmy tools from destroying jambs and trim. There are also several designs and finishes available to complement your existing door hardware, with most including 3" security screws to anchor into the wall stud.



**Defender[®]
Security**



U-9481 | Door Protector

- » Used on inswing or outswing doors
- » Secures against forced entry
- » 6" overall length
- » Extruded aluminum

LATCH SHIELDS

Secure your door latch or bolt against forced entry with these latch shields. Available for both inswing and outswinging doors. Suitable for residential or commercial use on wood or metal doors.



U-9512 | Latch Shield

- » Used on inswinging doors
- » Interlocking brackets protect against forced entry
- » 6" overall length
- » Steel



U-9500 | Latch Shield

- » Used on outswinging doors
- » Secures against forced entry
- » 7" overall length
- » Steel

**Defender[®]
Security**



U-9547 | Door & Lock Reinforcer

- » Solid brass
- » For 2-3/8" backset
- » For 1-3/8" thick doors
- » Assists in preventing forced entry



U-10893 | Door Jamb Reinforcement Kit

- » Wraps around existing door jamb to reinforce latch strike area
- » For 2-3/8" backset
- » For 1-3/4" thick doors

U-9567 | Door Edge Reinforcer

- » Solid brass
- » For 1-3/4" thick doors
- » Assists in preventing forced entry



REINFORCERS

Over half of all burglaries are initiated by forced entry. A majority of these are accomplished by kicking in a door. Lock & door reinforcers help prevent door kick in attacks. A secure metal barrier prevents jimmy tools from destroying jambs. Lock & door reinforcers are available to fit most door thickness and backset configurations. There are also several designs and finishes available to complement your existing door hardware.



**Defender[®]
Security**

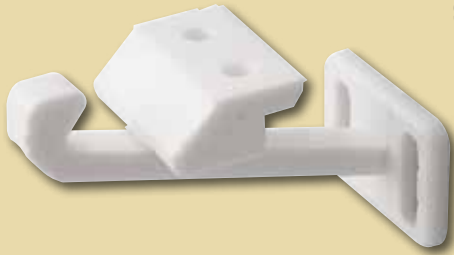

S-4462 | Catch

- » White plastic
- » For use on cabinets & drawers to deter small children's access

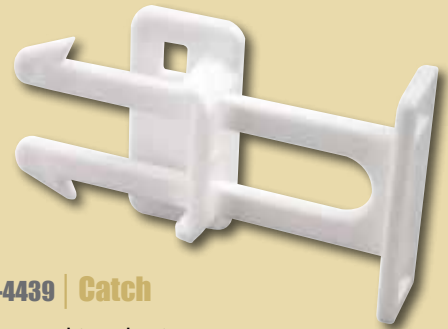

S-4439 | Catch

- » White plastic
- » For use on cabinets & drawers to deter small children's access

S-4624 | Strap Lock

- » White plastic
- » Attaches over knobs
- » Ratcheting action holds door closed



S-4623 | Safety Cleat

- » Clear plastic
- » Helps keep window blind cords out of reach

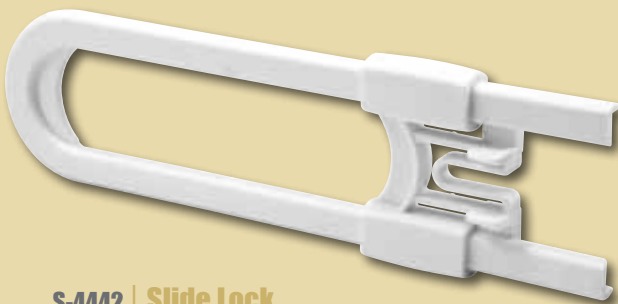

S-4442 | Slide Lock

- » White plastic
- » Attaches over knobs



S-4441 | Door Knob Cover

- » White plastic
- » Slips over most door knobs to keep toddlers from gaining entry to off-limits areas



S-4445 | Corner Cushion

- » Clear plastic
- » Self adhesive

S-4460 | Shock Guard

- » Clear plastic
- » Protects tiny fingers or prying objects from causing electrical shock



S-4461 | Swivel Outlet Cover

- » White plastic
- » Spring loaded
- » Protects tiny fingers or prying objects from causing electrical shock

CHILD SAFETY
Hardware

Home safety made easy. A complete line of safety products designed to help protect your children in all the areas of your home.





MAILBOX LOCK Hardware

According to the U.S. Postal Service, 44 million addresses change every year. Mail box lock changes are a necessary part of the move. Prime-Line offers a vast assortment of mail box locks for every type of need.



S-4140 | Mailbox Lock (5-Cam)

- » Nickel plated finish
- » Fits American, Florence, Miami-Carey, Bommer and Auth
- » Uses Hudson keyway, ILCO 1003M

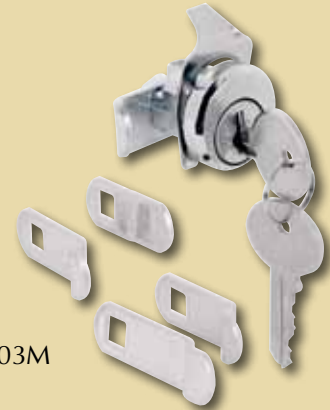

S-4533 | Mailbox Lock (5-Cam)

- » Nickel plated finish
- » Uses Hudson keyway, ILCO 1003M



S-4648 | Mailbox Lock (3-Cam)

- » Brass finish
- » Fits Bommer, Auth-Electric & United
- » Uses Hudson keyway, ILCO 1098 (98X)



S-4573 | Mailbox Lock (5-Cam)

- » Nickel plated finish
- » Fits American, Florence, Miami-Carey, Bommer and Auth
- » Uses National keyway



SP-9601 | Extension Spring

- » Nickel plated spring steel
- » Outside diameter: 5/16"
- » Length: 1-1/2"
- » Gauge: .020



SP-9608 | Extension Spring

- » Nickel plated spring steel
- » Outside diameter: 7/16"
- » Length: 2-1/2"
- » Gauge: .047



SP-9640 | Extension Spring

- » Nickel plated spring steel
- » Outside diameter: 5/16"
- » Length: 15-1/2"
- » Gauge: .050



SP-9706 | Compression Spring

- » Nickel plated spring steel
- » Outside diameter: 1/2"
- » Length: 1-1/2"
- » Gauge: .041

SP-9713 | Compression Spring

- » Nickel plated spring steel
- » Outside diameter: 7/8"
- » Length: 4"
- » Gauge: .080



HANDYMAN Springs

A "Must Have" category for all hardware stores and home centers. Prime-Line's 120 item program contains the most commonly needed items today's shopper looks for to make repairs around their home or business. With incremental sizes from 1.3 lbs. to 352 lbs. in load, our program can satisfy every demand while keeping your stock unit count low.



Handyman SPRINGS



GD-52109 | Pulley With Strap

- » 3" O.D. case hardened steel race with steel ball bearings
- » Galvanized steel pulley and strap



GD-52104 | Hinge

- » Heavy duty 14 gauge galvanized steel
- » Roller tube accepts standard 7/16" dia. stem



GD-52110 | Roller

- » 1-7/8" O.D. steel ball bearing roller with steel inner race
- » 4" stem length



GD-52100 | Extension Cable

- » 12' cable with loop ends
- » Galvanized carbon steel aircraft cable

GD-12151 | Cable Ferrules & Stops

- » Extruded aluminum
- » For 1/8" cable



GD-12194 | Extension Spring

- » For door sizes: Wood door; 9' x 7', 2 panels, 4 sections, 2 springs on door
Fiberglass door; 16' x 7', 2 Panels, 4 springs on door
- » Safety cable included





GD-52122 | Locking Handle

- » Chrome plated
- » 5/16" square shaft, 3" long



GD-52130 | Lift Handle

- » 6" hole centers
- » Galvanized steel



GD-52118 | Inside Deadlock

- » Steel slide bolt with galvanized steel housing
- » Works from inside for extra protection

GARAGE DOOR Hardware

Keeping the hardware on your garage door in good condition ensures a long lasting and trouble free operation. We supply a complete line of garage door replacement parts & accessories that most often need replacing. Over 230 items are available to keep your door operating smoothly.



**Garage Door
HARDWARE**



K-5035 | Door Spring

- » Adjustable
- » Zinc plated finish
- » Adjusts from 13-5/8" min. to 16-3/4" max.

K-5120 | Closer (Heavy Duty)

- » For outswing wood or metal doors
- » Adjustable closing speed
- » Full 90° opening



K-5073 | Closer

- » For outswing wood or metal doors
- » Adjustable closing speed
- » Full 90° opening

K-5071 | Push Button Latch

- » For outswing wood or metal doors
- » Fits 1" to 1-1/4" thick doors
- » No-lockout feature



K-5000 | Knob Latch

- » For outswing wood or metal doors
- » Fits 5/8" to 1-1/4" thick doors



K-5003 | Strike

- » Adjustable
- » Includes two 1/16" shims for height adjustment



K-5167 | Push Bar

- » White plastic ends with steel reinforced vinyl bars
- » Fits doors up to 36" wide



K-5026 | Protector Chain

- » Heavy gauge spring wire and steel chain
- » Protects outswinging doors from wind damage

SCREEN & STORM DOOR Hardware

Prime-Line's Screen and Storm Door Hardware line is made using the highest quality materials and finest protective finishes. Our products have been in use by manufacturers and consumers for over 30 years, providing you with quality you can count on. The wide selection satisfies any regional requirements for replacement hardware or new manufacturing demands.



PL-7813 | Screen Frame Kit

- » 3/4" x 5/16" x 48" aluminum frame
- » Kit includes corners & spline



PL-7727 | Corner

- » Plastic
- » For 3/4" x 5/16 square cut frame

PL-14139 | Spreader Bar

- » .025 aluminum, 72"
- » Used to prevent frame bow on screens with 36" or larger span



PL-7916 | Screen Clip

- » Bronze plastic
- » 5/16" offset



PL-14079 | Screen Frame

- » .020 aluminum, 94"



PL-15517 | Door Grille

- » Molded plastic
- » 20" high, 34-1/2" width can be trimmed down to fit smaller doors

P-7515 | Re-screening Kit

- » 36" x 84" fiberglass screen cloth
- » 30' of .155 spline
- » Plastic rolling tool, with convex & concave wheels



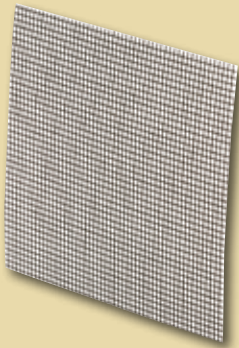

P-8096 | Repair Patch

- » 3" x 3"
- » Adhesive backed
- » Fiberglass

P-7630 | Spline

- » .120 diameter vinyl
- » Round, serrated, hollow core



P-7505 | Rolling Tool

- » Steel convex & concave rollers
- » Wood handle
- » For spline size .115 - .165

WINDOW & SCREEN Repair

Over 3500 items are available in our re-screening or making new window screens product category. Prime-Line offers a comprehensive program, encompassing all facets of screening and glazing of windows and doors. Prime-line's extrusion facility produces screen spline, glazing channel, corner protectors and dozens of other items used in our window screen program. Our facilities also include roll formers that can be configured to make any size or shape screen frame lineal.



MAKE 2 FIT



GIB CLOSER

Gibcloser provides three different products to the residential, commercial and industrial building markets. We also cater to the specialty manufacturing sectors such as cabinet and case work manufacturers, transaction hardware manufacturers, children's furniture designers and builders of all kinds.

The Gibcloser products are designed and tested to perform trouble free for many years. Our products have been in continuous use in some cases since 1926. All of our door closers are Underwriters Laboratory (UL & cUL) approved, and approved for 1/2 hour fire rated doors. They require no maintenance and are simple to install.



Gibcloser®

48

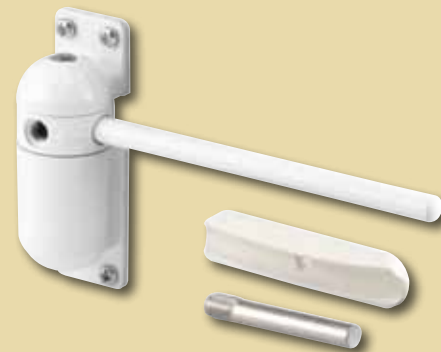

KC50HD | Screen & Gate Closer

- » Reversible
- » Adjustable closing force
- » For doors & gates up to 57 lbs.

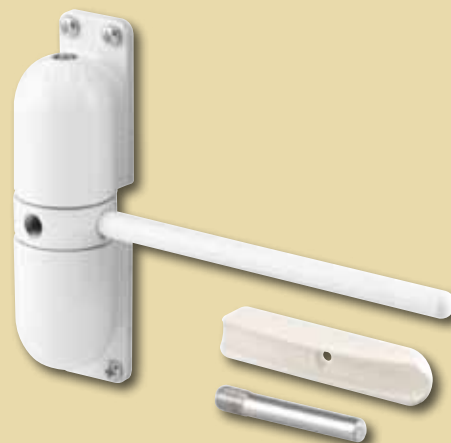

KC10HD | Door Closer

- » Reversible
- » U.L. Listed
- » Adjustable closing force
- » For doors up to 150 lbs.



KC30US | Door Closer

- » Concealed 5/8" O.D. barrel
- » U.L. Listed for 1/2" hour fire door test
- » For use on doors up to 150 lbs.



E-2400 | Re-Keying Kit

» For Kwikset 5-pin locksets

RE-KEY A LOCK

Our Re-Key A Lock system provides homeowners and apartment managers with an easy-to-use re-keying system. The kit includes all the necessary tools, 3 keys and enough pins to re-key up to six locks or deadbolts.

Re-Key A Lock kits are designed for all major lock types including: Kwikset, Titan, Schlage, and Weiser. Kits include tweezers for easy pin insertion. Color-coded pins for easy re-keying.

Will not detract from in-store re-keying services. Most homeowners do not bring in locksets from their home for re-keying.

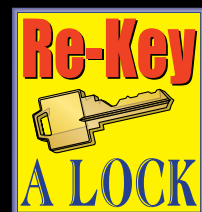



FLAG POLE HOLDERS

Prime-Line banner and flag pole holders are the perfect choice for the retail marketer. Colorful, space-saving packaging allows easy product identification and consumer appeal. 21 different products in one category offers the widest selection in the industry.

Fixed angle and multi-position mounts allow a full range of consumer applications. Weather-resistance provides greater consumer satisfaction. Multiple finishes for wider decorative appeal.



U-9378 | Holder

- » Zinc plated finish
- » 30° Projection from vertical
- » For 3/4" pole

U-10044 | Holder

- » Cast aluminum
- » 30° Projection from vertical
- » For 3/4" pole



U-9375 | Adjustable Holder

- » Plastic
- » Multi-position adjustability
- » For poles up to 1-1/8"



U-9374 | Holder

- » Plastic
- » For poles up to 1"

J-4551 | Door Stop

- » Cast iron, aluminum finish
- » Spring loaded
- » Rubber tip



J-4595 | Door Stop

- » Diecast zinc, aluminum finish
- » Spring loaded
- » Rubber tip



J-4533 | Door Stop

- » Diecast zinc, bronze finish
- » Spring loaded
- » Rubber tip

J-4618 | Kick Plate

- » 8" x 34"
- » Brite brass on aluminum



COMMERCIAL Hardware

Prime-line offers an extensive assortment of 523 commercial door hardware items. From store front locks to commercial door closers to push and pull plates and kick plates in a wide variety of sizes. All are available in a number of finishes.

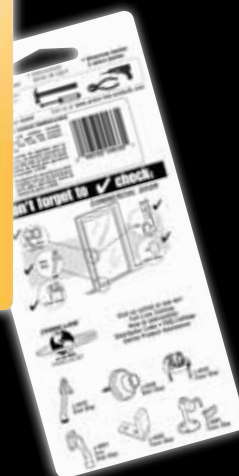

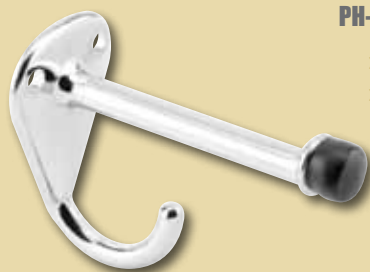

PH-17156 | Hook & Bumper

- » 3" projection
- » Chrome plated zamak

PH-17027 | Pivot Hinge

- » For 1-1/4" post size
- » Chrome plated zamak



PH-17003 | Pull

- » 3-1/2" hole centers
- » Chrome plated zamak



PH-17070 | Concealed Latch

- » Chrome plated zamak



PH-17039 | Slide Latch

- » 2-3/4" hole centers
- » Chrome plated zamak



PH-17008 | Strike

- » For 1-1/4" post size
- » Chrome plated zamak



PH-17015 | Cast Wall Brackets

- » For 1" panels
- » Chrome plated zamak

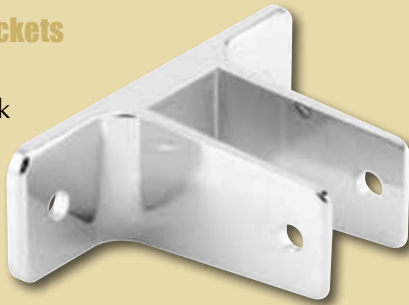

650-8157 | Stamped Wall Brackets

- » For 1" panels
- » Stainless steel

650-8139 | Extruded Wall Brackets

- » For 1" panels
- » Clear anodized aluminum

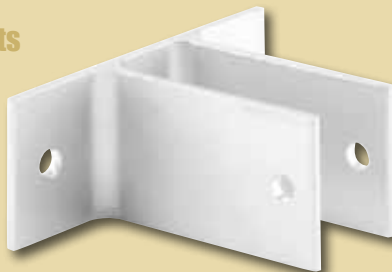

TOILET PARTITION Hardware

Originally established in 1975, we have been supplying hardware for installing and maintaining toilet partitions, in public restrooms, for over 30 years.

With over 1,000 items, our ever expanding inventory makes it possible to offer repair parts for all makes of toilet partitions. Our "West Coast" distribution center has allowed us to increase product selection and dramatically improve service and freight costs to the western united states.

Sentry
SUPPLY LLC



DOOR KNOB & WALL SHIELDS

The door knob and wall shield protects interior walls from impact damage by shielding contact point of wall and door. The self-adhesive backer eliminates need for tools or fasteners. It's paintable surface accepts both latex or oil based paints.

Eliminates the need for unsightly spring or rigid type, base moulding stops. Easily repairs door knob holes in wall board without messy spackling.



Round Shield (U-9244 shown)

- » Available in 3-1/4" and 5"
- » White & Ivory
- » Smooth or textured surface
- » Rigid vinyl



U-9140 | Hex Shield

- » 5"
- » White & Ivory
- » Textured surface
- » Flexible vinyl



U-10900 | Hanger Strip

- » (2) 16" pieces
- » Paintable
- » Easy to install



OVER-DOOR HANGER STRIP

The latest innovation from Prime-line is the over the door hanger strip. This easy to install strip is the perfect addition for any laundry room. Simply install above existing door frame for instant space savings. Paintable to match any décor.

Hang-ups





SHUTTER REPAIR

Quick and easy shutter repair. Designed to fix broken hooks between shutter slat & tilt rod. It's a simple to use, cost-effective solution for repairing broken shutters.



U-10907 | Shutter Repair

» Self adhesive

Quick n' Easy

Shutter Repair

OUR VALUE PROPOSITION...

- » Extensive product assortment
- » Competitive wholesale pricing
- » Largest selection of current and hard-to-find hardware
- » In stock, ready to ship inventory
- » Nationwide coverage
- » Outstanding customer service
- » Personalized account management
- » State of the art ordering systems





Facebook



YouTube



Twitter



Google+

CONNECT With Prime-Line

primeline.net

PRIME-LINE
The Replacement Hardware Company

Home | Where to Buy | Catalogs | How To's | FAQ's | Safety

Product Categories: Search [All Categories]

Repair/Replacement Parts
 Exterior Door Hardware
 Interior Door Hardware
 Tub & Shower Door Hardware
 Window Hardware
 Drawer And Cabinet Hardware
 RV And Mobile Home Hardware
 Builders Hardware
 Window And Screen Repair
 Commercial Restroom Hardware
 Repair Springs

Safety and Security Products
 Child Safety Products
 Door Security
 Sliding Patio Door Security
 Window Security
 Cabinet Security
 Miscellaneous Security
 GR Cover

North America's Largest Supplier of Window & Door Replacement Hardware!

Items currently in stock: 1881
How to view repairs: 4176

Repair/Replacement Parts (16)

Safety and Security Products (16)

Copyright ©2012 PRIME-LINE Products. All rights reserved.
 Home | About Us | Contact Us | Careers | Site Map

PRIME-LINE®

26950 San Bernardino Ave., Redlands, CA 92374
(909) 887-8118 • FAX - (909) 880-8968
Outside CA - (800) 255-3505 • FAX - (800) 437-7405

primeline.net

