



OMNIA

STAINLESS STEEL

Stainless Steel Latchsets

- Will fit 2⁷/₈" bore.
- 2³/₈" and 2³/₄" backsets available.
- Supplied for 2³/₈" backset and 1³/₈" door thickness unless otherwise specified.
- All lever latchsets are ADA approved.

Latch Features

- 28° retraction.
- 8 mm hub.
- Adjustable faceplate/armor plate for beveled doors.
- Built-in privacy feature with automatic release by inside lever or depression of latch nose.
- All dimensions are standard to fit existing bores for replacement installations.
- No. 013 "T" strike supplied as a standard or No. 014 "Full Lip" strike as an option at no extra charge. No. 019 4⁷/₈" ASA strike also available. Specify when ordering. (See page 8 for diagram.)

Concealed Screw Roses:

Self-aligning, spring-assisted roses.

- 2⁷/₁₆" dia. x 3⁸/₁₆" proj. Shipped standard.
- 2⁷/₁₆" square x 3⁸/₁₆" proj. or 2" dia. x 7¹⁶/₁₆" proj. Optional. (To achieve a privacy function with a 2" dia. rose, a separate mortise privacy bolt must be ordered.)

Functions

Passage: Latch operates by lever from either side of door. Uses 8mm solid spindle.

Privacy: Latch operates by lever from either side. Push button on interior rose engages privacy; emergency release hole is on exterior rose. Turning inside lever will release privacy and retract latchbolt. For bathroom or bedroom. Uses 8mm split spindle.

Pair Dummy: Trim on both sides of door.

Single Dummy: Trim on one side of door only.

Passage Latches (8mm Hub)

107LPA38 2³/₈" backset
Passage Lever Latch

107LPA34 2³/₄" backset
Passage Lever Latch

Privacy Latches (8mm Hub)

108LPR38 2³/₈" backset
Privacy Lever Latch

108LPR34 2³/₄" backset
Privacy Lever Latch

The above part numbers should be used when ordering latches only.



All OMNIA lever latchsets meet ADA accessibility requirements.

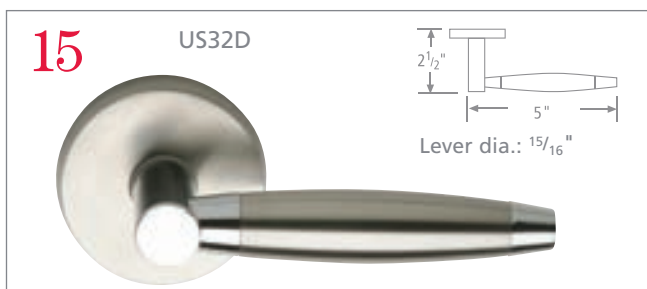
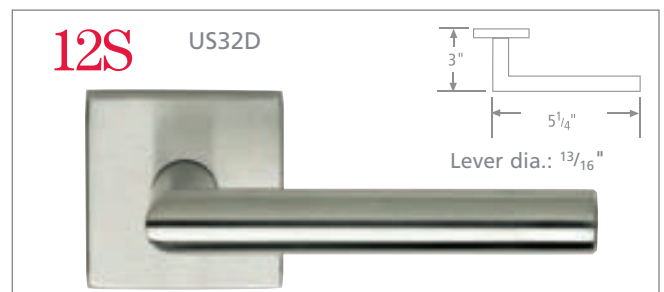

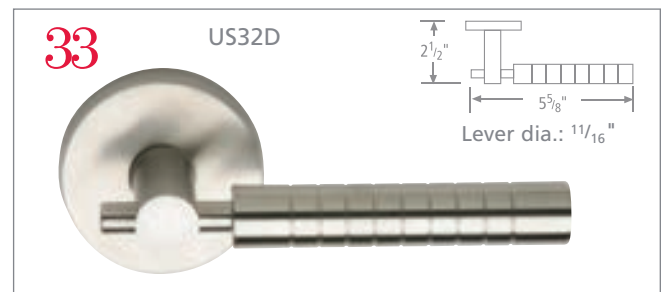
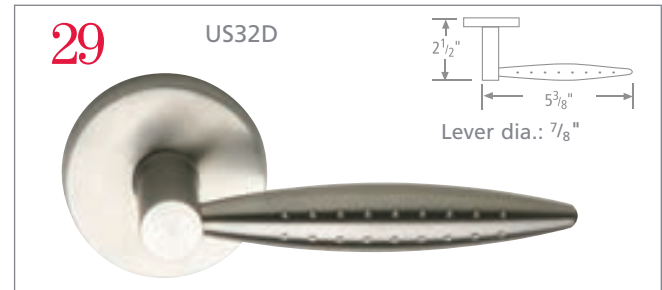
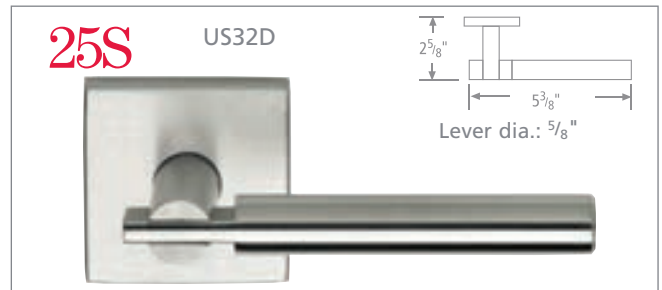

Stainless Steel Mortise Locksets with Plates or Roses

Available with two backset options — 2½" or 2¾". Please specify when ordering.

Lock Options: **A, F, EW, J, L, N, PD and SD** (see box below)



Made in U.S.A.
Conforms to ANSI/BHMA
Series 1000 Standards

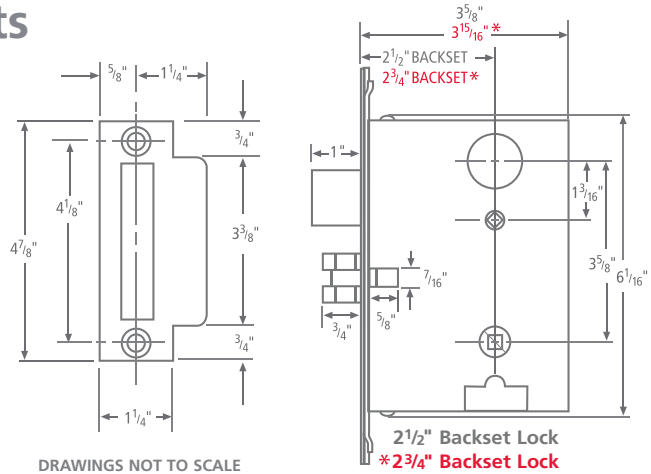

DRAWINGS NOT TO SCALE

Same strike supplied with both 2½" and 2¾" b.s. locks.

Stainless Steel 5½ c.c. Deadbolt Locksets with Plates

Available with two backset options — 2¾" or 2¾". Please specify when ordering.

Lock Options: **A, AC, PD and SD** (see box below)

12012 Mortise Lockset with Plates
D12012 Deadbolt Lockset with Plates (5½" c.c.)

2012 Mortise Lockset with Roses



Interior with Turnpiece



Stainless Steel Mortise and Deadbolt Rose and Backplate Dimensions

2000 Series – Modern Roses 2 7/16" dia. x 3/8"

12000 Series – Modern Backplates 10 9/16" x 2 2/16" x 3/8"

Lock Options

- Single Cylinder – **A**
- Double Cylinder – **AC**
- Panic Proof Entry – **F**
- Storeroom – **EW**
- Classroom – **J**
- Privacy – **L**
- Passage – **N**
- Pair Dummy – **PD**
- Single Dummy – **SD**

■ Other Functions Available ■



All OMNIA lever locksets meet ADA accessibility requirements.





Not for standard 2 1/8" door prep.

Stainless Steel Auxiliary Deadbolt Kits

Available in 2 3/8" or 2 3/4" backset. D9000 and D9000S fit in 2 1/8" standard bore. D9002 fits in 1 1/2" bore. Door Thickness: The D9000, D9000S and the D9002 are available for 1 3/8" or 1 3/4" thick doors.

Lock Options: **A and AC** (see box page 4)

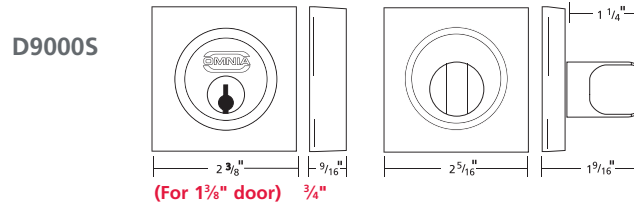
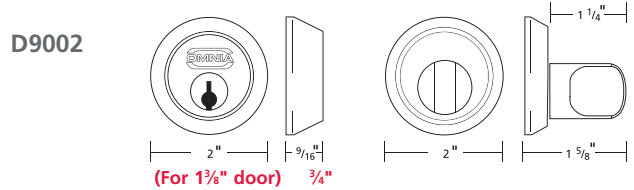
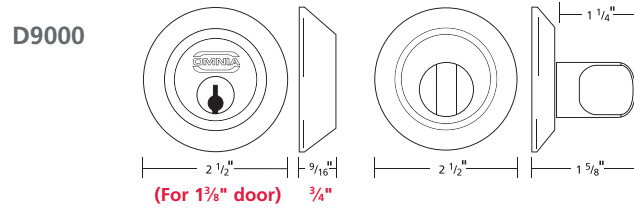

All OMNIA cylinders are provided with a Schlage C keyway.

Mortise Deadlock

041 Mortise Deadlock
US3, US26, US26D, US10B, US14, US15, US32D

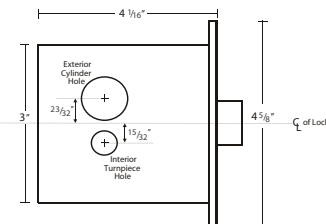

- Backset:** Available with 2 3/4" backset only.
- Doors:** 1 3/4" thick with 4 1/2" minimum stile as standard. For doors over 1 3/4" thick, please specify door thickness.
- Case:** Heavy wrought steel with zinc dichromate finish for corrosion resistance. 4" w x 3" h
- Front:** Adjustable armored steel front, with 1 1/8" w x 4 5/8" h solid brass or stainless steel faceplate for all lock bodies.
- Deadbolt:** 1" proj. x 5/8" thick x 1 1/16" h full throw stainless steel.
- Springs:** High carbon steel.
- Strike:** Solid brass or stainless steel strike plate. 1 1/8" w x 3 1/2" h
- Cylinder:** Solid brass from bar stock. Made in USA. Schlage "C" keyway supplied as standard, with two OMNIA nickel silver keys. When applicable, cylinder collars are supplied with compression spring. Available on special orders with a variety of other keyways & key combinations.
- Keying:** Specify Keyed Alike (KA) when needed. Master/Grand/Construction keying available at additional cost.

Stainless Steel Privacy Bolt

6000

Privacy Bolt
US32D



6001

Privacy Bolt
US32D



6001S

Privacy Bolt
US32D

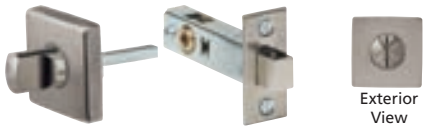

6000 & 6001 Available in 2 3/8" or 2 3/4" backset. Faceplate: 2 1/4" x 1". Strike: 2 3/4" dia. x 1 1/8". Inside & Outside Rose: 2" dia. Inside Turnpiece with Rose: 1 3/8" proj. Bolt: 5/8" proj.

6001S Available in 2 3/8" or 2 3/4" backset. Faceplate: 2 1/4" x 1". Strike: 2 3/4" dia. x 1 1/8". Inside & Outside Rose: 2" square. Inside Turnpiece with Rose: 1 3/8" proj. Bolt: 5/8" proj.

Ball Catch*

Faceplate: 2 5/8" l x 1" w. Strike Plate: 2 1/8" l x 1 3/8" w. Barrel Diameter: 3/4" dia. x 1 1/4" l.

1600F

Ball Catch
US15



* Ball projection is adjustable.

Available in other finishes

Stainless Steel Metro and Urban Tubular Deadbolt Handlesets

Available with two backset options – 2³/₈" or 2³/₄" (2³/₈" backset shipped standard). Please specify when ordering.

Lockset Options: **F, PD, SDE, SDI** (see box below)

Metro Dimensions

5¹/₂" center to center
 Exterior (Top Plate) and Interior:
 10¹/₄" x 2⁹/₁₆" x 7¹/₁₆"
 Exterior (Bottom Rose): 2¹/₁₆" diameter

Overall:
 Exterior: Length 16⁷/₈" x 3³/₁₆" projection
 Interior: Length 10¹/₄" x 2⁷/₈" projection

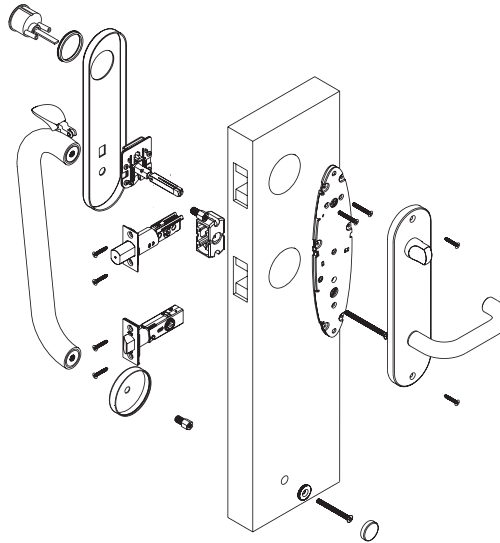

Urban Dimensions

5¹/₂" center to center
 Exterior (Top Plate) and Interior:
 10¹/₂" x 2¹/₂" x 7¹/₁₆"
 Exterior (Bottom Rose): 2" square

Overall:
 Exterior: Length 16³/₄" x 2³/₈" projection
 Interior: Length 10¹/₂" x 2⁵/₈" projection

Lock Options

- Single Cylinder – **A**
- Double Cylinder – **AC**
- Panic Proof Entry – **F**
- Pair Dummy – **PD**
- Single Dummy Exterior – **SDE**
- Single Dummy Interior – **SDI**

Metro Handleset

Tubular Deadbolt
Lockset

5¹/₂" Center to Center

US32D

Metro
Interior Trim
With 12 Lever

Metro
Interior Trim
With 11 Lever

Urban Handleset

Tubular Deadbolt
Lockset

5¹/₂" Center to Center

US32D

Urban
Interior Trim
With 12 Lever

Urban
Interior Trim
With 43 Lever

Stainless Steel Floor Door Stop

- 7000 1¹/₁₆" dia. x 1¹¹/₁₆" h 7605 1" dia. x 3³/₄" proj.
 7001 7⁸/₁₆" dia. x 1³/₁₆" h 7610 1" dia. x 1³/₈" h
 7602 1" dia. x 1¹¹/₁₆" h 7620 1" sq. x 1³/₈" h



*Available in other finishes

Stainless Steel Cup & Flush Pulls

- 7500 2⁹/₁₆" dia. x 5⁸/₈" d 7504 2³/₈" sq. x 3⁸/₈" d
 7501 2" dia. x 5⁸/₈" d 7505 4³/₄" l x 1⁹/₁₆" w x 1²/₂" d
 7502 1³/₈" dia. x 1²/₂" d 7506 4" l x 2" w x 1²/₂" d
 7503 2¹/₈" dia. x 3⁸/₈" d 7507 3⁹/₁₆" dia. x 1³/₁₆" d



*Available in other finishes

Stainless Steel Pocket Door Hardware

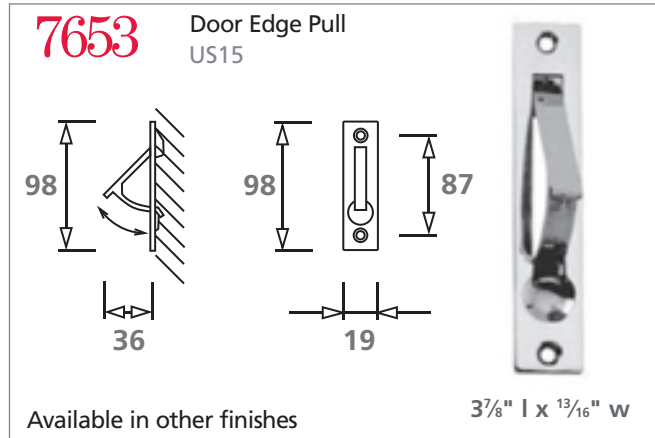

- A) Door knob/lever (2)
- B) Set Screws (2)
- C) Spindle (Teardrop groove positioned towards set screw)
- Da) Finished Rose
- Db) Nylon Sub-Rose
- E) Thru-bolt Screws (2)
- F) Privacy Locking Block Machine Screw
- G) Privacy Locking Block Locking Stopper
- H) Privacy Locking Block
- I) Tubular Latch
- J) Tubular Latch Faceplate
- K) Tubular Latch Strike Plate
- L) Tubular Latch Dust Box
- Ma) Nylon Sub-Rose
- Mb) Finished Rose
- N) Privacy Locking Pin

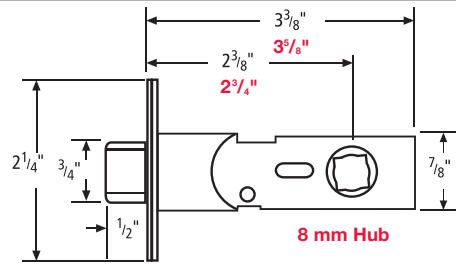

SPECIFY 2 3/8" OR 2 3/4" BACKSET.

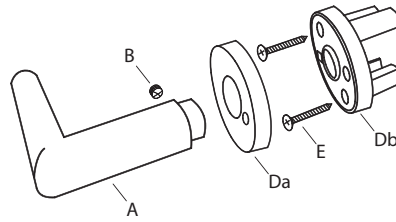

All roses are concealed screw mounted.

PRIVACY LATCHSET SHOWN

DRAWINGS NOT TO SCALE

DRAWINGS NOT TO SCALE

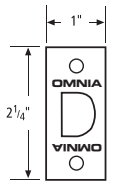

FACEPLATE

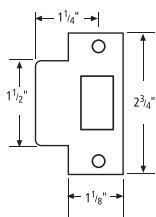

**NO. 013
"T" STRIKE —
STANDARD**

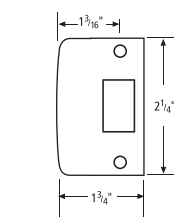

**NO. 014
"FULL LIP" STRIKE —
OPTIONAL**

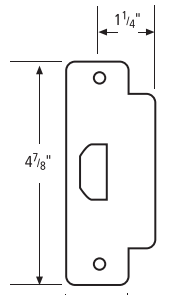

**NO. 019
"ASA" STRIKE —
OPTIONAL**

CARE OF PRODUCT

OMNIA's Stainless Steel requires minimal attention and will not tarnish or corrode under normal circumstances. However, exposure to certain chemical or environmental conditions may promote surface oxidation. Please be aware that this is not a defect in the stainless steel but a reaction on the surface of the finish to the chemical environment which can be removed with a stainless steel polish, or an abrasive pad.

FINISH OPTIONS

- US32 . . . Polished Stainless Steel
- US32D . . . Satin Stainless Steel

Please refer to the *OMNIA Stainless Steel Cabinet Hardware & Door Pulls Catalog* for a full line of door pulls and cabinet hardware.



9100



9181



9457



9450



720



721



722

OMNIA
INDUSTRIES, INC.



Box 330, Cedar Grove, NJ 07009 ■ www.OmniaIndustries.com ■ 973.239.7272 ■ Fax: 973.239.5960

© Copyright 2015, OMNIA Industries, Inc.



No. SSDH0515