

OMNIA



L A T C H S E T S & L O C K S E T S



Solid Brass Latchsets and Locksets

Since 1964, Omnia has supplied the industry with architectural hardware that is uniquely and stylishly designed, yet exceptionally functional. Today, Omnia continues to provide aesthetically pleasing and useful designs.

This catalog is a showcase of our exquisite collection of knob and lever latchsets, mortise and deadbolt locksets, and narrow backset locksets. It is fully enhanced with technical specifications, including diagrams that are exploded to show generous details.























































We are proud of the attention given to every element, from quality to innovation, from service to marketing. A blending of traditions of excellence, coupled with a strong commitment to modern technologies, makes Omnia the sound choice for any residential or commercial application. That is why for five decades Omnia has been opening and closing hundreds of thousands of doors all around the world.

TABLE OF CONTENTS

Section	Page
Product Locator Index	1-4
Finish Index	4
LATCHSETS SECTION	5-21
Latchsets Product Data	7-9
Lever Latchsets	10-14
Knob Latchsets	15-17
Narrow Plate Latchsets	18-21
Narrow Plate Latchsets Product Data	19
Mortise Privacy Bolt	19
LOCKSETS SECTION	22-40
Mortise & Deadbolt Locksets	24-37
Mortise & Deadbolt Locksets Product Data	24-26
Narrow Backset Locks	38-40
Narrow Backset Locks Product Data	39
Auxiliary Deadbolt Kits	41-43
Auxiliary Deadbolt Kits Product Data	42
Lockset Accessories	44-45



PRODUCT LOCATOR INDEX

Number /Type	Page	Number /Type	Page	Number /Type	Page
LATCHSETS		LATCHSETS		LATCHSETS	
 20	Lever 10	 400	Knob 15	 858	Lever 13
 36	Lever 10	 405	Knob 15	 860	Knob 17
 365	Lever 10	 412	Knob 16	 890	Lever 13
 42	Lever 10	 415	Knob 16	 892	Lever 13
 55	Lever 10	 417	Knob 16	 904	Lever 13
 59	Knob 15	 426	Knob 16	 905	Lever 14
 137	Knob 15	 430	Knob 16	 910	Lever 14
 171	Lever 10	 432	Knob 16	 914	Lever 14
 1715	Lever 10	 433	Knob 16	 9145	Lever 14
 198	Knob 15	 440	Knob 17	 915	Lever 14
 229	Lever 10	 441	Knob 17	 916	Lever 14
 231	Lever 11	 442	Knob 17	 9165	Lever 14
 232	Knob 15	 560	Lever 12	 943	Lever 14
 233	Lever 11	 568	Lever 12	NARROW PLATE LATCHSETS	
 235	Lever 11	 570	Lever 12	 13055	Lever 20
 251	Lever 11	 572	Lever 12	 13752	Lever 20
 252	Lever 11	 723	Knob 17	 13904	Lever 20
 260	Knob 15	 752	Lever 12	 14723	Knob 20
 294	Knob 15	 762	Lever 12		
 362	Lever 11	 774	Lever 13		
 364	Lever 11	 782	Lever 13		
 368	Lever 12	 794	Lever 13		
 3685	Lever 12	 798	Lever 13		

Number /Type Page

Number /Type Page

Number /Type Page

NARROW PLATE LATCHSETS

MORTISE & DEADBOLT LOCKSETS

MORTISE & DEADBOLT LOCKSETS



16858 Lever 20



17036 Lever 20



17368 Lever 21

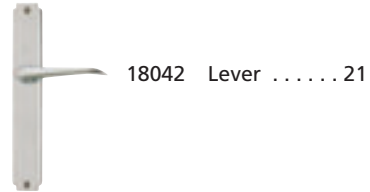

18042 Lever 21

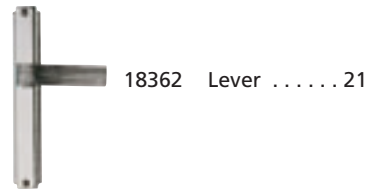

18362 Lever 21

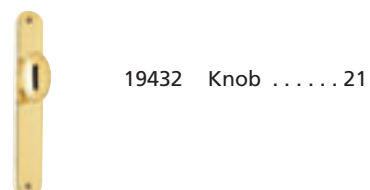

19432 Knob 21



21252 Lever 21



22251 Lever 21



3405 Knob 27



3432 Knob 27



3752 Lever 27



4036 Lever 27



4368 Lever 28



4762 Lever 28

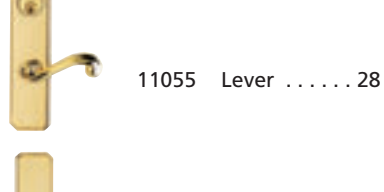

11055 Lever 28

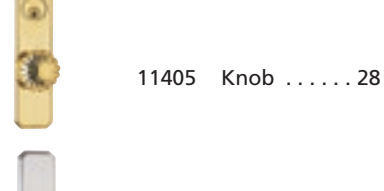

11405 Knob 28

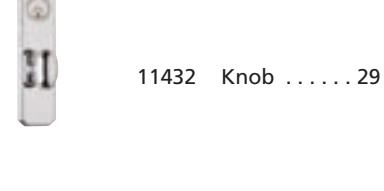

11432 Knob 29

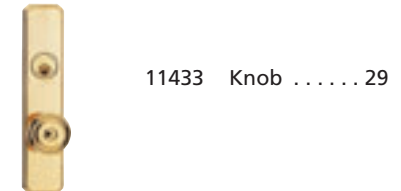

11433 Knob 29

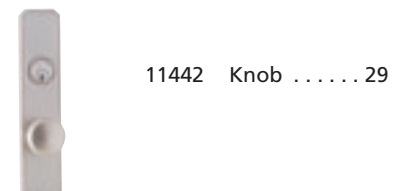

11442 Knob 29



11568 Lever 29

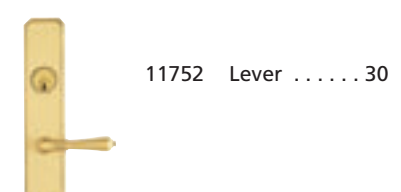

11752 Lever 30

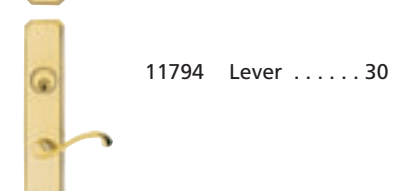

11794 Lever 30



11858 Lever 30

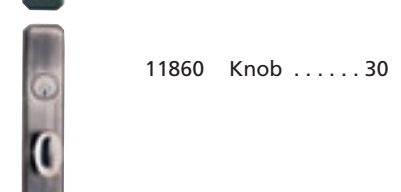



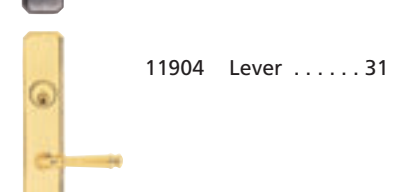



























11860 Knob 30



11904 Lever 31

PRODUCT LOCATOR INDEX

Number /Type	Page	Number /Type	Page	Number /Type	Page
MORTISE & DEADBOLT LOCKSETS					
	12036 Lever 31		12798 Lever 33		52233 Lever 36
	12042 Lever 31		24441 Knob 33		54229 Lever 36
	12198 Knob 31		24570 Lever 33		54294 Knob 36
	12362 Lever 32		25430 Knob 34		55231 Lever 37
	12368 Lever 32		26858 Lever 34		56232 Knob 37
	12415 Knob 32		26860 Knob 34		56252 Lever 37
	12560 Lever 32		50251 Lever 35	NARROW BACKSET LOCKSETS	
	12762 Lever 33		51260 Knob 35		60231 Lever 40
					60251 Lever 40

Number /Type	Page	Number /Type	Page	Number /Type	Page
NARROW BACKSET LOCKSETS		NARROW BACKSET LOCKSETS		AUXILIARY DEADBOLT KITS	
	63904 Lever 40		65752 Lever 40		D0806T 43
	64036 Lever 40		65858 Lever 40		D0806 43
					D0806L 43

FINISH INDEX

STANDARD STOCK — Available as indicated.

CODE	DESCRIPTION	CODE	DESCRIPTION
US3	 POLISHED BRASS, LACQUERED	US15	 SATIN NICKEL PLATED, LACQUERED
US4	 SATIN BRASS, LACQUERED	US15A	 PEWTER, LACQUERED
US26	 POLISHED CHROME PLATED	VI	 VINTAGE IRON
US26D	 SATIN CHROME PLATED	VC	 VINTAGE COPPER
SB	 SHADED BRONZE, LACQUERED	VB	 VINTAGE BRASS
US10B	 OIL-RUBBED BRONZE, LACQUERED	MB	 MAX-BRASS® <i>No Tamish...Guaranteed!</i>
US14	 POLISHED NICKEL PLATED	MS	 MAX STEEL®

LATCHSETS





Latchsets with Solid Brass Trim

Omnia's latchsets in this program are packaged complete with knobs or levers, specified roses, tubular latch, spring loaded sub-rose, spindle, and all mounting hardware. An installation template is included. Lever latchsets are supplied with extra heavy duty latches.

Functions are passage, privacy, pair dummy and single dummy. These latchsets are designed both for new installations and for replacement hardware on doors with standard bore up to 2 1/8". Backsets of 2 3/8" and 2 3/4" are available.

The designs range from traditional to contemporary to ornate in a selection of finishes to complement any design motif.

Knob and Lever Latchsets

- Will fit 2¹/₈" bore.
- For commercial and residential use. *For commercial use, please specify at time of order.*
- 2³/₈" and 2³/₄" backsets available.
- Supplied for 2³/₈" backset and 1³/₈" door thickness unless otherwise specified.
- All lever latchsets are ADA approved.

Concealed Screw Roses:

Modern	2 ⁹ / ₁₆ " dia. x 7 ¹ / ₁₆ " proj.
Traditional	2 ⁵ / ₈ " dia. x 1/2" proj.
Square	2 ⁹ / ₁₆ " sq. x 7 ¹ / ₁₆ " proj.
Beaded	2 ⁵ / ₈ " dia. x 1/2" proj.
Roped	2 ⁵ / ₈ " dia. x 1/2" proj.
Reed & Ribbon	2 ⁵ / ₈ " dia. x 1/2" proj.
Ornate	2 ⁵ / ₈ " dia. x 1/2" proj.

Roses have been specifically designed for use with the knobs and levers with which they are shown in this catalog. Each set consists of solid brass knobs or levers, concealed screw finished roses, nylon thru-bolting rose cassette, latch, strike, dust box, faceplate, spindle, all necessary mounting screws, installation template and instructions.

About our Tubular Latch

- All dimensions are standard to fit existing bores for replacement installations.
- Tough, non-rusting materials used throughout. Face covers and strikes are solid brass. No. 013 "T" strike supplied as a standard or No. 014 "Full Lip" strike as an option. Specify when ordering.
- Critical interior parts are made of solid brass.
- For five decades Omnia's latches have been opening and closing hundreds of thousands of doors all around the world.
- 28° rotation to retract latch.

Knob Latches (7 mm hub)

- 105KPA38:** 2³/₈" backset, passage knob latch
- 105KPA34:** 2³/₄" backset, passage knob latch
- 106KPR38:** 2³/₈" backset, privacy knob latch
- 106KPR34:** 2³/₄" backset, privacy knob latch

Lever Latches (7 mm hub)

- 105LPA38:** 2³/₈" backset, passage lever latch
- 105LPA34:** 2³/₄" backset, passage lever latch
- 106LPR38:** 2³/₈" backset, privacy lever latch
- 106LPR34:** 2³/₄" backset, privacy lever latch



All Omnia lever latchsets meet ADA accessibility requirements.

DRAWINGS NOT TO SCALE

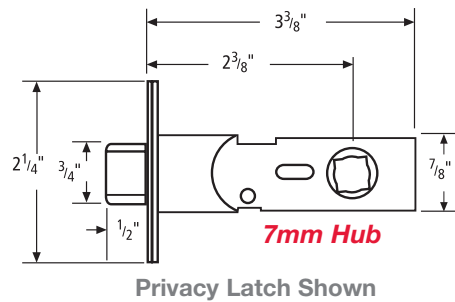
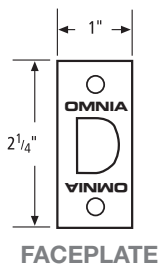

■ SPECIFY 2³/₈" OR 2³/₄" BACKSET. ■

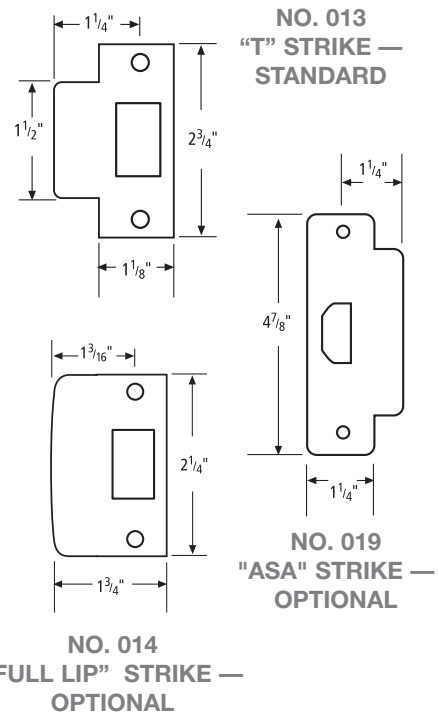
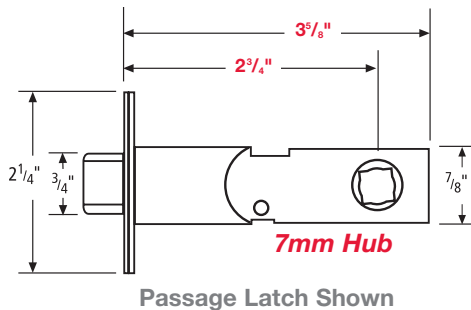

Sub-Rose Cassette Features

Nylon sub-roses feature self-aligning thru-bolts. Fits a standard 2 1/8" bore. Spring-assisted inside & outside, for levers only. Universal for passage & privacy.

#982 Sub-Rose Cassette: 2 7/16" diameter x 3/8" projection (without finished rose cover). Shipped standard for rose designs: 622 (square passage), 623 (square privacy), 677 (modern passage), 683 (ornate passage), 809 (modern privacy), 810 (ornate privacy).

#983 Sub-Rose Cassette: 2 7/16" diameter x 1/2" projection (without finished rose cover). Shipped standard for rose designs: 577 (beaded passage), 579 (roped passage), 671 (traditional passage), 806 (beaded privacy), 807 (roped privacy), 808 (traditional privacy), 811 (ribbon & reed privacy), 855 (ribbon & reed passage).



PRODUCT DATA

Additional Components

027-BLK: Black nylon washer used for installation/assembly of finished rose covers (used for the following finishes: US10B, VC).

027-GLD: Gold nylon washer used for installation/assembly of finished rose covers (used for the following finishes: US3, US4, MB, SB, VB).

027-WH: White nylon washer used for installation/assembly of finished rose covers (used for the following finishes: US26, US26D, US14, US15, US15A, MS, VI).

124.35: 35 mm long privacy function pin, inside only, matching finishes (used for 1 3/8" or 1 3/4" thick doors).

124.EXT: 8 mm long extension for privacy function pins (used for 2" plus thick doors).

984: Nylon washer installation tool used for assembly of finished roses.

985: Nylon privacy function emergency release key.

Latchset — Exploded To Show Detail

- A) Door knob/lever (2)
- B) Set Screws (2)
- Ca) Finished Rose
- Cb) Nylon Sub-Rose (Modern and ornate sub-rose with flat neck. All others with 1/8" neck.)
- D) Thru-bolt Screws (2)
- E) Spindle (Teardrop groove positioned towards set screw)
- F) Privacy Locking Block
- G) Tubular Latch
- H) Tubular Latch Faceplate
- I) Tubular Latch Strike Plate
- J) Tubular Latch Dust Box
- Ka) Nylon Sub-Rose (Modern and ornate sub-rose with flat neck. All others with 1/8" neck.)
- Kb) Finished Rose
- L) Privacy Locking Pin
- M) Nylon threaded washers (2)
- N) Washer Installation Tool
- O) Emergency Release Key

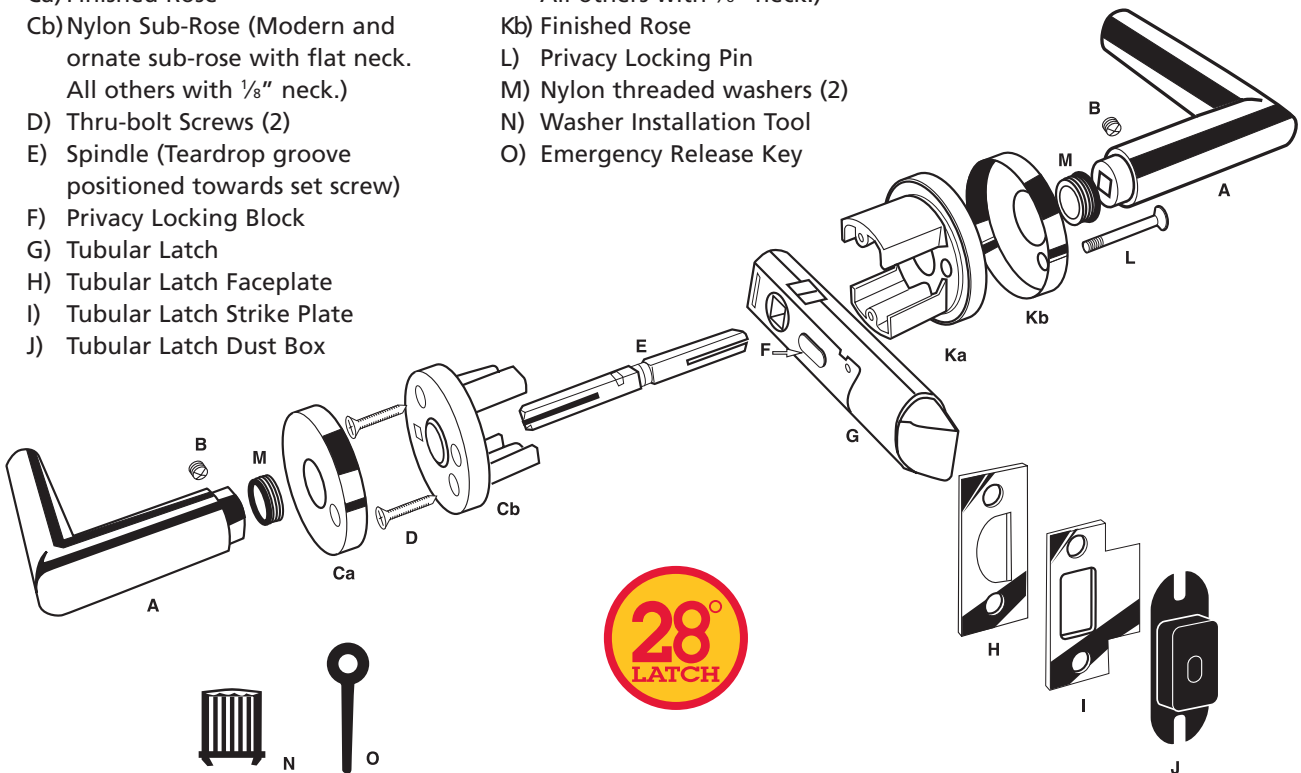

Functions

Passage: Latch operates by knob or lever from either side of door.

Privacy: Latch operates by lever from either side. Push button on interior rose engages privacy; emergency release hole is on exterior rose. Turning inside lever will release privacy and retract latchbolt. For bathroom or bedroom. Uses 7mm split spindle.

Pair Dummy: Trim on both sides of door. Knob or lever with thru-bolted, concealed screw rose set.

Single Dummy: Trim on one side of door only. Available for surface mounting or thru-bolting. Knob or lever with rose. .

Dummy applications not recommended for commercial use.



Single or Pair Dummy Roses

Single Dummy Rose Options

**1. Surface Mounted (a.) —
Concealed Screws**

**2. Thru-bolted (b.) —
Concealed Screws**

Assembly for either surface mounted or thru-bolted installation is included. Surface mounted installation (a.) is a clean look with no exposed screws. Thru-bolted installation (b.) is our strongest mounting format as the entire door supports the dummy. The screws are concealed for a clean look on the exterior side. Thru-bolt screw heads and decorative washers are visible on the interior side. This method of mounting requires the door be drilled through for installation.

Both installation options are shipped unassembled, requiring site assembly.

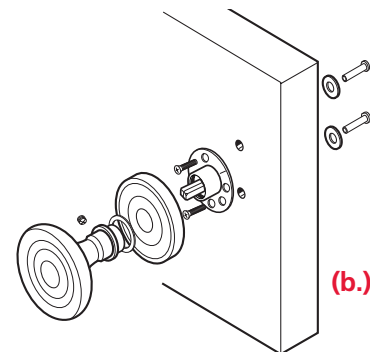
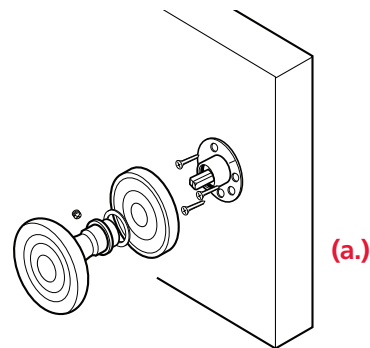

Pair Dummy Rose

**1. Thru-bolted, —
Concealed Screws**

No screws are exposed in this format. Shipped unassembled, requiring site assembly.

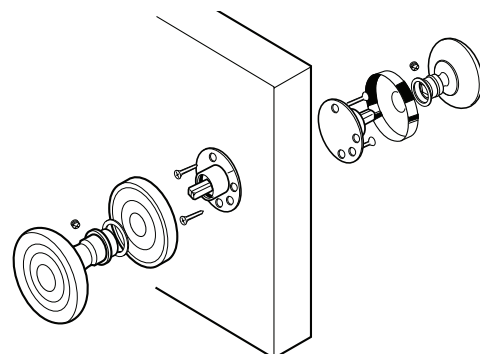

20

US3, US26

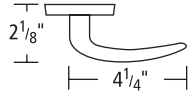

36

US3, US26, US26D,
US10B, US14, US15,
MS

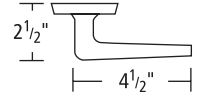

36S

US3, US26, US26D,
US10B, US14, US15

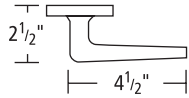

42

US3, US26, US26D,
US10B, US14,
US15, MB, MS

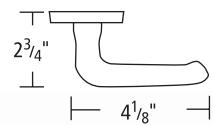

55

US3, US26, SB, MB
MS

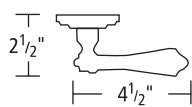

171

U26, US26D, US10B,
US15

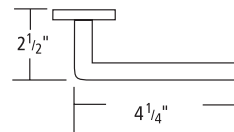

171S

US26, US26D,
US10B, US15

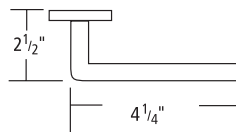

229

US3, SB, US15

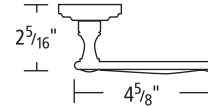

231 US3, SB

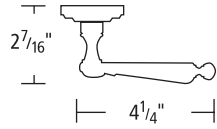

233 US3, SB

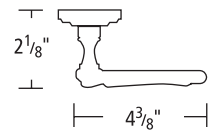

235 US3, SB

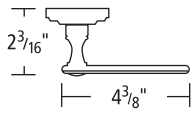

251 US3, SB, US14*, US15, MB*

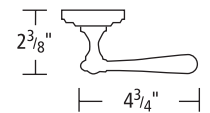

*MB & US14 not available with ornate rose shown. Traditional rose will be substituted.

252 US3, SB

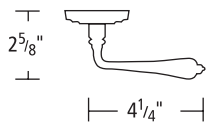

362 US3, US26

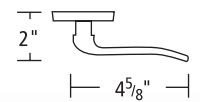

364 U26, US26D, US15

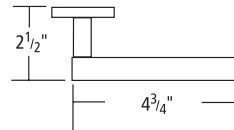

368

US3, US26, US26D,
US10B, US15

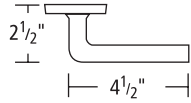

368S

US3, US26, US26D,
US10B, US15

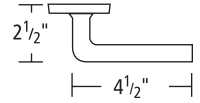

560

US3, US26

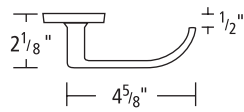

568

US3, US26, SB, MB

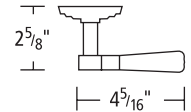

570

US3, US26, SB

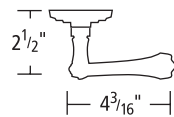

572

US3, SB



752

US3, US4, US26, SB,
US10B, US14, US15,
US15A, VB, VC, VI,
MB, MS

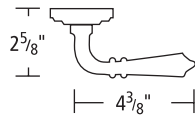

762

US3, US26, US26D

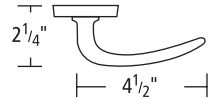

774 US26

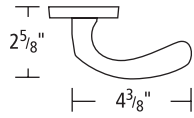

782 US3, US26

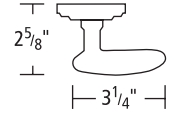

794 US3, US26

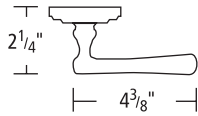

798 US3, US26, US26D

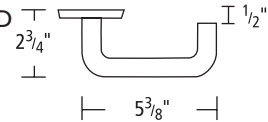

858 US3, US26, SB, US10B, US14, US15, US15A, VB, VC, VI

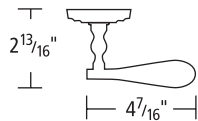

890 US3, US26, US26D, US15

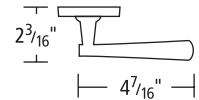

892 US3, US26, US26D, US15

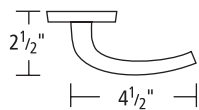

904 US3, US26, US15

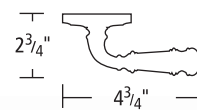

905

US3, US26, US26D,
US15

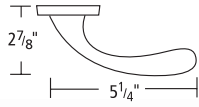

910

US3, US26, US26D,
US15

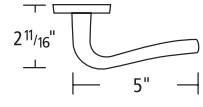

914

U26, US26D,
US10B, US15

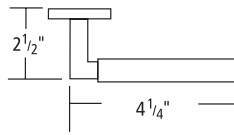

914S

U26, US26D,
US10B, US15

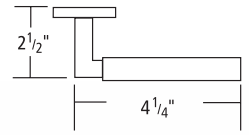

915

US3, US26, US26D,
US15

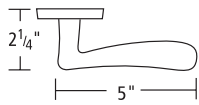

916

US26, US26D, US15

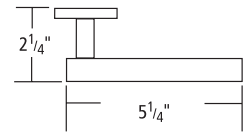

916S

US26, US26D, US15

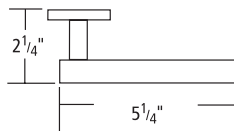

943

US26, US26D,
US10B, US15

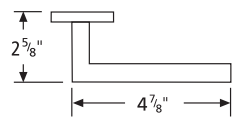

59

US3, SB

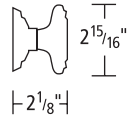

137

US3, US26

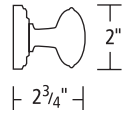

198*

US26, US26D

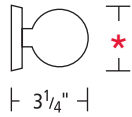

* 198/50 2" dia.
198/60 2 3/8" dia.

232

US3, SB, US15

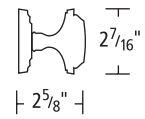

260

US3, SB, US14*, US15, MB*

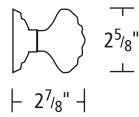

*MB & US14 not available with beaded rose shown. Traditional rose will be substituted.

294

US3, SB

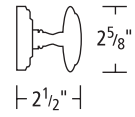

400

US3

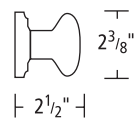

405

US3, US26, SB, VB, VC, VI

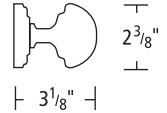

412 US3, US15

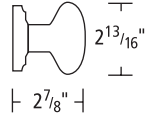

415 US3, US26, US26D

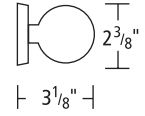

417 US3, SB

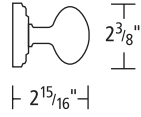

426 US3, US26

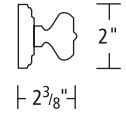

430 US3, US26, SB, US15

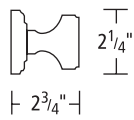

432 US3, US26, US26D, SB, US14, MB, MS

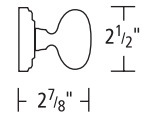

433

US3, US26, SB, US15

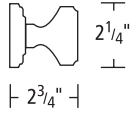

440

US3, SB

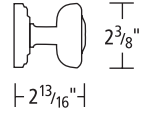

441

US3, US26, SB

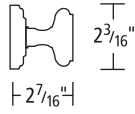

442

US3, US26, US26D, SB,
US10B, US14, US15,
VB, VC, VI, MS

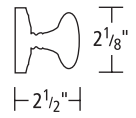

723

US3, US26

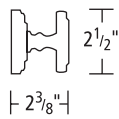

860

US3, US4, US26, SB, US10B,
US15, US15A, VB, VC, VI

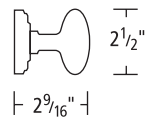



Narrow Plate Latchsets with Solid Brass Trim

Omnia's line of tubular latchsets continues with its collection of narrow plate designs. Each set employs a solid brass knob or lever, partnered with an elegant, slender plate.

Functions are: passage, privacy, pair dummy and single dummy. The privacy set uses a privacy mortise bolt constructed of a metal case and featuring a solid brass bolt.

Narrow plate latchsets include two knobs or levers, thru-bolt assembly backplates, tubular latch, spindle and all mounting hardware. An installation template is included. Lever latchsets are supplied with extra heavy duty latches.

Narrow Plate Latchsets

- Features our tubular latch used worldwide.
- For commercial and residential use. *For commercial use, please specify at time of order.*
- 2³/₈" and 2³/₄" backsets available.
- Supplied for 2³/₈" backset and 1³/₈" door thickness unless otherwise specified.
- All levers are ADA approved.

Functions

Passage: Latch operates by knob or lever from either side.

Privacy: Latch operates by knob or lever from either side. Locks by privacy bolt with turnpiece on inside; emergency release on outside plate. For bathroom or bedroom.

Pair Dummy: Trim only. Available for surface mounting or with thru-bolt assembly. *Dummy lever application not recommended for commercial use.*

Single Dummy: Trim, one side only. Surface mounted. *Dummy lever application not recommended for commercial use.*

Solid Brass Backplates

13000 Series	9 ³ / ₈ " x 1 ⁷ / ₁₆ " x 1/4" proj.
14000 Series	9 ³ / ₁₆ " x 1 ¹ / ₁₆ " x 1/4" proj.
16000 Series	9 ³ / ₈ " x 1 ³ / ₈ " x 1/4" proj.
17000 Series	8 ¹ / ₄ " x 1 ⁵ / ₁₆ " x 7/32" proj.
18000 Series	9 ¹ / ₄ " x 1 ⁷ / ₁₆ " x 7/32" proj.
19000 Series	9 ⁷ / ₁₆ " x 1 ¹ / ₂ " x 1/4" proj.
21000 Series	10 ⁹ / ₁₆ " x 1 ³ / ₄ " x 1/4" proj.
22000 Series	11 ⁷ / ₁₆ " x 1 ³ / ₄ " x 1/4" proj.

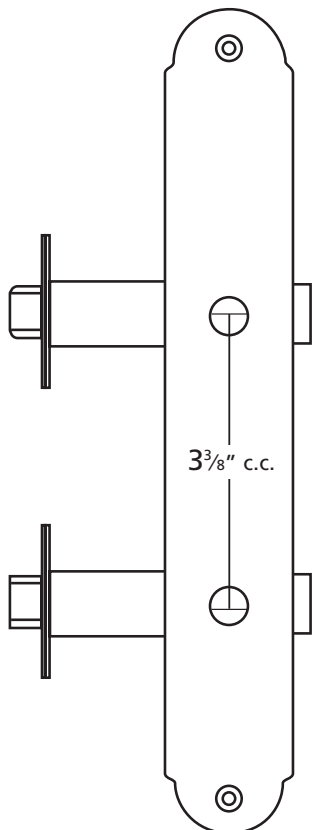

DRAWING NOT TO SCALE

Mortise Privacy Bolt

- 455/238 Privacy Bolt: 2³/₈" backset.
- 455/234 Privacy Bolt: 2³/₄" backset.

Available in 2³/₈" and 2³/₄" backsets.

Supplied with an outside rose for emergency release.

Faceplate/Strike: 2¹/₄" x 1"
 Inside Rose: 1³/₄" dia. x 1/4" depth
 Inside Turnpiece: 1⁵/₈" x 1¹/₈" proj.
 Bolt: 9/16" throw solid brass bolt

Item No. 455

Finishes

- US3
- US26
- US26D
- SB
- US10B
- US15A
- US15



All Omnia lever latchsets meet ADA accessibility requirements.

NARROW PLATE LATCHSETS

13055

US3, US26



13752

US3, US26



13904

US3, US26



14723

US3, US26



16858

US3, US26, SB



17036

US3, US26, US26D



17368

US3, US26, US26D



18042

US3, US26, US26D



18362

US3, US26



19432

US3, US26, SB



21252

US3, SB



22251

US3, SB



LOCKSETS

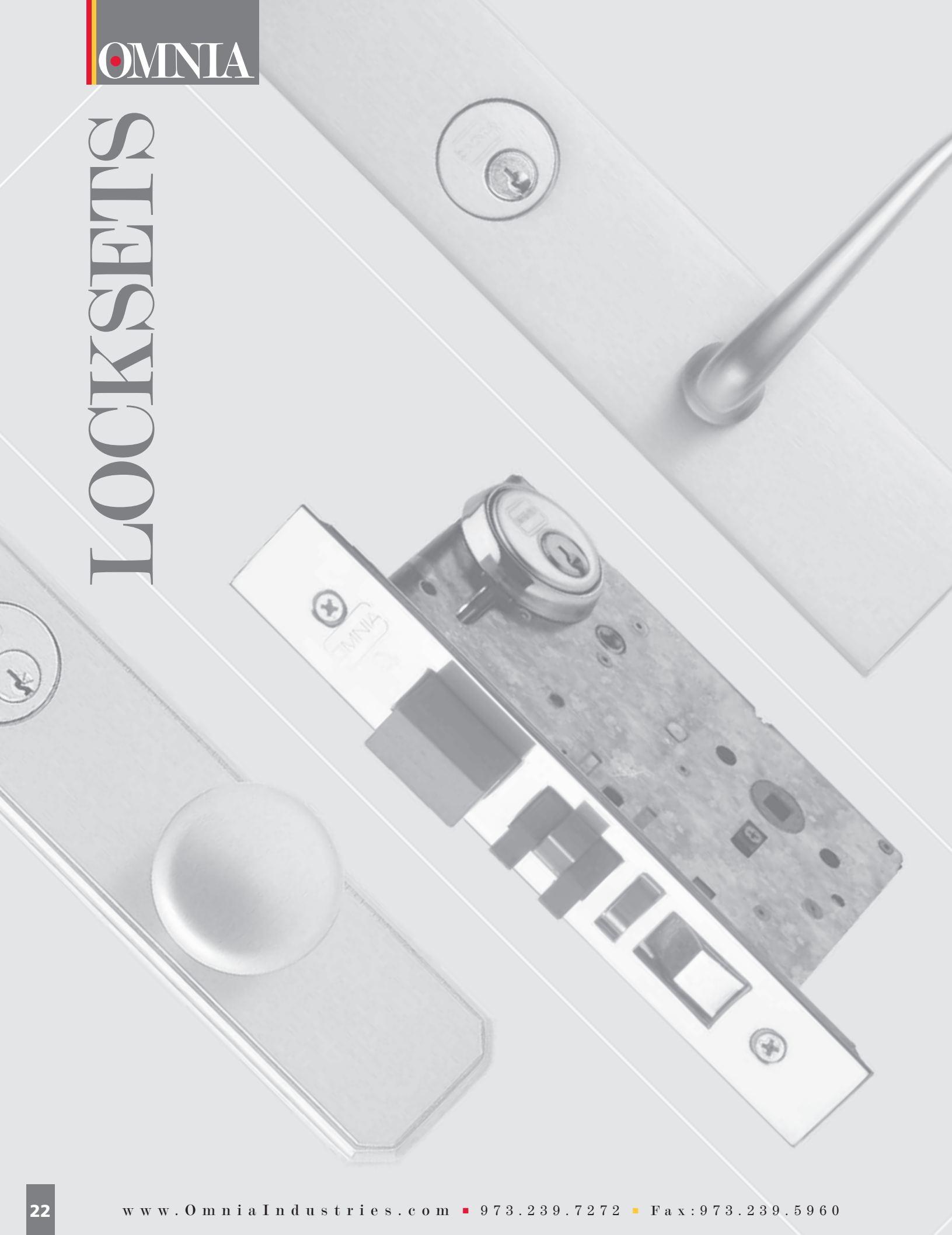



Mortise with
2 1/2" Backset



Mortise with
2 3/4" Backset



Deadbolt with
2 3/8" or 2 3/4" Backset

Made in U.S.A.

Mortise and Deadbolt Locksets with Solid Brass Trim

Omnia's locksets with solid brass trim are the locks of choice when optimum security and stunning design are the objective. An extensive range of knob and lever styles in traditional, ornate and contemporary motifs are available with either mortise or tubular deadbolt lock options.

Built to withstand heavy use, our commercial grade, **UL listed**, fire rated, mortise locks combine precision engineering for security and durability with attractive designs. Available with two backset options (2 1/2" and 2 3/4"), all of our mortise locks are designed for use with heavy brass knobs or levers, with special springing provided on lever sets. A special rose assembly is bolted through the locks, and backplates feature a unique inside-to-outside mounting. Outside roses or backplates are always screwless.

Omnia's line of deadbolt locksets provide the ease of installation, while maintaining the stylish look of a mortise lockset. Unique to all Omnia deadbolt locksets is the sleek, distinctive, flush-mount cylinder design which not only enhances their appearance, but provides excellent protection against tampering with the cylinder mechanism.

To truly set off an entry in the grand style, while providing unmatched security, only Omnia mortise or deadbolt locksets will do.

Mortise & Deadbolt Solid Brass Backplates

1000 Series — Traditional Roses — $2\frac{5}{8}$ " diameter x $\frac{9}{16}$ ".	12000 Series — Modern Backplates — $10\frac{9}{16}$ " x $2\frac{3}{8}$ " x $\frac{5}{16}$ ".	52000 Series — Ornate Backplates — 13 " x $2\frac{3}{8}$ " x $\frac{7}{16}$ ".
2000 Series — Modern Roses — $2\frac{9}{16}$ " diameter x $\frac{3}{8}$ ".	24000 Series — Roped Backplates — $10\frac{5}{8}$ " x $2\frac{7}{16}$ " x $\frac{3}{8}$ ".	54000 Series — Ornate Backplates — $13\frac{3}{4}$ " x $2\frac{5}{16}$ " x $\frac{3}{8}$ ".
2000S Series — Square Roses — $2\frac{9}{16}$ " square x $\frac{7}{16}$ ".	25000 Series — Beaded Backplates — $10\frac{5}{8}$ " x $2\frac{3}{8}$ " x $\frac{5}{16}$ ".	55000 Series — Ornate Backplates — $15\frac{1}{8}$ " x $2\frac{5}{16}$ " x $\frac{3}{8}$ ".
3000 Series — Traditional Backplates — $10\frac{9}{16}$ " x $2\frac{3}{8}$ " x $\frac{5}{16}$ ".	26000 Series — Traditional Backplates — $10\frac{5}{16}$ " x $2\frac{3}{4}$ " x $\frac{5}{16}$ ".	56000 Series — Ornate Backplates — $11\frac{1}{4}$ " x $2\frac{5}{16}$ " x $\frac{3}{8}$ ".
4000 Series — Modern Backplates — $8\frac{1}{4}$ " x 2 " x $\frac{1}{4}$ ".	50000 Series — Ornate Backplates — $17\frac{3}{4}$ " x $2\frac{5}{16}$ " x $\frac{1}{8}$ ".	
11000 Series — Traditional Backplates — $10\frac{5}{8}$ " x $2\frac{3}{8}$ " x $\frac{5}{16}$ ".	51000 Series — Ornate Backplates — $14\frac{15}{16}$ " x $3\frac{3}{8}$ " x $\frac{1}{8}$ ".	

Mortise Locksets

Available with two backset options— $2\frac{1}{2}$ " or $2\frac{3}{4}$ ". Please specify when ordering.

Backset: Available with two backset options: $2\frac{1}{2}$ " or $2\frac{3}{4}$ ". Please specify backset on order.

For Doors: $1\frac{3}{4}$ " thick as standard. For doors over $1\frac{3}{4}$ " thick, please specify door thickness.

- $2\frac{1}{2}$ " b.s.: with $\frac{3}{8}$ " minimum stile
- $2\frac{3}{4}$ " b.s.: with $\frac{1}{2}$ " minimum stile

Case: Heavy wrought steel with zinc dichromate finish for corrosion resistance.

- $2\frac{1}{2}$ " b.s.: $3\frac{3}{8}$ " x $6\frac{1}{16}$ " x $\frac{7}{8}$ "
- $2\frac{3}{4}$ " b.s.: $4\frac{3}{16}$ " x $6\frac{1}{16}$ " x 1 "

Front: Adjustable armored steel front, with 8 " x $1\frac{1}{4}$ " solid brass faceplate for all lock bodies. Finished to match trim.

Latchbolt: Two-piece anti-friction design made from solid brass ($2\frac{1}{2}$ " b.s.) or stainless steel ($2\frac{3}{4}$ " b.s.). Both lock bodies with 1 " x $\frac{5}{8}$ " x $\frac{3}{4}$ " full throw.

Deadbolt:

- $2\frac{1}{2}$ " b.s.: $1\frac{3}{16}$ " x $\frac{9}{16}$ " x 1 " full throw solid brass with sawproof insert.
- $2\frac{3}{4}$ " b.s.: $1\frac{1}{8}$ " x $\frac{1}{2}$ " x 1 " full throw stainless steel.

Springs: High carbon steel.

Strike: Solid brass curved lip strike. $4\frac{7}{8}$ " x $1\frac{1}{4}$ " x lip $\frac{1}{4}$ " to center. Finished to match trim. Dust box supplied as standard. Extended lip strikes available.

Hand: Fully reversible. ($2\frac{3}{4}$ " b.s. can be reversed without opening case.) When ordering specify right or left hand, and reverse bevel if applicable.

Cylinder: Solid brass from bar stock. Made in USA. Schlage "C" keyway supplied as a standard, with two Omnia nickel silver keys. When

applicable, cylinder collars are supplied with compression spring. Available on special order with a variety of other keyways & key combinations.

Keying: Specify Keyed Alike (KA) when needed. Master / Grand / Construction keying available at additional cost.

Safety Standards:

- $2\frac{1}{2}$ " b.s.: Conforms to requirements of ANSI/BHMA A156.13 Series 1000.
- $2\frac{3}{4}$ " b.s.: UL Listed for class "A" or lesser doors. Conforms to requirements of ANSI/BHMA A156.2 Series 1000.

Made In U.S.A.

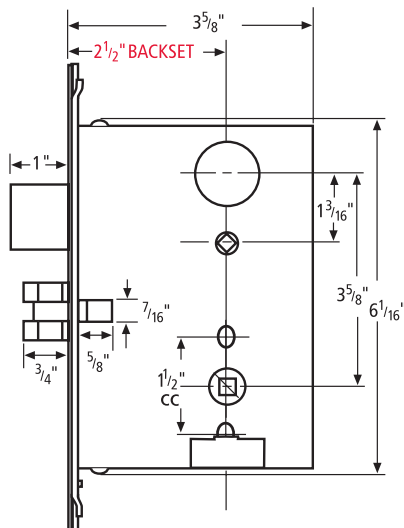

2 $\frac{1}{2}$ " Backset Lock

Case must be opened to reverse handing and/or bevel.

Same strike supplied with both $2\frac{1}{2}$ " and $2\frac{3}{4}$ " b.s. locks.

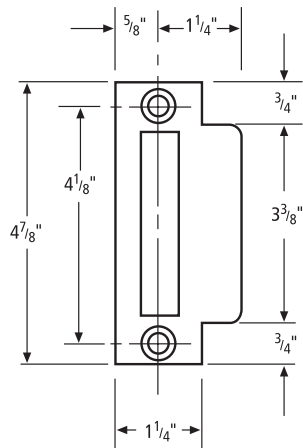

Extended lip strikes available.

DRAWINGS NOT TO SCALE

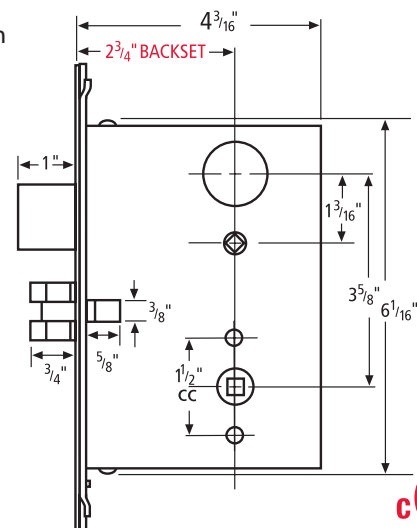

2 $\frac{3}{4}$ " Backset Lock

Fully reversible without opening case.



Mortise Locksets

Available with two backset options—2½" or 2¾". Please specify when ordering.

All lever entry sets provide a lever outside and a lever inside with matching rose or backplate. If the outside trim is a lever with plate, the inside trim will match. If the outside trim is a lever with rose, the inside trim will be a lever with rose. The same is true for sets employing knobs. For additional trim options, see our Latchsets section.

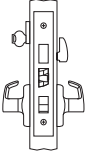
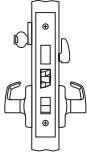
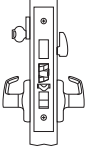
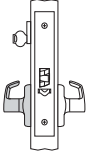
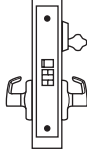
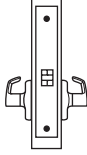
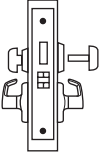
<p>STANDARD ENTRY — A ANSI# F08</p> <p>Latchbolt operates by knob or lever from either side except when outside trim is locked by stopbutton; then opens by key outside, by knob or lever inside. Deadbolt activated by key outside and by turnpiece inside.</p> 	<p>DOUBLE CYLINDER ENTRY — AC</p> <p>Latchbolt operates by knob or lever from either side except when outside trim is locked by stopbutton; then opens by key outside, by knob or lever inside. Deadbolt activated only by key from either side.</p> 	<p>PANIC - PROOF ENTRY — F ANSI# F12</p> <p>Latchbolt operates by knob or lever from either side except when outside trim is locked by stop button. Deadbolt activated by key outside and turnpiece inside. Turning of inside knob or lever will retract both deadbolt and latchbolt at the same time.</p> 	
<p>STOREROOM — EW ANSI# F07</p> <p>Latchbolt operates by knob or lever inside and by key outside. The outside knob or lever is rigid. Auxiliary latchbolt deadlocks latchbolt.</p> 	<p>CLASSROOM — J ANSI# FO5</p> <p>Latchbolt operates by knob or lever except when outside knob or lever is locked or unlocked by key in the cylinder. Auxiliary latchbolt deadlocks latchbolt.</p> 	<p>PASSAGE — N ANSI# FO1</p> <p>Latchbolt operates by knob or lever either side.</p> 	<p>PRIVACY — L ANSI# FO2</p> <p>Latchbolt operates by knob or lever either side. Deadbolt by turnpiece inside and emergency key outside. Turning of inside knob or lever will retract both deadbolt and latchbolt at the same time.</p> 

Commercial Installations: Please specify when ordering locksets for commercial use.

Dummy applications are not recommended for commercial use.



All Omnia lever locksets meet ADA accessibility requirements.



Made In U.S.A.

Sectional Trim Mortise Locksets

When ordering mortise locksets with sectional trim, please note: Locks in the **1000 Series**, will be supplied with the rose as shown with that specific model knob or lever in the Latchset section of this catalog (traditional, beaded, ornate or roped). Locks in the **2000 Series**, will be supplied with the modern rose as shown with that specific knob or lever in the Latchset section of this catalog. Locks in the **2000S Series** will be supplied with the square rose as shown below.



1000 Series

Shown No. 1055



2000 Series

Shown No. 2560



2000S Series

Shown No. 20365

Deadbolt Locksets

Standard — A

Latchbolt operates by knob or lever from either side. Deadbolt activated by key outside and turnpiece inside.

Double Cylinder — AC

Latchbolt operates by knob or lever from either side. Deadbolt activated only by key from either side.

Tubular Deadbolt with Mortise Cylinder

- Available with backset of $2\frac{3}{8}$ " or $2\frac{3}{4}$ ".
- Supplied for $2\frac{3}{8}$ " backset and $1\frac{3}{4}$ " door thickness unless otherwise specified.
- Fits narrow stiles of less than 4".
- For $2\frac{3}{8}$ " backset, stile width can be as narrow as $3\frac{3}{8}$ ".
- For $2\frac{3}{4}$ " backset, stile width can be as narrow as 4".
- Suitable for most pre-existing bores for cylindrical locks.
- Full 1" throw deadbolt.
- Supplied with Schlage "C" keyway as a standard. Available on special order with a variety of other keyways and key combinations.
- Deadbolt employs standard mortise cylinder for ease of re-keying and key changes.

Tubular Latch Specifications

- All dimensions are standard for most replacement installations.
- Tough, non-rusting materials used throughout. Face covers and strikes are solid brass.
- Critical interior parts are made of solid brass.
- For five decades these latches have been opening and closing hundreds of thousands of doors all around the world.

Specify either $2\frac{3}{8}$ " or $2\frac{3}{4}$ " backset.

BACKPLATE

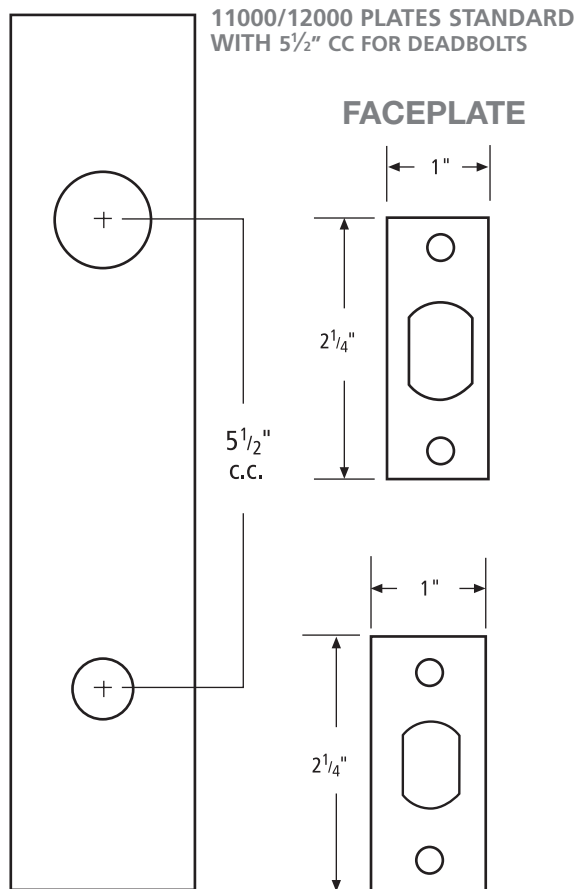

DRAWINGS NOT TO SCALE

HIGH SECURITY DEADBOLT

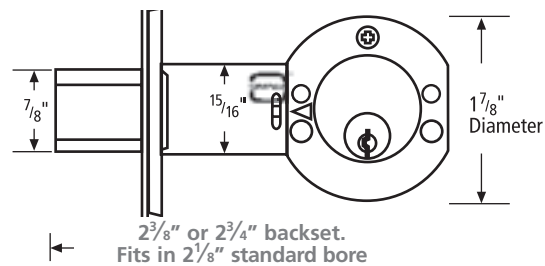

HEAVY DUTY TUBULAR LATCH

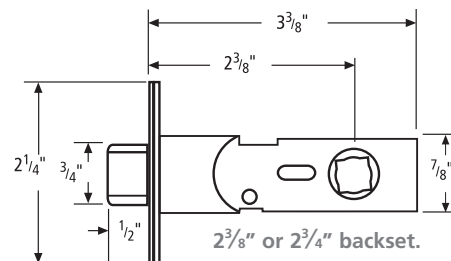

■ Auxiliary deadbolt kits (with collar) are also available. See pages 41-43. ■



3405 Mortise With Plates
 1405 Mortise With Roses
 D3405 Deadbolt With Plates
 10⁹/₁₆" Overall
 Standard: 2³/₈" (60 mm) dia. knob.
 Option: 2¹/₄" (70 mm) dia. knob.
 US3, US26, SB



3432 Mortise With Plates
 1432 Mortise With Roses
 D3432 Deadbolt With Plates
 10⁹/₁₆" Overall
 US3, US26, US26D, SB



3752 Mortise With Plates
 1752 Mortise With Roses
 D3752 Deadbolt With Plates
 10⁹/₁₆" Overall
 US3, US26, SB



4036 Mortise With Plates
 2036 Mortise With Roses
 2036S Mortise With Square
 Roses
 8¹/₄" Overall
 US3*, US26, US26D
 *Not available with
 Square Rose



4368 Mortise With Plates
 2368 Mortise With Roses
 2368S Mortise With Square
 Roses
 8¹/₄" Overall

US3*, US26, US26D
 *Not available with
 Square Rose



4762 Mortise With Plates
 2762 Mortise With Roses
 8¹/₄" Overall

US3, US26, US26D



11055 Mortise With Plates
 1055 Mortise With Roses
 D11055 Deadbolt With Plates
 10⁵/₈" Overall

US3, US26, SB, MS



11405 Mortise With Plates
 1405 Mortise With Roses
 D11405 Deadbolt With Plates
 10⁵/₈" Overall

Standard: 2³/₈" (60 mm) dia. knob.[†]
 Option: 2³/₄" (70 mm) dia. knob.

US3, US26, SB, VB,[†] VC,[†] VI[†]



11432 Mortise With Plates
 1432 Mortise With Roses
 D11432 Deadbolt With Plates
 10⁵/₈" Overall

US3, US26, US26D, SB



11433 Mortise With Plates
 1433 Mortise With Roses
 D11433 Deadbolt With Plates
 10⁵/₈" Overall

US3, US26, SB, US15



11442 Mortise With Plates
 1442 Mortise With Roses
 D11442 Deadbolt With Plates
 10⁵/₈" Overall

US3, US26, US26D,
 SB, US10B, US15, VB,
 VC, VI, MS



11568 Mortise With Plates
 1568 Mortise With Roses
 D11568 Deadbolt With Plates
 10⁵/₈" Overall

US3, US26, SB

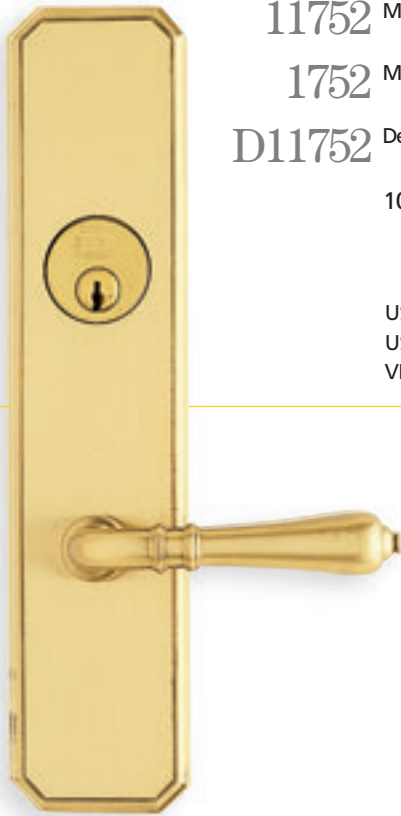

11752 Mortise With Plates
 1752 Mortise With Roses
 D11752 Deadbolt With Plates

10⁵/₈" Overall

US3, US4, US26, SB,
 US10B, US15, US15A,
 VB, VC, VI, MS



11794 Mortise With Plates
 1794 Mortise With Roses
 D11794 Deadbolt With Plates

10⁵/₈" Overall

US3, US26



11858 Mortise With Plates
 1858 Mortise With Roses
 D11858 Deadbolt With Plates

10⁵/₈" Overall

US3, US26, SB,
 US10B, US15, US15A,
 VB, VC, VI



11860 Mortise With Plates
 1860 Mortise With Roses
 D11860 Deadbolt With Plates

10⁵/₈" Overall

US3, US4, US26, SB,
 US10B, US15, US15A,
 VB, VC, VI



11904 Mortise With Plates
1904 Mortise With Roses
D11904 Deadbolt With Plates
 10⁵/₁₆" Overall

 US3, US26, US15



12036 Mortise With Plates
2036 Mortise With Roses
2036S Mortise With Square Roses
D12036 Deadbolt With Plates
 10⁹/₁₆" Overall

 US3*, US26, US26D, US10B, US15, MS*
 *Not available with Square Rose



12042 Mortise With Plates
2042 Mortise With Roses
D12042 Deadbolt With Plates
 10⁹/₁₆" Overall

 US3, US26, US26D, US10B, US15, MS



12198 Mortise With Plates
2198 Mortise With Roses
D12198 Deadbolt With Plates
 10⁹/₁₆" Overall

 Standard: 2³/₈" (60 mm) dia. knob.

 US3, US26, US26D



12362 Mortise With Plates
 2362 Mortise With Roses
 D12362 Deadbolt With Plates
 10⁹/₁₆" Overall
 US3, US26



12368 Mortise With Plates
 2368 Mortise With Roses
 2368S Mortise With Square
 Roses
 D12368 Deadbolt With Plates
 10⁹/₁₆" Overall
 US3*, US26, US26D,
 US10B, US15
 *Not available with
 Square Rose



12415 Mortise With Plates
 2415 Mortise With Roses
 D12415 Deadbolt With Plates
 10⁹/₁₆" Overall
 2³/₈" Dia. Knob
 US3, US26, US26D



12560 Mortise With Plates
 2560 Mortise With Roses
 D12560 Deadbolt With Plates
 10⁹/₁₆" Overall
 US3, US26



12762 Mortise With Plates
 2762 Mortise With Roses
 D12762 Deadbolt With Plates
 10³/₁₆" Overall
 US3, US26, US26D



12798 Mortise With Plates
 2798 Mortise With Roses
 D12798 Deadbolt With Plates
 10³/₁₆" Overall
 US3, US26, US26D



24441 Mortise With Plates
 1441 Mortise With Roses
 D24441 Deadbolt With Plates
 10⁵/₈" Overall
 US3, US26, SB



24570 Mortise With Plates
 1570 Mortise With Roses
 D24570 Deadbolt With Plates
 10⁵/₈" Overall
 US3, US26, SB



25430 Mortise With Plates
 1430 Mortise With Roses
 D25430 Deadbolt With Plates
 10⁵/₈" Overall
 US3, US26, SB

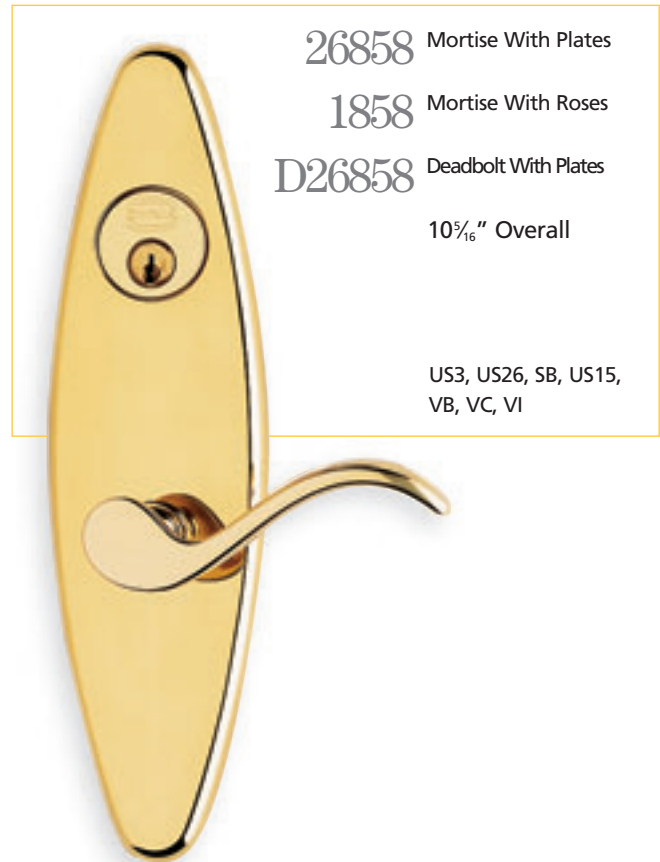

26858 Mortise With Plates
 1858 Mortise With Roses
 D26858 Deadbolt With Plates
 10⁵/₁₆" Overall
 US3, US26, SB, US15,
 VB, VC, VI



26860 Mortise With Plates
 1860 Mortise With Roses
 D26860 Deadbolt With Plates
 10⁵/₁₆" Overall
 US3, US26, SB, US15,
 VB, VC, VI



50251 Mortise With Plates
1251 Mortise With Roses
D50251 Deadbolt With Plates
17³/₄" Overall

US3, SB



51260 Mortise With Plates
1260 Mortise With Roses
D51260 Deadbolt With Plates
14¹⁵/₁₆" Overall

US3, SB



52233 Mortise With Plates
 1233 Mortise With Roses
 D52233 Deadbolt With Plates

13" Overall

US3, SB



54229 Mortise With Plates
 1229 Mortise With Roses
 D54229 Deadbolt With Plates

13³/₄" Overall

US3, SB



54294 Mortise With Plates
 1294 Mortise With Roses
 D54294 Deadbolt With Plates

13³/₄" Overall

US3, SB



55231 Mortise With Plates
 1231 Mortise With Roses
 D55231 Deadbolt With Plates
 15 1/4" Overall

US3, SB



56232 Mortise With Plates
 1232 Mortise With Roses
 D56232 Deadbolt With Plates
 11 1/4" Overall

US3, SB



56252 Mortise With Plates
 1252 Mortise With Roses
 D56252 Deadbolt With Plates
 11 1/4" Overall

US3, SB



Narrow Backset Locksets with Solid Brass Trim

Omnia's narrow backset mortise locksets are ideal for use wherever a slim, elegant look is desired. In addition to enhancing any setting where they are employed, these slender designs provide superlative security with a standard mortise cylinder lock. This lock can also be used with Omnia's standard thru-bolted roses. A perfect blending of classic style in a range of finishes, combined with American made reliability.

PRODUCT DATA

1 1/2" and 2" Narrow Backset Mortise Locks

Available with two backset options -- 1 1/2" or 2". Please specify when ordering. Available for levers only. Specify right hand or left hand. Not reversible.

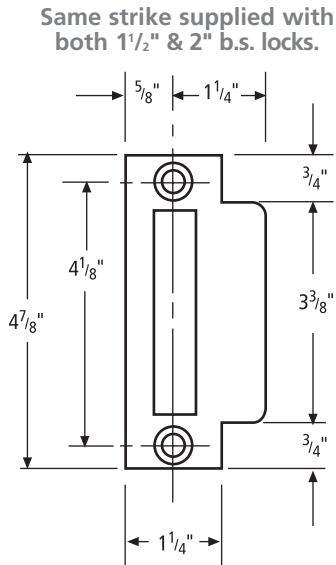

Extended lip strikes are available.

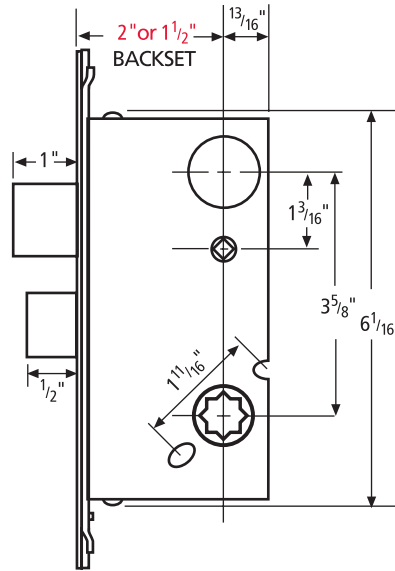

DRAWINGS NOT TO SCALE

Solid Brass Backplates

60000 Series	1 7/16" x 1 3/4" x 1/4" proj.
63000 Series	10 7/8" x 1 3/4" x 3/8" proj.
64000 Series	8 3/4" x 2" x 1/4" proj.
65000 Series	9 1/2" x 1 9/16" x 3/8" proj.

Made in U.S.A.

Backset: Available with two backset options 1 1/2" and 2". Please specify backset on order.

Case: Heavy gauge plated steel.

- 1 1/2" b.s.: 6 1/16" x 2 3/16" x 3/4"
- 2" b.s.: 6 1/16" x 2 13/16" x 3/4"

Accommodates thru-bolted roses.

Front: Adjustable armored steel front, with 8" x 1 1/4" solid brass faceplate for both bodies. Finished to match trim.

Latchbolt: Solid brass with 1/2" x 1" x 1/2" throw.

Deadbolt: Solid brass with 1/2" x 3/4" x 1" throw.

Strike: Solid brass curved lip strike. 4 7/8" x 1 1/4" x lip 1 1/4" to center. Finished to match trim. Dust box supplied as standard. Extended lip strikes are available.

Cylinder: Solid brass from bar stock. Made in USA. Schlage "C" keyway supplied as a standard, with two Omnia brass keys. When applicable, cylinder collars are supplied with compression spring. Available on special order in a variety of other keyways and key combinations.

Keying: Specify Keyed Alike (KA) when needed. Master / Grand / Construction Keying available at additional cost.

ENTRY — B *Shipped Standard*

Latchbolt by lever either side. Deadbolt by key outside and turnpiece inside. No locking rocker switch; hubs always operable.

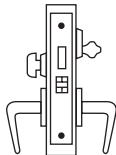

SINGLE CYLINDER — A

Latchbolt by lever either side except when outside lever is locked by the rocker switch in the front; then by key outside, lever inside. Deadbolt by key outside and turnpiece inside.

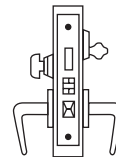

PRIVACY — L:

Latchbolt by lever either side. Deadbolt by turnpiece inside and emergency key outside.

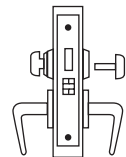

ENTRY DOUBLE CYLINDER — BAC

Latchbolt by lever either side. Deadbolt by key either side. No locking rocker switch; hubs always operable.

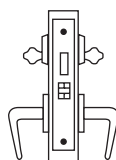

DOUBLE CYLINDER — AC

Latchbolt by lever either side except when the outside lever is locked by the rocker switch in the front; then by key outside, lever inside. Deadbolt by key either side.

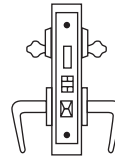

PASSAGE — N

Latchbolt by lever either side.

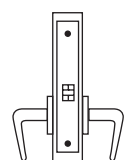

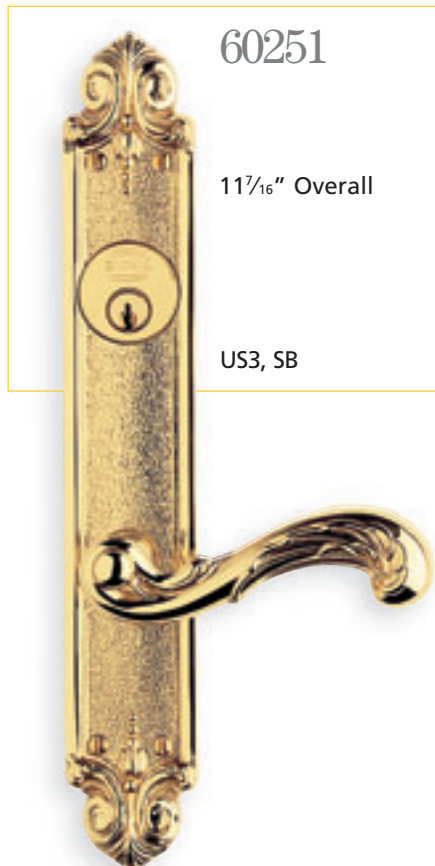

All shown trim can also be used with 2¹/₂" and 2³/₄" backset mortise locks.





Auxiliary Deadbolt Kits with Solid Brass Trim

Omnia's line of auxiliary deadbolt kits has many features which ensure a product of high security and style. The exterior collars are made of forged solid brass in three designs: traditional, modern and modern low profile. The interiors have large oval turnpieces which are both aesthetically pleasing and easy to operate. Both the 1" deadbolt throw with sawproof inserts and the armored strike reinforcement with 3" wood screws provide additional security.

SPECIFICATIONS

- Available in 2³/₈" or 2³/₄" backsets. Please specify backset and door thickness at time of order.
- Suitable for most pre-existing bores for cylindrical locks.
- Supplied with Schlage "C" keyway as a standard. Available on special order with a variety of other keyways and key combinations.
- Deadbolt employs standard mortise cylinder for ease of re-keying and key changes.

LOCK FUNCTIONS

- A** — Activated by key outside and turnpiece inside.
- AC** — Activated by key only from either side.

Supplied with:

- 2³/₄" x 1¹/₈" finished strike.
- 2³/₄" x 1¹/₈" x 3³/₁₆" armored strike reinforcement.
- Two #10 x 3" wood screws to reach door frame studs, two #8 x 3/4" combo wood/metal screws, two #8 x 3/4" sheet metal screws, and dustbox.

FACEPLATE

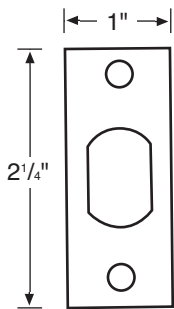

HIGH SECURITY DEADBOLT

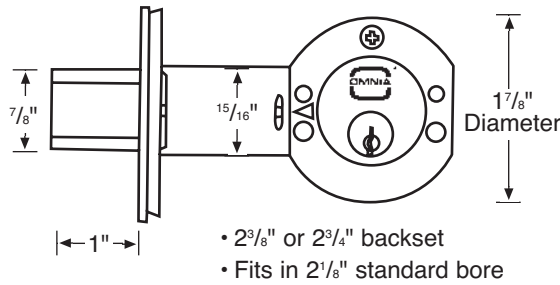

Made in U.S.A.

INSTALLATION OF DUST BOX, REINFORCER AND STRIKE

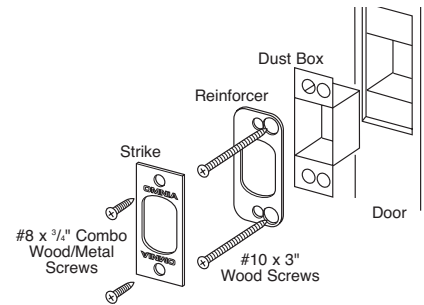

AUXILIARY DEADBOLT — Exploded View Shown as "A" Function

- A — Key
- B — Cylinder
- C — Cam
- D — "O" Ring
- E — Rose
- F — Housing
- G — Rose Screws
- H — Turnpiece
Rose Assembly
- I — Tailpiece
- J — Housing Screws
- K — Cylinder Set
Screws
- L — Faceplate
- M — Screws
- N — Deadbolt

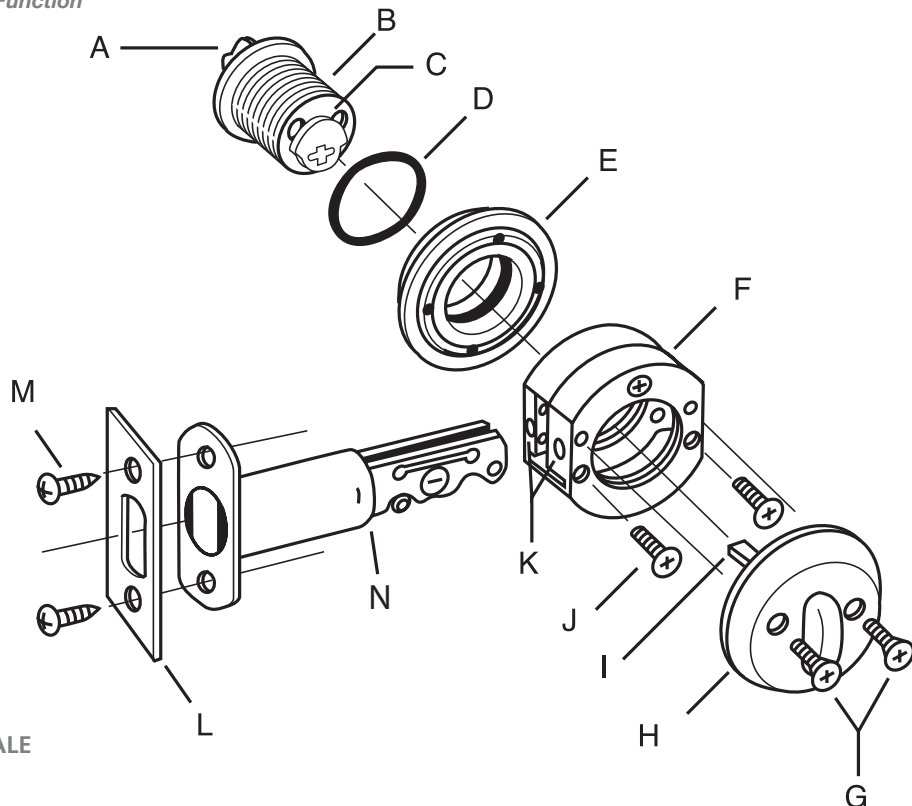

DRAWINGS NOT TO SCALE



D0806T TRADITIONAL
 US3, US26, US26D, SB, US10B, US14, US15,
 US15A, VB, VC, VI, MB, MS

2 1/2" Diameter
 9/16" Exterior Projection
 1 3/16" Interior Turnpiece Projection

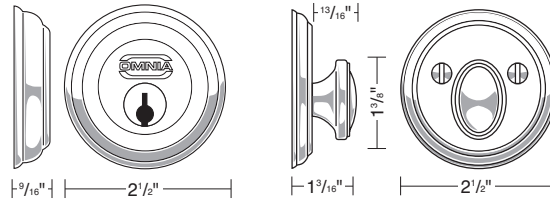

D0806 MODERN
 US3, US26, US26D, SB, US10B, US14, US15,
 MB, MS

2 1/2" Diameter
 9/16" Exterior Projection
 1 1/8" Interior Turnpiece Projection

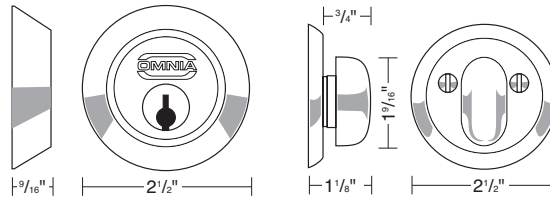

D0806L MODERN LOW PROFILE
 US3, US26, US26D, SB, US10B, US14, US15,
 MB, MS

2 1/2" Diameter
 3/8" Exterior Projection
 1 1/8" Interior Turnpiece Projection

For 1 3/4" or thicker doors

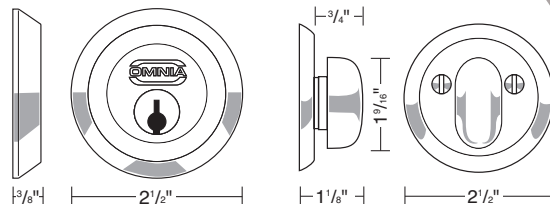

065/00 Turnpiece: 1¼" x ¾"
Rose: 2⅜" x 1⅜"
Projection: 1⅝"

US3, SB



068/05 Turnpiece: 1⅞" x 1⅜"
Rose: 1¾" dia.
Projection: 1⅝"

US3, SB,
US15, MB

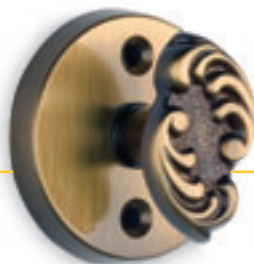

102/04 Turnpiece: 1½" x ¼"
Rose: 1¾" dia.
Projection: 1⅝"

US3, US26,
US26D, US10B,
US14, US15,
MS



102/624 Turnpiece: 1½" x ¼"
Rose: 1⅞" x 1⅞"
Projection: 1⅝"

US3, US26,
US26D,
US10B, US14,
US15



103/04 Turnpiece: 1¾" x ½"
Rose: 1¾" dia.
Projection: 1½"

US3, US4, US26,
US26D, SB,
US10B, US14,
US15, US15A,
VB, VC, VI,
MB, MS

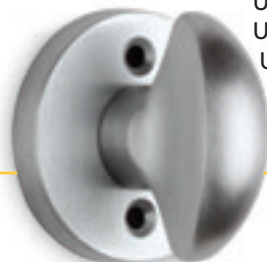

104/04 Turnpiece: 1⅝" x 1⅜"
Rose: 1¾" dia.
Projection: 1⅝"

US3, SB,
US15, MB



105/04 Turnpiece: 1⅝" x 1⅜"
Rose: 1¾" dia.
Projection: 1⅝"

US3, SB, MB

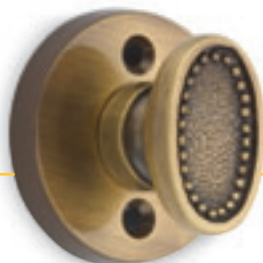

9163/35TP
Turnpiece: 1⅞" x 1⅜"
Rose: 1⅞" x 1⅞"
Projection: 1⅝"

US3, US26,
US14, US15



592

1 3/4" dia.
3/8" projection

US3, US26,
US26D, SB

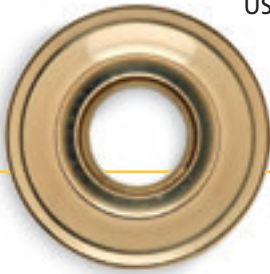

592B

1 3/4" dia.
3/8" projection

US3, US26, SB



597

1 3/4" dia.
3/8" projection

US3, US26,
US26D, SB,
US15



In addition to the selection of latchsets and locksets shown in this catalog, Omnia has also created striking collections of Stainless Steel and Max•Steel door and architectural hardware.

An extensive line of beautifully crafted solid brass decorative cabinet hardware, trim hardware and hinges are also available. For a comprehensive view of all of our lines, please visit our website at:

www.OmniaIndustries.com

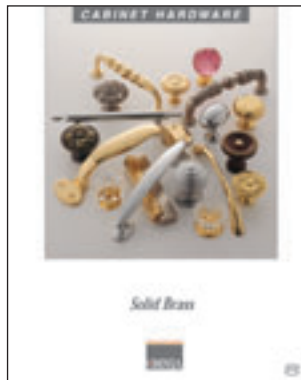



OMNIA

INDUSTRIES, INC.

Box 330, Cedar Grove, NJ 07009 ■ www.OmniaIndustries.com ■ 973.239.7272 ■ Fax: 973.239.5960

© Copyright 2014, Omnia Industries, Inc.



No. LLC0214