

2015 MEDECO PRODUCT CATALOG



ASSA ABLOY, the global leader
in door opening solutions

medeco
ASSA ABLOY

Table of Contents

Medeco

Key Control.....	4
How to Order.....	8
Shipping & Returns Policy	11
Warranty	13
Architectural Specifications.....	14

eCylinders

Medeco XT.....	16
Rim & Mortise Cylinders	17
Key-In-Knob/Lever	17
Interchangeable Core Cylinders	19
Padlocks.....	19
Cam and Utility Cylinders	20
Retail/Showcase Locks	20
International Cylinders	21
Specialty Cylinder Formats	21
Keys and Accessories	22
Programming and Management	22

Medeco ³ CLIQ™	24
Rim & Mortise Cylinders	25
Key-In-Knob/Lever	25
Interchangeable Core Cylinders	27
Deadbolts.....	28
Padlocks.....	29
International Cylinders.....	29
Keys and Accessories.....	30
Programming and Management	31

Medeco CLIQ™	32
Rim & Mortise Cylinders	33
Key-In-Knob/Lever	33
Interchangeable Core Cylinders	36
Padlocks.....	36
Deadbolts.....	37
Cam and Utility Cylinders	38
Retail/Showcase Locks	38
International Cylinders.....	39
Specialty Cylinder Formats	39
Keys and Accessories	40
Programming and Management	40

Aperio.....	42
Mortise Cylinder.....	43
Cabinet Lock.....	45
Hubs and Integrator Tools.....	46

Mechanical Technologies

Medeco ³ Technology	47
BiLevel Technology.....	48
Medeco X4 Technology.....	49

Mechanical Products

Rim & Mortise Cylinders	51
Key-In-Knob/Lever Cylinders	61
Interchangeable Cores	82
LFIC.....	83
SFIC.....	90
Medeco T21 Key Management System	94
International Cylinders.....	95
Deadbolts	123
Maxum	124
Residential Maxum	136
14 Series.....	138
Padlocks.....	140
Protector II Series.....	142
System Series.....	145
Hockey Puck.....	156
G8R.....	157
Cam/Cabinet & Switch Locks	158
Cam Locks	160
Removable Core Cam Locks.....	163
Cabinet Locks.....	169
Showcase Locks.....	171
Plunger Locks.....	172
Micro Switch Lock.....	173
Rotary Switch Lock.....	175

Accessories

Keying Charges.....	177
Keys.....	179
Pin Kits.....	183
Components	186
Tools and Key Machines.....	187
Software & Support	188
Product Index.....	189
Finishes.....	198

Key Control

Medeco's Approach

The security of any locking system is dependent upon two very important factors. The first is protection against attacks such as picking, drilling, bumping and forcing. The second is the ability to control duplication of existing keys. Historically, unauthorized key duplication has played a major role in compromising even the most sophisticated security systems. Anyone with even temporary access to original keys has no problem getting duplicates made for their own use if the keys and key blanks are not patent protected. Even stamping "Do Not Duplicate" on a key merely warns someone not to copy the key – it is not a promise of legal protection or enforcement. The only way to ensure that keys cannot be copied without the consent of the owner is a key system with patent protected keys.

Medeco has counteracted the key control problem by doing three things:

1. Medeco manufactures cylinders which use keys that must be made on special key cutting machines. These machines are capable of reproducing the angled cuts and critical tolerances necessary to produce a workable Medeco key, and are not found at general hardware stores.
2. Medeco sells its high quality, precision machined cylinders and locks only to security industry professionals. Every restricted Medeco key blank is custom coined and tracked by Medeco to identify it as an authorized key blank which protects against unauthorized copies.
3. Medeco invests heavily in research and development to establish strong patents and legal agreements to protect its locks and key blanks from unauthorized distribution or manufacture. In this way, Medeco can litigate to protect its rights and the security of its customers.

A Key Control Program That's Right for You

Not every user has the same key control needs. That's why Medeco has designed different key control programs and different keyways to meet a wide range of security specifications and key access requirements.



Dealer/Service Center

This program offers instant local access to additional keys with protection from unauthorized copying. Consumers simply return to the security provider from which they purchased the locks. This security professional will have a signature card on file completed by the owner of the key system at the time the system was installed.



Card Programs

Authorized individuals are issued a card with embossed control data and a space for their signature. To obtain key duplicates, card holders present the card to any participating Medeco security professional. The data and signature will be verified and a key can then be issued. A card program is ideal for residential or businesses that need keys available nationwide.



End User Program

The End User program is for large facilities that have their own locksmith on staff and that want to produce Medeco keys themselves. This program offers individualized control over key duplication procedures.



Commercial Program

The Commercial Program is designed for users who use Medeco locks primarily for protection against picking, drilling and other forms of physical attack. Keys may be obtained from any Medeco locksmith without specific authorization.



Factory Program

Additional keys are only available from the Medeco factory and only with the proper signature.









eCylinder Systems

eCylinder systems allow the end user the ability to control their own system to electronically change access to any cylinder or key onsite and obtain audit information.

Visit our website at www.medeco.com for more information on all key programs.

MEDECO® KEY CONTROL PROGRAM REFERENCE CHART

- M3** = Medeco³ patent expiration date: 2021.
- BIA** = Biaxial patent expiration date: 2005. Upgrading to Medeco³ recommended.
- ORG** = Original patent expiration date: 1985. Upgrading to Medeco³ recommended.
-  = Permission for copying keys is obtained by presenting a signed authorization card, which is matched to proper identification.
-  = Permission for copying keys is provided by identification and signature verification, which must be presented to either the original locksmith provider or the facility manager.
-  = Keys can be cut on-site by dealers or end-users that are contracted to participate in the respective key program.
-  = Keys are ordered locally and cut at a regional service center and then shipped back to the dealer.
-  = Keys are cut at the Medeco factory and shipped to dealer. Authorization is provided by signature verification.
-  = Medeco recommended high security—UL 437 Listed, ultimate Grade 1 strength, and A156.5-2001 and A156.30 Level A Certified.

MEDECO³® IS RECOMMENDED BY SECURITY PROFESSIONALS AS THE LEADER IN HIGH SECURITY AND PATENTED KEY CONTROL.

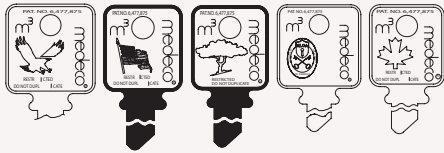

Medeco³ Dealer

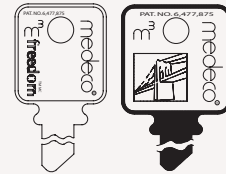

Freedom® / Gotham™

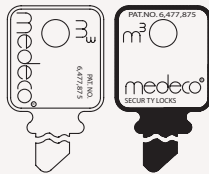

DND / NYC

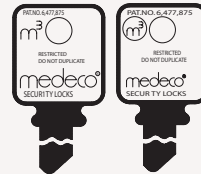

Medeco³ End-User

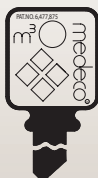

Medeco³ Factory Restricted



BIAXIAL KEYS



Biaxial® Dealer

BIA

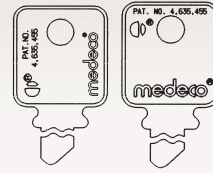

Gold (GLD) / Platinum (NUK)

BIA

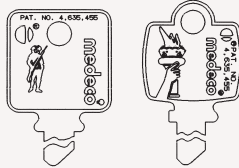

Patriot® / Liberty™

BIA



Biaxial® End-User

BIA



Biaxial® Factory Restricted

BIA



ORIGINAL KEYS



Original® Dealer

ORG



SKY

ORG



Original® End-User

ORG



Original® Factory Restricted

ORG



COMMERCIAL KEYS



Commercial
(Original & Biaxial Version)

ORG

BIA

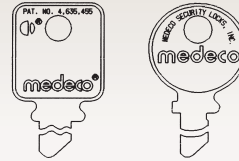

OEM / Other

If you have a Medeco key that isn't on this chart, it is highly likely that it is from an original equipment manufacturer using Medeco products. You will need to return to the original manufacturer of the product for duplicate keys

MEDECO X4 KEYS

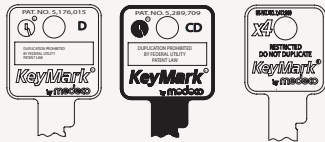

Medeco X4 Dealer

KM



X4

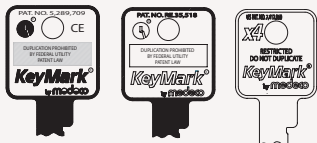

Medeco® KM/X4 End-User

KM



X4

X4

= Medeco X4 patent expiration date: 2027.

KM

= KeyMark patent expiration date: 2011.



= Permission for copying keys is obtained by presenting a signed authorization card, which is matched to proper identification.



= Permission for copying keys is provided by identification and signature verification, which must be presented to either the original locksmith provider or the facility manager.



= Keys can be cut on-site by dealers or end-users that are contracted to participate in the respective key program.



= Keys are ordered locally and cut at a regional service center and then shipped back to the dealer.



= Keys are cut at the Medeco factory and shipped to dealer. Authorization is provided by signature verification.



Medeco KM Silver

KM



Medeco X4 Chrome



X4

Submitting Your Orders to Medeco:

To help you reach greater efficiencies & to create the best ordering experience, submit your orders through our three order channels: eBusiness, Email & Fax

**eBusiness Order Channel**

Your Benefit: Immediately transmit clean orders to reduce entry time to speed up delivery.

EDI

EDI stands for Electronic Data Interchange. It's the easiest method to use for the transmission of orders. Orders are generated directly from your ERP system & sent directly into Medeco's order entry system. EDI allows for instant & accurate transmission.

Online Order Entry

Online Order Entry is a convenient web-based form which allows customers to easily use drop down menus & filtering options to assist with product search & selection. A perfect part number is selected every time!

Visit <http://extranet.assaabloydss.com> to access.

Email Order Channel

Your Benefit: Immediately submit your orders directly into our Digital Filing System to speed up processing time

orders@medeco.com

orders@medeco.com allows customers to submit purchase orders directly into Medeco's Digital Filing System. Once the order is submitted by email, an automatic email notification is sent to you stating the order has been received by Medeco thus ensuring the order was not lost in transmission.

Fax Order Channel

Your Benefit: Immediately submit orders directly into our Digital Filing System to speed up processing time. Typed submissions receive EDI benefits of faster processing & accuracy

Fax: 800.421.6615

Faxing orders to 800.421.6615 allows customers to submit purchase orders directly into Medeco's Digital Filing System. If a faxed order is typed versus handwritten, Medeco will be able to use an internal tool to send typed faxed orders through the EDI portal to create faster order processing & reducing entry errors.

Special Pricing (SP) and Quotations

The SP or quote number must be referenced on the order.

Any invoiced order that has the incorrect discount applied to it and did not have the SP or quote number written on the order will have a service fee of \$100.00 net DEDUCTED from any sales credit issued for the difference in the discount.

Training

Factory certification is offered on a regular basis at Medeco's Salem, VA facility and at other meetings around the United States and Canada.

Medeco® offers factory certification classes with a comprehensive study of our patented Medeco³ technology used in Medeco® cylinders. Additionally, we offer certification classes for our Medeco X4®, Medeco³ CLIQ eCylinder and Medeco XT eCylinder product lines.

Overviews of other Medeco® technologies and product lines are available online at the Medeco-Arrow University. Here you will find installation videos, product overview videos, sales technique videos and many other tools to assist you.

To visit the online University please visit <https://medeco.exceedlms.com/>. If you do not already have an account, you will need to register for one. Registration and online classes are complimentary.

Medeco App

Medeco has an app with *quick reference* material helpful for mechanical and eCylinder products. The Medeco app is available at no charge for iPhones and Android devices. There are resource links to videos pertaining to Medeco's eCylinder and Mechanical product lines.

Medeco Site Survey Wizard App

Collecting accurate and detailed door information is an important element in preparing quotes, developing key schedules and winning business. Identifying the proper hardware, retrofit cylinder and other door details ensures a project is completed on time and on budget. Medeco's Site Survey Wizard App will help guarantee the job is done right, the first time!

The App uses the Medeco Cylinder Cross Reference Database to reference part numbers while completing the site survey. Once the survey is complete, the user will then be able to export a summary document to a laptop or desktop for further use.

The Medeco App and Medeco Site Survey Wizard App can be downloaded via iTunes or Google Apps.

Provide All of the Needed Information to Avoid Delays!
Use the Medeco Check List to Submit Clean Orders for Faster Processing

Medeco Order Check List for All Orders

- | | |
|--|--|
| <input type="checkbox"/> Account Number | <input type="checkbox"/> Base Part Number |
| <input type="checkbox"/> Purchase Order Number | <input type="checkbox"/> Finish |
| <input type="checkbox"/> Billing Address | <input type="checkbox"/> Keyway |
| <input type="checkbox"/> Shipping Address | <input type="checkbox"/> Cam/Tailpiece |
| <input type="checkbox"/> Shipping Instructions | <input type="checkbox"/> Keying Instructions |
| <input type="checkbox"/> Special Pricing/Quote ID* | <input type="checkbox"/> Quantity |
| <input type="checkbox"/> Special Instructions | |

*The SP or quote number must be referenced on the order.

Any invoiced order that has the incorrect discount applied to it and did not have the SP or quote number written on the order will have a service fee of \$100.00 net DEDUCTED from any sales credit issued for the difference in the discount.

Master Key Check List

- | | |
|--|--|
| <input type="checkbox"/> New Master Key System: | <input type="checkbox"/> Existing Master Key System |
| <input type="checkbox"/> Master Key Request Form | <input type="checkbox"/> Registry Number |
| <input type="checkbox"/> Name of End User | <input type="checkbox"/> Name of End User |
| <input type="checkbox"/> Electronic Key Schedule | <input type="checkbox"/> Electronic Key Schedule |
| <input type="checkbox"/> Serialization Instructions | <input type="checkbox"/> Serialization Instructions |
| <input type="checkbox"/> Stamping Instructions | <input type="checkbox"/> Stamping Instructions |
| <input type="checkbox"/> Letters of Authorizations | <input type="checkbox"/> Letters of Authorizations |

Medeco³ CLIQ™ Check List

- | | |
|---|---|
| <input type="checkbox"/> New System: | <input type="checkbox"/> Existing System |
| <input type="checkbox"/> End User Name | <input type="checkbox"/> System Number |
| <input type="checkbox"/> End User Email Address | <input type="checkbox"/> End User Name |
| <input type="checkbox"/> Time Zone | <input type="checkbox"/> End User Email Address |
| | <input type="checkbox"/> Time Zone |

Medeco XT Check List

- | | |
|---|---|
| <input type="checkbox"/> New System: | <input type="checkbox"/> Existing System |
| <input type="checkbox"/> End User Name | <input type="checkbox"/> System Number |
| <input type="checkbox"/> End User Email Address | <input type="checkbox"/> End User Name |
| | <input type="checkbox"/> End User Email Address |

Hybrid Check List

- Site Code
- Serial Number

U.S. Customers – Door Security

Phone: 877-633-3261

Mailing address:

Medeco Security Locks, Inc.

P.O. Box 3075

Salem, VA 24153

Attn: Door Security Customer Service

Fax: 800-421-6615

E-mail: orders@medeco.com

Hours of operation:

Monday – Friday, 8:00 a.m. – 5:00 p.m. ET

Canada Customers

Phone: 905-532-4970

Toll-free (in Canada only) 1-888-633-3264

Mailing address:

Medeco Canada

160 Four Valley Drive

Vaughan, ON L4K 4T9 CANADA

Fax: 905-532-4971 or

1-888-263-3326 (in Canada only)

E-mail: orders@medecocanada.com

Hours of operation:

Monday – Friday, 8:00 a.m. – 4:30 p.m. ET

Customers Outside the U.S. and Canada

Phone: 540-380-1603 or 540-380-1741

Mailing address:

Medeco Security Locks, Inc.

P.O. Box 3075

Salem, VA 24153

Attn: International Customer Service

E-mail: export@medeco.com

Hours of operation:

Monday – Friday, 8:00 a.m. – 5:00 p.m. ET

Medeco Shipping & Return Policies

The Medeco Commitment

Medeco strives to maintain consistent pricing at the lowest possible level. However, unexpected increases may cause changes in our pricing. Therefore, all published prices are subject to change without notice and are not guaranteed. All shipments will be made at prices prevailing at time of shipment. As much as we try to publish error free material, we reserve the right to correct typographical, clerical, editorial, pricing, quantity, or any other errors in this or any publications produced by Medeco Security Locks, Inc. without prior written notice or disclaimer.

Shipping Times:

Many items are available for shipment within 7 work days, and most items will be shipped in 10 days or less.

Shipping Charges:

For most U.S. customers published freight rates will apply. Contact Medeco Customer Service for more information about Medeco's shipping and handling charges.

Customers Outside the U.S.:

Due to specific taxes, import/export fees, and exchange rates, pricing and shipping will vary from U.S. list prices for customers in Canada and elsewhere outside of the United States.

Product Returns:

Medeco accepts product returns if the product is defective from a manufacturing flaw. If you need to make a return, fill out the enclosed RGA Form and fax it to: 800-421-6615 or email to: orders@medeco.com. The RGA Number must be visible on the outside of any package returned to Medeco.

Damaged Goods:

All orders are carefully filled, checked, and packaged. However, on rare occasions, a package may be damaged in transit. If this occurs, please make note of it on the delivery receipt before signing. To return merchandise that was damaged during the shipping or delivery process, call Medeco Customer Service.

Partial Shipments:

If all items on your order are not available at the time your order is processed, you must specify whether you want Medeco to hold the shipment until it is complete or send partial shipments as items are available. Orders received without specific shipping instructions will be filled at the discretion of Medeco.

Medeco® Warranty for Mechanical & Electromechanical Products

Medeco Security Locks Inc. (“Medeco”) warrants to the original purchaser of a Medeco branded lock, lock cylinder, or electromechanical door hardware product (referred to collectively as “Product”) to be free of defects in material and/or workmanship for a period of two (2) years from the date of original purchase for use. This Warranty may also apply to other specific products. For additional Warranty information or Warranty claim service contact Medeco Customer Service at (800) 839-3157 or in Canada (888) 633-3264.

In the event of a defect in material or workmanship during the Warranty period, Medeco will repair or replace (at its option) the Product under the conditions of this Warranty, this action being the sole remedy available to the purchaser under this express limited Warranty.

Limitations, Exclusions and other Rights:

- a. Medeco disclaims liability for implied warranties including but not limited to those of merchantability or fitness for any particular purpose.
- b. Medeco disclaims liability for indirect, incidental or consequential damage at any time.
- c. Medeco warrants that Maxum deadbolt products are free from defects in materials and workmanship for the life of the product. This warranty does not cover defects or damage arising from improper installation, lack of or improper maintenance, ordinary wear and tear, misuse, abuse, or accident.
- d. This Warranty gives specific legal rights and a buyer may also have other rights that may vary from state to state. Some states do not allow limitations on indirect, incidental, and consequential damages or implied warranties so that the above limitations may not fully apply.
- e. Medeco keyblanks are made from a special nickel silver alloy. Medeco warrants its keys against defects in workmanship or breakage for the life of the Product. Bitted Medeco keys must be precisely cut to exact angles and depths, and require special duplication. This Warranty shall be void and Medeco disclaims liability of any kind in the event any key other than a genuine Medeco key has been used with the Product or that the key has been cut on any machine other than a Medeco or Medeco-approved key cutting machine.
- f. Medeco shall not be held responsible for damage arising from, in its sole judgment, improper installation, failure to provide normal maintenance, extreme environmental conditions, use rates in excess of the industry standards defined for the type of product, use of incompatible parts or products not made or authorized by Medeco, or application of force not resulting from normal use.
- g. Unless otherwise specified by separate warranty, finishes are warranted for a period of two years following purchase for use. This finish Warranty shall be considered void after installation if, in the sole judgment of Medeco, the damage to the finish is the direct result of extreme climatic conditions, chemical or abrasive actions.

Medeco³ Suggested Architectural Specifications

Furnished cylinders must provide the capability of a high security, patented, pick and attack resistant design with angled key cuts, rotating tumblers, a keyway side bitting, and a slider mechanism. Cylinders shall provide the option of certified listing to Underwriters Laboratories Listed Standard--UL437--for key locks. Cylinders shall provide the option of certification under American National Standards Institute (ANSI)/Builder's Hardware Manufacturer's Association (BHMA) certification A156.30 2007 (High Security Cylinders) "Levels M1AAAM", and ANSI/BHMA A156.5 2010 "Grade 1."

The furnished key system must allow the capability to combine within the same key system, and using the same patent-protected keys, high security rated cylinders as described above, with non-high security rated cylinders providing greater economy within a single master key system. Furthermore, the furnished key system shall allow the incorporation of software controlled, electro-mechanical cylinders ("eCylinders") with the capability of utilizing the same credential and a single key system controlling both mechanical cylinders and e-Cylinders.

All cylinders with the high security option shall incorporate three locking elements, consisting of a slider mechanism, a sidebar mechanism with tumbler rotation, and pin tumbler elevation. The critical parts of the locking mechanism such as pins, shear line, sidebar, and slider mechanism shall be afforded extra protection from drilling and other forceful attack by the strategic placement of hardened steel inserts in a minimum of 7 possible locations within the cylinder. The lock tumblers shall combine a dual-axis action, with one axis utilized for pin tumbler rotation and the other axis utilized for positioning key cuts. Randomly selected tumbler pins shall incorporate a hardened steel insert for additional drill resistance.

All cylinders with the non-high security option shall incorporate two locking elements, consisting of a slider and sidebar combination, and conical tip, pin tumbler elevation.

The locking system is to be furnished in a restricted key section for which key blanks are not made available from the manufacturer's factory or any other source by uncontrolled distribution methods. The key and cylinder must have utility patent protection so as to hinder unlawful or unauthorized key duplication. Such patent protection shall be afforded in the United States of America, Canada, Mexico, and a plurality of other countries. The keys and key blanks must be capable of being furnished to allow an upgrade to a dual mechanical and electronic credential by the single exchange of a field removable key bow. The key blank thickness should be no less than .125" (one hundred, twenty-five thousandths).

The manufacturer shall have the capability of establishing a key system with a minimum of six angled cuts in six possible pin positions with the capability of two distinct positions of cut per pin chamber, if required by the parameters of the system. The manufacturer shall have the capability of producing a patent-protected keying system in either of two distinct and different keying specifications and pinning specifications. The system shall be capable of incorporating a key which is capable of more than one bitting per position to expand master keying and key changes. The key shall also incorporate the capacity to include twelve possible side bittings along the key blade located on two different planes or surfaces of the key. The system shall also have the capability to provide a single master key with over 1,000,000 (1 million) usable, non-interchangeable change keys in a single profile.

The cylinders shall be immediately rekeyable to new combinations or a new system at any time desired and shall be serviceable on location in the field. Installation of cylinders shall require no modification to U.S. manufactured commercial grade locksets.

The locking system established for this project shall be proprietary and the owner will furnish the manufacturer a list of those persons and their signatures that will be authorized and required to order additional pinned materials or duplicate keys. Orders not bearing authorized signatures shall not be filled.

All master keys and bitting lists for this project shall be sent using appropriate shipping carriers from the factory directly to the owner. Prior to shipment of keys, the owner shall verify in writing preference for shipping carrier and destination.

Medeco X4 Architectural Product Specifications

Cylinders shall be of the knob, rim, mortise, or interchangeable core type. All cylinder components (excluding tumbler pins) shall be constructed of machined extruded brass. All cylinders, cores and housings shall be available in all standard architectural finishes and shall match the cylinder housing and lock and door hardware. Further, cylinders and housings shall be plated, not scalped with the appropriate finish.

Cylinders to be of the 6 or 7 pin tumbler type, providing the maximum unique, non-interchangeable key combinations respectively. All cylinders shall incorporate two locking elements consisting of pin tumbler elevation and a slider mechanism. Further expansion of a master key system shall be available by use of additional multiplex keyways. Cylinders shall not lose any combinations due to MACs (maximum adjacent cut) loss.

All cylinders shall use a .150" space dimension between tumbler pin chambers and shall be capable of using industry standard tumbler pins. Cylinder shall contain standard pins, a portion of which (both bottom and top pins) shall be spooled to resist pick attacks.

All non-I/C rim and mortise cylinders shall be so constructed to use threaded set screws, not staked covers or caps, to cover each individual tumbler pin chamber.

All cut keys, key blanks and cylinders (knob, rim, mortise, and interchangeable core-type) shall be so constructed to be capable of being keyed in the same system, allowing the convenience of one master key to operate all types of listed cylinders. Further, the key or key blank's tip shall be so constructed to correctly locate the bits of the key beneath the proper chamber of an interchangeable core cylinder by locating against a key stop on the rear core. Additionally, the key or key blank's shoulder shall serve as a stop to correctly locate the bits of the key beneath the proper plug chamber of rim, mortise and knob-type cylinders by locating against the front face of the cylinder. The key blank thickness should be no less than .093" (ninety three thousandths).

All cut keys and key blanks shall be utility patented and controlled by a contract between the end user and the manufacturer. Key blanks for this project shall be delivered directly from the factory to the end user unless otherwise requested in writing by the end user.

All keys must be capable of being configured to allow an upgrade to a dual mechanical/electronic credential by the simple exchange of a field removable key bow.

The key shall incorporate the capacity to include eight possible side bittings along the key blade located on two different planes or surfaces of the key.

All key blanks shall be custom coined with the end user's name or other unique identification mark. All cut keys and key blanks are to be constructed from nickel silver.

All keys shall be capable of being cut by a punch machine that originates the exact cut in the key from the code sheet, instead of using patterns.

Cylinders shall be immediately rekeyable to new combinations or a new system at any time desired and shall be serviceable on location in the field. Installation of the cylinders shall require no modifications to U.S. manufactured commercial grade locksets.

The locking system established for this project shall be proprietary and the owner will furnish the manufacturer a list of those persons and their signatures that will be authorized and required to order additional pinned materials or duplicate keys. Orders not bearing authorized signatures will not be filled.

All cylinders, cores, housings, keys and key blanks shall be made in the USA.

Medeco® XT

Medeco® XT Electronic Locking Systems

Medeco® XT is a complete electronic locking system providing *Controlled Access, Accountability, Physical Security, and System Management*. More than just a way to protect your property, equipment and assets, Medeco® XT is also a business tool that can lead to a substantial return on investment.

Controlled Access – Keys are electronically programmed to open only specific locks during a designated schedule. Schedules may also contain an expiration point to completely disable the key until it is audited and reprogrammed.

Accountability – Audit information recorded in both the lock and key shows a time-and-date stamped record of every event, including authorized accesses and unauthorized attempts.

Electronic Rekeying & Scheduling – Respond quickly to security threats, lost or stolen keys, or personnel changes without the added cost of changing your locks and keys.

Easy Installation – Medeco® XT key provides all power to the cylinder, eliminating the need for any hard wiring or power supply. Simply remove the existing mechanical cylinder and install the Medeco® XT cylinder.

Physical Security – Medeco® XT products add a wide variety of intelligent features without compromising on physical security. Attack-resistant design and tamper-proof features provide strong protection against forced entry.



Audit Accountability

Audit information recorded in both the lock and key shows a time-and-date stamped record of every event, including authorized accesses and unauthorized attempts.



Uses Existing Hardware

Medeco® XT key provides all power to the cylinder, eliminating the need for any hard wiring or power supply. Simply remove the existing mechanical cylinder and install the Medeco® XT cylinder.



Reduces Risk of Lost Keys

Respond quickly to security threats, lost or stolen keys, or personnel changes without the added cost of changing your locks and keys.



Electronic Scheduling

Keys are electronically programmed to open only specific locks during a designated schedule. Schedules may also contain an expiration point to completely disable the key until it is audited and reprogrammed.

Key Features:

- Small, robust electronic key with stainless steel housing
- All programming done at the key
- Key holds operating and expiration schedule
- Rechargeable battery, 500-800 openings per charge
- Access: 5,000 cylinders maximum
- Audit: 5,000 events maximum
- Heavy duty stainless steel construction
- Stand-alone, network, WEB and mobile programming options

Warranty:

Medeco Security Locks warrants Medeco® XT products to be free of defects in material and/or workmanship for a period of two (2) years from date of original purchase.

Product Specifications:

Lock / Cylinder Features

- No wiring required—all power provided by the key
- Indoor / outdoor use—stainless steel shell construction
- 2000 audit events
- Unauthorized key list
- Variety of retrofit cylinder formats

Medeco® XT

Rim and Mortise Cylinders

The Medeco® XT Rim & Mortise electronic cylinders are a simple and direct replacement for mechanical Rim & Mortise cylinders. Ideal for Loss & Liability management with flexible authorization and auditing capabilities. Respond quickly to security threats, lost or stolen keys, or personnel changes without the added cost of changing your locks and keys. Medeco® XT is a complete electronic locking system providing Controlled Access, Accountability, Physical Security, and System Management with no wiring requirements. Mortise & Rim cylinders are available in many popular lengths to fit nearly any application in your office, business and retail applications.



Mortise Cylinder

Rim Cylinder

Medeco® XT Mortise Cylinders

Description	Part Number	Price
1 1/4" Mortise Cylinder	100500 G	\$244.50
1 3/8" Mortise Cylinder	105100 G	\$244.50

Medeco® XT Rim Cylinders

Description	Part Number	Price
Rim Cylinder, horizontal tailpiece	100400H G	\$244.50
Rim Cylinder, vertical tailpiece	100400V G	\$244.50

Key-In-Knob/Lever Cylinders

The Medeco® XT Key in Knob/Lever electronic cylinder is a direct replacement for mechanical KIK/KIL cylinders and is ideal for Loss & Liability management. The cylinder requires no wiring to the door and is powered by the Medeco® XT rechargeable key. Audit trail, user access schedules and the ability to quickly add or remove a key electronically from a system, allow for fast response to security threats, lost or stolen keys, or personnel changes without the added cost of changing your locks and keys. KIK/KIL cylinders are designed for quick retrofit of nearly all popular brands of knob and lever type cylindrical locksets making them an ideal application for office doors, storage and file rooms, or residential doors; virtually any door where cylindrical hardware is used.



Medeco® XT Arrow Cylinders

Description	Part Number	Price
Medeco® XT cylinder for all Arrow RK & MK series knobs and GL series levers. For RK & MK series, replace original spacer with Medeco CP-160321 (included)	20200A1 G	\$244.50

Medeco® XT Cylinders for Cal-Royal

Description	Part Number	Price
Cylinder for Cal-Royal Apollo series SL00 knob lock and LX01 lever lock	2020049 G	\$244.50
Cylinder for Cal-Royal CL503 classroom function Gr. 2 lever lock	20200V1 G	\$244.50

Medeco® XT Cylinders for Corbin Russwin

Description	Part Number	Price
Cylinder for Corbin 800 lever lockset CL3300, CL3400, CL3500 & CL3600	2020073 G	\$244.50
Cylinder for Corbin Russwin CL3900 series leversets	20200V9 G	\$244.50

Medeco® XT Cylinders for Falcon

Description	Part Number	Price
Cylinder for Falcon B, LY, X, S & T series. Includes: CT-V03, CT-Y49, CT-Y54, CT-Y58, CTY68, CT-Y71, CT-Y72, CP-160311	20200F1 G	\$244.50
Cylinder for Falcon F521, F561, F581, and N series knobs	2020051 G	\$244.50
Cylinder for Falcon T-381 (inside)	2020073 G	\$244.50
Cylinder for Falcon T & RU series, T381 (exterior)	20200V3 G	\$244.50

Medeco® XT Cylinders for KABA-Mas-Hamilton

Description	Part Number	Price
Cylinder for Kaba E-plex 5000	2020000 G	\$244.50
Cylinder for Mas-Hamilton Power Lever	20200V1 G	\$244.50

Medeco® XT Cylinders for LSDA

Description	Part Number	Price
LSDA cylinder package fits 100, L100, LH1000, LX1000, Includes: CT-Y49, CT-Y70, CT-Y73, CTY78	20200L1 G	\$244.50

Medeco® XT Cylinder for Marks

Description	Part Number	Price
Cylinder for Marks 110, 170, 180, 190, 195, 295 series Vestibule, Communicating, Classroom, & Classroom Security functions (DA, DC, SB, S).	20200V0 G	\$244.50
Cylinder for Marks Lever 110, 170, 180, 190, 195, 295 series in Entrance, Institution, Storeroom, and Corridor functions (AB, DW, F, T)	20200V1 G	\$244.50

Medeco® XT Cylinders for Olympus

Description	Part Number	Price
Cylinder for Olympus 700 LCM & 800 LCM Key Retaining	20200S1 G	\$244.50

Medeco® XT Cylinders for PDQ

Description	Part Number	Price
Cylinder for PDQ Lever SP & ST Series, GT, XGT, & GP Series	20200V2 G	\$244.50

Medeco® XT Cylinders for Sargent

Description	Part Number	Price
Cylinder for Sargent 10 line locksets, order with '30' option prefix (note: cylinder will extend from lever more than standard cylinder)	20200S1 G	\$244.50

Medeco® XT Cylinders for Schlage

Description	Part Number	Price
Cylinder Package for Schlage A, AL, C, D, ND & Olympiad lever designs, includes: CT-Y49 (A, AL, & D Olympiad Lever & C & D Plymouth), CT-Y52 (C & D heavy duty knobs Ball, Globe & Sphere designs only), CT-Y53 (A series Orbit), CT-Y73 (ND series Gr. 1 lever & AL thick doors), and CTY74 (45-101 padlock)	20200S1 G	\$244.50
Cylinder for Schlage S Series Lever	2020097 G	\$244.50

Medeco® XT Cylinders for TACO

Description	Part Number	Price
Cylinder for Olympus 700 LCM & 800 LCM Key Retaining	20200S1 G	\$244.50

Medeco® XT Cylinders for Yale

Description	Part Number	Price
Cylinder for Yale 6 pin 5300LN, 5400LN and 4300 Knobs	200503 G	\$244.50

Interchangeable Core Cylinders

The Medeco® XT Small Format Interchangeable (SFIC) Core is ideal for loss and liability management as a direct replacement for mechanical SFIC cylinders without any hardware modifications. An easy-to-upgrade SFIC solution, ready to install and use without wiring or power supply. Complete SFIC is easily installed or removed to existing hardware with the simple use of a programmed control key. Now you can audit keys, program a schedule and track who opens a lock and when – all while eliminating the cost of rekeying mechanical locks. Attack-resistant design and tamper-proof features provide strong protection against forced entry. Well suited for facilities with high turnover of employees, such as fast food restaurants, convenience stores, and other similar businesses, but is also suitable for apartments, office buildings, schools, and hospitals.



Medeco® XT Small Format Interchangeable Core

Description	Part Number	Price
Small Format Interchangeable Core (SFIC) Cylinder	EA-100108	\$244.50

Padlocks

The Medeco® XT electronic padlock cylinders are ideal for Loss & Liability management at off site or hard to reach locations. This robust cylinder securely operates in challenging environments with stainless steel components, and is designed for interior and exterior use. Keys are electronically programmed to open only specific locks during a designated schedule and audit information is recorded in both the lock and key. With no wiring or power supply required, these padlocks are an ideal application for your perimeter fences and gates, or access to equipment storage areas where traditional EAC is practically impossible to install.



Medeco XT Padlocks

Description	Part Number	Price
Medeco XT Hockey Puck Padlock	5293000 G	\$296.00
Indoor/Outdoor Padlock, Non-Key Retaining, 1 1/8" Shackle Clearance, With Cylinder	5451500 G	\$284.00
Indoor/Outdoor Padlock, Key Retaining, 1 1/8" Shackle Clearance, With Cylinder	54515R0 G	\$284.00
Indoor/Outdoor Padlock, Non-Key Retaining, 2 3/8" Shackle Clearance, With Cylinder	5451F00 G	\$287.00
Indoor/Outdoor Padlock, Key Retaining, 2 3/8" Shackle Clearance, With Cylinder	5451FR0 G	\$287.00
Indoor/Outdoor Padlock, Non-Key Retaining, 1 3/8" Shackle Clearance, With Cylinder	5452500 G	\$301.50
Indoor/Outdoor Padlock, Key Retaining, 1 3/8" Shackle Clearance, With Cylinder	54525R0 G	\$301.50
Indoor/Outdoor Padlock, Non-Key Retaining, 1 7/8" Shackle Clearance, With Cylinder	5471500 G	\$304.50
Indoor/Outdoor Padlock, Key Retaining, 1 7/8" Shackle Clearance, With Cylinder	54715R0 G	\$304.50
Indoor/Outdoor Padlock, Non-Key Retaining, 1 7/8" Shackle Clearance, With Cylinder	5471F00 G	\$307.50
Indoor/Outdoor Padlock, Key Retaining, 1 7/8" Shackle Clearance, With Cylinder	5471FR0 G	\$307.50
Shrouded Padlock, Non-Key Retaining, 3/4" Shackle Clearance, With Cylinder	5472500 G	\$330.50
Shrouded Padlock, Key Retaining, 3/4" Shackle Clearance, With Cylinder	54725R0 G	\$330.50

Medeco XT Padlock Cylinders

Description	Part Number	Price
Medeco XT System Series Padlock, Cylinder Only	510600 G	\$234.50
Medeco G8TR Padlock, Pop-Out Cylinder Only – Round Deadbolt	EV-8501D	\$234.00
Medeco G8TR Padlock, Pop-Out Cylinder Only – Round Springbolt	EV-8501S	\$234.00

Cam and Utility Cylinders

Medeco® XT cam locks are built for strong physical security and offer all the benefits of the Medeco® XT Electronic Locking System. Medeco® XT cam locks are available in lengths of 7/8" and 1-1/8" with a wide variety of cams and security collars. The cylinder is designed for interior and exterior use and requires no wiring or modification to the door. Audit information recorded in both the lock and key shows a time-and-date stamped record of every event, including authorized accesses and unauthorized attempts. A quick retrofit to existing hardware - all in one convenient package. An excellent application for utility cabinets, retail fixtures, narcotics storage, safes and more.



Cam Locks

Description	Part Number	Price
7/8" Cam lock assembly	EN-150002-XXX (Op Code)	\$234.00
1 1/8" Cam lock assembly	EN-150003-XXX (Op Code)	\$234.00

Cam Lock Operation Codes

Description	Op Code
2 flat, 1 keypull, clockwise 90 degree	219
2 flat, 1 keypull, counter-clockwise 90 degree	239
2 flat, 1 keypull, clockwise 180 degrees	259

Retail/Showcase Locks

Medeco® XT has an electronic cylinder for many types of retail applications. Ideal for Loss & Liability management with flexible authorization and auditing capabilities. Respond quickly to security threats, lost or stolen keys, or personnel changes without the added cost of changing your locks and keys. The cylinder is powered by the rechargeable key so no wiring or power supply is needed. Medeco® XT Plunger Locks are specifically designed for use in wooden or metal sliding doors. Cabinet style locks are also available and along with the plunger locks are ideal applications for security merchandise showcases, metal cabinets, and laboratory and office furniture.



Medeco XT Retail/Showcase Locks

Description	Part Number	Price
Cabinet Lock, Latchbolt	490359 G	\$342.50
Cabinet Lock, Deadbolt	490366 G	\$751.50

International Cylinders

The Medeco® XT Modular Half Profile, Euro Double & Thumb Turn electronic cylinders are a direct replacement for like mechanical cylinders and are ideal for loss and liability management. In addition to international uses, many of these cylinders fit imported hardware used in North America. The cylinder requires no wiring or modification to the door or frame and is designed for interior and exterior use. Attack-resistant design and tamper-proof features provide strong protection against forced entry and flexible key programming and auditing capabilities allow for quick response to security threats, lost or stolen keys, or personnel changes. Cylinders are widely used at government installations, airports, hotels, universities and schools. Medeco® XT is a complete electronic locking system providing Controlled Access, Accountability, Physical Security, and System Management.



Medeco XT International Cylinders

Description	Part Number	Price
Lockwood Oval	23031S G	\$229.00
Cylinder Module EURO 1/2 Module - 30mm	232201S 300 G	\$209.00
Cylinder Module EURO 1/2 Module - 35mm	232201S 301 G	\$213.00
Cylinder Module EURO 1/2 Module - 40mm/85mm	232201S 302 G	\$209.00
Cylinder Module Single/Double	232202S G	\$209.00
Single/Double cylinder Module EURO 1/2 Module - 30mm	232202S 300 G	\$209.00
Single/Double cylinder Module EURO 1/2 Module - 35mm	232202S 301 G	\$213.00
Single/Double cylinder Module EURO 1/2 Module - 40mm/85mm	232202S 302 G	\$209.00
Euro T/T Profile - 30mm/30mm Assembled	23230XS X00 G	\$272.00
Euro T/T Profile - 35mm/35mm Assembled	23230XS X11 G	\$280.00
Modular Profile Cylinder - 30mm Half Profile - Assembled	232301S 800 G	\$244.50
Modular Profile Cylinder - 35mm Half Profile - Assembled	232301S 801 G	\$248.50
Euro 1/2 Profile 30mm Assembled (True 30mm)	232301ST 800 G	\$244.50
Euro Double Profile - 30mm/30mm Assembled	23230E5 X00 G	\$327.00
Euro Double Profile - 35mm/35mm Assembled	23230E5 X11 G	\$335.00

Specialty Cylinder Formats

The Medeco® XT Electronic T-handle Cylinders are an ideal for loss and liability management in a pop out cylinder application. The cylinder requires no wiring to the door and is powered by the Medeco® XT rechargeable key. The cylinder is designed for interior and exterior use and has both key authorization/scheduling and auditing capabilities to track time and user accesses. More than just a way to protect your property, equipment and assets, Medeco® XT is also a business tool that can lead to a substantial return on investment. Cylinders are available in spring-latch and dead-bolt configurations. Stainless steel shell and bolt for lasting strength, durability and strong protection against physical attack. Fits all NAMA Standard T-Handles. Ideal for vending & bottling, bill changers, ATM equipment or other custom OEM applications.



Pop-Out Cylinders

Description	Part Number	Price
Pop-Out Cylinder Deadbolt assembly, round bolt	EV-8501D	\$234.00
Pop-Out Cylinder, springbolt assembly, round bolt	EV-8501S	\$234.00

Keys and Accessories

The Medeco® XT Key is a convenient, robust electronic key with a heavy duty stainless steel housing that fits right on your key ring. A portable key charger and rechargeable battery assures keys are always fully charged for up to 800 openings, eliminating the need for battery maintenance. Convenient key programming and flexible system management eliminates the need for removal of cylinder in order to make changes. This key holds operating and expiration schedule and flexible memory allocation lets the user decide how the memory is used; Access: up to 5,000 cylinders. Audit: up to 5,000 events. With Medeco® XT, flexible authorization, auditing of use and quick retrofit to existing hardware are all available in one convenient package.



Medeco® XT Keys

Description	Part Number	Price
Medeco XT Slim Line Key	EA-10156	\$99.00
Medeco® XT Industrial Key (can be programmed to operate as a user key, control key, or audit function)	EA-100107	\$119.00
Medeco® XT Industrial Key & Portable Charger	940239	\$138.00

Programming and Management

Medeco® XT software contains tools that will help you manage your security more efficiently. Flexible programming, scheduled access and full audit reports are offered with the convenience of stand-alone or web-based software. Medeco XT Web Hosting provides a global solution to programming and scheduling XT Keys & Cylinders. Key administrators have the ability to change schedules and retrieve audit information from their Medeco® XT keys without having to physically possess the key. With the downloadable programming client, a key holder can dock and synchronize with the XT Web Server from anywhere in the world with a PC and an internet connection. Our web-hosted programming offers secure web access, no start-up fees and year-round 24/7 access, making it a cost-effective electronic solution to meet any customer's needs.



Medeco® XT Web Hosting Service

Description	Elements	Part Number	Price
Medeco® XT Annual Web Hosting, Entry	2 to 50	SW-500301-1	\$441.00
Medeco® XT Annual Web Hosting, Basic	51 to 200	SW-500301-2	\$1,177.00
Medeco® XT Annual Web Hosting, Corporate	201 to 999	SW-500301-3	\$3,680.50
Medeco® XT Annual Web Hosting, Enterprise	1000 to 2999	SW-500301-4	\$6,625.00

Medeco® XT Manager Software

Description	Elements	Part Number	Price
Medeco® XT Software (Local Client)		EV-4515	\$798.00
Medeco® XT Host Kit (Software, USB Cable, USB Programming Station, USB Security Dongle)		EV-4514	\$1,083.50
Self Host Software		SW-600901	\$14,997.00
Annual Self Host Maintenance		SW-600901-R	\$2,142.50



Medeco® XT Programmer

Description	Part Number	Price
Medeco® XT USB Programming Station only (order cable separately)	EA-100109	\$223.50
Medeco® XT Remote Wall Programmer - Program and update Medeco XT Keys remotely via an internet connection to the Medeco XT Web Manager	EA-100158	\$3,621.50
Wall Mount Kit	94-0294	\$49.00
Desktop Mount Kit	94-0295	\$89.00

Medeco® XT Kits & Accessories

Description	Part Number	Price
Medeco® XT Portable Key Charging Adapter only (order cable separately)	EA-100088	\$46.50
Medeco® XT Multi Key Charger - Charge up to 10 Medeco XT Keys simultaneously (does not program keys)	EA-100138	\$512.50
Medeco® XT USB System Dongle	EA-250050	\$66.00
Medeco XT Key Wall Charger Kit	94-0291	\$90.00
Medeco XT Key Vehicle charger Kit	94-0292	\$89.00
Medeco XT Key PC Kit (USB Cable and Charging Adapter)	94-0290	\$68.50
Smart SFIC Solutions Demo Kit (Includes Arrow, Medeco X4, and Medeco® XT SFIC cylinders, keys, dongle, charger, cable and Web software access)	940261	\$1,628.00
SFIC -A Sales Kit (Includes Arrow, Medeco X4, Demo Medeco® XT cylinder and keys)	940276	\$555.00
Medeco® XT Try Me Demo Keys & SFIC with charger and USB cable - NOT PROGRAMMABLE	940264	\$723.50

Stand Alone Software - End User Startup Checklist:

Description	Quantity	Part Number
XT Programming Device	1	EA-100109
USB Cable	1	EA-200058
USB System Dongle	1	EA-250050
XT Software	1	EV-4515

Web Hosted Service - End User Startup Checklist:

Description	Quantity	Part Number
XT Programming Device	1	EA-100109
USB Cable	1	EA-200058
XT Web - Level by Elements	1	SW-500301-X

Medeco³ CLIQ™

Medeco³ CLIQ merges the features of electronics with reliable mechanical technology – all in a retrofit cylinder. Medeco³ CLIQ offers end users audit trail, user access schedules and the ability to quickly add or remove a key electronically from a system.

Medeco³ CLIQ installs with no wiring in a matter of minutes and digital keys and digital cylinders reprogram for quick changes. Medeco³ CLIQ can be combined with systems featuring Medeco³ or BiLevel mechanical products to offer a blended security solution.



Audit Accountability

Audit information recorded in both the lock and key shows a time-and-date stamped record of every event, including authorized accesses and unauthorized attempts.



Uses Existing Hardware

The Medeco³ CLIQ key provides all power to the cylinder, eliminating the need for any hard wiring or power supply. Simply remove the existing mechanical cylinder and install the Medeco³ CLIQ cylinder. Medeco³ CLIQ can be keyed in with Medeco mechanical systems featuring Medeco³ or BiLevel.



Reduces Risk of Lost Keys

Respond quickly to security threats, lost or stolen keys, or personnel changes without the added cost of changing your locks and keys.



Electronic Scheduling

Keys are electronically programmed to open only specific locks during a designated schedule. Schedules may also contain an expiration point to completely disable the key until it is audited and reprogrammed.

Key Features:

- Mechanical and Electronic technology are combined for superior security with Medeco® patented key control
- Audit key up to 1,000 audit records provides information unavailable in a mechanical system
- Self-cleaning electronic contact point for a long lasting key and reliable connection
- Powered by an easily replaceable CR2025 Battery with 20,000 cycle battery life
- Available with RFID/PROX coil insert for dual use with HID compatible systems
- Rated for -20 degrees Fahrenheit to 122 degrees Fahrenheit (cylinder and key)
- Visible and audible status feedback
- Compact size in water resistant housing

Warranty:

Medeco® warrants the Medeco³ CLIQ products to be free of defects in material and/or workmanship for a period of two (2) years from date of original purchase

Finishes:

- Available in several finish options

Technical Information:

- **Memory:** Non-volatile Memory Storing 750 Audit Events in the lock and 1,000 in the keycap
- **Software:** Local software client or web hosted option available
- **Power:** Power supplied by the key, no hard wiring required
- **Lockcase:** Fits standard Rim & Mortise Housing as well as other various platforms
- **Weather Resistant:** Can be used in indoor or outdoor applications
- **Physical Security:** Drill and Tamper Resistant
- **Formats:** Available in all common cylinder formats including KIK/KIL, LFIC, padlocks and deadbolts

Medeco³ CLIQ™

Rim and Mortise Cylinders

A simple replacement of rim or mortise cylinders with Medeco³ CLIQ cylinders provide audit and scheduling along with expiration of credentials for any existing opening utilizing mortise hardware. Cylinders are available in all popular lengths and in any existing mechanical mechanical keyway, and are an ideal upgrade for offices or as convenient loss and liability control or as override for traditional EAC equipment.



Medeco³ CLIQ Mortise Cylinders

Description	Part Number	Price
1 1/8" Mortise Cylinder	100200 S	\$595.50
1 1/4" Mortise Cylinder	100500 S	\$595.50
1 3/8" Mortise Cylinder	105100 S	\$576.00
1 1/2" Mortise Cylinder	105200 S	\$620.00
1 3/4" Mortise Cylinder	105400 S	\$678.00

Medeco³ CLIQ Rim Cylinders

Description	Part Number	Price
Rim Cylinder, Horizontal Tailpiece	100400H S	\$596.00
Rim Cylinder, Vertical Tailpiece	100400V S	\$596.00
Rim Cylinder, Lazy Motion	100700 S	\$596.00

Key-In-Knob/Lever Cylinders

Medeco³ CLIQ merges the flexibility of electronics with reliable mechanical technology – all in a key in knob or key in lever retrofit cylinder. Offers user audit trail, user access schedules and the ability to quickly add or remove a key electronically from a system, allowing quick response to security threats or lost/stolen keys. These cylinders fit nearly all popular brands and styles of hardware and are therefore an ideal application for offices, storage and file rooms, as well as any door where cylindrical hardware is used.



Medeco³ CLIQ Cylinders for Arrow

Description	Part Number	Price
Cylinder Package for Arrow RK & MK Series Knobs & GL Series levers. Includes CT-Y70, CTY73, & CP-160321. Original cylinder spacer must be replaced with Medeco cylinder spacer CP-160321	20200A1 S	\$597.50
Cylinder for Arrow Revolution & DB Series Deadbolt	200901 S	\$597.50
Cylinder for Arrow Knobs and D & E Deadbolts	200902 S	\$597.50

Medeco³ CLIQ Cylinders for Alarm Lock

Description	Part Number	Price
Cylinder for Alarm Lock Trilogy T1, T2, T3	20200V1 S	\$596.00

Medeco³ CLIQ Cylinders for Cal-Royal

Description	Part Number	Price
Cylinder for Cal-Royal SL00 knob lock and LX01 lever lock	2020049 S	\$596.00
Cylinder for Cal-Royal CLS03 Classroom function Grade 2 lever lock	20200V1 S	\$596.00

Medeco³ CLIQ Cylinders for Corbin Russwin

Description	Part Number	Price
Cylinder for Corbin Russwin CL3900	20200V9 S	\$596.00
Cylinder for Corbin Russwin 800, CL3300, CL3400, CL3500, & CL3600	20211730 S	\$596.00

Mechanical keyways are represented by the following letters:
 S = Medeco³ CLIQ, V = Medeco Biaxial CLIQ, Z = Medeco Original KW CLIQ

Medeco³ CLIQ Cylinders for Dorma

Description	Part Number	Price
Cylinder for Dorma CL853, CL860 (exterior), CL880, CL882, CL80EL, CL80EU Grade 1 lever, CK853, CK860 (exterior), CK880, CK882, CK80EL, & CK80EU Grade 1 knobs	20200V1 S	\$596.00
Cylinder for Dorma CL860 (interior), CL870, CL872, CL873, CL877 Grade 1 Lever, CK860 (interior), CK870, CK872, CK873 & CK 877 Grade 1 Knobs	20200V0 S	\$596.00
Cylinder for Dorma CL700 Series	2020049 S	\$596.00

Medeco³ CLIQ Cylinders for Embassy

Description	Part Number	Price
Cylinder for Embassy in Entrance, Institution, Storeroom, Corridor Functions. For Embassy Levers sold thru 9/06 and ALL Knobs	20200V1 S	\$596.00
Cylinder for Embassy Vestibule, Communicating, Classroom & Classroom Security Functions. For Embassy Levers sold thru 9/06 & ALL Knobs	20200V0 S	\$596.00

Medeco³ CLIQ Cylinders for Falcon

Description	Part Number	Price
Cylinder for Falcon B Series	2020049 S	\$597.50
Cylinder for Falcon B (CT-Y49), LY (CT-Y72), X (CT-Y68, except H knob or CT-Y71 - H knob), S (CT-Y54 - except H knob, or CT-Y58 - H knob) & F521, F561, F581, and N Series Knobs (CT-Y49 horizontal)	20200F1 S	\$597.50
Cylinder for Falcon Inside Cylinder T-381	2020073 S	\$597.50
Cylinder for Falcon T & RU Series, T381 Outside Cylinder	20200V3 S	\$597.50

Medeco³ CLIQ Cylinders for KABA Mas Hamilton

Description	Part Number	Price
Cylinder for Kaba E-plex 5000	2020000 S	\$596.00
Cylinder for Mas-Hamilton Power Lever	20200V1 S	\$596.00

Medeco³ CLIQ Cylinders for LSDA

Description	Part Number	Price
LSDA Cylinder package fits 100, , L100, LH1000, LX1000 Series. Includes: CT-Y49, CT-Y70, CTY73, CT-Y78	20200L1 S	\$597.50

Medeco³ CLIQ Cylinders for Marks

Description	Part Number	Price
Cylinder for Marks 110, 170, 180, 190, 195, 295 Series DA-Vestibule, DC & SB Communicating, S-Classroom & Classroom Security functions	20200V0 S	\$596.00
Cylinder for Marks Lever 110, 170, 180, 190, 195 & 295 Series in AB-Entrance, DWInstitution, F-Storeroom, & T-Corridor Functions	20200V1 S	\$596.00

Medeco³ CLIQ Cylinder for Olympus

Description	Part Number	Price
Cylinder for Olympus 700LCM & 800 LCM Key Retaining, Includes: CT-Y49, CT-Y52, CT-Y53, CTY54	20200S1 S	\$597.50
6 Pin Cylinder for Olympus 700LCM & 800LCM	2000954 S	\$597.50

Medeco³ CLIQ Cylinders for PDQ

Description	Part Number	Price
Cylinder for PDQ Lever SP & ST Series, GT, XGT, & GP Series	20200V2 S	\$596.00

Mechanical keyways are represented by the following letters:
 S = Medeco³ CLIQ, V = Medeco Biaxial CLIQ, Z = Medeco Original KW CLIQ

Medeco³ CLIQ Cylinder for Sargent

Description	Part Number	Price
Cylinder for Sargent 10 Line lockset ordered with a '30' option prefix (Note: cylinder will extend from lever more than the standard cylinder)	2020051 S	\$597.50
Cylinder for Sargent 6, 7 and 10 Line KIK Series	2080147 S	\$597.50
Cylinder for Sargent 11 Line KIK Series	2080148 S	\$597.50

Medeco³ CLIQ Cylinders for Schlage

Description	Part Number	Price
Cylinder Package for Schlage A, AL, C, D, ND & Olympiad lever designs, includes: CT-Y49 (A, AL, & D Olympiad Lever & C & D Plymouth), CT-Y52 (C & D heavy duty knobs Ball, Globe & Sphere designs only), CT-Y53 (A series Orbit), CT-Y73 (ND series Gr. 1 lever & AL thick doors), and CTY74 (45-101 padlock)	2020051 S	\$597.50
Cylinder for Schlage S Series Lever	2020097 S	\$597.50
Cylinder for Schlage B, E & F160 Series	2000954 S	\$597.50

Medeco³ CLIQ Cylinders for Yale

Description	Part Number	Price
6 pin cylinder for Yale 5300LN, 5400LN and 4300 Series	200503 S	\$597.50

Medeco³ CLIQ Cylinders for TACO

Description	Part Number	Price
Cylinder for TACO LXV Lever Lockset	2020078 S	\$597.50

Interchangeable Core Cylinders

Medeco® Large Format Interchangeable Core (LFIC) cylinders are designed so that cores can quickly and easily be changed by non-technical personnel by using a special control key. Locks can, in effect, be “rekeyed” without having a working knowledge of the lock or without having to take the lock apart. Medeco³ CLIQ format additionally provides the benefits of audit and scheduling features. LFIC cylinders fit many of the industry standard formats making them appropriate for almost any door/hardware application.



Medeco³ CLIQ LFIC Cylinders

Description	Part Number	Price
Cylinder for Medeco 6 pin LFIC	320201 S	\$595.50
Cylinder for Yale 6 pin LFIC	310100 S	\$595.50
Cylinder for Yale 7 pin LFIC	310100A S	\$595.50

Deadbolts

In addition to the physical security of the Maxum deadbolt, the Medeco³ CLIQ cylinder provides an audit trail, the ability to schedule user access rights and the freedom to quickly add or remove a key from the system. The Medeco³ CLIQ deadbolt installs with no wiring in a matter of minutes and is available in existing mechanical keyways. Attack-resistant design and tamper-proof features provide strong protection against forced entry and allow for flawless integration into any home or business application.



*All Medeco³ CLIQ Double Cylinder Deadbolts use Mechanical Cylinders on the inside of the deadbolt

Medeco³ CLIQ Deadbolt Cylinders

Description	Part Number	Price
Cylinder for Arrow D & E series single cylinder deadbolt	320201 S	\$595.50
Cylinder for Sargent 470 & 480 Single Cylinder Deadbolt	310100 S	\$595.50
Cylinder for Sargent 470 & 480 Double Cylinder Deadbolt	310100A S	\$595.50

Medeco³ CLIQ Maxum Deadbolts - Commercial Trim

Description	Part Number	Price
Single Cylinder Maxum Deadbolt, 1 1/8" Faceplate, 2 3/8" Backset	11C601 S	\$708.50
Single Cylinder Maxum Deadbolt, 1 1/8" Faceplate, 2 3/4" Backset	11C602 S	\$708.50
Single Cylinder Maxum Deadbolt, 1" Faceplate, 2 3/8" Backset	11C603 S	\$708.50
Single Cylinder Maxum Deadbolt, 1" Faceplate, 2 3/4" Backset	11C604 S	\$708.50
Single Cylinder Maxum Deadbolt, Drive In Front, 2 3/8" Backset	11C605 S	\$708.50
Single Cylinder Maxum, Drive In Front, 2 3/4" Backset	11C606 S	\$708.50
Single Cylinder Maxum Deadbolt, Less Bolt	11C60L S	\$647.50
Double Cylinder Maxum Deadbolt, 1 1/8" Faceplate, 2 3/8" Backset	11C621 S	\$786.50
Double Cylinder Maxum Deadbolt, 1 1/8" Faceplate, 2 3/4" Backset	11C622 S	\$786.50
Double Cylinder Maxum Deadbolt, 1" Faceplate, 2 3/8" Backset	11C623 S	\$786.50
Double Cylinder Maxum Deadbolt, 1" Faceplate, 2 3/4" Backset	11C624 S	\$786.50
Double Cylinder Maxum Deadbolt, Drive In Front, 2 3/8" Backset	11C625 S	\$786.50
Double Cylinder Maxum, Drive In Front, 2 3/4" Backset	11C626 S	\$786.50
Double Cylinder Maxum Deadbolt, Less Bolt	11C62L S	\$725.50

Medeco³ CLIQ Maxum Deadbolts - Residential Trim

Description	Part Number	Price
Single Cylinder Maxum Deadbolt, 1 1/8" Faceplate, 2 3/8" Backset	11R601 S	\$708.50
Single Cylinder Maxum Deadbolt, 1 1/8" Faceplate, 2 3/4" Backset	11R602 S	\$708.50
Single Cylinder Maxum Deadbolt, 1" Faceplate, 2 3/8" Backset	11R603 S	\$708.50
Single Cylinder Maxum Deadbolt, 1" Faceplate, 2 3/4" Backset	11R604 S	\$708.50
Single Cylinder Maxum Deadbolt, Drive In Front, 2 3/8" Backset	11R605 S	\$708.50
Single Cylinder Maxum Deadbolt, Drive In Front, 2 3/4" Backset	11R606 S	\$708.50
Single Cylinder Maxum Deadbolt, Less Bolt	11R60L S	\$647.50
Double Cylinder Maxum Deadbolt, 1 1/8" Faceplate, 2 3/8" Backset	11R621 S	\$786.50
Double Cylinder Maxum Deadbolt, 1 1/8" Faceplate, 2 3/4" Backset	11R622 S	\$786.50
Double Cylinder Maxum Deadbolt, 1" Faceplate, 2 3/8" Backset	11R623 S	\$786.50
Double Cylinder Maxum Deadbolt, 1" Faceplate, 2 3/4" Backset	11R624 S	\$786.50
Double Cylinder Maxum Deadbolt, Drive In Front, 2 3/8" Backset	11R625 S	\$786.50
Double Cylinder Maxum Deadbolt, Drive In Front, 2 3/4" Backset	11R626 S	\$786.50
Double Cylinder Maxum Deadbolt, Less Bolt	11R62L S	\$725.50

Mechanical keyways are represented by the following letters:
 S = Medeco³ CLIQ, V = Medeco Biaxial CLIQ, Z = Medeco Original KW CLIQ

Padlocks

Medeco³ CLIQ padlocks are available to provide accountability in a weather resistant padlock that can be used in indoor or outdoor applications. Padlocks have robust reprogramming abilities, as well as audit and scheduling capabilities. Outstanding performance for your perimeter fences and gates, or access to equipment storage areas where traditional EAC is practically impossible to install.



Medeco³ CLIQ Padlock Cylinders

Description	Part Number	Price
System Series padlock cylinder (padlock body sold separately)	510600 S	\$596.00
Cylinder for Abus Padlock Series 83KNK/45, 83KNK/50 & 83KNK/55. Use Abus driver M	2020000 S	\$596.00
Cylinder for American 3600/3700 Padlock (Note: use American driver DR-MED6)	2020000 S	\$596.00
Cylinder for New Standard padlocks	2020052 S	\$596.00
Cylinder for Master 20 and 6600, 6700 Pro Series (Note: use Master driver 0298-627)	2020000 S	\$596.00
Cylinder for Schlage 45-101 padlock	2020074 S	\$597.50

Medeco³ CLIQ Padlock Options

Refer to the Padlock section in the full-line catalog for a complete list of 5/16" and 7/16" padlocks, with and without shackle guards. System Series Padlocks.

International Cylinders

Medeco's international cylinders are designed to fit in locksets of major world manufacturers. In addition to international uses, many of these cylinders fit imported hardware used in North America. These Medeco³ CLIQ cylinders can be installed into standard hardware with no wiring or other modifications, as power is supplied by the key. Reprogramming, audit and key scheduling capabilities are available with easy to use software. Cylinders are widely used at high security government installations, industrial and institutional organizations, airports, hotels, power plants, palaces, museums, universities and schools, and office buildings.



Medeco³ CLIQ International Cylinders

Description	Part Number	Price
Cylinder Module Single/Double 36 mm	2322016 300 S	\$358.00
Cylinder Module Single/Double 41mm	2322016 301 S	\$362.00
*Euro Single Assembled 36mm/36mm	23230X6 S	\$580.00
**Euro Double Assembled 36mm/36mm	23230E6 X00 S	\$580.00
Euro Half 0mm	2323016 800 S	\$358.00
Euro Half 5mm Extended	2323016 801 S	\$358.00

* Standard sizes available from the factory.

** Only one side is electronic, the other is mechanical.

Medeco³ CLIQ™

Keys and Accessories

Medeco³ CLIQ electro-mechanical keys operate both CLIQ cylinders as well as compatible mechanical cylinders for unmatched system flexibility and security. Maintaining and ensuring your system integrity by means of key audit to obtain historic user access information, as well as the ability to schedule access to doors is an invaluable tool. Medeco³ CLIQ keys are also mechanically compatible with Medeco³ and Medeco³ Bilevel products with potential to integrate into an already existing key system. Keys are user friendly with visible and audible status feedback, are compact in size with water resistant housing and are powered by an easily replaceable CR2025 battery. Utility patented key control provides protection against unauthorized key duplication.



Medeco³ CLIQ Cut Keys

Description	Part Number	Price
Medeco ³ E2 Quartz User Key	KEC 44X002	\$99.00
Medeco ³ E3 Dynamic User Key	KEC 44X003	\$99.00
Medeco ³ E2 Quartz Prox User Key	KEC 44XP02	\$110.00
Medeco ³ E3 Dynamic Prox User Key	KEC 44XP03	\$110.00
Medeco ³ LFIC Control	KEC 44X023	\$99.00
Medeco ³ Yale LFIC Control Key*	KEC 44X103	\$99.00

*Yale Control Key Required if Ordering 31 series IC Indicate "6" or "7" pin at first "X". Example: KEC446013

Original/Biaxial E2 Quartz User Key	KEC 45X002	\$99.00
Original/Biaxial E3 Dynamic User Key	KEC 45X003	\$99.00
Original/Biaxial E2 Prox Quartz User Key	KEC 45XP02	\$110.00
Original/Biaxial E3 Prox Dynamic User Key	KEC 45XP03	\$110.00
Original/Biaxial LFIC Control Key	KEC 45X023	\$99.00
Original/Biaxial Yale LFIC Control Key*	KEC 45X103	\$99.00

*Yale Control Key Required if Ordering 31 series IC Indicate "6" or "7" pin at first "X". Example: KEC456013

- Quartz Key systems require Loading Authorizations On Lock via the system C-Key.
- Dynamic Key systems require Loading Authorizations On Key via a desktop or remote programming device.

Please consult with your Medeco eCylinder representative to determine which strategy is best for the desired application/installation.

C-Key for Medeco ³	KEB 44600C	\$129.50
C-Key for Original or Biaxial	KEB 45600C	\$295.00
V-Prox Battery Cap Programmed - Black (25)	940281 001	\$269.00
V-Prox Battery Cap, No Programming - Black (25)	940282 001	\$269.00
Prox Battery Cap, Programmed - Black	EA-500041-001	\$21.50

Medeco³ CLIQ™

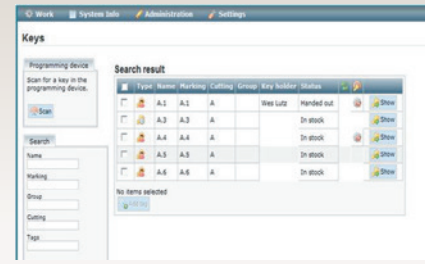

Programming and Management

Medeco³ CLIQ with CLIQ technology offers Web Management of Key Systems utilizing CLIQ Web Manager. This robust and versatile system allows system administrators the ability to manage Medeco³ CLIQ keys and cylinders from anywhere with internet access. With the optional Remote Wall Programming Device, keys can be updated and/or reauthorized with timely expirations for enhanced security while retrieving audit data simultaneously. Several Web Management and stand alone software options are available to meet any customer's requirements.

Medeco³ CLIQ Web Hosting Service – *See detailed description on page 41.

Description	Part Number	Hosting Setup	Annual Service Fee
Basic	SW500101-1	\$300.00	\$500.00
Remote	SW500101-2	\$500.00	\$1,000.00
Remote Plus	SW500101-3	\$900.00	\$1,500.00
Enterprise	SW500101-4	\$1,200.00	\$2,000.00
Enterprise Plus	SW500101-5	\$1,200.00	\$3,000.00
Enterprise Plus with Web Services	SW500101-6	\$1,600.00	\$4,000.00

Medeco³ CLIQ Customer Web Hosted Service – *See detailed description on page 41.

Description	Part Number	1-Time License Fee	Annual Maintenance
Basic	SW600801-1	\$15,000.00	\$300.00
Remote	SW600801-2	\$15,000.00	\$500.00
Remote Plus	SW600801-3	\$15,000.00	\$900.00
Enterprise	SW600801-4	\$15,000.00	\$1,200.00
Enterprise Plus	SW600801-5	\$15,000.00	\$1,200.00
Enterprise Plus with Web Services	SW600801-6	\$15,000.00	\$1,600.00

Medeco CLIQ System Management Software

Description	Elements	Part Number	Price
Manager PC Software (Single System)		EA-900081	\$958.50
Manager + PC Software for Multiple Systems		EA-900082	\$2,053.50

Other Tools

Additional system support tools such as programming devices, USB cables, remote wall programming devices, specialty control keys for I/C Core, or key caps with Prox Programming capabilities are all readily available. We also offer friendly and efficient technical service support.



Medeco³ CLIQ Programming Devices

Description	Part Number	Price
Vertical Medeco ³ CLIQ Programming Device (Includes USB Cable)	EA-100113	\$1,047.50
Remote Wall PD for Medeco ³ CLIQ	EA-100126	\$741.00
Medeco ³ CLIQ Mobile Programmer	EA-100142	\$704.00
Outdoor, Vandal Resistant, Wall Programmer for Web enabled Medeco ³ CLIQ keys	EA-100160	\$1,335.00

Medeco³ CLIQ Kits & Accessories

Description	Part Number	Price
Smart Security Solutions Kit; Includes a Medeco ³ , BiLevel, and Medeco ³ CLIQ Cylinder all operated by a single key.	940273	\$886.00
Medeco ³ CLIQ End User Kit (Manager Software, Programming Device, C-Key)	940270 S	\$1,614.50
Biaxial and Medeco ³ Bottom Pin Kit for use with Medeco ³ CLIQ (Original Product uses standard pin kit)	.KW5401	\$555.00
Metal Cylinder Protector Cover	CP-287260	\$68.50

Medeco CLIQ™

Medeco CLIQ merges the features of electronics with reliable mechanical technology – all in a retrofit cylinder. Medeco CLIQ offers end users audit trail, user access schedules and the ability to quickly add or remove a key electronically from a system.

Medeco CLIQ installs with no wiring in a matter of minutes and digital keys and digital cylinders reprogram for quick changes.



Audit Accountability

Audit information recorded in both the lock and key shows a time-and-date stamped record of every event, including authorized accesses and unauthorized attempts.



Uses Existing Hardware

The Medeco CLIQ key provides all power to the cylinder, eliminating the need for any hard wiring or power supply. Simply remove the existing mechanical cylinder and install the Medeco CLIQ cylinder.



Reduces Risk of Lost Keys

Respond quickly to security threats, lost or stolen keys, or personnel changes without the added cost of changing your locks and keys.



Electronic Scheduling

Keys are electronically programmed to open only specific locks during a designated schedule. Schedules may also contain an expiration point to completely disable the key until it is audited and reprogrammed.

Key Information:

- Audit key holds up to 1,000 audit records and provides information unavailable in a mechanical system
- Self-cleaning electronic contact point for a long lasting key and reliable connection
- Powered by an easily replaceable CR2025 Battery with 20,000 cycle battery life
- Available with HID Prox coil insert for dual use with HID compatible EAC systems
- Rated for -20 degrees Fahrenheit to 122 degrees Fahrenheit (cylinder and key)
- Visible status feedback
- Compact size in water resistant housing

Warranty:

Medeco® warrants the Medeco CLIQ products to be free of defects in material and/or workmanship for a period of two (2) years from date of original purchase

Finishes:

- Available in several finish options

Technical Features:

- **Memory:** Non-volatile Memory Storing 750 Audit Events in the cylinder and up to 1,000 in the key (depending on key type).
- **Software:** Local software client or web hosted option available
- **Power:** Power supplied by the key, no hard wiring required
- **Lockcase:** Fits standard Rim & Mortise Housing as well as other various platforms
- **Weather Resistant:** Can be used in indoor or outdoor applications
- **Physical Security:** Drill and Tamper Resistant
- **Formats:** Available in all common cylinder formats including KIK/KIL, LFIC, padlocks and deadbolts

Medeco CLIQ™

Rim and Mortise Cylinders

A simple replacement of rim or mortise cylinders with classic logic cylinders provides audit and scheduling along with expiration of credentials for any existing opening utilizing mortise hardware. Cylinders are available in all popular lengths and are an ideal upgrade for offices or as override for traditional EAC equipment.



Medeco CLIQ Mortise Cylinders

Description	Part Number	Price
1 1/4" Mortise Cylinder	100500 C	\$638.50
1 3/8" Mortise Cylinder	105100 C	\$638.50
1 1/2" Mortise Cylinder	105200 C	\$688.00
1 3/4" Mortise Cylinder	105400 C	\$751.00
2" Mortise Cylinder	105500 C	\$751.00
2 1/2" Mortise Cylinder	105700 C	\$751.00

Medeco CLIQ mortise cylinders are not available longer than 2 1/2"

Medeco CLIQ Rim Cylinders

Description	Part Number	Price
Rim Cylinder - Horizontal Tailpiece	100400H C	\$638.00
Rim Cylinder - Vertical Tailpiece	100400V C	\$638.00
Rim Cylinder - Sargent Mounting Style, Horizontal Tailpiece	100403H C	\$638.00
Rim Cylinder - Sargent Mounting Style, Vertical Tailpiece	100403V C	\$638.00
Rim Cylinder - 180 Degree Lazy Motion	100700 C	\$638.00

Key-In-Knob/Lever Cylinders

Medeco's Key-in-Knob cylinders are designed to retrofit knob type cylindrical locksets, lever type cylindrical locksets, padlocks and bored type auxiliary deadlatches and deadlocks. Medeco CLIQ KIK/KIL cylinders additionally offer user audit trail, user access schedules and the ability to quickly add or remove a key electronically from a system, allowing fast response to security threats or lost/stolen keys. These cylinders fit nearly all popular brands and styles of hardware and are therefore an ideal application for office doors, storage and file rooms, or residential doors; virtually any door where cylindrical hardware is used.



Medeco CLIQ Cylinders for Alarm Lock

Description	Part Number	Price
Cylinder for Alarm Lock Trilogy T1, T2, T3	20200V1 C	\$638.50

Medeco CLIQ Cylinders for Arrow

Description	Part Number	Price
Cylinder Package for Arrow MK Series include CT-Y70, CT-Y73, CP-160321	20200A1 C	\$640.00
Cylinder for Arrow RK Series & MK Series (Except Ball), original cylinder spacer must be replaced with Medeco spacer CP-160321	2020070 C	\$638.50
Cylinder for Arrow MK Series (Ball knob only) and GL series	2020073 C	\$638.50
Cylinder for Arrow H & S Knob Series, L, ML, Q, & W Series Lever	2020249 C	\$638.50
Cylinder for Arrow JL Series Interconnected lock, deadbolt cylinder also necessary	2020249 C	\$638.50

Medeco CLIQ Cylinder for Cal-Royal

Description	Part Number	Price
Cylinder for Cal-Royal SL00 Knob Lock and LX01 Lever Lock	2020049 C	\$638.50
Cylinder for Cal-Royal CLS03 Classroom Function Grade 2 Lever Lock	20200V1 C	\$638.50

Medeco CLIQ Cylinder for Corbin Russwin

Description	Part Number	Price
Cylinder for Corbin Russwin CL3900	20200V9 C	\$638.50
Cylinder for Corbin Russwin 800, CL3300, CL3400, CL3500, CL3600	20211730 C	\$638.50
Cylinder for Corbin Russwin CK4200 (new style)	205005 C	\$638.50

Medeco CLIQ Cylinder for Dorma

Description	Part Number	Price
Cylinder for Dorma® CL700 series	2020049 C	\$638.50
Cylinder for Dorma® CL860 (Interior), CL870, CL872, CL873, CL877 Grade 1 Lever, CK860 (Interior), CK870, CK872, CK873, & CK877 Grade 1 Knobs	20200V0 C	\$638.50
Cylinder for Dorma® CL853, CL860 (exterior), CL880, CL882, CL80EL, CL80EU Grade 1 Lever, CK853, CK860 (exterior), CK880, CK882, CK80EL, & CK80EU Grade 1 Knobs	20200V1 C	\$638.50

Medeco CLIQ Cylinder for Embassy

Description	Part Number	Price
Cylinder for Embassy lockset in Entrance, Institution, Storeroom, Corridor functions.	20200V1 C	\$638.50

Medeco CLIQ Cylinder for Hager

Description	Part Number	Price
Cylinder for Hager Lever Locksets, Model 3553,3570,3579,3580	2020249 C	\$638.50

Medeco CLIQ Cylinder for KABA - Mas-Hamilton

Description	Part Number	Price
Kaba E-plex 5000	2020000 C	\$638.50
MAS-Hamilton Power Lever	20200V1 C	\$638.50

Medeco CLIQ Cylinder for LSDA

Description	Part Number	Price
LSDA Cylinder Package Fits 100, L100, LH1000, LX1000 Series. Includes: CT-Y49, CT-Y70 (for 100 Series Knob, except B and L100 Series Lever), CT-Y73 (for 100 Series B knob), CT-Y78 (for LX1000 Lever)	20200L1 C	\$638.50

Medeco CLIQ Cylinder for Marks

Description	Part Number	Price
Cylinder for Marks 110, 170, 180, 190, 195, 295 series Vestibule, Communicating, Classroom, & Classroom Security functions (DA, DC, SB, S).	20200V0 C	\$638.50
Cylinder for Marks Lever 110, 170, 180, 190, 195, 295 series in Entrance, Institution, Storeroom, and Corridor functions (AB, DW, F, T)	20200V1 C	\$638.50

Medeco CLIQ Cylinder for Olympus

Description	Part Number	Price
Cylinder for Olympus 700 LCM and 800 LCM Key Retaining cabinet lock, includes: CTY49, CT-Y52, CT-Y53, CT-Y54	20200S1 C	\$640.00

Medeco CLIQ Cylinder for PDQ

Description	Part Number	Price
Cylinder for PDQ Lever SP & ST series, GT, XGT & GP Series	20200V2 C	\$638.50

Medeco CLIQ Cylinder for Sargent

Description	Part Number	Price
Cylinder for Sargent 10 line locksets order with '30' option prefix (note: cylinder will extend from lever more than standard cylinder)	20200S1 C	\$640.00

Medeco CLIQ Cylinders for Schlage

Description	Part Number	Price
Cylinder Package for Schlage A, AL, C, D, ND & Olympiad lever designs, includes: CT-Y49 (A, AL, & D Olympiad Lever & C & D Plymouth), CT-Y52 (C & D heavy duty knobs Ball, Globe & Sphere designs only), CT-Y53 (A series Orbit), CT-Y73 (ND series Gr. 1 lever & AL thick doors), and CTY74 (45-101 padlock)	20200S1 C	\$640.00
Cylinder for Schlage D Series Lever, Athen, Rhodes, & Sparta designs	2020249 C	\$638.50

Medeco CLIQ Cylinder for TACO

Description	Part Number	Price
Cylinder for TACO LXV lever lockset	2020078 C	\$638.00

Medeco CLIQ Cylinder for Yale

Description	Part Number	Price
Cylinder for Yale 6 pin 5300LN, 5400LN and 4300 Knobs	200503 C	\$638.00

Medeco CLIQ™

Interchangeable Core Cylinders

Medeco CLIQ LFIC cores offer end users the ability to obtain an audit trail, schedule user access rights and quickly and easily remove a key electronically from a system. This cylinder installs into standard Schlage style LFIC housing hardware with no wiring or other modifications. Drill and tamper resistant, and ideal for indoor or outdoor installations. Common applications include business entrances such as banks and shopping centres, as well as many school and university applications.



Medeco CLIQ Cylinders for Schlage

Description	Part Number	Price
CLIQ cylinder for Schlage style LFIC	322201 C	\$638.00

Padlocks

Medeco CLIQ retrofit cylinder are available for the System Series, Hockey Puck and G8R Medeco® padlocks, as well as several other popular brands such as American, Schlage or Master. These locks are weather resistant and therefore can be used in indoor or outdoor applications. Padlocks have simple reprogramming abilities, as well as audit and scheduling capabilities for your perimeter fences and gates, or access to equipment storage areas where traditional EAC is practically impossible to install.



Medeco CLIQ Padlock Cylinders

Description	Part Number	Price
Medeco System Series padlock cylinder (padlock body sold separately)	510600 C	\$638.50
G8R Padlock popout cylinder, deadbolt function (padlock body sold separately)	641201 C	\$638.50
G8R Padlock popout cylinder, springbolt function (padlock body sold separately)	641200 C	\$638.50
Cylinder for American 3600/3700 padlock (Note: use American driver DR-MED6)	2020000 C	\$638.50
Cylinder for New Standard padlocks	2020052 C	\$638.50
Cylinder for Master 20 and 6600, 6700 Pro Series (Note: User Master driver 0298-627 for Pro Series)	2020000 C	\$638.50
Cylinder for Schlage 45-101 padlock	2020074 C	\$638.50
Cylinder for Abus Padlock Series 83KNK/45, 83KNK/50 & 83KNK/55. Use Abus driver M	2020000 C	\$638.50

Medeco CLIQ Padlock Options

Refer to the Padlock Section in the full-line catalog for G8R options G8R Refer to the Padlock section in the full-line catalog for a complete list of 5/16" and 7/16" padlocks, with and without shackle guards System Series Padlocks

Medeco CLIQ™

Deadbolts

The Medeco CLIQ Maxum deadbolt provides a loss and liability solution in Medeco's Maxum deadbolt platform. In addition to the physical security of the Maxum deadbolt, the Medeco CLIQ cylinder provides an audit trail, the ability to schedule user access rights and the freedom to quickly add or remove a key from the system. The Medeco CLIQ deadbolt installs in a matter of minutes without cumbersome wiring. Attack-resistant design and tamper-proof features provide strong protection against forced entry and allow for flawless integration into any home or business application.



Medeco CLIQ Deadbolt Cylinders

Description	Part Number	Price
Cylinder for Arrow D, E & DB Series Single Cylinder Deadbolts	200901 C	\$640.00
Cylinder for Arrow Revolution deadbolt	200901 C	\$640.00
Cylinder for Sargent 470 & 480 single cylinder deadbolt	200901 C	\$640.00
Cylinder for Sargent 470 & 480 double cylinder deadbolt	200902 C	\$640.00
Lazy Motion Cylinder for Schlage B series (old style) deadbolt	200904 C	\$640.00

Medeco CLIQ Maxum Deadbolts - Commercial Trim

Description	Part Number	Price
Single Cylinder Maxum Deadbolt, 1 1/8" Faceplate, 2 3/8" Backset	11C601 C	\$758.00
Single Cylinder Maxum Deadbolt, 1 1/8" Faceplate, 2 3/4" Backset	11C602 C	\$758.00
Single Cylinder Maxum Deadbolt, 1" Faceplate, 2 3/8" Backset	11C603 C	\$758.00
Single Cylinder Maxum Deadbolt, 1" Faceplate, 2 3/4" Backset	11C604 C	\$758.00
Single Cylinder Maxum Deadbolt, Drive In Front, 2 3/8" Backset	11C605 C	\$758.00
Single Cylinder Maxum, Drive In Front, 2 3/4" Backset	11C606 C	\$758.00
Single Cylinder Maxum Deadbolt, Less Bolt	11C60L C	\$697.00

Medeco CLIQ Maxum Deadbolts - Residential Trim

Description	Part Number	Price
Single Cylinder Maxum Deadbolt, 1 1/8" Faceplate, 2 3/8" Backset	11R601 C	\$758.00
Single Cylinder Maxum Deadbolt, 1 1/8" Faceplate, 2 3/4" Backset	11R602 C	\$758.00
Single Cylinder Maxum Deadbolt, 1" Faceplate, 2 3/8" Backset	11R603 C	\$758.00
Single Cylinder Maxum Deadbolt, 1" Faceplate, 2 3/4" Backset	11R604 C	\$758.00
Single Cylinder Maxum Deadbolt, Drive In Front, 2 3/8" Backset	11R605 C	\$758.00
Single Cylinder Maxum Deadbolt, Drive In Front, 2 3/4" Backset	11R606 C	\$758.00
Single Cylinder Maxum Deadbolt, Less Bolt	11R60L C	\$697.00

Medeco CLIQ™

Cam and Utility Cylinders

Medeco® CLIQ cam locks are recognized throughout the world as the standard for protection. Medeco® offers a complete line of various camlock sizes and functions to meet your specific needs. In addition to providing the ultimate defense against drilling, pulling, and other forms of vandal attacks, locks have both electronic auditing and scheduling capabilities that offer further security in many applications. Storage cabinets, vending machines, lockers and tool boxes can all be accommodated without any wiring and be utilized in either indoor or outdoor use.



Medeco CLIQ Cam Locks

Description	Part Number	Price
7/8" Cam lock	60810 XXX C	\$638.50
7/8" Cam lock with hardened plug face	60810D XXX C	\$699.50
1 1/8" Cam lock	60820 XXX C	\$638.50
1 1/8" Cam lock with hardened steel plug face	60820D XXX C	\$699.50

Medeco CLIQ Cam Lock Codes

Description	Op Code
1 Flat, 1 Key Pull, Clockwise 90 degree	119
2 Flat, 1 Key Pull, Clockwise 90 degree	219
2 Flat, 2 Key Pull, Clockwise 90 degree	229
2 Flat, 1 Key Pull, Counterclockwise 90 degree	239
2 Flat, 2 Key Pull, Counterclockwise 90 degree	249
2 Flat, 1 Key Pull, Clockwise 180 degree	259
2 Flat, 2 Key Pull, Clockwise 180 degree	269

Retail/Showcase Cylinders

Medeco CLIQ Showcase & Cabinet locks offer end users audit trail, user access schedules and the ability to quickly add or remove a key electronically from a system. Installs with no wiring in a matter of minutes and digital keys and digital cylinders reprogram for instant changes. With ease of tracking capabilities, in a retail environment these locks are ideal to protect against both customer and employee theft, and to allow efficient access for sales associates with full audit accountability. Available to fit many types of display cases, as well as cash drawers and inventory cabinets.



Medeco CLIQ Cabinet Locks

Description	Part Number	Price
Plunger Lock, Round Bolt	490358 C	\$751.50
Plunger Lock, T- Bolt	490368 C	\$751.50
Cabinet Lock, Latchbolt	490359 C	\$726.00
Cabinet Lock, Deadbolt	490366 C	\$1,121.00
Showcase Ratchet Lock	490361 C	\$679.00

Medeco CLIQ™

International Cylinders

Medeco's international cylinders are designed to fit in locksets of major world manufacturers. In addition to international uses, many of these cylinders fit imported hardware used in North America. These Medeco CLIQ cylinders can be installed into standard hardware with no wiring or other modifications, as power is supplied by the key. Reprogramming, audit and key scheduling capabilities are available with easy to use software. These cylinders are widely used at high security government installations, industrial and institutional organizations, airports, hotels, power plants, palaces, museums, universities and schools, and office buildings.

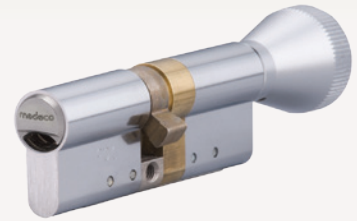

Medeco CLIQ International Cylinders

Description	Part Number	Price
Thumbturn Profile - Assembled 30/30mm	2325005 C	\$878.50
Double Cylinder Profile - Assembled 30/30mm	2325025 C	\$1,338.50

Specialty Cylinder Formats

Medeco CLIQ specialty Cylinders offers industrial or route management vendors electronic control over their assets. Medeco CLIQ offers end users audit trail, user access schedules and the ability to quickly add or remove a key electronically from a system. Installs with no wiring in a matter of minutes and digital keys and digital cylinders reprogram for instant changes. Audit information recorded in both the lock and key shows a time-and-date stamped record of every event, including authorized accesses and unauthorized attempts. Medeco® CLIQ products add a wide variety of intelligent features without compromising on physical security. Attack-resistant design and tamper-proof features provide strong protection against forced entry.



Medeco CLIQ Pop-Out Cylinders

Description	Part Number	Price
CLIQ Pop-out Cylinder, Springbolt	641200 C	\$638.50
CLIQ Pop-out, Springbolt, Hardened Plug	641200D C	\$699.50
CLIQ Pop-out Cylinder, Deadbolt	641201 C	\$638.50
CLIQ Pop-Out Cylinder, Deadbolt, Hardened Plug	641201D C	\$699.50

Medeco CLIQ™

Keys and Accessories

Medeco CLIQ keys provide electronic technology to offer superior security and accountability. Maintaining and ensuring system integrity with audit information stored on the key allows administrators to obtain historic user access information, as well as the ability to schedule and expire access to doors is an invaluable tool. Keys are user friendly with visible status feedback and are powered by an easily replaceable CR2025 battery. Available in a factory controlled key section, with optional RFID coil insert for dual use with HID compatible systems.



Medeco CLIQ Keys

Description	Part Number	Price
E2/Quartz User Key - Key Only	KEC 42602B	\$99.00
E3/Dynamic User Key - Key Only	KEC 42603B	\$99.00
C-Key	KEC 4260CR	\$129.50
E2/Quartz User Key with 125kHz PROX Cover	KEC 426P2B	\$110.00
E3/Dynamic User Key with 125kHz PROX Cover	KEC 426P3B	\$110.00
CLIQ Battery Cover w/Proximity-upgrade standard CLIQ keys to RFID Proximity Keys (sold in pack of 25) - Black only	940249	\$314.50

- Quartz Key systems require Loading Authorizations On Lock via the system C-Key.
 - Dynamic Key systems require Loading Authorizations On Key via a desktop or remote programming device.
- Please consult with your Medeco eCylinder representative to determine which strategy is best for the desired application/installation.

Programming and Management

Medeco CLIQ, with CLIQ technology, offers Web Management of Key Systems utilizing CLIQ Web Manager. This robust and versatile system allows system administrators the ability to manage CLIQ keys and cylinders from anywhere with internet access. With the optional Remote Wall Programming Device, keys can be updated and/or reauthorized with timely expirations for enhanced security while retrieving audit data simultaneously. Several Web Management and stand alone software options are available to meet any customer's requirements.

Medeco CLIQ Web Hosting Service – * See detailed description on page 41.

Description	Part Number	Hosting Setup	Annual Service Fee
Basic	SW500101-1	\$300.00	\$500.00
Remote	SW500101-2	\$500.00	\$1,000.00
Remote Plus	SW500101-3	\$900.00	\$1,500.00
Enterprise	SW500101-4	\$1,200.00	\$2,000.00
Enterprise Plus	SW500101-5	\$1,200.00	\$3,000.00
Enterprise Plus with Web Services	SW500101-6	\$1,600.00	\$4,000.00

Medeco CLIQ Customer Web Hosted Service – * See detailed description on page 41.

Description	Part Number	1-Time License Fee	Annual Maintenance
Basic	SW600801-1	\$15,000.00	\$300.00
Remote	SW600801-2	\$15,000.00	\$500.00
Remote Plus	SW600801-3	\$15,000.00	\$900.00
Enterprise	SW600801-4	\$15,000.00	\$1,200.00
Enterprise Plus	SW600801-5	\$15,000.00	\$1,200.00
Enterprise Plus with Web Services	SW600801-6	\$15,000.00	\$1,600.00

Medeco CLIQ System Management Software

Description	Part Number	Price
Medeco CLIQ Manager PC Software (Single System)	EA-900081	\$958.50
Medeco CLIQ Web Self Host Software	EA-900082	\$2,053.50

Medeco CLIQ™

Other Tools

Additional system support tools such as programming devices, USB cables, Remote Wall Programming Devices or key caps with Prox programming capabilities are all readily available. We also offer friendly and efficient technical service support.



Medeco CLIQ Programming

Description	Part Number	Price
Medeco CLIQ Programming Device (Includes USB Cable)	EA-100099	\$1,089.00
Remote Wall PD for CLIQ	EA-100121	\$771.00
Medeco CLIQ Mobile Programmer	EA-100145	\$704.00
Outdoor, Vandal Resistant, Wall Programmer for Web enabled Medeco CLIQ keys	EA-100159	\$1,335.00

Medeco CLIQ Kits & Accessories

Description	Part Number	Price
Medeco CLIQ Service Kit and Product Certification Training	940224	\$5,468.00
Medeco CLIQ EndUser Kit (Manager Software, Programming Device & C Key)	940225	\$1,697.00
Plastic Cylinder Protection Cover	CP-170930	\$50.50
Metal Cylinder Protection Cover	CP-287260	\$68.50

* CLIQ Web Manager is licensed based upon Feature Packages for both Medeco Hosted Services and Customer Self Hosted Software. Each ascending package is inclusive of the Features of the previous level(s). Please contact your Medeco eCylinder Sales Representative for additional benefits and/or requirements of any listed features.

CLIQ Web Manager 3.0 and Above

Package	Features					
Basic	Domain Administration	Remote + Revalidation	Access Profile	Flexible Revalidation	Cylinder Group	
Remote						
Remote Plus						
Enterprise						
Enterprise Plus						
Enterprise Plus w/Web Svs.						Web Services

Aperio

Wireless possibilities for online access control

Aperio utilizes local wireless communication between the lock and a communications hub to connect to an online electronic access control system. You can easily expand the reach of existing access control systems and secure openings that would otherwise go unprotected.



Audit Accountability

Audit information is collected real time by communication with the access control system.



Uses Existing Hardware

The Aperio Mortise cylinder can be retrofitted to replace existing mechanical cylinders, eliminating the need for any hard wiring or power supply. Simply remove the existing mechanical cylinder and install the Medeco Aperio Mortise cylinder.



Wireless No Hardwiring

Uses wireless communications between the lock and the hub that is connected to an EAC system.



Electronic Scheduling

Access is electronically programmed to open only specific locks during a designated schedule.

Key Features:

- Utilizes IEEE 802.15.4 wireless communication between the lock and an Aperio hub that is connected to the electronic access control system.
- Real-time communication with the access control system for greater security and control
- Advanced data security with standard encryption techniques
- AES 128-bit encryption
- Global wireless platform that addresses a wide range of applications and security requirements
- Supports HID® 13.56 MHz iCLASS® (full authentication, all formats) credentials and 125KHz Prox

Warranty:

Medeco Security Locks warrants Aperio products to be free of defects in material and/or workmanship for a period of two (2) years from date of original purchase.

Technical Information:

- Retrofit Mortise (M100)
- Cabinet lock (K100)
- Integrated Reader and Radio
- Takes a standard CR-2 battery (M100) or CR123A (K100)
- Provides alarms for Tamper, Low Battery and Lock Jamb messages
- Auto Re-lock

Aperio

Mortise Cylinders

The Medeco M100 Mortise Cylinder with Aperio Technology offers an easy retrofit solution for mechanical door hardware. This retrofit lock design will work with most Mortise applications. Local wireless communication between the M100 and an Aperio hub connects to the access control system, eliminating the cost and inconvenience of bringing wiring to the door. Real-time door locked status monitoring with integrated tamper, and low battery signals allow you to respond immediately to situations at the opening. Add access control to any door in the time it takes to switch out a cylinder.



Aperio Mortise Cylinder Assembly – M100 (iClass)

Description	Part Number	Price
M100 Mortise		
Mortise Cylinder Assembly, 13.56MHz iClass technology, 360° Bi-directional rotation Contains: One (1) M100 and one (1) each of CAM Z01-Yale, Z02 Adams Rite, Z34 Schlage, Z00 Corbin, Z20 Sargent	10-15016	\$695.00
M100 Rim		
RIM Cylinder Assembly, 13.56MHz iClass technology, 360° Bi-directional rotation Contains: One (1) M100 and one (1) each of CAM Z01-Yale, Z02 Adams Rite, Z34 Schlage, Z00 Corbin, Z20 Sargent	10-15014	\$695.00
M100 Mortise & Wiegand Hub One-door Kit/iClass		
Mortise Cylinder Assembly, 13.56MHz iClass technology, 360° Bi-directional rotation, & Wiegand Hub – Designed for easy installation. No special training required. Units come paired together from the factory and only requires Hub be wired to EAC panel via standard Wiegand interface connection. Contains: One (1) M100 and one (1) Wiegand Hub that have been factory paired and locked in Customer Mode. Units cannot be un-paired in the field. Also contains one (1)each of CAM Z01-Yale, Z02 Adams Rite, Z34 Schlage, Z00 Corbin, Z20 Sargent	EA-100151-003	\$945.00
M100 Rim & Wiegand Hub One-door Kit/iClass		
RIM Cylinder Assembly, 13.56MHz iClass technology, 360° Bi-directional rotation, & Wiegand Hub – Designed for easy installation. No special training required. Units come paired together from the factory and only requires Hub be wired to EAC panel via standard Wiegand interface connection. Contains: One (1) M100 and one (1) Wiegand Hub that have been factory paired and locked in Customer Mode. Units cannot be un-paired in the field. Also contains one (1)each of CAM Z01-Yale, Z02 Adams Rite, Z34 Schlage, Z00 Corbin, Z20 Sargent	EA-100155-003	\$945.00

Aperio Mortise Cylinder Assembly – M100 (Prox)

Description	Part Number	Price
<p>M100 Prox Mortise</p> <p>Mortise Cylinder Assembly, 125KHz Prox technology, 360° Bi-directional rotation – Contains: One (1) M100 and one (1) each of CAM Z01-Yale, Z02 Adams Rite, Z34 Schlage, Z00 Corbin, Z20 Sargent</p>	10-15015	\$695.00
<p>M100 Prox Rim</p> <p>RIM Cylinder Assembly, 125KHz Prox technology, 360° Bi-directional rotation – Contains: One (1) M100 and one (1) each of CAM Z01-Yale, Z02 Adams Rite, Z34 Schlage, Z00 Corbin, Z20 Sargent</p>	10-15013	\$695.00
<p>M100 Mortise & Wiegand Hub Paired One-door Kit/Prox</p> <p>Mortise Cylinder Assembly, 125KHz Prox technology, 360° Bi-directional rotation, & Wiegand Hub – Designed for easy installation. No special training required. Units come paired together from the factory and only requires Hub be wired to EAC panel via standard Wiegand interface connection. Contains: One (1) M100 and one (1) Wiegand Hub that have been factory paired and locked in Customer Mode. Units cannot be un-paired in the field. Also contains one (1)each of CAM Z01-Yale, Z02 Adams Rite, Z34 Schlage, Z00 Corbin, Z20 Sargent</p>	EA-100151-004	\$945.00
<p>M100 Rim & Wiegand Hub Paired One-door Kit/Prox</p> <p>RIM Cylinder Assembly, 125KHz Prox technology, 360° Bi-directional rotation, & Wiegand Hub – Designed for easy installation. No special training required. Units come paired together from the factory and only requires Hub be wired to EAC panel via standard Wiegand interface connection. Contains: One (1) M100 and one (1) Wiegand Hub that have been factory paired and locked in Customer Mode. Units cannot be un-paired in the field. Also contains one (1)each of CAM Z01-Yale, Z02 Adams Rite, Z34 Schlage, Z00 Corbin, Z20 Sargent</p>	EA-100155-004	\$945.00
<p>M100 Mounted Sample w/M100 (Sales Demo)</p> <p>Mortise Cylinder Assembly, 125KHz Prox technology, 360° Bi-directional rotation – Contains One (1) M100, One (1) Prox Keyfob and One (1) Aluminum Mount. M100 is mounted and programmed with one override credential (keyfob) to allow for demonstration of stand-alone functionality. Unit can also be paired with a hub (available separately) that can be connected to an EAC system for full functionality demonstration or try-me purposes.</p>	EA-100163	\$900.00

Aperio

Cabinet Locks

The Medeco K100 battery operated cabinet lock with Aperio Technology makes it easy and cost effective to bring access control to applications where audit trail and monitoring are becoming increasingly critical. It uses local wireless communication between the lock and an Aperio hub to connect to an access control system, eliminating the cost and inconvenience of bringing wiring to the cabinet. Providing 90,000 cycles of operation with a single CR123A battery, produces an extremely long life with minimal impact to the environment. Available across a range of locking hardware from ASSA ABLOY Group brands, Aperio provides the flexibility to address a variety of applications throughout your facility.



Aperio Mortise Cylinder Assembly – K100

Description	Part Number	Price
Cabinet Lock Assembly iClass & Weigand hub Kit, Black, Knob 1 Cabinet Lock Assembly, 13.56MHz iClass technology & Wiegand Hub - Designed for easy installation. No special training required. Units come paired together from the factory and only requires Hub be wired to EAC panel via standard Wiegand interface connection. Contains: One (1) K100 and one (1) Wiegand Hub that have been factory paired and locked in Customer Mode. Units cannot be un-paired in the field.	EA-100150-001	\$800.00
Cabinet Lock Assembly Prox paired with Weigand 1:1 hub, Black, Knob 1 Cabinet Lock Assembly, 125KHz Prox technology & Wiegand Hub - Designed for easy installation. No special training required. Units come paired together from the factory and only requires Hub be wired to EAC panel via standard Wiegand interface connection. Contains: One (1) K100 and one (1) Wiegand Hub that have been factory paired and locked in Customer Mode. Units cannot be un-paired in the field.	EA-100150-002	\$800.00
Cabinet Lock Assembly iCLASS paired with Weigand 1:1 hub, White, Knob 1 Cabinet Lock Assembly, 13.56MHz iClass technology & Wiegand Hub - Designed for easy installation. No special training required. Units come paired together from the factory and only requires Hub be wired to EAC panel via standard Wiegand interface connection. Contains: One (1) K100 and one (1) Wiegand Hub that have been factory paired and locked in Customer Mode. Units cannot be un-paired in the field.	EA-100150-003	\$800.00
Cabinet Lock Assembly Prox paired with Weigand 1:1 hub, White, Knob 1 Cabinet Lock Assembly, 125KHz Prox technology & Wiegand Hub - Designed for easy installation. No special training required. Units come paired together from the factory and only requires Hub be wired to EAC panel via standard Wiegand interface connection. Contains: One (1) K100 and one (1) Wiegand Hub that have been factory paired and locked in Customer Mode. Units cannot be un-paired in the field.	EA-100150-004	\$800.00
Cabinet Lock Assembly (iClass)(Black)	10-15010.-001	\$550.00
Cabinet Lock Assembly (Prox)(Black)	10-15010.-002	\$550.00
Cabinet Lock Assembly (iClass)(White)	10-15010.-003	\$550.00
Cabinet Lock Assembly (Prox)(White)	10-15010.-004	\$550.00

Aperio

Hubs and Integrator Tools

Aperio technology offers fully-encrypted AES 128 wireless communication between the Aperio lock and the hub. The Integrated reader, monitoring and short range wireless radio simplifies installation and eliminates the cost and inconvenience of wiring in and around the door. High security standardized communications ensure data security. Aperio supports HID® 13.56 MHz iCLASS® and 125KHz Prox contactless credentials (full authentication, all formats) and also integrates easily with existing smart card credential systems. Aperio is supported globally by a growing list of access control systems. Please contact your local ASSA ABLOY sales consultant for more information on integrating Aperio with your access control system.

Aperio Hub and Intergrator Tools

Description	Part Number	Price
Programming Kit Contains: EA-200065 Radio Dongle & EA-200070 Programming APA Tool (software) on USB – Must be certified CI or ACP to purchase	EA-100134	\$550.00
USB Radio Dongle – Must be authorized CI or ACP to purchase – Sargent part #APD-10-USB	EA-200065	\$450.00
USB Programming APA Tool, Programmed Must be authorized CI or ACP to purchase – Sargent part #APA-10-PC	EA-200070	\$100.00
COMHUB - Wiegand Kit, Packaged (For non-integrated 1:1 Applications ONLY) – Sargent part #AH20W14	EA-200071	\$250.00
COMHUB - RS485 Kit, Packaged (For Integrated 1:1 and 1:8 applications) Check with local sales representative for current Integrator list – Sargent part #AH30R12	EA-200072	\$350.00

NA COMHUB - Mercury: *MUST be purchased through your EAC Manufacturer.*

Medeco³

High Security Cylinders & Locking Systems

Medeco³ High Security Cylinders feature UL437 Listed physical strength components like the triple locking technology for ultimate pick resistance and solid brass construction with strategically placed hardened inserts to thwart drilling attacks.

Passing UL437 and BHMA's rigid testing procedures reaffirms Medeco³'s ability to protect people and property. Medeco³ builds on Medeco's over 40 years of lock engineering innovation and takes security to the next level while still offering the highest level of protection against unauthorized key duplication.



Patented Key Control

Protects against unauthorized duplication of your keys.



Uses Existing Hardware

Can be masterkeyed into a system containing Medeco BiLevel and Medeco³ mechanical as well as Medeco³ CLIQ eCylinders. Medeco³ cylinders are available in a wide variety of formats, retrofitting most hardware on the market today.



Can Be Masterkeyed

Can be masterkeyed into a system containing Medeco BiLevel and Medeco³ mechanical as well as Medeco³ CLIQ eCylinders.



Protection From Physical Attack

Medeco³ cylinders are UL 437 listed and stand up to drilling, picking and other forms of physical attack.



Special Angle Cut Keys

Requires a special key cutting machine and access to Medeco specific blanks, available in a variety of restrictions to support every need.



Picking and Bumping Protection

Medeco³ cylinders use a sidebar that prevent the key from rotating until it is elevated, rotated and aligned in the correct position. This feature protects against bumping and picking attacks.

Technical Information:

- 40,000 cycle endurance test
- Resistance to picking or key fitting tests
- **UL437:**
 - Tests prescribed in Underwriters Laboratory Standard for Safety for Key Locks are primarily design to measure a locking cylinder's ability to resist physical attack.
- **ANSI/BHMA A156.30:**
 - Builders Hardware Manufacturing Association (BHMA) standards are certified by the American National Standards Institute (ANSI) which works with industry leaders to provide manufacturers and consumers with product quality and performance ratings based on preset criteria and standardized testing.
 - BHMA standard A156.30-2003, approved and adopted by ANSI, covers high security cylinders and was developed by BHMA to provide specific guidance as to which products can be considered as high security cylinders.
 - Medeco³ cylinders have been tested to BHMA's highest certification level by an independent laboratory and achieved certification in the high security cylinders category.
 - The cylinders meet or exceed BHMA A156.30 criteria for strength and durability, key control, and surreptitious entry resistance.

Applications:

- Medeco³ retrofit cylinders are ideal for any application requiring key control and physical security of your cylinders

Warranty:

Medeco³ cylinders are warranted for two years against manufacturer's defects. See the Medeco[®] limited warranty for full details

Medeco BiLevel

BiLevel cylinders offer affordable key control through patent protected keys. Standard locking systems without utility patent protected keys allow anyone who gains possession of a key to easily and inexpensively make a copy. With an unauthorized duplicate key, a thief has complete access to a building, its physical and intellectual property, and the people inside. BiLevel locking systems ensure that the keys to a facility can only be duplicated by certified Medeco dealers and only with the proper authorization.

Medeco® BiLevel cylinders can tie in with other Medeco® mechanical and eCylinder products for master keying purposes.



Patented Key Control

Protects against unauthorized duplication of your keys.



Uses Existing Hardware

Medeco offers the largest selection of retrofit cylinders that reduce cost by eliminating the need to replace your existing hardware.



Can Be Masterkeyed

Can be masterkeyed into a system containing Medeco BiLevel and Medeco³ mechanical as well as Medeco³ CLIQ eCylinders.



Special Angle Cut Keys

Requires a special key cutting machine and access to Medeco specific blanks, available in a variety of restrictions to support every need.



Picking and Bumping Protection

Medeco³ cylinders use a sidebar that prevent the key from rotating until it is elevated, rotated and aligned in the correct position. This feature protects against bumping and picking attacks.

Technical Information:

- Can be keyed with Medeco³ and Medeco³ CLIQ products

Applications:

The Medeco BiLevel retrofit cylinders are ideal for any application patented key control where physical high security is not necessary

Warranty:

Medeco BiLevel cylinders are warranted for two years against manufacturer's defects. See the Medeco® limited warranty for full details

Cylinder Formats:

- Rim & Mortise
- Key in Knob/Lever Cylinders
- Large Format Interchangeable Cores
- 14 Series Grade 2 Deadbolt
- Padlocks

Medeco X4

All facilities need patented key control to effectively secure exterior and interior openings. This strength of integrity allows security managers to have peace of mind when it comes to managing the system. Unfortunately, instituting a new key system is not always easy... or economical.

Medeco X4 is an economic and efficient solution to rekeying needs. Medeco X4 has one of the largest master key capabilities on the market, allowing facility managers to tie everything together under one key for ease, convenience and efficiency. Additionally, Medeco X4 easily retrofits into existing systems, significantly reducing installation time.

Medeco X4 is the perfect security upgrade for small format interchangeable core (SFIC) installations. In addition to SFIC cylinders, Medeco X4 is also available in many other styles of retrofit cylinders that can all be keyed into a single system.



Patented Key Control

Protects against unauthorized duplication of your keys.



Uses Existing Hardware

Medeco X4 is available in a large selection of retrofit cylinder formats that can all be keyed into a single system.



Quickly Change Cores

Medeco X4 SFIC cylinder provides quick and easy cylinder changes in the event keys are lost or stolen.



Can be Masterkeyed

Available in Small Format Interchangeable Cores (SFIC) and other retrofit cylinder formats which can be masterkeyed together, eliminating the need to replace your existing hardware.

Technical Information:

- Superior Masterkey Capabilities, up to four (4) times that of similar style cylinders
- One key flexibility for different cylinder styles compatible
- Patented key control lasting until the year 2027
- Custom key coining for added security

Applications:

The Medeco X4 retrofit cylinders are ideal for any application requiring key control and physical security of your cylinders

Warranty:

Medeco X4 cylinders are warranted for two years against manufacturer's defects. See the Medeco® limited warranty for full details

Cylinder Formats:

- Rim & Mortise
- Key in Knob/Lever Cylinders
- Small Format Interchangeable Cores
- Large Format Interchangeable Cores
- 14 Series Grade 2 Deadbolt
- Padlocks

Rim & Mortise Cylinders

FEATURES	Medeco ³	BiLevel	Medeco X4	CLIQ	Medeco XT
Utility patented key control provides protection from unauthorized duplication of keys	●	●	●	●	●
UL437 Listing and BHMA Certification provide validation of high security from recognized, independent testing laboratories	●				
Triple locking principle provides pick resistance and large numbers of combinations for master keying flexibility to accommodate systems of virtually any size	●				
Hardened steel inserts in the cylinder face provide proven drill resistance	●				
Nickel plated pins provide exceptional wear resistance and additional hardened stainless steel pins provide drill resistance	●	●			
Solid nickel silver pins provide exceptional wear resistance			●		
Retrofits into virtually any manufacturers' locksets for cost effective improved security	●	●	●	●	●
High security and key control may be incorporated in a single system for cost effective system flexibility	●	●		●	
Keys may be integrated with Hybrid proximity head for greater system retrofit	●	●	●	●	

Medeco³ Premium High Security

For effective mechanical protection against most forms of attack as well as protection against unauthorized duplicate keys, Medeco³ cylinders are recommended. Security features including hardened steel components, pins that must be elevated, rotated, and interact with both a sidebar and a slider, and additional pick resistant features make Medeco³ the cylinder of choice to protect people, property and information.

Medeco³ BiLevel Patented Key Control

Medeco³ BiLevel cylinders may be incorporated into a master key system with Medeco³ high security, offering protection against all types of attack where needed, and patented key control cylinders for areas requiring less protection. BiLevel cylinders offer patented control against unauthorized duplication of keys without the additional security features protecting against force or surreptitious attack.

Medeco X4 Patented Key Control

Medeco X4 cylinders offer patented control against unauthorized duplication of keys without the additional security features protecting against force or surreptitious attack.

Loss & Liability Control

Many of the cylinders in this section are also available with an eCylinder Loss & Liability Control Solution. See the eCylinder Section for more details.

Rim & Mortise Cylinders

Medeco® Rim and Mortise cylinders provide patented key control and the Medeco³ version provides UL437 Physical Security in adaptable retrofit cylinder formats. Medeco® Mortise cylinders have threads on the outside of the shell and are designed to be screwed into other manufacturer's mortise lock cases. A cam on the back of the cylinder operates the lock mechanism and a set screw holds the mortise cylinder in place. Medeco® Rim cylinders are used with auxiliary rim locks such as: surface mounted deadbolts, night latches, panic devices and jimmyproof locks (also know as vertical dropbolts or interlocking deadbolts). Rim cylinders are held in place with a back plate and two mounting screws. 10 series, rim and mortise cylinders, are UL437 Listed for drill and pick resistance, and the those that incorporate the Medeco³, BiLevel, or Medeco X4 design, offer utility patented key control.



Patented Key Control

Protects against unauthorized duplication of your keys.



Uses Existing Hardware

Medeco offers the largest selection of retrofit Rim & Mortise cylinders that reduce cost by eliminating the need to replace your existing hardware.



Can Be Masterkeyed

Medeco³ and BiLevel Rim & Mortise cylinders can be masterkeyed into a system containing Medeco BiLevel and Medeco³ mechanical as well as Medeco³ CLIQ eCylinders.



Protection From Physical Attack

Medeco³ Rim & Mortise cylinders are UL 437 listed and stand up to drilling, picking and other forms of physical attack.



Special Angle Cut Keys

Requires a special key cutting machine and access to Medeco specific blanks, available in a variety of restrictions to support every need.



Picking and Bumping Protection

Medeco³ cylinders use a sidebar that prevent the key from rotating until it is elevated, rotated and aligned in the correct position. This feature protects against bumping and picking attacks.

Applications

Flexible options designed to retrofit various manufacturers of Mortise and Rim locks

Warranty:

Warranted for two (2) years against manufacturer's defects. See the Medeco® limited warranty for full details

Technical Features:

- BHMA A156.30 Certification assures patent protected key control and physical strength
- BHMA A156.5 Grade 1 Certification assures consistent quality for heavy use applications
- Solid brass construction provides high quality and long cylinder life
- Set screw pin chamber caps allow quick and easy pinning and re-keying without the need to take the cylinder apart
- Large variety of cylinder lengths and cam/tailpiece configurations provide excellent retrofit capability and reduce the need to replace the entire locking device

Finishes:

- Available in all standard finishes to match existing hardware

Available Key Technologies:

Mechanical:

- Medeco³
- Medeco³ BiLevel*
- Medeco X4*

eCylinder:

- Medeco³ CLIQ
- Medeco CLIQ
- Medeco XT
- Aperio

Standard Mortise Cylinders

Description	Part Number	Medeco ³	BiLevel	Medeco X4	eCylinder
1" 5 Pin Mortise Cylinder	100100 (P)	\$118.50	\$64.41	\$80.50	
	100100 (S)	\$109.00	\$59.41	\$71.00	
1" 5 Pin Mortise Cylinder with 120° notch along top of shell for (alternate retaining location)	100101 (P)	\$118.50	\$64.41		
	100101 (S)	\$109.00	\$59.41		
1-1/8" 6 Pin Mortise Cylinder	100200 (P)	\$118.50	\$64.41	\$80.50	●
	100200 (S)	\$109.00	\$59.41	\$71.00	
1-1/4" 6 Pin Mortise Cylinder	100500 (P)	\$122.50	\$66.59	\$81.00	●
	100500 (S)	\$113.00	\$61.59	\$71.50	
1-3/8" 6 Pin Mortise Cylinder	105100 (P)	\$129.00	\$70.13	\$91.50	●
	105100 (S)	\$119.50	\$65.13	\$82.00	
1-1/2" 6 Pin Mortise Cylinder	105200 (P)	\$173.00	\$94.11		●
	105200 (S)	\$163.50	\$89.11		
1-5/8" 6 Pin Mortise Cylinder	105300 (P)	\$178.00	\$96.83	\$178.00	
	105300 (S)	\$168.00	\$91.83	\$168.50	
1-3/4" 6 Pin Mortise Cylinder	105400 (P)	\$183.50	\$99.83	\$183.00	●
	105400 (S)	\$174.00	\$94.83	\$173.50	
2" 6 Pin Mortise Cylinder	105500 (P)	\$193.50	\$105.28	\$193.00	●
	105500 (S)	\$184.00	\$100.28	\$183.50	
2-1/4" 6 Pin Mortise Cylinder	105600 (P)	\$204.00	\$111.00		●
	105600 (S)	\$194.50	\$106.00		
2-1/2" 6 Pin Mortise Cylinder	105700 (P)	\$214.50	\$116.73	\$213.00	●
	105700 (S)	\$205.00	\$111.73	\$203.50	
2-3/8" 6 Pin Mortise Cylinder	105904 (P)	\$209.00			
	105904 (S)	\$199.50			
2-3/4" 6 Pin Mortise Cylinder	105104 (P)	\$227.50			
	105104 (S)	\$218.00			
3-1/4" 6 Pin Mortise Cylinder	105900 (P)	\$245.50			
	105900 (S)	\$236.00			
4-1/8" 6 Pin Mortise Cylinder	105800 (P)	\$202.00			
	105800 (S)	\$272.50			
5" 6 Pin Mortise Cylinder	105901 (P)	\$318.00			
	105901 (S)	\$308.50			
6-7/8" 6 Pin Mortise Cylinder	105903 (P)	\$396.00			
	105903 (S)	\$386.00			
8" 6 Pin Mortise Cylinder	105902 (P)	\$442.50			
	105902 (S)	\$433.00			

6 Pin high security cylinders may be pinned 6 or 7 Pin in Medeco X4. Check the eCylinder section for pricing and technology available.

**Refer to the eCylinder section for more detail on specific technologies available and pricing. Technologies are represented by the following letters:
T = Medeco³, S = Medeco³ CLIQ, J = Medeco³ BiLevel, W = Biaxial, V = Medeco Biaxial CLIQ, K = Medeco KM, N = Medeco X4, C = Medeco CLIQ,
“-” = Original, Z = Medeco Original KW CLIQ, G = Medeco XT ***See key section for surcharges for custom coined cut keys or special stamping requirements.
Note: (P) refers to **Pinned** and **(S)** to **Sub-Pinned** at the end of each part string in the price book.

Residential Mortise Cylinders

Description	Part Number	Medeco ³	BiLevel	Medeco X4	eCylinder
1" 5 pin, Thin head mortise cylinder	1014506 (P)	\$118.50			
	1014506 (S)	\$109.00			
1-1/8" 5 pin, Thin head mortise cylinder	1014500 (P)	\$118.50			
	1014500 (S)	\$109.00			
1-1/4" 5 pin, Thin head mortise cylinder	1014501 (P)	\$123.50			
	1014501 (S)	\$114.00			
1-3/8" 5 pin, Thin head mortise cylinder	1014502 (P)	\$129.00			
	1014502 (S)	\$119.50			
1-1/2" 5 pin, Thin head mortise cylinder	1014503 (P)	\$173.50			
	1014503 (S)	\$164.00			
1-5/8" 5 pin, Thin head mortise cylinder	1014504 (P)	\$177.00			
	1014504 (S)	\$167.50			
1-3/4" 5 pin, Thin head mortise cylinder	1014505 (P)	\$181.00			
	1014505 (S)	\$171.50			
2" 5 pin, Thin head mortise cylinder	1014507 (P)	\$187.50			
	1014507 (S)	\$178.00			
2-1/4" 5 pin, Thin head mortise cylinder	1014508 (P)	\$196.00			
	1014508 (S)	\$186.50			
2-1/2" 5 pin, Thin head mortise cylinder	1014509 (P)	\$202.50			
	1014509 (S)	\$193.00			
1-1/8" 6 pin, Thin head mortise cylinder	1014600 (P)	\$118.50			
	1014600 (S)	\$109.00			
1-1/4" 6 pin, Thin head mortise cylinder	1014601 (P)	\$122.50			
	1014601 (S)	\$113.00			
1-3/8" 6 pin, Thin head mortise cylinder	1014602 (P)	\$129.00			
	1014602 (S)	\$119.50			
1-1/2" 6 pin, Thin head mortise cylinder	1014603 (P)	\$173.00			
	1014603 (S)	\$163.50			
1-5/8" 6 pin, Thin head mortise cylinder	1014604 (P)	\$176.00			
	1014604 (S)	\$166.50			
1-3/4" 6 pin, Thin head mortise cylinder	1014605 (P)	\$181.50			
	1014605 (S)	\$171.50			
2" 6 pin, Thin head mortise cylinder	1014607 (P)	\$187.50			
	1014607 (S)	\$178.00			
2-1/4" 6 pin, Thin head mortise cylinder	1014608 (P)	\$196.00			
	1014608 (S)	\$186.50			
2-1/2" 6 pin, Thin head mortise cylinder	1014609 (P)	\$202.50			
	1014609 (S)	\$193.00			

**Refer to the eCylinder section for more detail on specific technologies available and pricing. Technologies are represented by the following letters:
T = Medeco³, S = Medeco³ CLIQ, J = Medeco³ BiLevel, W = Biaxial, V = Medeco Biaxial CLIQ, K = Medeco KM, N = Medeco X4, C = Medeco CLIQ,
“-” = Original, Z = Medeco Original KW CLIQ, G = Medeco XT ***See key section for surcharges for custom coined cut keys or special stamping requirements.
Note: (P) refers to **Pinned** and **(S)** to **Sub-Pinned** at the end of each part string in the price book.

Jumbo/Mogul Mortise Cylinders

Description	Part Number	Medeco ³	BiLevel	Medeco X4	eCylinder
6 Pin Jumbo Mortise Cylinder (1 19/64" Long, 1 3/8" Shell Dia.) Corbin Russwin® Master Ring Cylinder Replacement	101350 (P)	\$155.50	\$84.57	\$123.00	
	101350 (S)	\$146.00	\$79.57	\$113.50	
6 Pin 1 1/4" Mogul Cylinder for Prison Locks (1 1/4" Long, 2" Shell Dia.)	104001 (P)	\$162.50			
	104001 (S)	\$153.00			
6 Pin 1 1/4" Mogul Mortise Cylinder 2" Shell Dia., Limited Rotation: CK 145° CCW and CW, MK 360° CCW and CW	104003 (P)	\$183.00			
	104003 (S)	\$173.50			
6 Pin 1 1/4" Mogul Mortise Cylinder 2" Shell Dia., Limited Rotation: CK 145° CW, MK 360° CCW and CW	108001 (P)	\$188.50			
	108001 (S)	\$179.00			
6 Pin 1 1/4" Mogul Mortise Cylinder 2" Shell Dia., Limited Rotation: CK 145° CCW, MK 360° CCW and CW	108002 (P)	\$188.50			
	108002 (S)	\$179.00			

Limited Rotation Mortise Cylinders

Description	Part Number	Medeco ³	BiLevel	Medeco X4	eCylinder
6 Pin 1 1/4" Mortise Cylinder with Raised Plug, Limited Rotation: CK 145° CW and 145° CCW	100500H (P)	\$157.00			
	100500H (S)	\$147.50			
6 Pin 1 1/4" Mortise Cylinder Hotel Function, Uses Spring Loaded Stop Pins with Notched and Un-Notched Keys to Provide Directional and Limited Rotation	100501 (P)	\$146.50			
	100501 (S)	\$137.00			
6 Pin 1/3/16" Length Mortise Cylinder Limited Rotation: CK 145° CCW, MK 360° CCW and CW	490078 (P)	\$134.50			
	490078 (S)	\$125.00			
6 Pin 1 3/16" Length Mortise Cylinder, Limited Rotation: CK 145° CW, MK 360° CCW and CW	490079 (P)	\$134.50			
	490079 (S)	\$125.00			

Specialty Mortise Cylinders

Description	Part Number	Medeco ³	BiLevel	Medeco X4	eCylinder
5 Pin Otis® Elevator Mortise Cylinder, 1 Key Pull Position	100903 (P)	\$131.50			
	100903 (S)	\$122.00			
5 Pin Otis® Elevator Mortise Cylinder, 2 Key Pull Positions (not used in MK systems)	100909 (P)	\$131.50			
	100909 (S)	\$122.00			
1 7/32" 6 Pin Mortise Cylinder with Mini Micro Switch, 7 Amp, SPDT, 1 Key Pull (requires quick connect leads: CP-270511)	100200A (P)	\$204.40	\$139.41	\$136.00	
	100200A (S)	\$194.90	\$134.41	\$126.50	
1 1/8" 6 Pin Concealed Face Mortise Cylinder for Schlage® "K" Locks, Trim Style 712, 714, 202	100202 (P)	\$134.50	\$73.13	\$95.50	
	100202 (S)	\$125.00	\$68.13	\$86.00	
1 1/8" 6 Pin Mortise Cylinder with Extended Plug & Second Cam Washer Reversed to Close Bottom of Keyway	104207 (P)	\$129.00	\$70.13		
	104207 (S)	\$119.50	\$65.13		
1 1/8" 6 Pin Mortise Cylinder with Extended Plug	104207A (P)	\$129.00	\$70.13		
	104207A (S)	\$119.50	\$65.13		
6 Pin 1/C Mortise Cylinder with 15 Amp Micro Switch	320200B (P)	\$290.00			
	320200B (S)	\$280.50			
1 1/4" 6 Pin Mortise Cylinder for VingCard® Persona®	490214 (P)	\$122.50	\$66.59		
	490214 (S)	\$113.00	\$61.59		

**Refer to the eCylinder section for more detail on specific technologies available and pricing. Technologies are represented by the following letters:

T = Medeco³, S = Medeco³ CLIQ, J = Medeco³ BiLevel, W = Biaxial, V = Medeco Biaxial CLIQ, K = Medeco KM, N = Medeco X4, C = Medeco CLIQ, "-" = Original, Z = Medeco Original KW CLIQ, G = Medeco XT ***See key section for surcharges for custom coined cut keys or special stamping requirements.

Note: (P) refers to Pinned and (S) to Sub-Pinned at the end of each part string in the price book.

Mortise Cylinder Plugs

Description	Part Number	Price
Plug for 10-0200 (Medeco Original®)	12005002 -	\$46.00
Plug for 10W0200 (Medeco Biaxial®)	12005006 W	\$46.00
Plug for 10T0200 (Medeco ³ ®)	1200500 T	\$46.00
Plug for 10-0500 (Medeco Original®)	12020002 -	\$46.00
Plug for 10W0500 (Medeco Biaxial®)	12020006 W	\$46.00
Plug for 10T0500 (Medeco ³ ®)	1202000 T	\$46.00
Plug for 10-0100 (Medeco Original®)	12021002 -	\$46.00
Plug for 10W0100 (Medeco Biaxial®)	12021006 W	\$46.00
Plug for 10T0100 (Medeco ³ ®)	1202100 T	\$46.00
Plug for 10J0500 (Medeco ³ BiLevel®)	1239000 J	\$46.00
Plug for 10J0100 (Medeco ³ BiLevel®)	1239100 J	\$46.00
Plug for 10J0200 (Medeco ³ BiLevel®)	1251300 J	\$46.00

Finish & Keyway Include finish and keyway with all part #'s .

Medeco³ or Medeco BiLevel Slider package sold separately .

**Refer to the eCylinder section for more detail on specific technologies available and pricing. Technologies are represented by the following letters:
T = Medeco³, S = Medeco³ CLIQ, J = Medeco³ BiLevel, W = Biaxial, V = Medeco Biaxial CLIQ, K = Medeco KM, N = Medeco X4, C = Medeco CLIQ,
“-” = Original, Z = Medeco Original KW CLIQ, G = Medeco XT ***See key section for surcharges for custom coined cut keys or special stamping requirements.
Note: (P) refers to **Pinned** and **(S)** to **Sub-Pinned** at the end of each part string in the price book.

Mortise Cams

	Description	Part Number	Price
	Corbin Russwin® Type	CT-Z00	\$3.42
	Standard Yale® Type	CT-Z01	\$3.42
	Adams Rite® Type	CT-Z02	\$3.42
	Keil® Norwalk Type	CT-Z04	\$3.42
	Schlage® Type	CT-Z05	\$3.42
	Medium Yale® Type	CT-Z06	\$3.42
	Segal® Type	CT-Z07	\$3.42
	Lockwood® Type	CT-Z08	\$3.42
	Corbin Russwin® Type	CT-Z09	\$3.42
	Segal® Deadbolt Type	CT-Z16	\$3.42
	Corbin Russwin® Oversized Jumbo	CT-Z17	\$3.42
	For Night Deposit Lock	CT-Z18	\$3.42
	General® Lock	CT-Z19	\$3.42
	Sargent® Type	CT-Z20	\$3.42
	Ruko® Type	CT-Z21	\$3.42

**Refer to the eCylinder section for more detail on specific technologies available and pricing. Technologies are represented by the following letters:
 T = Medeco³, S = Medeco³ CLIQ, J = Medeco³ BiLevel, W = Biaxial, V = Medeco Biaxial CLIQ, K = Medeco KM, N = Medeco X4, C = Medeco CLIQ,
 "-" = Original, Z = Medeco Original KW CLIQ, G = Medeco XT ***See key section for surcharges for custom coined cut keys or special stamping requirements.
Note: (P) refers to **Pinned** and **(S)** to **Sub-Pinned** at the end of each part string in the price book.

Mortise Cams

	Description	Part Number	Price
	Falcon® Type	CT-Z22	\$3.42
	Schlage® Type	CT-Z34	\$3.42
	Mogul Lock	CT-Z45	\$3.42
	Yale® Mortise After 1982	CT-Z47	\$3.42
	Dominion®	CT-Z48	\$3.42
	Corbin Russwin® Jumbo	CT-Z55	\$3.42
	Yale® Medium After 1982	CT-Z56	\$3.42
	Medeco Residential	CT-Z57	\$3.42
	Falcon® Type	CT-Z58	\$3.42
	Corbin Russwin® Clover Leaf master ring for Dealbolt Function Locks Made Since 6/93	CT-Z59	\$3.42
	Hook Type for Detention Locks	CT-Z61	\$4.02
	Clover Leaf Mogul	CT-Z69	\$9.50
	Best® Hotel Function Reversible Lock	CT-Z70	\$3.42
	Marks® J Type	CT-Z84	\$3.42
	VingCard® Persona®	CT-Z87	\$3.42
	Falcon® Type	CT-Z99	\$3.42

**Refer to the eCylinder section for more detail on specific technologies available and pricing. Technologies are represented by the following letters:
 T = Medeco³, S = Medeco³ CLIQ, J = Medeco³ BiLevel, W = Biaxial, V = Medeco Biaxial CLIQ, K = Medeco KM, N = Medeco X4, C = Medeco CLIQ,
 "-" = Original, Z = Medeco Original KW CLIQ, G = Medeco XT ***See key section for surcharges for custom coined cut keys or special stamping requirements.
Note: (P) refers to **Pinned** and **(S)** to **Sub-Pinned** at the end of each part string in the price book.

Mortise Components

Description	Part Number	Price
1 1/2" Dia. Threaded Adapter Ring for Corbin® Jumbo Mortise Cylinder (converts conventional size Mortise Cylinder to Jumbo thread size) Contains: CP-050131 Adapter Ring and CP-011013-030		
# 8-32 x 3/16" Set Screws	940010	\$41.50
Medeco ³ Slider Package, Includes Slider & Spring	940174	\$11.50
Medeco ³ BiLevel slider package	940227	\$11.50
# 2-56 UNC x 5/16" Length Phillips® Head Screws- Stainless Steel (used to attach cams to Mortise Cylinders)	CP-010203-050	\$0.17
Set Screws (for Medeco X4 pin chamber) # 6-32 x 1/8"	CP-011011-020	\$0.18
Set Screws (for High Security pin chambers) #8-32 x 1/8"	CP-011013-020	\$0.22
Cam Washer for Mortise Cylinders	CP-021011	\$0.61
Sidebar Spring-Stainless Steel	CP-030018	\$0.09
Mounting Nut for Mortise Cylinder 1.150"-32 UNS Inside Dia.	CP-050120	\$9.14
5 Pin Sidebar Assembly, .123" high for Door Hardware Cylinders	CP-084571	\$6.20
6 Pin Sidebar Assembly, .123" high for Door Hardware Cylinders	CP-084671	\$6.20

Rim Cylinders

Description	Part Number	Medeco ³	BiLevel	Medeco X4	eCylinder
5 Pin 1 1/16" Rim Cylinder- Horizontal Tailpiece	100300H (P)	\$121.50	\$66.04	\$87.50	
	100300H (S)	\$112.00	\$61.04	\$78.00	
5 Pin 1 1/16" Rim Cylinder- Vertical Tailpiece	100300V (P)	\$121.50	\$66.04	\$87.50	
	100300V (S)	\$112.00	\$61.04	\$78.00	
5 Pin 1 1/16" Rim Cylinder, Sargent® Mounting Style, Horizontal Tailpiece	100305H (P)	\$121.50	\$66.04	\$87.50	
	100305H (S)	\$112.00	\$61.04	\$78.00	
5 Pin 1 1/16" Rim Cylinder, Sargent® Mounting Style, Vertical Tailpiece	100305V (P)	\$121.50	\$66.04	\$87.50	
	100305V (S)	\$112.00	\$61.04	\$78.00	
5 Pin 1 1/16" Rim Cylinder, 180 Degree Lazy Motion	100600 (P)	\$129.50	\$70.40		
	100600 (S)	\$120.00	\$65.40		
5 Pin Segal® Inside Cylinder before 10/99 for double cylinder dropbolt	100800 (P)	\$112.50		\$77.00	
	100800 (S)	\$103.00		\$67.50	
6 Pin, 1 1/8" Rim Cylinder Horizontal Tailpiece	100400H (P)	\$129.50	\$70.40	\$87.00	●
	100400H (S)	\$120.00	\$65.40	\$77.50	
6 Pin, 1 1/8" Rim Cylinder Vertical Tailpiece	100400V (P)	\$129.50	\$70.40	\$87.00	●
	100400V (S)	\$120.00	\$65.40	\$77.50	
6 Pin 1 1/8" Rim Cylinder- Sargent® Mounting Style, Horizontal Tailpiece	100403H (P)	\$129.50	\$70.40	\$87.00	●
	100403H (S)	\$120.00	\$65.40	\$77.50	
6 Pin 1 1/8" Rim Cylinder- Sargent® Mounting Style, Vertical Tailpiece	100403V (P)	\$129.50	\$70.40	\$87.00	●
	100403V (S)	\$120.00	\$65.40	\$77.50	
6 Pin 1 1/8" Rim Cylinder, 180 Degree Lazy Motion	100700 (P)	\$129.50	\$70.40	\$87.00	●
	100700 (S)	\$120.00	\$65.40	\$77.50	
6 Pin Jumbo Rim Cylinder Corbin Russwin® Master Ring Cylinder Replacement	101355 (P)	\$166.00			
	101355 (S)	\$156.50			
6 Pin 1 15/32" Rim Cylinder with Extended Plug and Horizontal Tailpiece	10407HA (P)	\$129.50			
	10407HA (S)	\$120.00			

6 Pin high security cylinders are available in 7 Pin in Medeco X4. Check the eCylinder section for pricing and technology available.

**Refer to the eCylinder section for more detail on specific technologies available and pricing. Technologies are represented by the following letters:
T = Medeco³, S = Medeco³ CLIQ, J = Medeco³ BiLevel, W = Biaxial, V = Medeco Biaxial CLIQ, K = Medeco KM, N = Medeco X4, C = Medeco CLIQ,

"-" = Original, Z = Medeco Original KW CLIQ, G = Medeco XT ***See key section for surcharges for custom coined cut keys or special stamping requirements.

Note: (P) refers to Pinned and (S) to Sub-Pinned at the end of each part string in the price book.

Rim Cylinder Plugs

Description	Part Number	Price
Plug for 10-0300H or 10-0300V (Medeco Original®)	12001002 -	\$46.00
Plug for 10W0300H & 10W0300V (Medeco Biaxial®)	12001006 W	\$46.00
Plug for 10T0300 (Medeco ³ ®)	1200100 T	\$46.00
Plug for 10-0400H or 10-0400V (Medeco Original®)	12030002 -	\$46.00
Plug for 10W0400H & 10W0400V (Medeco Biaxial®)	12030006 W	\$46.00
Plug for 10T0400 (Medeco ³ ®)	1203000 T	\$46.00
Plug for 10J0300 (Medeco BiLevel®)	1238900 J	\$46.00
Plug for 10J0400 (Medeco BiLevel®)	1251200 J	\$46.00

Add finish and keyway to all part #'s .

Medeco³ or Medeco BiLevel Slider package sold separately .

Rim Components

Description	Part Number	Price
Medeco ³ Slider Package, Includes Slider & Spring	940174	\$11.50
Medeco BiLevel slider package	940227	\$11.50
Set Screws (for Medeco X4 pin chamber) #6-32 x1/8"	CP-011011-020	\$0.18
Set Screws (for HS pin chambers) #8-32 x1/8"	CP-011013-020	\$0.22
Rim Cylinder Mounting Screws (#12-24 UNF x 1 57/64" Length)	CP-012917-000	\$0.43
Rim Cylinder Plug Retainer	CP-020010	\$0.51
Screw-on Cap Rim Tailpiece Retainer	CP-021121	\$11.00
Sidebar Spring-Stainless Steel	CP-030018	\$0.09
Back of Plug Roll Pin 3/32" Dia. x .437" Length	CP-060203	\$0.34
5 Pin Sidebar Assembly, .123" high for Door Hardware Cylinders	CP-084571	\$6.20
6 Pin Sidebar Assembly, .123" high for Door Hardware Cylinders	CP-084671	\$6.20
Rim Cylinder Mounting Plate	CP-180031	\$1.34





**Refer to the eCylinder section for more detail on specific technologies available and pricing. Technologies are represented by the following letters:

T = Medeco³, S = Medeco³ CLIQ, J = Medeco³ BiLevel, W = Biaxial, V = Medeco Biaxial CLIQ, K = Medeco KM, N = Medeco X4, C = Medeco CLIQ,



"-" = Original, Z = Medeco Original KW CLIQ, G = Medeco XT ***See key section for surcharges for custom coined cut keys or special stamping requirements.

Note: (P) refers to **Pinned** and **(S)** to **Sub-Pinned** at the end of each part string in the price book.

Collars & Cylinder Rings

	Description	Part Number	Price
	Tapered Cylinder Collar	940188	\$13.00
	1/4" Thick Spacer Ring 1.165" Inside Diameter x 1.375 Outside Diameter	CP-070011	\$21.50
	1/8" Thick Spacer Ring 1.165" Inside Diameter x 1.375 Outside Diameter	CP-070451	\$17.50
	Raised Cylinder Ring	CP-180021	\$7.69
	Flush Cylinder Ring	CP-180041	\$7.47
	Adjustable Cylinder Collar	CP-160180	\$21.50

Rim Tailpieces

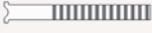
	Description	Part Number	Price
	Tailpiece for Rim Cylinder (155/64") Before 1980, After 1983	CT-Y02	\$3.42
	Lazy Motion Tailpiece (2 29/64")	CT-Y08	\$3.42
	Tailpiece for Rim Cylinder (2 9/16")	CT-Y32	\$3.42

**Refer to the eCylinder section for more detail on specific technologies available and pricing. Technologies are represented by the following letters:
 T = Medeco³, S = Medeco³ CLIQ, J = Medeco³ BiLevel, W = Biaxial, V = Medeco Biaxial CLIQ, K = Medeco KM, N = Medeco X4, C = Medeco CLIQ,
 "-" = Original, Z = Medeco Original KW CLIQ, G = Medeco XT ***See key section for surcharges for custom coined cut keys or special stamping requirements.
Note: (P) refers to **Pinned** and **(S)** to **Sub-Pinned** at the end of each part string in the price book.

Key-in-Knob/Lever Cylinders

FEATURES	Medeco ³	BiLevel	Medeco X4	CLIQ	Medeco XT
Utility patented key control provides protection from unauthorized duplication of keys	●	●	●	●	●
UL437 Listing and BHMA Certification provide validation of high security from recognized, independent testing laboratories	●				
Triple locking principle provides pick resistance and large numbers of combinations for master keying flexibility to accommodate systems of virtually any size	●				
Hardened steel inserts in the cylinder face provide proven drill resistance	●				
Nickel plated pins provide exceptional wear resistance and additional hardened stainless steel pins provide drill resistance	●	●			
Solid nickel silver pins provide exceptional wear resistance			●		
Retrofits into virtually any manufacturers' locksets for cost effective improved security	●	●	●	●	●
High security and key control may be incorporated in a single system for cost effective system flexibility	●	●		●	
Keys may be integrated with Hybrid proximity head for greater system retrofit	●	●	●	●	

Medeco³ Premium High Security

For effective mechanical protection against most forms of attack as well as protection against unauthorized duplicate keys, Medeco³ cylinders are recommended. Security features including hardened steel components, pins that must be elevated, rotated, and interact with both a sidebar and a slider, and additional pick resistant features make Medeco³ the cylinder of choice to protect people, property and information.

Medeco³ BiLevel Patented Key Control

Medeco³ BiLevel cylinders may be incorporated into a master key system with Medeco³ high security, offering protection against all types of attack where needed, and patented key control cylinders for areas requiring less protection. BiLevel cylinders offer patented control against unauthorized duplication of keys without the additional security features protecting against force or surreptitious attack.

Medeco X4 Patented Key Control

Medeco X4 cylinders offer patented control against unauthorized duplication of keys without the additional security features protecting against force or surreptitious attack.

Loss & Liability Control

Many of the cylinders in this section are also available with an eCylinder Loss & Liability Control Solution. See the eCylinder Section for more details.

Key-in-Knob/Lever Cylinders

Medeco³ Key-in-Knob cylinders are designed to retrofit knob type cylindrical locksets, lever type cylindrical locksets, padlocks and bored type auxiliary deadlatches and deadlocks. The 20 series, Key-in-Knob cylinders are UL437 Listed for drill and pick resistance, and the those that incorporate the Medeco³ design, offer utility patented key control.



Patented Key Control

Protects against unauthorized duplication of your keys.



Uses Existing Hardware

Medeco offers the largest selection of retrofit Key in Knob and Key in Lever cylinders that reduce cost by eliminating the need to replace your existing hardware.



Can Be Masterkeyed

Medeco³ and BiLevel KIK/KIL cylinders can be masterkeyed into a system containing Medeco BiLevel and Medeco³ mechanical as well as Medeco³ CLIQ eCylinders.



Protection From Physical Attack

Medeco³ KIK/KIL cylinders are UL 437 listed and use hardened steel inserts positioned in critical areas of the cylinder, providing a high degree of drill and picking resistance.



Special Angle Cut Keys

Requires a special key cutting machine and access to Medeco specific blanks, available in a variety of restrictions to support every need.



Picking and Bumping Protection

Medeco³ cylinders use a sidebar that prevent the key from rotating until it is elevated, rotated and aligned in the correct position. This feature protects against bumping and picking attacks.

Applications:

Over 100 different cylinder designs and tailpiece configurations enable Medeco[®] to offer the largest retrofit capability in the industry. More retrofit cylinders means fewer replacements of the complete lockset

Warranty:

Warranted for two (2) years against manufacturer's defects. See the Medeco[®] limited warranty for full details

Technical Information:

- ANSI A156.30 Level A certification assures patent protected key control and physical strength
- ANSI A156.5 Grade 1 certification assures consistent quality for heavy use applications
- The package contains one cylinder and a variety of different tailpieces, providing a greater retrofit capability, while at the same time reducing the amount on inventory required
- All Medeco cylinders are constructed of durable machined brass components, designed to last the life of your equipment

Finishes:

- Available in all standard finishes to match existing hardware

Available Key Technologies:

Mechanical:

- Medeco³
- Medeco³ BiLevel
- Medeco X4*

eCylinder:

- Medeco³ CLIQ
- Medeco CLIQ
- Medeco XT

Alarm Lock Cylinder

Description	Part Number	Medeco ³	BiLevel	Medeco X4	eCylinder
 6 Pin Cylinder for Alarm Lock Trilogy® T1, T2, T3	20200V1 (P)	\$ 111.00	\$60.32	\$69.50	●
	20200V1 (S)	\$ 101.50	\$55.32	\$60.00	

Anderson® Cylinder

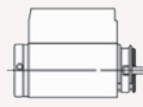

Description	Part Number	Medeco ³	BiLevel	Medeco X4	eCylinder
 5 Pin Cylinder for Anderson® Doors Frenchwood Hinged and Out Swinging Doors Estate and Metro Design	20110039 (P)	\$ 111.00	\$60.32		●
	20110039(S)	\$ 101.50	\$55.32		

Arrow Cylinder

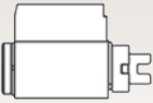

Description	Part Number	Medeco ³	BiLevel	Medeco X4	eCylinder
 6 Pin Cylinder Package for Arrow® "MK" Series includes CT-Y70, CT-Y73, CP-160321	20200A1 (P)	\$ 112.5	\$61.82	\$71.00	●
	20200A1 (S)	\$ 103.00	\$56.82	\$61.50	
 Arrow® and Schlage® Packages Combined	20200H1 (P)	\$ 118.50	\$67.82	\$77.00	●
	20200H1 (S)	\$ 109.00	\$62.82	\$67.50	
 6 Pin Cylinder for Arrow® "MK" Series (Except Ball) Original Cylinder Spacer must be replaced with Medeco Cylinder Spacer CP-160321	2020070 (P)	\$ 111.00	\$60.32	\$69.50	●
	2020070 (S)	\$ 101.50	\$55.32	\$60.00	
 6 Pin Cylinder for Arrow RK Series	2020071 (P)	\$ 111.00	\$60.32	\$69.50	●
	2020071 (S)	\$ 101.50	\$55.32	\$60.00	
 6 Pin Cylinder for Arrow® "MK" Series (B Knob Only) & GL Series Levers	2020073 (P)	\$ 111.00	\$60.32	\$69.50	●
	2020073 (S)	\$ 101.50	\$55.32	\$60.00	
 6 Pin Cylinder for Arrow Revolution V1 Leverset (requires plastic insert provided with Revolution lockset)	20202V9 (P)	\$ 111.00	\$60.32	\$69.50	●
	20202V9 (S)	\$ 101.50	\$55.32	\$60.00	
 6 Pin Cylinder for Arrow® "H", "S", & "HK" Knob Series, "Q", "L" Series Lever	2020249 (P)	\$ 111.00	\$60.32	\$69.50	●
	2020249 (S)	\$ 101.50	\$55.32	\$60.00	
 6 pin cylinder for Arrow "QL" and "MLX" Series Levers	2020049 (P)	\$ 111.00	\$60.32	\$69.50	●
	2020049 (S)	\$ 101.50	\$55.32	\$60.00	
 6 Pin Cylinder for Arrow "V3" Revolution Lever	2020249 (P)	\$ 111.00	\$60.32	\$69.50	●
	2020249 (S)	\$ 101.50	\$55.32	\$60.00	
 6 Pin Cylinder for Arrow® "M" Series (Tulip or Tudor) Knobs	208008 (P)	\$ 111.00	\$60.32	\$69.50	●
	208008 (S)	\$ 101.50	\$55.32	\$60.00	
 6 Pin Cylinder for Arrow® "RL" Series Levers	2080700 (P)	\$ 111.00	\$60.32	\$69.50	●
	2080700 (S)	\$ 101.50	\$55.32	\$60.00	

**Refer to the eCylinder section for more detail on specific technologies available and pricing. Technologies are represented by the following letters:
T = Medeco³, S = Medeco³ CLIQ, J = Medeco³ BiLevel, W = Biaxial, V = Medeco Biaxial CLIQ, K = Medeco KM, N = Medeco X4, C = Medeco CLIQ,
"- " = Original, Z = Medeco Original KW CLIQ, G = Medeco XT ***See key section for surcharges for custom coined cut keys or special stamping requirements.
Note: (P) refers to **Pinned** and (S) to **Sub-Pinned** at the end of each part string in the price book.

Baldwin® Cylinders

Description	Part Number	Medeco ³	BiLevel	Medeco X4	eCylinder
 5 Pin Cylinder for Baldwin® for 5245, 5250, 5255 Levers & 5215, 5225 Knobs	2001300 (P)	\$111.00	\$60.32		
	2001300 (S)	\$101.50	\$55.32		
 5 Pin Cylinder for Baldwin® for 5205, 5210 Knobs & 5270, 5280 Levers, Available in Medeco Biaxial & Medeco ³ Technologies Only	2001200 (P)	\$111.00	\$60.32		
	2001200 (S)	\$101.50	\$55.32		

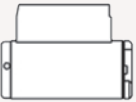
Cal-Royal Cylinders

Description	Part Number	Medeco ³	BiLevel	Medeco X4	eCylinder
 6 Pin Cylinder for Cal-Royal SL00 Knob Lock and LX01 Lever Lock	2020049 (P)	\$111.00	\$60.32	\$69.50	
	2020049 (S)	\$101.50	\$55.32	\$60.00	●
 6 Pin Cylinder for Cal-Royal CLS03 Classroom Function Grade 2 Lever Lock	20200V1 (P)	\$111.00	\$60.32	\$69.50	
	20200V1 (S)	\$101.50	\$55.32	\$60.00	●



**Refer to the eCylinder section for more detail on specific technologies available and pricing. Technologies are represented by the following letters:
T = Medeco³, S = Medeco³ CLIQ, J = Medeco³ BiLevel, W = Biaxial, V = Medeco Biaxial CLIQ, K = Medeco KM, N = Medeco X4, C = Medeco CLIQ,
“-” = Original, Z = Medeco Original KW CLIQ, G = Medeco XT ***See key section for surcharges for custom coined cut keys or special stamping requirements.
Note: (P) refers to **Pinned** and **(S)** to **Sub-Pinned** at the end of each part string in the price book.

Corbin Russwin® Cylinders



Description	Part Number	Medeco ³	BiLevel	Medeco X4	eCylinder
 6 Pin Cylinder for Corbin Russwin® CL3900	20200V9 (P)	\$111.00	\$60.32	\$69.50	●
	20200V9 (S)	\$101.50	\$55.32	\$60.00	
 6 Pin Cylinder for Corbin Russwin® old style 3300 & 3400 Series	2020575 (P)	\$111.00	\$60.32	\$69.50	
	2020575 (S)	\$101.50	\$55.32	\$60.00	
 6 Pin Cylinder for Corbin Russwin® 6600 Old Series, CK3400, CK4400 Knob	2020777 (P)	\$111.00	\$60.32	\$69.50	
	2020777 (S)	\$101.50	\$55.32	\$60.00	
 6 Pin Cylinder for Corbin Russwin® 800, CL3300, CL3400, CL3500, CL3600	20211730 (P)	\$111.00	\$60.32	\$69.50	●
	20211730 (S)	\$101.50	\$55.32	\$60.00	
 5 Pin Cylinder for Corbin Russwin® Knob (Old Style)	205003 (P)	\$112.50	\$61.14	\$71.00	
	205003 (S)	\$103.00	\$56.14	\$61.50	
 6 Pin Cylinder for Corbin Russwin® 5460A, 5460E (Old Style), 46 F97, 46 F29, 83 F05	205004 (P)	\$111.00	\$60.32	\$69.50	
	205004 (S)	\$101.50	\$55.32	\$60.00	
 6 Pin Cylinder for Corbin Russwin® CK 4200 (New Style) UT5251	205005 (P)	\$111.00	\$60.32		●
	205005 (S)	\$101.50	\$55.32		
 6 Pin Cylinder for Corbin Russwin® 5460 B, C, D, G, M (Old Style)	205006 (P)	\$111.00	\$60.32	\$69.50	
	205006 (S)	\$101.50	\$55.32	\$60.00	
 5 Pin Cylinder for Corbin Russwin® 5600 Series Signet® & Ensign®	205008 (P)	\$111.00		\$69.50	
	205008(S)	\$101.50		\$60.00	

**Refer to the eCylinder section for more detail on specific technologies available and pricing. Technologies are represented by the following letters:
T = Medeco³, S = Medeco³ CLIQ, J = Medeco³ BiLevel, W = Biaxial, V = Medeco Biaxial CLIQ, K = Medeco KM, N = Medeco X4, C = Medeco CLIQ,
“-” = Original, Z = Medeco Original KW CLIQ, G = Medeco XT ***See key section for surcharges for custom coined cut keys or special stamping requirements.
Note: (P) refers to **Pinned** and **(S)** to **Sub-Pinned** at the end of each part string in the price book.

Dorma® Cylinders

Description	Part Number	Medeco ³	BiLevel	Medeco X4	eCylinder
 6 Pin Cylinder for Dorma® CL700 Series Grade 2 Levers	2020049 (P)	\$111.00	\$60.32	\$69.50	●
	2020049 (S)	\$101.50	\$55.32	\$60.00	
 6 Pin Cylinder for Dorma® CL860 (Interior), CL870, CL872, CL873, CL877 Grade 1 Lever, CK860 (Interior), CK870, CK872, CK873, & CK877 Grade 1 Knobs	20200V0 (P)	\$111.00	\$60.32	\$69.50	
	20200V0 (S)	\$101.50	\$55.32	\$60.00	
 6 Pin Cylinder for Dorma® CL853, CL860 (exterior), CL880, CL882, CL80EL, CL80EU Grade 1 Lever, CK853, CK860 (exterior), CK880, CK882, CK80EL, & CK80EU Grade 1 Knobs	20200V1 (P)	\$111.00	\$60.32	\$69.50	●
	20200V1 (S)	\$101.50	\$55.32	\$60.00	

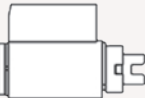
Emtek® Cylinders









Description	Part Number	Medeco ³	BiLevel	Medeco X4	eCylinder
 5 Pin Cylinder for Emtek® Knobs	2051100 (P)	\$111.00	\$60.32		
	2051100 (S)	\$101.50	\$55.32		
 5 Pin Cylinder for Emtek® Levers	2051200 (P)	\$111.00	\$60.32		
	2051200 (S)	\$101.50	\$55.32		

General Lock Cylinders

Description	Part Number	Medeco ³	BiLevel	Medeco X4	eCylinder
 6 Pin Cylinder for K200, L100, LX100, L200, LX200, Levers	20200S1 (P)	\$112.50	\$61.14	\$71.00	
	20200S1 (S)	\$103.00	\$56.14	\$61.50	

**Refer to the eCylinder section for more detail on specific technologies available and pricing. Technologies are represented by the following letters:
T = Medeco³, S = Medeco³ CLIQ, J = Medeco³ BiLevel, W = Biaxial, V = Medeco Biaxial CLIQ, K = Medeco KM, N = Medeco X4, C = Medeco CLIQ,
“-” = Original, Z = Medeco Original KW CLIQ, G = Medeco XT ***See key section for surcharges for custom coined cut keys or special stamping requirements.
Note: (P) refers to Pinned and (S) to Sub-Pinned at the end of each part string in the price book.

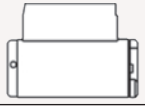
Falcon® Cylinders

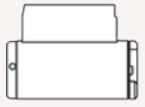
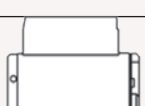

Description	Part Number	Medeco ³	BiLevel	Medeco X4	eCylinder
 6 Pin Cylinder for Falcon® Single Cylinder Deadbolt Lock (New Style)	200903 (P)	\$112.50	\$61.14	\$71.00	●
	200903 (S)	\$103.00	\$56.14	\$61.50	
 6 Pin Cylinder for Falcon® "B" Series	2020049 (P)	\$111.00	\$60.32	\$69.50	●
	2020049 (S)	\$101.50	\$55.32	\$60.00	
 6 Pin Cylinder for Falcon® F521, F561, F581 and "N" Series Knobs	2020051 (P)	\$111.00	\$60.32	\$69.50	●
	2020051 (S)	\$101.50	\$55.32	\$60.00	
 6 Pin Cylinder for Falcon® "S" Series (Except "H" Knob)	2020054 (P)	\$111.00	\$60.32	\$69.50	
	2020054 (S)	\$101.50	\$55.32	\$60.00	
 6 Pin Cylinder for Falcon® "S" Series ("H" Knob Only)	2020058 (P)	\$111.00	\$60.32	\$69.50	
	2020058 (S)	\$101.50	\$55.32	\$60.00	
 6 Pin Cylinder for Falcon® "X" Series (Except "H" Knob)	2020071 (P)	\$111.00	\$60.32	\$69.50	
	2020071 (S)	\$101.50	\$55.32	\$60.00	
 6 Pin Cylinder for Falcon® "X" Series ("H" Knobs Only) Original Cylinder Spacer must be replaced with Medeco Cylinder Spacer CP-16032	2020068 (P)	\$111.00	\$60.32	\$69.50	
	2020068 (S)	\$101.50	\$55.32	\$60.00	
 6 Pin Cylinder for Falcon® "LY" Lever	2020072 (P)	\$111.00	\$60.32	\$69.50	
	2020072 (S)	\$101.50	\$55.32	\$60.00	
 6 Pin Cylinder for Falcon® Inside Cylinder T-381	2020073 (P)	\$111.00	\$60.32	\$69.50	●
	2020073 (S)	\$101.50	\$55.32	\$60.00	
 6 Pin Cylinder for Falcon® "B", "LY", "X", "S", & "T" series includes: CT-Y49, CT-Y54, CTY58, CT-Y68, CT-Y71, CT-Y72, CT-V03, CP-160311	20200F1 (P)	\$112.50	\$61.14	\$71.00	●
	20200F1 (S)	\$103.00	\$56.14	\$61.50	
 6 Pin Cylinder for Falcon® "RU" Series and T381 Outside Cylinder	20200V3 (P)	\$111.00	\$60.32	\$69.50	
	20200V3 (S)	\$101.50	\$55.32	\$60.00	

**Refer to the eCylinder section for more detail on specific technologies available and pricing. Technologies are represented by the following letters:
T = Medeco³, S = Medeco³ CLIQ, J = Medeco³ BiLevel, W = Biaxial, V = Medeco Biaxial CLIQ, K = Medeco KM, N = Medeco X4, C = Medeco CLIQ,
"-." = Original, Z = Medeco Original KW CLIQ, G = Medeco XT ***See key section for surcharges for custom coined cut keys or special stamping requirements.
Note: (P) refers to **Pinned** and **(S)** to **Sub-Pinned** at the end of each part string in the price book.



Hager® Cylinders

Description	Part Number	Medeco ³	BiLevel	Medeco X4	eCylinder
 6 Pin Cylinder for Hager® Lever Locksets, 3500 Series	2020249 (P)	\$111.00	\$60.32	\$69.50	●
	2020249 (S)	\$101.50	\$55.32	\$60.00	





KABA® Mas-Hamilton Cylinders

Description	Part Number	Medeco ³	BiLevel	Medeco X4	eCylinder
 MAS-Hamilton® Power Lever	20200V1 (P)	\$111.00	\$60.32	\$69.50	●
	20200V1 (S)	\$101.50	\$55.32	\$60.00	
 6 pin cylinder for Kaba E-plex 2000 (18 bow key req. for Orig/Biax)	2051500 (P)	\$111.00	\$60.32	\$69.50	●
	2051500 (S)	\$101.50	\$55.32	\$60.00	

Lockwood® Cylinders



Description	Part Number	Medeco ³	BiLevel	Medeco X4	eCylinder
 5 Pin Cylinder for Lockwood® 530	201006 (P)	\$111.00			●
	201006 (S)	\$101.50			
 6 Pin Cylinder for Lockwood®	2020169 (P)	\$111.00	\$60.32	\$69.50	●
	2020169 (S)	\$101.50	\$55.32	\$60.00	

LSDA® Cylinders

Description	Part Number	Medeco ³	BiLevel	Medeco X4	eCylinder
 6 Pin cylinder for LSDA® 100 Series Knob (Except "B" Knob), L100 Series Lever	2020070 (P)	\$111.00	\$60.32	\$69.50	●
	2020070 (S)	\$101.50	\$55.32	\$60.00	
 6 Pin Cylinder for LSDA® 100 (B Knob Only)	2020073 (P)	\$111.00	\$60.32	\$69.50	●
	2020073 (S)	\$101.50	\$55.32	\$60.00	
 6 Pin Cylinder for LSDA® LX1000 Lever	2020078 (P)	\$111.00	\$60.32	\$69.50	●
	2020078 (S)	\$101.50	\$55.32	\$60.00	
 6 Pin cylinder package for LSDA® 100, L100, LH1000, LX1000 Series. Includes: CT-Y49, CTY70, CT-Y73, CT-Y78	20200L1 (P)	\$111.00	\$60.32	\$69.50	●
	20200L1 (S)	\$101.50	\$55.32	\$60.00	

**Refer to the eCylinder section for more detail on specific technologies available and pricing. Technologies are represented by the following letters:
T = Medeco³, S = Medeco³ CLIQ, J = Medeco³ BiLevel, W = Biaxial, V = Medeco Biaxial CLIQ, K = Medeco KM, N = Medeco X4, C = Medeco CLIQ,
“-” = Original, Z = Medeco Original KW CLIQ, G = Medeco XT ***See key section for surcharges for custom coined cut keys or special stamping requirements.
Note: (P) refers to **Pinned** and **(S)** to **Sub-Pinned** at the end of each part string in the price book.



Marks® Cylinders

Description	Part Number	Medeco ³	BiLevel	Medeco X4	eCylinder
 6 Pin Cylinder for Marks® 110, 170, 180, 190, 195, 295 Series DA-Vestibule, DC & SBCommunicating, S-Classroom & Classroom Security Functions	20200V0 (P)	\$111.00	\$60.32	\$69.50	
	20200V0 (S)	\$101.50	\$55.32	\$60.00	
 6 pin Cylinder for Marks 110, 170, 180, 190, 195, 295 Series in AB-Entrance, DWInstitution, F-Storeroom, & T Corridor Functions	20200V1 (P)	\$111.00	\$60.32	\$69.50	●
	20200V1 (S)	\$101.50	\$55.32	\$60.00	

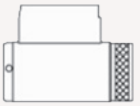

Marvin® Cylinders

Description	Part Number	Medeco ³	BiLevel	Medeco X4	eCylinder
 5 Pin Cylinder for Marvin® Auxiliary Locks	2000827 (P)	\$111.00	\$60.32		
	2000827 (S)	\$101.50	\$55.32		

Medeco Embassy® Cylinders



Description	Part Number	Medeco ³	BiLevel	Medeco X4	eCylinder
 6 Pin Cylinder for Embassy® Vestibule, Communicating, Classroom & Classroom Security Functions. For Embassy Levers sold thru 9/06 & ALL Knobs	20200V0 (P)	\$111.00	\$60.32	\$69.50	
	20200V0 (S)	\$101.50	\$55.32	\$60.00	
 6 Pin Cylinder for Embassy® in Entrance, Institution, Storeroom, Corridor Functions. For Embassy Levers sold thru 9/06 & ALL Knobs	20200V1 (P)	\$111.00	\$60.32	\$69.50	●
	20200V1 (S)	\$101.50	\$55.32	\$60.00	
 6 Pin Cylinder for Embassy Levers All Functions after 9/2006	2020249 (P)	\$111.00	\$60.32	\$69.50	●
	2020249 (S)	\$101.50	\$55.32	\$60.00	

Olympus® Cylinders

Description	Part Number	Medeco ³	BiLevel	Medeco X4	eCylinder
 6 Pin Cylinder for Olympus® 700LCM, 800LCM Non-key Retaining Cabinet Lock Includes: CT-F34-CT-F38	20009S4 (P)	\$115.00	\$64.32	\$73.50	●
	20009S4 (S)	\$105.50	\$59.32	\$64.00	
 6 Pin Cylinder for Olympus® 700LCM, 800LCM Key Retaining Cabinet lock, Includes: CT-Y49, CT-Y52, CTY53, CT-Y54	20200S1 (P)	\$112.50	\$61.82	\$71.00	●
	20200S1 (S)	\$103.00	\$59.82	\$61.50	

**Refer to the eCylinder section for more detail on specific technologies available and pricing. Technologies are represented by the following letters:
T = Medeco³, S = Medeco³ CLIQ, J = Medeco³ BiLevel, W = Biaxial, V = Medeco Biaxial CLIQ, K = Medeco KM, N = Medeco X4, C = Medeco CLIQ,
“-” = Original, Z = Medeco Original KW CLIQ, G = Medeco XT ***See key section for surcharges for custom coined cut keys or special stamping requirements.
Note: (P) refers to **Pinned** and (S) to **Sub-Pinned** at the end of each part string in the price book.





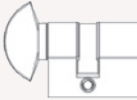

PDQ® Cylinders

Description	Part Number	Medeco ³	BiLevel	Medeco X4	eCylinder
 6 Pin Cylinder for PDQ® "SX" Series	2020149 (P)	\$111.00	\$60.32		
	2020149 (S)	\$101.50	\$55.32		
 6 Pin Cylinder for PDQ® "SV" Knob/Lever	203000 (P)	\$111.00	\$60.32	\$69.50	
	203000 (S)	\$101.50	\$55.32	\$60.00	
 6 Pin cylinder for PDQ® Lever SP & ST Series, GT, XGT & GP Series	20200V2 (P)	\$111.00	\$60.32	\$69.50	●
	20200V2 (S)	\$101.50	\$55.32	\$60.00	

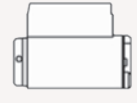
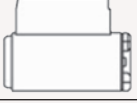
Pella® Cylinders

Description	Part Number	Medeco ³	BiLevel	Medeco X4	eCylinder
 5 Pin Knob cylinder to fit popular Pella storm and patio doors	2000827 (P)	\$111.00	\$60.32		
	2000827 (S)	\$101.50	\$55.32		
 5 Pin profile type cylinder to fit popular Pella and Anderson storm and patio doors	490258 (P)	\$146.00			
	490258 (S)	\$136.50			

Sargent® Cylinders

Description	Part Number	Medeco ³	BiLevel	Medeco X4	eCylinder
 6 Pin Cylinder for Sargent® 6 Line (Except for B Knob) & 6500 Lever - For Original Design, otherwise use 20*80147	2020170 (P)	\$111.00	\$60.32	\$69.50	
	2020170 (S)	\$101.50	\$55.32	\$60.00	
 6 Pin cylinder for Sargent® 6 Line (B Knob Only) Original Cylinder Spacer must be replaced with Medeco Cylinder Spacer CP-160321 (Included) - For Original Design, otherwise use 20*80147	2020173 (P)	\$111.00	\$60.32	\$69.50	
	2020173 (S)	\$101.50	\$55.32	\$60.00	
 6 Pin Cylinder for Sargent® 10 Line, Levers 7L & 8L - For Original Design, otherwise use 20*80147	2020349 (P)	\$111.00	\$60.32	\$69.50	
	2020349 (S)	\$101.50	\$55.32	\$60.00	
 6 Pin Cylinder for Sargent® 7600 Integra®	208005 (P)	\$111.00	\$60.32	\$69.50	
	208005 (S)	\$101.50	\$55.32	\$60.00	
 6 Pin Cylinder for Sargent® 7, 8, 9 Line (Excluding levers 7L, 8L, 9L) Includes: CT-Y35- CT-Y37- CT-Y17 & CT-Y45	208006 (P)	\$111.00	\$60.32	\$69.50	●
	208006 (S)	\$101.50	\$55.32	\$60.00	
 5 Pin Cylinder for Sargent® 6 Line Includes: CT-Y35, CT-Y37, CT-Y47, CT-Y55	208007 (P)	\$111.00	\$60.32	\$69.50	
	208007 (S)	\$101.50	\$55.32	\$60.00	
 6 Pin Cylinder for Sargent® 6, 7, & 10 line, 6500 Series (Not Available in Original Design) Includes: CT-Y35- CT-Y37- CT-Y47 & CT-Y55	2080147 (P)	\$112.50	\$61.14	\$71.00	●
	2080147 (S)	\$103.00	\$56.14	\$61.50	
 6 Pin Cylinder for Sargent® 11 Line (Not Available in Original Design)	2080148 (P)	\$112.50	\$61.14		
	2080148 (S)	\$103.00	\$56.14		

**Refer to the eCylinder section for more detail on specific technologies available and pricing. Technologies are represented by the following letters:
T = Medeco³, S = Medeco³ CLIQ, J = Medeco³ BiLevel, W = Biaxial, V = Medeco Biaxial CLIQ, K = Medeco KM, N = Medeco X4, C = Medeco CLIQ,

"-" = Original, Z = Medeco Original KW CLIQ, G = Medeco XT ***See key section for surcharges for custom coined cut keys or special stamping requirements.
Note: (P) refers to Pinned and (S) to Sub-Pinned at the end of each part string in the price book.

Schlage Cylinders

	Description	Part Number	Medeco ³	BiLevel	Medeco X4	eCylinder
	5 Pin Knob Cylinder for Schlage® "F" Series Plymouth & Ball Knob (Mfg prior to 2004)	2000400 (P)	\$111.00	\$60.32		
		2000400 (S)	\$101.50	\$55.32		
	6 Pin Cylinder for Schlage® "F" Series Orbit Design Only (Manufactured Prior to 2004)	2000700 (P)	\$111.00	\$60.32	\$69.50	
		2000700 (S)	\$101.50	\$55.32	\$60.00	
	5 Pin Cylinder for Schlage® "F" Series Lever (Manufactured Prior to 2004)	2001400 (P)	\$111.00	\$60.32		
		2001400 (S)	\$101.50	\$55.32		
	5 Pin Cylinder for Schlage® "F" Series Lever (Manufactured 2004 through 2007)	2001700 (P)	\$111.00	\$60.32		
		2001700 (S)	\$101.50	\$55.32		
	5 Pin Knob Cylinder for Schlage® "A" Series (Ply Only)	200700 (P)	\$111.00	\$60.32		
		200700 (S)	\$101.50	\$55.32		
	5 Pin Knob Cylinder for Schlage® "A" Series (Except Ply)	200701 (P)	\$111.00	\$55.32		
		200701 (S)	\$101.50	\$55.32		
	6 Pin Cylinder for Schlage® "A", "AL", & "D", Series Olympiad® Lever (Use CT-Y73, for "AL" thick doors)	2020049 (P)	\$111.00	\$60.32	\$69.50	●
		2020049 (S)	\$101.50	\$55.32	\$60.00	
	6 Pin Cylinder for Schlage® "C, D" Series (Ply Only)	2020051 (P)	\$111.00	\$60.32	\$69.50	●
		2020051 (S)	\$101.50	\$55.32	\$60.00	
	6 Pin Cylinder for Schlage® "C", & "D" Series Heavy Duty Knobs Ball, Globe & Sphere Designs Only	2020052 (P)	\$111.00	\$60.32	\$69.50	●
		2020052 (S)	\$101.50	\$55.32	\$60.00	
	6 Pin Cylinder for Schlage® "A" Series (Orbit® Only)	2020053 (P)	\$111.00	\$60.32	\$69.50	●
		2020053 (S)	\$101.50	\$55.32	\$60.00	
	6 Pin Knob Cylinder for Schlage® "ND" & "AL" Series Grade 1 Lever. **See note	2020073 (P)	\$111.00	\$60.32	\$69.50	●
		2020073 (S)	\$101.50	\$55.32	\$60.00	
	6 Pin Knob Cylinder for Schlage® "S" Series	2020097 (P)	\$111.00	\$60.32	\$69.50	
		2020097 (S)	\$101.50	\$55.32	\$60.00	
	6 Pin Knob Cylinder Assembly for Schlage® & Arrow® (Except Arrow "H" & "S" Series) Includes: CT-Y49, CT-Y52, CT-Y53, CT-Y70, CT-Y73, CT-Y74, CP-160321 **See note	20200H1 (P)	\$118.50	\$67.82	\$77.00	
		20200H1 (S)	\$109.00	\$62.82	\$67.50	



**Refer to the eCylinder section for more detail on specific technologies available and pricing. Technologies are represented by the following letters:

T = Medeco³, S = Medeco³ CLIQ, J = Medeco³ BiLevel, W = Biaxial, V = Medeco Biaxial CLIQ, K = Medeco KM, N = Medeco X4, C = Medeco CLIQ,

"-" = Original, Z = Medeco Original KW CLIQ, G = Medeco XT ***See key section for surcharges for custom coined cut keys or special stamping requirements.

Note: (P) refers to **Pinned** and (S) to **Sub-Pinned** at the end of each part string in the price book.

Schlage Cylinders



	Description	Part Number	Medeco ³	BiLevel	Medeco X4	eCylinder
	6 Pin Cylinder Package for Schlage A, AL, C, D, ND & Olympiad lever designs, includes: CT-Y49 (A, AL, & D Olympiad Lever & C & D Plymouth), CT-Y52 (C & D heavy duty knobs Ball, Globe & Sphere designs only), CT-Y53 (A series Orbit), CT-Y73 (ND series Gr. 1 lever & AL thick doors), and CT-Y74 (45-101 padlock) (Use CT-Y73 for thick doors) ** See note	20200S1 (P)	\$112.50	\$61.82	\$71.00	●
		20200S1 (S)	\$103.00	\$56.82	\$61.50	
	6 Pin Cylinder for Schlage D Series Lever, Athens, Rhodes & Sparta Designs	2020249 (P)	\$111.00	\$60.32	\$69.50	●
		2020249 (S)	\$101.50	\$55.32	\$60.00	

** The ND series with Sparta trim is not compatible with 17 bow (Biaxial large bow) keys. 12 bow (small bow) or 18 bow (largebow/extended throat) keys must be used instead.

Taco® Cylinders



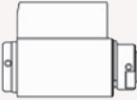



	Description	Part Number	Medeco ³	BiLevel	Medeco X4	eCylinder
	6 Pin Cylinder TACO® LXV Lever Lockset	200500 (P)	\$111.00	\$60.32	\$69.50	
		200500 (S)	\$101.50	\$55.32	\$60.00	

Yale® Cylinders



	Description	Part Number	Medeco ³	BiLevel	Medeco X4	eCylinder
	6 Pin Cylinder for Yale® Knobs 5300, 5400, 6100, 6200	200500 (P)	\$111.00	\$60.32	\$69.50	
		200500 (S)	\$101.50	\$55.32	\$60.00	
	6 Pin Cylinder for Yale® 5300LN, 5400LN, 4300 series knobs	200503 (P)	\$111.00	\$60.32	\$69.50	●
		200503 (S)	\$101.50	\$55.32	\$60.00	
	6 Pin cylinder for Yale® YMCL100, YMCL200	2020073 (P)	\$111.00	\$60.32	\$69.50	●
		2020073 (S)	\$101.50	\$55.32	\$60.00	
	6 Pin cylinder for Yale® 4600LN	2080700 (P)	\$111.00	\$60.32	\$69.50	
		2080700 (S)	\$101.50	\$55.32	\$60.00	

**Refer to the eCylinder section for more detail on specific technologies available and pricing. Technologies are represented by the following letters:
 T = Medeco³, S = Medeco³ CLIQ, J = Medeco³ BiLevel, W = Biaxial, V = Medeco Biaxial CLIQ, K = Medeco KM, N = Medeco X4, C = Medeco CLIQ,
 "-" = Original, Z = Medeco Original KW CLIQ, G = Medeco XT ***See key section for surcharges for custom coined cut keys or special stamping requirements.
Note: (P) refers to Pinned and (S) to Sub-Pinned at the end of each part string in the price book.

Arrow Deadbolt Cylinders

	Description	Part Number	Medeco ³	BiLevel	Medeco X4	eCylinder
	6 pin cylinder for Arrow JL Interconnected lock. (cylinder required for lever separately)	1065140 (P)	\$115.00	\$62.50	\$72.50	
		1065140 (S)	\$105.50	\$57.50	\$63.00	
	5 Pin Cylinder (6 Pin KeyMark) for Arrow D & E Series Single Cylinder Deadbolt includes CTF34 - CT-F-38	200801 (P)	\$112.50	\$61.14		
		200801 (S)	\$103.00	\$56.14		
	5 Pin Cylinder for Arrow D & E Series Double Cylinder Deadbolt	200802 (P)	\$112.50	\$61.14		
		200802 (S)	\$103.00	\$56.14		
	6 Pin Cylinder for Arrow D & E Series Single Cylinder Deadbolt	200901 (P)	\$112.50	\$61.14	\$71.00	●
		200901 (S)	\$103.00	\$56.14	\$61.50	
	6 Pin Cylinder for Arrow D & E Series Double Cylinder Deadbolt	200902 (P)	\$112.50	\$61.14	\$71.00	●
		200902 (S)	\$103.00	\$56.14	\$61.50	
	6 Pin cylinder for Arrow Revolution Deadbolt <i>*Contact Factory before ordering</i>	200901 (P)	\$112.50	\$61.14	\$71.00	●
		200901 (S)	\$103.00	\$56.14	\$61.50	

Baldwin® Deadbolt Cylinders

	Description	Part Number	Medeco ³	BiLevel	Medeco X4	eCylinder
	5 Pin Rim Type Lazy Motion Single Cylinder handlesets and deadbolts	1075127 (P)	\$135.50	\$80.04	\$76.50	
		1075127 (S)	\$126.00	\$75.04	\$67.00	
	5 Pin Lazy Motion cylinder for Baldwin 2 point lock handleset (lower cylinder)	2001851 (P)	\$111.00	\$60.32		
		2001851 (S)	\$101.50	\$55.32		



Cal-Royal Deadbolt Cylinder

	Description	Part Number	Medeco ³	BiLevel	Medeco X4	eCylinder
	6 Pin Cylinder for Cal-Royal T-300 Series Grade 2 Deadbolt, Includes: CT-F34, DT-F35, CTF36, CT-F37 & CT-F38	20009S4 (P)	\$115.00	\$64.32	\$73.50	●
		20009S4 (S)	\$105.50	\$59.32	\$64.00	

Corbin Russwin Deadbolt Cylinder



	Description	Part Number	Medeco ³	BiLevel	Medeco X4	eCylinder
	6 Pin Cylinder for Corbin Russwin DL2100, DL3100 Deadbolt	2051027 (P)	\$111.00	\$60.32	\$71.00	
		2051027 (S)	\$101.50	\$55.32	\$61.50	

Emtek® Deadbolt Cylinders

	Description	Part Number	Medeco ³	BiLevel	Medeco X4	eCylinder
	5 Pin Rim Lazy Motion Rim Type Cylinder to fit Emtek® Handleset & Deadbolt Outside Cylinder	1065140 (P)	\$115.00	\$62.50	\$72.50	
		1065140 (S)	\$105.50	\$57.50	\$63.00	
	5 Pin Rim Lazy Motion Rim Type Cylinder To Inside Cylinder w/ Emtek Tailpiece	1065244 (P)	\$121.50	\$66.04		
		1065244 (S)	\$112.00	\$61.04		

**Refer to the eCylinder section for more detail on specific technologies available and pricing. Technologies are represented by the following letters:
T = Medeco³, S = Medeco³ CLIQ, J = Medeco³ BiLevel, W = Biaxial, V = Medeco Biaxial CLIQ, K = Medeco KM, N = Medeco X4, C = Medeco CLIQ,
“-” = Original, Z = Medeco Original KW CLIQ, G = Medeco XT ***See key section for surcharges for custom coined cut keys or special stamping requirements.
Note: (P) refers to **Pinned** and (S) to **Sub-Pinned** at the end of each part string in the price book.

Falcon Deadbolt Cylinders

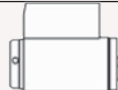
	Description	Part Number	Medeco ³	BiLevel	Medeco X4	eCylinder
	6 Pin Cylinder for Falcon Single Cylinder Deadbolt Lock (New Style)	200903 (P)	\$112.50	\$61.14	\$71.00	●
		200903 (S)	\$103.00	\$56.14	\$61.50	
	5 Pin Cylinder for Falcon Single Cylinder Deadbolt Lock (Old Style)	206005 (P)	\$112.50	\$61.14		
		206005 (S)	\$103.00	\$56.14		
	5 Pin Cylinder for Falcon Double Cylinder Deadbolt Lock (Old Style)	206100 (P)	\$111.00	\$60.32		
		206100 (S)	\$101.50	\$55.32		







Kwikset® Deadbolt Cylinders

	Description	Part Number	Medeco ³	BiLevel	Medeco X4	eCylinder
	6 Pin Lazy Motion Rim Type for Kwikset® Single Cylinder deadbolts, except Powerbolt	1012040 (P)	\$118.50	\$64.41		
		1012040 (S)	\$109.00	\$59.41		

PDQ Deadbolt Cylinder

	Description	Part Number	Medeco ³	BiLevel	Medeco X4	eCylinder
	6 Pin Cylinder for PDQ KV Series Deadbolt	200903 (P)	\$112.50	\$61.14	\$71.00	●
		200903 (S)	\$103.00	\$56.14	\$61.50	

Sargent Deadbolt Cylinder

	Description	Part Number	Medeco ³	BiLevel	Medeco X4	eCylinder
	6 Pin Cylinder for 470 & 480 Single Cylinder Deadbolt Lock	200901 (P)	\$112.50	\$61.14	\$71.00	●
		200901 (S)	\$103.00	\$56.14	\$61.50	
	6 Pin Cylinder for Sargent 470 & 480 Double Cylinder Deadbolt Lock	200902 (P)	\$112.50	\$61.14	\$71.00	●
		200902 (S)	\$103.00	\$56.14	\$61.50	
	5 Pin Cylinder for Sargent 470 & 480 Single Cylinder Deadbolt	200801 (P)	\$112.50	\$61.14		
		200801 (S)	\$103.00	\$56.14		
	5 Pin Cylinder for Sargent 470 & 480 Double Cylinder Deadbolt	200802 (P)	\$112.50	\$61.14		
		200802 (S)	\$103.00	\$56.14		
	5 Pin cylinder for Sargent 460 Single Cylinder deadbolt	200807 (P)	\$112.50	\$61.14		
		200807 (S)	\$103.00	\$56.14		
	6 Pin cylinder for Sargent 460 Single Cylinder deadbolt	200907 (P)	\$112.50	\$61.14	\$71.00	
		200907 (S)	\$103.00	\$56.14	\$61.50	
	5 Pin cylinder for Sargent 460 Double Cylinder deadbolt	200808 (P)	\$112.50	\$61.14		
		200808 (S)	\$103.00	\$56.14		
	6 Pin cylinder for Sargent 460 Double Cylinder deadbolt	200908 (P)	\$112.50	\$61.14	\$71.00	
		200908 (S)	\$103.00	\$56.14	\$61.50	



**Refer to the eCylinder section for more detail on specific technologies available and pricing. Technologies are represented by the following letters:

T = Medeco³, S = Medeco³ CLIQ, J = Medeco³ BiLevel, W = Biaxial, V = Medeco Biaxial CLIQ, K = Medeco KM, N = Medeco X4, C = Medeco CLIQ,

"-" = Original, Z = Medeco Original KW CLIQ, G = Medeco XT ***See key section for surcharges for custom coined cut keys or special stamping requirements.

Note: (P) refers to Pinned and (S) to Sub-Pinned at the end of each part string in the price book.

Schlage® Deadbolt Cylinder





	Description	Part Number	Medeco ³	BiLevel	Medeco X4	eCylinder
	5 Pin Lazy Motion Schlage® Outside Cylinder for "E", "H", B200, B400 Series Deadbolt (Rim Type Cylinder) includes CT-F34-CT-F38	10651S4 (P)	\$132.50	\$80.00	\$72.50	
		10651S4 (S)	\$123.00	\$75.00	\$63.00	
	5 Pin Lazy Motion Schlage® Inside Cylinder for B200/B400 Series Deadbolt Lock (Rim Type Cylinder) includes CT-F34-CT-F38	10652S4 (P)	\$130.50	\$74.04	\$76.50	
		10652S4 (S)	\$121.00	\$69.04	\$67.00	
	6 Pin Lazy Motion Schlage® Outside Cylinder for "E", "H", B200, B400 Series Deadbolt Lock (Rim Type Cylinder) includes: CT-F34-CT-F38	10661S4 (P)	\$133.00	\$77.54	\$78.50	
		10661S4 (S)	\$123.50	\$72.54	\$69.50	
	6 Pin Lazy Motion Schlage® Inside Cylinder for B200 and B400 Series Deadbolt Lock (Rim Type Cylinder) includes: CT-F34-CT-F38	10662S4 (P)	\$130.50	\$61.39	\$85.50	
		10662S4 (S)	\$121.00	\$56.39	\$76.00	
	5 Pin Laz Motion Cylinder for Schlage B Series Deadbolt Lock (less tailpiece)	2000800 (P)	\$111.00	\$60.32		
		2000800 (S)	\$101.50	\$55.32		
	5 Pin Knob Cylinder for Schlage B, E, and F160 Series Deadbolt lock, includes CT-F34, CT-F38	20008S4 (P)	\$111.50	\$62.41		
		20008S4 (S)	\$102.00	\$57.41		
	6 Pin Lazy Motion Cylinder Schlage B Series (Old Style) deadbolt	200904 (P)	\$112.50	\$61.14		●
		200904 (S)	\$103.00	\$56.14		
	6 Pin Lazy Motion Cylinder for Schlage B Series Deadbolt (less tailpiece) except B662 after 2001	2000900 (P)	\$111.00	\$60.32	\$69.50	●
		2000900 (S)	\$101.50	\$55.32	\$60.00	
	6 Pin Lazy Motion Knob Cylinder for Schlage® "B", "E", and F160 includes: CT-F34, CTF35, CT-F36, CT-F37, CT-F38	20009S4 (P)	\$115.00	\$64.32	\$73.50	●
		20009S4 (S)	\$105.50	\$59.32	\$64.00	

Segal® Deadbolt Cylinder

	Description	Part Number	Medeco ³	BiLevel	Medeco X4	eCylinder
5 Pin Segal® Inside Cylinder before 10/99 for double cylinder dropbolt		100800 (P)	\$112.50		\$77.00	
		100800 (S)	\$103.00		\$67.50	
5 Pin Segal® Inside Cylinder after 10/99 for double cylinder dropbolt		100805 (P)	\$112.50			
		100805 (S)	\$103.00			

**Refer to the eCylinder section for more detail on specific technologies available and pricing. Technologies are represented by the following letters:
T = Medeco³, S = Medeco³ CLIQ, J = Medeco³ BiLevel, W = Biaxial, V = Medeco Biaxial CLIQ, K = Medeco KM, N = Medeco X4, C = Medeco CLIQ,
“-” = Original, Z = Medeco Original KW CLIQ, G = Medeco XT ***See key section for surcharges for custom coined cut keys or special stamping requirements.
Note: (P) refers to **Pinned** and **(S)** to **Sub-Pinned** at the end of each part string in the price book.

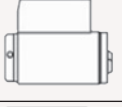
Weiser® Deadbolt Cylinders

	Description	Part Number	Medeco ³	BiLevel	Medeco X4	eCylinder
	5 Pin Lazy Motion Outside Cylinder for Weiser® Prestige Series Deadbolt and Entryset/ Handleset	100602 (P)	\$110.00	\$59.77	\$75.00	
		100602 (S)	\$100.50	\$54.77	\$65.50	
	6 Pin Lazy Motion Outside Cylinder for Weiser Prestige Entryset/Handleset	100702 (P)	\$115.00	\$62.50	\$77.00	
		100702 (S)	\$105.50	\$57.50	\$67.50	
	6 Pin Cylinder for Weiser® Single Cylinder Deadbolt, including powerbolt	200903 (P)	\$112.50	\$61.14	\$71.00	●
		200903 (S)	\$103.00	\$56.14	\$61.50	
	5 Pin Cylinder for Weiser® Single Cylinder Deadbolt	206005 (P)	\$112.50	\$61.14		
		206005 (S)	\$103.00	\$56.14		
	5 Pin Cylinder for Weiser® Double Cylinder Deadbolt	206100 (P)	\$111.00	\$60.32		
		206100 (S)	\$101.50	\$55.32		
	5 Pin Cylinder for Weiser® 4000, 4200 Single Cylinder Deadbolt	207001 (P)	\$112.50	\$61.14		
		207001 (S)	\$103.00	\$56.14		

Yale Deadbolt Cylinders

	Description	Part Number	Medeco ³	BiLevel	Medeco X4	eCylinder
	6 Pin Cylinder for Yale 3300, 3500, & 3600 Series Deadbolt Locks	2051027 (P)	\$111.00	\$60.32		
		2051027 (S)	\$101.50	\$55.32		

Abus Padlock Cylinders

	Description	Part Number	Medeco ³	BiLevel	Medeco X4	eCylinder
	6 Pin Cylinder for Abus® Padlock Series 83KNK/45, 83KNK/50 & 83KNK/55	2020000 (P)	\$111.00	\$49.32	\$69.50	●
		2020000 (S)	\$101.50	\$44.32	\$60.00	

American Padlock Cylinders

	Description	Part Number	Medeco ³	BiLevel	Medeco X4	eCylinder
	BiLevel KeyMark eCylinder 6 Pin Cylinder for American® 3600/3700 Padlock (Note: Use American® Driver DR-MED6)	2020000 (P)	\$111.00	\$49.32	\$69.50	●
		2020000 (S)	\$101.50	\$44.32	\$60.00	

Master Padlock Cylinders

	Description	Part Number	Medeco ³	BiLevel	Medeco X4	eCylinder
	6 Pin Cylinder for Master® “29” and 6600, 6700 Pro Series (Note: Use Master® Driver 0298-627 for Pro Series)	2020000 (P)	\$111.00	\$49.32	\$69.50	●
		2020000 (S)	\$101.50	\$44.32	\$60.00	

**Refer to the eCylinder section for more detail on specific technologies available and pricing. Technologies are represented by the following letters:

T = Medeco³, S = Medeco³ CLIQ, J = Medeco³ BiLevel, W = Biaxial, V = Medeco Biaxial CLIQ, K = Medeco KM, N = Medeco X4, C = Medeco CLIQ, “-” = Original, Z = Medeco Original KW CLIQ, G = Medeco XT ***See key section for surcharges for custom coined cut keys or special stamping requirements.

Note: (P) refers to Pinned and (S) to Sub-Pinned at the end of each part string in the price book.

Medeco System Series Padlock Cylinders

Description	Part Number	Medeco ³	BiLevel	Medeco X4	eCylinder
 6 Pin cylinder for System Series KIK style padlocks	510600 (P)	\$81.00	\$44.12	\$70.50	●
	510600 (S)	\$71.50	\$39.12	\$61.00	

New Standard Mfg. Co. Padlock Cylinders

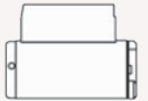
Description	Part Number	Medeco ³	BiLevel	Medeco X4	eCylinder
 6 Pin Cylinder for New Standard® Padlocks	2020052 (P)	\$111.00	\$60.32	\$69.50	●
	2020052 (S)	\$101.50	\$55.32	\$60.00	

Schlage Padlock Cylinders

Description	Part Number	Medeco ³	BiLevel	Medeco X4	eCylinder
 6 Pin Cylinder for Schlage® 45-101 Padlock	2020074 (P)	\$111.00	\$60.32	\$69.50	●
	2020074 (S)	\$101.50	\$55.32	\$60.00	

KIK/KIL Cylinder Components

Description	Part Number	Price
Medeco ³ Slider Package. (Includes slider & spring)	940174	\$11.39
Medeco BiLevel slider package	940227	\$11.39
Flat Head Machine Screw, 5/16" -#2-56 UNC, Phillips with Nylok Patch for 20-200XX Cylinders. Sold in Bags of 100	CP-010203-050	\$0.17 each
Pan Head Machine Screw, 1/4" -#2-56 UNC, Phillips with Nylok Patch for most Lazy Motion Cylinders. Sold in Bags of 100	CP-010503-040	\$0.29 each
Retaining Ring, Knob Cylinder "E" Clip	CP-020020	\$1.26
Retaining Ring, Knob Cylinder, Full Clip	CP-020040	\$2.54
Retaining Ring, Knob Cylinder Plug Retainer, "C" Clip	CP-020100	\$0.80
Lazy Motion Tailpiece Retainer for 20*090X cylinders	CP-021031	\$1.52
Tailpiece Retainer ring for Arrow and Sargent clip on tailpieces	CP-021130	\$2.31
Plug Retainer, Standard Knob	CP-021370	\$6.23
Castle Nut Retainer for Schlage type lazy motion cylinders	CP-021651	\$9.77
Compression Spring for Schlage type lazy motion cylinders	CP-030670	\$1.29
Drive Disk for Schlage® -type Lazy Motion Cylinders	CP-041200	\$3.31
Detent Pin for Schlage type lazy motion cylinders	CP-064490	\$1.44

KIK/KIL Cylinder Plugs

Description	Part Number	Price
Plug for 20-200XX- (Medeco Original)	12126002 -	\$46.00
Plug for 20W200XX (Medeco Biaxial®)	12126156 W	\$46.00
Plug for 20T200XX (Medeco ³ ®)	1212633 T	\$46.00

Mailbox Lock Cylinders

Description	Part Number	(S) Pricing	(P) Pricing
6 Pin Medeco ³ Rim Style mailbox cylinder, less slider	490357 T	\$132.50	\$142.00
6 Pin Medeco ³ Key in Knob Style mailbox cylinder, less slider	490375 T	\$129.00	\$138.50
6 Pin Medeco ³ BiLevel Mailbox cylinder	200104 J	\$61.50	\$66.50
6 Pin Mailbox cylinder. Medeco KM only	200155 K	\$88.00	\$97.50
6 Pin Mailbox cylinder	200156 K	\$88.00	\$97.50

**Refer to the eCylinder section for more detail on specific technologies available and pricing. Technologies are represented by the following letters:

T = Medeco³, S = Medeco³ CLIQ, J = Medeco³ BiLevel, W = Biaxial, V = Medeco Biaxial CLIQ, K = Medeco KM, N = Medeco X4, C = Medeco CLIQ, "-" = Original, Z = Medeco Original KW CLIQ, G = Medeco XT ***See key section for surcharges for custom coined cut keys or special stamping requirements.

Note: (P) refers to **Pinned** and (S) to **Sub-Pinned** at the end of each part string in the price book.

KIK/KIL Cylinder Tailpieces

Description	Part Number	Price
 Tailpiece for Schlage® B200, B400, B500, Series (Double Cylinder)	CT-F34	\$3.42
 Tailpiece for Schlage® F160, B100, B200, B400, B500 Series (Double Cylinder)	CT-F35	\$3.42
 Tailpiece for Schlage® B200, B400 Series (Double Cylinder)	CT-F36	\$3.42
 Tailpiece for Schlage® F160, B100, B200, B400, B500 Series (Double Cylinder)	CT-F37	\$3.42
 Tailpiece for Schlage® "E", F160, "H", B100, B200, B400, B500 Series (Single Cylinder)	CT-F38	\$3.42
 Tailpiece for Baldwin® Images Series	CT-F40	\$10.50
 Tailpiece for Marks® 190S Lever Lockset	CT-V00	\$3.42
 Tailpiece for Marks® 190AB Lever Lockset	CT-V01	\$3.42
 Tailpiece for PDQ® SP	CT-V02	\$3.42
 Tailpiece for Falcon® "T" Series	CT-V03	\$3.42
 Tailpiece for Corbin® Russwin® 3900 Series Lever Lock	CT-V19	\$3.42
 Tailpiece for Sargent® 11 Line TZone	CT-V35	\$7.29
 Tailpiece for Anderson® Door Locks	CT-V39	\$3.42
 Tailpiece for Kwikset®	CT-V40	\$14.50
 Tailpiece for Schlage® Lazy Motion	CT-Y08	\$3.42













**Refer to the eCylinder section for more detail on specific technologies available and pricing. Technologies are represented by the following letters:
T = Medeco³, S = Medeco³ CLIQ, J = Medeco³ BiLevel, W = Biaxial, V = Medeco Biaxial CLIQ, K = Medeco KM, N = Medeco X4, C = Medeco CLIQ,
“-” = Original, Z = Medeco Original KW CLIQ, G = Medeco XT ***See key section for surcharges for custom coined cut keys or special stamping requirements.
Note: (P) refers to **Pinned** and **(S)** to **Sub-Pinned** at the end of each part string in the price book.

KIK/KIL Cylinder Tailpieces

Description	Part Number	Price
 Tailpiece for Schlage® Deadbolt Lock (.542")	CT-Y24	\$3.42
 Tailpiece for Baldwin®, Falcon®, Marvin®, Weiser® & Yale® (Lazy Motion)	CT-Y27	\$3.42
 Tailpiece for Schlage® "G" Series Knob Lock	CT-Y28	\$16.50
 Tailpiece for Weiser® 4370 Deadbolt Lock	CT-Y29	\$3.42
 Tailpiece for Dexter® Double Cylinder Deadbolt Lock 4209	CT-Y31	\$3.42
 Tailpiece for Sargent® 6 Line (.685" Length)	CT-Y35	\$3.42
 Tailpiece for Sargent® 6 Line	CT-Y37	\$3.42
 Tailpiece for Russwin® Forum (20-5008) Line	CT-Y46	\$3.42
 Tailpiece for Arrow® 151 Knob and Sargent® 10 Line	CT-Y47	\$3.42
 Tailpiece for Schlage® "C", "D", & Olympiad® Lever & Falcon® "B", "F" Series	CT-Y49	\$3.42
 Tailpiece for Schlage® "A" Series & "C", "D" Series (Ball, Globe, Sphere Design)	CT-Y52	\$3.42
 Tailpiece for Schlage® "A" Series (Orbit Design Only)	CT-Y53	\$3.42
 Tailpiece for Falcon® "S" Series Knob (Except "H" Knob)	CT-Y54	\$3.42
 Tailpiece for Sargent® 10 Line	CT-Y55	\$3.42
 Tailpiece for Yale® AU5400 Lever Handle (Old Style)	CT-Y57	\$3.42

**Refer to the eCylinder section for more detail on specific technologies available and pricing. Technologies are represented by the following letters:
T = Medeco³, S = Medeco³ CLIQ, J = Medeco³ BiLevel, W = Biaxial, V = Medeco Biaxial CLIQ, K = Medeco KM, N = Medeco X4, C = Medeco CLIQ,
"-." = Original, Z = Medeco Original KW CLIQ, G = Medeco XT ***See key section for surcharges for custom coined cut keys or special stamping requirements.
Note: (P) refers to **Pinned** and **(S)** to **Sub-Pinned** at the end of each part string in the price book.

KIK/KIL Cylinder Tailpieces

Description	Part Number	Price
 Tailpiece for Falcon® "S" Series "H" Knob	CT-Y58	\$3.42
 Tailpiece for Yale® 5400LN Series Lever Lockset	CT-Y67	\$3.42
 Tailpiece for Falcon® "X" Series Knob (Except "H" Knob)	CT-Y68	\$3.42
 Tailpiece for Lockwood® Knob Lock	CT-Y69	\$3.42
 Tailpiece for Arrow® "M" Series, LSDA® 100 Series & Sargent® 6 Line	CT-Y70	\$3.42
 Tailpiece for Falcon® "X" Series "H" Knob	CT-Y71	\$3.42
 Tailpiece for Falcon® "X" Series Lever Lock	CT-Y72	\$3.42
 Tailpiece for Arrow® "M" Series, LSDA® 100 Series & Sargent® 6 Line (B Knob Only), Schlage ND lever	CT-Y73	\$3.42
 Tailpiece for Schlage® 45-101 Padlock	CT-Y74	\$3.42
 Tailpiece for Russwin® 3300 & 4300 Series	CT-Y75	\$3.42
 Tailpiece for Russwin® 3400 Series & Corbin® 6600 Series	CT-Y77	\$3.42
 Tailpiece for LSDA® LX1000 Lever Lockset	CT-Y78	\$3.42

**Refer to the eCylinder section for more detail on specific technologies available and pricing. Technologies are represented by the following letters:
T = Medeco³, S = Medeco³ CLIQ, J = Medeco³ BiLevel, W = Biaxial, V = Medeco Biaxial CLIQ, K = Medeco KM, N = Medeco X4, C = Medeco CLIQ,
"-." = Original, Z = Medeco Original KW CLIQ, G = Medeco XT ***See key section for surcharges for custom coined cut keys or special stamping requirements.
Note: (P) refers to **Pinned** and **(S)** to **Sub-Pinned** at the end of each part string in the price book.

KIK/KIL Tailpiece Packages

Description	Part Number	Price
Tailpiece Package for Arrow®: Listed as A1 in cylinder part number. Includes CT-Y70, CT-Y73 & CP-160321 (Spacer)	940034	\$9.94
Tailpiece Package for Schlage®: Listed as S1 in cylinder part number. Includes CT-Y49, CT-Y52, CT-Y53, CT-Y73, CT-Y74	940036	\$9.94
Tailpiece Package for Falcon®: Listed as F1 in cylinder part number. Includes CT-Y49, CT-Y54, CT-Y58, CT-Y68, CT-Y71, CT-Y72 & CP-160311	940035	\$9.94
Tailpiece Package for LSDA®: Listed as L1 in cylinder part number. Includes CT-Y49, CT-Y70, CT-Y73, CT-78	940272	\$9.94
Tailpiece Package for Schlage® "S" Series: Includes CT-Y97 & CP-021370	940051	\$25.50
Tailpiece package for Arrow®, Schlage® & Sargent®: Listed as H1 in cylinder part number. Includes CT-Y49, CT-Y52, CT-Y53, CT-Y54, CTY70, CT-Y73, & CP-160321	940061	\$18.00
Tailpiece Package for Sargent® & Arrow®: Includes CT-Y35, CT-Y37, CT-Y47, CT-Y55	940067	\$3.00
Tailpiece Package for Schlage® Deadbolt Cylinders: Listed as S4 in cylinder part number. Includes CT-F34, CT-F35, CT-F36, CT-F37, CT-F38	940098	\$9.94

**Refer to the eCylinder section for more detail on specific technologies available and pricing. Technologies are represented by the following letters:

T = Medeco³, S = Medeco³ CLIQ, J = Medeco³ BiLevel, W = Biaxial, V = Medeco Biaxial CLIQ, K = Medeco KM, N = Medeco X4, C = Medeco CLIQ, "-" = Original, Z = Medeco Original KW CLIQ, G = Medeco XT ***See key section for surcharges for custom coined cut keys or special stamping requirements.

Note: (P) refers to **Pinned** and **(S)** to **Sub-Pinned** at the end of each part string in the price book.

Interchangeable Core

FEATURES	Medeco ³	BiLevel	Medeco X4	CLIQ	Medeco XT
Utility patented key control provides protection from unauthorized duplication of keys	●	●	●	●	●
UL437 Listing and BHMA Certification provide validation of high security from recognized, independent testing laboratories	●				
Triple locking principle provides pick resistance and large numbers of combinations for master keying flexibility to accommodate systems of virtually any size	●				
Hardened steel inserts in the cylinder face and hardened steel driver pins provide proven drill resistance	●				
Solid brass construction provides high quality and long cylinder life	●	●	●		
Nickel plated pins designed to provide exceptional wear resistance (Medeco X4 solid Nickel)	●	●	●		
Retrofits into virtually any manufacturers' locksets with a wide selection of interchangeable cams to fit various manufacturers' mortise series hardware for cost effective improved security	●	●	●	●	●
Ability to key with non-interchangeable core cylinders, including rim and mortise, knob style for Medeco BiLevel cost effective system flexibility	●	●	●		
High security and key control may be incorporated in a single system for cost effective system flexibility	●	●		●	
Keys may be integrated with Hybrid proximity head for greater system retrofit	●	●	●	●	

Medeco³ Premium High Security

For effective mechanical protection against most forms of attack as well as protection against unauthorized duplicate keys, Medeco³ cylinders are recommended. Security features including hardened steel components, pins that must be elevated, rotated, and interact with both a sidebar and a slider, and additional pick resistant features make Medeco³ the cylinder of choice to protect people, property and information.

Medeco³ BiLevel Patented Key Control

Medeco³ BiLevel cylinders may be incorporated into a master key system with Medeco³ high security, offering protection against all types of attack where needed, and patented key control cylinders for areas requiring less protection. BiLevel cylinders offer patented control against unauthorized duplication of keys without the additional security features protecting against force or surreptitious attack.

Medeco X4 Patented Key Control

Medeco X4 cylinders offer patented control against unauthorized duplication of keys without the additional security features protecting against force or surreptitious attack.

Loss & Liability Control

Many of the cylinders in this section are also available with an eCylinder Loss & Liability Control Solution. See the eCylinder Section for more details.

Large Format Interchangeable Cores

Offering increased security with rapid combination changes, interchangeable core cylinders enable quick and easy cylinder changes by non-technical personnel by using a special control key to remove the cylinder (core) from the lock housing. A core with a new combination can then be inserted, which in effect rekeys the lock. All of this can be done without having to take the lock apart, which reduces the expense of calling outside service personnel to perform routine lock rekeys. These cylinder/core combinations are often used on doors of high-turnover businesses, like fast-food or manufacturing environments, where rapid rekeying is often desirable. Medeco's patented high security technology provides protection against unauthorized duplication of keys, along with hardened inserts to resist drilling and features that protect against other types of attack.



Patented Key Control

Protects against unauthorized duplication of your keys.



Uses Existing Hardware

Medeco offers the largest selection of retrofit Large Format Interchangeable Cores (LFIC) that reduce cost by eliminating the need to replace your existing hardware.



Quickly Change Cores

Provides quick and easy cylinder changes in the event keys are lost or stolen.



Protection From Physical Attack

Medeco³ LFIC cylinders are UL 437 listed and use hardened stainless steel inserts in the cylinder face to provide drill and pick resistance resistance.



Special Angle Cut Keys

Requires a special key cutting machine and access to Medeco specific blanks, available in a variety of restrictions to support every need.



Picking and Bumping Protection

Medeco³ cylinders use a sidebar that prevent the key from rotating until it is elevated, rotated and aligned in the correct position. This feature protects against bumping and picking attacks.

Technical Information:

- ANSI A156.30 Level A certification assures patent protected key control and physical strength
- ANSI A156.5 Grade 1 certification assures consistent quality for heavy use applications
- 32 Series are available in 5 and 6 Pin versions
- Solid brass construction provides high quality and long cylinder life
- Nickel plated pins provide exceptional wear resistance and additional hardened stainless steel pins provide drill resistance
- Ability to key with non-interchangeable core cylinders, including rim & mortise and knob style for cost effective system flexibility

Applications:

Office buildings, Universities, Apartments, Perimeter Doors, Schools and Hospitals.

Warranty:

Warranted for two (2) years against manufacturer's defects. See Medeco's limited warranty for full details.

Finishes:

Available in all standard finishes to match with existing hardware.

Available Key Technologies:











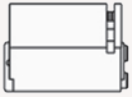

Mechanical:

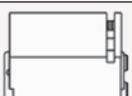
- Medeco³
- Medeco³ BiLevel
- Medeco X4

eCylinder:





- Medeco³ CLIQ
- Medeco CLIQ

Large Format Interchangeable Core

Description	Part Number	Medeco ³	BiLevel	Medeco X4	eCylinder
 Yale® Large Format Interchangeable Core, 6 Pin (Masterkey upcharges apply)	310100 (P)	\$119.00	\$65.00	\$78.00	●
	310100 (S)	\$109.50	\$60.00	\$68.50	
 6 Pin Control Keyblank for 31-0100 cylinders	KYB XX6611	\$7.14			
 6 Pin Core for 7 Pin Yale® Large Format Interchangeable Core Housing (Masterkey upcharges apply)	310100A (P)	\$119.00	\$65.00	\$78.00	●
	310100A (S)	\$109.50	\$60.00	\$68.50	
 7 Pin Control Keyblank for high security 31-0100A cylinders	KYB XX7600	\$7.14			
 7 Pin Control keyblank for KeyMark 31-0100A cylinders	KYB XX7611		\$7.14		
 6 Pin Interchangeable Core Insert Construction Core (Yale® Style) Cut keys provided separately – 12 keys Maximum	310100CC BI R1	\$119.00			
 5 Pin Large Format Interchangeable Core (Masterkey upcharges apply)	320101 (P)	\$118.00	\$64.13		
	320101 (S)	\$108.50	\$59.13		
 5 Pin Large Format Interchangeable Core for Simplex® Unican® 1000-2m Manufactured Before 2/10/92 (Masterkey upcharges apply)	320101H (P)	\$118.00			
	320101H (S)	\$108.50			
 6 Pin Large Format Interchangeable Core (Masterkey upcharges apply)	320201 (P)	\$119.00	\$64.68		●
	320201 (S)	\$109.50	\$59.68		
 6 Pin Large Format Interchangeable Core for Simplex® Unican® 1000-2m Manufactured Before 2/10/92 (Masterkey upcharges apply)	320201H (P)	\$119.00	\$64.68		
	320201H (S)	\$109.50	\$59.68		
 6 Pin Large Format Removable Core Insert Construction Core Cut keys sold separately – 12 keys maximum	320201CC BI R1	\$119.00			
 6 Pin Large Format Hotel Function Interchangeable Core (Masterkey upcharges apply)	321201 (P)	\$122.00			
	321201 (S)	\$112.50			
 6 Pin Large Format Interchangeable Core Hotel Function with Extended Plug Face (Masterkey upcharges apply)	321201D (P)	\$139.50			
	321201D (S)	\$130.00			
 6 Pin Large Format Interchangeable Core with Extended Plug Face (Masterkey upcharges apply)	324201 (P)	\$119.00	\$64.68		
	324201 (S)	\$109.50	\$59.68		

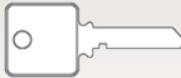
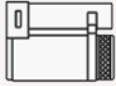
**Refer to the eCylinder section for more detail on specific technologies available and pricing. Technologies are represented by the following letters:
T = Medeco³, S = Medeco³ CLIQ, J = Medeco³ BiLevel, W = Biaxial, V = Medeco Biaxial CLIQ, K = Medeco KM, N = Medeco X4, C = Medeco CLIQ,
“-” = Original, Z = Medeco Original KW CLIQ, G = Medeco XT ***See key section for surcharges for custom coined cut keys or special stamping requirements.
Note: (P) refers to **Pinned** and **(S)** to **Sub-Pinned** at the end of each part string in the price book.

Large Format Interchangeable Core

Description	Part Number	Medeco ³	BiLevel	Medeco X4	eCylinder
 6 Pin Emergency Keyblank for 321201	KYB XX6620 XX 05	\$7.14			
 6 Pin Large Format Interchangeable Core (Schlage®) (Masterkey upcharges apply)	322201 (P)			\$81.00	●
	322201 (S)			\$71.50	
 7 Pin Control Keyblank for 322201	KYB XX7631 XX 05			\$7.14	
 6 Pin Large Format Interchangeable Core (Corbin Russwin®) (Masterkey upcharges apply)	322301 (P)	\$119.00		\$81.00	
	322301 (S)	\$109.50		\$71.50	
 6 Pin Large Format Interchangeable Core (Sargent®), (Masterkey upcharges apply)	322401 (P)	\$119.00		\$81.00	
	322401 (S)	\$109.50		\$71.50	
 7 Pin Large Format Interchangeable Core (Corbin Russwin®), (Masterkey upcharges apply)	322801 (P)			\$89.50	
	322801 (S)			\$80.00	

**Refer to the eCylinder section for more detail on specific technologies available and pricing. Technologies are represented by the following letters:
 T = Medeco³, S = Medeco³ CLIQ, J = Medeco³ BiLevel, W = Biaxial, V = Medeco Biaxial CLIQ, K = Medeco KM, N = Medeco X4, C = Medeco CLIQ,
 "-" = Original, Z = Medeco Original KW CLIQ, G = Medeco XT ***See key section for surcharges for custom coined cut keys or special stamping requirements.
Note: (P) refers to **Pinned** and **(S)** to **Sub-Pinned** at the end of each part string in the price book.

LFIC Mortise Cylinders













Description	Part Number	Medeco ³	BiLevel	Medeco X4	eCylinder
 6 Pin Mortise Cylinder for Yale® (Masterkey upcharges apply)	310101 (P)	\$195.50	\$141.50		
	310101 (S)	\$186.00	\$136.50		
 7 Pin Mortise Cylinder Assembly for Yale® (Masterkey upcharges apply)	310101A (P)	\$195.50	\$141.50		
	310101A (S)	\$186.00	\$136.50		
 5 Pin 1" Mortise Cylinder Assembly (Masterkey upcharges apply)	320100 (P)	\$194.50	\$141.50		
	320100 (S)	\$185.00	\$136.50		
 6 Pin 1 1/4" Mortise Cylinder Assembly (Masterkey upcharges apply)	320200 (P)	\$195.50	\$141.50		
	320200 (S)	\$186.00	\$136.50		
 6 Pin LFIC Mortise Cylinder Assembly Hotel Function (Masterkey upcharges apply)	321200 (P)	\$198.00			
	321200 (S)	\$188.50			
 6 Pin Mortise Cylinder Master Corbin Russwin® Ring Size Assembly (Masterkey upcharges apply)	321350 (P)	\$224.00			
	321350 (S)	\$214.50			
 6 Pin LFIC Mortise Cylinder Assembly with Raised Plug Face (Masterkey upcharges apply)	324200 (P)	\$195.50			
	324200 (S)	\$186.00			
 6 Pin 1 1/2" LFIC Mortise Cylinder Assembly (Masterkey upcharges apply)	325200 (P)	\$325.00			
	325200 (S)	\$315.50			
 6 Pin 1 3/4" LFIC Mortise Cylinder Assembly (Masterkey upcharges apply)	325400 (P)	\$335.50			
	325400 (S)	\$326.00			
 6 Pin 2" LFIC Mortise Cylinder Assembly (Masterkey upcharges apply)	325500 (P)	\$346.00			
	325500 (S)	\$336.50			
 6 Pin 2 1/4" LFIC Mortise Cylinder Assembly (Masterkey upcharges apply)	325300 (P)	\$356.00			
	325300 (S)	\$346.00			
 6 Pin 2 5/8" LFIC Mortise Assembly (Masterkey upcharges apply)	325600 (P)	\$372.00			
	325600 (S)	\$362.50			
 6 Pin 3" LFIC Mortise Assembly (Masterkey upcharges apply)	325700 (P)	\$387.50			
	325700 (S)	\$378.00			

**Refer to the eCylinder section for more detail on specific technologies available and pricing. Technologies are represented by the following letters:

T = Medeco³, S = Medeco³ CLIQ, J = Medeco³ BiLevel, W = Biaxial, V = Medeco Biaxial CLIQ, K = Medeco KM, N = Medeco X4, C = Medeco CLIQ,
 "-." = Original, Z = Medeco Original KW CLIQ, G = Medeco XT ***See key section for surcharges for custom coined cut keys or special stamping requirements.

Note: (P) refers to **Pinned** and (S) to **Sub-Pinned** at the end of each part string in the price book.

LFIC Mortise Housings

Description	Part Number	Medeco ³	BiLevel	Medeco X4	eCylinder
 5 Pin Mortise Cylinder Housing	320175	\$76.00			
 6 Pin Mortise Cylinder Housing	320275	\$76.00			
 6 Pin Jumbo Mortise Cylinder Housing for Corbin® Russwin® Master Ring Cylinders	321375	\$104.50			
 1 1/2" Mortise Cylinder Housing for 32-5200	325275	\$206.00			
 1 3/4" Mortise Cylinder Housing for 32-5400	325475	\$216.50			
 2" Mortise Cylinder Housing for 32-5500	325575	\$226.50			
 2 1/4" Mortise Cylinder Housing for 32-5300	325375	\$237.00			
 2 5/8" Mortise Cylinder Housing for 32-5600	325675	\$252.50			
 3" Mortise Cylinder Housing for 32-5700	325775	\$268.00			
 6 Pin 1 3/8" Mortise Cylinder Housing (Yale®)	310175	\$76.00			
 7 Pin Mortise Cylinder Housing (Yale®)	310175A	\$76.00			
 2 1/4" Mortise Cylinder Housing (Yale®)	315375	\$230.00			

**Refer to the eCylinder section for more detail on specific technologies available and pricing. Technologies are represented by the following letters:
 T = Medeco³, S = Medeco³ CLIQ, J = Medeco³ BiLevel, W = Biaxial, V = Medeco Biaxial CLIQ, K = Medeco KM, N = Medeco X4, C = Medeco CLIQ,
 "-" = Original, Z = Medeco Original KW CLIQ, G = Medeco XT ***See key section for surcharges for custom coined cut keys or special stamping requirements.
Note: (P) refers to **Pinned** and **(S)** to **Sub-Pinned** at the end of each part string in the price book.

LFIC Rim Cylinders

Description	Part Number	Medeco ³	BiLevel	Medeco X4	eCylinder
 6 Pin Rim Cylinder Assembly for Yale®, Horizontal Tailpiece (Masterkey upcharges apply)	310102H (P)	\$201.00	\$147.40		
	310102H (S)	\$191.50	\$142.00		
 6 Pin Rim Cylinder Assembly for Yale®, Vertical Tailpiece (Masterkey upcharges apply)	310102V (P)	\$201.00	\$147.40		
	310102V (S)	\$191.50	\$142.00		
 7 Pin Rim Cylinder Assembly for Yale®, Horizontal Tailpiece (Masterkey upcharges apply)	310104H (P)	\$201.00			
	310104H (S)	\$191.50			
 7 Pin Rim Cylinder Assembly for Yale®, Vertical Tailpiece (Masterkey upcharges apply)	310104V (P)	\$201.00			
	310104V (S)	\$191.50			
 5 Pin Rim Cylinder Assembly with Horizontal Tailpiece and Staked Tailpiece Retainer for Thin Door Applications (Masterkey upcharges apply)	320300H (P)	\$190.00	\$134.96		
	320300H (S)	\$180.50	\$129.96		
 5 Pin Rim Cylinder Assembly, Vertical Tailpiece (Masterkey upcharges apply)	320300V (P)	\$190.00	\$134.96		
	320300V (S)	\$180.50	\$129.96		
 6 Pin Rim Cylinder Assembly, Horizontal Tailpiece (Masterkey upcharges apply)	320400H (P)	\$201.00	\$142.88		
	320400H (S)	\$191.50	\$137.88		
 6 Pin Rim Cylinder Assembly, Vertical Tailpiece (Masterkey upcharges apply)	320400V (P)	\$201.00	\$142.88		
	320400V (S)	\$191.50	\$137.88		
 5 Pin Rim Cylinder Assembly with Lazy Motion Tailpiece (Masterkey upcharges apply)	320600 (P)	\$194.25			
	320600 (S)	\$184.75			
 6 Pin Lazy Motion Rim Cylinder Assembly (Masterkey upcharges apply)	320700 (P)	\$202.00			
	320700 (S)	\$192.50			
 6 pin Rim Cylinder with Sargent mounting holes (Masterkey upcharges apply)	320405H (P)	\$214.50			
	320405H (S)	\$205.00			

**Refer to the eCylinder section for more detail on specific technologies available and pricing. Technologies are represented by the following letters:
T = Medeco³, S = Medeco³ CLIQ, J = Medeco³ BiLevel, W = Biaxial, V = Medeco Biaxial CLIQ, K = Medeco KM, N = Medeco X4, C = Medeco CLIQ,
“-” = Original, Z = Medeco Original KW CLIQ, G = Medeco XT ***See key section for surcharges for custom coined cut keys or special stamping requirements.
Note: (P) refers to **Pinned** and **(S)** to **Sub-Pinned** at the end of each part string in the price book.

LFIC Rim Cylinder Housings

Description	Part Number	Price
 7 Pin Rim Cylinder Housing (Yale®), Horizontal Tailpiece	310153H	\$82.00
 7 Pin Rim Cylinder Housing (Yale®), Vertical Tailpiece	310153V	\$82.00
 6 Pin 1 1/2" Rim Cylinder Housing (31 series for Yale®), Horizontal Tailpiece	310375H	\$82.00
 6 Pin 1 1/2" Rim Cylinder Housing (31 series for Yale), Vertical Tailpiece	310375V	\$82.00
 6 Pin Rim Cylinder Housing - 31 Series with Sargent® mounting hole spacing	310375S	\$82.00
 5 Pin Rim Cylinder Housing, Horizontal Tailpiece	320375H	\$72.00
 5 Pin Rim Cylinder Housing, Vertical Tailpiece	320375V	\$72.00
 6 Pin Rim Cylinder Housing, Horizontal Tailpiece	320475H	\$82.00
 6 Pin Rim Housing, Vertical Tailpiece	320475V	\$82.00
 6 Pin Rim Cylinder Housing - 32 Series with Sargent® mounting hole spacing	320477H	\$82.00
 5 Pin Rim Cylinder Housing with Lazy Motion Tailpiece	320675	\$76.00
 6 Pin Rim Lazy Motion Cylinder Housing	320775	\$83.00

**Refer to the eCylinder section for more detail on specific technologies available and pricing. Technologies are represented by the following letters:
T = Medeco³, S = Medeco³ CLIQ, J = Medeco³ BiLevel, W = Biaxial, V = Medeco Biaxial CLIQ, K = Medeco KM, N = Medeco X4, C = Medeco CLIQ,
“-” = Original, Z = Medeco Original KW CLIQ, G = Medeco XT ***See key section for surcharges for custom coined cut keys or special stamping requirements.
Note: (P) refers to **Pinned** and **(S)** to **Sub-Pinned** at the end of each part string in the price book.

Small Format Interchangeable Core

Medeco X4 leads the market in patent protected small format interchangeable core (SFIC) cylinders, large format interchangeable core (LFIC) cylinders, conventional mortise, rim and key-in-knob cylinders designed to retrofit virtually any door. One key will operate interchangeable cores and conventional cylinders. With patents extending through 2027 and the ability to expand key systems to four times that of standard SFIC, Medeco X4 is guaranteed to be an important product to suit your needs.



Patented Key Control

Protects against unauthorized duplication of your keys.



Uses Existing Hardware

Industry standard Small Format Interchangeable Cores (SFIC) size, reduces cost by eliminating the need to replace your existing hardware.



Quickly Change Cores

Provides quick and easy cylinder changes in the event keys are lost or stolen.



Available in eCylinder

SFIC cores are also available in the Medeco XT eCylinder format for Loss & Liability control.

Technical Information:

- Utilizes the standard A2 pinning system in conjunction with a bitted slider locking arrangement which allows for more master keying capabilities for large master key systems. Up to 65,536 unique change keys in a 7 pin master key system on a single keyway
- Expandable, simple master keying available in SFIC and LFIC, as well as standard key-in-knob, mortise, and rim cylinders
- SFIC's are available in six or seven pin cylinders, and can replace Best style cores
- Standard Medeco cams and tailpieces can be used on Medeco X4 cylinders
- Keys can be cut using many standard code type key machines such as the Pro-Lok Blue Punch, A1 Green Machine, the ITL 9000/9700, HPC 1200 and HPC Code Max

- Solid brass construction for excellent durability
- Spool shaped top and bottom pins add a measure of pick resistance
- Solid nickel silver bottom pins increase wear resistance
- Individual pin chamber caps provide for ease of servicing
- Locks can be keyed alike, keyed different, or master keyed depending on your specific needs.

Applications:

Provides a key control retrofit for other manufacturers SFIC products in use in a variety of facilities.

Warranty:

Warranted for two (2) years against manufacturer's defects. See the Medeco® limited warranty for full details.

Finishes:

Available in all standard finishes to match with existing hardware.

Available Key Technologies:





Mechanical:

– Medeco X4



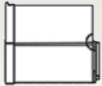
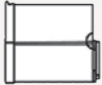

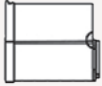

eCylinder:

– Medeco XT

Small Format Interchangeable Core

Description	Part Number	Medeco ³	BiLevel	Medeco X4	eCylinder
 6 Pin Small Format Interchangeable Core with Clip Retainer, Removable Front Plate	33600006 (P)			\$65.00	
	33600006 (S)			\$54.00	
 7 Pin Small Format Interchangeable Core with Clip Retainer, Removable Front Plate	33700006 (P)			\$65.00	
	33700006 (S)			\$54.00	
 6 Pin Small Format Interchangeable Core Construction Core (cut keys ordered separately - 12 keys maximum)	33600006 BI CC K			\$65.00	
 6 Pin Small Format Interchangeable Core, Extended Plug Head with Clip Retainer, Removable Front Plate, Medeco KM Only	33600007 K (P)			\$65.00	
	33600007 K (S)			\$54.00	
 7 Pin Small Format Interchangeable Core, Extended Plug Head with Clip Retainer, Removable Front Plate, Medeco KM Only	33700007 K (P)			\$65.00	
	33700007 K (S)			\$54.00	
 Medeco X4 Specialty Sliding Door Cylinder	33700005 (P)			\$71.00	
	33700005 (S)			\$59.50	

SFIC Rim Cylinders

Description	Part Number	Medeco ³	BiLevel	Medeco X4	eCylinder
 6 Pin SFIC with 1 1/4" Rim Assembly	33602032 (P)			\$102.50	
	33602032 (S)			\$91.50	
 7 Pin SFIC with 1 1/2" Rim Assembly	33602042 (P)			\$102.50	
	33602042 (S)			\$91.50	
 7 Pin SFIC with 1 1/2" Rim Assembly	33702042 (P)			\$102.50	
	33702042 (S)			\$91.50	
 7 Pin SFIC with Corbin Russwin® Master Ring Assembly	337020B2 (P)			\$119.00	
	337020B2 (S)			\$108.00	
 6 Pin SFIC with 1 1/2" Ext.Face Rim Assembly. Medeco KM only.	33602033 K (P)			\$102.50	
	33602033 K (S)			\$91.50	
 6 Pin SFIC with 1 1/2" Ext.Face Rim Assembly. Medeco KM only.	33602043 K (P)			\$102.50	
	33602043 K (S)			\$91.50	
 7 Pin SFIC with 1 1/2" Ext.Face Rim Assembly. Medeco KM only.	33702043 K (P)			\$102.50	
	33702043 K (S)			\$91.50	

**Refer to the eCylinder section for more detail on specific technologies available and pricing. Technologies are represented by the following letters:
 T = Medeco³, S = Medeco³ CLIQ, J = Medeco³ BiLevel, W = Biaxial, V = Medeco Biaxial CLIQ, K = Medeco KM, N = Medeco X4, C = Medeco CLIQ,
 "-" = Original, Z = Medeco Original KW CLIQ, G = Medeco XT ***See key section for surcharges for custom coined cut keys or special stamping requirements.
Note: (P) refers to Pinned and (S) to Sub-Pinned at the end of each part string in the price book.

SFIC Mortise Cylinders

Description	Part Number	Medeco ³	BiLevel	Medeco X4	eCylinder
 6 Pin SFIC 1 1/4" Mortise Assembly	33602012 (P)				\$99.50
	33602012 (S)				\$88.50
 7 Pin SFIC 1 3/8" Mortise Assembly	33702022 (P)				\$99.50
	33702022 (S)				\$88.50
 7 Pin SFIC 1 3/8" Corbin® Jumbo Assembly	337020C2 (P)				\$117.00
	337020C2 (S)				\$105.50
 7 Pin SFIC 1 1/2" Mortise Cylinder Assembly	337020E2 (P)				\$99.50
	337020E2 (S)				\$88.50
 6 Pin SFIC 1 1/4" Ext. Face Mortise Assembly Medeco KM only	33602013 K (P)				\$99.50
	33602013 K (S)				\$88.50
 7 Pin SFIC 1 3/8" Ext. Face Mortise Assembly Medeco KM only	33702023 K (P)				\$99.50
	33702023 K (S)				\$88.50
 6 Pin SFIC 7/8" body length (1 3/8" overall) Tapered Head Mortise Assembly	33602052 (P)				\$99.50
	33602052 (S)				\$88.50
 6 Pin SFIC 1" body length (1 1/2" overall) Tapered Head Mortise Assembly (can accept 7 pin core)	33602062 (P)				\$99.50
	33602062 (S)				\$88.50
 6 Pin SFIC 7/8" body length (1 3/8" overall) Ext. Face Tapered Head Mortise Assembly	33602053 K (P)				\$99.50
	33602053 K (S)				\$88.50
 6 Pin SFIC 1" body length (1 1/2" overall) Ext. Face Tapered Head Mortise Assembly (can accept 7 pin core)	33602063 K (P)				\$99.50
	33602063 K (S)				\$88.50

**Refer to the eCylinder section for more detail on specific technologies available and pricing. Technologies are represented by the following letters:
T = Medeco³, S = Medeco³ CLIQ, J = Medeco³ BiLevel, W = Biaxial, V = Medeco Biaxial CLIQ, K = Medeco KM, N = Medeco X4, C = Medeco CLIQ,
“-” = Original, Z = Medeco Original KW CLIQ, G = Medeco XT ***See key section for surcharges for custom coined cut keys or special stamping requirements.
Note: (P) refers to **Pinned** and **(S)** to **Sub-Pinned** at the end of each part string in the price book.

SFIC Housings

Description	Part Number	Medeco ³	BiLevel	Medeco X4	eCylinder
 6 Pin 1 1/4" Mortise Housing Only	33076011				\$34.50
 6 or 7 Pin 1 3/8" Mortise Housing Only*	33076021				\$34.50
 7 Pin 1 1/2" SFICMortise Housing Only* * If using 6 Pin core spacer CP-160420 required	33076025				\$34.50
 7 Pin 1 3/8" Housing Only for Corbin® Russwin® Master Ring Cylinders*	33076028				\$34.50
 6 Pin 7/8" Tapered Head Mortise Housing Only	33076051				\$34.50
 6 or 7 Pin 1" Tapered Head Mortise Housing Only	33076061				\$34.50
 6 Pin 1 1/2" Rim Cylinder Housing Only	3307603H				\$34.50
 7 Pin 1 1/2" Rim Cylinder Housing Only	3307604H				\$34.50
 7 Pin Corbin® Jumbo Rim Housing Only	33076048				\$34.50

**Refer to the eCylinder section for more detail on specific technologies available and pricing. Technologies are represented by the following letters:
 T = Medeco³, S = Medeco³ CLIQ, J = Medeco³ BiLevel, W = Biaxial, V = Medeco Biaxial CLIQ, K = Medeco KM, N = Medeco X4, C = Medeco CLIQ,
 "-" = Original, Z = Medeco Original KW CLIQ, G = Medeco XT ***See key section for surcharges for custom coined cut keys or special stamping requirements.
Note: (P) refers to **Pinned** and **(S)** to **Sub-Pinned** at the end of each part string in the price book.

Medeco T21 Key Management System

The Medeco T21 is a sophisticated stand-alone key management system which combines innovative RFID technology and robust design to provide small to medium sized businesses with the advanced management of 21 keys or keysets in a plug and play solution.



Operation:

- Stand-alone Plug & Play solution with advanced RFID technology
- Touchscreen interface
- PIN access to designated keys or keysets which are individually locked in place
- Keys are securely attached using special security seals
- Simple to configure through the setup wizard
- No requirement for network connection or PC
- Concealed robust fixing points allow secure wall fixing
- Mains operated with optional battery backup

Technical Information:

- User, key and access rights administration
- Multilingual functionality
- Screen based audit trail and reporting capability or export via USB port
- 21 robust, long-live iFobs with security seals
- 21 locking receptors with LEDs
- Robust and compact steel housing eliminates exposed hinges and obvious access points
- Manual override and door release functions in case of emergency
- Audible alarms

Warranty:

Medeco security locks warrants the T21 to be free of defects in material and/or workmanship for a period of one (1) year from date of original purchase.

iFob

Once attached to an iFob with a robust security seal, individual keys or keysets are assigned to a specific user.



Security Seal

The secure one-time security seal is cost-effective and simple to apply without the need for specific tools.

T21 Key Management System

Description	Part Number	Price
Medeco T21 Key Management System, comes with 21 ifobs and security seals.	EA-100117	\$2,499.00

International Cylinders

Medeco® cylinders are used to protect facilities worldwide such as high security government installations, industrial and institutional organizations, airports, hotels, power plants, palaces, museums, universities and schools, and office buildings. Medeco's international cylinders are designed to fit in locksets of major world manufacturers. In addition to international uses, many of these cylinders fit imported hardware used in North America. Medeco® offers a variety of export cylinders including European profile and modular cylinders. These products are available in both mechanical and eCylinder technologies.

The Medeco® European Profile cylinder has a teardrop shape that fits into storm doors, upscale hardware and specialty applications and is available in single, half and double cylinder versions. Additional cylinders in the 23 series include: oval, round, and "snowman" designs.



Patented Key Control

Protects against unauthorized duplication of your keys.



Uses Existing Hardware

European profile cylinders retrofit into virtually any manufacturers' locksets requiring DIN standard cylinders



Available in eCylinder

Medeco's international cylinders are also available in eCylinder format for Loss & Liability control.



Protection From Physical Attack

Medeco³ international cylinders use hardened steel inserts positioned in critical areas of the cylinder to stand up to drilling, picking and other forms of physical attack.



Can Be Masterkeyed

Can be masterkeyed into a system containing Medeco BiLevel and Medeco³ mechanical as well as Medeco³ CLIQ eCylinders.

Technical Information:

- Utility patented key control provides protection from unauthorized duplication of keys in most countries
- Superior master keying capability to accommodate systems of virtually any size
- Solid brass construction provides high quality and long cylinder life
- Nickel plated pins provide exceptional wear resistance and additional hardened stainless steel pins provide drill resistance
- European profile Cylinders retrofit into virtually any manufacturers' locksets requiring DIN Standard cylinders
- Pin chamber set screws provide ease of rekeying and resist comb attacks
- 5 and 6 pin cylinder available

Certification:

- SKG *** Netherlands
- Swedish Standards SS3522
- EN1303 - 2005
- DIN18254

Warranty:

Warranted for two (2) years against manufacturer's defects. See the Medeco® limited warranty for full details

Available Key Technologies:

Mechanical:

- Medeco³
- Medeco³ BiLevel
- Medeco X4

eCylinder:

- Medeco³ CLIQ
- Medeco CLIQ
- Medeco XT

EPIC–Euro Profile Interchangeable Core

Medeco Profile cylinders can now be ordered to accept a special, slab-sided, small format interchangeable core (SFIC) cylinders to retrofit into most standard European Profile applications.

Medeco Euro profiles can be furnished with Medeco's patented X4 technology, offering unmatched key control, the widest array of retrofit cylinders and four times the master keying capability.



Patented Key Control

Protects against unauthorized duplication of your keys.



Uses Existing Hardware

European profile cylinders retrofit into virtually any manufacturers' locksets requiring DIN standard cylinders



Superior Masterkeying Capability

Furnished with Medeco X4 SFIC, EPIC offers superior masterkeying to accommodate very large systems

Medeco X4 Technical Information

- 6 and 7 Pin cylinders available
- Solid nickel silver pins
- Many cylinder formats available
- Profiles available in multiple sizes, finishes and functions
- Where interchangeable core is not required, Euro's are also available in modular components and assembled standard lengths.
- Solid brass construction provides high quality and long cylinder life
- Solid Nickel Silver Pins and Keys
- European Profile Cylinders retrofit into virtually any manufactureres' locksets equivalent to DIN Standards

Warranty

Warranted for two years against manufacturing defects. See Medeco Limited Warranty for full details.

Part Numbers

6 Pin Part Numbers

- 2326D21 XX EPIC Euro Double 37.9 mm/37.9mm
- 2326H01 XX EPIC Euro Half 37.9mm
- 2326S12X XX EPIC Euro with T'Turn 40mm int/39.2 mm ext
- 3360000R – SFIC Part Number

7 Pin Part Numbers

- 2324D21 XX EPIC Euro Double 41.73mm/41.73mm
- 2324D25 XX EPIC Euro Double 41.73mm/55mm
- 2324H01 XX EPIC Euro Half 41.73mm
- 2324H05 XX EPIC Euro Half 55mm
- 2324S12X XX EPIC with T'Turn 40mm int/43mm ext
- 2324S15X XX EPIC with T'Turn 40mm int/55mm ext
- 2324S52X XX EPIC with T'Turn 55mm int/43mm ext
- 3370000R – SFIC Part Number

How To Order International Cylinders - Euro-Profile

<p>1</p> <p>23130 05500 base part #</p> <p>Refer to pages 98-121 for descriptions and technical specifications to find the corresponding base part number.</p>	<p>2</p> <p>T cylinder</p> <ul style="list-style-type: none"> - = Original W = BiAxial B = BiLevel T = Medeco³ J = Medeco³ BiLevel N = Medeco X4 G = Medeco XT 	<p>3</p> <p>05 finish</p> <p>Refer to the inside back cover of this catalog for finish options. Include the corresponding two digit finish number.</p>	<p>4</p> <p>LT keyway</p> <p>Insert keyway if known or contact Customer Service for help.</p>	<p>5</p> <p>S pinning</p> <table border="1"> <tr> <td> <p>S =</p> <p>Sub-Assembled (Uncombined)</p> <p>No additional information needed</p> </td> <td> <p>P =</p> <p>Pinned (Combined)</p> <p>Keyed alike (KA)</p> <p>Keyed different (KD)</p> <p>2 keys per cylinder</p> </td> <td> <p>M =</p> <p>Master Keyed</p> <p>Provide specific pinning or contact Customer Service for support</p> <p>Must specify quantity for keys.</p> </td> </tr> </table>	<p>S =</p> <p>Sub-Assembled (Uncombined)</p> <p>No additional information needed</p>	<p>P =</p> <p>Pinned (Combined)</p> <p>Keyed alike (KA)</p> <p>Keyed different (KD)</p> <p>2 keys per cylinder</p>	<p>M =</p> <p>Master Keyed</p> <p>Provide specific pinning or contact Customer Service for support</p> <p>Must specify quantity for keys.</p>
<p>S =</p> <p>Sub-Assembled (Uncombined)</p> <p>No additional information needed</p>	<p>P =</p> <p>Pinned (Combined)</p> <p>Keyed alike (KA)</p> <p>Keyed different (KD)</p> <p>2 keys per cylinder</p>	<p>M =</p> <p>Master Keyed</p> <p>Provide specific pinning or contact Customer Service for support</p> <p>Must specify quantity for keys.</p>					

BUILD A BASE PART #:

23130 X X X X X X

International High Security Cylinder

Profile Design

Function

- *0 = Thumbturn Cylinder with "SR" Round Knob
- 1 = Half Cylinder
- 2 = Double Cylinder
- *3 = Thumbturn Cylinder with Low Profile "LP" Knob
- *4 = Thumbturn Cylinder with Decorative "RD" Knob
- *5 = Thumbturn Cylinder with Lever "RL" Knob
- 13 = Euro Profile
- 22 = EuroLine Modular Profile Module
- 23 = EuroLine Modular Cylinder Complete

Number of Pins

- 5 = 5 Pins
- 6 = 6 Pins
- 7 = 7 Pins

Assembly Variation For the BiLevel with Original Technology

- H = High Security
- B = Standard Security

Interior/Exterior Length Extensions

0 = No Extension	5 = 25 mm (.984")
1 = 5 mm (.197")	6 = 30 mm (1.18")
2 = 10 mm (.394")	7 = 35 mm (1.38")
3 = 15 mm (.591")	8 = 40 mm (1.57")
4 = 20 mm (.787")	9 = 45 mm (1.77")

Cam Position (from outside with Bible down)

- 1 = 1 o'clock
- 2 = 10 point multi-gear
- 3 = EuroLine Module
- 5 = 5 o'clock
- 7 = 7 o'clock
- 8 = Multiposition (half cylinder only)
- 0 = 11 o'clock

*Thumbturn/Cam position available at 5 and 11 o'clock only

**Refer to the eCylinder section for more detail on specific technologies available and pricing.
 ***See key section for surcharges for custom coined cut keys or special stamping requirements.
Note: (P) refers to **Pinned** and **(S)** to **Sub-Pinned** at the end of each part string in the price book.

How To Order Other International Cylinders

Complete part numbers are required for all orders. To determine the correct part number, fill in the "X's" in sequential order.

1	2	3	4	5						
<p>2305016 base part #</p> <p>Refer to pages 98-121 for descriptions and technical specifications to find the corresponding base part number.</p>	<p>T cylinder</p> <p>- = Original W = BiAxial B = BiLevel T = Medeco³ G = Medeco XT</p>	<p>05 finish</p> <p>Refer to the inside back cover of this catalog for finish options. Include the corresponding two digit finish number.</p>	<p>LT keyway</p> <p>Insert keyway if known or contact Customer Service for help.</p>	<p>S pinning</p> <table border="1"> <thead> <tr> <th>S =</th> <th>P =</th> <th>M =</th> </tr> </thead> <tbody> <tr> <td>Sub-Assembled (Uncombined) No additional information needed</td> <td>Pinned (Combined) Keyed alike (KA) Keyed different (KD) 2 keys per cylinder</td> <td>Master Keyed Provide specific pinning or contact Customer Service for support Must specify quantity for keys.</td> </tr> </tbody> </table>	S =	P =	M =	Sub-Assembled (Uncombined) No additional information needed	Pinned (Combined) Keyed alike (KA) Keyed different (KD) 2 keys per cylinder	Master Keyed Provide specific pinning or contact Customer Service for support Must specify quantity for keys.
S =	P =	M =								
Sub-Assembled (Uncombined) No additional information needed	Pinned (Combined) Keyed alike (KA) Keyed different (KD) 2 keys per cylinder	Master Keyed Provide specific pinning or contact Customer Service for support Must specify quantity for keys.								

BUILD A BASE PART #:

23050 X X X X

International High Security Cylinder

Design

- 01 = Danish Round (Ruko Round)
- 03 = Australian Oval
- 04 = British Oval (Union Oval)† No extension.*
- 05 = Scandinavian Oval Ext. (ASSA Oval)
- 06 = Scandinavian Oval Int. (ASSA Oval)
- 07 = Norwegian Oval (TrioVing Oval)
- 08 = Scandinavian Snowman
- 09 = Scandinavian Round Ext. (ASSA Round)
- 10 = Scandinavian Round Int. (ASSA Round)
- 14 = Italian Outer Gate Lock, 3 Pin
- 15 = Italian Outer Gate Lock, 5 Pin
- 16 = Italian Roller Shutter, 4 Pin

Function*

- 0 = Thumbturn Cylinder with "RL" Knob Union Oval only
- 1 = Half Cylinder
- 2 = Double Cylinder

† Union Oval Thumbturn Position at 5 and 11 o'clock only.

* British Oval is the only design that requires a function number and cam position to be selected. It is non extending.

Cam Position (British Oval)*

- 0 = 11 o'clock
- 1 = 1 o'clock
- 5 = 5 o'clock
- 7 = 7 o'clock

BiLevel w/ Original Technology

- H = High Security
- B = Standard Security

Number of Pins

- 3 = 3 Pins
- 4 = 4 Pins
- 5 = 5 Pins
- 6 = 6 Pins

**Refer to the eCylinder section for more detail on specific technologies available and pricing.

***See key section for surcharges for custom coined cut keys or special stamping requirements.

Note: (P) refers to **Pinned** and (S) to **Sub-Pinned** at the end of each part string in the price book.

Medeco Premium High Security Euro Thumbturn Profile Cylinder

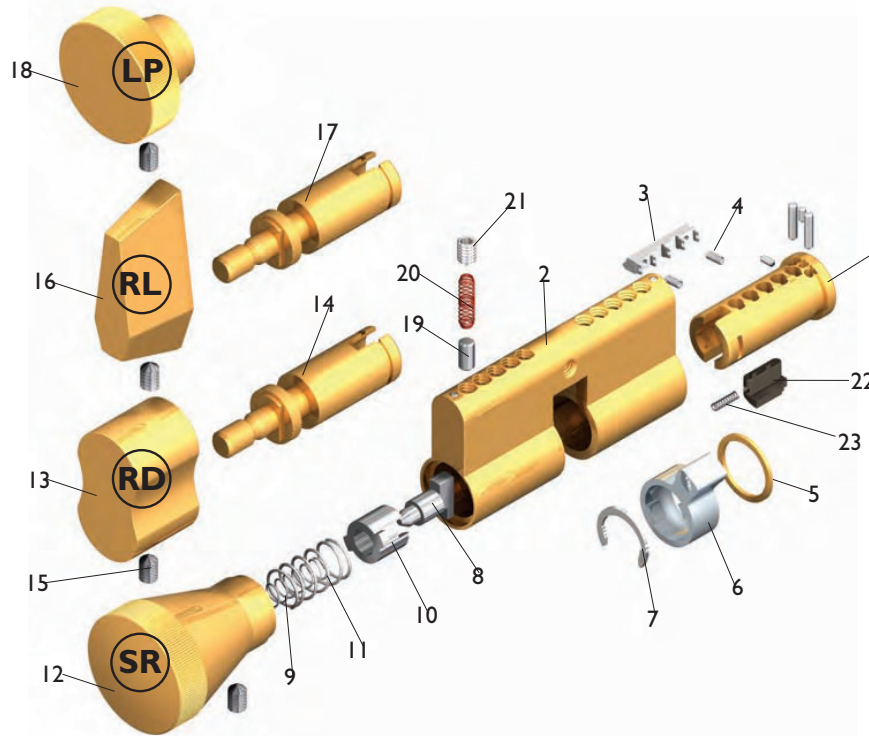

Item	Description	Part Number
1	Plug	Cylinder Specific
2	Shell	Cylinder Specific
3	Sidebar	CP-084X71
4	Sidebar Springs	CP-030018
5	Plug Retainer Ring	CP-021490
6	Cam	CT-Z51
7	Thumbturn Retaining Clip	CP-020031
8	Actuator	CP-100111
9	Actuator Spring	CP-030025
10	Actuator Pilot	CP-280261
11	Pilot Spring	CP-030024
12	Standard Round "SR" Thumbturn	CP-285961
13	Decorative "RD" Thumbturn	CP-285901
14	Thumbturn Shaft - 6 Pin	CP-240761-5XX
15	Thumbturn Allen Set Screw #6-32 x 3/16" Knurled Cup Point	CP-012411-040
16	Lever "RL" Thumbturn	CP-285931
17	Thumbturn Shaft - 5 Pin	CP-240761-5XX
18	Low Profile "LP" Thumbturn	CP-285991
19	Thumbturn Retaining Pin	TP-F10-1T
20	Thumbturn Retaining Pin Spring	CP-030001
21	Thumbturn Retaining Pin Allen Set Screw #8-32 x 1/4"	CP-011013-040
22	Slider (varies related to keyway)	CP-084591
23	Slider Spring	CP-030910
24	Spade Thumbturn (Not Pictured "Special Order")	CP-286051
25	Crescent Thumbturn (Not Pictured "Special Order")	CP-286021

Medeco Premium High Security Euro Half Profile Cylinder

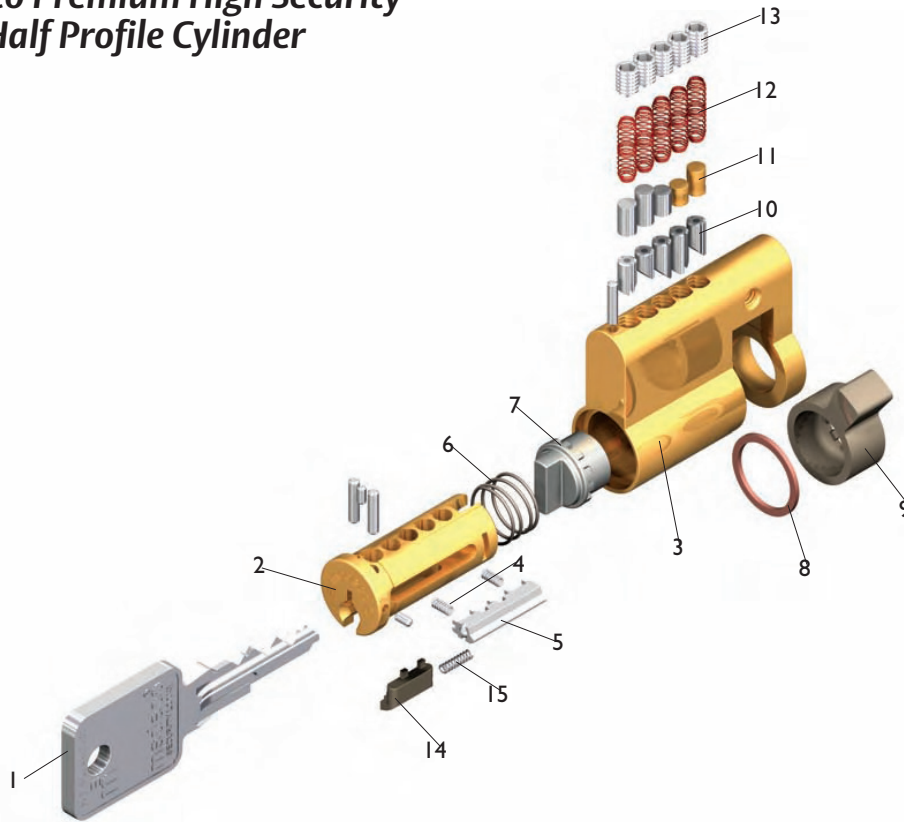

Item	Description	Part Number
1	Key	As Required
2	Plug	Cylinder Specific
3	Shell	Cylinder Specific
4	Sidebar Springs	CP-030018
5	Sidebar	CP-084X71
6	Cam Spring	CP-030860
7	Actuator	CP-220090
8	Plug Retainer	CP-021490
9	Cam	CT-Z88
10	Bottom Pins	As Required
11	Top Pins	As Required
12	Springs (Phosphor Bronze)	CP-030001
13	Pin Chamber Allen Set Screws #8-32 x 1/4"	CP-011013-040
14	Slider – (varies related to keyway)	CP-084591
15	Slider Spring	CP-030910

Medeco Premium High Security Exterior Scandinavian Oval Cylinder

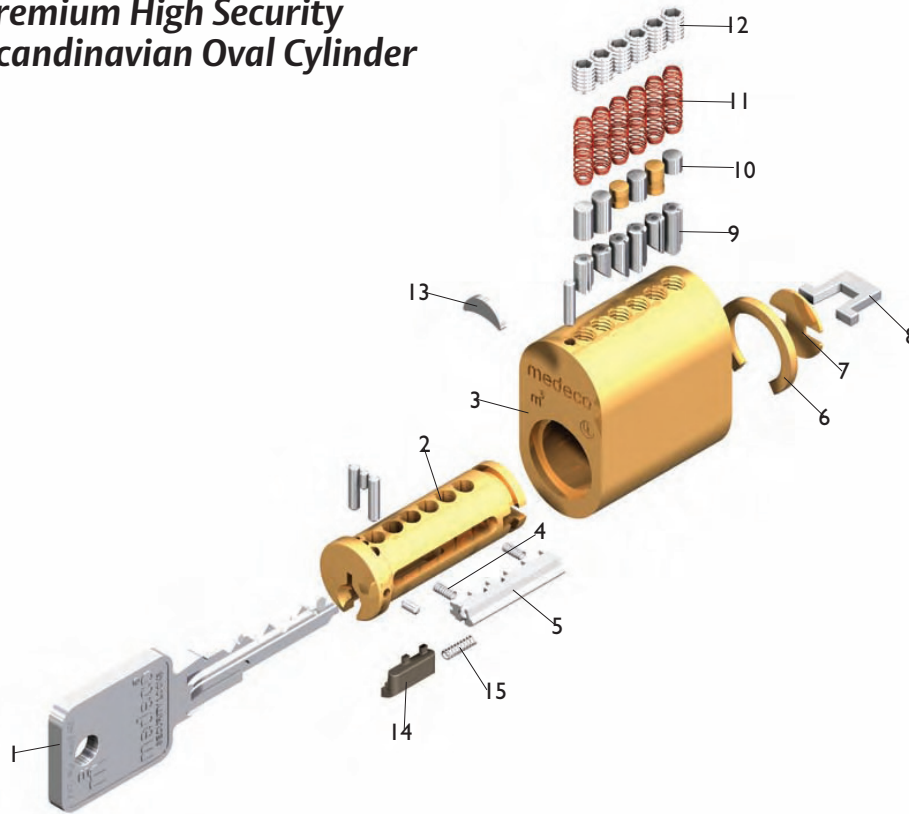

Item	Description	Part Number
1	Key	As Required
2	Plug	Cylinder Specific
3	Shell	Cylinder Specific
4	Sidebar Springs	CP-030018
5	Sidebar, 6 Pin	CP-084671
6	Plug Retainer	CP-021040
7	Plate	CP-180830
8	Tailpiece	CT-Y76
9	Bottom Pins	As Required
10	Top Pins	As Required
11	Springs (Phosphor Bronze)	CP-030001
12	Pin Chamber Allen Set Screws #8-32 x 1/4"	CP-011013-040
13	Crescent Steel Insert	CP-180011
14	Slider – (varies related to keyway)	CP-084591
15	Slider Spring	CP-030910

Medeco Premium High Security Interior Scandinavian Oval Cylinder

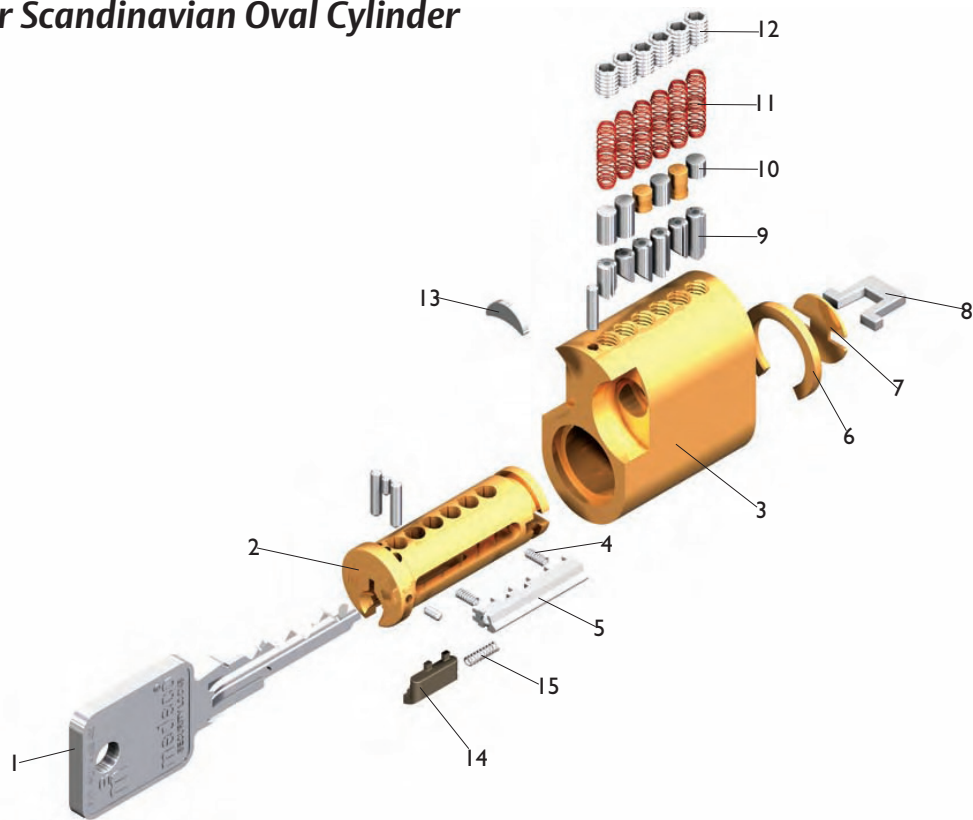

Item	Description	Part Number
1	Key	As Required
2	Plug	Cylinder Specific
3	Shell	Cylinder Specific
4	Sidebar Springs	CP-030018
5	Sidebar, 6 Pin	CP-084671
6	Plug Retainer	CP-021040
7	Plate	CP-180830
8	Tailpiece	CT-Y76
9	Bottom Pins	As Required
10	Top Pins	As Required
11	Springs (Phosphor Bronze)	CP-030001
12	Pin Chamber Allen Set Screws #8-32 x 1/4"	CP-011013-040
13	Crescent Steel Inserts	CP-180011
14	Slider – (varies related to keyway)	CP-084591
15	Slider Spring	CP-030910

Medeco Premium High Security Euro Double Profile

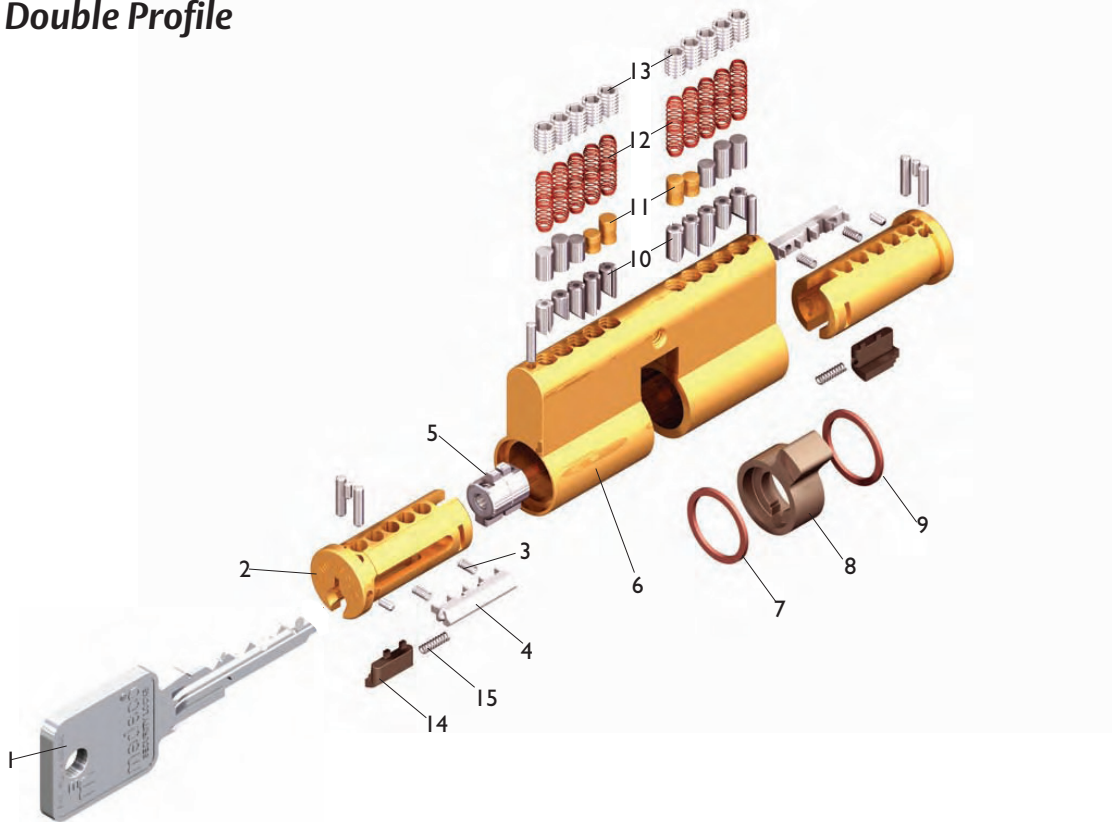

Item	Description	Part Number
1	Key	As Required
2	Plug	Cylinder Specific
3	Sidebar Springs	CP-030018
4	Sidebar, 5 Pin	CP-084571
5	Clutch	CP-220071
6	Shell	Cylinder Specific
7	Plug Retainer	CP-021490
8	Cam	CT-Z50
9	Plug Retainer	CP-021490
10	Bottom Pins	As Required
11	Top Pins	As Required
12	Springs (Phosphor Bronze)	CP-030001
13	Pin Chamber Allen Set Screws #8-32 x 1/4"	CP-0110113-040
14	Slider – (varies related to keyway)	CP-084591
15	Slider Spring	CP-030910

Medeco Premium High Security EuroLine Modular Profile Cylinder System

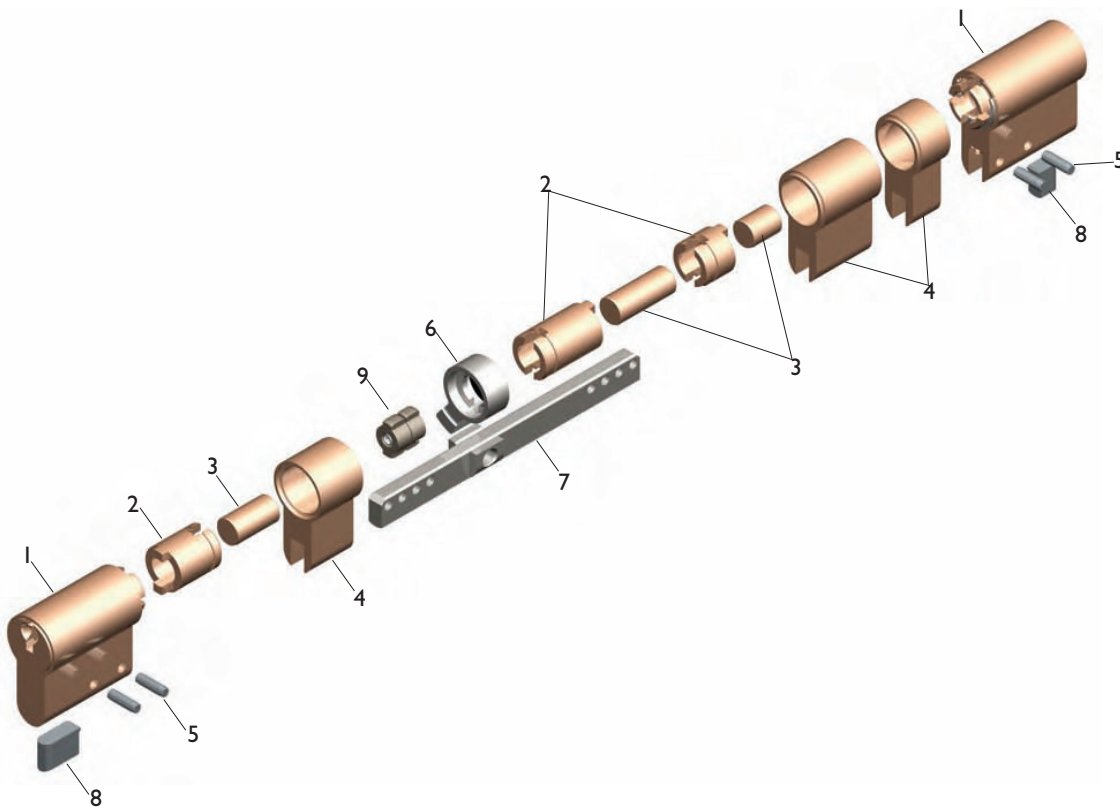

Modular Profile Double Cylinder

Item	Description	Part Number
1	Cylinder Module (5 or 6 Pin)	232201X 30X
2	Outer Plug Extension - 10mm – 25mm extensions available	CP-200751
3	Inner Plug Extension - 5mm – 25mm extensions available	CP-200761
4	Brass Shell Extension - finish required	CP-200771
5	Groove Pins	CP-063220
6	Cam	CT-Z50
7	Connecting Bar - requires length designation	CP-200801
8	Bar Filler	CP-160661
9	Clutch Assembly	CP-220071

Medeco Premium High Security EuroLine Modular Profile Cylinder System

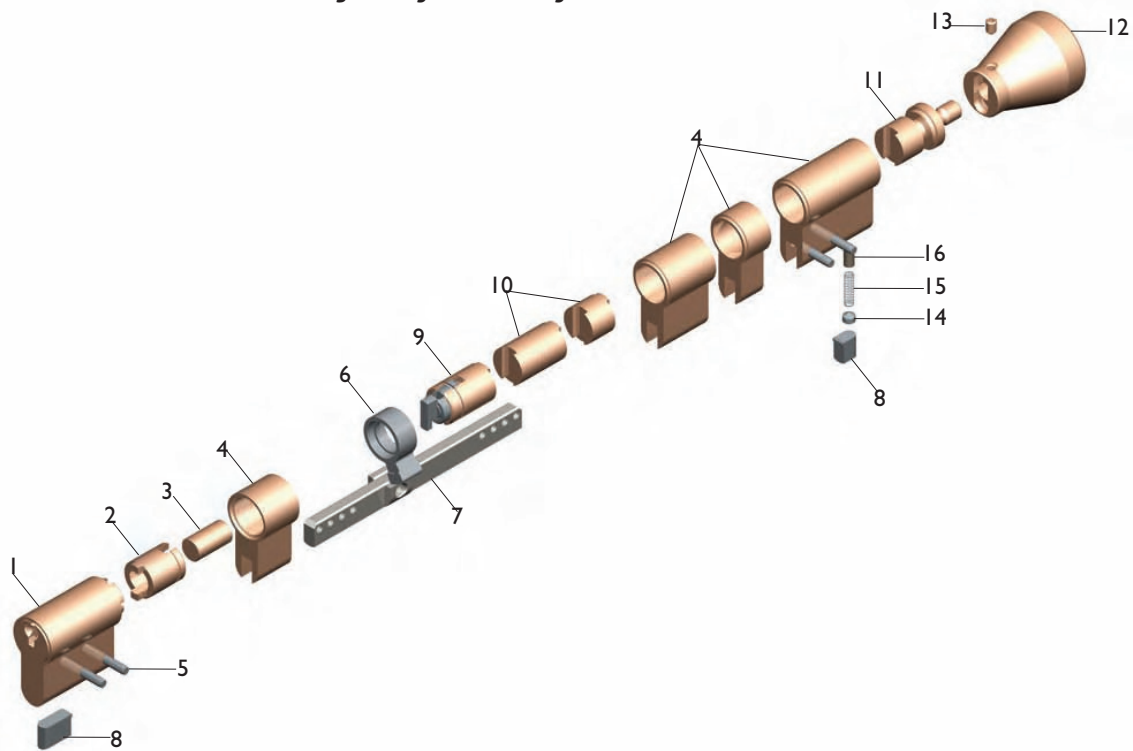

Modular Profile Single Cylinder with Thumbturn

Item	Description	Part Number
1	Thumbturn Cylinder Module (5 or 6 pin), requires knob selection	23X220XX-300
2	Outer Plug Extension, 10-25 mm extension	CP-200751
3	Inner Plug Extension, 5-25 mm extension	CP-200761
4	Brass Shell Extension, Finish required	CP-200771
5	Groove Pins	CP-063220
6	Cam	CP-Z51
7	Connecting Bar	CP-200801
8	Bar Filler	CP-160661
9	Thumbturn Actuator Cartridge	CP-220131
10	Thumbturn Cartridge Extension, 5-25 mm extension	CP-200781
11	Thumbturn Shaft – Modular Only	CP-240771-XP
12	Thumbturn Knob	See Page 117
13	Thumbturn Set Screw	CP-011013-020
14	Thumbturn Retaining Set Screw 8- 32 x 1/4"	CP-011013-040
15	Thumbturn Retaining Pin Spring	CP-030001
16	Thumbturn Retaining Pin	TP-F10-IT

Euro Profile Technical Information

A = Total Length
B = Interior Length

C = Exterior Length
KP =

EURO PROFILE SINGLE CYLINDER WITH THUMBTURN

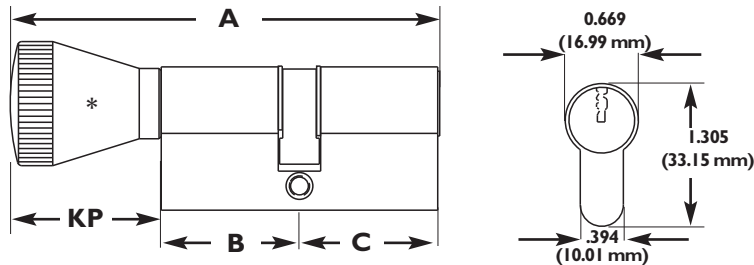

Euro Profile Single Cylinder with Thumbturn

Part#	A	B	C	KP
2313005 X00 *	99.04	31.98	31.98	35.08
2313035 X00	81.44	31.98	31.98	17.48
2313045 X00	83.09	31.98	31.98	19.13
2313055 X00	84.1	31.98	31.98	20.14
2313006 X00 *	107.68	36.3	36.3	35.08
2313036 X00	90.08	36.3	36.3	17.48
2313046 X00	91.73	36.3	36.3	19.13
2313056 X00	92.74	36.3	36.3	20.14
2313065 X00 (490264)	84.3	31.98	31.98	20.35
2313066 X00 (490291)	92.94	36.3	36.3	20.35

Euro Profile Technical Information

A = Total Length
B = Interior Length

C = Exterior Length

EURO PROFILE DOUBLE CYLINDER

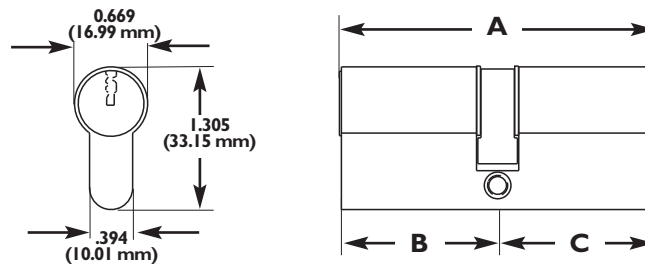

Euro Profile Single Cylinder with Thumbturn

Part#	A	B	C
2313025 X00	63.96	31.98	31.98
2313026 X00	72.59	36.3	36.3
2313025 X01	68.96	31.98	36.98
2313025 X02	73.96	31.98	41.99
2313025 X11	73.96	36.98	36.98
2313025 X12	78.97	36.98	41.99
2313026 X01	77.6	36.3	41.3
2313026 X02	82.6	36.3	46.3
2313026 X12	87.6	41.3	46.3

All table measurements in millimeters.

Euro Profile Technical Information

A = Total Length
 B = Interior Length
 C = Exterior Length

EURO PROFILE DOUBLE CYLINDER

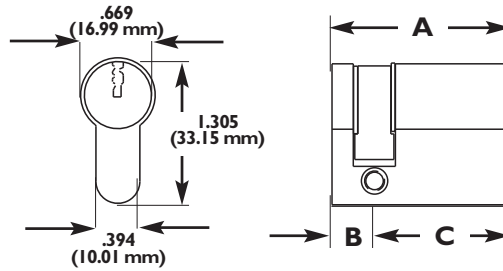

Euro Profile Single Cylinder with Thumbturn

Part#	A	B	C
2313015 800	41.99	10.01	31.98
2313016 800	46.4	10.01	36.3
2313015 801	46.99	10.01	36.98
2313016 801	51.31	10.01	41.3

All table measurements in millimeters.

Euro Profile Technical Information

Single Cylinder with Thumbturn (Standard Length)

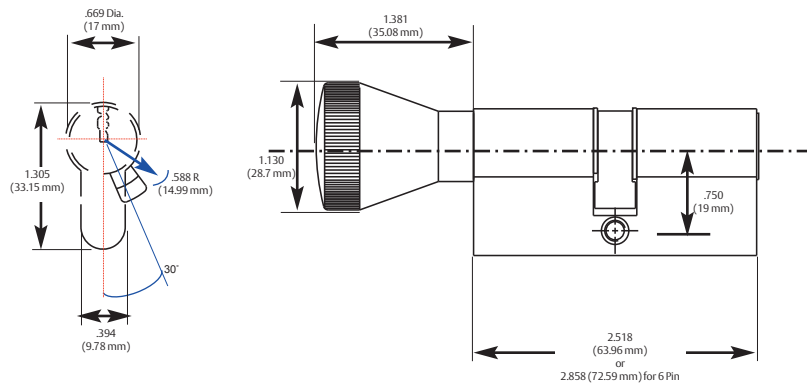

Cam position code as shown from outside.

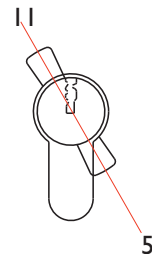

Part #: 2313005 XXX 5 Pin
 2313006 XXX 6 Pin

Half Cylinder (Standard Length)

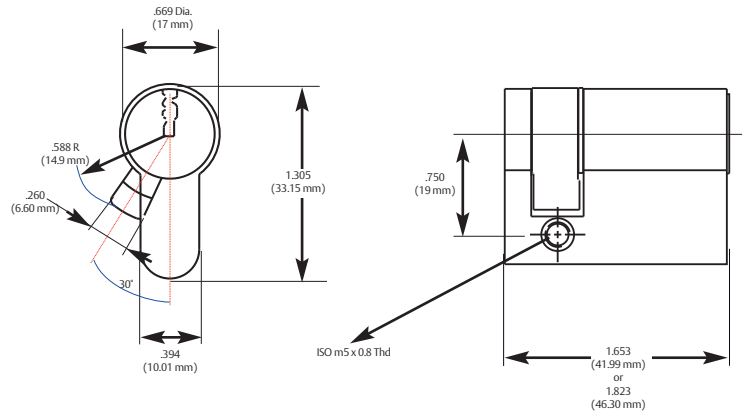

Cam position code as shown from outside.

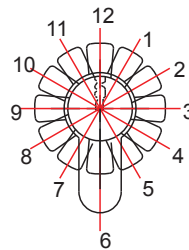

Multi-indexing cam with 12 positions. Cam is set at 5 o'clock from the factory

Part #: 2313015 8XX 5 Pin
2313016 8XX 6 Pin

Double Cylinder 5 Pin (Standard and Extended)

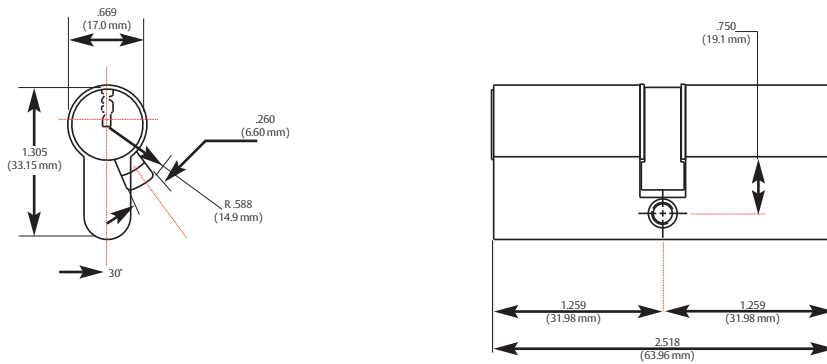

Cam position code as shown from outside.

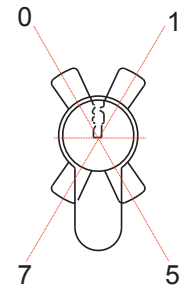

Part #: 2313025 X00 5 Pin
In 5mm steps up to 45mm

Double Cylinder 6 Pin (Standard and Extended)

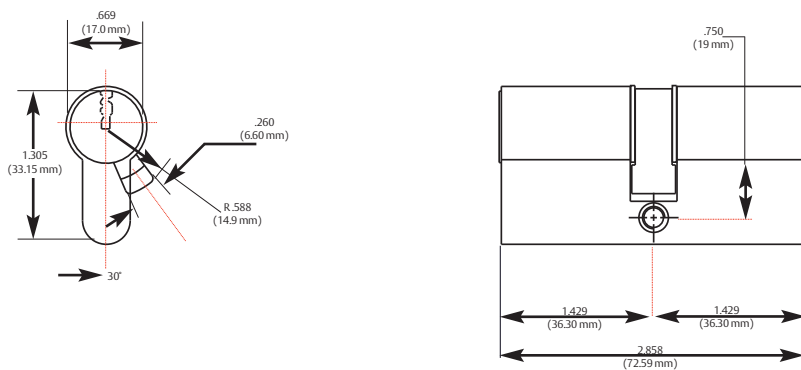

Cam position code as shown from outside.

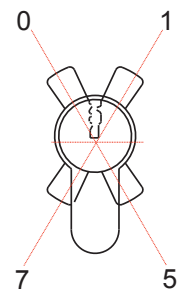

Part #: 2313026 X00 6 Pin
In 5mm steps up to 45mm

Union Single with Thumbturn

Cam position code as shown from outside.

Part #: **2304005 X00 5 Pin**
2304006 X00 6 Pin

Union Half Cylinder

Cam position code as shown from outside.

Part #: **2304015 X00 5 Pin**
2304016 X00 6 Pin

Union Double Cylinder

Cam position code as shown from outside.

Part #: **2304025 X00 5 Pin**
2304026 X00 6 Pin

Scandinavian Oval – Exterior for ASSA/Ruko®

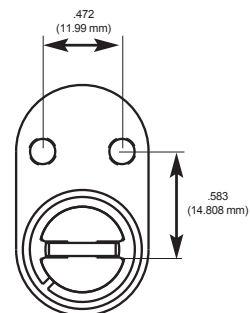
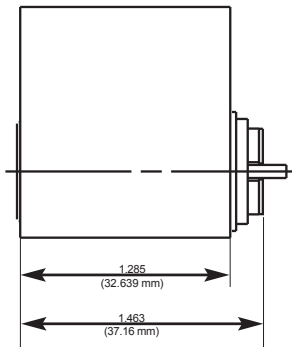
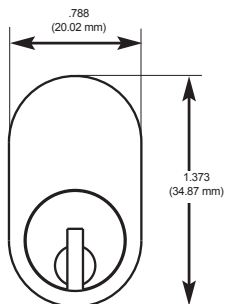

Tailpiece CT-Y76

Part #: 2305016 6 Pin

Scandinavian Oval – Interior for ASSA/Ruko®

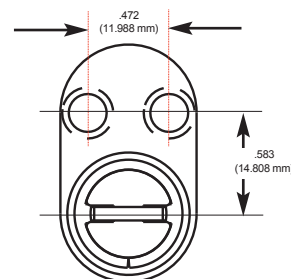
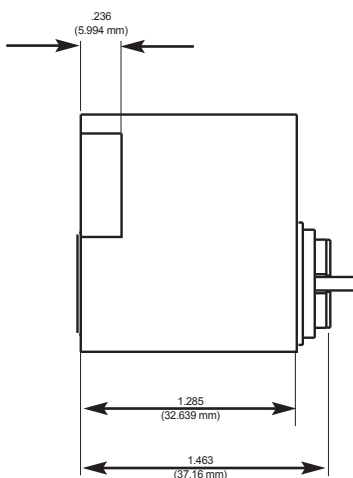
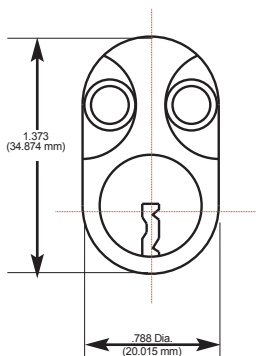

Tailpiece CT-Y76

Part #: 2306016 6 Pin

Scandinavian Padlock – for ASSA/Ruko®

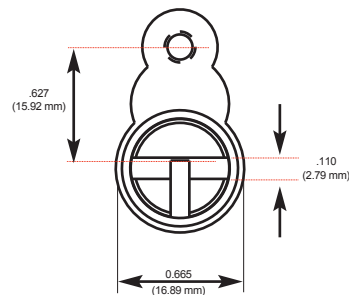
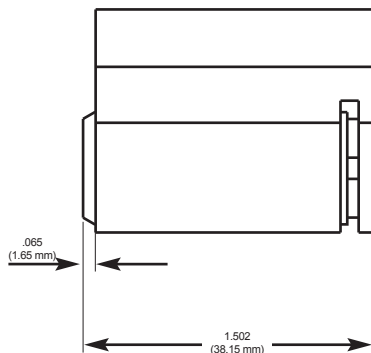
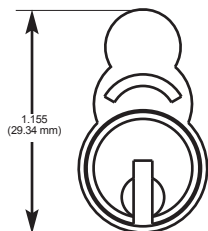

Part #: 2308016X 6 Pin

Scandinavian Round Exterior – for ASSA/Ruko®

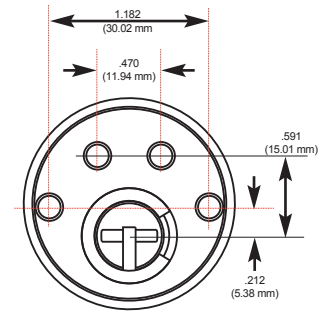
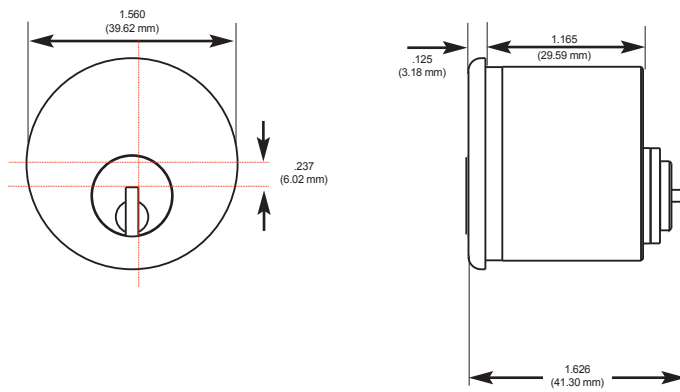

Part #: 2309016 6 Pin

Scandinavian Round Interior – for ASSA/Ruko®

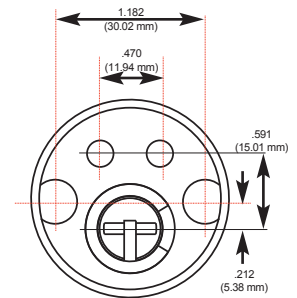
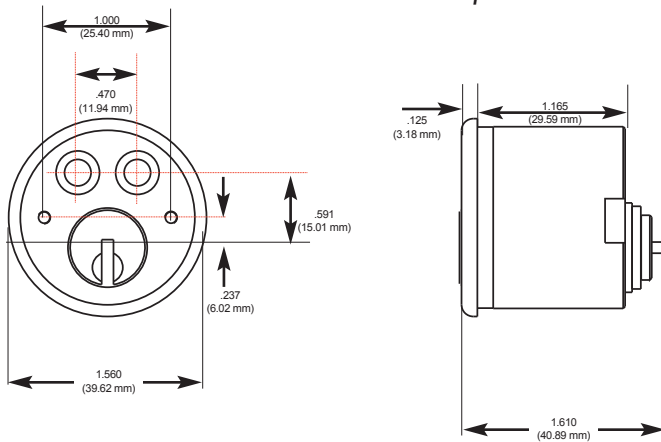

Part #: 2310016 6 Pin

Danish Round – Exterior for Ruko®

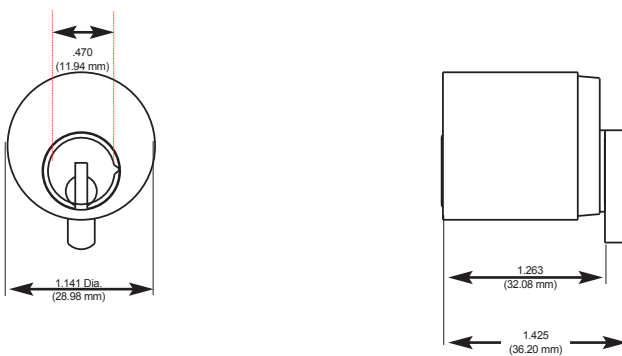

Special pinning required due to chamber height

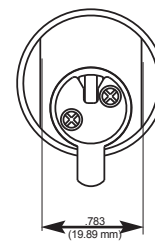

Part #: 2301016 6 Pin

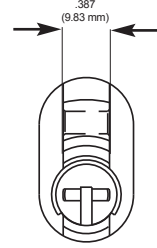
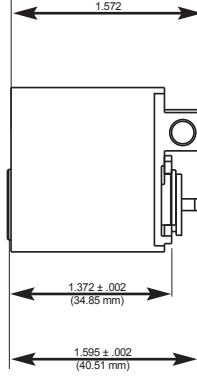
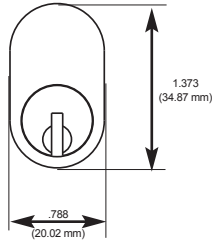
Norwegian Single Cylinder for Trio Ving®**Part #: 23070165 6 Pin**

Euroline Modular Profile Kit

Description	Part Number	Price
Euroline Modular Profile Kit - Danish	940243	\$4,277.31
Medeco XT Half Profile Modular Kit	940279	\$2,794.72
Euro Single/Double Thumbturn Kit Mechanical/Electric Available in Medeco XT or Medeco ³ CLIQ	940219	\$4,340.21
Medeco XT Cam for Doubles – Not included in kit	CT-Z98	\$3.42

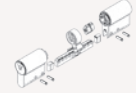
**Euroline Modular Cylinder Assembled**

Description	Part Number	Price
5 Pin Double Cylinder	2323025 X00	\$131.50
6 Pin Double Cylinder	2323026 X00	\$141.00
5 Pin Double Thumbturn/Cylinder	23230X5 X00	\$130.50
6 Pin Double Thumbturn/Cylinder	23230X6 X00	\$137.50

Euroline Modular eCylinder Assembled

Description	Part Number	Price
Medeco XT, 5 pin half, extended nose	232301S 800 G	\$244.50
Medeco XT, 5 pin extended .5mm half, extended nose	232301S 801 G	\$248.50
Medeco ³ CLIQ, Thumbturn/Cylinder, 36/36mm	23230X6 X00 S	\$576.00
Medeco ³ CLIQ Double, 36/36mm	23230E6 X00 S	\$576.00
Special Pin Kit for Biaxial/Medeco ³ CLIQ Pinning	.KW5401	\$536.00
Euro 1/2 Profile-30mm Assembled	232301S 800 G	\$244.50
Euro 1/2 Profile-35mm Assembled	232301S 801 G	\$248.50
Euro 1/2 Profile-30mm Assembled (True 30mm)	232301ST 800 G	\$244.50
Euro T/T Profile-30mm/30mm Assembled	23230XS X00 G	\$272.00
Euro T/T Profile-35mm/35mm Assembled	23230XS X11 G	\$280.00
Euro Dbl Profile Ectl/Mech-30mm/30mm Assembled	23230E5 X00 G	\$327.00
Euro Dbl Profile Ectl/Mech-35mm/35mm Assembled	23230E5 X11 G	\$335.00

**EuroLine Profile Cylinder Modules**

Description	Part Number	Price
5 Pin Cylinder	2322015 300	\$44.50
5 Pin Cylinder + 5mm	2322015 301	\$48.50
6 Pin Cylinder	2322016 300	\$49.00
6 Pin Cylinder + 5mm	2322016 301	\$53.00
Medeco x4 Standard 7 Pin Cylinder	2322017 300 N	\$37.00
Medeco x4 7 Pin + 5mm Cylinder	2322017 301 N	\$41.00

**Refer to the eCylinder section for more detail on specific technologies available and pricing. Technologies are represented by the following letters:
 T = Medeco³, S = Medeco³ CLIQ, J = Medeco³ BiLevel, W = Biaxial, V = Medeco Biaxial CLIQ, K = Medeco KM, N = Medeco X4, C = Medeco CLIQ,
 "-" = Original, Z = Medeco Original KW CLIQ, G = Medeco XT ***See key section for surcharges for custom coined cut keys or special stamping requirements.
Note: (P) refers to **Pinned** and **(S)** to **Sub-Pinned** at the end of each part string in the price book.

Euroline eCylinder Profile Medeco XT Modules

Description	Part Number	Price
Medeco XT 30mm Half Only	232201S 300 G	\$209.00
Medeco XT 35mm Half Only	232201S 301 G	\$213.00
Euro 1/2 Module-30mm	232201S 300 G	\$209.00
Euro 1/2 Module-35mm	232201S 301 G	\$213.00
Euro 1/2 Module-40mm-85mm	232201S 302 G	\$209.00
Single/Double Cylinder Module-30mm	232202S 300 G	\$209.00
Single/Double Cylinder Module-35mm	232202S 301 G	\$213.00
Single/Double Cylinder Module-40mm-85mm	232202S 302 G	\$209.00

Euroline eCylinder Profile Medeco³ CLIQ Modules

Description	Part Number	Price
Medeco ³ CLIQ, 6 pin Module	2322016 300 S	\$357.00
Medeco ³ CLIQ 6 pin + 5mm	2322016 301 S	\$361.00



EuroLine Profile Thumbturn Modules

Description	Part Number	Price
5 Pin Thumbturn	23220X5 300	\$47.50
6 Pin Thumbturn	23220X6 300	\$51.50

Euroline Profile Medeco XT Thumbturn Modules

Description	Part Number	Price
Euro Thumbturn Module - 30mm	23220XS 300	\$48.50

To order the Euro Thumbturn Module 35mm, you must add the shell ext. CP20071-05 and cart ext. CP-200781-05 to the 30mm Module

Special Cylinders

Description	Part Number	Price
Lockwood Oval retrofit	2303016 G	\$229.00
Aus 530 Style	201006 G	\$244.00
3-Tailpieces – For Australia Package	94-0283	\$20.00
Medeco XT Ruko Oval	2305016 G	\$253.00

**Refer to the eCylinder section for more detail on specific technologies available and pricing. Technologies are represented by the following letters:
T = Medeco³, S = Medeco³ CLIQ, J = Medeco³ BiLevel, W = Biaxial, V = Medeco Biaxial CLIQ, K = Medeco KM, N = Medeco X4, C = Medeco CLIQ,

“-” = Original, Z = Medeco Original KW CLIQ, G = Medeco XT ***See key section for surcharges for custom coined cut keys or special stamping requirements.

Note: (P) refers to **Pinned** and (S) to **Sub-Pinned** at the end of each part string in the price book.

Plug Extensions – Outer

*Quantities shown in parentheses below are included in the 94-0219 Euroline modular profile kit listed above. Additional items may be ordered individually.

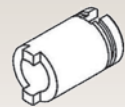

Description	Part Number	Price
10mm Kit Qty (20)	CP-200751-10	\$4.17
15mm Kit Qty (10)	CP-200751-15	\$4.49
20mm Kit Qty (5)	CP-200751-20	\$4.85
25mm Kit Qty (5)	CP-200751-25	\$5.85
30mm	CP-200751-30	\$6.18
40mm	CP-200751-40	\$6.84
45mm	CP-200751-45	\$7.16
50mm	CP-200751-50	\$8.02
55mm	CP-200751-55	\$8.36
60mm	CP-200751-60	\$8.68
65mm	CP-200751-65	\$9.03
70mm	CP-200751-70	\$9.52
75mm	CP-200751-75	\$9.83
80mm	CP-200751-80	\$10.17
85mm	CP-200751-85	\$10.54
90mm	CP-200751-90	\$10.86

Plug Extensions – Inner



Description	Part Number	Price
5mm Kit Qty (20)	CP-200761-05	\$2.67
10mm Kit Qty (20)	CP-200761-10	\$3.02
15mm Kit Qty (10)	CP-200761-15	\$3.36
20mm Kit Qty (5)	CP-200761-20	\$3.66
25mm Kit Qty (5)	CP-200761-25	\$4.49
30mm	CP-200761-30	\$4.85
40mm	CP-200761-40	\$5.50
45mm	CP-200761-45	\$6.50
50mm	CP-200761-50	\$6.84
55mm	CP-200761-55	\$7.16
60mm	CP-200761-60	\$7.69
65mm	CP-200761-65	\$8.02
70mm	CP-200761-70	\$10.86
75mm	CP-200761-75	\$11.18
80mm	CP-200761-80	\$11.53
85mm	CP-200761-85	\$11.86
90mm	CP-200761-90	\$12.17

Brass Shell Extensions



Description	Part Number	Price
5mm Kit Qty (20)	CP-200771-05	\$5.67
10mm Kit Qty (20)	CP-200771-10	\$6.58
15mm Kit Qty (10)	CP-200771-15	\$7.46
20mm Kit Qty (5)	CP-200771-20	\$8.52
25mm Kit Qty (5)	CP-200771-25	\$9.40

**Refer to the eCylinder section for more detail on specific technologies available and pricing. Technologies are represented by the following letters:

T = Medeco³, S = Medeco³ CLIQ, J = Medeco³ BiLevel, W = Biaxial, V = Medeco Biaxial CLIQ, K = Medeco KM, N = Medeco X4, C = Medeco CLIQ,
 “-” = Original, Z = Medeco Original KW CLIQ, G = Medeco XT ***See key section for surcharges for custom coined cut keys or special stamping requirements.

Note: (P) refers to **Pinned** and (S) to **Sub-Pinned** at the end of each part string in the price book.

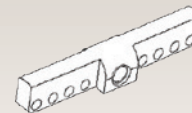

Connecting Bar

Description	Part Number	Price
5mm Kit Qty (15)	CP-200801-00	\$22.50
10mm Kit Qty (5)	CP-200801-02	\$24.50
20mm Kit Qty (5)	CP-200801-04	\$26.00
30mm Kit Qty (5)	CP-200801-06	\$27.50
40mm Kit Qty (1)	CP-200801-08	\$29.00
50mm Kit Qty (1)	CP-200801-0A	\$31.00
10/10mm Kit Qty (5)	CP-200801-22	\$26.00
10/20mm Kit Qty (5)	CP-200801-24	\$27.50
10/30mm Kit Qty (3)	CP-200801-26	\$29.00
10/40mm Kit Qty (1)	CP-200801-28	\$31.00
10/50mm Kit Qty (1)	CP-200801-2A	\$32.50
20/20mm Kit Qty (3)	CP-200801-44	\$29.00
20/30mm Kit Qty (1)	CP-200801-46	\$31.00
20/40mm Kit Qty (1)	CP-200801-48	\$32.50
20/50mm Kit Qty (1)	CP-200801-4A	\$34.50
30/30mm Kit Qty (1)	CP-200801-66	\$32.50
30/40mm Kit Qty (1)	CP-200801-68	\$34.50
30/50mm Kit Qty (1)	CP-200801-6A	\$36.00
40/40mm Kit Qty (1)	CP-200801-88	\$36.00
40/50mm Kit Qty (1)	CP-200801-8A	\$37.50
50/50mm Kit Qty (1)	CP-200801-AA	\$40.00



Modular Thumbturn Shaft

Description	Part Number	Price
5 Pin Kit Qty (2)	CP-240771-5P	\$8.11
6 Pin Kit Qty (2)	CP-240771-6P	\$8.39

Modular Service Tools



Description	Part Number	Price
Modular Assembly Block Kit Qty (1)	94-0208	\$812.00
Pinning Block Kit Qty (2)	94-0203	\$8.28
Pinning Block Medeco X4	94-0285	\$8.50
Capping Tool Kit Qty (2)	94-0207	\$1.45
Small flat blade screwdriver Kit Qty (1)	94-0221	\$37.50
Removing Punch, 2.3 mm Kit Qty (1)	94-0222	\$112.00
Installing punch, 6.35 mm Kit Qty (1)	94-0223	\$112.00
Allen Wrench, 1.588 mm Kit Qty (1)	CP-280330	\$2.56

Miscellaneous Components

Description	Part Number	Price
Groove Pin Kit Qty (200)	CP-063220	\$0.48
Clutch Piece Assembly Kit Qty (20)	CP-220071	\$6.31
5 Pin Cover Kit Qty (50)	CP-170730-5	\$0.49
6 Pin Cover Kit Qty (50)	CP-170730-6	\$0.49
Double Cam Kit Qty (20)	CT-Z50	\$3.42
Thumbturn Cam Kit Qty (20)	CT-Z51	\$3.42

**Refer to the eCylinder section for more detail on specific technologies available and pricing. Technologies are represented by the following letters:







T = Medeco³, S = Medeco³ CLIQ, J = Medeco³ BiLevel, W = Biaxial, V = Medeco Biaxial CLIQ, K = Medeco KM, N = Medeco X4, C = Medeco CLIQ,
 “-” = Original, Z = Medeco Original KW CLIQ, G = Medeco XT ***See key section for surcharges for custom coined cut keys or special stamping requirements.

Note: (P) refers to **Pinned** and **(S)** to **Sub-Pinned** at the end of each part string in the price book.

Top Pins

Description	Part Number	Price
1 top pin Kit Qty (200)	TP-F10-4T (.180")	\$0.36
2 top pin Kit Qty (200)	TP-F10-5T (.150")	\$0.36
3 top pin Kit Qty (200)	TP-H10-9W (.135")	\$0.34
4 top pin Kit Qty (200)	TP-F10-4W-6T (.120")	\$0.34
5 top pin Kit Qty (200)	TP-F10-3W (.090")	\$0.34
6 top pin Kit qty (200)	TP-F10-2W (.060")	\$0.34

Thumbturn Knobs

Description	Part Number	Price
 Decorative "RD"	CP-285901	\$15.00
 Lever "RL"	CP-285931	\$22.00
 Round "SR"	CP-285961	\$22.00
 Low Profile "LP"	CP-285991	\$15.00
 Crescent "CR"	CP-286021	\$11.50
 Spade "SP"	CP-286051	\$11.50

Finish required.

**Refer to the eCylinder section for more detail on specific technologies available and pricing. Technologies are represented by the following letters:
 T = Medeco³, S = Medeco³ CLIQ, J = Medeco³ BiLevel, W = Biaxial, V = Medeco Biaxial CLIQ, K = Medeco KM, N = Medeco X4, C = Medeco CLIQ,
 "-" = Original, Z = Medeco Original KW CLIQ, G = Medeco XT ***See key section for surcharges for custom coined cut keys or special stamping requirements.
Note: (P) refers to **Pinned** and **(S)** to **Sub-Pinned** at the end of each part string in the price book.

Medeco XT Half Cylinder Connecting Bar

*Quantities shown in parentheses below are included in the 94-0279 Euroline half cylinder kit listed above. Additional items may be ordered individually.



Description	Part Number	Price
40, 45mm Kit Qty (6)	CP-200801-12	\$19.00
50, 55mm Kit Qty (5)	CP-200801-14	\$21.00
60, 65mm Kit Qty (3)	CP-200801-16	\$22.50
70, 75mm Kit Qty (3)	CP-200801-18	\$24.50
80, 85 mm Kit Qty (3)	CP-200801-1A	\$26.00



Plug Extensions Outer for 94-0279

Description	Part Number	Price
10mm Kit Qty (20)	CP-200751-10	\$4.17
15mm Kit Qty (15)	CP-200751-15	\$4.49
20mm Kit Qty (5)	CP-200751-20	\$4.85
25mm Kit Qty (5)	CP-200751-25	\$5.85

Brass Shell Extensions for 94-0279

Description	Part Number	Price
5mm Kit Qty (20)	CP-200771-05	\$5.67
10mm Kit Qty (20)	CP-200771-10	\$6.58
15mm Kit Qty (10)	CP-200771-15	\$7.46
20mm Kit Qty (5)	CP-200771-20	\$8.52
25mm Kit Qty (5)	CP-200771-25	\$9.40

Bar Filler (2 per Cylinder) for 94-0279

Description	Part Number	Price
5 Pin, 0mm Kit Qty (20)	CP-160661-50	\$1.01
5 Pin, 5mm Kit Qty (20)	CP-160661-55	\$1.05

Miscellaneous Components for 94-0279







Description	Part Number	Price
Half Shell Backend Kit Qty (20)	CP-200830	\$14.00
Actuator Spring Kit Qty (25)	CP-030860	\$0.92
Indexable Actuator Kit Qty (20)	CP-220090	\$3.86
Security Pin Kit Qty (25)	CP-060106	\$1.09
Groove Pin Kit Qty (65)	CP-063220	\$0.48
Indexible Cam	CT-Z88	\$3.42

**Refer to the eCylinder section for more detail on specific technologies available and pricing. Technologies are represented by the following letters:

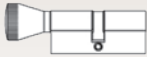
T = Medeco³, S = Medeco³ CLIQ, J = Medeco³ BiLevel, W = Biaxial, V = Medeco Biaxial CLIQ, K = Medeco KM, N = Medeco X4, C = Medeco CLIQ,
 “-” = Original, Z = Medeco Original KW CLIQ, G = Medeco XT ***See key section for surcharges for custom coined cut keys or special stamping requirements.

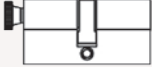
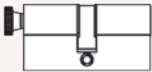
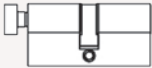
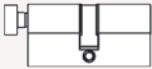

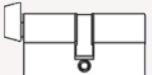

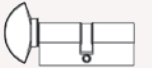
Note: (P) refers to **Pinned** and **(S)** to **Sub-Pinned** at the end of each part string in the price book.

Euro Profile Single Cylinder with Thumbturn



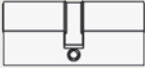

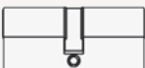
Description	Part Number	Price
 5 Pin, Standard Round "SR" Thumbturn	2313005 X00	\$130.50
 6 Pin, Standard Round "SR" Thumbturn	2313006 X00	\$137.50
 5 Pin, Low Profile "LP" Thumbturn	2313035 X00	\$130.50
 6 Pin, Low Profile "LP" Thumbturn	2313036 X00	\$137.50
 5 Pin, Removable Decorative "RD" Thumbturn	2313045 X00	\$130.50
 6 Pin, Removable Decorative "RD" Thumbturn	2313046 X00	\$137.50
 5 Pin, Removable Lever "RL" Thumbturn	2313055 X00	\$130.50
 6 Pin, Removable Lever "RL" Thumbturn	2313056 X00	\$137.50
 5 Pin, Euro Crescent "CR" Thumbturn	2313065 X00	\$130.50
 6 Pin, Euro Crescent "CR" Thumbturn	2313066 X00	\$137.50

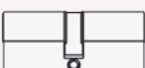
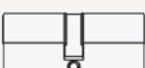
**Refer to the eCylinder section for more detail on specific technologies available and pricing. Technologies are represented by the following letters:
T = Medeco³, S = Medeco³ CLIQ, J = Medeco³ BiLevel, W = Biaxial, V = Medeco Biaxial CLIQ, K = Medeco KM, N = Medeco X4, C = Medeco CLIQ,
“-” = Original, Z = Medeco Original KW CLIQ, G = Medeco XT ***See key section for surcharges for custom coined cut keys or special stamping requirements.
Note: (P) refers to **Pinned** and **(S)** to **Sub-Pinned** at the end of each part string in the price book.

Euro Profile Double Cylinder

Description	Part Number	Price
 5 Pin, No Extension	2313025 X00	\$131.50
 5 Pin Extended, 5 mm Ext. Side (0mm/5mm)	2313025 X01	\$135.50
 5 Pin Extended, 10 mm Ext. Side (0mm/10mm)	2313025 X02	\$139.50
 5 Pin Extended, (5mm/5mm)	2313025 X11	\$139.50
 5 Pin Extended, (5mm/10mm)	2313025 X12	\$143.50
 6 Pin, No Extension	2313026 X00	\$141.00
 6 Pin Extended, 5mm Ext. Side (0 mm/5 mm)	2313026 X01	\$145.00
 6 Pin Extended, 10mm Ext. Side (0 mm/10 mm)	2313026 X02	\$149.00
 6 Pin Extended, (5mm/10mm)	2313026 X12	\$153.00

Euro Profile Double Cylinder

Description	Part Number	Price
 5 Pin with 12 Position Indexable Cam	2313015 800	\$111.50
 5 Pin, Extended 5 mm with 12 Position Indexable Cam	2313015 801	\$115.50
 6 Pin with 12 Position Indexable Cam	2313016 800	\$113.00
 6 Pin, Extended 5 mm with 12 Position Indexable Cam	2313016 801	\$117.00

**Refer to the eCylinder section for more detail on specific technologies available and pricing. Technologies are represented by the following letters:
 T = Medeco³, S = Medeco³ CLIQ, J = Medeco³ BiLevel, W = Biaxial, V = Medeco Biaxial CLIQ, K = Medeco KM, N = Medeco X4, C = Medeco CLIQ,
 “-” = Original, Z = Medeco Original KW CLIQ, G = Medeco XT ***See key section for surcharges for custom coined cut keys or special stamping requirements.
Note: (P) refers to **Pinned** and **(S)** to **Sub-Pinned** at the end of each part string in the price book.

Other International Cylinders

Description	Part Number	Price
Danish Round Mortise Cylinder	2301016	\$104.00
Danish Special Cam Lock (Ruko®)	23010168	\$75.50
Australian Oval - Less Cams and Pins	2303016A	\$121.00
5 Pin British Oval Single Cylinder with Thumbturn	2304005	\$175.00
6 Pin British Oval Single Cylinder with Thumbturn	2304006	\$145.50
5 Pin British Oval Half Cylinder	2304015	\$107.00
6 Pin British Oval Half Cylinder	2304016	\$183.50
5 Pin British Oval Double Cylinder	2304025	\$148.00
6 Pin British Oval Double Cylinder	2304026	\$143.00
Scandinavian Oval Exterior Cylinder	2305016	\$108.50
Scandinavian Oval Interior Cylinder	2306016	\$108.50
Norwegian Oval Shape Cylinder	23070165	\$121.00
Scandinavian Snowman Cylinder	23080166	\$124.00
Scandinavian Round Exterior Cylinder	2309016	\$161.50
Scandinavian Round Interior Cylinder	2310016	\$161.50
Italian Cylinder Inner Gate Lock, 3 Pin	2314003	\$76.50
Italian Cylinder Exterior Gate Lock, 5 Pin	2315005	\$87.00
Italian Roller Shutter 4 Pin	2316004	\$87.00
Danish Special Oval Cylinder Assembly	2317016	\$114.00
Danish Cam Lock (for Ruko®) w/ 90° Stop	2320016	\$104.50

**Refer to the eCylinder section for more detail on specific technologies available and pricing. Technologies are represented by the following letters:

T = Medeco³, S = Medeco³ CLIQ, J = Medeco³ BiLevel, W = Biaxial, V = Medeco Biaxial CLIQ, K = Medeco KM, N = Medeco X4, C = Medeco CLIQ,
 “-” = Original, Z = Medeco Original KW CLIQ, G = Medeco XT ***See key section for surcharges for custom coined cut keys or special stamping requirements.

Note: (P) refers to **Pinned** and **(S)** to **Sub-Pinned** at the end of each part string in the price book.

Profile Components

Description	Part Number	Price
5 Pin Plug For Half Cylinder	12286	\$44.40
5 Pin Double Cylinder Profile Plug	12286	\$44.40
6 Pin Plug For Half Cylinder	12288	\$44.40
6 Pin Double Cylinder Profile Plug	12288	\$44.40
5 Pin Double Cylinder Profile Shell	13327	\$65.00
6 Pin Double Cylinder Profile Shell	13346	\$65.00
5 Pin Shell For Half Cylinder	13365	\$65.00
6 Pin Shell For Half Cylinder	13375	\$65.00
Thumbturn Set Screw	CP-011013-020	\$0.22
Profile Cylinder Set Screw, #8-32 x 1/4"	CP-011013-040	\$0.32
Set Screw for "CR" Thumbturn	CP-012409-030	\$0.47
Thumbturn Set Screw	CP-012411-030	\$0.61
Set Screw For Removable Thumbturn	CP-012411-040	\$0.61
Thumbturn Retaining Clip	CP-020031	\$4.49
Cartridge Retainer	CP-020240	\$0.18
Plug Retaining Clip - Old Style, C Clip	CP-021400	\$1.04
Plug Retaining Clip - Continuous Ring	CP-021490	\$1.28
Tumbler Spring	CP-030001	\$0.09
Single Cylinder Profile Pilot Spring	CP-030024	\$0.51
Single Cylinder Profile Thumbturn Actuator Spring	CP-030025	\$0.17
Actuator Spring For Half Cylinder	CP-030860	\$0.92
Snap Ring	CP-031030	\$0.53
Single Cylinder Profile Actuator	CP-100111	\$8.56
Double Cylinder Profile Clutch	CP-220071	\$6.31
5 and 6 Pin Actuator For Half Cylinder	CP-220090	\$3.86
Clutch Assembly, Emergency	CP-220120	\$23.00
Double Cylinder Profile Gear Cam	CP-230081	\$7.49
Thumbturn Cylinder Profile Gear Cam	CP-230091	\$7.49
Single Cylinder Profile Thumbturn Actuator Pilot	CP-280261	\$11.50
Standard Round "SR" Thumbturn Assembly 5 Pin	CP-285981-500	\$67.00
Low Profile "LP" Thumbturn Assembly 5 Pin	CP-286011-500	\$67.00
Lever "RL" Thumbturn Assembly 5 Pin	CP-285951-500	\$67.00
Crescent "CR" Thumbturn Assembly 5 Pin	CP-286041-500	\$67.00
Decorative "RD" Thumbturn Assembly 5 Pin	CP-285921-500	\$67.00
Decorative "RD" Thumbturn Only	CP-285901	\$22.00
Lever "RL" Thumbturn Only	CP-285931	\$22.00
Low Profile "SR" Thumbturn Only	CP-285961	\$15.00
Low Profile "LP" Thumbturn Only	CP-285991	\$26.00
Oval Int./Ext. Cylinder tailpiece	CT-Y76	\$3.42
Cam, British Oval (Half/Double)	CT-Z26	\$3.42
Cam, British Oval (Thumbturn)	CT-Z29	\$3.42
Double Cylinder Profile Cam	CT-Z50	\$3.42
Thumbturn Cylinder Profile Cam, Non Indexing	CT-Z51	\$3.42
Indexing Cam For Half Cylinders	CT-Z88	\$3.42
Cam, Medeco XT Double Profile Cyl	CT-Z98	\$3.42

**Refer to the eCylinder section for more detail on specific technologies available and pricing. Technologies are represented by the following letters:

T = Medeco³, S = Medeco³ CLIQ, J = Medeco³ BiLevel, W = Biaxial, V = Medeco Biaxial CLIQ, K = Medeco KM, N = Medeco X4, C = Medeco CLIQ,
 "-." = Original, Z = Medeco Original KW CLIQ, G = Medeco XT ***See key section for surcharges for custom coined cut keys or special stamping requirements.

Note: (P) refers to **Pinned** and **(S)** to **Sub-Pinned** at the end of each part string in the price book.

Maxum Deadbolts

FEATURES	Medeco ³	BiLevel	Medeco X4	CLIQ
UL Listed for use on fire doors having a rating up to three hours	●	●	●	●
ANSI/BHMA 156.36 Grade 1 Certification for auxiliary locks and associated products	●			
ANSI/BHMA A156.30 Level A Certification on the cylinder assures patent protected key control and physical strength	●			
Can be incorporated into existing master key systems	●	●	●	
Security features to protect against drill, wrench, ice pick, kick-in, hammer, bumping and prying attacks	●	●		
Solid brass construction provides high quality and long cylinder life	●	●	●	
Deadbolt is designed to accommodate both mortise and drive-in face applications for greater flexibility and ease of installation.	●	●	●	
Large thumbturn provides ease of use for physically challenged individuals	●	●	●	
Keys may be integrated with Hybrid proximity head for greater system retrofit.	●	●	●	
Double cylinder captive thumbturn safety option available	●	●		

Medeco³ Premium High Security

For effective mechanical protection against most forms of attack as well as protection against unauthorized duplicate keys, Medeco³ cylinders are recommended. Security features including hardened steel components, pins that must be elevated, rotated, and interact with both a sidebar and a slider, and additional pick resistant features make Medeco³ the cylinder of choice to protect people, property and information.

Medeco³ BiLevel Patented Key Control

Medeco³ BiLevel cylinders may be incorporated into a master key system with Medeco³ high security, offering protection against all types of attack where needed, and patented key control cylinders for areas requiring less protection. BiLevel cylinders offer patented control against unauthorized duplication of keys without the additional security features protecting against force or surreptitious attack.

Medeco X4 Patented Key Control

Medeco X4 cylinders offer patented control against unauthorized duplication of keys without the additional security features protecting against force or surreptitious attack.

Loss & Liability Control

Many of the cylinders in this section are also available with an eCylinder Loss & Liability Control Solution. See the eCylinder Section for more details.

Medeco Maxum® Deadbolts

Deadbolts are about strength. Just hold a Medeco® ANSI Grade 1 Maxum® deadbolt in your hand, and you know this is one tough hunk of protection. As tough as a Maxum® deadbolt is on the outside, it's that smart on the inside. It can be ordered with the triple-locking security of a Medeco³ cylinder. Recommended for residential and business use, it's available as a single- or double-cylinder or with a unique "captive thumbturn." The captive thumbturn converts the inside cylinder to a thumbturn for safe exit when the facility is occupied. A quick conversion when the facility is not occupied returns it to double cylinder mode and guards against unauthorized entry or exit. Maxum® deadbolts offer maximum protection with solid-brass construction, along with anti-drilling and anti-prying features.



Patented Key Control

Protects against unauthorized duplication of your keys.



Certified Grade 1

BHMA certified Grade 1, passes to the highest standards in the industry.



Drill Protection

Offers maximum protection with solid-brass construction and strategically placed drill pins.



Protection From Physical Attack

Medeco³ Medeco Maxum Deadbolts are UL 437 listed and stand up to prying, picking and other forms of physical attack.



Special Angle Cut Keys

Requires a special key cutting machine and access to Medeco specific blanks, available in a variety of restrictions to support every need.



Picking and Bumping Protection

Medeco³ cylinders use a sidebar that prevent the key from rotating until it is elevated, rotated and aligned in the correct position. This feature protects against bumping and picking attacks.

Technical Information:

- SFIC cylinder options include Medeco X4 and Nexgen XT
- Unique "captive thumbturn"
- Bolt is designed for easy conversion accommodating either mortise and drive-in applications
- Solid-brass construction with steel inserts for added protection

- ANSI/BHMA A156.36 Grade 1 and UL437 Listed cylinders for high security
- Fits doors 1 3/8" to 2 1/2" thick
- Standard 2 1/8" crossbore and 1" edge bore (ANSI A115.13 prep)

Warranty:

Lifetime warranty against defects in material and workmanship.

Finishes:

Available in all standard finishes to match existing hardware.

Applications:

It is the ideal choice for a wide variety of commercial and heavy duty residential applications where consistent quality, ease of use and installation are required. Ideal applications include:

- Office buildings
- Hospitals
- Schools
- Restaurants
- Apartments
- Retail outlets

Available Key Technologies:

Mechanical:

- Medeco³
- Medeco³ BiLevel
- Medeco X4

eCylinder:

- Medeco³ CLIQ
- Medeco CLIQ

How to Order:

<p>1</p> <p>11C601 base part #</p> <p>Refer to pages 125-138 for descriptions and technical specifications to find the corresponding base part number.</p>	<p>2</p> <p>T cylinder</p> <ul style="list-style-type: none"> - = Original K = Medeco KM T = Medeco³ W = Biaxial J = Medeco³ BiLevel C = Medeco CLIQ N = Medeco X4 	<p>3</p> <p>05 finish</p> <p>Refer to the inside back cover of this catalog for finish options. Include the corresponding two digit finish number.</p> <p>Upcharge for split finish.</p>	<p>4</p> <p>LT keyway</p> <p>Insert keyway if known or contact Customer Service for help.</p>	<p>5</p> <table border="1"> <tr> <td> <p>S = Sub-Assembled (Uncombined) No additional information needed</p> </td> <td> <p>P = Pinned (Combined) Keyed alike (KA) Keyed different (KD) 2 keys per cylinder</p> </td> <td> <p>M = Master Keyed Provide specific pinning or contact Customer Service for support Must specify quantity for keys.</p> </td> </tr> </table>	<p>S = Sub-Assembled (Uncombined) No additional information needed</p>	<p>P = Pinned (Combined) Keyed alike (KA) Keyed different (KD) 2 keys per cylinder</p>	<p>M = Master Keyed Provide specific pinning or contact Customer Service for support Must specify quantity for keys.</p>
<p>S = Sub-Assembled (Uncombined) No additional information needed</p>	<p>P = Pinned (Combined) Keyed alike (KA) Keyed different (KD) 2 keys per cylinder</p>	<p>M = Master Keyed Provide specific pinning or contact Customer Service for support Must specify quantity for keys.</p>					

BUILD A MAXUM DEADBOLT BASE PART#

11XXXX

<p>Maxum Deadbolt _____</p> <p>Trim _____</p> <ul style="list-style-type: none"> C = Commercial R = Residential <p>Cylinder Type _____</p> <ul style="list-style-type: none"> 2 = Blank Plate 3 = LFIC (6 Pin) 4 = LFIC (Less Core) 5 = Medeco (5 Pin) 6 = Medeco (6 Pin) 7 = SFIC (Less Core) 8 = SFIC (6 Pin) 9 = SFIC (7 Pin) <p>Function _____</p> <ul style="list-style-type: none"> 0 = Cylinder x Thumbturn 1 = Cylinder x Thumbturn (Classroom) 2 = Cylinder x Cylinder 3 = Cylinder x Cylinder (Captive) 4 = Cylinder x Plate 5 = Dummy x Thumbturn 6 = Dummy x Cylinder 7 = Dummy x Plate 8 = Plate x Thumbturn 9 = Plate x Cylinder D = Dummy x Dummy P = Plate x Plate 	<p>Backset</p> <ul style="list-style-type: none"> 1 = 2 3/8" Backset, 1 1/8" Front 2 = 2 3/4" Backset, 1 1/8" Front 3 = 2 3/8" Backset, 1" Front 4 = 2 3/4" Backset, 1" Front 5 = 2 3/8" Backset, Round Front 6 = 2 3/4" Backset, Round Front L = Less Bolt Assembly
--	--

**Refer to the eCylinder section for more detail on specific technologies available and pricing. Technologies are represented by the following letters:
 T = Medeco³, S = Medeco³ CLIQ, J = Medeco³ BiLevel, W = Biaxial, V = Medeco Biaxial CLIQ, K = Medeco KM, N = Medeco X4, C = Medeco CLIQ,
 "-" = Original, Z = Medeco Original KW CLIQ, G = Medeco XT ***See key section for surcharges for custom coined cut keys or special stamping requirements.
Note: (P) refers to **Pinned** and **(S)** to **Sub-Pinned** at the end of each part string in the price book.

Single Cylinder Maxum® Deadbolt- Commercial Trim

Description	Part Number	Medeco ³	BiLevel	Medeco X4	eCylinder
Maxum® Deadbolt Lock, Blank Plate Outside with Inside Thumbturn, 1 1/8" Faceplate†, 2 3/8" Backset	11C281	\$176.00			
Maxum® Deadbolt Lock, Blank Plate Outside with Inside Thumbturn, 1 1/8" Faceplate†, 2 3/4" Backset	11C282	\$176.00			
Single Cylinder Maxum® Deadbolt Lock, 1 1/8" Faceplate, 2 3/8" Backset	11C601 (P) 11C601 (S)	\$207.50 \$198.00	\$173.30 \$168.30		•
Single Cylinder Maxum® Deadbolt Lock, 1 1/8" Faceplate, 2 3/4" Backset	11C602 (P) 11C602 (S)	\$207.50 \$198.00	\$173.30 \$168.30		•
Single Cylinder Maxum® Deadbolt Lock, 1" Faceplate, 2 3/8" Backset	11C603 (P) 11C603 (S)	\$207.50 \$198.00	\$173.30 \$168.30		•
Single Cylinder Maxum® Deadbolt Lock, 1" Faceplate, 2 3/4" Backset	11C604 (P) 11C604 (S)	\$207.50 \$198.00	\$173.30 \$168.30		•
Single Cylinder Maxum® Deadbolt Lock, Drive In Front, 2 3/8" Backset	11C605 (P) 11C605 (S)	\$207.50 \$198.00	\$173.30 \$168.30		
Single Cylinder Maxum® Deadbolt Lock, Drive In Front, 2 3/4" Backset	11C606 (P) 11C606 (S)	\$207.50 \$198.00	\$173.30 \$168.30		•
Single Cylinder Maxum® Deadbolt Lock, Less Bolt	11C60L (P) 11C60L (S)	\$146.50 \$137.00	\$112.30 \$107.30		
Single Cylinder Maxum® Deadbolt Lock, Classroom Function, 1 1/8" Faceplate, 2 3/8" Backset	11C611 (P) 11C611 (S)	\$213.00 \$203.50			
Single Cylinder Maxum® Deadbolt Lock, Classroom Function, Drive In, 2 3/8" Backset	11C615 (P) 11C615 (S)	\$213.00 \$203.50			
Single Cylinder Maxum® Deadbolt Lock, Classroom Function, Drive In, 2 3/4" Backset	11C616 (P) 11C616 (S)	\$213.00 \$203.50			
Single Cylinder Maxum® Deadbolt Lock, Classroom Function, Less Bolt	11C61L (P) 11C61L (S)	\$152.00 \$131.50			
Single Cylinder Maxum® Deadbolt Lock, Classroom Function, 1 1/8" Faceplate, 2 3/4" Backset	11C612 (P) 11C612 (S)	\$213.00 \$203.50			
Single Cylinder Maxum® Deadbolt Lock, Classroom Function, 1" Faceplate, 2 3/8" Backset	11C613 (P) 11C613 (S)	\$213.00 \$203.50			
Single Cylinder Maxum® Deadbolt Lock, Classroom Function, 1" Faceplate, 2 3/4" Backset	11C614 (P) 11C614 (S)	\$213.00 \$203.50			
Single Cylinder Maxum® Deadbolt Lock with Blank Plate Inside, 1 1/8" Faceplate, 2 3/8" Backset	11C641 (P) 11C641 (S)	\$203.50 \$194.00			
Single Cylinder Maxum® Deadbolt Lock with Blank Plate Inside, 1 1/8" Faceplate, 2 3/4" Backset	11C642 (P) 11C642 (S)	\$203.50 \$194.00			
Single Cylinder Maxum® Deadbolt Lock, with Blank Plate Outside, 1 1/8" Faceplate*, 2 3/8" Backset	11C691 (P) 11C691 (S)	\$203.50 \$194.00			
Single Cylinder Maxum® Deadbolt Lock, with Blank Plate Outside, 1 1/8" Faceplate, 2 3/4" Backset	11C692 (P) 11C692 (S)	\$203.50 \$194.00			

**Refer to the eCylinder section for more detail on specific technologies available and pricing. Technologies are represented by the following letters:

T = Medeco³, S = Medeco³ CLIQ, J = Medeco³ BiLevel, W = Biaxial, V = Medeco Biaxial CLIQ, K = Medeco KM, N = Medeco X4, C = Medeco CLIQ,

"-" = Original, Z = Medeco Original KW CLIQ, G = Medeco XT ***See key section for surcharges for custom coined cut keys or special stamping requirements.

Note: (P) refers to Pinned and (S) to Sub-Pinned at the end of each part string in the price book.

LFIC Single Cylinder Maxum® - Commercial Trim

Description	Part Number	Medeco ³	BiLevel	Medeco X4	eCylinder
LFIC Single Cylinder Maxum® Deadbolt Lock, Less Bolt	11C30L (P)	\$221.00			
	11C30L (S)	\$211.50			
LFIC Single Cylinder Maxum® Deadbolt Lock, 1 1/8" Faceplate, 2 3/8" Backset	11C301 (P)	\$282.00			
	11C301 (S)	\$272.50			
LFIC Single Cylinder Maxum® Deadbolt Lock, 1 1/8" Faceplate, 2 3/4" Backset	11C302 (P)	\$282.00			
	11C302 (S)	\$272.50			
LFIC Single Cylinder Maxum® Deadbolt Lock, 1" Faceplate, 2 3/8" Backset	11C303 (P)	\$282.00			
	11C303 (S)	\$272.50			
LFIC Single Cylinder Maxum® Deadbolt Lock, 1" Faceplate, 2 3/4" Backset	11C304 (P)	\$282.00			
	11C304 (S)	\$272.50			
LFIC Single Cylinder Maxum® Deadbolt Lock, Drive-In Front, 2 3/8" Backset	11C305 (P)	\$282.00			
	11C305 (S)	\$272.50			
LFIC Single Cylinder Maxum® Deadbolt Lock, Drive-In Front, 2 3/4" Backset	11C306 (P)	\$282.00			
	11C306 (S)	\$272.50			
LFIC Single Cylinder Maxum® Deadbolt Lock Classroom Function, 1 1/8" Faceplate, 2 3/8" Backset	11C311 (P)	\$287.50			
	11C311 (S)	\$278.00			
LFIC Single Cylinder Maxum® Deadbolt Lock Classroom Function, 1 1/8" Faceplate, 2 3/4" Backset	11C312 (P)	\$287.50			
	11C312 (S)	\$278.00			
LFIC Single Cylinder Maxum® Deadbolt Lock Classroom Function, 1" Faceplate, 2 3/8" Backset	11C313 (P)	\$287.50			
	11C313 (S)	\$278.00			
LFIC Single Cylinder Maxum® Deadbolt Lock Classroom Function, 1" Faceplate, 2 3/4" Backset	11C314 (P)	\$287.50			
	11C314 (S)	\$278.00			
LFIC Single Cylinder Maxum® Deadbolt Lock Classroom Function, Drive-In Front, 2 3/8" Backset	11C315 (P)	\$287.50			
	11C315 (S)	\$278.00			
LFIC Single Cylinder Maxum® Deadbolt Lock Classroom Function, Drive-In Front, 2 3/4" Backset	11C316 (P)	\$287.50			
	11C316 (S)	\$278.00			
LFIC Single Cylinder Maxum® Deadbolt Lock Classroom Function, Less Bolt	11C31L (P)	\$226.50			
	11C31L (S)	\$217.00			
LFIC Single Cylinder Maxum® Deadbolt Lock, Blank Inside, 1 1/8" Faceplate, 2 3/8" Backset	11C341 (P)	\$278.00			
	11C341 (S)	\$268.50			
LFIC Single Cylinder Maxum® Deadbolt Lock, Blank Inside, 1 1/8" Faceplate, 2 3/4" Backset	11C342 (P)	\$278.00			
	11C342 (S)	\$268.50			
LFIC Single Cylinder Maxum® Deadbolt Lock, Blank Outside, 1 1/8" Faceplate *, 2 3/8" Backset	11C391 (P)	\$278.00			
	11C391 (S)	\$268.50			
LFIC Single Cylinder Maxum® Deadbolt Lock, Blank Outside, 1 1/8" Faceplate *, 2 3/4" Backset	11C392 (P)	\$278.00			
	11C392 (S)	\$268.50			
LFIC Single Cylinder Maxum® Deadbolt Lock, 1 1/8" Faceplate, Less Core, 2 3/8" Backset	11C401	\$163.00			
LFIC Single Cylinder Maxum® Deadbolt Lock, 1 1/8" Faceplate, Less Core, 2 3/4" Backset	11C402	\$163.00			
LFIC Single Cylinder Maxum® Deadbolt Lock, Drive-In Front, Less Core, 2 3/8" Backset	11C405	\$163.00			
LFIC Single Cylinder Maxum® Deadbolt Lock, Drive-In Front, Less Core, 2 3/4" Backset	11C406	\$163.00			

**Refer to the eCylinder section for more detail on specific technologies available and pricing. Technologies are represented by the following letters:

T = Medeco³, S = Medeco³ CLIQ, J = Medeco³ BiLevel, W = Biaxial, V = Medeco Biaxial CLIQ, K = Medeco KM, N = Medeco X4, C = Medeco CLIQ,

"-" = Original, Z = Medeco Original KW CLIQ, G = Medeco XT ***See key section for surcharges for custom coined cut keys or special stamping requirements.

Note: (P) refers to **Pinned** and (S) to **Sub-Pinned** at the end of each part string in the price book.

SFIC Single Cylinder Maxum® - Commercial Trim

Description	Part Number	Medeco ³	BiLevel	Medeco X4	eCylinder
SFIC Single Cylinder Maxum® Deadbolt Lock, 1 1/8" Faceplate, Less Core, 2 3/8" Backset	11C701			\$154.00	
SFIC Single Cylinder Maxum® Deadbolt Lock, 1 1/8" Faceplate, Less Core, 2 3/4" Backset	11C702			\$154.00	
SFIC Single Cylinder Maxum® Deadbolt Lock, 1" Faceplate, Less Core, 2 3/8" Backset	11C703			\$154.00	
SFIC Single Cylinder Maxum® Deadbolt Lock, 1" Faceplate, Less Core, 2 3/4" Backset	11C704			\$154.00	
SFIC Single Cylinder Maxum® Deadbolt Lock, Drive-In Front, Less Core, 2 3/8" Backset	11C705			\$154.00	
SFIC Single Cylinder Maxum® Deadbolt Lock, Drive-In Front, Less Core, 2 3/4" Backset	11C706			\$154.00	
SFIC Single Cylinder Maxum® Deadbolt Lock, Classroom Function, 1 1/8" Faceplate, Less Core, 2 3/8" Backset	11C711			\$159.50	
SFIC Single Cylinder Maxum® Deadbolt Lock, Classroom Function, 1 1/8" Faceplate, Less Core, 2 3/4" Backset	11C712			\$159.50	
SFIC Single Cylinder Maxum® Deadbolt Lock, Classroom Function, 1" Faceplate, Less Core, 2 3/8" Backset	11C713			\$159.50	
SFIC Single Cylinder Maxum® Deadbolt Lock, Classroom Function, 1" Faceplate, Less Core, 2 3/4" Backset	11C714			\$159.50	
SFIC Single Cylinder Maxum® Deadbolt Lock, Classroom Function, Drive-In Front, Less Core, 2 3/8" Backset	11C715			\$159.50	
SFIC Single Cylinder Maxum® Deadbolt Lock, Classroom Function, Drive-In Front, Less Core, 2 3/4" Backset	11C716			\$159.50	
SFIC Single Cylinder Maxum® Deadbolt Lock, 1 1/8" Faceplate, 6 Pin SFIC Cylinder, 2 3/8" Backset	11C801 (P) 11C801 (S)			\$217.50 \$208.00	
SFIC Single Cylinder Maxum® Deadbolt Lock, 1 1/8" Faceplate, 6 Pin SFIC Cylinder, 2 3/4" Backset	11C802 (P) 11C802 (S)			\$217.50 \$208.00	
SFIC Single Cylinder Maxum® Deadbolt Lock, 1" Faceplate, 6 Pin SFIC Cylinder, 2 3/8" Backset	11C803 (P) 11C803 (S)			\$217.50 \$208.00	
SFIC Single Cylinder Maxum® Deadbolt Lock, 1" Faceplate, 6 Pin SFIC Cylinder, 2 3/4" Backset	11C804 (P) 11C804 (S)			\$217.50 \$208.00	
SFIC Single Cylinder Maxum® Deadbolt Lock, Drive-In Front, 6 Pin SFIC Cylinder, 2 3/8" Backset	11C805 (P) 11C805 (S)			\$217.50 \$208.00	
SFIC Single Cylinder Maxum® Deadbolt Lock, Drive-In Front, 6 Pin SFIC Cylinder, 2 3/4" Backset	11C806 (P) 11C806 (S)			\$217.50 \$208.00	
SFIC Single Cylinder Maxum® Deadbolt Lock, Classroom Funct., 1 1/8" Faceplate, 6 Pin SFIC Cyl. 2 3/8" Backset	11C811 (P) 11C811 (S)			\$222.50 \$213.00	
SFIC Single Cylinder Maxum® Deadbolt Lock, Classroom Funct., 1 1/8" Faceplate, 6 Pin SFIC Cyl. 2 3/4" Backset	11C812 (P) 11C812 (S)			\$222.50 \$213.00	
SFIC Single Cylinder Maxum® Deadbolt Lock, Classroom Funct., 1" Faceplate, 6 Pin SFIC Cyl. 2 3/8" Backset	11C813 (P) 11C813 (S)			\$222.50 \$213.00	
SFIC Single Cylinder Maxum® Deadbolt Lock, Classroom Funct., 1" Faceplate, 6 Pin SFIC Cyl. 2 3/4" Backset	11C814 (P) 11C814 (S)			\$222.50 \$213.00	

**Refer to the eCylinder section for more detail on specific technologies available and pricing. Technologies are represented by the following letters:

T = Medeco³, S = Medeco³ CLIQ, J = Medeco³ BiLevel, W = Biaxial, V = Medeco Biaxial CLIQ, K = Medeco KM, N = Medeco X4, C = Medeco CLIQ, "-" = Original, Z = Medeco Original KW CLIQ, G = Medeco XT ***See key section for surcharges for custom coined cut keys or special stamping requirements.

Note: (P) refers to **Pinned** and (S) to **Sub-Pinned** at the end of each part string in the price book.

SFIC Single Cylinder Maxum® - Commercial Trim

Description	Part Number	Medeco ³	BiLevel	Medeco X4	eCylinder
SFIC Single Cylinder Maxum® Deadbolt Lock, Classroom Function, Drive-In Front, 6 Pin SFIC Cylinder, 2 3/8" Backset	11C815 (P)			\$222.50	
	11C815 (S)			\$213.00	
SFIC Single Cylinder Maxum® Deadbolt Lock, Classroom Function, Drive-In Front, 6 Pin SFIC Cylinder, 2 3/4" Backset	11C816 (P)			\$222.50	
	11C816 (S)			\$213.00	
SFIC Single Cylinder Maxum® Deadbolt Lock, Blank Inside, 1 1/8" Faceplate, 6 Pin SFIC Cylinder, 2 3/8" Backset	11C841 (P)			\$213.50	
	11C841 (S)			\$204.00	
SFIC Single Cylinder Maxum® Deadbolt Lock, Blank Inside, 1 1/8" Faceplate, 6 Pin SFIC Cylinder, 2 3/4" Backset	11C842 (P)			\$213.50	
	11C842 (S)			\$204.00	
SFIC Single Cylinder Maxum® Deadbolt Lock, Blank Outside, 1 1/8" Faceplate, 6 Pin SFIC Cylinder *, 2 3/8" Backset	11C891 (P)			\$213.50	
	11C891 (S)			\$204.00	
SFIC Single Cylinder Maxum® Deadbolt Lock, Blank Outside, 1 1/8" Faceplate, 6 Pin SFIC Cylinder *, 2 3/4" Backset	11C892 (P)			\$213.50	
	11C892 (S)			\$204.00	
SFIC Single Cylinder Maxum® Deadbolt Lock, 1 1/8" Faceplate, 7 Pin SFIC Cylinder, 2 3/8" Backset	11C901 (P)			\$217.50	
	11C901 (S)			\$208.00	
SFIC Single Cylinder Maxum® Deadbolt Lock, 1 1/8" Faceplate, 7 Pin SFIC Cylinder, 2 3/4" Backset	11C902 (P)			\$217.50	
	11C902 (S)			\$208.00	
SFIC Single Cylinder Maxum® Deadbolt Lock, 1" Faceplate, 7 Pin SFIC Cylinder, 2 3/8" Backset	11C903 (P)			\$217.50	
	11C903 (S)			\$208.00	
SFIC Single Cylinder Maxum® Deadbolt Lock, 1" Faceplate, 7 Pin SFIC Cylinder, 2 3/4" Backset	11C904 (P)			\$217.50	
	11C904 (S)			\$208.00	
SFIC Single Cylinder Maxum® Deadbolt Lock, Drive-In Front, 7 Pin SFIC Cylinder, 2 3/8" Backset	11C905 (P)			\$217.50	
	11C905 (S)			\$208.00	
SFIC Single Cylinder Maxum® Deadbolt Lock, Drive-In Front, 7 Pin SFIC Cylinder, 2 3/4" Backset	11C906 (P)			\$217.50	
	11C906 (S)			\$208.00	
SFIC Single Cylinder Maxum® Deadbolt Lock, Classroom Function, 1 1/8" Faceplate, 7 Pin SFIC Cylinder, 2 3/8" Backset	11C911 (P)			\$222.50	
	11C911 (S)			\$213.00	
SFIC Single Cylinder Maxum® Deadbolt Lock, Classroom Function, 1 1/8" Faceplate, 7 Pin SFIC Cylinder, 2 3/4" Backset	11C912 (P)			\$222.50	
	11C912 (S)			\$213.00	
SFIC Single Cylinder Maxum® Deadbolt Lock, Classroom Function, 1" Faceplate, 7 Pin SFIC Cylinder, 2 3/8" Backset	11C913 (P)			\$222.50	
	11C913 (S)			\$213.00	
SFIC Single Cylinder Maxum® Deadbolt Lock, Classroom Function, 1" Faceplate, 7 Pin SFIC Cylinder, 2 3/4" Backset	11C914 (P)			\$222.50	
	11C914 (S)			\$213.00	
SFIC Single Cylinder Maxum® Deadbolt Lock, Classroom Function, Drive-In Front, 7 Pin SFIC Cylinder, 2 3/8" Backset	11C915 (P)			\$222.50	
	11C915 (S)			\$213.00	
SFIC Single Cylinder Maxum® Deadbolt Lock, Classroom Function, Drive-In Front, 7 Pin SFIC Cylinder, 2 3/4" Backset	11C916 (P)			\$222.50	
	11C916 (S)			\$213.00	
SFIC Single Cylinder Maxum® Deadbolt Lock, Blank Inside, 1 1/8" Faceplate, 7 Pin SFIC Cylinder, 2 3/8" Backset	11C941 (P)			\$213.50	
	11C941 (S)			\$204.00	
SFIC Single Cylinder Maxum® Deadbolt Lock, Blank Inside, 1 1/8" Faceplate, 7 Pin SFIC Cylinder, 2 3/4" Backset	11C942 (P)			\$213.50	
	11C942 (S)			\$204.00	
SFIC Single Cylinder Maxum® Deadbolt Lock, Blank Outside, 1 1/8" Faceplate, 7 Pin SFIC Cylinder *, 2 3/8" Backset	11C991 (P)			\$213.50	
	11C991 (S)			\$204.00	
SFIC Single Cylinder Maxum® Deadbolt Lock, Blank Outside, 1 1/8" Faceplate, 7 Pin SFIC Cylinder *, 2 3/4" Backset	11C992 (P)			\$213.50	
	11C992 (S)			\$204.00	

**Refer to the eCylinder section for more detail on specific technologies available and pricing. Technologies are represented by the following letters:
 T = Medeco³, S = Medeco³ CLIQ, J = Medeco³ BiLevel, W = Biaxial, V = Medeco Biaxial CLIQ, K = Medeco KM, N = Medeco X4, C = Medeco CLIQ,
 "-." = Original, Z = Medeco Original KW CLIQ, G = Medeco XT ***See key section for surcharges for custom coined cut keys or special stamping requirements.
Note: (P) refers to **Pinned** and **(S)** to **Sub-Pinned** at the end of each part string in the price book.

Double Cylinder Maxum® Deadbolt - Commercial Trim

Description	Part Number	Medeco ³	BiLevel	Medeco X4	eCylinder
Double Cylinder Maxum® Deadbolt Lock, 1 1/8" Faceplate, 2 3/8" Backset	11C621 (P)	\$285.50	\$236.53		
	11C621 (S)	\$266.50	\$226.53		
Double Cylinder Maxum® Deadbolt Lock, 1 1/8" Faceplate, 2 3/4" Backset	11C622 (P)	\$285.50	\$236.53		
	11C622 (S)	\$266.50	\$226.53		
Double Cylinder Maxum® Deadbolt Lock, 1" Faceplate, 2 3/8" Backset	11C623 (P)	\$285.50	\$236.53		
	11C623 (S)	\$266.50	\$226.53		
Double Cylinder Maxum® Deadbolt Lock, 1" Faceplate, 2 3/4" Backset	11C624 (P)	\$285.50	\$236.53		
	11C624 (S)	\$266.50	\$226.53		
Double Cylinder Maxum® Deadbolt Lock, Drive- In Front, 2 3/8" Backset	11C625 (P)	\$285.50	\$236.53		
	11C625 (S)	\$266.50	\$226.53		
Double Cylinder Maxum® Deadbolt Lock, Drive-In Front, 2 3/4" Backset	11C626 (P)	\$285.50	\$236.53		
	11C626 (S)	\$266.50	\$226.53		
Double Cylinder Maxum® Deadbolt Lock, Less Bolt	11C62L (P)	\$224.50	\$170.53		
	11C62L (S)	\$205.50	\$165.53		

Double Cylinder Captive Thumbturn Maxum®- Commercial Trim

Description	Part Number	Medeco ³	BiLevel	Medeco X4	eCylinder
Captive Double Cylinder Maxum® Deadbolt Lock, Less Bolt, 1 3/4" - 2" door	11C63L (P)	\$263.00	\$203.25		
	11C63L (S)	\$244.00	\$198.25		
Captive Double Cylinder Maxum® Deadbolt Lock, 1 1/8" Faceplate, 1 3/4" - 2" door , 2 3/8" Backset	11C631 (P)	\$324.00	\$264.25		
	11C631 (S)	\$305.00	\$259.25		
Captive Double Cylinder Maxum® Deadbolt Lock, 1 1/8" Faceplate, 2 1/4" - 2 1/2" door, 2 3/8" Backset	11C631T (P)	\$324.00	\$264.25		
	11C631T (S)	\$305.00	\$259.25		
Captive Double Cylinder Maxum® Deadbolt Lock, 1 1/8" Faceplate, 1 3/4" - 2" door, 2 3/4" Backset	11C632 (P)	\$324.00	\$264.25		
	11C632 (S)	\$305.00	\$259.25		
Captive Double Cylinder Maxum® Deadbolt Lock, 1 1/8" Faceplate, 2 1/4" - 2 1/2" door, 2 3/4" Backset	11C632T (P)	\$324.00	\$264.25		
	11C632T (S)	\$305.00	\$259.25		
Captive Double Cylinder Maxum® Deadbolt Lock, 1" Faceplate, 1 3/4" - 2" door, 2 3/8" Backset	11C633 (P)	\$324.00	\$264.25		
	11C633 (S)	\$305.00	\$259.25		
Captive Double Cylinder Maxum® Deadbolt Lock, 1" Faceplate, 2 1/4" - 2 1/2" door, 2 3/8" Backset	11C633T (P)	\$324.00	\$264.25		
	11C633T (S)	\$305.00	\$259.25		
Captive Double Cylinder Maxum® Deadbolt Lock, 1" Faceplate, 1 3/4" - 2" door	11C634 (P)	\$324.00	\$264.25		
	11C634 (S)	\$305.00	\$259.25		
Captive Double Cylinder Maxum® Deadbolt Lock, 1" Faceplate, 2 1/4" - 2 1/2" door, 2 3/4" Backset	11C634T (P)	\$324.00	\$264.25		
	11C634T (S)	\$305.00	\$259.25		
Captive Double Cylinder Maxum® Deadbolt Lock, Drive-In Front, 1 3/4" - 2" door, 2 3/8" Backset	11C635 (P)	\$324.00	\$264.25		
	11C635 (S)	\$305.00	\$259.25		
Captive Double Cylinder Maxum® Deadbolt Lock, Drive-In Front, 2 1/4" - 2 1/2" door, 2 3/8" Backset	11C635T (P)	\$324.00	\$264.25		
	11C635T (S)	\$305.00	\$259.25		
Captive Double Cylinder Maxum® Deadbolt Lock, Drive-In Front, 1 3/4" - 2" door, 2 3/4" Backset	11C636 (P)	\$324.00	\$264.25		
	11C636 (S)	\$305.00	\$259.25		
Captive Double Cylinder Maxum® Deadbolt Lock, Drive-In Front, 2 1/4" - 2 1/2" door, 2 3/4" Backset	11C636T (P)	\$324.00	\$264.25		
	11C636T (S)	\$305.00	\$259.25		
Captive Double Cylinder Maxum® Deadbolt Lock, Less Bolt, 2 1/4" - 2 1/2" door	11C63LT (P)	\$263.00	\$203.25		
	11C63LT (S)	\$244.00	\$198.25		

**Refer to the eCylinder section for more detail on specific technologies available and pricing. Technologies are represented by the following letters:

T = Medeco³, S = Medeco³ CLIQ, J = Medeco³ BiLevel, W = Biaxial, V = Medeco Biaxial CLIQ, K = Medeco KM, N = Medeco X4, C = Medeco CLIQ,

"-" = Original, Z = Medeco Original KW CLIQ, G = Medeco XT ***See key section for surcharges for custom coined cut keys or special stamping requirements.

Note: (P) refers to **Pinned** and (S) to **Sub-Pinned** at the end of each part string in the price book.

LFIC Double Cylinder Maxum® - Commercial Trim

Description	Part Number	Medeco ³	BiLevel	Medeco X4	eCylinder
LFIC Double Cylinder Maxum® Deadbolt Lock, 1" Faceplate, 2 3/8" Backset	11C323 (P)	\$435.00			
	11C323 (S)	\$416.00			
LFIC Double Cylinder Maxum® Deadbolt Lock, Less Bolt	11C32L (P)	\$374.00			
	11C32L (S)	\$355.00			
LFIC Double Cylinder Maxum® Deadbolt Lock, 1" Faceplate, 2 3/4" Backset	11C324 (P)	\$435.00			
	11C324 (S)	\$416.00			
LFIC Double Cylinder Maxum® Deadbolt Lock, 1 1/8" Faceplate, 2 3/8" Backset	11C321 (P)	\$435.00			
	11C321 (S)	\$416.00			
LFIC Double Cylinder Maxum® Deadbolt Lock, 1 1/8" Faceplate, 2 3/4" Backset	11C322 (P)	\$435.00			
	11C322 (S)	\$416.00			
LFIC Double Cylinder Maxum® Deadbolt Lock, Drive-In Front, 2 3/8" Backset	11C325 (P)	\$435.00			
	11C325 (S)	\$416.00			
LFIC Double Cylinder Maxum® Deadbolt Lock, Drive-In Front, 2 3/4" Backset	11C326 (P)	\$435.00			
	11C326 (S)	\$416.00			
LFIC Double Cylinder Maxum® Deadbolt Lock, 1 1/8" Faceplate, Less Core, 2 3/8" Backset	11C421	\$196.50			
LFIC Double Cylinder Maxum® Deadbolt Lock, 1 1/8" Faceplate, Less Core, 2 3/4" Backset	11C422	\$196.50			
LFIC Double Cylinder Maxum® Deadbolt Lock, Drive-In Front, Less Core, 2 3/8" Backset	11C425	\$196.50			
LFIC Double Cylinder Maxum® Deadbolt Lock, Drive-In Front, Less Core, 2 3/4" Backset	11C426	\$196.50			

**Refer to the eCylinder section for more detail on specific technologies available and pricing. Technologies are represented by the following letters:

T = Medeco³, S = Medeco³ CLIQ, J = Medeco³ BiLevel, W = Biaxial, V = Medeco Biaxial CLIQ, K = Medeco KM, N = Medeco X4, C = Medeco CLIQ,
 "-" = Original, Z = Medeco Original KW CLIQ, G = Medeco XT ***See key section for surcharges for custom coined cut keys or special stamping requirements.

Note: (P) refers to **Pinned** and **(S)** to **Sub-Pinned** at the end of each part string in the price book.

SFIC Double Cylinder Maxum® - Commercial Trim

Description	Part Number	Medeco ³	BiLevel	Medeco X4	eCylinder
SFIC Double Cylinder Maxum® Deadbolt Lock, 1 1/8" Faceplate, Less Core, 2 3/8" Backset	11C721	\$187.50			
SFIC Double Cylinder Maxum® Deadbolt Lock, 1 1/8" Faceplate, Less Core, 2 3/4" Backset	11C722	\$187.50			
SFIC Double Cylinder Maxum® Deadbolt Lock, 1" Faceplate, Less Core, 2 3/8" Backset	11C723	\$187.50			
SFIC Double Cylinder Maxum® Deadbolt Lock, 1" Faceplate, Less Core, 2 3/4" Backset	11C724	\$187.50			
SFIC Double Cylinder Maxum® Deadbolt Lock, Drive-In Front, Less Core, 2 3/8" Backset	11C725	\$187.50			
SFIC Double Cylinder Maxum® Deadbolt Lock, Drive-In Front, Less Core, 2 3/4" Backset	11C726	\$187.50			
SFIC Double Cylinder Maxum® Deadbolt Lock, 1 1/8" Faceplate, 6 Pin Cylinder, 2 3/8" Backset	11C821 (P) 11C821 (S)			\$312.60 \$295.00	
SFIC Double Cylinder Maxum® Deadbolt Lock, 1 1/8" Faceplate, 6 Pin Cylinder, 2 3/4" Backset	11C822 (P) 11C822 (S)			\$312.60 \$295.00	
SFIC Double Cylinder Maxum® Deadbolt Lock, 1" Faceplate, 6 Pin Cylinder, 2 3/8" Backset	11C823 (P) 11C823 (S)			\$312.60 \$295.00	
SFIC Double Cylinder Maxum® Deadbolt Lock, 1" Faceplate, 6 Pin Cylinder	11C824 (P) 11C824 (S)			\$312.60 \$295.00	
SFIC Double Cylinder Maxum® Deadbolt Lock, Drive-In Front, 6 Pin Cylinder, 2 3/8" Backset	11C825 (P) 11C825 (S)			\$312.60 \$295.00	
SFIC Double Cylinder Maxum® Deadbolt Lock, Drive-In Front, 6 Pin Cylinder, 2 3/4" Backset	11C826 (P) 11C826 (S)			\$312.60 \$295.00	
SFIC Double Cylinder Maxum® Deadbolt Lock, 1 1/8" Faceplate, 7 Pin Cylinder, 2 3/8" Backset	11C921 (P) 11C921 (S)			\$312.60 \$295.00	
SFIC Double Cylinder Maxum® Deadbolt Lock, 1 1/8" Faceplate, 7 Pin Cylinder, 2 3/4" Backset	11C922 (P) 11C922 (S)			\$312.60 \$295.00	
SFIC Double Cylinder Maxum® Deadbolt Lock, 1" Faceplate, 7 Pin Cylinder, 2 3/8" Backset	11C923 (P) 11C923 (S)			\$312.60 \$295.00	
SFIC Double Cylinder Maxum® Deadbolt Lock, 1" Faceplate, 7 Pin Cylinder, 2 3/4" Backset	11C924 (P) 11C924 (S)			\$312.60 \$295.00	
SFIC Double Cylinder Maxum® Deadbolt Lock, Drive-In Front, 7 Pin Cylinder, 2 3/8" Backset	11C925 (P) 11C925 (S)			\$312.60 \$295.00	
SFIC Double Cylinder Maxum® Deadbolt Lock, Drive-In Front, 7 Pin Cylinder, 2 3/4" Backset	11C926 (P) 11C926 (S)			\$312.60 \$295.00	

Interchangeable Core Cylinders for Maxum® Deadbolts

Description	Part Number	Medeco ³	BiLevel	Medeco X4	eCylinder
6 pin LFIC Cylinder	320201 (P)	\$119.00	\$64.68		
	320201 (S)	\$109.50	\$59.68		
6 Pin SFIC Cylinder Medeco KM	33600006 (P)			\$65.00	
	33600006 (S)			\$54.00	
7 Pin SFIC Cylinder Medeco KM	33700006 (P)			\$65.00	
	33700006 (S)			\$54.00	

**Refer to the eCylinder section for more detail on specific technologies available and pricing. Technologies are represented by the following letters:
T = Medeco³, S = Medeco³ CLIQ, J = Medeco³ BiLevel, W = Biaxial, V = Medeco Biaxial CLIQ, K = Medeco KM, N = Medeco X4, C = Medeco CLIQ,

"-" = Original, Z = Medeco Original KW CLIQ, G = Medeco XT ***See key section for surcharges for custom coined cut keys or special stamping requirements.

Note: (P) refers to **Pinned** and **(S)** to **Sub-Pinned** at the end of each part string in the price book.

Maxum Deadbolt Cylinder Assemblies

Description	Part Number	Medeco ³	BiLevel	Medeco X4	eCylinder
6 Pin Outside Cylinder Assembly for Maxum [®] Deadbolt Lock	110A04 (P)	\$111.50	\$91.70		
	110A04 (S)	\$102.00	\$86.70		
6 Pin Inside Cylinder Assembly for Maxum [®] Deadbolt Lock	110A05 (P)	\$111.50	\$91.70		
	110A05 (S)	\$102.00	\$86.70		
LFIC Outside Cylinder Assembly for Maxum [®] Deadbolt Lock	110A08 (P)	\$206.50			
	110A08 (S)	\$197.00			
LFIC Inside Cylinder Assembly for Maxum [®] Deadbolt Lock	110A09 (P)	\$228.00			
	110A09 (S)	\$218.50			
6 Pin Outside Captive Cylinder	110A06	\$117.50			
6 Pin Inside Captive Cylinder	110A07	\$117.50			

Cylinder Housing & Plugs for Maxum[®] Deadbolt

Description	Part Number	Medeco ³	BiLevel	Medeco X4	eCylinder
LFIC Outside Cylinder Housing for Maxum [®] Deadbolt Lock	110A08L	\$87.50			
LFIC Inside Cylinder Housing for Maxum [®] Deadbolt Lock	110A09L	\$108.50			
6 Pin Plug for Maxum Deadbolt (except Inside Captive Thumbturn)	1202800	\$46.00			
6 Pin Plug for Maxum Deadbolt Inside Captive Thumbturn	1202900	\$46.00			

Bolt Assemblies for Maxum[®] Deadbolt

Description	Part Number	Medeco ³	BiLevel	Medeco X4	eCylinder
2 3/8" Maxum [®] Bolt 1" X 2 1/4" Faceplate	110A1911	\$63.00			
2 3/8" Maxum [®] Bolt 1 1/8" X 2 1/4" Faceplate	110A1912	\$63.00			
2 3/8" Maxum [®] Drive-in Bolt (Available in 26 finish only)	110A1913	\$63.00			
2 3/4" Maxum [®] Bolt 1" X 2 1/4" Faceplate	110A1921	\$63.00			
2 3/4" Maxum [®] Bolt 1 1/8" X 2 1/4" Faceplate	110A1922	\$63.00			
2 3/4" Maxum [®] Drive-in Bolt (Available in 26 finish only)	110A1923	\$63.00			
5 Pack Round Front Assembly For Maxum [®] Drive-In Bolt (Includes: CP-180961-26 and CP-011016-020)	94-0058-MED	\$126.50			
Round Front Assembly For Maxum [®] Drive-In Bolt (Includes: CP-180961-26 and CP-011016-020)	94-0059	\$31.00			

**Refer to the eCylinder section for more detail on specific technologies available and pricing. Technologies are represented by the following letters:
T = Medeco³, S = Medeco³ CLIQ, J = Medeco³ BiLevel, W = Biaxial, V = Medeco Biaxial CLIQ, K = Medeco KM, N = Medeco X4, C = Medeco CLIQ,
“-” = Original, Z = Medeco Original KW CLIQ, G = Medeco XT ***See key section for surcharges for custom coined cut keys or special stamping requirements.
Note: (P) refers to **Pinned** and **(S)** to **Sub-Pinned** at the end of each part string in the price book.

Maxum Deadbolt Components

Description	Part Number	Price
6 Pin Length Deadbolt Lock Outside Dummy Cylinder	110A16	\$58.50
Residential Blank Inside Plate Assembly for Maxum® Deadbolt Lock	110A17	\$39.00
5 Pin Length Deadbolt Lock Outside Dummy Cylinder	110A18	\$58.50
Commercial Blank Inside Plate Assembly for Maxum® Deadbolt Lock	110A14	\$39.00
Residential Style Thumbturn To Fit On Captive Thumbturn Key (Original/Biaxial)	110A20	\$30.00
Residential Style Thumbturn To Fit On Captive Thumbturn Key (Medeco ³)	110A21	\$30.00
Commercial Thumbturn and Base Plate Assembly	110A12	\$75.00
Commercial Style Thumbturn To Fit On Captive Thumbturn Key (Medeco ³)	110018	\$30.00
Commercial Thumbturn & set screw	110A22	\$43.50
Residential Thumbturn & set screw	110A23	\$43.50
Residential Thumbturn and Base Plate Assembly	110A10	\$75.00
Commercial Style Thumbturn To Fit On Captive Thumbturn Key (Original/Biaxial)	110092	\$30.00
Thumbturn Trim Plate Package for Maxum® Deadbolt Lock	940210	\$6.83
Inside Cylinder Trim Plate Package for Commercial Maxum® I/C Deadbolt Lock (includes CP-021090 & CP-180141)	94-0030	\$6.00
Spacer Rings for 1 3/8" Door for Maxum® Deadbolt Lock (Package of 2)	940212	\$33.00
Inside Cylinder Trim Plate Package for Maxum® Double Cylinder Deadbolt Lock (Includes CP-021090 & CP-180131)	94-0029	\$6.00
#8 x 2" FHWS Strike Box mounting screws	CP-010234-320	\$0.61
#8 x 3/4" comb. Wood/Machine S Bolt & Strike mounting screws	CP-010235-120-XX	\$0.61
Screw Package for 5 and 6 Pin Single Cylinder Maxum® Deadbolt Lock	CP-011762	\$15.00
Screw Package for 5 Pin Double Cylinder Maxum® Deadbolt Lock	CP-011763	\$15.00
Screw Package for 6 Pin Double Cylinder Maxum® Deadbolt Lock	CP-011764	\$15.00
Screw Package for Blank x Thumbturn Maxum® Deadbolt Lock	CP-011751	\$15.00
Screw Package for Blank x Cylinder Maxum® Deadbolt Lock	CP-011767	\$15.00
Screw Package for Blank x Thumbturn Maxum® Deadbolt Lock for 2 1/4" - 2 1/2" thick door	CP-011753	\$7.46
Screw Package for Blank x Cylinder Maxum® Deadbolt Lock for 2 1/4" - 2 1/2" thick door	CP-011754	\$7.46
Screw Package for 6 Pin Classroom Function Maxum® Deadbolt Lock	CP-011757	\$15.00
Collar for Maxum® Residential Style Deadbolt Lock 5 Pin	CP-070691	\$53.50
Collar for Maxum® Residential Style Deadbolt Lock 6 Pin	CP-070701	\$53.50

**Refer to the eCylinder section for more detail on specific technologies available and pricing. Technologies are represented by the following letters:

T = Medeco³, S = Medeco³ CLIQ, J = Medeco³ BiLevel, W = Biaxial, V = Medeco Biaxial CLIQ, K = Medeco KM, N = Medeco X4, C = Medeco CLIQ, "-" = Original, Z = Medeco Original KW CLIQ, G = Medeco XT ***See key section for surcharges for custom coined cut keys or special stamping requirements.

Note: (P) refers to **Pinned** and (S) to **Sub-Pinned** at the end of each part string in the price book.

Maxum® Deadbolt Components

Description	Part Number	Price
Collar for Maxum® Commercial Style Deadbolt Lock (Inside & Outside)	CP-070711	\$53.50
Collar for Maxum® Residential Style Deadbolt Lock Thick Door Captive Thumbturn 5 Pin	CP-070721	\$53.50
Collar for Maxum® Residential Style Deadbolt Lock Thick Door Captive Thumbturn 6 Pin	CP-070731	\$53.50
Collar for Maxum® Commercial Style Deadbolt Lock Thick Door Captive Thumbturn	CP-070741	\$53.50
Strike for Maxum® Deadbolt Lock	CP-180061	\$13.50
Ball bearings (Allen head of mounting screws) .191" diameter silver	CP-250010	\$0.17
Ball bearings (tip of mounting screws) .202" diameter black	CP-250020	\$0.17
Strike Reinforcement Strike Box for Maxum® Deadbolt Lock	CP-280620	\$4.49
Keyblank for Captive Thumbturn Key for Maxum® Deadbolt 6 Pin Varies by Key Section (factory will supply correct part number)	KYB XX6605	\$9.14

Maxum® Deadbolt Tailpieces

Description	Part Number	Price
Thumbturn Tailpiece for Maxum® Deadbolt lock for 1 3/4" - 2 1/2" thick door	CT-F42	\$5.96
Thumbturn Tailpiece for Classroom Function Maxum® Deadbolt lock, 1 3/4" - 2" thick doors	CT-F43	\$5.96
Thumbturn Tailpiece for Classroom Function Maxum® Deadbolt lock for doors 2 1/4" - 2 1/2" thick	CT-F44	\$5.96
Tailpiece for Maxum® Deadbolt lock, outside cylinder, .532" length, for doors up to 1 3/4" thick	CT-Y60	\$2.24
Tailpiece for Maxum® Deadbolt outside cylinder, 1.430" length for doors over 1 3/4" thick	CT-Y61	\$2.24

**Refer to the eCylinder section for more detail on specific technologies available and pricing. Technologies are represented by the following letters:
 T = Medeco³, S = Medeco³ CLIQ, J = Medeco³ BiLevel, W = Biaxial, V = Medeco Biaxial CLIQ, K = Medeco KM, N = Medeco X4, C = Medeco CLIQ,
 "-" = Original, Z = Medeco Original KW CLIQ, G = Medeco XT ***See key section for surcharges for custom coined cut keys or special stamping requirements.
Note: (P) refers to **Pinned** and **(S)** to **Sub-Pinned** at the end of each part string in the price book.

Medeco Maxum[®] Residential Deadbolt

Designed with a residential aesthetic, the ANSI Grade 1 Maxum deadbolt offers superior physical protection from breaking and attack. Available as a single-cylinder, double-cylinder or with a unique “captive thumbturn” cylinder, the Medeco³ cylinder provides triple locking security from picking and key duplication. The captive thumbturn converts the inside cylinder to a thumbturn for safe exit when the facility is occupied. A quick conversion when the facility is not occupied returns it to double cylinder mode and guards against unauthorized entry or exit. Maxum[®] deadbolts offer maximum protection with solid-brass construction, along with anti-drilling and anti-prying features.



Patented Key Control

Protects against unauthorized duplication of your keys.



Certified Grade 1

BHMA certified Grade 1, passes to the highest standards in the industry.



Drill Protection

Offers maximum protection with solid-brass construction and strategically placed drill pins.



Protection From Physical Attack

Medeco³ Medeco Maxum Deadbolts are UL 437 listed and stand up to prying, picking and other forms of physical attack.



Special Angle Cut Keys

Requires a special key cutting machine and access to Medeco specific blanks, available in a variety of restrictions to support every need.



Picking and Bumping Protection

Medeco³ cylinders use a sidebar that prevent the key from rotating until it is elevated, rotated and aligned in the correct position. This feature protects against bumping and picking attacks.

Technical Information:

- SFIC cylinder options include Medeco X4 and Nexgen XT
- Unique “captive thumbturn” available
- Bolt is designed for easy conversion accommodating either mortise and drive-in applications
- Solid-brass construction with steel inserts for added protection

- ANSI/BHMA A156.30 and UL437 Listed cylinders for high security
- Fits doors 1 3/8” to 2 1/2” thick
- Standard 2 1/8” crossbore and 1” edge bore (ANSI A115.13 prep)

Warranty:

Lifetime warranty against defects in material and workmanship

Finishes:

Available in all standard finishes to match existing hardware

Applications:

It is the ideal choice for a wide variety of commercial and heavy duty residential applications where consistent quality, ease of use and installation are required. Ideal applications include:

- Apartments
- Retail outlets
- Residences
- Multi-family Units

Available Key Technologies:

Mechanical:

- Medeco³
- Medeco³ BiLevel
- Medeco X4

eCylinder:

- Medeco³ CLIQ
- Medeco CLIQ

Single Cylinder Maxum® Deadbolt - Residential Trim

Description	Part Number	Medeco ³	BiLevel	Medeco X4	eCylinder
5 Pin Single Cylinder Deadbolt, 1" Faceplate, 2-3/8" Backset	11R503 (P)	\$207.50	\$173.30		
	11R503 (S)	\$198.00	\$168.30		
5 Pin Single Cylinder Deadbolt, 1" Faceplate, 2-3/4" Backset	11R504 (P)	\$207.50	\$173.30		
	11R504 (S)	\$198.00	\$168.30		
6 Pin Single Cylinder Deadbolt, 1" Faceplate, 2-3/8" Backset	11R603 (P)	\$207.50	\$173.30		●
	11R603 (S)	\$198.00	\$168.30		
6 Pin Single Cylinder Deadbolt, 1" Faceplate, 2-3/4" Backset	11R604 (P)	\$207.50	\$173.30		●
	11R604 (S)	\$198.00	\$168.30		
Single Dummy Trim Deadbolt (5 Pin Length)	11R57L	\$152.00			
Single Dummy Trim Deadbolt (6 Pin Length)	11R67L	\$152.00			

Double Cylinder Maxum® Deadbolt - Residential Trim

Description	Part Number	Medeco ³	BiLevel	Medeco X4	eCylinder
5 Pin Double Cylinder Deadbolt 1" Faceplate, 2 3/8" Backset	11R523 (P)	\$285.50	\$236.53		
	11R523 (S)	\$266.50	\$226.53		
5 Pin Double Cylinder Deadbolt 1" Faceplate, 2 3/4" Backset	11R524 (P)	\$285.50	\$236.53		
	11R524 (S)	\$266.50	\$226.53		
6 Pin Double Cylinder Deadbolt, 1" Faceplate, 2 3/8" Backset	11R623 (P)	\$285.50	\$236.53		
	11R623 (S)	\$266.50	\$226.53		
6 Pin Double Cylinder Deadbolt, 1" Faceplate, 2 3/4" Backset	11R624 (P)	\$285.50	\$236.53		
	11R624 (S)	\$266.50	\$226.53		
Double Dummy Trim Deadbolt (5 Pin Length)	11R5DL	\$206.00			
Double Dummy Trim Deadbolt (6 Pin Length)	11R6DL	\$206.00			

Double Cyl. Captive Thumbturn Maxum®-Residential Trim

Description	Part Number	Medeco ³	BiLevel	Medeco X4	eCylinder
5 Pin Captive Thumbturn Double Cylinder Deadbolt, 2 3/8" Backset	11R533 (P)	\$324.00	\$269.25		
	11R533 (S)	\$305.00	\$259.25		
5 Pin Captive Thumbturn Double Cylinder Deadbolt, 2 3/4" Backset	11R534 (P)	\$324.00	\$269.25		
	11R534 (S)	\$305.00	\$259.25		
6 Pin Captive Thumbturn Double Cylinder Deadbolt, 1" Faceplate, 2 3/8" Backset	11R633 (P)	\$324.00	\$269.25		
	11R633 (S)	\$305.00	\$259.25		
6 Pin Captive Thumbturn Double Cylinder Deadbolt, 1" Faceplate, 2 3/4" Backset	11R634 (P)	\$324.00	\$269.25		
	11R634 (S)	\$305.00	\$259.25		

Cylinder Plugs for Maxum®-Residential Deadbolts

Description	Part Number	Medeco ³	BiLevel	Medeco X4	eCylinder
6 pin plug for Maxum Residential Deadbolt (except inside captive thumbturn)	120280	\$46.00			
6 pin plug for Maxum Residential Deadbolt inside captive thumbturn	120290	\$46.00			
5 pin plug for Maxum Residential Deadbolt (except inside captive thumbturn)	123620	\$46.00			
5 pin plug for Maxum Residential Deadbolt inside captive thumbturn	124340	\$46.00			

**Refer to the eCylinder section for more detail on specific technologies available and pricing. Technologies are represented by the following letters:
T = Medeco³, S = Medeco³ CLIQ, J = Medeco³ BiLevel, W = Biaxial, V = Medeco Biaxial CLIQ, K = Medeco KM, N = Medeco X4, C = Medeco CLIQ,

"-" = Original, Z = Medeco Original KW CLIQ, G = Medeco XT ***See key section for surcharges for custom coined cut keys or special stamping requirements.

Note: (P) refers to **Pinned** and (S) to **Sub-Pinned** at the end of each part string in the price book.

14 Series Deadbolts

The Medeco® 14 Series is a Grade 2 commercial deadbolt that provides an outstanding combination of cylinder options, performance and value. It is the ideal choice for a wide variety of commercial and heavy duty residential applications where consistent quality, ease of use and installation are required. Ideal applications include: office buildings, hospitals, schools, restaurants, apartments and retail outlets. The Medeco® 14 Series can be used in conjunction with either Medeco³, BiLevel, or Medeco X4 Key Control cylinders as well as Medeco® eCylinders. When offered alongside the Medeco® Maxum deadbolt, it provides end users a choice to select from these options of smart deadbolt solutions.



Patented Key Control

Protects against unauthorized duplication of your keys.



Certified Grade 2

BHMA certified Grade 2 protection.



Drill Protection

Used with a Medeco³ cylinder, the 14 Series offers drilling protection with strategically placed drill pins in the cylinder.



Wrench Protection

Free turning outer ring on collar resist wrenching attacks.



Special Angle Cut Keys

Requires a special key cutting machine and access to Medeco specific blanks, available in a variety of restrictions to support every need.



Picking and Bumping Protection

Medeco³ cylinders use a sidebar that prevent the key from rotating until it is elevated, rotated and aligned in the correct position. This feature protects against bumping and picking attacks.

Technical Information:

- SFIC cylinder options include Medeco X4 and Nexgen XT
- One inch throw bolt with hardened steel free spinning steel pin insert resists sawing
- Bolt mechanism designed to adjust for both 2 3/8 inch or 2 3/4 inch backset, with 2 3/4 inch fixed backset also available, which provides greater flexibility and ease of installation
- Free turning outer ring on collar resist wrenching attacks

Applications:

It is the ideal choice for a wide variety of commercial and heavy duty residential applications where consistent quality, ease of use and installation are required. Ideal applications include:

- Office buildings
- Hospitals
- Schools
- Restaurants
- Apartments
- Retail outlets

Finishes:

- Available in 05 polished brass, 09 antique brass and 26 satin chrome finish

Warranty:

Warranted for two (2) years against manufacturer's defects. See the Medeco® limited warranty for full details.

Available Key Technologies:

Mechanical:

- Medeco³
- Medeco³ BiLevel

Single Cylinder Grade 2 Deadbolts

Description	Part Number	Medeco ³	BiLevel	Medeco X4	eCylinder
Single cylinder Gr. 2 deadbolt, adjustable backset	1412110 (P)	\$158.50	\$108.41	\$116.00	●
	1412110 (S)	\$149.00	\$103.41	\$106.50	
6 Pin SFIC Single Cylinder Gr. 2 Deadbolt, Adjustable Backset	1413110 (P)			\$120.50	
	1413110 (S)			\$111.00	
7 Pin SFIC Single Cylinder Gr. 2 Deadbolt, Adjustable Backset	1414110 (P)			\$120.50	
	1414110 (S)			\$111.00	
SFIC Single Cylinder Gr. 2 Deadbolt, Adjustable Backset, Less Core	1415110			\$57.00	

Available in 05-Polished Brass, 09-Antique Brass, 13-Oil Rubbed Bronze, 19-Satin Steel, and 26-Satin Chrome Finish.

Double Cylinder Grade 2 Deadbolts

Description	Part Number	Medeco ³	BiLevel	Medeco X4	eCylinder
Double Cylinder Grade 2 Deadbolt, Adjustable Backset	1412120 (P)	\$227.00	\$154.35	\$175.00	
	1412120 (S)	\$208.00	\$144.35	\$165.50	
6 Pin SFIC Double Cylinder Gr. 2 Deadbolt, Adjustable Backset	1413120 (P)			\$197.00	
	1413120 (S)			\$187.50	
7 Pin SFIC Double Cylinder Gr. 2 Deadbolt, Adjustable Backset	1414120 (P)			\$197.00	
	1414120 (S)			\$187.50	
SFIC Double Cylinder Gr. 2 Deadbolt, Adjustable Backset, Less Core	1415120			\$79.50	
Single Deadbolt Cylinder	2000938	\$120.00	\$69.82	\$79.00	
		\$111.00	\$64.82	\$69.50	
Double Deadbolt Cylinder	2000956	\$110.00	\$59.32	\$68.50	
		\$100.50	\$54.32	\$59.00	

Available in 05-Polished Brass, 09-Antique Brass, and 26-Satin Chrome Finish.

**Refer to the eCylinder section for more detail on specific technologies available and pricing. Technologies are represented by the following letters:
T = Medeco³, S = Medeco³ CLIQ, J = Medeco³ BiLevel, W = Biaxial, V = Medeco Biaxial CLIQ, K = Medeco KM, N = Medeco X4, C = Medeco CLIQ,
“-” = Original, Z = Medeco Original KW CLIQ, G = Medeco XT ***See key section for surcharges for custom coined cut keys or special stamping requirements.
Note: (P) refers to **Pinned** and **(S)** to **Sub-Pinned** at the end of each part string in the price book.

Padlocks

FEATURES	Medeco ³	BiLevel	Medeco X4	CLIQ	Medeco XT	Nexgen
Protector II						
Protector II body accepts 6 pin knob style cylinders	●	●	●	●	●	
Protector II is available as key retaining only	●	●	●	●	●	
System Series						
System Series body accepts knob style cylinders	●	●	●	●	●	
System Series body accepts large format interchangeable cylinders	●	●		●		
System Series body accepts 6 or 7 pin small format interchangeable cores			●		●	
Non-Key retaining and key retaining models available	●	●	●	●	●	
Hockey Puck						
Hockey Puck body accepts knob style 5 pin cylinder	●	●				
Hockey Puck body accepts knob style 6 pin cylinder			●			
Hockey Puck is available as non- key retaining only	●	●	●		●	
G8R						
G8R body accepts a pop-out cylinder	●			●	●	●
Sold less cylinder	●			●	●	●
All Padlocks						
UL437 Listing & BHMA Certification for high security	●					
Easily integrated into master key systems for key security and convenience	●	●	●			
Patented key control to protect against unauthorized duplication	●	●	●			

Medeco³ Premium High Security

For effective mechanical protection against most forms of attack as well as protection against unauthorized duplicate keys, Medeco³ cylinders are recommended. Security features including hardened steel components, pins that must be elevated, rotated, and interact with both a sidebar and a slider, and additional pick resistant features make Medeco³ the cylinder of choice to protect people, property and information.

Medeco³ BiLevel Patented Key Control

Medeco³ BiLevel cylinders may be incorporated into a master key system with Medeco³ high security, offering protection against all types of attack where needed, and patented key control cylinders for areas requiring less protection. BiLevel cylinders offer patented control against unauthorized duplication of keys without the additional security features protecting against force or surreptitious attack.

Medeco X4 Patented Key Control

Medeco X4 cylinders offer patented control against unauthorized duplication of keys without the additional security features protecting against force or surreptitious attack.

Loss & Liability Control

Many of the cylinders in this section are also available with an eCylinder Loss & Liability Control Solution. See the eCylinder Section for more details.

How to Order The Protector II Padlock:

<p>1</p> <p>50047320 base part #</p> <p>Refer to pages 142-143 for descriptions and technical specifications to find the corresponding base part number.</p>	<p>2</p> <p>T cylinder</p> <p>- = Original T = Medeco³ W = Biaxial C = Medeco CLIQ N = Medeco X4 G = Medeco XT K = Medeco KM</p>	<p>3</p> <p>LT keyway</p> <p>Insert keyway if known or contact Customer Service for help.</p>	<p>4</p> <p>S pinning</p> <table border="1"> <tr> <td> <p>S = Sub-Assembled (Uncombined) No additional information needed</p> </td> <td> <p>P = Pinned (Combined) Keyed alike (KA) Keyed different (KD) 2 keys per cylinder</p> </td> <td> <p>M = Master Keyed Provide specific pinning or contact Customer Service for support Must specify quantity for keys.</p> </td> </tr> </table>	<p>S = Sub-Assembled (Uncombined) No additional information needed</p>	<p>P = Pinned (Combined) Keyed alike (KA) Keyed different (KD) 2 keys per cylinder</p>	<p>M = Master Keyed Provide specific pinning or contact Customer Service for support Must specify quantity for keys.</p>
<p>S = Sub-Assembled (Uncombined) No additional information needed</p>	<p>P = Pinned (Combined) Keyed alike (KA) Keyed different (KD) 2 keys per cylinder</p>	<p>M = Master Keyed Provide specific pinning or contact Customer Service for support Must specify quantity for keys.</p>				

BUILD A SYSTEM SERIES PADLOCK BASE PART

50XXXX X X

<p>Prefix</p> <p>Key Function</p> <p>04 = Padlock With Cylinder 81 = Padlock Less Cylinder</p> <p>Shackle Clearance</p> <p>7 = 1-3/8" 8 = 1-7/8"</p>	<p>Shackle Material</p> <p>03 = Hardened Boron Alloy Steel</p>	<p>Standard Options</p> <p>0 = No Dust Cover 1 = Dust Cover</p> <p>Shackle Diameter</p> <p>2 = 7/16" Large (2-1/2") 4 = 5/16" Medium (2-1/8")</p>
---	---	---

Protector II Series Padlocks

The Protector II Series padlock is made of durable, industrial grade stainless steel and offers excellent resistance to harsh weather and extreme conditions.

The hardened boron alloy steel shackles stand up to physical attack, providing strong resistance against cutting, sawing and prying. The patented Medeco³ mechanical cylinder resists picking, drilling and other sophisticated forms of physical attack. Also available in eCylinder formats for Loss and Liability Control.



Patented Key Control

Protects against unauthorized duplication of your keys.



Special Angled Key Cuts

Requires a special key cutting machine and access to Medeco specific blanks, available in a variety of restrictions to support every need.



Can Be Masterkeyed

Medeco System Series Padlocks can be masterkeyed into a system containing Medeco BiLevel and Medeco³ mechanical as well as Medeco³ CLIQ or XT eCylinders.



Protection From Shackle Attack

Hardened boron alloy steel shackles (5/16" and 7/16" diameters) provide strong resistance against cutting, sawing and prying. Available in both 1 3/8" and 1 7/8" lengths.



Proprietary Deadlocking Shackle

Unique deadlocking shackle locking mechanism for resistance to physical attack.



Weather Resistant

Body made of cast stainless steel to provide excellent resistance in harsh and extreme weather conditions.



Protection From Physical Attack

Medeco³ cam locks are UL 437 listed and stand up to drilling, picking and other forms of physical attack.



Picking and Bumping Protection

Medeco³ cylinders use a Sidebar that prevents the key from rotating until it is elevated, rotated and aligned in the correct position. This feature protects against bumping and picking attacks.

- All Medeco[®] cylinders are constructed of durable machined brass components, designed to last the life of your equipment.
- Patented Medeco³ keys may only be duplicated by Medeco[®] or an authorized Medeco[®] service outlet, and only at your request.
- Boron alloy steel shackle which protects against cutting and pulling attacks.
- Locks can be keyed alike, keyed different, or master keyed depending on your specific needs.

Applications:

The Medeco[®] new premium high security padlocks can be used in a variety of different indoor or outdoor applications where high security and key control are a primary concern.

Technical Features:

- Uses key retaining operation.
- Uses a dedicated 6 pin KIK/KIL cylinder that can be pinned to 5.

Warranty:

Warranted for two (2) years against manufacturer's defects. See the Medeco[®] limited warranty for full details.

Finishes:

The padlock comes in a standard industrial stainless steel finish and the cylinders are furnished in the satin brass finish.

Available Key Technologies:

Mechanical:

- Medeco³
- Medeco³ BiLevel
- Medeco X4

eCylinder:

- Medeco3 CLIQ
- Medeco CLIQ
- Medeco XT

Benefits:

- Hardened stainless steel inserts inside the cylinder provide the ultimate defense against drilling and other forms of physical attack.
- Unique elevating and rotating tumbler pin system is virtually pick proof.

Protector Series II Padlock

Description	Part Number	Price
Large Body - 7/16" dia shackle, Less Cyl, 1 3/8" clearance	50-81732	\$113.00
Large Body - 7/16" dia shackle, Less Cyl, 1 3/8" clearance, Dust cover	50-817321	\$125.00
Large Body - 7/16" dia shackle, Less Cyl, 1 7/8" clearance	50-81832	\$117.00
Large Body - 7/16" dia shackle, Less Cyl, 1 7/8" clearance, Dust cover	50-818321	\$129.00
Med Body - 5/16" dia shackle, Less Cyl, 1 3/8" clearance	50-81734	\$94.00
Med Body - 5/16" dia shackle, Less Cyl, 1 3/8" clearance, Dust cover	50-817341	\$106.00
Med Body - 5/16" dia shackle, Less Cyl, 1 7/8" clearance	50-81834	\$98.00
Med Body - 5/16" dia shackle, Less Cyl, 1 7/8" clearance, Dust cover	50-818341	\$110.00
Large Body - 7/16" dia shackle, 1 3/8" clearance	5004732	\$179.00
Large Body - 7/16" dia shackle, 1 3/8" clearance, Dust cover	50047321	\$191.00
Large Body - 7/16" dia shackle, 1 7/8" clearance	5004832	\$183.00
Large Body - 7/16" dia shackle, 1 7/8" clearance, Dust cover	50048321	\$195.00
Med Body - 5/16" dia shackle, 1 3/8" clearance	5004734	\$169.00
Med Body - 5/16" dia shackle, 1 3/8" clearance, Dust cover	50047341	\$181.00
Med Body - 5/16" dia shackle, 1 7/8" clearance	5004834	\$173.00
Med Body - 5/16" dia shackle, 1 7/8" clearance, Dust cover	50048341	\$185.00

Protector Series II Padlock Parts

Description	Part Number	Price
Disk For Standard Key In Knob Cylinder	CP-171011	\$11.80
Disk For CLIQ Cylinder	CP-171021	\$11.80
Disk For Nexgen Cylinder	CP-171031	\$11.80

Protector Series II Padlock Cylinder

Description	Part Number	Price
Knob Cylinder	500020	\$76.00

How to Order System Series Padlocks:

<p>1</p> <p>5451500 base part #</p> <p>Refer to pages 145-154 for descriptions and technical specifications to find the corresponding base part number.</p>	<p>2</p> <p>T cylinder</p> <ul style="list-style-type: none"> - = Original T = Medeco³ W = Biaxial J = Medeco³ BiLevel C = Medeco CLIQ N = Medeco X4 G = Medeco XT K = Medeco KM 	<p>3</p> <p>06 finish</p> <p>Insert 06 for Satin Brass finish.</p>	<p>4</p> <p>LT keyway</p> <p>Insert keyway if known or contact Customer Service for help.</p>	<p>5</p> <p>S pinning</p> <table border="1"> <tr> <td> <p>S =</p> <p>Sub-Assembled (Uncombined)</p> <p>No additional information needed</p> </td> <td> <p>P =</p> <p>Pinned (Combined)</p> <p>Keyed alike (KA)</p> <p>Keyed different (KD)</p> <p>2 keys per cylinder</p> </td> <td> <p>M =</p> <p>Master Keyed</p> <p>Provide specific pinning or contact Customer Service for support</p> <p>Must specify quantity for keys.</p> </td> </tr> </table>	<p>S =</p> <p>Sub-Assembled (Uncombined)</p> <p>No additional information needed</p>	<p>P =</p> <p>Pinned (Combined)</p> <p>Keyed alike (KA)</p> <p>Keyed different (KD)</p> <p>2 keys per cylinder</p>	<p>M =</p> <p>Master Keyed</p> <p>Provide specific pinning or contact Customer Service for support</p> <p>Must specify quantity for keys.</p>
<p>S =</p> <p>Sub-Assembled (Uncombined)</p> <p>No additional information needed</p>	<p>P =</p> <p>Pinned (Combined)</p> <p>Keyed alike (KA)</p> <p>Keyed different (KD)</p> <p>2 keys per cylinder</p>	<p>M =</p> <p>Master Keyed</p> <p>Provide specific pinning or contact Customer Service for support</p> <p>Must specify quantity for keys.</p>					

BUILD A SYSTEM SERIES PADLOCK BASE PART

54XXXX X X

<p>Prefix _____</p> <p>Shackle (Diameter), Feature, Clearance _____</p> <ul style="list-style-type: none"> 315 = 5/16" Diameter, Weather, 1 1/8" SFIC 31F = 5/16" Diameter, Weather, 2 3/8" SFIC 325 = 5/16" Diameter, Shrouded, 3/4" SFIC 335 = 5/16" Diameter, Weather, 1 1/8" SFIC 7 Pin 33F = 5/16" Diameter, Weather, 2 3/8" SFIC 7 Pin 345 = 5/16" Diameter, Shrouded, 3/4" SFIC 7 Pin 415 = 7/16" Diameter, Weather, 1 3/8" SFIC 41F = 7/16" Diameter, Weather, 1 7/8" SFIC 425 = 7/16" Diameter, Shrouded, 3/4" SFIC 435 = 7/16" Diameter, Weather, 1 3/8" SFIC 7 Pin 43F = 7/16" Diameter, Weather, 1 7/8" SFIC 7 Pin 445 = 7/16" Diameter, Shrouded, 3/4" SFIC 7 Pin 515 = 5/16" Diameter, Weather, 1 1/8" KIK 51F = 5/16" Diameter, Weather, 2 3/8" KIK 525 = 5/16" Diameter, Shrouded, 3/4" KIK 615 = 5/16" Diameter, Weather, 1 1/8" LFIC 61F = 5/16" Diameter, Weather, 2 3/8" LFIC 625 = 5/16" Diameter, Shrouded, 3/4" LFIC 715 = 7/16" Diameter, Weather, 1 3/8" KIK 71F = 7/16" Diameter, Weather, 1 7/8" KIK 725 = 7/16" Diameter, Shrouded, 3/4" KIK 815 = 7/16" Diameter, Weather, 1 3/8" LFIC 81F = 7/16" Diameter, Weather, 1 7/8" LFIC 825 = 7/16" Diameter, Shrouded, 3/4" LFIC 	<p>Standard Options</p> <ul style="list-style-type: none"> Blank = None T = Thick Head (SFIC Only) <p>Shackle Material</p> <ul style="list-style-type: none"> 0 = Boron Alloy Steel 1 = Stainless Steel <p>Key Function</p> <ul style="list-style-type: none"> 0 = Non-Key Retaining K = Less Cylinder (Key Retaining) L = Less Cylinder (Non-Key Retaining) R = Key Retaining
--	---

System Series Padlocks

The Medeco® System Series padlock offers a high security solution for a multitude of applications and are available in two distinctive body styles, an indoor/outdoor weather resistant design or with a shrouded shackle. Both models utilize a boron alloy steel shackle which provides protection to resist cutting and increased tensile strength to resist pulling attacks. The boron alloy steel also ensures that the shackle has an exceptional degree of ductility and is not brittle. The cylinder itself uses hardened, stainless steel inserts to provide the ultimate defense against drilling, pulling and other forms of vandal attack. Patented key programs prevent the unauthorized duplication of keys and maintain system integrity. Medeco's new premium high security padlocks can be keyed alike, keyed differently, or masterkeyed with existing door hardware systems. The Medeco³ unique design provides triple locking action, making the locks virtually pick proof. All Medeco³ keys and locks are protected under patent, trademark, and copyright laws. Medeco³ keys may only be duplicated by Medeco® or by a Medeco® authorized sales outlet, and only at your request.



Patented Key Control

Protects against unauthorized duplication of your keys.



Protection From Physical Attack

Medeco³ padlock cylinders are UL 437 listed and stand up to drilling, picking and other forms of physical attack.



Proprietary Deadlocking Shackle

Boron alloy steel shackles protect against cutting and pulling attacks.



Can Be Masterkeyed

Medeco System Series Padlocks can be masterkeyed into a system containing Medeco BiLevel and Medeco³ mechanical as well as Medeco³ CLIQ eCylinders.



Available in eCylinder

System Series Padlocks are also available with Medeco eCylinders for Loss & Liability control.



Special Angle Cut Keys

Requires a special key cutting machine and access to Medeco specific blanks, available in a variety of restrictions to support every need.



Picking and Bumping Protection

Medeco³ cylinders use a sidebar that prevent the key from rotating until it is elevated, rotated and aligned in the correct position. This feature protects against bumping and picking attacks.

Technical Features:

- Available with either a 5/16 inch or a 7/16 inch shackle diameter.
- Available in Indoor/Outdoor weather resistant design or with a shrouded shackle.
- Extended shackles available for Indoor/Outdoor padlocks only.
- The shrouded shackle design provides extra shackle protection against cutting attacks.
- All Medeco® cylinders are constructed of durable machined brass components, designed to last the life of your equipment.
- Boron alloy steel shackle which protects against cutting and pulling attacks.
- Available in a variety of different shackle lengths.

Applications:

Used in a variety of different indoor or outdoor applications where high security and key control are a primary concern.

Warranty:

Warranted for two (2) years against manufacturer's defects. See the Medeco® limited warranty for full details.

Finishes:

The padlock comes in a standard black body cover and the cylinders are furnished in the satin brass finish.

Available Key Technologies:

Mechanical:

- Medeco³
- Medeco³ BiLevel
- Medeco X4

eCylinder:

- Medeco3 CLIQ
- Medeco CLIQ
- Medeco XT

Indoor/Outdoor Padlock, 5/16" Shackle -KIK

Description	Part Number	Medeco ³	BiLevel	Medeco X4	eCylinder
Indoor/Outdoor Padlock, Non-Key Retaining, 1 1/8" Shackle Clearance, With Cylinder	5451500 (P)	\$120.50	\$83.50	\$110.00	●
	5451500 (S)	\$111.00	\$78.50	\$100.50	
Indoor/Outdoor Padlock, Key Retaining, 1 1/8" Shackle Clearance, With Cylinder	54515R0 (P)	\$120.50	\$83.50	\$110.00	●
	54515R0 (S)	\$111.00	\$78.50	\$100.50	
Indoor/Outdoor Padlock, Non-Key Retaining, 2 3/8" Shackle Clearance, With Cylinder	5451F00 (P)	\$123.50	\$86.50	\$113.00	●
	5451F00 (S)	\$114.00	\$81.50	\$103.50	
Indoor/Outdoor Padlock, Key Retaining, 2 3/8" Shackle Clearance, With Cylinder	5451FR0 (P)	\$123.50	\$0.00	\$113.00	●
	5451FR0 (S)	\$114.00	\$81.50	\$103.50	
Indoor/Outdoor Padlock, Key Retaining, 1 1/8" Shackle Clearance, Less Cylinder	54515K0	\$42.00			
Indoor/Outdoor Padlock, Non-Key Retaining, 1 1/8" Shackle Clearance, Less Cylinder	54515L0	\$39.50			
Indoor/Outdoor Padlock, Key Retaining, 2 3/8" Shackle Clearance, Less Cylinder	5451FK0	\$45.00			
Indoor/Outdoor Padlock, Non-Key Retaining, 2 3/8" Shackle Clearance, Less Cylinder	5451FL0	\$45.00			

Indoor/Outdoor Padlock, 5/16" Shackle -6 Pin LFIC

Description	Part Number	Medeco ³	BiLevel	Medeco X4	eCylinder
Indoor/Outdoor Padlock, Non-Key Retaining, 1 1/8" Shackle Clearance, With Cylinder	5461500 (P)	\$160.50	\$106.75		
	5461500 (S)	\$151.00	\$101.75		
Indoor/Outdoor Padlock, Key Retaining, 1 1/8" Shackle Clearance, With Cylinder	54615R0 (P)	\$160.50	\$106.75		
	54615R0 (S)	\$151.00	\$101.75		
Indoor/Outdoor Padlock, Non-Key Retaining, 2 3/8" Shackle Clearance, With Cylinder	5461F00 (P)	\$165.00	\$111.25		
	5461F00 (S)	\$155.50	\$106.25		
Indoor/Outdoor Padlock, Key Retaining, 2 3/8" Shackle Clearance, With Cylinder	5461FR0 (P)	\$165.00	\$111.25		
	5461FR0 (S)	\$155.50	\$106.25		
Indoor/Outdoor Padlock, Key Retaining, 1 1/8" Shackle Clearance, Less Cylinder	54615K0	\$41.50			
Indoor/Outdoor Padlock, Non-Key Retaining, 1 1/8" Shackle Clearance, Less Cylinder	54615L0	\$41.50			
Indoor/Outdoor Padlock, Key Retaining, 2 3/8" Shackle Clearance, Less Cylinder	5461FK0	\$49.50			
Indoor/Outdoor Padlock, Non-Key Retaining, 2 3/8" Shackle Clearance, Less Cylinder	5461FL0	\$49.50			

**Refer to the eCylinder section for more detail on specific technologies available and pricing. Technologies are represented by the following letters:

T = Medeco³, S = Medeco³ CLIQ, J = Medeco³ BiLevel, W = Biaxial, V = Medeco Biaxial CLIQ, K = Medeco KM, N = Medeco X4, C = Medeco CLIQ,
 "-." = Original, Z = Medeco Original KW CLIQ, G = Medeco XT ***See key section for surcharges for custom coined cut keys or special stamping requirements.

Note: (P) refers to **Pinned** and (S) to **Sub-Pinned** at the end of each part string in the price book.

Indoor/Outdoor Padlock, 5/16" Shackle -6 Pin SFIC

Description	Part Number	Medeco ³	BiLevel	Medeco X4	eCylinder
Indoor/Outdoor Padlock, Non-Key Retaining, 1 1/8" Shackle Clearance, With Cylinder	5431500 (P)			\$106.00	
	5431500 (S)			\$95.00	
Indoor/Outdoor Padlock, Key Retaining, 1 1/8" Shackle Clearance, With Cylinder	54315R0 (P)			\$106.00	
	54315R0 (S)			\$95.00	
Indoor/Outdoor Padlock, Non-Key Retaining, 2 3/8" Shackle Clearance, With Cylinder	5431F00 (P)			\$110.00	
	5431F00 (S)			\$99.00	
Indoor/Outdoor Padlock, Key Retaining, 2 3/8" Shackle Clearance, With Cylinder	5431FR0 (P)			\$110.00	
	5431FR0 (S)			\$99.00	

Indoor/Outdoor Padlock, 5/16" Shackle -7 Pin SFIC

Description	Part Number	Medeco ³	BiLevel	Medeco X4	eCylinder
Indoor/Outdoor Padlock, Non-Key Retaining, 1 1/8" Shackle Clearance, With Cylinder	5433500 (P)			\$104.50	
	5433500 (S)			\$95.00	
Indoor/Outdoor Padlock, Key Retaining, 1 1/8" Shackle Clearance, With Cylinder	54335R0 (P)			\$104.50	
	54335R0 (S)			\$95.00	
Indoor/Outdoor Padlock, Non-Key Retaining, 2 3/8" Shackle Clearance, With Cylinder	5433F00 (P)			\$108.50	
	5433F00 (S)			\$99.00	
Indoor/Outdoor Padlock, Key Retaining, 2 3/8" Shackle Clearance, With Cylinder	5433FR0 (P)			\$108.50	
	5433FR0 (S)			\$99.00	

Indoor/Outdoor Padlock, 5/16" Shackle -Less SFIC

Description	Part Number	Price
Indoor/Outdoor Padlock, Key Retaining, 1 1/8" Shackle Clearance, Less Cylinder	54315K0	\$41.50
Indoor/Outdoor Padlock, Non-Key Retaining, 1 1/8" Shackle Clearance, Less Cylinder	54315L0	\$41.50
Indoor/Outdoor Padlock, Key Retaining, 2 3/8" Shackle Clearance, Less Cylinder	5431FK0	\$47.50
Indoor/Outdoor Padlock, Non-Key Retaining, 2 3/8" Shackle Clearance, Less Cylinder	5431FL0	\$47.50

**Refer to the eCylinder section for more detail on specific technologies available and pricing. Technologies are represented by the following letters:

T = Medeco³, S = Medeco³ CLIQ, J = Medeco³ BiLevel, W = Biaxial, V = Medeco Biaxial CLIQ, K = Medeco KM, N = Medeco X4, C = Medeco CLIQ,
 "-" = Original, Z = Medeco Original KW CLIQ, G = Medeco XT ***See key section for surcharges for custom coined cut keys or special stamping requirements.

Note: (P) refers to **Pinned** and (S) to **Sub-Pinned** at the end of each part string in the price book.

Indoor/Outdoor Padlock, 7/16" Shackle -KIK

Description	Part Number	Medeco ³	BiLevel	Medeco X4	eCylinder
Indoor/Outdoor Padlock, Non-Key Retaining, 1 3/8" Shackle Clearance, With Cylinder	5471500 (P)	\$141.00	\$104.00	\$130.50	●
	5471500 (S)	\$131.50	\$99.00	\$121.00	
Indoor/Outdoor Padlock, Key Retaining, 1 3/8" Shackle Clearance, With Cylinder	54715R0 (P)	\$141.00	\$104.00	\$130.50	●
	54715R0 (S)	\$131.50	\$99.00	\$121.00	
Indoor/Outdoor Padlock, Non-Key Retaining, 1 7/8" Shackle Clearance, With Cylinder	5471F00 (P)	\$144.00	\$107.00	\$133.50	●
	5471F00 (S)	\$134.50	\$102.00	\$124.00	
Indoor/Outdoor Padlock, Key Retaining, 1 7/8" Shackle Clearance, With Cylinder	5471FR0 (P)	\$144.00	\$107.00	\$133.50	●
	5471FR0 (S)	\$134.50	\$102.00	\$124.00	
Indoor/Outdoor Padlock, Key Retaining, 1 3/8" Shackle Clearance, Less Cylinder	54715K0	\$62.50			
Indoor/Outdoor Padlock, Non-Key Retaining, 1 3/8" Shackle Clearance, Less Cylinder	54715L0	\$62.25			
Indoor/Outdoor Padlock, Key Retaining, 1 7/8" Shackle Clearance, Less Cylinder	5471FK0	\$65.50			
Indoor/Outdoor Padlock, Non-Key Retaining, 1 7/8" Shackle Clearance, Less Cylinder	5471FL0	\$65.50			

Indoor/Outdoor Padlock, 7/16" Shackle -6 Pin LFIC

Description	Part Number	Medeco ³	BiLevel	Medeco X4	eCylinder
Indoor/Outdoor Padlock, Non-Key Retaining, 1 3/8" Shackle Clearance, With Cylinder	5481500 (P)	\$183.50			
	5481500 (S)	\$174.00			
Indoor/Outdoor Padlock, Key Retaining, 1 3/8" Shackle Clearance, With Cylinder	54815R0 (P)	\$183.50			
	54815R0 (S)	\$174.00			
Indoor/Outdoor Padlock, Non-Key Retaining, 1 7/8" Shackle Clearance, With Cylinder	5481F00 (P)	\$186.50			
	5481F00 (S)	\$177.00			
Indoor/Outdoor Padlock, Key Retaining, 1 7/8" Shackle Clearance, With Cylinder	5481FR0 (P)	\$186.50			
	5481FR0 (S)	\$177.00			
Indoor/Outdoor Padlock, Key Retaining, 1 3/8" Shackle Clearance, Less Cylinder	54815K0	\$68.00			
Indoor/Outdoor Padlock, Non-Key Retaining, 1 3/8" Shackle Clearance, Less Cylinder	54815L0	\$68.00			
Indoor/Outdoor Padlock, Key Retaining, 1 7/8" Shackle Clearance, Less Cylinder	5481FK0	\$71.00			
Indoor/Outdoor Padlock, Non-Key Retaining, 1 7/8" Shackle Clearance, Less Cylinder	5481FL0	\$71.00			

**Refer to the eCylinder section for more detail on specific technologies available and pricing. Technologies are represented by the following letters:

T = Medeco³, S = Medeco³ CLIQ, J = Medeco³ BiLevel, W = Biaxial, V = Medeco Biaxial CLIQ, K = Medeco KM, N = Medeco X4, C = Medeco CLIQ,
 "-." = Original, Z = Medeco Original KW CLIQ, G = Medeco XT ***See key section for surcharges for custom coined cut keys or special stamping requirements.

Note: (P) refers to **Pinned** and (S) to **Sub-Pinned** at the end of each part string in the price book.

Indoor/Outdoor Padlock, 7/16" Shackle - 6 Pin SFIC

Description	Part Number	Medeco ³	BiLevel	Medeco X4	eCylinder
Indoor/Outdoor Padlock, Non-Key Retaining, 1 3/8" Shackle Clearance, With Cylinder	5441500 (P)			\$129.00	
	5441500 (S)			\$118.00	
Indoor/Outdoor Padlock, Key Retaining, 1 3/8" Shackle Clearance, With Cylinder	54415R0 (P)			\$129.00	
	54415R0 (S)			\$118.00	
Indoor/Outdoor Padlock, Non-Key Retaining, 1 7/8" Shackle Clearance, With Cylinder	5441F00 (P)			\$132.00	
	5441F00 (S)			\$121.00	
Indoor/Outdoor Padlock, Key Retaining, 1 7/8" Shackle Clearance, With Cylinder	5441FR0 (P)			\$132.00	
	5441FR0 (S)			\$121.00	

Indoor/Outdoor Padlock, 7/16" Shackle - 7 Pin SFIC

Description	Part Number	Medeco ³	BiLevel	Medeco X4	eCylinder
Indoor/Outdoor Padlock, Non-Key Retaining, 1 3/8" Shackle Clearance With Cylinder	5443500 (P)			\$127.50	
	5443500 (S)			\$118.00	
Indoor/Outdoor Padlock, Key Retaining, 1 3/8" Shackle Clearance, With Cylinder	54435R0 (P)			\$127.50	
	54435R0 (S)			\$118.00	
Indoor/Outdoor Padlock, Non-Key Retaining, 1 7/8" Shackle Clearance, With Cylinder	5443F00 (P)			\$130.50	
	5443F00 (S)			\$121.00	
Indoor/Outdoor Padlock, Key Retaining, 1 7/8" Shackle Clearance, With Cylinder	5443FR0 (P)			\$130.50	
	5443FR0 (S)			\$121.00	

Indoor/Outdoor Padlock, 7/16" Shackle - Less SFIC

Description	Part Number	Medeco ³	BiLevel	Medeco X4	eCylinder
Indoor/Outdoor Padlock, Key Retaining, 1 3/8" Shackle Clearance, Less Cylinder	54415K0			\$66.50	
Indoor/Outdoor Padlock, Non-Key Retaining, 1 3/8" Shackle Clearance, Less Cylinder	54415L0			\$66.50	
Indoor/Outdoor Padlock, Key Retaining, 1 7/8" Shackle Clearance, Less Cylinder	5441FK0			\$69.50	
Indoor/Outdoor Padlock, Non-Key Retaining, 1 7/8" Shackle Clearance, Less Cylinder	5441FL0			\$69.50	

Shrouded Padlock, 5/16" Shackle - KIK

Description	Part Number	Medeco ³	BiLevel	Medeco X4	eCylinder
Shrouded Padlock, Non-Key Retaining, 3/4" Shackle Clearance, With Cylinder	5452500 (P)	\$138.00	\$101.00	\$127.50	
	5452500 (S)	\$128.50	\$96.00	\$118.00	
Shrouded Padlock, Key Retaining, 3/4" Shackle Clearance, With Cylinder	54525R0 (P)	\$138.00	\$101.00	\$127.50	
	54525R0 (S)	\$128.50	\$96.00	\$118.00	
Shrouded Padlock, Key Retaining, 3/4" Shackle Clearance, Less Cylinder	54525K0	\$59.50			
Shrouded Padlock, Non-Key Retaining, 3/4" Shackle Clearance, Less Cylinder	54525L0	\$59.50			

**Refer to the eCylinder section for more detail on specific technologies available and pricing. Technologies are represented by the following letters:
T = Medeco³, S = Medeco³ CLIQ, J = Medeco³ BiLevel, W = Biaxial, V = Medeco Biaxial CLIQ, K = Medeco KM, N = Medeco X4, C = Medeco CLIQ,

"-" = Original, Z = Medeco Original KW CLIQ, G = Medeco XT ***See key section for surcharges for custom coined cut keys or special stamping requirements.

Note: (P) refers to **Pinned** and (S) to **Sub-Pinned** at the end of each part string in the price book.

Shrouded Padlock, 5/16" Shackle - 6 Pin LFIC

Description	Part Number	Medeco ³	BiLevel	Medeco X4	eCylinder
Shrouded Padlock, Non-Key Retaining, 3/4" Shackle Clearance, With Cylinder	5462500 (P)	\$179.00			
	5462500 (S)	\$169.50			
Shrouded Padlock, Key Retaining, 3/4" Shackle Clearance, With Cylinder	54625R0 (P)	\$179.00			
	54625R0 (S)	\$169.50			
Shrouded Padlock, Key Retaining, 3/4" Shackle Clearance, Less Cylinder	54625K0	\$63.50			
Shrouded Padlock, Non-Key Retaining, 3/4" Shackle Clearance, Less Cylinder	54625L0	\$63.50			

Shrouded Padlock, 5/16" Shackle - 6 Pin SFIC

Description	Part Number	Medeco ³	BiLevel	Medeco X4	eCylinder
Shrouded Padlock, Non-Key Retaining, 3/4" Shackle Clearance, With Cylinder	5432500 (P)			\$124.50	
	5432500 (S)			\$113.50	
Shrouded Padlock, Key Retaining, 3/4" Shackle Clearance, With Cylinder	54325R0 (P)			\$124.50	
	54325R0 (S)			\$113.50	

Shrouded Padlock, 5/16" Shackle - 7 Pin SFIC

Description	Part Number	Medeco ³	BiLevel	Medeco X4	eCylinder
Shrouded Padlock, Non-Key Retaining, 3/4" Shackle Clearance, With Cylinder	5434500 (P)			\$123.00	
	5434500 (S)			\$113.50	
Shrouded Padlock, Key Retaining, 3/4" Shackle Clearance, With Cylinder	54345R0 (P)			\$123.00	
	54345R0 (S)			\$113.50	

Shrouded Padlock, 5/16" Shackle - Less SFIC

Description	Part Number	Medeco ³	BiLevel	Medeco X4	eCylinder
Shrouded Padlock, Key Retaining, 3/4" Shackle Clearance, Less Cylinder	54325K0			\$62.00	
Shrouded Padlock, Non-Key Retaining, 3/4" Shackle Clearance, Less Cylinder	54325L0			\$62.00	

**Refer to the eCylinder section for more detail on specific technologies available and pricing. Technologies are represented by the following letters:
T = Medeco³, S = Medeco³ CLIQ, J = Medeco³ BiLevel, W = Biaxial, V = Medeco Biaxial CLIQ, K = Medeco KM, N = Medeco X4, C = Medeco CLIQ,
“-” = Original, Z = Medeco Original KW CLIQ, G = Medeco XT ***See key section for surcharges for custom coined cut keys or special stamping requirements.
Note: (P) refers to **Pinned** and **(S)** to **Sub-Pinned** at the end of each part string in the price book.

Shrouded Padlock, 7/16" Shackle - KIK

Description	Part Number	Medeco ³	BiLevel	Medeco X4	eCylinder
Shrouded Padlock, Non-Key Retaining, 3/4" Shackle Clearance, With Cylinder	5472500 (P)	\$167.00	\$130.00	\$156.50	●
	5472500 (S)	\$157.50	\$125.00	\$147.00	
Shrouded Padlock, Key Retaining, 3/4" Shackle Clearance, With Cylinder	54725R0 (P)	\$167.00	\$130.00	\$156.50	●
	54725R0 (S)	\$157.50	\$125.00	\$147.00	
Shrouded Padlock, Key Retaining, 3/4" Shackle Clearance, Less Cylinder	54725K0	\$88.50			
Shrouded Padlock, Non-Key Retaining, 3/4" Shackle Clearance, Less Cylinder	54725L0	\$88.50			

Shrouded Padlock, 7/16" Shackle - 6 Pin LFIC

Description	Part Number	Medeco ³	BiLevel	Medeco X4	eCylinder
Shrouded Padlock, Non-Key Retaining, 3/4" Shackle Clearance, With Cylinder	5482500 (P)	\$207.00			
	5482500 (S)	\$197.50			
Shrouded Padlock, Key Retaining, 3/4" Shackle Clearance, With Cylinder	54825R0 (P)	\$207.00			
	54825R0 (S)	\$197.50			
Shrouded Padlock, Key Retaining, 3/4" Shackle Clearance, Less Cylinder	54825K0			\$91.50	
Shrouded Padlock, Non-Key Retaining, 3/4" Shackle Clearance, Less Cylinder	54825L0			\$91.50	

Shrouded Padlock, 7/16" Shackle - 6 Pin SFIC

Description	Part Number	Medeco ³	BiLevel	Medeco X4	eCylinder
Shrouded Padlock, Non-Key Retaining, 3/4" Shackle Clearance, With Cylinder	5442500 (P)			\$152.50	
	5442500 (S)			\$141.50	
Shrouded Padlock, Key Retaining, 3/4" Shackle Clearance, With Cylinder	54425R0 (P)			\$152.50	
	54425R0 (S)			\$141.50	

Shrouded Padlock, 7/16" Shackle - 6 Pin SFIC

Description	Part Number	Medeco ³	BiLevel	Medeco X4	eCylinder
Shrouded Padlock, Non-Key Retaining, 3/4" Shackle Clearance, With Cylinder	5444500 (P)			\$148.10	
	5444500 (S)			\$141.50	
Shrouded Padlock, Key Retaining, 3/4" Shackle Clearance, With Cylinder	54445R0 (P)			\$148.10	
	54445R0 (S)			\$141.50	

**Refer to the eCylinder section for more detail on specific technologies available and pricing. Technologies are represented by the following letters:
T = Medeco³, S = Medeco³ CLIQ, J = Medeco³ BiLevel, W = Biaxial, V = Medeco Biaxial CLIQ, K = Medeco KM, N = Medeco X4, C = Medeco CLIQ,
“-” = Original, Z = Medeco Original KW CLIQ, G = Medeco XT ***See key section for surcharges for custom coined cut keys or special stamping requirements.
Note: (P) refers to **Pinned** and **(S)** to **Sub-Pinned** at the end of each part string in the price book.

Shrouded Padlock, 7/16" Shackle - Less SFIC

Description	Part Number	Medeco ³	BiLevel	Medeco X4	eCylinder
Shrouded Padlock, Key Retaining, 3/4" Shackle Clearance, Less Cylinder	54425K0	\$90.00			
Shrouded Padlock, Non-Key Retaining, 3/4" Shackle Clearance, Less Cylinder	54425L0	\$90.00			

52 Series Padlock, 5/16" Shackle

Description	Part Number	Medeco ³	BiLevel	Medeco X4	eCylinder
1 1/8" Clearance, Boron Alloy Shackle	526201 (P)	\$120.00			
	526201 (S)	\$110.50			
2 3/8" Clearance, Boron Alloy Shackle	526301 (P)	\$120.50			
	526301 (S)	\$110.50			
1 1/8" Clearance, Boron Alloy Shackle, Less Cylinder	526200	\$69.20			
2 3/8" Clearance, Boron Alloy Shackle, Less Cylinder	526200	\$69.20			
1 1/8" Clearance, Stainless Steel Shackle	526211 (P)	\$120.00			
	526211 (S)	\$110.50			
2 3/8" Clearance, Stainless Steel Shackle	526311 (P)	\$120.00			
	526311 (S)	\$110.50			
1 1/8" Clearance, Stainless Steel Shackle, Less Cylinder	526210	\$69.20			
2 3/8" Clearance, Stainless Steel Shackle, Less Cylinder	526310	\$69.20			

*Padlock body is solid brass with 26 plated finish.

52 Series Padlock, 5/16" Shackle, Removable Core

Description	Part Number	Medeco ³	BiLevel	Medeco X4	eCylinder
1 1/8" Clearance, Boron Alloy Shackle, Removable Core, Less Cylinder	526202	\$86.50			
2 3/8" Clearance, Boron Alloy Shackle, Removable Core, Less Cylinder	526302	\$86.50			
1 1/8" Clearance, Stainless Steel Shackle, Removable Core, Less Cylinder	526212	\$86.50			
2 3/8" Clearance, Stainless Steel Shackle, Removable Core, Less Cylinder	526312	\$86.50			

Padlock body is solid brass with 26 plated finish

**Refer to the eCylinder section for more detail on specific technologies available and pricing. Technologies are represented by the following letters:
 T = Medeco³, S = Medeco³ CLIQ, J = Medeco³ BiLevel, W = Biaxial, V = Medeco Biaxial CLIQ, K = Medeco KM, N = Medeco X4, C = Medeco CLIQ,
 "-" = Original, Z = Medeco Original KW CLIQ, G = Medeco XT ***See key section for surcharges for custom coined cut keys or special stamping requirements.
Note: (P) refers to **Pinned** and **(S)** to **Sub-Pinned** at the end of each part string in the price book.

52 Series Padlock, 7/16" Shackle

Description	Part Number	Medeco ³	BiLevel	Medeco X4	eCylinder
1 3/8" Clearance, Boron Alloy Shackle	526001 (P)	\$120.00			
	526001 (S)	\$110.50			
1 7/8" Clearance, Boron Alloy Shackle	526101 (P)	\$120.00			
	526101 (S)	\$110.50			
1 3/8" Clearance, Boron Alloy Shackle, Less Cylinder	526000	\$69.20			
1 7/8" Clearance, Boron Alloy Shackle, Less Cylinder	526100	\$69.20			
1 3/8" Clearance, Stainless Steel Shackle	526011 (P)	\$120.00			
	526011 (S)	\$110.50			
1 7/8" Clearance, Stainless Steel Shackle	526111 (P)	\$120.00			
	526111 (S)	\$110.50			
1 3/8" Clearance, Stainless Steel Shackle, Less Cylinder	526010	\$69.20			
1 7/8" Clearance, Stainless Steel Shackle, Less Cylinder	526110	\$69.20			

*52 Series Padlock body is solid brass with 26 plated finish.

52 Series Padlock, 7/16" Shackle, Removable Core

Description	Part Number	Medeco ³	BiLevel	Medeco X4	eCylinder
1 3/8" Clearance, Boron Alloy Shackle, Removable Core, Less Cylinder	526002	\$86.50			
1 7/8" Clearance, Boron Alloy Shackle, Removable Core, Less Cylinder	526102	\$86.50			
1 3/8" Clearance, Stainless Steel Shackle, Removable Core, Less Cylinder	526012	\$86.50			
1 7/8" Clearance, Stainless Steel Shackle, Removable Core, Less Cylinder	526112	\$86.50			

Padlock body is solid brass with 26 plated finish.

52 series Padlocks Cover Options: 00 = Standard, 01 = Case Cover, 10 = Dust Cover

**Refer to the eCylinder section for more detail on specific technologies available and pricing. Technologies are represented by the following letters:
T = Medeco³, S = Medeco³ CLIQ, J = Medeco³ BiLevel, W = Biaxial, V = Medeco Biaxial CLIQ, K = Medeco KM, N = Medeco X4, C = Medeco CLIQ,
“-” = Original, Z = Medeco Original KW CLIQ, G = Medeco XT ***See key section for surcharges for custom coined cut keys or special stamping requirements.
Note: (P) refers to **Pinned** and **(S)** to **Sub-Pinned** at the end of each part string in the price book.

Padlock Cylinders

Description	Part Number	Medeco ³	BiLevel	Medeco X4	eCylinder
5 Pin Cylinder (6 pin Medeco X4) for Hockey Puck Style Padlock sold after 9/2004 (KIK style cylinder)	2001600 (P)	\$81.00	\$44.12	\$70.50	
	2001600 (S)	\$71.50	\$39.12	\$61.00	
6 Pin Cylinder for LFIC Medeco Padlock, for 54 Series Padlocks	320201 (P)	\$119.00	\$64.68		•
	320201 (S)	\$109.50	\$59.68		
6 Pin Cylinder for KIK Medeco Padlock, for 54 Series Padlocks	510600 (P)	\$81.00	\$44.12	\$70.50	•
	510600 (S)	\$71.50	\$39.12	\$61.00	
5 Pin Spring Bolt Cylinder (non-key retaining), for G8R Padlock	960357 (P)	\$81.50			
	960357 (S)	\$72.00			
5 Pin Deadbolt Cylinder (key retaining), for G8R Padlock	960358 (P)	\$81.50			
	960358 (S)	\$72.00			
Spacer for use with 5 Pin Cylinders, for G8R Padlock	CP-160691	\$1.49			
5 Pin cylinder (cam lock style) for 52-6 series padlocks	66418 (P)	\$59.50			
	66418 (S)	\$54.50			
4 Pin Removable plug for 52-6 padlocks	66391 (P)	\$56.40			
	66391 (S)	\$51.00			

eCylinder Padlock Cylinders

eCylinders are available for many of the padlocks. Please check the eCylinder section for specific part numbers and pricing.

**Refer to the eCylinder section for more detail on specific technologies available and pricing. Technologies are represented by the following letters:
 T = Medeco³, S = Medeco³ CLIQ, J = Medeco³ BiLevel, W = Biaxial, V = Medeco Biaxial CLIQ, K = Medeco KM, N = Medeco X4, C = Medeco CLIQ,
 "-" = Original, Z = Medeco Original KW CLIQ, G = Medeco XT ***See key section for surcharges for custom coined cut keys or special stamping requirements.
Note: (P) refers to **Pinned** and **(S)** to **Sub-Pinned** at the end of each part string in the price book.

Components

Description	Part Number	Price
Component Package for 54 Series Padlocks, NonKey Retaining. Includes CP-130510 Cylinder Extension/Actuator, Spring & Washer, CP-022030 Cylinder Retainer, CP-011511-000 Retainer Screw, CP-250140 Steel Ball Bearing	94-0199	\$11.00
Cylinder Retainer Sleeve (Fits over Cylinder Bible Chamber & holds cylinder in padlock body)	CP-022030	\$5.69
Retainer Screw, #6-32 UNC-2A x .312" length	CP-011511-000	\$0.52
Cylinder Extension/Actuator, Non Key Retaining, Spring & Washer for 54 Series Padlocks	CP-130510	\$4.76
Stainless Steel Ball Bearing for 54 Series Padlocks, .360" Diameter	CP-250140	\$0.52
Cylinder Extension/Actuator, Key Retaining, for 54 Series Padlocks	CP-200720	\$4.76

Shackles for Indoor/Outdoor Padlocks

Description	Boron Alloy Steel		Stainless Steel	
	Part Number	Price	Part Number	Price
Standard Shackle for 54-51 Indoor/Outdoor Padlock, 1-1/8" Shackle Clearance x 5/16" Diameter	CP-144120	\$8.38	CP-144180	\$12.50
Extra Length Shackle for 54-51 Indoor/Outdoor Padlock, 2-3/8" Shackle Clearance x 5/16" Diameter	CP-144130	\$10.00	CP-144190	\$14.00
Standard Shackle for 54-71 Indoor/Outdoor Padlock, 1-3/8" Shackle Clearance x 7/16" Diameter	CP-144150	\$10.00	CP-144210	\$14.00
Extra Length Shackle for 54-71 Indoor/Outdoor Padlock, 1-7/8" Shackle Clearance x 7/16" Diameter	CP-144160	\$11.00	CP-144220	\$15.50

Shackles for Shrouded Padlocks

Description	Boron Alloy Steel		Stainless Steel	
	Part Number	Price	Part Number	Price
Standard Shackle for 54-52 Shrouded Padlock, 3/4" Shackle Clearance x 5/16" Diameter	CP-144110	\$8.38	CP-144170	\$12.50
Standard Shackle for 54-72 Shrouded Padlock, 3/4" Shackle Clearance x 7/16" Diameter	CP-144140	\$10.00	CP-144200	\$14.00

Hockey Puck Padlocks

Medeco® offers a variety of High Security Padlocks that are designed to accept both mechanical and eCylinders. The Medeco® Hockey Puck style padlocks come with hardened, solid steel bodies, a shackle-less design for the highest level of protection against bolt cutter attacks, and patent protected key control. Every padlock cylinder is UL 437 Listed and can be keyed into any existing 10 series product. The Medeco³ unique design provides triple locking action, making the locks virtually pick proof. All Medeco³ keys and locks are protected under patent, trademark, and copyright laws. Medeco³ keys may only be duplicated by Medeco® or by a Medeco® authorized sales outlet, and only at your request.



Patented Key Control

Protects against unauthorized duplication of your keys.



Protection From Physical Attack

Medeco³ padlock cylinders are UL 437 listed and stand up to drilling, picking and other forms of physical attack. The Hockey Pucks shackle-less design provides the highest protection from bolt cutter attacks.



Can Be Masterkeyed

Medeco Hockey Puck Padlocks can be masterkeyed into existing Medeco 10 Series products.



Available in eCylinder

Medeco's Hockey Puck Padlocks are also available with Medeco eCylinders for Loss & Liability control.



Special Angle Cut Keys

Requires a special key cutting machine and access to Medeco specific blanks, available in a variety of restrictions to support every need.



Picking and Bumping Protection

Medeco³ cylinders use a sidebar that prevent the key from rotating until it is elevated, rotated and aligned in the correct position. This feature protects against bumping and picking attacks.

Technical Features:

- Hardened steel body.
- 5 pin, key-in-knob cylinder.
- Requires a key to relock.
- Hardened solid steel, black chrome plated body.
- All Medeco® cylinders are constructed of durable machined brass components, designed to last the life of your equipment.

Applications:

Hockey Puck style padlocks can be used in a variety of different applications including vending, storage and transportation.

Warranty:

Warranted for two (2) years against manufacturer's defects. See the Medeco® limited warranty for full details.

Available Key Technologies:

Mechanical:

- Medeco³
- Medeco³ BiLevel*
- Medeco X4*

eCylinder:

- Medeco XT

52-9 Series Hockey Puck Padlock

Description	Part Number	Medeco ³	BiLevel	Medeco X4	eCylinder
Hockey Puck Padlock, With 5 Pin High Security or 6 Pin Medeco X4 Cylinder	5293000 (P)	\$132.50	\$95.50	\$122.00	
	5293000 (S)	\$123.00	\$90.50	\$112.50	
Hockey Puck Padlock, Non-Key Retaining, Less Cylinder	52930L0	\$51.50			

Hockey Puck uses unique cylinders and can be keyed to a door hardware key. Not available with LFIC or SFIC.

G8R Padlocks

Medeco® offers a variety of High Security Padlocks that are designed to accept both mechanical and eCylinders. With its tough, weather resistant construction, this is the padlock of choice for extreme environments such as trailers, cargo containers, and gates. The Medeco® G8R body is constructed of solid stainless steel. You can choose from either a stainless steel shackle for maximum corrosion resistance, or hardened steel to withstand severe physical attack. Each padlock includes a weather seal cap attached by a cable. The Medeco® G8R will accept either an eCylinder or mechanical t-handle cylinder. The mechanical cylinders provide the benefit of patented key control and pick resistance. The eCylinder adds sophisticated audit and control features transforming the G8R into a portable access control system for extreme environments.

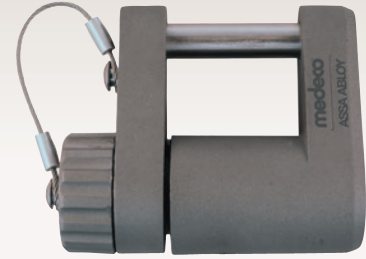

Patented Key Control

Protects against unauthorized duplication of your keys.



Protection From Physical Attack

Medeco³ padlock cylinders are UL 437 listed and stand up to drilling, picking and other forms of physical attack. Available in either a hardened steel shackle to withstand severe physical attack or a stainless steel shackle for maximum corrosion resistance.



Weather Resistant Construction

Uses a weather seal cap, attached by a cable, to provide protection from water and road grime.



Available in eCylinder

Medeco G8R Padlocks are also available with Medeco eCylinders for Loss & Liability control.



Special Angle Cut Keys

Requires a special key cutting machine and access to Medeco specific blanks, available in a variety of restrictions to support every need.



Picking and Bumping Protection

Medeco³ cylinders use a sidebar that prevent the key from rotating until it is elevated, rotated and aligned in the correct position. This feature protects against bumping and picking attacks.

Technical Information:

- 300 series, cast stainless steel body.
- Padlock is sold less cylinder. Compatible with Medeco® mechanical and NEXGEN electronic t-handle cylinders.
- Padlocks are shipped with a weather seal cap attached by a steel cable. A finish plate is included for applications that do not require the weather seal cap.
- Sealed construction protects cylinders from water and road grime.
- Stainless steel body resists attack and corrosion.
- Shackles can be specified in stainless or hardened steel to fit your application.

Applications:

- The G8R Series was designed for locking installations requiring weather resistance and strong physical security. Applications include:
 - Cargo containers
 - Trailer doors
 - Gates
 - Vending machines

Warranty:

Warranted for two (2) years against manufacturer's defects. See the Medeco® limited warranty for full details

Available Key Technologies:

Mechanical:

- Medeco³

eCylinder:

- Medeco XT
- Medeco CLIQ
- Medeco Nexgen

G8R Series Padlock

Description	Part Number	Price
G8R Weather-tight Padlock, 5/16" Stainless Steel Shackle, less pop-out cylinder	52110040	\$111.00
G8R Weather-tight Padlock, 5/16" Hardened Steel Shackle, less pop-out cylinder	52111040	\$111.00
G8R Weather-tight Padlock, 7/16" Stainless Steel Shackle, less pop-out cylinder	52120040	\$111.00
G8R Weather-tight Padlock, 7/16" Hardened Steel Shackle, less pop-out cylinder	52121040	\$111.00
G8R cap and seal kit	94-0213	\$21.50

G8R padlocks are sold less cylinder and use a cam lock style key with pop-out plug.

Keys are charged separately for this style cylinder.

Cam, Cabinet & Switch Locks

FEATURES	Medeco ³	CLIQ	Medeco XT
Easily integrated into existing cam lock master key systems	●	●	●
Easy installation	●	●	●
Completely serviceable and may be rekeyed in the event of a lost or stolen key	●	●	●
UL437 Listing on cylinder for high security	●		
Cam locks available in all standard lengths, flats, and rotations	●	●	●
Switch locks available in single or double switch models and momentary and maintained positions with silver or gold contacts (for low amperage applications) designed to accept quick connect leads	●	●	●

Medeco³ Premium High Security

For effective mechanical protection against most forms of attack as well as protection against unauthorized duplicate keys, Medeco³ cylinders are recommended. Security features including hardened steel components, pins that must be elevated, rotated, and interact with both a sidebar and a slider, and additional pick resistant features make Medeco³ the cylinder of choice to protect people, property and information.

Loss & Liability Control

Many of the cylinders in this section are also available with an eCylinder Loss & Liability Control Solution. See the eCylinder Section for more details.

Cam Locks

Cam Locks Installation Instructions & Op Codes

Medeco Cam Lock Part Number Configurations

Model Number	Operation Code	Cylinder	Finish	Keyway	"Cam Lock Operation Code" – Describes the function of the lock. Direction of key turn, rotation, key retaining or two key-pull.
XXXXXXXX	XXX	X	26	XX	

Cam Lock Operation Codes – Fixed Core Cam Locks

Describes the function of the lock

Operation Code	Rotation Distance	Direction to Unlock	Key Retaining or 2 Key Pull
219	90°	Clockwise	Key Retaining
229	90°	Clockwise	2 Key Pull
239	90°	Counter-clockwise	Key Retaining
249	90°	Counter-clockwise	2 Key Pull
259	180°	Clockwise	Key Retaining
269	180°	Clockwise	2 Key Pull
279	180°	Counter-clockwise	Key Retaining
289	180°	Counter-clockwise	2 Key Pull

Note: Key Retaining – Key is removable in the locked position only.

2 Key Pull – Key is removable in both the locked and unlocked positions.

Cam Lock Operation Codes – Removable Core Cam Locks

Describes the function of the lock

Operation Code	Rotation Distance	Direction to Unlock	Key Retaining or 2 Key Pull
219	90°	Clockwise	Key Retaining
239	90°	Counter-clockwise	Key Retaining
259	180°	Clockwise	Key Retaining
279	180°	Counter-clockwise	Key Retaining

Note: Removable core cam locks are available in key retaining only.

Cam Locks

Medeco® high security cam locks are recognized throughout the world as the standard for protection in a 3/4 inch diameter lock. Medeco® Cam Locks utilize hardened, stainless steel inserts throughout the cylinder to provide the ultimate defense against drilling, pulling, and other forms of vandal attacks. Patented key control programs prevent the unauthorized duplication of keys and maintain system integrity. Keyed alike, keyed different, or master keyed, Medeco® offers a complete line of cam locks in a wide variety of sizes and functions to meet your specific needs.



Patented Key Control

Protects against unauthorized duplication of your keys.



Available in eCylinder

Medeco cam locks are also available with Medeco eCylinders for Loss & Liability control.



Can Be Masterkeyed

Medeco cam locks can be keyed alike, keyed different or masterkeyed.



Protection From Physical Attack

Medeco3 cam locks are UL 437 listed and stand up to drilling, picking and other forms of physical attack.

Benefits:

- All Medeco® cylinders are constructed of durable machined brass components.
- Hardened stainless steel inserts inside the cylinder provide the ultimate defense against drilling and other forms of physical attack.
- Unique elevating and rotating tumbler pin system is virtually pick proof.
- Patented Medeco³ keys may only be duplicated by Medeco® or an authorized Medeco® service outlet, and only at your request.
- Locks can be keyed alike, keyed different, or master keyed depending on your specific needs.
- Available in various lengths and rotations.

Technical Information:

- Four or five pin models available depending on size
- Available in three standard sizes, 1 1/16 inch, 7/8 inch and 1 1/8 inch
- Two flat models available, key retaining only
- Clockwise or counterclockwise rotation, 90 or 180 degrees
- Keyed alike, keyed different or master keyed

Warranty:

Warranted for two (2) years against manufacturer's defects. See the Medeco® limited warranty for full details

Finishes:

- 26 satin chrome finish standard
- Other finishes available, depending on volume

Certification:

- UL437 Listed

Applications:

Medeco® Cam Locks can be used in any standard 3/4 inch diameter application and a multitude of markets including:

- Safe
- Communication
- Alarm
- Access control
- Banking
- Utility
- Data Encryption
- Cabinet
- Transit
- Lockers

Available Key Technologies:

Mechanical:

– Medeco³

eCylinder:

– Medeco CLIQ
– Medeco XT

Medeco³ All-In-One Cam Lock Kits

Description	Part Number	Medeco ³	BiLevel	Medeco X4	eCylinder
7/8" Length 5 Pin Cam Lock Kit	600350T KIT (P)	\$78.70			
	600350T KIT (S)	\$73.80			
11/8" Length 5 Pin Cam Lock Kit	600650T KIT (P)	\$79.20			
	600650T KIT (S)	\$73.80			
5/8" Length 5 Pin Cam Lock Kit	601150T KIT (P)	\$79.20			
	601150T KIT (S)	\$73.80			
1 1/2" 5 Pin Cam Lock Kit	601450T KIT (P)	\$83.00			
	601450T KIT (S)	\$77.60			

Medeco X4 Cam Lock Kit

Description	Part Number	Medeco ³	BiLevel	Medeco X4	eCylinder
Medeco X4 7 pin cam lock kit with two cams, hex nut, lock washer, mounting washer, and spacer collar.	210503 (P)	\$75.00			
	210503 (S)	\$65.50			

There is a 6 piece minimum order quantity for high security cam locks.

All cam lock kits include: CP-040500 pronged washer, CT-A05 flat cam, CT-D05 flat cam, CT-J01 offset cam, CT-H07 offset cam, CP-040451 90 degree stop washer, CP-050060 3/4" - 27 mounting nut and 2 keys.

Master keying is not available in a cam lock kit, but may be custom ordered with specific cam locks listed on the following pages.

**Refer to the eCylinder section for more detail on specific technologies available and pricing. Technologies are represented by the following letters:
T = Medeco³, S = Medeco³ CLIQ, J = Medeco³ BiLevel, W = Biaxial, V = Medeco Biaxial CLIQ, K = Medeco KM, N = Medeco X4, C = Medeco CLIQ,
“-” = Original, Z = Medeco Original KW CLIQ, G = Medeco XT ***See key section for surcharges for custom coined cut keys or special stamping requirements.
Note: (P) refers to **Pinned** and **(S)** to **Sub-Pinned** at the end of each part string in the price book.

High Security Cam Locks

Description	Part Number	Medeco ³	BiLevel	Medeco X4	eCylinder
5 pin, 1 1/16" Camlock	600250T (P)	\$71.90			
	600250T (S)	\$66.50			
5 pin, 7/8" Camlock	600350T (P)	\$71.90			
	600350T (S)	\$66.50			
5 pin, 1" Camlock	600450T (P)	\$71.90			
	600450T (S)	\$66.50			
4 pin, 7/8" Camlock	600550T (P)	\$70.40			
	600550T (S)	\$65.00			
5 pin, 1 1/8" Camlock	600650T (P)	\$71.90			
	600650T (S)	\$66.50			
4 pin, 1 1/16" Camlock	600750T (P)	\$70.40			
	600750T (S)	\$65.00			
4 pin, 5/8" Camlock	600850T (P)	\$70.40			
	600850T (S)	\$65.00			
5 pin, 3/4" Camlock	600950T (P)	\$71.90			
	600950T (S)	\$66.50			
5 pin, 5/8" Camlock	601150T (P)	\$71.90			
	601150T (S)	\$66.50			
3 pin, 7/16" Camlock	601250T (P)	\$62.90			
	601250T (S)	\$57.50			
3 pin, 5/8" Camlock	601251T (P)	\$62.90			
	601251T (S)	\$57.50			
5 pin, 1 1/2" Camlock	601450T (P)	\$74.90			
	601450T (S)	\$69.50			
5 pin, 2" Camlock	601452T (P)	\$77.90			
	601452T (S)	\$72.50			

You must specify the operation code to complete the part number. Keys and cams are ordered separately. Standard sizes described, contact Medeco customer service or medeco.com for variations not listed.

There is a 6 piece minimum order quantity for high security cam locks.

Cam Lock Operation Codes

Description	Part Number
2 flat, 1 Keypull, Clockwise 90 degree	219
2 Flat, 2 Keypull, Clockwise 90 degree	229
2 Flat, 1 Keypull, Counterclockwise 90 degree	239
2 Flat, 2 Keypull, Counterclockwise 90 degree	249
2 Flat, 1 Keypull, Clockwise 180 degree	259
2 Flat, 2 Keypull, Clockwise 180 degree	269
2 Flat, 1 Keypull, Counterclockwise 180 degree	279
2 Flat, 2 Keypull, Counterclockwise 180 degree	289

**Refer to the eCylinder section for more detail on specific technologies available and pricing. Technologies are represented by the following letters:

T = Medeco³, S = Medeco³ CLIQ, J = Medeco³ BiLevel, W = Biaxial, V = Medeco Biaxial CLIQ, K = Medeco KM, N = Medeco X4, C = Medeco CLIQ, "-" = Original, Z = Medeco Original KW CLIQ, G = Medeco XT ***See key section for surcharges for custom coined cut keys or special stamping requirements.

Note: (P) refers to **Pinned** and (S) to **Sub-Pinned** at the end of each part string in the price book.

Removable Core Cam Locks

Medeco® Cam Locks are available with a removable core feature allowing cores to be changed out in seconds, to provide an entirely new keying combination. For applications that may require instantaneous re-keying due to lost or stolen keys, or where periodic re-keying is done as a matter of good business practice, Medeco® Removable Core Cam Locks save valuable time and money. Removable Core Cam Locks offer the same high security features of a Medeco® Cam Lock with the convenience of a removable core.



Patented Key Control (Light Bulb)

Protects against unauthorized duplication of your keys.



Quickly Change Cores (Stopwatch)

Medeco removable provide quick and easy cylinder changes in the event keys are lost or stolen.



Protection From Physical Attack (Drill)

Medeco³ cam locks are UL 437 listed and stand up to drilling, picking and other forms of physical attack.

Benefits:

- Removable cores can be changed out in seconds to provide a new, secure keying combination.
- All Medeco® cylinders are constructed of durable machined brass components.
- Hardened stainless steel inserts inside the cylinder provide the ultimate defense against drilling and other forms of physical attack.
- Unique elevating and rotating tumbler pin system is virtually pick proof.
- Patented Medeco³ keys may only be duplicated by Medeco® or an authorized Medeco® service outlet, and only at your request.
- Locks can be keyed alike, keyed different, or master keyed depending on your specific needs.
- Available in various lengths and rotations.

Technical Information:

- Four or five pin models available depending on size
- Available in three standard sizes, 11/16 inch, 7/8 inch and 1 1/8 inch
- Two flat models available, key retaining only
- Clockwise or counterclockwise rotation, 90 or 180 degrees
- Keyed alike, keyed different or master keyed

Warranty:

Warranted for two (2) years against manufacturer's defects. See the Medeco® limited warranty for full details

Finishes:

- 26 satin chrome finish standard
- Other finishes available, depending on volume

Applications:

- Medeco® Removable Core Cam Locks can be used in any standard 3/4 inch diameter application and a multitude of markets including:
 - Safe
 - Communication
 - Alarm
 - Access control
 - Banking
 - Utility
 - Data Encryption
 - Cabinet
 - Transit
 - Lockers

Available Key Technologies:

Mechanical:

– Medeco³

High Security Removable Core Cam Locks

Description	Part Number	Medeco ³	BiLevel	Medeco X4	eCylinder
4 pin, 1 1/16" Removable core camlock	607155XT (P)	\$84.40			
	607155XT (S)	\$79.00			
4 pin, 7/8" Removable core camlock	607255XT (P)	\$84.40			
	607255XT (S)	\$79.00			
4 pin, 1 1/8" Removable core camlock	607355XT (P)	\$102.10			
	607355XT (S)	\$82.00			
5 pin, 1 1/8" Removable core camlock	607455XT (P)	\$85.50			
	607455XT (S)	\$80.50			
5 pin, 7/8" Removable core camlock	607555XT (P)	\$85.50			
	607555XT (S)	\$80.50			
Plug for Removable Core Cam Locks. Cam locks are provided with plug, but additional plugs may be ordered separately.	66391 (P)	\$56.40			
	66391 (S)	\$51.00			

Keys may be ordered separately.

X = Rotation for Removable Core Cam Lock

Description	Part Num-
90 degree Clockwise	0
90 degree Counter Clockwise	1
180 degree Clockwise	2
180 degree Counter Clockwise	3



A Series Flat Cams

Description	Part Number	Price
5/8" Flat Cam	CT-A00	\$2.24
3/4" Flat Cam	CT-A01	\$2.24
7/8" Flat Cam	CT-A02	\$2.24
1" Flat Cam	CT-A03	\$2.24
1 1/8" Flat Cam	CT-A04	\$2.24
1 1/4" Flat Cam	CT-A05	\$2.24
1 3/8" Flat Cam	CT-A06	\$2.24
1 1/2" Flat Cam	CT-A07	\$2.24
1 5/8" Flat Cam	CT-A08	\$2.24
1 3/4" Flat Cam	CT-A09	\$2.24
2" Flat Cam	CT-A11	\$2.24
2 1/8" Flat Cam	CT-A12	\$2.24
2 1/4" Flat Cam	CT-A13	\$2.24
2 3/8" Flat Cam	CT-A14	\$2.24
2 1/2" Flat Cam	CT-A15	\$2.24
2 5/8" Flat Cam	CT-A16	\$2.24
3" Flat Cam	CT-A19	\$2.24

**Refer to the eCylinder section for more detail on specific technologies available and pricing. Technologies are represented by the following letters:

T = Medeco³, S = Medeco³ CLIQ, J = Medeco³ BiLevel, W = Biaxial, V = Medeco Biaxial CLIQ, K = Medeco KM, N = Medeco X4, C = Medeco CLIQ, "-" = Original, Z = Medeco Original KW CLIQ, G = Medeco XT ***See key section for surcharges for custom coined cut keys or special stamping requirements.

Note: (P) refers to **Pinned** and (S) to **Sub-Pinned** at the end of each part string in the price book.

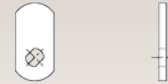

C Series Flat Cams, 45° Tenon

Description	Part Number	Price
7/8" Flat Cam	CT-C02	\$2.24
1 1/8" Flat Cam	CT-C04	\$2.24
1 1/4" Flat Cam	CT-C05	\$2.24
1 5/8" Flat Cam	CT-C08	\$2.24
1 3/4" Flat Cam	CT-C09	\$2.24
2" Flat Cam	CT-C11	\$2.24

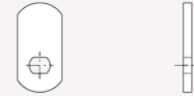

D Series Flat Cams, Horizontal Tenon

Description	Part Number	Price
5/8" Flat Cam	CT-D00	\$2.24
3/4" Flat Cam	CT-D01	\$2.24
7/8" Flat Cam	CT-D02	\$2.24
1" Flat Cam	CT-D03	\$2.24
1 1/8" Flat Cam	CT-D04	\$2.24
1 1/4" Flat Cam	CT-D05	\$2.24
1 3/8" Flat Cam	CT-D06	\$2.24
1 1/2" Flat Cam	CT-D07	\$2.24
1 5/8" Flat Cam	CT-D08	\$2.24
1 3/4" Flat Cam	CT-D09	\$2.24
2" Flat Cam	CT-D11	\$2.24
2 1/8" Flat Cam	CT-D12	\$2.24
2 1/2" Flat Cam	CT-D15	\$2.24
3" Flat Cam	CT-D19	\$2.24



H Series Offset Cam, Vertical Tenon

Description	Part Number	Price
1 1/4" Cam with 1/8" offset	CT-H00	\$2.35
1 1/8" Cam with 7/32" offset	CT-H07	\$2.35
1 1/8" Cam with 1/8" offset	CT-H09	\$2.35
1 1/2" Cam with 7/32" offset	CT-H14	\$2.35
1 1/4" Cam with 7/32" offset	CT-H15	\$2.35
1 1/8" Cam with 5/16" offset	CT-H16	\$2.35
1 1/4" Cam with 5/16" offset	CT-H17	\$2.35
1 3/4" Cam with 5/16" offset	CT-H19	\$2.35
2" Cam with 5/16" offset	CT-H20	\$2.35
7/8" Cam with 5/32" offset	CT-H27	\$2.35
1 3/4" Cam with 7/32" offset	CT-H30	\$2.35
1 1/2" Cam with 5/16" offset	CT-H32	\$2.35

**Refer to the eCylinder section for more detail on specific technologies available and pricing. Technologies are represented by the following letters:
 T = Medeco³, S = Medeco³ CLIQ, J = Medeco³ BiLevel, W = Biaxial, V = Medeco Biaxial CLIQ, K = Medeco KM, N = Medeco X4, C = Medeco CLIQ,
 "-" = Original, Z = Medeco Original KW CLIQ, G = Medeco XT ***See key section for surcharges for custom coined cut keys or special stamping requirements.
Note: (P) refers to **Pinned** and **(S)** to **Sub-Pinned** at the end of each part string in the price book.



J Series Offset Cam, Horizontal

Description	Part Number	Price
1 1/8" Cam with 7/32" offset	CT-J01	\$2.35
1" Cam with 1/8" offset	CT-J05	\$2.35
1 1/4" Cam with 1/8" offset	CT-J07	\$2.35
1 5/8" Cam with 1/8" offset	CT-J08	\$2.35
2 1/8" Cam with 1/8" offset	CT-J11	\$2.35
1 1/4" Cam with 7/32" offset	CT-J12	\$2.35
1 1/8" Cam with 5/16" offset	CT-J13	\$2.35
1 1/4" Cam with 5/16" offset	CT-J14	\$2.35
1 5/8" Cam with 5/16" offset	CT-J15	\$2.35
2 1/8" Cam with 5/16" offset	CT-J18	\$2.35
1 1/8" Cam with 5/32" offset	CT-J22	\$2.35
1 1/2" Cam with 5/16" offset	CT-J27	\$2.35
2 1/8" Cam with 7/32" offset	CT-J28	\$2.35
7/8" Cam with 5/32" offset	CT-J29	\$2.35

3/4" Removable Plug Lock

Description	Part Number	Medeco ³	BiLevel	Medeco X4	eCylinder
1 keypull, 3/4" Removable plug lock	640250T (P)	\$75.40			
	640250T (S)	\$70.00			
2 keypull, 3/4" Removable plug lock	640251T (P)	\$75.00			
	640251T (S)	\$70.00			

1 1/8" Removable Plug Lock

Description	Part Number	Medeco ³	BiLevel	Medeco X4	eCylinder
1 keypull, vertical flats, flush mount	640550T (P)	\$89.40			
	640550T (S)	\$82.00			
1 keypull, horizontal flats, flush mount	640550AT (P)	\$89.40			
	640550AT (S)	\$82.00			
2 keypull, vertical flats, surface mount with tapered bezel	640550FT (P)	\$89.40			
	640550FT (S)	\$82.00			

Keys are ordered separately.

**Refer to the eCylinder section for more detail on specific technologies available and pricing. Technologies are represented by the following letters:
 T = Medeco³, S = Medeco³ CLIQ, J = Medeco³ BiLevel, W = Biaxial, V = Medeco Biaxial CLIQ, K = Medeco KM, N = Medeco X4, C = Medeco CLIQ,
 "-" = Original, Z = Medeco Original KW CLIQ, G = Medeco XT ***See key section for surcharges for custom coined cut keys or special stamping requirements.
Note: (P) refers to **Pinned** and **(S)** to **Sub-Pinned** at the end of each part string in the price book.

Security Collars

Description	Part Number	Price
Cam lock security collar	CP-070501	\$7.44
Cam lock security collar	CP-070131	\$7.44
Cam lock security collar	CP-070161	\$7.44
Cam lock security collar	CP-070171	\$7.44
Cam lock security collar	CP-070441	\$7.44
Cam lock security collar	CP-070201	\$7.44
Cam lock security collar	CP-070111	\$7.44
Cam lock security collar	CP-070141	\$7.44
Cam lock security collar	CP-070181	\$7.44
Cam lock security collar	CP-070481	\$7.44

Security Collars

Part Number	(H)	(I)	(J)	(K)	(L)
CP-070501	1.000"	.142"	.170"	.312"	1.290"
CP-070131	.885"	.142"	.170"	.312"	1.210"
CP-070161	.885"	.188"	.250"	.438"	1.356"
CP-070171	.885"	.200"	.238"	.438"	1.290"
CP-070441	.885"	.260"	.070"	.330"	1.210"
CP-070201	.885"	.262"	.050"	.312"	1.210"
CP-070111	.885"	.278"	.160"	.438"	1.290"
CP-070141	.885"	.325"	.050"	.375"	1.275"
CP-070181	1.000"	.450"	.050"	.500"	1.250"
CP-070481	1.000"	.638"	.050"	.688"	1.313"

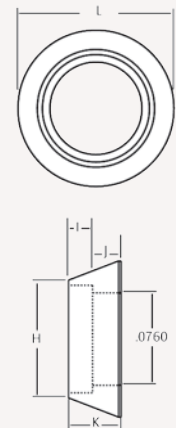

Spacers

Description	Part Number	Price
Cam lock spacer, obtain specific part number from following dimension chart.	CP-160XXX	Empty Field!

Spacers

Part Number	(M)	(N)
CP-160051	.125"	.875"
CP-160101	.140"	.875"
CP-160071	.188"	.875"
CP-160111	.200"	.875"
CP-160081	.250"	.875"
CP-160091	.275"	.875"
CP-160301	.375"	.875"
CP-160121	.400"	.875"
CP-160061	.530"	.875"
CP-160271	.437"	.875"
CP-160541	.031"	.875"
CP-160551	.062"	.875"
CP-160571	.312"	.875"
CP-160591	.062"	.995"
CP-160601	.125"	.995"
CP-160611	.250"	.995"

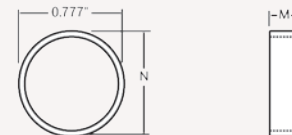

**Refer to the eCylinder section for more detail on specific technologies available and pricing. Technologies are represented by the following letters:
 T = Medeco³, S = Medeco³ CLIQ, J = Medeco³ BiLevel, W = Biaxial, V = Medeco Biaxial CLIQ, K = Medeco KM, N = Medeco X4, C = Medeco CLIQ,
 "-" = Original, Z = Medeco Original KW CLIQ, G = Medeco XT ***See key section for surcharges for custom coined cut keys or special stamping requirements.
Note: (P) refers to Pinned and (S) to Sub-Pinned at the end of each part string in the price book.

Pop-Out, T-Handle Cylinder

Description	Part Number	Medeco ³	BiLevel	Medeco X4	eCylinder
5 pin, zinc deadbolt	640155CT (P)	\$63.40			
	640155CT (S)	\$58.00			
5 pin, zinc springbolt	640155T (P)	\$63.40			
	640155T (S)	\$58.00			
4 pin, zinc springbolt	640750ET (P)	\$64.90			
	640750ET (S)	\$59.50			
4 pin, zinc deadbolt	640750GT (P)	\$64.90			
	640750GT (S)	\$59.50			
4 pin, steel springbolt	640950T (P)	\$71.40			
	640950T (S)	\$66.00			
4 pin, steel deadbolt	640952T (P)	\$71.40			
	640952T (S)	\$66.00			
4 pin, steel springbolt, steel shell	641050T (P)	\$95.40			
	641050T (S)	\$90.00			
4 pin, steel deadbolt, steel shell	641051T (P)	\$95.40			
	641051T (S)	\$90.00			

Keys are ordered separately.

**Refer to the eCylinder section for more detail on specific technologies available and pricing. Technologies are represented by the following letters:
T = Medeco³, S = Medeco³ CLIQ, J = Medeco³ BiLevel, W = Biaxial, V = Medeco Biaxial CLIQ, K = Medeco KM, N = Medeco X4, C = Medeco CLIQ,
“-” = Original, Z = Medeco Original KW CLIQ, G = Medeco XT ***See key section for surcharges for custom coined cut keys or special stamping requirements.
Note: (P) refers to **Pinned** and **(S)** to **Sub-Pinned** at the end of each part string in the price book.

Cabinet Locks

Medeco® Cabinet Locks are specifically designed for drawer or cabinet door applications where a conventional utility cam lock may not be suitable. Cabinet Locks utilize heavy-duty bolts and multi-point attachment to the mounting surface in order to withstand the heavy use and higher physical security some applications may require. All Medeco® Cabinet Locks feature solid brass and steel construction, available in either fixed or removable core. Patented key programs prevent the unauthorized duplication of keys and maintain system integrity. Keyed alike, keyed different, or master keyed, the Medeco® Cabinet Lock is the perfect solution for your showcase security needs.



Patented Key Control

Protects against unauthorized duplication of your keys.



Available in eCylinder

Medeco cabinet locks are also available with Medeco eCylinders for Loss & Liability control.



Protection From Physical Attack

Medeco³ cabinet locks are UL 437 listed and stand up to drilling, picking and other forms of physical attack.

Benefits:

- Medeco® high security cabinet locks are constructed of durable machined brass and solid steel components.
- Available in either fixed or removable core depending on your specific requirements.
- Available in either deadbolt or spring latch models.
- Unique elevating and rotating tumbler pin system is virtually pick proof.
- Patented Medeco³ keys may only be duplicated by Medeco® or an authorized Medeco® service outlet, and only at your request.
- Medeco® Cabinet Locks can be keyed in with other 60 Series products.
- Locks can be keyed alike, keyed different, or master keyed depending on your specific needs.

Technical Information:

- Five pin models available in either deadbolt or spring latch versions.
- 7/8 inch diameter, surface mount, fixed or removable core available.
- One and two flat models available, key retaining or not.
- Deadbolt fixed core available in non-key retaining.
- Keyed alike, keyed different, or master keyed.

Warranty:

Warranted for two (2) years against manufacturer's defects. See the Medeco® limited warranty for full details.

Finishes:

- 26 satin chrome finish standard.
- Other finishes available, depending on volume.

Applications:

- Medeco® Cabinet Locks are specifically designed for use in metal or wooden drawer and cabinet door applications including:
 - Medical and narcotics
 - Chests and cabinets
 - Showcases
 - Cash carts
 - Drawers

Available Key Technologies:

Mechanical:

– Medeco³

eCylinder:

– Medeco XT

High Security Cabinet Locks

Description	Part Number	Medeco ³	BiLevel	Medeco X4	eCylinder
Cabinet lock with deadbolt, single keypull	6210555 (P)	\$100.40			
	6210555 (S)	\$95.00			
Cabinet lock with deadbolt, double keypull	6212555 (P)	\$100.40			
	6212555 (S)	\$95.00			
Cabinet lock with spring bolt, single keypull	6211555 (P)	\$112.40			
	6211555 (S)	\$107.00			
Removable core cabinet lock with deadbolt, single keypull, less plug	6270515	\$63.50			
Removable core cabinet lock with spring bolt, single keypull, less plug	6271515	\$70.50			
Plug for removable plug cabinet lock	66391 (P)	\$56.40			
	66391 (S)	\$51.00			

Keyed Cabinet Locks are supplied with two keys.

Screws & Caps

Description	Part Number	Price
5 Pin, Pin Hole Covers-Brass (sold in bags of 100)	CP-170021	\$0.43
4 Pin, Pin Hole Covers-Brass (Sold in bags of 100)	CP-170041	\$0.43
3 Pin, Pin Hole Covers-Brass (sold in bags of 100)	CP-170031	\$0.43

SFIC Cabinet Locks

Description	Part Number	Price
Cabinet lock with deadbolt for SFIC cylinder. Works with Medeco X4, Medeco XT SFIC, or Best style SFIC. SFIC ordered separately.	3307311	\$56.50
Cabinet lock with spring latch for SFIC cylinder. Works with Medeco X4, Medeco XT SFIC, or Best style SFIC. SFIC ordered separately.	3307321	\$56.50
File Cabinet Lock for SFIC cylinder. Works with Medeco X4, Medeco XT SFIC or Best style SFIC Cylinders	3307350	\$56.50
Door/Drawer Lock for SFIC cylinder. Works with Medeco X4, Medeco XT SFIC, or best style SFIC. SFIC ordered separately.	3307331	\$56.50

**Refer to the eCylinder section for more detail on specific technologies available and pricing. Technologies are represented by the following letters:

T = Medeco³, S = Medeco³ CLIQ, J = Medeco³ BiLevel, W = Biaxial, V = Medeco Biaxial CLIQ, K = Medeco KM, N = Medeco X4, C = Medeco CLIQ, "-" = Original, Z = Medeco Original KW CLIQ, G = Medeco XT ***See key section for surcharges for custom coined cut keys or special stamping requirements.

Note: (P) refers to **Pinned** and (S) to **Sub-Pinned** at the end of each part string in the price book.

Showcase Locks

The Medeco® Showcase Lock is specifically designed for installation on sliding cabinet door applications that require extra protection beyond what ordinary showcase locks provide. Complete with a solid steel locking bar and anti-spread housing, the Medeco® Showcase Lock is ideal for securing showcases and cabinets where two sliding surfaces are to be locked. No other lock can be compared with Medeco’s proven track record of security and long term reliability. Patented key programs prevent the unauthorized duplication of keys and maintain system integrity. Keyed alike, keyed different, or master keyed, the Medeco® showcase lock is the perfect solution for your showcase security needs.



Patented Key Control

Protects against unauthorized duplication of your keys.



Available in eCylinder

Medeco showcase locks are also available with Medeco eCylinders for Loss & Liability control.



Protection From Physical Attack

Medeco³ showcase locks are UL 437 listed and stand up to drilling, picking and other forms of physical attack.

Benefits:

- Solid machined brass plug, high density zinc die cast housing, and nickel plated steel locking bar
- Unique elevating and rotating tumbler pin system is virtually pick proof
- Patented Medeco³ keys may only be duplicated by Medeco® or an authorized Medeco® service outlet, and only at your request
- Medeco® Showcase Locks are completely serviceable, and can be re-keyed in case of lost or stolen keys

Technical Information:

- Four pin key retaining cylinder is standard
- Self-locking latch, 90 degrees counterclockwise rotation to unlock
- Keyed alike, keyed different, or master keying available

Showcase Locks

Description	Part Number	Medeco ³	BiLevel	Medeco X4	eCylinder
Showcase Locks	6231550T (P)	\$101.00			
	6231550T (S)	\$95.70			
Showcase lock for SFIC cylinder. Works with Medeco X4, Medeco XT SFIC, or best style SFIC. SFIC ordered separately.	3307340	\$70.00			

Warranty:

Warranted for two (2) years against manufacturer’s defects. See the Medeco® limited warranty for full details.

Finishes:

- 26 satin chrome finish standard.
- Other finishes available, depending on volume.

Applications:

Medeco® Showcase Locks are specifically designed to secure showcase or cabinets where two sliding doors need to be secured, including:

- Jewelry and electronics showcases
- Drug and Medical cabinets
- Furniture
- Laboratory
- Office Credenzas

Available Key Technologies:

- | | |
|-----------------------|-------------------|
| Mechanical: | eCylinder: |
| – Medeco ³ | – Medeco CLIQ |

Plunger Locks

Medeco® Plunger Locks are specifically designed for use in wooden or metal sliding doors. Complete with a spring loaded pop out cylinder, the Medeco® Plunger Lock is ideal for security merchandise showcases, metal cabinets, and laboratory and office furniture. Plunger Locks require no key when locking the device; simply push in on the cylinder to relock. Patented key programs prevent the unauthorized duplication of keys and maintain system integrity. Keyed alike, keyed different, or master keyed, the Medeco® Plunger Lock is the perfect solution for your security needs.



Patented Key Control

Protects against unauthorized duplication of your keys.



Can Be Masterkeyed

Medeco switch locks can be keyed alike, keyed different or masterkeyed.



Protection From Physical Attack

Medeco³ switch locks are UL 437 listed and stand up to drilling, picking and other forms of physical attack.

Benefits:

- Medeco® Plunger Locks are constructed of durable machined brass and solid steel components
- Unique elevating and rotating tumbler pin system is virtually pick proof
- Patented Medeco³ keys may only be duplicated by Medeco® or an authorized Medeco® service outlet, and only at your request
- Medeco® Plunger Locks are completely serviceable, and can be re-keyed in case of lost or stolen keys
- Locks can be keyed alike, keyed different, or master keyed depending on your specific needs

Technical Information:

- Four and five pin models available
- Non-key retaining cylinders
- 45 degree clockwise rotation to unlock
- Keyed alike, keyed different or master keyed

Warranty:

Warranted for two (2) years against manufacturer's defects. See the Medeco® limited warranty for full details.

Finishes:

- 26 satin chrome finish standard.
- Other finishes available, depending on volume.

Applications:

- Medeco® Plunger Locks are specifically designed for use in metal or wooden sliding door applications including:
 - Jewelry and other merchandise showcases
 - Metal cabinets
 - Laboratory furniture
 - Office furniture

Available Key Technologies:

- Mechanical:** **eCylinder:**
 – Medeco³ – Medeco CLIQ

Plunger Locks

Description	Part Number	Medeco ³	BiLevel	Medeco X4	eCylinder
Plunger lock, 5 pin round bolt	6221557 (P)	\$111.00			
	6221557 (S)	\$106.00			
Plunger lock, 5 pin glass mount	6261557T (P)	\$133.50			
	6261557T (S)	\$128.50			
Plunger lock, 4 pin round bolt	6221554 (P)	\$111.00			
	6221554 (S)	\$106.00			

Micro Switch Locks

Medeco's 3/4" diameter, high security switch locks offer a wide range of electrical functions with the physical security and patented key control of a Medeco cylinder. Available in either single or double switch models, Medeco switch locks are ideally suited for applications requiring controlled access to electrically activated systems, including alarms, ATMs, time delay safes, encryption devices, heavy power equipment, control panels and electrically accessed doors and gates. The Medeco® 3/4 inch diameter, high security Switch Lock offer a wide range of electrical functions with the physical security and patented key control of a Medeco® cylinder. The Medeco³ unique design provides triple locking action, making the locks virtually pick proof. All Medeco³ keys and locks are protected under patent, trademark and copyright laws. Medeco® keys may only be duplicated by Medeco® or by an authorized Medeco® dealer, and only at your request.

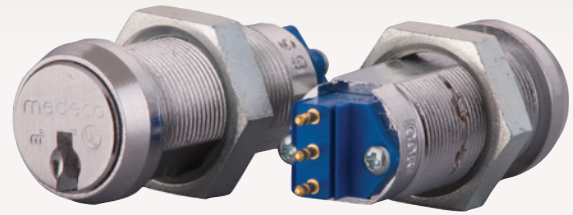

Patented Key Control (Light Bulb)

Protects against unauthorized duplication of your keys.



Can Be Masterkeyed (globe)

Medeco switch locks can be keyed alike, keyed different or masterkeyed.



Protection From Physical Attack (Drill)

Medeco³ switch locks are UL 437 listed and stand up to drilling, picking and other forms of physical attack.

Benefits:

- All Medeco® cylinders are constructed of durable machined brass components, designed to last the life of your equipment.
- Available in single or double switch models, momentary and maintained positions.
- Silver or gold contacts (for low amperage applications) designed to accept quick connect leads.
- Hardened stainless steel inserts inside the cylinder provide the ultimate defense against drilling and other forms of physical attack.
- Unique elevating and rotating tumbler pin system is virtually pick proof.
- Patented Medeco³ keys may only be duplicated by Medeco® or an authorized Medeco® service outlet, and only at your request.
- Medeco® Switch Locks are completely serviceable, and can be re-keyed in case of lost or stolen keys.
- Locks can be keyed alike, keyed different, or master keyed depending on your specific needs.

Certification:

- UL 437 Listed
- Switch - UL Registered, CSA Certified

Applications:

- Medeco® High Security Switch Locks can be used in any standard 3/4 inch diameter switch lock application and a multitude of markets including:
 - Heavy Power Machinery
 - Time Delay Safes
 - Material Handline Equipment
 - Construction Vehicles
 - Electrically Accessed Gates
 - Cash Control Systems
 - Encryption Devices
 - Alarms
 - Control Panels
 - ATMs

Warranty:

Warranted for two (2) years against manufacturer's defects. See the Medeco® limited warranty for full details.

Technical Information:

- Five pin, 3/4 inch double "D" mounting standard.
- Available in either single or double switch models with either silver or gold contacts.
- Rated at 7 amps resistive at 125/250 VAC.
- Contacts designed to accept quick connect leads (AMP connector number 60598-3)

Finishes:

- 26 satin chrome finish standard.
- Other finishes available, depending on volume.

Available Key Technologies:

Mechanical:

- Medeco³

Single Switch Locks

Description	Part Number	Medeco ³	BiLevel	Medeco X4	eCylinder
1 switch, Maintained 1 Keypull	652150T 011 (P)	\$122.30			
	652150T 011 (S)	\$87.50			
1 switch, Maintained 2 Keypull	652150T 012 (P)	\$122.30			
	652150T 012 (S)	\$87.50			
1 switch, Momentary 1 Keypull	652150T 021 (P)	\$122.30			
	652150T 021 (S)	\$87.50			

Keys are ordered separately.

Double Switch Locks

Description	Part Number	Medeco ³	BiLevel	Medeco X4	eCylinder
2 position, maintained, 1 keypull	652650T 101 (P)	\$189.30			
	652650T 101 (S)	\$154.50			
2 position, maintained, 2 keypull	652650T 102 (P)	\$189.30			
	652650T 102 (S)	\$154.50			
2 position, momentary, 1 keypull	652650T 111 (P)	\$189.30			
	652650T 111 (S)	\$154.50			
3 position, maintained, 1 keypull	652650T 131 (P)	\$189.30			
	652650T 131 (S)	\$154.50			
3 position, maintained, 2 keypull	652650T 132 (P)	\$189.30			
	652650T 132 (S)	\$154.50			
3 position, maintained, 3 keypull	652650T 133 (P)	\$189.30			
	652650T 133 (S)	\$154.50			

Keys are ordered separately.

Switch Lock Accessories for 652150 and 652650

Description	Part Number	Price
Double Pole/Double Throw	CP-150082	\$46.50
Gold Sub Miniature Snap Action Switch. Double Pole/Double Throw	CP-150102	\$62.00
Sleeve Kit. Includes chrome plated zinc sleeve with rubber grommet, plain washer, 1 pronged washer locks for mounting cam locks in harsh environments.	650003	\$35.00
Silver Sub Miniature Snap Action Switch. Single Pole-Single or Double Throw	CP-150142	\$23.50
Gold Sub Miniature Snap Action Switch. Single Pole-Single or Double Throw	CP-150152	\$33.50
4" Leadwire	CP-270511	\$1.52
6" Leadwire	CP-270521	\$1.79
12" Leadwire	CP-270531	\$2.42
18" Leadwire	CP-270541	\$3.04
24" Leadwire	CP-270551	\$6.43
36" Leadwire	CP-270561	\$6.43

**Refer to the eCylinder section for more detail on specific technologies available and pricing. Technologies are represented by the following letters:

T = Medeco³, S = Medeco³ CLIQ, J = Medeco³ BiLevel, W = Biaxial, V = Medeco Biaxial CLIQ, K = Medeco KM, N = Medeco X4, C = Medeco CLIQ, "-" = Original, Z = Medeco Original KW CLIQ, G = Medeco XT ***See key section for surcharges for custom coined cut keys or special stamping requirements.

Note: (P) refers to **Pinned** and (S) to **Sub-Pinned** at the end of each part string in the price book.

Rotary Switch Locks

The Medeco® Rotary Switch Lock is designed for use with most brands of rotary switches, providing maximum versatility in systems requiring multiple switch functions. Switch Locks are available with a variety of key withdrawals at either 45 degrees or 30 degree increments. Positive stops are available to eliminate over-torquing of switch stops. Switch locks use a five pin cylinder to maximize keyed different and master keying capabilities. Medeco® design and engineering resources are available to assist customers with special functional requirements. The Medeco³ unique design provides triple locking action, making the locks virtually pick proof. All Medeco³ keys and locks are protected under patent, trademark and copyright laws. Medeco³ keys may only be duplicated by Medeco® or by an authorized Medeco® dealer, and only at your request.



Patented Key Control (Light Bulb)

Protects against unauthorized duplication of your keys.



Can Be Masterkeyed (globe)

Medeco switch locks can be keyed alike, keyed different or masterkeyed.



Protection From Physical Attack (Drill)

Medeco³ switch locks are UL 437 listed and stand up to drilling, picking and other forms of physical attack.

Benefits:

- All Medeco cylinders are constructed of durable machined brass components, designed to last the life of your equipment.
- Hardened stainless steel inserts inside the cylinder provide the ultimate defense against drilling and other forms of physical attack.
- Unique elevating and rotating tumbler pin system is virtually pick proof.
- Patented Medeco³ keys may only be duplicated by Medeco® or an authorized Medeco® service outlet, and only at your request.
- Medeco® Switch Locks are completely serviceable, and can be re-keyed in case of lost or stolen keys.
- Locks can be keyed alike, keyed different, or master keyed depending on your specific needs.

Warranty:

Warranted for two (2) years against manufacturer's defects. See the Medeco® limited warranty for full details.

Technical Information:

- Five pin, 3/4 inch double "D" mounting standard.

Finishes:

- 26 satin chrome finish standard.
- Other finishes available, depending on volume.

Certification:

- Switch - UL Registered, CSA Certified

Applications:

- Medeco® Rotary Switch Locks can be used to retrofit many switch lock applications including:
 - Heavy Power Machinery
 - Time Delay Safes
 - Material Handline Equipment
 - Construction Vehicles
 - Electrically Accessed Gates
 - Cash Control Systems
 - Encryption Devices
 - Alarms
 - Control Panels
 - ATMs

Available Key Technologies:

Mechanical:

- Medeco³

Double Switch Rotary

Description	Part Number	Medeco ³	BiLevel	Medeco X4	eCylinder
2 position, 1 keypull A, maintained at B	6522560T 121 (P)	\$90.40			
	6522560T 121 (S)	\$85.00			
2 position, 2 keypull A&B, maintained	6522560T 122 (P)	\$90.40			
	6522560T 122 (S)	\$85.00			
3 position, 2 keypull A&B, maintained	6522560T 132 (P)	\$90.40			
	6522560T 132 (S)	\$85.00			
3 position, 3 keypull A, B&C, maintained	6522560T 133 (P)	\$90.40			
	6522560T 133 (S)	\$85.00			
3 position, 2 keypull A&C, maintained at B	6522560T 134 (P)	\$90.40			
	6522560T 134 (S)	\$85.00			
2 position, 1 keypull A, momentary at B	6522560T 221 (P)	\$90.40			
	6522560T 221 (S)	\$85.00			

Keys ordered separately.

**Refer to the eCylinder section for more detail on specific technologies available and pricing. Technologies are represented by the following letters:
T = Medeco³, S = Medeco³ CLIQ, J = Medeco³ BiLevel, W = Biaxial, V = Medeco Biaxial CLIQ, K = Medeco KM, N = Medeco X4, C = Medeco CLIQ,
“-” = Original, Z = Medeco Original KW CLIQ, G = Medeco XT ***See key section for surcharges for custom coined cut keys or special stamping requirements.
Note: (P) refers to **Pinned** and **(S)** to **Sub-Pinned** at the end of each part string in the price book.

Keying Charges

Description	Part Number	Price
Less Key Credit		-6.90
MK surcharge to pinned door hardware cylinders and IC cylinders except SFIC cylinders.		\$5.50
No MK surcharge is applied to the pinned cylinder price for Medeco X4 SFIC cylinders.		
MK surcharge to pinned cam lock type product (less keys)		\$3.75
Key Stamping (Standard Key Code Stamping at No Charge)		\$2.00
Lock Stamping (No charge for SFIC)		\$5.00
Surcharge - Medeco X4 Custom Coined Cut keys require a minimum of 100 keys and must be specified on the order. Non-custom coined cut keys are standard from the factory. The surcharge is added to the cut key price.		\$1.90
Surcharge - High Security Custom Coined Cut keys require a minimum of 100 keys and must be specified on the order. Non-custom coined cut keys are standard from the factory. The surcharge is added to the cut key price.		\$1.90
Sub-assembled deduct applied for door products		\$9.50
Sub-assembled deduct applied for Medeco X4 SFIC		\$11.00
Sub-assembled deduct applied for 60 Series products		\$5.40
Non-Masterkeyed cylinders *less keys	RE-PIN	\$43.50
Masterkeyed Cylinders (5 and 6 pin)* Less keys	RE-PIN-MK	\$52.00
Decode Key Service	DE-CODE-KEY	\$27.00
Decode Lock Service (Not Available for Padlocks)	DE-CODE-LOK	\$27.50
Sharpen Cutter for Medeco ³ and Medeco X4 (*exchange program; old cutter must be returned upon receipt with RGA)	KM-SHARP-CUT	\$166.00

Cut Keys

Description	Part Number	Price
High Security Cut Keys for Cam Style Locks and for Door Hardware (Specify Keyway)		\$15.00
Medeco X4 Cut Keys (Specify Keyway)		\$12.80
High Security Custom Coined Cut Keys (Minimum order 100 cut keys)		\$16.90
Medeco X4 Custom Coined Cut Keys (Minimum order 100)		\$14.70

Part#: Contact Customer Service for specific part number.

Coining Dies

Description	Part Number	Price
Standard Coining Die-All keyway technologies	CN-DIES	\$466.00 (NET)
Laser Die	ST-LASER	\$112.10 (NET)

**Refer to the eCylinder section for more detail on specific technologies available and pricing. Technologies are represented by the following letters:
 T = Medeco³, S = Medeco³ CLIQ, J = Medeco³ BiLevel, W = Biaxial, V = Medeco Biaxial CLIQ, K = Medeco KM, N = Medeco X4, C = Medeco CLIQ,
 "-" = Original, Z = Medeco Original KW CLIQ, G = Medeco XT ***See key section for surcharges for custom coined cut keys or special stamping requirements.
Note: (P) refers to **Pinned** and **(S)** to **Sub-Pinned** at the end of each part string in the price book.

Key Code Cards

Description	Part Number	Price
Authorization Card for 6 Pin Key (Patriot®, Liberty, Freedom, Gotham)	CARD 1 X XX	\$9.03
Authorization Card for 5 Pin Key (Patriot®, Liberty, Freedom, Gotham)	CARD 2 X XX	\$9.03
Authorization Card for 5 Pin (60Series) Key (Patriot,Liberty, Freedom, Gotham)	CARD 6 X XX	\$9.03
Authorization Card with (2) 6 Pin Keys (Medeco KM Silver)	CARD KS XX 8E	\$21.53
Authorization Card with (2) 5 Pin Keys (Patriot, Liberty, GLD,DND, Freedom, Gotham)	CARD XX 56 XX	\$26.03
Authorization Card with (2) 6 Pin Keys (Patriot, Liberty, GLD, DND, Freedom, Gotham)	CARD XX 66 XX	\$26.03
Printed Key Code Tag For Dealer Keyways	CP-286131	\$0.93

Code Books, Vouchers, & Paper

Description	Part Number	Price
Medeco ³ Code Book	CB-CODE-BIA	\$37.50 (NET)
Medeco Original Code Book	CB-CODE-BOK	\$37.50 (NET)
Electronic Roll Receipts For Patriot/ FreedomSystem (French)	PK-130002	\$3.11 (NET)
Electronic Roll Receipts For Patriot®/Liberty/Freedom System	PK-130030	\$3.11 (NET)
Patriot/Freedom/Liberty Reader, Refurbished	94-0056-MED	\$221.50 (NET)
Patriot/Liberty/Freedom Printer, Refurbished	94-0115	\$221.50 (NET)

Sales Tools

Description	Part Number	Price
Smart SFIC Solutions Demo Kit (Includes Arrow, Medeco X4, and Medeco® XT SFIC Cylinders)	94-0261	\$814.00 (NET)
Medeco ³ Display Kit Includes Captive T-Turn Deadbolt Cut-away Cylinder, Cam Lock	94-0204	\$174.50 (NET)
Medeco X4 Presentation Kit Includes: Std.Rim & Mortise Cylinder SFIC Rim & Mortise, Key-In-Knob Cylinder, all LFIC cylinders in Plastic Case	94-0269	\$257.50 (NET)
6 Pin Medeco ³ BiLevel Cut-Away Cylinder	10400 CUT J	\$57.00 (NET)
6 Pin Medeco ³ Cut-AwayCylinder	10400 CUT T	\$78.50 (NET)
Cut-Away Ruko® Oval Cylinder	23-050CUT	\$74.50 (NET)
Cut-Away 5 Pin Profile Cylinder	23130 CUT	\$85.50 (NET)
Cut-Away Cam Lock Assembly	60T300 CUT T 219	\$49.00 (NET)
Plastic Display Sleeve for Maxum (Lock Not Included)	90-0028	\$16.00 (NET)
Install/Demo Key (works cylinders not yet programmed to a system)	EA-100111	\$187.50
Install/Demo Control Key (works I/C cylinders not yet programmed to a system)	EA-100110	\$187.50

M100 Mounted Sample w/M100 (Sales Demo)

Mortise Cylinder Assembly, 125KHz Prox technology, 360° Bi-directional rotation – Contains One (1) M100, One (1) Prox Keyfob and One (1) Aluminum Mount. M100 is mounted and programmed with one override credential (keyfob) to allow for demonstration of stand-alone functionality. Unit can also be paired with a hub (available separately) that can be connected to an EAC system for full functionality demonstration or try-me purposes.

EA-100144 \$930.50

**Refer to the eCylinder section for more detail on specific technologies available and pricing. Technologies are represented by the following letters:

T = Medeco³, S = Medeco³ CLIQ, J = Medeco³ BiLevel, W = Biaxial, V = Medeco Biaxial CLIQ, K = Medeco KM, N = Medeco X4, C = Medeco CLIQ,
 “-” = Original, Z = Medeco Original KW CLIQ, G = Medeco XT ***See key section for surcharges for custom coined cut keys or special stamping requirements.

Note: (P) refers to **Pinned** and **(S)** to **Sub-Pinned** at the end of each part string in the price book.

Keyblanks for Cam Lock Style - Original, Medeco Biaxial, Medeco³

Description	Part Number	Price
5 Pin Commercial Original Keyblank for 60 Series, Thick Head (Non Custom Coined)	KYB 115400 XX 00	\$7.14
5 Pin Commercial Original Keyblank for 60 Series, Thin Head (Non Custom Coined)	KYB 105400 XX 00	\$7.14
5 Pin Commercial Medeco Biaxial Keyblank for 60 Series, Thick Head (Non Custom Coined)	KYB 115400 S6 43	\$7.14
5 Pin Keyblank for 60 Series (Large Bow, Custom Coined)	KYB XX5400 XX 99	\$6.84

Keyblanks for Door Hardware - Original, Medeco Biaxial, Medeco³

Description	Part Number	Price
5 or 6 Pin Keyblank Round Bow (Non Custom Coined)	KYB 10X600 XX XX	\$7.14
5 or 6 Pin Keyblank for Medeco ³ (Small Bow, Custom Coined)	KYB 34X600 XX 99	\$6.84
5 or 6 Pin Keyblank for Medeco ³ (Large Bow, Custom Coined)	KYB 33X600 XX 99	\$6.84
5 or 6 Pin Keyblank for Medeco Biaxial Rectangular (Small Bow, Custom Coined)	KYB 12X600 XX 99	\$6.84
5 or 6 Pin Keyblank for Medeco Biaxial, Square (Large Bow, Custom Coined)	KYB 17X600 XX 99	\$6.84
5 or 6 Pin Keyblank for Thumbturn (blade only)	KYB 10X605 XX	\$9.14

Keyblanks for Door Hardware - Medeco KM, Medeco X4

Description	Part Number	Price
6 or 7 Pin Keyblank for Medeco KM (Small Bow, Custom Coined)	KYB 32X600 XX 99	\$6.34
6 or 7 Pin Keyblank for Medeco KM (Large Bow, Custom Coined)	KYB 38X600 XX 99	\$6.34
6 or 7 Pin Keyblank for Medeco X4 (Small Bow, Custom Coined)	KYB 32X900 XX 99	\$6.34
6 or 7 Pin Keyblank for Medeco X4 (Large Bow, Custom Coined)	KYB 38X900 XX 99	\$6.34

**Refer to the eCylinder section for more detail on specific technologies available and pricing. Technologies are represented by the following letters:
T = Medeco³, S = Medeco³ CLIQ, J = Medeco³ BiLevel, W = Biaxial, V = Medeco Biaxial CLIQ, K = Medeco KM, N = Medeco X4, C = Medeco CLIQ,

"-" = Original, Z = Medeco Original KW CLIQ, G = Medeco XT ***See key section for surcharges for custom coined cut keys or special stamping requirements.

Note: (P) refers to **Pinned** and **(S)** to **Sub-Pinned** at the end of each part string in the price book.

Keys with Hybrid Heads – 125 kHz Proximity

Description	Part Number	Price
Original/Biaxial heads only	EA-300069-01-EL	\$15.50
Medeco ³ /Medeco X4, Medeco KM Heads only	EA-300070-01-EL	\$15.50
Medeco X4, Medeco KM/Medeco ³ dimpled blade	KYB 77663F NM XX	\$21.74
Original/Biaxial dimpled blade	KYB 74563F NM XX	\$21.74
5 pin Medeco ³ key blank	KYB 35563P XX 99	\$21.74
6 pin Medeco ³ key blank	KYB 35663P XX 99	\$21.74
5 pin Original/Biaxial key blank	KYB 74563P XX 99	\$21.74
6 pin Original/Biaxial key blank	KYB 74663P XX 99	\$21.74
6 pin Medeco KM key blank	KYB 77663P XX 99	\$21.74
7 pin Medeco KM key blank	KYB 77763P XX 99	\$21.74
6 pin Medeco X4 key blank	KYB 77693P XXX 99	\$21.74
7 pin Medeco X4 key blank	KYB 77793P XXX 99	\$21.74
5 pin Medeco ³ cut key	KYC 35563P XX 99	\$31.84
6 pin Medeco ³ cut key	KYC 35663P XX 99	\$31.84
5 pin Original/Biaxial cut key	KYC 74563P XX 99	\$31.84
6 pin Original/Biaxial cut key	KYC 74663P XX 99	\$31.84
6 pin Medeco KM cut key	KYC 77663P XX 99	\$31.84
7 pin Medeco KM cut key	KYC 77763P XX 99	\$31.84
6 pin Medeco X4 cut key	KYC 77693P XX 99	\$31.84
7 pin Medeco X4 cut key	KYC 77793P XXX 99	\$31.84

Stamping is required on all restricted keyblanks .

Please see the eCylinder section for eCylinder key information.

**Refer to the eCylinder section for more detail on specific technologies available and pricing. Technologies are represented by the following letters:
 T = Medeco³, S = Medeco³ CLIQ, J = Medeco³ BiLevel, W = Biaxial, V = Medeco Biaxial CLIQ, K = Medeco KM, N = Medeco X4, C = Medeco CLIQ,
 "-" = Original, Z = Medeco Original KW CLIQ, G = Medeco XT ***See key section for surcharges for custom coined cut keys or special stamping requirements.
Note: (P) refers to **Pinned** and **(S)** to **Sub-Pinned** at the end of each part string in the price book.

Keys with Hybrid 2k Bit Heads – 13.56 MHz iCLASS

Description	Part Number	Price
Original/Biaxial heads only	EA-300086-01-EL	\$19.00
Medeco ³ /Medeco X4 Heads only	EA-300087-01-EL	\$19.00
Original/Biaxial dimpled blade	KYB 74563H NM XX	\$24.95
Medeco X4/Medeco ³ dimpled blade	KYB 77663H NM XX	\$24.95
5 pin Medeco ³ key blank	KYB 35563K XX 99	\$24.95
6 pin Medeco ³ key blank	KYB 35663K XX 99	\$24.95
5 pin Original/Biaxial key blank	KYB 74563K XX 99	\$24.95
6 pin Original/Biaxial key blank	KYB 74663K XX 99	\$24.95
6 pin Medeco X4 key blank	KYB 77693K XXX 99	\$24.95
7 pin Medeco X4 key blank	KYB 77793K XXX 99	\$24.95
5 pin Medeco ³ cut key	KYC 35563K XX 99	\$35.01
6 pin Medeco ³ cut key	KYC 35663K XX 99	\$35.01
5 pin Original/Biaxial cut key	KYC 74563K XX 99	\$35.01
6 pin Original/Biaxial cut key	KYC 74663K XX 99	\$35.01
6 pin Medeco X4 cut key	KYC 77693K XXX 99	\$35.01
7 pin Medeco X4 cut key	KYC 77793K XXX 99	\$35.01

Stamping is required on all restricted keyblank

Keys with Hybrid 16k Bit Heads – 13.56 MHz iCLASS

Description	Part Number	Price
Original/Biaxial heads only	EA-300088-01-EL	\$27.00
Medeco ³ /Medeco X4 Heads only	EA-300089-01-EL	\$27.00
Original/Biaxial dimpled blade	KYB 74563N NM XX	\$32.40
Medeco X4/Medeco ³ dimpled blade	KYB 77663N NM XX	\$32.40
5 pin Medeco ³ key blank	KYB 35563J XX 99	\$32.40
6 pin Medeco ³ key blank	KYC 35663J XX 99	\$32.40
5 pin Original/Biaxial key blank	KYC 74563J XX 99	\$32.40
6 pin Original/Biaxial key blank	KYB 74663J XX 99	\$32.40
6 pin Medeco X4 key blank	KYB 77693J XXX 99	\$32.40
7 pin Medeco X4 key blank	KYB 77793J XXX 99	\$32.40
5 pin Medeco ³ cut key	KYC 35563J XX 99	\$42.46
6 pin Medeco ³ cut key	KYC 35663J XX 99	\$42.46
5 pin Original/Biaxial cut key	KYC 74563J XX 99	\$42.46
6 pin Original/Biaxial cut key	KYC 74663J XX 99	\$42.46
6 pin Medeco X4 cut key	KYC 77693P XXX 99	\$42.46
7 pin Medeco X4 cut key	KYC 77793J XXX 99	\$42.46

Stamping is required on all restricted keyblank

Hybrid Dummy heads only

Description	Part Number	Price
Original/Biaxial (25 pack)	CP-286531-25-EL	\$47.00
Medeco X4/Medeco ³ (25 pack)	CP-286541-25-EL	\$47.00

**Refer to the eCylinder section for more detail on specific technologies available and pricing. Technologies are represented by the following letters:
 T = Medeco³, S = Medeco³ CLIQ, J = Medeco³ BiLevel, W = Biaxial, V = Medeco Biaxial CLIQ, K = Medeco KM, N = Medeco X4, C = Medeco CLIQ,
 "-." = Original, Z = Medeco Original KW CLIQ, G = Medeco XT ***See key section for surcharges for custom coined cut keys or special stamping requirements.
Note: (P) refers to **Pinned** and **(S)** to **Sub-Pinned** at the end of each part string in the price book.

Hybrid Dummy heads with key blanks

Description	Part Number	Price
5 pin Medeco ³	KYB 355640 XX 99	\$7.88
6 pin Medeco ³	KYB 356640 XX 99	\$7.88
5 pin Original/Biaxial	KYB 745640 XX 99	\$7.88
6 pin Original/Biaxial	KYB 746640 XX 99	\$7.88
6 pin Medeco KM	KYB 776640 XX 99	\$7.88
7 pin Medeco KM	KYB 777640 XX 99	\$7.88
6 pin Medeco X4 key blank	KYB 776940 XXX 99	\$7.88
7 pin Medeco X4 key blank	KYB 777940 XXX 99	\$7.88

Stamping is required on all restricted key blanks.

Hybrid Dummy heads with cut keys

Description	Part Number	Price
5 pin Medeco ³	KYC 355640 XX 99	\$17.94
6 pin Medeco ³	KYC 356600 XX 99	\$17.94
5 pin Original/Biaxial	KYC 745640 XX 99	\$17.94
6 pin Original/Biaxial	KYC 746640 XX 99	\$17.94
6 pin Medeco KM	KYC 776640 XX 99	\$17.94
7 pin Medeco KM	KYC 777640 XX 99	\$17.94
6 pin Medeco X4 cut key	KYC 776940 XXX 99	\$17.94
7 pin Medeco X4 cut key	KYC 777940 XXX 99	\$17.94

Hybrid Blades only, no heads, key blanks

Description	Part Number	Price
5 pin Medeco ³	KYB 355600 XX 99	\$6.84
6 pin Medeco ³	KYB 356600 XX 99	\$6.84
5 pin Original/Biaxial	KYB 745600 XX 99	\$6.84
6 pin Original/Biaxial	KYB 746600 XX 99	\$6.84
6 pin Medeco KM	KYB 776600 XX 99	\$6.84
7 pin Medeco KM	KYB 777600 XX 99	\$6.84
6 pin Medeco X4 key blank	KYB 776900 XXX 99	\$6.84
7 pin Medeco X4 key blank	KYB 777940 XXX 99	\$6.84

Stamping is required on all restricted key blanks.

Hybrid Blades only, no heads, cut keys

Description	Part Number	Price
5 pin Medeco ³	KYC 355600 XX 99	\$16.90
6 pin Medeco ³	KYC 356600 XX 99	\$16.90
5 pin Original/Biaxial	KYC 745600 XX 99	\$16.90
6 pin Original/Biaxial	KYC 746600 XX 99	\$16.90
6 pin Medeco KM	KYC 776600 XX 99	\$16.90
7 pin Medeco KM	KYC 777600 XX 99	\$16.90
6 pin Medeco X4 cut key	KYC 776900 XXX 99	\$16.90
7 pin Medeco X4 cut key	KYC 777900 XXX 99	\$16.90

**Refer to the eCylinder section for more detail on specific technologies available and pricing. Technologies are represented by the following letters:
 T = Medeco³, S = Medeco³ CLIQ, J = Medeco³ BiLevel, W = Biaxial, V = Medeco Biaxial CLIQ, K = Medeco KM, N = Medeco X4, C = Medeco CLIQ,
 "-" = Original, Z = Medeco Original KW CLIQ, G = Medeco XT ***See key section for surcharges for custom coined cut keys or special stamping requirements.
Note: (P) refers to **Pinned** and **(S)** to **Sub-Pinned** at the end of each part string in the price book.

Medeco³/Biaxial Door Hardware Pin Kits

Description	Part Number	Price
Medeco Biaxial 10 through 50 Series broached and milled pin combination (Door Hardware), Large Metal Box, 30 Each of Bottom, Master, Top Pins	K5005	\$737.00
Medeco Biaxial 10 Through 50 Series (Door Hardware), Large Metal Box, 100 Each of Bottom, Master, & Top Pins	K5006	\$1,608.50
Medeco Biaxial 10 Through 50 Series (Door Hardware), Small Metal Box, 10 Each of Bottom, Master & Top Pins	K5007	\$553.50
Medeco Biaxial Pin Kit with 30 ea. 53 Series (broached) Pins for Biaxial Cylinders with Sidebars Manufactured Prior to 2/2003	K5011	\$737.00
Medeco Biaxial Pin Kit with 100 ea. 53 Series (broached) Pins for Biaxial Cylinders with Sidebars Manufactured Prior to 2/2003	K5012	\$1,608.50
Medeco Biaxial Pin Kit for 32 Series LFIC Cylinders. 4, 5, and 6 Pins Only with 50 each 53 Series Pins	K5010	\$366.50
Medeco Biaxial/Medeco ³ Pin Kit for Medeco ³ CLIQ	.KW5401	\$555.00

Medeco³/Biaxial Cam and Switch Lock Pin Kits

Description	Part Number	Price
Medeco Biaxial 60 Series (Cam & Switch locks), 100 Each of Bottom Pins (Top Pins Not Used)	K9001	\$1,013.50
Medeco Biaxial 60 Series (Cam & Switch Locks), Small Metal Box, 10 Each of Bottom Pins (Top Pins Not Used)	K9003	\$324.00

Medeco³ BiLevel Pin Kits

Description	Part Number	Price
Medeco ³ BiLevel Pin Kit (100 ea. BiLevel Top & Bottom Pins)	KJ1501	\$645.00

Medeco KM and X4 Pin Kits

Description	Part Number	Price
Medeco KM and X4 Pin Kit for SFIC; Large Wood Kit, 100 Each Bottom and Master/Top Pins. Springs, Caps, Spring Covers, Set Screws, Pinning Fixture, Capping Punch, Pin Ejector and Key Gauge Included.	K4001	\$858.00
Medeco KM and X4 mini Pin Kit for SFIC; Small Metal Pin Kit, 30 Each Bottom Pins, 60 Each Master/Top Pins. Spring, Caps, and Spring Covers included.	K4002	\$209.00
Medeco X4 Pin Kit for Conventional Cylinders (.511 plug), not SFIC; 100 Each Bottom and Master/Top Pins. Springs, Spring Covers, Set Screws, and Key Gauge included.	K4006	\$624.00

***Contact Factory for LFIC Pinning Requirements.

**Refer to the eCylinder section for more detail on specific technologies available and pricing. Technologies are represented by the following letters:
T = Medeco³, S = Medeco³ CLIQ, J = Medeco³ BiLevel, W = Biaxial, V = Medeco Biaxial CLIQ, K = Medeco KM, N = Medeco X4, C = Medeco CLIQ,
“-” = Original, Z = Medeco Original KW CLIQ, G = Medeco XT ***See key section for surcharges for custom coined cut keys or special stamping requirements.
Note: (P) refers to **Pinned** and **(S)** to **Sub-Pinned** at the end of each part string in the price book.

Medeco Original Door Hardware Pin Kits

Description	Part Number	Price
Medeco Original Door Hardware Pins, Full Step, Plastic Box, 30 Ea. of Bottom & Top Pins	.K-1001	\$333.50
Medeco Original Door Hardware Pins, Full Step, Plastic Box, 100 Ea. of Bottom & Top Pins	.K-1002	\$976.00
Medeco Original Door Hardware Pins, Full Step, Plastic Box, 100 Ea. of Master Pins #1 - #5 Only	.K-1003	\$71.50
Medeco Original Door Hardware Pins, Small Metal Box, 10 Ea. of Bottom, Master, & Top Pins	.K-1005	\$332.00
Medeco Original Door Hardware Pins, 1/2 Step, Large Metal Box, 100 Ea. of Bottom, Master & Top Pins	.K-1006	\$1,613.50

Medeco Original Cam & Switch Lock Pin Kits

Description	Part Number	Price
Medeco Original Cam & Switch Type Pins, Full Step, Plastic Box, 100 Ea. of Bottom Pins (Top Pins Not Used)	.K-6001	\$807.50
Medeco Original Cam & Switch Style Pins, Full Step, Plastic Box, 100 Ea. of Master Pins (Top Pins Not Used)	.K-6002	\$945.00

Pins (Sold in bags of 100)

Description	Part Number	Price
Medeco Original Bottom Pins (.030" increment)	TP-F10-XX	\$0.92
Medeco Original Master Wafer (.030" increment)	TP-F10-XW	\$0.34
Mushroom driver	TP-F10-3M	\$0.58
Standard Driver	TP-F10-XT	\$0.36
Medeco ³ /Biaxial Bottom Pin (.025" increment)	TP-F50-XX	\$0.92
Medeco ³ /Biaxial Master Wafer (.025 increment)	TP-F50-XW	\$0.34
Original 60 Series Pins TP-F60-XX 0.81		
Medeco ³ /Biaxial 60 Series Pins (.025 increment)	TP-F90-XX	\$0.92
Medeco KM and X4 Bottom Pins, #0B-9B (qty of 100 pack) Note: Medeco X4 SFIC only	TP-K40-XX-BH	\$9.27
Medeco KM and X4 Top Pins #02-19T (qty of 100 in pack)	TP-K40-XX-TH	\$8.38
Medeco X4 Bottom Pins for Conventional Cylinders #00-09	TP-K43-XX-BH	\$13.50
Medeco BiLevel Top Pins	TP-F15-XT	\$0.35
Medeco BiLevel Bottom Pins (.025 increment)	TP-F15-XB	\$0.41
Medeco ³ /Medeco Biaxial Broached Bottom Pins (.025" increment)	TP-F53-XX	\$0.92

**Refer to the eCylinder section for more detail on specific technologies available and pricing. Technologies are represented by the following letters:

T = Medeco³, S = Medeco³ CLIQ, J = Medeco³ BiLevel, W = Biaxial, V = Medeco Biaxial CLIQ, K = Medeco KM, N = Medeco X4, C = Medeco CLIQ, "-" = Original, Z = Medeco Original KW CLIQ, G = Medeco XT ***See key section for surcharges for custom coined cut keys or special stamping requirements.

Note: (P) refers to **Pinned** and **(S)** to **Sub-Pinned** at the end of each part string in the price book.

Caps (Sold in bags of 100)

Description	Part Number	Price
Medeco X4 I/C Pin Spring Caps (Stamped) (for rekeying)	CP-170430	\$4.64
Medeco X4 I/C Pin Spring Caps (Machined) (for new cylinder)	CP-170440	\$4.64
6 Pin Spring Cover for Medeco 32 & 31 Series I/C, Sargent, KeyMark Corbin (7Pin) Medeco X4 Yale (6&7 Pin), Brass, 1.010" Length	CP-170011	\$0.43
5 Pin Spring Covers for Medeco 32 Series I/C, Cams and Switch Lock Plugs, Brass, .840" Length	CP-170021	\$0.43
3 Pin Spring Cover for Cam and Switch Lock Plugs, Brass, .500" Length	CP-170031	\$0.43
4 Pin Spring Covers for Cam and Switch Lock Plugs, Brass, .670"	CP-170041	\$0.43
6 Pin Spring Covers for Medeco and Medeco X4 20 Series Key-in-Knob Cyls, Medeco X4 Schlage LFIC, Stainless Steel, .980" - Old Style	CP-170051	\$0.43
5 Pin Spring Cover for Medeco 20 Series Key-in-Knob Cyls, Stainless Steel, .810" - Old Style	CP-170061	\$0.43
6 Pin Spring Cover for Medeco ³ 32*0202 Removeable Cylinder for 50 Series Brass Body Padlocks, Brass, 1.010" (Notch in cover for steel ball bearing retainer)	CP-170271	\$0.43
6 Pin Spring Covers for Medeco & Medeco X4 20 Series Key-in-Knob Cylinders & Medeco X4 Schlage Style LFIC	CP-170730-6	\$0.49
5 Pin Spring Cover for Medeco 20 Series Key-in-Knob Cylinders	CP-170730-5	\$0.49

Springs (Sold in bags of 100)

Description	Part Number	Price
Tumbler Spring, 10 Series Door Hardware	CP-030001	\$0.09 ea.
Tumbler Spring, 60 Series Cam & Switch Locks	CP-030017	\$0.09 ea.
Sidebar Spring	CP-030018	\$0.09 ea.
Tumbler Spring, 32 Series (stainless steel)	CP-030042	\$0.10 ea.
Medeco ³ Slider Spring	CP-030910	\$0.10 ea.
Medeco X4 Springs (Bag of 300)	CP-030590	\$15.00 ea.

**Refer to the eCylinder section for more detail on specific technologies available and pricing. Technologies are represented by the following letters:

T = Medeco³, S = Medeco³ CLIQ, J = Medeco³ BiLevel, W = Biaxial, V = Medeco Biaxial CLIQ, K = Medeco KM, N = Medeco X4, C = Medeco CLIQ, "-" = Original, Z = Medeco Original KW CLIQ, G = Medeco XT ***See key section for surcharges for custom coined cut keys or special stamping requirements.

Note: (P) refers to **Pinned** and **(S)** to **Sub-Pinned** at the end of each part string in the price book.

Screws (Sold in bags of 100)

Description	Part Number	Price
#2-56 x 3/16" Flat Head Cam Screw for 10-0100 Cylinder	CP-010203-030	\$0.17
#2-56 x 1/4" Flat Head Screw for 32 Series I/C Housing	CP-010103-040	\$0.51
#2-56 x 5/16" Flat Head Phillips, Nylon Patch Cam Screw for Mortise Cylinders	CP-010203-050	\$0.17
#2-56 x 1/4" Pan Head Screw for 20-0901 and Other Lazy Motion Retainers	CP-010503-040	\$0.29
#8-32 x 1/8" Allen Set Screw Cone for Pin Chambers (10 Series Rim & Mortise)	CP-011013-020	\$0.22
#8-32 x 1/4" Allen Set Screw Cone for Pin Chambers (23 Series Profile Cylinders)	CP-011013-040	\$0.32
Set Screw for non-I/C Medeco X4 Rim & Mortise Cylinders	CP-011011-020	\$0.18

Misc. Components

Description	Part Number	Price
5 Pin Sidebar Assembly .123" for Door Hardware Cylinders	CP-084571	\$6.20
6 Pin Sidebar Assembly .123" for Door Hardware Cylinders	CP-084671	\$6.20
Slider Package Includes : Medeco ³ Slider and Spring	94-0174	\$11.39
Medeco BiLevel Slider and Spring	94-0227	\$11.39
Medeco X4 Locking Pin	CP-064231	\$3.60
Medeco X4 Locking Pin Spring	CP-031170	\$0.28
Medeco X4 Slider Spring	CP-031180	\$0.13

Cam & Tailpiece Kit







Description	Part Number	Price
10 and 20 Series Tailpieces (Plastic Box, Assorted Cams and Tailpieces for 10 & 20 Series) Includes: CT-Y02, CT-Y08, CT-Y24, CTY32, CT-Y49, CT-Y52, CT-Y53, CT-Z00, CT-Z01, CT-Z02, CT-Z04, CT-Z06, CT-Z07, CT-Z08, CTZ09, CT-Z16	K1099	\$447.00

Empty Pin Boxes - Any Technology

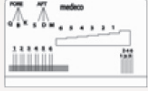
Description	Part Number	Price
Large Latched Metal Pin Box (Empty) 60 Assorted Size Compartments. Overall Measurements 1.875" Deep, 13.56" wide, 9.75 front to back.	CP-282460	\$188.50
Small Latched Metal Pin Box (Empty) 67 Assorted Size Compartments, Overall .688" Deep, 8.876" Wide, 5.875" Front to Back	CP-282470	\$113.50

**Refer to the eCylinder section for more detail on specific technologies available and pricing. Technologies are represented by the following letters:
T = Medeco³, S = Medeco³ CLIQ, J = Medeco³ BiLevel, W = Biaxial, V = Medeco Biaxial CLIQ, K = Medeco KM, N = Medeco X4, C = Medeco CLIQ,
“-” = Original, Z = Medeco Original KW CLIQ, G = Medeco XT ***See key section for surcharges for custom coined cut keys or special stamping requirements.
Note: (P) refers to **Pinned** and **(S)** to **Sub-Pinned** at the end of each part string in the price book.

Tools & Fixtures

Description	Part Number	Price
Spanner Wrench for Rim Cylinder Tailpiece Nut	90-0001	\$3.00
 Medeco³/Biaxial Key Gauge/Decoder	94-0298	\$26.00
Installation Tool for Key-in-Knob capping	94-0207	\$1.45 (NET)
 5 Pin Staking Tool, 60 Series Cam/ Switch Locks and 32 Series LFIC	CP-282430	\$103.50
 Holding Block Assembly (use with 10, 20, 32, & 60 Series Cylinders)	CP-282451	\$754.00
 Switch Lock Tool (Facilitates spring insertion on momentary function)	T-7155	\$23.00
 Medeco X4 I/C Pinning Block (6 or 7 Pin)	CP-282500	\$157.00
 Medeco X4 I/C Pin Ejector	CP-282530	\$38.50
 Medeco X4 I/C Hand Capping Punch	CP-282540	\$25.00
Medeco X4 Key Decoder	CP-286350	\$28.50

Lubricants

Description	Part Number	Price
KeyLube 2.0 (5.25 oz.)	PX-KYLUB203	\$15.00
CLIQ Electromechanical Lube	PX-KYLUBL-50	\$21.50

**Refer to the eCylinder section for more detail on specific technologies available and pricing. Technologies are represented by the following letters:
 T = Medeco³, S = Medeco³ CLIQ, J = Medeco³ BiLevel, W = Biaxial, V = Medeco Biaxial CLIQ, K = Medeco KM, N = Medeco X4, C = Medeco CLIQ,
 "-" = Original, Z = Medeco Original KW CLIQ, G = Medeco XT ***See key section for surcharges for custom coined cut keys or special stamping requirements.
Note: (P) refers to **Pinned** and **(S)** to **Sub-Pinned** at the end of each part string in the price book.

Key Machines

Description	Part Number	Price
Key Machine, Original, 115V	95-M11000	\$10,883.50
Key Machine, Biaxial, 115V	95-M23000	\$10,883.50
Key Machine, Universal, 115V	95-M34000	\$11,529.50
Key Machine, KM, 115V	95-M45000	\$10,883.50
Key Machine, Medeco X4, 115V	95-M55000	\$10,883.50
Key Machine, Medeco X4 A2/A4, 115V	95-M56000	\$11,220.50
Medeco KM Key Punch Machine	95-000200	\$2,950.00
Medeco X4 Key Punch Machine	95-001100	\$2,950.00

Power Key Machines are also available in 220V versions. Ask your customer service representative for details.



Key Machine Parts

Description	Part Number	Price
Clamp Kit (Clamp, Handle, Plunger, QC Pin) -XX / Keyway	95-210100-XX	\$617.50
Clamp Kit (Clamp, Handle, Plunger, QC Pin) - MED3 / Medeco ³	95-210100-MED3	\$617.50
Clamp Kit (Clamp, Handle, Plunger, QC Pin) - UNIV / Universal (Selected Biax)	95-210100-UNIV	\$617.50
Clamp Retrofit Kit (Clamp, Handle, Plunger) - XX / Keyway	95-210130-XX	\$555.50
Clamp Retrofit Kit (Clamp, Handle, Plunger) - MED3 / Medeco ³	95-210130-MED3	\$555.50
Clamp Retrofit Kit (Clamp, Handle, Plunger) - UNIV / Universal (Selected Biax)	95-210130-UNIV	\$555.50

Key Machine Cutters

Description	Part Number	Price
Cutter for all High Security technologies	95-100400	\$439.00
Cutter for Medeco X4 key machine	95-100070	\$439.00
Re-Sharpener Cutter	KM-SHARP-CUT	\$166.00

Key Wizard® Key Management Software

Description	Part Number	Price
Key Wizard Key Management Software Yearly Support, Upgrade, and Maintenance Fee **PRICE SHOWN IS NET**	SW-500001	\$133.50 (NET)
Key Wizard Key Management Software Single User Version*	SW-600001	\$1,035.00
Key Wizard Key Management Software Network Version*	SW-600201	\$1,246.00
Key Wizard Key Management Software Single User Upgrade To Network Version*	SW-600401	\$626.00
Key Wizard Demo Disk (N/C)	SW-200001	No Charge

Note: Visit www.keywizard.net for more information

**Refer to the eCylinder section for more detail on specific technologies available and pricing. Technologies are represented by the following letters:
 T = Medeco³, S = Medeco³ CLIQ, J = Medeco³ BiLevel, W = Biaxial, V = Medeco Biaxial CLIQ, K = Medeco KM, N = Medeco X4, C = Medeco CLIQ,
 "-" = Original, Z = Medeco Original KW CLIQ, G = Medeco XT ***See key section for surcharges for custom coined cut keys or special stamping requirements.
Note: (P) refers to **Pinned** and **(S)** to **Sub-Pinned** at the end of each part string in the price book.

Product No.	Page	Product No.	Page	Product No.	Page	Product No.	Page
12286.....	122	940239.....	22	52121040.....	157	100800 (P).....	58
12288.....	122	940243.....	113	CP-200771-15.....	115	100800 (P).....	75
13327.....	122	940249.....	40	.K-1001.....	184	100800 (S).....	58
13346.....	122	940261.....	23	.K-1002.....	184	100800 (S).....	75
13365.....	122	940264.....	23	.K-1003.....	184	100805 (P).....	75
13375.....	122	940272.....	81	.K-1005.....	184	100805 (S).....	75
110018.....	134	940273.....	31	.K-1006.....	184	100903 (P).....	54
110092.....	134	940276.....	23	.K-6001.....	184	100903 (S).....	54
120280.....	137	940279.....	113	.K-6002.....	184	100909 (P).....	54
120290.....	137	1202800.....	133	.KW5401.....	31, 113, 183	100909 (S).....	54
123620.....	137	1202900.....	133	00104 J.....	77	1012040 (P).....	74
124340.....	137	1415110.....	139	100100 (P).....	52	1012040 (S).....	74
310175.....	87	1415120.....	139	100100 (S).....	52	101350 (P).....	54
315375.....	87	2000938.....	139	100101 (P).....	52	101350 (S).....	54
320175.....	87	2000956.....	139	100101 (S).....	52	101355 (P).....	58
320275.....	87	2301016.....	121	100200 (P).....	52	101355 (S).....	58
320775.....	89	2304005.....	121	100200 (S).....	52	1014500 (P).....	53
321375.....	87	2304006.....	121	100200 S.....	25	1014500 (S).....	53
325275.....	87	2304015.....	121	100200A (P).....	54	1014501 (P).....	53
325375.....	87	2304016.....	121	100200A (S).....	54	1014501 (S).....	53
325475.....	87	2304025.....	121	100202 (P).....	54	1014502 (P).....	53
325575.....	87	2304026.....	121	100202 (S).....	54	1014502 (S).....	53
325675.....	87	2305016.....	121	100300H (P).....	58	1014503 (P).....	53
325775.....	87	2306016.....	121	100300H (S).....	58	1014503 (S).....	53
500020.....	143	2309016.....	121	100300V (P).....	58	1014504 (P).....	53
526000.....	153	2310016.....	121	100300V (S).....	58	1014504 (S).....	53
526002.....	153	2314003.....	121	100305H (P).....	58	1014505 (P).....	53
526010.....	153	2315005.....	121	100305H (S).....	58	1014505 (S).....	53
526012.....	153	2316004.....	121	100305V (P).....	58	1014506 (P).....	53
526100.....	153	2317016.....	121	100305V (S).....	58	1014506 (S).....	53
526102.....	153	2320016.....	121	100400H (P).....	58	1014507 (P).....	53
526110.....	153	3307311.....	170	100400H (S).....	58	1014507 (S).....	53
526112.....	153	3307321.....	170	100400H G.....	17	1014508 (P).....	53
526200.....	152	3307331.....	170	100400H S.....	25	1014508 (S).....	53
526200.....	152	3307340.....	171	100400V (P).....	58	1014509 (P).....	53
526202.....	152	3307350.....	170	100400V (S).....	58	1014509 (S).....	53
526210.....	152	5004732.....	143	100400V G.....	17	1014600 (P).....	53
526212.....	152	5004734.....	143	100400V S.....	25	1014600 (S).....	53
526302.....	152	5004832.....	143	100403H (S).....	58	1014601 (P).....	53
526310.....	152	5004834.....	143	100403V (P).....	58	1014601 (S).....	53
526312.....	152	6270515.....	170	100403V (S).....	58	1014602 (P).....	53
650003.....	174	6271515.....	170	100500 (P).....	52	1014602 (S).....	53
940010.....	58	23010168.....	121	100500 (S).....	52	1014603 (P).....	53
940034.....	81	23070165.....	121	100500 G.....	17	1014603 (S).....	53
940035.....	81	23080166.....	121	100500 S.....	25	1014604 (P).....	53
940036.....	81	33076011.....	93	100500H (P).....	54	1014604 (S).....	53
940051.....	81	33076021.....	93	100500H (S).....	54	1014605 (P).....	53
940061.....	81	33076025.....	93	100501 (P).....	54	1014605 (S).....	53
940067.....	81	33076028.....	93	100501 (S).....	54	1014607 (P).....	53
940098.....	81	33076048.....	93	100600 (P).....	58	1014607 (S).....	53
940174.....	58, 59, 77	33076051.....	93	100600 (S).....	58	1014608 (P).....	53
940188.....	60	50047321.....	143	100602 (P).....	76	1014608 (S).....	53
940210.....	134	50047341.....	143	100602 (S).....	76	1014609 (P).....	53
940212.....	134	50048321.....	143	100700 (P).....	58	1014609 (S).....	53
940219.....	113	50048341.....	143	100700 (S).....	58	10-15010.-001.....	45
940224.....	41	52110040.....	157	100700 S.....	25	10-15010.-002.....	45
940225.....	41	52111040.....	157	100702 (P).....	76	10-15010.-003.....	45
940227.....	58, 59, 77	52120040.....	157	100702 (S).....	76	10-15010.-004.....	45

Product No.	Page	Product No.	Page	Product No.	Page	Product No.	Page
10-15013	44	10662S4 (P)	75	11C314 (S)	127	11C611 (P)	126
10-15014	43	10662S4 (S)	75	11C315 (P)	127	11C611 (S)	126
10-15015	44	1075127 (P)	73	11C315 (S)	127	11C612 (P)	126
10-15016	43	1075127 (S)	73	11C316 (P)	127	11C612 (S)	126
10400 CUT J	178	108001 (P)	54	11C316 (S)	127	11C613 (P)	126
10400 CUT T	178	108001 (S)	54	11C31L (P)	127	11C613 (S)	126
104001 (P)	54	108002 (P)	54	11C31L (S)	127	11C614 (P)	126
104001 (S)	54	108002 (S)	54	11C321 (P)	131	11C614 (S)	126
104003 (P)	54	110A04 (P)	133	11C321 (S)	131	11C615 (P)	126
104003 (S)	54	110A04 (S)	133	11C322 (P)	131	11C615 (S)	126
10407HA (P)	58	110A05 (P)	133	11C322 (S)	131	11C616 (P)	126
10407HA (S)	58	110A05 (S)	133	11C323 (P)	131	11C616 (S)	126
104207 (P)	54	110A06	133	11C323 (S)	131	11C61L (P)	126
104207 (S)	54	110A07	133	11C324 (P)	131	11C61L (S)	126
104207A (P)	54	110A08 (P)	133	11C324 (S)	131	11C621 (P)	130
104207A (S)	54	110A08 (S)	133	11C325 (P)	131	11C621 (S)	130
105100 (P)	52	110A08L	133	11C325 (S)	131	11C621 S	28
105100 (S)	52	110A09 (P)	133	11C326 (P)	131	11C622 (P)	130
105100 G	17	110A09 (S)	133	11C326 (S)	131	11C622 (S)	130
105100 S	25	110A09L	133	11C32L (P)	131	11C622 S	28
105104 (P)	52	110A10	134	11C32L (S)	131	11C623 (P)	130
105104 (S)	52	110A12	134	11C341 (P)	127	11C623 (S)	130
105200 (P)	52	110A14	134	11C341 (S)	127	11C623 S	28
105200 (S)	52	110A16	134	11C342 (P)	127	11C624 (P)	130
105200 S	25	110A17	134	11C342 (S)	127	11C624 (S)	130
105300 (P)	52	110A1911	133	11C391 (P)	127	11C624 S	28
105300 (S)	52	110A1912	133	11C391 (S)	127	11C625 (P)	130
105400 (P)	52	110A1913	133	11C392 (P)	127	11C625 (S)	130
105400 (S)	52	110A1921	133	11C392 (S)	127	11C625 S	28
105400 S	25	110A1922	133	11C401	127	11C626 (P)	130
105500 (P)	52	110A1923	133	11C402	127	11C626 (S)	130
105500 (S)	52	110A20	134	11C405	127	11C626 S	28
105600 (P)	52	110A21	134	11C406	127	11C62L (P)	130
105600 (S)	52	110A22	134	11C421	131	11C62L (S)	130
105700 (P)	52	110A23	134	11C422	131	11C62L S	28
105700 (S)	52	11C281	126	11C425	131	11C631 (P)	130
105800 (P)	52	11C282	126	11C426	131	11C631 (S)	130
105800 (S)	52	11C301 (P)	127	11C601 (P)	126	11C631T (P)	130
105900 (P)	52	11C301 (S)	127	11C601 (S)	126	11C631T (S)	130
105900 (S)	52	11C302 (P)	127	11C601 S	28	11C632 (P)	130
105901 (P)	52	11C302 (S)	127	11C602 (P)	126	11C632 (S)	130
105901 (S)	52	11C303 (P)	127	11C602 (S)	126	11C632T (P)	130
105902 (P)	52	11C303 (S)	127	11C602 S	28	11C632T (S)	130
105902 (S)	52	11C304 (P)	127	11C603 (P)	126	11C633 (P)	130
105903 (P)	52	11C304 (S)	127	11C603 (S)	126	11C633 (S)	130
105903 (S)	52	11C305 (P)	127	11C603 S	28	11C633T (P)	130
105904 (P)	52	11C305 (S)	127	11C604 (P)	126	11C633T (S)	130
105904 (S)	52	11C306 (P)	127	11C604 (S)	126	11C634 (P)	130
1065140 (P)	73	11C306 (S)	127	11C604 S	28	11C634 (S)	130
1065140 (S)	73	11C30L (P)	127	11C605 (P)	126	11C634T (P)	130
10651S4 (P)	75	11C30L (S)	127	11C605 (S)	126	11C634T (S)	130
10651S4 (S)	75	11C311 (P)	127	11C605 S	28	11C635 (P)	130
1065244 (P)	73	11C311 (S)	127	11C606 (P)	126	11C635 (S)	130
1065244 (S)	73	11C312 (P)	127	11C606 (S)	126	11C635T (P)	130
10652S4 (P)	75	11C312 (S)	127	11C606 S	28	11C635T (S)	130
10652S4 (S)	75	11C313 (P)	127	11C60L (P)	126	11C636 (P)	130
10661S4 (P)	75	11C313 (S)	127	11C60L (S)	126	11C636 (S)	130
10661S4 (S)	75	11C314 (P)	127	11C60L S	28	11C636T (P)	130

Product No.	Page	Product No.	Page	Product No.	Page	Product No.	Page
11C636T (S).....	130	11C822 (S).....	132	11C991 (S).....	129	12030002 -	59
11C63L (P).....	130	11C823 (P).....	132	11C992 (P).....	129	12030006 W.....	59
11C63L (S).....	130	11C823 (S).....	132	11C992 (S).....	129	12126002 -	77
11C63LT (P).....	130	11C824 (P).....	132	11R503 (P).....	137	12126156 W.....	77
11C63LT (S).....	130	11C824 (S).....	132	11R503 (S).....	137	1212633 T.....	77
11C641 (P).....	126	11C825 (P).....	132	11R504 (P).....	137	1238900 J.....	59
11C641 (S).....	126	11C825 (S).....	132	11R504 (S).....	137	1239000 J.....	55
11C642 (P).....	126	11C826 (P).....	132	11R523 (P).....	137	1239100 J.....	55
11C642 (S).....	126	11C826 (S).....	132	11R523 (S).....	137	1251200 J.....	59
11C691 (P).....	126	11C841 (P).....	129	11R524 (P).....	137	1251300 J.....	55
11C691 (S).....	126	11C841 (S).....	129	11R524 (S).....	137	1412110 (P).....	139
11C692 (P).....	126	11C842 (P).....	129	11R533 (P).....	137	1412110 (S).....	139
11C692 (S).....	126	11C842 (S).....	129	11R533 (S).....	137	1412120 (P).....	139
11C701.....	128	11C891 (P).....	129	11R534 (P).....	137	1412120 (S).....	139
11C702.....	128	11C891 (S).....	129	11R534 (S).....	137	1413110 (P).....	139
11C703.....	128	11C892 (P).....	129	11R57L.....	137	1413110 (S).....	139
11C704.....	128	11C892 (S).....	129	11R5DL.....	137	1413120 (P).....	139
11C705.....	128	11C901 (P).....	129	11R601 S.....	28	1413120 (S).....	139
11C706.....	128	11C901 (S).....	129	11R602 S.....	28	1414110 (P).....	139
11C711.....	128	11C902 (P).....	129	11R603 (P).....	137	1414110 (S).....	139
11C712.....	128	11C902 (S).....	129	11R603 (S).....	137	1414120 (P).....	139
11C713.....	128	11C903 (P).....	129	11R603 S.....	28	1414120 (S).....	139
11C714.....	128	11C903 (S).....	129	11R604 (P).....	137	2000400 (P).....	71
11C715.....	128	11C904 (P).....	129	11R604 (S).....	137	2000400 (S).....	71
11C716.....	128	11C904 (S).....	129	11R604 S.....	28	2000700 (P).....	71
11C721.....	132	11C905 (P).....	129	11R605 S.....	28	2000700 (S).....	71
11C722.....	132	11C905 (S).....	129	11R606 S.....	28	2000800 (P).....	75
11C723.....	132	11C906 (P).....	129	11R60L S.....	28	2000800 (S).....	75
11C724.....	132	11C906 (S).....	129	11R621 S.....	28	2000827 (P).....	69, 70
11C725.....	132	11C911 (P).....	129	11R622 S.....	28	2000827 (S).....	69, 70
11C726.....	132	11C911 (S).....	129	11R623 (P).....	137	20008S4 (S).....	75
11C801 (P).....	128	11C912 (P).....	129	11R623 (S).....	137	2000900 (P).....	75
11C801 (S).....	128	11C912 (S).....	129	11R623 S.....	28	2000900 (S).....	75
11C802 (P).....	128	11C913 (P).....	129	11R624 (P).....	137	20009S4 (P).....	69, 73, 75
11C802 (S).....	128	11C913 (S).....	129	11R624 (S).....	137	20009S4 (S).....	69, 73, 75
11C803 (P).....	128	11C914 (P).....	129	11R624 S.....	28	2000S4 (P).....	75
11C803 (S).....	128	11C914 (S).....	129	11R625 S.....	28	2001200 (P).....	64
11C804 (P).....	128	11C915 (P).....	129	11R626 S.....	28	2001200 (S).....	64
11C804 (S).....	128	11C915 (S).....	129	11R62L S.....	28	2001300 (P).....	64
11C805 (P).....	128	11C916 (P).....	129	11R633 (P).....	137	2001300 (S).....	64
11C805 (S).....	128	11C916 (S).....	129	11R633 (S).....	137	2001400 (P).....	71
11C806 (P).....	128	11C921 (P).....	132	11R634 (P).....	137	2001400 (S).....	71
11C806 (S).....	128	11C921 (S).....	132	11R634 (S).....	137	200155 K.....	77
11C811 (P).....	128	11C922 (P).....	132	11R67L.....	137	200156 K.....	77
11C811 (S).....	128	11C922 (S).....	132	11R6DL.....	137	2001600 (P).....	154
11C812 (P).....	128	11C923 (P).....	132	1200100 T.....	59	2001600 (S).....	154
11C812 (S).....	128	11C923 (S).....	132	12001002 -	59	2001700 (P).....	71
11C813 (P).....	128	11C924 (P).....	132	12001006 W.....	59	2001700 (S).....	71
11C813 (S).....	128	11C924 (S).....	132	1200500 T.....	55	2001851 (P).....	73
11C814 (P).....	128	11C925 (P).....	132	12005002 -	55	2001851 (S).....	73
11C814 (S).....	128	11C925 (S).....	132	12005006 W.....	55	200500 (P).....	72
11C815 (P).....	129	11C926 (P).....	132	1202000 T.....	55	200500 (S).....	72
11C815 (S).....	129	11C926 (S).....	132	12020002 -	55	200503 (P).....	72
11C816 (P).....	129	11C941 (P).....	129	12020006 W.....	55	200503 (S).....	72
11C816 (S).....	129	11C941 (S).....	129	1202100 T.....	55	200503 G.....	18
11C821 (P).....	132	11C942 (P).....	129	12021002 -	55	200700 (P).....	71
11C821 (S).....	132	11C942 (S).....	129	12021006 W.....	55	200700 (S).....	71
11C822 (P).....	132	11C991 (P).....	129	1203000 T.....	59	200701 (P).....	71

Product No.	Page	Product No.	Page	Product No.	Page	Product No.	Page
200701 (S).....	71	2020074 (P).....	77	2020249 (P).....	63, 68, 69, 72	2305016 G.....	114
200801 (P).....	73, 74	2020074 (S).....	77	2020249 (S).....	63, 68, 69, 72	23-050CUT	178
200801 (S).....	73, 74	2020074 S	29	20202V9 (P).....	63	23130 CUT.....	178
200802 (P).....	73, 74	2020078 (P).....	68	20202V9 (S).....	63	2313005 X00.....	119
200802 (S).....	73, 74	2020078 (S).....	68	2020349 (P).....	70	2313006 X00.....	119
200807 (P).....	74	2020078 S	27	2020349 (S).....	70	2313015 800.....	120
200807 (S).....	74	2020097 (P).....	71	2020575 (P).....	65	2313015 801.....	120
200808 (P).....	74	2020097 (S).....	71	2020575 (S).....	65	2313016 800.....	120
200808 (S).....	74	2020097 G	18	2020777 (P).....	65	2313016 801.....	120
200901 (P).....	73, 74	2020097 S	27	2020777 (S).....	65	2313025 X00.....	120
200901 (S).....	73, 74	20200A1 (P).....	63	20211730 (P).....	65	2313025 X01.....	120
200902 (P).....	73, 74	20200A1 (S).....	63	20211730 (S).....	65	2313025 X02.....	120
200902 (S)	73, 74	20200A1 G	17	20211730 S	25	2313025 X11.....	120
200903 (P).....	67, 74, 76	20200A1 S	25	203000 (P).....	70	2313025 X12.....	120
200903 (S).....	67, 74, 76	20200F1 (P).....	67	203000 (S).....	70	2313026 X00.....	120
200904 (P).....	75	20200F1 (S)	67	205003 (P).....	65	2313026 X01.....	120
200904 (S).....	75	20200F1 G	18	205003 (S).....	65	2313026 X02.....	120
200907 (P).....	74	20200F1 S	26	205004 (P).....	65	2313026 X12.....	120
200907 (S).....	74	20200H1 (P).....	63, 71	205004 (S).....	65	2313035 X00.....	119
200908 (P).....	74	20200H1 (S).....	63, 71	205005 (P).....	65	2313036 X00.....	119
200908 (S).....	74	20200L1 (P).....	68	205005 (S).....	65	2313045 X00.....	119
201006 (P).....	68	20200L1 (S).....	68	205006 (P).....	65	2313046 X00.....	119
201006 (S).....	68	20200L1 G	18	205006 (S).....	65	2313055 X00.....	119
201006 G.....	114	20200L1 S	26	205008 (P).....	65	2313056 X00.....	119
20110039 (P).....	63	20200S1 (P)	69, 72	205008(S).....	65	2313065 X00.....	119
20110039(S).....	63	20200S1 (S)	69, 72	2051027 (P).....	73, 76	2313066 X00.....	119
2020000 (P).....	76	20200S1 G	18	2051027 (S).....	73, 76	2322015 300.....	113
2020000 (S).....	76	20200S1 S	26, 27	2051100 (P).....	66	2322015 301.....	113
2020000 G.....	18	20200S1(P)	66	2051100 (S).....	66	2322016 300.....	113
2020000 S	26, 29	20200S1(S)	66	2051200 (P).....	66	2322016 300 S	29, 114
2020049 (P)....	63, 64, 66, 67, 71	20200V0 (P).....	66, 69	2051200 (S).....	66	2322016 301.....	113
2020049 (S)....	63, 64, 66, 67, 71	20200V0 (S).....	66, 69	2051500 (P).....	68	2322016 301 S	29, 114
2020049 G.....	17	20200V0 G	18	2051500 (S).....	68	2322017 300 N.....	113
2020049 S	25, 26	20200V0 S	26	206005 (P).....	74, 76	232201S 300 G	21, 114
2020051 (P).....	67, 71	20200V1 (P)....	63, 64, 66, 68, 69	206005 (S).....	74, 76	232201S 301 G	21, 114
2020051 (S).....	67, 71	20200V1 (S)....	63, 64, 66, 68, 69	206100 (P).....	74, 76	232201S 302 G	21, 114
2020051 G.....	18	20200V1 G	17, 18	206100 (S).....	74, 76	232202S 300 G	21, 114
2020052 (P).....	71, 77	20200V1 S	25, 26	207001 (P).....	76	232202S 301 G	21, 114
2020052 (S).....	71, 77	20200V2 (P).....	70	207001 (S).....	76	232202S 302 G	21, 114
2020052 S	29	20200V2 (S).....	70	208005 (P).....	70	232202S G	21
2020053 (P).....	71	20200V2 G	18	208005 (S).....	70	23220X5 300.....	114
2020053 (S).....	71	20200V2 S	26	208006 (P).....	70	23220X6 300.....	114
2020054 (P).....	67	20200V3 (P).....	67	208006 (S).....	70	23220XS 300	114
2020054 (S).....	67	20200V3 (S).....	67	208007 (P).....	70	2323016 800 S	29
2020058 (P).....	67	20200V3 G	18	208007 (S).....	70	2323016 801 S	29
2020058 (S).....	67	20200V3 S	26	208008 (P).....	63	232301S 800 G	21, 113
2020068 (P).....	67	20200V9 (P).....	65	208008 (S).....	63	232301S 801 G	21, 113
2020068 (S).....	67	20200V9 (S).....	65	2080147 (P).....	70	232301ST 800 G.....	21, 113
2020070 (P).....	63, 68	20200V9 G.....	17	2080147 (S).....	70	2323025 X00.....	113
2020070 (S).....	63, 68	20200V9 S	25	2080148 (P).....	70	2323026 X00.....	113
2020071 (P).....	63, 67	2020149 (P).....	70	2080148 (S).....	70	23230E5 X00 G	21, 113
2020071 (S).....	63, 67	2020149 (S).....	70	2080700 (P).....	63, 72	23230E5 X11 G	113
2020072 (P).....	67	2020169 (P).....	68	2080700 (S).....	63, 72	23230E6 X00 S	29, 113
2020072 (S).....	67	2020169 (S).....	68	210503 (P).....	161	23230X5 X00.....	113
2020073 (P)....	63, 67, 68, 71, 72	2020170 (P).....	70	210503 (S).....	161	23230X6 S	29
2020073 (S)....	63, 67, 68, 71, 72	2020170 (S).....	70	2303016 G.....	114	23230X6 X00.....	113
2020073 G.....	17, 18	2020173 (P).....	70	2303016A.....	121	23230X6 X00 S.....	113
2020073 S	26	2020173 (S).....	70	23031S G	21	23230XS X00 G.....	21, 113

Product No.	Page	Product No.	Page	Product No.	Page	Product No.	Page
23230XS X11 G.....	21, 113	320477H.....	89	33602042 (P).....	91	510600 (S).....	77, 154
2325005 C.....	39	320600 (P).....	88	33602042 (S).....	91	510600 G.....	20
2325025 C.....	39	320600 (S).....	88	33602043 K (P).....	91	510600 S.....	29
310100 (P).....	84	320700 (P).....	88	33602043 K (S).....	91	526001 (P).....	153
310100 (S).....	84	320700 (S).....	88	33602052 (P).....	92	526001 (S).....	153
310100 S.....	27	321200 (P).....	85	33602052 (S).....	92	526011 (P).....	153
310100 S.....	28	321200 (S).....	85	33602053 K (P).....	92	526011 (S).....	153
310100A (P).....	84	321201 (P).....	84	33602053 K (S).....	92	526101 (P).....	153
310100A (S).....	84	321201 (S).....	84	33602062 (P).....	92	526101 (S).....	153
310100A S.....	27, 28	321201D (P).....	84	33602062 (S).....	92	526111 (P).....	153
310100CC BI R1.....	84	321201D (S).....	84	33602063 K (P).....	92	526111 (S).....	153
310101 (P).....	85	321350 (P).....	85	33602063 K (S).....	92	526201 (P).....	152
310101 (S).....	85	321350 (S).....	85	33700006 (P).....	91, 132	526201 (S).....	152
310101A (P).....	85	322201 (P).....	85	33700006 (S).....	91, 132	526211 (P).....	152
310101A (S).....	85	322201 (S).....	85	33700007 K (P).....	91	526211 (S).....	152
310102H (P).....	88	322301 (P).....	85	33700007 K (S).....	91	526301 (P).....	152
310102H (S).....	88	322301 (S).....	85	3370000S (P).....	91	526301 (S).....	152
310102V (P).....	88	322401 (P).....	85	3370000S (S).....	91	526311 (P).....	152
310102V (S).....	88	322401 (S).....	85	33702022 (P).....	92	526311 (S).....	152
310104H (P).....	88	322801 (P).....	85	33702022 (S).....	92	5293000 (P).....	156
310104H (S).....	88	322801 (S).....	85	33702023 K (P).....	92	5293000 (S).....	156
310104V (P).....	88	324200 (P).....	85	33702023 K (S).....	92	5293000 G.....	19
310104V (S).....	88	324200 (S).....	85	33702042 (P).....	91	52930L0.....	156
310153H.....	89	324201 (P).....	84	33702042 (S).....	91	5431500 (P).....	147
310153V.....	89	324201 (S).....	84	33702043 K (P).....	91	5431500 (S).....	147
310175A.....	87	32-5200.....	87	33702043 K (S).....	91	54315K0.....	147
310375H.....	89	325200 (P).....	85	337020B2 (P).....	91	54315L0.....	147
310375S.....	89	325200 (S).....	85	337020B2 (S).....	91	54315R0 (P).....	147
310375V.....	89	32-5300.....	87	337020C2 (P).....	92	54315R0 (S).....	147
320100 (P).....	85	325300 (P).....	85	337020C2 (S).....	92	5431F00 (P).....	147
320100 (S).....	85	325300 (S).....	85	337020E2 (P).....	92	5431F00 (S).....	147
320101 (P).....	84	32-5400.....	87	337020E2 (S).....	92	5431FK0.....	147
320101 (S).....	84	325400 (P).....	85	490078 (P).....	54	5431FR0 (P).....	147
320101H (P).....	84	325400 (S).....	85	490078 (S).....	54	5431FR0 (S).....	147
320101H (S).....	84	32-5500.....	87	490079 (P).....	54	5432500 (P).....	150
320200 (P).....	85	325500 (P).....	85	490079 (S).....	54	5432500 (S).....	150
320200 (S).....	85	325500 (S).....	85	490214 (P).....	54	54325K0.....	150
320200B (P).....	54	32-5600.....	87	490214 (S).....	54	54325L0.....	150
320200B (S).....	54	325600 (P).....	85	490258 (P).....	70	54325R0 (P).....	150
320201 (P).....	84, 132, 154	325600 (S).....	85	490258 (S).....	70	54325R0 (S).....	150
320201 (S).....	84, 132, 154	32-5700.....	87	490357 T.....	77	5433500 (P).....	147
320201 S.....	27, 28	325700 (P).....	85	490358 C.....	38	5433500 (S).....	147
320201CC BI R1.....	84	325700 (S).....	85	490359 C.....	38	54335R0 (P).....	147
320201H (P).....	84	3307603H.....	93	490359 G.....	20	54335R0 (S).....	147
320201H (S).....	84	3307604H.....	93	490361 C.....	38	5433F00 (P).....	147
320300H (P).....	88	33600006 (P).....	91, 132	490366 C.....	38	5433F00 (S).....	147
320300H (S).....	88	33600006 (S).....	91, 132	490366 G.....	20	5433FR0 (P).....	147
320300V (P).....	88	33600006 BI CC K.....	91	490368 C.....	38	5433FR0 (S).....	147
320300V (S).....	88	33600007 K (P).....	91	490375 T.....	77	5434500 (P).....	150
320375H.....	89	33600007 K (S).....	91	50-81732.....	143	5434500 (S).....	150
320375V.....	89	33602012 (P).....	92	50-817321.....	143	54345R0 (P).....	150
320400H (P).....	88	33602012 (S).....	92	50-81734.....	143	54345R0 (S).....	150
320400H (S).....	88	33602013 K (P).....	92	50-817341.....	143	5441500 (P).....	149
320400V (P).....	88	33602013 K (S).....	92	50-81832.....	143	5441500 (S).....	149
320400V (S).....	88	33602032 (P).....	91	50-818321.....	143	54415K0.....	149
320405H (P).....	88	33602032 (S).....	91	50-81834.....	143	54415L0.....	149
320405H (S).....	88	33602033 K (P).....	91	50-818341.....	143	54415R0 (P).....	149
320475H.....	89	33602033 K (S).....	91	510600 (P).....	77, 154	54415R0 (S).....	149

Product No.	Page	Product No.	Page	Product No.	Page	Product No.	Page
5441F00 (P)	149	5461FR0 (P)	146	600550T (P)	162	640155T (S)	168
5441F00 (S)	149	5461FR0 (S)	146	600550T (S)	162	640250T (P)	166
5441FK0	149	5462500 (P)	150	600650T (P)	162	640250T (S)	166
5441FL0	149	5462500 (S)	150	600650T (S)	162	640251T (P)	166
5441FR0 (P)	149	54625K0	150	600650T KIT (P)	161	640251T (S)	166
5441FR0 (S)	149	54625L0	150	600650T KIT (S)	161	640550AT (P)	166
5442500 (P)	151	54625R0 (P)	150	600750T (P)	162	640550AT (S)	166
5442500 (S)	151	54625R0 (S)	150	600750T (S)	162	640550FT (P)	166
54425K0	152	5471500 (P)	148	600850T (P)	162	640550FT (S)	166
54425L0	152	5471500 (S)	148	600850T (S)	162	640550T (P)	166
54425R0 (P)	151	5471500 G	19	600950T (P)	162	640550T (S)	166
54425R0 (S)	151	54715K0	148	600950T (S)	162	640750ET (P)	168
5443500 (P)	149	54715L0	148	601150T (P)	162	640750ET (S)	168
5443500 (S)	149	54715R0 (P)	148	601150T (S)	162	640750GT (P)	168
54435R0 (P)	149	54715R0 (S)	148	601150T KIT (P)	161	640750GT (S)	168
54435R0 (S)	149	54715R0 G	19	601150T KIT (S)	161	640950T (P)	168
5443F00 (P)	149	5471F00 (P)	148	601250T (P)	162	640950T (S)	168
5443F00 (S)	149	5471F00 (S)	148	601250T (S)	162	640952T (P)	168
5443FR0 (P)	149	5471F00 G	19	601251T (P)	162	640952T (S)	168
5443FR0 (S)	149	5471FK0	148	601251T (S)	162	641050T (P)	168
5444500 (P)	151	5471FL0	148	601450T (P)	162	641050T (S)	168
5444500 (S)	151	5471FR0 (P)	148	601450T (S)	162	641051T (P)	168
54445R0 (P)	151	5471FR0 (S)	148	601450T KIT (P)	161	641051T (S)	168
54445R0 (S)	151	5471FR0 G	19	601450T KIT (S)	161	641200 C	39
5451500 (P)	146	5472500 (P)	151	601452T (P)	162	641200D C	39
5451500 (S)	146	5472500 (S)	151	601452T (S)	162	641201 C	39
5451500 G	19	5472500 G	19	607155XT (P)	164	641201D C	39
54515K0	146	54725K0	151	607155XT (S)	164	652150T 011 (P)	174
54515L0	146	54725L0	151	607255XT (P)	164	652150T 011 (S)	174
54515R0 (P)	146	54725R0 (P)	151	607255XT (S)	164	652150T 012 (P)	174
54515R0 (S)	146	54725R0 (S)	151	607355XT (P)	164	652150T 012 (S)	174
54515R0 G	19	54725R0 G	19	607355XT (S)	164	652150T 021 (P)	174
5451F00 (P)	146	5481500 (P)	148	607455XT (P)	164	652150T 021 (S)	174
5451F00 (S)	146	5481500 (S)	148	607455XT (S)	164	6522560T 121 (P)	176
5451F00 G	19	54815K0	148	607555XT (P)	164	6522560T 121 (S)	176
5451FK0	146	54815L0	148	607555XT (S)	164	6522560T 122 (P)	176
5451FL0	146	54815R0 (P)	148	60810 XXX C	38	6522560T 122 (S)	176
5451FR0 (P)	146	54815R0 (S)	148	60810D XXX C	38	6522560T 132 (P)	176
5451FR0 (S)	146	5481F00 (P)	148	60820 XXX C	38	6522560T 132 (S)	176
5451FR0 G	19	5481F00 (S)	148	60820D XXX C	38	6522560T 133 (P)	176
5452500 (P)	149	5481FK0	148	60T300 CUT T 219	178	6522560T 133 (S)	176
5452500 (S)	149	5481FL0	148	6210555 (P)	170	6522560T 134 (P)	176
5452500 G	19	5481FR0 (P)	148	6210555 (S)	170	6522560T 134 (S)	176
54525K0	149	5481FR0 (S)	148	6211555 (P)	170	6522560T 221 (P)	176
54525L0	149	5482500 (P)	151	6211555 (S)	170	6522560T 221 (S)	176
54525R0 (P)	149	5482500 (S)	151	6212555 (P)	170	652650T 101 (P)	174
54525R0 (S)	149	54825K0	151	6212555 (S)	170	652650T 101 (S)	174
54525R0 G	19	54825L0	151	6221554 (P)	172	652650T 102 (P)	174
5461500 (P)	146	54825R0 (P)	151	6221554 (S)	172	652650T 102 (S)	174
5461500 (S)	146	54825R0 (S)	151	6221557 (P)	172	652650T 111 (P)	174
54615K0	146	600250T (P)	162	6221557 (S)	172	652650T 111 (S)	174
54615L0	146	600250T (S)	162	6231550T (P)	171	652650T 131 (P)	174
54615R0 (P)	146	600350T (P)	162	6231550T (S)	171	652650T 131 (S)	174
54615R0 (S)	146	600350T (S)	162	6261557T (P)	172	652650T 132 (P)	174
5461F00 (P)	146	600350T KIT (P)	161	6261557T (S)	172	652650T 132 (S)	174
5461F00 (S)	146	600350T KIT (S)	161	640155CT (P)	168	652650T 133 (P)	174
5461FK0	146	600450T (P)	162	640155CT (S)	168	652650T 133 (S)	174
5461FL0	146	600450T (S)	162	640155T (P)	168	66391 (P)	154, 164, 170

Product No.	Page	Product No.	Page	Product No.	Page	Product No.	Page
66391 (S)	154, 164, 170	CARD XX 56 XX	178	CP-060203	59	CP-160611	167
66418 (P)	154	CARD XX 66 XX	178	CP-063220	116, 118	CP-160661-50	118
66418 (S)	154	CB-CODE-BIA	178	CP-064231	186	CP-160661-55	118
90-0001	187	CB-CODE-BOK	178	CP-064490	77	CP-160691	154
90-0028	178	CN-DIES	177	CP-070011	60, 167	CP-160XXX	167
94-0029	134	CP-010103-040	186	CP-070131	167	CP-170011	185
94-0030	134	CP-010203-030	186	CP-070141	167	CP-170021	170, 185
94-0056-MED	178	CP-010203-050	58, 77, 186	CP-070161	167	CP-170031	170, 185
94-0058-MED	133	CP-010234-320	134	CP-070171	167	CP-170041	170, 185
94-0059	133	CP-010235-120-XX	134	CP-070181	167	CP-170051	185
94-0115	178	CP-010503-040	77, 186	CP-070201	167	CP-170271	185
94-0174	186	CP-011011-020	58, 59, 186	CP-070441	167	CP-170430	185
94-0199	155	CP-011013-020	58, 59, 122, 186	CP-070451	60	CP-170440	185
94-0203	116	CP-011013-040	122, 186	CP-070481	167	CP-170730-5	116, 185
94-0204	178	CP-011511-000	155	CP-070501	167	CP-170730-6	116, 185
94-0207	116, 187	CP-011751	134	CP-070691	134	CP-170930	41
94-0208	116	CP-011753	134	CP-070701	134	CP-171011	143
94-0213	157	CP-011754	134	CP-070711	135	CP-180021	60
94-0221	116	CP-011757	134	CP-070721	135	CP-180031	59
94-0222	116	CP-011762	134	CP-070731	135	CP-180041	60
94-0223	116	CP-011763	134	CP-070741	135	CP-180061	135
94-0227	186	CP-011764	134	CP-084571	58, 59, 186	CP-200720	155
94-0261	178	CP-011767	134	CP-084671	58, 59, 186	CP-200751-10	115, 118
94-0269	178	CP-012409-030	122	CP-100111	122	CP-200751-15	115, 118
940270 S	31	CP-012411-030	122	CP-130510	155	CP-200751-20	115, 118
940281 001	30	CP-012411-040	122	CP-144110	155	CP-200751-25	115, 118
94-0283	114	CP-012917-000	59	CP-144120	155	CP-200751-30	115
94-0285	116	CP-020010	59	CP-144130	155	CP-200751-40	115
94-0290	23	CP-020020	77	CP-144140	155	CP-200751-45	115
94-0291	23	CP-020031	122	CP-144150	155	CP-200751-50	115
94-0292	23	CP-020040	77	CP-144160	155	CP-200751-55	115
94-0294	23	CP-020100	77	CP-144170	155	CP-200751-60	115
94-0295	23	CP-020240	122	CP-144180	155	CP-200751-65	115
94-0298	187	CP-021011	58	CP-144190	155	CP-200751-70	115
95-000200	188	CP-021031	77	CP-144200	155	CP-200751-75	115
95-001100	188	CP-021121	59	CP-144210	155	CP-200751-80	115
95-100070	188	CP-021130	77	CP-144220	155	CP-200751-85	115
95-100400	188	CP-021370	77	CP-150082	174	CP-200751-90	115
95-210100-MED3	188	CP-021400	122	CP-150102	174	CP-200761-05	115
95-210100-UNIV	188	CP-021490	122	CP-150142	174	CP-200761-10	115
95-210100-XX	188	CP-021651	77	CP-150152	174	CP-200761-15	115
95-210130-MED3	188	CP-022030	155	CP-160051	167	CP-200761-20	115
95-210130-UNIV	188	CP-030001	122, 185	CP-160061	167	CP-200761-25	115
95-210130-XX	188	CP-030017	185	CP-160071	167	CP-200761-30	115
95-M11000	188	CP-030018	58, 59, 185	CP-160081	167	CP-200761-40	115
95-M23000	188	CP-030024	122	CP-160091	167	CP-200761-45	115
95-M34000	188	CP-030025	122	CP-160101	167	CP-200761-50	115
95-M45000	188	CP-030042	185	CP-160111	167	CP-200761-55	115
95-M55000	188	CP-030590	185	CP-160121	167	CP-200761-60	115
95-M56000	188	CP-030670	77	CP-160180	60	CP-200761-65	115
960357 (P)	154	CP-030860	118, 122	CP-160271	167	CP-200761-70	115
960357 (S)	154	CP-030910	185	CP-160301	167	CP-200761-75	115
960358 (P)	154	CP-031030	122	CP-160321	63	CP-200761-80	115
960358 (S)	154	CP-031170	186	CP-160541	167	CP-200761-85	115
CARD 1 X XX	178	CP-031180	186	CP-160551	167	CP-200761-90	115
CARD 2 X XX	178	CP-041200	77	CP-160571	167	CP-200771-05	115, 118
CARD 6 X XX	178	CP-050120	58	CP-160591	167	CP-200771-10	115, 118
CARD KS XX 8E	178	CP-060106	118	CP-160601	167	CP-200771-15	118

Product No.	Page	Product No.	Page	Product No.	Page	Product No.	Page
CP-200771-20	115, 118	CP-285951-500	122	CT-F43	135	CT-Y69	80
CP-200771-25	115, 118	CP-285961	117, 122	CT-F44	135	CT-Y70	80
CP-200801-00	116	CP-285981	122	CT-H00	165	CT-Y71	80
CP-200801-02	116	CP-285991	117, 122	CT-H07	165	CT-Y72	80
CP-200801-04	116	CP-286011-500	122	CT-H09	165	CT-Y73	80
CP-200801-06	116	CP-286021	117	CT-H14	165	CT-Y74	80
CP-200801-08	116	CP-286041-500	122	CT-H15	165	CT-Y75	80
CP-200801-0A	116	CP-286051	117	CT-H16	165	CT-Y76	122
CP-200801-12	118	CP-286131	178	CT-H17	165	CT-Y77	80
CP-200801-14	118	CP-286350	187	CT-H19	165	CT-Y78	80
CP-200801-16	118	CP-286531-25-EL	181	CT-H20	165	CT-Z00	56
CP-200801-18	118	CP-286541-25-EL	181	CT-H27	165	CT-Z01	56
CP-200801-1A	118	CP-287260	31, 41	CT-H30	165	CT-Z02	56
CP-200801-22	116	CP-CP-171031	143	CT-H32	165	CT-Z04	56
CP-200801-24	116	CT-A00	164	CT-J01	166	CT-Z05	56
CP-200801-26	116	CT-A01	164	CT-J05	166	CT-Z06	56
CP-200801-28	116	CT-A02	164	CT-J07	166	CT-Z07	56
CP-200801-2A	116	CT-A03	164	CT-J08	166	CT-Z08	56
CP-200801-44	116	CT-A04	164	CT-J11	166	CT-Z09	56
CP-200801-46	116	CT-A05	164	CT-J12	166	CT-Z16	56
CP-200801-48	116	CT-A06	164	CT-J13	166	CT-Z17	56
CP-200801-4A	116	CT-A07	164	CT-J14	166	CT-Z18	56
CP-200801-66	116	CT-A08	164	CT-J15	166	CT-Z19	56
CP-200801-68	116	CT-A09	164	CT-J18	166	CT-Z20	56
CP-200801-6A	116	CT-A11	164	CT-J22	166	CT-Z21	56
CP-200801-88	116	CT-A12	164	CT-J27	166	CT-Z22	57
CP-200801-8A	116	CT-A13	164	CT-J28	166	CT-Z26	122
CP-200801-AA	116	CT-A14	164	CT-J29	166	CT-Z29	122
CP-200830	118	CT-A15	164	CT-V00	78	CT-Z34	57
CP-220071	116, 122	CT-A16	164	CT-V01	78	CT-Z45	57
CP-220090	118, 122	CT-A19	164	CT-V02	78	CT-Z47	57
CP-220120	122	CT-C02	165	CT-V03	78	CT-Z48	57
CP-230081	122	CT-C04	165	CT-V19	78	CT-Z50	116, 122
CP-230091	122	CT-C05	165	CT-V35	78	CT-Z51	116, 122
CP-240771-5P	116	CT-C08	165	CT-V39	78	CT-Z55	57
CP-240771-6P	116	CT-C09	165	CT-V40	78	CT-Z56	57
CP-250010	135	CT-C11	165	CT-Y02	60	CT-Z57	57
CP-250020	135	CT-D00	165	CT-Y08	60, 78	CT-Z58	57
CP-250140	155	CT-D01	165	CT-Y24	79	CT-Z59	57
CP-270511	174	CT-D02	165	CT-Y27	79	CT-Z61	57
CP-270521	174	CT-D03	165	CT-Y28	79	CT-Z69	57
CP-270531	174	CT-D04	165	CT-Y29	79	CT-Z70	57
CP-270541	174	CT-D05	165	CT-Y31	79	CT-Z84	57
CP-270551	174	CT-D06	165	CT-Y32	60	CT-Z87	57
CP-270561	174	CT-D07	165	CT-Y35	79	CT-Z88	118, 122
CP-280261	122	CT-D08	165	CT-Y37	79	CT-Z98	113, 122
CP-280330	116	CT-D09	165	CT-Y46	79	CT-Z99	57
CP-280620	135	CT-D11	165	CT-Y49	79	DE-CODE-KEY	177
CP-282430	187	CT-D12	165	CT-Y52	79	DE-CODE-LOK	177
CP-282451	187	CT-D15	165	CT-Y53	79	E23230E5 X11 G	21
CP-282460	186	CT-D19	165	CT-Y54	79	EA-100088	23
CP-282470	186	CT-F34	78	CT-Y55	79	EA-100099	41
CP-282500	187	CT-F35	78	CT-Y57	79	EA-100107	22
CP-282530	187	CT-F36	78	CT-Y58	80	EA-100108	19
CP-282540	187	CT-F37	78	CT-Y60	135	EA-100109	23
CP-285901	117, 122	CT-F38	78	CT-Y61	135	EA-100109	23
CP-285921-500	122	CT-F40	78	CT-Y67	80	EA-100110	178
CP-285931	117, 122	CT-F42	135	CT-Y68	80	EA-100111	178

Product No.	Page	Product No.	Page	Product No.	Page	Product No.	Page
EA-100113	31	KEC 426P2B	40	KYB 77693J XXX 99	181	ST-LASER	177
EA-100121	41	KEC 426P3B	40	KYB 77693K XXX 99	181	SW-200001	188
EA-100126	31	KEC 44X002	30	KYB 77693P XXX 99	180	SW-500001	188
EA-100134	46	KEC 44X003	30	KYB 776940 XXX 99	182	SW-500101-1	31
EA-100138	23	KEC 44X013	30	KYB 777600 XX 99	182	SW-500101-2	31
EA-100142	31	KEC 44X023	30	KYB 77763P XX 99	180	SW-500101-3	31
EA-100144	178	KEC 44XP02	30	KYB 77793J XXX 99	181	SW-500101-4	31
EA-100145	41	KEC 44XP03	30	KYB 77793K XXX 99	181	SW-500301-1	22
EA-100150-001	45	KEC 45X002	30	KYB 77793P XXX 99	180	SW-500301-2	22
EA-100150-002	45	KEC 45X003	30	KYB 777940 XXX 99	182	SW-500301-3	22
EA-100150-003	45	KEC 45X013	30	KYB XX5400 XX 99	179	SW-500301-4	22
EA-100150-004	45	KEC 45X023	30	KYB XX6605	135	SW-500301-X	23
EA-100151-003	43	KEC 45XP02	30	KYB XX6611	84	SW-500901	22
EA-100151-004	44	KEC 45XP03	30	KYB XX6620 XX 05	85	SW-600001	188
EA-100155-003	43	KJ1501	183	KYB XX7600	84	SW-600201	188
EA-100155-004	44	KM KYB 776640 XX 99	182	KYB XX7611	84	SW-600401	188
EA-100158	23	KM KYB 777640 XX 99	182	KYC 355600 XX 99	182	T-7155	187
EA-100159	41	KM-SHARP-CUT	177, 188	KYC 35563J XX 99	181	TP-F10-2W (.060i)	117
EA-100160	31	KYB 105400 XX 00	179	KYC 35563K XX 99	181	TP-F10-3M	184
EA-100163	44	KYB 10X600 XX XX	179	KYC 35563P XX 99	180	TP-F10-3W (.090i)	117
EA-10156	22	KYB 10X605 XX	179	KYC 355640 XX 99	182	TP-F10-4T (.180i)	117
EA-200058	23	KYB 115400 S6 43	179	KYC 356600 XX 99	182	TP-F10-4W-6T (.120i)	117
EA-200065	46	KYB 115400 XX 00	179	KYC 356600 XX 99	182	TP-F10-5T (.150i)	117
EA-200070	46	KYB 12X600 XX 99	179	KYC 35663J XX 99	181	TP-F10-XT	184
EA-200071	46	KYB 17X600 XX 99	179	KYC 35663K XX 99	181	TP-F10-XW	184
EA-200072	46	KYB 32X600 XX 99	179	KYC 35663P XX 99	180	TP-F10-XX	184
EA-250050	23	KYB 32X900 XX 99	179	KYC 745600 XX 99	182	TP-F15-XB	184
EA-300069-01-EL	180	KYB 33X600 XX 99	179	KYC 74563J XX 99	181	TP-F15-XT	184
EA-300070-01-EL	180	KYB 34X600 XX 99	179	KYC 74563K XX 99	181	TP-F50-XW	184
EA-300086-01-EL	181	KYB 355600 XX 99	182	KYC 74563P XX 99	180	TP-F50-XX	184
EA-300087-01-EL	181	KYB 35563J XX 99	181	KYC 745640 XX 99	182	TP-F53-XX	184
EA-300088-01-EL	181	KYB 35563K XX 99	181	KYC 746600 XX 99	182	TP-F60-XX 0.81	184
EA-300089-01-EL	181	KYB 35563P XX 99	180	KYC 74663J XX 99	181	TP-F90-XX	184
EA-500041-001	30	KYB 355640 XX 99	182	KYC 74663K XX 99	181	TP-H10-9W (.135i)	117
EA-900081	31, 40	KYB 356600 XX 99	182	KYC 74663P XX 99	180	TP-K40-XX-BH	184
EA-900082	31, 40	KYB 35663K XX 99	181	KYC 746640 XX 99	182	TP-K40-XX-TH	184
EN-150002-XXX (Op Code)	20	KYB 35663P XX 99	180	KYC 776600 XX 99	182	TP-K43-XX-BH	184
EN-150003-XXX (Op Code)	20	KYB 356640 XX 99	182	KYC 77663P XX 99	180		
EV-4514	22	KYB 38X600 XX 99	179	KYC 776640 XX 99	182		
EV-4515	22, 23	KYB 38X900 XX 99	179	KYC 776900 XXX 99	182		
EV-8501D	20, 21	KYB 745600 XX 99	182	KYC 77693K XXX 99	181		
EV-8501S	20, 21	KYB 74563F NM XX	180	KYC 77693P XX 99	180		
K1099	186	KYB 74563H NM XX	181	KYC 77693P XXX 99	181		
K4001	183	KYB 74563K XX 99	181	KYC 776940 XXX 99	182		
K4002	183	KYB 74563N NM XX	181	KYC 777600 XX 99	182		
K4006	183	KYB 74563P XX 99	180	KYC 77763P XX 99	180		
K5005	183	KYB 745640 XX 99	182	KYC 777640 XX 99	182		
K5006	183	KYB 746600 XX 99	182	KYC 777900 XXX 99	182		
K5007	183	KYB 74663J XX 99	181	KYC 77793J XXX 99	181		
K5010	183	KYB 74663K XX 99	181	KYC 77793K XXX 99	181		
K5011	183	KYB 74663P XX 99	180	KYC 77793P XXX 99	180		
K5012	183	KYB 746640 XX 99	182	KYC 777940 XXX 99	182		
K9001	183	KYB 776600 XX 99	182	PK-130002	178		
K9003	183	KYB 77663F NM XX	180	PK-130030	178		
KEB 44600C	30	KYB 77663H NM XX	181	PX-KYLUB203	187		
KEC 42602B	40	KYB 77663N NM XX	181	PX-KYLUBL-50	187		
KEC 42603B	40	KYB 77663P XX 99	180	RE-PIN	177		
KEC 4260CR	40	KYB 776900 XXX 99	182	RE-PIN-MK	177		

Finishes Available - Commercial & Industrial Locks

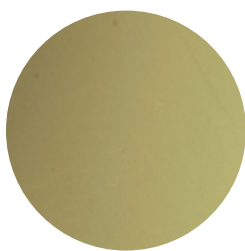

05
(US03)
Bright Brass

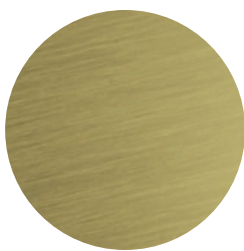

06
(US04)
Satin Brass



09
(US5)
Antique Brass

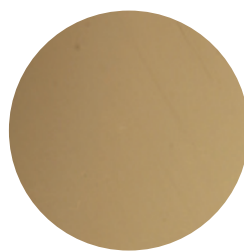

11
(US9)
Bright Bronze



12
(US10)
Satin Bronze



13
(US10B)
**Dark Bronze/
Oil Rubbed**

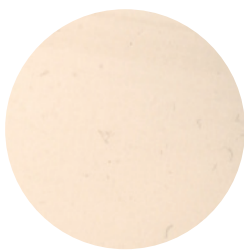

18
(US14)
Bright Nickel



19
(US15)
Satin Nickel

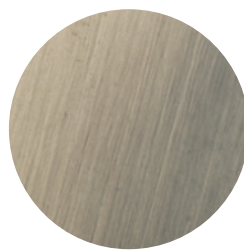

20
(US15A)
Antique Nickel

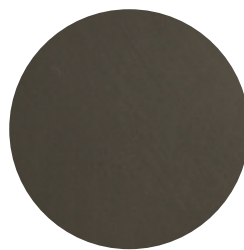

22
(US19)
Flat Black

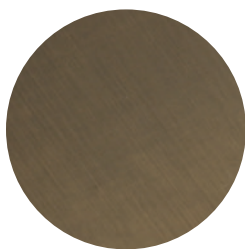

24
(US20A)
**Dark Bronze/
Clear Coat**

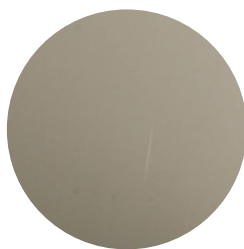

25
(US26)
Bright Chrome



26
(US26A)
Satin Chrome

Note: Product appearance may differ from this chart as a result of the differences in plated versus printed materials.



MEDECO U.S.: 3625 Alleghany Drive | P.O. Box 3075 | Salem, Virginia 24153-0330
Customer Service: 1-877-633-3261

MEDECO CANADA: 160 Four Valley Drive | Vaughan, ON L4K 4T9 CANADA
Customer Service: 1-888-633-3264

ASSA ABLOY, the global leader in door opening solutions, dedicated to satisfying end-user needs for security, safety, and convenience.



facebook.com/medeco



twitter.com/medecolocks



youtube.com/medeco



newsletter sign up: medeco.com