

 MARKSUSA®

CUSTOM LOCKSET DIVISON

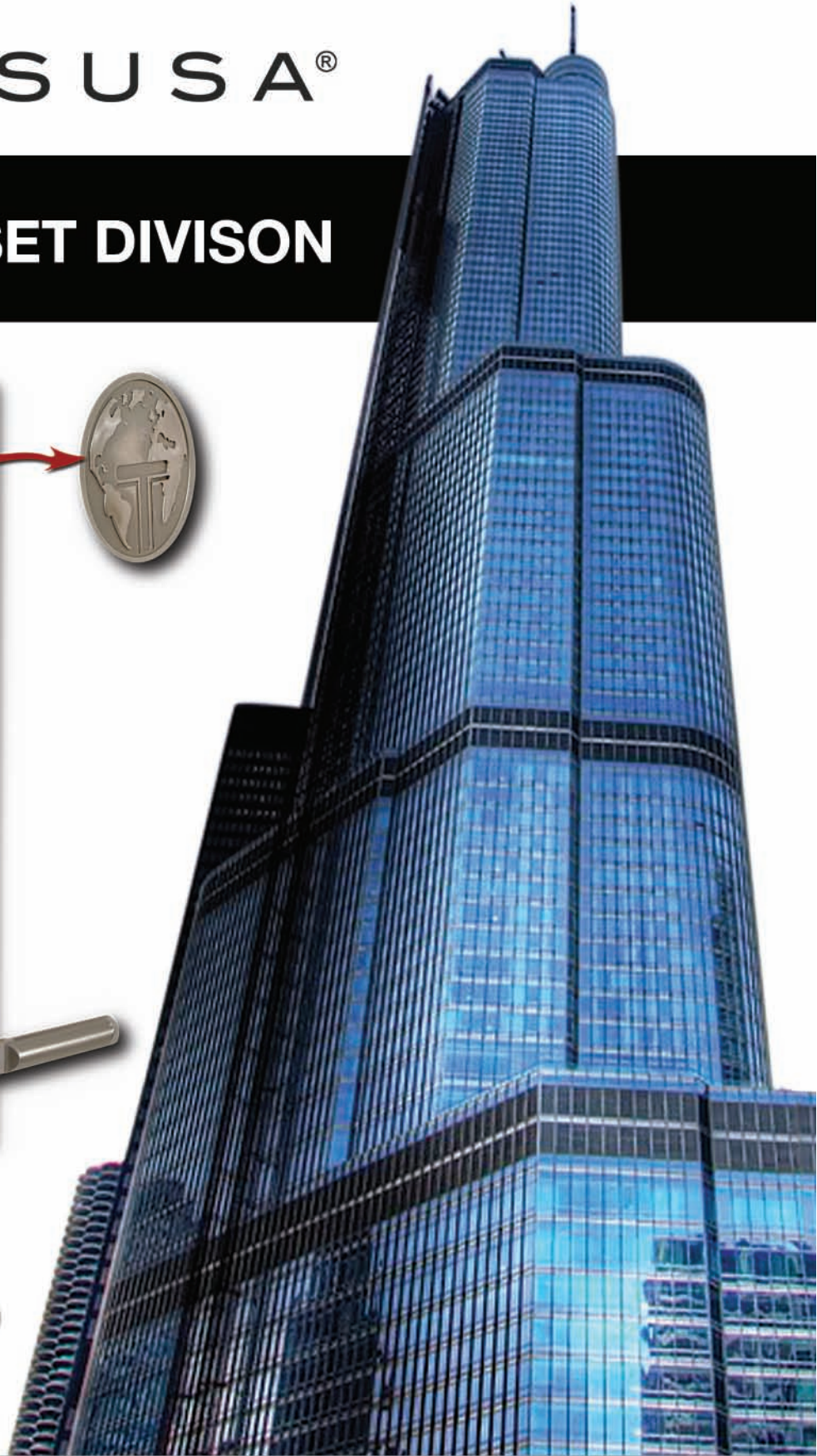

**Levers, Knobs & Escutcheons
For Interior & Exterior Doors**

MARKS USA CUSTOM LOCKSET DIVISION

Marks USA Custom Lockset Division product is manufactured with the quality engineered mechanical locksets that carry our Lifetime Mechanical Warranty. These products are non-stocked due to the large array of both designs and finishes and thus require longer lead times and minimum order quantities. This catalogue is only a sampling of the designs that can be supplied. Standard mortise & tubular lock trim are usually stocked and are available in normal lead times.

Table of Contents:

Stainless Steel Investment Cast Levers2-14
Stainless Steel Tubular Levers15-19
Standard Mortise & Tubular Lock Trim & Rose Styles20
Custom Forged Brass Levers21
Turnpieces22
Custom Forged Brass Trim23
Custom Escutcheon Plates24-26

Lifetime Mechanical Limited Warranty

MARKS USA warrants that its products are free from defects in materials and workmanship. This warranty is limited to the lifetime of the door on which our lock is installed. In the event our product does not conform to this warranty, MARKS USA will repair or replace the product free of charge. This warranty does not cover defects or damage arising from improper installation, lack of or improper maintenance, improper storage, shipping and handling, ordinary wear and tear, misuse, abuse, accident, unauthorized service, or use with unauthorized non-MARKS products or parts. We reserve the right to make changes in materials, components or manufacturing methods. Liability under all warranties expressed or implied is limited to replacement of the defective goods. This warranty does not cover nor provide for the reimbursement or payment of incidental or consequential damages. Additionally, the company will not warrant ANSI A156.2 Grade 2 lever product installed in educational facilities and student housing.



Common pin tumbler cylinders may be compromised by picking, drilling or key bumping.

For applications where a greater security level is required, we suggest using drill/pick resistant cylinders with multiple pin planes such as those with sidebars.

Marks USA HI-SECURITY™ Cylinders are constructed with sidebars and are drill, pick and bump resistant.

STAINLESS STEEL INVESTMENT CAST LEVER HANDLE FOR GRADE 1 MORTISE & TUBULAR LOCKSETS

SF001

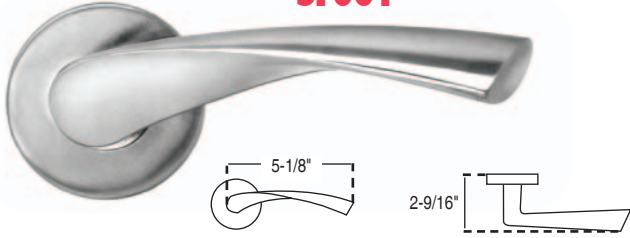

SF002



SF003

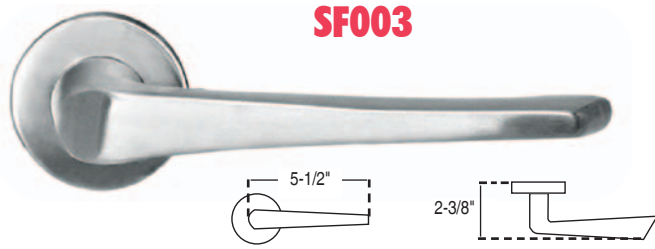

SF004



SF005

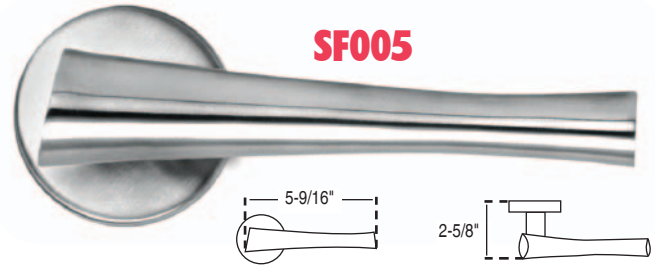

SF006

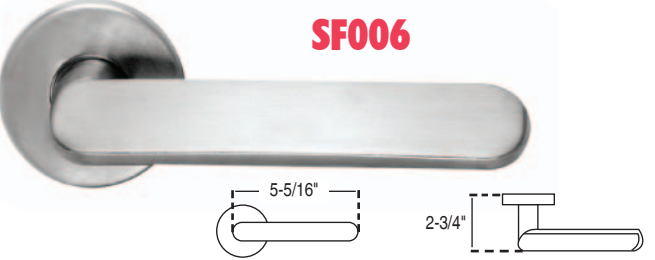

SF007

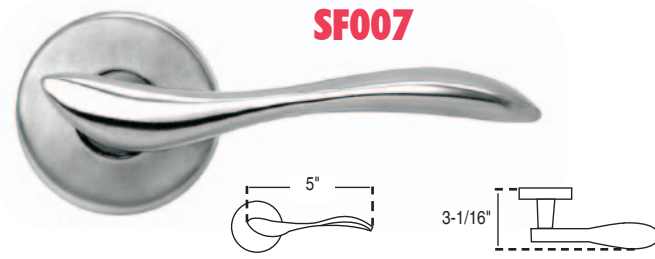

SF008



SF009



SF010

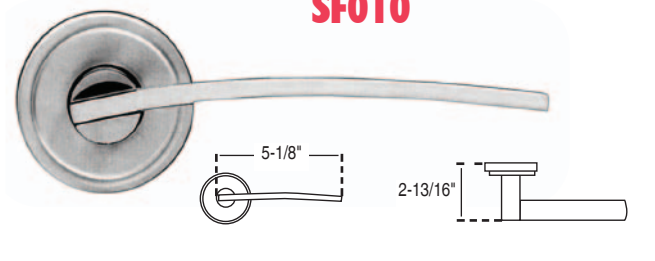

SF011

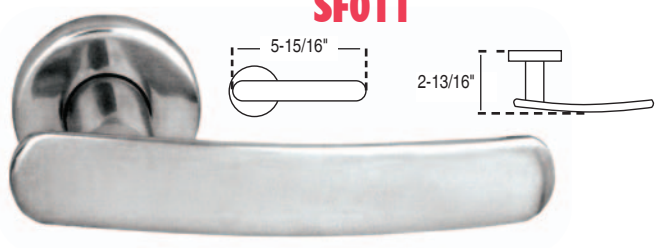

SF012

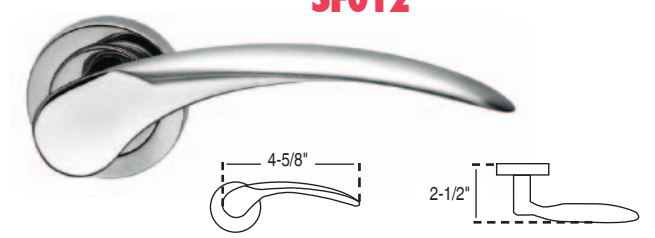

STAINLESS STEEL INVESTMENT CAST LEVER HANDLE FOR GRADE 1 MORTISE & TUBULAR LOCKSETS

SF013

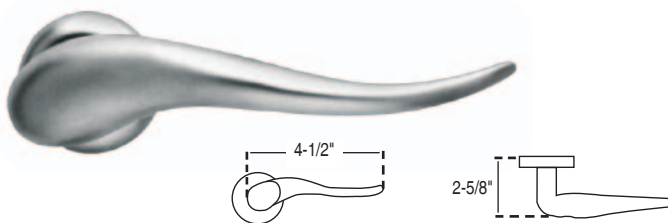

SF014

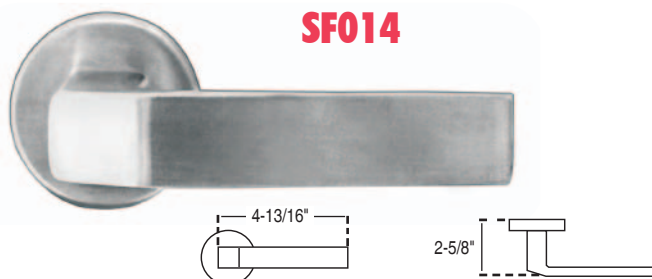

SF015

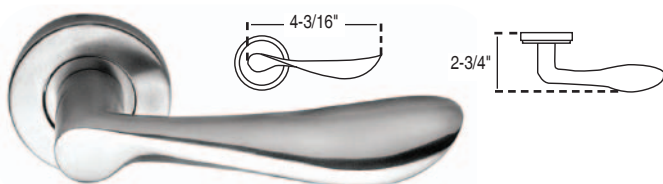

SF016

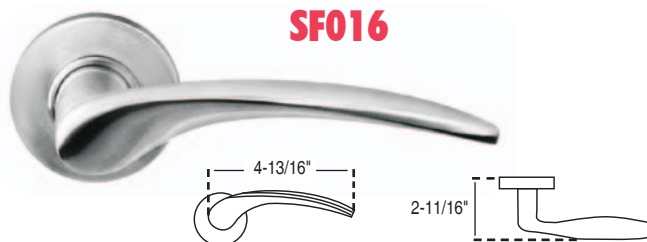

SF017



SF018

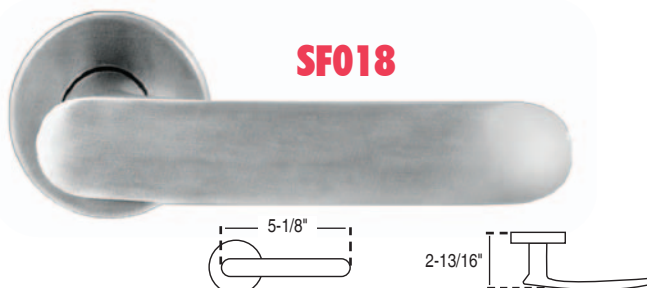

SF019

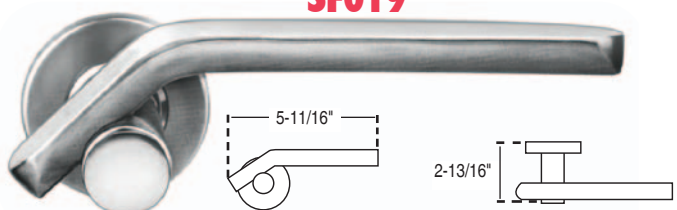

SF020

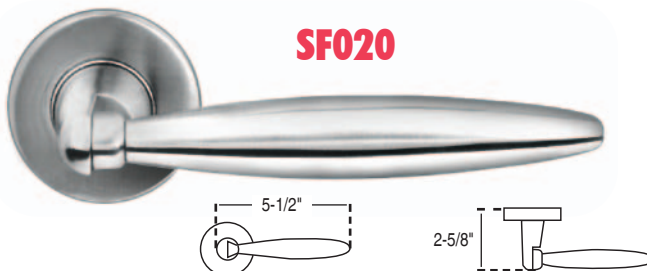

SF021

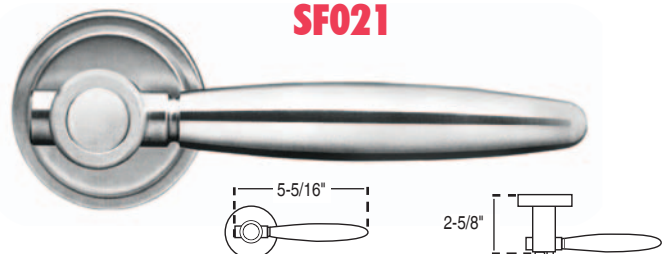

SF022

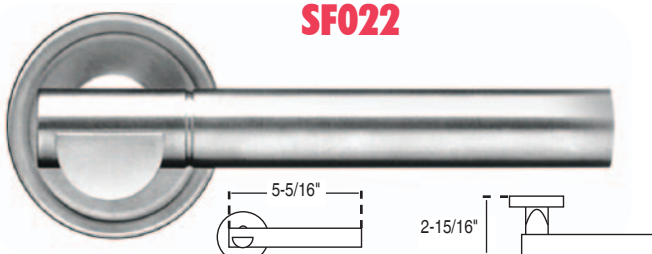

SF023

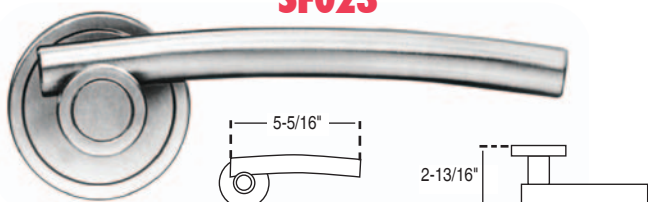

SF024



STAINLESS STEEL INVESTMENT CAST LEVER HANDLE FOR GRADE 1 MORTISE & TUBULAR LOCKSETS

SF025

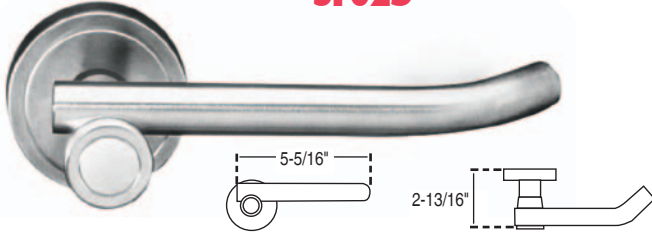

SF026

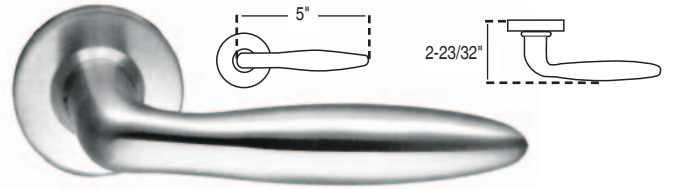

SF027

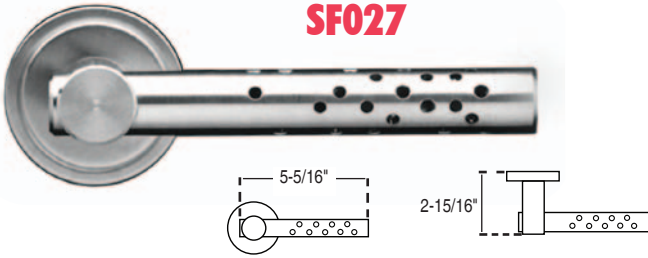

SF029

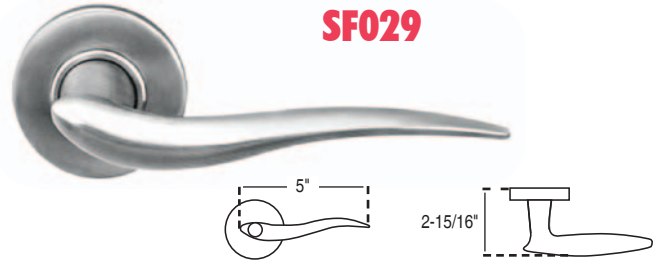

SF030

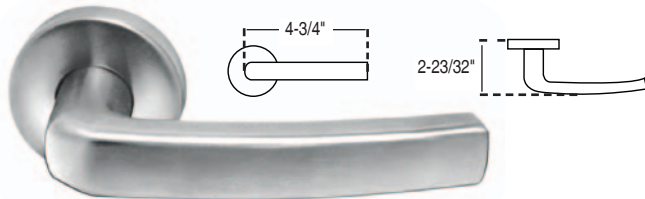

SF031

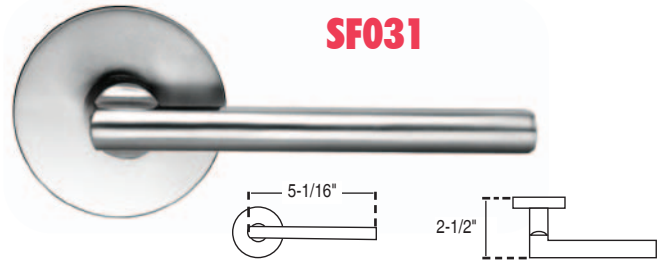

SF032



SF033



SF034

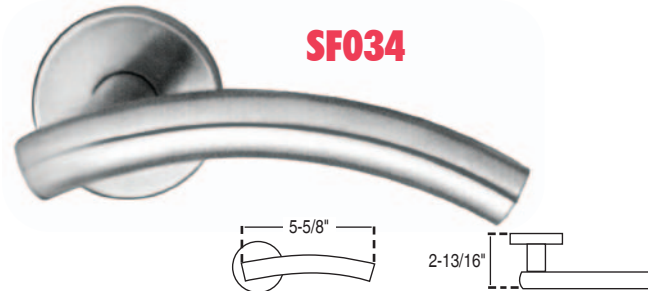

SF035

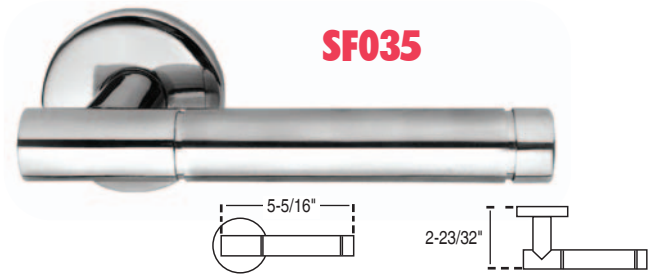

SF035A

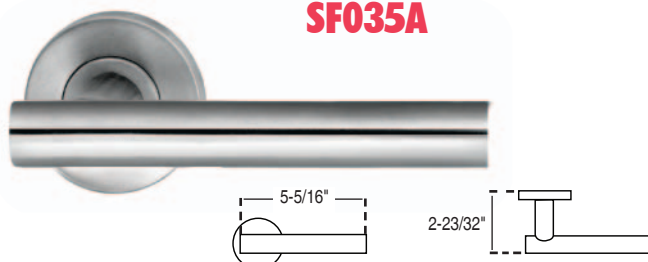

SF036



STAINLESS STEEL INVESTMENT CAST LEVER HANDLE FOR GRADE 1 MORTISE & TUBULAR LOCKSETS

SF037

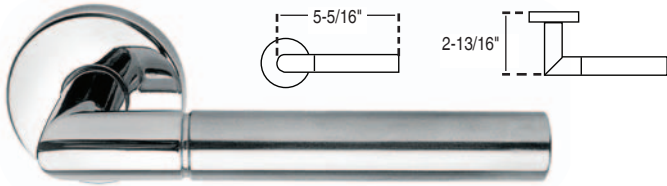

SF037A

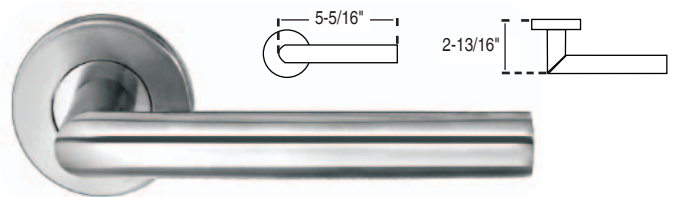

SF038



SF040

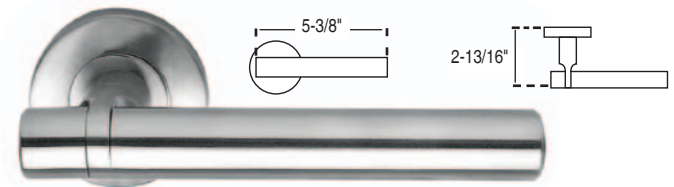

SF041

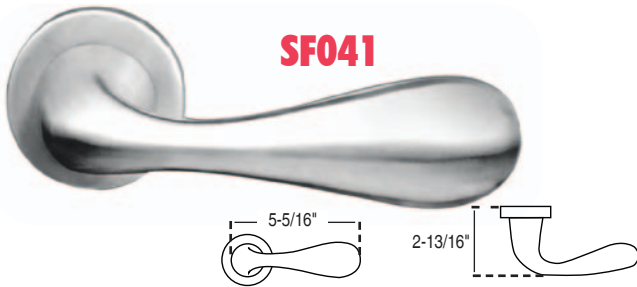

SF042

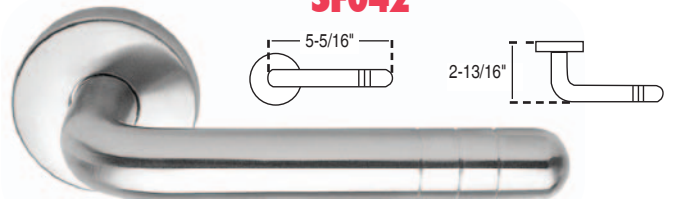

SF043

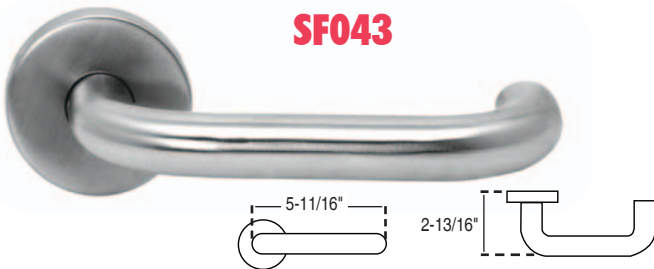

SF044

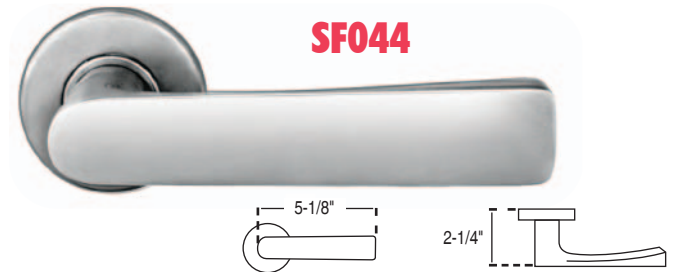

SF045



SF046



SF047

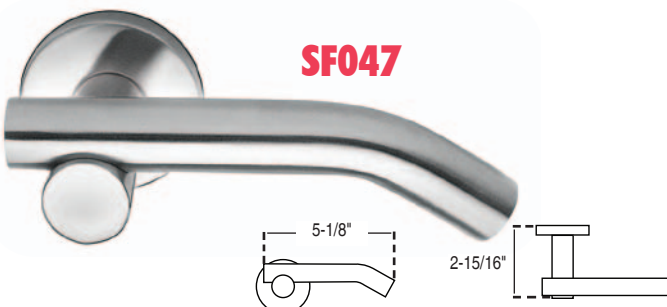

SF048

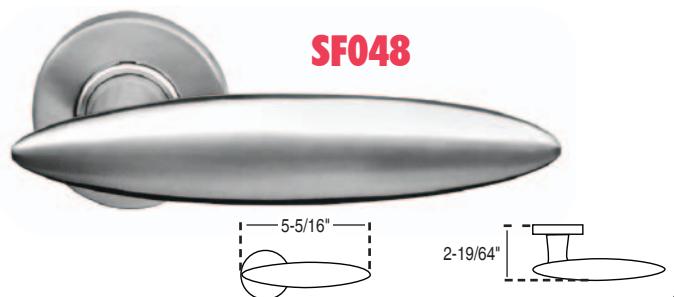

STAINLESS STEEL INVESTMENT CAST LEVER HANDLE FOR GRADE 1 MORTISE & TUBULAR LOCKSETS

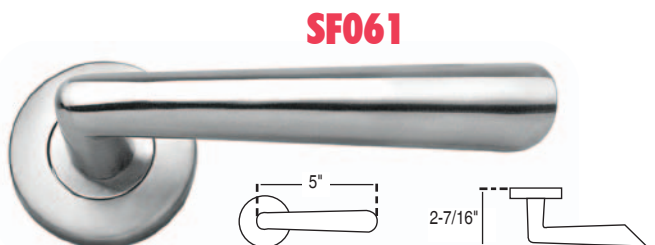
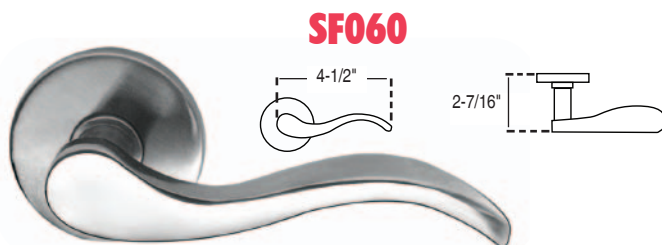
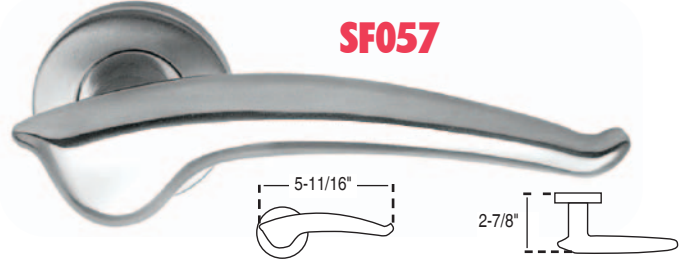
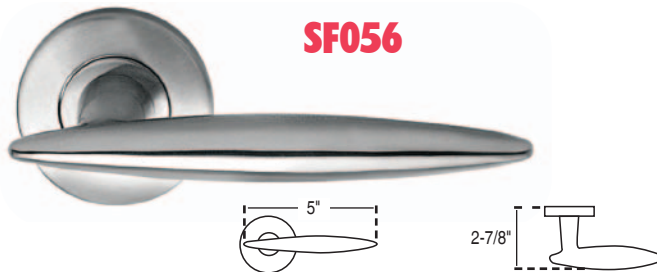
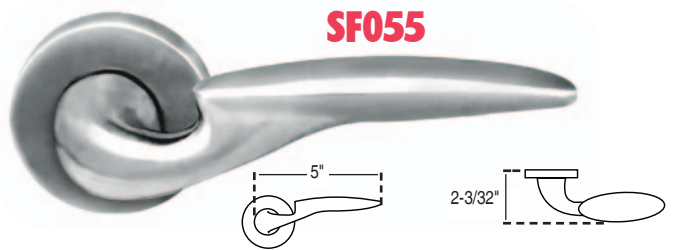
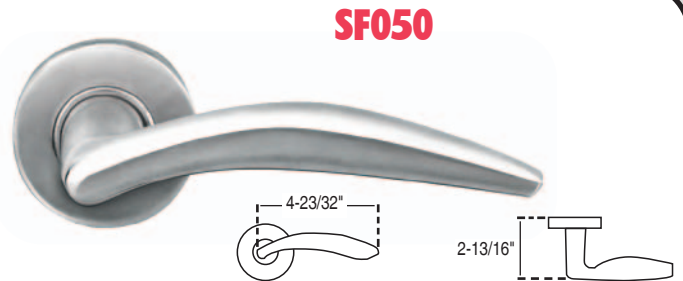
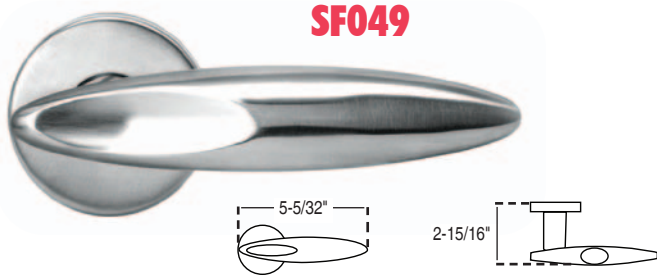

STAINLESS STEEL INVESTMENT CAST LEVER HANDLE FOR GRADE 1 MORTISE & TUBULAR LOCKSETS

SF062

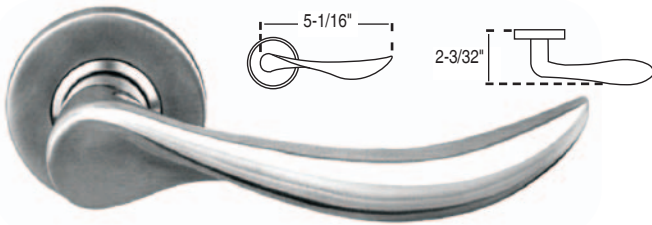

SF063

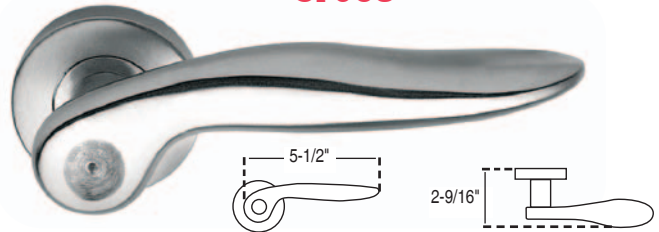

SF064

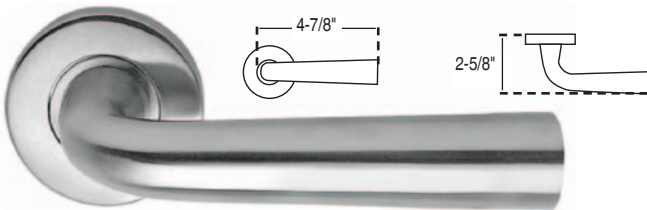

SF065

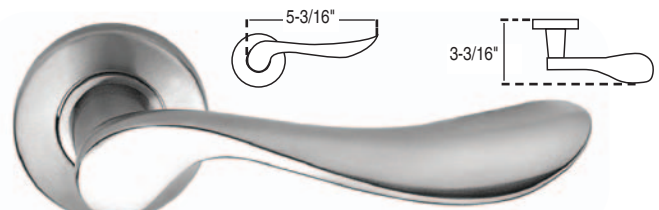

SF067

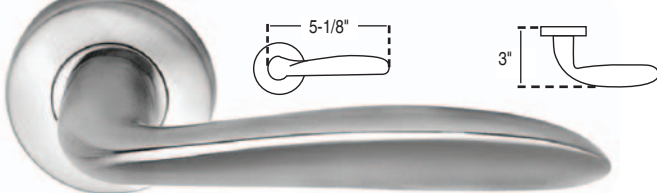

SF068

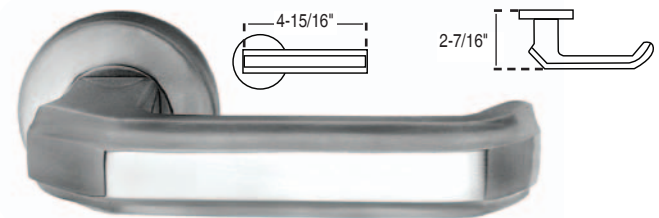

SF069

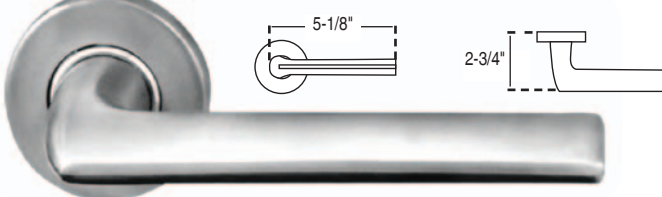

SF070

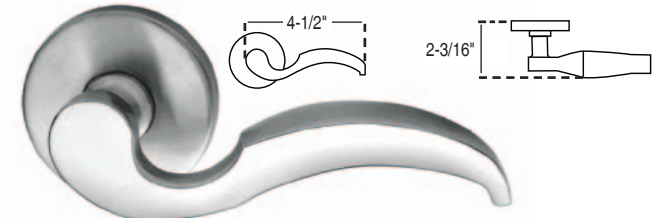

SF071

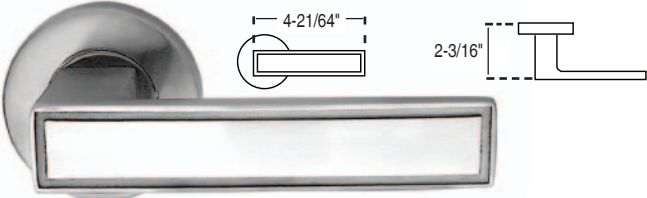

SF072

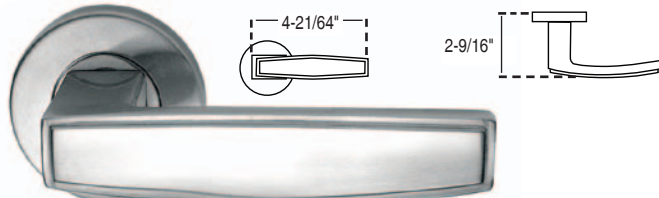

SF073

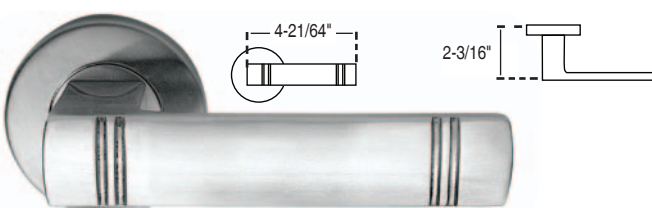

SF074

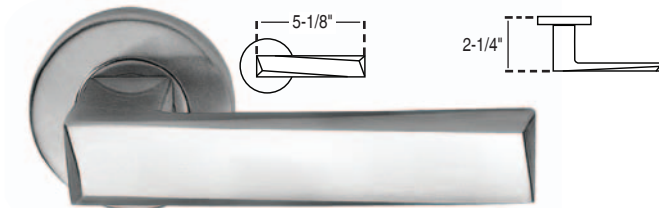

STAINLESS STEEL INVESTMENT CAST LEVER HANDLE FOR GRADE 1 MORTISE & TUBULAR LOCKSETS

SF075

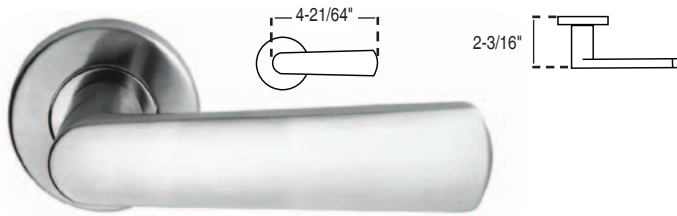

SF076

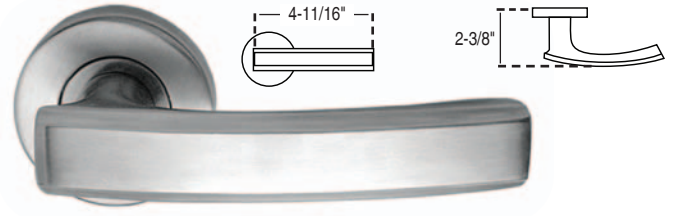

SF077



SF078

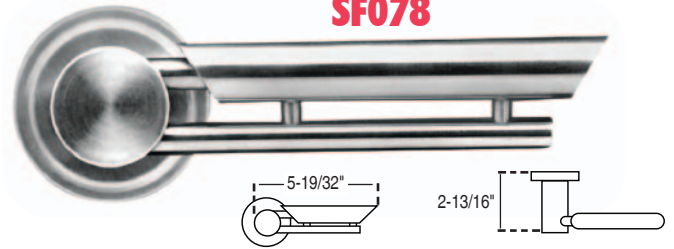

SF080

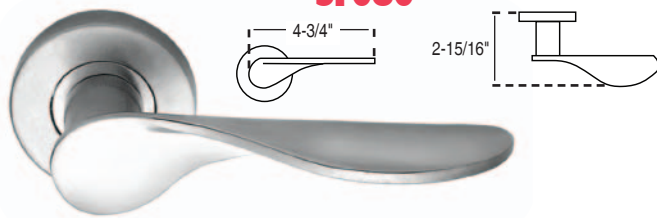

SF081

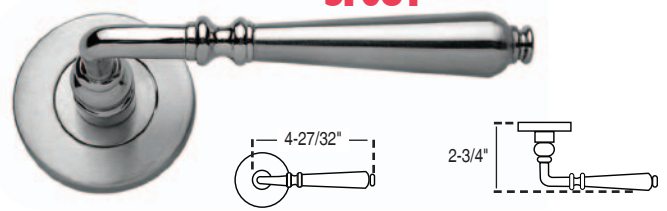

SF082

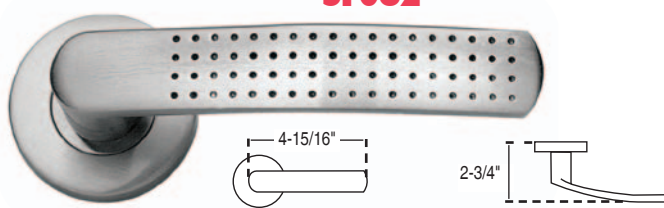

SF083

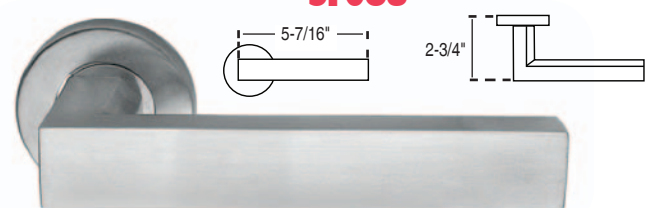

SF084

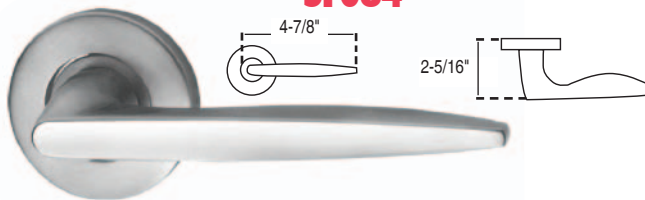

SF085



SF086

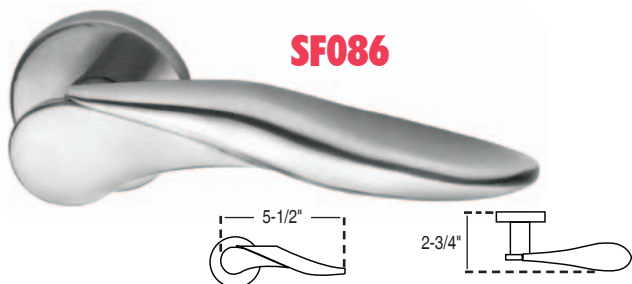

SF087

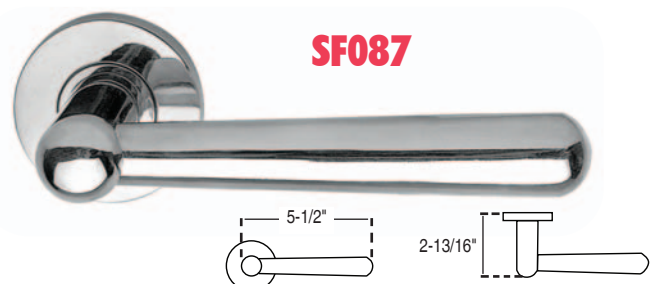

STAINLESS STEEL INVESTMENT CAST LEVER HANDLE FOR GRADE 1 MORTISE & TUBULAR LOCKSETS

SF088

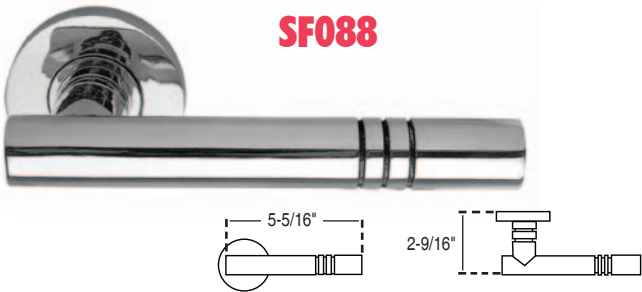

SF089

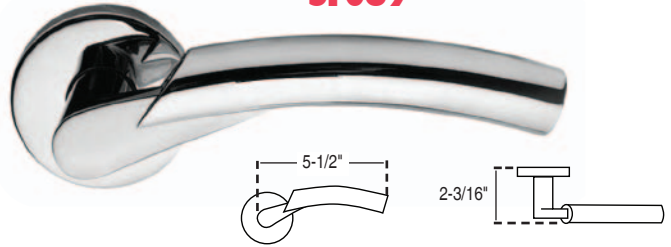

SF090



SF091



SF092

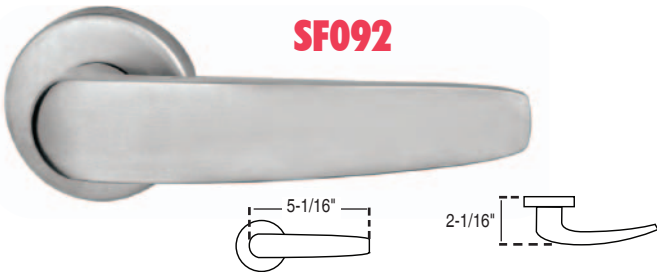

SF093



SF094

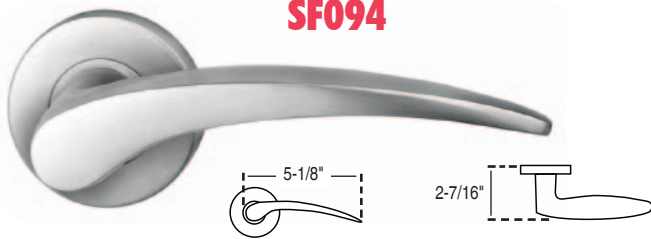

SF095



SF096



SF097

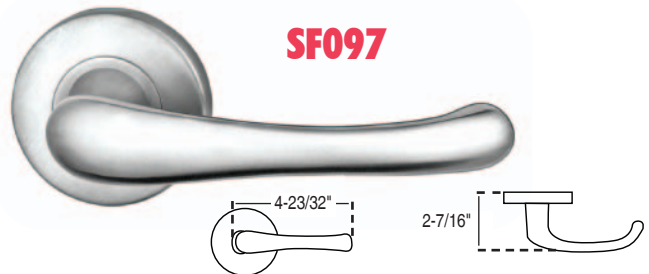

SF098

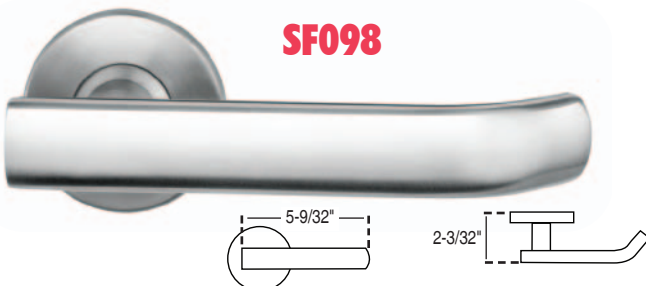

SF099



STAINLESS STEEL INVESTMENT CAST LEVER HANDLE FOR GRADE 1 MORTISE & TUBULAR LOCKSETS

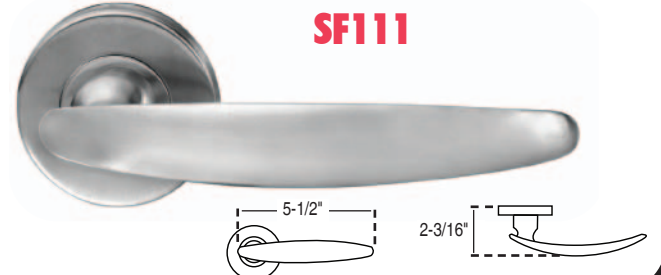
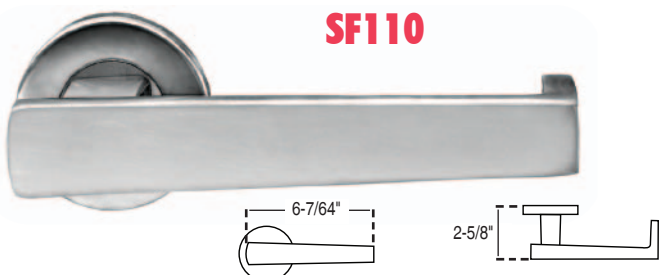
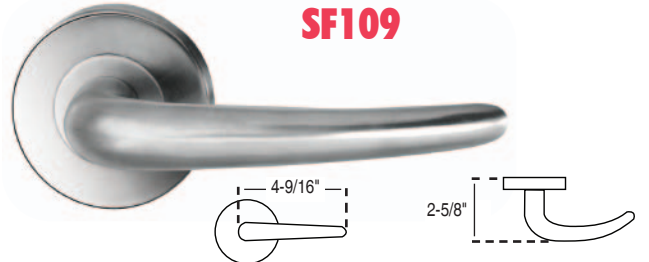
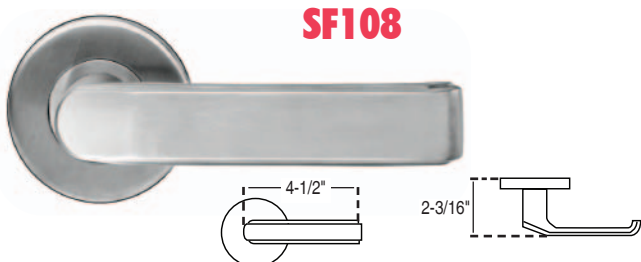
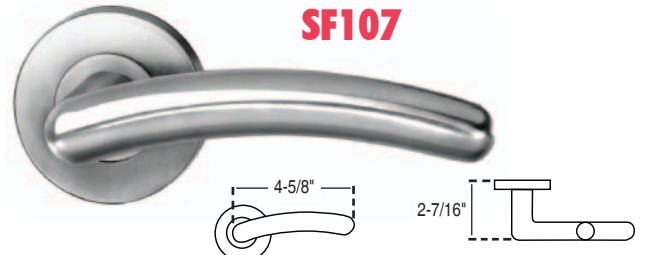
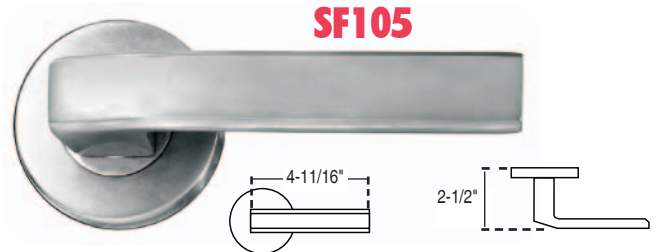
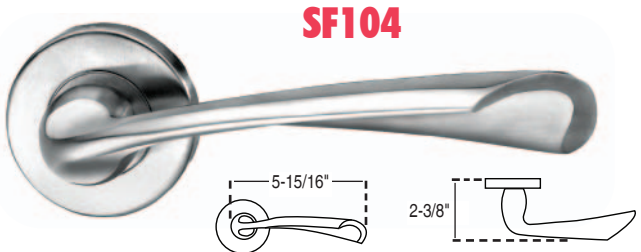
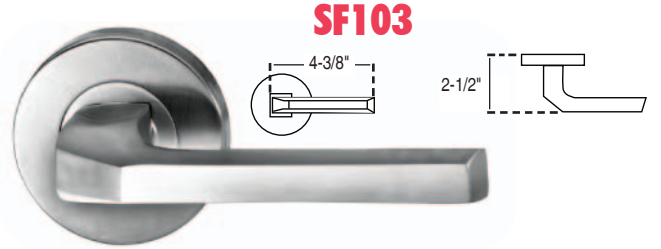
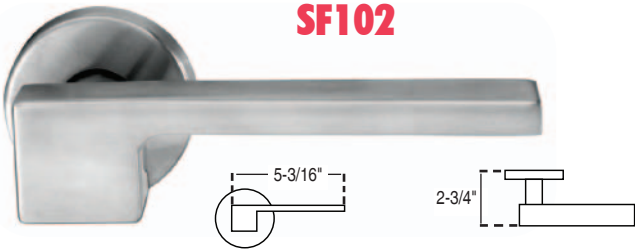
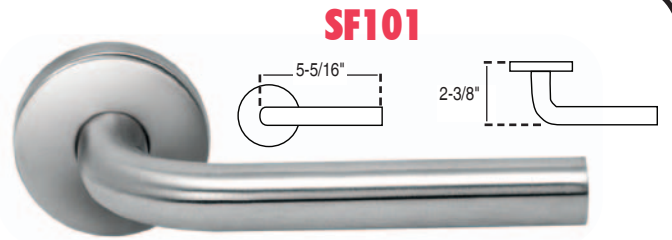
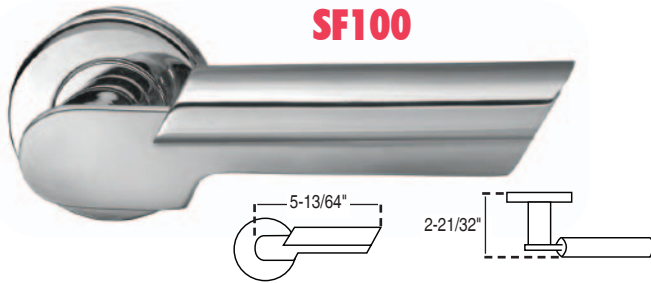

STAINLESS STEEL INVESTMENT CAST LEVER HANDLE FOR GRADE 1 MORTISE & TUBULAR LOCKSETS

SF112

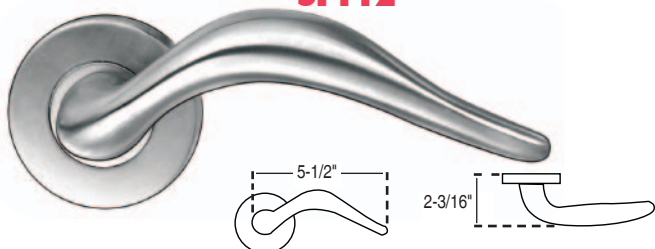

SF113



SF114

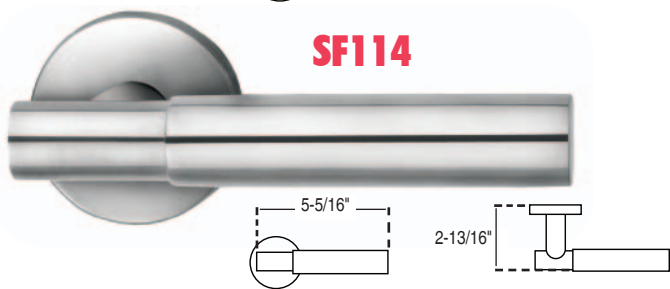

SF115

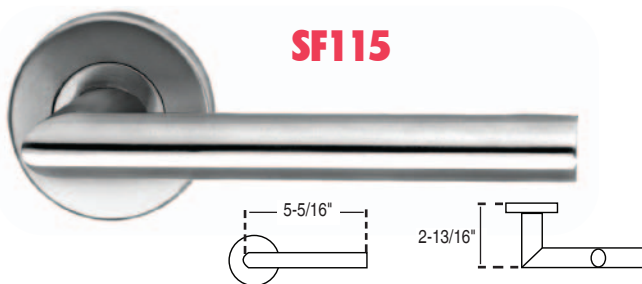

SF116

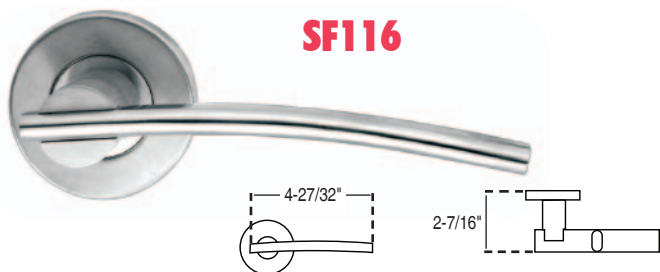

SF117

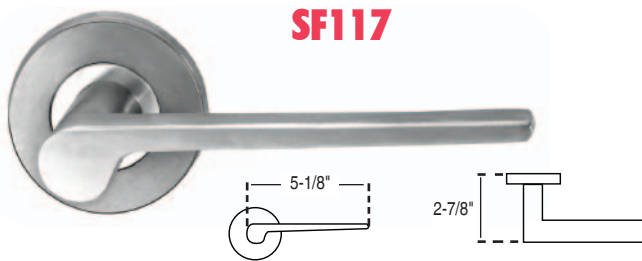

SF118



SF119

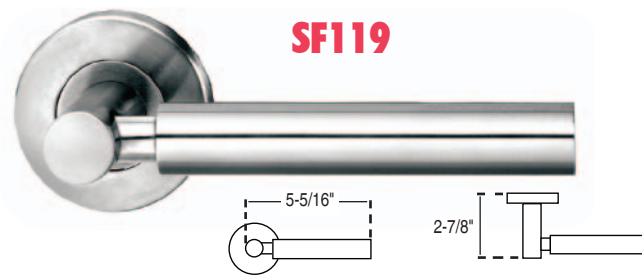

SF120



SF121

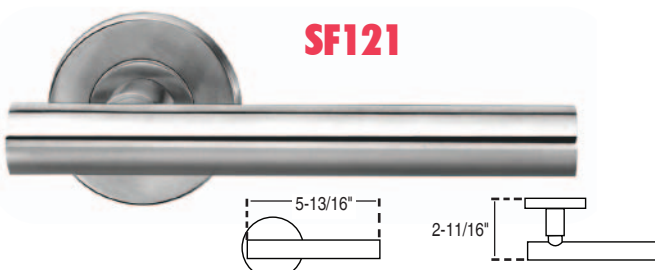

SF122

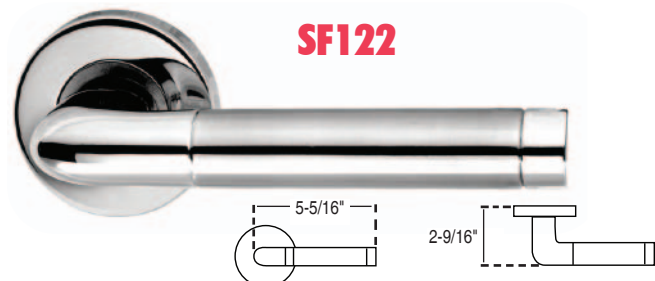

SF123

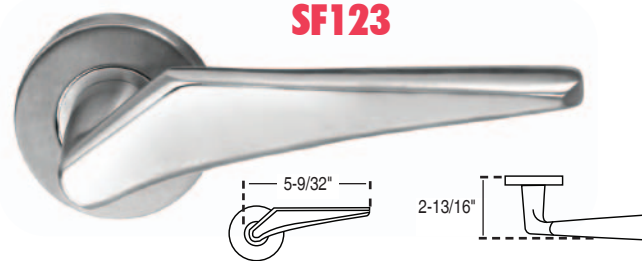

STAINLESS STEEL INVESTMENT CAST LEVER HANDLE FOR GRADE 1 MORTISE & TUBULAR LOCKSETS

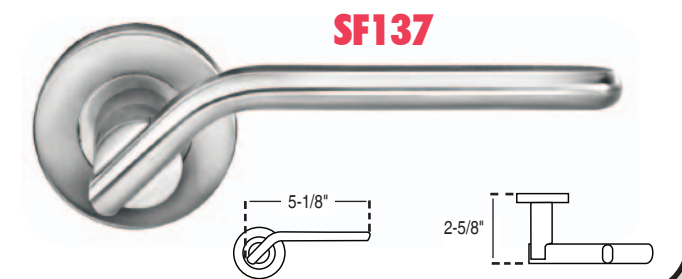
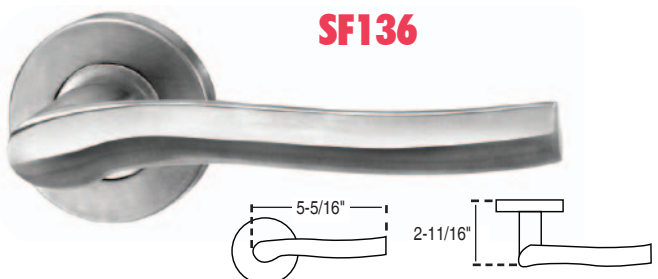
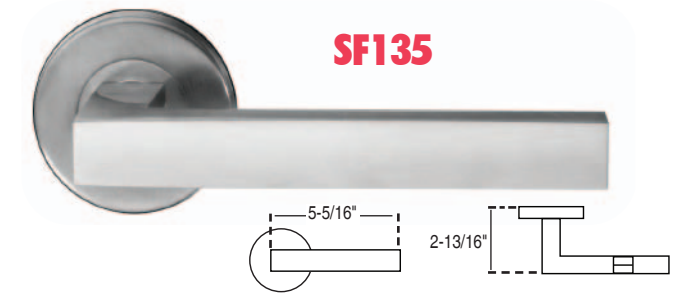
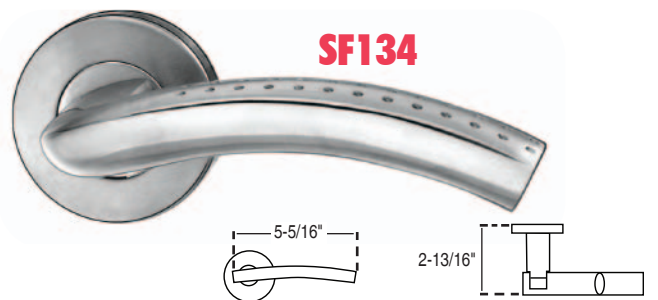
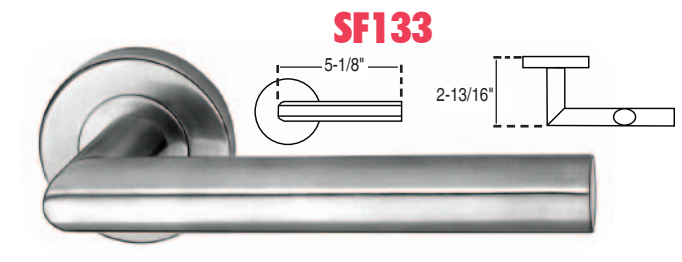
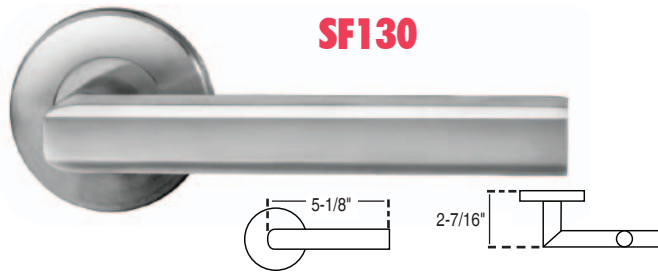
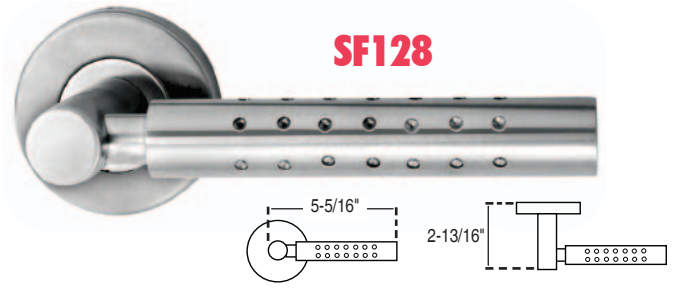
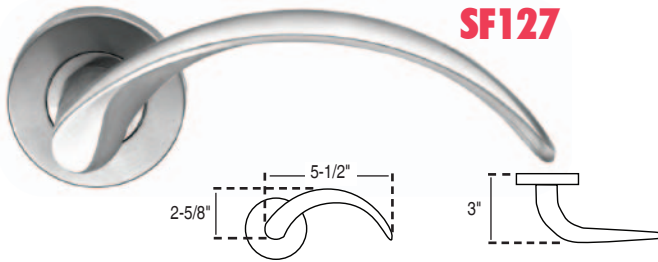
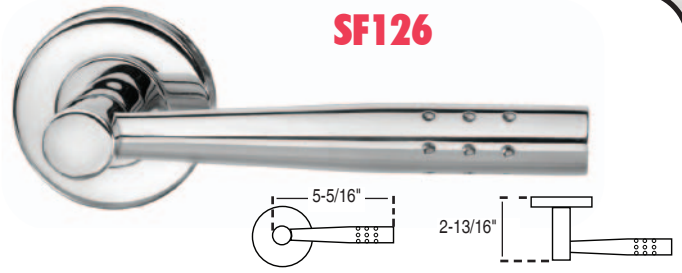
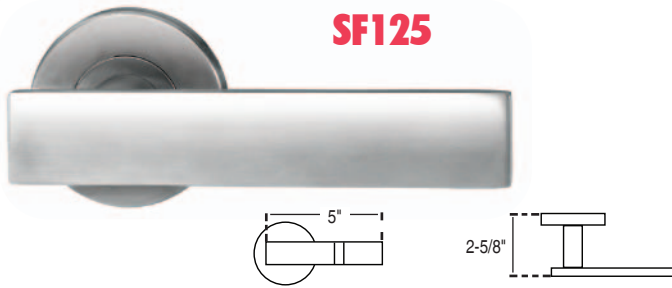

STAINLESS STEEL INVESTMENT CAST LEVER HANDLE FOR GRADE 1 MORTISE & TUBULAR LOCKSETS

SF138

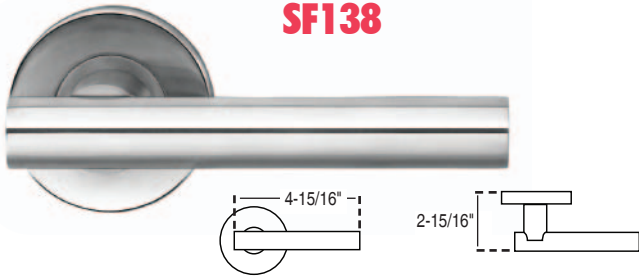

SF139



SF140



SF141

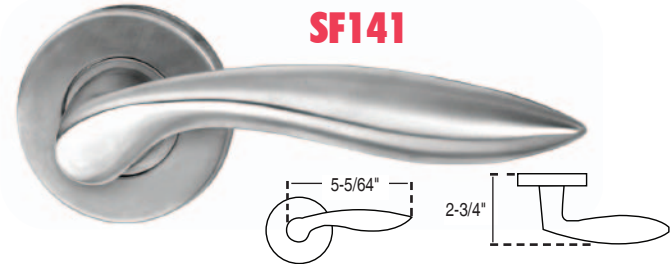

SF142



SF144



SF145



SF146

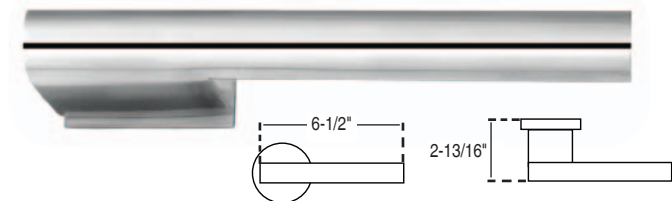

SF147



SF148

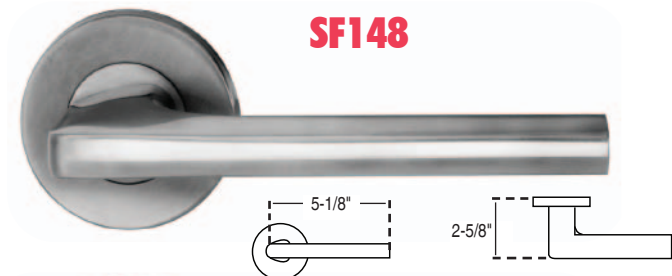

SF149

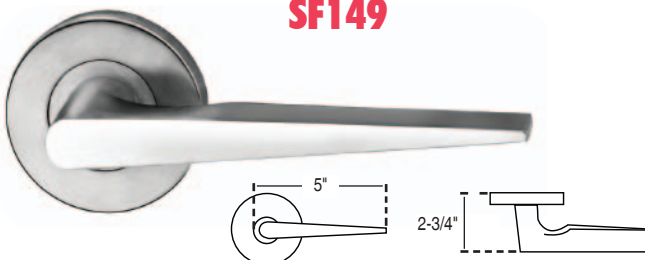

SF150

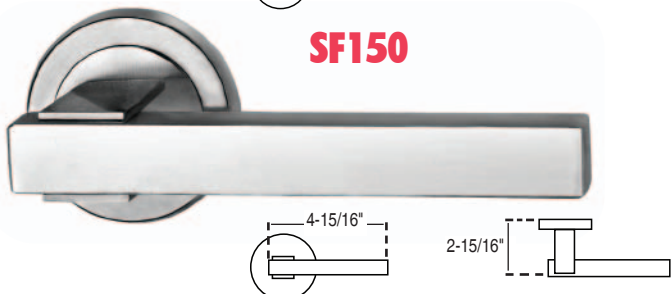

STAINLESS STEEL INVESTMENT CAST LEVER HANDLE FOR GRADE 1 MORTISE & TUBULAR LOCKSETS

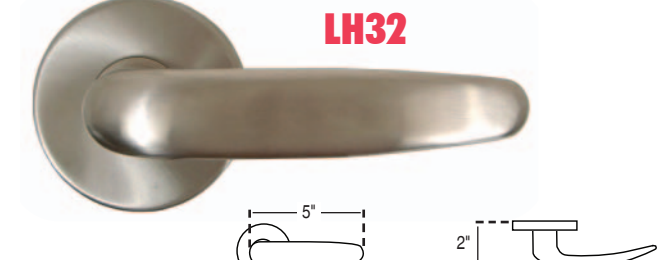
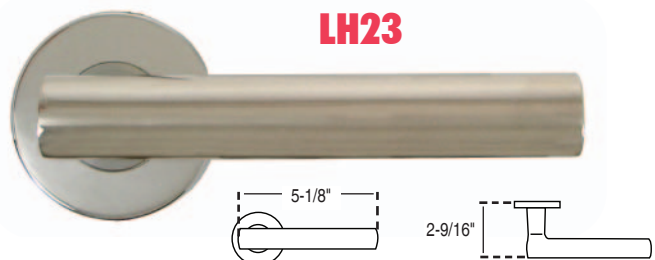
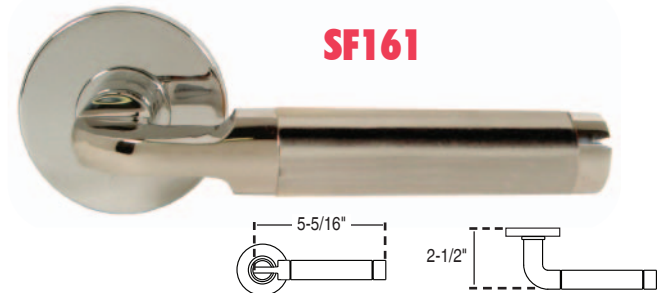
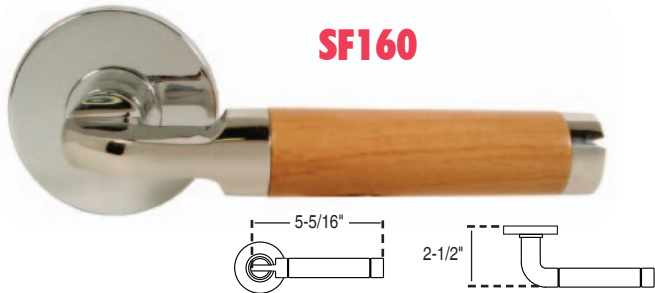
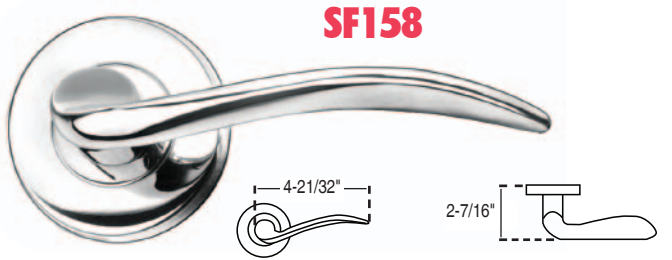
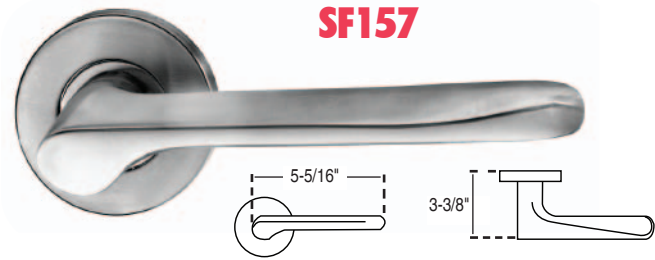
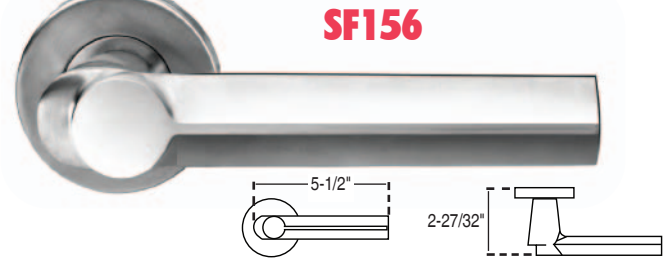
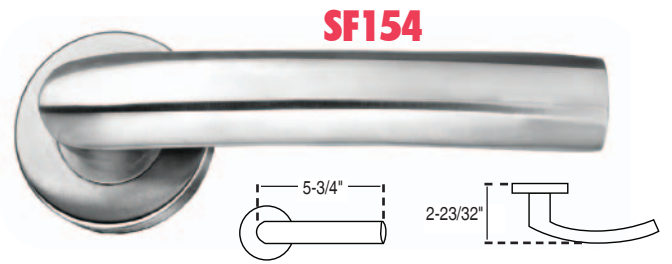
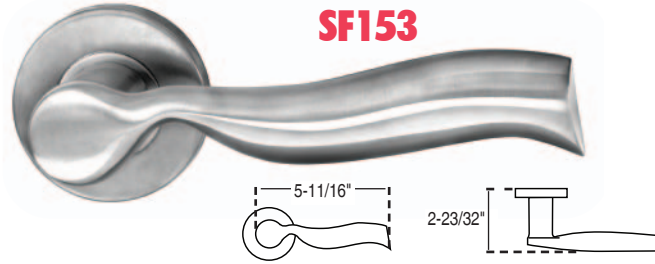
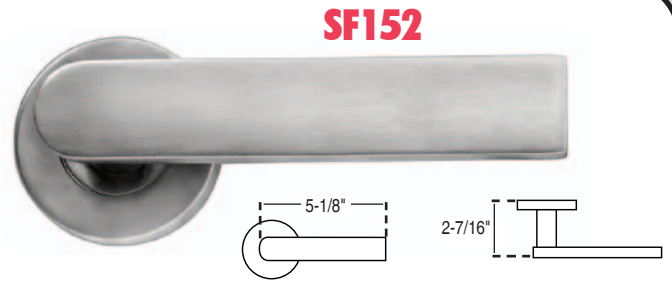
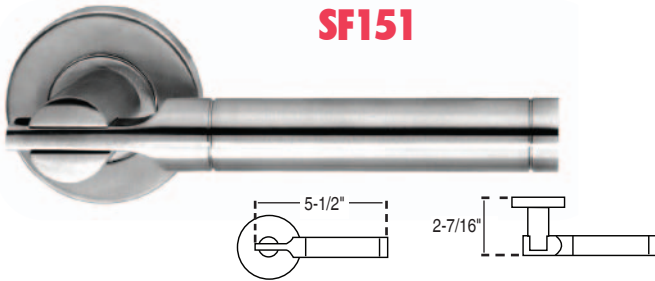

STAINLESS STEEL TUBULAR LEVERS FOR TUBULAR LOCKSETS

SD001

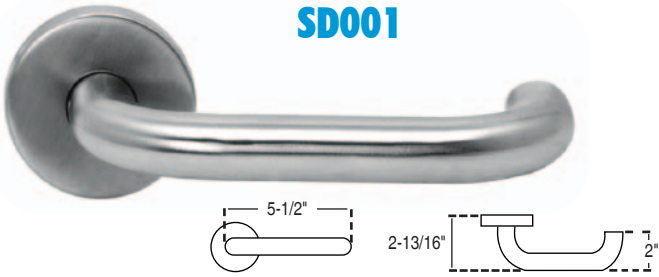

SD002

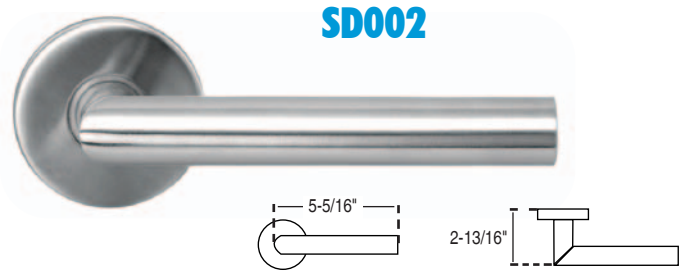

SD002A

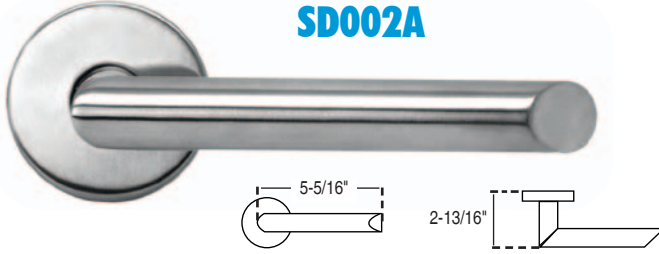

SD002B

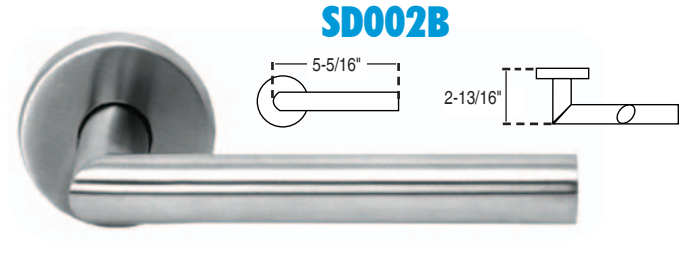

SD003



SD004



SD005

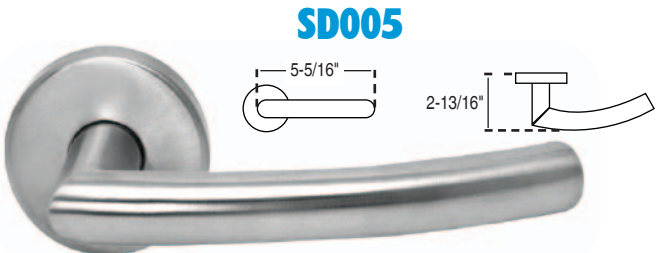

SD006

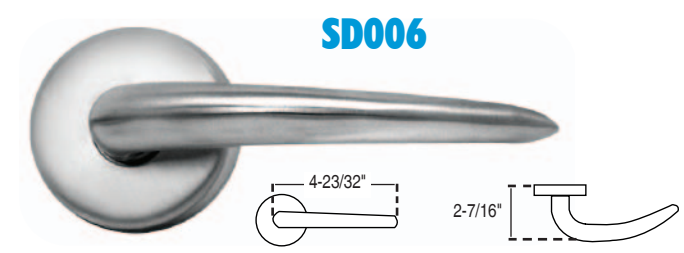

SD007

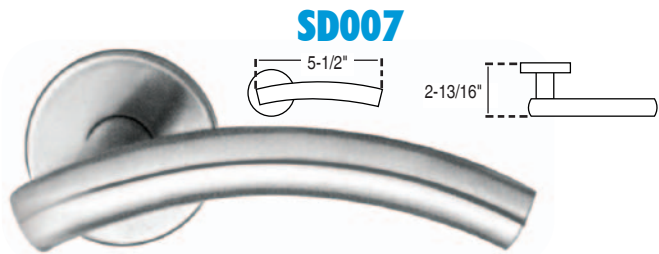

SD008



SD009



SD010

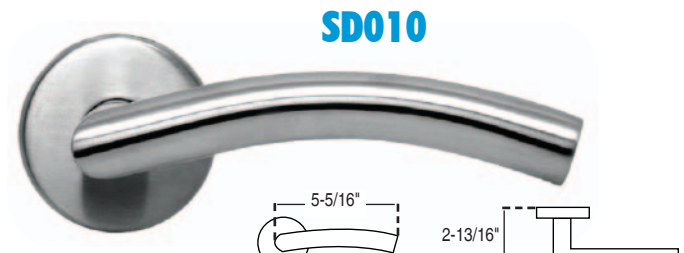

STAINLESS STEEL TUBULAR LEVERS FOR TUBULAR LOCKSETS

SD011

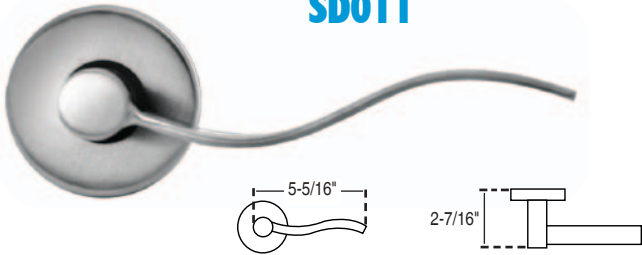

SD012



SD013

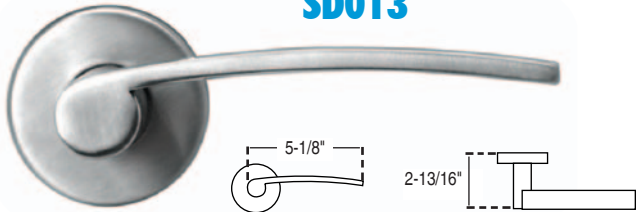

SD014

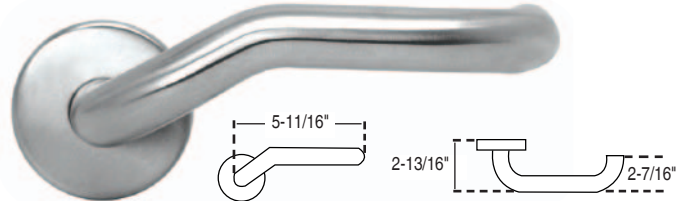

SD015

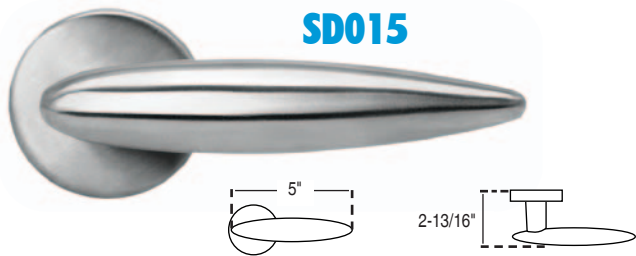

SD015A

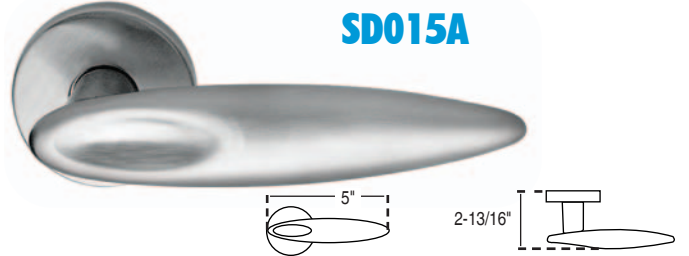

SD016

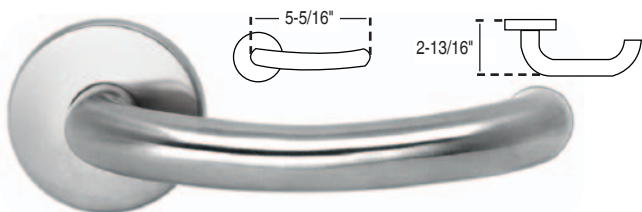

SD017

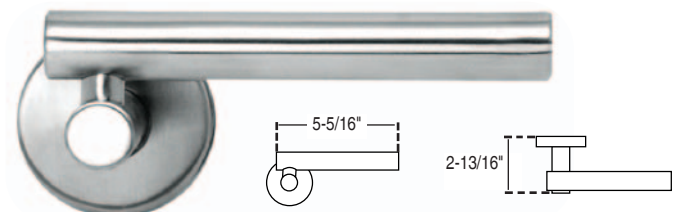

SD018



SD019



SD020

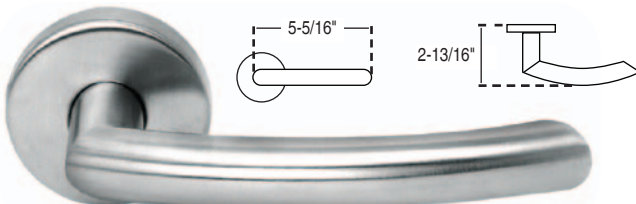

SD021

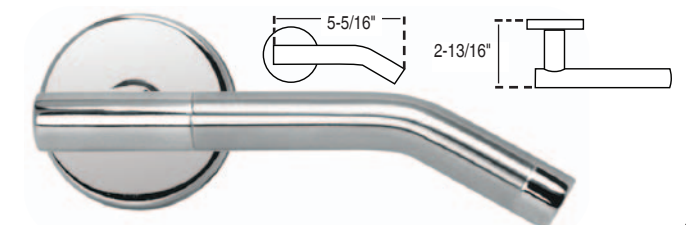

STAINLESS STEEL TUBULAR LEVERS FOR TUBULAR LOCKSETS

SD022



SD023



SD024

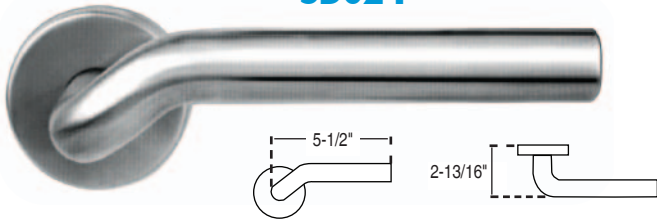

SD025

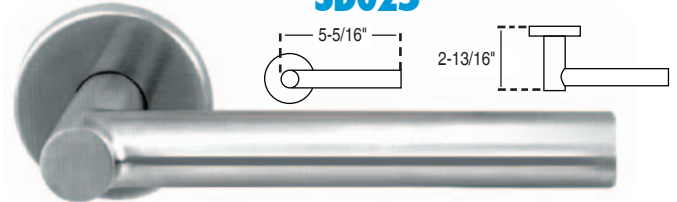

SD026

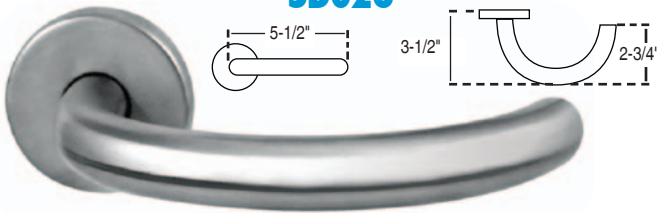

SD027



SD028

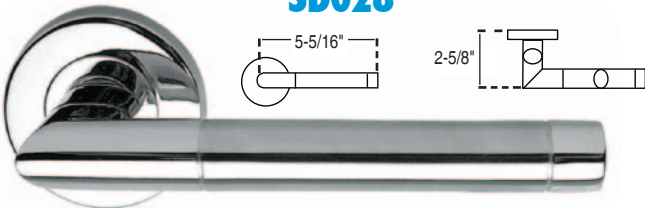

SD029



SD030



SD031



SD032

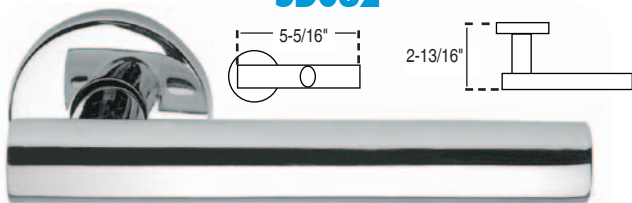

SD033

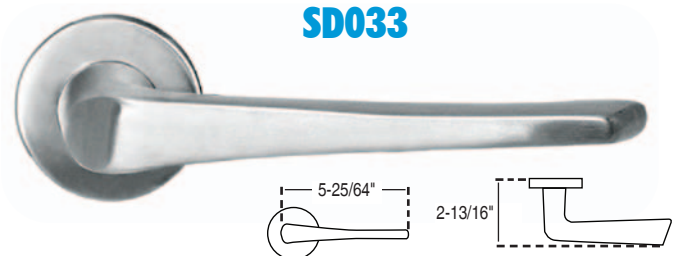

STAINLESS STEEL TUBULAR LEVERS FOR TUBULAR LOCKSETS

SD034

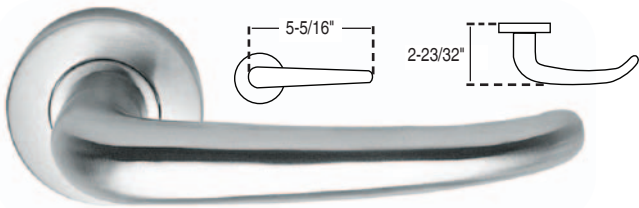

SD035

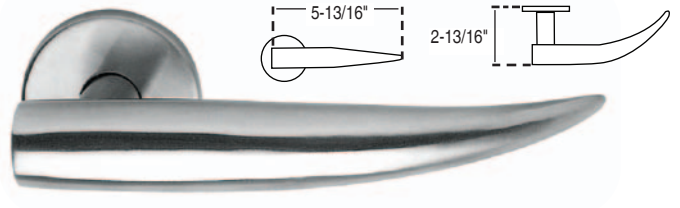

SD036

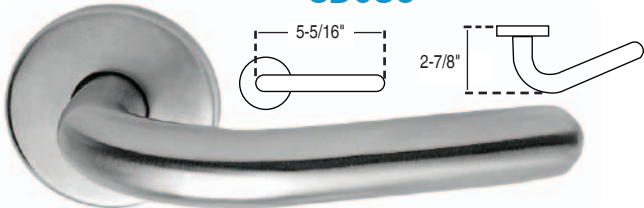

SD037

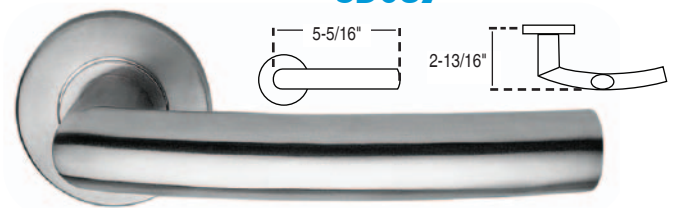

SD038

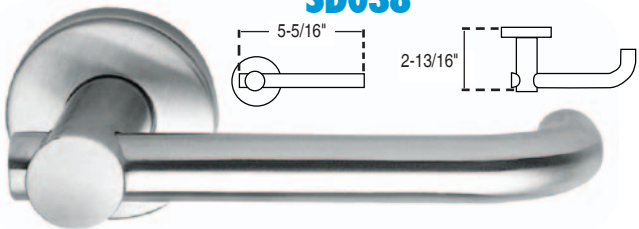

SD039

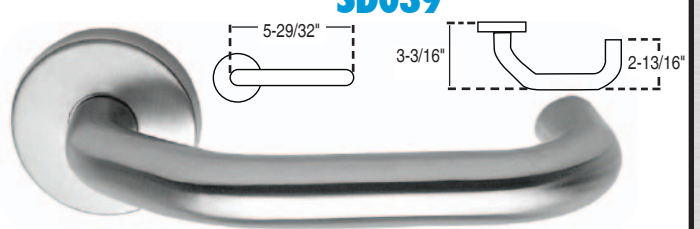

SD040

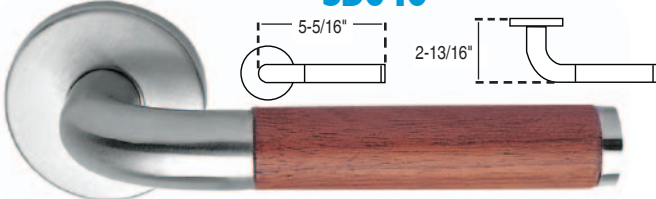

SD041



SD042

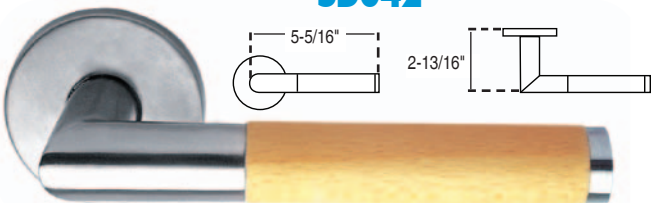

SD043

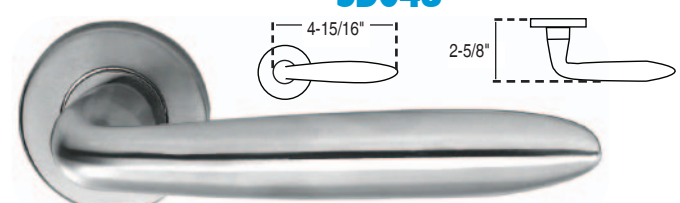

SD046

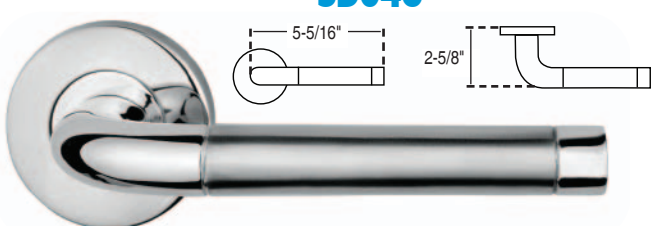

SD047

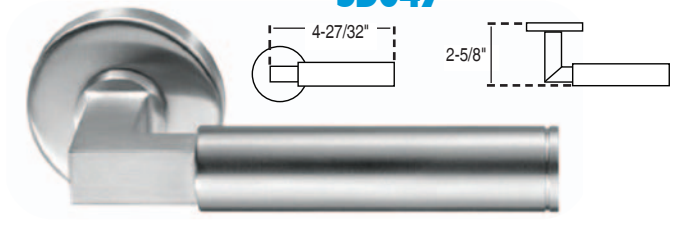

STAINLESS STEEL TUBULAR LEVERS FOR TUBULAR LOCKSETS

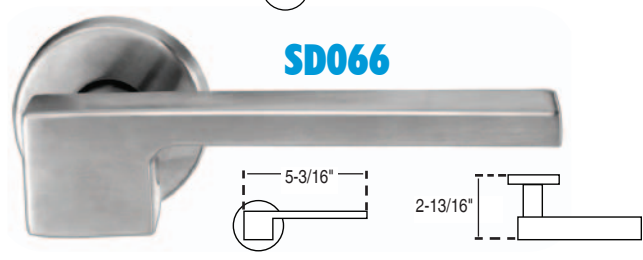
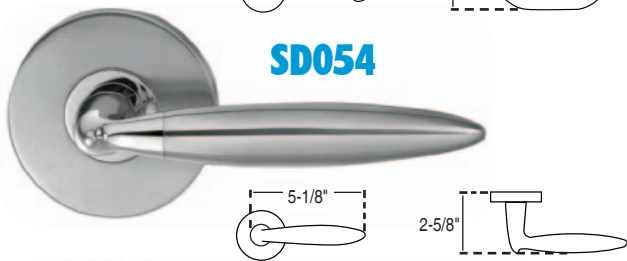
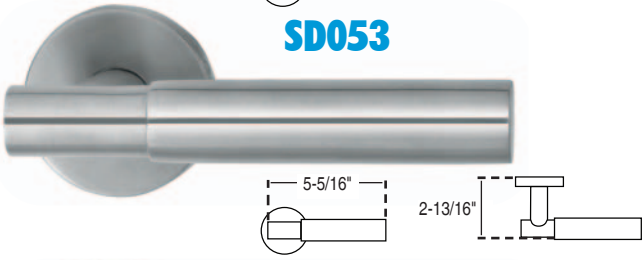
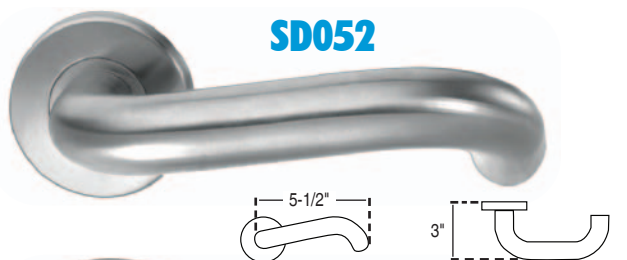
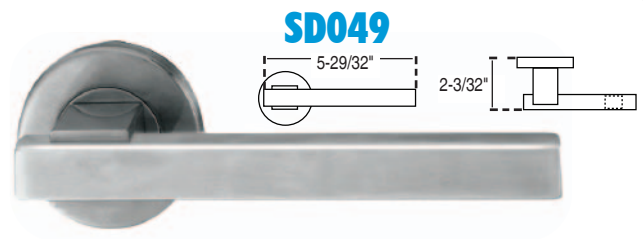
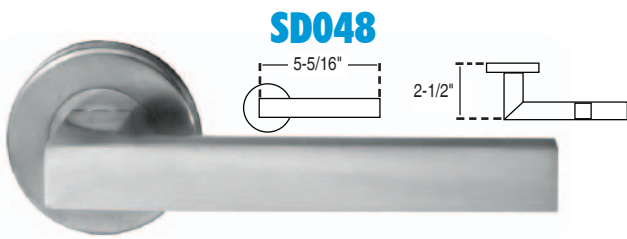

STANDARD MORTISE & TUBULAR LOCK TRIM & ROSE STYLES

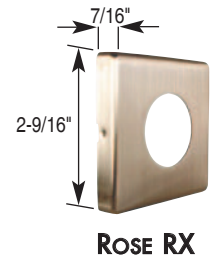
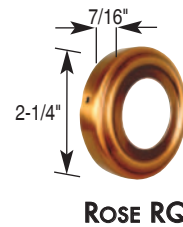
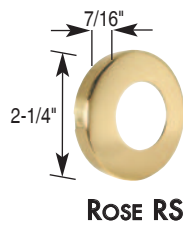
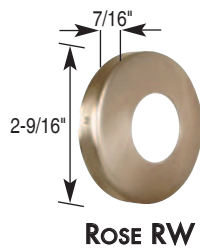
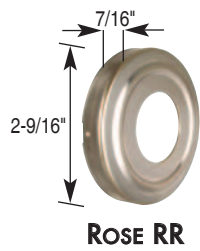

NOTE: Roses are available in a wide variety of finishes



ROUND 10

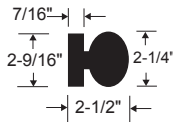

STANHOPE 5644

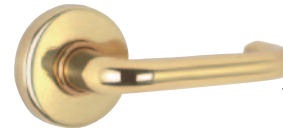
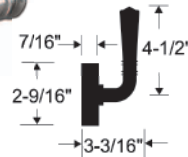

PLAZA 82

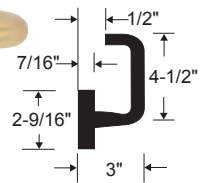

BALL 20/30

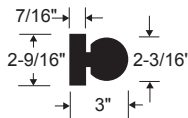

MONACO 57

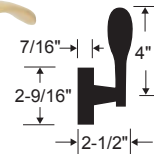

Dayton 83

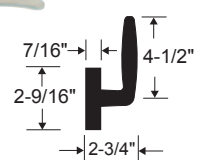

ECLIPSE 60

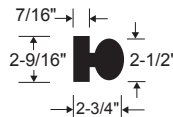

TOWNE 72

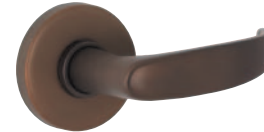
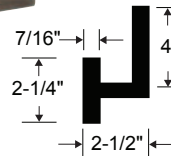

CRESCENT 86

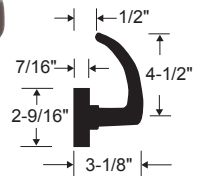

MADISON 52

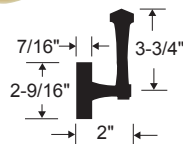

MAXWELL 77

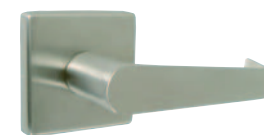
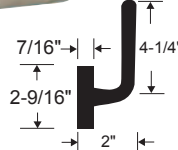

AMERICAN 92

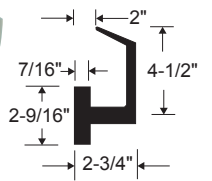

OMNI 78

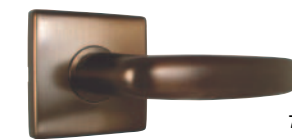
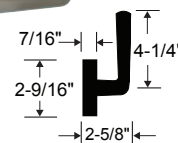

TITAN 96

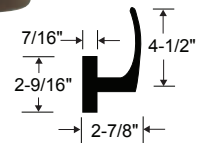

CUSTOM FORGED BRASS LEVERS

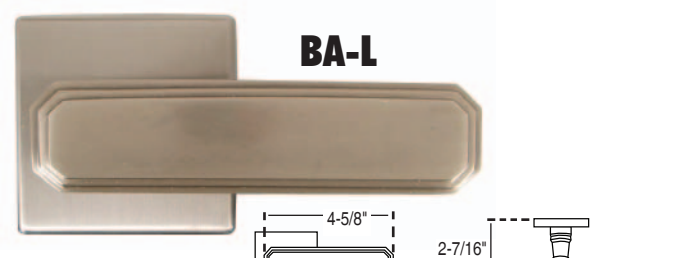
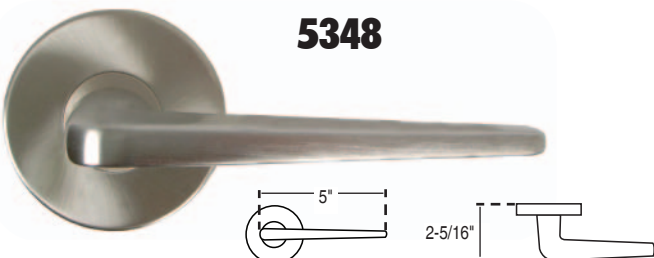
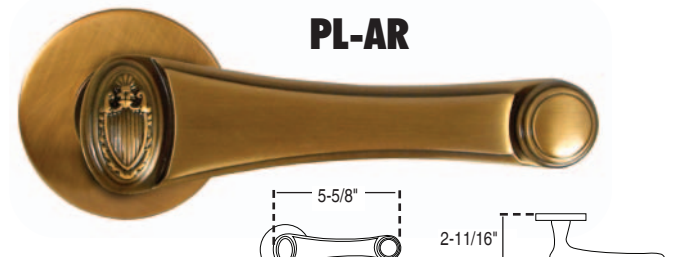
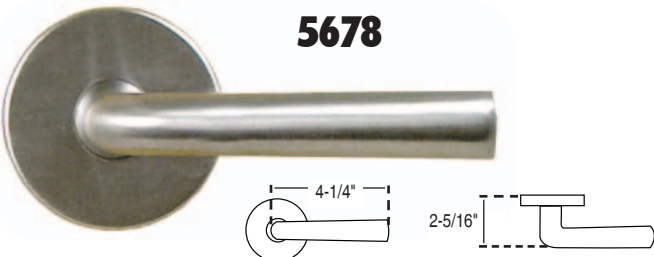
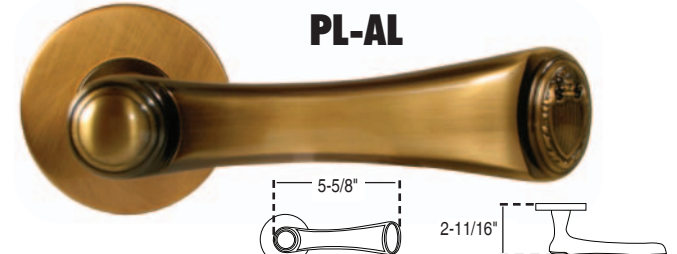
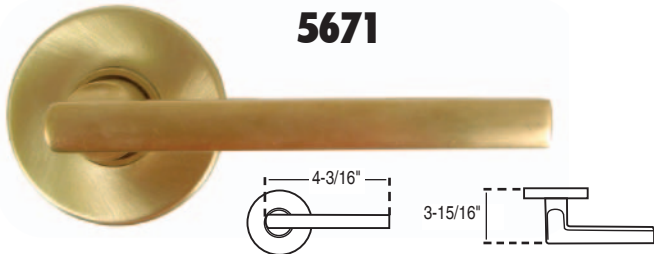
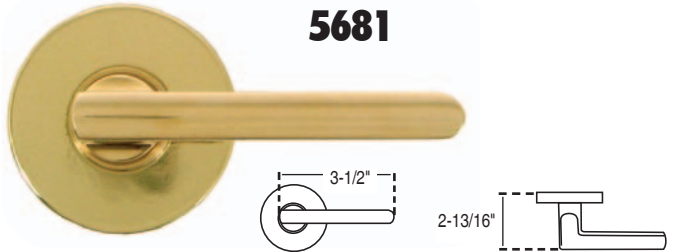
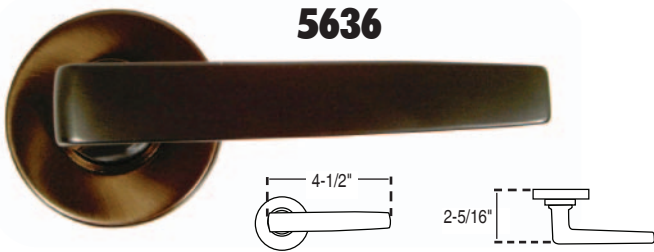
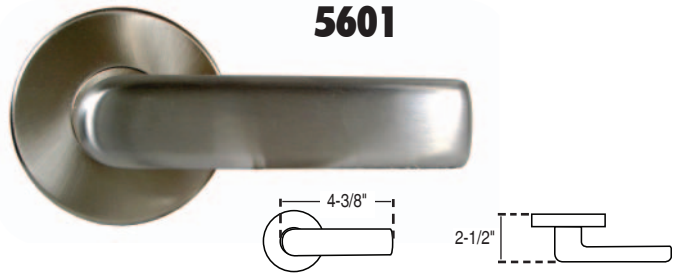
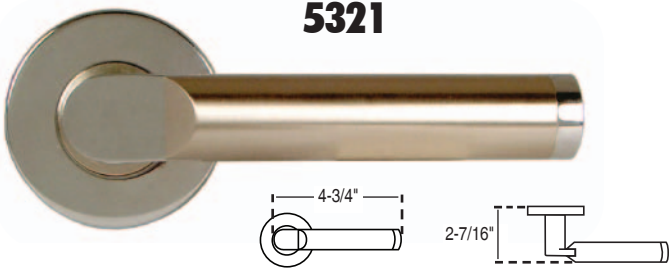

TURNPIECES

OPTION CODE T1

Base Metal: Brass & Stainless Steel

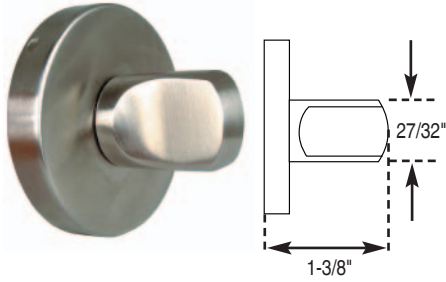

OPTION CODE T2

Base Metal: Stainless Steel

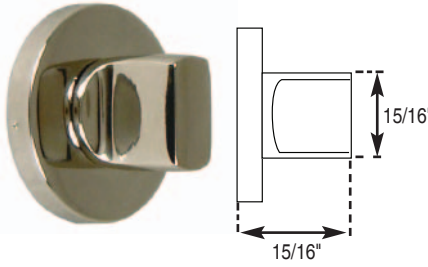

OPTION CODE T3

Base Metal: Zinc

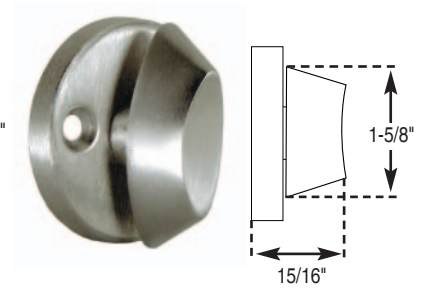

OPTION CODE T4

Base Metal: Brass & Stainless Steel

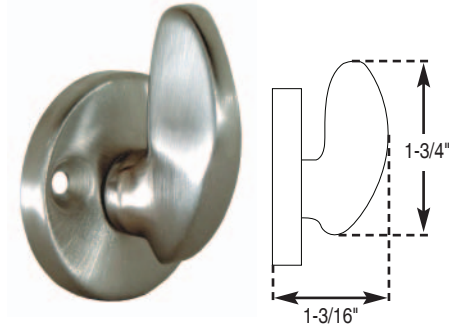

OPTION CODE T5

Base Metal: Stainless Steel

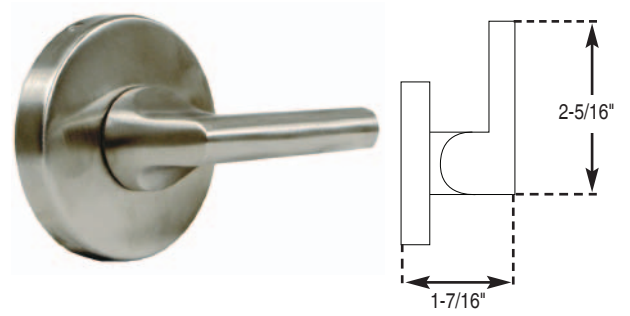

OPTION CODE T6

Base Metal: Stainless Steel

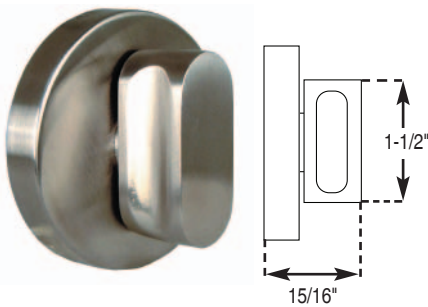

OPTION CODE T7

Base Metal: Brass

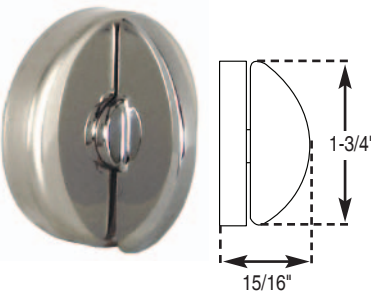

OPTION CODE T8

Base Metal: Stainless Steel

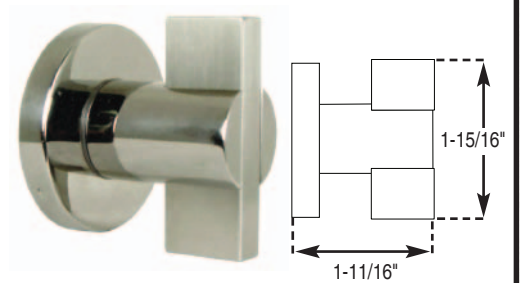

OPTION CODE T9

Base Metal: Stainless Steel

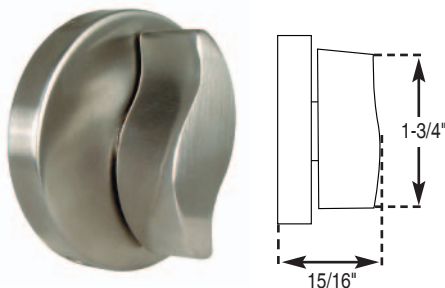

OPTION CODE T16

Base Metal: Stainless Steel

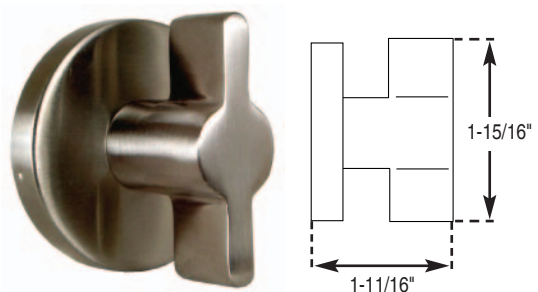

CUSTOM FORGED BRASS TRIM

CUSTOM 1

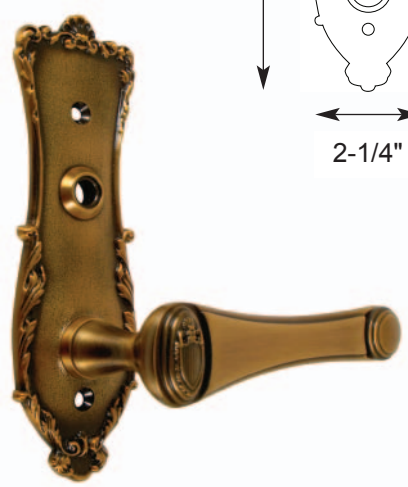
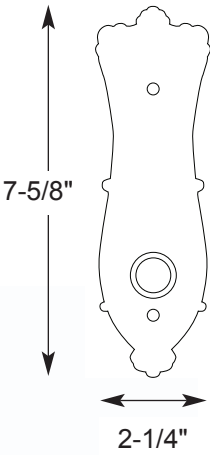
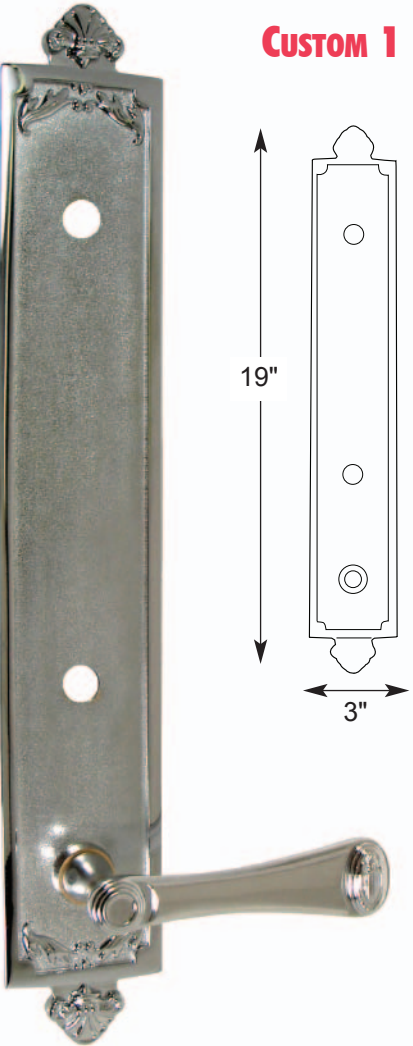

CUSTOM 2

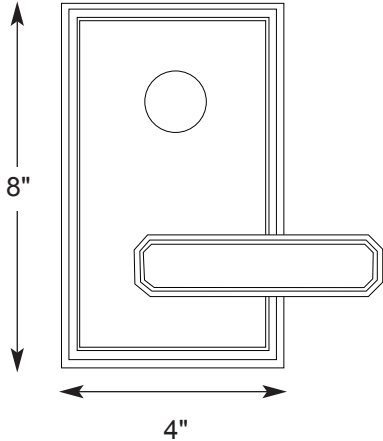

CUSTOM ESCUTCHEON PLATES

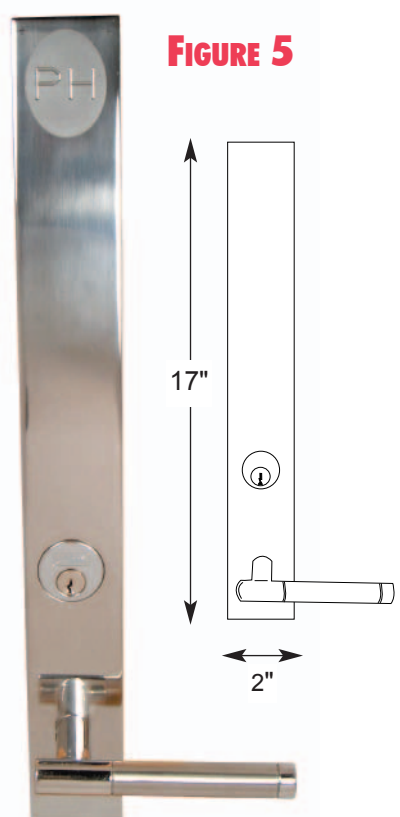
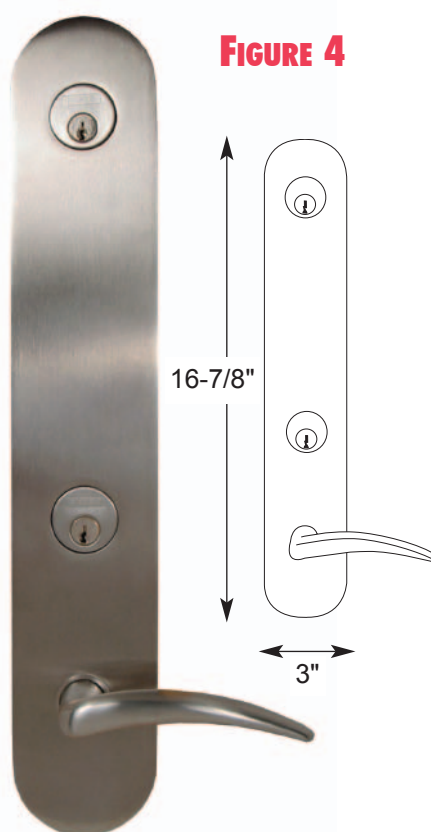
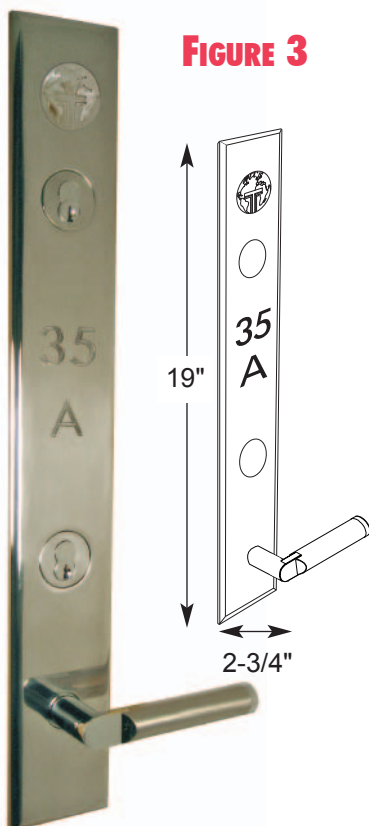
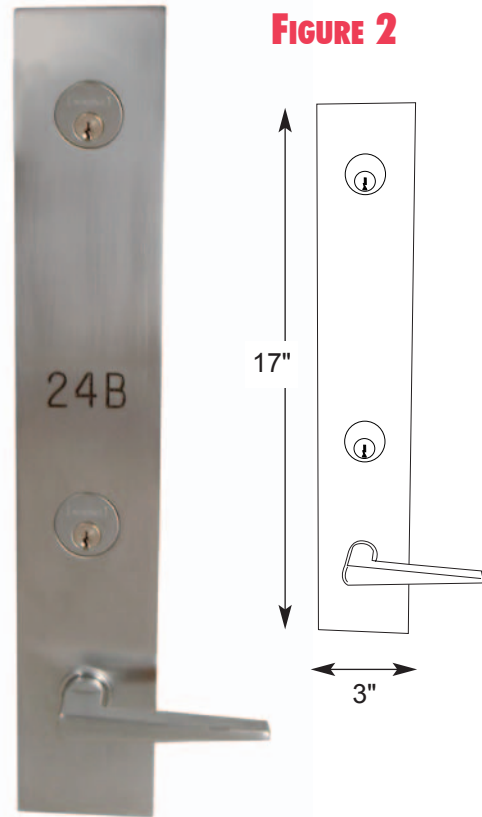
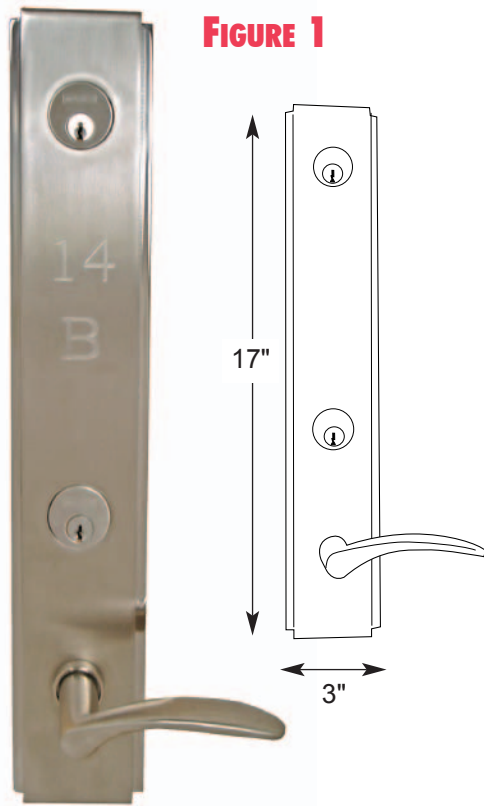

CUSTOM ESCUTCHEON PLATES

FIGURE 6

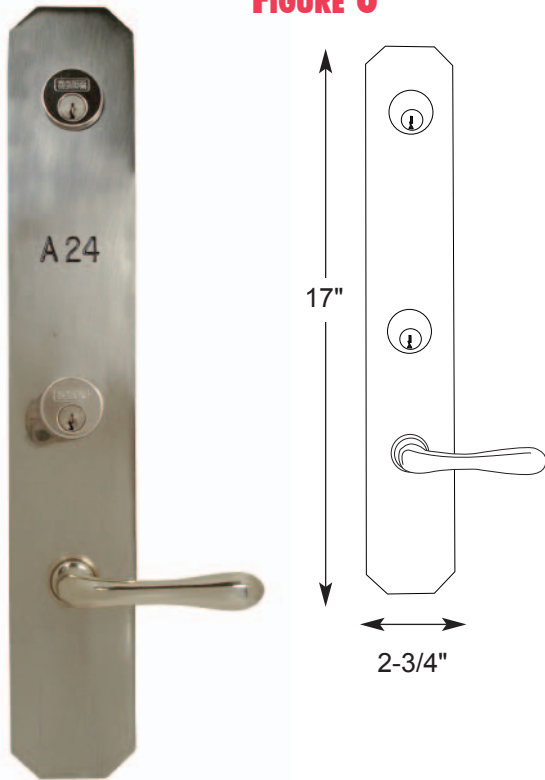

FIGURE 7

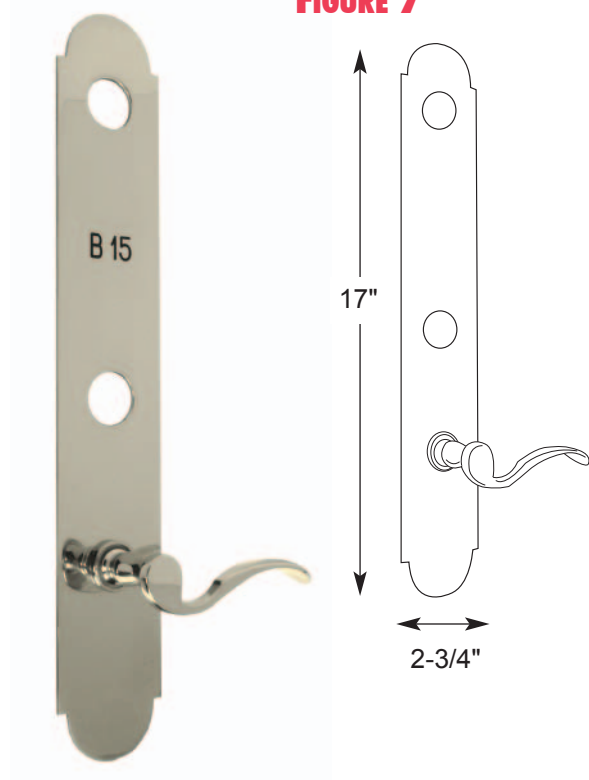

FIGURE 8

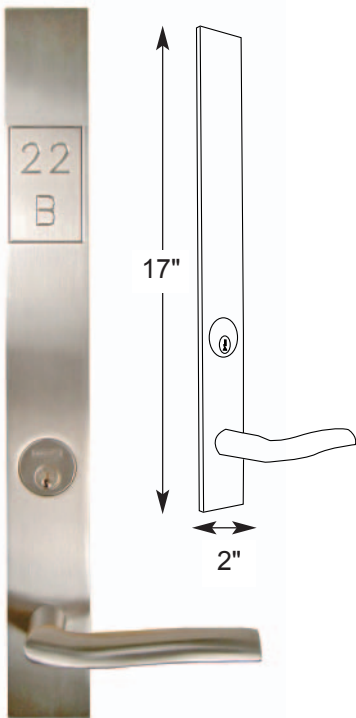

FIGURE 9

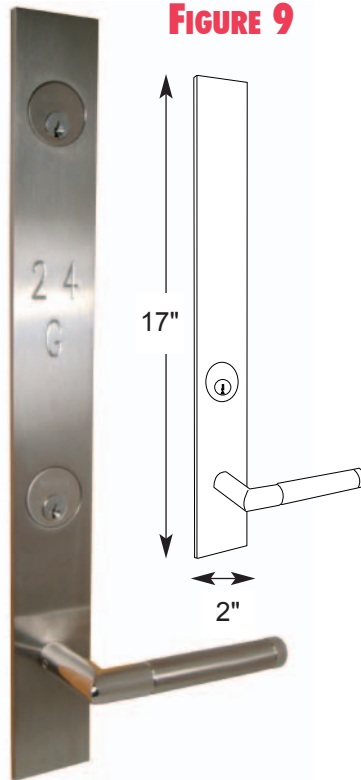
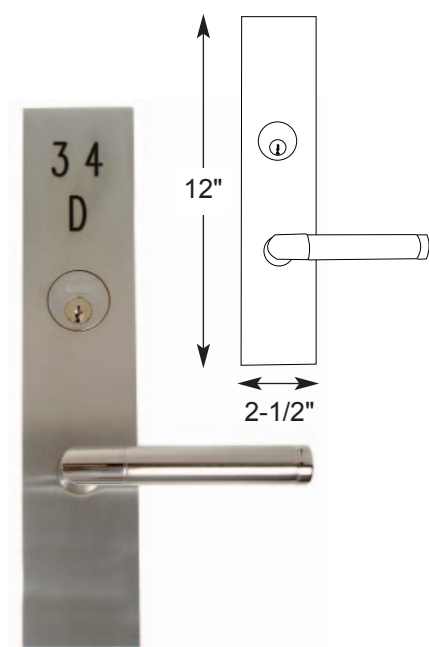

FIGURE 10



CUSTOM ESCUTCHEON PLATES



FIGURE 11

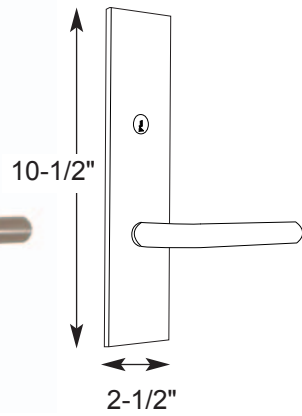

FIGURE 12

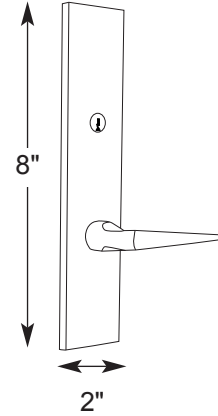

FIGURE 13

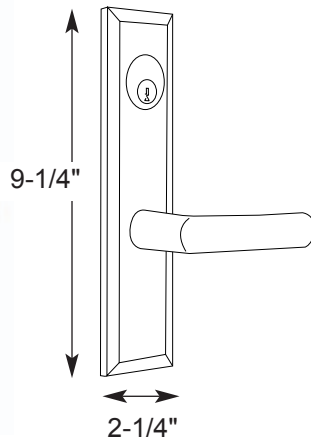

FIGURE 14

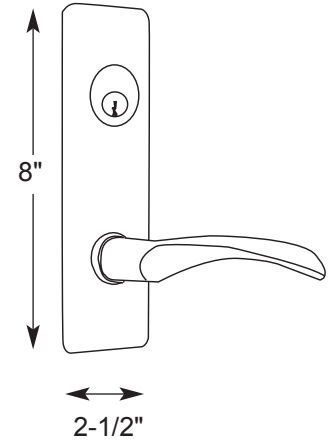

FIGURE 15

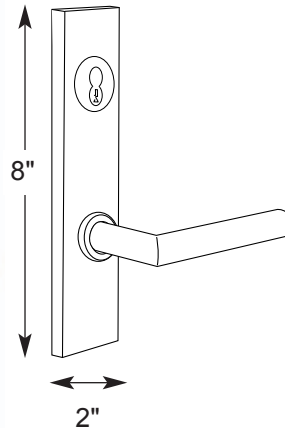

FIGURE 16

