

LCN®

Price book 2

Effective October 6, 2014 • Rev. 1/15



This price list supersedes and cancels all previous price lists. Prices shown are subject to change without notice.

Administrative Offices

Allegion Administrative Office
11819 N. Pennsylvania St.
Carmel, IN 46032
allegion.com/us

Placing orders

You can place orders with Allegion via the fax number or email listed below:

Fax#: 1-800-248-1460
Email: Order_LcnClosers@allegion.com

Customer Care

Our Customer Care Representatives are available for questions or assistance.

You can reach them at **877-671-7011** (Press 1 for Sales Support | Press 2 for Product Support | Press 3 for SSC) or through the email addresses listed below:

Sales Support

Carolinas

(North Carolina, South Carolina, Virginia)
Carolinas_Sales_Support@allegion.com

Central

(Arkansas, Illinois, Iowa, Kansas, Missouri, Nebraska, Oklahoma)
Central_Sales_Support@allegion.com

Chicago

(Illinois-Northern, Wisconsin)
Chicago_Sales_Support@allegion.com

Florida

Florida_Sales_Support@allegion.com

Great Lakes

(New York, Pennsylvania)
Great_Lakes_Sales_Support@allegion.com

Metro New York

Metro_New_York_Sales_Support@allegion.com

Michigan

Michigan_Sales_Support@allegion.com

Mid Atlantic

(Delaware, Maryland, New Jersey)
Mid_Atlantic_Sales_Support@allegion.com

Midwest

(Indiana, Kentucky, Ohio, West Virginia)
Midwest_Sales_Support@allegion.com

Mountain States

(Colorado, Idaho, Montana, Nevada, Utah, Wyoming)
Mountain_States_Sales_Support@allegion.com

New England

(Connecticut, Main, Massachusetts, New Hampshire, Rhode Island, Vermont)
New_England_Sales_Support@allegion.com

North Central

(Minnesota, North Dakota, South Dakota)
North_Central_Sales_Support@allegion.com

Northern California

Northern_California_Sales_Support@allegion.com

Northwest

(Alaska, Oregon, Washington)
Northwest_Sales_Support@allegion.com

South

(Alabama, Georgia, Louisiana, Mississippi, Tennessee)
South_Sales_Support@allegion.com

Southern California

(California-Southern, Hawaii)
Southern_California_Sales_Support@allegion.com

Southwest

(Arizona, New Mexico)
Southwest_Sales_Support@allegion.com

Texas

Texas_Sales_Support@allegion.com

Technical Product Support

Closers

Closers_TechProdSupport@allegion.com

Request for Quote

Carolinas

(North Carolina, South Carolina, Virginia)
Carolinas.Quotes@allegion.com

Central

(Arkansas, Illinois, Iowa, Kansas, Missouri, Nebraska, Oklahoma)
Central.Quotes@allegion.com

Chicago

(Illinois-Northern, Wisconsin)
Chicago.Quotes@allegion.com

Florida

Florida.Quotes@allegion.com

Great Lakes

(New York, Pennsylvania)
GreatLakes.Quotes@allegion.com

Metro New York

Metro.Quotes@allegion.com

Michigan

Michigan.Quotes@allegion.com

Mid Atlantic

(Delaware, Maryland, New Jersey)
MidAtlantic.Quotes@allegion.com

Midwest

(Indiana, Kentucky, Ohio, West Virginia)
Midwest.Quotes@allegion.com

Mountain States

(Colorado, Idaho, Montana, Nevada, Utah, Wyoming)
Mtn.States.Quotes@allegion.com

New England

(Connecticut, Main, Massachusetts, New Hampshire, Rhode Island, Vermont)
NewEngland.Quotes@allegion.com

North Central

(Minnesota, North Dakota, South Dakota)
NorthCentral.Quotes@allegion.com

Northern California

NoCal.Quotes@allegion.com

Northwest

(Alaska, Oregon, Washington)
Northwest.Quotes@allegion.com

South

(Alabama, Georgia, Louisiana, Mississippi, Tennessee)
South.Quotes@allegion.com

Southern California

(California-Southern, Hawaii)
SoCal.Quotes@allegion.com

Southwest

(Arizona, New Mexico)
Southwest.Quotes@allegion.com

Texas

Texas.Quotes@allegion.com

TABLE OF CONTENTS

Contact Information.....	2	Control Boxes.....	24-25
Table of Contents/ How To Order.....	3	Compressors	25
Available Finishes/SRI.....	4	Control Box Components.....	26-27
Order Form.....	5	Actuator/Sensors Quick Find Guide	28-29
General Terms.....	6-9	Actuators, Sensors and Accessories	30-47
Door Closer Specialists	10	Parts & Accessories.....	48-59
Complete Door Closers.....	11-21	Senior Swing Diagram	60
Magnets.....	22	Benchmark Diagram.....	61
Specialty Products, Fasteners.....	23	Glossary of Abbreviations.....	62
		LCN Warranty.....	63

HOW TO ORDER CLOSERS, COMPONENTS, PARTS & ACCESSORIES

1. **Identify** the closer series; 1460, 2030, 4040XP, 4210T, 4310ME, 4640, 6030, etc.
2. Determine if any **additional information** is required, such as: handing, finish, spring size, voltage, etc.
3. Order the material using suffix number with the description and include all necessary information.
Examples: 4111 Closer x RH x CUSH x AL or 4040SE Closer x 24v x DKBRZ
4. For additional information on how to order specific closers, please see the 'How to Order' page in each individual closer section of the **LCN General Catalog** or call **LCN Customer Care**.

SPECIAL NOTES

1. All **RAL** custom finishes will be powder coated and metal covers (**list add \$5**) will be substituted for standard covers for all closers except the 1460 series. 1460 series closers may be custom finished but a **DS** cover (**list add \$25**) must be selected.
2. **LCN** offers more than 180 **RAL** custom finishes. There is a list add of (**\$30**) per closer for an **RAL** finish. Most series require a metal cover (**MC**) (**\$5 add**). **LCN** also offers a Brite Metallic (**MTLPC**) powder coat finish. There is a list add of (**\$60**) per closer for the **MTLPC** finish. Most series require a metal cover (**MC**) (**\$5 add**).
3. **LCN** plated list prices already include -72MC (1460 includes -72DS). Disregard the additional list add for metal cover (**MC**).
4. **LCN** powder finishes exceed **ANSI/BHMA standard A156.4** for corrosion resistance by at least a factor of four. **LCN** powder coat finishes combined with the **LCN Special Rust Inhibitor (SRI)** pre-treatment exceed this standard even further.
5. **Special Rust Inhibitor (SRI)** is a pretreatment that is applied prior to the **LCN** powder coat finish and greatly exceeds **ANSI/BHMA Standard A156.4** for corrosion resistance. **LCN** requires an additional (**list add \$36**) charge per closer, component or part.
6. **LCN** plated finishes exceed **ANSI/BHMA standard A156.4** for corrosion resistance.
7. Optional **TORX** security screw packs can be substituted for standard screw packs on most closers. See '**Add for TORX Screw Pack**' for additional charge. In some cases, not all fasteners can be provided as **TORX**, consult factory for details.
8. **LCN** can mark individual closer boxes with door or opening #'s. Please specify 'itemized' when ordering. **LCN** requires an additional (**net add \$2**) charge per closer, component or part.
9. **Special Template (ST)** pricing is available by contacting **LCN Technical/Product Support or LCN Customer Care**.
10. All closers conform to standards **UL10C** and **UBC 7-2** (1997).
11. If an item or price is not listed in the **LCN October 6, 2014 Price List**, consult factory for availability & pricing.
12. Prices listed in the **LCN October 6, 2014 Price List** are subject to change without notice. The current '**Terms of Sale**' applies. All prices listed in the **LCN October 6, 2014** are in US dollars.

Powder Coated Finishes

LCN closers can be specified in six standard or over 180 custom powder coated finishes. Powder coating provides superior protection against the effects of weathering and provides a durable, chip resistant finish. For information about custom finishes, plated finishes and a special rust inhibiting (SRI) process, see the LCN General Catalog.

Standard Powder Coated Finishes

See LCN General Catalog, page 5 for exact colors.

- **AL (BHMA 689) - Aluminum**
- **DKBRZ (BHMA 695) - Dark Bronze**
- **BRASS (BHMA 696) - Brass**
- **LTBRZ (BHMA 691) - Light Bronze**
- **STAT (BHMA 690) - Statuary**
- **BLACK (BHMA 693) - Black**

Optional Custom Powder Coated Finishes

- **180 Custom Finishes (contact customer service for availability)**
- **Superior Appearance**
- **Environmentally Friendly Process**
- **Durable and Chip Resistant**
- **Corrosion Resistant**
- **Match Doors, Frames, and Hardware**

Optional SRI

When powder coated closers are installed in high humidity or potentially corrosive installations like swimming pools, water treatment facilities or near large bodies of water, specify LCN SRI Pretreatment. This optional process extends the corrosion protection offered by powder coat finishes.

Optional Plated Finishes

LCN offers 7 plated finishes at additional cost: US 3, US 4, US 10, US 10B, US 15, US 26 and US 26D

For a list of available BAA/ARRA compliant products please contact your local SSC or sales representative to see the Ingersoll Rand Security Technologies BAA/ARRA catalog.

ORDER FORM

Sold To: _____

Purchase Order # _____
Purchase Order Date _____
Requested Ship Date _____
Project Name _____
Shipping Instructions _____

Ship To: _____

THIS SPACE FOR FACTORY USE ONLY	
Acct # _____	WOG - Y/N _____
Quantity _____	PL _____
Ship Date _____	Inv # _____
Itemize Code 1_2_3 _____	Verify _____

QTY	Closer Series	Arm Type or Part #	Description As Listed in Catalog or Parts List	Hand		Finish	
				RH	LH	Painted	Plated

Orders can be faxed to (800) 248-1460 or emailed to Order_LCNClosers@allegion.com

Terms and Conditions

Allegion General Terms and Conditions of Sale and Service

1. GENERAL/ACCEPTANCE. (a) This Agreement contains the only terms and conditions by which Company will quote and sell Deliverables to Customer; (b) The terms "purchase order" or "order" for the purposes of this Agreement include the term "request for quotation," as appropriate; (c) This Agreement supersedes all pre-printed or boilerplate terms and conditions set forth in any purchase order issued by Customer; (d) No reference herein to Customer's purchase order will in any way incorporate different or additional terms and conditions, all of which Company hereby expressly objects to; **(e) ANY ACCEPTANCE BY COMPANY OF CUSTOMER'S PURCHASE ORDER IS EXPRESSLY CONDITIONED ON THE CUSTOMER'S ASSENT TO AND ACCEPTANCE OF THE TERMS AND CONDITIONS CONTAINED IN THIS AGREEMENT;** (f) Company reserves the right to decline any order, in whole or in part, for any reason.

2. ORDERS.

a. **Order Processing.** When Customer wishes to place an order for Deliverables, it will deliver to Company a purchase order. All such purchase orders must (i) be in a written format acceptable to Company, (ii) be legible, (iii) include a purchase order number, (iv) include Customer's account number, invoice address, ship to address, shipping method, shipper's letter of instruction for international shipments, part number, pricing, and designated contact information, (v) include, if applicable, any special configuration ID numbers, necessary programming information, special factory instructions, and requested specifications regarding a particular finish, handling, design, basket, or strike, and (vi) reference any applicable pricing discounts under an ongoing buying program or based on a written quote from Company, along with the applicable buying program number or quotation number.

b. **Minimum Orders.** In the event the order value does not meet any required minimum net Deliverable value, Company may, at its sole discretion, (i) increase the quantity of items in the order to meet the minimum net Deliverable value requirement; (ii) apply a minimum order charge; (iii) reject the order, or (iv) waive the requirement, provided that the waiver of a requirement for one order shall not constitute a waiver of the requirement for any future orders.

c. **Acceptance of Purchase Orders.** Company will endeavor to (i) acknowledge receipt of each purchase order issued in accordance with this Agreement, and (ii) notify Customer whether Company accepts or rejects the purchase order. If Company fails to accept or reject a purchase order within a reasonable time period, such failure to respond will be deemed a rejection of the entire order.

d. **Changes to Order/ Cancellation of Orders.** Additional terms and conditions regarding order changes and cancellations are available on the Allegion customer website, **WHICH TERMS ARE EXPRESSLY INCORPORATED HEREIN BY REFERENCE.** Unless otherwise provided herein, Customer acknowledges that (i) requesting a Change Order may cause a delay in the scheduled shipment date, a longer lead time or result in a new scheduled shipment date; (ii) Orders may not be changed after 48 hours of Company's order acknowledgment; (iii) After 48 hours of Company's order acknowledgment, all changes to an accepted purchase order will be subject to a Change Order charge of 25% of the net Deliverable value, plus the cost of labor and fabrication or raw material that Company incurred prior to the receipt of the Change Order from Customer, or that may be required due to the Change Order; (iv) the requested change may result in additional charges for labor, fabrication, and raw material, and (v) if Customer cancels an order or portion of an order that includes Deliverables that have been manufactured and prepped for shipping, **a 45% restocking fee will apply.** Notwithstanding the foregoing, Customer cannot change or cancel credential orders, reader orders, biometrics orders or any non-cataloged, special, Custom or nonstandard items once they have been placed. All cancelled orders for a Non Recurring Expense (NRE), credential orders, reader orders, biometrics orders, and/or Custom orders will be subject to a cancellation charge of 100% of the acknowledged price.

e. **Add-ons.** Add-on orders will not be accepted. Additions to orders will be entered as separate stand-alone orders and must qualify for all terms of sale, including discounts, on an individual basis.

f. **Fast-Track Orders.** No changes or cancellations will be accepted on the 24-Hour Fast Track Program. For 3-day Fast Track orders, changes and cancellations may only be requested by Customer within 24 hours of Company's order acknowledgment if the order has not shipped. For 5-Day Fast Track orders, changes and cancellations may only be requested by Customer if the order has not shipped and if the request is made to Company within 48 hours of Company's order acknowledgment. Return Material Authorization (RMA) for Deliverables must be processed through Fast Track Customer Service.

g. **Steelcraft Orders.** For all Steelcraft orders, changes or cancellations are allowed without penalty only if made within 48 hours of Company's order acknowledgment, and provided that the order has not shipped. Some exceptions do apply – please consult the factory. Changes are not allowed on Rapid Program orders after the order has been entered and acknowledged. After 48 hours of Company's order acknowledgment, all changes or cancellations are subject to a charge of 25% of the order. Unless otherwise specified by Company in writing, any changes to orders acknowledged by Company that affect the delivery date will be deemed a new order and will require acknowledgement by Company as provided in this Section.

Additional products, features, terms and conditions regarding the Rapid Program are available on the Allegion customer website, WHICH TERMS ARE EXPRESSLY INCORPORATED HEREIN BY REFERENCE.

3. PRICES, INVOICES AND PAYMENT.

a. **Prices.** The prices in Company's Price Book are subject to change at any time, without notice to Customer. Company may charge Customer additional amounts if Customer requests special packing, marking, shipment, product modification, or engineering services. Oral prices specified by Company are null and void. Quote numbers must be referenced on Customer's purchase order in order for the Company's quoted pricing to apply. Orders that do not reference a quote number will receive buy program pricing or book net pricing. Quoted prices are for those specific products quoted for a specified job, and are subject to the Price Book in effect at the time the quote was issued by Company.

b. **Taxes.** Prices do not include any present or future federal, state or local property, license, privilege, sales, use, excise, gross receipts or other like taxes or assessments which may result from transactions or any services performed in connection therewith. Any taxes, charges, or duties imposed by any governmental authority on the sale of Deliverables will be paid by Customer, in addition to the selling price specified by Company.

c. **Payment Terms.** Company will deliver to Customer an invoice with each shipment of Deliverables hereunder. Customer will pay all invoiced amounts within 35 days of the invoice date, provided that Customer may take a 2% discount if Customer pays in cash and Company receives said payment within 20 days of the invoice date. For the avoidance of doubt, cash discounts do not apply to credit card payments. Customer will make all payments in United States dollars. Past due invoices will be subject to a late payment service charge of 1.5% per month on any overdue unpaid balance, equivalent to 18% per annum, or the maximum rate permitted by law, whichever is less. Customer shall reimburse Company for all costs of

collection, including, without limitation, reasonable attorneys' fees, for any overdue amount owed by Customer to Company, and such collection costs shall also be subject to interest charges.

4. QUOTATIONS.

a. **Project Quotations.** Project or new construction quotes are restricted to the specific project quoted for the quantities, finishes, and series of Deliverables referenced on the quote. Company reserves the right to require proof of sale of Company products for any quoted project.

b. **Stock Quotations.** Deliverables fulfilling stock quotations may only be used for the following: i) Stocking of the Customer's shelves for small, quick-turn, discretionary projects, or ii) Sale to a general contractor or installer for new construction. Stock quotations may not be used for any project containing any Company no-substitution, specified products. Deliverables purchased under Stock Quotations cannot be redistributed to other Customer branch locations or re-sold to other resellers or used for aftermarket sales, end-user annual contracts or sold over the counter to any walk in trade.

c. **General.** All quotes are subject to this Agreement, unless otherwise specified by Company, and are subject to change at any time prior to Company's acceptance of a purchase order referencing the applicable quote number. Company, its representatives and employees reserve the right, in their sole discretion and for any reason, to refuse a Customer's request to quote a price other than the standard list price, regardless of whether Company or its representatives or employees have previously quoted discounted prices to the Customer on some or all of its orders. Customer's failure to comply with this Section 4 will be considered a material breach of this Agreement, and will entitle Company to immediately terminate any purchase orders and/or Customer's ability to distribute Company's products.

5. SECURITY INTEREST. Customer grants Company, and Company retains, a purchase money security interest and lien on any and all of Customer's rights, title and interest in each Deliverable sold by Company to Customer, wherever located, until the invoice for the applicable Deliverable(s) is paid in full, including any late charges and costs of collection. Customer authorizes Company to, and will assist Company in, taking all necessary steps to perfect and maintain Company's interest in such Deliverables.

6. CREDIT TERMS. Unless Customer pre-pays all of its purchase orders in advance, its purchase orders will be subject to the credit limit and other terms of credit ("Credit Terms") set forth in Company's credit application, which Credit Terms Customer acknowledges are subject to change by Company at any time. Company reserves the right to request payment in advance of shipment or any order or to request adequate assurances for Customer's payment of an order and may withhold or stop shipment, without any liability to Company, until Customer submits payment or adequate assurance of payment.

7. RESALE OF DELIVERABLES. Customer agrees and warrants that it will offer Company products in support of Company-written specifications and will maintain sufficient inventory to adequately support End Users, installers, and/or general contractors' needs. **Company may implement an MSRP or a resale pricing programs at any time in its sole discretion. Failure to comply with such program(s) will be considered a material breach of this Agreement, and will entitle Company to immediately terminate any purchase order and/or Customer's ability to distribute Company's products.** Customer shall, at its own expense, gain and maintain sufficient knowledge of the industry and products competitive with Deliverables so as to be able to (a) explain in detail to End Users, installers, and/or general contractors the differences between the Deliverables and competing products, (b) ensure that an adequate number of trained, capable and qualified technical personnel with sufficient knowledge of the Deliverables and who have obtained all necessary licenses and permits are available to assist End Users, installers, and/or general contractors, and (c) respond to such End Users, installers, and/or general contractors with respect to the general operation and use of the Deliverables including, but not limited to, (1) acting as a liaison between the End Users, installers and/or general contractors and Company in matters requiring Company participation, (2) providing general product information and configuration support on standard protocols and features, (3) collecting relevant technical problem identification information, and (4) posting and distributing any warranty information concerning the Products in accordance with Company's instructions. Customer is responsible for all service and support resulting from the re-sale of any Deliverable to End-Users, installers and/or general contractors, examples of which may include, but are not limited to, support activities such as installation, initialization, software set-up, training, trouble-shooting, technical support and field service. In the event Customer is unwilling or unable to perform said support activities, Company reserves the right to recover from Customer any and all expenses incurred by Company to resolve the aforementioned End-User, installer and/or general contractor issues. Technical product training is recommended for Customer in order to fully service and support Deliverables purchased from Company that are resold to End-Users, installers and/or general contractors.

8. DEFAULT. If Customer is in default of payment or otherwise with respect to any purchase order or other contract with Company, Company shall have the right, in addition to all other legal remedies and without prejudice to any of its right hereunder, to defer further shipments under that or any other purchase order until such default is corrected and to declare all outstanding bills of Customer to be immediately due and payable.

9. INSPECTION AND DELIVERY.

a. **Inspection.** Customer will inspect all Deliverables immediately after receiving them. Customer will be deemed to have accepted the Deliverables unless Customer notifies Company in writing of any nonconformance within 10 days of delivery and provides Company written evidence reasonably documenting that nonconformance. Inspection of Deliverables at Company's facility is not permitted.

b. **Delivery.** Delivery schedules for Deliverables are based upon current production capacities, material or component availability, and inventory, and may be changed by Company as conditions require. Delivery schedules for services are based upon Company's prompt receipt of, and prompt access to, Customer's equipment and all information necessary to complete the services. In no event will any delivery date be construed as falling within the meaning of "time is of the essence." Partial delivery shall be accepted by Customer and paid for at the price and on the terms stated herein. Any partial delivery shall constitute a separate sale, and payment shall be separately made when due. If any part of a delivery hereunder is not delivered by Company in accordance with Customer's purchase order, this Agreement shall not be affected thereby.

10. TITLE & RISK OF LOSS. Unless otherwise specified by Company, (i) where the Customer is located in the United States, all Deliverables will be sold "Uniform Commercial Code, FOB Origin, Company's factory"; and (ii) where the Customer is located outside of the United

States, all Products will be sold "Ex-works, Company's factory (Incoterms 2010)." In either instance, title and risk of loss will pass to Customer upon delivery to the carrier at Company's factory, provided, however, as set forth herein, Company shall retain a security interest in the Deliverables until full payment has been made therefore, and Customer agrees, upon request, to do all things and acts necessary to protect Company's interest by adequately insuring the Deliverables against loss or damage from any cause and to have Company named as an additional insured. Customer will promptly provide Company with a copy of the relevant certificate of insurance upon Company's request.

11. SHIPPING & SHIPPING PROGRAMS.

a. **Freight Charges.** Company will ship all Deliverables in accordance with Company's freight shipment guidelines, which are set forth on the Allegion customer website ("Freight Shipping Guidelines"). **WHICH TERMS ARE EXPRESSLY INCORPORATED HEREIN.**

b. **Rush Charges.** Expedited order options are available as set forth in Company's freight shipping guidelines.

c. **Packing and Marking.** Company will pack, mark, and ship Deliverables according to its standard procedures for shipment, unless the parties agree, in writing, that Company will comply with any special instructions provided by Customer. Special instructions may result in an increased price.

d. **International Shipments.** For all international orders, a Shipper's letter of instruction must be submitted in writing with the order. Failure to do so will result in the order being rejected. Complete adherence to this order requirement will be strictly enforced. Company will not be held liable for any charges resulting from delays due to lack of complete required information being supplied.

e. Once received by the Company, a purchase order cannot be combined with any other order to qualify for freight allowances. In addition, Customer may not combine any Company brands or product categories on a single order to meet the applicable net freight allowance, except in the case of: i) FastTrack 24 Hour/5 Day Program, which is available for Schlage, Von Duprin, LCN and Glynn-Johnson products; ii) FastTrack 24 Hour/3 Day Program, which is available for Falcon Locks, Exits and Closers and Ives products. When an order includes products from the brands listed in both (i) and (ii) above, the order will automatically default to the FastTrack 24 Hour/5 Day Program lead times and freight allowance.

12. CLAIMS. All claims must be submitted in writing to Company as follows: (i) All claims for prices must be submitted within thirty (30) days from the date of invoice; (ii) All claims regarding Deliverable quantity or incorrect orders must be submitted within ten (10) days from the date of delivery; (iii) All claims for damage to Deliverables (while in the care, custody, and control of Company) must be submitted within thirty (30) days from the date of invoice; (iv) All claims for loss or damage to Deliverables while in the care, custody, and/or control of a carrier will be the responsibility of Customer, unless otherwise agreed by the parties.

13. PRODUCT CHANGES. Company's product policy is one of ongoing update and revision, and accordingly, Company reserves the right to change, without notice, the design of, or the process of manufacturing, the Deliverables covered by this Agreement.

14. PRODUCT USAGE LIMITATION. Customer agrees: (i) not to sell or use a Deliverable in any manner contrary to the manner in which the Deliverable is intended to be used; and/or (ii) not to modify the design of any Deliverable for use with another product without the prior written consent of Company.

15. PRODUCT RETURNS. Unless otherwise agreed by the parties in writing, Deliverables that are correctly furnished by Company per the purchase order may not be returned unless Customer receives written authorization from Company. If returns are authorized by Company, a return merchandise authorization ("RMA") number must be provided by Company. Deliverables identified under such RMA must be returned to Company within 90 days of issuance of the RMA. Such RMA number and any accompanying RMA documents, the original invoice number, and a written explanation for the return must be included with the returned Deliverables in order for Company to inspect and approve a credit for the return. **For warranty returns,** a credit in the amount of the original purchase price will only be issued if, after Company's receipt and inspection of the returned Deliverables, Company confirms, in its sole discretion, the defect is valid and approves the return. **For non-warranty returns/convenience returns,** in the event Company approves such a return, in its sole discretion, the following shall apply: (a) the total amount of Deliverables requested to be returned shall be a minimum of \$250.00; (b) a credit will be made to Customer's account in the amount of the original purchase price less freight and a handling charge of 45% of the net material on the original invoice; and (c) only Deliverables that are new, current, standard, non-obsolete, non-specially manufactured, unused, in their original condition as at the time of sale by Company to Customer, in their original packaging and in Customer's inventory less than 180 days from the date of shipment by the Company, and not ordered as part of a master key solution or the ProExpress or Fast Track programs may be considered by Company for return. Such credit will only be issued if, after Company's receipt and inspection of Deliverables, Company approves the return. The amount of final credit will be determined upon receipt at the factory and following Company's inspection and analysis of the condition of the returned material. Company retains the right to deny credit to anyone for any reason.

16. CONFIDENTIAL INFORMATION.

a. **Non-Use And Non-Disclosure.** Customer shall not use the Confidential Information of the Company except for the purpose of performing its obligations under this Agreement or exercising the rights granted herein (the "Purpose"). Customer shall protect Confidential Information of the Company from disclosure and unauthorized use in the same manner that it protects its own Confidential Information, but in no event shall such standard of care be less than reasonable care. Customer may disclose Confidential Information of the Company only to its employees who require such information for the Purpose and who are subject to confidentiality obligations at least as protective as those set forth herein.

b. **Proprietary Information and Advice.** (a) All designs, data, and specifications provided by Company are proprietary and may not be disclosed or reused by Customer without the prior written consent of Company; (b) Company assumes no obligation or liability for any advice given by Company, the results obtained, or damages incurred as a result of such advice, and all such advice is given and accepted at Customer's risk.

c. **Return.** Upon the termination or expiration of a purchase order or this Agreement or upon the request of the Company, the Customer agrees to end all further use of, to immediately return to the Company the original version of, and to delete or destroy all copies of, any and all Confidential Information of the Company.

17. TRADEMARKS. Except as agreed to by Company in writing, Customer agrees not to (a) use Company's name in any form of publicity; or (b) use, create, register or market, directly or indirectly, in whole or in part, Company's names, logos, brands, or any other trademarks, or names that are now or may hereafter be owned by Company, as part of Customer's corporate or business name, as part of an internet domain name, uniform resource locator (URL), or in any way connected with Customer's business, trade address or other designations. Upon termination of this Agreement or upon the request of company for any reason, any use of Company's trademarks or names will be immediately discontinued.

18. LIMITED WARRANTY.

COMPANY MAKES NO OTHER WARRANTIES EXCEPT THOSE STATED IN COMPANY'S LIMITED WARRANTY IN EFFECT ON THE DATE COMPANY ACCEPTS EACH APPLICABLE PURCHASE ORDER ("LIMITED WARRANTY"). THE LIMITED WARRANTY MAY BE FOUND IN THE APPLICABLE PRICE BOOK AND ON THE ALLEGION CUSTOMER WEBSITE, WHICH TERMS ARE EXPRESSLY INCORPORATED HEREIN BY REFERENCE. COMPANY WILL MAIL CUSTOMER A HARD COPY OF THIS WARRANTY UPON CUSTOMER'S WRITTEN REQUEST. IN THE EVENT THAT CERTAIN DELIVERABLE WARRANTIES ARE NOT FURNISHED BY THE COMPANY TO CUSTOMER, COMPANY WARRANTS ONLY TO CUSTOMER THAT THE DELIVERABLES WILL BE FREE FROM DEFECTS IN MATERIAL AND WORKMANSHIP FOR A PERIOD OF 12 MONTHS FROM THE DATE OF SHIPMENT OF THE DELIVERABLES. COMPANY'S SOLE OBLIGATION UNDER THIS WARRANTY IS LIMITED TO REPAIRING OR REPLACING, AT COMPANY'S OPTION, THE DEFECTIVE DELIVERABLE, PROVIDED WRITTEN NOTICE OF THE DEFECT OR NONCONFORMANCE IS PROVIDED BY CUSTOMER WITHIN 30 DAYS OF DISCOVERY OF THE DEFECT OR NONCONFORMANCE. COMPANY DISCLAIMS ALL OTHER WARRANTIES, EXPRESS OR IMPLIED, WITH RESPECT TO THE DELIVERABLES, INCLUDING BUT NOT LIMITED TO, ANY IMPLIED WARRANTIES OF NON-INFRINGEMENT, MERCHANTABILITY, OR FITNESS FOR A PARTICULAR PURPOSE.

a. **Exclusions.** The provisions of this Limited Warranty do not apply to Deliverables that: (A) are not the proper size for the application; (B) are not installed in accordance with Company's published installation instructions; (C) are installed with improper or incorrect parts and/or are used for purposes for which they are not designed or intended; (D) have been repaired or altered without the Company's prior written consent; (E) have been subjected to misuse, abuse, negligence or accident; (F) have been improperly stored, installed, maintained or operated; (G) have been used in violation of written instructions provided by Company to Customer; (H) have been subjected to improper temperature, humidity, or other environmental conditions, or (I) have been affected by normal wear and tear. In addition, the provisions of this Limited Warranty do not apply to any defects or issues with the design or performance of equipment or products not manufactured by Company, nor does it apply to any code compliance or permit requirements for the assembly, installation, erection or construction of any goods. Company is not responsible for loss or damage resulting from use of Deliverables in conjunction with parts or systems not manufactured by Company. Accessories or products furnished by the Company, but manufactured by others, shall carry whatever warranty the manufacturers have conveyed to the Company and which can be passed to Customer.

b. **Services.** Company warrants that its services will be free from defects in material and workmanship for a period of 12 months from the date of completion of the particular items of service. Company's sole obligation under this service warranty is limited to repair or reperformance, at its option of the service, provided however, if repair or reperformance is either impractical or impossible, the Company will refund to Customer that portion of the price paid to Company for any defective service, provided written notice of the defect or nonconformance is provided by Customer within 30 days of discovery of the nonconformance.

c. **Notification.** Customer agrees to immediately notify Company in writing if any claim is made against Customer for any damages caused by any modules, parts, products, service or other Deliverables which may be the direct result of any defect in the manufacture of such aforementioned products. Customer agrees to cooperate with Company and its counsel in the defense of such claim and Customer agrees not to settle such claim without Company's written consent. If Customer fails to notify Company of such claim or fails to cooperate in such defense as aforesaid, then Company shall be discharged from any obligations under this Section and shall have no further liability to Customer.

d. **Exceptions.** The following costs and expenses are not covered by the provisions of these limited warranties: (i) labor costs for the removal and reinstallation of Deliverables or other manufacturer's products; (ii) shipping and freight expenses required to return Deliverables to Company; (iii) normal maintenance; and (iv) economic losses. In addition, the provisions of this warranty are not applicable to anything other than defects in Company's material (products only) or workmanship.

19. LIMITATION OF REMEDIES.

CUSTOMER'S EXCLUSIVE AND SOLE REMEDY ON ACCOUNT OF, OR IN RESPECT OF, THE FURNISHING OF NON-CONFORMING DELIVERABLES, SHALL BE TO (A) SECURE REPAIR OR REPLACEMENT OF THE PRODUCTS; OR (B) SECURE REPAIR OR RE-PERFORMANCE OF THE SERVICES OR TO OBTAIN A REFUND OF THE PRICE PAID FOR THE DEFECTIVE SERVICE, ALL AT COMPANY'S OPTION. IN NO EVENT WILL THE COMPANY'S MAXIMUM LIABILITY EXCEED THE SELLING PRICE FOR THE DELIVERABLE. THE WARRANTY, OBLIGATIONS AND LIABILITIES OF COMPANY (INCLUDING ITS SUPPLIERS) AND THE RIGHTS AND REMEDIES OF CUSTOMER ARE EXCLUSIVE AND ARE IN LIEU OF AND CUSTOMER HEREBY WAIVES AND RELEASES ALL OTHER WARRANTIES, OBLIGATIONS, REPRESENTATIONS OR LIABILITIES EXPRESS OR IMPLIED ARISING BY LAW, IN CONTRACT, TORT (INCLUDING NEGLIGENCE OR STRICT LIABILITY) OR OTHERWISE, INCLUDING BUT NOT LIMITED TO (I) ANY IMPLIED WARRANTY OF MERCHANTABILITY OR FITNESS FOR A PARTICULAR PURPOSE OR ANY WARRANTY IMPLIED THROUGH COURSE OF PERFORMANCE, COURSE OF DEALING, OR USAGE OF TRADE OR (II) CLAIMS ARISING OUT OF THE NEGLIGENCE OF COMPANY OR COMPANY'S SUPPLIERS OR (III) ANY OTHER CLAIM ARISING OUT OF, CONNECTED WITH, OR RESULTING FROM THE PERFORMANCE OF COMPANY OR FROM THE DESIGN, MANUFACTURE, SALE, REPAIR, LEASE OR USE OF THE DELIVERABLE, OR ANY COMPONENT THEREOF, DELIVERED OR RENDERED HEREUNDER OR OTHERWISE.

20. INDEMNIFICATION AND LIMITATION OF LIABILITY. a. Customer shall indemnify, defend and hold Company, and its officers, directors, employees, customers, Affiliates, suppliers, users and agents, (collectively the "Indemnitees") harmless from and against any and all damages, claims, losses, expenses, costs, obligations, liabilities, including without limiting the generality of the foregoing, liabilities for court costs and attorneys' fees,

Terms and Conditions

suffered directly or indirectly by an Indemnitee by reason of, or arising out of any injury, death or loss to any person, or injury to any property (collectively, "Damages"), received or sustained by any person(s) or property, arising out of, occasioned by, attributable or related to i) any breach of any representation or warranty made by Customer, its officers, directors, employees, affiliates, users, agents, representatives or customers to Company or any third party, (ii) any failure by Customer to perform or fulfill any of its covenants, acts and/or omissions to Company or to any third party, or (iii) any litigation, proceeding or claim by any third party relating in any way to the obligations of Customer and/or the Deliverables sold by Company to Customer hereunder. Customer shall not consummate any settlement of any indemnified claim without the Indemnitees' prior written consent. Customer's obligation to indemnify Indemnitees will continue in full force and effect notwithstanding the termination or expiration of any order under this Agreement. In any claim against an Indemnitee by an employee of Customer or any subcontractor or anyone directly or indirectly employed by any of them or anyone for whose acts they may be liable, the indemnification obligations set forth in this Section shall not be limited in any way by or for Customer or any subcontractor under any applicable worker's compensation act, disability or other employee benefit act, or insurance coverage. This provision shall survive termination of any order or Agreement. **IN NO EVENT WILL COMPANY, ITS OFFICERS, DIRECTORS, EMPLOYEES, CUSTOMERS, AFFILIATES, USERS AND AGENTS, (NOR COMPANY'S SUPPLIERS) BE LIABLE FOR ANY INCIDENTAL, CONSEQUENTIAL, INDIRECT, SPECIAL, OR PUNITIVE DAMAGES OF ANY KIND OR NATURE UNDER ANY CIRCUMSTANCES INCLUDING, BUT NOT LIMITED TO, LOSS OF USE OF THE PRODUCTS, SERVICE INTERRUPTION, LOSS OF PROFITS, LOSS OF REVENUE, LOSS OF INTEREST, LOST GOODWILL, LOSS OF DATA, WORK STOPPAGE, IMPAIRMENT OF OTHER GOODS, LOSS BY REASON OF SHUTDOWN OR NON-OPERATION, INCREASED EXPENSES OF OPERATION, OR CLAIMS OF CUSTOMER'S CUSTOMERS, OR ANY OTHER LOSSES OR DAMAGES ARISING OUT OF ANY LACK OR LOSS OF USE OF THE DELIVERABLES WHETHER BASED ON CONTRACT, WARRANTY, TORT (INCLUDING, BUT NOT LIMITED TO, STRICT LIABILITY OR NEGLIGENCE), PATENT INFRINGEMENT, OR OTHERWISE, EVEN IF ADVISED OF THE POSSIBILITY OF SUCH DAMAGES.**

b) **INTELLECTUAL PROPERTY INDEMNITY.** Company makes no representation or warranty to the Customer that the Deliverables shall not infringe any intellectual property rights including, without limitations, claims arising from patent, copyright, trademark, trade secret, or other intellectual property infringement. Customer agrees to hold Company harmless from and defend the Company against any such claim of intellectual property infringement, including any Damages resulting from that claim, the cost of complying with any preliminary or permanent injunction, and all other costs of defense (including the attorneys' fees and costs), in connection with the foregoing.

c) To the extent that applicable law does not permit any limitations set out in this Agreement, such limitation shall not be applied or invoked. Nothing in this Agreement will be interpreted to disclaim liability of Company or the Indemnitees for gross negligence or willful misconduct. The limitations of remedy and liability herein shall not be interpreted to affect Company's obligations, if any, for claims for (i) property damage, (ii) personal injury, or (iii) wrongful death asserted by persons who are not parties to or beneficiaries of this Agreement. Further, the limitations of remedy and liability herein shall not be interpreted to limit Company's or Customer's right, if permitted by applicable law, to assert a claim for contribution among joint tortfeasors in connection with a claim by a person who is not a party to this Agreement.

21. CERTIFICATIONS. Certification of Deliverables for compliance with UL and ANSI standards are tested and performed by third-party independent laboratories. Any field modification or alteration of certified Deliverables will void certification and Company is not liable to Customer to certify any modified or altered Deliverable.

22. TERM FOR CLAIMS. NO ACTION ARISING OUT OF ANY CLAIMED BREACH OF THIS AGREEMENT BY COMPANY MAY BE BROUGHT BY CUSTOMER MORE THAN ONE (1) YEAR AFTER THE CAUSE OF ACTION HAS ARISEN.

23. CONSUMER PRODUCTS WITH RESPECT TO "CONSUMER PRODUCTS" AS DEFINED UNDER THE MAGNUSON-MOSS WARRANTY ACT ("MMWA"), THE FOLLOWING STATEMENTS ARE MADE. (A) SOME STATES OR LOCAL LAWS DO NOT ALLOW LIMITATIONS ON HOW LONG AN IMPLIED WARRANTY LASTS, SO THE ABOVE LIMITATION MAY NOT APPLY TO YOU; (B) IF ANY IMPLIED WARRANTY IS PROVIDED UNDER THE MMWA, IT IS LIMITED TO THE DURATION OF THE WARRANTY PROVIDED IN SECTION 18 ABOVE. (C) SOME STATES OR LOCAL LAWS DO NOT ALLOW THE EXCLUSION OR LIMITATION OF INCIDENTAL OR CONSEQUENTIAL DAMAGES, SO THE ABOVE LIMITATION OR EXCLUSION MAY NOT APPLY TO YOU; AND (D) THIS WARRANTY GIVES YOU SPECIFIC LEGAL RIGHTS AND YOU MAY ALSO HAVE OTHER RIGHTS WHICH VARY FROM STATE TO STATE OR LOCATION TO LOCATION.

24. FORCE MAJEURE/EXCUSABLE DELAY. Any delay or failure of Company to perform its obligations hereunder will be excused to the extent that it is caused by an event or occurrence beyond Company's control such as, by way of example and not by way of limitation, acts of God, acts by any governmental authority (whether valid or invalid), governmental laws and regulations not presently in effect, fires, floods, windstorms, explosions, riots, natural disasters, wars, sabotage, accidents, labor problems (including, without limitation, lockouts, strikes, and slowdowns) at Company's facility, its source plant or their suppliers, inability to obtain power, material, labor equipment, or transportation, or court injunction or order. The delivery date will be extended for a time equal to that of the delay and the schedule for Company's performance will be deemed adjusted to that effect.

25. ENTIRE AGREEMENT AND AMENDMENT. This Agreement, together with the attachments, exhibits, webpages, or supplements specifically referenced and incorporated herein, constitute the entire agreement between Company and Customer with respect to the matters contained herein and supersede all previous communications, representations, or agreements, either oral or written between Company and Customer. No agreement or understanding varying or expanding this Agreement will be binding upon either party unless it is in writing and signed by a duly authorized representative of each party hereto.

26. CONFLICTS. In the event of any conflict or inconsistency between the terms of any agreement, or any part of an agreement or the various documents (including, but not limited to, electronic documents) between Company and Customer, unless the parties agree otherwise in writing, the various components of the agreements shall be given the following precedence (in descending order of precedence): a) any master agreement or long term agreement between Company and Customer; b) any specific terms, conditions and/or warranties of the individual products or Deliverables; c) the terms and conditions of this Agreement, and d) any purchase order.

27. UNSATISFACTORY CREDIT/TERMINATION FOR INSOLVENCY OR DEFAULT.

Customer shall furnish Company with statements evidencing Customer's financial condition as Company may, from time to time, reasonably request, and shall notify Company immediately of any and all events that may have a material adverse effect on Customer's business or financial condition. If Company determines, in its sole discretion, that Customer's financial condition or creditworthiness is inadequate or unsatisfactory, then in addition to Company's other rights, Company may without liability or penalty, take any of the following actions: (i) modify the payment terms for any outstanding and/or future purchases; (ii) cancel any previously accepted orders; (iii) delay any further shipment of Deliverables to Customer; or (iv) any combination of the above.

Company may immediately terminate an order from Customer by giving written notice to Customer in the event of the happening of any of the following or any other comparable event: (i) insolvency of the Customer; (ii) filing of a petition in bankruptcy by or against the Customer; (iii) appointment of a receiver or trustee for the Customer; (iv) execution of an assignment for the benefit of creditors by the Customer, all of which will allow Company to demand reclamation of all affected orders; (v) Customer ceases or threatens to cease to trade; (vi) Company determines that Customer does not meet or no longer meets the credit requirements of Company or Customer's credit account is closed; (vii) any Customer violation of law, specifically including, without limitation, those laws set forth in this Agreement.

In the event of termination in accordance with this section, Company will not be obligated to accept any existing or additional orders from Customer and Company will be released from its obligation to deliver under orders accepted prior to such termination. The rejection or termination of any order by Company will not entitle Customer to any termination or severance compensation, or to any payment in respect to any goodwill established by Customer, or render Company liable for damages on account of the loss of prospective profits, or on account of any loss, expenditure, investment or obligation incurred or made by Customer.

No action taken under this Section 27 by Company (nor any failure of Company to act under this Section 27) will constitute a waiver by Company of any of its rights to enforce Customer's obligations, including the obligation of Customer to make payments as required under this Agreement. Upon termination of any order, all amounts owed by Customer to Company will become immediately due and payable, whether or not otherwise then due or payable.

28. CREDIT RISK ON RESALE OF DELIVERABLES. Customer is responsible for all credit risks with respect to, and for collecting payment for, all Deliverables sold to third parties (including End Users, installers, and/or general contractors) whether or not Customer has made full payment to Company for such Deliverables. The inability of Customer to collect payment for any Deliverable shall not affect Customer's obligation to pay Company for any Deliverable.

29. GOVERNING LAW; VENUE; AND EXPENSES. Any dispute or claim relating to this Agreement shall be governed by and construed according to the laws of the State of Indiana (excluding its conflict of laws principles); and not by the provisions of the 1980 United Nations Convention on the International Sale of Goods. Any disputes or claims shall be instituted and maintained in the courts of the State of Indiana. Customer consents to the exercise of jurisdiction over it by such courts and agrees that Indiana is not an inconvenient forum for any action arising from or relating to this Agreement. Customer agrees to pay for all expenses (including, but not limited to, collection costs, court costs and attorneys' fees) incurred by Company in enforcing the obligations of Customer under this Agreement.

30. RELATIONSHIP OF THE PARTIES. Nothing in this Agreement or any other document creates an employment, partnership, joint venture, or agency relationship between Company and Customer, including that of franchisee/franchisor. No party will have any power or authority to enter into any commitment on behalf of or otherwise bind the any other party on any matter. No employee of Customer will be deemed to be an employee of Company. If any provision of this Agreement is deemed to create a franchise relationship or business opportunity between the Parties, then Company may terminate any purchase order or this Agreement or the Parties shall negotiate in good faith to modify this Agreement so as to effect the original intent of the Parties as closely as possible in a mutually acceptable manner in order that the transactions contemplated hereby are consummated as a reseller agreement and not a franchise or business opportunity agreement.

31. SETOFF. Customer does not have the right to setoff or to back charge against any amounts which become payable to Company under this Agreement or otherwise. Company will not accept responsibility for backcharges for the cost of material or labor by Customer or any third party.

32. ELECTRONIC COMMUNICATIONS AND ELECTRONIC SIGNATURES. Both parties expressly agree to electronic transactions and acknowledge that documents they sign electronically will bind them to the same extent as a paper signature. Customer represents and warrants to Company that only employees authorized to bind Customer legally shall electronically sign any document under this Agreement. Customer shall comply with any method of electronic communication/payment processing specified by Company, including electronic funds transfer, pay-on-receipt processes/systems, order transmission, releases, electronic signature, and electronic communication systems, including, without limitation, the use of electronic data interchange ("EDI") portals. Notwithstanding the foregoing, e-mails, even those containing a signature block of one of Company's representatives, shall not constitute a signed writing.

33. COMPLIANCE WITH APPLICABLE LAWS.

a. **General.** Company and Customer will comply with all applicable federal, state and municipal laws, regulations, codes, ordinances and orders that pertain to the Deliverables, including but not limited to full compliance with any applicable provisions of The Health Insurance Portability and Accountability Act. Where the Customer is located outside the United States, or where the customer intends to ship the product outside the United States, the Customer shall be responsible for compliance with all U.S. export laws, and for filing all U.S. Electronic Export Information, as applicable.

b. The Customer acknowledges and agrees that: (i) it shall not violate applicable laws and regulations in performing its duties under this Agreement; (ii) it does not and shall not engage in any conduct that shall violate any applicable anti-bribery or anti-corruption laws or regulations; (iii) it (and its owners, officers, directors, employees and agents) shall not pay, offer, promise or authorize the payment of, either directly or indirectly, anything of value (including but not limited to cash, gifts and entertainment) to (a) any government official or employee of any government; (b) any official or employee of any department, agency, or

instrumentality of a government; (c) any employee of any corporation or entity owned or controlled by a government; (d) any family member of such officials or employees; (e) any political party, party official, or political candidate; or (f) any other persons, owners, officers, directors, employees and agents of any corporation or entity; to improperly or illegally assist in obtaining or retaining business (including but not limited to any contracts, avoidance of duties or reduction of tariffs, reduction of taxes or to obtain money owed, or to obtain regulatory approval) or for the purpose of causing, soliciting or inducing the sale and purchase of the Deliverables by any party, and (iv) it has full knowledge of and will comply with the Company's Code of Conduct for Business Partners as set forth on the Allegion customer website, **WHICH IS HEREBY INCORPORATED BY REFERENCE.**

c. The Customer shall indemnify and hold the Company harmless from any claim, demand, expense or cost arising from any breach of this Article.

d. The Customer shall permit the Company to conduct an audit or review of the Customer's financial books and records and business operations at such other times that the Company considers it necessary to confirm compliance with this provision. Such audit may be conducted by representatives of the Company or, at the Company's sole discretion, by a certified public accounting firm selected by the Company. The Customer shall cooperate with any inquiries from the Company's Ethics & Compliance Group.

e. A violation of this provision constitutes a material breach of this Agreement and the Company may terminate any purchase order or this Agreement immediately, with no opportunity to cure, in accordance with Section 27 of this Agreement.

f. Notwithstanding the foregoing provisions of this Section 33, (i) Company is not responsible for obtaining or maintaining any permits for the performance of services or the verification or compliance with any code requirements relative to the performance of services, (ii) to the extent any sale of Deliverables pursuant to this Agreement may require approval of the U.S. Government, Company's obligations under this Agreement are conditioned upon the grant of such approval and upon compliance by Customer with any restrictions imposed by the U.S. Government in connection with such approval, and (iii) in the event the Deliverables are to be used in a nuclear facility, the Customer shall, prior to such use, arrange for insurance or governmental indemnity protecting Company against liability. The Customer hereby releases and agrees to indemnify Company and its suppliers for any nuclear damage including, but not limited to, loss of use, in any manner arising out of the nuclear incident, whether alleged to be due, in whole or in part by Company or its suppliers.

g. **No Inducements.** Each party represents to each other that neither it nor any person acting on its behalf has, in contravention of any applicable law, given or offered to give or will give or offer to give, any sum of money or other material consideration to any person, directly or indirectly, as an inducement to obtain business hereunder or to influence the granting of licenses or other governmental permissions to enter into this Agreement or perform obligations hereunder.

h. **Equal Employment Opportunity.** Company is a U.S. federal contractor that complies with Executive Order 11246, as amended, and applicable regulations in 41 CFR Parts 60-1 through 60-60, 29 U.S.C. § 793 and applicable regulations in 41 CFR § 60-741; and 28 U.S.C. § 4212 and applicable regulations in 41 CFR Part 60-250 and 60-300. **THE FOLLOWING PROVISIONS ARE INCORPORATED HEREIN BY REFERENCE: Executive Order 11246, as amended by Executive Order 13672, and 41 CFR § 60-4.3(a); Executive Order 11701 and 41 CFR § 60-250.5(a), 60-300.5; Executive Order 11758 and 41 CFR § 60-741.5(a); U.S. immigration laws, including the L-1 Visa Reform Act of 2004 and the H-1B Visa Reform Act of 2004; and Executive Order 13496.**

i. **Ethical Business Conduct.** Customer shall adopt and comply with Company's Business Partner Code of Conduct which is **EXPRESSLY INCORPORATED HEREIN BY REFERENCE.**

34. REPRESENTATIONS AND WARRANTIES. Customer represents, warrants and covenants to Company that: (a) it has the right, power, and authority to enter into this Agreement and fully perform its obligations hereunder; (b) it has all necessary rights in and to its respective Content and Marks for use within the scope of this Agreement, including the licenses granted herein; and (c) it complies, and at all times shall comply, with all laws, rules, and regulations in effect that are applicable to its performance under this Agreement, including obtaining all such approvals and/or permits as may be required hereunder.

35. NO THIRD-PARTY BENEFICIARY. Each party is entering into this Agreement solely based on the representations contained herein for its own purposes and not for the benefit of any third party.

36. NOTICES AND CHANGE OF ADDRESS. All notices or other communications under this Agreement shall be in writing and delivered in person, or sent by receipted courier, express mail, e-mail, or postage prepaid certified or registered mail, addressed to the party for whom it is intended, at the addresses set forth in this Agreement. Either party may change its address for notice by giving written notice to the other party. Any notice or other communication shall be deemed given no later than the date actually received. Notice by courier, express mail, certified mail, or registered mail shall be deemed given on the date it is officially recorded as delivered and, in the absence of such record of delivery, it shall be rebuttably presumed to have been delivered on the third Business Day after it was deposited. Notices sent by e-mail require tangible confirmation of receipt from addressee.

37. ASSIGNMENT. Customer may not assign this Agreement without the prior written consent of Company. Company may assign its rights and delegate its duties under this Agreement, without the prior consent of Customer, to an Affiliate, or to a third party in the event of a spin-off, merger, business combination, consolidation or sale of all, or substantially all, of its assets or business that are related to this Agreement. The rights and duties in this Agreement shall bind and inure to the benefit of any such assignee.

38. SEVERABILITY. If any provision of this Agreement is held to be invalid, illegal, or unenforceable under any statute, regulation, ordinance, executive order, or other rule of law, that provision will be deemed severed to the extent necessary to comply with such statute, regulation, ordinance, order, or rule. In the event such provision is deemed severed, the parties will negotiate in good faith to arrive at an alternative arrangement approximating the original business objective of the parties. The remaining terms and conditions of this Agreement will remain in effect.

39. NO IMPLIED WAIVER. The failure of either party at any time to require performance by the other party of any provision of this Agreement will in no way affect the right to require such performance at any time thereafter, nor will the waiver of either party of a breach of any provision of this Agreement constitute a waiver of any succeeding breach of the same or any other provision.

40. MISCELLANEOUS. (a) This Agreement does not make either party the agent or legal representative of the other party. Neither party is authorized to create any obligation on behalf of the other party including, but not limited to, the obligation for payment of any

service or warranty obligation hereunder; (b) The rights and remedies herein reserved to Company are cumulative and additional to any other rights and remedies provided at law or equity; (c) The official text of this Agreement is in the English language. If this Agreement is translated into another language, the English text will govern any question with respect to interpretation; (d) The headings in this Agreement are for convenience of reference only and do not affect the meaning of this Agreement in any manner.

DEFINITIONS.

Capitalized terms have the meanings set forth in this Section, or in the Section in which they first appear in this Agreement.

"Agreement" means these Allegion Terms and Conditions of Sale and Service, together with any applicable Country Supplement or Region Supplement provided by Company, and all of the documents referenced herein or therein.

"Affiliate" means any Person that directly or indirectly, through one or more intermediaries, controls, is controlled by, or is under common control with, the Company. The term "control" (including the terms "controlled by" and "under common control with") means the possession, directly or indirectly, of the power to direct or cause the direction of the management and policies of a Person, whether through the ownership of voting securities, by contract or otherwise.

"Business Day" means any day except Saturday, Sunday or any other day on which commercial banks located in the United States are authorized or required by Law to be closed for business.

"Company" means Schlage Lock Company, LLC or any subsidiary or affiliate thereof selling products that are part of the Allegion product portfolio. Schlage Lock Company and/or its subsidiary or affiliates will be severally but not jointly liable under the Agreement.

"Company Marks" refers to the Marks of Company.

"Confidential Information" shall mean any and all information provided by either party to the other party pertaining to the disclosing party's business. Confidential Information shall include, but not be limited to, any bidding lists, formulae for products, manufacturing processes, production techniques, packaging processes, methods, research materials, ideas, marketing plans and related materials, quality standards, test results and data, apparatus, engineering drawings, contract documents, computer software, hardware, or firmware, business activities information such as financial information, reports, projections, books and records, customer and supplier information, and operations, customer and supplier lists and data, specifications, know how, and other Proprietary Information or Trade Secrets (as defined herein) that either party may furnish to the other party. Confidential Information shall not include information that: (a) is or becomes publicly known if such public knowledge or disclosure is not the result of any act or failure to act on the part of the receiving party; (b) is, at the time of disclosure, already known to the Receiving Party without utilizing the Confidential Information; (c) is information disclosed to the Receiving Party by a third party which is not to the Receiving Party's knowledge, after inquiry of the third party, under a duty of confidentiality to the Disclosing Party; or (d) is independently developed by the Receiving Party without the use of Confidential Information. The Receiving Party shall have the burden of proof as to prior knowledge and absence of breach. Confidential Information may be furnished in any tangible or intangible form including, but not limited to, writings, drawings, computer and other electronic media, logic diagrams, component specifications, graphs, prototypes, samples, or verbal communications and regardless of whether such information is marked or designated as "confidential." For the avoidance of doubt, all information, knowledge or data disclosed by Company to Customer, regardless of whether disclosed in written, tangible, oral, visual or other form, including, without limitation, sample products, equipment, software, or other objects or material, provided by Company to Customer, and all information, knowledge or data which was obtained by Customer from visits to Company's facilities, shall be considered "Confidential Information" under this Agreement.

"Content" means all information (including without limitation any text, music, sound, photographs, video, graphics, data or software), in any medium, on a particular Company Web page or Website or in Marketing Materials.

"Customer" means the purchaser of Deliverables from Company.

"Deliverables" means any good or service or both purchased by Customer from Company under these General Terms and Conditions of Sale and Service.

"End Users" means the purchaser that (a) has acquired a Deliverable from Customer for (i) its own and its Affiliate's/Affiliates' internal use and not for resale, remarketing or distribution or (ii) incorporation into its own products and (b) is an individual or entity, other than any federal, state or local agency, office or division.

"IP" means all intellectual property and industrial property rights comprising or relating to/ of the following: (a) Patents; (b) Trademarks; (c) internet domain names, whether or not Trademarks, registered by any authorized private registrar or Governmental Authority, web addresses, web pages, website and URLs; (d) works of authorship, expressions, designs and design registrations, whether or not copyrightable, including copyrights and copyrightable works, software and firmware, application programming interfaces, architecture, files, records, schematics, data, data files, and databases and other specifications and documentation; (e) Trade Secrets; and (f) all other intellectual property and industrial property rights, and all rights, interests and protections that are associated with, equivalent or similar to, or required for the exercise of, any of the foregoing, however arising, in each case whether registered or unregistered and including all registrations and applications for, and renewals or extensions of, such rights or forms of protection pursuant to the Laws of any jurisdiction throughout in any part of the world.

"Marketing Materials" means all marketing brochures, buckslips, pamphlets, emails, text, call scripts or other material, whether in printed format, audio or audiovisual format, or in any other format, that contain any (i) Content relating to the Company Deliverables or (ii) Company Marks.

"Marks" means collectively the domain names, trademarks, trade names, service marks, trade dress, logos, and the like used or provided by either party for use in connection with this Agreement.

"Patents" means all patents (including all reissues, divisionals, provisionals, continuations and continuations-in-part, re-examinations, renewals, substitutions and extensions thereof), patent applications, and other patent rights and any other Governmental Authority-issued indicia of invention ownership (including inventor's certificates, petty patents and patent utility models).

"Person" means a person or entity.

"Price Books" mean Company's current Price Book in effect for the applicable Deliverable being purchased by Customer.

"Trade Secrets" means and includes business or technical information of either party, including processes, formulas, devices, techniques, compilations and other material that a party attempts to maintain in secret and that derive commercial value for such party from not being generally known to the public or readily ascertainable through independent development or reverse engineering.

DOOR CLOSER SPECIALISTS

Since its founding in 1926, LCN has specialized in solving door control problems through the use of high quality, innovative door control products. By adhering to high standards of performance, LCN has earned a leadership role within the industry and is committed to meeting door control challenges of the future. With representatives located throughout the world, LCN provides the products and services necessary to solve your door control problems.

The LCN formula for success



Cast Iron

Heavy-duty cast iron. There isn't a stronger, harder, more reliable material for door closers that are expected to deliver millions of cycles. Cast iron is more compatible with high grade steel components and is more resistant to the wear of millions of opening/closing cycles.



Princeton, IL

LCN has been manufacturing its door closers in Princeton, IL since we moved from Chicago in 1949. We're committed to continuing to provide the quality you expect, from a brand you trust most.

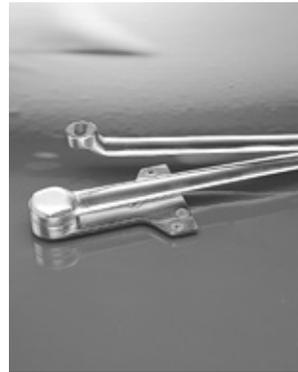

Forged Steel Arms

The closing power and control generated within LCN closers is transferred to the door through forged steel arms. Forged steel arms have greater strength, better appearance and less bulk.



Patented Green Dial

The patented green dial was first introduced on the 4040 in the year 2000. The green dial indicates the spring size setting on the closer which allows for fast and accurate installation and maintenance.



Heat-Treated

LCN forged steel pinions have larger, stronger teeth and are double heat-treated for the greatest possible strength on the shaft. Heat treating makes the pinion harder, better able to resist wear after years of service and results in less stress on the cylinder.



Special Templates

When a standard door closer won't do the job, there is only one proven, reliable source for special solutions—LCN. With over 3,000 special templates on file, LCN can provide a door control solution for one-of-a-kind doors such as vault, balanced, oversized and arch doors.



All Weather Fluid

LCN uses a special formula hydraulic fluid that acts as an insulator to keep closer components working smoothly. This unique all-weather hydraulic fluid eliminates the need for seasonal adjustments.



Customer Care

Call us! We're ready to assist with your door control needs.

COMPLETE DOOR CLOSERS

PRICE LIST



CLOSER SERIES		STANDARD POWDER COAT FINISHES	PLATED FINISHES			S H E E P I N G
SERIES NUMBER	ARM TYPE		US26D	US 3 US 4 US 10	US 10B US 15 US 26	

AL (689)
DKBRZ (695)
BRASS (696)
LTBRZ (691)
STAT (690)
BLACK (693)

1260 Series - Surface Mount

1261.....REG	\$222	N/A	N/A	11
1261.....Rw/PA	227	N/A	N/A	12
1261.....Rw/62A	242	N/A	N/A	12
1261.....LONG	222	N/A	N/A	11
1261.....H	248	N/A	N/A	11
1261.....Hw/PA	253	N/A	N/A	12
1261.....HLONG	248	N/A	N/A	11
1261.....EDA	248	N/A	N/A	13
1261.....EDA w/62G	248	N/A	N/A	13
1261.....HEDA (Handed)	273	N/A	N/A	13
1261.....HEDA w/62G (Handed)	273	N/A	N/A	13
1261.....CUSH	273	N/A	N/A	12
1261.....HCUSH	323	N/A	N/A	12

Add for; Slim Cover (**SLIM**) (\$9), TORX Fasteners (**TORX**) (\$12), Special Rust Inhibitor (**SRI**) (\$36)
For parts & accessories, see page 48.

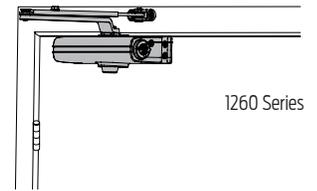

1460 Series - Surface Mount

1461.....REG	\$285	\$516	\$580	9
1461.....Rw/PA	290	566	645	11
1461.....Rw/62A	305	581	660	11
1461.....LONG	285	516	580	9
1461.....H	311	524	595	10
1461.....Hw/PA	316	574	660	11
1461.....HLONG	311	524	595	10
1461.....HD	300	531	595	9
1461.....HD/PA	305	581	660	11
1461.....HDw/62A	320	596	675	11
1461.....HD/LONG	300	531	595	10
1461.....EDA	311	612	680	12
1461.....EDA w/62G	311	612	680	12
1461.....HEDA (Handed)	336	637	705	12
1461.....HEDA w/62G (Handed)	336	637	705	12
1461.....CUSH	336	637	705	11
1461.....HCUSH	386	687	755	11
1461.....SCUSH	386	687	755	11
1461.....SHCUSH	436	737	805	11

Add for; Delay Action (**DEL**) (\$30), Designer Series Cover (**DS**) (\$25), Full Cover (**FC**) (\$5), TORX Fasteners (**TORX**) (\$12), Special Rust Inhibitor (**SRI**) (\$36), Custom Powder Finish (**RAL**___)* (\$30), Brite Metallic (**MTLPC**)* (\$60)
For parts & accessories, see page 48.

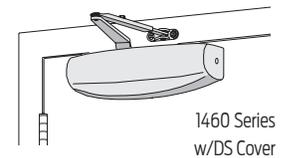
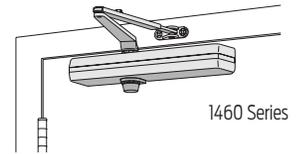

1460T Series - Surface Mount

1460T, 1461T.....STD	\$345	\$570	\$635	12
1460T, 1461T.....H	365	590	655	12
1460T, 1461T.....BUMPER	355	580	645	12
1460T, 1461T.....H BUMPER	375	600	665	12

Add for; Designer Series Cover (**DS**) (\$25), Full Cover (**FC**) (\$5), TORX Fasteners (**TORX**) (\$12), Special Rust Inhibitor (**SRI**) (\$36), Custom Powder Finish (**RAL**___)* (\$30), Brite Metallic (**MTLPC**)* (\$60)
For parts & accessories, see page 49.



COMPLETE DOOR CLOSERS

PRICE LIST



CLOSER SERIES		STANDARD POWDER COAT FINISHES	PLATED FINISHES			S H E E P L I G H T
SERIES NUMBER	ARM TYPE		US26D	US 3 US 4 US 10	US 10B US 15 US 26	

2010 Series - Concealed (Requires Handing)

2011, 2013-2016	STD	\$528	\$796	\$886	13
2011, 2013-2016	H	548	816	906	14
2011, 2013-2016	BUMPER	538	806	896	13
2011, 2013-2016	H BUMPER	558	826	916	14

Add for; TORX Fasteners (**TORX**) (\$12), Special Rust Inhibitor (**SRI**) (\$36), Custom Powder Finish (**RAL**)* (\$30), Brite Metallic (**MTLPC**)* (\$60)

For parts & accessories, see page 49.

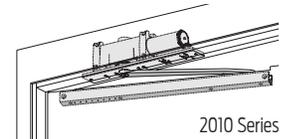

2030 Series - Concealed (Requires Handing)

2031-2035	STD	\$880	\$1,252	\$1,355	14
2031-2035	H	900	1,272	1,375	14
2031-2035	BUMPER	890	1,262	1,365	14
2031-2035	H BUMPER	910	1,282	1,385	14

Add for; TORX Fasteners (**TORX**) (\$12), Special Rust Inhibitor (**SRI**) (\$36), Custom Powder Finish (**RAL**)* (\$30), Brite Metallic (**MTLPC**)* (\$60)

For parts & accessories, see page 49.

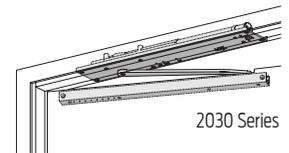

2210 Series - Concealed (Requires Handing)

2213-2215	STD	\$736	\$1,047	\$1,113	17
2213DPS-2215DPS	STD	826	1,137	1,203	17

Add for; Advanced Variable Backcheck (**AVB**) (\$15), Special Rust Inhibitor (N/A with DPS) (**SRI**) (\$36), Custom Powder Finish (**RAL**)* (\$30), Brite Metallic (**MTLPC**)* (\$60)

For parts & accessories, see page 49.

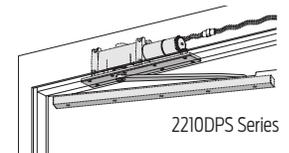

2310ME Series - Concealed (Requires Handing & Voltage)

2314ME	STD	\$978	\$1,246	\$1,336	17
--------	-----	--------------	---------	---------	----

Add for; Bypass Cylinder (**B80**) or (**B140**) (\$75), TORX Fasteners (**TORX**) (\$12), Custom Powder Finish (**RAL**)* (\$30), Brite Metallic (**MTLPC**)* (\$60)

For parts & accessories, see page 50.

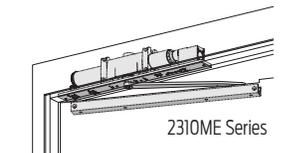

2610 Series - Concealed (Requires Handing)

2613-2614	STD	\$1,776	\$2,099	\$2,193	22
2613DPS-2614DPS	STD	1,946	\$2,269	\$2,363	22

Add for; Custom Powder Finish (**RAL**)* (\$30), Brite Metallic (**MTLPC**)* (\$60)

See pages 24-25 for control boxes and compressors. Also, see pages 30-47 for actuators, tubing, & accessories.

For parts & accessories, see page 50.

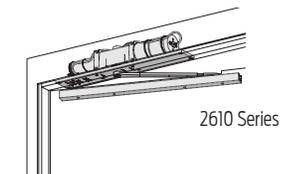

COMPLETE DOOR CLOSERS

PRICE LIST

CLOSER SERIES		STANDARD ANODIZED FINISHES	PLATED FINISHES		S H E E T P I N G	
SERIES NUMBER	ARM TYPE		N/A	N/A		



2810 Series - Concealed (Requires Handing)

2811.....STD/CP **\$3,871**
 2811.....STD/OP **3,979**

ANCLR or ANDKB
 ANCLR or ANDKB

78
 78



2810 Series

Header lengths available 33" to 48" on operators without **POS** or **BKY** (please specify).
 Header lengths available 36" to 48" on operators with **POS** or **BKY** (please specify).
 STD/CP arm has 2 3/4" spindle center, STD/OP arm has 3 3/4" spindle center.
 Add for; Double Door Header (49" to 98" – please specify) (**DD**) (**\$205**),
 Positive Mechanical Stop (STD/CP arm only) (**POS**) (**\$25**), Breakaway Stop (STD/CP arm only) (**BKY**) (**\$90**)
 See pages 30-47 for actuators & accessories.
 For parts & accessories, see page 50.



2850 Series - Concealed/Simultaneous Pair

2853.....STD/CP **\$6,615**
 2853.....STD/OP **6,832**

ANCLR or ANDKB
 ANCLR or ANDKB

155
 155



2850 Series

Header lengths available 52" to 98" on operators without **POS** or **BKY** (please specify).
 Header lengths available 70" to 98" on operators with **POS** or **BKY** (please specify).
 STD/CP arm has 2 3/4" spindle center, STD/OP arm has 3 3/4" spindle center.
 Add for; Positive Mechanical Stop (STD/CP arm only) (**POS**) (**\$50**), Breakaway Stop (STD/CP arm only) (**BKY**) (**\$180**)
 See pages 30-47 for actuators & accessories.
 For parts & accessories, see page 50.



2860 Series - Concealed/Independent Pair

2863.....STD/CP **\$7,795**
 2863.....STD/OP **8,012**

ANCLR or ANDKB
 ANCLR or ANDKB

155
 155



2860 Series

Header lengths available 65" to 98" on operators without **POS** or **BKY** (please specify).
 Header lengths available 70" to 98" on operators with **POS** or **BKY** (please specify).
 STD/CP arm has 2 3/4" spindle center, STD/OP arm has 3 3/4" spindle center.
 Add for; Positive Mechanical Stop (STD/CP arm only) (**POS**) (**\$50**), Breakaway Stop (STD/CP arm only) (**BKY**) (**\$180**)
 See pages 30-47 for actuators & accessories.
 For parts & accessories, see page 51.

COMPLETE DOOR CLOSERS

PRICE LIST



CLOSER SERIES		STANDARD POWDER COAT FINISHES	PLATED FINISHES			S H E E T P I P P I N G
SERIES NUMBER	ARM TYPE		US26D	US 3 US 4 US 10	US 10B US 15 US 26	

3030 Series - Concealed (Requires Handing)

3031-3034.....	REG	\$380	\$547	\$591	6
3031-3034.....	H	410	577	621	6

Add for; TORX Fasteners (**TORX**) (\$12), Special Rust Inhibitor (**SRI**) (\$36), Custom Powder Finish (**RAL**___)* (\$30), Brite Metallic (**MTLPC**)* (\$60)
For parts & accessories, see page 51.

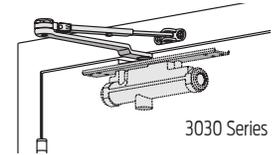

3130 Series - Concealed (Requires Handing)

3131-3133.....	STD	\$436	\$605	\$652	8
3131-3133.....	H	456	625	672	8
3131-3133.....	BUMPER	446	615	662	8
3131-3133.....	H BUMPER	466	635	682	8

Add for; TORX Fasteners (**TORX**) (\$12), Special Rust Inhibitor (**SRI**) (\$36), Custom Powder Finish (**RAL**___)* (\$30), Brite Metallic (**MTLPC**)* (\$60)
For parts & accessories, see page 51.

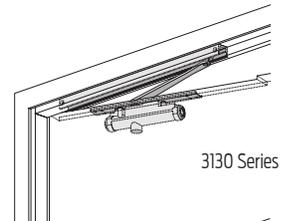

3130SE Series - Concealed (Requires Handing & Voltage)

3133SE-3134SE	STD	\$671	\$840	\$887	8
3133SE-3134SE	LONG	671	840	887	8

Add for; TORX Fasteners (**TORX**) (\$12), Custom Powder Finish (**RAL**___)* (\$30), Brite Metallic (**MTLPC**)* (\$60)
For parts & accessories, see page 51.

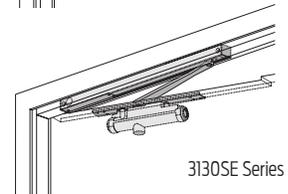

4000T Series - Wall Pocket (SEM7800 Series Available Separately)

4003T-4004T	STD	\$439	\$703	\$792	15
-------------------	-----	--------------	-------	-------	----

Add for; Metal Cover (**MC**) (\$5), TORX Fasteners (**TORX**) (\$12), Special Rust Inhibitor (**SRI**) (\$36), Custom Powder Finish (**RAL**___)* (\$30), Brite Metallic (**MTLPC**)* (\$60)
For parts & accessories, see page 51.

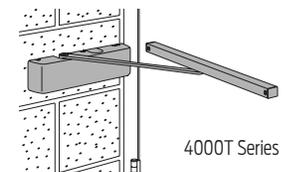

4010 Series - Surface Mount (Requires Handing)

4011 or 4016	REG	\$391	\$748	\$867	11
4011 or 4016	H	416	773	892	12
4011 or 4016	FL	504	NA	NA	15

Add for; Delay Action (**DEL**) (\$30) (4011 only), Telephone Cylinder (**TEL**) (\$30), Metal Cover (**MC**) (\$5), TORX Fasteners (**TORX**) (\$12), Special Rust Inhibitor (**SRI**) (\$36), Custom Powder Finish (**RAL**___)* (\$30), Brite Metallic (**MTLPC**)* (\$60)
Note - 4010 Series is available as 4011 (Adjustable 1-5) or 4016 (Size 6 Only - Not ADA Compliant).
For parts & accessories, see page 51.

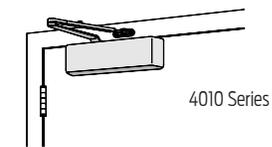

4010T Series - Surface Mount (Requires Handing)

4011T, 4013T-4014T	STD	\$433	\$689	\$764	16
4011T, 4013T-4014T	H	453	709	784	16
4011T, 4013T-4014T	BUMPER	443	699	774	16
4011T, 4013T-4014T	H BUMPER	463	719	794	16
4011T, 4013T-4014T	DE	473	729	804	16
4011T, 4013T-4014T	DE HO	493	749	824	16
4011T, 4013T-4014T	DE BUMPER	483	739	814	16
4011T, 4013T-4014T	DE H BUMPER	503	759	834	16

Add for; Metal Cover (**MC**) (\$5), TORX Fasteners (**TORX**) (\$12), Special Rust Inhibitor (**SRI**) (\$36), Custom Powder Finish (**RAL**___)* (\$30), Brite Metallic (**MTLPC**)* (\$60)
For parts & accessories, see page 52.

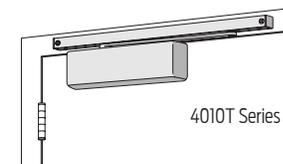

COMPLETE DOOR CLOSERS

PRICE LIST



CLOSER SERIES		STANDARD POWDER COAT FINISHES	PLATED FINISHES			S H E E T P I N T G
SERIES NUMBER	ARM TYPE		US26D	US 3 US 4 US 10	US 10B US 15 US 26	

AL (689)
DKBRZ (695)
BRASS (696)
LTBRZ (691)
STAT (690)
BLACK (693)

4020 Series - Surface Mount (Requires Handing)

4021 or 4026..... REG	\$391	\$748	\$867	11
4021 or 4026..... LONG	416	773	892	11
4021 or 4026..... H	416	773	892	12
4021 or 4026..... FL	504	NA	NA	12

Add for; Delay Action (**DEL**) (\$30) (4021 only), Telephone Cylinder (**TEL**) (\$30), Metal Cover (**MC**) (\$5), TORX Fasteners (**TORX**) (\$12), Special Rust Inhibitor (**SRI**) (\$36), Custom Powder Finish (**RAL**___)* (\$30), Brite Metallic (**MTLPC**)* (\$60)

Note - 4020 Series is available as 4021 (Adjustable 1-5) or 4026 (Size 6 Only - Not ADA Compliant).
For parts & accessories, see page 52.

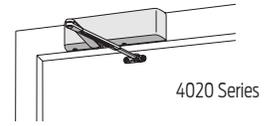

4020 Series

4020T Series - Surface Mount (Requires Handing)

4021T, 4023T-4024T STD	\$433	\$689	\$764	15
4021T, 4023T-4024T H	453	709	784	16
4021T, 4023T-4024T BUMPER	443	699	774	15
4021T, 4023T-4024T H BUMPER	463	719	794	16

Add for; Metal Cover (**MC**) (\$5), TORX Fasteners (**TORX**) (\$12), Special Rust Inhibitor (**SRI**) (\$36), Custom Powder Finish (**RAL**___)* (\$30), Brite Metallic (**MTLPC**)* (\$60)
For parts & accessories, see page 52.

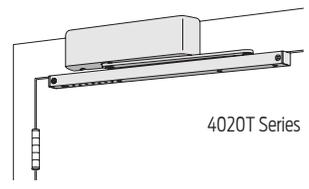

4020T Series

4030 Series - Surface Mount

4031 REG	\$337	\$598	\$687	8
4031Rw/PA	342	648	752	9
4031 Rw/62A	357	663	767	8
4031 LD	317	563	637	8
4031 LD/PA	322	613	702	8
4031 LD/62A	337	628	717	8
4031 LONG	337	598	687	8
4031 H	368	622	709	8
4031Hw/PA	373	672	774	9
4031 HLONG	368	622	709	8
4031 EDA	346	684	761	9
4031HEDA (Handed)	371	709	786	9
4031 CUSH	371	709	786	9
4031 HCUSH	421	759	836	9
4031 SCUSH	421	759	836	9
4031 SHCUSH	471	809	886	9

Add for; Special Rust Inhibitor (**SRI**) (\$36), Custom Powder Finish (**RAL**___)* (\$30), Brite Metallic (**MTLPC**)* (\$60)
For parts & accessories, see page 52.

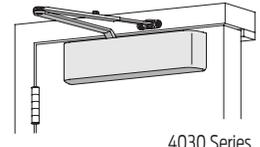

4030 Series

4030T Series - Surface Mount

4031T STD	\$387	\$638	\$705	9
4031T H	407	658	725	9

Add for; Special Rust Inhibitor (**SRI**) (\$36), Custom Powder Finish (**RAL**___)* (\$30), Brite Metallic (**MTLPC**)* (\$60)
For parts & accessories, see page 53.



4030T Series

COMPLETE DOOR CLOSERS

PRICE LIST



CLOSER SERIES		STANDARD POWDER COAT FINISHES	PLATED FINISHES			S H I P P I N G
SERIES NUMBER	ARM TYPE		US26D	US 3 US 4 US 10	US 10B US 15 US 26	

AL (689)
DKBRZ (695)
BRASS (696)
LTBRZ (691)
STAT (690)
BLACK (693)

4040XP Series - Surface Mount

4040XP REG	\$408	\$774	\$901	13
4040XPRw/PA	413	824	966	13
4040XP LONG	408	774	901	14
4040XP XLONG	433	799	926	14
4040XP Rw/62A	428	839	981	12
4040XP H	452	810	931	13
4040XPHw/PA	457	875	1,011	12
4040XP HLONG	452	810	931	12
4040XP EDA	436	800	925	14
4040XP EDA w/62G	436	800	925	13
4040XPHEDA (Handed)	461	825	950	14
4040XP HEDA w/62G (Handed)	461	825	950	13
4040XP CUSH	461	825	950	14
4040XPHCUSH	511	875	1,000	14
4040XPSCUSH	511	875	1,000	15
4040XPSHCUSH	561	925	1,050	15

Add for; Delay Action (**DEL**) (**\$30**) (Standard 4041 Cylinder - Not XP), Metal Cover (Handed) (**MC**) (**\$5**), TORX Fasteners (**TORX**) (**\$12**), Special Rust Inhibitor (**SRI**) (**\$36**), Custom Powder Finish (RAL___)* (**\$30**), Brite Metallic (**MTLPC**)* (**\$60**)
For parts & accessories, see page 53.

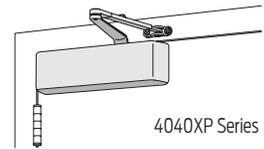

4040XP Series

4040XPT Series - Surface Mount

4040XPT STD	\$447	\$700	\$772	15
4040XPT H	467	720	792	16
4040XPTBUMPER	457	710	782	15
4040XPTH BUMPER	477	730	802	16
4040XPTDE (Handed)	487	740	812	16
4040XPT DE H (Handed)	507	760	832	16
4040XPTDE BUMPER (Handed)	497	750	822	16
4040XPT ..DE H BUMPER (Handed)	517	770	842	16

Add for; Metal Cover (Handed) (**MC**) (**\$5**), TORX Fasteners (**TORX**) (**\$12**), Special Rust Inhibitor (**SRI**) (**\$36**), Custom Powder Finish (RAL___)* (**\$30**), Brite Metallic (**MTLPC**)* (**\$60**)
For parts & accessories, see page 53.

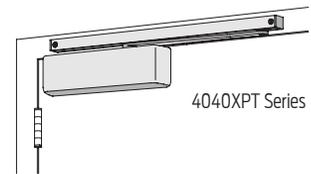

4040XPT Series



4040SE Series - Surface Mount (Requires Voltage)

4040SE STD	\$716	\$978	\$1,065	12
4040SE LONG	716	978	1,065	12
4040SEDE (Handed)	756	1,018	1,105	12

Add for; Metal Cover (Handed) (**MC**) (**\$5**), TORX Fasteners (**TORX**) (**\$12**), Custom Powder Finish (RAL___)* (**\$30**), Brite Metallic (**MTLPC**)* (**\$60**)
For parts & accessories, see page 54.

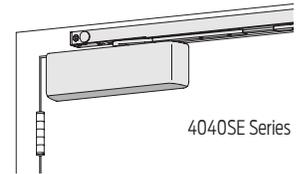

4040SE Series



4040SEH Series - Surface Mount Arm & Track Only (Requires Voltage) (Closer Available Separately)

4040SEH4040SEH-3038 w/Arm	\$443	\$599	\$633	8
---------------------------------	--------------	-------	-------	---

Add for; TORX Fasteners (**TORX**) (**\$12**)
Note - Includes 4040SEH Track & 4040SEH Arm Only.
For parts & accessories, see page 54.

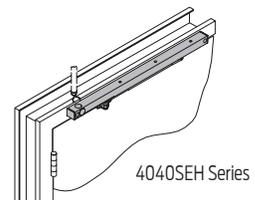

4040SEH Series

COMPLETE DOOR CLOSERS

PRICE LIST



CLOSER SERIES		STANDARD POWDER COAT FINISHES	PLATED FINISHES			S H E E P I N G
SERIES NUMBER	ARM TYPE		US26D	US 3 US 4 US 10	US 10B US 15 US 26	

AL (689)
DKBRZ (695)
BRASS (696)
LTBRZ (691)
STAT (690)
BLACK (693)

4110 Series - Surface Mount (Requires Handing)

4111 or 4116	EDA	\$391	\$748	\$867	13
4111 or 4116	EDA w/62G	391	748	867	13
4111 or 4116	HEDA	416	773	892	13
4111 or 4116	HEDA w/62G	416	773	892	13
4111 or 4116	FL	504	NA	NA	15
4111 or 4116	CUSH	436	793	912	13
4111	HCUSH	486	843	962	14
4111 or 4116	SCUSH	486	843	962	15
4111	SHCUSH	536	893	1,012	15

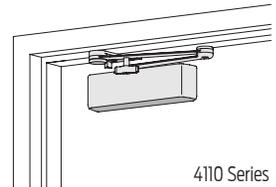

Add for; Delay Action (**DEL**) (\$30) (4111 only), Advanced Variable Backcheck (**AVB**) (\$15), Telephone Cylinder (**TEL**) (\$30), Metal Cover (**MC**) (\$5), TORX Fasteners (**TORX**) (\$12), Special Rust Inhibitor (**SRI**) (\$36), Custom Powder Finish (**RAL**___)* (\$30), Brite Metallic (**MTLPC**)* (\$60)
Note - 4110 Series is available as 4111 (Adjustable 1-5) or 4116 (Size 6 Only - Not ADA Compliant).
For parts & accessories, see page 54.

4110T Series - Surface Mount (Requires Handing)

4111T, 4113T-4114T	STD	\$433	\$689	\$764	15
4111T, 4113T-4114T	H	453	709	784	16
4111T, 4113T-4114T	BUMPER	443	699	774	15
4111T, 4113T-4114T	H BUMPER	463	719	794	16

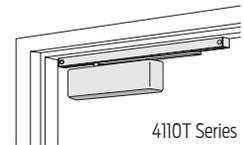

Add for; Metal Cover (**MC**) (\$5), TORX Fasteners (**TORX**) (\$12), Special Rust Inhibitor (**SRI**) (\$36), Custom Powder Finish (**RAL**___)* (\$30), Brite Metallic (**MTLPC**)* (\$60)
For parts & accessories, see page 54.

4210 Series - Surface Mount (Requires Handing)

4211 or 4216	EDA	\$432	\$582	\$622	14
4211 or 4216	CUSH	477	627	667	14
4211	HCUSH	527	677	717	15

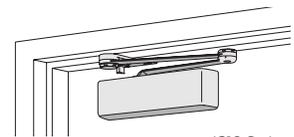

Add for; Delay Action (**DEL**) (\$30) (4211 only), Advanced Variable Backcheck (**AVB**) (\$15), Special Rust Inhibitor (**SRI**) (\$36), Custom Powder Finish (**RAL**___)* (\$30), Brite Metallic (**MTLPC**)* (\$60)
Note - 4210 Series is available as 4211 (Adjustable 1-5) or 4216 (Size 6 Only - Not ADA Compliant).
For parts & accessories, see page 54.

4210T Series - Surface Mount (Requires Handing)

4211T, 4213T-4214T	STD	\$530	\$795	\$870	15
--------------------	-----	--------------	-------	-------	----

Add for; Advanced Variable Backcheck (**AVB**) (\$15), Special Rust Inhibitor (**SRI**) (\$36), Custom Powder Finish (**RAL**___)* (\$30), Brite Metallic (**MTLPC**)* (\$60)
For parts & accessories, see page 55.

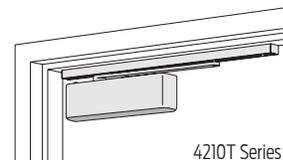

4310HSA Series - Surface Mount (Requires Handing & Voltage)

4311HSA	STD	\$1,048	\$1,344	\$1,424	22
4311HSA	DE	1,088	1,384	1,464	22

Add for; Custom Powder Finish (**RAL**___)* (\$30), Brite Metallic (**MTLPC**)* (\$60)
For parts & accessories, see page 55.



4310ME Series - Surface Mount (Requires Handing & Voltage)

4314ME	SF	\$1,001	\$1,306	\$1,386	17
4314ME	DE	1,041	1,346	1,426	17

Add for; Bypass Cylinder (**B80**) or (**B140**) (\$75), TORX Fasteners (**TORX**) (\$12), Custom Powder Finish (**RAL**___)* (\$30), Brite Metallic (**MTLPC**)* (\$60)
For parts & accessories, see page 55.



COMPLETE DOOR CLOSERS

PRICE LIST



CLOSER SERIES		STANDARD POWDER COAT FINISHES	PLATED FINISHES			S H E E P I N G
SERIES NUMBER	ARM TYPE		US26D	US 3 US 4 US 10	US 10B US 15 US 26	



4410HSA Series - Surface Mount (Requires Handing & Voltage)

4412HSA REG	\$1,006	\$1,403	\$1,527	22
4412HSA LONG	1031	1,428	1,552	22

Add for; Custom Powder Finish (RAL__)* (\$30), Brite Metallic (MTLPC)* (\$60)
 Closer price includes 4410HSA-18 for regular mount or 4410HSA-18G (please specify) plate for flush mount application.)
 For parts & accessories, see page 55.



4410HSA Series



4410ME Series - Surface Mount (Requires Handing & Voltage)

4414ME REG	\$931	\$1,328	\$1,452	17
4414ME LONG	956	1,353	1,477	17

Add for; Bypass Cylinder (B80) or (B140) (\$75), TORX Fasteners (TORX) (\$12),
 Custom Powder Finish (RAL__)* (\$30), Brite Metallic (MTLPC)* (\$60)
 Closer price includes 4410ME-18 for regular mount or 4410ME-18G (please specify) plate for flush mount application.
 For parts & accessories, see page 55.

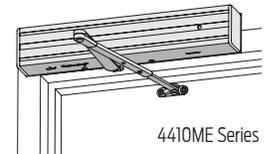

4410ME Series



4510 Series - Surface Mount (Requires Handing)

4511 or 4516 EDA	\$432	\$582	\$622	14
------------------------	--------------	-------	-------	----

Add for; Delay Action (\$30) (4511 only), Advanced Variable Backcheck (AVB) (\$15),
 Special Rust Inhibitor (SRI) (\$36), Custom Powder Finish (RAL__)* (\$30), Brite Metallic (MTLPC)* (\$60)
 Note - 4510 Series is available as 4511 (Adjustable 1-5) or 4516 (Size 6 Only - Not ADA Compliant)
 For parts & accessories, see page 56.

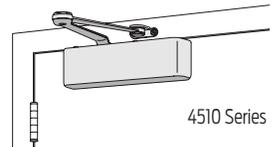

4510 Series



4510T Series - Surface Mount (Requires Handing)

4511T, 4513T-4514T STD	\$530	\$795	\$870	15
------------------------------	--------------	-------	-------	----

Add for; Advanced Variable Backcheck (AVB) (\$15), Special Rust Inhibitor (SRI) (\$36),
 Custom Powder Finish (RAL__)* (\$30), Brite Metallic (MTLPC)* (\$60)
 For parts & accessories, see page 56.



4510T Series



4630 Series - Surface Mount

4631 STD	\$4,987	\$5,319	\$5,420	40
----------------	----------------	---------	---------	----

Add for; TORX Fasteners (TORX) (\$12), Custom Powder Finish (RAL__)* (\$30), Brite Metallic (MTLPC)* (\$60)
 Note - Optional Concealed On/Off Switch (CS) Available (\$0) - Please Specify.
 See pages 30-47 for actuators & accessories.
 For parts & accessories, see page 56.



4630 Series



4640 Series - Surface Mount

4642 REG	\$4,914	\$5,350	\$5,492	40
4642 LONG	4,939	\$5,375	\$5,517	40

Add for; TORX Fasteners (TORX) (\$12), Custom Powder Finish (RAL__)* (\$30), Brite Metallic (MTLPC)* (\$60)
 Note - Optional Concealed On/Off Switch (CS) Available (\$0) - Please Specify.
 See pages 30-47 for actuators & accessories.
 For parts & accessories, see page 56.



4640 Series

COMPLETE DOOR CLOSERS

PRICE LIST



S
H
E
E
T
P
I
C
E
L
I
S
T

CLOSER SERIES		STANDARD POWDER COAT FINISHES <i>AL (689) DKBRZ (695) BRASS (696) LTBRZ (691) STAT (690) BLACK (693)</i>	PLATED FINISHES		
SERIES NUMBER	ARM TYPE		US26D	US 3 US 4 US 10	US 10B US 15 US 26



4810 Series - Surface Mount

4811.....STD **\$1,735** \$2,022 \$2,118 19

Add for; Custom Powder Finish (RAL___)* (\$30), Brite Metallic (MTLPC)* (\$60)

See pages 24-25 for control boxes and compressors. Also, see pages 30-47 for actuators, tubing, & accessories. For parts & accessories, see page 57.



4810 Series



4820 Series - Surface Mount

4822.....REG **\$1,662** \$2,053 \$2,190 19

4822.....LONG **1,687** 2,078 2,215 19

Add for; Custom Powder Finish (RAL___)* (\$30), Brite Metallic (MTLPC)* (\$60)

Closer price includes 4820-18 plate for regular mount or 4820-18G (please specify) plate for flush mount application.

See pages 24-25 for control boxes and compressors. Also, see pages 30-47 for actuators, tubing, & accessories. For parts & accessories, see page 57.

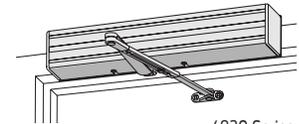

4820 Series



4840 Series - Surface Mount

4841.....EDA **\$1,690** \$2,079 \$2,214 20

4841.....CUSH **1,715** 2,104 2,239 20

4841.....SCUSH **1,765** 2,154 2,289 20

Add for; Custom Powder Finish (RAL___)* (\$30), Brite Metallic (MTLPC)* (\$60)

See pages 24-25 for control boxes and compressors. Also, see pages 30-47 for actuators, tubing, & accessories. For parts & accessories, see page 57.

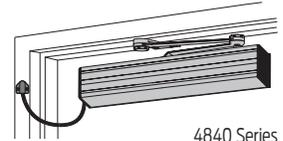

4840 Series

Shown w/4840-459 Door Loop (LCN)

5010 Series - Concealed (Requires Handing)

5011-5016.....REG **\$488** \$814 \$947 12

5011-5016.....H **513** 839 972 13

Add for; Delay Action (DEL) (\$30), TORX Fasteners (TORX) (\$12), Special Rust Inhibitor (SRI) (\$36),

Custom Powder Finish (RAL___)* (\$30), Brite Metallic (MTLPC)* (\$60)

For parts & accessories, see page 57.

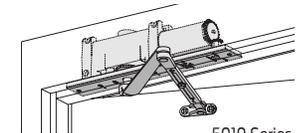

5010 Series

5030 Series - Concealed (Requires Handing)

5031, 5033-5036.....REG **\$829** \$1,250 \$1,394 14

5031, 5033-5036.....H **854** 1,275 1,419 14

Add for; TORX Fasteners (TORX) (\$12), Special Rust Inhibitor (SRI) (\$36),

Custom Powder Finish (RAL___)* (\$30), Brite Metallic (MTLPC)* (\$60)

For parts & accessories, see page 57.

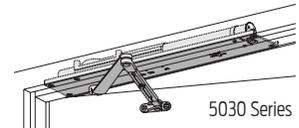

5030 Series

6030 Series - Concealed/Double Acting

6031-6035.....BUMPER **\$1,059** \$1,386 \$1,592 17

6031-6035.....H BUMPER **1,079** 1,406 1,612 17

Add for; TORX Fasteners (TORX) (\$12), Special Rust Inhibitor (SRI) (\$36), Custom Powder Finish (RAL___)* (\$30),

Brite Metallic (MTLPC)* (\$60)

For parts & accessories, see page 58.

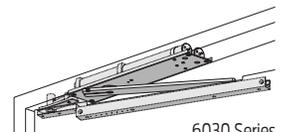

6030 Series

Shown w/ 7253 Pivot (Ives)

COMPLETE DOOR CLOSERS

PRICE LIST



CLOSER SERIES		STANDARD ANODIZED FINISHES	PLATED FINISHES		S H I P P I N G
SERIES NUMBER	ARM TYPE		N/A	N/A	
		ANCLR ANDKB			



9130 Series - Surface Mount

9131.....STD (Pull) **\$3,051**
 27" cover (MC) is standard - Optional 'Full Cover' (FC) (36") available (please specify)
 Add for Full Cover (FC) (\$80)
 See pages 30-47 for actuators & accessories.
 For parts & accessories, see page 58.

Plated finish not available
 ANCLR or ANDKB

38

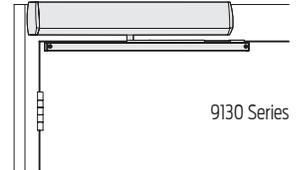

9130 Series



9140 Series - Surface Mount

9142REG (Push) **\$3,051**
 9142LONG (Push) **3,051**
 27" cover (MC) is standard - Optional 'Full Cover' (FC) (36") available (please specify)
 Add for Full Cover (FC) (\$80)
 See pages 30-47 for actuators & accessories.
 For parts & accessories, see page 58.

Plated finish not available
 ANCLR or ANDKB
 ANCLR or ANDKB

38

38

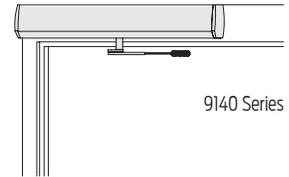

9140 Series



9150 Series - Surface Mount

9153.....REG2 (Push) **\$6,099**
 9153.....LONG2 (Push) **6,099**
 72" cover (MC) is standard. Additional lengths are not available.
 See pages 30-47 for actuators & accessories.
 For parts & accessories, see page 58.

Plated finish not available
 ANCLR or ANDKB
 ANCLR or ANDKB

85

85



9150 Series

COMPLETE DOOR CLOSERS

PRICE LIST

CLOSER SERIES		STANDARD ANODIZED FINISHES	PLATED FINISHES		S H E I P I N G	
SERIES NUMBER	ARM TYPE		N/A	N/A		
		ANCLR ANDKB				



9530 Series - Surface Mount (Requires Handing)

9531.....STD (Pull) **\$3,902**

Header lengths available 33" to 48" (please specify).
 Angle Brackets (**HL/B**) are standard, End Dress Plates (**HL/D**) are optional (please specify).
 STD arm has 2 3/4" spindle center.
 Add for; Double Door Header (49" to 98" – please specify) (**DD**) (**\$205**)
 See pages 30-47 for actuators & accessories.
 For parts & accessories, see page 58.

Plated finish not available
ANCLR or ANDKB

78

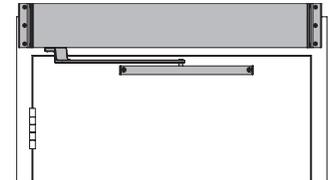

9530 Series



9540 Series - Surface Mount (Requires Handing)

9542REG (Push) **\$3,902**

9542LONG (Long Push) **3,902**

Header lengths available 33" to 48" (please specify).
 Angle Brackets (**HL/B**) are standard, End Dress Plates (**HL/D**) are optional (please specify).
 REG or LONG arm has 2 3/4" spindle center.
 Optional 12 1/4" spindle available (requires minimum 43" header).
 Add for; Double Door Header (49" to 98" – please specify) (**DD**) (**\$205**)
 See pages 30-47 for actuators & accessories.
 For parts & accessories, see page 59.

Plated finish not available
ANCLR or ANDKB
ANCLR or ANDKB

78
78

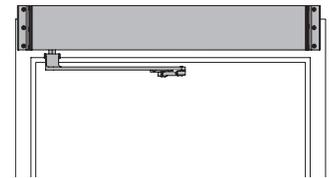

9540 Series



9550 Series - Surface Mount (DE Requires Handing) Plated finish not available

9553.....REG2 (Push Pair) **\$6,740**

9553.....LONG2 (Long Push Pair) **6,740**

9553.....STD2 (Pull Pair) **6,740**

9553.....REG/STD (Double Egress) **6,740**

Header lengths available 52" to 98" (please specify) on operators with REG or LONG (push) arms.
 Header lengths available 60" to 98" (please specify) on operators with STD (pull) arms.
 Header lengths available 60" to 98" (please specify) on operators with REG/STD (double egress) arms.
 Angle Brackets (**HL/B**) are standard, End Dress Plates (**HL/D**) are optional (please specify).
 REG, LONG, STD or REG/STD has 2 3/4" spindle center.
 Optional 12 1/4" spindle available (requires minimum 71" header).
 See pages 30-47 for actuators & accessories.
 For parts & accessories, see page 59.

ANCLR or ANDKB
ANCLR or ANDKB
ANCLR or ANDKB
ANCLR or ANDKB

155
155
155
155

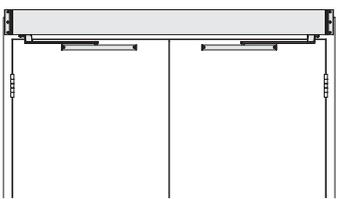

9550 Series



9560 Series - Surface Mount (DE Requires Handing) Plated finish not available

9563REG2 (Push Pair) **\$8,019**

9563LONG2 (Long Push Pair) **8,019**

9563STD2 (Pull Pair) **8,019**

9563REG/STD (Double Egress) **8,019**

Header lengths available 65" to 98" (please specify) on operators with REG or LONG (push) arms.
 Header lengths available 65" to 98" (please specify) on operators with STD (pull) arms.
 Header lengths available 65" to 98" (please specify) on operators with REG/STD (double egress) arms.
 Angle Brackets (**HL/B**) are standard, End Dress Plates (**HL/D**) are optional (please specify).
 REG, LONG, STD or REG/STD has 2 3/4" spindle center.
 Optional 12 1/4" spindle available (requires minimum 84" header).
 See pages 30-47 for actuators & accessories.
 For parts & accessories, see page 59.

ANCLR or ANDKB
ANCLR or ANDKB
ANCLR or ANDKB
ANCLR or ANDKB

155
155
155
155

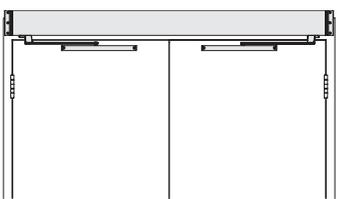

9560 Series

SEM SERIES MAGNETS PRICE LIST

SPECIALTY PRODUCTS		STANDARD POWDER COAT FINISHES	S H E E P I N G	
PRODUCT NUMBER	DESCRIPTION	AL (689) DKBRZ (695)		

SEM7800 Series Magnet Extension Kits

SEM7810-517.....SEM Extension Kit (55 pcs)

\$827

8

Note - Extension Kit includes 1/2" extensions (10), 3/4" extensions (10), 1" extensions (10), 2" extensions (5) & ball pivot/connector links (20 ea). Individual extensions & ball pivot/connector links are available, please see page 48 in this price book for part number and list price.

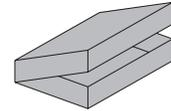

SEM7810



SEM7800 Series Magnets

SEM7820.....Floor Mount Magnet (Single Side)

\$577

5

Low Profile Armature, Metal Housing,
Tri Voltage (12v/24v/120v) w/ 35lbs. holding force.

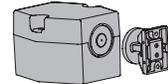

SEM7820

SEM7830.....Wall Mount Magnet

327

4

Low Profile Armature, Metal Housing,
Tri Voltage (12v/24v/120v) w/ 35lbs. holding force.

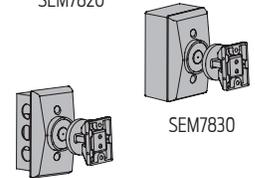

SEM7830

SEM7840.....Recessed Wall Mount Magnet

327

4

Low Profile Armature, Metal Housing,
Tri Voltage (12v/24v/120v) w/ 35lbs. holding force.

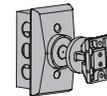

SEM7840

SEM7850.....Recessed Wall Mount Magnet

327

4

Standard Profile Armature, Metal Housing,
Tri Voltage (12v/24v/120v) w/ 35lbs. holding force.
For parts & accessories, see page 48.

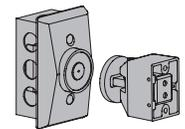

SEM7850

PAH60, PAINT AND FASTENERS

PRICE LIST

SPECIALTY PRODUCTS		STANDARD POWDER COAT FINISHES <i>AL (689) DKBRZ (695) BRASS (696) LTBRZ (691) STAT (690) BLACK (693)</i>	PLATED FINISHES			S H E E P I P I N G	
PRODUCT NUMBER	DESCRIPTION		US26D	US 3 US 4 US 10	US 10B US 15 US 26		

Parallel Arm Holder

PAH60 (Handed)..... Door Holder

\$115

\$302

\$352

3

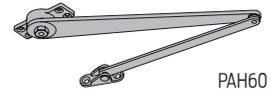

PAH60

Force Gauge

ADA/FG Force Gauge

\$53

1/2



ADA/FG

LCN Spray Paint - Available in single cans or cases of 6 (same color) cans

Can..... Spray Paint

\$24

Per can

1

Case..... Spray Paint

110

Per case (6 cans, same color)

4

Fasteners - Individual & Sets

SRT (1 ea.)..... SRT Screw (1 ea.)

\$1

Self reaming & tapping screw.
Size required. 1 ea.

SRT (Set of 4 ea.) SRT Screw (4 ea.)

3

Self reaming & tapping screw.
Size required. 4 ea.

MS (1 ea.) Machine Screw (1 ea.)

1

3

5

Machine screw. Size required. 1 ea.

MS (Set of 4 ea.) Machine Screw (4 ea.)

3

10

13

Machine screw. Size required. 4 ea.

WS (1 ea.) Wood Screw (1 ea.)

1

Wood screw. Size required. 1 ea.

WS (Set of 4 ea.) Wood Screw (4 ea.)

3

Wood screw. Size required. 4 ea.

TORX (1 ea.) TORX Screw (1 ea.)

2

6

9

TORX machine screw. Size required. 1 ea.

TORX (Set of 4 ea.) TORX Screw (4 ea.)

5

13

17

TORX machine screw. Size required. 4 ea.

TB 1 3/4" (1 ea.) Thru Bolt, Female

2

6

9

Through bolt. 1 3/4" length.

TB 1 3/8" (1 ea.) Thru Bolt, Female

2

6

9

Through bolt. 1 3/8" length

TB 1 5/8" (1 ea.) Thru Bolt, Female

2

6

9

Through bolt. 1 5/8" length

TB 1 3/4" (Set of 4 ea.) .. Thru Bolt, Female (4 ea.)

5

21

25

Through bolt. Set of 4 ea. Size required

TB 1 3/8" (Set of 4 ea.) .. Thru Bolt, Female (4 ea.)

5

21

25

Through bolt. Set of 4 ea. Size required.

TB 1 5/8" (Set of 4 ea.) .. Thru Bolt, Female (4 ea.)

5

21

25

Through bolt. Set of 4 ea. Size required.

TB/MS (1 ea.) TB(1) & MS(1)

2

7

9

TB & MS. Set of 1 ea.

TB/MS (Set of 4 ea.) TB(4) & MS(4)

6

23

33

Size and Series required.

TB & MS. Set of 4 ea.

Size and Series required.

Torx (Security) Driver Bits

T-10 TORX Bit Torx Bit, T-10

\$12

TORX driver bit, size T-10.

T-15 TORX Bit Torx Bit, T-15

12

TORX driver bit, size T-15.

T-20 TORX Bit Torx Bit, T-20

12

TORX driver bit, size T-20.

T-25 TORX Bit Torx Bit, T-25

12

TORX driver bit, size T-25.

T-27 TORX Bit Torx Bit, T-27

12

TORX driver bit, size T-27.

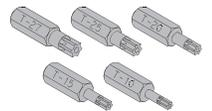

Adjustment Wrenches

T1157 Hold Open Wrench

\$4

Hold Open Adjustment Wrench

Green Hex Wrenches - NOW AVAILABLE!

One end has 3/32" hex for regulation valve adjustment and cover attachment. The other end has 5/32" hex for spring power adjustment.

Great for training seminars.

GHW1 Green Hex Wrench

\$7 Each

Green Hex Wrench. 1 Each.

GHW12 Green Hex Wrench

\$72 / Pack of 12

Green Hex Wrench. Pack of 12.

GHW100 Green Hex Wrench

\$500 / Pack of 100

Green Hex Wrench. Pack of 100.

CONTROL BOXES

PRICE LIST

CONTROL BOXES & COMPRESSORS				
PRODUCT NUMBER	PRODUCT DESCRIPTION	LIST PRICE	S H I P P I N G	

7980 Series Control Boxes

7981.....	Control Box, Pnuematic, Internal Compressor. Self-contained control box/compressor combination for single door application. Includes -3960 Compressor Assembly.	\$2,526	27
7981ES.....	Control Box, Pnuematic, Electric Strike (ES) Relay, Internal Compressor. Self-contained control box/compressor combination for single door application. Includes -3960 Compressor Assembly, -3390A Relay.	2,939	27
7982.....	Control Box, Pnuematic, Internal Compressor Self-contained control box/compressor combination for either independent or simultaneous operation of two (2) door leaves. Includes -3960 Compressor Assembly.	3,576	34
7982S.....	Control Box, Pnuematic, Sequential (S) Feature, Internal Compressor. Self-contained control box/compressor combination for independent, simultaneous or sequential operation of two (2) door leaves. Includes -3960 Compressor Assembly, -3426 Sequencer Card.	3,885	34
7982ES.....	Control Box, Pnuematic, Electric Strike (ES) Relays, Internal Compressor. Self-contained control box/compressor combination for independent or simultaneous operation of two (2) door leaves. Includes -3960 Compressor Assembly, -3390A & -3390B Relays.	4,300	34
7982SES.....	Control Box, Pnuematic, Sequential (S) Feature, Electric Strike (ES) Relays, Internal Compressor. Self-contained control box/compressor combination for independent, simultaneous or sequential operation of two (2) door leaves. Includes -3960 Compressor Assembly, -3390A & -3390B Relays, -3426 Sequencer Card.	4,577	34

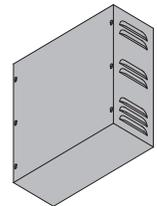

7980 Series Control Box
(15" x 15" x 6")

7900 Series Control Boxes

7901.....	Control Box, Pnuematic Single door application or independent control of single door in multiple door systems. Two door leaves can be operated, if activated simultaneously. Requires a separate 900 Series compressor.	\$1,734	14
7901ES.....	Control Box, Pnuematic Electric Strike (ES) Relay. Single door application or independent control of single door in multiple door systems. Two door leaves can be operated, if activated simultaneously. Includes -3390A Relay. Requires a separate 900 Series compressor.	2,149	14
7902.....	Control Box, Pnuematic Independent operation of two (2) door leaves or simultaneous and/or sequential operation of four (4) door leaves. Requires a separate 900 Series compressor.	2,373	15
7902S.....	Control Box, Pnuematic, Sequential (S) Feature Independent operation of two (2) door leaves or simultaneous operation and/or sequential operation of four (4) door leaves. Includes -3426 Sequencer Card. Requires a separate 900 Series compressor.	2,678	15
7902ES.....	Control Box, Pnuematic, Electric Strike (ES) Relays Independent operation of two (2) door leaves or simultaneous of four (4) door leaves. Includes -3390A & -3390B Relays. Requires a separate 900 Series compressor.	3,105	15
7902SES.....	Control Box, Pnuematic, Sequential (S), Electric Strike (ES) Relays Independent operation of two (2) door leaves or simultaneous and/or sequential operation of four (4) door leaves. Includes -3390A & -3390B Relays, -3426 Sequencer Card. Requires a separate 900 Series compressor.	3,398	15

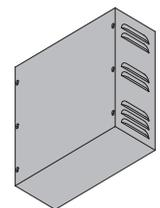

7900 Series Control Box
(15" x 15" x 6")

Note - Locate a 7980 Series Control Box within 50 linear tubing feet of the door. Locate a 7900 Series Control Box within 100 linear tubing feet of the door. Use -925 Pnuematic Tubing to connect operator and control box. 7900 Series Control Boxes require a separate air source, LCN 900 Series Compressors are recommended. For parts & accessories, see pages 26-27.

CONTROL BOXES AND COMPRESSORS

PRICE LIST

CONTROL BOXES & COMPRESSORS			S H E I P P I N G	
PRODUCT NUMBER	PRODUCT DESCRIPTION	LIST PRICE		

7940 Series Control Boxes - (Requires LCN 900 series compressor)

7949	Control Box, Pneumatic, Auxiliary 'Blow-Open' Control box works with or without 7901/7902 Series Control Box and one or two pneumatic Auto Equalizers. Controlled by the smoke evacuation system, the 7949 Series Control Box will open the door(s) to allow fresh air into building.	\$1,442	14
7949ES	Control Box, Pneumatic, Auxiliary 'Blow-Open', Electric Strike (ES) Relay. Auxiliary 'blow-open' control box works with or without 7901ES/7902ES Series Control Box and one or two pneumatic Auto Equalizers. Controlled by the smoke evacuation system, the 7949 Series Control Box will unlock and open the door(s) to allow fresh air into building.	1,792	14

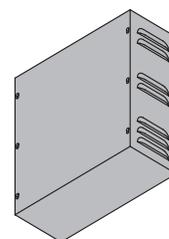

7940 Series Control Box
(15" x 15" x 6")

Note - A 'blow-open' system requires a separate air source. A 'blow-open' system that includes an automatic or power operator function also requires a separate air source and is limited to the operation of two (2) door leaves. In both cases, the LCN 900 Series Compressors are recommended. 7940 Series Control Boxes should be installed within 100 linear tubing feet of the automatic operator(s).
For parts & accessories, see pages 26-27.

900 Series Compressors - (Specify 115V or 230V on 922 and 923 Series)

920	Compressor, 2 Gallon Tank (Gast #1HAB-85T-M100X) Normal usage would allow the function of up to two (2) Auto Equalizers. Includes auto drain. 23" length x 9" width x 17" height.	\$2,421	48
921	Compressor, 12 Gallon Tank (Gast #2HBC-59T-M200X) Normal usage would allow the function of up to four (4) Auto Equalizers. Includes auto drain. 31" length x 14" width x 21" height.	3,756	90
922*	Compressor, 20 Gallon Tank (Gast #4HCC-95T-M450X) Normal usage would allow the function of up to eight (8) Auto Equalizers. Includes auto drain. 33" length x 20" width x 27" height.	4,981	118
923*	Compressor, 30 Gallon Tank (Gast #7HDD-71T-M750X) Normal usage would allow the function of up to twenty (20) Auto Equalizers. Includes auto drain. 38" length x 23" width x 30" height.	9,769	175

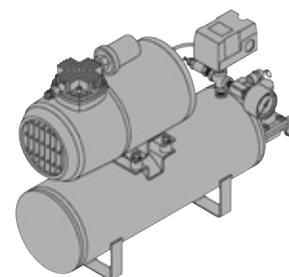

900 Series Compressor

Note - 900 Series Compressors should be installed within 500 linear feet of the 7900 or 7940 Series Control Box. 900 Series Compressors are not manufactured by LCN and would carry the one (1) year warranty offered by the original manufacturer.

For warranty questions, please contact Gast Manufacturing at (269) 926-6171.

Parts & accessories are not available.

* - 922 & 923 Compressors are special order and require an approximate eight (8) week lead time.

CONTROL BOX COMPONENTS PRICE LIST



CONTROL BOX COMPONENTS		LIST PRICE	PRODUCT DESCRIPTION
PRODUCT NUMBER	DESCRIPTION		

Control Box Components

293G	Muffler	\$22	Exhaust muffler for 7901, 7902, 7981, or 7982 Series Control Boxes.
319	Fitting, "T"	2	"T" fitting to connect 925 pneumatic tubing.
320	Fitting, "Inline"	2	"Inline" fitting to connect 925 pneumatic tubing.
329	Air Filter Assembly	57	Replacement inlet air filter for the 7981 or 7982 Series Control Boxes.
329G	Air Filter Assembly	183	Replacement inlet air filter for the 7901 or 7902 Series Control Boxes. Includes -929 Air Filter Assembly.
390	Relay	183	Single pole, double throw (SPDT) relay only for the 7901, 7902, 7981, & 7982 Series Control Boxes.
390C	Relay	193	Double pole, double throw (DPDT) relay only for the 7949 series 'blow open' Series Control Box.
900	Power Supply, 10T	421	Main power supply/input board for the 7901, 7902, 7981, & 7982 Series Control Boxes. Ten (10) terminals.
903	Timer Module	183	0-30 second timer module for 7901, 7902, 7981, & 7982 Series Control Box. Plugs into the -900 Power Supply Board.
925	Pneumatic Tubing	2.00/ft	Flexible pneumatic tubing with an 1/8" inner diameter & 1/4" outer diameter. Specify number of linear feet required when ordering.
929	Filter & Seal	24	Internal filter & seal component to the 329G Air Filter Assembly.
941	Valve Assembly	623	Regulator valve assembly for the 7901 series control box.
941C	Valve Assembly	623	Regulator valve assembly for the 7949 series control box.
942	Valve Assembly	1,201	Regulator valve assembly for the 7902 series control box.
962	Isolator	20	Rubber isolator for 7981 or 7982 compressor (-3960) assembly.

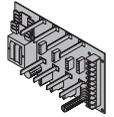

900



903

Control Box Components

3293	Filter Service Kit	\$77	Filter replacement for 7981 or 7982 Series Control Box. Includes -329 Inlet Filter, plastic elbow, short piece of -925 tubing.
3299A	Solenoid Assembly Valve 'A'	352	Air valve assembly for the 7981 Series Control Box or the 'A' circuit valve assembly in the 7982 Series Control Box.
3299B	Solenoid Assembly Valve 'B'	381	Air valve assembly for the 'B' circuit in the 7982 Series Control Box.
3328	Copper Coupler	20	Converts pneumatic tubing connection to copper.
3390A	'A' Relay Package	417	Electric strike (ES) relay for 7901 and 7982 Series Control Boxes or the 'A' circuit ES relay assembly used in the 7902 and 7982 Series Control Boxes. Can be added to a standard control box to convert to ES operation. Includes -390 Relay, relay base and wire harness. The 3390A is included when either a 7901ES, 7902ES, 7981ES or 7982ES is ordered.
3390B	'B' Relay Package	417	Electric strike (ES) relay for 'B' circuit in either the 7902 or 7982 Series Control Boxes. Can be added to a standard control box to convert to ES operation. Includes -390 Relay, relay base and wire harness. The 3390B is included when either a 7902ES or 7982ES is ordered.
3390C	'C' Relay Package	417	Electric strike (ES) relay assembly for the 7949 series 'blow-open' control box. Includes -390C Relay, relay base and wire harness. The 3390C is included when a 7949ES is ordered.
3426	Sequencer Card	279	Dual, 0-30 second timer module for 7902 or 7982 Series Control Box. Can be added to a standard 7902 or 7982 Series Control Box to convert box to sequential operation. -3426 Sequencer card is included when either a 7902S or 7982S Series Control Box is ordered.
3592	Compressor Service Kit	60	Service kit for air pressure adjustment in the either the 7981 or 7982 Series Control Box.
3960	Compressor Assembly	1,570	Internal air pump assembly for the 7981 or 7982 Series Control Box. -3960 Compressor Assembly includes starter capacitor, -962 Isolators and -329 Air Filter Assembly.

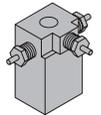

3299A

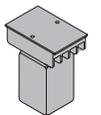

3390A

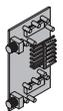

3426



3960

Control Box Components



293G

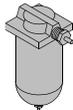

329G



329



390

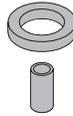

929



962

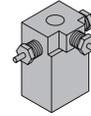

3299A

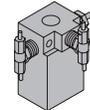

3299B

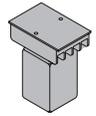

3390A

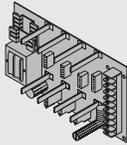

900

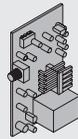

903

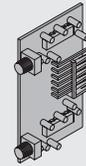

3426

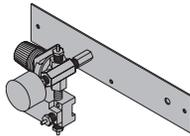

941

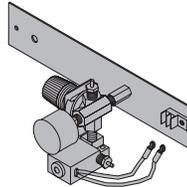

941C

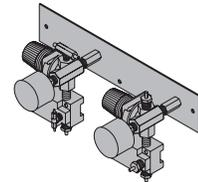

942

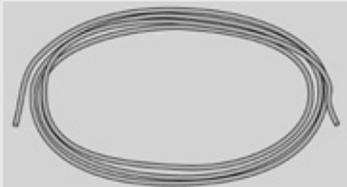

925

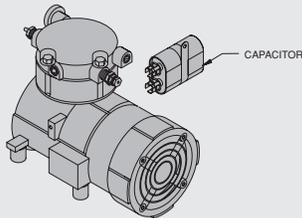

3960

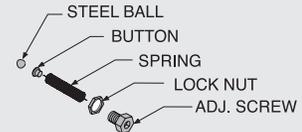

3592

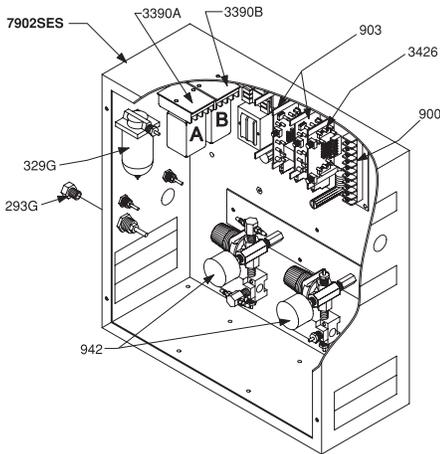

7902SES

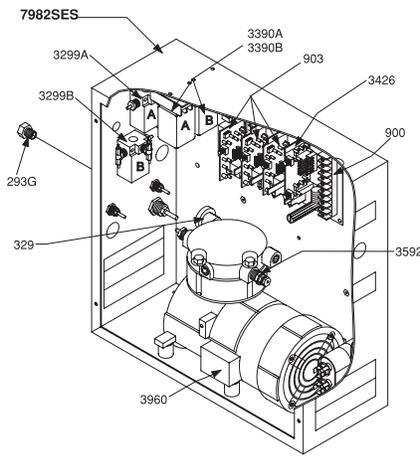

7982SES

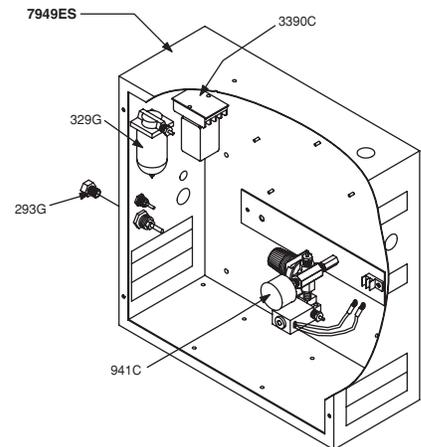

7949ES

Actuator/Sensor Quick Find PRICE LIST

ACTUATOR/SENSOR QUICK FIND GUIDE		LIST PRICE	PRODUCT DESCRIPTION	
PRODUCT NUMBER	ITEM PAGE(S)			

8310-800	38	\$19	Ring, Weather, 4½" Round
8310-801	38	19	Ring, Weather, 4½" x 4½"
8310-802	38	19	Ring, Weather, 6" Round
8310-804-1	40	1,043	Sensor, Door Mount, Safety
8310-804-2	40	1,406	Sensor, Door Mount, Safety
8310-805	42	46	Switch, Door Position
8310-805C	42	46	Switch, Door Position
8310-806K	46	173	Switch, Key
8310-806R	46	173	Switch, Rocker
8310-807	46	173	Filter, Line
8310-813	32	759	Actuator, Wall Mount, 4¾" x 4¾"
8310-818	30	142	Actuator, Jamb Mount, Logo, 1½" x 4¾"
8310-818T	30	142	Actuator, Jamb Mount, Logo, Text, 1½" x 4¾"
8310-819F	38	32	Box Only, Jamb Mount, Flush Mount, 1½" x 4¾"
8310-819S	38	32	Box Only, Jamb Mount, Surface Mount, 1½" x 4¾"
8310-824	42	66	Transformer
8310-824P	42	66	Transformer
8310-836T	34	811	Actuator, Full Length, Logo, Text, 36" x 6"
8310-836TW	34	925	Actuator, Full Length, Logo, Text, Wireless, 36" x 6"
8310-844	44	162	Transmitter Kit, Wall Mount, 9v
8310-844J	44	162	Transmitter Kit, Jamb Mount, 3v
8310-845	46	265	Relay and Door Sequencer
8310-846	42	23	Harness, Header Mount
8310-847	42	93	Harness, Door Mount
8310-852	34	218	Actuator, Wall Mount, Logo, 6" Round
8310-852T	34	218	Actuator, Wall Mount, Logo, Text, 6" Round
8310-852TWP	34	569	Actuator, Wall Mount, Logo, Text, Wireless, Package, 6" Round
8310-852WP	34	569	Actuator, Wall Mount, Logo, Wireless, Package, 6" Round
8310-853	32	209	Actuator, Wall Mount, Logo, 4¾" x 4¾"
8310-853T	32	209	Actuator, Wall Mount, Logo, Text, 4¾" x 4¾"
8310-853TWP	32	569	Actuator, Wall Mount, Logo, Text, Wireless, Package, 4¾" x 4¾"
8310-853WP	32	569	Actuator, Wall Mount, Logo, Wireless, Package, 4¾" x 4¾"
8310-854	40	645	Sensor, Header Mount, Activation
8310-854ECA	42	170	Bracket, Drop Ceiling
8310-854ERA	42	113	Cover, Protective
8310-855	32	333	Actuator, Wall Mount, Logo, Dual Vestibule
8310-856	30	165	Actuator, Wall Mount, Logo
8310-856T	30	165	Actuator, Wall Mount, Logo, Text
8310-859	42	142	Remote, Handheld
8310-861	44	162	Transmitter, Handheld, 1 Channel
8310-862	44	162	Transmitter, Handheld, 2 Channel
8310-863	44	162	Transmitter, Handheld, 3 Channel
8310-864	44	162	Transmitter, Handheld, 4 Channel
8310-865	30, 32, 34, 44	170	Receiver
8310-866	44	746	Post, Bollard, Accommodates Bollard Actuator, 42" x 4" x 6"
8310-866FLA	44	746	Post, Bollard, Accommodates Full Length Actuator, 42" x 4" x 6"
8310-866CAP	44	122	Cap

Actuator/Sensor Quick Find PRICE LIST

ACTUATOR/SENSOR QUICK FIND GUIDE		LIST PRICE	PRODUCT DESCRIPTION
PRODUCT NUMBER	ITEM PAGE(S)		
8310-867F	38	\$137	Box, Flush Mount, 4¾" x 4¾"
8310-867S	38	137	Box, Surface Mount, 4¾" x 4¾"
8310-868F	38	123	Box, Flush Mount, 4½" Round
8310-868S	38	123	Box, Surface Mount, 4½" Round
8310-869F	38	133	Box, Flush Mount, 6" Round
8310-869S	38	133	Box, Surface Mount, 6" Round
8310-874	38	305	Escutcheon, 4½" Round
8310-876	38	305	Escutcheon, 6" Round
8310-877	40	1,231	Sensor, Header Mount, Safety
8310-877S	42	133	Spacer, Header Mount
8310-887	46	18	Cable Assembly, Retrofit
8310-3134	46	276	Cable Kit, Retrofit
8310-3803	42	470	Conversion Kit, Wireless, Jamb Mount
8310-3809	42	470	Conversion Kit, Wireless, Wall Mount
8310-3818TWF	30	320	Actuator, Jamb Mount, Logo, Text, Wireless, Flush, 1½" x 4¾"
8310-3818TWS	30	320	Actuator, Jamb Mount, Logo, Text, Wireless, Surface, 1½" x 4¾"
8310-3818WF	30	320	Actuator, Jamb Mount, Logo, Wireless, Flush, 1½" x 4¾"
8310-3818WS	30	320	Actuator, Jamb Mount, Logo, Wireless, Surface, 1½" x 4¾"
8310-3822T	36	332	Actuator Package, Logo, Text, 1½" x 4¾"
8310-3822TW	36	801	Actuator Package, Logo, Text, Wireless, 1½" x 4¾"
8310-3836T	44	1,451	Full Length Actuator / Bollard Package
8310-3836TW	44	1,602	Full Length Actuator / Bollard Package, Wireless
8310-3852TWF	34	502	Actuator, Wall Mount, Logo, Text, Wireless, Flush, 6" Round
8310-3852TWS	34	502	Actuator, Wall Mount, Logo, Text, Wireless, Surface, 6" Round
8310-3852WF	34	502	Actuator, Wall Mount, Logo, Wireless, Flush, 6" Round
8310-3852WS	34	502	Actuator, Wall Mount, Logo, Wireless, Surface, 6" Round
8310-3853TWB	44	353	Actuator, Bollard, Logo, Text, Wireless, 4¾" x 4¾"
8310-3853TWF	32	502	Actuator, Wall Mount, Logo, Text, Flush, 4¾" x 4¾"
8310-3853TWS	32	502	Actuator, Wall Mount, Logo, Text, Surface, 4¾" x 4¾"
8310-3853WB	44	353	Actuator, Bollard, Logo, Wireless, 4¾" x 4¾"
8310-3853WF	32	502	Actuator, Wall Mount, Logo, Wireless, Flush, 4¾" x 4¾"
8310-3853WS	32	502	Actuator, Wall Mount, Logo, Wireless, Surface, 4¾" x 4¾"
8310-3855WF	32	749	Actuator, Wall Mount, Logo, Wireless, Flush, Dual Vestibule, 4¾" x 4¾"
8310-3855WS	32	749	Actuator, Wall Mount, Logo, Wireless, Surface, Dual Vestibule, 4¾" x 4¾"
8310-3856TWF	30	445	Actuator, Wall Mount, Logo, Text, Wireless, Flush, 4½" Round
8310-3856TWS	30	445	Actuator, Wall Mount, Logo, Text, Wireless, Surface, 4½" Round
8310-3856WF	30	445	Actuator, Wall Mount, Logo, Wireless, Flush, 4½" Round
8310-3856WS	30	445	Actuator, Wall Mount, Logo, Wireless, Surface, 4½" Round
8310-3857T	36	658	Actuator Package, Logo, Text, 4¾" x 4¾"
8310-3857TW	36	1,163	Actuator Package, Logo, Text, Wireless, 4¾" x 4¾"
8310-3860T	36	547	Actuator Package, Logo, Text, 4½" Round
8310-3860TW	36	1,052	Actuator Package, Logo, Text, Wireless, 4½" Round
8310-3881	40	5,281	Sensor Package
8310-3881L	40	3,945	Sensor Package
8310-3882	40	8,040	Sensor Package
8310-3882L	40	5,368	Sensor Package
8310-3883	40	1,286	Sensor Package
8310-3888	42	30	Harness, Safety Module
8310-3889	42	424	Safety Module Kit
8310-3891	40	6,815	Sensor Package
8310-3892	40	8,112	Sensor Package



ACTUATORS & ACCESSORIES

PRICE LIST

ACTUATORS & ACCESSORIES		LIST PRICE	PRODUCT DESCRIPTION	
PRODUCT NUMBER	DESCRIPTION			

8310 Series Actuators - Jamb Mount - 1-1/2" x 4-3/4" Rectangle - Interior Installation Only

8310-818.....	Actuator, Jamb Mount	\$142	Actuator, 1-1/2" x 4-3/4" Rectangle, Logo	
8310-818T.....	Actuator, Jamb Mount	142	Actuator, 1-1/2" x 4-3/4" Rectangle, Logo, Text	
8310-3818WF.....	Actuator, Jamb Mount	320	Actuator, 1-1/2" x 4-3/4" Rectangle, Logo, Wireless, Flush Mount Includes 8310-818 Actuator, 8310-844J Transmitter Kit, 8310-819F Flush Box. Requires 8310-865 Receiver.	
8310-3818WS.....	Actuator, Jamb Mount	320	Actuator, 1-1/2" x 4-3/4" Rectangle, Logo, Wireless, Surface Mount Includes 8310-818 Actuator, 8310-844J Transmitter Kit, 8310-819S Surface Box. Requires 8310-865 Receiver.	
8310-3818TWF.....	Actuator, Jamb Mount	320	Actuator, 1-1/2" x 4-3/4" Rectangle, Logo, Text, Wireless, Flush Mount Includes 8310-818T Actuator, 8310-844J Transmitter Kit, 8310-819F Flush Box. Requires 8310-865 Receiver.	
8310-3818TWS.....	Actuator, Jamb Mount	320	Actuator, 1-1/2" x 4-3/4" Rectangle, Logo, Text, Wireless, Surface Mount Includes 8310-818T Actuator, 8310-844J Transmitter Kit, 8310-819S Surface Box. Requires 8310-865 Receiver.	
8310-865.....	Receiver	170	Receiver, Wireless, 1 Channel, Sequencing Feature Used in conjunction w/ Wireless Actuators & Transmitters	8310-818T

8310 Series Actuators - Wall Mount - 4-1/2" Round

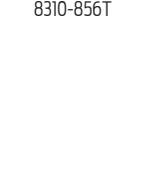
8310-856.....	Actuator, Wall Mount	\$165	Actuator, 4-1/2" Round, Logo	
8310-856T.....	Actuator, Wall Mount	165	Actuator, 4-1/2" Round, Logo, Text	
8310-3856WF.....	Actuator, Wall Mount	445	Actuator, 4-1/2" Round, Logo, Wireless, Flush Mount. Includes 8310-856 Actuator, 8310-844 Transmitter Kit, 8310-868F Flush Box, 8310-800 Weather Ring. Requires 8310-865 Receiver.	
8310-3856WS.....	Actuator, Wall Mount	445	Actuator, 4-1/2" Round, Logo, Wireless, Surface Mount Includes 8310-856 Actuator, 8310-844 Transmitter Kit, 8310-868S Surface Box, 8310-800 Weather Ring. Requires 8310-865 Receiver.	
8310-3856TWF.....	Actuator, Wall Mount	445	Actuator, 4-1/2" Round, Logo, Text, Wireless, Flush Mount Includes 8310-856T Actuator, 8310-844 Transmitter Kit, 8310-868F Flush Box, 8310-800 Weather Ring. Requires 8310-865 Receiver.	
8310-3856TWS.....	Actuator, Wall Mount	445	Actuator, 4-1/2" Round, Logo, Text, Wireless, Surface Mount Includes 8310-856T Actuator, 8310-844 Transmitter Kit, 8310-868S Surface Box, 8310-800 Weather Ring. Requires 8310-865 Receiver.	
8310-865.....	Receiver	170	Receiver, Wireless, 1 Channel, Sequencing Feature Used in conjunction w/ Wireless Actuators & Transmitters	8310-856T

8310 Series Actuators

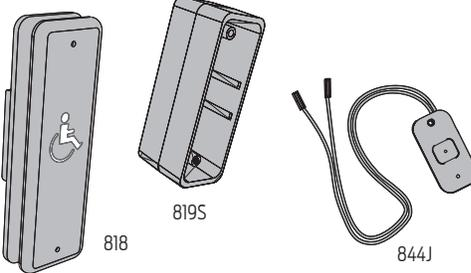
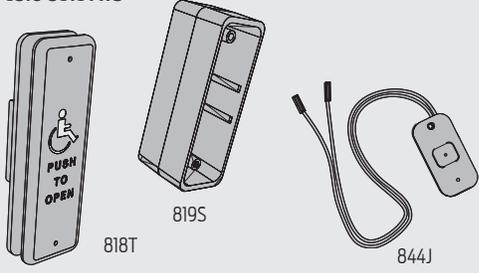
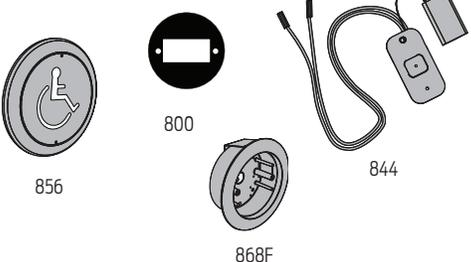
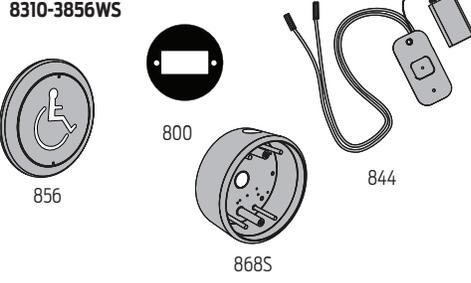
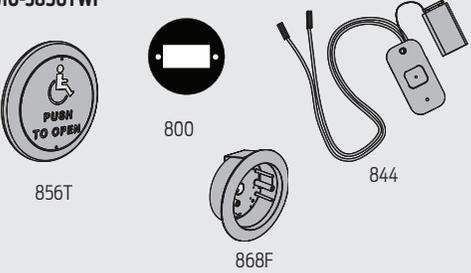
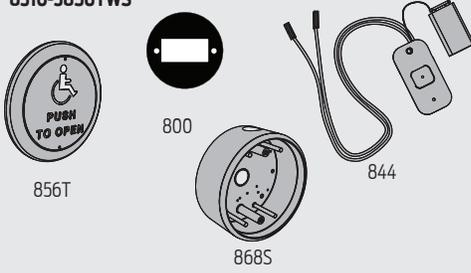

<p>8310-818</p> 	<p>8310-3818WF</p>  <p>818</p>	<p>8310-3818WS</p>  <p>818</p>
<p>8310-818T</p> 	<p>8310-3818TWF</p>  <p>818T</p>	<p>8310-3818TWS</p>  <p>818T</p>
<p>8310-856</p> 	<p>8310-3856WF</p>  <p>856</p>	<p>8310-3856WS</p>  <p>856</p>
<p>8310-856T</p> 	<p>8310-3856TWF</p>  <p>856T</p>	<p>8310-3856TWS</p>  <p>856T</p>

ACTUATORS & ACCESSORIES

PRICE LIST

ACTUATORS & ACCESSORIES		LIST PRICE	PRODUCT DESCRIPTION	
PRODUCT NUMBER	DESCRIPTION			

8310 Series Actuators - Wall Mount - 4-3/4" Square

8310-853	Actuator, Wall Mount	\$209	Actuator, 4-3/4" Square, Logo	
8310-853T	Actuator, Wall Mount	209	Actuator, 4-3/4" Square, Logo, Text	
8310-853WP	Actuator, Wall Mount	569	Actuator, 4-3/4" Square, Logo, Wireless, Surface Mount Easy mount, 'all in one', low profile, surface mount, wireless actuator. Requires 8310-865 Receiver	
8310-853TWP	Actuator, Wall Mount	569	Actuator, 4-3/4" Square, Logo, Text, Wireless, Surface Mount Easy mount, 'all in one', low profile, surface mount, wireless actuator. Requires 8310-865 Receiver	
8310-3853WF	Actuator, Wall Mount	502	Actuator, 4-3/4" Square, Logo, Wireless, Flush Mount Includes 8310-853, 8310-844 Transmitter Kit, 8310-867F Flush Box, 8310-801 Weather Ring. Requires 8310-865 Receiver	
8310-3853WS	Actuator, Wall Mount	502	Actuator, 4-3/4" Square, Logo, Wireless, Surface Mount Includes 8310-853, 8310-844 Transmitter Kit, 8310-867S Surface Box, 8310-801 Weather Ring. Requires 8310-865 Receiver	
8310-3853TWF	Actuator, Wall Mount	502	Actuator, 4-3/4" Square, Logo, Text, Wireless, Flush Mount Includes 8310-853T, 8310-844 Transmitter Kit, 8310-867F Flush Box, 8310-801 Weather Ring. Requires 8310-865 Receiver	
8310-3853TWS	Actuator, Wall Mount	502	Actuator, 4-3/4" Square, Logo, Text, Wireless, Surface Mount Includes 8310-853T, 8310-844 Transmitter Kit, 8310-867S Surface Box, 8310-801 Weather Ring. Requires 8310-865 Receiver	
8310-865	Receiver	170	Receiver, Wireless, 1 Channel, Sequencing Feature Used in conjunction w/ Wireless Actuators & Transmitters	

8310 Series Actuators - Wall Mount - 4-3/4" Square

8310-813	Actuator, Wall Mount	\$759	Actuator, 4-3/4" Square, Touchless, Wall Mount 'K' Band Technology 'Hands Free' operation, system is activated by movement near actuator face. Mounts in 4" x 4" electrical box - Includes black plexiglass cover	
8310-855	Actuator, Wall Mount	333	Actuator, 4-3/4" Square, Logo, Dual Vestibule	
8310-3855WF	Actuator, Wall Mount	749	Actuator, 4-3/4" Square, Logo, Dual Vestibule, Wireless, Flush Mount Includes 8310-855 Actuator, 8310-844 Transmitter (2), 8310-867F Flush Box, 8310-801 Weather Ring. Requires 8310-865 Receiver (2)	
8310-3855WS	Actuator, Wall Mount	749	Actuator, 4-3/4" Square, Logo, Dual Vestibule, Wireless, Surface Mount Includes 8310-855 Actuator, 8310-844 Transmitter (2), 8310-867S Surface Box, 8310-801 Weather Ring. Requires 8310-865 Receiver (2)	
8310-865	Receiver	170	Receiver, Wireless, 1 Channel, Sequencing Feature Used in conjunction w/ Wireless Actuators & Transmitters	

8310 Series Actuators



8310-853



8310-3853WF



853



801

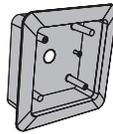

867F



844

8310-3853WS



853



801

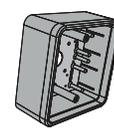

867S

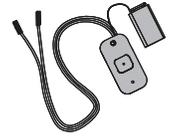

844

8310-853T



8310-3853TWF



853T

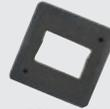

801

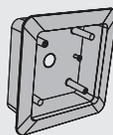

867F



844

8310-3853TWS



853T

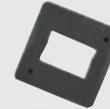

801

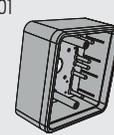

867S



844

8310-853WP



8310-853TWP



8310-813



8310-865

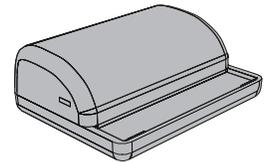

8310-855



8310-3855WF



855

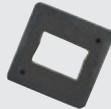

801

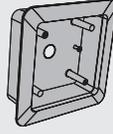

867F



844

8310-3855WS



855



801

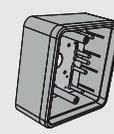

867S



844

ACTUATORS & ACCESSORIES

PRICE LIST

ACTUATORS & ACCESSORIES		LIST PRICE	PRODUCT DESCRIPTION	
PRODUCT NUMBER	DESCRIPTION			

8310 Series Actuators - Wall Mount - 6" Round

8310-852.....	Actuator, Wall Mount	\$218	Actuator, 6" Round, Logo
8310-852T	Actuator, Wall Mount	218	Actuator, 6" Round, Logo, Text
8310-852WP	Actuator, Wall Mount	569	Actuator, 6" Round, Logo, Wireless, Surface Mount Easy mount, 'all in one', low profile, surface mount, wireless actuator. Requires 8310-865 Receiver.
8310-852TWP	Actuator, Wall Mount	569	Actuator, 6" Round, Logo, Text, Wireless, Surface Mount Easy mount, 'all in one', low profile, surface mount, wireless actuator. Requires 8310-865 Receiver.
8310-3852WF	Actuator, Wall Mount	502	Actuator, 6" Round, Logo, Wireless, Flush Mount Includes 8310-852 Actuator, 8310-844 Transmitter Kit, 8310-869F Flush Box, 8310-802 Weather Ring. Requires 8310-865 Receiver.
8310-3852WS	Actuator, Wall Mount	502	Actuator, 6" Round, Logo, Wireless, Surface Mount Includes 8310-852 Actuator, 8310-844 Transmitter Kit, 8310-869S Surface Box, 8310-802 Weather Ring. Requires 8310-865 Receiver.
8310-3852TWF	Actuator, Wall Mount	502	Actuator, 6" Round, Logo, Text, Wireless, Flush Mount Includes 8310-852T Actuator, 8310-844 Transmitter Kit, 8310-869F Flush Box, 8310-802 Weather Ring. Requires 8310-865 Receiver.
8310-3852TWS	Actuator, Wall Mount	502	Actuator, 6" Round, Logo, Text, Wireless, Surface Mount Includes 8310-852T Actuator, 8310-844 Transmitter Kit, 8310-869S Surface Box, 8310-802 Weather Ring. Requires 8310-865 Receiver.
8310-865.....	Receiver	170	Receiver, Wireless, 1 Channel, Sequencing Feature Used in conjunction w/ Wireless Actuators & Transmitters



8310-852



8310-852T



8310-852WP



8310-852TWP

8310 Series Actuators - Specialty

8310-836T	Actuator, Full Length	811	Actuator, 36" x 6" Full Length, Logo, Text
8310-836TW	Actuator, Full Length	925	Actuator, 36" x 6" Full Length, Logo, Text, Wireless Includes 8310-844J. Requires 8310-865. Easy Mount, All-In-One, Low Profile Surface Mount, Wireless Actuator.



836T

8310 Series Actuators



8310-852



3852WF

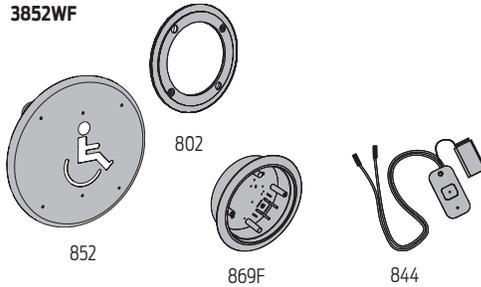

3852WS

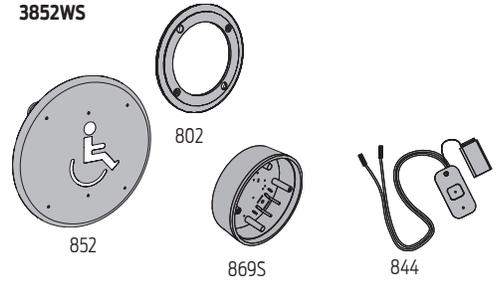

8310-852T



3852TWF

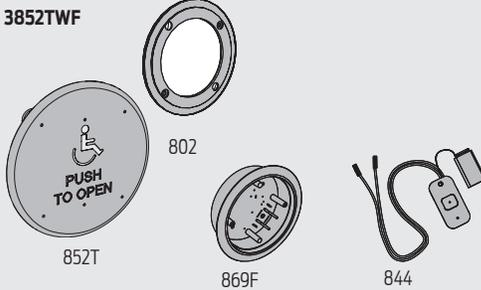

3852TWS

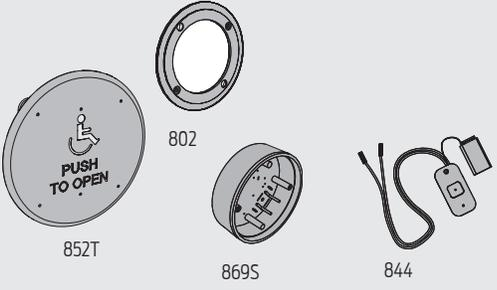

8310-852WP



8310-852TWP



8310-865

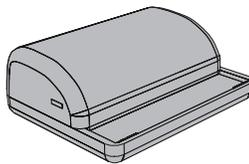

8310-836T



8310-836TW

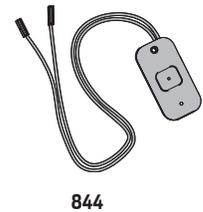

844

836T

ACTUATORS & ACCESSORIES

PRICE LIST

ACTUATORS & ACCESSORIES		LIST PRICE	PRODUCT DESCRIPTION	
PRODUCT NUMBER	DESCRIPTION			

8310 Series Actuators - Wall Mount - 4-3/4" Square

8310-3822T	Actuator Package	\$332	Actuator Package, 1-1/2" x 4-3/4", Jamb Mount Includes 8310-818T (2) Jamb Mount Actuator, (2) Surface Mount Box, 8310-819S Recommended for interior use only.
8310-3822TW	Actuator Package	801	Actuator Package, 1-1/2" x 4-3/4", Wireless, Jamb Mount Includes 8310-818T (2) Jamb Mount Actuator, 8310-819S (2) Surface Mount Box, 8310-844J (2) Jamb Mount Transmitter, 8310-865 Receiver. Recommended for interior use only.
8310-3860T	Actuator Package	547	Actuator Package, 4-1/2" Round, Wall Mount. Includes 8310-856T (2) Wall Mount Actuator, 8310-868S Surface Mount Box
8310-3860TW	Actuator Package	1,052	Actuator Package, 4-1/2" Round, Wireless, Wall Mount Includes 8310-856T (2) Wall Mount Actuator, 8310-868S (2) Surface Mount Box, 8310-800 (2) Weather Ring, 8310-844 (2) Transmitter, 8310-865 Receiver
8310-3857T	Actuator Package	658	Actuator Package, 4-3/4" Square, Wall Mount. Includes 8310-853T (2) Wall Mount Actuator, 8310-867S (2) Surface Mount Box
8310-3857TW	Actuator Package	1,163	Actuator Package, 4-3/4" Square, Wall Mount. Includes 8310-853T (2) Wall Mount Actuator, 8310-867S (2) Surface Mount Box, 8310-801 (2) Weather Ring, 8310-844 (2) Transmitter, 8310-865 Receiver

8310 Series Actuator Packages



8310-3822T

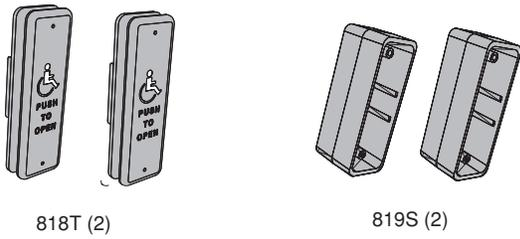

8310-3822TW

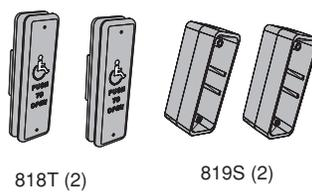

844J (2)

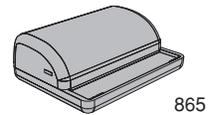

865

8310-3860T

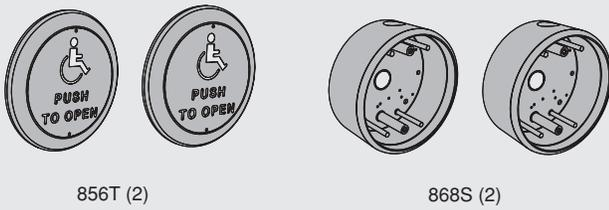

8310-3860TW

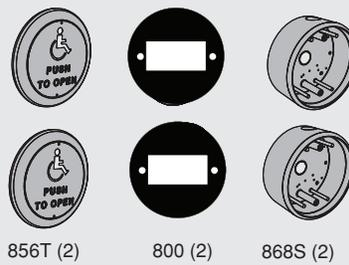

844 (2)

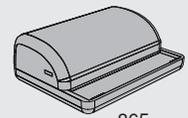

865

8310-3857T

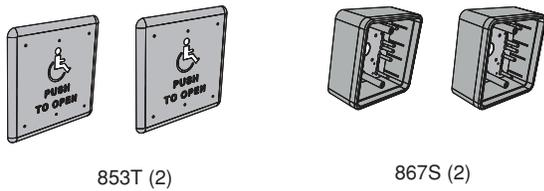

8310-3857TW

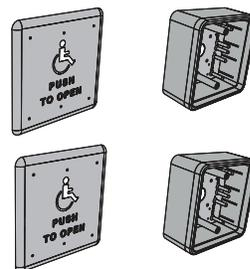

801 (2)

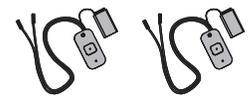

844 (2)

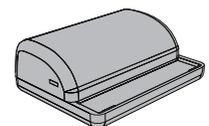

865

ACTUATORS & ACCESSORIES

PRICE LIST



ACTUATORS & ACCESSORIES		LIST PRICE	PRODUCT DESCRIPTION
PRODUCT NUMBER	DESCRIPTION		

8310 Series Actuator Accessories

8310-800.....Ring, Weather	\$19	Weather Ring, 4-1/2" Round Optional accessory. Can be used w/ any 4-1/2" round actuator
8310-801.....Ring, Weather	19	Weather Ring, 4-1/2" Square Optional accessory. Can be used w/ any 4-1/2" square actuator
8310-802.....Ring, Weather	19	Weather Ring, 6" Round Optional accessory. Can be used w/ any 6" round actuator
8310-819F.....Box Only, Jamb Mount	32	Jamb Box Only, 1-1/2" x 4-3/4" Rectangle, Flush Mount Optional accessory. Should be used on an interior installation only. Can be used w/ any 1-1/2" x 4-3/4" jamb mount actuator
8310-819S.....Box Only, Jamb Mount	32	Jamb Box Only, 1-1/2" x 4-3/4", Rectangle, Surface Mount Optional accessory. Should be used on an interior installation only. Can be used w/ any 1-1/2" x 4-3/4" jamb mount actuator
8310-867F.....Box, Flush Mount	137	Box Only, 4-3/4" Square, Flush Mount Optional accessory. Can be used w/ any 4-3/4" square actuator
8310-867S.....Box, Surface Mount	137	Box Only, 4-3/4" Square, Surface Mount Optional accessory. Can be used w/ any 4-3/4" square actuator
8310-868F.....Box, Flush Mount	123	Box Only, 4-1/2" Round, Flush Mount Optional accessory. Can be used w/ any 4-1/2" round actuator
8310-868S.....Box, Surface Mount	123	Box Only, 4-1/2" Round, Surface Mount Optional accessory. Can be used w/ any 4-1/2" round actuator
8310-869F.....Box, Flush Mount	133	Box Only, 6" Round, Flush Mount Optional accessory. Can be used w/ any 6" round actuator
8310-869S.....Box, Surface Mount	133	Box Only, 6" Round, Surface Mount Optional accessory. Can be used w/ any 6" round actuator
8310-874.....Escutcheon	305	Escutcheon, 4-1/2" Round, Decorative, Protective Optional accessory. Can be used w/ any 4-1/2" round actuator
8310-876.....Escutcheon	305	Escutcheon, 6" Round, Decorative, Protective Optional accessory. Can be used w/ any 6" round actuator



8310-800



8310-819S

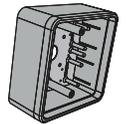

8310-867S



8310-868S

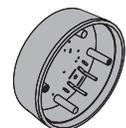

8310-869S

8310 Series Actuator Accessories

October
2014

8310-800



8310-801



8310-802



8310-819F



8310-819S

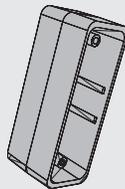

8310-867F

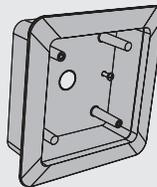

8310-867S

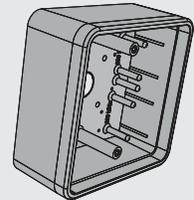

8310-868F

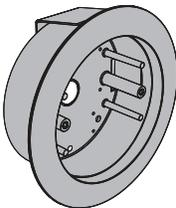

8310-868S

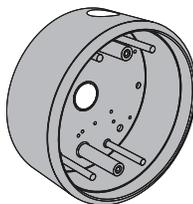

8310-869F

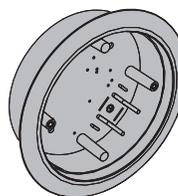

8310-869S

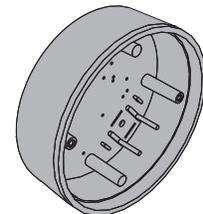

8310-874

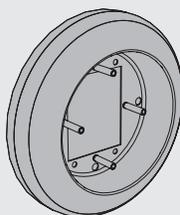

8310-876

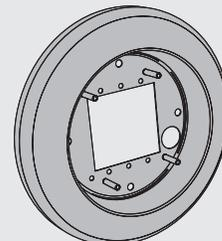

ACTUATORS & ACCESSORIES

PRICE LIST

ACTUATORS & ACCESSORIES		LIST PRICE	PRODUCT DESCRIPTION	
PRODUCT NUMBER	DESCRIPTION			

8310 Series Activation/Safety Sensors

8310-804-1.....	Sensor, Door Mount, Safety	\$1,043
8310-804-2.....	Sensor, Door Mount, Safety	1,406
8310-854.....	Sensor, Header Mount, Activation	645
8310-877.....	Sensor, Header Mount, Safety	1,231

Door Mount Safety Sensor, Sensor with one element
Used to sense obstruction(s) on leading edge of door

Door Mount Safety Sensor, Sensor with two elements
Used to sense obstruction(s) on full face of door

Header Mount Activation Sensor, 'K' Band Technology

Header Mount Safety Sensor, 'Diffused Infrared' Technology
Provides 'safety function' during door open & door closed position.
Nine selectable/programmable patterns.
Optional 8310-859 Handheld Remote Control can be used to program 8310-877 Sensor from a distance. Includes 8310-846 Harness.

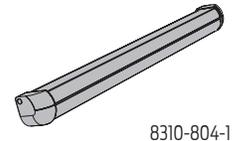

8310-804-1

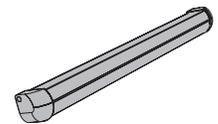

8310-804-2

8310 Series Activation/Safety Sensor Packages

8310-3881L.....	Sensor Package	\$3,945
8310-3881.....	Sensor Package	5,281
8310-3882L.....	Sensor Package	5,368
8310-3882.....	Sensor Package	8,040
8310-3883.....	Sensor Package	1,286
8310-3891.....	Sensor Package	6,815
8310-3892.....	Sensor Package	8,112

Activation/Safety Sensor Package, Single Door, Basic Pack
Includes 8310-854 (2) Header Mount Activation Sensor, 8310-877 Header Mount Safety Sensor, 8310-877S Header Mount Spacer, 8310-804-2 Door Mount Safety Sensor, 8310-847 Harness

Activation/Safety Sensor Package, Single Door, Complete Pack
Includes 8310-854 (2) Header Mount Activation Sensor, 8310-877 Header Mount Safety Sensor, 8310-877S Header Mount Spacer, 8310-847 Harness, 8310-804-2 (2) Door Mount Safety Sensor

Activation/Safety Sensor Package, Double Door, Basic Pack
Includes 8310-854 (2) Header Mount Activation Sensor, 8310-877 Header Mount Safety Sensor, 8310-877S Header Mount Spacer, 8310-847 (2) Harness, 8310-804-2 (2) Door Mount Safety Sensor

Activation/Safety Sensor Package, Double Door, Complete Pack
Includes 8310-854 (2) Header Mount Sensor, 8310-877 Header Mount Sensor, 8310-877S Header Mount Spacer, 8310-847 (2) Harness, 8310-804-2 (4) Door Mount Safety Sensor

Activation/Safety Sensor Package, Low Energy Convenience, Single Door.
Includes 8310-804-1 Door Mount Safety Sensor, 8310-805C Door Position Switch (Concealed), 8310-845 Programmable Relay Module

Activation/Safety Sensor Package, Health Care I, Simultaneous Pair
Includes 8310-877 Header Mount Sensor, 8310-877S Header Mount Spacer, 8310-804-2 (4) Door Mount Sensor, 8310-847 (2) Harness.

Activation/Safety Sensor Package, Health Care II, Independent Pair
Includes 8310-877 (2) Header Mount Sensor, 8310-877S (2) Header Mount Spacer, 8310-804-2 (4) Door Mount Sensor, 8310-847 (2) Harness

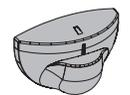

8310-854

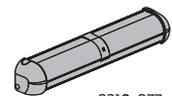

8310-877

8310 Series Activation/Safety Sensor Packages



8310-804-1

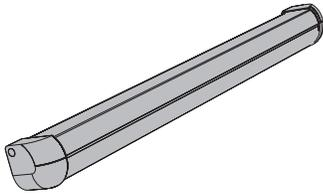

8310-804-2

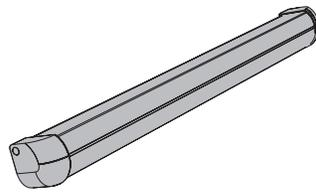

8310-854

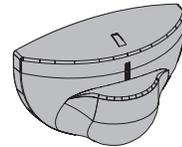

8310-877

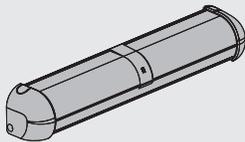

8310-3883

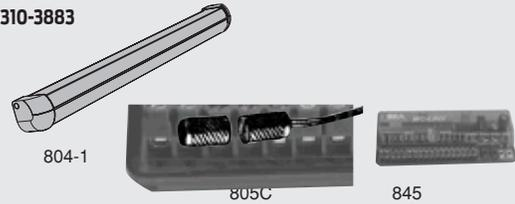

8310-3891

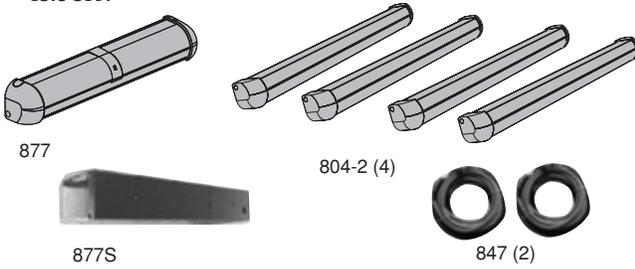

8310-3892

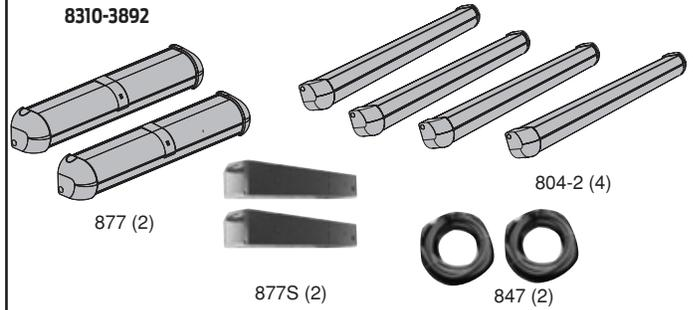

8310-3881

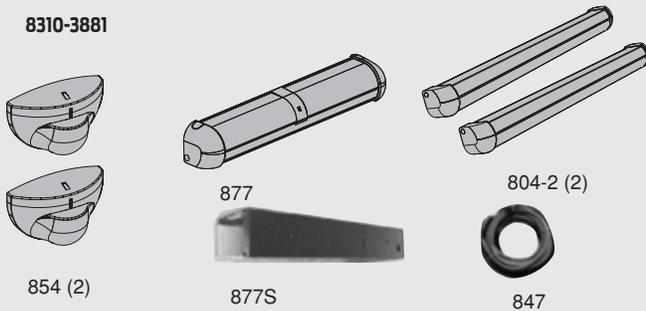

8310-3882

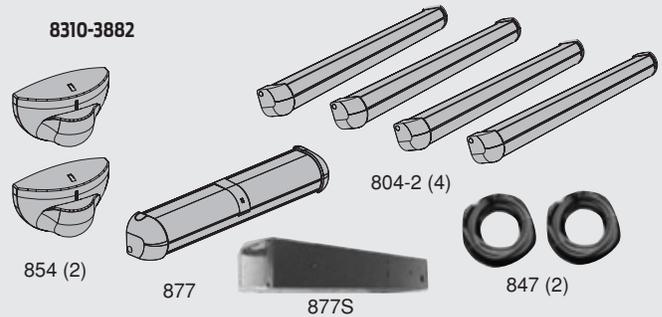

8310-3881L

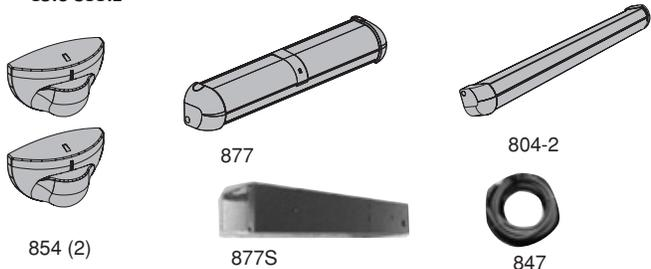

8310-3882L

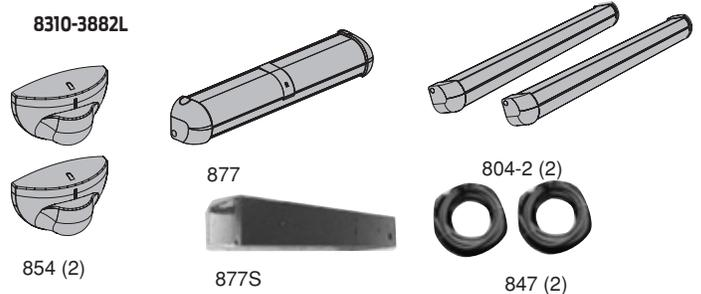

ACTUATORS & ACCESSORIES

PRICE LIST

			
ACTUATORS & ACCESSORIES	LIST PRICE	PRODUCT DESCRIPTION	
PRODUCT NUMBER		DESCRIPTION	

8310 Series Activation/Safety Sensor Accessories

8310-805	Switch, Door Position	\$46	Switch, Door Position, Surface Mount. Used when 8310-804-1 Surface Mount or 8310-804-2 Door Mounted Safety Sensor is installed in conjunction w/ either a 4630 or 4640 Series Automatic Operator. Disables approach side sensor when door is closed
8310-805C	Switch, Door Position	46	Switch, Door Position, Concealed. Used when 8310-804-1 Concealed or 8310-804-2 Door Mounted Safety Sensor is installed in conjunction w/ either a 4630 or 4640 Series Automatic Operator. Disables approach side sensor when door is closed
8310-824	Transformer	66	Transformer, 24v, Hardwired. Optional accessory - Used to remotely power any 24v sensor/receiver
8310-824P	Transformer	66	Transformer, 24v, Plug In. Optional accessory - Used to remotely power any 24v sensor/receiver
8310-846	Harness, Header Mount	23	Harness, Header Mount. Used w/ 8310-877 Header Mount Safety Sensor
8310-847	Harness, Door Mount	93	Harness, Door Mount. Used w/ 8310-804-1 or 8310-804-2 Door Mount Safety Sensor
8310-854ECA	Bracket, Drop Ceiling	170	Bracket, Drop Ceiling. Optional bracket used w/ 8310-854 Header Mount Activation Sensor
8310-854ERA	Cover, Protective	113	Cover, Protective Optional cover used w/ 8310-854 Header Mount Activation Sensor
8310-859	Remote, Handheld	142	Remote Control, Handheld. Optional handheld remote that can be used to program 8310-877 Header Mount Safety Sensor or 8310-854 Header Mount Motion Sensor
8310-877S	Spacer, Header Mount	133	Header Mount Safety Sensor Spacer. Required when 8310-804-1 or 8310-804-2 Door Mount Safety Sensors are used w/ 8310-877 Header Mount Safety Sensor
8310-3803	Conversion Kit, Wireless, Jamb Mount	470	Wireless Conversion Kit, Jamb Mount, 3v Converts standard jamb actuator to wireless version Requires 8310-819 Jamb Box - Includes 8310-865 Receiver, 8310-844J (2) Jamb Mounted Transmitter Kit
8310-3809	Conversion Kit, Wireless, Wall Mount	470	Wireless Conversion Kit, Wall Mount, 9v Converts standard wall mount actuator to wireless version Requires Surface Box & Weather Ring - Includes 8310-865 Receiver, 8310-844 (2) Wall Mount Transmitter Kit
8310-3888	Harness, Safety Module	30	Harness, Safety Module, Service Part. Safety Module Harness included in 8310-3889 Safety Module & Kit
8310-3889	Safety Module Kit	424	Safety Module & Kit Used w/ 7901, 7902, 7981, 7982 Control Boxes. Includes 8310-3888 Safety Module Harness, 8310-845 Time Delay Relay. Required when 8310-877 Header Mount Safety Sensor is used w/ Pneumatic Automatic Operators (2610, 4810, 4820 or 4840 Series)

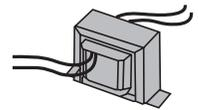

8310-824



8310-859

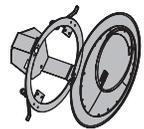

8310-854ECA



8310-854ERA

8310 Series Activation/Safety Sensor Packages



8310-805



8310-805C



8310-824

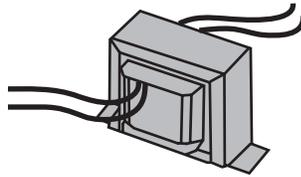

8310-824P

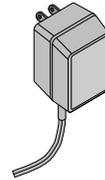

8310-846



8310-847



8310-854ECA

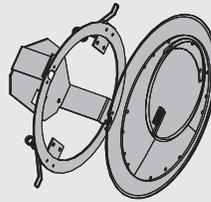

8310-854ERA

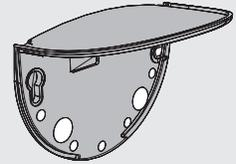

8310-859



8310-8775



8310-3888



8310-3889



8310-3803

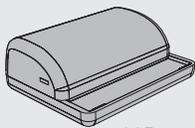

865

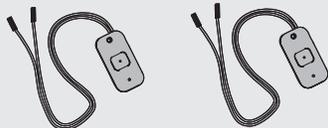

844J (2)

8310-3809

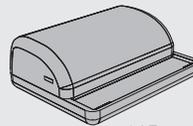

865

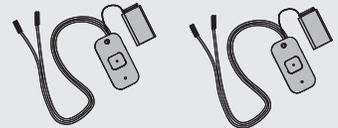

844 (2)

ACTUATORS & ACCESSORIES

PRICE LIST



ACTUATORS & ACCESSORIES	LIST PRICE	PRODUCT DESCRIPTION
PRODUCT NUMBER DESCRIPTION		

8310 Series Actuators, Sensors & Accessories

8310-844Transmitter Kit, Wall Mount	\$162	Transmitter, Wireless, 1 Channel, Wall Mount, 9v Used to convert standard wall mount actuator to wireless. Requires 8310-865 Receiver
8310-844J.....Transmitter Kit, Jamb Mount	162	Transmitter, Wireless, 1 Channel, Jamb Mount, 3v Used to convert standard jamb mount actuator to wireless. Requires 8310-865 Receiver
8310-861.....Transmitter, Handheld	162	Transmitter, Wireless, 1 Channel, Handheld, 9v Requires 8310-865 Receiver
8310-862.....Transmitter, Handheld	162	Transmitter, Wireless, 2 Channel, Handheld, 9v Requires at least one 8310-865 Receiver
8310-863.....Transmitter, Handheld	162	Transmitter, Wireless, 3 Channel, Handheld, 9v Requires at least one 8310-865 Receiver
8310-864Transmitter, Handheld	162	Transmitter, Wireless, 4 Channel, Handheld, 9v Requires at least one 8310-865 Receiver
8310-865.....Receiver	170	Receiver, Wireless, 1 Channel, Sequencing Feature Used in conjunction w/ Wireless Actuators & Transmitters



8310-844



8310-861

8310 Series Bollard Posts, Bollard Post Actuators & Accessories

8310-866 Post, Bollard	\$746	42" x 4" x 6" Bollard Post, Mounting Base, Actuator Cut-Out Requires 8310-3853WB Bollard Actuator or 8310-3853TWB Bollard Actuator. Can be used w/ 8310-853 Wall Mount Actuator, 8310-853T Wall Mount Actuator or 8310-855 Wall Mount Actuator. Includes 8310-866CAP. Available in AL or DKBRZ (please specify).
8310-866FLA..... Post, Bollard	746	42" x 4" x 6" Bollard Post, Mounting Base, Full Length Actuator Only Requires 8310-836T Full Length Actuator or 8310-836TW Full Length Actuator. Includes 8310-866CAP. Available in AL or DKBRZ (please specify).
8310-866CAP Cap	122	Plastic Cap, Protective Cover, Service Part. Formed plastic cap for 8310-866 Bollard Post
8310-3853WB..... Actuator, Bollard	353	4-3/4" Square w/ Logo, Wireless. For use w/ 8310 866 Bollard Post. Includes 8310-853 Actuator, 8310-844 Transmitter Kit. Requires 8310-865 Receiver.
8310-3853TWB.....Actuator, Bollard	353	4-3/4" Square w/ Logo, Text, Wireless. For use w/ 8310-866 Bollard Post. Includes 8310-853T Actuator, 8310-844 Transmitter Kit. Requires 8310-865 Receiver.
8310-3836T Actuator, Full Length	1,451	Actuator, 36" x 6" Full Length, Logo, Text Bollard Post Available In AL or DKBRZ (Please Specify). Includes 8310-866FLA Bollard Post and 8310-836T Full Length Actuator.
8310-3836TW..... Actuator, Full Length	1,602	Actuator, 36" x 6" Full Length, Logo, Text, Wireless Includes 8310-844J. Requires 8310-865 Bollard Post Available In AL or DKBRZ (Please Specify). Includes 8310-866FLA Bollard Post, 8310-836T Full Length Actuator and 8310-844 Wireless Transmitter Kit.
8310-865.....Receiver	170	Receiver, Wireless, 1 Channel, Sequencing Feature Used in conjunction w/ Wireless Actuators & Transmitters

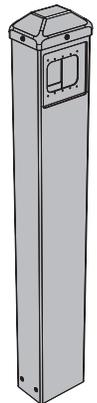

8310-866



8310-865

8310 Series Actuators, Sensors & Accessories



8310-844

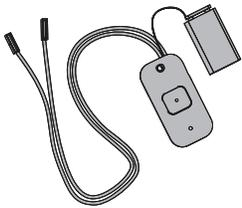

8310-844J

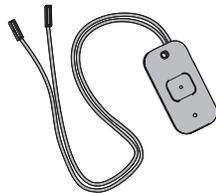

8310-865

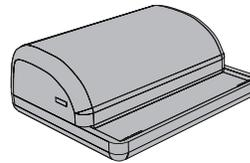

8310-866CAP

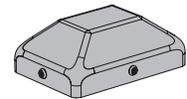

8310-3853WB

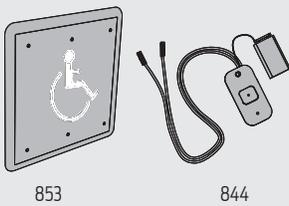

853

844

8310-866

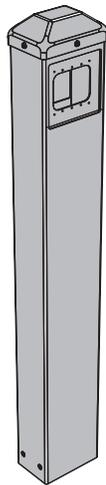

8310-866FLA

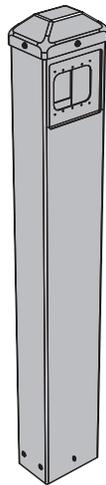

8310-3836T

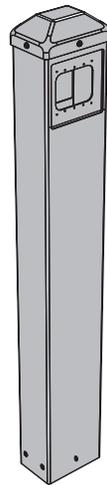

866FLA



836T

8310-3836TW

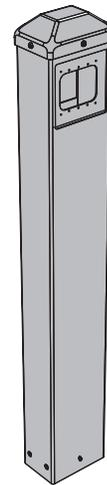

866FLA



836TW



844

8310-3853TWB

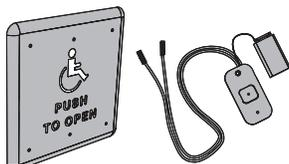

853T

844

8310-861

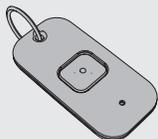

8310-862

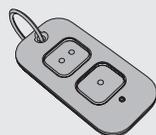

8310-863



8310-864



ACTUATORS & ACCESSORIES

PRICE LIST

			
ACTUATORS & ACCESSORIES PRODUCT NUMBER DESCRIPTION	LIST PRICE	PRODUCT DESCRIPTION	

8310 Series Accessories

8310-806KSwitch, Key	\$173	Switch, Key Type, 3 Position (On/Off/Hold-Open) Optional switch used w/ Senior Swing, Benchmark, or 4630/4640 Operators with (CS) option
8310-806RSwitch, Rocker	173	Switch, Rocker Type, 3 Position (On/Off/Hold-Open) Optional switch w/ Senior Swing or Benchmark Operators.
8310-807Filter, Line	173	Line Filter, AC, 120v. Optional filter used w/ Senior Operators to reduce 'line noise'.
8310-845Relay and Door Sequencer	265	Programmable Relay and Door Sequencer Used to coordinate electric locking Programmable device release for Senior Swing, also functions as door sequencer. Operator manufactured prior to 9/06. Also, is a component to the 8310-8337 Low Energy Convenience Package
8310-887Cable Assembly, Retrofit	18	Retrofit Cable Allows newer style Senior Swing digital control to be activated by existing switches when replacing older control purchased prior to September 2006.
8310-3134Cable Kit, Retrofit	276	Retrofit Cable Kit Allows newer style Senior Swing digital control to be activated by existing switches when replacing older control purchased prior to September 2006. Also includes cables to allow Safety Sensors to activate. Includes 8310-887 plus Safety Sensor Cables.

8310 Series Accessories



8310-806K



8310-806R

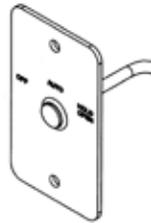

8310-807



8310-845



8310-887

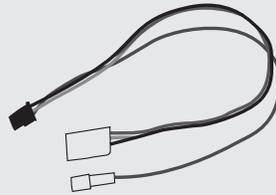

8310-3134



PARTS & ACCESSORIES

PRICE LIST

PARTS & ACCESSORIES	STANDARD POWDER COAT FINISHES	PLATED FINISHES			PARTS & ACCESSORIES	STANDARD POWDER COAT FINISHES	PLATED FINISHES		
	AL (689) DKBRZ (695) BRASS (696) LTBRZ (691) STAT (690) BLACK (693)	US26D	US 3 US 4 US 10	US 10B US 15 US 26		AL (689) DKBRZ (695) BRASS (696) LTBRZ (691) STAT (690) BLACK (693)	US26D	US 3 US 4 US 10	US 10B US 15 US 26

SEM7800 Series

SEM7810-E050.....Extension 1/2"	18.00
SEM7810-E075.....Extension 3/4"	24.00
SEM7810-E100.....Extension 1"	27.00
SEM7810-E200.....Extension 2"	33.00
SEM7810-E400.....Extension 4"	36.00
SEM7810-514.....Ball Pivot/Connection Link	27.00
SEM7820-515.....Fastener Kit	54.00
SEM7820-72.....Standard Cover & Base	407.00
SEM7820-825.....Door Armature	107.00
SEM7820-516.....Magnet Core Assembly	148.00
SEM7830-515.....Fastener Kit	20.00
SEM7830-72.....Standard Cover	82.00
SEM7830-268.....Surface Mount Box	30.00
SEM7830-516.....Magnet Core Assembly	136.00
SEM7830-825.....Door Armature	107.00
SEM7840-515.....Fastener Kit	20.00
SEM7840-72.....Standard Cover	82.00
SEM7840-516.....Magnet Core Assembly	136.00
SEM7840-825.....Door Armature	107.00
SEM7850-515.....Fastener Kit & Bracket	20.00
SEM7850-516.....Magnet Core Assembly	136.00
SEM7850-72.....Standard Cover	82.00
SEM7850-828.....Door Armature	155.00

1260 Series

1261-3071.....Std Cylinder Assy	152.00
1260-3077.....Reg Arm	70.00
1260-3077/PA.....Reg Arm w/62PA	75.00
1260-3077/62A.....Reg Arm w/62A	90.00
1260-3077L.....Long Arm	70.00
1260-3049.....Hold Open Arm	96.00
1260-3049/PA.....Hold Open Arm w/62PA	101.00
1260-3049L.....Hold Open Long Arm	96.00
1260-3077EDA.....EDA Arm	96.00
1260-3077EDA/G.....EDA Arm w/62G	96.00
1260-3049EDA.....HEDA Arm	121.00
1260-3049EDA/G.....HEDA Arm w/62G	121.00
1260-3077CUSH.....CUSH Arm	121.00
1260-3049CUSH.....HCUSH Arm	171.00
1260-72.....Standard Cover	9.00
1260-SRT.....Screw Pack	15.00
1260-TBSRT.....Screw Pack	15.00
1260-WMS.....Screw Pack	15.00
1260-TBWMS.....Screw Pack	15.00
1260-TORX.....Screw Pack	19.00
1260-TBTRX.....Screw Pack	19.00
1260-18.....Plate	40.00
1260-18PA.....Plate	40.00
1260-18QF.....Plate	40.00
1260-30.....Cush Shoe Support	19.00
1260-37.....Hold Open Stud	22.00
1260-41.....Hold Open Nut	5.90
1260-45.....Hold Open Shoe	20.00
1260-49.....Hold Open Main Arm	52.00
1260-61.....Spacer	21.00
1260-62A.....Auxiliary Shoe	35.00
1260-62PA.....PA Shoe	12.00
1260-77.....Arm & Forearm	69.00
1260-78H.....H Head & Tube	60.00
1260-78HL.....Head & Long Tube	60.00
1260-79.....Rod & Shoe	23.00
1260-79LR.....Long Rod & Shoe	23.00
1260-83.....Arm Screw	2.30
1260-83H.....H Arm Screw	2.30
1260-146.....Shaft Cover	2.30
1260-159.....Arm Screw	2.30
1260-201.....Spacer	3.30
1260-384.....Stop	17.00
1260-419.....Panel Adapter	50.00

1260-3048.....Head & Tube Assy	68.00		
1260-3048L.....Head & Long Tube Assy	68.00		
1260-Flat Box.....Flat Box w/Label	4.00		
1260-Instruction Sheet.....Instruction Sheet	3.00		
1260-Rebox Kit.....Box & Instruction Sheet	5.00		

1460 Series

1461-3071.....Std Cylinder Assy	200.00		
1461-3071DEL.....Del Action Cylinder Assy	230.00		
1460-3077.....Reg Arm	70.00	176.00	210.00
1460-3077/PA.....Reg Arm w/62PA	75.00	226.00	275.00
1460-3077/62A.....Reg Arm w/62A	90.00	241.00	290.00
1460-3077HD.....Heavy Duty Arm	85.00	191.00	225.00
1460-3077HD/PA.....HD Arm w/62PA	90.00	241.00	290.00
1460-3077HD/62A.....HD Arm w/62A	105.00	256.00	305.00
1460-3077HD/L.....HD Long Arm	85.00	191.00	225.00
1460-3077L.....Long Arm	70.00	176.00	210.00
1460-3049.....Hold Open Arm	96.00	184.00	225.00
1460-3049/PA.....H Arm w/62PA	101.00	234.00	290.00
1460-3049L.....H Long Arm	96.00	184.00	225.00
1460-3077EDA.....EDA Arm	96.00	272.00	310.00
1460-3077EDA/G.....EDA Arm w/62G	96.00	272.00	310.00
1460-3049EDA.....H EDA Arm	121.00	297.00	335.00
1460-3049EDA/G.....H EDA Arm w/62G	121.00	297.00	335.00
1460-3077CNS.....Cush Arm	121.00	297.00	335.00
1460-3049CNS.....H Cush Arm	171.00	347.00	385.00
1460-3077SCNS.....S Cush Arm	171.00	347.00	385.00
1460-3049SCNS.....Spring H Cush Arm	221.00	397.00	435.00
1460-72.....Standard Cover	15.00		
1460-72DS1.....Designer Series Cover	40.00	140.00	170.00
1460-72FC.....Full Cover	20.00		
1460-SRT.....Screw Pack	15.00	35.00	45.00
1460-TBSRT.....Screw Pack	15.00	35.00	45.00
1460-WMS.....Screw Pack	15.00	35.00	45.00
1460-TBWMS.....Screw Pack	15.00	35.00	45.00
1460-TORX.....Screw Pack	19.00	49.00	59.00
1460-TBTRX.....Screw Pack	19.00	49.00	59.00
1460-18.....Plate	49.00		
1460-18DS.....Plate	49.00	170.00	205.00
1460-18FC.....Plate	49.00		
1460-18PA.....Plate	49.00		
1460-18PADS.....Plate	49.00	170.00	205.00
1460-18PAFC.....Plate	49.00		
1460-30.....Cush Shoe Support	19.00	56.00	69.00
1460-30A.....Mounting Bracket	3.10		
1460-37.....Hold Open Stud	22.00		
1460-41.....Hold Open Nut	5.90		
1460-45.....Hold Open Shoe	20.00		
1460-49.....Hold Open Main Arm	52.00		
1460-58.....Spring & Screw (used w/-80G)	9.00		
1460-61.....Spacer	21.00	58.00	71.00
1460-62A.....Auxiliary Shoe	35.00	89.00	103.00
1460-62PA.....PA Shoe	12.00	76.00	89.00
1460-77.....Arm & Forearm	69.00		
1460-77HD.....Heavy Duty Arm & Forearm	86.00		
1460-78H.....H Head & Tube	60.00		
1460-78HL.....Head & Long Tube	60.00		
1460-79.....Rod & Shoe	23.00	75.00	108.00
1460-79LR.....Long Rod & Shoe	49.00	101.00	134.00
1460-80G.....SC Block (used w/-58)	42.00		
1460-83.....Arm Screw	2.30		
1460-83H.....H Arm Screw	2.30		
1460-124.....Plug	2.30		
1460-146.....Shaft Cover	2.30		
1460-159.....Arm Screw	2.30		
1460-163.....Arm Insert	2.30		
1460-201.....Spacer	3.30		
1460-384.....Stop	17.00		
1460-419.....Panel Adapter	50.00	132.00	146.00
1460-3048.....Head & Tube Assy	68.00		

1460 Series continued on next page

PARTS & ACCESSORIES

PRICE LIST

PARTS & ACCESSORIES	STANDARD POWDER COAT FINISHES <small>AL (689) DKBRZ (695) BRASS (696) LTBRZ (691) STAT (690) BLACK (693)</small>	PLATED FINISHES			PARTS & ACCESSORIES	STANDARD POWDER COAT FINISHES <small>AL (689) DKBRZ (695) BRASS (696) LTBRZ (691) STAT (690) BLACK (693)</small>	PLATED FINISHES		
		US26D	US 3 US 4 US 10	US 10B US 15 US 26			US26D	US 3 US 4 US 10	US 10B US 15 US 26

1460 Series continued

1460-3048L.....Head & Long Tube Assy	68.00
1460-3080.....SC Block (incl -58 & -80G)	49.00
1460-3373.....Adapter Kit	2.50
1460-Flat Box.....Flat Box w/Label	4.00
1460-Instruction Sheet.....Instruction Sheet	3.00
1460-Rebox Kit.....Box & Instruction Sheet	5.00

1460T Series

1460T-3071.....Std Cylinder Assy	200.00
1461T-3071.....Std Cylinder Assy	200.00
1460T-3077T.....Standard Arm	65.00
1460T-3038.....Standard Track	50.00
1460T-3038B.....Track w/Bumper	60.00
1460T-3038H.....Track w/Hold Open	70.00
1460T-3038HB.....Track w/Hold Open & Bumper	80.00
1460T-72.....Standard Cover	15.00
1460T-72DS1.....Designer Series Cover	40.00
1460T-72FC.....Full Cover	20.00
1460T-SRT.....Screw Pack (incl -3034)	29.00
1460T-TBSRT.....Screw Pack (incl -3034)	29.00
1460T-WMS.....Screw Pack (incl -3034)	29.00
1460T-TBWMS.....Screw Pack (incl -3034)	29.00
1460T-TORX.....Screw Pack (incl -3034)	33.00
1460T-TBTRX.....Screw Pack (incl -3034)	33.00
1460T-18.....Plate	49.00
1460T-18DS.....Plate	49.00
1460T-18FC.....Plate	49.00
1460T-18GFC.....Plate	49.00
1460T-18PA.....Plate	49.00
1460T-18PADS.....Plate	49.00
1460T-18P AFC.....Plate	49.00
1460T-30A.....Mounting Bracket	3.10
1460T-73.....End Cap	6.90
1460T-78.....Arm & Tube	60.00
1460T-82.....Rod	50.00
1460T-83H.....H Arm Screw	2.30
1460T-141-1.....Plug	2.30
1460T-141-2.....Plug	2.30
1460T-146.....Shaft Cover	2.30
1460T-159.....Arm Screw	2.30
1460T-163.....Arm Insert	2.30
1460T-169.....Bumper Assy	17.00
1460T-425.....Roller Lock Screw	3.30
1460T-3034.....Track Roller	15.00
1460T-3054.....Hold Open Clip	25.00
1460T-Flat Box.....Flat Box w/Label	4.00
1460T-Instruction Sheet.....Instruction Sheet	3.00
1460T-Rebox Kit.....Box & Instruction Sheet	5.00

2010 Series

2011(3,4,5,6)-3071.....Std Cylinder Assy	343.00
2010-3077T.....Standard Arm	80.00
2010-3038.....Standard Track	50.00
2010-3038B.....Track w/Bumper	60.00
2010-3038H.....Track w/Hold Open	70.00
2010-3038HB.....Track w/Hold Open & Bumper	80.00
2010-WMS.....Screw Pack (incl -3034)	29.00
2010-TORX.....Screw Pack (incl -3034)	33.00
2010-11.....Finish Plate	40.00
2010-31.....Cover Screw	2.30
2010-159.....Arm Screw	2.30
2010-169.....Bumper Assy	17.00
2010-420.....Fire Shield	50.00
2010-425.....Roller Lock Screw	3.30
2010-3034.....Track Roller	15.00
2010-3054.....Hold Open Clip	25.00

2010-SPL-3034.....P-1152 Roller	34.00
2010-SPL-3038.....P-1224 Track	63.00
2010-Flat Box.....Flat Box w/Label	4.00
2010-Instruction Sheet.....Instruction Sheet	3.00
2010-Rebox Kit.....Box & Instruction Sheet	5.00

2030 Series

2031(2,3,4,5)-3071.....Std Cylinder Assy	725.00	941.00	1002.00
2031(2,3,4,5)-3971.....Cylinder Only	675.00		
2030-3077T.....Standard Arm	90.00	246.00	288.00
2030-3038.....Standard Track	50.00		
2030-3038B.....Track w/Bumper	60.00		
2030-3038H.....Track w/Hold Open	70.00		
2030-3038HB.....Track w/Hold Open & Bumper	80.00		
2030-WMS.....Screw Pack (incl -3034)	29.00	49.00	59.00
2030-TORX.....Screw Pack (incl -3034)	33.00	53.00	63.00
2030-159.....Arm Screw	2.30		
2030-169.....Bumper Assy	17.00		
2030-416.....Wood Clip Set	130.00	188.00	236.00
2030-417.....Wood Clip Set	130.00	188.00	236.00
2030-420.....Fire Shield	50.00		
2030-425.....Roller Lock Screw	3.30		
2030-3002.....Mounting/Finish Plate	123.00	241.00	286.00
2030-3034.....Track Roller	15.00		
2030-3054.....Hold Open Clip	25.00		
2030-SPL-3034.....P-1152 Roller	34.00		
2030-SPL-3038.....P-1224 Track	63.00		
2030-Flat Box.....Flat Box w/Label	4.00		
2030-Instruction Sheet.....Instruction Sheet	3.00		
2030-Rebox Kit.....Box & Instruction Sheet	5.00		

2210 Series

2213(4,5)-3071.....Std Cylinder Assy	484.00		
2213(4,5)-3071AVB.....AVB Cylinder Assy	499.00		
2210-3077T.....Standard Arm	107.00	298.00	314.00
2210-72.....Finish Plate (11&12)	45.00	165.00	215.00
2210-3038.....Standard Track	80.00		
2210-TORX.....Screw Pack	33.00	53.00	63.00
2210-11.....Finish Plate	26.00	90.00	108.00
2210-12.....Short Finish Plate	24.00	87.00	106.00
2210-31.....Cover Screw	2.30		
2210-159.....Arm Screw	2.30		
2210-3034.....Track Roller	20.00		
2210-Flat Box.....Flat Box w/Label	4.00		
2210-Instruction Sheet.....Instruction Sheet	3.00		
2210-Rebox Kit.....Box & Instruction Sheet	5.00		

2210DPS Series

2213(4,5)DPS-3071.....Std Cylinder Assy	574.00		
2213(4,5)DPS-3071AVB.....AVB Cylinder Assy	589.00		
2210DPS-3077T.....Standard Arm	107.00	298.00	314.00
2210DPS-72.....Finish Plate (11&12)	45.00	165.00	215.00
2210DPS-3038.....Standard Track	80.00		
2210DPS-TORX.....Screw Pack	33.00	53.00	63.00
2210DPS-11.....Finish Plate	26.00	90.00	108.00
2210DPS-12.....Short Finish Plate	24.00	87.00	106.00
2210DPS-31.....Cover Screw	2.30		
2210DPS-159.....Arm Screw	2.30		
2210DPS-493.....DPS Test Kit	61.00		
2210DPS-3034.....Track Roller	20.00		
2210DPS-3340.....Wire Harness	61.00		
2210DPS-Flat Box.....Flat Box w/Label	4.00		
2210DPS-Instruction Sheet.....Instruction Sheet	3.00		
2210DPS-Rebox Kit.....Box & Instruction Sheet	5.00		

PARTS & ACCESSORIES

PRICE LIST

	STANDARD POWDER COAT FINISHES	PLATED FINISHES			PARTS & ACCESSORIES	STANDARD POWDER COAT FINISHES	PLATED FINISHES	
	AL (689) DKBRZ (695) BRASS (696) LTBRZ (691) STAT (690) BLACK (693)	US26D	US 3 US 4 US 10	US 10B US 15 US 26		ANCLR ANDKB		

2310ME Series

2314ME-3071..... Std Cylinder Assy	788.00
2314ME-3071B80..... B80 Cylinder Assy	863.00
2314ME-3071B140..... B140 Cylinder Assy	863.00
2314ME-3971..... Cylinder Only	738.00
2314ME-3971B80..... B80 Cylinder Only	813.00
2314ME-3971B140..... B140 Cylinder Only	813.00
2310ME-3077T..... Standard Arm	80.00
2310ME-72..... Finish Plate (11&12)	45.00
2310ME-3038..... Standard Track	50.00
2310ME-WMS..... Screw Pack (incl -3034)	29.00
2310ME-TORX..... Screw Pack (incl -3034)	33.00
2310ME-11..... Finish Plate	26.00
2310ME-12..... Short Finish Plate	24.00
2310ME-31..... Cover Screw	2.30
2310ME-159..... Arm Screw	2.30
2310ME-172..... Wiring Cover	6.90
2310ME-420..... Fire Shield	50.00
2310ME-425..... Roller Lock Screw	3.30
2310ME-3034..... Track Roller	15.00
2310ME-3210..... Transformer	59.00
2310ME-3431..... Input Jumper	4.90
2310ME-3351..... ME Switch Assy	72.00
2310ME-Flat Box..... Flat Box w/Label	4.00
2310ME-Instruction Sheet..... Instruction Sheet	3.00
2310ME-Rebox Kit..... Box & Instruction Sheet	5.00

2610 Series

2613(4)-3071..... Std Cylinder Assy	1625.00	1790.00	1838.00
2613(4)-3071DPS..... DPS Cylinder Assy	1795.00	1960.00	2008.00
2613(4)-3971..... Cylinder Only	1525.00		
2613(4)-3971DPS..... DPS Cylinder Only	1695.00		
2610-3077T..... Standard Arm	86.00	244.00	290.00
2610-3038..... Standard Track	50.00		
2610-WMS..... Screw Pack (incl -3034)	29.00	49.00	59.00
2610-61..... Spacer	10.50		
2610-78..... Arm & Tube	60.00		
2610-82..... Rod	50.00		
2610-83H..... H Arm Screw	2.30		
2610-155-1..... Caution Decal	4.90		
2610-155-2..... Activation Decal	4.90		
2610-159..... Arm Screw	2.30		
2610-425..... Roller Lock Screw	3.30		
2610-3002..... Mounting/Finish Plate	123.00	241.00	286.00
2610-3034..... Track Roller	15.00		
2610-Flat Box..... Flat Box w/Label	4.00		
2610-Instruction Sheet..... Instruction Sheet	3.00		
2610-Rebox Kit..... Box & Instruction Sheet	5.00		

2810 Series - (ANCLR or ANDKB only)

2810-3077CP..... Center Pivot Arm	200.00
2810-3077OP..... Offset/Butt Hung Arm	175.00
2810-3077OPCM*Offset Arm w/Track & Conc Channel	338.00
2810-3572HL*..... Header Assy	285.00
2810-3572HL/S*..... Header Assy w/Stop Prep	285.00
2810-3572DD*..... Double Door Header Assy	490.00
2810-3572DD/S*Double Door Header Assy w/Stop Prep	490.00
2810-3572DD/MPDouble Door Header w/Manual Prep	1090.00
2810-MS..... Screw Pack	15.00
2810-11A..... Spindle Plate - 2 3/4"	64.00
2810-11B..... Spindle Plate - 3 3/4"	64.00
2810-12*..... Blank Filler Plate	78.00
2810-78..... Arm & Tube	172.00
2810-82..... Rod	99.00
2810-107..... Pivot Body	57.00
2810-110..... Pivot Post	45.00
2810-117..... Bottom Pivot Plate	45.00

2810-168..... Slide	33.00
2810-275..... Mounting Bracket - 2 3/4"	86.00
2810-334..... Header Endcaps	37.00
2810-334-2..... End Cap	64.00
2810-375..... Mounting Bracket - 3 3/4"	86.00
2810-384B..... Breakaway Door Stop	130.00
2810-384F..... Fixed Door Stop	61.00
2810-511*..... Dress Plate Extrusion Only	15.00 / ft
2810-518..... Cable/Parts Bag	78.00
2810-572*..... Header Extrusion Only	45.00 / ft
2810-572HL*..... Header Only	185.00
2810-572HL/S*..... Header Only w/Stop Prep	185.00
2810-572DD*..... Double Door Header Only	390.00
2810-572DD/S*Double Door Header Only w/Stop Prep	390.00
2810-3018..... Rear Mount Bracket	86.00
2810-3072*..... Concealing Channel	189.00
2810-3107..... Bottom Pivot Assembly	135.00
2810-3155..... Label Kit	23.00
2810-3454..... Motor Gearbox (Std Force)	1890.00
2810-3462..... Controller	1190.00

2850 Series - (ANCLR or ANDKB only)

2850-3077CP..... Center Pivot Arm	200.00
2850-3077OP..... Offset/Butt Hung Arm	175.00
2850-3077OPCM*Offset Arm w/Track & Conc Channel	338.00
2850-3572HL*..... Header Assy	490.00
2850-3572HL/S*..... Header Assy w/Stop Prep	490.00
2850-MS..... Screw Pack	15.00
2850-11A..... Spindle Plate - 2 3/4"	64.00
2850-11B..... Spindle Plate - 3 3/4"	64.00
2850-12*..... Blank Filler Plate	78.00
2850-78..... Arm & Tube	172.00
2850-82..... Rod	99.00
2850-107..... Pivot Body	57.00
2850-110..... Pivot Post	45.00
2850-117..... Bottom Pivot Plate	45.00
2850-168..... Slide	33.00
2850-275..... Mounting Bracket - 2 3/4"	86.00
2850-334..... Header Endcaps	37.00
2850-334-2..... End Cap	64.00
2850-375..... Mounting Bracket - 3 3/4"	86.00
2850-384B..... Breakaway Door Stop	130.00
2850-384F..... Fixed Door Stop	61.00
2850-511*..... Dress Plate Extrusion Only	15.00 / ft
2850-518..... Cable/Parts Bag	78.00
2850-572*..... Header Extrusion Only	45.00 / ft
2850-572HL*..... Header Only	390.00
2850-572HL/S*..... Header Only w/Stop Prep	390.00
2850-982..... Companion Cable	58.00
2850-3018..... Rear Mount Bracket	86.00
2850-3072*..... Concealing Channel	189.00
2850-3107..... Bottom Pivot Assembly	135.00
2850-3155..... Label Kit	23.00
2850-3454..... Motor Gearbox (Std Force)	1890.00
2850-3462..... Controller	1190.00

*Require length - please note when ordering

PARTS & ACCESSORIES

PRICE LIST

PARTS & ACCESSORIES	STANDARD POWDER COAT FINISHES	PLATED FINISHES			PARTS & ACCESSORIES	STANDARD POWDER COAT FINISHES	PLATED FINISHES		
	AL (689) DKBRZ (695) BRASS (696) LTBRZ (691) STAT (690) BLACK (693)	US26D	US 3 US 4 US 10	US 10B US 15 US 26		AL (689) DKBRZ (695) BRASS (696) LTBRZ (691) STAT (690) BLACK (693)	US26D	US 3 US 4 US 10	US 10B US 15 US 26

2860 Series - (ANCLR or ANDKB only)

2860-3077CP.....Center Pivot Arm	200.00
2860-3077OP.....Offset/Butt Hung Arm	175.00
2860-3077OPCM*.....Offset Arm	338.00
w/Track & Conc Channel	
2860-3572HL*.....Header Assy	490.00
2860-3572HL/S*.....Header Assy w/Stop Prep	490.00
2860-MS.....Screw Pack	15.00
2860-11A.....Spindle Plate - 2 3/4"	64.00
2860-11B.....Spindle Plate - 3 3/4"	64.00
2860-12*.....Blank Filler Plate	78.00
2860-78.....Arm & Tube	172.00
2860-82.....Rod	99.00
2860-107.....Pivot Body	57.00
2860-110.....Pivot Post	45.00
2860-117.....Bottom Pivot Plate	45.00
2860-168.....Slide	33.00
2860-275.....Mounting Bracket - 2 3/4"	86.00
2860-334.....Header Endcaps	37.00
2860-334-2.....End Cap	64.00
2860-375.....Mounting Bracket - 3 3/4"	86.00
2860-384B.....Breakaway Door Stop	130.00
2860-384F.....Fixed Door Stop	61.00
2860-511*.....Dress Plate Extrusion Only	15.00 / ft
2860-518.....Cable/Parts Bag	78.00
2860-572*.....Header Extrusion Only	45.00 / ft
2860-572HL*.....Header Only	390.00
2860-572HL/S*.....Header Only w/Stop Prep	390.00
2860-3018.....Rear Mount Bracket	86.00
2860-3072*.....Concealing Channel	189.00
2860-3107.....Bottom Pivot Assembly	135.00
2860-3155.....Label Kit	23.00
2860-3454.....Motor Gearbox (Std Force)	1890.00
2860-3462.....Control Box	1190.00

3030 Series

3031(2,3,4)-3071.....Std Cylinder Assy	281.00		
3030-3077.....Reg Arm	99.00	266.00	310.00
3030-3049.....Hold Open Arm	129.00	296.00	340.00
3030-WMS.....Screw Pack	15.00	35.00	45.00
3030-TORX.....Screw Pack	19.00	53.00	63.00
3030-37.....Hold Open Stud	22.00		
3030-41.....Hold Open Nut	5.90		
3030-48.....Hold Open Forearm	56.00		
3030-49.....Hold Open Main Arm	52.00		
3030-77.....Arm & Forearm	69.00		
3030-79.....Rod & Shoe	23.00	75.00	108.00
3030-79H.....H Rod & Shoe	23.00	75.00	108.00
3030-83.....Arm Screw	2.30		
3030-83H.....H Arm Screw	2.30		
3030-159.....Arm Screw	2.30		
3030-421.....Arm Stud	7.80		
3030-Flat Box.....Flat Box w/Label	4.00		
3030-Instruction Sheet.....Instruction Sheet	3.00		
3030-Rebox Kit.....Box, Inst., & Screw Pk	5.00		

3130 Series

3131(2,3)-3071.....Std Cylinder Assy	281.00		
3130-3077T.....Standard Arm	90.00	259.00	306.00
3130-3038.....Standard Track	50.00		
3130-3038B.....Track w/Bumper	60.00		
3130-3038H.....Track w/Hold Open	70.00		
3130-3038HB.....Track w/Hold Open & Bumper	80.00		
3130-WMS.....Screw Pack (incl -3034)	29.00	49.00	59.00
3130-TORX.....Screw Pack (incl -3034)	33.00	53.00	63.00
3130-2.....Channel	7.80		
3130-159.....Arm Screw	2.30		

3130-169.....Bumper Assy	17.00
3130-425.....Roller Lock Screw	3.30
3130-3034.....Track Roller	15.00
3130-3054.....Hold Open Clip	25.00
3130-Flat Box.....Flat Box w/Label	4.00
3130-Instruction Sheet.....Instruction Sheet	3.00
3130-Rebox Kit.....Box & Instruction Sheet	5.00

3130SE Series

3133(4)SE-3071.....Std Cylinder Assy	281.00		
3130SE-3077T.....Standard Arm	90.00	259.00	306.00
3130SE-3077L.....Long Arm	90.00	259.00	306.00
3130SE-3038.....Standard Track	285.00		
3130SEL-3038SEL.....Long Track	285.00		
3130SE-WMS.....Screw Pack (incl. -81)	15.00	35.00	45.00
3130SE-TORX.....Screw Pack (incl. -81)	33.00	53.00	63.00
3130SE-59A.....Cover Plate	4.50		
3130SE-60.....Cover Plate Screw	2.30		
3130SE-73.....End Cap	6.90		
3130SE-78.....Arm & Tube	60.00		
3130SE-81.....Connector w/Ring	4.30		
3130SE-82.....Rod	50.00		
3130SE-83H.....H Arm Screw	2.30		
3130SE-159.....Arm Screw	2.30		
3130SE-168.....Slider	5.90		
3130SE-425.....Roller Lock Screw	3.30		
3130SE-3034.....Track Roller	15.00		
3130SE-3210.....Transformer	59.00		
3130SE-3436.....On/off Switch Assy	60.00		
3130SE-Flat Box.....Flat Box w/Label	4.00		
3130SE-Instruction Sheet.....Instruction Sheet	3.00		
3130SE-Rebox Kit.....Box & Instruction Sheet	5.00		

4000T Series

4003(4)T-3071.....Std Cylinder Assy	269.00		
4000T-3077T.....Standard Arm	85.00	199.00	248.00
4000T-3038.....Standard Track	50.00		
4000T-72.....Standard Cover	20.00		
4000T-72MC.....Metal Cover	25.00	170.00	210.00
4000T-WMS.....Screw Pack (incl -3034)	29.00	49.00	59.00
4000T-TBWMS.....Screw Pack (incl -3034)	29.00	49.00	59.00
4000T-TORX.....Screw Pack (incl -3034)	33.00	53.00	63.00
4000T-TBTRX.....Screw Pack (incl -3034)	33.00	53.00	63.00
4000T-31.....Cover Screw	2.30		
4000T-61.....Spacer	10.50		
4000T-73.....End Cap	6.90		
4000T-141-2.....Plug	2.30		
4000T-159.....Arm Screw	2.30		
4000T-163.....Arm Insert	2.30		
4000T-164.....Screw Insert	2.30		
4000T-425.....Roller Lock Screw	3.30		
4000T-3034.....Track Roller	15.00		
4000T-Flat Box.....Flat Box w/Label	4.00		
4000T-Instruction Sheet.....Instruction Sheet	3.00		
4000T-Rebox Kit.....Box & Instruction Sheet	5.00		

4010 Series

4011(6)-3071.....Std Cylinder Assy	269.00		
4011-3071DEL.....Del Act Cyl Assy	299.00		
4011(6)-3071TEL.....TEL Cylinder Assy	299.00		
4010-3077.....Reg Arm	102.00	309.00	388.00
4010-3049.....Hold Open Arm	127.00	334.00	413.00
4010-3049FL.....FL Arm	215.00		
4010-72.....Standard Cover	20.00		
4010-72MC.....Metal Cover	25.00	170.00	210.00
4010-SRT.....Screw Pack	15.00	35.00	45.00
4010-TBSRT.....Screw Pack	15.00	35.00	45.00

*Require length - please note when ordering

4010 Series continued on next page

PARTS & ACCESSORIES

PRICE LIST

PARTS & ACCESSORIES	STANDARD POWDER COAT FINISHES	PLATED FINISHES			PARTS & ACCESSORIES	STANDARD POWDER COAT FINISHES	PLATED FINISHES		
	AL (689) DKBRZ (695) BRASS (696) LTBRZ (691) STAT (690) BLACK (693)	US26D	US 3 US 4 US 10	US 10B US 15 US 26		AL (689) DKBRZ (695) BRASS (696) LTBRZ (691) STAT (690) BLACK (693)	US26D	US 3 US 4 US 10	US 10B US 15 US 26
<i>4010 Series continued</i>									
4010-WMS.....Screw Pack	15.00	35.00		45.00	4020-TBSRT.....Screw Pack	15.00			45.00
4010-TBWMS.....Screw Pack	15.00	35.00		45.00	4020-WMS.....Screw Pack	15.00			45.00
4010-TORX.....Screw Pack	19.00	49.00		59.00	4020-TBWMS.....Screw Pack	15.00			45.00
4010-TBTRX.....Screw Pack	19.00	49.00		59.00	4020-TORX.....Screw Pack	19.00			59.00
4010-18.....Plate	49.00	170.00		205.00	4020-TBTRX.....Screw Pack	19.00			59.00
4010-28.....Fusible Link	8.90				4020-18.....Plate	49.00			205.00
4010-31.....Cover Screw	2.30				4020-18G.....Plate	49.00			205.00
4010-37.....Hold Open Stud	22.00				4020-28.....Fusible Link	8.90			
4010-37FL.....FL Hold Open Stud	22.00				4020-31.....Cover Screw	2.30			
4010-41.....Hold Open Nut	5.90				4020-37.....Hold Open Stud	22.00			
4010-48.....Hold Open Forearm	56.00				4020-37FL.....FL Hold Open Stud	22.00			
4010-49.....Hold Open Main Arm	52.00				4020-41.....Hold Open Nut	5.90			
4010-49FL.....FL Main Arm & Rod	52.00				4020-48.....Hold Open Forearm	56.00			
4010-77.....Arm & Forearm	98.00				4020-49.....Hold Open Main Arm	52.00			
4010-79.....Rod & Shoe	23.00	75.00		108.00	4020-49FL.....FL Main Arm & Rod	52.00			
4010-79H.....H Rod & Shoe	23.00	75.00		108.00	4020-77.....Arm & Forearm	98.00			
4010-83.....Arm Screw	2.30				4020-79.....Rod & Shoe	23.00	75.00		108.00
4010-83H.....H Arm Screw	2.30				4020-79H.....H Rod & Shoe	23.00	75.00		108.00
4010-95.....Arm Stud	10.50				4020-79LR.....Long Rod & Shoe	23.00	75.00		108.00
4010-136FL.....FL Forearm	192.00				4020-83.....Arm Screw	2.30			
4010-159.....Arm Screw	2.30				4020-83H.....H Arm Screw	2.30			
4010-Flat Box.....Flat Box w/Label	4.00				4020-136FL.....FL Forearm	192.00			
4010-Instruction Sheet.....Instruction Sheet	3.00				4020-159.....Arm Screw	2.30			
4010-Rebox Kit.....Box & Instruction Sheet	5.00				4020-Flat Box.....Flat Box w/Label	4.00			
					4020-Instruction Sheet.....Instruction Sheet	3.00			
					4020-Rebox Kit.....Box & Instruction Sheet	5.00			
4010T Series									
4011(3,4)T-3071.....Std Cylinder Assy	269.00				4020T Series				
4010T-3077T.....Standard Arm	79.00	185.00		220.00	4021(3,4)T-3071.....Std Cylinder Assy	269.00			
4010T-3077DE.....DE Arm	119.00	225.00		260.00	4020T-3077T.....Standard Arm	79.00	185.00		220.00
4010T-3038.....Standard Track	50.00				4020T-3038.....Standard Track	50.00			
4010T-3038B.....Track w/Bumper	60.00				4020T-3038B.....Track w/Bumper	60.00			
4010T-3038H.....Track w/Hold Open	70.00				4020T-3038H.....Track w/Hold Open	70.00			
4010T-3038HB.....Track w/Hold Open & Bumper	80.00				4020T-3038HB.....Track w/Hold Open & Bumper	80.00			
4010T-72.....Standard Cover	20.00				4020T-72.....Standard Cover	20.00			
4010T-72MC.....Metal Cover	25.00	170.00		210.00	4020T-72MC.....Metal Cover	25.00	170.00		210.00
4010T-SRT.....Screw Pack (incl -3034)	29.00	49.00		59.00	4020T-SRT.....Screw Pack (incl -3034)	29.00	49.00		59.00
4010T-TBSRT.....Screw Pack (incl -3034)	29.00	49.00		59.00	4020T-TBSRT.....Screw Pack (incl -3034)	29.00	49.00		59.00
4010T-WMS.....Screw Pack (incl -3034)	29.00	49.00		59.00	4020T-WMS.....Screw Pack (incl -3034)	29.00	49.00		59.00
4010T-TBWMS.....Screw Pack (incl -3034)	29.00	49.00		59.00	4020T-TBWMS.....Screw Pack (incl -3034)	29.00	49.00		59.00
4010T-TORX.....Screw Pack (incl -3034)	33.00	53.00		63.00	4020T-TORX.....Screw Pack (incl -3034)	33.00	53.00		63.00
4010T-TBTRX.....Screw Pack (incl -3034)	33.00	53.00		63.00	4020T-TBTRX.....Screw Pack (incl -3034)	33.00	53.00		63.00
4010T-18.....Plate	49.00	170.00		205.00	4020T-18.....Plate	49.00	170.00		205.00
4010T-31.....Cover Screw	2.30				4020T-31.....Cover Screw	2.30			
4010T-73.....End Cap	6.90				4020T-73.....End Cap	6.90			
4010T-78DE.....Main Arm & Tube	83.00				4020T-141-2.....Plug	2.30			
4010T-82.....Rod	50.00				4020T-159.....Arm Screw	2.30			
4010T-83H.....H Arm Screw	2.30				4020T-169.....Bumper Assy	17.00			
4010T-141-2.....Plug	2.30				4020T-425.....Roller Lock Screw	3.30			
4010T-159.....Arm Screw	2.30				4020T-3034.....Track Roller	15.00			
4010T-169.....Bumper Assy	17.00				4020T-3054.....Hold Open Clip	25.00			
4010T-425.....Roller Lock Screw	3.30				4020T-Flat Box.....Flat Box w/Label	4.00			
4010T-3034.....Track Roller	15.00				4020T-Instruction Sheet.....Instruction Sheet	3.00			
4010T-3054.....Hold Open Clip	25.00				4020T-Rebox Kit.....Box & Instruction Sheet	5.00			
4010T-Flat Box.....Flat Box w/Label	4.00								
4010T-Instruction Sheet.....Instruction Sheet	3.00				4030 Series				
4010T-Rebox Kit.....Box & Instruction Sheet	5.00				4031-3071.....Std Cylinder Assy	225.00			
					4030-3077.....Reg Arm	92.00	208.00		262.00
					4030-3077PA.....Reg Arm w/62PA	97.00	258.00		327.00
					4030-3077/62A.....Reg Arm w/62A	112.00	273.00		342.00
					4030-3077LD.....Light Duty Arm	72.00	173.00		212.00
					4030-3077LD/PA.....Light Duty Arm w/PA	77.00	223.00		277.00
					4030-3077LD/62A.....Light Duty Arm w/62A	92.00	238.00		292.00
					4030-3077L.....Long Arm	92.00	208.00		262.00
					4030-3049.....H Arm	123.00	232.00		284.00
					4030-3049/PA.....H Arm w/62PA	128.00	282.00		349.00
					4030-3049/L.....H Long Arm	123.00	232.00		284.00
					4030-3077EDA.....EDA Arm	101.00	294.00		336.00

4030 Series continued on next page

PARTS & ACCESSORIES

PRICE LIST

PARTS & ACCESSORIES	STANDARD POWDER COAT FINISHES <small>AL (689) DKBRZ (695) BRASS (696) LTBRZ (691) STAT (690) BLACK (693)</small>	PLATED FINISHES			PARTS & ACCESSORIES	STANDARD POWDER COAT FINISHES <small>AL (689) DKBRZ (695) BRASS (696) LTBRZ (691) STAT (690) BLACK (693)</small>	PLATED FINISHES			
		US26D	US 3 US 4 US 10	US 10B US 15 US 26			US26D	US 3 US 4 US 10	US 10B US 15 US 26	
<i>4030 Series continued</i>										
4030-3049EDA.....	H EDA Arm	126.00	319.00	361.00	4040XP-3049SCNS.....	Spring H Cush Arm	264.00	478.00	563.00	
4030-3077CNS.....	Cush Arm	126.00	319.00	361.00	4040XP-72.....	Standard Cover	20.00			
4030-3049CNS.....	H Cush Arm	176.00	369.00	411.00	4040XP-72MC.....	Metal Cover	25.00	170.00	210.00	
4030-3077SCNS.....	SCush Arm	176.00	369.00	411.00	4040XP-SRT.....	Screw Pack	15.00	35.00	45.00	
4030-3049SCNS.....	Spring H Cush Arm	226.00	419.00	461.00	4040XP-TBSRT.....	Screw Pack	15.00	35.00	45.00	
4030-72MC.....	Metal Cover	20.00	165.00	200.00	4040XP-WMS.....	Screw Pack	15.00	35.00	45.00	
4030-WMS.....	Screw Pack	15.00	35.00	45.00	4040XP-TBWMS.....	Screw Pack	15.00	35.00	45.00	
4030-TBWMS.....	Screw Pack	15.00	35.00	45.00	4040XP-TORX.....	Screw Pack	19.00	49.00	59.00	
4030-18PA.....	Plate	49.00	170.00	205.00	4040XP-TBTRX.....	Screw Pack	19.00	49.00	59.00	
4030-18TJ.....	Plate	49.00	170.00	205.00	4040XP-18.....	Plate	49.00	170.00	205.00	
4030-30.....	Cush Shoe Support	19.00	56.00	69.00	4040XP-18G.....	Plate	49.00	170.00	205.00	
4030-31.....	Cover Screw	2.30			4040XP-18PA.....	Plate	49.00	170.00	205.00	
4030-58.....	Spring & Screw (used w/-80G)	9.00			4040XP-18TJ.....	Plate	49.00	170.00	205.00	
4030-61.....	Spacer	21.00	58.00	71.00	4040XP-30.....	Cush Shoe Support	19.00	56.00	69.00	
4030-62A.....	Auxiliary Shoe	35.00	89.00	103.00	4040XP-31.....	Cover Screw	2.30			
4030-62PA.....	PA Shoe	12.00	76.00	89.00	4040XP-37.....	Hold Open Stud	22.00			
4030-77.....	Arm & Forearm	98.00			4040XP-37EDA.....	EDA Hold Open Stud	22.00			
4030-79.....	Rod & Shoe	23.00	75.00	108.00	4040XP-41.....	Hold Open Nut	5.90			
4030-79LR.....	Long Rod & Shoe	23.00	75.00	108.00	4040XP-45.....	Hold Open Shoe	20.00			
4030-80G.....	SC Block (used w/-58)	42.00			4040XP-48.....	Hold Open Forearm	56.00			
4030-83.....	Arm Screw	2.30			4040XP-49.....	Hold Open Main Arm	52.00			
4030-83H.....	H Arm Screw	2.30			4040XP-54.....	Snap-On Cover Clip Only	7.30			
4030-159.....	Arm Screw	2.30			4040XP-58.....	Spring & Screw (used with -80G)	9.00			
4030-201.....	Spacer	3.30			4040XP-61.....	Spacer	21.00	58.00	71.00	
4030-419.....	Panel Adapter	50.00	132.00	146.00	4040XP-62A.....	Auxiliary Shoe	35.00	89.00	103.00	
4030-3045.....	Hold Open Shoe	16.50			4040XP-62PA.....	PA Shoe	12.00	76.00	89.00	
4030-3048.....	Head & Tube Assy	68.00			4040XP-77.....	Arm & Forearm	106.00			
4030-3080.....	SC Block (incl -58 & -80G)	49.00			4040XP-78H.....	H Head & Tube	60.00			
4030-Flat Box.....	Flat Box w/Label	4.00			4040XP-78HL.....	Head & Long Tube	60.00			
4030-Instruction Sheet.....	Instruction Sheet	3.00			4040XP-79.....	Rod & Shoe	23.00	75.00	108.00	
4030-Rebox Kit.....	Box & Instruction Sheet	5.00			4040XP-79LR.....	Long Rod & Shoe	23.00	75.00	108.00	
					4040XP-79ELR.....	XL Rod & Shoe	49.00	101.00	134.00	
					4040XP-80G.....	SC Block (used with -58)	42.00			
					4040XP-83.....	Arm Screw	2.30			
					4040XP-83H.....	H Arm Screw	2.30			
					4040XP-95.....	Arm Stud	10.50			
					4040XP-124.....	Plug	2.30			
					4040XP-159.....	Arm Screw	2.30			
					4040XP-201.....	Spacer	3.30			
					4040XP-384.....	Stop	17.00			
					4040XP-419.....	Panel Adapter	50.00	132.00	146.00	
					4040XP-3048.....	Head & Tube Assy	71.00			
					4040XP-3048L.....	Head & Long Tube Assy	71.00			
					4040XP-3080.....	SC Block (incl -58 & -80G)	49.00			
					4040XP-Flat Box.....	Flat Box w/Label	4.00			
					4040XP-Instruction Sheet.....	Instruction Sheet	3.00			
					4040XP-Rebox Kit.....	Box & Instruction Sheet	5.00			
4030T Series										
4031T-3071.....	Std Cylinder Assy	225.00			4040XPT-3071.....	Std Cylinder Assy	277.00			
4030T-3077T.....	Standard Arm	77.00	183.00	215.00	4040XPT-3077T.....	Standard Arm	85.00	188.00	220.00	
4030T-3038.....	Standard Track	50.00			4040XPT-3077DE.....	DE Arm	125.00	228.00	260.00	
4030T-3038H.....	Track w/Hold Open	70.00			4040XPT-3038.....	Standard Track	50.00			
4030T-72MC.....	Metal Cover	20.00	165.00	200.00	4040XPT-3038B.....	Track w/Bumper	60.00			
4030T-WMS.....	Screw Pack	15.00	35.00	45.00	4040XPT-3038H.....	Track w/Hold Open	70.00			
4030T-TBWMS.....	Screw Pack	15.00	35.00	45.00	4040XPT-3038HB.....	Track w/Hold Open & Bumper	80.00			
4030T-73.....	End Cup	6.90			4040XPT-72.....	Standard Cover	20.00			
4030T-141-1.....	Plug	2.30			4040XPT-72MC.....	Metal Cover	25.00	170.00	210.00	
4030T-141-2.....	Plug	2.30			4040XPT-SRT.....	Screw Pack (incl -3034)	29.00	49.00	59.00	
4030T-159.....	Arm Screw	2.30			4040XPT-TBSRT.....	Screw Pack (incl -3034)	29.00	49.00	59.00	
4030T-425.....	Roller Lock Screw	3.30			4040XPT-WMS.....	Screw Pack (incl -3034)	29.00	49.00	59.00	
4030T-3054.....	Hold Open Clip	25.00			4040XPT-TBWMS.....	Screw Pack (incl -3034)	29.00	49.00	59.00	
4030T-Flat Box.....	Flat Box w/Label	4.00			4040XPT-TORX.....	Screw Pack (incl -3034)	33.00	53.00	63.00	
4030T-Instruction Sheet.....	Instruction Sheet	3.00			4040XPT-TBTRX.....	Screw Pack (incl -3034)	33.00	53.00	63.00	
4030T-Rebox Kit.....	Box & Instruction Sheet	5.00			4040XPT-18.....	Plate	49.00	170.00	205.00	
					4040XPT-18TJ.....	Plate	49.00	170.00	205.00	
					4040XPT-31.....	Cover Screw	2.30			
					4040XPT-54.....	Snap-On Cover Clip Only	7.30			
					4040XPT-61.....	Spacer	10.50			
					4040XPT-73.....	End Cap	6.90			
					4040XPT-78DE.....	Main Arm & Tube	83.00			
					4040XPT-78E.....	Rod	50.00			
					<i>4040XPT Series continued on next page</i>					

PARTS & ACCESSORIES

PRICE LIST

PARTS & ACCESSORIES	STANDARD POWDER COAT FINISHES	PLATED FINISHES			PARTS & ACCESSORIES	STANDARD POWDER COAT FINISHES	PLATED FINISHES			
	AL (689) DKBRZ (695) BRASS (696) LTBRZ (691) STAT (690) BLACK (693)	US26D	US 3 US 4 US 10	US 10B US 15 US 26		AL (689) DKBRZ (695) BRASS (696) LTBRZ (691) STAT (690) BLACK (693)	US26D	US 3 US 4 US 10	US 10B US 15 US 26	
<i>4040XPT Series continued</i>										
4040XPT-83H.....H Arm Set Screw	2.30				4110-3077CNS.....Cush Arm	147.00			354.00	433.00
4040XPT-141-1.....Plug	2.30				4110-3049CNS.....H Cush Arm	197.00			404.00	483.00
4040XPT-141-2.....Plug	2.30				4110-3077SCNS.....S Cush Arm	197.00			404.00	483.00
4040XPT-159.....Arm Screw	2.30				4110-3049SCNS.....Spring H Cush Arm	247.00			454.00	533.00
4040XPT-169.....Bumper Assy	17.00				4110-3049FL.....FL Arm	215.00				
4040XPT-425.....Roller Lock Screw	3.30				4110-72.....Standard Cover	20.00				
4040XPT-3034.....Track Roller	15.00				4110-72MC.....Metal Cover	25.00	170.00	210.00		
4040XPT-3054.....Hold Open Clip	25.00				4110-SRT.....Screw Pack	15.00	35.00	45.00		
4040XPT-Flat Box.....Flat Box w/Label	4.00				4110-TBSRT.....Screw Pack	15.00	35.00	45.00		
4040XPT-Instruction Sheet.....Instruction Sheet	3.00				4110-WMS.....Screw Pack	15.00	35.00	45.00		
4040XPT-Rebox Kit.....Box & Instruction Sheet	5.00				4110-TBWMS.....Screw Pack	15.00	35.00	45.00		
4040SE Series										
4040SE-3071.....Std Cylinder Assy	277.00				4110-TORX.....Screw Pack	19.00	49.00	59.00		
4040SE-3077T.....Standard Arm	119.00	231.00		278.00	4110-TBTRX.....Screw Pack	19.00	49.00	59.00		
4040SE-3077DE.....DE Arm	159.00	271.00		318.00	4110-18.....Plate	49.00	170.00	205.00		
4040SE-3038.....Standard Track	285.00				4110-18CUSH.....Plate	49.00	170.00	205.00		
4040SEL-3038SEL.....Long Track	285.00				4110-28.....Fusible Link	8.90				
4040SE-72.....Standard Cover	20.00				4110-30.....Cush Shoe Support	19.00	56.00	69.00		
4040SE-72MC.....Metal Cover	25.00	170.00		210.00	4110-31.....Cover Screw	2.30				
4040SE-WMS.....Screw Pack (inc. -81)	29.00	49.00		59.00	4110-37.....Hold Open Stud	22.00				
4040SE-TBWMS.....Screw Pack (inc. -81)	29.00	49.00		59.00	4110-41.....Hold Open Nut	5.90				
4040SE-TORX.....Screw Pack (inc. -81)	33.00	53.00		63.00	4110-48.....Hold Open Forearm	56.00				
4040SE-TBTRX.....Screw Pack (inc. -81)	33.00	53.00		63.00	4110-49FL.....FL Main Arm & Rod	52.00				
4040SE-18.....Plate	49.00	170.00		205.00	4110-58.....Spring & Screw (used with -80)	9.00				
4040SE-18PA.....Plate	49.00	170.00		205.00	4110-61.....Spacer	21.00	58.00	71.00		
4040SE-31.....Cover Screw	2.30				4110-62FL.....PA-FL Shoe	12.00				
4040SE-59A.....Cover Plate	4.50				4110-77EDA.....Main Arm	98.00				
4040SE-60.....Cover Plate Screw	2.30				4110-80G.....Block (used with -58)	42.00				
4040SE-61.....Spacer	10.50				4110-136FL.....FL Forearm	192.00				
4040SE-73.....End Cap	6.90				4110-159.....Arm Screw	2.30				
4040SE-78.....Arm & Tube	60.00				4110-201.....Spacer	3.30				
4040SE-78DE.....Main Arm & Tube	83.00				4110-419.....Panel Adapter	50.00	132.00	146.00		
4040SE-81.....Connector w/Ring	4.30				4110-3080.....Spring Cush Block (incl -58 & -80)	49.00				
4040SE-82.....Rod	50.00				4110-Flat Box.....Flat Box w/Label	4.00				
4040SE-83H.....H Arm Screw	2.30				4110-Instruction Sheet.....Instruction Sheet	3.00				
4040SE-141.....Plug	2.30				4110-Rebox Kit.....Box & Instruction Sheet	5.00				
4040SE-141-1.....Plug	2.30				4110T Series					
4040SE-141-2.....Plug	2.30				4111(3,4)T-3071.....Std Cylinder Assy	269.00				
4040SE-159.....Arm Screw	2.30				4110T-3077T.....Standard Arm	79.00	185.00	220.00		
4040SE-168.....Slider	5.90				4110T-3038.....Standard Track	50.00				
4040SE-425.....Roller Lock Screw	3.30				4110T-3038B.....Track w/Bumper	60.00				
4040SE-3034.....Track Roller	15.00				4110T-3038H.....Track w/Hold Open	70.00				
4040SE-3210.....SE Transformer	59.00				4110T-3038HB.....Track w/Hold Open & Bumper	80.00				
4040SE-3436.....On/Off Switch Assy	60.00				4110T-72.....Standard Cover	20.00				
4040SE-Flat Box.....Flat Box w/Label	4.00				4110T-72MC.....Metal Cover	25.00	170.00	210.00		
4040SE-Instruction Sheet.....Instruction Sheet	3.00				4110T-SRT.....Screw Pack (incl -3034)	29.00	49.00	59.00		
4040SE-Rebox Kit.....Box & Instruction Sheet	5.00				4110T-TBSRT.....Screw Pack (incl -3034)	29.00	49.00	59.00		
4040SEH Series										
4040SEH-3077SEH.....SEH Arm	158.00	314.00		348.00	4110T-WMS.....Screw Pack (incl -3034)	29.00	49.00	59.00		
4040SEH-3038.....Standard SEH Track	285.00				4110T-TBWMS.....Screw Pack (incl -3034)	29.00	49.00	59.00		
4040SEH-59A.....Cover Plate	4.50				4110T-TORX.....Screw Pack (incl -3034)	33.00	53.00	63.00		
4040SEH-78SEH.....Arm & Tube	60.00	150.00		205.00	4110T-TBTRX.....Screw Pack (incl -3034)	33.00	53.00	63.00		
4040SEH-82SEH.....Rod	50.00	114.00		141.00	4110T-18.....Plate	49.00	170.00	205.00		
4040SEH-83SEH.....Arm Screw	2.30				4110T-31.....Cover Screw	2.30				
4040SEH-3034.....Track Roller	15.00				4110T-73.....End Cap	6.90				
4110 Series										
4111(6)-3071.....Std Cylinder Assy	269.00				4110T-141-1.....Plug	2.30				
4111(6)-3071AVB.....AVB Cylinder Assy	284.00				4110T-159.....Arm Screw	2.30				
4111-3071DEL.....Del Act Cyl Assy	299.00				4110T-169.....Bumper Assy	17.00				
4111(6)-3071TEL.....TEL Cylinder Assy	299.00				4110T-425.....Roller Lock Screw	3.30				
4110-3077EDA.....EDA Arm	122.00	329.00		408.00	4110T-3034.....Track Roller	15.00				
4110-3077EDA/G.....EDA Arm w/62G	122.00	329.00		408.00	4110T-3054.....Hold Open Clip	25.00				
4110-3049EDA.....H EDA Arm	147.00	354.00		433.00	4110T-Flat Box.....Flat Box w/Label	4.00				
4110-3049EDA/G.....H EDA Arm w/62G	147.00	354.00		433.00	4110T-Instruction Sheet.....Instruction Sheet	3.00				
					4110T-Rebox Kit.....Box & Instruction Sheet	5.00				
4210 Series										
4211(6)-3071.....Std Cylinder Assy	300.00				<i>4210 Series continued on next page</i>					
4211(6)-3071AVB.....AVB Cylinder Assy	315.00									
4211-3071DEL.....Del Action Cylinder Assy	330.00									
4210-3077EDA.....EDA Arm	122.00									

PARTS & ACCESSORIES

PRICE LIST

PARTS & ACCESSORIES	STANDARD POWDER COAT FINISHES	PLATED FINISHES			PARTS & ACCESSORIES	STANDARD POWDER COAT FINISHES	PLATED FINISHES		
	AL (689) DKBRZ (695) BRASS (696) LTBRZ (691) STAT (690) BLACK (693)	US26D	US 3 US 4 US 10	US 10B US 15 US 26		AL (689) DKBRZ (695) BRASS (696) LTBRZ (691) STAT (690) BLACK (693)	US26D	US 3 US 4 US 10	US 10B US 15 US 26

4210 Series continued

4210-3077CNS..... Cush Arm	147.00
4210-3049CNS..... H Cush Arm	197.00
4210-72MC..... Metal Cover	30.00
4210-TORX..... Screw Pack	19.00
4210-TBTRX..... Screw Pack	19.00
4210-18..... Plate	69.00
4210-18CUSH..... Plate	69.00
4210-30..... Cush Shoe Support	19.00
4210-31..... Cover Screw	2.30
4210-61..... Spacer	21.00
4210-159..... Arm Screw	2.30
4210-201..... Spacer	3.30
4210-419..... Panel Adapter	50.00
4210-Flat Box..... Flat Box w/Label	4.00
4210-Instruction Sheet..... Instruction Sheet	3.00
4210-Rebox Kit..... Box & Instruction Sheet	5.00

4210T Series

4211(3,4)T-3071..... Std Cylinder Assy	300.00
4211(3,4)T-3071AVB..... AVB Cylinder Assy	315.00
4210T-3077T..... Standard Arm	100.00
4210T-3038..... Standard Track	80.00
4210T-72MC..... Metal Cover	30.00
4210T-TORX..... Screw Pack (incl. -3034)	33.00
4210T-TBTRX..... Screw Pack (incl. -3034)	33.00
4210T-18..... Plate	69.00
4210T-31..... Cover Screw	2.30
4210T-159..... Arm Screw	2.30
4210T-3034..... Track Roller	20.00
4210T-Flat Box..... Flat Box w/Label	4.00
4210T-Instruction Sheet..... Instruction Sheet	3.00
4210T-Rebox Kit..... Box & Instruction Sheet	5.00

4310HSA Series

4314HSA-3071..... Std Cylinder Assy	834.00
4314HSA-3971..... Cylinder Only	759.00
4310HSA-3077T..... Standard Arm	79.00
4310HSA-3077DE..... DE Arm	119.00
4310HSA-3038..... Standard Track	50.00
4310HSA-72MC..... Metal Cover	70.00
4310HSA-WMS..... Screw Pack (incl -3034)	29.00
4310HSA-TBWMS..... Screw Pack (incl -3034)	29.00
4310HSA-TORX..... Screw Pack (incl -3034)	33.00
4310HSA-TBTRX..... Screw Pack (incl -3034)	33.00
4310HSA-18..... Plate	151.00
4310HSA-31..... Cover Screw	2.30
4310HSA-61..... Spacer	10.50
4310HSA-73..... End Cap	6.90
4310HSA-83..... Arm Screw	2.30
4310HSA-141-2..... Plug	2.30
4310HSA-159..... Arm Screw	2.30
4310HSA-425..... Roller Lock Screw	3.30
4310HSA-3034..... Track Roller	15.00
4310HSA-3210..... Transformer	59.00
4310HSA-3428..... Scanner Module	136.00
4410HSA-3430..... HSA Solenoid Harness	6.20
4310HSA-3431..... Input Harness	4.90
4410HSA-3448..... HSA PCB Module	20.00
4310HSA-Flat Box..... Flat Box w/Label	4.00
4310HSA-Instruction Sheet..... Instruction Sheet	3.00
4310HSA-Rebox Kit..... Box & Instruction Sheet	5.00

4310ME Series

4314ME-3071..... Std Cylinder Assy	759.00
4314ME-3071B80..... B80 Cylinder Assy	834.00
4314ME-3071B140..... B140 Cylinder Assy	834.00
4314ME-3971..... Cylinder Only	709.00

4314ME-3971B80..... B80 Cylinder Only	784.00
4314ME-3971B140..... B140 Cylinder Only	784.00
4310ME-3077SF..... Swing Free Arm	107.00
4310ME-3077DE..... DE Arm	147.00
4310ME-3038..... Standard Track	50.00
4310ME-72MC..... Metal Cover	70.00
4310ME-WMS..... Screw Pack (incl -3034)	29.00
4310ME-TBWMS..... Screw Pack (incl -3034)	29.00
4310ME-TORX..... Screw Pack (incl -3034)	33.00
4310ME-TBTRX..... Screw Pack (incl -3034)	33.00
4310ME-18..... Plate	146.00
4310ME-31..... Cover Screw	2.30
4310ME-61..... Spacer	10.50
4310ME-73..... End Cap	6.90
4310ME-83..... Arm Screw	2.30
4310ME-141-2..... Plug	2.30
4310ME-159..... Arm Screw	2.30
4310ME-425..... Roller Lock Screw	3.30
4310ME-3034..... Track Roller	15.00
4310ME-3210..... Transformer	59.00
4310ME-3351..... ME Switch Assy	142.00
4310ME-3354..... ME Wire Harness	13.00
4310ME-3431..... Input Harness	4.90
4310ME-Flat Box..... Flat Box w/Label	4.00
4310ME-Instruction Sheet..... Instruction Sheet	3.00
4310ME-Rebox Kit..... Box & Instruction Sheet	5.00

4410HSA Series

4414HSA-3071..... Std Cylinder Assy	834.00
4414HSA-3071/18G..... Std Cyl. Assy w/18G	834.00
4414HSA-3971..... Cylinder Only	759.00
4410HSA-3077..... Reg Arm	102.00
4410HSA-3077L..... Long Arm	127.00
4410HSA-72MC..... Metal Cover	70.00
4410HSA-WMS..... Screw Pack	15.00
4410HSA-TBWMS..... Screw Pack	15.00
4410HSA-TORX..... Screw Pack	19.00
4410HSA-TBTRX..... Screw Pack	19.00
4410HSA-18..... Plate	151.00
4410HSA-18G..... Mounting Plate	151.00
4410HSA-31..... Cover Screw	2.30
4410HSA-77..... Arm & Forearm	98.00
4410HSA-77L..... Long Arm & Forearm	98.00
4410HSA-79..... Rod & Shoe	23.00
4410HSA-79L..... Long Rod & Shoe	49.00
4410HSA-83H..... H Arm Screw	2.30
4410HSA-159..... Arm Screw	2.30
4410HSA-3210..... Transformer	59.00
4410HSA-3428..... Scanner Module	136.00
4410HSA-3430..... HSA Solenoid Harness	6.20
4410HSA-3431..... Input Harness	4.90
4410HSA-3448..... HSA PCB Module	20.00
4410HSA-Flat Box..... Flat Box w/Label	4.00
4410HSA-Instruction Sheet..... Instruction Sheet	3.00
4410HSA-Rebox Kit..... Box & Instruction Sheet	5.00

4410ME Series

4414ME-3071..... Std Cylinder Assy	759.00
4414ME-3071/18G..... Std Cyl. Assy w/18G	759.00
4414ME-3071B80..... B80 Cylinder Assy	834.00
4414ME-3071B80G..... B80 Cyl. Assy w/18G	834.00
4414ME-3071B140..... B140 Cylinder Assy	834.00
4414ME-3071B140G..... B140 Cyl. Assy w/18G	834.00
4414ME-3971..... Cylinder Only	709.00
4414ME-3971B80..... B80 Cylinder Only	784.00
4414ME-3971B140..... B140 Cylinder Only	784.00
4410ME-3077..... Reg Arm	102.00
4410ME-3077L..... Long Arm	127.00

4410ME Series continued on next page

PARTS & ACCESSORIES

PRICE LIST

PARTS & ACCESSORIES	STANDARD POWDER COAT FINISHES AL (689) DKBRZ (695) BRASS (696) LTBRZ (691) STAT (690) BLACK (693)	PLATED FINISHES			PARTS & ACCESSORIES	STANDARD POWDER COAT FINISHES AL (689) DKBRZ (695) BRASS (696) LTBRZ (691) STAT (690) BLACK (693)	PLATED FINISHES		
		US26D	US 3 US 4 US 10	US 10B US 15 US 26			US26D	US 3 US 4 US 10	US 10B US 15 US 26

4410ME Series continued

4410ME-72MC.....Metal Cover	70.00	260.00		305.00	4630-78.....Arm & Tube	60.00	150.00		205.00
4410ME-WMS.....Screw Pack	15.00	35.00		45.00	4630-82.....Rod	50.00	114.00		141.00
4410ME-TBWMS.....Screw Pack	15.00	35.00		45.00	4630-83H.....H Arm Screw	2.30			
4410ME-TORX.....Screw Pack	19.00	49.00		59.00	4630-141-2.....Plug	2.30			
4410ME-TBTRX.....Screw Pack	19.00	49.00		59.00	4630-155-1.....Caution Decal	4.90			
4410ME-18.....Plate	146.00	251.00		324.00	4630-155-2.....Activation Decal	4.90			
4410ME-18G.....Mounting Plate	146.00	251.00		324.00	4630-159.....Arm Screw	2.30			
4410ME-31.....Cover Screw	2.30				4630-334.....End Cap	37.00			
4410ME-77.....Arm & Forearm	98.00	230.00		264.00	4630-334-2.....End Cap, Plain	37.00			
4410ME-77L.....Long Arm & Forearm	98.00	230.00		264.00	4630-334CS.....End Cap, Concealed Switch	37.00			
4410ME-79.....Rod & Shoe	23.00	75.00		108.00	4630-425.....Roller Lock Screw	3.30			
4410ME-79L.....ME Long Rod	23.00	75.00		108.00	4630-441A.....Plug 12 pin, 1-12	56.00			
4410ME-83H.....H Arm Screw	2.30				4630-441B.....Plug 12 pin, 13-24	56.00			
4410ME-159.....Arm Screw	2.30				4630-441C.....Connector Plug	9.00			
4410ME-3210.....Transformer	59.00				4630-480.....Shaft Extension	44.00			
4410ME-3351.....ME Switch Assy	142.00				4630-3018.....Mounting Plate Assy	2790.00			
4410ME-3354.....ME Wire Harness	13.00				4630-3034.....Track Roller	15.00			
4410ME-3431.....Input Harness	4.90				4630-3179-1.....On/Off Switch Assy	43.00			
4410ME-Flat Box.....Flat Box w/Label	4.00				4630-3179-2.....Hold Open Switch Assy	43.00			
4410ME-Instruction Sheet.....Instruction Sheet	3.00				4630-3180.....I/O Board Assy	306.00			
4410ME-Rebox Kit.....Box & Instruction Sheet	5.00				4630-3454.....Motor/Clutch Assy	1390.00			

4510 Series

4511(6)-3071.....Std Cylinder Assy	300.00			
4511(6)-3071AVB.....AVB Cylinder Assy	315.00			
4511-3071DEL.....Del Action Cylinder Assy	330.00			
4510-3077EDA.....EDA Arm	122.00			
4510-72MC.....Metal Cover	30.00	180.00		220.00
4510-TORX.....Screw Pack	19.00	49.00		59.00
4510-TBTRX.....Screw Pack	19.00	49.00		59.00
4510-18.....Plate	69.00	237.00		279.00
4510-31.....Cover Screw	2.30			
4510-159.....Arm Screw	2.30			
4510-Flat Box.....Flat Box w/Label	4.00			
4510-Instruction Sheet.....Instruction Sheet	3.00			
4510-Rebox Kit.....Box & Instruction Sheet	5.00			

4510T Series

4511(3,4)T-3071.....Std Cylinder Assy	300.00			
4511(3,4)T-3071AVB.....AVB Cylinder Assy	315.00			
4510T-3077T.....Standard Arm	100.00	215.00		250.00
4510T-3038.....Standard Track	80.00			
4510T-72MC.....Metal Cover	30.00	180.00		220.00
4510T-TORX.....Screw Pack	33.00	53.00		63.00
4510T-TBTRX.....Screw Pack	33.00	53.00		63.00
4510T-18.....Plate	69.00	237.00		279.00
4510T-31.....Cover Screw	2.30			
4510T-159.....Arm Screw	2.30			
4510T-3034.....Track Roller	20.00			
4510T-Flat Box.....Flat Box w/Label	4.00			
4510T-Instruction Sheet.....Instruction Sheet	3.00			
4510T-Rebox Kit.....Box & Instruction Sheet	5.00			

4630 Series

4631-3071.....Std Cylinder Assy	4683.00			
4631-3071CS.....Cyl Assy w/Conc I/O Switch	4683.00			
4631-3971.....Cylinder Only	1704.00			
4630-3077T.....Standard Arm	119.00	231.00		277.00
4630-3038.....Standard Track	50.00			
4630-72MC.....Metal Cover	120.00	340.00		395.00
4630-WMS.....Screw Pack (incl -3034)	49.00	69.00		79.00
4630-TBWMS.....Screw Pack (incl -3034)	49.00	69.00		79.00
4630-TORX.....Screw Pack (incl -3034)	53.00	73.00		83.00
4630-TBTRX.....Screw Pack (incl -3034)	53.00	73.00		83.00
4630-31.....Cover Screw	2.30			
4630-61.....Spacer	10.50			
4630-73.....End Cap	6.90			

4640 Series

4642-3071.....Std Cylinder Assy	4683.00			
4642-3071CS.....Cyl Assy w/Conc I/O Switch	4683.00			
4642-3971.....Cylinder Only	1704.00			
4640-3077.....Reg Arm	111.00	327.00		414.00
4640-3077L.....Long Arm	136.00	352.00		439.00
4640-72MC.....Metal Cover	120.00	340.00		395.00
4640-WMS.....Screw Pack	39.00	59.00		69.00
4640-TBWMS.....Screw Pack	39.00	59.00		69.00
4640-TORX.....Screw Pack	43.00	63.00		73.00
4640-TBTRX.....Screw Pack	43.00	63.00		73.00
4640-31.....Cover Screw	2.30			
4640-77.....Arm & Forearm	106.00	239.00		276.00
4640-79.....Rod & Shoe	23.00	75.00		108.00
4640-79LR.....Long Rod & Shoe	49.00	101.00		134.00
4640-83.....Arm Screw	2.30			
4640-155-1.....Caution Decal	4.90			
4640-155-2.....Activation Decal	4.90			
4640-159.....Arm Screw	2.30			
4640-334.....End Cap	37.00			
4640-334-2.....End Cap, Plain	37.00			
4640-334CS.....End Cap, Concealed Switch	37.00			
4640-441A.....Plug 12pin, 1-12	56.00			
4640-441B.....Plug 12pin, 13-24	56.00			
4640-441C.....Connector Plug	9.00			
4640-480.....Shaft Extension	44.00			
4640-3018.....Mounting Plate Assy	2790.00			
4640-3179-1.....On/Off Switch Assy	43.00			
4640-3179-2.....Hold Open Switch Assy	43.00			
4640-3180.....I/O Board Assy	306.00			
4640-3454.....Motor/Clutch Assy	1390.00			
4640-3462.....Controller Assy	1590.00			
4640-3498-1.....Ribbon Cable Connector	21.00			
4640-3498-2.....A/C Power Cable	43.00			
4640-Flat Box.....Flat Box w/Label	4.00			
4640-Instruction Sheet.....Instruction Sheet	3.00			
4640-Rebox Kit.....Box & Instruction Sheet	5.00			

PARTS & ACCESSORIES

PRICE LIST

PARTS & ACCESSORIES	STANDARD POWDER COAT FINISHES <i>AL (689)</i> <i>DKBRZ (695)</i> <i>BRASS (696)</i> <i>LTBRZ (691)</i> <i>STAT (690)</i> <i>BLACK (693)</i>	PLATED FINISHES			PARTS & ACCESSORIES	STANDARD POWDER COAT FINISHES <i>AL (689)</i> <i>DKBRZ (695)</i> <i>BRASS (696)</i> <i>LTBRZ (691)</i> <i>STAT (690)</i> <i>BLACK (693)</i>	PLATED FINISHES		
		US26D	US 3 US 4 US 10	US 10B US 15 US 26			US26D	US 3 US 4 US 10	US 10B US 15 US 26

4810 Series

4811-3071	Std Cylinder Assy	1451.00						
4811-3971	Cylinder Only	1401.00						
4810-3077T	Standard Arm	119.00	231.00	277.00				
4810-3038	Standard Track	50.00						
4810-72MC	Metal Cover	100.00	275.00	325.00				
4810-WMS	Screw Pack (incl -3034)	29.00	49.00	59.00				
4810-TBWMS	Screw Pack (incl -3034)	29.00	49.00	59.00				
4810-18	Plate	187.00						
4810-31	Cover Screw	2.30						
4810-31L	Long Cover Screw	2.30						
4810-61	Spacer	10.50						
4810-73	End Cap	6.90						
4810-78	Arm & Tube	60.00	150.00	205.00				
4810-82	Rod	50.00						
4810-83H	H Arm Screw	2.30						
4810-141-2	Plug	2.30						
4810-155-1	Caution Decal	4.90						
4810-155-2	Activation Decal	4.90						
4810-159	Arm Screw	2.30						
4810-163	Cover Insert	4.90						
4810-182	Stand Off	10.50						
4810-334	Cover End Cap	10.00						
4810-425	Roller Lock Screw	3.30						
4810-3034	Track Roller	15.00						
4810-Flat Box	Flat Box w/Label	4.00						
4810-Instruction Sheet	Instruction Sheet	3.00						
4810-Rebox Kit	Box & Instruction Sheet	5.00						

4820 Series

4822-3071	Std Cylinder Assy	1451.00						
4822-3071/18G	Std Cylinder Assy w/18G	1451.00						
4822-3971	Cylinder Only	1401.00						
4820-3077	Reg Arm	111.00	327.00	414.00				
4820-3077L	Long Arm	136.00	352.00	439.00				
4820-72MC	Metal Cover	100.00	275.00	325.00				
4820-WMS	Screw Pack	15.00	35.00	45.00				
4820-TBWMS	Screw Pack	15.00	35.00	45.00				
4820-18	Plate	187.00						
4820-186	Plate	187.00						
4820-31	Cover Screw	2.30						
4820-31L	Long Cover Screw	2.30						
4820-77	Arm & Forearm	106.00	239.00	276.00				
4820-79	Rod & Shoe	23.00	75.00	108.00				
4820-79LR	Long Rod & Shoe	49.00	101.00	134.00				
4820-83	Arm Screw	2.30						
4820-155-1	Caution Decal	4.90						
4820-155-2	Activation Decal	4.90						
4820-159	Arm Screw	2.30						
4820-163	Cover Insert	4.90						
4820-182	Stand Off	10.50						
4820-334	Cover End Cap	10.00						
4820-3377	DPS Conversion Kit	338.00						
4820-Flat Box	Flat Box w/Label	4.00						
4820-Instruction Sheet	Instruction Sheet	3.00						
4820-Rebox Kit	Box & Instruction Sheet	5.00						

4840 Series

4841-3071	Std Cylinder Assy	1451.00						
4841-3971	Cylinder Only	1401.00						
4840-3077EDA	EDA Arm	139.00	353.00	438.00				
4840-3077CNS	Cush Arm	164.00	378.00	463.00				
4840-3077SCNS	Spring Cush Arm	214.00	428.00	513.00				
4840-72MC	Metal Cover	100.00	275.00	325.00				
4840-WMS	Screw Pack	15.00	35.00	45.00				
4840-TBWMS	Screw Pack	15.00	35.00	45.00				
4840-30	Cush Shoe Support	19.00	56.00	69.00				
4840-31	Cover Screw	2.30						

4840-31L	Long Cover Screw	2.30						
4840-61	Spacer	21.00	58.00	71.00				
4840-124	Plug	2.30						
4840-155-1	Caution Decal	4.90						
4840-155-2	Activation Decal	4.90						
4840-159	Arm Screw	2.30						
4840-163	Cover Insert	4.90						
4840-182	Stand Off	10.50						
4840-201	Spacer	3.30						
4840-334	Cover End Cap	10.00						
4840-419	Panel Adapter	50.00	132.00	146.00				
4840-459	Door Loop Kit	111.00						
4840-460	Pneumatic Hinge	422.00						
4840-3080	Spring Cush Decal	49.00						
4840-Flat Box	Flat Box w/Label	4.00						
4840-Instruction Sheet	Instruction Sheet	3.00						
4840-Rebox Kit	Box & Instruction Sheet	5.00						

5010 Series

5011(2,3,4,5,6)-3071	Std Cylinder Assy	346.00						
5011(2,3,4,5)-3071DEL	Del Act Cyl Assy	376.00						
5010-3077	Reg Arm	102.00	308.00	391.00				
5010-3049	Hold Open Arm	127.00	333.00	416.00				
5010-WMS	Screw Pack	15.00	35.00	45.00				
5010-TORX	Screw Pack	19.00	49.00	59.00				
5010-11	Finish Plate	40.00	160.00	210.00				
5010-11DA	DA Finish Plate	40.00	160.00	210.00				
5010-31	Cover Screw	2.30						
5010-37	Hold Open Stud	22.00						
5010-41	Hold Open Nut	5.90						
5010-45	Hold Open Shoe	20.00	49.00	61.00				
5010-48	Hold Open Forearm	56.00						
5010-49	Hold Open Main Arm	52.00	129.00	136.00				
5010-77	Arm & Forearm	98.00	230.00	264.00				
5010-79	Rod & Shoe	23.00	75.00	108.00				
5010-79H	H Rod & Shoe	23.00	75.00	108.00				
5010-83	Arm Screw	2.30						
5010-83H	H Arm Screw	2.30						
5010-95	Arm Stud	10.50						
5010-159	Arm Screw	2.30						
5010-3002	Mounting/Finish Plate	58.00						
5010-Flat Box	Flat Box w/Label	4.00						
5010-Instruction Sheet	Instruction Sheet	3.00						
5010-Rebox Kit	Box & Instruction Sheet	5.00						

5030 Series

5031(3,4,5,6)-3071	Std Cylinder Assy	727.00	942.00	1003.00				
5031(3,4,5,6)-3971	Cylinder Only	677.00						
5030-3077	Reg Arm	102.00	308.00	391.00				
5030-3049	Hold Open Arm	127.00	333.00	416.00				
5030-WMS	Screw Pack	15.00	35.00	45.00				
5030-TORX	Screw Pack	19.00	49.00	59.00				
5030-37	Hold Open Stud	22.00						
5030-41	Hold Open Nut	5.90						
5030-48	Hold Open Forearm	56.00						
5030-49	Hold Open Main Arm	52.00	129.00	136.00				
5030-77	Arm & Forearm	98.00	230.00	264.00				
5030-79	Rod & Shoe	23.00	75.00	108.00				
5030-79H	H Rod & Shoe	23.00	75.00	108.00				
5030-83	Arm Screw	2.30						
5030-83H	H Arm Screw	2.30						
5030-159	Arm Screw	2.30						
5030-416	Wood Clip Set	130.00	188.00	236.00				
5030-417	Wood Clip Set	130.00	188.00	236.00				
5030-3002	Mounting/Finish Plate	123.00	241.00	286.00				
5030-Flat Box	Flat Box w/Label	4.00						
5030-Instruction Sheet	Instruction Sheet	3.00						
5030-Rebox Kit	Box & Instruction Sheet	5.00						

PARTS & ACCESSORIES

PRICE LIST

PARTS & ACCESSORIES	STANDARD POWDER COAT FINISHES AL (689) DKBRZ (695) BRASS (696) LTBRZ (691) STAT (690) BLACK (693)	PLATED FINISHES			PARTS & ACCESSORIES	STANDARD POWDER COAT FINISHES ANCLR ANDKB	PLATED FINISHES		
		US26D	US 3 US 4 US 10	US 10B US 15 US 26			US26D	US 3 US 4 US 10	US 10B US 15 US 26

6030 Series

6031(2,3,4,5)-3071..... Std Cylinder Assy	827.00	1022.00	1144.00
6031(2,3,4,5)-3971..... Cylinder Only	777.00		
6030-3077T..... Standard Arm	152.00	284.00	368.00
6030-3038B..... Track w/Bumper	60.00		
6030-3038HB..... Track w/Hold Open & Bumper	80.00		
6030-WMS..... Screw Pack (incl -3034)	29.00	49.00	59.00
6030-TORX..... Screw Pack (incl -3034)	33.00	53.00	63.00
6030-83..... Arm Screw	2.30		
6030-157..... Snubber	13.50		
6030-159..... Arm Screw	2.30		
6030-169..... Bumper Assy	17.00		
6030-416..... Wood Clip Set	130.00	188.00	236.00
6030-425..... Roller Lock Screw	3.30		
6030-3002..... Mounting/Finish Plate	161.00	270.00	328.00
6030-3034..... Track Roller	20.00		
6030-3054..... Hold Open Clip	25.00		
6030-Flat Box..... Flat Box w/Label	4.00		
6030-Instruction Sheet..... Instruction Sheet	3.00		
6030-Rebox Kit..... Box & Instruction Sheet	5.00		

9130 Series - (ANCLR or ANDKB only)

9130-3077T..... Standard Arm	135.00		
9130-3077PLCM..... Standard Arm w/Track	187.00		
9130-3038..... Track	60.00		
9130-72MC*..... Metal Cover	120.00		
9130-72FC*..... Full Metal Cover	200.00		
9130-MS..... Screw Pack	15.00		
9130-73..... Track End Cap	6.90		
9130-163..... Cover Insert	9.30		
9130-163-1..... Cover End Cap Insert	9.30		
9130-334..... Cover End Cap	35.00		
9130-360..... 24v SO Kit	20.00		
9130-3018..... Mounting Bracket	121.00		
9130-3155..... Label Kit	19.00		
9130-3034..... Track Roller	20.00		
9130-3351-1..... Switch Bracket 29"	56.00		
9130-3351-2..... Switch Bracket 41"	56.00		
9130-3351-3..... Switch Bracket 51"	56.00		
9130-3454..... Motor Gearbox Assembly	1490.00		
9130-3454S Motor Gearbox Assembly w/Switch	1490.00		
9130-3462SC..... Standard Control Box	990.00		
9130-3498-2A..... A/C Power Cable - 29"	34.00		
9130-3498-2B..... A/C Power Cable - 42"	34.00		
9130-3498-2C..... A/C Power Cable - 52"	34.00		

9140 Series - (ANCLR or ANDKB only)

9140-3077..... Regular Arm	115.00		
9140-3077L..... Long Arm	115.00		
9140-72MC*..... Metal Cover	120.00		
9140-72FC*..... Full Metal Cover	200.00		
9140-MS..... Screw Pack	15.00		
9140-77..... Main Arm	94.00		
9140-79..... Rod	19.00		
9140-79LR..... Long Rod	38.00		
9140-163..... Cover Insert	9.30		
9140-163-1..... Cover End Cap Insert	9.30		
9140-334..... Cover End Cap	35.00		
9140-360..... 24v SO Kit	20.00		
9140-3018..... Mounting Bracket	121.00		
9140-3155..... Label Kit	19.00		
9140-3351-1..... Switch Bracket 29"	56.00		
9140-3351-2..... Switch Bracket 41"	56.00		
9140-3351-3..... Switch Bracket 51"	56.00		
9140-3454..... Motor Gearbox Assembly	1490.00		
9140-3454S Motor Gearbox Assembly w/Switch	1490.00		
9140-3462SC..... Standard Control Box	990.00		
9140-3498-2A..... A/C Power Cable - 29"	34.00		

9140-3498-2B..... A/C Power Cable - 42"	34.00
9140-3498-2C..... A/C Power Cable - 52"	34.00

9150 Series - (ANCLR or ANDKB only)

9150-3077..... Regular Arm	115.00
9150-3077L..... Long Arm	115.00
9150-72MC*..... Metal Cover	225.00
9150-MS..... Screw Pack	15.00
9150-77..... Main Arm	94.00
9150-79..... Rod	19.00
9150-79LR..... Long Rod	38.00
9150-163..... Cover Insert	9.30
9150-163-1..... Cover End Cap Insert	9.30
9150-334..... Cover End Cap	35.00
9150-360..... 24v SO Kit	20.00
9150-3018..... Mounting Bracket	121.00
9150-3155..... Label Kit	19.00
9150-3351-1..... Switch Bracket 29"	56.00
9150-3351-2..... Switch Bracket 41"	56.00
9150-3351-3..... Switch Bracket 51"	56.00
9150-3454..... Motor Gearbox Assembly	1490.00
9150-3454S Motor Gearbox Assembly w/Switch	1490.00
9150-3462SC..... Standard Control Box	990.00
9150-3498-2A..... A/C Power Cable	34.00

9530 Series - (ANCLR or ANDKB only)

9530-3077T..... Standard Arm	230.00
9530-3077PLCM..... Standard Arm w/Track	286.00
9530-3038..... Track	60.00
9530-3572HL*..... Header Assy	285.00
9530-3572HL/S*..... Header Assy w/Stop Prep	285.00
9530-3572DD*..... Double Door Header Assy	490.00
9530-3572DD/S*..... Double Door Header Assy w/Stop Prep	490.00
9530-MS..... Screw Pack	15.00
9530-11A..... Spindle Plate - 2 3/4"	64.00
9530-11B..... Spindle Plate - 3 3/4"	64.00
9530-12*..... Blank Filler Plate	78.00
9530-18*..... Mounting Plate**	67.00 / ft
**Add 3 1/2" if Using Angled Brackets.....	
9530-73..... Track End Cap	6.90
9530-275..... Mounting Bracket - 2 3/4"	86.00
9530-334..... Header Endcap	37.00
9530-334-1..... Angled Bracket	135.00
9530-334-2..... End Dress Plate	64.00
9530-375..... Mounting Bracket - 3 3/4"	86.00
9530-511*..... Dress Plate Extrusion Only	15.00 / ft
9530-518..... Cable/Parts Bag	78.00
9530-572*..... Header Extrusion Only	45.00 / ft
9530-572HL*..... Header Only	185.00
9530-572DD*..... Double Door Header Only	390.00
9530-3018..... Rear Mount Bracket	86.00
9530-3034..... Track Roller	20.00
9530-3155..... Label Kit	23.00
9530-3454..... Motor Gearbox (Std Force)	1890.00
9530-3462..... Controller	1190.00

PARTS & ACCESSORIES

PRICE LIST

PARTS & ACCESSORIES	STANDARD POWDER COAT FINISHES ANCLR ANDKB	PLATED FINISHES			PARTS & ACCESSORIES	STANDARD POWDER COAT FINISHES ANCLR ANDKB	PLATED FINISHES		
		US26D	US 3 US 4 US 10	US 10B US 15 US 26			US26D	US 3 US 4 US 10	US 10B US 15 US 26

9540 Series - (ANCLR or ANDKB only)

9540-3077..... Regular Arm	210.00
9540-3077L..... Long Arm	210.00
9540-3572HL*..... Header Asy	285.00
9540-3572HL/S*..... Header Asy w/Stop Prep	285.00
9540-3572DD*..... Double Door Header Assy	490.00
9540-3572DD/S*..... Double Door Header Assy w/Stop Prep	490.00
9540-MS..... Screw Pack	15.00
9540-11A..... Spindle Plate - 2 3/4"	64.00
9540-11B..... Spindle Plate - 3 3/4"	64.00
9540-12*..... Blank Filler Plate	78.00
9540-18*..... Mounting Plate**	67.00 / ft
**Add 3 1/2" if Using Angled Brackets	
9540-77..... Main Arm	161.00
9540-79..... Rod	47.00
9540-79LR..... Long Rod	47.00
9540-82..... Rod	31.00
9540-82L..... Long Rod	31.00
9540-275..... Mounting Bracket - 2 3/4"	86.00
9540-334..... Header Endcap	37.00
9540-334-1..... Angled Bracket	135.00
9540-334-2..... End Dress Plate	64.00
9540-375..... Mounting Bracket - 3 3/4"	86.00
9540-511*..... Dress Plate Extrusion Only	15.00 / ft
9540-518..... Cable/Parts Bag	78.00
9540-572*..... Header Extrusion Only	45.00 / ft
9540-572HL*..... Header Only	185.00
9540-572DD*..... Double Door Header Only	390.00
9540-3018..... Rear Mount Bracket	86.00
9540-3155..... Label Kit	23.00
9540-3454..... Motor Gearbox (Std Force)	1890.00
9540-3462..... Controller	1190.00

9550 Series - (ANCLR or ANDKB only)

9550-3077..... Regular Arm	210.00
9550-3077L..... Long Arm	210.00
9550-3077T..... Standard Arm	230.00
9550-3077PLCM..... Standard Arm w/Track	286.00
9550-3038..... Track	60.00
9550-3572HL*..... Header Asy	490.00
9550-3572HL/S*..... Header Asy w/Stop Prep	490.00
9550-MS..... Screw Pack	15.00
9550-11A..... Spindle Plate - 2 3/4"	64.00
9550-11B..... Spindle Plate - 3 3/4"	64.00
9550-12*..... Blank Filler Plate	78.00
9550-18*..... Mounting Plate**	67.00 / ft
**Add 3 1/2" if Using Angled Brackets	
9550-77..... Main Arm	161.00
9550-79..... Rod	47.00
9550-79LR..... Long Rod	47.00
9550-82..... Rod	31.00
9550-82L..... Long Rod	31.00
9550-275..... Mounting Bracket - 2 3/4"	86.00
9550-334..... Header Endcap	37.00
9550-334-1..... Angled Bracket	135.00
9550-334-2..... End Dress Plate	64.00
9550-375..... Mounting Bracket - 3 3/4"	86.00
9550-511..... Dress Plate Extrusion Only	15.00 / ft
9550-518..... Cable/Parts Bag	78.00
9550-572*..... Header Extrusion Only	45.00 / ft
9550-572HL*..... Header Only	390.00
9550-982..... Companion Cable	58.00
9550-3018..... Rear Mount Bracket	86.00
9550-3034..... Track Roller	20.00
9550-3155..... Label Kit	23.00
9550-3454..... Motor Gearbox (Std Force)	1890.00
9550-3462..... Controller	1190.00

9560 Series - (ANCLR or ANDKB only)

9560-3077..... Regular Arm	210.00
9560-3077L..... Long Arm	210.00
9560-3077T..... Standard Arm	230.00
9560-3077PLCM..... Standard Arm w/Track	286.00
9560-3038..... Track	60.00
9560-3572HL*..... Header Asy	490.00
9560-3572HL/S*..... Header Asy w/Stop Prep	490.00
9560-MS..... Screw Pack	15.00
9560-11A..... Spindle Plate - 2 3/4"	64.00
9560-11B..... Spindle Plate - 3 3/4"	64.00
9560-12*..... Blank Filler Plate	78.00
9560-18*..... Mounting Plate**	67.00 / ft
**Add 3 1/2" if Using Angled Brackets	
9560-77..... Main Arm	161.00
9560-79..... Rod	47.00
9560-79LR..... Long Rod	47.00
9560-82..... Rod	31.00
9560-82L..... Long Rod	31.00
9560-275..... Mounting Bracket - 2 3/4"	86.00
9560-334..... Header Endcap	37.00
9560-334-1..... Angled Bracket	135.00
9560-334-2..... End Dress Plate	64.00
9560-375..... Mounting Bracket - 3 3/4"	86.00
9560-511*..... Dress Plate Extrusion Only	15.00 / ft
9560-518..... Cable/Parts Bag	78.00
9560-572*..... Header Extrusion Only	45.00 / ft
9560-572HL*..... Header Only	390.00
9560-3018..... Rear Mount Bracket	86.00
9560-3034..... Track Roller	20.00
9560-3155..... Label Kit	23.00
9560-3454..... Motor Gearbox (Std Force)	1890.00
9560-3462..... Controller	1190.00

Senior Swing® Basic Parts Diagram (2800 / 9500 Series)

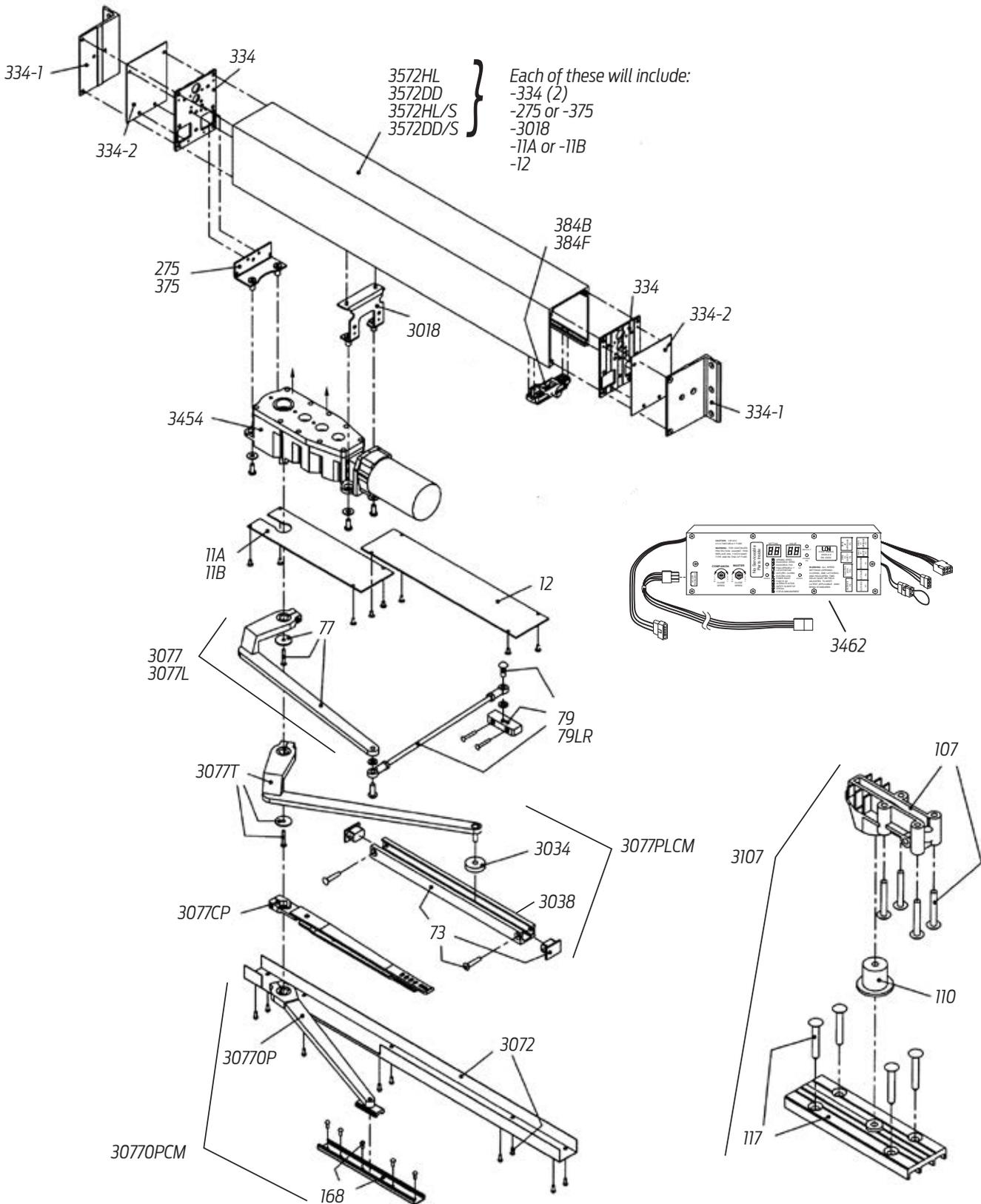

Benchmark Basic Parts Diagram

(9100 Series)

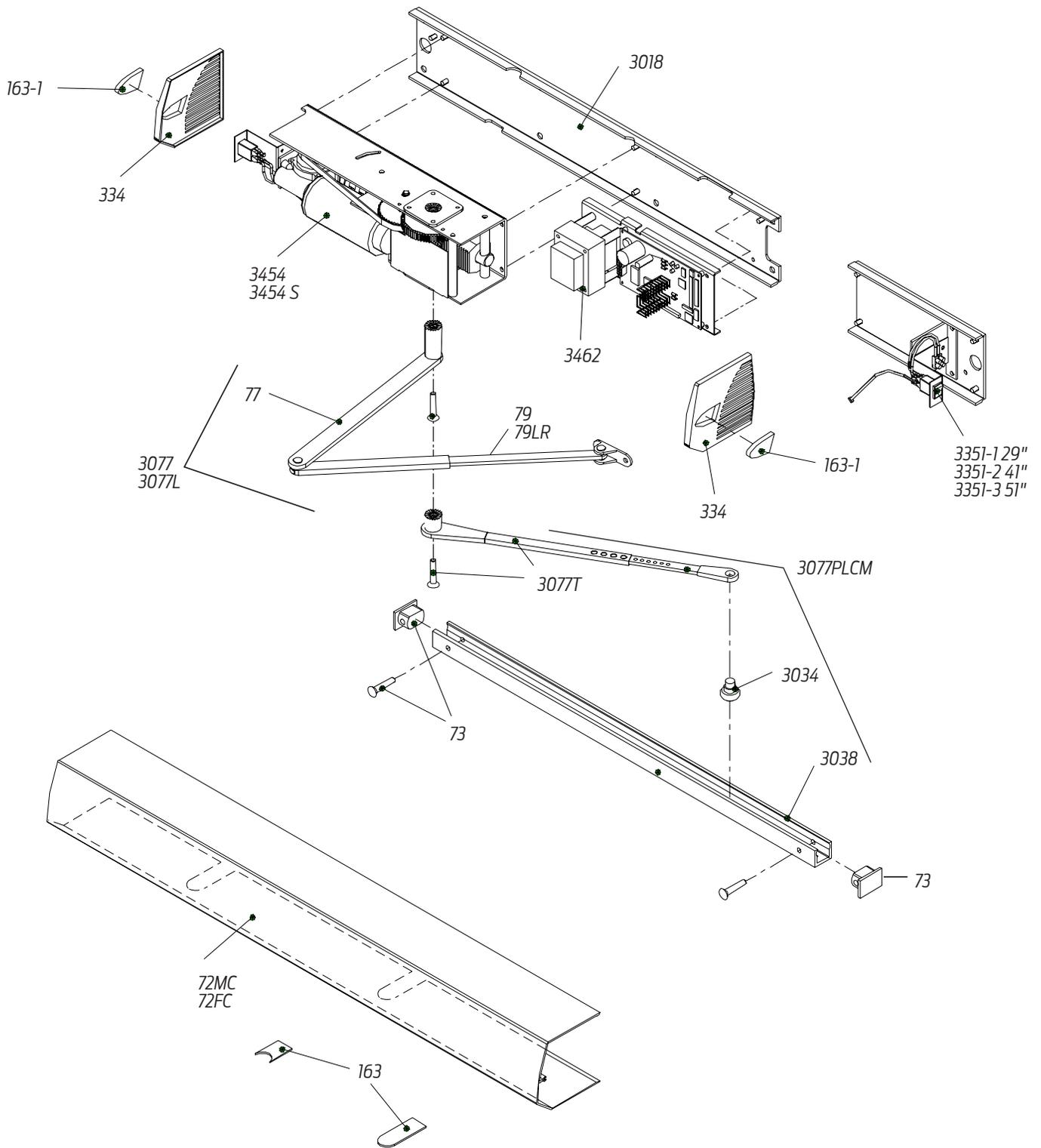

GLOSSARY OF ABBREVIATIONS

Arm Options

STD	- Standard Arm
REG	- Regular Arm
Rw/PA	- Regular Arm w/ Parallel Arm Shoe
Rw/62A	- Regular Arm w/ Auxiliary Parallel Arm Shoe
H	- Hold Open Arm
Hw/PA	- Hold Open Arm w/ Parallel Arm Shoe
HD	- Heavy Duty Arm (1460)
HDw/PA	- Heavy Duty Arm w/ Parallel Arm Shoe
LD	- Light Duty Arm
LDw/PA	- Light Duty Arm w/ Parallel Arm Shoe
LONG	- Long Arm
XLONG	- Extra Long Arm
HLONG	- Hold Open Long Arm
EDA	- Extra Duty Arm
EDAw/62G	- Extra Duty Arm w/ Thick Hub Shoe
HEDA	- Hold Open Extra Duty Arm
HEDAw/62G	- Hold Open Extra Duty Arm w/ 62G
CUSH (CNS)	- Cush -n- Stop Arm
HCUSH (HCNS)	- Hold Open Cush -n- Stop Arm
SCUSH (SCNS)	- Spring Cush -n- Stop Arm
SHCUSH (SHCNS)	- Spring Hold Open Cush -n- Stop Arm
SF	- Swing Free Arm (4310ME)
DE	- Double Egress Arm
FL	- Fusible Link Arm

Cylinder Options

STD	- Standard Cylinder
DEL (DA)	- Delay Action Cylinder
AVB	- Advanced Variable Backcheck
B80	- Bypass 80 Degree ME Cylinder
B140	- Bypass 140 Degree ME Cylinder
TEL	- Telephone Cylinder (4010/4020/4110)

Cover Options

STD	- Standard Plastic Cover
MC	- Metal Cover
FC	- Full Cover (1460)
DS (DS1)	- Designer Series Cover (1460)

Track Options

STD	- Standard Track
H	- Hold Open Track
BUMPER	- Track with Bumper
HBMP	- Hold Open Track with Bumper

Fastener Pack Options

WMS	- Wood & Machine Screws
TBWMS	- Thru-Bolt, Wood & Machine Screws
SRT	- Self Reaming & Tapping Screws
TBSRT	- Thru-Bolt, Self Reaming & Tapping Screws
TORX	- TORX Machine Screws
TBTRX	- Thru-Bolt, TORX Machine Screws

Finishes

AL	- Aluminum
DKBRZ	- Dark Bronze
BRASS	- Brass
LTBRZ	- Light Bronze
STAT	- Statuary
BLACK	- Black
MTLPC	- Bright Metallic
RAL	- Custom Finish Designation (RAL xxxx)
ANCLR	- Anodized Clear
ANDKB	- Anodized Dark Bronze

Swing Operator Terms

SF	- Standard Force Motor Gearbox
SC	- Standard Controller
POS	- Positive Mechanical Stop
BKY	- Breakaway Stop

Miscellaneous Terms

L	- Long
LR	- Long Rod
ELR	- Extra Long Rod
B80 or B140	- Bypass (Fire/Life Safety)
SRI	- Special Rust Inhibitor
SE	- Single Point Electronic (Fire/Life Safety)
ME	- Multi-Point Electronic (Fire/Life Safety)
PAH	- Parallel Arm Holder (PAH60)
ES	- Electric Strike (Control Boxes)
S (SEQ)	- Sequential (Control Boxes)
TJ	- Top Jamb
PA	- Parallel Arm
18G	- Flush Ceiling
T	- Track
DPS	- Door Position Switch (2210DPS)
FP	- Fire Protection Fluid

Header Options

Part	Extrusion (36" to 188") No Prep	Single Door* (36" to 49") Prepped	Door Pair (50" to 98") Prepped	Double Door Header** Prepped	Gearbox Brackets Included	Angle Brackets Included	End Caps Included	Filler Plates Included	Stop Prep*** Included
-572	X								
-572HL		X	X						
-572HL/S		X	X						X
-572DD				X					
-572DD/S				X					X
-3572HL		X	X		X	X	X	X	
-3572HL/S		X	X		X	X	X	X	X
-3572DD				X	X	X	X	X	
-3572DD/S				X	X	X	X	X	X

*2810, 9530 or 9540 only

**2850, 2860, 9550 or 9560 only

*** 2810, 2850 or 2860 only

LCN Limited Warranty

Subject to the terms and conditions of this limited warranty, Schlage Lock Company, LLC (the "Company") extends a limited warranty against defects in material and workmanship for its LCN branded product(s) identified in the Product Table below ("Products") as installed in the original location.

This limited warranty applies to Products purchased on or after **March 3, 2014**.

Product Table

4000 Series	30 Years
1460 Series	30 Years
1260 Series	20 Years
Concealed, High Security (except 2210DPS)	15Years
Automatic Operators; SE, ME, HSA, SEH Series; SEM Magnets; 2210 DPS (includes both electronic and mechanical components)	2 Years

Term: The limited warranty period for Products is as stated in the Product Table above. The "Commencement Date" for a limited warranty period shall be the date of Company's delivery to the original purchaser of the Products. Proof of Product purchase may be required by Company to confirm the Commencement Date.

What Company will do: Company may require proof of Product purchase in order to provide coverage under this limited warranty. As Company's only responsibility and user's only remedy under this limited warranty, Company will furnish a replacement Product upon receipt and confirmation by Company, in its sole opinion, that the Product has, in fact, failed due to a manufacturing defect under normal use and maintenance. In the event a replacement Product cannot be provided, Company will either provide a suitable replacement Product or a refund in the amount of the original purchase price.

What is not covered: The following costs, expenses, and damages are not covered by the provisions of this limited warranty: (i) labor costs including, but not limited to, such costs as removal and installation of Product; (ii) shipping and freight expenses required to return Product to Company; (iii) failures, defects, or damage caused by any third party product or service; (iv) any other incidental, consequential, indirect, special and/or punitive damages, whether based on contract, warranty, tort (including, but not limited to, strict liability or negligence), patent infringement, or otherwise, even if advised of the possibility of such damages.

The provisions of this limited warranty do not apply to Product that is: (i) not the proper size for the application for which the Product is used; (ii) not installed in accordance with Company's published Product installation instructions; (iii) installed with improper parts and/or incorrect parts (NOTE: It is recommended that Product be installed with LCN fasteners provided with Product); (iv) improperly stored, maintained, or operated; (v) modified, repaired, or altered in Company's sole opinion, in any manner, without the express written consent of Company; (vi) used for purposes for which the Product is not designed or intended; (vii) subjected to misuse, abuse, negligence, or accident; or (viii) subjected to improper temperature, humidity, or other environmental conditions.

Note: 900/7900 Series compressors are not manufactured by Company and are excluded from coverage under this limited warranty. For more information, parts, or repairs concerning the compressors, contact the compressor manufacturer directly at (269) 926-6171.

Additional Terms: This limited warranty is in lieu of all other warranties, express or implied. Company does not authorize any person to create for it any obligation or liability in connection with Product. Company's maximum liability hereunder is limited to the original purchase price of the Product. No action arising out any claimed breach of this limited warranty by Company may be brought by the user more than one (1) year after the cause of action has arisen.

How local law applies: This limited warranty gives you specific legal rights, and you may also have other rights as permitted by law. Some local laws do not allow limitations on how long an implied warranty lasts or the exclusions or limitation of incidental or consequential damages so the limitations or exclusions provided herein may not apply to you.

Program and Warranty Claims: All Product claimed to be defective under this limited warranty shall be sent to: LCN, Warranty and Replacement Department, 121 West Railroad Avenue, P.O. Box 100, Princeton, Illinois USA 61356-0100. For information, contact Customer Care at (877) 671-7011.

About Allegion

Allegion (NYSE: ALLE) creates peace of mind by pioneering safety and security. As a \$2 billion provider of security solutions for homes and businesses, Allegion employs more than 8,000 people and sells products in more than 120 countries across the world. Allegion comprises 27 global brands, including strategic brands CISA®, Interflex®, LCN®, Schlage® and Von Duprin®.

For more, visit www.allegion.com

aptiQ ■ LCN ■ **SCHLAGE** ■ STEELCRAFT ■ VON DUPRIN