



## A: GENERAL INFORMATION

Terms and Conditions	A:1
General Information	A:3
Weights and Measurements	A:12
Order Forms	A:15

## B: NEW PRODUCTS

Austin Handleset <b>NEW!</b>	B:1
Montara Handleset <b>NEW!</b>	B:2
Kwikset Contemporary Styles	B:3
Key Control Deadbolt Sell Sheet	B:4
Balboa Lever	B:5
SmartCode Contemporary Electronic LEVER	B:6
SmartCode Contemporary Electronic DBLT	B:7
Kwikset Smart Security App	B:8

## C: KWIKSET SIGNATURE SERIES

Handlesets	C:2
Levers	C:7
Knobs	C:10
Deadbolts	C:12
Specifications	C:13

## D: KWIKSET

Handlesets	D:2
Levers	D:3
Knobs	D:5
Deadbolts	D:6
Combo Packs	D:6
Specifications	D:7

## E: ELECTRONIC LOCKS

Electronics	E:1
Specifications	E:2

## F: LIGHT COMMERCIAL

Residential/Light Commercial	F:1
Specifications	F:2

## G: ACCESSORIES

Bath Hardware	G:1
Designer Roses	G:2
Pocket Door Locks	G:3
Trim and Installation Aids	G:4

## H: SERVICE PARTS

Keys	H:1
Pin & Tumbler	H:2
SmartKey	H:6
Key Control	H:7
Latches	H:8
Strikes	H:11
Screw Packs	H:14
Misc.	H:17
Electronics	H:19





## TERMS AND CONDITIONS OF SALE

Standard terms are 2% prompt payment discount for payment within 25 days from date of invoice; net 30 days from the date of invoice. Kwikset® reserves the right to charge and recover on invoices which are not paid within the above terms, a service charge of 1-1/2% a month for each month or fraction thereof during which the invoice remains unpaid, said service charge, however, not to exceed the highest applicable legal rate of interest. All orders, whether solicited or written by our sales representatives or forwarded by our customers are deemed to be mere offers to purchase in accordance with these Terms and Conditions of Sale until actually accepted by us at our home office in Lake Forest, CA. We reserve the right to refuse any order as well as the right to sell or not sell to any firm at our sole discretion. The acceptance of an order is expressly made conditional upon your assent to these Terms and Conditions of Sale. We object to the inclusion of any different or additional terms or conditions, even if the same are included in your order, a contract of sale will result upon the Terms and Conditions of Sale stated herein only. Prices reflected in this book apply to Wholesale customers only.

All sales are final.

## PRICES

Pricing based on full-case quantities only; orders for less than full case will be automatically adjusted up to the next full-case quantity. All prices are subject to change without notice and are not guaranteed. All taxes, duties or other charges are the responsibility of the customer.

## CLAIMS

Price claims must be submitted in writing to Kwikset, 19701 Da Vinci, Lake Forest, CA 92610 within 30 days from the date of invoice.

## CHANGES OR CANCELLATIONS

Beyond 5 working days of our acknowledgement date no changes can be made. Additions to an order will be handled as a separate order and must meet applicable minimum order requirements. Order cancellation on regular stock items only, or any portion thereof is allowed only upon prior written consent from Kwikset, and the payment of cancellation charges deemed appropriate.

## MINIMUM CHARGE

No order will be invoiced for less than \$100.00 net plus shipping charges except for lock accessory parts.

## MINIMUM ANNUAL SALES VOLUME

The company reserves the right to discontinue direct sales to any customer who does not meet the minimum annual sales volume requirement. The current annual requirement is \$50,000.00. Your annual purchases are determined by accepted, non-cancelled, and shipped orders received during each calendar year. Kwikset reserves the right to change any or all minimum annual sales volume requirements at any time. Any customer who does not meet the annual sales volume requirements may continue to purchase Kwikset products through a Kwikset distributor.

## RETURNS

Defective merchandise returned to our factories requires prior written authorization from a Kwikset Sales Rep or the Sales Office. A factory return authorization must accompany the returned shipment. The return authorization must include an itemized listing of the merchandise and an explanation stating the reason for return.

There will be a 20% product restocking fee on all returned merchandise.

## FREIGHT

All goods are invoiced FOB to our factory. Upon delivery of shipments to the carrier, title to, and the risk of loss or damage in transit for such shipments, passes to our customer. Kwikset's standard policy is to pay freight charges on all shipments of 300 locks (Accessories: 300 lbs.) to a single destination in the continental U.S., by carrier and route of our choice. Shipments less than these quantities will not be shipped on a

prepaid basis. If higher freight charges are incurred from customers specifying a carrier or route of their choice the additional cost will be added to that customer's invoice.

## DELIVERY CONDITIONS

Shipping schedules are our best estimates, and cannot be guaranteed. Kwikset is not responsible for any direct or consequential loss or damage resulting from an inability or delay in meeting shipping schedules.

## PRODUCT WARRANTY

Warranties cover the original residential user of Kwikset Products against defects in material and workmanship as long as the original user occupies the residential premises upon which the Product was originally installed. This warranty DOES NOT COVER abused or misused products or non-commercial products used in commercial applications. Upon return of a defective product to Kwikset Corporation, Kwikset shall either replace the product or refund the purchase price, at our discretion. If a covered defect occurs, call 1-800-327-LOCK (5625) in the U.S. and Canada or return it to Kwikset Corporation, Consumer Services, 19701 DaVinci, Lake Forest, California 92610. A finish deterioration occurring from the use of paints, solvents, or other chemicals is not a defect in the finish and is not covered by this warranty. Kwikset is not liable for incidental or consequential damages. Some states do not allow the exclusion or limitation of incidental or consequential damages, so the above exclusion may not apply to you. This warranty gives you specific legal rights and you may also have other rights that vary from state to state.

## PATENT INDEMNITY

We agree to defend any suit or proceeding brought against our customer so far as based on claim that our products, or any part thereof, made solely to our specifications and furnished to our customer constitute an infringement of any U.S. patent, if notified promptly in writing and given authority, information and assistance at our expense for the defense of same, and we shall pay all damages and costs awarded therein against our customer. In case our products, or any part thereof, is in such suit held to constitute infringement and their use is enjoined, we will, at our expense and discretion, either procure for our customer the right to continue using the products or replace same with non-infringing products, or modify them so they become non-infringing, or remove such products and refund the purchase price (less depreciation, prorated from the purchase date). The foregoing states our entire liability for patent infringement by our products or any part thereof.

## INTELLECTUAL PROPERTY

No person or entity may sell, distribute, advertise, market or promote Kwikset branded products distributed by Kwikset Corporation ("Kwikset"), a member of Black & Decker's HHI Group, without prior authorization from Kwikset. Customers of Kwikset who are authorized to sell Kwikset branded products are referred to herein as "Customers."

The Kwikset brand and all Kwikset trademarks, trade names, product depictions, colors, graphics or logos, whether or not registered or otherwise protected (the "Marks"), remain the sole and exclusive property of Kwikset and nothing arising out of the relationship between Kwikset and any Customer conveys to Customer any ownership rights in the Marks. Customer may use the Marks and then only in the sale or promotion of authentic Kwikset products in compliance with the terms of this policy. The Marks must be used exactly in the form provided and in conformity with all Kwikset trademark usage policies or guidelines, including, but not limited to, those relating to shape, color match and imprint quality. Any proposed deviation must be approved in writing by Kwikset prior to use. The Marks may not be used in or as part of any Customer domain name on the Internet. Prior to any use of the Marks on goods or services, Customer must submit samples for Kwikset's approval.

Additionally, no Customer may use product depictions, graphics, logos or text relating to Kwikset products that have not been provided by Kwikset in connection with the advertising, promotion or sale of Kwikset products without Kwikset's prior review and written approval of each such use. The Marks may not be used in or as part of any reseller or other third party (i) domain name or VRL on the Internet, (ii) trademark or service mark, or (iii) company or trade name. Any action on the part of a Customer that violates the terms of this policy or otherwise impairs the value of or goodwill associated with the Marks or is otherwise not in conformity with Kwikset's standards may result



in the suspension or termination of the Customer's authorization or any other remedy permitted by law.

Kwikset grants to each of its Customers limited, non-transferable, non-sublicenseable licenses of the patents relating to the Kwikset products that the Customer is authorized to sell and of the copyrights in any packaging or other written materials included therewith or related thereto. Said patent and copyright licenses are solely to sell such Kwikset products covered by such patents and to which such copyrights relate only to end-users and other Customers in compliance with the terms of this document. The sale of such patented Kwikset products and the sale or use of such copyrighted materials by a Customer that violate the terms of this document exceed the scope of the licenses herein granted to the Customer and may constitute patent and/or copyright infringement.

## **STANDARDS**

Kwikset meets or exceeds the testing requirements specified for each product grade or rating.

- American National Standards Institute (ANSI)
- Builders Hardware Manufacturers Association (BHMA)
- Underwriters Laboratories, Inc. (UL)
- Americans with Disabilities Act (ADA)

## **MISCELLANEOUS**

Substitution of non-Kwikset components/parts, and any alteration or modification of factory parts, and other lock manufacturer's parts may result in door hardware which does not function properly or will fail and will void all warranties. Orders not specified with keying requirements will be shipped Keyed Differently (KD). Orders with keying requirements of K10 or more must have a "Letter of Release" on file with Kwikset stating that Kwikset Corporation will not be held liable for cost and expense arising from any loss or damage to property utilizing Kwikset products where 10 or more locks have been keyed alike. Contact your Sales Office account representative for a copy of the release form. Kwikset reserves the right to revise or modify products, product information, or pricing without notice. Product specifications and pricing reflect available information at the time of printing. Kwikset is not responsible for typographic or printing errors.

## ORDER CODE BREAKOUT

Quantity	Specifies Quantity
Function & Style	Specifies Model and Function
Rose Design	Specifies Designer Rose
Handing	Handing Right or Left
Finish	Exterior/Interior
Keying	Special Keying
Code	Keying Code
Latch	Specifies Latch
Strike	Indicates Strike
Key Alike Qty	Keyed Alike

**Example:** "I would like to order 12 SmartKey Commonwealth levers, oval designer roses, satin nickel finish, round corner latch & strike, 3 keyed alike" Written as:

12-740CHL OVT 15 SMT RCAL RCS K3.

**NOTE:** All handlesets ordered LIP only.

## UNDERWRITERS LABORATORIES LISTED LOCKSETS



To meet Underwriters Laboratories' fire rating requirements UL listed locksets, UL listed latches, and UL listed strikes must be used together.

## AMERICAN WITH DISABILITIES ACT



Products displaying this symbol comply with the Americans with Disabilities Act of 1990.

## HOW TO ORDER 20MIN UL LOCKS

FD = 20 minute UL designation

**Example:** "I would like to order 12 passage Tustin levers with round corner latch and strike with 20 minute UL in Satin Nickel"

12-720TNL 15 RCALED RCS.

**NOTE:** The GAL latch configuration is not available with FD. There is a \$2.50 list price upcharge for 20 minute UL..

## KEYING

Code	Option
KD	Keyed Differently
K2, K3	Keyed Alike (2 Locksets, 3 Locksets)
MK	Master Keyed
PK	Builder (Protecto) Keyed
GMK	Grand Master Keyed
PMK	Builder (Protecto) Master Keyed
MAIS	Maison Keying
SEQ	Sequential Construction Keying
KBOX	Keys in One Box
SMT	SmartKey

**NOTE:** There is a \$2.30 upcharge per lock for specialty keying.

## BACKSET

Backset is the distance from center edge of door to center of the 2-1/8" (54mm) diameter hole, 2-3/8" or 2-3/4" in most cases.

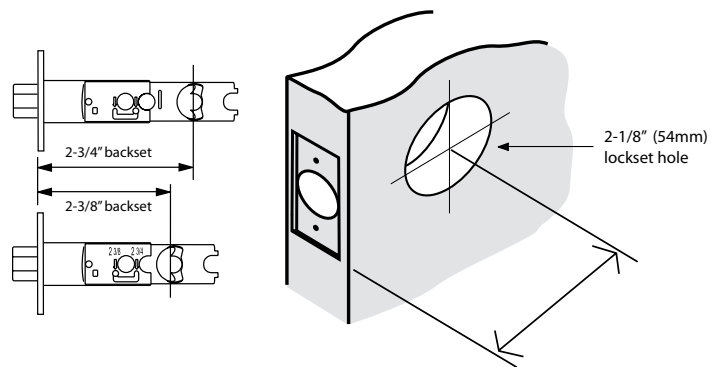

Model	Function
100	Patio/Porch
200/420/720/725	Passage/Hall/Closet
300/430/730/735	Privacy/Bed/Bath
334/335	Round Pocket Door Lock
400/401/740/741/745/746	Entry
405/406/409/413	Lever Keyed Entry
450/462/412/755/750	Storeroom/Vestibule
488/788	Half Dummy Trim, Surface Mounted
502/505/506/507/508	Interconnect
552	Gibson Handleset without deadbolt
553/687/800	Single Cylinder Handleset
554/689/801	Double Cylinder Handleset
555/699/802	Dummy Handleset
598	Single Cylinder Gatelatch
599	Double Cylinder Gatelatch
604/605/606	Interior Pack for Kwikset Handlesets
660/780/782/980/982/816/817	Single Cylinder Deadbolts
665/784/785/984/985	Double Cylinder Deadbolts
744/749	Classroom
907/909/911	Powerbolt/SmartCode Deadbolt/SmartCode Lever
966/967/968	Interior Pack for Kwikset Signature Series Handleset
978/979	Interior Pack for Montara Handleset

## HANDING

To determine the handing of a door face the OUTSIDE of the door. If the hinge is on the left side of the door, the door is left handed (LH). If the hinge is on the right side of the door, the door is right handed (RH).

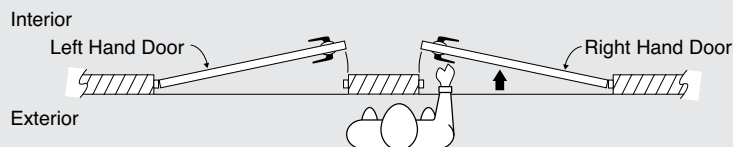

NOTE: Handing required for dummy levers and interior packs with levers when lever design is not symmetric.

Finish	Description	ANSI/BHMA	Latch	Description
3	Polished Brass	605	WFL	Wide Face Latch 2-1/4" x 1-1/8"
L03	Lifetime Polished Brass	605E	RCAL	Round Corner Adjustable Latch
5	Antique Brass	609	6AL	6-Way Adjustable Latch. All Parts Loose
11P	Venetian Bronze	---	SCAL	Square Corner Adjustable Latch
15	Satin Nickel	619	RFAL	Round Face Adjustable Latch
15A	Antique Nickel	620	RCAL FD	Round Corner Adjustable 20 Minute UL
26	Polished Chrome	625	SCAL FD	Square Corner Adjustable 20 Minute UL
26D	Satin Chrome	626	RFAL FD	Round Adjustable 20 Minute UL
501	Rustic Bronze	---		
502	Rustic Pewter	---		
514	Iron Black	---		

**NOTE:** List charge for 20 minute UL is \$2.50

# Kwikset

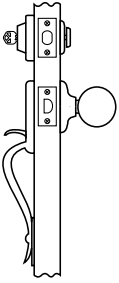
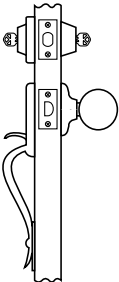
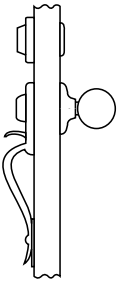
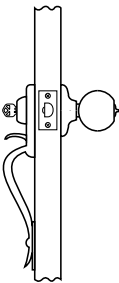
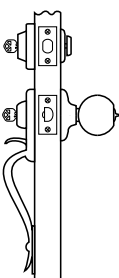
HANDLESETS	Function Name	Description	KWIKSET	KWIKSET SIGNATURE SERIES
	Handleset with Single Cylinder Deadbolt	Latch bolt operated by thumb piece outside and grip inside. Deadbolt operated by key outside and thumb turn inside.	687	800
	Handleset with Double Cylinder Deadbolt	Latch bolt operated by thumb piece outside and grip inside. Deadbolt operated by key both sides.	689	801
	Dummy Handleset with Dummy Deadbolt	Handle and grip act as a pull only. For inactive leaf of double doors. No operation.	699	802
	One Piece Handleset	Latch bolt operated by thumb piece outside and grip inside, except when both are locked by key outside or turn button inside.	N/A	552
	Two Point Locking Handleset with Single Cylinder Deadbolt	Latch bolt operated by thumb piece outside and grip inside, except when both are locked by key outside or turn button inside. Deadbolt operated by key outside or thumb turn inside.	N/A	553

# Kwikset

**HANDLESETS**      **Function Name**      **Description**      **KWIKSET**      **KWIKSET SIGNATURE SERIES**

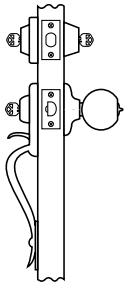

**Two Point Locking Handleset with Double Cylinder Deadbolt**

Latch bolt operated by thumb piece outside and grip inside, except when both are locked by key outside or turn button inside. Deadbolt operated by key both sides.

N/A

554

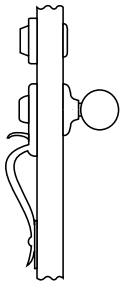

**Two Point Locking Dummy Handleset with Dummy Deadbolt**



Handle and grip act as a pull only. For inactive leaf of double doors. No operation.

N/A

555



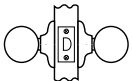
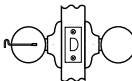
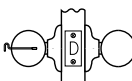
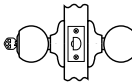
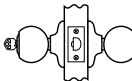
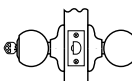
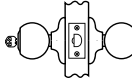

# Kwikset

KNOBBS	Function Name	Description	KWIKSET w/ BHMA	KWIKSET SIGNATURE SERIES w/ BHMA
	Patio/Porch	Both knobs locked or unlocked by turn button inside.	100 <i>F77</i>	N/A
	Passage/Hall/Closet	Both knobs always free.	200 <i>F75</i>	720/725UL <i>F75</i>
	Privacy/Bed/Bath	Both knobs locked or unlocked by turn button inside. Outside knob unlocked by emergency key.	300 <i>F76</i>	730/735UL <i>F76</i>
	Privacy/Bathroom	Same function as above. Inside knob polished chrome finish.	300 <i>F76</i>	730 <i>F76</i>
	Entry	Both knobs locked or unlocked by key outside or turn button inside.	400 <i>F82</i>	740/745UL <i>F82</i>
	Entry, Free Interior	Outside locked or unlocked by key outside or turn button inside. Inside always free.	401 <i>F81</i>	741/746UL <i>F81</i>
	Classroom	Outside locked or unlocked by key outside. Inside always free.	N/A	744/749UL <i>F84</i>
	Storeroom/Vestibule	Outside unlocked only while key is turned. Inside always free.	450 <i>F86</i>	750/755UL <i>F86</i>
	Half Dummy Trim, Surface Mounted	For doors where only a pull is required. No operation.	488	788



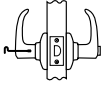
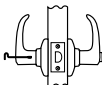
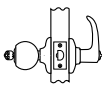
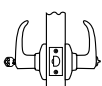
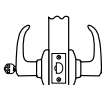
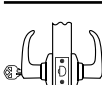

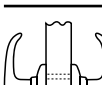



**NOTE:** BHMA code in *italics*

# Kwikset

LEVERS	Function Name	Description	KWIKSET w/ BHMA	KWIKSET SIGNATURE SERIES w/ BHMA
	Passage/Hall/Closet	Both levers always free.	200/420UL <i>F85</i>	720/725UL <i>F75</i>
	Privacy/Bed/Bath	Both levers locked or unlocked by turn button inside. Outside lever unlocked by emergency key.	300/430UL <i>F76</i>	730/735UL <i>F76</i>
	Privacy/Bathroom	Same function as above. Inside lever polished chrome finish.	300 <i>F76</i>	730 <i>F76</i>
	Entry	Both sides locked or unlocked by key outside or turn button inside.	400/410UL <i>F82</i>	N/A
	Keyed Entry Lever	Both levers locked or unlocked by key outside or turn button inside.	405/409UL <i>F82</i>	740/745UL <i>F82</i>
	Entry, Free Interior	Outside locked or unlocked by key outside or turn button inside. Inside always free.	406/413UL <i>F81</i>	741/746UL <i>F81</i>
	Storeroom/Vestibule	Outside unlocked only while key is turned. Inside always free.	462/412UL <i>F86</i>	750/755UL <i>F86</i>
	Half Dummy Trim, Surface Mounted	For doors where only a pull is required. No operation.	488	788
	Full Dummy Trim	For doors where only a pull is required. No operation.	N/A	490

**NOTE:** BHMA code in *italics*

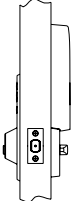
# Kwikset

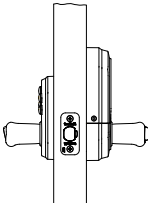
DEADBOLTS		Function Name	Description	KWIKSET w/ BHMA	KWIKSET SIGNATURE SERIES w/ BHMA
	Single Cylinder	Deadbolt operated by key outside and thumb turn inside.	660 <i>E0153</i>	980/982UL <i>E0151</i> 780/782UL <i>E0152</i> 816/817UL <i>E0152</i> 993	
	Double Cylinder	Deadbolt operated by key both sides.	665 <i>E0143</i>	985/984UL <i>E0141</i> 785/784UL <i>E0142</i> 994	
	Thumb Turn Only	Deadbolt operated by thumb turn one side. No trim on exterior.	663 <i>E0193</i>	N/A	
	Conversion Kit	Converts 663 to 667 when door is bored through.	664	N/A	
	Thumb Turn x Plate	Deadbolt operated by thumb turn on interior. Blank plate on exterior.	667/677UL <i>E01113</i>	N/A	
	Single Cylinder Gatelatch	Deadbolt operated by key outside and thumb turn inside.	N/A	598	
	Double Cylinder Gatelatch	Deadbolt operated by key both sides.	N/A	599	
ELECTRONIC DEADBOLTS		Function Name	Description	KWIKSET w/ BHMA	KWIKSET SIGNATURE SERIES w/ BHMA
	Powerbolt®	Deadbolt operated by key outside or electronic keypad and thumb turn inside.	907	N/A	
	SmartCode™ Deadbolt	Deadbolt operated by key outside or electronic keypad and thumb turn inside.	N/A	909	
	SmartCode™ Lever	Keyed lever operated by key outside or electronic keypad and thumb turn inside.	N/A	911	

**NOTE:** BHMA code in *italics*

# Kwikset

## ROUND POCKET

### DOOR LOCK

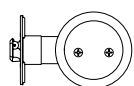

Passage

Pocket door lock always free.

KWIKSET w/ BHMA

334

KWIKSET SIGNATURE

SERIES w/ BHMA

N/A

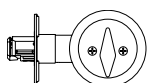

Privacy

Pocket door lock operated by thumb turn.

335

N/A

## LIGHT COMMERCIAL

### LEVER

Function Name

Description

LIGHT COMMERCIAL

w/ BHMA



Passage/Hall/Closet

Both levers always free.

720/725UL *F75*

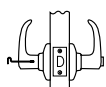

Privacy/Bed/Bath

Both levers locked or unlocked by ADA turn button inside. Outside lever unlocked by emergency key.

730/735UL *F76*

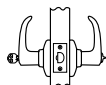

Entry

Both levers locked or unlocked by key outside or ADA turn button inside.

740/745UL *F82*

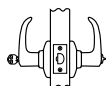

Entry, Free Interior

Outside locked or unlocked by key outside or turn button inside. Inside always free.

741/746UL *F81*

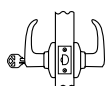

Storeroom/Vestibule

Outside unlocked only while key is turned. Inside always free.

750/755UL *F86*



Half Dummy Trim,  
Surface Mounted

For doors where only a pull is required. No operation.



788

**NOTE:** BHMA code in *italics*

# Kwikset

## METAL

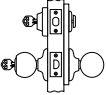
### INTERCONNECT

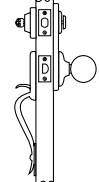
	Function Name	Description	METAL INTERCONNECT Model w/BHMA
	<b>Deadlock Latch</b>	Operated by grip either side except when locked by key outside and thumb turn inside. Deadbolt operated by key outside and thumb turn inside. Inside grip simultaneously retracts dead latch and deadbolt latch.	<b>506/505UL <i>F96</i></b>
	<b>Plain Latch</b>	Operated by grip either side. Deadbolt operated by key outside and thumb turn inside. Inside grip simultaneously retracts plain latch and deadbolt latch.	<b>508/507UL <i>F95</i></b>
	<b>Interior Assembly Only</b>	Grip inside simultaneously retracts plain latch and deadbolt latch when matched with handleset on outside.	<b>502</b>

**NOTE:** BHMA code in *italics*



BOX PACK	Unit					Master Case			
	Quantity	Length (in.)	Width (in.)	Height (in.)	Weight (lbs.)	Quantity	Length (in.)	Width (in.)	Height (in.)
<b>Kwikset Signature Series</b>									
<b>Deadbolts</b>									
780 Single Cylinder	1	4.6730	3.9230	3.0720	2.2500	12	12.8750	12.5000	5.3125
785 Double Cylinder	1	4.6730	3.9230	3.0720	2.7500	12	12.8750	12.5000	5.3125
816 Key Control	1	4.6730	3.9230	3.0720	2.2500	12	12.8750	12.5000	5.3125
980 Single Cylinder	1	4.6730	3.9230	3.0720	2.2500	12	12.8750	12.5000	5.3125
985 Double Cylinder	1	4.6730	3.9230	3.0720	2.7500	12	12.8750	12.5000	5.3125
993 Single Cylinder	1	4.6730	3.9230	3.0720	2.2500	12	12.8750	12.5000	5.3125
994 Single Cylinder	1	4.6730	3.9230	3.0720	2.7500	12	12.8750	12.5000	5.3125
<b>Electronic Deadbolts</b>									
907 Powerbolt	1	5.5	3.8	11.5	3.35	2	5.5	8	11.5
909 SmartCode	1	5.5	3.5	10	2.88	2	7.6	6	10.5
911 SmartCode Lever	1	3.5	6	10	61	2	7	12.5	10.4
<b>Handlesets</b>									
553 Single Cylinder	1	15.9380	7.1250	4.0000	6.2500	6	15.0000	12.1250	16.6255
554 Double Cylinder	1	15.9380	7.1250	4.0000	6.7500	6	15.0000	12.1250	16.6255
800 AUH Austin	1	15.9380	7.1250	4.0000	7.0000	6	15.0000	12.1250	16.6255
801 AUH Austin	1	15.9380	7.1250	4.0000	7.5000	6	15.0000	12.1250	16.6255
802 AUH Austin	1	15.9380	7.1250	4.0000	6.5000	6	15.0000	12.1250	16.6255
800ADH Ashfield, 800AVH Avalon	1	15.9380	7.1250	4.0000	7.0000	6	15.0000	12.1250	16.6255
801ADH Ashfield, 801AVH Avalon	1	15.9380	7.1250	4.0000	7.5000	6	15.0000	12.1250	16.6255
802ADH Ashfield, 802AVH Avalon	1	15.9380	7.1250	4.0000	6.5000	6	15.0000	12.1250	16.6255
800AN Arlington	1	15.9380	7.1250	4.0000	7.0000	6	15.0000	12.1250	16.6255
801AN Arlington	1	15.9380	7.1250	4.0000	7.5000	6	15.0000	12.1250	16.6255
802AN Arlington	1	15.9380	7.1250	4.0000	6.5000	6	15.0000	12.1250	16.6255
800AT Amherst	1	19.9380	7.6250	4.0000	8.9000	4	20.5000	16.0000	8.3875
801AT Amherst	1	19.9380	7.6250	4.0000	9.9000	4	20.5000	16.0000	8.3875
802AT Amherst	1	19.9380	7.6250	4.0000	6.9000	4	20.5000	16.0000	8.3875
800CE Chelsea	1	15.9380	7.1250	4.0000	6.0000	6	15.0000	12.1250	16.6255
801CE Chelsea	1	15.9380	7.1250	4.0000	6.5000	6	15.0000	12.1250	16.6255
802CE Chelsea	1	15.9380	7.1250	4.0000	5.5000	6	15.0000	12.1250	16.6255
800HE Hawthorne	1	15.9380	7.1250	4.0000	7.0000	4	16.4380	15.9380	7.8125
801HE Hawthorne	1	15.9380	7.1250	4.0000	8.0000	4	16.4380	15.9380	7.8125
802HE Hawthorne	1	15.9380	7.1250	4.0000	5.0000	4	16.4380	15.9380	7.8125
800SE Shelburne	1	15.9380	7.1250	4.0000	7.9000	4	16.4380	15.9380	7.8125
801SE Shelburne	1	15.9380	7.1250	4.0000	8.9000	4	16.4380	15.9380	7.8125
802SE Shelburne	1	15.9380	7.1250	4.0000	5.9000	4	16.4380	15.9380	7.8125
800 Tavaris	1	15.9380	7.1250	4.0000	8.0000	4	16.4380	16.6200	8.3800
801 Tavaris	1	15.9380	7.1250	4.0000	8.2500	4	16.4380	16.6200	8.3800
802 Tavaris	1	15.9380	7.1250	4.0000	8.0000	4	16.4380	16.6200	8.3800
800WN Wellington	1	19.9380	7.6250	4.0000	7.2000	4	20.5000	16.0000	8.3875
801WN Wellington	1	19.9380	7.6250	4.0000	8.2000	4	20.5000	16.0000	8.3875
802WN Wellington	1	19.9380	7.6250	4.0000	5.2000	4	20.5000	16.0000	8.3875
966 Single Cylinder	1	2.7	3.7	4.30	2.25	12	15.20	12.5	7
967 Double Cylinder	1	2.7	3.7	4.30	2.25	12	15.20	12.5	7
968 Dummy	1	2.7	3.7	4.30	2.25	12	15.20	12.5	7
986 Single Cylinder	1	2.7	3.7	4.30	2.25	12	15.20	12.5	7
987 Double Cylinder	1	2.7	3.7	4.30	2.25	12	15.20	12.5	7
983 Without Deadbolt	1	2.7	3.7	4.30	2.25	12	15.20	12.5	7
989 Dummy	1	2.7	3.7	4.30	2.25	12	15.20	12.5	7
<b>Knobs</b>									
720 Passage	1	8.1730	3.9230	2.7840	2.0000	12/30	12.3750	11.5000	8.8125
730 Privacy	1	8.1730	3.9230	2.7840	2.0000	12/30	12.3750	11.5000	8.8125
740 Entry	1	8.1730	3.9230	2.7840	2.3300	12/30	12.3750	11.5000	8.8125
788 Dummy	1	3.2360	2.7980	3.0100	0.3500	20	14.8750	12.5000	3.9375



BOX PACK	Unit					Master Case			
	Quantity	Length (in.)	Width (in.)	Height (in.)	Weight (lbs.)	Quantity	Length (in.)	Width (in.)	Height (in.)
<b>Kwikset Signature Series Continued</b>									
<b>Levers</b>									
720 Passage	1	7.8750	6.1250	3.1875	2.4200	12/20	19.7500	12.8750	8.5625
730 Privacy	1	7.8750	6.1250	3.1875	2.4200	12/20	19.7500	12.8750	8.5625
740 Entry	1	7.8750	6.1250	3.1875	2.4200	12/20	19.7500	12.8750	8.5625
788 Dummy	1	5.8610	3.1100	2.8220	0.4500	20	15.8750	12.1250	6.6245
720 LL, TNL	1	6.625	5.75	3.0	1.65	20	24	15.50	6.70
730 LL, TNL	1	6.625	5.75	3.0	1.70	20	24	15.50	6.85
740 LL, TNL	1	6.625	5.75	3.0	2.05	20	24	15.50	8.30
788 LL, TNL	1	5.861	3.11	2.822	0.450	20	15.875	12.125	6.6245

<b>Kwikset</b>									
<b>Combo Packs</b>									
690T Tylo Knob and Single Cylinder Deadbolt	1	11.3090	3.4230	2.7840	2.8000	6	8.7500	7.3120	11.9375
<b>Deadbolts</b>									
598 Single Cylinder Gate Latch	1	4.6730	3.9230	3.0720	2.2500	12	12.8750	12.5000	5.3125
599 Double Cylinder Gate Latch	1	4.6730	3.9230	3.0720	2.2500	12	12.8750	12.5000	5.3125
660 Single Cylinder	1	3.9480	3.4230	2.5720	0.5000	12	11.1250	11.0000	4.5625
665 Double Cylinder	1	3.9480	3.4230	2.5720	0.9000	12	11.1250	11.0000	4.5625
663 One-Sided	1	3.9480	3.4230	2.5720	0.5500	12	11.1250	11.0000	4.5625
667 One-Sided	1	3.9480	3.4230	2.5720	0.9000	12	11.1250	11.0000	4.5625
664 Retrofit Kit	1	3.9480	3.4230	2.5720	0.9000	12	11.1250	11.0000	4.5625
677 One-Sided	1	3.9480	3.4230	2.5720	0.2500	12	11.1250	11.0000	4.5625
<b>Handlesets</b>									
604 Single Cylinder	1	5.8000	3.9000	3.7000	2.25	12	15.20	12.5	7
605 Double Cylinder	1	5.8000	3.9000	3.7000	2.25	12	15.20	12.5	7
606 Dummy	1	5.8000	3.9000	3.7000	2.25	12	15.20	12.5	7
687 LIP	1	15.9380	7.1250	4.0000	3.6000	6	15.0000	12.1250	16.6255
689 LIP	1	15.9380	7.1250	4.0000	4.0000	6	15.0000	12.1250	16.6255
699 LIP	1	15.9380	7.1250	4.0000	3.6000	6	15.0000	12.1250	16.6255
<b>Knobs</b>									
200 Polo	1	8.1730	3.2980	2.7840	1.3000	30	17.1250	17.0000	8.8125
300 Polo	1	8.1730	3.2980	2.7840	1.3000	30	17.1250	17.0000	8.8125
400 Polo	1	8.1730	3.2980	2.7840	1.3000	30	17.1250	17.0000	8.8125
200 Tylo/Cove	1	7.3610	3.2980	2.7840	1.1500	30	17.1250	17.0000	8.1870
300 Tylo/Cove	1	7.3610	3.2980	2.7840	1.1500	30	17.1250	17.0000	8.1870
400 Tylo/Cove	1	7.3610	3.2980	2.7840	1.1500	30	17.1250	17.0000	8.1870
488 Dummy	1	3.2360	2.7980	3.0100	0.3500	20	14.8750	12.5000	3.9375
<b>Lever</b>									
200 Passage	1	6.7980	5.7660	2.9720	1.3500	20	23.6250	15.3750	7.4995
300 Privacy	1	6.7980	5.7660	2.9720	1.3500	20	23.6250	15.3750	7.4995
400 Knob x Lever	1	7.8750	6.1250	3.1875	1.3500	12	19.7500	12.8750	8.5625
405 Keyed Lever	1	6.7980	5.7660	2.9720	1.5800	20	23.6250	15.3750	7.4995
488 Dummy	1	5.8610	3.1100	2.8220	0.4500	20	15.8750	12.1250	6.6245
490 Full Dummy	1	6.7980	5.7660	2.9720	1.1300	20	23.6250	15.3750	7.6870

<b>Miscellaneous</b>									
<b>Pocket Door Hardware</b>									
334 Passage	1	4.3750	3.0000	2.0000	.65	12	12.5000	14.3750	2.2500
335 Privacy	1	4.3750	3.0000	2.0000	.8	12	12.5000	14.3750	2.2500







Customer Service Toll Free Line:  
**(800) 422-LOCK (800) 422-4278**  
**FAX (866) 507-8369**

Date: \_\_\_\_\_ Delivery Address: \_\_\_\_\_ Contact: \_\_\_\_\_  
 PO Number: \_\_\_\_\_ Phone: \_\_\_\_\_ Company Name: \_\_\_\_\_  
 Job Name: \_\_\_\_\_ Fax: \_\_\_\_\_ Address: \_\_\_\_\_  
 Notes: \_\_\_\_\_ Store Number: \_\_\_\_\_

Monday to Friday, 6:00 a.m. to 4:00 p.m. PST

Line No.	Function		Style		Handling	Rose		Finish		OPTIONS							
	Exterior	Interior	Exterior	Interior		Exterior	Interior	Exterior	Interior	Door Thickness	Latch	Strike	Cylinder	Keying	Quantity	Price	Extended Price
1																	
2																	
3																	
4																	
5																	
6																	
7																	
8																	
9																	
10																	
11																	
12																	
13																	
14																	
15																	
16																	
17																	
18																	
19																	
20																	

To order service parts, provide service part # and quantity.

How to order questions, refer back to page A.3 for General Information.





Customer Service Toll Free Line:  
**(800) 422-LOCK (800) 422-4278**  
**FAX (866) 507-8369**

Date: \_\_\_\_\_ Delivery Address: \_\_\_\_\_ Contact: \_\_\_\_\_  
 PO Number: \_\_\_\_\_ Phone: \_\_\_\_\_ Company Name: \_\_\_\_\_  
 Job Name: \_\_\_\_\_ Fax: \_\_\_\_\_ Address: \_\_\_\_\_  
 Notes: \_\_\_\_\_ Store Number: \_\_\_\_\_

Monday to Friday, 6:00 a.m. to 4:00 p.m. PST

Line No.	Function		Style		Handling	Rose		Finish		OPTIONS					Quantity	Price	Extended Price
	Exterior	Interior	Exterior	Interior		Exterior	Interior	Exterior	Interior	Door Thickness	Latch	Strike	Cylinder	Keying			
1																	
2																	
3																	
4																	
5																	
6																	
7																	
8																	
9																	
10																	
11																	
12																	
13																	
14																	
15																	
16																	
17																	
18																	
19																	
20																	

To order service parts, provide service part # and quantity.

How to order questions, refer back to page A.3 for General Information.





Customer Service Toll Free Line:  
**(800) 422-LOCK (800) 422-4278**  
**FAX (866) 507-8369**

Date: \_\_\_\_\_ Delivery Address: \_\_\_\_\_ Contact: \_\_\_\_\_

PO Number: \_\_\_\_\_ Phone: \_\_\_\_\_ Company Name: \_\_\_\_\_

Job Name: \_\_\_\_\_ Fax: \_\_\_\_\_ Address: \_\_\_\_\_

Notes: \_\_\_\_\_ Store Number: \_\_\_\_\_

Monday to Friday, 6:00 a.m. to 4:00 p.m. PST

Line No.	Function		Style		Handling	Rose		Finish		Door Thickness	OPTIONS				Quantity	Price	Extended Price
	Exterior	Interior	Exterior	Interior		Exterior	Interior	Exterior	Interior		Latch	Strike	Cylinder	Keying			
1																	
2																	
3																	
4																	
5																	
6																	
7																	
8																	
9																	
10																	
11																	
12																	
13																	
14																	
15																	
16																	
17																	
18																	
19																	
20																	

To order service parts, provide service part # and quantity.

How to order questions, refer back to page A.3 for General Information.





Customer Service Toll Free Line:  
**(800) 422-LOCK (800) 422-4278**  
**FAX (866) 507-8369**

Date: \_\_\_\_\_ Delivery Address: \_\_\_\_\_ Contact: \_\_\_\_\_  
 PO Number: \_\_\_\_\_ Phone: \_\_\_\_\_ Company Name: \_\_\_\_\_  
 Job Name: \_\_\_\_\_ Fax: \_\_\_\_\_ Address: \_\_\_\_\_  
 Notes: \_\_\_\_\_ Store Number: \_\_\_\_\_

Monday to Friday, 6:00 a.m. to 4:00 p.m. PST

Line No.	Function		Style		Handling	Rose		Finish		Door Thickness	OPTIONS				Quantity	Price	Extended Price
	Exterior	Interior	Exterior	Interior		Exterior	Interior	Exterior	Interior		Latch	Strike	Cylinder	Keying			
1																	
2																	
3																	
4																	
5																	
6																	
7																	
8																	
9																	
10																	
11																	
12																	
13																	
14																	
15																	
16																	
17																	
18																	
19																	
20																	

To order service parts, provide service part # and quantity.

How to order questions, refer back to page A.3 for General Information.







Customer Service Toll Free Line:  
**(800) 422-LOCK (800) 422-4278**  
**FAX (866) 507-8369**

Date: \_\_\_\_\_ Delivery Address: \_\_\_\_\_ Contact: \_\_\_\_\_  
 PO Number: \_\_\_\_\_ Phone: \_\_\_\_\_ Company Name: \_\_\_\_\_  
 Job Name: \_\_\_\_\_ Fax: \_\_\_\_\_ Address: \_\_\_\_\_  
 Notes: \_\_\_\_\_ Store Number: \_\_\_\_\_

Monday to Friday, 6:00 a.m. to 4:00 p.m. PST

Line No.	Function		Style		Handling	Rose		Finish		Door Thickness	OPTIONS				Quantity	Price	Extended Price
	Exterior	Interior	Exterior	Interior		Exterior	Interior	Exterior	Interior		Latch	Strike	Cylinder	Keying			
1																	
2																	
3																	
4																	
5																	
6																	
7																	
8																	
9																	
10																	
11																	
12																	
13																	
14																	
15																	
16																	
17																	
18																	
19																	
20																	

To order service parts, provide service part # and quantity.

How to order questions, refer back to page A.3 for General Information.





Customer Service Toll Free Line:  
**(800) 422-LOCK (800) 422-4278**  
**FAX (866) 507-8369**

Date: \_\_\_\_\_ Delivery Address: \_\_\_\_\_ Contact: \_\_\_\_\_

PO Number: \_\_\_\_\_ Phone: \_\_\_\_\_ Company Name: \_\_\_\_\_

Job Name: \_\_\_\_\_ Fax: \_\_\_\_\_ Address: \_\_\_\_\_

Notes: \_\_\_\_\_ Store Number: \_\_\_\_\_

Monday to Friday, 6:00 a.m. to 4:00 p.m. PST

Line No.	Function		Style		Handling	Rose		Finish		Door Thickness	OPTIONS				Quantity	Price	Extended Price
	Exterior	Interior	Exterior	Interior		Exterior	Interior	Exterior	Interior		Latch	Strike	Cylinder	Keying			
1																	
2																	
3																	
4																	
5																	
6																	
7																	
8																	
9																	
10																	
11																	
12																	
13																	
14																	
15																	
16																	
17																	
18																	
19																	
20																	

To order service parts, provide service part # and quantity.

How to order questions, refer back to page A.3 for General Information.



INTRODUCING

# AUSTIN

Simple yet rugged, Austin's rustic style brings a new level of charm and appeal to any space, whether in the city or country.

The Austin family includes a handleset, deadbolt and lever.

- Decorative Deadbolt Swing Cover on Handleset
- SmartKey® Re-key Technology with BumpGuard™ Protection
- ANSI/BHMA Grade 2 Security



**Kwikset**

# AUSTIN

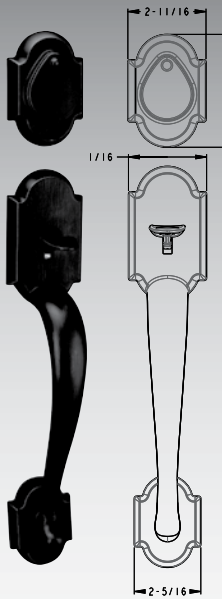

800 Austin Handleset

## Handleset Specifications:

<b>Door Prep</b>	Deadbolt: Cross Bore 2-1/8" or 1-1/2". Edge Bore 1". Latch Face 1" x 2-1/4". Handle: Cross Bore 2-1/8". Edge Bore 1". Latch Face 1" x 2-1/4".
<b>Backset</b>	Deadbolt: Adjustable to 2-3/8" or 2-3/4". Handle: Adjustable to 2-3/8" or 2-3/4".
<b>Door Thickness</b>	1-3/4" doors standard. 2-1/4" doors optional
<b>Cylinder</b>	SmartKey
<b>Faceplates</b>	1" x 2-1/4". Specify round corner, square corner or drive-in
<b>Strikes</b>	Deadbolt: 1-1/4" x 3-5/8". Specify round corner or square corner. Handle: 2-1/4" full lip. Specify round corner or square corner. Other options available.
<b>Bolt</b>	Deadbolt: 1" steel. Handle: 1/2" throw.
<b>UL</b>	Optional 1/3 hour fire rating for all functions except 802



980 Austin Deadbolt

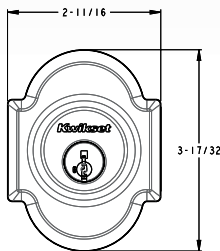

## Deadbolt Specifications:

<b>Door Prep</b>	Crossbore 2-1/8". Edge Bore 1". Latch Face 1" x 2-1/4"
<b>Backset</b>	Adjustable to 2-3/8" or 2-3/4"
<b>Door Thickness</b>	1-3/8" - 1-3/4" standard. 1-7/8" - 2-1/4" optional.
<b>Cylinder</b>	SmartKey.
<b>Faceplates</b>	1" x 2-1/4". Specify round corner, square corner, or drive-in.
<b>Strikes</b>	1-1/4" x 3-5/8". Specify round corner or square corner. Other options available.
<b>Bolt</b>	1" throw. Steel.
<b>ADA</b>	Interior turn piece meets 4.13.9 ADA requirements.



720 Austin Lever

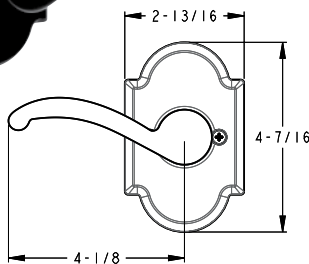

## Lever Specifications:

<b>Door Prep</b>	Cross Bore 2-1/8". Edge Bore 1".
<b>Backset</b>	Adjustable 2-3/8" or 2-3/4".
<b>Door Thickness</b>	1-3/8" to 1-3/4" standard.
<b>Cylinder</b>	SmartKey
<b>Faceplates</b>	1" x 2-1/4". Specify round corner or square corner or drive-in latch.
<b>Strikes</b>	2-1/4" full lip. Specify round corner or square corner. Other options available.
<b>Bolt</b>	1/2" throw.
<b>Door Handing</b>	Reversible for right or left hand doors.
<b>ADA</b>	720 function satisfies section 4.13.9 ADA requirements.

## Available Finishes:

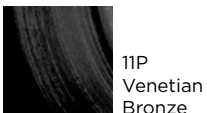

**Kwikset**

**SMARTKEY**  
RE-KEY TECHNOLOGY

19701 DaVinci • Lake Forest, CA 92610 • www.kwikset.com • 1-800-327-LOCK  
© 2012 Kwikset Corporation, Lake Forest, CA 92610

THE BEST SECURITY IS SMART SECURITY.

7/12 17870C

# Introducing MONTARA™

**2-Point Locking**  
for Increased Security

Enjoy increased security and easy fit with the Montara handleset. 2 points of locking, on the deadbolt and the handleset, provide double the security. And the Easy Fit Technology allows for convenient installation, adjusting to fit the bottom hole in your door.

- 2-Point Locking for Increased Security
- New Easy Fit Technology for easy installation
- SmartKey® Re-Key Technology with BumpGuard™ Protection
- ANSI/BHMA Grade 2 Certified Security



**Kwikset**

# MONTARA™

## Specifications:

<b>Door Prep</b>	Cross Bore 2 1/8". Edge Bore 1".
<b>Backset</b>	Adjustable to 2 3/8" or 2 3/4"
<b>Door Thickness</b>	1 3/4" standard
<b>Cylinder</b>	SmartKey®
<b>Faceplates</b>	1" x 2 1/4". Specify round corner, square corner or drive-in.
<b>Strikes</b>	2 1/4" full lip standard. Specify round corner, square corner. Other options available.
<b>Bolt</b>	1/2" throw.
<b>Door Handing</b>	Reversible for right or left-handed doors. Specify handing only on dummy and handleset interiors only.
<b>ANSI/BHMA</b>	Grade 2 Certified.

## Dimensions:

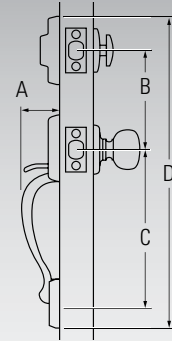

Design	A	B	C	D
Montara	2-19/32"	5-1/2"	9-1/8"	17-13/16"

## Finishes:



11P  
Venetian  
Bronze

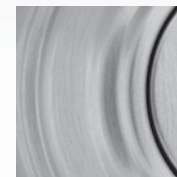

15  
Satin  
Nickel



3  
Polished  
Brass



featuring BumpGuard™

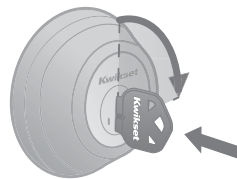

**1** Insert functioning key & turn 1/4 turn clockwise.

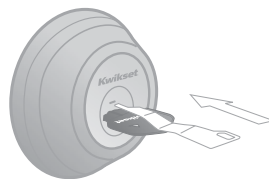

**2** Insert & remove the SmartKey learn tool. Remove functioning key.



**3** Insert new key & turn 1/2 turn counter-clockwise. Done. *Your lock is now re-keyed!*



**!** You must have your functioning key & the learn tool for the system to work.



# Kwikset®



*Signature Series*

## New Contemporary Designs

We are proud to announce the launch of the new contemporary style as part of our Kwikset Signature Series line. With five additional products, the contemporary family provides a modern approach to security door hardware.

---

### Features & Benefits

- **Features SmartKey® Re-key Technology with BumpGuard™ protection**
- **Available in a variety of finishes** - Satin Nickel, Polished Chrome, Satin Chrome, Venetian Bronze
- **Lifetime Finish & Mechanical Warranty**



THE BEST SECURITY IS SMART SECURITY.

# Kwikset

Signature Series



Tavaris™  
Handleset

## Handleset Specifications:

<b>Door Prep</b>	Deadbolt: Cross Bore 2-1/8" or 1-1/2". Edge Bore 1". Latch Face 1" x 2-1/4". Handle: Cross Bore 2-1/8". Edge Bore 1". Latch Face 1" x 2-1/4".
<b>Backset</b>	Deadbolt: Adjustable to 2-3/8" or 2-3/4". Handle: Adjustable to 2-3/8" or 2-3/4".
<b>Door Thickness</b>	1-3/4" doors standard. 2-1/4" doors optional
<b>Cylinder</b>	SmartKey
<b>Faceplates</b>	1" x 2-1/4". Specify round corner, square corner or drive-in
<b>Strikes</b>	Deadbolt: 1-1/4" x 3-5/8". Specify round corner or square corner. Handle: 2-1/4" full lip. Specify round corner or square corner. Other options available.
<b>Bolt</b>	Deadbolt: 1" steel. Handle: 1/2" throw.
<b>UL</b>	Optional 1/3 hour fire rating for all functions except 802



993 SQT  
Square  
Deadbolt



993 RDT  
Round  
Deadbolt

## Deadbolt Specifications:

<b>Door Prep</b>	Crossbore 2-1/8". Edge Bore 1". Latch Face 1" x 2-1/4"
<b>Backset</b>	Adjustable to 2-3/8" or 2-3/4"
<b>Door Thickness</b>	1-3/8" - 1-3/4" standard. 1-7/8" - 2-1/4" optional.
<b>Cylinder</b>	SmartKey.
<b>Faceplates</b>	1" x 2-1/4". Specify round corner, square corner, or drive-in.
<b>Strikes</b>	1-1/4" x 3-5/8". Specify round corner or square corner. Other options available.
<b>Bolt</b>	1" throw. Steel.
<b>ANSI/BHMA</b>	Grade 2 Certified
<b>ADA</b>	Interior turn piece meets 4.13.9 ADA requirements.
<b>UL</b>	1/3 hour fire rating for 996 and 997



Vedani™  
with Square Rose Lever



Katara™  
with Round Rose Lever

## Lever Specifications:

<b>Door Prep</b>	Cross Bore 2-1/8". Edge Bore 1".
<b>Backset</b>	Adjustable 2-3/8" or 2-3/4".
<b>Door Thickness</b>	1-3/8" to 1-3/4" standard.
<b>Cylinder</b>	SmartKey
<b>Faceplates</b>	1" x 2-1/4". Specify round corner or square corner or drive-in latch.
<b>Strikes</b>	2-1/4" full lip. Specify round corner or square corner. Other options available.
<b>Bolt</b>	1/2" throw.
<b>Door Handing</b>	Reversible for right or left hand doors.
<b>ANSI/BHMA</b>	Grade 2 Certified
<b>ADA</b>	720 function satisfies section 4.13.9 ADA requirements.
<b>UL</b>	3 hour fire rating for 725, 735, 745 Optional 1/3 hour fire rating for all functions

## Available Finishes:



11P  
Venetian  
Bronze



15  
Satin  
Nickel



26  
Polished  
Chrome



26D  
Satin  
Chrome



# Kwikset

## KEY CONTROL™ DEADBOLT

FEATURING  SMARTKEY.  
RE-KEY TECHNOLOGY

### PROVIDING ONE-KEY CONTROL FOR MULTI-FAMILY APPLICATIONS

#### Key Control

- Top concealed cylinder provides one-key control for the property manager
- Lower exposed cylinder allows unique user keys for the tenant
- Re-key your user or control cylinder at any time in seconds
- Maintain key control throughout tenant and employee turnover

#### Increased Efficiency

- Re-key the lock without removing from the door
- Save time & money by re-keying yourself



*Perfect for multi-family dwellings, student housing, assisted living & rental properties.*

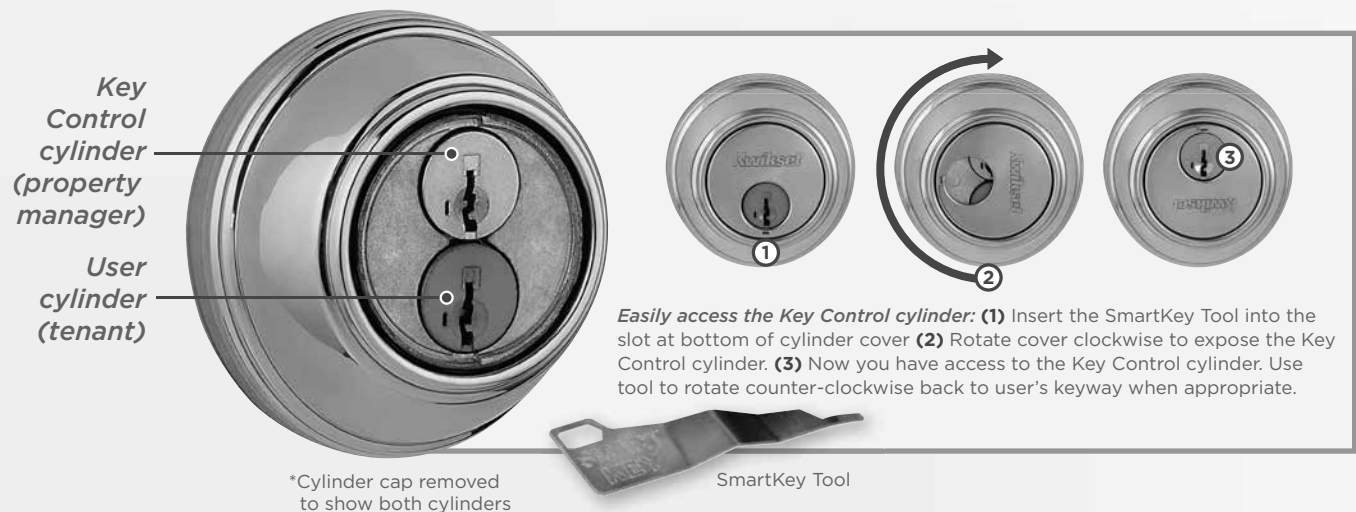

*Signature Series*

# THE SMART ALTERNATIVE TO MASTER KEYING

## BOTH CYLINDERS FEATURE SMARTKEY® RE-KEY TECHNOLOGY

- 1a Concealed Key Control cylinder has a unique patented keyway to provide increased security. Simply rotate the cylinder cap to expose the cylinder for use.
- 1b User cylinder utilizes the traditional Kwikset keyway and keys.
- 1c Gear assembly enables both cylinders to lock or retract the deadbolt latch.

## CERTIFIED GRADE 2 ANSI/BHMA SECURITY

### BUMPGUARD™-

- 2a Patented side locking bar technology offers improved security by protecting against lock bumping, an attack on conventional pin & tumbler locks.

### DRILL RESISTANCE-

- 2b Cylinder uses two steel balls inserted into the front of the key face to resist attacks from drilling.

### PICK RESISTANCE-

- 2c Superior SmartKey withstands the highest level of UL pick testing, the UL 437, Par. 11.6.

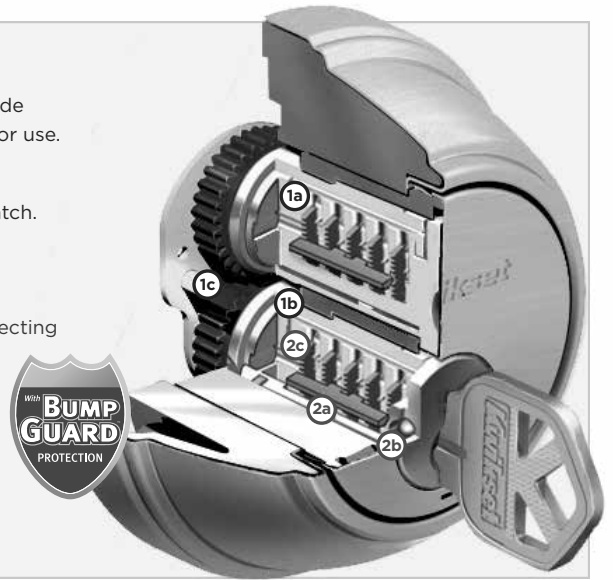

## SPECIFICATIONS:

<b>Standard Door Prep</b>	Cross Bore 2-1/8". Edge Bore 1" Latch Face 1" x 2-1/4"
<b>Door Thickness</b>	1-3/4"
<b>Cylinder</b>	2 SmartKey® cylinders: 1 standard Kwikset for users, 1 unique patented keyway for 1-Key Control
<b>Faceplate</b>	1" x 2-1/4"
<b>Strike</b>	1-1/4" x 3-5/8"
<b>Bolt</b>	1" throw
<b>ANSI/BHMA</b>	Grade 2 Certified
<b>ADA</b>	Interior turn piece meets 4.13.9 ADA
<b>UL</b>	Meets UL 3 hour fire rating for 817 UL Optional 1/3 hour UL fire rating for all functions

## FINISHES:



## FUNCTIONS:



**816 Key Control Deadbolt**  
**817 UL Key Control Deadbolt**  
Deadbolt operated by key outside and thumb turn inside.

## DIMENSIONS:

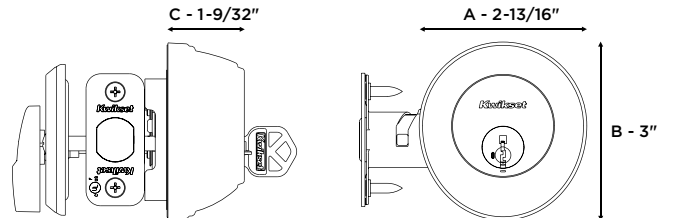

## EASILY RE-KEY IN 3 SIMPLE STEPS:

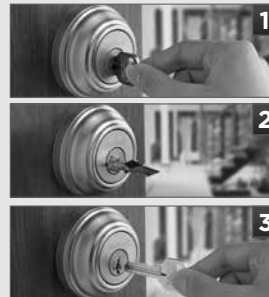

You must have your functioning key & your SmartKey tool for the system to work.

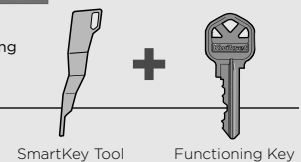

# Introducing BALBOA™

Featuring  **SMARTKEY**  
RE-KEY TECHNOLOGY



New Reversible Wave Style Lever  
Features SmartKey® Re-Key Technology  
with BumpGuard™ Protection  
ANSI/BHMA Grade 3 Certified Security & Quality  
Lifetime Mechanical Warranty

**Kwikset.**

# BALBOA™

## Specifications:

<b>Door Prep</b>	Cross Bore 2 1/8". Edge Bore 1".
<b>Backset</b>	Adjustable to 2 3/8" or 2 3/4"
<b>Door Thickness</b>	1 3/8" - 1 3/4" standard
<b>Cylinder</b>	SmartKey® or traditional 5-Pin Pin & Tumbler
<b>Faceplates</b>	1" x 2 1/4". Specify round corner, square corner or drive-in.
<b>Strikes</b>	2 1/4" full lip standard. Specify round corner, square corner. Other options available.
<b>Bolt</b>	1/2" throw.
<b>Door Handing</b>	Reversible for right or left-handed doors. Specify handing only on dummy and handleset interiors only.
<b>ANSI/BHMA</b>	Grade 3 Certified (all functions except 488).
<b>UL</b>	Optional 1/3 hour UL fire rating for all functions except 488

**SMARTKEY** featuring BumpGuard™:  
RE-KEY TECHNOLOGY

## EASILY RE-KEY IN THREE EASY STEPS



1  
Insert functioning key and turn 1/4 turn clockwise.

2  
Insert and remove the SmartKey learn tool. Remove functioning key.

3  
Insert new key and turn 1/2 turn counter-clockwise. Your lock is now re-keyed!

## Finishes:



Venetian Bronze (11P)

Satin Nickel (15)

Polished Brass (3)

Satin Chrome (26D)

Antique Brass (5)

## Functions:

	<b>200 Passage/Hall/Closet:</b> Both levers always free.
	<b>300 Privacy/Bed/Bath:</b> Both levers locked or unlocked by turnbutton inside. Outside lever unlocked by emergency key.
	<b>405 Keyed Entry:</b> Both levers locked or unlocked by key outside or turnbutton inside.
	<b>488 Half Dummy Trim, Surface Mounted:</b> For doors where only a pull is required. Must specify right or left hand.

Balboa also available as handleset interior style

## Dimensions:

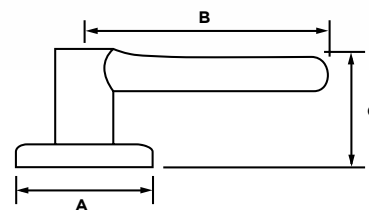

Design	A	B	C	C
Balboa™	2-5/8"	4-7/32"	1-15/16"	2-13/32" (keyed)

# Kwikset SMART CODE<sup>®</sup>

TOUCHPAD ELECTRONIC LEVER



SMALL OFFICE/HOME OFFICE



INTERIOR  
GARAGE  
DOOR/  
SIDE DOOR



UTILITY/  
STORAGE  
ROOM

*Signature Series*

## INCREASED SECURITY & KEYLESS CONVENIENCE

- ONE TOUCH LOCKING CONVENIENCE
- FOUR CUSTOMIZABLE ACCESS CODES FOR INCREASED SECURITY
- BACK-LIT KEYPAD FOR INCREASED VISIBILITY
- CUSTOMIZABLE AUTOMATIC DOOR LOCKING AFTER 30 SECONDS FOR INCREASED PEACE OF MIND
- INSTALLS IN MINUTES WITH JUST A SCREWDRIVER - NO HARD WIRING REQUIRED
- FITS STANDARD DOORS ( 1 3/8" - 1 3/4" ) WITH NO NEW SCREW HOLES REQUIRED

# SMARTCODE™ TOUCHPAD ELECTRONIC LEVER

## Specifications:

<b>Function</b>	Keyed Entry Lever
<b>Door Prep</b>	2 1/8" diameter face hole & 1" diameter latch hole
<b>Backset</b>	Adjustable 2 3/8" or 2 3/4"
<b>Door Thickness</b>	1 3/8" - 1 3/4" automatic adjustment
<b>Cylinder</b>	SmartKey® Re-key Technology
<b>Faceplates</b>	1" x 2 1/4" round corner standard
<b>Strikes</b>	Round corner strike 2 3/4" x 2 1/8"
<b>Latch</b>	Round corner adjustable 2 3/8" x 2 3/4"
<b>Bolt</b>	1/2" throw
<b>Door Handing</b>	Reversible
<b>Batteries</b>	4AA Required

## Dimensions:

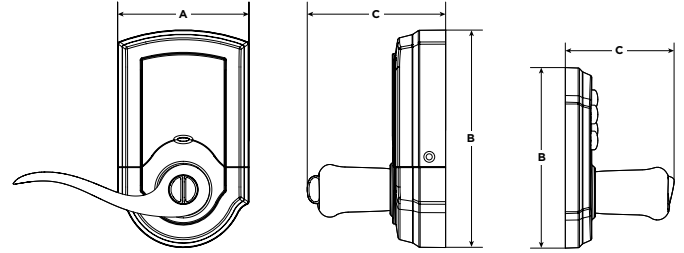

Design	A	B	C
SmartCode™ Lever Outer Trim	2-13/16"	4-7/16"	2-11/16"
SmartCode™ Lever Inner Trim	3-1/4"	5-3/8"	3-13/32"

## Finishes:

11P  
Venetian Bronze

LO3  
Polished Brass

15  
Satin Nickel



FEATURING

**SMARTKEY™**  
RE-KEY TECHNOLOGY

# Kwikset®

19701 DaVinci • Lake Forest, CA 92610  
www.kwikset.com • 1-800-327-LOCK



# Kwikset SMARTCODE<sup>®</sup>

TOUCHPAD ELECTRONIC DEADBOLT

## New Style SMARTCODE<sup>™</sup>



*Signature Series*

## NO MORE WORRYING ABOUT KEYS!

- **Keyless entry deadbolt** - the ultimate in convenience & security.
- **One touch locking** with a motorized deadbolt.
- **Two customizable access codes** - one code for the family, one code for temporary access.
- **Includes SmartKey<sup>®</sup>** re-key technology for increased peace of mind.

## EASY TO INSTALL, PROGRAM AND USE.

- **Installs in a minute** with just a screwdriver - no hard wiring required.
  - 4 AA batteries (not included)
- **Fits standard doors** (1 3/8" - 2") - no new screw holes required.
- **Quick Reference Guide** located under the interior cover.

FEATURING

 **SMARTKEY<sup>™</sup>**  
RE-KEY TECHNOLOGY

# SMARTCODE™ TOUCHPAD ELECTRONIC DEADBOLT

## Specifications:

<b>Function</b>	Single Cylinder Deadbolt
<b>Door Prep</b>	2-1/8" diameter face hole & 1" diameter
<b>Backset</b>	Adjustable 2-3/8" or 2-3/4"
<b>Door Thickness</b>	1 3/8" - 2" automatic adjustment
<b>Cylinder</b>	SmartKey® Re-key Technology
<b>Faceplates</b>	1" x 2-1/4" round corner standard
<b>Strikes</b>	Round corner strike 2-3/4" x 2-1/8"
<b>Latch</b>	Round corner adjustable 2-3/8" x 2-3/4"
<b>Bolt</b>	1" throw, steel deadbolt
<b>Door Handing</b>	Reversible
<b>Batteries</b>	4AA Required

## Dimensions:

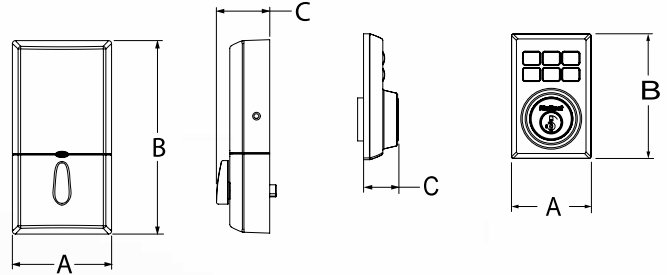

Design	A	B	C
SmartCode™ Outer Trim	2-23/32"	4-1/4"	1-3/16"
SmartCode™ Inner Trim	3-9/32"	6-13/32"	1-3/4"

## FEATURING



## Finishes:



26  
Polished  
Chrome



26D  
Satin  
Chrome

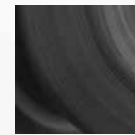

11P  
Venetian  
Bronze



15  
Satin  
Nickel



# Kwikset®

19701 DaVinci • Lake Forest, CA 92610  
www.kwikset.com • 1-800-327-LOCK

# INTRODUCING THE SMART SECURITY APP

The Kwikset Smart Security App was designed to educate users on Kwikset's broad array of products while facilitating the decision making process when purchasing door hardware.



Now available for iPhone, iPad and Android.



Visit [Kwikset.com/SmartSecurityTool](http://Kwikset.com/SmartSecurityTool) for more info.

**Kwikset**

THE BEST SECURITY IS SMART SECURITY.

# INTRODUCING THE SMART SECURITY APP

## ***House Pack Project Selector***

Determine the different types of door hardware needed for a particular project and select quantities of each type.

## ***Product Demonstrations***

Interact with Kwikset's innovative products. This tool includes product demonstrations of the Kwikset SmartKey® Re-key Technology, Key Control™ Deadbolt, SmartCode™ Keyless Entry and the SmartKey Reset Cradle, along with a video overview of our Home Connect technology.

## ***Image Gallery***

View Kwikset's core product portfolio. With this tool, users can view each product in every available finish.

## ***Re-key Savings Calculator***

Quickly and accurately assess the time and cost savings achieved in the re-keying process when using Kwikset SmartKey or Key Control Deadbolt instead of a traditional pin and tumbler lock.



***Kwikset***

# Kwikset

Signature Series



**NEW!**

## SUPERIOR SECURITY FEATURES

- ANSI/BHMA Grade 1 Certified 980/985 Deadbolt
- SmartKey® Re-Key Technology with BumpGuard™ Technology to Protect Against Lock Bumping\*

## ELEGANT STYLES AND FINISHES

- Unique Rustic Finishes
- Traditional to Contemporary Styles

## WARRANTY

- Lifetime Mechanical
- Lifetime Finish

\*Lock Bumping - an attack technique using specially cut keys that can defeat conventional pin & tumbler locks.

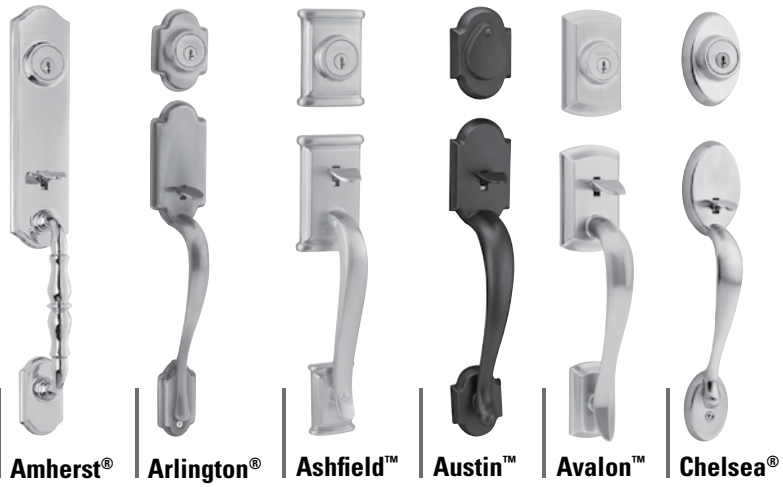

**Amherst® | Arlington® | Ashfield™ | Austin™ | Avalon™ | Chelsea®**



**Abbey® | Cameron® | Circa® | Copa®**



**Hancock® | Laurel® | Phoenix®**



**Ashfield™ | Austin | Avalon™**



**Brooklane® | Commonwealth® | Lido®**



**Katara® | Pembroke™ | Austin Deadbolt**



**Tustin® | Vedani®**



**Hawthorne™ | Montara™ | Shelburne™ | Tavaris® | Wellington®**

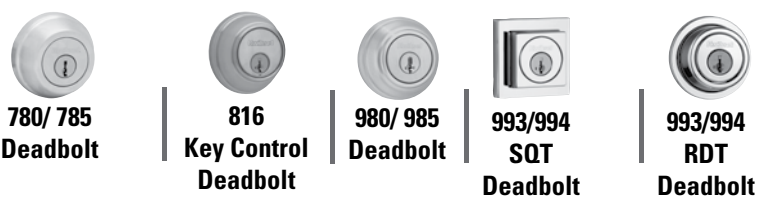

**780/785 Deadbolt | 816 Key Control Deadbolt | 980/985 Deadbolt | 993/994 SQT Deadbolt | 993/994 RDT Deadbolt**

# Kwikset<sup>®</sup>

## Signature Series

HANDLESETS

**Amherst<sup>®</sup>**



**Arlington<sup>®</sup>**



**Ashfield<sup>™</sup>**



**Austin<sup>™</sup>**  
NEW!



**Amherst<sup>®</sup>**

Model	Function	Finish										Case Qty		
		3	L03*	5	11P	15	15A	26	26D	501	502		514	
800AT	Single Cylinder				\$265.00	\$265.00								4
800AT SMT	Single Cylinder				\$265.00	\$265.00								4
801AT	Double Cylinder				\$271.00	\$271.00								4
801AT SMT	Double Cylinder				\$271.00	\$271.00								4
802AT	Dummy				\$233.00	\$233.00								4

**Arlington<sup>®</sup>**

Model	Function	3	L03	5	11P	15	15A	26	26D	501	502	514	Qty
800AN	Single Cylinder	\$167.00	\$187.50	\$187.50	\$187.50	\$187.50	\$187.50						6
800AN SMT	Single Cylinder	\$167.00	\$187.50	\$187.50	\$187.50	\$187.50	\$187.50						6
801AN	Double Cylinder	\$170.00	\$191.00	\$191.00	\$191.00	\$191.00	\$191.00						6
801AN SMT	Double Cylinder	\$170.00	\$191.00	\$191.00	\$191.00	\$191.00	\$191.00						6
802AN	Dummy	\$147.00	\$165.00	\$165.00	\$165.00	\$165.00	\$165.00						6
815AN	Handleset <sup>1</sup> with Hancock		\$205.00		\$205.00	\$205.00							6
815AN	Handleset <sup>1</sup> with Tustin		\$211.00		\$211.00	\$211.00							6

<sup>1</sup>Denotes handleset without deadbolt

**Ashfield<sup>™</sup>**

Model	Function	3	L03	5	11P	15	15A	26	26D	501	502	514	Qty
800ADH	Single Cylinder		\$241.50	\$241.50	\$241.50	\$241.50		\$241.50		\$251.50	\$251.50	\$251.50	4
800ADH SMT	Single Cylinder		\$241.50	\$241.50	\$241.50	\$241.50		\$241.50		\$251.50	\$251.50	\$251.50	4
801ADH	Double Cylinder		\$246.00	\$246.00	\$246.00	\$246.00		\$246.00		\$256.00	\$256.00	\$256.00	4
801ADH SMT	Double Cylinder		\$246.00	\$246.00	\$246.00	\$246.00		\$246.00		\$256.00	\$256.00	\$256.00	4
802ADH	Dummy		\$212.00	\$212.00	\$212.00	\$212.00		\$212.00		\$220.50	\$220.50	\$220.50	4

**Austin<sup>™</sup> NEW!**

Model	Function	3	L03	5	11P	15	15A	26	26D	501	502	514	Qty
800AUH SMT	Single Cylinder				\$246.00	\$246.00							4
801AUH SMT	Single Cylinder				\$246.00	\$246.00							4
802AUH SMT	Single Cylinder				\$246.00	\$246.00							4

NOTE: Handlesets ordered LIP only

# Kwikset

Signature Series

**Avalon™**



**Chelsea®**



**Hawthorne™**



**Montara™**

NEW!



**Avalon™**

Model	Function	Finish											Case Qty
		3	L03	5	11P	15	15A	26	26D	501	502	514	
800AVH	Single Cylinder		\$241.50	\$241.50	\$241.50	\$241.50		\$241.50		\$251.50	\$251.50	\$251.50	4
800AVH SMT	Single Cylinder		\$241.50	\$241.50	\$241.50	\$241.50		\$241.50		\$251.50	\$251.50	\$251.50	4
801AVH	Double Cylinder		\$246.00	\$246.00	\$246.00	\$246.00		\$246.00		\$256.00	\$256.00	\$256.00	4
801AVH SMT	Double Cylinder		\$246.00	\$246.00	\$246.00	\$246.00		\$246.00		\$256.00	\$256.00	\$256.00	4
802AVH	Dummy		\$212.00	\$212.00	\$212.00	\$212.00		\$212.00		\$220.50	\$220.50	\$220.50	4

**Chelsea®**

Model	Function	Finish											Qty
		3	L03	5	11P	15	15A	26	26D	501	502	514	
800CE	Single Cylinder	\$167.00	\$187.50	\$187.50	\$187.50	\$187.50	\$187.50	\$187.50	\$187.50				6
800CE SMT	Single Cylinder	\$167.00	\$187.50	\$187.50	\$187.50	\$187.50	\$187.50	\$187.50	\$187.50				6
801CE	Double Cylinder	\$170.00	\$191.00	\$191.00	\$191.00	\$191.00	\$191.00	\$191.00	\$191.00				6
801CE SMT	Double Cylinder	\$170.00	\$191.00	\$191.00	\$191.00	\$191.00	\$191.00	\$191.00	\$191.00				6
802CE	Dummy	\$147.00	\$165.00	\$165.00	\$165.00	\$165.00	\$165.00	\$165.00	\$165.00				6
815CE	Handleset <sup>1</sup> with Hancock		\$205.00		\$205.00	\$205.00							6
815CE	Handleset <sup>1</sup> with Tustin		\$211.00		\$211.00	\$211.00							6

<sup>1</sup>Denotes handleset without deadbolt

**Hawthorne™**

Model	Function	Finish											Qty
		3	L03	5	11P	15	15A	26	26D	501	502	514	
800HE	Single Cylinder				\$223.50	\$223.50	\$223.50					\$233.00	4
800HE SMT	Single Cylinder				\$223.50	\$223.50	\$223.50					\$233.00	4
801HE	Double Cylinder				\$228.00	\$228.00	\$228.00					\$237.00	4
801HE SMT	Double Cylinder				\$228.00	\$228.00	\$228.00					\$237.00	4
802HE	Dummy				\$196.50	\$196.50	\$196.50					\$204.00	4

**Montara™ NEW!**

Model	Function	Finish											Qty
		3	L03	5	11P	15	15A	26	26D	501	502	514	
553MNH SMT	Single Cylinder	\$243.50			\$264.50	\$264.50							4
554MNH SMT	Double Cylinder	\$249.50			\$270.50	\$270.50							4

NOTE: Handlesets ordered LIP only

# Kwikset

Signature Series

**Shelburne™**



**Tavaris®**



**Wellington®**



**Shelburne™**

Model	Function	Finish										Case Qty	
		3	L03	5	11P	15	15A	26	26D	501	502		514
800SE	Single Cylinder		\$223.50		\$223.50	\$223.50							4
800SE SMT	Single Cylinder		\$223.50		\$223.50	\$223.50							4
801SE	Double Cylinder		\$228.00		\$228.00	\$228.00							4
801SE SMT	Double Cylinder		\$228.00		\$228.00	\$228.00							4
802SE	Dummy		\$196.50		\$196.50	\$196.50							4

**Tavaris®**

Model	Function	Finish										Case Qty	
		3	L03	5	11P	15	15A	26	26D	501	502		514
800TVH SMT	Single Cylinder				\$241.50	\$241.50		\$241.50	\$241.50				4
801TVH SMT	Double Cylinder				\$246.00	\$246.00		\$246.00	\$246.00				4
802TVH	Dummy				\$212.00	\$212.00		\$212.00	\$212.00				4
815TVH SMT	Handleset with Katara Lever				\$260.50	\$260.50		\$260.50	\$260.50				4
815TVH SMT	Handleset with Vedani Lever				\$260.50	\$260.50		\$260.50	\$260.50				4

**Wellington®**

Model	Function	Finish										Case Qty	
		3	L03	5	11P	15	15A	26	26D	501	502		514
800WN	Single Cylinder				\$265.00	\$265.00							4
800WN SMT	Single Cylinder				\$265.00	\$265.00							4
801WN	Double Cylinder				\$271.00	\$271.00							4
801WN SMT	Double Cylinder				\$271.00	\$271.00							4
802WN	Dummy				\$233.00	\$233.00							4



## INTERIOR PACKS FOR TRADITIONAL 800/801/802 HANDLESETS

Model	Function	Series				Case Qty
		Signature Lever & Laurel	Signature Knob	Kwikset Lever	Kwikset Knob	
966	Single Cylinder	\$59.50	\$49.50	\$54.00	\$43.00	12
967	Double Cylinder	\$81.00	\$71.50	\$69.00	\$61.50	12
967 SMT	Double Cylinder	\$81.00	\$71.50	\$69.00	\$61.50	12
968	Dummy	\$48.50	\$39.00	\$45.50	\$32.50	12

Handleset Interior Pack Finish Options		3	L03	5	11P	15	15A	26	26D	501	502	514	Qty
<b>Kwikset</b> <i>Signature Series</i>	Abbey Knob	•		•				•	•				12
	Ashfield Lever	•		•	•	•		•		•	•	•	12
	Avalon Lever	•		•	•	•		•		•	•	•	12
	Brooklane Lever			•	•	•	•						12
	Cameron Knob	•			•	•							12
	Circa Knob	•		•	•	•	•	•	•				12
	Commonwealth Lever	•		•	•	•	•	•	•	•	•	•	12
	Copa Knob	•		•		•	•	•	•				12
	Hancock Knob	•		•	•	•	•	•	•	•	•	•	12
	Laurel Knob				•	•	•	•				•	12
	Lido Lever	•		•	•	•	•		•				12
	Pembroke Lever	•		•	•	•	•	•		•	•	•	12
	Phoenix Lever	•		•	•	•			•				12
	Tustin Lever	•		•	•	•	•	•	•				12
<b>Kwikset</b>	Cove Knob	•		•	•			•					12
	Balboa Lever	•		•	•			•					12
	Delta Lever	•		•			•	•	•				12
	Dorian Lever	•		•	•		•	•	•				12
	Polo Knob	•		•	•	•	•	•	•				12
Tylo Knob	•		•				•	•				12	

## CONTEMPORARY INTERIOR PACKS

Model	Function	Series				Case Qty
		Signature Lever	Signature Knob	Kwikset Lever	Kwikset Knob	
974	Single Cylinder	\$59.50				12
976 SMT	Double Cylinder	\$81.00				12
977	Dummy	\$48.50				12

Handleset Interior Pack Finish Options		3	L03	5	11P	15	15A	26	26D	501	502	514	Qty
<b>Kwikset</b> <i>Signature Series</i>	Katara Lever				•	•		•	•				12
	Vedani Lever				•	•		•	•				12

**NOTE:** 966, 968, 974 and 977 are not impacted by SmartKey cylinder.

## AUSTIN INTERIOR PACKS

Handleset Interior Pack Finish Options		3	L03	5	11P	15	15A	26	26D	501	502	514	Qty
<b>Kwikset</b> <i>Signature Series</i>	966AUL - Single Cylinder				•	•							12
	967AUL - Double Cylinder				•	•							12
	968AUL - Dummy				•	•							12

## MONTARA INTERIOR PACKS

Model	Function	Series				Case
		Signature Lever & Laurel	Signature Knob	Kwikset Lever	Kwikset Knob	Qty
978	Single Cylinder	\$62.50	\$51.50	\$62.50	\$45.00	12
979	Double Cylinder	\$85.50	\$75.50	\$85.50	\$65.50	12

Montara Handleset Interior Pack Finish Options		3	L03	5	11P	15	15A	26	26D	501	502	514	Qty
<b>Kwikset</b> <i>Signature Series</i>	Cameron Knob	•		•	•	•	•	•					12
	Circa Knob	•		•	•	•	•	•					12
	Juno Knob	•		•	•	•	•	•					12
	Lido Lever	•		•		•	•	•					12
	Tustin Lever	•		•	•	•	•	•					12
	Cove Knob	•		•	•				•				12
<b>Kwikset</b>	Polo Knob	•		•		•	•	•					12
	Tylo Knob	•		•				•	•				12

**NOTE:** 983, 986 and 988 are not impacted by SmartKey cylinder.

## DESIGNER ROSES



Model	Function	Finish											Case Qty	
		3	L03	5	11P	15	15A	26	26D	501	502	514		
83319 ART	Arch Rose Cover for Reversible Levers				\$20.00	\$20.00							\$21.50	12 Sets
83318 OVT	Oval Rose Cover for Reversible Levers				\$20.00	\$20.00							\$21.50	12 Sets

**NOTES:**

- Can be ordered as an accessory or configured with a Signature Series lever, except Austin.

## Ashfield™



Model	Function	Finish											Qty
		3	L03	5	11P	15	15A	26	26D	501	502	514	
720ADL	Hall/Closet				\$58.00	\$58.00		\$58.00		\$60.50	\$60.50	\$60.50	12
725ADL	Hall/Closet UL				\$63.50	\$63.50		\$63.50		\$66.00	\$66.00	\$66.00	12
730ADL	Bed/Bath				\$62.00	\$62.00		\$62.00		\$65.00	\$65.00	\$65.00	12
735ADL	Bed/Bath UL				\$67.50	\$67.50		\$67.50		\$70.50	\$70.50	\$70.50	12
740ADL	Entry				\$106.00	\$106.00		\$106.00		\$110.00	\$110.00	\$110.00	12
740ADL SMT	Entry				\$106.00	\$106.00		\$106.00		\$110.00	\$110.00	\$110.00	12
745ADL	Entry UL				\$111.50	\$111.50		\$111.50		\$115.50	\$115.50	\$115.50	12
745ADL SMT	Entry UL				\$111.50	\$111.50		\$111.50		\$115.50	\$115.50	\$115.50	12
788ADL	Half Dummy				\$26.50	\$26.50		\$26.50		\$27.50	\$27.50	\$27.50	20

## Austin



Model	Function	Finish											Qty
		3	L03	5	11P	15	15A	26	26D	501	502	514	
720AUL	Passage				\$58.00	\$58.00							12
730AUL	Privacy				\$62.00	\$62.00							12
740AUL SMT	Entry				\$106.00	\$106.00							12
788AUL	Dummy				\$26.50	\$26.50							12

## Avalon™



Model	Function	Finish											Qty
		3	L03	5	11P	15	15A	26	26D	501	502	514	
720AVL	Hall/Closet				\$58.00	\$58.00		\$58.00		\$60.50	\$60.50	\$60.50	12
725AVL	Hall/Closet UL				\$63.50	\$63.50		\$63.50		\$66.00	\$66.00	\$66.00	12
730AVL	Bed/Bath				\$62.00	\$62.00		\$62.00		\$65.00	\$65.00	\$65.00	12
735AVL	Bed/Bath UL				\$67.50	\$67.50		\$67.50		\$70.50	\$70.50	\$70.50	12
740AVL	Entry				\$106.00	\$106.00		\$106.00		\$110.00	\$110.00	\$110.00	12
740AVL SMT	Entry				\$106.00	\$106.00		\$106.00		\$110.00	\$110.00	\$110.00	12
745AVL	Entry UL				\$111.50	\$111.50		\$111.50		\$115.50	\$115.50	\$115.50	12
745AVL SMT	Entry UL				\$111.50	\$111.50		\$111.50		\$115.50	\$115.50	\$115.50	12
788AVL	Half Dummy				\$26.50	\$26.50		\$26.50		\$27.50	\$27.50	\$27.50	20

## Brooklane®



Model	Function	Finish											Qty
		3	L03	5	11P	15	15A	26	26D	501	502	514	
720BRL	Hall/Closet				\$58.00	\$58.00	\$58.00						12
725BRL	Hall/Closet UL				\$63.50	\$63.50	\$63.50						12
730BRL	Bed/Bath				\$62.00	\$62.00	\$62.00						12
735BRL	Bed/Bath UL				\$67.50	\$67.50	\$67.50						12
740BRL SMT	Entry				\$106.00	\$106.00	\$106.00						12
745BRL SMT	Entry UL				\$111.50	\$111.50	\$111.50						12
788BRL	Half Dummy				\$26.50	\$26.50	\$26.50						20

# Kwikset

## Signature Series

### Commonwealth®



		3	L03	5	11P	15	15A	26	26D	501	502	514	Qty
720CHL	Hall/Closet	\$46.00	\$54.00	\$54.00	\$54.00	\$54.00	\$54.00	\$54.00	\$54.00	\$56.50	\$56.50	\$56.50	12
725CHL	Hall/Closet UL	\$51.50	\$59.50	\$59.50	\$59.50	\$59.50	\$59.50	\$59.50	\$59.50	\$62.00	\$62.00	\$62.00	12
730CHL	Bed/Bath	\$48.50		\$57.00	\$57.00	\$57.00	\$57.00	\$57.00	\$57.00	\$60.00	\$60.00	\$60.00	12
735CHL	Bed/Bath UL	\$54.00		\$62.50	\$62.50	\$62.50	\$62.50	\$62.50	\$62.50	\$65.50	\$65.50	\$65.50	12
740CHL	Entry	\$85.00	\$100.00	\$100.00	\$100.00	\$100.00	\$100.00	\$100.00	\$100.00	\$103.50	\$103.50	\$103.50	12
740CHL SMT	Entry	\$85.00	\$100.00	\$100.00	\$100.00	\$100.00	\$100.00	\$100.00	\$100.00	\$103.50	\$103.50	\$103.50	12
745CHL	Entry UL	\$90.50	\$105.50	\$105.50	\$105.50	\$105.50	\$105.50	\$105.50	\$105.50	\$109.00	\$109.00	\$109.00	12
745CHL SMT	Entry UL	\$90.50	\$105.50	\$105.50	\$105.50	\$105.50	\$105.50	\$105.50	\$105.50	\$109.00	\$109.00	\$109.00	12
788CHL	Half Dummy	\$21.00		\$24.50	\$24.50	\$24.50	\$24.50	\$24.50	\$24.50	\$26.50	\$26.50	\$26.50	20

### Katara®



Model	Function	Finish											Case
		3	L03	5	11P	15	15A	26	26D	501	502	514	Qty
720KTL	Hall/Closet				\$54.00	\$54.00		\$54.00	\$54.00				12
730KTL	Bed/Bath				\$57.00	\$57.00		\$57.00	\$57.00				12
740KTL SMT	Keyed Entry				\$100.00	\$100.00		\$100.00	\$100.00				12
788KTL	Half Dummy				\$24.50	\$24.50		\$24.50	\$24.50				20

### Lido®



		3	L03	5	11P	15	15A	26	26D	501	502	514	Qty
720LL	Hall/Closet	\$37.50		\$42.00	\$42.00	\$42.00	\$42.00		\$42.00				20
730LL	Bed/Bath	\$40.00		\$44.00	\$44.00	\$44.00	\$44.00		\$44.00				20
740LL	Keyed Lever	\$61.00		\$67.00	\$67.00	\$67.00	\$67.00		\$67.00				20
740LL SMT	Keyed Lever	\$61.00		\$67.00	\$67.00	\$67.00	\$67.00		\$67.00				20
741LL	Free Interior, Keyed Lever	\$64.50		\$70.50	\$70.50	\$70.50	\$70.50		\$70.50				20
741LL SMT	Free Interior, Keyed Lever	\$64.50		\$70.50	\$70.50	\$70.50	\$70.50		\$70.50				20
745LL	Keyed Lever UL	\$66.50		\$72.50	\$72.50	\$72.50	\$72.50		\$72.50				20
745LL SMT	Keyed Lever UL	\$66.50		\$72.50	\$72.50	\$72.50	\$72.50		\$72.50				20
755LL	Vestibule Keyed Lever UL	\$70.00		\$76.00	\$76.00	\$76.00	\$76.00		\$76.00				20
755LL SMT	Vestibule Keyed Lever UL	\$70.00		\$76.00	\$76.00	\$76.00	\$76.00		\$76.00				20
746LL	Free Interior, Keyed Lever UL	\$70.00		\$76.00	\$76.00	\$76.00	\$76.00		\$76.00				20
746LL SMT	Free Interior, Keyed Lever UL	\$70.00		\$76.00	\$76.00	\$76.00	\$76.00		\$76.00				20
725LL	Hall/Closet UL	\$43.00		\$47.50	\$47.50	\$47.50	\$47.50		\$47.50				20
735LL	Bed/Bath UL	\$45.50		\$49.50	\$49.50	\$49.50	\$49.50		\$49.50				20
750LL	Vestibule Keyed Lever	\$64.50		\$70.50	\$70.50	\$70.50	\$70.50		\$70.50				20
750LL SMT	Vestibule Keyed Lever	\$64.50		\$70.50	\$70.50	\$70.50	\$70.50		\$70.50				20
788LL	Half Dummy	\$17.00		\$19.00	\$19.00	\$19.00	\$19.00		\$19.00				20

### Pembroke™



		3	L03	5	11P	15	15A	26	26D	501	502	514	Qty
720PML	Hall/Closet	\$49.00	\$58.00	\$58.00	\$58.00	\$58.00	\$58.00	\$58.00		\$60.50	\$60.50	\$60.50	12
725PML	Hall/Closet UL	\$54.50	\$63.50	\$63.50	\$63.50	\$63.50	\$63.50	\$63.50		\$66.00	\$66.00	\$66.00	12
730PML	Bed/Bath	\$52.50		\$62.00	\$62.00	\$62.00	\$62.00	\$62.00		\$65.00	\$65.00	\$65.00	12
735PML	Bed/Bath UL	\$58.00		\$67.50	\$67.50	\$67.50	\$67.50	\$67.50		\$70.50	\$70.50	\$70.50	12
740PML SMT	Keyed Entry	\$90.00	\$106.00	\$106.00	\$106.00	\$106.00	\$106.00	\$106.00		\$110.00	\$110.00	\$110.00	12
745PML SMT	Keyed Entry UL	\$95.50	\$111.50	\$111.50	\$111.50	\$111.50	\$111.50	\$111.50		\$115.50	\$115.50	\$115.50	12
788PML	Half Dummy	\$22.50		\$26.50	\$26.50	\$26.50	\$26.50	\$26.50		\$27.50	\$27.50	\$27.50	20

# Kwikset

## Signature Series

### Tustin™



Model	Function	Finish										Case	
		3	L03	5	11P	15	15A	26	26D	501	502		514
720TNL	Hall/Closet	\$37.50		\$42.00	\$42.00	\$42.00	\$42.00	\$42.00	\$42.00				20
730TNL	Bed/Bath	\$40.00		\$44.00	\$44.00	\$44.00	\$44.00	\$44.00	\$44.00				20
740TNL	Keyed Lever	\$61.00	\$67.00	\$67.00	\$67.00	\$67.00	\$67.00	\$67.00	\$67.00				20
740TNL SMT	Keyed Lever	\$61.00	\$67.00	\$67.00	\$67.00	\$67.00	\$67.00	\$67.00	\$67.00				20
741TNL	Free Interior, Keyed Lever	\$64.50		\$70.50	\$70.50	\$70.50	\$70.50	\$70.50	\$70.50				20
741TNL SMT	Free Interior, Keyed Lever	\$64.50		\$70.50	\$70.50	\$70.50	\$70.50	\$70.50	\$70.50				20
745TNL	Keyed Lever UL	\$66.50		\$72.50	\$72.50	\$72.50	\$72.50	\$72.50	\$72.50				20
745TNL SMT	Keyed Lever UL	\$66.50		\$72.50	\$72.50	\$72.50	\$72.50	\$72.50	\$72.50				20
755TNL	Vestibule Keyed Lever UL	\$70.00		\$76.00	\$76.00	\$76.00	\$76.00	\$76.00	\$76.00				20
755TNL SMT	Vestibule Keyed Lever UL	\$70.00		\$76.00	\$76.00	\$76.00	\$76.00	\$76.00	\$76.00				20
746TNL	Free Interior, Keyed Lever UL	\$70.00		\$76.00	\$76.00	\$76.00	\$76.00	\$76.00	\$76.00				20
746TNL SMT	Free Interior, Keyed Lever UL	\$70.00		\$76.00	\$76.00	\$76.00	\$76.00	\$76.00	\$76.00				20
725TNL	Hall/Closet UL	\$43.00		\$47.50	\$47.50	\$47.50	\$47.50	\$47.50	\$47.50				20
735TNL	Bed/Bath UL	\$45.00		\$49.50	\$49.50	\$49.50	\$49.50	\$49.50	\$49.50				20
750TNL	Vestibule Keyed Lever	\$64.50		\$70.50	\$70.50	\$70.50	\$70.50	\$70.50	\$70.50				20
750TNL SMT	Vestibule Keyed Lever	\$64.50		\$70.50	\$70.50	\$70.50	\$70.50	\$70.50	\$70.50				20
490TNL	Full Dummy, Keyed Profile Lever	\$35.00		\$40.00	\$40.00	\$40.00	\$40.00	\$40.00	\$40.00				20
788TNL	Half Dummy	\$17.00		\$19.00	\$19.00	\$19.00	\$19.00	\$19.00	\$19.00				20

### Vedani®



Model	Function	Finish										Qty	
		3	L03	5	11P	15	15A	26	26D	501	502		514
720VDL	Hall/Closet				\$54.00	\$54.00		\$54.00	\$54.00				20
730VDL	Bed/Bath				\$57.00	\$57.00		\$57.00	\$57.00				20
740VDL SMT	Keyed Entry				\$100.00	\$100.00		\$100.00	\$100.00				20
745VDL SMT	Keyed Lever UL				\$105.00	\$105.00		\$105.00	\$105.00				20
788VDL	Half Dummy				\$24.50	\$24.50		\$24.50	\$24.50				20

# Kwikset

Signature Series

## Abbey®



Model	Function	Finish											Case
		3	L03	5	11P	15	15A	26	26D	501	502	514	
720A	Hall/Closet	\$25.00		\$29.00					\$29.00				12
725A	Hall/Closet UL	\$30.50		\$34.50					\$34.50				12
730A	Bed/Bath	\$27.50		\$31.00					\$31.00				12
735A	Bed/Bath UL	\$33.00		\$36.50					\$36.50				12
740A	Entry	\$49.50		\$55.50					\$55.50				12
740A SMT	Entry	\$49.50		\$55.50					\$55.50				12
741A	Entry (Free Interior)	\$53.00		\$59.00					\$59.00				12
741A SMT	Entry (Free Interior)	\$53.00		\$59.00					\$59.00				12
744A	Classroom	\$53.00		\$59.00					\$59.00				12
744A SMT	Classroom	\$53.00		\$59.00					\$59.00				12
745A	Entry UL	\$55.00		\$61.00					\$61.00				12
745A SMT	Entry UL	\$55.00		\$61.00					\$61.00				12
746A	Entry, Free Interior UL	\$58.50		\$64.50					\$64.50				12
746A SMT	Entry, Free Interior UL	\$58.50		\$64.50					\$64.50				12
749A	Classroom UL	\$58.50		\$64.50					\$64.50				12
749A SMT	Classroom UL	\$58.50		\$64.50					\$64.50				12
750A	Vestibule	\$53.00		\$59.00					\$59.00				12
750A SMT	Vestibule	\$53.00		\$59.00					\$59.00				12
755A	Vestibule UL	\$58.50		\$64.50					\$64.50				12
755A SMT	Vestibule UL	\$58.50		\$64.50					\$64.50				12
788A	Half Dummy	\$11.50		\$13.00					\$13.00				20

## Cameron®



Model	Function	Finish											Qty
		3	L03	5	11P	15	15A	26	26D	501	502	514	
720CN	Hall/Closet	\$22.50			\$27.00	\$27.00							30
730CN	Bed/Bath	\$24.50			\$28.50	\$28.50							30
740CN	Entry	\$46.50			\$48.50	\$48.50							30
740CN SMT	Entry	\$46.50			\$48.50	\$48.50							30
741CN	Entry (Free Interior)	\$50.00			\$52.00	\$52.00							30
741CN SMT	Entry (Free Interior)	\$50.00			\$52.00	\$52.00							30
750CN	Vestibule	\$50.00			\$52.00	\$52.00							30
750CN SMT	Vestibule	\$50.00			\$52.00	\$52.00							30
788CN	Half Dummy	\$11.50			\$12.50	\$12.50							20

## Circa®



Model	Function	Finish											Qty
		3	L03	5	11P	15	15A	26	26D	501	502	514	
720CA	Hall/Closet	\$32.00			\$38.50	\$38.50	\$38.50	\$38.50	\$38.50				12
725CA	Hall/Closet UL	\$37.50			\$44.00	\$44.00	\$44.00	\$44.00	\$44.00				12
730CA	Bed/Bath	\$36.00			\$42.00	\$42.00	\$42.00	\$42.00	\$42.00				12
735CA	Bed/Bath UL	\$41.50			\$47.50	\$47.50	\$47.50	\$47.50	\$47.50				12
740CA SMT	Entry	\$60.50			\$69.00	\$69.00	\$69.00	\$69.00	\$69.00				12
741CA SMT	Entry (Free Interior)	\$64.00			\$72.50				\$72.50				12
744CA SMT	Classroom	\$64.00			\$72.50				\$72.50				12
745CA SMT	Entry UL	\$66.00			\$74.50	\$74.50	\$74.50	\$74.50	\$74.50				12
746CA SMT	Entry (Free Interior UL)	\$69.50			\$78.00				\$78.00				12
749CA SMT	Classroom UL	\$66.00			\$78.00				\$78.00				12
750CA SMT	Vestibule	\$64.00			\$72.50				\$72.50				12
755CA SMT	Vestibule UL	\$69.50			\$78.00				\$78.00				12
788CA	Half Dummy	\$14.50			\$17.00	\$17.00	\$17.00	\$17.00	\$17.00				20

# Kwikset

## Signature Series

### Copa®



Model	Function	Finish										Case Qty	
		3	L03	5	11P	15	15A	26	26D	501	502		514
720C	Hall/Closet	\$22.50		\$27.00		\$27.00	\$27.00	\$27.00	\$27.00				30
730C	Bed/Bath	\$24.50		\$28.50		\$28.50	\$28.50	\$28.50	\$28.50				30
740C SMT	Entry	\$46.50		\$48.50		\$48.50	\$48.50	\$48.50	\$48.50				30
741C SMT	Entry (Free Interior)	\$50.00		\$52.00		\$52.00	\$52.00	\$52.00	\$52.00				30
788C	Half Dummy	\$10.50		\$12.50		\$12.50	\$12.50	\$12.50	\$12.50				20

### Hancock®



Model	Function	Finish										Case Qty	
		3	L03	5	11P	15	15A	26	26D	501	502		514
720H	Hall/Closet	\$25.00	\$30.00	\$30.00	\$30.00	\$30.00	\$30.00	\$30.00	\$30.00	\$31.00	\$31.00	\$31.00	12
725H	Hall/Closet UL	\$30.50	\$35.50	\$35.50	\$35.50	\$35.50	\$35.50	\$35.50	\$35.50	\$36.50	\$36.50	\$36.50	12
730H	Bed/Bath	\$26.50		\$32.00	\$32.00	\$32.00	\$32.00	\$32.00	\$32.00	\$34.50	\$34.50	\$34.50	12
735H	Bed/Bath UL	\$32.00		\$37.50	\$37.50	\$37.50	\$37.50	\$37.50	\$37.50	\$40.00	\$40.00	\$40.00	12
740H	Entry	\$48.00	\$54.50	\$54.50	\$54.50	\$54.50	\$54.50	\$54.50	\$54.50	\$56.50	\$56.50	\$56.50	12
740H SMT	Entry	\$48.00	\$54.50	\$54.50	\$54.50	\$54.50	\$54.50	\$54.50	\$54.50	\$56.50	\$56.50	\$56.50	12
741H	Entry, Free Interior	\$51.50	\$58.00	\$58.00	\$58.00	\$58.00	\$58.00	\$58.00	\$58.00	\$60.00	\$60.00	\$60.00	12
741H SMT	Entry, Free Interior	\$51.50	\$58.00	\$58.00	\$58.00	\$58.00	\$58.00	\$58.00	\$58.00	\$60.00	\$60.00	\$60.00	12
744H	Classroom	\$51.50	\$58.00	\$58.00	\$58.00	\$58.00	\$58.00	\$58.00	\$58.00	\$60.00	\$60.00	\$60.00	12
744H SMT	Classroom	\$51.50	\$58.00	\$58.00	\$58.00	\$58.00	\$58.00	\$58.00	\$58.00	\$60.00	\$60.00	\$60.00	12
745H	Entry UL	\$53.50	\$60.00	\$60.00	\$60.00	\$60.00	\$60.00	\$60.00	\$60.00	\$62.00	\$62.00	\$62.00	12
745H SMT	Entry UL	\$53.50	\$60.00	\$60.00	\$60.00	\$60.00	\$60.00	\$60.00	\$60.00	\$62.00	\$62.00	\$62.00	12
746H	Entry, Free Interior UL	\$57.00	\$63.50	\$63.50	\$63.50	\$63.50	\$63.50	\$63.50	\$63.50				12
746H SMT	Entry, Free Interior UL	\$57.00	\$63.50	\$63.50	\$63.50	\$63.50	\$63.50	\$63.50	\$63.50				12
749H	Classroom UL	\$57.00	\$63.50	\$63.50	\$63.50	\$63.50	\$63.50	\$63.50	\$63.50				12
749H SMT	Classroom UL	\$57.00	\$63.50	\$63.50	\$63.50	\$63.50	\$63.50	\$63.50	\$63.50				12
750H	Vestibule	\$51.50	\$58.00	\$58.00	\$58.00	\$58.00	\$58.00	\$58.00	\$58.00	\$60.00	\$60.00	\$60.00	12
750H SMT	Vestibule	\$51.50	\$58.00	\$58.00	\$58.00	\$58.00	\$58.00	\$58.00	\$58.00	\$60.00	\$60.00	\$60.00	12
755H	Vestibule UL	\$57.00	\$63.50	\$63.50	\$63.50	\$63.50	\$63.50	\$63.50	\$63.50	\$65.50	\$65.50	\$65.50	12
755H SMT	Vestibule UL	\$57.00	\$63.50	\$63.50	\$63.50	\$63.50	\$63.50	\$63.50	\$63.50	\$65.50	\$65.50	\$65.50	12
788H	Half Dummy	\$11.50	\$13.50	\$13.50	\$13.50	\$13.50	\$13.50	\$13.50	\$13.50	\$14.00	\$14.00	\$14.00	20

### Laurel®



Model	Function	Finish										Case Qty	
		3	L03	5	11P	15	15A	26	26D	501	502		514
720L	Hall/Closet				\$50.50	\$50.50	\$50.50	\$50.50				\$52.50	12
730L	Bed/Bath				\$53.50	\$53.50	\$53.50	\$53.50				\$56.00	12
740L SMT	Entry				\$88.00	\$88.00	\$88.00	\$88.00				\$91.50	12
788L	Half Dummy				\$23.00	\$23.00	\$23.00	\$23.00				\$24.00	20

### Phoenix®



Model	Function	Finish										Case Qty	
		3	L03	5	11P	15	15A	26	26D	501	502		514
720PE	Hall/Closet	\$27.00		\$30.00	\$37.00	\$30.00							30
730PE	Bed/Bath	\$31.50		\$34.00	\$41.00	\$34.00							30
740PE SMT	Entry	\$55.00		\$55.00	\$61.50	\$55.00							30
788PE	Half Dummy	\$11.00		\$12.50	\$19.50	\$12.50							20

## Austin Deadbolt NEW!



		3	L03	5	11P	15	15A	26	26D	501	502	514	Qty
980AUD SMT	Single Cylinder				\$65.00	\$65.00							12
985AUD SMT	Double Cylinder				\$92.50	\$92.50							12

## 980/985



Model	Function	Finish										Case	
		3	L03	5	11P	15	15A	26	26D	501	502		514
980	Single Cylinder		\$62.50		\$62.50	\$62.50				\$65.00	\$65.00	\$65.00	12
980 SMT	Single Cylinder		\$62.50		\$62.50	\$62.50				\$65.00	\$65.00	\$65.00	12
982	Single Cylinder UL		\$68.00		\$68.00	\$68.00				\$70.50	\$70.50	\$70.50	12
982 SMT	Single Cylinder UL		\$68.00		\$68.00	\$68.00				\$70.50	\$70.50	\$70.50	12
984	Double Cylinder UL		\$94.50		\$94.50	\$94.50				\$98.00	\$98.00	\$98.00	12
984 SMT	Double Cylinder UL		\$94.50		\$94.50	\$94.50				\$98.00	\$98.00	\$98.00	12
985	Double Cylinder		\$89.00		\$89.00	\$89.00				\$92.50	\$92.50	\$92.50	12
985 SMT	Double Cylinder		\$89.00		\$89.00	\$89.00				\$92.50	\$92.50	\$92.50	12

## Contemporary Square Deadbolt



		3	L03	5	11P	15	15A	26	26D	501	502	514	Qty
993 SQT SMT	Single Cylinder				\$62.50	\$62.50		\$62.50	\$62.50				12
994 SQT SMT	Double Cylinder				\$89.00	\$89.00		\$89.00	\$89.00				12
996 SQT SMT	Single Cylinder UL				\$68.00	\$68.00		\$68.00	\$68.00				12
997 SQT SMT	Double Cylinder UL				\$94.50	\$94.50		\$94.50	\$94.50				12

## Contemporary Round Deadbolt



		3	L03	5	11P	15	15A	26	26D	501	502	514	Qty
993 RDT SMT	Single Cylinder				\$62.50	\$62.50		\$62.50	\$62.50				12
994 RDT SMT	Double Cylinder				\$89.00	\$89.00		\$89.00	\$89.00				12
996 RDT SMT	Single Cylinder				\$68.00	\$68.00		\$68.00	\$68.00				12
997 RDT SMT	Double Cylinder				\$94.50	\$94.50		\$94.50	\$94.50				12

## 780/785



		3	L03	5	11P	15	15A	26	26D	501	502	514	Qty
780	Single Cylinder	\$46.50	\$55.00	\$55.00	\$55.00	\$55.00	\$55.00	\$55.00	\$55.00				12
780 SMT	Single Cylinder	\$46.50	\$55.00	\$55.00	\$55.00	\$55.00	\$55.00	\$55.00	\$55.00				12
782	Single Cylinder UL	\$52.00	\$60.50	\$60.50	\$60.50	\$60.50	\$60.50	\$60.50	\$60.50				12
782 SMT	Single Cylinder UL	\$52.00	\$60.50	\$60.50	\$60.50	\$60.50	\$60.50	\$60.50	\$60.50				12
784	Double Cylinder UL	\$76.50	\$81.50	\$81.50	\$81.50	\$81.50	\$81.50	\$81.50	\$81.50				12
784 SMT	Double Cylinder UL	\$76.50	\$81.50	\$81.50	\$81.50	\$81.50	\$81.50	\$81.50	\$81.50				12
785	Double Cylinder	\$71.00	\$76.00	\$76.00	\$76.00	\$76.00	\$76.00	\$76.00	\$76.00				12
785 SMT	Double Cylinder	\$71.00	\$76.00	\$76.00	\$76.00	\$76.00	\$76.00	\$76.00	\$76.00				12

## Gatelatch



		3	L03	5	11P	15	15A	26	26D	501	502	514	Qty
598 SMT	Single Cylinder	\$67.00	\$78.00	\$78.00		\$78.00	\$78.00		\$78.00				12
599	Double Cylinder	\$79.00				\$88.50			\$88.50				12
599 SMT	Double Cylinder	\$79.00		\$88.50		\$88.50			\$88.50				12

## Key Control Deadbolt



		3	L03	5	11P	15	15A	26	26D	501	502	514	Qty
816 SMT	Key Control Deadbolt	\$58.00		\$67.50	\$67.50	\$67.50			\$67.50				12
817 SMT	Key Control Deadbolt UL	\$63.50		\$73.00	\$73.00	\$73.00			\$73.00				12



## KWIKSET SIGNATURE SERIES HANDLESETS

<b>Door Prep</b>	Deadbolt: Cross Bore 2-1/8" or 1-1/2". Edge Bore 1". Latch Face 1" x 2-1/4". Handle: Cross Bore 2-1/8". Edge Bore 1". Latch Face 1" x 2-1/4".
<b>Backset</b>	Deadbolt: Adjustable to 2-3/8" or 2-3/4". Handle: Adjustable to 2-3/8" or 2-3/4".
<b>Door</b>	1-3/4" doors standard. 2-1/4" doors optional.
<b>Thickness</b>	1 3/4" standard. Not designed for use on 1-3/8" doors.
<b>Cylinder</b>	SmartKey or Pin & Tumbler
<b>Faceplate</b>	1" x 2-1/4". Specify round corner, square corner or drive-in.
<b>Strikes</b>	Deadbolt: 1-1/4" x 3-5/8". Specify round corner or square corner. Others options available. Handle: 2-1/4" full lip. Specify round corner or square corner. Other options available.
<b>Bolt</b>	Deadbolt: 1" throw. Handle: 1/2" throw.
<b>Door Handing</b>	Reversible for right or left-hand doors.
<b>ANSI/BHMA</b>	Deadbolt is Grade 1 Certified
<b>ADA</b>	N/A
<b>UL</b>	Optional 1/3 hour UL fire rating for all functions except 802*

## KWIKSET SIGNATURE SERIES LEVERS

<b>Door Prep</b>	Cross Bore 2-1/8" Edge Bore 1" Latch Face 1" x 2-1/4"
<b>Backset</b>	Adjustable to 2-3/8" or 2-3/4".
<b>Door</b>	1-3/8" – 1-3/4" doors standard.
<b>Thickness</b>	2-1/4" doors optional on 720 and 740 models.
<b>Cylinder</b>	SmartKey or Pin & Tumbler.
<b>Faceplate</b>	1" x 2-1/4". Specify round corner, square corner or drive-in.
<b>Strikes</b>	2-1/4" full lip. Specify round corner or square corner. Other options available.
<b>Bolt</b>	1/2" throw.
<b>Door Handing</b>	Specify handing only with inactive levers
<b>ANSI/BHMA</b>	Grade 2 Certified
<b>ADA</b>	Functions 720, 788 satisfy section 4.13.9. ADA requirement.
<b>UL</b>	Meets UL 3 hour fire rating for 725, 735, 745, 746, 749, 755 Optional UL 1/3 hour fire rating for all functions*

## KWIKSET SIGNATURE SERIES 780-785 DEADBOLTS

<b>Door Prep</b>	780, 785: Crossbore 2-1/8" or 1-1/2". Edge Bore 1". Latch Face 1" x 2-1/4" 782, 784: Crossbore 2-1/8". Edge Bore 1". Latch Face 1" x 2-1/4"
<b>Backset</b>	Adjustable to 2-3/8" or 2-3/4" standard.
<b>Door</b>	
<b>Thickness</b>	1-3/8" – 1-3/4" standard. 1-7/8" – 2-1/4" optional.
<b>Cylinder</b>	6-pin removable core or SmartKey.
<b>Faceplate</b>	1" x 2-1/4". Specify round corner, square corner, or drive-in.
<b>Strikes</b>	1-1/4" x 3-5/8". Specify round corner or square corner. Other options available.
<b>Bolt</b>	1" throw.
<b>Door Handing</b>	Reversible for right or left-hand doors.
<b>ANSI/BHMA</b>	Grade 2 Certified
<b>ADA</b>	Interior turn piece meets 4.13.9 ADA requirements.
<b>UL</b>	Meets UL 3 hour fire rating for 782 and 784 Optional UL 1/3 hour fire rating for all functions*

## KWIKSET SIGNATURE SERIES KNOBS

<b>Door Prep</b>	Cross Bore: 2-1/8" Edge Bore: 1" Latch Face: 1"x 2-1/4".
<b>Backset</b>	Adjustable to 2-3/8" or 2-3/4". UL 2-3/4" standard 2-3/8" optional.
<b>Door</b>	1-3/4" doors standard.
<b>Thickness</b>	2-1/4" doors optional on 720 and 740 models only.
<b>Cylinder</b>	SmartKey or Pin & Tumbler.
<b>Faceplate</b>	1" x 2-1/4". Specify round corner, square corner or drive-in.
<b>Strikes</b>	2-1/4" full lip. Specify round corner or square corner. Other options available.
<b>Bolt</b>	1/2" throw.
<b>Door Handing</b>	Reversible for right- or left-hand doors.
<b>ANSI/BHMA</b>	Grade 2 Certified
<b>ADA</b>	N/A
<b>UL</b>	Meets UL 3 hour fire rating for 725, 735, 745, 746, 749 and 755 Optional UL 1/3 hour fire rating for all functions*

## KWIKSET SIGNATURE SERIES 980/985 DEADBOLTS

<b>Door Prep</b>	980, 985: Crossbore 2-1/8" or 1-1/2". Edge Bore 1". Latch Face 1" x 2-1/4". 982, 984: Crossbore 2-1/8". Edge Bore 1". Latch Face 1" x 2-1/4".
<b>Backset</b>	Adjustable to 2-3/8" or 2-3/4".
<b>Door</b>	
<b>Thickness</b>	SMT 1-3/4" P&T 1-3/4".
<b>Cylinder</b>	SmartKey or Pin & Tumbler.
<b>Faceplate</b>	1" x 2-1/4". Specify round corner, square corner or drive-in.
<b>Strikes</b>	Standard: Grade 2, 1-1/4" x 3-5/8" Specify round corner or square corner. For Grade 1 order 5278 Strike option and Ultra Strike Door Jamb Brace. Other options available.
<b>Bolt</b>	1" throw.
<b>Door Handing</b>	Reversible for right or left-hand doors.
<b>ANSI/BHMA</b>	Grade 1 Certified
<b>ADA</b>	Interior turn piece meets 4.13.9 ADA requirements.
<b>UL</b>	Meets UL 3 hour fire rating for 982 and 984 Optional UL 1/3 hour fire rating for all functions*

## KWIKSET KEY CONTROL 816 DEADBOLT

<b>Door Prep</b>	Cross Bore 2-1/8". Edge Bore 1". Latch Face 1" x 2-1/4"
<b>Door Thickness</b>	1-3/4" doors standard.
<b>Cylinder</b>	2 SmartKey cylinders: 1 Standard Kwikset for users. 1 Secure new patented keyway for Key Control.
<b>Faceplate</b>	1"x 2-1/4".
<b>Strike</b>	1" x 2-1/4".
<b>Bolt</b>	1" throw.
<b>Door Handing</b>	Reversible for right or left-hand doors.
<b>ANSI/BHMA</b>	Grade 2 Certified
<b>ADA</b>	Interior turn piece meets 4.13.9 ADA requirements.
<b>UL</b>	Meets UL 3 hour fire rating for 817 Optional UL 1/3 hour fire rating for all functions*

\*Optional UL 1/3 hour list price charge is \$2.50.

## KWIKSET SIGNATURE SERIES HANDLESET

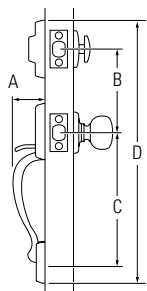

Design	A	B	C	D
Amherst®	3"	5-1/2"	8-13/32"	18-23/32"
Arlington®	2-1/2"	5-1/2"	11"	19-1/16"
Ashfield™	2-31/32"	5-1/2"	8-13/32"	17-3/4"
Austin	3-5/32"	5-1/2"	9-11/16"	18-27/64"
Avalon™	2-7/8"	5-1/2"	8-13/32"	18-5/32"
Chelsea®	2-3/16"	5-1/2"	9-11/16"	18-1/2"
Hawthorne™	2-7/8"	5-1/2"	8-13/32"	17-7/16"
Montara™	2-19/32"	5-1/2"	9-11/16"	17-13/16"
Shelburne™	2-7/8"	5-1/2"	8-13/32"	18-1/4"
Tavaris	2-1/2"	5-1/2"	8-3/7"	18"
Wellington®	2-7/8"	5-1/2"	8-13/32"	18-15/16"

## KWIKSET SIGNATURE SERIES LEVERS

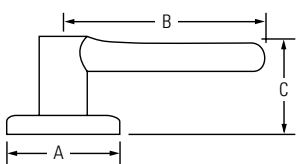

Design	A	B	C	C (Keyed)
Ashfield™	2-5/8"	4-3/16"	2-9/16"	2-9/16"
Austin	2-13/16"	4-1/8"	2-2/3"	2-3/4"
Avalon™	2-5/8"	4-1/4"	2-17/32"	2-7/16"
Brooklane®	2-5/8"	4-3/16"	2-11/16"	2-11/16"
Commonwealth®	2-5/8"	4-7/32"	2-7/16"	2-7/16"
Katara	4-4/9"	2-4/9"	2-2/3"	2-3/4"
Lido®	2-5/8"	3-3/4"	1-29/32"	2-15/32"
Pembroke™	2-5/8"	4-7/32"	2-23/32"	2-23/32"
Tustin®	2-5/8"	4-7/32"	2-3/32"	2-19/32"
Vedani	4-5/8"	2-2/3"	2-1/2"	2-3/4"

## KWIKSET SIGNATURE SERIES 980-985 DEADBOLT

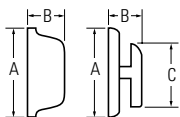

Design	A	B	C
980 Interior	2-19/32"	1-5/32"	1-13/16"
980 Exterior	2-5/8"	1-1/32"	
985 Interior	2-5/8"	1-1/32"	
985 Exterior	2-5/8"	1-1/32"	

## KWIKSET SIGNATURE SERIES 780-785 DEADBOLT

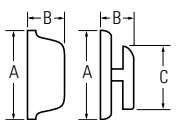

Design	A	B	C
780, 782 Interior	2-1/2"	15/16"	1-25/32"
780, 782 Exterior	2-5/8"	1-1/8"	
784, 785 Interior	2-5/8"	1-1/8"	
784, 785 Exterior	2-5/8"	1-1/8"	

## KWIKSET SIGNATURE SERIES 816-817 KEY CONTROL DEADBOLT

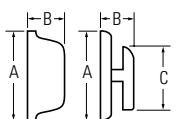

Design	A	B	C
816, 817 Interior	2-9/16"	7/8"	1-13/16"
816, 817 Exterior	3"	1-9/32"	

## KWIKSET SIGNATURE SERIES KNOBS

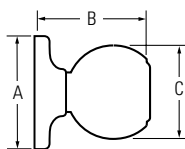

Design	A	B	C
Abbey®	2-5/8"	2-11/16"	2-1/32"
Cameron®	2-5/8"	2-13/32"	2-1/8"
Circa®	2-5/8"	2-31/32"	2-1/8"
Copa®	2-5/8"	2-7/16"	2-1/8"
Hancock®	2-5/8"	2-1/2"	2-3/8"
Laurel®	2-5/8"	2-7/16"	2-7/16"
Phoenix®	2-5/8"	2-1/2"	2-3/16"

## KWIKSET SIGNATURE SERIES 993-994 DEADBOLT

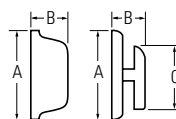

Round Design	A	B	C
993 Interior	2-5/9"	1-2/85"	1-4/5"
993 Exterior	2-5/9"	1-2/85"	
994 Interior	2-5/9"	1-2/85"	
994 Exterior	2-5/9"	1-2/85"	

Square Design	A	B	C
993 Interior	2-1/2"	1-1/16"	1-4/5"
993 Exterior	2-1/2"	1-1/16"	
994 Interior	2-1/2"	1-1/16"	
994 Exterior	2-1/2"	1-1/16"	

## KWIKSET SIGNATURE SERIES AUSTIN 980-985 DEADBOLT

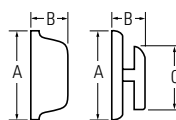

Design	A	B	C
980 Interior	3-13/32"	1-1/2"	1-7/16"
980 Exterior	3-17/32"	1-1/16"	
985 Interior	3-17/32"	1-1/16"	
985 Exterior	3-17/32"	1-1/16"	

## TRUSTED SECURITY



- ANSI/BHMA Grade 3
- Easy Installation
- Available with SmartKey® Re-Key Technology with Bumpguard™ Protection\*
- Most Recognized Styles

## WARRANTY

- Lifetime Mechanical
- Lifetime Finish

\*Lock Bumping - an attack technique using specially cut keys that can defeat conventional pin & tumbler locks.



| Balboa™

| Cove™

| 660/665 Deadbolt



| Delta®

| Polo®



| Belleview™

| Dakota™

| Dorian®

| Tylo®

**Bellevue™**



**Dakota™**



Bellevue™	Model	Function	Finish						Case		
			3	L03	5	11P	15	15A	26	26D	Qty
	687BW	Single Cylinder	\$93.20		\$105.10	\$110.30	\$105.10			\$99.20	6
	687BW SMT	Single Cylinder	\$98.20		\$110.10	\$115.30	\$110.10			\$104.20	6
	689BW	Double Cylinder	\$94.40		\$108.50	\$113.90	\$108.50			\$101.50	6
	689BW SMT	Double Cylinder	\$99.40		\$113.50	\$118.90	\$113.50			\$106.50	6
	699BW	Dummy	\$82.60		\$89.60	\$94.10	\$89.60			\$86.10	6

**Dakota™**

			3	L03	5	11P	15	15A	26	26D	Qty
	687DA	Single Cylinder	\$93.20		\$105.10	\$110.30	\$105.10	\$105.10		\$99.20	6
	687DA SMT	Single Cylinder	\$98.20		\$110.10	\$115.30	\$110.10	\$110.10		\$104.20	6
	689DA	Double Cylinder	\$94.40		\$108.50	\$113.90	\$108.50	\$108.50		\$101.50	6
	689DA SMT	Double Cylinder	\$99.40		\$113.50	\$118.90	\$113.50	\$113.50		\$106.50	6
	699DA	Dummy	\$82.60		\$89.60	\$94.10	\$89.60	\$89.60		\$86.10	6

### INTERIOR PACK FUNCTION OPTIONS

Model	Function	Series				Case
		Signature Lever & Laurel	Signature Knob	Kwikset Lever	Kwikset Knob	
604	Single Cylinder	\$50.50	\$41.60	\$47.40	\$36.60	12
605	Double Cylinder	\$68.90	\$59.30	\$59.70	\$49.50	12
605 SMT	Double Cylinder	\$73.90	\$64.30	\$64.70	\$54.50	12
606	Dummy	\$42.10	\$33.80	\$39.10	\$28.30	12

**NOTE:**604 and 606 interior packs not impacted by SmartKey.

### Kwikset Handleset & Interior Pack Finish Options

		L03	3	5	11P	15	15A	26	26D
<b>Kwikset</b> <i>Signature Series</i>	Abbey Knob		•	•				•	•
	Brooklane Lever								
	Cameron Knob		•	•	•	•	•	•	
	Circa Knob		•	•	•	•	•	•	•
	Commonwealth Lever								
	Copa Knob		•	•			•	•	•
	Hancock Knob		•	•	•	•	•	•	•
	Laurel Knob				•	•	•	•	
	Lido Lever		•	•		•	•	•	•
	Pembroke Lever								
Tustin Lever		•	•	•	•	•	•	•	
<b>Kwikset</b>	Balboa Knob		•	•	•	•			•
	Cove Knob		•	•	•	•			•
	Delta Lever		•	•		•	•	•	•
	Dorian Lever		•	•	•	•	•	•	•
	Polo Knob		•	•	•	•	•	•	•
	Tylo Knob		•	•				•	•

# Kwikset

## Balboa™

Model	Function	Finish							Case Qty	
		3	L03	5	11P	15	15A	26		26D
200BL	Hall/Closet	\$31.90		\$34.00	\$35.50	\$34.00			\$34.00	20
300BL	Bed/Bath	\$34.50		\$36.50	\$38.10	\$36.50			\$36.50	20
405BL	Keyed Lever	\$53.00		\$55.10	\$56.70	\$55.10			\$55.10	20
405BL SMT	Keyed Lever	\$58.00		\$60.10	\$61.70	\$60.10			\$60.10	20
488BL	Half Dummy	\$12.90		\$14.90	\$16.50	\$14.90			\$14.90	20



## Delta®

Model	Function	Finish							Case Qty	
		3	L03	5	11P	15	15A	26		26D
200DL	Hall/Closet	\$31.90		\$33.00			\$34.00	\$34.00	\$34.00	20
300DL	Bed/Bath	\$33.90		\$35.10			\$36.00	\$36.00	\$36.00	20
400DL	Entry (Knob & Lever)	\$42.40		\$43.50			\$43.90	\$43.90	\$43.90	12
400DL SMT	Entry (Knob & Lever)	\$47.40		\$48.50			\$48.90	\$48.90	\$48.90	12
405DL	Keyed Lever	\$52.80		\$54.10			\$55.20	\$55.20	\$55.20	20
405DL SMT	Keyed Lever	\$57.80		\$59.10			\$60.20	\$60.20	\$60.20	20
406DL	Free Interior, Keyed Lever	\$56.30		\$57.60			\$58.70	\$58.70	\$58.70	20
406DL SMT	Free Interior, Keyed Lever	\$61.30		\$62.60			\$63.70	\$63.70	\$63.70	20
409DL	Keyed Lever UL	\$58.30		\$59.60			\$60.70	\$60.70	\$60.70	20
409DL SMT	Keyed Lever UL	\$63.30		\$64.60			\$65.70	\$65.70	\$65.70	20
410DL	Entry (Knob & Lever) UL	\$47.90		\$49.00			\$49.40	\$49.40	\$49.40	20
410DL SMT	Entry (Knob & Lever) UL	\$52.90		\$54.00			\$54.40	\$54.40	\$54.40	20
412DL	Vestibule Keyed Lever UL	\$61.80		\$63.10			\$64.20	\$64.20	\$64.20	20
412DL SMT	Vestibule Keyed Lever UL	\$66.80		\$68.10			\$69.20	\$69.20	\$69.20	20
413DL	Free Interior, Keyed Lever UL	\$61.80		\$63.10			\$64.20	\$64.20	\$64.20	20
413DL SMT	Free Interior, Keyed Lever UL	\$66.80		\$68.10			\$69.20	\$69.20	\$69.20	20
420DL	Hall/Closet UL	\$37.40		\$38.50			\$39.50	\$39.50	\$39.50	20
430DL	Bed/Bath UL	\$39.40		\$40.60			\$41.50	\$41.50	\$41.50	20
462DL	Vestibule Keyed Lever	\$56.20		\$57.60			\$58.70	\$58.70	\$58.70	20
462DL SMT	Vestibule Keyed Lever	\$61.30		\$62.60			\$63.70	\$63.70	\$63.70	20
488DL	Half Dummy	\$13.00		\$14.10			\$14.80	\$14.80	\$14.80	20

**NOTE:** 400 function knob and lever includes Copa knob for 3, 5, 15A, 26 and 26D finishes. 11P and 15 use Cameron knob.

# Kwikset

**Dorian®**

Model	Function	Finish								Case Qty
		3	L03	5	11P	15	15A	26	26D	
200DNL	Hall/Closet	\$31.90		\$33.00	\$35.60	\$34.00	\$34.00	\$34.00	\$34.00	20
300DNL	Bed/Bath	\$33.90		\$35.10	\$37.80	\$36.00	\$36.00	\$36.00	\$36.00	20
400DNL	Entry (Knob & Lever)	\$42.40		\$43.50	\$45.90	\$43.90	\$43.90	\$43.90	\$43.90	12
400DNL SMT	Entry (Knob & Lever)	\$47.40		\$48.50	\$50.90	\$48.90	\$48.90	\$48.90	\$48.90	12
405DNL	Keyed Lever	\$52.80		\$54.10	\$58.00	\$55.20	\$55.20	\$55.20	\$55.20	20
405DNL SMT	Keyed Lever	\$57.80		\$59.10	\$63.00	\$60.20	\$60.20	\$60.20	\$60.20	20
406DNL	Free Interior, Keyed Lever	\$56.30		\$57.60	\$61.50	\$58.70	\$58.70	\$58.70	\$58.70	20
406DNL SMT	Free Interior, Keyed Lever	\$61.30		\$62.60	\$66.50	\$63.70	\$63.70	\$63.70	\$63.70	20
409DNL	Keyed Lever UL	\$58.30		\$59.60	\$63.50	\$60.70	\$60.70	\$60.70	\$60.70	20
409DNL SMT	Keyed Lever UL	\$63.30		\$64.60	\$68.50	\$65.70	\$65.70	\$65.70	\$65.70	20
410DNL	Entry (Knob & Lever) UL	\$47.90		\$49.00	\$51.40	\$49.40	\$49.40	\$49.40	\$49.40	20
410DNL SMT	Entry (Knob & Lever) UL	\$52.90		\$54.00	\$56.40	\$54.40	\$54.40	\$54.40	\$54.40	20
412DNL	Vestibule Keyed Lever UL	\$61.80		\$63.10	\$67.00	\$64.20	\$64.20	\$64.20	\$64.20	20
412DNL SMT	Vestibule Keyed Lever UL	\$66.80		\$68.10	\$72.00	\$69.20	\$69.20	\$69.20	\$69.20	20
413DNL	Free Interior, Keyed Lever UL	\$61.80		\$63.10	\$67.00	\$64.20	\$64.20	\$64.20	\$64.20	20
413DNL SMT	Free Interior, Keyed Lever UL	\$66.80		\$68.10	\$72.00	\$69.20	\$69.20	\$69.20	\$69.20	20
420DNL	Hall/Closet UL	\$37.40		\$38.50	\$41.10	\$39.50	\$39.50	\$39.50	\$39.50	20
430DNL	Bed/Bath UL	\$39.40		\$40.60	\$43.30	\$41.50	\$41.50	\$41.50	\$41.50	20
462DNL	Vestibule Keyed Lever	\$56.30		\$57.60	\$61.50	\$58.70	\$58.70	\$58.70	\$58.70	20
462DNL SMT	Vestibule Keyed Lever	\$61.30		\$62.60	\$66.50	\$63.70	\$63.70	\$63.70	\$63.70	20
488DNL	Half Dummy	\$13.00		\$14.10	\$15.60	\$14.80	\$14.80	\$14.80	\$14.80	20

**NOTE:** 400 function knob and lever includes Copa knob for 3, 5, 15A, 26 and 26D finishes. 11P and 15 use Cameron knob.

# Kwikset

## Cove™



Model	Function	Finish								Case Qty
		3	L03	5	11P	15	15A	26	26D	
200CV	Hall/Closet	\$20.70		\$20.70	\$23.10	\$23.10			\$20.70	30
300CV	Bed/Bath	\$23.50		\$23.50	\$25.20	\$25.20			\$23.50	30
400CV	Entry (Pin & Tumbler)	\$33.30		\$33.30	\$34.50	\$34.50			\$33.30	30
400CV SMT	Entry	\$38.30		\$38.30	\$39.50	\$39.50			\$38.30	30
488CV	Half Dummy	\$8.20		\$8.20	\$8.20	\$8.20			\$8.20	20

## Polo®



Model	Function	Finish								Case Qty
		3	L03	5	11P	15	15A	26	26D	
100P	Patio/Porch	\$23.00		\$25.90	\$27.20	\$25.90	\$25.90	\$25.90	\$23.00	30
200P	Hall/Closet	\$18.80		\$21.00	\$22.00	\$21.00	\$21.00	\$21.00	\$19.20	30
300P	Bed/Bath	\$20.80		\$23.00	\$24.10	\$23.00	\$23.00	\$23.00	\$21.10	30
400P	Entry	\$27.10		\$29.00	\$30.50	\$29.00	\$29.00	\$29.00	\$27.60	30
400P SMT	Entry	\$32.10		\$34.00	\$35.50	\$34.00	\$34.00	\$34.00	\$32.60	30
401P	Entry, Free Interior	\$30.60		\$32.50	\$34.00	\$32.50			\$31.10	30
401P SMT	Entry, Free Interior	\$35.60		\$37.50	\$39.00	\$37.50			\$36.10	30
450P	Vestible	\$30.60		\$32.50					\$31.10	30
450P SMT	Vestible	\$35.60		\$37.50					\$36.10	30
488P	Half Dummy	\$7.30		\$8.10	\$8.60	\$8.10	\$8.10	\$8.10	\$7.50	20

## Tylo®



Model	Function	Finish								Case Qty
		3	L03	5	11P	15	15A	26	26D	
100T	Patio/Porch	\$19.00		\$20.80				\$20.80	\$19.30	30
200T	Hall/Closet	\$16.60		\$18.40				\$18.40	\$17.00	30
300T	Bed/Bath	\$18.30		\$20.00				\$20.00	\$18.40	30
400T	Entry	\$24.50		\$26.40				\$26.40	\$25.30	30
400T SMT	Entry	\$29.50		\$31.40				\$31.40	\$30.30	30
401T	Entry, Free Interior	\$28.00		\$29.90					\$28.80	30
401T SMT	Entry, Free Interior	\$33.00		\$34.90					\$33.80	30
488T	Half Dummy	\$6.50		\$7.50				\$7.50	\$6.60	20

# Kwikset

## 660/665



Model	Function	Finish								Case Qty
		3	L03	5	11P	15	15A	26	26D	
660	Single Cylinder	\$26.00		\$28.30	\$29.80	\$28.30	\$28.30	\$28.30	\$26.70	12
660 SMT	Single Cylinder	\$31.00		\$33.30	\$34.80	\$33.30	\$33.30	\$33.30	\$31.70	12
665	Double Cylinder	\$33.70		\$36.00	\$37.80	\$36.00	\$36.00	\$36.00	\$34.40	12
665 SMT	Double Cylinder	\$43.70		\$46.00	\$47.80	\$46.00	\$46.00	\$46.00	\$44.40	12

## One-Sided



Model	Function	Finish								Case Qty
		3	L03	5	11P	15	15A	26	26D	
663	Thumbturn One Side	\$12.80		\$13.60	\$14.30	\$13.60	\$13.60	\$13.60	\$13.00	12
667	Thumbturn One Side with Exterior Plate	\$22.50		\$23.70	\$25.00	\$23.70	\$23.70	\$23.70	\$22.90	12
664	Retrofit Kit for 663	\$8.60		\$9.40	\$9.80	\$9.40			\$9.00	12
677	Thumbturn One Side with Exterior Plate UL	\$28.00		\$29.20	\$30.50	\$29.20			\$28.40	12

## Combo Pack Availability



Model	Function	Finish								Case Qty
		3	L03	5	11P	15	15A	26	26D	
690T	Keyed Entry Tylo Knob with Single Cylinder Deadbolt	\$50.50		\$54.60					\$52.00	6
690T SMT	Keyed Entry Tylo Knob with Single Cylinder Deadbolt	\$60.50		\$64.60					\$62.00	6







## KWIKSET HANDLESET

<b>Door Prep</b>	Deadbolt: Cross Bore 2-1/8" or 1-1/2". Edge Bore 1". Latch Face 1" x 2-1/4". Handle: Cross Bore 2-1/8". Edge Bore 1". Latch face 1" x 2 1/4"
<b>Backset</b>	Deadbolt: Adjustable to 2-3/8" or 2-3/4". Handle: Adjustable to 2-3/8" or 2-3/4".
<b>Door</b>	1-3/4" doors standard. 2-1/4" doors optional.
<b>Thickness</b>	Not designed for use on 1-3/8" doors.
<b>Cylinder</b>	SmartKey or traditional 5-Pin, Pin & Tumbler.
<b>Faceplate</b>	1" x 2-1/4". Specify round corner, square corner or drive-in
<b>Strikes</b>	Deadbolt: 1" x 2-1/4". Specify round corner or square corner. Other options available. Handle: 2-1/4" full lip. Specify round corner or square corner. Other options available.
<b>Bolt</b>	Deadbolt: 1" throw. Handle: 1/2" throw.
<b>Door Handing</b>	Reversible for right or left-hand doors.
<b>ANSI/BHMA</b>	Deadbolt is Grade 3 Certified
<b>ADA</b>	N/A
<b>UL</b>	Optional UL 1/3 hour fire rating for all functions except 699*

## KWIKSET LEVERS

<b>Door Prep</b>	Cross Bore 2-1/8". Edge Bore 1". Latch Face 1" x 2-1/4".
<b>Backset</b>	Adjustable to 2-3/8" or 2-3/4". UL 2-3/4" standard 2-3/8" optional.
<b>Door</b>	1-3/8" – 1-3/4" doors standard.
<b>Thickness</b>	2-1/4" doors optional on 200 and 400 functions only.
<b>Cylinder</b>	SmartKey or Pin & Tumbler.
<b>Faceplates</b>	1" x 2-1/4". Specify round corner, square corner or drive-in.
<b>Strikes</b>	2-1/4" full lip. Specify round corner or square corner. Other options available.
<b>Bolt</b>	1/2" throw.
<b>Door Handing</b>	Delta and Dorian are non-handed. Balboa is reversible for all functions except 488.
<b>ANSI/BHMA</b>	Grade 3 Certified. (all functions except 488)
<b>ADA</b>	Functions 200 and 420 satisfy section 4.13.9 ADA requirements.
<b>UL</b>	Meets UL 3 hour fire rating for 409, 410, 412, 413, 420, 430 Optional UL 1/3 hour fire rating for all functions*

## KWIKSET DEADBOLTS

<b>Door Prep</b>	660, 665: Crossbore 2-1/8". Edge Bore 1". Latch Face 1" x 2-1/4". 663: Crossbore 1-5/8". Edge Bore 1". Latch Face 1" x 2-1/4". 667: Crossbore 2-1/8" or 1-1/2". Edge Bore 1". Latch Face 1" x 2-1/4".
<b>Backset</b>	660, 665, 667: Adjustable latch standard. 663: 2-3/8" standard. 2-3/4" optional.
<b>Door</b>	660, 663, 665, 667: 1-3/8" – 1-3/4" doors standard.
<b>Thickness</b>	
<b>Cylinder</b>	660, 665: SmartKey or Pin & Tumbler.
<b>Faceplates</b>	1" x 2-1/4". Specify round corner, square corner or drive-in.
<b>Strikes</b>	1" x 2-1/4" full. Specify round corner or square corner. Other options available.
<b>Bolt</b>	1" throw.
<b>Door Handing</b>	Reversible for right or left-hand doors.
<b>ANSI/BHMA</b>	Grade 3 Certified
<b>ADA</b>	Interior turn piece meets 4.13.9 ADA requirements.
<b>UL</b>	Meets UL 3 hour fire rating for 677 Optional UL 1/3 hour fire rating for all functions*

## KWIKSET KNOBS

<b>Door Prep</b>	Cross Bore 2-1/8". Edge Bore 1".
<b>Backset</b>	Adjustable to 2-3/8" or 2-3/4". 5" available as service part
<b>Door</b>	1-3/8"–1-3/4" standard.
<b>Thickness</b>	2-1/4" doors optional on 200 and 400 models only.
<b>Cylinder</b>	SmartKey or Pin & Tumbler
<b>Faceplates</b>	1" x 2-1/4". Specify round corner or square corner. Also available as drive-in latch.
<b>Strikes</b>	2-1/4" full lip. Specify round corner or square corner. Other options available.
<b>Bolt</b>	1/2" throw.
<b>Door Handing</b>	Reversible for right or left hand doors.
<b>ANSI/BHMA</b>	Grade 3 Certified (all functions except 488)
<b>ADA</b>	N/A
<b>UL</b>	Optional UL 1/3 hour fire rating for all functions*

\*Optional UL 1/3 hour list price charge is \$2.50.

## KWIKSET HANDLESET

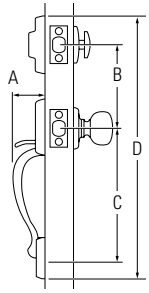

Design	A	B	C	D
Belleview™	2-5/32"	5-1/2"	8-13/32"	18-1/16"
Dakota™	2-5/32"	5-1/2"	8-13/32"	17-3/16"

## KWIKSET KNOB

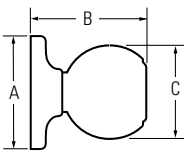

	A	B	C
Cove™	2-5/8"	2-1/2"	2-3/16"
Polo®	2-5/8"	2-23/32"	1-7/8"
Tylo®	2-5/8"	2-1/2"	1-7/8"

## KWIKSET LEVER

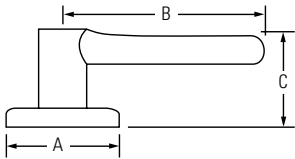

Design	A	B	C	C (Keyed)
Balboa™	2-5/8"	4-7/32"	1-15/16"	2-13/32"
Delta®	2-5/8"	3-5/8"	1-7/8"	2-15/32"
Dorian®	2-5/8"	3-3/4"	2-1/8"	2-11/16"

## KWIKSET DEADBOLT

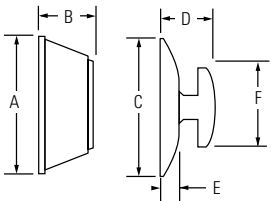

Design	A	B	C	D	E	F
660	2-7/16"	1-1/16"	2-1/2"	27/32"	5/16"	1-3/4"
663			2-1/2"	27/32"	5/16"	1-3/4"
665	2-7/16"	1-1/16"	2-1/2"	1-1/16"		
667	2-17/32"	3/8"	2-1/2"	27/32"	5/16"	1-3/4"
677	2-17/32"	3/8"	2-1/2"	27/32"	5/16"	1-3/4"

# Kwikset



## FEATURES

- Lock your door with the touch of a button
- Customizable Access Codes for Increased Security
- Back-Lit Keypad for Increased Visibility
- Customizable Automatic Door Locking After 30 Seconds for Peace Of Mind
- Installs In Minutes with Just a Screwdriver - No Hard Wiring Required
- Fits Standard Doors ( 1 3/8"-1 3/4" ) with No Screw Holes Required
- SmartCode™ Lever Ideal for - Small/Home Office, Utility/Storage Room, Interior Garage/Side Door
- SmartCode™ Deadbolt replaces any deadbolt for Keyless Entry convenience

## WARRANTY

- 1 Year Electronic Warranty
- Lifetime Finish & Mechanical Warranty

## Kwikset

PRODUCT	Model	Function	Finish										Case Qty	
			3	L03	5	11P	15	15A	26	26D	501	502		514
<b>Powerbolt®</b> 	907 SMT	Touchpad Electronic Deadbolt		\$139.75		\$143.00	\$143.00							2

PRODUCT	Model	Function	Finish										Case Qty	
			3	L03	5	11P	15	15A	26	26D	501	502		514
<b>SmartCode™</b> 	909 SMT	Touchpad Electronic Deadbolt		\$227.25		\$233.50	\$233.50							2

PRODUCT	Model	Function	Finish										Case Qty	
			3	L03	5	11P	15	15A	26	26D	501	502		514
<b>SmartCode™</b> 	909 CNT SMT	Touchpad Electronic Deadbolt - Contemporary				\$233.50	\$233.50		\$233.50	\$233.50				2

PRODUCT	Model	Function	Finish										Case Qty	
			3	L03	5	11P	15	15A	26	26D	501	502		514
<b>SmartCode™</b> 	911 SMT	Touchpad Electronic Lever		\$250.00		\$263.75	\$263.75							2

**NOTE:** L03 finish features the Lido Lever, 11P and 15 feature the Tustin Lever.

## KWIKSET POWERBOLT®

Door Prep	2-1/8" diameter face hole & 1" diameter latch hole.
Backset	Adjustable to 2-3/8" or 2-3/4".
Door	1-3/8" to 1-3/4" automatic adjustment.
Thickness	
Cylinder	SmartKey Re-Key Technology.
Faceplate	1" x 2-1/4". Round corner standard.
Strikes	Round corner strike 2-3/4" x 1-1/8"
Bolt	1" throw.
Door Handing	Reversible.
Batteries	4 AA.

## POWERBOLT®

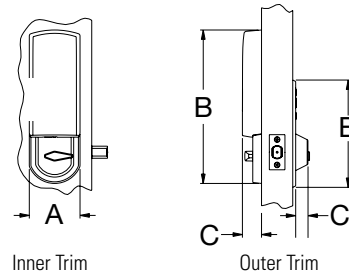

Design	A	B	C
Outer Trim	2-29/32"	6-7/8"	1-1/8"
Inner Trim	3-1/4"	9-27/32"	1-9/32"

## KWIKSET SMARTCODE™ DEADBOLT & CNT DEADBOLT

Door Prep	2-1/8" diameter face hole & 1" diameter latch hole.
Backset	Adjustable to 2-3/8" or 2-3/4".
Door	1-3/8" to 1-3/4" automatic adjustment.
Thickness	
Cylinder	SmartKey Re-Key Technology.
Faceplate	1" x 2-1/4". Round corner standard.
Strikes	Round corner strike 2-3/4" x 1-1/8"
Bolt	1" throw.
Door Handing	Reversible.
Batteries	4 AA.

## SMARTCODE™ DEADBOLT

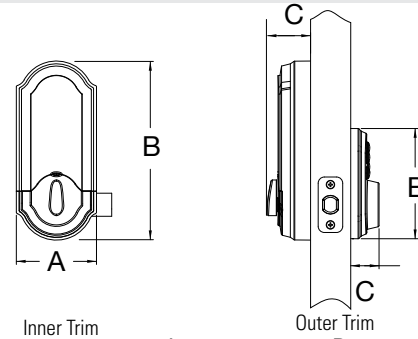

Design	A	B	C
Outer Trim	2-13/16"	4-7/16"	1-3/16"
Inner Trim	3-1/4"	7-1/4"	1-3/4"

## SMARTCODE™ CNT DEADBOLT

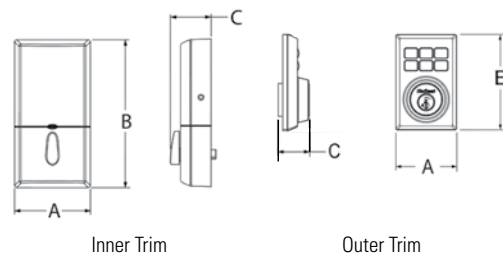

Design	A	B	C
Outer Trim	2-23/32"	4-1/4"	1-3/16"
Inner Trim	3-9/32"	6-13/32"	1-3/4"

## KWIKSET SMARTCODE™ LEVER

Door Prep	2-1/8" diameter face hole & 1" diameter latch hole.
Backset	Adjustable to 2-3/8" or 2-3/4".
Door	1-3/8" to 1-3/4" automatic adjustment.
Thickness	
Cylinder	SmartKey Re-Key Technology.
Faceplate	1" x 2-1/4". Round corner standard.
Strikes	2-1/4" full lip. Round corner.
Bolt	1/2" throw.
Door Handing	Reversible.
Batteries	4 AA.

## SMARTCODE™ LEVER

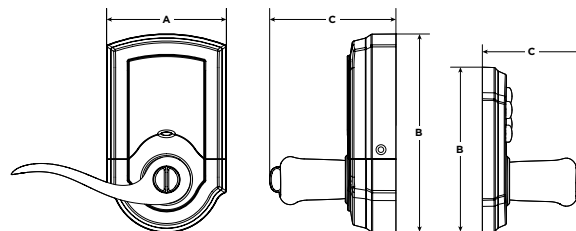

Design	A	B	C
Outer Trim	2-13/16"	4-7/16"	2-11/16"
Inner Trim	3-1/4"	5-3/8"	3-13/32"

NOTE: 1 year electronic warranty.

## Knobs & Levers - 780 - Deadbolt Options

Model	Function		Finish							
			3	L03	5	11P	15	15A	26	26D
506	Entry	Hancock	\$205.50	\$222.50	\$222.50	\$222.50	\$222.50	\$222.50	\$222.50	\$222.50
		Commonwealth	\$211.00	\$230.00		\$230.00	\$230.00			
		Tustin	\$205.50		\$222.50	\$222.50	\$222.50	\$222.50	\$222.50	\$222.50
		Kingston	\$205.50		\$222.50					\$222.50
508	Passage	Hancock	\$190.50	\$203.50	\$203.50	\$203.50	\$203.50	\$203.50	\$203.50	\$203.50
		Commonwealth	\$192.00	\$217.00		\$217.00	\$217.00			
		Tustin	\$190.50		\$203.50	\$203.50	\$203.50	\$203.50	\$203.50	\$203.50
		Kingston	\$190.50		\$203.50					\$203.50
506 SMT	Entry	Hancock	\$190.50	\$203.50	\$203.50	\$203.50	\$203.50	\$203.50	\$203.50	\$203.50
		Commonwealth	\$192.00	\$217.00		\$217.00	\$217.00			
		Tustin	\$190.50		\$203.50	\$203.50	\$203.50	\$203.50	\$203.50	\$203.50
		Kingston	\$190.50		\$203.50					\$203.50



## Levers - 660 - Deadbolt Options

Model	Function		Finish							
			3	L03	5	11P	15	15A	26	26D
505	Entry	Kingston	\$189.50		\$196.00					\$196.00
507	Passage	Kingston	\$176.50		\$180.00					\$180.00

## Knobs & Levers - Handleset Interior - Pack Options

Model	Function		Finish							
			3	L03	5	11P	15	15A	26	26D
502	Passage - 800 & 600 Series	Hancock	\$121.00		\$128.50	\$128.50	\$128.50	\$128.50	\$128.50	\$128.50
		Commonwealth	\$125.00		\$137.00	\$137.00	\$137.00	\$137.00	\$137.00	\$137.00
		Tustin	\$121.00		\$128.50	\$128.50	\$128.50	\$128.50	\$128.50	\$128.50
		Laurel	\$125.00		\$137.00	\$137.00	\$137.00	\$137.00	\$137.00	
		Kingston	\$121.00		\$126.00					\$126.00

## Residential Light Commercial - Grade 2 Levers

Model	Function		Finish					Case
			3	5	15A	26	26D	
Kingston™								Qty
720KNL	Hall/Closet	\$45.00					\$47.00	20
730KNL	Bed/Bath	\$48.00					\$50.50	20
740KNL	Keyed Entry	\$81.50					\$83.50	20
740KNL SMT	Keyed Entry	\$81.50					\$83.50	20
741KNL	Free Interior Keyed Entry	\$85.00					\$87.00	20
741KNL SMT	Free Interior Keyed Entry	\$85.00					\$87.00	20
745KNL UL	Keyed Entry UL	\$87.00					\$89.00	20
745KNL UL SMT	Keyed Entry UL	\$87.00					\$89.00	20
755KNL UL	Storeroom UL	\$90.50					\$92.50	20
755KNL UL SMT	Storeroom UL	\$90.50					\$92.50	20
746KNL UL	Keyed Entry UL	\$90.50					\$92.50	20
746KNL UL SMT	Keyed Entry UL	\$90.50					\$92.50	20
725KNL UL	Hall/Closet UL	\$50.50					\$52.50	20
735KNL UL	Bed/Bath UL	\$53.50					\$56.00	20
750KNL	Storeroom	\$85.00					\$87.00	20
750KNL SMT	Storeroom	\$85.00					\$87.00	20
788KNL	Half Dummy	\$22.50					\$23.50	20



## Key Control Deadbolt

Model	Function		Finish							Case	
			3	L03	5	11P	15	15A	26		26D
816 SMT	Key Control Deadbolt	\$58.00			\$67.50	\$67.50	\$67.50			\$67.50	12
817 SMT	Key Control Deadbolt UL	\$63.50			\$73.00	\$73.00	\$73.00			\$73.00	12



# Kwikset

## INTERCONNECT

<b>Door Prep</b>	Crossbore 2 1/8" Edge Bore 1" 5-1/2" center-to-center only.
<b>Backset</b>	Complete locksets: 2-3/4" UL or 2 3/8" UL - must specify Interior Assemblies: Determined by handleset ordered.
<b>Door Thickness</b>	1-3/4" and 2-1/4".
<b>Cylinder</b>	506, 508 - utilize 6-pin on 780 deadbolt. 505, 507 - utilize 5-pin on 660 deadbolt. 502 - determined by handleset ordered. SmartKey or Pin & Tumbler.
<b>Faceplate</b>	Complete locksets: No default—must specify faceplate. 1" round corner, 1" square corner, 1-1/8 WFL square. Interior assemblies: determined by handleset ordered. Complete locksets: UL 3028, 3031, (WFL option 3846).
<b>Strikes</b>	Deadbolt Strike: UL 5278, 3223 (WFL 4632 opt.). Interior assemblies: determined by handleset ordered.
<b>Handing</b>	506, 508, 505, 507 - reversible. 502 - specify handing.
<b>ANSI/BHMA</b>	506, 508, 505, 507 - Grade 3 Certified 502 - Determined by handleset ordered.
<b>ADA</b>	All lever options meet 4.13.9 ADA requirements.
<b>UL</b>	Meets UL 3 hour fire rating for all functions.

## KINGSTON LEVER

<b>Door Prep</b>	Crossbore 2-1/8" Edge Bore 1" Latch Face 1" x 2-1/4" Optional: 1-1/8" x 2-1/4" UL.
<b>Backset</b>	Adjustable to 2-3/8" or 2-3/4" UL 2-3/4" standard, 2-3/8" optional.
<b>Door Thickness</b>	1-3/8" – 1-3/4" doors standard. 1-3/4" on 740, 741, 745, 746 functions. 2-1/4" optional passage and entry functions.
<b>Cylinder</b>	Pin & Tumbler 5pin and SmartKey.
<b>Faceplate</b>	1" x 2-1/4". Specify round corner, square or drive-in. UL 1-1/8" square optional.
<b>Latches</b>	Adjustable to 2-3/8" or 2-3/4". Specify round corner, RFL.
<b>Strikes</b>	2-1/4" full lip. Specify round corner or square corner. Other options available. UL options include 2-3/4" T-Strike and 4-7/8" ASA.
<b>Door Handing</b>	Reversible for right or left-hand doors.
<b>ANSI/BHMA</b>	Grade 2 Certified
<b>ADA</b>	Lever functions satisfy 4.13.9 ADA requirements.
<b>UL</b>	Meets UL 3 hour fire rating for all functions. Optional UL 1/3 hour fire rating for all functions.

## INTERCONNECT

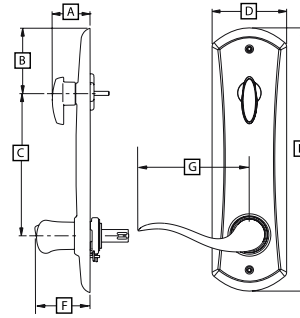

Design	A	B	C	D	E	F	G
Interconnect	1-7/16"	2-15/32"	5-1/2"	2-53/64"	10"	2-31/32"	4-7/32"

# Kwikset

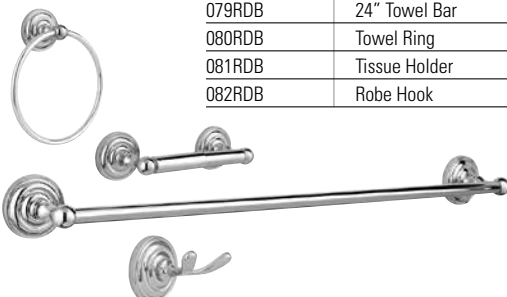
PRODUCT	Model	Function	Finish										Pkg	Case	
			3	L03	5	11P	15	15A	26	26D	501	502			514
<b>Redmond™</b> 	079RDB	24" Towel Bar	\$30.30			\$49.50	\$38.50		\$27.50					BP	6
	080RDB	Towel Ring	\$20.80			\$33.00	\$24.20		\$16.50					BP	6
	081RDB	Tissue Holder	\$22.70			\$34.10	\$27.50		\$22.00					BP	6
	082RDB	Robe Hook	\$8.70			\$12.10	\$12.10		\$8.80					BP	6

PRODUCT	Model	Function	Finish										Pkg	Case	
			3	L03	5	11P	15	15A	26	26D	501	502			514
<b>Ashfield™</b> 	0795ADB	24" Double Towel Bar				\$168.30	\$168.30		\$113.30		\$202.40	\$202.40		CP	4
	079ADB	24" Towel Bar				\$90.20	\$90.20		\$60.50		\$103.40	\$103.40		CP	4
	080ADB	Towel Ring				\$64.90	\$64.90		\$42.90		\$74.80	\$74.80		CP	4
	081ADB	Tissue Holder				\$70.40	\$70.40		\$45.10		\$91.30	\$91.30		CP	4
	082ADB	Robe Hook				\$38.50	\$38.50		\$27.50		\$46.20	\$46.20		CP	4

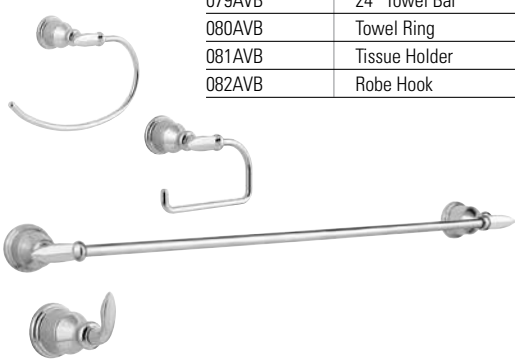
PRODUCT	Model	Function	Finish										Pkg	Case	
			3	L03	5	11P	15	15A	26	26D	501	502			514
<b>Avalon™</b> 	079AVB	24" Towel Bar				\$73.70	\$73.70		\$49.50		\$83.60	\$83.60		CP	4
	080AVB	Towel Ring				\$52.80	\$52.80		\$35.20		\$61.60	\$61.60		CP	4
	081AVB	Tissue Holder				\$57.20	\$57.20		\$37.40		\$74.80	\$74.80		CP	4
	082AVB	Robe Hook				\$31.90	\$31.90		\$23.10		\$37.40	\$37.40		CP	4

## DESIGNER ROSES



Model	Function	Finish											Case		
		3	L03	5	11P	15	15A	26	26D	501	502	514	Qty		
ART- Arch 83319	Rose Cover for Reversible Levers				\$20.00	\$20.00								\$21.50	12 Sets
OVT - Oval 83318	Rose Cover for Reversible Levers				\$20.00	\$20.00								\$21.50	12 Sets

**NOTES:**

- Can be ordered as separate accessory or configured with any Kwikset Signature Series lever.
- Only specify model number when ordering as accessory.



### Upgrade your Signature Series Lever with Designer Roses

- Two styles-arched or oval
- Sold separate or configured with lever
- Fits all SmartKey, passage, privacy, or dummy Signature Series reversible levers



# Kwikset

**Pocket Door Locks**

	Model	Function	Finish									Case Qty
			3	L03	5	10B	15	15A	26D	32	3x32	
Round												
	334	Passage	\$29.90		\$29.90	\$29.90	\$29.90	\$29.90	\$29.90	\$29.90		12



	Model	Function	Finish									Case Qty
			3	L03	5	10B	15	15A	26D	32	3x32	
Round												
	335	Privacy	\$33.20		\$33.20	\$33.20	\$33.20	\$33.20	\$33.20	\$33.20		12









	Model	Function	Finish									Case Qty
			3	L03	5	10B	15	15A	26D	32	3x32	
Notch												
	332	Passage	\$27.40		\$29.30						\$28.70	12

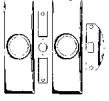
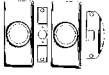

	Model	Function	Finish									Case Qty
			3	L03	5	10B	15	15A	26D	32	3x32	
Notch												
	333	Privacy	\$30.80		\$32.90						\$32.25	12



# Kwikset

Trims	Model	Description	Dimensions	Finish				Case	
				3	5	15	26D	Pkg	Qty
	214	Large Modernization Kit	3-1/2" x 10-1/2"	\$62.05				CP	10
	215	Small Modernization Kit	3-3/8" x 7-1/4"	\$43.45				CP	10
	239	Curved Colonial		\$55.35	\$58.65	\$56.10	\$56.10	CP	10
	249	Medium Rectangular Rosette	3-3/8" x 7-1/4"	\$19.50				CP	5
	262	Vertical Combo (CTC 3-5/8")	3-1/2" x 8-1/2"	\$29.05	\$33.20		\$32.35	CP	5
	263	Large Vertical Combo (CTC 5-1/2")	3-1/2" x 10-1/2"	\$29.05				CP	5
	288	Small Rectangular Rosette	3-15/16" x 4-7/32"	\$18.70				CP	5
	293	Round Rosette	3-13/16"	\$14.10	\$15.95	\$14.85	\$14.85	CP	4

## 138 Installation

Kit	Part #	Description	List Price	Qty per Pack	Master Pk Qty
	91380-001	138 Installation Kit	\$553.50	1	1
	89900-001	Jig with Wood Arm Guide	\$263.80	1	1
	89901-001	Wood Door In-Line Guide Arm	\$58.30	1	1
	89902-001	Metal Door In-Line Guide Arm	\$58.30	1	1

## 138 Installation

Kit Drill Bits	Part #	Description	List Price	Qty per Pack	Master Pk Qty
	89903-001	1" Spade Bit	\$19.50	1	3
	89904-001	2-1/8" Multi Spur Bit	\$85.80	1	3
	89905-001	1-1/2" Multi Spur Bit	\$71.30	1	3
	89906-001	2-1/8" Hole Saw Bit	\$17.95	1	3
	89907-001	Hole Saw Mandrel	\$17.95	1	1
	89908-001	Snap Rings	\$11.45	6	3

## 138 Installation

### Kit Mortise Tools

Part #	Description	List Price	Qty per Pack	Master Pk Qty
89909-001	Full Lip Strike Mortise Tool	\$32.35	1	3
89910-001	Full Lip Round Corner Strike Blades	\$9.70	3	3
89911-001	Full Lip Square Corner Strike Blades	\$9.70	3	3
89912-001	Latch Mortise Tool	\$34.10	1	3
89913-001	Latch Round Corner Blades	\$11.45	3	3
89914-001	Latch Square Corner Blades	\$11.45	3	3
89915-001	Strike Mortise Tool	\$35.65	1	1
89916-001	Strike Square Corner Blades	\$13.20	3	3
89917-001	Strike Round Corner Blades	\$13.20	3	3

## 138 Installation

### Kit Miscellaneous Parts

Part #	Description	List Price	Qty per Pack	Master Pk Qty
89918-001	Quick Bit Changer	\$22.80	1	1
89919-001	Strike Locator	\$5.20	1	1
89920-001	Strike Locator Tip	\$6.95	3	1
89921-001	Kit Box	\$29.15	1	1
89922-001	Jig Bushing	\$22.35	3	1
89923-001	1-1/2" Adapter Ring	\$10.25	1	1
89924-001	663 Boring Depth Stop	\$3.30	1	1
89925-001	Boring Template	\$3.00	1	1
89926-001	1/8" Hex Wrench	\$0.90	1	1

## Wood Door

### Installation Kit

Part #	Description	List Price	Qty per Pack	Master Pk Qty
91300-001	130WD Wood Door Installation Kit	\$28.50	1	3





# Kwikset

## KEYS & KEY BLANKS

### Kwikset Key Blanks

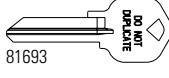
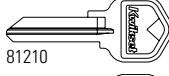
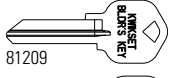
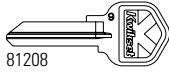
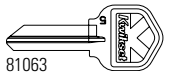

Model	Function	Qty.	List Price
81063-009	K Bow, Nickel Plated, 5 Pin	50	\$1.30
81208-001	K Bow, Nickel Plated, 6 Pin	50	\$1.30
81209-001	Solid Bow Builders Key - Brass Color	50	\$1.30
81210-001	Solid Bow Masters Key	50	\$1.30
81693-001	Do Not Duplicate Key	50	\$1.30
83559-008	Large Bow, Builder Key, 6 Pin	50	\$1.30
81695-001	Large Bow, Builder Key, 5 Pin	50	\$1.30
82245-001	Baldwin K-Key	50	\$1.80

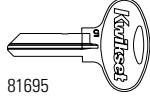
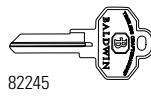
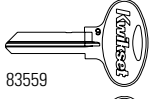

### Control Key Blanks (Rekeying Tools)

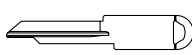
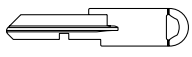

87615-001	Kwikset 6-Pin Knobs and Deadbolts	50	\$1.30
88122-001	Kwikset 6-Pin Knobs and Deadbolts, MK	50	\$1.30
88485-005	Kwikset Knobs and Deadbolts, Schlage® C	12	\$1.30
81804-001	Kwikset Key-In Lever, Standard "TC"	50	\$1.30
89991-001	Kwikset, Schlage® C	50	\$1.30

### Emergency Key

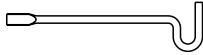

81087-001	For All Privacy Function Locksets	100	\$0.35
-----------	-----------------------------------	-----	--------

### Depth Key

88596-001	Depth Key Ring (Order in full pack quantities only)	5	\$7.00
-----------	---	---	--------

### Extra Cut Keys

#### KWIKSET 6 Pin

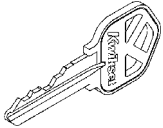

Random Cut	*Specify Cut		
81208-002	90009-074	Regular Key	\$2.55
81389-001		Set of Keys/ Ringed	\$4.00
81211-001		Set of Keys w/ Control Key	\$4.00
81210-002	90009-066	Master Key	\$3.30
81209-002	90009-069	Builder Key - Brass Color	\$2.55
	90009-082	Control Key	\$1.30

### Extra Cut Keys

#### KWIKSET 5 Pin

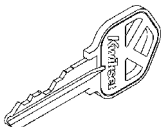

Random Cut	*Specify Cut		
81063-005		Regular Key	\$1.65
81057-002		Set of Keys/ Ringed	\$4.00
85991-001	90009-003	Master Key	\$2.75
82205-001	90009-004	Builder Key	\$2.30

**\*NOTE:** Must specify desired key cut when placing order.

**KEYING CHARGES  
& SUPPLIES**
**Competitive  
Keying Program  
- Replacement  
Parts**

Model	Function	Qty.	List Price
8486-75	780/785 Deadbolt, Schlage® keyway less cylinder cover (3, 26)	6	\$12.20
8486-76	780/785 Deadbolt, Weiser keyway less cylinder cover (3, 26)	6	\$12.20
8497-75	Kwikset Signature Series Knob, Schlage® keyway less cylinder cover (3, 26)	6	\$12.20
8497-76	Kwikset Signature Series Knob, Weiser keyway less cylinder cover (3, 26)	6	\$12.20
81354	Kwikset Signature Series Laurel Knob, Weiser cylinder (3, 26D)	6	\$17.30
81355	Kwikset Signature Series Laurel Knob, Schlage® cylinder (3, 26D)	6	\$17.30
8501-01	Kwikset Signature Series Knob cylinder cover - Hancock (15, 15A, 26, 26D, 3, 5, L03,11P, 690)	12	\$1.00
8501-11	Kwikset Signature Series Knob cylinder cover - Abbey (3, 5, 11P)	12	\$1.00
8501-15	Kwikset Signature Series Knob cylinder cover - Circa (15, 15A, 26D, 3, 5, 11P)	12	\$1.00
81236	980/985 Deadbolt double cylinder cover - interior (15, 15A, 26, 26D, 3, 5, L03,11P)	12	\$1.00
81327	780/785 Deadbolt single cylinder cover - exterior (15, 15A, 26, 26D, 3, 5, L03,11P)	12	\$1.00
81328	780/785 Deadbolt double cylinder cover - interior (3, 5, 11P)	12	\$1.00
87748-001	Knob plug - Kwikset 6 pin brass finish	20	\$1.45
87807-001	Deadbolt plug - Kwikset Signature Series 6-pin brass finish	20	\$1.45
87807-002	Deadbolt plug - Kwikset Signature Series 6-pin nickel finish	20	\$1.45
88485-005	Rekeying Tool - Schlage®	12	\$1.00

**NOTES:**

Order in full pack quantities only. Must specify finish in order.  
Competitive keying program not compatible with SmartKey Product.

**Keying Kits**

92360-001	236 Builder Pin Kit - small	1	\$122.30
92720-001	272 Pin Kit	1	\$216.15

**Keying Charges**

Master Keying	MK	\$2.30
Builder Keying (Protecto)	PK	\$2.30
Grand Master Keying	GMK	\$6.50
Builder Master Keying	PMK	\$4.00
Cross Keying / Maison Keying	MAIS	\$4.80
Sequential Construction Master Keying	SEQ	\$7.90

**KEYING CHARGES  
& SUPPLIES**

	Model	Function	Bottom Pin Size	Qty.	List Price
Competitive Replacement Pins	88550-023		0.156	50	\$0.12
	88550-024		0.165	50	\$0.12
	88550-025		0.168	50	\$0.12
	88550-026		0.172	50	\$0.12
	88550-027		0.18	50	\$0.12
	88550-028		0.187	50	\$0.12
	88550-029		0.195	50	\$0.12
	88550-030		0.204	50	\$0.12
	88550-031		0.21	50	\$0.12
	88550-032		0.218	50	\$0.12
	88550-033		0.22	50	\$0.12
	88550-034		0.225	50	\$0.12
	88550-035		0.234	50	\$0.12
	88550-036		0.24	50	\$0.12
	88550-037		0.25	50	\$0.12
	88550-038		0.255	50	\$0.12
	88550-039		0.258	50	\$0.12
	88550-040		0.265	50	\$0.12
	88550-041		0.27	50	\$0.12
	88550-042		0.276	50	\$0.12
88550-043		0.287	50	\$0.12	
88550-044		0.294	50	\$0.12	
88550-045		0.3	50	\$0.12	



**NOTE:** Competitive replacement pins are not compatible with SmartKey product.

**Kwikset Keying  
Parts**

80049-001	Key Gauge			1	\$5.95
80152-001	Plug Follower			1	\$6.40
80369-001	PK Anti-Pick Top Pin .160"			100	\$0.30
80370-001	Regular Anti-Pick Top Pin .180"			100	\$0.30
80371-001	Low Profile Deadbolt Spring Cover			10	\$1.00
81467-003	Cylinder Removal Tool			1	\$1.55
81777-001	Tumbler Spring			100	\$0.12
81858-001	Regular Top Pin .180"			100	\$0.12
82208-001	PK Balls			100	\$0.12
83100-001	#1 Bottom Pin .172"			100	\$0.12
83101-001	#2 Bottom Pin .195"			100	\$0.12
83103-001	#3 Bottom Pin .218"			100	\$0.12
83105-001	#4 Bottom Pin .241"			100	\$0.12
83106-001	#5 Bottom Pin .264"			100	\$0.12
83107-001	#6 Bottom Pin .287"			100	\$0.12
83108-001	#1 Master Pin .023"			100	\$0.12
83110-001	#2 Master Pin .046"			100	\$0.12
83112-001	#3 Master Pin .069"			100	\$0.12
83113-001	#4 Master Pin .092"			100	\$0.12
83114-001	#5 Master Pin .115"			100	\$0.12
83117-001	PK Top Pin .160"			100	\$0.12
83125-001	#6 Master Pin .138"			100	\$0.12
83561-001	Spring Cover (6-Pin)			50	\$0.90
84345-001	Knob Plug Retainer			100	\$0.14
84215-001	Deadlock Plug Retainer			100	\$0.14
85757-001	Spring Cover (5-Pin)			50	\$0.90
87619-001	Knob Control Lug (Locking Bar)			100	\$0.30
87632-001	Spring			100	\$0.45
87809-001	Deadlock Control Lug (Locking Bar)			100	\$0.55

# Kwikset

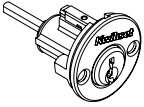
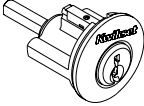
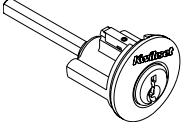
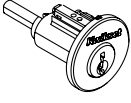
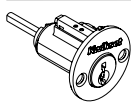
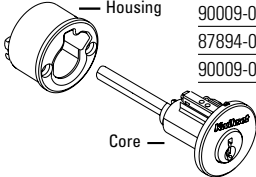
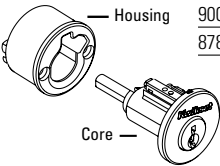
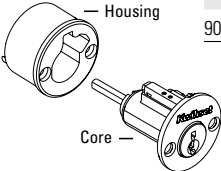
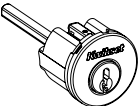
## DEADBOLT CYLINDERS

	Model	Function	List Price
	90009-016	2776 - 665 Interior (5 PIN)	\$12.55
	90009-017	2777 - 665 Exterior (5 PIN)	\$12.55
	90009-041	15843 - 660 Exterior (5 PIN)	\$12.55
	90009-045	785 Exterior without Housing (6 PIN)	\$14.20
	<b>NOTE:</b> Must specify finish when ordering cylinders		
	90009-046	785 Interior without Housing (6 PIN)	\$14.20
	90009-010	87765 - 780 with Housing, Complete Assembly	\$18.25
	87894-001	07894-01 Housing Only, Outside	\$4.10
	90009-044	8325 - 780 Core without Housing	\$14.20
	90009-019	7766 - 785 Exterior with Housing, Complete Assembly	\$18.25
	87894-001	07894-01 Housing Only, Outside	\$4.10
	90009-020	7767 - 785 Interior with Housing, Complete Assembly	\$18.25
	90009-065	13443 980CYL G1 (6 PIN)	\$37.10
	81227	13423 CVR BDY EXT G1	\$1.10
	90009-078	13448 985CYL Interior (6 PIN)	\$37.95
	90009-079	13450 985CYL Exterior (6 PIN)	\$37.10
	<b>NOTE:</b> Must specify finish when ordering cylinders		

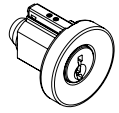

# Kwikset

**KNOB  
CYLINDERS****List  
Price**

Model	Function	List Price
90009-011	7750A - Abbey (6 PIN)	\$11.45

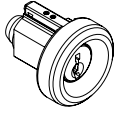

90009-012	13754 - Circa (6 PIN)	\$11.45
-----------	-----------------------	---------

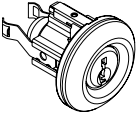

90009-042	15860 - Polo (5 PIN)	\$15.40
-----------	----------------------	---------

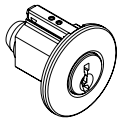

90009-043	13752 - Hancock (6 PIN)	\$11.45
-----------	-------------------------	---------

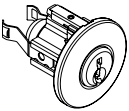

90009-013	1850 - All Other Kwikset & Kwikset Signature Knobs	\$15.40
-----------	--	---------

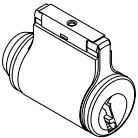
**LEVER  
CYLINDERS****List  
Price**

90009-077	24042 - 405 Lever/Gibson Handleset (5 PIN)	\$13.10
-----------	--	---------

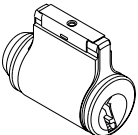

90009-076	21664 Kwikset Signatures Lever Cylinder (6 PIN)	\$13.10
-----------	---	---------

## SMARTKEY CYLINDERS

Model	Function	Finish											List Price	
		3	L03	5	15	15A	26	26D	690/11P	501	502	514		NA
83279	SMT Knob/Lever Cylinder Only	Gold			Silver				Bronze			Black		\$16.85
83373	SMT Deadbolt Cylinder Only (SGL CYL)	Gold			Silver				Bronze			Black		\$16.85
83280	SMT CN, C, H, T, CV Cylinder with Housing	•		•	•	•	•	•	•	•	•			\$18.80
83320	SMT CA, A with Housing	•	•	•	•	•	•	•	•					\$18.80
83281	SMT SNGL CYL DB with Housing 780/980		•	•	•	•	•	•	•	•	•			\$37.60
83343	SMT SNGL CYL DB with Housing 660	•		•	•	•	•	•	•					\$18.05
83344	SMT DBL CYL DB with Housing 665 Interior & Exterior	•		•	•	•	•	•	•					\$36.10

## SMARTKEY RE-KEY KITS

Model	Function	Finish											List Price	
		3	L03	5	15	15A	26	26D	690/11P	501	502	514		NA
83262	Carded CP Re-key Kit (4 silver/2 brass)												•	\$12.45
83335	4 cut keys with re-key tool												•	\$4.40
83336	6 cut keys with re-key tool												•	\$4.95







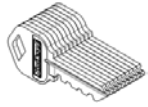

## SMARTKEY CONVERSION KITS

Model	Function	Finish											List Price	
		3	L03	5	15	15A	26	26D	690/11P	501	502	514		NA
83325	Abbey & Circa	•	•	•	•	•	•	•	•					\$22.00
83328	Cameron, Copa, Hancock, Tylo & Cove	•	•	•	•	•	•	•	•	•	•	•		\$22.00
83377	Polo	•		•	•	•	•	•	•					\$22.00
83326	780/980/800	•	•	•	•	•	•	•	•	•	•	•		\$39.60
83327	785	•	•	•	•	•	•	•	•	•	•	•		\$55.00
83340	985/801		•	•	•	•	•	•	•	•	•	•		\$55.00

## RE-KEYING TOOLS

Model	Function	Finish											List Price	
		3	L03	5	15	15A	26	26D	690/11P	501	502	514		NA
83282	Steel Learn Tool												•	\$0.11
83283	Red Plastic KW Learn Tool												•	\$2.50
83260	Reset Cradle												•	\$37.40
83338	Large Knob/Lever C-clip (Pack of 50)												•	\$27.50
83337	Large Deadbolt C-clip (Pack of 50)												•	\$27.50
83374	SmartKey Round Spindle (Knob)												•	\$0.80

## KEY CONTROL DEADBOLT PARTS

	Model	Function	Finish					Qty	List Price	
			3	5	11P	15	26D			N/A
	83382	Key Control Deadbolt Key Blanks						•	10	\$2.75
	83383	Key Control Deadbolt Cut Keys						•	10	\$3.30
	83389	Key Control Deadbolt Cylinder Cover	•	•	•	•	•		1	\$2.20
	83390	Key Control Deadbolt Mounting Screws	Gold		Bronze	Silver			1	\$4.95
	83388	Key Control Deadbolt Torque Blade						•	10	\$1.45
	83386	Key Control Deadbolt Gear Assembly						•	1	\$5.50
	83387	Key Control Deadbolt Screws for Gear Assembly						•	1	\$1.10
	83392	Key Control Deadbolt Tool						•	1	\$3.30
	83393	Key Control Deadbolt Security Mounting Screws	Gold	Gold	Bronze	Silver	Silver		1	\$3.30
	83394	Key Control Deadbolt Screw Torx Wrench						•	1	\$4.40

# Kwikset

## DEADBOLT ADJUSTABLE

### LATCHES

#### RCAL

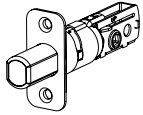

Model	Function	Finish									List Price
		3	5	15	15A	26/26D	690	514	NA		
81305	660 Series Deadbolt Standard	•	•	•	•	•	•	•			\$9.15
81258	980 Series Deadbolt Standard UL	•		•		•	•				\$23.65
83347	780/980 Series Deadbolt Standard	•	•	•	•	•	•	•	•		\$14.30
80391	Tapered Bolt Deadbolt*	•		•				•			\$23.65

\*Replacement Only

#### RFAL

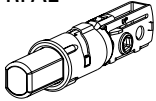

Model	Function	Finish									List Price
		3	5	15	15A	26/26D	690	514	NA		
81306	660 Series Deadbolt Standard									•	\$9.15
83371	780/980 Series Deadbolt Standard									•	\$14.30
80393	Tapered Bolt Deadbolt*	•		•				•			\$23.65

\*Replacement Only

#### SCAL

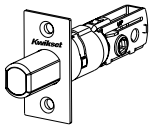

Model	Function	Finish									List Price
		3	5	15	15A	26/26D	690	514	NA		
81308	660 Series Deadbolt Standard	•	•	•	•	•	•	•			\$9.15
84513	780 Series Deadbolt Standard UL	•	•	•	•	•	•				\$17.15
81257	980 Series Deadbolt Standard UL	•		•		•	•				\$23.65
83370	780/980 Series Deadbolt Standard	•	•	•	•	•	•	•	•		\$14.30
80392	Tapered Bolt Deadbolt*	•		•				•			\$23.65

\*Replacement Only

## DEADBOLT SPECIALTY

### LATCHES

#### 5L

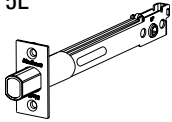

Model	Function	Finish									List Price
		3	5	15	15A	26/26D	690	514	NA		
82730	5" Kwikset (replacement part only)	•	•			•					\$12.55

#### Gatelatch

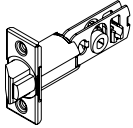

Model	Function	Finish									List Price
		3	5	15	15A	26/26D	690	514	NA		
83277	Gatelatch Standard	•	•			•					\$20.60

#### RCL

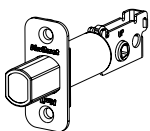

Model	Function	Finish									List Price
		3	5	15	15A	26/26D	690	514	NA		
82731	2-3/8" Backset	•	•			•	•				\$9.15
82732	2-3/4" Backset	•	•			•	•				\$9.15

#### RFL

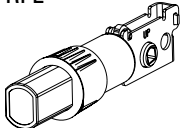

Model	Function	Finish									List Price
		3	5	15	15A	26/26D	690	514	NA		
82734	2-3/8" Backset									•	\$9.15
82735	2-3/4" Backset									•	\$9.15

#### SCL

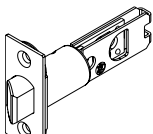

Model	Function	Finish									List Price
		3	5	15	15A	26/26D	690	514	NA		
82728	2-3/8" Backset	•	•			•	•				\$9.15
82729	2-3/4" Backset	•	•			•	•				\$9.15

# Kwikset

## 6-WAY ADJUSTABLE LATCHES

### AND PARTS

List  
Price

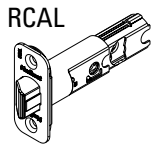

Model	Function	Finish									List Price
		3/L03	5	15	15A	26/26D	690	514	NA		
82246	RCAL Plain Latch	•	•	•	•	•	•	•	•	\$9.35	
82247	RCAL Dead Latch	•	•	•	•	•	•	•	•	\$10.80	

### Core Latch

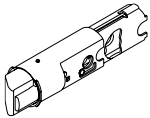

Model	Function	3/L03	5	15	15A	26/26D	690	514	NA	List Price
81846	6-Way Core Deadlatch								•	\$7.90
81847	6-Way Core Plain Latch								•	\$5.60

### Back Plate

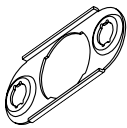

Model	Function	3/L03	5	15	15A	26/26D	690	514	NA	List Price
81827	6-Way Back Plate								•	\$0.20

### Drive in Collar



Model	Function	3/L03	5	15	15A	26/26D	690	514	NA	List Price
81828	6-Way Deadlatch Collar								•	\$1.55
81829	6-Way Plain Latch Collar								•	\$1.55

### Service Kits

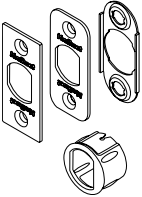

Model	Function	3/L03	5	15	15A	26/26D	690	514	NA	List Price
81844	6-Way Deadlatch Service Kit	•	•	•	•	•	•	•	•	\$3.95
81845	6-Way Plain Latch Service Kit	•	•	•	•	•	•	•	•	\$3.10

<p><b>Key:</b>                      5L - 5" Latch                      RCL - Round Corner Latch                      RFL - Round Face Latch (Drive-In Collar attached)                      SCL - Square Corner Latch</p>	<p>RCAL - Round Corner Adjustable Latch                      RFAL - Round Face Adjustable Latch                      SCAL - Square Corner Adjustable Latch                      WFAL - Wide Face Adjustable Latch                      NFAL - Narrow Face Adjustable Latch</p>
---	--

**NOTES:**

All plain and deadlatches can be used with all Kwikset and Kwikset Signatures knob and lever products. Plainlatches are used with passage and privacy functions. Deadlatches are used with entry functions. All fronts are 2-1/4" high. For fire rating. UL latches must be used with UL listed locksets and applicable strikes. UL Kwikset and Kwikset Signatures are rated for 3 hours, unless otherwise specified. Optional UL 1/3 hour fire rating is available for all functions.

# Kwikset

## SPECIALTY DEADLATCHES

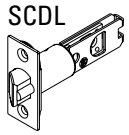

Model	Function	Finish									List Price
		3/L03	5	15	15A	26/26D	690	514	NA		
84292	2-3/4" Backset - UL	•	•	•	•	•	•			\$20.60	
84297	2-3/8" Backset - UL	•	•	•	•	•	•			\$20.60	

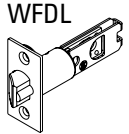

Model	Function	Finish									List Price
		3/L03	5	15	15A	26/26D	690	514	NA		
84255	2-3/4" Backset - UL	•	•	•	•	•	•			\$20.60	
84295	2-3/8" Backset - UL	•	•	•	•	•	•			\$20.60	

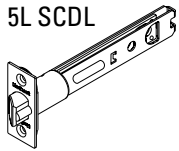

Model	Function	Finish									List Price
		3/L03	5	15	15A	26/26D	690	514	NA		
83014	5" Latch (replacement part only)	•	•			•				\$14.95	

## SPECIALTY PLAINLATCHES

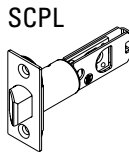

Model	Function	Finish									List Price
		3/L03	5	15	15A	26/26D	690	514	NA		
84290	2-3/4" Backset - UL	•	•	•	•	•	•			\$15.60	
84296	2-3/8" Backset - UL	•	•	•	•	•	•			\$15.60	



Model	Function	Finish									List Price
		3/L03	5	15	15A	26/26D	690	514	NA		
84254	2-3/4" Backset - UL	•	•	•	•	•	•			\$15.60	
84294	2-3/8" Backset - UL	•	•	•	•	•	•			\$15.60	

**KEY:**

- |   |                                       |
|---|---------------------------------------|
| 5L - 5" Latch                                     | RFAL - Round Face Adjustable Latch    |
| DL - Deadlatch                                    | SCAL - Square Corner Adjustable Latch |
| RC - Round Corner                                 | SCDL - Square Corner Deadlatch        |
| SC - Square Corner                                | SCPL - Square Corner Plainlatch       |
| RCL - Round Corner Latch                          | WFAL - Wide Face Adjustable Latch     |
| RFL - Round Face Latch (Drive In Collar attached) | WFDL - Wide Face Deadlatch            |
| SCL - Square Corner Latch                         | WFPL - Wide Face Plainlatch           |
| RCAL - Round Corner Adjustable Latch              |                                       |

## PLAINLATCH AND DEADLATCH

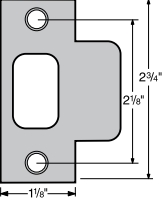
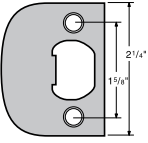
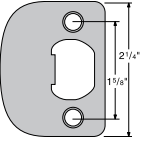
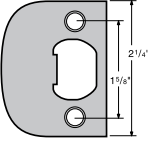
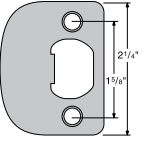
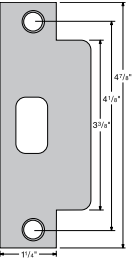
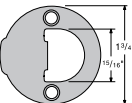
	Model	Function	Finish							List Price
			3	5	15	15A	26/26D	690	514	NA
	80318	Full Round, Adjustable Strike								
		500 per Box	•	•	•	•	•	•	•	
										\$10.55
	83028**	T (30 per carton)	•	•	•	•	•	•	•	\$2.75
		Standard on 588, 589 and UL Listed Knob and Lever sets. Add \$0.45 elsewhere.								
	83030**	Full Lip Square Corner Strike, UL	•	•	•	•	•	•	•	\$3.70
		UL Option								
	83031**	Full Lip 1/4" Round Corner Strike, UL	•	•	•	•	•	•	•	\$3.70
		UL Option								
	83437*	Full Lip Square Corner	•	•	•	•	•	•	•	\$2.75
		Standard on Non-UL Locksets								
	83796*	Full Lip 1/4" Round Corner (RCS4)	•	•	•	•	•	•	•	\$2.75
	83846**	ASA-1 (30 per carton)	•	•	•	•	•	•	•	\$8.80
		Add \$3.75 to Knob and Lever sets and specify 81967 strike box.								
	83929	Full Round 1- 3/4"	•	•	•	•	•	•	•	\$2.75

**NOTES:**

\*20-minute fire rating with UL locks and latchbolts.

\*\* 3-hour fire rating with UL Kwikset Signatures and 1.5 hour fire rating with UL Kwikset locks and latchbolts.

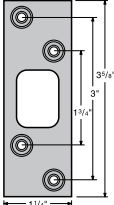
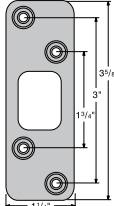
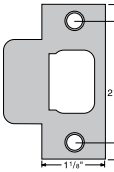
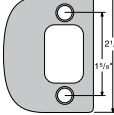
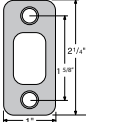
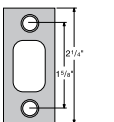
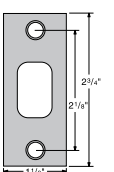
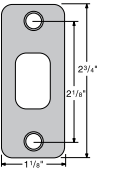
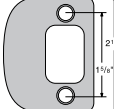
DEADBOLT	Model	Function	Finish							List Price
			3	5	15	15A	26/26D	690	514	
	83222**	Deadbolt Strike	•	•	•	•	•	•	•	\$3.30
	Standard on 780, 785, 980, 985 Deadbolts. Add \$1.45 to 660 Series Deadbolts									
	83223**	Deadbolt Round Corner Strike	•	•	•	•	•	•	•	\$3.30
	Standard on 780, 785, 980, 985 Deadbolts. Add \$1.45 to 660 Series Deadbolts									
	84632**	Deadbolt T-Strike (60 per carton)	•	•	•	•	•	•	•	\$2.75
	84638**	Deadbolt, Full Lip	•	•	•	•	•	•	•	\$2.75
	85063**	Deadbolt 1" x 2-1/4" Round Corner (RCS4)	•	•	•	•	•	•	•	\$2.75
	Standard on 660, 665 Deadbolts.									
	85072**	Deadbolt 1" x 2-1/4"	•	•	•	•	•	•	•	\$2.75
	Standard on 660, 665 Deadbolts.									
	85278**	Deadbolt, 1-1/8" x 2-3/4"	•	•	•	•	•	•	•	\$2.75
	Standard on 782, 784 Deadbolts.									
	85279**	Deadbolt, 1-1/8" x 2-3/4" Round Corner	•	•	•	•	•	•	•	\$2.75
	Standard on 782, 784 Deadbolts.									
	85303**	Deadbolt, Full lip Round Corner	•	•	•	•	•	•	•	\$2.75

**NOTES:**

\*20-minute fire rating with UL locks and latchbolts.

\*\* 3-hour fire rating with UL Kwikset Signatures and 1.5 hour fire rating with UL Kwikset locks and latchbolts.



# Kwikset

STRIKE BOXES	Model	Function	Finish							List	
			3	5	15	15A	26/26D	690	514	NA	Price
	81225	Box for 5278/5279 Strike								•	\$3.00
	81231	Box for 83028 T Strike								•	\$0.80
	83288	Box for Full Lip Strikes Add \$0.45 to locksets using full lip strike.								•	\$1.20
	81640	Box for all Deadbolt Strikes								•	\$0.80
	81967	Box for 83846 ASA-1 Strike								•	\$3.95

# Kwikset

## KNOBS AND LEVERS

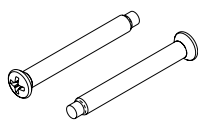

Model	Function	Finish								List Price	
		3	5	15/15A	26/26D	690/11P	501/502	514	NA		
81834	Machine Screws used on Signature Series styles include: A, CA, H, L									•	\$0.80
81835	Machine Screws used on Signature Series styles include: ADL, AVL, BRL, CHL, LL, PML, TNL and Kwikset styles include: BL, DL, DNL	•		•	•		•		•		\$0.45
83369	Machine Screws used on Signature Series styles include: C, CN, PE and Kwikset styles include: CV, P, T	•		•			•				\$0.45



Model	Function	Finish								List Price	
		3	5	15/15A	26/26D	690/11P	501/502	514	NA		
83258	New Reversible Lever Hex Wrench (3/32")									•	\$0.55

## REVERSIBLE LEVERSET SCREWS



Model	Function	Finish								List Price	
		3	5	15/15A	26/26D	690/11P	501/502	514	NA		
83254	Passage/Privacy/Interior Entry SMT									•	\$0.20
83255	Interior Pin & Tumbler Entry									•	\$0.20
83256	Exterior Entry Pin & Tumber									•	\$0.20
83257	Exterior Entry SMT									•	\$0.20

## HANDLESETS

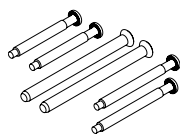

Model	Function	Finish								List Price	
		3	5	15/15A	26/26D	690/11P	501/502	514	NA		
86151	Kwikset Handleset Screw Pack Styles: A, CA, H, L, ADL, AVL, BRL, CHL, PML, CE, AVH, ADH, SE, HE, WN	•	•	•	•	•					\$1.10



Model	Function	Finish								List Price	
		3	5	15/15A	26/26D	690/11P	501/502	514	NA		
82215	Signatures Handleset Decorative Interior Screw Cap Cover Styles: ADH, AVH, AT, HE, SE, WN	•	•	•	•	•	•	•			\$1.75
82213	Screw & Washer									•	\$0.65

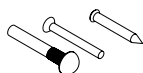

Model	Function	Finish								List Price	
		3	5	15/15A	26/26D	690/11P	501/502	514	NA		
88322	Sex Nut Set & Wood Screw	•	•	•	•	•					\$4.75

## DEADBOLTS

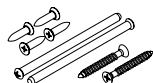

Model	Function	Finish								List Price	
		3	5	15/15A	26/26D	690/11P	501/502	514	NA		
86171	660 Deadbolt Screw Pack	•	•	•	•	•					\$1.10

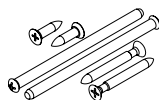

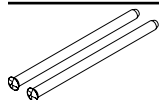

Model	Function	Finish								List Price	
		3	5	15/15A	26/26D	690/11P	501/502	514	NA		
86099	665 Deadbolt Screw Pack	•	•	•	•	•					\$1.75



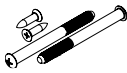
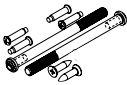
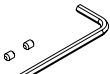

Model	Function	Finish								List Price	
		3	5	15/15A	26/26D	690/11P	501/502	514	NA		
86073	One-Way Screws, 665 Deadbolt	•	•	•	•	•					\$1.00

# Kwikset

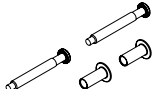
DEADBOLTS	Model	Function	Finish							List Price	
			3	5	15/15A	26/26D	690/11P	501/502	514		NA
	81247	P&T 980/982 Deadbolt Screw Pack	•	•	•	•	•				\$3.70
	81247	SMT 980/982 Deadbolt Screw Pack	•	•	•	•	•				\$3.70
	81247	P&T 780/782 Deadbolt Screw Pack	•	•	•	•	•				\$3.70
	81247	SMT 780/782 Deadbolt Screw Pack	•	•	•	•	•				\$3.70
			3	5	15/15A	26/26D	690/11P	501/502	514	NA	
	81261	P&T 985/984 Deadbolt Screw Pack	•	•	•	•	•				\$7.90
	81261	SMT 985/984 Deadbolt Screw Pack	•	•	•	•	•				\$7.90
	81261	SMT 785/784 Deadbolt Screw Pack	•	•	•	•	•				\$7.90
	81251	980 Series Deadbolt, Turnpiece Screw & Wrench								•	\$3.70

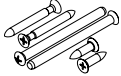
DUMMY/ IN-ACTIVE	Model	Function	Finish							List Price	
			3	5	15/15A	26/26D	690/11P	NA			
	81708	488 & 788 Dummy Mounting Screws	•	•	•	•	•				\$0.90
	81892	488 Dummy Adapter	•	•	•	•	•				\$4.70

LATCH	Model	Function	Finish							List Price	
			3	5	15/15A	26/26D	690/11P	NA			
	81711	Latch & Strike Screws	•	•	•	•	•				\$0.60
	82893	3846 Strike Screw Pack	•	•	•	•	•				\$2.40

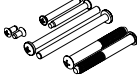
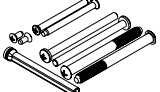
ADJUSTABLE INTERCONNECT	Model	Function	Finish							List Price	
			3	5	15/15A	26/26D	690/11P	NA			
	83269	Adjustable Interconnect Screw Pack	•	•	•	•	•				\$2.30
	83270	Adjustable interconnect Screw Pack (Thick Door Pack)	•	•	•	•	•				\$2.30

# Kwikset

**STRIKES** List Price

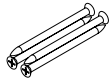
Model	Function	3	5	15/15A	26/26D	690/11P	NA	List Price
	86356	3" Strike Screws	•	•	•	•	•	\$3.75
	88604	Full Round Strike Screws	•	•	•	•	•	\$1.10

**THICK DOOR CONVERSION** List Price

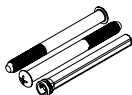
Model	Function	3	5	15/15A	26/26D	690/11P	NA	List Price
	81248	P&T 980/982 Deadbolt Thick Door Pack					•	\$4.75
	81248	SMT 980/982 Deadbolt Thick Door Pack					•	\$4.75
	81691	P&T 780/782 Deadbolt Thick Door Pack	•	•	•	•	•	\$4.75
	81691	SMT 780/782 Deadbolt Thick Door Pack	•	•	•	•	•	\$4.75

Model	Function	3	5	15/15A	26/26D	690/11P	NA	List Price
	81249	P&T 985/984 Deadbolt Thick Door Kit					•	\$4.75
	81249	SMT 985/984 Deadbolt Thick Door Kit					•	\$4.75
	81249	SMT 785/784 Deadbolt Thick Door Kit					•	\$4.75

Model	Function	3	5	15/15A	26/26D	690/11P	NA	List Price
	84221	P&T 784/785 Thick Door Pack					•	\$4.75

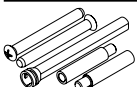
Model	Function	3	5	15/15A	26/26D	690/11P	NA	List Price
	86129	660 Thick Door Pack	•	•	•	•	•	\$4.75
	86130	665 Thick Door Pack	•	•	•	•	•	\$4.75

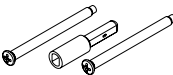

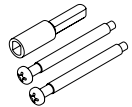

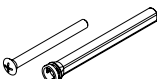





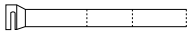

Model	Function	3	5	15/15A	26/26D	690/11P4	NA	List Price
	81714	Thick Door Pack, Signatures Knobs Styles: A, CA, H, L					•	\$4.75

Model	Function	3	5	15/15A	26/26D	690/11P	NA	List Price
	81706	Thick Door Pack, Kwikset and Signatures Knob & Lever Styles: CN, C, LL, TNL, P, T, CHL, DL, DNL, BL, ADL, AVL, CHL, BRL, PML	•	•	•	•	•	\$4.75







Model	Function	3	5	15/15A	26/26D	690/11P	NA	List Price
	81838	Thick Door Pack, Handleset Adapter	•	•	•	•	•	\$2.55

Model	Function	3	5	15/15A	26/26D	690/11P	NA	List Price
	81781	Thick Door Pack, All Active & Dummy Handlesets	•	•	•	•	•	\$4.75

# Kwikset

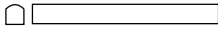
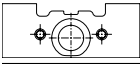
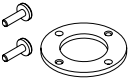
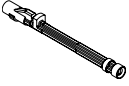
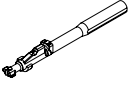
MISC. PARTS	Model	Function	Finish								List Price	
			3	5	15	15A	26	26D	11P	NA		
	82768	660/665 Cylinder Guard									•	\$3.00
	87760	780 Cylinder Guard									•	\$3.10
	82746	660/665 Cylinder Guard Cover	•	•	•	•	•	•	•	•		\$3.75
	87759	780 Cylinder Guard Cover	•	•	•	•	•	•	•	•		\$7.05
	82216	980 Cylinder Guard Cover	•	•	•	•	•	•	•	•		\$7.05
	84991	660 Torque Blade									•	\$1.55
	83273	660/663/667/677/588 Thumb Turn	•	•	•	•	•	•	•	•		\$6.15
	81692	780 Thumb Turn	•	•	•	•	•	•	•	•		\$17.50
	82217	980 Thumb Turn Exposed Screws	•	•	•	•	•	•	•	•		\$17.50
	88381	664, 667, 677 Exterior Plate	•	•				•	•	•		\$14.20
	81295	Kwik-Install Mounting Plate									•	\$2.40
	87789	Reinforcing Plate									•	\$1.20
	82778	699 Function Dummy Cylinder	•	•	•	•	•	•	•			\$3.95
	81402	800 Handleset Thick Door Spindle									•	\$1.45

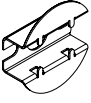

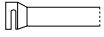
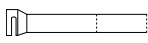
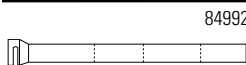
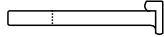
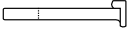

# Kwikset

MISC. PARTS	Model	Function	Finish								List Price	
			3	5	15	15A	26	26D	11P	NA		
	81239	Grade 1 Body Dummy Cylinder									•	\$9.15
	81226	Dummy Cylinder Cover	•	•	•	•	•	•	•	•		\$2.65
	84990	663/667/677/664 Tailpiece									•	\$1.55
	84568	663 Block, Bolt Mounting									•	\$0.90
	81404	Non-Handed Levers Dummy Adapter									•	\$9.45
	88841	300 Knobs Interior Round Spindle									•	\$0.55
	87628	740 Interior Round Spindle									•	\$0.80
	85624	3-1/2" Screw Driver Bit									•	\$4.00
	88448	U.L. Shield Knobs									•	\$4.40
	81857	U.L. Shield Deadbolts									•	\$4.40
	81822	DB 2-1/8" Adapter or 780/970/980									•	\$2.40
	84987	.835" Torque Blade									•	\$1.45
	84988	1.37" Torque Blade Double Cylinder Thick Door									•	\$1.45
	84992	2.491" Torque Blade Single Cylinder Thick Door									•	\$1.45
	84994	1.40" Torque Blade, Thick Door									•	\$1.00
	84993	1.097" Torque Blade, Standard Door									•	\$1.45
	83621	Finish Sample Ring									•	\$12.65

**ELECTRONIC  
SERVICE PARTS**

Model	Function	Finish								List Price
		L03	5	15	15A	26	26D	11P	N/A	
83306	909 Top Interior Cover	•		•					•	\$11.00
83307	909 & 911 Top Battery Holder								•	\$1.65

# Table of Contents

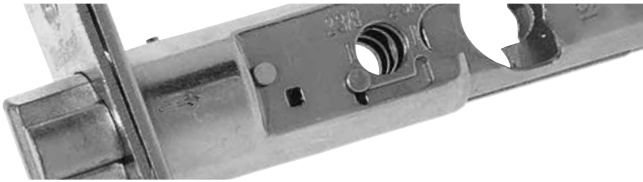
	<ul style="list-style-type: none"> <li>Ordering Information .....A1</li> <li>General Information.....A3</li> </ul>
	<ul style="list-style-type: none"> <li>■ New Products.....B5</li> </ul>
	<ul style="list-style-type: none"> <li>■ Kwikset Signature Series .....C19</li> <li>Handlesets .....C20</li> <li>Levers.....C21-22</li> <li>Knobs .....C23-24</li> <li>Combo Packs.....C25</li> <li>Deadbolts .....C26</li> </ul>
	<ul style="list-style-type: none"> <li>■ Kwikset .....D27</li> <li>Handlesets .....D28</li> <li>Levers .....D29</li> <li>Knobs .....D30-31</li> <li>Combo Packs.....D32</li> <li>Project Packs .....D33</li> <li>Deadbolts .....D34</li> </ul>
	<ul style="list-style-type: none"> <li>■ Electronic Locks.....E35</li> <li>Deadbolts .....E35</li> <li>Levers .....E35</li> </ul>
	<ul style="list-style-type: none"> <li>■ Light Commerical .....F37</li> <li>Key Control Deadbolt .....F37</li> </ul>
	<ul style="list-style-type: none"> <li>■ Parts &amp; Accessories</li> <li>Latches.....G39</li> <li>Rekeying Kit &amp; Parts.....G40</li> <li>138 Installation Kit &amp; Replacement Parts.....G41</li> <li>Pocket Door Hardware.....G42</li> <li>Trims.....G43</li> </ul>
	<ul style="list-style-type: none"> <li>■ Functions &amp; Measurements</li> <li>Kwikset Signature Series.....H45</li> <li>Kwikset .....H46</li> <li>Notes .....H47</li> </ul>





## HANDING

To determine the handing of a door, face the **OUTSIDE** of a door. If the hinge is on the left side of the door, the door is left-handed (LH). If the hinge is on the right side of the door, the door is right-handed (RH).

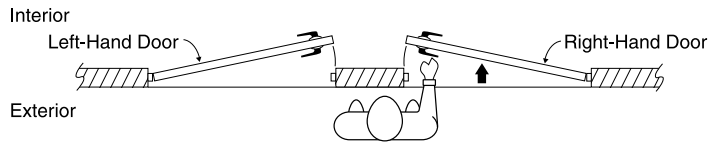

*Note: Handing only required for Dummy Kwikset Signature Series levers.*

## FINISHES

US	Description	BHMA	US	Description	BHMA
L03	Lifetime Polished Brass	605E	26D	Satin Chrome	626
3	Polished Brass	605	502	Rustic Pewter	
5	Antique Brass	609	501	Rustic Bronze	
11P	Venetian Bronze	510	514	Iron Black	
15	Satin Nickel	619			

## KEYING

Code	Option
K4, K6	Keyed Alike (4 Locksets, 6 Locksets)

## BACKSET

Backset is the length from center edge of door to center of the 2<sup>1</sup>/<sub>8</sub>" (54mm) diameter hole. 2<sup>3</sup>/<sub>8</sub>" or 2<sup>3</sup>/<sub>4</sub>" in most cases.

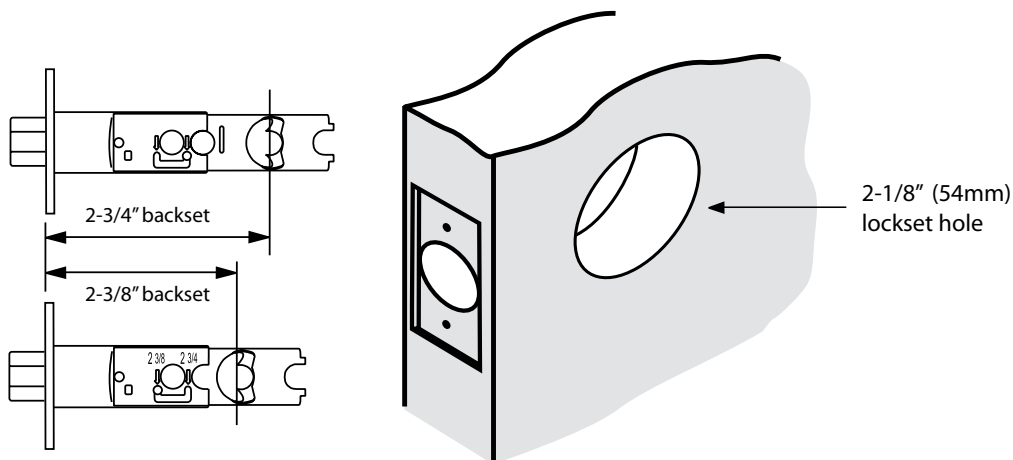

## FUNCTIONS

Model	Description	Model	Description
200/720	Passage/Hall & Closet	488/788	Half Dummy Trim, Surface Mounted
300/730	Privacy/Bed & Bath	553/687/800	Single Cylinder Handlesets
400/740	Keyed Entry Knob	660/816/980	Single Cylinder Deadbolts
405/740	Keyed Entry Lever	665/985	Double Cylinder Deadbolts
		907/909	Electronic Deadbolts
		911	Electronic Levers

## **TERMS AND CONDITIONS OF SALE**

Standard terms are 2% prompt payment discount for payment within 25 days from date of invoice; net 30 days from the date of invoice. Kwikset® reserves the right to charge and recover on invoices which are not paid within the above terms, a service charge of 1-1/2% a month for each month or fraction thereof during which the invoice remains unpaid, said service charge, however, not to exceed the highest applicable legal rate of interest. All orders, whether solicited or written by our sales representatives or forwarded by our customers are deemed to be mere offers to purchase in accordance with these Terms and Conditions of Sale until actually accepted by us at our home office in Lake Forest, CA. We reserve the right to refuse any order as well as the right to sell or not sell to any firm at our sole discretion. The acceptance of an order is expressly made conditional upon your assent to these Terms and Conditions of Sale. We object to the inclusion of any different or additional terms or conditions, even if the same are included in your order, a contract of sale will result upon the Terms and Conditions of Sale stated herein only.

All sales are final.

## **PRICES**

Pricing based on full-case quantities only; orders for less than full case will be automatically adjusted up to the next full-case quantity. All prices are subject to change without notice and are not guaranteed. All taxes, duties or other charges are the responsibility of the customer.

## **CLAIMS**

Price claims must be submitted in writing to Kwikset, 19701 DaVinci, Lake Forest, CA 92610 within 30 days from the date of invoice.

## **CHANGES OR CANCELLATIONS**

Beyond 5 working days of our acknowledgment date no changes can be made. Additions to an order will be handled as a separate order and must meet applicable minimum order requirements. Order cancellation on regular stock items only, or any portion thereof is allowed only upon prior written consent from Kwikset, and the payment of cancellation charges deemed appropriate.

## **MINIMUM CHARGE**

No order will be invoiced for less than \$100.00 net plus shipping charges except for lock accessory parts.

## **MINIMUM ANNUAL SALES VOLUME**

The company reserves the right to discontinue direct sales to any customer who does not meet the minimum annual sales volume requirement. The current annual requirement is \$50,000.00. Your annual purchases are determined by accepted, non-cancelled, and shipped orders received during each calendar year. Kwikset reserves the right to change any or all minimum annual sales volume requirements at any time. Any customer who does not meet the annual

sales volume requirements may continue to purchase Kwikset products through a Kwikset distributor.

## **RETURNS**

Defective merchandise returned to our factories requires prior written authorization from a Kwikset Sales Rep or the Sales Office. A factory return authorization must accompany the returned shipment. The return authorization must include an itemized listing of the merchandise and an explanation stating the reason for return.

There will be a 20% product restocking fee on all returned merchandise.

## **FREIGHT**

All goods are invoiced FOB our factory. Upon delivery of shipments to the carrier, title to, and the risk of loss or damage in transit for such shipments, passes to our customer. Kwikset's standard policy is to pay freight charges on all shipments of 300 locks (Accessories: 300 lbs.) to a single destination in the continental U.S., by carrier and route of our choice. Shipments less than these quantities will not be shipped on a prepaid basis.

If higher freight charges are incurred from customers specifying a carrier or route of their choice the additional cost will be added to that customer's invoice.

## **DELIVERY CONDITIONS**

Shipping schedules are our best estimates, and cannot be guaranteed. Kwikset is not responsible for any direct or consequential loss or damage resulting from an inability or delay in meeting shipping schedules.

### PRODUCT WARRANTY

Warranties cover the original residential user of Kwikset Products against defects in material and workmanship as long as the original user occupies the residential premises upon which the Product was originally installed. This warranty DOES NOT COVER abused or misused products or non-commercial products used in commercial applications. Upon return of a defective Product to Kwikset Corporation, Kwikset shall either replace the Product or refund the purchase price, at our discretion. If a covered defect occurs, call 1-800-327-LOCK (5625) in the U.S. and Canada or return it to Kwikset Corporation, Consumer Services, 19701 DaVinci, Lake Forest, California 92610. A finish deterioration occurring from the use of paints, solvents, or other chemicals is not a defect in the finish and is not covered by this warranty. Kwikset is not liable for incidental or consequential damages. Some states do not allow the exclusion or limitation of incidental or consequential damages, so the above exclusion may not apply to you. This warranty gives you specific legal rights and you may also have other rights that vary from state to state.

### PATENT INDEMNITY

We agree to defend any suit or proceeding brought against our customer so far as based on claim that our products, or any part thereof, made solely to our specifications and furnished to our customer constitute an infringement of any U.S. patent, if notified promptly in writing and given authority, information and assistance at our expense for the defense of same, and we shall pay all damages and costs awarded therein against our customer. In case our products, or any part thereof, is in such suit held to constitute infringement and

their use is enjoined, we will, at our expense and discretion, either procure for our customer the right to continue using the products or replace same with non-infringing products, or modify them so they become non-infringing, or remove such products and refund the purchase price (less depreciation, prorated from the purchase date). The foregoing states our entire liability for patent infringement by our products or any part thereof.

### STANDARDS

Kwikset meets or exceeds the testing requirements specified for each product grade or rating.

- American National Standards Institute (ANSI)
- Builders Hardware Manufacturers Association (BHMA)
- Underwriters Laboratories, Inc. (UL)
- ADA (Americans with Disabilities Act)

### MISCELLANEOUS

Substitution of non-Kwikset components/parts, and any alteration or modification of factory parts, and other lock manufacturer's parts may result in door hardware which does not function properly or will fail and will void all warranties.

Kwikset reserves the right to revise or modify products, product information, or pricing without notice. Product specifications and pricing reflect available information at the time of printing. Kwikset is not responsible for typographic or printing errors.





INTRODUCING

# AUSTIN

Simple yet rugged, Austin's rustic style brings a new level of charm and appeal to any space, whether in the city or country.

The Austin family includes a handleset, deadbolt and lever.

- Decorative Deadbolt Swing Cover on Handleset
- SmartKey® Re-key Technology with BumpGuard™ Protection
- ANSI/BHMA Grade 2 Security



**Kwikset**

# AUSTIN

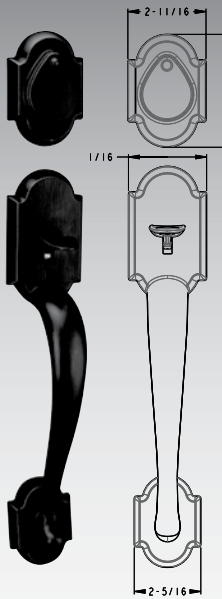

800 Austin Handleset

## Handleset Specifications:

**Door Prep** Deadbolt: Cross Bore 2-1/8" or 1-1/2". Edge Bore 1". Latch Face 1" x 2-1/4".  
Handle: Cross Bore 2-1/8". Edge Bore 1". Latch Face 1" x 2-1/4".

**Backset** Deadbolt: Adjustable to 2-3/8" or 2-3/4".  
Handle: Adjustable to 2-3/8" or 2-3/4".

**Door Thickness** 1-3/4" doors standard. 2-1/4" doors optional

**Cylinder** SmartKey

**Faceplates** 1" x 2-1/4". Specify round corner, square corner or drive-in

**Strikes** Deadbolt: 1-1/4" x 3-5/8". Specify round corner or square corner.  
Handle: 2-1/4" full lip. Specify round corner or square corner.  
Other options available.

**Bolt** Deadbolt: 1" steel. Handle: 1/2" throw.

**UL** Optional 1/3 hour fire rating for all functions except 802



980 Austin Deadbolt

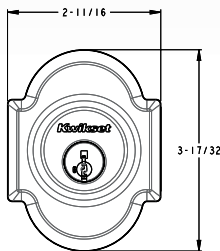

## Deadbolt Specifications:

**Door Prep** Crossbore 2-1/8". Edge Bore 1". Latch Face 1" x 2-1/4"

**Backset** Adjustable to 2-3/8" or 2-3/4"

**Door Thickness** 1-3/8" - 1-3/4" standard. 1-7/8" - 2-1/4" optional.

**Cylinder** SmartKey.

**Faceplates** 1" x 2-1/4". Specify round corner, square corner, or drive-in.

**Strikes** 1-1/4" x 3-5/8". Specify round corner or square corner.  
Other options available.

**Bolt** 1" throw. Steel.

**ADA** Interior turn piece meets 4.13.9 ADA requirements.



720 Austin Lever

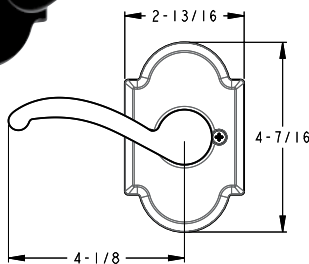

## Lever Specifications:

**Door Prep** Cross Bore 2-1/8". Edge Bore 1".

**Backset** Adjustable 2-3/8" or 2-3/4".

**Door Thickness** 1-3/8" to 1-3/4" standard.

**Cylinder** SmartKey

**Faceplates** 1" x 2-1/4". Specify round corner or square corner or drive-in latch.

**Strikes** 2-1/4" full lip. Specify round corner or square corner. Other options available.

**Bolt** 1/2" throw.

**Door Handing** Reversible for right or left hand doors.

**ADA** 720 function satisfies section 4.13.9 ADA requirements.

## Available Finishes:



11P  
Venetian  
Bronze



15  
Satin  
Nickel

**Kwikset**

**SMARTKEY**  
RE-KEY TECHNOLOGY

19701 DaVinci • Lake Forest, CA 92610 • www.kwikset.com • 1-800-327-LOCK  
© 2012 Kwikset Corporation, Lake Forest, CA 92610

THE BEST SECURITY IS SMART SECURITY.

# Introducing MONTARA™

**2-Point Locking**  
for Increased Security

Enjoy increased security and easy fit with the Montara handleset. 2 points of locking, on the deadbolt and the handleset, provide double the security. And the Easy Fit Technology allows for convenient installation, adjusting to fit the bottom hole in your door.

- 2-Point Locking for Increased Security
- New Easy Fit Technology for easy installation
- SmartKey® Re-Key Technology with BumpGuard™ Protection
- ANSI/BHMA Grade 2 Certified Security



**Kwikset**



# MONTARA™

## Specifications:

<b>Door Prep</b>	Cross Bore 2 1/8". Edge Bore 1".
<b>Backset</b>	Adjustable to 2 3/8" or 2 3/4"
<b>Door Thickness</b>	1 3/4" standard
<b>Cylinder</b>	SmartKey®
<b>Faceplates</b>	1" x 2 1/4". Specify round corner, square corner or drive-in.
<b>Strikes</b>	2 1/4" full lip standard. Specify round corner, square corner. Other options available.
<b>Bolt</b>	1/2" throw.
<b>Door Handing</b>	Reversible for right or left-handed doors. Specify handing only on dummy and handleset interiors only.
<b>ANSI/BHMA</b>	Grade 2 Certified.

## Dimensions:

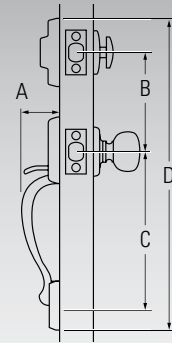

Design	A	B	C	D
Montara	2-19/32"	5-1/2"	9-1/8"	17-13/16"

## Finishes:



11P  
Venetian  
Bronze

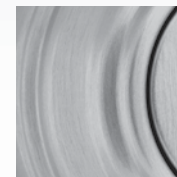

15  
Satin  
Nickel



3  
Polished  
Brass



featuring BumpGuard™

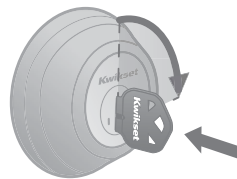

**1** Insert functioning key & turn 1/4 turn clockwise.

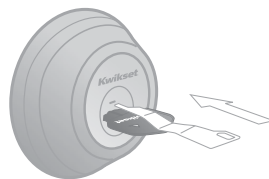

**2** Insert & remove the SmartKey learn tool. Remove functioning key.



**3** Insert new key & turn 1/2 turn counter-clockwise. Done. *Your lock is now re-keyed!*



**!** You must have your functioning key & the learn tool for the system to work.

# Kwikset

## SMART. SIMPLE. SECURE.

### SMARTKEY® RE-KEY TECHNOLOGY

#### The Lock You Can Re-key in Seconds

Re-key your locks, quickly & securely, without the extra hassle & cost of removing the lock from the door. SmartKey locks are incredibly secure & have passed the most stringent lock picking standards. Our patented BumpGuard™ technology provides superior lock bumping protection, while our high-security Grade 1 deadbolt is able to withstand the power typically associated with forced entries.

- Re-key in seconds—save time & money
- Available in all Kwikset keyed-entry products
- Pick Resistant—passes the most stringent lock picking standard, UL437, par 11.6
- 980 Series Deadbolt Certified ANSI/BHMA Grade 1 Security—the highest level of residential security available in the industry
- BumpGuard™ for protection against lock bumping



SmartKey® Signature Series™ deadbolts have earned the prestigious Best Buy rating from *Consumers Digest*.

[kwikset.com/smartkey](http://kwikset.com/smartkey)

### KEY CONTROL™ DEADBOLT

#### The Smart Alternative to Master Keying

Re-keying & managing a traditional master key system is labor intensive, time consuming & costly. With the first & only two cylinder Key Control Deadbolt, either cylinder can be re-keyed in seconds, without removing the lock from the door.

FEATURING



\*Rotate cylinder cap to expose Key Control cylinder

[kwikset.com/keycontrol](http://kwikset.com/keycontrol)

THE BEST SECURITY IS SMART SECURITY.

## BUMPGUARD™

SmartKey's patented side locking bar technology replaces the traditional pin-and-tumbler design and provides improved security against lock bumping.

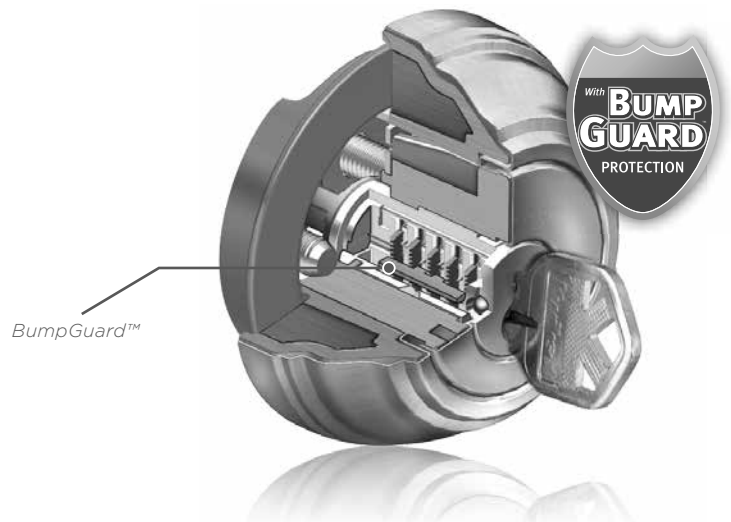

## RE-KEY IN 3 SIMPLE STEPS

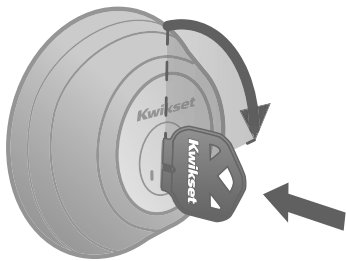

**1** Insert functioning key & turn 1/4 turn clockwise.

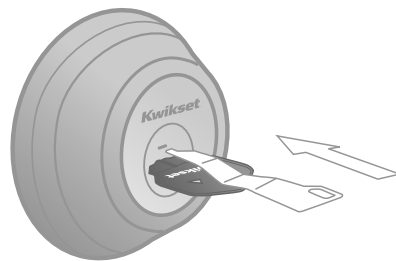

**2** Insert & remove the SmartKey learn tool. Remove functioning key.

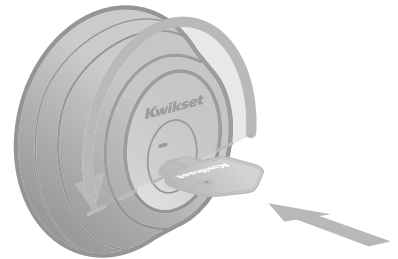

**3** Insert new key & turn 1/2 turn counter-clockwise. Done. *Your lock is now re-keyed!*



Functioning Key



SmartKey Learn Tool



New Key

**!** You must have your functioning key & the learn tool for the system to work.

### Reset Cradle

A tool used to reset the cylinder if the original key has been lost or to repair a SmartKey® cylinder that has been programmed incorrectly.



# Kwikset.

kwikset.com  
1-800-327-LOCK (5625)

# Kwikset

## KEY CONTROL™ DEADBOLT

FEATURING  SMARTKEY.  
RE-KEY TECHNOLOGY

### PROVIDING ONE-KEY CONTROL FOR MULTI-FAMILY APPLICATIONS

#### Key Control

- Top concealed cylinder provides one-key control for the property manager
- Lower exposed cylinder allows unique user keys for the tenant
- Re-key your user or control cylinder at any time in seconds
- Maintain key control throughout tenant and employee turnover

#### Increased Efficiency

- Re-key the lock without removing from the door
- Save time & money by re-keying yourself



*Perfect for multi-family dwellings, student housing, assisted living & rental properties.*

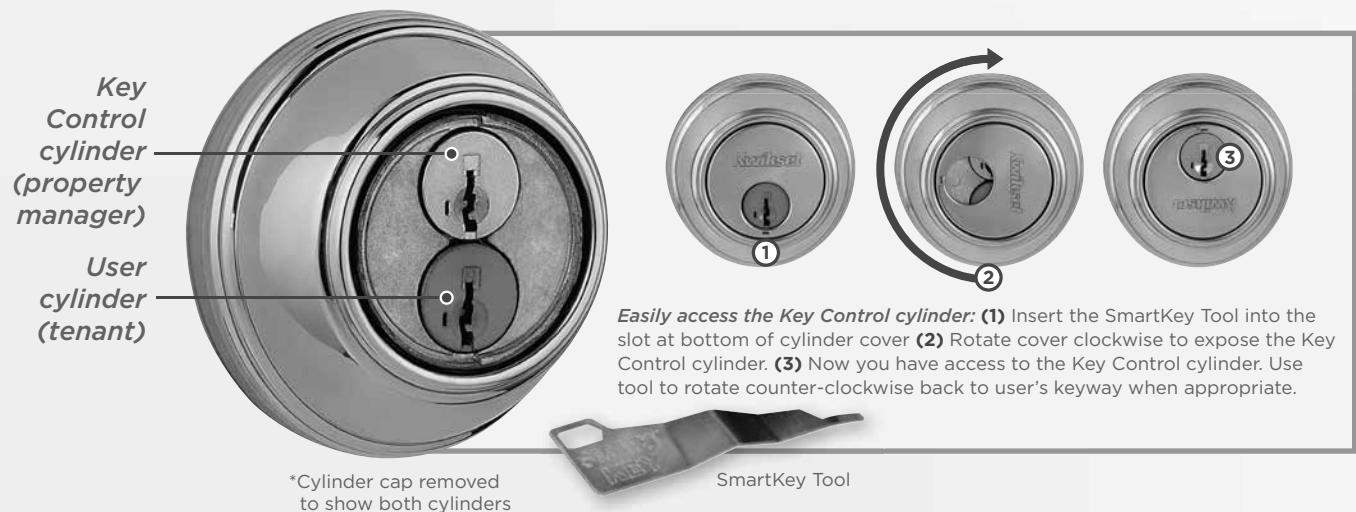

*Signature Series*

# THE SMART ALTERNATIVE TO MASTER KEYING

## BOTH CYLINDERS FEATURE SMARTKEY® RE-KEY TECHNOLOGY

- 1a Concealed Key Control cylinder has a unique patented keyway to provide increased security. Simply rotate the cylinder cap to expose the cylinder for use.
- 1b User cylinder utilizes the traditional Kwikset keyway and keys.
- 1c Gear assembly enables both cylinders to lock or retract the deadbolt latch.

## CERTIFIED GRADE 2 ANSI/BHMA SECURITY

### BUMPGUARD™-

- 2a Patented side locking bar technology offers improved security by protecting against lock bumping, an attack on conventional pin & tumbler locks.

### DRILL RESISTANCE-

- 2b Cylinder uses two steel balls inserted into the front of the key face to resist attacks from drilling.

### PICK RESISTANCE-

- 2c Superior SmartKey withstands the highest level of UL pick testing, the UL 437, Par. 11.6.

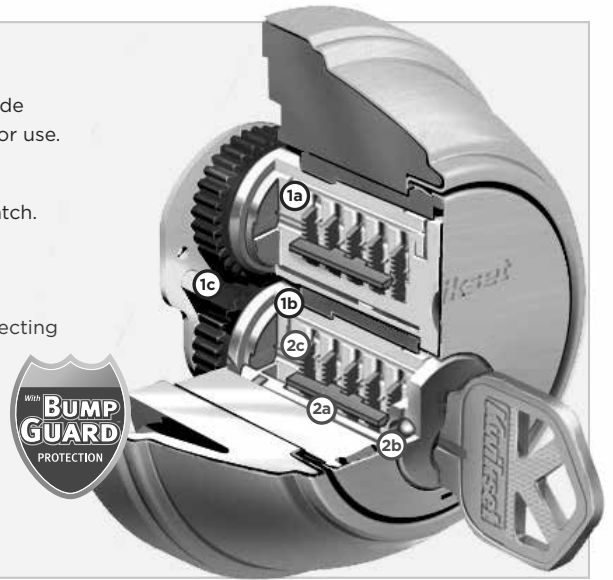

## SPECIFICATIONS:

<b>Standard Door Prep</b>	Cross Bore 2-1/8". Edge Bore 1" Latch Face 1" x 2-1/4"
<b>Door Thickness</b>	1-3/4"
<b>Cylinder</b>	2 SmartKey® cylinders: 1 standard Kwikset for users, 1 unique patented keyway for 1-Key Control
<b>Faceplate</b>	1" x 2-1/4"
<b>Strike</b>	1-1/4" x 3-5/8"
<b>Bolt</b>	1" throw
<b>ANSI/BHMA</b>	Grade 2 Certified
<b>ADA</b>	Interior turn piece meets 4.13.9 ADA
<b>UL</b>	Meets UL 3 hour fire rating for 817 UL Optional 1/3 hour UL fire rating for all functions

## FINISHES:



## FUNCTIONS:

**816 Key Control Deadbolt**  
**817 UL Key Control Deadbolt**

Deadbolt operated by key outside and thumb turn inside.

## DIMENSIONS:

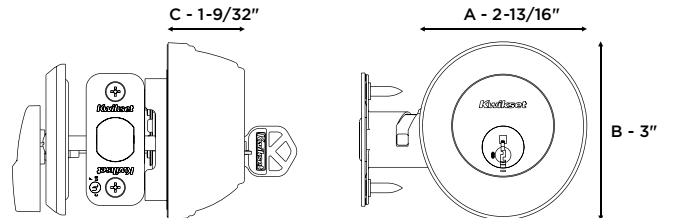

## EASILY RE-KEY IN 3 SIMPLE STEPS:

- 
- 
- 

You must have your functioning key & your SmartKey tool for the system to work.

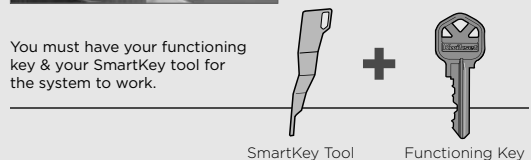

# Kwikset SMARTCODE<sup>®</sup>

TOUCHPAD ELECTRONIC DEADBOLT

New Style  
SMARTCODE<sup>™</sup>



Includes  
Back-Lit Keypad  
Increase Visibility



*Signature Series*

## NO MORE WORRYING ABOUT KEYS!

- **Keyless entry deadbolt** - the ultimate in convenience & security.
- **One touch locking** with a motorized deadbolt.
- **Two customizable access codes** - one code for the family, one code for temporary access.
- **Includes SmartKey<sup>®</sup>** re-key technology for increased peace of mind.

## EASY TO INSTALL, PROGRAM AND USE.

- **Installs in a minute** with just a screwdriver - no hard wiring required.  
- 4 AA batteries (not included)
- **Fits standard doors** (1 3/8" - 2") - no new screw holes required.
- **Quick Reference Guide** located under the interior cover.

FEATURING

 **SMARTKEY<sup>™</sup>**  
RE-KEY TECHNOLOGY

# SMARTCODE™ TOUCHPAD ELECTRONIC DEADBOLT

## Specifications:

<b>Function</b>	Single Cylinder Deadbolt
<b>Door Prep</b>	2-1/8" diameter face hole & 1" diameter
<b>Backset</b>	Adjustable 2-3/8" or 2-3/4"
<b>Door Thickness</b>	1 3/8" - 2" automatic adjustment
<b>Cylinder</b>	SmartKey® Re-key Technology
<b>Faceplates</b>	1" x 2-1/4" round corner standard
<b>Strikes</b>	Round corner strike 2-3/4" x 2-1/8"
<b>Latch</b>	Round corner adjustable 2-3/8" x 2-3/4"
<b>Bolt</b>	1" throw, steel deadbolt
<b>Door Handing</b>	Reversible
<b>Batteries</b>	4AA Required

## Dimensions:

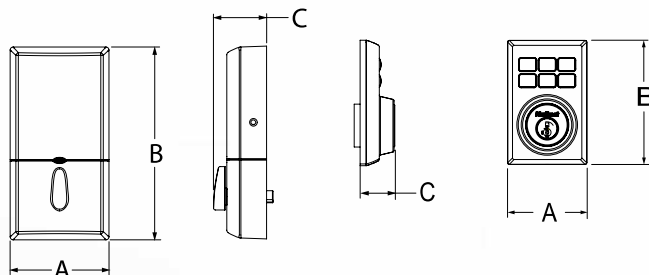

Design	A	B	C
SmartCode™ Outer Trim	2-23/32"	4-1/4"	1-3/16"
SmartCode™ Inner Trim	3-9/32"	6-13/32"	1-3/4"

## FEATURING



## Finishes:



26  
Polished  
Chrome



26D  
Satin  
Chrome

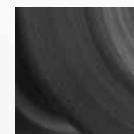

11P  
Venetian  
Bronze



15  
Satin  
Nickel

# Kwikset®

19701 DaVinci • Lake Forest, CA 92610  
www.kwikset.com • 1-800-327-LOCK

# Kwikset®



*Signature Series*

## New Contemporary Designs

We are proud to announce the launch of the new contemporary style as part of our Kwikset Signature Series line. With five additional products, the contemporary family provides a modern approach to security door hardware.

---

### Features & Benefits

- **Features SmartKey® Re-key Technology with BumpGuard™ protection**
- **Available in a variety of finishes** - Satin Nickel & Polished Chrome
- **Lifetime Finish & Mechanical Warranty**



THE BEST SECURITY IS SMART SECURITY.



# Kwikset

Signature Series



Tavaris™  
Handleset

## Handleset Specifications:

<b>Door Prep</b>	Deadbolt: Cross Bore 2-1/8" or 1-1/2". Edge Bore 1". Latch Face 1" x 2-1/4". Handle: Cross Bore 2-1/8". Edge Bore 1". Latch Face 1" x 2-1/4".
<b>Backset</b>	Deadbolt: Adjustable to 2-3/8" or 2-3/4". Handle: Adjustable to 2-3/8" or 2-3/4".
<b>Door Thickness</b>	1-3/4" doors standard. 2-1/4" doors optional
<b>Cylinder</b>	SmartKey
<b>Faceplates</b>	1" x 2-1/4". Specify round corner, square corner or drive-in
<b>Strikes</b>	Deadbolt: 1-1/4" x 3-5/8". Specify round corner or square corner. Handle: 2-1/4" full lip. Specify round corner or square corner. Other options available.
<b>Bolt</b>	Deadbolt: 1" steel. Handle: 1/2" throw.
<b>UL</b>	Optional 1/3 hour fire rating for all functions except 802



993 RDT  
Round  
Deadbolt

## Deadbolt Specifications:

<b>Door Prep</b>	Crossbore 2-1/8". Edge Bore 1". Latch Face 1" x 2-1/4"
<b>Backset</b>	Adjustable to 2-3/8" or 2-3/4"
<b>Door Thickness</b>	1-3/8" - 1-3/4" standard. 1-7/8" - 2-1/4" optional.
<b>Cylinder</b>	SmartKey.
<b>Faceplates</b>	1" x 2-1/4". Specify round corner, square corner, or drive-in.
<b>Strikes</b>	1-1/4" x 3-5/8". Specify round corner or square corner. Other options available.
<b>Bolt</b>	1" throw. Steel.
<b>ANSI/BHMA</b>	Grade 2 Certified
<b>ADA</b>	Interior turn piece meets 4.13.9 ADA requirements.
<b>UL</b>	1/3 hour fire rating for 996 and 997



Katara™  
with Round Rose Lever

## Lever Specifications:

<b>Door Prep</b>	Cross Bore 2-1/8". Edge Bore 1".
<b>Backset</b>	Adjustable 2-3/8" or 2-3/4".
<b>Door Thickness</b>	1-3/8" to 1-3/4" standard.
<b>Cylinder</b>	SmartKey
<b>Faceplates</b>	1" x 2-1/4". Specify round corner or square corner or drive-in latch.
<b>Strikes</b>	2-1/4" full lip. Specify round corner or square corner. Other options available.
<b>Bolt</b>	1/2" throw.
<b>Door Handing</b>	Reversible for right or left hand doors.
<b>ANSI/BHMA</b>	Grade 2 Certified
<b>ADA</b>	720 function satisfies section 4.13.9 ADA requirements.
<b>UL</b>	3 hour fire rating for 725, 735, 745 Optional 1/3 hour fire rating for all functions

## Available Finishes:



15  
Satin  
Nickel



26  
Polished  
Chrome



# INTRODUCING THE SMART SECURITY APP

The Kwikset Smart Security App was designed to educate users on Kwikset's broad array of products while facilitating the decision making process when purchasing door hardware.



Now available for iPhone, iPad and Android.



Visit [Kwikset.com/SmartSecurityTool](http://Kwikset.com/SmartSecurityTool) for more info.

**Kwikset**

THE BEST SECURITY IS SMART SECURITY.

# INTRODUCING THE SMART SECURITY APP

## ***House Pack Project Selector***

Determine the different types of door hardware needed for a particular project and select quantities of each type.

## ***Product Demonstrations***

Interact with Kwikset's innovative products. This tool includes product demonstrations of the Kwikset SmartKey® Re-key Technology, Key Control™ Deadbolt, SmartCode™ Keyless Entry and the SmartKey Reset Cradle, along with a video overview of our Home Connect technology.

## ***Image Gallery***

View Kwikset's core product portfolio. With this tool, users can view each product in every available finish.

## ***Re-key Savings Calculator***

Quickly and accurately assess the time and cost savings achieved in the re-keying process when using Kwikset SmartKey or Key Control Deadbolt instead of a traditional pin and tumbler lock.



***Kwikset***



## SUPERIOR SECURITY FEATURES

- ANSI/BHMA Grade 1 Certified 980/985 Deadbolt
- SmartKey® Re-Key Technology with BumpGuard™ Technology to Protect Against Lock Bumping\*

## ELEGANT STYLES AND FINISHES

- Unique Rustic Finishes

## WARRANTY

- Lifetime Mechanical
- Lifetime Finish

\*Lock Bumping - an attack technique using specially cut keys that can defeat conventional pin & tumbler locks.

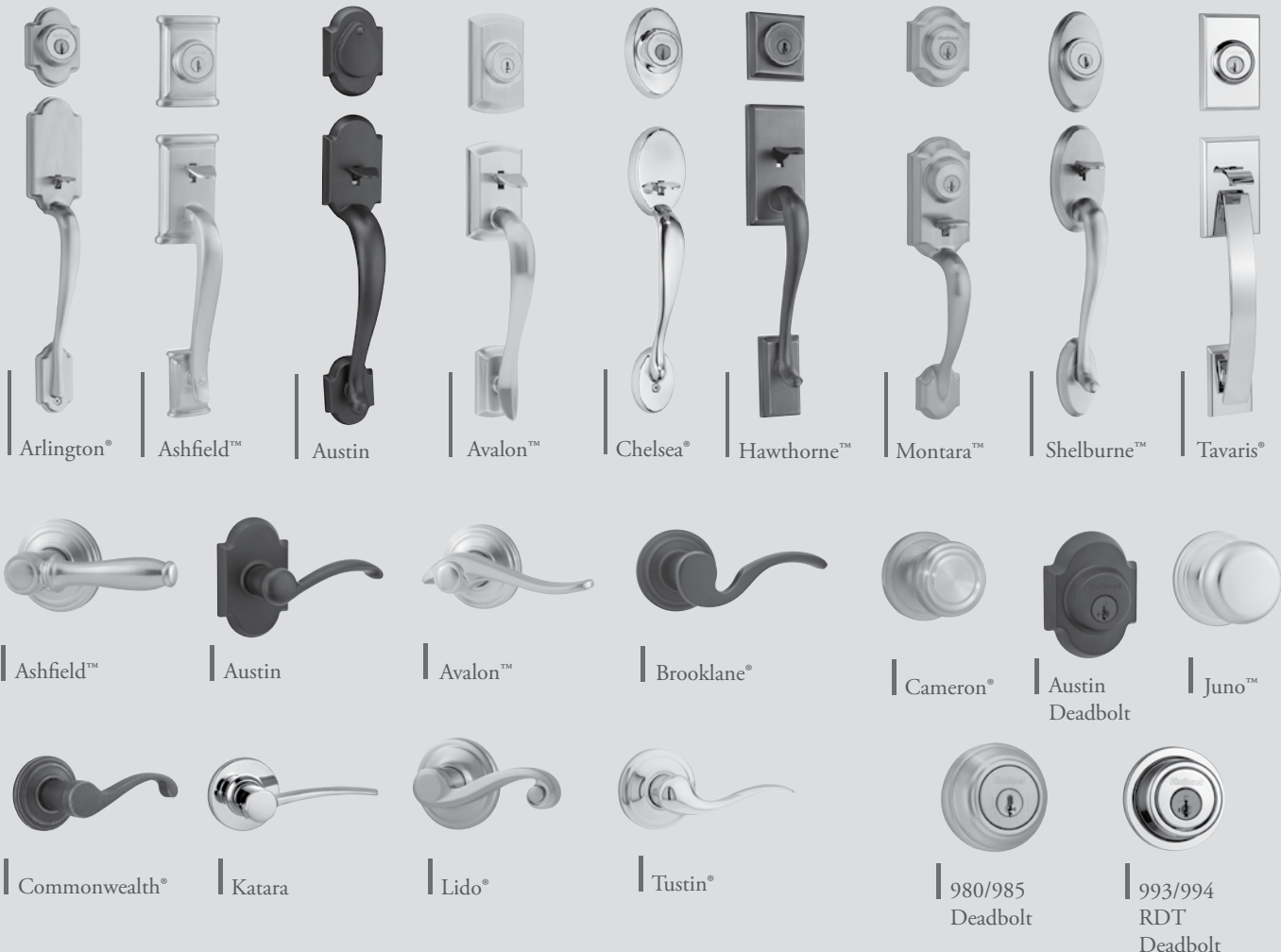

# HANDLESETS - All Keyed products below have SmartKey only

MFG Pro#	Function	Finish						Case Qty.	Price	
<b>Arlington® Handleset</b>		3	L03	5	11P	15	501	502		
98001-096	800ANXLL - Arlington X Lido		•						2	\$212.00
98001-122	800ANXC - Arlington X Copa			•					2	\$176.50
98001-095	800ANXLL - Arlington X Lido			•					2	\$201.50
98001-123	800ANXLL - Arlington X Lido				•				2	\$241.50
98001-094	800ANXLL - Arlington X Lido					•			2	\$232.00
98001-138	800ANXTNL - Arlington X Tustin							•	2	\$232.50
<b>Ashfield™ Handleset</b>		3	L03	5	11P	15	501	502	Case Qty.	Price
98001-098	800ADHXADL - Ashfield X Ashfield				•				2	\$291.00
98001-099	800ADHXADL - Ashfield X Ashfield						•		2	\$291.00
98001-119	800ADHXCHL - Ashfield X Commonwealth						•		2	\$291.00
98001-100	800ADHXADL - Ashfield X Ashfield							•	2	\$291.00
98001-136	800ADHXJ - Ashfield X Juno							•	2	\$266.50
<b>Austin Handleset - NEW</b>		3	L03	5	11P	15	501	502	Case Qty.	
98001-378	800AUHXAUL 15 SMT CP					•			2	\$298.00
98001-379	800AUHXAUL 11P SMT CP				•				2	\$298.00
<b>Avalon™ Handleset</b>		3	L03	5	11P	15	501	502	Case Qty.	
98001-101	800AVHXAVL - Avalon X Avalon					•			2	\$278.50
98001-141	800AVHXAVL Avalon x Avalon							•	2	\$291.00
<b>Chelsea® Handleset</b>		3	L03	5	11P	15	501	502	Case Qty.	Price
98001-125	800CEXCN - Chelsea X Cameron		•						2	\$185.50
98001-196	800CEXJ - Chelsea X Juno		•						2	\$168.50
98001-142	800CEXC - Chelsea X Copa		•						2	\$186.00
98001-126	800CEXLL - Chelsea X Lido		•						2	\$212.00
98001-143	800CEXTNL - Chelsea X Tustin				•				2	\$241.50
98001-124	800CEXCN - Chelsea X Cameron					•			2	\$203.00
98001-144	800CEXTNL - Chelsea X Tustin					•			2	\$232.50
<b>Hawthorne™ Handleset</b>		3	L03	5	11P	15	501	502	Case Qty.	Price
98001-104	800HEXJ - Hawthorne X Juno				•				2	\$266.50
98001-145	800HEXL - Hawthorne X Laurel				•				2	\$273.00
98001-128	800HEXCN - Hawthorne X Cameron					•			2	\$266.50
98001-137	800HEXJ - Hawthorne X Juno							•	2	\$266.50
<b>Montara™ Handleset - NEW</b>		3	L03	5	11P	15	501	502	Case Qty.	Price
95530-017	553MNXJ - Montara X Juno	•							2	\$295.00
95530-018	553MNXJ - Montara X Juno					•			2	\$316.00
95530-019	553MNXJ - Montara X Juno				•				2	\$316.00
<b>Shelburne™ Handleset</b>		3	L03	5	11P	15	501	502	Case Qty.	Price
98001-106	800SEXTNL - Shelburne X Tustin		•						2	\$273.00
98001-102	800SEXJ - Shelburne X Juno			•					2	\$254.50
98001-134	800SEXLL - Shelburne X Lido			•					2	\$259.00
98001-133	800SEXLL - Shelburne X Lido				•				2	\$273.00
98001-105	800SEXJ - Shelburne X Juno					•			2	\$254.50
98001-146	800SEXBRL - Shelburne X Brooklane					•			2	\$273.00
98001-107	800SEXTNL - Shelburne X Tustin					•			2	\$273.00
98001-131	800SEXAVL - Shelburne X Avalon					•			2	\$273.00
98001-132	800SEXCHL - Shelburne X Commonwealth							•	2	\$273.00
<b>Tavaris® Handleset</b>		3	L03	5	11P	15	501	502	Case Qty.	Price
98001-376	800TVHXKTL Tavaris X Katara					•			2	\$241.50
98001-377	800TVHXKTL Tavaris X Katara						•		2	\$241.50



ASHFIELD™



AUSTIN



AVALON™



BROOKLANE®

## LEVERS - All Keyed levers below have SmartKey only

MFG Pro#	Function	Finish							Case Qty.	Keying	Price
		3	L03	5	11P	15	501	502			
<b>Ashfield™ Lever</b>											
97200-671	720ADL - Hall/Closet				•				4		\$57.00
97300-696	730ADL - Bed/Bath				•				4		\$60.50
97402-533	740ADL - Entry				•				4	K4	\$99.00
97880-698	788ADL - Inactive				•				4		\$27.00
97200-670	720ADL - Hall/Closet						•		4		\$57.00
97300-695	730ADL - Bed/Bath						•		4		\$60.50
97402-532	740ADL - Entry						•		4	K4	\$99.00
97880-713	788ADL - Inactive						•		4		\$27.00
97200-669	720ADL - Hall/Closet							•	4		\$57.00
97300-694	730ADL - Bed/Bath							•	4		\$60.50
97402-531	740ADL - Entry							•	4	K4	\$99.00
97880-694	788ADL - Inactive							•	4		\$27.00
<b>Austin Lever - NEW</b>											
97200-771	720AUL - Passage	3	L03	5	11P	15	501	502	Case Qty.	Keying	Price
97300-807	730AUL - Privacy					•			4		\$58.00
97402-711	740AUL SMT - Entry					•			4		\$62.00
97200-772	720AUL - Passage				•				4		\$106.00
97300-808	730AUL - Privacy				•				4		\$58.00
97402-712	740AUL SMT - Entry				•				4		\$62.00
97402-712	740AUL SMT - Entry				•				4		\$106.00
<b>Avalon™ Lever</b>											
97200-668	720AVL - Hall/Closet	3	L03	5	11P	15	501	502	Case Qty.	Keying	Price
97300-693	730AVL - Bed/Bath					•			4		\$54.00
97402-535	740AVL - Entry					•			4	K4	\$56.50
97880-692	788AVL - LH Inactive					•			4		\$92.50
97880-693	788AVL - RH Inactive					•			4		\$25.50
97880-693	788AVL - RH Inactive					•			4		\$25.50
<b>Brooklane® Lever</b>											
97200-691	720BRL - Hall/Closet	3	L03	5	11P	15	501	502	Case Qty.	Keying	Price
97300-716	730BRL - Bed/Bath					•			4		\$57.00
97402-561	740BRL - Entry					•			4	K4	\$60.50
97880-706	788BRL - LH Inactive					•			4		\$99.00
97880-707	788BRL - RH Inactive					•			4		\$27.00
97200-692	720BRL - Hall/Closet					•			4		\$27.00
97300-717	730BRL - Bed/Bath					•			4		\$54.00
97402-562	740BRL - Entry					•			4	K4	\$56.50
97880-702	788BRL - LH Inactive					•			4		\$92.50
97880-703	788BRL - RH Inactive					•			4		\$25.50



COMMONWEALTH\*



LIDO\*



KATARA



TUSTIN\*

**LEVERS** - All Keyed levers below have SmartKey only

MFG Pro#	Function	Finish							Case Qty.	Keying	Price
		3	L03	5	11P	15	501	502			
<b>Commonwealth® Lever</b>		3	L03	5	11P	15	501	502			
97200-681	720CHL - Hall/Closet						•		4		\$57.00
97300-706	730CHL - Bed/Bath						•		4		\$60.50
97402-551	740CHL - Entry						•		4	K4	\$99.00
97880-734	788CHL - LH Inactive						•		4		\$27.00
97880-735	788CHL - RH Inactive						•		4		\$27.00
<b>Katara Lever</b>		3	L03	5	11P	15	501	502	Case Qty.	Keying	Price
97200-769	720KTL - Hall/Closet					•			4		\$54.00
97300-805	730KTL - Bed/Bath					•			4		\$57.00
97402-709	740KTL - Keyed Entry					•			4	K4	\$100.00
97880-853	788KTL LH - Inactive					•			4		\$24.50
97880-855	788KTL RH - Inactive					•			4		\$24.50
97200-770	720KTL - Hall/Closet						•		4		\$54.00
97300-806	730KTL - Bed/Bath						•		4		\$57.00
97402-710	740KTL - Keyed Entry						•		4	K4	\$100.00
97880-854	788KTL LH - Inactive						•		4		\$24.50
97880-856	788KTL RH - Inactive						•		4		\$24.50
<b>Lido® Lever</b>		3	L03	5	11P	15	501	502	Case Qty.	Keying	Price
97200-664	720LL - Hall/Closet	•							4		\$37.00
97300-689	730LL - Bed/Bath	•							4		\$39.00
97402-536	740LL - Keyed Entry	•							4	K4	\$69.50
97880-682	788LL LH - Inactive	•							4		\$16.50
97880-683	788LL RH - Inactive	•							4		\$16.50
97200-666	720LL - Hall/Closet			•					4		\$38.00
97300-691	730LL - Bed/Bath			•					4		\$40.50
97402-537	740LL - Keyed Entry			•					4	K4	\$70.50
97880-686	788LL LH - Inactive			•					4		\$17.50
97880-687	788LL RH - Inactive			•					4		\$17.50
97200-683	720LL - Hall/Closet				•				4		\$50.50
97300-708	730LL - Bed/Bath				•				4		\$54.50
97402-553	740LL - Keyed Entry				•				4	K4	\$85.00
97880-688	788LL LH - Inactive				•				4		\$21.50
97880-689	788LL RH - Inactive				•				4		\$21.50
97200-665	720LL - Hall/Closet					•			4		\$42.50
97300-690	730LL - Bed/Bath					•			4		\$45.00
97402-538	740LL - Keyed Entry					•			4	K4	\$79.00
97880-680	788LL LH - Inactive					•			4		\$19.00
97880-681	788LL RH - Inactive					•			4		\$19.00
<b>Tustin® Lever</b>		3	L03	5	11P	15	501	502	Case Qty.	Keying	Price
97200-663	720TNL - Hall/Closet	•							4		\$37.00
97300-688	730TNL - Bed/Bath	•							4		\$39.00
97402-539	740TNL - Keyed Entry	•							4	K4	\$69.50
97880-672	788TNL LH - Inactive	•							4		\$16.50
97880-675	788TNL RH - Inactive	•							4		\$16.50
97200-662	720TNL - Hall/Closet				•				4		\$50.50
97300-687	730TNL - Bed/Bath				•				4		\$54.50
97402-541	740TNL - Keyed Entry				•				4	K4	\$85.00
97880-678	788TNL LH - Inactive				•				4		\$21.50
97880-679	788TNL RH - Inactive				•				4		\$21.50
97200-661	720TNL - Hall/Closet					•			4		\$42.50
97300-686	730TNL - Bed/Bath					•			4		\$45.00
97402-540	740TNL - Keyed Entry					•			4	K4	\$79.00
97880-673	788TNL LH - Inactive					•			4		\$19.00
97880-676	788TNL RH - Inactive					•			4		\$19.00



CAMERON®

**KNOBS** - All Keyed products below have SmartKey only

MFG Pro#	Function	Finish							Case Qty.	Keying	Price
		3	L03	5	11P	15	501	502			
<b>Cameron® Knob</b>											
97200-685	720CN - Hall/Closet	•							4		\$23.00
97300-710	730CN - Bed/Bath	•							4		\$25.00
97402-555	740CN - Entry	•							4	K4	\$44.00
97880-714	788CN - Inactive	•							4		\$12.00
97200-695	720CN - Hall/Closet				•				4		\$34.00
97300-720	730CN - Bed/Bath				•				4		\$35.50
97402-566	740CN - Entry				•				4	K4	\$51.50
97880-745	788CN - Inactive				•				4		\$15.00
97200-684	720CN - Hall/Closet					•			4		\$26.50
97300-709	730CN - Bed/Bath					•			4		\$29.00
97402-554	740CN - Entry					•			4	K4	\$50.00
97880-715	788CN - Inactive					•			4		\$13.00





JUNO™

**KNOBS** - All Keyed products below have SmartKey only

MFG Pro#	Function	Finish						Case Qty.	Keying	Price
		3	L03	5	11P	15	501			
<b>Juno™ Knob</b>		•								
97200-672	720J - Hall/Closet	•						4		\$24.00
97300-697	730J - Bed/Bath	•						4		\$26.50
97402-542	740J - Entry	•						4	K4	\$43.50
97880-666	788J - Inactive	•						4		\$12.50
97200-673	720J - Hall/Closet			•				4		\$25.50
97300-698	730J - Bed/Bath			•				4		\$29.00
97402-543	740J - Entry			•				4	K4	\$46.00
97880-667	788J - Inactive			•				4		\$13.00
97200-675	720J - Hall/Closet				•			4		\$36.00
97300-700	730J - Bed/Bath				•			4		\$37.00
97402-545	740J - Entry				•			4	K4	\$50.50
97880-669	788J - Inactive				•			4		\$15.50
97200-674	720J - Hall/Closet					•		4		\$27.50
97300-699	730J - Bed/Bath					•		4		\$30.50
97402-544	740J - Entry					•		4	K4	\$49.00
97880-668	788J - Inactive					•		4		\$14.00
97200-676	720J - Hall/Closet						•	4		\$41.50
97300-701	730J - Bed/Bath						•	4		\$42.50
97402-546	740J - Entry						•	4	K4	\$55.50
97880-670	788J - Inactive						•	4		\$18.00



JUNO™  
COMBO PACK



LIDO®  
COMBO PACK



CAMERON®  
COMBO PACK



TUSTIN®  
COMBO PACK

**COMBO PACKS** - All combo packs include 980 deadbolt & keyed entry

MFG Pro#	Function	Finish						Case Qty.	Keying	Price
		3	L03	5	11P	15	502			
<b>991 Combo Pack - Cameron Knob with Single Cylinder Deadbolt</b>										
99910-045	991CN - Single Cylinder	•						4	K4	\$84.50
99910-044	991CN - Single Cylinder					•		4	K4	\$95.50
<b>991 Combo Pack - Lido Lever with Single Cylinder Deadbolt</b>										
99910-039	991LL - Single Cylinder	•						4	K4	\$110.50
99910-047	991LL - Single Cylinder				•			4	K4	\$131.50
99910-038	991LL - Single Cylinder					•		4	K4	\$124.50
<b>991 Combo Pack - Tustin Lever with Single Cylinder Deadbolt</b>										
99910-048	991TNL - Single Cylinder	•						4	K4	\$110.50
99910-041	991TNL - Single Cylinder				•			4	K4	\$131.50
99910-040	991TNL - Single Cylinder					•		4	K4	\$124.50
<b>991 Combo Pack - Juno Knob with Single Cylinder Deadbolt</b>										
99910-032	991J - Single Cylinder	•						4	K4	\$89.50
99910-033	991J - Single Cylinder			•				4	K4	\$72.00
99910-035	991J - Single Cylinder				•			4	K4	\$113.00
99910-034	991J - Single Cylinder					•		4	K4	\$108.50
<b>992 Combo Pack - Juno Knob with Double Cylinder Deadbolt</b>										
99920-005	992J - Double Cylinder	•						4	K4	\$99.50
99920-006	992J - Double Cylinder					•		4	K4	\$118.50



980 DEADBOLT



985 DEADBOLT



AUSTIN DEADBOLT

NEW!



993/994 RDT DEADBOLT

**DEADBOLTS** - All deadbolts have SmartKey

MFG Pro#	Function	Finish							Case Qty.	Keying	Price
Single Cylinder Deadbolt		3	L03	5	11P	15	501	502			
99800-087	980 - Single Cylinder	•							4	K4	\$54.00
99800-088	980 - Single Cylinder			•					4	K4	\$59.00
99800-089	980 - Single Cylinder				•				4	K4	\$62.50
99800-090	980 - Single Cylinder					•			4	K4	\$59.50
99800-092	980 - Single Cylinder						•		4	K4	\$62.50
99800-093	980 - Single Cylinder							•	4	K4	\$62.50
Double Cylinder Deadbolt		3	L03	5	11P	15	501	502			
99850-055	985 - Double Cylinder	•							4	K4	\$72.50
99850-057	985 - Double Cylinder				•				4	K4	\$87.00
99850-058	985 - Double Cylinder					•			4	K4	\$83.00
Austin Deadbolt		3	L03	5	11P	15	501	502			
99800-110	980AUD SMT - Single Cylinder					•			4		\$65.00
99800-111	980AUD SMT - Single Cylinder				•				4		\$65.00
99850-066	985AUD SMT - Double Cylinder					•			4		\$92.50
99850-067	985AUD SMT - Double Cylinder				•				4		\$92.50
Contemporary Single Cylinder Deadbolt		3	L03	5	11P	15	501	502			
99930-016	993 RDT - Single Cylinder					•			4	K4	\$62.50
99930-017	993 RDT - Single Cylinder						•		4	K4	\$62.50
Contemporary Double Cylinder Deadbolt		3	L03	5	11P	15	501	502			
99940-013	994 RDT - Double Cylinder					•			4	K4	\$89.00
99940-014	994 RDT - Double Cylinder						•		4	K4	\$89.00



## TRUSTED SECURITY

- ANSI/BHMA Grade 3
- Easy Installation
- Handlesets Now Feature SmartKey® Re-key Technology with Bumpguard™ Protection\*
- Most Recognized Style

## WARRANTY

- Lifetime Mechanical
- Lifetime Finish

\*Lock Bumping - an attack technique using specially cut keys that can defeat conventional pin & tumbler locks.



Balboa

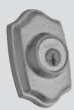

Belleview™



Dakota™



660/665 Deadbolt



Cove™



Delta®



Dorian®



Polo®



Tylo®





BELLEVIEW™



DAKOTA

**HANDLESETS** - All handlesets below have SmartKey only

MFG Pro#	Function	Finish					Case Qty.	Price
		3	5	11P	15	26D		
<b>Belleview™ Handleset</b>								
96870-098	687BWXT - Belleview X Tylo X SMT		•				2	\$125.50
96870-100	687BWXC - Belleview X Cove SMT			•			2	\$129.50
96870-099	687BWXP - Belleview X Polo SMT				•		2	\$129.50
<b>Dakota™ Handleset</b>								
96870-088	687DAXP - Dakota X Polo SMT	•					2	\$119.50
96870-091	687DAXT - Dakota X Tylo SMT	•					2	\$119.50
96870-087	687DAXT - Dakota X Tylo SMT		•				2	\$125.50
96870-090	687DAXP - Dakota X Polo SMT				•		2	\$129.50
96870-089	687DAXT - Dakota X Tylo SMT					•	2	\$125.50

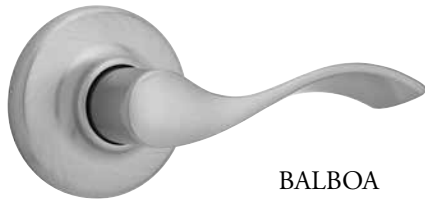

BALBOA

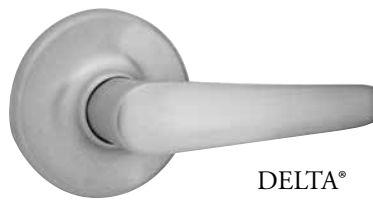

DELTA®



DORIAN®

## LEVERS

MFG Pro#	Function	Finish					Case Qty.	Keying	Price
		3	5	11P	15	26D			
<b>Balboa Lever</b>									
92001-405	200BL - Hall/Closet				•		6	\$34.00	
93001-638	300BL - Bed/Bath				•		6	\$36.00	
94050-428	405BL - Entry				•		6	K6 \$58.00	
94880-495	488BL LH - Inactive				•		4	\$15.00	
94880-496	488BL RH - Inactive				•		4	\$15.00	
<b>Delta® Lever</b>									
92001-287	200DL - Hall/Closet	•					6	\$29.80	
93001-512	300DL - Bed/Bath	•					6	\$31.60	
94050-351	405DL - Entry	•					6	K6 \$49.30	
94880-432	488DL - Inactive	•					4	\$12.10	
92001-290	200DL - Hall/Closet					•	6	\$31.70	
93001-515	300DL - Bed/Bath					•	6	\$33.60	
94050-354	405DL - Entry					•	6	K6 \$51.50	
94880-435	488DL - Inactive					•	4	\$13.80	
<b>Dorian® Lever</b>									
92001-291	200DNL - Hall/Closet	•					6	\$29.80	
93001-516	300DNL - Bed/Bath	•					6	\$31.60	
94050-355	405DNL - Entry	•					6	K6 \$49.30	
94880-436	488DNL - Inactive	•					4	\$12.10	
92001-293	200DNL - Hall/Closet					•	6	\$31.70	
93001-518	300DNL - Bed/Bath					•	6	\$33.60	
94050-357	405DNL - Entry					•	6	K6 \$51.50	
94880-438	488DNL - Inactive					•	4	\$13.80	



COVE™



POLO®

## KNOBS

MFG Pro#	Function	Finish					Case Qty.	Keying	Price
		3	5	11P	15	26D			
<b>Cove™ Knob</b>									
92001-397	200CV - Hall/Closet			•			6	\$22.70	
93001-630	300CV - Bed/Bath			•			6	\$24.10	
94002-541	400CV - Entry			•			6	K6 \$29.80	
94880-488	488CV - Inactive			•			4	\$10.60	
<b>Polo® Knob</b>									
92001-276	200P - Hall/Closet	•					6	\$16.40	
93001-500	300P - Bed/Bath	•					6	\$18.10	
94002-432	400P - Entry	•					6	K6 \$24.10	
94880-367	488P - Inactive	•					4	\$7.40	
92001-277	200P - Hall/Closet		•				6	\$18.40	
93001-501	300P - Bed/Bath		•				6	\$20.10	
94002-435	400P - Entry		•				6	K6 \$25.80	
94880-368	488P - Inactive		•				4	\$8.20	
92001-398	200P - Hall/Closet			•			6	\$19.40	
93001-631	300P - Bed/Bath			•			6	\$21.10	
94002-542	400P - Entry			•			6	K6 \$26.80	
94880-489	488P - Inactive			•			4	\$9.60	
92001-272	200P - Hall/Closet				•		6	\$18.40	
93001-496	300P - Bed/Bath				•		6	\$20.10	
94002-502	400P - Entry				•		6	K6 \$25.80	
94880-399	488P - Inactive				•		4	\$9.10	



POLO®



TYLO®

## KNOBS

MFG Pro#	Function	Finish					Case Qty.	Keying	Price
		3	5	11P	15	26D			
<b>Polo® Knob Continued</b>									
92001-275	200P - Hall/Closet					•	6		\$16.70
93001-499	300P - Bed/Bath					•	6		\$18.50
94002-429	400P - Entry					•	6	K6	\$24.50
94880-369	488P - Inactive					•	4		\$7.60
<b>Tylo® Knobs</b>									
92001-280	200T - Hall/Closet	•					6		\$14.40
93001-504	300T - Bed/Bath	•					6		\$16.00
94002-444	400T - Entry	•					6	K6	\$21.80
94880-363	488T - Inactive	•					4		\$6.60
92001-281	200T - Hall/Closet		•				6		\$16.10
93001-506	300T - Bed/Bath		•				6		\$17.50
94002-447	400T - Entry		•				6	K6	\$23.40
94880-364	488T - Inactive		•				4		\$7.60
92001-279	200T - Hall/Closet					•	6		\$14.70
93001-503	300T - Bed/Bath					•	6		\$16.20
94002-441	400T - Entry					•	6	K6	\$22.50
94880-365	488T - Inactive					•	4		\$6.70





COMBO PACK ENTRY KNOB/LEVER WITH DEADBOLT

**COMBO PACKS** - All combo packs include 660 or 665 deadbolt & keyed entry

MFG Pro#	Function	Finish					Case Qty.	Keying	Price
		3	5	11P	15	26D			
<b>690 Combo Pack - Cove™ Knob with Single Cylinder Deadbolt</b>									
96900-332	690CV			•			6	K6	\$53.80
<b>690 Combo Pack - Polo® Knob with Single Cylinder Deadbolt</b>									
96900-250	690P	•					6	K6	\$49.60
96900-251	690P		•				6	K6	\$53.60
96900-333	690P			•			6	K6	\$50.90
96900-320	690P				•		6	K6	\$51.60
96900-295	690P					•	6	K6	\$49.60
<b>690 Combo Pack - Tylo® Knob with Single Cylinder Deadbolt</b>									
96900-253	690T	•					6	K6	\$47.40
96900-254	690T		•				6	K6	\$51.20
96900-252	690T					•	6	K6	\$48.50
<b>690 Combo Pack - Delta® Lever with Single Cylinder Deadbolt</b>									
96900-312	690DL					•	6	K6	\$74.60
<b>695 Combo Pack - Polo® Knob with Double Cylinder Deadbolt</b>									
96950-160	695P	•					6	K6	\$56.80
96950-161	695P		•				6	K6	\$60.80
<b>695 Combo Pack - Tylo® Knob with Double Cylinder Deadbolt</b>									
96950-163	695T	•					6	K6	\$54.40
96950-164	695T		•				6	K6	\$58.30
96950-162	695T					•	6	K6	\$55.30
<b>Pre-Pack - Special Orders Only</b>									
91860-037	186 690T	•					36	K6	\$47.40
91860-039	186 690T		•				36	K6	\$51.20
91860-038	186 690T					•	36	K6	\$48.50



242 PROJECT PACK



243 PROJECT PACK

**PROJECT PACKS** - All 242 project packs include 660 deadbolt & keyed entry

MFG Pro#	Function	Finish					Case Qty.	Keying	Price
		3	5	11P	15	26D			
<b>Project Pack - 2 Keyed Tylo® Knobs with 2 Single Cylinder Deadbolts</b>		3	5	11P	15	26D			
92420-031	242T	•					6	K2	\$94.70
92420-032	242T		•				6	K2	\$102.30
92420-036	242T					•	6	K2	\$97.00
<b>Project Pack - 2 Keyed Tylo® Knobs</b>		3	5	11P	15	26D	Case Qty.	Keying	Price
92430-022	243T	•					6	K2	\$43.60
92430-023	243T		•				6	K2	\$46.80



660 SINGLE CYLINDER



663 ONE SIDED DEADBOLT



665 DOUBLE CYLINDER



MOBILE HOME LOCKS

## DEADBOLTS

MFG Pro#	Function	Finish					Case Qty.	Keying	Price
		3	5	11P	15	26D			
<b>Single Cylinder Deadbolt</b>		3	5	11P	15	26D			
96600-419	660 - Single Cylinder	•					6	K6	\$23.70
96600-420	660 - Single Cylinder		•				6	K6	\$25.80
96600-590	660 - Single Cylinder			•			6	K6	\$26.80
96600-564	660 - Single Cylinder				•		6	K6	\$25.80
96600-418	660 - Single Cylinder					•	6	K6	\$24.20
<b>One-Sided Deadbolt</b>		3	5	11P	15	26D	Case Qty.	Keying	Price
96630-059	663 - One Sided Deadbolt - RCL RCS	•					4		\$11.30
96630-061	663 - One Sided Deadbolt - RCL RCS		•				4		\$12.10
<b>Double Cylinder Deadbolt</b>		3	5	11P	15	26D	Case Qty.	Keying	Price
96650-390	665 - Double Cylinder	•					6	K6	\$30.50
96650-391	665 - Double Cylinder		•				6	K6	\$32.50
96650-438	665 - Double Cylinder				•		6	K6	\$32.50
96650-389	665 - Double Cylinder					•	6	K6	\$31.10
<b>Mobile Home Locks</b>		3	5	11P	15	26D	Case Qty.	Keying	Price
92001-271	200M - Hall/Closet	•					6		\$14.10
93001-495	300M - Bed/Bath	•					6		\$15.50
94002-503	400M - Entry	•					6	K6	\$21.10
92001-270	200M - Hall/Closet					•	6		\$14.30
93001-494	300M - Bed/Bath					•	6		\$15.80
94002-504	400M - Entry					•	6	K6	\$21.50
96600-565	660M - Mobile Home	•					6	K6	\$22.40
96600-566	660M - Mobile Home					•	6	K6	\$22.80



## FEATURES

- Lock Your Door with the Touch of a Button
- Customizable Access Codes for Increased Security
- Back-Lit Keypad for Increased Visibility
- Customizable Automatic Door Locking After 30 Seconds for Peace Of Mind
- Installs In Minutes with Just a Screwdriver - No Hard Wiring Required
- Fits Standard Doors ( 1 3/8" - 1 3/4" ) with No Screw Holes Required
- SmartCode™ Lever Ideal for - Small/Home Office, Utility/Storage Room, Interior Garage/Side Door
- SmartCode™ Deadbolts Replace any Deadbolt for Keyless Entry Convenience

## WARRANTY

- 1 Year Electronic Warranty
- Lifetime Finish & Mechanical Warranty



907 PowerBolt®



909 SmartCode™ Deadbolt



909 CNT SmartCode™ Deadbolt



911 SmartCode™ Lever

## ELECTRONIC LOCKS

MFG Pro#	Function	Finish							Case Qty.	Keying	Price
		3	L03	5	11P	15	26	26D			
<b>Powerbolt®</b>		3	L03	5	11P	15	26	26D			
99070-007	907 - Powerbolt®		•						2		\$139.75
99070-008	907 - Powerbolt®					•			2		\$143.00
99070-009	907 - Powerbolt®				•				2		\$143.00
<b>SmartCode™ Deadbolt</b>		3	L03	5	11P	15	26	26D			
99090-001	909 - SmartCode™ Deadbolt		•						2		\$227.25
99090-003	909 - SmartCode™ Deadbolt				•				2		\$233.50
99090-002	909 - SmartCode™ Deadbolt					•			2		\$233.50
99090-007	909 - CNT SmartCode™ Deadbolt					•			2		\$233.50
99090-008	909 - CNT SmartCode™ Deadbolt						•		2		\$233.50
99090-009	909 - CNT SmartCode™ Deadbolt						•		2		\$233.50
99090-013	909 - CNT SmartCode™ Deadbolt				•				2		\$233.50
<b>SmartCode™ Lever</b>		3	L03	5	11P	15	26	26D			
99110-004	911 - SmartCode™ Lever		•						2		\$250.00
99110-005	911 - SmartCode™ Lever					•			2		\$263.75
99110-006	911 - SmartCode™ Lever				•				2		\$263.75



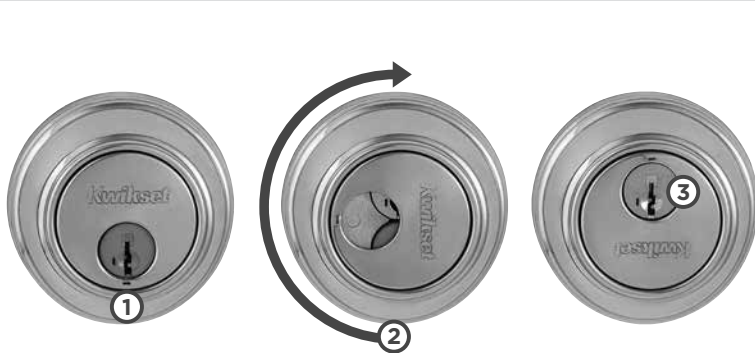

Easily access the Key Control cylinder: **(1)** Insert the SmartKey Tool into the slot at bottom of cylinder cover **(2)** Rotate cover clockwise to expose the Key Control cylinder. **(3)** Now you have access to the Key Control cylinder. Use tool to rotate counter-clockwise back to user's keyway when appropriate.

## FEATURES

- Two Separate Cylinders, Tenant & Property Manager, Allow for More Tenant Key Cuts Than a Traditional Master Key System
- New Proprietary Keyway Adds Security
- Property Manager Cylinder is Concealed When Not in Use to Avoid Tenant Confusion
- With Smartkey®, Re-Key the Lock Without Removing From the Door



KEY CONTROL DEADBOLT

LIGHT COMMERCIAL								
MFG Pro#	Function	Finish					Case Qty.	Price
Key Control Deadbolt		3	5	11P	15	26D		
98160-007	816 - Key Control Deadbolt	•					6	\$61.00
98160-006	816 - Key Control Deadbolt					•	6	\$69.00
98160-008	816 - Key Control Deadbolt				•		6	\$69.00



## RE-KEY TECHNOLOGY: EASY AS 1-2-3

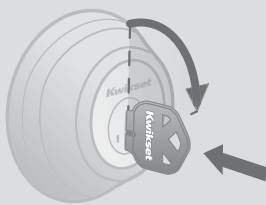

**1** Insert functioning key & turn 1/4 turn clockwise.

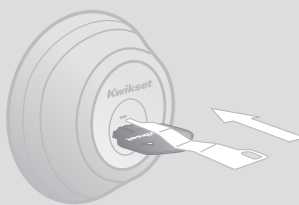

**2** Insert & remove the SmartKey learn tool. Remove functioning key.



**3** Insert new key & turn 1/2 turn counter-clockwise. Done. *Your lock is now re-keyed!*



**!** You must have your functioning key & the learn tool for the system to work.



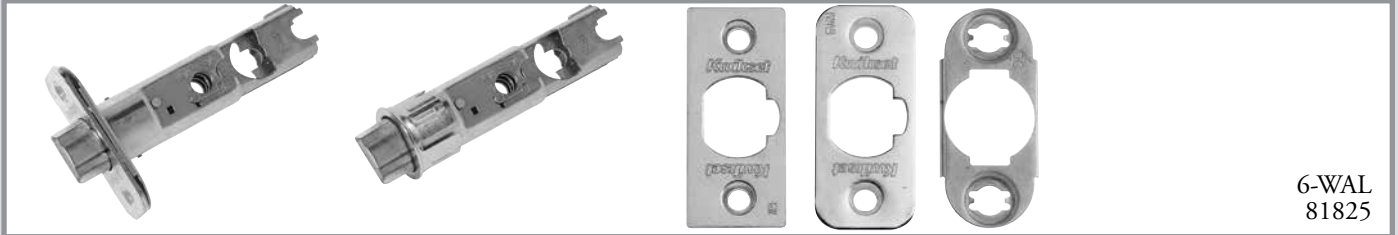

6-WAL  
81825

## PARTS

MFG Pro#	Function	Finish							Case Qty.	Price
		NA	3	L03	5	11P	15	26/26D		
<b>Plain Latches</b>										
81826	19843 6WAL PL		•		•			•	6	\$7.50
<b>Dead Latches</b>										
83014-015	Security - 5" Deadlatch, 1" Front		•						6	\$13.00
81825	19841 6WAL DL		•		•			•	6	\$10.35
<b>Deadbolt Latches</b>										
83146-001	11776 CP, RCAL DB LTCH		•						6	\$12.00
<b>Mobile Home Conversion Kits</b>										
80340-001	12077 CP, DB, RFL, CNV Kit		•						6	\$10.45
83228-001	22827 CP, DL, 2WAL, DI 3/26 CNV Kit		•						6	\$9.15
83229-001	12003 CP, PI, 7/8RF, 3/26 CNV Kit		•						6	\$6.50
<b>Strikes</b>										
83437	3437-01 CP, STRK, SQ CNR FULL LIP		•		•			•	6	\$3.40
83222-026	3222-01 3 CP STRK, DB		•						6	\$4.10

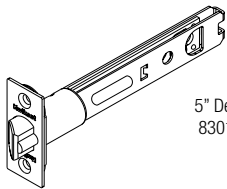

5" Deadlatch  
83014-015

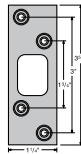

Deadbolt  
Square Corner Strike  
83222-026

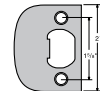

Full Lip  
Square Corner Strike  
83437

PARTS





REKEYING KIT

<b>KEYING</b>			
MFG Pro #	Description	Qty Per Pack	Price each
92720-001	272 Rekeying Kit	1	\$216.15
83108-001	#1 Master Pin .023"	100	\$0.12
83110-001	#2 Master Pin .046"	100	\$0.12
83112-001	#3 Master Pin .069"	100	\$0.12
83113-001	#4 Master Pin .092"	100	\$0.12
83114-001	#5 Master Pin .115"	100	\$0.12
83125-001	#6 Master Pin .138"	100	\$0.12
83100-001	#1 Bottom Pin .172"	100	\$0.12
83101-001	#2 Bottom Pin .195"	100	\$0.12
83103-001	#3 Bottom Pin .218"	100	\$0.12
83105-001	#4 Bottom Pin .241"	100	\$0.12
83106-001	#5 Bottom Pin .264"	100	\$0.12
83107-001	#6 Bottom Pin .287"	100	\$0.12
81858-001	Regular Top Pin .180"	100	\$0.12
83117-001	PK Top Pin .160"	100	\$0.12

<b>KEYING</b>			
MFG Pro #	Description	Qty Per Pack	Price each
80370-001	Regular Anti-Pick Top Pin .180"	100	\$0.30
80369-001	PK Anti-Pick Top Pin .160"	100	\$0.30
84345-001	Knob Plug Retainer	100	\$0.14
84215-001	Deadlock Plug Retainer	100	\$0.14
87619-001	Knob Control Lug (Locking Bar)	100	\$0.30
87809-001	Deadlock Control Lug (Locking Bar)	100	\$0.55
80371-001	Low Profile Deadbolt Spring Cover	100	\$1.00
85757-001	Spring Cover (5-Pin)	50	\$0.90
83561-001	Spring Cover (6-Pin)	50	\$0.90
87632-001	Spring	100	\$0.45
82208-001	PK Balls	100	\$0.12
81777-001	Tumbler Spring	100	\$0.12
81467-003	Cylinder Removal Tool	1	\$1.55
80152-001	Plug Follower	1	\$6.40
80049-001	Key Gauge	1	\$5.95

<b>SmartKey KEYING</b>			
MFG Pro #	Description	Case Qty.	Price
83262-001	Rekeying Kit CP SMT KW	6	\$12.45
83260-001	83260 SMT Reset Cradle	1	\$37.40



SMARTKEY SERVICE PARTS



83262-001



83260-001

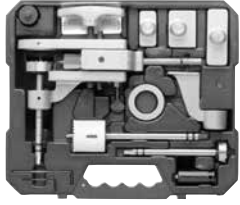

*Drill not included*

## 138 INSTALLATION KIT

### 138 INSTALLATION KIT & REPLACEMENT PARTS

MFG Pro#	Function	Quantity Per Pack	Master Pack Quantity	Price
<b>138 Installation Kit &amp; Replacement Parts</b>				
91380-001	138 Installation Kit	1	1	\$553.50
89900-001	Jig with Wood Arm Guide	1	1	\$263.80
89901-001	Wood Door In-Line Guide Arm	1	1	\$58.30
89902-001	Metal Door In-Line Guide Arm	1	1	\$58.30
<b>Drill Bits</b>		<b>Quantity Per Pack</b>	<b>Master Pack Quantity</b>	<b>Price</b>
89903-001	1" Spade Bit	1	3	\$19.50
89904-001	2-1/8" Multi Spur Bit	1	3	\$85.80
89905-001	1-1/2" Multi Spur Bit	1	3	\$71.30
89906-001	2-1/8" Hole Saw Bit	1	3	\$17.95
89907-001	Hole Saw Mandrel	1	1	\$17.95
89908-001	Snap Rings	6	3	\$11.45
<b>Mortise Tools</b>		<b>Quantity Per Pack</b>	<b>Master Pack Quantity</b>	<b>Price</b>
89909-001	Full Lip Strike Mortise Tool	1	3	\$32.35
89910-001	Full Lip Round Corner Strike Blades	3	3	\$9.70
89911-001	Full Lip Square Corner Strike Blades	3	3	\$9.70
89912-001	Latch Mortise Tool	1	3	\$34.10
89913-001	Latch Round Corner Blades	3	3	\$11.45
89914-001	Latch Square Corner Blades	3	3	\$11.45
89915-001	Security Strike Mortise Tool	1	1	\$35.65
89916-001	Security Square Corner Blades	3	3	\$13.20
89917-001	Security Round Corner Blades	3	3	\$13.20
<b>Miscellaneous Parts</b>		<b>Quantity Per Pack</b>	<b>Master Pack Quantity</b>	<b>Price</b>
89918-001	Quick Bit Changer	1	1	\$22.80
89919-001	Strike Locator	1	1	\$5.20
89920-001	Strike Locator Tip	3	1	\$6.95
89921-001	Kit Box	1	1	\$29.15
89922-001	Jig Bushing	3	1	\$22.35
89923-001	1-1/2" Adapter Ring	1	1	\$10.25
89924-001	663 Boring Depth Stop	1	1	\$3.30
89925-001	Boring Template	1	1	\$3.00
89926-001	1/8" Hex Ring	1	1	\$0.90
91300-001	Wood Door Installation Kit	1	3	\$28.50



334 PASSAGE

335 PRIVACY



NOTCH POCKET DOOR LOCKS



DESIGNER ROSES

### ROUND POCKET DOOR LOCK

MFG Pro#	Function	Finish						Case Qty.	Price
		3	L03	5	11P	15	26D		
<b>Round Pocket Door Lock</b>		3	L03	5	11P	15	26D		
93340-023	334 - Passage	•						6	\$22.80
93350-023	335 - Privacy	•						6	\$25.30
93340-024	334 - Passage					•		6	\$22.80
93350-024	335 - Privacy					•		6	\$25.30

### NOTCH POCKET DOOR LOCK

MFG Pro#	Function	Finish						Case Qty.	Price
		3	L03	5	11P	15	26D		
<b>Notch Pocket Door Lock</b>		3	L03	5	11P	15	26D		
93320-019	332 - Passage Lock	•						12	\$22.15
93330-017	333 - Privacy Lock	•						12	\$24.65
93320-021	332 - Passage Lock			•				12	\$23.80
93330-019	333 - Privacy Lock			•				12	\$26.30

### DESIGNER ROSES

MFG Pro#	Function	Finish							Case Qty.	Price
		3	L03	5	11P	15	26D	514		
<b>Oval Rose</b>		3	L03	5	11P	15	26D	514		
83318-001	Designer Rose for Reversible Levers				•				12 sets	\$20.00
83318-002	Designer Rose for Reversible Levers					•			12 sets	\$20.00
83318-006	Designer Rose for Reversible Levers							•	12 sets	\$21.50
<b>Arched Rose</b>										
83319-001	Designer Rose for for Reversible Levers				•				12 sets	\$20.00
83319-002	Designer Rose for Reversible Levers					•			12 sets	\$20.00
83319-006	Designer Rose for Reversible Levers							•	12 sets	\$21.50

**NOTES:**

- Ordered as separate accessory with any Kwikset Signature Series Reversible Lever.
- Must order in full case quantity.
- Boxpack Package Only.



Handle Trim  
Model 239



Trim Rosette  
Model 288



Round Trim  
Rosette  
Model 293

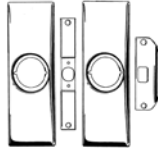

Modernization Kit  
Model 214

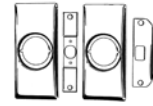

Modernization Kit  
Model 215



Combo Trim  
Escutcheon  
Model 262

## TRIMS

TRIMS										
Part #	Function	Finish						Dimensions	Case Qty.	Price
		3	L03	5	11P	15	26D			
Trims		•								
92140-001	Large Modernization Kit	•						3-1/2" x 10-1/2"	10	\$62.05
92150-001	Small Modernization Kit	•						3-3/8" x 7-1/4"	10	\$43.45
92390-022	Curved Colonial Handle	•							4	\$55.35
92390-009	Curved Colonial Handle BP			•					4	\$58.65
92390-021	Curved Colonial Handle BP					•			4	\$56.10
92490-001	Medium Rectangular Rosette	•						3-3/8" x 7-1/4"	5	\$19.50
92620-001	Vertical Combo	•						3-1/2" x 8-1/2"	5	\$29.05
92620-006	Vertical Combo			•				3-1/2" x 8-1/2"	5	\$33.20
92620-015	Vertical Combo					•		3-1/2" x 8-1/2"	5	\$32.35
92630-001	Large Vertical Combo	•						3-1/2" x 10-1/2"	5	\$29.05
92880-001	Small Rectangular Rosette	•						3-15/16" x 4-7/32"	5	\$18.70
92930-012	Round Rosette	•						3-13/16"	4	\$14.10
92930-013	Round Rosette			•				3-13/16"	4	\$15.95
92930-011	Round Rosette					•		3-13/16"	4	\$14.85
92930-014	Round Rosette					•		3-13/16"	4	\$14.85



## KWIKSET SIGNATURE SERIES HANDLESET FUNCTIONS

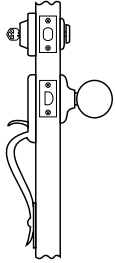

**Model**

800

**Function**

Handleset with Single Cylinder Deadbolt

**Description**

Latchbolt operated by thumbpiece outside and grip inside. Deadbolt operated by key outside and thumbturn inside.

## KWIKSET SIGNATURE SERIES KNOB & LEVER FUNCTIONS

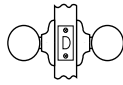

**Passage/Hall/Closet:** Both knobs always free.  
**720 F75**

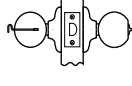

**Privacy/Bed/Bath:** Both knobs locked or unlocked by tumbbutton inside. Outside knob unlocked by emergency key.  
**730 F76**

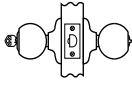

**Entry:** Both knobs locked or unlocked by key outside or tumbbutton inside.  
**740 F82**



**Half Dummy Trim, Surface Mounted:** For doors where only a pull is required. No operation.  
**788**

## KWIKSET SIGNATURE SERIES HANDLESET FUNCTIONS

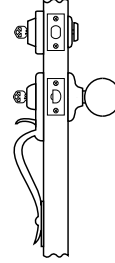

**Model**

553

**Function**

Handleset with Single Cylinder Deadbolt

**Description**

Latch bolt operated by thumb piece outside and grip inside, except when both are locked by key outside or turn button inside. Deadbolt operated by key outside or thumb turn inside.

## KWIKSET SIGNATURE SERIES DEADBOLT FUNCTIONS



**Single Cylinder:** Deadbolt operated by key outside and thumbturn inside.  
**980 E0151**

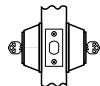

**Double Cylinder:** Deadbolt operated by key both sides.  
**985 E0141**

*Note: ANSI/BHMA functions are listed in italics.*

## Kwikset Signature Series Packaging Dimensions

	Unit Height	Unit Width	Unit Length	Unit Weight	Master Height	Master Width	Master Length	Cubic Ft.	Master Weight	Case Qty
Knobs	10	5	3	1.6	10.7	7.2	12.7	0.57	7.1	4
Levers	10	6.5	3	2.3	11	5.8	13.5	0.5	10.5	4
Deadbolts	9	4.5	3	2.5	9.25	5.25	12.25	0.53	10.3	4
Knob Combo	9.37	8	3	4.7	9.75	8.75	12.25	1.49	19.3	4
Lever Combo	9.37	9	3	4.8	9.75	9.75	12.25	1.49	19.3	4
Handlesets	21.8	8	5.5	10.3	12.5	9	22.3	0.31	20.6	2
Inactive Knobs	8.8	3.5	3.3	0.3	9.3	13.3	4.4	0.31	1.3	4
Inactive Levers	8.8	3.5	3.3	0.3	9.3	13.3	4.4	0.31	1.3	4

Note: All dimensions in inches. All weights in pounds and based on maximum weights of each function.

## KWIKSET HANDLESET FUNCTIONS

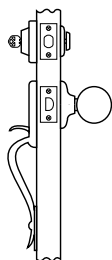

### Model

687 Dakota  
687 Belleview

### Function

Sectional Handleset  
with Single Cylinder  
Deadbolt

### Description

Latchbolt operated by  
thumbpiece outside  
and grip inside.  
Deadbolt operated  
by key outside and  
thumbturn inside.

## KWIKSET KNOB & LEVER FUNCTIONS

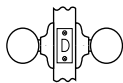

**Passage/Hall/Closet:** Both knobs  
always free.  
**200 F75**

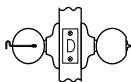

**Privacy/Bed/Bath:** Both knobs or levers locked  
or unlocked by turnbutton inside. Outside  
knob unlocked by emergency key. **300 F76**

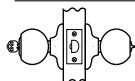

**Entry:** Both knobs or levers locked or unlocked by  
key outside or turnbutton inside.  
**400 F82 - 2 knobs**  
**405 F82 - 2 levers**



**Half Dummy Trim, Surface Mounted:**  
For doors where only a pull is required.  
No operation.  
**488**

## KWIKSET DEADBOLT FUNCTIONS



**Single Cylinder:** Deadbolt operated by key  
outside and thumbturn inside.  
**660/660M E0153**

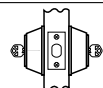

**Double Cylinder:** Deadbolt operated by  
key both sides.  
**665 E0143**



**Thumbturn Only:** Deadbolt operated by  
thumbturn one side. No trim on other side.  
**663 E0193**

*Note: ANSI/BHMA functions are listed in italics.*

## Kwikset Packaging Dimensions

	Unit Carton Height	Unit Carton Width	Unit Carton Depth	Unit Carton Weight	Master Carton Height	Master Carton Width	Master Carton Depth	Cubic Ft.	Master Carton Weight	Case Count
Knobs	6.5	8	3	1.4	6.875	17.187	8.5	0.581	8.4	6
Levers	10.125	7.5	3	2.13	11	3.625	19.875	1.09	14	6
Deadbolts	6.5	2.906	5.375	1.235	6.688	17.438	6.25	0.422	7.41	6
Combo Packs	10.5	7.875	3.25	2.5	11.4	8.875	18.125	1.061	15	6
Belleview	21	8.125	5.5	4.5	12.5	9	21.625	1.408	9	2
Dakota	21	8.125	5.5	6	12.5	9	21.625	1.408	12	2
Inactive Knobs	8.75	3.5	3.125	0.93	9.313	13.313	4.375	0.314	3.72	4
243	10.5	7.75	3	2.5	11.4	8.875	18.125	1.061	15	6
242	11.125	12.75	2.875	5	13.063	18.75	13.813	1.958	30	6
Inactive Levers	8.75	3	3.5	0.93	9.313	13.313	4.375	0.314	3.72	4

*Note: All dimensions in inches. All weights in pounds and based on maximum weights of each function.*

---

---

---

---

---

---

---

---

---

---

---

---

---

---

---

---

---

---

---

---

---

---

---

---