



## INDEX

The following Key Blank location index has been prepared to assist you in locating a key blank. Key Blank location is designated by section and page number. In the case of multiple listings for the same key blank, each location is shown.

ILCO Number	Sec - Page(s)	ILCO Number	Sec - Page(s)	ILCO Number	Sec - Page(s)	ILCO Number	Sec - Page(s)
GM-A	4B-5	BJ1R	3-11	FC1	3-24	L1T	3-32, 3-35
GM-B	4B-5	BKZ1	1-149, 3-8	FE1	3-24	L1TL	3-32
GM-C	4B-5	BM1	1-86	FF1	1-45	L1Y	3-37
GM-D	4B-5	BMW1	1-11	FIC1	2-28	LA1	1-87, 1-115
GM-E	4B-5	BN1	2-4	FL1	2-26	LAP1	3-32
GM-H	4B-5	BO1	2-6, 2-31	FLR1	3-25	LB1	5-3
GM-J	4B-5	BR1	3-13	FS1	1-33	LC1	3-33
GM-K	4B-5	BS1	3-13	FSP1	3-25	LD1	2-39
HARLOC	4B-2	BT1	3-9	FT1	3-25	LE1	3-32
HO01-SVC	1-65	BU1	1-29, 1-49, 1-110	FV1	1-31, 1-74, 1-89, 1-92,	LF1	3-36
HO01T5	1-63	BUR1	3-13		1-141, 1-148, 3-37	LK1	3-35
HOV01T5	1-63	BV1	3-13	GA1	3-16	LN1	3-42
NI01T	1-109	BVA1	3-9	GAV1	3-27	LO1	2-37, 2-41
NI02T	1-109	BY1	3-12	GB1	3-26	LP1	3-34
1	2-70	BYA1	3-9	GC1	1-49	LP1R	3-34
1B	7-1	BZK1	1-120	GE1	3-25	LPB1	3-34
1K	4B-2	C1S	3-19	GH1	1-141	LR1	3-32
1N	2-70	CB1	2-13	GL1	3-27	LT1	3-35
A1	2-50	CC1	1-59, 2-9	GN1	3-26	LU1	6B-2
AB1	3-2, 3-17	CD1	3-18	GR1	3-25	LWC1	3-35
AD1	1-7, 1-110, 1-148	CE1	3-14	GRD1	3-27	LUV1	1-53, 1-58
AE1	2-1	CER1	3-14	GT1	1-88	M1	2-41
AF1	2-3	CF1	3-16	GV1	3-27	M1-PC	2-41
AG1	2-3	CG1	1-32, 1-78, 1-110, 2-9	GV1R	3-27	MAS1	1-91
AG1R	3-2	CG1P-SI	1-18	GW1	3-26	MB1	3-38
AGU1	3-2	CH1C	2-3	HAW1	2-30	MCM1	3-37
AK1	3-2	CH1D	2-3	HD1	1-64	ME1	3-38
AL1-BLK	3-4, 3-39	CL1	2-10	HF1	1-96	MG1	1-15, 1-76, 1-146
ALARM B1	3-1	CLB1	1-27	HG1	3-28	MGM1	3-38
ALP1	3-18	CLP1	2-38	HH1	3-27	MGM1R	3-38
AM1	3-3	CN1	3-18	HL1	3-28	MIT1	1-24, 1-101
AP1	2-2	CO1	2-13	HN1	3-28	MIT1-P	1-24, 1-101
AR1	2-7	CS1	3-15	HO01-PT	1-63	MIT1-PC	1-24, 1-101
AR1-PC	2-1, 2-3	CT1	3-14	HO1	2-7	MN1	5-4
1A1A1	2-1	CTG1	3-17	HOD1	1-61	MO1	3-38
1A1B1	4B-1	CVL1	3-19	HR1	2-30	MON1	3-38
1A1C1	4B-1	CVL1R	3-19	HS1	3-28	MR1	2-44
1A1D1	4B-1	CW1	3-19	HYD1	1-59	MW1	3-38
1A1DD1	4B-1	D1A	3-19	ID1	2-32, 3-3, 3-50	MZ1	1-92
1A1E1	4B-1	D1K	3-19	IF1	3-29	N1	2-48
1A1F1	4B-1	D1T	3-19	IF1R	3-29	NA1	2-45
1A1FM1	4B-1	D1V	3-19	IG1	3-29	NC1	2-44
1A1G1	4B-1	DB1	1-146	IG1R	3-29	NCR1R	2-45
1A1H1	4B-1	DC1	1-23, 1-55, 1-74, 1-101,	IGS1	3-28	NE1	1-106
1A1J1	4B-1		1-138.	IL1	2-36	NF1	3-39
1A1K1	4B-1	DC1-P	1-23, 1-55, 1-74, 1-101,	ILL1	2-36	NH1	2-1, 2-45
1A1L1	4B-1		1-138.	IN1	2-33	NL1	1-22
1A1M1	4B-1	DE1	2-20	INS1	3-29	NN1	3-39
1A1Q1	4B-1	DD1	3-19	IS1	2-32	O1S	3-56
1A1R1	4B-1	DH1	1-31	IV1	1-76	OL1	2-49
1A1TA1	4B-1	DLP1	7-1	JG1	3-30	OPB1	1-110,
1A1WA1	4B-1	DN1	3-19	JH1	3-30	ORD1	3-42
1A1WB1	4B-1	DO1	2-22	JI1	3-30	P1	2-49
1A1WC1	4B-1	DO1M	3-20	JI1R	3-30	PA1	1-114
1A1WD1	4B-1	DO1S	1-14-, 3-20	JN1	3-31	PE1	1-11
1A1WE1	4B-1	DO1SR	3-20	JO1	3-30	PHA1	2-50
1A1WG1	4B-1	DP1	1-122	JP1	3-29	PJ1	3-30
1A1WH1	4B-1	DT1	1-106	JU1D	3-9, 3-31	PKR1	2-49
1A1WY1	4B-1	DW1	3-22	K1	2-38	PL1	3-19
AS1	3-4	DXB1	2-21	KA1	1-78	PO1	3-40
AT1	3-8	DXC1	2-21	KAB1	3-31	PN1	1-49
ATA1	3-8	DXD1	2-21	KB1	2-38	PR1	1-7, 1-29
AU1	3-3	EA1	2-23	KF1	3-24	PTKB1	4B-1
AUS1	3-8	EC1	3-22	KFV1	3-24, 3-28, 3-31, 3-43	PV1	2-50
B1	1-15, 1-49, 1-90, 1-100	EE1	3-22	KK1	1-81	PZ1	3-39
BA1	3-8	EL1	2-25	KK1-P	1-81	RA1	1-6
BAS1	3-8	ER1	2-25	KL1	1-2, 1-96	RC1	3-19, 3-32, 3-41
BAU1	2-4	ERS1	3-22	KM1	1-115	RD1	3-42
BAU1R	2-4	ES1	1-32, 3-23	KN1	3-32	RE1	2-51
BC1	3-12	ES1R	1-32, 3-23	KP1	1-120, 1-149	REH1	3-41
BD1A	3-12	ET1	3-23	KS1	1-11, 3-32	REHR	3-41
BD1B	3-12	EVA1R	3-23	KW1	2-23, 2-39, 2-49	RG1	3-41
BD1C	3-12	EX1	2-26, 3-45	KW1-BIG	2-39	RK1	3-43
BD1D	3-12	EZ1	2-26, 2-41	KW1-PC	2-23, 2-39, 2-50	RL1	3-42
BEL1	3-8	FA1	2-27	KYM1RP	1-85	RN1	3-42
BH1	1-89	FAS1	3-24, 3-46	L1	2-40	RO1	2-31, 2-46
BJ1	3-11	FB1	1-33	L1S	3-32	RU1	2-52



ILCO Number	Sec - Page(s)	ILCO Number	Sec - Page(s)	ILCO Number	Sec - Page(s)	ILCO Number	Sec - Page(s)
RV1	3-41	WA1	3-56	C2S	3-19	KYM2-SI	1-85
RX1	3-41	WAR1	1-155	CA2	1-28, 1-149	L2	2-40
S1	2-62	WB1	1-16	CB2	2-13	L2EX	3-32
SA1-AUS	3-44	WC1	3-56	CE2	1-147	LA2	1-87
SA1	2-57	WE1	2-69	CF2	3-16	LAP2	3-32
SAA1	1-129	WF1	2-70	CG2	1-32, 1-78, 1-110	LB2	5-3
SAA1-P	1-129	WG1	3-57	CG2RP-SI	1-18	LC2	3-33
SB1	1-128	WH1	3-56	CL2	3-13	LD2	2-40
SC1	2-64	WIL1	3-57	CLB2	1-27	LF2	3-36
SCH1	3-44	WK1	2-69	CN2	3-18	LI2	3-33
SC1-BIG	2-34	WN1	2-70	CNA2	1-19	LI2R	3-33
SC1-PC	2-64	WO1	3-56	CT2	3-14	LK2	3-35
SE1	2-65	WRE1	3-58	CTG2	3-17	LP2	3-34
SE1B	1-131	WS1	1-33	DA2	3-19	LPD2	3-34
SE1C	1-132	WT1	1-29	DB2	1-146	LT2	3-35
SF1	3-25	WTP1	1-70	DE2	2-20	LU2	6B-2
SIM1	3-45	X1	1-92, 1-106, 1-137	DH2	1-31	LWC2	3-35
SJ1	1-135	XPA1	3-39	DL2	3-19	MW2	2-42
SK1	2-14, 2-66	Y1	2-1, 2-77	DM2	1-120, 1-149	ME2	3-38
SL1	2-66	Y1E	2-77	DO2	2-22	MIT2	1-24, 1-101
SM1	1-26	Y1-PC	2-1, 2-77, 3-8, 3-17,	DT2	1-106	MW2	3-38
SN1	3-44		3-23, 3-40	DW2	3-22	MM2	3-37
SOS1	3-30, 3-46	YH1	1-155	DXB2	2-21	MR2	2-44
SP1	1-1, 1-33	YL1	2-70, 3-58	DXC2	2-21	MS2	1-23
SR1	1-126	YM1	1-96	DXD2	2-21	MTK2P	3-38
SS1	3-43	YS1	1-46, 1-111	EC2	3-22	MW2	3-38
ST1	3-46	YU1	1-160	EF2	3-23	MZ2	1-92
STA1	3-46	YY1	3+59	EL2	2-25	N2M	1-13, 1-140
SUB1	1-136	Z1	1-105, 1-160	ERS2	3-22	NC2	2-44
SUB1-P	1-136	ZC1	3-63	ET2	3-23	NE2	1-29
EB3-N-SUB1	1-136	ZE1	3-63	EZ2	2-26	EB3-H-NI02	1-73, 1-74, 1-109,
EK3-SUB1	1-136	ZIK1	3-60	FA2	2-26		1-110
SUZ1	1-139	ZK1	3-60	FB2	3-23	EK3-NI02	1-73, 1-109
SW1	3-47	ZKN1	3-60	FC2	1-16, 1-46	NL2	3-39
SX1	3-47	ZKN1R	3-60	FF2	1-49	P2	2-49
SY1	5-7	ZMK1	3-60	FL2	2-26	PHA2	2-50
SZ1	1-74	ZN1	3-63	FLR2	3-25	PJ2	3-30
T1	2-67	2B	7-1	FR2	2-28	PL2	3-40
TA1	1-142	2N	2-70	FSP2	3-25	PN2	1-50
TB1	3-50	A2	2-50	FTA2R	1-47	PO2	1-120
TBE1T5	1-77	AA2	1-8, 1-10, 1-16, 1-61,	FU2	1-101	PU2	2-50
TE1	3-48		1-76	GAV2	3-927	PZ2	3-39
TEK1	3-48	AG2	3-2	GB2	3-26	RA2	1-6
TG1	2-67	AK2	3-4, 3-39	GE2	1-122, 3-26	RD2	3-42
TH1-P	1-45	ALP2	3-3	GH2	1-141	RK2	3-43
TK1	3-48	AN2	3-4	GL2	3-27	RL2	3-42
TM1	2-68	AP2	2-7	GT2	1-32, 1-88	RN2	3-43
TMC1	1-7, 1-13, 1-17, 1-18,	AS2	3-5	HAW2	2-30	RU2	2-56
	1-32, 1-75, 1-85, 1-91,	AT2	3-8	HD2	1-64	RV2	3-41
	1-106, 1-118, 1-146,	ATA2	3-8	HG2	3-28	S2	2-62
TN1	3-49	AU2	3-3	HN2	3-28	S2-AUS	3-44
TO1	3-49	AUDS2	1-8	HR2	2-30, 2-37	SB2	1-128
TP1	1-142	AZ2	3-8	HU2	3-28	SE2	2-65
TR1	1-33	AZ2R	3-8	HY2	1-69, 1-101	SE2B	1-131
TS1	3-57	B2	1-52	HY2-P	1-6-9, 1-101	SE2C	1-132
TT1	1-141	B2M	7-1	HYD2	1-59	SG2	3-44
TY1	2-67	BA2	3-8	IF2	3-29	SH2	3-45
UCM1	3-30, 3-50	BAU2	2-4	IF2R	3-29	SIM2	3-45
UN1	1-147	BC2	3-12	ILL2	2-36	SJ2	1-135
UR1	3-52	BD2A	3-12	IN2	2-33	SM2	1-26
UR1R	3-52	BD2B	3-12	ISP2	1-60	SN2	3-44
V1S	3-52	BD2C	3-12	JA2	1-77	SP2	1-2, 1-33, 1-91
VA1	3-54	BD2D	3-12	JN2	3-31	SR2	1-126
VAE1	3-3, 3-52	BE2	2-5	JU2	3-31	SS2	3-43
VAT1	3-52	BEL2	3-9	JU2R	3-31	STA2	3-46
VCA1	3-52	BH2	3-12	K2	2-38	SUB2	1-136
VCA1R	3-52	BKS2	3-1	K2-A	4B-1	SUZ2	1-139
VEC1	3-55	BL2	3-11	KA2	1-78	SW2	3-47
VG1	3-55	BM2	3-12	KAB2	3-31	SY2	5-7
VL1	1-153	BMW2	1-12, 1-13	KB2	2-39	SZ2	1-74
VR1	3-55	BMW2-P	1-12, 1-13	KE2	3-31	T2	2-67
VR1R	3-55	BO2	1-92	KF2	3-24	TA2	1-142
VS1	1-118	BT2	1-149, 3-9	KK2	1-81	TB2	3-50
VT1	3-55	BUR2	3-13	KK2-P	1-82	TE2	3-48
VW1	1-45, 1-96, 1-149	BU2	1-29, 1-45, 1-110	KL2	1-45, 1-76	TK2	3-48
VW1CZ	1-149	BV2	3-13	KM2	1-50, 1-115, 1-131,	TM2	2-68
W1	2-70	BW2	2-3		3-41	TN2	3-49

	ILCO Number	Sec - Page(s)	ILCO Number	Sec - Page(s)	ILCO Number	Sec - Page(s)	ILCO Number	Sec - Page(s)
INDEX	TO2	3-49	BD3B	3-12	KIA3EHP	1-83	X3	1-92
	TOK2	3-48	BD3C	3-12	KIA3REHP	1-83	Y3	2-78
	TP2	1-142	BD3D	3-12	KK3	1-82	YH3	1-156
	TS2	3-48	BEL3	3-9	KK3-P	1-82	YL3	3-58
	UM2	3-50	BKS3	3-10	KM3	1-49, 1-115, 1-132	YM3	1-29, 1-45, 1-86, 1-96,
	UR2	3-52	BMW3	1-12	L3TX	3-32		1-110
	UR2R	3-52	BMW3-P	1-13	L3XY	3-32	Z3H	1-105
	VA2	3-54	BT3	3-9	LA3	1-87	ZC3	3-63
	VEC2	3-55	BU3	1-50, 3-11	LB3	5-3	ZK3	3-62
	VG2	3-55	BUR3	3-13	LC3	3-33	4	3-35
	WA2	3-56	C3AM	7-1	LF3	3-36	4R	3-35
	WAR2	1-155	C3M	7-1	LK3	3-35	AB4	3-1
	WB2	1-15, 1-76	C3S	3-19	LN3	3-42	AG4	3-2
	WC2	3-56	CA3	1-96	LT3	3-35	AK4	3-4
	WH2	3-56	CB3	2-13	LWC3	3-35	AL4	1-2, 1-33
	WIL2	3-57	CE3	1-10, 1-147	LWC3R	3-35	ALP4	3-3
	WK2	2-69	CH3	1-26, 1-118	M3	2-41	AM4	2-2
	WK2-PC	2-69	CL3	3-13	MCM3	3-37	AP4	2-7
	WL2	3-57	CLB3	1-27	ME3	3-38	AP4A	3-4
	WO2	3-56	CN3	3-18	MIT3	1-24, 1-102	AR4	2-2, 2-3
WPT2	1-70	CO3	2-13	MN3	5-4	AS4	3-5	
WR2	2-69	DA3	3-19	MR3	2-44	AU4	3-3	
WRE2	3-58	DC3	1-23, 1-56, 1-69, 1-74,	MZ3	1-92	B4	1-15	
WS2	1-33		1-101, 1-119	N3	2-48	BD4A	3-12	
WT2	1-29	DC3-P	1-23, 1-56, 1-69, 1-74,	NC3	2-44	BD4B	3-12	
WTP2	2-70		1-101, 1-119	NE3	3-39	BD4C	3-12	
X2	1-92	DC3-PC	1-23, 1-56, 1-69, 1-74,	PJ3	3-30	BD4D	3-12	
XPA2	3-39		1-101, 1-119	PN3	1-50	BEL4	3-9	
Y2	2-77	DK3	1-29, 1-110	PU3	2-50	BKS4	3-10	
YH2	1-155	DM3	1-89, 1-120, 1-149,	PZ3	3-39	BT4	3-9	
YL2	3-58		3-23	R3	2-51	BU4	3-11	
YS2	1-46, 1-111	DO3	2-22	RA3	1-6	BUR4	3-13	
YU2	1-60	DO3L	1-45, 3-20	RD3	3-42	C4S	3-19	
ZC2	3-63	DO3M	3-20	RK3	3-43	CA4	1-45	
ZK2	3-62	DT3	1-106	RL3	3-42	CE4	1-45	
ZKN2	3-60	DXB3	2-21	RO3	2-47	CH4	1-26	
ZMK2	3-60	DXC3	2-21	RU3	2-52	CLB4	1-27	
ZN2	3-60, 3-63	DXD3	2-21	S3	2-62	CN4	3-18	
3F-1033	7-8	EF3	3-23	S3-AUS	3-44	CR4R	1-96	
3F-1232	7-8	EL3	2-25	SB3	1-128	CR4RP	1-96	
3F-1630	7-8	ERS3	3-22	SE3B	1-131	DE4	2-21	
3F-1730	7-8	FA3	2-27	SE3C	1-132	DM4	1-120, 1-149	
3F-1738	7-9	FB3	3-23	SF3-SI	1-91	DO4	2-22	
3F-2532	7-9	FL3	2-26	SIM3	3-45	DT4	1-106	
3F-2635	7-9	FT3	1-45, 1-149	SJ3	1-135	DWO4RAP	1-31	
3F-2830	7-9	FTH3	3-25	SP3	1-33, 1-91	DWO4RT5	1-31, 1-57	
3F-2933	7-9	GB3	3-26	SO3	3-46	DWO4RT6	1-31, 1-57	
3F-4135	7-9	GE3	3-26	SR3	1-45	DXB4	2-21	
3F-4333	7-9	GE3R	3-26	SS3	3-43	DXC4	2-21	
3F-4535	7-9	GH3	1-141	SUB3	1-136	DXD4	2-21	
3F-4735	7-10	GL3	3-27	SUZ3	1-139	EV4	3-23	
3F-4935	7-10	GT3	1-32, 1-88, 1-92	SV3	3-47	FB4	1-133	
3F-6932	7-10	GU3	3-927, 3-41	SW3	3-47	FH4	3-24	
3M-2127	7-10	HAW3	2-30	SX3	3-47	FL4	2-26	
3M-2136	7-10	HD3	1-64	SY3-NS	5-7	FTH4	3-25	
3M-2734	7-10	HF3	1-96	T3	2-67	GB4	3-26	
3M-3427	7-10	HG3	3-28	TE3	2-30, 2-37, 3-48	GE4	1-122	
3M-3437	7-10	HL3	2-31	TK3	3-48	GL4	3-27	
3M-5935	7-10	HN3	1-60	TM3	2-68	GT4	1-88	
3S-1832	7-10	HO03-PT	1-63	TN3	3-49	GU4	3-27, 3-44	
3S-2332	7-11	EB3-S-HO03	1-2, 1-63	TO3	3-49	GU4R	3-27, 3-41	
3S-5332	7-11	EK3P-HO03	1-2, 1-63	TP3	1-142	HAW4	2-31	
3S-7032	7-11	HT3	3-54	UN3	3-50	HD4	1-64	
A3	2-50	HU3	3-28	UR3	3-52	HF4	1-96	
AA3	1-16, 1-76	HY3	1-69	UR3R	3-52	HO4	2-7	
AB3	3-1	HYD3	1-59	VA3	3-54	HU4	3-28	
AG3	3-2	IF3L	3-29	VS3	1-148	HY4	1-69	
AK3	3-4	IF3S	3-29	WA3	1-155	HY4-P	1-70	
AL3	1-2, 1-33	IN3	2-36	WAR3	1-155	HYD4	1-59	
ALP3	3-3	JU3	3-31	WB3	1-42	IN4	2-33	
AM3	2-2	JU3R	3-31	WH3	3-56	JU4	3-31	
AP3	2-7	KA3	1-78	WK3	3-57	K4	4B-1	
AS3	3-4	KAB3	3-31	WO3	3-57	KA4	1-78	
AT3	3-8	KB3	2-39	WR3	2-1, 2-69	KE4	3-31	
AU3	3-3	KE3	3-32	WRE3	3-58	KF4	3-24	
B3	1-14, 1-51, 1-59	KE3-SI	3-32	WS3	1-33	KK4	1-82	
BD3A	3-12	KF3	3-24	WT3	1-11	KK4-P	1-82	

ILCO Number	Sec - Page(s)	ILCO Number	Sec - Page(s)	ILCO Number	Sec - Page(s)	ILCO Number	Sec - Page(s)
KL4	1-11	W4-59B2-6	4B-1	KK5-P	1-82	BO6	1-92
KM4	1-50	W4-59C1-6	4B-1	KM5	1-50	BR6	1-15, 1-126, 1-132
L4	2-40	W4-59C2-6	4B-1	KW5	2-39	BUR6	3-13
L4A1	3-32	W4-59D1-6	4B-1	L5CR	3-33	C6S	3-19
L4RM	3-32	W4-59D2-6	4B-1	L5RC	3-33	CB6	3-18
LA4	1-87	WAR4	1-155	LA5	1-87	CE6	1-15, 1-45
LB4	5-3	WR4	2-27	LB5	5-3	CH6	1-26
LC4	3-33	WK4	3-57	LC5	3-33	CLB6	1-27
LF4	1-10, 1-16, 1-46, 1-127, 1-147	WS4	1-33	LC5R	3-33	CO6	2-16
LK4	3-35	X4	1-41, 1-92	LF5	1-90, 1-147, 3-36	DAT6BP	1-107
LN4	1-32, 1-88, 1-92	Y4	2-74	LK5	3-35	DAT6P	1-107
LWC4	3-35	YH4	1-156	LP5	3-34	DAT6RP	1-107
LWC4R	3-35	YL4	3-58	LWC5	3-35	DE6	2-1, 2-20
M4	2-42	YM4	1-96	LWC5R	3-35	DE6-PC	2-1, 2-20
ME4	3-35	Z4	1-50	M5	2-42	DM6	3-20
MIT4	1-24, 1-102	ZC4	3-63	MB5	1-14, 1-74, 1-89, 1-149, 1-154	DO6	2-22
MIT4-P	1-24, 1-102	ZK4	3-62	MIT5	1-24, 1-102	DT6	1-106
MS4R	2-41	5B	7-1	ME5	3-25	EP6	3-22
MZ4	1-41, 1-92	5D1R	4B-3	MZ5	1-41, 1-92	ERS6	3-22
NE4	1-15, 1-87, 1-115	5F	2-22	NE5	1-15, 1-60, 1-128	EV6	3-23
NI04T	1-73, 1-109	AB5	3-1	NI05T	1-74, 1-109	FB6	1-133
EK3P-NI04	1-110	AG5	3-2	P5	7-1	FL6	2-26
PJ4	3-30	AK5	3-4	PA5	1-7	FT6	1-15, 1-33, 1-45, 1-107, 1-115
PT04-PT	1-57	ALP5	3-3	PG5	1-117	FT6R	1-7, 1-15, 1-33, 1-76, 1-107
PT04-PT5	1-57	AP5	2-7	PO5	1-120	FTH6	3-25
PU4	2-50	AS5	3-4	PO5-P	1-120	GE6	3-26
PZ4	3-39	AU5	3-3	PU5	2-50	H6	1-37, 2-32
RA4	1-6	B5	1-6, 1-14, 1-81, 2-31	PW5	3-41	HD6	1-64
RD4	3-42	B5A	7-1	RI5	3-43	HF6	1-96
RK4	1-124	BD5A	3-12	RO5	2-47	HY6	1-70
RN4	3-43	BD5B	3-12	RV5	3-42	HY6-P	1-70
RN4R	3-37, 3-43	BD5C	3-12	SB5	1-128	HY6R	1-60
RO4	2-46	BD5D	3-12	S5	2-62	HYD6	1-59
RU4	2-52	BEL5	3-9	SE5F	1-132	HYN6EP	1-71
RV4	1-127	BK5	3-10, 3-11	SF5-SI	1-92	KA6	1-798
RV4-P	1-128	BKS5	3-10	SG5	5-8	KK6-P	1-82
S4	2-63	BR5	1-15, 1-126, 1-147	SJ5	1-135	KM6	1-49
S4-AUS	3-44	BUR5	3-13	SP5	1-9, 1-33	L6FM	3-33
SB4	1-128	C5S	3-19	SR5	1-135	L6S	3-33
SC4	2-1, 2-64	CE5	1-10, 1-147	SS5	2-66	LA6	1-33, 1-87
SE4B	1-131	CEM5	1-76	SUZ5	1-139	LB6	5-3
SE4C	1-132	CH5	1-26	SW5	3-47	LF6	3-36
SF4-SI	1-92	CLB5	1-27	SY5-NS	5-7	LK6	3-35
SG4	5-2, 5-5	CN5	3-19	SZ5	1-58	LP6	3-34
SJ4	1-135	CO5	2-16	SZ5P	1-139	ME6	3-38
SM4	1-115, 1-132	DE5	2-20	TA5	1-142	MIT6	1-102
SP4	1-33, 1-91	DO5	2-22	TK5	3-48	MIT6-P	1-102
SR4	1-135	DT5	1-106	TN5	3-49	MZ6	1-93
SS4	2-66	DWO5AP	1-31	TO5	3-50	NA6	2-48
ST4	2-67	DWO5RAP	1-31	TP5	1-142	NW6	3-39
SUB4-PT	1-137	DWO5T5	1-31	UN5	3-50	P6	7-1
EB3-P-SUB4	1-137	DWO5RT5	1-31	VE5	1-148	PA6	1-8
EK3-SUB4	1-137	DXG5	2-21	WK5	3-57	PO6	1-120
SUZ4	1-139	ER5	3-22	WL5	3-57	RI6	3-43
SV4	3-46	ERS5	3-22	WR5	2-69	RS6	3-43
SW4	3-47	EV5	3-23	WR5-PC	2-69	S6	2-63
SW4R	3-47	FB5	1-133	WS5	1-33, 1-120, 1-149	S6-AUS	3-31
SX4	3-47	FL5	2-26	WT5	1-7, 1-149	S6BW	1-12
SY4	5-7	FL5G	2-27	X5	1-41, 1-92	SB6	1-128
SZ4	1-58	FT5R	1-45	Y5	2-72	SC6	2-64
SZ4P	1-139	FTH5	3-25	YH5	1-156	SIM6	3-45
SZ4R	1-139	GE5	3-26	YL5	1-125, 2-71, 3-58	SJ6	1-135
SZ4RP	1-139	GL5	3-27	YM5	1-96	SM6	1-132
TA4	1-142	GT5	1-88	ZK5	3-62	SP6	1-10, 1-92
TE4	3-48	H5	1-37	AB6	3-1	SR6	1-136
TK4	3-48	HD5	1-64	AK6	3-4	SUZ6	1-139
TM4	2-67	HD5R	1-64	ALP6	3-3	SW6	3-47
TN4	3-49	HF5	1-96	AP6	3-4	SY6-NS	5-7
TO4	3-49	HU5	3-28	AS6	3-5	TA6	1-142
TP4	1-142	HY5	1-70, 1-101	AU6	3-3	TK6	3-48
UN4	3-50	HY5-P	1-70, 1-101	6D1R	4B-3	TM6	2-68
VA4	3-54	HYD5	1-59	B6	7-1	TO6	3-50
VE4	1-148	JU5R	3-31	BD6	3-11	TP6	1-142
W4-59A1-6	4B-1	K5	4B-1	BEL6	3-9	VA6	3-54
W4-59A2-6	4B-1	KA5	1-79	BKS6	3-10	VE6	1-148
W4-59B1-6	4B-1	KA5-SI	3-31	BL6	1-15, 1-76		
		KK5	1-82				

	ILCO Number	Sec - Page(s)	ILCO Number	Sec - Page(s)	ILCO Number	Sec - Page(s)	ILCO Number	Sec - Page(s)
INDEX	VL6	1-155	H7RE	3-53	FL8	2-26	HYD9	1-59
	VL6-P	1-155	H7RF	3-53	GE8	3-26	IL9	1-100, 2-37
	VO6	1-154	H7RG	3-53	HD8	1-64	K9	4B-4
	WK6	3-57	H7RH	3-53	HT8	3-54	EK3-KK9	1-85
	WR6	2-69	HD7	1-64	HYD8	1-59	KM9	1-115
	WS6	1-34	HYN7REHP	1-83	IN8	2-1, 2-34, 2-51	LA9	1-87
	X6	1-107, 1-135	HF7	1-97	KA8	1-78	LF9	3-36
	Y6	2-72	HYD7	1-59	KA8-SI	3-31	LK9	3-35
	YH6	1-156	K7	4B-1	KK8-P	1-82	MIT9-PT	1-102
	YH6-SI	1-156	KA7	1-79	KM8	1-115, 1-132, 3-33,	EB3-L-MIT9	1-25, 1-103, 1-104
	YH6R	1-156	KK7-PT	1-82		3-41	EK3-MIT9	1-25, 1-103
	YL6	3-58	KM7	1-50	LA8	1-87	MZ9	1-42, 1-93
	YM6	1-110	LA7	1-34, 1-87	LB8	5-4	MZ9-P	1-42, 1-93
	ZK6	2-62	LB7	5-3	LC8	3-34	NE9	1-34
	7B	7-2	LF7	1-90, 3-36	LF8	1-90, 3-36	NS9CS	3-17
	7DC	1-26, 1-114, 1-115, 1-121, 3-43	LK7	3-35	LK8	3-35	NSR9CS	3-17
			LP7	3-34	MIT8-PT	1-102	R9CS	3-17
	7GE	3-26	LP7R	3-34	EB3-K-MIT8	1-102	R9LF	3-59
	7LA	3-52	LR7GE	3-26	EK3-MIT8	1-102	R9LK	3-59
	7LB	3-52	MA7	2-41	MZ8	1-93	sp-aus	3-44
	7LC	3-52	ME7	3-38	NE8	1-12, 1-32	S9CS	3-17
	7LD	3-52	MIT7	1-107	PA8	1-8, 1-152	S9P	3-40
	7LDH	3-52	MZ7	1-93	PA8-P	1-8, 1-52	SC9	2-64
	7LE	3-52	NE7	1-15, 1-45, 1-141	SB8	1-129	SF9	1-3
	7LF	3-52	P7	7-1	SC8	2-64	SIM9R	3-45
7LG	3-52	PO7	1-120	SF8	1-3	SM9C	1-132	
7LH	3-52	R7DC	1-26, 1-117, 1-122	SIM8	3-45	SP9	1-3, 1-86	
7RA	3-52	RO7	2-46	SMS8	1-26, 1-132	SR9P	3-40	
7RB	3-52	RU7	2-55	SP8	1-10	SU9	3-47	
7RC	3-52	S7-AUS	3-31	SUZ8	1-139	SU9L	3-47	
7RD	3-52	S7BW-P	1-11	SY8-NS	5-7	SU9S	3-47	
7RE	3-52	S7JA	3-58	TA8	1-142	SUZ9	1-139	
7RF	3-52	SB7	1-128	TK8	3-48	SX9B	2-71	
7RG	3-52	SC7	2-64	TL8	3-49	SY9	2-65	
7RH	3-52	SF7AF	1-3	TM8	2-68	SZ9	1-139	
AB7	3-1	SM7	1-132	VA8	3-54	SZ9P	1-139	
ALP7	3-3	SP7	1-10, 1-92	VL8	1-155	TA9	1-142	
AS7	3-4	SUZ7	1-139	VL8-P	1-155	TM9	2-69	
B7M	7-2	SW7	3-47	WK8	3-57	U9P	3-40	
BD7	3-11	SY7	5-7	WS8	3-58	VK9	3-46, 3-55	
BEL7	3-9	T7	2-67	X8	1-149	WK9	3-57	
BKS7	3-10	TA7	1-142	Y8	3-58	X9	1-8, 1-120, 1-149	
BR7	1-15, 1-126, 1-147	TK7	3-48	YH8	1-156	Y9	2-78	
BU7	3-11	TM7	2-68	YL8	2-71	Y9E	2-71	
BUR7	3-13	TO7	3-50	YM8	1-110	YH9	1-156	
CB7	2-13	UN7	3-50	ZK8	3-62	YL9	3-58	
CE7	1-45	VA7	3-54	9B	7-2	YM9	1-110	
CH7	1-26, 1-118	WK7	3-57	9BA	3-8	zd9p	1-18, 1-105	
CLB7	1-27	X7	1-107	9CS	3-17	ZK9	3-62	
CO7	2-14	XL7	2-70, 3-58	9CX	3-17	AB10	3-1	
CU7	1-100	YH7	1-156	9D	3-20	ALP10	3-3	
DM7	3-20	YM7	1-110	9FAC	3-24	AS10	3-5	
DT7	1-106	ZD7	3-60	9MX	3-24	B10	1-52	
EP7	3-22	ZD7-SI	1-81, 1-105, 1-117, 1-146	9TK	3-49	BKS10	3-10	
EV7	3-23			AB9	3-1	BUR10	3-13	
FB7	1-134	ZK7	3-62	ALP9	3-3	CB10	2-13	
FC7	1-7, 1-28, 1-42, 1-48, 1-77, 1-114, 1-127	ZN7	3-63	AS9	3-5	CLB10	1-27	
		8	4B-4	BKS9	3-10	CO10	2-11	
FC7-P	1-7, 1-28, 1-42, 1-48, 1-77, 1-114, 1-127	8B	7-2	BR9	1-15, 1-126, 1-147	CS10	3-15	
		AB8	3-1	BUR9	3-13	CU10	1-100	
FL7	2-26	ALP8	3-3	CB9	2-13	DAV10	1-90	
GE7	1-28, 1-122	AS8	3-5	CLB9	1-27	DM10	3-20	
GR7	3-25	BKS8	3-10	CO9	2-11	DT10	1-107	
H7LA	3-53	BU8	3-11	CU9	1-100	DXB10	2-21	
H7LB	3-53	BUR8	3-13	D9	1-71	DXC10	2-21	
H7LC	3-53	CE8	1-46	DT9	2-21	DXD10	2-21	
H7LD	3-53	CH8	1-26	EC9	1-107	ec10	3-22	
H7LDH	3-53	CLB8	1-27	ER9	3-22	EL10	2-25	
H7LE	3+53	CU8	1-100	ES9	2-26	ER10	3-22	
H7LF	3-53	DE8	2-20	ET9	3-23	FL10	2-26	
H7LG	3-53	DM8	3-20	FC9	1-46	FT10	1-46	
H7LH	3-53	DT8	1-106	FL9	2-26	FT10R	1-46	
H7RA	3-53	E8	4B-4	GE9	1-122	GE10	3-26	
H7RB	3-53	EL8	2-34	GR9	3-25	gr10	2-25	
H7RC	3-53	ERS8	3-22	HD9	1-64	GT10BT2/5	1-34	
H7RD	3-53	ET8	3-23	HF9	1-97	H10F	3-53	
H7RDH	3-53	FC8	1-46	HY9	1-60	HD10	1-64	

ILCO Number	Sec - Page(s)	ILCO Number	Sec - Page(s)	ILCO Number	Sec - Page(s)	ILCO Number	Sec - Page(s)
HYD10	1-59	X11	1-139	MZ13R	1-93	EL15	2-26
KI10R	1-50	Y11	1-19, 1-101, 1-118, 2-31, 2-79	NE13	1-34, 1-123	GE15	3-26
KM10	1-115			PJ13	3-30	GT15RAP	1-3, 1-118
KW10	2-39, 2-68	YH11	1-156	RO13	2-47	GT15RBT2/5	1-34
KW10-PC	2-39, 2-68	ZK11	3-62	S13KE	3-32	GY15RDT5-SI	1-31, 1-115
LA10	1-87, 1-122	12B	7-2	SLA13	6A-2	GT15RP-SI	1-117
LK10	3-35	AB12	3-1	SY13	5-17	GT15RT2	1-3
LF10	3-36	AS12	3-5	TK13	3-48	HD15	1-64
LH10	3-11	BH12-SI	1-14	TM13	2-69	HF15	1-97
LS10	3-33	BKS12	3-10	WK13	3-57	HY15-P	1-71
M10	2-42	BUR12	3-13	X13	1-10, 1-16, 1-46, 1-127, 1-145	HYN15EHP	1-84
MZ10	1-472	CB12	2-13			KA15	1-79
MZ10-P	1-42, 1-93	CLB12	1-27	Y13	2-31, 2-79	KW15BP	1-79
NE10	1-14, 1-86, 1-90, 1-90	CO12	2-11	YH13	1-156	LF15	1-16
NSN10	1-73	CS12	3-15	YM13	1-111	MB15	1-97
OM10	1-32, 1-78, 1-110	CU12	1-100	ZK13	3-62	MB15-P	1-97
S10	2-62	DM12	3-20	14CM	7-2	MZ15	1-93
S10LAA-P	1-3	DT12	1-107	14K	3-59	NE15	1-123
SB10	1-128	EC12	3-22	14KH	3-59	RO15	2-48
SC10	2-64	FT12R	1-150	14KR	3-59	SC15	2-64
SF10	2-56	HD12	1-64	AB14	3-1	SLA15	2-66
SIM10	3-45	HF12	1-46, 1-111	AS14	3-7	SUZ15	1-138
SLA10	6A-2	HY12	1-70	AS14L	3-5	SUZ15-P	1-138
SUZ10	1-139	HY12-P	1-70	AS14S	3-4	TA15	1-142
SY10	5-7	HYD12	1-60, 1-170	BKS14	3-10	TK15	3-48
SZ10RP	1-139	KA12	1-79	BUR14	3-13	TM15	2-69
TK10	3-48	KA12-SI	1-80	CLB14	1-27	WK15	3-57
TM10	2-69	KW12BP-SI	1-80	CS14	3-15	YH15	1-156
VA10	3-54	LA12	1-87	DM14	3-20	YM15	1-46
WK10	3-57	LF12-SI	3-37	DT14	1-107	ZK15	3-62
WS10	1-50	M12	2-42	EC14	3-22	AB16	3-1
X10	1-107	MIT12-PT	1-103	GE14	1-122	AS16	3-6
YH10	1-156	MZ12	1-92, 1-106, 1-137	HD14	1-64	B16	1-15, 1-51
ZK10	3-62	NA12	1-101, 2-47	HF14	1-97	BKS16	3-10
AB11	3-1	OP12	1-111	HY14	1-70	BR16	1-16
AS11	3-5	PJ12	3-30	HY14-P	1-70	CG16	1-49, 1-72, 2-1, 2-31
B11	1-52, 1-90	SLA12	6A-2	HYN14EHP	1-84	CS16	3-15
B11M	7-2	SUZ12	1-139	HYN14REHP	1-71, 1-84	DM16	3-20
BKS11	3-10	SY12	5-7	HYN14RT14	1-72	DT16	1-107
BL11	1-90, 1-155	TA12	1-142	KA14	1-79	EC16	3-22
BUR11	3-13	TK12	3-48	KW14	1-79, 1-140, 1-146	GT16T2	1-3
CB11	2-13	TM12	2-69	KW14AP	1-79	HD16	1-64
CB11BH	2-13	WK12	3-57	KW14R	1-79	HY16-P	1-71
CLB11	1-27	X12	1-115, 1-123	LA14	1-87	HF16	1-97
CS11	3-15	Y12	1-19, 1-49, 1-118, 1-135, 2-312, 2-32, 2-79	LF14	3-36	KA16	1-80
DM11	3-20			M14	2-42	KW16CP-SI	1-80
DT11	1-107			MIT14-PT	1-104	KW16EH2	1-81
EL11	2-25	YH12	1-156	EB3-M-MIT14	1-104	LF16	3-36
GE11	3-925	ZK12	3-62	EK3-MIT14	1-104	LS16	3-33
HD11	1-64	13D	4B-4	MZ14	1-93	M16	2-42
HF11	1-111	AB13	3-1	NA14	2-46	MB16	1-97
HYD11	1-59	AS13	3-7	NE14	1-123	MB16R	1-97
IL11	2-37, 2-67	BKS13	3-10	PJ14	3-30	MIT16A-PT	1-104
KA11	1-79	BR13	1-16, 3-50	RO14	2-46	EK3P-MIT16	1-104
KW11	2-39	BUR13	3-13	SLA14	2-66	MZ16	1-93
LA11	1-87	CLB13	1-27	SZ14RAP	1-81, 1-139	MZ16-P	1-93
LF11	3-36	CS13	3-15	TA14	1-142	NE16	1-123
LS11	3-33	DM13	3-20	TK14	3-48	RU16	2-55
M11	2-42	DT13	1-107	TM14	2-69	S16	2-63
ME11	3-37	EA13	2-24	WK14	3-57	SIP16T2	1-88
MZ11	1-93	HD13	1-64	Y14	1-101, 1-135, 2-31, 2-79	SLA16	2-66
NE11	1-115	HF13	1-46			SUZ16	1-140
NSN11T2	1-108	HY13	1-70	YH14	1-156	TA16	1-142
OP11	1-55, 1-111	HY13-P	1-70	YM14		TK16	3-48
PJ11	3-30	HYD13	1-60, 1-85, 1-106	ZD14RP	1-120	TM16	2-69
RO11	2-46	KA13	1-79	ZK14	3-62	UN16	1-16, 1-76
SB11	1-129	L13	2-40	15D	4B-4	WK16	3-57
SF11	1-46	LA13	1-87	15K	4B-2	X16	1-23, 1-126, 1-137
SLA11	6A-2	LF13	1-16	AB15	3-1	Y16	1-13, 1-140, 1-146
SUZ11	1-139	LK13	3-35	AS15	3-6	YH16	1-156
SY11	5-7	M13	2-42	AU15	1-8	YM16	1-97
TA11	1-142	MAZ13AP	1-93	BKS15	3-10	ZD16RP-SI	1-6, 1-7, 1-11, 1-18, 1-91, 1-75, 1-91, 1-96, 1-118, 1-125, 1-141, 1-159
TK11	3-48	MAZ13EP	1-93	BUR15	3-13		
TL11	3-49	MS13	1-23	CLB15	1-27		
TL11R	3-49	MZ13	1-103	CS15	3-15		
WK11	3-57	MZ13-P	1-42, 1-93	DM15	3-20	ZK16	3-62
WS11	1-50	MZ13-PC	1-42, 1-93	DT15	1-107	17B	7-2

ILCO Number	Sec - Page(s)	ILCO Number	Sec - Page(s)	ILCO Number	Sec - Page(s)	ILCO Number	Sec - Page(s)
AB17	3-1	TK19	3-48	C22	2-33	VC24	1-27, 1-123
AS17	3-7	TM19	2-69	CG22	2-7	WK24	3-57
B17	7-2	WB19	2-69	CS22	3-1	X24	1-79
BKS17	3-10	WB19	2-70	DM22	3-20	YH24	1-156
CG17	2-7	WK19	3-57	DM22-SI	3-20	YM24	1-111
CO17	2-10	X19	1-65	DM22TVP	3-20	ZD24RDP-SI	1-11, 1-31, 1-59, 1-69, 1-86, 1-96, 1-105, 1-141, 1-146, 1-159
CS17	3-15	YH19	1-156	DT22W	2-3		
DM17	3-20	ZK19	3-62	DTL22W	2-3		
HD17	1-64	AB20	3-1	F22	1-34	ZD24REHP	1-69
HY17-P	1-71	AS20	3-6	HD22	1-64	ZD24RT5-SI	1-69, 1-159
HF17	1-149	B20	7-3	HY022-PT	1-71	ZD24RT14-SI	1-69, 1-159
KI17	1-50	BKS20	3-10	HF22	1-46	ZK24	3-62
LF17	1-17, 1-76, 1-92, 1-127	BR20	1-16, 1-46	LS22	3-33	25	2-6
LS17	3-33	C20	2-33	MZ22	1-94	25B	7-3
M17	2-42	CS20	3-15	NE22	1-123	25V	3-24
MB17	1-97	DA20	1-93, 1-107	S22	2-58	AS25	3-4
MD17	2-20	DM20	1-19	S22 1/2	2-58	BKS25	3-10
MIT17A-PT	1-103	DT20	1-107	SC22	2-64	CS25	3-15
EK3P-MIT17	1-104	DXB20	2-21	SK22RT1	1-134	DA25	1-107, 1-136
MZ17	1-93	DXC20	2-21	SIP22T5-SI	1-59, 1-118	DA25-P	1-107, 1-136
NE17	1-123	DXD20	2-21	TK22	3-48	DA25-PC	1-107, 1-136
SLA17	2-66	EL20	2-26	VC22	3-53	DM25	3-20
SUZ17	1-138	H20	4B-2	WK22	3-57	HD25	1-65
SUZ17-P	1-138	HD20	1-64	X22	1-46, 1-111	ILP25	3-29
SZ17REH2	1-140	HF20	1-12	YH22	1-156	LF25	3-37
TK17	3-48	HY20-PT	1-71, 1-83	YM22	1-111	LP25	3-34
TM17	2-69	EK3-HY20	1-72	ZD22RBP-SI	1-6, 1-11	M25	2-43
WK17	3-57	ILP20	3-37	ZK22	3-62	MZ25	1-94
X17	1-23, 1-126	LF20S	3-37	23B	7-7	MZ25-P	1-94
YH17	1-156	M20	2-43	23M	7-7	NA25	2-2, 2-48
ZD17RAP-SI	1-58, 1-118	MB20	1-97	AB23	3-2	NA25-PC	2-2, 2-48
ZK17	3-62	MZ20	1-94	AS23	3-4	RN25	1-5, 1-125
AB18	3-1	NE20	1-123, 1-132	BKS23	3-10	SP25A-P	1-3
AS18	3-7	SC20	2-64	CS23	3-15	TA25	1-143
BKS18	3-10	SL20	2-66	DA23	1-107, 1-136	TK25	3-48
BR18R	1-17	SUZ20-P	1-138	DA23-P	1-107, 1-136	TR25	1-143
CS18	3-15	TK20	3-48	DM23	3-20	VC25	1-25
DM18	3-20	TM20	2-69	HD23	1-61, 1-64	WK25	3-57
DX18R	2-21	VW20	1-149	HF23	1-46	X25	1-139
EC18	3-22	WK20	3-57	LF23	3-36	YH25	1-158
H18	1-38	X20	1-16, 1-46	LS23	3-33	YM25	1-111
HD18	1-64	YH20	1-156	NE23	1-3, 1-34	ZK25	3-62
HF18	1-106	ZK20	3-62	TA23	1-143	BKS26	3-10
IN18	2-35	21B	7-7	TK23	3-48	CO26	2-11, 2-31
LF18	3-36	AB21	3-1	VC23	3-53	CS26	3-15
LS18	3-33	AS21	3-7	WK23	3-57	DM26	3-20
M18	2-42	BKS21	3-10	X23	1-79	H26	1-38
MB18	1-97	C21	2-33	YH23	1-123	HD26	1-64
MB18-P	1-97	CC21	2-9	YM23	1-111	HF26	1-12, 1-106
NE18	1-26, 1-115, 1-123, 1-132	CS21	3-15	ZD23RCP-SI	1-11, 1-13, 1-75, 1-91	LP26	3-34
		DM21	3-20	ZD23RT5-SI	1-7, 1-91, 1-96	LP26S	3-34
SUZ18	1-138, 1-140	EL21	2-25	ZK23	3-62	M26	2-43
TK18	3-48	FO21EH2	1-77	24	3-35	NE26	1-132
TM18	2-69	FO21T7-SI	1-77	24A	3-36	TA26	1-143
TR18	1-142	HD21	1-64	24B	7-7	TK26	3-48
WK18	3-57	HF21	1-111	24B-AUS	3-36	TR26	1-143
YH18	1-156	HY021-PT	1-70	24CL	3-36	VC26	1-27, 1-126
X18	1-79, 1-156	LF21	3-36	AS24	3-5	WK26	3-57
ZK18	3-62	LP21W	3-34	B24	1-52	X26	1-42, 1-93, 1-119
19B	7-2	LK21	3-35	BKS24	3-10	YH26	1-158
AB19	3-1	M21	2-43	CS24	3-15	ZK26	3-62
AS19	3-6	TA21	1-143	DA24	1-107	27B	7-7
BKS19	3-10	TK21	3-48	DM24	3-20	AS27	3-7
CS19	3-15	VC21	3-53	HD24	1-65	BKS27	3-10
DM19	3-20	WK21	3-57	HON24	1-64	CS27	3-15
HD19	1-64	X21	1-46, 1-111	HON24RP	1-64	DM27	3-20
LF19	3-36	YH21	1-79, 1-156	IN24	2-4, 2-34	EA27	2-24
LS19	3-33	YM21	1-111	LF24	1-90, 3-37	H27	1-37
M19	2-43	ZD21P-SI	1-18, 1-88	LP24	3-34	LP27	3-34
MZ19	1-94	ZK21	3-62	MAZ24RT5	1-95	M27	2-42
MZ19-P	1-94	22BB	7-7	EB3-J-MAZ24	1-95	MZ27	1-94
MZ19-PC	1-94	22M	7-7	EK3-MAZ24	1-95	MZ27-P	1-94
NE19	1-132	22PO	2-22	NA24	2-6, 2-47	MZ27-PC	1-94
RT19	1-116, 1-123	AB22	3-2	RN24	1-5, 1-117, 1-125	NE27	1-116
SUZ19	1-140	AK22W	2-2	RN24-P	1-5, 1-11, 1-125	RN27	1-6, 1-125
SC19	2-64	AS22	3-7	TA24	1-142	TA27	1-143
TA19	1-143	BKS22	3-10	TK24	3-48	TK27	3-48



ILCO Number	Sec - Page(s)	ILCO Number	Sec - Page(s)	ILCO Number	Sec - Page(s)	ILCO Number	Sec - Page(s)
V27	1-151	LP30	3-34	33C	3-50	OP36	1-11
WK27	3-57	LP30R	3-34	33K	3-58	TK36	3-48
X27	1-42, 1-93	MZ30	1-94	33NO	3-50	X36	1-93
YH27	1-158	MZ30-P	1-94	AS33	3-5	YH36	1-6, 1-158
YM27	1-111	NE30	1-10	B33N	3-50	ZK36	3-62
YM27T2	1-111	RN30	1-6, 1-23, 1-117, 1-125	B33NB	3-50	37 MASTER	7-3
ZK27	3-62	S30FD-P	1-46	BKS33	3-10	37D	6B-4
28AM	7-3	TK30	3-48	CS33	3-15	AS37	3-6
AS28	3-7	VC30	1-27, 1-123	DA33	1-108	BK37	3-10, 3-11
28BM	7-3	WK30	3-57	DM33	3-21	CS37	3-15
BKS28	3-10	X30	1-154	F33	1-3, 1-34	DA37	1-108
CS28	3-15	YH30	1-158	HD33	1-61, 1-64	DA37-P	1-109
DA28	1-73, 1-108	YH30BP	1-157	HON33P	1-61	DM37	3-21
DM28	3-21	YH30P	1-158	IN33	2-34	FT37	1-3, 1-9, 1-32, 1-34, 1-76, 1-86, 1-114, 1-160
HD28	1-64	YH30RBP	1-157	LS33	3-33		
IN28	2-33	YH30RP	1-158	NE33	1-124	HD37	1-65
LP28	3-34	YM30	1-46, 1-111, 1-147	S33C	3-50	HF37	1-106
LP28S	3-34	YM30T5	1-129	S33FD-P	1-46	OP37	1-111
LS28	3-33	ZD30T5-SI	1-7, 1-105	S33FJ-P	1-47, 1-76	T37L	6A-9
M28	2-42	ZK30	3-62	S33P	3-50	TK37	3-48
T28	6A-9	AS31	3-5	TK33	3-48	TR37	1-60, 1-144
TA28	1-143	BKS31	3-10	TR33	1-60, 1-144	V37	1-152
TK28	3-48	CS31	3-15	TR33-P	1-61, 1-144	V37-P	1-152
TR28	1-143	DA31	1-73, 1-108, 1-136	TR33-PC	1-61, 1-144	V37-PC	1-152
TR28-P	1-143	DA31-P	1-73, 1-108, 1-136	V33	1-152	X37	1-143
VC28	1-27	DA31-PC	1-73, 1-108, 1-136	VC33	3-53	YH37	1-158
WK28	3-57	DM31	3-21	X33	1-157	ZK37	3-62
X28	1-125	HD31	1-61, 1-64	YH33	1-119, 1-158	AS38	3-6
YH28	1-158	HON31AP	1-67	ZK33	3-62	CS38	3-15
YH28BP	1-157	HON31BP	1-67	34B	7-7	DA38	1-109
YH28P	1-158	HON31P	1-67	AS34	3-5	DA38-P	1-109
YH28RBP	1-157	HON31CP-SI	1-68, 1-85	BKS34	3-10	DM38	3-21
YH28RP	1-158	HON31RAP	1-66	CS34	3-15	F38	1-2, 1-33
YM28	1-111	HON31RBP	1-66	DA34	1-108	FT38	1-3, 1-9, 1-32, 1-34, 1-76, 1-86, 1-114, 1-160
YM28T2	1-111	HON31RCP-SI	1-68	DA34-P	1-108		
ZD28RFP-SI	1-13	HON31RP	1-66	DM34	3-21	HD38	1-65
ZK28	3-62	LP31	3-34	HD34	1-64	HF38	1-111
AS29	3-6	LP31R	3-34	IN34	2-34	HON38RP	1-62
BKS29	3-10	MZ31	1-95	LP34S	3-34	MB38	1-99
CC29	2-9	NE31	1-116	LS34	3-33	TK38	3-48
CS29	3-15	RN31	1-6, 1-23, 1-125	NE34	1-132	X38	1-61, 1-65
DM29	3-21	S31	2-63	S34YS-P	1-97	YH38	1-119, 1-159
F29	1-3	TK31	3-48	TK34	3-48	ZK38	3-62
HD29	1-61, 1-64	VC31	1-27	VC34	3-53	AS39	3-6
HF29	1-106	WK31	3-57	X34	1-79	CS39	3-15
IN29	2-34	X31	1-129	Y34	2-71	DA39	1-109
LP29	3-34	YH31	1-157	YH34	1-119, 1-141, 1-158	DA39-P	1-109
LP29R	3-34	YH31R	1-157	YH34P-SI	1-75, 1-159	DM39	3-21
LS29	3-33	YH31RAP	1-157	YH34RP-SI	1-75, 1-159	F39	1-2
MZ29	1-94	YH31RBP	1-157	ZK34	3-62	HD39	1-65
NE29	1-123	ZK31	3-62	AS35	3-7	HON39P	1-64
RN29	1-5, 1-23, 1-125	AS32	3-5	BKS35	3-10	LP39	3-34
TK29	3-48	BKS32	3-16	CO35	2-13	MB39	1-99
VC29	1-123	CS32	3-15	DA35	1-108	MB39-P	1-99
WK29	3-57	DA32	1-108	DM35	3-21	NE39	1-116, 1-124
X29	1-10, 1-16, 1-127, 1-154	DA32-P	1-108	HD35	1-61, 1-64	T39	6B-1
YH29	1-156	DM32	3-22	HF35	1-150	TK39	3-48
YH29BP	1-157	EA32	2-24	IN35	2-33	TR39	1-144
YH29P	1-140, 1-158	HD32	1-61, 1-64	IN35-PC	2-33	X39	1-156
YH29RBP	1-157	HON32P	1-61	LS35	3-33	YH39	1-157
YH29RP	1-141, 1-158	LP32	3-34	TK35	3-48	ZK39	3-62
YM29	1-46, 1-111, 1-147	LP32R	1-34	V35	1-8	AS40	3-6
ZK29	3-62	LS32	3-33	V35-P	1-9	B40A	7-3
AS30	3-6	OP32	1-111	X35	1-79	CS40	3-15
BKS30	3-10	PH32	2-50	YH35	1-141, 1-159	DM40	3-21
C30M	7-7	RN32	1-6, 1-24	YH35RBP	1-157	F40	1-2, 1-33
CC30	2-9	RN32-P	1-6, 1-24	YH35REH2	1-158	HD40	1-65
CS30	3-15	S32	2-63	ZK35	3-62	HF40	1-12
DA30	1-108	S32FJ-P	1-47, 1-76	AS36	3-7	ILP40	3-29
DA30-P	1-108	S32YS-P	1-129	BKS36	3-10	MB40	1-99
DM30	3-21	TK32	3-48	CO36	2-14	NE40	1-124
DXB30	2-21	V32	1-81, 1-114, 1-150	CS36	3-15	RW40R	2-51
DXC30	2-21	VC32	3-53	DM36	3-21	T40	6B-1
DXD30	2-21	WK32	3-57	HD36	1-65	TOY40BT4	1-89
HD30	1-61, 1-64	X32	1-120	IN36	2-35	EB3-G-TOY40	1-82, 1-85, 1-89
ILP30	3-29	YH32	1-158	NE36	1-5, 1-125		
		ZK32	3-62				

	ILCO Number	Sec - Page(s)	ILCO Number	Sec - Page(s)	ILCO Number	Sec - Page(s)	ILCO Number	Sec - Page(s)
INDEX	EK3-TOY40	1-82, 1-89	45B	7-4	YH48	1-6, 1-13, 1-18, 1-80,	HF52-P	1-121
	TR40	1-31, 1-144	AS45	3-6		1-118, 1-140, 1-158	RU52	2-+55
	TR40-P	1-31, 1-144	B45	1-53	ZK48	3-62	SC52	3-44
	TR40-PC	1-31, 1-144	B45G	4A-1	49B	7-4	UN52	3-51
	X40	1-179	B45GP	4A-1	AS49	3-6	UN52L	3-51
	YH40	1-157	B45M	7-4	B49	1-53	X52	1-129
	ZK40	3-62	B45-P	1-53	B49G	4A-1	Y52	27-2
	41FD	2-6	B45-PC	1-53	B49GP	4A-1	ZK52	3-62
	AS41	1-129	CR45	2-20	B49-P	1-53	53 MASTER	7-4
	B41A	7-3	CS45	3-16	B49-PC	1-53	AS53	3-7
	B41B	7-3	DM45	3-21	CS49	3-16	B53	1-51, 1-56, 1-75
	B41C	7-3	FCT45	3-24	DM49	3-21	C53	7-4
	CS41	3-15	EB3-X-GM45	1-57	HD49	1-65	CS53	3-16
	DM41	3-21	EK3P-GM45	1-57	HF49	1-112	H53	1-40
	F41	1-2, 1-33	HD45	1-65	HU49AT2/5	1-8	HD53	1-65
	HF41	1-28	INF45-PT	1-73	HU49T1	1-153	RU53	2-53
	HO41	1-61, 1-65	NE45	1-116, 1-124	NE49	1-16	S53HF-P	1-97
	HON41-SI	1-68	RU45	2-53	S49HF-P	1-97	TR53	1-145
	HON41P-SI	1-68	T45	6A-4	TR49	1-144	TR53-P	1-145
	MB41	1-99	X45	1-143	X49	1-157	UN53	3-51
MB41-P	1-99	YH45	1-158	YH49	1-6, 1-13, 1-19, 1-80,	UN53L	3-51	
NE41	1-116	ZK45	3-62		1-119, 1-140, 1-158	X53	1-81, 1-114, 1-150	
T41	6B-1	AS46	3-6	ZK49	3-62	ZK53	3-62	
T41Y	3-28	B46	1-6, 1-53	50	3-46	54FA	2-22	
TK41	3-49	B46G	4A-1	50A	3-46	54FL	2-22	
X41	1-79	CR46	2-20	50AR	3-46	54KP	2-22	
YH41	1-157	CS46	3-16	AS50	3-6	54M	7-5	
ZK41	3-62	DM46	3-21	B50	1-52	A54B	2-1	
C42	7-3	FT46	1-5, 1-33, 1-37, 1-86	B50G	4A-1	A54F	2-22	
CS42	3-15		1-160	B50GP	4A-1	AS54	3-7	
DM42	3-21	HD46	1-65	B50-P	1-52	B54	1-56, 1-75	
HD42	1-64	HF46	1-28	B50-PC	1-52	CS54	3-16	
HON42	1-64	HU46T2	1-56	CS50	3-16	F54	1-9, 1-34, 1-132	
HON42AP	1-64	NE46	1-116	DM50	3-21	H54	1-40, 1-94	
NE42	1-116	RU46	2-53	H50	1-39, 1-94	H54-PC	1-40, 1-94	
S42	2-66	T46	6B-4	H50-P (-PC)	1-39, 1-94	L54K	2-22	
X42	1-65	TR46	1-145	HF50	1-112	L54WA	3-24	
YH42	1-157	TR46-P	1-145	ILP50	3-29	M54G	2-28	
ZK42	3-62	TR46-PC	1-145	LS50	3-33	ML54G	2-28	
AS43	37	X46	1-143	NE50	3-39	N54B	2-22	
B43	1-52	YH46	1-13, 1-19, 1-80, 1-119,	S50HF-P	1-97	N54G	2-22, 2-28	
CS43	3-15		1-158	T50	6A-4	NE54	1-34	
DM43	3-21	ZK46	3-62	TOY50-PT	1-89	P54F	2-6, 2-22	
FT43	1-5, 1-37, 1-86	AS47	3-7	TR50	1-145	S54F	2-22, 4B-2	
HD43	1-64	B47	1-53	UN50	3-51	S54F-PC	2-22	
HF43	1-28, 1-112	B47G	4A-1	UN50L	3-51	S54G	2-28	
HU43P	1-112	CS47	3-16	X50	1-16, 1-76	T54F	2-22	
HU43T2	1-112	DM47	3-21	YH50	1-13, 1-19, 1-119,	UN54	3-51	
NE43	1-116, 1-124	HD47	1-65		1-141, 1-157	UN54L	3-51	
OP43	1-112	HF47	1-112	ZK50	3-62	X54	1-23, 1-55, 1-74, 1-101,	
TOY43AT4	1-145	NE47	1-116	51	6B-4		1-138	
EB3-E-TOY43	1-131, 1-146	OP47	1-112	AS51	3-6	Y54	2-72	
EK3-TOY43	1-131, 1-146	TR47	1-145	B51	1-53	ZK54	3-62	
X43	1-65	TR47-P	1-145	B51G	4A-1	AS55	3-6	
YH43	1-157	TR47-PC	1-145	B51GP	4A-1	B55	1-56	
ZK43	3-62	WT47T	1-129	B51-P	1-53	CS55	3-16	
AS44	3-7	YH47	1-13, 1-19, 1-80, 1-119,	B51-PC	1-53	H55	1-40	
B44	1-152		1-140, 1-158	CS51	3-16	HF55-P	1-121	
B44G	4A-1	ZK47	3-62	DM51	3-21	NE55	1-34	
B44GP	4A-1	AS48	3-7	H51	1-39	UN55	3-51	
B44M	7-4	B48	1-52	H51-PC	1-39	UN55L	3-51	
B44-P	1-52	B48G	4A-1	HD51	1-65, 1-118	X55	1-16	
B44-PC	1-52	B48GP	4A-1	LS51	3-33	YM55	1-13, 1-19, 1-119, 1-159	
CS44	3-16	B48-P	1-52	SC51	3-44	ZK55	3-62	
DM44	3-21	B48-PC	1-52	UN51	3-51	AS56	3-6	
F44	1-3, 1-9, 1-34	CS48	3-16	UN51L	3-51	B56	1-56, 1-144	
HO44	1-61, 1-65	DM48	3-21	X51	1-8, 1-10, 1-16, 1-61,	CS56	3-16	
NE44	1-116	FT48	1-5		1+76	H56	1-40	
OP44	1-112	HD48	1-65	YH51	1-13, 1-19, 1-119,	HD56	1-65	
RU44	2-52	NE48	1-42, 1-81, 1-115,		1-141, 1-157	HF56	1-147	
T44	6B-2		1-127, 1-135	ZK51	3-62	NE56	1-34	
TOY44D-PT	1-145	S48HF-P	1-97	AS52	3-6	UN56	3-51	
TR44	1-144	EB3-F-TOY48	1-72, 1-89	52B	7-4	UN56L	3-51	
TR44-P	1-144	EK3-TOY48	1-89	B52	1-50	X56	1-10	
X44	1-61, 1-65	TOY48BT4	1-89	CS52	3-16	YM56	1-13, 1-19, 1-120, 1-159	
YH44	1-158	TR48	1-144	DM52	3-21	ZK56	3-62	
ZK44	3-62	X48	1-157	H52	1-40	AS57	3-6	



ILCO Number	Sec - Page(s)	ILCO Number	Sec - Page(s)	ILCO Number	Sec - Page(s)	ILCO Number	Sec - Page(s)
B57	1-75	60Z11	3-61	HO61D	1-66	62DH	1-16, 1-17, 1-126
CS57	3-16	60Z12	3-61	HO61E	1-66	62DJ	1-17
DM57	3-21	60Z13	3-61	HO61H	1-66	62DK	1-16, 1-77
HD57	1-18, 1-65	60Z14	3-61	HO61Q	1-65	62DM	1-16, 1-77
HF57	1-97	60Z16	3-61	HO61R	1-66	62DN	1-122, 1-147, 1-154
NE57	1-34	60Z17	3-61	HR61N	1-27	62DO	1-122
TOY57-PT	1-145	60Z18	3-61	HR61NA	1-29, 1-47, 1-98	62DP	1-7, 1-16, 1-77, 1-105,
UN57	3-51	60Z19	3-61	HR61P	1-133		1-125, 1-126, 1-1456,
UN57L	3-51	AS60	3-7	HV61	1-124, 1-133, 3-43		1-147, 1-154, 1-155
X57	1-65	DM60	3-21	HVR61	1-124, 1-133, 3-43	62DS	1-17, 1-154
ZK57	3-62	H60	1-40	L61D	1-4, 1-9, 1-35, 1-91	62DT	1-107, 1-135
AS58	3-6	HD60	1-65	L61G	1-4, 1-35	62DU	1-107
CS58	3-16	OP60C	1-112, 1-150	L61K	3-57	62DV	1-1070
DM58	3-21	R60HR	3-61	LR61D	1-4, 1-9, 1-35, 1-91	62DW	1-150
HD58	1-65	R60ZD	3-61	LR61G	1-4, 1-35	62DX	1-17, 1-77
HON58REHP-SI	1-68	S60	3-60	LR61JD	3-54	62E	3-32
JN58	3-31	S60HF-P	1-154	R61D	1-3, 1-35, 1-91	62EV	3-23
NE58	1-34	S60R	3-60	R61E	1-35	62FE	1-17
S58HF-P	1-97	T60	6B-3	R61G	1-4, 1-35, 1-105	62FG	1-17, 1-76
UN58	3-51	UN60	3-51	R61GA	1-4, 1-35	62FS	1-7, 1-17, 1-76, 1-110,
UN58L	3-51	UN60L	3-51	R61H	1-4, 1-35, 1-87, 1-88		1-146, 1-154
X58	1-65	X60	1-93	R61JD	3-4, 3-43	62FT	1-7, 1-11, 1-17, 1-42,
ZK58	3-62	Z1-60-5	4B-1	R61K	3-57		1-47, 1-76
AS59	3-7	Z1-60-6	4B-1	R61N	1-29	62H	3-54
B59	1-56	ZK60	3-62	R61NA	1-29, 1-47, 1-88, 1-97	62HA	1-126
CS59	3-16	61B	3-12	R61P	1-132	62HB	1-126
DM59	3-21	61D	1-3, 1-35, 1-91, 1-105	R61Q	3-4	62HC	1-126
H59	1-42	61E	1-3, 1-35	R61ST	1-4, 1-35	62HD	1-126
H59-P	1-42	61F	1-4, 1-35, 1-91	R61T	3-4	62HE	1-125
H59-PC	1-42	61G	1-4, 1-35	R61TS	1-3, 1-35, 1-91	62HF	1-126
HD59	1-65	61GA	1-4, 1-35	R61W	3-4	62HG	1-126
HF59	1-112	61H	1-4, 1-35, 1-87, 1-88	RE61F	1-115	62JB	1-126
HF59R	1-112	61J	1-35	RE61N	1-4, 1-14, 1-124	62JT	3-30
MB59	1-97	61JD	3-4, 3-11, 3-29, 3-37,	RE61XR	1-4, 1-116, 1-124,	62KD	3-53
NE59	1-35		3-43, 3-45		1-133	62KT	1-47
UN59	3-51	61K	3-57	S61JD	3-37	62KZ	3-63
UN59L	3-51	61N	1-12, 1-14, 1-29, 1-88,	SR61N	1-841, 1-105, 1-140	62L	3-23
X59	1-12, 1-13		1-97, 1-150	SR61W	1-129, 1-154	62LG	3-33
ZK59	3-62	61NA	1-29, 1-47, 1-88, 1-97	T61A	1-143	62M	3-55
Z1-59A1-6	4B-1	61NC	1-98, 1-121, 1-150	T61B	1-143	62PD	1-111
Z1-59A2-6	4B-1	61P	1-47, 1-132	T61C	1-143	62PE	1-112
Z1-59B1-6	4B-1	61PC	1-47, 1-33	T61C-P	1-143	62PF	1-112
Z1-59B2-6	4B-1	61PD	3-23	T61D	1-143	62PG	1-112
Z1-59C1-6	4B-1	61PE	1-116, 1-33	T61E	1-144	62PH	1-112
Z1-59C2-6	4B-1	61PS	1-116, 1-133	T61F	1-144	62PR	3-40
Z1-59D1-6	4B-1	61Q	3-4	T61G	1-144	62PT	3-40
Z1-59D2-6	4B-1	61T	3-4	T61VR	1-29, 1-47, 1-150	62QN	3-34
60.B9	3-60	61TS	1-3, 1-35	U61VW	1-150	62QS	3-34
60.CD	3-60	61VT	3-53	UN61	3-51	62QT	3-34
60.D	3-60	61VW	1-112, 1-121, 1-150	UN61L	3-51	62R	1-27, 1-114, 1-124,
60.GH	3-60	61W	3-4	V61A	1-154		1-133
60HA	3-61	61X	3-7	V61S	1-27, 1-50, 1-116,	62RG	3-31
60HB	3-61	A61Q	3-5		1-124, 1-148, 3-43	62RS	1-27, 1-133
60HR	3-61	A61T	3-5	V61VW	1-150	62SH	3-45
60.I9	3-60	A61W	3-5	VR61S	1-116, 1-124, 1-148,	62TA	3-47
60.IK	3-60	AR61Q	3-5		3-43	62TC	3-47
60.LM	3-60	AR61T	3-5	X61	1-124	62U	1-27, 1-124, 1-133
60.O	3-60	AR61W	3-5	Y61	1-105	62UC	1-27, 1-133
60.S9	3-60	AS61	3-7	ZK61	3-62	62VA	1-47, 1-87, 1-88, 1-98,
60UA	3-61	B61	1-56, 1-114	62	3-27		1-100, 1-141, 1-148
60UF	3-61	B61Y	3-56	62A	3-27	62VB	1-14
60UG	3-61	DM61	3-21	62B	3-12	62VC	1-47, 1-124, 1-150
60VF	3-61	DR61F	1-35	62BA	3-12	62VE	1-150
60VF9	3-60	H61G	1-4, 1-9, 1-35, 1-91	62BL	3-37	62VG	1-14, 1-29, 1-86, 1-150
60VG	3-60	H61N	1-27, 1-86	62BZ	1-114	62VH	1-14, 1-29, 1-35, 1-47,
60VG9	3-60	H61NA	1-29, 1-98	62C	3-23		1-86, 1-89, 1-112,
60ZD	3-61	H61P	1-133	62CKK	2-9		1-141
60Z1	3-61	H61SA	1-47	62CS	3-19	62VJ	1-98, 1-113
60Z2	3-61	H61SB	1-47	62DA	3-50	62VM	1-30, 1-113
60Z3	3-61	H61V	3-4	62DB	1-125, 155	62VO	1-12, 1-30, 1-113,
60Z4	3-61	H61VM	1-12, 1-13, 1-29, 1-98,	62DC	1-16, 1-77, 1-126,		1-150, 1-154
60Z5	3-61		1-150		1-129	62VP	1-113
60Z6	3-61	H61VO	1-29	62DE	1-16	62VW	1-150
60Z7	3-61	H61VR	1-16, 1-29, 1-33, 1-47,	62DF	1-16, 1-47, 1-129	62WA	1-30, 1-113
60Z8	3-61		1-98, 1-127, 1-50	62DG	1-4, 1-16, 1-47, 1-77,	62WB	1-8, 1-30
60Z9	3-61	HD61	1-65		1-126, 1-129, 1-147,	62X	3-30
60Z10	3-61	HO61C	1-66		1-154	62Z	1-27, 1-116, 1-124,

ILCO Number	Sec - Page(s)	ILCO Number	Sec - Page(s)	ILCO Number	Sec - Page(s)	ILCO Number	Sec - Page(s)
A62A	1-133	L62VA	1-28, 1-30, 1-59	63LL	1-113	64P	1-122
A62L	3-27	L62VB	1-30, 1-121, 1-150	63M	1-4, 1-117, 1-124	64R	1-124
A62QN	3-35	L62VJ	1-113	63P	1-117	64RD	2-33
A62VC	1-47, 1-150	L62VN	1-30, 1-112	63PX	1-117	64S	1-36
A62VN	1-30, 1-98, 1-113, 1-150	LR62DG	1-17	63Q	1-14, 1-117, 1-124	64SS	1-135
AB62A	3-2	LR62QT	3-35	63SP	1-4, 1-35	64X	1-124
AB62AR	3-2	LR62US	3-16	63ST	1-4, 1-36, 1-91	64Y	1-88
AB62C	3-2	LR62VA	1-28, 1-160	63TS	1-4, 1-36	AS64	3-6
AB62CR	3-2	LR62VB	1-30, 1-45	63TV	1-98	B64	1-53
AB62E	3-2, 3-17	LR62VJ	1-113	63TW	1-98	B64GP	4A-1
AB62ER	3-2, 3-17	R62B	3-12	63V	1-148	B64-P	1-53
AB62G	3-2, 3-17	R62BA	3-12	63VN	1-151	B64-PC	1-53
AB62GR	3-2, 3-17	R62BZ	1-114, 1-122	63VO	1-106	D64	3-20
AR62K	3-63	R62CA	3-14	63VP	1-12	DM64	3-21
AS62	3-7	R62DG	1-4, 1-126	63VR	1-151	H64	2-44
B62	1-52	R62DH	1-7, 1-17	63VS	1-151	H64E	1-48, 3-35
B62-P-1	1-54	R62DM	1-16, 1-77, 1-110, 1-127, 1-146	63W	1-88, 1-98	H64K	1-113
B62-P-2	1-54	R62EV	3-23	63WG	1-151	H64S	2-44
B62-P-3	1-54	R62K	3-16	63Y	1-12, 1-106, 1-113	HD64	1-66
B62-P-4	1-54	R62PD	1-111	A63L	1-151	HON64BP-SI	1-68
B62-P-5	1-54	R62PE	1-30, 1-113	AS63	3-6	HON64RBP-SI	1-68
B62-P-6	1-54	R62PF	1-112	B63	1-52	HR64K	1-114
B62-P-7	1-54	R62PG	1-112	B63GP	4A-1	HU64P-SI	1-99
B62-P-8	1-54	R62QB	3-34	B63-P	1-52	M64	2-44
B62-P-9	1-54	R62TA	3-37	B63-PC	1-52	R64	2-28
B62-P-10	1-54	R62TS	1-4, 1-35	CO63	2-31	P64H	1-114
B62-P-11	1-54	R62UC	1-27, 1-90, 1-91, 1-124, 1-133	DM63	3-21	P64K	1-114, 1-124
B62-P-12	1-54	R62US	3-16	G63Y	1-48	R64T	3-48
B62-P-13	1-54	R62VA	1-98, 1-160	H63	1-42	T64	6A-4
B62-P-14	1-54	R62VB	1-14, 1-48, 1-74	H63G	1-27, 1-50, 1-133	UN64	3-51
B62-P-15	1-54	R62VJ	1-98, 1-121, 1-151	H63M	1-99	UN64L	3-51
B62B	3-12	R62VN	1-8, 1-30	H63VO	1-151	VW64	1-152
B62DP	1-11, 1-17	R62WA	1-8, 1-30	HD63	1-66	VW64T	1-28, 1-152
B62DR	1-11, 1-17, 1-127, 1-147	R62X	3-30	L63G	1-117, 1-133	X64	1-5, 1-10, 1-36, 1-92
B62DV	3-9	R62Z	1-27, 1-116, 1-124, 1-133	LR63G	1-27, 1-117, 1-133	YM64	1-159
B62G	1-30, 3-68, 3-98	S62DP	1-17, 1-48, 1-155, 1-160	M63B	1-90, 1-99, 1-121, 1-154	ZK64	3-62
BS62DV	3-9	S62DR	1-17	M63BG	1-90, 1-99, 1-121, 1-151, 1-154	65CA	1-134
CO62	2-14	S62DW	1-151	M63E	1-98	65CB	1-134
D62SA	3-29	S62FD	1-98	MR63E	1-98	65CD	1-134
DM62	3-21	S62FD	1-98	N63G	1-116, 1-133	65CE	1-134
H62	1-41	S62KB	3-54	NR63G	1-116	65CF	1-134
H62-P	1-41	S62US	3-16	R63	2-28	65FA	1-36, 1-105
H62BM	3-53	S62VP	1-90, 1-113	R63E	1-30, 1-48	65G	1-36, 1-105
H62BZ	1-114	S62VT	1-113	R63G	1-116, 1-133	65J	1-48, 1-160
H62CM	3-53	U62VA	1-129	R63H	1-36, 1-50, 1-116, 1-133	65K	1-99
H62DG	1-127	U62VB	1-151	R63K	1-88, 1-98	65L	3-41
H62DM	3-53	U62VN	1-15	R63KE	1-48, 1-99	65M	1-14, 1-30, 1-36
H62DP	1-7, 1-17, 1-77, 1-125, 1-127, 1-146, 1-147, 1-155	U62VP	1-55, 1-111	R63P	1-117	65T	1-48
H62DR	1-17, 1-77, 1-146, 1-147	UN62	3-51	R63PX	1-117	65TA	1-107
H62FD	1-48, 1-151	UR62K	3-63	R63SP	1-4, 1-35, 1-91	AS65	3-6
H62KB	3-53	UN62L	3-51	R63ST	1-4, 1-36, 1-91	B65	1-51, 1-62, 1-75
H62PD	1-113	UR62VP	1-111	R63TK	1-48	B65-P	1-51, 1-63, 1-75
H62VG	1-14, 1-98	UR62X	3-30	R63TS	1-4, 1-36	DM65-11	3-21
H62VK	1-12, 1-30	VO62	1-8, 1-154	R63TY	1-46	DM65-17	3-21
H62VP	1-113	W62VB	1-151	R63V	1-148	DM65-20	3-21
HD62	1-66	W62VE	1-151	R63VS	1-151	F65	1-30, 1-86, 1-99, 1-134
HR62BZ	1-114	X62	1-158	R63W	1-86, 1-98	F65A	1-134
HR62DG	1-4, 1-17, 1-127, 1-138	Y62	1-35	R63WG	1-151	F65L	1-134
HR62FD	1-48, 1-151	YR62	1-35, 1-87	R63Y	1-12, 1-14, 1-48	FR65	1-134
HR62KB	3-53	ZK62	3-62	S63B	1-151	FR65A	1-134
HR62PD	1-113	63	1-30, 1-90, 1-92, 1-148, 3-37	U63H	1-99, 1-113, 1-121, 1-151	FR65S	1-134
HR62VG	1-14, 1-98	63A	1-30, 1-98, 1-100	UN63	3-51	H65	1-42
HR62VK	1-30, 1-150	63C	1-98	UN63L	3-51	H65-P	1-43
L62CS	3-19	63E	1-48, 1-74, 1-98	VW63	1-152	HD65	1-65
L62DM	3-51	63F	1-14, 1-86	VW63A	1-152	L65G	3-41
L62FD	1-11, 1-17, 1-48	63G	1-116, 1-133	X63	1-158	L65Y	3-41
L62KE	3-54	63H	1-50, 1-99, 1-116, 1-133	XD63	1-30, 1-90	LR65Y	3-41
L62QT	3-35	63J	1-160	YM63	1-159	M65F	3-44
L62TC	3-48	63JA	1-99	ZK63	3-62	P65A	1-114
L62UC	1-27, 1-116	63K	1-88, 1-98	64AL	1-88, 1-122	P65C	1-114
L62US	3-16	63L	1-12, 1-30, 1-64, 1-86, 1-90, 1-141, 1-151, 1-160, 3-40	64D	2-33	R65F	3-45
				64G	2-33	R65FA	1-36, 1-105
				64K	1-121, 1-147, 1-152	R65G	1-36, 1-105
				64KK	1-121	R65S	3-30
						R65U	3-4
						RS65G	3-41

ILCO Number	Sec - Page(s)	ILCO Number	Sec - Page(s)	ILCO Number	Sec - Page(s)	ILCO Number	Sec - Page(s)
S65CA	1-134	T67D	2-10	HD72	1-65	79B	7-5
S65F	3-44	T67E	2-10	M72F	1-16, 1-26	AS79	3-7
S65G	3-41	T67F	2-10	T72	6B-2	B79	1-54
SR65	3-45	U67K	1-67	V72E	1-152	B79G	4A-1
U65F	3-44	U67KR	1-67	V72N	1-152	H79M	1-67
UF65A	1-134	UN67	3-51	X72	1-6, 1-158	H79MR	1-67
UN65	3-51	UN67L	3-51	ZK72	3-62	O79JC	1-113
UN65L	3-51	VW67	1-152	73M	7-5	O79JD	1-113
X65	1-158	VW67S	1-152	73VB	1-8, 1-120, 1-149	O79JE	1-113
ZK65	3-62	W67	2-70	73VB-P	1-8, 1-120, 1-149	P79B	1-121
66A	1-36, 1-87, 1-105	X67	1-158	AS73	3-5	X79	1-5, 1-10, 1-36, 1-92
66B	7-5	ZK67	3-62	H73Z	1-67	ZK79	3-62
66BB	1-36, 1-87, 1-105	68M	7-5	H73-PT	1-43	80S	6B-3
66E	3-22	AS68	3-7	EB3-C-H73	1-43	AS80	3-7
AS66	3-6	B68	1-54	EK3-H73	1-43	B80	1-51
F66C	1-36	B68GP	4A-1	HD73	1-65	B80-P	1-51
H66	1-41, 1-100	B68-P	1-54	S73	2-63	R80B	1-125
H66-P	1-41	B68-PC	1-54	VO73	1-10, 1-16, 1-127,	T80	6A-4
HD66	1-66	CO68	2-31		1-154	T80J	1-144
HU66-P	1-153	F68C	1-88	VO73S	1-154	UN80	3-51
HU66A-P	1-9	F68YT	1-7, 1-11, 1-42, 1-47	X73	1-58	UN80L	3-51
HU66AT2	1-9	HD68	1-66	ZK73	3-62	V80P	1-129, 1-155
HU66AT6	1-9	M68	1-97	AS74	3-5	X80	1-155
HU66T1	1-153	S68	2-62	B74	1-62, 1-75	ZK80	3-62
HU66T5	1-122	UN68	3-51	B74-P	1-62, 1-75	A81N	1-5, 1-8, 1-121
HU66T6	1-153	UN68L	3-51	H74-PT	1-44	AS81	3-7
HU66T24	1-153	X68	1-158	HD74	1-67, 1-85	F81E	1-7, 1-76, 1-107
J66M	1-77	ZK68	3-62	NE74P-SI	1-117	UN81	3-51
P66E	1-122	AS69	3-7	NE74TS-SI	1-117	UN81L	3-51
R66E	3-22	B69	1-51, 1-56	T74	6B-3	X81	1-28
S66NN-P	1-154	HD69	1-67	X74	1-158	ZK81	3-62
UN66	3-51	UN69	3-51	ZK74	3-62	AS82	3-7
UN66L	3-51	UN69L	3-51	AS75	3-5	B82-P-2	1-54
X66	1-158	X69	1-158	H75	1-44	B82-P-3	1-54
ZK66	3-62	ZK69	3-62	H75-P	1-44	B82-P-4	1-54
67	4B-2	70S	6B-3	H75-PC	1-44	B82-P-5	1-54
67CL	2-9	AS70	3-7	HD75	1-67, 1-85	B82-P-6	1-54
67G	3-25	C70	7-5	T75	6B-3	B82-P-7	1-54
67H	1-66	F70S	1-16, 1-126	X75	1-158	B82-P-8	1-54
67J	1-65	H70	1-43	ZK75	3-62	B82-P-9	1-54
67LA	1-66	H70-P	1-43	AS76	3-5	B82-P-11	1-54
67LB	1-66	H70X	1-67	F76M	1-48	B82-P-12	1-54
67LC	1-66	H70XR	1-67	H76	1-44	B82-P-13	1-54
67LD	1-66	H70Z	1-67	H76-P	1-44	B82-P-14	1-54
67M	7-5	HD70	1-61	H76G	1-64	B82-P-15	1-54
67N	3-43	HD70U	1-61	H76-P	1-44	C82M	7-7
67P	3-43	HD70U-P	1-61	H76X	1-64	H82-PT	1-44
67Q	3-43	HON70EHP-SI	1-69	X76	1-158	HD82	1-61
67T	3-43	HON70T14-SI	1-68	Y76B	1-158	HD82-P	1-61
67U	3-43	S70	2-63	Y76C	1-158	UN82	3-51
67W	3-43	T70	6A-4	ZK76	3-62	UN82L	3-51
AS67	3-7	X70	1-59	AS77	3-5	X82	1-99
B67	1-54	ZK70	3-62	B77	1-53	ZK82	3-62
B67G	4A-1	71B	7-5	B77GP	4A-1	AS83	3-4
B67K	1-66	AS71	3-5	B77-P	1-53	UN83	3-51
C67K	1-67	H71-P	1-43	B77-PC	1-53	UN83L	3-51
D67K	1-67	H71	1-43	H77P	1-67	X83	1-99
E67K	1-64	HD71	1-61	H77PR	1-67	ZK83	3-62
H67	1-41	NE71R	1-127	K77L	3-8	84B	7-8
H67-P	1-41	NE71RDP-SI	1-117, 1-127	T77	6A-4	AS84	3-7
H67-PC	1-41	VW71	1-152	V77	1-154	B84	1-54
H67K	1-65	VW71A	1-152	VW77	1-48, 1-77, 1-152	B84GP	4A-1
L67A	2-9, 3-55	X71	1-61	X77	1-159	B84-P	1-54
L67B	2-9	Y71H	1-156	ZK77	3-62	EB3-D-H84	1-44, 1-95
R67F	3-25	YA71	3-58	78B	7-5	EK3-H84	1-44, 1-95
R67K	1-65	ZK71	3-62	AS78	3-5	X84	1-67, 1-85
R67N	3-43	AS72	3-7	B78	1-53	ZK84	3-67
R67P	3-43	B72	1-51	B78GP	4A-1	AS85	3-8
R67Q	3-43	B72-P	1-51	B78-P	1-53	B85	1-54
R67T	3-43	D72D	1-106	B78-PC	1-53	B85G	4A-1
S67B	2-10	D72Z	1-106	H78	1-44	UN85L	3-51
S67K	1-65	H72G	1-60	H78-P	1-44	X85	1-5, 1-125
S67NN-P	1-155	H72H	1-60	H78KR	1-60	ZK85	3-62
SR67K	1-65	H72-PT	1-43	V78JK	1-151	AS86	3-8
T67A	2-10	H72-PT-CLEAR	1-43	X78	1-5, 1-10, 1-36	B86	1-54
T67B	2-10	EB3-H72	1-43, 1-96	Y78	2-74	B86GP	4A-2
T67C	2-10	EK3-B-H72	1-43, 1-96	ZK78	3-62	B86-P	1-54

	ILCO Number	Sec - Page(s)	ILCO Number	Sec - Page(s)	ILCO Number	Sec - Page(s)	ILCO Number	Sec - Page(s)
INDEX	B86-PC	1-54		1-86, 1-92	SH91S	3-16	T95	6B-2
	H86-PT	1-44	F91CR	1-5, 1-10, 1-33, 1-36,	SK91E	1-134	X95	1-60
	H86-SERVICE	1-45		1-86, 1-92	SK91H	1-134	ZK95	3-62
	T86	6B-4	F91E	1-5, 1-10	SO91P	3-30, 3-46	B96	1-130
	X86	1-7, 1-28, 1-42, 1-48, 1-77, 1-114, 1-127	F91EH	1-5, 1-10	SOS91	3-30, 3-46	B96-P	1-130
	ZK86	3-62	F91ES	1-5, 1-10, 1-36	ST91	3-46	HD96	1-1
	CO87	2-16	F91F	1-5, 1-10	ST91A	3-16, 3-47	HD96-P	1-1
	CR87	2-20	F91FH	1-5, 1-10	ST91F	3-47	NC96K	2-44
	H87-P	1-45	F91FS	1-5, 1-10, 1-36	ST91S	3-46	NC96M	2-44
	X87	1-139	F91G	1-5, 1-1, 1-59	ST91V	3-47	T96	6B-2
	ZK87	3-62	F91GH	1-5, 1-10	TO91	3-48	X96	1-60
	B88	1-130	F91GS	1-5, 1-10, 1-36, 1-91	TT91	1-142	ZK96	3-62
	B88-P	1-130	F91H	1-5, 1-10	V91E	3-54	B97-PT	1-55
B88-PC	1-130	F91HH	1-5, 1-10	V91LA	3-54	B97GPT	4A-2	
CO88	2-16	F91HS	1-5, 1-10, 1-36	V91LD	3-54	B97-PT5	1-55	
CR88	2-20	FL91	3-25, 3-39	V91LE	3-54	CO97	2-16	
T88	6B-3	GA91	3-16	V91LF	3-54	HD97	1-1	
X88	1-8, 1-152	GAS91	3-16	V91LG	3-54	T97	6B-2	
ZK88	3-62	GIP91	3-26	V91LH	3-54	X97	1-60	
AS89	3-8	GU91	3-27	V91N	3-54	ZK97	3-62	
B89	1-54	GU91B	3-27, 3-41	VA91	3-45, 3-54	B98-PT	1-55	
B89GP	4A-2	GU91F	3-27, 3-41	VR91	3-55	B98GPT	4A-2	
B89-P	1-54	GU91G	3-27, 3-41	VR91A	3-55	B98-PT5	1-55	
CO89	2-15	HD91	1-62	VR91AR	3-27, 3-55	CO98	2-15	
CR89	2-20	HD91-P	1-62	VR91B	3-55	HD98	1-62	
T89	6B-3	JO91	3-30	VR91BR	3-55	HD98-P	1-62	
X89	1-115	JO91C	3-30	VR91C	3-55	HD98-PC	1-62	
ZK89	3-62	KS91C	3-9	VR91CR	3-55	HT98	1-58	
90B	7-6	KS91P	3-10	VR91R	3-55	X98	1-60	
AS90	3-8	KVR91	3-31	VR91S	3-55	ZK98	3-62	
HD90	1-62	MG91	3-38	W91C	3-57	B99-PT	1-55	
HD90-P	1-62	MG91C	3-38	WA91	3-52, 3-56	B99GPT	4A-2	
HD90-PC	1-62	MG91N	3-38	WA91C	3-56	B99-PT5	1-55	
INF90	1-72	MG91P	3-38	WA91L	3-52, 3-56	HD99	1-1	
LXP90-P	1-88, 1-95, 1-145	MG91R	3-38	WA91P	3-56	HD99-P	1-1	
LXV90-P	1-88, 1-95, 1-145	MG91S	3-38	WA91PR	3-56	X99	1-36	
X90	1-79	OA91	3-39	WA91S	3-56	ZK99	3-62	
ZK90	3-61	OA91D	3-39	WA91W	3-52, 3-56	100AM	2-7	
91B	7-6	OA91P	3-39	WA91WL	3-52, 3-56	100-C	4B-3	
AR91	3-4	OA91R	3-39	X91	1-79	100-E	4B-4	
B91	1-54	OP91G	1-113	Y91C	1-114	B100GPT	4A-2	
B91-GP	4A-2	OP91S	1-114	Z91	1-105	B100-PT	1-55	
B91-P	1-54	OP91SV	1-114	Z91K	3-60	B100-PT5	1-55	
B91GCP	4A-2	PA91	1-114	Z91KR	3-60	HD100-P	1-1	
B91GOP	4A-2	PR91	3-40, 3-44	ZE91C	3-14, 3-17, 3-63	HD100	1-1	
BL91	3-11	PR91A	3-40	ZE91CR	3-14, 3-17, 3-63	HU100-P	1-59	
BR91C	3-9, 3-31	PR91C	3-40	ZE91G	3-16, 3-17, 3-63	EB3-V-HU100	1-58, 1-130	
CA91	3-14, 3-17	PR91CS	3-40	ZK91	3-62	EK3P-HU100	1-58, 1-130	
CA91A	3-14, 3-17	PR91M	3-40	B92	1-55	X100	1-60	
CA91B	3-14, 3-17	PR91MS	3-40	B92GP	4A-2	ZK100	3-62	
CA91C	3-14, 3-17	PR91N	3-40	B92GV	4A-2	101AM	2-7	
CA91D	3-14, 3-17, 3-63	PR91NS	3-40	B92-P	1-55	101-CE	4B-4	
CA91L	3-14, 3-17	PR91S	3-40	C92	2-10	101-C NS	4B-4	
CA91S	3-14, 3-17	PR91SA	3-40	C92B	2-10	101C-NS-DND	2-63	
CAV91	3-14, 3-17	RO91	3-42	CO92	2-15	101C-NS-PLAIN	2-63	
CO91	2-15	RO91R	3-42	CR92	2-19	101-E	4B-4	
CR91	2-20	RU91C	3-43	HD92	1-1	101-EF	4B-4	
CS91	3-2	S91A	3-45	HD92-P	1-1	101-F	4B-4	
CS91B	3-2, 3-17	S91BV	3-45	TO92	3-49	101E-NS-DND	2-63	
CS91C	3-17	S91CV	3-45	X92	1-5, 1-125	B101	1-63, 1-75	
CS91CR	3-17	S91K	3-45	ZK92	3-62	B101-P	1-63, 1-75	
CS91E	3-17	S91P	3-45	B93	1-55	HD101	1-1	
CS91ER	3-17	S91R	3-45	B93-GP	4A-2	HD101-P	1-1	
CS91F	3-17	S91W	1-132	B93-P	1-55	HU101EHP	1-128	
CS91FR	3-17	SE91	3-44	B93GOP	4A-2	RU101	2-17, 2-54	
DK91D	1-30	SE91L	3-45	HD93	1-1	X101	1-60	
DK91G	1-30	SEL91	3-45	X93	1-60	Y101	1-135, 2-79	
DK91H	1-30	SEL91R	3-45	ZK93	3-62	ZK101	3-62	
DK91K	1-30	SES91	3-45	94	6B-4	102AM	2-7	
DK91L	1-30	SH91J	3-16	CO94	2-15	B102	1-55	
DK91U	1-30	SH91K	3-16	CR94	2-19	B102-GMP	4A-3	
F91C	1-5, 1-10, 1-33, 1-36, 1-86, 1-92	SH91L	3-16	HD94	1-62	B102GP	4A-2	
F91C2	1-5, 1-10, 1-33, 1-36, 1-86, 1-92	SH91M	3-16	X94	1-60	B102GCP	4A-2	
F91C8	1-5, 1-10, 1-33, 1-36,	SH91N	3-16	ZK94	3-62	B102GOP	4A-3	
		SH91P	3-16	CO95	2-15	B102-P	1-55	
		SH91Q	3-16	CR95	2-19	CO102	2-15	
		SH91R	3-16	HD95	1-62	HD102	1-1	

ILCO Number	Sec - Page(s)	ILCO Number	Sec - Page(s)	ILCO Number	Sec - Page(s)	ILCO Number	Sec - Page(s)
HD102-P	1-1	00116	4B-5	Y155-PC	1-22	G190F	2-30
VAC102T1	1-125	X116	1-117, 1-125	X157	1-17, 1-76, 1-92, 1-127	G190FA	2-30
ZK102	3-62	X117	1-6, 1-13, 1-18, 1-80, 1-119, 1-140, 1-158	Y157	1-22	G190M	2-30
103AM	2-7			Y157-P	1-22	G190MA	2-30
B103-PT	1-56	X118	1-6, 1-13, 1-18, 1-80, 1-119, 1-140, 1-159	Y157-PC	1-22	X190	1-62
B103-PT5	1-56			Y157-PC-GRN-N	1-22	191A	3-56
HD103	1-62	X119	1-6, 1-13, 1-18, 1-80, 1-119, 1-140, 1-159	Y157-PC-YEL-N	1-23	G191	2-29
HD103-P	1-62			X158	1-75	G191A	2-29
HD103-PC	1-62	X120	1-6, 1-13, 1-18, 1-80, 1-119, 1-140, 1-159	X159	1-144	SR191A	3-55
X103	1-79			Y159	1-23, 1-144	X191	1-62
Y103	2-31, 2-32, 2-65, 2-79	X121	1-23, 1-56, 1-69, 1-74, 1-101, 1-118	Y159-P	1-23	192	3-46
ZK103	3-62			X160	1-69, 1-101	192B	3-46
104AM	2-7	H122AL	1-78	Y160-PT	1-24	A192	3-4
B104-P-2	1-56	H122ALR	1-78	EB3-A-Y160	1-25, 1-26, 1-104, 1-135	G192	2-29
B104-P-3	1-56	K122AR	1-78			G192A	2-29
B104-P-4	1-56	X122	1-5, 1-23, 1-124	EK3-Y160	1-25	L192M	3-37
B104-P-5	1-56	X123	1-107, 1-123	X161	1-69	X192	1-51
B104-P-6	1-56	T124	6B-4	X162	1-56	G193	2-29
B104-P-7	1-56	X124	1-73, 1-108	Y162-PT	1-24	G193A	2-29
B104-P-8	1-56	125C	1-87	163SB	7-6	X193	1-1
B104-P-9	1-56	125CR	1-88	X163	1-90, 1-155	G194	2-29
B104-P-10	1-56	X125	1-60	EK3P-Y164	1-26, 1-104, 1-135	G194A	2-29
B104-P-11	1-56	X126	1-60	Y164-PT	1-24, 1-103	L194	1-90
B104-P-12	1-56	T127	6A-9	Y165-PT	1-24	X194	1-1
B104-P-13	1-56	X127	1-60	X166	1-5	G195	2-29
B104-P-14	1-56	X129	1-61	X167	1-160	G195A	2-29
B104-P-15	1-56	X130	1-61	X168	1-56, 1-114	X195	14-62
B104-PT	1-56	T131	6A-4	X169	1-42	G196	2-29
B104-PT5	1-56	X131	1-42, 1-93	170S	6B-3	G196A	2-29
HD104	1-62	X132	1-152	170S1	6B-3	X196	1-70, 1-101
X104	1-79	X133	1-60	170S6	6B-4	G197	2-29
HD105	1-67	Y133	1-20, 1-60, 1-135	170T	3-49	X197	1-108
T105	6A-4	X134	1-60	S170S1	6B-4	G198	2-29
X105	1-79	X135	1-60	X170	1-42, 1-81, 1-115, 1-127, 1-134	X198	1-62, 1-75
B106	1-30	136SB	7-6			G199	2-29
B106-P	1-30	X136	1-60	Y170PT	1-25	H199A	1-19
CO106	2-6, 2-12, 2-31	X137	1-144	EB3-T-Y170	1-26, 1-153	H199N	1-125
HD106-PT	1-63	138	1-90, 1-134, 1-148	EK3P-Y170	1-26, 1-153	X199	1-94
HD106-PT5	1-63	X138	1-67, 1-85	171S	6B-3	200W	4B-4
X106	1-79	Y138	1-21	X171	1-6, 1-23, 1-125	G200	2-30
B107-PT	1-63	139	1-134	C172F	3-24	X200	1-94
B107-PT5	1-63	T139	6B-2	X174	1-31, 1-144	Y200	2-71, 3-59
CO107	2-15	X139	1-8	X175	1-6, 1-24	201	3-36
HD107-PT5	1-63	X140	1-155	X176	1-24, 1-101	X201	1-94
T107	6A-4	X141	1-60	177	2-45	Y201	2-77, 3-59
X107	1-158	X142	1-60	X177	1-77	X202	1-42
CO108	2-15	143C	6B-4	178SB	7-6	Y202	2-77
HD108	1-67	143D	5-4	X178	1-93	X203	1-152
X108	1-136	X143	1-51, 1-56, 1-75	X179	1-139	X204	1-1
HD109	1-67	X144	1-12	180A	4B-4	Y204	3-59
X109	1-5, 1-37, 1-86	X145	1-56	S180UR	3-47	X205	1-1
B110	1-56	X146	1-56, 1-144	S180W	3-47	X206	1-94
B110-P	1-57	Y146	1-21	U180G	3-51	X207	1-42
C110	7-6	X147	1-6, 1-23, 1-117, 1-125	X180	1-51, 1-56	X208	1-1
DM110	3-21	X148	1-117	X181	1-62	X209	1-1
HD110-P	1-68	149	6B-3	X182	1-62	X210	1-73, 1-108, 1-136
X110	1-152	TS149	6B-4	X183	1-1	X211	1-144
B111-GPT	4A-3	Y149	1-22	184K	3-32	X212	1-145
B111-PT	1-57, 1-130	TS150	6B-4	X184	1-51, 1-62, 1-75	X213	1-24, 1-101
HD111-PT	1-1	X150	1-6, 1-125	185V	3-55	X214	1-62
EB3-H-HD111	1-2	X151	1-144	R185V	3-55	X215	1-62
EK3P-HD111	1-2	X152	1-5, 1-31, 1-37, 1-86, 1-60	X185	1-138	X216	1-70
X111	1-13, 1-19, 1-159			X186	1-138	X217	1-145
B112-PT	1-57	Y152	1-22	X187	1-69	X218	1-144
C112	7-6	Y152-PC	1-22	X188	1-63	C219	3-42
X112	1-13, 1-19, 1-159	T153	6A-1	X189	1-1	X219	1-44
00113	4B-5	X153	1-160	A190	3-3	X220	1-145
HD113-PT	1-64	Y153	1-22	G190	2-29	Y220	2-77
X113	1-37	Y153-P	1-22	G190A	2-29	X221	1-42
00114	4B-5	X154	1-56, 1-75	G190B	2-29	Y221	2-78
B114-PT	1-130	Y154	1-22	G190BA	2-29	X222	1-94
B114R-PT	1-130	Y154-P	1-22	G190C	2-29	Y222	2-78
EB3-W-B114R	1-31	Y154-PC	1-22	G190CA	2-29	X223	1-145
EK3P-B114R	1-31	155	5-4	G190D	2-29	Y223	2-78
X114	1-167	X155	1-76	G190DA	2-29	X224	1-24, 1-102
B115-PT	1-57	Y155	1-22	G190E	2-29	X225	1-51
X115	1-107, 1-136	Y155-P	1-22	G190EA	2-29	X226	1-60, 1-140

	ILCO Number	Sec - Page(s)	ILCO Number	Sec - Page(s)	ILCO Number	Sec - Page(s)	ILCO Number	Sec - Page(s)
INDEX	X227	1-108	623S	6A-3	O997A	2-71	998YH	2-76
	X228	1-108	625DH	6A-3	O997E	2-72	998YK	2-76
	X229	1-24, 1-102	625EH	6A-3	O997ER	2-72	998YMK	2-76
	X230	1-94	S625P	6A-1	O997G	2-72	998ZA	2-77
	X231	1-43	632M	6A-5	O997K	2-73	998ZB	2-77
	X232	1-70	633MH	6A-7	R997DA	2-71	998ZC	2-77
	X233	1-81	634	6A-5	R997EB	2-73	998ZG	2-77
	X234	1-60, 1-85, 1-106	660	6B-2	998	2-74	A998GST	2-73
	X235	1-70	662	6A-5	998A	2-74	D998GA	2-74
	X236	1-70	663	6A-1	998FD	2-73	2-74	2-74
	X237	1-108	665	6B-2	998GA	2-74	2-74	2-74
	X238	1-108	666	6B-2	998GB	2-74	2-74	2-74
	X239	1-127	667	6A-5	998GC	2-74	2-74	2-74
	X240	1-81	669	6B-1, 7-7	998GD	2-74	2-74	2-74
	X241	1-138, 1-140	671	6A-1	998GE	2-74	2-74	2-74
	X242	1-108	672	6A-1	998GF	2-74	2-74	2-74
	X243	1-109	687W	6A-2	998GG	2-74	2-74	2-74
	X244	1-44	687X	6A-2	998GH	2-74	2-74	2-74
	X245	1-24, 1-102	687Y	6A-2	998GK	2-74	2-74	2-74
	X246	1-67	703S	6B-4	998GL	2-73	2-74	2-74
X247	1-94	704K	1-20	998GST	2-73	2-74	2-74	
X248	1-159	706	5-4	998LA	2-73	2-74	2-74	
X249	1-95	719S	6B-4	998LB	2-73	2-74	2-74	
X250	1-63, 1-75	723	5-4	998LC	2-73	2-74	2-74	
X251	1-136	725	6A-1	998LD	2-73	2-74	2-74	
X252	1-67	750	2-23, 2-28	998LE	2-73	2-74	2-74	
X253	1-82	752	1-118, 2-23, 2-28	998LF	2-73	2-74	2-74	
X254	1-79	755	2-23	998LG	2-73	H998SA	2-75	
X255	1-79	755U	2-3	998LH	2-73	H998SB	2-75	
X256	1-79	757	2-23, 2-28	998LK	2-73	H998SC	2-75	
X257	1-80	759ST	2-65	998PA	2-77	H998SD	2-75	
X258	1-80	760	2-23	998PB	2-77	H998SE	2-75	
X259	1-18, 1-80, 1-106, 1-119, 1-140, 1-146	765 770	2-23 6A-4	998PC 998PD	2-77 2-77	H998SF H998SG	2-75 2-75	
X260	1-80, 1-119	775	2-28	998PE	2-77	H998SH	2-75	
X261	1-80, 1-119	884	5-7	998PF	2-77	H998SK	2-75	
X262	1-80, 1-119	884BR	5-7	998PG	2-77	H998SMK	2-75	
X263	1-102	884BS	5-7	998PH	2-77	H998SV	2-75	
X264	1-102	884R	5-7	998PK	2-77	H998TA	2-75	
X265	1-67	885	5-8	998S	2-74	H998TB	2-75	
X266	1-80	885BL	5-8	998SA	2-75	H998TC	2-75	
X267	1-82	885R	5-8	998SB	2-75	H998TD	2-75	
X268	1-109	886	5-8	998SC	2-75	H998TE	2-75	
X269	1-82	887	5-2, 5-8	998SD	2-75	H998TF	2-75	
X270	1-7, 1-13, 1-17, 1-18, 1-32, 1-75, 1-85, 1-90, 1-105, 1-118, 1-146	S900 997A 997B	2-39 2-71 2-71	998SE 998SF 998SG	2-75 2-75 2-75	H998TG H998TH H998TK	2-75 2-75 2-75	
X271	1-136	997D	2-71	998SH	2-75	H998TMK	2-75	
X272	1-136	997DA	2-71	998SK	2-75	H998VA	2-76	
X273	1-140	997DB	2-71	998SMK	2-75	H998VB	2-76	
X274	1-60	997E	2-72	998SV	2-77	H998VC	2-76	
X275	1-75	997EB	2-72, 3-10	998TA	2-75	H998VD	2-76	
X276	1-140	997ER	2-73, 3-10	998TB	2-75	H998VE	2-76	
X277	1-159	997G	2-72	998TC	2-75	H998VF	2-76	
275LA	4B-3	997GR	2-72	998TD	2-75	H998VG	2-76	
275S	4B-3	997GX	2-72	998TE	2-75	H998VH	2-76	
B308	4B-3	997GXR	2-72	998TF	2-75	H998VK	2-76	
B310	4B-3	997JA	2-72	998TG	2-75	H998YA	2-76	
C350	6B-1	997JB	2-72	998TH	2-75	H998YB	2-76	
355ST	6A-4	997JC	2-72	998TK	2-75	H998YC	2-76	
E374	6A-5	997JD	2-72	998TMK	2-75	H998YD	2-76	
E375	6A-5	997JE	2-72	998VA	2-76	H998YE	2-76	
401N-2	7-6	997JF	2-72	998VB	2-76	H998YF	2-76	
504	7-6	997JG	2-72	998VC	2-76	H998YG	2-76	
506	7-6	997JH	2-72	998VD	2-76	H998YH	2-76	
606AH	6A-5	997JK	2-72	998VE	2-76	H998YK	2-76	
606L	6A-5	997L	2-72	998VF	2-76	H998YMK	2-76	
606LH	6A-5	997LA	2-72	998VG	2-76	H998ZA	2-77	
610B	6A-5	997PA	2-72	998VH	2-76	H998ZB	2-77	
610BL	6A-5	997X	2-72	998VK	2-76	H998ZC	2-77	
611	6A-5	A997EH	2-72	998YA	2-76	H998ZG	2-77	
U611B	6A-5	B997EH	2-72	998YB	2-76	S998GA	2-74	
615	6A-5	H997E	2-72	998YC	2-76	S998GB	2-74	
619	6B-1	H997EB	2-72	998YD	2-76	S998GC	2-74	
621	6A-7	H997ER	2-72	998YE	2-76	999	2-1, 2-77, 3-8, 3-17, 3-22, 3-40	
621A	6A-3	J997M	2-72	998YF	2-76			
U621A	6A-3	J997MR	2-72	998YG	2-76	999A	2-77, 3-10, 3-16	





ILCO Number	Sec - Page(s)	ILCO Number	Sec - Page(s)	ILCO Number	Sec - Page(s)	ILCO Number	Sec - Page(s)
999B	2-77, 3-2	SX1000F	2-10	A1001MF	2-13	1004XM	2-40
999CA	2-77	SX1000FR	2-11	A1001MJ	2-14	H1004A	2-40
999GA	2-74, 3-10, 3-59	X1000F	2-11	A1001MJR	2-14	1005	2-40
999GB	2-74, 3-10, 3-59	X1000FR	2-10 2-44	B1001EJ	2-14	1006	2-40
999GC	2-74, 3-10, 3-59	X1000G	2-11	L1001ABM	2-15	1007	2-57
999GD	2-74, 3-10, 3-59	X1000GR	2-11	L1001AH	2-15	1007A	2-57
999GE	2-74, 3-10, 3-59	X1000KC	2-11	L1001AM	2-15	1007CA	2-58
999GF	2-74, 3-10, 3-59	X1000KR	2-52	L1001BH	2-15	1007CB	2-58
999GG	2-74, 3-10, 3-59	XO1000F	2-11	L1001BM	2-15	1007CC	2-58
999GH	2-74, 3-10, 3-59	XO1000FR	2-11	L1001C1	2-15	1007CD	2-58
999GK	2-74, 3-10, 3-59	XO1000GR	2-11	L1001C2	2-15	1007CE	2-58
999K1	2-78	1001	2-16	L1001CDM	2-15	1007CF	2-58
999K2	2-78	1001A	2-16	L1001CM	2-15	1007CG	2-58
999K3	2-78	1001A1	2-16	L1001D1	2-15	1007CH	2-58
999LA	2-73, 3-11, 3-59	1001A2	2-16	L1001D2	2-15	1007CJ	2-58
999LB	2-73, 3-11, 3-59	1001AB	2-16	L1001DH	2-15	1007CK	2-58
999LC	2-73, 3-11, 3-59	1001ABM	2-15	L1001DM	2-15	1007CL	2-58
999LD	2-73, 3-11, 3-59	1001AH	2-15	L1001EH	2-16	1007CM	2-58
999LE	2-73, 3-11, 3-59	1001AM	2-15	L1001FH	2-15	1007CN	2-58
999LF	2-73, 3-11, 3-59	1001BH	2-15	L1001GRM	2-15	1007G	2-57
999LG	2-73, 3-11, 3-59	1001BM	2-15	O1001E	2-16	1007HA	2-59
999LH	2-73, 3-11, 3-59	1001C	2-16	R1001CEM	2-13	1007HB	2-59
999LK	2-73, 3-11, 3-59	1001C1	2-15	R1001D	2-11	1007HC	2-59
999N	2-77	1001C2	2-15	R1001ED	2-13	1007HD	2-59
999R	2-77, 3-8, 3-11, 3-17, 3-22, 3-40, 3-59	1001CDM	2-15	R1001EE	2-13	1007HDH	2-59
		1001CM	2-15	R1001EF	2-13	1007HE	2-59
999T	2-77	1001CR	2-11	R1001EG	2-14	1007HF	2-59
999U	2-77	1001D	2-11	R1001EK	2-13	1007HG	2-59
999VA	2-76	1001D1	2-15	R1001EL	2-14	1007HH	2-59
999VB	2-76	1001D2	2-15	R1001EM	2-13	1007HJ	2-59
999VC	2-76	1001DA	2-12	R1001EN	2-14, 2-66	1007HK	2-59
999VD	2-76	1001DH	2-15	R1001EP	2-13	1007HL	2-59
999VE	2-76	1001DM	2-15	R1001ES	2-141	1007HM	2-59
999VG	2-76	1001E	2-13	R1001ET	2-14	1007HN	2-59
999VH	2-76	1001EA	2-13	R1001GA	2-16	1007KM	2-57
C999	2-78	1001EB	2-13	R1001MJ	2-14	1007LA	2-60
H999	2-78	1001EG	2-14	S1001JB	2-11	1007LB	2-60
H999R	2-78	1001EH	2-16	X1001KC	2-12, 2-52	1007LC	2-60
HS999	2-78	1001EJ	2-13	1002	2-16	1007LD	2-60
O999CR	2-78	1001EL	2-14	1002A	2-16	1007LDH	2-60
X999	2-78, 3-9, 3-11, 3-22	1001EN	2-14	1002B	2-16	1007LDM	2-60
X999A	3-11	1001ES	2-14	1003A	2-12	1007LE	2-60
X999R	3-11	1001FH	2-15	1003AB	2-12	1007LF	2-60
1000	2-13	1001GA	2-16	1003B	2-12	1007LG	2-60
1000A	2-13	1001GB	2-16	1003C	2-12	1007LH	2-60
1000AB	2-13	1001GH	2-16	1003CD	2-12	1007LHM	2-60
1000AB27	2-13	1001GRM	2-15	1003D	2-12	1007LJ	2-60
1000DA	2-11	1001JL	2-12	1003M	2-6, 2-12, 2-31	1007LK	2-60
1000F	2-10	1001K	2-12	L1003A	2-12	1007LL	2-60
1000FR	2-10	1001MA	2-13	L1003AB	2-12	1007LM	2-60
1000FX	2-10	1001MB	2-13	L1003B	2-12	1007RA	2-61
1000G	2-10	1001MC	2-13	L1003C	2-12	1007RB	2-61
1000H	2-10	1001MD	2-13	L1003CD	2-12	1007RC	2-61
1000HL	2-11	1001MG	2-13	L1003D	2-12	1007RD	2-61
1000JR	2-12	1001MJ	2-14	L1003M	1-100, 2-12	1007RDH	2-61
1000K	2-11	1001MK	2-16	R1003M	2-6, 2-31	1007RDM	2-61
1000KC	2-11	1001WL	2-12	S1003A	2-12	1007RE	2-61
1000P	2-11	A1001ABM	2-15	S1003AB	2-12	1007RF	2-61
1000T	2-11	A1001AH	2-15	S1003B	2-12	1007RG	2-61
1000V	2-11, 2-31	A1001AM	2-15	S1003C	2-12	1007RH	2-61
1000W	2-11	A1001BH	2-15	S1003CD	2-12	1007RHM	2-61
1000X	2-11, 2-31	A1001BM	2-15	S1003D	2-12	1007RJ	2-61
1000XK	2-11, 2-31	A1001C1	2-15	S1003M	2-12	1007RK	2-61
F1000VR	3-56	A1001C2	2-15	1004	2-40	1007RL	2-61
FR1000V	3-56	A1001CDM	2-15	1004A	2-40	1007RM	2-61
O1000GR	2-11	A1001CM	2-15	1004AL	2-40	A1007	2-57
O1000GX	2-11	A1001D1	2-15	1004AR	2-40	L1007CA	2-58
O1000H	2-11	A1001D2	2-15	1004AX	2-40	L1007CB	2-58
R1000HL	2-11	A1001DH	2-15	1004AXA	2-40	L1007CC	2-58
R1000T	2-11	A1001DM	2-15	1004AXM	2-40	L1007CD	2-58
R1000V	2-11	A1001EH	2-16	1004K	2-40	L1007CE	2-58
S1000T	2-11	A1001EHR	2-16	1004KL	2-40	L1007CF	2-58
S1000V	2-11, 2-31	A1001FH	2-15	1004L	2-40	L1007CG	2-58
S1000X	2-11	A1001GRM	2-15	1004M	2-40	L1007CH	2-58
S1000XK	2-11	A1001HP	2-14	1004N	2-40	L1007CJ	2-58
SR1000T	2-11	A1001MA	2-13	1004R	2-40	L1007CK	2-58
SR1000V	2-11	A1001MB	2-13	1004SN	2-40	L1007CL	2-58

	ILCO Number	Sec - Page(s)	ILCO Number	Sec - Page(s)	ILCO Number	Sec - Page(s)	ILCO Number	Sec - Page(s)
INDEX	L1007CM	2-58	O1007RH	2-61	A1011D12	2-53	1012-D12	2-18
	L1007CN	2-58	O1007RHM	2-61	A1011D34	2-53	1012-D34	2-18
	L1007LA	2-60	O1007RJ	2-61	A1011D41	2-53	1012-D41	2-18
	L1007LB	2-60	O1007RK	2-61	A1011H1	2-55	1012-60	2-18
	L1007LC	2-60	O1007RL	2-61	A1011H2	2-55	A1012-D1	2-18
	L1007LD	2-60	O1007RM	2-61	A1011H3	2-55	A1012-D2	2-18
	L1007LE	2-60	1008	2-62	A1011H5	2-55	A1012-D3	2-18
	L1007LF	2-60	1008A	2-62	A1011H6	2-55	A1012-D4	2-18
	L1007LG	2-60	A1008	2-62	A1011H7	2-55	A1012-D12	2-18
	L1007LH	2-60	A1008A	2-62	A1011H8	2-55	A1012-D34	2-18
	L1007LJ	2-60	O1009	2-62	A1011M	2-55	A1012-D41	2-18
	L1007LK	2-60	1009	2-62	A1011P	2-55	A1012-H1	2-18
	L1007LL	2-60	1009A	2-62	A1011PZ	2-56	A1012-H2	2-18
	L1007LM	2-60	1009M	2-62	A1011PZR	2-56	A1012-H3	2-18
	N1007KMA	2-60	1010	2-62	A1011S	2-55	A1012-H5	2-18
	N1007KMB	2-60	1010A	2-62	A1011T	2-55	A1012-H6	2-18
	N1007KMC	2-60	1010B	2-62	A1011-1N	2-56	A1012-H7	2-18
N1007RMA	2-61	1010M	2-62	A1011-2N	2-56	A1012-H8	2-18	
N1007RMB	2-61	1010N	2-62	A1011-3N	2-56	A1012-59A	2-19	
O1007CA	2-58	1010S	2-62	A1011-4N	2-56	A1012-59A1	2-19	
O1007CB	2-58	1010SA	2-62	A1011-5N	2-56	A1012-59A2	2-19	
O1007CC	2-58	1010T	2-62	A1011-6N	2-56	A1012-59AB	2-19	
O1007CD	2-58	1010U	2-62	A1011-7N	2-56	A1012-59AD	2-19	
O1007CDH	2-58	A1010U	2-63	A1011-8N	2-56	A1012-59B	2-19	
O1007CDM	2-58	L1010N	2-62	A1011-9N	2-56	A1012-59B1	2-19	
O1007CE	2-58	O1010	2-63	A1011-10N	2-56	A1012-59B2	2-19	
O1007CF	2-58	O1010A	2-63	A1011-11N	2-56	A1012-59C	2-19	
O1007CG	2-58	S1010B	2-62	A1011-12N	2-56	A1012-59C1	2-19	
O1007CH	2-58	1011	2-52	A1011-13N	2-56	A1012-59C2	2-19	
O1007CHM	2-58	1011A	2-52	A1011-14N	2-56	A1012-59CD	2-19	
O1007CJ	2-58	1011B	2-52	A1011-15N	2-56	A1012-59D	2-19	
O1007CK	2-58	1011D1	2-53	A1011-16N	2-56	A1012-59D1	2-19	
O1007CL	2-58	1011D2	2-53	A1011-17N	2-56	A1012-59D2	2-19	
O1007CM	2-58	1011D3	2-53	A1011-18N	2-56	A1012-60	2-18	
O1007CN	2-58	1011D4	2-53	A1011-19N	2-56	L1012-D1	2-18	
O1007CR	2-57	1011D12	2-53	A1011-20N	2-56	L1012-D2	2-18	
O1007HA	2-59	1011D34	2-53	A1011-21N	2-56	L1012-D3	2-18	
O1007HB	2-59	1011D41	2-53	A1011-22N	2-56	L1012-D4	2-18	
O1007HC	2-59	1011GH	2-52	A1011-23N	2-56	L1012-D12	2-18	
O1007HD	2-59	1011GJ	2-52	A1011-24N	2-56	L1012-D34	2-18	
O1007HDH	2-59	1011K1	2-55	A1011-25N	2-56	L1012-D41	2-18	
O1007HE	2-59	1011K2	2-55	A1011-26N	2-56	1013	2-23	
O1007HF	2-59	1011K3	2-55	A1011-27N	2-56	1013BF	2-67	
O1007HG	2-59	1011K4	2-55	A1011-28N	2-56	1013C	2-23	
O1007HH	2-59	1011K5	2-55	A1011-L1	2-17, 2-54	1013DL	2-23	
O1007HJ	2-59	1011K6	2-55	A1011-L2	2-17, 2-54	1013F	2-23	
O1007HK	2-59	1011K7	2-55	A1011-L3	2-17, 2-54	1013G	6B-2	
O1007HL	2-59	1011K8	2-55	A1011-L4	2-17, 2-54	1013GR	6B-2	
O1007HM	2-59	1011K9	2-55	A1011-L12	2-17, 2-54	1014	2-23	
O1007HN	2-59	1011K10	2-55	A1011-L34	2-17, 2-54	1014A	2-23	
O1007JA	2-57	1011K11	2-55	A1011-L41	2-17, 2-54	1014B	2-30	
O1007KM	2-57	1011K12	2-55	B1011D1	2-53	1014C	2-30	
O1007LA	2-60	1011K13	2-55	B1011D2	2-53	1014CE	2-24	
O1007LB	2-60	1011M	2-52	B1011D3	2-53	1014D	2-24, 2-30	
O1007LC	2-60	1011MA	2-52	B1011D4	2-53	1014DA	2-24	
O1007LD	2-60	1011MK	2-52	B1011D12	2-53	1014DB	2-24	
O1007LDH	2-60	1011P	2-52	B1011D34	2-53	1014DR	2-24	
O1007LDM	2-60	1011PAA	2-52	B1011D41	2-53	1014DS	2-24	
O1007LE	2-60	1011PH	2-55	L1011-L1	2-17, 2-54	1014DX	2-24	
O1007LF	2-60	1011PM	2-55	L1011-L2	2-17, 2-54	1014F	2-24	
O1007LG	2-60	1011PZ	2-55	L1011-L3	2-17, 2-54	1014J	2-24	
O1007LH	2-60	1011S	2-52	L1011-L4	2-17, 2-54	1014JM	2-24	
O1007LHM	2-60	1011T	2-52	L1011-L12	2-17, 2-54	1014JS	2-24	
O1007LJ	2-60	1011-04A	2-52	L1011-L34	2-17, 2-54	1014K	2-24	
O1007LK	2-60	1011-04AS	2-52	L1011-L41	2-17, 2-54	A1014DR	2-24	
O1007LL	2-60	1011-28N	2-56	N1011M	2-55	L1014D	2-24	
O1007LM	2-60	1011-L1	2-17, 2-54	N1011P	2-55	O1014J	2-24	
O1007NB	2-57	1011-L2	2-17, 2-54	N1011S	2-55	O1014JM	2-24	
O1007RA	2-61	1011-L3	2-17, 2-54	N1011T	2-55	O1014JS	2-24	
O1007RB	2-61	1011-L4	2-17, 2-54	X1011KR	2-52	O1014K	2-24	
O1007RC	2-61	1011-L12	2-17, 2-54	1012	2-56	O1014P	2-24	
O1007RD	2-61	1011-L34	2-17, 2-54	1012A	2-56	O1014S	2-24	
O1007RDH	2-61	1011-L41	2-17, 2-54	1012DM	2-56	O1014SM	2-24	
O1007RDM	2-61	A1011D1	2-53	1012-D1	2-18	X1014F	2-24, 2-30	
O1007RE	2-61	A1011D2	2-53	1012-D2	2-18	X1014L	2-37, 2-41	
O1007RF	2-61	A1011D3	2-53	1012-D3	2-18	1015	2-41	
O1007RG	2-61	A1011D4	2-53	1012-D4	2-18	1015A	2-41	



ILCO Number	Sec - Page(s)	ILCO Number	Sec - Page(s)	ILCO Number	Sec - Page(s)	ILCO Number	Sec - Page(s)
1015C	2-41	1028C	5-8	C1041L	2-8	1054WN	2-27
1015GM	2-78	1028D	5-5	C1041N	2-8	1054WP	2-27
A1015C	2-41	1028DC	5-8	C1041P	2-8	1054WR	2-27
A1015L	2-41	1028DD	5-1	C1041R	2-8	1054X	2-34
A1015LR	2-41	1028E	5-1	C1041SR	2-8	A1054KD	2-2
A1015M	2-41	1028F	5-1	C1041T	2-8	A1054WB	2-27, 2-69
A1015MR	2-41	1028G	5-1	C1041TR	2-8	A1054WC	2-27
A1015N	2-41	1028L	5-1	C1041YR	2-8	A1054WD	2-27
A1015NR	2-41	1028M	5-8	H1041T	2-8	A1054WF	2-27
A1015P	2-41	1028N	5-1	R1041DC	2-9	A1054WH	2-27
A1015PR	2-41	1028NN	5-2	R1041DV	2-9	A1054WJ	2-27
A1015Q	2-41	1028NR	2-45	S1041H	2-37	A1054WK	2-27
A1015QR	2-41	1028P	5-1	S1041JA	2-8	A1054WL	2-27
A1015R	2-41	O1028A	5-2	S1041T	2-8	A1054WN	2-27
A1015RR	2-41	O1028AH	5-2	SC1041R	2-8	A1054WP	2-27
A1015S	2-41	1031	6B-1, 6B-4	SC1041S	2-8	A1054WR	2-27
A1015SR	2-41	1033	3-51	SC1041SR	2-8	B1054B	2-34
A1015T	2-41	1033A	6B-1, 6B-4	SC1041T	2-8	C1054B	1-19
A1015TR	2-41	1033F	6B-1	SC1041TR	2-8	D1054K	2-1, 2-20
A1015U	2-41	1033G	3-26	SC1041YR	2-8	D1054KA	2-20
A1015UR	2-41	1033N	3-51	1042A	2-37	H1054B	2-34
A1015V	2-41	1034	2-49	1042B	2-37	H1054F	2-23
A1015VR	2-41	1034A	2-49	1042M	2-38	H1054L	2-34
A1015W	2-41	1034H	2-49	1042Z	2-37	H1054S	2-34
A1015WR	2-41	1034N	2-49	L1042A	2-37	H1054SR	2-23
A1015X	2-41	1036	2-4	L1042B	2-37, 2-38	K1054B	2-4, 2-34
A1015XR	2-41	1036A	2-4	L1042M	2-38	L1054AR	2-34
A1015Y	2-41	1036G	2-4	S1042Z	2-37	L1054B	2-1, 2-34, 2-51
A1015YR	2-41	1036S	2-4	S1042ZM	2-37	L1054F	2-23
L1015M	2-41	1036SF	2-5	S1042ZP	2-37	L1054G	2-28
L1015MR	2-41	1036U	2-5	S1042ZS	2-37	L1054JA	2-35
1016	2-49	1040	1-28, 1-100	1043B	1-100, 2-37	L1054JK	2-35
1016N	2-49	1040A	1-28, 1-100	1043C	2-37	L1054M	2-4
1016NB	2-49	1040B	1-28, 1-100	1043D	2-37	L1054WB	2-69
1017	2-48	1040C	1-28, 1-100	1043E	2-37	L1054WC	2-27
1017A	2-48	1040E	1-28, 1-100	1043ED	2-37	L1054WD	2-27
1017B	2-48	1040U	1-100	1043F	2-37	L1054WH	2-27
1017BA	2-48	R1040C	1-28, 1-100	1043G	2-37	M1054B	2-35
1017BB	2-48	R1040E	1-28, 1-100	1043J	2-37, 2-67	MD1054K	2-20, 2-43
1017BL	2-48	1041B	2-2	1043V	2-37	N1054K	2-35
A1017BL	2-48	1041C	2-2	1045	2-2	N1054WB	2-69
O1017B	2-48	1041CE	2-2	A1045	2-2	O1054	1-63
O1017M	2-48	1041CK	2-2	1046	2-2	O1054A	1-63
O1017ML	2-48	1041D	2-9	1046A	2-2	O1054K	2-43
O1017NL	2-48	1041DB	2-9	1047	2-57	O1054KR	2-43
O1017NX	2-49	1041DC	2-9	1047A	2-57	X1054AR	2-35
O1017VX	2-49	1041DE	2-9	1047CL	2-57	X1054BK	2-35
O1017WL	2-49	1041DH	2-9	1047CR	2-57	X1054C	2-35
O1017WX	2-49	1041DV	2-9	1047M	2-57	X1054F	2-35
1019	2-51	1041E	2-7	1049D	2-56	X1054GA	2-35
1019A	2-51	1041FE	2-9	1049E	2-56	X1054GB	2-35
1019C	2-51	1041FG	2-9	1052A	5-1	X1054GC	2-35
1019D	2-51	1041FM	2-8	1052B	5-1	X1054GD	2-35
1019DA	2-51	1041G	1-32, 1-78, 1-110, 2-9	1052C	5-1	X1054GE	2-35
1019R	2-51	1041GA	1-32, 1-78, 1-110, 2-9	X1053	2-33	X1054GF	2-35
1019XL	2-51	1041GB	1-118, 2-9	1054	2-33	X1054JA	2-35
A1019M	2-51	1041GR	1-118, 2-9	1054DL	2-33	X1054JK	2-36
1020	2-31	1041H	2-36	1054F	2-33	X1054K	2-36
1021A	2-4	1041HM	2-36	1054FN	2-33	X1054KF	2-36
1021B	2-4	1041K	1-118	1054G	2-25	X1054KR	2-36
1021BA	2-4	1041M	2-9	1054K	2-33	X1054LF	2-36
1021N	2-4	1041N	2-9	1054KD	2-20	X1054LR	2-36
1022	2-65	1041P	2-37	1054LB	2-33	X1054SC	2-36
1022AB	2-65	1041S	2-37	1054MT	2-34	X1054WA	2-69
1022H	2-65	1041T	1-49, 1-172, 2-7, 2-31	1054N	2-34	X1055GA	2-36
1022HR	2-65	1041TR	2-7	1054P	2-34	X1055GB	2-36
1022L	2-65	1041W	2-37	1054R	2-34	X1055JK	2-36
O1022	2-65	1041WC	2-37	1054TW	2-34	X1055JR	2-36
O1022A	2-55	1041X	2-7	1054UN	2-34, 5-3	1060C	5-8
O1022AB	2-65	1041Y	2-7	1054WB	2-1, 2-27	1063	5-5
O1022E	2-65	A1041U	2-2	1054WC	2-27	1063B	5-5
R1022L	2-65	C1041A	2-7	1054WD	2-27	1063D	5-6
1023	2-10	C1041B	2-7	1054WF	2-27	1063E	5-6
1023A	2-10	C1041C	2-7	1054WH	2-27	1063KW	4B-2
1028	5-1	C1041DN	2-9	1054WJ	2-27	1063KW-BR	4B-2
1028A	5-1	C1041J	2-8	1054WK	2-27	N1063KW	4B-2
1028AY	5-1	C1041JB	2-8	1054WL	2-27	1064	2-45

	ILCO Number	Sec - Page(s)	ILCO Number	Sec - Page(s)	ILCO Number	Sec - Page(s)	ILCO Number	Sec - Page(s)
INDEX	1064A	2-45	1074E	2-66	R1096EN	2-25	A1114E	2-5
	1064D	2-48	1074F	2-66	S1096B	2-26	A1114F	2-5
	1064L	2-45	1074G	2-66	S1096C	2-26	A1114FM	2-5
	1064M	2-45	1074N	2-66	S1096FL	2-26	A1114G	2-5
	L1064C	2-45	A1074B	2-66	S1096FM	2-26	A1114H	2-5
	R1064D	2-48	A1074E	2-66	S1096G	2-26, 3-34	A1114J	2-5
	R1064E	2-2, 2-48	A1074F	2-66	S1096JN	2-26	A1114K	2-5
	S1064A	2-45	A1074G	2-66	S1096P	2-26	A1114L	2-5
	1065	2-45	1079	2-38	1098DB	1-6, 1-14, 1-81, 2-31	A1114M	2-5, 2-27
	1065C	2-45	1079A	2-38	1098GM	1-15	A1114Q	2-5
	1065D	2-45	1079AB	2-38	1098GX	1-50	A1114R	2-6
	1065E	2-46	1079B	2-38	1098JD	1-72, 1-78, 1-160	A1114TB	2-6
	1065F	2-46	1080	2-51	1098L	1-14, 1-51, 1-59	P1114	1-56
	1066	5-1	1083	2-44	1098M	1-15, 1-489, 1-90, 1-100	1115	5-4
	1067B	2-10	1083C	2-44	1098NR	1-6	1115A	5-4
	1068	5-6	1083H	2-44	1098PB	1-115	1115AL	5-4
	1068B	5-6	1083J	2-44	1098X	1-14, 1-51, 2-31	1115B	5-5
	1068E	5-6	1083K	2-44	1098XL	1-15	1115BL	5-5
	1069	2-31, 2-46	1083L	2-44	C1098A	1-51	1115XL	5-5
1069-5X	2-47	1083M	2-44	C1098JD	1-72, 1-78, 1-160	1118	1-130	
1069-5Y	2-47	1083N	2-44	D1098B	2-20	1119	2-36	
1069-5Z	2-47	1083P	2-44	D1098BM	2-21	1119S	2-25, 2-51	
1069B	1-59, 2-31, 2-46	1083R	2-44	D1098JD	1-78	1120D	2-25, 2-51	
1069C	2-46	1083S	2-44	D1098X	2-21	1120F	2-66	
1069D	2-46	1083T	2-44	E1098JD	1-78	1120G	2-66	
1069E	2-46	1084	5-6	F1098JD	1-78	1120H	2-66	
1069F	2-46	1089C	5-2	H1098A	1-51	1120J	2-66	
1069FL	2-46	1091	5-4	H1098C	1-51	1120K	2-66	
1069FN	2-46	1092	2-41	H1098DB	1-15, 1-51	1120N	2-66	
1069FNA	2-46	1092B	2-42	H1098L	1-52	1120S	2-66	
1069G	2-46	1092C	2-42	H1098LA	1-52	1122D	2-78	
1069H	2-46	1092D	2-42	H1098M	1-52	E1122A	2-78	
1069HN	2-46	1092DD	2-42	H1098NR	1-6	F1122A	2-78	
1069L	2-46	1092DS	2-42	H1098X	1-52	F1122AR	2-78	
1069LA	2-47	1092E	2-42	L1098C	1-52	H1122A	2-78	
1069LB	1-101, 2-47	1092H	2-42	L1098LA	1-52	H1122AR	2-78	
1069LC	2-6, 2-47	1092J	2-42	L1098M	2-4	H1122F	2-78	
1069M	2-47	1092K	2-42	O1098B	14-52	H1122FR	2-78	
1069N	2-47	1092N	2-42	O1098D	1-52	H1122M	2-67	
1069P	2-47	1092NR	2-42	O1098LA	1-52	H1122W	2-78	
1069S	2-47	1092NTG	2-38	P1098A	1-52	K1122B	2-4	
1069SM	2-47	1092R	2-41	P1098AV	1-52	K1122C	2-4	
1069T	2-47	1092TG-ILCO	2-36, 2-38	P1098C	1-52	K1122D	2-4	
1069W	2-47	1092V	2-42	P1098CV	1-52	K1122N	2-4	
1069YM	2-47	1092VA	2-42	P1098E	1-52	L1122A	1-135, 2-78	
GF1069	2-30, 2-47	1092VB	2-42	P1098EV	1-53	L1122AR	1-135, 2-78	
LC1069	2-39	1092VM	2-42	P1098J	1-6, 1-53	L1122B	2-78	
M1069C	2-47	1092VR	2-42	P1098V	1-53, 1-58	N01122D	2-78	
M1069L	1-158, 2-47	1092-40	2-42	P1098WC	1-53	O1122	1-19, 1-101, 1-118, 2-31, 2-79	
N1069B	2-47	1092-52	2-42	P1098WE	1-53	O1122A	1-19, 1-49, 1-118, 1-135, 2-31, 2-32, 2-79	
N1069C	2-47	1092-600A	2-42	S1098B	1-53	O1122AR	1-101, 1-135, 2-31, 2-79	
N1069E	2-47	1092-900	2-43	S1098D	1-53	O1122B	2-31, 2-32, 2-65, 2-79	
N1069G	2-48	1092-6000	2-43	S1098H	1-53	O1122BE	2-31, 2-79	
N1069J	2-48	1092-6000B	2-43	S1098K	1-53	O1122BER	2-79	
N1069N	2-48	1092-7000	2-43	S1098WD	1-54	O1122BR	2-31, 2-79	
R1069L	2-46	1092-7000B	2-43	S1098WH	1-54	O1122C	2-31, 2-32, 2-79	
S1069G	2-+46	1092-8105	2-43	SC1098X	2-65	O1122NV	2-79	
S1069H	2-46	1093	5-8	P1099	1-54	O1122R	2-31, 2-79	
S1069M	2-47	1093H	5-8	P1101	1-54	1123	1-69	
S1069T	2-47	1095	5-4	S1105	1-54	1123A	1-69	
1071	2-70	1095A	5-4	P1106	1-54	1123S	2-26	
1071A	2-70	1095H	5-4	P1107	1-54	A1124	5-6	
1071AB	2-70	1095HL	5-4	P1108	1-130	1125	1-37, 2-32	
1071B	2-70	1096	2-25	1109V	1-55	1125A	1-37, 2-32, 2-36	
1071BD	2-780	1096C	2-25	P1109	1-55	1125D	1-37, 2-32	
1071BE	2-70	1096EN	2-8, 2-25	P1110	1-130	1125F	1-37	
1071BM	2-70	1096FL	2-25	1110A	5-8	1125G	1-37	
1071D	2-70	1096FM	2-25	1110B	5-8	1125H	1-37	
1071E	2-70	1096FS	2-25	P1111	1-54	1125K	1-37	
1071M	2-70	1096L	2-25	P1112	1-55	1125M	1-37	
1072	2-49	1096NL	2-25	P1113	1-55, 1-75	1125X	2-32	
1073	2-28	C1096C	2-25	1114	2-5	D1125	1-37, 2-32	
1073DF	2-66	C1096CN	2-25	A1114A	2-5	GP1125	2-32	
1073K	2-28	C1096LN	2-25	A1114B	2-5	O1125NR	5-6	
S1073DF	2-66	EB1096K	2-25	A1114C	2-5	1126M	1-37, 1-65	
1074B	2-66	EO1096K	2-25	A1114D	2-5			
1074BM	2-66	L1096CN	2-26	A1114DD	2-5			



ILCO Number	Sec - Page(s)	ILCO Number	Sec - Page(s)	ILCO Number	Sec - Page(s)	ILCO Number	Sec - Page(s)
1127	1-37	A1145EF	2-64	1181C	2-20	1262A	1-100
1127B	1-37	A1145F	2-64	1181FD	1-40	1270	6A-8
1127D	1-37	A1145FG	2-64	S1181FD	1-40	1270A	6A-8
1127DP	1-37	A1145G	2-64	1182	2-70	1270B	6A-8
1127DU	1-38	A1145H	2-64	1184FD	1-40	1270C	6A-8
1127ES	1-38	A1145J	2-64	1185FD	1-40	1270D	6A-1
1127F	1-38	A1145K	2-64	1185T-P	1-40	1270H	6A-8
1127FD	1-38	A1145L	2-64	1186TS	1-40	1271H	6A-8
1127FL	1-38	D1145	2-21	1186TS-P	1-40	1286	6A-2
1127FR	1-38	D1145A	2-21	S1186TS	1-40	1286B	6A-2
1127H	1-38	K1145	2-1	S1186TS-P	1-40	1286BR	6A-2
1127J	1-38	1146	2-51	1188LN-P	1-40	1286C	6A-2
1127K	1-38	1147	1-59, 1-160, 3-18, 6B-5	1190LN	1-40	1286E	6A-2
1127L	1-38	1148	1-72, 1-160, 6B-3, 6B-5	1191ET	1-41	N1286	6A-2
1127M	1-38	1154C	2-26, 2-36	1193FD	1-41	N1286R	6A-2
1127ME	1-38	1154ES	2-38	1193MU	1-41, 1-100	R1286E	6A-2
1127MP	1-38	1154G	2-36	1195FD	1-43	1303	6A-8
1127MU	1-38	1154GR	2-36	1196CM	1-44	1303S	6B-3
1127N	1-38	1154L	2-40	1196FD	1-44	1306	6A-8
1127P	1-39	1167FD	1-39	1196V	1-44	1306A	6A-8
1127T	1-39	S1167C	1-49	1199C	1-20	S1306A	6B-1
1127TB	1-39	S1167FD	1-39, 1-94	1199D	1-20	1307A	2-64
M1127A	1-39	1170	2-6	1199DR	1-20	1307W	2-64
P1127C	1-39	1170B	2-7	1199E	1-20	L1307A	2-64
S1127FD	1-39	1170BD	2-7	X1199A	1-20	L1307W	2-65
S1127FL	1-39	1170C	2-7	X1199AR	1-20, 1-135	R1307A	2-64
S1127FR	1-39	1170CJ	2-7	X1199B	1-20	R1307W	2-65
S1127LC	1-39	1170D	2-7	X1199G	1-20	1309	6A-8
S1127ME	1-39	1170E	2-7	X1199J	1-20	1321	6A-9
S1127MU	1-39	1170LN	1-39	XO1199B	1-20	1321H	6A-9
1130	2-2	1170M	2-7	XO1199G	1-20	1322S	6B-1
1130R	2-2	A1170B	2-7	1206A	6A-5	1323	5-5
1131	2-2	A1170C	2-7	1209	6A-5	1323L	5-5
1131R	2-2	A1170CB	2-7	1210A	6A-6	1326	6B-3
1132	2-79	A1170D	2-7	1211B	6A-6	1332	6B-B
H1132	2-79	L1170	2-7	1213A	6A-1	1332S	6A-2
HR1132	2-79	S1170LN	1-40	1213AH	6A-6	1333	5-2
R1132	2-79	1171	2-49	1213AS	6A-6	1334	5-2
1133	5-2	1171B	2-49	O1213	6A-6	1335S	5-2, 5-3
1133A	5-2	1171P	2-49	1214	6A-6	SC1345	2-63
1134	5-2	1175	2-69	1215A	6A-6	SC1347	2-63
1135	5-2	1175N	2-69	1215B	6A-6	SC1348	2-63
1136S	2-6	1176	2-23, 2-39, 2-49	O1215	6A-6	1360G	5-2, 5-6
1137B	1-13, 1-18, 1-60, 2-1, 2-6, 2-28, 2-36	1176D	2-39, 2-49	1217	6A-6	1362	5-2, 5-6
1137S	2-6	1176RK	2-39	1217A	6A-6	1365	5-1
L1137	2-6	A1176	2-39	1217D	6A-6	1366	6A-9
1140	2-51	A1176KT	2-39	1221AL	6A-3	SC1368	2-63
1140G	2-51	A1176ST	2-39, 2-67	1221L	6A-7	1370	6A-4
1140P	2-51	CR1176	2-39	O1221L	6A-7	1387	5-3, 5-6
1141	2-67	N1176	2-69	1222AL	6A-7	1387G	5-3, 5-6
1141E	2-67	S1176	2-39	1222B	6A-7	1388	5-3, 5-7
1141F	2-67	SC1176	2-39, 2-65	1222E	6A-7	1388L	5-3, 5-7
1141GE	2-67	1177	2-45	1222L	6A-7	1389G	5-7
1141GS	2-67	1177A	2-45	O1223	6A-3	1390	5-7
1141H	2-67	1177N	2-1, 2-45	O1223L	6A-3	1390G	5-7
1141JE	2-67	1178	2-7	1224	6A-3	1396S	5-3
1141JL	2-67	1179	2-1, 2-3	1224F	6A-3	SC1400	2-63
1141K	2-67	1179A	2-2, 2-3	1224L	6A-3	1412	6A-1
1141L	2-67	A1179E	2-3	1225	6A-3	1416	6B-1
1141W	2-67	A1179F	2-3	1225A	6A-3	1417	6A-1
1143	2-79	A1179G	2-3	1225BL	6A-7	1417A	6A-1
1145	2-64	A1179H	2-3	1225D	6A-3	1418	6A-2
1145A	2-1, 2-64	A1179J	2-3	1225E	6A-3	1422	6A-4
1145AST	2-67	A1179K	2-3	1225F	6A-7	1425	6A-2
1145CE	2-67	A1179L	2-3	1225G	6A-3	1426	6A-9
1145E	2-64	A1179N	2-3	1225PL	6A-4	1427	6A-4
1145EF	2-64	A1179P	2-3	O1225N	6A-7	1430	6B-1
1145F	2-64	A1179R	2-3	1226	6A-7	SC1456	2-63
1145FG	2-64	A1179S	2-3	1233M	6A-7	SC1460	2-63
1145G	2-64	A1179T	2-3	1239	6A-7	SC1467	2-63
1145H	2-64	A1179U	2-3	1242	6A-8	SC1468	2-63
1145J	2-64	A1179V	2-3	1242L	6A-8	1500A	7-8
1145K	2-64	B1179-1C	2-3	1243D	6A-8	1502	2-26
1145L	2-64	B1179-1D	2-3	SC1246	2-63	1502M	2-26
A1145CE	2-64	N1179	2-1, 2-3	SC1247	2-63	1503	2-26
A1145E	2-64	N1179A	2-3	SC1248	2-63	1510	2-3
		1180S	2-70	1259	6-8	1511	2-3

	ILCO Number	Sec - Page(s)	ILCO Number	Sec - Page(s)	ILCO Number	Sec - Page(s)	ILCO Number	Sec - Page(s)
INDEX	1512	2-32	1590K	1-27	1662	2-70		
	1515	2-43, 4B-3	1591L	1-27	1663	2-39		
	A1515	2-43, 4B-3	1591M	1-27	1664	1-19		
	1517	3-16	1591N	1-27	1665	2-69		
	A1517	2-43, 4B-3	1591P	1-27	1666	2-69		
	1518	2-43, 4B-3	1592	1-49	1667	2-69		
	1516	2-43, 4B-3	1594	2-6	1668	2-51		
	1519	1-85	1595	1-15	1701G	1-20		
	1521	2-24	1596	1-102	1702K	1-20		
	1522	2-26, 2-41	1597	2-30	1703K	1-20		
	1523	3-46	1598	2-30	1704K	1-21		
	1524	1-59, 1-122	1599	2-30	1705K	1-21		
	1525	2-32	1600	2-31	1706K	1-21		
	1526	5-3, 5-5	1601	2-68	1759P	1-21		
	1527	1-142	1602	2-69	D1759L	1-21		
	1528	2-38	1603	2-69	1761B	2-4		
	1528R	2-38	1604	2-69	1761LP	1-41		
	1529	1-142	1605	1-142	1761LS	1-41		
	1531	2-26	1606	2-69	1761MP	1-41		
	1533	2-25	1607	2-69	1761MS	1-41		
	1534	2-66	1608	2-69	1764P	1-21		
1536	1-142, 2-32	1609	2-69	1764S	1-21			
1536R	1-142, 2-32	1610	2-69	1766DT	1-21			
1537	2-38	1611	1-51	1766LN	1-41			
1538	2-33, 2-38	1611R	1-51	1766S	121			
1539	1-85	1612	2-69	S1766LN	1-4			
1540	1-85	1615	2-41	1767CH	1-21			
1541	2-38, 2-67	1616	2-70	1767DT	1-21			
1542	2-43, 4B-3	1617	2-28	S1767CH	1-21			
1543	2-43, 4B-3	1618	2-4	1768CH	1-21			
1544	2-48	1618R	2-4	S1768CH	1-21			
1545	2-48	1620	1-142	1769CH	1-21			
1546	1-50	1621	2-69	1770CH	1-12			
1548	2-6	1622	2-69	P1770U	1-22			
1549	2-6	1623	2-69	U1770CH	1-22			
1550	2-6	1624	2-67	P1771CR	1-23, 1-126, 1-137			
1551	2-28	1626	2-61	S1771CR	1-23, 1-126			
1552	2-28	1627	1-131	P1786	1-22			
1553	2-40	1628-P	1-49	P1789	1-22			
1554	2-79, 3-59	1629-P	1-49	P1790TC	1-24, 1-92			
1556	2-26	1630-P	1-135	1793V	1-22			
1555	4B-4	1631	2-6	P1793	1-22			
P1555	4B-4	1632	2-6	1794V	1-23			
1557	1-142	1634	2-70	P1794	1-22			
1558	2-6	1635J	2-2	P1795	1-23			
1559	2-65	1635K	2-2	1866-4	2-50			
1560	1-19	1635L	2-2	1866-7	2-50			
1561	1-15,2-31	1635V	2-2	1866-10	2-50			
1562	2-31	1636	2-67	1866-13	2-51			
1563	2-31	1637	2-66	1970AM	1-6			
1564	2-31	1638	2-43	S1970AM	1-6			
1565	1-142	A1638	2-43	K1994	1-81, 1-114			
1566	2-38	1639	2-39	2712	6B-1			
1567	2-39	1640	2-40	2714	6B-2			
1568	2-66	1641	1-19	3916-21	6B-5			
1569	1-49	1642	2-66	3916-22	6B-5			
1570	1-49	1643	2-44	4015	5-5			
1571	2-38	1644	2-44	4295	4B-3			
1573A	1-27	1645	2-28	4436	6A-9			
1573B	1-27	1645R	2-28	5981R	4B-3			
1573C	1-27	1646	2-69	6275LA	4B-3			
1573D	1-27	1646R	2-69	6750	7-8			
1573E	1-27	1647	2-26	07743	4B-2			
1573F	1-27	1648	2-4	08260KW	4B-2			
1574	1-50, 2-32	1649	2-38	9114	4B-4			
1574R	2-32	1650	2-69	9278	4B-5			
KB1577G	4B-2	1651	2-69	10119-001	4A-3			
P1577E	4B-2	1652	2-3	12344	4B-4			
1581G	1-27	1653	2-2	320433	4B-5			
1581H	1-27	1654	2-39	320514	4-B5			
1583	1-119, 1-104	1655	2-44	320560	4B-5			
1584	1-49	1656	1-81	320561	4B-5			
1585	2-40	1657	1-81	83559	4B-4			
1587	2-79, 5-8	1659	2-6					
1588	1-49	1659R	2-6					
1589I	1-27	1660	1-49					
1589J	1-27	1661	2-6					

# Key Blank Directory

## TABLE OF CONTENTS

<b>VEHICLE</b>	<b>Section 1</b>
<b>NORTH AMERICAN CYLINDER</b>	<b>Section 2</b>
<b>INTERNATIONAL CYLINDER</b>	<b>Section 3</b>
<b>ORIGINALS</b>	<b>Section 4A</b>
<b>LOOK-ALIKE</b>	<b>Section 4B</b>
<b>SAFE DEPOSIT</b>	<b>Section 5</b>
<b>FLAT STEEL</b>	<b>Section 6A</b>
<b>MISCELLANEOUS</b>	<b>Section 6B</b>
<b>BIT AND BARREL</b>	<b>Section 7</b>
<b>SPECIALTY KEYS</b>	<b>Section 8a</b>
<b>MERCHANDISING AIDS</b>	<b>Section 8b</b>
<b>KEY MACHINES</b>	<b>Section 9</b>
<b>CROSS REFERENCE</b>	<b>Section 10</b>

This directory contains the latest information available on our line of Key Blanks, Key Machines and Key Blank Assortments. We have made every attempt to ensure the accuracy of its contents. We believe we have produced a valuable tool if used as intended - as a guide. In the case of Key blank selection, we recommend you continue to check a selected Key Blank against the original Key for blade length, width, shape and milling before duplicating.

Kaba Ilco Corp. reserves the right to amend the information contained herein.

ILCO® and ILCO EZ® are registered trademarks of Kaba Ilco Corp.

## INTRODUCTION

This directory is designed to be a valuable reference tool for the professional locksmith. It contains extensive technical data and actual size drawings of key blanks and milling profiles. The directory is divided into color-coded sections; each section is organized in alphabetical order by lock manufacturer or application. The sections are as follows:

### INDEX

There are two indexes in this reference document. The first is ILCO key blank numbers. They are listed in numeric-alphabetical order with the section and page(s) they are shown on. The second is a brand index of lock manufacturers and applications. Key blanks that fit these brands can be found on the page(s) indicated.

### SECTION 1 - Worldwide Vehicle

Key blanks used in vehicles (automobiles, motorcycles, yard tractors, etc.) and applications related to vehicles (such as gas caps, steering wheel locks, toolboxes, etc.). This is a worldwide listing. Some of the key blanks in this section will have transponders and are identified with the symbol “”.

### SECTION 2 - North American Cylinder

Key blanks for residential and commercial applications (including padlocks) that are primarily sold in North America (Canada, United States, Australia and Mexico). Lock manufacturers are listed in alphabetical order. Some key blanks may be listed in other sections. If you cannot find a lock manufacturer in a particular section, be sure to refer to the brand index.

### SECTION 3 - International Cylinder

Key blanks for residential and commercial applications (including padlocks) that are primarily made and sold in markets other than North America or Australia. Lock manufacturers are organized in alphabetical order. Silca and Orion key blank numbers are referenced below the ILCO number.

### SECTION 4

#### 4A - Originals

Through licenses with vehicle manufacturers, we are now authorized to offer automotive key blanks with the original manufacturers' logos. This section includes Chrysler, Ford, and GM originals.

#### 4B - Look Alikes

Key blanks which are made as close to the original as legally possible. They would meet the industry standards of an original, except they do not carry the original or ILCO logo. They are also normally less expensive than original equipment key blanks.

### SECTION 5 - Safe Deposit

Worldwide listing of key blanks for safe deposit and some safe applications. Safe deposit manufacturers are shown in alphabetical order.

### SECTION 6

#### 6A - Flat Steel

Steel and other material key blanks that are used in warded padlocks, gym lockers, yard tractors, etc. They are organized by lock manufacturer where possible and listed in numerical order.

#### 6B - Specialty Keys and Assortments

Specialty key blanks such as large bow, neuter bow, painted keys and key blank assortments are shown in this section.

### SECTION 7 - Bit and Barrel

Keys are separated by type (i.e. bit or barrel). Technical data, including material (i.e. malleable iron, bi-metallic, brass, etc.), is shown beneath each key illustration.

### SECTION 8 - Miscellaneous

Specialty key blanks such as Ultralites, Plastic Color Head, Hotel Head, and Do Not Duplicate are shown in this section.

### SECTION 9 - Assortments and Merchandising Aids

Key displays, key towers, assortments, etc. to assist in organizing and displaying key inventory.

### SECTION 10 - Key Machines

A brief description of our most popular key machines from Ilco, Orion, and Silca that are currently offered by Kaba Ilco Corp..

### SECTION 11 - Cross Reference

The cross reference consists of three sections. The first two cross reference Dominion Lock and Taylor numbers to the Ilco number. The third cross reference lists major lock and replacement key manufacturers in alphabetical order with their key numbers in the appropriate sequence. The ILCO key equivalent is listed beside the original or competitors' key number. This listing is set up as a functional cross reference. Certain replacement key manufacturers have been omitted due to laws in their respective countries concerning the publishing of a cross reference.



### PAGE SET UP

- The manufacturer's name appears above the key blank drawings.
- The ILCO number appears below each key. Vehicle section references the EZ numbers below the ILCO number.
- International Cylinder section references Silca and Orion key blank numbers below the ILCO number.
- Key drawings may also show important information such as number of pins, the presence of a transponder in the head, etc.

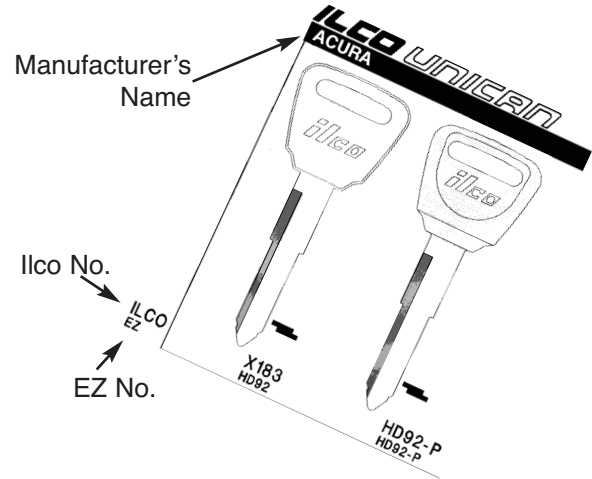

### KEY DRAWINGS

Key blank drawings and milling profiles are shown actual size.

Most single side keys are illustrated from the finger side. To determine the finger side, hold the key in the right hand between the thumb and index finger. Be sure the bitted area is facing up. The finger side is held by your index finger.

Where two milling profiles with different head shapes or configurations exist, both versions are shown.

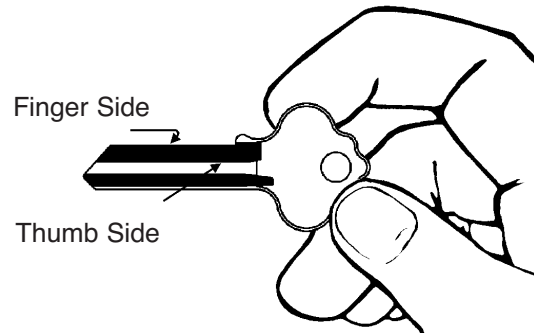

### CHECKING MILLING PROFILES

To check the milling profile, hold the key blank by the head and place the tip of the key over the milling profile. Looking straight down, check both sides of the milling profile to be certain of a match.

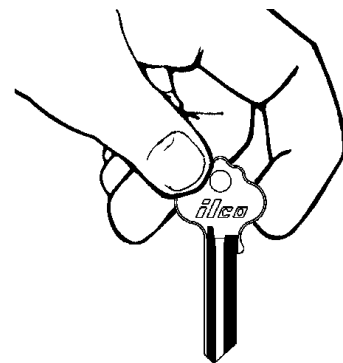

1054MT  
IN33

This directory illustrates all of the key blanks currently manufactured by Kaba Ilco Corp.; however, we are constantly adding new key blanks to keep up with market demands. We make every effort to keep the market informed of new key blanks, and any updates to this document will be in the format explained above.

This directory includes some key blanks that are made by Silca, a sister division of Kaba Ilco Corp.. These Silca key blanks have no ILCO equivalent, and have been added to our product line to meet the anticipated needs of our many markets.

**The ILCO KEY DIRECTORY is a valuable reference document and we welcome your comments on how to improve it in the future.**

## INTRODUCTION

Le présent répertoire est un outil précieux à l'usage du serrurier professionnel. Il contient nombre de caractéristiques techniques et d'illustrations grandeur réelle des clés brutes et de leurs profils. Il se divise en sections codées par couleur dans lesquelles les fabricants de serrures ou les applications figurent par ordre alphabétique. Les différentes sections sont les suivantes:

### INDEX

Ce document de référence comprend deux index. Le premier index est constitué des numéros de clés brutes ILCO. Ceux-ci figurent dans l'ordre alphanumérique et comportent l'indication de la section et le(s) numéro(s) de (s) page(s) sur lesquelles figure la clé correspondante. Le deuxième index est consacré aux marques de fabricants de serrures et de différentes applications. Les clés brutes correspondant à ces marques figurent sur la/les page(s) indiquée(s).

### SECTION 1 — Véhicules internationaux

Clés brutes utilisées pour les véhicules (automobiles, motos, tracteurs de manutention, etc.) et les applications connexes (clés de bouchons de réservoir d'essence, de volants, de boîtes à outils, etc.). Il s'agit d'une liste de clés utilisées à l'échelle internationale. Certaines clés brutes de cette section sont dotées d'un transpondeur et sont désignées par la lettre «X».

### SECTION 2 — Cylindres nord-américains

Clés brutes connues pour les applications commerciales (y compris les cadenas) qui sont principalement vendues en Amérique du Nord (Canada, États-Unis, Mexique, Australie). Les fabricants de serrures apparaissent dans l'ordre alphabétique. Certaines clés brutes peuvent figurer dans d'autres sections. Si vous ne trouvez pas un fabricant de serrure dans une certaine section, assurez-vous de consulter l'index des marques.

### SECTION 3 — Cylindres internationaux

Clés brutes pour les applications à usage résidentiel ou commercial (y compris les cadenas) principalement fabriquées et vendues à l'extérieur de l'Amérique du Nord et de l'Australie. Les fabricants de serrures apparaissent dans l'ordre alphabétique. Les numéros de clés brutes Silca et Orion figurent au-dessous du numéro ILCO.

### SECTION 4

#### 4a — Originaux

Par le biais d'accords passés avec les constructeurs de véhicules, nous sommes dorénavant autorisés à offrir les clés brutes de véhicules munies du logo original du constructeur. Cette section comprend les clés originales de Chrysler, Ford et GM.

#### 4b — Ligne Look Alike

La fabrication des clés brutes est, dans les limites prévues par la loi, pratiquement identique à la fabrication des clés originales, mis à part le fait qu'elles ne sont pas munies du logo original ILCO. Il est évident qu'elles sont également moins chères que les clés brutes originales.

### SECTION 5 — Coffres-forts

Clés brutes utilisées dans le monde entier pour les coffres-forts et autres applications connexes. Les noms de fabricants de coffres-forts figurent dans l'ordre alphabétique.

### SECTION 6

#### 6A — Clés et Assortiments Spécialisés

Dans cette section, on peut voir des clés brutes spécialisées, telles que des clés à grand anneau, des clés à anneau neutre, des clés peintes et des assortiments de clés brutes.

#### 6B — Clés spéciales

Choix de clés brutes pour utilisations spéciales. Classées éventuellement par fabricant de serrure et dans l'ordre numérique.

### SECTION 7 — Clés à panneton et clés forées

Clés classées selon leur type (à panneton ou forées) et éventuellement par fabricant. Les caractéristiques techniques, y compris le matériau (p. ex.: fonte malléable, bimétallique, laiton, etc.) figurent sous chaque illustration.

### SECTION 8 — Divers

Clés brutes spéciales: clés pour utilisations spécifiques, clés à tête de plastique de couleur, clés pour hôtels, clés impossible à dupliquer.

### SECTION 9 — Assortiments et accessoires promotionnels

Présentoirs de clés, tours de clés, assortiments, etc., pour vous aider à ranger et à présenter vos stocks de clés.

### SECTION 10 — Machines à tailler les clés

Brève description des machines à tailler les clés les plus courantes de Ilco, Orion et Silca actuellement offertes par Kaba Ilco Corp..

### SECTION 11 — Renvois

Les renvois sont classés selon trois sections. Les deux premières sections renvoient les numéros Dominion Lock et Taylor à un numéro Ilco. La troisième section dresse la liste des principaux fabricants de serrures et de clés de rechange dans l'ordre alphabétique et des numéros de clés dans l'ordre séquentiel. La clé ILCO équivalente figure à côté du numéro de la clé originale ou de la clé du concurrent. Cette liste est établie sous forme de table de correspondance fonctionnelle. Certains fabricants de clés de rechange ont été omis en vertu des lois en vigueur dans leurs pays respectifs sur la publication des renvois.



## DISPOSITION DES PAGES

- Le nom du fabricant figure au-dessus des illustrations des clés brutes.  
Le numéro Ilco figure au-dessous de chaque clé.
- La section Véhicules indique les numéros EZ au-dessous du numéro ILCO.
- La section Cylindres internationaux indique les numéros des clés brutes Silca et Orion au-dessous du numéro Ilco.
- Les illustrations des clés comportent parfois des renseignements importants tels que le nombre de goupilles, la présence d'un transpondeur dans la tête de la clé, etc.

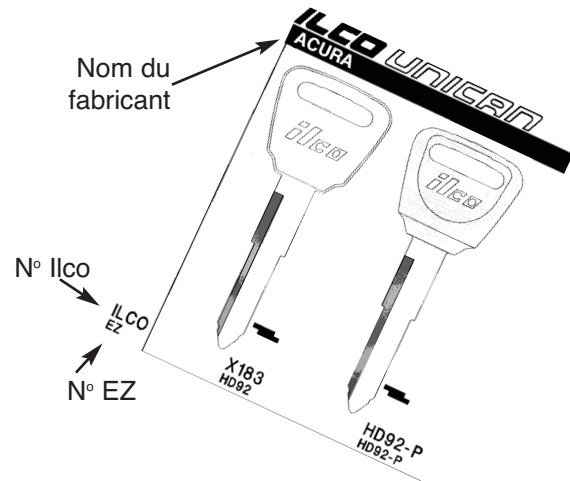

## ILLUSTRATION DES CLÉS

Les illustrations des clés brutes et de leur profil sont présentées en grandeur réelle.

La plupart des clés à simple lame active sont illustrées «côté doigt». Pour se positionner ainsi, tenir la clé dans la main droite entre le pouce et l'index, la lame vers le haut. Le «côté doigt» est celui en contact avec l'index.

Lorsque deux types de profil de clé ont des têtes ou des configurations différentes, les deux versions sont illustrées.

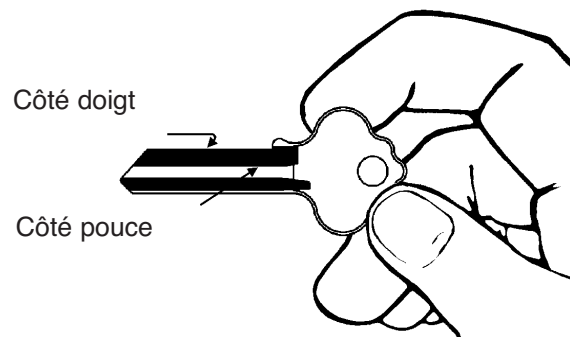

## VÉRIFICATION DES PROFILS

Pour vérifier le profil d'une clé, il suffit d'en saisir la tête en plaçant la pointe de la clé au-dessus du profil. Regarder vers le bas et vérifier les deux côtés du profil afin de s'assurer du bon appariement.

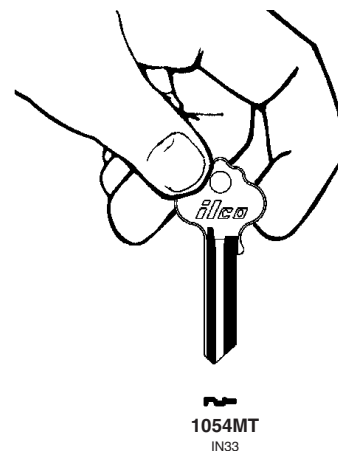

Ce répertoire illustre toutes les clés brutes actuellement fabriquées par Kaba Ilco Corp.. Toutefois, nous ajoutons constamment de nouvelles clés brutes afin de répondre à la demande du marché. Nous déployons tous nos efforts pour tenir le marché informé de la création des dernières clés brutes et toutes les mises à jour de ce catalogue se présenteront dans le format expliqué ci-dessous.

Le répertoire comprend certaines clés brutes fabriquées par Silca, une division associée de Kaba Ilco Corp.. Il n'y a pas de modèle équivalent de ces clés brutes Silca à Kaba Ilco Corp.. Les clés Silca ont été ajoutées à notre gamme de produits dans le but de répondre aux besoins de nos nombreux marchés, voire de les devancer.

**Le présent RÉPERTOIRE DE CLÉS ILCO constitue un précieux document de référence. N'hésitez pas à nous faire part de vos commentaires sur une amélioration éventuelle de ce répertoire.**

## INTRODUCCIÓN

Esta guía pretende ser una referencia útil para el cerrajero profesional. En ella se ofrecen abundantes datos técnicos y dibujos de llaves en bruto a tamaño real y de perfiles de fresado. La guía está dividida en secciones de colores. Cada sección está organizada por orden alfabético del fabricante o de la aplicación. Las secciones son las siguientes:

### ÍNDICE

Hay dos índices. El primero son los números de las llaves en bruto de ILCO listados por orden numérico-alfabético, con las secciones y las páginas en donde aparecen. El segundo es un índice de marcas de fabricantes de cerraduras y de aplicaciones. Las llaves en bruto que corresponden a esas marcas se pueden encontrar en la página indicada.

### SECCIÓN 1 – Vehículos de todo el mundo

Llaves en bruto para vehículos (automóviles, motocicletas, tractores, etc.) y para aplicaciones relacionadas con ellos (tapón del depósito de gasolina, dispositivo de bloqueo de la dirección, caja de herramientas, etc.). Esta lista es mundial. Algunas de las llaves que aparecen en esta sección están equipadas con mando a distancia, en cuyo caso se identifican con el símbolo "X".

### SECCIÓN 2 – Cilindro norteamericano

Llaves en bruto para uso residencial y comercial (incluyendo candados), vendidas sobre todo en América del Norte (Canadá, Estados Unidos y México, Australia). Los fabricantes de cerraduras aparecen listados por orden alfabético. Algunas llaves pueden aparecer también en otras secciones. Si tiene dificultades para encontrar un fabricante de cerraduras, verifique el índice de marcas.

### SECCIÓN 3 – Cilindro internacional

Llaves en bruto para uso residencial y comercial (incluyendo candados), vendidas sobre todo al exterior de América del Norte y de Australia. Los fabricantes de cerraduras aparecen listados por orden alfabético. Los números de las llaves Silca y Orion son citados según la numeración ILCO.

### SECCIÓN 4

#### 4A – Originales

Gracias a las autorizaciones otorgadas por los fabricantes de automóviles, ahora podemos ofrecer llaves en bruto de vehículos con el símbolo del fabricante. En esta sección pueden encontrarse originales de Chrysler, Ford y GM.

#### 4B – Copias

Llaves en bruto tan parecidas a la original como la ley lo permite. Cumplen las normas de la industria con la única diferencia de que no llevan el símbolo original o el de ILCO. Normalmente son más baratas que las llaves de origen.

### SECCIÓN 5 – Cajas de seguridad

Listado mundial de llaves en bruto para cajas de seguridad y otras aplicaciones de seguridad. Los fabricantes de cajas de seguridad aparecen listados por orden alfabético.

### SECCIÓN 6

#### 6A – Variedades y Llaves Especiales

En esta sección se muestran variedades de llaves en blanco y llaves en blanco especiales como llaves de curvatura grande, de curvatura neutra y llaves pintadas

#### 6B - Por especialidad

Una selección de llaves en bruto para usos específicos. En la medida de lo posible se presentan por fabricante de cerraduras y en orden alfabético.

### SECCIÓN 7 - Paletón y cilindro

Las llaves están divididas por tipo, es decir, con paletón o con cilindro. Los datos técnicos, incluyendo el material (hierro maleable, bimetálico, latón, etc.), se presentan debajo de cada ilustración.

### SECCIÓN 8 – Diversas

Llaves en bruto de diversos tipos como ultraligeras, con empuñadura de plástico de color o con el nombre de un hotel, o con la inscripción "Copia prohibida".

### SECCIÓN 9 – Accesorios de venta

Vitrinas para llaves, expositores en forma de torre, accesorios, etc. para la organización y presentación del inventario de llaves.

### SECCIÓN 10 – Máquinas para llaves

Breves descripciones de las máquinas para llaves más populares de Ilco, Orion y Silca, ofrecidas actualmente por Kaba Ilco Corp..

### SECCIÓN 11 – Referencias cruzadas

La tabla de referencias cruzadas tiene tres secciones. Las dos primeras indican los números Dominion Lock y Taylor y su correspondiente de Ilco. La tercera presenta los fabricantes más importantes de llaves de reemplazamiento y de cerraduras, clasificados por orden alfabético con sus números de llaves en la secuencia apropiada. La llave ILCO equivalente se lista al lado del número de la llave original o del de la competencia. El listado se presenta en forma de referencia cruzada funcional. Algunos fabricantes de llaves de reemplazamiento se han omitido debido a las normas legales de sus países relativas a la publicación de referencias cruzadas.

## PRESENTACIÓN DE LA PÁGINA

- El nombre del fabricante aparece encima de los dibujos de las llaves en bruto.
- El número de ILCO se presenta debajo de cada llave.
- La sección de vehículos indica los números EZ debajo del número ILCO.
- La sección "cilindro internacional" da los números de las llaves en bruto Silca y Orion debajo del número ILCO.
- Los dibujos de las llaves pueden mostrar también informaciones importantes, como el número de paletones de la llave, si dispone de un mando a distancia, etc.

### Dibujos de las llaves

Los dibujos de las llaves en bruto y de los perfiles de fresado se presentan a tamaño natural.

La mayor parte de las llaves que tienen un solo lado se muestran desde el lado derecho. Para saber cuál es el lado derecho, coja la llave con la mano derecha con los dedos pulgar e índice. Asegúrese de que la zona del paletón está boca arriba. El lado derecho es donde se apoya su dedo índice.

Cuando hay dos perfiles de fresado con diferentes empuñaduras o configuraciones, se presentan las dos versiones.

### VERIFICACIÓN DEL PERFIL DE FRESADO

Para verificar el perfil de fresado, coja la llave en bruto por la empuñadura y coloque el extremo de la llave sobre el perfil de fresado. Verifique los dos lados del perfil de fresado para asegurarse del ajuste.

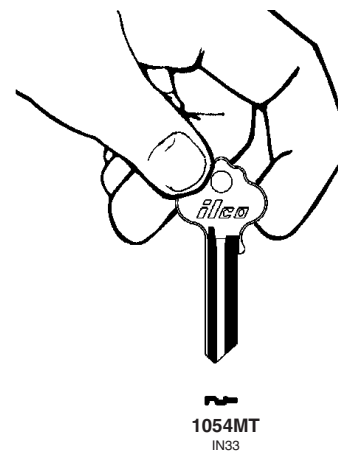
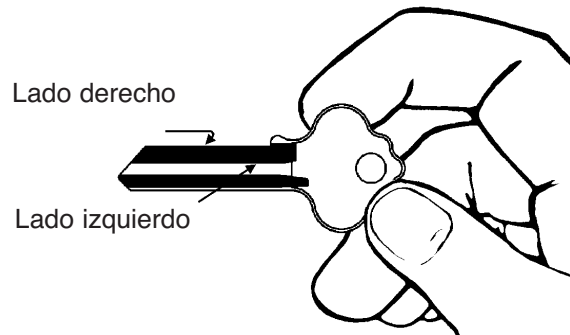
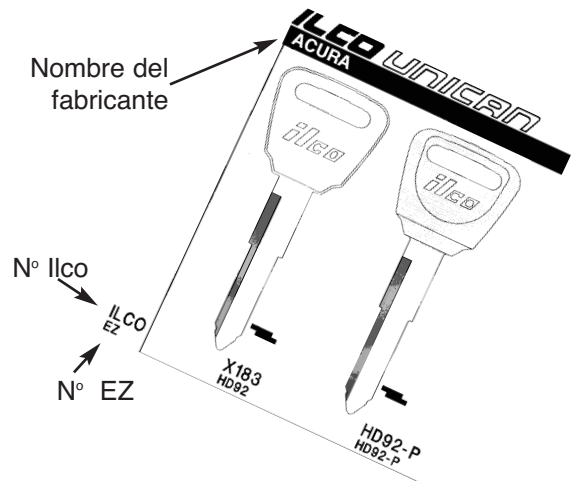

Esta guía ilustra todas las llaves en bruto fabricadas actualmente por Kaba Ilco Corp.. Sin embargo, añadimos constantemente nuevas llaves para satisfacer la demanda e intentamos informar de ello al mercado lo más rápidamente posible. Todas las actualizaciones de este documento se harán en el formato explicado anteriormente.

La guía incluye también algunas llaves en bruto fabricadas por Silca, una división filial de Kaba Ilco Corp.. Esas llaves en bruto Silca no tienen equivalente ILCO y se han añadido a nuestra línea de productos para anticipar las necesidades de los múltiples mercados en los que actuamos.



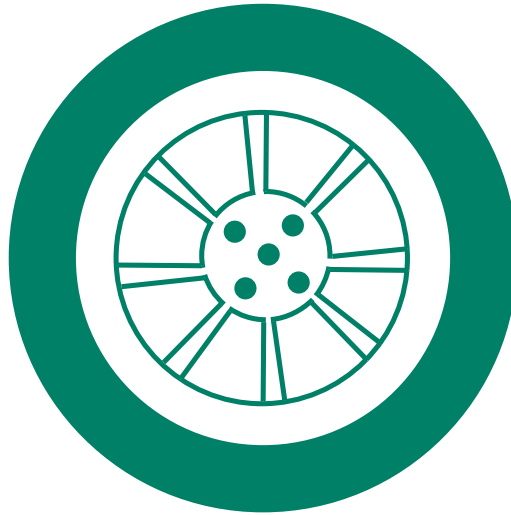

**La GUÍA ILCO es un documento de consulta muy útil. No duden en enviarnos cualquier comentario o sugerencia que nos permita mejorarlo.**



## Section 1 VEHICLE

Key blanks for automobiles, motorcycles, airplanes, boats, garden tractors, etc., designed and manufactured worldwide. The manufacturers are listed in alphabetical order with keys listed in numerical sequence where possible.

There are several symbols and suffixes used in this section. Below is a legend of their use.

	Transponder Key
	Electronic Key
	Special Key Machine Required
	Cloning Tool Required
-P	Plastic Head Key
-PC	Color Plastic Head Key
-P (-PC)	Available with Black or Color Plastic Head

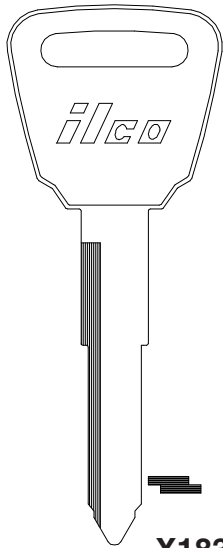
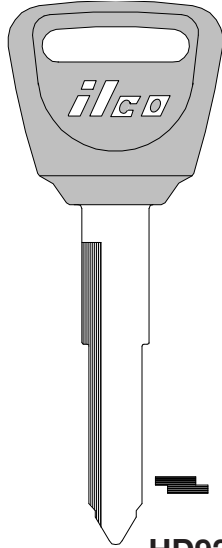
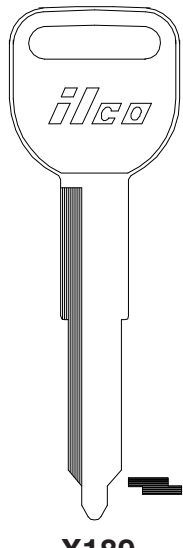
**ACURA****X183**  
HD92**HD92-P**  
—**X189**  
HD93

VALET FOR X183 &amp; HD92-P

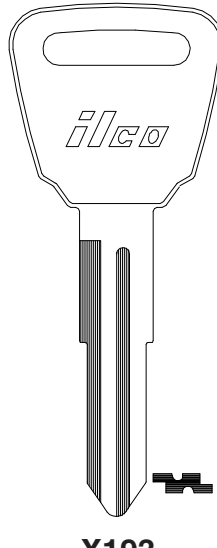
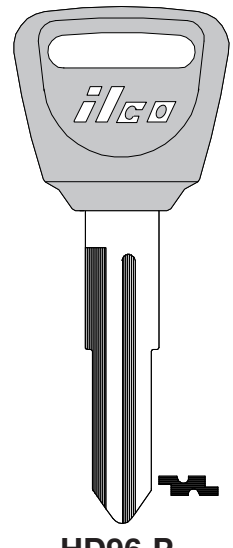
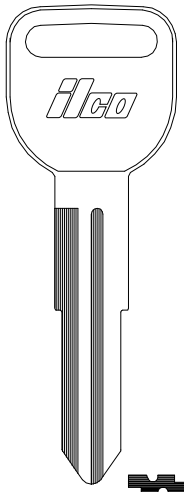
**X193**  
HD96**HD96-P**  
—**ILCO**  
EZ**ACURA****X194**  
HD97

VALET FOR X193 &amp; HD96-P

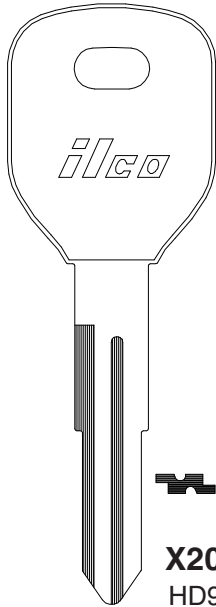
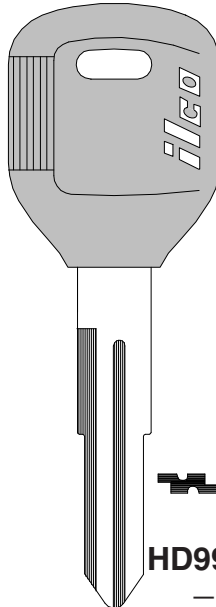
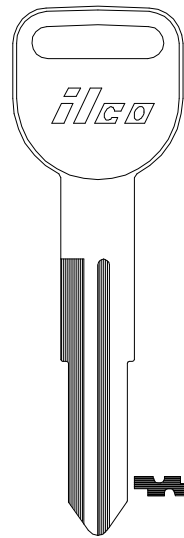
**X204**  
HD99**HD99-P**  
—**X205**  
HD100

VALET FOR X204 &amp; HD99-P

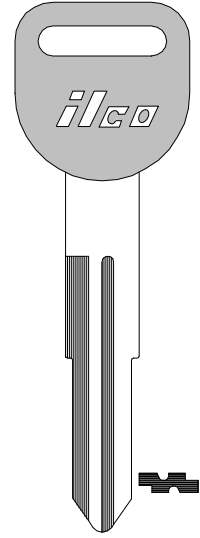
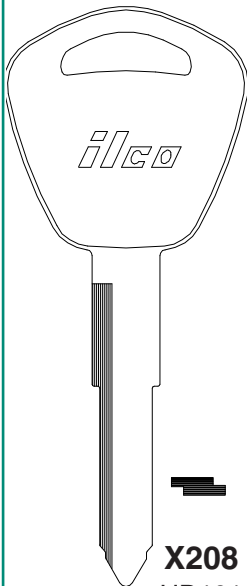
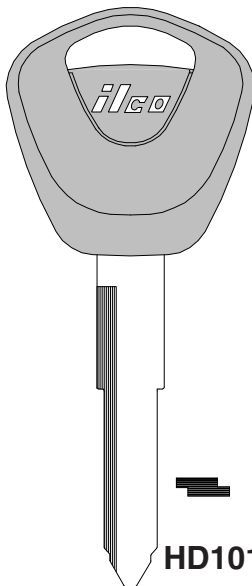
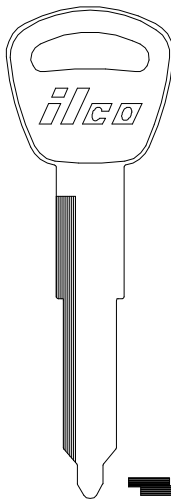
**HD100-P**  
—**ILCO**  
EZ**ACURA****X208**  
HD101**HD101-P**  
—**X209**  
HD102

VALET FOR X208 &amp; HD101-P

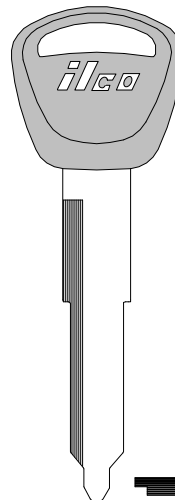
**HD102-P**  
—

VALET FOR X208 &amp; HD101-P

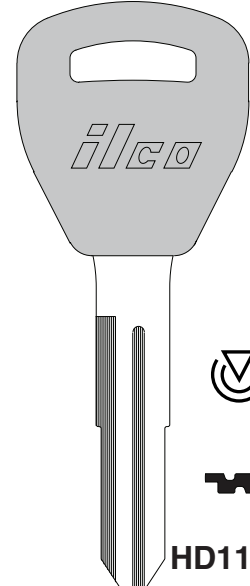
**HD111-PT****ILCO**  
EZ

ACURA

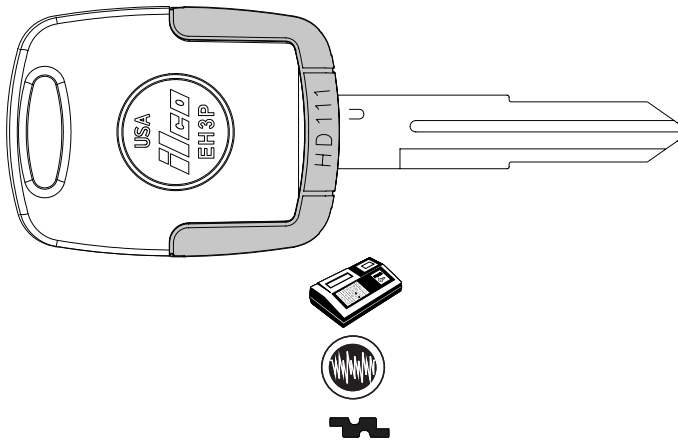

**EH3P**  
(Head Only)

  
**EB3-U-HD111**  
(Blade Only)

**EK3P-HD111**  
(Complete Key)

ILCO  
EZ

ACURA

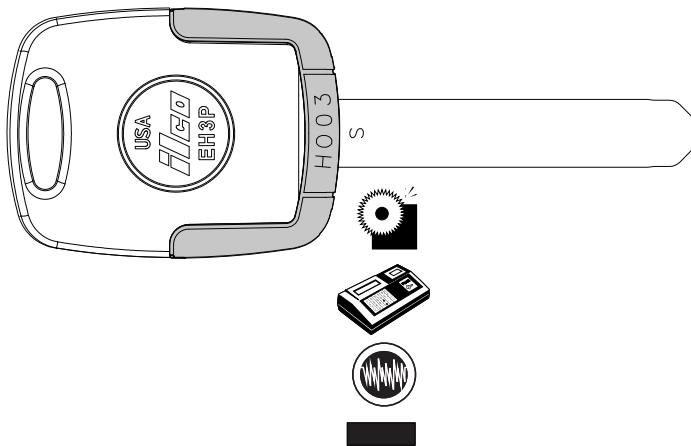

**EH3P**  
(Head Only)

  
**EB3-S-HO03**  
(Blade Only)

**EK3P-HO03**  
(Complete Key)

ALFA ROMEO

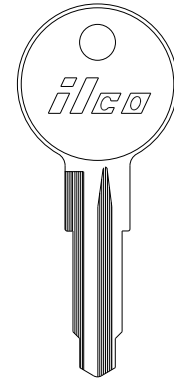

**FS1**

ILCO  
EZ

ALFA ROMEO

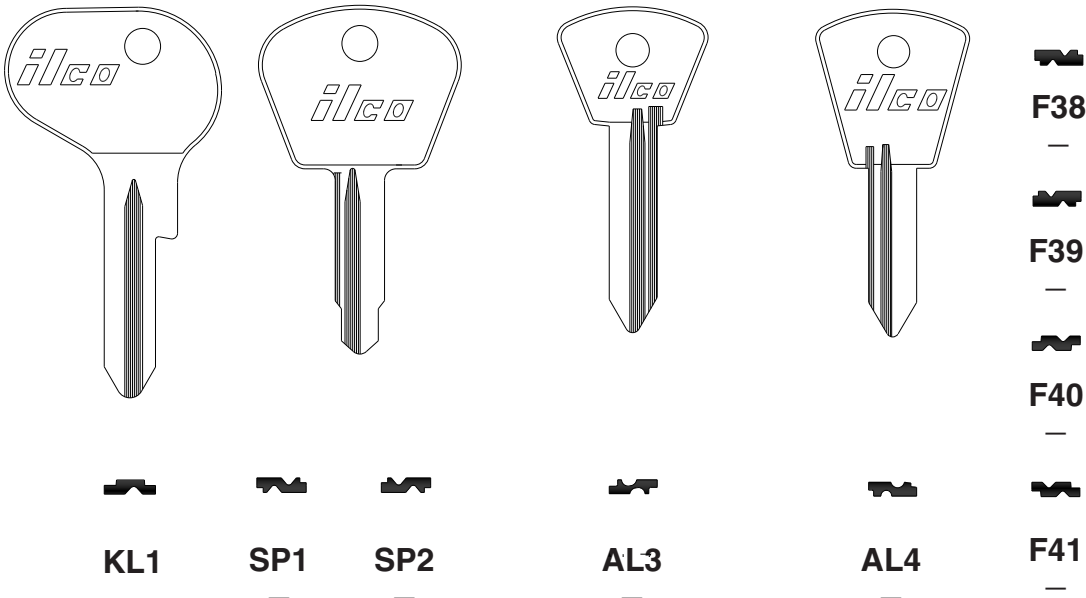

ILCO  
EZ

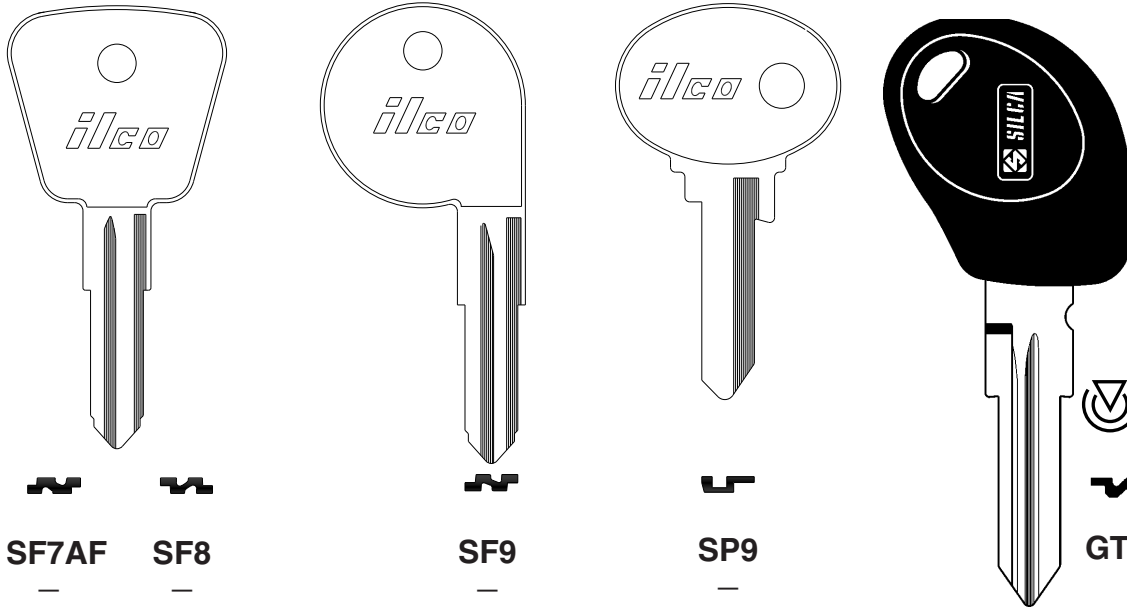
**ALFA ROMEO**

**ILCO**  
EZ

**SF7AF**  
—

**SF8**  
—

**SF9**  
—

**SP9**  
—

**GT15RT2**  
—

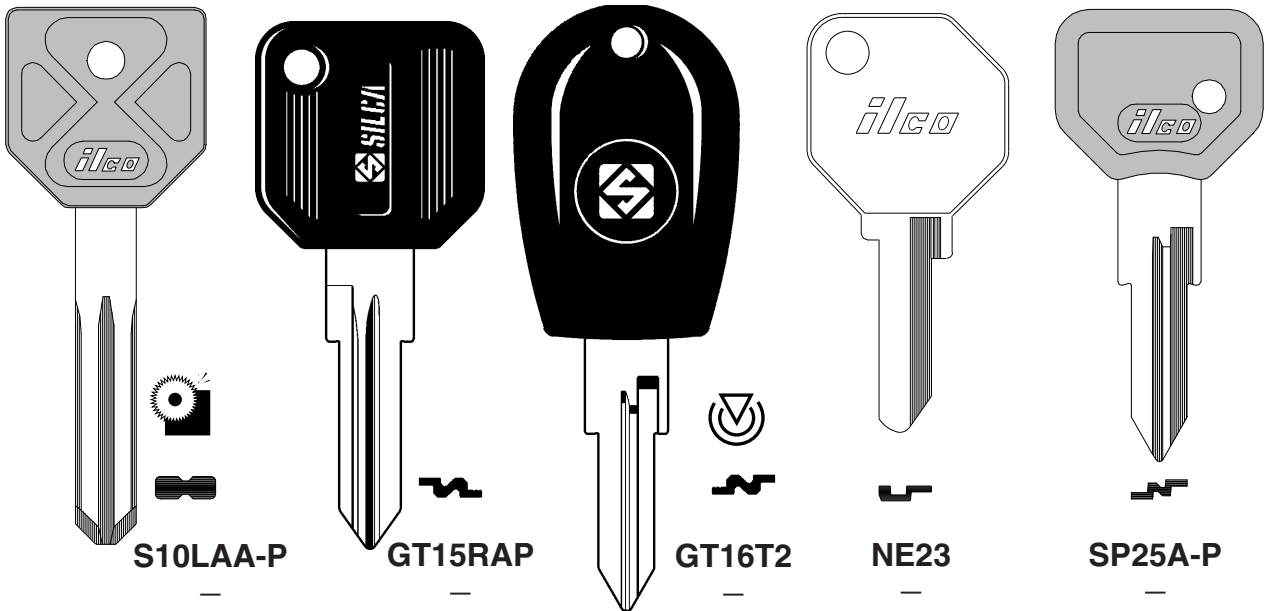
**ALFA ROMEO**

**ILCO**  
EZ

**S10LAA-P**  
—

**GT15RAP**  
—

**GT16T2**  
—

**NE23**  
—

**SP25A-P**  
—

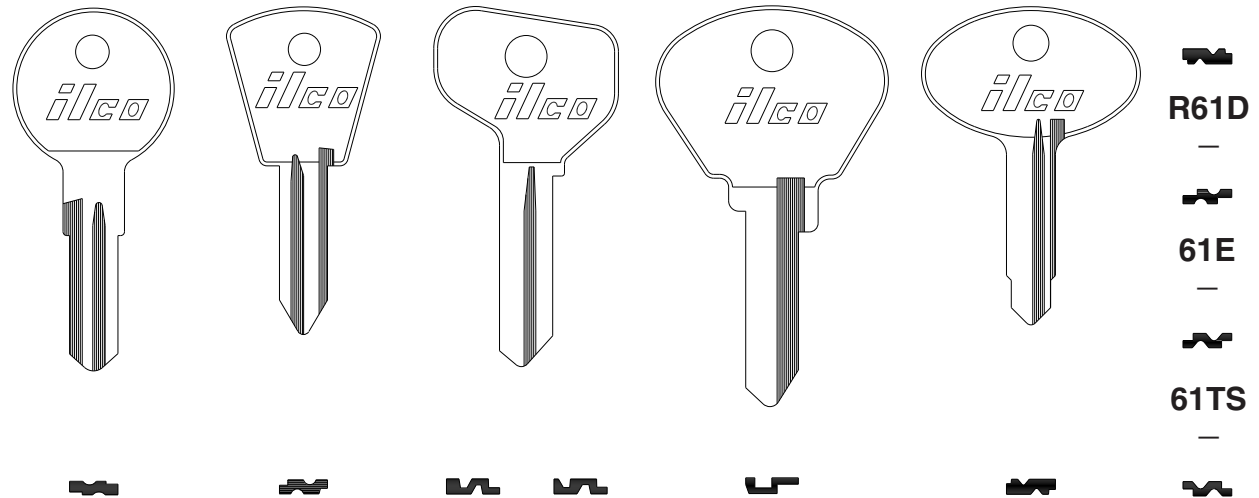
**ALFA ROMEO**

**ILCO**  
EZ

**F29**  
—

**F33**  
—

**FT37**  
—

**FT38**  
—

**F44**  
—

**61D**  
—

**R61TS**  
—

**R61D**  
—

**61E**  
—

**61TS**  
—

ALFA ROMEO

VEHICLE

sec 1 page 4

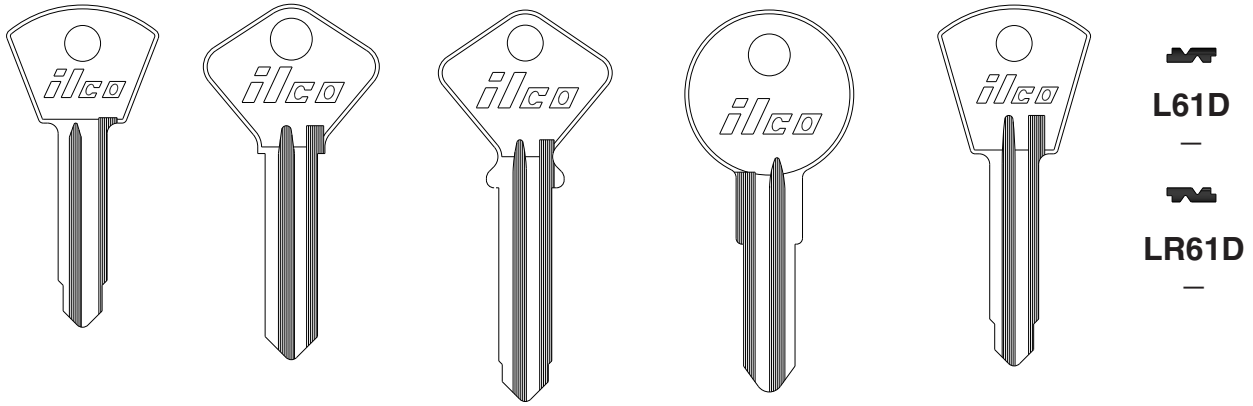

**M**  
L61D  
—  
**N**  
LR61D  
—

**61F**    **61G**    **R61G**    **61GA**    **R61GA**    **61H**    **R61H**    **H61G**  
—        —        —        —        —        —        —        —

ILCO  
EZ

ALFA ROMEO

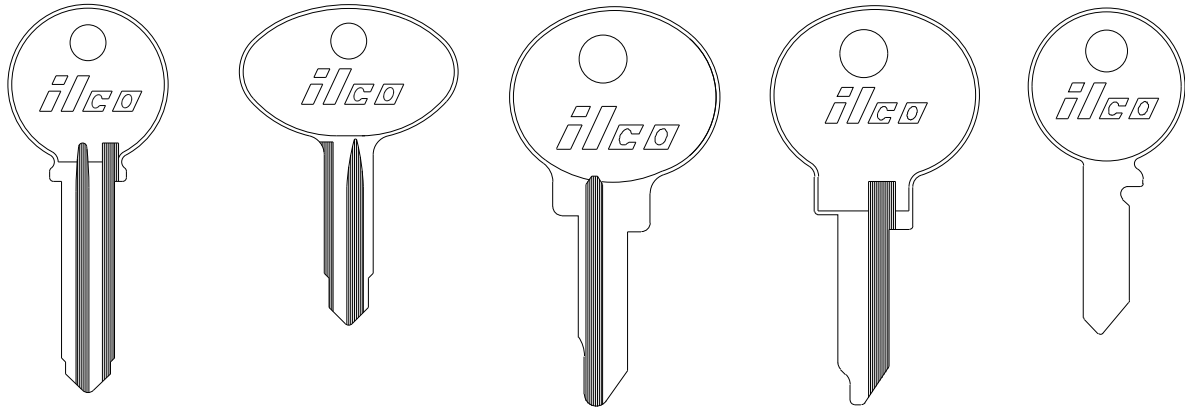

**L61G**    **LR61G**    **R61ST**    **R62TS**        **RE61N**        **RE61XR**        **62DG**    **R62DG**  
—        —        —        —                —                —        —        —

ILCO  
EZ

ALFA ROMEO

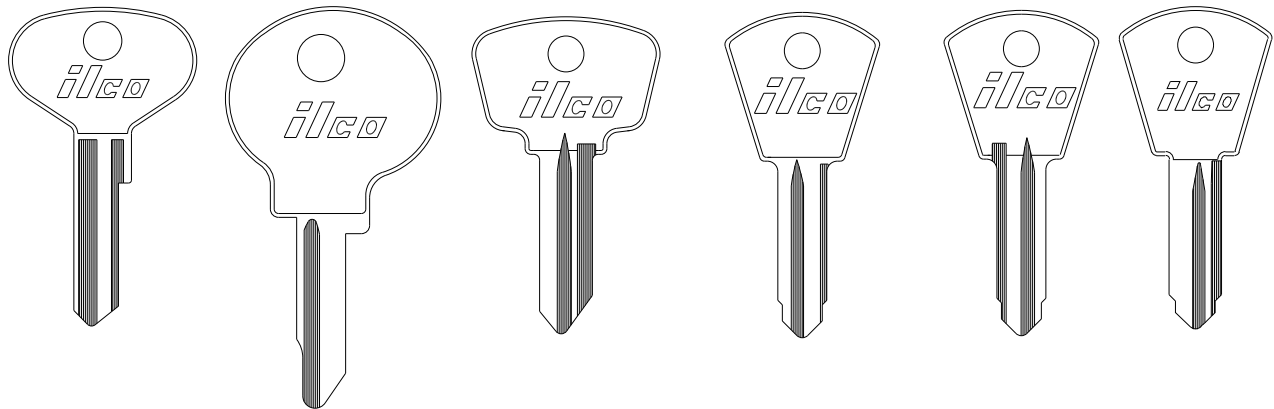









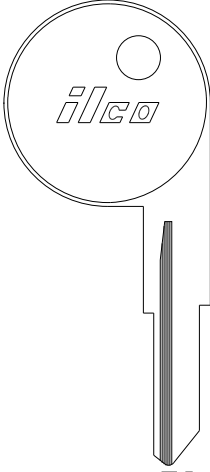

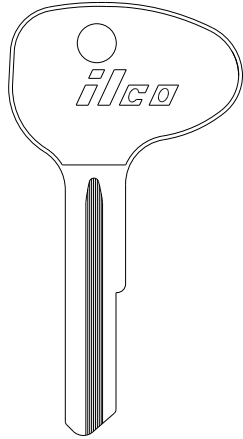
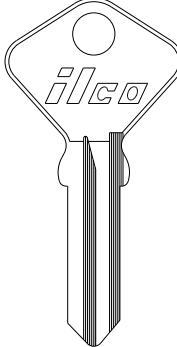

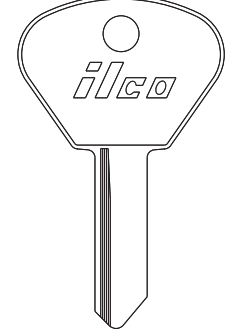
**HR62DG**    **63M**        **63SP**    **R63SP**    **63ST**    **R63ST**    **63TS**        **R63TS**  
—            —            —            —            —            —            —            —









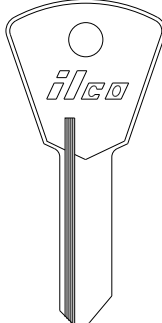

ILCO  
EZ

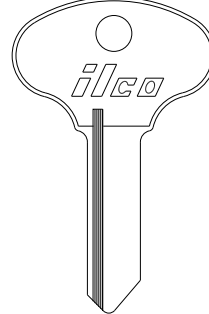

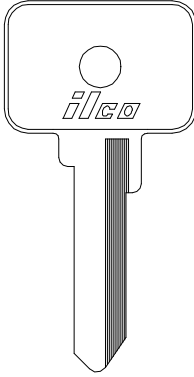
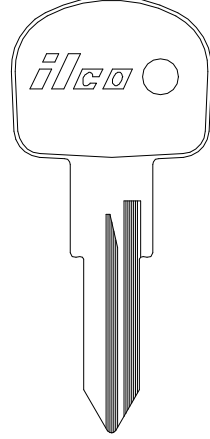
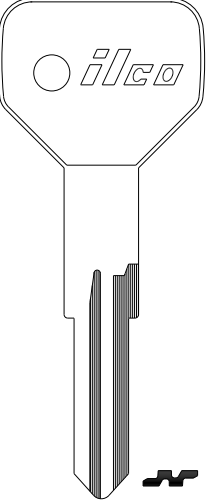

**ALFA ROMEO**

<b>ILCO</b> EZ		 <b>X78</b> SP8			 <b>F91CR</b> —		 <b>F91F</b> —
		 <b>X79</b> SP7			 <b>F91C2</b> —		 <b>F91G</b> —
					 <b>F91C8</b> —		 <b>F91H</b> —
		 <b>X64</b> SP6	<b>A81N</b> —	<b>F91C</b> —		<b>F91E</b> —	

**ALFA ROMEO**

<b>ILCO</b> EZ		 <b>F91FH</b> —		 <b>F91FS</b> —			
		 <b>F91GH</b> —		 <b>F91GS</b> —			
		 <b>F91HH</b> —		 <b>F91HS</b> —			
		 <b>F91EH</b> —	<b>F91ES</b> —		<b>X109</b> FT43	<b>X152</b> FT46	<b>X166</b> FT48

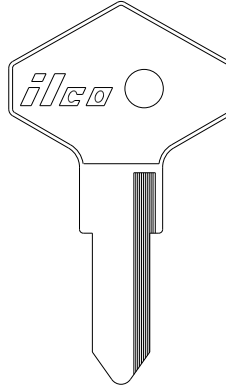
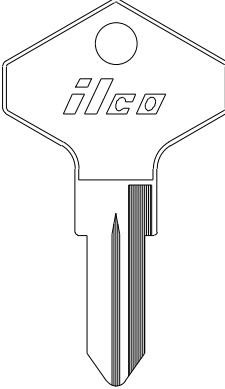
**AMERICAN MOTORS / JEEP / RENAULT**

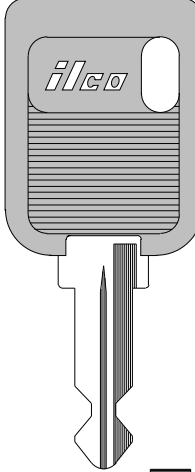
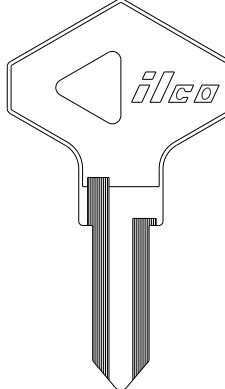
<b>ILCO</b> EZ					
	<b>X85</b> NE36	<b>X92</b> RN25	<b>X116</b> RN24	<b>RN24-P</b> —	<b>X122</b> RN29

AMERICAN MOTORS / JEEP / RENAULT

VEHICLE

sec 1 page 6

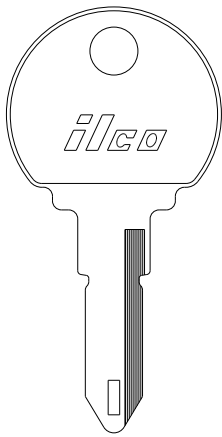

**X147**  
RN30

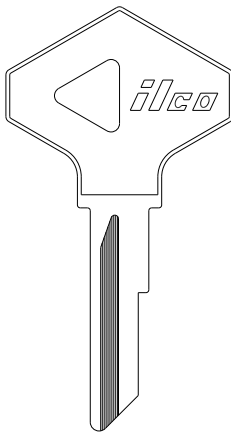

**X150**  
RN27

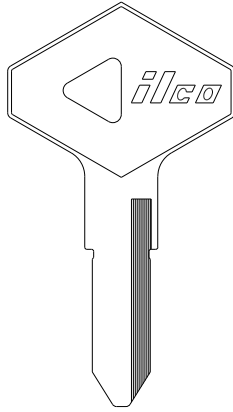

**X171**  
RN31

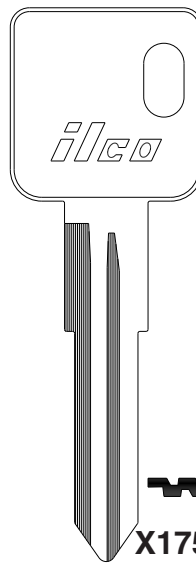

**X175**  
RN32

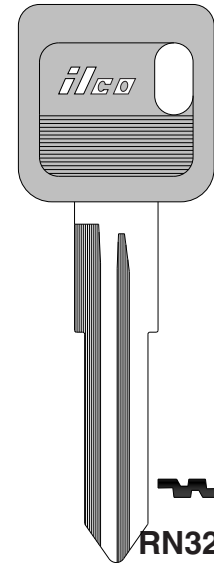

**RN32-P**  
—

ILCO  
EZ

AMERICAN MOTORS / JEEP / RENAULT

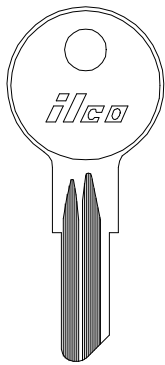

**1098DB**  
B5

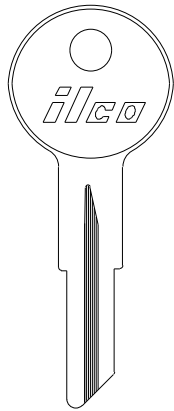

**1098NR**  
RA1

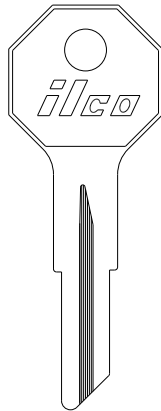

**H1098NR**  
RA2

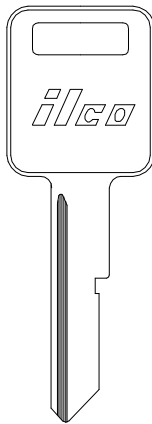

**P1098J**  
B46

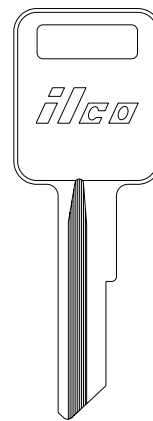

**1970AM**  
RA4

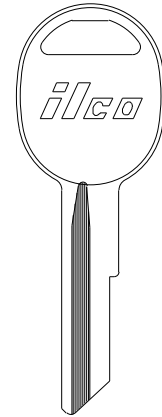

**S1970AM**  
RA3

ILCO  
EZ

ARTIC CAT

APRILIA

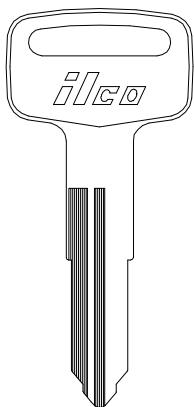

**X117**  
YH48

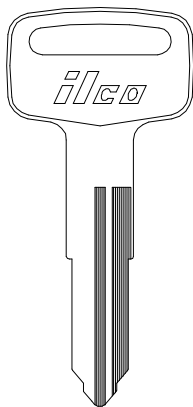

**X118**  
YH49

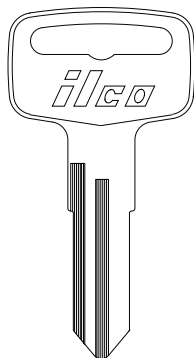

**X72**  
YH36

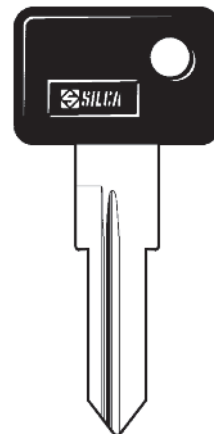

**ZD16RP-SI**  
—

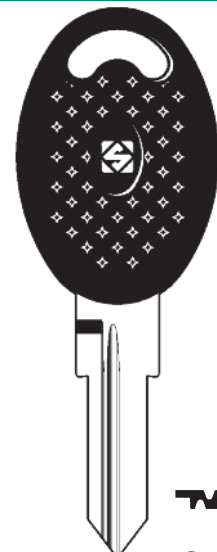

**ZD22RBP-SI**  
—

ILCO  
EZ

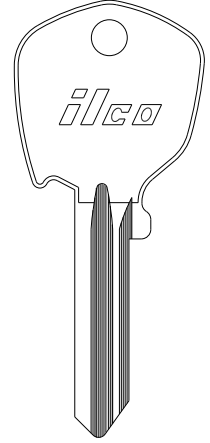
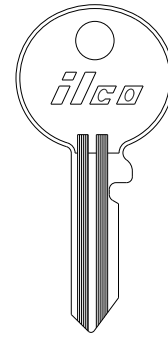
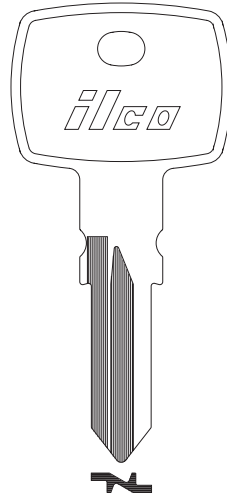
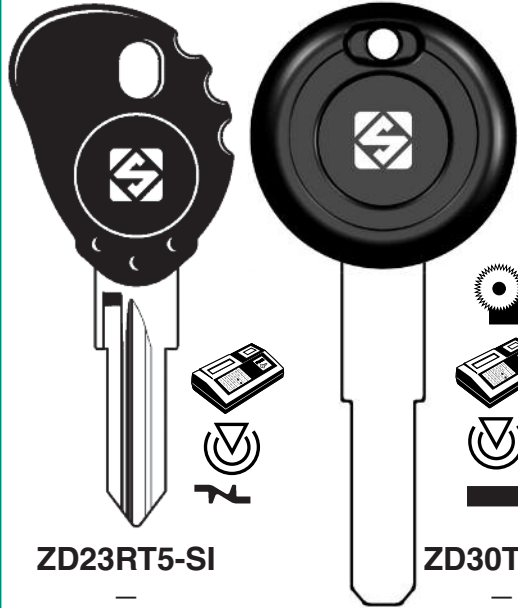
**APRILIA**
**ARIEL**
**ASTON MARTIN**

**ILCO**  
EZ

**ZD23RT5-SI**  
—

**ZD30T5-SI**  
—

**X270**  
TMC1

**R62DH**  
—

**FT6R**  
F81E

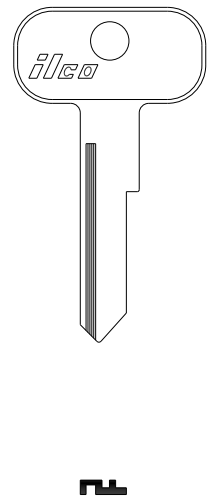
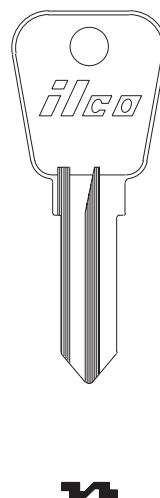
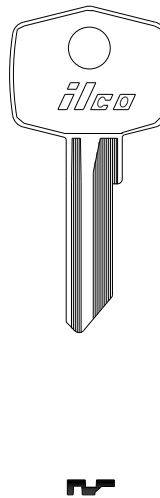
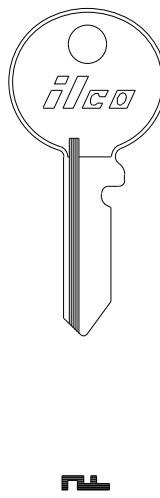
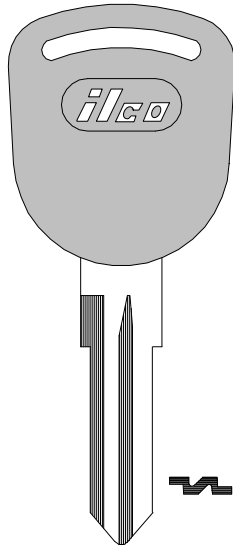
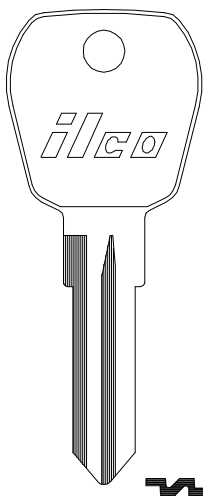
**ASTON MARTIN**

**ILCO**  
EZ

**X86**  
FC7

**FC7-P**  
—

**62DP**  
—

**62FS**  
—

**62FT**  
F68YT

**H62DP**  
—

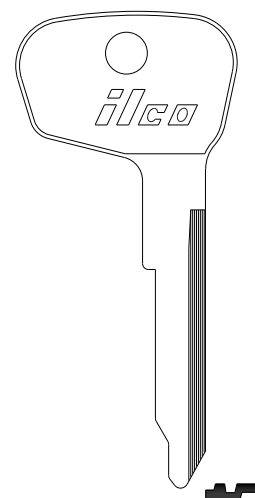
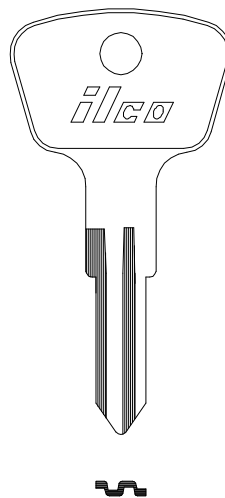
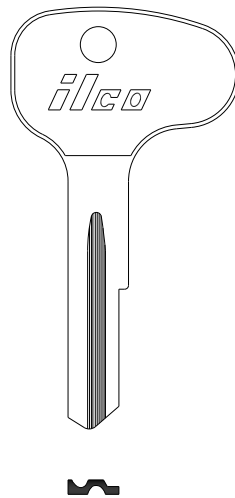
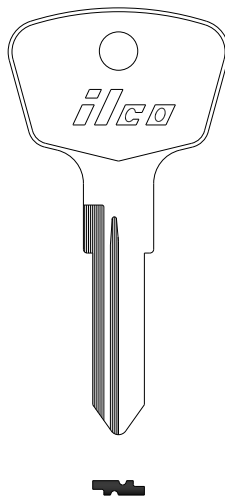
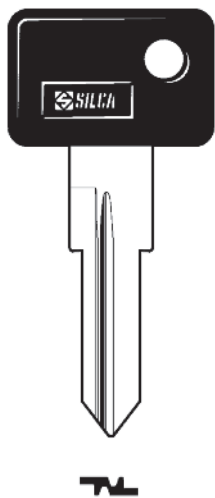
**ATALA**
**AUDI**

**ILCO**  
EZ

**ZD16RP-SI**  
—

**AD1**  
—

**PR1**  
—

**PA5**  
—

**WT5**  
—

AUDI

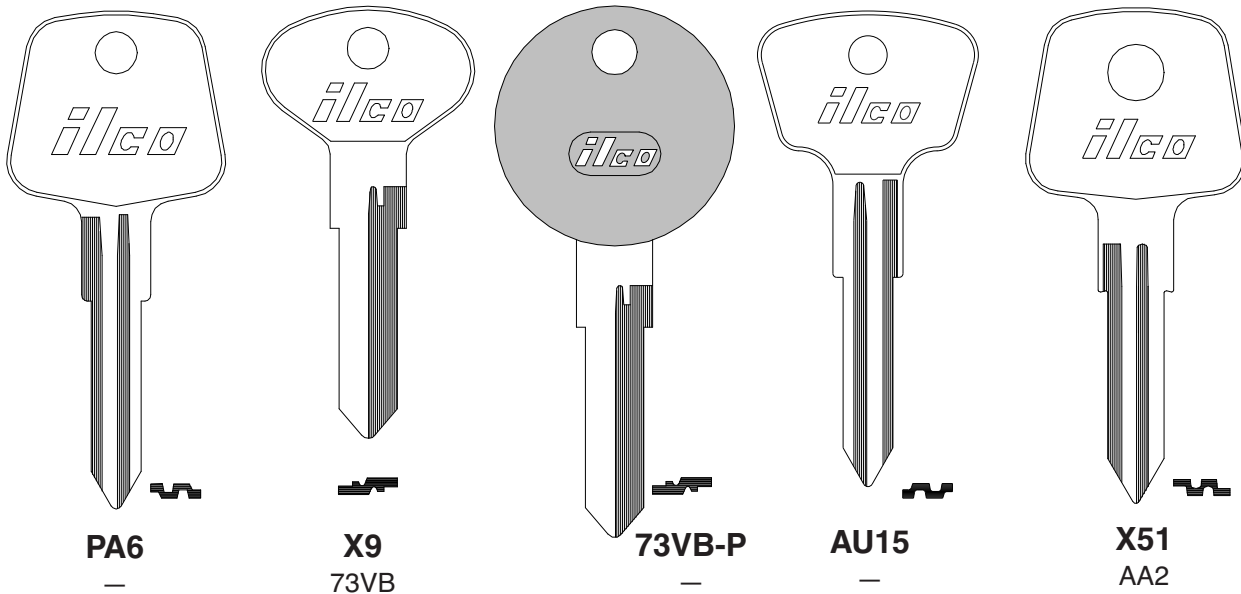

ILCO  
EZ

AUDI

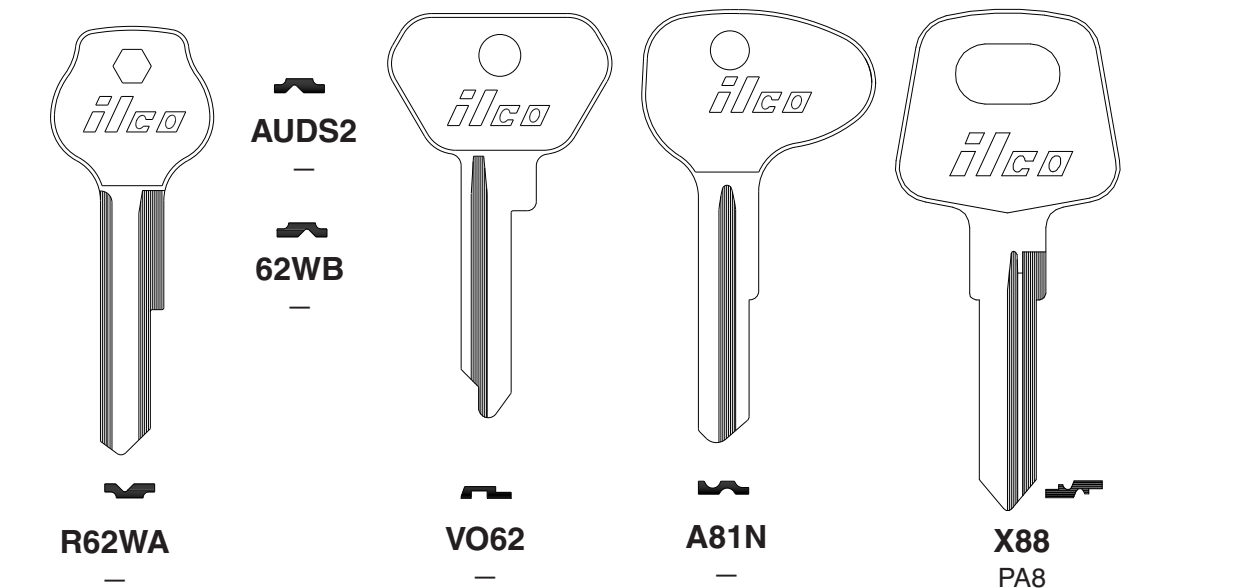

ILCO  
EZ

AUDI

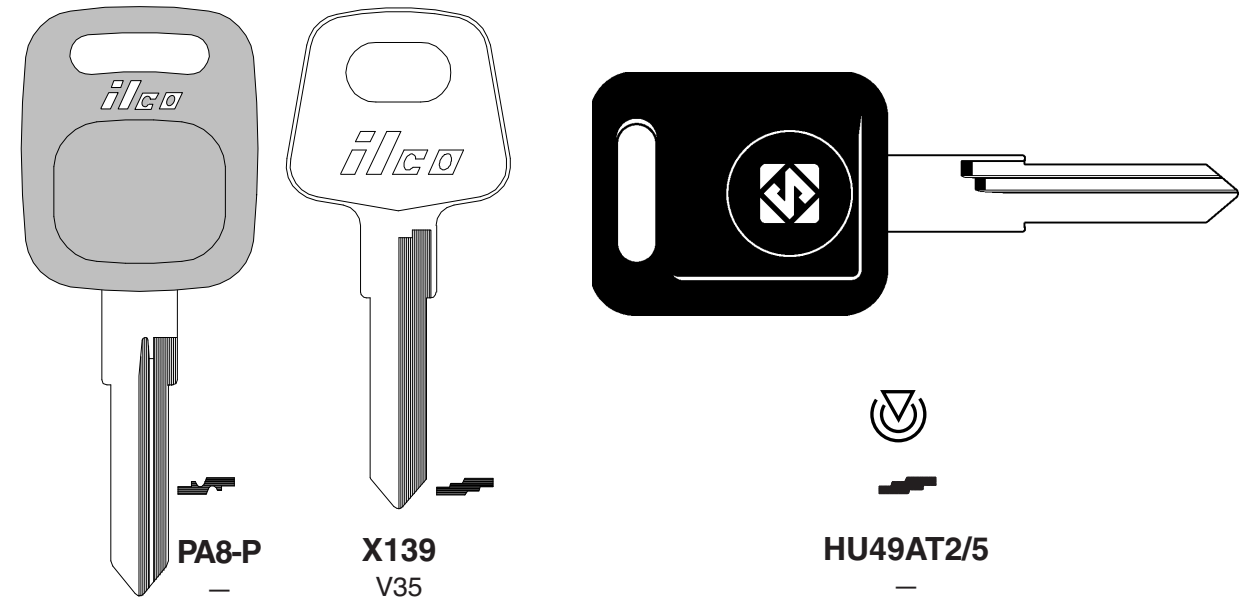

ILCO  
EZ

AUDI

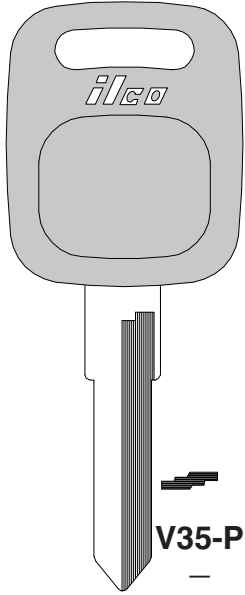

V35-P  
—

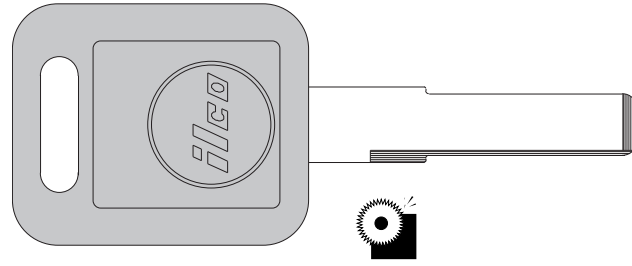

HU66A-P  
—

ILCO  
EZ

AUDI

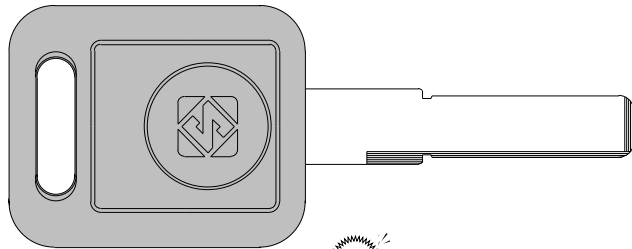

HU66AT2  
—

AUSTIN

SEE  
BRITISH  
LEYLAND

HU66AT5  
HU66AT6  
—

AUTOBIANCHI

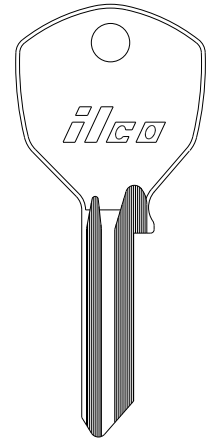

DM20  
—

ILCO  
EZ

AUTOBIANCHI

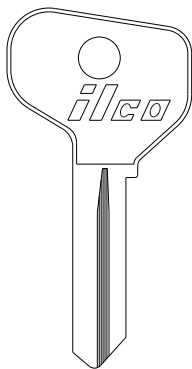

FT37 FT38  
— —

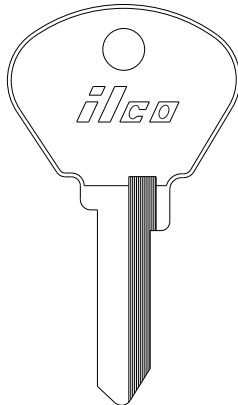

F44  
—

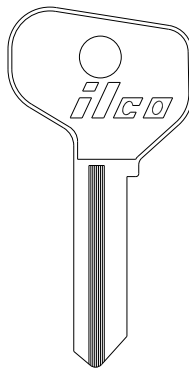

F54  
—

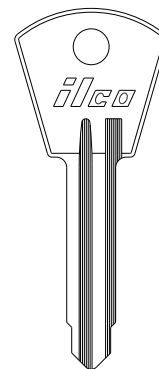

H61G  
—

L61D  
—

LR61D  
—

SP5  
—

ILCO  
EZ

AUTOBIANCHI

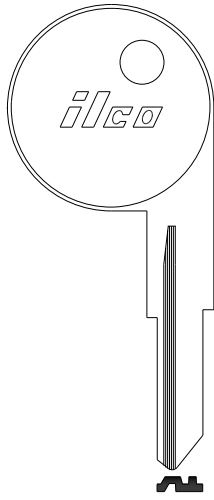

**X78**  
SP8

**X79**  
SP7

**X64**  
SP6

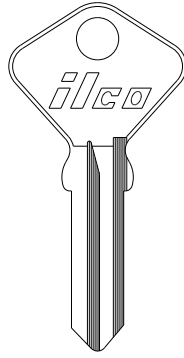

**F91CR**  
—

**F91C2**  
—

**F91C8**  
—

**F91C**  
—



**F91F**  
—

**F91G**  
—

**F91H**  
—

**F91E**  
—

ILCO  
EZ

AUTOBIANCHI

BARRI-LOCK

BASTA LOCK

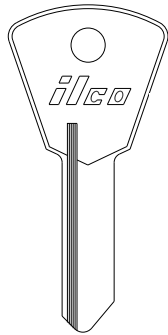

**F91FH**  
—

**F91GH**  
—

**F91HH**  
—

**F91EH**  
—

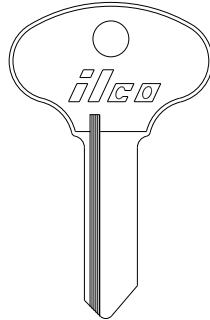

**F91FS**  
—

**F91GS**  
—

**F91HS**  
—

**F91ES**  
—

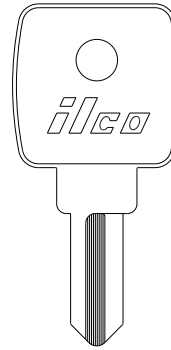

**X56**  
—

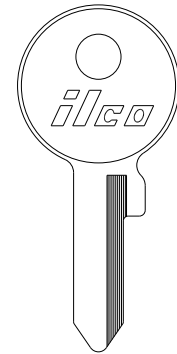

**NE30**  
—

ILCO  
EZ

BEDFORD

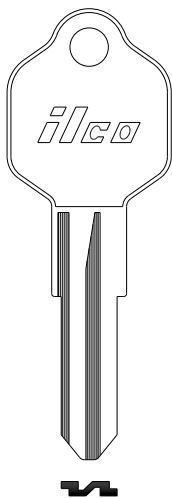

**CE3**  
—

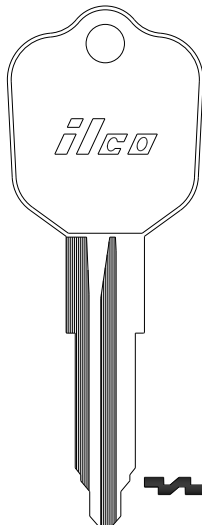

**CE5**  
—

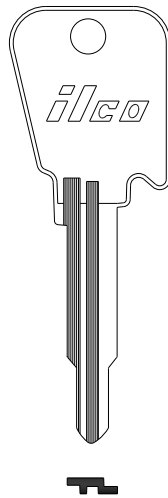

**X13**  
LF4

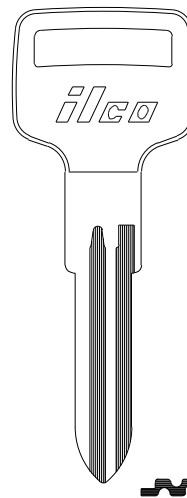

**X29**  
VO73

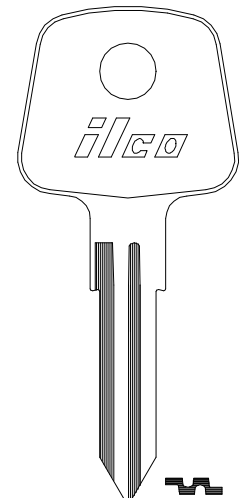

**X51**  
AA2

ILCO  
EZ

BEDFORD

BENTLEY

BETA

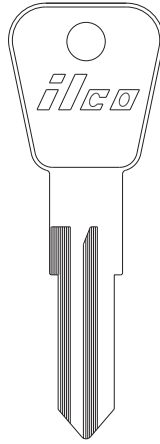
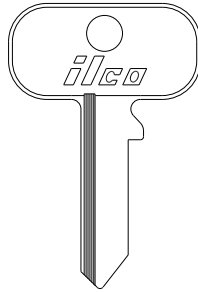
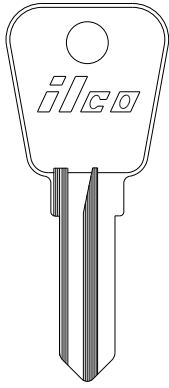

SEE  
ROLLS  
ROYCE

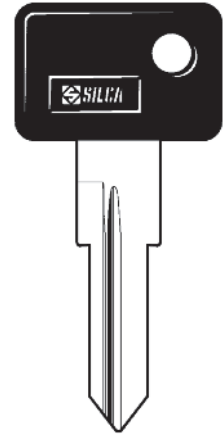

ILCO  
EZ

62FT  
F68YT

B62DP B62DR  
— —

L62FD  
—

ZD16RP-SI  
—

sec 1 page 11

VEHICLE

BIMOTA

BMW

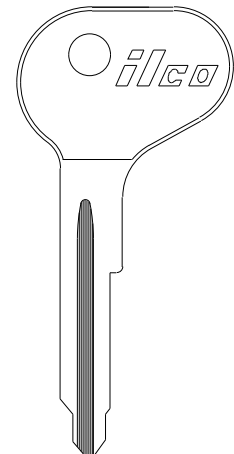
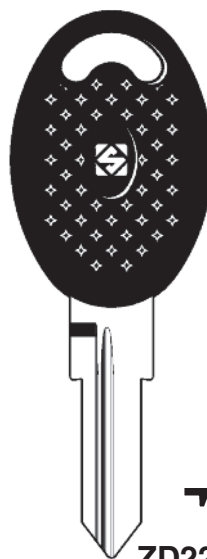

ILCO  
EZ

ZD23RCP-SI  
—

ZD24RDP-SI  
—

ZD22RBP-SI  
—

BMW1  
—

BMW

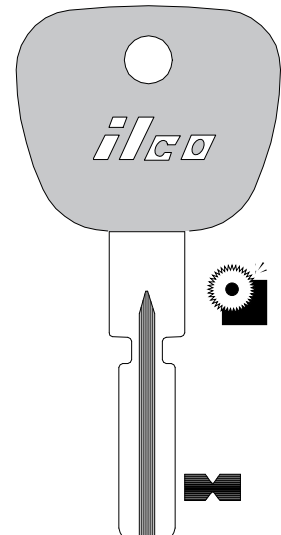
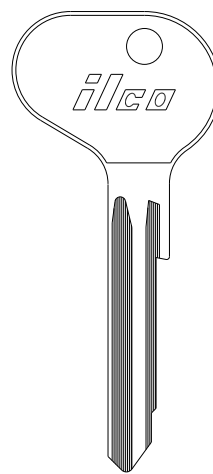
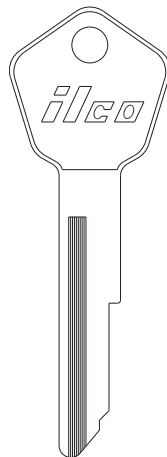
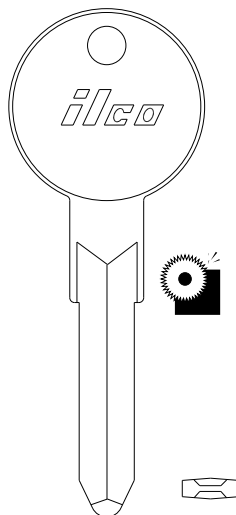
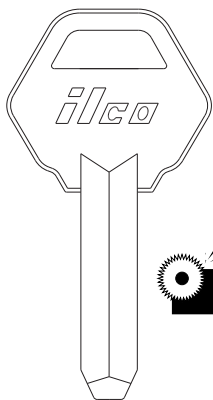

ILCO  
EZ

KS1  
—

PE1  
—

WT3  
—

KL4  
—

S7BW-P  
—



BMW

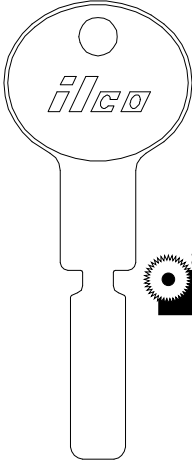

S6BW

—

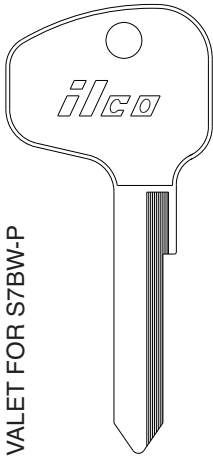

NE8

—

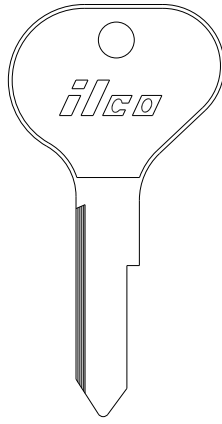

HF20

—

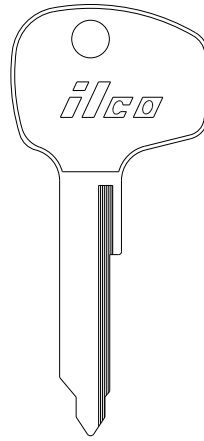

HF26

—

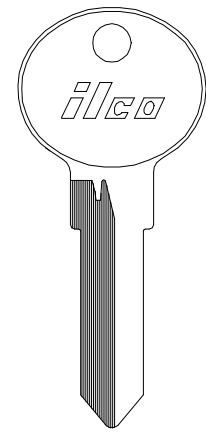

X59

BMW2



VALET FOR S7BW-P

ILCO  
EZ

BMW

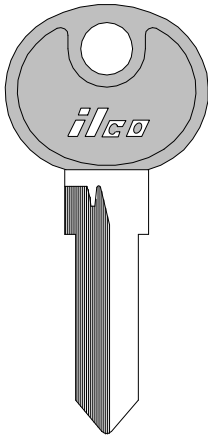

BMW2-P

—

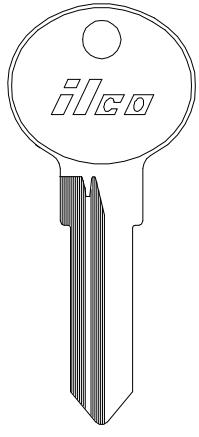

HF40

—

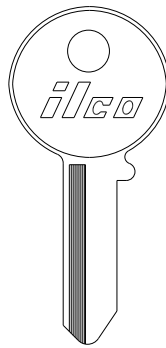

61N

—

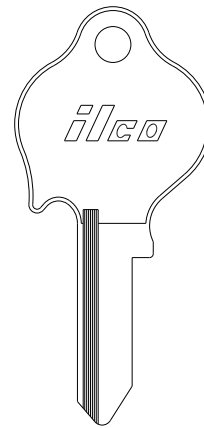

H61VM

—



62VO

—

VALET FOR X59 AND BMW2-P

ILCO  
EZ

BMW

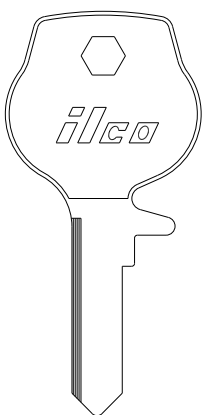

X62VK

—

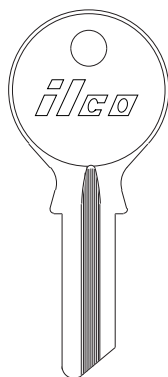

63L

—

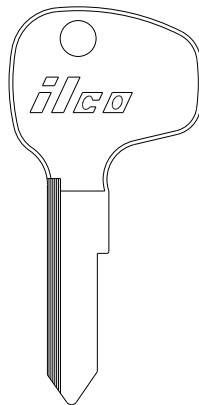

63VP

—

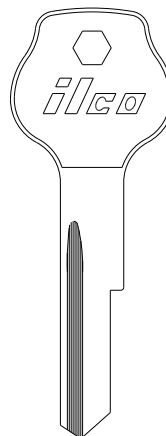

63Y

—



R63Y

—

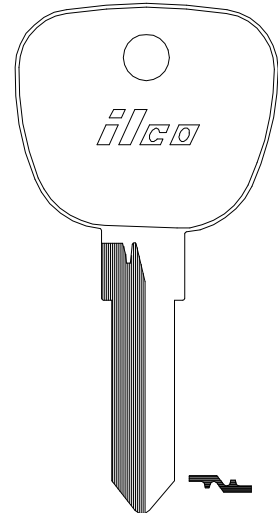

X144

BMW3

ILCO  
EZ

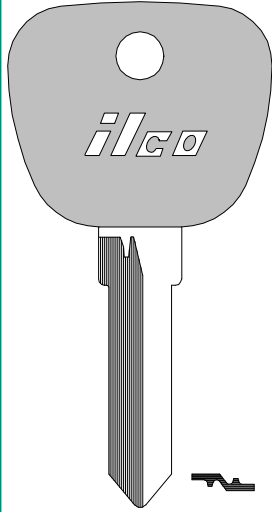
**BMW**
**BMW MOTORCYCLE**

**BMW3-P**

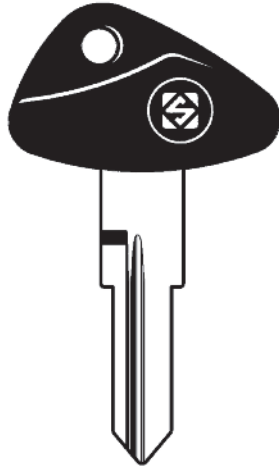
—

**ZD28RFP-SI**

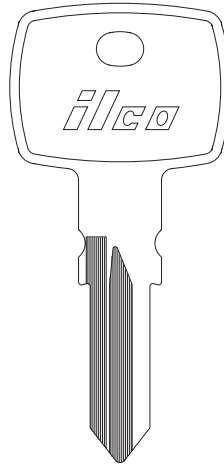
—

**X270**

TMC1

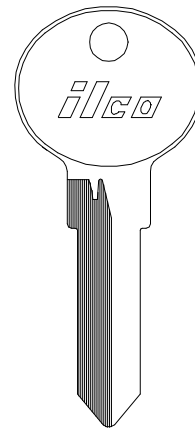
**X59**

BMW2

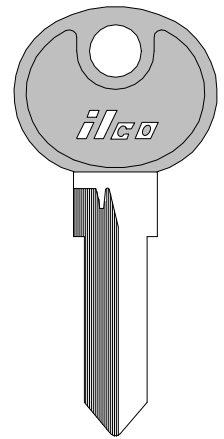

**BMW2-P**

—

 ILCO  
EZ

VEHICLE

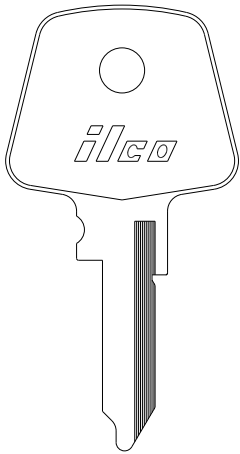
sec 1 page 13

**BMW MOTORCYCLE**
**BOMBARDIER**

**Y16**

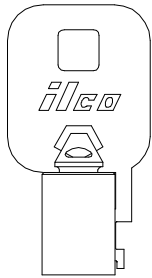
—



 OD .377" - 9.6mm  
ID .312" - 7.9mm  
(BRASS)

**1137B**

—

**ZD23RCP-SI**

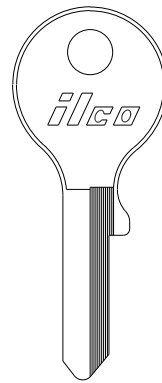
—

**N2M**

—

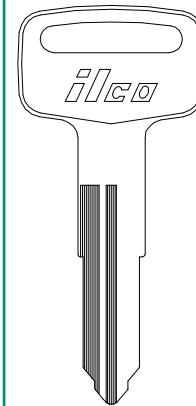

**X117**

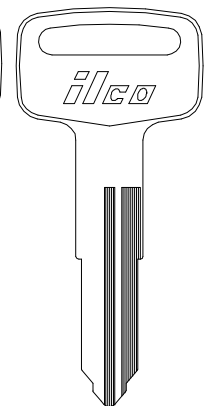
YH48

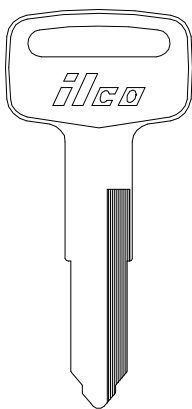

**X118**

YH49

 ILCO  
EZ

**BOMBARDIER**

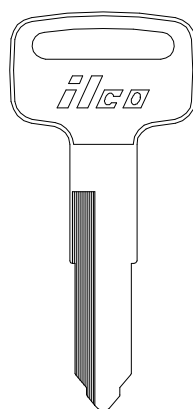
**X119**

YH47

**X120**

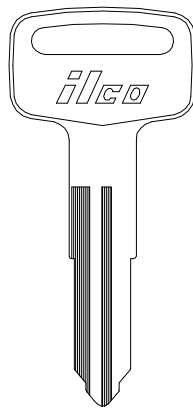
YH46

**YH50**

—

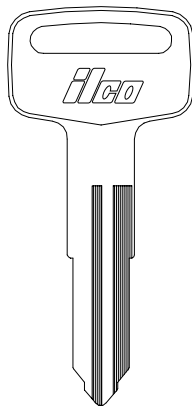
**YH51**

—

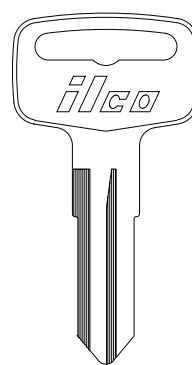
**X111**

YM55

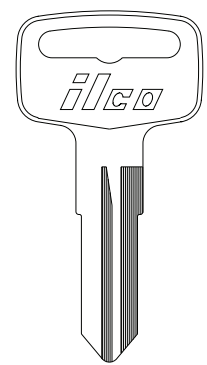
**X112**

YM56

 ILCO  
EZ

BORGWARD

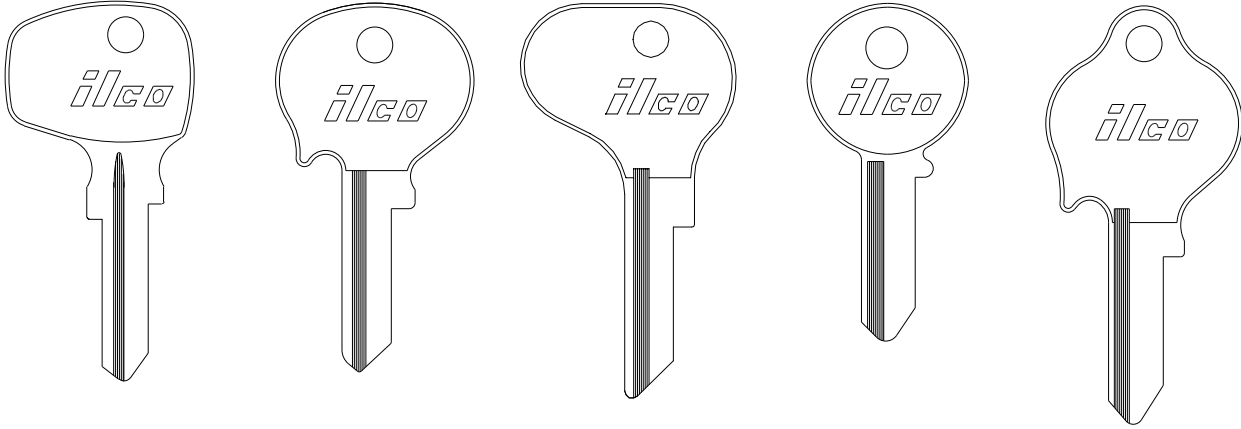

<b>MB5</b>	<b>NE5</b>	<b>NE10</b>	<b>61N</b>	<b>H61VM</b>
—	—	—	—	—

ILCO  
EZ

BORGWARD

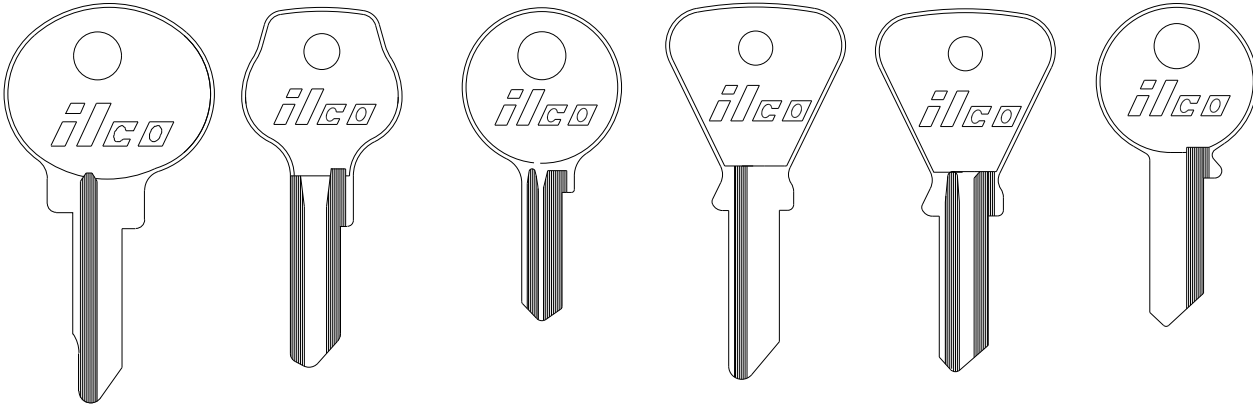

<b>RE61N</b>	<b>62VB</b>	<b>R62VB</b>	<b>62VG</b>	<b>62VH</b>	<b>H62VG</b>	<b>HR62VG</b>	<b>63F</b>
—	—	—	—	—	—	—	—

ILCO  
EZ

BORGWARD                      BOSCH                      B & S/STRATTEC

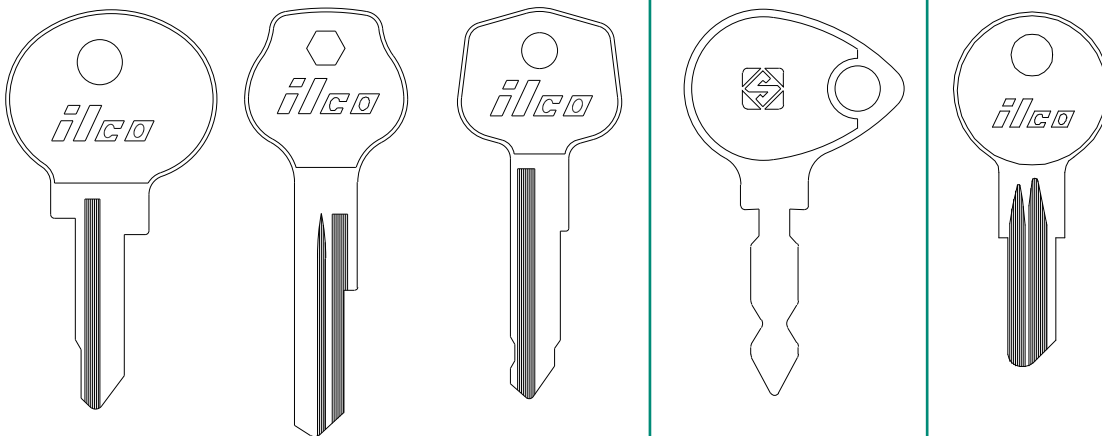

<b>63Q</b>	<b>R63Y</b>	<b>65M</b>	<b>BH12-SI</b>	<b>1098L B3</b>
—	—	—	—	
				<b>1098X</b>
				—
				<b>1098DB</b>
				B5

ILCO  
EZ

BRIGGS & STRATTON / STRATTEC

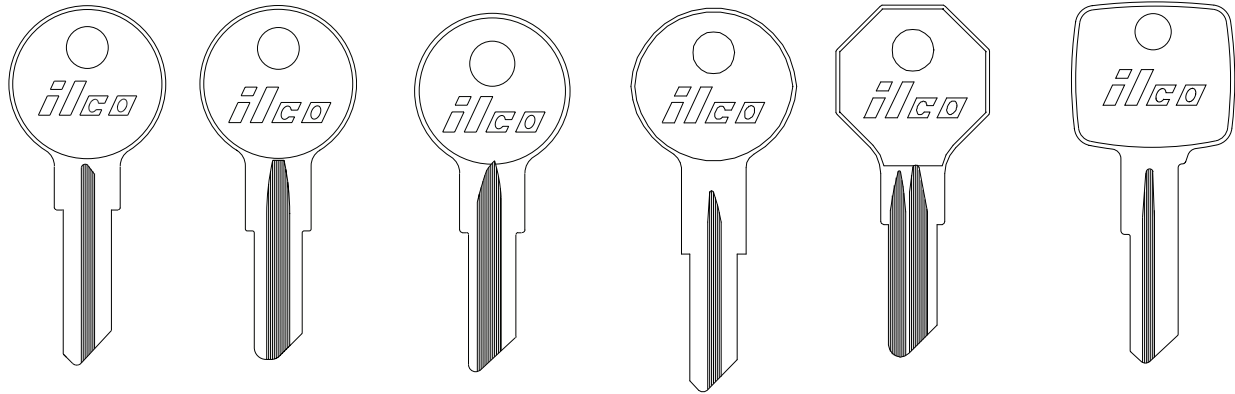

ILCO EZ	1561	1098GM	1098M	1098XL	H1098DB	1595
	—	—	B1	B4	B16	—

BRITISH LEYLAND

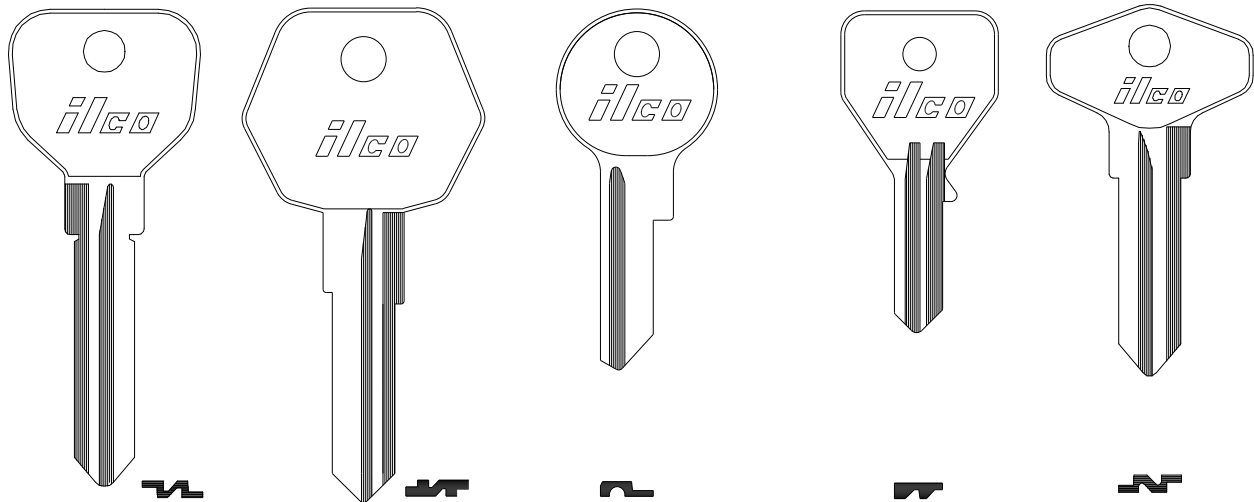

ILCO EZ	MG1	WB2	NE4	BR5	BL6
	—	—	—	—	—

BRITISH LEYLAND

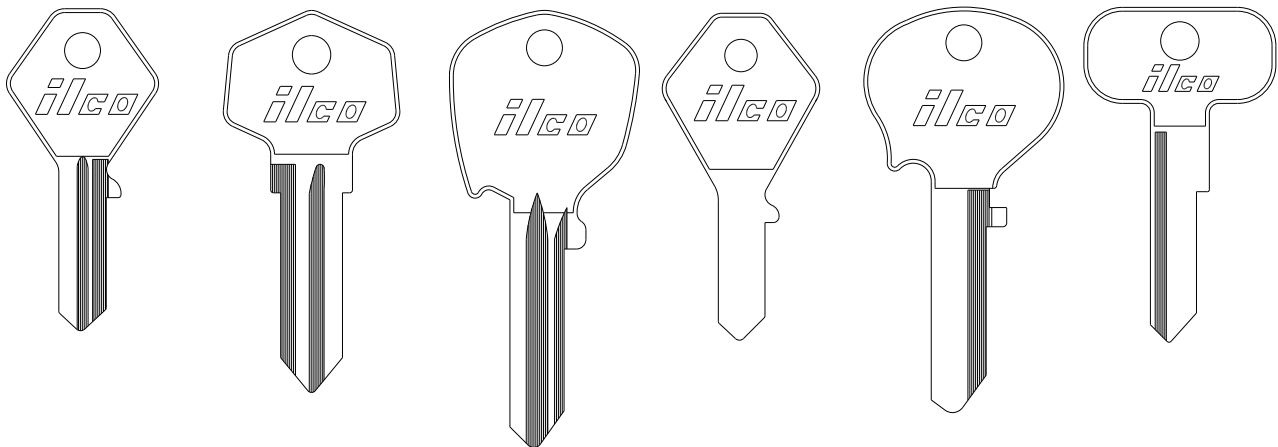

ILCO EZ	BR6	CE6	FT6	FT6R	BR7	NE7	BR9
	—	—	—	F81E	—	—	—

BRITISH LEYLAND

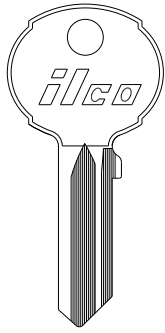

BR13

—

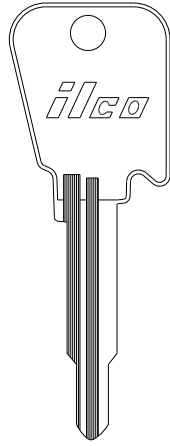

X13

LF4

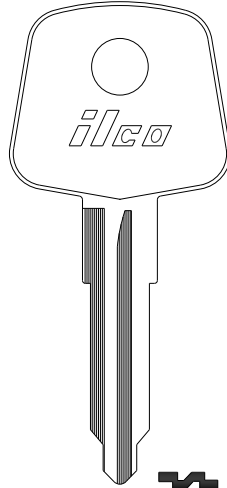

LF15

—



BR16

—

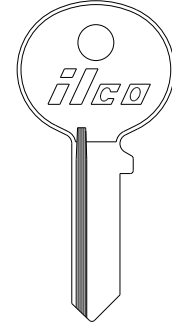

UN16

—

ILCO  
EZ

sec 1 page 16

BRITISH LEYLAND

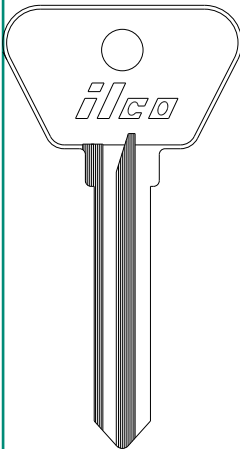

BR20

—

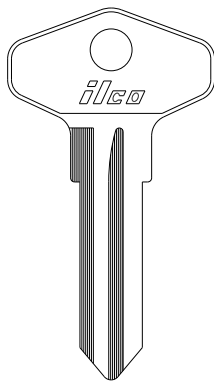

X20

FC2

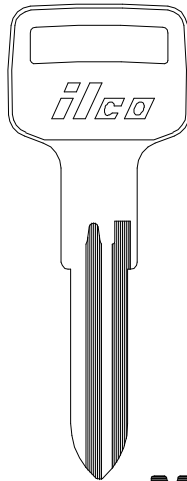

X29

VO73

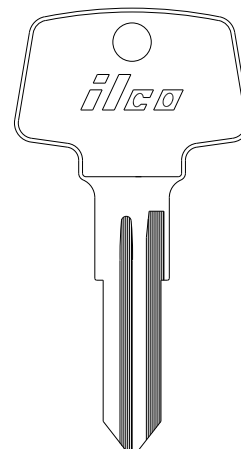

NE49

—

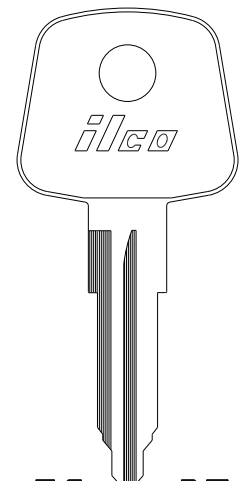

X50

AA3

LF13

—

ILCO  
EZ

BRITISH LEYLAND

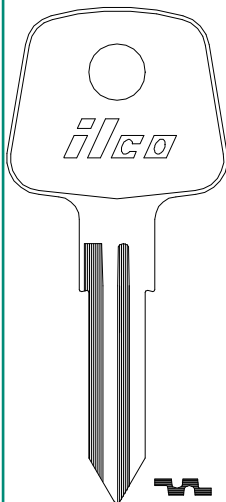

X51

AA2

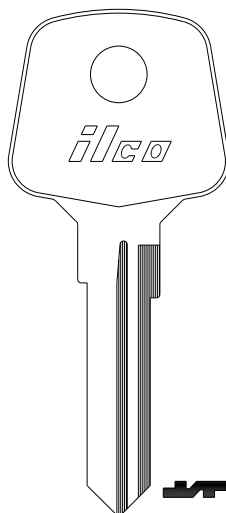

X55

WB1

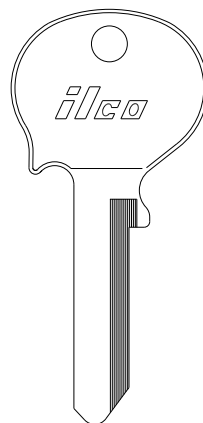

H61VR

—



62DC

—

62DE

—

62DF

—

62DG

—



62DH

—

62DK

—

62DM

—

R62DM

—



62DP

—

F70S

—

M72F

—

ILCO  
EZ

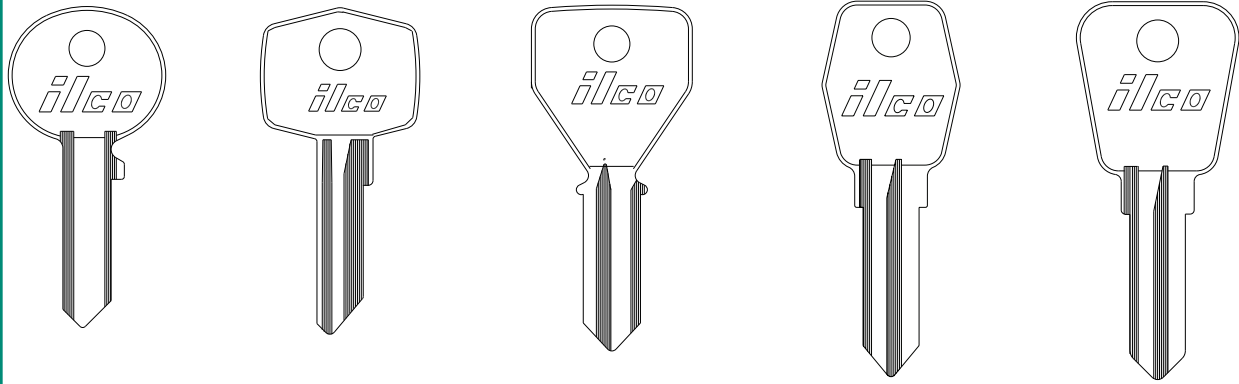
**BRITISH LEYLAND**

ILCO EZ	62DJ	62DS	62DX	62FS	62FE	62FG	62FT
	—	—	—	—	—	—	F68YT

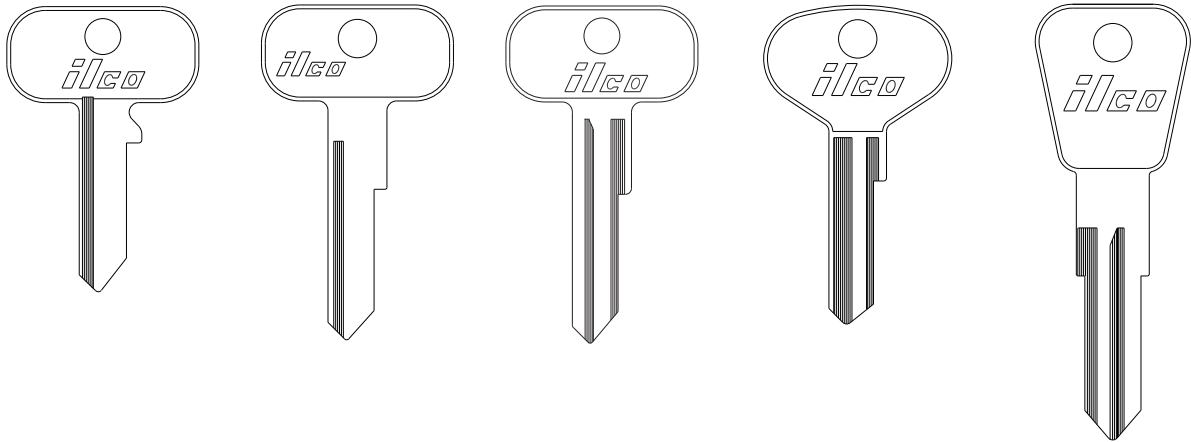
**BRITISH LEYLAND**

ILCO EZ	B62DP	B62DR	H62DP	H62DR	BR18R	HR62DG	L62FD
	—	—	—	—	—	—	—

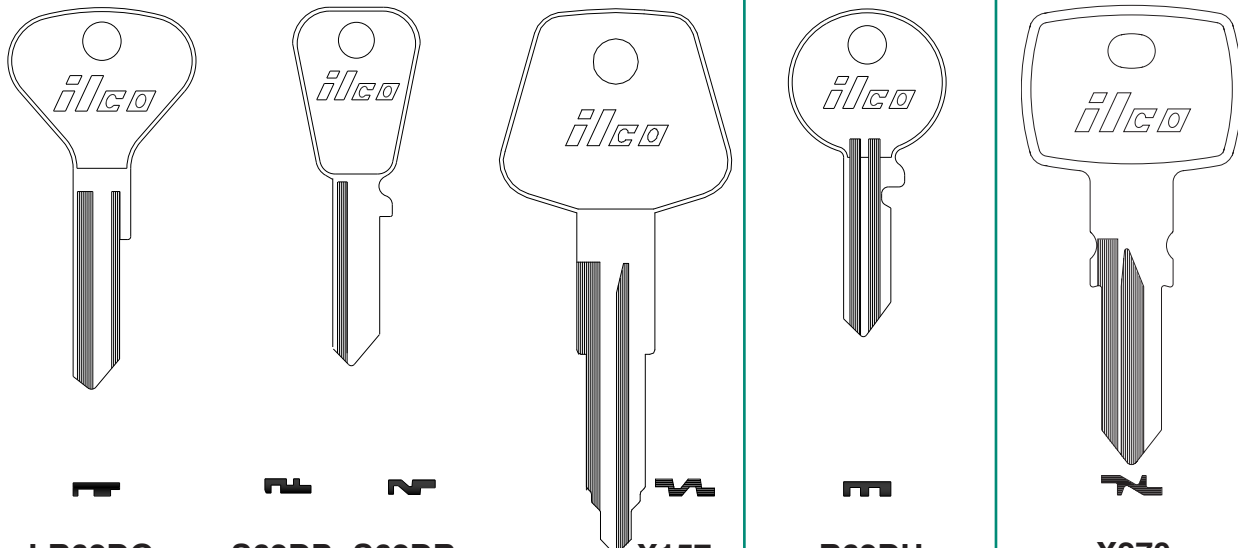
**BRITISH LEYLAND**
**B.S.A.**
**BUELL**

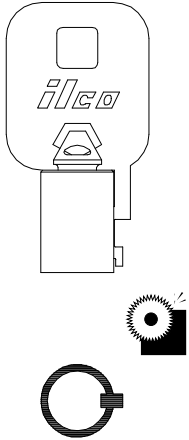
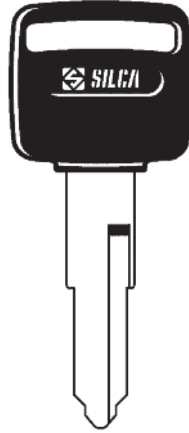
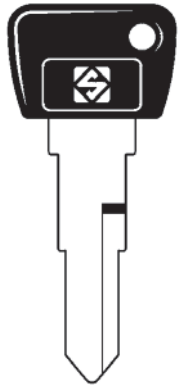

ILCO EZ	LR62DG	S62DP	S62DR	X157	R62DH	X270
	—	—	—	LF17	—	TMC1

BUELL	BUICK	CADILLAC	CAGIVA	
 <p>OD .377" - 9.6mm ID .312" - 7.9mm (BRASS)</p> <p><b>1137B</b></p>	<p><b>SEE GENERAL MOTORS (GM)</b></p>	<p><b>SEE GENERAL MOTORS (GM)</b></p>	 <p><b>ZD21P-SI</b></p>	 <p><b>CG1P-SI</b></p>
—			—	—

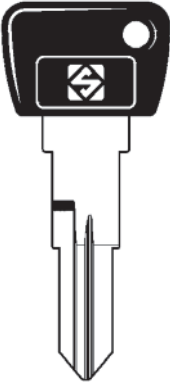
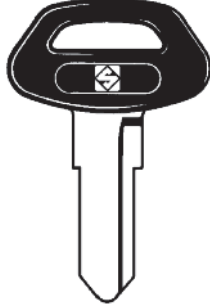
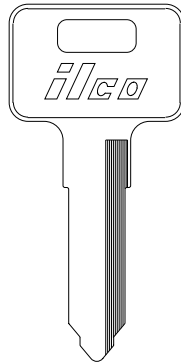
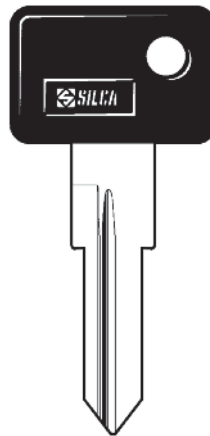
ILCO EZ

CAGIVA			
 <p><b>CG2RP-SI</b></p>	 <p><b>SZ4AP-SI</b></p>	 <p><b>X259</b></p>	 <p><b>ZD16RP-SI</b></p>
—	—	—	—

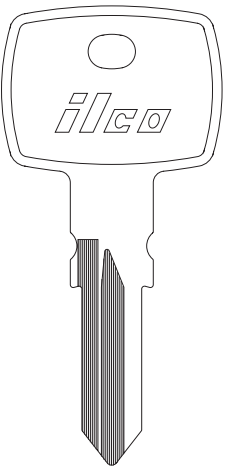
ILCO EZ

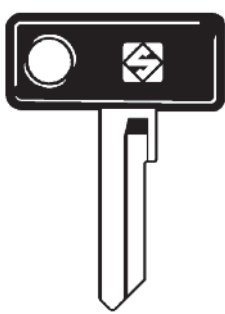
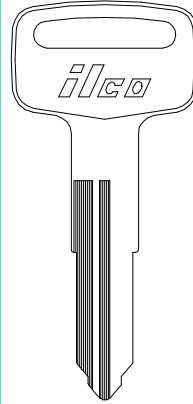
CAGIVA		CAN-AM	
 <p><b>X270</b> TMC1</p>	 <p><b>HD57</b></p>	 <p><b>ZD9P-SI</b></p>	 <p><b>X117</b> YH48</p>
—	—	—	—

ILCO EZ



CAN-AM

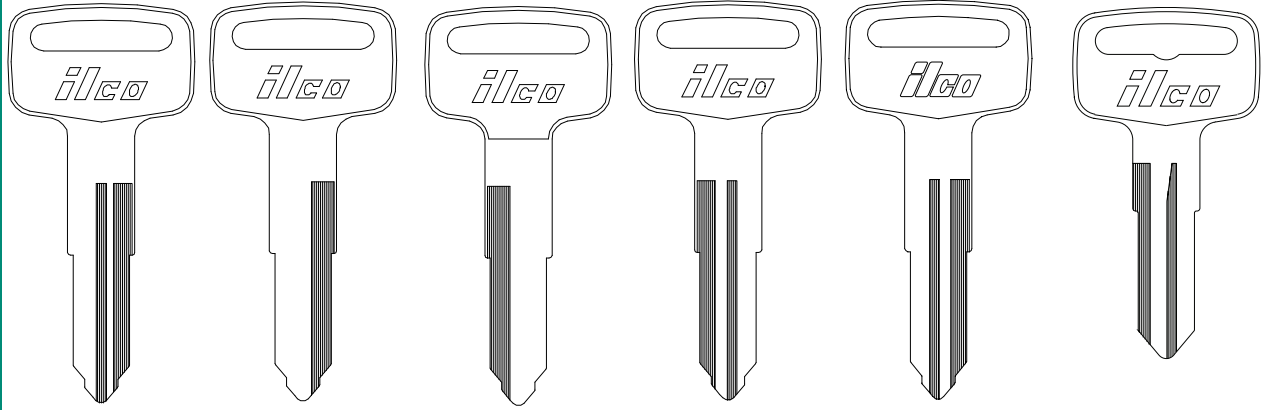

**X118**  
YH49



**X119**  
YH47



**X120**  
YH46



**YH50**  
—



**YH51**  
—



**X111**  
YM55

ILCO  
EZ

CAN-AM

CATERPILLAR

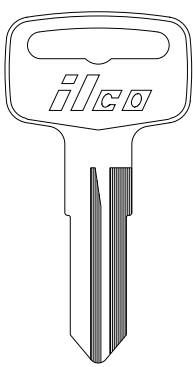

**X112**  
YM56

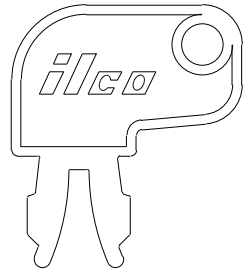

**CNA2**  
—

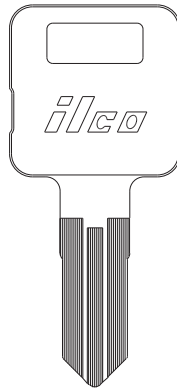

**1560**  
—

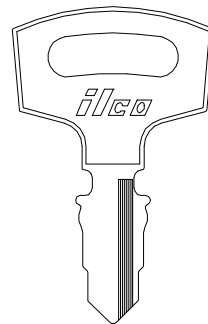

**1583**  
—

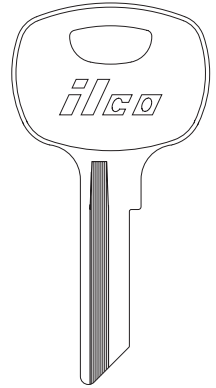

**1641**  
—

ILCO  
EZ

CESSNA

CHEVROLET

CHRYSLER

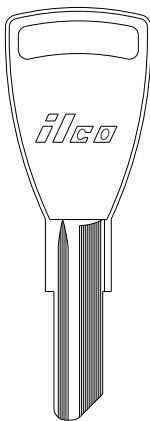

**C1054B**  
—

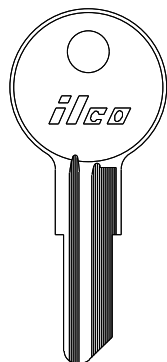

**O1122**  
Y11



**O1122A**  
Y12

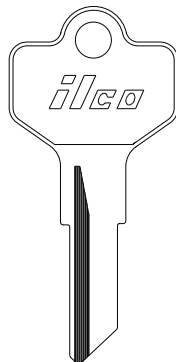

**1664**  
—

**SEE  
GENERAL  
MOTORS  
(GM)**

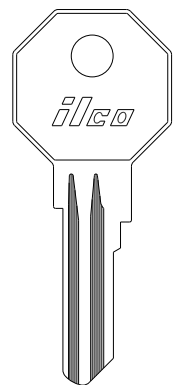

**H199A**  
—

ILCO  
EZ

CHRYSLER

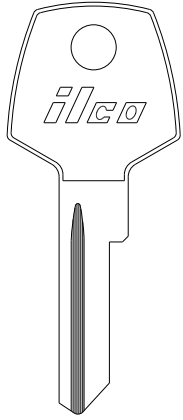

704K

—

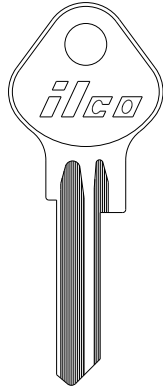

1199C

—

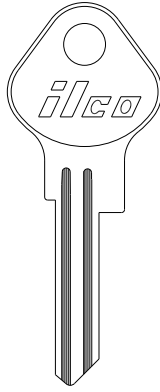

1199D

—

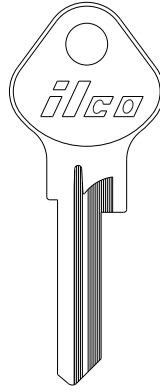

1199DR

—

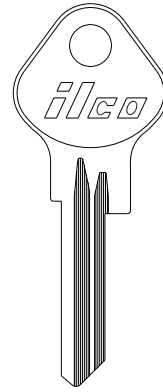

1199E

—

ILCO  
EZ

CHRYSLER

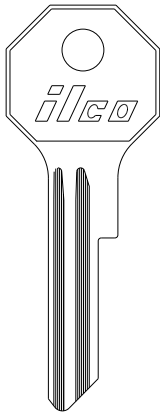

X1199A

—

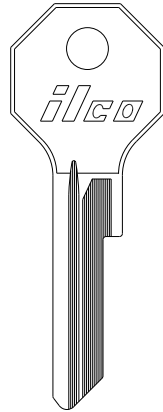

X1199AR

Y133

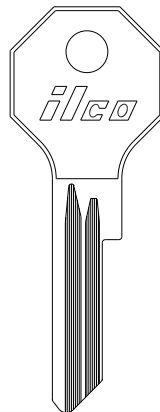

X1199B

—

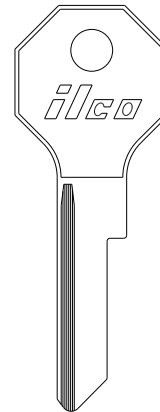

X1199G

—

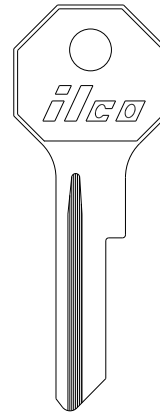

X1199J

—

ILCO  
EZ

CHRYSLER

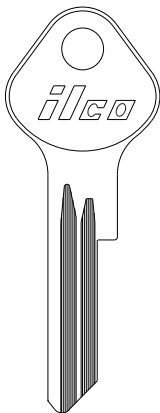

XO1199B

—

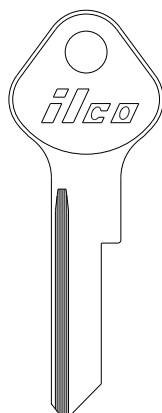

XO1199G

—

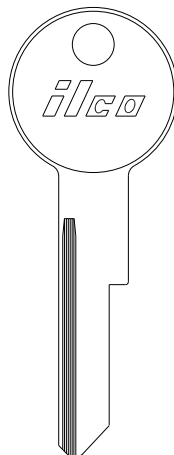

1701G

—

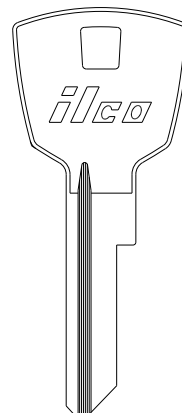

1702K

—

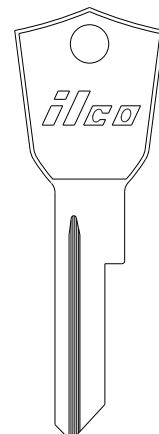

1703K

—

ILCO  
EZ

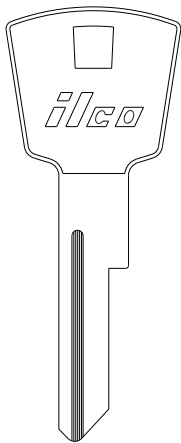
**CHRYSLER**

**1704K**

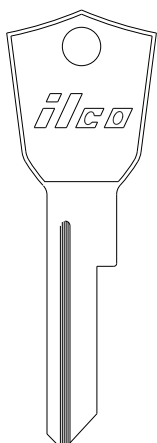
—

**1705K**

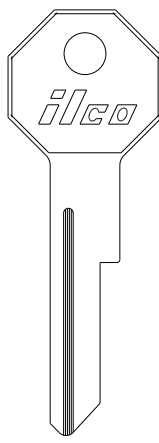
—

**1706K**

—

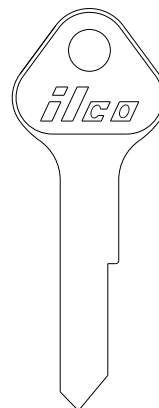
**1759P**

—

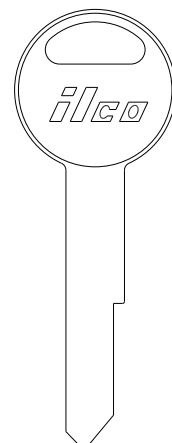
**D1759L**

—

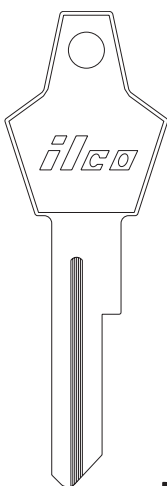
**ILCO  
EZ**
**CHRYSLER**

**1764P**

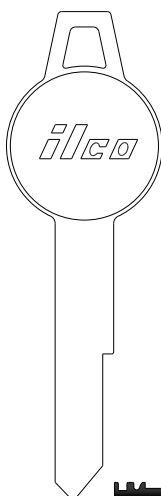
—

**1764S**

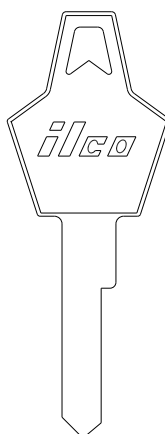
—

**1766DT**

—

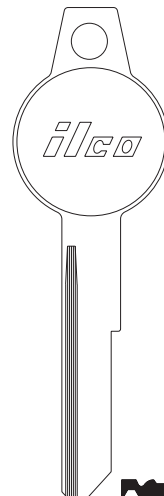
**1766S**

—

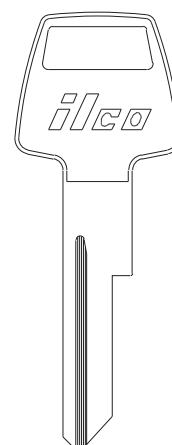
**1767CH**

Y146

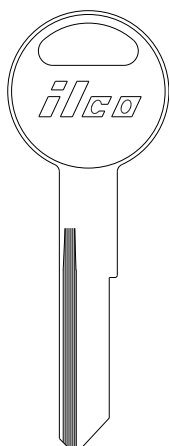
**ILCO  
EZ**
**CHRYSLER**

**S1767CH**

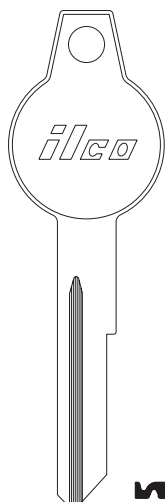
Y138

**1767DT**

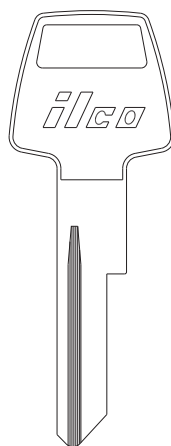
—

**1768CH**

—

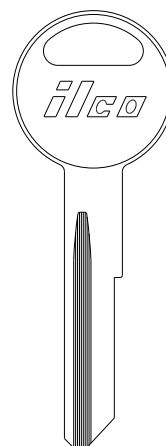
**S1768CH**

—

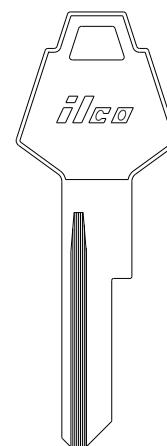
**1769CH**

—

**ILCO  
EZ**

CHRYSLER

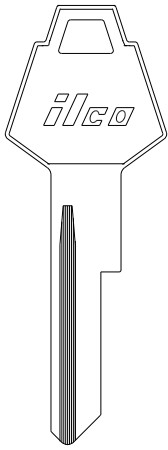

1770CH

—

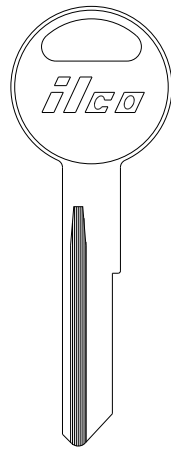

U1770CH

—

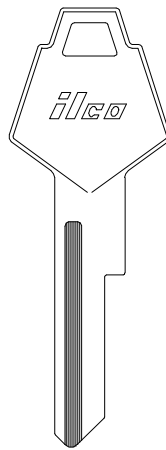

P1770U

Y152

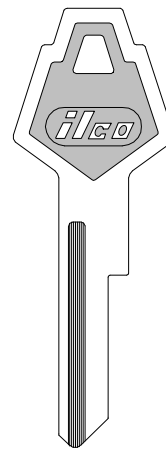

Y152-PC

—

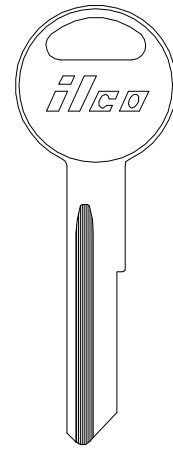

S1770U

Y149

ILCO  
EZ

CHRYSLER

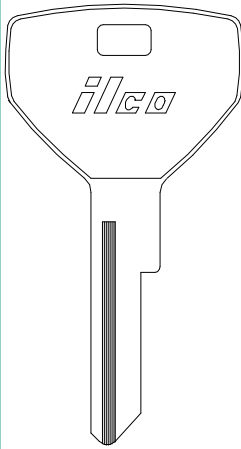

P1786

Y153

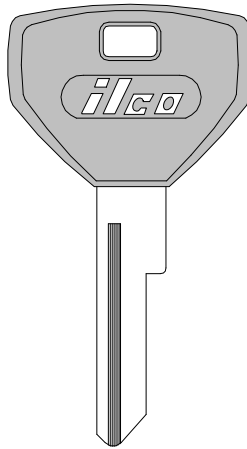

Y153-P

—

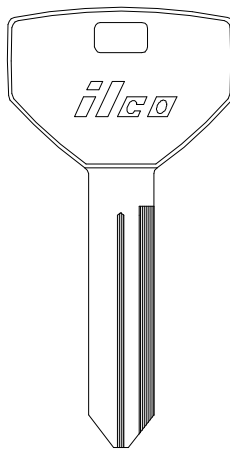

P1789

Y154

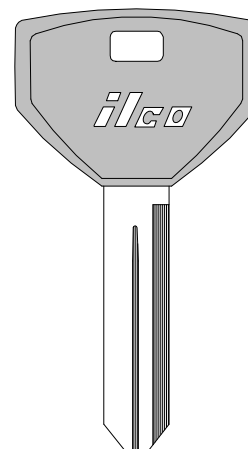

Y154-P (-PC)

—

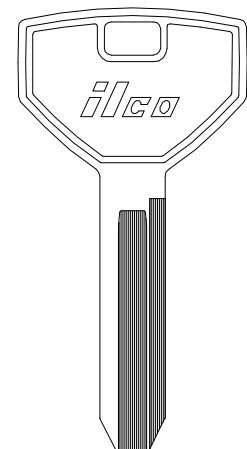

P1793

Y155

ILCO  
EZ

CHRYSLER

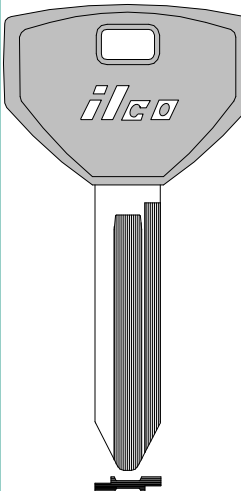

Y155-P (-PC)

—

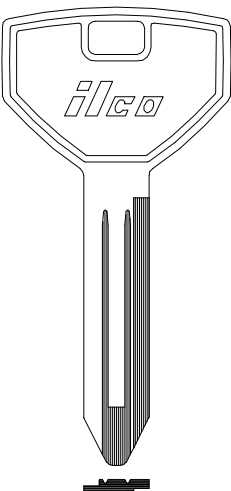

1793V

—

VALET FOR P1793 & Y155-P (-PC)

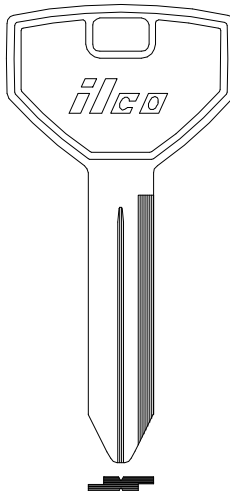

P1794

Y157

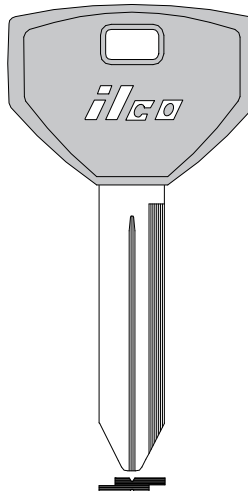

Y157-P (-PC)

—

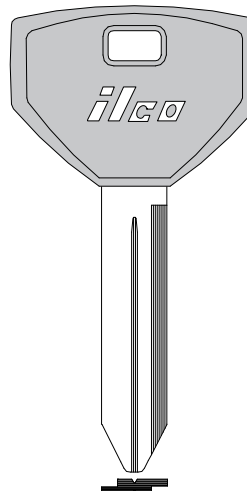

Y157-PC-GRN-N  
(GREEN)

ILCO  
EZ

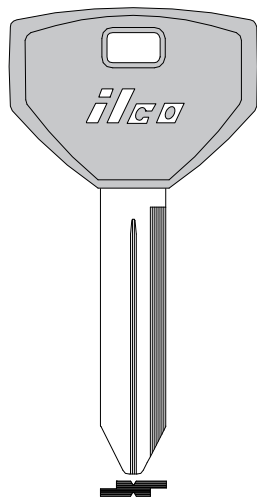
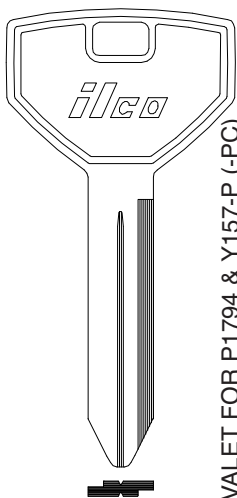
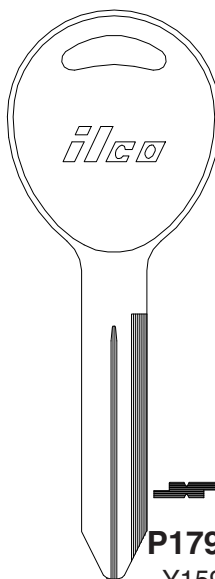
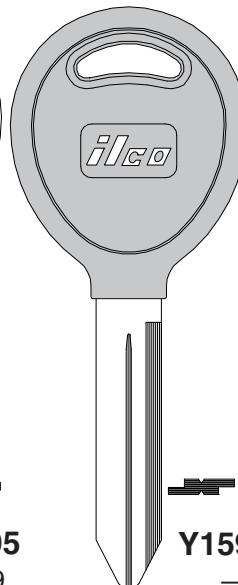
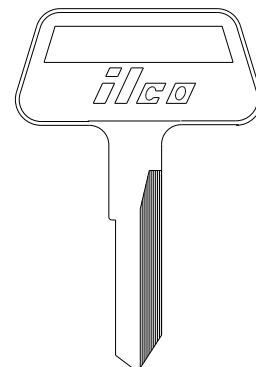
**CHRYSLER**

**ILCO**  
EZ  
**Y157-PC-YEL-N**  
(YELLOW)

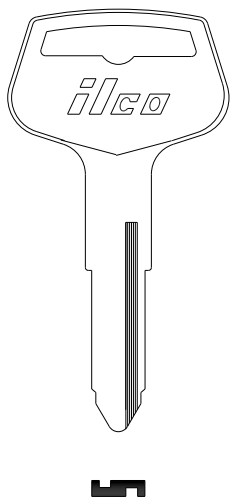
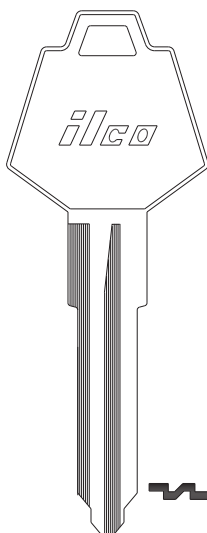
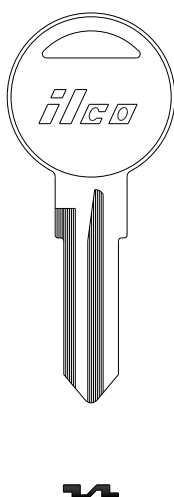
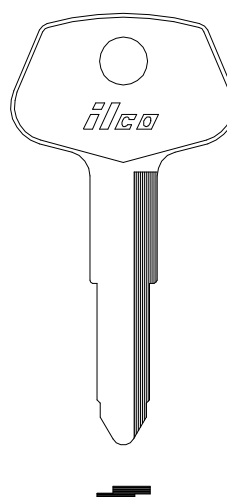
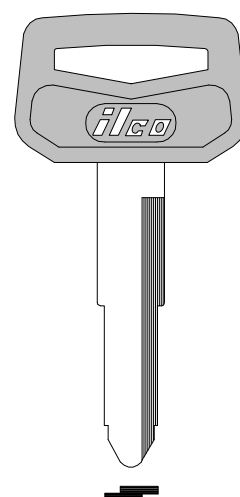
**1794V**  
—

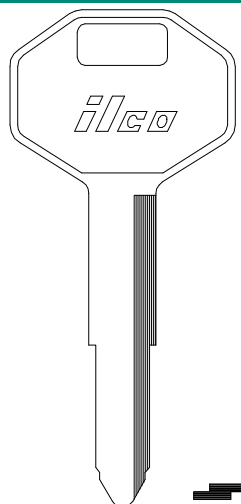
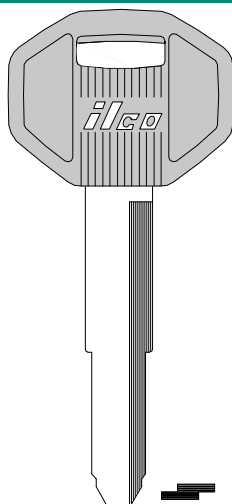
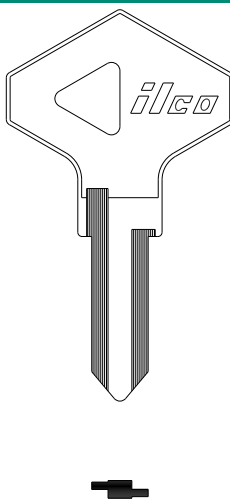
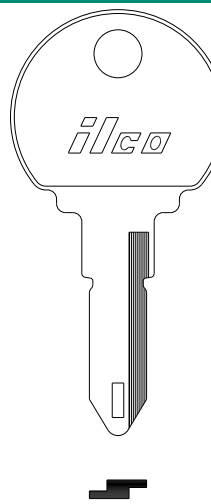
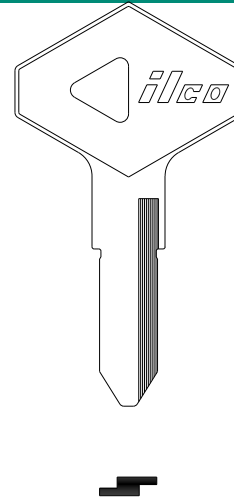
**P1795**  
Y159

**Y159-P**  
—

**MS2**  
—

VALET FOR P1794 &amp; Y157-P (-PC)

**CHRYSLER**

**ILCO**  
EZ  
**MS13**  
—

**X16**  
P1771CR

**X17**  
S1771CR

**X54**  
DC1

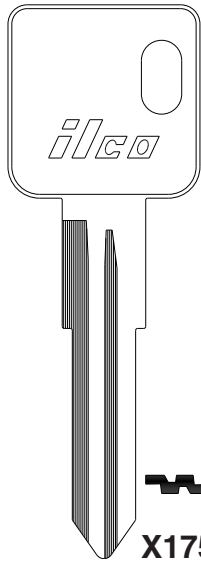
**DC1-P**  
—

**CHRYSLER**

**ILCO**  
EZ  
**X121**  
DC3

**DC3-P (-PC)**  
—

**X122**  
RN29

**X147**  
RN30

**X171**  
RN31

CHRYSLER

VEHICLE

sec 1 page 24



X175  
RN32

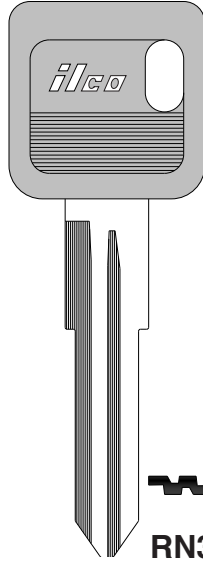

RN32-P  
—

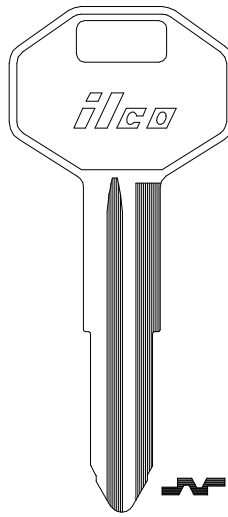

X176  
MIT1

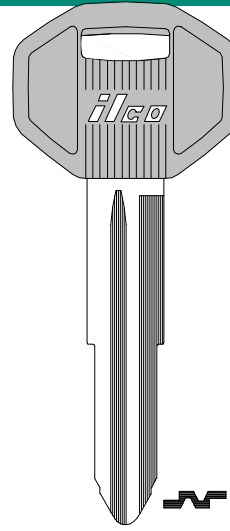

MIT1-P (-PC)  
—

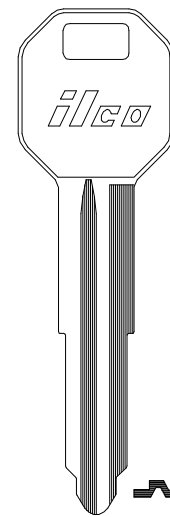

X213  
MIT2

VALET FOR X176 & MIT1-P (-PC)

ILCO  
EZ

CHRYSLER

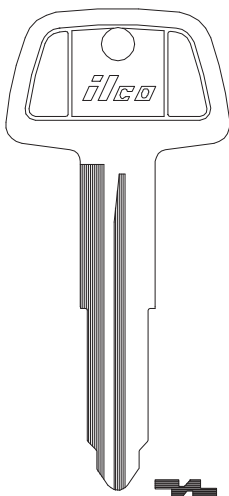

X224  
MIT3

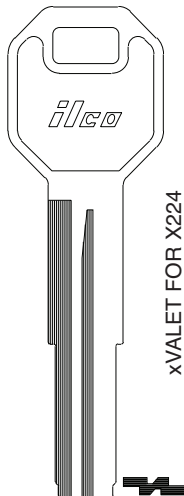

X229  
MIT5

xVALET FOR X224

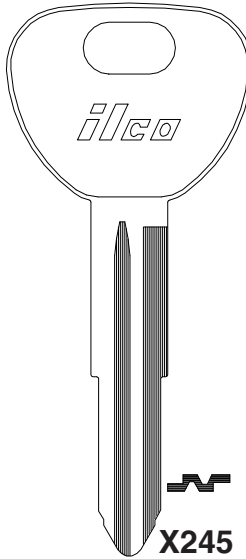

X245  
MIT4

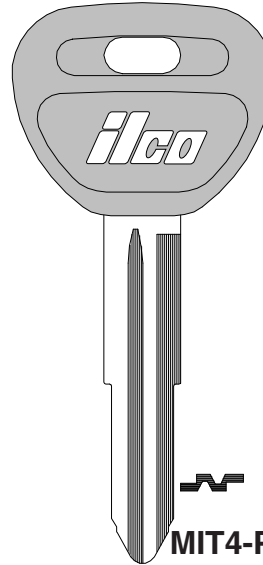

MIT4-P  
—

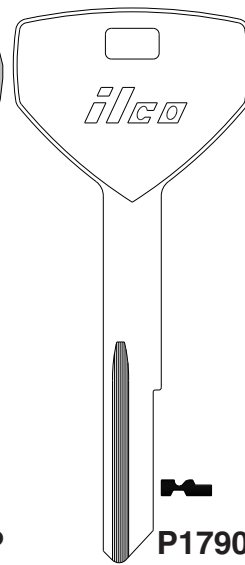

P1790TC  
—

ILCO  
EZ

CHRYSLER

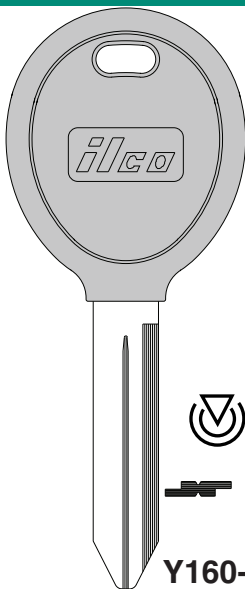

Y160-PT  
—

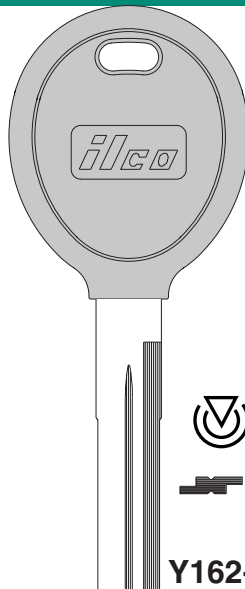

Y162-PT  
—

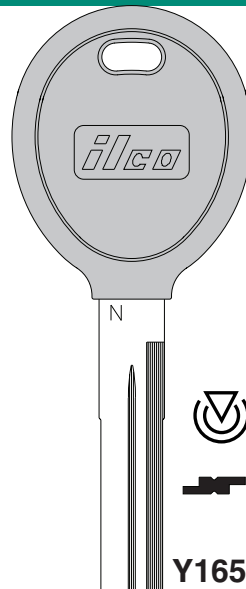

Y165-PT  
—

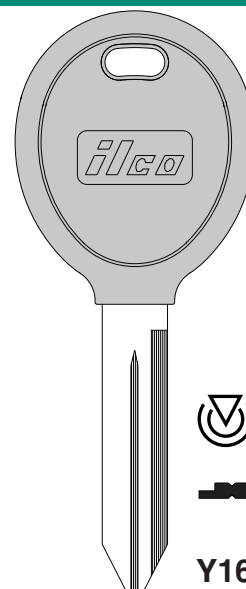

Y164-PT  
—

ILCO  
EZ

CHRYSLER

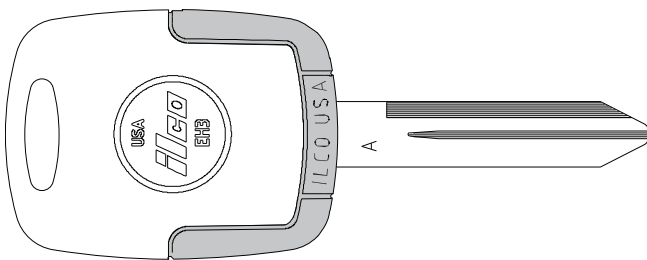

**EH3**  
(Head Only)



**EB3-A-Y160**  
(Blade Only)



**Y160-EK3**  
(Complete Key)

ILCO  
EZ

CHRYSLER

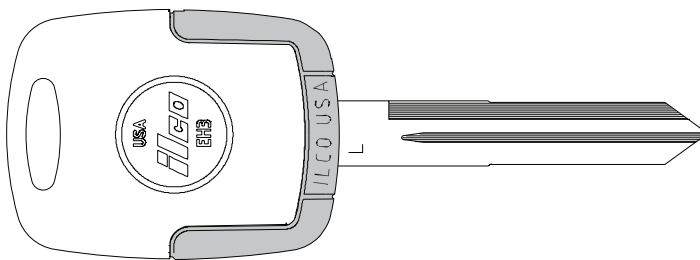

**EH3**  
(Head Only)



**EB3-L-MIT9**  
(Blade Only)



**MIT9-EK3**  
(Complete Key)

ILCO  
EZ

CHRYSLER

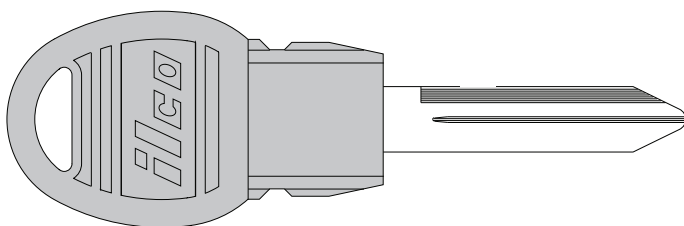

**Y170-PT**  
—

ILCO  
EZ



CHRYSLER

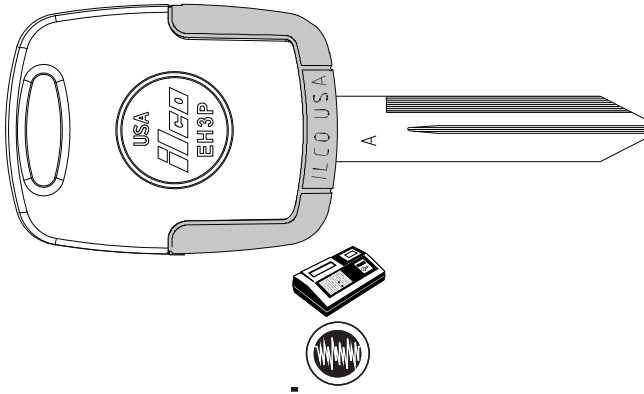

**EH3P**  
(Head Only)

  
**EB3-A-Y160**  
(Blade Only)

**EK3P-Y164**  
(Complete Key)

ILCO  
EZ

CHRYSLER

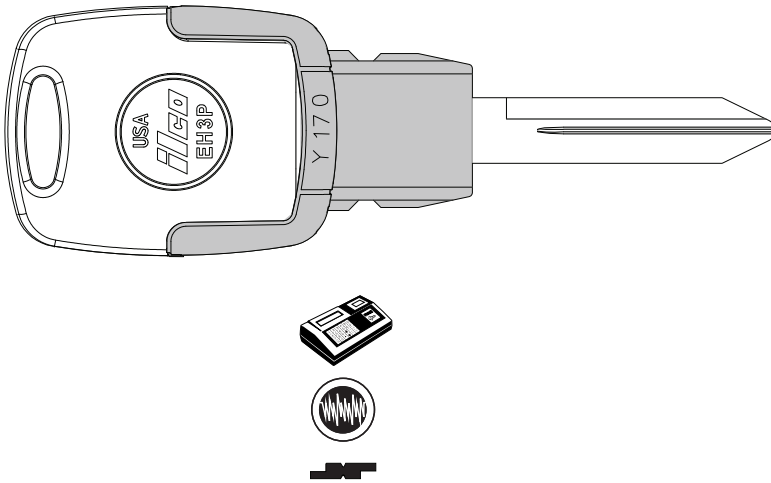

**EH3P**  
(Head Only)

  
**EB3-T-Y170**  
(Blade Only)

**EK3P-Y170**  
(Complete Key)

ILCO  
EZ

CHRYSLER OUTBOARDS

CITROEN

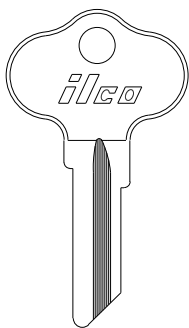

  
**CH4**        
                    **CH8**

  
**CH5**

  
**CH6**

  
**CH3**

  
**CH7**

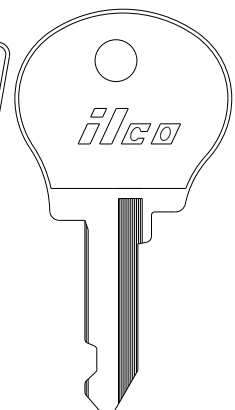
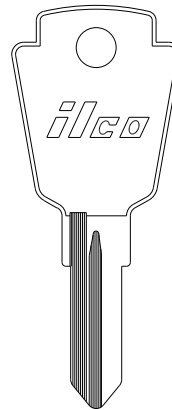
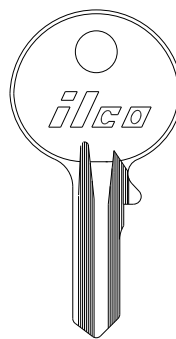
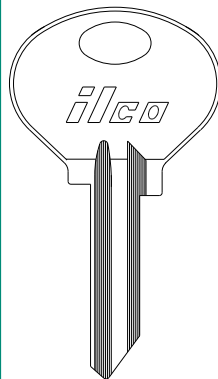

  
**SM1**

  
**SM2**

  
**7DC**

  
**R7DC**

  
**SMS8**

  
**NE18**

ILCO  
EZ

CITROEN

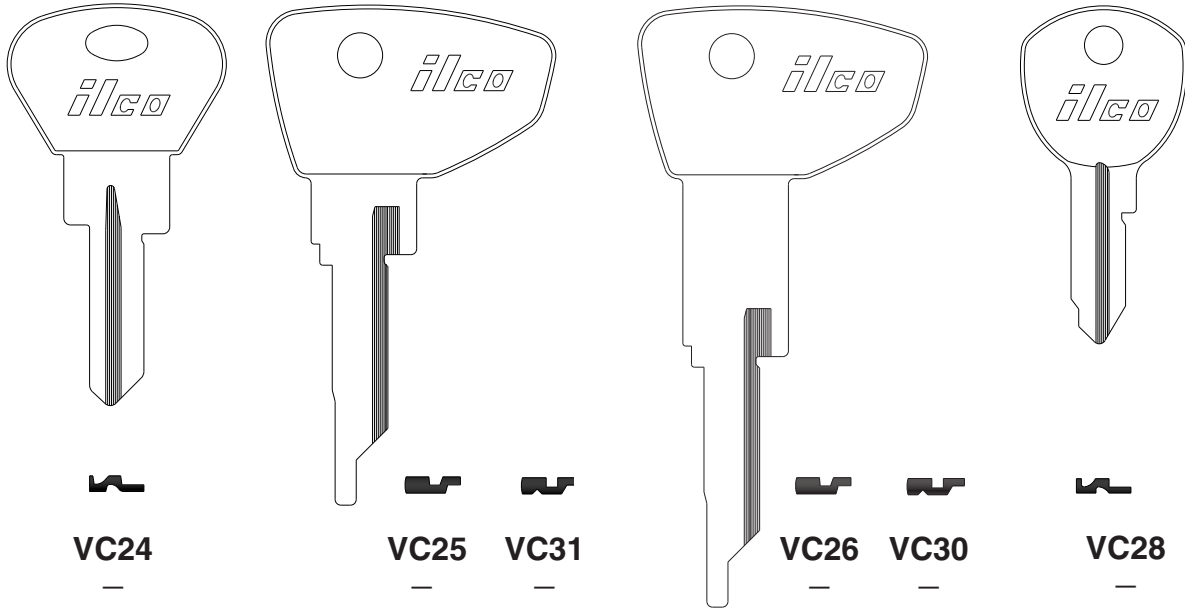

ILCO  
EZ

VC24  
—

VC25 VC31  
— —

VC26 VC30  
— —

VC28  
—

CITROEN

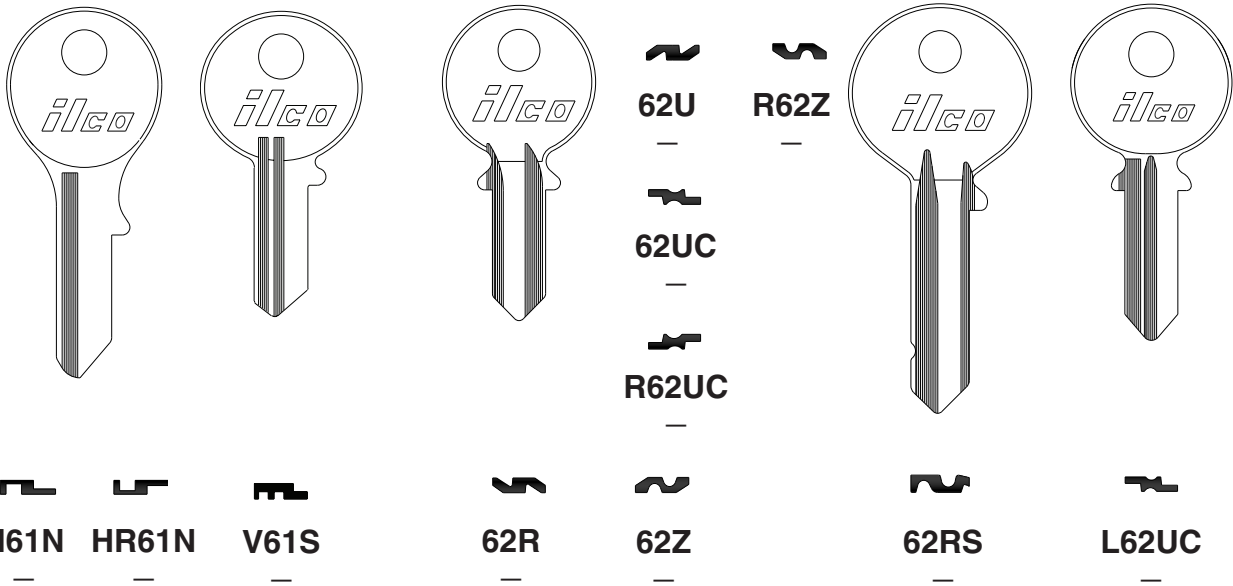

ILCO  
EZ

H61N HR61N  
— —

V61S  
—

62R  
—

62U  
—

R62Z  
—

62UC  
—

R62UC  
—

62Z  
—

62RS  
—

L62UC  
—

CITROEN

THE CLUB

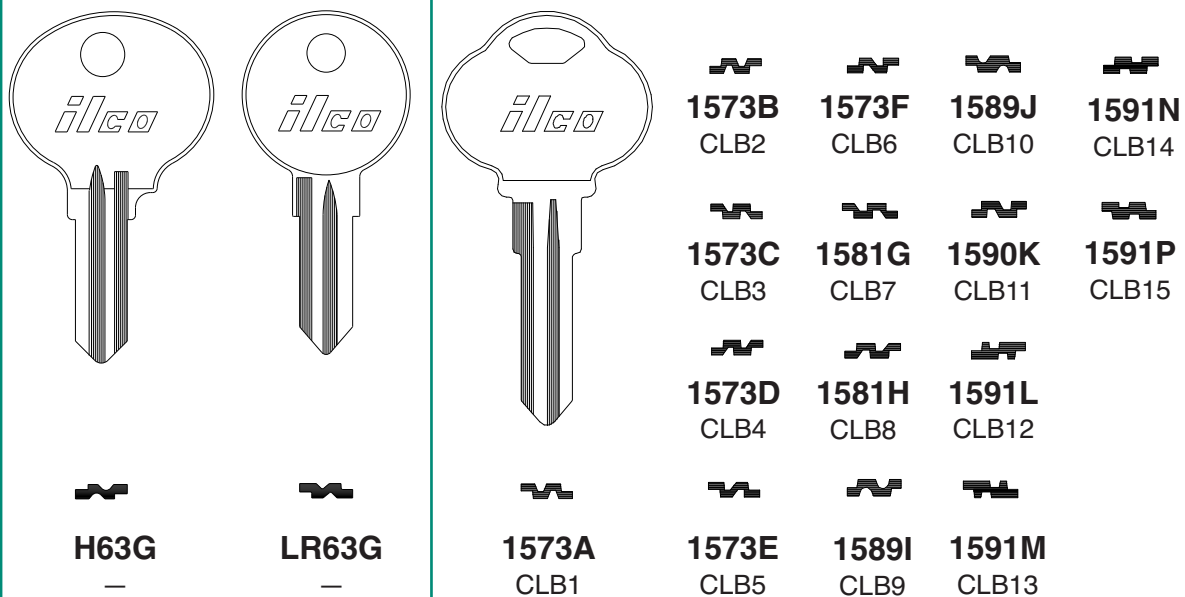

ILCO  
EZ

H63G  
—

LR63G  
—

1573A  
CLB1

1573B  
CLB2

1573C  
CLB3

1573D  
CLB4

1573E  
CLB5

1573F  
CLB6

1581G  
CLB7

1581H  
CLB8

1589I  
CLB9

1589J  
CLB10

1590K  
CLB11

1591L  
CLB12

1591M  
CLB13

1591N  
CLB14

1591P  
CLB15

CLUM INBOARD MOTORS

VEHICLE

sec 1 page 28

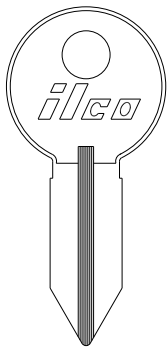

1040

—



1040A

—

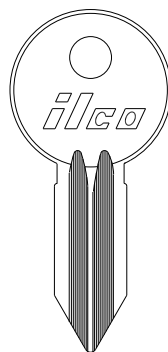

1040B

—

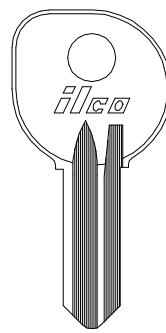

1040C

—

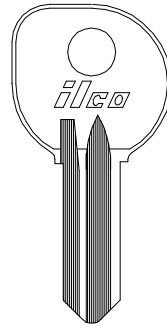

R1040C

—

ILCO  
EZ

CLUM INBOARD MOTORS

COSMOPOLITIAN

D.A.F.

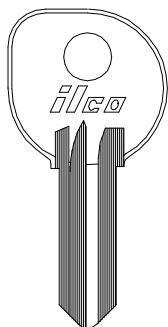

1040E

—

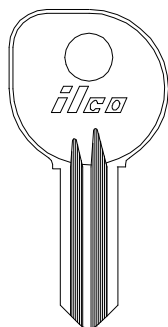

R1040E

—

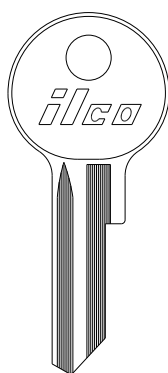

GE7

—

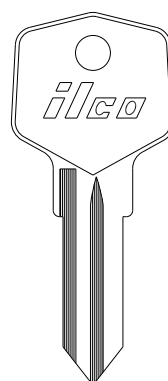

CA2

—

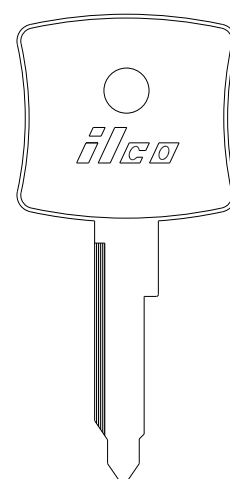

HF41

—

ILCO  
EZ

D.A.F.

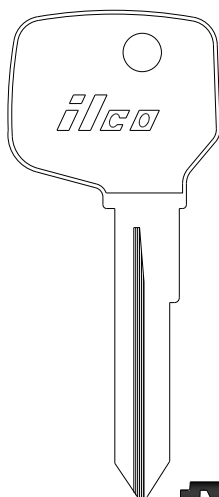

HF43

—

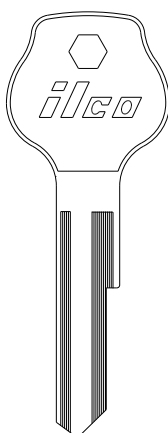

L62VA

—

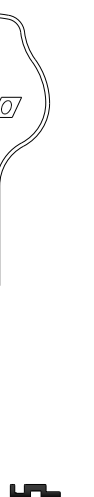

LR62VA

—

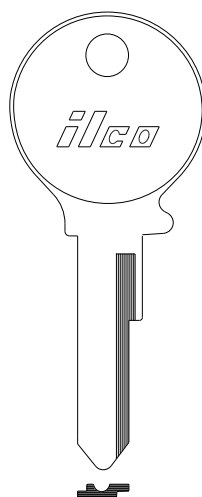

VW64T

—

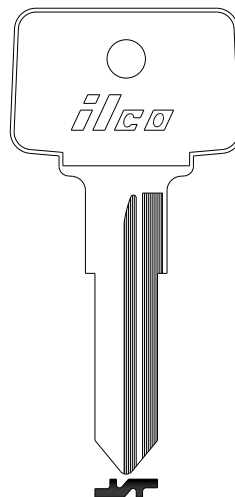

X81

HF46

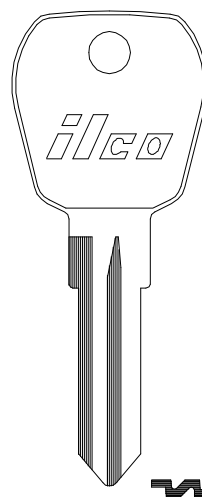

X86

FC7

ILCO  
EZ

D.A.F.

D. K. W.

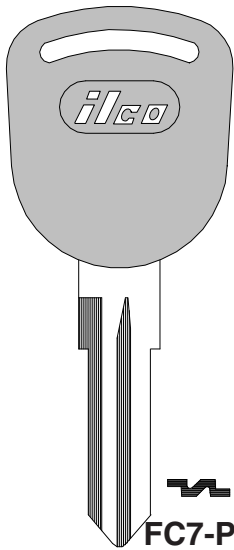

**FC7-P**  
—

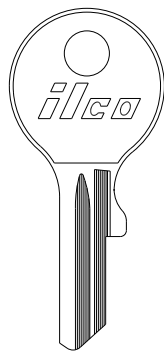

**BU1**  
—

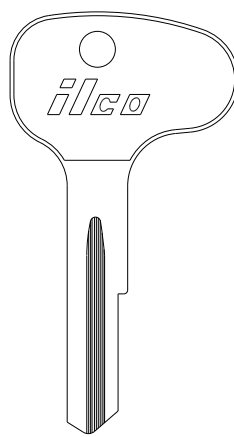

**BU2**  
—

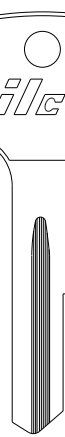

**PR1**  
—

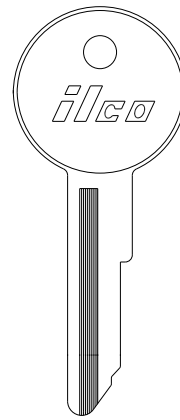

**WT1**  
—

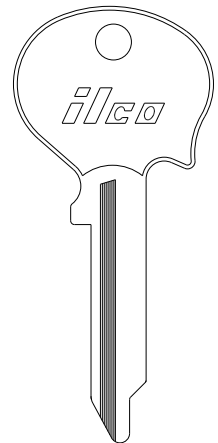

**NE2**  
—

ILCO  
EZ

VEHICLE

sec 1 page 29

D. K. W.

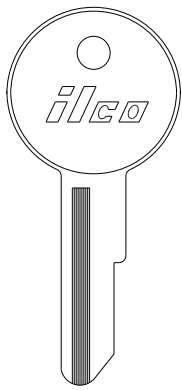

**WT2**  
—

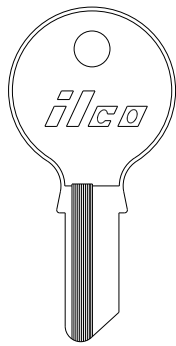

**DK3**  
—

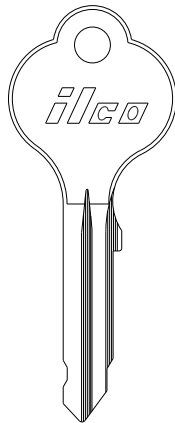

**YM3**  
—



**61N**  
—

**61NA**  
—

**R61NA**  
—

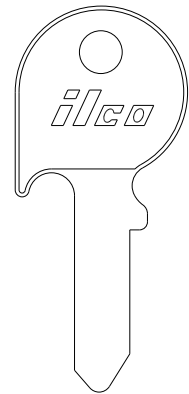

**H61NA**  
—

**HR61NA**  
—

ILCO  
EZ

D. K. W.

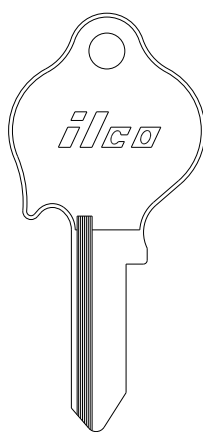

**H61VM**  
—

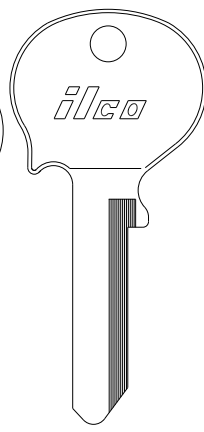

**H61VO**  
—

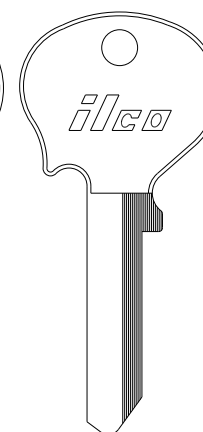

**H61VR**  
—

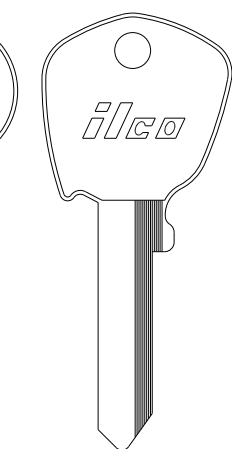

**R61N**  
—



**T61VR**  
—

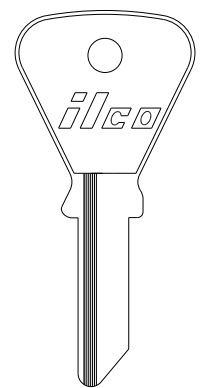

**62VG**  
—

ILCO  
EZ

**62VH**  
—

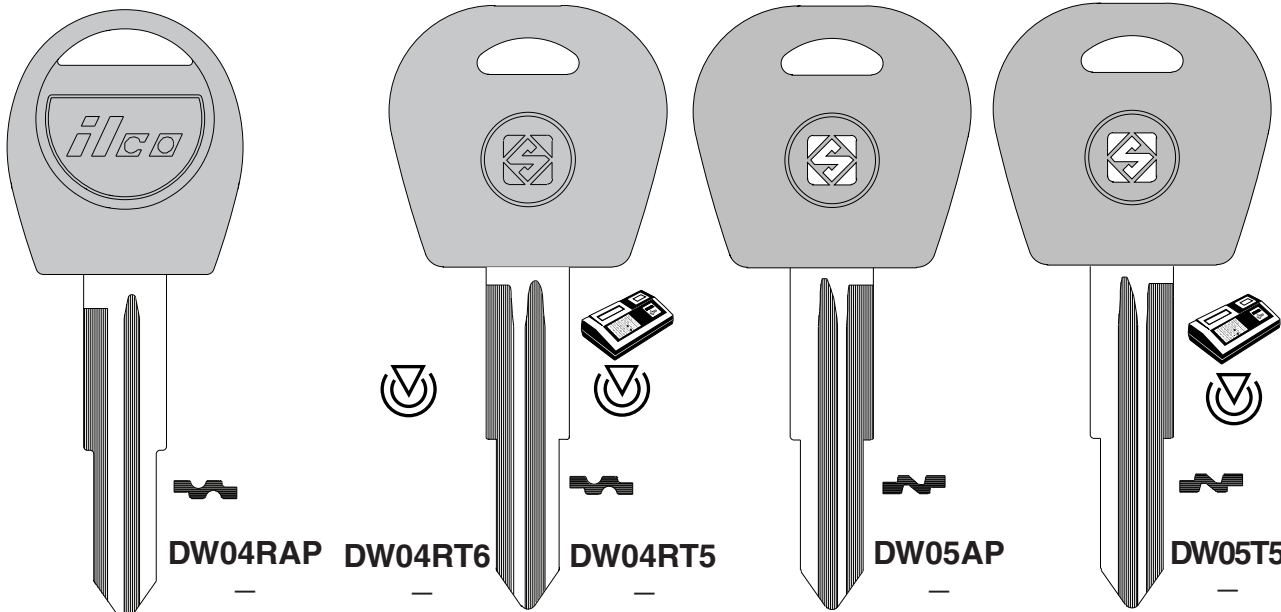

## DAEWOO

 ILCO  
EZ

DW04RAP

DW04RT6

DW04RT5

DW05AP

DW05T5

## DAIHATSU

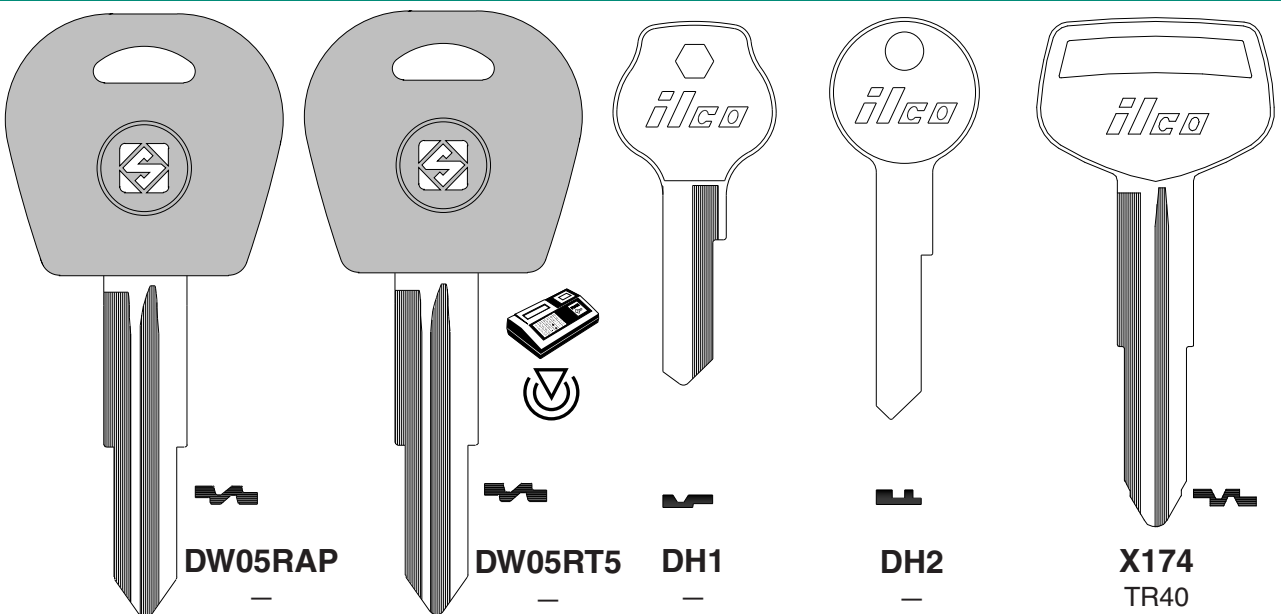
 ILCO  
EZ

DW05RAP

DW05RT5

DH1

DH2

 X174  
TR40

## DAIHATSU

## DATSUN

## DENZAL

## DERBI

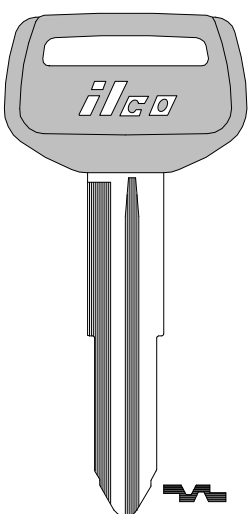
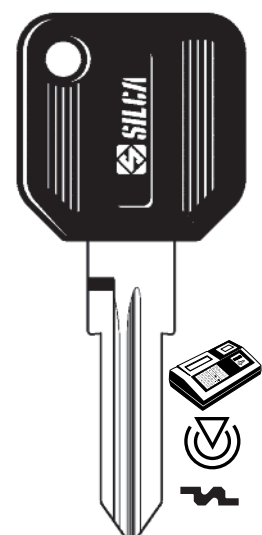
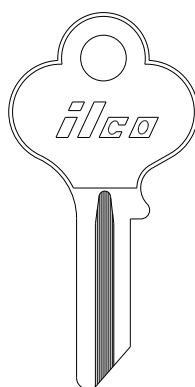
 SEE  
NISSAN

 ILCO  
EZ

TR40-P (-PC)

FV1

ZD24RDP-SI

GT15RDT5-SI

DERBI DIAMOND REO DODGE DUCATI

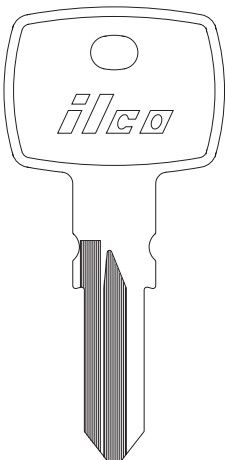

**X270**  
TMC1

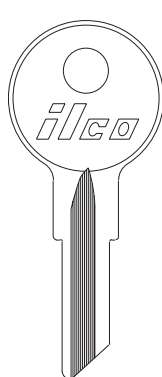

**1098M**  
B1

**SEE CHRYSLER**

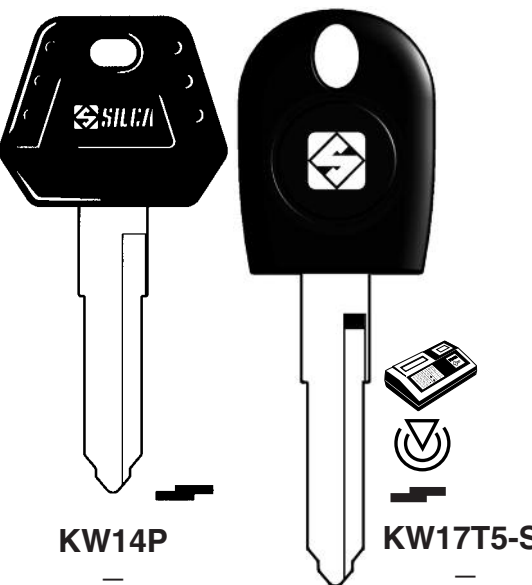

**KW14P**  
—

**KW17T5-SI**  
—

ILCO  
EZ

DUCATI EAGLE ESCURRA EVINRUDE MOTORS

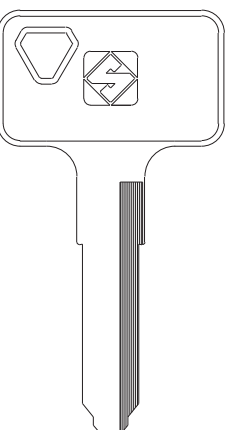

**X259**  
KW14

**SEE CHRYSLER**

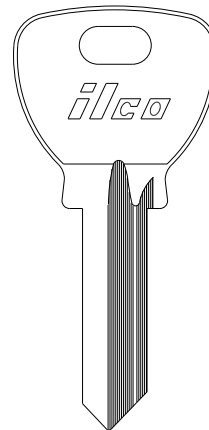

**ES1**    **ES1R**  
—        —

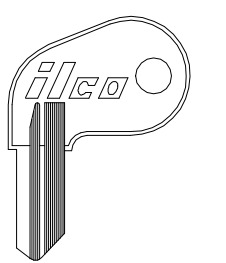

**OM10**  
—

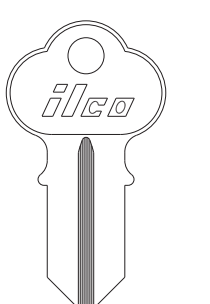

**1041G**  
CG1

ILCO  
EZ

EVINRUDE MTRS FERRARI



**1041GA**  
CG2

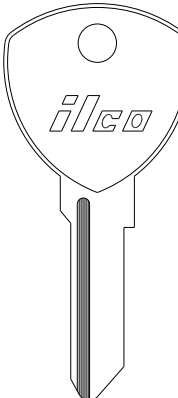

**GT2**    **GT3**  
—        —

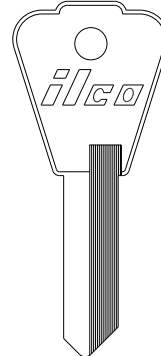

**LN4**  
—

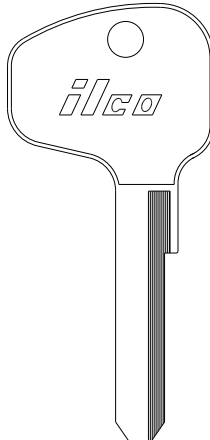

**NE8**  
—

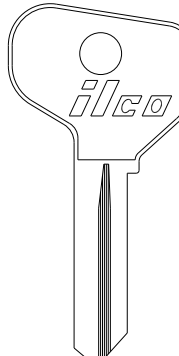

**FT37**    **FT38**  
—        —

ILCO  
EZ

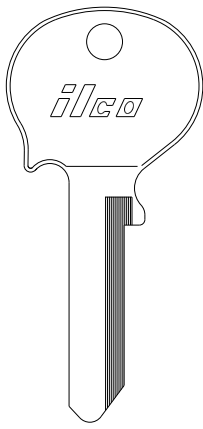

**FERRARI**
**FIAT**

**H61VR**  
—

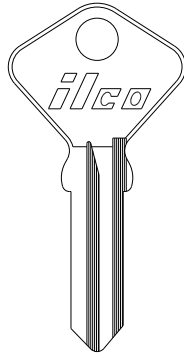

**F91C**  
—

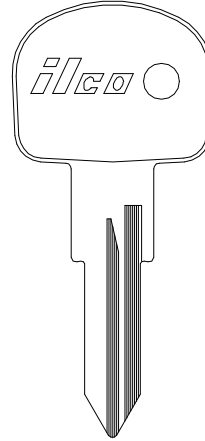

**X152**  
FT46

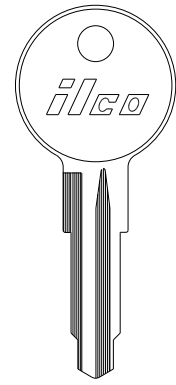

**FS1**  
—

ILCO  
EZ

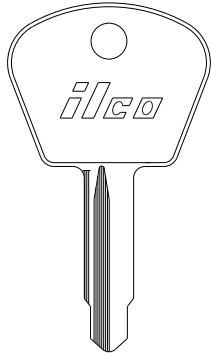
**FIAT**

**SP1**   **SP2**  
—   —

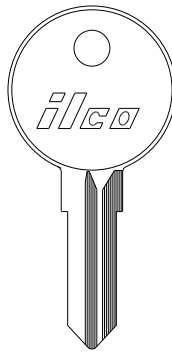

**TR1**  
—

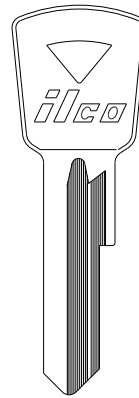

**WS1**   **WS3**  
—   —

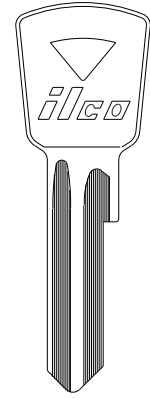

**WS2**   **WS4**  
—   —

ILCO  
EZ

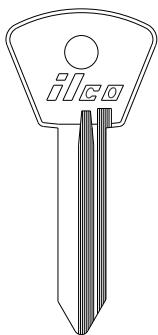
**FIAT**

**AL3**  
—

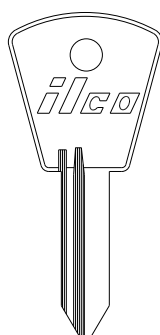

**AL4**  
—

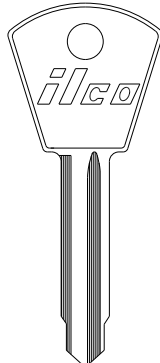

**SP5**  
—

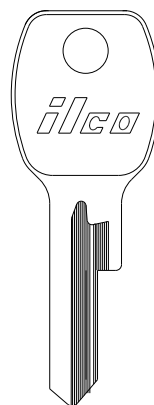

**WS5**  
—

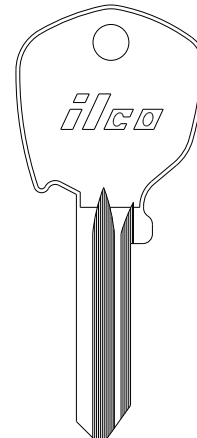

**FT6**  
—

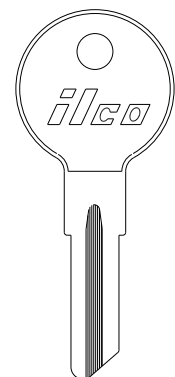

**FT6R**  
F81E

**LA6**  
—

ILCO  
EZ

FIAT

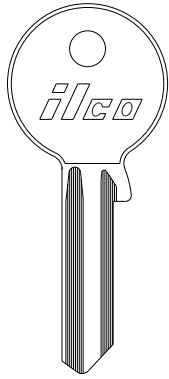

WS6  
—

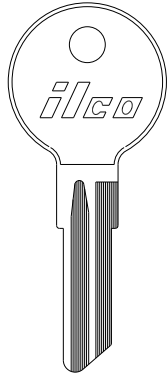

LA7  
—

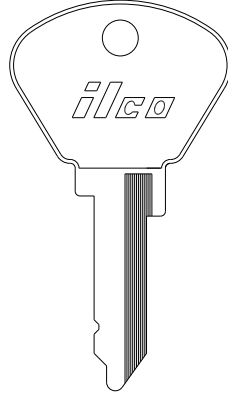

NE9  
—

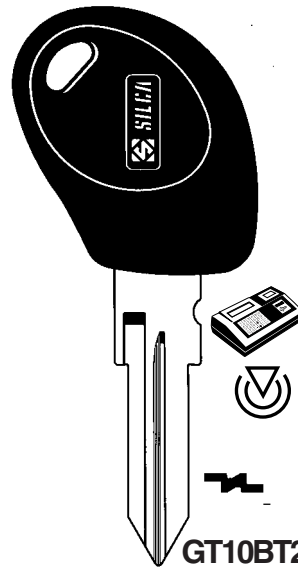

GT10BT2/5  
—

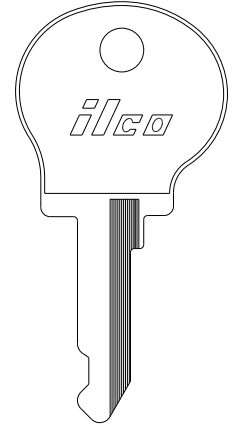

NE13  
—

ILCO  
EZ

FIAT

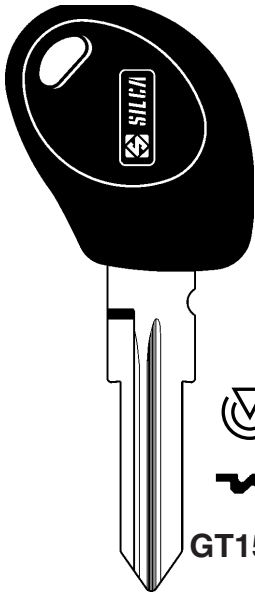

GT15RBT2/5  
—

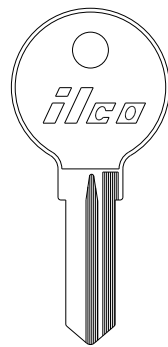

F22  
—

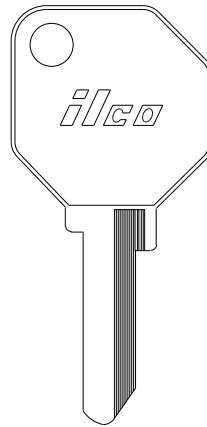

NE23  
—

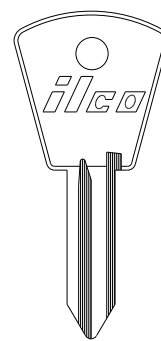

F33  
—

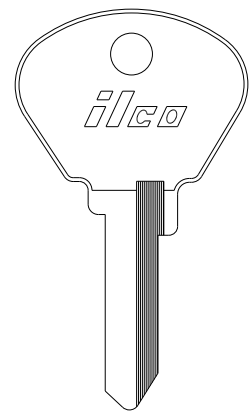

F44  
—

ILCO  
EZ

FIAT

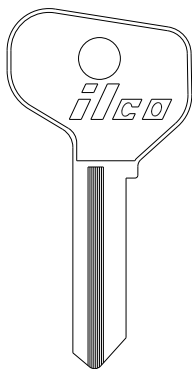

F54  
—

FT37  
—  
FT38  
—

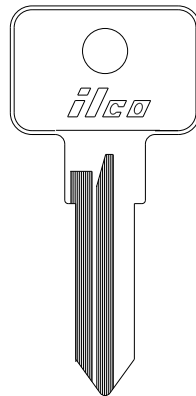

NE54  
—

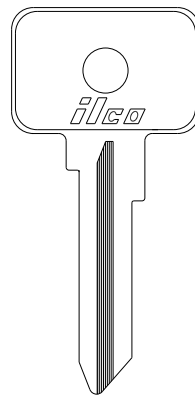

NE55  
—

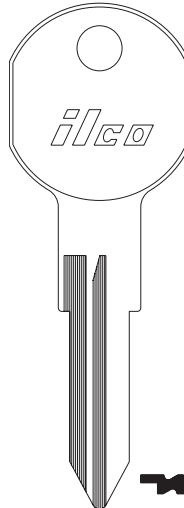

NE56  
—

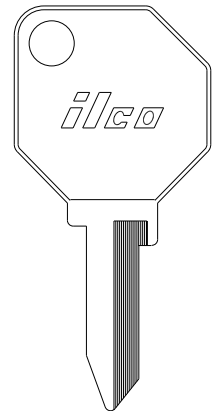

NE57  
—

ILCO  
EZ

## FIAT

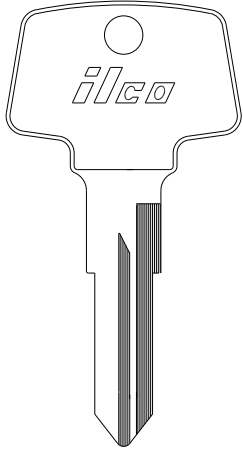
**NE59**

—

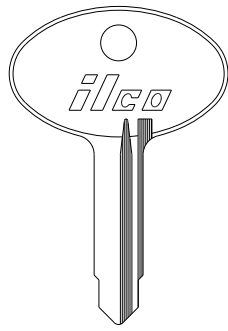
**61D**

—

**R61D**

—

**61E**

—

**61TS**

—

**R61E**

—

**R61TS**

—

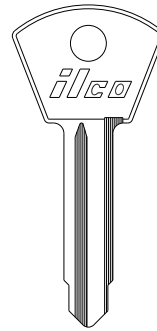
**61F**

—

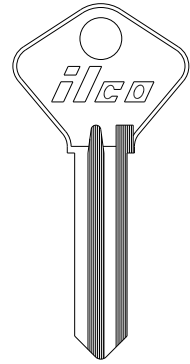
**61G**

—

**R61G**

—

 ILCO  
EZ

## FIAT

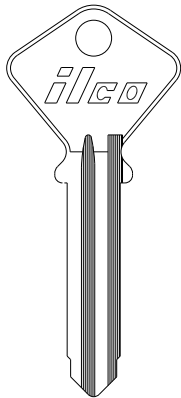
**61GA**

—

**R61GA**

—

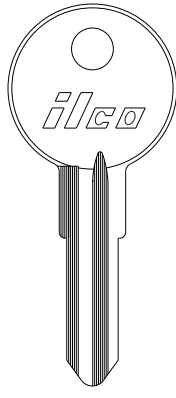
**61H**

—

**R61H**

—

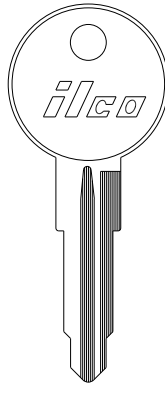
**61J**

—

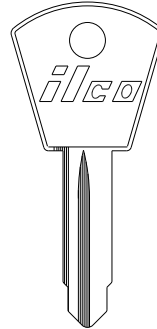
**DR61F**

—

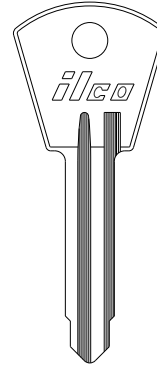
**H61G**

—

  
**L61D**

—

  
**LR61D**

—

 ILCO  
EZ

## FIAT

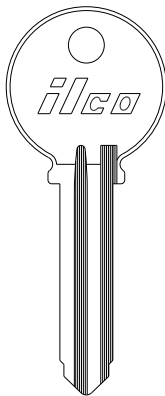
**L61G**

—

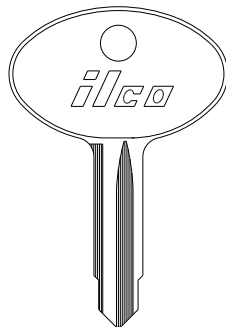
**LR61G**

—

**R61ST**

—

**R62TS**

—

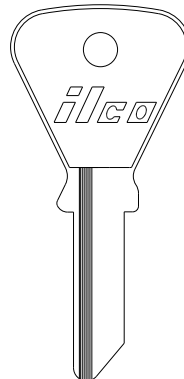
**62VH**

—

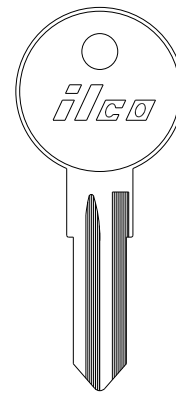
**Y62**

—

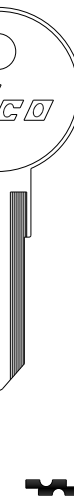
**YR62**

—

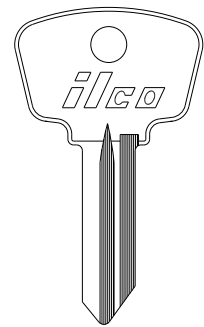
**63SP**

—

**R63SP**

—

 ILCO  
EZ

FIAT

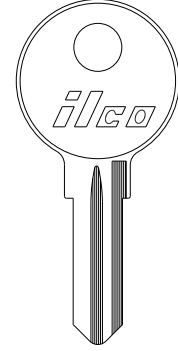
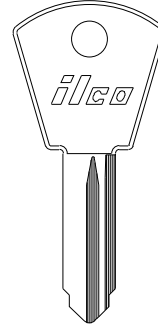
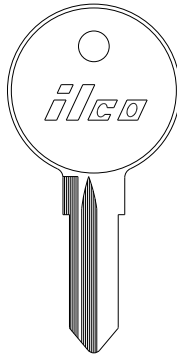
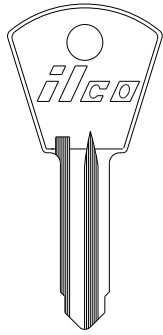
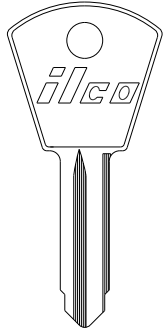

63ST R63ST

— —

63TS

—

R63H

—

R63TS

—

64S

—

ILCO  
EZ

FIAT

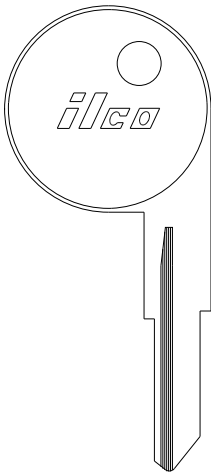

X64  
SP6

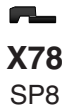

X78  
SP8



X79  
SP7

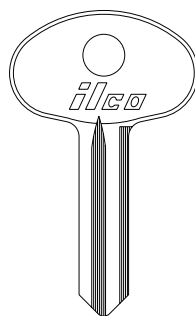

65FA

—



R65FA

—



65G

—



R65G

—

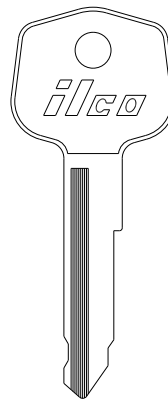

65M

—

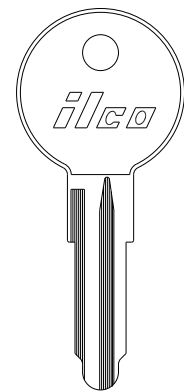

66A

—

ILCO  
EZ

FIAT

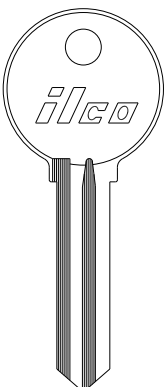

66BB

—

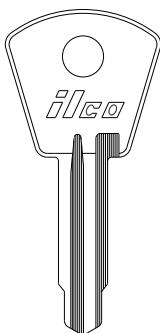

F66C

—

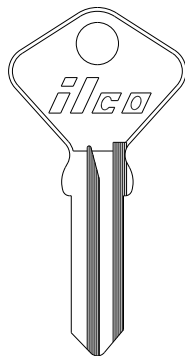

F91C

—



F91CR

—



F91C2

—



F91C8

—

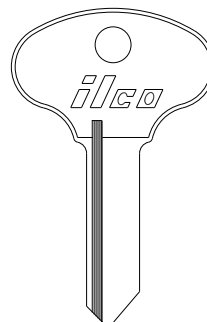

F91ES

—



F91FS

—



F91GS

—



F91HS

—

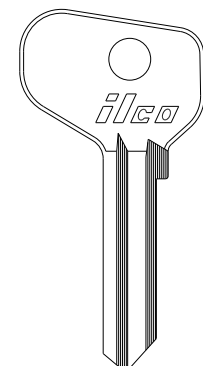

X99

—

ILCO  
EZ

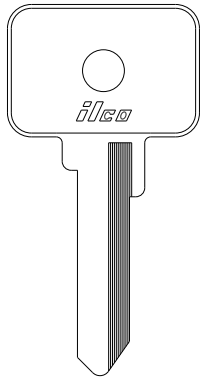
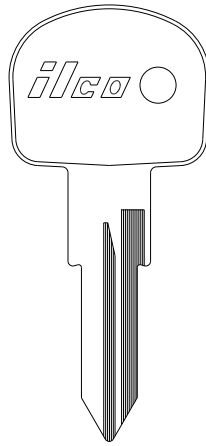
**FIAT**
**FORD**

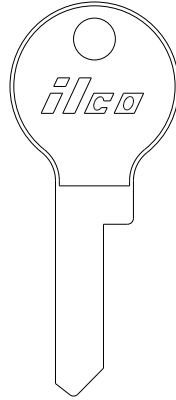
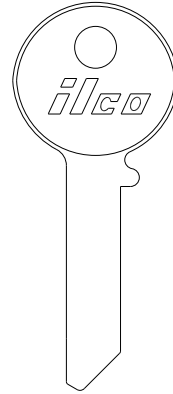
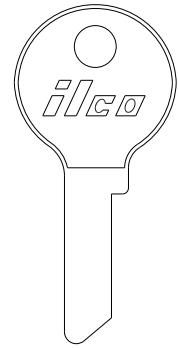
**X109**  
FT43

**X113**  
—

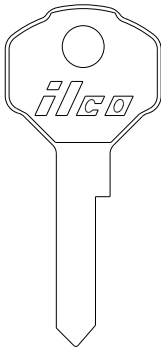
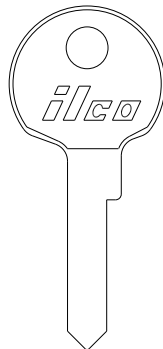
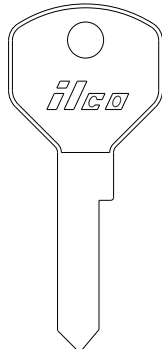
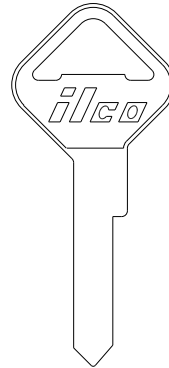
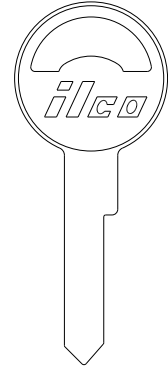
**X152**  
FT46

**1125**  
H6

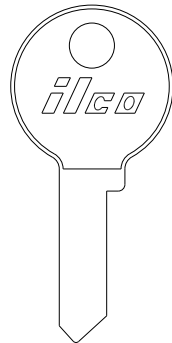
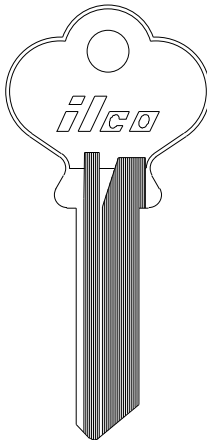
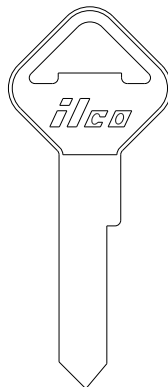
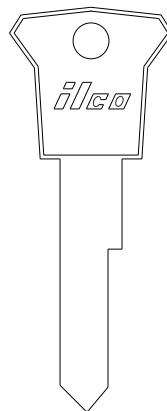
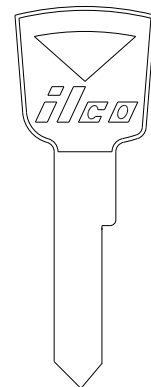
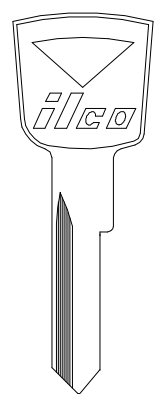
**1125A**  
—

**1125D**  
—

**ILCO**  
EZ

**FORD**

**1125F**  
—

**1125G**  
—

**1125H**  
H5

**1125K**  
—

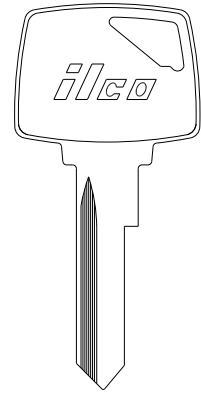
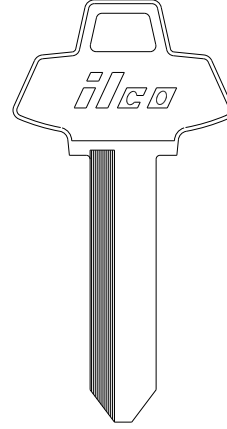
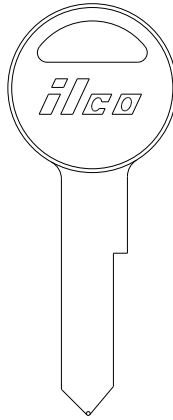
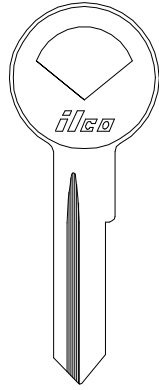
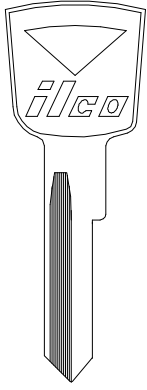
**1125M**  
—

**ILCO**  
EZ

**FORD**

**D1125**  
—

**1126M**  
—

**1127**  
—

**1127B**  
—

**1127D**  
—

**1127DP**  
H27

**ILCO**  
EZ

FORD



1127DU  
H18

1127ES  
H26

1127F  
—

1127FD  
—

1127FL  
—

ILCO  
EZ

FORD

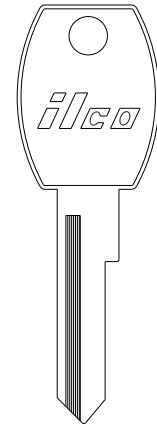
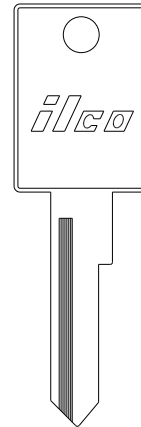
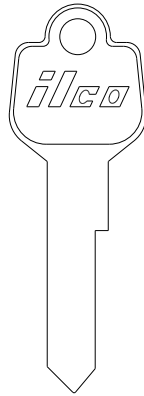
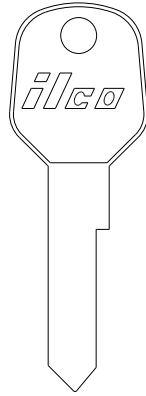
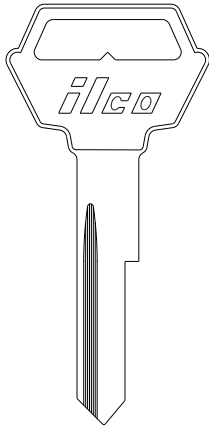

1127FR  
—

1127H  
—

1127J  
—

1127K  
—

1127L  
—

ILCO  
EZ

FORD

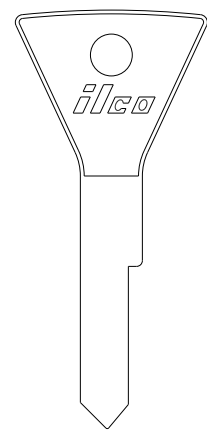
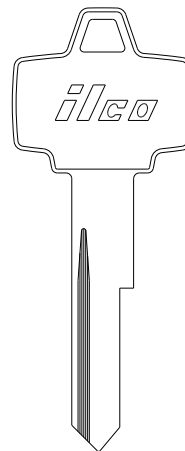
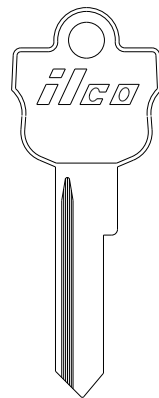
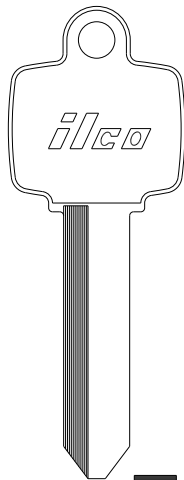
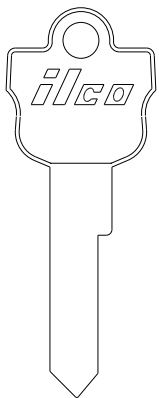

1127M  
—

1127ME  
—

1127MP  
—

1127MU  
—

1127N  
—

ILCO  
EZ

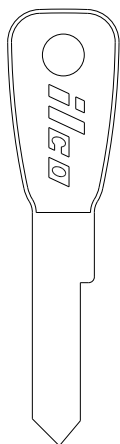
**FORD****1127P**

—

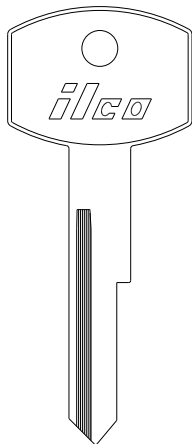
**1127T**

—

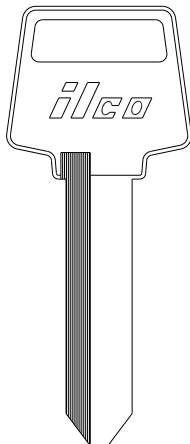
**1127TB**

—

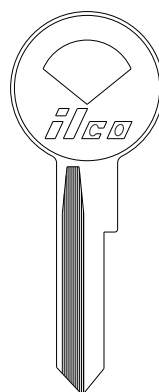
**M1127A**

—

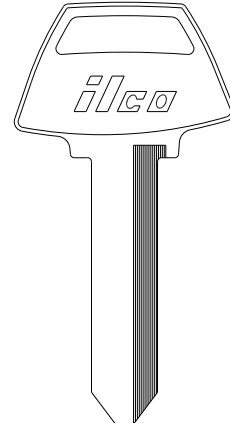
**S1127FD**

—

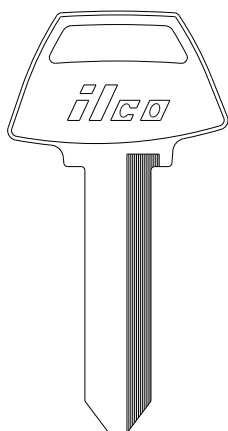
**ILCO  
EZ****FORD****S1127FL**

—

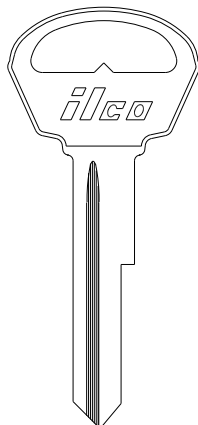
**S1127FR**

—

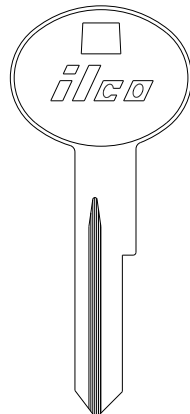
**S1127LC**

—

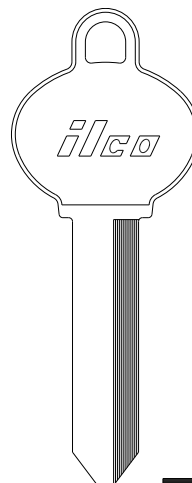
**S1127ME**

—

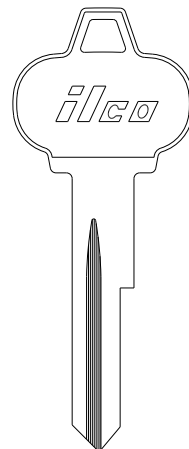
**S1127MU**

—

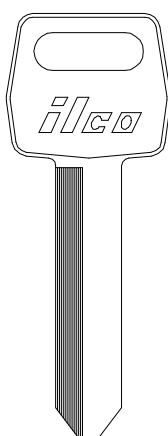
**ILCO  
EZ****FORD****1167FD**

H51

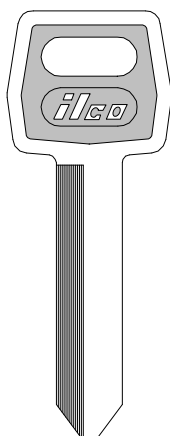
**H51-PC**

—

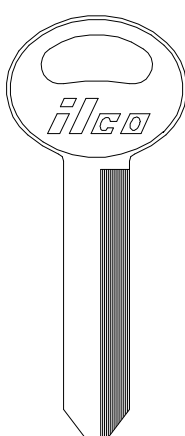
**S1167FD**

H50

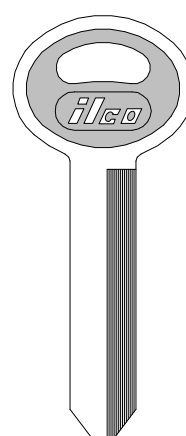
**H50-PC**

—

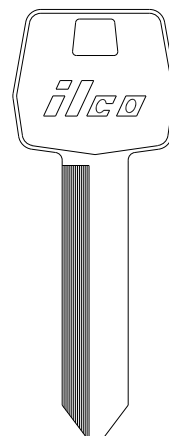
**1170LN**

—

**ILCO  
EZ**

FORD

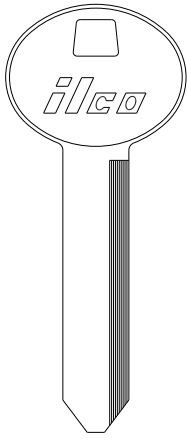

S1170LN  
—

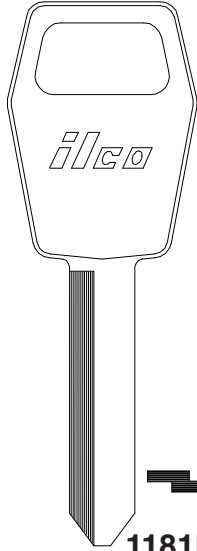

1181FD  
H53

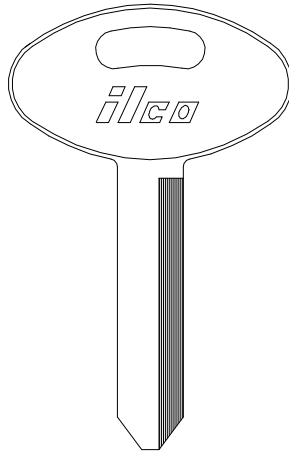

S1181FD  
H52

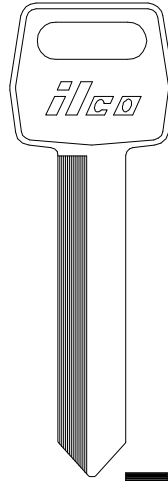

1184FD  
H54

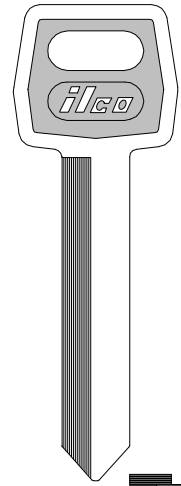

H54-PC  
—

ILCO  
EZ

FORD

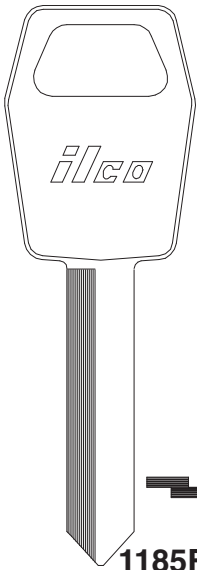

1185FD  
H55

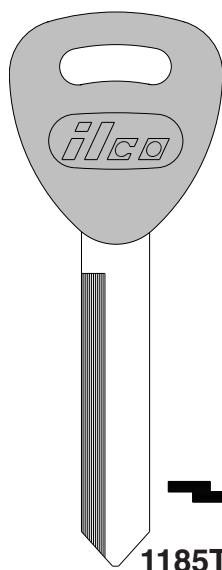

1185T-P  
—

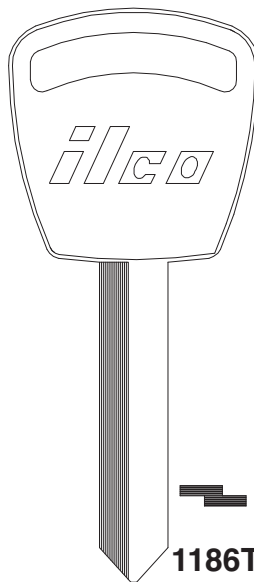

1186TS  
H56

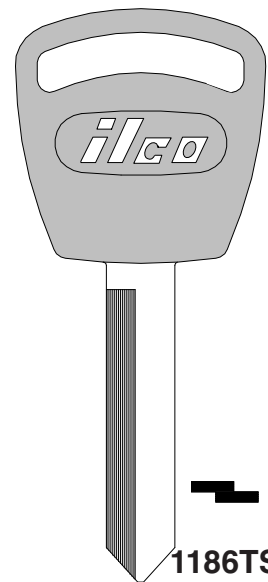

1186TS-P  
—

ILCO  
EZ

FORD

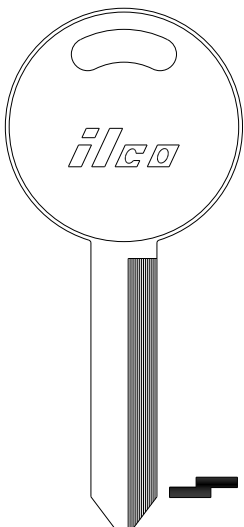

S1186TS  
—

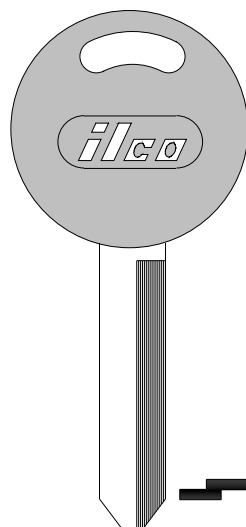

S1186TS-P  
—

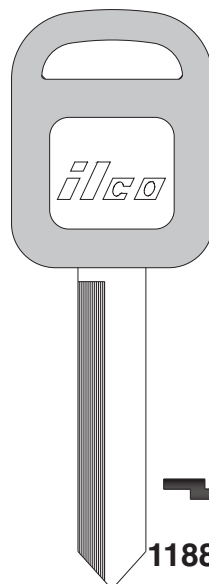

1188LN-P  
—

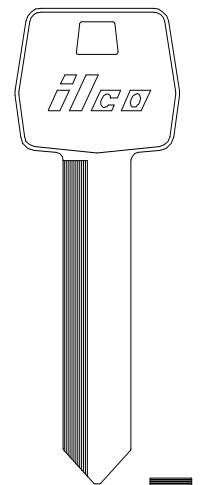

1190LN  
H60

ILCO  
EZ

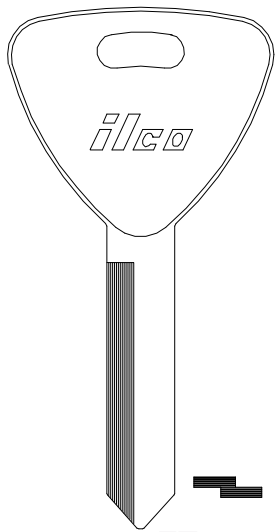
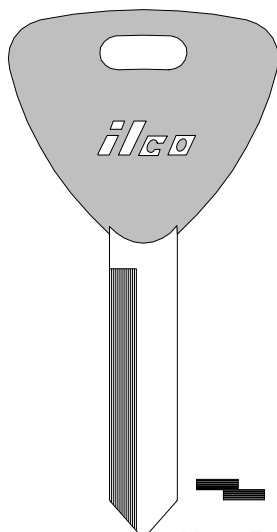
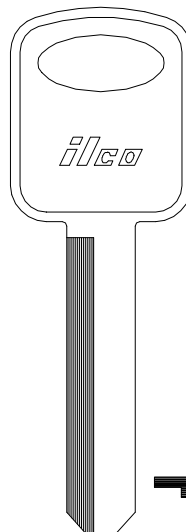
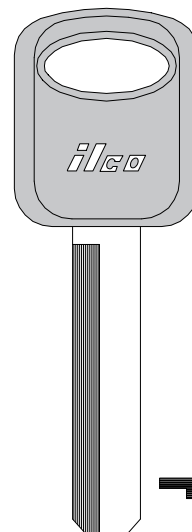
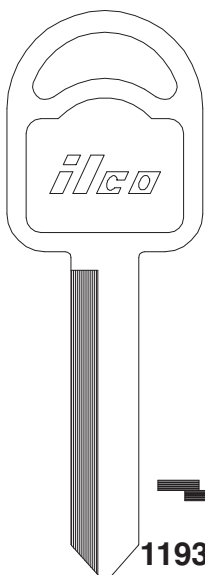
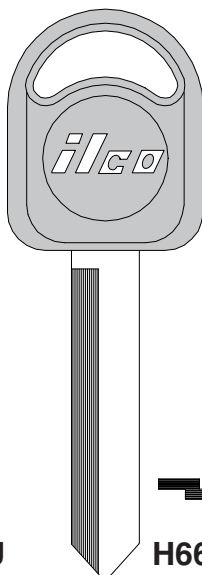
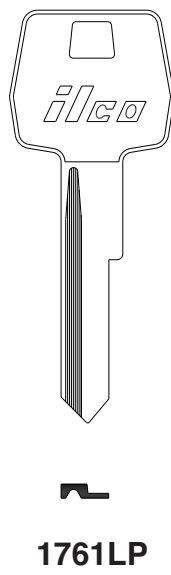
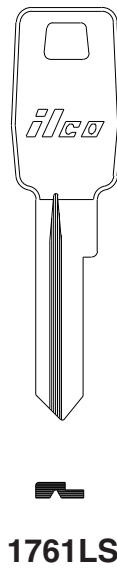
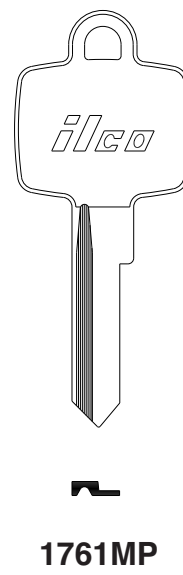
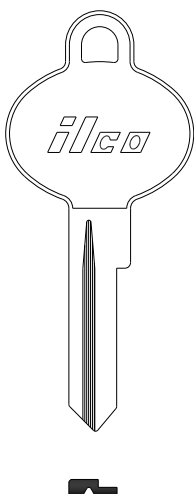
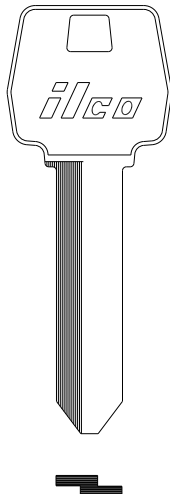
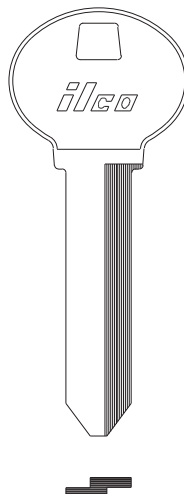
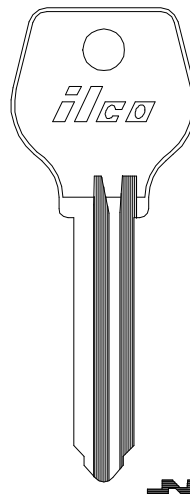
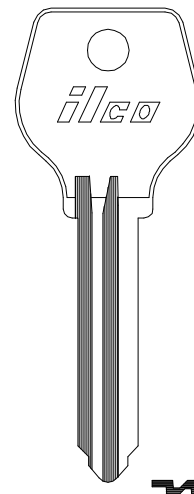

**FORD****1191ET**  
H62**H62-P**  
—**1193FD**  
H67**H67-P (-PC)**  
—**ILCO**  
EZ**FORD****1193MU**  
H66**H66-P**  
—**1761LP**  
—**1761LS**  
—**1761MP**  
—**ILCO**  
EZ**FORD****1761MS**  
—**1766LN**  
—**S1766LN**  
—**X4**  
MZ4**X5**  
MZ5**ILCO**  
EZ

FORD

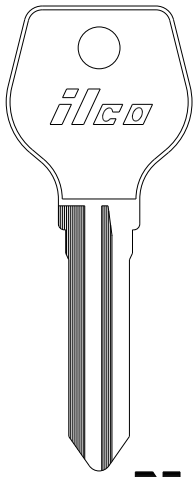

**X26**  
MZ9

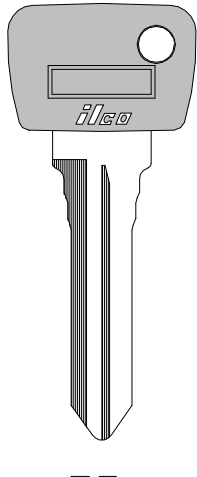

**MZ9-P**  
—

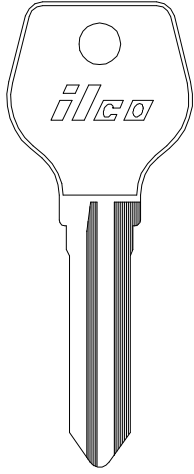

**X27**  
MZ10

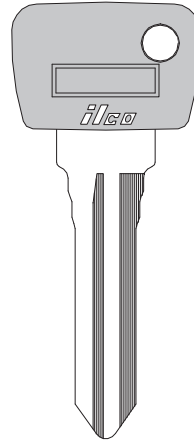

**MZ10-P**  
—

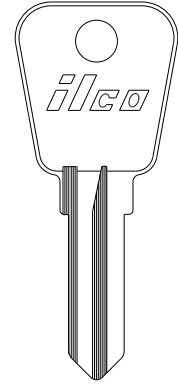

**62FT**  
F68YT

**ILCO**  
EZ

FORD

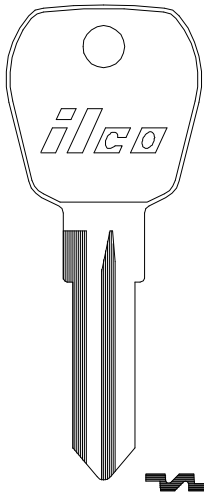

**X86**  
FC7

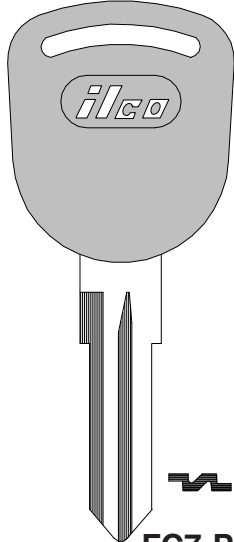

**FC7-P**  
—

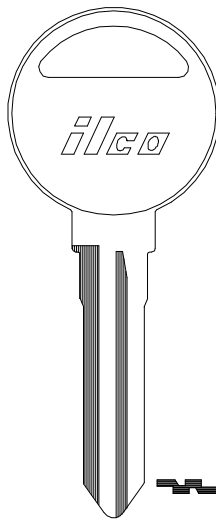

**X131**  
MZ13

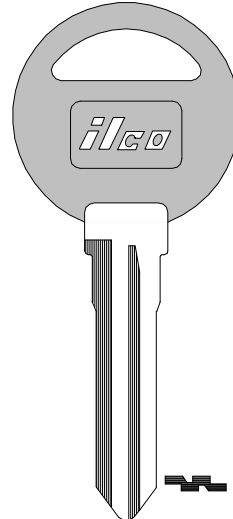

**MZ13-P (-PC)**  
—

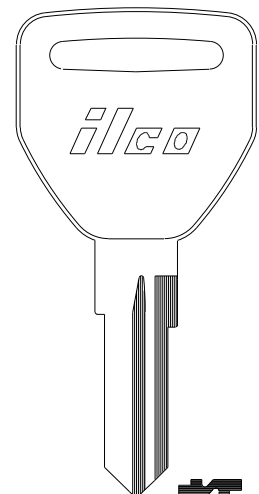

**X169**  
WB3

**ILCO**  
EZ

FORD

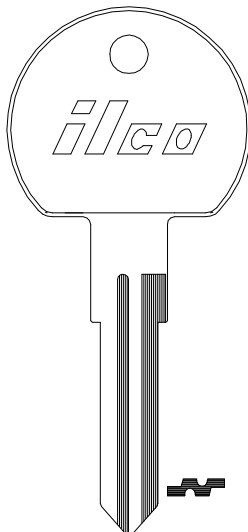

**X170**  
NE48

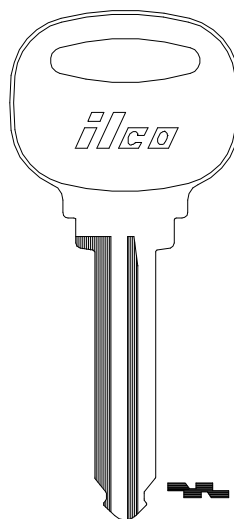

**X202**  
H59

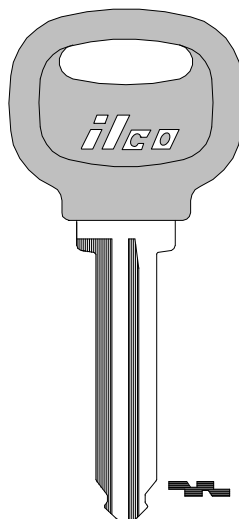

**H59-P (-PC)**  
—

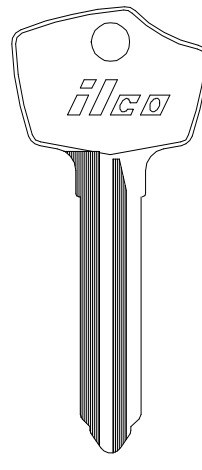

**X207**  
H63

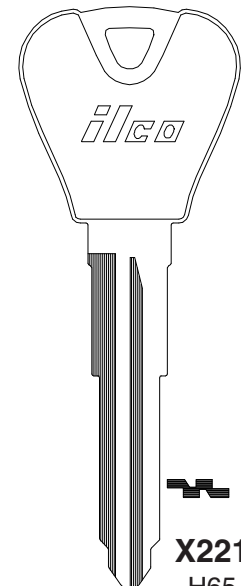

**X221**  
H65

**ILCO**  
EZ

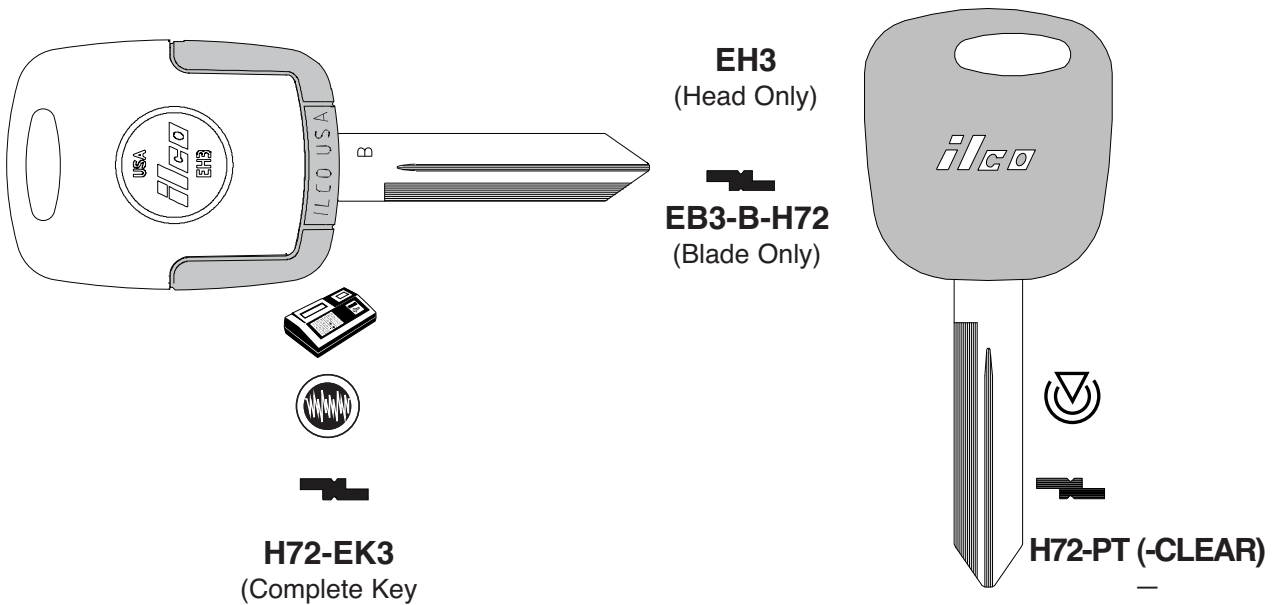
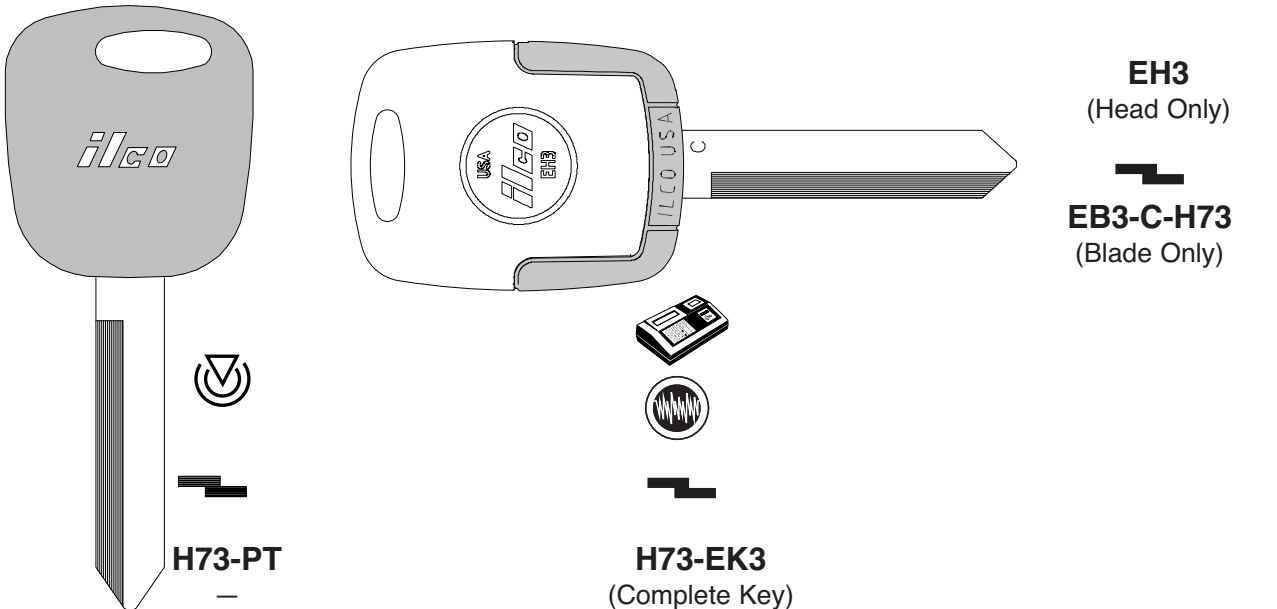
**FORD****ILCO**  
EZ**H65-P**  
—**X231**  
H70**H70-P**  
—**1195FD**  
H71**H71-P**  
—**FORD****ILCO**  
EZ**H72-EK3**  
(Complete Key)**EH3**  
(Head Only)**EB3-B-H72**  
(Blade Only)**H72-PT (-CLEAR)**  
—**FORD****ILCO**  
EZ**H73-PT**  
—**H73-EK3**  
(Complete Key)**EH3**  
(Head Only)**EB3-C-H73**  
(Blade Only)

FORD

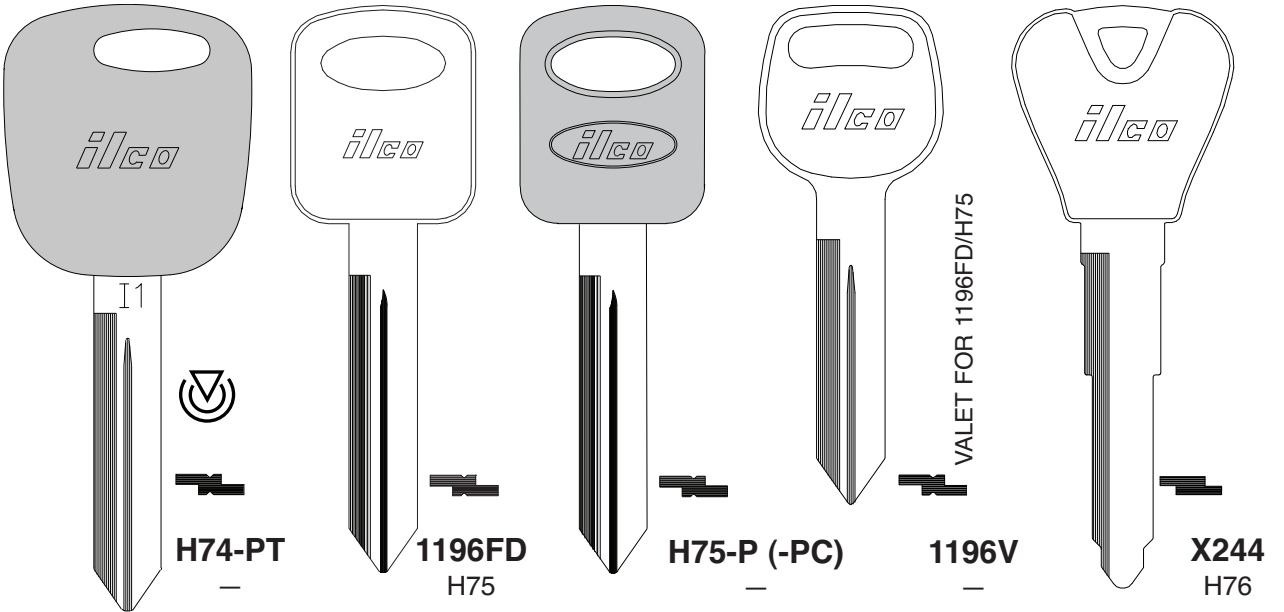

ILCO  
EZ

FORD

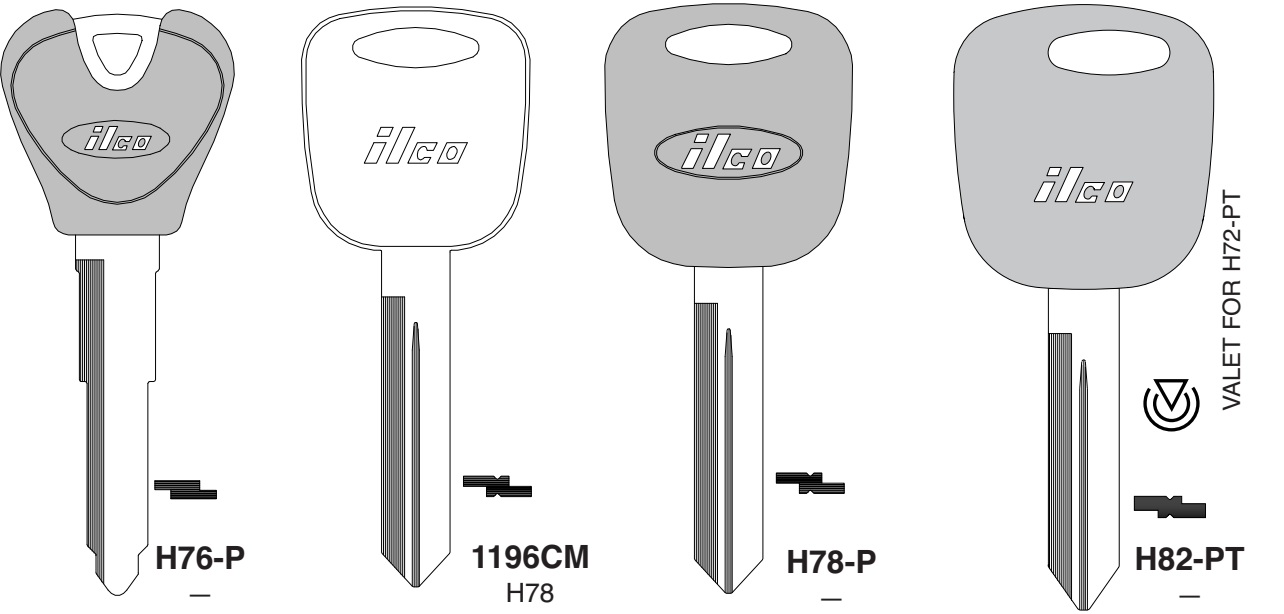

ILCO  
EZ

FORD

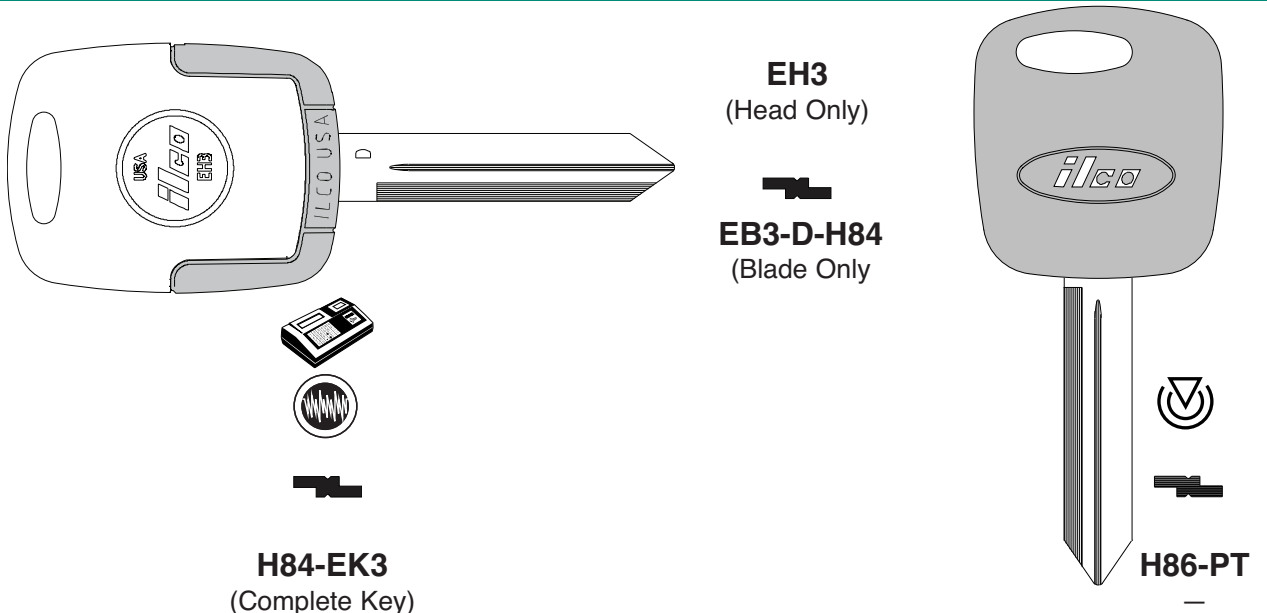

ILCO  
EZ

FORD

FORD INTERNATIONAL

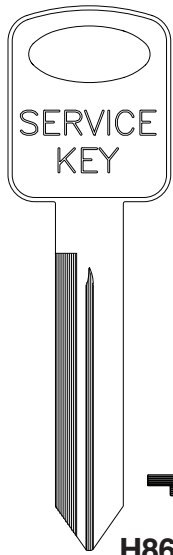

H86-SERVICE KEY

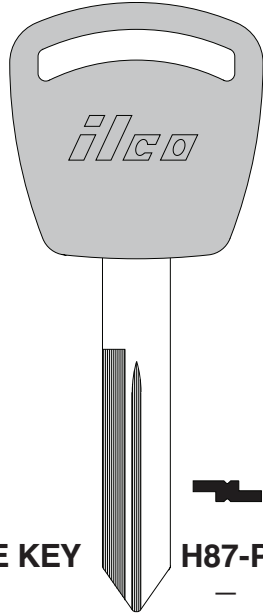

H87-P

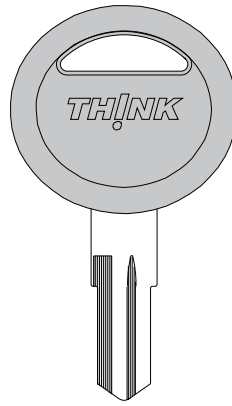

TH1-P

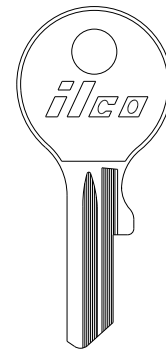

BU1

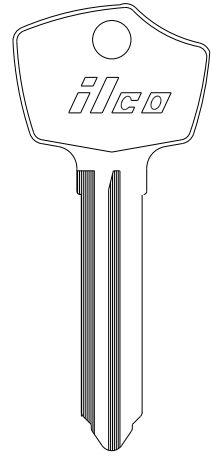

FF1



ILCO  
EZ

FORD

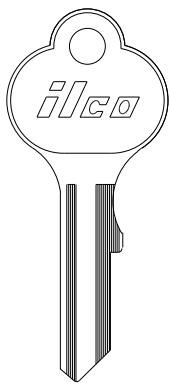

VW1

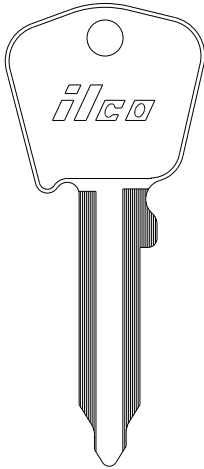

KL2

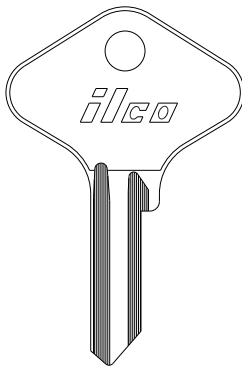

FT5R

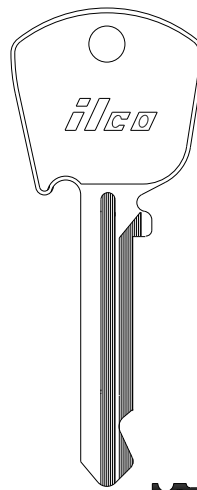

DO3L

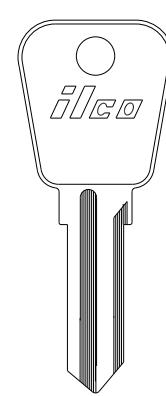

FT3

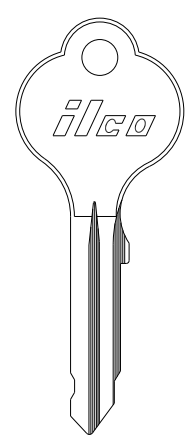

SR3



YM3

ILCO  
EZ

FORD INTERNATIONAL

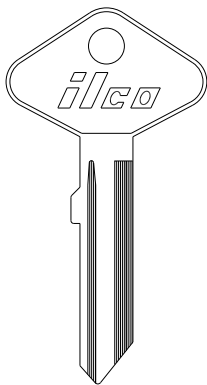

CA4

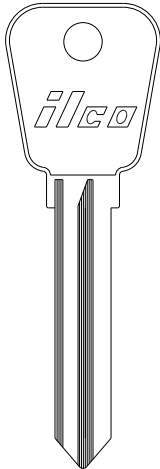

CE4

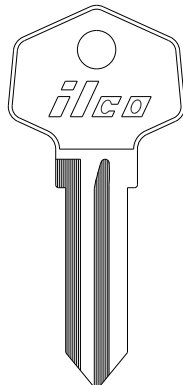

CE6

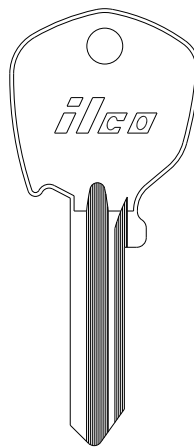

FT6

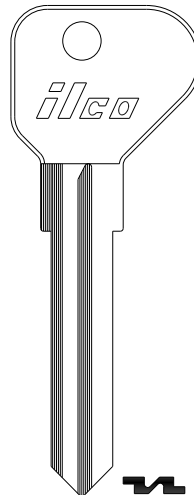

CE7

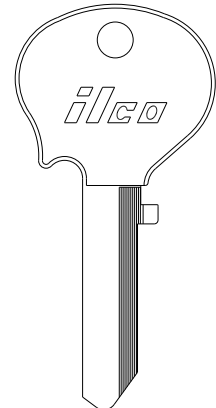

NE7

ILCO  
EZ

FORD INTERNATIONAL

VEHICLE

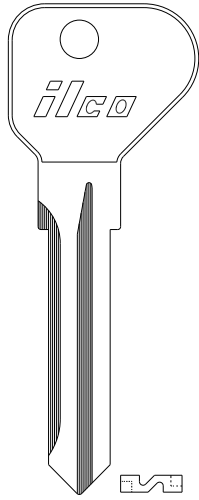

CE8

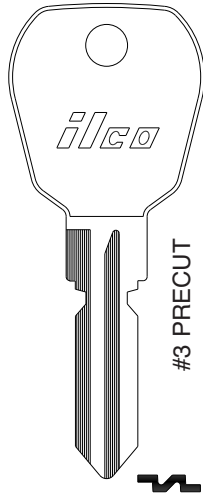

FC8

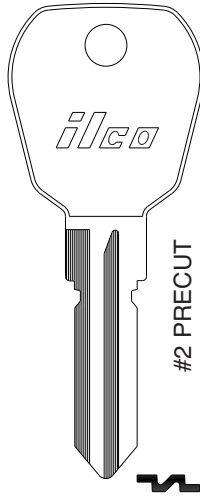

FC9

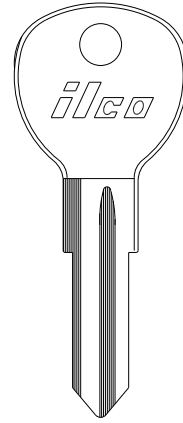

FT10 FT10R

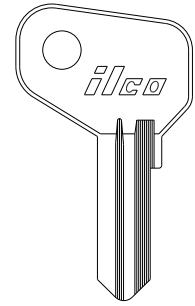

SF11

ILCO  
EZ

FORD INTERNATIONAL

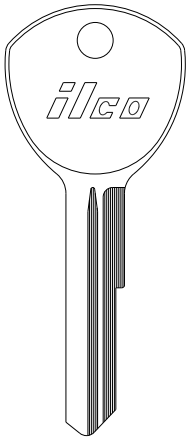

HF12 HF13

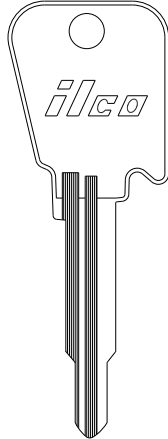

X13  
LF4

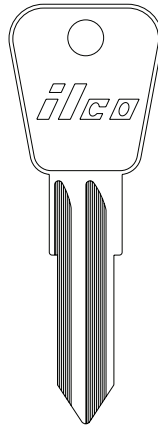

YM15

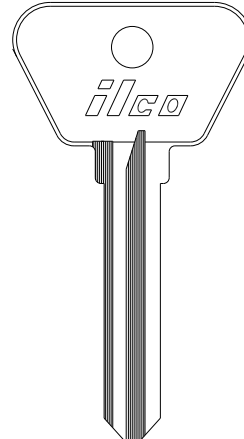

BR20

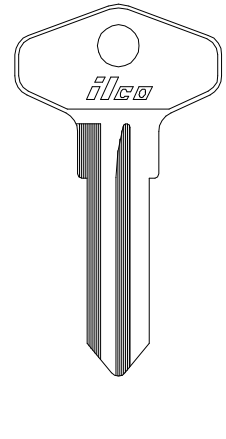

X20  
FC2

ILCO  
EZ

FORD INTERNATIONAL

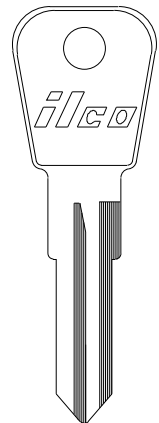

X21  
YS1

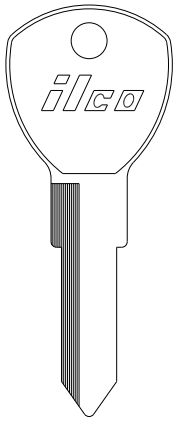

HF22 HF23

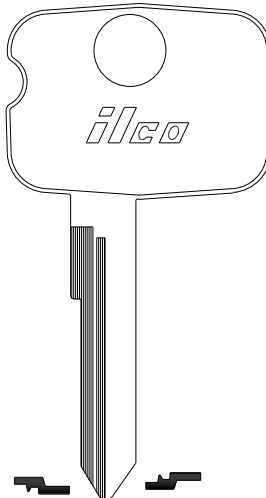

YM29 YM30

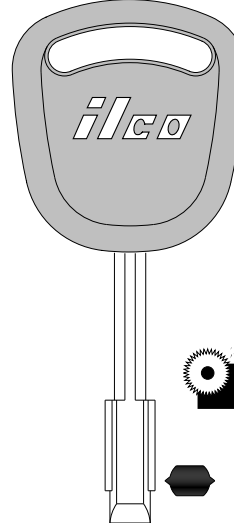

S30FD-P

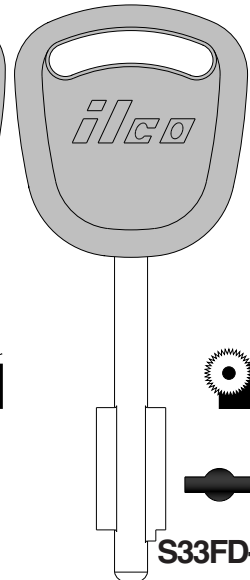

S33FD-P

ILCO  
EZ

FORD INTERNATIONAL

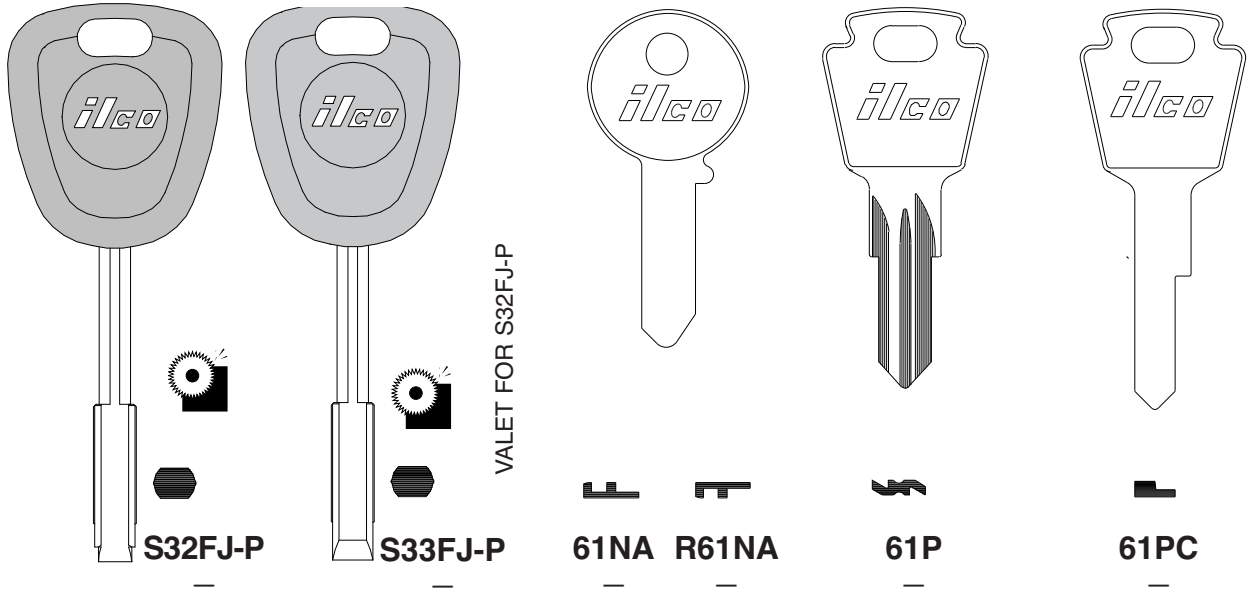

ILCO  
EZ

VEHICLE

sec 1 page 47

FORD INTERNATIONAL

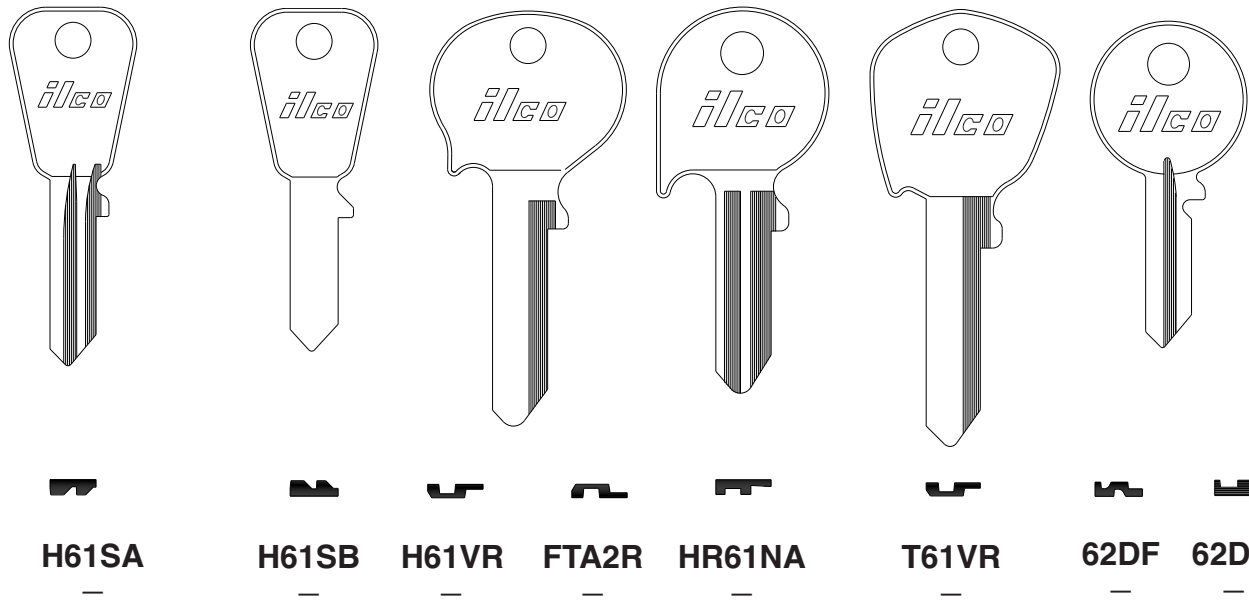

ILCO  
EZ

FORD INTERNATIONAL

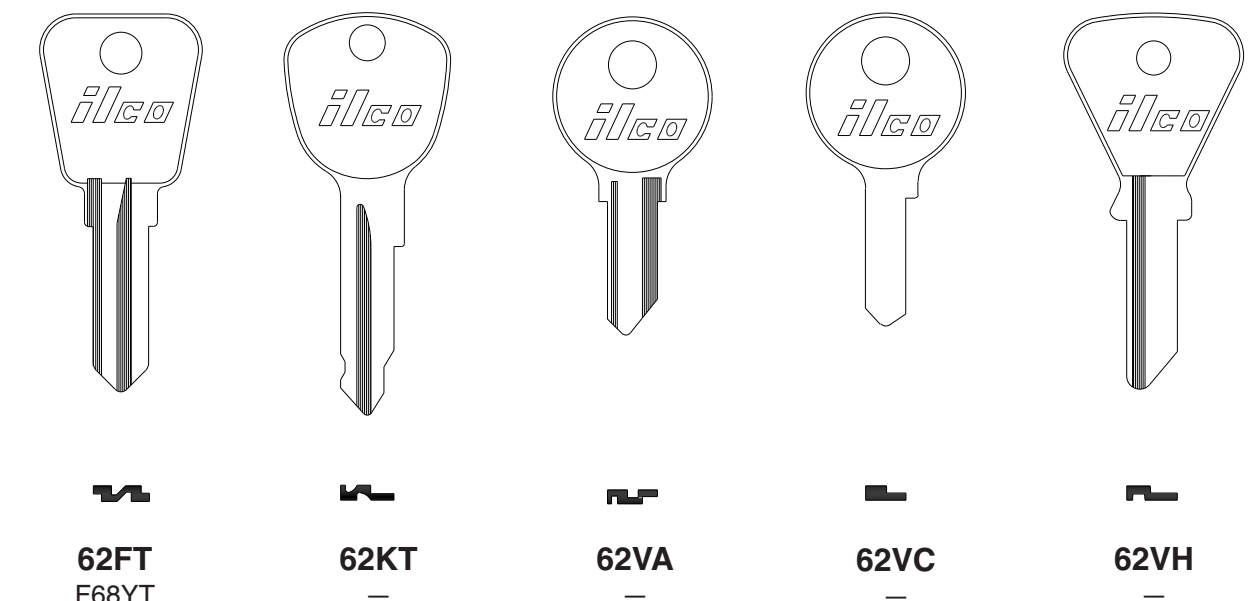

ILCO  
EZ

FORD INTERNATIONAL

VEHICLE



A62VC

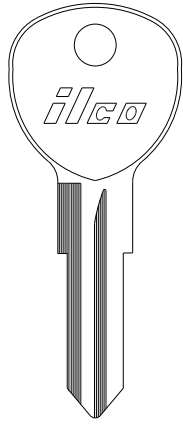

H62FD

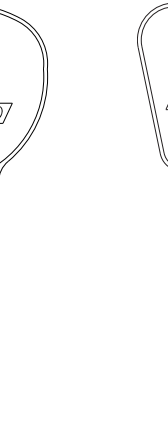

HR62FD

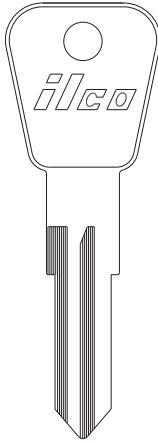

L62FD

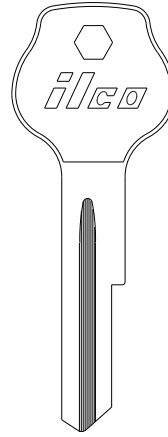

LR62VB



R63Y

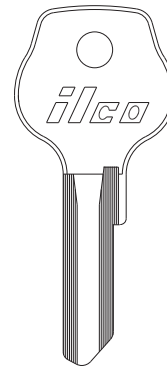

R62VB



G63Y

ILCO  
EZ

FORD INTERNATIONAL

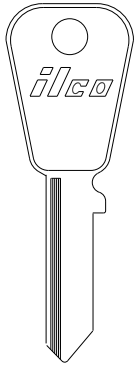

S62DP

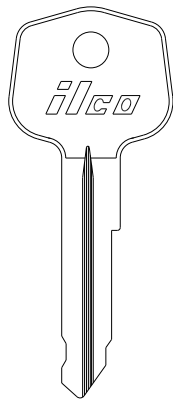

63E

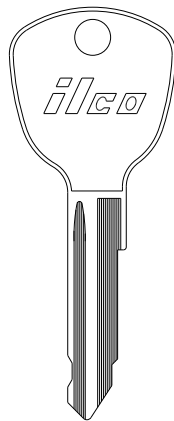

R63E

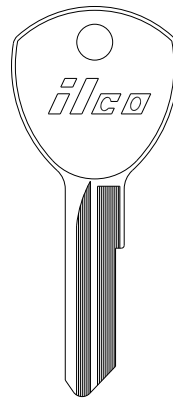

R63KE

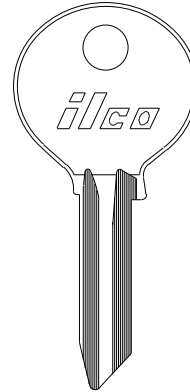

R63TK

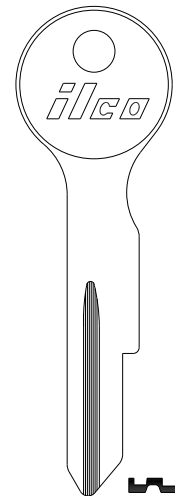

R63TY

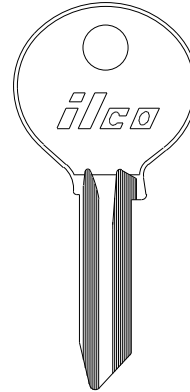

H64E

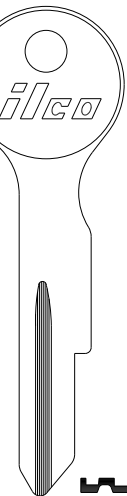

65J

ILCO  
EZ

FORD INTERNATIONAL

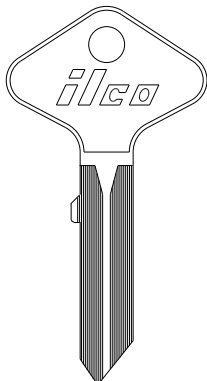

65T

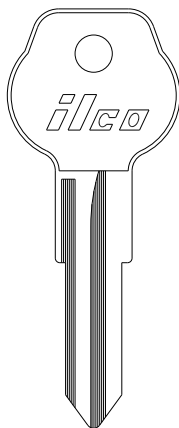

F76M

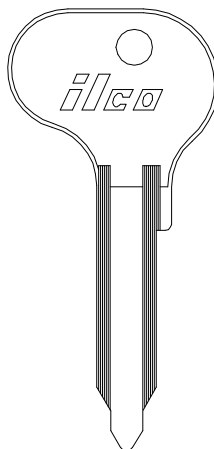

VW77

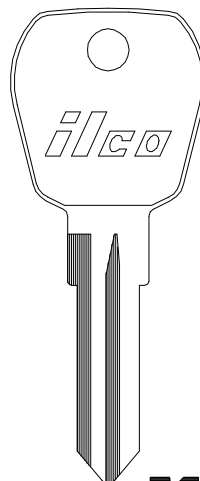

X86

FC7

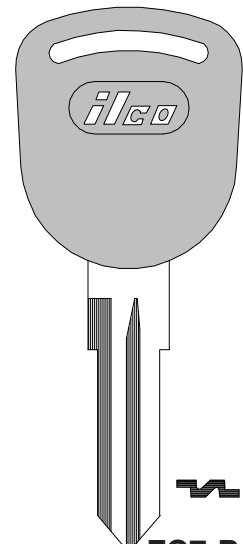

FC7-P

ILCO  
EZ

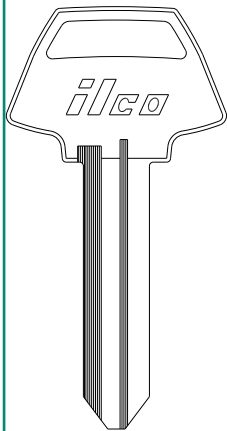
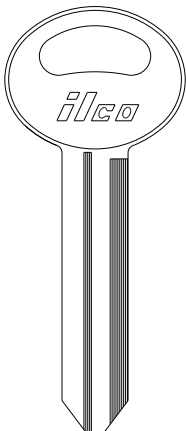
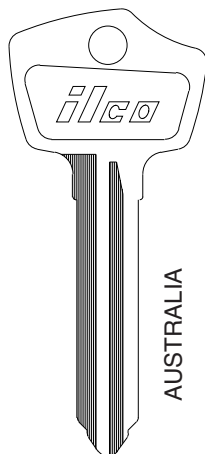

**FORD INTERNATIONAL**
**FORD AUSTRALIA FORD TRACTOR**

**P1127C**

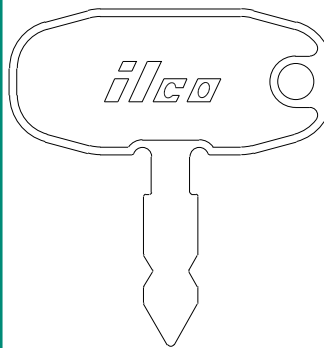
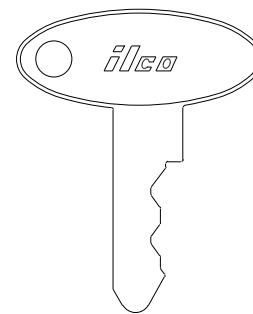
**S1167C**

**FF2**

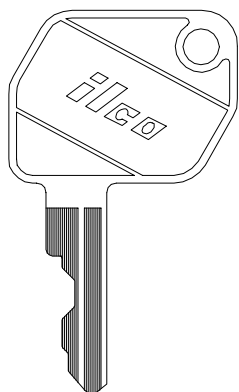
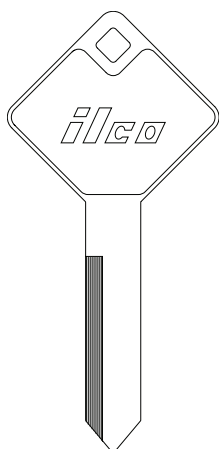
AUSTRALIA

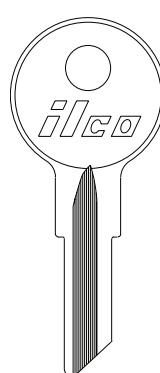
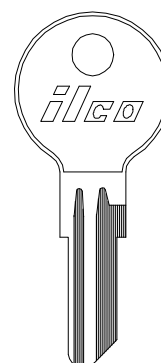
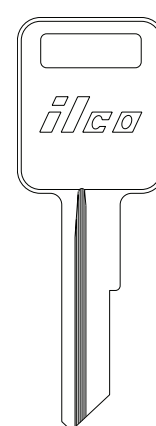

**1569**

**1570**

 ILCO  
EZ

**FORD TRACTOR**
**FORD TRUCK COVER FREIGHTLINER**

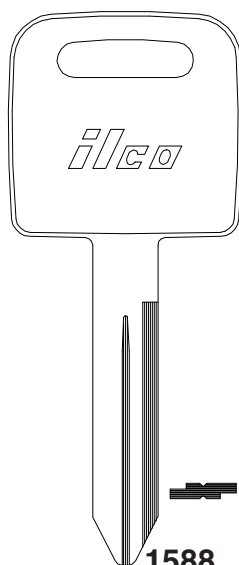
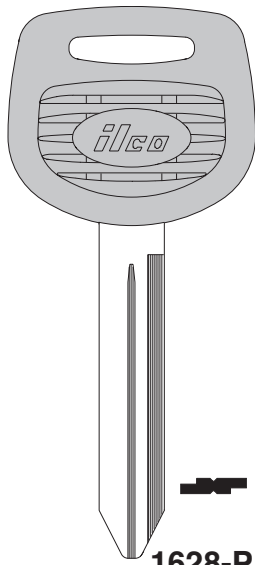
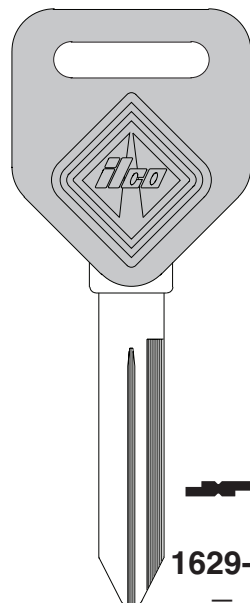
**1592**

**1660**

**1041T**  
CG16

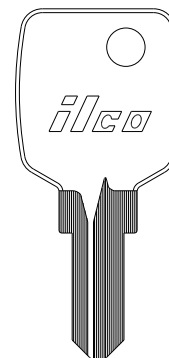
**1098M**  
B1

**O1122A**  
Y12

**1584**

 ILCO  
EZ

**FREIGHTLINER**
**GAS CAP LOCK**

**1588**

**1628-P**

**1629-P**

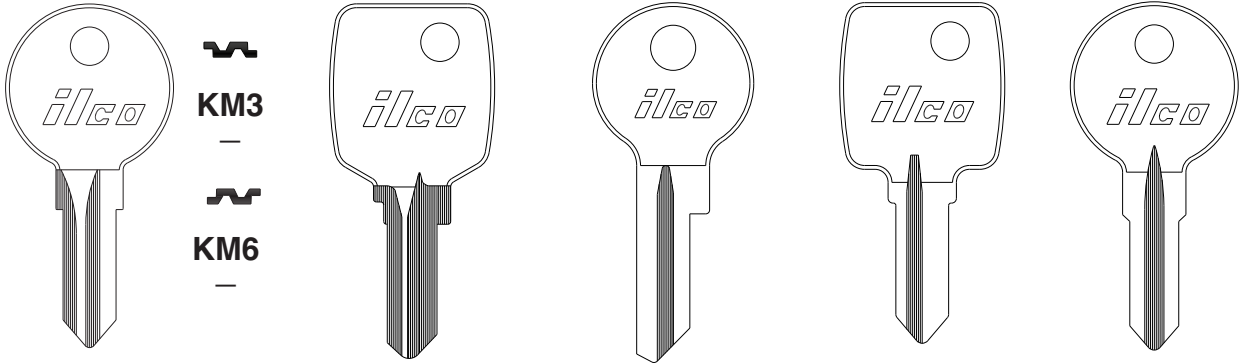
**GC1**

**PN1**

 ILCO  
EZ

GAS CAP LOCK



<b>KM2</b>	<b>PN2</b>	<b>BU3</b>	<b>PN3</b>	<b>KM4</b>
—	—	—	—	—

ILCO  
EZ

GAS CAP LOCK

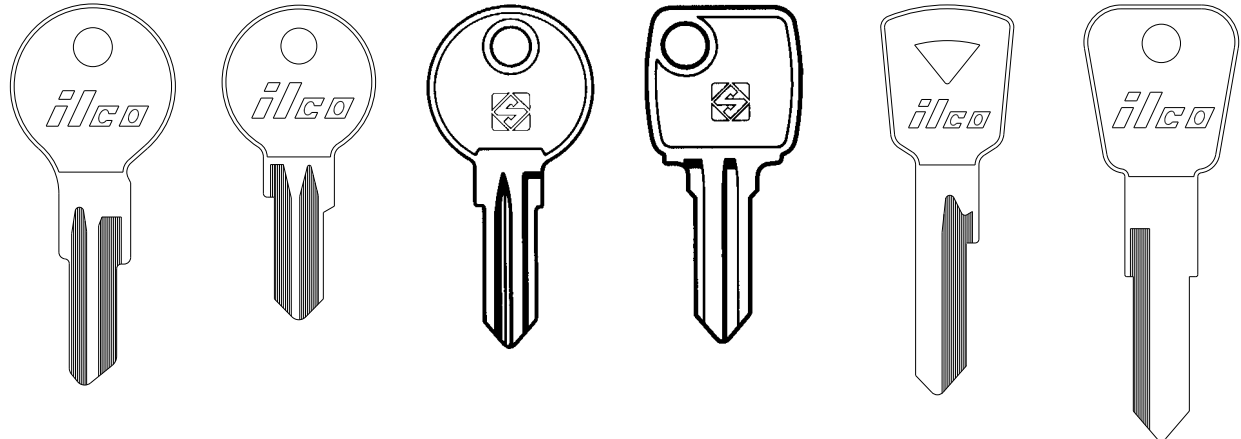

<b>Z4</b>	<b>KM5</b>	<b>KM7</b>	<b>KI10R</b>	<b>KI17</b>	<b>WS10</b>	<b>WS11</b>
—	—	—	—	—	—	—

ILCO  
EZ

GAS CAP LOCK

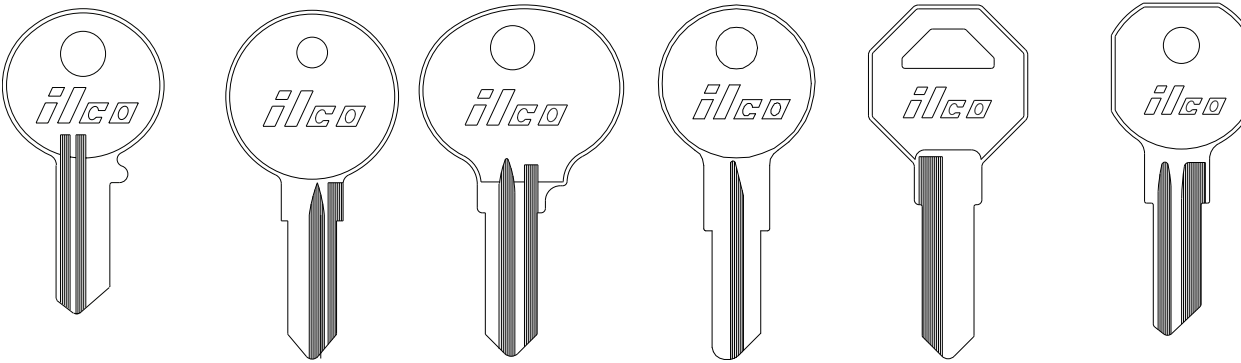

<b>V61S</b>	<b>63H</b>	<b>R63H</b>	<b>H63G</b>	<b>1098GX</b>	<b>1546</b>	<b>1574</b>
—	—	—	—	B52	—	—

ILCO  
EZ

**GAS CAP LOCK**

**GEO**

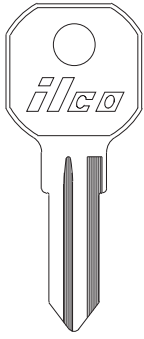

**1611**  
—

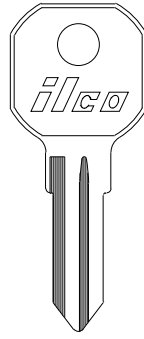

**1611R**  
—

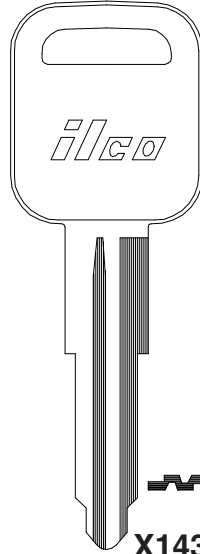

**X143**  
B53

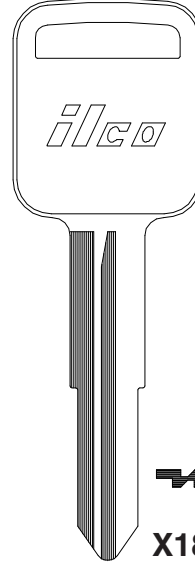

**X180**  
B69

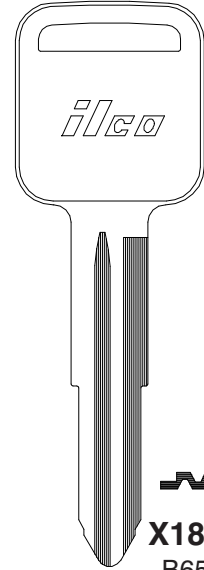

**X184**  
B65

**ILCO**  
EZ

**GEO**

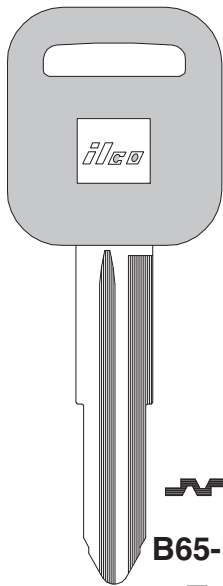

**B65-P**  
—

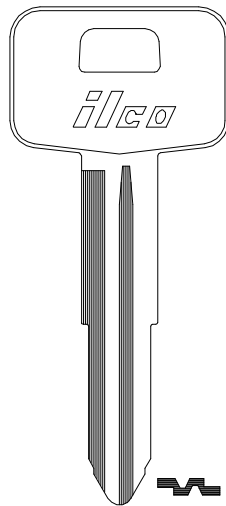

**X192**  
B72

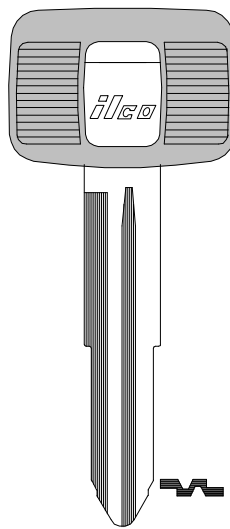

**B72-P**  
—

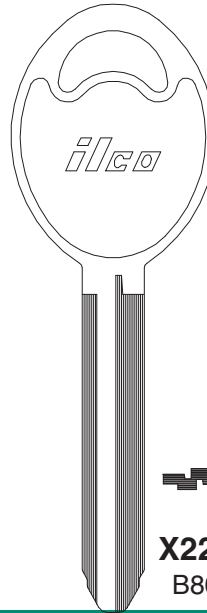

**X225**  
B80

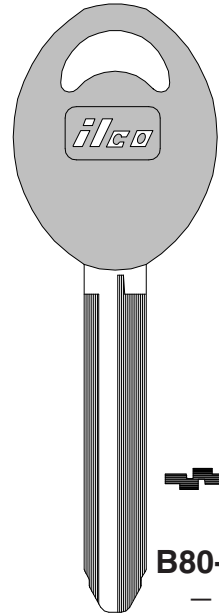

**B80-P**  
—

**ILCO**  
EZ

**GENERAL MOTORS**

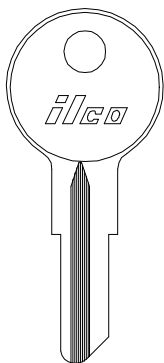

**1098L**  
B3

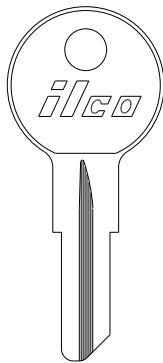

**1098X**  
—

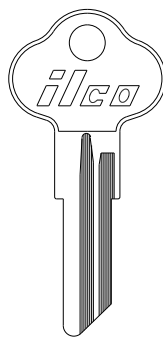

**C1098A**  
—

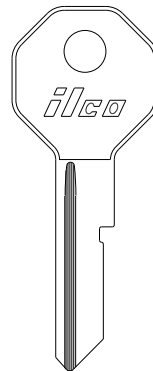

**H1098A**  
—

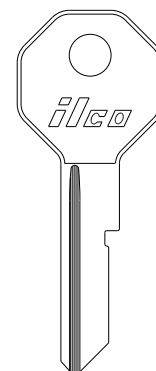

**H1098C**  
—

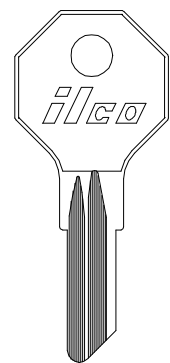

**H1098DB**  
B16

**ILCO**  
EZ

GENERAL MOTORS

VEHICLE

sec 1 page 52



<b>H1098L</b> —	<b>H1098LA</b> B10	<b>H1098M</b> B2	<b>H1098X</b> B24	<b>L1098C</b> —	<b>L1098LA</b> —

ILCO  
EZ

GENERAL MOTORS

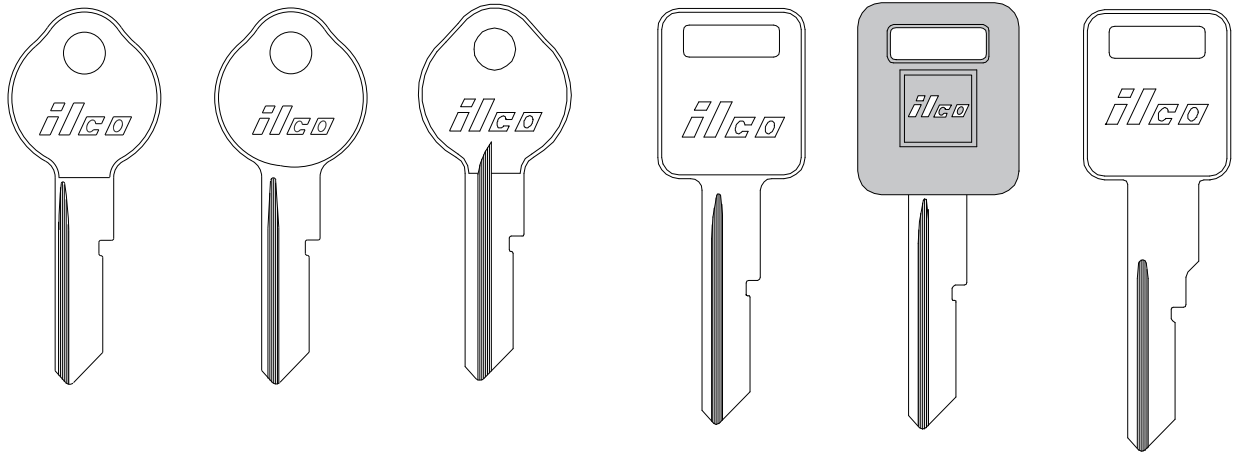

<b>O1098B</b> —	<b>O1098D</b> B43	<b>O1098LA</b> B11	<b>P1098A</b> B48	<b>B48-P (-PC)</b> —	<b>P1098AV</b> B62

ILCO  
EZ

GENERAL MOTORS

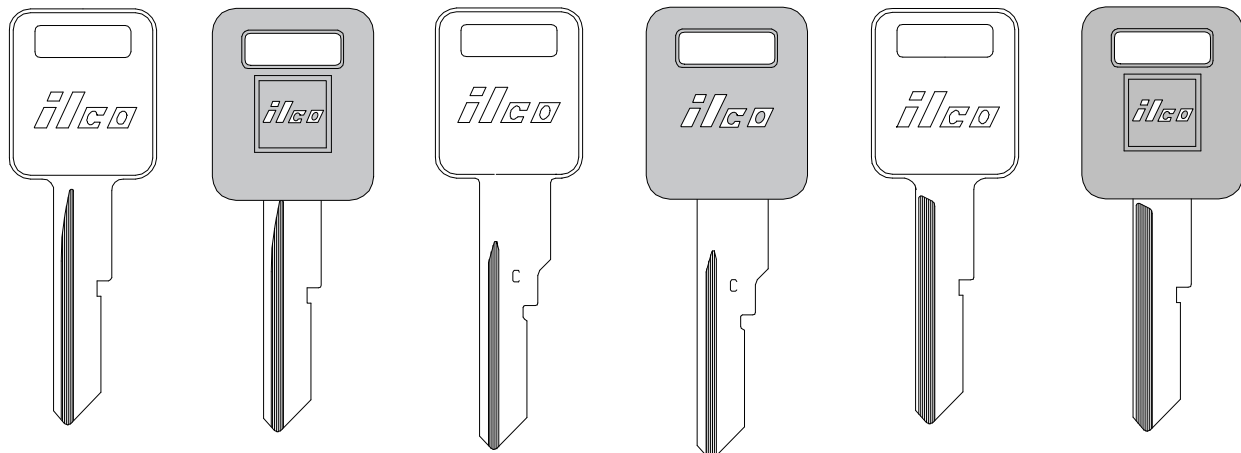

<b>P1098C</b> B50	<b>B50-P (-PC)</b> —	<b>P1098CV</b> B63	<b>B63-P (-PC)</b> —	<b>P1098E</b> B44	<b>B44-P (-PC)</b> —

ILCO  
EZ

GENERAL MOTORS

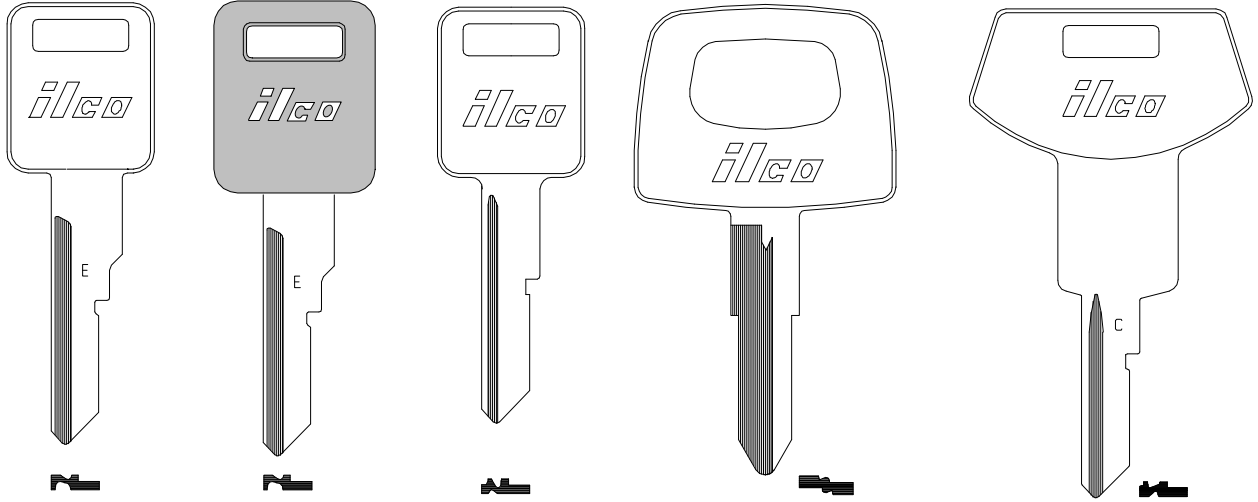

ILCO  
EZ

**P1098EV**  
B77

**B77-P (-PC)**  
—

**P1098J**  
B46

**P1098V**  
LUV1

**P1098WC**  
B64

GENERAL MOTORS

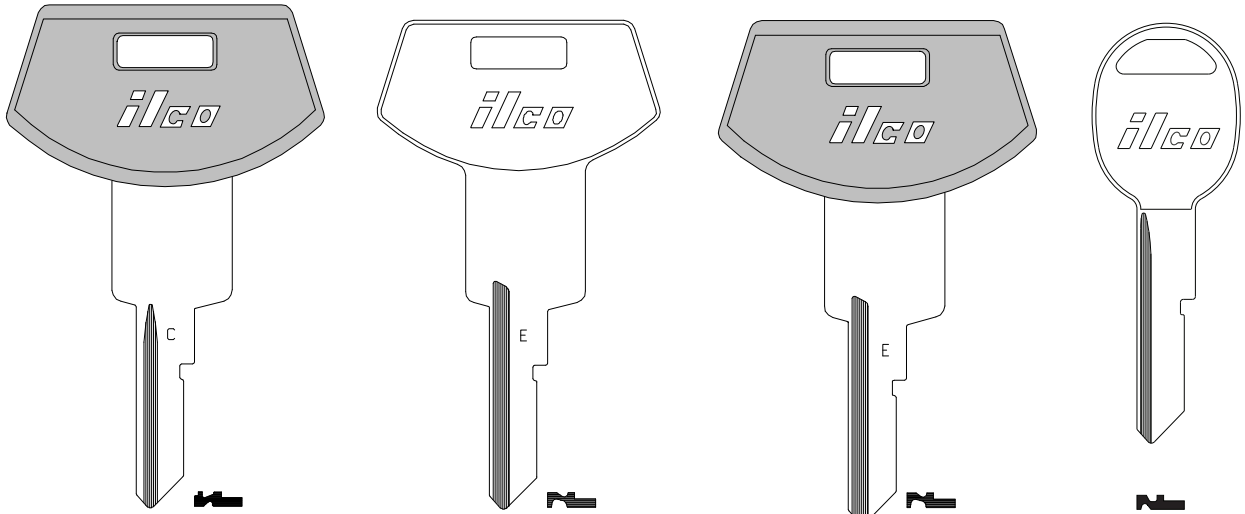

ILCO  
EZ

**B64-P (-PC)**  
—

**P1098WE**  
B78

**B78-P (-PC)**  
—

**S1098B**  
B49

GENERAL MOTORS

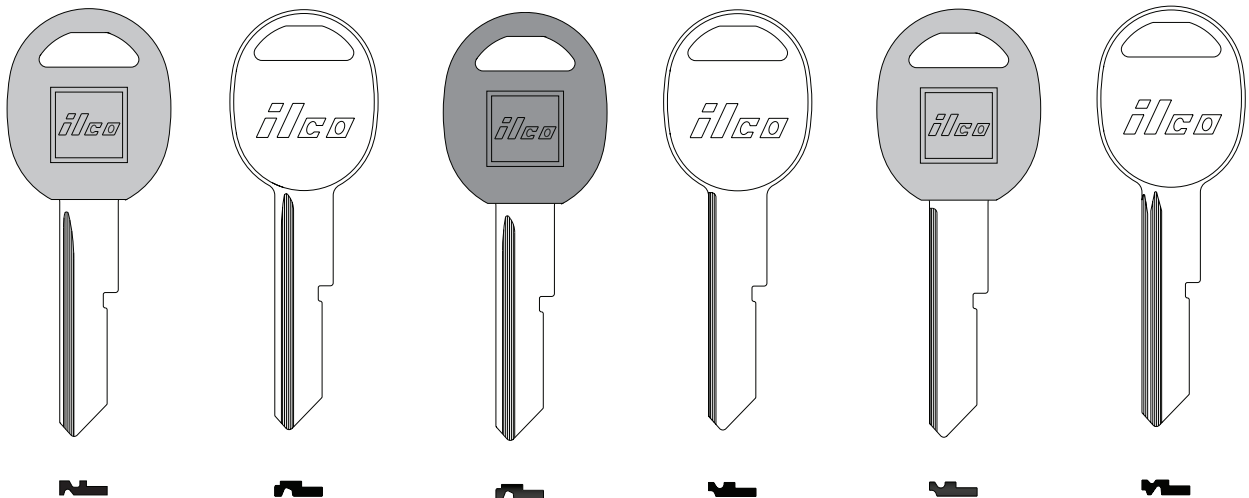

ILCO  
EZ

**B49-P (-PC)**  
—

**S1098D**  
B51

**B51-P (-PC)**  
—

**S1098H**  
B45

**B45-P (-PC)**  
—

**S1098K**  
B47

GENERAL MOTORS

VEHICLE

sec 1 page 54

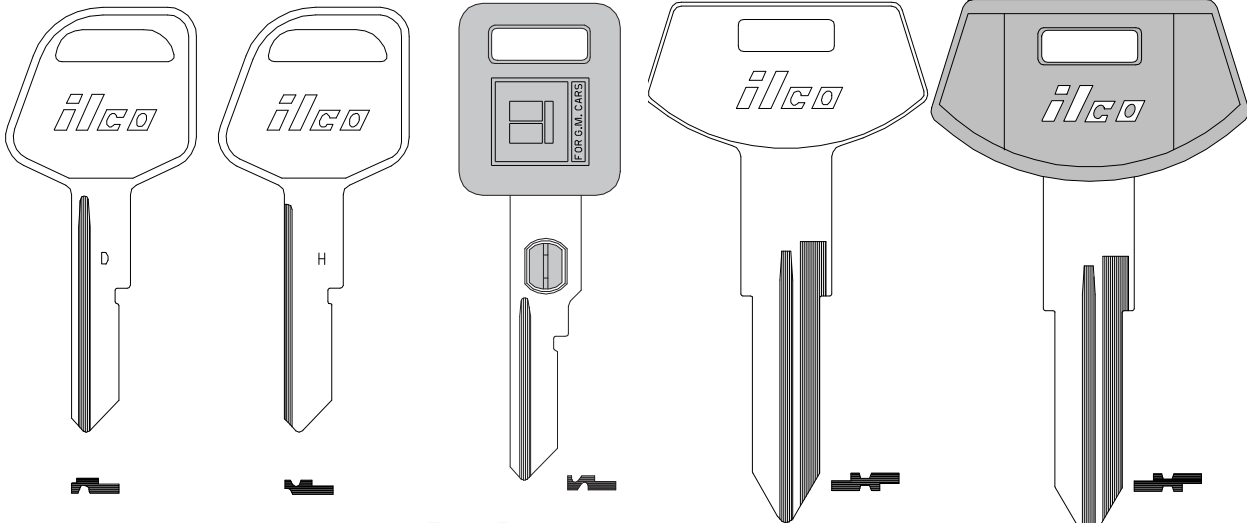

**S1098WD**  
B67

**S1098WH**  
B79

**B62-P-1 thru 15**  
VATS

**P1099**  
B68

**B68-P (-PC)**  
-

**ILCO**  
EZ

GENERAL MOTORS

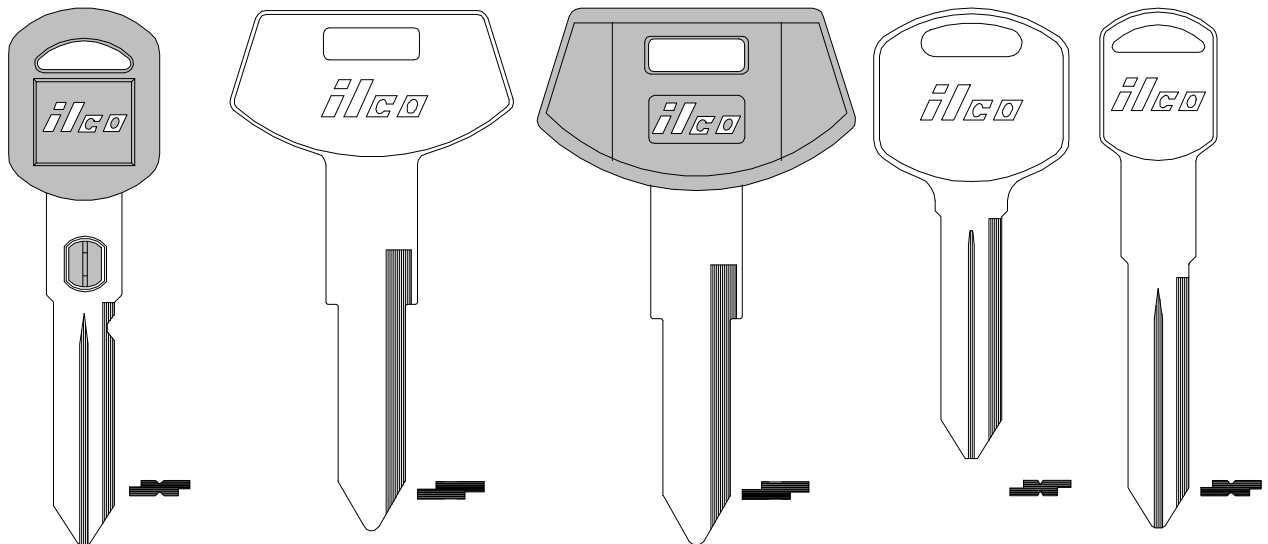

**B82-P-2 thru 15**  
VATS

**P1101**  
B84

**B84-P**  
-

**S1105**  
B85

**P1106**  
B86

**ILCO**  
EZ

GENERAL MOTORS

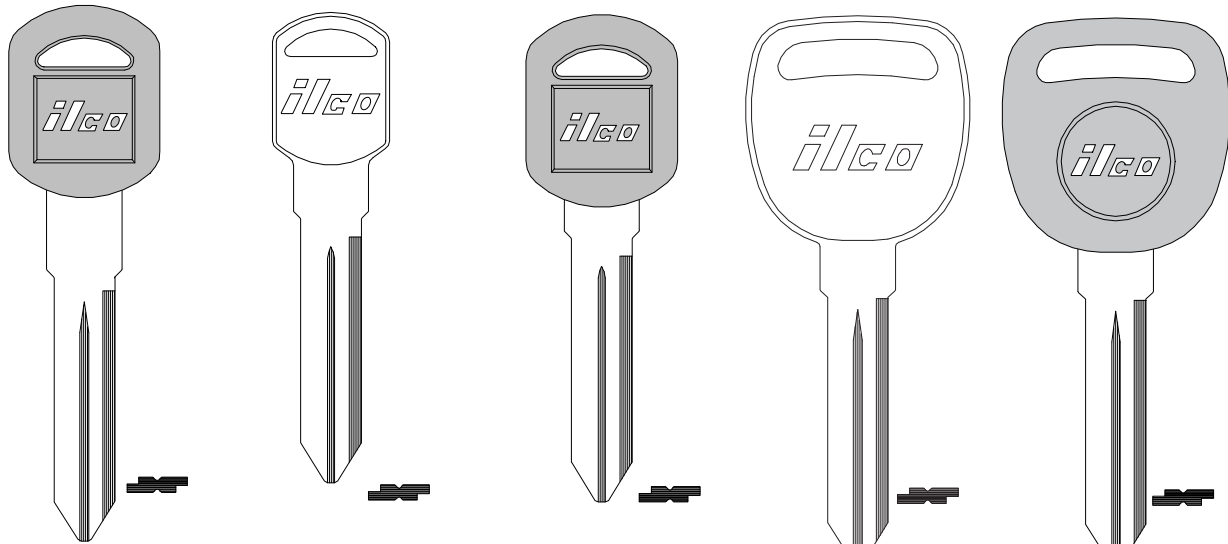

**B86-P (-PC)**  
-

**P1107**  
B89

**B89-P**  
-

**P1111**  
B91

**B91-P**  
-

**ILCO**  
EZ

GENERAL MOTORS

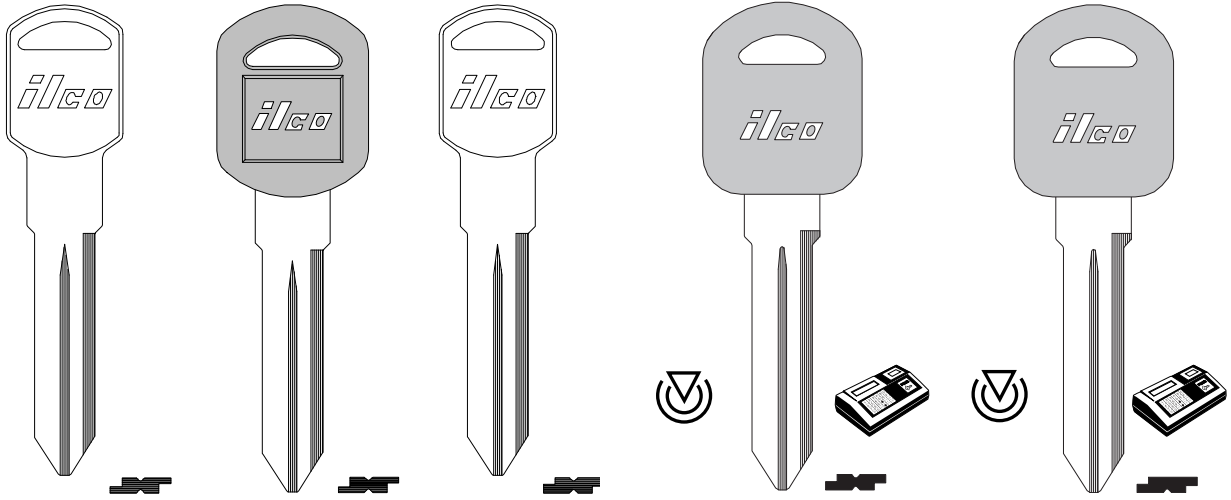

ILCO  
EZ

**P1109**  
B92

**B92-P**  
—

**1109V**  
—

**B97-PT**  
—

**B97-PT5**  
—

**B98-PT**  
—

**B98-PT5**  
—

GENERAL MOTORS

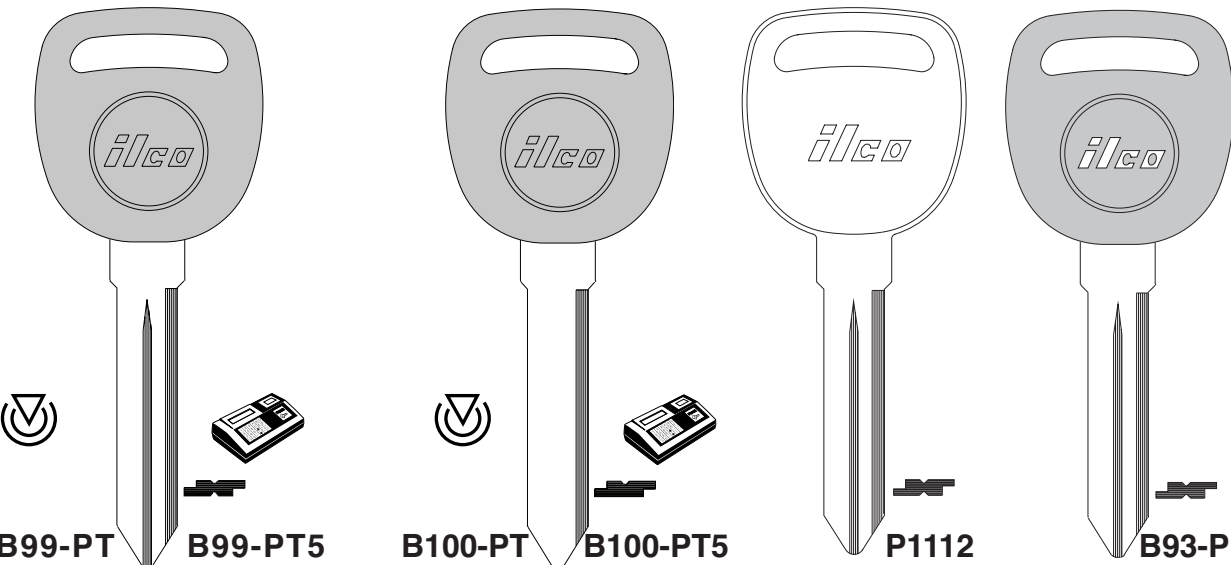

ILCO  
EZ

**B99-PT**  
—

**B99-PT5**  
—

**B100-PT**  
—

**B100-PT5**  
—

**P1112**  
B93

**B93-P**  
—

GENERAL MOTORS

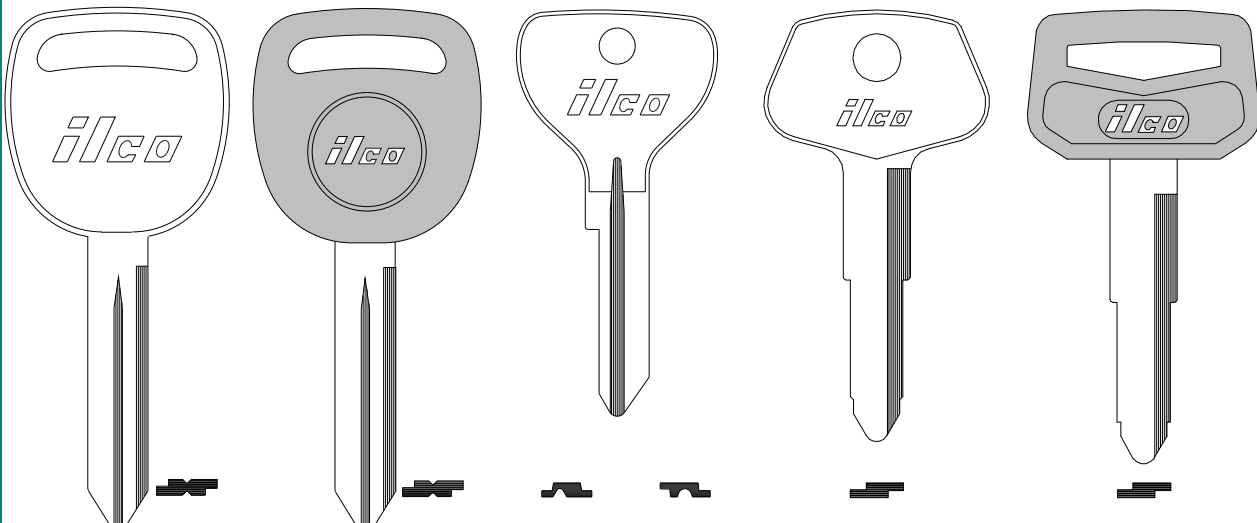

ILCO  
EZ

**P1113**  
B102

**B102-P**  
—

**OP11** **U62VP**  
— —

**X54**  
DC1

**DC1-P**  
—

GENERAL MOTORS

**X121**  
DC3

**DC3-P (-PC)**  
—

**X143**  
B53

**X145**  
B55

**X146**  
B56

**ILCO**  
EZ

GENERAL MOTORS

**X154**  
B54

**X162**  
B59

**X168**  
B61

**X180**  
B69

**HU46T2**  
—

**ILCO**  
EZ

GENERAL MOTORS

**B103-PT**  
—

**B103-PT5**  
—

**B104-PT**  
—

**B104-PT5**  
—

**B104-P-2 thru 15**  
VATS

**P1114**  
B110

**ILCO**  
EZ

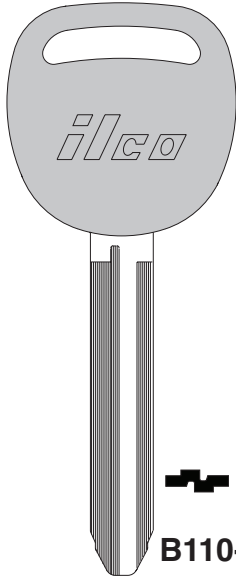
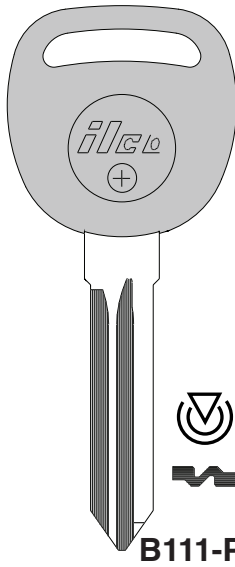
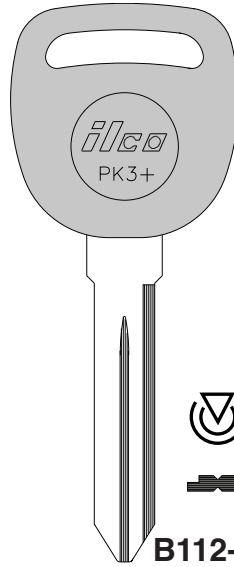
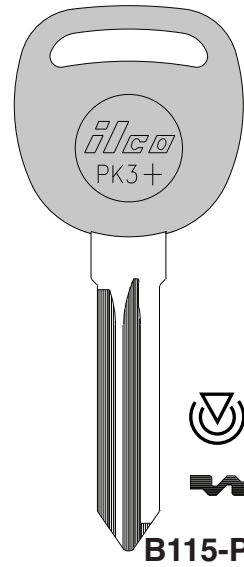
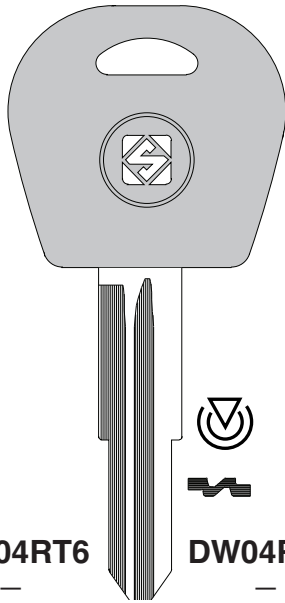
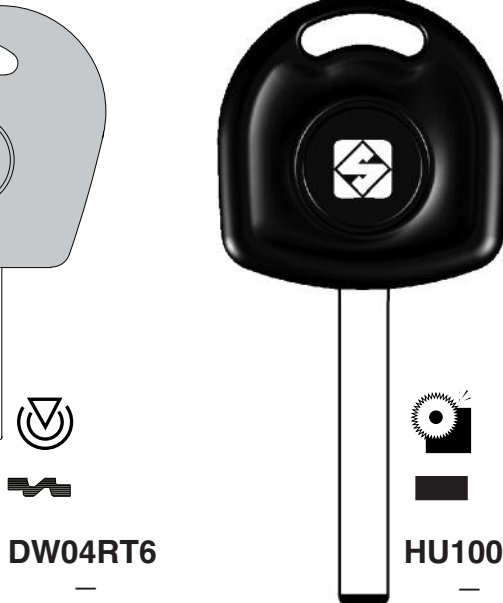
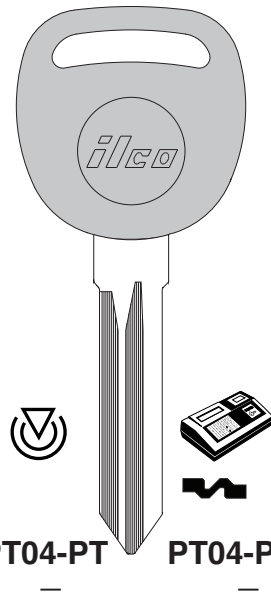
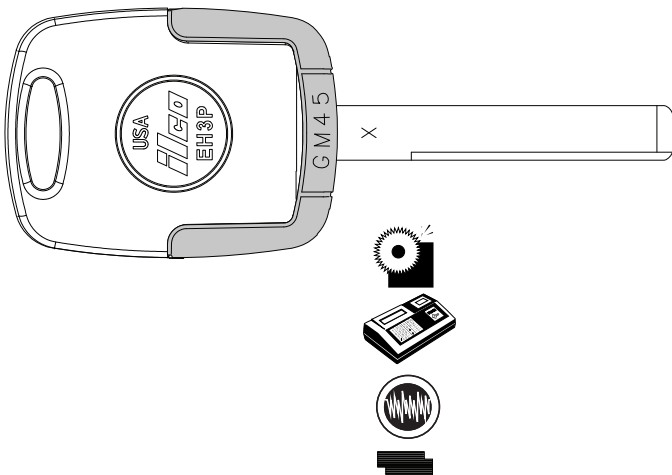

**GENERAL MOTORS****B110-P****B111-PT****B112-PT****B115-PT**ILCO  
EZ**GENERAL MOTORS****DW04RT6****HU100-P****PT04-PT****PT04-PT5**ILCO  
EZ**GENERAL MOTORS****EK3P-GM45**  
(Complete Key)**EH3P**  
(Head Only)**EB3-X-GM45**  
(Blade Only)ILCO  
EZ

GENERAL MOTORS

VEHICLE

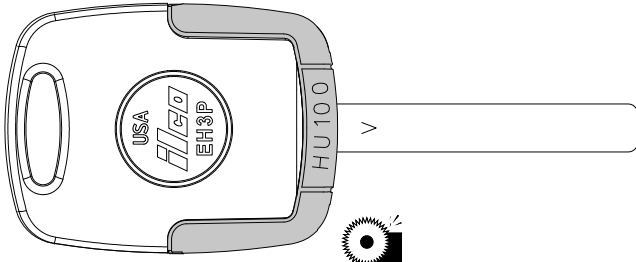

**EH3P**  
(Head Only)



**EB3-V-HU100**  
(Blade Only)



**EK3P-HU100**  
(Complete Key)

ILCO  
EZ

sec 1 page 58

GENERAL MOTORS

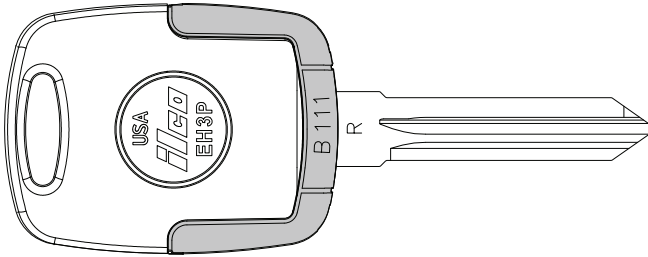

**EH3P**  
(Head Only)



**EB3-R-B111**  
(Blade Only)



**EK3P-B111**  
(Complete Key)

ILCO  
EZ

GENERAL MOTORS INTERNATIONAL

GILERA

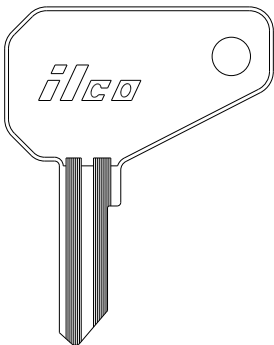

**SZ4**  
—

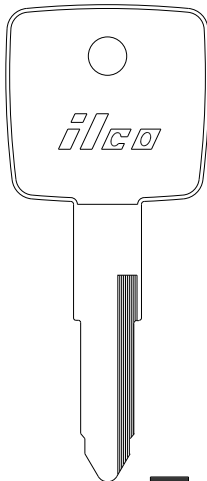

**SZ5**  
—



**HT98**  
—

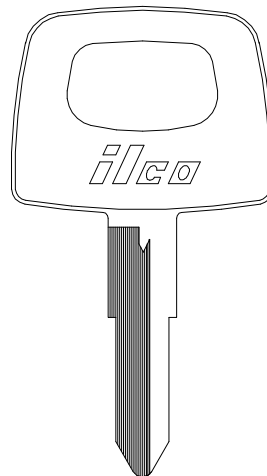

**P1098V**  
LUV1



**ZD17RAP-SI**  
LUV1

ILCO  
EZ

GILERA

GOGOMOBILE

GOLF CART



ZD24RDP-SI

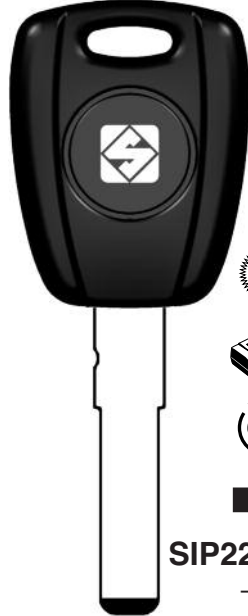

SIP22T5-SI

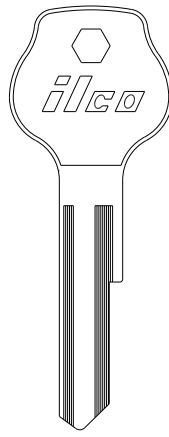

L62VA

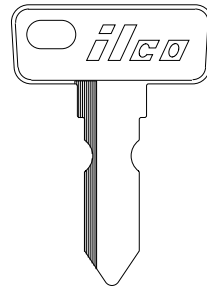

CC1

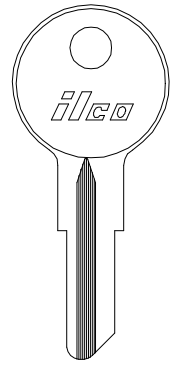

1098L  
B3

ILCO  
EZ

GOLF CART

GRUMMAN LONG LIFE  
VEHICLE (POST OFFICE)

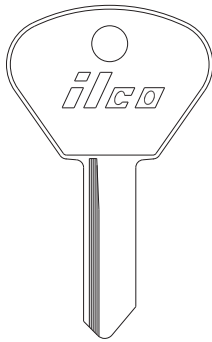

F91G

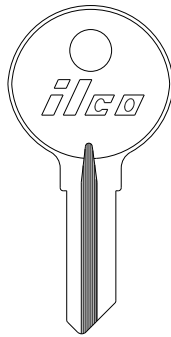

1069B

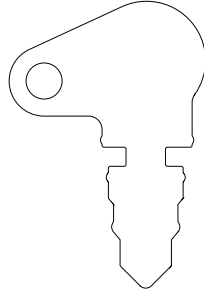

1147

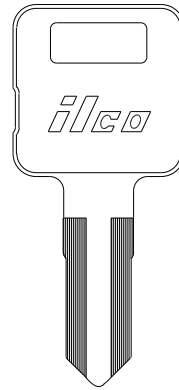

1524

ILCO  
EZ

HARLEY DAVIDSON

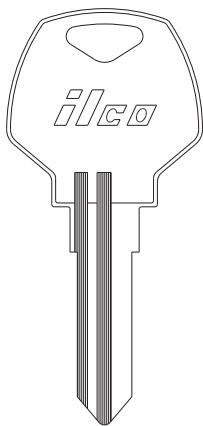

HYD1



HYD2



HYD3

HYD5

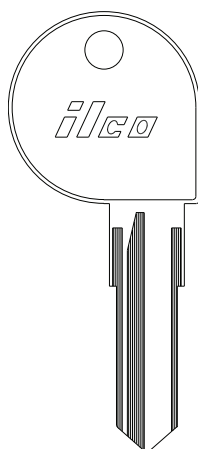

HYD6



HYD7



HYD8

HYD10



HYD11

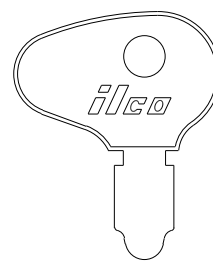

X70

ILCO  
EZ

HARLEY DAVIDSON

								ILCO EZ
X94	X98	X125						
—	—	—						
X95	X100	X126						
—	—	—						
X96	X101	X127						
—	—	—						
X93	X97	X102		H72G	H72H	H78KR	X234	
—	—	—		—	—	—	HYD13	

HARLEY DAVIDSON

						ILCO EZ
				X134	X142	
				—	—	
				X135		
				—		
				X136		
				—		
HY6R	HY9	ISP2	X133	X141		
—	—	—	—	—		

HARLEY DAVIDSON      HEINKEL      HINO

	  OD .377" - 9.6mm ID .312" - 7.9mm (BRASS)				ILCO EZ
X226	1137B	NE5	X274	TR37	
HYD12	—	—	HN3	TR33	

**HINO HODAKA HONDA (AUTOMOBILES)**

ILCO EZ							
	TR33-P (-PC)	HOD1	HD23	HD29	HD33	X38	X44
	—	—	—	—	—	HO41	HO44
	HD30	HD31	HD32	HD30	HD35		
	—	—	—	—	—		

**HONDA (AUTOMOBILES)**

ILCO EZ					
	X51	HD70	HON32P	HD71	HON33P
	AA2	—	—	—	—
	X51	HD70	HON32P	HD71	HON33P
	—	—	—	—	—

**HONDA (AUTOMOBILES)**

ILCO EZ					
	X71	HD70U-P	X129	HD82-P	X130
	HD70U	—	HD82	—	—
	X71	HD70U-P	X129	HD82-P	X130
	—	—	—	—	—

VEHICLE

HONDA (AUTOMOBILES)

<b>HON38RP</b> —	<b>X181</b> HD90	<b>HD90-P (-PC)</b> —	<b>X190</b> HD94	<b>X182</b> HD91

VALET FOR X181 & HD90-P (-PC)

ILCO  
EZ

HONDA (AUTOMOBILES)

<b>HD91-P</b> —	<b>X195</b> HD98	<b>HD98-P (-PC)</b> —	<b>X191</b> HD95	<b>X198</b> B74

VALET FOR X182, HD90-P,  
X195 & HD98-P (-PC)

ILCO  
EZ

HONDA (AUTOMOBILES)

<b>B74-P</b> —	<b>X214</b> HD103	<b>HD103-P (-PC)</b> —	<b>X215</b> HD104	<b>X184</b> B65

VALET FOR X214, HD103-P (-PC)

ILCO  
EZ

**HONDA (AUTOMOBILES)**

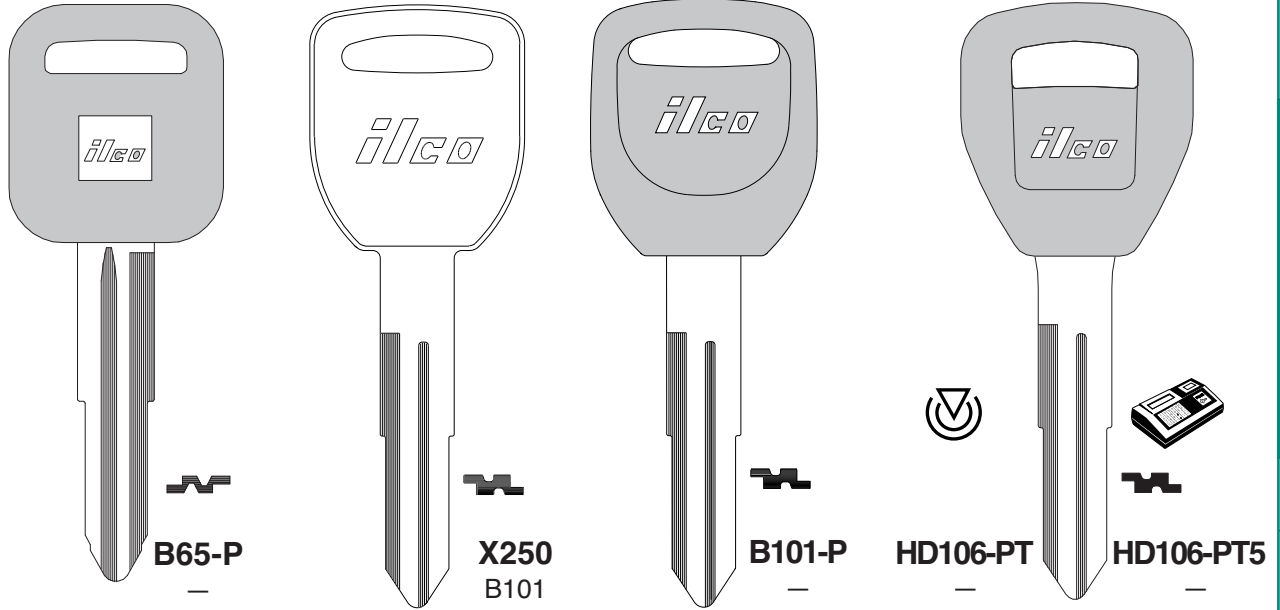
 ILCO  
EZ

VEHICLE

sec 1 page 63

**HONDA (AUTOMOBILES)**

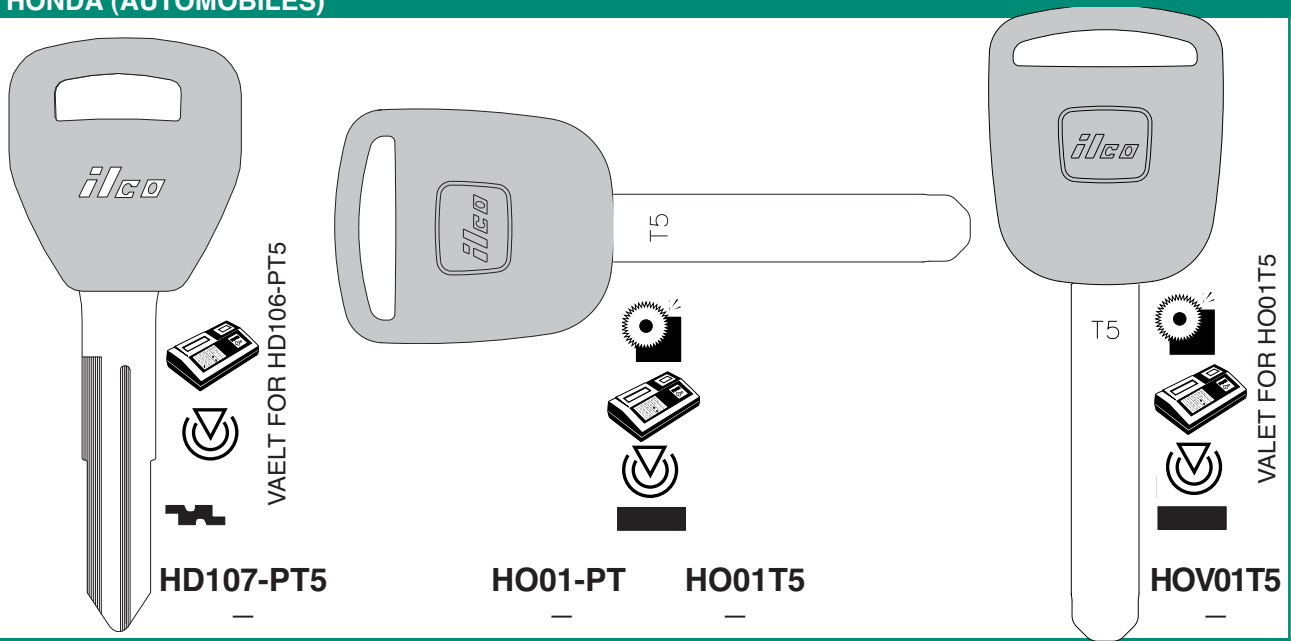
 ILCO  
EZ

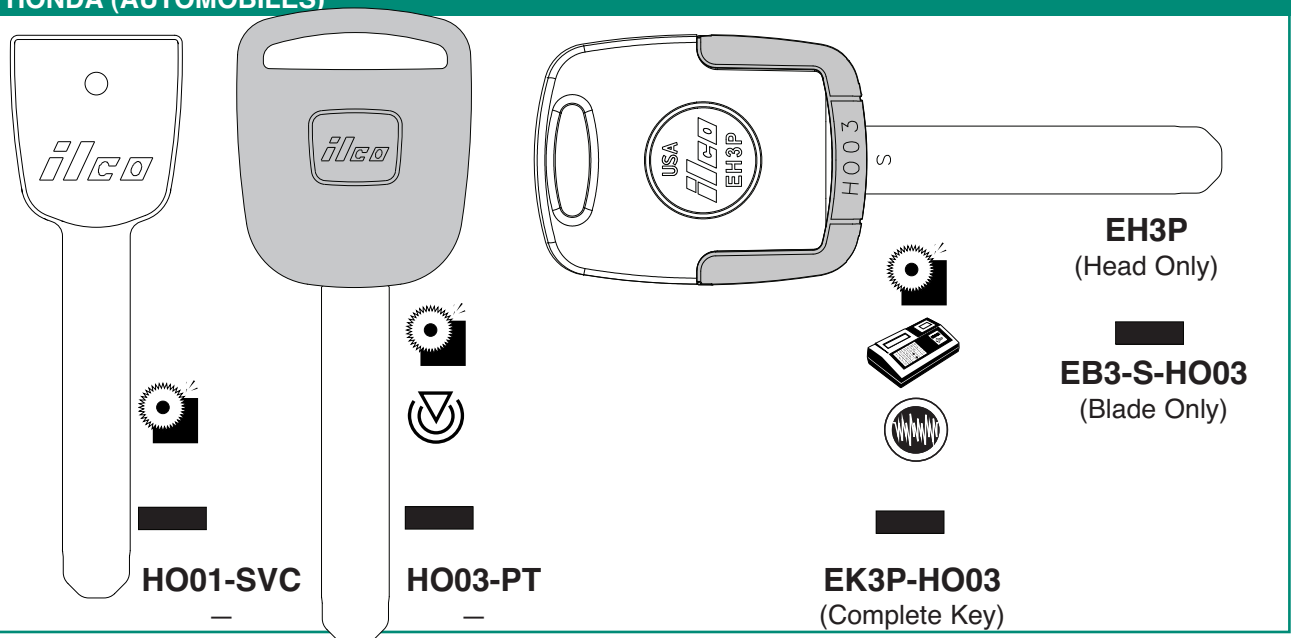
**HONDA (AUTOMOBILES)**

 ILCO  
EZ

**EH3P**  
(Head Only)

**EB3-S-HO03**  
(Blade Only)

**EK3P-HO03**  
(Complete Key)

HONDA (AUTO) HONDA (MOTORCYCLES)

<p>HD113-PT</p>	<p>HD1</p>	<p>HD2</p>	<p>HD3</p>	<p>HD4</p>	<p>HD5</p>	<p>HD9</p>	<p>HD17</p>	<p>HD19</p>	<p>HD20</p>	<p>HD21</p>	<p>HD22</p>	<p>HD26</p>	<p>HD18</p>	<p>HD28</p>	<p>HD5R</p>
	—	—	—	—	—	—	—	—	—	—	—	—	—	—	—
	—	—	—	—	—	—	—	—	—	—	—	—	—	—	—
	—	—	—	—	—	—	—	—	—	—	—	—	—	—	—

ILCO EZ

HONDA (MOTORCYCLES)

<p>HD6</p>	<p>HD16</p>	<p>E67K</p>	<p>HON24</p>	<p>HON24RP</p>	<p>HON39P</p>	<p>HON42</p>
—	—	—	—	—	—	—
—	—	—	—	—	—	—
—	—	—	—	—	—	—

ILCO EZ

HONDA (MOTORCYCLES)

<p>HON42AP</p>	<p>HD7</p>	<p>HD23</p>	<p>HD29</p>	<p>HD30</p>	<p>HD31</p>	<p>HD32</p>	<p>HD33</p>	<p>HD34</p>	<p>HD35</p>	<p>HD8</p>	<p>HD10</p>	<p>HD11</p>	<p>HD12</p>	<p>HD13</p>	<p>HD14</p>	<p>HD15</p>	<p>HD42</p>	<p>HD43</p>	<p>H76G</p>	<p>H76X</p>
—	—	—	—	—	—	—	—	—	—	—	—	—	—	—	—	—	—	—	—	—
—	—	—	—	—	—	—	—	—	—	—	—	—	—	—	—	—	—	—	—	—
—	—	—	—	—	—	—	—	—	—	—	—	—	—	—	—	—	—	—	—	—

ILCO EZ

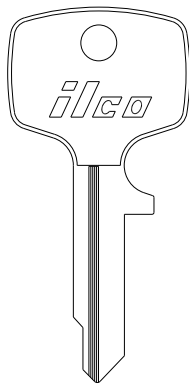

**HONDA (MOTORCYCLES)**

**HO61Q**  
—

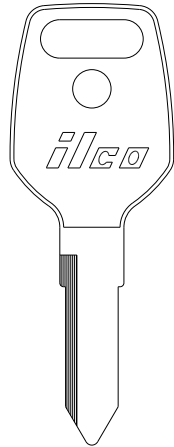
**67J**  
—

**R67K**  
—

**X19**  
HD40

**X38**  
HO41

**HD25**  
—

**H67K**  
—

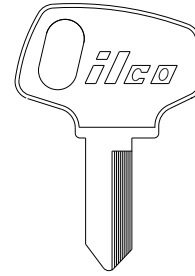
**S67K**  
—

**SR67K**  
—

**HD37**  
—

**HD38**  
—

**HD39**  
—

**HD24**  
—

**HD36**  
—

**HD46**  
—

**ILCO**  
EZ

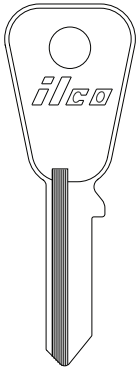
**HONDA (MOTORCYCLES)**

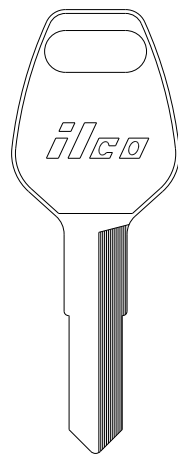
**X42**  
HD47

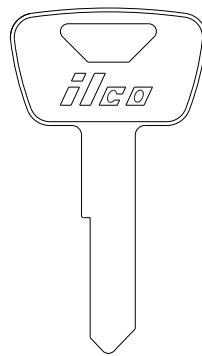
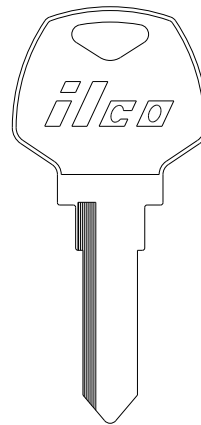
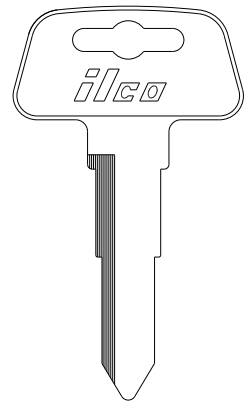
**X43**  
HD48

**X44**  
HO44

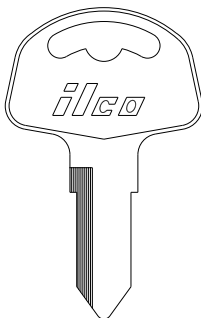
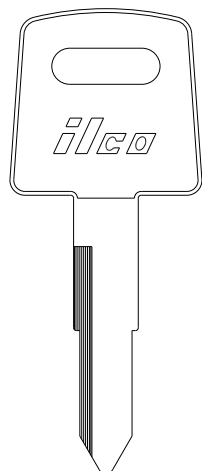
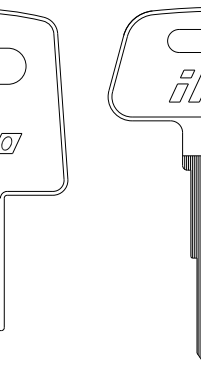
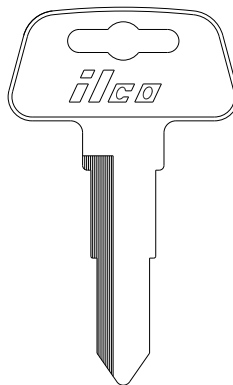
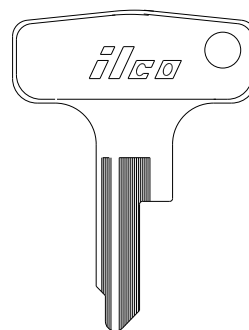
**HD45**  
—

**HD49**  
—

**HD51**  
—

**HD53**  
—

**ILCO**  
EZ

**HONDA (MOTORCYCLES)**

**HD56**  
—

**X57**  
HD72

**X58**  
HD73

**HD58**  
—

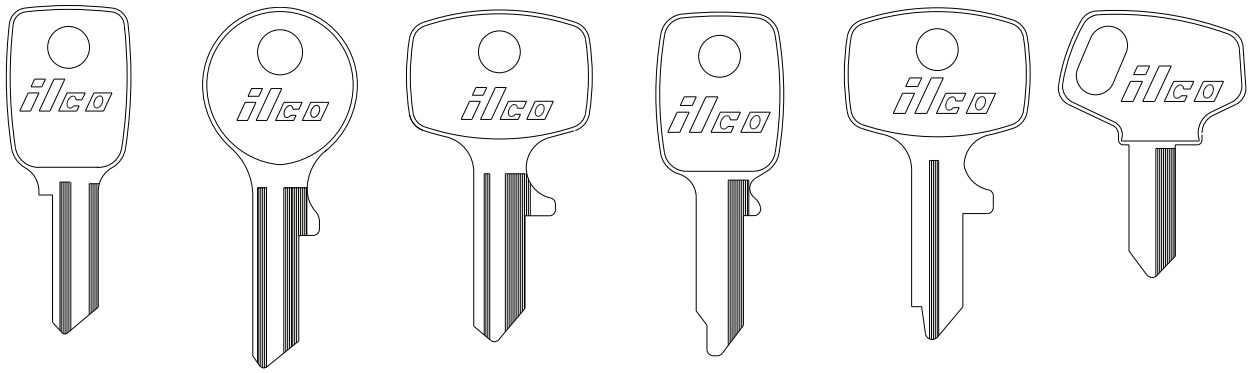
**HD59**  
—

**HD60**  
—

**HD61**  
—

**ILCO**  
EZ

HONDA (MOTORCYCLES)



HO61C	HO61D	HO61E	HO61H	HO61R	HD62
—	—	—	—	—	—

ILCO  
EZ

HONDA (MOTORCYCLES)

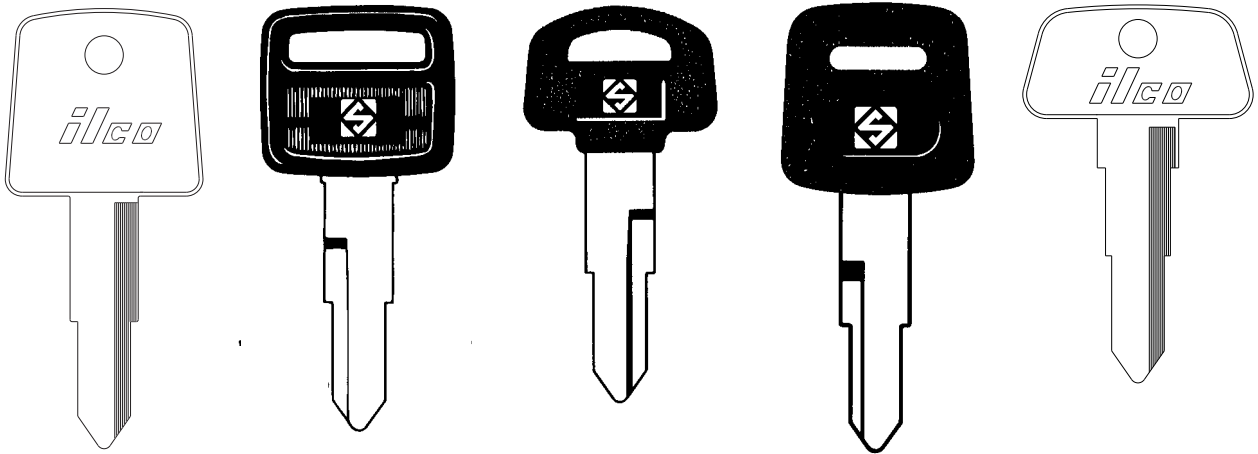

HD63	HON31RAP	HON31RBP	HON31RP	HD64
—	—	—	—	—

ILCO  
EZ

HONDA (MOTORCYCLES)

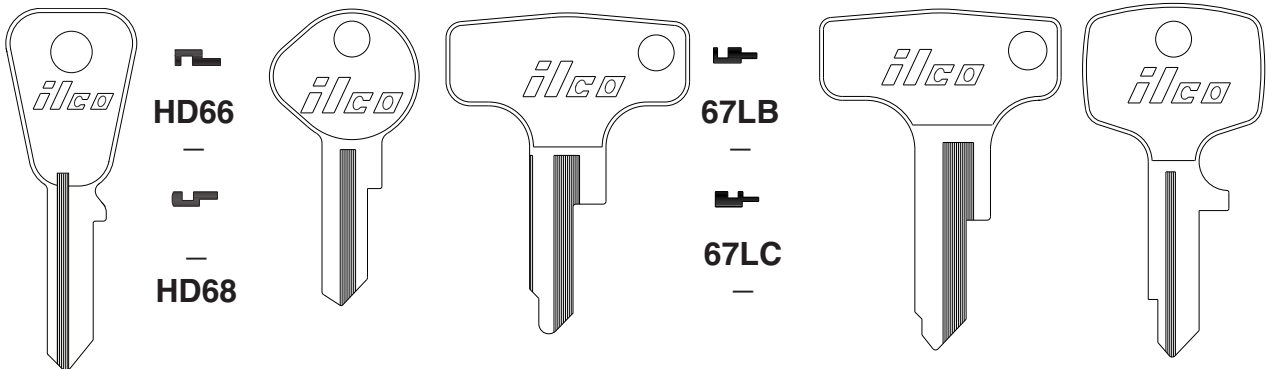

HD66	—	—	67LB	—	—
—		—	—	67LC	—
—	—	—	—	—	—
HD65	67H	67LA	67LD	B67K	—
—	—	—	—	—	—

ILCO  
EZ

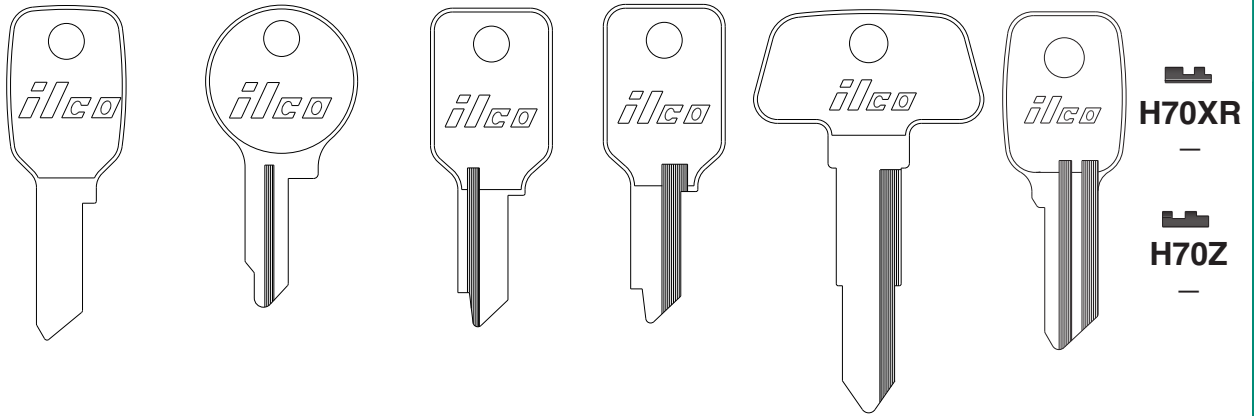
**HONDA (MOTORCYCLES)**

**ILCO**  
EZ

<b>C67K</b>	<b>D67K</b>	<b>U67K</b>	<b>U67KR</b>	<b>HD69</b>	<b>H70X</b>
—	—	—	—	—	—

sec 1 page 67

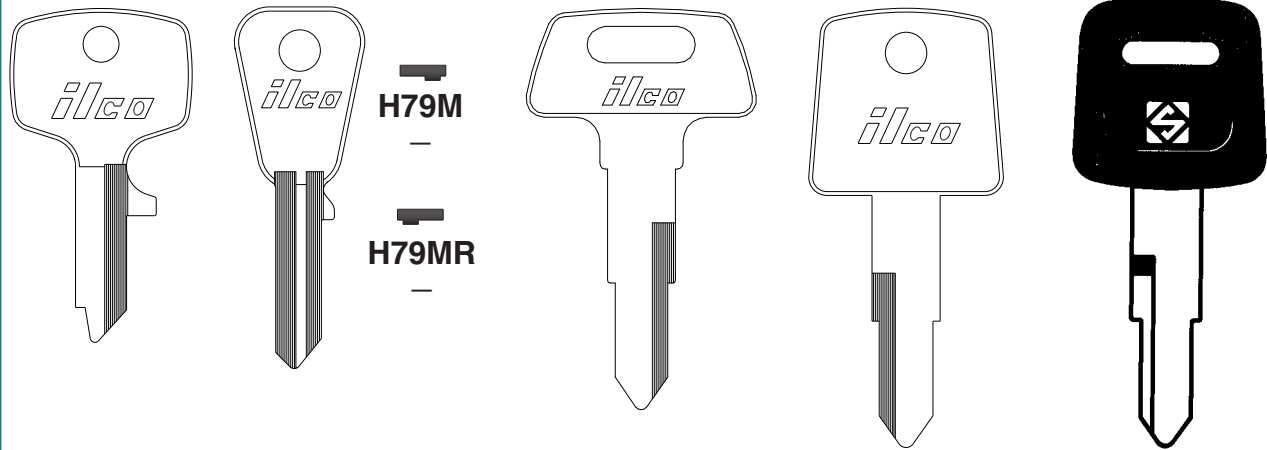
VEHICLE

**HONDA (MOTORCYCLES)**

**ILCO**  
EZ

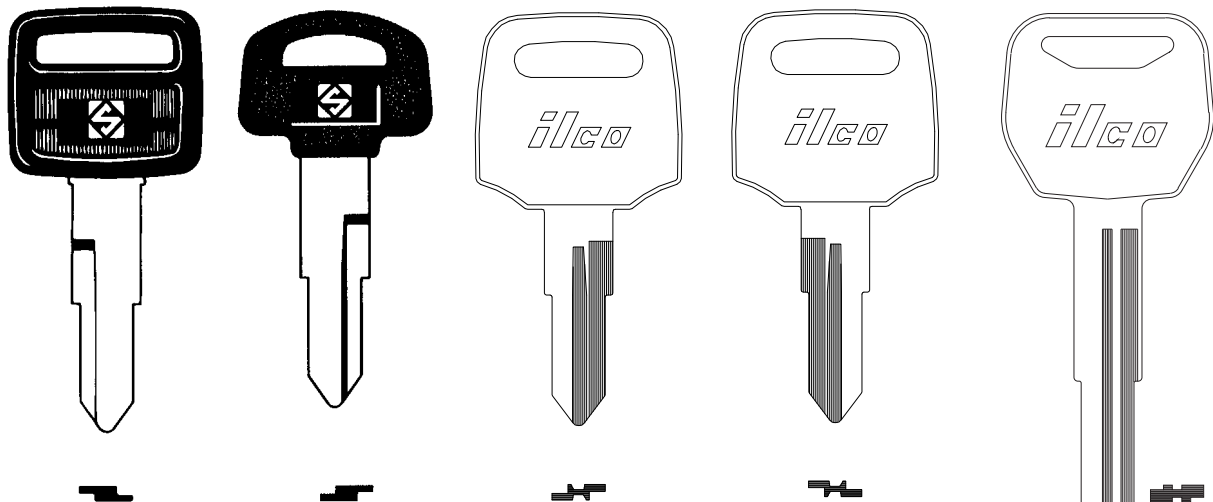
<b>H73Z</b>	<b>H77P</b>	<b>H77PR</b>	<b>X84</b>	<b>X138</b>	<b>HON31P</b>
—	—	—	<b>HD74</b>	<b>HD75</b>	—

**HONDA (MOTORCYCLES)**

**ILCO**  
EZ

<b>HON31AP</b>	<b>HON31BP</b>	<b>X246</b>	<b>X252</b>	<b>X265</b>
—	—	<b>HD105</b>	<b>HD108</b>	<b>HD109</b>

HONDA (MOTORCYCLES)

VEHICLE

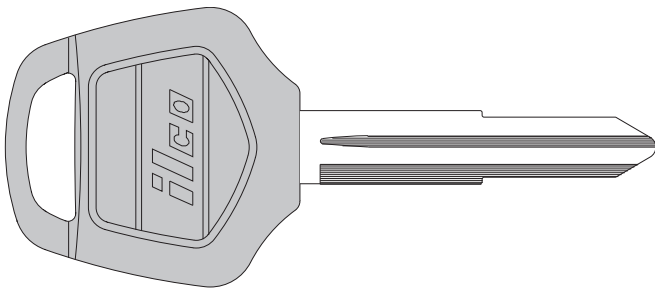
sec 1 page 68



HD110-P  
—

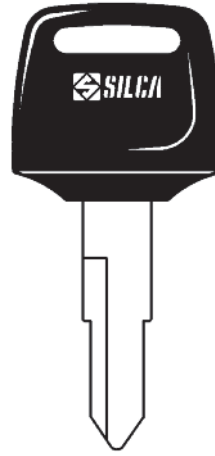

HON31CP-SI  
—

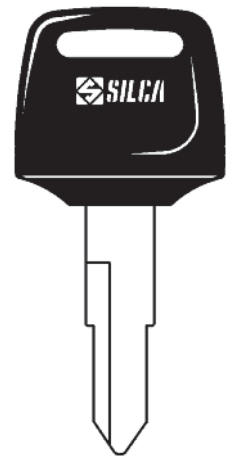

HON31RCP-SI  
—

ILCO  
EZ

HONDA (MOTORCYCLES)

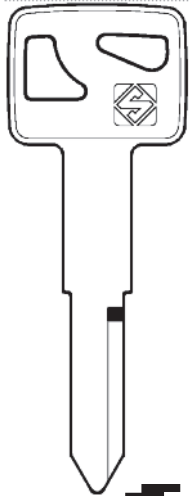

HON41-SI  
—

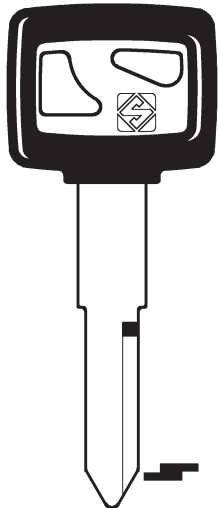

HON41P-SI  
—

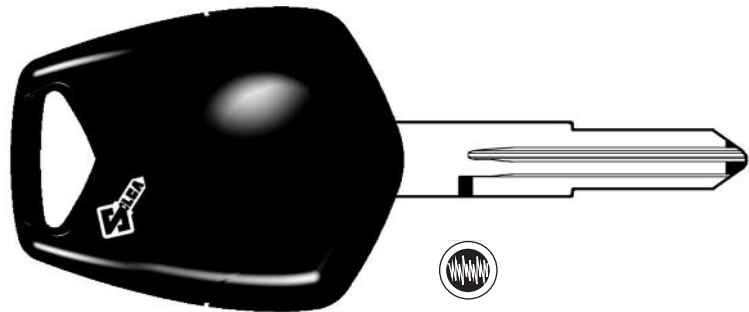

HON58REHP-SI  
—

ILCO  
EZ

HONDA (MOTORCYCLES)



HON64BP-SI  
—



HON64RBP-SI  
—

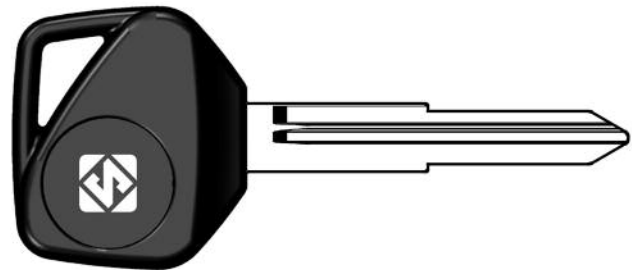

HON70T14-SI  
—

ILCO  
EZ

**HONDA (MOTORCYCLES)****ZD24RDP-SI**

—

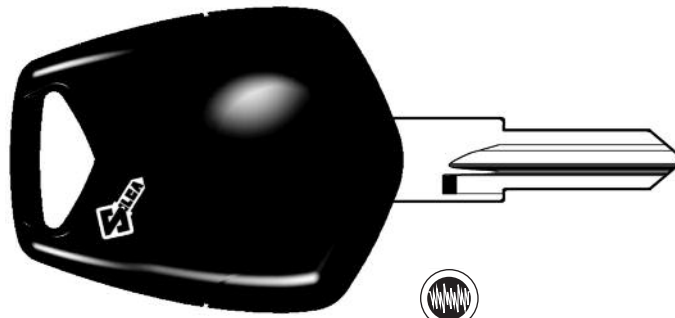
**HON70EHP-SI**

—

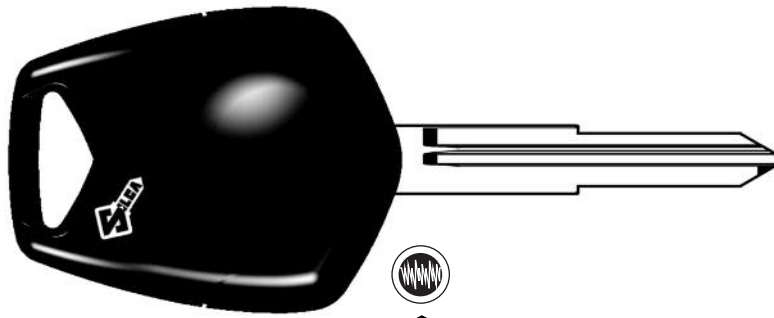
ILCO  
EZ**HONDA (MOTORCYCLES)****ZD24REHP**

—

**ZD24RT14-SI**

—

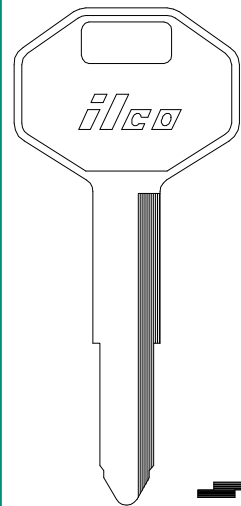
**HYUNDAI****X121**

DC3

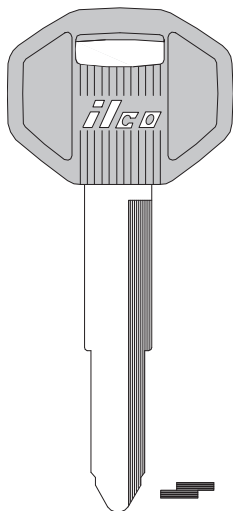
ILCO  
EZ**HYUNDAI****DC3-P (-PC)**

—

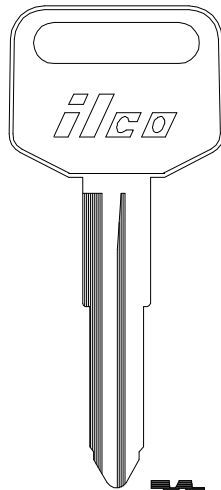
**X160**

HY2

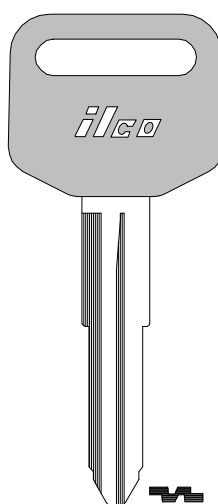
**HY2-P**

—

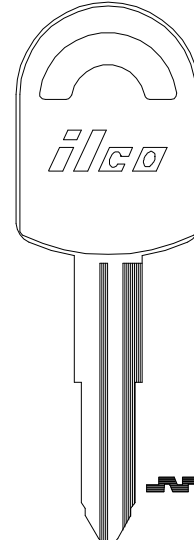
**X161**

HY3

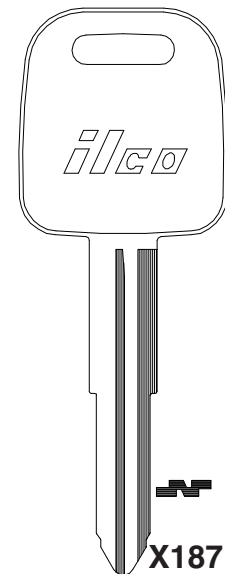
**X187**

HY4

ILCO  
EZ

HYUNDAI

VEHICLE

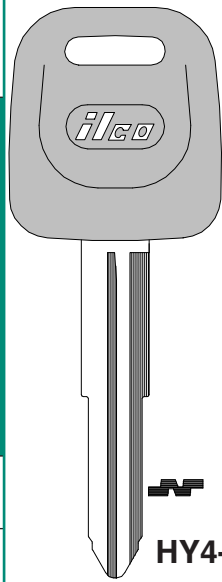

HY4-P  
—

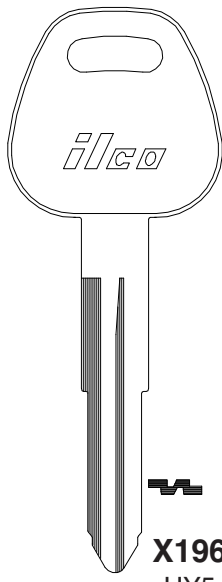

X196  
HY5

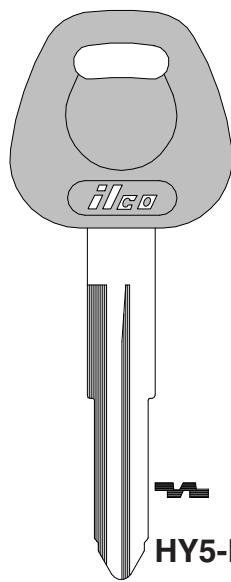

HY5-P  
—

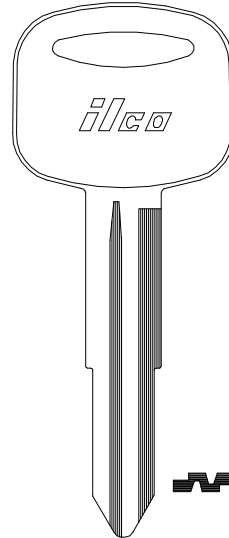

X216  
HY6

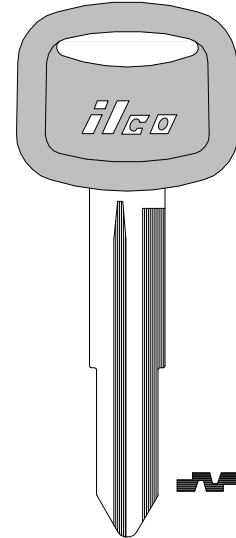

HY6-P  
—

ILCO  
EZ

HYUNDAI

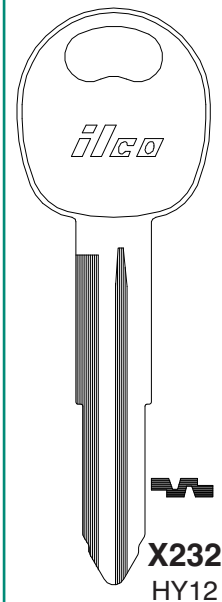

X232  
HY12

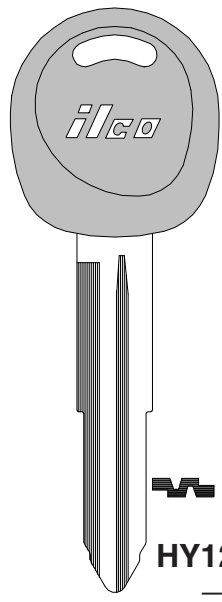

HY12-P  
—

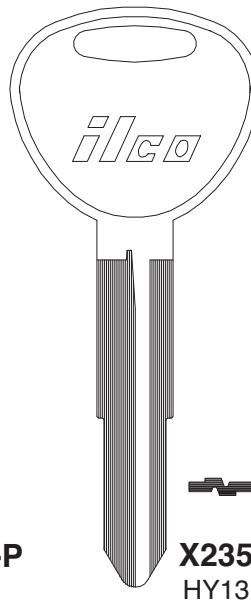

X235  
HY13

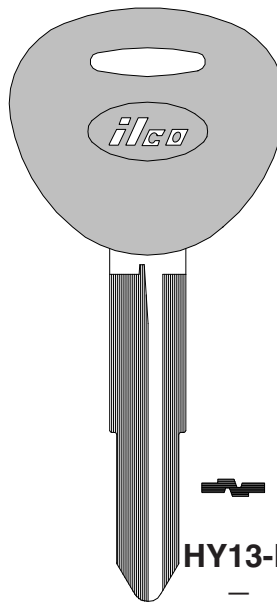

HY13-P  
—

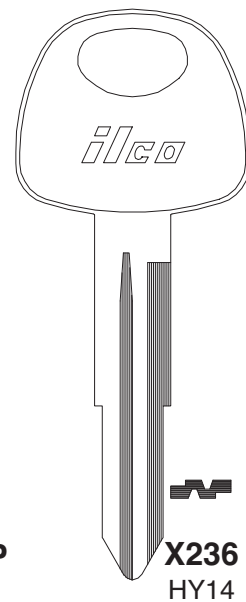

X236  
HY14

ILCO  
EZ

HYUNDAI

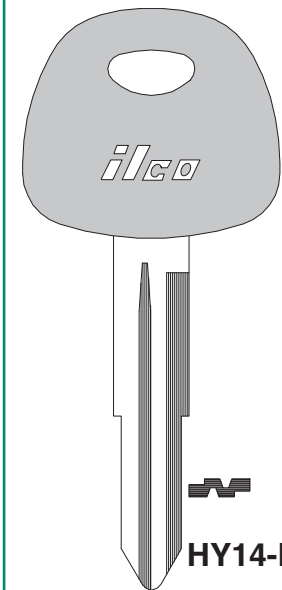

HY14-P  
—

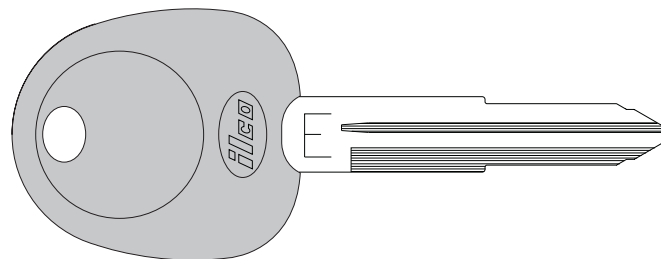

HY021-PT  
—

ILCO  
EZ

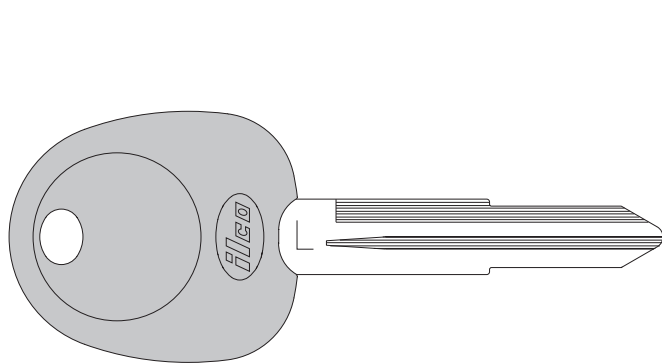
**HYUNDAI****HY022-PT**

—

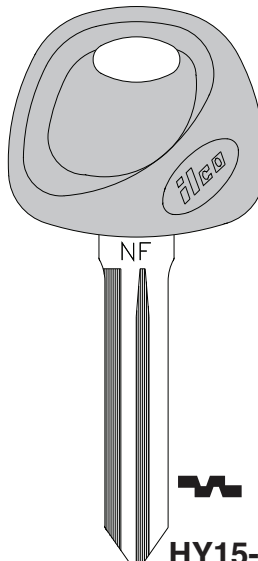
**HY15-P**

—

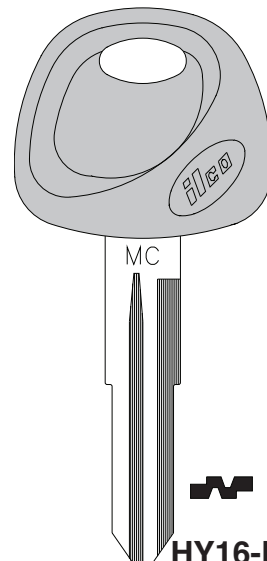
**HY16-P**

—

ILCO  
EZ

VEHICLE

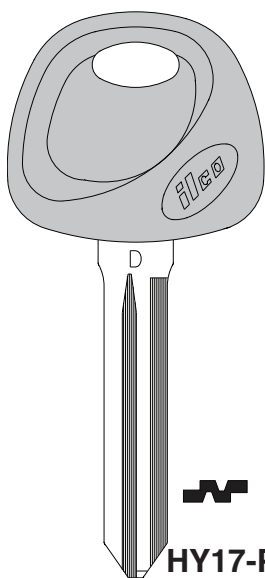
sec  
1 page  
71**HYUNDAI****HY17-P**

—

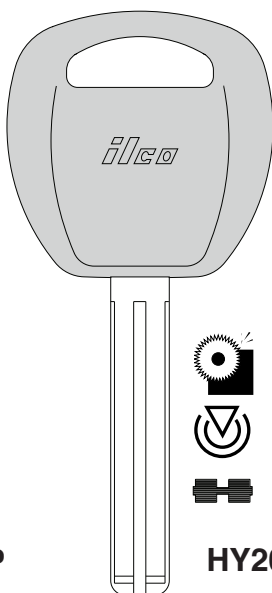
**HY20-PT**

—

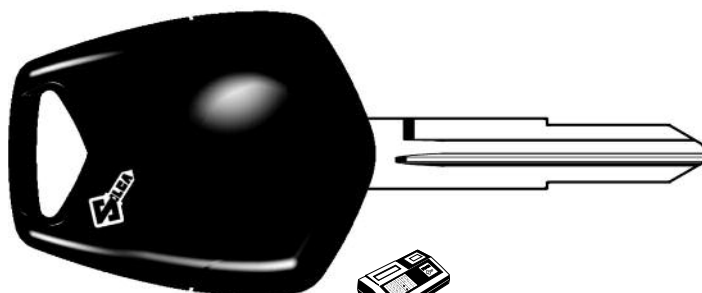
**HYN6EHP**

—

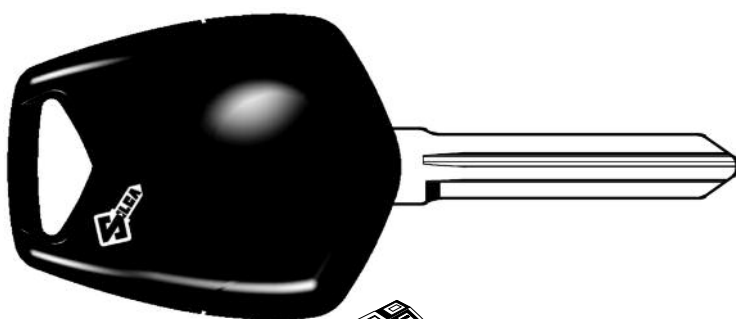
ILCO  
EZ**HYUNDAI****HYN14REHP**

—

ILCO  
EZ

HYUNDAI

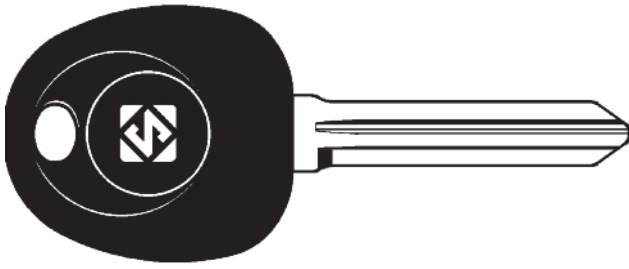

HYN14RT14

—

ILCO  
EZ

HYUNDAI

INDAK

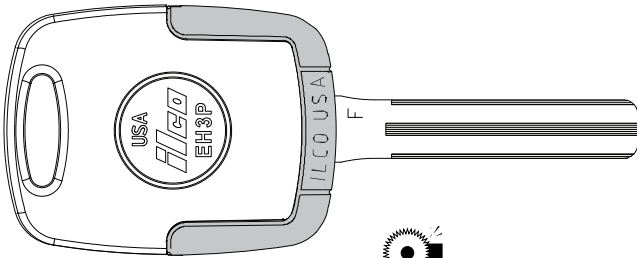

EK3P-HY20  
(Complete Key)

EH3P  
(Head Only)

EB3-F-TOY48  
(Blade Only)

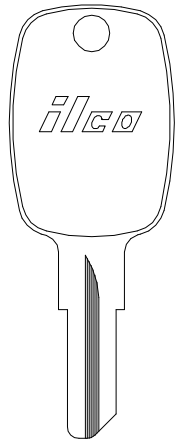

1098JD

—

ILCO  
EZ

INDAK

INDIAN

INFINITI/NISSAN

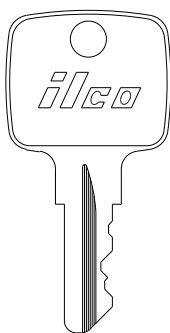

C1098JD

—



1148

—

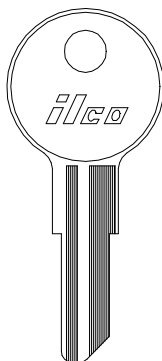

1041T  
CG16

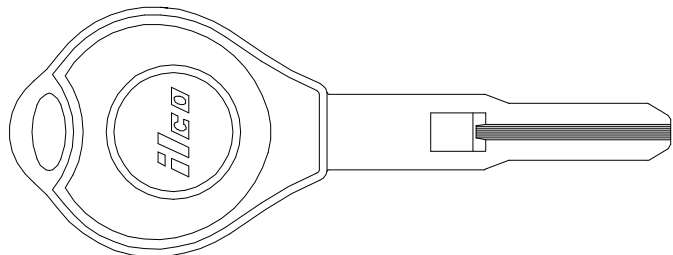

INF90

—

ILCO  
EZ

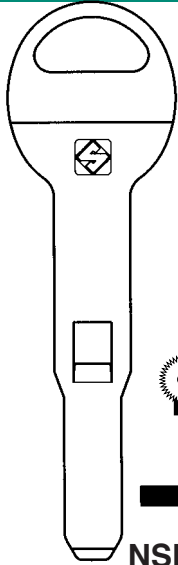

**INFINITI/NISSAN**
**ILCO  
EZ**

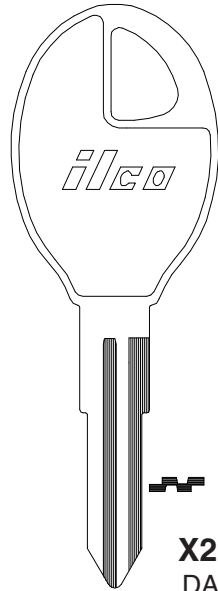
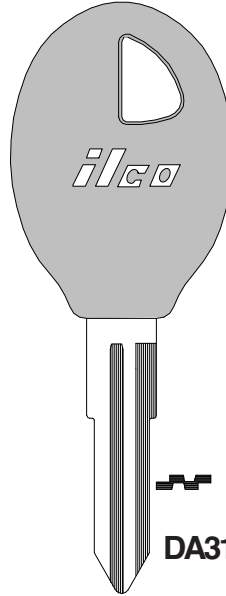
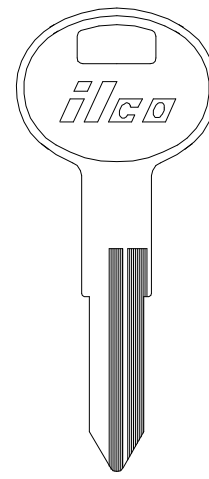
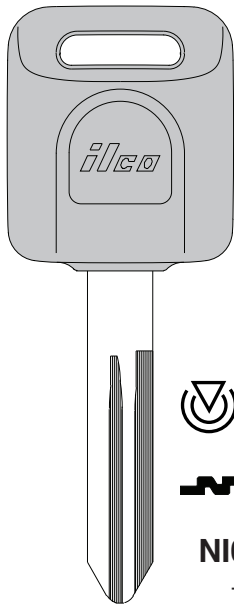
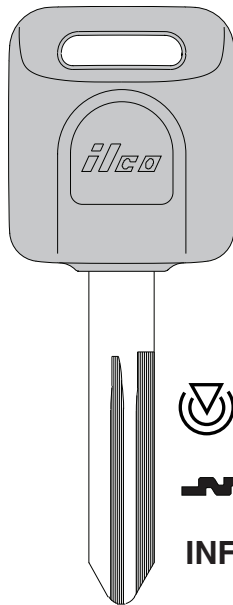
**NSN10**  
—

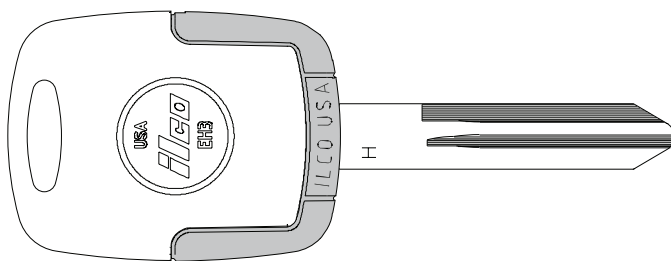
**VALET FOR  
INF90**

**X210  
DA31**

**DA31-P (-PC)**  
—

**X124  
DA28**
**VALET FOR X210 AND DA431-P (-PC)**
**INFINITI/NISSAN**
**ILCO  
EZ**

**NI04T**  
—

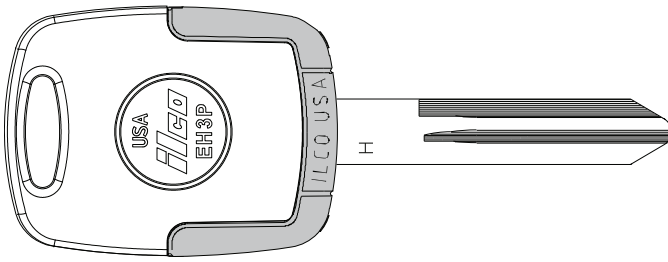
**INF45-PT**  
—

**INFINITI/NISSAN**
**ILCO  
EZ**

**NI02-EK3  
(Complete Key)**

**EH3  
(Head Only)**
  
**EB3-H-NI02  
(Blade Only)**

INFINITI/NISSAN

VEHICLE



**EH3P**  
(Head Only)

  
**EB3-H-NI02**  
(Blade Only)



**NI05**  
—



**EK3P-NI04**  
(Complete Key)

**ILCO**  
EZ

sec 1 page 74

ISETTA

ISUZU



**FV1**  
—

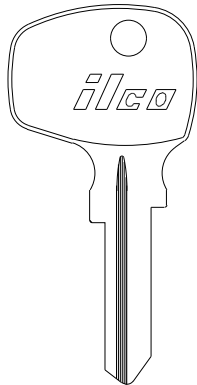

**MB5**  
—

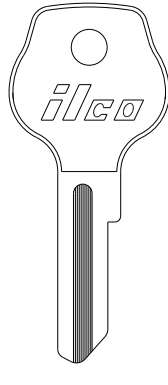

**R62VB**  
—

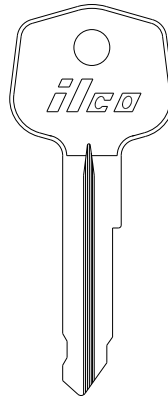

**63E**  
—

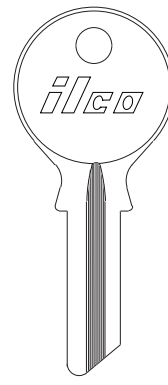

**63L**  
—

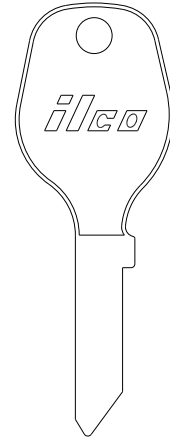

**SZ1**  
—

**ILCO**  
EZ

ISUZU

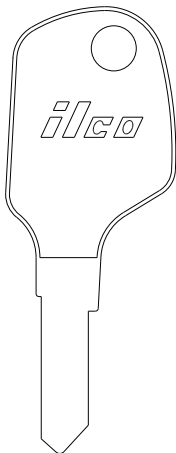

**SZ2**  
—

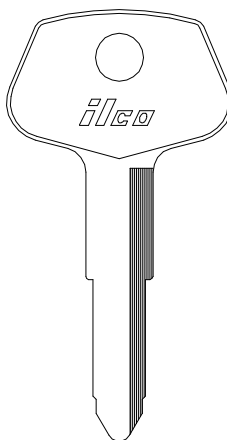

**X54**  
DC1

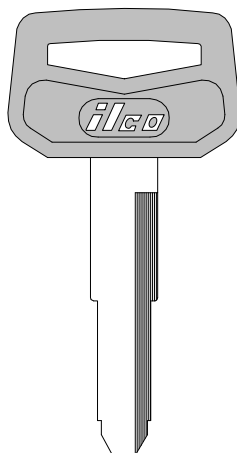

**DC1-P**  
—

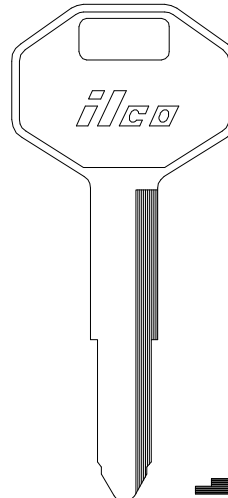

**X121**  
DC3

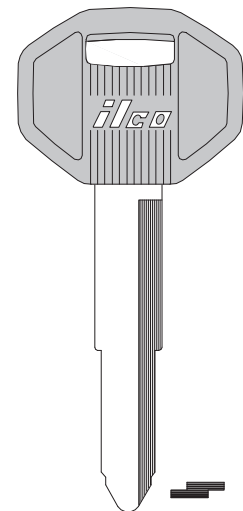

**DC3-P (-PC)**  
—

**ILCO**  
EZ

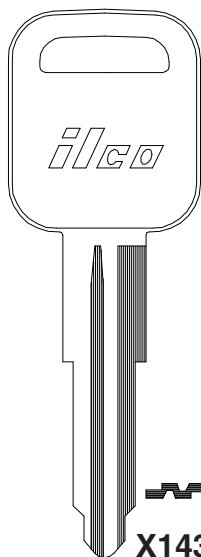
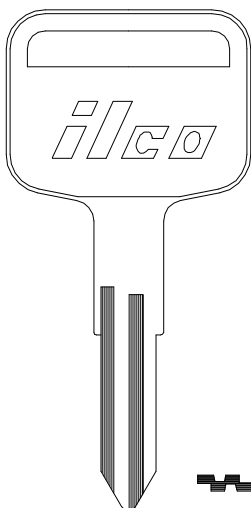
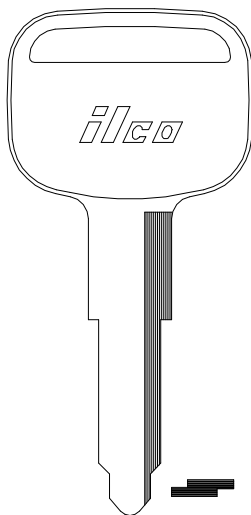
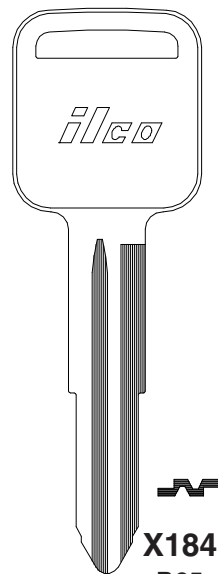
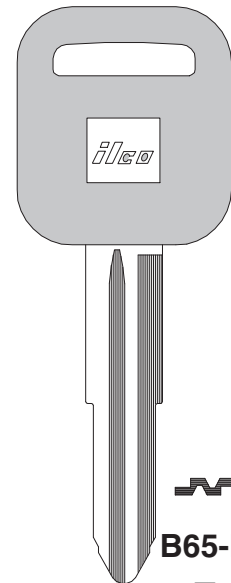
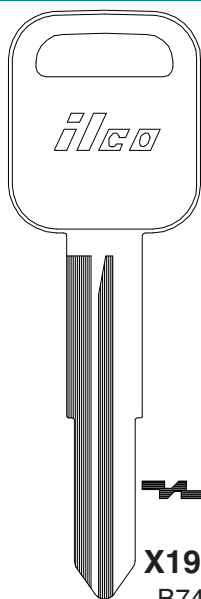
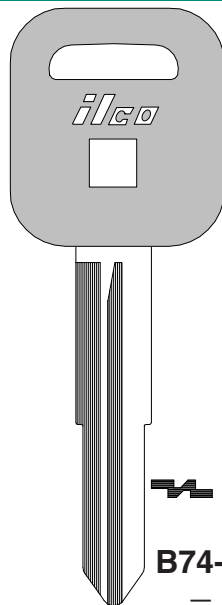
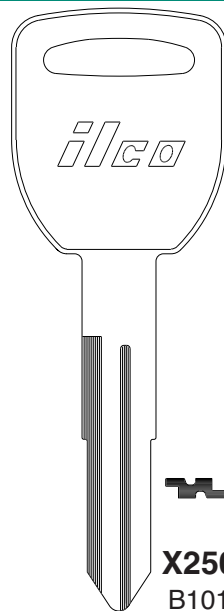
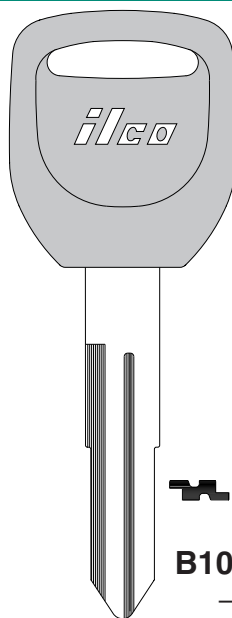
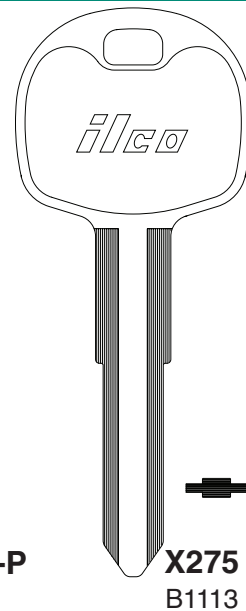
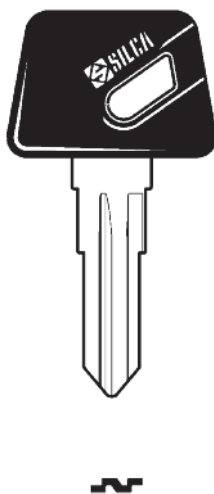
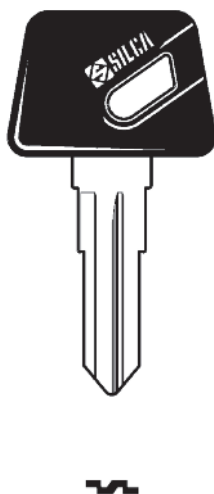
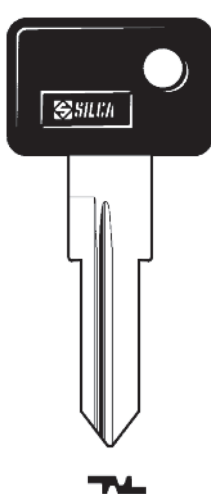
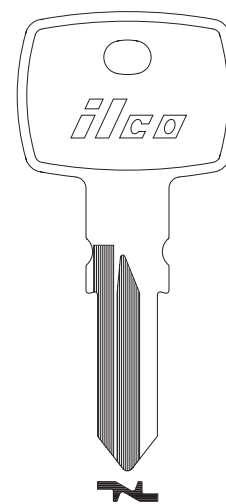
**ISUZU****X143**  
B53**X154**  
B54**X158**  
B57**X184**  
B65**B65-P**  
—**ILCO**  
EZ**ISUZU****X198**  
B74**B74-P**  
—**X250**  
B101**B101-P**  
—**X275**  
B1113**ILCO**  
EZ**ITALJET****YH34P-SI**  
—**YH34RP-SI**  
—**ZD16RP-SI**  
—**ZD23RCP-SI**  
—**X270**  
TMC1**ILCO**  
EZ

IVECO

JAGUAR

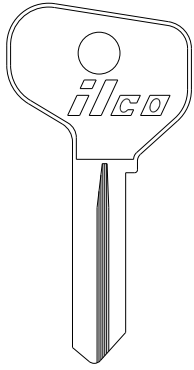

**FT37**  
—

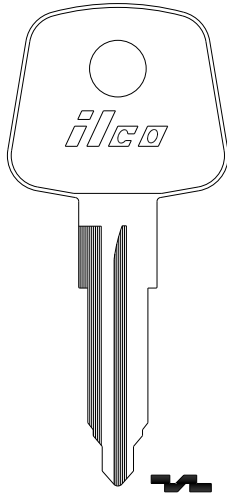

**X50**  
AA3

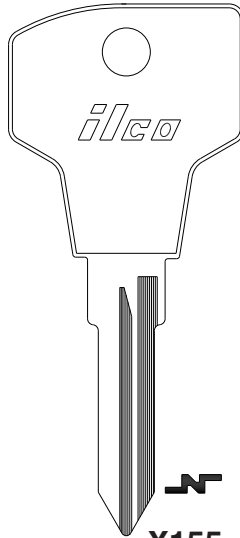

**X155**  
IV1

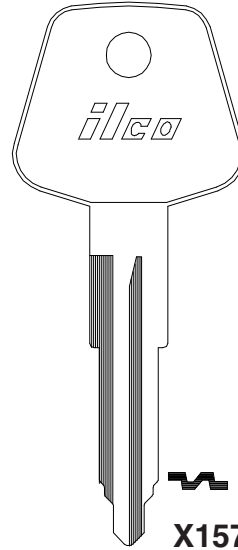

**X157**  
LF17

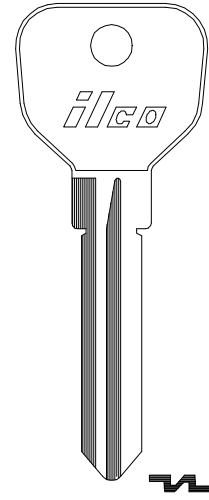

**MG1**  
—

**ILCO**  
EZ

JAGUAR

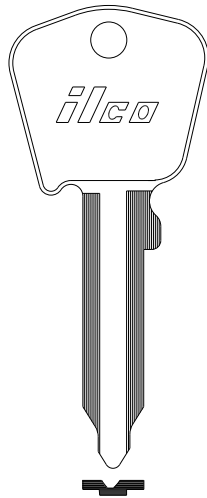

**KL2**  
—

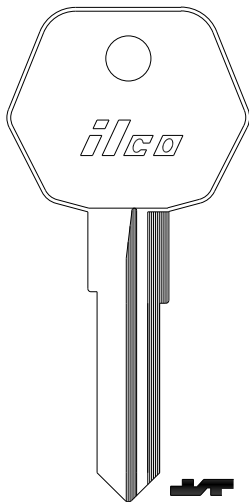

**WB2**  
—

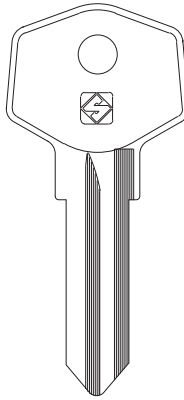

**CEM5**  
—

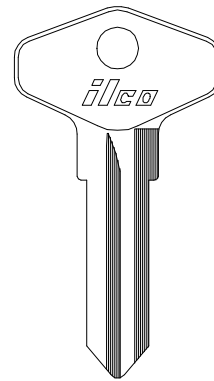

**BL6**  
—

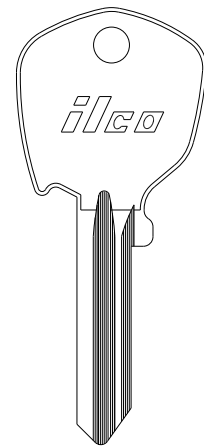

**FT6R**  
F81E

**ILCO**  
EZ

JAGUAR

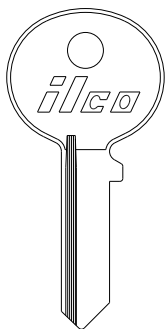

**UN16**  
—

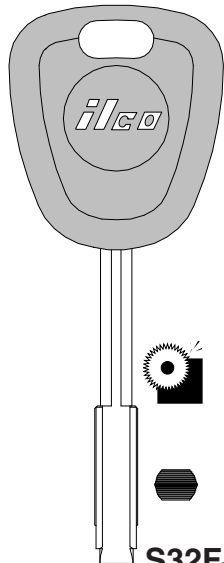

**S32FJ-P**  
—

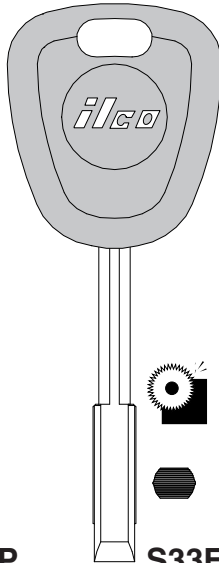

**S33FJ-P**  
—

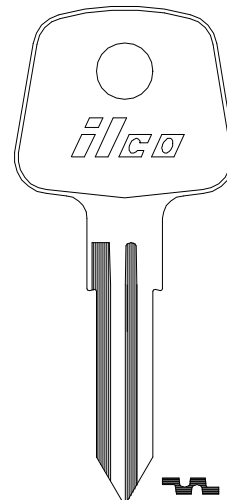

**X51**  
AA2

**ILCO**  
EZ

**JAGUAR**

<b>62DG</b>	—	<b>62DM</b>	—	—	—	—
—			—	—	—	—
—	<b>62DH</b>	<b>62DP</b>	—	—	—	—
—			—	—	—	—
—	<b>62DK</b>	<b>R62DM</b>	—	—	—	—
—						
<b>62DC</b>	—	<b>62DX</b>	<b>62FS</b>	<b>62FG</b>	<b>62FT</b>	<b>B62DR</b>
—	—	—	—	—	<b>F68YT</b>	<b>B62DP</b>
—	—	—	—	—	—	—

**ILCO**  
EZ

sec 1 page 77

VEHICLE

**JAGUAR**

<b>VW77</b>	<b>X86</b>	<b>FC7-P</b>	<b>X177</b>	<b>TBE1T5</b>
—	<b>FC7</b>	—	<b>JA2</b>	—

**ILCO**  
EZ

**JAGUAR**
**JAWA CYCLE**

<b>FO21T7-SI</b>	<b>FO21EH2</b>	<b>J66M</b>
—	—	—

**ILCO**  
EZ

JEEP

JOHN DEERE

SEE  
AMERICAN  
MOTORS  
OR  
CHRYSLER

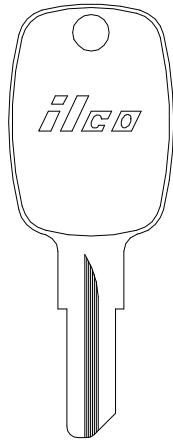

1098JD

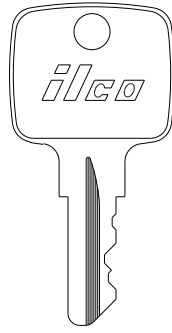

C1098JD

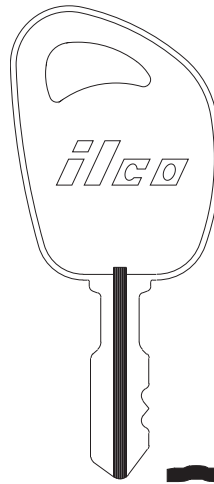

D1098JD

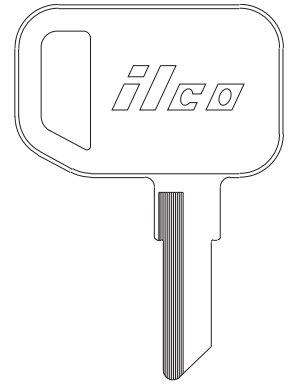

E1098JD

ILCO  
EZ

JOHN DEERE

JOHNSTON MOTORS

KAISER FRAISER

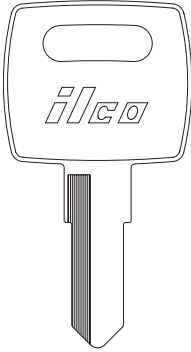

F1098JD

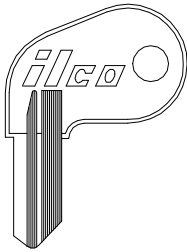

OM10

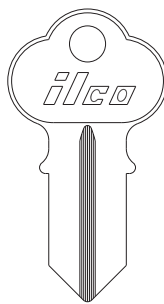

1041G  
CG1

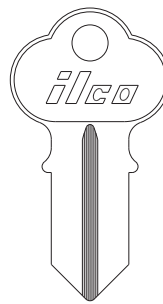

1041GA  
CG2

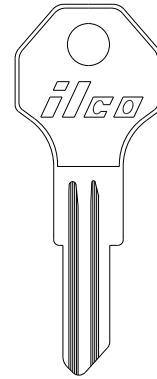

H122AL



H122ALR

ILCO  
EZ

KAISER FRAISER

KAWASAKI

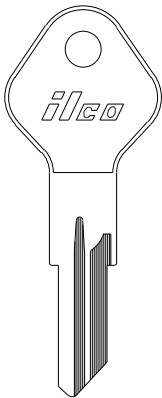

K122AR

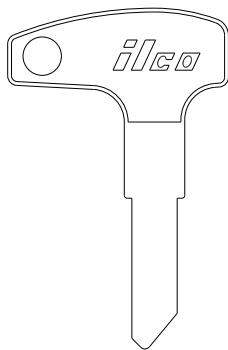

KA1



KA2



KA3

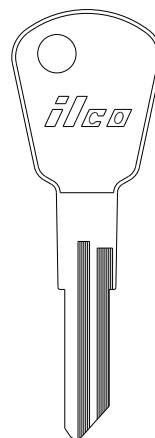

KA4

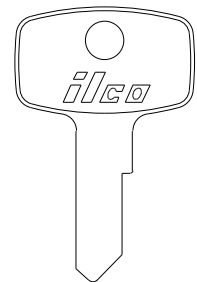

KA8

ILCO  
EZ

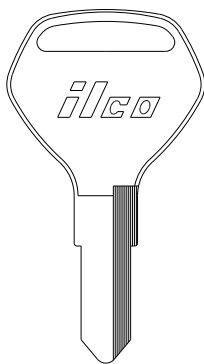
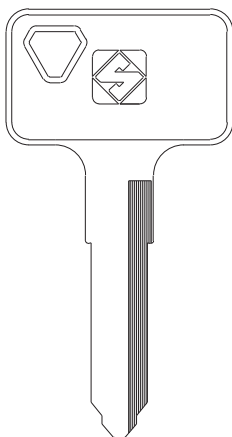
**KAWASAKI**

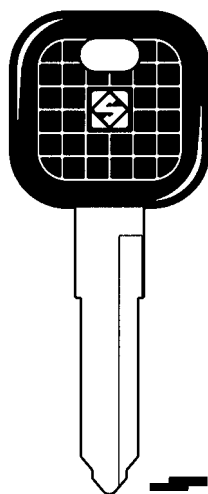
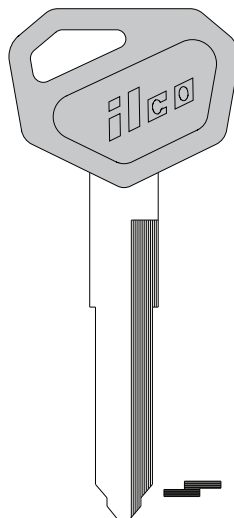
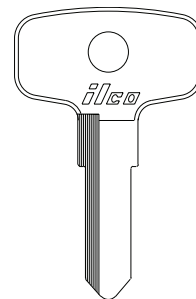
  
**KA12**  
 —

  
**KW14**  
 —

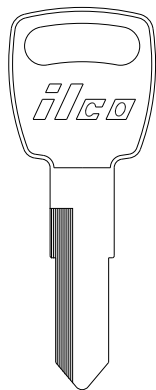
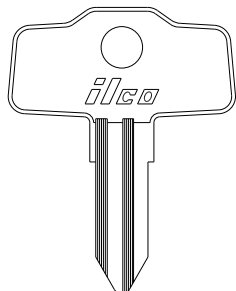
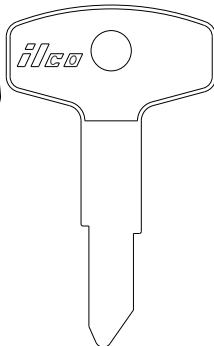
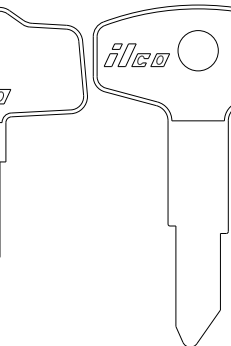
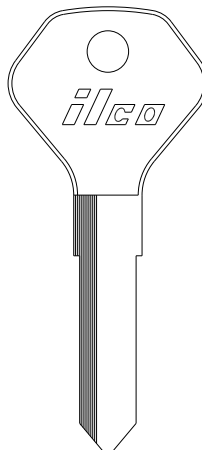
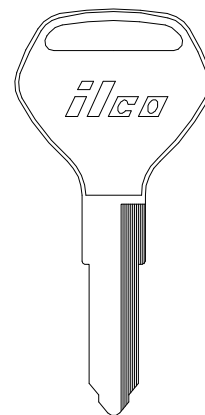
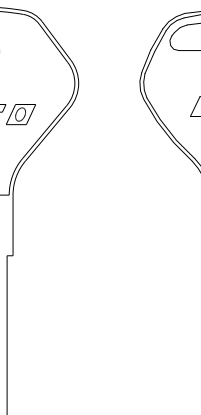
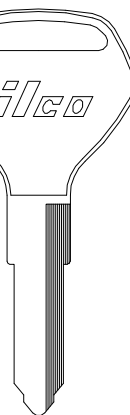
  
**KW14R**  
 —

  
**KW14AP**  
 —

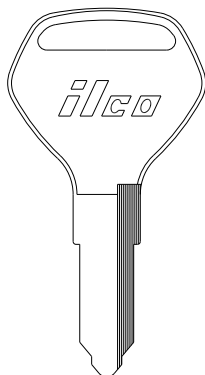
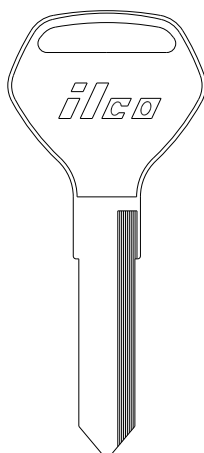
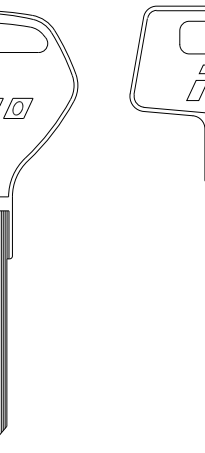
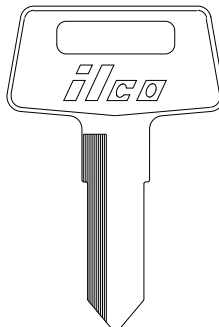
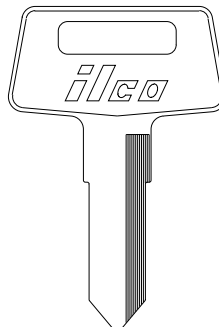
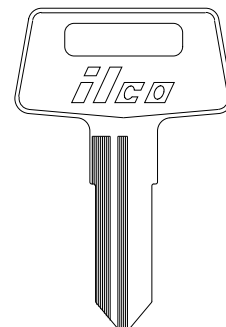
  
**KW15BP**  
 —

  
**X18**  
 YH21

**ILCO**  
 EZ

**KAWASAKI**

  
**X24**  
 KA7

  
**X40**  
 KA5

  
**X34**  
 —

  
**X41**  
 —

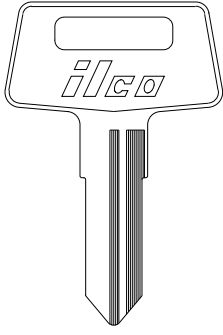
  
**X35**  
 —

  
**X90**  
 —

  
**X91**  
 —

  
**X103**  
 KA14

**ILCO**  
 EZ

**KAWASAKI**

  
**X104**  
 KA13

  
**X105**  
 KA11

  
**X106**  
 KA15

  
**X254**  
 —

  
**X255**  
 —

  
**X256**  
 —

**ILCO**  
 EZ

KAWASAKI



X257

—

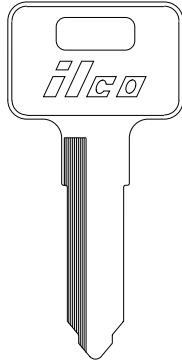

X258

—

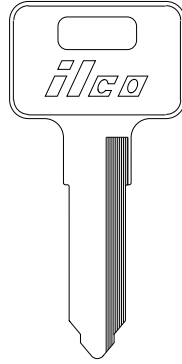

X259

—

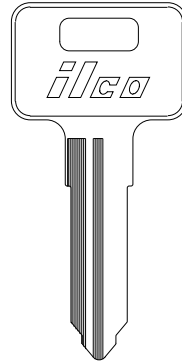

X260

—

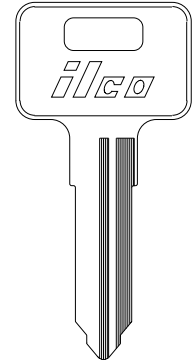

X261

—

ILCO  
EZ

KAWASAKI

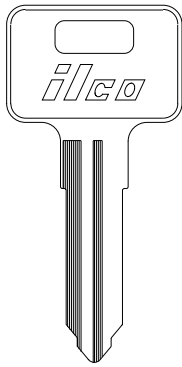

X262

—

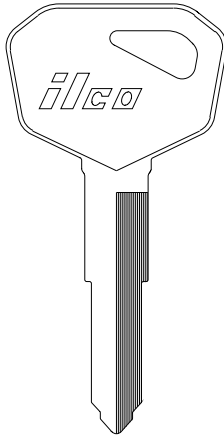

X266

KA16

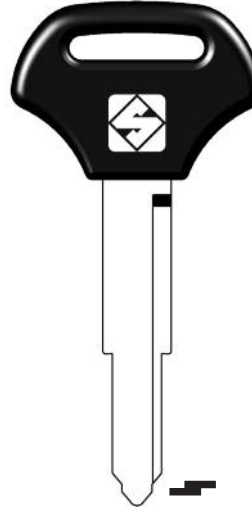

KW16CP-SI

—



KW12-SI

—

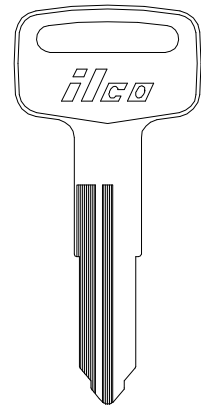

X117

YH48

ILCO  
EZ

KAWASAKI

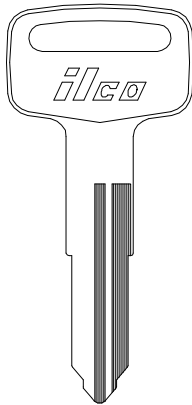

X118

YH49

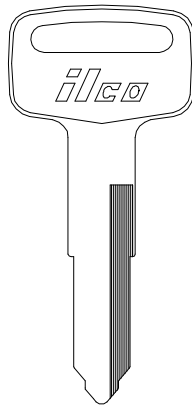

X119

YH47

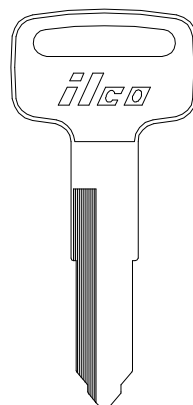

X120

YH46

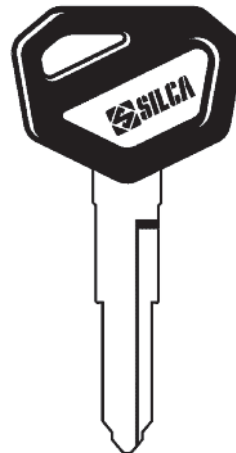

KW12BP-SI

—

ILCO  
EZ

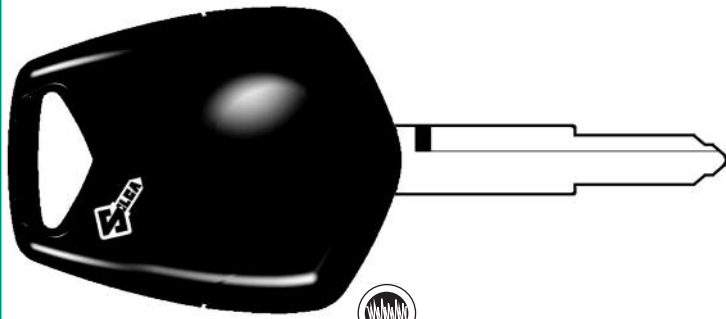
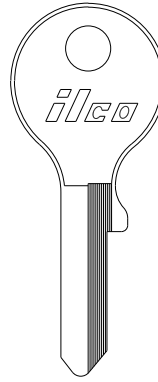
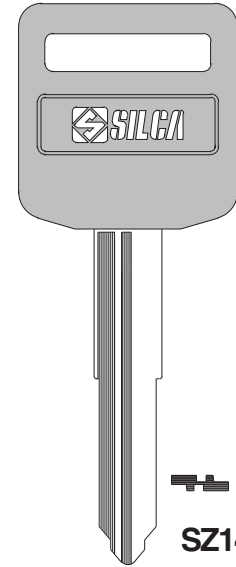

**KAWASAKI**

**KW16EH2**  
—

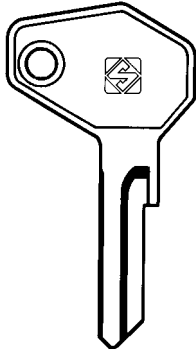
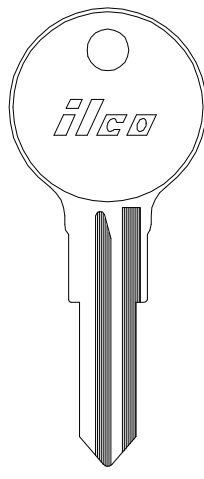
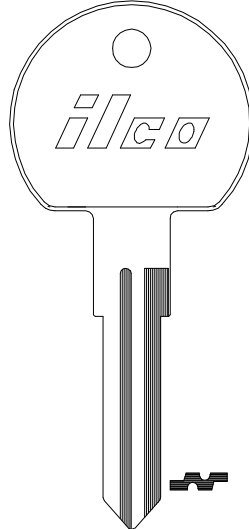
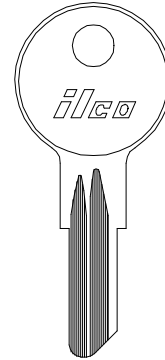
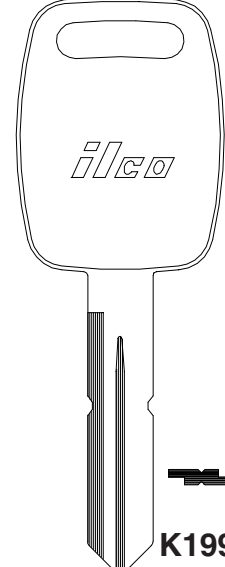
**SR61N**  
—

**SZ14RAP**  
—

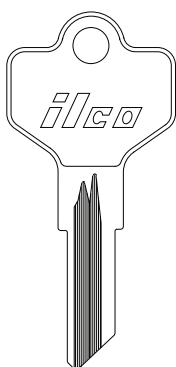
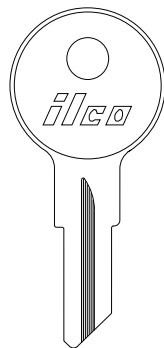
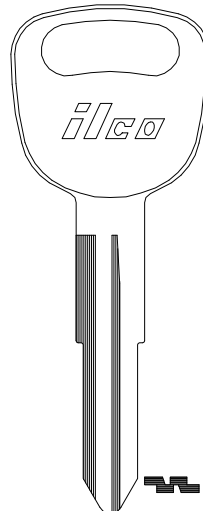
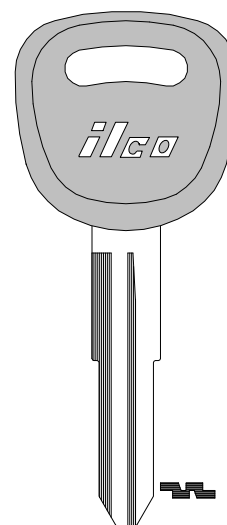
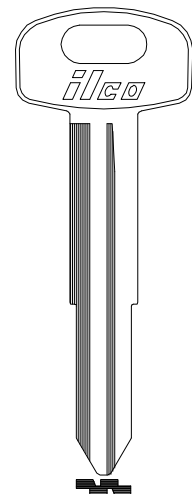
**ILCO**  
EZ

**KAWASAKI**
**KENWORTH**

**ZD7-SI**  
—

**X53**  
V32

**X170**  
NE48

**1098DB**  
B5

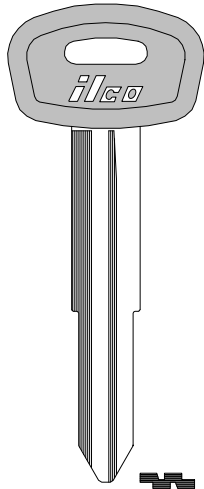
**K1994**  
—

**ILCO**  
EZ

**KENWORTH**
**KIA**

**1656**  
—

**1657**  
—

**X233**  
KK1

**KK1-P**  
—

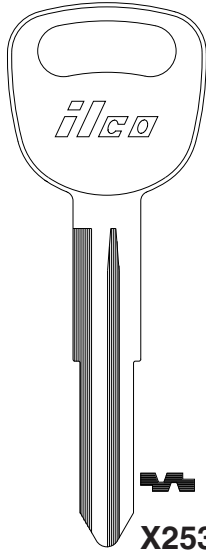
**X240**  
KK2

**ILCO**  
EZ

KIA



KK2-P  
—



X253  
KK3

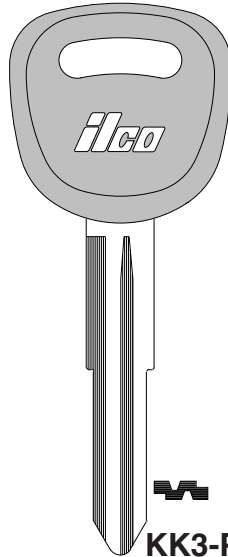

KK3-P  
—

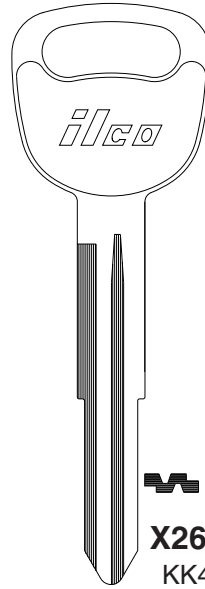

X267  
KK4

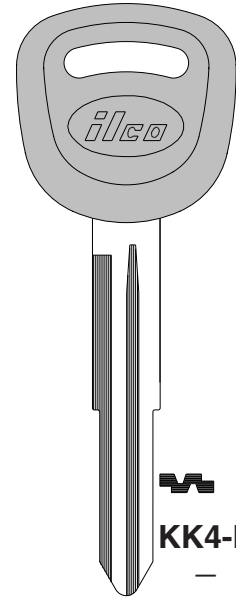

KK4-P  
—

ILCO  
EZ

KIA

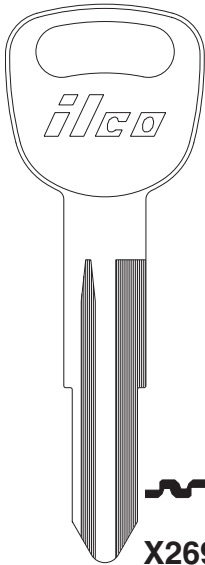

X269  
KK5

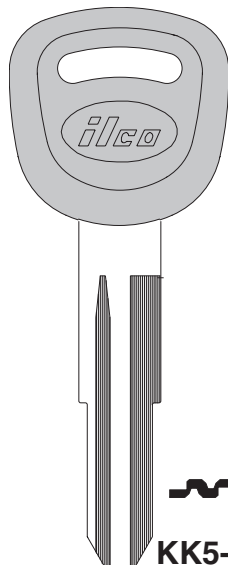

KK5-P  
—

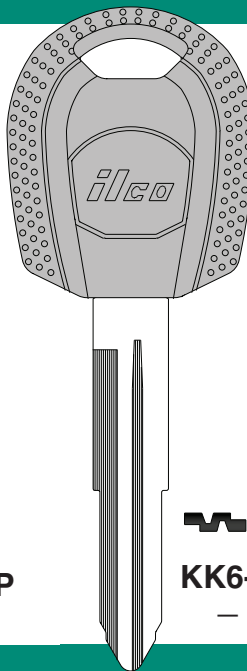

KK6-P  
—

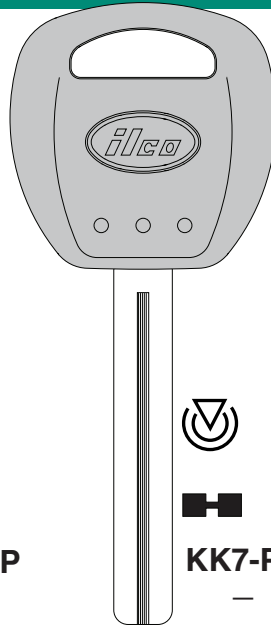

KK7-PT  
—

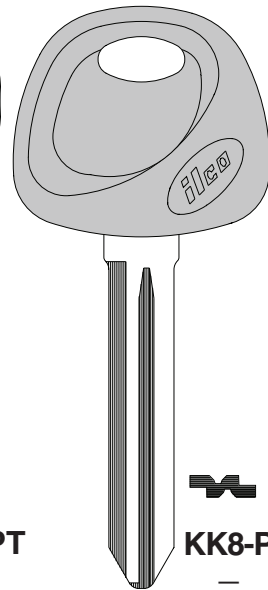

KK8-P  
—

ILCO  
EZ

KIA

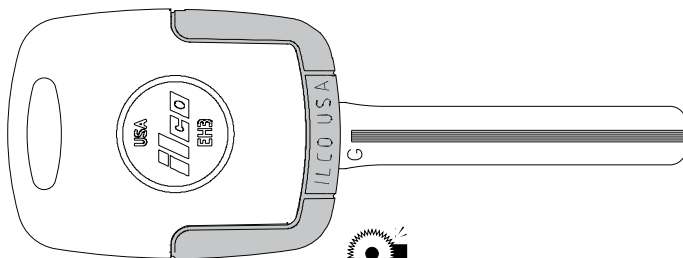

TOY40-EK3  
(Complete Key)



EH3  
(Head Only)

EB3-G-TOY40  
(Blade Only)

ILCO  
EZ

KIA

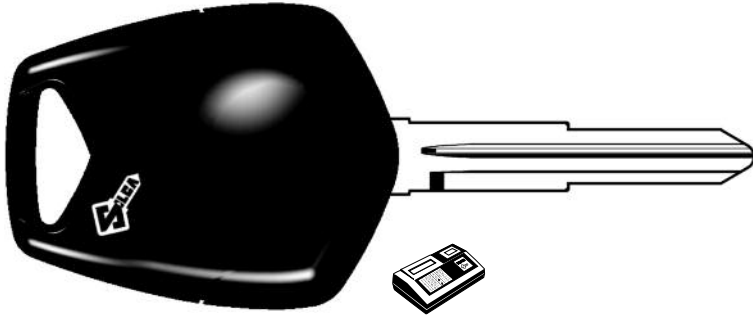

KIA3EHP

—

ILCO  
EZ

KIA

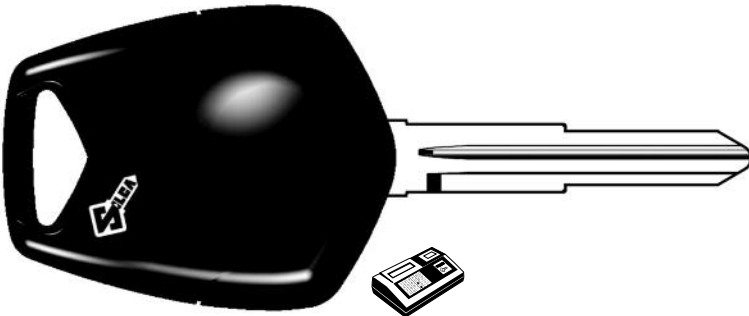

KIA3REHP

—

ILCO  
EZ

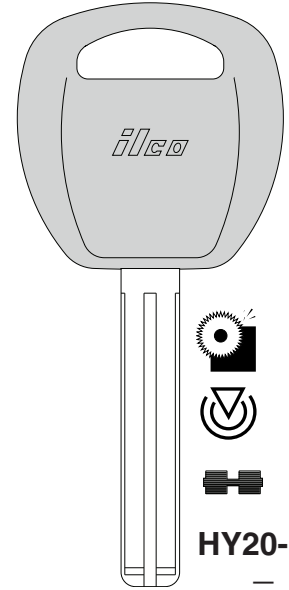

HY20-PT

—

KIA

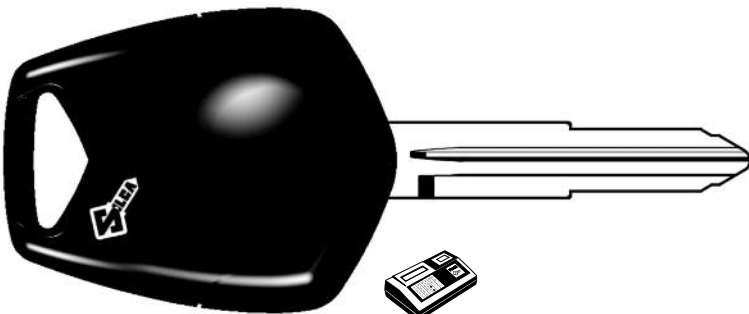

HYN7REHP

—

ILCO  
EZ

KIA

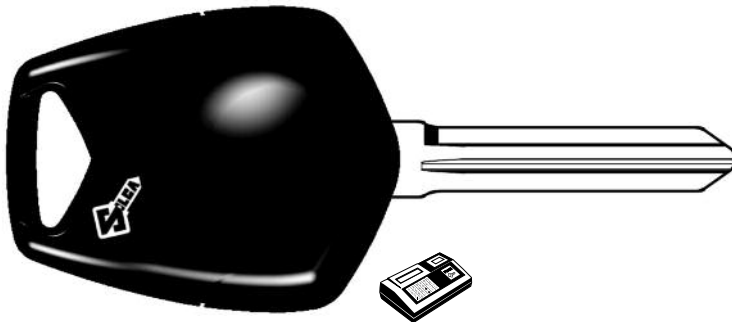

HYN14EHP

—

ILCO  
EZ

KIA

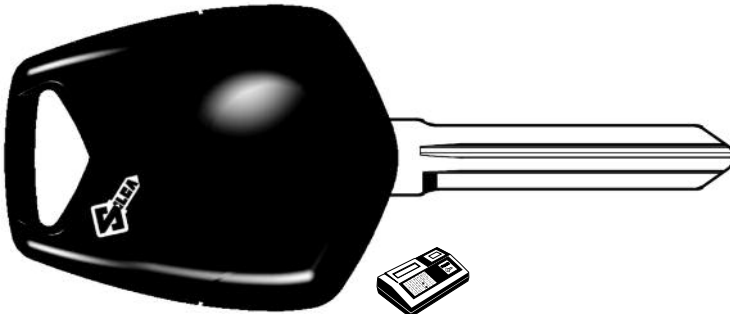

HYN14REHP

—

ILCO  
EZ

KIA

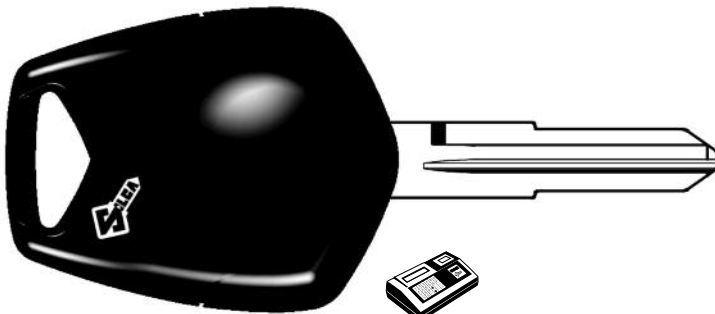

HYN15EHP

—

ILCO  
EZ

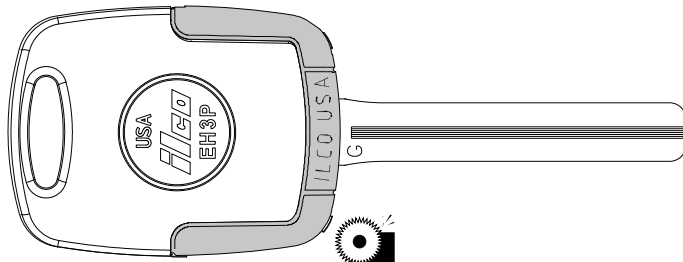
**KIA**
**KOMATSU**

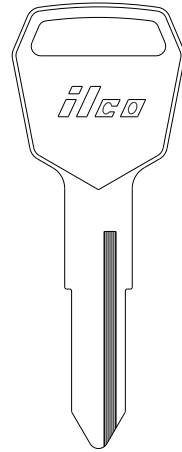
**EH3P**  
(Head Only)

  
**EB3-G-TOY40**  
(Blade Only)

**1519**  
—

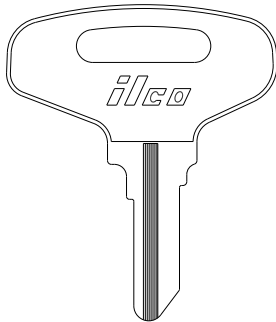
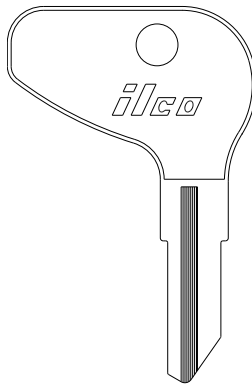
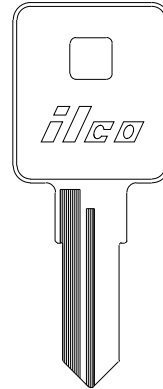
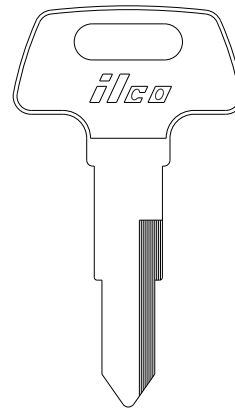
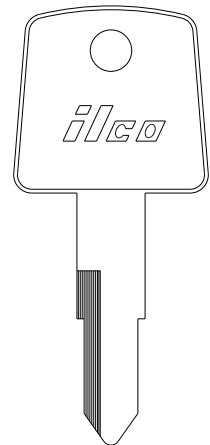
**ILCO**  
EZ

**EK3P-KK9**  
(Complete Key)

**KUBOTA**
**KYMCO**

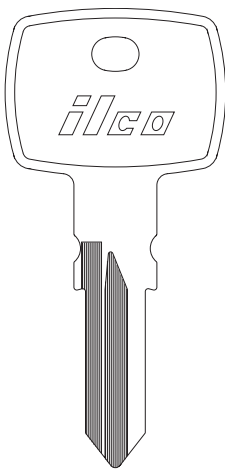
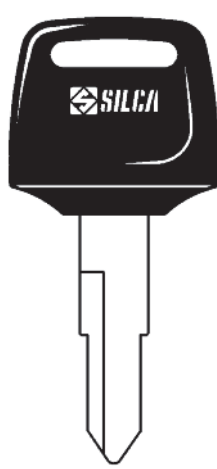
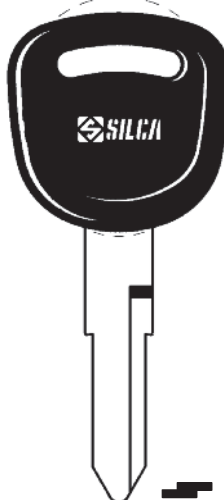
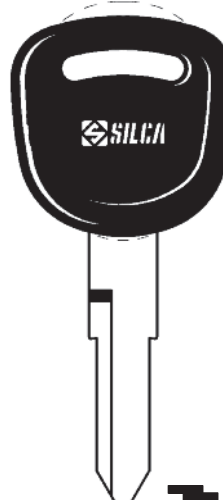
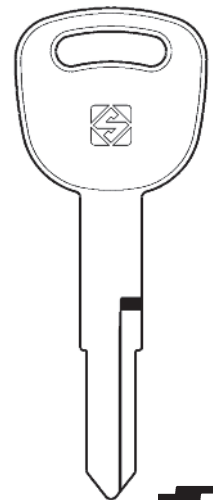
**1539**  
—

**1540**  
—

**X234**  
HYD13

**X84**  
HD74

**X138**  
HD75

**ILCO**  
EZ

**KYMCO**

**X270**  
TMC1

**HON31CP-SI**  
—

**KYM1P-SI**  
—

**KYM1RP-SI**  
—

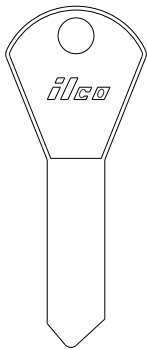
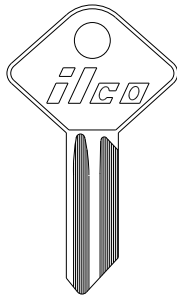
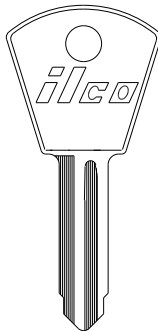
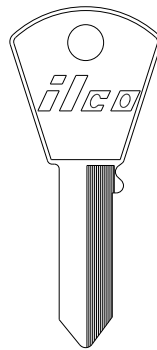
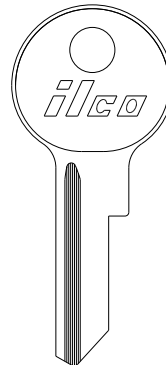
**KYM2-SI**  
—

**ILCO**  
EZ

KYMCO	L.K.W.					
 ZD24RDP-SI —	 BM1 —	 YM3 —	 NE10 —	 62VG —	 62VH —	ILCO EZ

L.K.W.					LADA	
 B62G —	 63F —	 63L —	 R63W —	 F65 —	 SP9 —	ILCO EZ

LADA	LAMBORGHINI							
 FT37 —	 FT38 —	 F91C —	 F91CR —	 F91C2 —	 F91C8 —	 X109 FT43	 X152 FT46	ILCO EZ

**LAMBRETТА**

**LA1**  
—

**LA2**  
—

**LA3**  
—

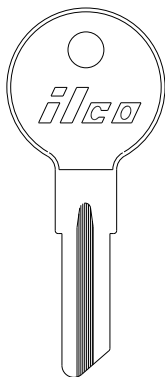
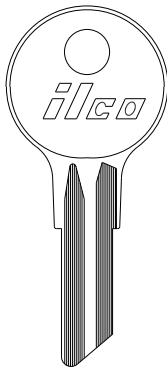
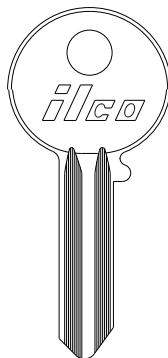
**LA4**  
—

**NE4**  
—

**LA5**  
—

**LA14**  
—

**ILCO**  
EZ

**LAMBRETТА**

**LA6**  
—

**LA7**  
—

**LA8**  
—

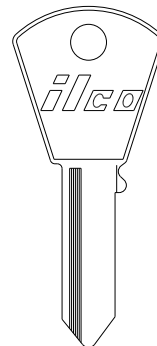
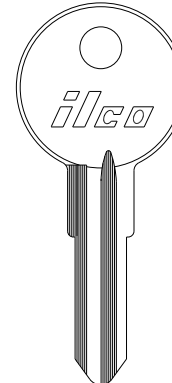
**LA9**  
—

**LA10**  
—

**LA11**  
—



**LA12**  
—

**LA13**  
—

**61H**  
—

**R61H**  
—

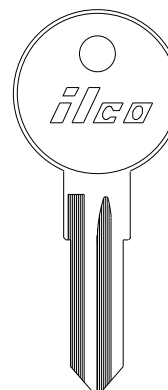
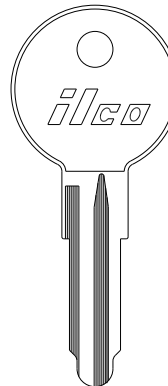
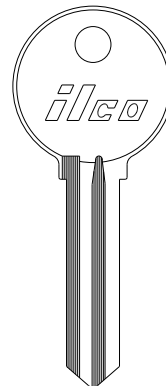
**ILCO**  
EZ

**LAMBRETТА**

**H61N**  
—

**62VA**  
—

**YR62**  
—

**66A**  
—

**66BB**  
—

**125C**  
—

**ILCO**  
EZ

LAMBRETTA	LANCIA							
125CR	GT1	GT2	GT3	GT4	LN4	SIP16T2	61H	R61H
-	-	-	-	-	-	-	-	-

ILCO EZ

LANCIA					
61N	61NA	62VA	63K	63W	64AL
-	-	-	-	-	-
R61NA	R63K				64Y
-	-				-

ILCO EZ

LANCIA	LAND ROVER	LAVERDA	LEXUS/TOYOTA	
	SEE ROVER			
F68C	SEE ROVER	ZD21P-SI	LXP90-P	LXV90-P
-		-	-	-

VALET FOR LXP90-P

ILCO EZ



LEXUS/TOYOTA

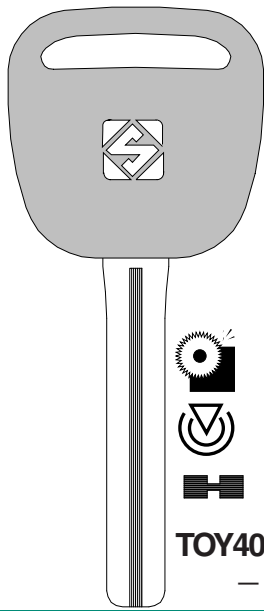

TOY40BT4

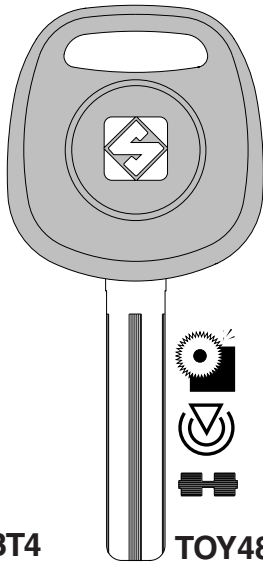

TOY48BT4

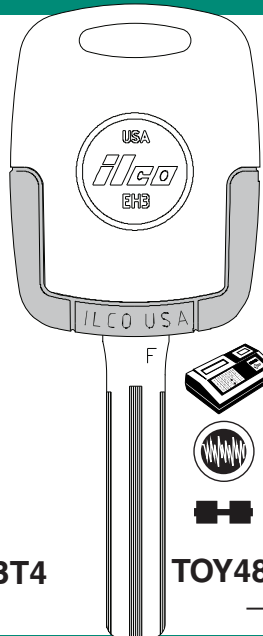

TOY48-EK3



EB3-F-TOY48  
(Blade Only)

ILCO  
EZ

LEXUS/TOYOTA

LINCOLN

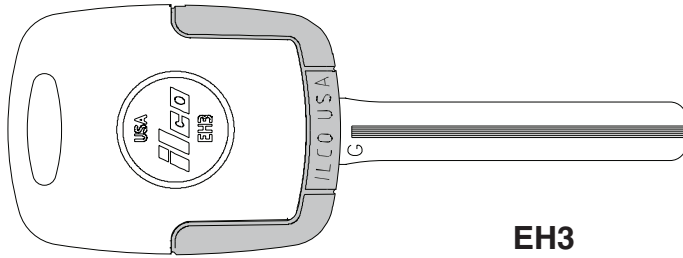

EH3  
(Head Only)



EB3-G-TOY40  
(Blade Only)

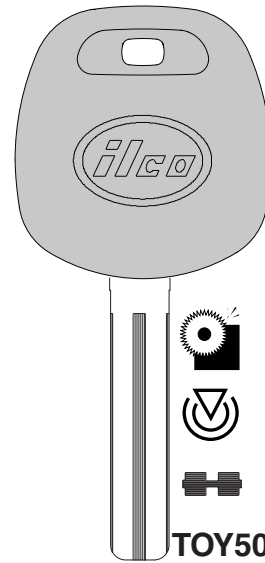

TOY50-PT

SEE  
FORD

ILCO  
EZ

LLOYD

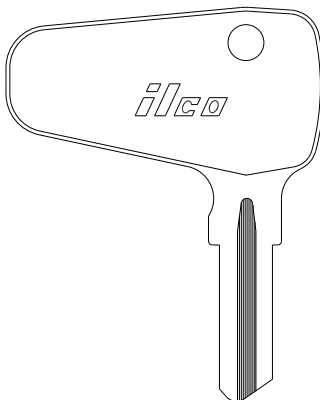

BH1

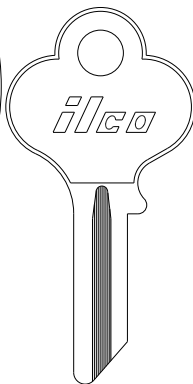

FV1

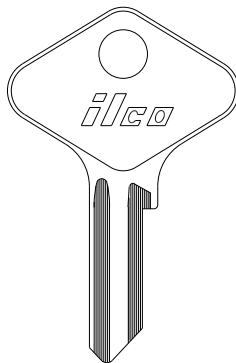

DM3

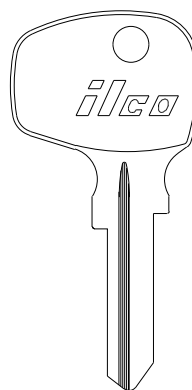

MB5

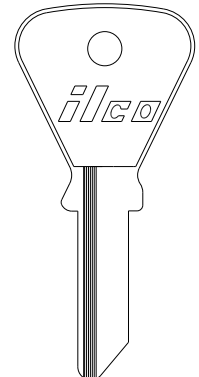

62VH

ILCO  
EZ

LLOYD

<b>S62VP</b>	<b>63</b>	<b>M63BG</b>	<b>63L</b>	<b>M63B</b>	<b>XD63</b>
—	—	—	—	—	—

ILCO  
EZ

LLOYD      LOWE & FLETCHER      MACK

<b>138</b>	<b>LF5</b>	<b>LF7</b>	<b>LF8</b>	<b>LF24</b>	<b>L194</b>	<b>DAV10</b>
—	—	—	—	—	—	—

ILCO  
EZ

MACK      MAGIRUS-DEUTZ

<b>NE10</b>	<b>R62UC</b>	<b>X163</b>	<b>1098M</b>	<b>DAV10</b>
—	—	BL11	B1	—

ILCO  
EZ

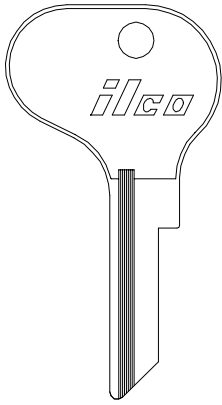
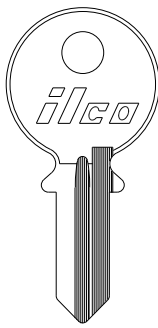
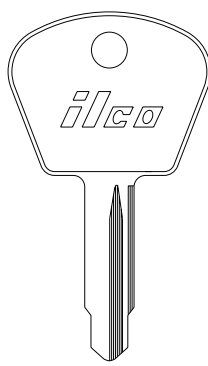
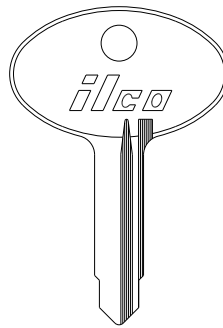
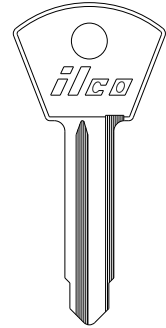
**MAGIRUS-DEUTZ**
**MAGNETI-MARELLI**

  
**NE10**  
 —

  
**R62UC**  
 —

  
**SP2**  
 —

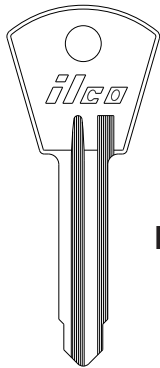
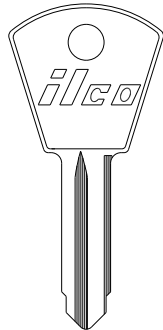
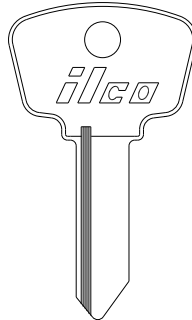
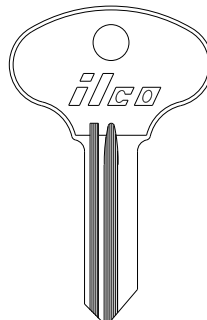
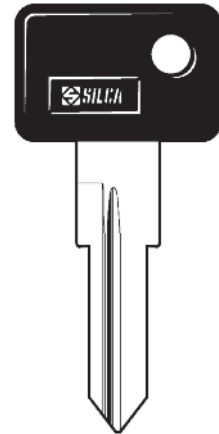
  
**61D**  
 —

  
**61F**  
 —

**ILCO**  
 EZ

sec 1 page 91

VEHICLE

**MAGNETI-MARELLI**
**MALAGUTI**

  
**L61D**  
 —  
  
**LR61D**  
 —

  
**63ST**  
 —

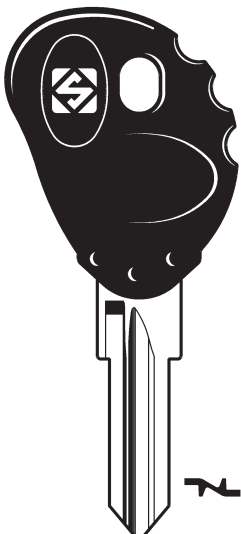
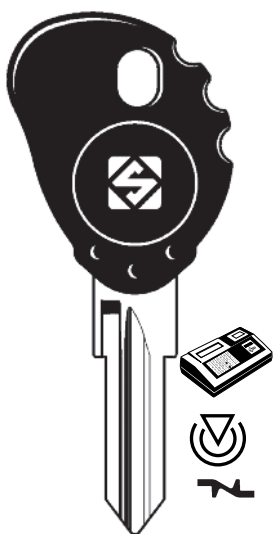
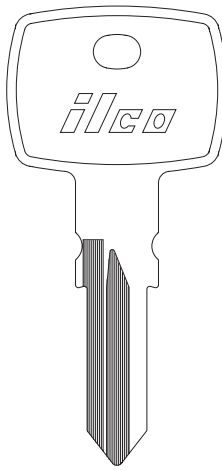
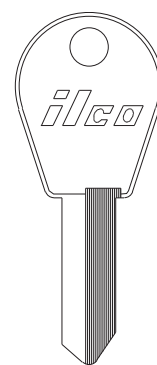
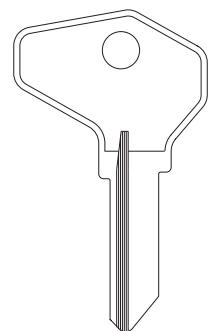
  
**R63ST**  
 —

  
**R63SP**  
 —

  
**ZD16RP-SI**  
 —



  
**F91GS**  
 —

**ILCO**  
 EZ

**MALAGUTI**
**MASERATI**

  
**ZD23RCP-SI**  
 —

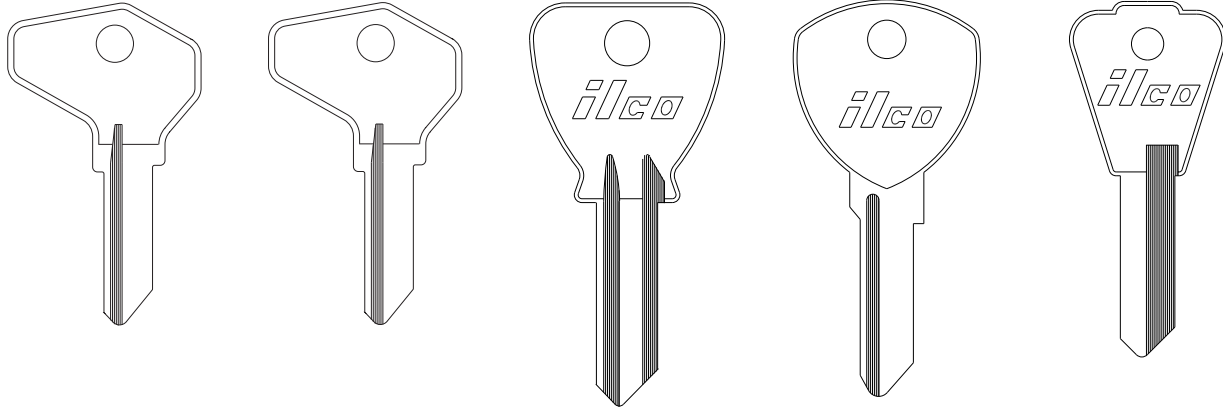
  
**ZD23RT5-SI**  
 —

  
**X270**  
 TMC1

  
**MAS1**  
 —

  
**SF3-SI**  
 —

**ILCO**  
 EZ

MASERATI



<b>SF4-SI</b>	<b>SF5-SI</b>	<b>BO2</b>	<b>BO6</b>	<b>GT3</b>	<b>LN4</b>
—	—	—	—	—	—

ILCO  
EZ

MASERATI MATADOR

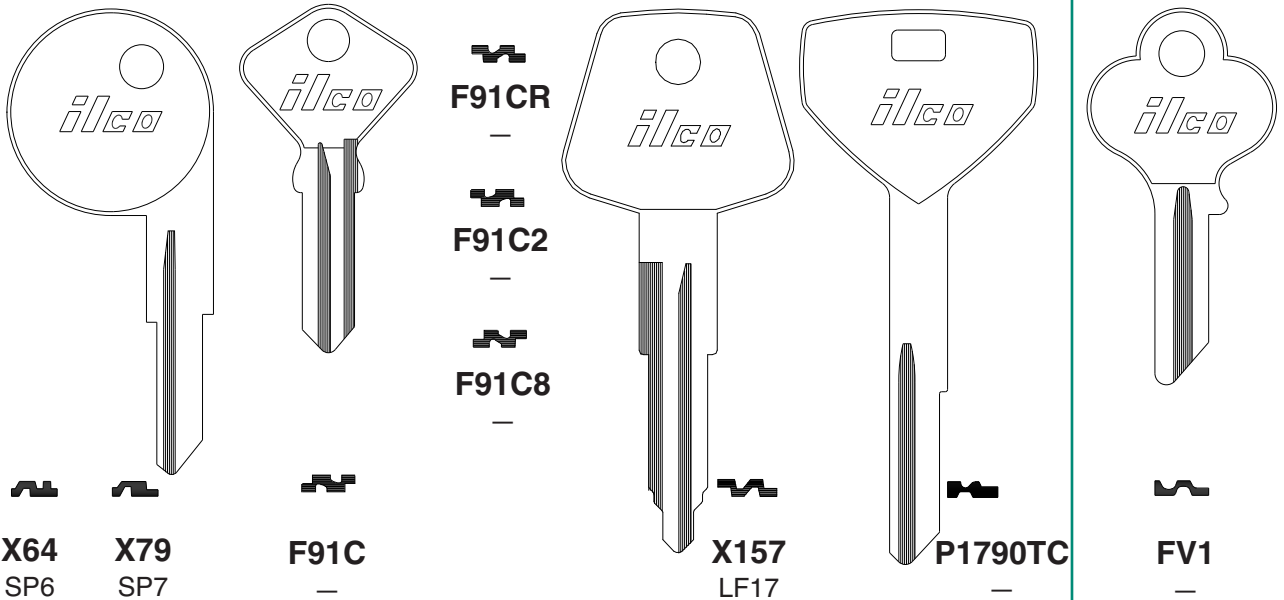

<b>X64</b>	<b>X79</b>	<b>F91C</b>	<b>F91CR</b>	<b>F91C2</b>	<b>F91C8</b>	<b>X157</b>	<b>P1790TC</b>	<b>FV1</b>
SP6	SP7	—	—	—	—	LF17	—	—

ILCO  
EZ

MATADOR MAZDA

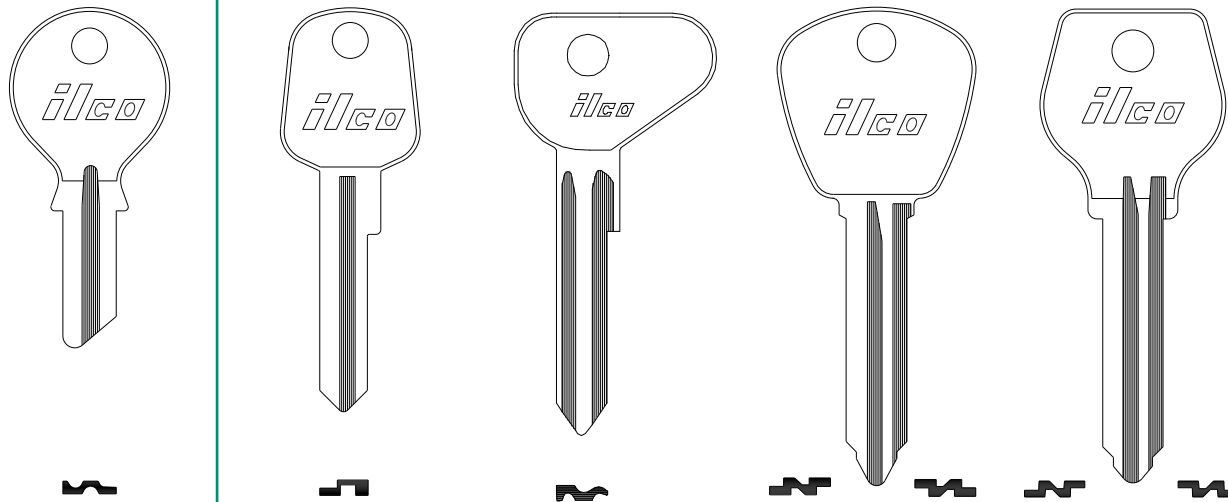

<b>63</b>	<b>MZ1</b>	<b>X1</b>	<b>X2</b>	<b>X3</b>	<b>X4</b>	<b>X5</b>
—	—	MZ12	MZ3	MZ2	MZ4	MZ5

ILCO  
EZ

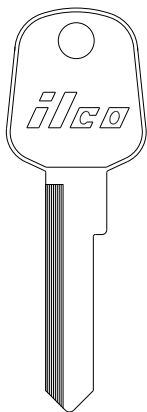
**MAZDA**

**MZ6**

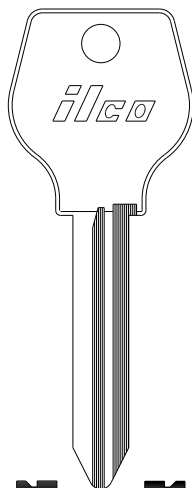
-

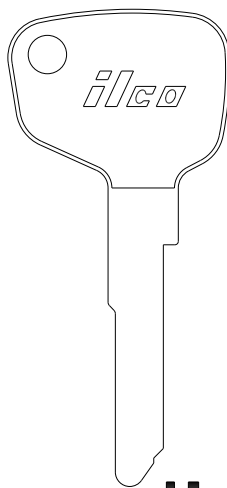

**MZ7 MZ8**

-

-

**MZ15**

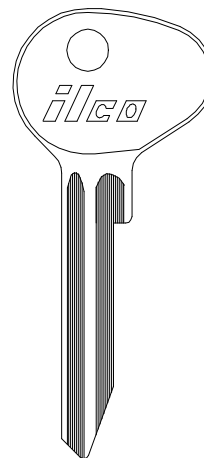
-

**DA20**

-

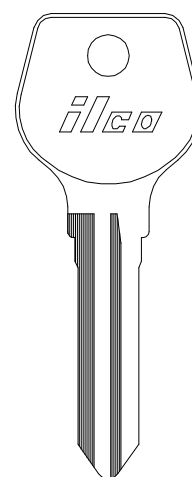

**X26**

MZ9

**X27**

MZ10

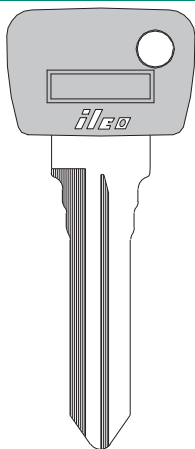
**ILCO**  
EZ

**MAZDA**

**MZ9-P**

-

**MZ10-P**

-

**X36**

MZ11

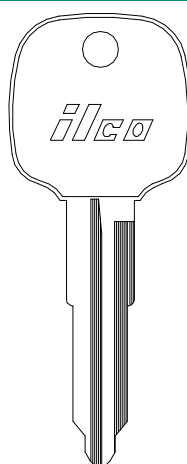
**X60**

MZ14

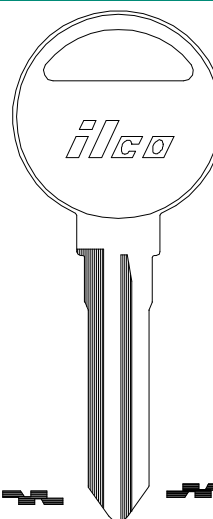
**X131**

MZ13

**MZ13R**

-

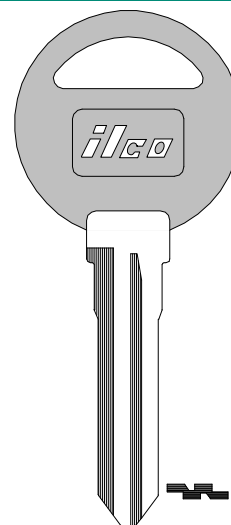

**MZ13-P (-PC)**

-

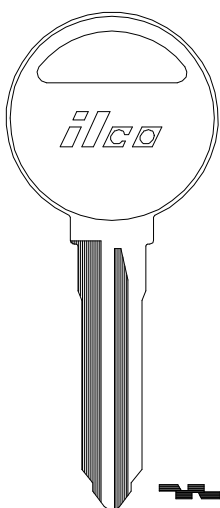
**ILCO**  
EZ

**MAZDA**

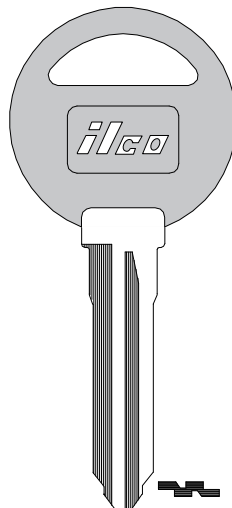
**X178**

MZ16

**MZ16-P**

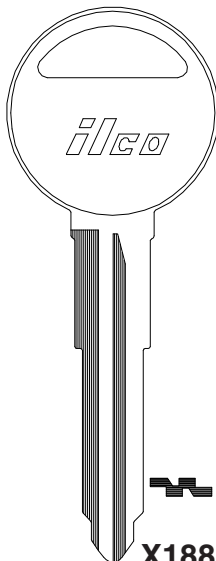
-

**X188**

MZ17

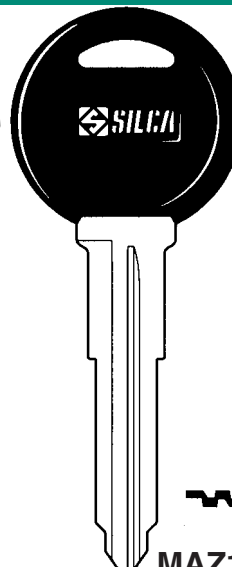
**MAZ13AP**

-

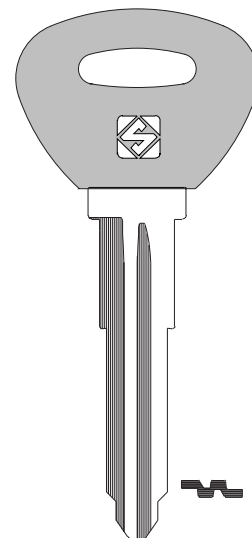

**MAZ13EP**

-

**ILCO**  
EZ

**MAZDA**

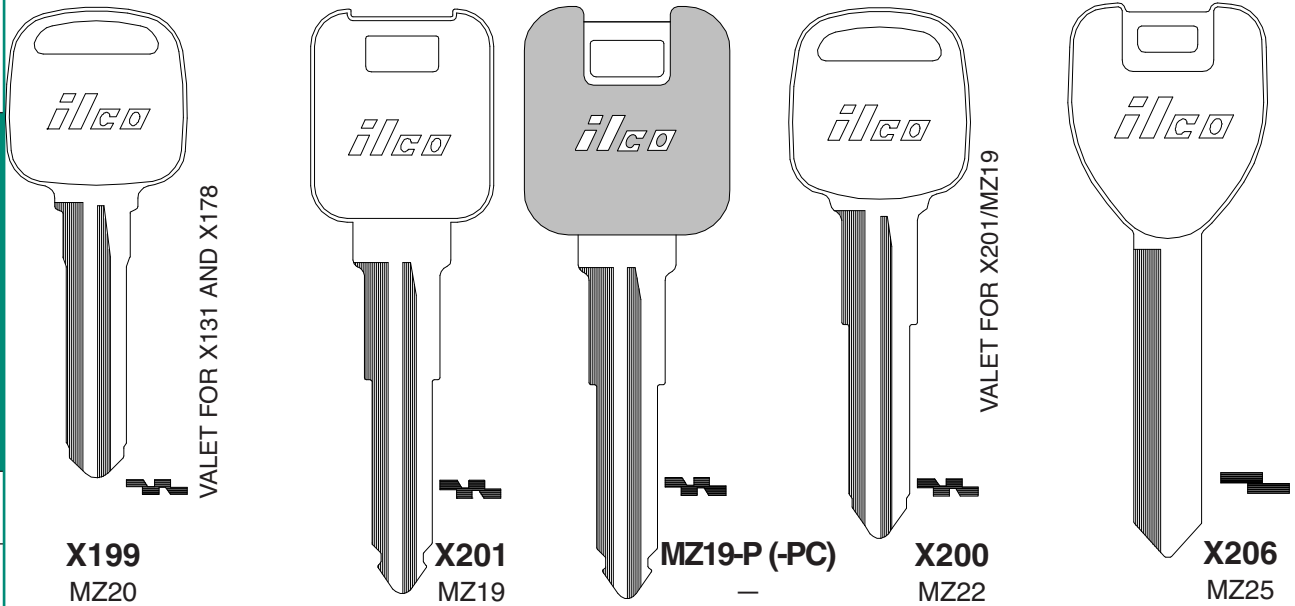
**MAZDA**



**X199**  
MZ20

**X201**  
MZ19

**MZ19-P (-PC)**  
—

**X200**  
MZ22

**X206**  
MZ25

**ILCO**  
EZ

**MAZDA**

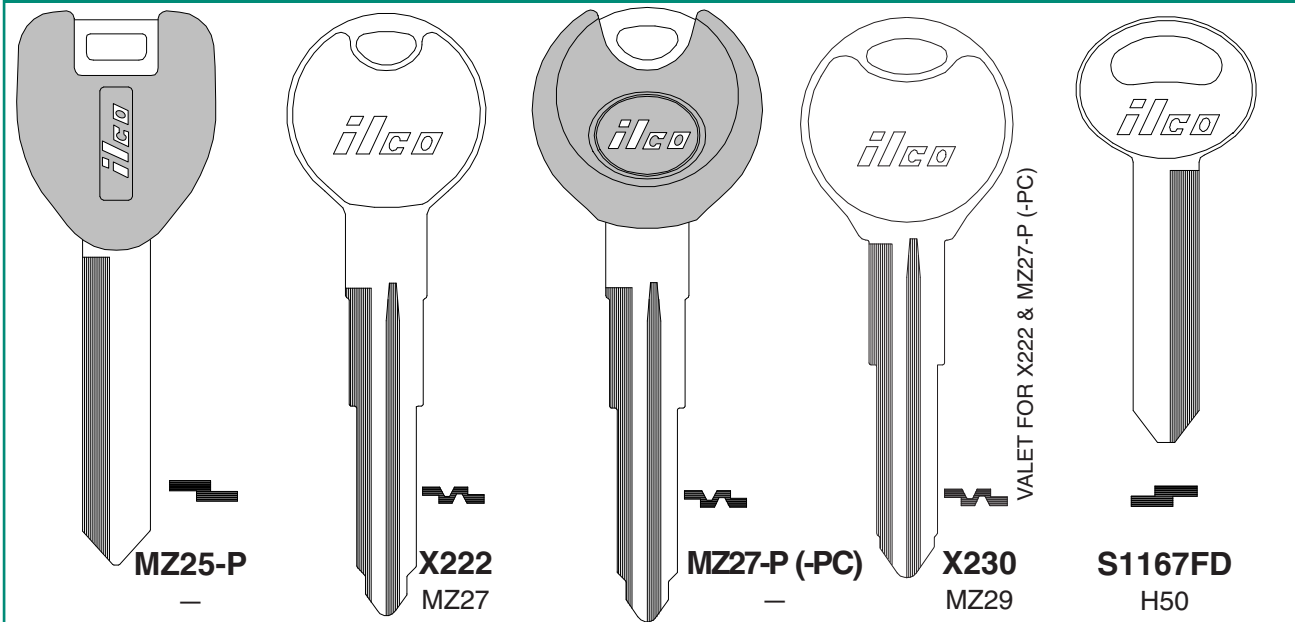

**MZ25-P**  
—

**X222**  
MZ27

**MZ27-P (-PC)**  
—

**X230**  
MZ29

**S1167FD**  
H50

**ILCO**  
EZ

**MAZDA**

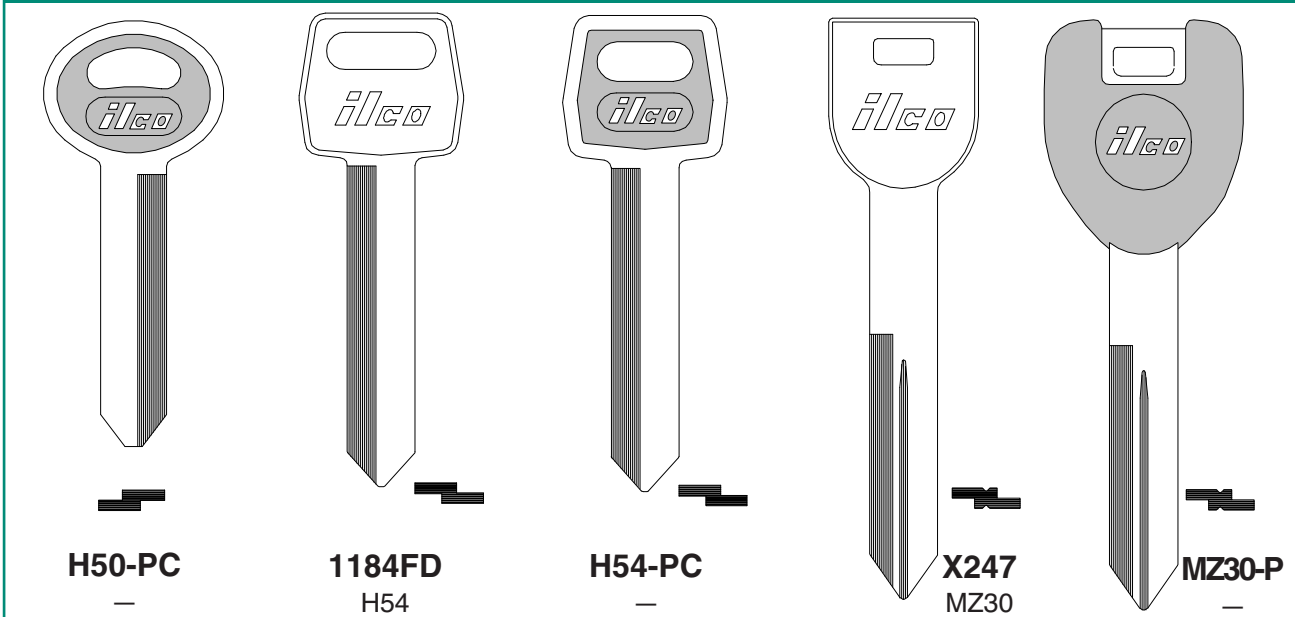

**H50-PC**  
—

**1184FD**  
H54

**H54-PC**  
—

**X247**  
MZ30

**MZ30-P**  
—

**ILCO**  
EZ

MAZDA

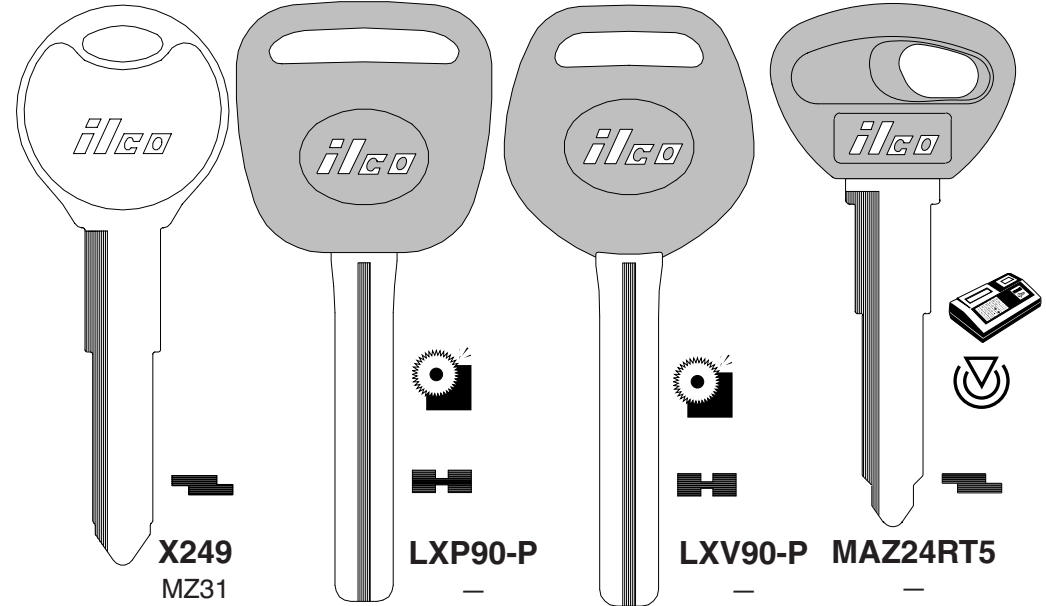

ILCO  
EZ

**X249**  
MZ31

**LXP90-P**  
—

**LXV90-P**  
—

**MAZ24RT5**  
—

VEHICLE

sec 1 page 95

MAZDA

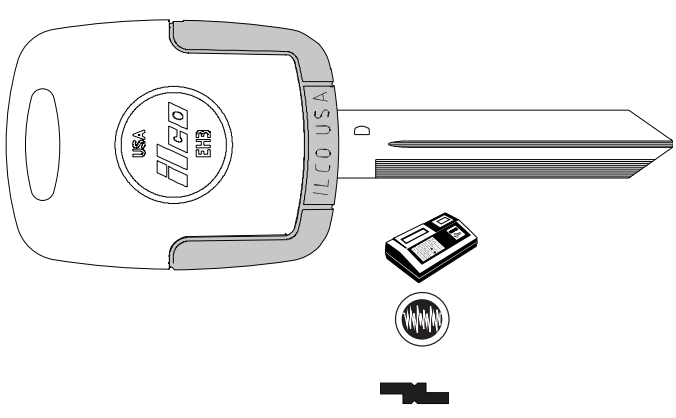

**EH3**  
(Head Only)

**EB3-D-H84**  
(Blade Only)

**H84-EK3**  
(Complete Key)

ILCO  
EZ

MAZDA

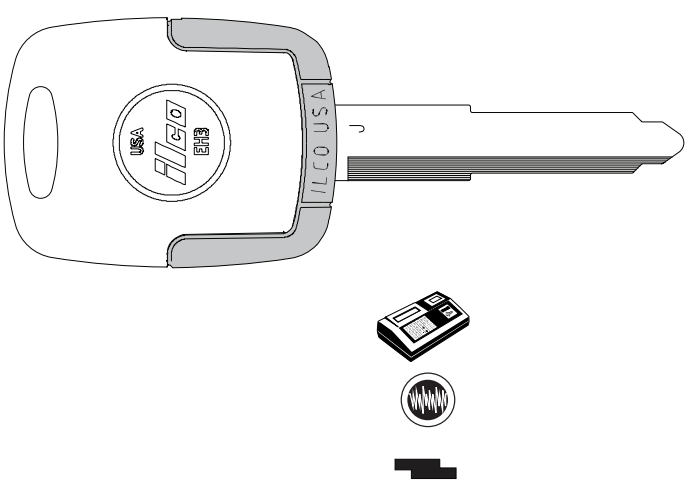

**EH3**  
(Head Only)

**EB3-J-MAZ24**  
(Blade Only)

**MAZ24-EK3**  
(Complete Key)

ILCO  
EZ

**MAZDA - MERCEDES BENZ**

**MAZDA**

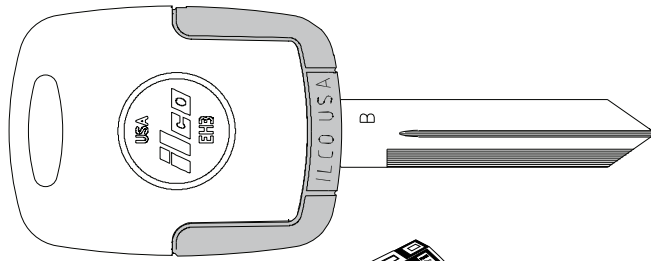

**EH3**  
(Head Only)

**EB3-B-H72**  
(Blade Only)

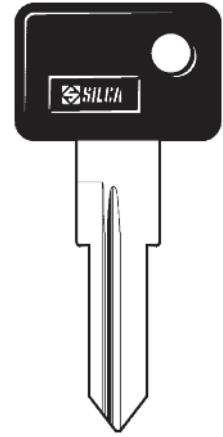

**ZD16RP-SI**

**H72-EK3**  
(Complete Key)

**ILCO**  
EZ

VEHICLE

sec 1 page 96

**MAZDA**

**MERCEDES BENZ**

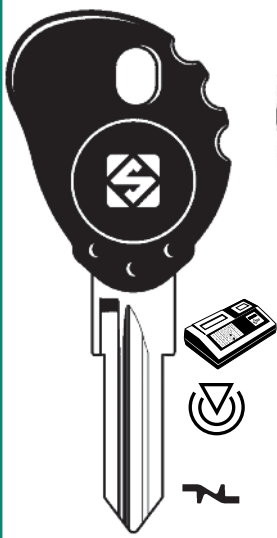

**ZD23RT5-SI**



**ZD24RDP-SI**

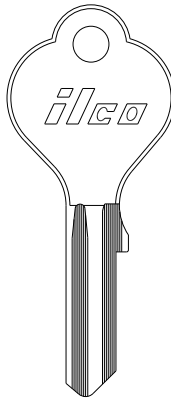

**HF1**



**HF3**



**HF4**



**HF5**



**HF6**

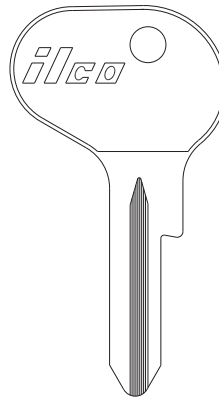

**KL1**

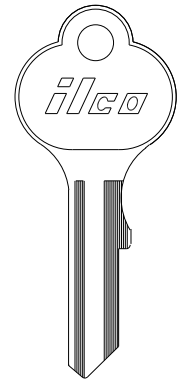

**VW1**

**ILCO**  
EZ

**MERCEDES BENZ**

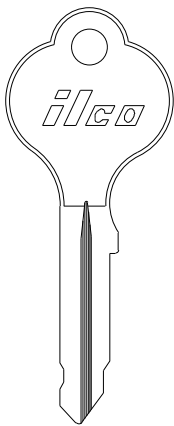

**YM1**



**YM3**



**YM4**



**YM5**

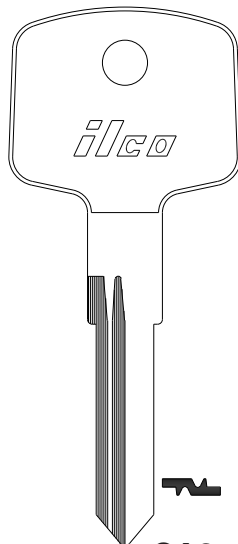

**CA3**

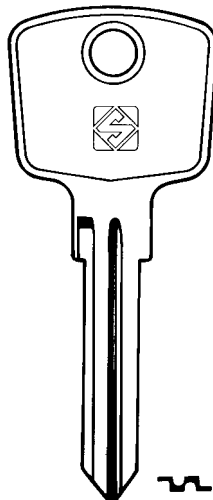

**CR4R**

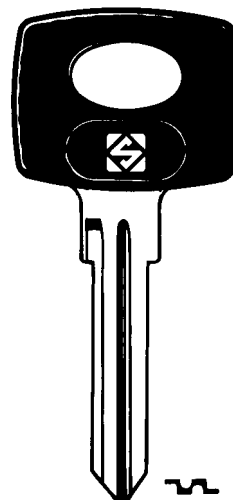









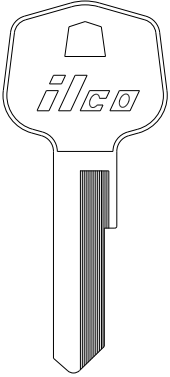

**CR4RP**

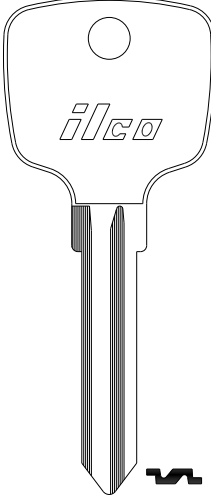
**ILCO**  
EZ

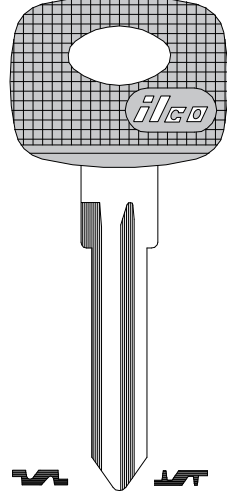
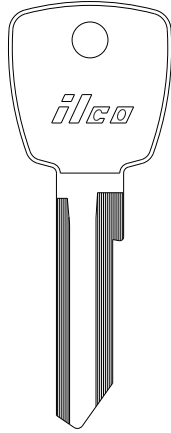

MERCEDES BENZ

ILCO EZ															
	HF9	HF14	HF15	HF7	HF16	MB18	MB15	MB16	MB16R	MB17	MB18-P	MB15-P	MB18-P	YM16	
	-	-	-	-	-	-	-	-	-	-	-	-	-	-	-

MERCEDES BENZ

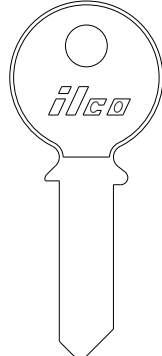
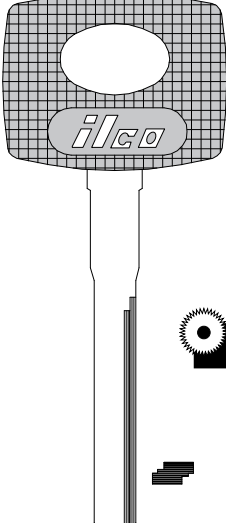
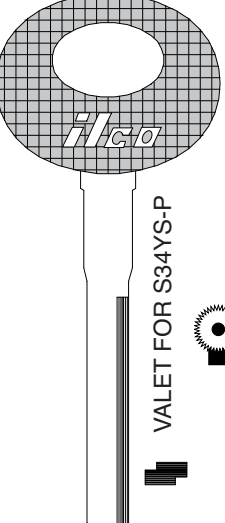
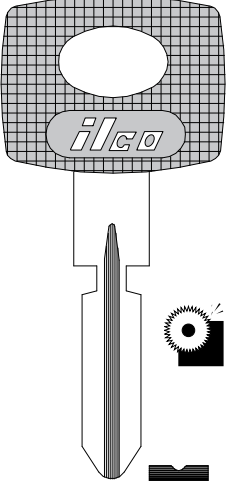
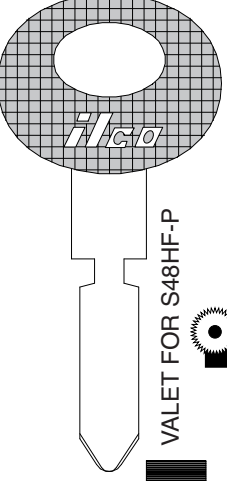
ILCO EZ					
	MB20	S34YS-P	S58HF-P	S48HF-P	S49HF-P
	-	-	-	-	-

MERCEDES BENZ

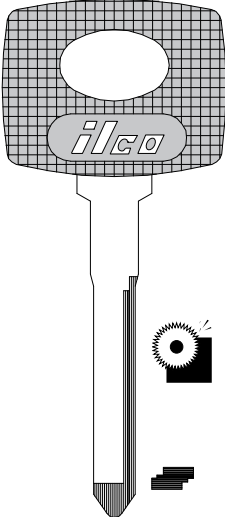
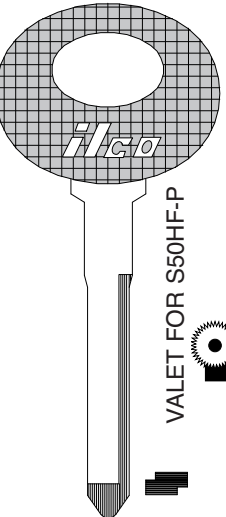
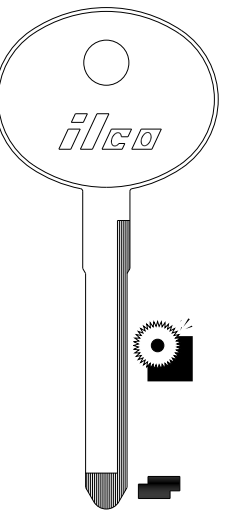
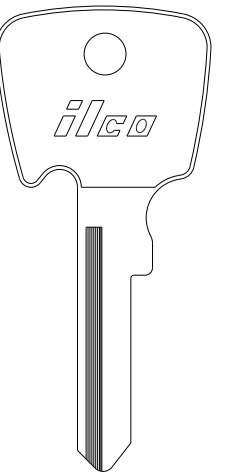
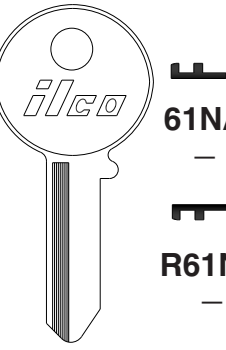
ILCO EZ					
	S50HF-P	S53HF-P	HF57	MB59	61N
	-	-	-	M68	-

MERCEDES BENZ

VEHICLE



<b>61NC</b>	<b>H61NA</b>	<b>HR61NA</b>	<b>H61VM</b>	<b>H61VR</b>	<b>62VA</b>	<b>62VJ</b>
-	-	-	-	-	-	-

ILCO  
EZ

MERCEDES BENZ

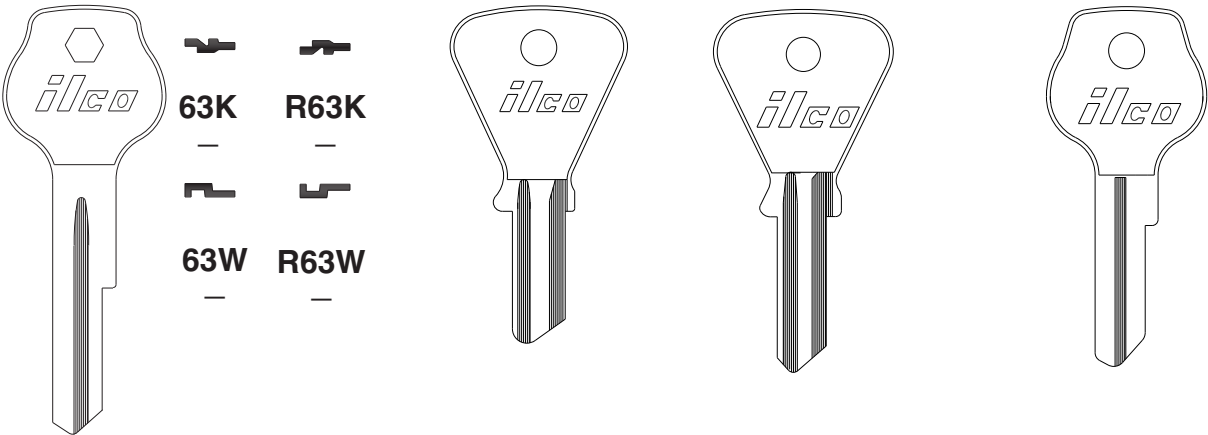

<b>63K</b>	<b>R63K</b>					
-	-					
<b>63W</b>	<b>R63W</b>					
-	-					
<b>A62VN</b>	<b>B62G</b>	<b>H62VG</b>	<b>HR62VG</b>	<b>R62VA</b>	<b>R62VN</b>	
-	-	-	-	-	-	

ILCO  
EZ

MERCEDES BENZ



					<b>63TV</b>	<b>63TW</b>
					-	-
<b>S62FD</b>	<b>63A</b>	<b>M63BG</b>	<b>63C</b>	<b>63E</b>	<b>M63E</b>	<b>MR63E</b>
-	-	-	-	-	-	-

ILCO  
EZ

**MERCEDES BENZ**

<b>63H</b>	<b>63JA</b>	<b>H63M</b>	<b>M63B</b>	<b>R63KE</b>	<b>U63H</b>
—	—	—	—	—	—

**ILCO**  
EZ

**MERCEDES BENZ**

<b>65K</b>	<b>F65</b>	<b>X82</b> <b>MB41</b>	<b>MB41-P</b>	<b>MB38</b>
—	—	—	—	—

**ILCO**  
EZ

VALET FOR X82 AND MB41-P

**MERCEDES BENZ**
**MERCURY**

				<b>SEE FORD</b>
<b>X83</b> <b>MB39</b>	<b>MB39-P</b>	<b>MB40</b>	<b>HU64P-SI</b>	
—	—	—	—	

**ILCO**  
EZ

VALET FOR X83 AND MB39-P



MERCURY/MARINER OUTBOARDS

							ILCO EZ
1040	1040A	1040B	1040C	R1040C	1040E	R1040E	

MERCURY/MARINER OUTBOARDS

MERKUR

MESSERSCHMIDT

 CU9 —  CU9 — 1040U —	 CU10 —  CU12 —	 1262A — 	 1193MU H66 	<p>SEE FORD INTERNATIONAL</p>	 62VA — 	ILCO EZ
--	--------------------------------	--------------------	-----------------------	---------------------------------------	-------------------	------------

MESSERSCHMIDT MG

MISC. SWITCHES

 63A —	<p>SEE BRITISH LEYLAND</p>	 1098M B1 	 L1003M — 	 1043B IL9 	ILCO EZ
--------------	------------------------------------	---------------------	---------------------	----------------------	------------

MISC. SWITCHES

MITSUBISHI

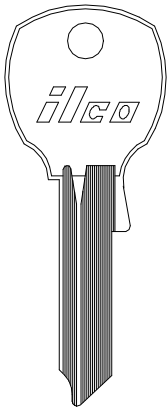

**1069LB**  
NA12

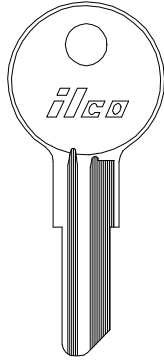

**O1122**  
Y11

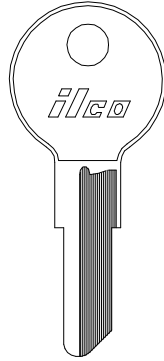

**O1122AR**  
Y14

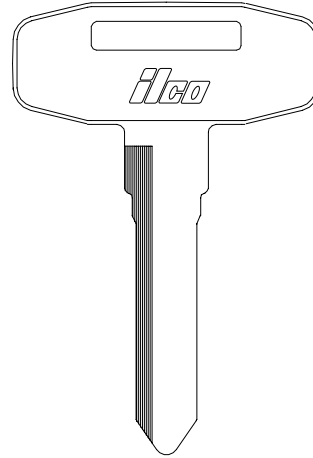

**FU2**  
—

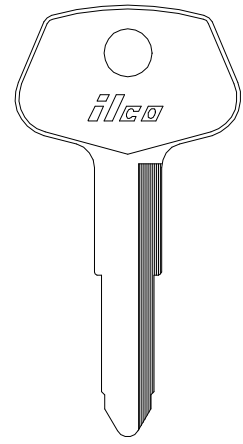

**X54**  
DC1

ILCO  
EZ

MITSUBISHI

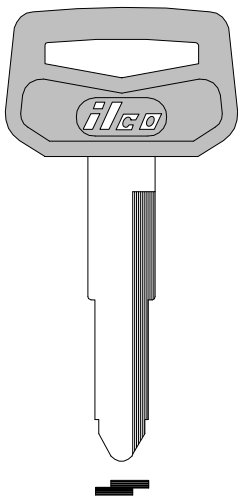

**DC1-P**  
—

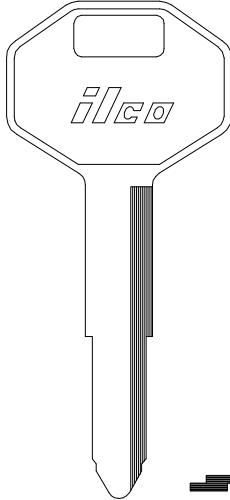

**X121**  
DC3

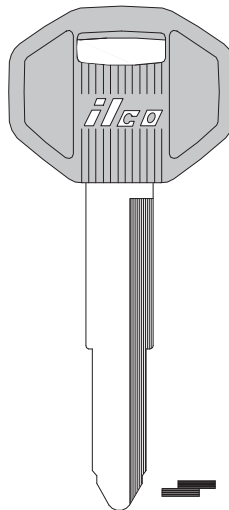

**DC3-P (-PC)**  
—

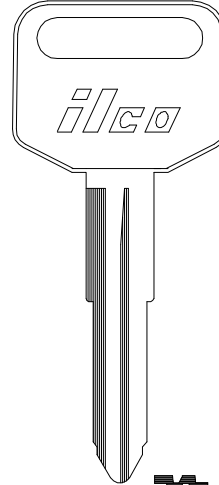

**X160**  
HY2

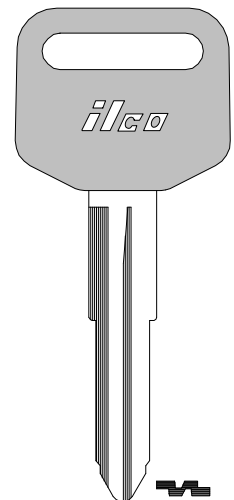

**HY2-P**  
—

ILCO  
EZ

MITSUBISHI

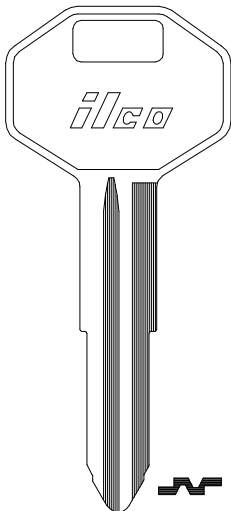

**X176**  
MIT1

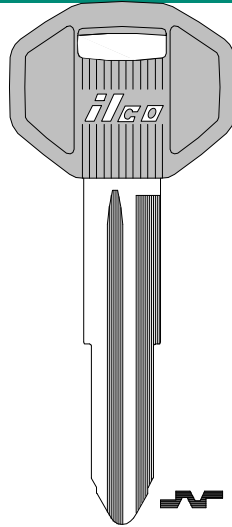

**MIT1-P (-PC)**  
—

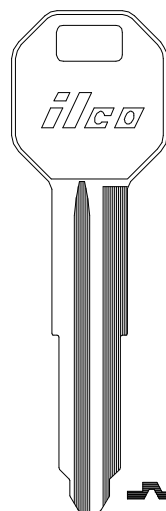

**X213**  
MIT2

VALET FOR X176 & MIT1-P (-PC)

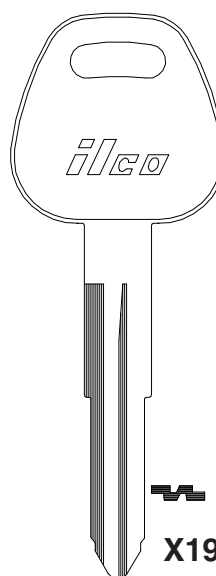

**X196**  
HY5

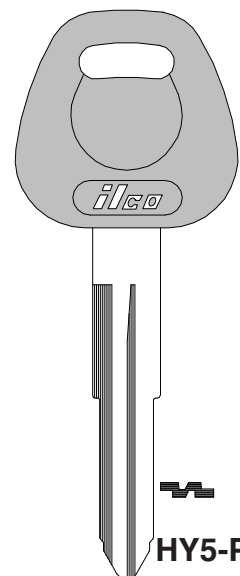

**HY5-P**  
—

ILCO  
EZ

MITSUBISHI

VEHICLE

sec 1 page 102

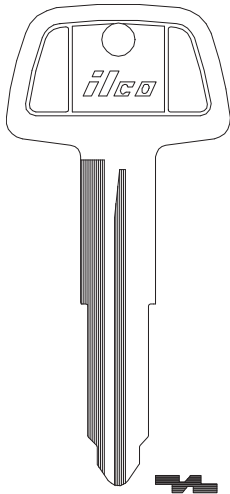

**X224**  
MIT3

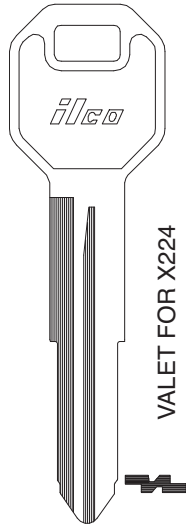

**X229**  
MIT5

VALET FOR X224

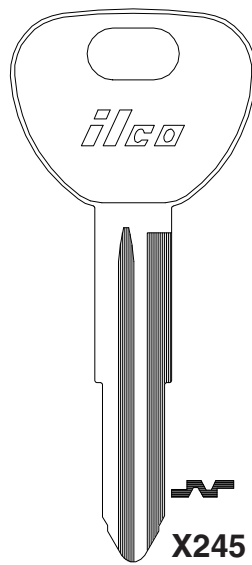

**X245**  
MIT4

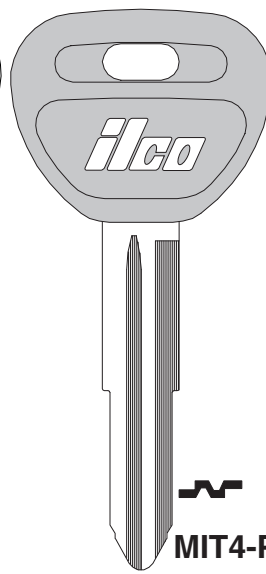

**MIT4-P**  
—

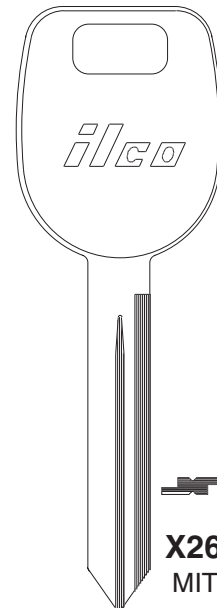

**X263**  
MIT6

**ILCO**  
EZ

MITSUBISHI

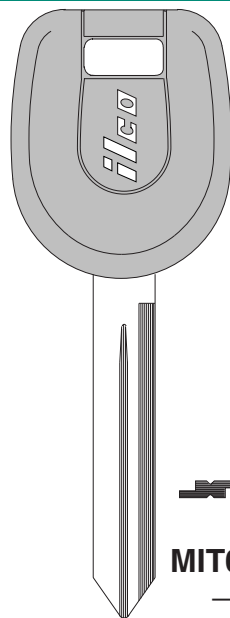

**MIT6-P**  
—

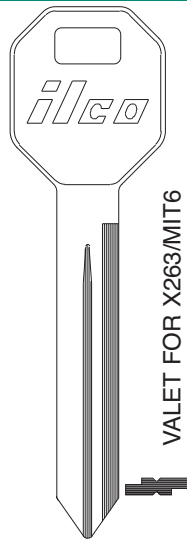

**X264**  
MIT7

VALET FOR X263/MIT6

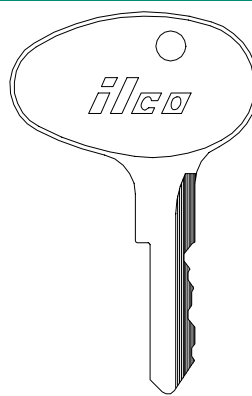

**1596**  
—

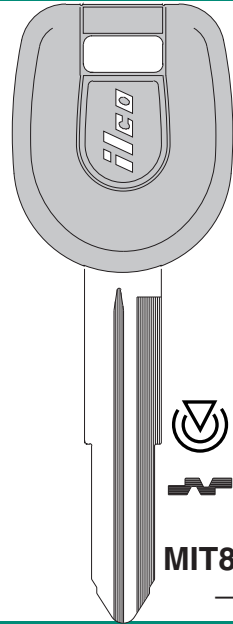

**MIT8-PT**  
—

**ILCO**  
EZ

MITSUBISHI

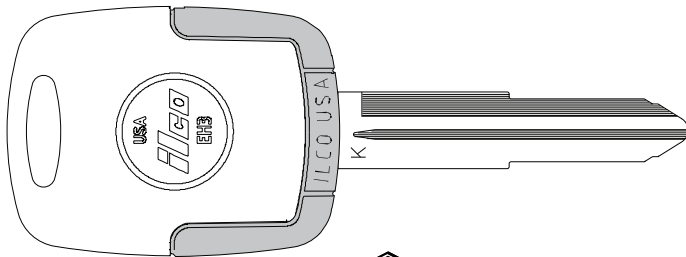

**MIT8-EK3**  
(Complete Key)



**EH3**  
(Head Only)



**EB3-K-MIT8**  
(Blade Only)

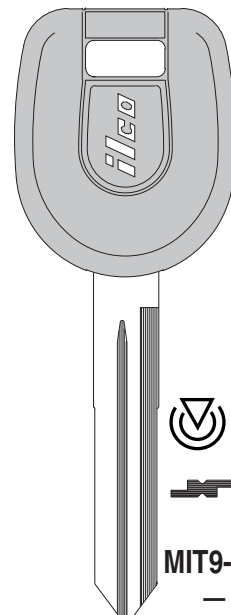

**MIT9-PT**  
—

**ILCO**  
EZ

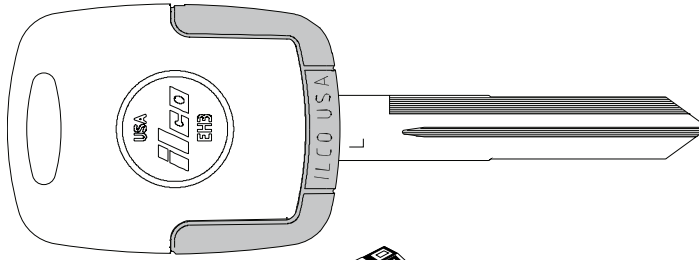
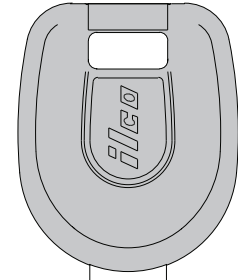
**MITSUBISHI****MIT9-EK3**  
(Complete Key)**EH3**  
(Head Only)**EB3-L-MIT9**  
(Blade Only)**MIT12-PT**  
—ILCO  
EZ

VEHICLE

sec 1 page 103

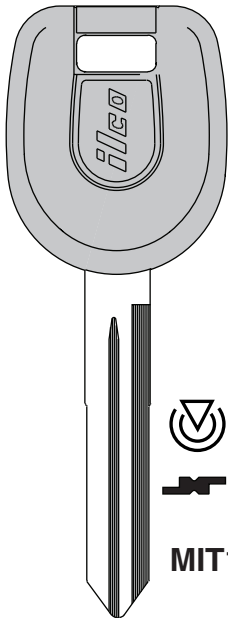
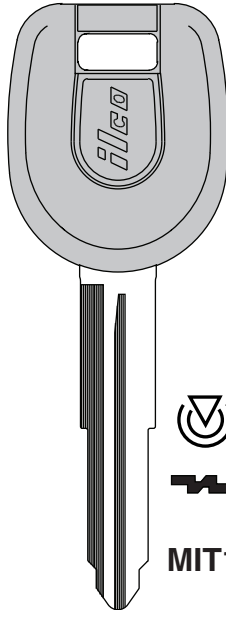
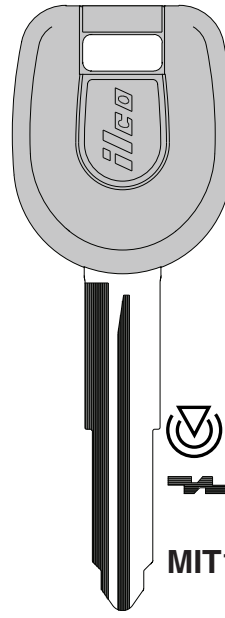
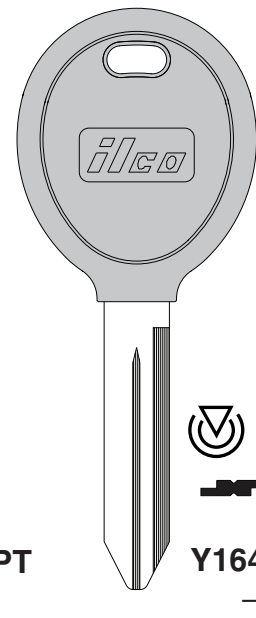
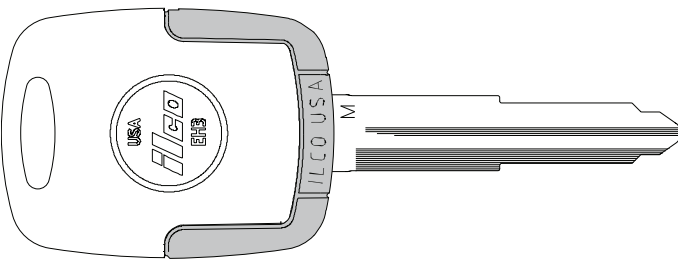
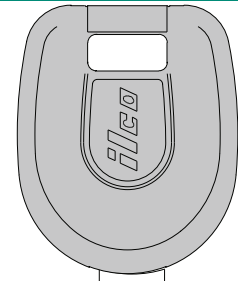
**MITSUBISHI****MIT13-PT**  
—**MIT14-PT**  
—**MIT17A-PT**  
—**Y164-PT**  
—ILCO  
EZ**MITSUBISHI****MIT14-EK3**  
(Complete Key)**EH3**  
(Head Only)**EB3-M-MIT14**  
(Blade Only)**MIT16A-PT**  
—ILCO  
EZ

MITSUBISHI

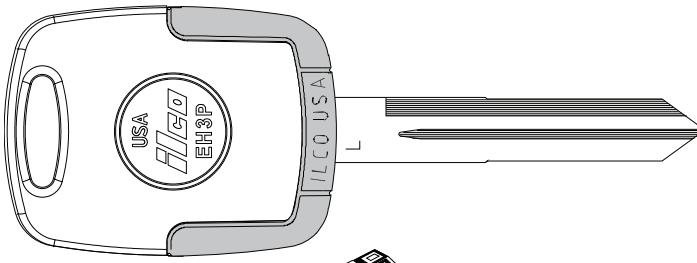

**EH3P**  
(Head Only)



**EB3-L-MIT9**  
(Blade Only)



**EK3P-MIT16**  
(Complete Key)

ILCO  
EZ

MITSUBISHI

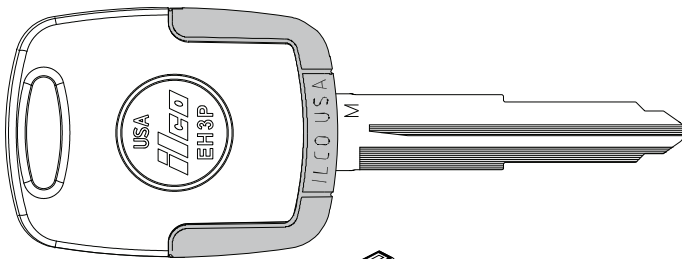

**EH3P**  
(Head Only)



**EB3-M-MIT14**  
(Blade Only)



**EK3P-MIT17**  
(Complete Key)

ILCO  
EZ

MITSUBISHI

MITSUBISHI-CATERPILLAR

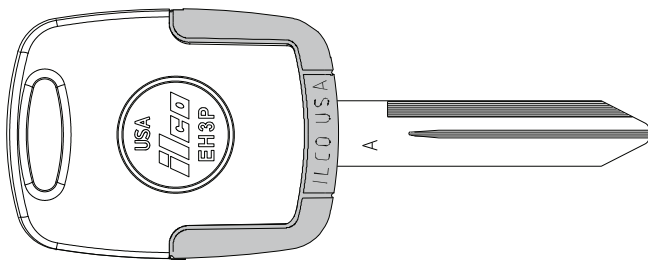

**EH3P**  
(Head Only)

**EB3-A-Y160**  
(Blade Only)



**EK3P-Y164**  
(Complete Key)

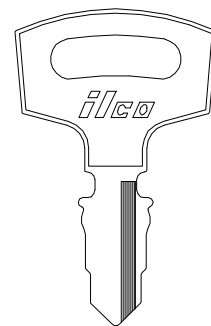

**1583**

—

ILCO  
EZ

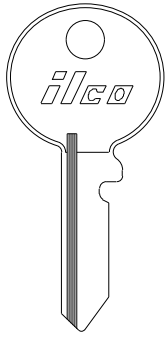
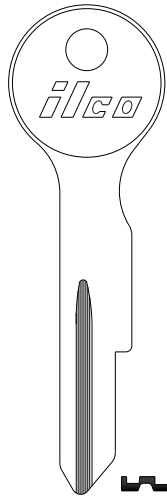
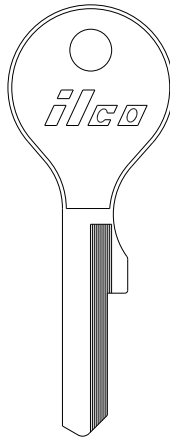
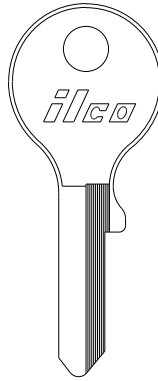
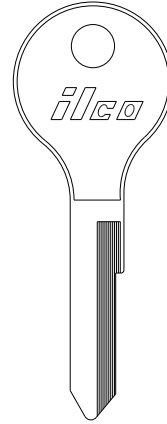
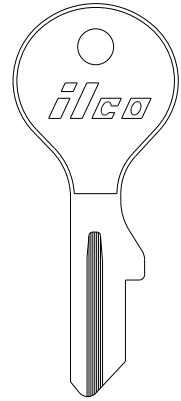

**MOB**
**MOPED**

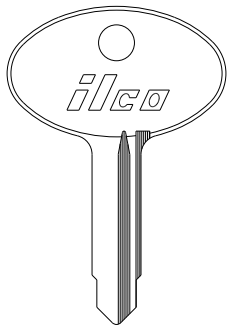
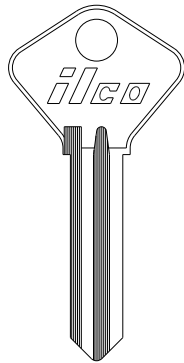
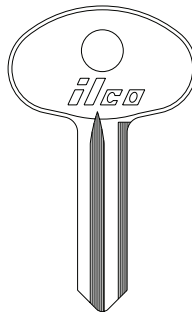
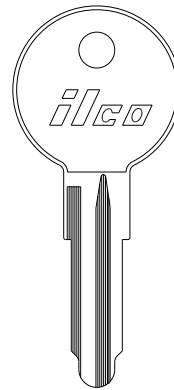
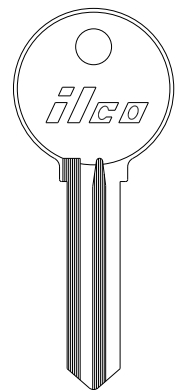
  
**62DP**

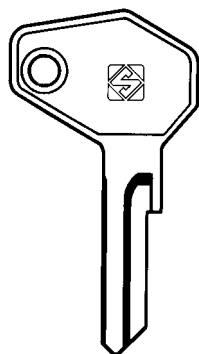
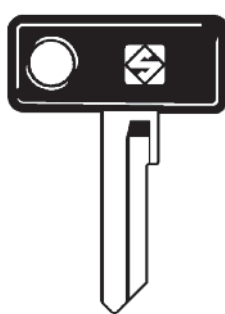
  
**Z1**

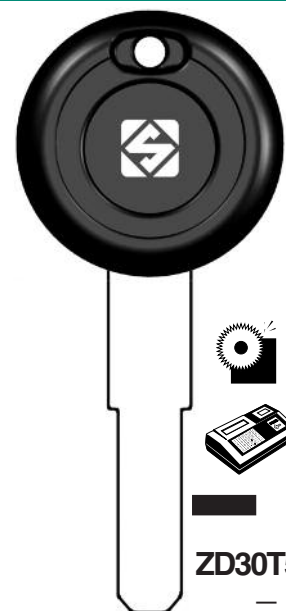
  
**Z3H**

  
**SR61N**

  
**Y61**

  
**Z91**
**ILCO**  
EZ

**MORETTI**

  
**61D**

  
**R61G**

  
**65FA**
  
**65G**
  
**R65G**

  
**66A**

  
**66BB**
**ILCO**  
EZ

**MORGAN**
**MOTO GUZZI**
**SEE  
BRITISH  
LEYLAND**

  
**ZD7-SI**

  
**ZD9P-SI**

  
**ZD24RDP-SI**

  
**ZD30T5-SI**
**ILCO**  
EZ

MOTO GUZZI	MV	MZ	N.S.U.
<b>X234</b> HYD13	<b>X270</b> TMC1	<b>X259</b> —	<b>NE1</b> —

ILCO  
EZ

N.S.U.

<b>HF18</b> —	<b>HF26</b> —	<b>HF29</b> —	<b>HF37</b> —	<b>63VO</b> —

ILCO  
EZ

N.S.U. NISSAN

		<table border="0"> <tr> <td>5 PIN</td> <td>6 PIN</td> </tr> <tr> <td></td> <td></td> </tr> <tr> <td><b>DT5</b></td> <td><b>DT4</b></td> </tr> <tr> <td>—</td> <td>—</td> </tr> <tr> <td></td> <td></td> </tr> <tr> <td><b>D72Z</b></td> <td><b>DT7</b></td> </tr> <tr> <td>—</td> <td>—</td> </tr> <tr> <td></td> <td></td> </tr> <tr> <td><b>D72D</b></td> <td><b>DT8</b></td> </tr> <tr> <td>—</td> <td>—</td> </tr> </table>	5 PIN	6 PIN			<b>DT5</b>	<b>DT4</b>	—	—			<b>D72Z</b>	<b>DT7</b>	—	—			<b>D72D</b>	<b>DT8</b>	—	—			
5 PIN	6 PIN																								
<b>DT5</b>	<b>DT4</b>																								
—	—																								
<b>D72Z</b>	<b>DT7</b>																								
—	—																								
<b>D72D</b>	<b>DT8</b>																								
—	—																								
	<table border="0"> <tr> <td>5 PIN</td> <td>6 PIN</td> </tr> <tr> <td></td> <td></td> </tr> </table>	5 PIN	6 PIN																						
5 PIN	6 PIN																								
<b>63Y</b> —	<b>DT1</b> —	<b>DT6</b> —	<b>X1</b> MZ12	<b>DT2</b> —	<b>DT3</b> —																				

ILCO  
EZ

## NISSAN

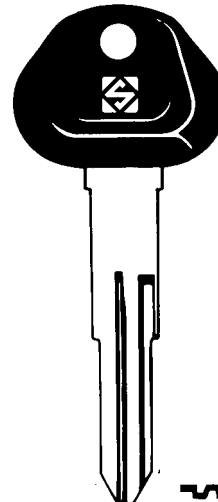
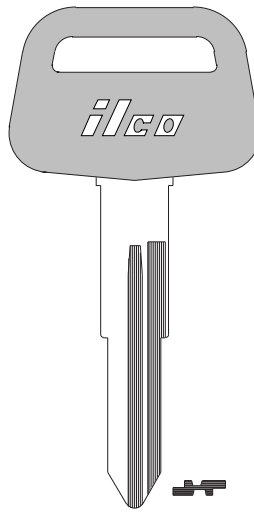
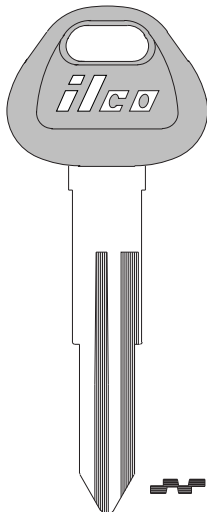
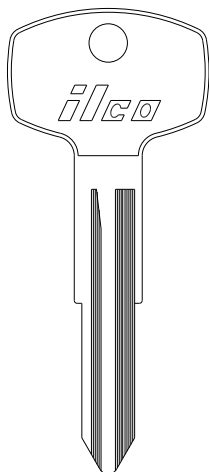
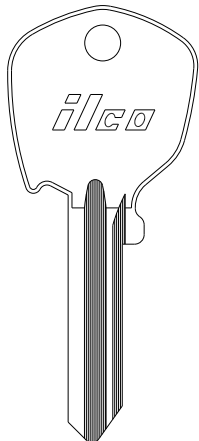
 ILCO  
EZ

**FT6**  
—

**FT6R**  
F81E

**X6**  
62DT

**X7**  
62DU

**DAT6P**  
—

**DAT6BP**  
—

**DAT6RP**  
—

## NISSAN

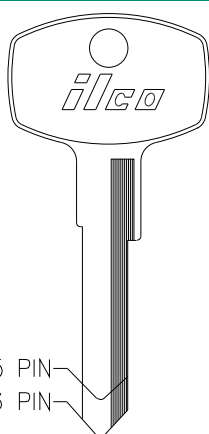
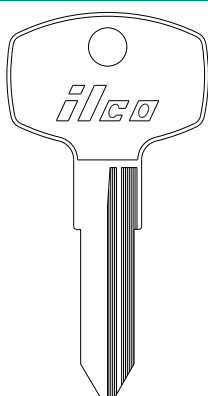
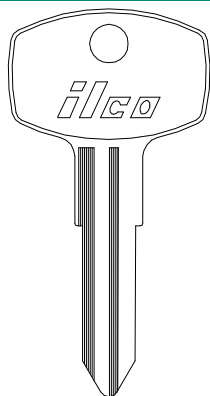
 5 PIN  
6 PIN

5 PIN

6 PIN

**DT13**  
—

**DT9**  
—

5 PIN

6 PIN

**DT14**  
—

**DT10**  
—

**DT15**  
—

**DT11**  
—

**DT16**  
—

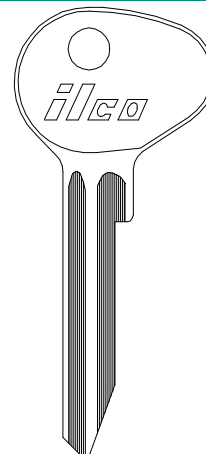
**DT12**  
—

 ILCO  
EZ

**X10**  
62DV

**DT20**  
—

**DA20**  
—

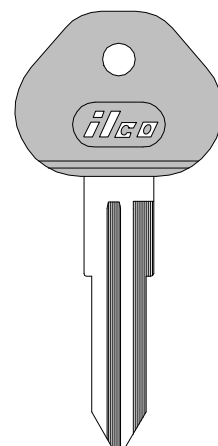
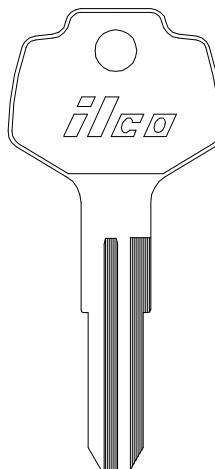
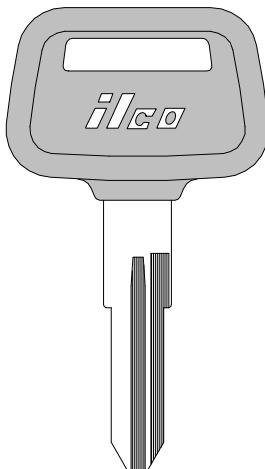
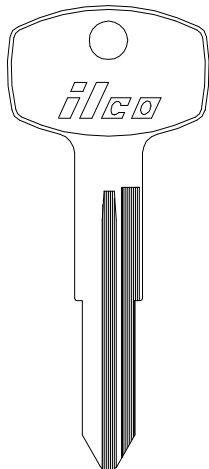
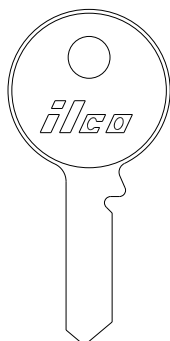
## NISSAN

 ILCO  
EZ

**65TA**  
—

**X115**  
DA23

**X114**  
DA24

**DA23-P**  
—

**X123**  
DA25

**DA25-P (-PC)**  
—

NISSAN

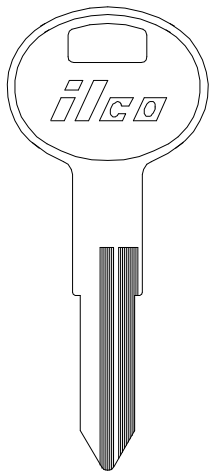

X124  
DA28

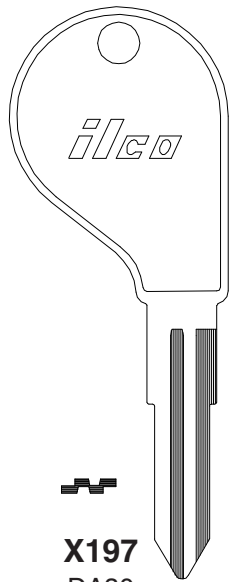

X197  
DA30

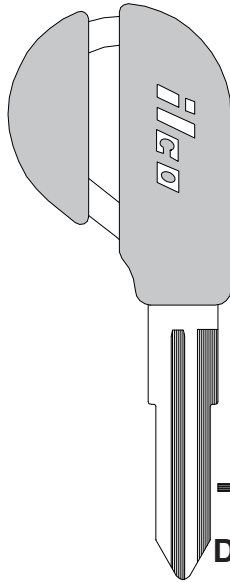

DA30-P  
—

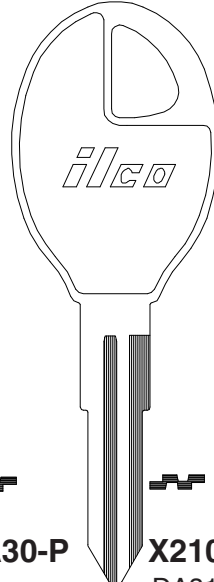

X210  
DA31

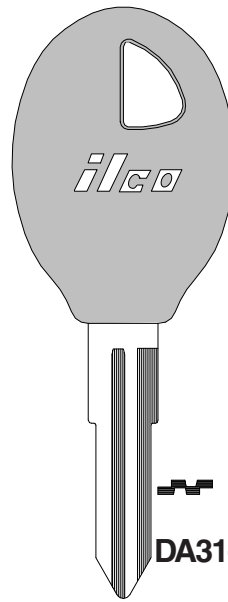

DA31-P (-PC)  
—

ILCO  
EZ

NISSAN

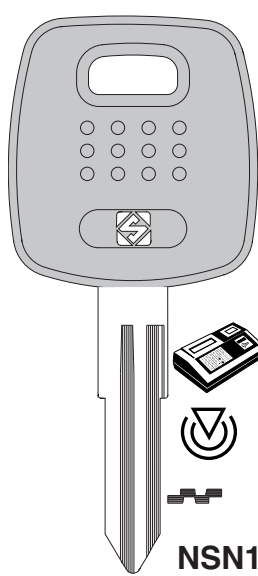

NSN11T2  
—

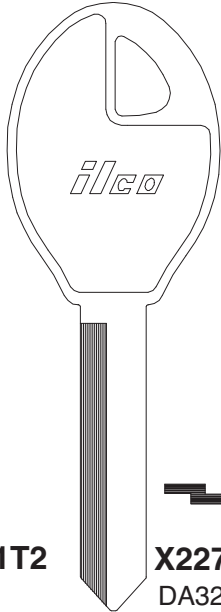

X227  
DA32

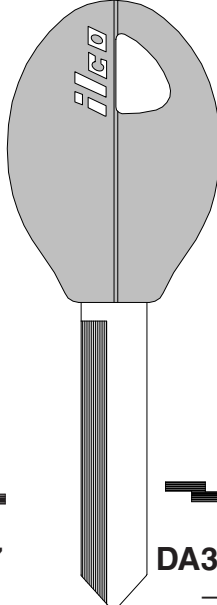

DA32-P  
—

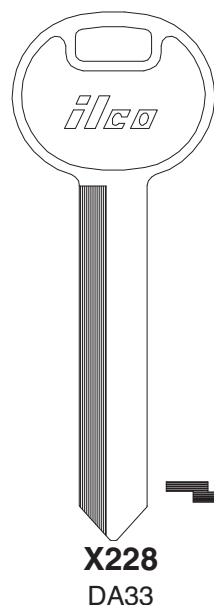

X228  
DA33

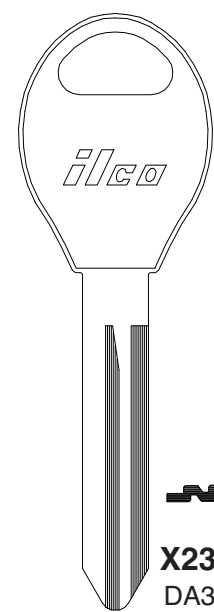

X237  
DA34

ILCO  
EZ

NISSAN

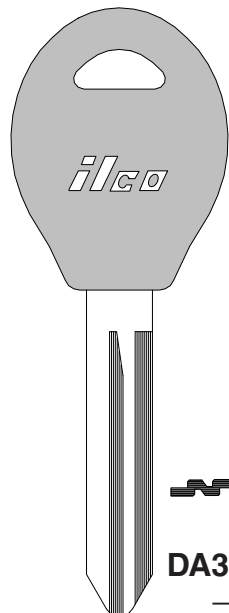

DA34-P  
—

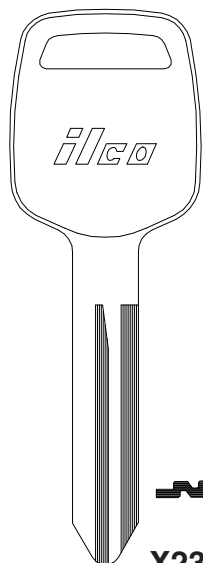

X238  
DA35

VALET FOR X237 & DA34-P

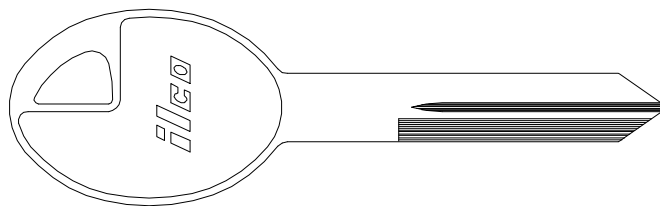

X242  
DA37

ILCO  
EZ

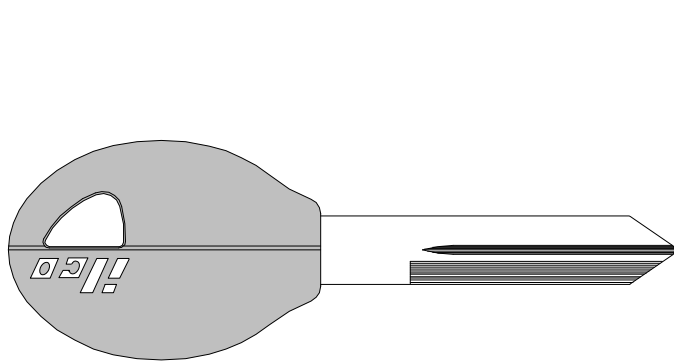
**NISSAN****DA37-P**

-

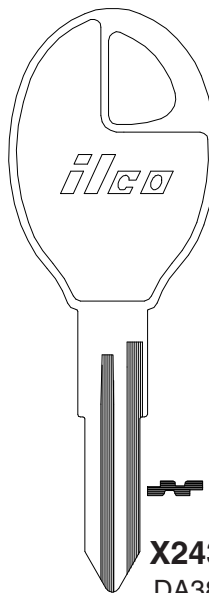
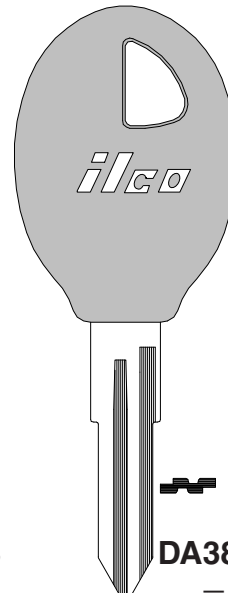
**X243**  
DA38**DA38-P**

-

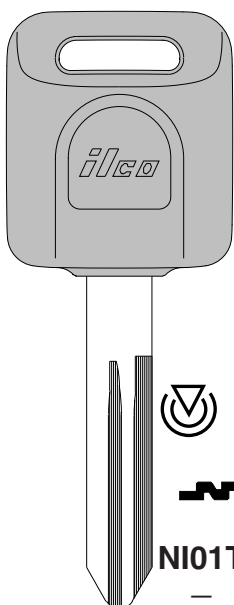
**ILCO**  
EZ**NISSAN****NI01T**

-

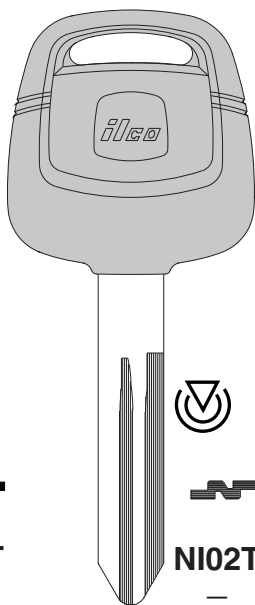
**NI02T**

-

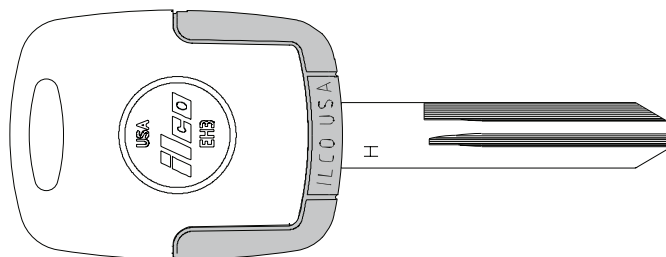
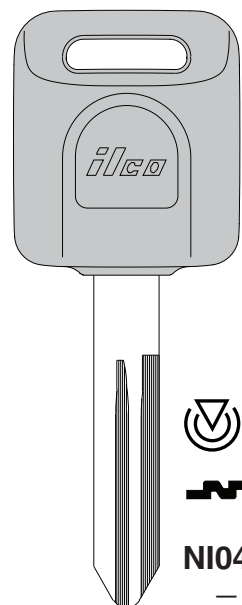
**NI02-EK3**  
(Complete Key)**EH3**  
(Head Only)**EB3-H-NI02**  
(Blade Only)**ILCO**  
EZ**NISSAN****NI04T**

-

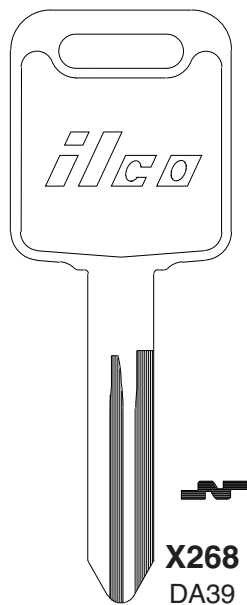
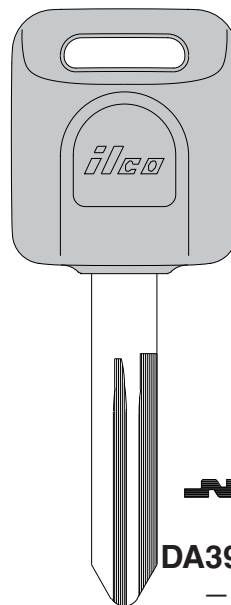
**X268**  
DA39**DA39-P**

-

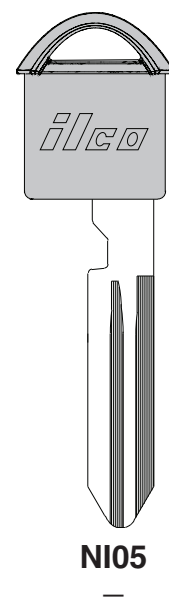
**NI05**

-

**ILCO**  
EZ

NISSAN

NORTON

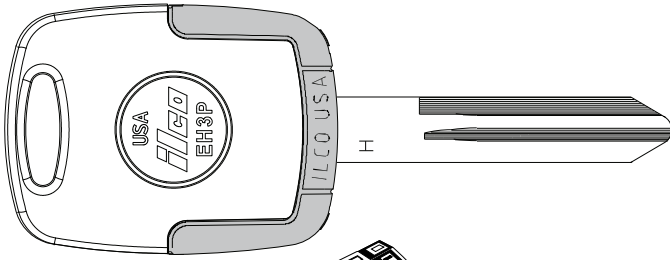

**EH3P**  
(Head Only)



**EB3-H-NI02**  
(Blade Only)



**62FS**  
—



**EK3P-NI04**  
(Complete Key)

ILCO  
EZ

NORTON

OLDSMOBILE

OMC (JOHNSON & EVINRUDE)

OPEL

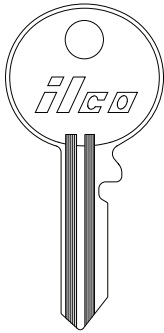

**R62DM**  
—

**SEE  
GENERAL  
MOTORS  
(GM)**

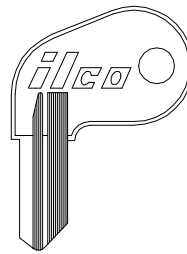

**OM10**  
—

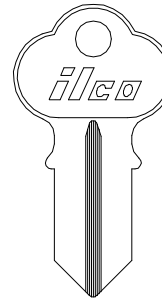

**1041G**  
CG1



**1041GA**  
CG2

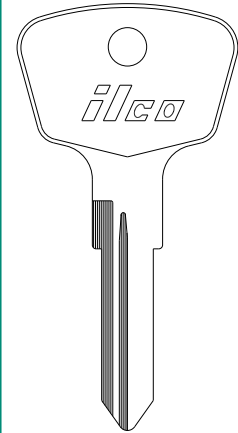

**AD1**  
—

ILCO  
EZ

OPEL

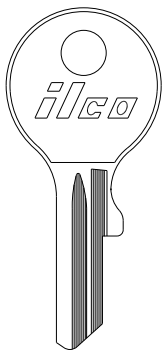

**BU1**  
—

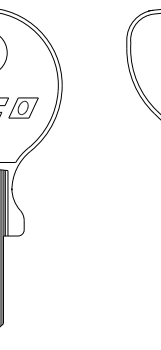

**BU2**  
—

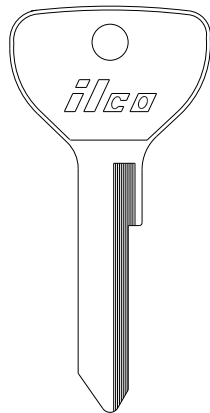

**OPB1**  
—

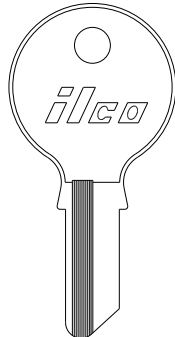

**DK3**  
—

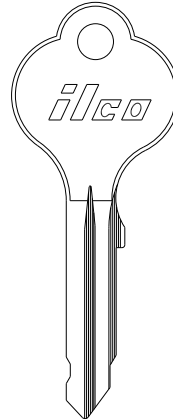

**YM3**  
—

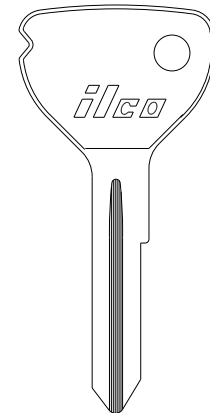

**YM6**  
—



**YM7**  
—



**YM8**  
—



**YM9**  
—

ILCO  
EZ

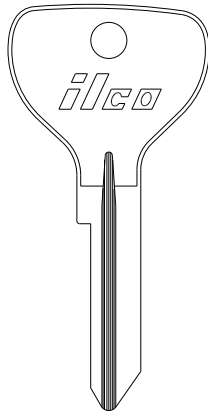
**OPEL**

**62PD**  
—

**R62PD**  
—

**U62VP**  
—

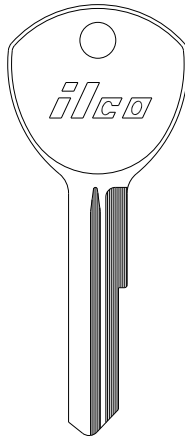
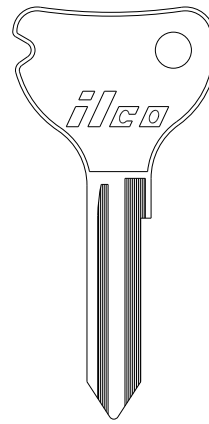
**UR62VP**  
—

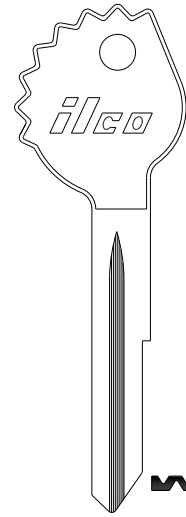
**HF21**  
—

**HF12**  
—

**OP12**  
—

**OP37**  
—

**YM13**  
—

**OP11**  
—

**HF11**  
—

**HF12**  
—

**OP12**  
—

**OP37**  
—

**YM13**  
—

**ILCO**  
EZ

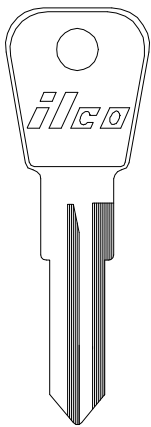
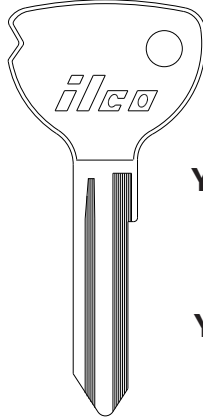
**OPEL**

**X21**  
YS1

**YM21**  
—

**YM23**  
—

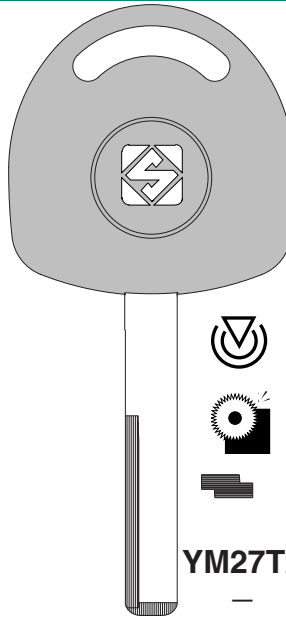
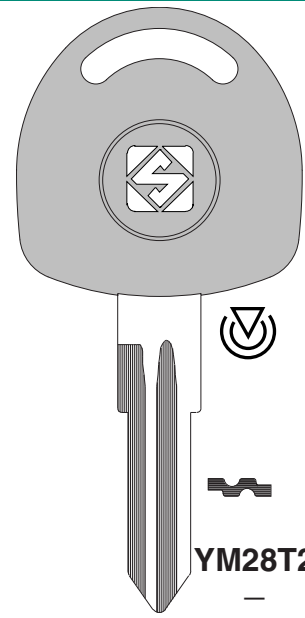

**YM24**  
—

**YM25**  
—

**YM27**  
—

**YM22**  
—

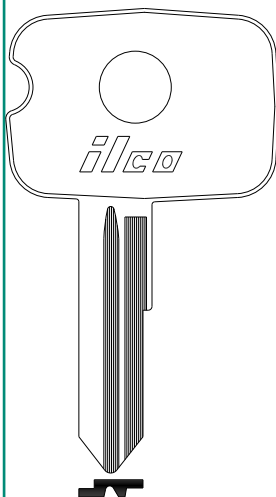
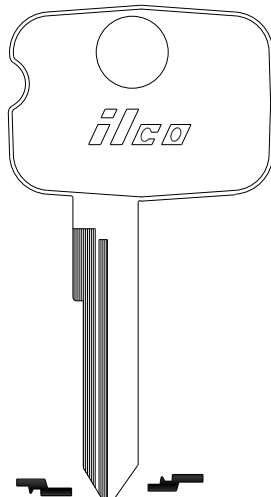
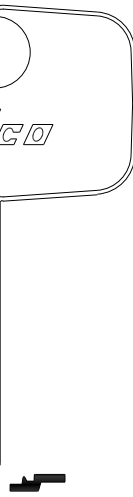
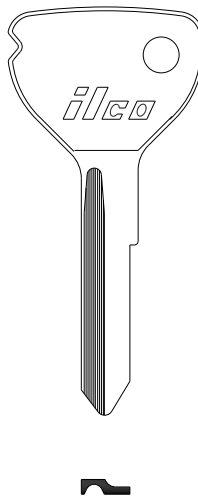
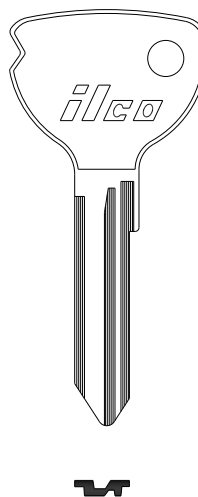
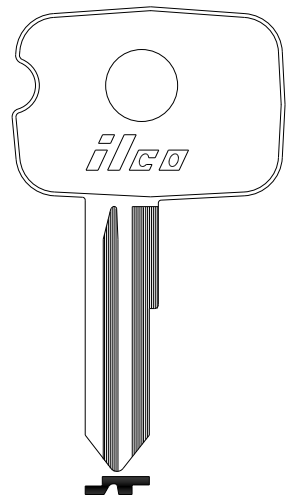
**YM27T2**  
—

**YM28T2**  
—

**ILCO**  
EZ

**OPEL**

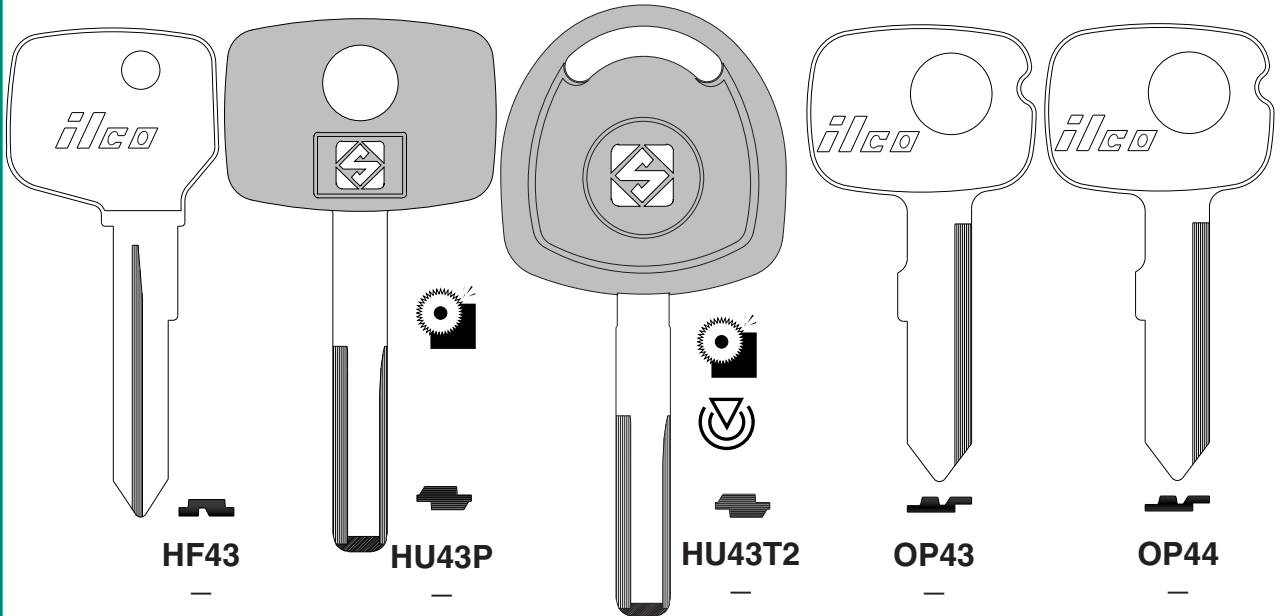
**YM28**  
—

**YM30**  
—

**YM29**  
—

**OP32**  
—

**OP36**  
—

**HF38**  
—

**ILCO**  
EZ

OPEL



HF43

HU43P

HU43T2

OP43

OP44

ILCO  
EZ

OPEL

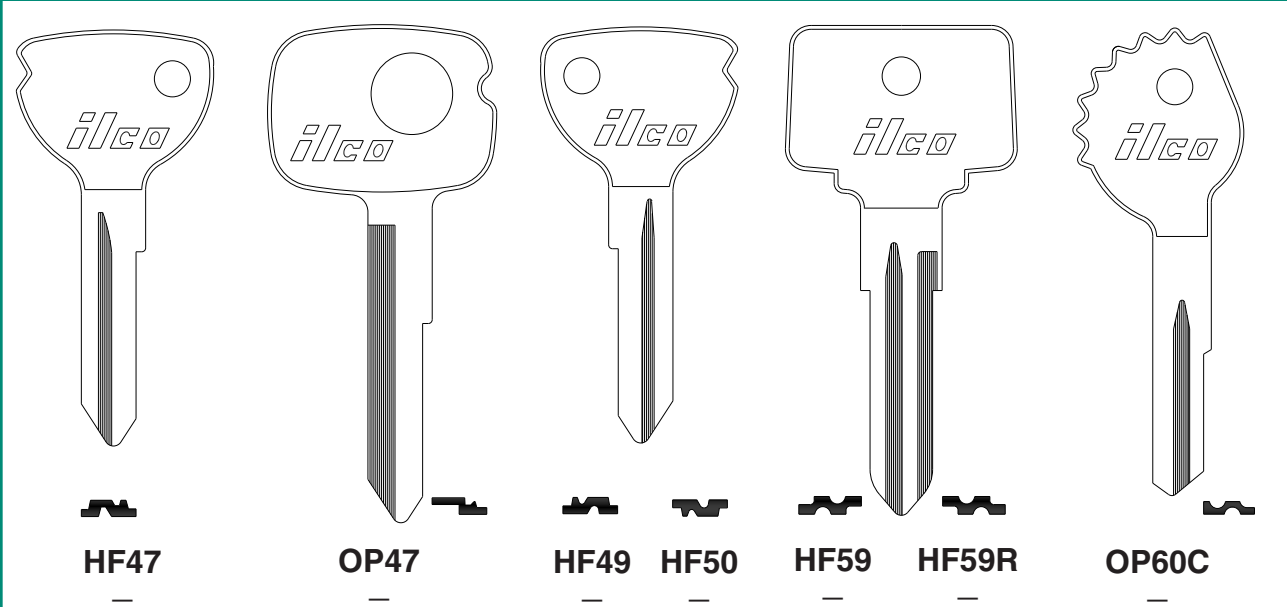

HF47

OP47

HF49

HF50

HF59

HF59R

OP60C

ILCO  
EZ

OPEL

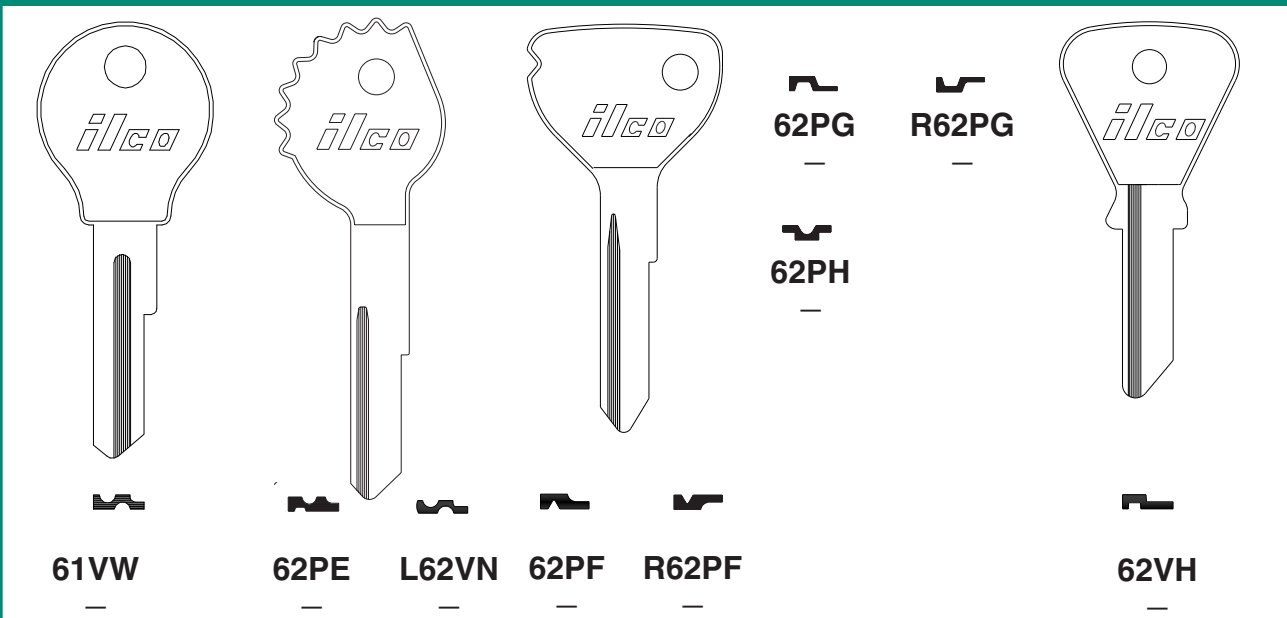

61VW

62PE

L62VN

62PF

R62PF

62PG

R62PG

62PH

62VH

ILCO  
EZ



OPEL

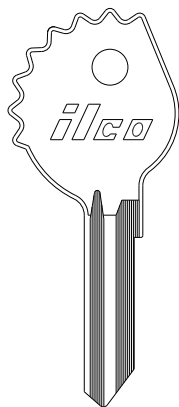

**62VJ**  
—

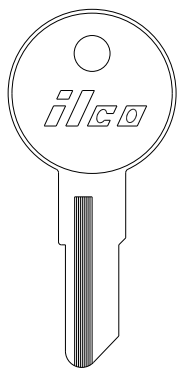

**62VM**  
—

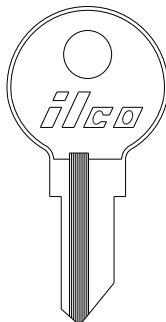

**62VO**  
—

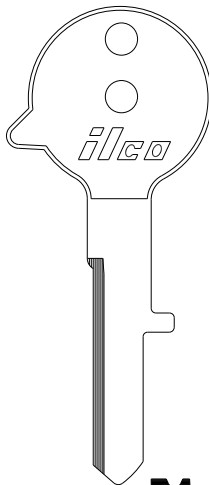

**62VP**  
—

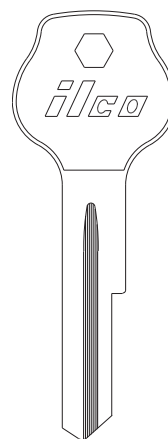

**A62VN**  
—

**62WA**  
—

**R62PE**  
—

**63Y**  
—

ILCO  
EZ

OPEL

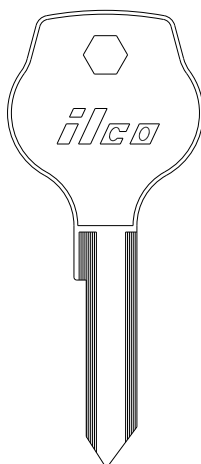

**H62PD**  
—

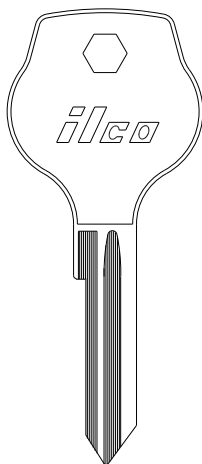

**HR62PD**  
—

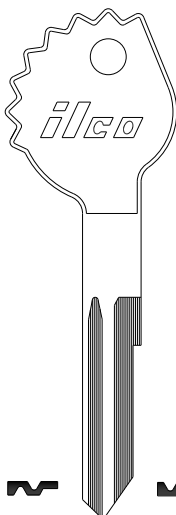

**L62VJ**  
—



**LR62VJ**  
—

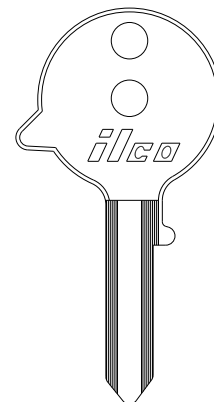

**S62VP**  
—



**H62VP**  
—

**S62VT**  
—

ILCO  
EZ

OPEL

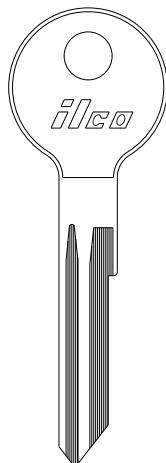

**63LL**  
—

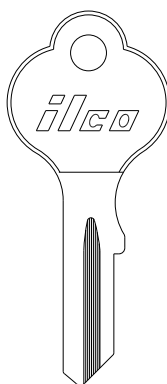

**U63H**  
—

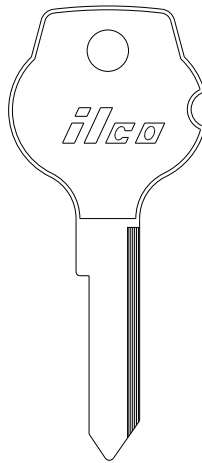

**O79JE**  
—

**O79JC**  
O79JC

**O79JD**  
O79JD



**OP91G**  
—

ILCO  
EZ

OPEL

PANHARD

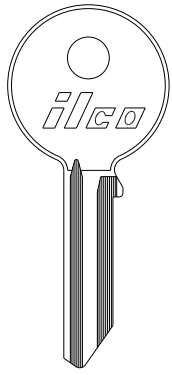

OP91S

—

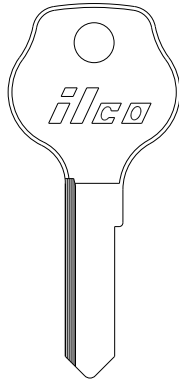

OP91SV

—

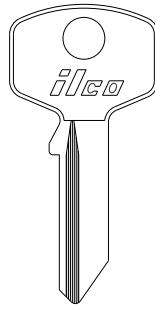

Y91C

—

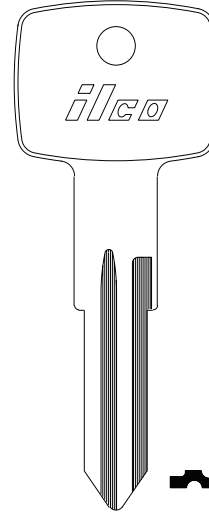

X168

B61

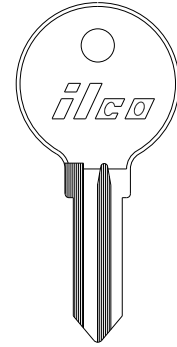

PA1

—

ILCO  
EZ

PANHARD

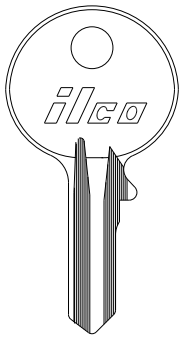

7DC

—

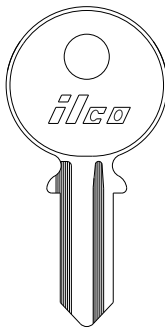

62BZ

—

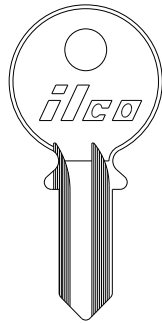

R62BZ

—

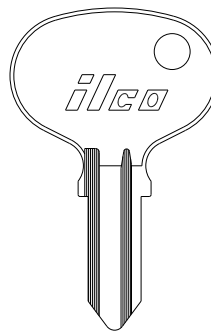

62R

—



H64K

—



HR64K

—



P64K

—



P65A

—



P65C

—



P64H

—

ILCO  
EZ

PANHARD

PANTERA

PETERBILT

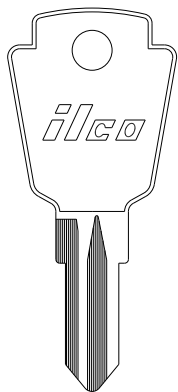

PA91

—

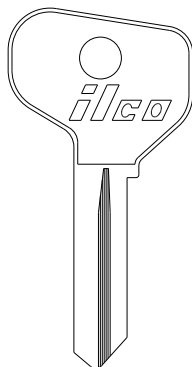

FT37 FT38

—

—

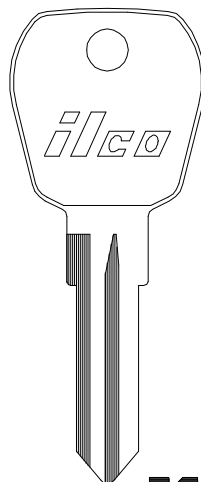

X86

FC7

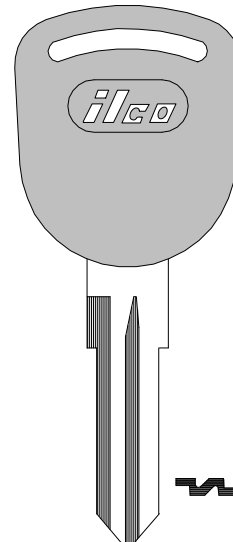

FC7-P

—

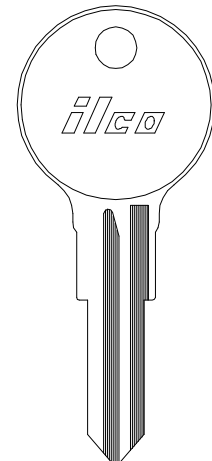

X53

V32

ILCO  
EZ

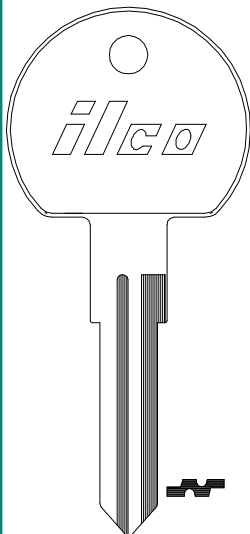
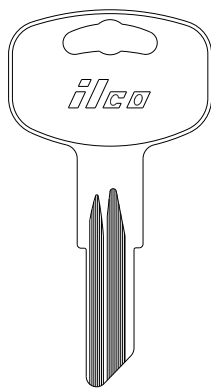
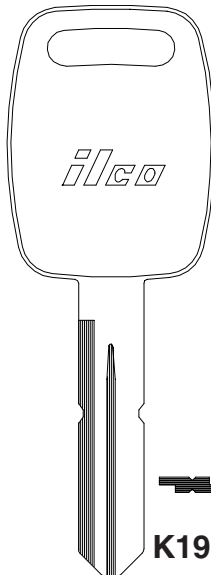
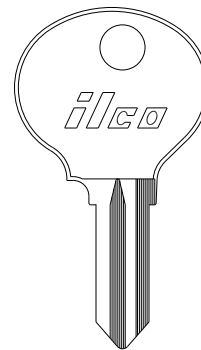
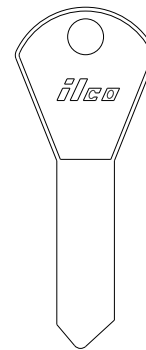
**PETERBILT**
**PEUGEOT**

**X170**  
NE48

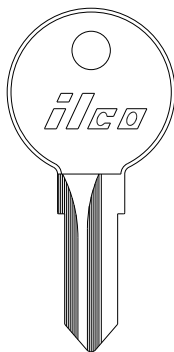
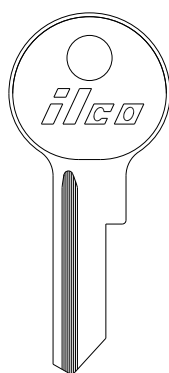
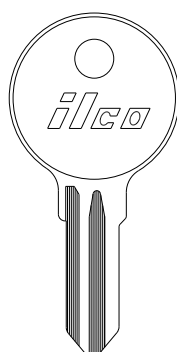
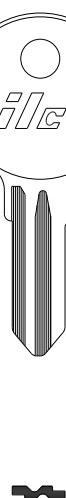
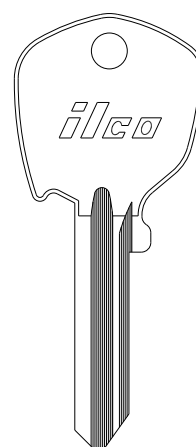
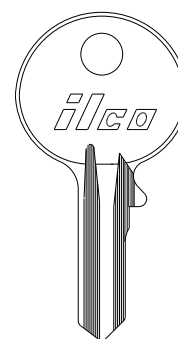
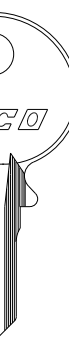
**1098PB**  
—

**K1994**  
—

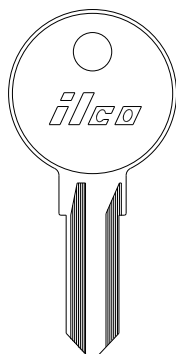
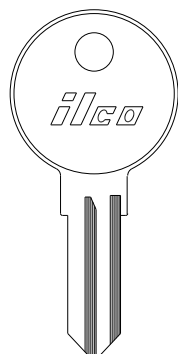
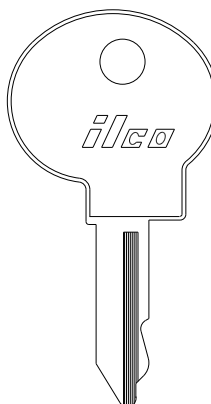
**KM1**  
—

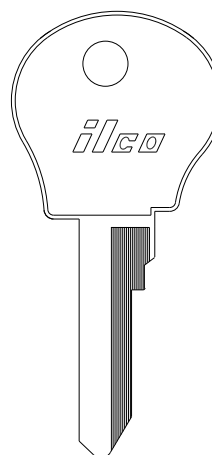
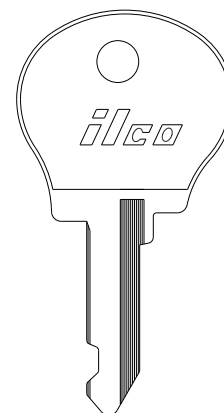
**LA1**  
—

**ILCO**  
EZ

**PEUGEOT**

**KM2**  
—

**KM3**  
—

**NE4**  
—

**SM4**  
—

**FT6**  
—

**7DC**  
—

**R7DC**  
—

**ILCO**  
EZ

**PEUGEOT**

**KM8**  
—

**X89**  
KM9

**KM10**  
—

**NE11**  
—

**X12**  
RE61F

**NE18**  
—

**ILCO**  
EZ

PEUGEOT

						NE42
						-
						NE43
						-
RT19	NE27	NE31	NE39	NE41		
-	-	-	-	-		

ILCO  
EZ

PEUGEOT

NE44	NE45	NE47	NE46	61PE	61PS	RE61XR
-	-	-	-	-	-	-

ILCO  
EZ

PEUGEOT

									N63G	NR63G
									-	-
V61S	VR61S	62Z	R62Z	L62UC	63G	R63G	63H	R63H		
-	-	-	-	-	-	-	-	-		

ILCO  
EZ

## PEUGEOT

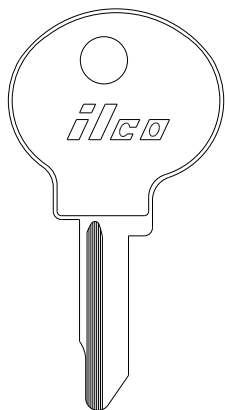
**63M**

-

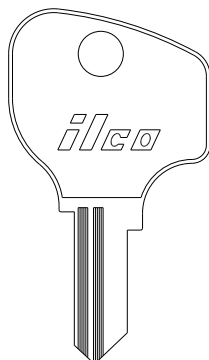
**63Q**

-

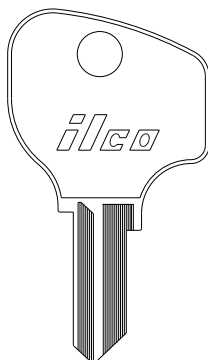
**63P**

-

**63PX**

-

**R63PX**

-

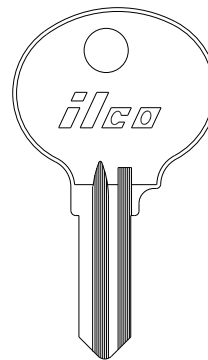
**H63G**

-

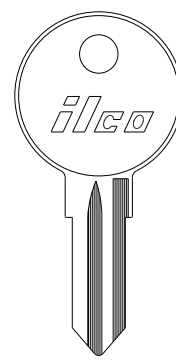
**L63G**

-

**LR63G**

-

 ILCO  
EZ

sec 1 page 117

VEHICLE

## PEUGEOT

## PEUGEOT MOTORCYCLE

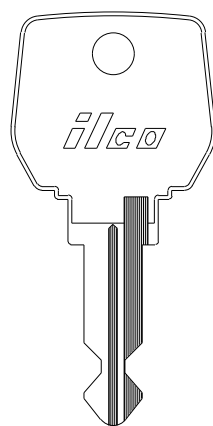
**X116**

RN24

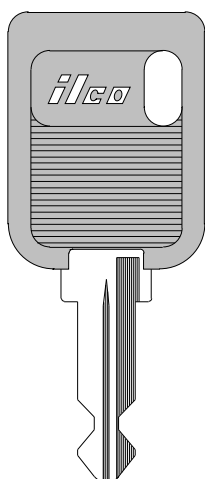
**RN24-P**

-

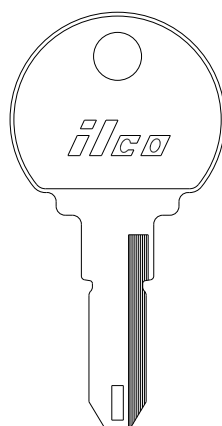
**X147**

RN30

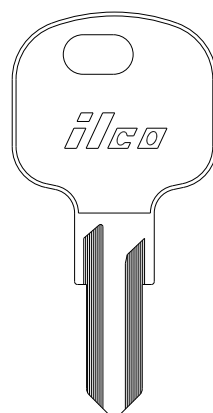
**X148**

PG5

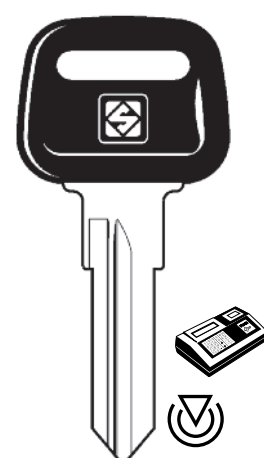

**NE74T5-SI**

-

 ILCO  
EZ

## PEUGEOT MOTORCYCLE

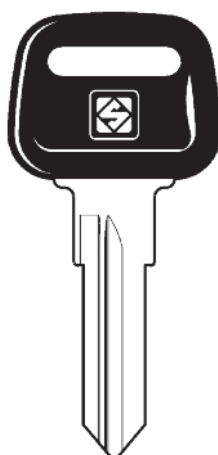
## PIAGGIO

**NE74P-SI**

-

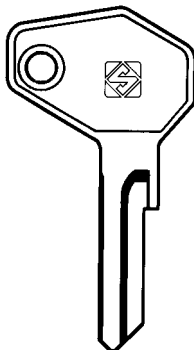
**ZD7-SI**

-

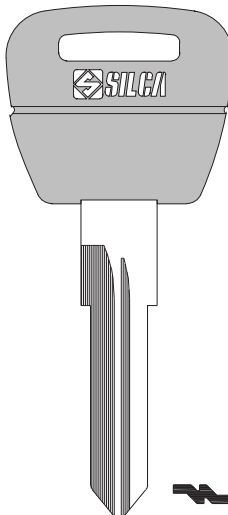
**NE71RDP-SI**

-

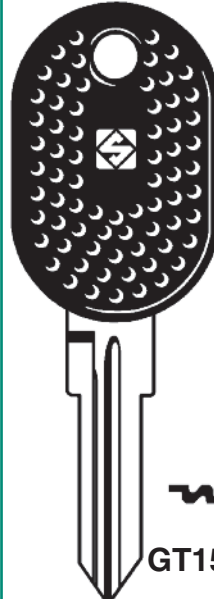
**GT15RP-SI**

-

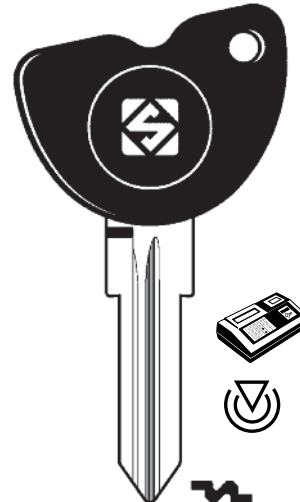
**GT15RDT5-SI**

-

 ILCO  
EZ

PIAGGIO

GT15RAP	ZD17RAP-SI	ZD16RP-SI	SIP22T5-SI	X270 TMC1

ILCO  
EZ

PIPER AIRCRAFT    PLYMOUTH    POLARIS

	<b>SEE CHRYSLER</b>				
O1122 Y11			HD51	752	1041GB

ILCO  
EZ

POLARIS

1041GR	1041K	CH3	CH7	X117 YH48

ILCO  
EZ

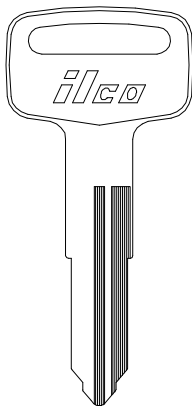
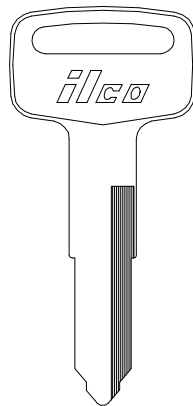
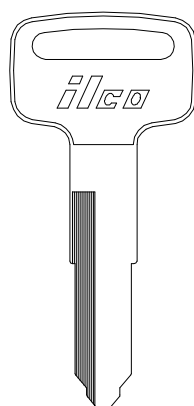
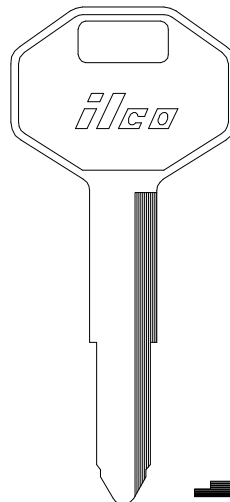
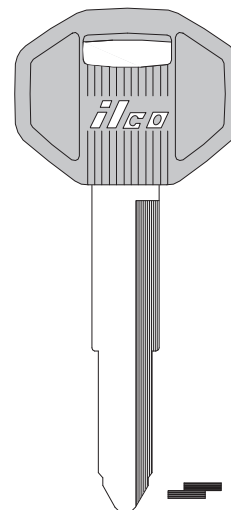
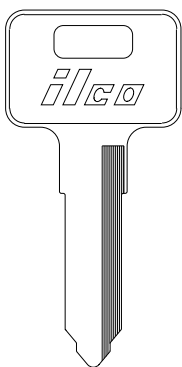
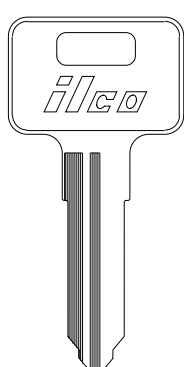
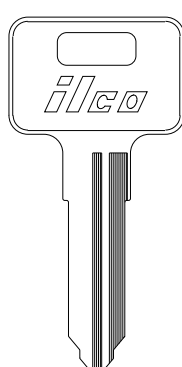
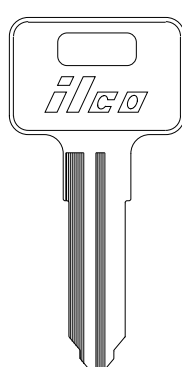
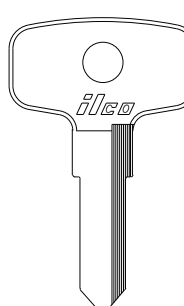
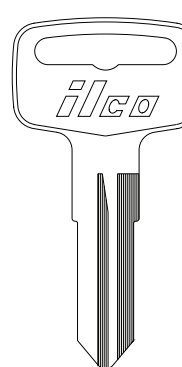
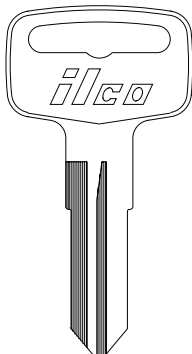
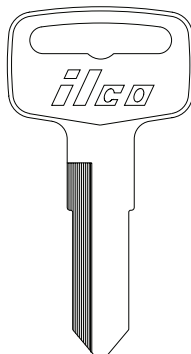
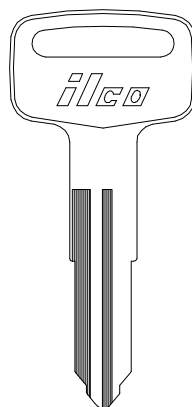
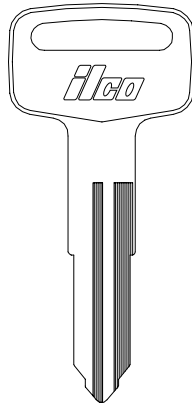
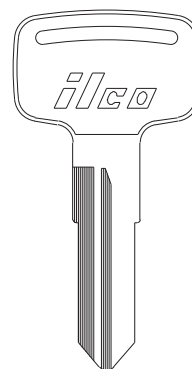
**POLARIS****X118**  
YH49**X119**  
YH47**X120**  
YH46**X121**  
DC3**DC3-P (-PC)**  
—ILCO  
EZ**POLARIS****X259**  
—**X260**  
—**X261**  
—**X262**  
—**YH26**  
—**YH33**  
—ILCO  
EZ**POLARIS****YH34**  
—**YH38**  
—**YH50**  
—**YH51**  
—**YM55**  
—ILCO  
EZ

POLARIS PONTIAC PORSCHE

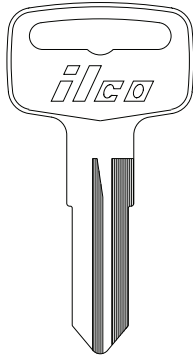

YM56

—

SEE  
GENERAL  
MOTORS  
(GM)

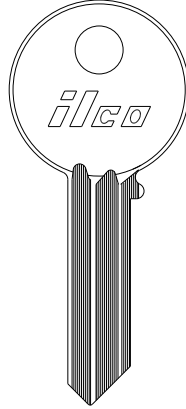

BZK1

—

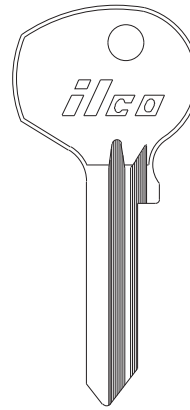

KP1

—

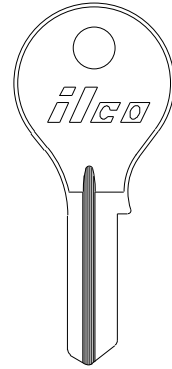

PO2

—

ILCO  
EZ

PORSCHE

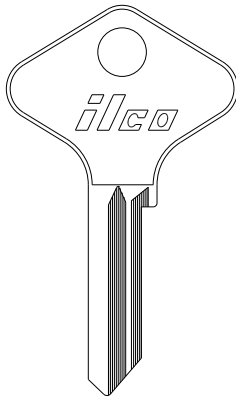

DM2

—

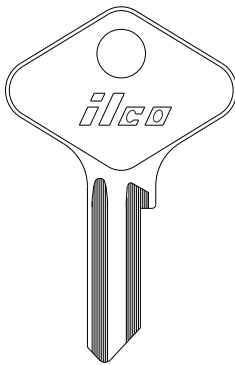

DM3

—

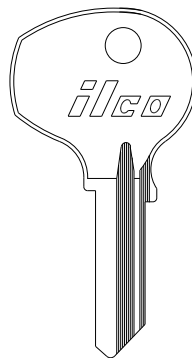

DM4

—

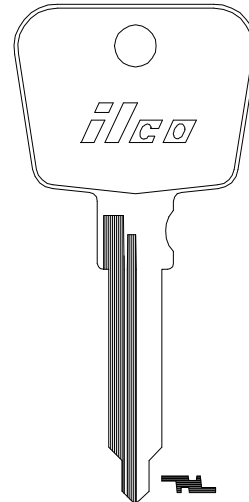

PO5

—

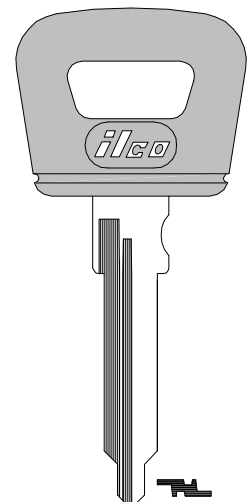

PO5-P

—

ILCO  
EZ

PORSCHE

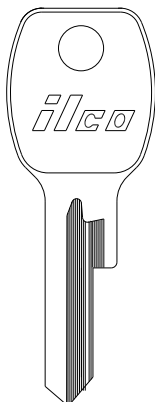

WS5

—

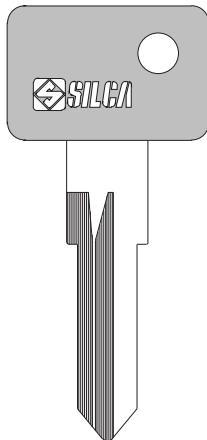

ZD14RP

—

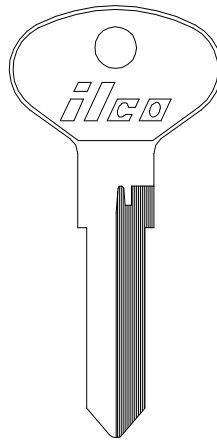

X9

73VB

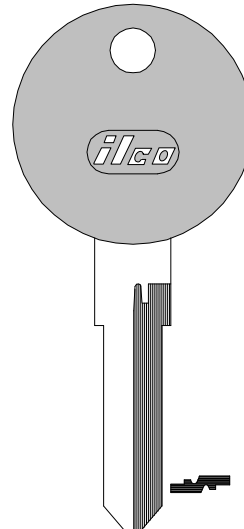

73VB-P

—

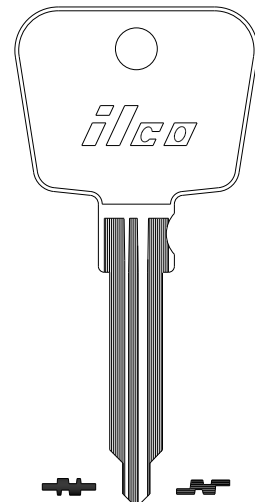

X32

PO6

PO7

—

ILCO  
EZ

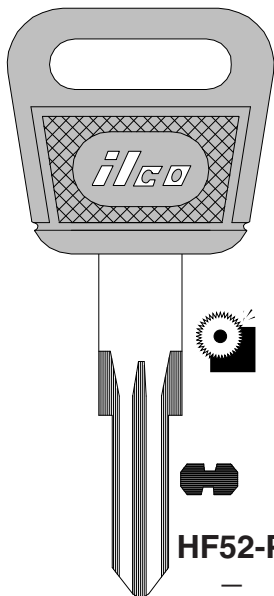
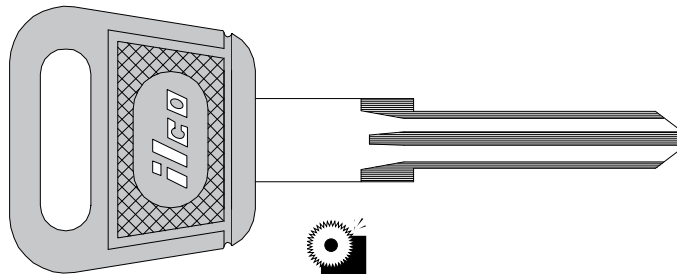
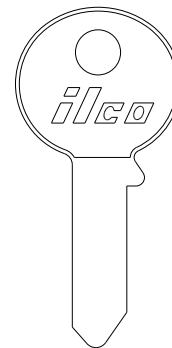

**PORSCHE**

**HF52-P**  
—

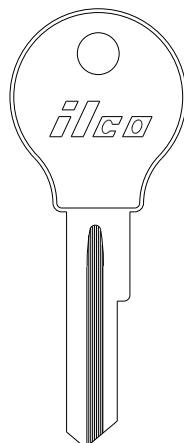
**HF55-P**  
—

**61NC**  
—

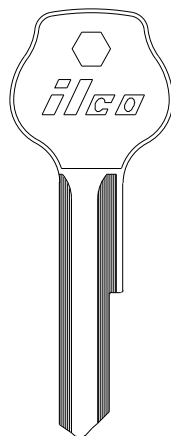
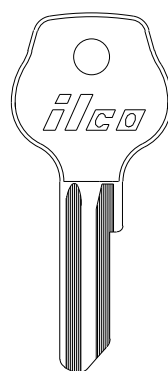
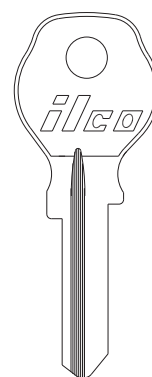
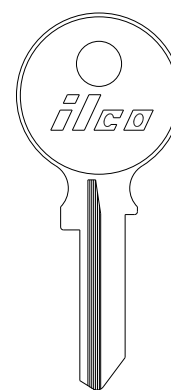
**ILCO**  
EZ

**PORSCHE**

**61VW**  
—

**U61VW**  
—

**V61VW**  
—

**L62VB**  
—

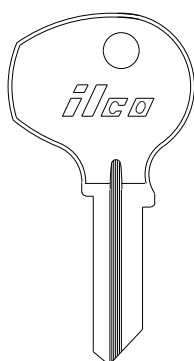
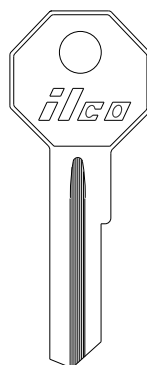
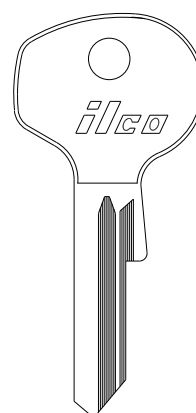
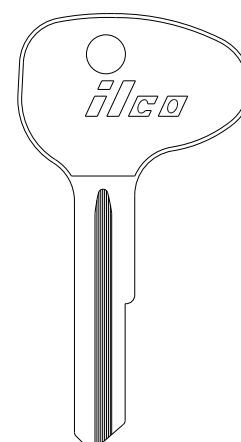
**R62VN**  
—

**M63BG**  
—

**M63B**  
—

**ILCO**  
EZ

**PORSCHE**

**U63H**  
—

**64K**  
—

**64KK**  
—

**P79B**  
—

**A81N**  
—

**ILCO**  
EZ

PORSCHE - RENAULT





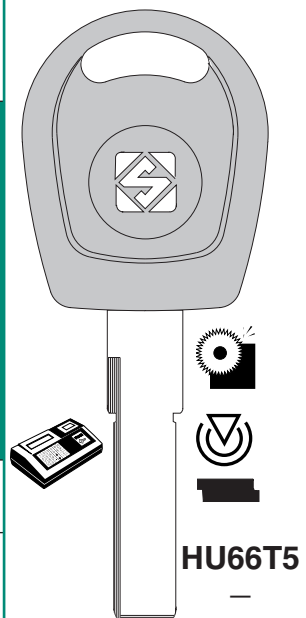
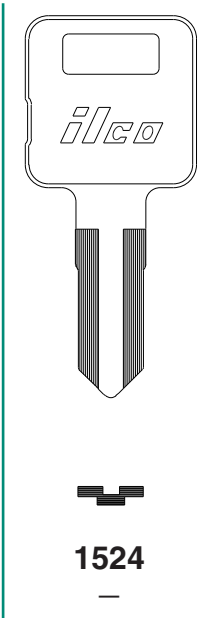
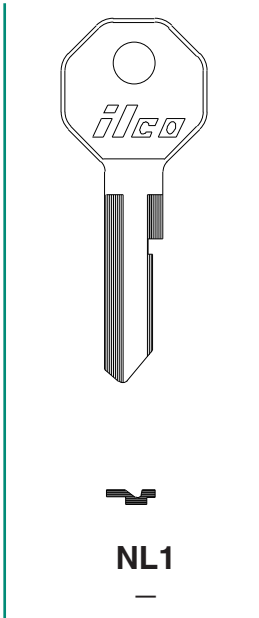
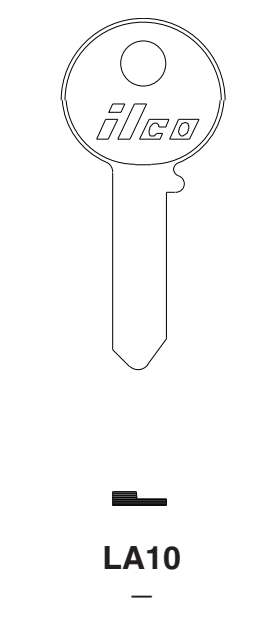
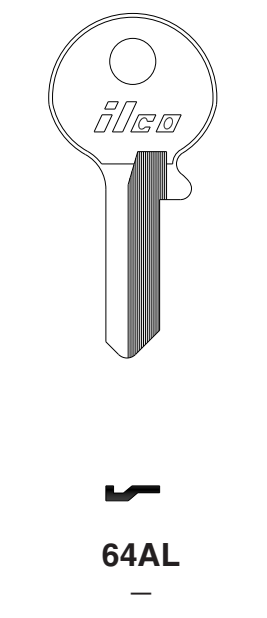

VEHICLE

sec 1 page 122

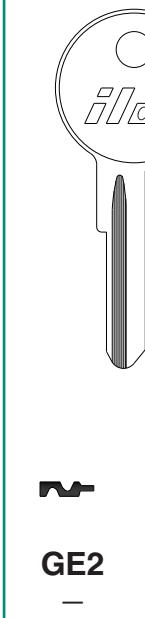
PORSCHE POST OFFICE PRINCE

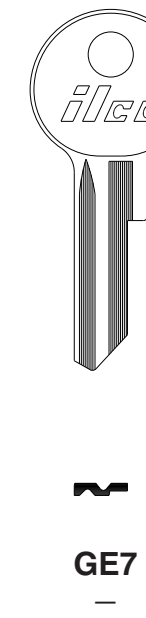
 <p>HU66T5</p>	 <p>1524</p>	 <p>NL1</p>	 <p>LA10</p>	 <p>64AL</p>	<p>ILCO EZ</p>
---	---	--	--	---	--------------------

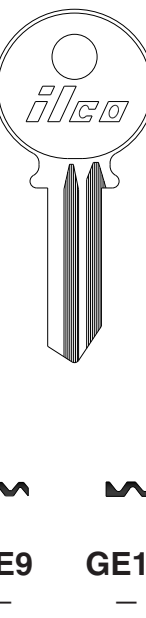
PUCH-SEARS

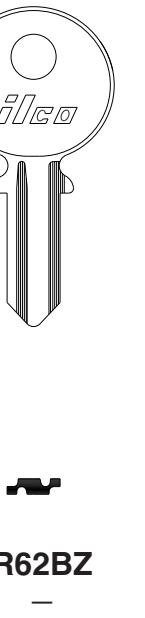
 <p>GE2</p>	 <p>GE4</p>	 <p>GE7</p>	 <p>GE9</p>	 <p>GE14</p>	 <p>R62BZ</p>	 <p>64P</p>	<p>ILCO EZ</p>
---	---	---	---	--	--	---	--------------------

PUCH-SEARS RALEIGH CYCLE RENAULT

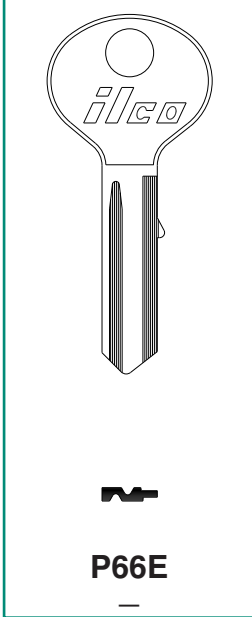
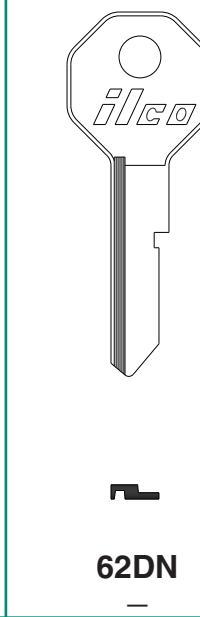
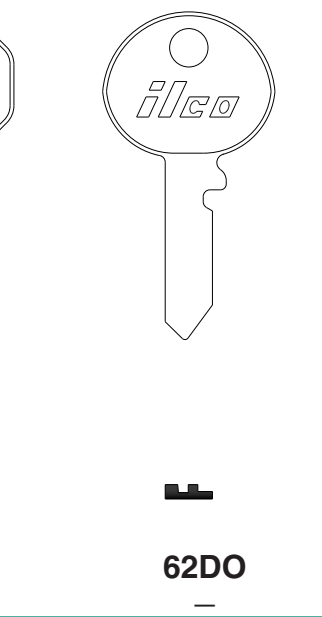
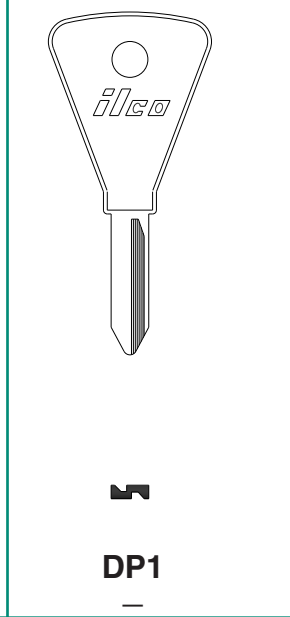
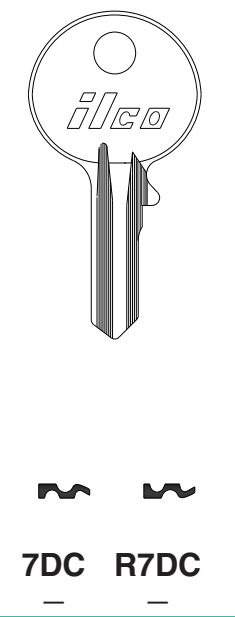
 <p>P66E</p>	 <p>62DN</p>	 <p>62DO</p>	 <p>DP1</p>	 <p>7DC R7DC</p>	<p>ILCO EZ</p>
---	---	---	---	---	--------------------

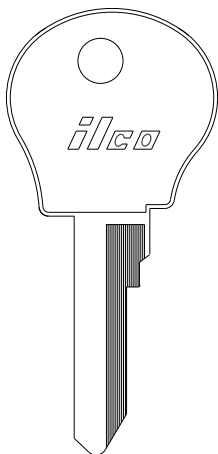
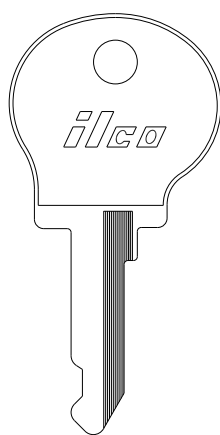
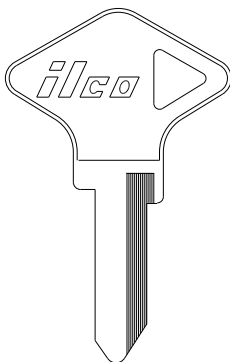
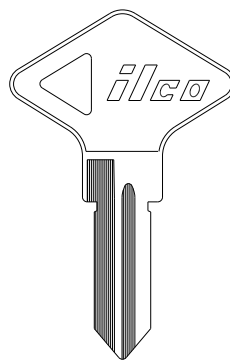
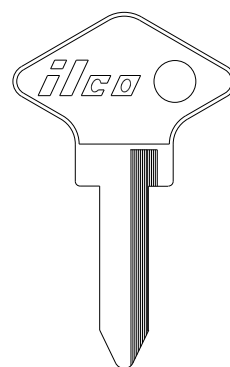
**RENAULT**

**X12**  
RE61F

**NE13**  
—

**NE14**  
—

**NE15**  
—

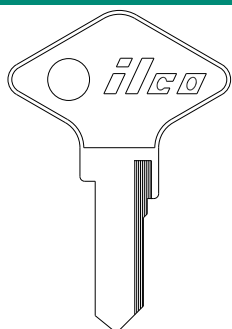
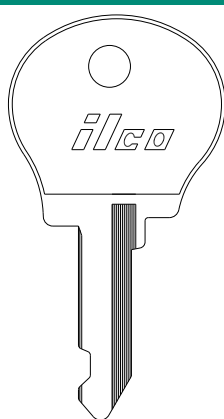
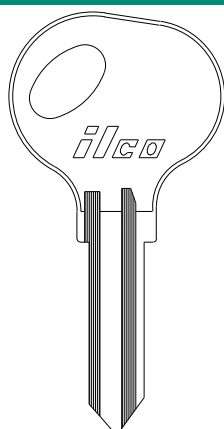
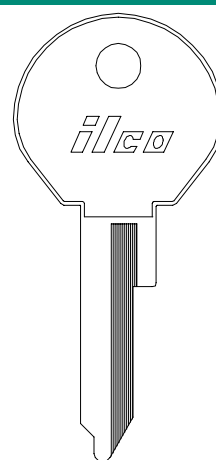
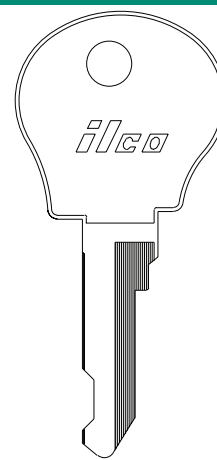
**NE16**  
—

**NE29**  
—

**ILCO**  
EZ

sec 1 page 123

VEHICLE

**RENAULT**

**NE17**  
—

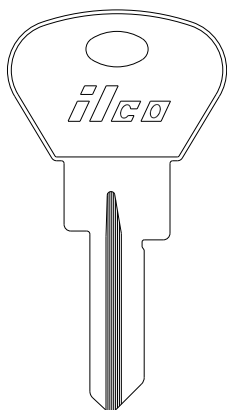
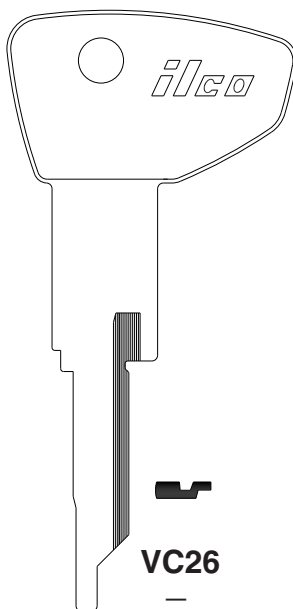
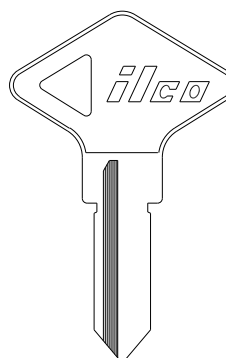
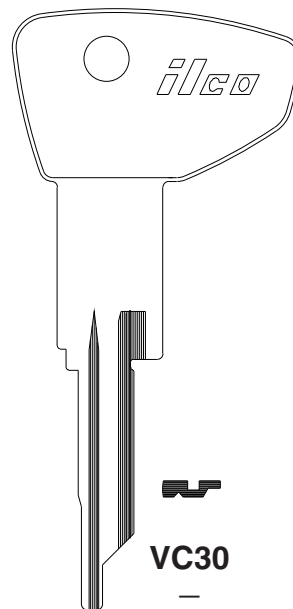
**NE18**  
—

**RT19**  
—

**NE20**  
—

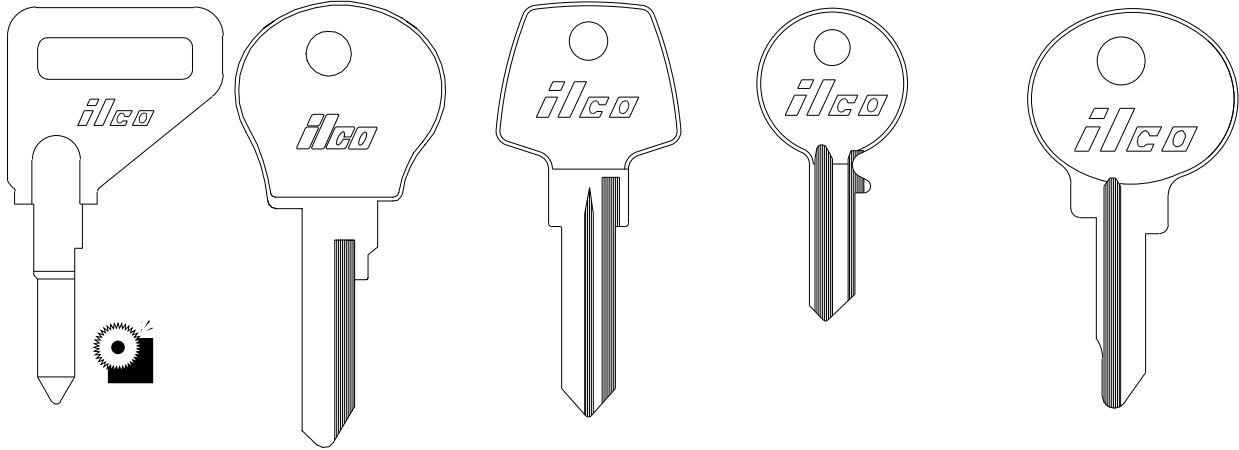
**NE22**  
—

**ILCO**  
EZ

**RENAULT**

**VC24**  
—

**VC26**  
—

**VC29**  
—

**VC30**  
—

**ILCO**  
EZ

RENAULT



**NE33**      **NE39**      **NE45**      **HV61 HVR61**      **RE61N**

ILCO  
EZ

RENAULT

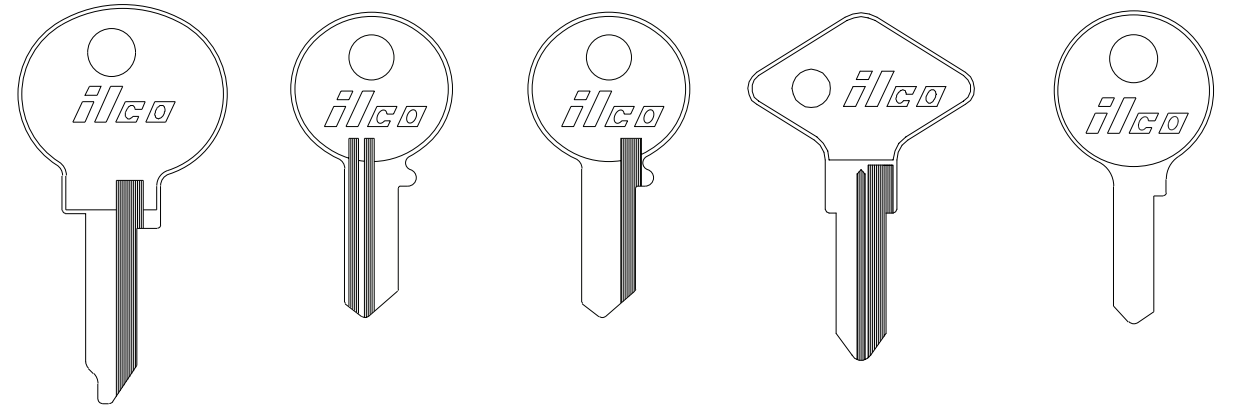

**RE61XR**      **V61S**      **VR61S**      **X61**  
NE40      **62VC**

ILCO  
EZ

RENAULT

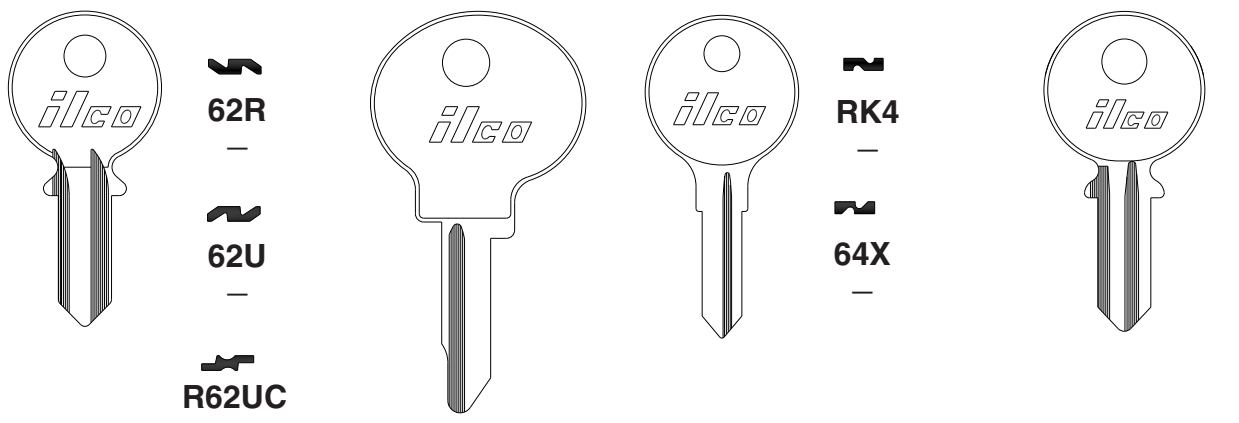

**62R**      **62U**      **R62UC**      **62Z**      **R62Z**      **63M**      **63Q**      **64R**      **RK4**      **64X**      **P64K**

ILCO  
EZ

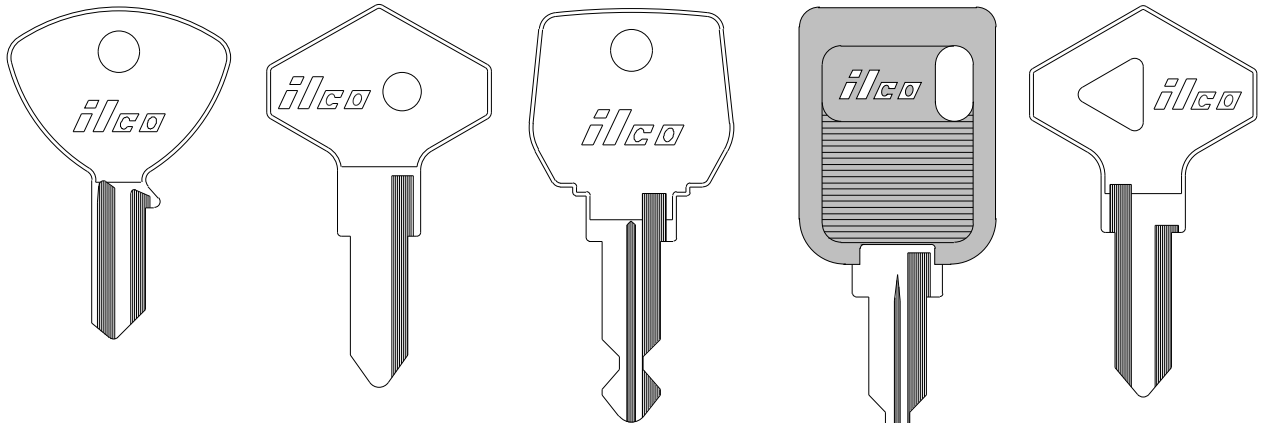
**RENAULT**

**R80B**  
—



**X85**  
NE36



**X92**  
RN25



**X116**  
RN24



**RN24-P**  
—



**X122**  
RN29

**ILCO**  
EZ

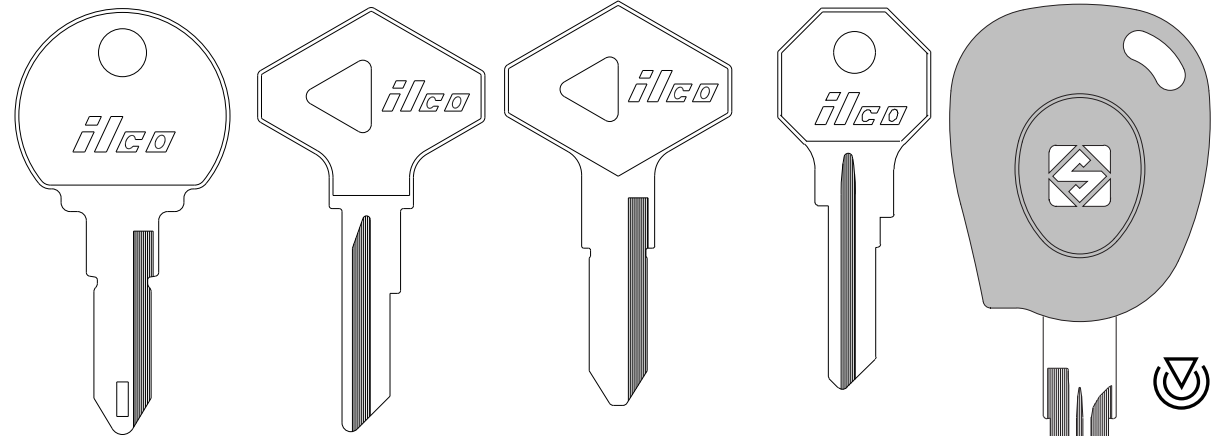
**RENAULT**

**X147**  
RN30



**X150**  
RN27



**X171**  
RN31



**H199N**  
—



**VAC102T1**  
—

**ILCO**  
EZ

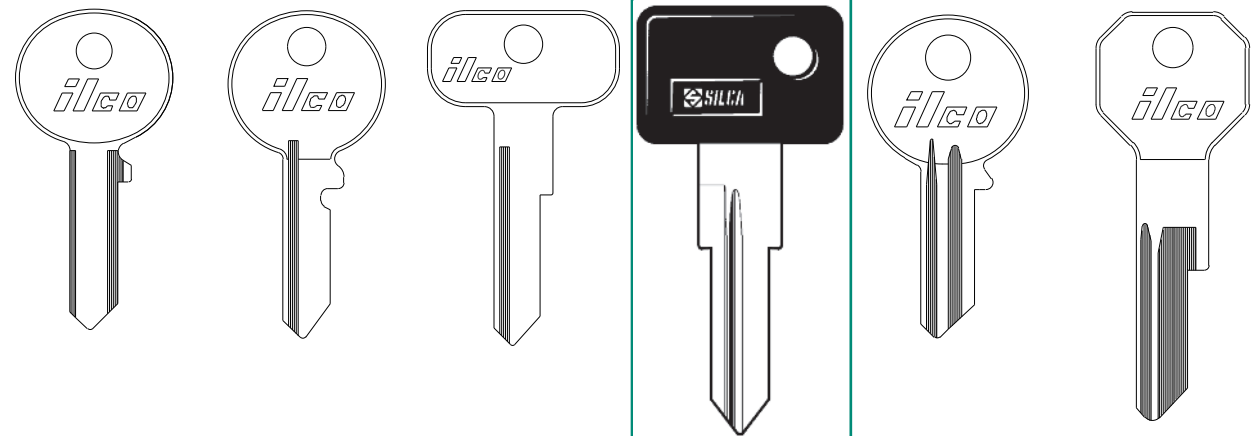
**RILEY**
**RIZZATO**
**ROLLS ROYCE**

**62DB**  
—



**62DP**  
—



**H62DP**  
—



**ZD16RP-SI**  
—



**YL5**  
—



**X28**  
62HE

**ILCO**  
EZ

ROLLS ROYCE/BENTLEY

VEHICLE



62HA

—



62HB

—



62HC

—



62HD

—



62HF

—



62HG

—

ILCO  
EZ

sec 1 page 126

ROLLS ROYCE/BENTLEY ROOTES GROUP

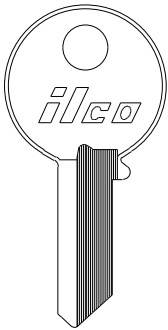

62JB

—



SR1

—

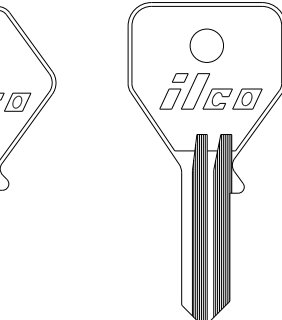

SR2

—

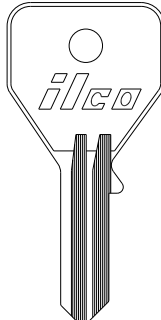

BR5

—

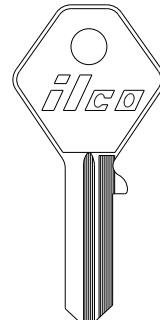

BR6

—

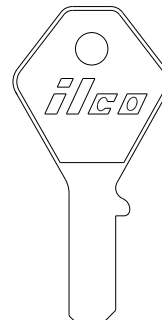

BR7

—

ILCO  
EZ

ROOTES GROUP

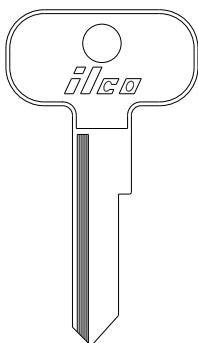

BR9

—

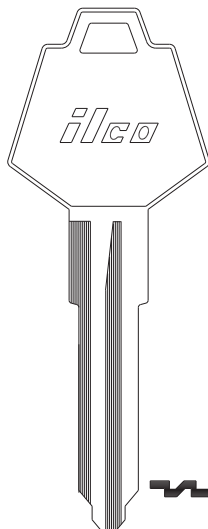

X16

P1771CR

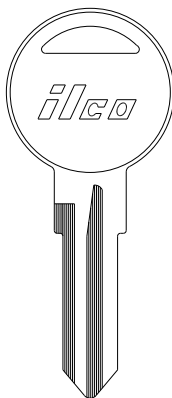

X17

S1771CR



62DC

—



62DG

—



R62DG

—



62DH

—



62DP

—



F70S

—



M72F

—

ILCO  
EZ

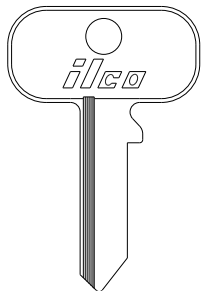
**ROOTES GROUP**
**ROVER**

**B62DR**

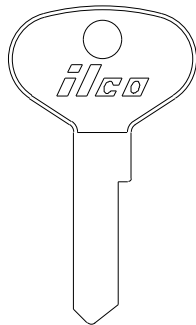
—

**H62DG**

—

**HR62DG**

—

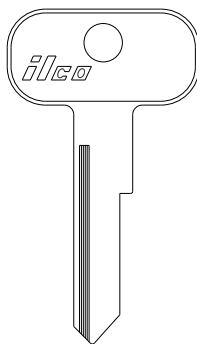
**H62DP**

—

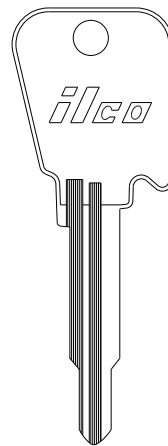
**X13**

LF4

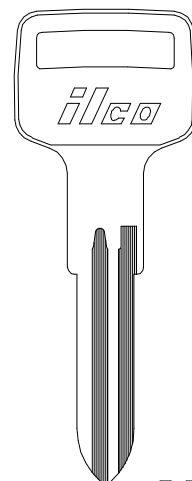
**X29**

VO73

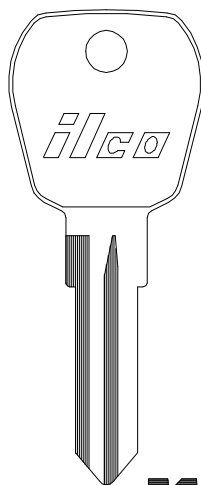
**ILCO  
EZ**
**ROVER**

**X86**

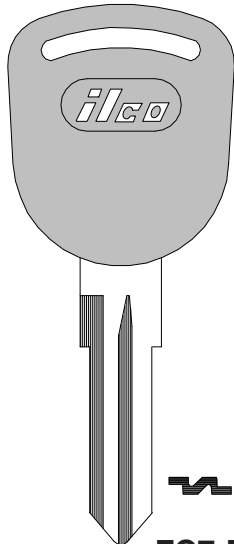
FC7

**FC7-P**

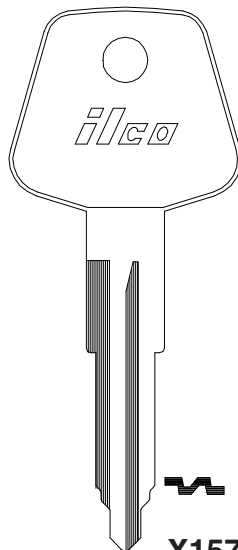
—

**X157**

LF17

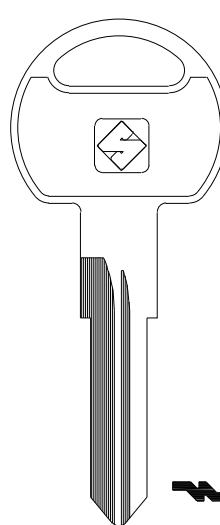
**NE71R**

—

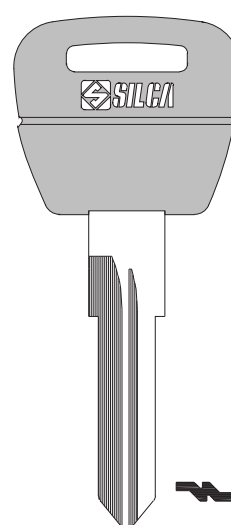
**NE71RDP**

—

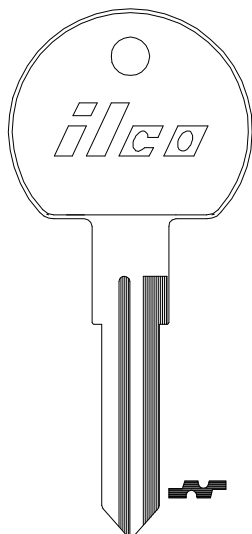
**ILCO  
EZ**
**ROVER**

**X170**

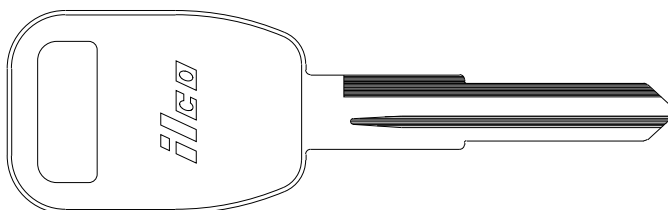
NE48

**X239**

RV4

**ILCO  
EZ**

ROVER

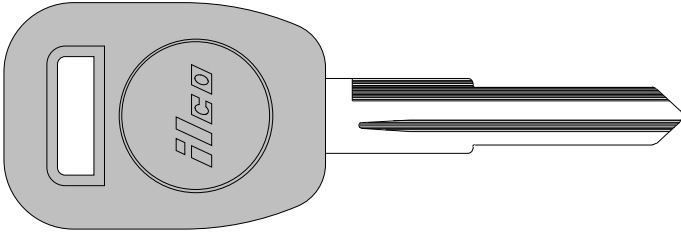

RV4-P

—

ILCO  
EZ

ROVER SAAB

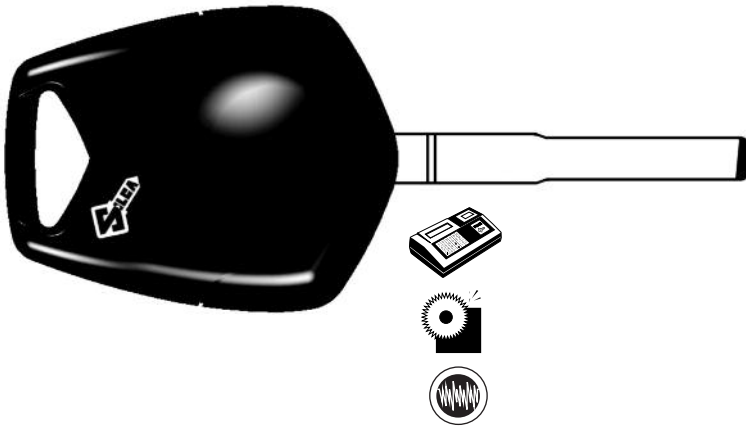

HU101EHP

—

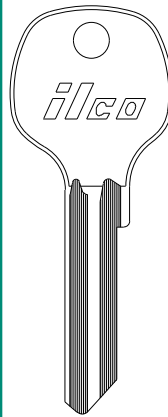

SB1

—

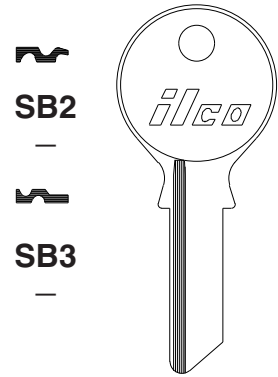

SB2

—



SB3

—



SB4

—

ILCO  
EZ

SAAB

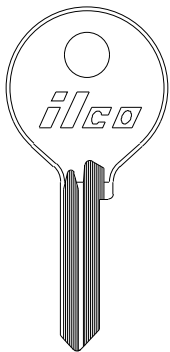

SB5

—

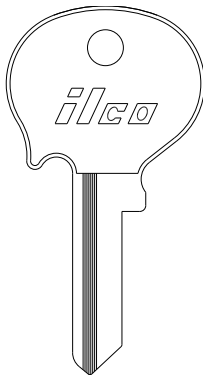

NE5

—

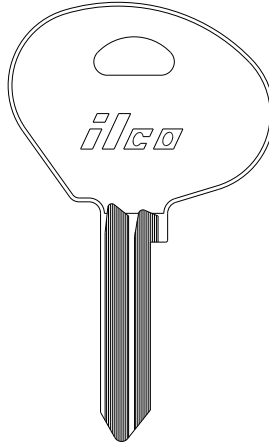

SB6

—

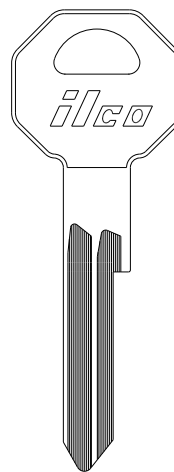

SB7

—

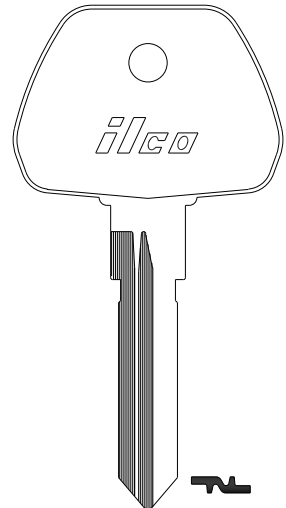

SB10

—

ILCO  
EZ

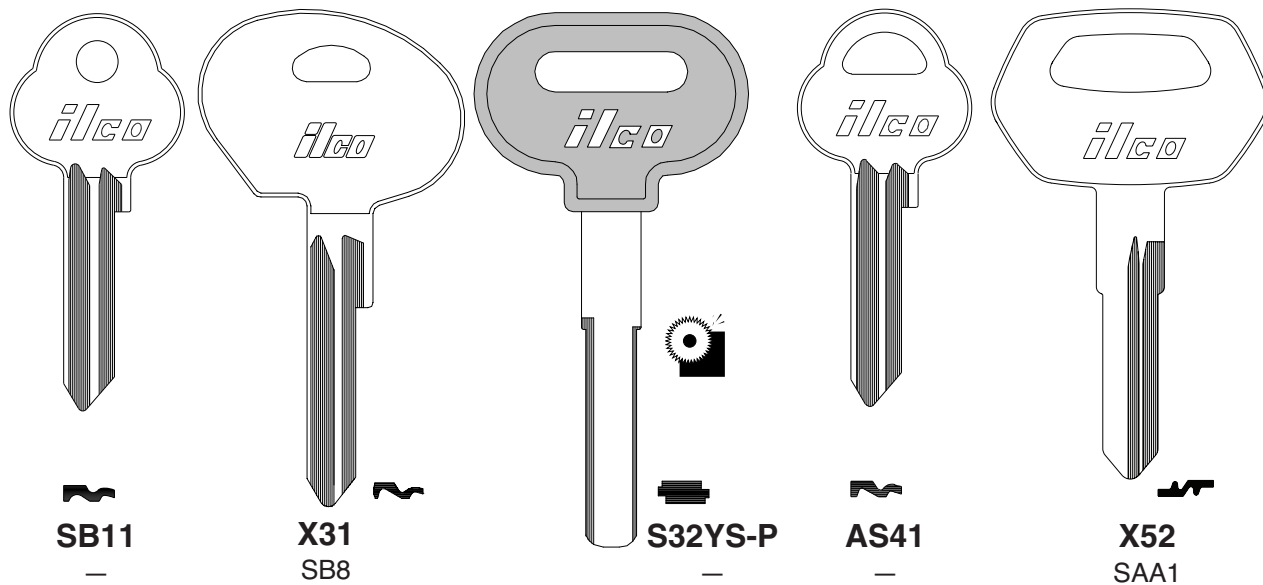

**SAAB**

ILCO  
EZ

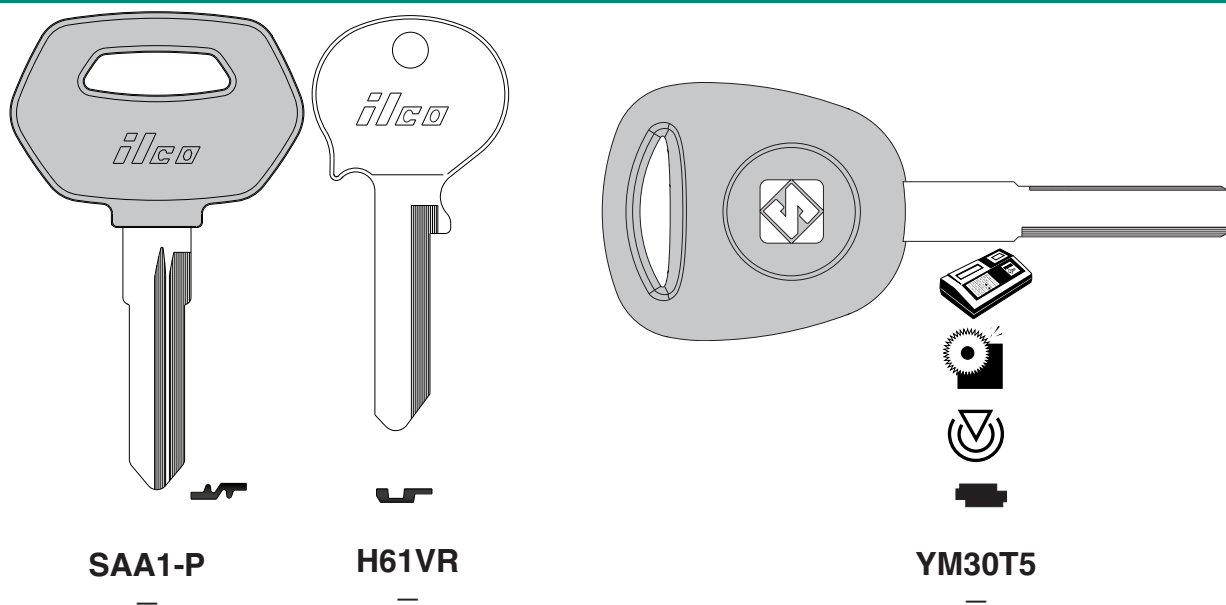
**SAAB**

ILCO  
EZ

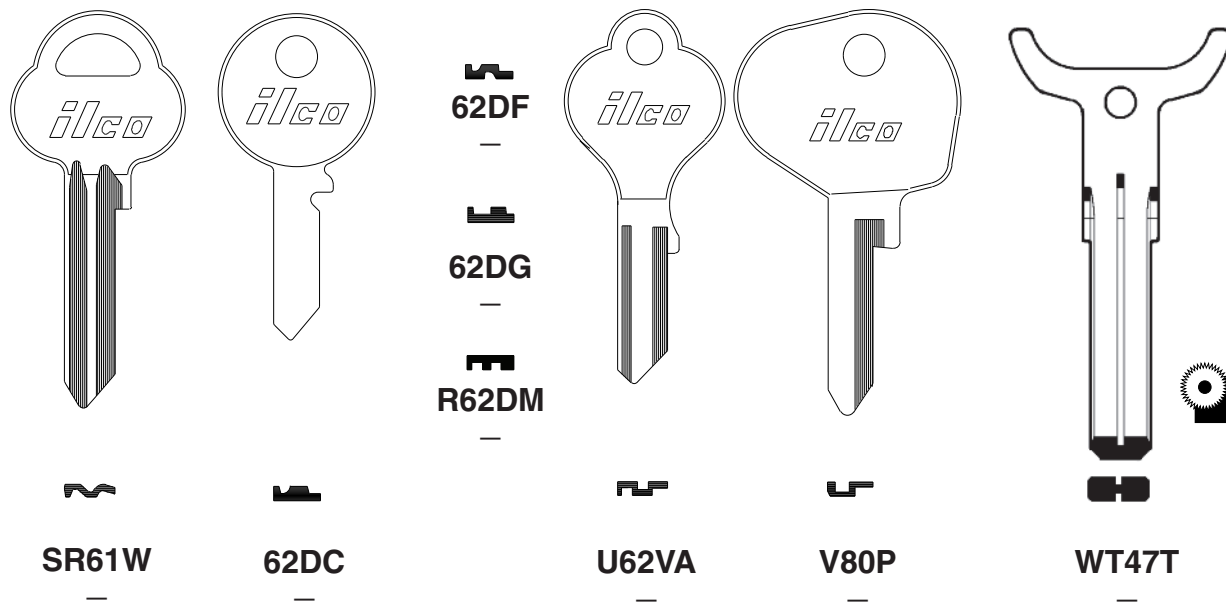
**SAAB**

ILCO  
EZ

SATURN

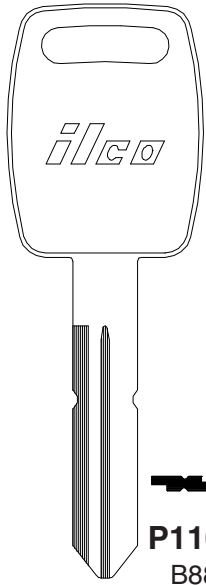

P1108  
B88

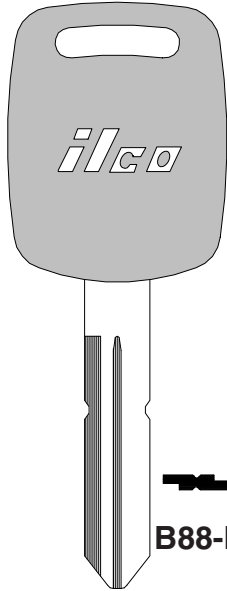

B88-P (-PC)  
—

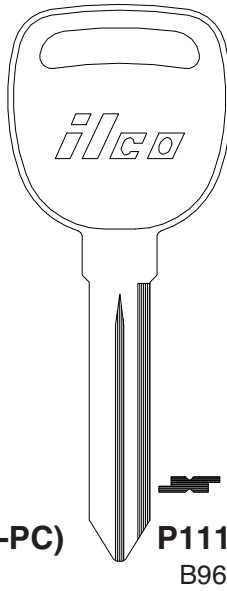

P1110  
B96

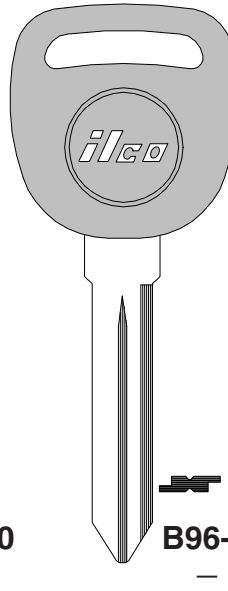

B96-P  
—

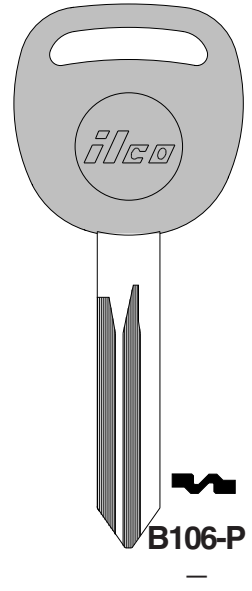

B106-P  
—

ILCO  
EZ

SATURN

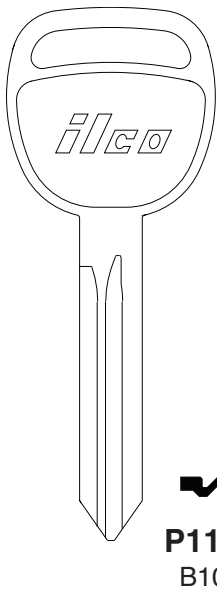

P1115  
B106

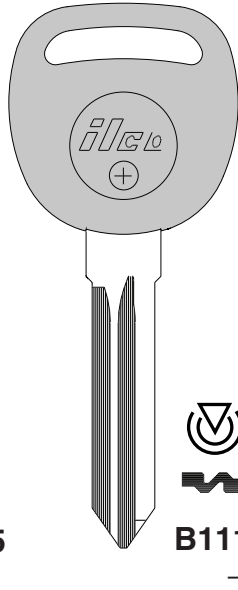

B111-PT  
—

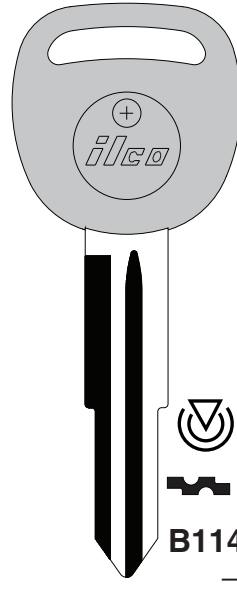

B114-PT  
—

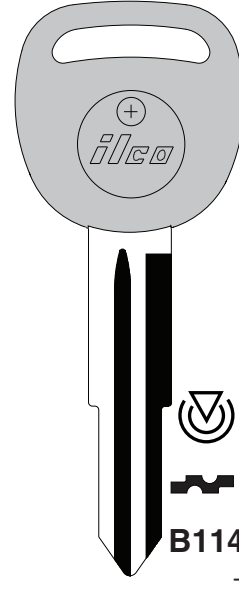

B114R-PT  
—

ILCO  
EZ

SATURN

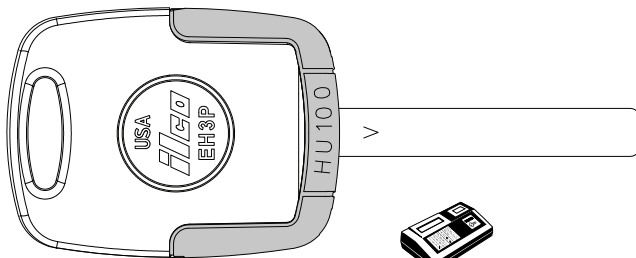

**EH3P**  
(Head Only)

**EB3-V-HU100**  
(Blade Only)



**EK3P-HU100**  
(Complete Key)

ILCO  
EZ

## SATURN

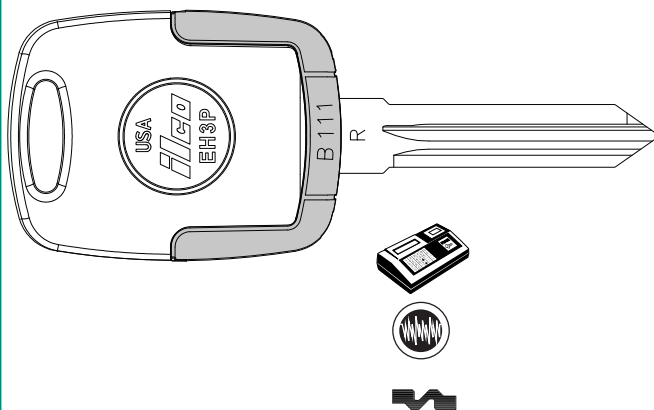

**EH3P**  
 (Head Only)

**EB3-R-B111**  
 (Blade Only)

**EK3P-B111**  
 (Complete Key)

 ILCO  
 EZ

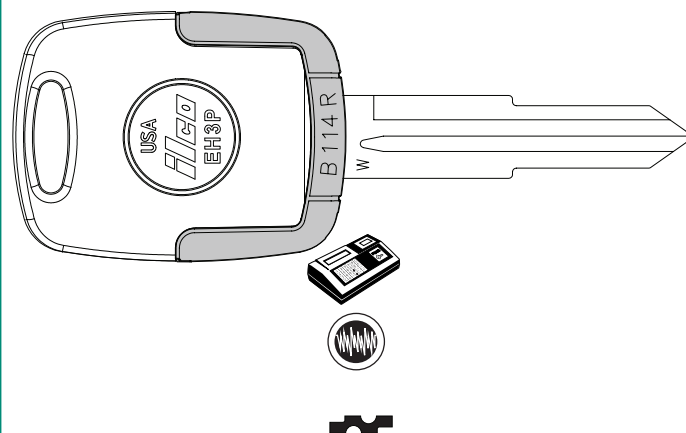
## SATURN

**EH3P**  
 (Head Only)

**EB3-W-114R**  
 (Blade Only)



**EK3P-B114R**  
 (Complete Key)

 ILCO  
 EZ

## SATURN

## SCISSOR LIFT

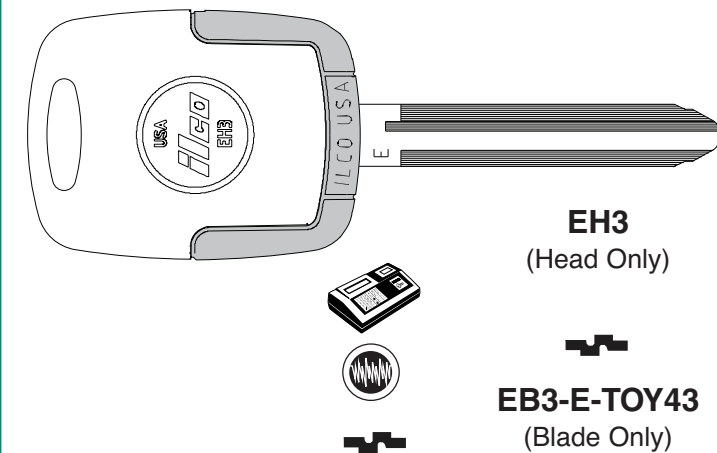
## SEAT

**EH3**  
 (Head Only)

**EB3-E-TOY43**  
 (Blade Only)

**TOY43-EK3**  
 (Complete Key)

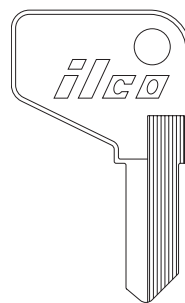
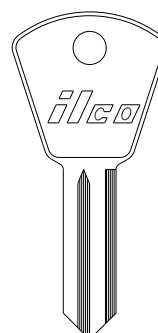
 ILCO  
 EZ

**1627**  
 —

**SE1B**  
 —



**SE2B**  
 —

**SE3B**  
 —

**SE4B**  
 —

SEAT

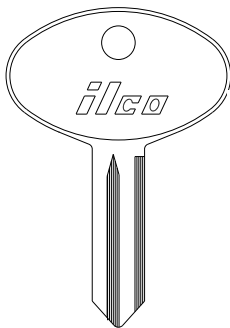
SIMCA/TALBOT/MATRA



SE1C  
—

SE2C  
—  
 SE3C  
—  
 SE4C  
—

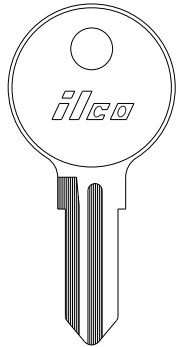

SE5F  
—

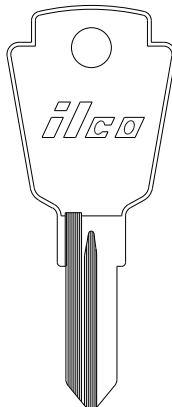

SMS8  
—

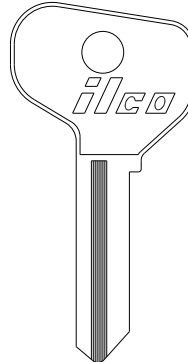

F54  
—

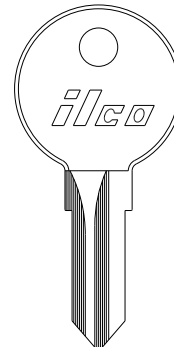

KM2  
—

KM3  
—

ILCO  
EZ

SIMCA/TALBOT/MATRA

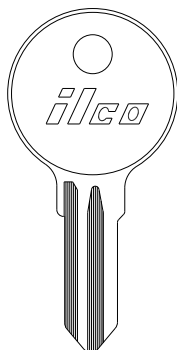

SM4  
—

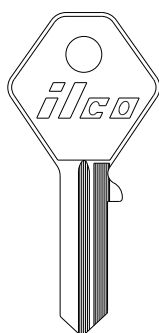

BR6  
—

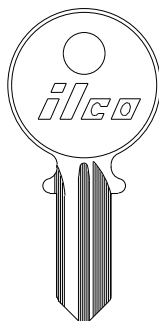

SM6  
—

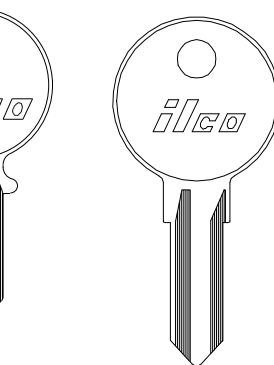

SM7  
—

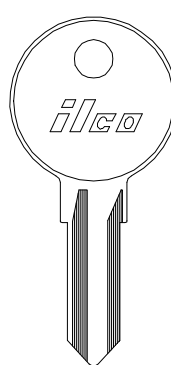

KM8  
—

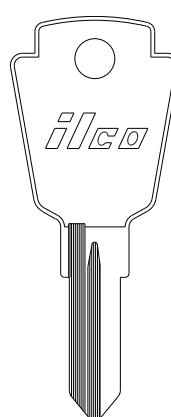

SMS8  
—

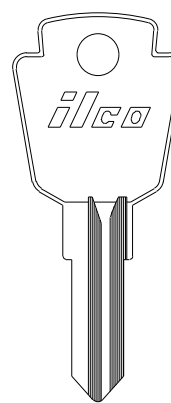

SM9C  
—

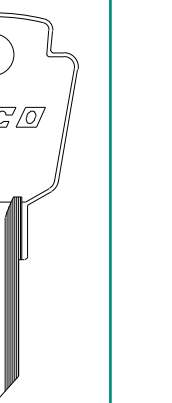

S91W  
—

ILCO  
EZ

SIMCA/TALBOT/MATRA

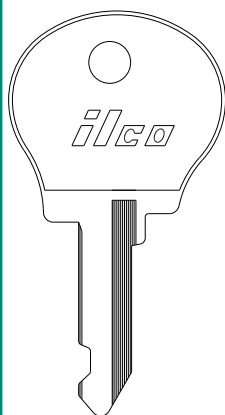

NE18  
—

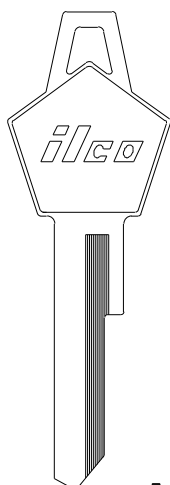

NE19  
—

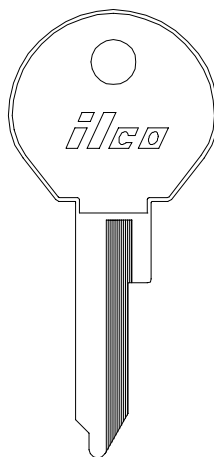

NE20  
—

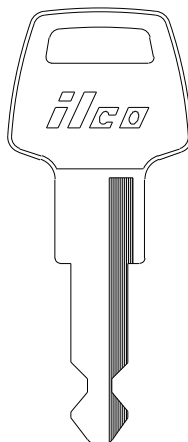

NE26  
—

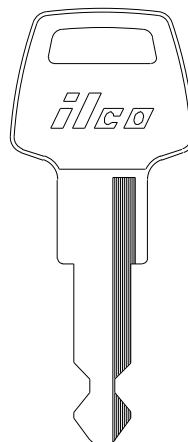

NE34  
—

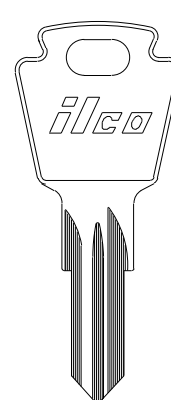

61P  
—

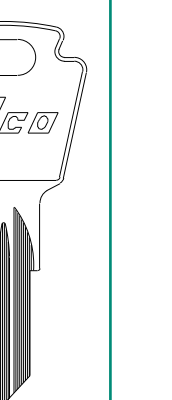

R61P  
—

ILCO  
EZ

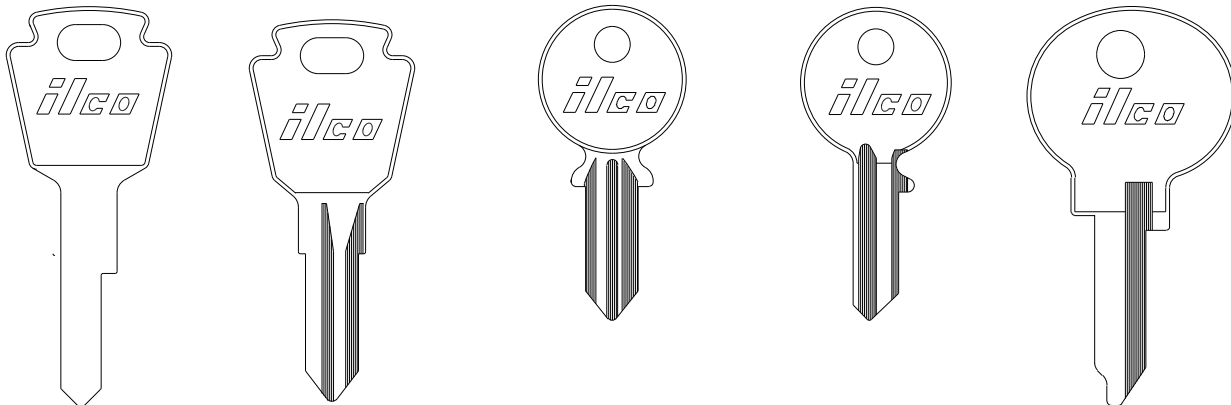
**SIMCA/TALBOT/MATRA**

**61PC**   
 **61PE**   
 **61PS**   
 **H61P**   
 **HR61P**   
 **HV61**   
 **HVR61**   
 **RE61XR**

**ILCO**  
EZ

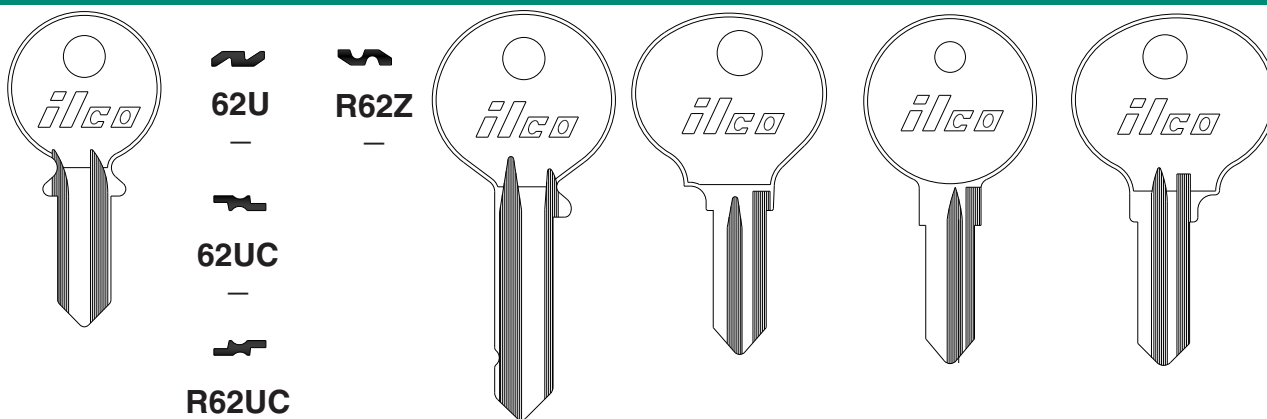
**SIMCA/TALBOT/MATRA**

**62U**   
 **R62Z**

**62UC**

**R62UC**

**62R**   
 **62Z**   
 **62RS**   
 **63G**   
 **R63G**   
 **63H**   
 **R63H**   
 **H63G**

**ILCO**  
EZ

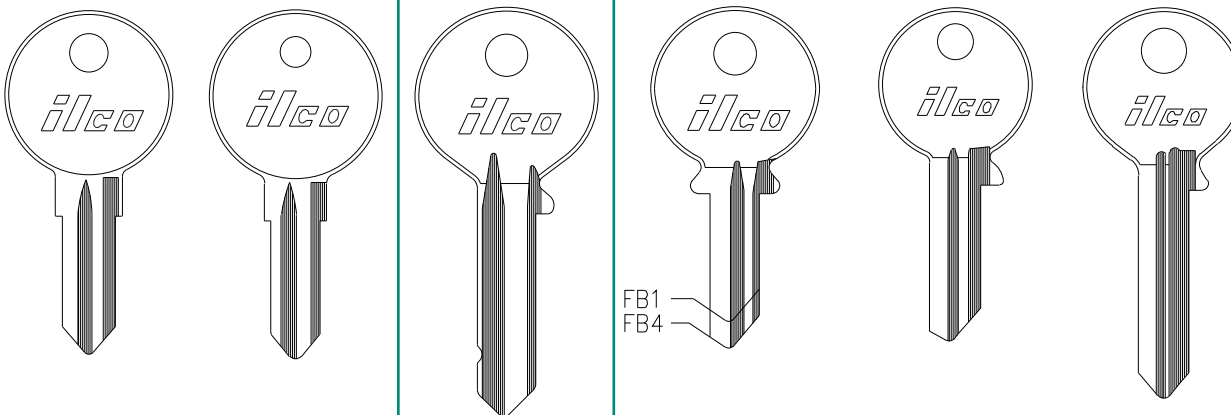
**SIMCA/TALBOT/MATRA**
**SIMPLES**
**SKODA**

**L63G**   
 **LR63G**   
 **N63G**   
 **62RS**   
 **FB1**   
 **FB4**   
 **FB5**   
 **FB6**

**ILCO**  
EZ

**SKODA**

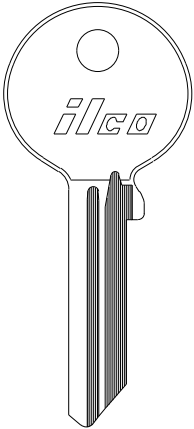

**65CD**  
—

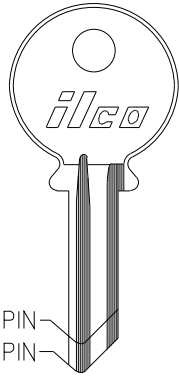

**65CE**  
—



**65CF**  
—

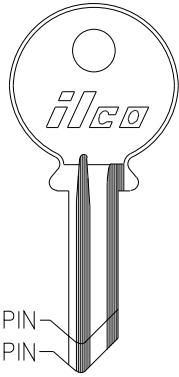

4 PIN  
**FR65**  
—

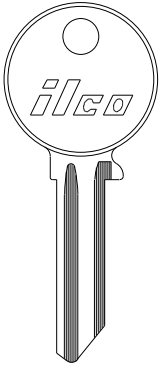

5 PIN  
**FR65A**  
—



**65CA**  
—



**65CB**  
—



4 PIN  
**F65**  
—



5 PIN  
**F65A**  
—



**F65L**  
—



**FR65S**  
—

**ILCO**  
EZ

**SKODA**

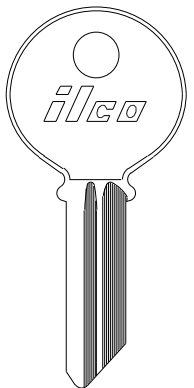

**S65CA**  
—

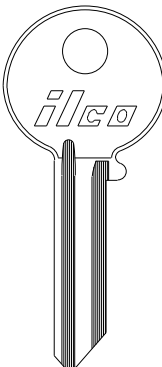

**UF65A**  
—

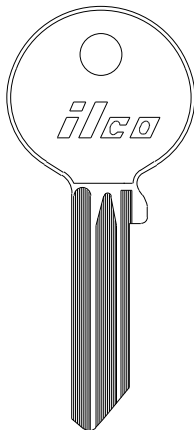

**SK91E**  
—



**SK91H**  
—

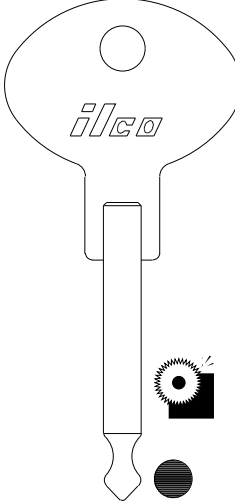

**138**  
—

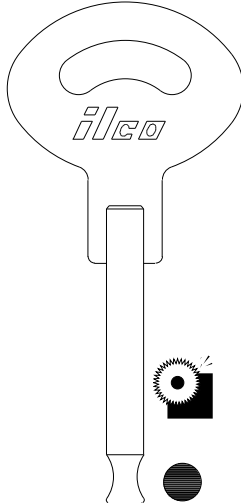

**139**  
—

**ILCO**  
EZ

**SKODA SKODA MOTORBIKE STERLING**

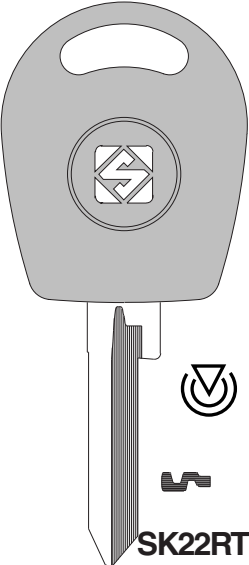

**SK22RT1**  
—

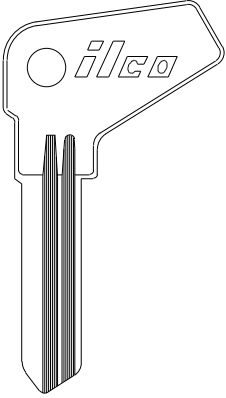

**FB7**  
—

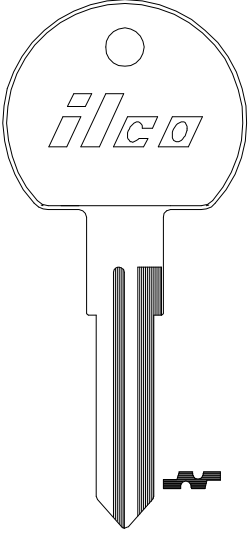

**X170**  
**NE48**

**ILCO**  
EZ

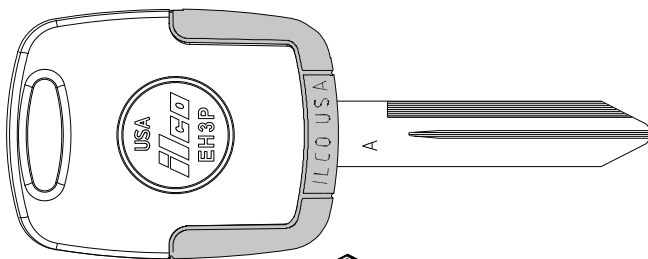
**STERLING**
**STERLING TRUCK**

**EH3P**  
(Head Only)

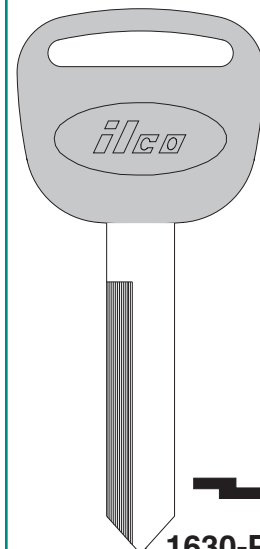

  
**EB3-A-Y160**  
(Blade Only)

**EK3P-Y164**  
(Complete Key)

**1630-P**  
—

**ILCO**  
EZ

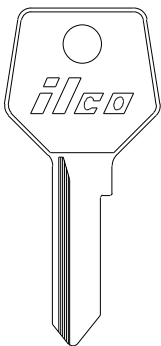
sec 1 page 135

VEHICLE

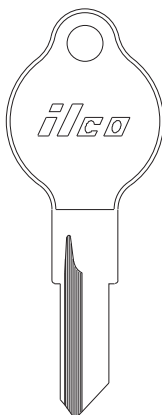
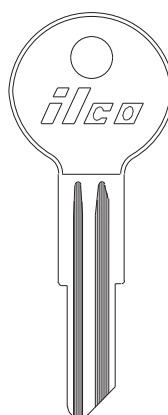
**STREBOR**
**STUDEBAKER**

**SR4**  
—

**SR5**  
—

**64SS**  
—

**L1122A L1122AR**

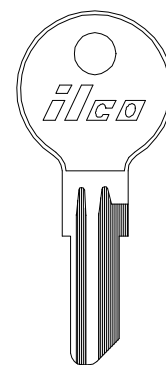
Y101



—



**O1122A**

Y12

**O1122AR**

Y14

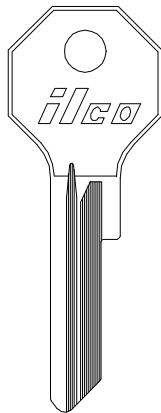
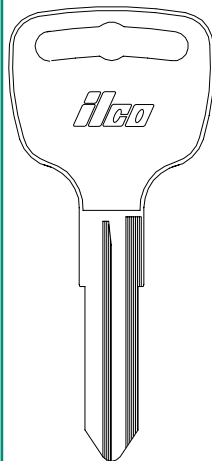
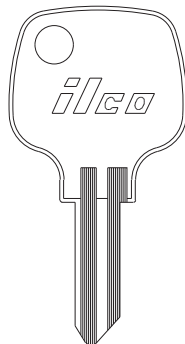
**ILCO**  
EZ

**STUDEBAKER SUBARU**

**X1199AR**  
Y133

**SJ1**  
—

**SJ2**

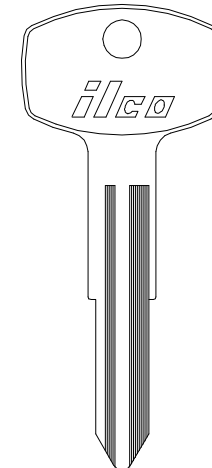
**SJ3**  
—

  
**SJ4**  
—

  
**SJ5**  
—

**SJ6**  
—

**X6**  
62DT

**ILCO**  
EZ

SUBARU

VEHICLE

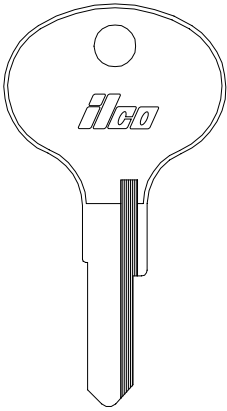
sec 1 page 136



**X108**  
SR6

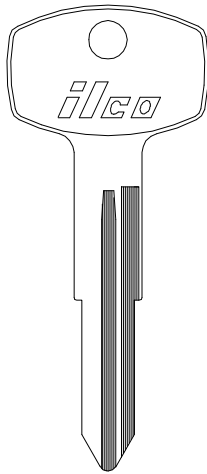

**X115**  
DA23

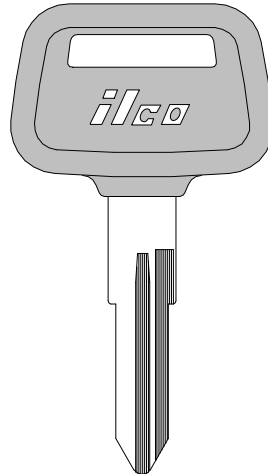

**DA23-P**  
—

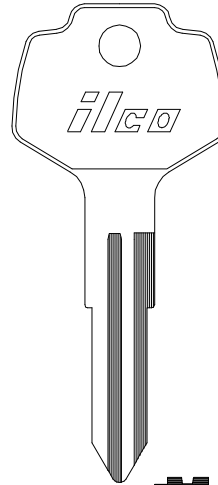

**X123**  
DA25

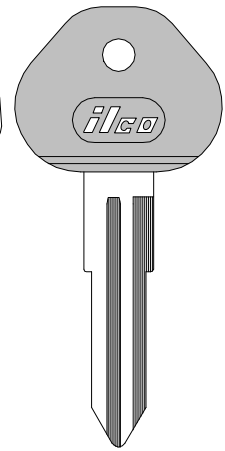

**DA25-P (-PC)**  
—

**ILCO**  
EZ

SUBARU

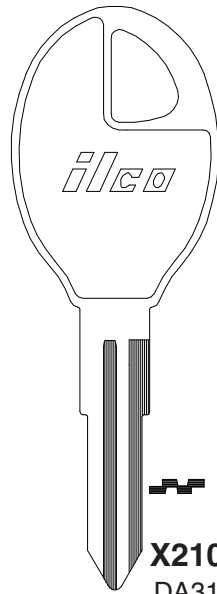

**X210**  
DA31

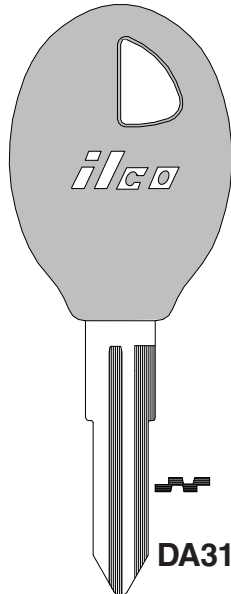

**DA31-P (-PC)**  
—

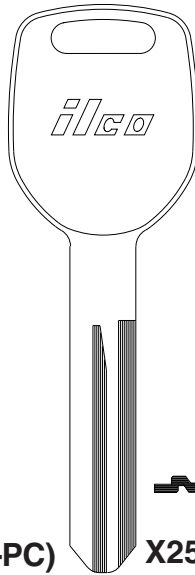

**X251**  
SUB1

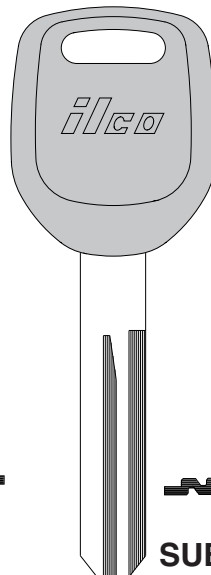

**SUB1-P**  
—

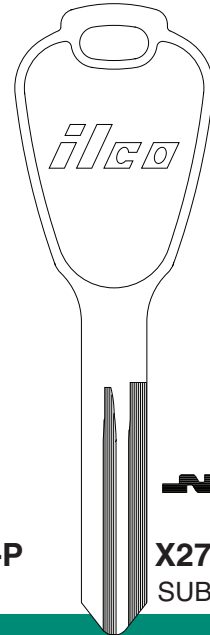

**X271**  
SUB2

**ILCO**  
EZ

SUBARU

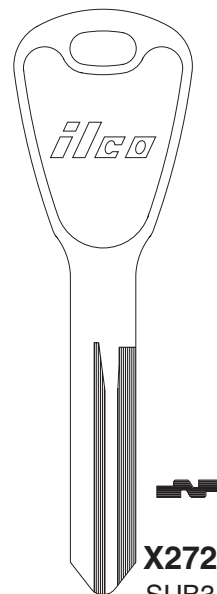

**X272**  
SUB3

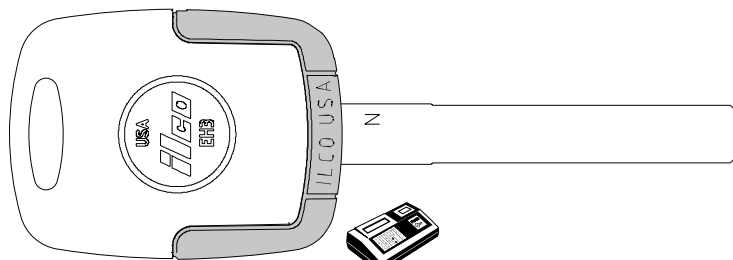

**SUB1-EK3**  
(Complete Key)

**EH3**  
(Head Only)

**EB3-N-SUB1**  
(Blade Only)

**ILCO**  
EZ



SUBARU

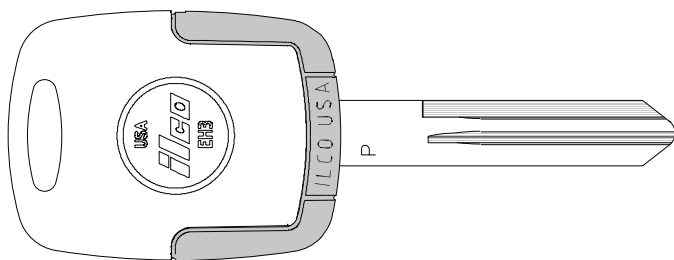

**EH3**  
(Head Only)



**EB3-P-SUB4**  
(Blade Only)



**SUB4-EK3**  
(Complete Key)

ILCO  
EZ

VEHICLE

sec 1 page 137

SUBARU

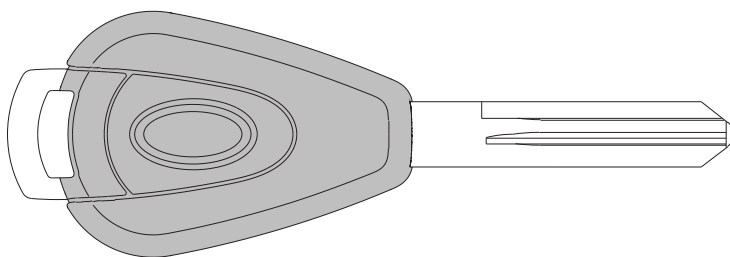

**SUB4-PT**  
—

ILCO  
EZ

SUBARU

SUNBEAM (See Rootes Group also)

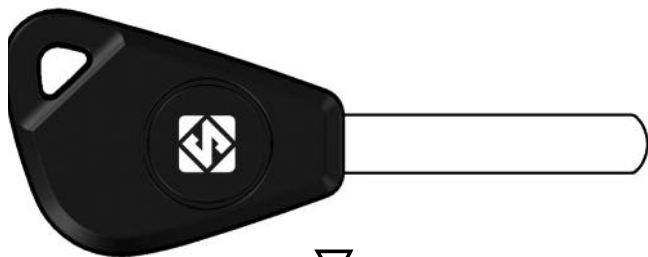

**DAT17T13**  
—

ILCO  
EZ

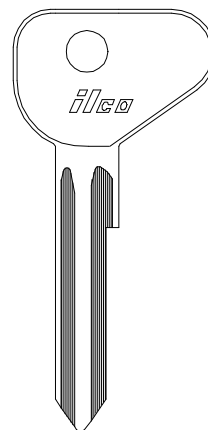

**X1**  
MZ12

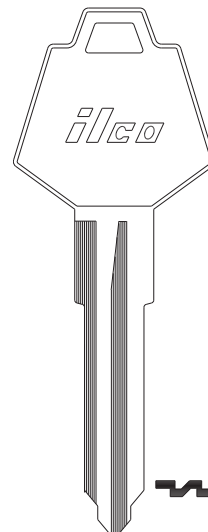

**X16**  
P1771CR

SUNBEAM

SUZUKI AUTOMOBILES

VEHICLE

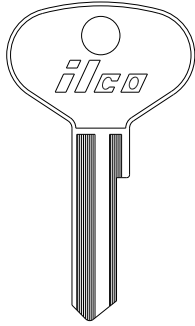

HR62DG

—

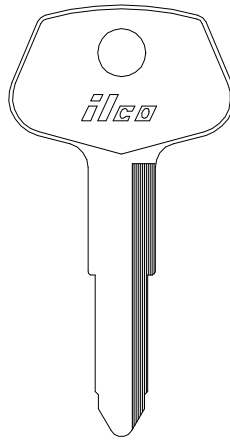

X54

DC1

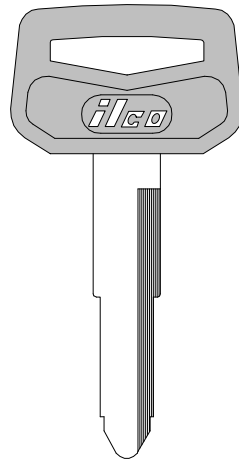

DC1-P

—

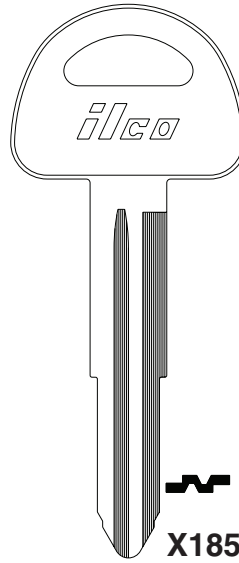

X185

SUZ15

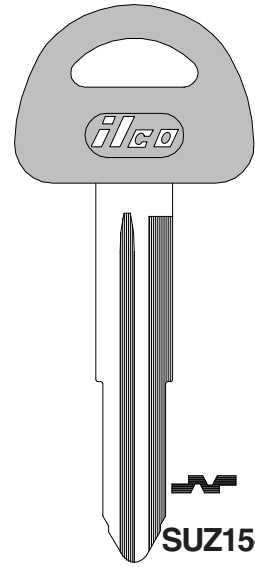

SUZ15-P

—

ILCO  
EZ

sec 1 page 138

SUZUKI AUTOMOBILES

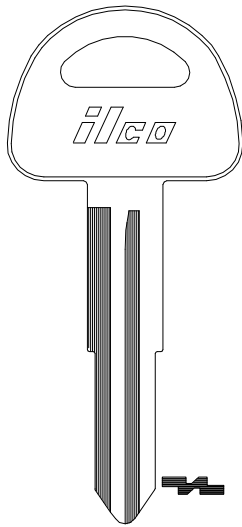

X186

SUZ17

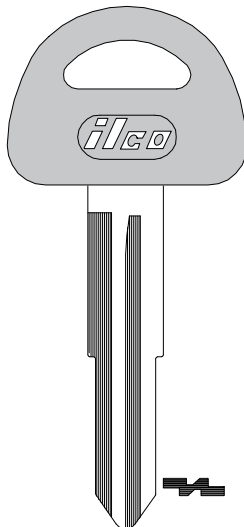

SUZ17-P

—

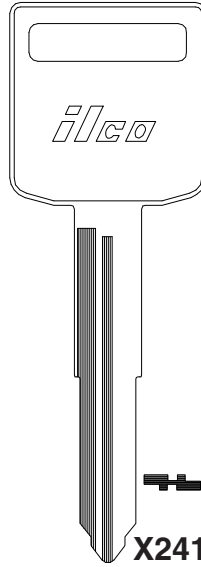

X241

SUZ18

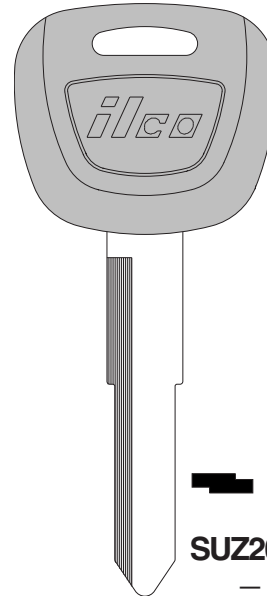

SUZ20-P

—

ILCO  
EZ

SUZUKI AUTOMOBILES

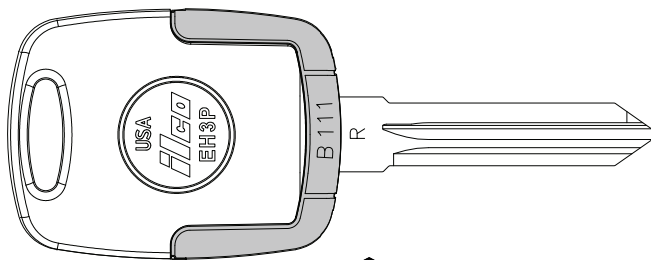

EH3P

(Head Only)



EB3-R-B111

(Blade Only)



EK3P-B111  
(Complete Key)

ILCO  
EZ

SUZUKI MOTORCYCLES

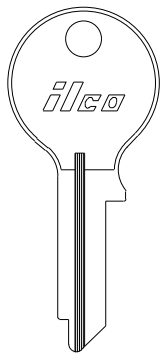

SUZ2  
—

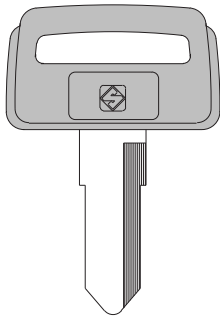

SZ4P  
—

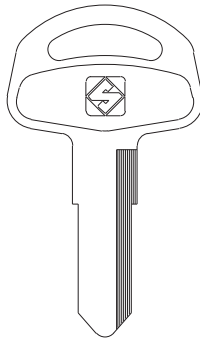

SZ4R  
—

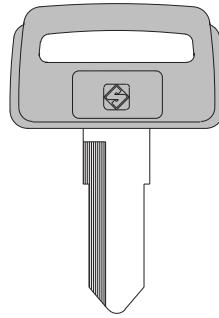

SZ4RP  
—

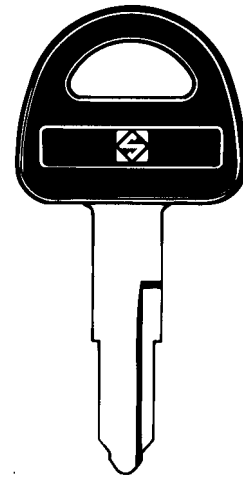

SZ5P  
—

SUZ3  
—

SUZ4  
—



SUZ1  
—

ILCO  
EZ

SUZUKI MOTORCYCLES

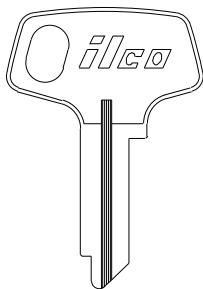

SUZ8  
—

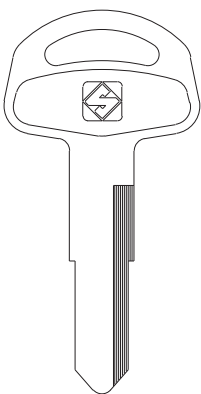

SZ9  
—

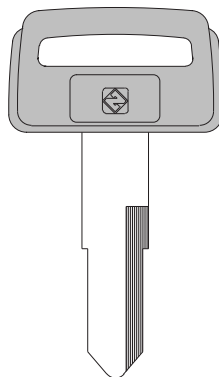

SZ9P  
—

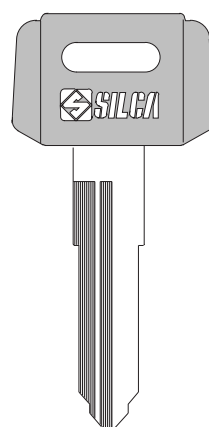

SZ10RP  
—

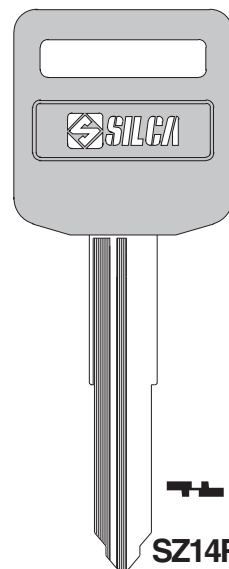

SZ14RAP  
—

SUZ9  
—



SUZ6  
—



SUZ7  
—

ILCO  
EZ

SUZUKI MOTORCYCLES

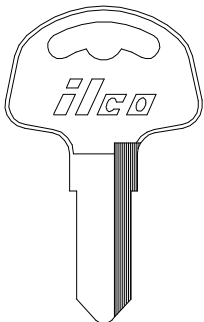

SUZ10  
—

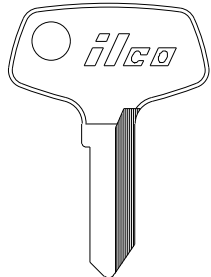

X11  
SUZ5

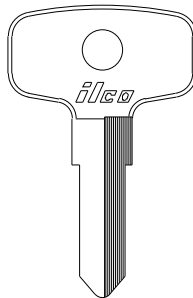

X25  
—

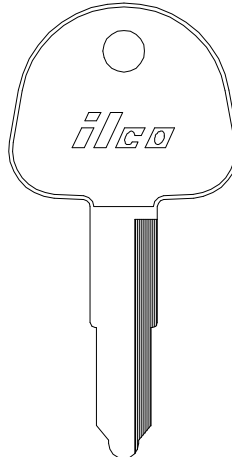

X87  
SUZ11

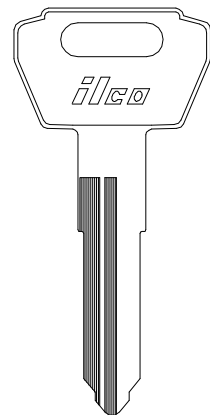

X179  
SUZ12

ILCO  
EZ

SUZUKI MOTORCYCLES

VEHICLE

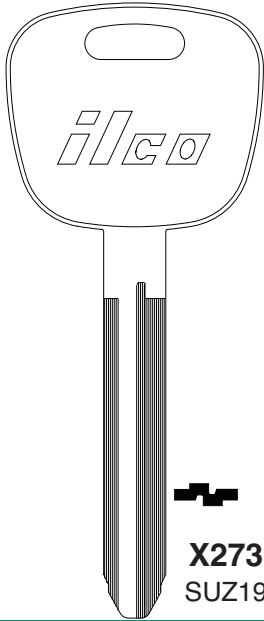

**X273**  
SUZ19

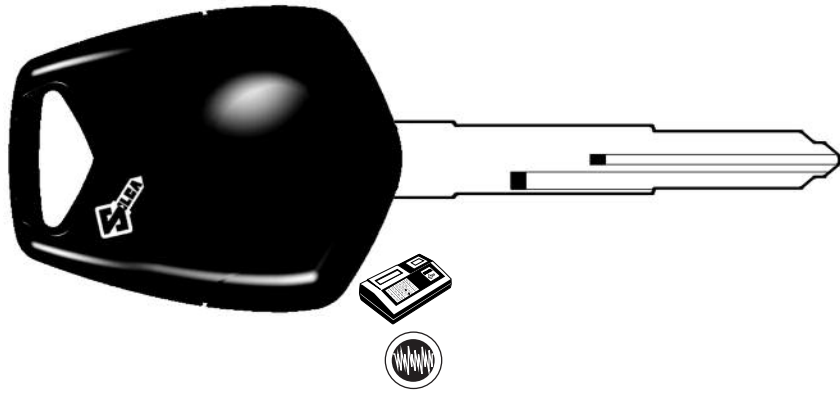

**SZ17REH2**  
—

**ILCO**  
EZ

sec 1 page 140

SUZUKI MOTORCYCLES

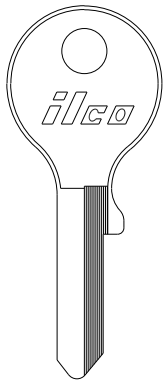

**N2M**  
SR61N

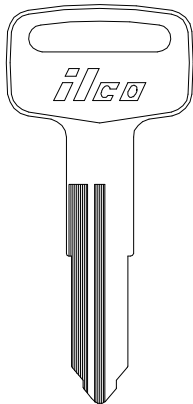

**X117**  
YH48

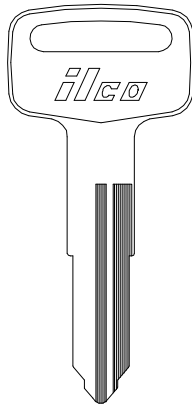

**X118**  
YH49

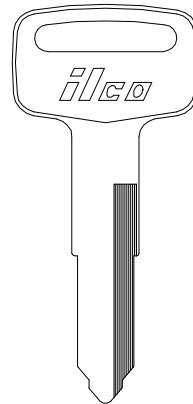

**X119**  
YH47

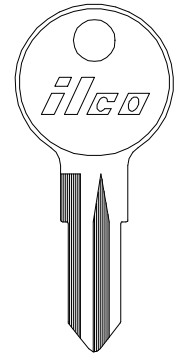

**X226**  
HYD12

**ILCO**  
EZ

SUZUKI MOTORCYCLES

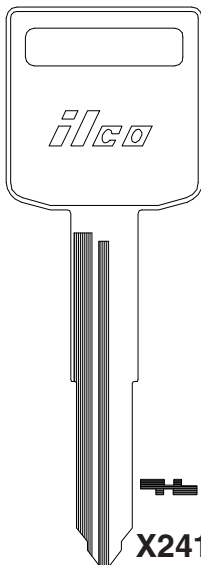

**X241**  
SUZ18

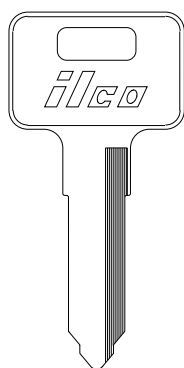

**X259**  
KW14

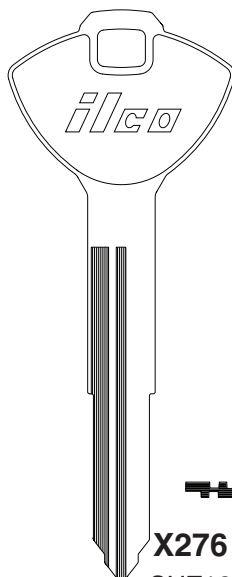

**X276**  
SUZ16

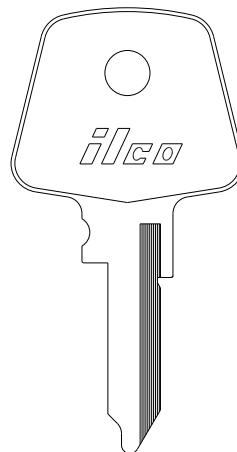

**Y16**  
—

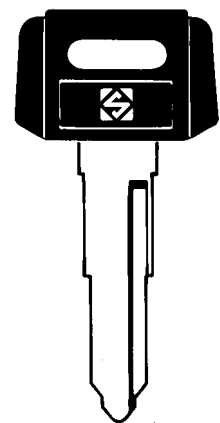

**YH29P-SI**  
—

**ILCO**  
EZ

SUZUKI MOTORCYCLES

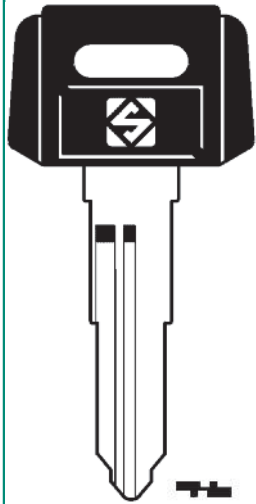

YH29RP-SI

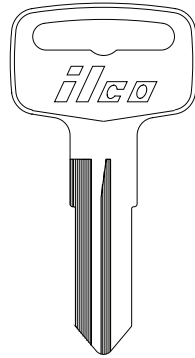

YH34

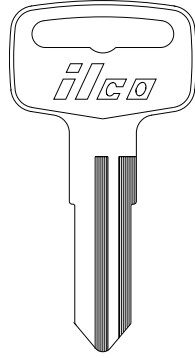

YH35

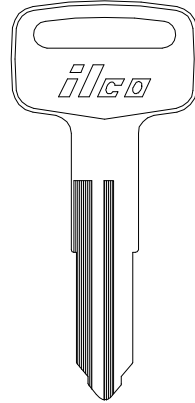

YH50

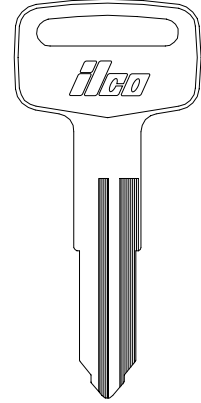

YH51



ILCO  
EZ

SUZUKI MOTORCYCLES

SWEDISH CAMP CAR

TAUNUA

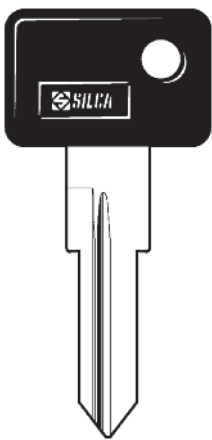

ZD16RP-SI



ZD24RDP-SI

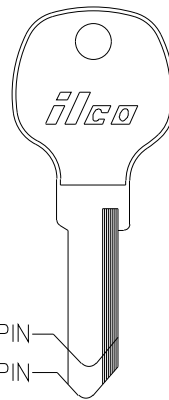

5 PIN  
GH3

5 PIN  
6 PIN

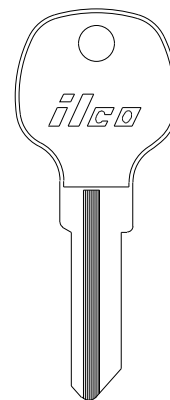

6 PIN  
GH1



GH2



SEE  
FORD  
INTERNATIONAL

ILCO  
EZ

TEMPO

TITAN

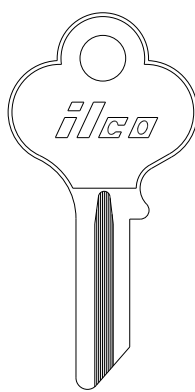

FV1  
FV1

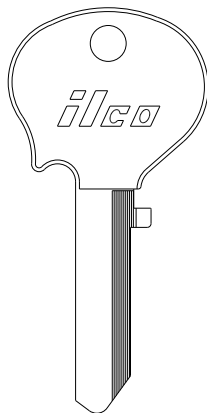

NE7

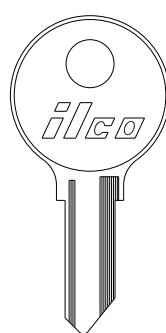

62VA

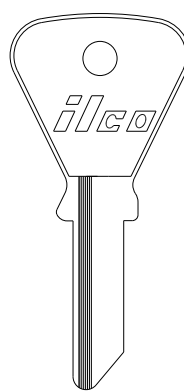

62VH

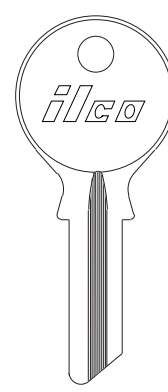

63L

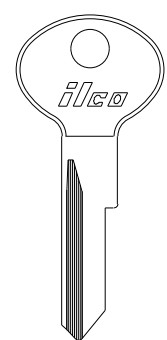

TT1

ILCO  
EZ

TITAN	TOOL BOX					
TT91	1527	1529	1536	1536R	1557	1565
-	-	-	-	-	-	-

ILCO  
EZ

TOOL BOX		TOYOTA			
1605	1620	TA1	TA14	TP1	TP4
-	-	-	-	-	-

TP2	TP3
-	-
TP5	TP6
-	-

ILCO  
EZ

TOYOTA							
TA2	TA12	TA4	TA5	TA6	TA8	TA7	TR18
-	-	-	-	-	-	-	-

TA11	TA16
-	-

TR18  
TA7

ILCO  
EZ

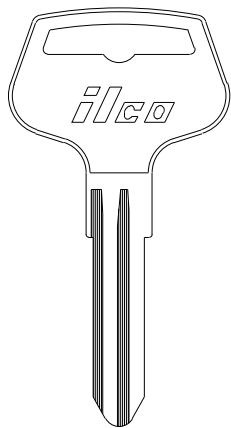
**TOYOTA**

**TA19**

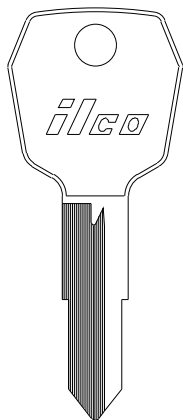
—

**TA23**

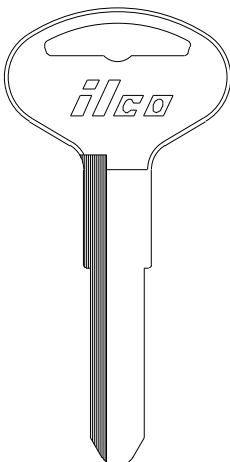
—

**TA24**

—

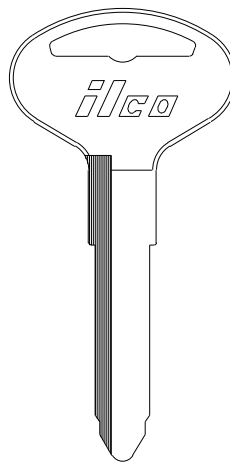
**TA25**

—

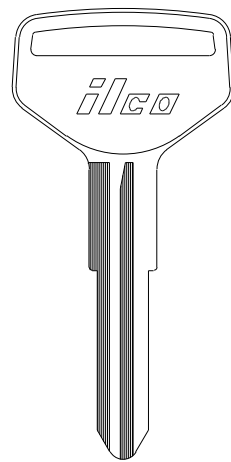
**TR25**

—

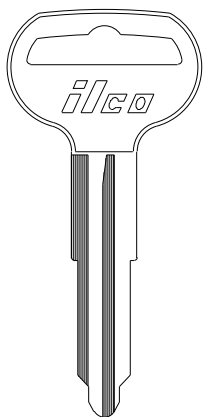
**ILCO  
EZ**
**TOYOTA**

**TA26**

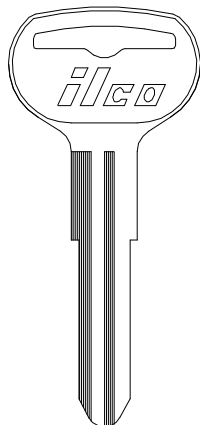
—

**TR26**

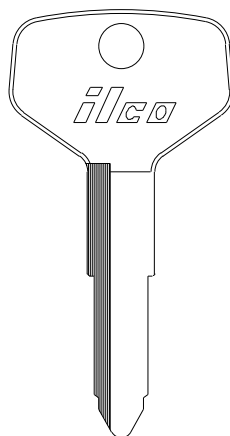
—

**TA28**

—

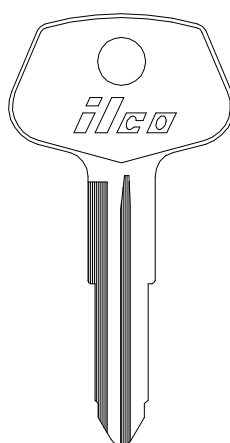
**X37**

TR28

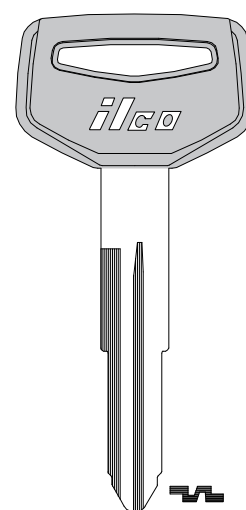
**TR28-P**

—

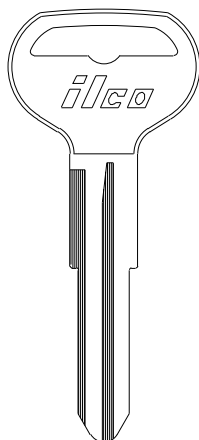
**ILCO  
EZ**
**TOYOTA**

**X46**

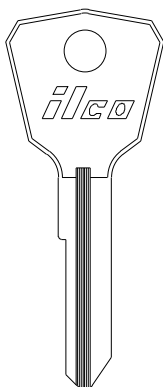
TA27

**T61A**

—

**T61B**

—

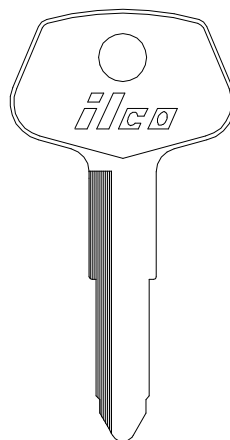
**T61C**

—

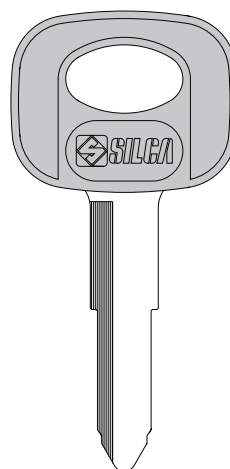
**T61C-P**

—

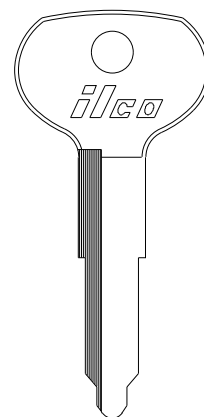
**T61D**

—

**X45**

TA21

**ILCO  
EZ**

TOYOTA

VEHICLE

sec 1 page 144

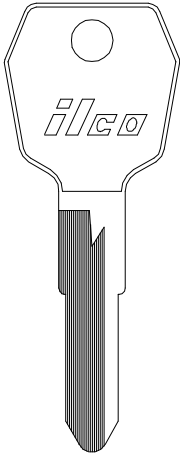

T61F

—

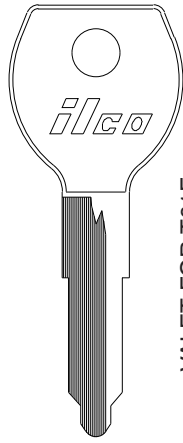

T61E

—

VALET FOR T61F

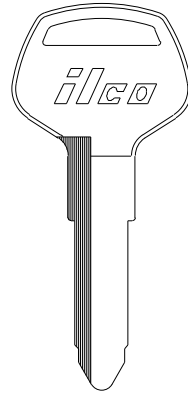

T61G

—

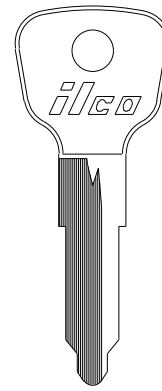

T80J

—

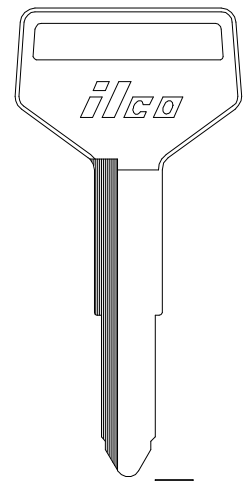

X137  
TR33

—

ILCO  
EZ

TOYOTA

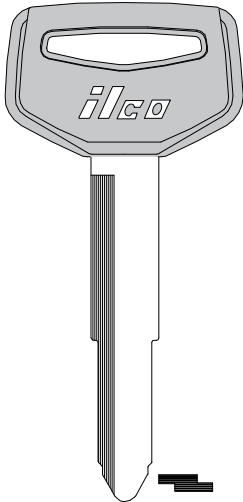

TR33-P (-PC)

—

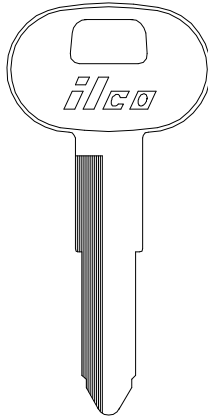

X146  
B56

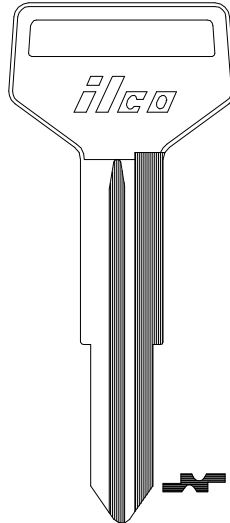

X151  
TR39

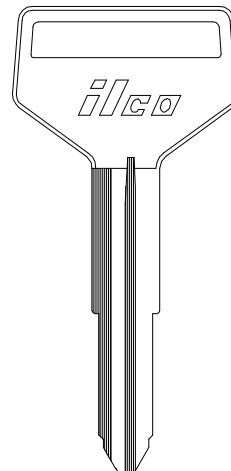

X159  
TR37

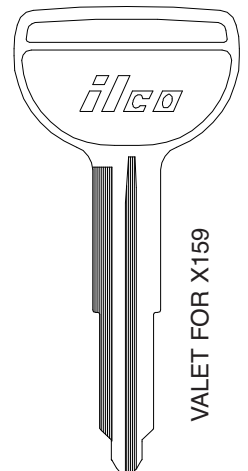

X218  
TR49



VALET FOR X159

ILCO  
EZ

TOYOTA

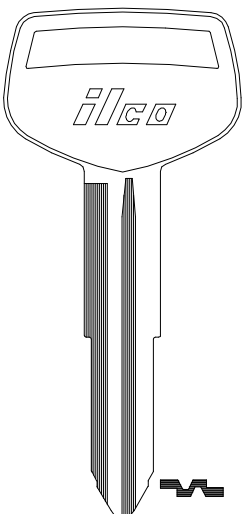

X174  
TR40

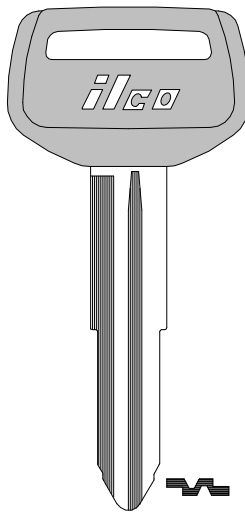

TR40-P (-PC)

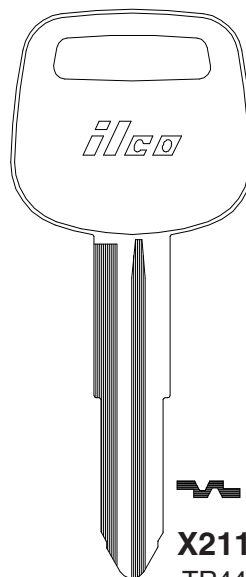

X211  
TR44

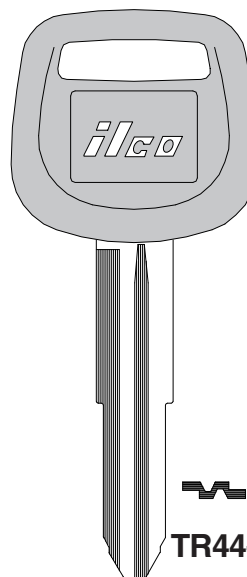

TR44-P

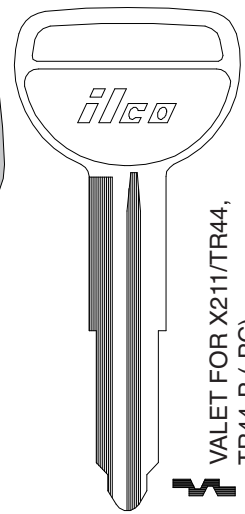

X219  
TR48



VALET FOR X211/TR44,  
TR44-P (-PC)

ILCO  
EZ

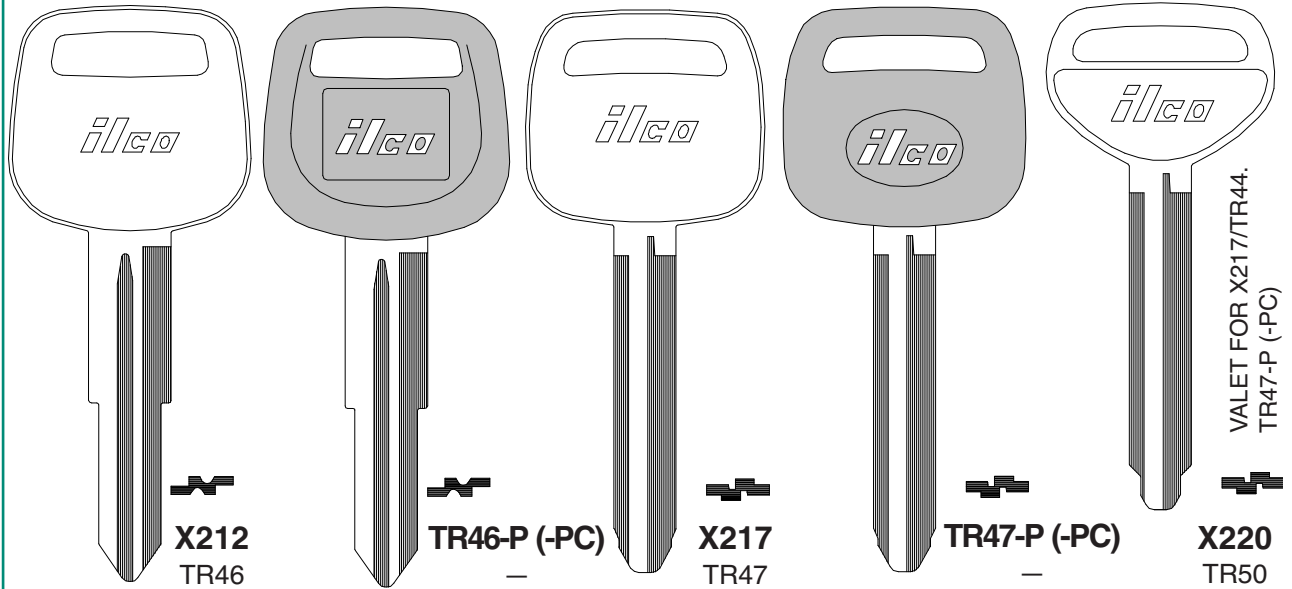

## TOYOTA

ILCO  
EZsec  
1 page  
145

VEHICLE

## TOYOTA

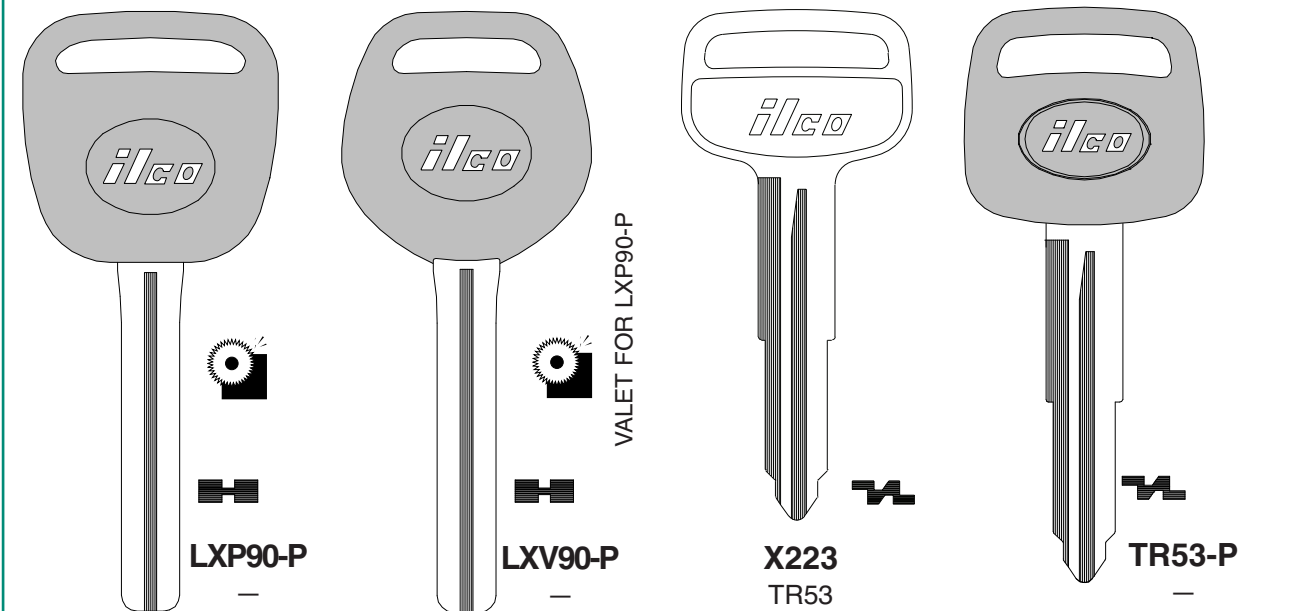
ILCO  
EZ

## TOYOTA

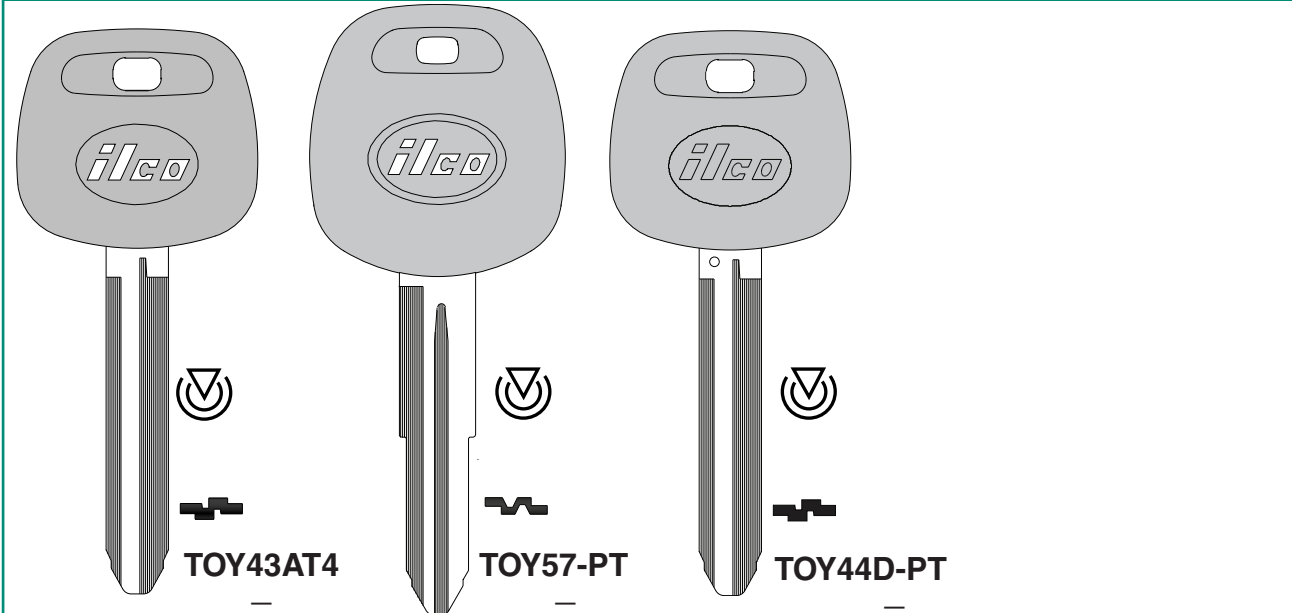
ILCO  
EZ

TOYOTA

TRABANT

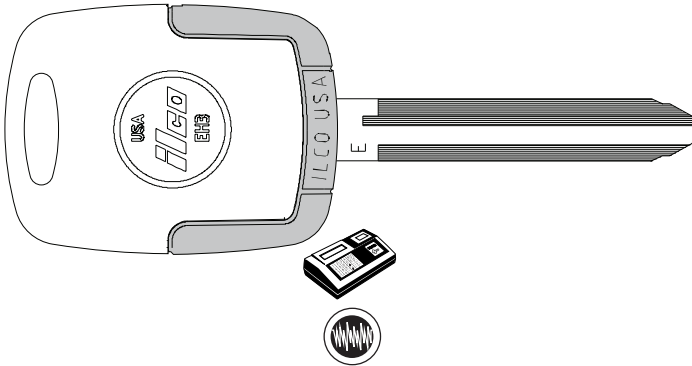

**EH3**  
(Head Only)

  
**EB3-E-TOY43**  
(Blade Only)

  
**TOY43-EK3**  
(Complete Key)

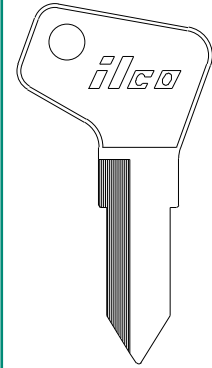

   
**DB1 DB2**  
— —

**ILCO**  
EZ

TRIUMPH

TRIUMPH MOTORCYCLE

**SEE  
BRITISH  
LEYLAND**

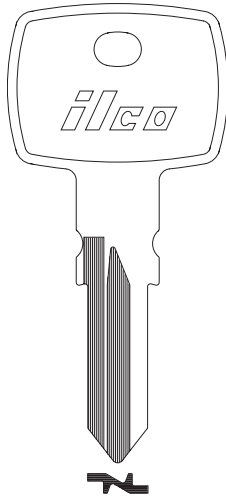

  
**X270**  
TMC1

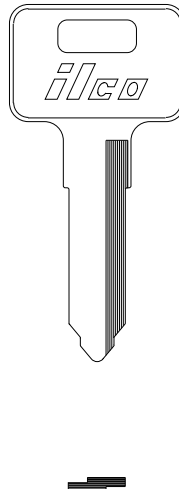

  
**X259**  
KW14

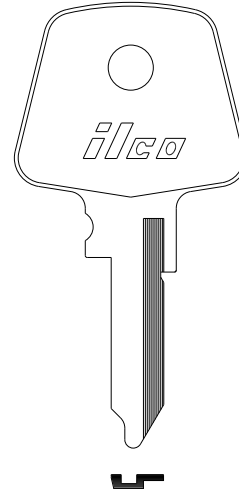

  
**Y16**  
—

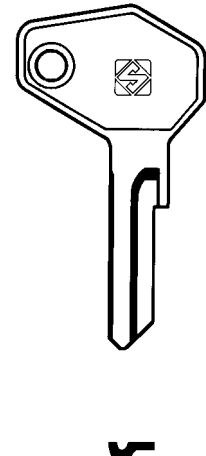

  
**ZD7-SI**  
—

**ILCO**  
EZ

TRIUMPH MOTORCYCLE

VAN GUARD

VAUXHALL



  
**ZD24RDP-SI**  
—

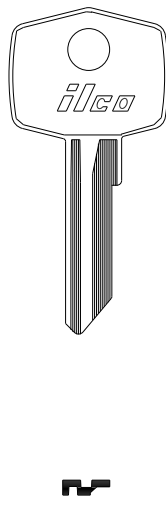

  
**62FS**  
—

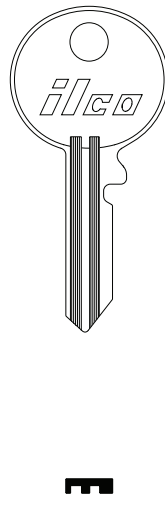

  
**R62DM**  
—

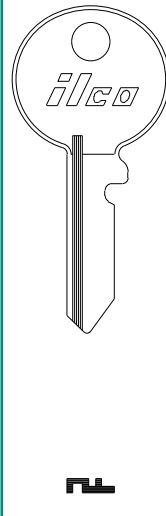

  
**62DP**  
—

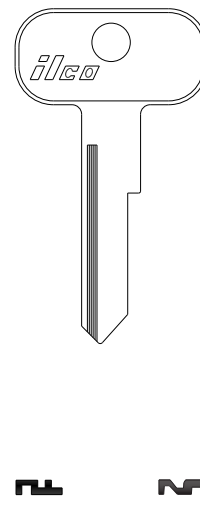

  
**H62DP**  
—

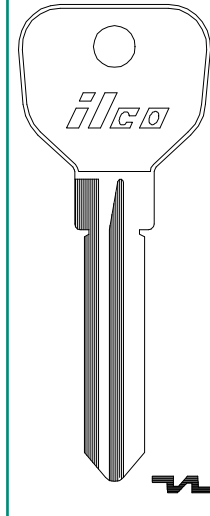

  
**MG1**  
—

**ILCO**  
EZ

## VAUXHALL

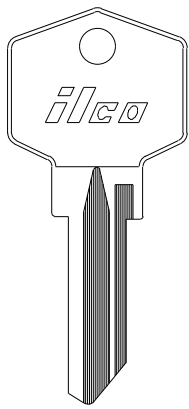

UN1

—

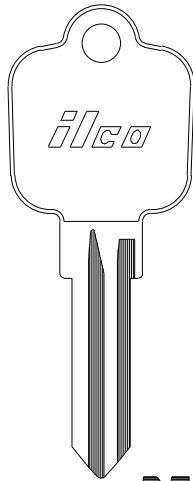

CE2

—

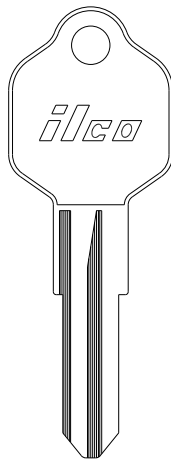

CE3

—

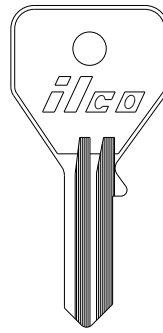

BR5

—

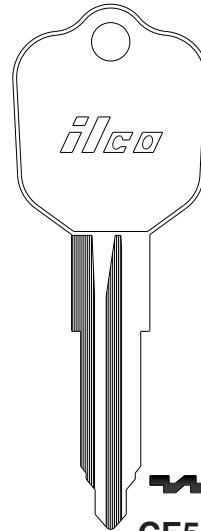

CE5

—

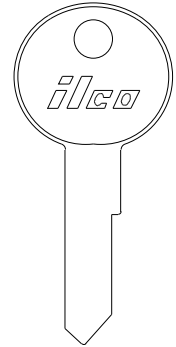

LF5

—

ILCO  
EZ

## VAUXHALL

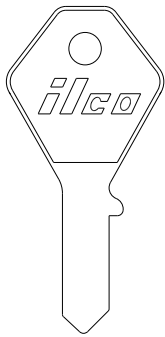

BR7

—

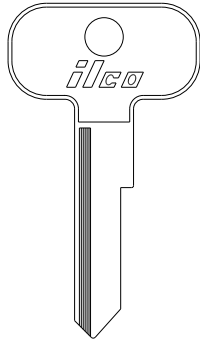

BR9

—

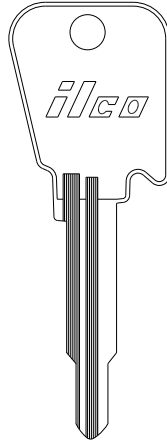

X13

LF4

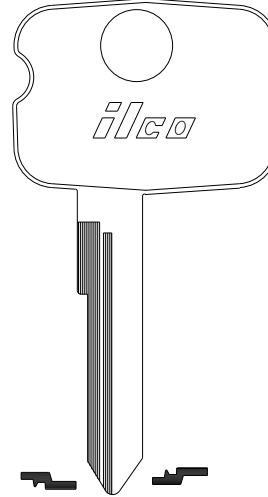

YM29

—

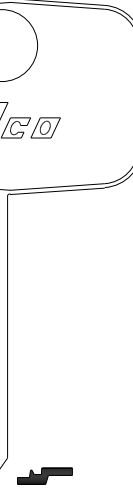

YM30

—

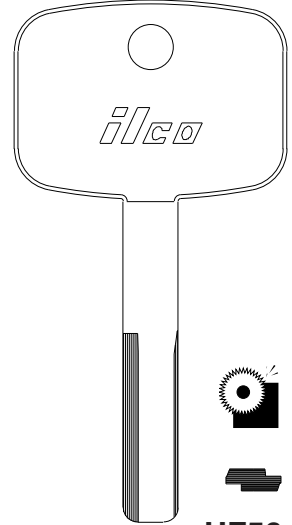

HF56

—

ILCO  
EZ

## VAUXHALL



62DG

—

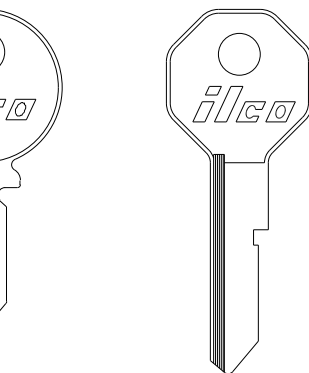

62DP

—

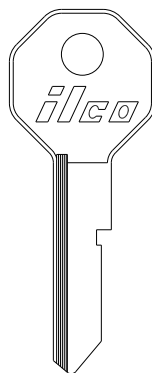

62DN

—

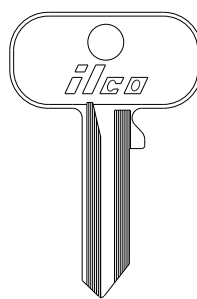

B62DR

—

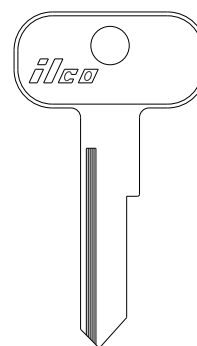

H62DP

—



H62DR

—



64K

—

ILCO  
EZ

VESPER

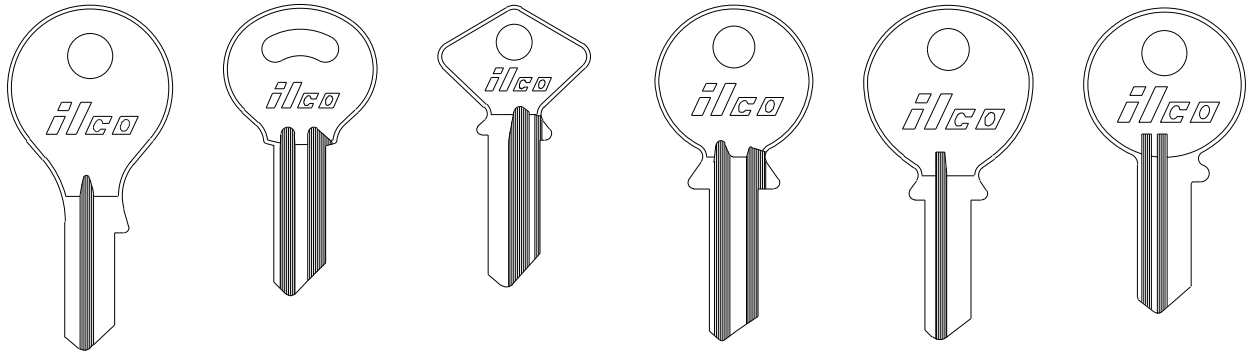

									ILCO
DO1S	VS1	VS3	VE4	VE5	VE6	V61S	VR61S		EZ
-	-	-	-	-	-	-	-		

VESPER

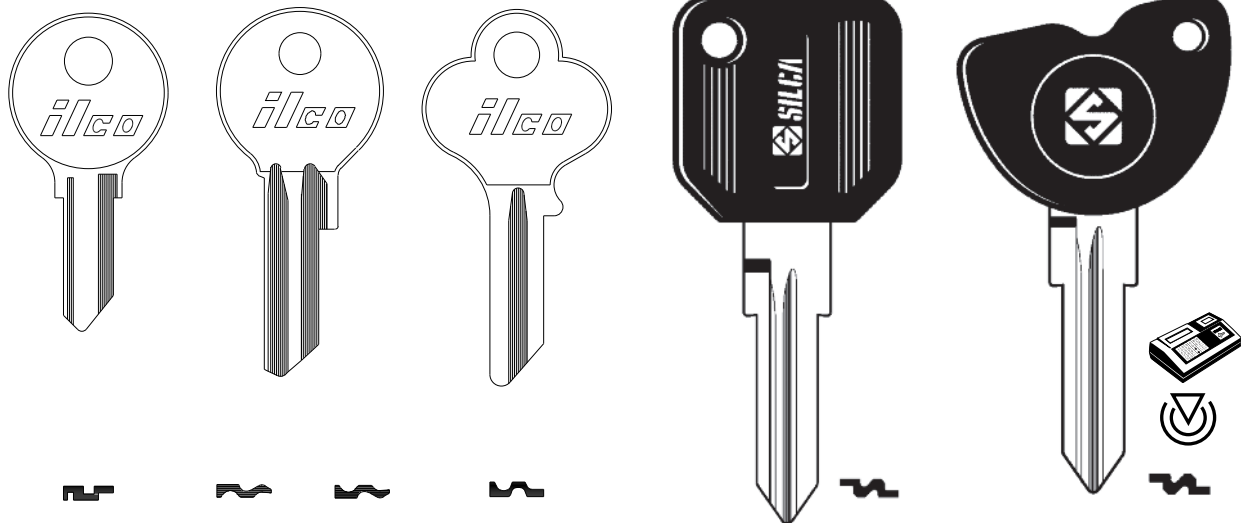

							ILCO
62VA	63V	R63V	FV1	GTI5RAP-SI	GTI5RDT5-SI		EZ
-	-	-	-	-	-		

VESPER      VICTORY      VIKING

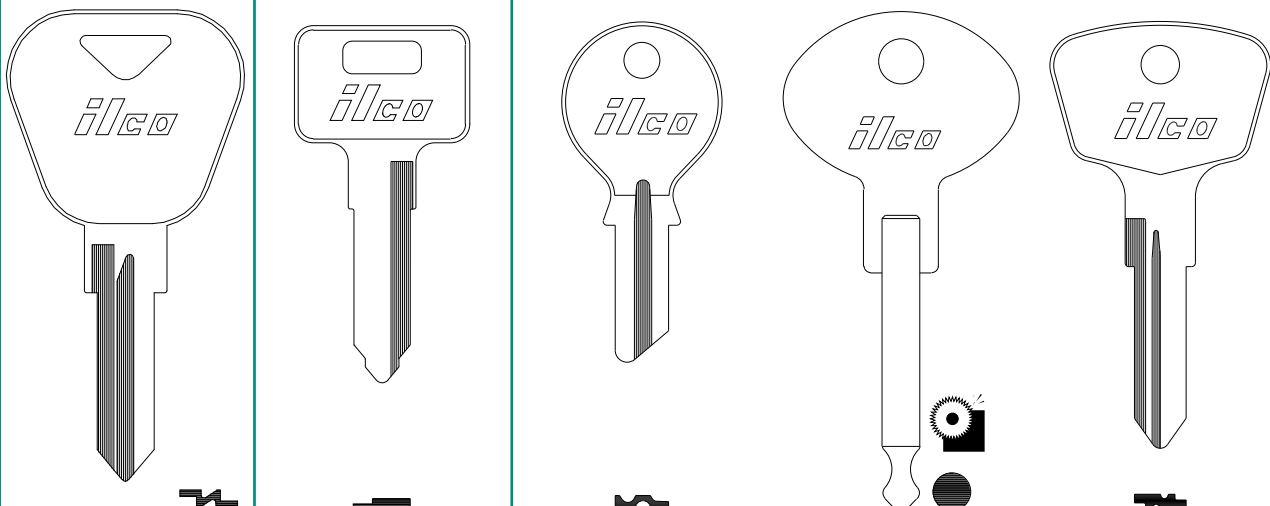

					ILCO
X167	X259	63	138	AD1	EZ
YU2	KW14	-	-	-	

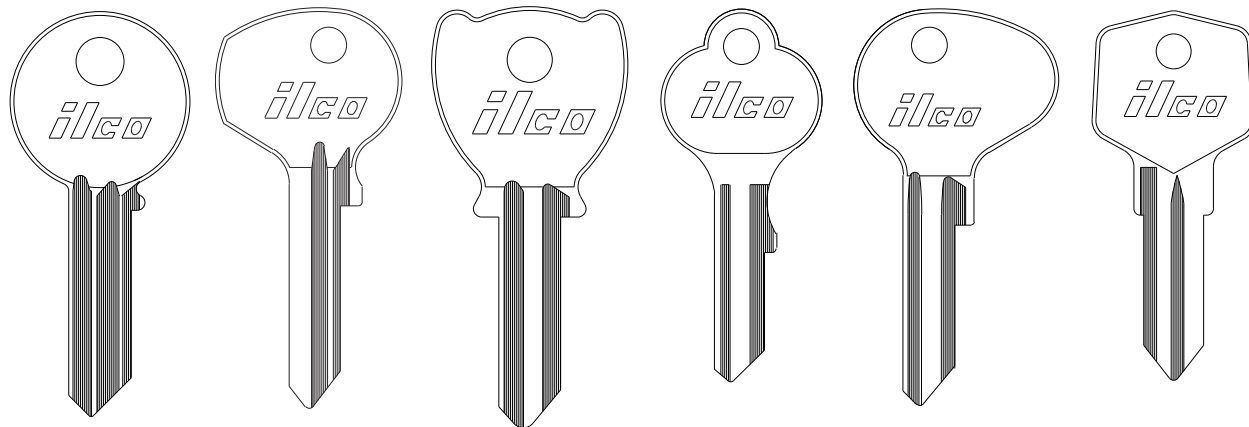
**VOLKSWAGEN**

**BKZ1**

—

**KP1**

—

**BT2**

—

**VW1**

—

**VW1CZ**

—

**CA2**

—

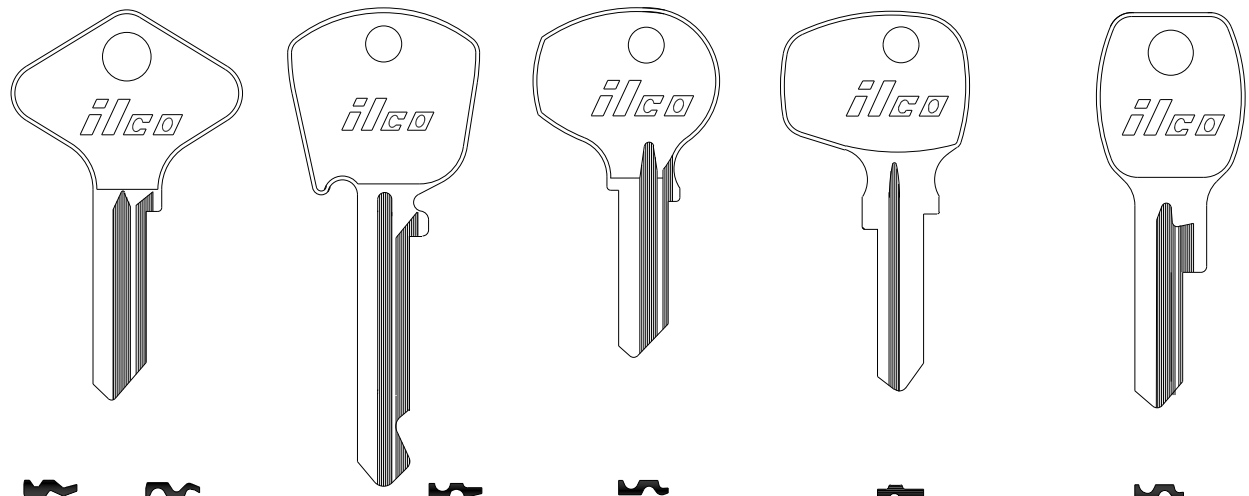
**ILCO  
EZ**
**VOLKSWAGEN**

**DM2**

—

**DM3**

—

**FT3**

—

**DM4**

—

**MB5**

—

**WS5**

—

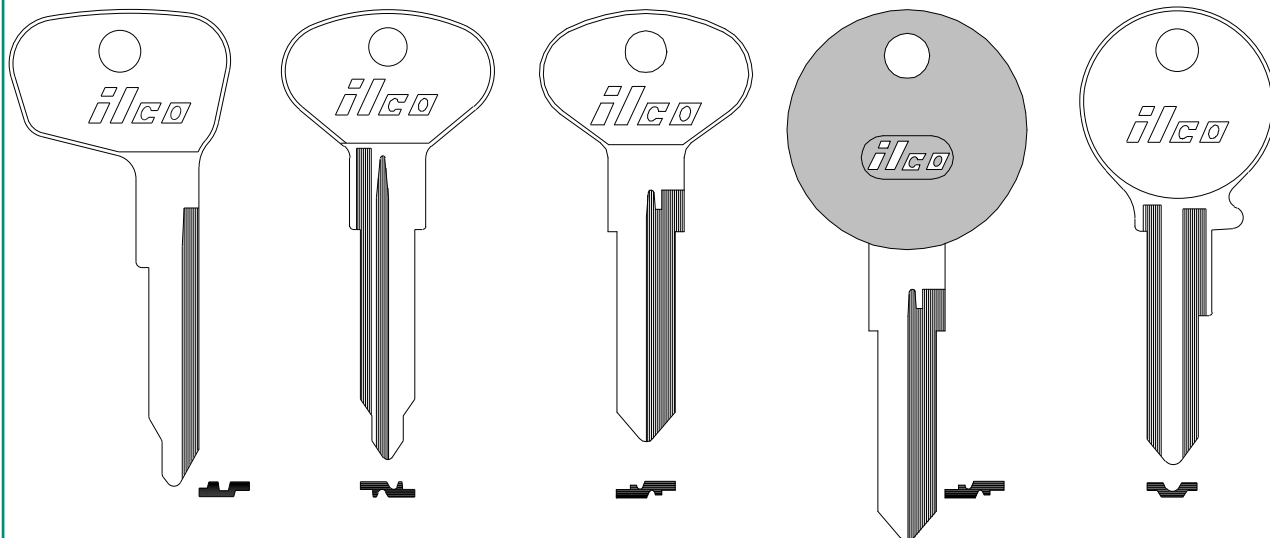
**ILCO  
EZ**
**VOLKSWAGEN**

**WT5**

—

**X8**

VW20

**X9**

73VB

**73VB-P**

—

**HF17**

—

**ILCO  
EZ**

VOLKSWAGEN

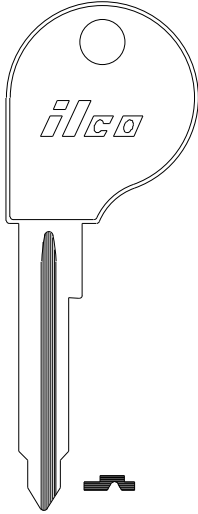

HF35  
—

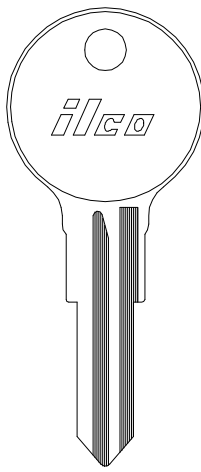

X53  
V32

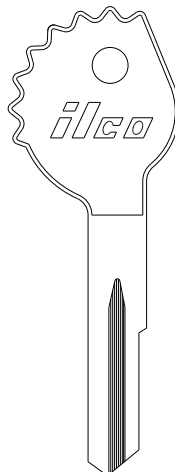

OP60C  
—



61N  
—



61NC  
—

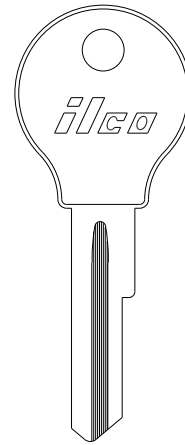

61VW  
—



U61VW  
—



V61VW  
—

ILCO  
EZ

VOLKSWAGEN

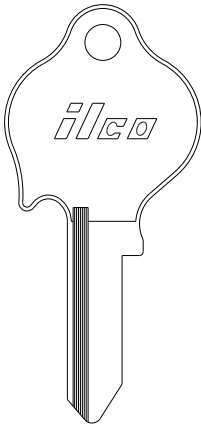

H61VM  
—

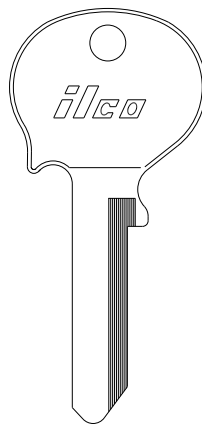

H61VR  
—

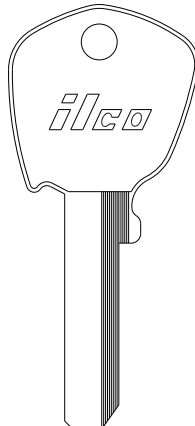

FT12R  
—

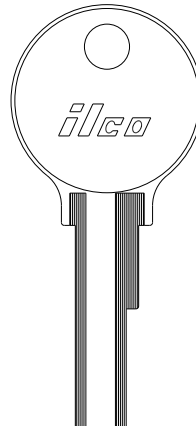

T61VR  
—



62DW  
—

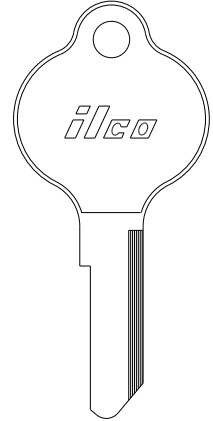

62VC  
—

62VE  
—

ILCO  
EZ

VOLKSWAGEN



62VG  
—

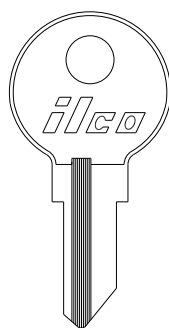

62VO  
—

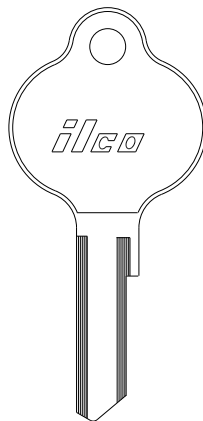

62VW  
—

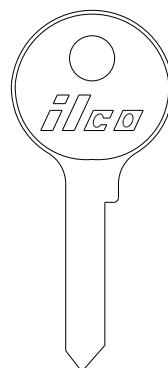

A62VC  
—

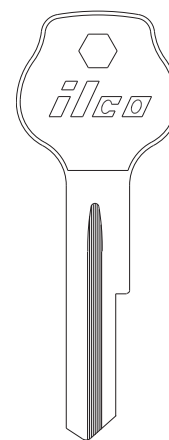

A62VN  
—



HR62VK  
—



L62VB  
—

ILCO  
EZ

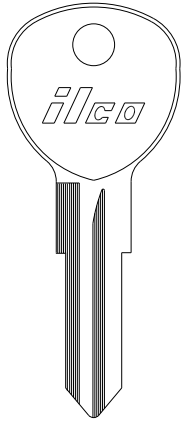
**VOLKSWAGEN**

**H62FD**

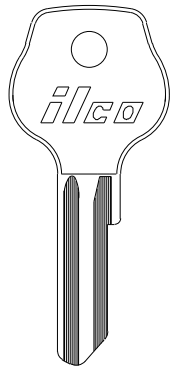
—

**HR62FD**

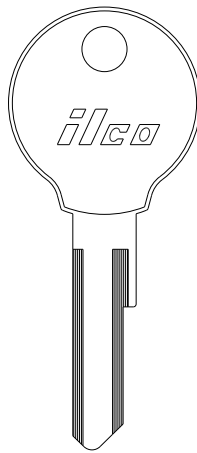
—

**R62VN**

—

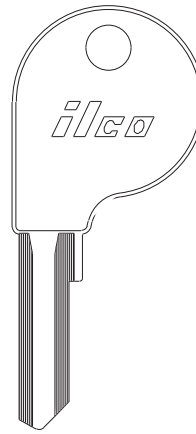
**S62DW**

—

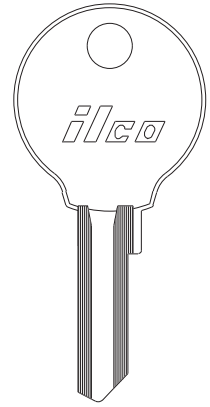
**U62VB**

—

**U62VN**

—

**W62VB**

—

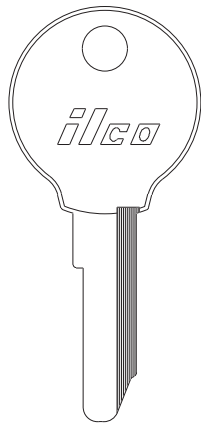
**ILCO  
EZ**
**VOLKSWAGEN**

**W62VE**

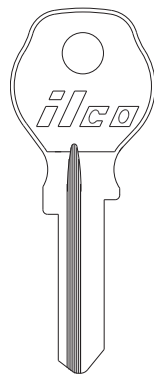
—

**M63BG**

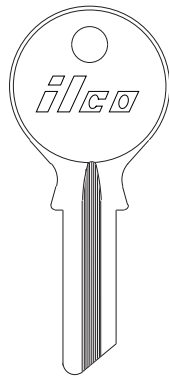
—

**63L**

—

**A63L**

—

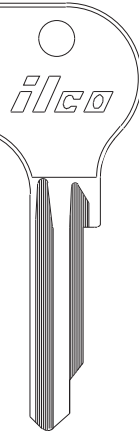
**63VN**

—

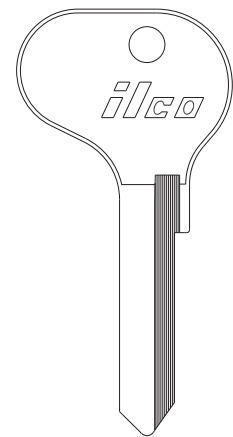
**63VR**

—

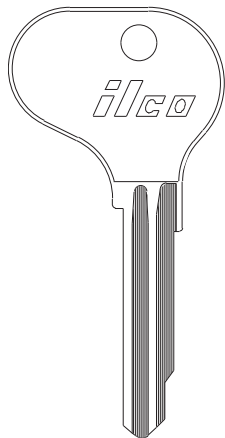
**ILCO  
EZ**
**VOLKSWAGEN**

**63VS**

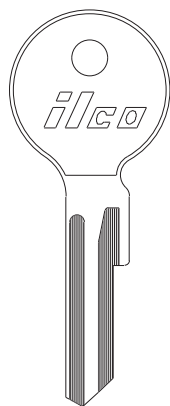
—

**R63VS**

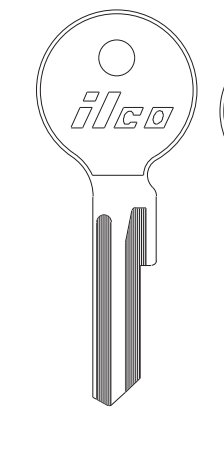
—

**63WG**

—

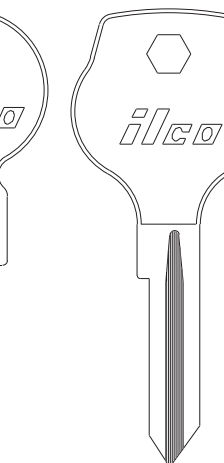
**R63WG**

—

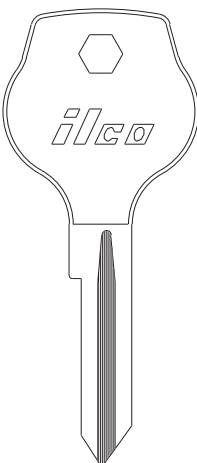
**H63VO**

—

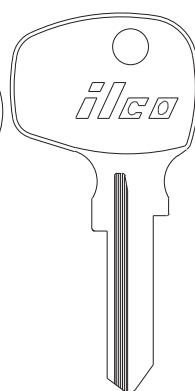
**S63B**

—

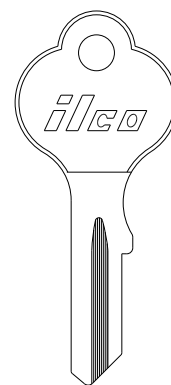
**U63H**

—

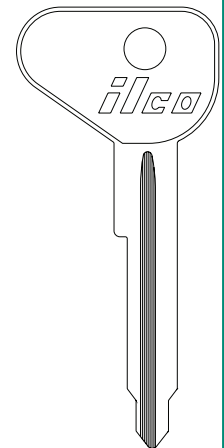
**V27**

V78JK

**ILCO  
EZ**

VOLKSWAGEN

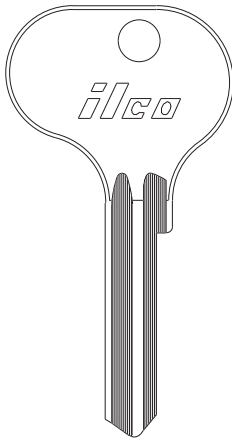

VW64  
—

V72N  
—



VW63  
—

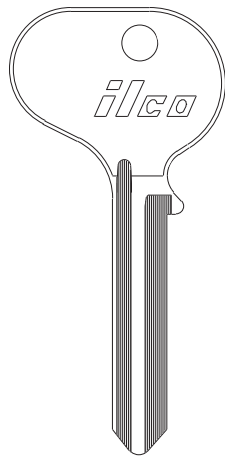

VW63A  
—

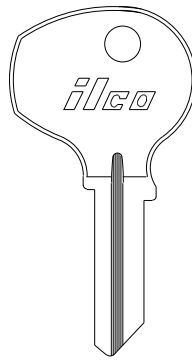

64K  
—

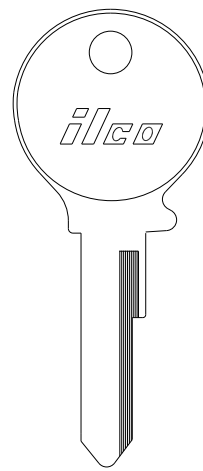

VW64T  
—

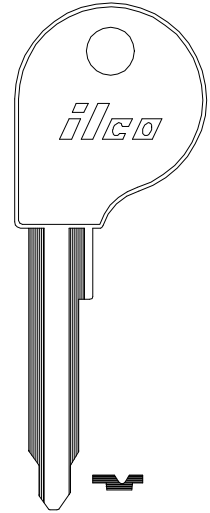

VW67  
—

ILCO  
EZ

VOLKSWAGEN

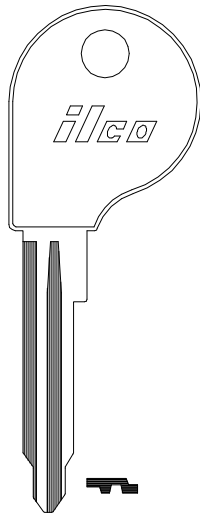

VW67S  
—

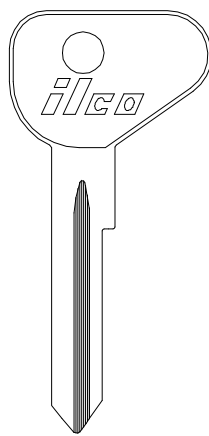

VW71



VW71A  
—

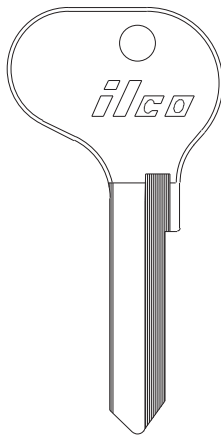

V72E  
—

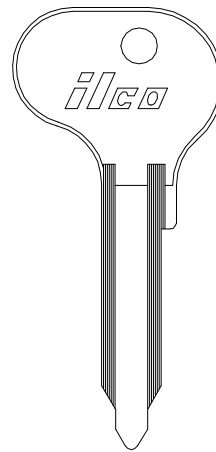

VW77  
—

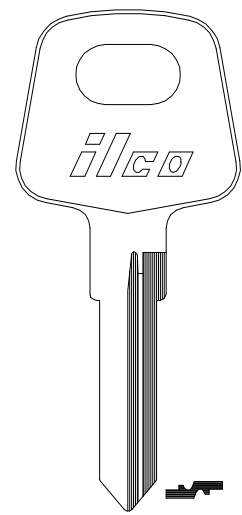

X88  
PA8

ILCO  
EZ

VOLKSWAGEN

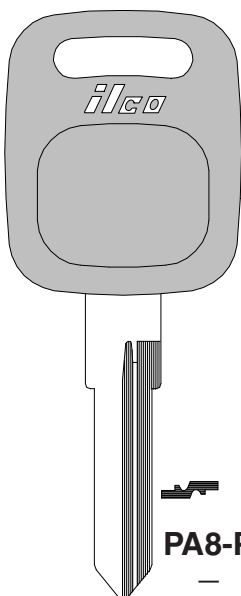

PA8-P  
—

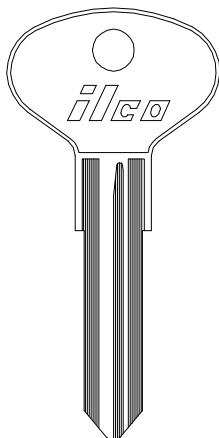

X110  
V33

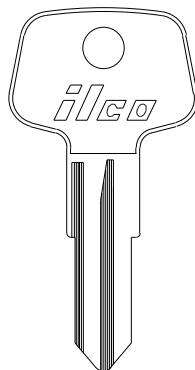

X132  
—

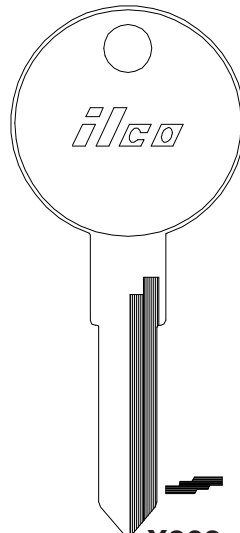

X203  
V37

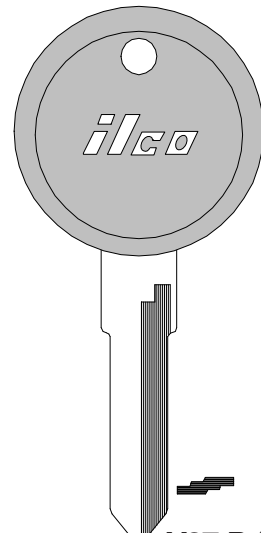

V37-P (-PC)  
—

ILCO  
EZ

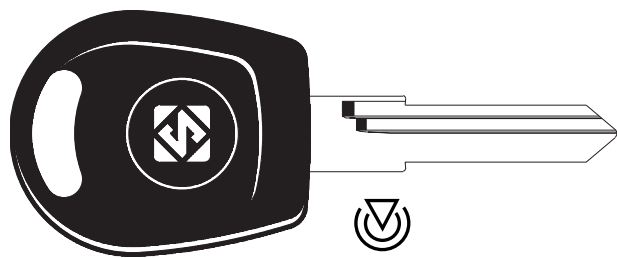
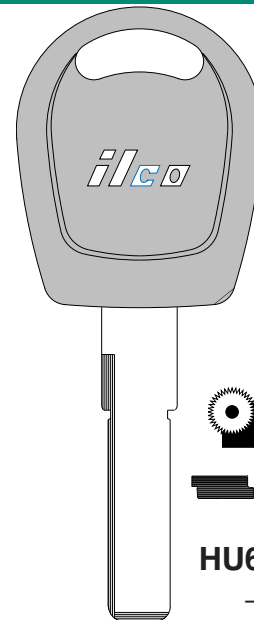

**VOLKSWAGEN**

**HU49T1**  
—

**HU66-P**  
—

**ILCO**  
EZ

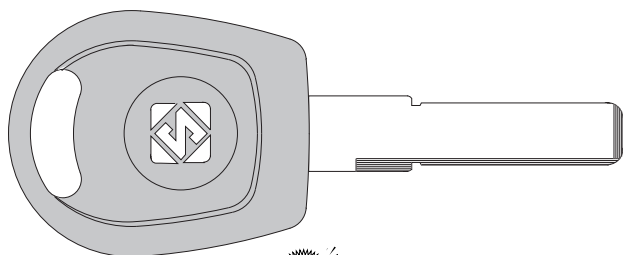
**VEHICLE**

sec 1 page 153

**VOLKSWAGEN**
**VOLVO**

**HU66T5**  
**HU66T6**  
**HU66T24**

**HU66T1**  
—

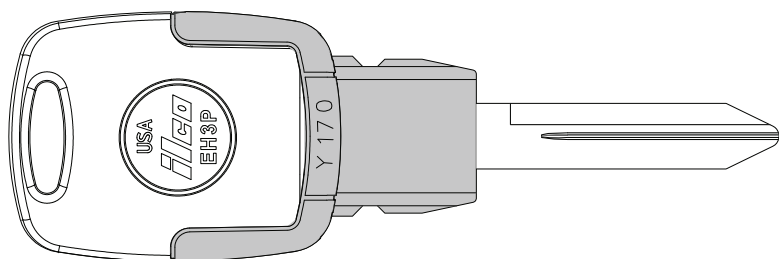
**ILCO**  
EZ

**VOLKSWAGEN**
**VOLVO**

**EH3P**  
(Head Only)

**EB3-T-Y170**  
(Blade Only)

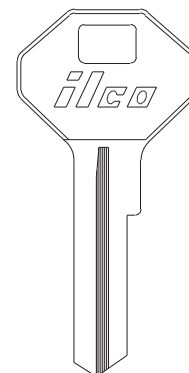
**EK3P-Y170**  
(Complete Key)

**ILCO**  
EZ

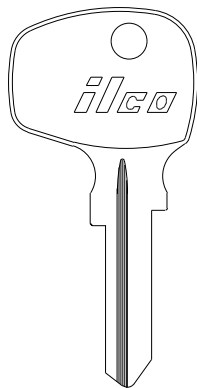
**VL1**  
—

VOLVO

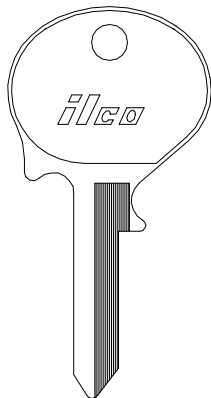

MB5

—



VO6

V77

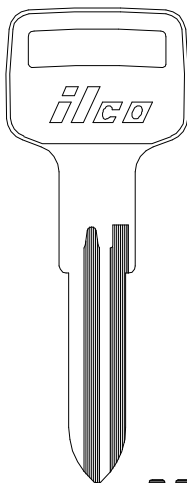

X29

VO73

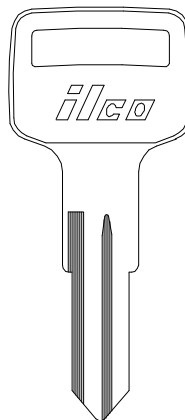

X30

VO73S

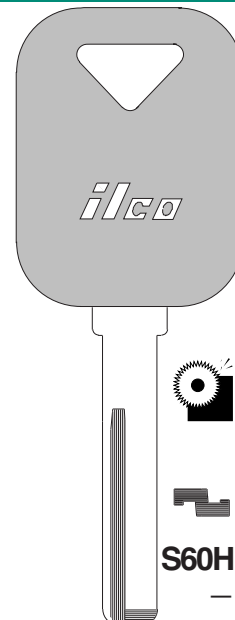

S60HF-P

—

ILCO

EZ

VOLVO

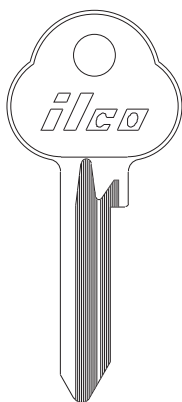

SR61W

—

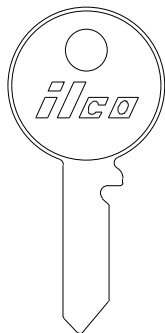

62DG 62DP

—

—

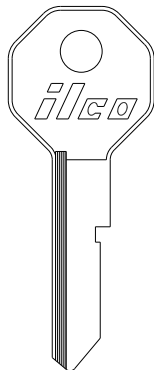

62DN

—



62DS

—



62FS

—



62VO

—

ILCO

EZ

VOLVO

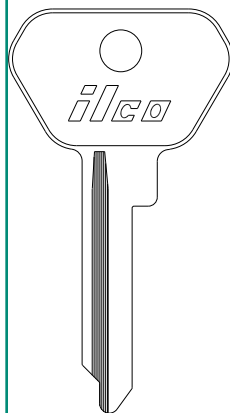

VO62

—

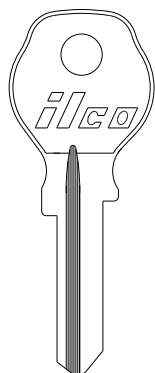

M63BG

—

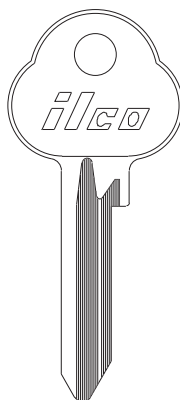

V61A

—

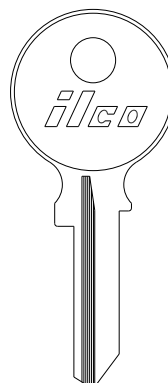

M63B

—

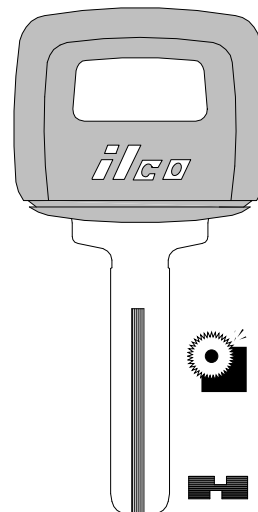

S66NN-P

—

ILCO

EZ

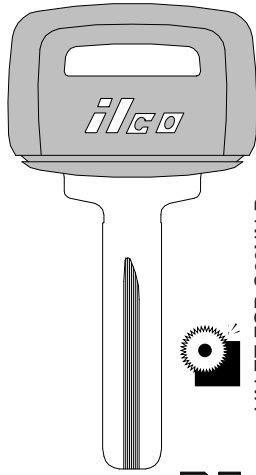
**VOLVO**

VALET FOR S66NN-P

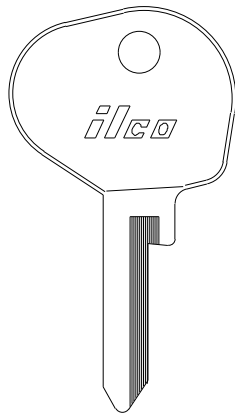
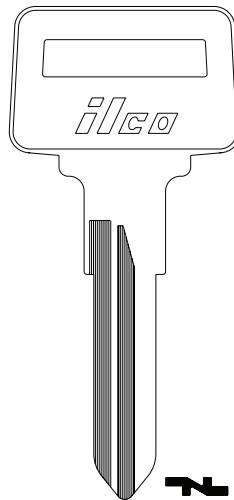
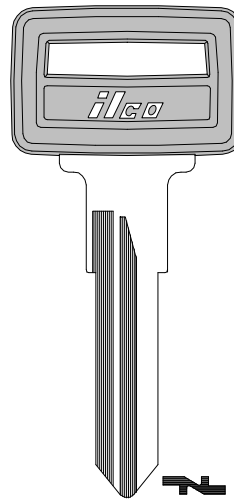
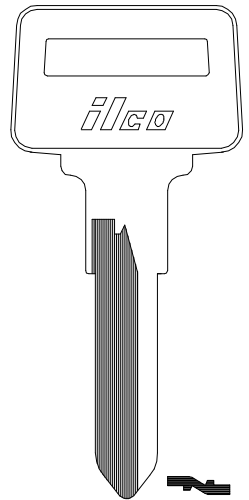

**S67NN-P**  
—

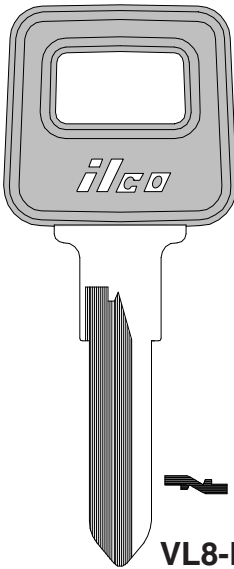
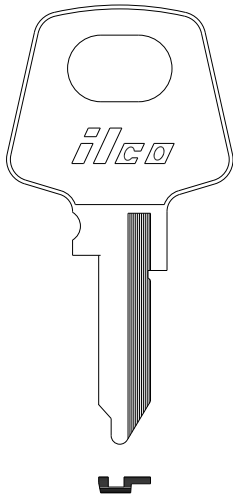
**V80P**  
—

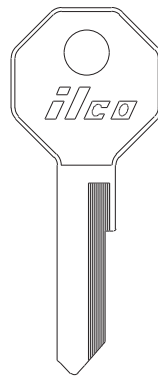
**X80**  
VL6

**VL6-P**  
—

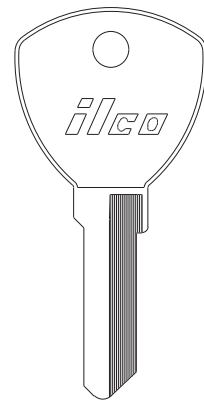
**X140**  
VL8

**ILCO**  
EZ

**VOLVO**

**VL8-P**  
—

**X163**  
BL11

**WARTBURG**

**WAR1**  
—

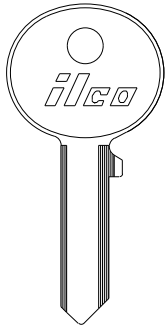
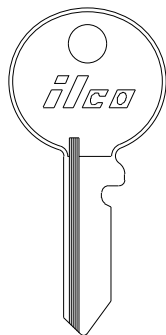
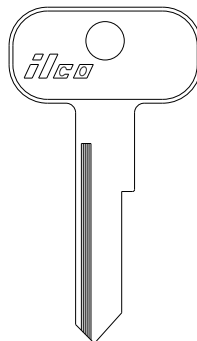
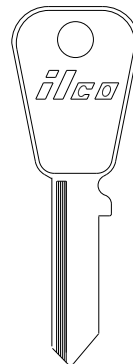
**WAR3**  
—

**WAR4**  
—

**WA3**  
—

**ILCO**  
EZ

**WOLSLEY**

**62DB**  
—

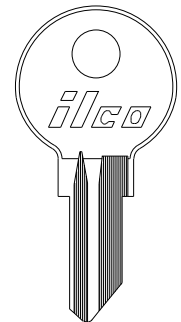
**62DP**  
—

**H62DP**  
—

**S62DP**  
—

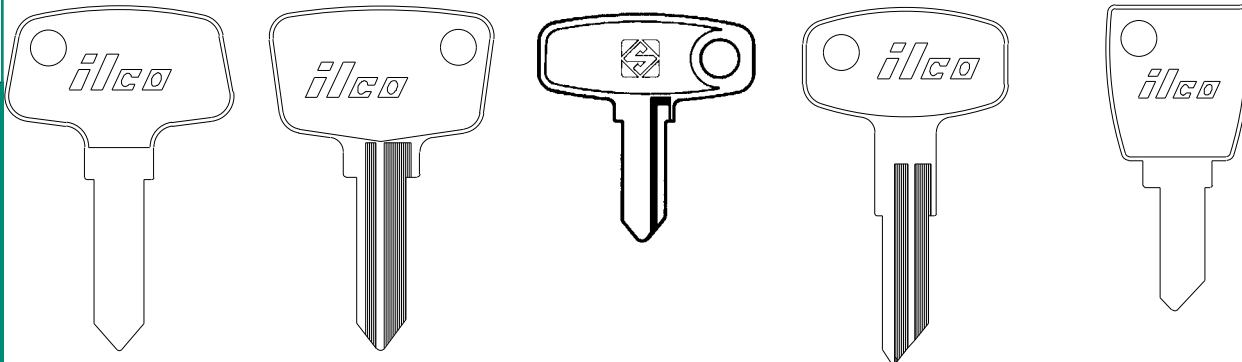
**ILCO**  
EZ

**YAMAHA**

**YH1**  
—

**YH2**  
—

YAMAHA



YH3

—



YH4

—



YH5

—



YH6-SI

—



YH6R

—



YH6

—



YH15

—



YH7

—

ILCO  
EZ

YAMAHA

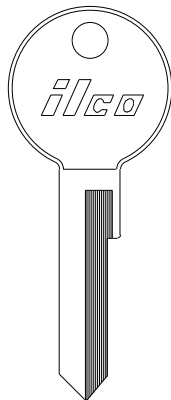
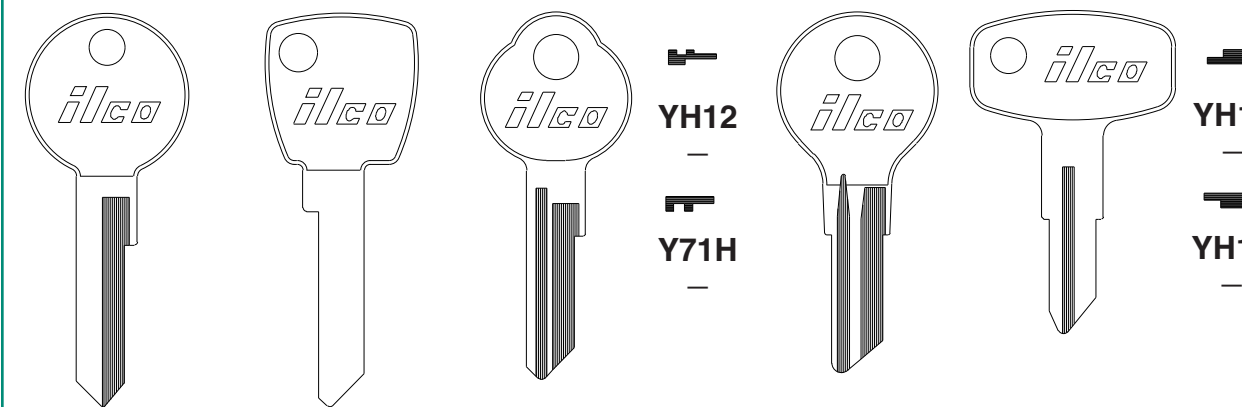

YH8

—

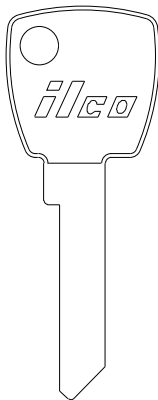

YH9

—

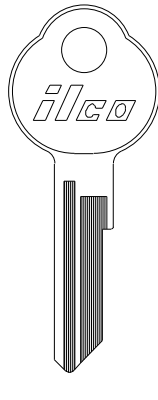

YH16

—



YH12

—



Y71H

—

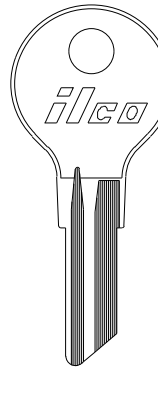

YH11

—

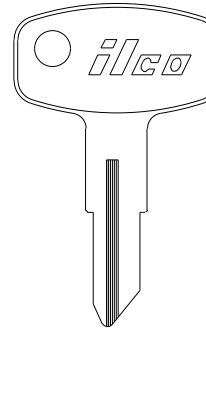

YH14

—



YH17

—



YH13

—

ILCO  
EZ

YAMAHA

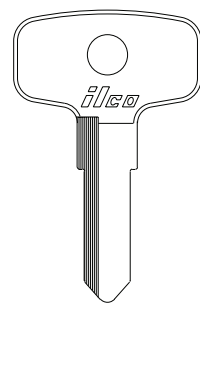
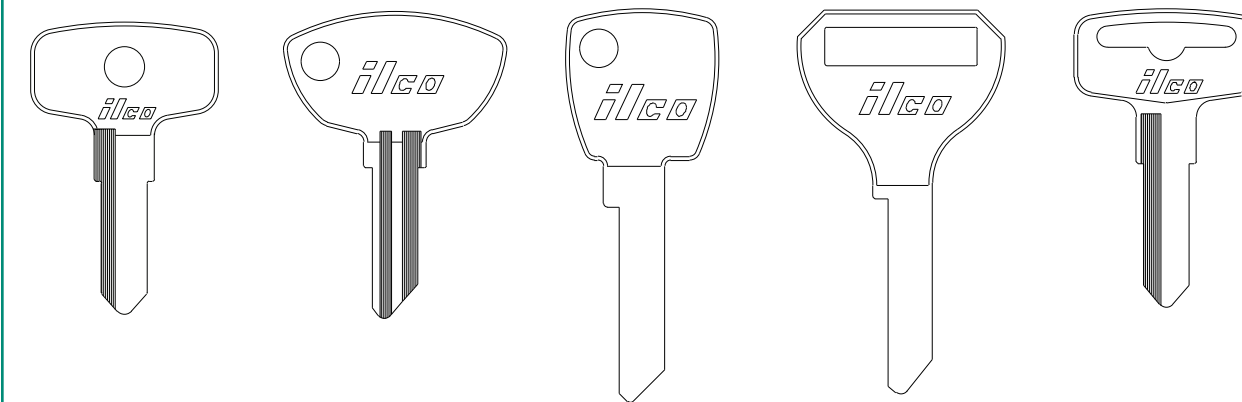

X18

YH21



X39

YH19



YH18

—



YH20

—



YH22

—



YH23

—



YH24

—



YH29

—

ILCO  
EZ

YAMAHA

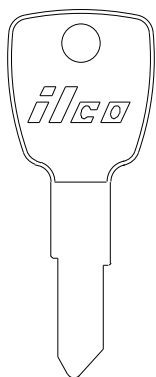

YH31

—

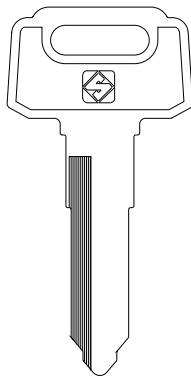

YH31R

—

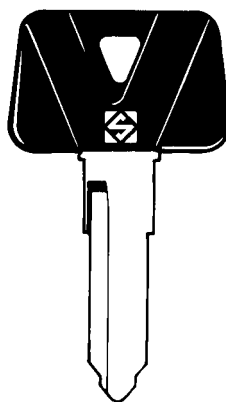

YH31RAP

—

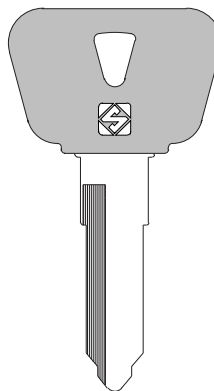

YH31RBP

—

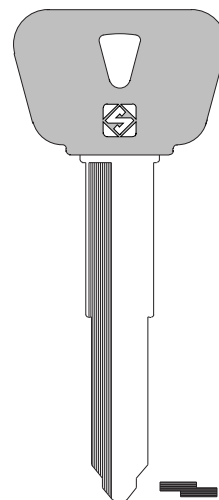

YH35RBP

—

ILCO  
EZ

YAMAHA



X33

—

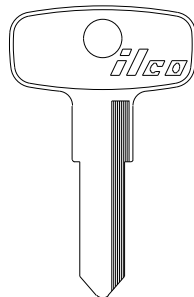

X48

—



YH40

—



YH43

—

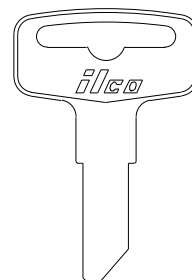

YH41

—



YH42

—

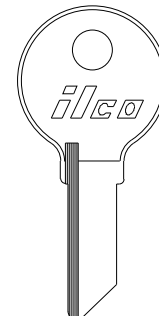

X49

—

ILCO  
EZ

YAMAHA

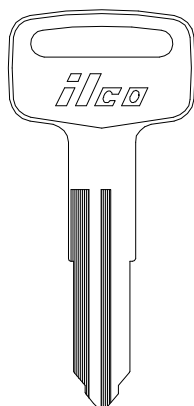

YH50

—



YH51

—

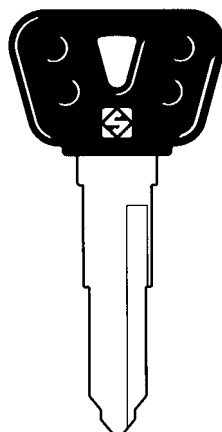

YH28BP

—



YH28RBP

—



YH29BP

—



YH29RBP

—



YH30BP

—



YH30RBP

—

ILCO  
EZ

YAMAHA

VEHICLE

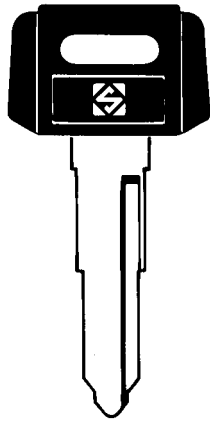

YH28P  
—

YH28RP  
—

YH29P  
—

YH29RP  
—

YH30P  
—

YH30RP  
—

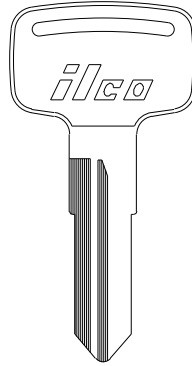

X69  
YH37

X72  
YH36

X75  
YH33

X74  
YH34

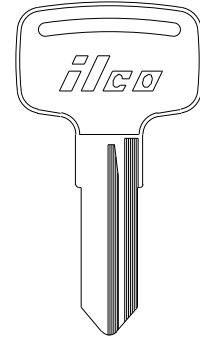

X62  
YH44



X107  
YH45



X63  
YH32



X76  
YH30

ILCO  
EZ

sec 1 page 158

YAMAHA

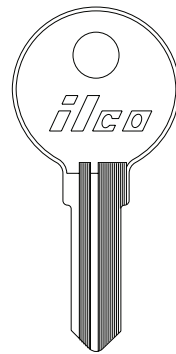
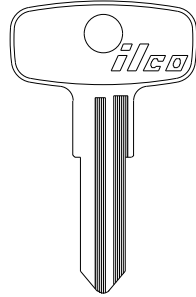
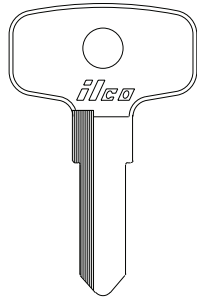

X65  
YH25



X66  
YH26



X67  
YH28



X68  
YH27



Y76B  
—



Y76C  
—

ILCO  
EZ

YAMAHA

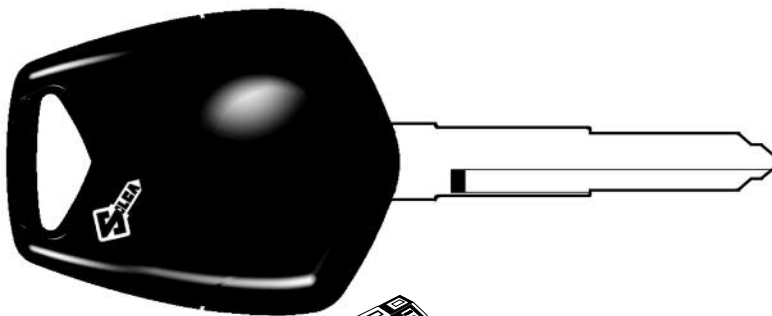

YH35REH2  
—

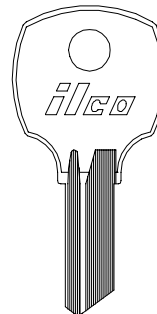

M1069L  
—

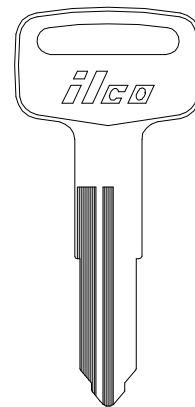

X117  
YH48

ILCO  
EZ

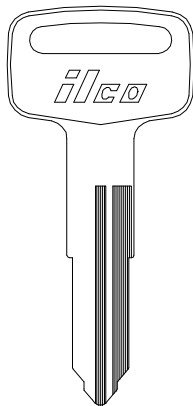
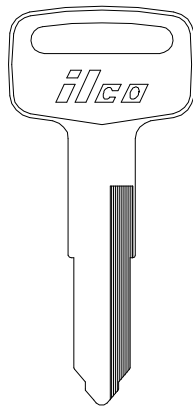
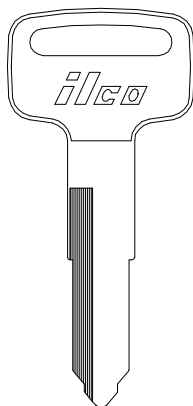
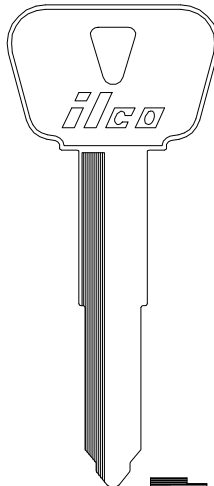
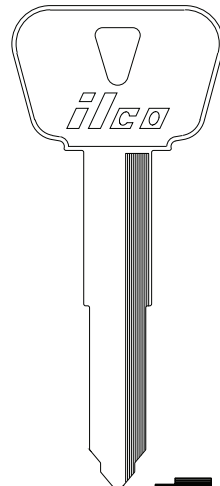
**YAMAHA**

**X118**  
YH49

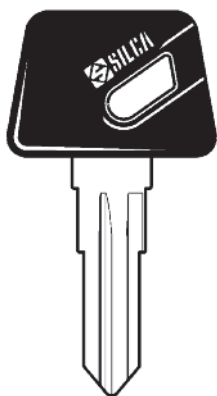
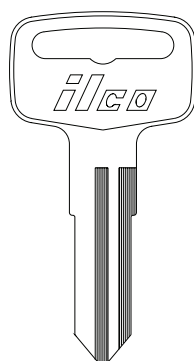
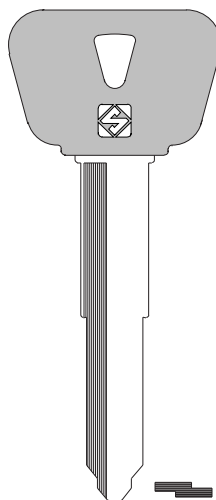
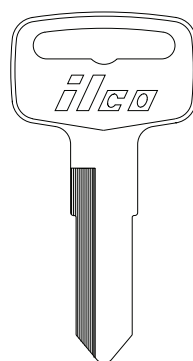
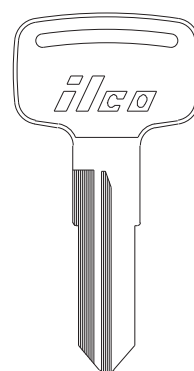
**X119**  
YH47

**X120**  
YH46

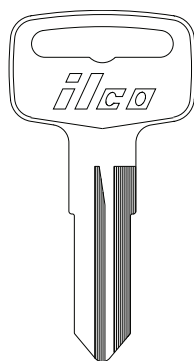
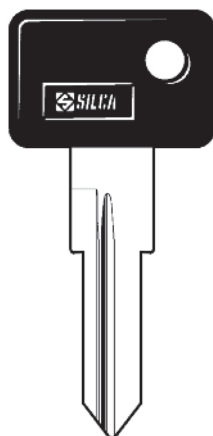
**X248**  
YM63

**X277**  
YM64

**ILCO**  
EZ

**YAMAHA**

**YH34P-SI**  
—

**YH35**  
—

**YH35RPB-SI**  
—

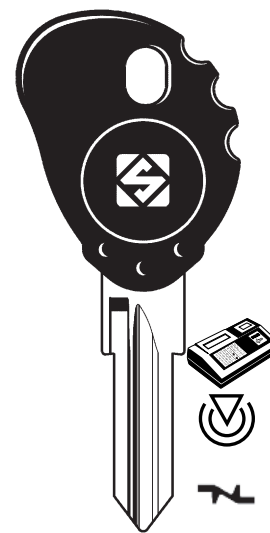
**YH38**  
X77

**YM55**  
X111

**ILCO**  
EZ

**YAMAHA**

**YM56**  
X112

**ZD16RP-SI**  
—

**ZD24RAT22-SI**  
—

**ZD24RDP-SI**  
—

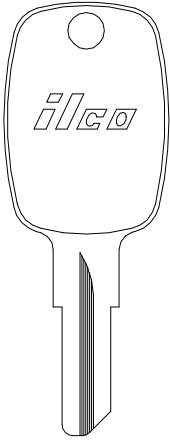
**ZD24RT5-SI**  
—

**ILCO**  
EZ

YARD TRACTOR YUGO

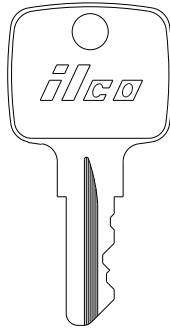

1098JD



C1098JD

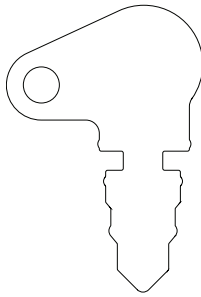

1147



1148

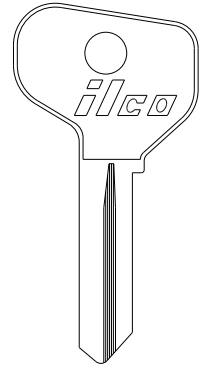

FT37



FT38

ILCO  
EZ

YUGO ZEPHYR ZUNDAPP

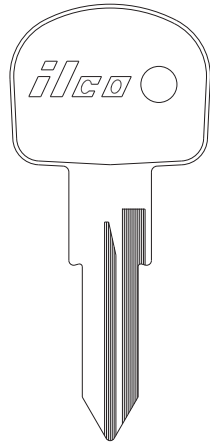

X152  
FT46

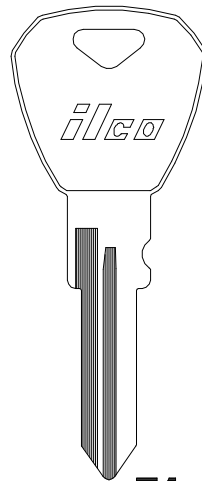

X153  
YU1

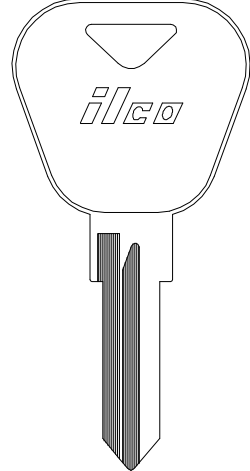

X167  
YU2

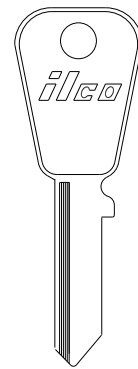

S62DP

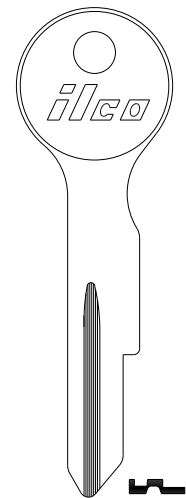

Z1

ILCO  
EZ

ZUNDAPP

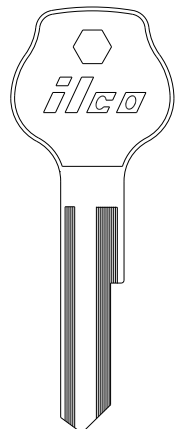

LR62VA

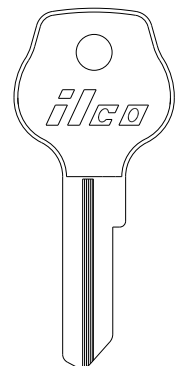

R62VA

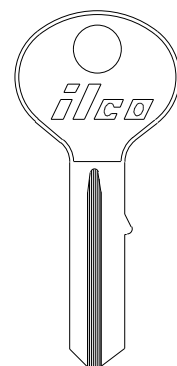

63J

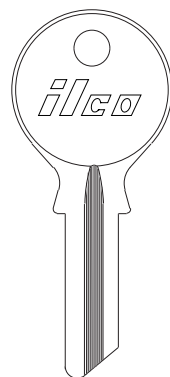

63L

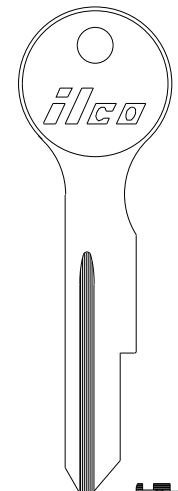

65J

ILCO  
EZ





## Section 2 NORTH AMERICAN CYLINDER

Key Blanks designed for locks used primarily in the North American Market. The lock manufacturers are listed in alphabetical order where possible.

There are several symbols and suffixes used in this section. Below is a legend of their use.



Special Key Machine Required

Color Plastic Head Key

-PC

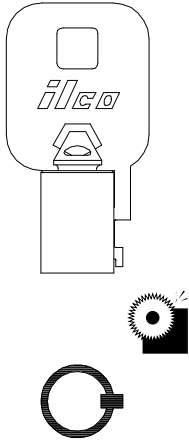
**ACE**
**ACORN**
**ADAMS RITE**

OD .377" - 9.6mm  
ID .312" - 7.9mm  
(BRASS)

**1137B**

—

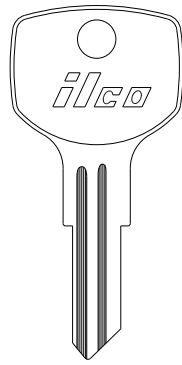

**A54B**

—

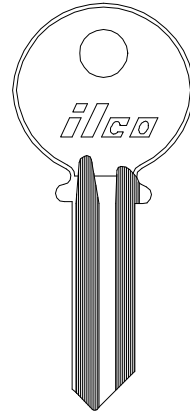

**999**

Y1

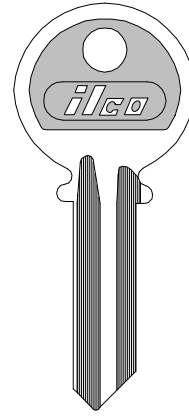

**Y1-PC**

—

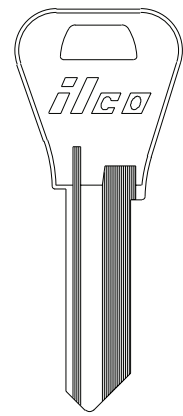

**1054WB**

WR3

**ILCO**  
EZ

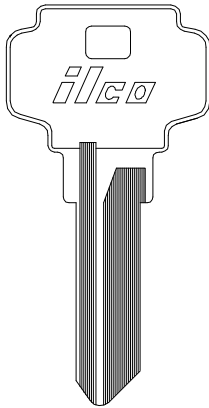
**ADAMS RITE**
**ALMET**

**D1054K**

DE6

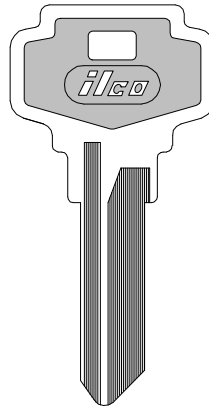

**DE6-PC**

—

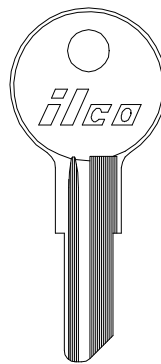

**L1054B**

IN8

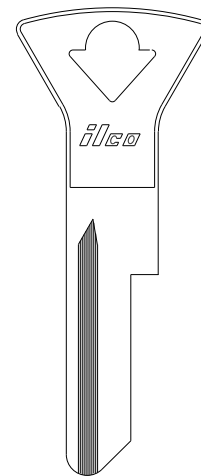

**K1145**

—

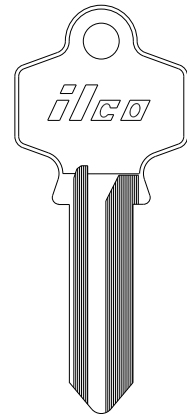

**AE1**

—

**ILCO**  
EZ

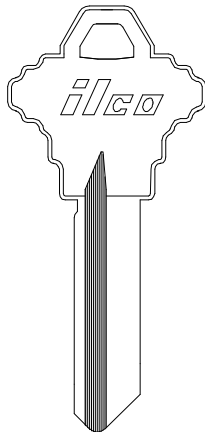
**ALMET**

**1145A**

SC4

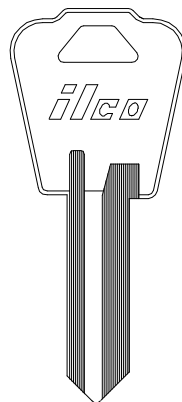

**1177N**

NH1

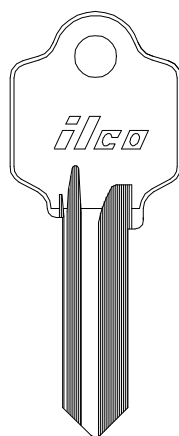

**1179**

AR1

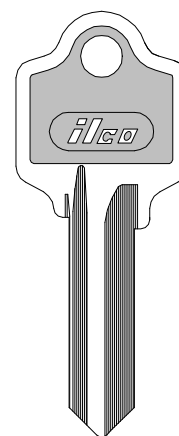

**AR1-PC**

—

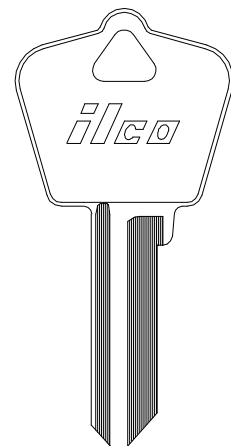

**N1179**

—

**ILCO**  
EZ

ALMET		AMERICAN LOCK			
1179A AR4	1041B —	1041C AM1	1041CK — 1041CE —	5 PIN 1045 AM3	6 PIN A1045 —

ILCO  
EZ

AMERICAN LOCK			AMEROCK		
5 PIN 1046 —	6 PIN 1046A —	6 PIN A1041U — 1653 AM4	— AK22W —	— R1064E NA25	— NA25-PC —

ILCO  
EZ

ARCO				ARFE			
— 1130 —	— 1130R —	— 1131 —	— 1131R —	— 1635J —	— 1635K —	— 1635L —	— 1635V —

ILCO  
EZ

**ARROW**

5 PIN 6 PIN	6 PIN				
<b>ILCO</b> EZ DT22W	<b>DTL22W</b>	<b>755U</b>	<b>1179</b> AR1	<b>AR1-PC</b>	<b>N1179</b>
—	—	—	—	—	—

**ARROW**

<b>ILCO</b> EZ 1179A AR4	<b>N1179A</b>	<b>A1179E</b>	<b>A1179J</b>	<b>A1179P</b>	<b>A1179U</b>	
—	—	—	—	—	—	—

**ARROW**
**AUTH FLORENCE BALDWIN**

					5 PIN 6 PIN	
<b>ILCO</b> EZ B1179-1C	<b>B1179-1D</b>	<b>CH1C</b>	<b>CH1D</b>	<b>1652</b> AF1	<b>1510</b> BW2	<b>1511</b>
—	—	—	—	—	—	—

**BARGMAN** **BARROWS**

	 <b>K1054B</b> IN24				
<b>L1054M</b>	<b>K1122N</b>	<b>L1098M</b>	<b>K1122D</b> BN1	<b>1761B</b>	<b>1021A</b>
—	—	—	—	—	—

ILCO  
EZ

**BARROWS** **BAUER**

<b>1021B</b>	<b>1021BA</b>	<b>1021N</b>	<b>1618</b> BAU1	<b>1618R</b> BAU1R
—	—	—	—	—

ILCO  
EZ

**BAUER** **BELLEVILLE**

<b>1648</b> BAU2	<b>1036</b>	<b>1036A</b>	<b>1036G</b>	<b>1036S</b>
—	—	—	—	—

ILCO  
EZ

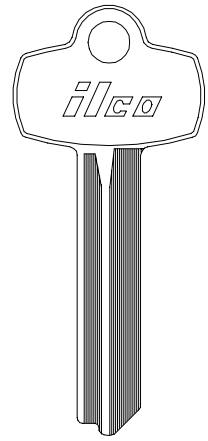
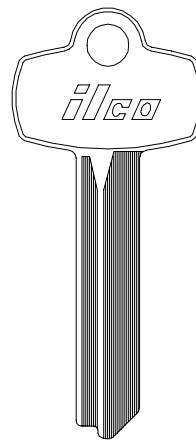
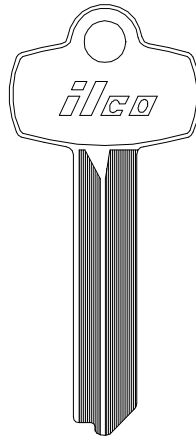
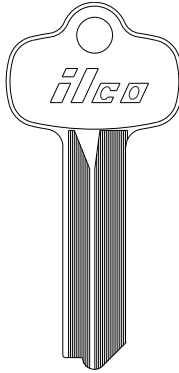
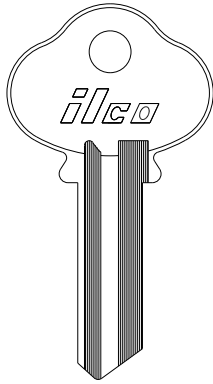
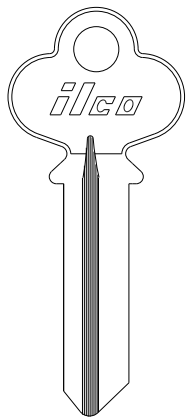
**BELLEVILLE**
**BEST**

**ILCO**  
EZ

**1036SF**  
—

**1036U**  
—

**1114**  
—

**A1114A**  
BE2

**A1114B**  
—

**A1114C**  
—

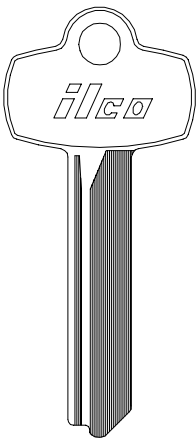
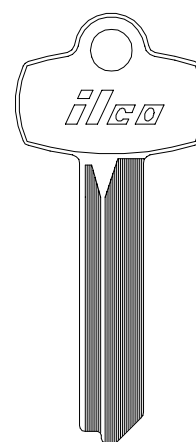
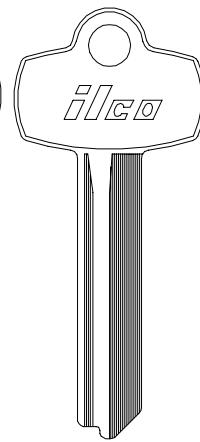
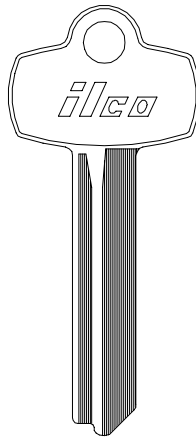
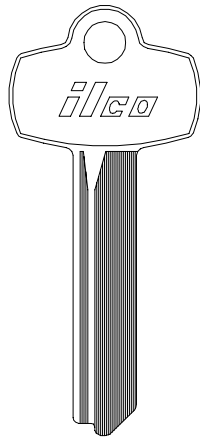
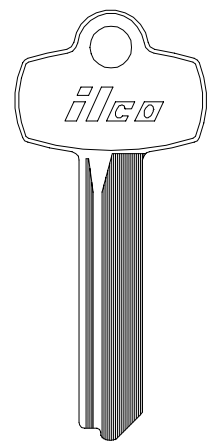
**BEST**

**ILCO**  
EZ

**A1114D**  
—

**A1114DD**  
—

**A1114E**  
—

**A1114F**  
—

**A1114FM**  
—

**A1114G**  
—

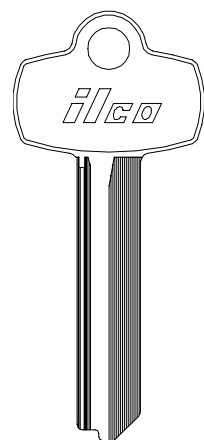
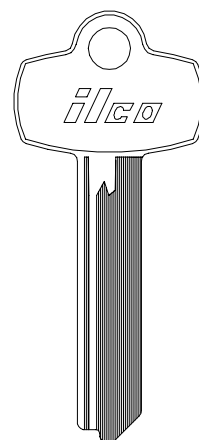
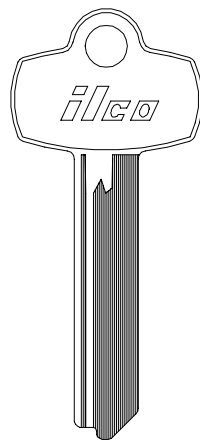
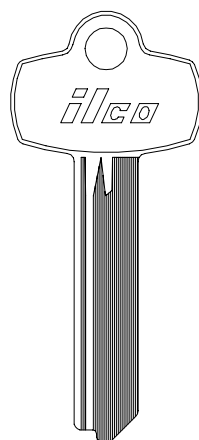
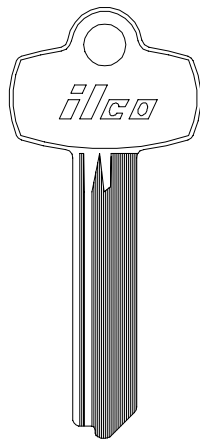
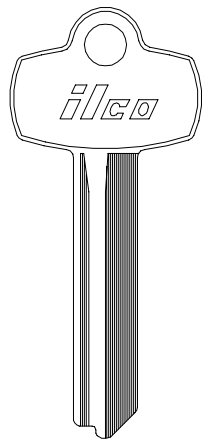
**BEST**

**ILCO**  
EZ

**A1114H**  
—

**A1114J**  
—

**A1114K**  
—

**A1114L**  
—

**A1114M**  
—

**A1114Q**  
—

BEST		BOMMER			CAM LOCK	CANADIAN BLDR.
<b>A1114R</b>	<b>A1114TB</b>	<b>1003M</b>	<b>R1003M</b>	<b>1069LC</b>	<b>1631</b>	<b>25</b>
—	—	CO106	BO1	NA24	—	—

**ILCO**  
EZ

CANADA POST					
<b>P54F</b>	<b>752</b>	<b>1558</b>	<b>1594</b>	<b>1632</b>	<b>LF25</b>
—	—	—	—	—	—

**ILCO**  
EZ

CANADA POST			CEMEX	CHALLENGER	
<b>1659</b>	<b>1659R</b>	<b>1661</b>	<b>1548</b>	<b>1549</b>	<b>1550</b>
—	—	—	—	—	—

**ILCO**  
EZ

**CHALLENGER**

	A1170C	1170BD		
	—	—		
	A1170CB	1170CJ		
	—	—		
	A1170D	1170E		
	—	—		
	5 PIN 6 PIN	1170C	1170D	1170M
	1170B A1170B	—	—	—
	HO1 HO4			

**ILCO**  
EZ

**NORTH AMERICAN**  
CYLINDER

**CHALLENGER CHANTRELL CHESSLER CHICAGO**

	<b>SEE LOCKWOOD</b>			
L1170		1178	100AM AP5	1041E CG22
—		—		
			101AM AP1	
			102AM AP2	
			103AM AP3	
			104AM AP4	

**ILCO**  
EZ

sec 2 page 7

**CHICAGO**

1041T CG16	1041TR	1041X	1041Y CG17	C1041A	C1041C	C1041B
—	—	—	—	—	—	—

**ILCO**  
EZ



CHICAGO

NORTH AMERICAN  
CYLINDER

<b>C1041L</b>	—	<b>C1041N</b>	—	<b>C1041J</b>	<b>H1041T</b>	<b>S1041JA</b>	<b>S1041T</b>	<b>1041FM</b>	
—		—		—		—			
—		—		—		—			
—		—		—		—			

ILCO  
EZ

sec 2 page 8

CHICAGO

	4 PIN		5 PIN		4 PIN		5 PIN		
	<b>SC1041R</b>	<b>C1041R</b>	<b>SC1041TR</b>	<b>C1041TR</b>	—	—	—	—	
	—	—	—	—	—	—	—	—	
	<b>SC1041S</b>	<b>C1041JB</b>	<b>SC1041YR</b>	<b>C1041YR</b>	—	—	—	—	
	—	—	—	—	—	—	—	—	
4 PIN		5 PIN		—	—	—	—	—	
<b>SC1041SR</b>	<b>C1041SR</b>	—	—	—	—	—	—	—	
—	—	—	—	—	—	—	—	—	
<b>SC1041T</b>	<b>C1041T</b>	—	—	—	—	—	—	—	
—	—	—	—	—	—	—	—	—	

ILCO  
EZ

CHICAGO

OD .365" - 9.3mm ID .300" - 7.6mm (STEEL)	OD .377" - 9.6mm ID .312" - 7.9mm (BRASS)	OD .X377" - 9.6mm ID .312" - 7.9mm (STEEL)	OD .399" - 10.1mm ID .329" - 8.4mm (STEEL)	
<b>1136S</b>	<b>1137B</b>	<b>1137S</b>	<b>L1137</b>	<b>41FD</b>
—	—	—	—	—

ILCO  
EZ

CHICAGO

CLUB CAR



CC29  
—



CC30  
—

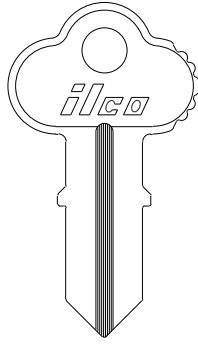

1041DB  
—



1041DC  
—



1041DH  
—

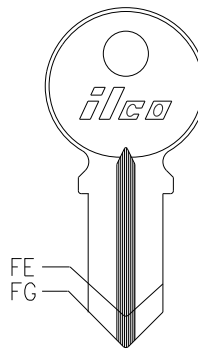

FE FG  
1041FE 1041FG  
— —

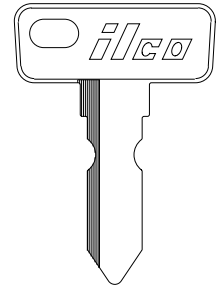

CC1  
—



CC21  
—



1041D  
—

ILCO  
EZ

CHICAGO

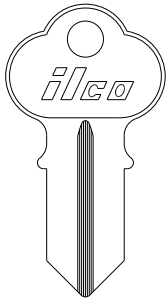

1041GA  
CG2



1041N  
—



1041GB  
—



1041GR  
—



1041G  
CG1



1041K  
—

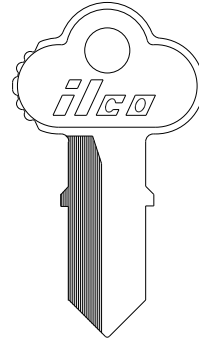

1041DE  
—



R1041DC  
—



1041DV  
—



R1041DV  
—

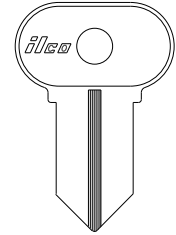

1041M  
—

ILCO  
EZ

CHICAGO

CHUCKAMKEE

CLINTON

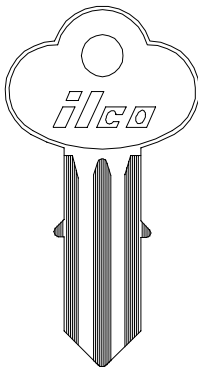

C1041DN  
—

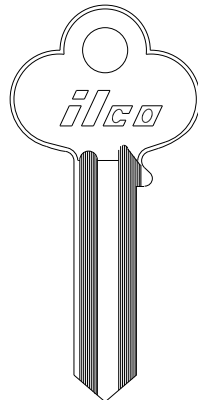

62CKK  
—

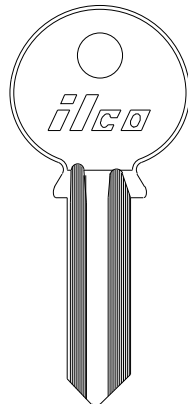

67CL  
—

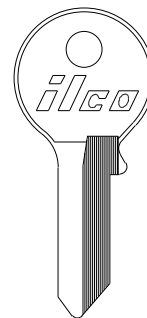

L67A  
—

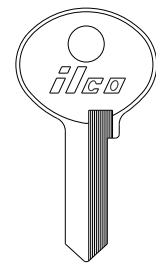

L67B  
—

ILCO  
EZ

CLINTON

4 PIN 5 PIN					
4 PIN      5 PIN					
<b>S67B</b> <b>1067B</b>	<b>T67A</b>	<b>T67B</b>	<b>T67C</b>	<b>T67D</b>	
—	—	—	—	—	—

ILCO  
EZ

sec 2    page 10

CLINTON

				5 PIN 6 PIN	
				5 PIN      6 PIN	
<b>T67E</b>	<b>T67F</b>	<b>C92</b>	<b>C92B</b>	<b>1023</b>	<b>1023A</b>
—	—	—	—	CL1	—

ILCO  
EZ

CCL (formerly Corbin Cabinet Lock)

	<b>5 DISC</b> <b>1000G</b>		
4 DISC 5 DISC 6 DISC	—		<b>X1000F</b>
	<b>6 DISC</b> <b>1000F</b> <b>CO17</b>		
			<b>X1000FR</b>
			—
4 DISC			
<b>1000H</b>		<b>1000FR</b>	<b>1000FX</b>
—		—	—

ILCO  
EZ

**CCL - (formerly Corbin Cabinet Lock)**

	<u>5 DISC</u>	<u>6 DISC</u>		
	<b>X1000GR</b>	<b>SX1000FR</b>		
	—	—		
	—	<b>XO1000F</b>		
	—	—		
	<b>XO1000GR</b>	<b>XO1000FR</b>		
	—	—		

	<u>5 DISC</u>	<u>6 DISC</u>
	<b>X1000G</b>	<b>SX1000F</b>
	CO10	—

<b>O1000H</b>	<b>O1000GX</b>	<b>O1000GR</b>
—	—	—

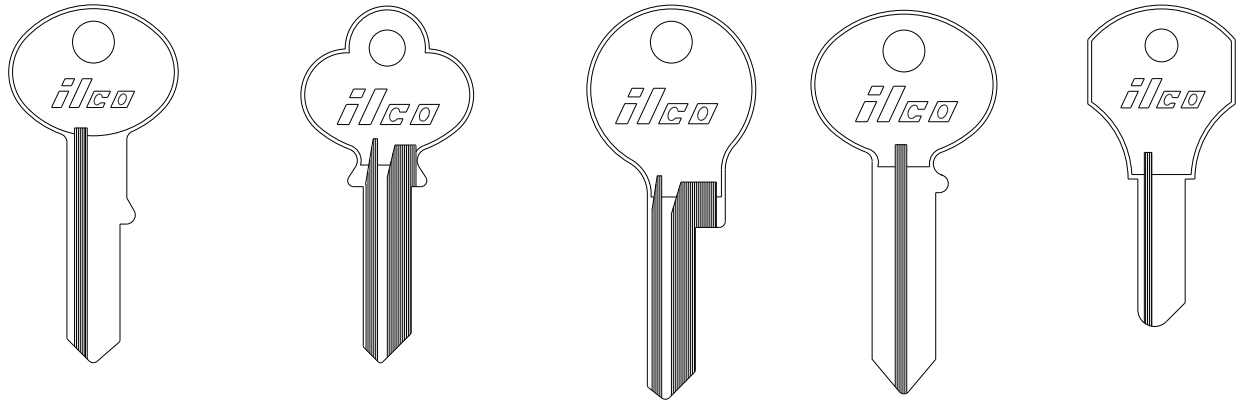
**ILCO  
EZ**
**CCL (formerly Corbin Cabinet Lock)**

<b>1000HL</b>	<b>R1000HL</b>	<b>1000KC</b>	<b>1000K</b>
—	—	—	—

<b>X1000KC</b>
CO9

<b>1000DA</b>	<b>1000W</b>
—	—

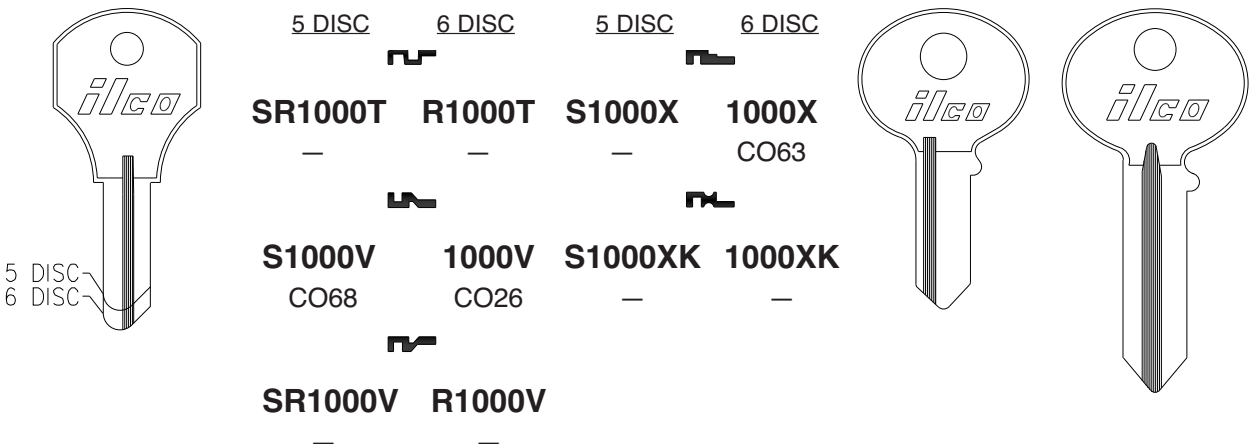
**ILCO  
EZ**
**CCL (formerly Corbin Cabinet Lock)**

	<u>5 DISC</u>	<u>6 DISC</u>		
	<b>SR1000T</b>	<b>R1000T</b>	<b>S1000X</b>	<b>1000X</b>
	—	—	—	CO63
	<b>S1000V</b>	<b>1000V</b>	<b>S1000XK</b>	<b>1000XK</b>
	CO68	CO26	—	—
	<b>SR1000V</b>	<b>R1000V</b>		
	—	—		

	<u>5 DISC</u>	<u>6 DISC</u>
	<b>S1000T</b>	<b>1000T</b>
	—	CO12

<b>1001CR</b>	<b>1001D</b>	<b>R1001D</b>
—	—	—

**ILCO  
EZ**

CCL (formerly Corbin Cabinet Lock)

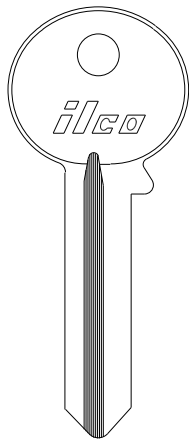

1001DA

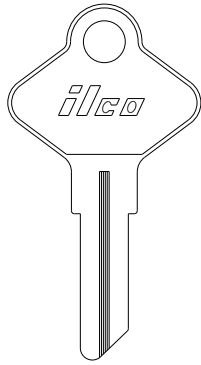

1001JL



1000JR



1001K

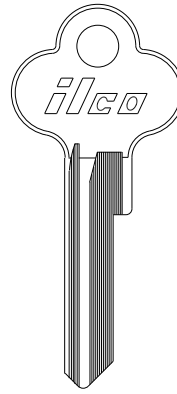

X1001KC

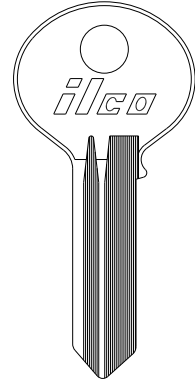

1001WL



NORTH AMERICAN  
CYLINDER

ILCO  
EZ

sec 2 page 12

CCL (formerly Corbin Cabinet Lock)

4 PIN	S1003A —	S1003B —	S1003C —	S1003D —
5 PIN	1003A —	1003B —	1003C —	1003D —
6 PIN	L1003A —	L1003B —	L1003C —	L1003D —

4 PIN	S1003AB —	S1003CD —
5 PIN	1003AB —	1003CD —
6 PIN	L1003AB —	L1003CD —

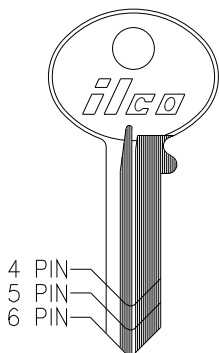







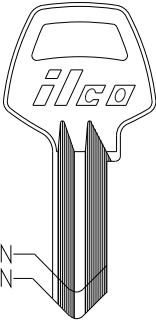
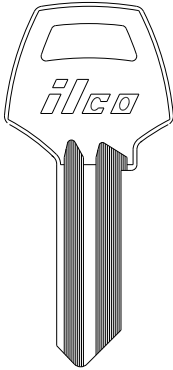
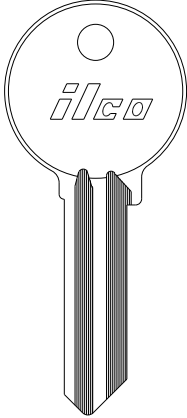
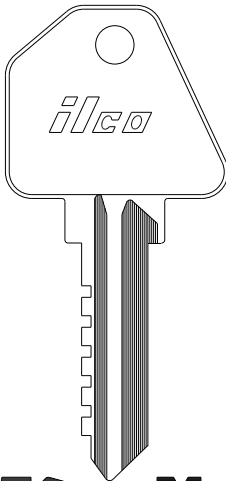
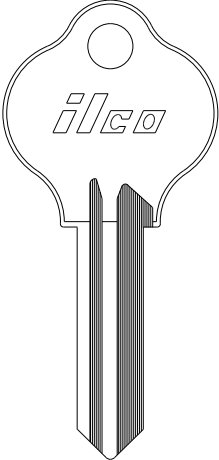

4 PIN  
5 PIN  
6 PIN







4 PIN	S1003M —
5 PIN	1003M CO106
6 PIN	L1003M —

ILCO  
EZ

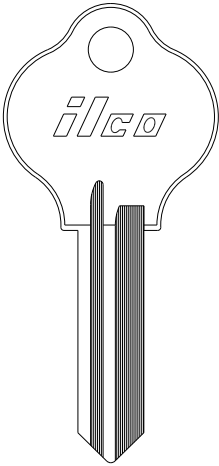
**CORBIN (now Corbin / Russwin)**

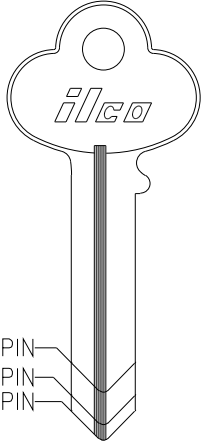
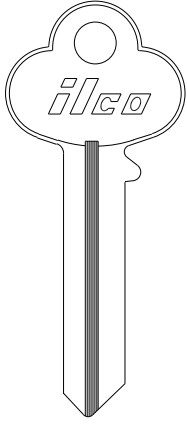







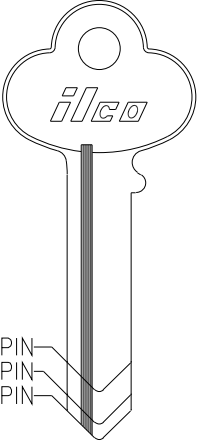
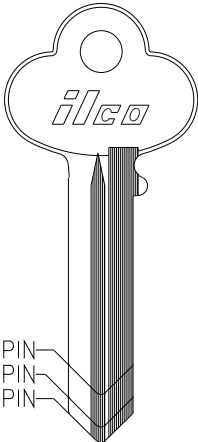

					
	3 PIN 4 PIN				
					
					
<b>ILCO</b>	<b>CB1</b>	<b>CB2</b>	<b>CB3</b>	<b>CB7</b>	<b>CB9</b>
<b>EZ</b>	—	—	—	—	—

**NORTH AMERICAN  
CYLINDER**
**CORBIN (now Corbin / Russwin)**

				
			5 PIN 6 PIN 7 PIN	6 PIN 7 PIN
				
<b>ILCO</b>	<b>CB11BH</b>	<b>CB12</b>	<b>1000</b>	<b>1000AB</b>
<b>EZ</b>	—	—	<b>CO1</b>	—

sec 2 page 13

**CORBIN (now Corbin / Russwin)**

						
	6 PIN 7 PIN	5 PIN 6 PIN 7 PIN	5 PIN	6 PIN	6 PIN	7 PIN
						
<b>ILCO</b>	<b>1001EA</b>	<b>1001E</b>	<b>R1001EF</b>	<b>1001MC</b>	<b>R1001EE</b>	<b>1001EJ</b>
<b>EZ</b>	(MASTER)	(MASTER)	—	—	CO35	—
			<b>R1001CEM</b>	<b>1001MD</b>	<b>R1001EK</b>	<b>A1001MA</b>
			(MASTER)	—	—	—
			<b>1001MA</b>	<b>1001MG</b>	<b>R1001EP</b>	<b>A1001MB</b>
			—	—	—	—
			<b>1001MB</b>	<b>R1001ED</b>	<b>R1001EM</b>	<b>A1001MF</b>
			—	—	(MASTER)	—

CORBIN (Now Corbin/Ruswin)

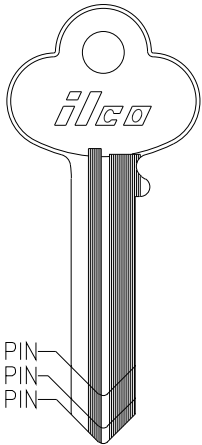

5 PIN  
6 PIN  
7 PIN

5 PIN  
 6 PIN  
  
1001MJ A1001MJ  
— —

1001EN 1001EG  
(MASTER) (MASTER)  
CO7 CO36

1001ES B1001EJ  
(MASTER) (MASTER)  
— —

6 PIN  
   
A1001HP 1001EL  
(MASTER)  
— —

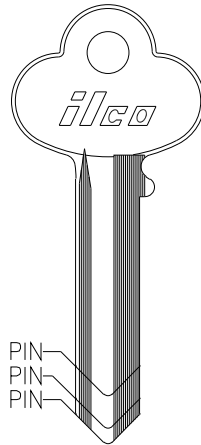

5 PIN  
6 PIN  
7 PIN

5 PIN  
 6 PIN  
  
R1001MJ R1001EG  
(MASTER) (MASTER)  
— CO62

R1001EN R1001ET  
(MASTER) (MASTER)  
SK1 —

R1001ES R1001EL  
(MASTER) (MASTER)  
— —

6 PIN  
  
A1001MJR  
—

NORTH AMERICAN  
CYLINDER

ILCO  
EZ

CORBIN (now Corbin / Russwin)

ILCO  
EZ

5 PIN	1001AH —	1001FH —	1001BH —	1001DH —	1001C1 —	1001C2 —	1001D1 —	1001D2 —
6 PIN	A1001AH CO91	A1001FH CO92	A1001BH CO94	A1001DH CO95	A1001C1 CO98	A1001C2 CO102	A1001D1 CO107	A1001D2 CO108
7 PIN	L1001AH —	L1001FH —	L1001BH —	L1001DH —	L1001C1 —	L1001C2 —	L1001D1 —	L1001D2 —

5 PIN	1001AM —	1001BM —	1001CM —	1001DM —
6 PIN	A1001AM —	A1001BM —	A1001CM —	A1001DM —
7 PIN	L1001AM —	L1001BM —	L1001CM —	L1001DM —

5 PIN	1001ABM —	1001CDM —
6 PIN	A1001ABM CO89	A1001CDM —
7 PIN	L1001ABM —	L1001CDM —

5 PIN	1001GRM —
6 PIN	A1001GRM —
7 PIN	L1001GRM —

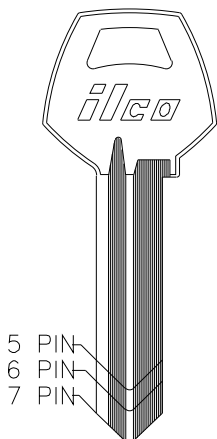

NORTH AMERICAN  
CYLINDER



**CORBIN (Corbin / Russwin)**

NORTH AMERICAN CYLINDER

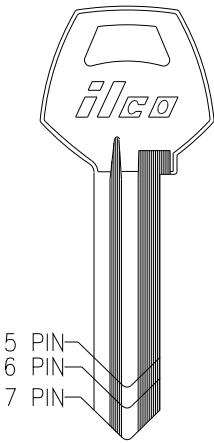

6 PIN  
**A1001EH**  
CO88

7 PIN  
**L1001EH**  
—

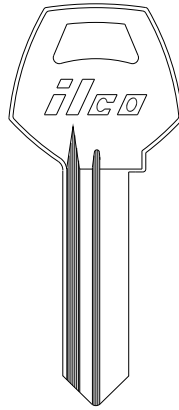

**A1001EHR**  
—

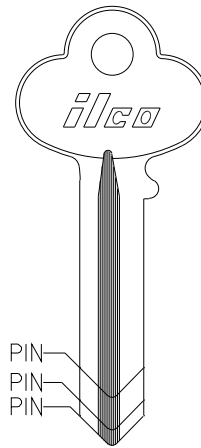

6 PIN  
**1001AB**  
C06

7 PIN  
**1001A**  
—

5 PIN  
**1001EH**  
CO87

**1001**  
CO5

**ILCO**  
EZ

**CORBIN (now Corbin / Russwin)**

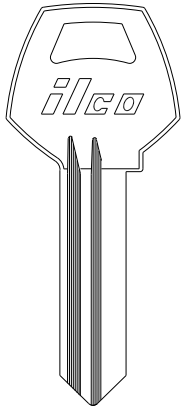

**1001A1** **1001A2**  
— —

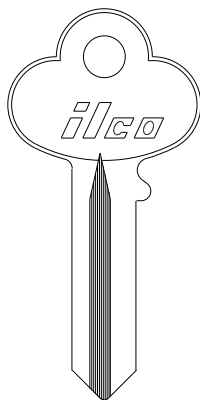

**1001C**  
—

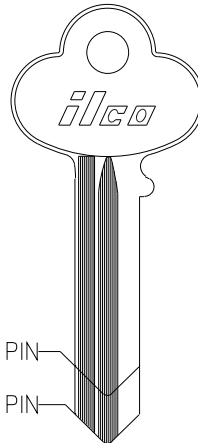

7 PIN  
  
**1001GA**  
—

**R1001GA**  
—

**1001GB**  
—

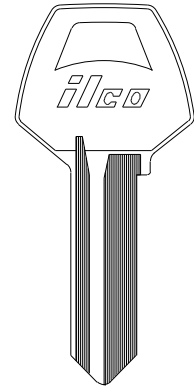

**1001GH**  
CO97

**ILCO**  
EZ

**CORBIN (now Corbin / Russwin)**

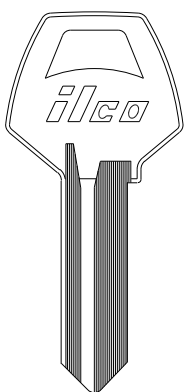

**1001MK**  
—

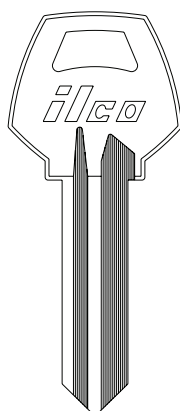

**O1001E**  
—

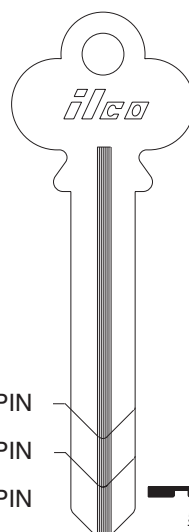

6 PIN  
**1002A**  
—

7 PIN  
**1002**  
—

5 PIN  
**1002B**  
—

**ILCO**  
EZ

ILCO  
EZ

NORTH AMERICAN  
CYLINDER

5 PIN	<b>1011-L1</b> —	<b>1011-L2</b> —	<b>1011-L3</b> —	<b>1011-L4</b> —
6 PIN	<b>A1011-L1</b> —	<b>A1011-L2</b> —	<b>A1011-L3</b> —	<b>A1011-L4</b> RU101
7 PIN	<b>L1011-L1</b> —	<b>L1011-L2</b> —	<b>L1011-L3</b> —	<b>L1011-L4</b> —

5 PIN	<b>1011-L12</b> —	<b>1011-L34</b> —
6 PIN	<b>A1011-L12</b> —	<b>A1011-L34</b> —
7 PIN	<b>L1011-L12</b> —	<b>L1011-L34</b> —

5 PIN	<b>1011-L41</b> —
6 PIN	<b>A1011-L41</b> —
7 PIN	<b>L1011-L41</b> —

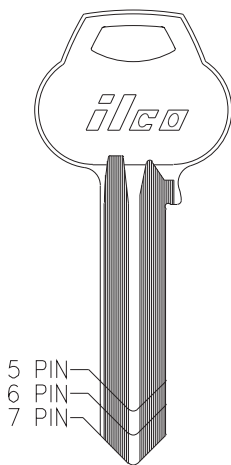

CORBIN / RUSSWIN

NORTH AMERICAN  
CYLINDER

sec 2 page 18

5 PIN	1012-D1 —	1012-D2 —	1012-D3 —	1012-D4 —
6 PIN	A1012-D1 —	A1012-D2 —	A1012-D3 —	A1012-D4 —
7 PIN	L1012-D1 —	L1012-D2 —	L1012-D3 —	L1012-D4 —

5 PIN	1012-D12 —	1012-D34 —
6 PIN	A1012-D12 —	A1012-D34 —
7 PIN	L1012-D12 —	L1012-D34 —

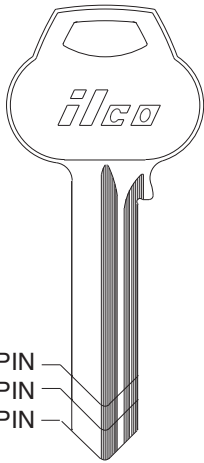

5 PIN  
6 PIN  
7 PIN

5 PIN	1012-D41 —
6 PIN	A1012-D41 —
7 PIN	L1012-D41 —

ILCO  
EZ

CORBIN / RUSSWIN

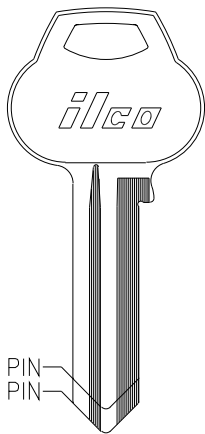

6 PIN  
A1012-60  
—

5 PIN  
6 PIN

5 PIN  
1012-60  
—

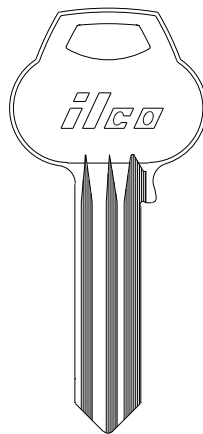

A1012-H1 A1012-H6  
— —

A1012-H2 A1012-H7  
— —

A1012-H3 A1012-H8  
— —

A1012-H5  
—

ILCO  
EZ

## CORBIN / RUSSWIN

A1012-59A1	A1012-59A2 CR92	A1012-59B1 CR94	A1012-59B2 CR95	A1012-59C1	A1012-59C2	A1012-59D1	A1012-59D2
—	—	—	—	—	—	—	—



A1012-59A  
—

A1012-59B  
—

A1012-59C  
—

A1012-59D  
—



A1012-59AB  
—

A1012-59CD  
—



A1012-59AD  
—

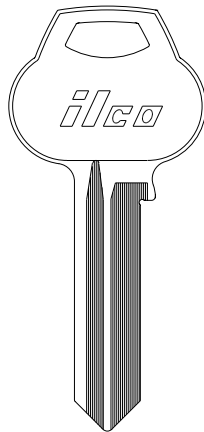

ILCO  
EZ

NORTH AMERICAN  
CYLINDER

sec 2 page 19

CORBIN / RUSSWIN

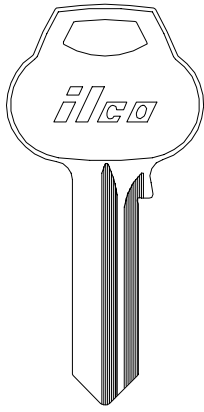

CR45

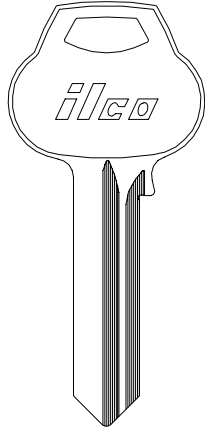

CR46

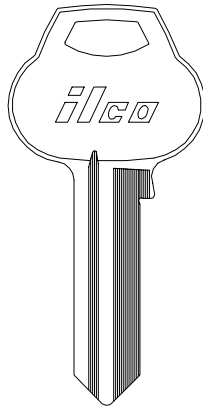

CR87

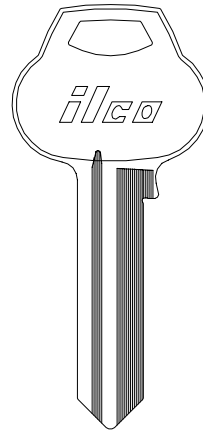

CR88

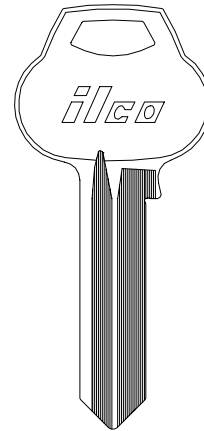

CR89

ILCO  
EZ

NORTH AMERICAN  
CYLINDER

sec 2 page 20

CORBIN/RUSSWIN

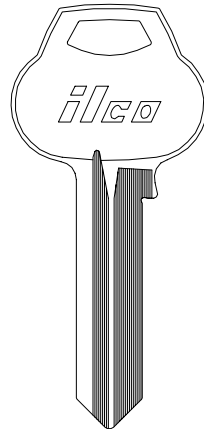

CR91

CRAFTSMAN

SEE  
ELGIN

CUTLER

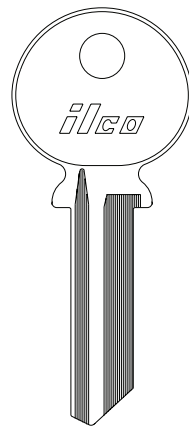

1181C

DEXTER / MASTER

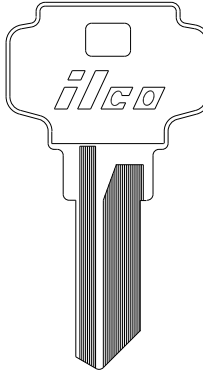

1054KD  
DE1

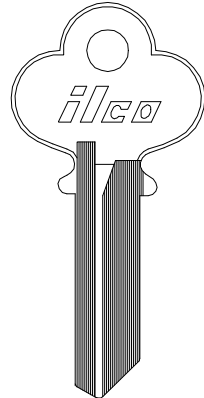

A1054KD  
DE5

ILCO  
EZ

DEXTER / MASTER

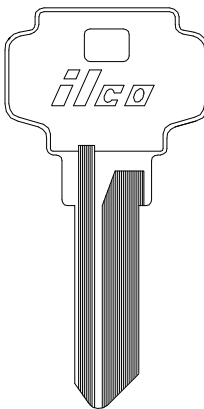

D1054K  
DE6

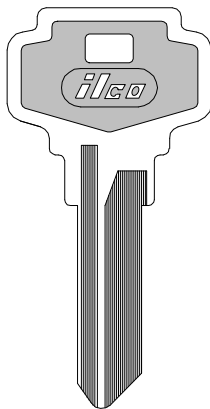

DE6-PC

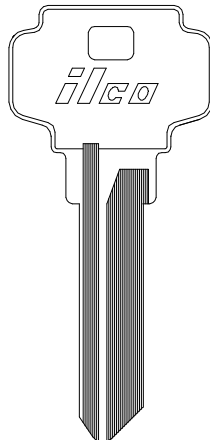

D1054KA  
DE8

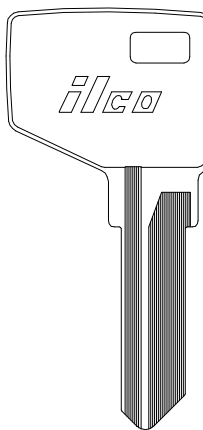

MD1054K  
MD17

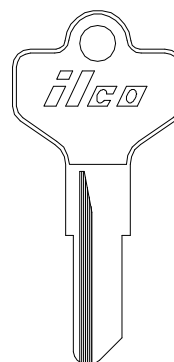

D1098B  
DE2

ILCO  
EZ

DEXTER / MASTER

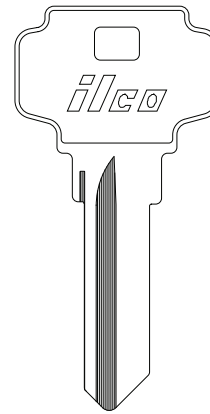
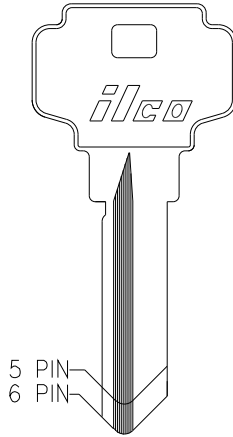
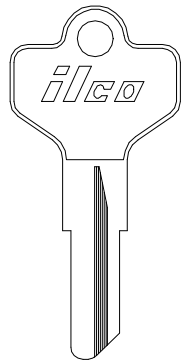
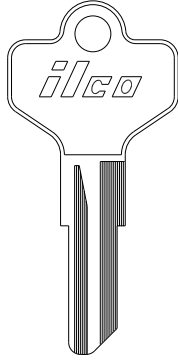

**D1098BM**

**D1098X**

5 PIN  
**D1145**    6 PIN  
**D1145A**

**DS1145**

—

DE4

—

—

DE9

ILCO  
EZ

NORTH AMERICAN  
CYLINDER

sec 2    page 21

DEXTER / MASTER



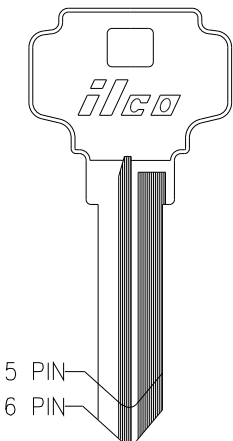
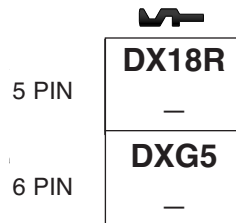
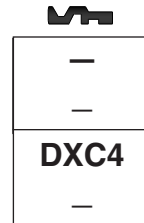
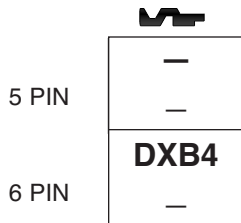



5 PIN	<b>DXB10</b>	<b>DXB20</b>	<b>DXB30</b>	<b>DXC10</b>	<b>DXC20</b>	<b>DXC30</b>	<b>DXD10</b>	<b>DXD20</b>	<b>DXD30</b>
	—	—	—	—	—	—	—	—	—
6 PIN	<b>DXB1</b>	<b>DXB2</b>	<b>DXB3</b>	<b>DXC1</b>	<b>DXC2</b>	<b>DXC3</b>	<b>DXD1</b>	<b>DXD2</b>	<b>DXD3</b>
	—	—	—	—	—	—	—	—	—

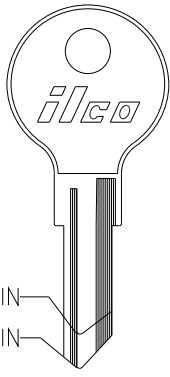

5 PIN  
6 PIN

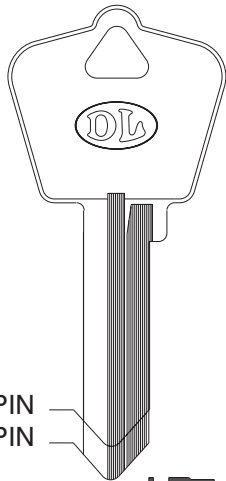
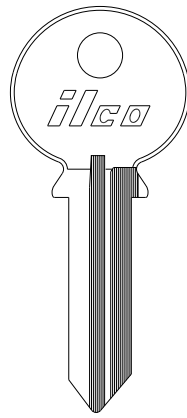
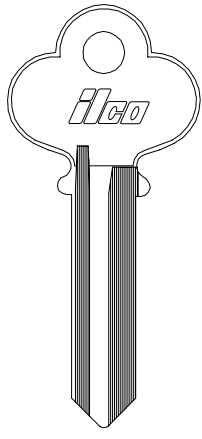
DOMINION LOCK







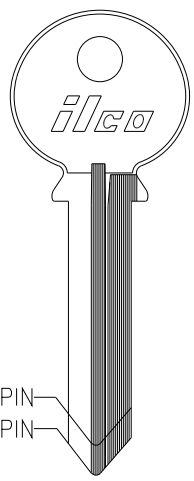
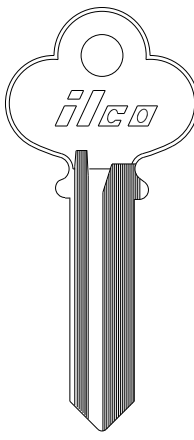
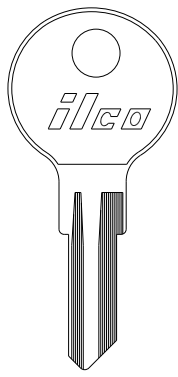
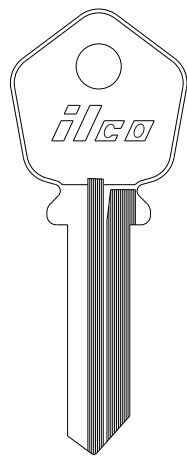
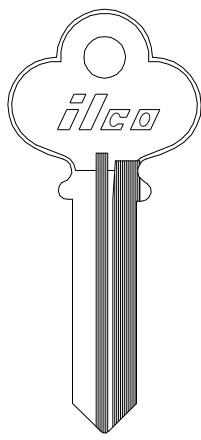

NORTH AMERICAN  
CYLINDER

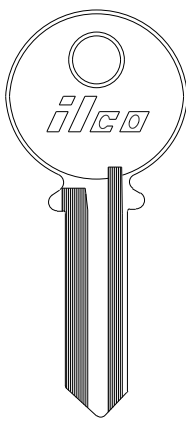
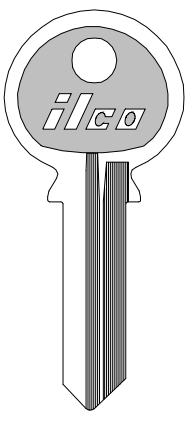
	5 PIN <b>D03</b> —	6 PIN  <b>D04</b> —			
5 PIN 6 PIN			5 PIN 6 PIN		
	5 PIN <b>D01</b> —	6 PIN <b>D02</b> —	5 PIN <b>D05</b> —	6 PIN  <b>D06</b> —	 <b>5F</b> —
				 <b>22PO</b> —	<b>ILCO</b> EZ

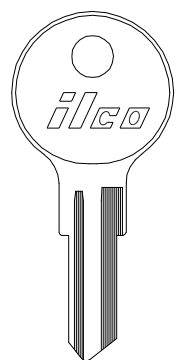
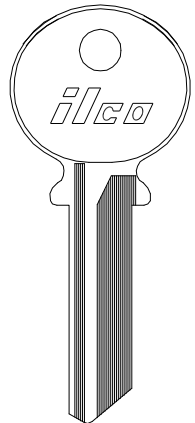
DOMINION LOCK

				
6 PIN 7 PIN				
6 PIN <b>54FA</b> —	7 PIN <b>54FL</b> —	<b>54KP</b> —	<b>N54B</b> —	<b>A54F</b> —
				<b>P54F</b> —
				<b>ILCO</b> EZ

DOMINION LOCK

				
				
<b>S54F</b> —	<b>S54F-PC</b> —	<b>T54F</b> —	<b>N54G</b> —	<b>L54K</b> —
				<b>ILCO</b> EZ

DOMINION LOCK

ILCO EZ						
	752	750	757	L1054B	H1054F	L1054F
	—	—	—	—	—	—

NORTH AMERICAN  
CYLINDER

DONNER DURA STEEL DYNALOCK EAGLE LOCK

ILCO EZ				SEE ILCO	
	1176 KW1	KW1-PC	H1054SR		1013
	—	—	—		—

sec 2 page 23

EAGLE LOCK

ILCO EZ					6 PIN 1014A
					—
	1013C	1013DL	1013F	5 PIN 1014 EA1	—
	—	—	—	—	—



EAGLE LOCK

 5 PIN <b>1014DR</b> —	 6 PIN <b>A1014DR</b> —	 <b>1014K</b> —	 <b>1014CE</b> —	 5 PIN <b>1014D</b> —	 6 PIN <b>1014DA</b> —	 <b>1014DB</b> —	 4 PIN <b>1014DS</b> —	 5 PIN <b>1014DX</b> EA13	ILCO EZ
---------------------------------	----------------------------------	-----------------------	------------------------	--------------------------------	---------------------------------	------------------------	---------------------------------	------------------------------------	------------

NORTH AMERICAN CYLINDER

sec 2 page 24

EAGLE LOCK

 <b>1014F</b> —	 <b>1014J</b> EA32	 <b>1014JM</b> —	 <b>1014JS</b> —	 <b>L1014D</b> —	 4 PIN <b>O1014JS</b> —	 5 PIN <b>O1014J</b> —	ILCO EZ
-----------------------	--------------------------	------------------------	------------------------	------------------------	----------------------------------	---------------------------------	------------

EAGLE LOCK

EAGLE PADLOCK

 4 PIN <b>O1014JM</b> —	 5 PIN <b>O1014SM</b> —	 <b>O1014K</b> —	 <b>O1014P</b> —	 <b>O1014S</b> —	 <b>X1014F</b> EA27	 <b>1521</b> —	ILCO EZ
----------------------------------	----------------------------------	------------------------	------------------------	------------------------	---------------------------	----------------------	------------

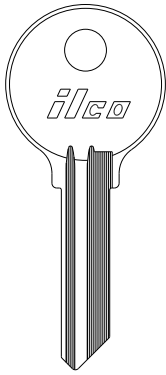
**EAGLE PADLOCK**
**EARLE**
**ELGIN**

**1533**

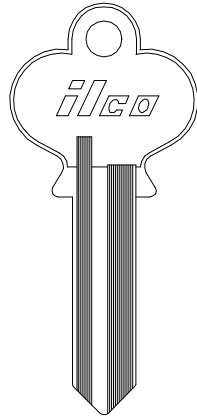
—

**1119**

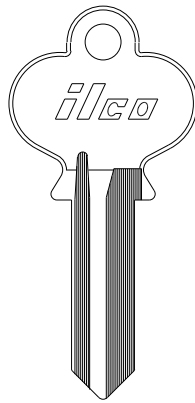
ER1

**1119S**

—

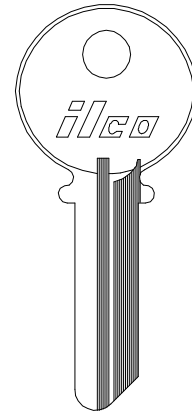
**1096**

EL2

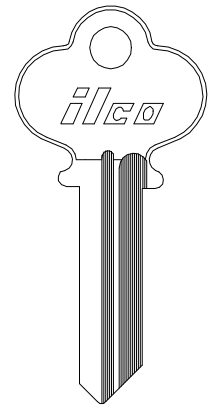
**1096C**

EL1

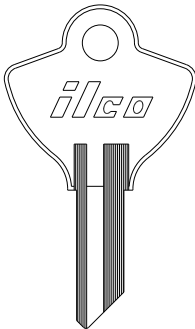
**ILCO  
EZ**
**ELGIN**

**1096EN**

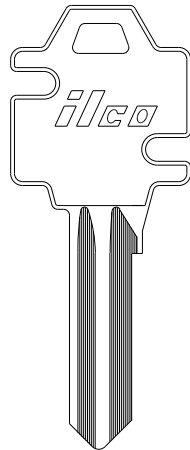
—

**R1096EN**

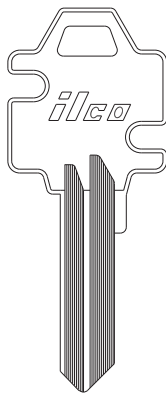
EL21

**1096FL**

—

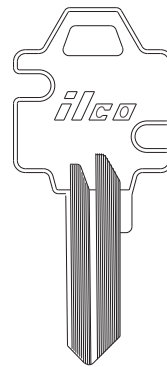
**1096FM**

—

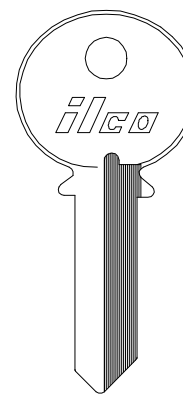
**1096FS**

—

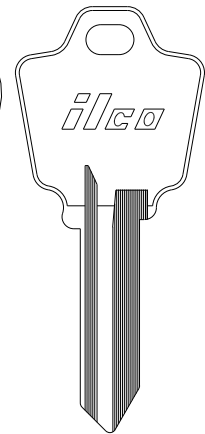
**1096L**

EL3

**ILCO  
EZ**
**1096NL**

—

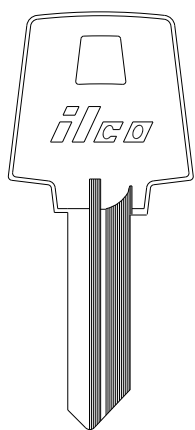
**ELGIN**

**C1096C**

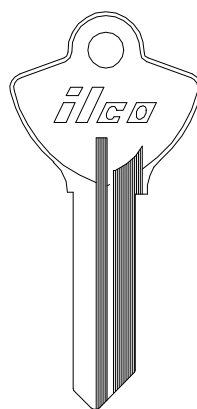
—

**C1096CN**

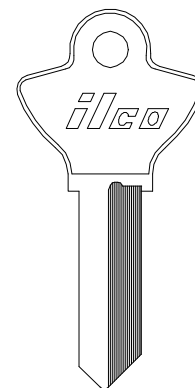
EL10

**C1096LN**

EL11

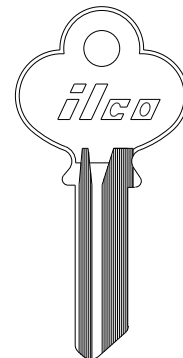
**EB1096K**

—

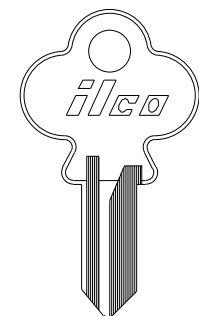



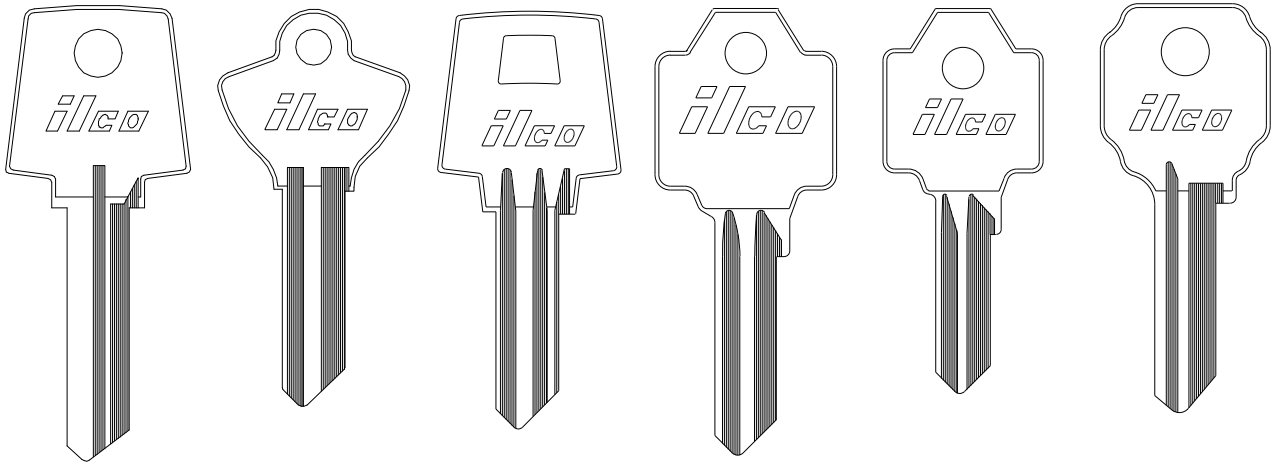

**EO1096K**

—

**ILCO  
EZ**

ELGIN



					
<b>L1096CN</b> EL15	<b>S1096B</b> EL20	<b>S1096C</b> —	<b>S1096FL</b> —	<b>S1096FM</b> —	<b>S1096G</b> —

ILCO  
EZ

sec 2 page 26



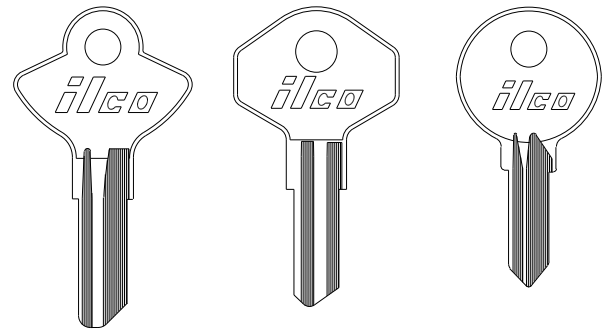

ELGIN

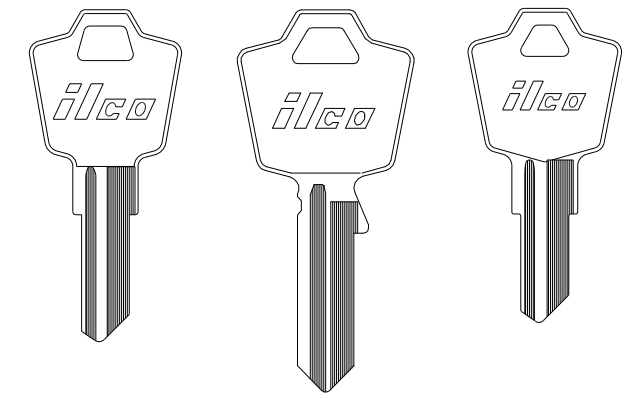

		
<b>S1096JN</b> —	<b>S1096P</b> —	<b>1154C</b> —

ESP



			
<b>1502</b> —	<b>1502M</b> — (MASTER)	<b>1503</b> ES9	<b>1531</b> —

ILCO  
EZ









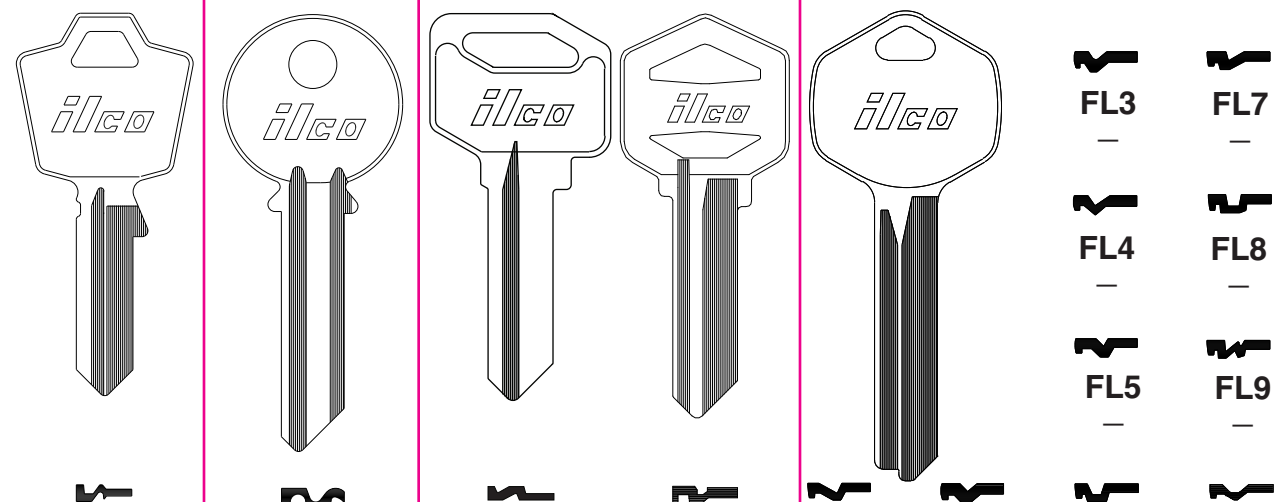



ESP

EXCEL

EZ SET

FALCON



							
<b>1556</b> —	<b>EX1</b> —	<b>1647</b> EZ2	<b>1522</b> EZ1	<b>FL1</b> —	<b>FL2</b> —	<b>FL3</b> —	<b>FL7</b> —
							
						<b>FL4</b> —	<b>FL8</b> —
							
						<b>FL5</b> —	<b>FL9</b> —
							
						<b>FL6</b> —	<b>FL10</b> —

ILCO  
EZ

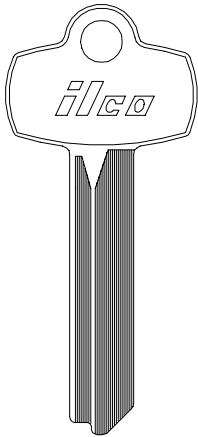
**FALCON**

(MASTER)  
**A1114FM**

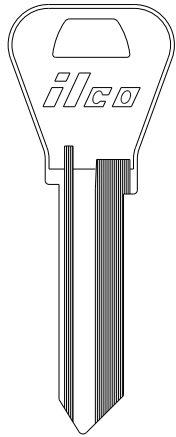

**FL5G**

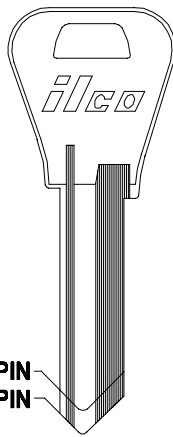

5 PIN 6 PIN  
**1054WB A1054WB**  
— WR4

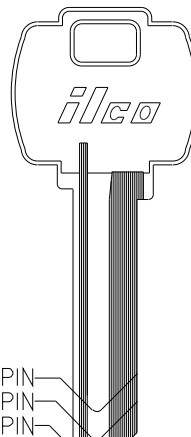

6 PIN  
**A1054WC**  
FA2

7 PIN  
**L1054WC**  
—

5 PIN  
**1054WC**  
FA1

ILCO  
EZ

NORTH AMERICAN  
CYLINDER

sec 2 page 27

**FALCON**

ILCO  
EZ

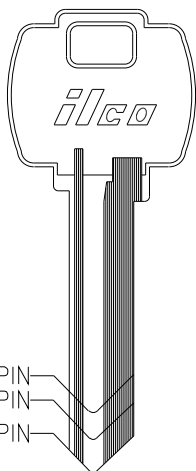
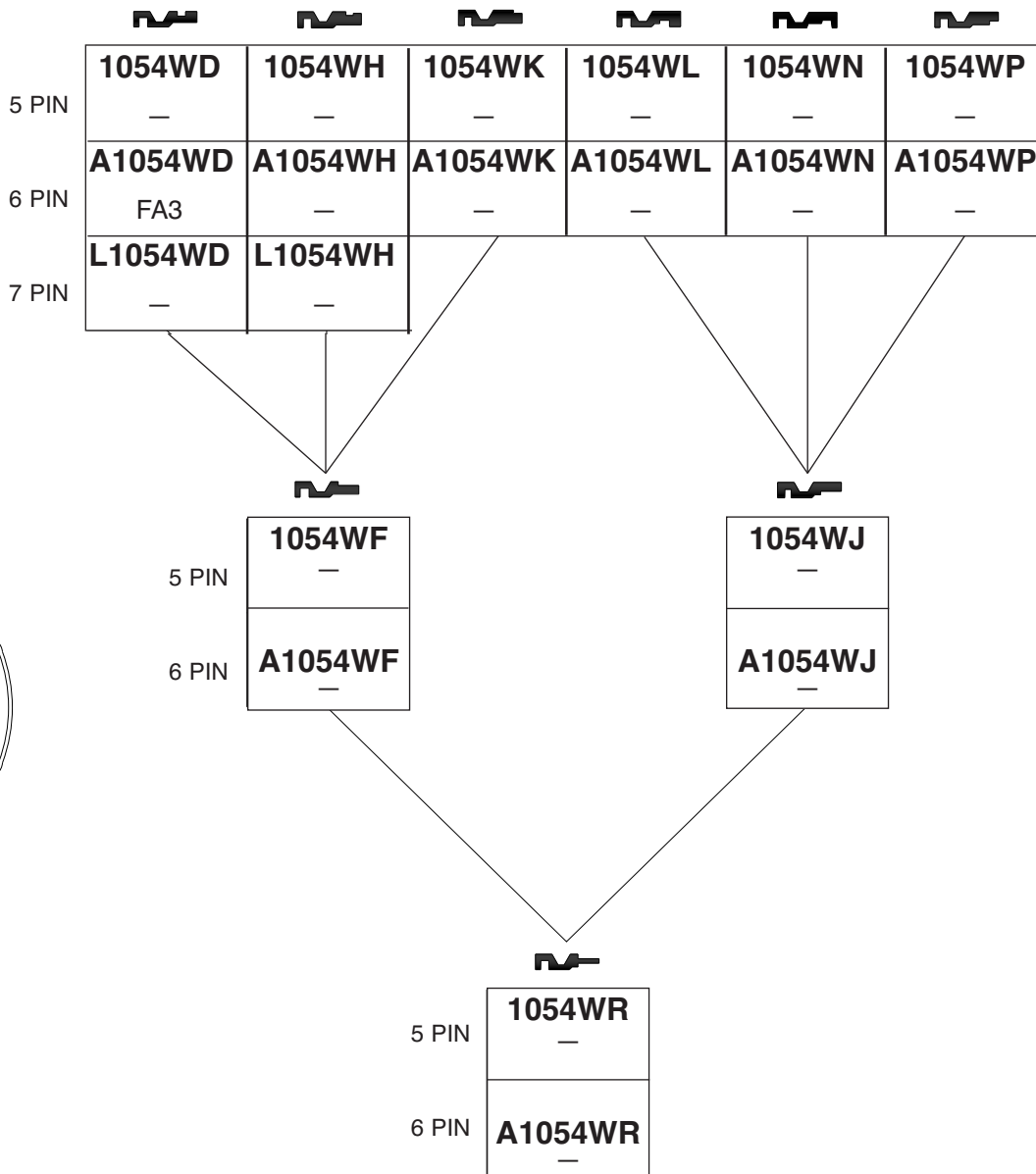

NORTH AMERICAN CYLINDER

sec 2 page 28

FANAL				FIC	FORT
<b>R63</b>	<b>R64</b>	<b>1551</b>	<b>1552</b>	<b>1617</b> FIC1	<b>M54G</b>
—	—	—	—	—	—

ILCO  
EZ

FORT					
<b>ML54G</b>	<b>N54G</b>	<b>S54G</b>	<b>1054G</b>	<b>752</b>	<b>757</b>
—	—	—	—	—	—

5 PIN  
**1054G**  
—  
6 PIN  
**L1054G**  
FR2

4 PIN  
5 PIN  
6 PIN

ILCO  
EZ

FORT		FRAIM	FULTON HITCH	
<b>775</b>	<b>1137B</b>	<b>1073</b>	<b>1073K</b>	<b>1645</b>
—	—	—	—	—

OD .377" - 9.6mm  
ID .312" - 7.9mm  
(BRASS)

ILCO  
EZ

GENERAL

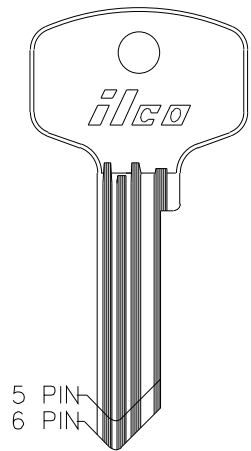

5 PIN	<b>G191</b> —	<b>G192</b> —	<b>G193</b> —	<b>G194</b> —
6 PIN	<b>G191A</b> —	<b>G192A</b> —	<b>G193A</b> —	<b>G194A</b> —

5 PIN	<b>G190B</b> —
6 PIN	<b>G190BA</b> —

ILCO  
EZ

NORTH AMERICAN  
CYLINDER

sec 2 page 29

GENERAL

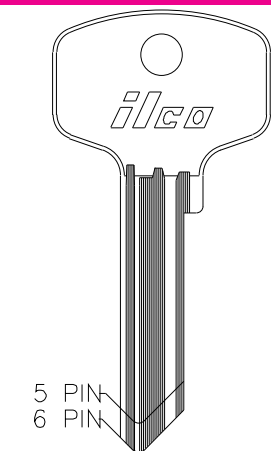

5 PIN	<b>G191</b> —	<b>G195</b> —	<b>G196</b> —	<b>G197</b> —
6 PIN	<b>G191A</b> —	<b>G195A</b> —	<b>G196A</b> —	— —

5 PIN	<b>G190C</b> —
6 PIN	<b>G190CA</b> —

ILCO  
EZ

GENERAL

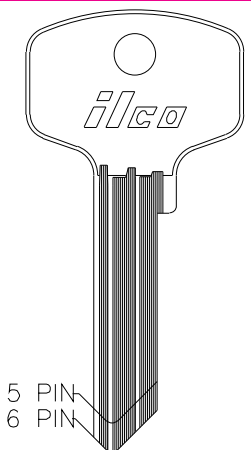

5 PIN	<b>G192</b> —	<b>G195</b> —	<b>G198</b> —	<b>G199</b> —	<b>G193</b> —	<b>G196</b> —	<b>G198</b> —	<b>G190</b> —
6 PIN	<b>G192A</b> —	<b>G195A</b> —	— —	— —	<b>G193A</b> —	<b>G196A</b> —	— —	<b>G190A</b> —

5 PIN	<b>G190D</b> —
6 PIN	<b>G190DA</b> —

5 PIN	<b>G190E</b> —
6 PIN	<b>G190EA</b> —

ILCO  
EZ

GENERAL

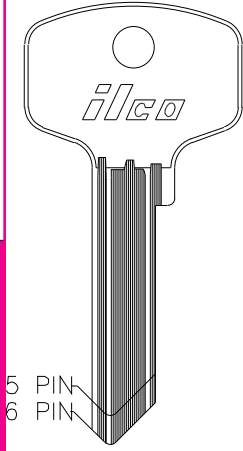

5 PIN	<b>G194</b>	<b>G197</b>	<b>G199</b>	<b>G190</b>
	—	—	—	—
6 PIN	<b>G194A</b>	—	—	<b>G190A</b>
	—	—	—	—

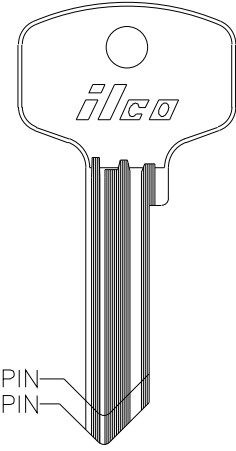

5 PIN	<b>G190F</b>
	—
6 PIN	<b>G190FA</b>
	—

5 PIN	<b>G190M</b>	<b>G190MA</b>
	—	—

ILCO  
EZ

NORTH AMERICAN  
CYLINDER

sec 2 page 30

GENERAL

GENERAL FIRE  
PROOF SAFE

HARLOC

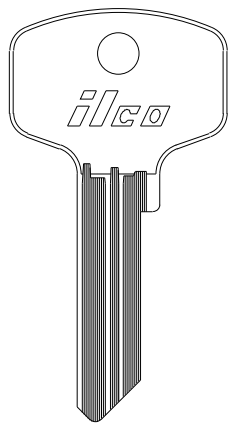

**G200**

—

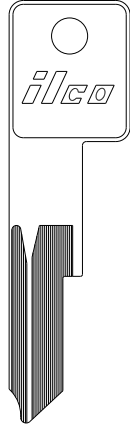

**GF1069**

—

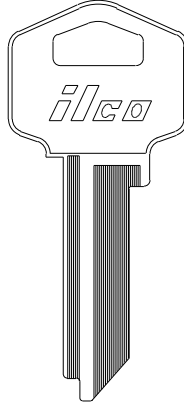

**TE3**  
HR2

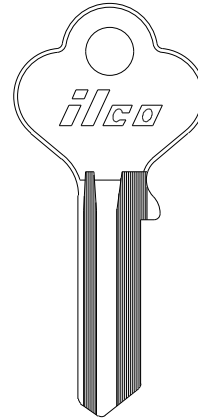

**1014B**

—

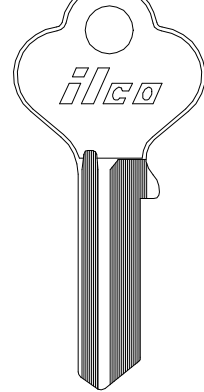

**1014C**  
HR1

ILCO  
EZ

HARLOC

HAWORTH

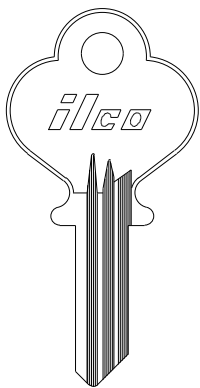

**1014D**

—

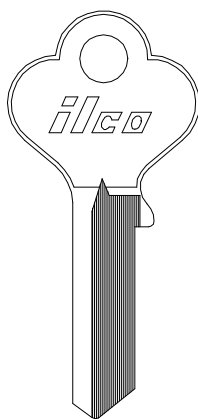

**X1014F**  
EA27

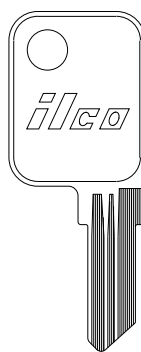

**1597**  
HAW1

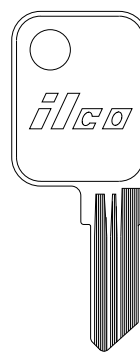

**1598**  
HAW2

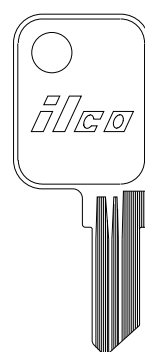

**1599**  
HAW3

ILCO  
EZ

**HAWORTH**

**HUBER**

**HUDSON**

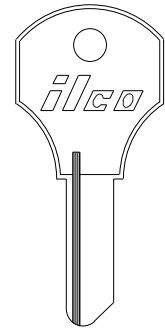
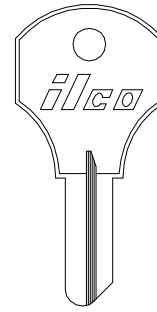
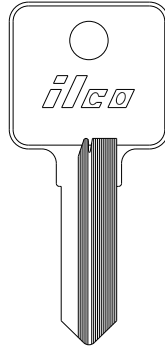
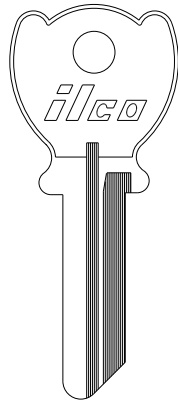
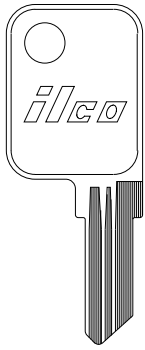

5 DISC

6 DISC



**1600**  
HAW4

**1020**  
—

**HL3**  
—

**S1000V**  
CO68

**1000V**  
CO26

**1000X**  
CO63

**1000XK**  
—

ILCO  
EZ

**HUDSON**

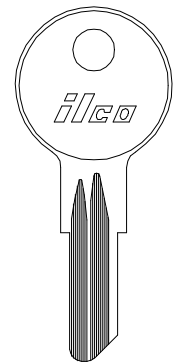
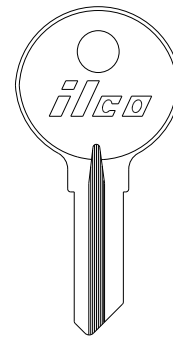
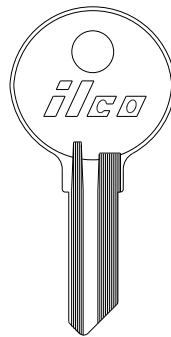
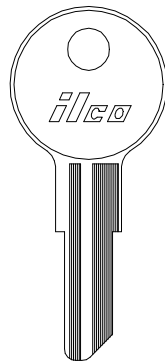
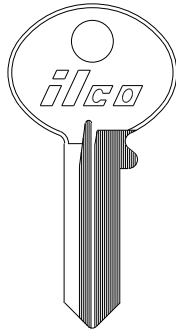

**1003M**  
CO106

**R1003M**  
BO1

**1041T**  
CG16

**1069**  
RO1

**1069B**  
—

**1098DB**  
B5

ILCO  
EZ

**HUDSON**

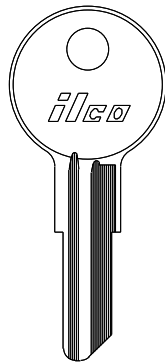
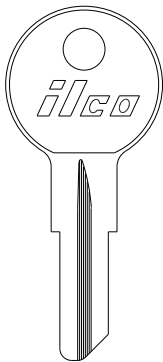

**O1122A**  
Y12

**O1122AR**  
Y14

**O1122B**  
Y103

**O1122BR**  
—

**O1122BE**  
—

**O1122C**  
—

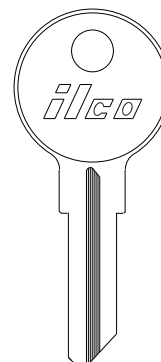

**1562**  
—

**1563**  
—

**1564**  
—



**1098X**  
—

**O1122**  
Y11

**O1122R**  
Y13

**1561**  
—

ILCO  
EZ



HUDSON HURD

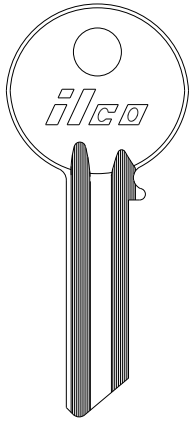

1512

—



1525

—

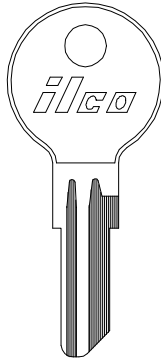

O1122A

Y12



O1122B

Y103

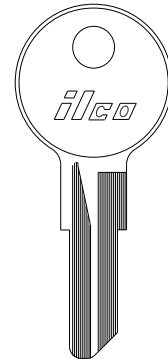

O1122C

—

ILCO  
EZ

HURD

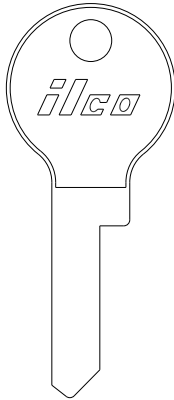

1125

H6

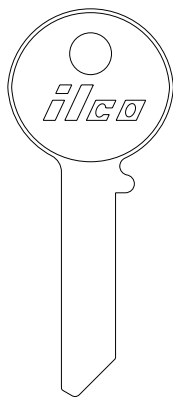

1125A

—

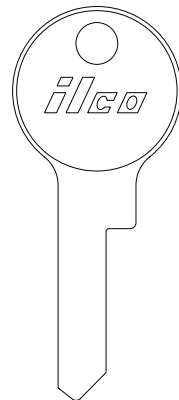

1125D

—

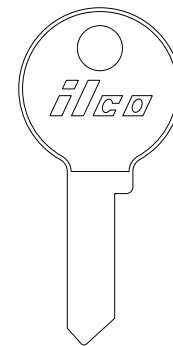

D1125

—

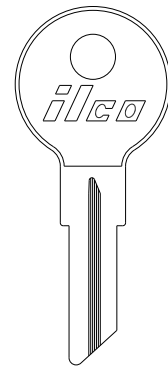

1125X

—

ILCO  
EZ

HURD IDEAL

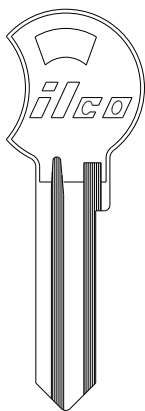

GP1125

—

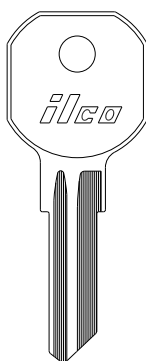

1536 1536R

—

—



1574 1574R

—

—

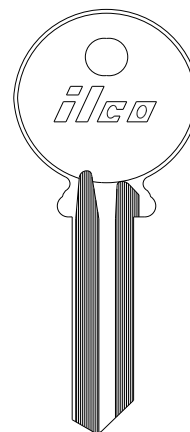

ID1

—

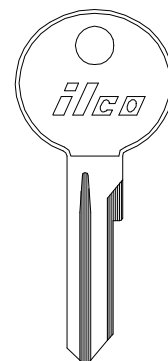

IS1

—

ILCO  
EZ

## IDEAL

## ILCO

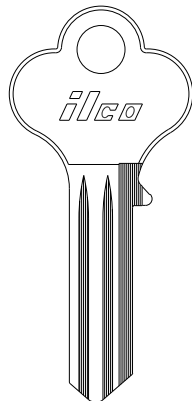
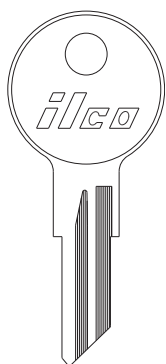
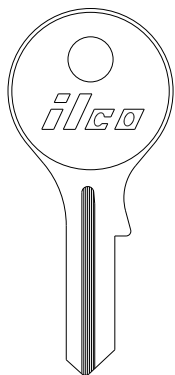
**64D**

—

**64RD**

—

**64G**

—

**1538**

—

**C20**

—

**C21**

—

**ILCO  
EZ**

## ILCO

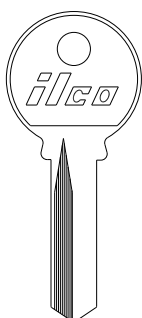
**C22**

—

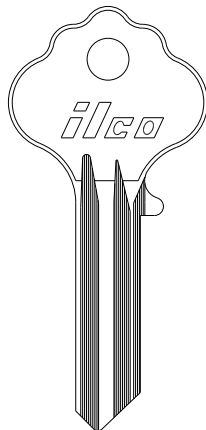
**X1053**

—

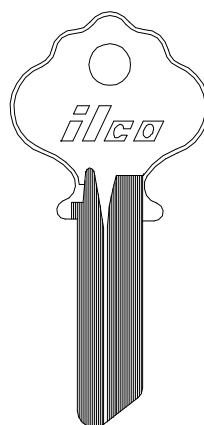
**1054**

IN2

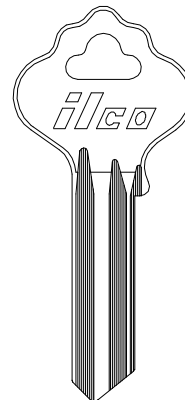
**1054DL**

IN35

**ILCO  
EZ**

## ILCO

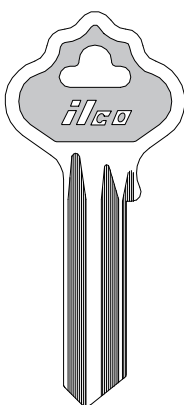
**IN35-PC**

—

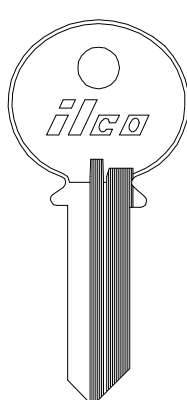
**1054F**

IN1

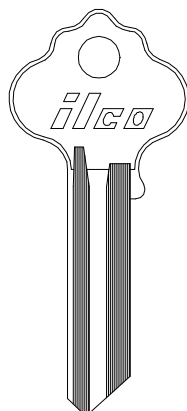
**1054FN**

IN28

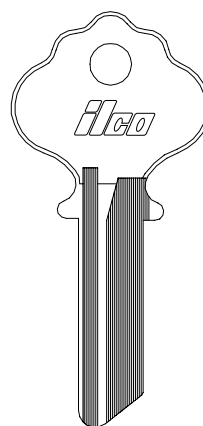
**1054K**

—

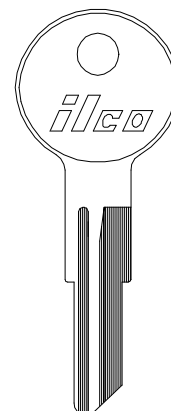
**1054LB**

IN4

**ILCO  
EZ**

ILCO

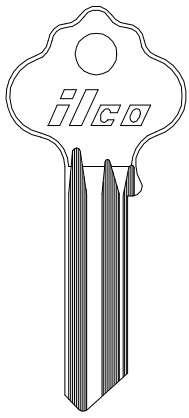

**1054MT**  
IN33

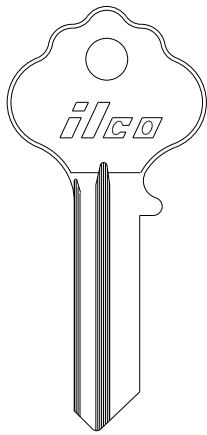

**1054R**  
—

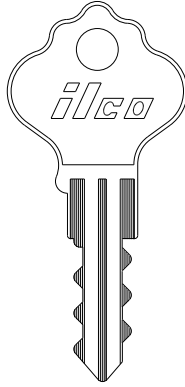

**1054N\***  
—

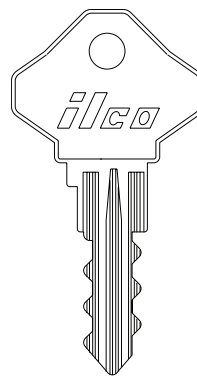

**1054P\***  
—

\* NOTE: This special blank is not a cut key. It is to be used the same as regular blanks for duplicating, cutting from code or from depth keys. It will save the locksmith 80% of his work, and the key can be cut more accurately and in less time. After cutting the special blank, when compared with the original keys, they will not be exactly alike in the pass cut positions, but this is not important as long as they match with the original where the tumblers rest on the key.

ILCO  
EZ

ILCO

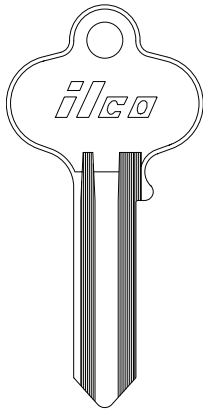

**1054TW**  
IN34

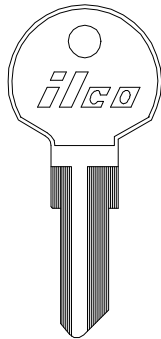

**1054UN**  
IN29

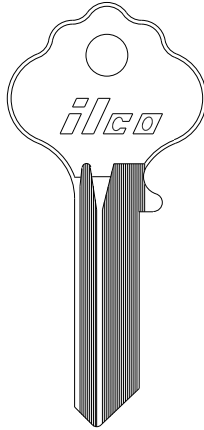

**1054X**  
—



**B1054B**  
—

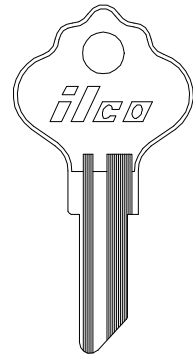

**H1054B**  
EL8

ILCO  
EZ

ILCO

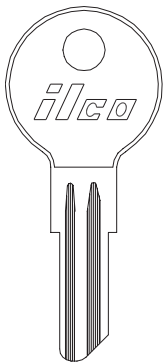

**H1054S**  
—



**H1054L**  
—

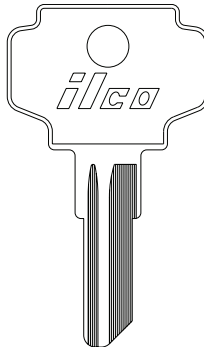

**K1054B**  
IN24

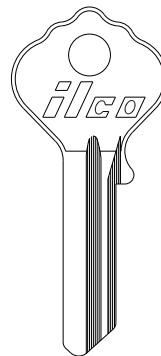

**L1054AR**  
—

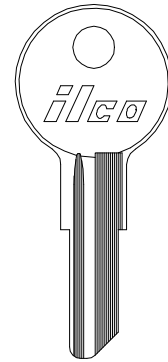

**L1054B**  
IN8

ILCO  
EZ

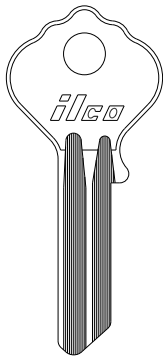
**ILCO****L1054JA**

—

**L1054JK**

—

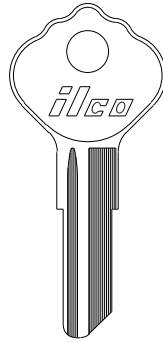
**M1054B**

—

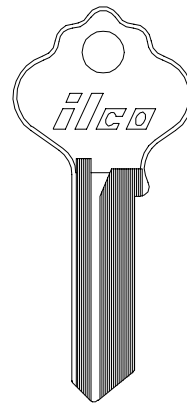
**N1054K**

in36

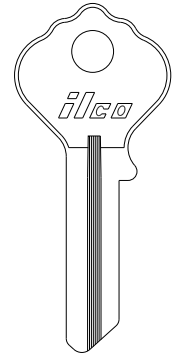
**X1054AR**

—

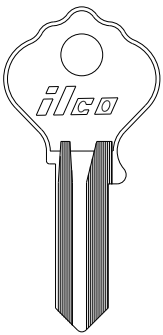
**ILCO  
EZ****ILCO****X1054BK**

—

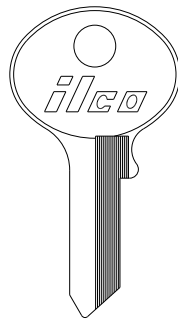
**X1054C**

—

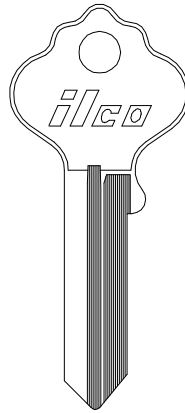
**X1054F**

IN18

**X1054GA**

—

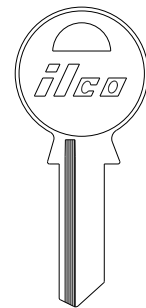
**X1054GB**

—

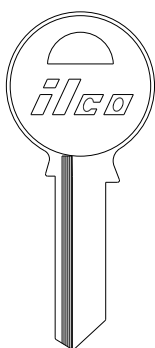
**ILCO  
EZ****ILCO****X1054GC**

—

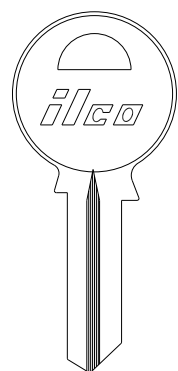
**X1054GD**

—

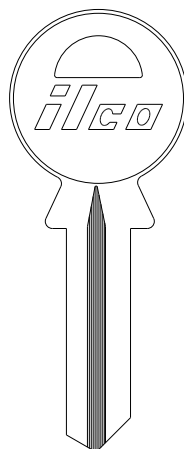
**X1054GE**

—

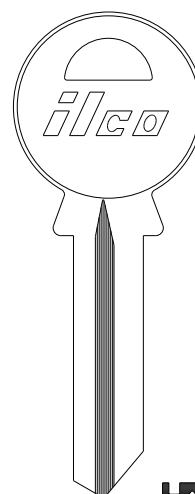
**X1054GF**

—

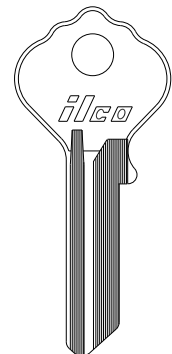
**X1054JA**

—

**ILCO  
EZ**

**ILCO**

			 <b>X1054KR</b> —	
			 <b>X1054LF</b> —	
			 <b>X1054LR</b> —	
 <b>X1054JK</b> —	 <b>X1054K</b> IN3	 <b>X1054KF</b> —	GOVERNMENT PADLOCKS	 <b>X1054SC</b> —

ILCO  
EZ

**ILCO**

	 <b>X1055GB</b> —			
	 <b>X1055JK</b> —			
	 <b>X1055JR</b> —			
 <b>X1055GA</b> —	GOVERNMENT PADLOCKS	 <b>1092TG-ILCO</b> —	<b>1118</b> —	 <b>1125A</b> —

ILCO  
EZ

**ILCO**

OD .377" - 9.6mm ID .312" - 7.9mm (BRASS) <b>1137B</b> —	 <b>1154C</b> —	 <b>1154G</b> —	 <b>1154GR</b> —

**ILLINOIS**

 <b>ILL1</b> —	 <b>ILL2</b> —	 <b>1041H</b> IL1	 <b>1041HM</b> —

ILCO  
EZ

## ILLINOIS

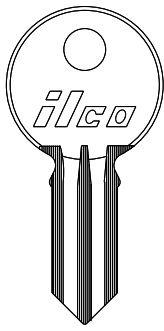
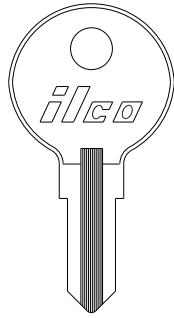
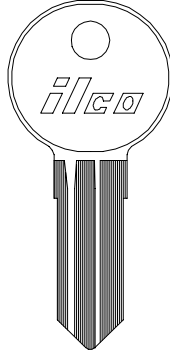
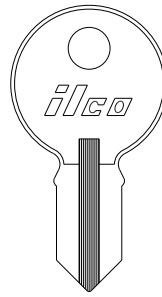
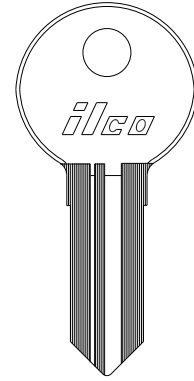
 1041P  
—

 1041S  
—

 1041W  
—

 S1041H  
—

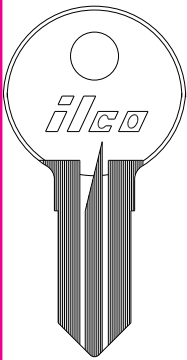
 1042A  
—



  
1042B  
—  
  
1042Z  
—

 ILCO  
EZ

## ILLINOIS

  
S1042ZM  
—

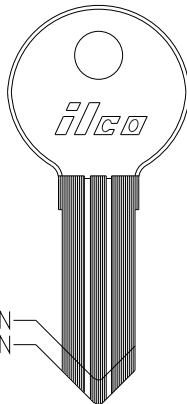
  
S1042ZP  
—

  
S1042ZS  
—

 5 PIN  
  
1041WC  
—

  
1043C  
—

  
1043D  
—

  
1043E  
—

 S1042Z  
—

 5 PIN 6 PIN  
 L1042A L1042B  
— —

 1043ED  
—

 1043B  
IL9  
—

 1043G  
—

 ILCO  
EZ

## ILLINOIS

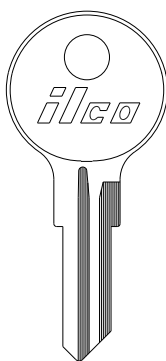
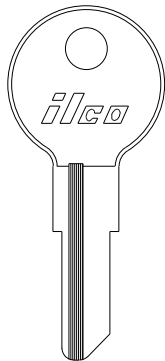
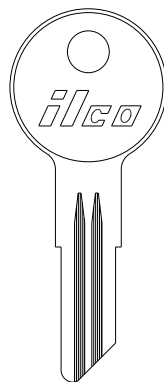
  
1043F  
—

  
1043J  
IL11

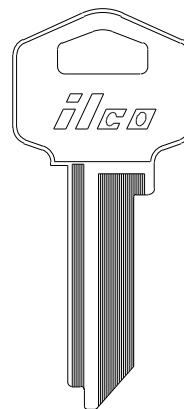
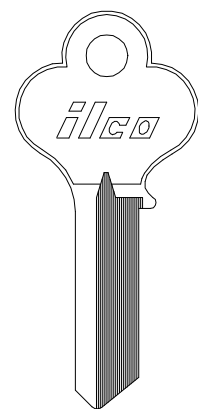
  
1043V  
—

## IMPORT

  
TE3  
HR2

  
X1014L  
LO1

 ILCO  
EZ

 NORTH AMERICAN  
CYLINDER

IMPORT



<b>1528</b>	<b>1528R</b>	<b>1537</b>	<b>1538</b>	<b>1541</b>	<b>1566</b>
—	—	CLP1	—	—	—

ILCO  
EZ

IMPORT G. R. KEY CO.

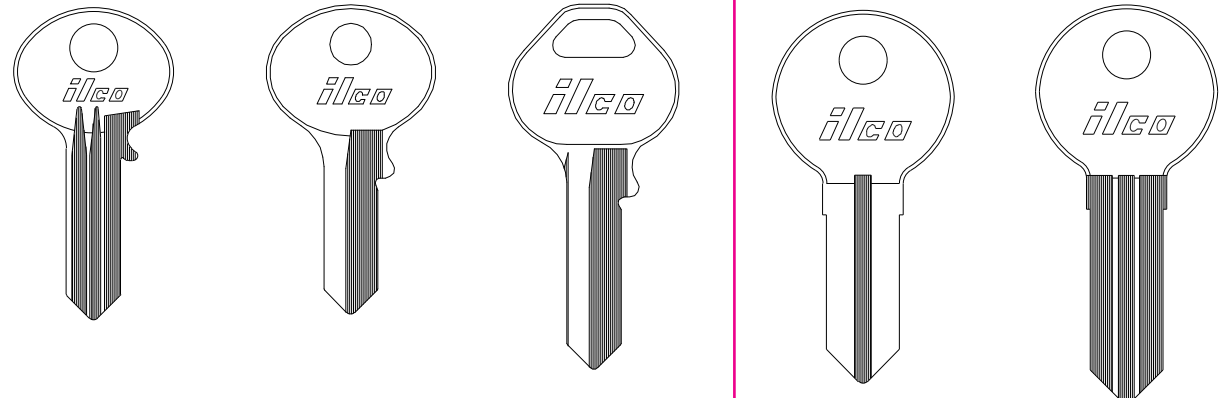

<b>1571</b>	<b>1092TG-ILCO</b>	<b>1092NTG</b>	<b>1042M</b>	<b>L1042M</b>	<b>L1042B</b>
—	—	—	—	—	—

ILCO  
EZ

KEIL KIMBALL

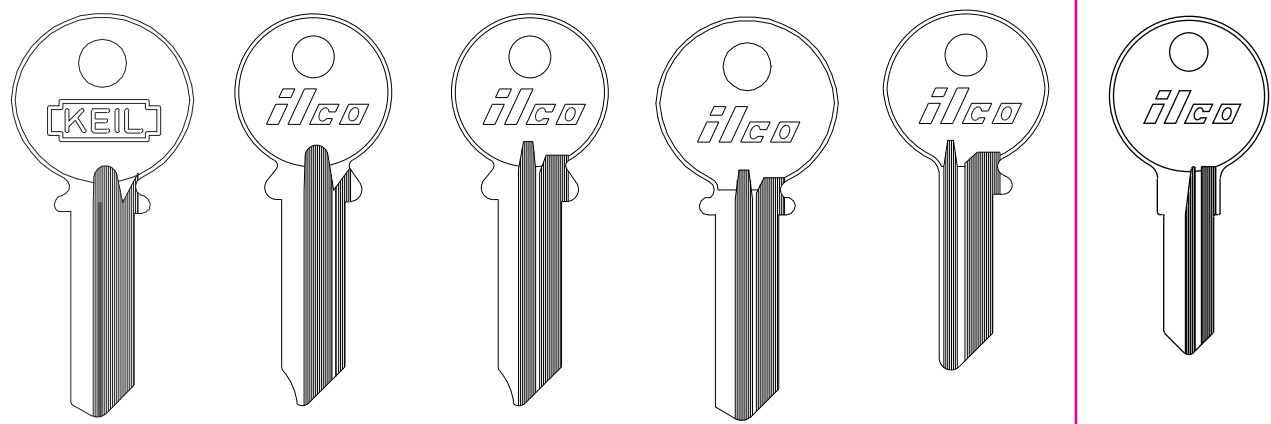

<b>1079</b>	<b>1079A</b>	<b>1079AB</b>	<b>1079B</b>	<b>1154ES</b>	<b>1649</b>
K1	—	—	K2	—	KB1

ILCO  
EZ

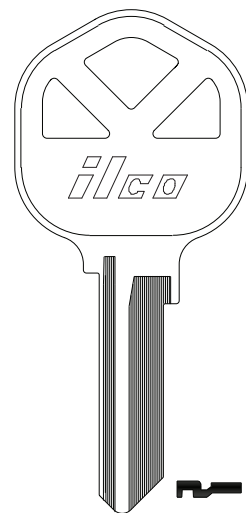
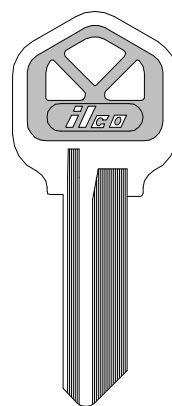
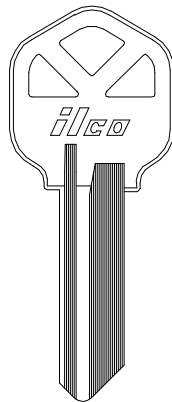
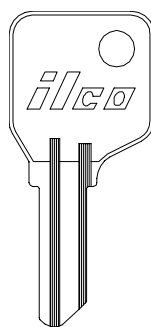
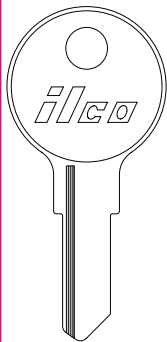
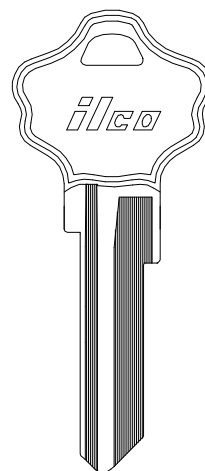
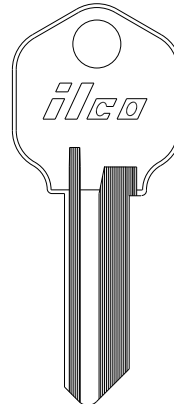
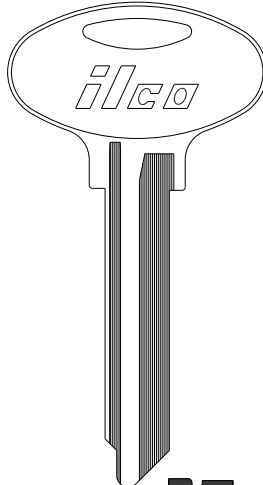
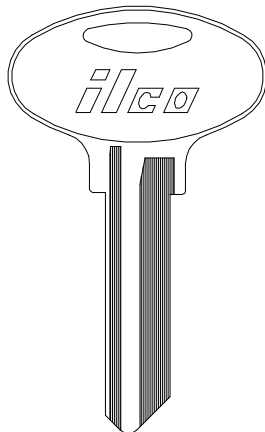
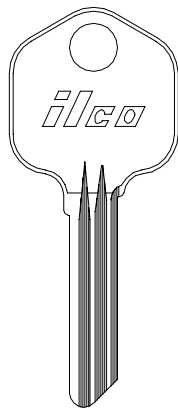
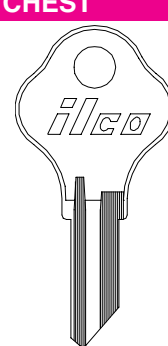
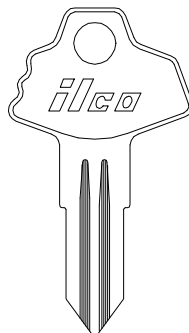
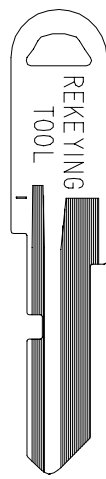
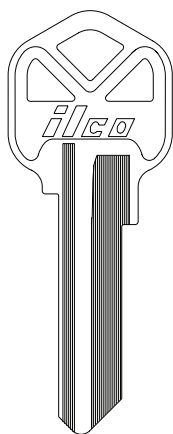
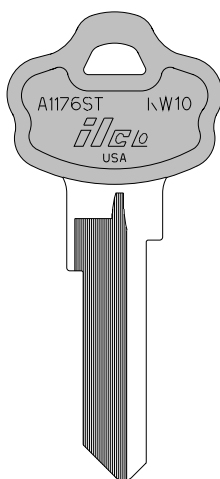
**KIMBALL**
**KRYPTONITE**
**KWIKSET**

**ILCO  
EZ**
**1654  
KB2**
**1663  
KB3**
**1567  
—**
**1176  
KW1**
**KW1-PC  
—**
**KW1-BIG  
—**
**KWIKSET**

**ILCO  
EZ**
**1176D  
—**
**A1176  
KW5**
**CR1176  
—**
**S1176  
—**
**A1176ST  
KW10**
**KWIKSET**
**LAGARD**
**LANE CEDAR  
CHEST**
**LARSON DOOR**

**ILCO  
EZ**
**KW10-PC  
—**
**A1176KT  
KW11**
**1176RK  
—**
**S900  
—**
**LC1069  
—**
**1639  
LD1**



LARSON DOOR	LOCK MEXICO		LOCK-O-PHONE LOCKWOOD	
				 6 PIN <b>1004A</b> L4  7 PIN <b>1004AL</b> —  5 PIN <b>1004</b> L1
<b>1640</b> LD2	<b>1553</b> —	<b>1585</b> —	<b>1154L</b> —	<b>1004</b> L1

ILCO  
EZ

**LOCKWOOD**

5 PIN 6 PIN	5 PIN 6 PIN	5 PIN 6 PIN	5 PIN 6 PIN			
<b>1004AX</b> —	<b>1004AXA</b> —	<b>1004XM</b> —	<b>1004AXM</b> —	<b>1004K</b> —	<b>1004KL</b> —	<b>1004L</b> —

ILCO  
EZ

**LOCKWOOD**

		5 PIN 6 PIN	5 PIN 6 PIN				
<b>1004M</b> —	<b>1004N</b> L13	<b>1004R</b> —	<b>1004AR</b> —	<b>1004SN</b> —	<b>H1004A</b> —	<b>1005</b> L2	<b>1006</b> —

ILCO  
EZ

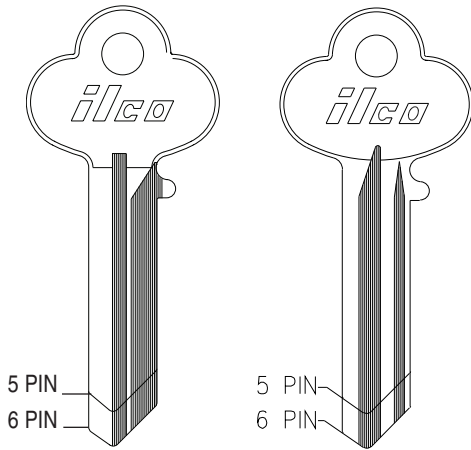
**LOCKWOOD**

5 PIN 6 PIN 5 PIN 6 PIN  
**1015 1015A 1015C A1015C**

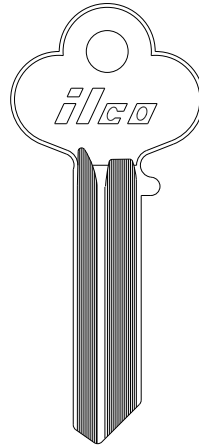

(MASTER)  
 6 PIN  
**A1015M**

<b>A1015L</b>	<b>A1015R</b>	<b>A1015V</b>
-	-	-
<b>A1015N</b>	<b>A1015S</b>	<b>A1015W</b>
-	-	-
<b>A1015P</b>	<b>A1015T</b>	<b>A1015X</b>
-	-	-
<b>A1015Q</b>	<b>A1015U</b>	<b>A1015Y</b>
-	-	-

ILCO  
EZ

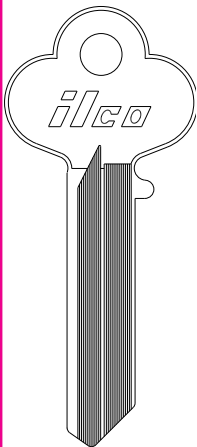
**LOCKWOOD**
**LSDA**

(MASTER)

**A1015MR**

<b>A1015LR</b>	<b>A1015RR</b>	<b>A1015VR</b>
-	-	-
<b>A1015NR</b>	<b>A1015SR</b>	<b>A1015WR</b>
-	-	-
<b>A1015PR</b>	<b>A1015TR</b>	<b>A1015XR</b>
-	-	-
<b>A1015QR</b>	<b>A1015UR</b>	<b>A1015YR</b>
-	-	-

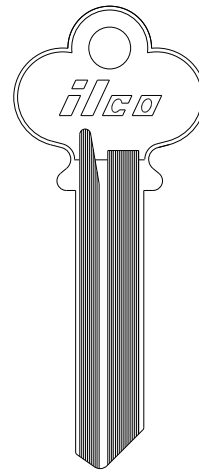

7 PIN 7 PIN

**L1015M L1015MR**  
 -(MASTER)-

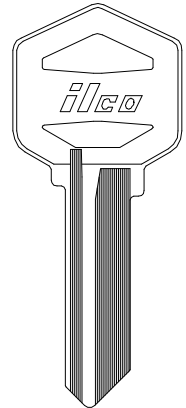

**1522**  
 EZ1

ILCO  
EZ

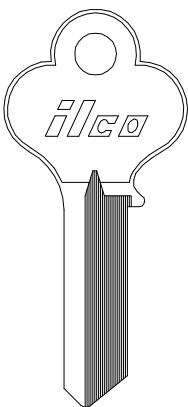
**LORI**
**MASTER**

**X1014L**  
 LO1

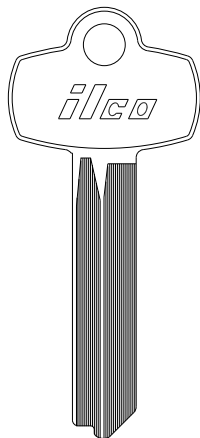

**1615**  
 -

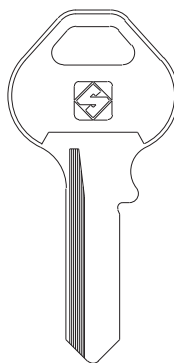

**MS4R**  
 -

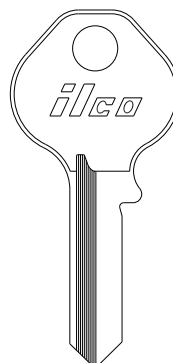

**MA7**  
 -



**1092**  
 M1



**1092R**  
 -

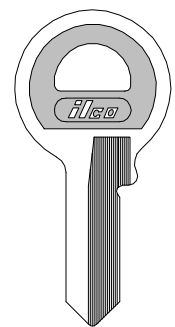

**M1-PC**  
 M1-PC

ILCO  
EZ

MASTER

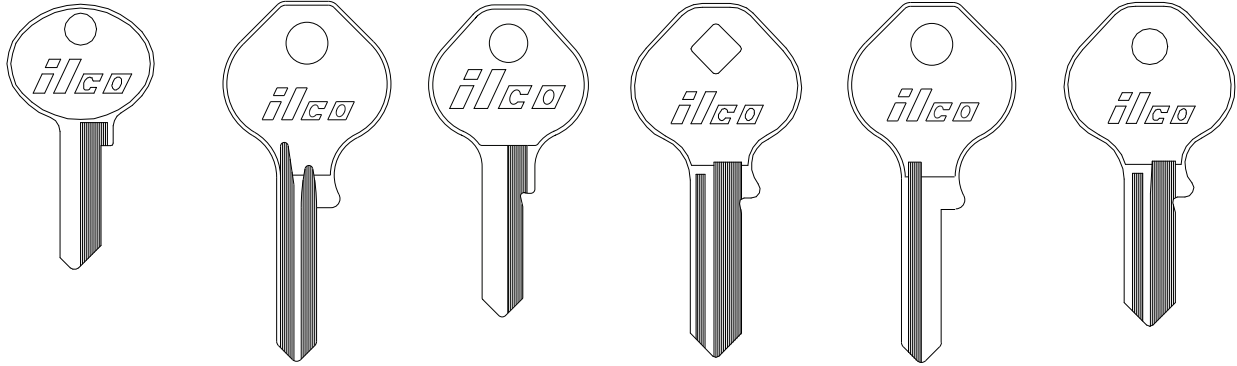

<b>1092B</b> M2	<b>1092C</b> M17	<b>1092CNTLBI</b> —	<b>1092D</b> M12	<b>1092DD</b> —	<b>1092E</b> —	<b>1092DS</b> M13

ILCO  
EZ

MASTER

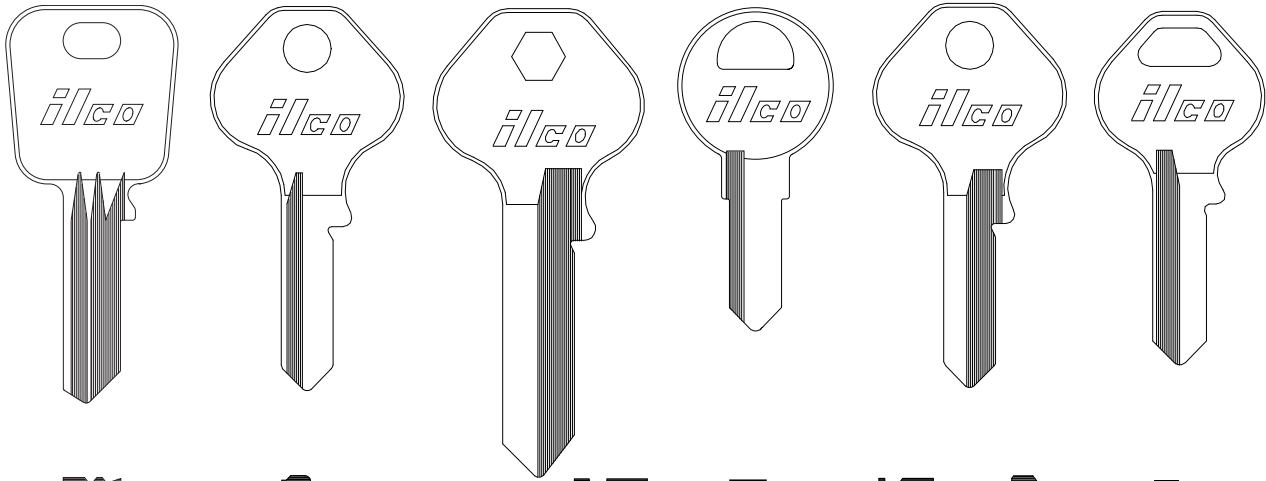

<b>1092F</b> M27	<b>1092H</b> M11	<b>1092J</b> M14	<b>1092K</b> M28	<b>1092N</b> M10	<b>1092NR</b> M16	<b>1092V</b> M4

ILCO  
EZ

MASTER

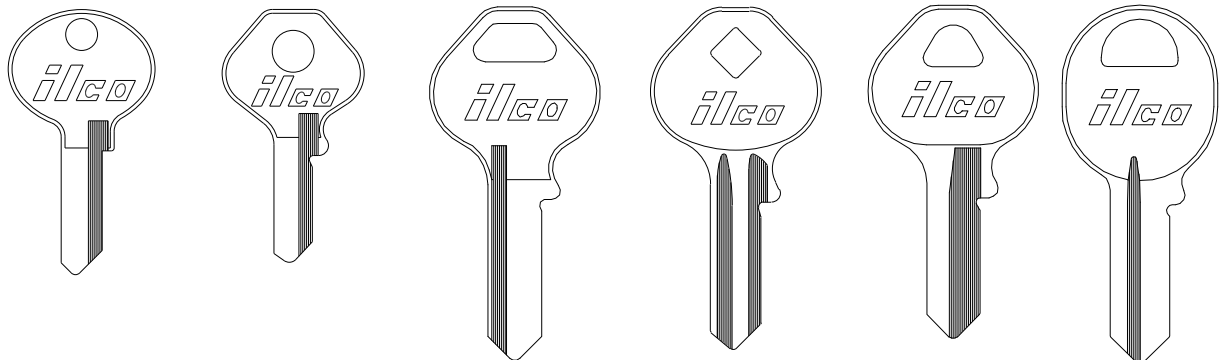

<b>1092VA</b> —	<b>1092VR</b> M3	<b>1092VB</b> —	<b>1092VM</b> M5	<b>1092-40</b> M18	<b>1092-52</b> —	<b>1092-600A</b> —

ILCO  
EZ

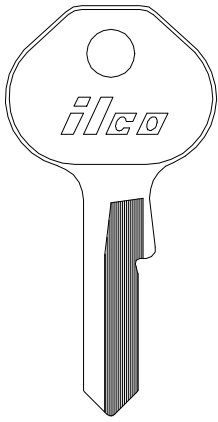
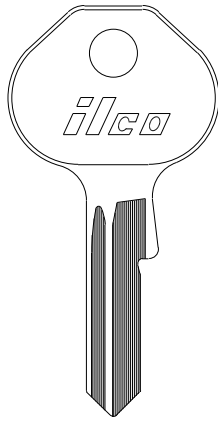
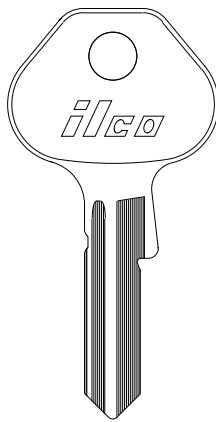
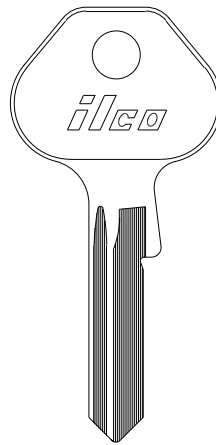
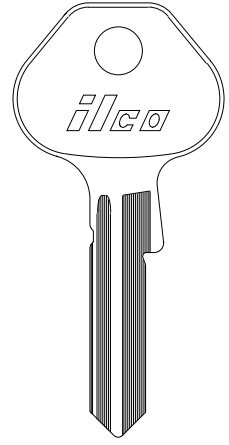
**MASTER**

**1092-900**  
M19

**1092-6000**  
M20

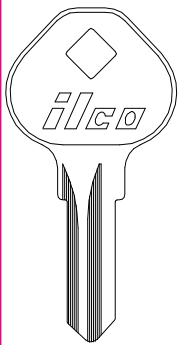
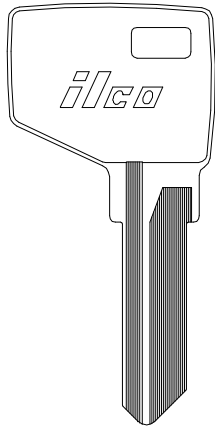
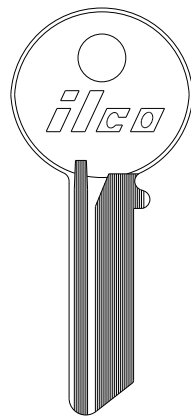
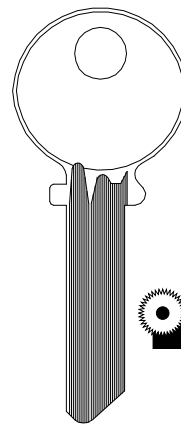
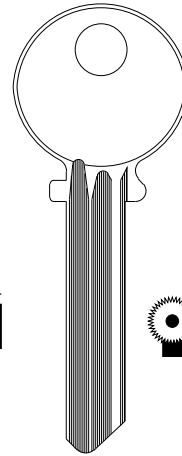
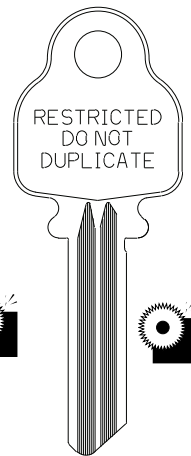
**1092-6000B**  
M25

**1092-7000**  
M21

**1092-7000B**  
M26

**ILCO**  
EZ

**NORTH AMERICAN**  
CYLINDER

**MASTER**
**MCKINNEY**
**MEDECO**

**1092-8105**  
—

**MD1054K**  
—

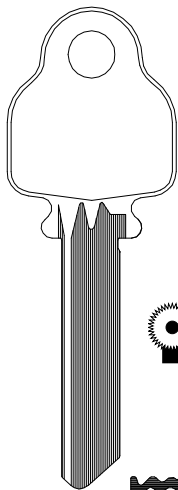
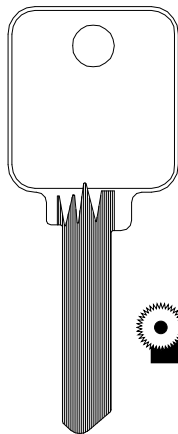
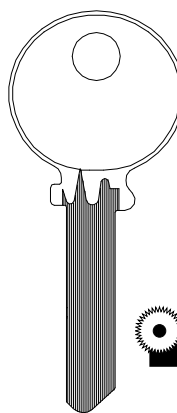
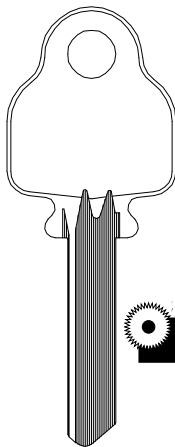
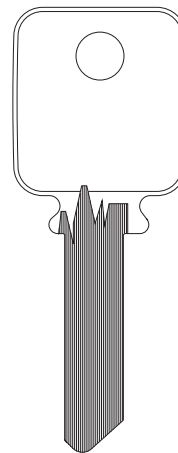
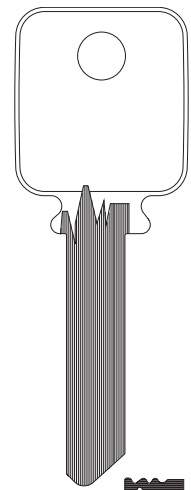
**O1054K O1054KR**  
—

**1515**  
—

**A1515**  
—

**1517**  
—

**ILCO**  
EZ

sec 2 page 43

**MEDECO**

**A1517**  
—

**1518**  
—

**1542**  
—

**1543**  
—

**1638**  
—

**A1638**  
—

**ILCO**  
EZ

MEDECO		METALROUSSEAU					
1644	1655	MR1	5 PIN MR3	6 PIN MR2	4 PIN H64S	5 PIN H64	M64
—	—	—	—	—	—	—	—

ILCO  
EZ

MINTCRAFT PADLOCK NATIONAL CASH REGISTER						
1643	NC1	NC2	NC3	NC96K	NC96M	
—	—	—	—	—	—	

ILCO  
EZ

NATIONAL CASH REGISTER							
X1000FR	1083	1083C	1083H	1083J	1083K	1083P	
—	—	—	—	—	—	—	
					1083L	1083R	
					—	—	
					1083M	1083S	
					—	—	
					1083N	1083T	
					—	—	

ILCO  
EZ

NATIONAL E-Z SET

NCL

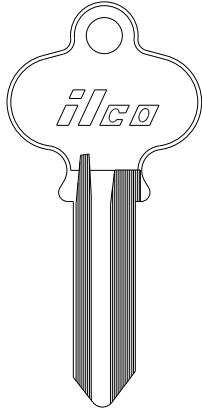

177  
—

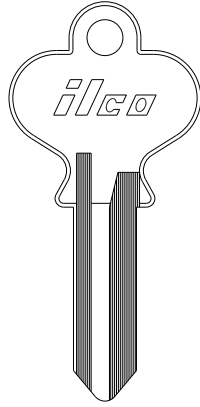

1177  
—

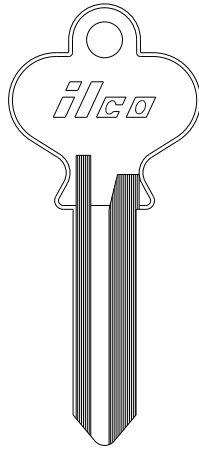

1177A  
—

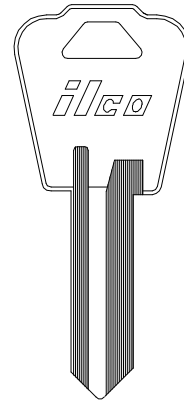

1177N  
NH1

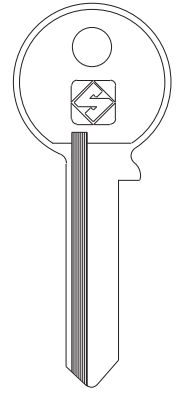

NCR1R  
—

ILCO  
EZ

NCL / NATIONAL CABINET

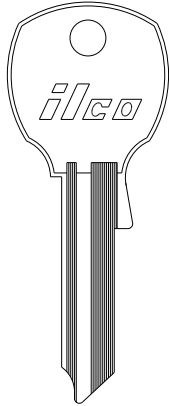

1028NR  
—



1064  
NA1

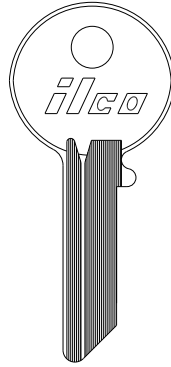

1064A  
—

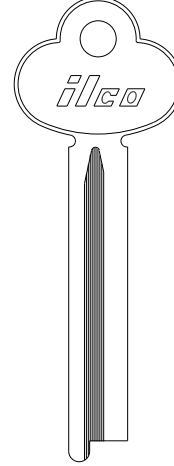

1064L  
—

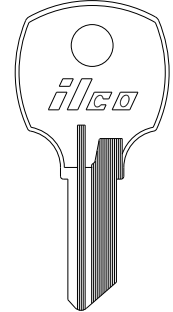

1064M  
—

ILCO  
EZ

NCL / NATIONAL CABINET

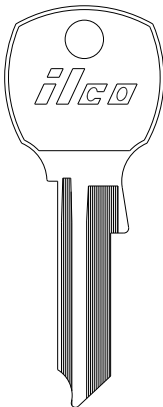

L1064C  
—

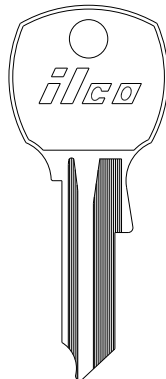

S1064A  
—



1065  
—



1065C  
—

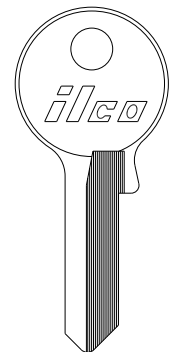

1065D  
—

ILCO  
EZ

NCL / NATIONAL CABINET

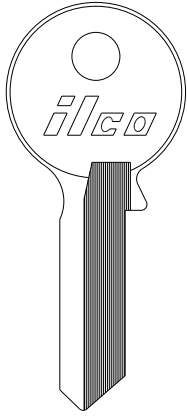

  
1065E  
—

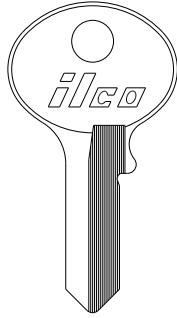

  
1065F  
—

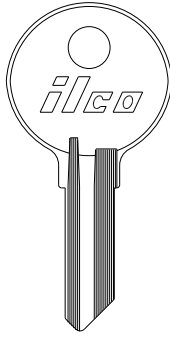

  
1069  
RO1

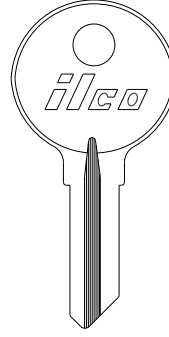

  
1069B  
—

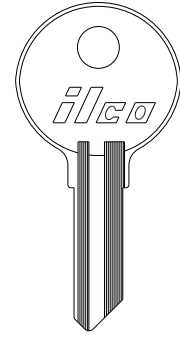

  
1069C  
—

ILCO  
EZ

NORTH AMERICAN  
CYLINDER

NCL / NATIONAL CABINET



  
1069D  
—

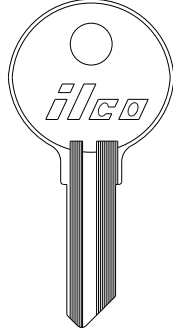

  
1069E  
RO14

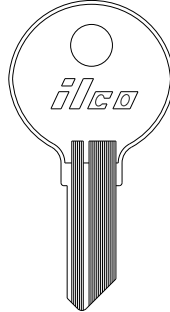

  
1069F  
—

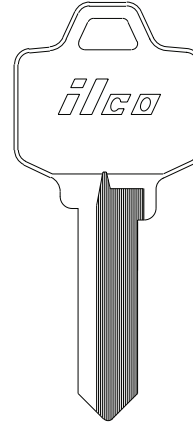

  
1069FN  
—

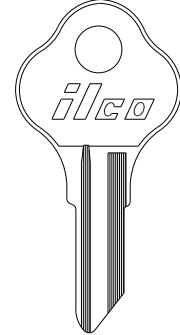

  
1069FNA  
—

ILCO  
EZ

NCL / NATIONAL CABINET



  
1069FL  
RO4

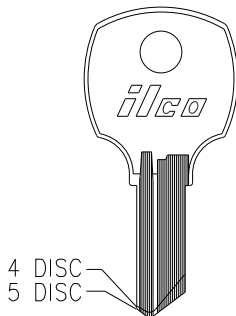

  
4 DISC 5 DISC  
S1069G 1069G  
— RO7

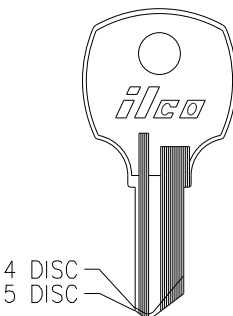

  
4 DISC 5 DISC  
S1069H 1069H  
— RO11

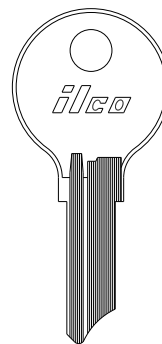

  
1069HN  
—



  
1069L R1069L  
NA14 —

ILCO  
EZ

NCL / NATIONAL CABINET

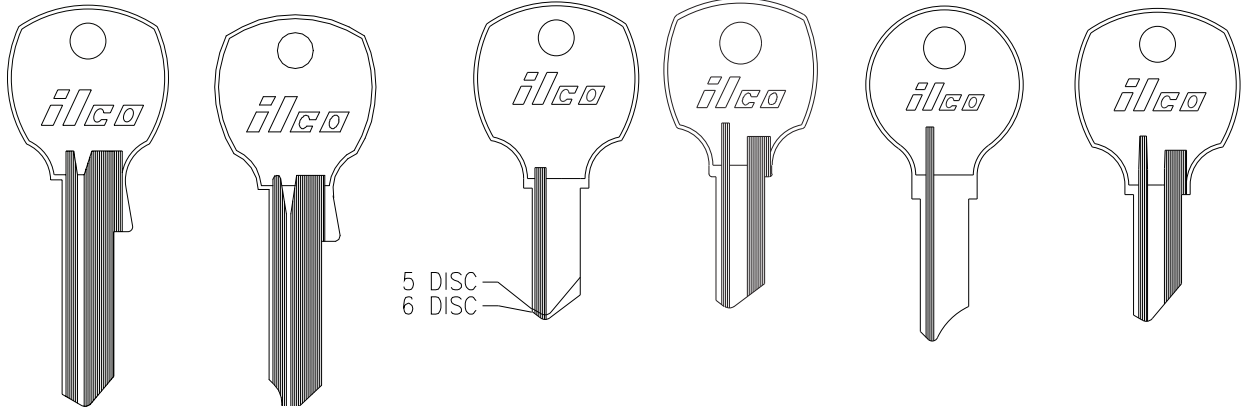

<b>1069LA</b>	<b>1069LB</b>	<b>1069LC</b>	<b>S1069M</b>	<b>1069M</b>	<b>1069N</b>	<b>1069P</b>	<b>1069S</b>
—	NA12	NA24	—	RO5	RO3	—	—

ILCO  
EZ

NCL / NATIONAL CABINET

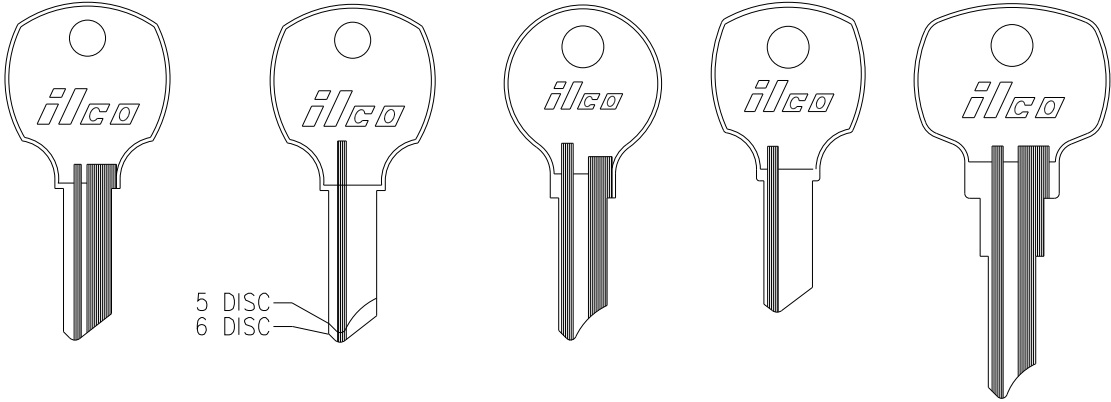

<b>1069SM</b>	<b>S1069T</b>	<b>1069T</b>	<b>1069W</b>	<b>1069YM</b>	<b>1069-5X</b>
—	—	—	—	—	—

ILCO  
EZ

	<b>1069-5Y</b>
—	—
	<b>1069-5Z</b>
—	—

NCL / NATIONAL CABINET

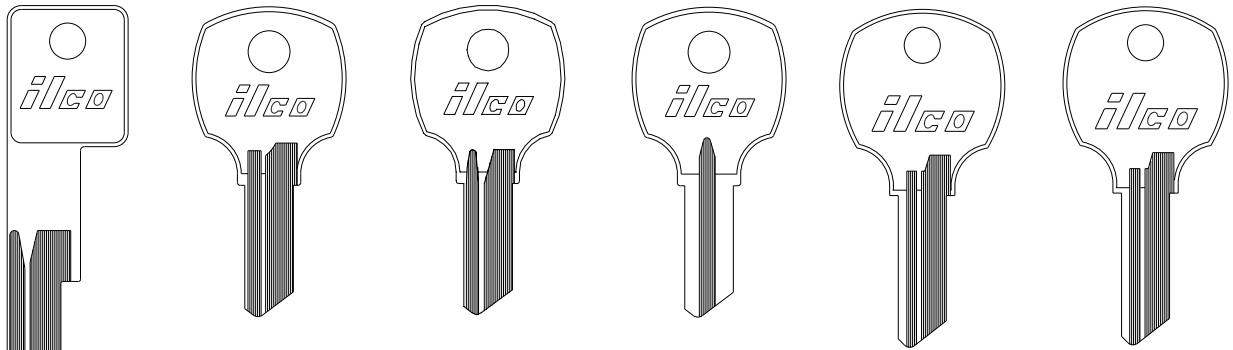

<b>GF1069</b>	<b>M1069C</b>	<b>M1069L</b>	<b>N1069B</b>	<b>N1069C</b>	<b>N1069E</b>
—	—	—	RO13	—	—

ILCO  
EZ



NCL / NATIONAL CABINET

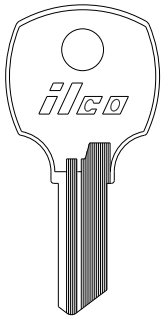

N1069G

—



N1069J

—



N1069N  
RO15

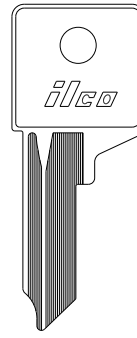

1544

—

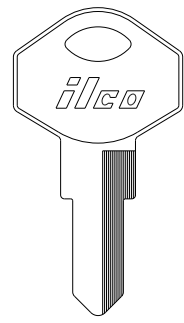

1545

—

ILCO  
EZ

NORTH AMERICAN  
CYLINDER

sec 2 page 48

NATIONAL LOCK HARDWARE



1064D

—

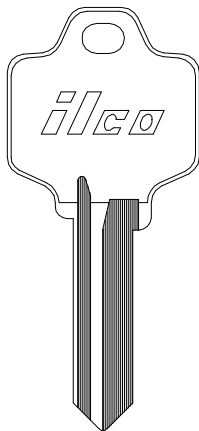

R1064D

NA6

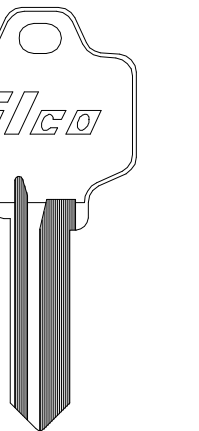

R1064E

NA25

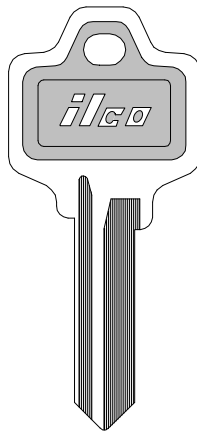

NA25-PC

—

NORWALK

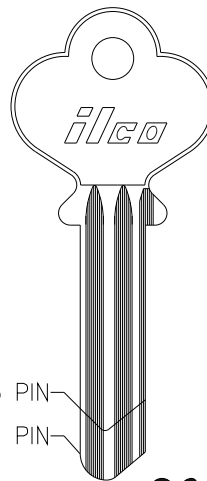

5 PIN  
6 PIN

5 PIN

1017  
N1

6 PIN

1017A

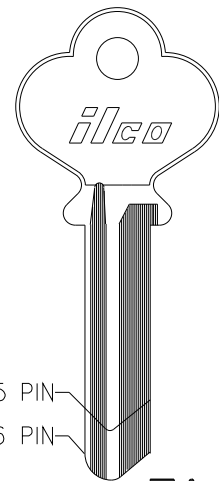

5 PIN  
6 PIN

5 PIN

1017B  
N3

6 PIN

1017BA

ILCO  
EZ

NORWALK

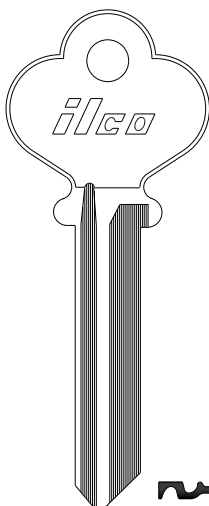

1017BB

—

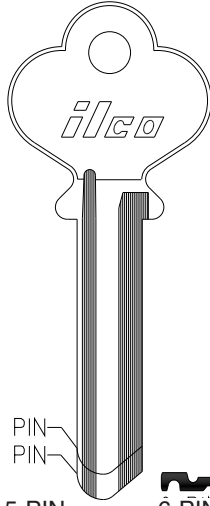

5 PIN  
6 PIN

5 PIN



6 PIN

1017BL  
A1017BL

—

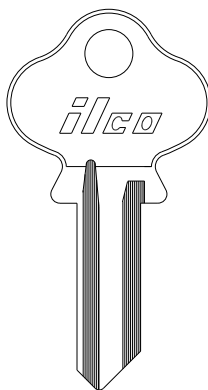

O1017B

—

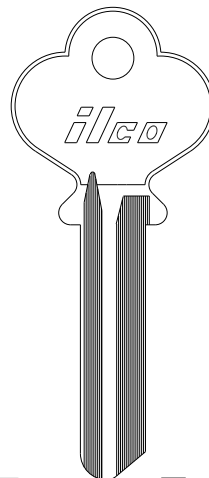

O1017ML  
O1017NL

—

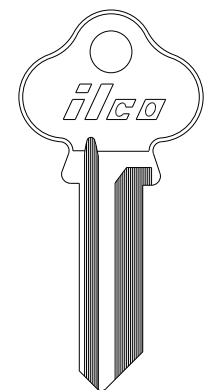

O1017M

—

ILCO  
EZ

NORWALK

OLYMPIC

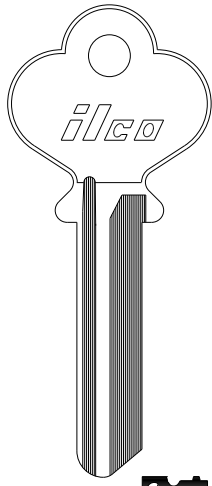

O1017WL

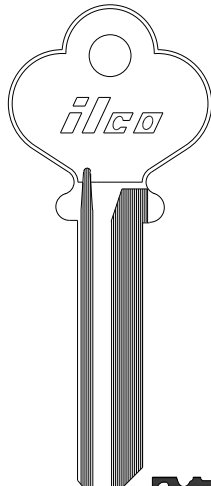

O1017NX

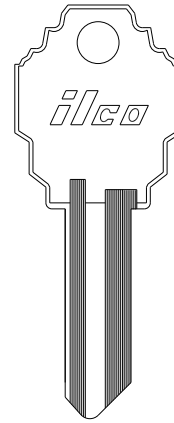
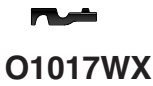

1171

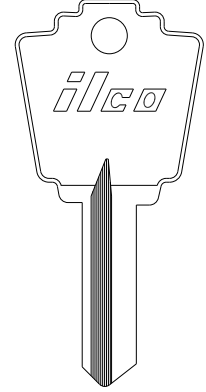

1171B

1171P  
OL1

ILCO  
EZ

PARKER

PENN

PETERBORO

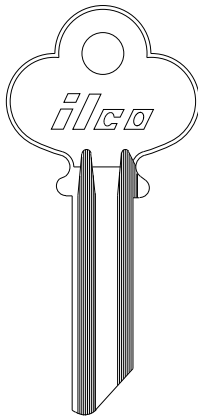

PKR1

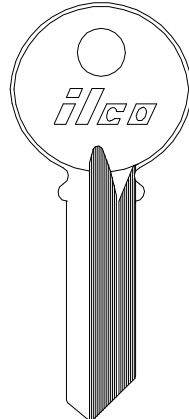

1016  
P1

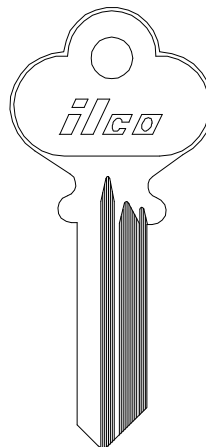

1016N  
P2

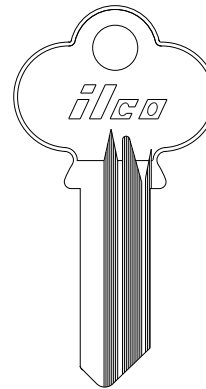

1016NB

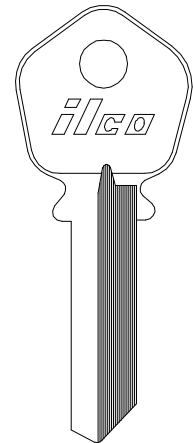

1034

ILCO  
EZ

PETERBORO

PETCO

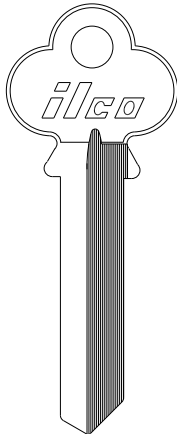

1034A

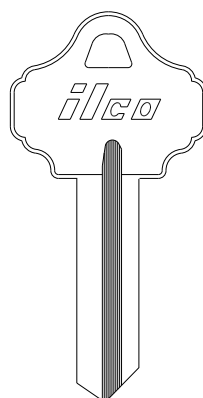

1034H

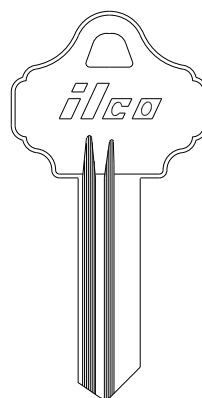

1034N

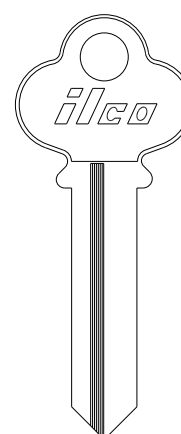

1072

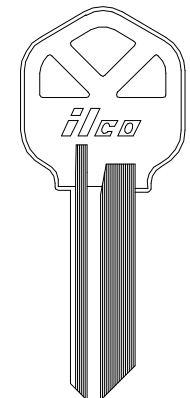

1176  
KW1

ILCO  
EZ

PETCO PHILLIPS

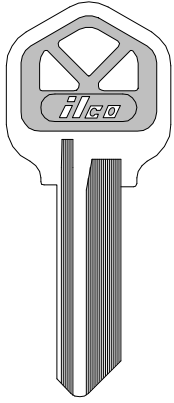

KW1-PC

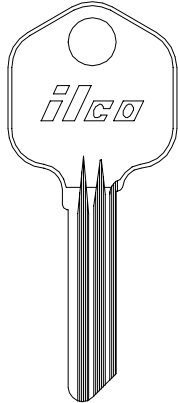

1176D

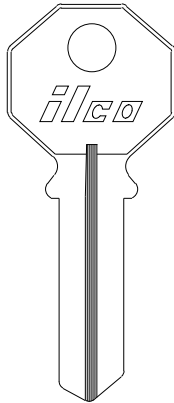

A1

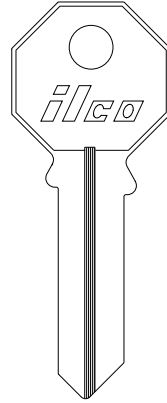

PHA1

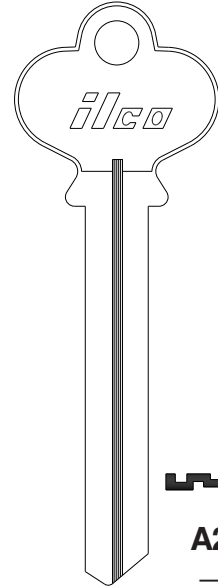

A2

ILCO  
EZ

PHILLIPS PUNDRA

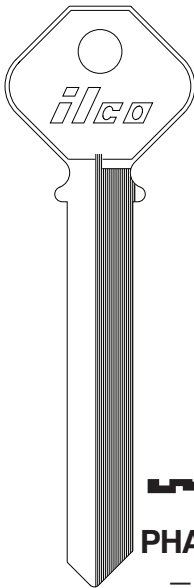

PHA2

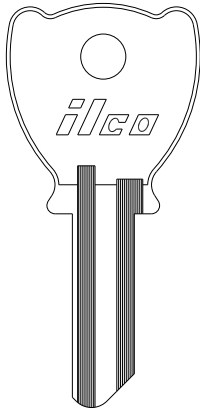

A3

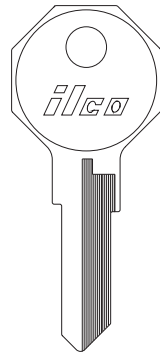

PH32

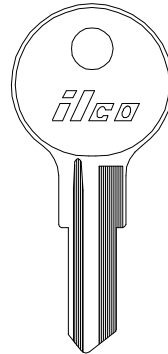

PU1



PU2

ILCO  
EZ

PUNDRA

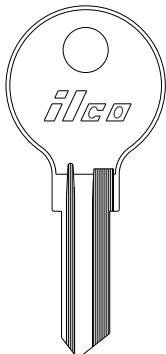

PU3

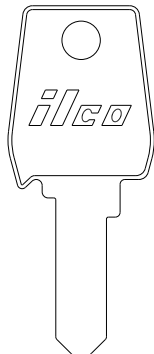

PU4

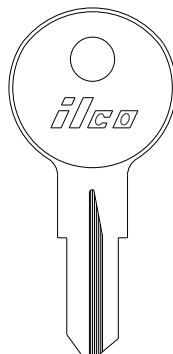

PU5



1866-4



1866-7

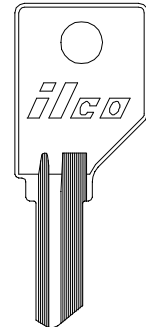

1866-10

ILCO  
EZ

PUNDRRA

RAD

READING

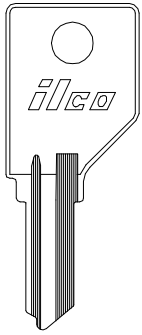

1866-13

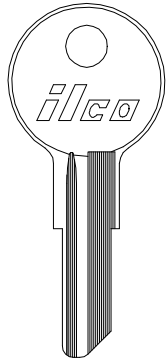

L1054B  
IN8

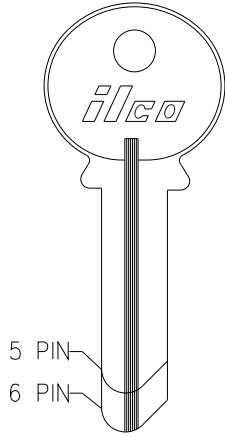

5 PIN  
6 PIN



5 PIN 6 PIN  
1019 1019A  
RE1

5 PIN  
 1019R

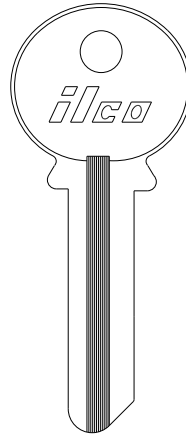

1019C

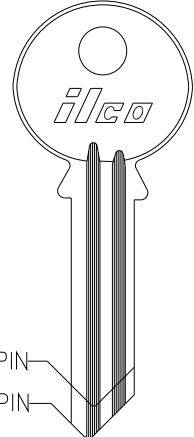

5 PIN  
6 PIN



5 PIN 6 PIN  
1019D 1019DA

ILCO  
EZ

READING

REESE

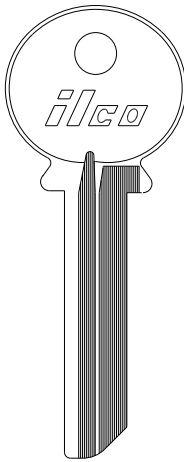

1019XL

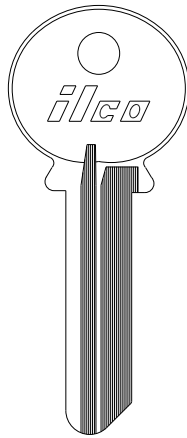

A1019M

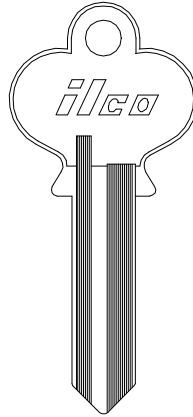

1119

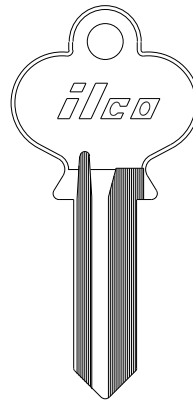

1119S

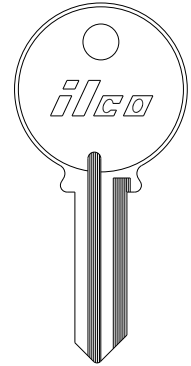

1140

ILCO  
EZ

REESE

RICHILIEU

RIXSON

RUSSWIN

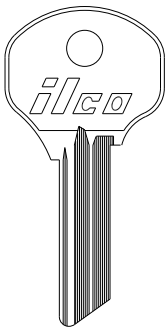

1140G  
R3



1140P

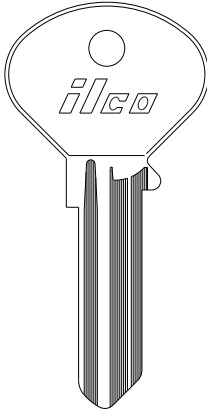

1146

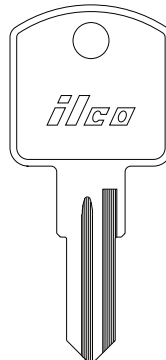

1668

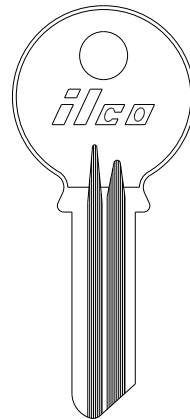

1080

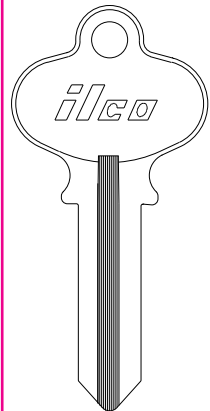

RW40R

ILCO  
EZ

**RUSSWIN (now Corbin/Russwin)**

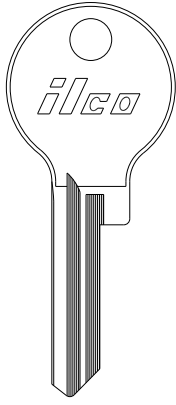

**X1000KR**

—

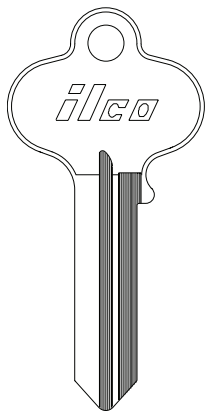

**1011**

RU1

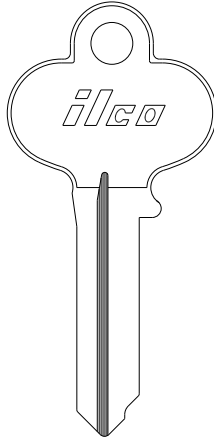

**1011-04A**

—

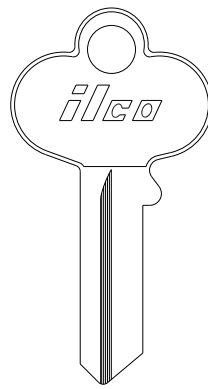

**1011-04AS**

—

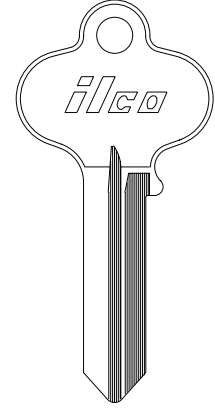

**1011A**

—

**ILCO  
EZ**

**NORTH AMERICAN  
CYLINDER**

sec 2 page 52

**RUSSWIN (now Corbin/Russwin)**

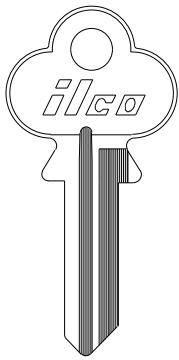

**1011B**

RU3

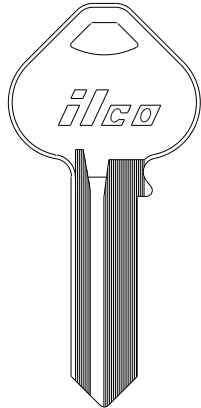

**1011GH**

RU44

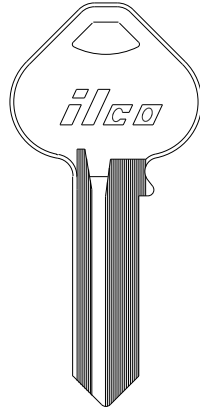

**1011GJ**

—

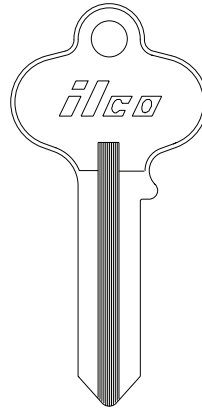

**1011M**

—

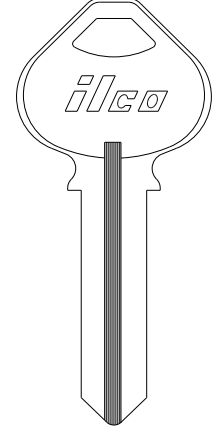

**1011MA**

—

**ILCO  
EZ**

**RUSSWIN (now Corbin/Russwin)**

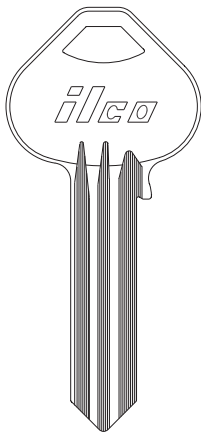

**1011MK**

—

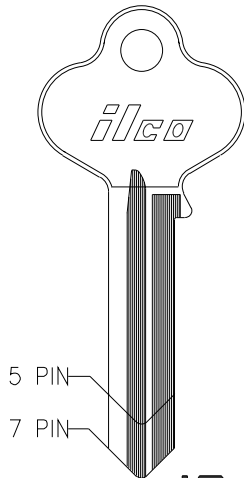

5 PIN  
7 PIN

5 PIN  
**1011P**  
RU4



7 PIN  
**1011PAA**

—

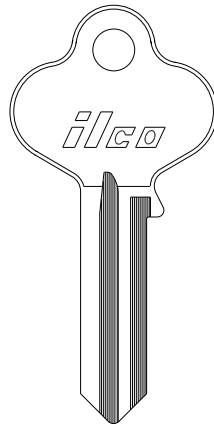

**1011S**

—

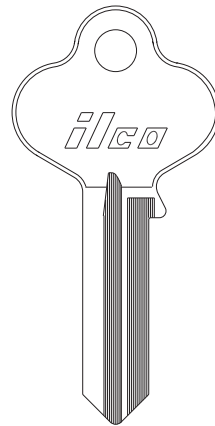

**1011T**

—

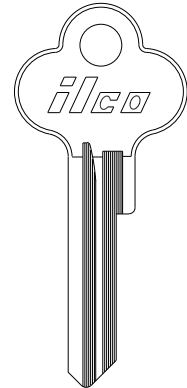

**X1011KR**

—



**X1001KC**

—

**ILCO  
EZ**

ILCO  
EZ

5 PIN	<b>1011D1</b> RU45	<b>1011D2</b> —	<b>1011D3</b> —	<b>1011D4</b> —
6 PIN	<b>A1011D1</b> RU46	<b>A1011D2</b> —	<b>A1011D3</b> —	<b>A1011D4</b> —
7 PIN	<b>B1011D1</b> —	<b>B1011D2</b> —	<b>B1011D3</b> —	<b>B1011D4</b> —

5 PIN	<b>1011D12</b> —	<b>1011D34</b> —
6 PIN	<b>A1011D12</b> —	<b>A1011D34</b> —
7 PIN	<b>B1011D12</b> —	<b>B1011D34</b> —

5 PIN	<b>1011D41</b> —
6 PIN	<b>A1011D41</b> RU53
7 PIN	<b>B1011D41</b> —

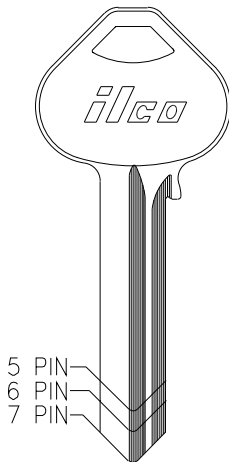

5 PIN	1011-L1 —	1011-L2 —	1011-L3 —	1011-L4 —
6 PIN	A1011-L1 —	A1011-L2 —	A1011-L3 —	A1011-L4 RU101
7 PIN	L1011-L1 —	L1011-L2 —	L1011-L3 —	L1011-L4 —

5 PIN	1011-L12 —	1011-L34 —
6 PIN	A1011-L12 —	A1011-L34 —
7 PIN	L1011-L12 —	L1011-L34 —

5 PIN	1011-L41 —
6 PIN	A1011-L41 —
7 PIN	L1011-L41 —

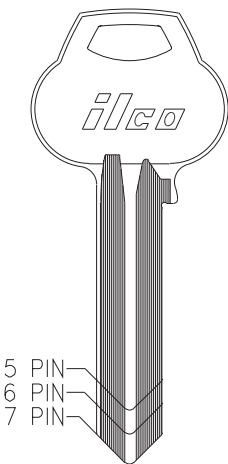

RUSSWIN (now Corbin / Russwin)

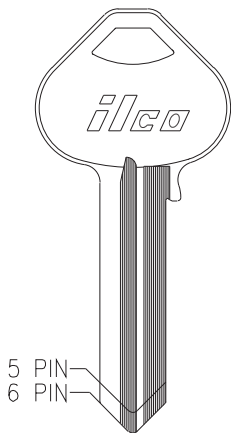

5 PIN	<b>N1011P</b> RU52	<b>N1011S</b> —	<b>N1011T</b> —
6 PIN	<b>A1011P</b> RU16	<b>A1011S</b> —	<b>A1011T</b> —
	 <b>N1011M</b> RU7		
	 <b>A1011M</b> —		

ILCO  
EZ

NORTH AMERICAN  
CYLINDER

sec 2 page 55

RUSSWIN (now Corbin / Russwin)

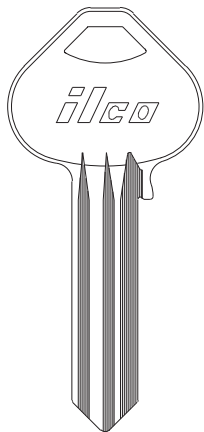

	<b>A1011H1</b> —	<b>A1011H6</b> —
	<b>A1011H2</b> —	<b>A1011H7</b> —
	<b>A1011H3</b> —	<b>A1011H8</b> —
	<b>A1011H5</b> —	

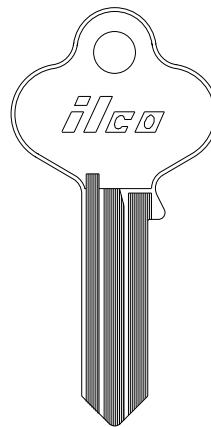

	<b>1011PH</b> —
	<b>1011PM</b> —
	<b>(MASTER) 1011PZ</b> —

ILCO  
EZ

RUSSWIN (now Corbin / Russwin)

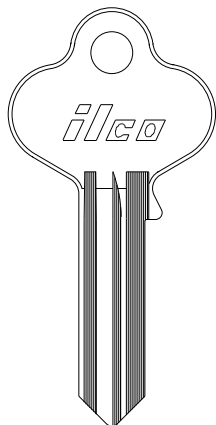

	<b>1011K1</b> —	<b>1011K5</b> —	<b>1011K9</b> —	<b>1011K13</b> —
	<b>1011K2</b> —	<b>1011K6</b> —	<b>1011K10</b> —	
	<b>1011K3</b> —	<b>1011K7</b> —	<b>1011K11</b> —	
	<b>1011K4</b> —	<b>1011K8</b> —	<b>1011K12</b> —	

ILCO  
EZ



**RUSSWIN (now Corbin / Russwin)**

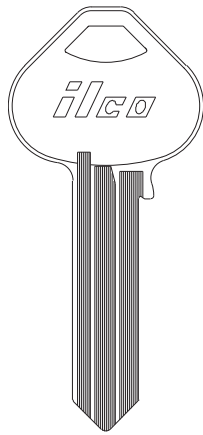

	<b>A1011-1N</b>	<b>A1011-5N</b>	<b>A1011-9N</b>	<b>A1011-13N</b>
	-	-	-	-
	<b>A1011-2N</b>	<b>A1011-6N</b>	<b>A1011-10N</b>	<b>A1011-14N</b>
	-	-	-	-
	<b>A1011-3N</b>	<b>A1011-7N</b>	<b>A1011-11N</b>	
	-	-	-	
	<b>A1011-4N</b>	<b>A1011-8N</b>	<b>A1011-12N</b>	
	-	-	-	

(MASTER)  
**A1011PZ**

**ILCO  
EZ**

**NORTH AMERICAN  
CYLINDER**

sec 2 page 56

**RUSSWIN (now Corbin / Russwin)**

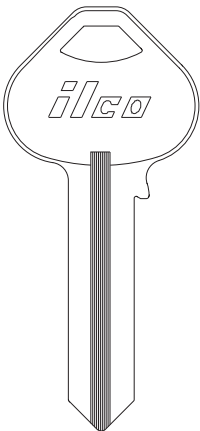

	<b>A1011-15N</b>	<b>A1011-19N</b>	<b>A1011-23N</b>	<b>A1011-27N</b>
	-	-	-	-
	<b>A1011-16N</b>	<b>A1011-20N</b>	<b>A1011-24N</b>	<b>A1011-28N</b>
	-	-	-	-
	<b>A1011-17N</b>	<b>A1011-21N</b>	<b>A1011-25N</b>	
	-	-	-	
	<b>A1011-18N</b>	<b>A1011-22N</b>	<b>A1011-26N</b>	
	-	-	-	

(MASTER)  
**A1011PZR**

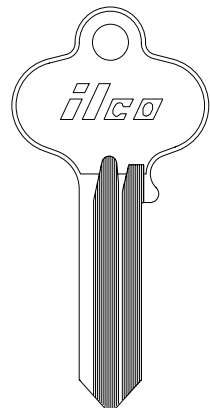

**1012  
RU2**

**ILCO  
EZ**

**RUSSWIN (now Corbin/Russwin)**

**SAFE**

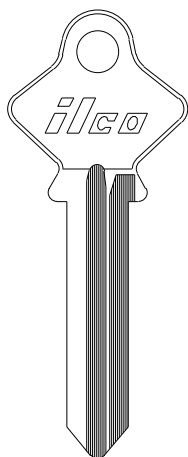

**1012A**

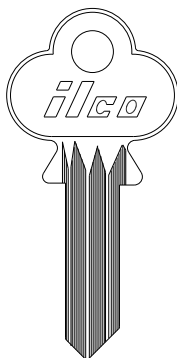

**1012DM**

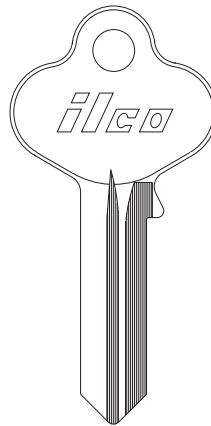

**1011-28N**

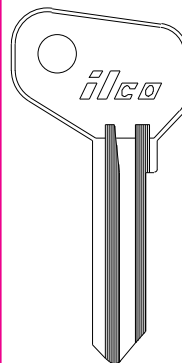

**SF10**

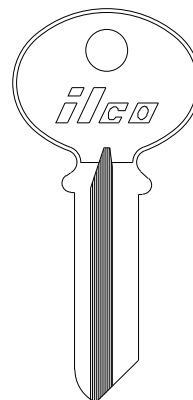

**1049D**

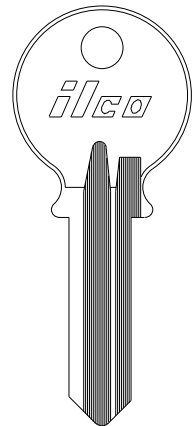

**1049E**

**ILCO  
EZ**

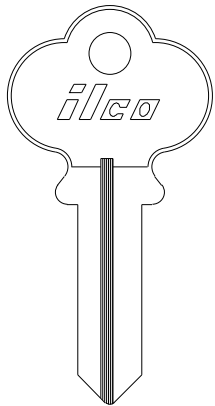
**SAGER****1047**

—

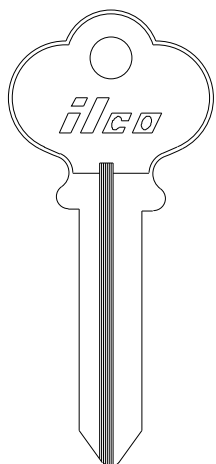
**1047A**

—

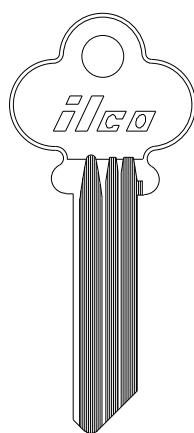
**1047CL**

—

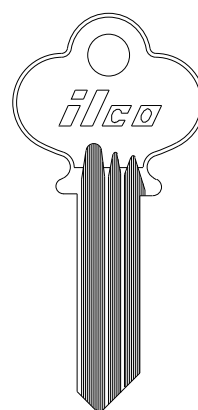
**1047CR**

SA1

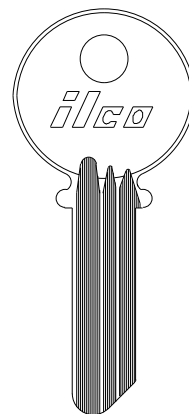
**1047M**

—

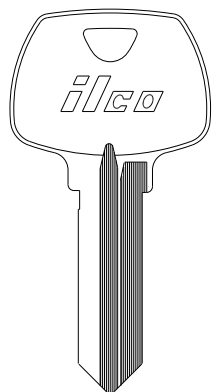
ILCO  
EZ**SARGENT****1007**

—

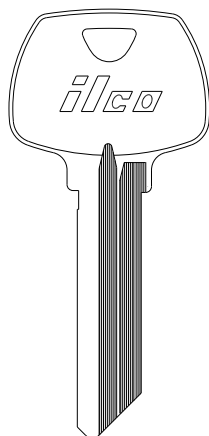
**A1007**

—

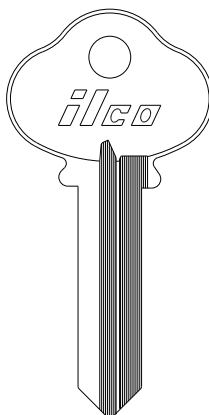
**1007A**

—

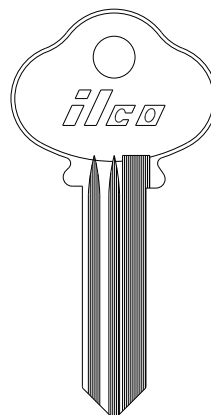
**1007G**

—

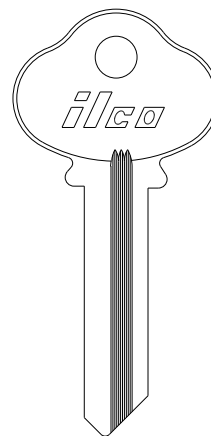
**1007KM**

—

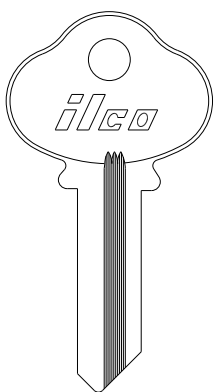
ILCO  
EZ**SARGENT****O1007KM**

—

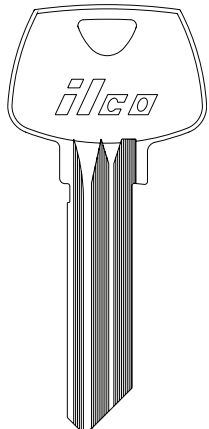
**O1007CR**

—

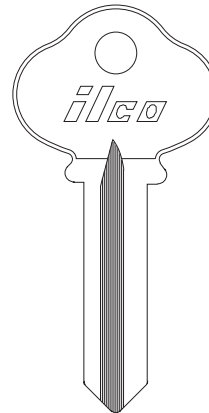
**O1007JA**

—

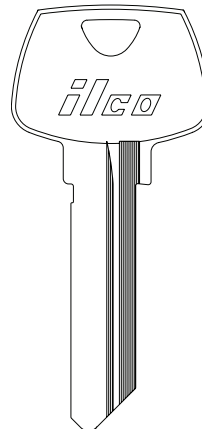
**O1007NB**

—

ILCO  
EZ

SARGENT

5 PIN	1007ca S22½	1007CB —	1007CC —	1007CE —	1007CF —	1007CG —	1007CJ —	1007CK —	1007CL —
6 PIN	O1007CA S22	O1007CB —	O1007CC —	O1007CE —	O1007CF —	O1007CG —	O1007CJ —	O1007CK —	O1007CL —
7 PIN	L1007CA —	L1007CB —	L1007CC —	L1007CE —	L1007CF —	L1007CG —	L1007CJ —	L1007CK —	L1007CL —

ILCO  
EZ

NORTH AMERICAN  
CYLINDER

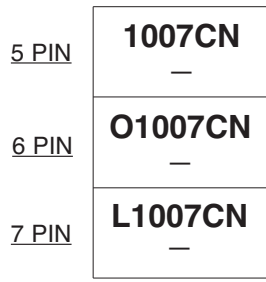
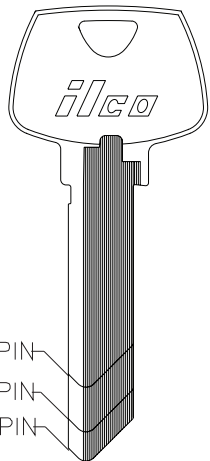
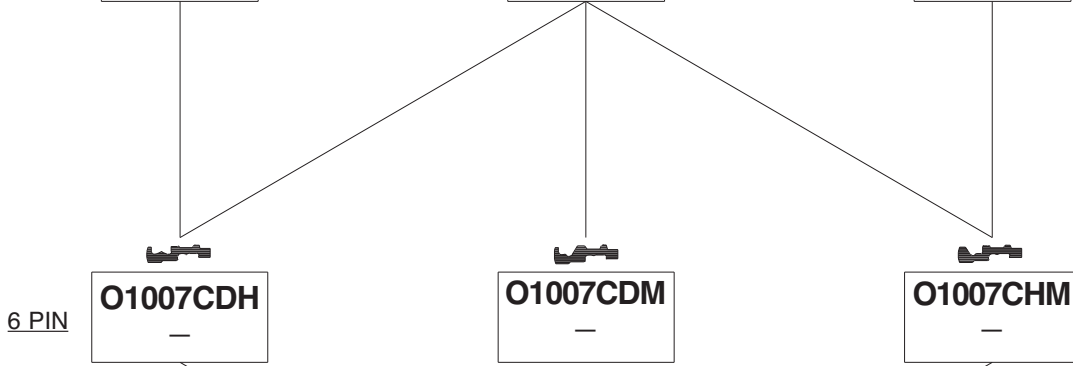
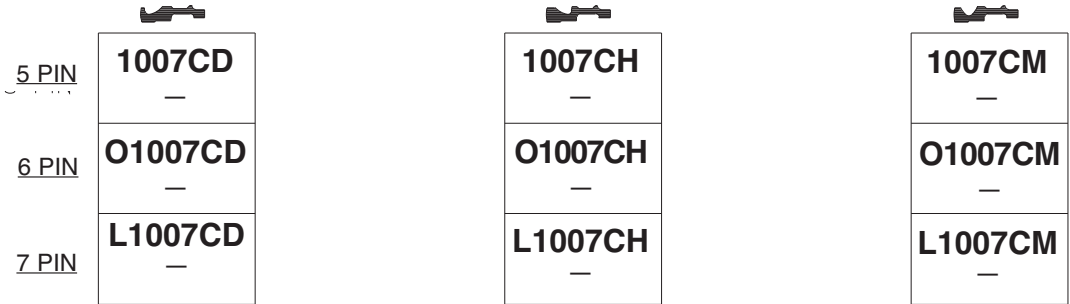

**SARGENT**

5 PIN	1007HA —	1007HB —	1007HC —	1007HE —	1007HF —	1007HG —	1007HJ —	1007HK —	1007HL —
6 PIN	O1007HA —	O1007HB —	O1007HC —	O1007HE —	O1007HF —	O1007HG —	O1007HJ —	O1007HK —	O1007HL —

ILCO  
EZ

5 PIN	1007HD —
6 PIN	O1007HD —

5 PIN	1007HH —
6 PIN	O1007HH —

5 PIN	1007HM —
6 PIN	O1007HM —

5 PIN	1007HDH —
6 PIN	O1007HDH —

5 PIN	1007HN —
6 PIN	O1007HN —

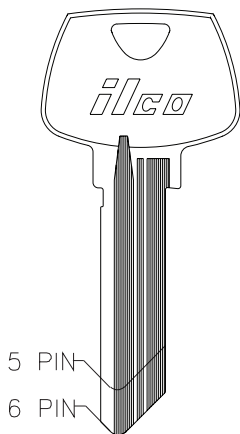

SARGENT

5 PIN	1007LA —	1007LB —	1007LC —	1007LE —	1007LF —	1007LG —	1007LJ —	1007LK —	1007LL —
6 PIN	O1007LA —	O1007LB —	O1007LC —	O1007LE —	O1007LF —	O1007LG —	O1007LJ —	O1007LK —	O1007LL —
7 PIN	L1007LA —	L1007LB —	L1007LC —	L1007LE —	L1007LF —	L1007LG —	L1007LJ —	L1007LK —	L1007LL —

ILCO  
EZ

NORTH AMERICAN  
CYLINDER

5 PIN

	1007LD —
6 PIN	O1007LD —
7 PIN	L1007LD —

	1007LH —
6 PIN	O1007LH —
7 PIN	L1007LH —

	1007LM —
6 PIN	O1007LM —
7 PIN	L1007LM —

5 PIN

	1007LDH —
6 PIN	O1007LDH —

	1007LDM —
6 PIN	O1007LDM —

	1007LHM —
6 PIN	O1007LHM —

6 PIN

5 PIN

	N1007KMB —
6 PIN	N1007KMA —
7 PIN	N1007KMC —

6 PIN

7 PIN

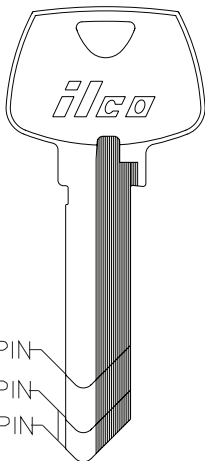

5 PIN

6 PIN

7 PIN

SARGENT

5 PIN	1007RA —	1007RB —	1007RC —	1007RE —	1007RF —	1007RG —	1007RJ —	1007RK —	1007RL —
6 PIN	O1007RA —	O1007RB —	O1007RC —	O1007RE —	O1007RF —	O1007RG —	O1007RJ —	O1007RK —	O1007RL —

ILCO  
EZ

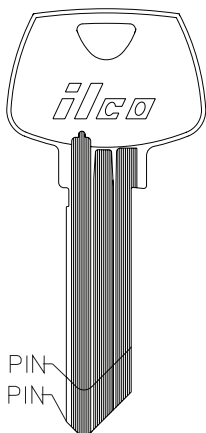
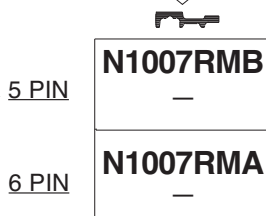
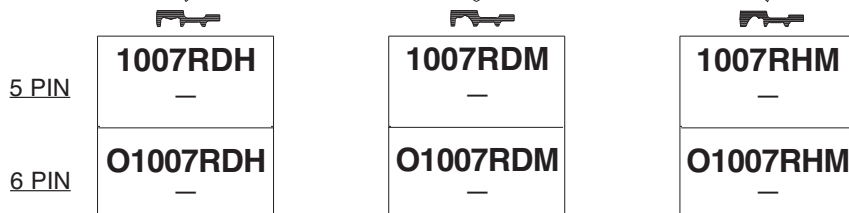
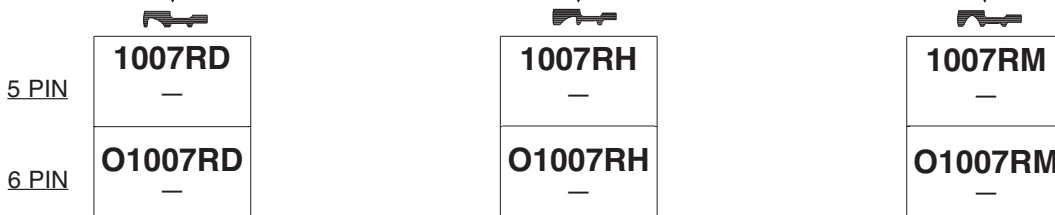

5 PIN  
6 PIN

SARGENT

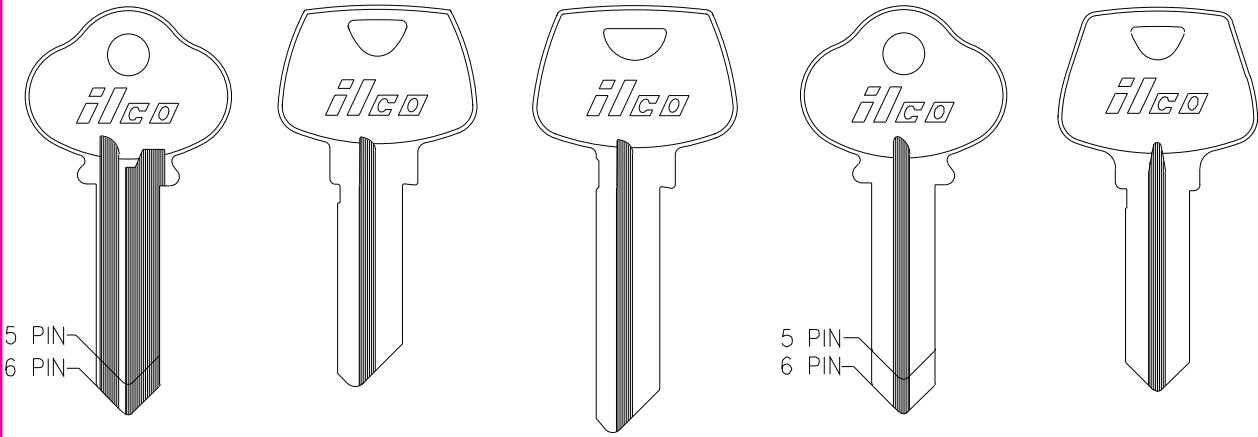

						
5 PIN	6 PIN			5 PIN	6 PIN	
<b>1008</b>	<b>1008A</b>	<b>A1008</b>	<b>A1008A</b>	<b>1009</b>	<b>1009A</b>	<b>1009M</b>
—	—	—	—	S1	S5	—

ILCO  
EZ

NORTH AMERICAN  
CYLINDER

sec 2 page 62

SARGENT

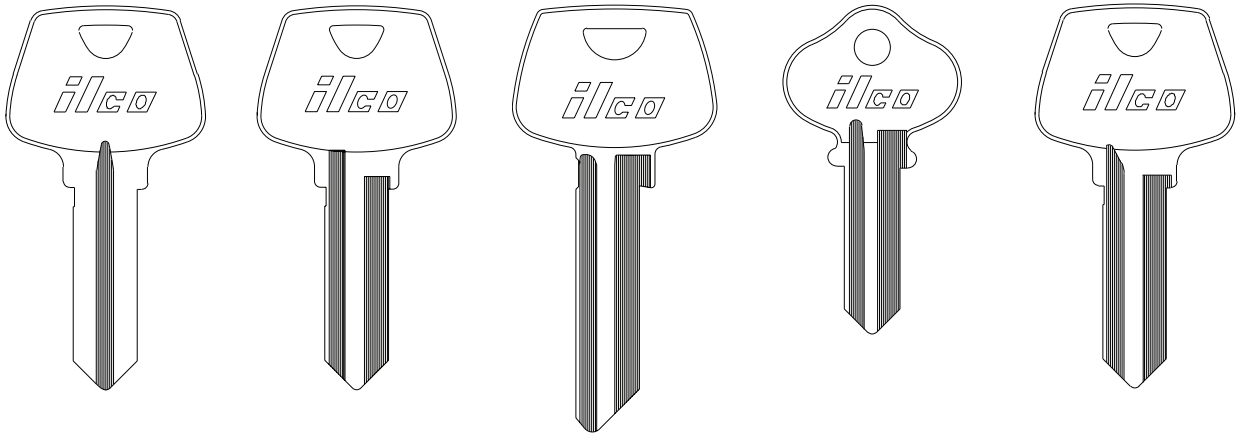

					
<b>O1009</b>	<b>1010</b>	<b>1010A</b>	<b>1010B</b>	<b>S1010B</b>	<b>1010M</b>
S2	S3	—	S10	—	—

ILCO  
EZ

SARGENT

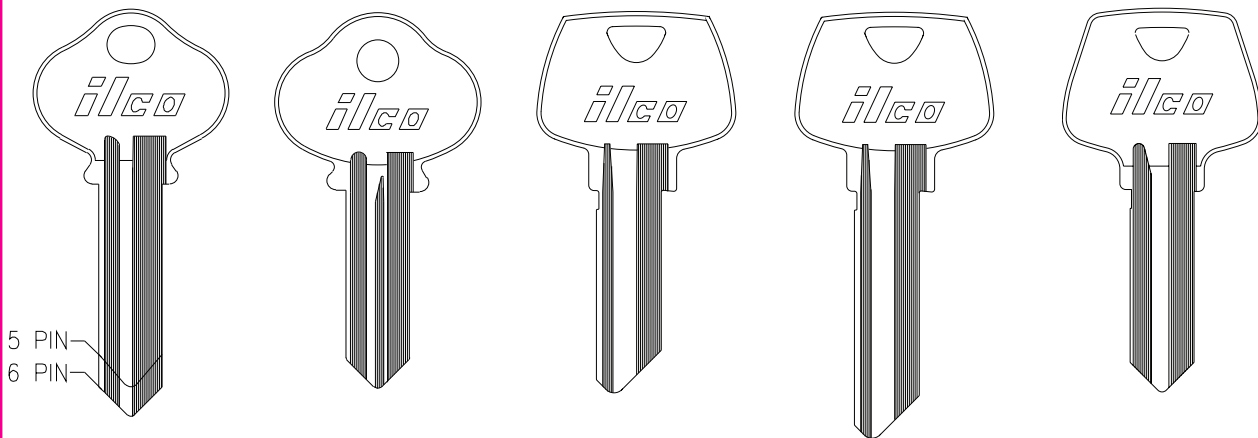

					
5 PIN	6 PIN				
<b>1010S</b>	<b>1010SA</b>	<b>1010T</b>	<b>1010N</b>	<b>L1010N</b>	<b>1010U</b>
—	—	—	S68	—	—

ILCO  
EZ

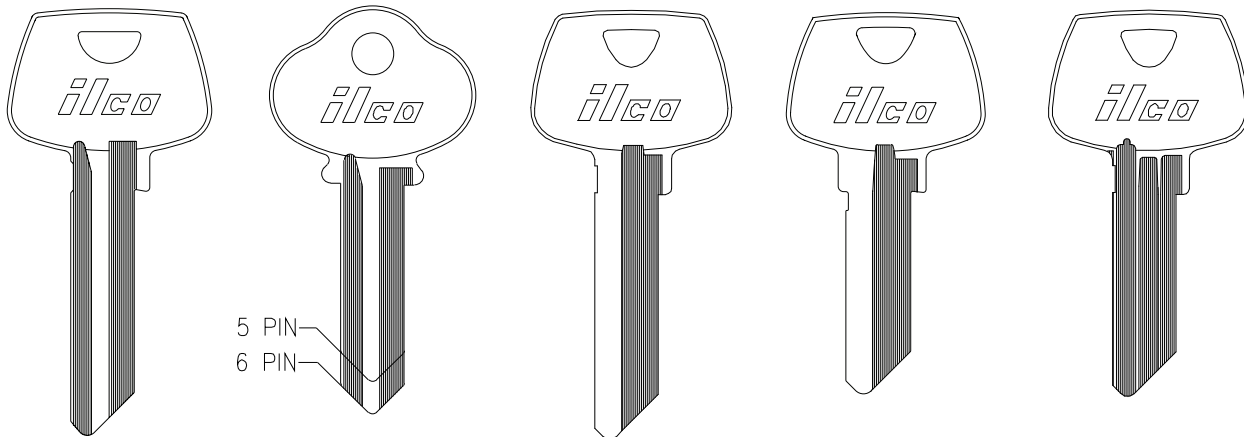
**SARGENT**

<b>A1010U</b>	<b>O1010</b> 5 PIN S4	<b>O1010A</b> 6 PIN	<b>S6</b>	<b>S16</b>
—	—	—	—	—

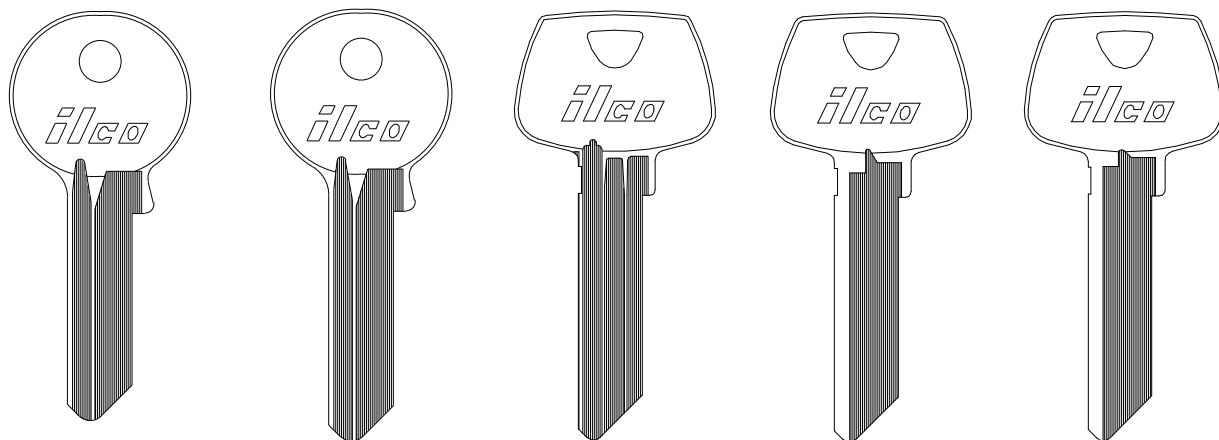
**ILCO  
EZ**
**SARGENT**

<b>O1054</b>	<b>O1054A</b>	<b>S31</b>	<b>S70</b>	<b>S73</b>
—	—	—	—	—

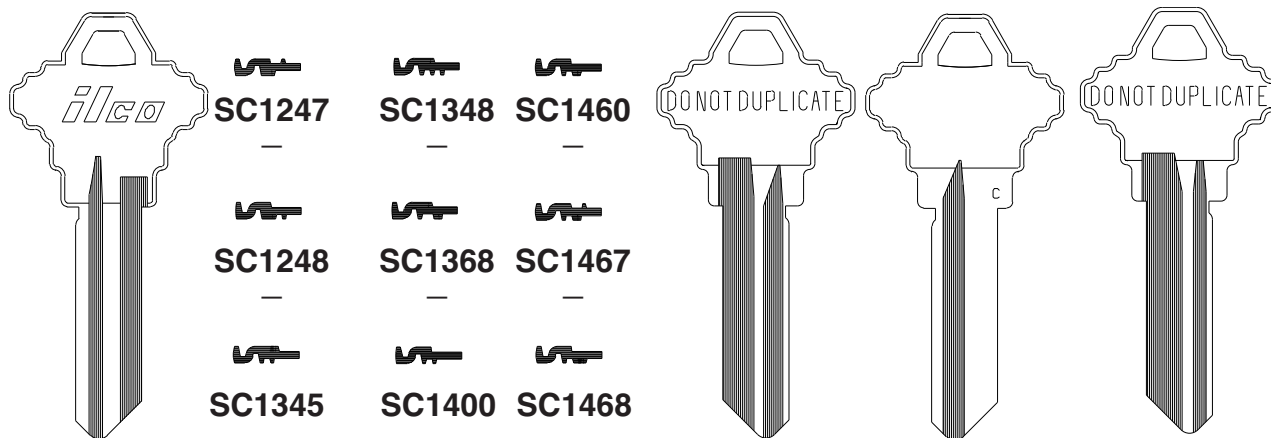
**ILCO  
EZ**
**SCHLAGE**

<b>SC1247</b>	<b>SC1248</b>	<b>SC1345</b>	<b>SC1348</b>	<b>SC1368</b>	<b>SC1400</b>	<b>SC1460</b>
—	—	—	—	—	—	—
<b>SC1246</b>	<b>SC1347</b>	<b>SC1456</b>	<b>SC1248</b>	<b>SC1368</b>	<b>SC1467</b>	<b>SC1468</b>
—	—	—	—	—	—	—
<b>SC1246</b>	<b>SC1347</b>	<b>SC1456</b>	<b>101C-NS-DND</b>	<b>101C-NS-PLAIN</b>	<b>101E-NS-DND</b>	
—	—	—	—	—	—	—

**ILCO  
EZ**



SCHLAGE



5 PIN	<b>1145</b> SC1	<b>1145CE</b> —	<b>1145E</b> SC8	<b>1145EF</b> —	<b>1145F</b> SC7	<b>1145FG</b> —	<b>1145G</b> —
6 PIN	<b>1145A</b> SC4	<b>A1145CE</b> —	<b>A1145E</b> SC9	<b>A1145EF</b> —	<b>A1145F</b> SC10	<b>A1145FG</b> —	<b>A1145G</b> —

NORTH AMERICAN CYLINDER

ILCO EZ

sec 2 page 64

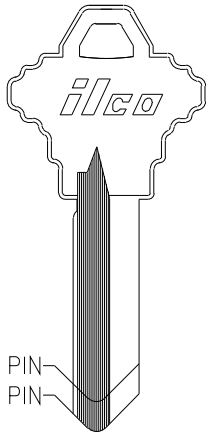

5 PIN	<b>1145H</b> —
6 PIN	<b>A1145H</b> SC15

5 PIN	<b>1145J</b> —
6 PIN	<b>A1145J</b> —

5 PIN	<b>1145K</b> —
6 PIN	<b>A1145K</b> —

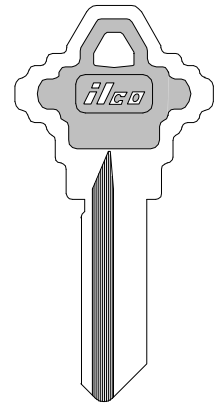

5 PIN	<b>1145L</b> SC19
6 PIN	<b>A1145L</b> SC20



**SC1-PC**  
—

ILCO EZ

SCHLAGE

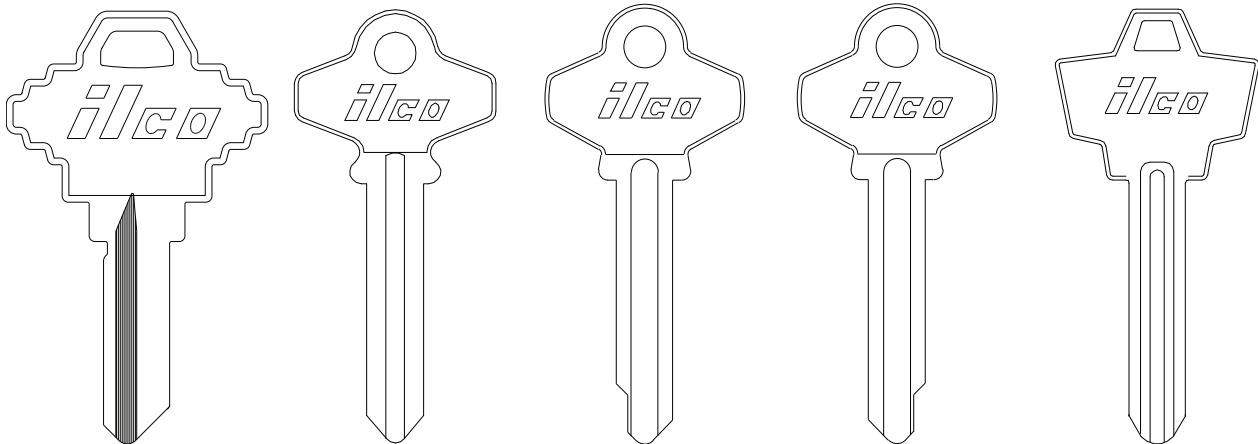

**SC1-BIG**  
—

**1307A**  
SC6

**L1307A**  
—

**R1307A**  
—

**1307W**  
SC22

ILCO EZ

SCHLAGE

SCHROEDER

SCHROEDER THOMPSON

SECURITY

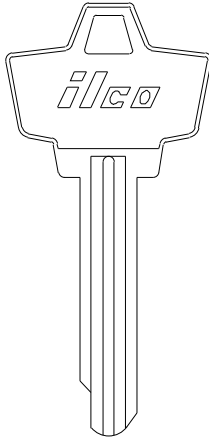

L1307W

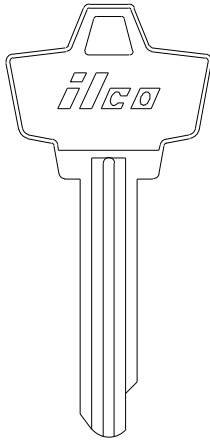

R1307W

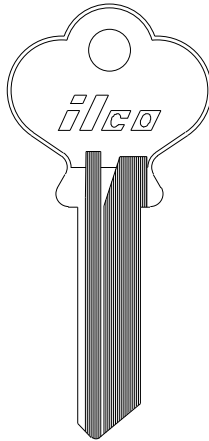

(MASTER)  
1126M



759ST

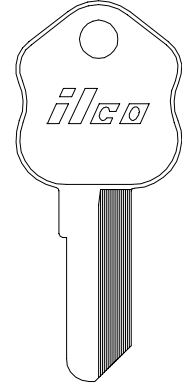

SY9

ILCO  
EZ

SECURITY

SECURITY MAILBOX

SEGAL

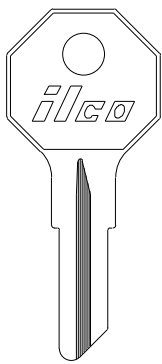

SC1098X

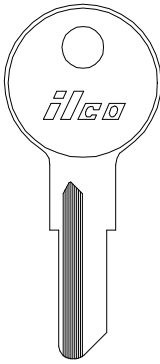

O1122B  
Y103

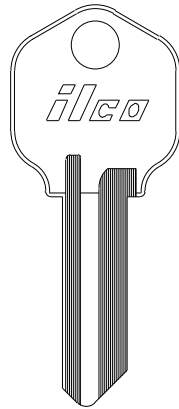

SC1176

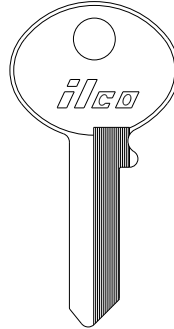

1559

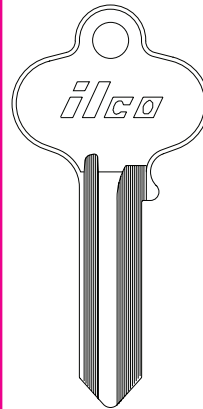

1022  
SE1



O1022  
SE2

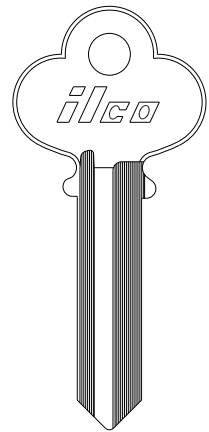

1022AB



O1022AB

ILCO  
EZ

SEGAL

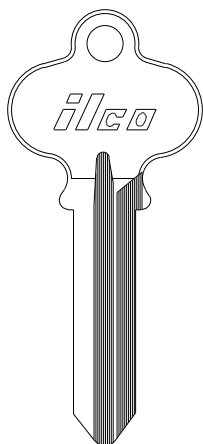

1022H

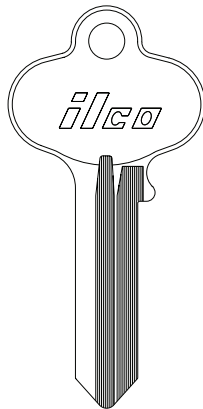

1022HR

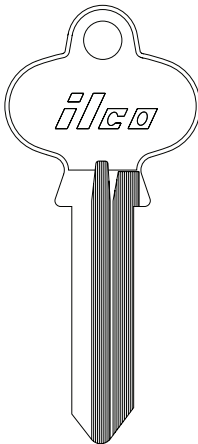

R1022L

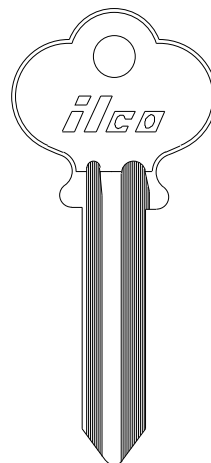

O1022A

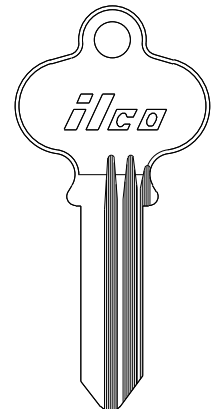

O1022E

ILCO  
EZ

SENTRY SAFES		SHAW WALKER		SKILLMAN	SKYTRAK
1626 SS4	1637 SS5	1534 —	1568 —	R1001EN SK1	1642 —

ILCO  
EZ

SLAYMAKER					
SLA14 —	SLA15 —	SLA16 —	1074E —	A1074E —	1074B —
		SLA17 —	1074F —	A1074F —	1074N —
			1074G —	A1074G —	1074DF —
			1074N —	1074B —	A1074B —

ILCO  
EZ

SLAYMAKER						SOLON
1074BM —	1120K —	1120D SL1	1120F SL20	1120J —	1120N —	S42 —
			1120G —	1120S —		
			1120H —			

ILCO  
EZ

SOUTHERN IMPERIAL SUN

STANLEY PADLOCK

TAYLOR

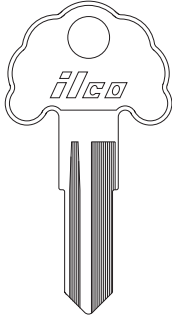

1624

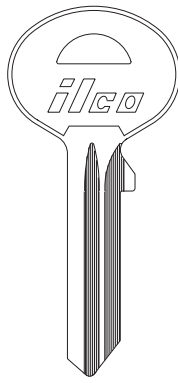

1636

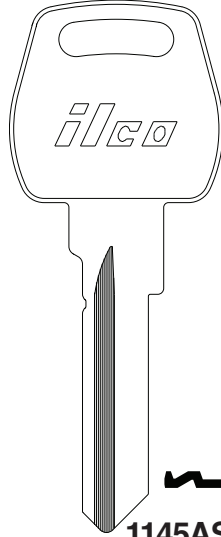

1145AST  
ST4

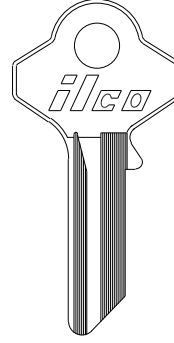

TY1

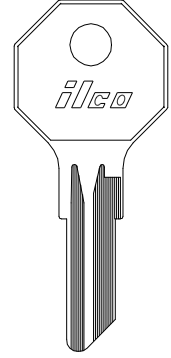

H1122M  
T2

ILCO  
EZ

TAYLOR

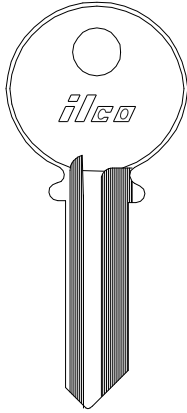

1141  
T1

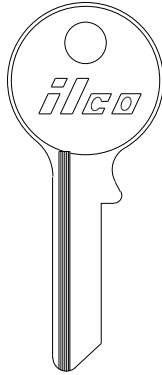

1141E

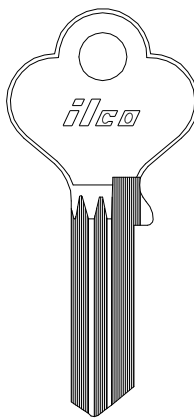

1141F  
T3

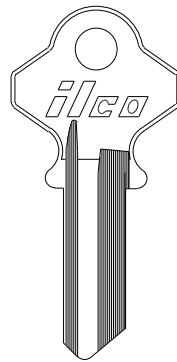

1141GE  
T7

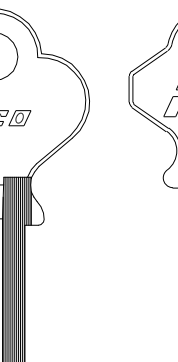

1141GS

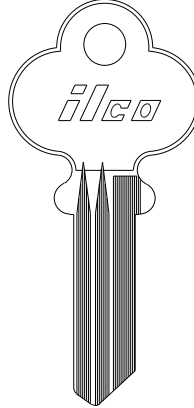

1141H

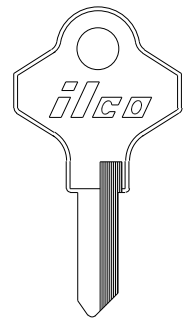

1141JE

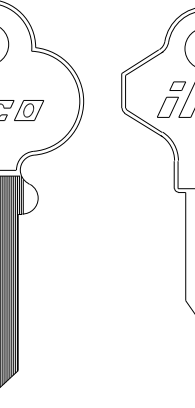

1141JL

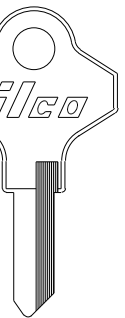

1141K

ILCO  
EZ

TAYLOR

TEGCO

THERMOSTAT  
BOX

TIMBERLINE

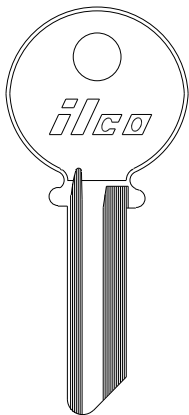

1141L

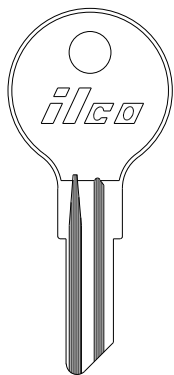

1141W

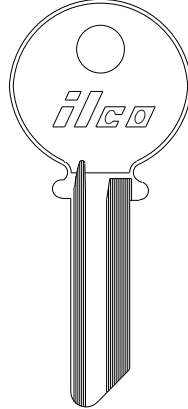

TG1

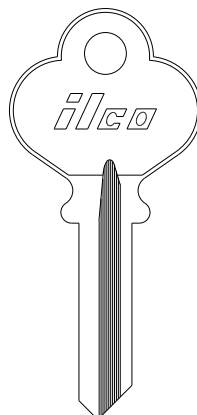

1013BF

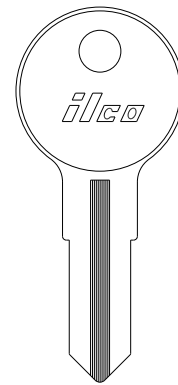

1541

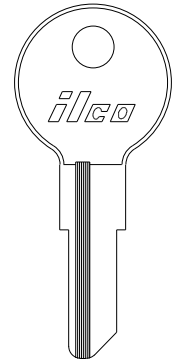

1043J  
IL11

ILCO  
EZ

NORTH AMERICAN CYLINDER

sec 2 page 68

**TITAN / KWIKSET**

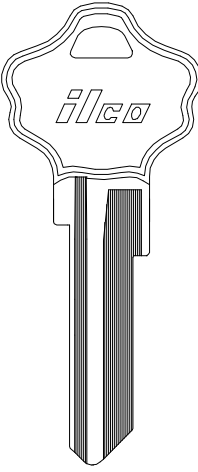
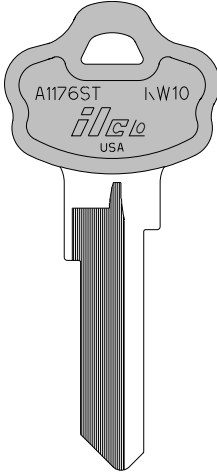
**A1176ST**  
KW10

**KW10-PC**  
—

**TRIMARK**

**1601**  
TM1

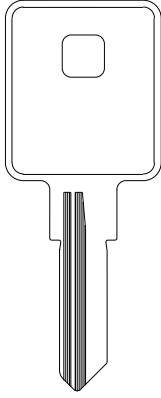
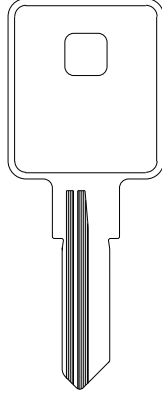
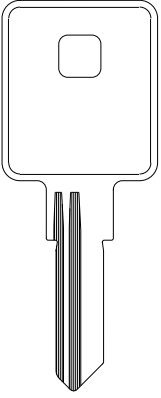
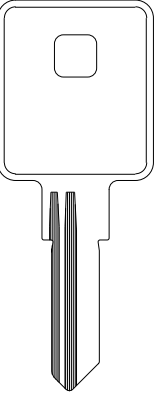
**1602**  
TM2

**1603**  
TM3

**1604**  
TM4

ILCO EZ

**TRIMARK**

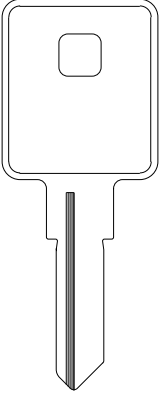
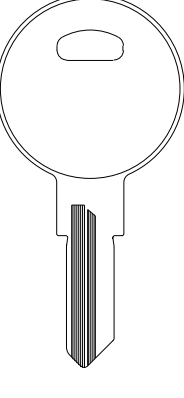
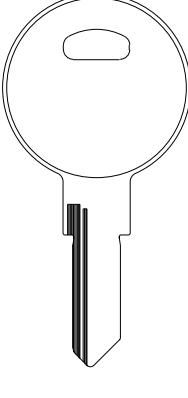
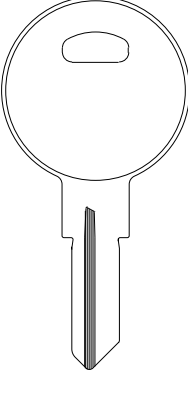
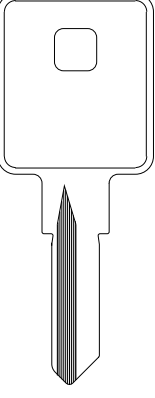
**1606**  
TM6

**1607**  
TM7

**1608**  
TM8

**1609**  
TM9

**1610**  
TM10

ILCO EZ

**TRIMARK**

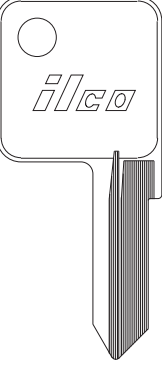
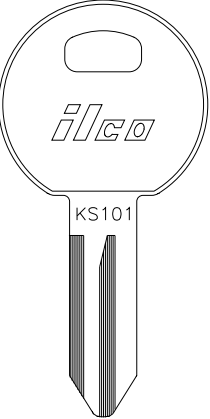
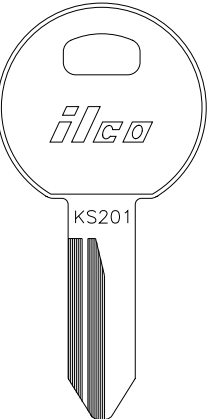
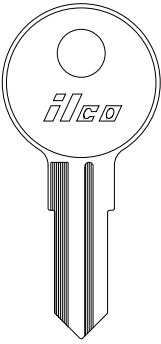
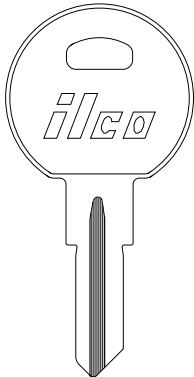
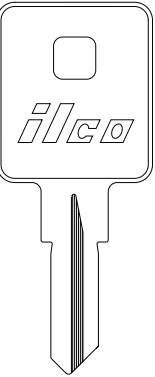
**1612**  
TM12

**1621**  
TM13

**1622**  
TM14

**1623**  
TM15

**1650**  
TM16

**1651**  
TM17

ILCO EZ

TRIMARK

UNICAN

USPS

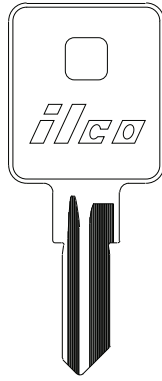
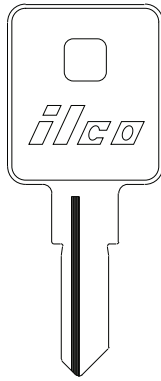
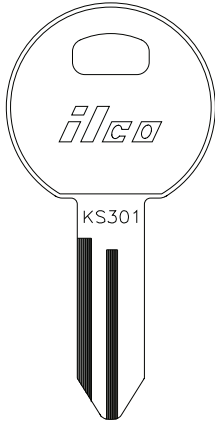

SEE  
ILCO

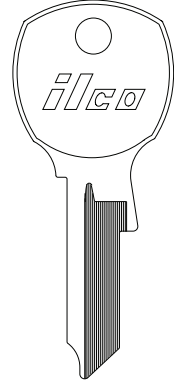
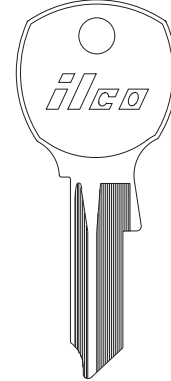

ILCO  
EZ

1665  
TM18

1666  
TM19

1667  
TM20

1646  
—

1646R  
—

VIMCAR

WEISER

SEE  
OLYMPIC

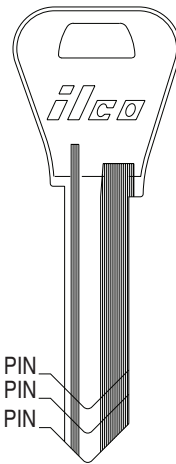
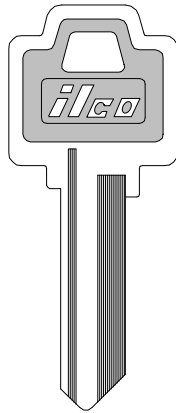
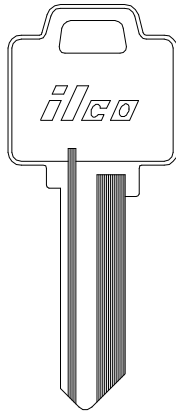

6 PIN  
A1054WB  
WR4

7 PIN  
L1054WB  
—

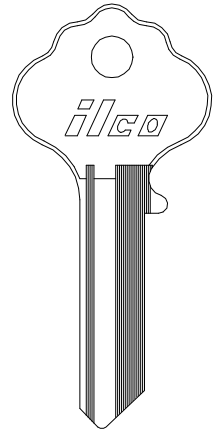

ILCO  
EZ

N1054WB  
WR5

WR5-PC  
—

5 PIN  
1054WB  
WR3

X1054WA  
WR2

WELCH

WESLOCK

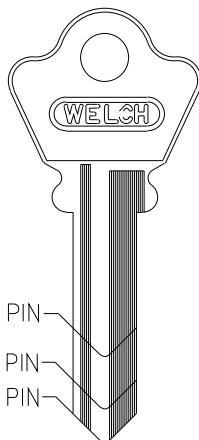
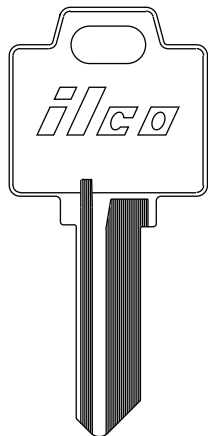

5 PIN  
1123  
WE1

6 PIN  
1123A  
—

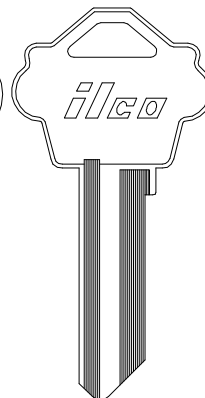
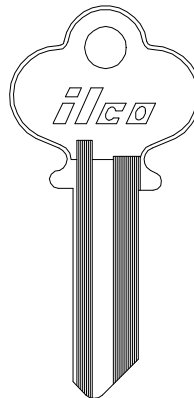

ILCO  
EZ

N1176  
WR6

4 PIN  
1123S  
—

1175  
WK1

1175N  
WK2

WESLOCK WILSON-BOHANNON

  <b>WK2-PC</b> -	  <b>WB19</b> -	  <b>1071B</b> -	5 PIN <b>1071</b> W1 6 PIN <b>1071A</b> -	  <b>1071AB</b> -
----------------------------	--------------------------	---------------------------	--	----------------------------

ILCO  
EZ

WILSON-BOHANNON WIND WINFIELD WISE PADLOCK

 4 PIN 5 PIN <b>1071BD 1071D)</b> - - <b>1071BE 1071E)</b> - - <b>1071BM 1071M)</b> - -  4 PIN 5 PIN	  <b>1634</b> WN1	  <b>WF1</b> -	  <b>W67</b> -
--	----------------------------	-------------------------	-------------------------

ILCO  
EZ

WRIGHT PRODUCTS XL LOCK YALE

  <b>1616</b> WTP1	  <b>1662</b> WTP2	  <b>1180S</b> XL7	  <b>1182</b> -	  <b>1</b> -	  <b>1N</b> -
-----------------------------	-----------------------------	-----------------------------	--------------------------	-----------------------	------------------------

ILCO  
EZ

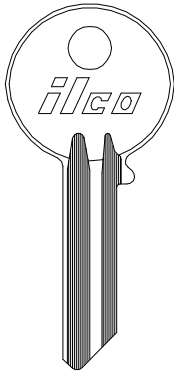
**YALE**

**YL1**  
—

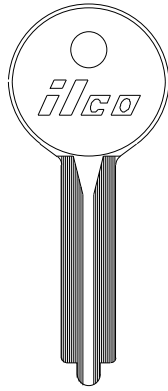

**2N**  
—



**YL5**  
—

**O997A**  
—

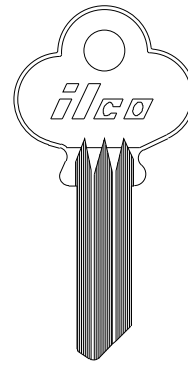

**Y8**  
—

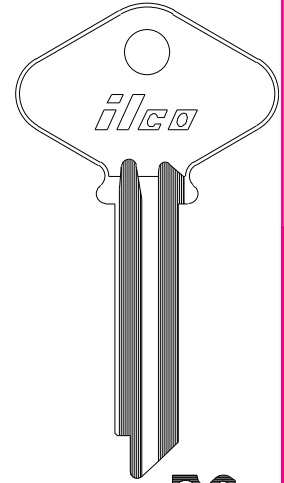

**D9**  
—

ILCO  
EZ

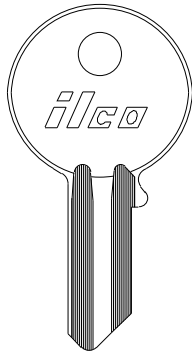
**YALE**

**SX9B**  
—

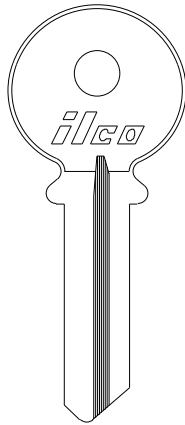

**Y9E**  
—

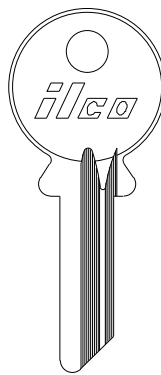

**Y204**  
—

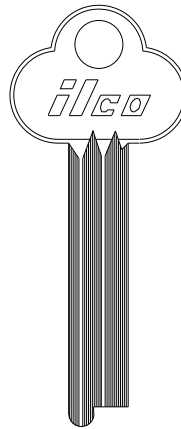

**889A**  
—

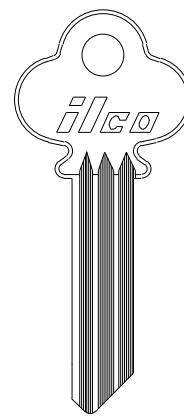

**994ARM**  
—

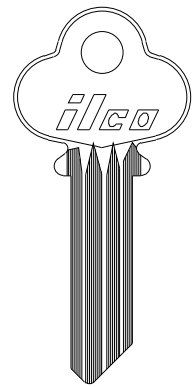

**994M**  
—

ILCO  
EZ

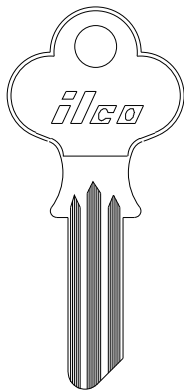
**YALE**

**996M**  
—

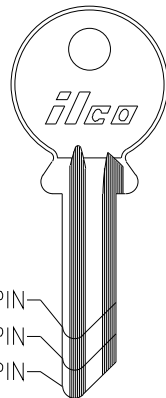

**4 PIN**  
**997B**  
—

**5 PIN**  
**Y200**  
—

**6 PIN**  
**997A**  
—

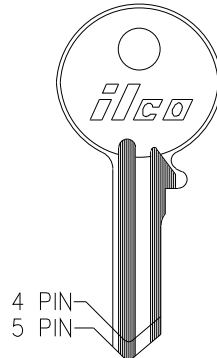

**4 PIN** **5 PIN**  
**997DB** **997D**  
—

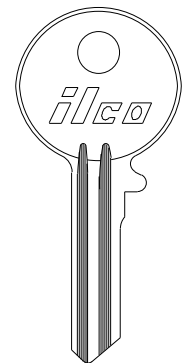

**997DA** **R997DA**  
Y34 —

ILCO  
EZ



YALE

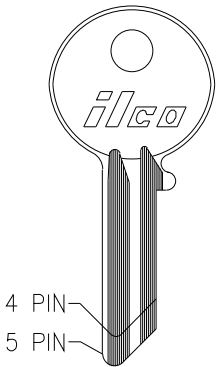

4 PIN  
5 PIN

4 PIN 5 PIN

**997EB** **997E**  
Y5 Y52

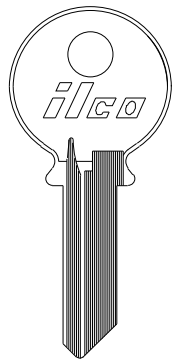

**997G** **997GR**

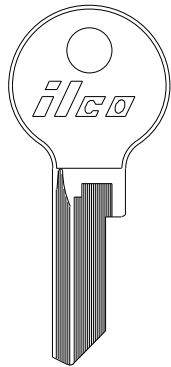

**997GX** **997GXR**

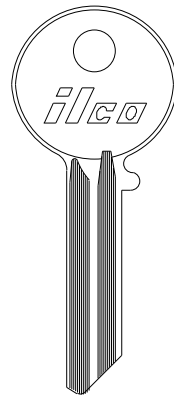

**997JA**  
—



**997JB**

—



**997JC**

—



**997JD**

—



**997JF**

—



**997JG**

—



**997JH**

—



**997JK**

—

ILCO  
EZ

NORTH AMERICAN  
CYLINDER

sec 2 page 72

YALE

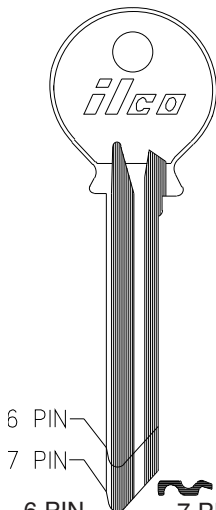

6 PIN  
7 PIN

6 PIN 7 PIN  
**997L** **997LA**

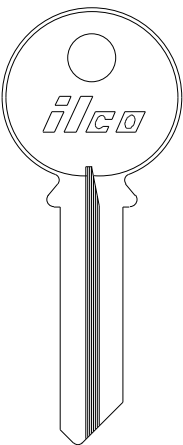

**997PA**

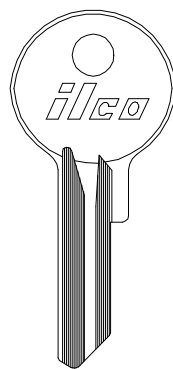

**997X**  
Y6

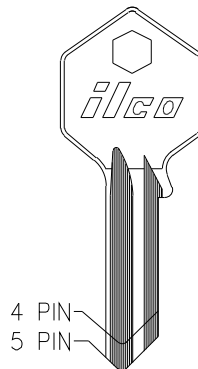

4 PIN  
5 PIN

4 PIN 5 PIN  
**H997EB** **H997E**

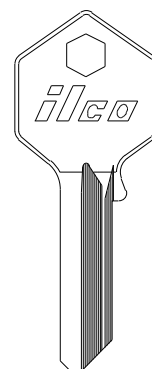

**H997ER**

ILCO  
EZ

YALE

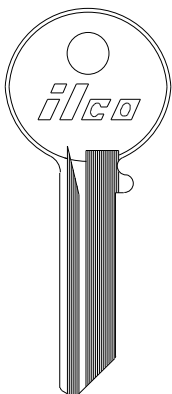

**J997M** **J997MR**

— —

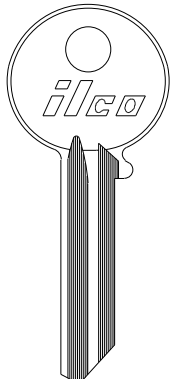

**A997EH**

—

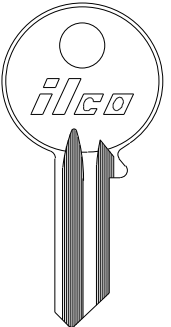

**B997EH**

—

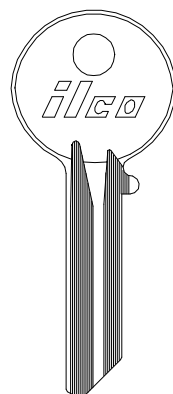

**O997E** **O997ER**

Y54 —

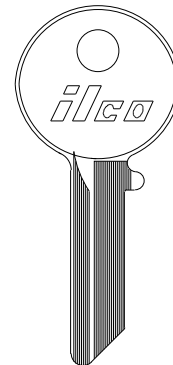

**O997G**

—

ILCO  
EZ

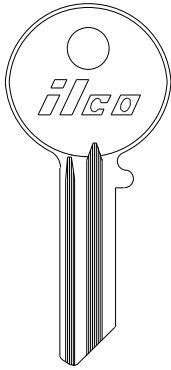
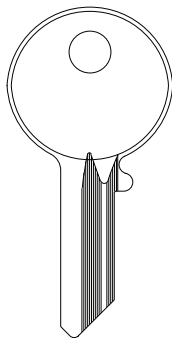
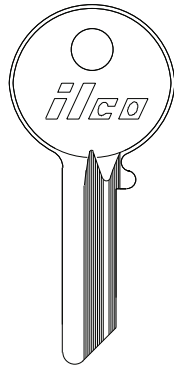
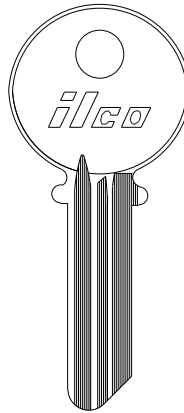
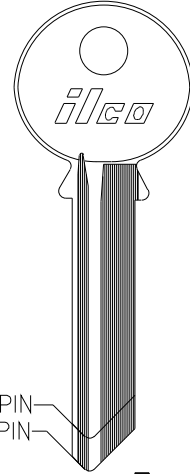
**YALE**

**O997K**

**R997EB**

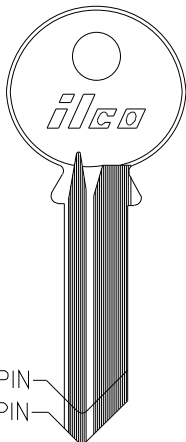
**997ER**

**998FD**

 6 PIN  
7 PIN

**998GST**
**A998GST**
**ILCO  
EZ**
**YALE**

5 PIN	<b>999LA</b> —	<b>999LB</b> —	<b>999LC</b> —	<b>999LD</b> —	<b>999LE</b> —	<b>999LF</b> —	<b>999LG</b> —	<b>999LH</b> —	<b>999LK</b> —
6 PIN	<b>998LA</b> —	<b>998LB</b> —	<b>998LC</b> —	<b>998LD</b> —	<b>998LE</b> —	<b>998LF</b> —	<b>998LG</b> —	<b>998LH</b> —	<b>998LK</b> —

 5 PIN  
6 PIN

**998GL**

6 PIN

YALE

NORTH AMERICAN  
CYLINDER

5 PIN	999GA —	999GB —	999GC —	999GD —	999GE —	999GF —	999GG —	999GH —	999GK —
6 PIN	998GA Y78	998GB —	998GC —	998GD —	998GE —	998GF —	998GG —	998GH —	998GK —
7 PIN	S998GA —	S998GB —	S998GC —	— —	— —	— —	— —	— —	— —
7 PIN	D998GA —	D998GB —	D998GC —	D998GD —	D998GE —	D998GF —	D998GG —	D998GH —	D998GK —
7 1/2 PIN	H998GA —	H998GB —	H998GC —	H998GD —	H998GE —	H998GF —	H998GG —	H998GH —	H998GK —

ILCO  
EZ

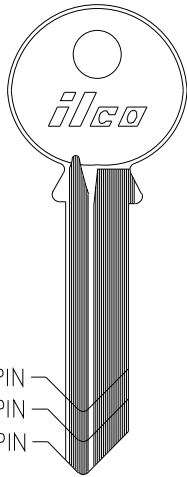

5 PIN  
6 PIN  
7 PIN

**998G SERIES**  
**999G SERIES**  
**S998G SERIES**

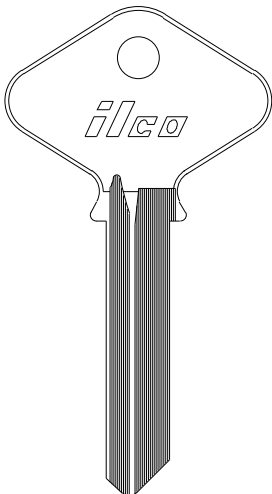

**D998G SERIES**

5 PIN	998S —
6 PIN	998 Y4
7 PIN	998A —
7 1/2 PIN	H998 —

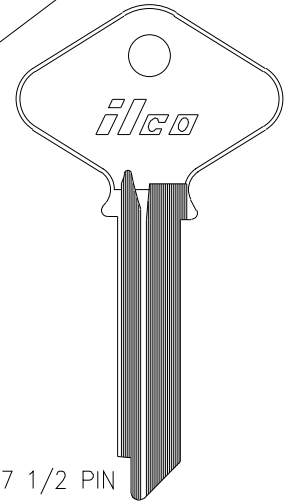

7 1/2 PIN

**H998G SERIES**

YALE

6 PIN	998SA —	998SB —	998SC —	998SD —	998SE —	998SF —	998SG —	998SH —	998SK —
7 1/2 PIN	H998SA —	H998SB —	H998SC —	H998SD —	H998SE —	H998SF —	H998SG —	H998SH —	H998SK —

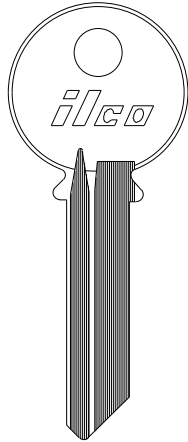

6 PIN

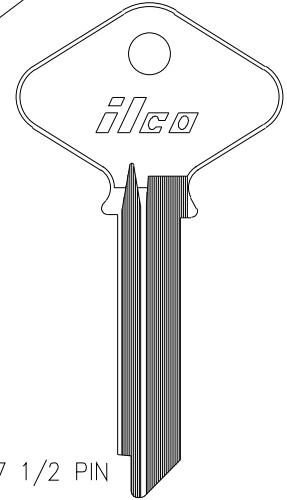

7 1/2 PIN

6 PIN		998SMK —
7 1/2 PIN		H998SMK —

6 PIN	998TA —	998TB —	998TC —	998TD —	998TE —	998TF —	998TG —	998TH —	998TK —
7 1/2 PIN	H998TA —	H998TB —	H998TC —	H998TD —	H998TE —	H998TF —	H998TG —	H998TH —	H998TK —

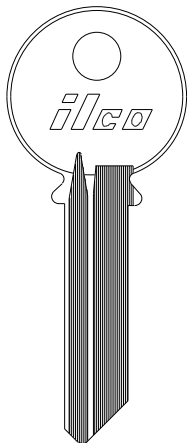

6 PIN

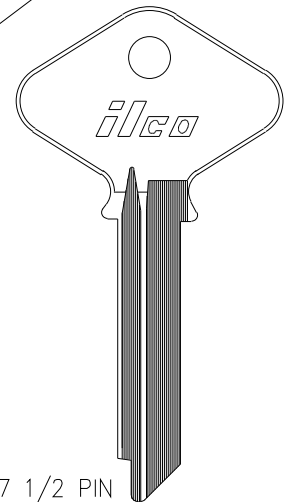

7 1/2 PIN

6 PIN		998TMK —
7 1/2 PIN		H998TMK —

YALE

NORTH AMERICAN  
CYLINDER

sec 2 page 76

5 PIN	999VA —	999VB —	999VC —	998VD —	999VE —	— —	999VG —	999VH —	— —
6 PIN	998VA —	998VB —	998VC —	998VD —	998VE —	998VF —	998VG —	998VH —	998VK —
7 1/2 PIN	H998VA —	H998VB —	H998VC —	H998VD —	H998VE —	H998VF —	H998VG —	H998VH —	H998VK —

ILCO  
EZ

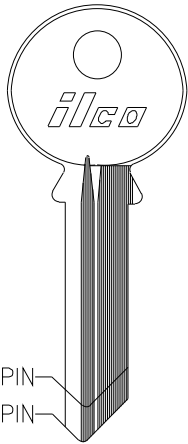

6 PIN	998R —
7 1/2 PIN	H998R —

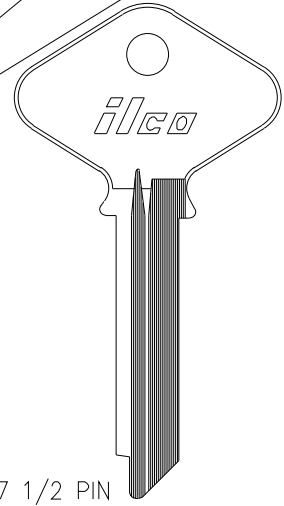

6 PIN	998YA —	998YB —	998YC —	998YD —	998YE —	998YF —	998YG —	998YH —	998YK —
7 1/2 PIN	H998YA —	H998YB —	H998YC —	H998YD —	H998YE —	H998YF —	H998YG —	H998YH —	H998YK —

ILCO  
EZ

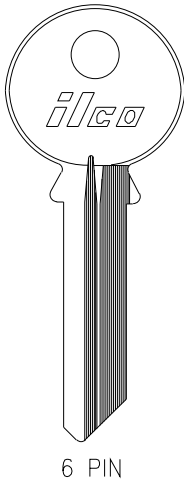

6 PIN	998YMK —
7 1/2 PIN	H998YMK —

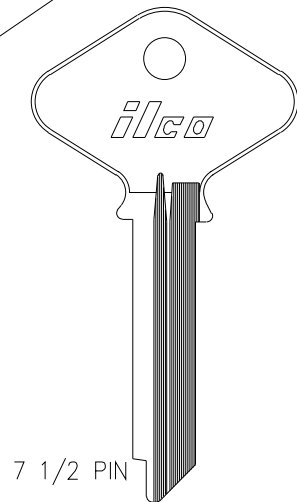

ILCO  
EZ

YALE

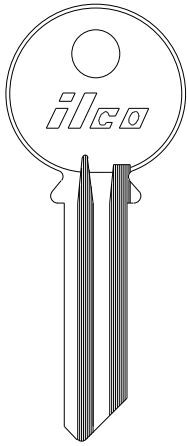

6 PIN

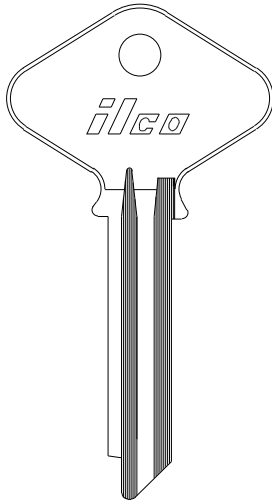

7 1/2 PIN

6 PIN      7 1/2 PIN



998ZA    H998ZA



998ZB    H998ZB



998ZC    H998ZC



998ZG    H998ZG

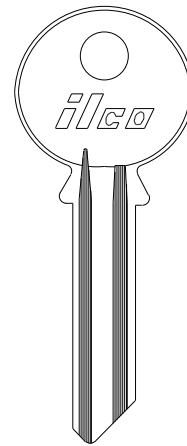

998PA



998PB



998PC



998PD



998PE



998PF



998PG



9098PH



998PK

ILCO  
EZ

YALE

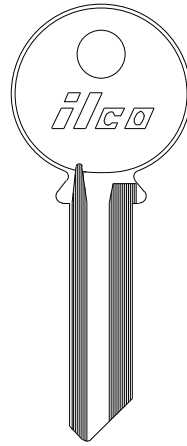

998SV

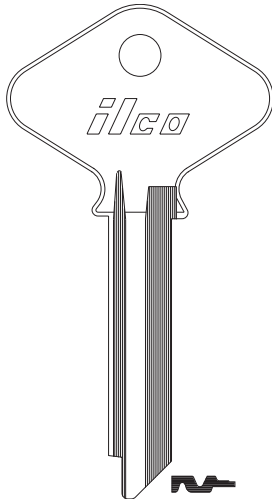

H998SV

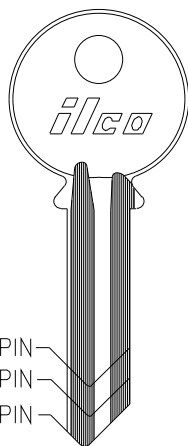

4 PIN  
5 PIN  
6 PIN

4 PIN  
999B  
Y220

5 PIN  
999  
Y1

6 PIN  
999A  
Y2

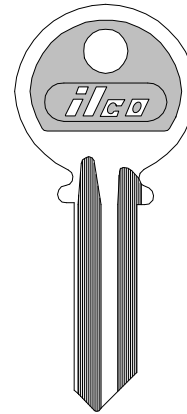

Y1-PC

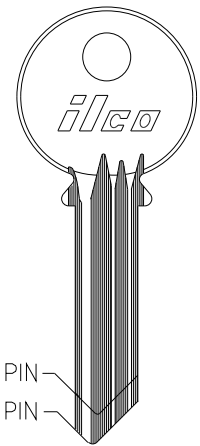

5 PIN  
6 PIN

5 PIN      6 PIN  
Y201      999CA

ILCO  
EZ

YALE

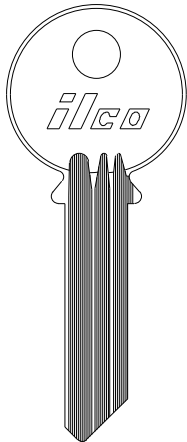

Y202

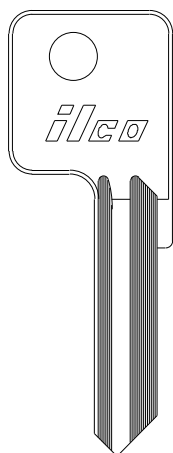

999N  
Y1E

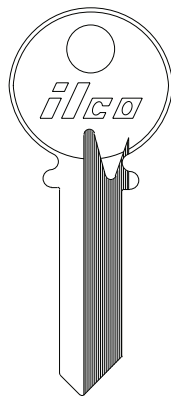

999R

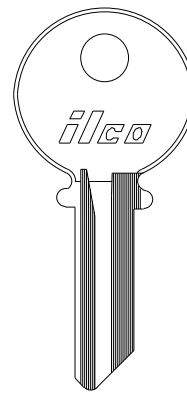

999T

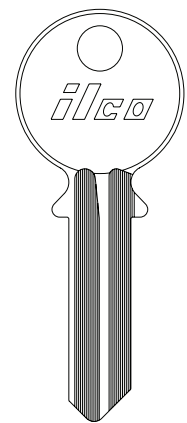

999U

ILCO  
EZ

NORTH AMERICAN  
CYLINDER

YALE

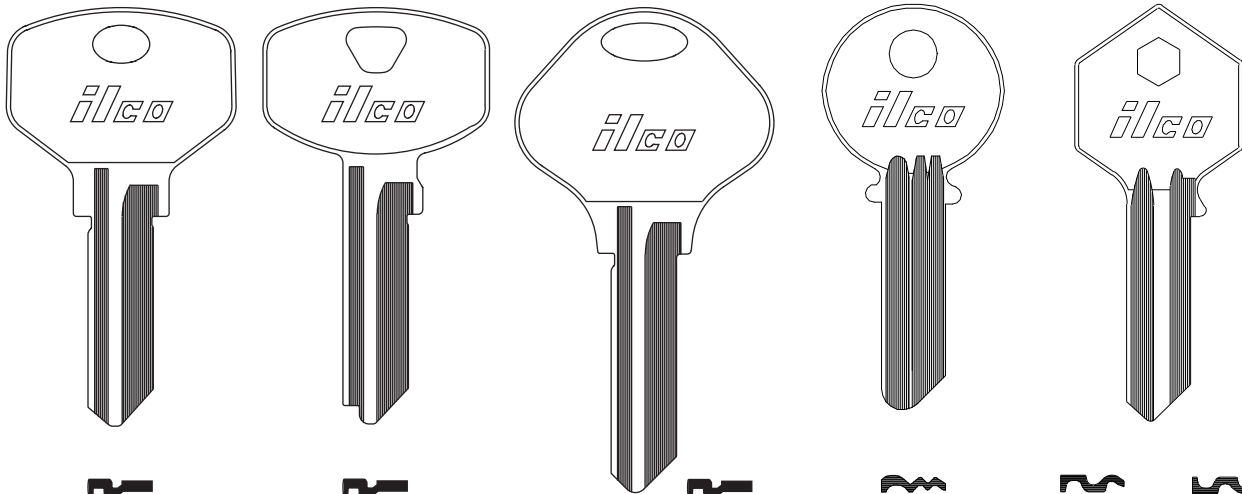

<b>999K1</b>	<b>999K2</b>	<b>999K3</b>	<b>C999</b>	<b>H999</b>	<b>H999R</b>
Y221	Y222	Y223	Y3	—	—

ILCO  
EZ

YALE

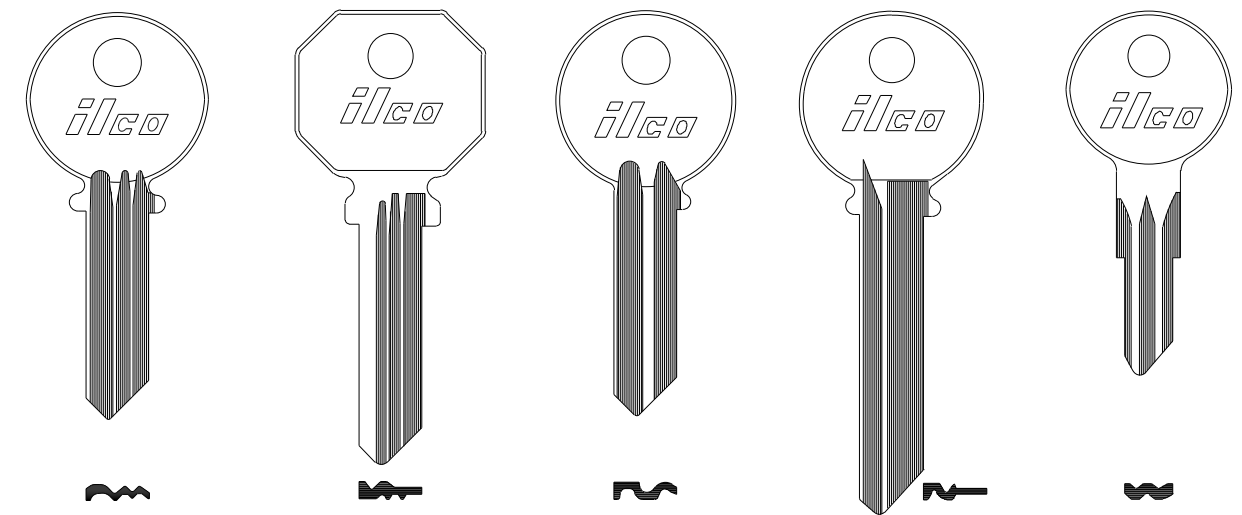

<b>O999CR</b>	<b>HS999</b>	<b>X999</b>	<b>1015GM</b>	<b>1122D</b>
—	—	—	—	—

ILCO  
EZ

YALE

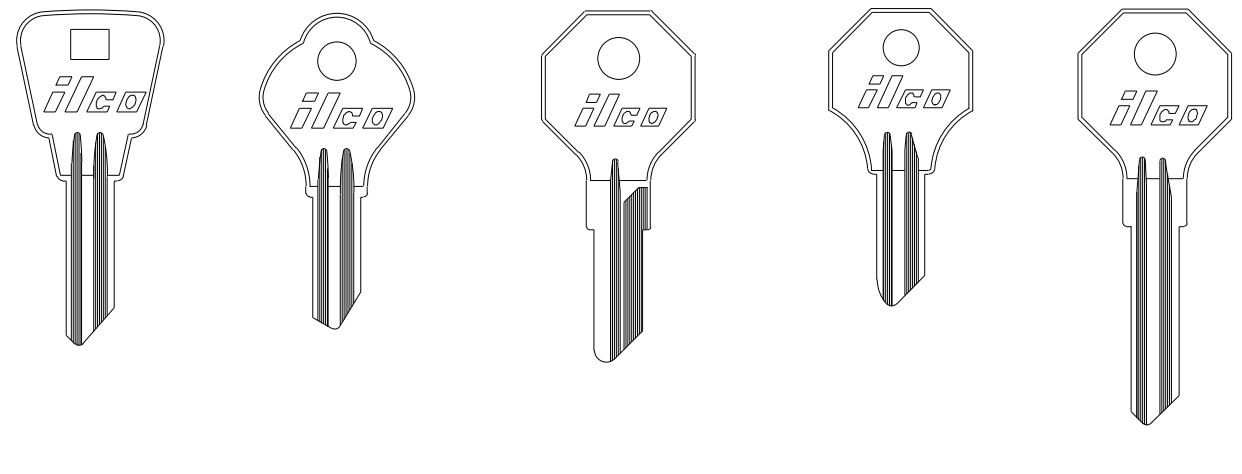

<b>E1122A</b>	<b>F1122A</b>	<b>F1122AR</b>	<b>H1122AR</b>	<b>H1122A</b>	<b>H1122F</b>	<b>H1122FR</b>	<b>H1122W</b>
—	—	—	—	—	Y9	—	—

ILCO  
EZ

YALE

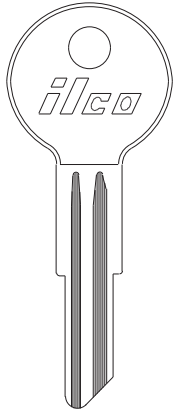

L1122AR  
—

L1122B  
—

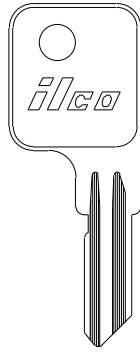

NO1122D  
—

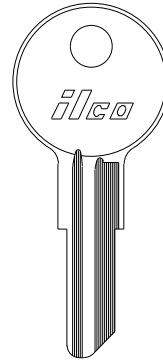

O1122A  
Y12

O1122B  
Y103

O1122BE  
—

O1122AR  
Y14

O1122BR  
—

O1122BER  
—

L1122A  
Y101

O1122  
Y11

O1122R  
Y13

O1122C  
—

ILCO  
EZ

YALE

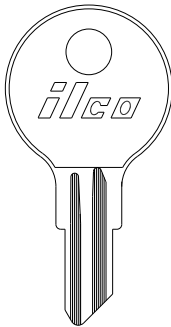

O1122NV  
—



1132  
—

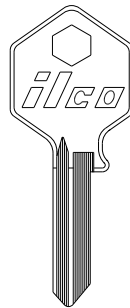

R1132  
—

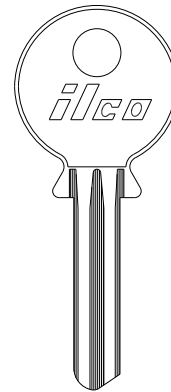

H1132  
—

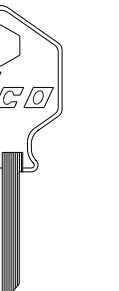

HR1132  
—

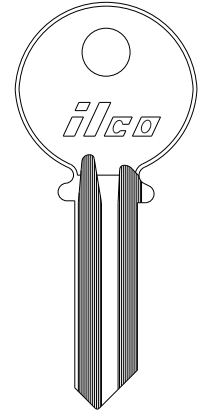

1143  
—

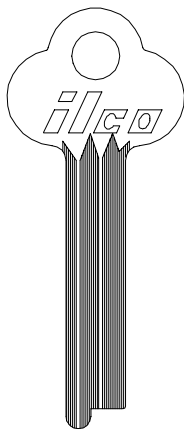

1554  
—

ILCO  
EZ

YALE

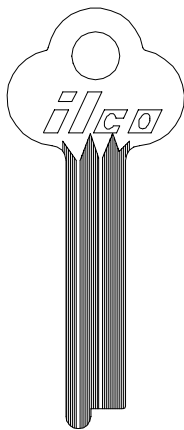

1587  
—

ILCO  
EZ

NORTH AMERICAN  
CYLINDER





### Section 3

## INTERNATIONAL CYLINDER

Key Blanks designed for locks used primarily outside of North America. Manufacturers are listed in alphabetical order and keys are listed by manufacturer in a numerical order where possible.

Throughout this section you will notice . This symbol indicates that a special key machine is required to cut that blank.

ABLOY

ABUS

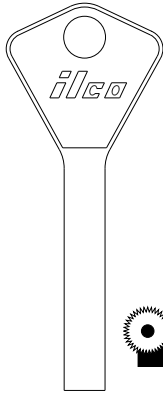

(BLACK)  
**AL1-BLK**  
AY1P  
S11ABYP

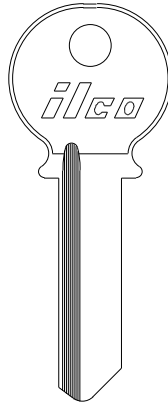

**AB3**  
—  
—



**AB4**  
—  
—

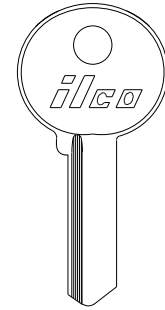

**AB5**  
—  
—



**AB6**  
—  
—

**AB7**  
—  
—

—  
**AB8**  
—

ILCO  
SILCA  
ORION

ABUS

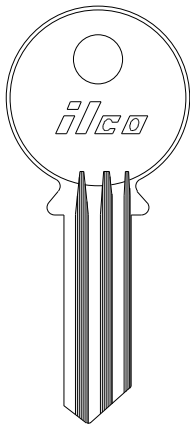

**AB9**  
AB4

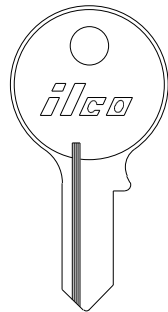

**AB10**  
—

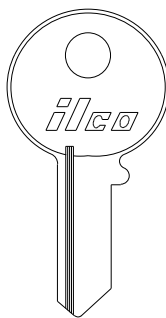

**AB11**  
—

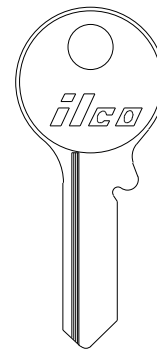

**AB12**  
AB17R

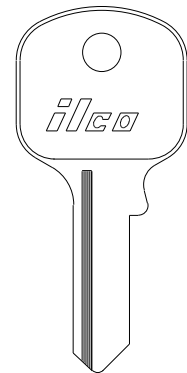

**ABS14L**  
**AB13**  
—

—  
**AB14**  
—

ILCO  
SILCA  
ORION

ABUS

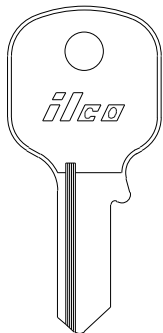

**AB15**  
AB16R

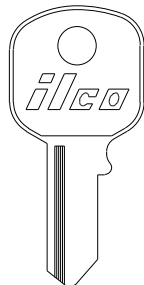

**AB16**  
AB15R

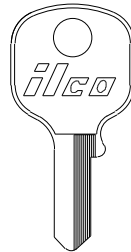

**AB17**  
CS23

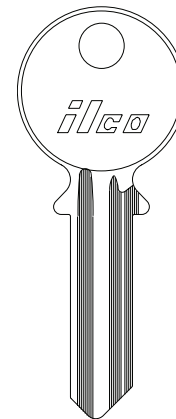

**ABS20**  
**AB18**  
AB10

**ABS12**  
**AB19**  
AB8

**AB20**  
AB8R  
ABS11L

**AB21**  
AB10R  
ABS12L

ILCO  
SILCA  
ORION

ABUS



**AB22**

—  
—



**AB23**

AB19

—



**AB62A**

AB9

—



**AB62AR**

—

—



**AB62CR**

—

—



**AB62C**

CS6

—

**ILCO**  
SILCA  
ORION

ABUS

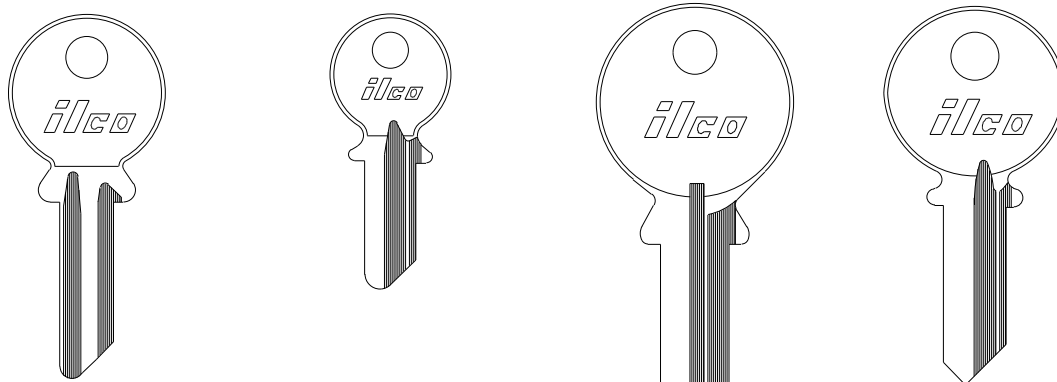

**AB62E**

CS7  
CSA5P



**AB62ER**

CS7R  
CSA5PL



**AB62G**

CS9



**AB62GR**

CS9R

5 PIN  
6 PIN

5 PIN

**CS91**

CS500  
CSA50



6 PIN

**AB1**

CS501  
CSA51



**CS91B**

CS205



**999B**

YA6  
YAL4

**ILCO**  
SILCA  
ORION

AGE

AGUIA

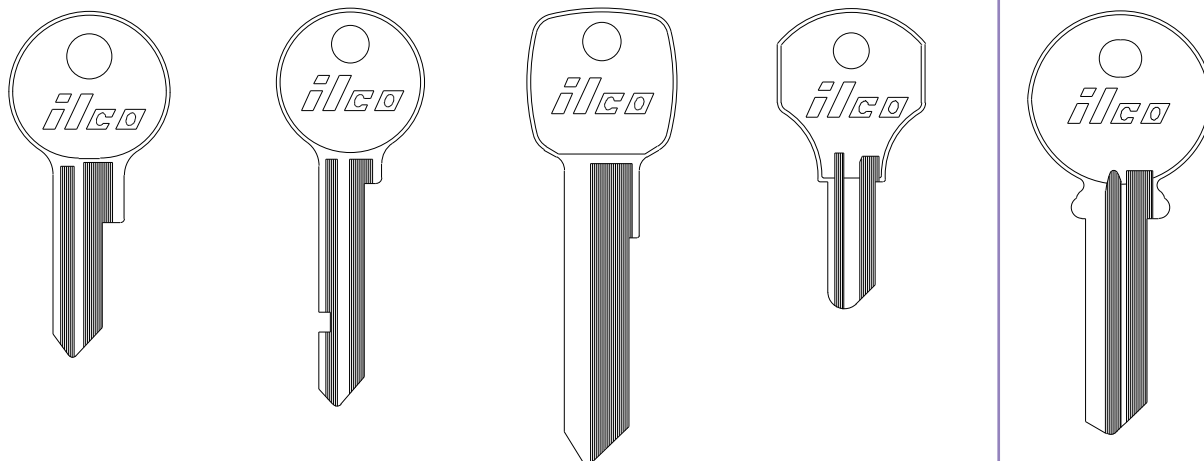

**AG1**

AG2R

—



**AG3**

—

—



**AG2**

AG1R

—



**AG4**

AGE4R

—



**AG5**

AGE1

AGE10



**AGU1**

—

—



**AG1R**

—

—

**ILCO**  
SILCA  
ORION

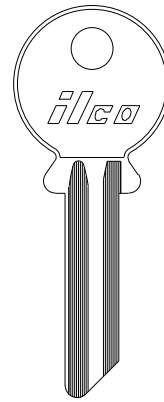
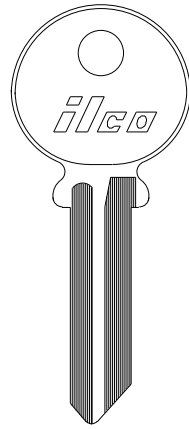
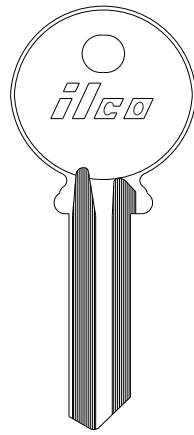
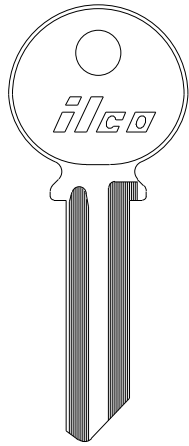
**AGUIA**
**AJAX**

**ILCO**  
SILCA  
ORION

**AU1**  
AG4  
AGU14  
**AU2**  
AG4R  
AGU14L

**ID1**  
—  
—

**AU3**  
AG3  
AGU13  
**AU4**  
AG3R  
AGU13L

**AU5**  
—  
—  
**AU6**  
—  
—

**VAE1**  
VAC1  
—

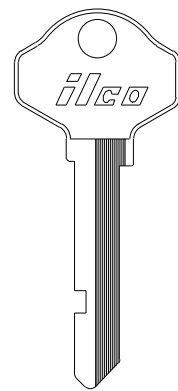
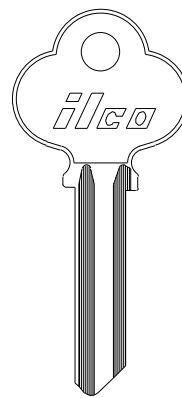
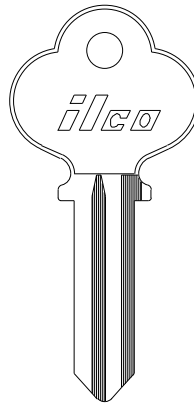
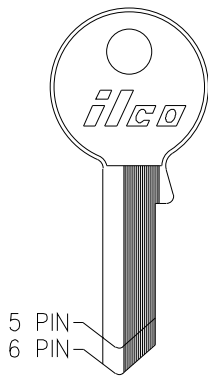
**ALPHA**

**5 PIN ALP2**  
ALP8R  
**6 PIN ALP3**  
ALP7R

**ALP4**  
ALP1  
APH1

**ALP5**  
ALP2  
—

**ALP6**  
—  
—

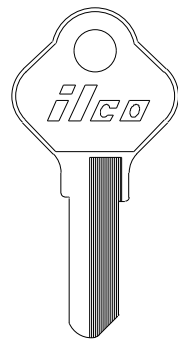
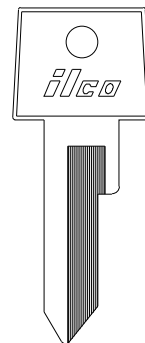
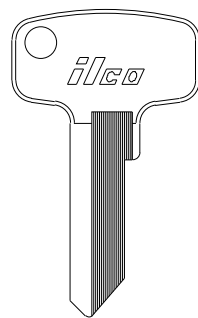
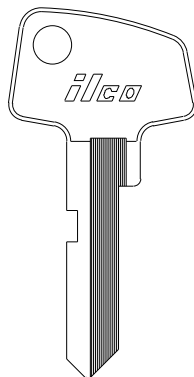
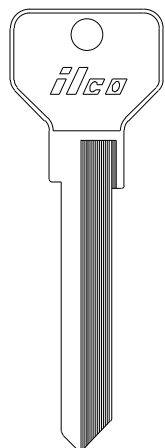
**ILCO**  
SILCA  
ORION

**ALPHA**

**ILCO**  
SILCA  
ORION

**ALP7**  
AD2  
—

**ALP8**  
—  
—

**ALP9**  
OLT1  
—

**ALP10**  
AP10  
—

**A190**  
ALP5R  
—

ALPHA	ALPHA ALARM	ANKER		
	 AUSTRALIA	 3 PIN 4 PIN 5 PIN	 4 PIN <b>AK2</b> AKR2 ANK11 5 PIN <b>AK3</b> — ANK12	
 <b>A192</b> — —	 <b>AP6</b> — —	 <b>AK1</b> AKR1 ANK10	 <b>AN2</b> AKR3 —	 <b>AK4</b> AKR5 —

ILCO  
SILCA  
ORION

ANKER	ANTAR		APEX	
 <b>AK5</b> — —	 <b>AK6</b> AKR4 —	 <b>61JD</b> RO8 RN16	 <b>R61JD</b> RO8R RN16L	 <b>H61V</b> — ANT10
				 <b>AP4A</b> — —

ILCO  
SILCA  
ORION

ARMOR	ASSA			
 <b>AR91</b> — —	 <b>R65U</b> — —	 <b>AS1</b> ASS11 A28G	 <b>AS3</b> ASS11R A28M	 <b>AS5</b> ASS33 A28K  <b>AS23</b> ASS10 A28S  <b>61Q</b> ASS31 A28E  <b>AS7</b> ASS33R A28L  <b>AS25</b> ASS10R A28R  <b>R61Q</b> ASS31R A28F  <b>61W</b> ASS2 A28N  <b>AS14S</b> — —  <b>R61W</b> ASS2R A28P  <b>AS83</b> — —
		 <b>61T</b> — A28A	 <b>R61T</b> ASS9R A28B	

ILCO  
SILCA  
ORION

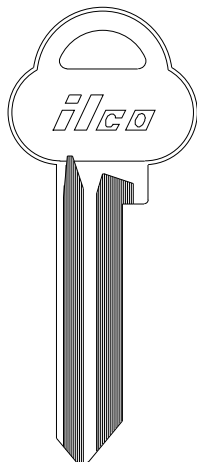
**ASSA**



**AS6**  
ASS32  
A34K



**AS8**  
ASS17R  
A34L



**A61W**  
ASS38  
A34N



**AR61W**  
ASS38R  
A34P



**AS24**  
ASS42  
A34S



**AS14L**  
ASS136R  
A34RC



**A61Q**  
ASS40  
A34E



**AR61Q**  
ASS40R  
A34F



**ILCO**  
SILCA  
ORION



**AS2**  
ASS12  
A34G



**AS4**  
ASS12R  
A34M



**A61T**  
ASS3  
A34A



**AR61T**  
ASS3R  
A34B



**AS11**  
ASS35R  
A29V



**AS9**  
ASS13R  
A29T

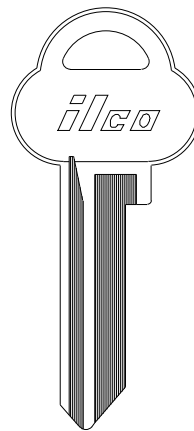

**AS31**  
ASS37R  
A29X



**AS33**  
ASS37  
A29Z



**AS71**  
ASS69  
A29D



**AS73**  
ASS64R  
A29H



**AS75**  
ASS7  
A29U

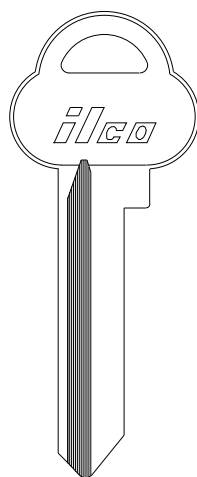

**AS77**  
ASS7R  
A29W

**ASSA**



**AS32**  
ASS36R  
A35X



**AS34**  
ASS36  
A35Z



**AS76**  
ASS8  
A35U



**AS78**  
ASS8R  
A35W



**AS74**  
ASS4R  
A35H



**ILCO**  
SILCA  
ORION



**AS10**  
ASS15R  
A35T



**AS12**  
ASS34R  
A35V

ASSA

5 PIN	<b>AS19</b> ASS15 A29AK	<b>AS15</b> ASS13 A29AL	<b>AS55</b> ASS17 A29AM	<b>AS37</b> ASS21 A29BK	<b>AS45</b> ASS19 A29BL	<b>AS39</b> ASS23 A29BM	<b>AS29</b> ASS25 A29DK	<b>AS49</b> ASS27 A29DL	<b>AS51</b> ASS29 A29DM
6 PIN	<b>AS20</b> ASS16 A35AK	<b>AS16</b> ASS14 A35AL	<b>AS56</b> ASS18 A35AM	<b>AS38</b> ASS22 A35AM	<b>AS46</b> ASS20 A35BL	<b>AS40</b> — A35BM	<b>AS30</b> ASS26 A35DK	<b>AS50</b> ASS28 A35DL	<b>AS52</b> ASS30 A35DM

INTERNATIONAL  
CYLINDER

ILCO  
SILCA  
ORION

sec 3 page 6

5 PIN	<b>AS63</b> ASS65 A29AS	<b>AS65</b> ASS66 A29BS	<b>AS57</b> ASS67 A29DS
6 PIN	<b>AS64</b> ASS80 A35AS	<b>AS66</b> ASS81 A35BS	<b>AS58</b> ASS82 A35DS

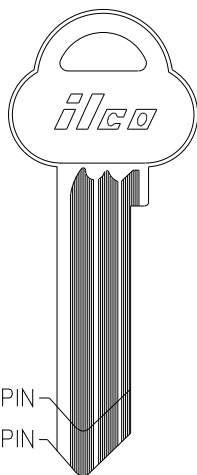

5 PIN  
6 PIN

ILCO  
SILCA  
ORION

ILCO  
SILCA  
ORION

**ASSA**

<u>5 PIN</u>	<b>AS17</b> — A29EK	<b>AS13</b> ASS13R A29EL	<b>AS21</b> — A29EM	<b>AS35</b> — A29FK	<b>AS43</b> ASS19R A29FL	<b>AS69</b> ASS23R A29FM	<b>AS27</b> — A29GK	<b>AS47</b> — A29GL	<b>AS53</b> ASS29R A29GM
<u>7 PIN</u>	<b>AS18</b> — A35EK	<b>AS14</b> ASS14R A35EL	<b>AS22</b> — A35EM	<b>AS36</b> ASS22R A35FK	<b>AS44</b> ASS20R A35FL	<b>AS70</b> ASS24R A35FM	<b>AS28</b> ASS26R A35GK	<b>AS48</b> ASS28R A35GL	<b>AS54</b> ASS30R A35GM

**ILCO**  
SILCA  
ORION

<u>5 PIN</u>	<b>AS61</b> ASS65R A29ES
<u>7 PIN</u>	<b>AS62</b> ASS80R A35ES

	<b>AS67</b> ASS66R A29FS
	<b>AS68</b> ASS81R A35FS

	<b>AS59</b> ASS67R A29GS
	<b>AS60</b> ASS82R A35GS

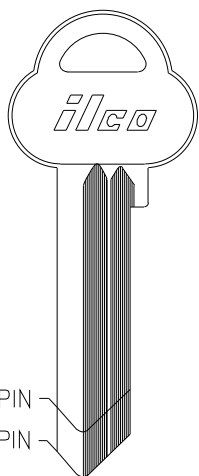
**ILCO**  
SILCA  
ORION

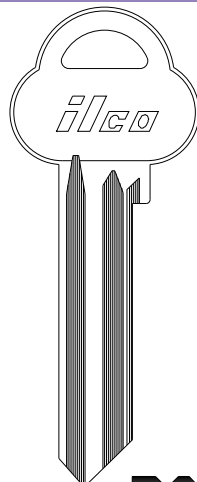
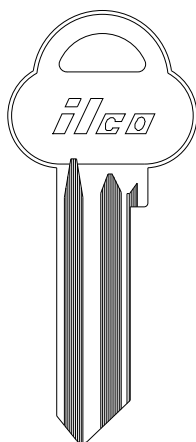
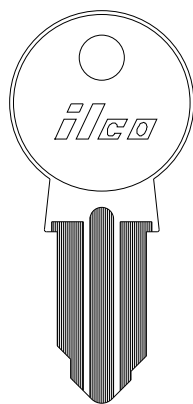
**INTERNATIONAL  
CYLINDER**
**ASSA**

**AS72**  
—  
A35D

**AS82**  
ASS52R  
A37HH

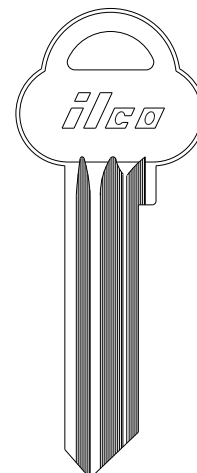
**ILCO**  
SILCA  
ORION

**61X**  
—  
—

**AS79**  
ASS73  
A31DD

**AS81**  
ASS73R  
A31HH

**AS80**  
ASS52  
A37DD

**AS84**  
—  
—



ASSA ASTRA

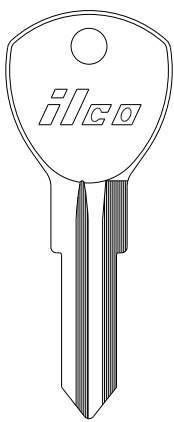

**AS85**  
—  
—

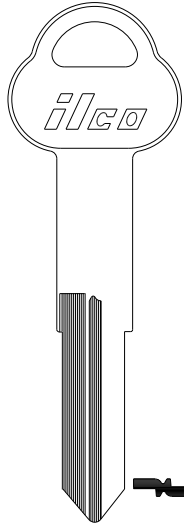

**AS86**  
ASS61  
—

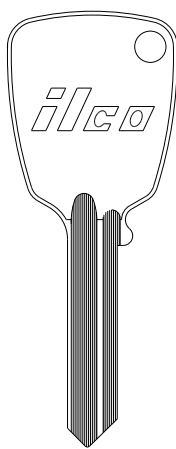

**AS89**  
ASS60  
ASA1

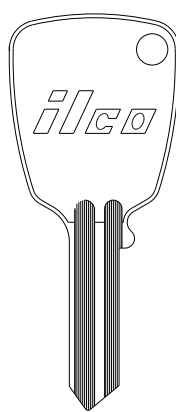

**AS90**  
ASS59  
ASA2

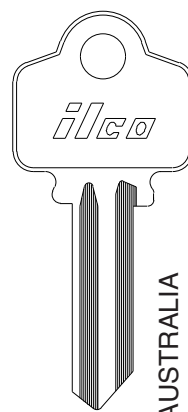

**AT1**  
—  
—

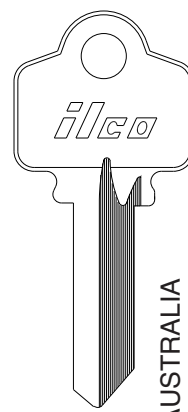

**AT2**  
—  
—

AUSTRALIA

AUSTRALIA

**ILCO**  
SILCA  
ORION

ASTRA ATAKA AUSTRAL AUSTRALIA AZBE

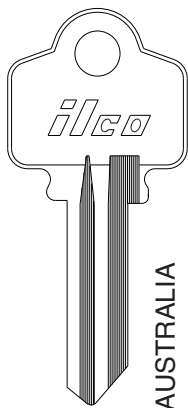

**AT3**  
—  
—

AUSTRALIA

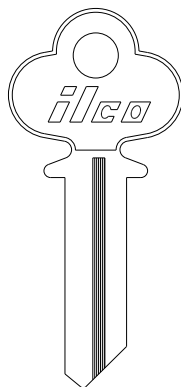

**ATA1** **ATA2**  
— —  
— —

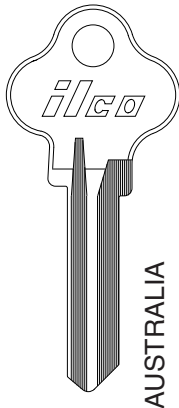

**AUS1**  
—  
—

AUSTRALIA

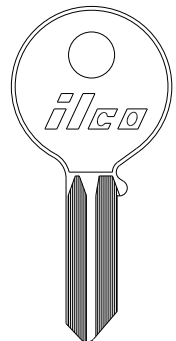

**K77L**  
—  
—

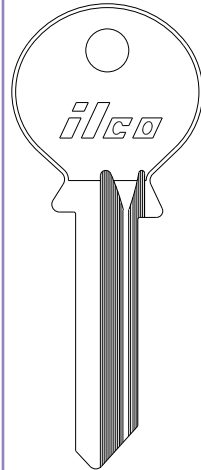

**AZ2** **AZ2R**  
AZ1R AZ1  
AZB11L AZB11

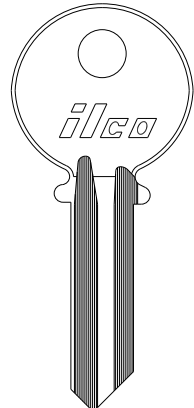

**999** **999R**  
Y1 YA1R  
YAL13 —

**ILCO**  
SILCA  
ORION

AZBE BAAL BASTA BELL

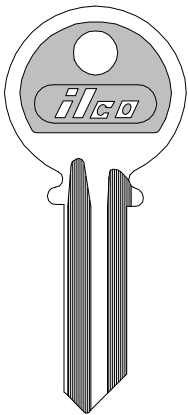

**Y1-PC**  
—  
—

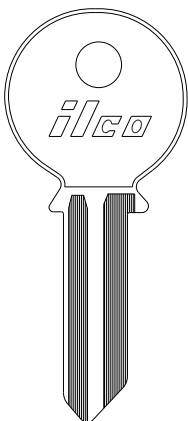

**BA1**  
BAL1  
—

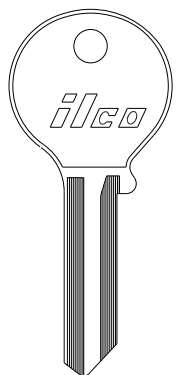

**BA2**  
BAL3  
—

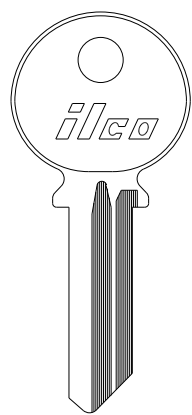

**BAS1**  
BAS1  
BS2

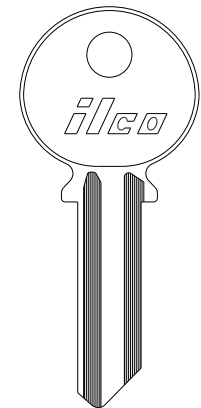

**9BA**  
—  
—

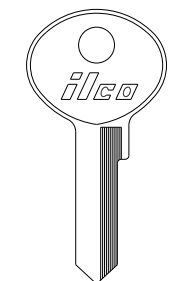

**BEL1**  
—  
—

**ILCO**  
SILCA  
ORION

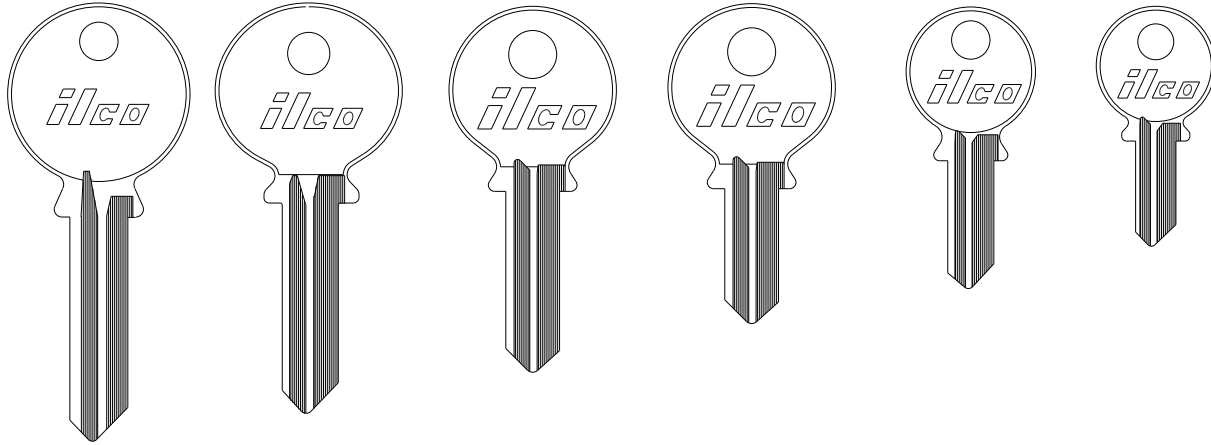
**BELL**

**BEL2**

 —  
—

**BEL3**

 BLL1  
—

**BEL4**

 BLL2  
—

**BEL5**

 BLL3  
—

**BEL6**

 BLL4  
—

**BEL7**

 BLL5  
—

**ILCO**  
SILCA  
ORION

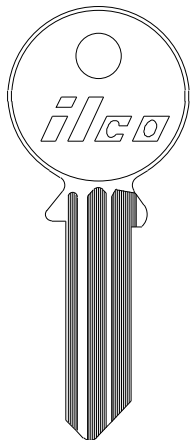
**BERIA**

**BR91C**

 JW1R  
—

**JU1D**

 JW1  
—

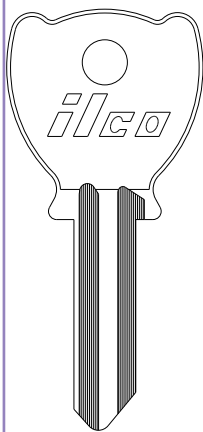
**ILCO**  
SILCA  
ORION

**BETA**

**BT1**

 —  
BTA4

**BT3**

 —  
BTA4L

**BT2**

 —  
BTA5

**BT4**

 —  
BTA5L

**B & G**

**B62DV**

 —  
UN14

**BS62DV**

 —  
—

sec 3 page 9

 INTERNATIONAL  
CYLINDER

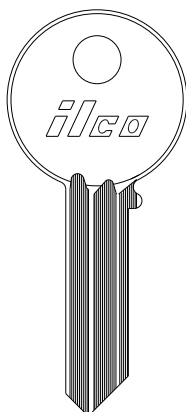
**BKS**

**BKZ1**

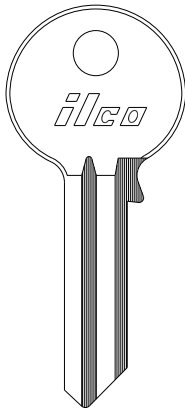
 YA9  
YAL21

**ILCO**  
SILCA  
ORION

**BVA1**

VYA

**BYA1**

YYA

**KS91C**

BK1

**X999**

YA1

BKS10

BKS

	<b>BKS3</b> BKS-11 BKS25	<b>BKS7</b> BKS-15 BKS29	<b>BKS11</b> BKS-19 BKS33	<b>BKS15</b> BKS-23 BKS37	<b>BKS19</b> BKS-27 BKS41	<b>BKS23</b> BKS-31 BKS45	
	<b>BKS4</b> BKS-12 BKS26	<b>BKS8</b> BKS-16 BKS30	<b>BKS12</b> BKS-20 BKS34	<b>BKS16</b> BKS-24 BKS38	<b>BKS20</b> BKS-28 BKS42	<b>BKS24</b> BKS-32 BKS46	
<b>BKS5</b> BKS-13 BKS27	<b>BKS9</b> BKS-17 BKS31	<b>BKS13</b> BKS-21 BKS35	<b>BKS17</b> BKS-25 BKS39	<b>BKS21</b> BKS-29 BKS43			
<b>BKS2</b> BKS-10 BKS24	<b>BKS6</b> BKS-14 BKS28	<b>BKS10</b> BKS-18 BKS32	<b>BKS14</b> BKS-22 BKS36	<b>BKS18</b> BKS-26 BKS40	<b>BKS22</b> BKS-30 BKS44		<b>BK5</b> X9E —

ILCO  
SILCA  
ORION

BKS

	<b>BKS26</b> BK3-2 —	<b>BKS30</b> BK3-6 —	<b>BKS34</b> BK3-10 —		
<b>BKS27</b> BK3-3 —	<b>BKS31</b> BK3-7 —	<b>BKS35</b> BK3-11 —			
<b>BKS28</b> BK3-4 —	<b>BKS32</b> BK3-8 —	<b>BKS36</b> BK3-12 —			
<b>BKS25</b> BK3-1 —	<b>BKS29</b> BK3-5 —	<b>BKS33</b> BK3-9 —	<b>BK37</b> — —	<b>KS91P</b> YA3 —	

ILCO  
SILCA  
ORION

BKS

<b>997EB</b> YA8 YAL10	<b>997ER</b> YA3R YAL12L	<b>999A</b> YA5 YAL15	<b>999GA</b> GYA YAL13A	<b>999GB</b> GYB YAL13B	<b>999GF</b> GYF YAL13F
				<b>999GC</b> GYC YAL13C	<b>999GG</b> — YAL13G
				<b>999GD</b> — YAL13D	<b>999GH</b> GYH YAL13H
				<b>999GE</b> GYE YAL13E	<b>999GK</b> GYK YAL13K

ILCO  
SILCA  
ORION

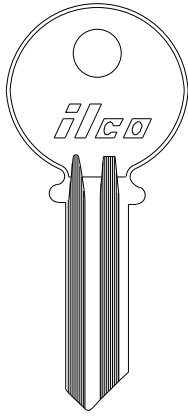
**BKS**
**BLACK & DECKER**

**999LB** 999LF  
LYB LYF  
YAL41B YAL41F

**999LC** 999LG  
LYC LYG  
YAL41C YAL41G

**999LD** 999LH  
LYD LYH  
YAL41D YAL41H

**999LA**  
LYA  
YAL41A

**999LE** 999LK  
LYE LYK  
YAL41E YAL41K

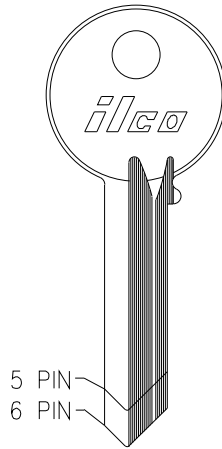

5 PIN  
6 PIN

**999R**  
YA1R  
—

**5 PIN** **6 PIN**  
**X999** **X999A**  
YA1 —  
BKS10 —  
**X999R** —  
YA1R —  
BKS10L —

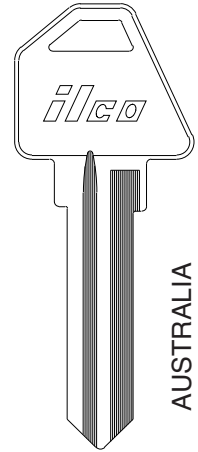

AUSTRALIA

**LH10**  
—  
—

ILCO  
SILCA  
ORION

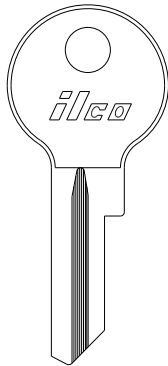
**BLAU**
**BLOCUS**

**BU3**  
—  
—



**BU4**  
HM1  
—

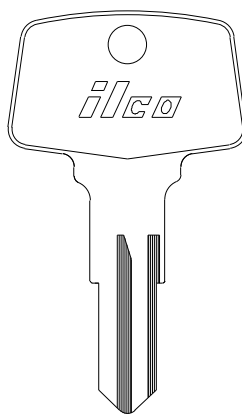

**BU7** **BU8**  
BT2R BT2  
— —

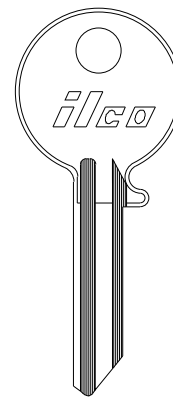

**BL2** **BL91**  
— BL1  
BLK10L BLK10

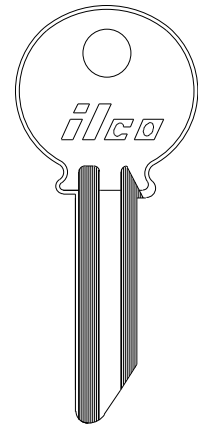

**BK5**  
—  
—

ILCO  
SILCA  
ORION

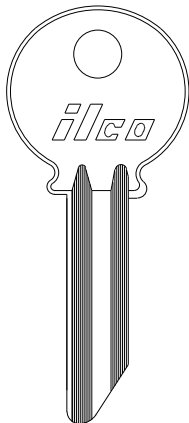
**BLOCUS**
**BO**
**BODA**

**BK37**  
—  
—

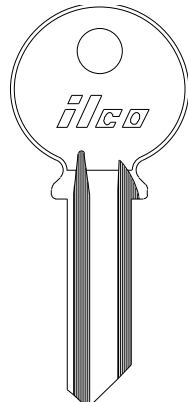

**61JD**  
RO8  
RN16

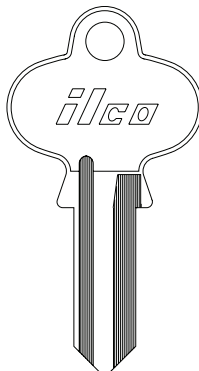

**BJ1** **BJ1R**  
— —  
— —

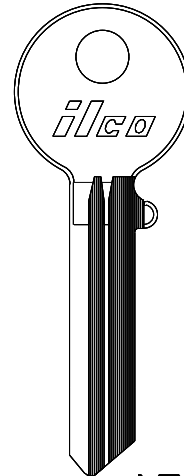

**BD6**  
—  
—

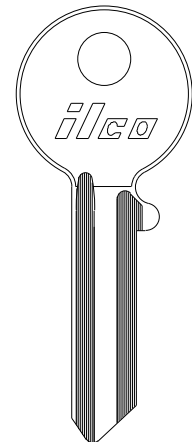

**BD7**  
—  
—

ILCO  
SILCA  
ORION

BODA						BOMORO
	 BD1A — —	 — BD2A — —	 — BD3A — —	 — BD4A — —	 — BD5A — —	
	 BD1B — —	 — BD2B — —	 — BD3B — —	 — BD4B — —	 — BD5B — —	
	 BD1C — —	 — BD2C — —	 — BD3C — —	 — BD4C — —	 — BD5C — —	
	 BD1D — —	 — BD2D — —	 — BD3D — —	 — BD4D — —	 — BD5D — —	
						 BM2 NE11 —

ILCO  
SILCA  
ORION

BORKEY	BOSCH	
 BY1 — —	 BH2 — —	 138 XOM1 —

ILCO  
SILCA  
ORION

BREVETTO			BRICARD	
 61B — —	 62BA — —	 R62BA — —  R62B — —  B62B — —	 BC1 — —	 BC2 — —

ILCO  
SILCA  
ORION

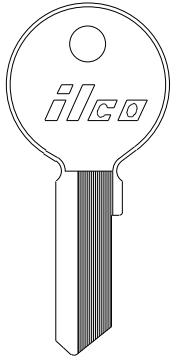
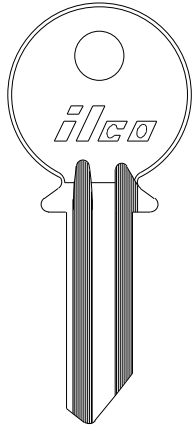
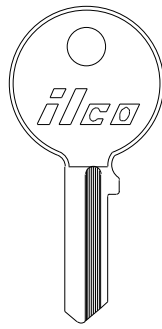
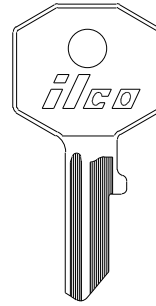
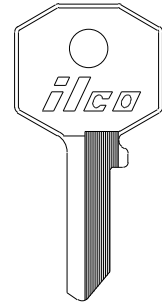
**BROTHERS**
**BRUMME**
**BURG**

**BS1**  
—  
—

**BR1**  
BRM1  
—

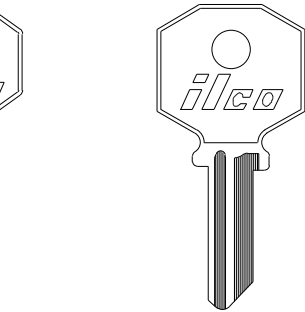
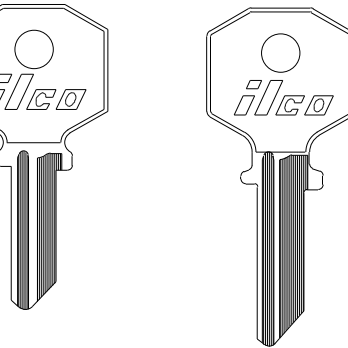
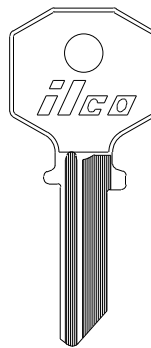
**BUR1**  
BUR17R  
—

**BUR2**  
—  
—

**BUR3**  
—  
—

**ILCO**  
SILCA  
ORION

**BURG**

**BUR4**  
BUR4  
BRD7

**BUR5**  
BUR11  
BRG8

**BUR6**  
BUR6  
BRG14

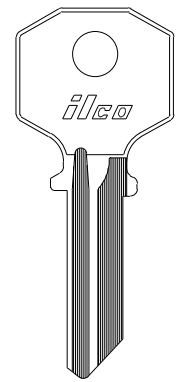
**BUR7**  
BUR2  
BRG11

**BUR8**  
BUR2R  
BRG11L

**BUR9**  
BUR7  
BRG17

**BUR10**  
—  
BRG8

**BUR11**  
BUR1  
BRG12

**BUR12**  
BUR1R  
BRG12L

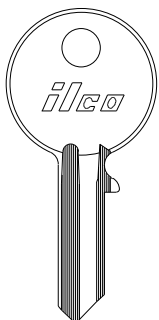
**ILCO**  
SILCA  
ORION

**BURG**
**BUVA**
**CANARIO LUCAS**

**BUR13**  
BUR16  
—

**BUR14**  
—  
BRG20

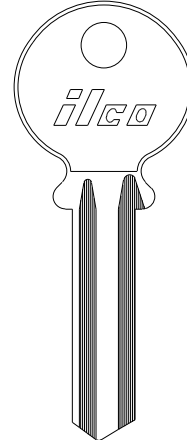
**BUR15**  
—  
—

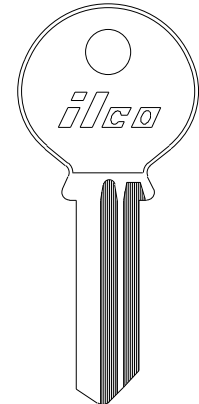
**ILCO**  
SILCA  
ORION

**BV1**  
BVA1  
—

**BV2**  
BVA1R  
—

**CL2**  
—  
—

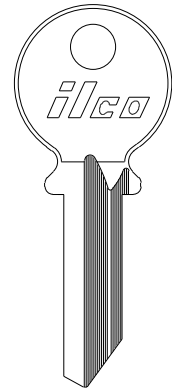
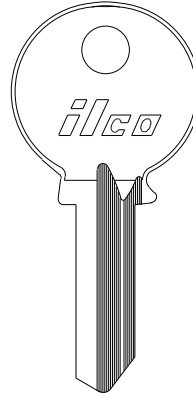
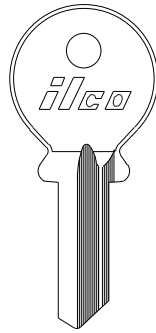
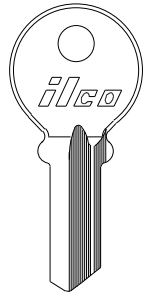
**CL3**  
—  
—

CAVERS



**CA91**  
CA5  
CV10



**CA91A**  
CA4  
CV11



**CA91B**  
CA3  
CV12



**CA91C**  
CA7  
—



**CA91D**  
CA7  
CV19

**ILCO**  
SILCA  
ORION

CAVERS

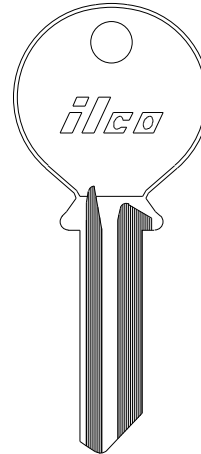
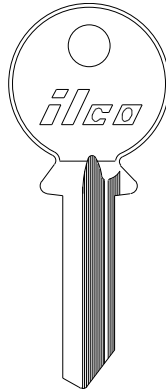
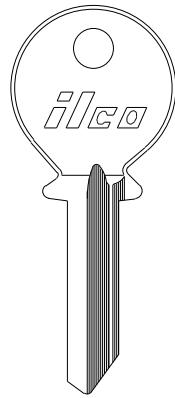
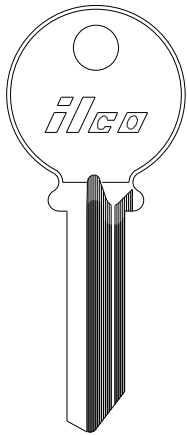

**CA91L**  
CA2  
—



**CA91S**  
CA1  
—



**CAV91**  
CA1  
—



**ZE91C**  
CA2R  
CV14L



**ZE91CR**  
—  
CV14

**ILCO**  
SILCA  
ORION

CENTURY

CERRAMARC

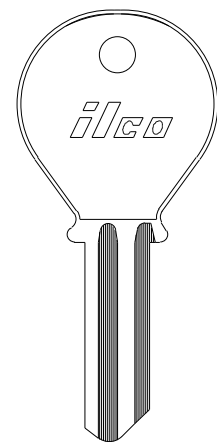
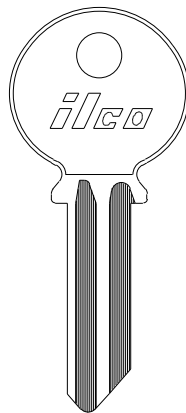
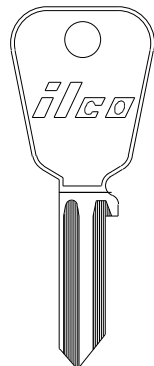
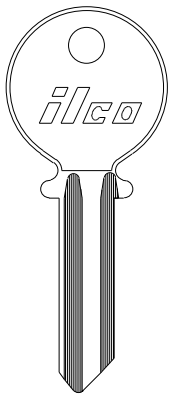

**CT1**  
—  
—



**CT2**  
—  
—



**CE1**  
CEN1  
—



**R62CA**  
—  
—



**CER1**  
—  
—

**ILCO**  
SILCA  
ORION

C.E. SCHULTE

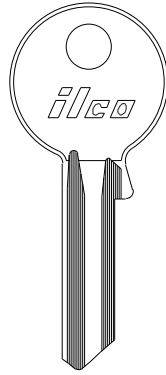
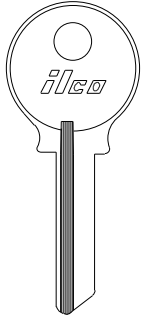

CS16

CS20

CS24

—

—

—

CS17

CS21

—

—

CS18

CS22

—

—



CS1

—

—



CS10

—

CE11



CS11

—

CE11L



CS19

—

—



CS23

—

—

ILCO  
SILCA  
ORION

C.E. SCHULTE

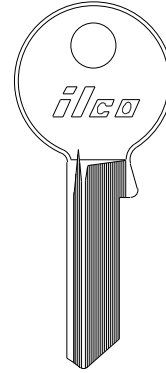
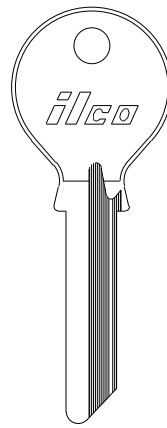
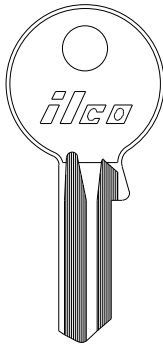

CS12

CE7

CE20



CS13

CE7R

CE20L



CS14

CE13

—



CS15

CE13R

—



CS25

—

—



CS26

—

—



CS27

—

—



CS28

CE10

—

ILCO  
SILCA  
ORION

C.E. SCHULTE

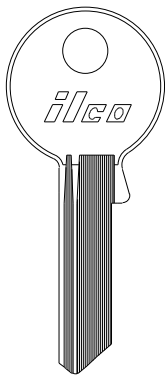

CS30

—

—

CS31

—

—

CS32

—

—

CS34

—

—

CS35

—

—

CS36

—

—

CS38

—

—

CS39

—

—

CS40

—

—

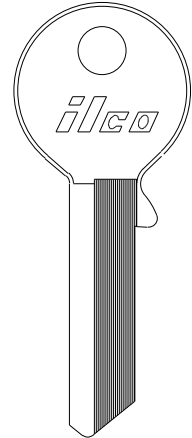

CS29

CE8

CE16



CS33

—

—



CS37

—

—



CS41

—

—



CS42

—

—



CS43

—









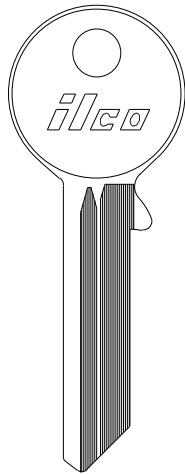







—

ILCO  
SILCA  
ORION





C.E.SCHULTE

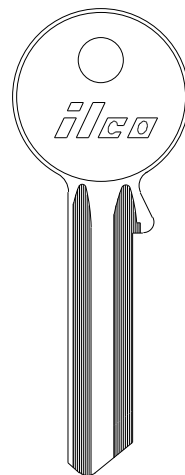

 <b>CS45</b> CE14-16 —	 <b>CS49</b> CE14-26 —	 <b>CS53</b> — —	 <b>CS57</b> CE14-46 —
 <b>CS46</b> CE14-17 —	 <b>CS50</b> — —	 <b>CS54</b> — —	 <b>CS58</b> CE14-47 —
 <b>CS47</b> CE14-18 —	 <b>CS51</b> CE14-28 —	 <b>CS55</b> CE14-38 —	 <b>CS59</b> CE14-48 —
 <b>CS44</b> CE14-15 —	 <b>CS48</b> CE14-25 —	 <b>CS52</b> CE14-35 —	 <b>CS56</b> — —



 <b>L62US</b> — CE15	 <b>LR62US</b> CE1R CE15L
---	---

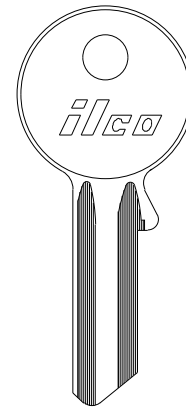







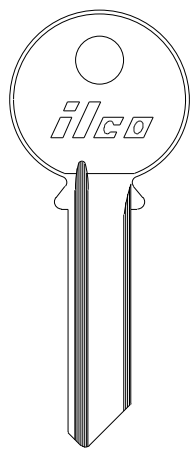

 <b>S62US</b> — —
---

**ILCO**  
SILCA  
ORION

C.E. SCHULTE



 <b>SH91K</b> CE15 —	 <b>SH91Q</b> — —
 <b>SH91L</b> — —	 <b>SH91R</b> — —
 <b>SH91M</b> — —	 <b>SH91P</b> — —
 <b>SH91J</b> — —	 <b>SH91N</b> — —

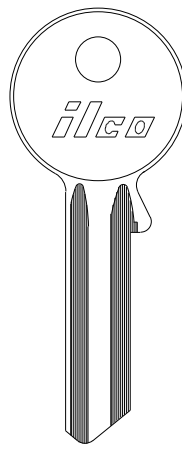

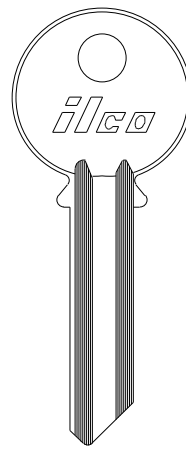

 <b>ST91A</b> CE2 CE14	 <b>R62US</b> CE2R CE14L
--	--

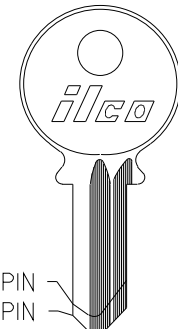

 <b>999A</b> YA5 —
--

C.H. GABON



 <b>GA1</b> GB2 GBN12	 <b>GAS91</b> 7CH GBN13
---	---

**ILCO**  
SILCA  
ORION

C.H. GABON

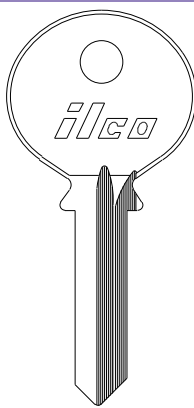

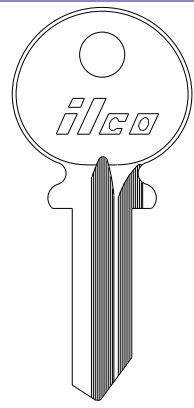

 <b>GA91</b> GB1 GBN11
--



 <b>ZE91G</b> GB5 GBN10
---

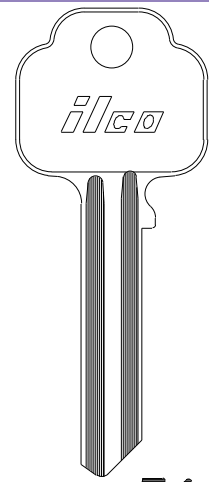

CHUBB

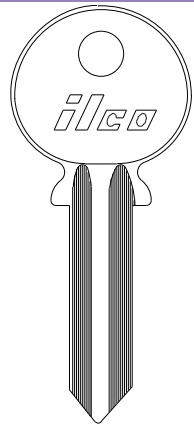

 <b>1516</b> CHU6 CH6
---

CIEF



 <b>CF1</b> — —	 <b>CF2</b> FEB2R —
--	---

**ILCO**  
SILCA  
ORION

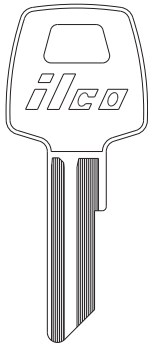
**CISA**

**9CX**  
CS10  
CSA20

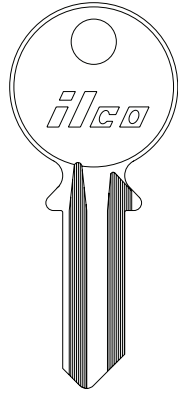

**NS9CS**  
—  
CSA4

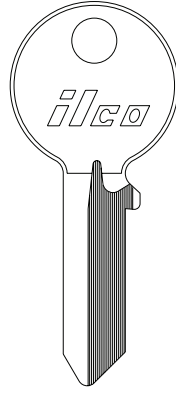

**NSR9CS**  
—  
CSA4L

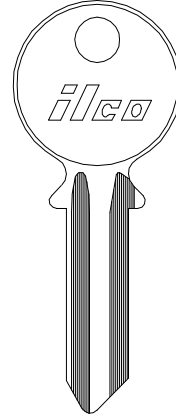

**R9CS**  
—  
—

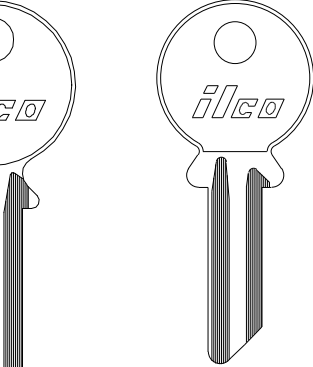

**9CS**  
CS206  
—

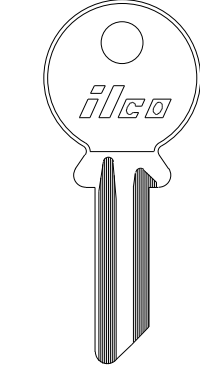

**AB62E**  
CS7  
—



**AB62ER**  
CS7R  
—

**ILCO**  
SILCA  
ORION

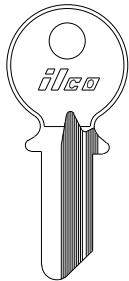
**CISA**

**AB62G**  
CS9  
—

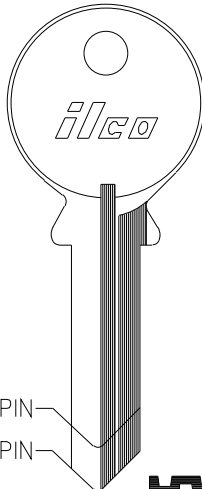

**AB62GR**  
CS9R  
—

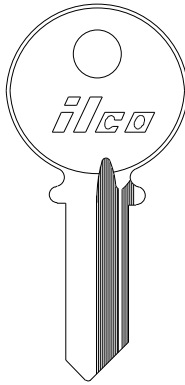

**AB1**  
CS501  
—

5 PIN  
6 PIN

**CS91B**  
CS205  
—

**S9CS**  
—  
—

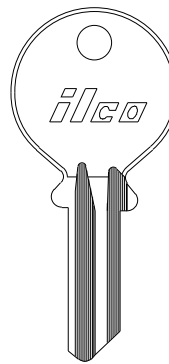

**CS91CR**  
CS6  
—

**CS91C**  
CS6R  
—

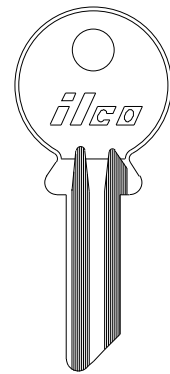

**CS91E**  
CS7  
—

**CS91ER**  
CS7R  
—

**ILCO**  
SILCA  
ORION

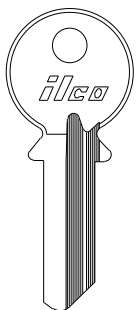
**CISA**
**CITIGO**
**CITY**

**CS91F**  
CS8R  
—

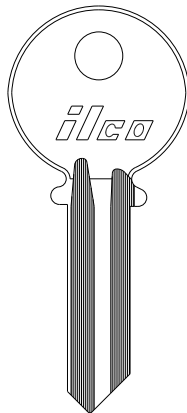

**CS91FR**  
CS8  
—

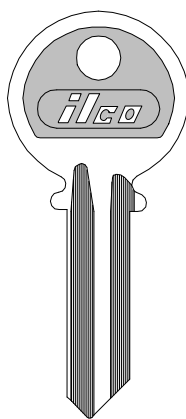

**999**  
YA1  
YAL13

**999R**  
YA1R  
—

**Y1-PC**  
—  
—

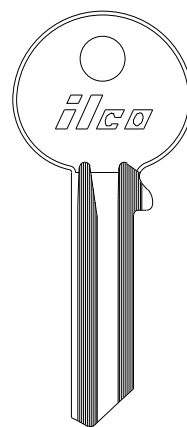

**CTG1**  
—  
—

**CTG2**  
—  
—



**CA91**  
CA5  
CV10



**CA91A**  
CA4  
CV11

**ILCO**  
SILCA  
ORION

CITY



<b>CA91B</b> CA3 CV12	<b>CA91C</b> — —	<b>CA91D</b> CA7 CV19	<b>CA91L</b> CA2 —	<b>CA91S</b> — —	<b>CAV91</b> CA1 —

**ILCO**  
SILCA  
ORION

CITY

CLICK-IT

COBRA ALARM

COLE - HERSEE

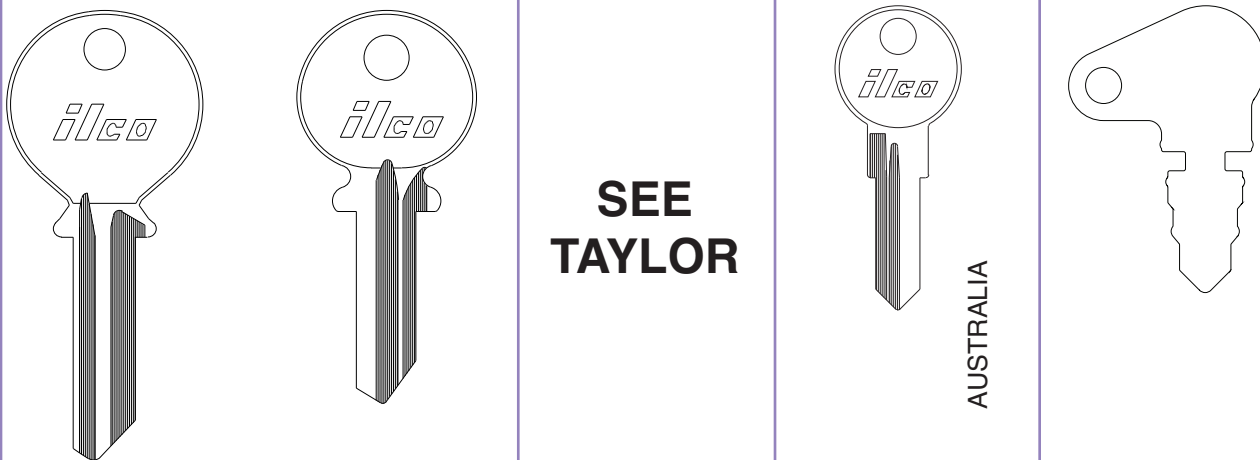

**SEE  
TAYLOR**

AUSTRALIA

<b>ZE91C</b> CA2R CV14L	<b>ZE91CR</b> L62K CV14	<b>ZE91G</b> GB5 GBN10	<b>ALARM1</b> — —	<b>1147</b> — —

**ILCO**  
SILCA  
ORION

COMMADORE

CORBIN

CORONA

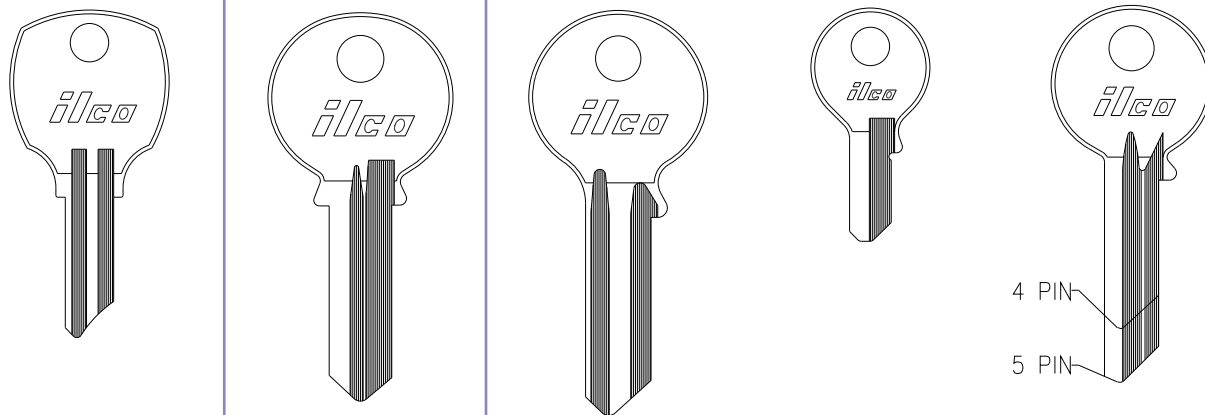

4 PIN  
5 PIN

<b>CD1</b> — —	<b>CB6</b> — —	<b>CN1</b> COR1 —	<b>CN2</b> — —	<b>4 PIN CN3</b> — —	<b>5 PIN CN4</b> — —

**ILCO**  
SILCA  
ORION

ILCO  
SILCA  
ORION

 ILCO  
SILCA  
ORION

 ILCO  
SILCA  
ORION

CORONA		COUILLET		C.P.I		CROSSLY WINDOW	
<b>CN5</b> — —	<b>RC1</b> RIC1 GRQ16	<b>62CS</b> — —	<b>L62CS</b> — —	<b>CW1</b> — —			
CUIRASSEE			CVL		DAD		
<b>C1S</b> — —	<b>C2S</b> — —	<b>C3S</b> — —	<b>C4S</b> — —	<b>C5S</b> — —	<b>C6S</b> — —	<b>D1K</b> DD3 DAD13	<b>D1T</b> DD2 DAD10
<b>C1S</b> — —	<b>C2S</b> — —	<b>C6S</b> — —	<b>CVL1</b> CVL1R CV10L	<b>CVL1R</b> CVL1 CVL10	<b>D1A</b> DD4 DAD12	<b>D1V</b> DD1 DAD11	
DAMM		DIAMOND		D.I.P.		DOBELN	
<b>DA3</b> BK1 —	<b>DA2</b> BK1R DAM10L	<b>DD1</b> — —	<b>PL1</b> — —	<b>DL2</b> DL2 DPT11	<b>DN1</b> DB48R —		

DOM

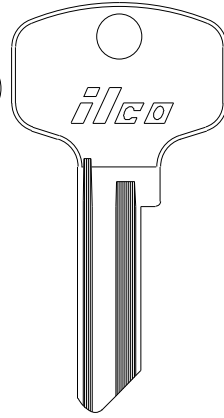
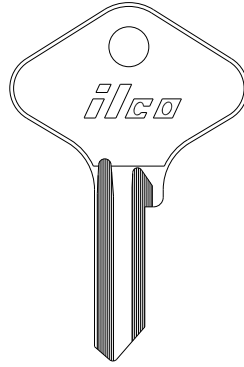
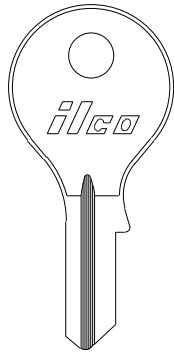
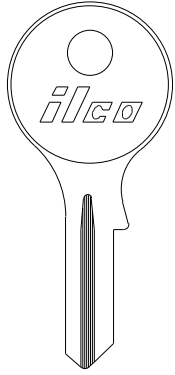

**DM7**  
DM12  
DO93

**DM8**  
DM66  
DO49

**D64**  
DM14  
DO21

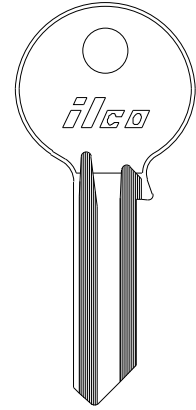

**DO1M**  
DM4R  
—

**DO3M**  
DM2  
—

**DO1S**  
DM6R  
DO11L

**DO1SR**  
DM6  
DO11

**DO3L**  
DM15  
—

**DM6**  
DM69  
DO94

**9D**  
—  
—

**ILCO**  
SILCA  
ORION

DOM

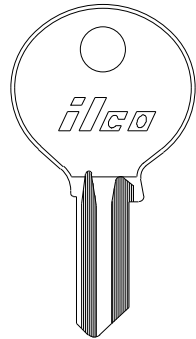
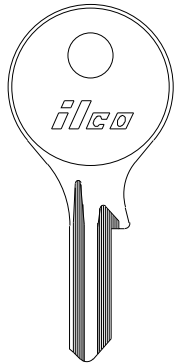

**DM12**  
—  
—

**DM16**  
—  
—

**DM13**  
—  
—

**DM17**  
—  
—

**DM14**  
—  
—

**DM18**  
—  
—

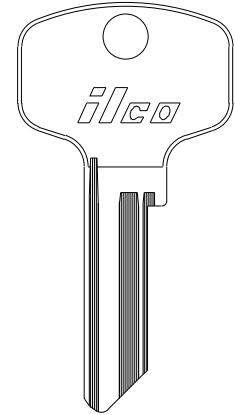
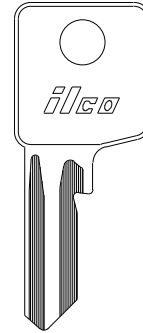

**DM10**  
DM8  
DO12

**DM27**  
—  
DO12L

**DM11**  
DM11  
DO18

**DM15**  
—  
—

**DM19**  
—  
—

**DM21**  
DM16  
DO16

**DM22**  
DM46  
DO71

**ILCO**  
SILCA  
ORION

DOM

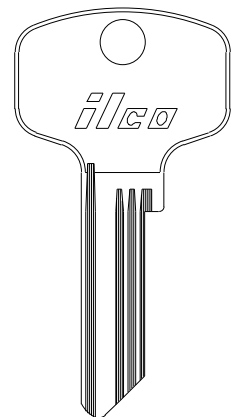
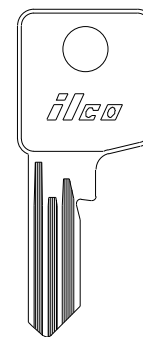
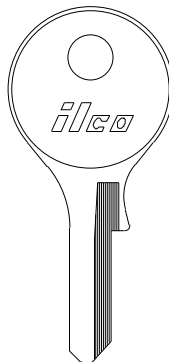
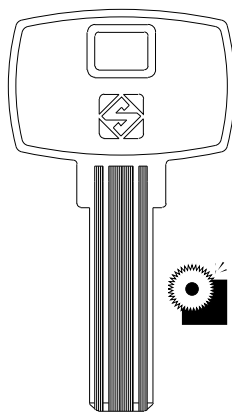
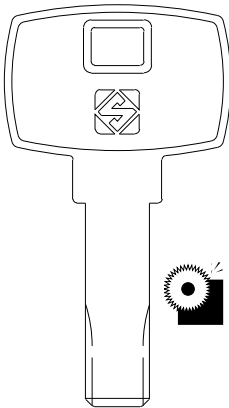

**DM22-SI**  
DM22  
—

**DM22TVP**  
DM22TVP  
—

**DM23**  
DM39R  
DO84L

**DM24**  
—  
DO129

**DM25**  
DM26  
DO44

**DM26**  
DM44R  
DO69L

**ILCO**  
SILCA  
ORION

## DOM

	 <b>DM29</b> — —  <b>DM30</b> — —			 <b>DM33</b> DM86 —	 <b>DM37</b> DM90 —	 <b>DM41</b> DM94 —	 <b>DM45</b> DM88R —	 <b>DM49</b> DM92R —
				 <b>DM34</b> DM87 —	 <b>DM38</b> DM91 —	 <b>DM42</b> DM95 —	 <b>DM46</b> DM89R —	 <b>DM50</b> DM93R —
				 <b>DM35</b> DM88 —	 <b>DM39</b> DM92 —	 <b>DM43</b> DM86R —	 <b>DM47</b> DM90R —	 <b>DM51</b> DM94R —
	 <b>DM28</b> — —	 <b>DM31</b> DM10 DO10	 <b>DM32</b> DM10R DO10L	 <b>DM36</b> DM89 —	 <b>DM40</b> DM93 —	 <b>DM44</b> DM87R —	 <b>DM48</b> DM91R —	 <b>DM52</b> DM95R —

 ILCO  
 SILCA  
 ORION

## DOM

		 3 PIN 4 PIN				
 <b>DM57</b> — —	 <b>DM58</b> — —	 <b>DM59</b> — —	 <b>DM61</b> DM25 —	 <b>DM60</b> DM17 DO23	 <b>DM63</b> DM17R DO23L	 <b>DM62</b> — —

 ILCO  
 SILCA  
 ORION

## DOM

 <b>DM64</b> — —	 <b>DM65-11</b> DM65-11	 <b>DM65-17</b> DM65-17	 <b>DM65-20</b> 65-20	 <b>DM110</b> — —

 ILCO  
 SILCA  
 ORION

DOM	DOMWARE	EFCO			
<b>X999</b> YA1 BKS10	<b>5 PIN DW1</b> — — <b>6 PIN DW2</b> — —	<b>EC1</b> — —	<b>EC2</b> — —	<b>EC9</b> — —	<b>EC10</b> — —

ILCO  
SILCA  
ORION

EFCO	EGO	E. P. PADLOCK	
<b>EC14</b> — — <b>EC16</b> — — <b>EC18</b> — —	<b>EE1</b> EGO1R EGO12L	<b>EP6</b> — —	<b>EP7</b> — —

ILCO  
SILCA  
ORION

ERA	ERICSSON							
<b>ER5</b> ER1 ERA10	<b>ERS3</b> — TKA12L	<b>ERS8</b> — TKA13L <b>ER9</b> — TKA13 <b>ER10</b> — TKA12	<b>ERS5</b> TK3R TKA14L	<b>ERS6</b> TK3 TKA14	<b>66E</b> — TKA11	<b>R66E</b> — TKA11L	<b>999</b> YA1 YAL13	<b>999R</b> YA1R —

ILCO  
SILCA  
ORION

**ILCO**  
 SILCA  
 ORION

ERICSSON	ESCURRA		ETAS			
<b>Y1-PC</b> YA1 —	<b>ES1</b> — —	<b>ES1R</b> — —	<b>ET1</b> ETA1 —	<b>ET2</b> — —	<b>ET8</b> — —	<b>ET9</b> — ETS10

**ILCO**  
 SILCA  
 ORION

ETAS	ETF		EUR	EUREKA
<b>62C</b> — —	<b>62L</b> — —	<b>EF2</b> — —	<b>EF3</b> — —	<b>61PD</b> — RN22



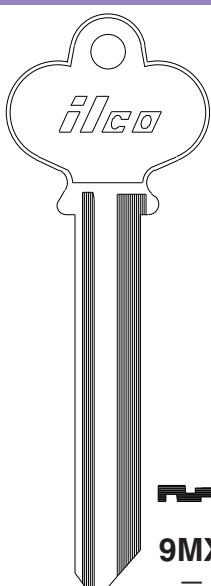
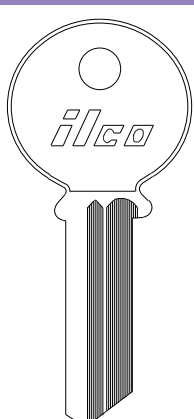

**ILCO**  
 SILCA  
 ORION

EVVA	FAB	
<b>EVA1R</b> EV3R EVA3	<b>EV4</b> EV2 EVA1	<b>EV5</b> EV5 EVA6
	<b>62EV</b> EV4 EVA4	<b>R62EV</b> EV4R EVA5
	<b>EV6</b> EV10 EVA14	
	<b>EV7</b> EV6R —	<b>FB2</b> — —
		<b>FB3</b> SK3 SK13



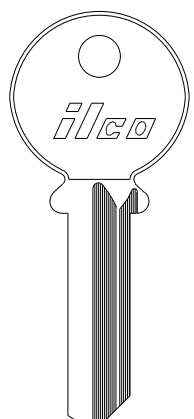
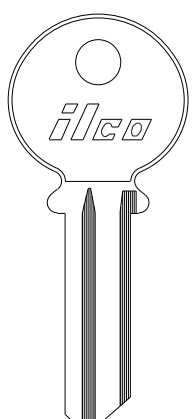

<p>F.A.C.</p>  <p><b>9FAC</b> FAC11 —</p>	 <p><b>9MX</b> — —</p>	<p>F.A.C.</p>  <p><b>FAS1</b> FS1 FAS10</p>
--	--	--

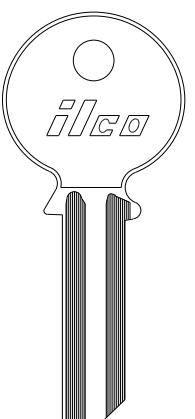
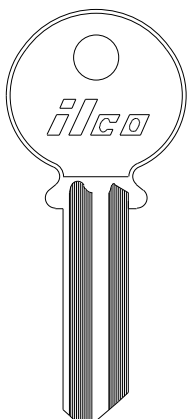
**ILCO**  
SILCA  
ORION

<p>F.C. AREIRO</p>  <p><b>FC1</b> — —</p>	<p>FCV-FLIETHER</p>  <p><b>KF1</b> — —</p>	 <p><b>KF2</b> — —</p>  <p><b>KF3</b> — —</p>  <p><b>KF4</b> — —</p>	 <p><b>KFV1</b> KF1 —</p>	 <p><b>25V</b> — —</p>
---	--	---	--	--

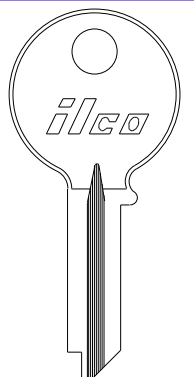
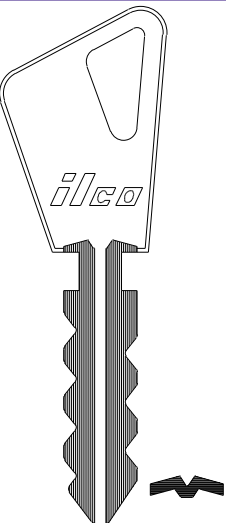
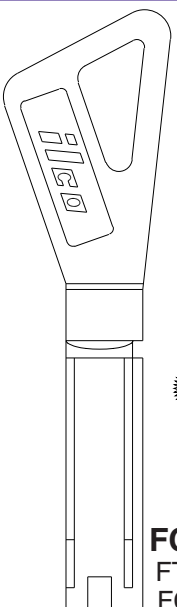
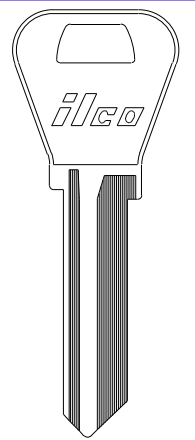
**ILCO**  
SILCA  
ORION

<p>FEDERAL EQUIP.</p>  <p><b>FE1</b> — —</p>	<p>FICHET</p>  <p><b>FH4</b> FT4C S18FCT</p>	 <p><b>FCT45</b> FT 500 FCT45</p>	<p>FIRMADOOR</p>  <p><b>L54WA</b> — —</p>	 <p><b>C172F</b> — —</p> <p>AUSTRALIA</p>
---	---	--	---	--

**ILCO**  
SILCA  
ORION

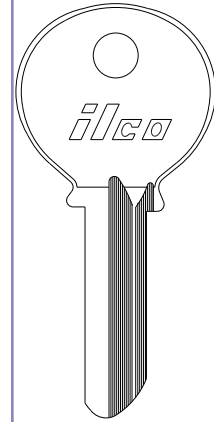
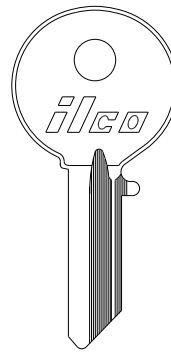
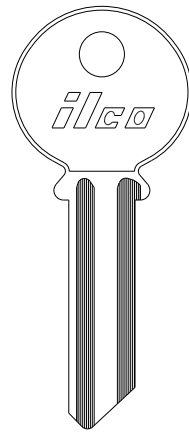
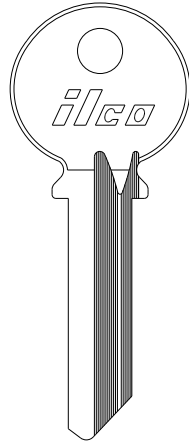
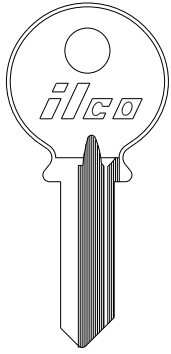
**FLOHR-FLOHR**
**FRATELLI GUISSAN FSI**

**FLR1** **FLR2**  
— —  
— —

**67G**  
—  
—

**R67F** **FL91**  
— —  
— —

**ME5**  
—  
—

**SF1**  
—  
—

**ILCO**  
SILCA  
ORION

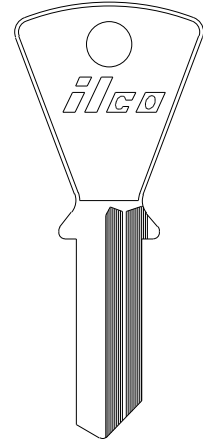
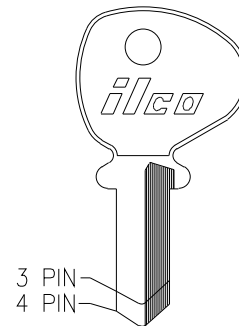
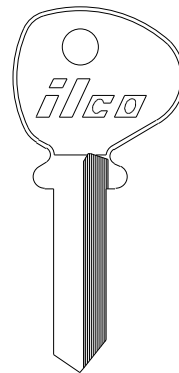
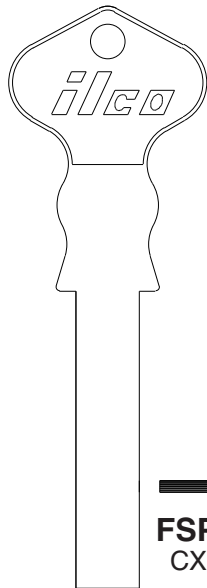
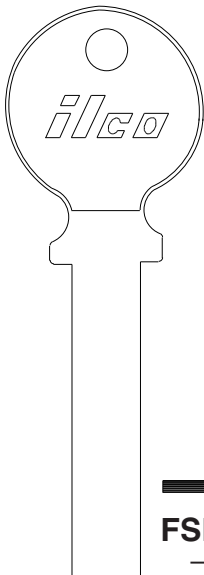
**FSP**
**FTH**

**FSP1**  
—  
—

**FSP2**  
CX7  
—

**FT1**  
FH3  
—

**3 PIN** **4 PIN**  
**FTH3** **FTH4**  
FH1 FH2  
— —

**FTH5**  
FH6  
FTH14

**ILCO**  
SILCA  
ORION

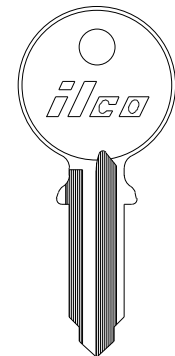
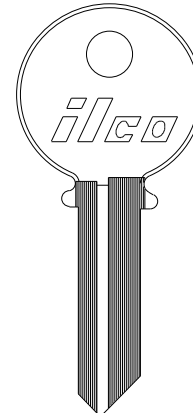
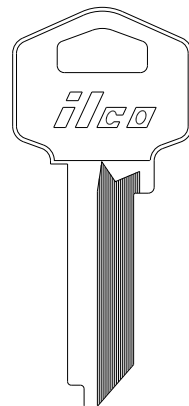
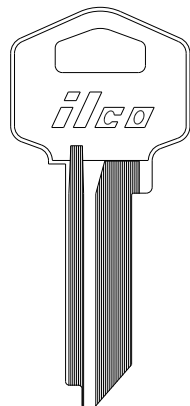
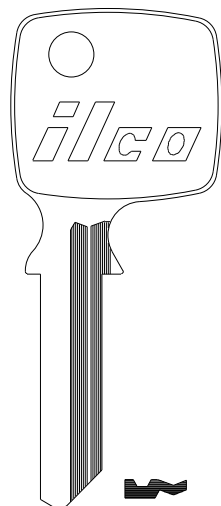
**FTH**
**GAINSBOROUGH**
**GARI**
**GEGE**

**FTH6**  
FH7  
FTH16

**GR7** **GR9**  
— —  
— —

**GR10**  
—  
—

**GR1**  
—  
—

**GE1** **GE11**  
— —  
— —

**ILCO**  
SILCA  
ORION

GEGE

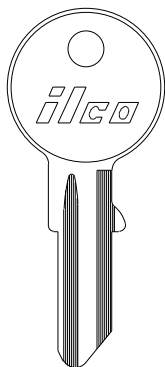

  
**GE2**  
GE17  
—

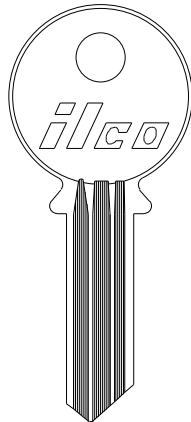

  
**GE3**  
GE1  
—

  
**GE5**  
GE1  
GE10  
  
**GE6**  
GE4R  
—  
  
**GE15**  
GE41  
GE18



  
**7GE**  
GE2  
—

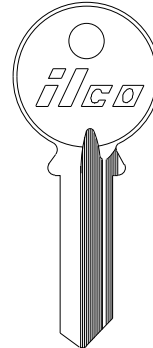

  
**LR7GE**  
GE3  
—

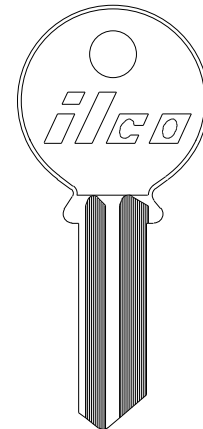

  
**GE8**  
—  
—  
  
**GE3R**  
GE1R  
GE10L

**ILCO**  
SILCA  
ORION

GEGE

GEWIRU

GIBBONS

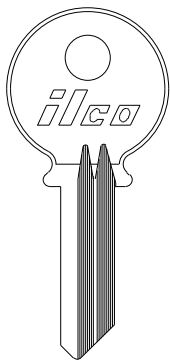

  
**GE10**  
—  
—

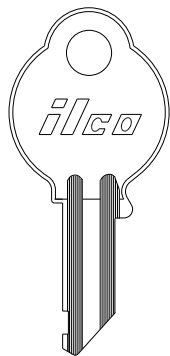

  
**GW1**  
—  
—

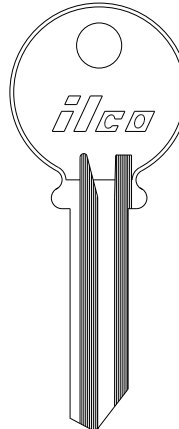

  
**GN1**  
—  
—

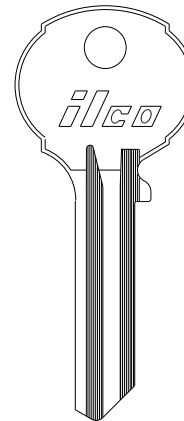

  
**1033G**  
GN1  
—

**ILCO**  
SILCA  
ORION

GIP

GLOBE

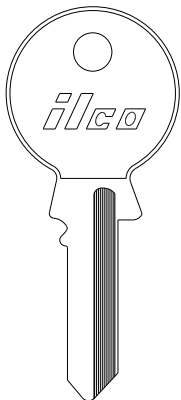

  
**GIP91**  
GP1  
GIP10

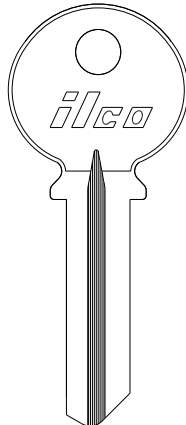

  
**GB1**  
GL10R  
GLB19L

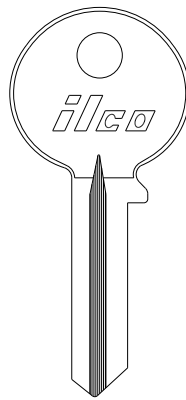

  
**GB2**  
—  
—

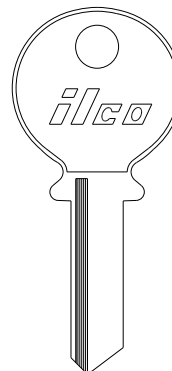

  
**GB3**  
—  
GLB22

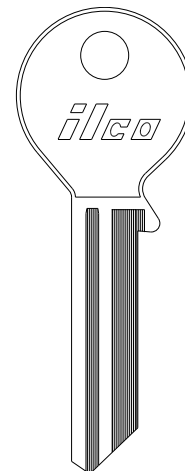

  
**GB4**  
GL6  
GLB15

**ILCO**  
SILCA  
ORION

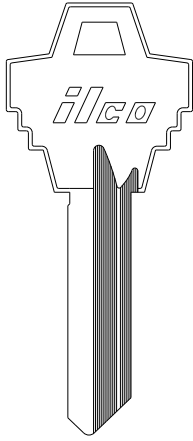
**GOAL**
**GUARD**

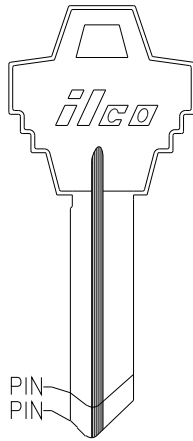
**GL2**

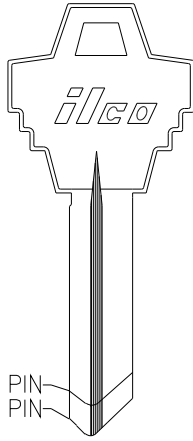
 —  
—

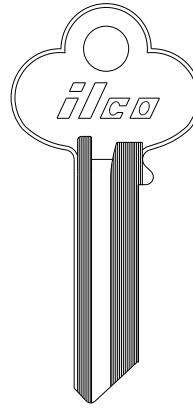
 5 PIN  
6 PIN

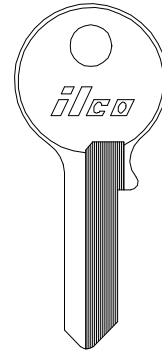
**GL3**  
GO1R  
GOL10L  
**GL1**  
GO2R  
GOL11L

 5 PIN  
6 PIN

**GL4**  
—  
—  
**GL5**  
—  
—

**GRD1**

 —  
—

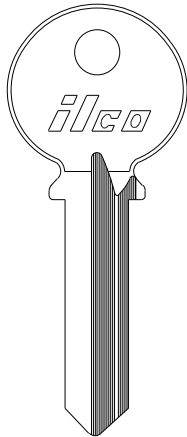
**VR91AR**

 VIO82  
VRO5P

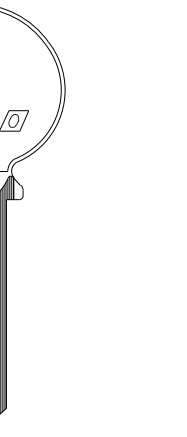
**ILCO**  
SILCA  
ORION

**GUERVILLE**

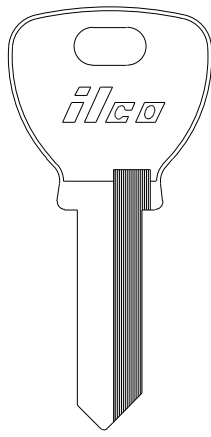
**GU3**

 RIQ4R  
GRQ15L

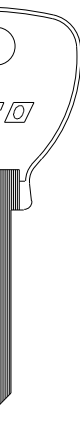
**GU91B**

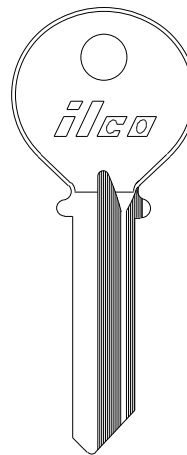
 RIQ4  
GRQ15

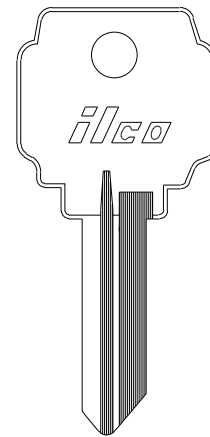
**GU4**

 RIQ1  
GRQ1

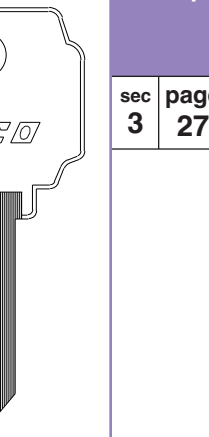
**GU4R**

 RIQ1R  
GRQ1R

**GU91**

 RIQ4R  
—

**GU91F**

 RIQ3  
—

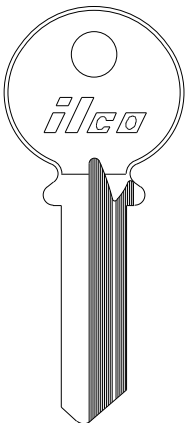
**GU91G**

 RIQ2  
—

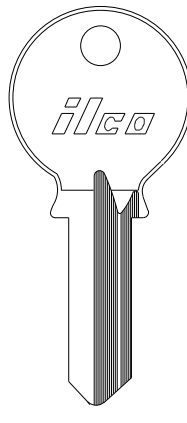
**ILCO**  
SILCA  
ORION

**G.V.**
**H.H.**
**H.F.L.**

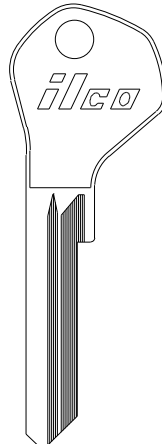
**GAV1**

 —  
—

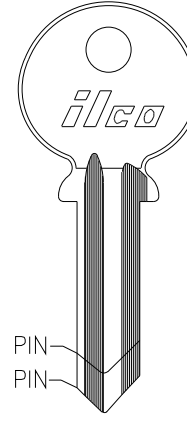
**GAV2**

 —  
—

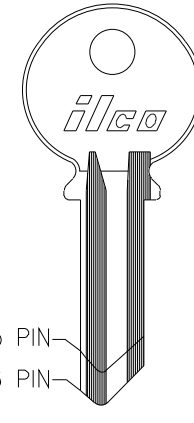
**HH1**

 —  
—

 5 PIN  
6 PIN

**62**

 —  
—

 5 PIN  
6 PIN

**A62A**

 —  
—

**A62L**

 —  
—

**ILCO**  
SILCA  
ORION

H.S.A.		HALO	HENDERSON.		HONG KONG
<b>KKV1</b> — —	<b>HL1</b> — —	<b>HN1</b> — HED11	<b>HN2</b> — HED10	<b>T41Y</b> — —	<b>ILCO</b> SILCA ORION
HORSE		HUGIN	HUTRA		
<b>HS1</b> — —	<b>HG1</b> — —	<b>HG2</b> — —	<b>HG3</b> — HGI11	<b>HU5</b> — —	<b>ILCO</b> SILCA ORION
HUWILL			I.G.S.		
<b>HU2</b> — —	<b>HU3</b> — HWL12	<b>HU4</b> — —	<b>IGS1</b> — —		<b>ILCO</b> SILCA ORION

## IFAM

## ILARGI

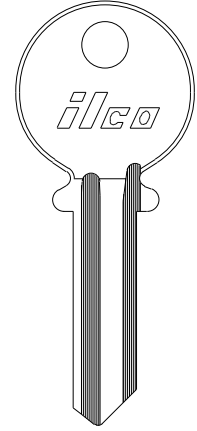
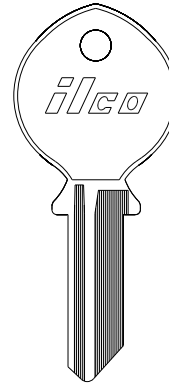
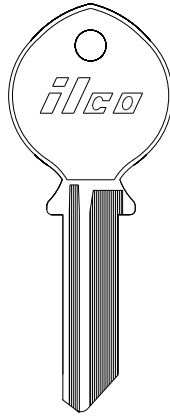
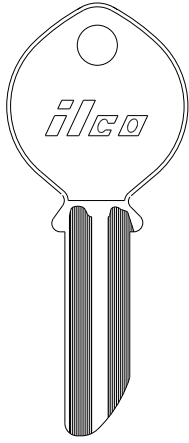
 ILCO  
SILCA  
ORION

**IF1**  
IF1  
—

**IF1R**  
—  
—

**IF2** **IF2R**  
IF4 IF4R  
IFM13 IFM13L

**IF3L**  
IF3  
IFM12

**IF3S**  
IF2  
IFM11

**IG1** **IG1R**  
IL1R IL1  
— —

## ILCO AUSTRALIA



AUSTRALIA



AUSTRALIA



AUSTRALIA

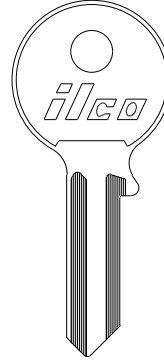

AUSTRALIA

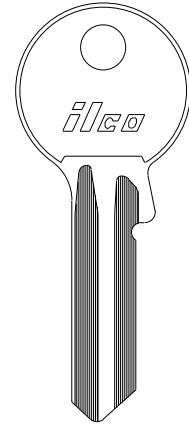

AUSTRALIA

**ILP20**  
—  
—

**ILP25**  
—  
—

**ILP30**  
—  
—

**ILP40**  
—  
—

**ILP50**  
—  
—

 ILCO  
SILCA  
ORION

## INSA

## JAEGER PRELAC

## J.D.

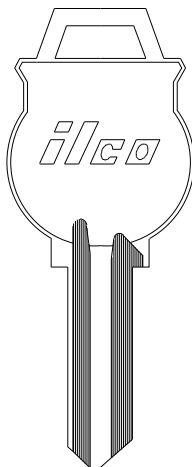
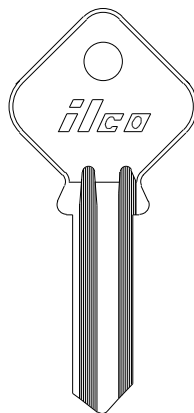
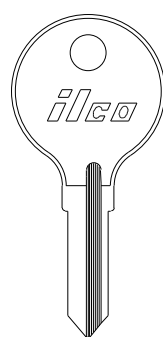
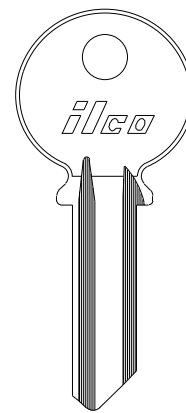
**INS1**  
INS1  
—

**D62SA**  
—  
INS10

**JP1**  
—  
—

**61JD**  
RO8  
RN16

 ILCO  
SILCA  
ORION

J.I.P.		J.I.S.		J.M.A.	JEHA
<b>PJ1</b> — —	<b>PJ2</b> — —	<b>JI1</b> JS3R —	<b>JI1R</b> JS3 —	<b>UCM1</b> AC1 —	<b>JH1</b> — —
<b>PJ3</b> — —	<b>PJ4</b> — —	<b>JI1</b> JS3R —	<b>JI1R</b> JS3 —	<b>UCM1</b> AC1 —	<b>JH1</b> — —
<b>PJ11</b> RO22R —	<b>PJ12</b> — —	<b>JI1</b> JS3R —	<b>JI1R</b> JS3 —	<b>UCM1</b> AC1 —	<b>JH1</b> — —
<b>PJ13</b> — —	<b>PJ14</b> — —	<b>JI1</b> JS3R —	<b>JI1R</b> JS3 —	<b>UCM1</b> AC1 —	<b>JH1</b> — —

ILCO  
SILCA  
ORION

JOLY JOWIL

<b>SOS1</b> — —	<b>SO91P</b> SO6 —	<b>SOS91</b> SO4 —	<b>R65S</b> — —	<b>JO1</b> JOW1 —	<b>62JT</b> — —

ILCO  
SILCA  
ORION

JOWIL JUNGST

<b>62X</b> — JWL10L	<b>R62X</b> — JWL10	<b>UR62X</b> — —	<b>JO91</b> JOW1 —	<b>JO91C</b> JOW4R JWL13L	<b>JG1</b> — —

ILCO  
SILCA  
ORION

JUNIE

JUWEL

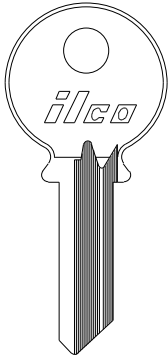

**JN1**  
—  
—

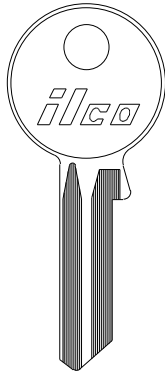

**JN2**  
JU2  
—



**JN58**  
JU1  
—

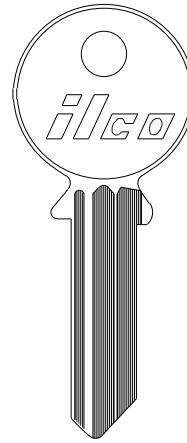

**BR91C**  
JW1R  
—



**JU2**  
JW6  
JW5



**JU4**  
JW4R  
JUW2



**JU2R**  
JW6R  
JUW6



**JU5R**  
JW7R  
JUW10



**JU3**  
JW5  
JUW3



**JU1D**  
JUW1  
—



**JU3R**  
JW5R  
JUW4

ILCO  
SILCA  
ORION

K.F.V.

K.V.R.

KABA

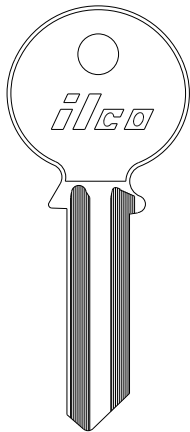

**KFV1**  
KF1  
—

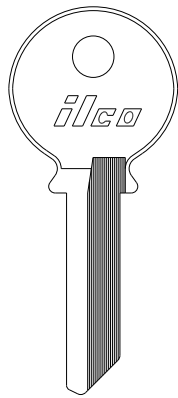

**KVR91**  
CA9  
KVR11

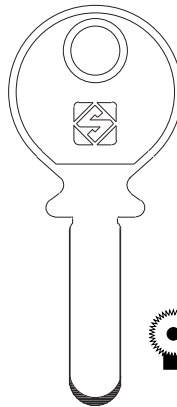

**KA5-SI**  
KA5  
—

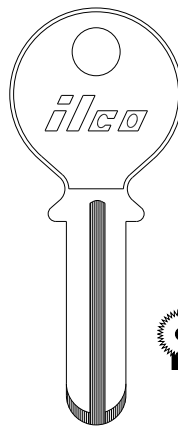

**KAB1**  
KA1  
—

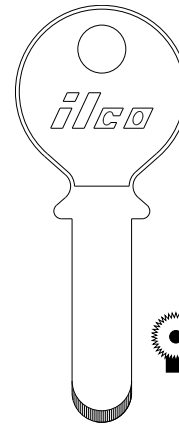

**KAB2**  
KA2  
—

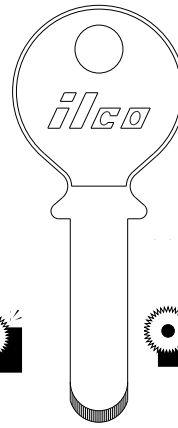

**KAB3**  
—  
—

ILCO  
SILCA  
ORION

KABA

KAMSING

KAWAKAMI

KENRICK

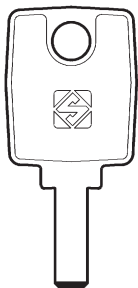

**KA8-SI**  
—  
—

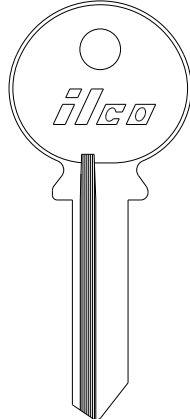

**62RG**  
—  
—

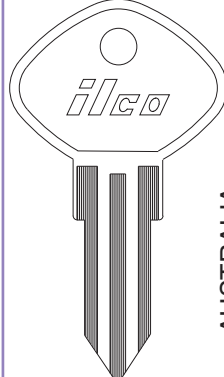

AUSTRALIA



**S6-AUS**  
—  
—

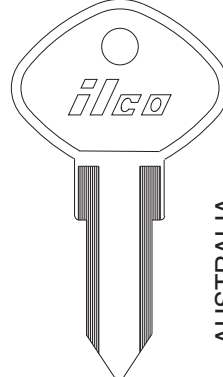

AUSTRALIA



**S7-AUS**  
—  
—

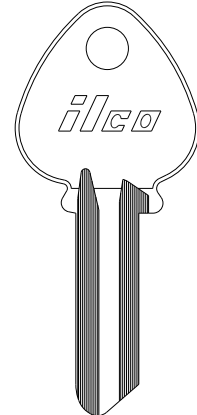

**KE2**  
—  
—



**KE4**  
—  
—

ILCO  
SILCA  
ORION



KENRICK		KESO			A. KNAPP
<b>KE3</b> — —	<b>62E</b> — —	<b>KE3-SI</b> KE3 —	<b>KS1</b> LP11 —	<b>S13KE</b> KE4 S13KE	<b>KN1</b> — —

ILCO  
SILCA  
ORION

KUMAHIRA	LANES	LAPERCHE	LAPORTE	LARK
<b>184K</b> — —	<b>LH1</b> — —	<b>LE1</b> LH1 —	<b>5 PIN LAP2</b> LAP2 —	<b>6 PIN LAP1</b> LAP3 LP11

AUSTRALIA

ILCO  
SILCA  
ORION

L.A.S.						
<b>L1S</b> KI15 KF23	<b>L1T</b> KI15R KF23L	<b>RC1</b> RIC1 GRQ16	<b>L2EX</b> KI16 KF24	<b>L3TX</b> KI6 KF14	<b>L3XY</b> KI7 KF15	<b>L4A1</b> LS9 —

ILCO  
SILCA  
ORION

L.A.S.

LASBOLAGET

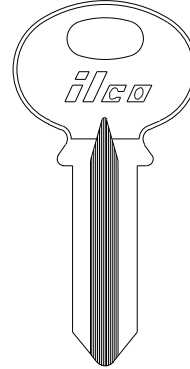
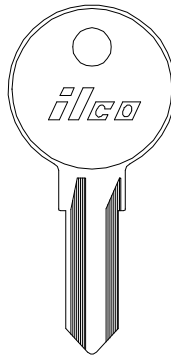
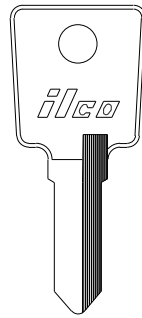
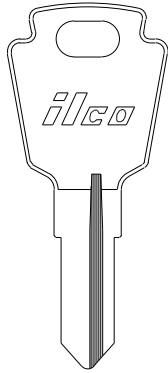

**LS18**  
LB18  
LG18

**LS19**  
LB19  
LG19

**LS22**  
LB22  
LG22

**LS23**  
LB23  
LG23

**LS32**  
LB32  
LG32

**LS33**  
LB33  
—



**ILCO**  
SILCA  
ORION

**L5CR**  
—  
—

**L5RC**  
—  
—

**L6FM**  
LS14  
LAS2

**L6S**  
LS13  
LAS1

**KM8**  
LS1  
—

**LS10**  
LB10  
LG10

**LS11**  
LB11  
LG11

**LS34**  
LB34  
—

**LS35**  
LB35  
LG35

LASBOLAGET

LEGGI

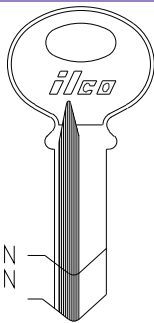

**3 PIN**  
**LS17**  
—  
—

**4 PIN**  
**LS29**  
LB29  
—

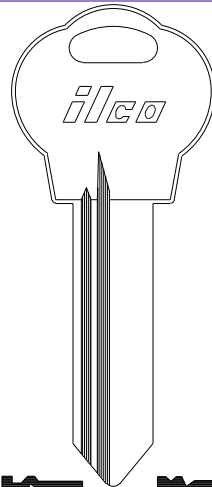

**LS50**  
—  
—

**LS51**  
—  
—

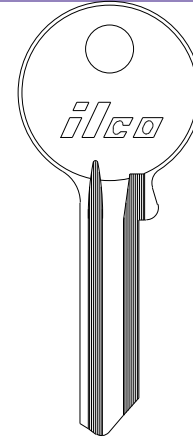

**62LG**  
LEG1  
LEG10

3 PIN  
4 PIN

**3 PIN**  
**LS16**  
—  
—

**4 PIN**  
**LS28**  
—  
—

**ILCO**  
SILCA  
ORION

LINCE (ALSO SEE ELGIN IN SECTION 2)

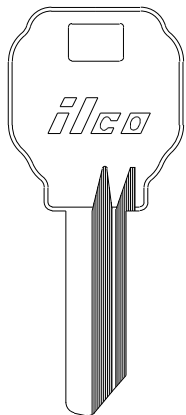

**LI2**  
—  
—

**LI2R**  
—  
—

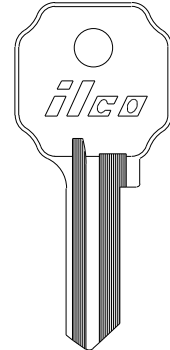
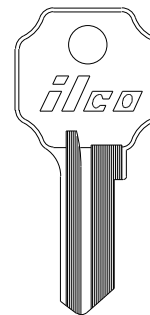

**ILCO**  
SILCA  
ORION

**LC1**  
LC1  
LC10

**LC2**  
LC1R  
LC10L

**LC3**  
LC5  
LC14

**LC4**  
LC4  
LC13

**LC5**  
LC3  
LC12

**LC5R**  
LC3R  
LC12L

LINCE (ALSO SEE ELGIN IN SECTION 2) LIPS

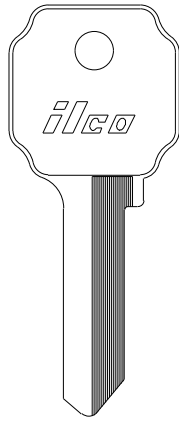

**LC8**  
LC2R  
—

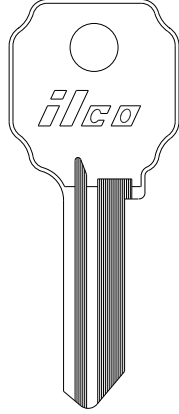

**S1096G**  
ELG10  
LC11

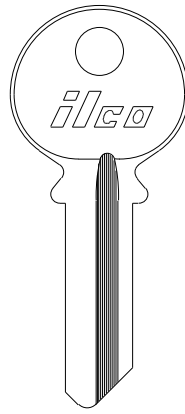

**LP1**  
LP13R  
LPS12L

**LP1R**  
LP13  
LPS12

**LPB1**  
—  
—

**LP24**  
LP5  
LPS10

**LP25**  
LP5R  
LPS10L

**LPD2**  
LP19R  
LPS22L

**LP28S**  
LP7R  
LPS11L

**LP39**  
LP7  
LPS11

**LP26S**  
LP20R  
—

**LP34S**  
—  
—

ILCO  
SILCA  
ORION

LIPS

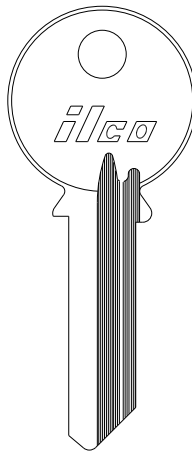

**LP6**  
LP12R  
LPS15L

**LP27**  
LP12  
LPS15

**LP28**  
LP8R  
LPS14L

**R62QB**  
LP8  
LPS14

**LP29**  
LP2R  
LPS13L

**LP29R**  
LP2  
—

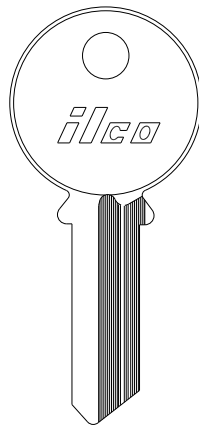

**LP5**  
LP17R  
—

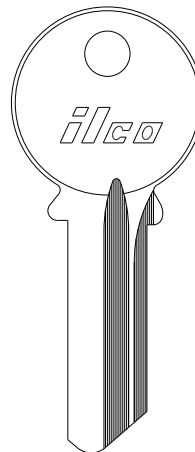

**LP21W**  
LP9

**LP2**  
LP18R  
—

**LP26**  
LP38R  
LPS44L

**LP7**  
LP3  
LPS16

**LP7R**  
LP3R  
LPS16L

ILCO  
SILCA  
ORION

LIPS

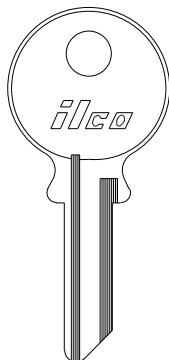

**LPS25L**  
**LP31**  
LP15R

**LPS23L**  
**LP31R**  
LP15

**LPS24L**  
**LP32**  
LP14R

**LPS24**  
**LP32R**  
LP14



**62QS**  
—

**62QT**  
—

**LP30**  
LP16

**LP30R**  
LPS25  
LP16R

**LPS23**  
**62QN**  
—



ILCO  
SILCA  
ORION

LIPS

LISTA

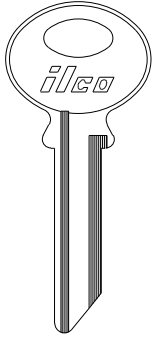
LITTO



 **L62QT**  
 **LR62QT**

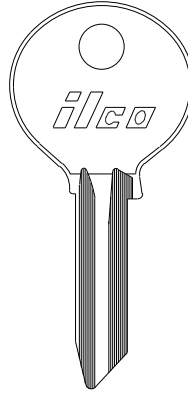

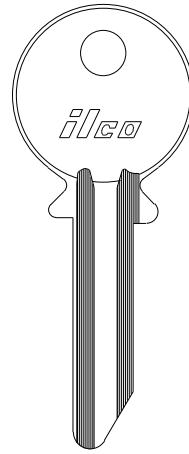

 **H64E**  
DM7

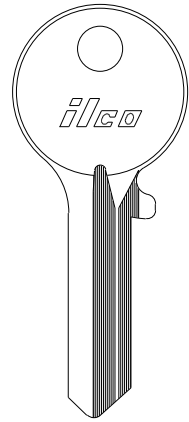

 **DO19**  
**LT1**  
LT1

 **LIT11**  
**LT2**  
-



 **LT3**  
LT2

ILCO  
SILCA  
ORION

 **A62QN**  
-

LOCKWOOD AUSTRALIA

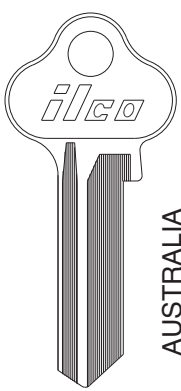

 **LK2**  
-  
-

 **LK6**  
-  
-

 **LK10**  
-  
-

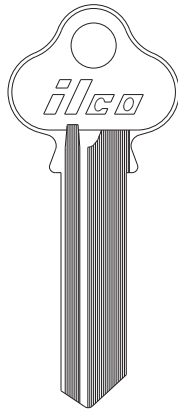

 **LK3**  
-  
-

 **LK7**  
-  
-

 **LK13**  
-  
-

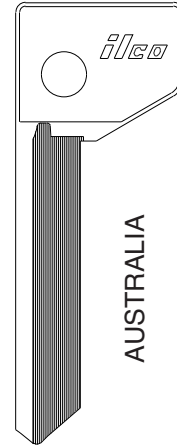

 **LK4**  
-  
-

 **LK8**  
-  
-

**AUSTRALIA**

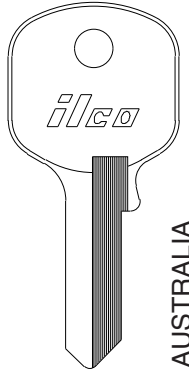

 **LK5**  
-  
-

 **LK9**  
-  
-

 **LK21**  
-  
-

 **LWC1**  
-  
-

 **LIT10**  
**4**  
-

 **4R**  
-

 **LK1**  
-

 **LK5**  
-

 **LK9**  
-

 **LK21**  
-

 **LWC1**  
-

ILCO  
SILCA  
ORION

LOCKWOOD AUSTRALIA

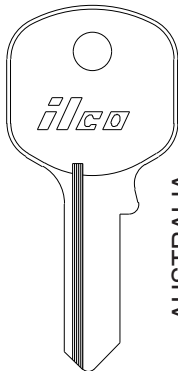

**AUSTRALIA**

 **LWC2**  
-

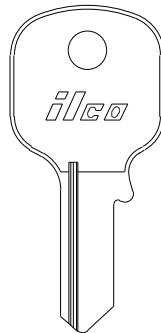

**AUSTRALIA**

 **LWC3**  
-

 **LWC3R**  
-

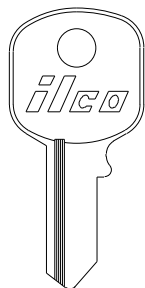

**AUSTRALIA**

 **LWC4**  
-

 **LWC4R**  
-

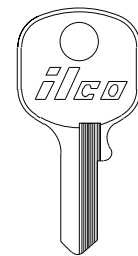

**AUSTRALIA**

 **LWC5**  
-

 **LWC5R**  
-

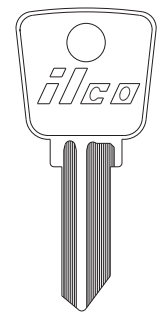

**AUSTRALIA**

 **24**  
-

ILCO  
SILCA  
ORION

LOCKWOOD AUSTRALIA

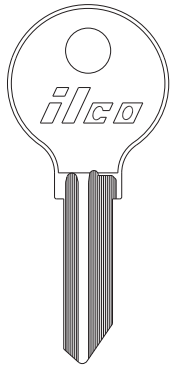

AUSTRALIA

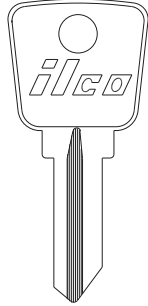

AUSTRALIA

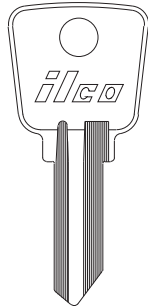

AUSTRALIA

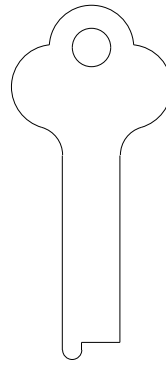
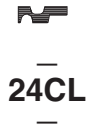

AUSTRALIA

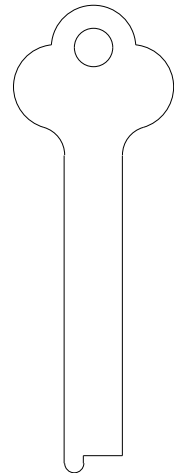

AUSTRALIA



ILCO  
SILCA  
ORION

LOWE & FLETCHER

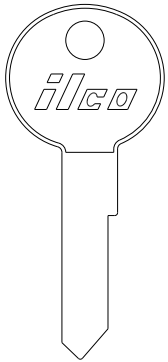

LF2  
—  
—  
LF3  
—  
—

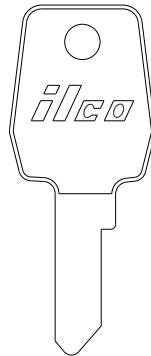
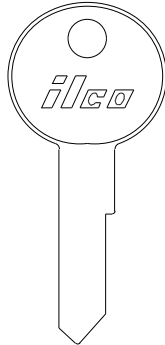

LF10  
LF17  
LF26  
LF11  
—  
—  
LF16  
LF15R  
LF25L

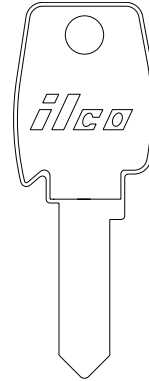

LF8  
—  
—  
LF9  
—  
—

ILCO  
SILCA  
ORION

LOWE & FLETCHER

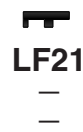
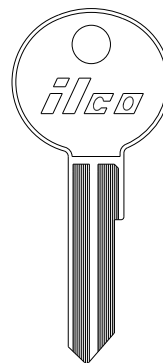
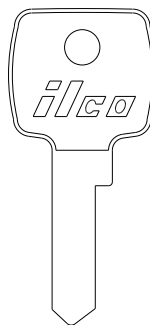
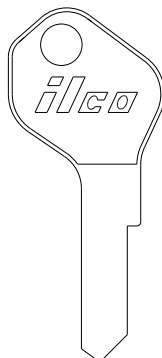
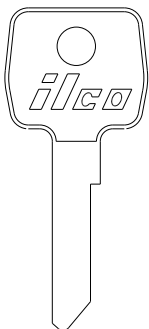

ILCO  
SILCA  
ORION

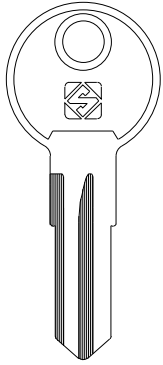
**LOWE & FLETCHER**
**LOWE & FLETCHER (AUSTRALIA)**

**LF12-SI**  
LF12-SI  
—

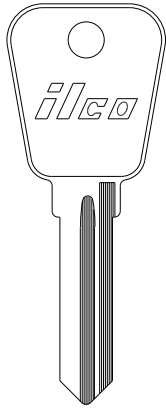

**LF24**  
LF19  
—

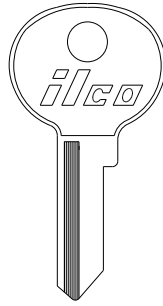

**L192M**  
—  
—

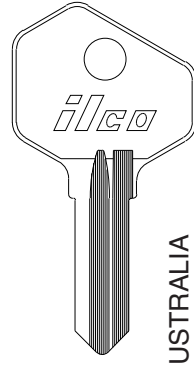

**C209**  
—  
—



**LF20**  
—  
—

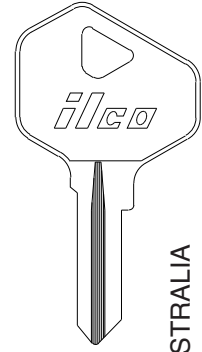

**LF20S**  
—  
—



**LF25**  
—  
—

AUSTRALIA

AUSTRALIA

AUSTRALIA

 ILCO  
SILCA  
ORION

 INTERNATIONAL  
CYLINDER

sec 3 page 37

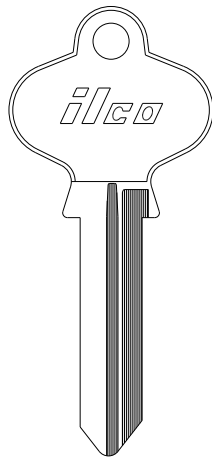
**LUCKY**
**LUDELL**
**M.C.M.**

**L1Y**  
—  
—

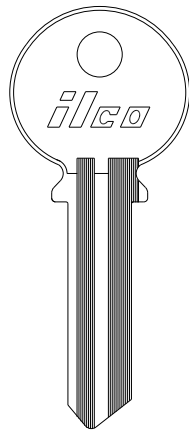

**62BL**  
—  
—

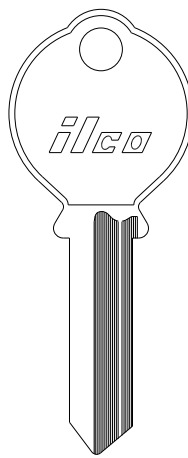

**MCM1**  
—  
—

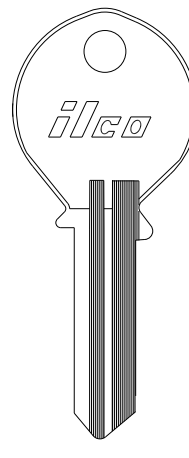

**MCM3**  
MC3  
—

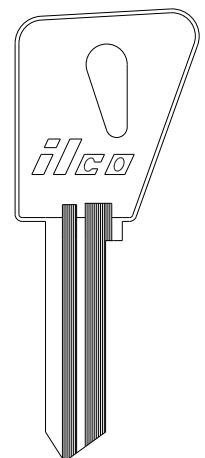

**MM2**  
—  
MCM11

 ILCO  
SILCA  
ORION

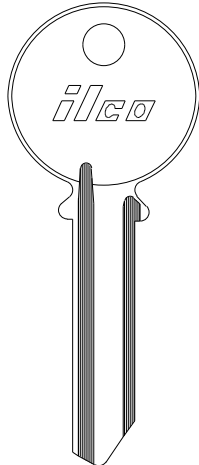
**MAFOR**
**MATADOR**
**MECO**

**RN4R**  
RO9  
—

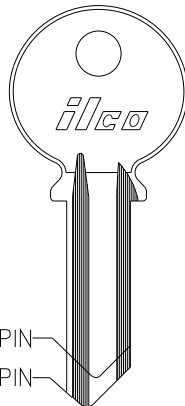
 4 PIN  
5 PIN

**S61JD** **61JD**  
— —  
RN15 RO8  
RN16



**FV1**  
—  
—



**63**  
LAP4R  
—

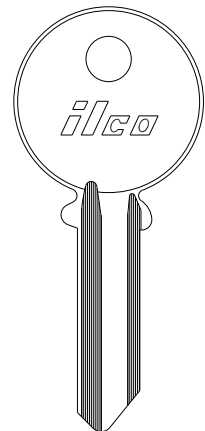

**ME11**  
MEC1  
—

 ILCO  
SILCA  
ORION

MERONI				METEOR	
		4 PIN <b>ME1</b> MER5 MRN4P  5 PIN <b>ME3</b> MER4 MRN5P			
	3 PIN <b>ME6</b> MER6 MRN3P	3 PIN <b>ME7</b> MER27	4 PIN <b>ME2</b> MER1		
<b>ME4</b>				<b>MO1</b> MET1 MTR10	
MG		MGM		MIWA	
<b>MG91</b> MN6	<b>MG91R</b> MN6R	<b>MG91C</b> MG1	<b>MG91N</b> MG1R	<b>MG91P</b> MG2	<b>MG91S</b> MG2R
				<b>MGM1</b>	<b>MGM1R</b>
					<b>MIW2</b> MIW2
MMW		MON	MOM-BLOCK	MUL - T - LOCK	
<b>MW1</b> BT1 BU10	<b>MW2</b> BT1R BU10L	<b>MON1</b> MON1R MON10L	<b>MB1</b> MB1 MBL10	<b>MTK2P</b> MTK2P	

ILCO  
SILCA  
ORION

ILCO  
SILCA  
ORION

ILCO  
SILCA  
ORION

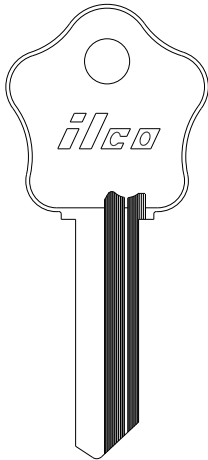
**NELFA      NELSON      NEMEF      NEWHALL**

**ILCO**  
SILCA  
ORION

**NF1    NL2**  
NF1R    NF1  
NLF10L    NLF10

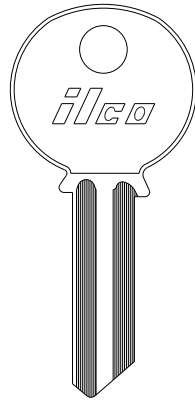

**NN1**  
—  
—

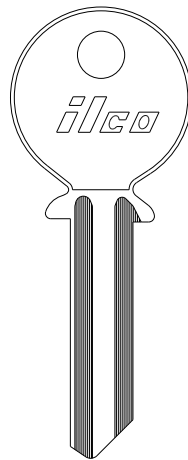

**NE3**  
—  
—

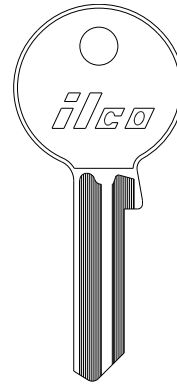

**NE50**  
—  
—

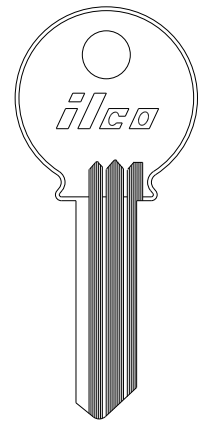

**NW6**  
—  
—

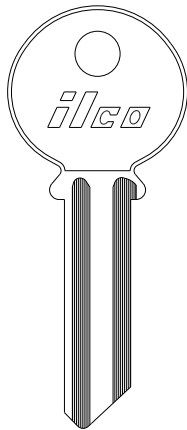
**NORDWEST      OAL      ODA**

**ILCO**  
SILCA  
ORION

**FL91**  
FL2  
FLO5



**OA91    OA91R**  
OAL1R    OAL1  
OAL3PL    OAL3P

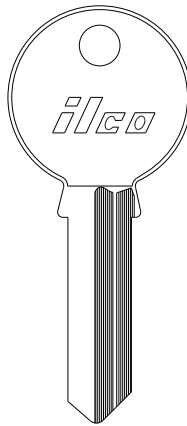

**OA91D**  
OAL4R  
OAL5L

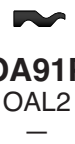

**OA91P**  
OAL2  
—

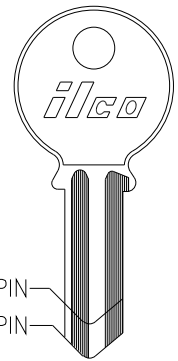

3 PIN  
4 PIN

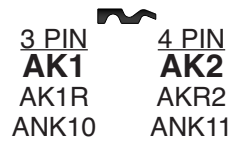

**3 PIN    4 PIN**  
**AK1    AK2**  
AK1R    AKR2  
ANK10    ANK11

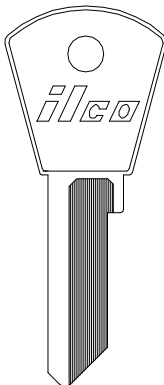
**PAPAIZ**

**ILCO**  
SILCA  
ORION

**PZ1**  
PZ1  
PA10

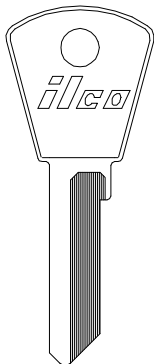

**PZ2**  
PZ2  
PA11

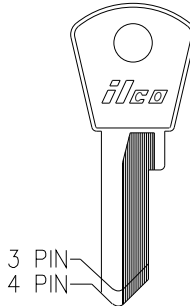

3 PIN  
4 PIN

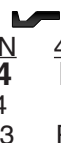

**3 PIN    4 PIN**  
**PZ4    PZ3**  
PZ4    PZ3  
PA13    PZ12

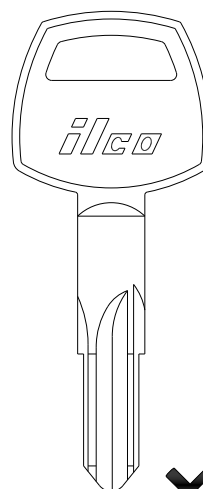

**X**  
**XPA1**  
XPZ1  
XPA1

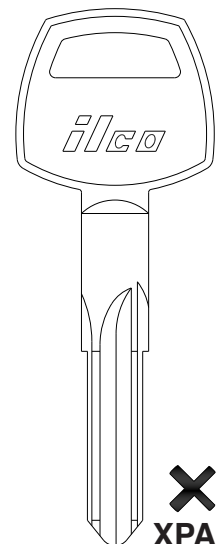

**X**  
**XPA2**  
XPZ2  
XPA2



PLODARI		PREFER			
<b>PO1</b> PC1 —	<b>PL2</b> PC1R —	<b>SR9P</b> PF209 PRF3L	<b>S9P</b> PF208 PRF3	<b>U9P</b> PF212 PRF4	<b>PR91N</b> PF210 PRF5
					 <b>PR91A</b> PF211 PRF5L   <b>PR91C</b> PFO92S PRF28F

ILCO  
SILCA  
ORION

PREFER					
<b>PR91M</b> PFO73 PRF5PL	<b>PR91MS</b> PFO71 PRF4PL	<b>PR91</b> PFO70 PRF4P	<b>PR91NS</b> PF209 PRF4L	<b>PR91SA</b> PF208 PRF4	<b>PR91S</b> PF4R PRF3PL
					 <b>PR91CS</b> PF2S PRF4SF

ILCO  
SILCA  
ORION

PREFER		PRESTA		PRESTO	
<b>999</b> YA1 YAL13	<b>999R</b> YA1R —	<b>Y1-PC</b> — —	<b>62PT</b> — —	<b>63L</b> LAP1 LP10	<b>62PR</b> — —

ILCO  
SILCA  
ORION

ILCO  
SILCA  
ORION







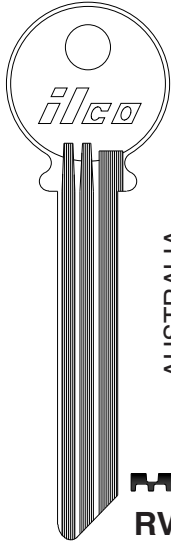
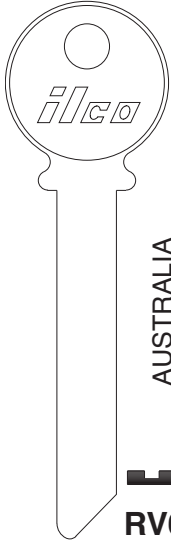
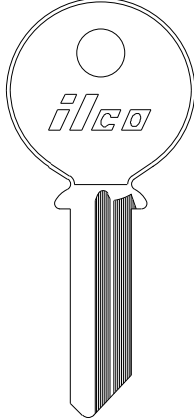

PWA	REIG	REGAL	REX	RICOUARD
<b>PW5</b> — —	<b>REI1 REI1R</b> — —	<b>RG1 RG1</b> —	<b>RX1 RX2</b> —	<b>RC1 RIC1 GRQ16</b>

 ILCO  
SILCA  
ORION

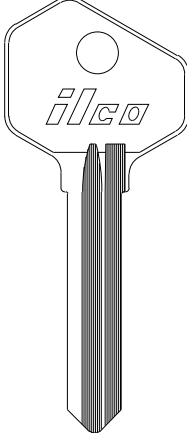





RICOUARD	RIQUIER			
<b>KM2 KM8</b> KI10 LS1 — —	<b>GU3 GU91B</b> RIQ4R RIQ4 GRQ15L GRQ15	<b>65L</b> — —	<b>5 PIN 6 PIN</b> <b>RS65G</b> RIQ5R GRQ10L	<b>5 PIN 6 PIN</b> <b>S65G GU4R</b> RIQ5 RIQ1 GRQ10 GRQ1

 ILCO  
SILCA  
ORION

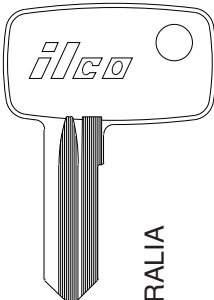
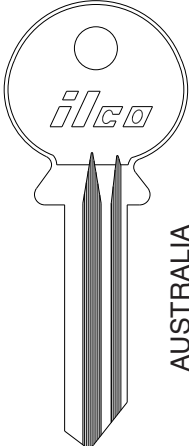
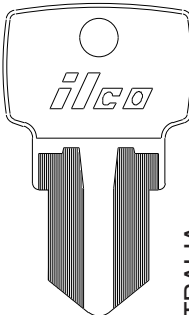
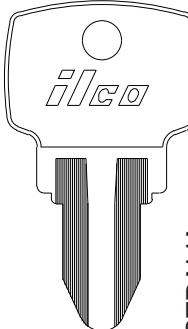
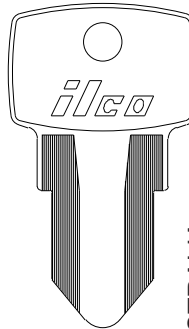







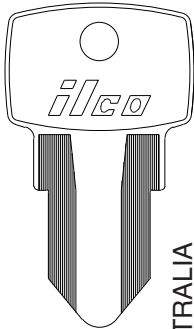

RIQUIER	RIVERS (AUSTRALIA)			
<b>L65G LR65G</b> — — — —	<b>L65Y LR65Y</b> RIQ8R RIQ8 GRQ18L GRQ18	<b>GU91G GU91F</b> RIQ2 RIQ3 — —	<b>RV1</b> — —	<b>RV2</b> — —

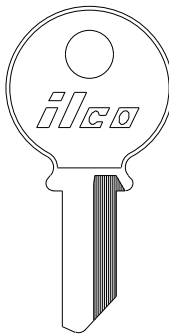
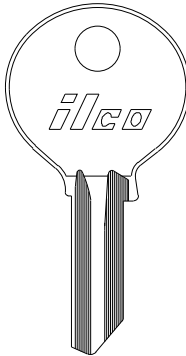
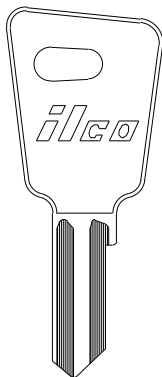
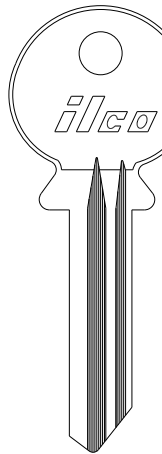
RIVERS (AUSTRALIA)		ROCHEL		ROLL A DOOR (AUSTRALIA)	
					
AUSTRALIA	AUSTRALIA				
					
RV5	RV6	R091	R091R	C218	
—	—	—	—	—	

ILCO  
SILCA  
ORION

ROLL A DOOR (AUSTRALIA)				
				
AUSTRALIA	AUSTRALIA	AUSTRALIA	AUSTRALIA	AUSTRALIA
				
C219	ORD1	RD1	RD2	RD3
—	—	—	—	—

ILCO  
SILCA  
ORION

ROLL A DOOR		ROLL-IT		RONEO		RONIS	
							
AUSTRALIA							
							
RD4	RL1	RL2	RL3	RN1	LN1	LN3	
—	RL1	RL2	RL3	RN1	RO23	RO27	
—	—	—	—	—	RN32	RN37	

ILCO  
SILCA  
ORION

**RONIS**

<b>RN4</b> RO9R RN17L	<b>RN4R</b> RO9 RN17	<b>RI5</b> RO34 RN41	<b>RI6</b> RO60 —	<b>7DC</b> RO20 RN11	<b>61JD</b> RO8 RN16	<b>R61JD</b> RO8R RN16L	<b>HV61</b> RO21 RN10	<b>HVR61</b> RO21R RN10L	

**ILCO**  
SILCA  
ORION

 INTERNATIONAL  
CYLINDER

sec 3 page 43

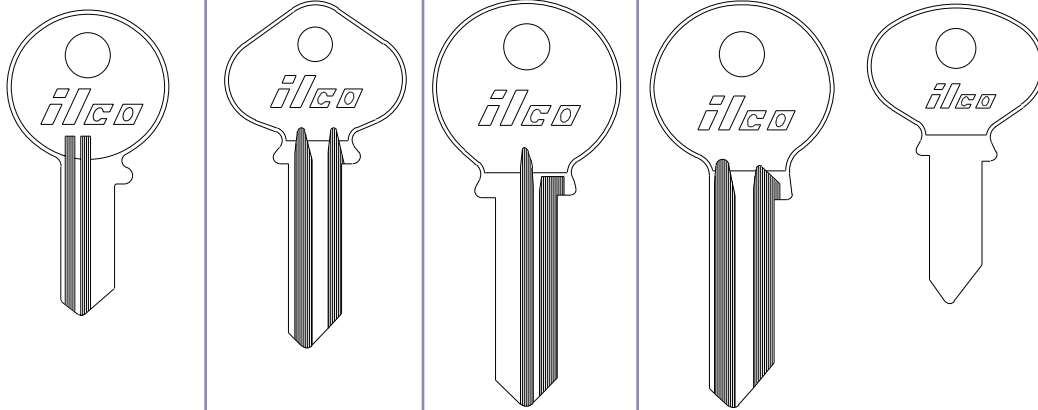
**RONIS      RONIS MATIS      RUSSWIN      RUKO**

<b>V61S</b> RO4 RN13	<b>VR61S</b> RO4R RN13L	<b>RN2</b> RO2 —	<b>RS6</b> — —	<b>RK1</b> RU1 —	<b>RK2</b> — —

**ILCO**  
SILCA  
ORION

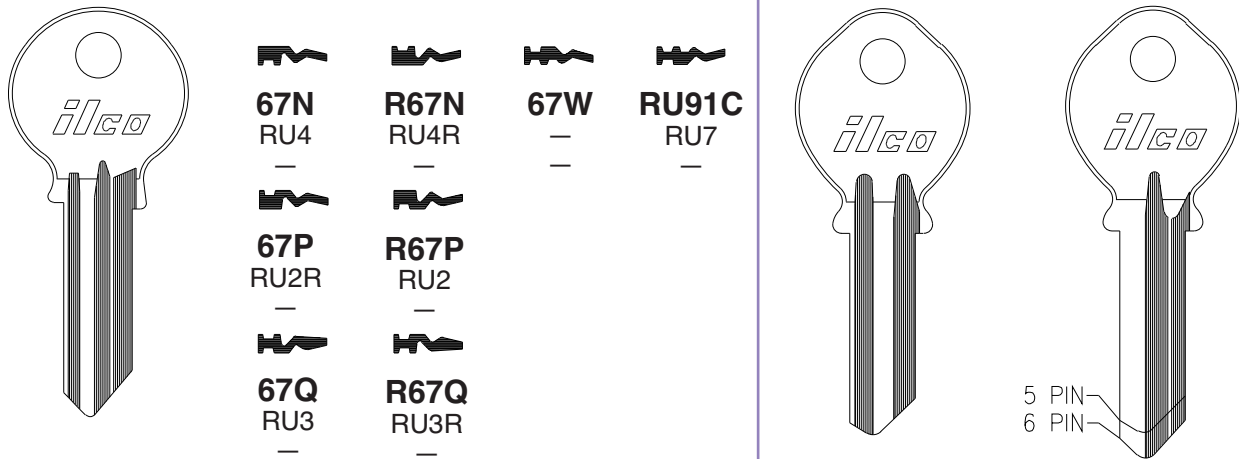
**RUKO      SAN SEBASTIAN**

<b>67N</b> RU4 —	<b>67P</b> RU2R —	<b>67Q</b> RU3 —	<b>67T</b> — —	<b>R67N</b> RU4R —	<b>R67P</b> RU2 —	<b>R67Q</b> RU3R —
<b>67W</b> — —	<b>67U</b> RU5 —	<b>67T</b> — —	<b>R67T</b> — —	<b>RU91C</b> RU7 —		
<b>RK3</b> RU5R —	<b>67U</b> RU5 —	<b>67T</b> — —	<b>R67T</b> — —	<b>SS1</b> — —	<b>5 PIN SS2</b> — —	<b>6 PIN SS3</b> — —

**ILCO**  
SILCA  
ORION

 5 PIN  
6 PIN

SANTIS		SANWA (AUSTRALIA)		
<b>SN1</b> SAN1R	<b>SN2</b> CE4	<b>S1-AUS</b>	<b>S2-AUS</b>	<b>S3-AUS</b>
—	—	—	—	—

ILCO  
SILCA  
ORION

SANWA (AUSTRALIA)		SARA	S & G	SCHUCO
<b>S4-AUS</b>	<b>S9-AUS</b>	<b>PR91</b> PFO70	<b>SG2</b>	<b>KFV1</b> KF1
—	—	—	—	—

ILCO  
SILCA  
ORION

SCHLECHTENDAHL	SCHULTE SCHLAGBAUM		SELECT	
<b>SCH1</b>	<b>SC51</b>	<b>SC52</b>	<b>5 PIN</b> <b>S65F</b>	<b>SE91</b>
—	—	—	—	—
			<b>6 PIN</b> <b>U65F</b>	
			—	
			<b>7 PIN</b> <b>M65F</b>	
			—	
			5 PIN	
			6 PIN	
			7 PIN	

ILCO  
SILCA  
ORION

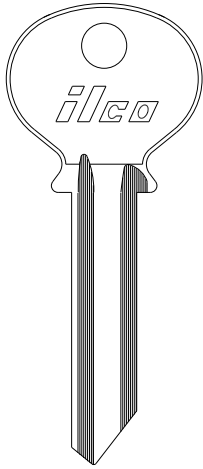
**SELECT**
**SESA**

**SE91L**  
SE5  
SLC12



**R65F**  
—  
SLC12L

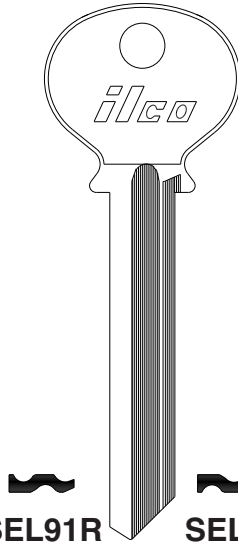

**SEL91R**  
SE7R  
SLC13L



**SEL91**  
SEL7  
SLC13

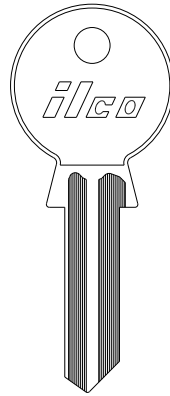

**SES91**  
SE3  
SLC11



**SR65**  
SE3R  
SLC11L

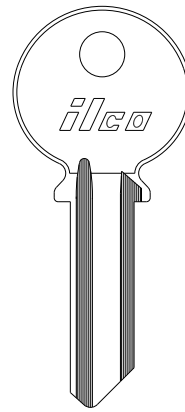

**61JD**  
RO8  
RN16

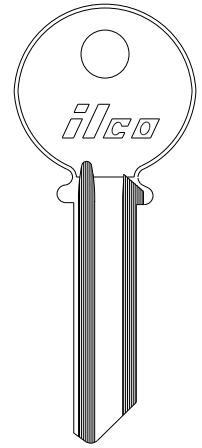

**VA91**  
RO9  
RN17

**ILCO**  
SILCA  
ORION

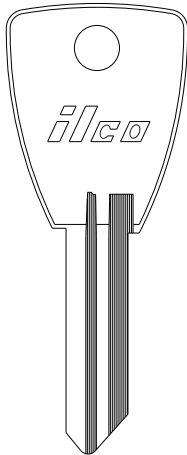
**SHAW**
**SIDLEEN**
**SIMECA**

**SH2**  
—  
—

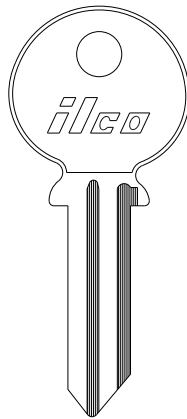

**62SH**  
SHW1  
—

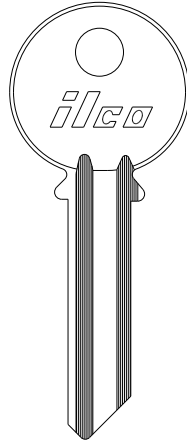

**EX1**  
SD1  
SLE10

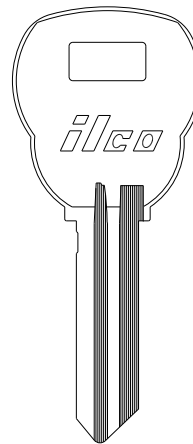

**SIM1**  
SM6  
SMG15



**SIM6**  
—  
—



**SIM8**  
—  
SMG17



**SIM9R**  
—  
SMG18L

**ILCO**  
SILCA  
ORION

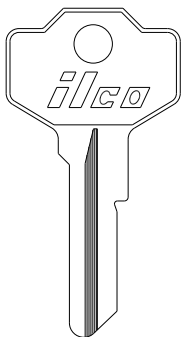
**SIMECA**

**SIM2**  
SM1  
SMG10

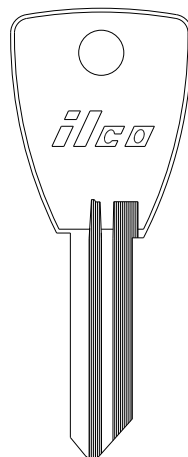

**SIM3**  
—  
—

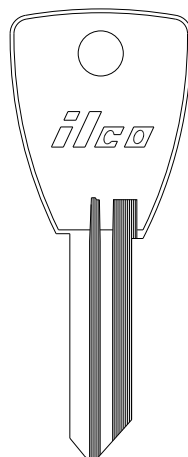

**SIM10**  
—  
—

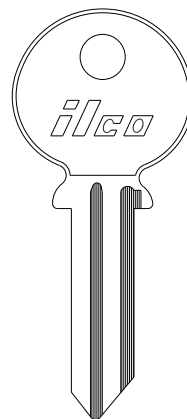

**S91A**  
SM2  
—

**S91BV**  
SM3  
—

**S91K**  
SM5  
SMG14

**S91CV**  
SM4  
SMG13

**S91R**  
SM14R  
SMG23L

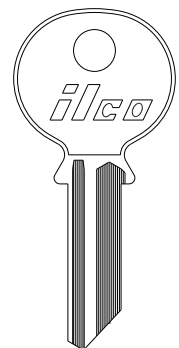

**S91P**  
SM11  
—

**ILCO**  
SILCA  
ORION

SIS	SONNETTE	SOS		
<b>1523</b> SS10 —	<b>VK9</b> — —	<b>SOS1</b> — —	<b>SO91P</b> SO6 —	<b>SOS91</b> SO4 —

**ILCO**  
SILCA  
ORION

SPRINGER		SQUIRE		
<b>50</b> SRN1R —	<b>50A</b> — —	<b>SQ3</b> — —	<b>192</b> SQ1 —	<b>192B</b> — —

**ILCO**  
SILCA  
ORION

STA-LOCK		STENMAN		STUV	
<b>STA1</b> — SCR10	<b>STA2</b> — SCR11	<b>FAS1</b> FS1 FAS10	<b>ST1</b> FS1R FAS10L	<b>SV4</b> — —	<b>ST91</b> CE4R —

**ILCO**  
SILCA  
ORION

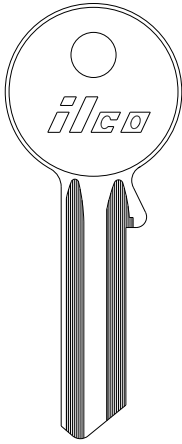
**STUV**
**SUREX**

**ST91A**  
CE2  
CE14

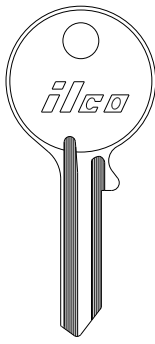

**ST91F**  
SV1  
STV10

**ST91V**  
SV1R  
STV10L

**SV3**  
—  
STV11L

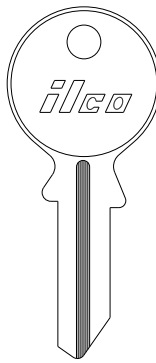

**SX1**  
—  
—

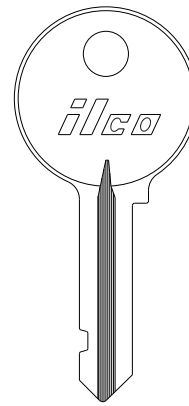

**SX3**  
SR7  
SRX14

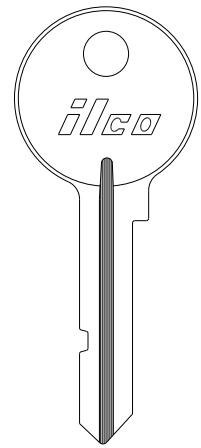

**SX4**  
SR8  
SRX15

**ILCO**  
SILCA  
ORION

**SUREX**
**SWEDA**

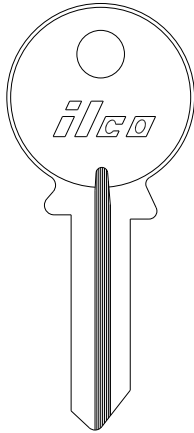

**SU9**  
SR1  
SRX10

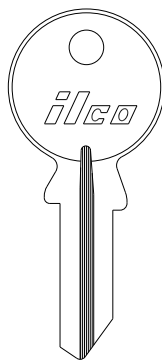

**SU9L**  
SR4  
—

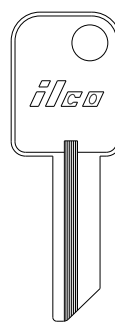

**SU9S**  
SR2  
—



**SW1**  
SW2  
—

**SW2**  
SW1R  
—

**S180UR**  
—  
—

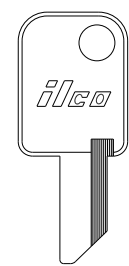

**SW3**  
SW3  
—

**ILCO**  
SILCA  
ORION

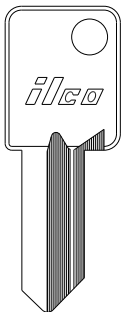
**SWEDA**
**TACO**

**SW4**  
—  
—

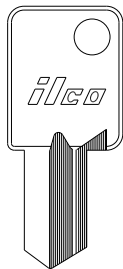

**SW4R**  
—  
—

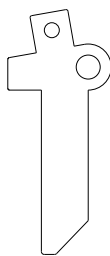

**SW5**  
—  
—

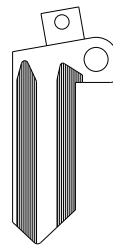

**SW6**  
—  
—

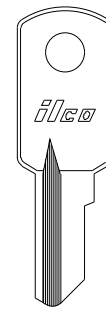

**SW7**  
—  
—

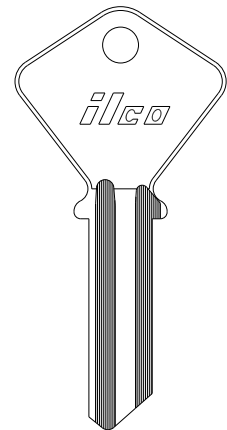

**S180W**  
—  
—

**ILCO**  
SILCA  
ORION

**62TA R62TA**  
—  
—



TACO	TEKA	TESA			
 6 PIN 7 PIN  6 PIN 7 PIN <b>62TC L62TC</b> — — — —	  <b>TEK1</b> — —	  <b>TE1</b> TE1 TSA10	  <b>TE2</b> TE1R TSA10L	  <b>TS2</b> — —	  <b>R64T</b> — —

ILCO  
SILCA  
ORION

TESA		TOK				
  <b>TE3</b> TE3 TSA11	  <b>TE4</b> TE2 TSA12	  <b>TK1</b> TO4 —	  <b>TK2</b> — —	  <b>TO91</b> TO1 —	  <b>TOK2</b> — —	  <b>TK3</b> TO3 —

ILCO  
SILCA  
ORION

TOK									
	 <b>TK4</b> TO8X1 TOK1X	 <b>TK8</b> TO8X5 TOK5X	 <b>TK13</b> TO8X10 TOK10X	 <b>TK17</b> TO8X14 TOK14X	 <b>TK21</b> TO8X18 TOK18X	 <b>TK25</b> TO9Y4 TOK4Y	 <b>TK29</b> — TOK8Y	 <b>TK33</b> TO9Y12 TOK12Y	 <b>TK37</b> TO9Y16 TOK16Y
	 <b>TK5</b> TO8X2 TOK2X	 <b>TK10</b> TO8X7 TOK7X	 <b>TK14</b> — TOK11X	 <b>TK18</b> TO8X15 TOK15X	 <b>TK22</b> TO9Y1 TOK1Y	 <b>TK26</b> TO9Y5 TOK5Y	 <b>TK30</b> — TOK9Y	 <b>TK34</b> TO9Y13 TOK13Y	 <b>TK38</b> TO9Y17 TOK17Y
	 <b>TK6</b> TO8X3 TOK3X	 <b>TK11</b> — TOK8X	 <b>TK15</b> TO8X12 TOK12X	 <b>TK19</b> TO8X16 TOK16X	 <b>TK23</b> TO9Y2 TOK2Y	 <b>TK27</b> TO9Y6 TOK6Y	 <b>TK31</b> TO9Y10 TOK10Y	 <b>TK35</b> TO9Y14 TOK14Y	 <b>TK39</b> TO9Y18 TOK18Y
	 <b>TK7</b> TO8X4 TOK4X	 <b>TK12</b> — TOK9X	 <b>TK16</b> TO8X13 TOK13X	 <b>TK20</b> TO8X17 TOK17X	 <b>TK24</b> TO9Y3 TOK3Y	 <b>TK28</b> TO9Y7 TOK7Y	 <b>TK32</b> TO9Y11 TOK11Y	 <b>TK36</b> TO9Y15 TOK15Y	

ILCO  
SILCA  
ORION

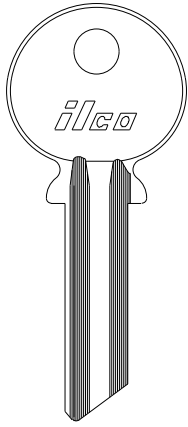
**TOK**
**TORONTO**
**TRIANGLE**

**9TK**  
—  
—

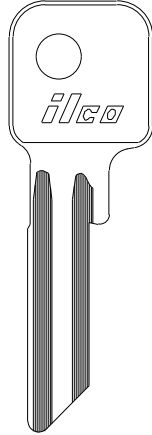

**TK41**  
—  
TRL10

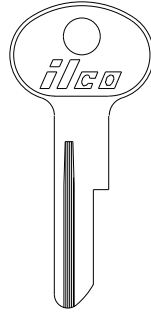

**TO92**  
—  
—

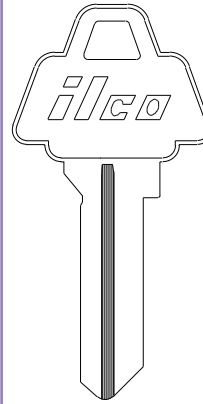

**170T**  
—  
—

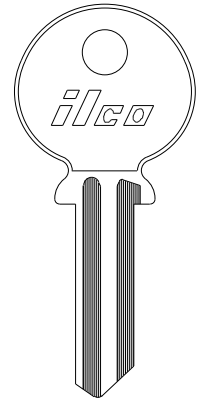

**TN1**  
—  
—

**ILCO**  
SILCA  
ORION

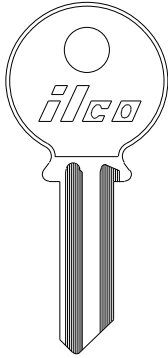
**TRIANGLE**
**TRI - CIRCLE**

**TN2**  
—  
—

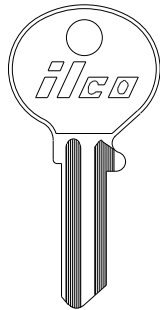

**TN5**  
—  
—



**TN3**  
—  
—



**TN4**  
—  
—

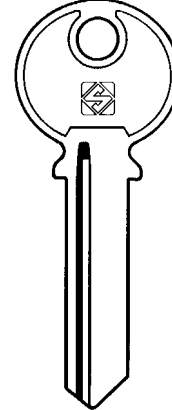

**TL8**  
TL8R  
—

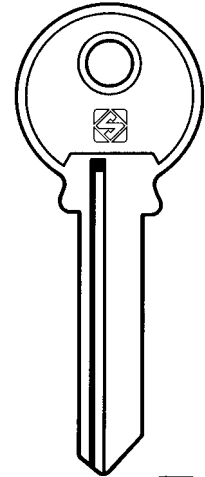

**TL11**  
TL11  
—

**ILCO**  
SILCA  
ORION

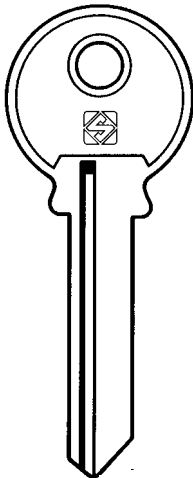
**TRI-CIRCLE**
**TRIO**

**TL11R**  
TL11R  
—

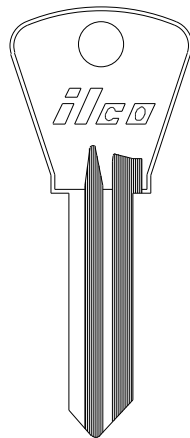

**TO1**  
TR1  
TO1

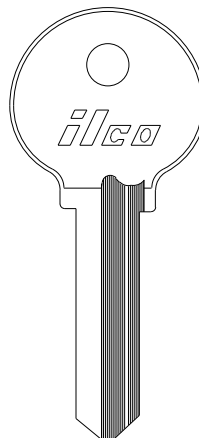

**TO2**  
—  
—

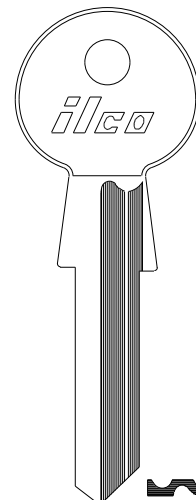

**TO3**  
—  
—

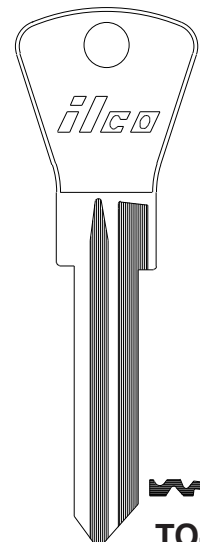

**TO4**  
—  
—

**ILCO**  
SILCA  
ORION

TRIO			TUBE		UCEM
<b>TO5</b> TR3 TO5	<b>TO6</b> TR4 —	<b>TO7</b> — —	<b>TB1</b> — —	<b>TB2</b> — —	<b>UCM1</b> AC1 —

ILCO  
SILCA  
ORION

UMF		UNION				
<b>ID1</b> DM3 —	<b>UM2</b> UM1R —	<b>UN3</b> — —	<b>UN4</b> — —	<b>UN5</b> UNI27 UN36	<b>UN7</b> — —	<b>UN7</b> — —
					<b>BR13</b> — —	
					<b>62DA</b> UNI23 —	
					<b>S33P</b> UNI30 UN38	









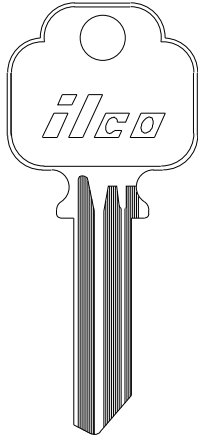







ILCO  
SILCA  
ORION

UNION				
<b>33C</b> — —	<b>33NO</b> UNI3 —	<b>B33N</b> — —	<b>B33NB</b> — —	<b>S33C</b> UNI56R UN33

ILCO  
SILCA  
ORION

## UNION









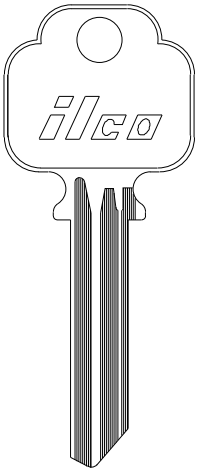

















 <b>UN51</b> UNI33 —	 <b>UN55</b> — —	 <b>UN59</b> UNI41 —	 <b>UN63</b> UNI37R —	 <b>UN67</b> UNI39R —	 <b>UN81</b> — —
 <b>UN52</b> UNI34 —	 <b>UN56</b> UNI40 —	 <b>UN60</b> UNI35R —	 <b>UN64</b> UNI38R —	 <b>UN68</b> UNI36R —	 <b>UN82</b> — —
 <b>UN53</b> UNI37 —	 <b>UN57</b> UNI39 —	 <b>UN61</b> UNI33R —	 <b>UN65</b> — —	 <b>UN69</b> UNI41R —	 <b>UN83</b> — —
 <b>UN50</b> UNI35 —	 <b>UN54</b> UNI38 —	 <b>UN58</b> UNI36 —	 <b>UN62</b> UNI34R —	 <b>UN66</b> UNI40R —	 <b>UN80</b> — —

 ILCO  
SILCA  
ORION

## UNION



 <b>UN51L</b> UNI44 —	 <b>UN55L</b> — —	 <b>UN59L</b> UNI50 —	 <b>UN63L</b> UNI48R —	 <b>UN67L</b> UNI52R —	 <b>UN81L</b> — —
 <b>UN52L</b> UNI45 —	 <b>UN56L</b> UNI51 —	 <b>UN60L</b> UNI46R —	 <b>UN64L</b> UNI49R —	 <b>UN68L</b> UNI47R —	 <b>UN82L</b> — —
 <b>UN53L</b> UNI48 —	 <b>UN57L</b> UNI52 —	 <b>UN61L</b> UNI41R —	 <b>UN65L</b> — —	 <b>UN69L</b> UNI50R —	 <b>UN83L</b> — —
 <b>UN50L</b> UNI46 —	 <b>UN54L</b> UNI49 —	 <b>UN58L</b> UNI47 —	 <b>UN62L</b> UNI45R —	 <b>UN66L</b> UNI51R —	 <b>UN80L</b> — —

 ILCO  
SILCA  
ORION

## UNION

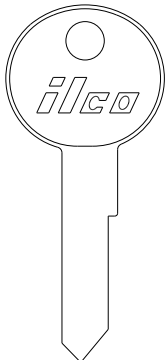
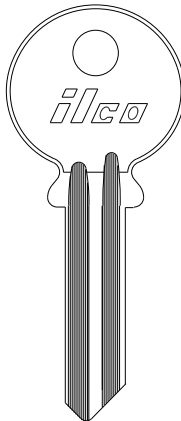
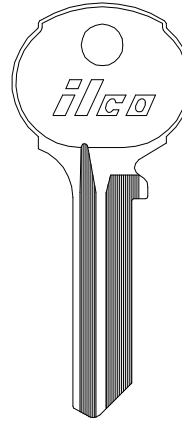
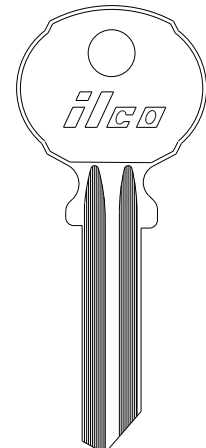
  
**L62DM**  
UNI29  
UNI37

  
**1033**  
—  
UNI13

  
**1033N**  
UNI3  
UNI12

  
**U180G**  
UNI28  
—

 ILCO  
SILCA  
ORION

UNIVERSAL				URKO			
<b>WA91W</b> ULO52 UNL4	<b>WA91</b> ULO53 UNL4L	<b>WA91WL</b> ULO50 UNL5	<b>WA91L</b> ULO51 UNL5L	<b>UR1</b> — —	<b>UR1R</b> — —	<b>UR2</b> UR2R —	<b>UR2R</b> — —

ILCO  
SILCA  
ORION

URKO		VACHETTE		
<b>UR3</b> UR1 —	<b>UR3R</b> UR1R —	<b>V1S</b> VAC11 VA10	<b>VAE1</b> VAC1 —	<b>VAT1</b> VAC5 —
		<b>VCA1</b> VAC3 —	<b>VCA1R</b> VAC30R —	

ILCO  
SILCA  
ORION

VACHETTE					
		<b>7LA</b>		<b>7LE</b>	
	—	—	—	—	
		<b>7LB</b>		<b>7LF</b>	
	—	—	—	—	
		<b>7LC</b>		<b>7LG</b>	
	—	—	—	—	
		<b>7LDH</b>		<b>7LH</b>	
	—	—	—	—	
		<b>7RA</b>		<b>7RE</b>	
	—	—	—	—	
		<b>7RB</b>		<b>7RF</b>	
	—	—	—	—	
		<b>7RC</b>		<b>7RG</b>	
	—	—	—	—	
		<b>7RD</b>		<b>7RH</b>	
	—	—	—	—	

ILCO  
SILCA  
ORION

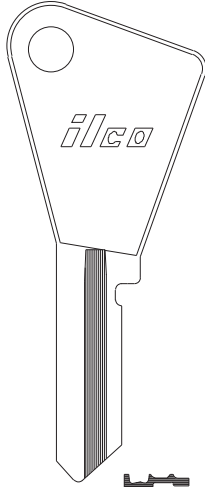
**VACHETTE**

**H7LA**  
VAC15R  
VA27L

**H7LE**  
—  
VA31L

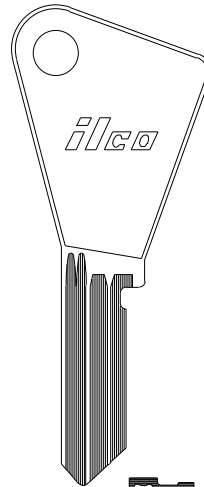

**H7RA**  
VAC15  
VA27

**H7RE**  
VAC19N  
VA31

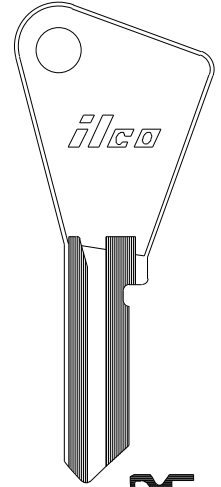

**H10F**  
VAC2  
VA14

**H7LB**  
VAC16R  
VA28L

**H7LF**  
VAC20RN  
VA34L

**H7RB**  
VAC16  
VA28

**H7RF**  
VAC20N  
VA34

**H7LC**  
VAC17R  
VA29L

**H7LG**  
VAC21RN  
VA36L

**H7RC**  
VAC17  
VA29

**H7RG**  
VAC21N  
VA36

(MASTER)  
**H7LDH**  
—  
VA40L

**H7LD**  
VAC18R  
VA30L

**H7LH**  
VAC22RN  
VA38L

(MASTER)  
**H7RDH**  
VAC6  
VA40

**H7RD**  
VAC18  
VA30

**H7RH**  
VAC22N  
VA38

**ILCO**  
SILCA  
ORION

INTERNATIONAL  
CYLINDER

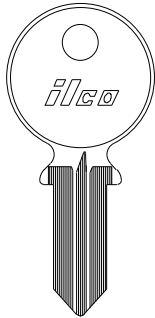
**VACHETTE**

**VC21**  
VAC10  
VA26

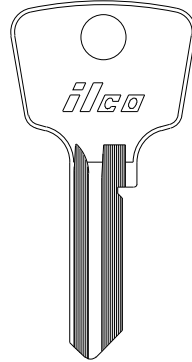

**VC22**  
VAC14  
VA23

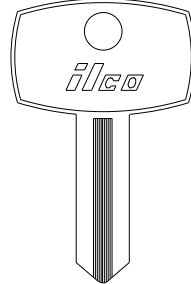

**VC23**  
—  
—

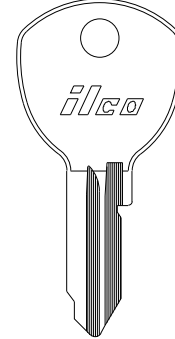

**VC32**  
VAC33  
VA13

**VC33**  
VAC33R  
VA13L

**VC34**  
—  
VA12L

**ILCO**  
SILCA  
ORION

sec 3 page 53

**VACHETTE**

**61VT**  
—  
—



**62KD**  
—  
—

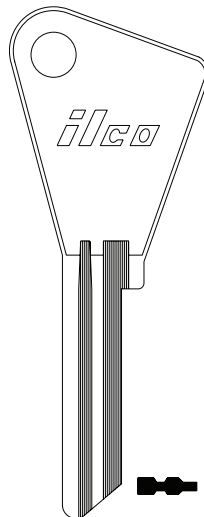

**H62BM**  
—  
—

**H62CM**  
—  
—

**H62DM**  
—  
—

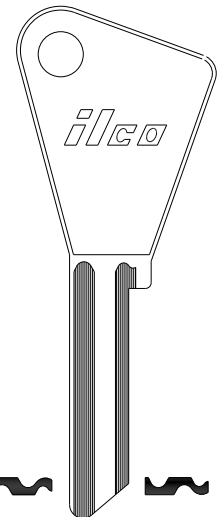

**H62KB**  
—  
VA15

**HR62KB**  
—  
—

**ILCO**  
SILCA  
ORION

VACHETTE

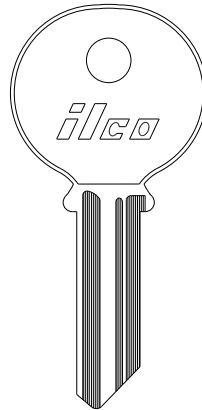
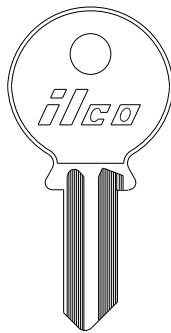
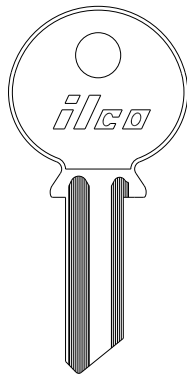
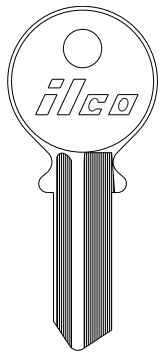

  
V91LE  
VAC19  
—

  
V91LF  
VAC20  
—

  
V91LG  
VAC21  
—

  
L62KE  
—  
—

  
S62KB  
—  
—

  
V91E  
VAC8  
VA25

  
V91LA  
—  
—

  
V91LD  
—  
—

  
V91LH  
VAC22  
—

ILCO  
SILCA  
ORION

VACHETTE

VAUGHAN

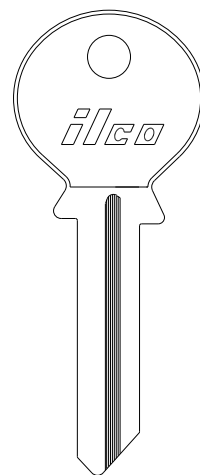
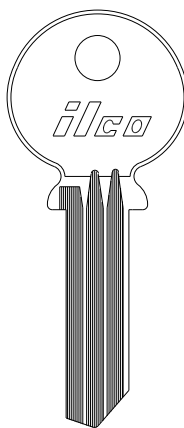
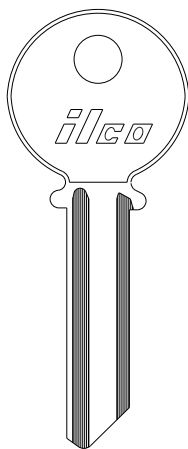
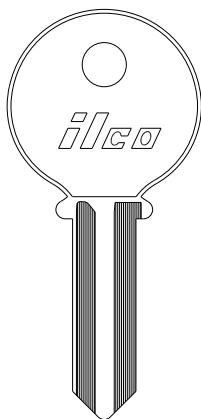

  
V91N  
VAC29  
VA42

  
VA91  
RO9  
RN17

  
LR61JD  
—  
RN17L

  
VA1  
HT2  
—

  
VA2  
HT1  
—

  
VA3  
—  
—

  
62H  
—  
—

  
HT3  
—  
—

ILCO  
SILCA  
ORION

VAUGHAN

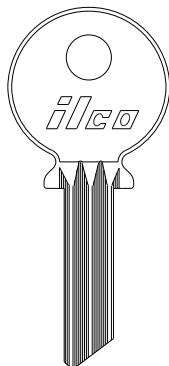
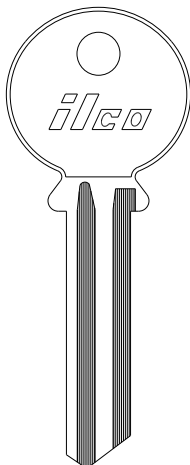

  
VA7  
—  
—  
  
VA8  
—  
—

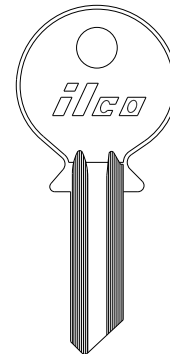
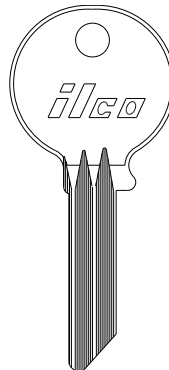











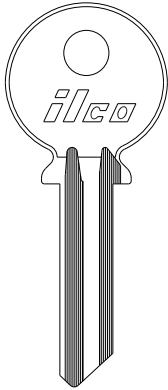
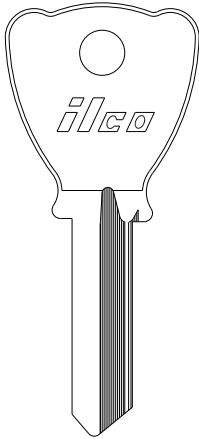
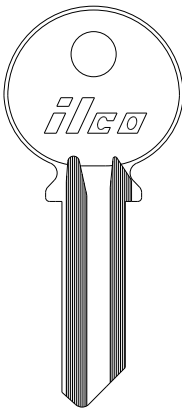

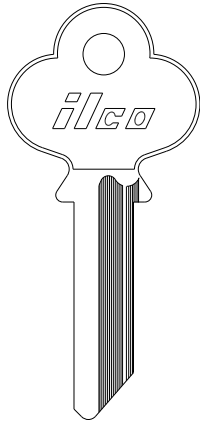





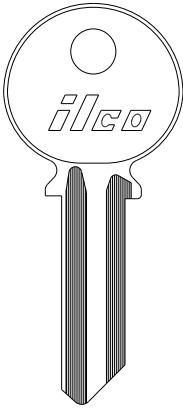
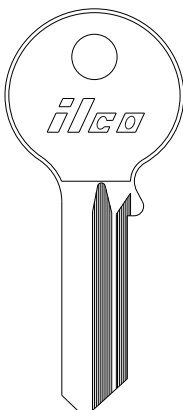
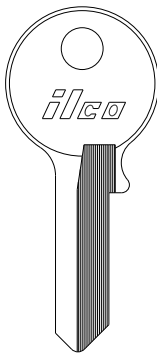
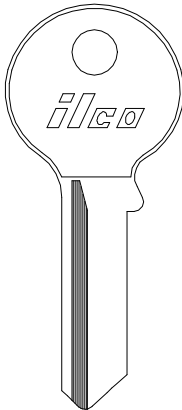





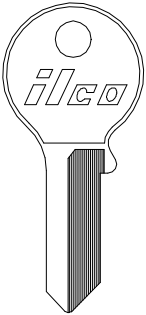

  
VA4  
—  
—

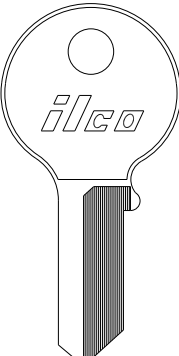
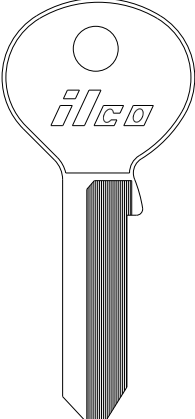
  
VA6  
—  
—

  
HT8  
—  
—

  
VA10  
—  
—

ILCO  
SILCA  
ORION

	VAUGHAN	VECO	VEGA	VICTORY	VIKING			
ILCO SILCA ORION								
	 <b>62M</b> — —	 <b>VEC1</b> VC1R VCO10L	 <b>VEC2</b> VC1 VCO10	 <b>VG2</b> VEG1 VGA10	 <b>VT1</b> — —	 <b>VK9</b> — —		
	VING	VIRO						
ILCO SILCA ORION								
	 <b>VG1</b> VG1 —	 <b>VR1</b> VI1R VRO5XL	 <b>VR1R</b> VI1 VRO5X	 <b>VR91A</b> VIO87 VRO5PL	 <b>VR91AR</b> VIO82 VRO5P	 <b>VR91R</b> VIO81 VRO5	 <b>VR91</b> VIO80 VRO5	
	VIRO							
ILCO SILCA ORION								
	 <b>VR91B</b> VIO84 VRO4P	 <b>VR91BR</b> VIO85 VRO4PL	 <b>L67A</b> — —	 <b>VR91C</b> VIO89 VRO3PL	 <b>VR91CR</b> VIO88 VRO3P	 <b>VR91S</b> VIO82 VRO4	 <b>SR191A</b> — VRO4L	 <b>185V</b> — —



VIRO	WAH-TUNG			
<b>191A</b> GD2 —	<b>O1S</b> — —	<b>WH1</b> — —	<b>WH2</b> — —	<b>WH3</b> — —

**ILCO**  
SILCA  
ORION

WAH-TUNG	WALLY						
<b>FR1000V</b> — —	<b>F1000VR</b> — —	<b>B61Y</b> — WLY5P	<b>WA91W</b> ULO52 UNL4	<b>WA91</b> ULO53 UNL4L	<b>WA91C</b> JW1 —	<b>WA91WL</b> ULO50 UNL5	<b>WA91L</b> ULO51 UNL5L

**ILCO**  
SILCA  
ORION

WALLY		WECO		WEST ALLOY		WHITCO		
<b>WA91P</b> — —	<b>WA91PR</b> WA4 —	<b>WA91S</b> CS12 —	<b>WC1</b> — —	<b>WC2</b> — —	<b>WA1</b> GT13A —	<b>WA2</b> — —	<b>WO1</b> — —	<b>WO2</b> — —

**ILCO**  
SILCA  
ORION

AUSTRALIA

AUSTRALIA

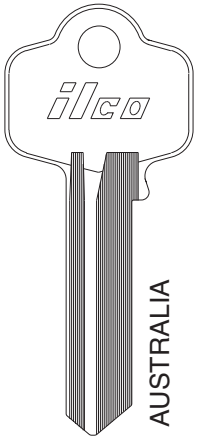
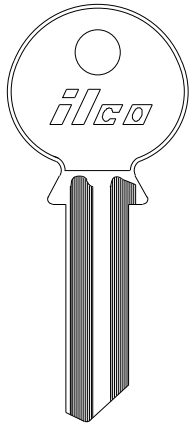
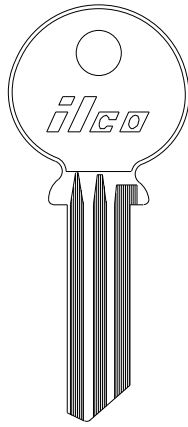
**WHITCO**
**WILKA**

**AUSTRALIA**
  
**WO3**  
 —  
 —

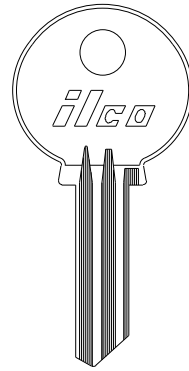
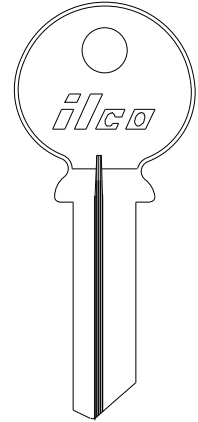
  
**W91C**  
 WK1  
 WIL10

  
**WIL1**  
 WK10  
 —

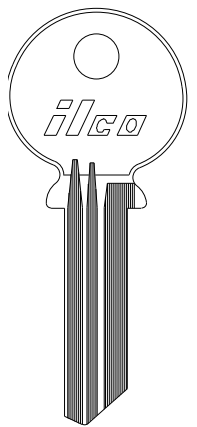
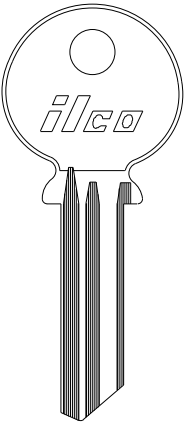
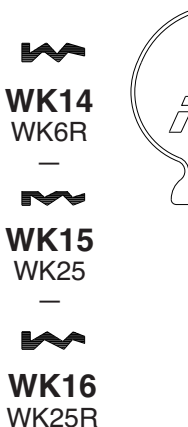
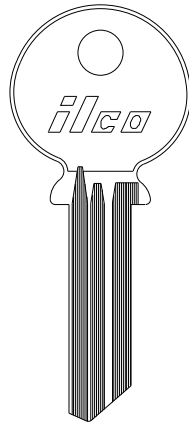
  
**WK4**  
 —  
 —  
  
**WK5**  
 —  
 —  
  
**WK6**  
 —  
 —

  
**WK7**  
 WK2  
 —  
  
**WK8**  
 —  
 —  
  
**WK9**  
 —  
 —

  
**WIL2**  
 —  
 —

  
**WK3**  
 WK3  
 —  
  
**WK10**  
 WK11  
 —  
  
**WK11**  
 WK11  
 —

**ILCO**  
 SILCA  
 ORION

**WILKA**

  
**WK12**  
 WK26  
 —

  
**WK13**  
 WK7  
 —

  
**WK14**  
 WK6R  
 —  
  
**WK15**  
 WK25  
 —  
  
**WK16**  
 WK25R  
 —  
**WK17**  
 —  
 —

  
**WK18**  
 WK33  
 —

  
**WK19**  
 WK32  
 —

  
**WK20**  
 WK29  
 —

  
**WK21**  
 WK37  
 —

  
**WK22**  
 WK34  
 —

  
**WK23**  
 WK28  
 —

  
**WK24**  
 WK35  
 —

  
**WK25**  
 WK31  
 —

  
**WK26**  
 —  
 —

  
**WK27**  
 WK36  
 —

  
**WK28**  
 WK38  
 —

  
**WK29**  
 WK30  
 —

  
**WK30**  
 WK39  
 —

  
**WK31**  
 —  
 —

  
**WK32**  
 WK27  
 —

sec 3 page 57

**ILCO**  
 SILCA  
 ORION

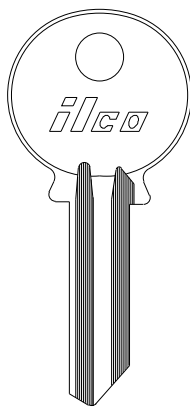
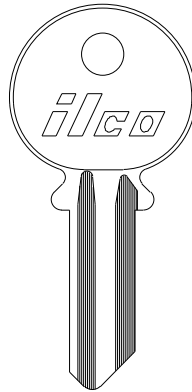
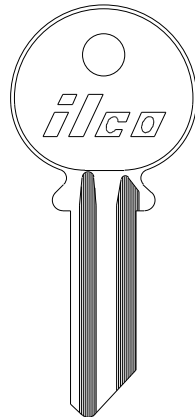
**WILLEN**
**WING-KOO**
**WIRE ROPE**

  
**WL5**  
 —  
 —

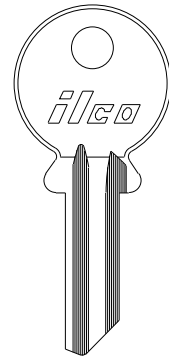
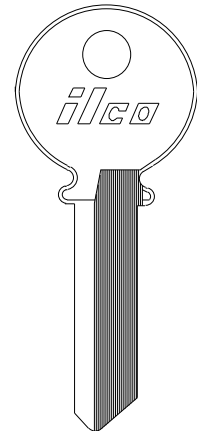
  
**61K**  
 —  
 WLK4

  
**R61K**  
 —  
 WLK4L

  
**L61K**  
 —  
 WLK5

  
**WL2**  
 —  
 WLK5L

  
**WG1**  
 —  
 —

  
**TS1**  
 WR1  
 —

**ILCO**  
 SILCA  
 ORION

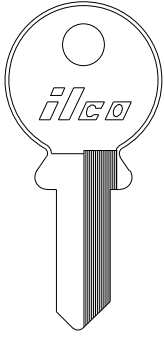
WIRE ROPE

WOLF



**WRE1**  
—  
—

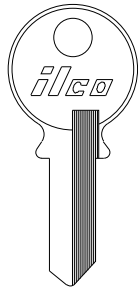

**WRE2**  
WR4  
—



**WRE3**  
—  
—

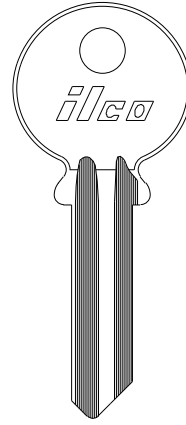

**33K**  
—  
—

ILCO  
SILCA  
ORION

WS

YALE

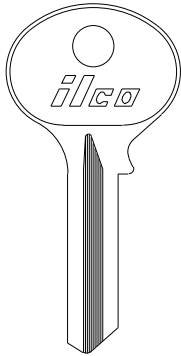

**WS8**  
—  
—

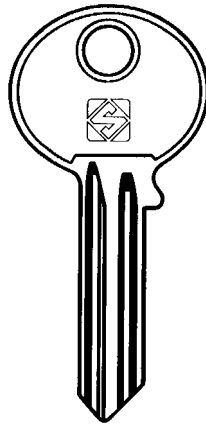

**YA71**  
—  
—

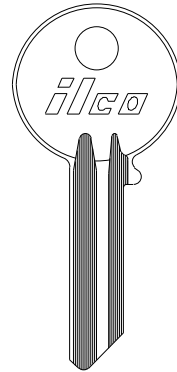

**YL1**  
—  
—

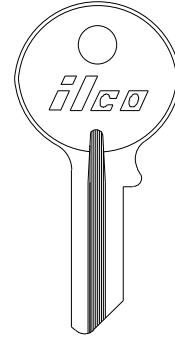

**YL2**  
—  
—

**YL5**  
YA15  
—  
**YL8**  
YA8  
—

ILCO  
SILCA  
ORION

YALE

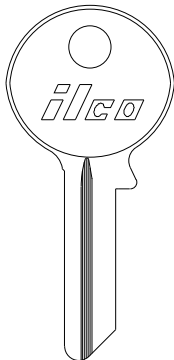

**YL3**  
—  
—

**YL6**  
YA30  
—  
**YL9**  
YA3  
—

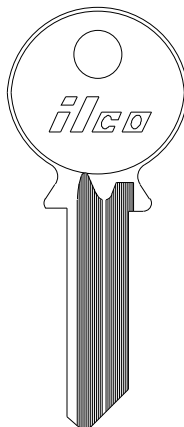

**YL4**  
—  
—

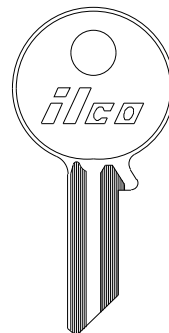

**S7JA**  
—  
—

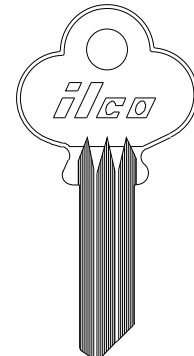

**Y8**  
—  
—

ILCO  
SILCA  
ORION

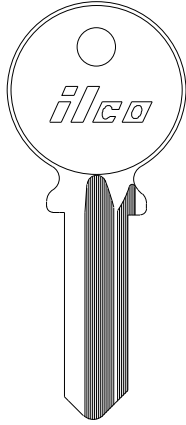
**YALE**

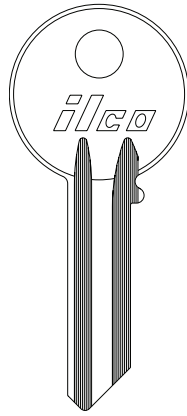
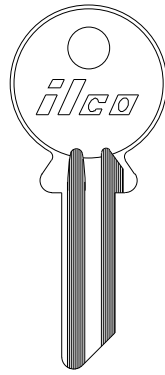
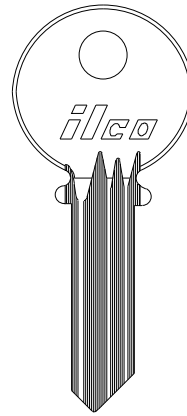
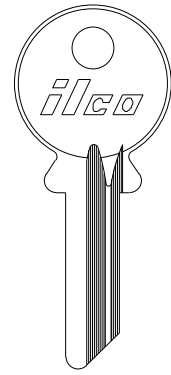
**14K**

**14KR**

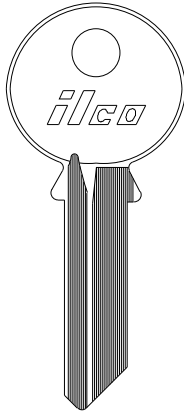
**14KH**  
YA226

**Y200**  
YA3

**Y201**

**Y204**  
CS204

**ILCO**  
SILCA  
ORION

**YALE**

**999GA**  
GYA  
YAL13A

**999GB**  
GYB  
YAL13B

**999GC**  
GYC  
YAL13C

**999GD**  
GYD  
YAL13D

**999GE**  
GYE  
YAL13E

**999GF**  
GYF  
YAL13F

**999GG**  
GYG  
YAL13G

**999GH**  
GYH  
YAL13H

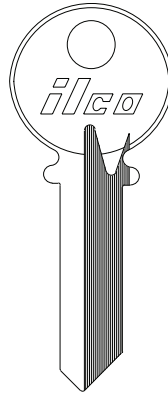
**999GK**  
GYK  
YAL13K

**999R**  
YA1R

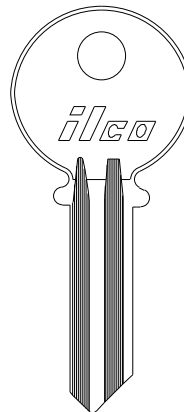
**ILCO**  
SILCA  
ORION

**YALE**

**999LA**  
LYA  
YAL41A

**999LB**  
LYB  
YAL41B

**999LC**  
LYC  
YAL41C

**999LD**  
LYD  
YAL41D

**999LE**  
LYE  
YAL41E

**999LF**  
LYF  
YAL41F

**R9LF**  
—  
—

**999LG**  
LYG  
YAL41G

**999LH**  
LYH  
YAL41H

**999LK**  
LYK  
YAL41K

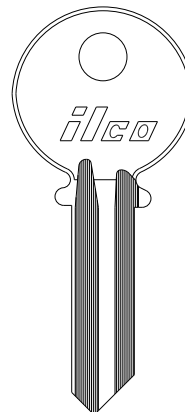
**R9LK**  
—  
—

**1554**  
YA83

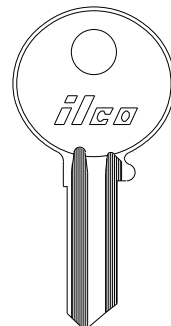
**ILCO**  
SILCA  
ORION

**YUEN-YUEN**

**YY1**

ZADI	ZEISS-IKON			
			 <b>Z91K</b> ZE5 -  <b>Z91KR</b> ZE3R ZE110L	  <b>ZMK1</b> ZE6R -  <b>ZMK2</b> ZE6 -
 <b>ZD7</b> ZD7 -	 <b>ZK1</b> ZE1DR ZE111	 <b>ZIK1</b> - ZE110	 <b>ZKN1</b> ZE1 ZE110	 <b>ZKN1R</b> ZE1R -

ILCO  
SILCA  
ORION

ZEISS-IKON				
			 <b>60.CD</b> - -  <b>60.D</b> - -  <b>60.GH</b> - -  <b>60.IK</b> - -	 <b>60.I9</b> - -  <b>60.LM</b> - -  <b>60.S9</b> - -  <b>60.O</b> - -
 <b>ZKN2</b> ZE1R -	 <b>ZN2</b> - -	 <b>60.B9</b> - -		

ILCO  
SILCA  
ORION

ZEISS-IKON			
	 <b>60VG</b> - -  <b>60VG9</b> - -		
 <b>60VF9</b> - -		 <b>S60</b> - ZE112	 <b>S60R</b> - ZE112L

ILCO  
SILCA  
ORION

## ZEISS-IKON

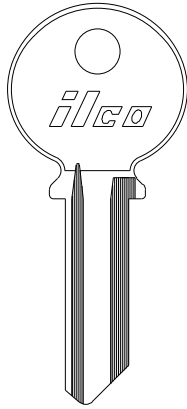

60HB	60UF	60Z2	60Z6	60Z10	60Z14	60Z19	
—	—	—	—	—	—	—	—
60HR	60UG	60Z3	60Z7	60Z11	60Z16	60ZD	
—	—	—	—	—	—	—	—
R60HR	60VF	60Z4	60Z8	60Z12	60Z17	R60ZD	
—	—	—	—	—	—	—	—
60HA	60UA	60Z1	60Z5	60Z9	60Z13	60Z18	
—	—	—	—	—	—	—	—
—	—	—	—	—	—	—	—

 ILCO  
SILCA  
ORION

 INTERNATIONAL  
CYLINDER

 sec page  
3 61

 ILCO  
SILCA  
ORION

 ILCO  
SILCA  
ORION

ZEISS-IKON

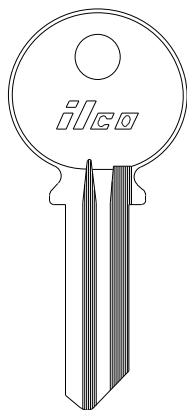

ZK3	ZK7	ZK11	ZK15	ZK19	ZK23	ZK27	ZK31
-	-	-	-	-	-	-	-
ZK4	ZK8	ZK12	ZK16	ZK20	ZK24	ZK28	ZK32
-	-	-	-	-	-	-	-
ZK5	ZK9	ZK13	ZK17	ZK21	ZK25	ZK29	ZK33
-	-	-	-	-	-	-	-
ZK2 ZE10	ZK6	ZK10	ZK14	ZK18	ZK22	ZK26	ZK30
-	-	-	-	-	-	-	-

ILCO  
SILCA  
ORION

ZEISS-IKON

ZK35	ZK39	ZK43	ZK47	ZK51	ZK55	ZK59	ZK63	ZK67	ZK71
-	-	-	-	-	-	-	-	-	-
ZK36	ZK40	ZK44	ZK48	ZK52	ZK56	ZK60	ZK64	ZK68	ZK72
-	-	-	-	-	-	-	-	-	-
ZK37	ZK41	ZK45	ZK49	ZK53	ZK57	ZK61	ZK65	ZK69	ZK73
-	-	-	-	-	-	-	-	-	-
ZK38	ZK42	ZK46	ZK50	ZK54	ZK58	ZK62	ZK66	ZK70	ZK74
-	-	-	-	-	-	-	-	-	-

ILCO  
SILCA  
ORION

ZEISS-IKON

ZK75	ZK79	ZK83	ZK87	ZK91	ZK95	ZK99	ZK103
-	-	-	-	-	-	-	-
ZK76	ZK80	ZK84	ZK88	ZK92	ZK96	ZK100	
-	-	-	-	-	-	-	
ZK77	ZK81	ZK85	ZK89	ZK93	ZK97	ZK101	
-	-	-	-	-	-	-	
ZK78	ZK82	ZK86	ZK90	ZK94	ZK98	ZK102	
-	-	-	-	-	-	-	

ILCO  
SILCA  
ORION

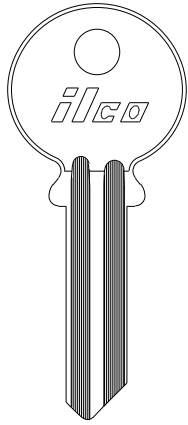
**ZENI**
**ZENICA**

**ZN1**  
ZN1  
ZN15

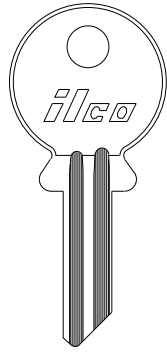

**ZN2**  
—  
—

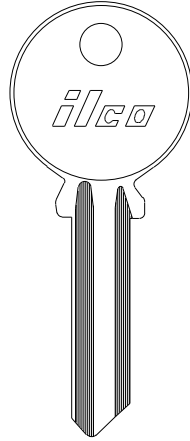

**ZN7**  
—  
—

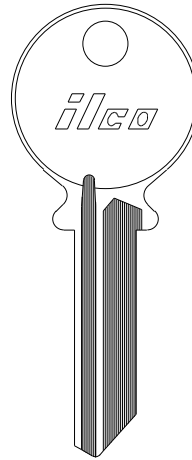

**ZC1**  
CA14  
CV18

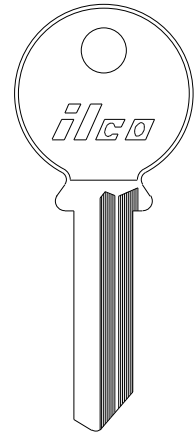

**ZC2**  
—  
CV17

**ILCO**  
SILCA  
ORION

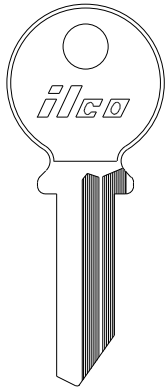
**ZENICA**
**ZENITH**

**ZC3**  
—  
CV16



**ZC4**  
—  
CV15

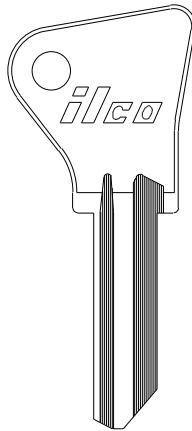

**ZE1**  
—  
—

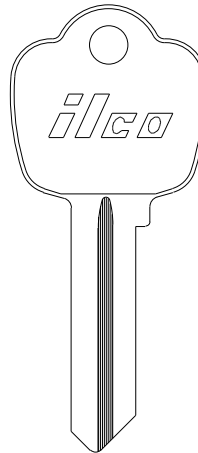

**62KZ**  
—  
—

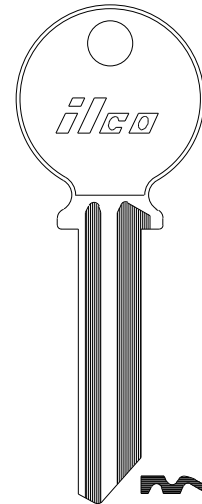

**AR62K**  
CA10  
CV21

**ILCO**  
SILCA  
ORION

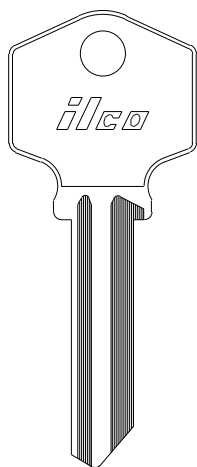
**ZENITH**

**UR62K**  
CA11  
CV22

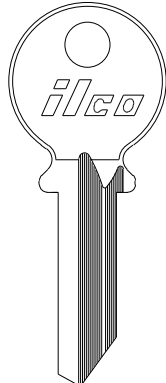

**CA91D**  
CA7  
CV19

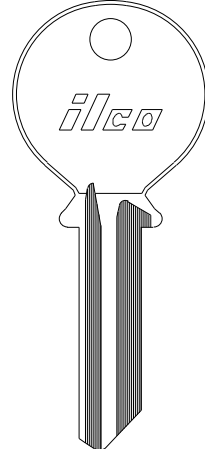

**ZE91C**  
CA2R  
CV14L



**ZE91CR**  
CA2  
CV14

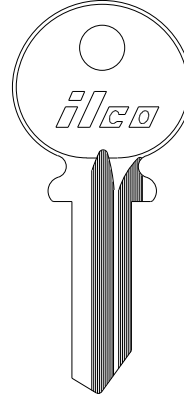

**ZE91G**  
GB5  
GBN10

**ILCO**  
SILCA  
ORION



## Section 4

This section is separated into two parts as follows.



### Section 4a **ORIGINALS**

Key Blanks with the authorized Original Manufacturer's logos and/or designs.



### Section 4b **LOOK ALIKE®**

Key Blanks manufactured to look just like the Original Manufacturer's key, without the brand name.

Look Alike Key Number	Ilco Equivalent	Ilco EZ Equivalent	Fits	Finish	Look Alike Key Number	Ilco Equivalent	Ilco EZ Equivalent	Fits	Finish
320560	1970AM	RA4	American Motors	NP	1063KW-BR-250PK	1176	KW1	Kwikset	BR
320561	S1970AM	RA3	American Motors	NP	1063KW-NP-250PK	1176	KW1	Kwikset	NP
PTKB1	1045	AM3	American	BR	N1063KW	1176	KW1	Kwikset	NP
CH1C	B1179-1C	-	Arrow	NS	B308	1004	L1	Lockwood	NP
CH1D	B1179-1D	-	Arrow	NS	B310	1004A	L4	Lockwood	NP
K2-A	1179	AR1	Arrow	BR	15K	1092N	M16	Master	BR
K7	1179A	AR4	Arrow	NS	1K	1092	M16	Master	BR
1A1A1	A1114A	BE2	Best	NS	1515	-	-	Medeco	NS
1A1B1	A1114B	-	Best	NS	1517	-	-	Medeco	NS
1A1C1	A1114C	-	Best	NS	1518	-	-	Medeco	NS
1A1D1	A1114D	-	Best	NS	1542	-	-	Medeco	NS
1A1DD1	A1114DD	-	Best	NS	1543	-	-	Medeco	NS
1A1E1	A1114E	-	Best	NS	1638	-	-	Medeco	NP
1A1F1	A1114F	-	Best	NS	1644	-	-	Medeco	NP
1A1FM1	A1114FM	-	Best	NS	1655	-	-	Medeco	NS
1A1G1	A1114G	-	Best	NS	A1515	-	-	Medeco	NS
1A1H1	A1114H	-	Best	NS	A1517	-	-	Medeco	NS
1A1J1	A1114J	-	Best	NS	A1638	-	-	Medeco	NP
1A1K1	A1114K	-	Best	NS	4295	R1064E	NA25	National	BR
1A1L1	A1114L	-	Best	NS	5981R	N1011P	RU52	Russwin	NS
1A1M1	A1114M	-	Best	NS	5D1R	1011D1	RU45	Russwin	NS
1A1Q1	A1114Q	-	Best	NS	6D1R	A1011D1	RU46	Russwin	NS
1A1R1	A1114R	-	Best	NS	275LA	1007LA	S22 1/2	Sargent	NS
1A1TA1	-	-	Best	NS	275S	1010N	S68	Sargent	NS
1A1TB1	A1114TB	-	Best	NS	6275LA-NP	01007LA	S22	Sargent	NP
1A1WA1	-	-	Best	NS	6275LA-NS	01007LA	S22	Sargent	NS
1A1WB1	-	-	Best	NS	100-C	1145	SC1	Schlage	NP
1A1WC1	-	-	Best	NS	100-C-250PK	1145	SC1	Schlage	NP
1A1WD1	-	-	Best	NS	100C-BR	1145	SC1	Schlage	BR
1A1WE1	-	-	Best	NS	100-C-NS	1145	SC1	Schlage	NS
1A1WG1	-	-	Best	NS	100C-NS 250PK	1145	SC1	Schlage	NS
1A1WH1	-	-	Best	NS	100-E	1145E	SC8	Schlage	NP
1A1WY1	-	-	Best	NS	100-E-NS	1145E	SC8	Schlage	NS
K4	1041G	CG1	Chicago	BR	101-C	1145A	SC4	Schlage	NP
K5	C1041P	-	Chicago	BR	101C-BR	1145A	SC4	Schlage	BR
320433	S1768CH	-	Chrysler	NP	101C-BR-250PK	1145A	SC4	Schlage	BR
320514	1769CH	-	Chrysler	NP	101-CE-NS	A1145CE	-	Schlage	NS
Z1-59A1-6	A1001AH	CO91	Corbin	NS	101-C-NS	1145A	SC4	Schlage	NS
Z1-59A2-6	A1001FH	CO92	Corbin	NS	101C-NS 250PK	1145A	SC4	Schlage	NS
Z1-59B1-6	A1001BH	CO94	Corbin	NS	101-E	A1145E	SC9	Schlage	NP
Z1-59B2-6	A1001DH	CO95	Corbin	NS	101-EF-NS	A1145EF	-	Schlage	NS
Z1-59C1-6	A1001C1	CO98	Corbin	NS	101-E-NS	A1145E	SC9	Schlage	NS
Z1-59C2-6	A1001C2	CO102	Corbin	NS	101E-NS 250PK	A1145E	SC9	Schlage	NS
Z1-59D1-6	A1001D1	CO107	Corbin	NS	101-F	A1145F	SC10	Schlage	NP
Z1-59D2-6	A1001D2	CO108	Corbin	NS	101-F-NS	A1145F	SC10	Schlage	NS
Z1-60-5	1001EH	CO87	Corbin	NS	180A	1307A	SC6	Schlage	NP
Z1-60-6	A1001EH	CO88	Corbin	NS	200W	1307W	SC22	Schlage	NP
67	D1054K	DE6	Dexter	BR	K9	1120D	SL1	Segal	BR
S54F	-	-	Dominion	NP	83559	A1176ST	KW10	Titan	NP
KB1577G	A1054WD	FA3	Falcon	NS	08260KW	A1176ST	KW10	Titan	NS
P1577E	A1054WC	FA2	Falcon	NS	07743	-	-	Titan (Lg. Head)	NP
00113	1167FD	H51	Ford	NP	13D	VR91AR	VR7	Viro	NP
00114	S1167FD	H50	Ford	NP	15D	VR91AR	VR2	Viro	NP
00116	1184FD	H54	Ford	NP	1555	1054WB	WR3	Weiser	NP
GM-A	P1098A	B48	GM	NP	1555-NP-250PK	1054WB	WR3	Weiser	NP
GM-B	S1098B	B49	GM	NP	1555-NS	1054WB	WR3	Weiser	NS
GM-C	P1098C	B50	GM	NP	P1555	N1054WB	WR5	Weiser	NP
GM-D	S1098D	B51	GM	NP	P1555-BR-250PK	N1054WB	WR5	Weiser	BR
GM-E	P1098E	B44	GM	NP	P1555-NS	N1054WB	WR5	Weiser	NS
GM-H	S1098H	B45	GM	NP	12344	1175N	WK2	Weslock	BR
GM-J	P1098J	B46	GM	NP	12344-NS	1175N	WK2	Weslock	NS
GM-K	S1098K	B47	GM	NP	8	999	Y1	Yale	BR
HARLOC	X1014F	EA27	Harloc	BR	9114	01122	Y11	Yale	BR
H20	1003M	CO106	Hudson	BR	9278	01122A	Y12	Yale	BR
H21	R1003M	BO1	Hudson	BR	8 YALE-250PK	999	Y1	Yale	BR
1063KW	1176	KW1	Kwikset	NP	E8	999N	Y1E	Yale	BR
1063KW-BR	1176	KW1	Kwikset	BR					

GM

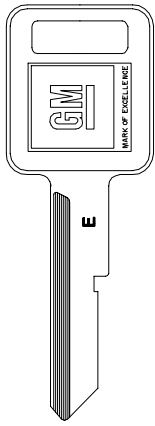

 B46G

 B48G

 B50G

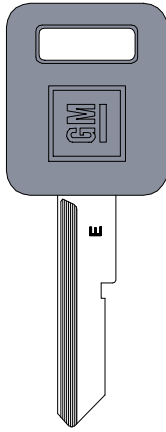

 B48GP

 B50GP

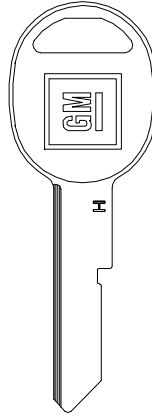

 B47G

 B49G

 B51G

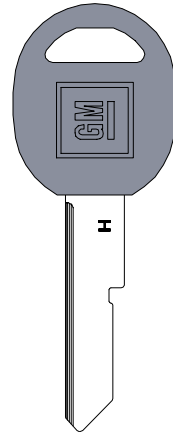

 B49GP

 B51GP



B44G



B44GP



B45G



B45GP

ILCO

GM

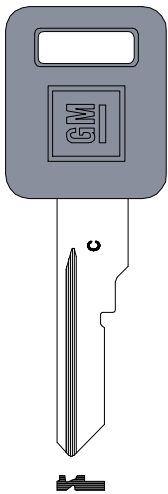

B63GP

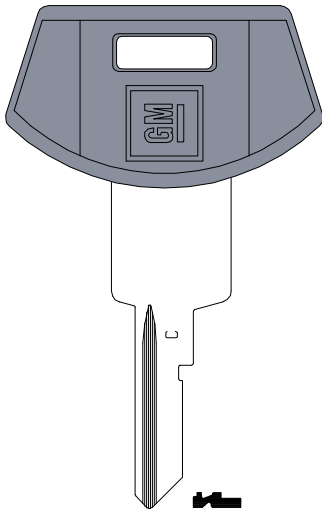

B64GP

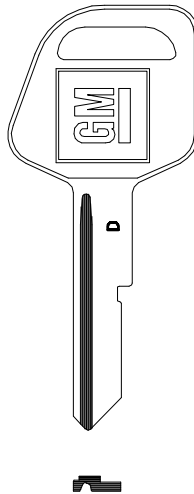

B67G

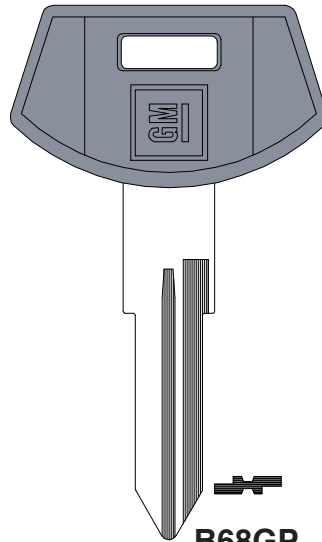

B68GP

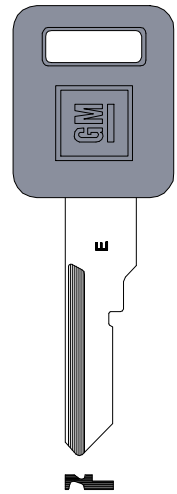

B77GP

ILCO

GM

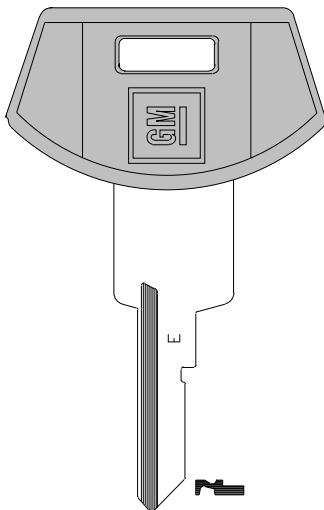

B78GP

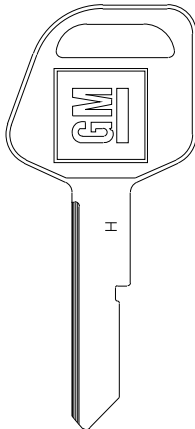

B79G

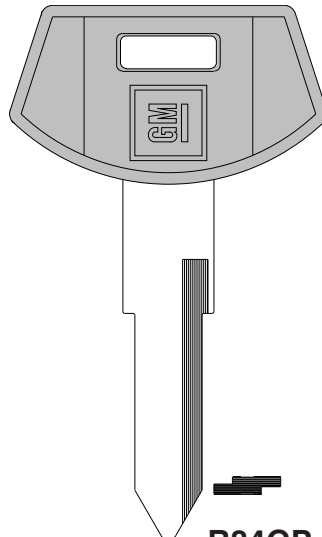

B84GP

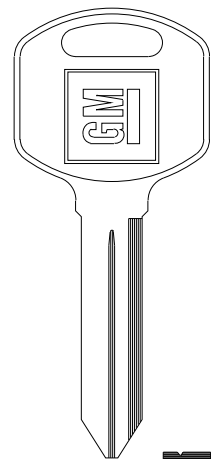

B85G

ILCO

GM

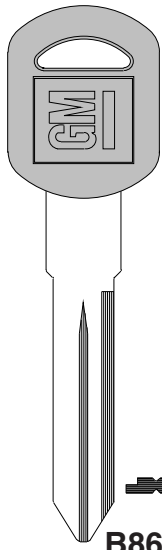

B86GP

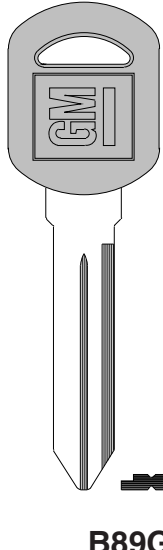

B89GP

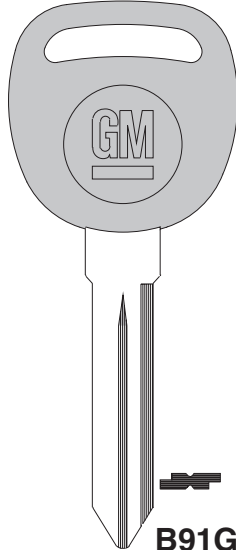

B91GP

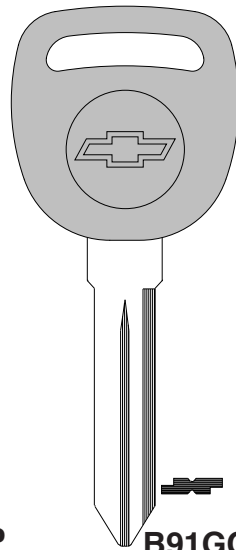

B91GCP

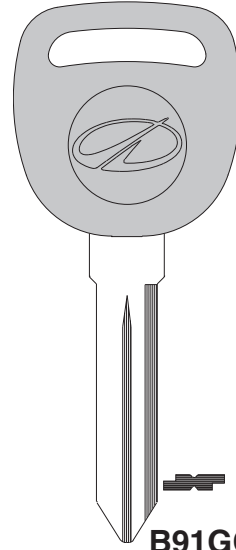

B91GOP

ILCO

GM

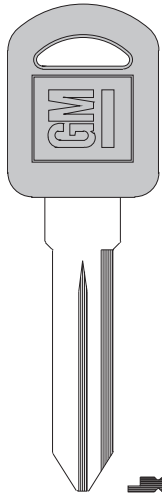

B92GP

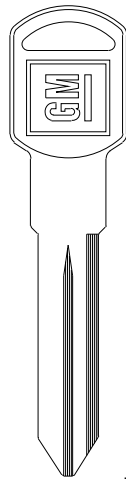

VALET FOR B92GP

B92GV

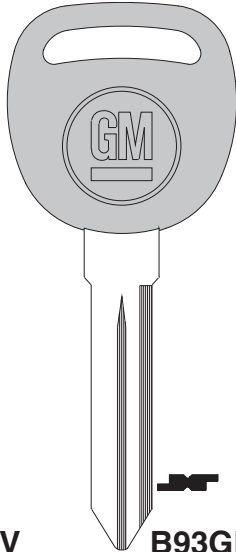

B93GP

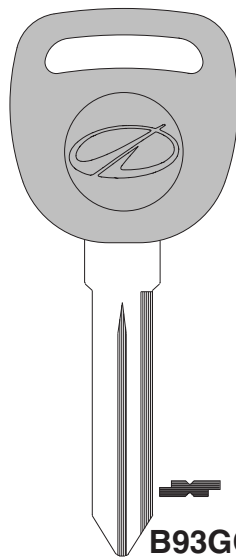

B93GOP

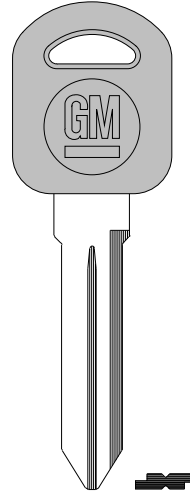

B97GPT

ILCO

GM

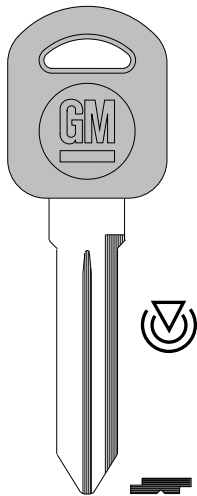

B98GPT

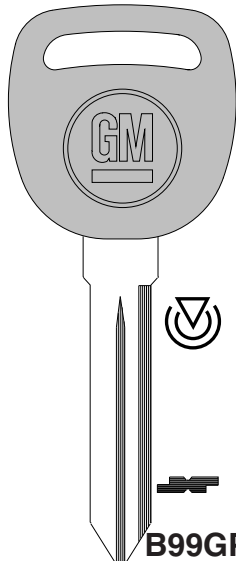

B99GPT

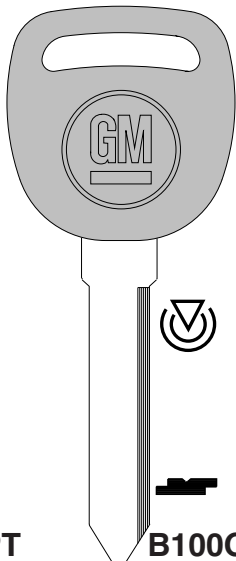

B100GPT

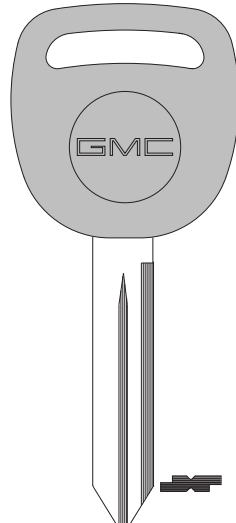

B102GP

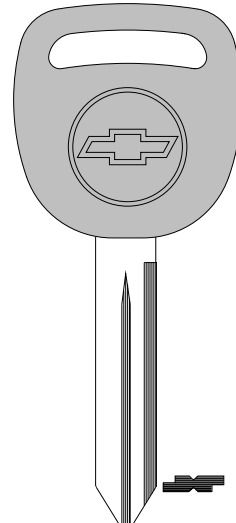

B102GCP

ILCO

GM

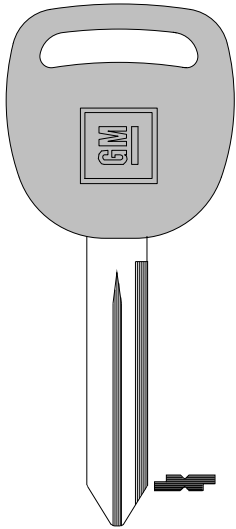

B102GMP

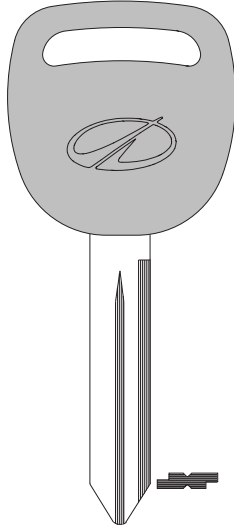

B102GOP

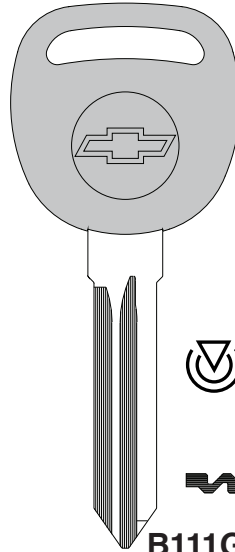

B111GCPT

ILCO

ORIGINALS

sec page  
4a 3

ILCO

KWIKSET



10119-001

ILCO

AMERICAN LOCK

ARROW

BEST

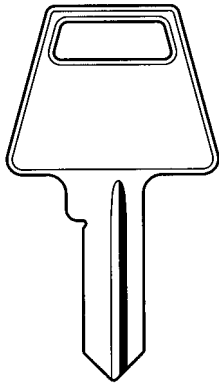

PTKB1

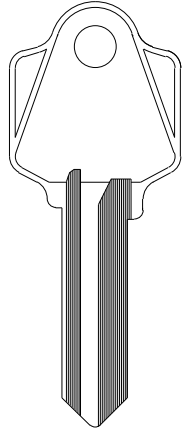

K2-A

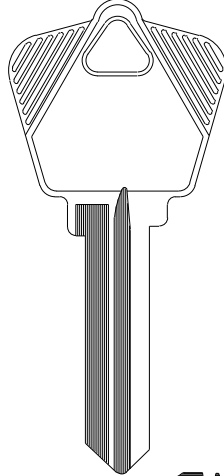

K7  
NICKEL SILVER

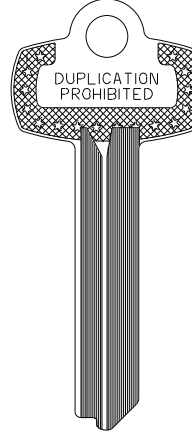

1A1A1  
NICKEL SILVER

- |  |        |  |        |
|--|--------|--|--------|
|  | 1A1B1  |  | 1A1J1  |
|  | 1A1C1  |  | 1A1K1  |
|  | 1A1D1  |  | 1A1L1  |
|  | 1A1DD1 |  | 1A1M1  |
|  | 1A1E1  |  | 1A1Q1  |
|  | 1A1F1  |  | 1A1R1  |
|  | 1A1G1  |  | 1A1FM1 |
|  | 1A1H1  |  |        |

Orig. No.

BEST

CHICAGO

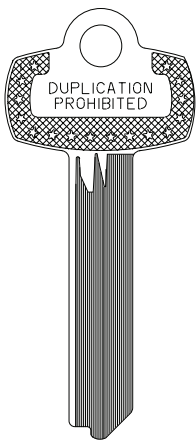

1A1T1  
NICKEL SILVER

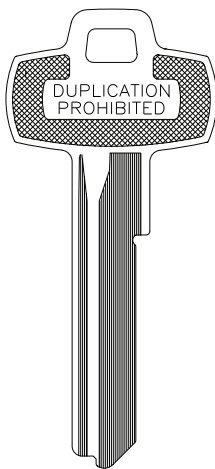

1A1WA1  
NICKEL SILVER

- |  |        |  |        |
|--|--------|--|--------|
|  | 1A1WB1 |  | 1A1WC1 |
|--|--------|--|--------|

- |  |        |  |        |
|--|--------|--|--------|
|  | 1A1WD1 |  | 1A1WE1 |
|--|--------|--|--------|

- |  |        |  |        |
|--|--------|--|--------|
|  | 1A1WG1 |  | 1A1WH1 |
|--|--------|--|--------|

- |  |        |
|--|--------|
|  | 1A1WY1 |
|--|--------|

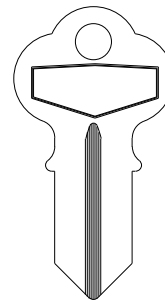

K4

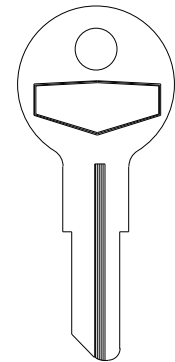

K5

Orig. No.

CORBIN (now Corbin/Russwin)

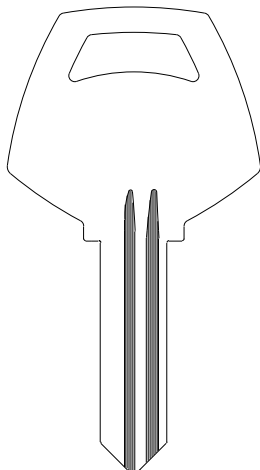

W4-59A1-6  
NICKEL SILVER

- |  |           |
|--|-----------|
|  | W4-59A2-6 |
|  | W4-59B1-6 |
|  | W4-59B2-6 |
|  | W4-59C1-6 |
|  | W4-59C2-6 |
|  | W4-59D1-6 |
|  | W4-59D2-6 |

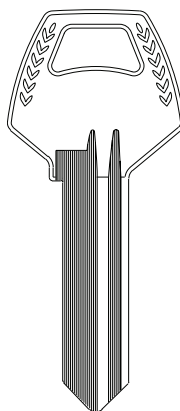

Z1-59A1-6  
NICKEL SILVER

- |  |           |
|--|-----------|
|  | Z1-59A2-6 |
|  | Z1-59B1-6 |
|  | Z1-59B2-6 |
|  | Z1-59C1-6 |
|  | Z1-59C2-6 |
|  | Z1-59D1-6 |
|  | Z1-59D2-6 |

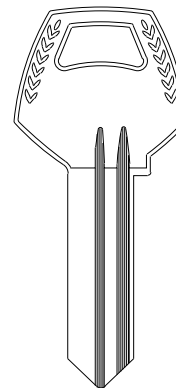

Z1-60-5  
NICKEL SILVER

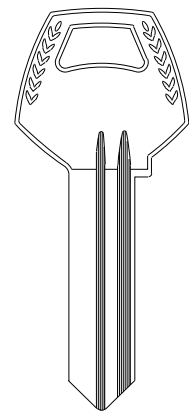

Z1-60-6  
NICKEL SILVER

Orig. No.

LOOK ALIKE®

	DEXTERMMASTER	DOMINION	FALCON		HARLOC	HUDSON
Orig. No.	67	S54F	P1577E NICKEL SILVER	KB1577G NICKEL SILVER	HARLOC	H20

	HUDSON	KWIKSET			
Orig. No.	H21	1063KW	1063KW-BR	N1063KW	07743

	KWIKSET/TITAN	LOCKWOOD		MASTER	
Orig. No.	08260KW	B308	B310	1K	15K

LOOK ALIKE®

sec 4b page 2

MEDECO®

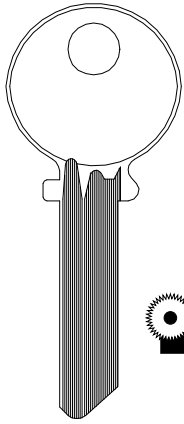

**1515**

NICKEL SILVER

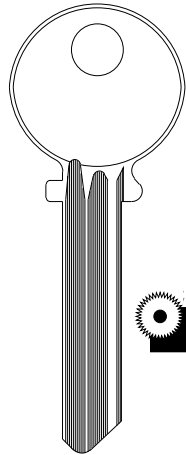

**A1515**

NICKEL SILVER

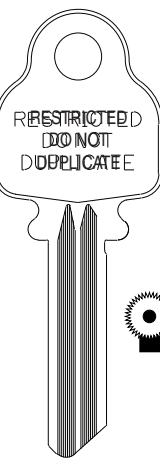

**1517**

NICKEL SILVER

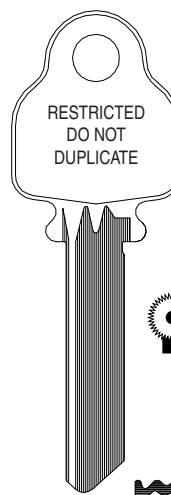

**A1517**

NICKEL SILVER

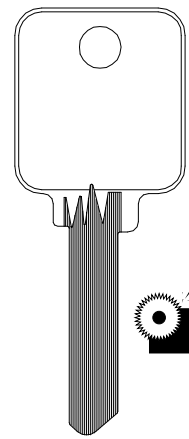

**1518**

NICKEL SILVER

Orig. No.

MEDECO®

NATIONAL/AMEROCK

RUSSWIN

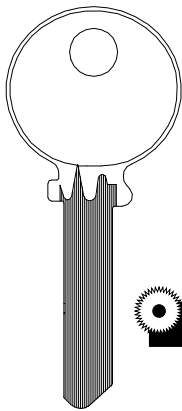

**1542**

NICKEL SILVER

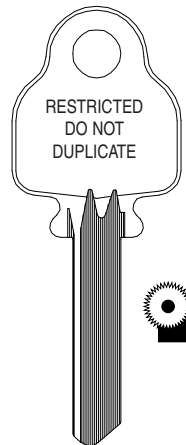

**1543**

NICKEL SILVER

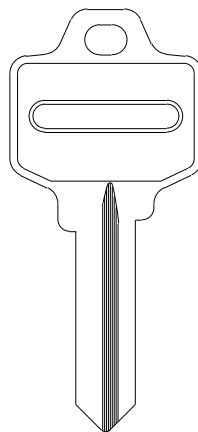

**4295**

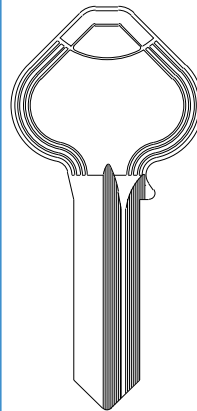

**5D1R**

NICKEL SILVER

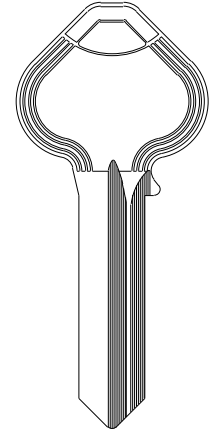

**6D1R**

NICKEL SILVER

Orig. No.

SARGENT

SCHLAGE

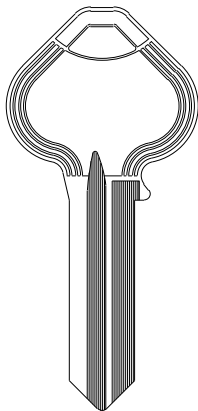

**5981R**

NICKEL SILVER

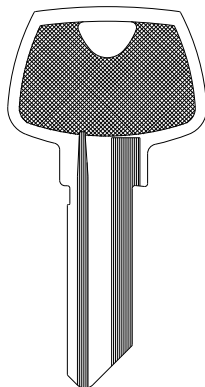

**275S**

NICKEL SILVER

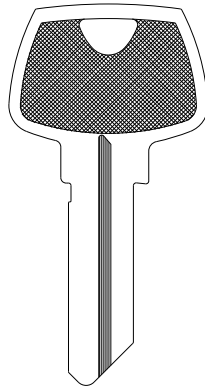

**275LA**

NICKEL SILVER

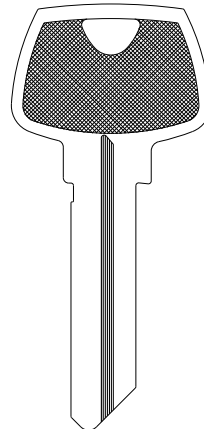

**6275LA**

NICKEL SILVER

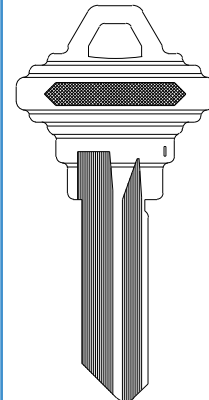

**100-C**

100C-NS

Orig. No.

LOOK ALIKE®

sec 4b page 3



SCHLAGE

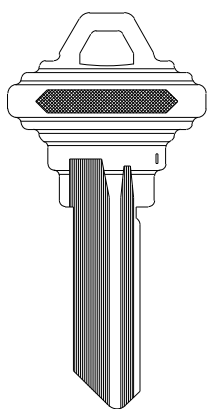

**100-E**  
100E-NS

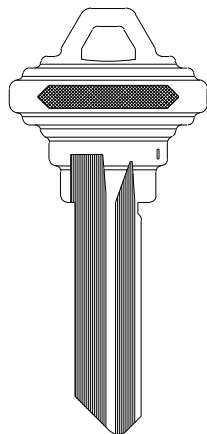

**101-C**  
101C-NS

**101E**  
101E-NS  
  
**101CE-NS**  
  
**101EF-NS**



**101-F**  
101F-NS

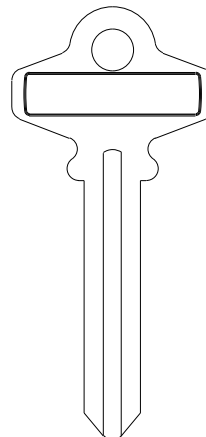

**180A**

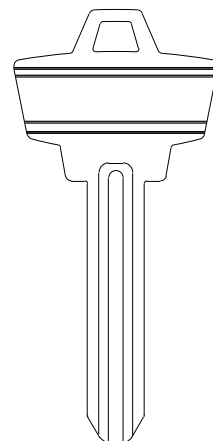

**200W**

Orig. No.

SEGAL

TITAN

VIRO

WEISER

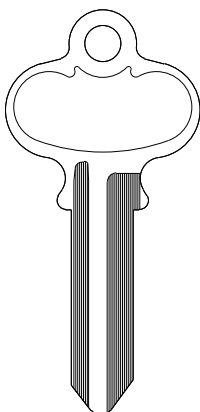

**K9**

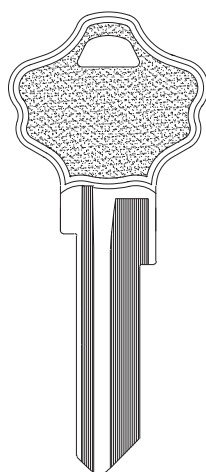

**83559**

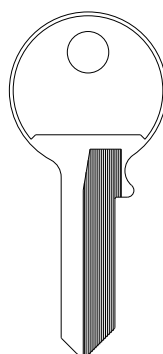

**13D**

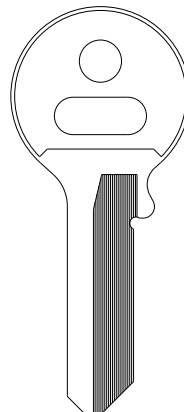

**15D**

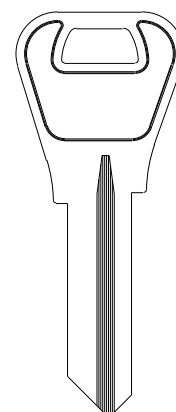

**1555**  
1555-NS

Orig. No.

WEISER

WESLOCK

YALE

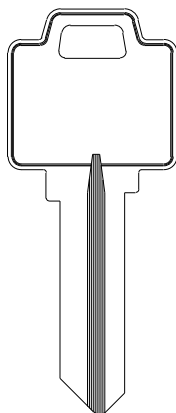

**P1555**  
P1555-NS

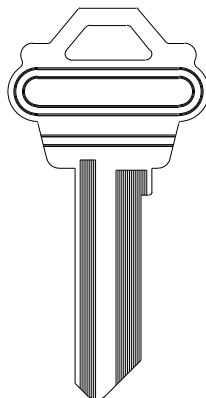

**12344**  
12344-NS

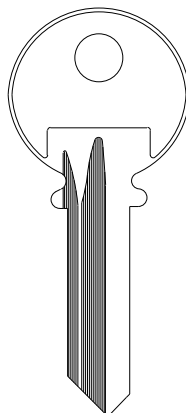

**8**  
8-YALE-NS

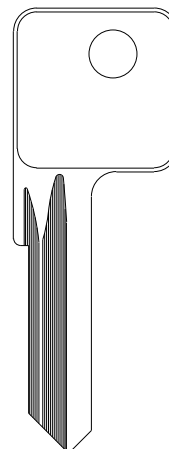

**E8**

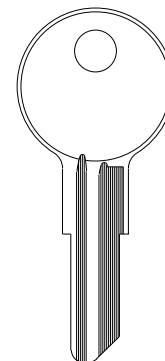

**9114**

Orig. No.

LOOK ALIKE®

sec page  
4b 4

YALE

AMERICAN MOTORS

CHRYSLER

FORD

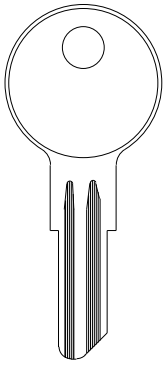

9278

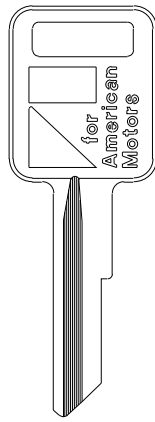

320560

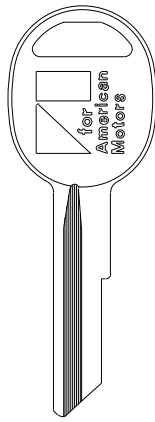

320561

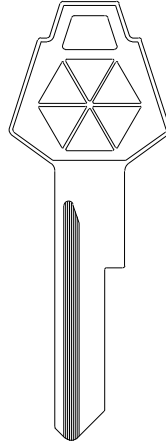

320514

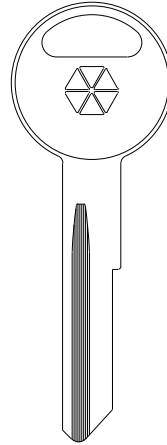

320433

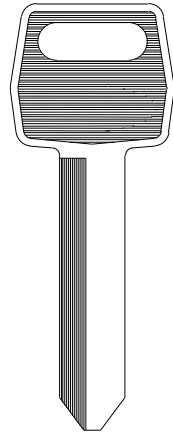

00113

Orig. No.

FORD

GENERAL MOTORS

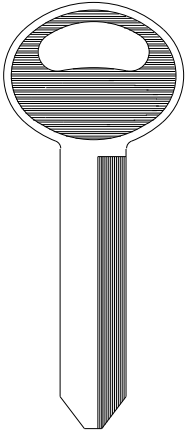

00114

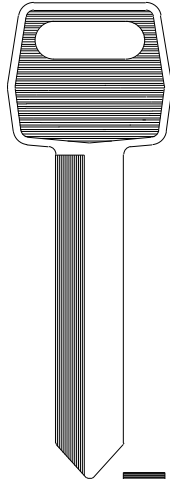

00116

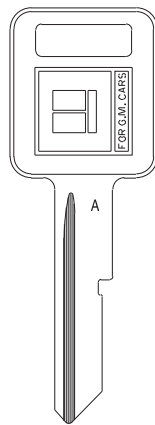

GM-A

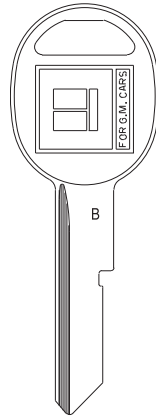

GM-B

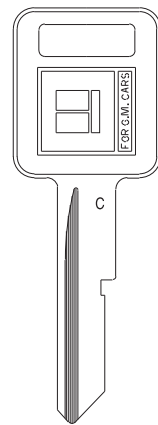

GM-C

Orig. No.

GENERAL MOTORS

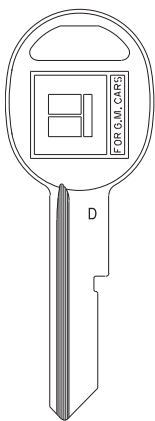

GM-D

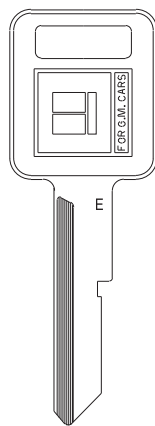

GM-E

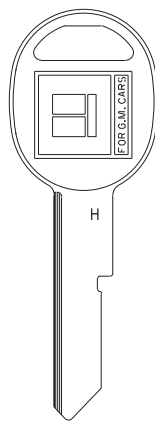

GM-H

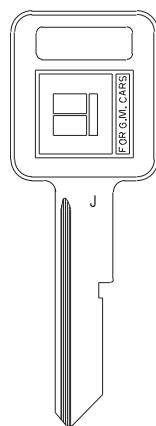

GM-J

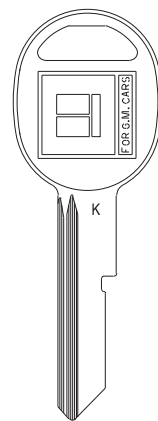

GM-K

Orig. No.

LOOK ALIKE®

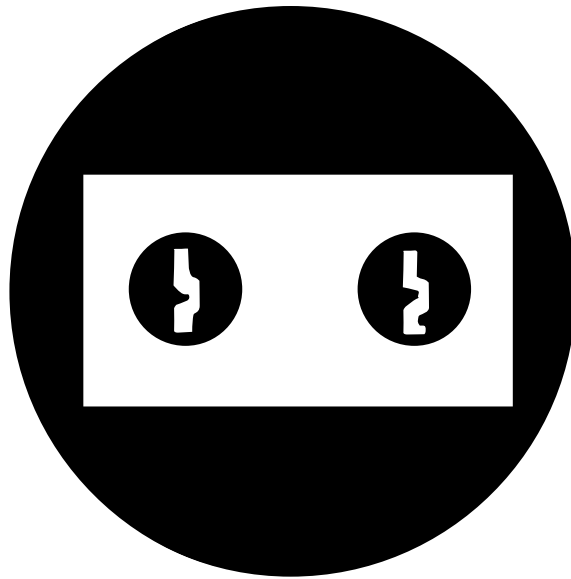

## Section 5 **SAFE DEPOSIT**

Worldwide safe deposit keys. Organized by lock manufacturer in alphabetical order with the keys listed in numerical order. Flat keys with no milling do not show a key profile in this section.

**DIEBOLD**

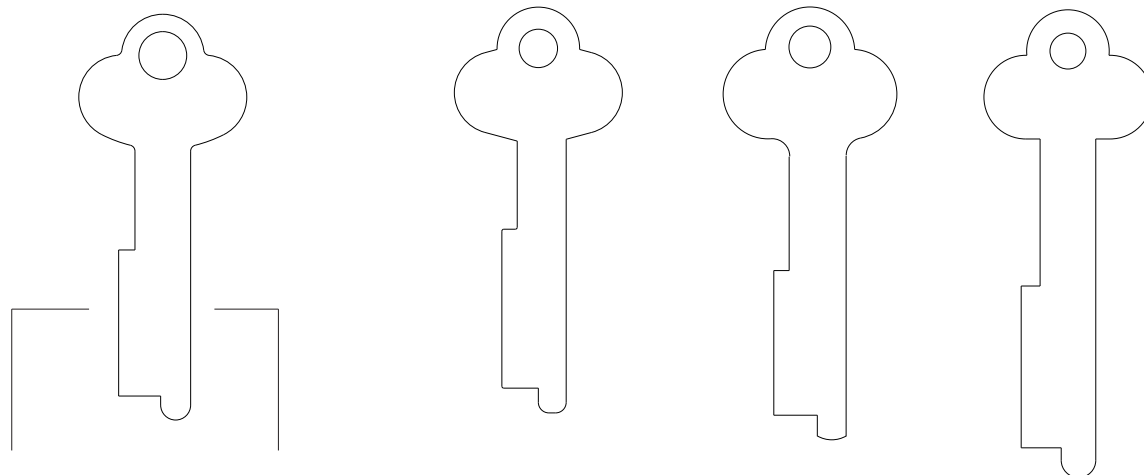

THICK  
WIDTH  
ILCO

.055" - 1.4mm  
.375" - 9.5mm  
**1028**

.050" - 1.3mm  
.375" - 9.5mm  
**1028L**

.055" - 1.4mm  
.340" - 8.6mm  
**1028DD**

.050" - 1.3mm  
.375" - 9.5mm  
**1028E**

.055" - 1.4mm  
.390" - 9.9mm  
**1028F**

**DIEBOLD**

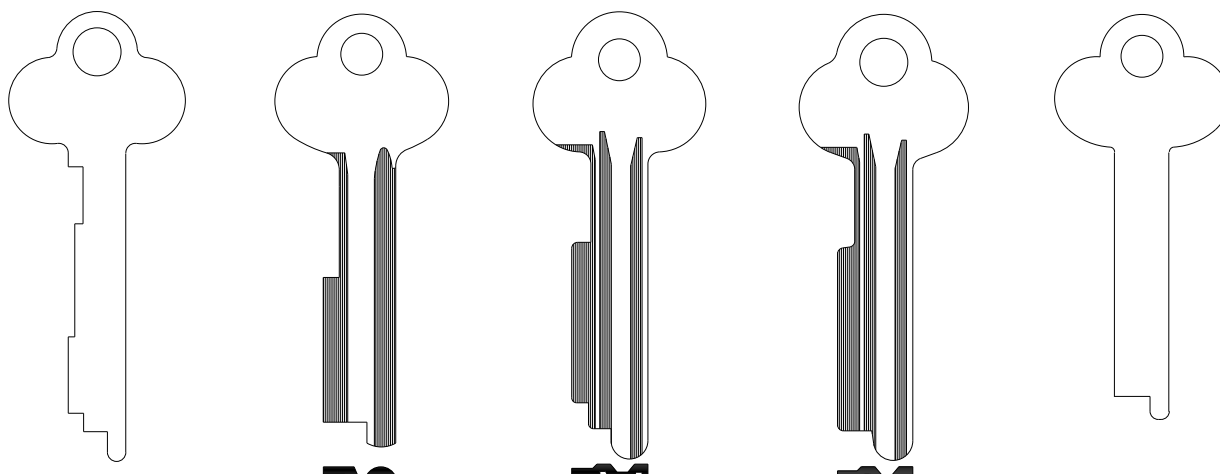

THICK  
WIDTH  
ILCO

.060" - 1.5mm  
.300" - 7.6mm  
**1028P**

.075" - 1.9mm  
.375" - 9.5mm  
**1052A**

.085" - 2.2mm  
.390" - 9.9mm  
**1052B**

.085" - 2.2mm  
.390" - 9.9mm  
**1052C**

.050" - 1.3mm  
.285" - 7.2mm  
**1066**

**DIEBOLD**

**HHM / YORK**

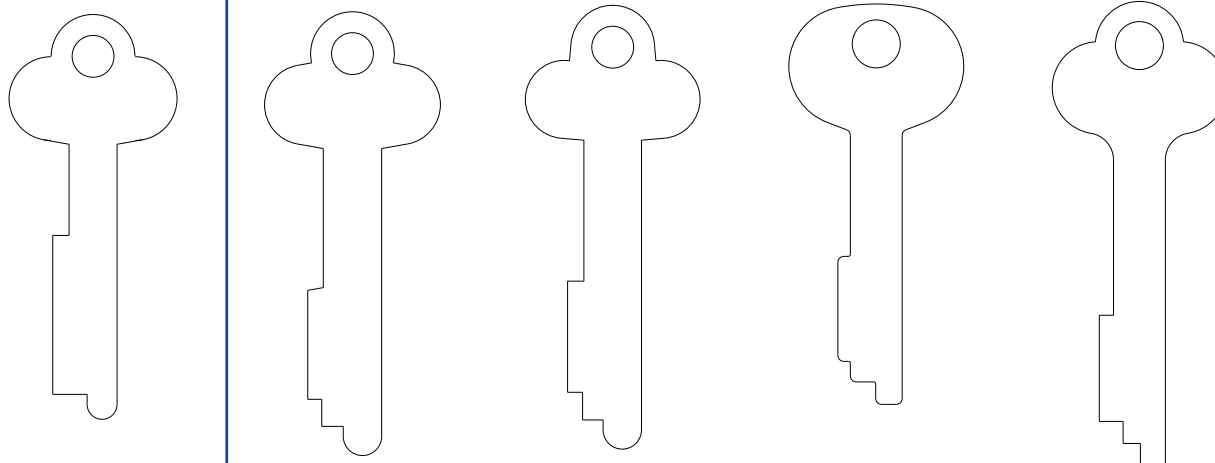

THICK  
WIDTH  
ILCO

.050" - 1.3mm  
.340" - 8.5mm  
**1365**

.050" - 1.3mm  
.385" - 9.8mm  
**1028A**

.055" - 1.4mm  
.385" - 9.8mm  
**1028AY**

.060" - 1.3mm  
.335" - 8.5mm  
**1028G**

.060" - 1.3mm  
.335" - 8.5mm  
**1028N**

HHM / YORK

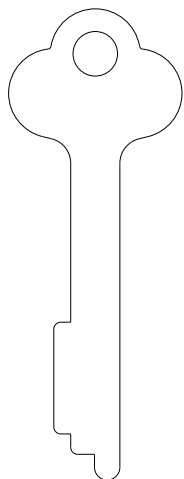

.060" - 1.5mm  
.340" - 8.6mm  
**1028NN**

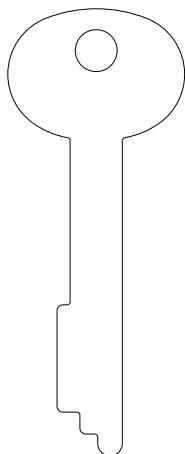

.050" - 1.3mm  
.340" - 8.6mm  
**O1028A**

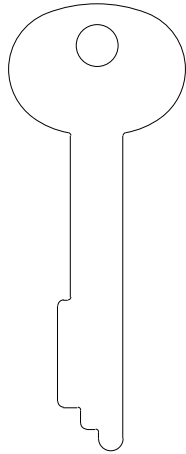

.060" - 1.5mm  
.340" - 8.6mm  
**O1028AH**

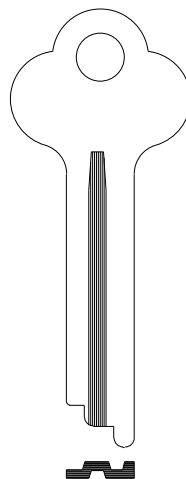

.085" - 2.2mm  
.350" - 8.9mm  
**1133**

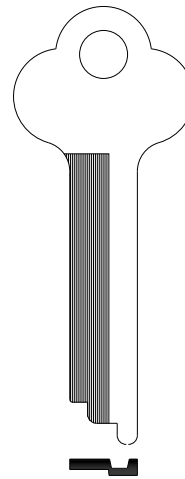

.085" - 2.2mm  
.350" - 8.9mm  
**1133A**

THICK  
WIDTH  
ILCO

HHM / YORK

ILCO / KABA MAS

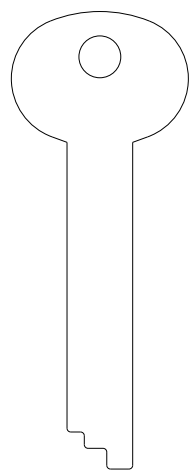

.050" - 1.3mm  
.350" - 8.9mm  
**1134**

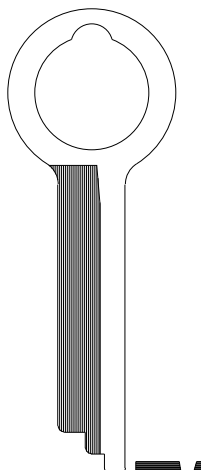

.080" - 2.0mm  
.350" - 8.9mm  
**1135**

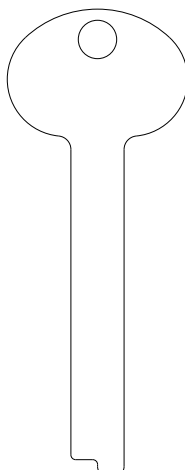

.080" - 2.0mm  
.280" - 7.1mm  
**SG4**

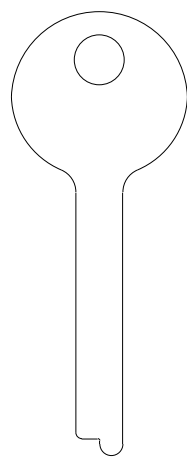

.060" - 1.5mm  
.240" - 6.1mm  
**887**

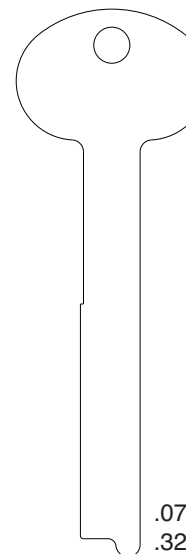

.070" - 1.8mm  
.320" - 8.1mm  
**1089C**

THICK  
WIDTH  
ILCO

ILCO / KABA MAS

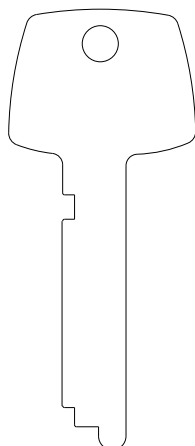

.070" - 1.8mm  
.330" - 8.4mm  
**1333**

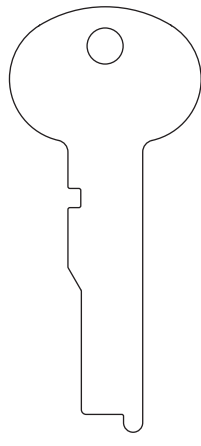

.070" - 1.8mm  
.320" - 8.1mm  
**1334**

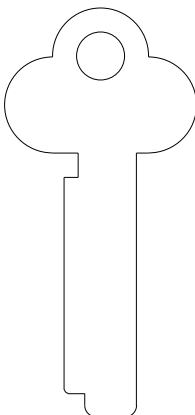

.080" - 2.2mm  
.375" - 9.5mm  
**1335S**

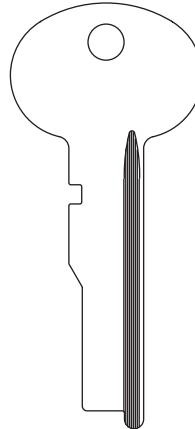

.085" - 2.2mm  
.320" - 8.1mm  
**1360G**

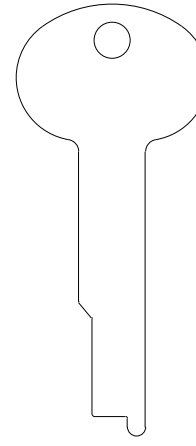

.070" - 1.8mm  
.280" - 7.1mm  
**1362**

THICK  
WIDTH  
ILCO

ILCO / KABA MAS

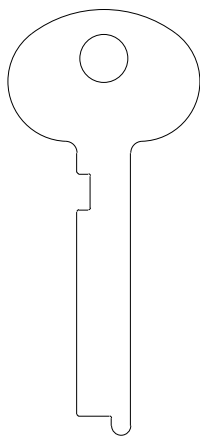

.080" - 2.0mm  
.280" - 7.1mm

**1387**

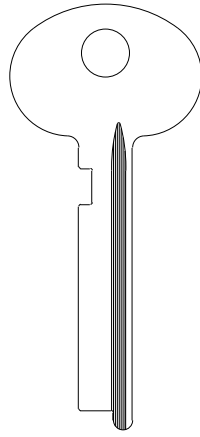

.080" - 2.0mm  
.280" - 7.1mm

**1387G**

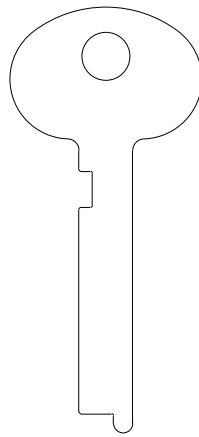

.070" - 1.8mm  
.280" - 7.1mm

**1388**

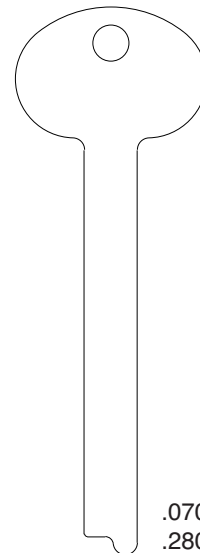

.070" - 1.8mm  
.280" - 7.1mm

**1388L**

THICK  
WIDTH  
ILCO

ILCO / KABA MAS

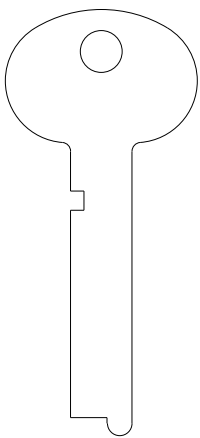

.070" - 1.8mm  
.320" - 8.1mm

**1396S**

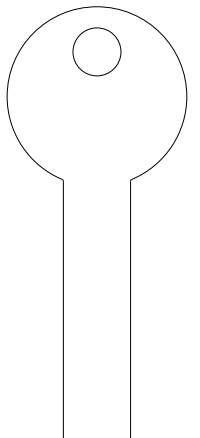

.055" - 1.4mm  
.350" - 8.9mm

**1526**

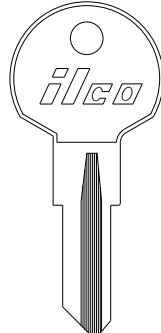

**1054UN**

LEFEBURE

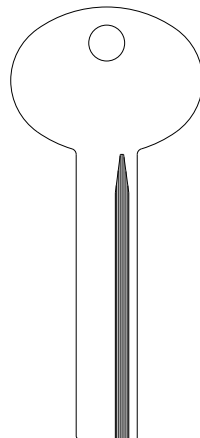

.070" - 1.8mm  
.320" - 8.1mm

**LB1**

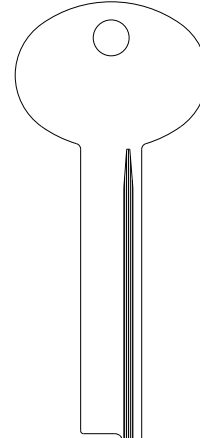

.070" - 1.8mm  
.320" - 8.1mm

**LB2**

THICK  
WIDTH  
ILCO

LEFEBURE

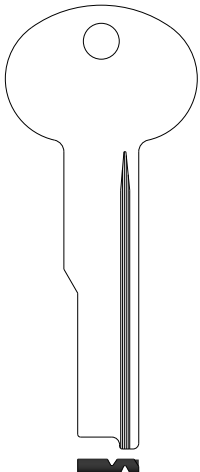

.070" - 1.8mm  
.320" - 8.1mm

**LB3**

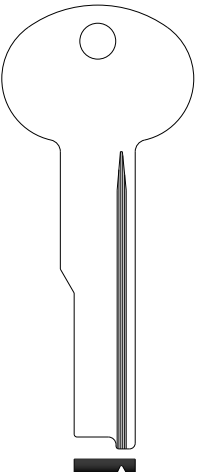

.070" - 1.8mm  
.320" - 8.1mm

**LB4**

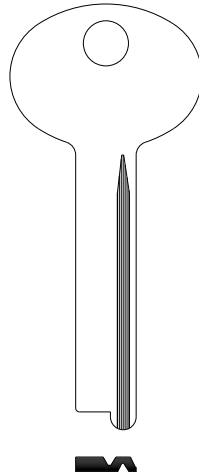

.080" - 2.0mm  
.320" - 8.1mm

**LB5**

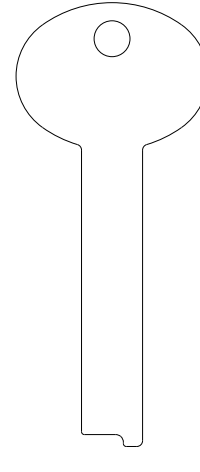

.070" - 1.8mm  
.320" - 8.1mm

**LB6**

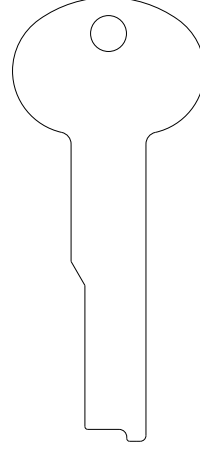

.070" - 1.8mm  
.320" - 8.1mm

**LB7**

THICK  
WIDTH  
ILCO

LEFEBURE	MILES OSBORNE		MOSLER	
.070" - 1.8mm .350" - 8.9mm <b>LB8</b>	.081" - 2.1mm .435" - 11.0mm <b>MN1</b>	.050" - 1.3mm .315" - 8.0mm <b>MN3</b>	.040" - 1.0mm .305" - 7.7mm <b>143D</b>	.080" - 2.0mm .350" - 8.9mm <b>155</b>

THICK  
WIDTH  
ILCO

MOSLER				
.060" - 1.5mm .330" - 8.4mm <b>706</b>	.060" - 1.5mm .375" - 9.5mm <b>723</b>	.060" - 1.5mm .335" - 8.5mm <b>1091</b>	.040" - 1.0mm .300" - 7.6mm <b>1095</b>	.050" - 1.3mm .300" - 7.6mm <b>1095HL</b>

THICK  
WIDTH  
ILCO

MOSLER				
.060" - 1.5mm .300" - 7.6mm <b>1095H</b>	.040" - 1.0mm .300" - 7.6mm <b>1095A</b>	.085" - 2.2mm .350" - 8.9mm <b>1115</b>	.085" - 2.2mm .350" - 8.9mm <b>1115A</b>	.085" - 2.2mm .355" - 9.0mm <b>1115AL</b>

THICK  
WIDTH  
ILCO

MOSLER

THICK  
WIDTH  
ILCO

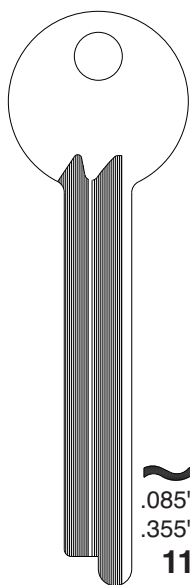

.085" - 2.2mm  
.355" - 9.0mm

**1115XL**

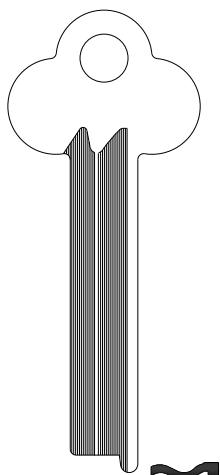

.085" - 2.2mm  
.350" - 8.9mm

**1115B**

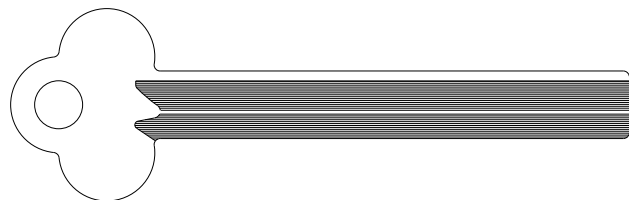

.085" - 2.2mm  
.350" - 8.9mm

**1115BL**

MOSLER

THICK  
WIDTH  
ILCO

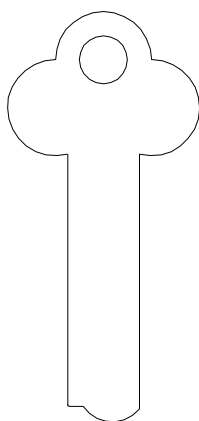

.060" - 1.5mm  
.380" - 9.7mm

**1323**

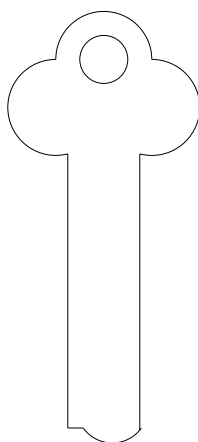

.060" - 1.5mm  
.380" - 9.7mm

**1323L**

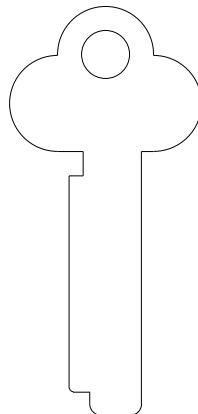

.060" - 1.5mm  
.375" - 9.5mm

**1335S**

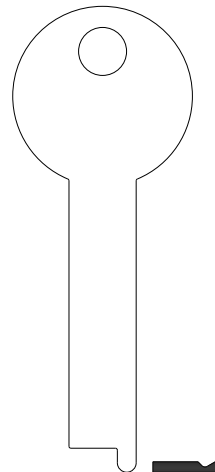

.055" - 1.4mm  
.350" - 8.9mm

**1526**

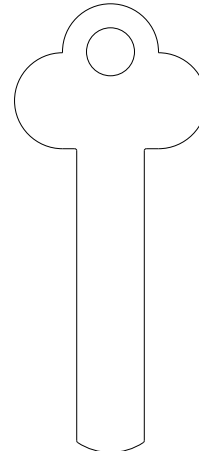

.060" - 1.5mm  
.350" - 8.9mm

**4015**

PRECISION

SARGENT & GREENLEAF / S & G

**SEE ILCO/  
KABA  
MAS**

THICK  
WIDTH  
ILCO

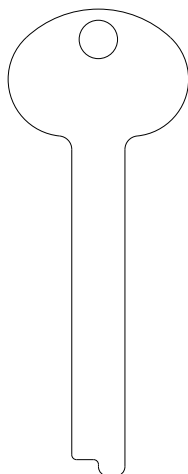

.080" - 2.0mm  
.280" - 7.1mm

**SG4**

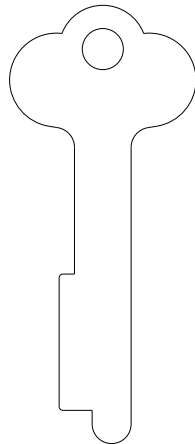

.050" - 1.3mm  
.375" - 9.5mm

**1028D**

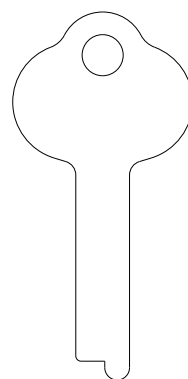

.060" - 1.5mm  
.280" - 7.1mm

**1063**

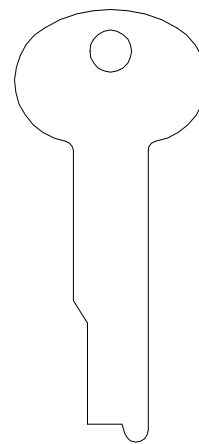

.070" - 1.8mm  
.375" - 9.5mm

**1063B**



SARGENT & GREENLEAF / S & G

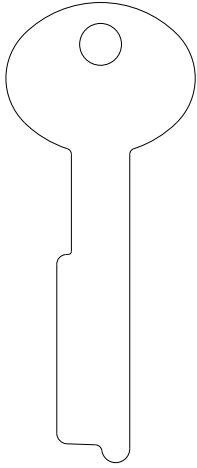

.070" - 1.8mm  
.380" - 9.7mm  
**1063D**

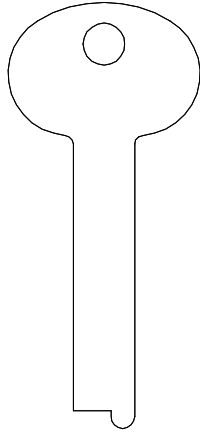

.070" - 1.8mm  
.320" - 8.1mm  
**1063E**

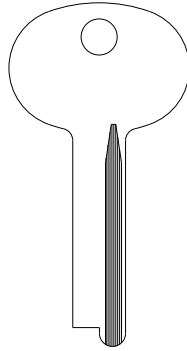

.085" - 2.2mm  
.275" - 7.0mm  
**1068**

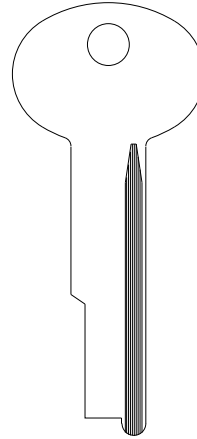

.085" - 2.2mm  
.320" - 8.1mm  
**1068B**

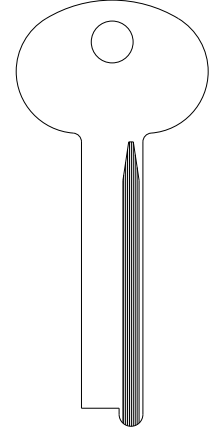

.085" - 2.2mm  
.320" - 8.1mm  
**1068E**

THICK  
WIDTH  
ILCO

SARGENT & GREENLEAF / S & G

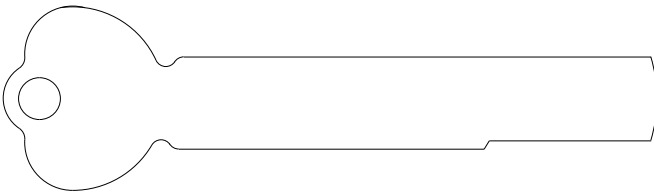

.050" - 1.3mm  
.435" - 11.2mm  
**1084**

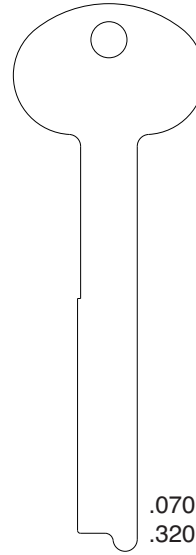

.070" - 1.8mm  
.320" - 8.1mm  
**1089C**

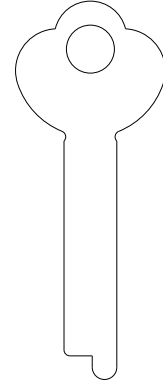

.050" - 1.3mm  
.275" - 7.0mm  
**A1124**

THICK  
WIDTH  
ILCO

SARGENT & GREENLEAF / S & G

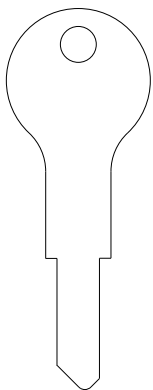

.075" - 1.9mm  
.215" - 5.5mm  
**O1125NR**

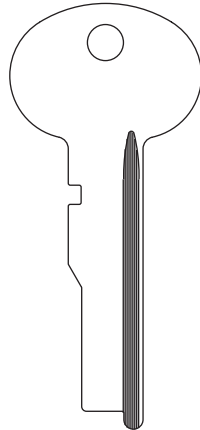

.085" - 2.2mm  
.320" - 8.1mm  
**1360G**

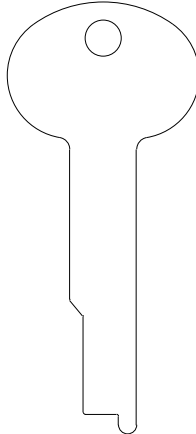

.070" - 1.8mm  
.280" - 7.1mm  
**1362**

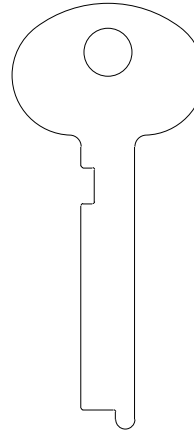

.080" - 2.0mm  
.280" - 7.1mm  
**1387**

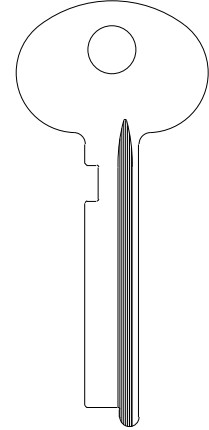

.080" - 2.0mm  
.280" - 7.1mm  
**1387G**

THICK  
WIDTH  
ILCO

SARGENT & GREENLEAF / S & G

THICK WIDTH ILCO	.070" - 1.8mm .280" - 7.1mm <b>1388</b>	.070" - 1.8mm .280" - 7.1mm <b>1388L</b>	.085" - 2.2mm .380" - 9.7mm <b>1389G</b>	.070" - 1.8mm .380" - 9.7mm <b>1390</b>	.080" - 2.0mm .380" - 9.7mm <b>1390G</b>

SECURITY / KUMAHIRA

		5 PIN	6 PIN			
		SY1	SY5-NS			
		SY2	SY6-NS			
		SY4	SY8-NS			
		SY7	SY3-NS			
THICK WIDTH ILCO				.075" - 1.9mm .440" - 11.2mm <b>SY10</b>	.055" - 1.4mm .310" - 7.9mm <b>SY11</b>	.055" - 1.4mm .315" - 8.0mm <b>SY12</b>

SECURITY / KUMAHIRA YALE

THICK WIDTH ILCO	.055" - 1.4mm .315" - 8.0mm <b>SY13</b>	.085" - 2.2mm .355" - 9.0mm <b>884</b>	.085" - 2.2mm .355" - 9.0mm <b>884R</b>	.080" - 2.0mm .350" - 8.9mm <b>884BR</b>	.085" - 2.2mm .350" - 8.9mm <b>884BS</b>

YALE

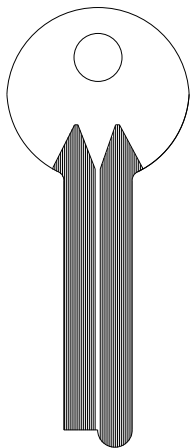

  
 .080" - 2.0mm  
 .355" - 9.0mm  
**885**

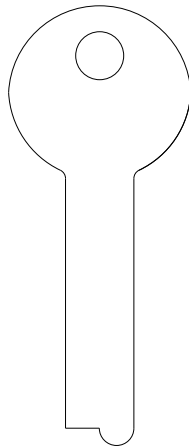

  
 .080" - 2.0mm  
 .355" - 9.0mm  
**885R**

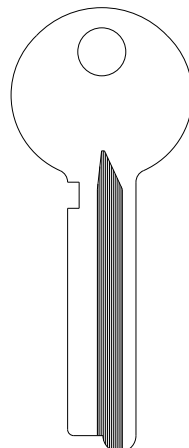

  
 .085" - 2.2mm  
 .350" - 8.5mm  
**886**

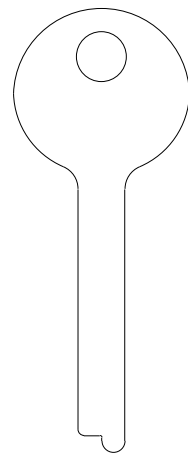



.060" - 1.5mm  
 .240" - 6.1mm  
**887**

THICK  
WIDTH  
ILCO

YALE

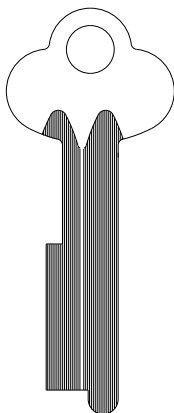
MISCELLANEOUS



  
 .080" - 2.0mm  
 .370" - 9.4mm  
**1028M**

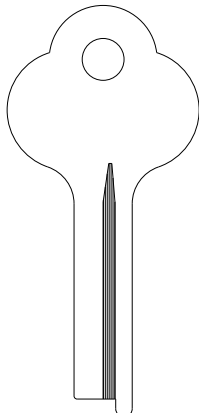

  
 .090" - 2.3mm  
 .300" - 7.6mm  
**1060C**

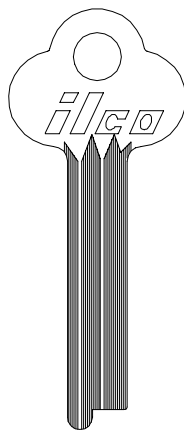

  
 .085" - 2.15mm  
 .300" - 7.6mm  
**1587**

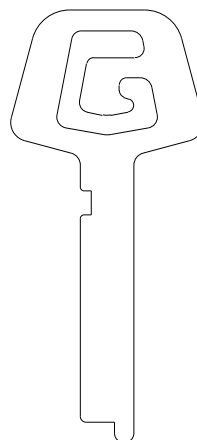

.070" - 1.8mm  
 .280" - 7.1mm  
**SG5**

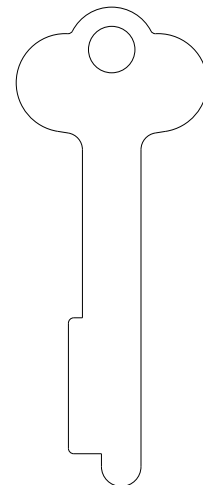

.050" - 1.3mm  
 .375" - 9.5mm  
**1028C**

THICK  
WIDTH  
ILCO

SAFE DEPOSIT

sec 5 page 8

MISCELLANEOUS

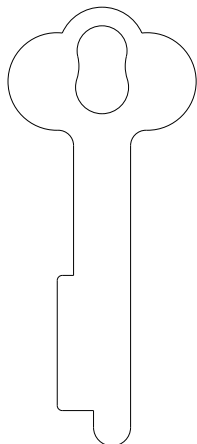

.050" - 1.3mm  
 .380" - 9.7mm  
**1028DC**

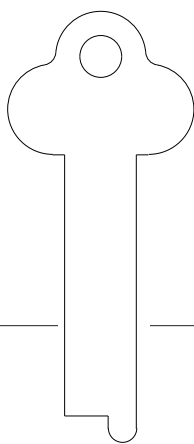

.050" - 1.3mm  
 .375" - 9.5mm  
**1093**



.060" - 1.5mm  
 .375" - 9.5mm  
**1093H**

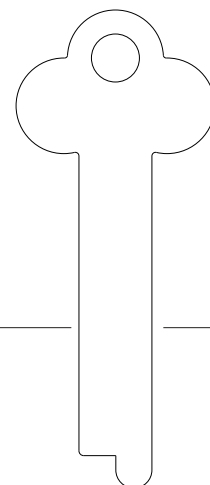

.050" - 1.3mm  
 .380" - 9.7mm  
**1110A**



.060" - 1.5mm  
 .380" - 9.7mm  
**1110B**

THICK  
WIDTH  
ILCO

## Section 6

This section is separated into two parts as follows:



### Section 6a FLAT STEEL

Worldwide flat steel keys. Organized by lock manufacturer where possible and listed in numerical order. Only keys with keyway milling or corrugation are illustrated with a profile view.



### Section 6b MISCELLANEOUS KEYS

A selection of special purpose keys organized by lock manufacturer where possible and listed in numerical sequence.

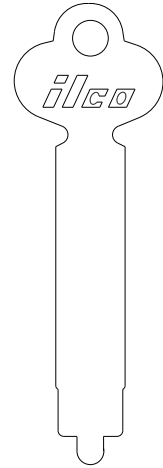
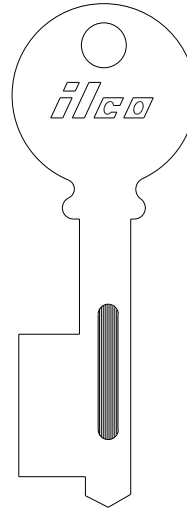
**CORBIN**
**DUTCH LOCK**
**EAGLE**

**THICK  
WIDTH  
ILCO**

.070" - 1.8mm  
.310" - 7.9mm  
**725**

.060" - 1.5mm  
.583" - 14.8mm  
**663**

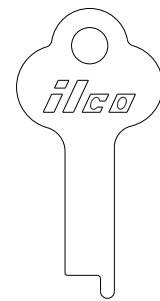
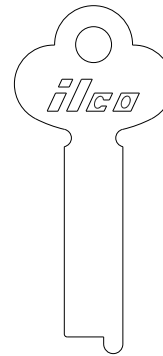
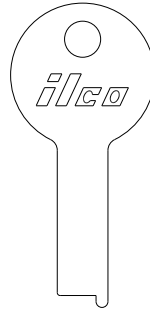
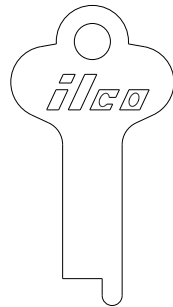
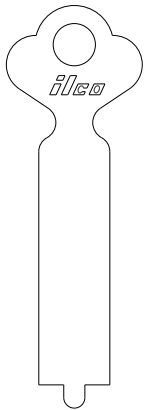
.050" - 1.3mm  
.361" - 9.2mm  
**671**

**EAGLE**

**THICK  
WIDTH  
ILCO**

.050" - 1.3mm  
.365" - 9.3mm  
**672**

.040" - 1.0mm  
.310" - 7.9mm  
**1214**

.050" - 1.3mm  
.265" - 6.7mm  
**1270D**

.060" - 1.5mm  
.300" - 7.6mm  
**1412**

.050" - 1.3mm  
.260" - 6.6mm  
**1417**

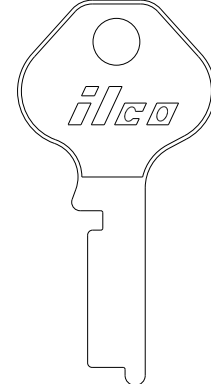
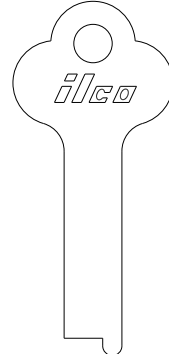
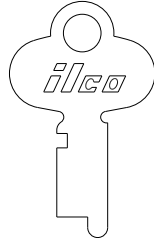
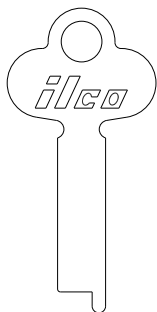
**EAGLE**
**FRANKLIN**
**LOCKWOOD AUSTRALIA**
**MASTER**

**THICK  
WIDTH  
ILCO**

.060" - 1.5mm  
.250" - 6.4mm  
**1417A**

.050" - 1.3mm  
.250" - 6.4mm  
**S625P**

.065" - 1.7mm  
.300" - 7.6mm  
**201**

.065" - 1.7mm  
.300" - 7.6mm  
**T153**

**FLAT STEEL**

MASTER



.060" - 1.5mm  
.350" - 8.9mm  
**687W**



.050" - 1.3mm  
.320" - 8.1mm  
**687X**



.050" - 1.3mm  
.268" - 6.8mm  
**687Y**

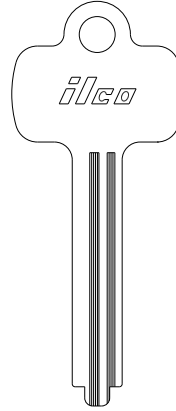

**1286**

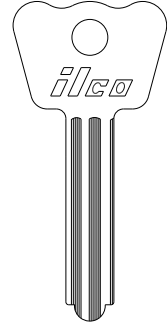

**1286B**



**1286BR**

THICK  
WIDTH  
ILCO

MASTER

MEDART

SLAYMAKER

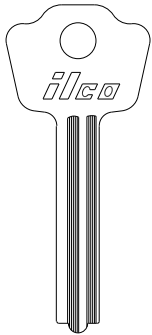

**1286C**

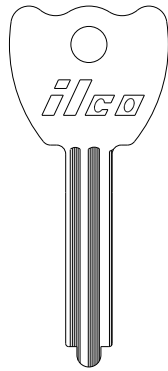

**1286E R1286E N1286 N1286R**

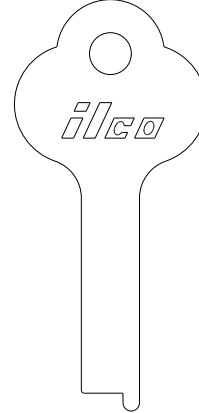
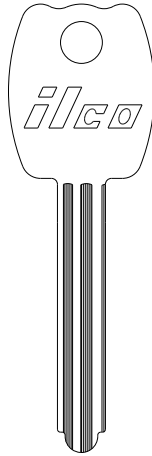

.060" - 1.5mm  
.300" - 7.6mm  
**1332S**

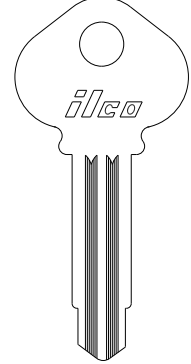

**SLA10**

THICK  
WIDTH  
ILCO

SLAYMAKER

SWITCH KEY

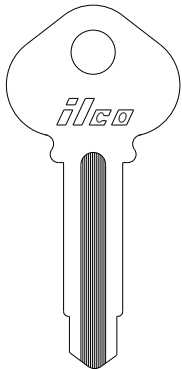

**SLA11**

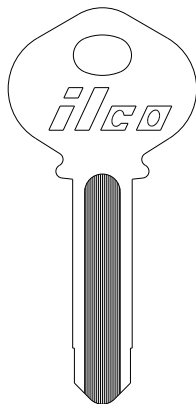

**SLA12**

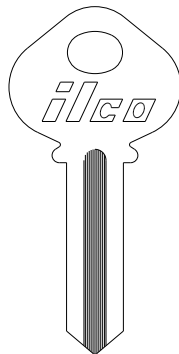

**SLA13**

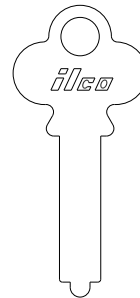

.050" - 1.3mm  
.215" - 5.6mm  
**1418**

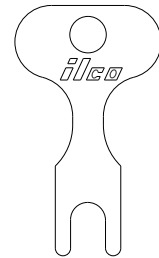

.060" - 1.5mm  
.340" - 8.7mm  
**1425**

THICK  
WIDTH  
ILCO

FLAT STEEL

YALE

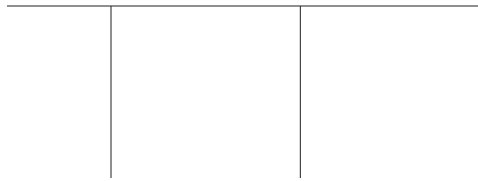
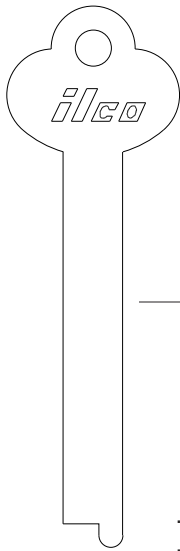
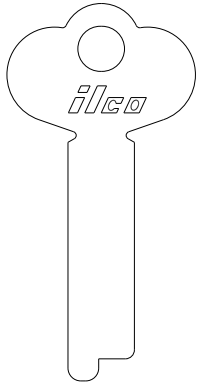

.050" - 1.3mm  
.340" - 8.7mm  
**623S**

.060" - 1.5mm  
.310" - 7.9mm  
**621A**

.040" - 1.0mm  
.310" - 7.9mm  
**U621A**

.050" - 1.2mm  
.310" - 7.9mm  
**1221AL**

THICK  
WIDTH  
ILCO

YALE

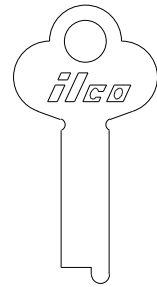
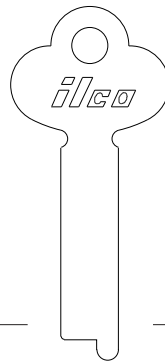
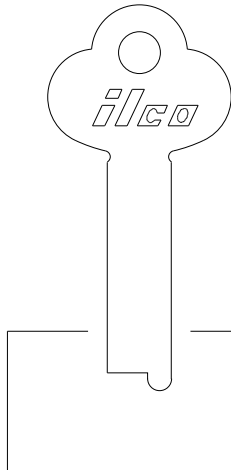

.060" - 1.5mm  
.335" - 8.5mm  
**O1223**

.050" - 1.3mm  
.335" - 8.5mm  
**O1223L**

.050" - 1.3mm  
.300" - 7.6mm  
**1224**

.060" - 1.5mm  
.300" - 7.6mm  
**1224F**

.040" - 1.0mm  
.300" - 7.6mm  
**1224L**

.040" - 1.0mm  
.250" - 6.4mm  
**1225**

THICK  
WIDTH  
ILCO

YALE

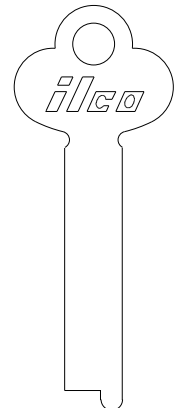
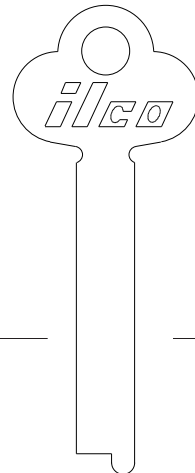
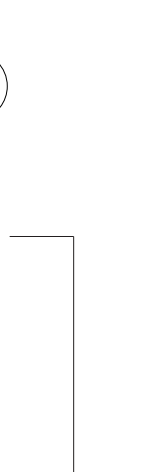
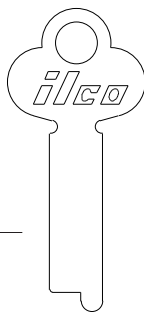
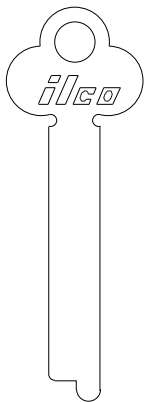

.050" - 1.3mm  
.270" - 6.8mm  
**1225A**

.040" - 1.0mm  
.275" - 7.0mm  
**1225D**

.060" - 1.5mm  
.275" - 7.0mm  
**625DH**

.040" - 1.0mm  
.305" - 7.8mm  
**1225E**

.060" - 1.5mm  
.305" - 7.8mm  
**625EH**

.040" - 1.0mm  
.300" - 7.6mm  
**1225G**

THICK  
WIDTH  
ILCO

YALE

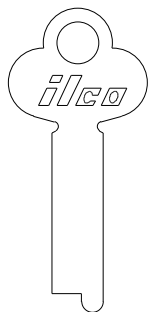

.040" - 1.0mm  
.265" - 6.7mm  
**1225PL**

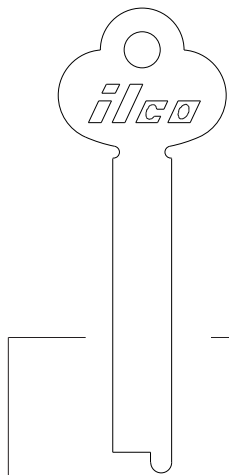

.050" - 1.3mm  
.305" - 7.8mm  
**1370**



.060" - 1.5mm  
.305" - 7.8mm  
**770**

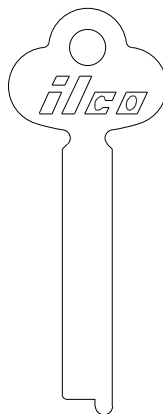

.040" - 1.0mm  
.260" - 6.6mm  
**1422**

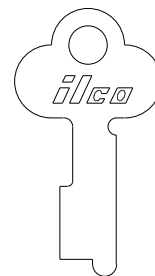

.050" - 1.3mm  
.295" - 7.5mm  
**1427**

THICK  
WIDTH  
ILCO

MISCELLANEOUS FLAT STEEL

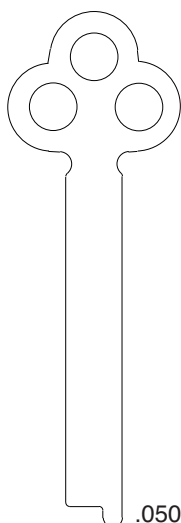

.050" - 1.3mm  
.300" - 7.6mm  
**T45**



.050" - 1.3mm  
.265" - 6.7mm  
**T50**

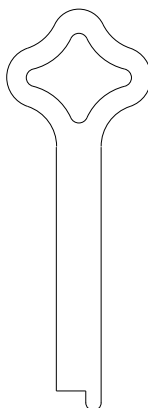

.040" - 1.0mm  
.250" - 6.4mm  
**T64**

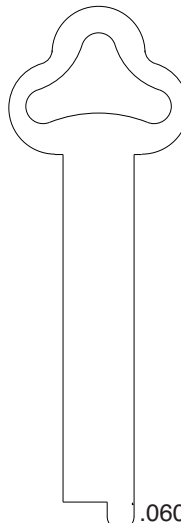

.060" - 1.5mm  
.375" - 9.5mm  
**T70**

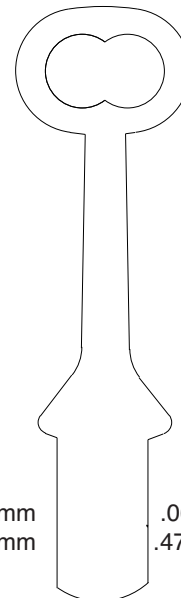

.060" - 1.5mm  
.475" - 12.1mm  
**T77**

THICK  
WIDTH  
ILCO

FLAT STEEL

sec 6a page 4

MISCELLANEOUS FLAT STEEL

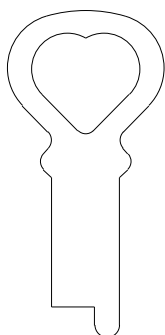

.070" - 1.8mm  
.355" - 9.0mm  
**T80**

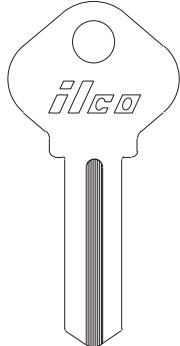

**T105**

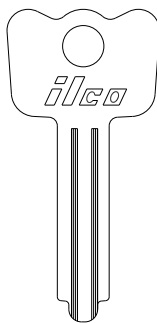

**T107**

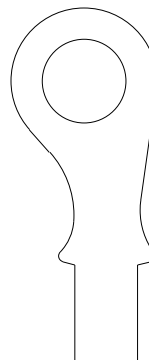

.050" - 1.3mm  
.330" - 8.4mm  
**T131**

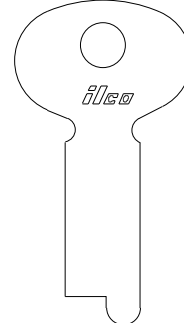

.065" - 1.7mm  
.390" - 9.9mm  
**355ST**

THICK  
WIDTH  
ILCO



MISCELLANEOUS FLAT STEEL

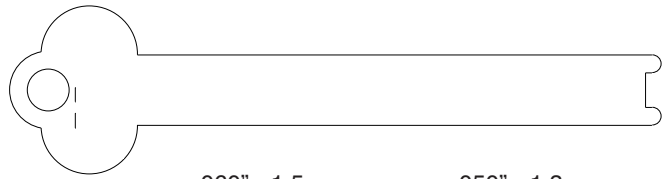
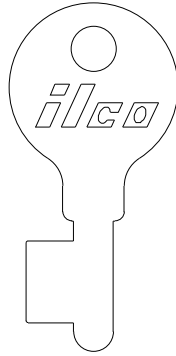
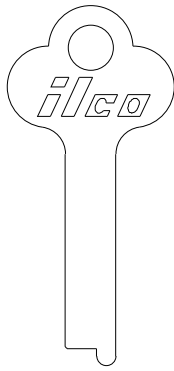

.060" - 1.5mm  
.365" - 9.3mm  
**606AH**

.050" - 1.3mm  
.365" - 9.3mm  
**1206A**

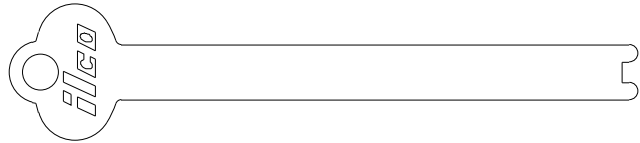

.050" - 1.3mm  
.295" - 7.5mm  
**606L**

.060" - 1.5mm  
.295" - 7.5mm  
**606LH**

THICK  
WIDTH  
ILCO

.050" - 1.3mm  
.265" - 6.7mm  
**E374**

.065" - 1.7mm  
.460" - 11.7mm  
**E375**

MISCELLANEOUS FLAT STEEL

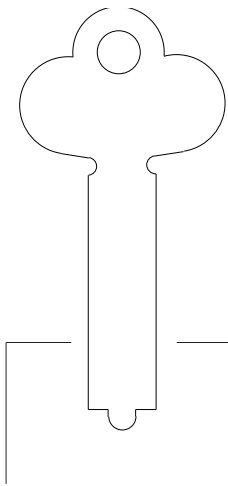

.060" - 1.5mm  
.350" - 8.1mm  
**610B**

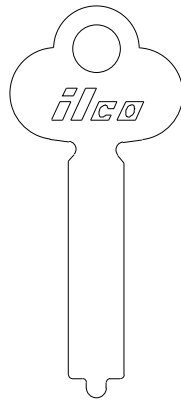

.050" - 1.3mm  
.350" - 8.1mm  
**610BL**

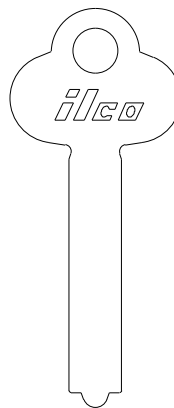

.060" - 1.5mm  
.300" - 7.5mm  
**611**

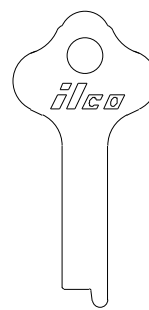

.050" - 1.3mm  
.265" - 6.7mm  
**U611B**

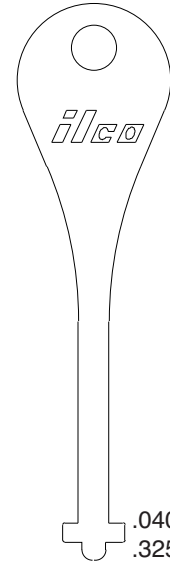

.040" - 1.0mm  
.250" - 6.4mm  
**615**

.040" - 1.0mm  
.325" - 8.3mm  
**632M**

THICK  
WIDTH  
ILCO

MISCELLANEOUS FLAT STEEL

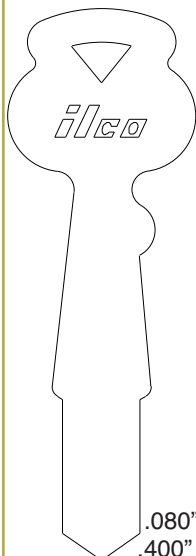

.080" - 2.0mm  
.400" - 10.2mm  
**634**

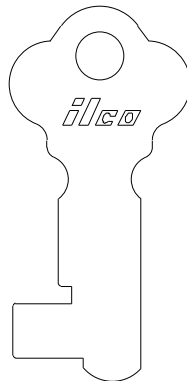

.075" - 1.7mm  
.668" - 17.0mm  
**662**

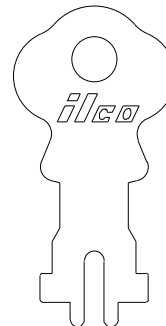

.060" - 1.5mm  
.562" - 14.3mm  
**667**

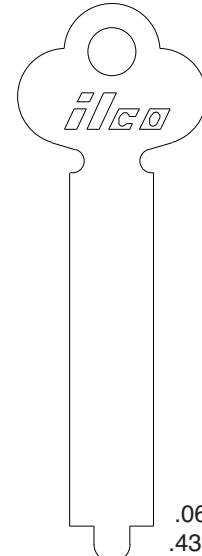

.060" - 1.5mm  
.435" - 11.0mm  
**1209**

THICK  
WIDTH  
ILCO

MISCELLANEOUS FLAT STEEL

					THICK WIDTH ILCO
.060" - 1.5mm .400 - 10.2mm	.050" - 1.3mm .250" - 6.4mm	.050" - 1.3mm .300" - 7.6mm	.060" - 1.5mm .300" - 7.6mm	.060" - 1.5mm .315" - 8.0mm	
<b>1210A</b>	<b>1211B</b>	<b>1213A</b>	<b>1213AH</b>	<b>1213AS</b>	

MISCELLANEOUS FLAT STEEL

					THICK WIDTH ILCO
.050" - 1.3mm .315" - 8.0mm	.040" - 1.0mm .250" - 6.4mm	.040" - 1.0mm .250" - 6.4mm	.050" - 1.3mm .290" - 7.4mm	.040" - 1.0mm .275" - 7.0mm	
<b>O1213</b>	<b>1215A</b>	<b>1215B</b>	<b>O1215</b>	<b>1217</b>	

MISCELLANEOUS FLAT STEEL

		THICK WIDTH ILCO
.050" - 1.3mm .325" - 8.3mm	.050" - 1.3mm .270" - 6.9mm	
<b>1217A</b>	<b>1217D</b>	

FLAT STEEL

sec 6a page 6

MISCELLANEOUS FLAT STEEL

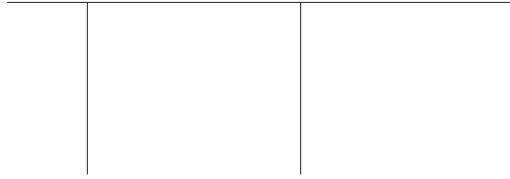
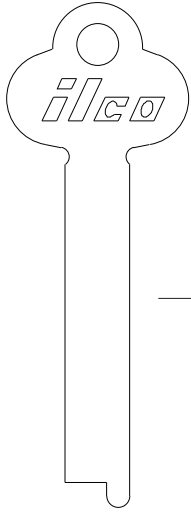

.050" - 1.3mm  
.335" - 8.5mm

**1221L**

.040" - 1.0mm  
.335" - 8.5mm

**O1221L**

.060" - 1.5mm  
.335" - 8.5mm

**621**

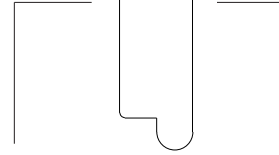
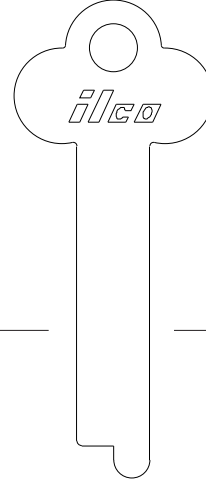

.050" - 1.3mm  
.380" - 9.7mm

**1222AL**

.040" - 1.0mm  
.380" - 9.7mm

**1222E**

THICK  
WIDTH  
ILCO

MISCELLANEOUS FLAT STEEL

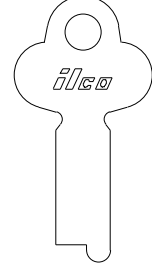
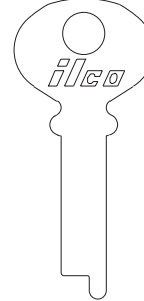
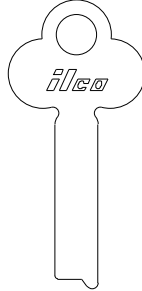
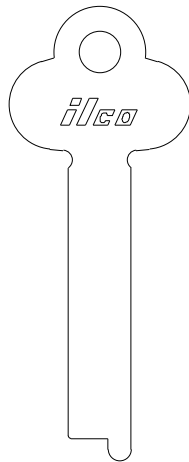
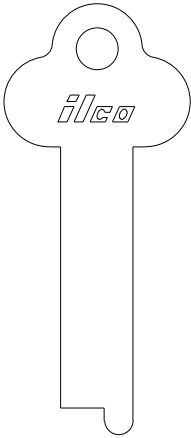

.050" - 1.3mm  
.375" - 9.5mm

**1222B**

.050" - 1.3mm  
.325" - 8.3mm

**1222L**

.040" - 1.0mm  
.225" - 5.7mm

**1225BL**

.040" - 1.0mm  
.245" - 6.2mm

**1225F**

.050" - 1.3mm  
.285" - 7.2mm

**O1225N**

THICK  
WIDTH  
ILCO

MISCELLANEOUS FLAT STEEL

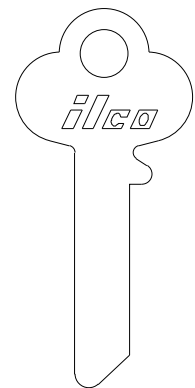
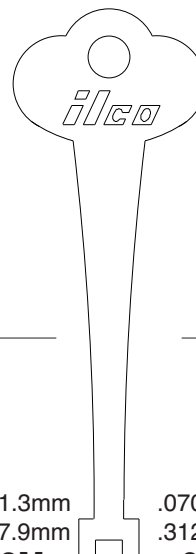
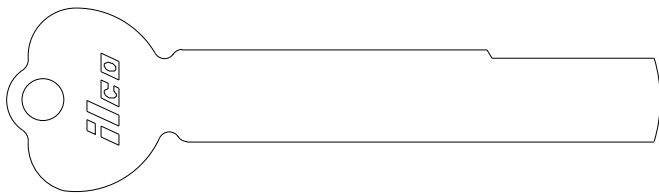

.050" - 1.3mm  
.435" - 11.1mm

**1226**

.050" - 1.3mm  
.312" - 7.9mm

**1233M**

.070" - 1.8mm  
.312" - 7.9mm

**633MH**

.040" - 1.0mm  
.285" - 7.2mm

**1239**

THICK  
WIDTH  
ILCO

MISCELLANEOUS FLAT STEEL

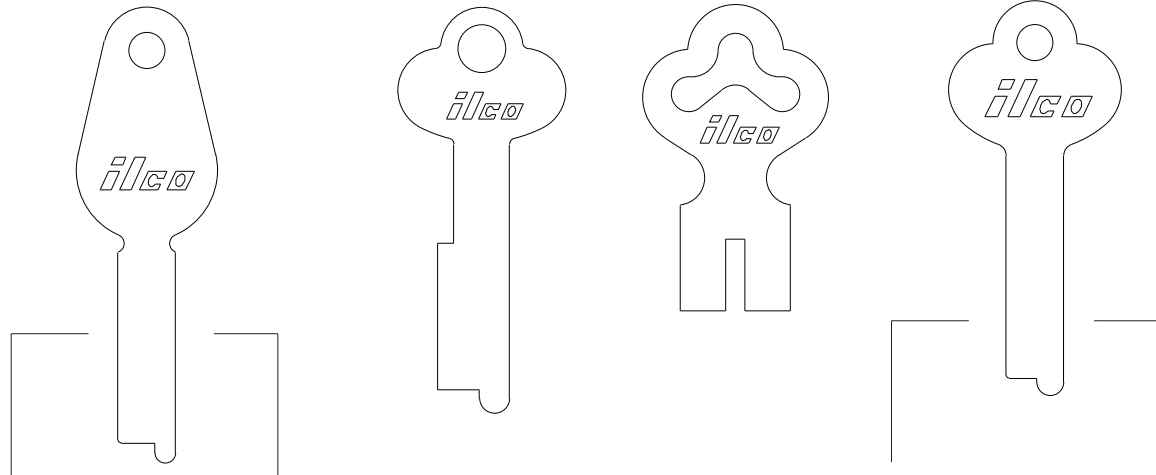

.070" - 1.8mm .300" - 7.6mm <b>1242</b>	.060" - 1.5mm .300" - 7.6mm <b>1242L</b>	.050" - 1.3mm .375" - 9.5mm <b>1243D</b>	.060" - 1.5mm .575" - 14.6mm <b>1259</b>	.040" - 1.0mm .300" - 7.6mm <b>1270</b>	.060" - 1.5mm .300" - 7.6mm <b>1270H</b>
---	--	--	--	---	--

THICK  
WIDTH  
ILCO

MISCELLANEOUS FLAT STEEL

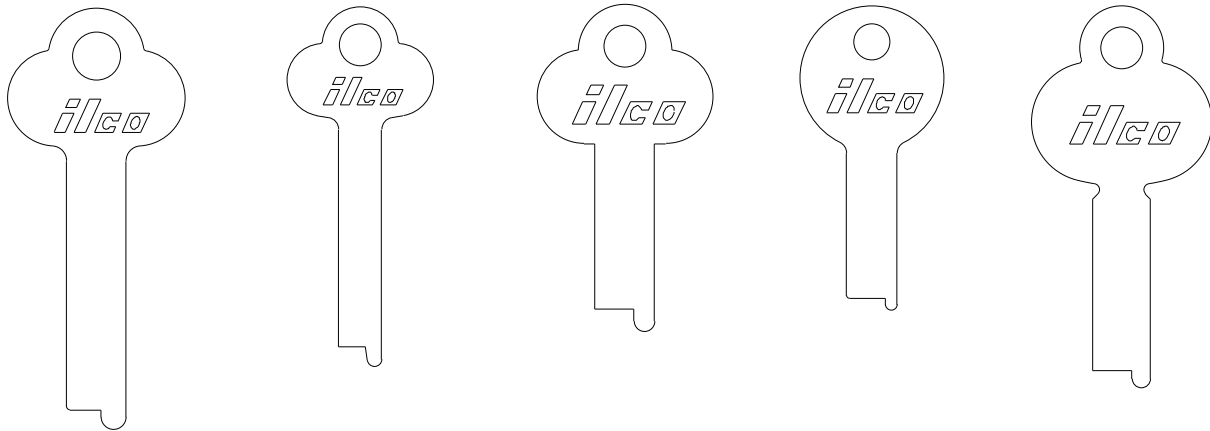

.040" - 1.0mm .300" - 7.6mm <b>1270A</b>	.050" - 1.3mm .255" - 6.5mm <b>1270B</b>	.060" - 1.5mm .310" - 7.9mm <b>1270C</b>	.065" - 1.6mm .265" - 6.5mm <b>1271H</b>	.060" - 1.5mm .300" - 7.6mm <b>1303</b>
--	--	--	--	---

THICK  
WIDTH  
ILCO

MISCELLANEOUS FLAT STEEL

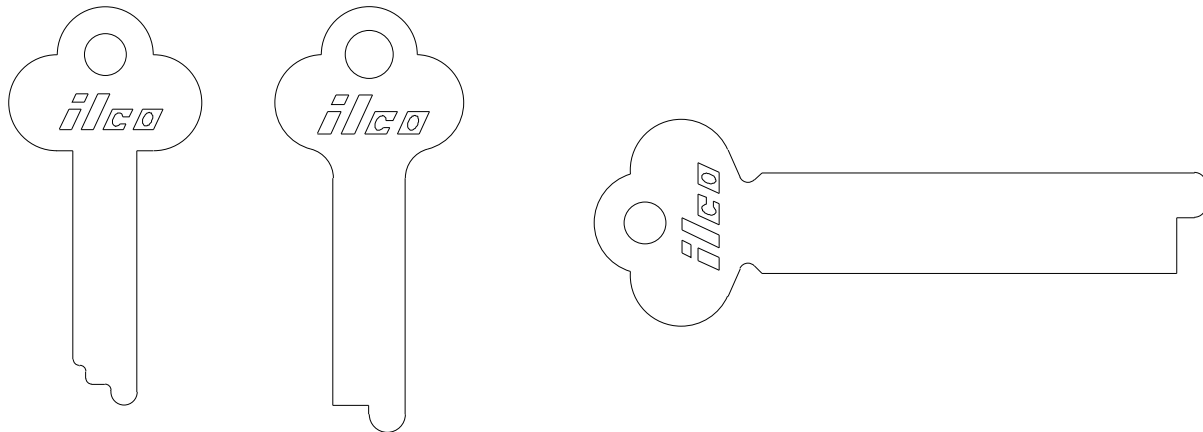

.060" - 1.5mm .325" - 8.3mm <b>1306</b>	.050" - 1.3mm .375" - 9.5mm <b>1306A</b>	.070" - 1.8mm .525" - 13.3mm <b>1309</b>
---	--	--

THICK  
WIDTH  
ILCO

MISCELLANEOUS FLAT STEEL



THICK  
WIDTH  
ILCO

.050" - 1.3mm  
.305" - 7.8mm

**1321**

.060" - 1.5mm  
.305" - 7.8mm

**1321H**

.050" - 1.3mm  
.285" - 7.2mm

**1366**

.050" - 1.3mm  
.300" - 7.6mm

**1426**



**T28**

MISCELLANEOUS FLAT STEEL

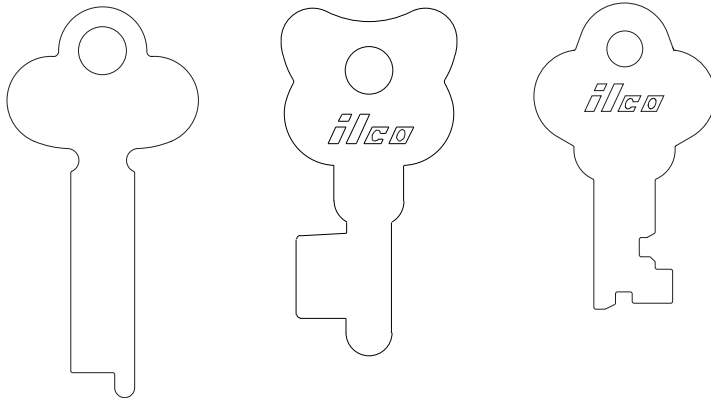

THICK  
WIDTH  
ILCO

.050" - 1.3mm  
.335" - 8.5mm

**T37L**

.060" - 1.5mm  
.495" - 12.6mm





**T127**

.055" - 1.3mm  
.320" - 8.1mm

**4436**

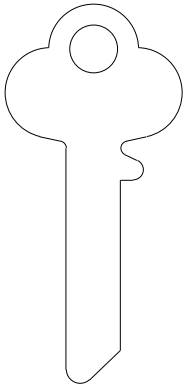
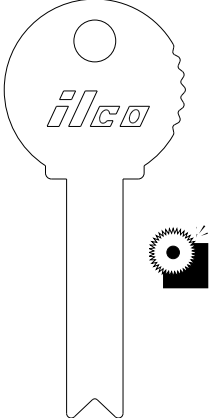

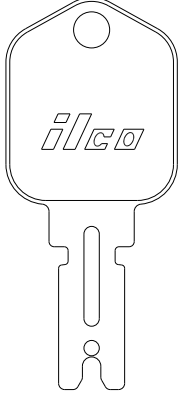
THICK  
WIDTH  
ILCO

AMER. TOURISTER BELL LOCKER, CABINET LOCK & DUDLEY CHENEY CLARK FORK LIFT

 <p>NICKEL SILVER</p> <p>.040" - 1.0mm .285" - 7.2mm</p> <p><b>1031</b></p>	 <p>BRASS</p> <p>.085" - 2.2mm .295" - 7.5mm</p> <p><b>1033F</b></p>	 <p>STEEL</p>  <p><b>C350</b></p>	 <p>STEEL</p>  <p>.080" - 2.0mm .344" - 8.7mm</p> <p><b>1430</b></p>
--	---	--	--

THICK  
WIDTH  
ILCO

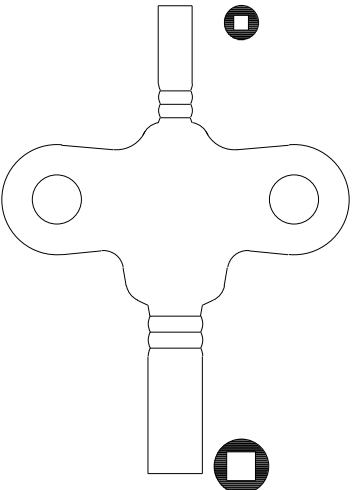
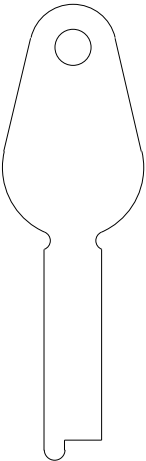
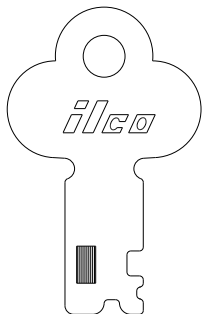
CLOCK KEY DURAND LOCKER EAGLE

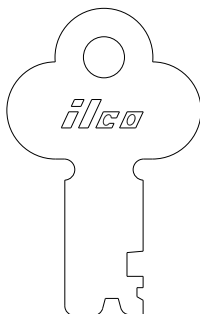
 <p>PRECISION CAST</p> <p><b>669</b></p>	 <p>NICKEL SILVER</p> <p>.060" - 1.5mm .300" - 7.6mm</p> <p><b>1033A</b></p>	 <p>STEEL</p>  <p><b>T39</b></p>	 <p>STEEL</p> <p>.060" - 1.5mm .041" - 1.04mm</p> <p><b>T40</b></p>
--	--	--	---

THICK  
WIDTH  
ILCO

EAGLE

 <p>STEEL</p>  <p><b>T41</b></p>	 <p>NICKEL SILVER</p> <p>.050" - 1.3mm .375" - 9.5mm</p> <p><b>S1306A</b></p>	 <p>NICKEL SILVER</p> <p>.050" - 1.3mm .275" - 7.0mm</p> <p><b>1322S</b></p>	 <p>STEEL</p> <p>.050" - 1.3mm .365" - 9.3mm</p> <p><b>1416</b></p>	 <p>STEEL</p> <p>.050" - 1.3mm .312" - 7.92mm</p> <p><b>2712</b></p>
--	--	---	---	---

THICK  
WIDTH  
ILCO

MISCELLANEOUS

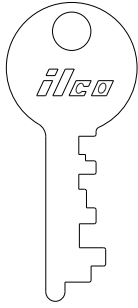
**EAGLE EVERLASTING**

STEEL

 .050" - 1.3mm  
 .312" - 7.92mm

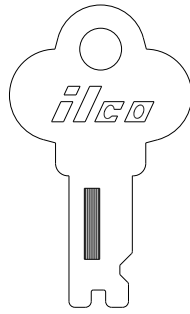
**2714**

STEEL

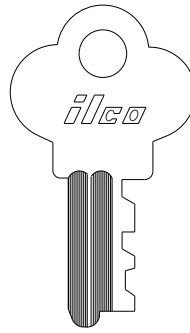
**T44**

STEEL

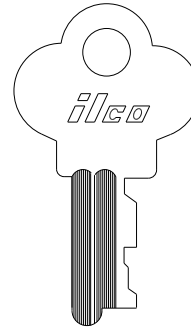
**T95**

STEEL

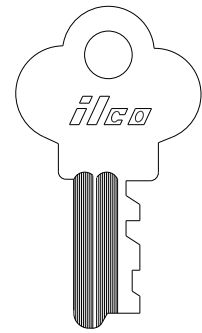
**T96**

STEEL

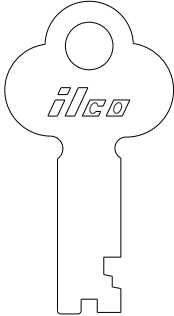
**T97**
**THICK  
WIDTH  
ILCO**
**EXCELSIOR**
**GAS & COMBINE**
**GERMAN BANK LOCK**

STEEL

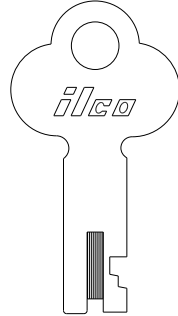
**T72**

STEEL

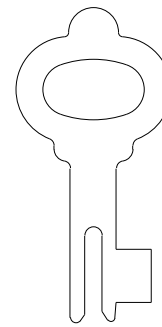

**T139**

STEEL

**666**

STEEL

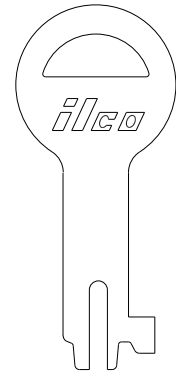
 .070" - 1.8mm  
 .421" - 10.7 mm

**660**

STEEL

 .080" - 2.0mm  
 .479" - 12.17mm

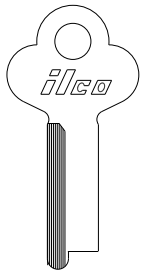
**665**
**THICK  
WIDTH  
ILCO**
**GERSTNER TOOL BOX**
**JAPAN CAR ANTENNA**
**LUCAS**

BRASS

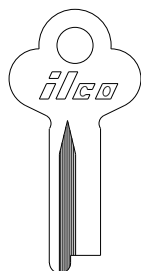
**1013G**

BRASS

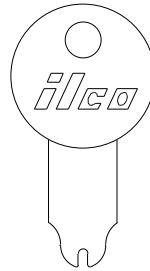
**1013GR**

STEEL

 .050/.055" - 1.3/1.4mm  
 .357" - 9.07mm

**619**

STEEL

 .050" - 1.3mm  
 .300" - 7.6mm

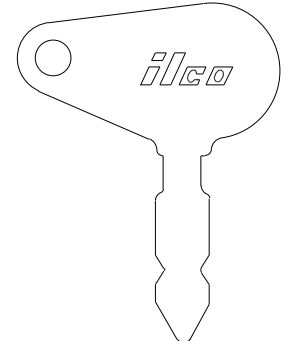
**LU1**

STEEL

 .080" - 2.0mm  
 .279" - 7.09mm

**LU2**
**THICK  
WIDTH  
ILCO**

LYONS		MEDART		NEUMAN	
NICKEL SILVER .060" - 1.5mm .300" - 7.6mm <b>1303S</b>	NICKEL SILVER .060" - 1.5mm .305" - 7.8mm <b>1326</b>	NICKEL SILVER .060" - 1.5mm .300" - 7.6mm <b>1332</b>	STEEL .060" - 1.5mm .264" - 6.7mm <b>T74</b>	STEEL .065" - 1.65mm .266" - 6.76mm <b>T75</b>	<b>THICK WIDTH ILCO</b>

POLARIS		PRESTO		SAMSONITE	
STEEL <b>1148</b>	STEEL  <b>T60</b>	STEEL  <b>T88</b>	STEEL  <b>T89</b>	BRASS  <b>70S</b>	<b>THICK WIDTH ILCO</b>

SAMSONITE				
BRASS <b>80S</b>	STEEL  <b>149</b>	BRASS  <b>170S</b>	BRASS <b>171S</b>	BRASS  <b>170S1</b>

MISCELLANEOUS

sec 6b page 3

**THICK WIDTH ILCO**



**SAMSONITE**

**YALE**

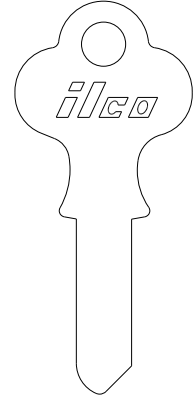
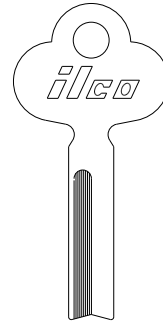
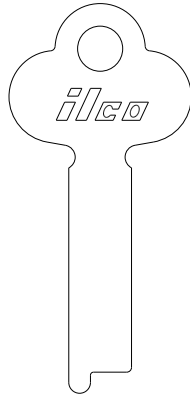
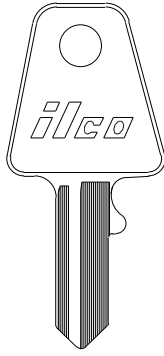
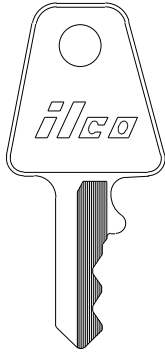

**THICK  
WIDTH  
ILCO**

**170S6**

**S170S1**

NICKEL SILVER  
.060" - 1.5mm  
.335" - 8.4mm  
**37D**

NICKEL SILVER  
**51**

BRASS  
.040" - 1.0mm  
.290" - 7.37mm  
**94**

**YALE**

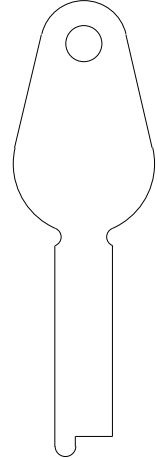
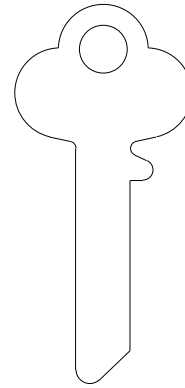
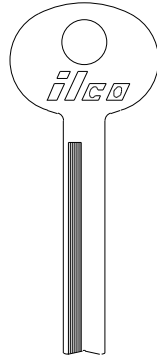
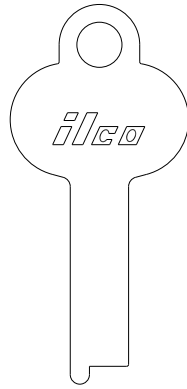
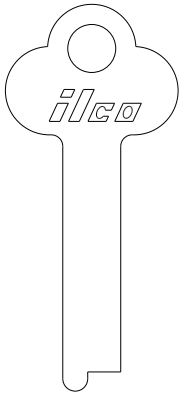

NICKEL SILVER  
.060" - 1.5mm  
.301" - 7.6mm  
**143C**

NICKEL SILVER  
.060" - 1.5mm  
.304" - 7.7mm  
**703S**

NICKEL SILVER  
  
**719S**

NICKEL SILVER  
.040" - 1.0mm  
.285" - 7.2mm  
**1031**

NICKEL SILVER  
.060" - 1.5mm  
.300" - 7.6mm  
**1033A**

**THICK  
WIDTH  
ILCO**

**MISCELLANEOUS**

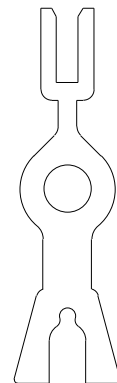
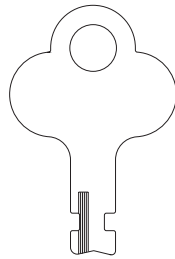
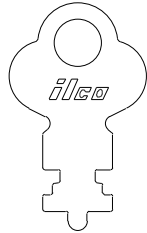

STEEL

STEEL

STEEL

STEEL

STEEL

**THICK  
WIDTH  
ILCO**

**T46**

**T86**

**T124**

**TS149**

**TS150**

MISCELLANEOUS

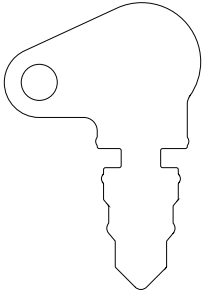

STEEL

.080" - 2.0mm  
.412" - 10.46mm

**1147**



STEEL

**1148**



STEEL



**3916-21**

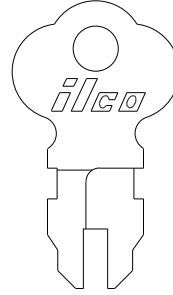

STEEL



**3916-22**

THICK  
WIDTH  
ILCO

MISCELLANEOUS

THICK  
WIDTH  
ILCO

THICK  
WIDTH  
ILCO



**Section 7**  
**BIT AND BARREL**

Keys are separated by type - bit or barrel and are in number sequence

## DETERMINING SPECIFICATIONS ON BIT KEYS

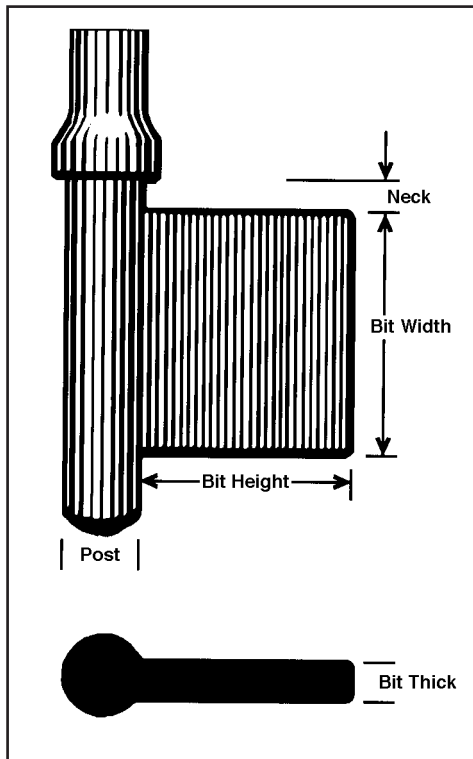

Dimensions of a Bit Key

The following pages show our selection of Bit and Barrel Key Blanks. This page will help you identify the key blank you are looking for.

- The chart below lists various types of materials used in Bit and Barrel key blanks.
- Measurements below each key drawing are shown in hundredths of an inch and tenths of a millimeter. Please understand that these styles of key blanks are not made to the same tolerances of cylinder key blanks by the nature of the processes utilized. If the dimensions are close they will more than likely work.

Diagrams (left) show how the bit and barrel keys are measured so you can understand what to measure for comparison.

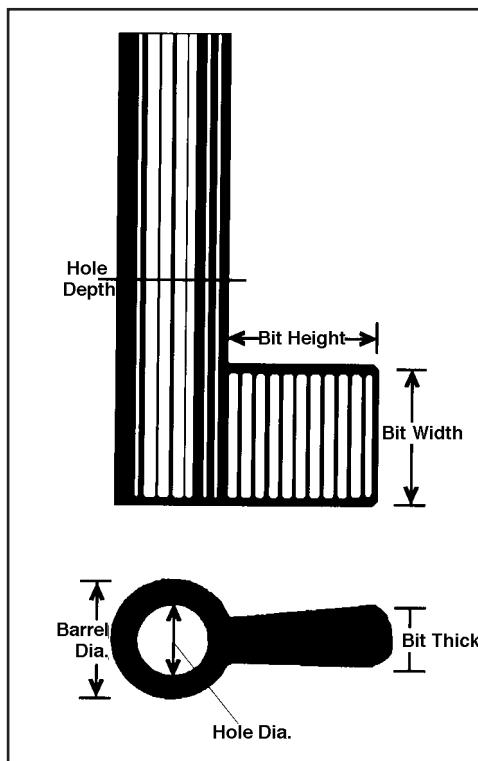

Dimensions of a Barrel Key

### Materials Used

- MI** - malleable iron
- Steel/Plastic** - a nickel plated steel shaft with a plastic tip
- Steel/Zinc** - a nickel plated steel shaft with a die cast zinc tip
- Brass** - a brass die cast key blank
- Prec. Cast** - a precision zinc die cast key blank

**BIT KEYS**

**1B**

**DLP1**

<b>P5</b>	
MI	
.20"	(5.1mm)
.10"	(2.5mm)
.37"	(9.3mm)
.37"	(9.3mm)
.14"	(3.6mm)

<b>P6</b>	
MI	
.20"	(5.1mm)
.10"	(2.5mm)
.37"	(9.3mm)
.37"	(9.3mm)
.14"	(3.6mm)

**P7**

**2B**

**B2M**

**ILCO**  
Material  
Post  
Neck  
Bit Height  
Bit Width  
Bit Thick

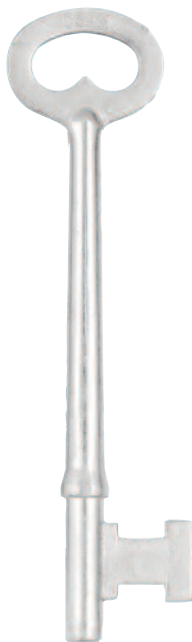
**BIT KEYS**

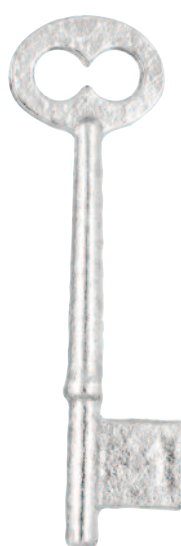
**C3AM**

**C3M**

**5B**

**B6**

**7B**

**ILCO**  
Material  
Post  
Neck  
Bit Height  
Bit Width  
Bit Thick

	<b>C3AM</b>	<b>C3M</b>	<b>5B</b>	<b>B6</b>	<b>7B</b>
Material	MI	PRECISION CAST	MI	STEEL/ZINC	STEEL/PLASTIC
Post	.21" (5.3mm)	.20" (5.1mm)	.20" (5.1mm)	.20" (5.1mm)	.20" (5.1mm)
Neck	.13" (3.3mm)	.13" (3.3mm)	.09" (2.3mm)	.09" (2.3mm)	.10" (2.5mm)
Bit Height	.47" (12mm)	.44" (11.2mm)	.44" (11.2mm)	.47" (11.9mm)	.41" (10.4mm)
Bit Width	.44" (11.2mm)	.38" (9.7mm)	.50" (12.7mm)	.49" (12.4mm)	.39" (9.9mm)
Bit Thick	.10" (2.5mm)	.06" (11.5mm)	.09" (2.3mm)	.08" (2.0mm)	.08" (2.0mm)

BIT KEYS

<b>B7M</b>	<b>8B</b>	<b>9B</b>	<b>B11M</b>	<b>12B</b>	<b>ILCO</b>
STEEL/ZINC	MI	MI	BI-METALLIC	MI	Material
.20" (5.1mm)	.19" (4.8mm)	.18" (4.6mm)	.25" (6.4mm)	.19" (4.8mm)	Post
.10" (2.5mm)	.08" (2.0mm)	.09" (2.3mm)	.08" (2.0mm)	.07" (1.8mm)	Neck
.41" (10.4mm)	.50" (12.7mm)	.50" (13.5mm)	.50" (12.7mm)	.45" (11.4mm)	Bit Height
.39" (9.9mm)	.45" (11.4mm)	.49" (12.4mm)	.56" (14.2mm)	.66" (16.8mm)	Bit Width
.08" (2.0mm)	.08" (2.0mm)	.07" (1.8mm)	.11" (2.8mm)	.08" (2.0mm)	Bit Thick

BIT KEYS

<b>14CM</b>	<b>17B</b>	<b>B17</b>	<b>B20</b>	<b>25B</b>	<b>ILCO</b>
MI	MI	STEEL/ZINC	STEEL/ZINC	MI	Material
.19" (4.8mm)	.19" (4.8mm)	.19" (4.8mm)	.17" (4.3mm)	.17" (4.3mm)	Post
.13" (3.3mm)	.09" (2.8mm)	.10" (2.5mm)	.08" (2.0mm)	—	Neck
.44" (11.2mm)	.50" (12.7mm)	.50" (12.7mm)	.40" (10.2mm)	.69" overall (17.5mm)	Bit Height
.45" (11.4mm)	.50" (12.7mm)	.50" (12.7mm)	.47" (11.9mm)	.22" (5.6mm)	Bit Width
.16" (4.1mm)	.08" (2.0mm)	.08" (2.0mm)	.10" (2.5mm)	.08" (2.0mm)	Bit Thick

**BIT KEYS**

**28AM**

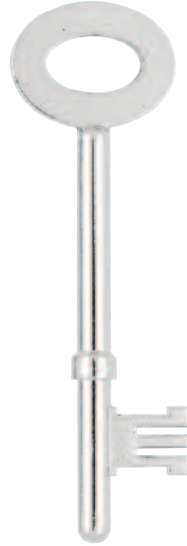
**28BM**

**37 MASTER**

**B40A**

**B41A**

<b>ILCO</b>					
Material	MI	MI	MI	BI-METALLIC	BI-METALLIC
Post	.23" (4.8mm)	.20" (5.1mm)	.20" (5.1mm)	.22" (5mm)	.20" (5.1mm)
Neck	.08" (2.0mm)	.12" (3 mm)	.13" (3.3mm)	.11" (2.8mm)	.08" (2mm)
Bit Height	.47" (11.9mm)	.40" (10.2mm)	.34" (11.2mm)	.45" (11.4mm)	.50" (12.7mm)
Bit Width	.63" (16mm)	.41" (10.4mm)	.37" (11.9mm)	.43" (10.9mm)	.59" (15mm)
Bit Thick	.16" (4.1mm)	.10" (2.5mm)	.09" (2.3mm)	.10" (2.5mm)	.09" (2.3mm)

**BIT KEYS**

**B41B**

**B41C**

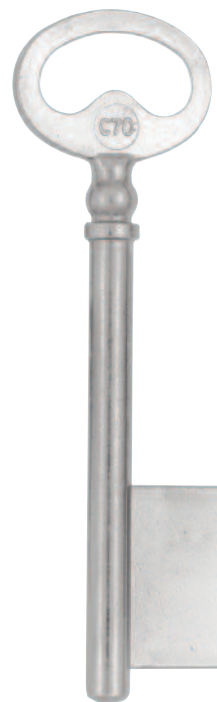
**C42**

**C70**

<b>ILCO</b>				
Material	BI-METALLIC	BI-METALLIC	BI-METALLIC	PRECISION CAST
Post	.19" (4.8mm)	.22" (5mm)	.20" (5.1mm)	.24" (6.1mm)
Neck	.08" (2mm)	.06" (2.5mm)	.055" (1.40mm)	.98" (24.9mm)
Bit Height	.45" (11.4mm)	.45" (11.4mm)	.32" (8.13mm)	.55" (14.0mm)
Bit Width	.45" (11.4mm)	.45" (11.4mm)	.265" (6.73mm)	.18" (4.8mm)
Bit Thick	.09" (2.3mm)	.11" (2.8mm)	.085" (2.16mm)	.17" (4.3mm)

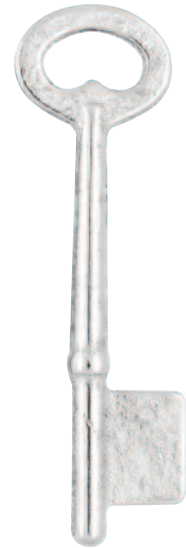
BIT KEYS



**B44M**

**45B**

STEEL/ZINC

MI

.19" (4.8mm)

.18" (4.6mm)

.05" (1.3mm)

.09" (2.3mm)

.71" (18.0mm)

.43" (10.9mm)

.63" (16.0mm)

.62" (15.7mm)

.09" (2.3mm)

.06" (1.5mm)

**ILCO**  
Material  
Post  
Neck  
Bit Height  
Bit Width  
Bit Thick

BIT KEYS

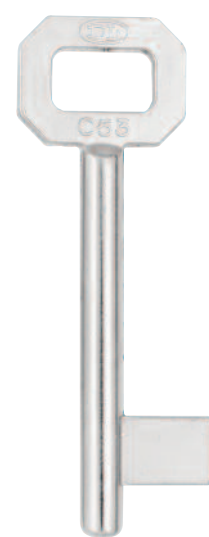
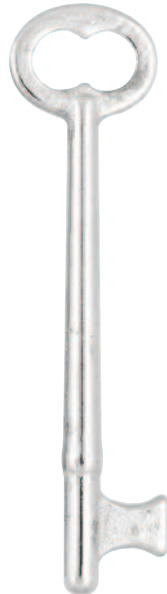

**B45M**

**49B**

**52B**

**53 MASTER**

**C53**

BI-METALLIC

MI

BRASS

MI

PRECISION CAST

.20" (5mm)

.18" (4.6mm)

.20" (5mm)

.19" (4.8mm)

.24" (6.1mm)

.11" (2.8mm)

.12" (3.0mm)

.08" (2mm)

.13" (3.3mm)

—

.51" (13mm)

.37" (9.4mm)

.34" (8.6mm)

.43" (10.9mm)

.48" (12.2mm)

.39" (9.9mm)

.35" (8.9mm)

.60" (15.2mm)

.46" (11.7mm)

.38" (9.7mm)

.09" (2.3mm)

.06" (1.5mm)

.11" (2.8mm)

.09" (2.3mm)

.17" (4.3mm)

**ILCO**  
Material  
Post  
Neck  
Bit Height  
Bit Width  
Bit Thick



**BIT KEYS**

<b>ILCO</b>	<b>54M</b>	<b>66B</b>	<b>67M</b>	<b>68M</b>	<b>69B</b>
Material	MI	MI	MI	MI	BRASS
Post	.24" (6.1mm)	.20" (5.1mm)	.23" (6.1mm)	.19" (4.8mm)	.26" (6.6mm)
Neck	.16" (4.1mm)	.06" (2.5mm)	.10" (3.3mm)	.10" (3.3mm)	—
Bit Height	.44" (11.2mm)	.53" (14.0mm)	.61" (15.49mm)	.47" (11.9mm)	.52" (13.2mm)
Bit Width	.63" (16.0mm)	.50" (12.7mm)	.60" (15.11mm)	.53" (13.5mm)	.82" (20.8mm)
Bit Thick	.14" (3.6mm)	.09" (2.0mm)	.9" (22.86mm)	.08" (2.0mm)	.14" (3.6mm)

**BIT KEYS**

<b>ILCO</b>	<b>71B</b>	<b>73M</b>	<b>78B</b>	<b>79B</b>	<b>90B</b>
Material	MI	MI	MI	MI	MI
Post	.20" (5.1mm)	.19" (5.1mm)	.18" (4.8mm)	.21" (5.3mm)	.18" (4.6mm)
Neck	.10" (2.5mm)	.08" (2.3mm)	.15" (3.6mm)	.12" (3.0mm)	.08" (2.3mm)
Bit Height	.44" (11.2mm)	.41" (10.2mm)	.46" (11.2mm)	.44" (11.2mm)	.53" (11.4mm)
Bit Width	.46" (11.7mm)	.44" (11.2mm)	.68" (17.3mm)	.37" (9.4mm)	.50" (12.7mm)
Bit Thick	.06" (1.5mm)	.08" (2.0mm)	.17" (4.3mm)	.07" (1.8mm)	.09" (2.3mm)

BIT KEYS

					<b>ILCO</b> Material Post Neck Bit Height Bit Width Bit Thick
<b>91B</b>	<b>C110</b>	<b>C112</b>	<b>136SB</b>	<b>163SB</b>	
MI	PRECISION CAST	PRECISION CAST	MI	MI	
.20" (5.1mm)	.22" (5.6mm)	.21" (5.3mm)	.24" (6.4mm)	.18" (4.8mm)	
.09" (2.3mm)	.52" (13.2mm)	.08" (2.3mm)	.12" (3.0mm)	.13" (3.0mm)	
.53" (13.5mm)	.45" (11.4mm)	.36" (9.1mm)	.44" (11.2mm)	.49" (12.2mm)	
.57" (14.5mm)	.09" (2.3mm)	.59" (15.0mm)	.61" (15.5mm)	.52" (12.9mm)	
.09" (2.3mm)	.10" (2.5mm)	.13" (3.3mm)	.16" (4.1mm)	.16" (3.8mm)	

BIT KEYS

				<b>ILCO</b> Material Post Neck Bit Height Bit Width Bit Thick
(Silca No. 6M36) <b>178SB</b>	<b>401N-2</b>	<b>504</b>	<b>506</b>	
MI	MI	MI	MI	
.26" (6.6mm)	.20" (5.0mm)	.22" (5.6mm)	.16" (4.1mm)	
.09" (2.3mm)	.09" (2.3mm)	.12" (3.0mm)	.12" (3.0mm)	
.54" (13.7mm)	.41" (10.4mm)	.48" (12.2mm)	.45" (11.4mm)	
.69" (17.5mm)	.45" (11.4mm)	.45" (11.4mm)	.62" (15.7mm)	
.20" (5.0mm)	.12" (3.0mm)	.11" (2.8mm)	.06" (1.5mm)	

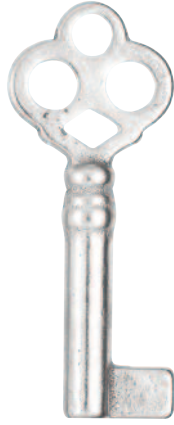
**BARREL KEYS**

**ILCO**

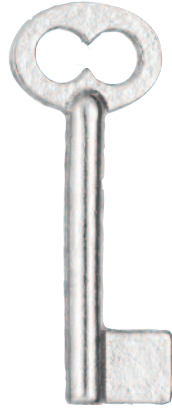
	<b>21B</b>	<b>22BB</b>	<b>22M</b>	<b>23B</b>	<b>23M</b>
Material	MI	MI	MI	MI	MI
Barrel Dia.	.21" (5.3mm)	.24" (6.1mm)	.21" (5.3mm)	.21" (5.3mm)	.21" (5.3mm)
Hole Dia.	.14" (3.6mm)	.15" (3.8mm)	.14" (3.6mm)	.14" (3.6mm)	.14" (3.6mm)
Hole Depth	.68" (17.3mm)	.80" (20.3mm)	.50" (12.7mm)	.50" (12.7mm)	.47" (11.9mm)
Bit Height	.38" (9.7mm)	.34" (8.6mm)	.28" (7.1mm)	.28" (7.1mm)	.26" (6.6mm)
Bit Width	.29" (7.4mm)	.27" (6.9mm)	.24" (6.1mm)	.24" (6.1mm)	.29" (7.4mm)
Bit Thick	.11" (2.8mm)	.11" (2.8mm)	.09" (2.3mm)	.09" (2.3mm)	.11" (2.8mm)

**BARREL KEYS**

**ILCO**

	<b>24B</b>	<b>27B</b>	<b>C30M</b>	<b>34B</b>	<b>C82M</b>
Material	MI	MI	PREC. CAST	MI	PRECISION CAST
Barrel Dia.	.19" (4.8mm)	.22" (5.6mm)	.24" (6.1mm)	.19" (4.8mm)	.23 (5.8mm)
Hole Dia.	.13" (3.3mm)	.15" (3.8mm)	.16" (4.1mm)	.13" (3.3mm)	.31 (7.9mm)
Hole Depth	.43" (10.9mm)	.60" (15.2mm)	.61" (15.5mm)	.56" (14.7mm)	.28 (7.1mm)
Bit Height	.22" (5.6mm)	.37" (9.4mm)	.37" (9.4mm)	.38" (9.7mm)	.11 (2.8mm)
Bit Width	.19" (4.8mm)	.43" (10.9mm)	.28" (7.1mm)	.34" (8.7mm)	.14 (3.6mm)
Bit Thick	.09" (2.3mm)	.10" (2.5mm)	.10" (2.5mm)	.08" (2.0mm)	.60 (15.2mm)

BARREL KEYS



**84B**  
MI

**669**  
PREC. CAST  
CLOCK KEY

**1500A**  
MI

**6750**  
STEEL  
HANDCUFF KEY

**ILCO**  
Material  
Barrel Dia.  
Hole Dia.  
Hole Depth  
Bit Height  
Bit Width  
Bit Thick

.19"	(4.8mm)
.13"	(3.3mm)
.43"	(10.9mm)
.22"	(5.6mm)
.19"	(4.8mm)
.09"	(2.3mm)

.22	(5.6mm)
.14	(3.6mm)
.19	(4.8mm)
.56	(14.2mm)
.09	(2.3mm)

BARREL KEYS



**3F-1033**  
BRASS

**3F-1232**  
BRASS

**3F-1630**  
BRASS

**3F-1730**  
BRASS

**ILCO**  
Material  
Barrel Dia.  
Hole Dia.  
Hole Depth  
Bit Height  
Bit Width  
Bit Thick

.24"	(6.0mm)
.16"	(4.0mm)
.87"	(22.0mm)
.36"	(9.1mm)
.35"	(9.0mm)
.11"	(2.8mm)

.24"	(6.0mm)
.16"	(4.0mm)
.87"	(22.0mm)
.36"	(9.1mm)
.34"	(8.6mm)
.13"	(3.2mm)

.23"	(6.0mm)
.16"	(4.0mm)
.86"	(22.0mm)
.36"	(9.1mm)
.36"	(9.1mm)
.12"	(3.0mm)

.23"	(6.0mm)
.16"	(4.0mm)
.86"	(22.0mm)
.36"	(9.1mm)
.35"	(9.0mm)
.12"	(3.0mm)

**BARREL KEYS**

**3F-1738**

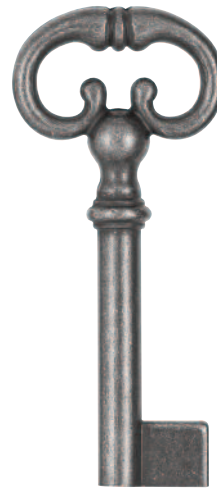
**3F-2532**

**3F-2635**

**3F-2830**

**ILCO**  
Material  
Barrel Dia.  
Hole Dia.  
Hole Depth  
Bit Height  
Bit Width  
Bit Thick

Material	BRASS	BRASS	BRASS	BRASS
Barrel Dia.	.23" (6.0mm)	.23" (6.0mm)	.23" (6.0mm)	.23" (6.0mm)
Hole Dia.	.16" (4.0mm)	.16" (4.0mm)	.16" (4.0mm)	.16" (94.0mm)
Hole Depth	.86" (22.0mm)	.86" (22.0mm)	.86" (22.0mm)	.86" (22.0mm)
Bit Height	.36" (9.1mm)	.35" (8.9mm)	.36" (9.1mm)	.36" (9.1mm)
Bit Width	.34" (8.8mm)	.35" (9.0mm)	.35" (9.0mm)	.36" (9.1mm)
Bit Thick	.12" (3.0mm)	.12" (3.1mm)	.13" (3.2mm)	.13" (3.2mm)

**BARREL KEYS**

**3F-2933**

**3F-4135**

**3F-4333**

**3F-4535**

**ILCO**  
Material  
Barrel Dia.  
Hole Dia.  
Hole Depth  
Bit Height  
Bit Width  
Bit Thick

Material	BRASS	BRASS	BRASS	BRASS
Barrel Dia.	.23" (6.0mm)	.23" (6.0mm)	.23" (6.0mm)	.23" (6.0mm)
Hole Dia.	.16" (4.0mm)	.16" (4.0mm)	.16" (4.0mm)	.16" (4.0mm)
Hole Depth	.86" (22.0mm)	.86" (22.0mm)	.86" (22.0mm)	.86" (22.0mm)
Bit Height	.36" (9.1mm)	.36" (9.1mm)	.36" (9.1mm)	.36" (9.1mm)
Bit Width	.35" (9.0mm)	.35" (9.0mm)	.34" (8.8mm)	.35" (9.0mm)
Bit Thick	.11" (2.9mm)	.11" (2.9mm)	.12" (3.0mm)	.10" (2.5mm)



BARREL KEYS

<b>3F-4735</b>	<b>3F-4935</b>	<b>3F-6932</b>	<b>3M-2127</b>	<b>3M-2136</b>	<b>ILCO</b>
BRASS	BRASS	BRASS	BRASS	BRASS	Material
.23" (6.0mm)	.23" (6.0mm)	.23" (6.0mm)	.22" (5.7mm)	.22" (5.7mm)	Barrel Dia.
.16" (4.0mm)	.16" (4.0mm)	.16" (4.0mm)	.14" (3.5mm)	.14" (3.5mm)	Hole Dia.
.86" (22.0mm)	.86" (22.0mm)	.86" (22.0mm)	.86" (22.0mm)	.86" (22.0mm)	Hole Depth
.36" (9.1mm)	.36" (9.1mm)	.36" (9.1mm)	.25" (6.4mm)	.25" (6.4mm)	Bit Height
.34" (8.7mm)	.35" (9.0mm)	.34" (8.6mm)	.29" (7.5mm)	.29" (7.5mm)	Bit Width
.12" (3.0mm)	.12" (3.1mm)	.14" (3.5mm)	.10" (2.5mm)	.10" (2.5mm)	Bit Thick

BARREL KEYS

<b>3M-2734</b>	<b>3M-3427</b>	<b>3M-3437</b>	<b>3M-5935</b>	<b>3S-1832</b>	<b>ILCO</b>
BRASS	BRASS	BRASS	BRASS	BRASS	Material
.22" (5.7mm)	.22" (5.7mm)	.22" (5.7mm)	.22" (5.7mm)	.23" (6.0mm)	Barrel Dia.
.14" (3.5mm)	.14" (3.5mm)	.14" (3.5mm)	.14" (3.5mm)	.16" (4.0mm)	Hole Dia.
.86" (22.0mm)	.86" (22.0mm)	.86" (22.0mm)	.86" (22.0mm)	.86" (22.0mm)	Hole Depth
.25" (6.4mm)	.25" (6.4mm)	.25" (6.4mm)	.25" (6.4mm)	.35" (9.0mm)	Bit Height
.35" (9.0mm)	.31" (8.0mm)	.31" (8.0mm)	.30" (7.6mm)	.35" (9.0mm)	Bit Width
.10" (2.5mm)	.10" (2.5mm)	.10" (2.5mm)	.10" (2.5mm)	.14" (3.5mm)	Bit Thick

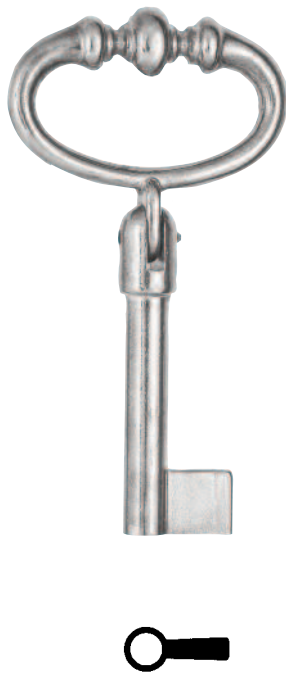
**BARREL KEYS**

**ILCO**
**3S-2332**
**3S-5332**
**3S-7032**

Material	BRASS	BRASS	BRASS
Barrel Dia.	.23" (6.0mm)	.23" (6.0mm)	.23" (6.0mm)
Hole Dia.	.16" (4.0mm)	.16" (4.0mm)	.16" (4.0mm)
Hole Depth	.86" (22.0mm)	.86" (22.0mm)	.86" (22.0mm)
Bit Height	.36" (9.1mm)	.36" (9.1mm)	.36" (9.1mm)
Bit Width	.35" (9.0mm)	.35" (9.0mm)	.36" (9.1mm)
Bit Thick	.12" (3.0mm)	.12" (3.0mm)	.12" (3.0mm)

**BARREL KEYS**
**ILCO**

Material  
 Barrel Dia.  
 Hole Dia.  
 Hole Depth  
 Bit Height  
 Bit Width  
 Bit Thick

## Section 8

This section is separated into two parts as follows:

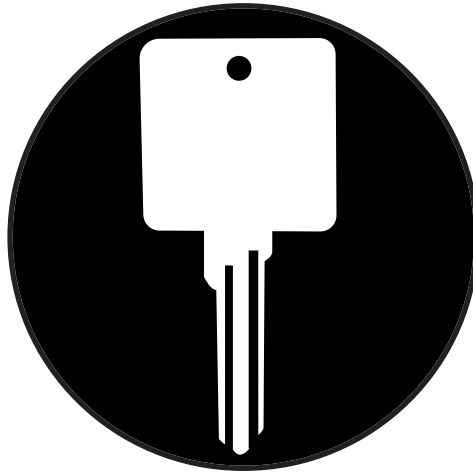

### Section 8a

## SPECIALTY KEYS

This section contains Large Bow, Neuter Bow, Personalized Keys and Painted keys.



### Section 8b

## MERCHANDISING AIDS

This section describes available ways to merchandise Ilco® key blanks.





### **Decorated (Painted) Keys**

Your consumer's eyes are sure to be drawn to this line of keys. Whether they are choosing a fun way to express their individual style or a functional way to differentiate one key from another, this popular category offers an ever changing variety of designs, patterns and officially licensed key blanks. See our web site for the latest designs.

Our patented decorating process allows for intricate, detailed designs as well as a specific and precise color match. This specialized process also provides Ilco brand decorated keys with a durable, scratch and chip resistant finish.



### **Personalized**

These keys are made to help you to promote your business and assure repeat business. Ilco offers you a wide variety of keyways and bow (head) styles for your personalized information. Two types of personalization are available; state-of-the-art laser engraving or a high quality embossed customer logo and/or other information. You can also choose from original manufacturers bow shapes, the neuter/security bow, or from several custom shapes.



### **Neuter Bow**

Security Head keys have a common or "neuter" bow and may be incised with "DO NOT DUPLICATE". The common bow does not have an identifying number which helps to deter unauthorized duplication. The back of the key is blank and may be imprinted with your specific information, room numbers, etc. The most popular residential and commercial keyways are available in this line of keys.



### **Large Bow**

Large bow keys (also known as hotel keys) offer your customers another option to meet their requirements. This line is made from nickel silver stock to provide greater torque strength; providing more resistance to twisting and breakage. Keys feature a "blank" area for stamping. This line may also be coined to your specifications by adding logos and special designs.



### **Color Plastic Head**

Color plastic head keys offer you customers another solution for visual identification.

Ilco offers two styles for you to choose from; Cool Colors are a line of "soft-gel", transparent color plastic head keys. Solid Color Plastic Head include an opaque color plastic that is framed in metal.

### Key Center

The modular Key Cutting Center allows you to maximize profits per square foot. From a small footprint, you have the flexibility to build from a smaller, single tier tower to the larger double tower with the most popular of both residential and commercial key blanks.

Add Key Tower accessories that fit your requirements. Accessories include a 4-wheel cart with built in shelving, to garage side racks for “niche” keys, to a garage with shelf for additional equipment or storage.

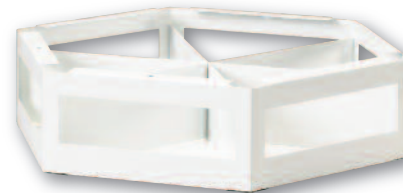



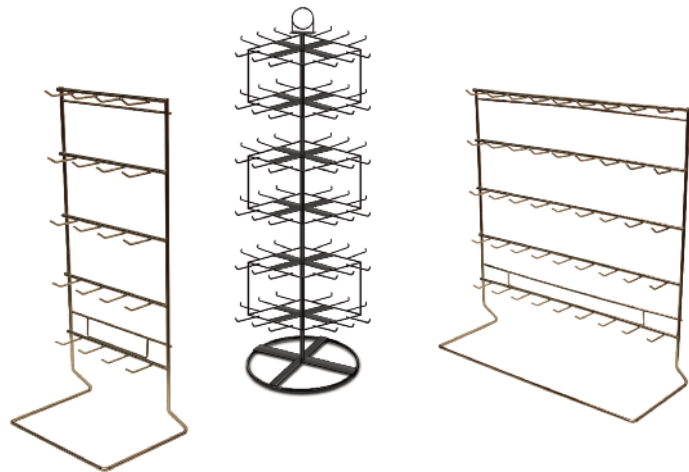

**Displays**

For merchandising, choose from rotating racks, carded racks or flat panel displays. Our selection of displays ranges from small “free-standing” to large “wall-mounted”. These are perfect for your specialized or “niche” assortments or for consolidating consumer favorites such as painted keys.

A specialized grouping of painted keys can be featured on a small acrylic display. This display with insert is included with many of our assortments or you can order the plain display and develop your own insert for localized, personal promotions.

Displays are updated to meet changing requirements. Check with your distributor for current offering.

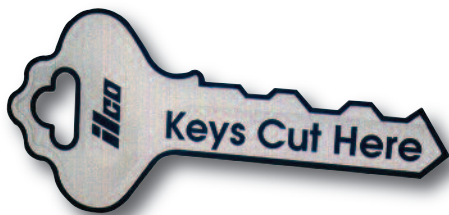

**Point Of Sale (POS) Support**

Ilco offers an ever changing assortment of POS support materials. This includes signs, banners, decals, and more to help maintain and support product sales.

POS support items are updated to meet changing requirements. Check with your distributor for current offering.





**Section 9**  
**KEY MACHINES**

This section presents the current line-up of Ilco and Silca brand standard and specialty key machines.

**008A - Manual  
Duplicator (Cylinder/Automotive)**

The Mini-Mite manual duplicator is a lightweight, compact machine that is perfect for carrying right to the job. Weighs only 10 lbs. (4.5 kg.). Use the optional 27X accessory pack to convert the 008A to cut flat style keys.

Weight: 10 lbs. (4.5 kg)  
Dim.: 8"W x 5.25"D x 4" H  
(20.3cm x 13.3cm x 10.2cm)

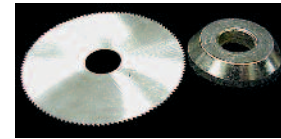
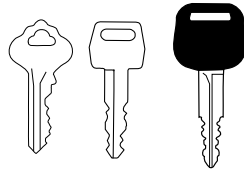

27X

**044 HD - Semi-Automatic  
Duplicator (Cylinder/Automotive)**

This lever controlled semi-automatic machine cuts accurate duplicate keys with speed! A typical single sided key can be cut in just seven seconds. Extra wide vise jaw spacing accommodates keys with large bows and long blades. Compatible with most generators/inverters 500 watt output and higher. Maintenance free Ball Bearing cutter spindle system, hardened shafts, Super Jaw 3 "sure grip" vises.

Weight: 42 lbs. (19 kg)  
Dim.: 14.5"W x 16"D x 10"H  
(36.8cm) x (37cm) x (28cm)

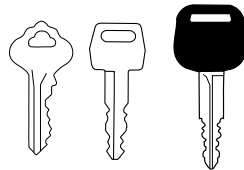

**PERFORMANCE  
Series**

**045 HD - Manual  
Duplicator (Cylinder/Automotive)**

The 045 is the perfect basic duplicator for any store or shop. It is accurate, economical and easy to use! The offset carriage lets you gauge keys at their tip or shoulder as needed for maximum versatility. Maintenance free Ball Bearing cutter spindle system, hardened shafts, Super Jaw 3 "sure grip" vises.

Weight: 32.8 lbs. (14.9 kg)  
Dim.: 14.5"W x 17.5"D x 8.75"H  
(36.8cm) x 44.5cm x 22.2cm)

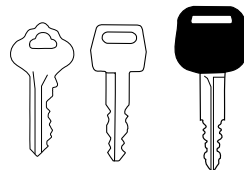

**PERFORMANCE  
Series**

**040 HD - Manual/Automatic  
Duplicator (Cylinder/Automotive)**

Designed to handle keys with large bows or long blades, the 040 is an automatic machine that can be used manually as needed. The Super Jaw 3 vises can be set four different ways to hold virtually any key. A very versatile key machine. Maintenance free Ball Bearing cutter spindle system, hardened shafts, Super Jaw 3 "sure grip" vises

Weight: 36 lbs. (16.4 kg)  
Dim.: 15.5"W x 16"D x 8.5"H  
(39.4cm x 40.6cm x 21.6cm)

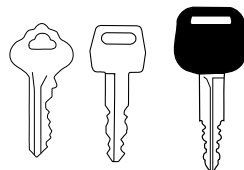

**PERFORMANCE  
Series**





**KD50C - Semi-Automatic Duplicator (Cylinder/Automotive)**

Remarkable speed and accuracy in a superbly crafted machine. Cuts single sided keys in as little as five seconds! The vise jaws are engineered to grip even the most troublesome double-sided auto keys. Loaded with features every user will appreciate. Superior design provides outstanding cutting accuracy and dependable, long term performance.

Weight: 55 lbs. (25 kg)  
 Dim.: 16"W x 18"D x 10" H  
 (41cm x 46cm x 25cm)

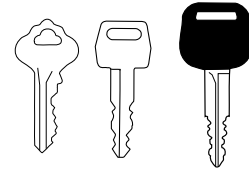

**Bravo III (with EZ-Jaw™ vises) - Semi-Automatic Duplicator (Cylinder/Automotive)**

A sturdy machine designed to deliver years of service. The Bravo III features quickly to rotatable, EZ-Grip 4-position vise jaws, twin carriage shafts, a safety release carriage, and a micrometer adjustable tracing guide. Precision machined parts and ergonomic design provide for unsurpassed accuracy and ease of use.

Weight: 42 lbs. (21 kg)  
 Dim.: 15"W x 18"D x 9.5"H  
 (42cm x 53cm x 30cm)

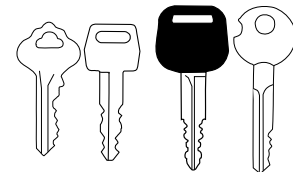

*PERFORMANCE Series*

**029A - Manual Duplicator/Code Cutter (Cylinder/Auto)**

A dual function machine designed to cut automotive keys by code\* or by duplication. Engineered for the increasingly precise newer generation of locks. Built to last and produce keys in an economical manner. Code capabilities can be expanded with economical code component kits. \*Code accessories sold separately.

Weight: 42 lbs. (19 kg)  
 Dim.: 15"W x 14.5"D x 9"H  
 (38cm x 37cm x 23cm)

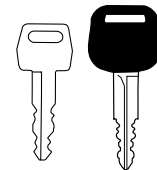

**Ultracode® Deluxe- Electronic Code Cutter (Cylinder/Automotive)**

The Ultracode® Deluxe, an innovative electronic code-cutting machine features automatic calibration, key registration and code cuts keys either stand-alone or linked to a personal computer. Using its patented optical reader, the Ultracode is also able to duplicate keys with incredible accuracy. A variety of cutters, jaws and adapters are available making this a very versatile machine.

Weight: 81 lbs. (37 kg)  
 Dim.: 19.75"W x 19.75"D x 16.5"H  
 (50.16cm x 50.16cm x 41.9cm)

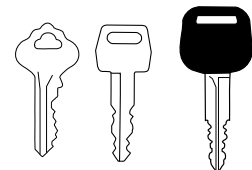

**Universal II - Dial Operated  
Code Cutter (Cylinder/Automotive)**

The ultimate "card-type" code machine! The Universal II allows the operator to switch from originating keys for one lock system to another in seconds. Special performance features include dial-type depth adjustment, wide key alignment gauge and "EZ View" code cards with special space and depth markings for faster, more precise operation. Supplied with two cutters and 140+ code cards.

Weight: 37.5 lbs. (17 kg)  
Dim.: 12"W x 14"D x 10"H  
(30.4cm x 35.6cm x 25.4cm)

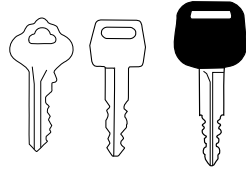

**Ilco EZ<sup>®</sup>-Code  
Code Cutter (Cylinder/Automotive)**

The Ilco EZ<sup>®</sup>-Code electronic code machine cuts traditional automotive and commercial keys by indirect code, biting number, or duplication. Includes an internal database containing over 200 automotive code series, and electronic cut specifications that allow it to originate keys for hundreds of different locking systems. Can also be used in conjunction with Kreate-A-Key<sup>™</sup> code software and a customer supplied PC. Microprocessor controlled for maximum accuracy.

Weight: 52 lbs. (23.6 kg)  
Dim.: 10.5"W x 19.5"D x 9"H  
(26.67cm x 49.53cm x 22.86cm)

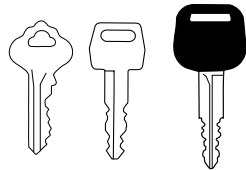

**Tri-Code HS  
Code Cutter (Cylinder/Automotive)**

The electronic Tri-code HS is designed for cutting internal and external "wave style" high security keys. Cuts by indirect code or biting number, it can also decode and copy a working key. Straightforward menu driven operation, three position vise clamp, and "single cutter" design, makes for a very simple cutting process. Easy to read LCD screen and intuitive keypad operation. Advanced electronics and precision parts combine to deliver superior cutting accuracy.

Weight: 95 lbs. (43.2 kg)  
Dim.: 19.7"W x 19.7"D x 18.9"H  
(49.96cm x 49.96cm x 47.98cm)

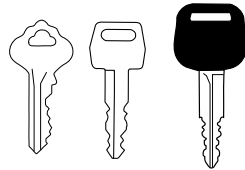

**Crown - Lever Assisted  
Specialty (High Security)**

The self centering synchronized key vise clamps are designed for precision duplication of tubular keys. In addition to the key styles that can be duplicated by the standard key vise clamps, additional clamps are available for cutting highly specialized tubular key types. (T10 Jaw is supplied with machine).

Weight: 37.4 lbs. (17 kg)  
Dim.: 9"W x 17.75"D x 7"H  
(23cm x 45cm x 18cm)

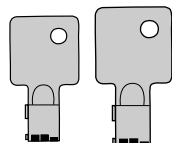



**Delta FO - Manual Specialty (High Security) Code Machine**

Simple to operate, the Delta FO is designed to cut by code the unique cuts required for Ford Tibbe and Jaguar Tibbe style keys. Ergonomic design, direct drive motor and high strength polymer base makes the Delta FO the ideal solution for cutting these high security keys.

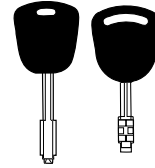

Weight: 30 lbs. (17 kg)  
 Dim.: 8.5"W x 14.75"D x 10"H  
 (21cm x 3cm x 25cm)



**Matrix S - Lever Assisted Duplicator & Code (High Security)**

Precision control in all three axis provide the ability to duplicate laser and dimple style keys with ease. The Matrix vise jaws handle a wide variety of keys without the need for adapters. Many types of commercial and automotive keys now use keys that can be duplicated only on a Matrix style key machine. Includes electronic adjustment feature. Cutters available for cutting various specialty key types.

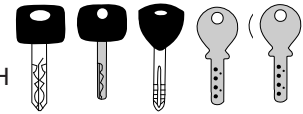

Weight: 44 lbs. (20.15kg)  
 Dim.: 13.75"W x 15.75"D x 17.9"H  
 (34.8cm x 39.9cm x 45.5cm)



**Triax-e.Code - Electronic Duplicator & Code (High Security)**

The Triax-E.code is the first three axis stand alone machine that duplicates and cuts by code high security keys. It will also decode keys and automatically convert the cuts back to original lock specifications. The machine features quick and easy tool changes, automatic calibration and dual speed motor. The Triax can also be connected to a PC with an optional software package.

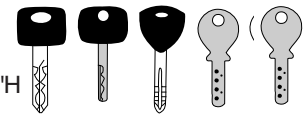

Weight: 92.4 lbs. (42 kg)  
 Dim.: 16.75"W x 2.3"D x 19.75"H  
 (42.5cm x 51.5cm x 50cm)



**Quattrocode - Electronic Duplicator & Code (High Security)**

This computer operated high security key machine automates many functions. It can decode a sample key, compare it to an on-board database, and automatically adjust to original lock specifications. Software includes popular high security code series for cutting by code.

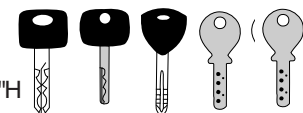

Weight: 132 lbs. (60kg)  
 Dim.: 15.38"W x 22.5"D x 22.5"H  
 (39cm x 57 cm x 57cm)



### 046 HD - Manual Duplicator (Flat and Safe Deposit)

The perfect basic duplicator for flat style keys. Accurate, economical and easy to use. The offset carriage permits gauging of keys from tip or shoulder. Equipped with a .045" thick titanium nitride coated side milling slotter blade. Maintenance free Ball Bearing cutter spindle system, hardened shafts, Super Jaw 3 "sure grip" vises.



Weight: 32.8 lbs. (14.9kg)  
Dim.: 14.5"W x 17.5"D x 8.75"H  
(36.8cm x 44.5cm x 22.2cm)



### Engrave-It

Engrave keys, pet tags, luggage tags, ID tags, and brass plates with this durable, compact engraving unit. Featuring simple menu driven operation, the Engrave-It is the perfect complement to key duplication services. A broad range of engravable tag items is available. Visit our website [www.kaba-ilco.com](http://www.kaba-ilco.com) to view the versatile Engrave-It in operation!

Weight: 48 lbs. (21.7kg)  
Dim.: 13.5"W x 13.25"D x 14.5"H  
(36.8cm x 44.5cm x 22.2cm)



### Engrave-It PRO

A commercial duty engraving product for engraving multiples of the same item. Accessory key blank holders accommodate up to 24 blanks at a time; cylinder and core holder capacity varies dependent on item size. Can also be used for engraving brass metal plates and ID tags. A broad range of accessory holders are available. Includes special software and is intended for use with a customer supplied PC. Visit our website [www.kaba-ilco.com](http://www.kaba-ilco.com) to view the Engrave-It PRO in operation!

Weight: 65 lbs. (29.48kg)  
Dim.: 19"W x 22.5"D x 14.5"H  
(48.26cm x 57.15cm x 36.83cm)





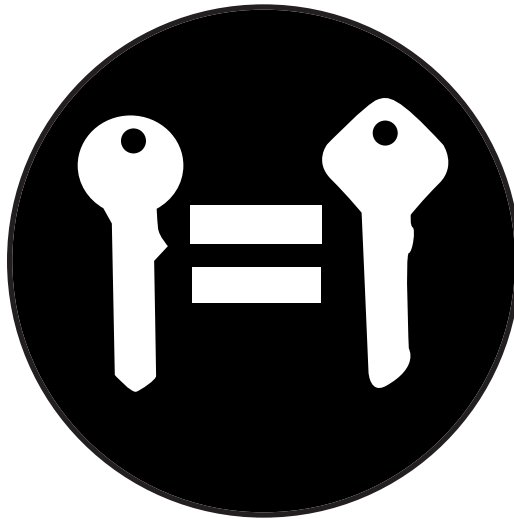

## **Section 11**

# **CROSS REFERENCE**

This section lists major lock and replacement key manufacturers in alphabetical order and their key numbers in the appropriate sequence. The ILCO key equivalent is listed beside the original or competitors' key number. This listing is set up as a functional cross reference. Certain replacement key manufacturers have been omitted due to laws in their respective countries concerning the publishing of a cross reference.



ALBA		ALBA	ILCO	ALBA	ILCO	ALBA	ILCO	ALBA	ILCO
A1	H1098LA	A82	P1099	EX21C	MZ13R	FC3	R1286E	S9	A1145E
A12/A15	X1199AR	A82A	P1101	EX21L	X188	FC4	N1286	SC22	1307W
A21/A22	H1098NR	A82P	B68-P	EX21P	MZ13-P	FC5	1286G	T11	O1122BE
A23	H1098DB	A83P	DA30-P	EX22	X174	H51	1167FD	T11D	O1122BR
A24/A28D	H1098M	A84P/F41LP	MB18-P	EX23A/MZ19	X201	HD99	X204	T28	T60
A24N/A24R	1098M	A86	X168	EX24A	X217	IN20/R26A	X1054K	T3	O1122A
A24RN/A23R	1098DB	A88	X180	EX26	X160	M1	1092	T32	PH32
A29X	D1759L	A89	P1106	EX27	X187	M12	170S	T37	TA16
A38	F91C	A89P	B86-P	EX28	X216	M15/M1L	1092N	T3NR	1550
A4	H199A	A89S	P1107	EX29	X196	M15A	1092H	T4	O1122R
A43	1767CH	A89SP	B89-P	EX30	X198	M16/M6L	1092J	T40	1043B
A43N	1704K	C3	687Y	EX31	X154	M18	1092D	T43	SC1098X
A44/A68	P1770U	CG16	1041T	EX33	X214	M19	PZ1	T44	X132
A44N	S1767CH	CO26/T25	1000V	EX34/HD92	X183	M1C	1092R	T48	HG3
A45	63JA	CO6E/E120	X999	EX36	X224	M2/M2C	1092VR	T49	SW3
A46C	NE11	CY10	1N	EX39	X144	M6	VR91	T50	SW2
A46R	NE39	CY4	1	EX40	X140	M6C	VR91R	T51	SW1
A47C	VR61S	E1	1001EN	EX7	X54	M9	L67A	T52	1180S
A48	MR63E	E10/E24	1041GB	EX8	MB16	MZ20	X199	T55	101AM
A48A	HF1	E105	1096C	EX8A	MB15	P109	1233M	T55A	102AM
A48B	A62VN	E106	R1001EM	EX8B	MB18	P110	633MH	T6	L1054B
A5	1199DR	E107/E1LL/E2LL	1001EL	EX9	FT38	P2	1210A	T6B	1069
A50	R62PF	E108N	1175N	EX92	X193	P45	1569	X14	1176D
A50C	62PF	E109	1176	EX9A	FT37	P5	1215B	X16C	T61B
A50D	R62PD	E110	D1098X	EYA1C	H999R	R12L	998	X18P	S48HF-P
A50M	YM6	E119/HL1	1003M	EYA3/Y3/Y5	H997E	R11/Y5E/Y6	H999	X5	1137B
A50N	R62PG	E119C/HL2	R1003M	EYA3C/Y4	H997ER	R20A	1553	X7	XPA2
A51	V61A	E12L	1000F	F1	1125D	R20C/E10L	1041G	Y1	997EB
A58A	63TV	E12LD	1000FR	F16	62DG	R20N	1585	Y10	O1122AR
A59	63TW	E14	1013	F16C	62DC	R24	LP21W	Y15	997GX
A6/A7	H1098A	E16L	L1014D	F16N	62DP	R25	S54F-PC	Y2	R997EB
A60	BR6	E19	C1041DN	F17	HF35	R26	1054K	Y30	YH20
A61A	DT15	E1L	1001EG	F17C	HF17	R30	1016	Y30D	YH6
A61C	DT16	E21L	1001A	F19	61VW	R38	1033D	Y35/Y35P/Y40	HD57
A61N	X6	E22	1000	F1M	M1127A	R4	1079B	Y35C	HD56
A61NC	X7	E22LL	1000A	F2	1125F	R42	R61T	Y36	X84
A61NP	DAT6P	E23	1041FG	F22	LR62VJ	R42A/R62	61T	Y36C	HD63
A63	YM8	E27	1041GR	F22N	62PE	R46	D1098B	Y37	X103
A63A	UR62VP	E28	1041GA	F23N	L62VJ	R47	A1054KD	Y38	KA12
A64	P1098A	E2L	1001EA	F24	61G	R47L	D1054KA	Y39	X87
A64A	1970AM	E3	1009	F24A	R61G	R47N	D1054K	Y40C	X120
A64P	B48-P	E38A	SX1000F	F24D	R61D	R5	1079	Y41C	X118
A65	S1098B	E3L	1009A	F24DC	61D	R52	PHA1	<b>AMERICAN</b>	
A65P/FC36	B49-P	E40	1016N	F28	VW63A	R52L	PHA2	<b>AMERICAN</b>	<b>ILCO</b>
A66	P1098C	E41/Y41	X117	F29	VW63	R53	1054WB	BKB	1041C
A66NP	B64-P	E42A	1549	F2A/H50	S1167FD	R53L	A1054WB	BKB-A	1041CK
A66P/X25	B50-P	E42AN	9MX	F2E	1193FD	R53N	1054WC	BKB-C	1041CE
A67	S1098D	E42DN	1548	F2EP	H67-P	R55	R63	HTKB-7	1137B
A67P	B51-P	E45/E45A	1041W	F2H	1196FD	R57	R64	LPKB-4	1041B
A68P	Y153-P	E4A	1010U	F2L/H54	1184FD	R60	CB10	PT747-1	A1041U
A69	S1770U	E5	1022	F2LL	1190LN	R61	1045	PTKB-1	1046
A70	P1098E	E7	1011	F2LL-P	1185T-P	R61L	A1045	PTKB-2	1046A
A70P	B44-P	E79	1014	F2X	1127DU	R63	1179	<b>ARROW</b>	
A71	S1970AM	E80	1014F	F30	R62DH	R63L	1179A	<b>ARROW</b>	<b>ILCO</b>
A72	P1098J	E84	1007LF	F30C	62DK	R65	R1064E	K2	1179
A73	S1098H	E84A	1007LB	F33	B62DR	R66	1069LB	K3	N1179
A73P	B45-P	E84D	1007LG	F35/F35P	VW71	R67	1011D1	K4	755U
A74	T61D	E88	A1114A	F37	X1	R67L	A1011D1	K7	1179A
A74L	X137	E97AN	R1001EN	F39	VC29	R69	PR91C	91E	A1179E
A74LC	X121	EAZ3/R8L	999A	F40	BU4	R6L	1054DL	91F	A1179F
A75	U1770CH	ETE1C	TE1	F41/F50	X9	RGA	998GA	91G	A1179G
A76	RT19	ETE8C/R59	TE4	F41P/F50P	73VB-P	RGD	998GD	91H	A1179H
A77	LM1	EV35/R1	999	F42/F47	X92	RGE	998GE	91J	A1179J
A78	S1098K	EV35C/P36/R2	999R	F43	NE14	RGH	998GH	91K	A1179K
A79C	X123	EX10	P1098V	F44	NE15	RGK	998GK	91L	A1179L
A79CAP	DA31-P	EX11/F36C/F36CP		F45	X61	S1	1307A	91N	A1179N
A79CP	DA25-P	VW71A		F46	X53	S10	1145E	91P	A1179P
A8/A10	X1199B	EX11A	V27	F48	X85	S14	A1145CE	91R	A1179R
A80	X124	EX12A	X51	F51	X139	S15	A1145L	91S	A1179S
A81	P1789	EX12C	X138	F52	NE34	S16	1145CE	91T	A1179T
A81A	P1793	EX13	X46	F53	X116	S17	A1145EF	91U	A1179U
A81AP	Y155-P	EX14	X27	F53P	RN24-P	S1A	R1307A	91V	A1179V
A81D	P1794	EX14A	X26	F54	X221	S1B/S20	L1307A	<b>BEST</b>	
A81DP	Y157-P	EX17	BR16	F8	1132	S5	1145A	<b>BEST</b>	<b>ILCO</b>
A81P	Y154-P	EX20	X71	FC15	1286BR	S6/SC1	1145	1A1A1	A1114A
		EX21/MZ13	X131	FC25	SLA13	S7	A1145F	1A1B1	A1114B
				FC26	SLA11	S8	1145F	1A1C1	A1114C

BEST	ILCO	B & S	ILCO	B & S	ILCO	CHICAGO	ILCO	CHICAGO	ILCO
1A1D1	A1114D	322050	P1098WE	690556	B103-PT	K102	102AM	B50	P1098C
1A1E1	A1114E	322177	B85G	690556	B103-PT5	K103	103AM	B51	S1098D
1A1F1	A1114F	322465	B92GV	690898	B99-PT	K104	104AM	B53	X143
1A1G1	A1114G	322727	1098M	690898	B99-PT5	K10-5	C1041B	B54	X154
1A1H1	A1114H	323789	Y158VCHY			K137	1137B	B55	X145
1A1J1	A1114J	593196	B48-P		<b>CCL</b>	K16	1041DC	B56	X146
1A1K1	A1114K	593196	B48-PC	4193C-AR	1000DA	K19	1041DH	B61	X168
1A1L1	A1114L	593196	B48GP	4193C-BL	R1001D	K2	1041D	B63	P1098CV
1A1M1	A1114M	593197	B49-P	4193C-BR	1001D	K20	H1041T	B64	P1098WC
1A1Q1	A1114Q	593197	B49-PC	4193C-WL	1001WL	K21	CC21	B65	X184
1A1R1	A1114R	593197	B49GP	4195C-BR	1001DA	K23	C1041C	B67	S1098WD
1A1TB1	A1114TB	593578	Y153-P	4197 1/4-YB	1001K	K29	CC29	B68	P1099
		593578	P1786	5860-KM	S1000XK	K2W	1041N	B69	X180
		593578	Y153PCHY	5860-KS	S1000X	K30	CC30	B74	X198
		593719	B51-P	5861-KM	1000XK	K35/K46	1041E	B77	P1098EV
		593719	B51-PC	5861-KS	1000X	K35M	C1041J	B78	P1098WE
		593719	B51GP	5862C-R34	S1003CD	K37	C1041L	B79	S1098WH
		593746	B64-P	5864-JL	SR1000T	K38	C1041N	B86	P1106
		593746	B64-PC	5865-JL	1001JL	K39	C1041P	B88	P1108
		593746	B64GP	5865-JR	S1000T	K4	1041G	BA2	1021BA
		593942	B63-P	5865-JS	S1001JB	K40	1041DE	BE2	A1114A
		593942	B63-PC	5865-JVL	SR1000V	K43	1041DV	BM2	X59
		593942	B63GP	5865-JVR	S1000V	K44	R1041DV	BM3	X144
		594032	B50-P	8618C-CL	X1000GR	K4L	1041GA	BN1	K1122D
		594032	B50-PC	8618C-CR	1000G	K4R	1041GR	BN3	L1098M
		594032	B50GP	8618C-CR	X1000G	K4W	C1041DN	BN3	L1054M
		594145	Y154PCHY	8618C-R1	1003A	K4XV	1041GB	BN7	K1122N
		595198	B45-P	8618C-R12	1003AB	K5	1041T	BO1	R1003M
		595198	B45-PC	8618C-R14	1003M	K5K	S1041T	C2	1040
		595293	Y154PJP	8618C-R2	1003B	K5M	C1041A	C3	1040A
		595311	B44-P	8618C-R3	1003C	K6	1041M	C5	1040C
		595311	B44-PC	8618C-R34	1003CD	K7	1041K	C6	R1040C
		595312	B78-P	8618C-R4	1003D	K9	1041TR	C7	CH4
		595312	B78-PC	8618C-VR	O1000GX	KP1	1041Y	C8	1040E
		595312	B78GP	8632C-CR	1000H	KP12	C1041R	CG1	1041G
		595313	B77-P	8632C-CR	1001CR	KP13	C1041T	CG14	1041Y
		595313	B77-PC	8632C-R1	S1003A	KP14	C1041JB	CG15	1041T
		595313	B77GP	8632C-R12	S1003AB	KP16	C1041YR	CG16	1041E
		596504	P1794	8632C-R14	S1003M	KP17	C1041TR	CG2	1041GA
		596508	Y157PJP	8632C-R2	S1003B	KP18	C1041SR	CG4	1041GR
		596756	H65F	8632C-R3	S1003C	KP2	SC1041R	CG6	1041N
		596757	H66M	8632C-R4	S1003D	KP3	SC1041S	CH6	A1015M
		596758	1193FD	8632C-VL	O1000GR	KP4	SC1041T	CL1	1023
		596758	H67F	8632C-VL	XO1000GR	KP6	SC1041YR	CLB1	1573A
		596807	K1994	8632C-VR	O1000H	KP7	SC1041TR	CLB2	1573B
		596862	DA37-P	8658-JL	R1000T	KP8	SC1041SR	CLB3	1573C
		596862	X242	8658-JR	1000JR	KP9	S1041JA	CLB4	1573D
		597158	Y157PNEONY	8658-JR	1000T			CLB5	1573E
		597253	B92GP	8658-JS	1000P	<b>COLE</b>	<b>ILCO</b>	CLB6	1573F
		597500	B89-P	8658-JVL	R1000V	AB1	AB62C	CLB7	1581G
		597500	B89GP	8658-JVR	1000V	AM1	1041C	CLB8	1581H
		597638	H75F	8673C-CL	R1000HL	AM3	1045	CO1	1000
		597791	B91BCP	8673C-CR	1000HL	AM4	1046	CO10	1000G
		597796	B93GOP	8687C-CL	1000FR	AM6	A1045	CO10	X1000G
		597798	B93GP	8687C-CL	SX1000FR	AP1	101AM	CO105	L1003M
		597800	B93-P	8687C-CR	1000F	AP2	102AM	CO106	1003M
		598007	B102GCP	8687C-CR	SX1000F	AP3	103AM	CO107	1000X
		598009	B102GP	8687C-R1	L1003A	AP4	104AM	CO12	1000T
		598152	MIT6-P	8687C-R12	L1003AB	AP5	100AM	CO17	1000F
		598152	X263	8687C-R14	L1003M	AR1	1179	CO19	X1000F
		598333	H72-PT	8687C-R2	L1003B	AR2	755	CO2	1000AB
		598333	H72-PT-CLEAR	8687C-R3	L1003C	AR3	760	CO26	1000V
		599045	MZ30-P	8687C-R34	L1003CD	AR3	765	CO3	1001EB
		599045	X247	8687C-R4	L1003D	AR4	1179A	CO33	1001E
		599114	H74-PT	8687C-VL	XO1000FR	AU6	PA6	CO35	R1001EE
		599312	Y157PRAM	8687C-VR	XO1000F	AU8	X139	CO37	1001EL
		690222	Y160-PT	8688C-CL	X1000FR	B1	1098GM	CO5	1001
		690230	Y159-P	8688C-CR	X1000F	B1	1098M	CO54	1000FR
		690230	Y159PCHY	8688C-VR	1000FX	B10	H1098LA	CO54	X1000FR
		690230	Y159CHY	S1-26-5	X1001KC	B11	O1098LA	CO60	R1000T
		690231	Y157PNEONG	S1-96-5	1000K	B44	P1098E	CO61	1000P
		690231	Y157-PC-YEL-			B45	S1098H	CO63	R1001EG
		690503	Y161PJP	<b>CHICAGO</b>	<b>ILCO</b>	B46	P1098J	CO64	X1001KC
		690552	B97-PT	HTKB-7	1137B	B47	S1098K	CO65	1001EH
		690552	B97-PT5	K10	1041X	B48	P1098A	CO66	A1001EH
		690554	B104-PT	K100M	100AM	B49	S1098B	CO67	1011GH
		690554	B104-PT5	K101	101AM	B5	1098DB	CO67	1001GH

**CROSS REFERENCE**





COLE	ILCO	COLE	ILCO	COLE	ILCO	COLE	ILCO	CORBIN	ILCO
CO7	1001EN	IN1	X1054F	RT15	X12	VL6	X80	990.25	CB2
CO8	1000K	IN1	1054F	RT22	X116	VR1	VR91R	993.25	CB3
CO89	A1001ABM	IN10	S1096B	RT30	X147	VR2	VR91	6901	CB12
CO9	1000KC	IN10	1054FN	RU1	1011	VR3	VR91B	6903	CB1
CO90	L1001ABM	IN2	1054X	RU13	N1011S	VR4	VR91A	6906	CB7
DA21	X7	IN2	1054	RU13	1011S	VR5	VR91CR	K1-80-5	1001GH
DA22	X6	IN24	X1054JA	RU16	A1011P	VR6	L67A	L12-5PIN-10	1011-L12
DA23	DA23	IN29	1054UN	RU18	A1011PZ	VR7	VR91AR	L12-6PIN-10	A1011-L12
DA24	X114	IN3	X1054K	RU20	1011D1	VW10	V61VW	L12-7PIN-10	L1011-L12
DA25	X123	IN3	1054K	RU21	A1011D1	VW23	X9	L1-5PIN-10	1011-L1
DA26	X124	IN33	1054MT	RU22	1011GJ	VW24	VW71	L1-6PIN-10	A1011-L1
DA31	X210	IN34	1054TW	RU4	1011P	VW25	VW71A	L1-7PIN-10	L1011-L1
DE1	1054KD	IN35	1054DL	RU5	1011A	VW32	X53	L2-5PIN-10	1011-L2
DE3	D1098X	IN8	L1054B	S1	1009	VW32	X21	L2-6PIN-10	A1011-L2
DE7	D1054K	JA64	X10	S16	N1007KMB	VW37	X203	L2-7PIN-10	L1011-L2
DE8	D1054KA	JA74	X36	S22	O1007LA	VW42	X110	L34-5PIN-10	1011-L34
EA1	1014	JA77	X44	S23	O1007LB	VW9	U61VW	L34-6PIN-10	A1011-L34
EA27	1014F	JA80	HD71	S24	O1007LC	W1	1071	L34-7PIN-10	L1011-L34
EA27	X1014F	K1	1079	S25	O1007LE	WE1	1123	L3-5PIN-10	1011-L3
EA3	1013F	K2	1079B	S26	O1007LF	WK1	1175N	L3-6PIN-10	A1011-L3
EL10	C1096CN	KW1	S1176	S27	O1007LG	WK1	1175	L3-7PIN-10	L1011-L3
EL10	1096C	KW1	1176	S28	O1007LJ	WR1	X1054WA	L41-5PIN-10	1011-L41
EL11	C1096LN	KW10	A1176ST	S29	O1007LK	WR2	1054WB	L41-6PIN-10	A1011-L41
EL11	1096L	L1	1004	S3	1010	WR5	A1054WB	L41-7PIN-10	L1011-L41
EL15	L1096CN	L4	1004A	S30	O1007LL	XL7	1180S	L4-5PIN-10	1011-L4
EL16	S1096FL	L5	1004AL	S31	N1007RMA	Y1	999	L4-6PIN-10	A1011-L4
EL16	1096FL	M1	1092	S32	N1007RMB	Y101	L1122A	L4-7PIN-10	L1011-L4
EL17	S1096FM	M10	1092N	S4	1010U	Y103	O1122B	SY4-L2-6	CB11
EL17	1096FM	M11	1092H	S4	O1010	Y104	O1122BR	W-L2-6	CB9
EL8	S1096JN	M12	1092D	S43	1010N	Y105	O1122C	X1-057-6	R1001EM
EN13	X22	M13	1092J	S44	L1010N	Y106	X16	X1-067-5	1001ES
EN13	62FT	M2	1092B	S45	O1007RA	Y107	X121	X1-077-5	R1001ES
EN15	MG1	M3	1092VM	S46	O1007RB	Y109	1132	X1-077-6	R1001ET
EN2	62FS	M60	1092-6000	S47	O1007RC	Y11	O1122	X1-27-5	1001EB
ES9	1503	M70	1092-7000	S48	O1007RE	Y111	998GST	X1-27-6	1001EA
F5	FT38	M9	1092-900	S49	N1007KMC	Y12	O1122A	X1-27D2-6	R1001EP
F51	FT37	MD17	MD1054K	S7	1007	Y13	O1122R	X1-57A1-5	R1001EF
F77	FT6R	ME62	MB15	SB12	X31	Y131	X1199G	X1-57A1-6	R1001EE
FA3	A1054WD	ME63	MB16	SC1	1145	Y133	X1199AR	X1-57A1-7	A1001MF
FO153	61VW	ME66	MB18	SC10	A1145J	Y14	H1122FR	X1-57A2-6	1001MB
FO417	VW67S	MIT1	X176	SC11	1145E	Y14	O1122AR	X1-57A2-7	A1001MB
FO453	DA20	MZ10	X27	SC20	A1145L	Y141	1764S	X1-57B1-6	1001MA
FR2	F44	MZ12	X1	SC22	1307W	Y144	O1122BE	X1-57B1-7	A1001MA
GE1	VW67	MZ15	X131	SC4	1145A	Y145	999B	X1-57B2-6	R1001ED
GE2	FT5R	MZ19	X201	SC6	1307A	Y149	S1770U	X1-67-5	1001EN
GE26	PO5	MZ27	X222	SC7	A1145F	Y152	P1770U	X1-67-6	1001EG
H12	1125H	MZ4	X4	SC8	A1145H	Y153	P1786	X1-67-7	1001EL
H26	1127ES	MZ5	X5	SC9	A1145E	Y154	P1789	X1-67A1-6	A1001MJ
H27	1127DP	MZ9	X26	SE1	1022	Y155	P1793	X1-67A1-7	B1001EJ
H32	S1167FD	NA10	1064D	SE2	O1022	Y157	P1794	X1-67B2-6	A1001HP
H33	1167FD	NA12	1069LB	SE8	1022AB	Y159	P1795	X1-77-5	R1001EN
H54	1184FD	NA14	1069L	SF7	1049E	Y1E	999N	X1-77-6	R1001EG
H56	1186TS	NA5	R1064D	SK1	R1001EN	Y2	999A	X1-77-7	R1001EL
H6	1125D	NA6	R1064E	SL1	1120D	Y3	C999	X1-77A1-5	R1001MJ
H60	1190LN	NC2	1083H	SL15	1120F	Y34	997DA	X1-97-5	1001
H67	1193FD	NH1	1177N	SL17	1074B	Y4	998	X1-97-6	1001AB
H7	X20	OL1	1171	SL18	1120H	Y52	997E	X1-97-7	1001A
H70	X231	P1	1016	SL20	1120S	Y54	O997E	X1-99-5	1000
H75	1196FD	P2	1016N	SL24	1120J	Y57	J997M	X1-99-6	1000AB
H76	X244	PA1	1528	SQ1	192	Y7	996M	X1-99-7	1000A
H78	1196CM	PA2	1528R	T1	1141	Y78	998GA	Z1-059A-5	1001AM
HD103	X214	PH1	A1	T2	H1122M	Y79	998GB	Z1-059A-6	A1001AM
HD70	X71	PR6	X32	T4	1141E	Y80	998GC	Z1-059A-7	L1001AM
HD82	X129	PR7	PO7	T4	1141GE	Y81	998GD	Z1-059AB-5	1001ABM
HD90	X181	PZ1	PZ1	T7	1141F	Y82	998GE	Z1-059AB-6	A1001ABM
HD91	X182	RA3	S1970AM	TO20	T61C	Y83	998GF	Z1-059AB-7	L1001ABM
HO3	1170B	RA4	1970AM	TO22	T61F	Y84	998GG	Z1-059AD-5	1001GRM
HR1	1014C	RO1	1069	TO25	TR25	Y85	998GH	Z1-059AD-6	A1001GRM
HY12	X232	RO10	1069-5X	TO33	X137	Y87	998R	Z1-059AD-7	L1001GRM
HY13	X235	RO14	1069YM	TO37	X159	Y89	998VC	Z1-059B2-6	A1001DH
HY14	X236	RO3	1069B	TO39	X151	Y89		Z1-059B-5	1001BM
HY4	X187	RO3	N1069B	TO40	X174			Z1-059B-6	A1001BM
HY5	X196	RO4	1069FL	TO47	X217			Z1-059B-7	L1001BM
HY6	X216	RO5	1069E	TO53	X223			Z1-059C-5	1001CM
IL1	1041H	RO6	1069-5Y	VL12	VO62			Z1-059C-6	A1001CM
IL8	1043B	RO7	1069G	VL4	X30			Z1-059C-7	L1001CM
IL9	1043D	RO9	1069W	VL5	X29			Z1-059CD-5	1001CDM

**CORBIN/  
RUSSWIN**

**CORBIN**

**ILCO**

98  
98.25  
98.5

1002B  
1002A  
1002

**CROSS REFERENCE**

CORBIN	ILCO	CURTIS	ILCO	CURTIS	ILCO	CURTIS	ILCO	CURTIS	ILCO
Z1-059CD-6	A1001CDM	223	1225A	AR4	1179A	BM1	WT3	CM4	1040C
Z1-059CD-7	L1001CDM	226	1217	B1	1098GM	BM3	X144	CM5	R1040C
Z1-059D-5	1001DM	233	O1225N	B1	1098M	BN1	K1122D	CM6	1040E
Z1-059D-6	A1001DM	233 1/2	1427	B10	L1098LA	BN7	K1122N	CM7	R1040E
Z1-059D-7	L1001DM	239	1370	B10	H1098LA	BO1	R1003M	CO1	1000
Z1-59A1-5	1001AH	242	1332	B102	P1113	BV4	1036S	CO10	X1000G
Z1-59A1-6	A1001AH	242	1332S	B102-R	B102-P	BV5	1036U	CO10	1000G
Z1-59A1-7	L1001AH	242 1/2	1213AH	B11	O1098LA	BX2	1558	CO101	1001MK
Z1-59A2-5	1001FH	243	1224L	B2	H1098M	BX3	1594	CO102	A1001C2
Z1-59A2-6	A1001FH	243 1/2	1225G	B24	H1098X	CA10	A1170D	CO103	1003A
Z1-59A2-7	L1001FH	244	1270	B3	1098L	CA9	A1170C	CO105	L1003M
Z1-59B1-5	1001BH	245	1095A	B31	1764S	CB2	CH4	CO106	1003M
Z1-59B1-6	A1001BH	245	1270A	B31	1759P	CB3	CH5	CO107	A1001D1
Z1-59B1-7	L1001BH	249	1213A	B31	D1759L	CB4	CH6	CO108	A1001D2
Z1-59B2-5	1001DH	251	1033A	B4	1098X	CB5	CH7	CO110	R1001EK
Z1-59B2-7	L1001DH	251	1242L	B44	P1098E	CB6	CH8	CO12	1000T
Z1-59C1-5	1001C1	252	1426	B45	S1098H	CG1	H1041T	CO13	1000A
Z1-59C1-6	A1001C1	254	1303	B46	P1098J	CG1	1041G	CO17	1000F
Z1-59C1-7	L1001C1	254	1303S	B47	S1098K	CG13	1041FE	CO18	XO1000F
Z1-59C2-5	1001C2	257	1225E	B48	H1098A	CG16	C1041C	CO18 1	O1000GX
Z1-59C2-6	A1001C2	258	1321	B48	P1098A	CG16	C1041B	CO19	X1000F
Z1-59C2-7	L1001C2	259	1214	B49	O1098B	CG16	1041T	CO2	1000AB
Z1-59D1-5	1001D1	261	1221AL	B49	S1098B	CG17	1041Y	CO21	1000H
Z1-59D1-6	A1001D1	262	1270C	B5	1098DB	CG17 1	SC1041YR	CO22	1000HL
Z1-59D1-7	L1001D1	264	O1213	B50	H1098C	CG18	C1041R	CO23	R1000HL
Z1-59D2-6	A1001D2	265	1213AS	B50	L1098C	CG18 1	SC1041R	CO26	1000V
Z1-59D2-7	L1001D2	268 1/2	1222L	B50	P1098C	CG18 3	SC1041TR	CO27	R1000V
Z1-60-5	1001EH	270	1217A	B51	O1098D	CG19	1041DC	CO28	1001A
Z1-60-6	A1001EH	279	O1221L	B51	S1098D	CG2	1041GA	CO3	1001EB
Z1-60-7	L1001EH	280	O1223L	B52	X154	CG20	C1041DN	CO30	1001C
Z1-62A1-6	1001A1	290	1210A	B53	X143	CG22	1041E	CO33	1001E
Z1-62A2-6	1001A2	302	1206A	B55	X145	CG23	C1041J	CO34	R1001ED
Z1-70-6	A1001EHR	304	1028D	B56	X146	CG24 3	SC1041SR	CO35	R1001EE
	<b>CURTIS</b>	305	1306A	B57	X158	CG26	C1041L	CO35 1	R1001EF
	<b>ILCO</b>	305	S1306A	B59	X162	CG27	C1041P	CO351	CB6
2	2B	306	1243D	B61	X168	CG27 1	S1041T	CO36	1001EG
3	7B	308	1222B	B62	P1098AV	CG29	1041TR	CO37	1001EL
5	45B	308	1093	B63	P1098CV	CG3	1041GB	CO4	1001EA
7	25B	313	1222E	B64	P1098WC	CG31	C1041A	CO41	1000P
13	9B	314	1028A	B67	S1098WD	CG33	1041FG	CO42	R1000T
16	49B	322	1084	B68	P1099	CG34	1041DH	CO43	1001K
17	12B	322	1226	B69	X180	CG35	1041M	CO44	1001MA
20	17B	337	1309	B70	X184	CG37	CC21	CO45	1001MB
27	19B	342	1425	B72	X192	CG38	1041DV	CO5	1001
29	66B	345	1323	B74	X198	CG39	R1041DV	CO54	1000FR
33	8B	406	1286E	B77	P1098EV	CG4	1041GR	CO54 1	X1000FR
39	56B	407	R1286E	B78	P1098WE	CG41	S1041JA	CO57	A1001HP
40	3B	411	1286C	B79	S1098WH	CG43	1041DE	CO6	1001AB
47	71B	412	N1286	B80	X225	CG44	R1041DC	CO60	A1001MF
48	78B	415	N1286R	B84	P1101	CG45	C1041YR	CO61	A1001MB
49	79B	421	1286B	B85	S1105	CG46	C1041TR	CO62	R1001EG
50	5B	516	1233M	B86	P1106	CG47	C1041SR	CO63	1000X
56	6B	525	T44	B87	K1994	CG5	1041K	CO64	A1001MA
60	1B	543	1416	B88	P1108	CG6	1041N	CO68	S1000V
63	67B	573	70S	B89	P1107	CG7	1041X	CO69	A1001MJ
67	136SB	603	1147	B90	1588	CH1	1015	CO7	1001EN
73	92B	606	1148	B91	P1111	CH10	A1015N	CO71	1001EJ
74	91B	A71 1/22	1007CB	B91PH	B91-P	CH11	A1015P	CO75	X1001KC
106	84B	AA1	H61VR	B92	P1109	CH12	A1015Q	CO77	S1000X
107	24B	AA2	X51	B93	P1112	CH13	A1015R	CO8	1000K
108	23B	AA3	X50	B96	P1110	CH14	A1015S	CO83 1	A1001MJR
109	21B	AM1	1041C	BA1	1021B	CH15	A1015T	CO85	1001DA
112	34B	AM3	1045	BA2	1021BA	CH16	A1015U	CO87	1001GRM
115	22BB	AM3	1046	BC3	R7DC	CH17	A1015V	CO88	A1001EH
134	27B	AM4	1041CE	BD1	63F	CH18	A1015W	CO89	A1001GRM
201 1/2	1225BL	AM5	1046A	BD2	H62VG	CH19	A1015X	CO9	1000KC
202	1270B	AM7	A1045	BD3	62VH	CH20	A1015Y	CO91	A1001AH
204	O1215	AP1	101AM	BE1	1114	CH3	1015C	CO92	A1001FH
205	1215B	AP2	102AM	BE10	A1114H	CH5	1015M	CO93	A1001AM
206	1215A	AP3	103AM	BE2	A1114A	CH6	A1015M	CO94	A1001BH
208	1211B	AP4	104AM	BE3	A1114B	CH7	A1015C	CO95	A1001DH
210	1417A	AP5	100AM	BE4	A1114D	CH9	A1015L	CO97	1001GH
213	1422	AR1	1179	BE5	A1114E	CL1	1023	CO98	A1001C1
215	1270D	AR2	750	BE6	A1114C	CL2	1023A	CS1	1178
215	1417	AR2	755	BE7	A1114F	CM1	1040B	CU2	1181C
215 1/2	1225PL	AR3	760	BE8	A1114FM	CM2	1040	CY1	CE1
220	1217D	AR3	765	BE9	A1114G	CM3	1040A	DA12	DT9

**CROSS REFERENCE**

CURTIS	ILCO	CURTIS	ILCO	CURTIS	ILCO	CURTIS	ILCO	CURTIS	ILCO
DA13	DT10	FC9	FC9	HD69	X44	KA20	X254	NA1	1064
DA14	DT11	FO201	VR91	HD70	HD70	KA21	X255	NA12	1069LA
DA15	DT12	FO202	VR91AR	HD71	HD71	KA22	X256	NA12	1069LB
DA16	DT13	FO203	VR91B	HD73	X58	KA23	X257	NA14	1069L
DA17	DT14	FR1	TE3	HD74	HD63	KA24	X258	NA26	R1064E
DA18	DT6	FS1	FU2	HD75	X138	KA25	X259	NA6	R1064D
DA19	DT16	FT11	LA7	HD80	X129	KA26	X260	NC1	1083
DA20	DA20	FT16	61E	HD81	X130	KA27	X261	NH1	1177N
DA21	X7	FT16	SE1C	HD84	HD59	KA28	X262	NH1	1177
DA22	X6	FT16	61TS	HD90	X182	KA6	X23	NH2	1177A
DA23	DA23	FT19	61D	HD90PH	HD91-P	KA7	X24	OP11	OP11
DA24	X114	FT2	F91E	HD91	X181	KK1	X233	OP15	YM6
DA27	X123	FT22	61F	HD91PH	HD90-P	KK2	X240	OP19	U62VP
DA27PH	DA25-P	FT28	F91EH	HD92	X183	KK3	X253	OP8	62PD
DA28	X124	FT28	F91ES	HD95	X191	KU1	1539	P1	1016
DA32	X227	FT29	F91FS	HD96	X193	KU2	1540	P2	1016N
DA34	X237	FT29	F91FH	HD98	X195	KW1	S1176	PA2	PO5
DA34PH	DA34-P	FT29	F91F	HD99	X204	KW10	A1176ST	PA5	PA5
DA35	X238	FT30	F91GS	HL3	X95	KW2	1176D	PA6	PA6
DA37	X242	FT30	F91GH	HL4	X96	KW4	1176	PA7	X32
DA37PH	DA37-P	FT30	F91G	HO1	1170B	KW5	A1176	PA8	X88
DA38	X243	FT31	F91HH	HR1	1014C	L1	1004	PE1	1034
DA38PH	DA38-P	FT31	F91H	HU1	1020	L10	1004M	PL7	DM4
DC2	X54	FT32	F91C	HY14	X236	L10	L1054JA	PP1	7DC
DC3	X121	FT33	F91CR	HY14PH	HY14-P	L13	1004N	PU10	1866-10
DE1	1054KD	FT36	F44	HY2	X160	L14	H1004A	PU13	1866-13
DE2	D1098B	FT37	FT37	HY3	X187	L2	1005	R1	1140
DE4	D1098X	FT38	FT38	HY3PH	HY4-P	L21	1004SN	R2	1146
DE5	A1054KD	FT39	NE9	HY4	X196	L22	1004AR	R3	1140G
DE6	D1054K	FT39	NE20	HY4PH	HY5-P	L3	1006	RA1	1098NR
DE8	D1054KA	FT43	X109	HY6	X216	L4	1004A	RA2	H1098NR
DO1	L54K	GF1	H62FD	HY8	X232	L5	1004AL	RA3	S1970AM
DO2	22PO	GR1	1524	HY8PH	HY12-P	LF1	X13	RA4	1970AM
DO3	P54F	H10	1125H	HY9	X235	LF2	LF2	RA7	1584
EA1	1014	H10	1125F	HY9PH	HY13-P	LUV1	P1098V	RD4	1069HN
EA10	L1014D	H19	1761B	IL1	1041H	M1	1092	RE1	1019
EA12	1014A	H26	1127ES	IL10	1043D	M10	1092N	RE2	1019A
EA13	1014DX	H27	1127DP	IL13	ILL1	M11	1092H	RN16	LM1
EA13	1014D	H50	S1167FD	IL14	ILL2	M12	1092D	RN17	NE18
EA14	1014DA	H51	1127TB	IL15	1043C	M13	1092DS	RN23	X12
EA27	1014F	H51	1127ME	IL17	1043E	M15	1092R	RN24	X116
EA27	X1014F	H51	1167FD	IL2	1041P	M16	1092NR	RN25	X92
EA3	1013F	H52	S1181FD	IL4	1041S	M2	1092B	RN27	X150
EA32	O1014J	H53	1181FD	IL5	S1042Z	M3	1092VR	RN30	X147
EA35	1014K	H54	1184FD	IL7	S1042ZS	M4	1092VM	RN32	X175
EA36	1014DB	H55	1185FD	IL9	1043B	M4	1092V	RN33	X171
EA47	O1014S	H56	1186TS	IN1	1054F	M6	1092VA	RN5	RE61N
EA8	1013DL	H59	X202	IN12	1125A	M7	1092C	RN9	RE61XR
EC1	EX1	H6	1125D	IN14	1054N	M70	1092-7000	RO1	1069
EL1	1096C	H60	1190LN	IN17	1054P	M8	1092DD	RO3	S1069H
EL10	C1096CN	H62	1191ET	IN18	X1054F	M9	1092E	RO4	1069FL
EL11	C1096LN	H65	X221	IN2	1054X	MB33	MB18	RO5	1069M
EL12	S1096JN	H67	1193FD	IN2	1054	MB34	MB15	RO7	1069G
EL13	X1054JK	H70	X231	IN20	X1054K	MB35	MB16	RO8	1069-5Y
EL14	1096EN	H70PH	H70-P	IN22	X1054AR	MD17	MD1054K	RS1	M64
EL15	L1096CN	H71	1195FD	IN23	X1054BK	MG1	MG1	RS2	H64
EL16	1096FL	H71PH	H71-P	IN24	K1054B	MR2	MR2	RS3	MR1
EL17	1096FM	H74PH	1188LN-P	IN25	K1122B	MT1	X176	RU1	1011
EL18	1096FS	H75	1196FD	IN26	L1054M	MT3	X224	RU16	A1011P
EL2	1096	H75PH	H75-P	IN27	K1122C	MT5	X245	RU3	1011B
EL3	1096L	H76	X244	IN28	1054FN	MT5PH	MIT4-P	RU4	N1011P
EL5	EB1096K	H76PH	H76-P	IN29	1054UN	MT6	X263	RU4	1011P
EL5	X1054JA	H78	1196CM	IN3	1054K	MZ10	X27	RU44	1011GH
EL8	H1054B	H78PH	H78-P	IN32	H1054S	MZ12	X60	RU45	1011D1
ER1	1119	H79	1196V	IN33	1054MT	MZ14	X131	RU46	A1011D1
F2	1073	H9	1125G	IN34	1054TW	MZ14PH	MZ13-P	RU7	1011M
F8	1073K	HD103	X214	IN4	1054LB	MZ15	X178	RV1	X170
FA1	1054WC	HD104	X215	IN5	1054R	MZ16	X188	RV4	X239
FA2	A1054WC	HD109	X265	IN8	L1054B	MZ18	X201	S1	1009
FA3	A1054WD	HD23	HD11	IV1	X155	MZ20	X199	S10	1010B
FC1	BR20	HD23	67LD	JA1	FT5R	MZ21	X200	S16	N1007KMB
FC2	X20	HD30	67LB	JA2	X177	MZ25	X206	S2	O1009
FC4	X36	HD32	HD32	K1	1079	MZ27	X222	S22	O1007LA
FC5	X4	HD37	HD12	K2	1079B	MZ30	X247	S22 1/2	1007LA
FC6	X5	HD38	HD10	K3	1079AB	MZ31	X249	S23	O1007LB
FC7	X86	HD52	HD43	K4	1079A	MZ9	X26	S24 1/2	1007LC
FC8	FC8	HD67	X38	KA17	KW14R	N1	1017	S25	O1007LE

CROSS REFERENCE



CURTIS	ILCO	CURTIS	ILCO	CURTIS	ILCO	CURTIS	ILCO	DEXTER	ILCO
S25 1/2	1007LE	SU5	X11	VL3	VO62	Y251	H998GB	62-BM	DXB4
S26	O1007LF	SU6	X25	VL4	X30	Y252	H998GC	62-C1	DXC1
S27	O1007LG	SU7	X87	VL5	X29	Y3	C999	62-C2	DXC2
S27 1/2	1007LG	T1	1141	VL6	X80	Y3	1047M	62-C3	DXC3
S29	O1007LK	T2	1140P	VO2	185V	Y34	997DA	62-CM	DXC4
S29 1/2	1007LK	T2	H1122M	W1	1071	Y4	998	62-D1	DXD1
S3	1010	T3	1141E	WE1	1123	Y52	997E	62-D2	DXD2
S30 1/2	1007LL	T4	1141F	WE3	1123S	Y53	997ER	62-D3	DXD3
S31	N1007RMA	T7	1141GE	WK1	1175	Y54	O997E	62-DM	DXD4
S32	N1007RMB	TR13	TP3	WK2	1175N	Y55	997G	62-GM	DXG5
S4	O1010	TR17	T61A	WR1	X1054WA	Y57	J997M	67-B1	DXB10
S5	1009A	TR18	TR18	WR3	1054WB	Y58	J997MR	67-B2	DXB20
S51	O1007RB	TR2	TP1	WR4	A1054WB	Y59	997JA	67-B3	DXB30
S57	O1007RK	TR20	T61C	WR5	N1054WB	Y6	997X	67-C1	DXC10
S58	O1007RL	TR21	T61D	WS2	FT6R	Y60	997JB	67-C2	DXC20
S58 1/2	1007RL	TR22	T61E	WS2	X1	Y61	997JC	67-C3	DXC30
S6	N1007KMA	TR23	T61F	XL7	1180S	Y62	997JD	67-D1	DXD10
S68	1010N	TR25	TR25	Y1	X999	Y63	997JE	67-D2	DXD20
S69	L1010N	TR26	TR26	Y1	999	Y64	997JF	67-D3	DXD30
S70 1/2	1007CA	TR27	TA15	Y10	H1122FR	Y64 1/2	997JG	67N	D1054K
S73	O1007CE	TR28	X37	Y101	L1122A	Y64 1/2	997JH	<b>DOMINION</b>	
S73 1/2	1007CE	TR3	TP2	Y102	L1122B	Y64 3/2	997JK	<b>DOMINION</b>	<b>ILCO</b>
S74 1/2	1007CF	TR33	X137	Y103	O1122B	Y7	996M	0	1000
S75 1/2	1007CG	TR37	X159	Y104	O1122BR	Y78	998GA	1	1
S76	O1007CJ	TR39	X151	Y105	O1122C	Y78 1/2	999GA	1	1001
S76 1/2	1007CJ	TR40	X174	Y109	1132	Y79	998GB	2	1002
S77	O1007CK	TR44	X211	Y11	O1122	Y79 1/2	999GB	4	1004
S77 1/2	1007CK	TR46	X212	Y116	998SA	Y80	998GC	7	Y200
S82	O1007CN	TR47	X217	Y117	998SB	Y80 1/2	999GC	7	1007
S82 1/2	1007CN	TR5	TP4	Y118	998SC	Y81	998GD	8	998
SA1	1047CR	TR53	X223	Y119	998SD	Y81 1/2	999GD	8	1008
SA3	1047	TR6	TA2	Y12	O1122A	Y82	998GE	9	999
SB10	X31	TR7	TP6	Y120	998SE	Y82 1/2	999GE	9	1009
SB11	X52	TR9	T61B	Y121	998SF	Y83	998GF	10	1010S
SC1	1145	UN1	62DK	Y122	998SG	Y83 1/2	999GF	11	1011
SC10	A1145F	UN16	UN16	Y123	998SH	Y84	998GG	12	1012
SC11	1145G	UN17	X17	Y124	998SK	Y84 1/2	999GG	13	1013
SC12	A1145G	UN17	62FT	Y133	X1199AR	Y85	998GH	14	1014
SC13	1145H	UN18	62FS	Y138	S1767CH	Y85 1/2	999GH	16	1016
SC14	A1145H	UN2	62DG	Y138	1766S	Y86	998GK	19	1019
SC15	1145J	UN26	X16	Y138	1701G	Y86 1/2	999GK	22	1022
SC16	A1145J	UN3	62DP	Y138	X1199B	Y87	998R	23	1023
SC17	1145K	V10	PR1	Y138	X1199G	Y89	998S	25	25
SC18	A1145K	V10	61VW	Y14	H1122AR	Y9	H1122F	26	VA1
SC19	1145L	V11	U61VW	Y14	O1122AR	Y91	999CA	26.5	VA2
SC20	A1145L	V12	V61VW	Y149	S1770U	Y92	Y202	27	1000AB27
SC21	A1145CE	V13	VW63	Y15	999N	Y98	1060C	31	1031
SC22	1307W	V14	VW63A	Y150	1769CH	YM35	X39	33	1033
SC23	1145EF	V15	62DW	Y152	P1770U	YM36	X18	34	1034
SC24	A1145EF	V17	VW64	Y153	P1786	YM41	YH39	36	1036
SC26	A1145FG	V18	63VR	Y154	P1789	YM42	YH40	47	1047
SC4	1145A	V19	VW64T	Y155	P1793	YM43	X62	50	50
SC6	1307A	V2	62VW	Y156	1793V	YM52	X76	51	51
SC7	1145F	V23	W62VE	Y157	P1794	YM57	X120	54	1054
SC8	1145E	V24	VW77	Y158	1794V	YM58	X119	62	62
SC9	A1145E	V25	VW67S	Y159	P1795	YM59	X117	63	63
SE1	1022	V26	VW67	Y2	999A	YM60	X118	67	W67
SE2	O1022	V27	V27	Y203	998VB	YM61	YH50	68	1068
SK1	R1001EN	V28	VW71	Y204	998TE	YM62	YH51	69	1069W
SK2	R1001EM	V29	VW71A	Y206	998TG	YM63	X248	70	DA2
SK4	R1001EL	V30	X9	Y207	998TH	YS1	X21	71	1071
SL1	1120D	V31	X8	Y208	998TMK	YS2	X22	72	1072
SL16	1074B	V32	X53	Y209	998VD	YU1	X153	79	1079
SL2	A1074B	V33	X110	Y211	998VE	YU2	X167	84	1084
SL20	1120F	V35	X139	Y212	998TA			91	1091
SL24	1154L	V36	X203	Y213	998TB			92	1092
SL24	1120S	V5	62VO	Y214	998TC			94	94
SL8	1074BM	V6	62VE	Y220	999B	<b>DEXTER</b>	<b>ILCO</b>	96	1096
SM1	N63G	V9	U62VN	Y222	998GL	11	D1098B	115	1115
SM12	NE19	VA1	VA1	Y225	998SMK	13	D1098BM	119	1119
SQ1	192	VA2	X122	Y227	998GST	61	1054KD	123	1123
SR2	X108	VL1	VO6	Y234	885BL	62	D1054KA	125	1125D
SR8	X251	VL10	X140	Y236	998VG	63	D1098X	127	1127
SU14	X179	VL10PH	VL8-P	Y238	998VH	67	A1054KD	132	1132
SU15	X185	VL11	NE10	Y239	998VK	62-B1	DXB1	137	1137S
SU17	X186	VL2	WS2	Y240	889A	62-B2	DXB2	138	138
SU18	X241	VL3	FTA2R	Y250	H998GA	62-B3	DXB3	139	139

**CROSS REFERENCE**

DOMINION	ILCO	DOMINION	ILCO	DOMINION	ILCO	DOMINION	ILCO	DOMINION	ILCO
141	1141	00G	1000G	07LM	1007LM	127F	1127F	199DR	1199DR
143	1143	00H	1000H	07LN	N1007KMB	127FD	1127FD	199E	1199E
145	1145	00K	1000K	07RA	1007RA	127FL	1127FL	19A	1019A
149	149	00KC	1000KC	07RB	1007RB	127FR	1127FR	19D	1019D
155	155	00KT	1000XK	07RC	1007RC	127H	1127H	19R	1019R
170	1170C	00T	1000T	07RD	1007RD	127J	1127J	19XL	1019XL
175	1175	00V	1000V	07RDH	1007RDH	127K	1127K	1N	1N
176	S1176	00X	1000X	07RDM	1007RDM	127L	1127L	22EZ	1177N
177	177	00Z	1001EH	07RE	1007RE	127LC	1761LP	22L	1022AB
191	VR91AR	01A	1001A	07RF	1007RF	127LS	1761LS	22M	22M
192	192	01A1	1001AH	07RG	1007RG	127M	1127M	22NE	1177
201	201	01A2	1001FH	07RH	1007RH	127ME	1127ME	22PO	22PO
423	1323	01AB	1001AB	07RHM	1007RHM	127MP	1127MP	22W	AR1-PC
609	1209	01AM	1001AM	07RJ	1007RJ	127MU	1127MU	22W	1179
611	611	01B1	1001BH	07RK	1007RK	127N	1127N	23A	1023A
615	615	01B2	1001DH	07RL	1007RL	127P	1127P	23M	23M
616	616	01BM	1001BM	07RM	1007RM	127T	1127T	25C	RO91R
618	T131	01C1	1001C1	07RN	N1007RMB	127TB	1127TB	25V	25V
619	619	01C2	1001C2	08A	1008A	12A	1012A	28A	1028A
621	621	01CM	1001CM	09A	1009A	13BF	1013BF	28BM	28BM
624	1224	01D	1001D	10A	1010SA	13C	1013C	28DC	1028DC
625	1225	01D1	1001D1	10F	V91N	13DL	1013DL	28DD	1028DD
626	1226	01D2	1001D2	10M	1010M	13F	1013F	28DS	1028D
634	634	01DA	1001DA	10N	1010N	141E	1141E	28N	1028NN
639	1239	01DM	1001DM	10T	1010T	141GE	1141GE	28P	1028P
642	1242	01E	1001E	11-04A	1011-04A	141JE	1141JE	2M	2B
659	1259	01EA	1001EA	11-04AS	1011-04AS	141JL	1141JL	2N	2N
660	660	01EB	1001EB	115B	1115B	141L	1141L	318ST	T105
661	661	01EG	1001EG	11B	1011B	143C	1143C	33A	1033A
662	662	01EL	1001EL	11D1	1011D1	143D	1143D	33C	33C
663	663	01EN	1001EN	11D2	1011D2	145CE	1145CE	33G	1033G
665	665	01GH	1001GH	11D3	1011D3	145E	1145E	33K	33K
666	666	01GM	1001ABM	11D4	1011D4	145EF	1145EF	33N	1033N
667	667	01GRM	1001GRM	11GH	1011GH	145F	1145F	33NO	33NO
669	669	01JB	1000P	11GJ	1011GJ	145FG	1145FG	33Z	ZN1
671	671	01JL	1001JL	11K1	1011K1	145G	1145G	34A	1034A
672	672	01JR	1000JR	11K10	1011K10	145H	1145H	34H	1034H
686	1286	01K	1001K	11K11	1011K11	145J	1145J	34N	1034N
703	1303	01MA	1001MA	11K12	1011K12	145K	1145K	355ST	355ST
706	706	01MB	1001MB	11K13	1011K13	145L	1145L	36A	1036A
723	723	01MC	1001MC	11K2	1011K2	14C	1014CE	36G	1036G
725	725	01MD	1001MD	11K3	1011K3	14CM	114CM	36S	1036S
750	750	01MG	1001MG	11K4	1011K4	14D	1014D	36SF	1036SF
752	752	01MJ	1001MJ	11K5	1011K5	14DA	1014DA	36U	1036U
755	755	01RM	1001CDM	11K6	1011K6	14DB	1014DB	37 MASTER	37
757	757	02A	1002A	11K7	1011K7	14DR	1014DR	37D	37D
760	760	02B	1002B	11K8	1011K8	14DS	1014DS	3916-21	3916-21
765	765	03A	1003A	11K9	1011K9	14DX	1014DX	3916-22	3916-22
770	770	03AB	1003AB	11KM	1011PZ	14J	1014J	41A	104AM
775	775	03B	1003B	11M	1011M	14JE	O1014S	41AB	103AM
812	1412	03C	1003C	11MA	1011MA	14JM	1014JM	41AC	101AM
815	1270D	03CD	1003CD	11P	1011P	14JS	O1014JS	41AD	102AM
816	1416	03D	1003D	11S	N1011S	14K	1014K	41AM	100AM
817	1417	03M	1003M	11T	N1011T	14T	1014F	41B	1043B
825	1425	04A	1004A	120D	1120D	15C	1015C	41C	1041C
841	1133	04AL	1004AL	120F	1120F	15M	1015M	41CK	1041CK
884	884	04AR	1004AR	120G	1120G	167FD	1167FD	41CM	1041CE
885	885	04KL	1004KL	120H	1120H	16N	1016N	41D	1041D
886	886	04M	1004M	120J	1120J	16NB	1016NB	41DC	1041DC
953	T89	04N	1004N	120K	1120K	170B	1170BD	41DE	1041DE
954	T88	04R	1004R	120N	1120N	170C	1170B	41DH	1041DH
970	T73	07A	1007A	120S	1120S	170CJ	1170CJ	41DV	1041DV
972	T74	07G	1007G	122D	1122D	170CL	A1170B	41E	1041T
973	T75	07LA	1007LA	123A	1123A	170D	1170D	41F	C1041J
2712	2712	07LB	1007LB	125A	1125A	170E	1170E	41FD	41FD
2714	2714	07LC	1007LC	125C	1125C	170S	1170S	41FE	1041FE
4015	4015	07LD	1007LD	125D	D1125	170T	1170T	41FG	1041FG
4436	4436	07LDH	1007LDH	125E	1125G	176D	1176D	41G	1041G
5985	T72	07LDM	1007LDM	125G	1125F	17B	1017B	41GA	1041GA
5987	T139	07LE	1007LE	125H	1125H	17BB	1017BB	41GB	1041GB
8446	T41	07LF	1007LF	125K	1125K	17M	117B	41GR	1041GR
00A	1000A	07LG	1007LG	125M	1125M	191A	1191A	41H	1041H
00AB	1000AB	07LH	1007LH	125X	1125X	191B	VR91B	41J	C1041N
00BH	R1003M	07LHM	1007LHM	127B	1127B	191C	VR91CR	41JA	SC1041R
00F	1000F	07LJ	1007LJ	127D	1127D	192B	1192B	41JB	SC1041S
00FR	1000FR	07LK	1007LK	127DP	1127DP	199C	1199C	41K	1041K
00FX	1000FX	07LL	1007LL	127ES	1127ES	199D	1199D	41M	1041M

DOMINION	ILCO	DOMINION	ILCO	DOMINION	ILCO	DOMINION	ILCO	DOMINION	ILCO
41N	1041N	60Z3	60Z3	62DK	62DK	62VC	62VC	65U	AR91
41P	1041P	60Z4	60Z4	62DM	62DM	62VE	62VE	65Y	GU91F
41S	1041S	60Z5	60Z5	62DN	62DN	62VG	62VG	663SG	1063E
41T	1041E	60Z6	60Z6	62DO	62DO	62VH	62VH	66A	66A
41UN	R1096EN	60Z7	60Z7	62DP	62DP	62VJ	62VJ	66B	66BB
41W	1041W	60Z8	60Z8	62DR	62FS	62VK	V61VW	66E	66E
41WA	1042A	60Z9	60Z9	62DS	62DS	62VM	62VM	66M	66B
41WC	1041WC	60ZD	60ZD	62DT	BR9	62VO	62VO	670C	1270C
41X	1046	610B	610B	62DV	B62DV	62VP	62VP	67B	1067B
41Y	1041Y	610BL	610BL	62DW	62DW	62WA	62WA	67C	67CL
42B	1043D	611B	1211B	62DX	62DX	62WB	62WB	67CT	RC1
42Z	1042Z	615A	1215A	62DY	VW64T	62X	62X	67F	FL91
43C	1043C	615B	1215B	62E	62E	62XL	EX1	67G	67G
43E	1043ED	617GL	617GL	62EV	62EV	62Z	62Z	67H	67H
43F	1043F	617J	617J	62F	KE4	632M	632M	67J	67J
47A	1047A	617JL	617JL	62FD	62FT	633M	1233M	67LA	67LA
47CR	1047CR	61B	61B	62FE	62FE	633MH	633MH	67LB	67LB
49D	1049D	61D	61D	62FG	62FG	63A	63A	67LC	67LC
49E	1049E	61E	61E	62GE	GE8	63B	MB5	67LD	67LD
4ARM	994ARM	61F	61F	62GP	GIP91	63C	63C	67N	67N
4M	994M	61G	61G	62H	62H	63D	1063D	67P	67P
50A	50A	61GA	61GA	62HA	62HA	63E	63E	67Q	67Q
50AR	50AR	61H	61H	62HB	62HB	63F	63F	67S	CA91C
52A	1052A	61J	61J	62HC	62HC	63G	63G	67T	67T
52B	1052B	61JD	61JD	62HD	62HD	63H	63H	67U	67U
53 MASTER	53	61K	61K	62HE	X28	63JA	63JA	67W	67W
54F	1054F	61N	61N	62HF	62HF	63K	63K	686B	1286B
54FA	54FA	61NA	61NA	62HG	62HG	63L	63L	686C	1286C
54FL	54FL	61NC	61NC	62HL	VA4	63M	63M	686E	1286E
54G	1054G	61P	61P	62J	VA6	63P	63P	687W	687W
54K	1054K	61PC	61PC	62JA	VA7	63PX	63PX	687X	687X
54KD	1054KD	61PD	61PD	62JB	62JB	63Q	63Q	687Y	687Y
54KP	54KP	61PE	61PE	62JT	62JT	63SG	F91GS	68M	68M
54LB	1054LB	61PS	61PS	62K	ZE91G	63SH	F91HS	69-5X	1069-5X
54M	54M	61Q	61Q	62KA	VAT1	63SP	63SP	69-5Y	1069-5Y
54N	1054N	61SA	BR5	62KB	VCA1	63ST	63ST	69-5Z	1069-5Z
54P	1054P	61SB	BR7	62KC	62RG	63TS	63TS	69B	1069B
54TW	1054TW	61SC	BR6	62KD	62KD	63TV	63TV	69C	1069C
54UN	1054UN	61T	61T	62KE	VAE1	63TW	63TW	69E	1069E
5F	5F	61TS	61TS	62KF	KFV1	63VM	VW63A	69G	1069P
5M	Y8	61V	VG2	62KG	CA91D	63VN	63VN	69M	1069MD
60.B9	60.B9	61VT	61VT	62KT	62KT	63VO	63VO	69T	1069T
60.CD	60.CD	61W	61W	62KZ	62KZ	63VP	63VP	6M	996M
60.D	60.D	61X	61X	62L	ET9	63VR	63VR	701G	1701G
60.GH	60.GH	61Y	WA91W	62LG	62LG	63VS	63VS	702K	1702K
60.I9	60.I9	61Z	ZKN1	62M	62M	63W	63W	703K	1703K
60.IK	60.IK	621A	621A	62ME	S91A	63WG	63WG	703S	703S
60.LM	60.LM	621AL	1221AL	62MK	S91K	63Y	63Y	704K	704K
60.S9	60.S9	621L	1221L	62N	ZN2	642L	1242L	705K	1705K
600B	T77	623S	623S	62P	LP7	643CL	O1028AH	706K	1706K
606A	1206A	624F	1224F	62PD	62PD	64A	1064	707A	1307A
606AH	606AH	624L	1224L	62PE	62PE	64D	DO1M	707K	D1707K
606L	606L	625A	1225A	62PF	62PF	64D	64D	707W	1307W
606LH	606LH	625D	1225D	62PG	62PG	64E	VW1CZ	70R	DA3
60C	1060C	625DH	625DH	62PH	62PH	64G	64G	719S	719S
60HA	60HA	625E	1225E	62PR	62PR	64GS	DO3M	71A	1071A
60HB	60HB	625EH	625EH	62PT	62PT	64K	64K	71AB	1071AB
60HR	60HR	625G	1225G	62Q	LP29R	64L	1064L	71B	1071B
60HU	HU5	625K	1427	62QA	LP27	64R	64R	732S	1332S
60UA	60UA	625PL	1225PL	62QB	LP28	64RD	64RD	73DF	1073DF
60UF	60UF	62A	62A	62QD	LP26	64SS	64SS	73DG	A1074B
60UG	60UG	62B	B62B	62QN	62QN	64T	TS2	73M	73M
60VF	60VF	62BA	62BA	62QS	62QS	64X	64X	74E	1074E
60VF9	60VF9	62BL	62BL	62QT	62QT	64Y	64Y	74F	1074F
60VG	60VG	62BZ	62BZ	62R	62R	65CA	65CA	74G	1074G
60VG9	60VG9	62C	62C	62RE	RG1	65CB	65CB	74N	1074N
60Z1	60Z1	62CA	CE1	62RS	62RS	65CD	65CD	755U	755U
60Z10	60Z10	62CKK	62CKK	62SA	INS1	65CE	65CE	759L	D1759L
60Z11	60Z11	62CS	62CS	62SH	62SH	65CF	65CF	761MP	1761MP
60Z12	60Z12	62DA	62DA	62SN	VK9	65F	SE91L	761MS	1761MS
60Z13	60Z13	62DB	62DB	62TA	62TA	65G	GU4	764P	1764P
60Z14	60Z14	62DC	62DC	62TC	62TC	65J	65J	764S	1764S
60Z16	60Z16	62DE	62DE	62U	62U	65K	65K	765D	1028
60Z17	60Z17	62DF	62DF	62UC	62UC	65L	65L	765S	1766S
60Z18	60Z18	62DG	62DG	62US	ST91A	65M	65M	765T	1767DT
60Z19	60Z19	62DH	62DH	62VA	62VA	65S	SOS91	768CH	1768CH
60Z2	60Z2	62DJ	62DJ	62VB	62VB	65T	65T	769CH	1769CH

**CROSS REFERENCE**

DOMINION	ILCO	DOMINION	ILCO	DOMINION	ILCO	DOMINION	ILCO	DOMINION	ILCO
770CH	1770CH	8GST	998GST	9PS	PR91SA	A41X	1046A	AS13	AS13
770L	1370	8LA	998LA	9PT	PR91C	A54B	A54B	AS14	AS14
770U	P1770U	8LB	998LB	9R	999R	A54F	A54F	AS15	AS15
771CH	X16	8LC	998LC	9RY	ER5	A61Q	A61Q	AS16	AS16
79AB	1079AB	8LD	998LD	9T	999T	A61T	A61T	AS17	AS17
79B	1079B	8LE	998LE	9TK	9TK	A61W	A61W	AS18	AS18
7A	997A	8LF	998LF	9U	999U	A62A	A62A	AS19	AS19
7B	997B	8LG	998LG	9VA	999VA	A62L	A62L	AS2	AS2
7CH	GAS91	8LH	998LH	9VB	999VB	A62QN	A62QN	AS20	AS20
7D	997D	8LK	998LK	9VC	999VC	A62VC	A62VC	AS21	AS21
7DA	997DA	8PA	998PA	9VD	999VD	A62VN	A62VN	AS22	AS22
7DB	997DB	8R	998R	9VE	999VE	A63L	A63L	AS23	AS23
7DC	7DC	8S	998S	9VG	999VG	A74E	A1074E	AS24	AS24
7DE	V91E	8SA	998SA	9VH	999VH	A74F	A1074F	AS25	AS25
7E	997E	8SB	998SB	9W	W91C	A74G	A1074G	AS27	AS27
7EB	997EB	8SC	998SC	A01MA	A1001MA	A7EH	A997EH	AS28	AS28
7EH	YL1	8SD	998SD	A01MB	A1001MB	A8GST	A998GST	AS29	AS29
7ER	997ER	8SE	998SE	A01MF	A1001MF	AA1	ATA1	AS3	AS3
7F	Y204	8SF	998SF	A01MJ	A1001MJ	AA2	ATA2	AS30	AS30
7G	997G	8SG	998SG	A1	A1	AB1	AB1	AS31	AS31
7GE	7GE	8SH	998SH	A10N	L1010N	AB10	AB10	AS32	AS32
7GR	997GR	8SM	998SMK	A114A	A1114A	AB11	AB11	AS33	AS33
7GX	997GX	8TA	998TA	A114B	A1114B	AB12	AB12	AS34	AS34
7GXR	997GXR	8VA	998VA	A114C	A1114C	AB13	AB13	AS35	AS35
7JA	997JA	8VB	998VB	A114D	A1114D	AB14	AB14	AS36	AS36
7JB	997JB	8VC	998VC	A114DD	A1114DD	AB15	AB15	AS37	AS37
7JC	997JC	8VD	998VD	A114E	A1114E	AB16	AB16	AS38	AS38
7JD	997JD	8VE	998VE	A114F	A1114F	AB17	AB17	AS39	AS39
7JE	997JE	8VG	998VG	A114G	A1114G	AB18	AB18	AS4	AS4
7JF	997JF	8VH	998VH	A114GM	A1114M	AB19	AB19	AS40	AS40
7JG	997JG	8VK	998VK	A114H	A1114H	AB20	AB20	AS41	AS41
7JH	997JH	92B	1092B	A114J	A1114J	AB21	AB21	AS43	AS43
7JK	997JK	92C	1092C	A114K	A1114K	AB22	AB22	AS44	AS44
7K	YL5	92V	1092V	A114L	A1114L	AB3	AB3	AS45	AS45
7KV	KVR91	92VM	1092VM	A114M	A1114FM	AB4	AB4	AS46	AS46
7L	997L	951R	T60	A11D1	A1011D1	AB5	AB5	AS47	AS47
7LA	7LA	96C	1096C	A11D2	A1011D2	AB6	AB6	AS48	AS48
7LB	7LB	96L	1096L	A11D3	A1011D3	AB7	AB7	AS49	AS49
7LC	7LC	970AM	1970AM	A11D4	A1011D4	AB8	AB8	AS5	AS5
7LD	7LD	98DB	1098DB	A11P	A1011P	AB9	AB9	AS50	AS50
7LDH	7LDH	98JD	1098JD	A11S	A1011S	AC1	1131	AS51	AS51
7LE	7LE	98L	1098L	A11T	A1011T	AC2	1131R	AS52	AS52
7LF	7LF	98M	1098M	A145	1145A	AD1	AD1	AS53	AS53
7LG	7LG	98X	1098X	A145CE	A1145CE	AE1	AE1	AS54	AS54
7LH	7LH	98XL	1098XL	A145E	A1145E	AG1	AG1	AS55	AS55
7M	7B	9A	999A	A145EF	A1145EF	AG2	AG2	AS56	AS56
7RA	7RA	9BA	999BA	A145F	A1145F	AG3	AG3	AS57	AS57
7RB	7RB	9C	Y201	A145FG	A1145FG	AG4	AG4	AS58	AS58
7RC	7RC	9CA	999CA	A145G	A1145G	AG5	AG5	AS59	AS59
7RD	7RD	9CR	Y202	A145H	A1145H	AK1	AK1	AS6	AS6
7RE	7RE	9CS	999CS	A145J	A1145J	AK2	AK2	AS60	AS60
7RF	7RF	9CX	999CX	A145K	A1145K	AK22W	AK22W	AS61	AS61
7RG	7RG	9D	ID1	A145L	A1145L	AK3	AK3	AS62	AS62
7RH	7RH	9D	9D	A14DR	A1014DR	AK4	AK4	AS63	AS63
7X	997X	9ET	LT1	A15C	A1015C	AK5	AK5	AS64	AS64
816A	816A	9FAC	9FAC	A15L	A1015L	AK6	AK6	AS65	AS65
817A	1214	9GA	999GA	A15M	A1015M	AL1	AL1-BLK	AS66	AS66
8418N	T80	9GB	999GB	A15N	A1015N	AM1	BIL1	AS67	AS67
841A	1133A	9GC	999GC	A15P	A1015P	AP1	ALP1	AS68	AS68
8446F	T40	9GD	999GD	A15Q	A1015Q	AP10	ALP10	AS69	AS69
8446R	T39	9GE	999GE	A15R	A1015R	AP2	ALP2	AS7	AS7
884BR	884BR	9GF	999GF	A15S	A1015S	AP3	ALP3	AS70	AS70
884BS	884BS	9GG	999GG	A15T	A1015T	AP4	ALP4	AS71	AS71
884R	884R	9GH	999GH	A15U	A1015U	AP5	ALP5	AS72	AS72
885BL	885BL	9GK	999GK	A15V	A1015V	AP6	ALP6	AS73	AS73
885R	885R	9K	GU91B	A15W	A1015W	AP7	ALP7	AS74	AS74
8A	998A	9LA	999LA	A15X	A1015X	AP8	ALP8	AS75	AS75
8FD	998FD	9LB	999LB	A15Y	A1015Y	AP9	ALP9	AS76	AS76
8GA	998GA	9LC	999LC	A170B	A1170CB	AR1	MAS1	AS77	AS77
8GB	998GB	9LD	999LD	A170C	A1170C	AR61Q	AR61Q	AS78	AS78
8GC	998GC	9LE	999LE	A170D	A1170D	AR61T	AR61T	AS79	AS79
8GD	998GD	9LF	999LF	A2	A2	AR61W	AR61W	AS8	AS8
8GE	998GE	9LG	999LG	A3	A3	AR62K	AR62K	AS80	AS80
8GF	998GF	9LH	999LH	A41JA	C1041R	AS1	AS1	AS81	AS81
8GG	998GG	9LK	999LK	A41JB	C1041JB	AS10	AS10	AS82	AS82
8GH	998GH	9MX	9MX	A41JC	C1041T	AS11	AS11	AS86	AS86
8GK	998GK	9P	PR91N	A41U	A1041U	AS12	AS12	AS89	AS89

DOMINION	ILCO	DOMINION	ILCO	DOMINION	ILCO	DOMINION	ILCO	DOMINION	ILCO
AS9	AS9	BK11	BKS11	CA2	CA2	CS31	CS31	DM12	DM12
AS90	AS90	BK12	BKS12	CA3	CA3	CS32	CS32	DM13	DM13
AU1	AU1	BK13	BKS13	CA4	CA4	CS33	CS33	DM14	DM14
AU2	AU2	BK14	BKS14	CA5	X110	CS34	CS34	DM15	DM15
AU3	AU3	BK15	BKS15	CB1	CB1	CS35	CS35	DM16	DM16
AU4	AU4	BK16	BKS16	CB10	CB10	CS36	CS36	DM17	DM17
AU5	AG1R	BK17	BKS17	CB11	CB11	CS37	CS37	DM18	DM18
AU5	AU5	BK18	BKS18	CB2	CB2	CS38	CS38	DM19	DM19
AU6	AU6	BK19	BKS19	CB3	CB3	CS39	CS39	DM2	DM2
B17	B17	BK2	BKS2	CB6	CB12	CS40	CS40	DM20	DM20
B20	B20	BK20	BKS20	CB7	CB7	CS41	CS41	DM21	DM21
B2M	B2M	BK21	BKS21	CB9	CB9	CS42	CS42	DM22	DM22
B33N	B33N	BK22	BKS22	CC1	C1041SR	CS43	CS43	DM23	DM23
B33NB	B33NB	BK23	BKS23	CC2	C1041TR	CS44	CS44	DM24	DM24
B40A	B40A	BK24	BKS24	CC21	CC21	CS45	CS45	DM25	DM25
B41A	B41A	BK25	BKS25	CC29	CC29	CS46	CS46	DM26	DM26
B41B	B41B	BK26	BKS26	CC3	SC1041TR	CS47	CS47	DM27	DM27
B41C	B41C	BK27	BKS27	CC30	CC30	CS48	CS48	DM28	DM28
B44	B44M	BK28	BKS28	CC4	SC1041SR	CS49	CS49	DM29	DM29
B5A	B5A	BK29	BKS29	CC5	C1041YR	CS50	CS50	DM3	DM3
B6	B6	BK3	BKS3	CD1	CD1	CS51	CS51	DM30	DM30
B61Y	B61Y	BK30	BKS30	CE1	BR20	CS52	CS52	DM31	DM31
B62DP	B62DP	BK31	BKS31	CE2	CE2	CS53	CS53	DM32	DM32
B62DR	B62DR	BK32	BKS32	CE3	CE3	CS54	CS54	DM33	DM33
B62G	B62G	BK33	BKS33	CE4	CE4	CS55	CS55	DM34	DM34
B62Q	LP24	BK34	BKS34	CE5	CE5	CS56	CS56	DM35	DM35
B62QB	LP28S	BK35	BKS35	CE6	CE6	CS57	CS57	DM36	DM36
B62QR	LP25	BK36	BKS36	CE7	CE7	CS58	CS58	DM37	DM37
B67K	B67K	BK4	BKS4	CE8	CE8	CS59	CS59	DM38	DM38
B7EH	B997EH	BK5	BKS5	CE9	X86	CT1	CT1	DM39	DM39
B7M	B7M	BK6	BKS6	CE9-2X	FC9	CT2	CT2	DM4	DM4
B9	B9	BK7	BKS7	CE9-3X	FC8	CU1	1040	DM40	DM40
B9CS	CS91CR	BK8	BKS8	CE9-RH	FC7-P	CU10	CU10	DM41	DM41
B9E	B9E	BK9	BKS9	CF1	CF1	CU11	1040U	DM42	DM42
BA1	BAS1	BL1	BL91	CF2	CF2	CU12	CU12	DM43	DM43
BC1	BC1	BL2	BL2	CH1	1147	CU2	1040A	DM44	DM44
BC2	BC2	BM1	BM1	CH3	CH3	CU3	R1040C	DM45	DM45
BD1A	BD1A	BM2	BM2	CH4	CH4	CU4	1040C	DM46	DM46
BD1B	BD1B	BO1	BO6	CH5	CH5	CU5	1040E	DM47	DM47
BD1C	BD1C	BO2	BO2	CH6	CH6	CU6	R1040E	DM48	DM48
BD1D	BD1D	BR1	BR1	CH7	CH7	CU7	CU7	DM49	DM49
BD2A	BD2A	BR62QB	LP39	CH8	CH8	CU8	CU8	DM5	DM5
BD2B	BD2B	BR9CS	CS91C	CL1	CL3	CU9	CU9	DM50	DM50
BD2C	BD2C	BS1	BS1	CL2	CL2	CW1	CW1	DM51	DM51
BD2D	BD2D	BT1	BT1	CM1	L1096CN	CY1	CA91L	DM52	DM52
BD3A	BD3A	BT2	BT2	CM2	C1096C	D1A	D1A	DM57	DM57
BD3B	BD3B	BT3	BT3	CM3	1096FL	D1K	D1K	DM58	DM58
BD3C	BD3C	BT4	BT4	CM4	1096FM	D1T	D1T	DM59	DM59
BD3D	BD3D	BU1	BU1	CM5	1096FS	D1V	D1V	DM6	DM6
BD4A	BD4A	BU2	BU2	CN1	CN1	D61Y	WA91S	DM60	DM60
BD4B	BD4B	BU3	BU3	CN2	CN2	D62SA	D62SA	DM61	DM61
BD4C	BD4C	BU4	BU4	CN3	CN3	D64	D64	DM62	DM62
BD4D	BD4D	BU7	BU7	CN4	CN4	D67K	D67K	DM63	DM63
BD5A	BD5A	BU8	BU8	CN5	CN5	D8	H998	DM64	DM64
BD5B	BD5B	BV1	BV1	CO1	CTG1	D8GA	D998GA	DM7	DM7
BD5C	BD5C	BV2	BV2	CO2	CTG2	D8GB	D998GB	DM8	DM8
BD5D	BD5D	BW1	1511	CS10	CS10	D8GC	D998GC	DM9	FT6R
BD6	BD6	BW2	1510	CS11	CS11	D8GD	D998GD	DN1	DN1
BD7	BD7	BY1	BY1	CS12	CS12	D8GE	D998GE	DO1	DO1
BE1	BEL1	C1S	C1S	CS13C	CS13	D8GF	D998GF	DO2	DO2
BE2	BEL2	C2S	C2S	CS14	CS14	D8GG	D998GG	DO3	DO3
BE3	BEL3	C30M	C30M	CS15	CS15	D8GH	D998GH	DO4	DO4
BE4	BEL4	C350	C350	CS16	CS16	D8GK	D998GK	DO5	DO5
BE5	BEL5	C3S	C3S	CS17	CS17	D9	D9	DO6	DO6
BE6	BEL6	C41C	C1041C	CS18	CS18	D98BM	D1098BM	DP1	DP1
BE7	BEL7	C4S	C4S	CS19	CS19	D98E	D1098B	DR61F	DR61F
BG1	K1122C	C53	C53	CS20	CS20	D98X	D1098X	DR9CS	AB62F
BG2	L1054M	C5S	C5S	CS21	CS21	D9CS	AB62FR	DT1	DT1
BG3	K1054B	C61Y	WA91PR	CS22	CS22	DB1	DB1	DT10	DT10
BG4	K1122B	C67K	C67K	CS23	CS23	DB2	DB2	DT11	DT11
BG5	L1098M	C6S	C6S	CS24	CS24	DD1	DD1	DT12	DT12
BG6	K1122D	C9	C999	CS25	CS25	DH1	DH1	DT13	DT13
BG7	K1122N	C92	C92	CS26	CS26	DH2	DH2	DT14	DT14
BH1	BH1	C92B	C92B	CS27	CS27	DL2	DL2	DT15	DT15
BH2	BH2	C98A	C1098A	CS28	CS28	DM1	FT6	DT16	DT16
BK1	BKZ1	CA1	X9	CS29	CS29	DM10	DM10	DT17	X10
BK10	BKS10	CA1-RH	73VB-P	CS30	CS30	DM11	DM11	DT18	X6

**CROSS REFERENCE**



DOMINION	ILCO	DOMINION	ILCO	DOMINION	ILCO	DOMINION	ILCO	DOMINION	ILCO
DT19	X7	F65L	F65L	H122F	H1122F	H98DB	H1098DB	HF13	HF13
DT2	DT2	FA1	X99	H122FR	H1122FR	H98L	H1098L	HF14	HF14
DT20	DT20	FA54WA	A1054WC	H122M	H1122M	H98LA	H1098LA	HF15	HF15
DT21	DA23	FB1	FB1	H122W	H1122W	H98M	H1098M	HF16	HF16
DT22	X114	FB2	FB2	H132	H1132	H98X	H1098X	HF17	HF17
DT22W	DT22W	FB3	FB3	H175	1175N	H98XL	H1098NR	HF18	HF18
DT23	X123	FB4	FB4	H176	1176	H9R	H999R	HF19	VW67
DT24	X124	FB5	FB5	H199A	H199A	HD1	HD1	HF20	HF20
DT3	DT3	FB6	FB6	H199N	H199N	HD10	HD10	HF21	HF21
DT4	DT4	FB7	FB7	H22W	N1179	HD11	HD11	HF22	HF22
DT5	DT5	FE1	FE1	H41X	A1045	HD12	HD12	HF23	HF23
DT6	DT6	FF1	FF1	H54B	H1054B	HD13	HD13	HF24	MB18
DT7	DT7	FH1	FCT45	H54F	H1054F	HD14	HD14	HF25	MB15
DT8	DT8	FH4	FH4	H54KD	D1054K	HD15	HD15	HF26	HF26
DT9	DT9	FL1	FL1	H54WA	1054WB	HD16	HD16	HF27	X8
DTL22W	DTL22W	FL2	FL2	H61G	H61G	HD17	HD17	HF28	BMW1
DW1	DW1	FL3	FL3	H61N	H61N	HD18	HD18	HF29	HF29
DW2	DW2	FL4	FL4	H61NA	H61NA	HD19	HD19	HF3	HF3
DXB1	DXB1	FL5	FL5	H61P	H61P	HD2	HD2	HF30	PO5
DXB2	DXB2	FL54WA	L1054WC	H61SA	H61SA	HD20	HD20	HF31	X32
DXB3	DXB3	FL5G	FL5G	H61SB	H61SB	HD21	HD21	HF32	VW71A
DXBM	DXB4	FL5H	A1054WD	H61V	H61V	HD22	HD22	HF33	VW71
DXC1	DXC1	FR00V	FR1000V	H61VM	H61VM	HD23	HD23	HF34	PO7
DXC2	DXC2	FR1	FLR1	H61VO	H61VO	HD24	HD24	HF35	HF35
DXC3	DXC3	FR2	FLR2	H61VR	H61VR	HD25	HD25	HF36	X53
DXCM	DXC4	FR65	FR65	H62BM	H62BM	HD26	HD26	HF37	HF37
DXD1	DXD1	FR65A	FR65A	H62BZ	H62BZ	HD28	HD28	HF38	HF38
DXD2	DXD2	FR65S	FR65S	H62CM	H62CM	HD29	HD29	HF39	X59
DXD3	DXD3	FS1	FS1	H62DG	H62DG	HD3	HD3	HF4	HF4
DXDM	DXD4	FT1	FT1	H62DM	H62DM	HD30	HD30	HF40	HF40
DXGM	DXG5	FT3	FTH3	H62DP	H62DP	HD31	HD31	HF41	HF41
E122A	E1122A	FT4	FTH4	H62DR	H62DR	HD32	HD32	HF43	HF43
E374	E374	FT5	FTH5	H62FD	H62FD	HD33	HD33	HF44	X82
E375	E375	FT6	FTH6	H62KB	H62KB	HD34	HD34	HF44-RH	MB41-P
E67K	E67K	FV1	FV1	H62PD	H62PD	HD35	HD35	HF45	MB38
E8GA	H998GA	GA1	1098GX	H62QN	LP30	HD36	HD36	HF46	X81
E8GB	H998GB	GB1	GB1	H62QS	LP31	HD37	HD37	HF47	HF47
E8GC	H998GC	GB2	GB2	H62QT	LP32	HD38	HD38	HF48	AU15
E8GD	H998GD	GB3	GB3	H62VB	62VW	HD39	HD39	HF49	HF49
E8GE	H998GE	GB4	GB4	H62VG	H62VG	HD4	HD4	HF5	HF5
E8GF	H998GF	GC1	GC1	H62VK	H62VK	HD40	X19	HF50	HF50
E8GG	H998GG	GE1	GE1	H62VN	61VW	HD41	X38	HF56	HF56
E8GH	H998GH	GE10	GE10	H62VP	H62VP	HD42	HD42	HF57	HF57
E8GK	H998GK	GE11	GE11	H63G	H63G	HD43	HD43	HF59	HF59
E96LN	C1096LN	GE14	GE14	H63M	H63M	HD44	X44	HF59R	HF59R
EB96K	EB1096K	GE15	GE15	H63N	MB59	HD45	HD45	HF6	HF6
EF2	EF2	GE2	GE2	H63VO	H63VO	HD46	HD46	HF7	HF7
EF3	EF3	GE3	GE3	H64	H64	HD47	X42	HF9	HF9
EG1	C1096CN	GE4	GE4	H64E	H64E	HD48	X43	HG1	HG1
EG2	S1096JN	GE5	GE5	H64K	H64K	HD49	HD49	HG2	HG2
EG3	1154C	GE6	GE6	H64S	H64S	HD5	HD5	HG3	HG3
ER1	ERS1	GE7	GE7	H67K	H67K	HD50	X57	HH1	HH1
ER2	ERS2	GE9	GE9	H69	1069N	HD51	HD51	HL1	HL1
ER3	ERS3	GH1	GH1	H7E	H997E	HD52	X58	HL22W	1179A
ER4	ER10	GH2	GH2	H7EB	H997EB	HD53	HD53	HL3	HL3
ER5	ERS5	GH3	GH3	H7ER	H997ER	HD54	HD70	HL54KD	D1054KA
ER6	ERS6	GL1	GL1	H7LA	H7LA	HD55	HD71	HL54WA	A1054WB
ER7	ER9	GL2	GL2	H7LB	H7LB	HD56	HD56	HN1	HN1
ER8	ERS8	GL3	GL3	H7LC	H7LC	HD57	HD57	HN2	HN2
ES1	ES1	GL4	GL4	H7LD	H7LD	HD58	HD58	HO1	HOD1
ES1R	ES1R	GL5	GL5	H7LDH	H7LDH	HD59	HD59	HR1	1014B
ET1	ET1	GN1	GN1	H7LE	H7LE	HD6	HD6	HR132	HR1132
EV3	EVA1R	GO1	GO1	H7LF	H7LF	HD60	HD60	HR2	1014C
EV4	EV4	GR1	GRD1	H7LG	H7LG	HD61	HD61	HR61N	HR61N
EV5	EV5	GT1	GT1	H7LH	H7LH	HD62	HD62	HR61NA	HR61NA
EV6	EV6	GT2	GT2	H7RA	H7RA	HD63	HD63	HR61P	HR61P
EV7	EV7	GT3	GT3	H7RB	H7RB	HD64	HD64	HR62BZ	HR62BZ
EZ1	ELZ1	GT4	GT4	H7RC	H7RC	HD66	HD66	HR62DG	HR62DG
F00V	F1000VR	GT5	GT5	H7RD	H7RD	HD68	HD68	HR62FD	HR62FD
F1	1190LN	GV1	GAV1	H7RDH	H7RDH	HD69	HD69	HR62KB	HR62KB
F122A	F1122A	GV2	GAV2	H7RE	H7RE	HD7	HD7	HR62PD	HR62PD
F122AR	F1122AR	GW1	GW1	H7RF	H7RF	HD71	X129	HR62QN	LP30R
F2	1185FD	H10F	H10F	H7RG	H7RG	HD8	HD8	HR62QS	LP31R
F3	1184FD	H122A	H122A	H7RH	H7RH	HD9	HD9	HR62QT	LP32R
F54WA	1054WC	H122AL	H122AL	H9	H999	HF1	HF1	HR62VG	HR62VG
F65	F65	H122ALR	H122ALR	H98A	H1098A	HF11	HF11	HR62VK	HR62VK
F65A	F65A	H122AR	H1122AR	H98C	H1098C	HF12	HF12	HR64K	HR64K

DOMINION	ILCO	DOMINION	ILCO	DOMINION	ILCO	DOMINION	ILCO	DOMINION	ILCO
HS1	HS1	L01C1	L1001C1	LA12	LA12	LS18	LS18	NC1	NC1
HS9	HS999	L01C2	L1001C2	LA13	LA13	LS19	LS19	NC2	NC2
HSX167FD	S1181FD	L01CM	L1001CM	LA14	LA14	LS22	LS22	NC3	NC3
HT98	HT98	L01D1	L1001D1	LA2	LA2	LS23	LS23	NC91F	1083P
HU2	HU2	L01D2	L1001D2	LA3	LA3	LS28	LS28	NC91T	1083S
HU3	HU3	L01DM	L1001DM	LA4	LA4	LS29	LS29	NC96D	1083H
HU4	HU4	L01GM	L1001ABM	LA5	LA5	LS32	LS32	NC96K	NC96K
HV61	HV61	L01GRM	L1001GRM	LA6	LA6	LS33	LS33	NC96M	NC96M
HVR61	HVR61	L01RM	L1001CDM	LA7	LA7	LS34	LS34	NC96T	1083
HY1	HYD1	L03A	L1003A	LA8	LA8	LS35	LS35	NE1	NE1
HY10	HYD10	L03AB	L1003AB	LA9	LA9	LS50	LS50	NE10	NE10
HY11	HYD11	L03B	L1003B	LB1	LB1	LS51	LS51	NE11	NE11
HY2	HYD2	L03C	L1003C	LB2	LB2	LSR	LSR1	NE12	VO62
HY3	HYD3	L03CD	L1003CD	LB3	LB3	LT1	LT3	NE13	NE13
HY4	HYD4	L03D	L1003D	LB4	LB4	LU1	LU1	NE14	NE14
HY5	HYD5	L03M	L1003M	LB5	LB5	LU2	LU2	NE15	NE15
HY6	HYD6	L122A	L1122A	LB6	LB6	M127	1127DU	NE16	NE16
HY7	HYD7	L122AR	L1122AR	LB7	LB7	M127A	M1127A	NE17	NE17
HY8	HYD8	L125D	1125	LC1	LC1	M63B	M63B	NE18	NE18
HY9	HYD9	L137	L1137	LC2	LC2	M63E	M63E	NE19	NE19
IGS1	IGS1	L14D	L1014D	LC3	LC3	M64	M64	NE2	NE2
IL1	ILL1	L15M	L1015M	LC4	LC4	M65F	M65F	NE20	NE20
IL2	ILL2	L170	L1170	LC5	LC5	M69C	M1069C	NE21	X51
IS1	IS1	L191A	VR91	LC6	S1096G	M69G	1069M	NE22	NE22
J20	SOS1	L1S	L1S	LC8	LC8	MA1	1092N	NE23	NE23
J7M	J997M	L1T	L1T	LE1	LE1	MA2	1092H	NE24	X29
J7MR	J997MR	L1TL	L1TL	LF1	LF1	MA4	1092D	NE25	X30
JG1	JG1	L1Y	L1Y	LF10	LF10	MA5	1092DS	NE26	NE26
JH1	JH1	L2EX	L2EX	LF11	LF11	MA6	1092J	NE27	NE27
JN1	JN1	L3TX	L3TX	LF12	X50	MA7	MA7	NE29	NE29
JN2	JN2	L3XY	L3XY	LF13	LF13	MB1	MB1	NE30	NE30
JN58	JN58	L41WB	L1042B	LF14	LF14	ME1	ME1	NE31	NE31
JP1	JP1	L4A1	L4A1	LF15	LF15	ME2	ME2	NE32	X12
JW1	JO91C	L4RM	L4RM	LF16	LF16	ME3	ME3	NE33	NE33
K122AR	K122AR	L54B	L1054B	LF17	X157	ME4	ME4	NE34	NE34
K9	999N	L54G	L1054G	LF18	LF18	ME5	ME5	NE35	X80
KA1	KAB1	L54K	L54K	LF19	LF19	ME6	ME6	NE36	X85
KA2	KAB2	L54KD	A1054KD	LF2	LF2	ME7	ME7	NE37	X92
KA3	KAB3	L54WA	L54WA	LF21	LF21	MG1	AL3	NE39	NE39
KF1	KF1	L5CR	L5CR	LF23	LF23	MM2	MM2	NE4	NE4
KF2	KF2	L5RC	L5RC	LF24	LF24	MN1	MN1	NE40	X61
KF3	KF3	L61D	L61D	LF3	LF3	MO1	MO1	NE41	NE41
KF4	KF4	L61G	L61G	LF4	X13	MR1	MR1	NE42	NE42
KL1	KL1	L61JD	VA91	LF5	LF5	MR2	MR2	NE43	NE43
KL2	KL2	L61K	L61K	LF6	LF6	MR3	MR3	NE44	NE44
KL3	VW63	L61Y	WA91WL	LF7	LF7	MR63E	MR63E	NE45	NE45
KL4	KL4	L62CS	L62CS	LF8	LF8	MS12	X54	NE46	NE46
KL5	VW77	L62DM	L62DM	LF9	LF9	MS13	MS13	NE47	NE47
KL6	X20	L62FD	L62FD	LM1	LM1	MS15	X121	NE48	X170
KM1	KM1	L62K	ZE91CR	LM2	RT19	MS2	MS2	NE49	NE49
KM10	KM10	L62KE	L62KE	LN1	LN1	MT1	1181C	NE5	NE5
KM2	KM2	L62QT	L62QT	LN3	LN3	MW1	MW1	NE50	X140
KM3	KM3	L62TC	L62TC	LP1	LP1	LAP1	MW2	NE54	NE54
KM4	KM4	L62UC	L62UC	LP2	LP2	LAP2	MZ1	NE55	NE55
KM5	KM5	L62US	L62US	LR1	LR1	MZ10	X27	NE56	NE56
KM6	KM6	L62VA	L62VA	LR191A	VR91R	MZ11	X36	NE57	NE57
KM7	KM7	L62VB	L62VB	LR61D	LR61D	MZ12	X1	NE58	NE58
KM8	KM8	L62VJ	L62VJ	LR61G	LR61G	MZ13	MZ15	NE59	NE59
KM9	X89	L62VN	L62VN	LR61JD	LR61JD	MZ14	X60	NE6	VO6
KN1	KN1	L63G	L63G	LR61K	WL2	MZ15	X131	NE62	X139
KP1	KP1	L64B	1069LB	LR61Y	WA91L	MZ15R	MZ13R	NE62-RH	V35-P
KS1	KS1	L64C	L1064C	LR62DG	LR62DG	MZ2	X3	NE7	NE7
KW1	KA1	L65F	SEL91	LR62K	ZE91C	MZ3	X2	NE8	NE8
KW2	KA2	L65G	L65G	LR62QT	LR62QT	MZ4	X4	NE9	NE9
KW3	KA3	L65Y	L65Y	LR62US	LR62US	MZ5	X5	NF1	NF1
KW4	KA4	L67A	L67A	LR62VA	LR62VA	MZ6	MZ6	NF2	NL2
KW5	X40	L67B	L67B	LR62VB	LR62VB	MZ7	MZ7	NL1	NL1
KW6	X23	L68	1068E	LR62VJ	LR62VJ	MZ8	MZ8	NR63G	NR63G
KW7	X24	L69FD	1069YM	LR63G	LR63G	MZ9	X26	NR64D	R1064E
KW8	KA8	L6FM	L6FM	LR65F	SEL91R	N54B	N54B	NS9CS	NS9CS
L00Z	L1001EH	L6S	L6S	LR65G	LR65G	N54G	N54G	NSR9CS	NSR9CS
L01A1	L1001AH	L707A	L1307A	LR65Y	LR65Y	N63G	N63G	NU07CA	O1007CA
L01A2	L1001FH	L707W	L1307W	LR7GE	LR7GE	N64D	1064D	NU07CB	O1007CB
L01AM	L1001AM	L98C	L1098C	LS10	LS10	N686	N1286	NU07CC	O1007CC
L01B1	L1001BH	LA1	LA1	LS11	LS11	N686R	N1286R	NU07CD	O1007CD
L01B2	L1001DH	LA10	LA10	LS16	LS16	N704K	1704K	NU07CDH	O1007CDH
L01BM	L1001BM	LA11	LA11	LS17	LS17	N98XL	1098NR	NU07CDM	O1007CDM

DOMINION	ILCO	DOMINION	ILCO	DOMINION	ILCO	DOMINION	ILCO	DOMINION	ILCO
NU07CE	O1007CE	R61N	R61N	R707W	R1307W	S61W	V61A	SJ1	SJ1
NU07CF	O1007CF	R61NA	R61NA	R7DA	R997DA	S625P	S625P	SJ2	SJ2
NU07CG	O1007CG	R61P	R61P	R7DC	R7DC	S62DP	S62DP	SJ3	SJ3
NU07CH	O1007CH	R61Q	R61Q	R7EB	R997EB	S62DR	S62DR	SJ4	SJ4
NU07CHM	O1007CHM	R61ST	R61ST	R9CS	R9CS	S62DV	BS62DV	SJ5	SJ5
NU07CJ	O1007CJ	R61T	R61T	R9ET	LT2	S62DW	S62DW	SJ6	SJ6
NU07CK	O1007CK	R61TS	R61TS	R9K	GU3	S62FD	S62FD	SK1	SUZ1
NU07CL	O1007CL	R61W	R61W	R9LF	R9LF	S62K	GA91	SK10	SUZ10
NU07CM	O1007CM	R61Y	WA91	R9LK	R9LK	S62KB	S62KB	SK11	X87
NU07CN	O1007CN	R61Z	ZKN2	R9P	PR91A	S62QA	LP1R	SK2	SUZ2
O1S	O1S	R62B	R62B	R9PS	PR91NS	S62QD	LPD2	SK3	SUZ3
OL1	1171	R62BA	R62BA	RA01MJ	A1001MJR	S62US	S62US	SK4	SUZ4
OL2	1171B	R62BZ	R62BZ	RI5	RI5	S62VP	S62VP	SK5	X11
OM1	OM10	R62CA	R62CA	RI6	RI6	S62VT	S62VT	SK6	SUZ6
P54F	P54F	R62DG	R62DG	RK1	RK1	S63B	S63B	SK7	SUZ7
P64H	P64H	R62DH	R62DH	RL1	RL1	S64A	S1064A	SK8	SUZ8
P64K	P64K	R62DM	R62DM	RL2	RL2	S64D	DO1S	SK9	SUZ9
P65A	P65A	R62EV	R62EV	RL3	RL3	S65	SES91	SL10	SLA10
P65C	P65C	R62GE	GE3R	RN1	RN1	S65CA	S65CA	SL11	SLA11
P98A	P1098A	R62K	R62K	RS1	1140G	S65F	S65F	SL12	SLA12
P98C	P1098C	R62KB	VCA1R	RS65G	RS65G	S65G	S65G	SL13	SLA13
P98E	P1098E	R62ME	S91BV	RU22A	1022H	S67B	S67B	SL14	SLA14
P98J	P1098J	R62P	LP7R	RUK1	A1011-1N	S67K	S67K	SL15	SLA15
PE1	PE1	R62PD	R62PD	RUK10	A1011-10N	S69	70S	SL16	SLA16
PJ1	PJ1	R62PE	R62PE	RUK11	A1011-11N	S69T	S1069T	SL17	SLA17
PJ11	PJ11	R62PF	R62PF	RUK12	A1011-12N	S73DE	1074BM	SM1	SM1
PJ12	PJ12	R62PG	R62PG	RUK13	A1011-13N	S73DF	S1073DF	SM2	SM2
PJ13	PJ13	R62Q	LP29	RUK2	A1011-2N	S73DG	1074B	SN1	1010B
PJ14	PJ14	R62QA	LP6	RUK3	A1011-3N	S770CH	U1770CH	SN2	S1010B
PJ2	PJ2	R62QB	R62QB	RUK4	A1011-4N	S770U	S1770U	SP1	SP1
PJ3	PJ3	R62TA	R62TA	RUK5	A1011-5N	S7CH	GA1	SP2	SP2
PJ4	PJ4	R62TS	R62TS	RUK6	A1011-6N	S7JA	S7JA	SP3	SP3
PK1	PKR1	R62UC	R62UC	RUK7	A1011-7N	S970AM	S1970AM	SP4	SP4
PL1	PL1	R62US	R62US	RUK8	A1011-8N	S98B	S1098B	SP5	SP5
PN1	PN1	R62VA	R62VA	RUK9	A1011-9N	S98D	S1098D	SP6	X64
PN2	PN2	R62VB	R62VB	RUKM	A1011PZ	S98H	S1098H	SP7	X79
PN3	PN3	R62VK	U61VW	RUN15	A1011-15N	S98K	S1098K	SP8	X78
PO1	PO1	R62VN	R62VN	RUN16	A1011-16N	S9CS	S9CS	SP9	SP9
PO2	PL2	R62WA	R62WA	RUN17	A1011-17N	S9P	S9P	SQ3	SQ3
PR1	PR1	R62X	R62X	RUN18	A1011-18N	SA1	STA1	SR1	SR1
PU1	PU1	R62Z	R62Z	RUN19	A1011-19N	SB1	SB1	SR191A	SR191A
PU2	PU2	R63E	R63E	RUN20	A1011-20N	SB10	SB10	SR2	SR2
PU3	PU3	R63G	R63G	RUN21	A1011-21N	SB2	SB2	SR3	SR3
PU4	PU4	R63H	R63H	RUN22	A1011-22N	SB3	SB3	SR33N	BR13
PU5	PU5	R63K	R63K	RUN23	A1011-23N	SB4	SB4	SR4	SR4
PZ1	PZ1	R63KE	R63KE	RUN24	A1011-24N	SB5	SB5	SR5	SR5
PZ2	PZ2	R63PX	R63PX	RUN25	A1011-25N	SB6	SB6	SR61N	SR61N
PZ3	PZ3	R63Q	RE61XR	RUN26	A1011-26N	SB7	SB7	SR61W	SR61W
PZ4	PZ4	R63SP	R63SP	RUN27	A1011-27N	SB8	X31	SR62QA	LP1
R00T	R1000T	R63ST	R63ST	RUN28	A1011-28N	SB9	X52	SR65	SR65
R00V	R1000V	R63TK	R63TK	S00KT	S1000XK	SC51	SC51	SR67K	SR67K
R01D	R1001D	R63TS	R63TS	S00T	S1000T	SC52	SC52	SR9CS	CS91B
R01ED	R1001ED	R63TY	R63TY	S00V	S1000V	SD1	1148	SR9P	SR9P
R01EE	R1001EE	R63VM	FT3	S00X	S1000X	SE1	SIM1	SS1	SS1
R01EF	R1001EF	R63VS	R63VS	S01JB	S1001JB	SE10	SIM10	SS2	SS2
R01EG	R1001EG	R63W	R63W	S127FD	S1127FD	SE2	SIM2	SS3	SS3
R01EL	R1001EL	R63WG	R63WG	S127FL	S1127FL	SE3	SIM3	ST1	ST1
R01EN	R1001EN	R63Y	R63Y	S127FR	S1127FR	SE6	SIM6	ST2	FAS1
R01ES	R1001ES	R64D	R1064D	S127LC	S1127LC	SE8	SIM8	SV1	ST91F
R01MJ	R1001MJ	R64T	R64T	S127ME	S1127ME	SE9R	SIM9R	SV2	ST91V
R132	R1132	R65F	R65F	S127MU	S1127MU	SF1	F91C2	SV3	SV3
R191	VR91A	R65G	GU4R	S137	1136S	SF10	SF10	SV4	SV4
R191B	VR91BR	R65S	R65S	S167FD	S1167FD	SF11	SF11	SW1	SW1
R191C	VR91C	R65U	R65U	S191A	VR91S	SF2	F91C	SW2	SW2
R22L	R1022L	R65Y	GU91G	S33C	S33C	SF3	F91CR	SW3	SW3
R41DC	R1041DC	R66E	R66E	S33N	UN5	SF4	F91C8	SW4	SW4
R41DV	R1041DV	R67F	R67F	S33P	S33P	SF5	FT37	SW5	SW5
R41Y	SC1041YR	R67K	R67K	S41E	S1041T	SF6	FT38	SW6	SW6
R60HR	R60HR	R67N	R67N	S42M	S1042ZM	SF7	SF7AF	SW7	SW7
R60ZD	R60ZD	R67P	R67P	S42Z	S1042Z	SF8	SF8	SX1	SX1
R61D	R61D	R67Q	R67Q	S54G	S54G	SF9	SF9	SX2	SU9L
R61E	R61E	R67T	R67T	S5M	5B	SG1	1063	SX3	SX3
R61G	R61G	R67U	RK3	S60	S60	SG2	SG2	SX4	SX4
R61GA	R61GA	R67W	RU91C	S60R	S60R	SG3	1063B	SX9B	SX9B
R61H	R61H	R686B	1286BR	S61	Z91K	SG4	SG4	SY1	SY1
R61JD	R61JD	R686E	R1286E	S61JD	S61JD	SG5	SG5	SY10	SY10
R61K	R61K	R707A	R1307A	S61R	Z91KR	SH1	SCH1	SY11	SY11



DOMINION	ILCO	DOMINION	ILCO	DOMINION	ILCO	DOMINION	ILCO	DOMINION	ILCO
SY12	SY12	TK22	TK22	U07LK	O1007LK	UN54L	UN54L	VE1	VEC1
SY2	SY2	TK23	TK23	U07LL	O1007LL	UN55	UN55	VE2	VEC2
SY3	SY3-NS	TK24	TK24	U07LM	O1007LM	UN55L	UN55L	VG1	VG1
SY4	SY4	TK25	TK25	U07LN	N1007KMA	UN56	UN56	VL1	VL1
SY5	SY5-NS	TK26	TK26	U07RA	O1007RA	UN56L	UN56L	VR1	VR1
SY6	SY6-NS	TK27	TK27	U07RB	O1007RB	UN57	UN57	VR61S	VR61S
SY7	SY7	TK28	TK28	U07RC	O1007RC	UN57L	UN57L	VS1	VS1
SY8	SY8-NS	TK29	TK29	U07RD	O1007RD	UN58	UN58	VS3	VS3
SY9	SY9	TK30	TK30	U07RDH	O1007RDH	UN58L	UN58L	VT1	VT1
SZ1	SZ1	TK31	TK31	U07RDM	O1007RDM	UN59	UN59	W1	N1054WB
SZ2	SZ2	TK32	TK32	U07RE	O1007RE	UN59L	UN59L	W62VB	W62VB
SZ4	SZ4	TK33	TK33	U07RF	O1007RF	UN60	UN60	W62VE	W62VE
SZ5	SZ5	TK34	TK34	U07RG	O1007RG	UN60L	UN60L	WA1	WA1
T167FD	1181FD	TK35	TK35	U07RH	O1007RH	UN61	UN61	WA2	WA2
T35	T95	TK36	TK36	U07RHM	O1007RHM	UN61L	UN61L	WB1	X55
T36	T96	TK37	TK37	U07RJ	O1007RJ	UN62	UN62	WB19	WB19
T37	T97	TK38	TK38	U07RK	O1007RK	UN62L	UN62L	WB2	WB2
T41Y	T41Y	TK39	TK39	U07RL	O1007RL	UN63	UN63	WC1	WC1
T44	T44	TK4	TK4	U07RM	O1007RM	UN63L	UN63L	WC2	WC2
T54F	T54F	TK41	TK41	U07RN	N1007RMA	UN64	UN64	WE1	WRE1
T61VR	T61VR	TK5	TK5	U09	O1009	UN64L	UN64L	WE2	WRE2
T67A	T67A	TK6	TK6	U10	O1010	UN65	UN65	WE3	WRE3
T67B	T67B	TK7	TK7	U10A	O1010A	UN65L	UN65L	WF1	WF1
T67C	T67C	TK8	TK8	U122	O1122	UN66	UN66	WG1	WG1
T67D	T67D	TN1	TN1	U122A	O1122A	UN66L	UN66L	WH1	WH1
T67E	T67E	TN2	TN2	U122AR	O1122AR	UN67	UN67	WH2	WH2
T67F	T67F	TN3	TN3	U122B	O1122B	UN67L	UN67L	WH3	WH3
TA1	TA1	TN4	TN4	U122BE	O1122BE	UN68	UN68	WK1	WIL1
TA10	TR18	TN5	TN5	U122BER	O1122BER	UN68L	UN68L	WK10	WK10
TA11	TA11	TO1	TO1	U122BR	O1122BR	UN69	UN69	WK11	WK11
TA12	TA12	TO2	TO2	U122C	O1122C	UN69L	UN69L	WK12	WK12
TA13	T61F	TO3	TO3	U122R	O1122R	UN80	UN80	WK13	WK13
TA14	TA14	TO4	TO4	U14JM	O1014JM	UN80L	UN80L	WK14	WK14
TA15	TA15	TO5	TO5	U14JS	O1014J	UN81	UN81	WK15	WK15
TA16	TA16	TO6	TO6	U14T	X1014F	UN81L	UN81L	WK16	WK16
TA17	T61C	TO7	TO7	U22	O1022	UN82	UN82	WK17	WK17
TA18	T61D	TR1	TR1	U22A	O1022AB	UN82L	UN82L	WK18	WK18
TA19	TA19	TS1	TS1	U611B	U611B	UN83	UN83	WK19	WK19
TA2	TA2	TT1	TT1	U615	O1215	UN83L	UN83L	WK2	WIL2
TA20	TR26	TY1	TY1	U621A	U621A	UN85L	UN85L	WK20	WK20
TA21	X45	TY2	1141F	U621L	O1221L	UN90	UN16	WK21	WK21
TA22	X37	TY3	1141K	U623	O1223	UR1	BUR1	WK22	WK22
TA23	TA23	U00F	XO1000F	U623L	O1223L	UR10	BUR10	WK23	WK23
TA24	TA24	U00FR	XO1000FR	U62VA	U62VA	UR11	BUR11	WK24	WK24
TA25	TA25	U00GR	O1000GR	U62VB	U62VB	UR12	BUR12	WK25	WK25
TA26	TA26	U00GX	O1000GX	U62VN	U62VN	UR13	BUR13	WK26	WK26
TA27	X46	U00H	O1000H	U62VP	U62VP	UR14	BUR14	WK27	WK27
TA28	TA28	U00Z	A1001EH	U63H	U63H	UR15	BUR15	WK28	WK28
TA29	X137	U01A1	A1001AH	U65F	U65F	UR2	BUR2	WK29	WK29
TA3	T61B	U01A2	A1001FH	U65S	SO91P	UR3	BUR3	WK3	WK3
TA4	TA4	U01AM	A1001AM	U67K	U67K	UR4	BUR4	WK30	WK30
TA5	TA5	U01B1	A1001BH	U759L	1759P	UR5	BUR5	WK31	WK31
TA6	TA6	U01B2	A1001DH	U7A	O997A	UR6	BUR6	WK32	WK32
TA7	TA7	U01BM	A1001BM	U7E	O997E	UR62K	UR62K	WK4	WK4
TA8	TA8	U01C1	A1001C1	U7ER	O997ER	UR62VP	UR62VP	WK5	WK5
TA9	TA9	U01C2	A1001C2	U7G	O997G	UR62X	UR62X	WK6	WK6
TB1	TB1	U01CM	A1001CM	U7K	O997K	UR67K	UR67K	WK7	WK7
TB2	TB2	U01D1	A1001D1	U98B	O1098B	UR7	BUR7	WK8	WK8
TE1	TE1	U01D2	A1001D2	U98D	O1098D	UR8	BUR8	WK9	WK9
TE2	TE2	U01DM	A1001DM	U98LA	O1098LA	UR9	BUR9	WR1	WAR1
TE3	TE3	U01E	O1001E	U9CR	O999CR	UR9CS	CS91ER	WR2	WAR2
TE4	TE4	U01GM	A1001ABM	U9CS	CS91E	V61	V61	WR3	WAR3
TG1	TG1	U01GRM	A1001GRM	U9P	U9P	V61S	V61S	WR4	WAR4
TK1	TK1	U01RM	A1001CDM	U9TK	TO91	VC21	VC21	WS1	WS1
TK10	TK10	U07JA	O1007JA	UF65A	UF65A	VC22	VC22	WS10	WS10
TK11	TK11	U07LA	O1007LA	UM2	UM2	VC23	VC23	WS11	WS11
TK12	TK12	U07LB	O1007LB	UN1	UN1	VC24	VC24	WS2	WS2
TK13	TK13	U07LC	O1007LC	UN2	MG1	VC25	VC25	WS3	WS3
TK14	TK14	U07LD	O1007LD	UN50	UN50	VC26	VC26	WS4	WS4
TK15	TK15	U07LDH	O1007LDH	UN50L	UN50L	VC27	VC27	WS5	WS5
TK16	TK16	U07LDM	O1007LDM	UN51	UN51	VC28	VC28	WS6	WS6
TK17	TK17	U07LE	O1007LE	UN51L	UN51L	VC29	VC29	WS7	DA20
TK18	TK18	U07LF	O1007LF	UN52	UN52	VC30	VC30	WT1	WT1
TK19	TK19	U07LG	O1007LG	UN52L	UN52L	VC31	VC31	WT2	WT2
TK2	TK2	U07LH	O1007LH	UN53	UN53	VC32	VC32	WT3	WT3
TK20	TK20	U07LHM	O1007LHM	UN53L	UN53L	VC33	VC33	WT4	WT4
TK21	TK21	U07LJ	O1007LJ	UN54	UN54	VC34	VC34	WT5	WT5

# DOMINION - ESP

DOMINION	ILCO	DOMINION	ILCO	DOMINION	ILCO	ESP	ILCO	ESP	ILCO
WT6	PA5	YH46	X120	ZK33	ZK33	AB1	AB62C	CO95	A1001DH
WT7	PA6	YH47	X119	ZK34	ZK34	AM1	1041C	CO97	1001GH
WT9	X88	YH48	X117	ZK35	ZK35	AM3	1046	CO98	A1001C1
X00F	X1000F	YH49	X118	ZK36	ZK36	AP1	101AM	CO99	A1001C2
X00FR	X1000FR	YH5	YH5	ZK37	ZK37	AP2	102AM	DA21	X7
X00KC	X1001KC	YH50	YH50	ZK38	ZK38	AP3	103AM	DA22	X6
X00KR	X1011KR	YH51	YH51	ZK39	ZK39	AP4	104AM	DA23	DA23
X199A	X1199A	YH6	YH6	ZK4	ZK4	AR1	1179	DA24	X114
X199AR	X1199AR	YH7	YH7	ZK40	ZK40	AR4	1179A	DA25	X123
X199B	X1199B	YH8	YH8	ZK41	ZK41	B1	1098M	DA31	X210
X199G	X1199G	YH9	YH9	ZK42	ZK42	B10	H1098LA	DC2	X54
X199J	X1199J	YM1	YM1	ZK43	ZK43	B11	O1098LA	DC3	X121
X54F	X1054F	YM13	YM13	ZK44	ZK44	B2	H1098M	DE6	D1054K
X54FN	1054FN	YM14	YM14	ZK45	ZK45	B24	H1098X	DE8	D1054KA
X54JA	X1054JA	YM15	YM15	ZK46	ZK46	B4	1098X	E137	1137B
X54JK	X1054JK	YM16	YM16	ZK47	ZK47	B40	H1098A	EA1	1014
X54K	X1054K	YM17	MB16	ZK48	ZK48	B41	O1098B	EA27	X1014F
X54MT	1054MT	YM18	MB16R	ZK49	ZK49	B42	H1098C	EL10	C1096CN
X54WA	X1054WA	YM19	MB17	ZK5	ZK5	B43	O1098D	EL11	C1096LN
X62VK	X62VK	YM20	X21	ZK50	ZK50	B44	P1098E	EL3	1096L
X63	XD63	YM21	YM21	ZK51	ZK51	B45	S1098H	ER1	1119
X9	X999	YM22	YM22	ZK52	ZK52	B46	P1098J	ES8	1502
X9A	X999A	YM23	YM23	ZK53	ZK53	B47	S1098K	ES8M	1502M
X9B	999B	YM24	YM24	ZK54	ZK54	B48	P1098A	ES9	1503
X9CS	AB62GR	YM25	YM25	ZK55	ZK55	B49	S1098B	FC2	X20
X9E	BK5	YM26	X22	ZK56	ZK56	B5	1098DB	FC5	X4
X9R	X999R	YM27	YM27	ZK57	ZK57	B50	P1098C	FC6	X5
XL1	1180S	YM28	YM28	ZK58	ZK58	B51	S1098D	FC7	X86
XL2	1182	YM29	YM29	ZK59	ZK59	B53	X143	FT36	F44
XR9CS	AB62G	YM3	YM3	ZK6	ZK6	B55	X145	FT37	FT37
XR9CS	AB62ER	YM30	YM30	ZK60	ZK60	B56	X146	FT38	FT38
XU199B	XO1199B	YM31	X83	ZK61	ZK61	B63	P1098CV	GAS	1098GX
XU199G	XO1199G	YM31-RH	MB39-P	ZK62	ZK62	B64	P1098WC	H26	1127ES
XU9CS	AB62E	YM32	MB40	ZK63	ZK63	B65	X184	H27	1127DP
Y61	Y61	YM4	YM4	ZK64	ZK64	B72	X192	H50	S1167FD
Y62	Y62	YM5	YM5	ZK65	ZK65	B78	P1098WE	H51	1167FD
Y9E	Y9E	YM6	YM6	ZK66	ZK66	B84	P1101	H54	1184FD
YH1	YH1	YM7	YM7	ZK67	ZK67	B86	P1106	H60	1190LN
YH10	YH10	YM8	YM8	ZK68	ZK68	B88	P1108	H67	1193FD
YH11	YH11	YM9	YM9	ZK69	ZK69	BE2	A1114A	H75	1196FD
YH12	YH12	YR62	YR62	ZK7	ZK7	BM2	X59	HD69	X44
YH13	YH13	YU1	YY1	ZK70	ZK70	BM3	BMW1	HD70	X71
YH14	YH14	ZC1	ZC1	ZK71	ZK71	BN1	K1122D	HD80	X129
YH15	YH15	ZC2	ZC2	ZK72	ZK72	BN7	K1122N	HD90	X181
YH16	YH16	ZC3	ZC3	ZK73	ZK73	CG1	1041G	HD91	X182
YH17	YH17	ZC4	ZC4	ZK74	ZK74	CG16	1041T	HD98	X195
YH18	YH18	ZE1	ZE1	ZK75	ZK75	CG2	1041GA	HL2	R1003M
YH19	X39	ZK1	ZK1	ZK76	ZK76	CG3	1041GR	HO3	1170B
YH2	YH2	ZK10	ZK10	ZK77	ZK77	CG6	1041N	HR1	1014C
YH20	YH20	ZK100	ZK100	ZK78	ZK78	CO1	1000	HR2	TE3
YH21	X18	ZK101	ZK101	ZK79	ZK79	CO10	X1000G	HY2	X160
YH22	YH22	ZK102	ZK102	ZK8	ZK8	CO10	1000G	HY5	X196
YH23	YH23	ZK103	ZK103	ZK80	ZK80	CO106	1003M	IN1	1054F
YH24	YH24	ZK11	ZK11	ZK81	ZK81	CO2	1000AB	IN18	X1054F
YH25	X65	ZK12	ZK12	ZK82	ZK82	CO26	1000V	IN28	1054FN
YH26	X66	ZK13	ZK13	ZK83	ZK83	CO3	1001EB	IN29	1054UN
YH27	X68	ZK14	ZK14	ZK84	ZK84	CO34	R1001ED	IN3	X1054K
YH28	X67	ZK15	ZK15	ZK85	ZK85	CO35	R1001EE	IN35	1054DL
YH29	YH29	ZK16	ZK16	ZK86	ZK86	CO36	1001EG	IN8	L1054B
YH3	YH3	ZK17	ZK17	ZK87	ZK87	CO4	1001EA	JE1	OM10
YH30	X76	ZK18	ZK18	ZK88	ZK88	CO44	1001MA	K2	1079B
YH31	YH31	ZK19	ZK19	ZK89	ZK89	CO45	1001MB	KW1	1176
YH32	X63	ZK2	ZK2	ZK9	ZK9	CO5	1001	KW10	A1176ST
YH33	X75	ZK20	ZK20	ZK90	ZK90	CO51	A1001D1	KW5	A1176
YH34	X74	ZK21	ZK21	ZK91	ZK91	CO52	A1001D2	L1	1004
YH35	X73	ZK22	ZK22	ZK92	ZK92	CO58	R1001EK	L37	1004KL
YH36	X72	ZK23	ZK23	ZK93	ZK93	CO6	1001AB	L4	1004A
YH37	X69	ZK24	ZK24	ZK94	ZK94	CO62	R1001EG	L5	1004AL
YH38	X77	ZK25	ZK25	ZK95	ZK95	CO66	A1001EH	M1	1092
YH39	YH39	ZK26	ZK26	ZK96	ZK96	CO68	S1000V	M10	1092N
YH4	YH4	ZK27	ZK27	ZK97	ZK97	CO7	1001EN	M11	1092H
YH40	YH40	ZK28	ZK28	ZK98	ZK98	CO87	1001EH	M12	1092D
YH41	YH41	ZK29	ZK29	ZK99	ZK99	CO89	A1001ABM	M13	1092DS
YH42	YH42	ZK3	ZK3	ZU1	ZU1	CO90	1001ABM	M2	1092B
YH43	YH43	ZK30	ZK30			CO91	A1001AH	M4	1092V
YH44	X62	ZK31	ZK31	ESP	ESP	CO92	A1001FH	MB33	MB18
YH45	X107	ZK32	ZK32	AA2	AA2	CO94	A1001BH	MB34	MB15

CROSS REFERENCE

ESP	ILCO	ESP	ILCO	FORT LOCK	ILCO	ILCO/EZ	ILCO	ILCO/EZ	ILCO
MD17	MD1054K	V28M	VW71	ML54G	ML54G	L1	1004	RO3	1069N
MG1	MG1	V29R	VW71A			LD1	1639	RU3	1011B
MIT1	X176	V30F	X9	<b>GENERAL</b>		LO1	X1014L	S3	1010
MZ10	X27	V32FB	X53	<b>GENERAL</b>		LUV1	P1098V	TM3	1603
MZ12	X1	V35	X139	100-A1	G191	M1	1092	WR3	1054WB
MZ13	X131	VL3	VO62	100-A10	G190	N1	1017	Y3	C999
MZ27	X222	VL4	X30	100-A2	G192	NA1	1064	AM4	1653
MZ9	X26	VL5	X29	100-A29	G190B	NH1	1177N	AP4	104AM
NA12	1069LB	VL6	X80	100-A3	G193	OL1	1171P	AR4	1179A
NA14	1069L	WE1	1123	100-A30	G190C	P1	1016	B4	1098XL
NA24	1069LC	WE3	1123S	100-A31	G190D	PZ1	PZ1	CLB4	1573D
NA6	R1064D	WK2	1175N	100-A32	G190E	RA1	1098NR	CO4	1001EA
NA6	R1064E	WR3	1054WB	100-A33	G190F	RE1	1019	DE4	D1098X
OP11	OP11	WR4	A1054WB	100-A4	G194	RO1	1069	HAW4	1600
OP19	U62VP	WR5	N1054WB	100-A5	G195	RU1	1011	HO4	A1170B
PA2	PO5	WS2	FT6R	100-A6	G196	S1	1009	IN4	1054LB
PA5	PA5	XL7	1180S	100-A7	G197	SA1	1047CR	L4	1004A
PA6	PA6	Y1	999	100-A8	G198	SC1	1145	M4	1092V
PA7	X32	Y103	O1122B	100-A800	G190M	SE1	1022	RA4	1970AM
PP10	X12	Y104	O1122BR	100-A9	G199	SK1	R1001EN	RO4	1069FL
RA3	S1970AM	Y11	O1122	101-A1	G191A	SL1	1120D	RU4	1011P
RA4	1970AM	Y12	O1122A	101-A10	G190A	T1	1141	S4	1010
RN24	X116	Y13	O1122R	101-A2	G192A	TM1	1601	SC4	1145A
RO1	1069	Y14	O1122AR	101-A29	G190BA	W1	1071	SS4	1626
RO3	1069N	Y149	S1767CH	101-A3	G193A	WE1	1123	ST4	1145AST
RO4	1069FL	Y152	1770CH	101-A30	G190CA	WK1	1175	TM4	1604
RO5	1069M	Y154	P1789	101-A31	G190DA	WN1	1634	WR4	A1054WB
RU1	1011	Y155	P1793	101-A32	G190EA	WTP1	1616	Y4	998
RU16	A1011P	Y157	P1794	101-A33	G190FA	Y1	999	AP5	100AM
RU18	1011PZ	Y1E	999N	101-A4	G194A	Y1E	999N	B5	1098DB
RU19	1011D41	Y2	999A	101-A5	G195A	AP2	102AM	CLB5	1573E
RU2	1012	Y220	999B	101-A6	G196A	B2	H1098M	CO5	1001
RU20	A1011D41	Y3	C999	101-A800	G190MA	BAU2	1648	DE5	A1054KD
RU21	N1011M	Y4	998	<b>HARLOCK</b>		BE2	A1114A	H5	1125H
RU22	A1011M	Y52	997E	<b>HARLOCK</b>	<b>ILCO</b>	BW2	1510	KW5	A1176
RU4	N1011P	Y54	O997E	SE-1	1014B	CG2	1041GA	M5	1092VM
RU45	1011D1	Y6	997X	SE-1	1014C	CLB2	1573B	RO5	1069M
RU46	A1011D1	YS1	X21	<b>HYM/YORK</b>		DE2	D1098B	S5	1009A
S1	1009	YS2	X22	<b>HYM/YORK</b>	<b>ILCO</b>	EL2	1096	SS5	1637
S16	N1007KMB	<b>FALCON</b>		S2801	1133	EZ2	1647	VR5	VR91B
S22	O1007LA	<b>FALCON</b>	<b>ILCO</b>	S4404	1135	FA2	A1054WC	WR5	N1054WB
S221/2	1007LA	12628A	FL1	<b>HUDSON</b>		FR2	L1054G	Y5	997EB
S3	1010	12628B	FL2	<b>HUDSON</b>	<b>ILCO</b>	HAW2	1598	CLB6	1573F
S31	N1007RMA	12628BD	FL4	H02L	1562	HR2	TE3	DE6	D1054K
S32	N1007RMB	12628D	FL3	H03L	1563	IN2	1054	H6	1125
S4	1010U	12628E	FL5	H07L	1564	K2	1079B	NA6	R1064D
S4	O1010	12628F	FL6	H10L	1561	KB2	1654	S6	S6
S6	N1007KMA	12628G	FL7	"670-12,H21"	R1003M	LD2	1640	SC6	1307A
S68	1010N	12628H	FL8	<b>ILCO/EZ</b>		M2	1092B	TM6	1606
S69	L1010N	12628J	FL9	<b>ILCO/EZ</b>	<b>ILCO</b>	P2	1016N	WR6	N1176
SB11	X52	KB1573G	1054WD	AF1	1652	RA2	H1098NR	Y6	997X
SC1	1145	KB1573H	1054WH	AM1	1041C	RU2	1012	CLB7	1581G
SC10	A1145F	KB1573I	1054WF	AP1	101AM	S2	1009	CO7	1001EN
SC20	A1145L	KB1573K	1054WK	AR1	1179	SE2	1022	RO7	1069G
SC22	1307W	KB1573L	1054WL	B1	1098M	T2	H1122M	RU7	N1011M
SC4	1145A	KB1573N	1054WN	BAU1	1618	TM2	1602	SC7	1145F
SC6	1307A	KB1577F	A1054WF	BAU1R	1618R	VR2	VR91	T7	1141GE
SC7	1145F	KB1577G	FL5G	BN1	K1122D	WK2	1175N	TM7	1607
SC8	1145E	KB1577G	A1054WD	BO1	R1003M	WR2	X1054WA	VR7	VR91AR
SC9	A1145E	KB1577H	A1054WH	CG1	1041G	WTP2	1662	XL7	1180S
SE1	1022	KB1577J	A1054WJ	CL1	1023	Y2	999A	CLB8	1581H
SK1	R1001EN	KB1577K	A1054WK	CLB1	1573A	AM3	1045	DE8	D1054KA
SL1	1120D	KB1577L	A1054WL	CO1	1000	AM3L	1045L	EL8	H1054B
T7	1141GE	KB1577N	A1054WN	DE1	1054KD	AP3	103AM	IN8	L1054B
TR20	T61C	KB1577P	A1054WP	EA1	1014	B3	1098L	SC8	1145E
TR23	T61F	KB1577R	A1054WR	EL1	1096C	BAU3	1676	TM8	1608
TR25	TR25	P1573E	1054WC	ER1	1119	CLB3	1573C	CLB9	1589I
TR28	X37	P1577E	A1054WC	EZ1	1522	CO3	1001EB	CO9	1000KC
TR33	X137	P1581E	L1054WC	FA1	1054WC	EL3	1096L	DE9	DS1145
TR37	X159	<b>FORT LOCK</b>		FIC1	1617	FA3	A1054WD	ES9	1503
TR39	X151	<b>FORT LOCK</b>	<b>ILCO</b>	HAW1	1597	HAW3	1599	IL9	1043B
TR40	X174	K54G	1054G	HO1	1170B	IN3	X1054K	SC9	A1145E
TR47	X217	K750D	750	HR1	1014C	KB3	1663	TM9	1609
UN16	UN16	K752	752	IL1	1041H	M3	1092VR	Y9	H1122F
UN18	62FS	K757	757	IN1	1054F	N3	1017B	B10	H1098LA
UN3	62DP	KL54G	L1054G	K1	1079	R3	1140G	CLB10	1589J
V26K	V27	M54G	M54G	KB1	1649	RA3	S1970AM	CO10	X1000G
				KW1	1176				

**ILCO/EZ - JET**

ILCO/EZ	ILCO	ILCO/EZ	ILCO	ILCO/EZ	ILCO	JET	ILCO	JET	ILCO		
EL10	C1096CN	S31	S31	CO97	1001GH	11SD-NS	998SD	8260KW-NS	08260KW		
KW10	A1176ST	EA32	1014J	CO98	A1001C1	11SE-NS	998SE	8-NS	8-YALE-NS		
M10	1092N	S32	S32	RU101	RU101	11SF-NS	998SF	A191	AG2		
S10	1010B	IN33	1054MT	Y101	L1122A	11SG-NS	998SG	A192	A192		
SC10	A1145F	IN34	1054TW	B102	P1113	11SH-NS	998SH	AB1	AB62C		
TM10	1610	Y34	997DA	CO102	A1001C2	11SK-NS	998SK	AB3	AB62ER		
B11	01098LA	CO35	R1001EE	Y103	01122B	11SMK-NS	998SMK	AB4	AB62E		
CLB11	1590K	IN35	1054DL	CR105	A1011-L41	137B	1137B	AIR 5-NS	1515		
EL11	C1096LN	CO36	1001EG	B106	P1115	137S	1137S	AIR 6-NS	A1515		
IL11	1043J	IN36	N1054K	CO106	1003M	191B	VR91B	AM1	1041C		
KW11	A1176KT	B44	P1098E	CO107	A1001D1	1A1A1-NS	1A1A1	AM3	1046		
M11	1092H	RU44	1011GH	CO108	A1001D2	1A1B1-NS	A1114B	AM6	1045		
Y11	1122	B45	S1098H	B110	P1114	1A1B1-NS	1A1B1	AM7	A1045		
CLB12	1591L	CR45	CR45	Y133	X1199AR	1A1C1-NS	A1114C	AR1	1179		
CO12	1000T	RU45	1011D1	Y138	S1767CH	1A1C1-NS	1A1C1	AR-1C-NS	B1179-1C		
M12	1092D	B46	P1098J	Y146	1767CH	1A1D1-NS	A1114D	AR-1D-NS	B1179-1D		
NA12	1069LB	CR46	CR46	Y149	S1770U	1A1D1-NS	1A1D1	AR3 or K6-NS	N1179A		
TM12	1612	RU46	A1011D1	Y152	P1770U	1A1DD1-NS	A1114DD	AR4	1179A		
Y12	01122A	B47	S1098K	Y153	P1786	1A1E1-NS	A1114E	AR-ER	A1019M		
CLB13	1591M	B48	P1098A	Y154	P1789	1A1E1-NS	1A1E1	B1	1098M		
EA13	1014DX	B49	S1098B	Y155	P1793	1A1F1-NS	A1114F	B10 or B10-NP	H1098LA		
L13	1004N	B50	P1098C	Y157	P1794	1A1F1-NS	1A1F1	B102	P1113		
M13	1092DS	H50	S1167FD	Y159	P1795	1A1G1-NS	A1114G	B102-PH	B102-P		
TM13	1621	B51	S1098D	Y220	999B	1A1G1-NS	1A1G1	B103-N-PHT	B103-PT5		
Y13	01122R	H51	1167FD	Y221	999K1	1A1H1-NS	A1114H	B103-PHT	B103-PT		
CLB14	1591N	B52	1098GX	Y222	999K2	1A1H1-NS	1A1H1	B11	O1098LA		
M14	1092J	H52	S1181FD	Y223	999K3	1A1J1-NS	A1114J	B2 or B2-NP	H1098M		
NA14	1069L	RU52	N1011P	<b>ILLINOIS</b>						B4	1098XL
TM14	1622	Y52	997E	ILLINOIS	ILCO	1A1J1-NS	1A1J1	B44	P1098E		
Y14	01122AR	H53	1181FD	100	S1041H	1A1K1-NS	A1114K	B44-PH	B44-P		
CLB15	1591P	RU53	A1011D41	105	ILL1	1A1L1-NS	A1114L	B45	S1098H		
EL15	L1096CN	H54	1184FD	110	1041H	1A1L1-NS	1A1L1	B45-PH	B45-P		
RO15	N1069N	Y54	O997E	115	1041HM	1A1M1-NS	A1114M	B46	P1098J		
TM15	1623	H55	1185FD	210	S1042Z	1A1M1-NS	1A1M1	B47	S1098K		
B16	H1098DB	H56	1186TS	210	S1042ZP	1A1Q1-NS	A1114Q	B48	P1098A		
CG16	1041T	H60	1190LN	220	1042Z	1A1Q1-NS	1A1Q1	B48-PH	B48-P		
M16	1092NR	B62	P1098AV	220	S1042ZS	1A1R1-NS	A1114R	B49	S1098B		
RU16	A1011P	CO62	R1001EG	260	1043D	1A1R1-NS	1A1R1	B49-PH	B49-P		
S16	S16	H62	1191ET	265	1043E	1A1TB1-NS	A1114TB	B5	1098DB		
TM16	1650	B63	P1098CV	270	1043G	275RF-NS	1007RF	B50	P1098C		
CG17	1041Y	CO63	1000X	275	1043ED	275RG-NS	1007RG	B50-PH	B50-P		
CO17	1000F	B64	P1098WC	310	1041P	54G	1054G	B51	S1098D		
M17	1092C	H66	1193MU	360	1043B	57A1-6-NS	R1001EE	B51-PH	B51-P		
MD17	MD1054K	B67	S1098WD	510	1042A	57A2-6-NS	1001MB	B52 or GAS	1098GX		
TM17	1651	H67	1193FD	610	1042B	57B1-6-NS	1001MA	B53-NP	X143		
H18	1127DU	B68	P1099	210M	S1042ZM	57B2-6-NS	R1001ED	B54-NP	X154		
IN18	X1054F	CO68	S1000V	360M	1043C	59A2-6-NS	A1012-59A2	B55-NP	X145		
M18	1092-40	S68	1010N	610X	L1042B	59B1-6-NS	A1012-59B1	B56-NP	X146		
TM18	1665	S70	S70	X410	1041W	59B2-6-NS	A1012-59B2	B59-NP	X162		
M19	1092-900	H71	1195FD	<b>JET</b>						B61-NP	X168
TM19	1666	S73	S73	JET	ILCO	59C1-6-NS	A1012-59C1	B62	P1098AV		
EL20	S1096B	H75	1196FD	191	VR91AR	59C2-6-NS	A1012-59C2	B63	P1098CV		
M20	1092-6000	B77	P1098EV	057AD-6-NP	R1001EM	59D1-6-NS	A1012-59D1	B64	P1098WC		
SC20	A1145L	B78	P1098WE	100C-NP	100C	59D2-6-NS	A1012-59D2	B65-NP	X184		
SL20	1120F	H78	1196CM	100C-NS	100C-NS	6275LA-NS	6275LA	B67	S1098WD		
TM20	1667	Y78	998GA	100E-NS	100E-NS	6275LB-NS	O1007LB	B68	P1099		
EL21	R1096EN	B79	S1098WH	101CE-NS	A1145CE	6275LC-NS	O1007LC	B68	P1099		
M21	1092-7000	B84	P1101	101C-NP	101C	6275LD-NS	O1007LD	B69-NP	X180		
CG22	1041E	B85	S1105	101C-NS	101C-NS	6275LE-NS	O1007LE	B72-NP	X192		
S22	S22	B86	P1106	101C-NS	101C-NS	6275LF-NS	O1007LF	B77	P1098EV		
S22 1/2	S22 1/2	CO87	1001EH	101EF-NS	A1145EF	6275LG-NS	O1007LG	B78	P1098WE		
SC22	1307W	CR87	CR87	101E-NP	101E	6275LH-NS	O1007LH	B79	S1098WH		
B24	H1098X	B88	P1108	101E-NS	101E-NS	6275LJ-NS	O1007LJ	B84	P1101		
IN24	K1054B	CO88	A1001EH	101FG-NS	A1145FG	6275LK-NS	O1007LK	B86	P1106		
NA24	1069LC	CR88	CR88	101F-NS	101F-NS	6275LL-NS	O1007LL	B86-PH	B86-P		
M25	1092-6000B	B89	P1107	101G-NS	A1145G	6275LM-NS	O1007LM	B88	P1108		
NA25	R1064E	CO89	A1001ABM	11GB-NS	998GB	6275RA-NS	O1007RA	B89	P1107		
CO26	1000V	CR89	CR89	11GC-NS	998GC	6275RB-NS	O1007RB	B91	P1111		
H26	1127ES	B91	P1111	11GD-NS	998GD	6275RC-NS	O1007RC	B91-PH	B91-P		
M26	1092-7000B	CO91	A1001AH	11GE-NS	998GE	6275RD-NS	O1007RD	B92	P1109		
EA27	X1014F	CR91	CR91	11GF-NS	998GF	6275RE-NS	O1007RE	B93	P1112		
H27	1127DP	B92	P1109	11GG-NS	998GG	6275RF-NS	O1007RF	B96-NP	P1110		
M27	1092F	CO92	A1001FH	11GH-NS	998GH	6275RG-NS	O1007RG	B96-PH	B96-P		
IN28	1054FN	B93	P1112	11GI-NS	998GI	6275RH-NS	O1007RH	B106-NP	P1115-B106		
M28	1092K	CO94	A1001BH	11GK-NS	998GK	6275RJ-NS	O1007RJ	B112-CP-PHT	B111-PT		
IN29	1054UN	CO95	A1001DH	11SA-NS	998SA	6275RK-NS	O1007RK	B114-PHT	B114R-PT		
M29	1092M	B96	P1110	11SB-NS	998SB	6275RL-NS	O1007RL	BE2 or 1A1A1-NSA1114A			
				11SC-NS	998SC	6275RM-NS	O1007RM	BMW1	BMW1		



JET	ILCO	JET	ILCO	JET	ILCO	JET	ILCO	JET	ILCO
BMW3-NP	X144	D8782	1069S	H67	1193FD	IL260	1043D	M1	1092
BMW3-PH	BMW3-P	D8783	1069G	H67F-PH	H67F	IL360	1043B	M10	1092N
BN1-NP	K1122D	D8784	S1069M	H67-PH	H67-P	IL360	1043J	M11	1092H
CB1	1573A	D8785	1069N	H71	1195FD	IL510	1042A	M12	1092D
CB10	1589J	D8787	1069FL	H72-PHT	H72-PT	IL510	L1042A	M13	1092DS
CB11	1590K	D8788	1069M	H72-PHT-T	H72-PT-CLEAR	IL610	1042B	M19	1092J
CB12	1591L	D8789	1069E	H72-N-B	EB3-B-H72	IL610	L1042B	M1-RV	1092R
CB13	1591M	DA21-NP	X7	H72-N-PHT	EK3-H72	IN1	1054F	M2	1092B
CB14	1591N	DA22-NP OR SR1-NP	X6	H73-PHT	H73-PT	IN18	X1054F	M27	1092NR
CB15	1591P	DA23-NP	DA23	H74-PHT	H74-PT	IN20	1054K	M3	1092VR
CB2	1573B	DA24-NP	X114	H75	1196FD	INFQ45-PHT	INF45-PT	M4	1092V
CB3	1573C	DA25-NP	X123	H75F-NP	H75FM	IN28	1054FN	M5	1092VM
CB4	1573D	DA25-PH	DA25-P	H75F-PH	H75F	IN29	1054UN	M6000	1092-6000
CB5	1573E	DA28-NP	X124	H75-PH	H75-P	IN3	X1054K	M6000B	1092-6000B
CB6	1573F	DA31-NP	X210	H76 OR H76-NP	X244	IN33	1054MT	M7000	1092-7000
CB7	1581G	DA31-N-PHT	NSN11T2	H76F-PH	H76F	IN35	1054DL	M7000B	1092-7000B
CB8	1581H	DA31-PH	DA31-P	H78	1196CM	IN8	L1054B	M900	1092-900
CB9	1589I	DA34-N-B	EB3-H-NI02	H86-PH	H86-PT	INF90-PH	INF90	MAZ24-N-PHT	MAZ24RT5
CCL1	CB3	DA34-N-PHT	EK3-NI02	H90-N-B	EB3-D-H84	K1	1079	MB16-NP	MB16
CG1	1041G	DA34-NP	X237	H90-N-PHT	EK3-H84	K100M	100AM	MB41-NP	X82
CG16	1041T	DA34-PH	DA34-P	HD103-NP	X214	K101	101AM	MD17	MD1054K
CG2	1041GA	DA37-PH	DA37-P	HD103-PH	HD103-P	K102	102AM	MIT1-NP	X176
CG22	1041E	DA40-PHT	NI04T	HD106-N-PHT	HD106-PT5	K103	103AM	MIT1-PH	MIT1-P
CG4	1041GB	DC2-NP	X54	HD70,71-NPNS	X71	K104	104AM	MIT3-NP	X224
CL1	1023	DC3-NP	X121	HD74-NP	X84	K2	1079B	MIT4-NP	X245
CLP1-NP	1537	DE6	D1054K	HD75-NP	X138	K7-NS	K7	MIT4-PH	MIT4-P
CO1	1000	DE8	D1054KA	HD82-NP	X129	KA14-NP	X103	MIT12-N-B	EB3-K-MIT8
CO10	X1000G	DIE-1-NS	1028L	NSHD83,90-PHNS	HD90-P	KA15-NP	X106	MIT12-N-PHT	EK3-MIT8
CO17	SX1000F	DIE-2-NS	1052A	HD83-NP	X181	KA31-NP	KW16CP-SI	MIT12-PHT	MIT12-PT
CO19	1000FR	DIE-3-NS	1028	HD90-NP	X181	KB577E-NS	P1577E	MIT13-N-B	EB3-L-MIT9
CO19	X1000F	DO6	DO6	HD91-NP	X182	KB577F-NS	A1054WF	MIT13-N-PHT	EK3-MIT9
CO2	1000A	DW47-N-PHT	DW05T5	HD91-PH	HD91-P	KB577G-NS	KB1577G	MIT13-PHT	MIT13-PT
CO26	1000V	DW47-PH	DW05AP	HD92-NP or HD84-NP	X183	KB577J-NS	A1054WJ	MIT16-PHT	MIT16A-PT
CO3	1001EB	DW47R-N-PHT	DW05RT5	HD96-NP	X193	KK1-NP	X233	MIT17-PHT	MIT17A-PT
CO33	1001E	DW47R-PH	DW05RAP	HD98-NP	X195	KP1	1041Y	MOS-1-NS	1091
CO36	1001EG	E42DN	1548	HD103-PH	HD103-SVC	KP2	SC1041R	MOS-2-NS	1323L
CO37	1001EL	EA27	X1014F	HD106-N-PHT	HD106-PT	KP9	S1041JA	MOS-3-NS	1115
CO4	1001EA	EA27	X1014L	HD110-N-PHT	HO01-PT	KW1	1176	MOS-4-NS	884BR
CO5	1001	EA47	O1014S	HD112-PHT	HO03-PT	KW10 or KW10-NP		MOS-5-NS	1323
CO51	A1001D1	EM1	1528	HD113-PHT	HD111-PT	A1176ST		MZ9-NP	X26
CO52	A1001D2	EM1R	1528R	HMM-1-NS	1028N	KW1-PHC	KW1-PC	MZ13-NP	X131
CO54 1/2	X1000FR	ES1	1556	HMM-2-NS	1133	KW5	A1176	MZ13-PH	MZ13-P
CO6	1001AB	ES8	1502	HK1	1597	KW9-RT	1176RK	MZ16-NP	X178
CO62 OR 77-6-NS		ES8M	1502M	HK2	1598	L01ABM	L1001ABM	MZ17-NP	X188
R1001EG		ES9	1503	HK3	1599	L01EH	L1001EH	MZ19-NP	X201
CO68	S1000V	EZ1	1522	HK4	1600	L07KMA	N1007KMC	MZ19-PH	MZ19-P
CO7	1001EN	FA1	1054WC	HL1	1003M	L1	1004	MZ27-NP	X222
CO87	1001EH	FA2	A1054WC	HL2	R1003M	L11D1	B1011D1	MZ27-PH	MZ27-P
CO88	A1001EH	FA3	A1054WD	HR1	1014C	L11D41	B1011D41	MZ31-NP	X249
CO89	A1001ABM	FC7-NP	X86	HR2	TE3	L11P	1011PAA	MZ34-N-B	EB3-J-MAZ24
CO90	1001ABM	FT36	F44	HU66VW-N-PHT	HU66AT2	L12-6-NS	A1011-L12	MZ34-N-PHT	EK3-MAZ24
CO91	A1001AH	FT36-NP	NE9	HU66VW-N-PHT	HU66AT5	L1-6-NS	A1011-L1	NA12	1069LA
CO92	A1001FH	FT37-NP	FT37	HU66VW-PH	HU66-P	L191A	VR91	NA12	1069LB
CO94	A1001BH	FT38-NP	FT38	HU67-PHT	HU66T6	L2-6-NS	A1011-L2	NA14	1069L
CO95	A1001DH	FT46-NP	X152	HU68-PHT	HU66T24	L34-6-NS	A1011-L34	NA24	1069LC
CO97	1001GH	GM97-N-PHT	B97-PT5	HY12-NP	X232	L3-6-NS	A1011-L3	NA6	R1064E
CO98	A1001C1	GM97-PHT	B97-PT	HY12-PH	HY12-P	L37	1004LK	NH1	1177N
CO99	A1001C2	GM99NPHT	B99-PT	HY13-NP	X235	L4	1004A	O4KA	1004K
CO-KW1	1001MK	GM99-N-PHT	B99-PT5	HY13-PH	HY13-P	L41-NS-6	A1011-L41	O4KA	X1054KF
CR45	CR45	GMX320-PHT	B112-PT	HY14-NP	X236	CR-L41-6	A1011-L41	O59AD-6	A1001GRM
CR45	1012-D1	GMT265-PHT	B115-PT	HY14-PH	HY14-P	L4-6-NS	A1011-L4	O59AD-7	L1001GRM
CR46	CR46	GMX380CP-PHT	B111-GCPT	HY2-NP	X160	CR-L4-6	A1011-L4	P54F	P54F
CR87	CR87	H50	S1167FD	HY2-PH	HY2-P	L5	1004AL	PR7	PR91C
CR87	1012-60	H50F-NP	H50F	HY4-NP	X187	L54G	L1054G	PU1	1866-13
CR88	CR88	H50L-NP	H50L	HY5-NP	X196	L6M	A1015M	PZ1	PZ1
CR88/60-6-NS	A1012-60	H51	1167FD	HY6-NP	X216	L6MR	A1015MR	R52	A1
CR91	CR91	H51F-NP	H51F	HY12-PH	KK6-P	L7M	L1015M	R52L	A2
CR91/59A1-6-NSA1012-59A1		H51L-NP	H51L	HY15-PH	HY15-P	L7MR	L1015MR	R55	A3
CR-L4-5	1011-L4	H54	1184FD	HY16-PH	HY16-P	LEB-1-NS	LB1	R55	1551
CR-L4-6	A1011-L4	H55	1185FD	HY17-PH	HY17-P	LEB-2-NS	LB2	R59	TE1
D1-6-NS or CR46A1012-D1		H56-PH	1186TS-P	IL1	1041H	LEB-3-NS	LB3	R59	TE4
D2-6-NS	A1012-D2	H60	1190LN	IL210	S1042Z	LEB-4-NS	LB4	RA3	S1970AM
D3-6-NS	A1012-D3	H60L-NP	H60L	IL210	S1042ZP	LEB-6-NS	LB6	RA4	1970AM
D4-6-NS	A1012-D4	H62F-PH	H62F	IL210M	S1042ZM	LEB-7-NS	LB7	RN24-NP	X116
D8780	S1069G	H62-PH	H62-P	IL220	1042Z	LO80-5	80	RN30-NP	X147
		H65 OR H65-NP	X221	L220	S1042ZS	LR191A	VR91R	RO1	1069
		H65-P	H65-P			LXP90-PH	LXP90-P	RU1	1011

JET	ILCO	JET	ILCO	JET	ILCO	LOCKWOOD	ILCO	NATIONAL CAB.	ILCO
RU16	A1011P	TM400	1602	Y157C-PH	Y157PCHY	B318U	A1015UR	D8796	N1069E
RU18	1011PZ	TM700	1606	Y157-PH	Y157-P	B318V	A1015VR	D8797	N1069J
RU18 1/2	A1011PZ	TMC1-NP	X270-TMC1	Y157V or Y159V	1794V	B318W	A1015WR	D8798	1069T
RU19	1011D41	TR20-NP	T61C	Y159	P1795	B318X	A1015XR	<b>NATIONAL DOOR</b>	
RU20	A1011D41	TR20-PH	T61C-P	Y159C-NP	Y159CHY	B318Y	A1015YR		
RU21	N1011M	TR23-NP	T61F	Y159C-PH	Y159PCHY	B325	1004N	<b>NATIONAL EZ</b>	
RU22	A1011M	TR25	TR26	Y159-PH	Y159-P	B346	1004AL		
RU4	N1011P	TR25-NP	TR25	Y160-N-B	EB3-A-Y160	B346KL	1004KL	<b>NATIONAL EZ</b>	
RU45	1011D1	TR33-NP	X137	Y160-N-PHT	EK3-Y160	<b>MASTER</b>			
RU46	A1011D1	TR33-PH	TR33-P	Y165-PHT	Y164-PT	<b>MASTER</b>		<b>ORION</b>	
S&G-1-NS	1063D	TR37-NP	X159	Y166-PHT	Y170-PT	1525	1092VA		
S&G-2-NS	1063B	TR37-PH	VC33	Y1E	999N	105K	1286C	<b>ORION</b>	
S&G-3-NS	1063E	TR39-NP	X151	Y1R	999R	130K	1092DS		
S1	1009	TR40-NP	X174	Y2 or 11-NP	999A	150K	1092D	<b>ORION</b>	
S16	N1007KMB	TR40-PH	TR40-P	Y220	999B	15K	1092N		
S22 1/2LA	1007LA	TR44-NP	X211	Y221	SX9B	17K	1092H	<b>ORION</b>	
S22-LA	O1007LA	TR46-NP	X212	Y227	998GST	19K	1092J		
6275LA-NS	O1007LA	TR47-NP	X217	Y4 or 11GMK-NS	998	1K	1092	<b>ORION</b>	
S30FD-N-PHT	FO21EH2	TR47-PH	TR47-P	Y5	997EB	22KL	1286B		
S31	N1007RMB	TR47-PHT	TOY43AT4	Y52	997E	22KR	1286BR	<b>ORION</b>	
S32	N1007RMA	TR47-N-B	EB3-E-TOY43	Y52/Y52E	997D	27K	1092NR		
6270RN-NS	N1007RMA	TR48-N-B	EB3-F-TOY48	Y54 or Y54E	O997E	2K	1092R	<b>ORION</b>	
S34YS-PH	S34YS-P	TR48-N-PHT	EK3-TOY48	Y6 or Y6E	997X	500KL	1286E		
JET	ILCO	TR49-N-B	EB3-G-TOY40	Y78 or 11GA-NS	998GA	500KR	R1286E	<b>ORION</b>	
S4	1010U	TR49-N-PHT	EK3-TOY40	YAL-1-NS	885BL	510K	N1286R		
S48HF-PH	S48HF-P	TR51-PHT	TOY44D-PT	YAL-2-NS	1095	52K	1092-52	<b>ORION</b>	
S50HF-PH	S50HF-P	TR51-N-PHT	EK3-TOY43	YAL-3-NS	1095HL	600K	1092-600A		
S54F	S54F	TR53-NP	X223	YH38-NP	X77	7K	1092B	<b>ORION</b>	
S6 or 6270LN-NS	N1007KMA	TR60-PHT	TOY50-PT	YH46-NP	X120	81KM	1092VM		
S66NN-PH	S66NN-P	V26K-NP	VW67	YH47-NP	X119	81KR	1092V	<b>ORION</b>	
S68	1010N	V28M-NP	VW71	YH48/50-NP	X117	<b>MILES</b>			
S69	L1010N	V29R-NP	VW71A	YH49/51-NP	X118	<b>OSBORNE</b>			
S7BW-PH	S7BW-P	V30-NP	X9	YOR-1-NS	1028AY	<b>MILES OSBORNE</b>			
SAA1-NP	X52	PA8-NP	X9	YOR-2-NS	1028D	<b>ILCO</b>			
SC1	1145	V37-NP	X203	YU1-NP	X153	V10	MN1	<b>ORION</b>	
SC10	A1145F	V37-PH	V37-P	YU2-NP	X167	X4	MN3		
SC19 or 100L-NS	1145L	VL4-NP	X30	KWIKSET	ILCO	<b>MOSLER</b>			
SC1-PHC	SC1-PC	VL6-NP	X80	KWIKSET	ILCO	<b>MOSLER</b>			
SC20 OR 101L-NS	A1145L	VL8-NP	X140	1-1063	1176	3731	706	<b>ORION</b>	
SC22	1307W	WB1A	1071	08260KW	A1176ST	73735	143D		
SC4	1145A	JET	ILCO	<b>KWIKSET</b>		73737	1323	<b>ORION</b>	
SC6	1307A	WB1B	1071BD	<b>KWIKSET</b>	<b>ILCO</b>	73863	4015		
SC7	1145F	WB1C	1071BE	1-1063	1176	84924	1115	<b>ORION</b>	
SC8	1145E	WB2A	1071A	08260KW	A1176ST	MO-1S	1335S		
SC9	A1145E	WB2B	1071D	<b>LOCKWOOD</b>		<b>NATIONAL</b>			
SCH-3	EH3	WB2C	1071E	<b>LOCKWOOD</b>	<b>ILCO</b>	<b>CABINET</b>			
SE1 or SE1-NP	1022	WE1	1123	50	1015	<b>NATIONAL CAB.</b>			
SE8	1022AB	WK2	1175N	51	1015A	<b>ILCO</b>			
SK1	R1001EN	WR3	1054WB	101B	1006	4291	1064	<b>ORION</b>	
SK4	R1001EL	WR5 or WR5-NP		306B	1005	4291	1069L		
SKY 5-NS	1517	N1054WB		54K	1015C	4292	1069LB	<b>ORION</b>	
SKY 6-NS	A1517	WR5-PHC	WR5-PC	A317L	A1015L	4293	1069LC		
SL1	1120D	WR6	A1054WB	B308	1004	641K	1065	<b>ORION</b>	
SR8-N-B	EB3-P-SUB4	XL7	1180S	B308R	1004R	643K	1065C		
SR8-N-PHT	EK3-SUB4	Y1 or 8-NP	999	B310	1004A	644K	1065D	<b>ORION</b>	
SR9-N-B	EB3-N-SUB1	Y103	O1122B	B310R	1004AR	646K	1065E		
SR9-N-PHT	EK3-SUB1	Y11	O1122	B315M	1015M	664K	1065F	<b>ORION</b>	
SUZ11-NP	X87	Y12	O1122A	B317M	A1015M	D8770	1069-5X		
SUZ17-NP	X186	Y13	O1122R	B317N	A1015N	D8771	1069-5Y	<b>ORION</b>	
SUZ18-NP	X241-SUZ18	Y14	O1122AR	B317P	A1015P	D8772	1069-5Z		
SW1	1534	Y149	S1768CH	B317Q	A1015Q	D8780	1069F	<b>ORION</b>	
T146	1270D	Y149	S1770U	B317R	A1015R	D8782	1069FNA		
T21	O1225N	Y152	1768CH	B317S	A1015S	D8782	1069S	<b>ORION</b>	
T23	1270C	Y152	P1770U	B317T	A1015T	D8782	1069G		
T26	1242L	Y153	P1786	B317U	A1015U	D8784	S1069M	<b>ORION</b>	
T3	1141E	Y153-PH	Y153-P	B317V	A1015V	D8785	1069N		
T3NR	1550	Y154-C-NP	Y154CHY	B317W	A1015W	D8785	1069V	<b>ORION</b>	
T7	1141GE	Y154-C-PH	Y154PCHY	B317X	A1015X	D8786	N1069B		
TM100	1603	Y154-PH	Y154-P	B317Y	A1015Y	D8786	1069B	<b>ORION</b>	
TM110	1610	Y155	P1793	B318L	A1015LR	D8787	1069FL		
TM130	1608	Y155C-NP	Y155CHY	B318M	A1015MR	D8787	1069G	<b>ORION</b>	
TM150	1609	Y155C-PH	Y155PCHY	B318N	A1015NR	D8787	1069G		
TM180	1607	Y155-PH	Y155-P	B318P	A1015PR	D8787	1069M	<b>ORION</b>	
TM200	1604	Y155V	1793V	B318Q	A1015QR	D8787	1069		
TM300	1601	Y157	P1794	B318R	A1015RR	D8787	1069E	<b>ORION</b>	
		Y157C-NP	Y157CHY	B318S	A1015SR	D8787	1069FL		
				B318T	A1015TR	D8787	1069G	<b>ORION</b>	
						D8792	1069M		
						D8794	1069SM	<b>ORION</b>	
						D8795	1069YM		
						D8795	1069SM	<b>ORION</b>	
						D8795	1069SM		
						D8795	S1069T	<b>ORION</b>	
						D8795	N1069C		

CROSS REFERENCE

<b>ORION</b>	<b>ILCO</b>	<b>ORION</b>	<b>ILCO</b>	<b>ORION</b>	<b>ILCO</b>	<b>ORION</b>	<b>ILCO</b>	<b>ORION</b>	<b>ILCO</b>
1041GA	1041GA	1597	1597	A1145CE	A1145CE	A35BS	AS66	AGU13L	AU4
1041GB	1041GB	1598	1598	A1145E	A1145E	A35DK	AS30	AGU14	AU1
1041GR	1041GR	1599	1599	A1145EF	A1145EF	A35DL	AS50	AGU14L	AU2
1041H	1041H	1600	1600	A1145F	A1145F	A35DM	AS52	AKS1	63VS
1041K	1041K	1793V	1793V	A1145FG	A1145FG	A35DS	AS58	AKS1L	R63VS
1041N	1041N	1794V	1794V	A1145G	A1145G	A35EK	AS18	AKS2	AD1
1041W	1041W	1CH	52B	A1145H	A1145H	A35EL	AS14	AM10	AA3
1041Y	1041Y	25	25	A1145J	A1145J	A35EM	AS22	AM10L	LF13
1043J	1043J	2CH	53B	A1145K	A1145K	A35ES	AS62	AM11	DM20
1046	1046	999N	999N	A1145L	A1145L	A35FK	AS36	AN10	SP6
1046A	1046A	999N	Y1E	A1176ST	A1176ST	A35FL	AS44	AN2	SF9
104AM	104AM	A1001AH	A1001AH	A28A	61T	A35FM	AS70	AN3	SP7
1054	1054	A1001BH	A1001BH	A28B	R61T	A35FS	AS68	AN5	SP8
1054FN	1054FN	A1001C1	A1001C1	A28E	61Q	A35GK	AS28	AN8	SF9
1054LB	1054LB	A1001C2	A1001C2	A28F	R61Q	A35GL	AS48	ANK10	AK1
1054MT	1054MT	A1001D1	A1001D1	A28G	AS1	A35GM	AS54	ANK11	AK2
1054TW	1054TW	A1001D2	A1001D2	A28K	AS5	A35GS	AS60	ANK12	AK3
1054UN	1054UN	A1001DH	A1001DH	A28L	AS7	A35H	AS74	ANK13	AK6
1054WC	1054WC	A1001EH	A1001EH	A28M	AS3	A35NN	AS84	ANK14	AK4
1054WD	1054WD	A1001FH	A1001FH	A28N	61W	A35T	AS10	ANK15	AN2
1069	1069	A1001GRM	A1001GRM	A28P	R61W	A35U	AS76	ANT10	H61V
1069H	1069H	A1001MJ	A1001MJ	A28R	AS25	A35V	AS12	APH1	C171
1069HN	1069HN	A1001MJR	A1001MJR	A28S	AS23	A35W	AS78	APH10	ALP4
1069LB	1069LB	A1011-10N	A1011-10N	A29AK	AS19	A35X	AS32	APH11	ALP5
1069N	1069N	A1011-11N	A1011-11N	A29AL	AS15	A35Z	AS34	APH1L	C171R
1071	1071	A1011-12N	A1011-12N	A29AM	AS55	A37DD	AS80	APH2L	A190
1079B	1079B	A1011-13N	A1011-13N	A29AS	AS63	A37HH	AS82	APH4L	ALP3
1092	1092	A1011-15N	A1011-15N	A29BK	AS37	ABA11	SF11	APH5L	ALP2
1092-6000	1092-6000	A1011-16N	A1011-16N	A29BL	AS45	ABC1	UCM1	AR1A	AL6
1092-7000	1092-7000	A1011-17N	A1011-17N	A29BM	AS39	ABS10	AB62A	AR3A	AL7
1092B	1092B	A1011-18N	A1011-18N	A29BS	AS65	ABS11	AB19	AR5A	AL8
1092D	1092D	A1011-19N	A1011-19N	A29D	AS71	ABS11L	AB20	ARW11	755U
1092DS	1092DS	A1011-1N	A1011-1N	A29DK	AS29	ABS12	AB18	ARW12	1025AR
1092H	1092H	A1011-20N	A1011-20N	A29DL	AS49	ABS12L	AB21	ARW12	1025B
1092J	1092J	A1011-21N	A1011-21N	A29DM	AS51	ABS14	AB14	ARW12	1025R
1092N	1092N	A1011-22N	A1011-22N	A29DS	AS57	ABS14L	AB12	AS4	SF7AF
1092NR	1092NR	A1011-23N	A1011-23N	A29EK	AS17	ABS14L	AB13	AS6	SF8
1092R	1092R	A1011-24N	A1011-24N	A29EL	AS13	ABS18	CS91C	ASA1	AS90
1092V	1092V	A1011-25N	A1011-25N	A29EM	AS21	ABS18L	CS91CR	ASA111	V61A
1092VA	1092VA	A1011-26N	A1011-26N	A29ES	AS61	ABS19	CS91E	ASA111L	SR61W
1092VM	1092VM	A1011-27N	A1011-27N	A29FK	AS35	ABS19L	CS91ER	ASA11L	AS41
1092VR	1092VR	A1011-2N	A1011-2N	A29FL	AS43	ABS20	AB17	ASA11L	SB11
1096C	1096C	A1011-3N	A1011-3N	A29FM	AS69	ABS24	191AB	ASA12	SB7
1096L	1096L	A1011-4N	A1011-4N	A29FS	AS67	ABS26	AB23	ASA13	SB8
1098JD	1098JD	A1011-5N	A1011-5N	A29GK	AS27	ABS4	191AB	ASA15	SB6
1098X	1098X	A1011-6N	A1011-6N	A29GL	AS47	ABS5L	AB10	ASA2	AS89
1120D	1120D	A1011-7N	A1011-7N	A29GM	AS53	ABS5L	AB16	ASA20	61X
1120F	1120F	A1011-8N	A1011-8N	A29GS	AS59	ABS6L	AB11	ASA3	AS86
1120G	1120G	A1011-9N	A1011-9N	A29H	AS73	ABS6L	AB15	ASA5	SB10
1123	1123	A1011D1	A1011D1	A29T	AS9	ABS7	AB9	ASA5P	SB10
1141GE	1141GE	A1011D12	A1011D12	A29U	AS75	AD10	PA5	ASL1	AUS1
1145	1145	A1011D2	A1011D2	A29V	AS11	AD11	WT5	AT1L	AT2
1145A	1145A	A1011D3	A1011D3	A29W	AS77	AD12	PA6	AT1O	AT1
1145CE	1145CE	A1011D34	A1011D34	A29X	AS31	AD13	PA8	AT2L	AT3
1145E	1145E	A1011D4	A1011D4	A29Z	AS33	AD13AP	PA8P	AZB11	AZ2R
1145EF	1145EF	A1011D41	A1011D41	A31DD	AS79	AD13BP	PA8P	AZB11L	AZ2
1145F	1145F	A1011P	A1011P	A31HH	AS81	AD13P	73VBP	AZB12	999
1145FG	1145FG	A1011PZ	A1011PZ	A34A	A61T	AD13P	PA8P	AZB12L	999R
1145G	1145G	A1011PZR	A1011PZR	A34B	AR61T	AD13P	X88	B62P1	B62P1
1145H	1145H	A1054WC	A1054WC	A34E	A61Q	AD14L	PA6	B62P10	B62P10
1145J	1145J	A1054WD	A1054WD	A34F	AR61Q	AD15	V35	B62P11	B62P11
1145K	1145K	A1114A	A1114A	A34G	AS2	AD15AP	V35P	B62P12	B62P12
1145L	1145L	A1114B	A1114B	A34K	AS6	AD15BP	V35P	B62P13	B62P13
1176	1176	A1114C	A1114C	A34L	AS8	AD15CP	V35	B62P14	B62P14
1179	1179	A1114D	A1114D	A34M	AS4	AD15CP	V35P	B62P15	B62P15
1179A	1179A	A1114DD	A1114DD	A34N	A61W	AD15P	V35P	B62P2	B62P2
1307A	1307A	A1114E	A1114E	A34P	AR61W	AD15P	V37P	B62P3	B62P3
1307W	1307W	A1114F	A1114F	A34R	AS26	AD33	PA8	B62P4	B62P4
1430	1430	A1114FM	A1114FM	A34RC	AS14L	AD33	X88	B62P5	B62P5
1502M	1502M	A1114G	A1114G	A34S	AS24	ADS11	ALP7	B62P6	B62P6
1512O	1512	A1114H	A1114H	A35AK	AS20	AGE10	AG5	B62P7	B62P7
1536	1536	A1114J	A1114J	A35AL	AS16	AGE12	AG1	B62P8	B62P8
1536R	1536R	A1114K	A1114K	A35AM	AS56	AGE13L	AG4	B62P9	B62P9
1539	1539	A1114L	A1114L	A35AS	AS64	AGU11L	AG2	B80	B80
1540	1540	A1114M	A1114M	A35BK	AS38	AGU12	AG1R	B80	X225
1559	1559	A1114Q	A1114Q	A35BL	AS46	AGU12L	AG1	B80P	B80P
1560	1560	A1114R	A1114R	A35BM	AS40	AGU13	AU3	B82	B82

**ORION**

ORION	ILCO	ORION	ILCO	ORION	ILCO	ORION	ILCO	ORION	ILCO
B82	P1102	BKS34	BKS12	BW10	HF20	CRN10	CN1	DA11LP	62DU
B82P	B82P	BKS35	BKS13	BW11	NE8	CS150	CA4	DA11LP	DA24
B82P10	B82P10	BKS36	BKS14	BW12	WT3	CS160	CA3	DA11P	62DT
B82P11	B82P11	BKS37	BKS15	BW13	KL4	CSA18	CS91FR	DA12	62DV
B82P12	B82P12	BKS38	BKS16	BW14	BMW1	CSA18L	CS91F	DA12LBP	SJ1
B82P13	B82P13	BKS39	BKS17	BW14P	BMW1	CSA19	AB62G	DA13	DT4
B82P14	B82P14	BKS40	BKS18	BW15	BMW2	CSA19L	AB62GR	DA13L	DT6
B82P15	B82P15	BKS41	BKS19	BW15FP	BMW3P	CSA20	9CX	DA14	DT8
B82P2	B82P2	BKS42	BKS20	BW15P	BMW2P	CSA22	WA91S	DA14L	DT7
B82P3	B82P3	BKS43	BKS21	BW16	HF40	CSA33	AB17	DA15	DT5
B82P4	B82P4	BKS44	BKS22	C1096CN	C1096CN	CSA4	NS9CS	DA15L	DT1
B82P5	B82P5	BKS45	BKS23	C1096LN	C1096LN	CSA4L	CS91B	DA16	D72Z
B82P6	B82P6	BKS46	BKS24	CE10L	CS13	CSA4L	NSR9CS	DA16	DT14
B82P7	B82P7	BL10	BO2	CE110	CS32	CSA4P	CS91CR	DA16L	D72A
B82P8	B82P8	BL10L	BO6	CE11L	CS11	CSA4PL	CS91C	DA18	DA23
B82P9	B82P9	BLK10	BL91	CE110	CS10	CSA5	9CS	DA18BP	DA23P
B83	B83	BLK10L	BL2	CE12L	CS25	CSA50	CS91	DA18L	DA24
B83	P1103	BLS11	WK9	CE12O	CS26	CSA51	AB1	DA18LP	DA24
B83P	B83P	BLS12	WK4	CE13O	CS43	CSA5L	R9CS	DA18NP	DA23P
B84	B84	BMR10	62VH	CE14	62CS	CSA5P	AB62E	DA18P	DA23-P
B84	P1101	BMR10	OP91	CE14	ST91A	CSA5P	CS91E	DA19	62DT
B84P	B84P	BMR12	63F	CE14L	R62US	CSA5PL	AB62ER	DA21	DT20
B85	S1105	BMR13	B62G	CE15L	LR62US	CSA5PL	CS91ER	DA22	DA25
B86	B86	BMR14	H62VG	CE15O	L62US	CSN10	C1054B	DA22	X123
B86	P1106	BMR14L	HR62VG	CE16O	CS29	CV10	CA91	DA22P	DA25P
B86P	B86P	BO1	138	CE18O	CS28	CV11	CA91A	DA23	DA25
BAL2O	BA1	BO10	NE10	CE19O	CS1	CV12	CA91B	DA23BP	DA25P
BAL4O	BA2	BO10P	NE10	CE20LO	CS13	CV13	CA91C	DA23L	B54
BD1O	C219	BO11	KL1	CE20O	CS12	CV13	ZE91G	DA23LBP	B54
BD2O	C216	BO12	H76U	CE21	CS14	CV14	CA91L	DA23P	DA25-P
BD3O	C218	BO13	BH1	CE21L	CS15	CV14	ZE91CR	DA24	DA28
BDA1A	BD1A	BO14	BH3	CE22	CS44	CV14L	ZE1	DA24P	DA28
BDA1B	BD1B	BO15	BH1	CE23	BD6	CV14L	ZE91C	DA25	INF90
BDA1C	BD1C	BO2O	139	CE24	CS46	CV15	ZC4	DA25P	INF90
BDA2A	BD2A	BRG10L	BUR3	CE25	CS47	CV16	ZC3	DA29	DA28
BDA2B	BD2B	BRG11	BUR7	CE26	CS48	CV17	ZC2	DA29P	DA28
BDA2C	BD2C	BRG11L	BUR8	CE27O	CS49	CV18	ZC1	DA30	DA30
BDA2D	BD2D	BRG12	BUR11	CE28O	CS50	CV19	CA91D	DA30	X197
BDA3A	BD3A	BRG12L	BUR12	CE29	CS51	CV21	AR62K	DA30P	DA30P
BDA3B	BD3B	BRG14	BUR6	CE30O	CS52	CV22	UR62K	DA31	DA31
BDA3C	BD3C	BRG17	BUR9	CE31O	CS53	CVL10	CVL1R	DA31	X210
BDA3D	BD3D	BRG20	BUR1	CE32	CS54	CVL10L	CVL1	DA31P	DA31P
BDA4A	BD4A	BRG20	BUR14	CE33O	CS55	CY100	1767CH	DA32	DA32
BDA4B	BD4B	BRG26	BUR13	CE34O	CS56	CY100	D1707K	DA32	X227
BDA4C	BD4C	BRG27L	BUR1	CE35O	CS57	CY110	D1759L	DA32P	DA32P
BDA5A	BD5A	BRG7	BUR4	CE36O	CS58	CY110	S1767DP	DA33	DA33
BDA5B	BD5B	BRG8	BUR5	CE37	CS59	CY12O	1701G	DA33	X228
BEL10	BEL3	BRU5	BR1	CE38	SH91K	CY13O	1769CH	DA34	DA34
BEL11	BEL4	BS10L	1098DB	CE6O	CS45	CY14O	S1768CH	DA34	X237
BEL12	BEL5	BS11	1098M	CEM9	NE49	CY15	L1098C	DA34P	DA34P
BEL13	BEL6	BS12	H1098LA	CF5	CF1	CY17	U1770CH	DA35	DA35
BEL14	BEL7	BS12	O1098LA	CF6	CF2	CY18O	1768CH	DA35	X238
BKS10	DA3	BS12L	O1098LA	CH6O	1516	CY19O	P1770U	DA37	DA37
BKS10	KS91C	BS13	X1199B	CHG15	752	CY19O	Y152	DA37	X242
BKS10L	X999R	BS14	X1199G	CHG16L	1042Z	CY1O	P1786	DA37P	DA37P
BKS12	BKS25	BS15	O1122A	CLM12	1040A	CY1P	P1786P	DAD10	D1V
BKS13	BKS26	BS15L	O1122AR	CLM13	R1040C	CY20O	S1770U	DAD11	D1T
BKS14	BKS27	BS16L	125C	CLM14	1040C	CY21	P1170U	DAD12	D1K
BKS15	BKS28	BS21	PN2	CLM15	R1040E	CY22L	CH3	DAD13	D1A
BKS16	BKS29	BS2O	BAS1	CLM16	1040E	CY22L	CU7	DAM10L	DA2
BKS17	BKS30	BT10	1970AM	CNA2	CNA2	CY22O	CH4	DAV10	DAV10
BKS18	BKS31	BT11	S1970AM	CNT10	CE1	CY22O	CU8	DF11	CA2
BKS19	BKS32	BTA4	BT1	CNT10L	R62CA	CY23L	CH5	DO100	DM57
BKS20	BKS33	BTA4L	BT3	CNT11	CT1	CY23L	CU9	DO101	G191
BKS21	BKS34	BTA5	BT2	CNT12	CT2	CY23O	CH6	DO102	G193
BKS22	BKS35	BTA5L	BT4	CRB11	CB12	CY23O	CU10	DO103	G194
BKS23	BKS36	BU10	BU2	CRB12	1001DH	CY24L	1040U	DO104	G196
BKS24	BKS2	BU10	MW1	CRB28	BC1	CY24L	CH7	DO105	G197
BKS25	BKS3	BU10L	BU1	CRB28	CB7	CY24O	CU12	DO106	G199
BKS26	BKS4	BU10L	MW2	CRB29	1001GH	CY25	CH8	DO107	G190
BKS27	BKS5	BU11	BU8	CRB31	CB10	D998GA	D998GA	DO10L	DM32
BKS28	BKS6	BU11	X132	CRB43	1001A2	DA10	MZ12	DO11L	DO1S
BKS29	BKS7	BU11L	BU7	CRB44	CB9	DA10BP	MZ12	DO11O	DO1SR
BKS30	BKS8	BU17	BU3	CRB46L	LH10	DA10P	MZ12	DO121	G200
BKS31	BKS9	BVA10	BV1	CRB4P	CB1	DA11	62DT	DO12L	DM27
BKS32	BKS10	BVA10L	BV2	CRB5	CB3	DA11BP	62DT	DO12O	DM10
BKS33	BKS11	BW10	63VP	CRB5P	CB2	DA11L	62DU	DO13L	64D

**CROSS REFERENCE**



ORION	ILCO	ORION	ILCO	ORION	ILCO	ORION	ILCO	ORION	ILCO
DO130	64RD	DUB10L	P65C	FA2B	R61H	FD32	1190LN	GM8L	B69
DO14	DO3M	DUB11	P65C	FA2D	61G	FD34	H63	GM90	X184
DO140	DM33	DUB11L	P65C	FA2O	F91C2	FD34	X207	GMA	B48
DO140L	DM43	DUB12	HR62BZ	FA2S	R61G	FD35P	1188LNP	GMA	P1098A
DO141	DM34	DUB12	R62BZ	FA2S	R61GA	FD36	1191ET	GMAP	GMAP
DO141L	DM44	DUB12L	PA91F	FA3	FT38	FD36	H62	GMAV	B62
DO142	DM35	DUB13	HR64K	FA4	F91C	FD36P	H62P	GMAV	P1098AV
DO142L	DM45	DUB13	PA91H	FA6O	F91CR	FD38L	H59	GMAVP	P1098AV
DO143	DM36	DUB13L	H64K	FA8	F91C8	FD38LAP	X202	GMB	B49
DO143L	DM46	DUB13L	PA91K	FAA10	65CB	FD38LP	H59P	GMB	S1098B
DO144	DM37	DXT5	D1054K	FAA10	SK91A	FD42	1195FD	GMBP	GMBP
DO144L	DM47	DXT5B1	DXB10	FAA11	65CD	FD42CP	H71P	GMC	B50
DO145	DM38	DXT5B2	DXB20	FAA11	SK91D	FD4P	S1186TSP	GMC	P1098C
DO145L	DM48	DXT5B3	DXB30	FAA15L	65CE	FD5	1185FD	GMC	P1098C
DO146	DM39	DXT5C1	DXC10	FAAO	R61D	FD5P	1185TP	GMCV	P1098CV
DO146L	DM49	DXT5C2	DXC20	FAAO	SP1	FD6P	S1185TP	GMCVP	B63P
DO147	DM40	DXT5C3	DXC30	FAB14	X99	FD7	1184FD	GMCW	P1098WC
DO147L	DM50	DXT5CM	54CM	FABO	61D	FD7P	1186TSP	GMCWP	B64P
DO148	DM41	DXT5D1	DXD10	FABO	R63TS	FD7P	H54	GMD	B51
DO148L	DM51	DXT5D2	DXD20	FABO	SP2	FD8	1127DU	GMD	S1098D
DO149	DM42	DXT5D3	DXD30	FAC	SP3	FD9	S1170LN	GMDP	B51P
DO149L	DM52	DXT5DM	54DM	FAD	R61TS	FD9L	H50	GMDP	GMDP
DO158	G190C	DXT5GM	54GM	FAD	SP4	FD9L	S1167FD	GMDW	S1098WD
DO16	DM21	DXT6	D1054KA	FAE	R63SP	FEB5	CF1	GME	B44
DO161	G190B	DXT6B1	DXB1	FAF	63SP	FEB5L	CF2	GME	P1098E
DO165	DM65-11	DXT6B2	DXB2	FAG	F91G	FI10	NE57	GMEP	B44P
DO168	G195A	DXT6B3	DXB3	FAG2	NE54	FI4CP	GT15RAP	GMEV	P1098EV
DO171	G197A	DXT6BM	DXB4	FAG2BP	NE54	FL20	Z4	GMEVP	B77P
DO172	G190A	DXT6C1	DXC1	FAG2P	YU2	FLO5	FL91	GMEW	P1098WE
DO174	G192A	DXT6C2	DXC2	FAG2YP	X167	FLO5L	R67F	GMEWP	B78P
DO175	G196A	DXT6C3	DXC3	FAG2YP	YU2	FMR10	C172F	GMH	B45
DO18	DM11	DXT6CM	DXC4	FAG3	NE55	FTH10	FTH3	GMH	S1098H
DO180	G200	DXT6D1	DXD1	FAH	F91H	FTH11	FTH4	GMHP	B45P
DO19	DO4F	DXT6D2	DXD2	FAK	FT46	FTH12	FT1	GMHW	S1098WH
DO19	H64E	DXT6D3	DXD3	FAK	NE59	FTH14	FTH5	GMJ	B46
DO195	G194A	DXT6DM	DXD4	FAKAP	FT46	FTH16	FTH6	GMJ	P1098J
DO197	G191A	DXT6GM	DXG5	FAKBP	X152P	GBN10	ZE91G	GMK	B47
DO198	G193A	EFCK	C185CK	FAKGP	NE54	GBN10L	R62K	GMK	S1098K
DO201	G190E	EFCK	EC10	FAS10	FAS1	GBN11	GA91	GMR	B55
DO21	D64	EFDA	C185DA	FAS10L	ST1	GBN12	GA1	GMRP	B55
DO215	DM110	EFDA	EC12	FAX	F43	GBN13	GAS91	GMS	L98AS
DO22	DM58	EFDB	C185DB	FAY	NE56	GBT10	LN4	GMV	LP98A
DO227	G190MA	EFDB	EC14	FAYP	NE56	GE10	GE5	GMV	GOL10L
DO229	DM62	EFDK	C185DK	FD10	FC2	GE10	GE8	GOL11L	GL1
DO23	DM60	EFDK	EC16	FD11	CE6	GE10L	GE3R	GRQ1	GU4
DO23L	DM63	EFDM	C185DM	FD12	FC7	GE11	7GE	GRQ10	S65G
DO24	ID1	EFDM	EC18	FD12AP	FC7-P	GE12L	LR7GE	GRQ10L	RS65G
DO25	DM3	EGO12L	EE1	FD12P	FC7P	GE13L	GE6	GRQ12	GU91F
DO29	DM29	ELZ10	ELZ1	FD13	FC9	GE180	GE15	GRQ13	GU91G
DO29L	DM30	ERA10	ER5	FD14	FC8	GE37L	GE4	GRQ14	65L
DO30	DM61	ESA10	ES1	FD15	62KT	GH10	GH2	GRQ15	GU91B
DO31	G198	ESA10L	ES1R	FD16	KL2	GH2	GH1	GRQ15L	GU3
DO44	DM25	ETS10	ET9	FD17	H62FD	GH3	GH3	GRQ16	RC1
DO45	HU4	ETS11	62C	FD17L	HR62FD	GIB10	1033G	GRQ17	LR65G
DO49	DM8	ETS2	ET8	FD18	HF22	GIP10	GIP91	GRQ17L	L65G
DO5	DM25	EVA1	EV4	FD18L	HF23	GLB13	GB2	GRQ18	LR65Y
DO69L	DM26	EVA14	EV2	FD19	FT10	GLB15	GB4	GRQ18L	L65Y
DO71	DM22	EVA2	EVA1	FD19	YM14	GLB19L	GB1	GRQ1L	GU4R
DO73	DM61	EVA3	EVA1R	FD19L	FT10R	GLB22	GB3	GSN12L	D1098B
DO79	G192	EVA4	62EV	FD19L	YM15	GM10P	B53	GUA50	191A
DO8	DM2	EVA5	R62EV	FD10	WB3	GM12L	B72	H1054F	H1054F
DO84L	DM23	EVA6	EV5	FD1P	WB3	GM12L	X192	H1098DB	H1098DB
DO86	G195	EVA8	EV7	FD2	WB2	GM12LP	B72P	H1098M	H1098M
DO9	FT6	EZC10L	ES1	FD20	YS2	GM13P	DC3	H1098X	H1098X
DO93	DM7	F1122A	F1122A	FD20L	YS1	GM14L	B74	H1122M	H1122M
DO94	DM6	F1122AR	F1122AR	FD21	1127D	GM14LP	B74P	H65	H65
DO9L	FT6R	FA1A	LR61D	FD22	1127DP	GM15O	P1099	H65	X221
DO9LAP	FT6R	FA1B	AB2B	FD23	1127ES	GM15PO	B68P	H65P	H65P
DO9LP	FT6R	FA1C	H61G	FD24	1167FD	GM16L	P1100	H66	1193MU
DON10L	S54F	FA1D	R61GA	FD24	H51	GM16L	P1108	H66	H66
DON11	DO1	FA1D	SP5	FD25	BR20	GM16LP	B76P	H66P	H66P
DPT10L	PL1	FA1L	SF10	FD26	FC7	GM2O	H1098LA	H67	1193FD
DPT11	DL2	FA1O	FT37	FD27	FF1	GM4O	1098DB	H67	H67
DPT12	LAP2	FA1P	FT37	FD28	S1181FD	GM5O	B53	H67P	H67P
DT13L	TR40	FA21	NE58	FD31	P1127C	GM5O	X143	H70	H70
DT13LP	TR40	FA21UP	NE58	FD31L	S1167C	GM5P	B53	H70	X231
DUB10	P65A	FA2A	YR62	FD31P	P1127C	GM7L	B56	H70P	H70P

# ORION

ORION	ILCO	ORION	ILCO	ORION	ILCO	ORION	ILCO	ORION	ILCO
H75	1196FD	4HF33L	S62DW	HO20HP	HD75	HO92P	HD92P	ILG10	IG1R
H75	H75	HF35	R62VB	HO20L	HD63	HO93	HD93	ILG10L	IG1
H75P	H75P	HF35L	61VW	HO20LBP	HD63	HO93	X189	INS10	D62SA
H998	H998	HF35L	62VB	HO20LHP	HD63	HO93P	HD93P	ISZ10	SZ4
H998GA	H998GA	HF35L	62VW	HO20LHP	HD74	HO94	HD94	ISZ2	B57
H998GB	H998GB	HF35L	L62VB	HO20LP	HD63	HO94	X190	ISZ2P	B57
H998GC	H998GC	HF36	OP60H	HO20P	HD58	HO94AP	HD86	ISZ4	SZ3
H998GD	H998GD	HF36L	R62PE	HO20P	HD75	HO94AP	HD94	JA2	JA2
H998GE	H998GE	HF37	R62VN	HO21	HD70	HO95	HD95	JA2	X177
H998GF	H998GF	HF38	HF15	HO21P	HD70	HO95	X191	JA2P	X177
H998GG	H998GG	HF38	HF4	HO22	HD71	HO95AP	HD89	JNH10L	HH1
H998GH	H998GH	HF38L	HF7	HO22P	HD71	HO95AP	HD95	JSS10L	J12
H998GK	H998GK	HF39	63W	HO23	HD23	HO96	HD96	JUN10	JN58
H998R	H998R	HF39L	R63W	HO24	HD33	HO96	X193	JUN11	JN2
H998VA	H998VA	HF40	HF6	HO25	HD35	HO96P	HD96P	JUW1	JU4R
H998VB	H998VB	HF40	HF9	HO26	HD34	HO97	HD97	JUW10	JU5R
H998VC	H998VC	HF40	R63K	HO27	HD32	HO97	X194	JUW19	JU1D
H998VD	H998VD	HF40L	HF16	HO28	HD30	HO97P	HD97P	JUW19	WA91C
H998VE	H998VE	HF40L	HF5	HO29	HD4	HO98	HD98	JUW19L	BR91C
H998VF	H998VF	HF41	62VG	HO29L	HD18	HO98	X195	JUW2	JU4
H998VG	H998VG	HF42	OP60C	HO30	HD20	HO98P	HD98P	JUW3	JU3
H998VH	H998VH	HF43	G63Y	HO30L	HD19	HO99	HD99	JUW4	JU3R
H998VK	H998VK	HF44	62WB	HO32	67LD	HO99	X204	JUW5	JU2
H998YA	H998YA	HF45	R62WA	HO34	HD31	HO99P	HD99P	JUW6	JU2R
H998YB	H998YB	HF45L	AUDS2	HO35	HD29	HOR11	HS1	JUW9	JU5
H998YC	H998YC	HF47	62PE	HO36	67J	HRD1	X101	JWL10	R62X
H998YD	H998YD	HF47	HF13	HO36L	HD24	HRD10L	HYD12	JWL10L	62X
H998YE	H998YE	HF47L	HF12	HO37	67K	HRD10L	X226	JWL13L	JO91C
H998YF	H998YF	HF52P	HF52P	HO37L	HO61S	HRD13L	HYD13	JWL15	JU2
H998YG	H998YG	HF54	B61	HO37L	R67K	HRD13L	X234	K1054B	K1054B
H998YH	H998YH	HF54	X168	HO50	HD10	HRD1L	X102	K1122D	K1122D
H998YK	H998YK	HF54P	B61	HO50L	HD12	HRD2L	HYD5	KA10	KA2
H998YMK	H998YMK	HF55P	HF55P	HO51	HD14	HRD3	X100	KA10L	KA1
HA10	BU4	HF56	BMW3	HO51L	HD11	HRD3L	X93	KA12	YH25
HA10L	BU4R	HF56P	BMW3P	HO52	HD15	HRD4	X126	KA12L	YH26
HD12L	1003M	HF57P	HF52P	HO52	HD61	HRD4L	X127	KA13	KA5
HED10	HN2	HF61L	B59	HO52L	H76G	HRD5	X96	KA14	X41
HED11	HN1	HF64P	S34YS-P	HO52L	HD60	HRD5L	HY6R	KA14L	X34
HF10	A62VN	HF65P	S58HF-P	HO53	HD68	HRD6	X97	KA15	KA12
HF11	G1	HGI11	HG3	HO53L	HD65	HRD6L	X98	KA16	KA14
HF11L	R62VA	HO1	HD8	HO54	HD67	HRD7	X95	KA17	KA15
HF12	L62VA	HO10	HO61TR	HO54L	HD66	HRD7L	X94	KA17L	KA11
HF12L	LR62VA	HO100	HD100	HO55	HD83	HRD8L	HD51	KA19	KA13
HF13	63Y	HO100	X205	HO55P	HD83P	HRD9	HY9	KA1L	KA11
HF14	62PD	HO100P	HD100P	HO56	HD82	HTV10	VA2	KA1O	KA15
HF14	HR62PD	HO101	HD101	HO56L	X130	HTV10L	62H	KA2P	KA14
HF14L	H62PD	HO101P	HD101P	HO56LP	X130	HTV11	VA1	KA3P	KA14
HF14L	R62PD	HO102P	HD102P	HO56P	HD82P	HUN1	HY3	KA4CP	KW14P
HF15	H62VP	HO103	HD103	HO58	HD74	HUN11	HY13	KA4L	KW14R
HF15	U62VP	HO103	X214	HO58	X84	HUN11	X235	KA6L	KA6
HF15L	UR62VP	HO103P	HD103P	HO58L	HD58	HUN11P	HY13P	KA6L	X23
HF16	HF10	HO104	HD104	HO58LP	HD58	HUN12	HY14	KA6O	KA7
HF16L	HF11	HO104	X215	HO58LP	HD75	HUN12	X236	KA6O	X24
HF17	MB15	HO10L	HO61T	HO58P	HD63	HUN12P	HY14P	KB10	63VN
HF17P	MB15P	HO11	HD14	HO58P	HD69	HUN1P	HY3	KB10B	VW63
HF18	MB18	HO11	HD5R	HO58P	HD74	HUN2L	HY2	KB11	VW63
HF18P	MB18P	HO11L	HD5	HO60	HD85	HUN2LP	HY2P	KCDA22	DA25
HF19	HF21	HO12	HD13	HO60	HD86	HUN4	HY4	KF10	PJM
HF20	YM25	HO12	HD61	HO60AP	HD85	HUN4	X187	KF11	SM3
HF20L	YM27	HO12L	67LB	HO60AP	HD86	HUN4P	HY4P	KF11L	SM4
HF21	HF47	HO12L	H76G	HO60P	HD85	HUN5L	HY5	KF12	NR63G
HF21	HF50	HO12L	HD60	HO60P	HD86	HUN5L	X196	KF12L	N63G
HF21L	HF49	HO13	HD7	HO64FP	X265	HUN5LP	HY5P	KF13	KM5
HF22	HF37	HO14	HD45	HO71	HD70U	HUN6	HY6	KF13L	KM7
HF23	HF41	HO14L	HO44	HO71P	HD70UP	HUN6	X216	KF14	L3TX
HF24	AU15	HO15	HD72	HO88	HD91	HUN6P	HY6P	KF15	L3XY
HF25	OP44	HO15L	HD73	HO88	X182	HUN8L	HY12	KF18	KM2
HF26	MB18	HO15LP	HD73	HO88P	HD91P	HUN8L	X232	KF20	63H
HF26P	MB18-P	HO15LP	HO41	HO89	HD89	HUN8LP	HY12P	KF20	PJH
HF27	HF43	HO15P	HD40	HO89AP	HD89	HWL10	HU2	KF20L	R63H
HF28	MB41	HO15P	HD72	HO90	HD90	HWL12	HU3	KF21	KM6
HF28P	MB41P	HO17	HD49	HO90	X181	IFM10	IF1	KF22	L1TL
HF29	MB38	HO2	HD59	HO90P	HD90P	IFM11	IF3S	KF23	L1S
HF29P	MB38	HO20	HD75	HO91	HD88	IFM12	IF3L	KF23L	L1T
HF30	HF46	HO20	X138	HO91P	HD88P	IFM13	IF2	KF24	L2EX
HF31	R63Y	HO20BP	HD75	HO92	HD92	IFM13L	IF2R	KF30	KM3
HF32	OP42	HO20HP	HD58	HO92	X183	IGS10	IGS1	KF30	PJM

CROSS REFERENCE

ORION	ILCO	ORION	ILCO	ORION	ILCO	ORION	ILCO	ORION	ILCO
KF31	N63G	LF16O	LF4	LPS24	LP31R	MNT4	MG91P	NN24P	NE27
KF31L	NR63G	LF16P	BR19	LPS24L	LP31	MNT4L	MG91S	NN25	Z3H
KF32	KM2	LF16P	LF4	LPS25	LP30	MNT4P	MG91	NN26H	NE34
KF32	RC2	LF17O	LF17	LPS25L	LP30R	MNT4PL	MG91R	NN26HAP	RN24
KF32L	KM10	LF17O	X157	LPS29L	LP26S	MNT5	MG91C	NN26HCP	RN24
KF8	61PS	LF17P	LF17	LPS42L	LP2	MNT5L	MG91N	NN26HDP	RN24-P
KF8L	PA91	LF18	L62FD	LPS44L	LP26	MON10L	MON1	NN26HP	RN24P
KF9	64R	LF20O	WB1	LXP90P	LXP90P	MPP10	61B	NN26HSP	RN24P
KF9L	RK4	LF20P	WB1	LXV90P	LXV90P	MPP11	B62B	NN26X	NE26
KFV10	KFV1	LF21	LF14	M64	M64	MPP12	R62B	NN27	NE20
KI1L	KK1	LF23	LF6	MA10	MZ4	MPP13	62BA	NN28	RE61F
KI1L	X233	LF24O	62FG	MA10	X4	MPP14	R62BA	NN29	VO73S
KI1LAP	KK1P	LF24O	CE3	MA10AP	MZ3	MPP5	PO1	NN3	NE36
KI4L	X240	LF25L	LF16	MA10AP	MZ4	MPP5L	PL2	NN30	VO73
KI5LAP	KK3-P	LF26O	LF10	MA10L	MZ5	MRN12	ME2	NN30P	VO73
KVR11	KVR91	LF27O	LF24	MA10L	MZ8	MRN3P	ME6	NN31	NE40
L1001AH	L1001AH	LF2L	C209R	MA10L	X5	MRN4P	ME1	NN33	Y61
L1001EH	L1001EH	LF2O	C209	MA10LAP	MZ2	MRN5P	ME3	NN34	RT20
L1001GRM	L1001GRM	LF31	LF23	MA10LAP	MZ5	MRN9	ME7	NN35	NE30
L1003AB	L1003AB	LF32O	LF19	MA10LP	MZ8	MS10L	DC1	NN36	NE41
L1010N	L1010N	LF38L	LF8	MA10P	MZ7	MS10LP	DC1P	NN37	NE43
L1054B	L1054B	LF39L	LF18	MA11	MZ9	MS11L	DC3	NN39	NE42
L1054G	L1054G	LF3O	LF20	MA11	X26	MS11LP	DC3P	NN4	63Q
L1054WB	L1054WB	LF40L	LF25	MA11AP	MZ9P	MS11P	TR33P	NN41	NE48
LA11	GT3	LF44L	LF25	MA11L	MZ10	MS19L	FU2	NN41FP	NE48
LA11L	GT4	LF53O	C209L	MA11L	X27	MS3O	MIT3	NN41P	NE48
LA12	GT1	LF6O	LF9	MA11LAP	MZ10P	MS3O	X224	NN41QP	NE48
LA12L	GT2	LG10	LS10	MA11LP	MZ10P	MS4	MIT2	NN43	H61N
LAD3LP	LA-2P	LG11	LS11	MA11P	MZ9P	MS4	X213	NN44	BO3
LAS1	L6S	LG17	LS17	MA12	MZ11	MS5	MIT5	NN44	BO6
LAS11	KM4	LG18	LS18	MA13	MZ15	MS5	X229	NN44	NE5
LAS14	L4A1	LG19	LS19	MA14	MZ14	MS8AP	MIT4P	NN45	RT7
LAS2	L6FM	LG22	LS22	MA15	X131	MS8CP	MIT1	NN46	63JA
LAS20	KM8	LG23	LS23	MA16	MZ13	MS8O	MIT1	NN47	H61VO
LAS20L	KM9	LG28	LS28	MA16	X131	MS8O	X176	NN48	H61VM
LAS3	L5CR	LG29	LS29	MA16AP	MZ13	MS8P	MIT1P	NN49	RT16
LAS3L	L5RC	LG32	LS32	MA16AP	MZ13P	MST10	1092	NN50	VL6
LAS6	PN3	LG33	LS33	MA16L	MZ13R	MST3	MA3	NN50P	VL6P
LAS8	L4RM	LG34	LS34	MA16P	MZ13P	MTR10	MO1	NN52	RN25
LC10L	LC2	LG35	LS35	MA19	MZ13	N1007KMA	N1007KMA	NN52DP	NE36
LC10O	LC1	LIT10	LT3	MA19L	MZ13R	N1007KMB	N1007KMB	NN52DP	RN25
LC11O	S1096G	LIT11	LT1	MA22AP	MZ16P	N1007RMA	N1007RMA	NN56	RN31
LC12L	LC5R	LL10	RD4	MA23	MZ17	N1007RMB	N1007RMB	NN57	RN30
LC12O	S1096F	LM10	LM2	MA23AP	MZ17	N1011P	N1011P	NN58	RN30
LC13O	LC4	LM3L	LA13	MA23DP	MZ19P	N1011S	N1011S	NN58	X147
LC14	LC3	LM3O	LA4	MA23FP	MAZ13EP	N1069B	N1069B	NN58AP	RN30
LC15O	S1096D	LMP10	LM1	MA23P	MZ17P	N1179	N1179	NN58BP	RN30
LCW10L	1004R	LMP11	RT19	MA25	MZ22	N54G	N54G	NN58P	RN30
LCW12	24	LMP12	SM10	MA26	MZ20	NH3	1098GM	NN60X	NE33
LCW13	4	LMP13	NE47	MA26	X199	NH3	1098M	NN62	VL8
LCW13L	4R	LMP14	NE45	MA27	MZ16	NLF10	NL2	NN62P	VL8P
LCW14	LK1	LP10O	63L	MA27	X178	NLF10L	NF1	NN63BP	NE48
LCW14L	LK2	LP13L	63	MA27AP	MAZ-6DP	NN10	63M	NN75P	RV4P
LCW15L	24B	LP13L	63L	MA27AP	MZ16P	NN11	RE61XR	NN81P	RN24
LCW16	24CL	LP13L	LE1	MA27P	MZ16P	NN11P	RE61XR	NN9PP	RN30
LCW17	LK5	LPS10	LP24	MA28	MZ25	NN12	NE11	NS13	DT3
LCW18	LK8	LPS10L	LP25	MA28	X206	NN13	NE1	NS13L	DT2
LCW19	LK7	LPS11	LP39	MA28P	MZ25P	NN14	H63M	NS17L	SR6
LCW20	LK4	LPS11L	LP28S	MA30	MZ27	NN15	SR61N	NU10	63VO
LCW21	LK3	LPS12	LP1R	MA30	X222	NN16	MB59	NU11	HF26
LCW22	LK6	LPS12L	LP1	MA30EP	MZ27P	NN17	NE2	NU12	HF29
LCW23	24A	LPS13	LP23	MAC10	ME11	NN17	VO62	NU13	HF18
LCW24	DL91	LPS13L	LP29	MBL10	MB1	NN18	H61VR	O1007CA	O1007CA
LCW25	RD1	LPS14	R62QB	MCM10	MCM2	NN18L	FTA2R	O1007CB	O1007CB
LCW26	RD2	LPS14L	LP28	MCM10L	MCM2R	NN19	NE22	O1007CE	O1007CE
LCW29	LK13	LPS15	LP27	MCM11	MM2	NN2	NE39	O1007LA	O1007LA
LCW30	GR9	LPS15L	LP6	MCM12L	MCM1	NN20	V80P	O1007LB	O1007LB
LCW32	1004	LPS16	LP7	MD12	1518	NN20	VO6	O1007LC	O1007LC
LCW32L	1004R	LPS16L	LP7R	MD3	A1515	NN21	NE13	O1007LD	O1007LD
LCW35L	LK21	LPS17	LP21	MD4O	1515	NN22	AA2	O1007LDH	O1007LDH
LEG10	62LG	LPS17L	LP21R	MD8	1542	NN22P	AA2	O1007LDM	O1007LDM
LF11O	LF1	LPS20L	LP5	MG4	MG91P	NN23	NE31	O1007LE	O1007LE
LF11Q	LF1	LPS21L	LP2	MG4L	MG91S	NN23BP	BL11	O1007LF	O1007LF
LF12O	LF7	LPS21L	LPBS	MG5	MG91C	NN23P	RE61XR	O1007LG	O1007LG
LF14LQ	LF1	LPS22L	LPD2	MME	F91EH	NN24	NE18	O1007LH	O1007LH
LF15	HR62DG	LPS23	LP32R	MMF	F91FH	NN24	NE27	O1007LHM	O1007LHM
LF15	LR62DG	LPS23L	LP32	MMH	F91HH	NN24P	NE18	O1007LJ	O1007LJ

# ORION

ORION	ILCO	ORION	ILCO	ORION	ILCO	ORION	ILCO	ORION	ILCO
O1007LK	O1007LK	PU3	PU3	RUK12	67Q	SLC13	SEL91	SU21L	SUZ17
O1007LL	O1007LL	PW10	PO5	RUK12L	R67Q	SLC13	U65F	SU21L	X186
O1007LM	O1007LM	PW10P	PO5P	RUK13	67N	SLC13L	SEL91R	SU21LP	SUZ17P
O1007RA	O1007RA	PW11	PO6	RUK13L	R67N	SLE10	EX1	SU22	SUZ15
O1007RB	O1007RB	PW11P	PO6	RUK14	67U	SMG10	SIM2	SU22	X185
O1007RC	O1007RC	PW12	PO7	RUK14L	RK3	SMG10L	D1098BM	SU22P	SUZ15P
O1007RD	O1007RD	PW12P	PO7	RUK16	RU91C	SMG11	S91A	SW1	SAN1
O1007RDH	O1007RDH	R1000V	R1000V	S1000V	S1000V	SMG12	S91BV	SWA10L	SW2
O1007RDM	O1007RDM	R1001EF	R1001EF	S1042Z	S1042Z	SMG13	S91CV	SWA11	SW1
O1007RE	O1007RE	R1001EG	R1001EG	S1042ZM	S1042ZM	SMG14	S91K	SWA12	SW3
O1007RF	O1007RF	R1001EN	R1001EN	S1042ZS	S1042ZS	SMG15	SIM1	SX1000F	SX1000F
O1007RG	O1007RG	R1003M	R1003M	S1069G	S1069G	SMG17	SIM3	SX1000FR	SX1000FR
O1007RH	O1007RH	R1064E	R1064E	S1069H	S1069H	SMG17	SIM8	T19DA31	NSN11T2
O1007RHM	O1007RHM	REX10	RX2	S1069M	S1069M	SMG18	SIM10	T19F11C	GT10BT5
O1007RJ	O1007RJ	REX11	RX1	S1096G	S1096G	SMG18L	SIM9R	T19FI4A	GT15RT2
O1007RK	O1007RK	RGL10	RG1	S10LAAP	S10LAAP	SMG20	S91P	T19HF54	HU46T2
O1007RL	O1007RL	RM10	H1098NR	S10MTK	MTK1	SMG22	S91P	T19HF66	HU66T5
O1007RM	O1007RM	RN10	HV61	S10PE	PE1	SMG23L	S91R	T19HO107	HD107-PT5
O1014S	O1014S	RN10L	HVR61	S10PEP	PE1	SOS10	SOS91	T19HO88	HD106-PT5
O1122B	O1122B	RN11	7DC	S1176	S1176	SOS11	SO91P	T19MA34L	MAZ24RT5
O1122BE	O1122BE	RN11L	R7DC	S11ABY	AL1	SOS12	SOS1	T19S32FJ	TBE1T5
O1122BER	O1122BER	RN13	V61S	S11ABYP	AL1-BLK	SOS13	R65S	T19SK31L	SK22RT1
O1122BR	O1122BR	RN13L	VR61S	S12KBA	KA5-SI	SP11	NE9	T19SP27A	GT16T2
O1122C	O1122C	RN14	H61P	S12KE	KE3-SI	SP12	NE19	T19TY51A	TOY43AT4
OAL3P	OA91R	RN14	SM6	S13KE	S13KE	SP12	NE23	T30H72	H72PT
OAL3PL	OA91	RN14L	HR61P	S16CHGT	1137B	SP12P	NE19	T30H73	H73PT
OAL4P	OA91P	RN14L	SM7	S18FCT	FH4	SP12P	SP9	T31LXP90	TOY40BT4
OAL5L	OA91D	RN15	S61JD	S1CHGT	1136S	SP12UP	F44	T33P1795	Y160-PT
OAL5P	OA91P	RN16	61JD	S1LPS	KS1	SP12UP	NE23	T41VW25A	HU49AT2
OLT10	ALP9	RN16L	R61JD	S20KBA	KAB2	SP24	IV1	TB10	DB1
P1789	P1789	RN17	RN4R	S21ABS	AB32	SP24	X155	TB10L	DB2
P1789	Y154	RN17L	RN4	S2CHGT	L1137	SP24P	IV1	TBP	CE2
P1789P	P1789P	RN18	62Z	S30FDP	S30FDP	SP25AP	SP25AP	TH10	1148
P1793	P1793	RN18L	R62Z	S32FJP	S32FJP	SPK10	VW1CZ	TJC	BL2
P1793P	Y155P	RN19	61P	S32YSP	S32YSP	SQU10	192	TKA10L	VL1
P1794	P1794	RN19L	R61P	S33FDP	S33FDP	SQU11	192B	TKA11	66E
P1794P	Y157P	RN21	62UC	S33FJP	S33FJP	SR1000V	SR1000V	TKA11L	R66E
P1795	P1795	RN21L	R62UC	S34YSP	S34YS-P	SRX11	SX1	TKA12	TKA12
P1795	Y159	RN22	61PE	S3FDP	S3FDP	SRX12	SU9L	TKA12L	ERS3
P1795P	Y159P	RN22L	RC2	S48HFP	S48HFP	SRX14	SX3	TKA13	ER9
P54F	P54F	RN23	L62UC	S49HFP	S49HFP	SRX15	SX4	TKA13L	ERS8
PA10	PZ1	RN24	63P	S50HFAP	S50HF-P	ST10	SE1B	TKA14	ERS6
PA11	PZ2	RN25	NE15	S50HFP	S50HFP	ST10	SE1C	TKA14L	ERS5
PA12	PZ3	RN26	NE17	S53HFP	S53HFMP	ST12	F54	TO10	TO1
PA13	PZ4	RN27	62U	S58HFP	S58HFP	STB10	62FE	TO20	TO2
PA15	PZ2	RN27L	62R	S60HFP	S60HFP	STB11	SR4	TO30	TO3
PB1005	FSP2	RN29	62RS	S66NNP	S66NNP	STB12	SR1	TO40	TO4
PB1021	621A	RN30	PJ1	S67NNP	S67NNP	STB12L	SR2	TO50	TO5
PC5L	PL2	RN31	PJ11	S6BW	S6BW	STB13	SR5	TO60	TO6
PH110	DM4	RN32	LN1	S7BWP	S7BWP	STS10L	SN1	TO70	TO7
PH12	KP1	RN34	PJ2	S8KBA	KAB1	STV10	ST91F	TO8	TO8
PH12	PO4	RN34L	PJ12	SAN10	170S	STV10L	ST91V	TOK10	TO91
PJ20	PJK	RN36	PJ3	SAN11	70S	STV11	SV3	TOK10X	TK13
PJ21	PN1	RN36L	PJ13	SC1041R	SC1041R	STV11L	SV3	TOK10Y	TK31
PL10	OM10	RN37	LN3	SC1041S	SC1041S	STV12	ST91S	TOK11	TK3
PR10	AU4	RN38	61PC	SC1247	SC1247	STV12L	ST91	TOK11Y	TK32
PR12	DK91E	RN40	SMS8	SC1400	SC1400	STW1	1568	TOK12	TK1
PR12L	DK91C	RN41L	R15	SCL10	SCH1	SU10	SUZ1	TOK12X	TK15
PR13	LR62VB	RN53	RN27	SCR10	STA1	SU10	SUZ6	TOK12Y	TK33
PR13L	L62VB	RN58	R16	SCR11	STA2	SU10L	SUZ2	TOK13X	TK16
PR15	A63L	RR10	62HB	SHA10	62SH	SU10L	SUZ7	TOK13Y	TK34
PRF11	PR91L	RR11	62HA	SHG11	SHA-1	SU11	SUZ3	TOK14X	TK17
PRF28F	PR91C	RR12	62HC	SI10	SM1	SU11	SUZ8	TOK14Y	TK35
PRF3	S9P	RR13	62JB	SI11	VC30	SU11L	SUZ4	TOK15X	TK18
PRF3L	SR9P	RR14	62HE	SI12	VC31	SU11L	SUZ9	TOK16X	TK19
PRF3PL	PR91S	RR14	X28	SIS10	1523	SU12	SUZ5	TOK16Y	TK37
PRF4	PR91SA	RR15	62HD	SK100	FB5	SU13	HD57	TOK17X	TK20
PRF4	U9P	RR16L	62HF	SK130	FB3	SU13	SUZ10	TOK17Y	TK38
PRF4L	PR91NS	RR17L	62HG	SK19	65CF	SU13L	HD56	TOK18X	TK21
PRF4P	PR91	RR18L	62HG	SK210	FB7	SU13P	HD57	TOK18Y	TK39
PRF4PL	PR91MS	RT11	X16	SK22	FB7	SU13P	SUZ10	TOK1X	TK4
PRF4SF	PR91CS	RT11P	P1771CR	SK24	FB1	SU14	SUZ11	TOK1Y	TK22
PRF5	PR91N	RT12	CE5	SLC10	SM6	SU14	X87	TOK2X	TK5
PRF5L	PR91A	RT12P	AA3	SLC11	SES91	SU14P	SUZ11	TOK2Y	TK23
PRF5P	SIC1	RUK10	RK1	SLC11L	SR65	SU20L	SUZ12	TOK3X	TK6
PRF5PL	PR91M	RUK11	R67P	SLC12	S65F	SU20L	X179	TOK3Y	TK24
PRV1L	PR11	RUK11L	67P	SLC12L	R65F	SU20LP	SUZ12	TOK4X	TK7

CROSS REFERENCE



ORION	ILCO	ORION	ILCO	ORION	ILCO	ORION	ILCO	ORION	ILCO
TOK4Y	TK25	TY49	X212	UN53L	UN60L	VA68	H62BM	WIL13	WK26
TOK5X	TK8	TY49P	TR46P	UN54	UN58L	VA70	RN29	WIL14	WK3
TOK5Y	TK26	TY50	TR50	UN54L	UN68L	VA73	L62KE	WIL15	WK17
TOK6X	TK9	TY50	X220	UN55	UN53L	VA75	NE46	WIL15L	WK14
TOK6Y	TK27	TY51	TR47	UN55L	UN63L	VA75	RN29	WIL16	WK13
TOK7X	TK10	TY51	X217	UN56	UN54L	VA75	X122	WIL17	WK3
TOK7Y	TK28	TY51P	TR47P	UN56L	UN64L	VA75P	RN29	WIL19	WIL1
TRC30	TR15D	TY52	TR48	UN57	UN57L	VA80	PG5	WIL20	WK10
TRL10	TK41	TY52	X219	UN57L	UN67L	VCO10	VEC2	WIL28	WK32
TSA11	TE3	TY53	TR53	UN58	UN56L	VCO10L	VEC1	WIL29	WK23
TSA20	TE1	TY53	X223	UN58L	UN66L	VGA10	VG2	WIL30	WK20
TSA20L	TE2	TY53P	TR53P	UN59	UN59L	VNG10	VG1	WIL31	WK29
TSA22	GR10	UCM5S	UCM1	UN59L	UN69L	VNG13	VG1	WIL32	WK25
TSA22	TE4	UMF10L	UM2	UN61	62DB	VRO3P	VR91CR	WIL33	WK31
TTM	CE8	UN10	62DM	UN62L	S33C	VRO3PL	VR91C	WIL34	WK28
TTN14	TT91	UN10L	R62DH	UNL4	WA91W	VRO4	VR91S	WIL35	WK22
TTN16	TT1	UN10L	R62DM	UNL4L	WA91	VRO4L	SR191A	WIL36	WK19
TY10	TA2	UN11	62DO	UNL5	WA91WL	VRO4P	VR91B	WIL37	WK27
TY10L	TA12	UN11	BR12	UNL5L	WA91L	VRO4PL	VR91BR	WIL38	WK18
TY11	TA5	UN12	1033N	URK10	UR3	VRO5	VR91	WIL39	WK21
TY11L	TA4	UN13	U180G	URK10L	UR3R	VRO5L	VR91R	WIL4	WK12
TY12	TA11	UN14	B62DV	URK4PL	UR2	VRO5P	VR91AR	WIL40	WK30
TY12L	TA16	UN14	WA2	VA1	VAE1	VRO5PL	VR91A	WIL41	WK24
TY13	TA8	UN14L	BS62DV	VA10	61VT/V1S	VRO5X	VR1R	WIL50	WK15
TY13	TA9	UN14L	WA1	VA11	62KD	VRO5XL	VR1	WIL50L	WK16
TY13L	TA6	UN15	62DG	VA12	VC28	VS10	VS1	WIL9	WK9
TY14	T61C	UN15	H62DG	VA12L	VC34	VW10	61VW	WLK4	61K
TY14A	TA28	UN15L	HR62DG	VA13	VC32	VW11	U61VW	WLK4L	R61K
TY14LBP	T61C	UN15L	R62DG	VA13L	VC33	VW11L	V61VW	WLY4	WA91W
TY14LP	DC1-P	UN16	H62DP	VA14	H10F	VW12	FT3F	WLY4L	WA91
TY14LP	T61C-P	UN17	62FT	VA15	H62KB	VW12L	FT3	WLY4P	WA91P
TY14P	T61CP	UN19	62DP	VA16	VAT1	VW13	61VW	WLY4PL	WA91P
TY15	TR28	UN2	62DX	VA17	63PX	VW13	62DW	WLY5	WA91WL
TY15P	TR28P	UN20	B62DP	VA17L	R63PX	VW13	62VW	WLY5L	WA91L
TY16	T61F	UN21	62FS	VA17P	63PX	VW13	S62DW	WRP10	TS1
TY16AP	P1098V	UN22	F70S	VA18	VC24	VW13	W62VB	WRP13	WRE2
TY17	T61D	UN23	H62DR	VA19	VC25	VW14	HF35	WS10	WS2
TY18	TA21	UN23L	BR18R	VA20	VC26	VW14L	VW67	WS10L	WS4
TY18	TA26	UN24	62DK	VA21	VC27	VW14LP	V27	WS11	WS11
TY19	TA19	UN25	UN1	VA22	VC29	VW14LP	V67	WS12	WS3
TY20	TR26	UN26	UN16	VA23	VC22	VW14LP	VW67	WS13	WS1
TY22	TA25	UN27	62DE	VA24	H7RDH	VW15	VW67S	WS1LO	SC51
TY23	TA7	UN28	BR9	VA25	V91E	VW15P	VW67S	WS1O	SC52
TY24	TA24	UN29	MG1	VA26	VC21	VW16	VW20	WS8	WS10
TY25	TR25	UN29P	MG1	VA27	H7RA	VW17	U62VN	WS9	DA20
TY25BP	TA27	UN30	S62DP	VA27L	H7LA	VW18	73VB	WS10	9TK
TY25BP	TR25	UN31	B62DR	VA28	H7RB	VW18BP	73VBP	WSL10	1175N
TY26	TA15	UN32	S62DR	VA28L	H7LB	VW18HP	73VB-P	WSL11	1175N
TY27	TA23	UN34	62DA	VA29	H7RC	VW18HP	73VBP	WT11L	WAR3
TY28	1519	UN35	62DJ	VA29L	H7LC	VW18P	73VBP	WT11O	WAR4
TY28	MS13	UN36	UN5	VA30	H7RD	VW19	VW71	X1000F	X1000F
TY35	TR33	UN37	L62DM	VA30L	H7LD	VW19P	VW71	X1000FR	X1000FR
TY35	X137	UN38	S33P	VA31	H7RE	VW19P	VW71V	X1014F	X1014F
TY35LP	DC1-P	UN41	UN51	VA31L	H7LE	VW20	VW71A	X1053	X1053
TY35P	TR33P	UN41L	UN61	VA32L	H7RE	VW20P	VW71A	X1054F	X1054F
TY36	TR37	UN42	UN52	VA34	H7RF	VW22	V33	X1054GA	X1054GA
TY36	X159	UN42L	UN62	VA34L	H7LF	VW22P	V33	X1054GB	X1054GB
TY36P	TR28P	UN43	UN50	VA35	H7LF	VW23	73VB	X1054GC	X1054GC
TY36P	TR37	UN43L	UN60	VA35L	H7RF	VW23	PA8	X1054GD	X1054GD
TY37	TR39	UN44	UN58	VA36	H7RG	VW25	V37	X1054GE	X1054GE
TY37P	TR39	UN44L	UN68	VA36L	H7LG	VW25	X203	X1054GF	X1054GF
TY38	TR37	UN45	UN53	VA37	H7LG	VW28	73VB	X1054K	X1054K
TY38P	TR28-P	UN45L	UN63	VA37L	H7RG	WBR10	WC1	XPA1	XPA1
TY39	TR33	UN46	UN54	VA38	H7RH	WBR12	WC2	XPA2	XPA2
TY39P	TR33P	UN46L	UN64	VA38L	H7LH	WCO11	WO1	YAL1	997A
TY40	TR25	UN47	UN57	VA39	H7LH	WCO11	WO2	YAL10	997B
TY40P	TR25	UN47L	UN67	VA39L	H7RH	WCO12	WO3	YAL10	997DB
TY41	TR40	UN48	UN56	VA40	H7RDH	WE10	VW64T	YAL10	997EB
TY41	X174	UN48L	UN66	VA40L	H7LDH	WE11	62VE	YAL10L	R997EB
TY41P	TR40P	UN49	UN59	VA42	V91N	WE11	W62VE	YAL11	O1122
TY45	TR25	UN49L	UN69	VA43	VCA1	WEI11	A1054WB	YAL11L	O1122R
TY46	TR49	UN50	771NH	VA43L	VCA1R	WEI12	FL5G	YAL12	997D
TY46	X218	UN51	UN51L	VA45	H7LDH	WEI14	1054WC	YAL12	997E
TY48	TR44	UN51L	UN61L	VA53	SM12	WEI14	N1054WB	YAL12	Y200
TY48	X211	UN52	UN52L	VA55L	VC34	WEI15	A1054WC	YAL12L	997ER
TY48P	TR44P	UN52L	UN62L	VA57	H62DM	WIL10	W91C	YAL13	999
TY49	TR46	UN53	UN50L	VA58	H62CM	WIL11	WK7	YAL13A	999GA

ORION	ILCO	ORION	ILCO	ORION	ILCO	ORION	ILCO	ORION	ILCO
YAL13AL	999VA	YAL41F	999LF	YM33	YH32	YS8L	MR63E	ZEI554	ZK54
YAL13B	999GB	YAL41FL	R9LF	YM33L	YH30	YS9	R63E	ZEI555	ZK55
YAL13BL	999VB	YAL41G	999LG	YM34	YM56	YS9	R63KE	ZEI556	ZK56
YAL13C	999GC	YAL41H	999LH	YM34L	YM34	YS9L	63E	ZEI557	ZK57
YAL13CL	999VC	YAL41K	999LK	YM34L	YM55	YTI11	T67E	ZEI558	ZK58
YAL13D	999GD	YAL41KL	R9LK	YM35	YM51X75	YTI13	T67F	ZEI559	ZK59
YAL13DL	999VD	YAL42A	998LA	YM35L	Y50	YTI21	T67A	ZEI560	ZK60
YAL13E	999GE	YAL42AL	998YA	YM35L	YH34	YTI23	T67D	ZEI561	ZK61
YAL13EL	999VE	YAL42B	998LB	YM35L	YM50	ZD15	X47	ZEI562	ZK62
YAL13F	999GF	YAL42BL	998YB	YM35L	YM55	ZEI10	ZIK1	ZEI563	ZK63
YAL13G	999GG	YAL42C	998LC	YM36	YH47	ZEI10L	Z91KR	ZEI564	ZK64
YAL13GL	999VG	YAL42CL	998YC	YM36AP	YH47	ZEI11	ZK1	ZEI565	ZK65
YAL13H	999GH	YAL42D	998LD	YM36L	YH46	ZEI12	S60	ZEI566	ZK66
YAL13HL	999VH	YAL42DL	998YD	YM36LAP	YH46	ZEI12L	S60R	ZEI567	ZK67
YAL13K	999GK	YAL42E	998LE	YM36LP	YH46	ZEI15	ZE91G	ZEI568	ZK68
YAL13KL	999VK	YAL42EL	998YE	YM36P	YH47	ZEI152	ZKN1	ZEI569	ZK69
YAL13L	999R	YAL42F	998LF	YM37	YH49	ZEI152L	ZKN1R	ZEI570	ZK70
YAL13L	X999R	YAL42FL	998YF	YM37AP	YH49	ZEI17	CN5	ZEI571	ZK71
YAL14	998	YAL42G	998LG	YM37L	X117	ZEI18	ZK102	ZEI572	ZK72
YAL14L	998R	YAL42GL	998YG	YM37L	YH48	ZEI18L	ZK100	ZEI573	ZK73
YAL15	999A	YAL42H	998LH	YM37LAP	YH48	ZEI2	60ZD	ZEI574	ZK74
YAL15	X999A	YAL42HL	998YH	YM37LP	YH48	ZEI22	ZMK1	ZEI575	ZK75
YAL15A	998GA	YAL42K	998LK	YM37P	YH46	ZEI22L	ZMK2	ZEI576	ZK76
YAL15AL	998VA	YAL42KL	998YK	YM37P	YH49	ZEI2L	R60ZD	ZEI577	ZK77
YAL15B	998GB	YAL43	999N	YM38	YH51	ZEI502	ZK2	ZEI578	ZK78
YAL15BL	998VB	YAL4P	H997EB	YM38L	YH50	ZEI503	ZK3	ZEI579	ZK79
YAL15C	998GC	YAL5	14KH	YM38LAP	YH50	ZEI504	ZK4	ZEI580	ZK80
YAL15CL	998VC	YAL5	H999	YM38LP	YH50	ZEI505	ZK5	ZEI581	ZK81
YAL15D	998GD	YAL56	J997M	YM38P	YH51	ZEI506	ZK6	ZEI582	ZK82
YAL15DL	998VD	YAL56L	J997MR	YM40L	SUZ12	ZEI507	ZK7	ZEI583	ZK83
YAL15E	998GE	YAL58	998GL	YM9L	YH41	ZEI508	ZK8	ZEI584	ZK84
YAL15EL	998VE	YAL58L	998YMK	YM9O	YH42	ZEI509	ZK9	ZEI585	ZK85
YAL15F	998GF	YAL5L	H999R	YS10	62PG	ZEI510	ZK10	ZEI586	ZK86
YAL15FL	998VF	YAL5P	H997E	YS10L	R62PG	ZEI511	ZK11	ZEI587	ZK87
YAL15G	998GG	YAL5PL	H997ER	YS11	R62PF	ZEI512	ZK12	ZEI588	ZK88
YAL15GL	998VG	YAL6	14KH	YS11L	62PF	ZEI513	ZK13	ZEI589	ZK89
YAL15H	998GH	YAL60	998S	YS12	62PH	ZEI514	ZK14	ZEI590	ZK90
YAL15HL	998VH	YAL83	999	YS13	YH6	ZEI515	ZK15	ZEI591	ZK91
YAL15K	998GK	YAL85	N01122D	YS14	YH7	ZEI516	ZK16	ZEI592	ZK92
YAL15KL	998VK	YAL88L	9C	YS14L	YH8	ZEI517	ZK17	ZEI593	ZK93
YAL15L	X999RA	YAL88L	Y201	YS15	YH9	ZEI518	ZK18	ZEI594	ZK94
YAL16	F1122A	YGO1	YU1	YS16	MB16	ZEI519	ZK19	ZEI595	ZK95
YAL16	H1122F	YGO1P	YU1	YS16L	MB16R	ZEI520	ZK20	ZEI596	ZK96
YAL16L	F1122AR	YM10L	YH20	YS16P	MB16	ZEI521	ZK21	ZEI597	ZK97
YAL16L	H1122FR	YM10L	YH22	YS17	MB17	ZEI522	ZK22	ZEI598	ZK98
YAL16L	O1122AR	YM100	YH16	YS17P	MB17	ZEI523	ZK23	ZEI599	ZK99
YAL17	997GX	YM100	YH23	YS19	YH21	ZEI524	ZK24	ZNI5	ZN1
YAL17L	997GXR	YM110	YH9	YS19A	OP12	ZEI525	ZK25		
YAL18	YL5	YM12L	YH40	YS19AL	OP37	ZEI526	ZK26	<b>PPI</b>	<b>PPI</b>
YAL19	997B	YM120	YH43	YS19L	YH22	ZEI527	ZK26	DI-1	ILCO 1028
YAL19	997EB	YM13L	X33	YS20	YH23	ZEI527	ZK27	DI-2	1052A
YAL19	YL8	YM130	X48	YS20L	YH24	ZEI528	ZK28	LB-2	LB2
YAL2	O997K	YM14L	YH27	YS21	OP43	ZEI529	ZK29	P-1	1333
YAL20	999	YM140	YH28	YS22	OP47	ZEI530	ZK30	P-175	1028P
YAL21	BKZ1	YM16L	YH24	YS22L	YH30	ZEI531	ZK31	P60S	1334
YAL22	1702K	YM160	YH29	YS22LP	YH30	ZEI532	ZK32	P87	1388
YAL23	X1199G	YM17L	YH38	YS22P	YH29	ZEI533	ZK33	P96S	1396S
YAL24	1764S	YM18L	YH44	YS23	SAA1	ZEI534	ZK34	SC1-6P-A	SY5-NS
YAL24	D1759L	YM19L	YH25	YS23TP	SAA1P	ZEI535	ZK35	SC1-6P-B	SY6-NS
YAL24	S1767CH	YM190	YH26	YS24	MB39	ZEI536	ZK36	SC1-6P-C	SY3-NS
YAL25	HR1132	YM23L	YH36	YS24P	MB39P	ZEI537	ZK37	SC1-6P-G	SY8-NS
YAL25L	H1132	YM24L	YH30	YS25	MB40	ZEI538	ZK38	Y766-000	885BL
YAL26	1041T	YM240	YH32	YS25P	MB40	ZEI539	ZK39	Y766-C10L	885R
YAL26L	1041TR	YM25L	YH33	YS26	DK91H	ZEI540	ZK40	Y766-C10R	885
YAL27	E1122A	YM26L	YH34	YS27	YH16	ZEI541	ZK41	Y766-C15L	886
YAL28	YL5	YM26O	YH35	YS28	YH13	ZEI542	ZK42	Y766-D2L	884R
YAL35	P1770U	YM29	YH19	YS31	HF59R	ZEI543	ZK43	Y766-D2R	884
YAL36	999B	YM29L	YH21	YS33	FT48	ZEI544	ZK44		
YAL39	999N	YM30	YH37	YS33P	FT48	ZEI545	ZK45	<b>RUSSWIN</b>	<b>ILCO</b>
YAL4	999B	YM30L	YH38	YS35L	RN32	ZEI546	ZK46	751	1011GH
YAL41A	999LA	YM31L	YH44	YS35LP	RN32P	ZEI547	ZK47	5252	1011A
YAL41AL	BVA1	YM31L	YH43	YS5	SV4	ZEI548	ZK48	5852	1011
YAL41AL	BYA1	YM32	YH35	YS6	L62VJ	ZEI549	ZK49	5981	1011P
YAL41B	999LB	YM32	YH49	YS6L	LR62VJ	ZEI550	ZK50	5981	N1011P
YAL41C	999LC	YM32L	YH36	YS7	63TW	ZEI551	ZK51	5982	1011S
YAL41D	999LD	YM32L	YH48	YS7L	63TV	ZEI552	ZK52	5982	N1011S
YAL41E	999LE	YM33	YH30	YS8	M63E	ZEI553	ZK53	5983	N1011T

RUSSWIN	ILCO	SAMSONITE	ILCO	SARGENT	ILCO	S & G	ILCO	SILCA	ILCO
6961	A1011P	SAMSONITE	181	6270RDM	O1007RDM	92	A1124	AB2	AB62C
6962	A1011S	170S	170S1	6270RHM	O1007RHM	96	1063E	AB3	AB62E
6963	A1011T	70S	70S	6270RM	O1007RM	9609	1362	AB32	AB32
9612	A1011M	70S	70S	6270RN	N1007RMA	60G	1068B	AB38P	AB38P
9812	N1011M	80S	80S	6273CD	O1007CD	87G	1387G	AB3R	AB62ER
5980-10K	1011K10	S181	S170S1	6273CDH	O1007CDH	87H	SG4	AB4	AB9
5980-11K	1011K11	S96	170S6	6273CDM	O1007CDM	87H	1387	AB43	AB43
5980-12K	1011K12			6273CH	O1007CH	89A	1390	AB60P	AB60P
5980-13K	1011K13	<b>SARGENT</b>	<b>ILCO</b>	6273CM	O1007CM	89AG	1390G	AB8	AB19
5980-1K	1011K1	265B	1008	6273CN	O1007CN	89G	1389G	AB8R	AB20
5980-2K	1011K2	265D	O1009	6275LA	O1007LA	92H	1063	AB9	AB62A
5980-3K	1011K3	265K	1010	6275LB	O1007LB	96G	1068E	ABS2	1635J
5980-4K	1011K4	265R	1009	6275LC	O1007LC	SY3B	887	ABS2	SF11
5980-5K	1011K5	265U	1010U	6275LE	O1007LE			ABS2R	1635V
5980-6K	1011K6	265U	O1010	6275LF	O1007LF			AC1	UCM1
5980-7K	1011K7	265UT	1010T	6275LG	O1007LG	<b>SCHLAGE</b>		AD2	ALP7
5980-8K	1011K8	270LD	1007LD	6275LJ	O1007LJ	<b>SCHLAGE</b>	<b>ILCO</b>	AF14A	61H
5980-9K	1011K9	270LDH	1007LDH	6275LK	O1007LK	1246-6	SC1246	AF14A	YR62
5980-GGM	1011PZ	270LDM	1007LDM	6275LL	O1007LL	1248-6	SC1248	AF14A	R61H
5D12R	1011D12	270LDH	1007LDH	6275NB	O1007NB	1348-6	SC1348	AF14B	R61H
5D1R	1011D1	270LH	1007LH	6275RA	O1007RA	1468-6	SC1468	AF14B	Y62
5D2R	1011D2	270LHM	1007LHM	6275RB	O1007RB	35-100C	1145	AF1A	AL4
5D34R	1011D34	270LM	1007LM	6275RC	O1007RC	35-100CE	1145CE	AF1A	DR61F
5D3R	1011D3	270LN	N1007KMB	6275RE	O1007RE	35-100E	1145E	AF1A	F24
5D41R	1011D41	270LN	O1007KMB	6275RF	O1007RF	35-100EF	1145EF	AF1A	F25
5D4R	1011D4	270RD	1007RD	6275RG	O1007RG	35-100F	1145F	AF1A	F38
6960-10N	A1011-10N	270RDH	1007RDH	6275RH	O1007RH	35-100FG	1145FG	AF1A	R61D
6960-11N	A1011-11N	270RDM	1007RDM	6275RJ	O1007RJ	35-100G	1145G	AF1A	R63ST
6960-12N	A1011-12N	270RHM	1007RHM	6275RK	O1007RK	35-100H	1145H	AF1A	SE4B
6960-13N	A1011-13N	270RM	1007RM	6275RL	O1007RL	35-100J	1145J	AF1A	SP1
6960-14N	A1011-14N	270RN	N1007RMB	6275SA	L1010N	35-100K	1145K	AF1B	61D
6960-15N	A1011-15N	273CD	1007CD	6275SB	O1007SB	35-100L	1145L	AF1B	F26
6960-16N	A1011-16N	273CH	1007CH	6275SC	O1007SC	35-101C	1145A	AF1B	F38
6960-17N	A1011-17N	273CM	1007CM	6275SD	O1007SD	35-101CE	A1145CE	AF1B	F39
6960-18N	A1011-18N	273CN	1007CN	6275SE	O1007SE	35-101E	A1145E	AF1B	R63TS
6960-19N	A1011-19N	275LA	1007LA	6275SF	O1007SF	35-101EF	A1145EF	AF1B	SP2
6960-1N	A1011-1N	275LB	1007LB	6275SG	O1007SG	35-101F	A1145F	AF1C	61TS
6960-20N	A1011-20N	275LC	1007LC	6275SH	O1007SH	35-101FG	A1145FG	AF1C	63ST
6960-21N	A1011-21N	275LE	1007LE	6275SI	O1007SI	35-101G	A1145G	AF1C	F27
6960-22N	A1011-22N	275LF	1007LF	6275SJ	O1007SJ	35-101H	A1145H	AF1C	F28
6960-23N	A1011-23N	275LG	1007LG	6275SK	O1007SK	35-101I	A1145I	AF1C	F40
6960-24N	A1011-24N	275LJ	1007LJ	6275SL	O1007SL	35-101J	A1145J	AF1C	F40
6960-25N	A1011-25N	275LK	1007LK	7270LD	L1007LD	35-101K	A1145K	AF1C	SP3
6960-26N	A1011-26N	275LL	1007LL	7270LH	L1007LH	35-101L	A1145L	AF1D	63TS
6960-27N	A1011-27N	275RA	1007RA	7270LM	L1007LM	35-180	1307A	AF1D	F30
6960-28N	A1011-28N	275RB	1007RB	7270LN	1007KM	35-181	L1307A	AF1D	F37
6960-2N	A1011-2N	275RC	1007RC	7270LN	N1007KMC	35-182	R1307A	AF1D	F41
6960-3N	A1011-3N	275RE	1007RE	7273CD	L1007CD	35-200	1307W	AF1D	R61TS
6960-4N	A1011-4N	275RF	1007RF	7273CH	L1007CH	35-201	L1307W	AF1D	SP4
6960-5N	A1011-5N	275RG	1007RG	7273CM	L1007CM	35-202	R1307W	AF2A	AB1A
6960-6N	A1011-6N	275RJ	1007RJ	7273CN	L1007CN	922B	O1054A	AF2A	LR61D
6960-7N	A1011-7N	275RK	1007RK	7275LA	L1007LA			AF2A	R62TS
6960-8N	A1011-8N	275RL	1007RL	7275LB	L1007LB			AF2B	AB2B
6960-9N	A1011-9N	275SA	1010N	7275LC	L1007LC			AF2B	L61D
6960-GGM	A1011PZ	278CA	1007CA	7275LE	L1007LE	<b>SECURITY</b>		AF2C	61F
6960-GGMR	A1011PZR	278CB	1007CB	7275LF	L1007LF	<b>CORP.</b>		AF2C	AB3C
6D12R	A1011D12	278CC	1007CC	7275LG	L1007LG	<b>SECURITY CORP</b>	<b>ILCO</b>	AF2D	AB4D
6D1R	A1011D1	278CE	1007CE	7275LJ	L1007LJ	KD73-7	SY11	AF2D	R61ST
6D2R	A1011D2	278CF	1007CF	7275LK	L1007LK	KD73-L	SY12	AF2D	SP5
6D34R	A1011D34	278CG	1007CG	7275LL	L1007LL	KD76	SY10	AF2D	AL2
6D3R	A1011D3	278CJ	1007CJ	7278CA	L1007CA			AF3A	R61G
6D41R	A1011D41	278CK	1007CK	7278CB	L1007CB			AF3A	61G
6D4R	A1011D4	278CL	1007CL	7278CC	L1007CC			AF3B	AL1
6H1R	A1011H1	6265B	1008A	7278CE	L1007CE			AF4A	F91C2
6H2R	A1011H2	6265K	1010SA	7278CF	L1007CF			AF4A	F91C
6H3R	A1011H3	6265KE	O1007JA	7278CG	L1007CG			AF4B	F91C
6H58R	1011MK	6265R	1009A	7278CJ	L1007CJ			AF4C	F91CR
752B	1012	6265U	A1010U	7278CK	L1007CK			AF4D	F91C8
752-GGM	1011M	6265U	O1010A	7278CL	L1007CL			AF4D	F91E
7D1R	B1011D1	6270LD	O1007LD	F258BF	1010B			AF5A	F91ES
7D2R	B1011D2	6270LDH	O1007LDH			<b>SILCA</b>		AF5A	R63SP
7D3R	B1011D3	6270LDM	O1007LDM			AB10	AB-18	AF5B	63SP
7D4R	B1011D4	6270LH	O1007LH	<b>SARGENT &amp; GREENLEAF</b>		AB10R	AB21	AF5B	F91F
861B	1011B	6270LHM	O1007LHM	<b>S &amp; G</b>	<b>ILCO</b>	AB14	191AB	AF5B	F91FS
861UB	X1000KR	6270LM	O1007LM	53	1028D	AB15R	AB16	AF5C	F91G
861UB	X1011KR	6270LN	N1007KMA	60	1063B	AB16R	AB11	AF5C	F91GS
		6270RD	O1007RD	89	1063D	AB16R	AB15	AF5D	F91H
		6270RDH	O1007RDH	90	1089C	AB17R	AB12	AF5D	F91HS
				91	1388L	AB19	AB23	AF7A	FT37

**CROSS REFERENCE**



# SILCA

SILCA	ILCO	SILCA	ILCO	SILCA	ILCO	SILCA	ILCO	SILCA	ILCO
AF7AP	FT37	ASS2	61W	ASS8R	AS78	BES17	A1114R	BO6	63WG
AF7C	FT38	ASS20	AS46	ASS9	61T	BES18	A1114M	BO6	BO2
AG1R	AG2	ASS20R	AS44	ASS98	SR61W	BES19	A1114TB	BO6	H62VG
AG2	AG1R	ASS1R	AS37	ASS9R	R61T	BES2	A1114B	BO6R	BO91
AG2R	AG1	ASS21R	AS35	AT1	AT1	BES20	B1179-1C	BO6R	HR62VG
AG3	AU3	ASS22	AS38	AT1R	AT2	BES21	B1179-1D	BO6R	R63WG
AG3R	AU4	ASS22R	AS36	AT2R	AT3	BES3	A1114C	BOR1	R1003M
AG4	AU1	ASS23	AS39	AU1	AA3	BES4	A1114D	BOR1R	1003M
AG4R	AU2	ASS23R	AS69	AU1R	LF13	BES5	A1114E	BRG1R	K1122D
AGE1	AG5	ASS24	AS40	AUS1	AUS1	BES6	A1114F	BRG2	L1098M
AGE3	AG1	ASS24R	AS70	AW1	1025	BES7	A1114G	BRG3	K1122B
AGE4R	AG4	ASS25	AS29	AW1	1025A	BES8	A1114H	BRG4	K1122C
AK1	VW64	ASS25R	AS27	AW1	750	BES9	A1114J	BRG5	K1122N
AK1R	R63VS	ASS26	AS30	AW1	755U	BH10	AL5	BRG6	L1054M
AK1R	VW64R	ASS26R	AS28	AW10R	A1179G	BH10	KL1	BRM1	BR1
AK2	AD1	ASS27	AS49	AW11R	A1179H	BH11	H76U	BT1	BU2
AK2	AU14	ASS27R	AS47	AW12R	A1179J	BH4	NE10	BT1R	BU1
AK2	AUC	ASS28	AS50	AW13R	A1179K	BH4P	NE10	BT2	BU8
AKR1	AK1	ASS28R	AS48	AW14R	A1179L	BH6	BH1	BT2R	BU7
AKR1	AN1	ASS29	AS51	AW15R	A1179N	BH7	BH3	BUR1	BUR11
AKR2	AK2	ASS29R	AS53	AW16R	A1179P	BK1	DA3	BUR11	BUR5
AKR2	AN3	ASS2R	R61W	AW17R	A1179R	BK1	KS91C	BUR16	BUR13
AKR3	AN2	ASS3	A61T	AW18R	A1179S	BK1R	DA2	BUR17R	BUR1
AKR4	AK6	ASS30	AS52	AW19R	A1179T	BK3-1	BKS25	BUR1R	BUR12
AKR5	AK4	ASS30R	AS54	AW2	1025AR	BK3-10	BKS34	BUR2	BUR7
AKR6	AN2	ASS31	61Q	AW2	760	BK3-11	BKS35	BUR2R	BUR8
ALP1	ALP4	ASS31R	R61Q	AW20R	A1179U	BK3-12	BKS36	BUR3R	BUR3R
ALP15R	ALP15R	ASS32	AS6	AW21R	A1179V	BK3-2	BKS26	BUR4	BUR4
ALP2	ALP5	ASS32R	AS8	AW5	1179A	BK3-3	BKS27	BUR6	BUR6
ALP5R	A190	ASS33	AS5	AW6	N1179	BK3-4	BKS28	BUR7	BUR9
ALP7R	ALP3	ASS33R	AS7	AW7	1179	BK3-5	BKS29	BVA1	BV1
ALP8R	ALP2	ASS34	AS10	AW8R	A1179E	BK3-6	BKS30	BVA1R	BV2
AM1	DM20	ASS34R	AS12	AW9R	A1179F	BK3-7	BKS31	BW1	63VP
AM2R	NE56	ASS35	AS9	AY1	ABL1	BK3-8	BKS32	BW1	HF20
AM2R	X113	ASS35R	AS11	AY1	AL1	BK3-9	BKS33	BW3	BM3
AM2RP	NE56	ASS36	AS34	AY13	AY13	BK5-10	BKS2	BW3	NE8
AMK1	AK22W	ASS36R	AS32	AZ1	AZ2R	BK5-11	BKS3	BW4	BM4
AML1R	1041C	ASS37	AS33	AZ1R	AZ2	BK5-12	BKS4	BW4	WT1
AML2R	A1045	ASS37R	AS31	B100-PT	B100-PT	BK5-13	BKS5	BW4	WT3
AML3R	1045	ASS38	A61W	B100-PT5	B100-PT5	BK5-14	BKS6	BW5	BM9
AN1	H61V	ASS38R	AR61W	B103-PT	B103-PT	BK5-15	BKS7	BW5	KL4
AR10	SP8	ASS3R	AR61T	B103-PT5	B103-PT5	BK5-16	BKS8	BW5	VW63
AR4	SF9	ASS40	A61Q	B104-PT	B104-PT	BK5-17	BKS9	BW6	BMW1
AR6R	SF7AF	ASS40R	AR61Q	B104-PT5	B104-PT5	BK5-18	BKS10	BW6P	BMW1
AR7	SF8	ASS42	AS24	B97-PT	B97-PT	BK5-19	BKS11	BW7	X59
AR8	SP6	ASS42R	AS26	B97-PT5	B97-PT5	BK5-20	BKS12	BW7AP	BMW3-P
AR9	SP7	ASS43	SB7	B98-PT	B98-PT	BK5-21	BKS13	BW7P	BMW2-P
ARC1	1130R	ASS45	AS84	B98-PT5	B98-PT5	BK5-22	BKS14	BW8	HF40
ARC1R	1130	ASS46	SB8	B99-PT	B99-PT	BK5-23	BKS15	BY1	BY1
ARC2	1131R	ASS49	SB10	B99-PT5	B99-PT5	BK5-24	BKS16	CA1	CA91S
ARC2R	1131	ASS49P	SB10	BA1	1098M	BK5-25	BKS17	CA1	CAV91
ASS1	V61A	ASS4R	AS74	BA2	H1098LA	BK5-26	BKS18	CA10	AR62K
ASS10	AS23	ASS5	SB6	BA2	O1098LA	BK5-27	BKS19	CA11	UR62K
ASS10R	AS25	ASS52	AS80	BA2R	O1098LA	BK5-28	BKS20	CA14	ZC1
ASS11	AS1	ASS52R	AS82	BA3	X1199B	BK5-29	BKS21	CA2	CA91L
ASS11R	AS3	ASS59	AS90	BA4	X1199G	BK5-30	BKS22	CA2R	ZE91C
ASS12	AS2	ASS60	AS89	BA5	O1122A	BK5-31	BKS23	CA2R	ZE91CR
ASS12R	AS4	ASS61	AS86	BA5R	1125M	BK5-32	BKS24	CA3	CA91B
ASS13	AS15	ASS64	AS71	BA5R	O1122AR	BL1	BL91	CA4	CA91A
ASS136R	AS14L	ASS64R	AS73	BA7R	1125G	BL1R	BL2	CA5	CA91
ASS13R	AS13	ASS65	AS63	BA7R	1125H	BLL1	BEL3	CA7	CA91C
ASS13R	AS9	ASS65R	AS61	BA8R	1098DB	BLL2	BEL4	CA7	CA91D
ASS14	AS16	ASS66	AS65	BA8R	ELM1	BLL3	BEL5	CA9	KVR91
ASS149	61X	ASS66R	AS67	BA8R	H1098DB	BLL4	BEL6	CB1	CB3
ASS14R	AS14	ASS67	AS57	BAB29	BAB29	BLL5	BEL7	CB10	1001DH
ASS14R	AS9L	ASS67R	AS59	BAL1	BA1	BLO1	BLO1	CB11	R1001EN
ASS15	AS19	ASS7	AS75	BAL3	BA2	BLO1R	BO6	CB11R	1001EN
ASS15R	AS17	ASS73	AS79	BAS1	BAS1	BLV1R	1036	CB12	A1001MJR
ASS16	AS20	ASS73R	AS81	BE200	BE91S	BLV2R	1036S	CB12R	B1001EJ
ASS16R	AS18	ASS7R	AS77	BE201	BE91C	BLV3	1036G	CB13	R1000V
ASS17	AS55	ASS8	AS76	BE202	BE91	BMB1R	BMB1R	CB13R	1000V
ASS17R	AS21	ASS80	AS64	BE203	BE91L	BO2	62VH	CB14	SR1000V
ASS18	AS56	ASS80R	AS62	BES1	A1114A	BO2	OP91	CB14R	S1000V
ASS18R	AS22	ASS81	AS66	BES10	A1114K	BO4	63F	CB18	1001GH
ASS19	AS45	ASS81R	AS68	BES11	A1114L	BO4	BO4	CB20	CB10
ASS19R	AS43	ASS82	AS58	BES12	A1114FM	BO5	B62G	CB22R	L1001GRM
ASS1R	SB11	ASS82R	AS60	BES16	A1114Q	BO5	DK91	CB23R	A1001GRM

CROSS REFERENCE



SILCA	ILCO	SILCA	ILCO	SILCA	ILCO	SILCA	ILCO	SILCA	ILCO
CB24R	1001GRM	CE14-28	CS51	CNB2	1558	DAT14	DT20	DM123-4	DM14
CB25R	L1001EH	CE14-35	CS52	COR1	CN1	DAT14	X124	DM123-5	DM17
CB26R	A1001EH	CE14-36	CS53	CR4R	CR4R	DAT14P	DA28	DM14	D64
CB27R	1001EH	CE14-37	CS54	CS10	9CX	DAT15	DA30	DM15	DM3
CB28R	L1003AB	CE14-38	CS55	CS12	WA91S	DAT15	X197	DM15	DO3L
CB29	R1001EG	CE14-45	CS56	CS204	S9CS	DAT15DP	DA30-P	DM16	DM21
CB29R	1001EG	CE14-46	CS57	CS205	CS91B	DAT16	DA28	DM17	DM60
CB3	CB2	CE14-47	CS58	CS206	9CS	DAT16DP	DA28	DM17R	DM63
CB33R	A1001AH	CE14-48	CS59	CS207	R9CS	DAT1R	DT15	DM1R	DM5
CB33R-A1	A1001AH	CE15	SH91K	CS23	AB17	DAT1R	DT6	DM1R	FT6R
CB33R-A2	A1001FH	CE1R	LR62US	CS500	CS91	DAT2	DT5	DM1RAP	FT6R
CB33R-B1	A1001BH	CE2	ST91A	CS501	AB1	DAT2R	DT1	DM1RP	FT6R
CB33R-B2	A1001DH	CE22-16	BD6	CS6	CS91CR	DAT3	D72Z	DM2	DO3M
CB33R-C1	A1001C	CE2R	R62US	CS6R	CS91C	DAT3R	D72D	DM20	DM58
CB33R-C1	A1001C1	CE34	CS32	CS7	CS91E	DAT3R	SR6	DM22	DM22-SI
CB33R-C2	A1001C2	CE35	CS30	CS7R	CS91ER	DAT4	DT14	DM22TVP	DM22TVP
CB33R-D1	A1001D1	CE36	CS31	CS8	AB62FR	DAT4	DT8	DM23	DO3M
CB33R-D2	A1001D2	CE4	CS2	CS8	CS91FR	DAT4R	DT13	DM25	DM61
CB35	XO1000GR	CE4	SN2	CS8R	AB62F	DAT4R	DT7	DM26	DM25
CB35R	XO1000F	CE4	ST91S	CS8R	CS91F	DAT5	MZ12	DM3	ID1
CB36R	1000AB	CE4R	ST91	CS9	AB62G	DAT5	X1	DM39R	DM23
CB37	R1001EF	CE5	CS43	CS9R	AB62GR	DAT5BP	MZ12	DM4	64RD
CB38	SX1000FR	CE7	CS12	CTN1R	1023	DAT5P	MZ12	DM44R	DM26
CB38R	SX1000F	CE7R	CS13	CTR1R	1560	DAT6	X6	DM46	DM22
CB39R	1001EB	CE8	CS29	CVL1	CVL1R	DAT6BP	62DT	DM4R	DO1M
CB4	CB1	CEM1	CE2	CVL1R	CVL1	DAT6P	62DT	DM4R	PO2
CB40R	L1001AH	CEM2	CE8	CX7	FSP2	DAT6R	X7	DM50	DM25
CB41R	1001AH	CEM3	BL6	CY1	1767CH	DAT6RP	62DU	DM6	DO1SR
CB44R	LH1	CEM1	CE1	CY1	D1707K	DAT6RP	DA24	DM65-11	DM65-11
CB45R	1000	CH1	1041G	CY10	1769CH	DAT7	62DV	DM65-14	G195A
CB46R	R1001EE	CH10	1041Y	CY11	S1770U	DAT7	X10	DM65-17	DM65-17
CB47	1000F	CH11	104AM	CY12	CU8	DAT7RBP	SJ1	DM65-18	G190A
CB47R	1000FR	CH12	101AM	CY12R	CU7	DAT9	X115	DM65-2	G192A
CB48	X1000G	CH13	102AM	CY13	CU10	DAT9BP	DA23-P	DM65-20	DM65-20
CB49	R1000T	CH14	103AM	CY13R	CU9	DAT9P	DA23-P	DM65-40	G194A
CB49R	1000T	CH15	100AM	CY14	CU12	DAT9R	X114	DM65-41	G190BA
CB50	R1000V	CH16T	1136S	CY14R	1040U	DAT9RP	DA24	DM65-42	G190CA
CB50R	1000V	CH17T	L1137	CY15R	P1786	DB48R	DN1	DM65-43	G190DA
CB51	1000X	CH18	1525	CY15RP	Y153-P	DD1	D1V	DM65-44	G190EA
CB52R	A1001ABM	CH19	1041E	CY16	P1789	DD2	D1T	DM65-45	G190FA
CB53	1001GH	CH2	1041GA	CY16P	Y154-P	DD3	D1K	DM65-46	G190MA
CB54R	1001	CH20R	1041TR	CY17P	MIT1	DD4	D1A	DM65-6	G194A
CB55R	S1000V	CH21	1041X	CY18	X213	DF2	CA2	DM65-8	G191A
CB57R	1001ABM	CH22	1041T	CY19	P1793	DF2	DF1	DM65-9	G193A
CB59	S1000X	CH23	C1041J	CY19P	Y155-P	DH4R	TR40	DM66	DM8
CB6	CB7	CH24R	SC1041R	CY2	D1759L	DH4RP	TR40	DM68	DM7
CB60	S1000XK	CH25R	SC1041S	CY2	S1767DP	DL2	DL2	DM69	DM6
CB61R	1001EA	CH26R	S1041JA	CY20	1793V	DL3	LAP2	DM6R	DO1S
CB62R	1003A	CH27	C1041T	CY21R	X1199AR	DM1	FT6	DM7	DO4F
CB63R	1003AB	CH3	1041GB	CY22	P1794	DM10	DM31	DM7	H64E
CB64R	A1001AM	CH4	1041GR	CY22P	Y157-P	DM10	HU4	DM8	DM10
CB65R	A1001BM	CH5	1041K	CY23	1794V	DM103	DM57	DM86	DM33
CB66R	L1003A	CH6	752	CY24	P1795	DM10R	DM32	DM86R	DM43
CB67R	L1003M	CH7R	1042Z	CY24BP	Y159-P	DM11	DM11	DM87	DM34
CB68R	S1000T	CH8	1041N	CY24CP	Y159-P	DM110	DM110	DM87R	DM44
CB69	1000XK	CH9T	1137B	CY3	1701G	DM12-11	G199	DM88	DM35
CB71	A1011-L1	CH9T	1137S	CY3	1766S	DM12-14	G195	DM88R	DM45
CB72	A1011-L2	HU6	1516	CY3	S1767CH	DM12-15	G198	DM89	DM36
CB73	A1011-L3	CI4	S62FD	CY4	P1770U	DM12-17	G197	DM89R	DM46
CB74	A1011-L4	CI6	CA3	CY5	S1768CH	DM12-18	G190	DM8R	DM27
CB75	A1011-L12	CL1	1040A	CY5	S1769CH	DM12-2	G192	DM9	DM2
CB76	A1011-L34	CL2	R1040C	CY5	S1770U	DM12-20	G196	DM90	DM37
CB77	A1011-L41	CL3	1040C	CY6	L1098C	DM12-25	G200	DM90R	DM47
CB9	CB12	CL4	R1040E	CY7	P1770U	DM12-40	G194	DM91	DM38
CE1	L62US	CL5	1040E	CY8	U1770CH	DM12-41	G190B	DM91R	DM48
CE10	CS28	CLU1	1573B	CY9	1768CH	DM12-42	G190C	DM92	DM39
CE11	CS1	CLU1R	1573A	DAT1	DT16	DM12-43	G190D	DM92R	DM49
CE12	S62US	CLU2	1573D	DAT1	DT4	DM12-44	G190E	DM93	DM40
CE13	CS14	CLU2R	1573C	DAT10	62DT	DM12-45	G190F	DM93R	DM50
CE13R	CS15	CLU3	1573F	DAT12BP	DA25-P	DM12-46	G190M	DM94	DM41
CE14-15	CS44	CLU3R	1573E	DAT12P	DA25-P	DM12-6	G194	DM94R	DM51
CE14-16	CS45	CLU4	1581H	DAT12R	B54	DM12-8	G191	DM95	DM42
CE14-17	CS46	CLU4R	1581G	DAT12R	X154	DM12-9	G193	DM95R	DM52
CE14-18	CS47	CLU5	1589J	DAT12RBP	B54	DM123-1	DM13	DO10	22PO
CE14-25	CS48	CLU5R	1589I	DAT13	X123	DM123-10	DM18	DO11	1054LB
CE14-26	CS49	CN1	C1054B	DAT13P	DA25-P	DM123-2	DM16	DO12	N54B
CE14-27	CS50	CNB1R	25	DAT14	DA28	DM123-3	DM15	DO13	N54G

SILCA	ILCO	SILCA	ILCO	SILCA	ILCO	SILCA	ILCO	SILCA	ILCO
DO1R	S54F	ELG2	H1054B	FO27	1191ET	GE1R	GE3R	GM35R	H1098M
DO2R	DO6	ELG3R	C1096LN	FO27	H59	GE2	7GE	GM36	H1098X
DO3R	DO5	ELG4R	R1096EN	FO27P	H62-P	GE3R	LR7GE	GM37	P1102
DO4R	H1054F	ELG5	S1096B	FO28B	X207	GE41	GE15	GM37EP	B82-P
DO5R	1054F	ELG6R	C1096CN	FO29	1193MU	GE4R	GE6	GM38	1098XL
DO5R	L1054F	ELG7R	1096C	FO29BP	H66-P	GHE1	GH2	GM39	P1106
DO6	L54K	ELG8R	1096	FO3	1127D	GHE2	GH1	GM39EP	B86-P
DO7R	54FL	ELG9R	1096L	FO30	1193FD	GHE3	GH3	GM3BP	GMB-P
DO8R	54FA	ER1	ER5	FO30BP	H67-P	GM1	H1098A	GM3DP	B49-P
DO9R	P54F	ERL1	1119	FO31R	X221	GM1	L1098LA	GM4	O1098D
DU1	P65A	ERL2	1119S	FO31RAP	H65-P	GM1	O1098LA	GM4	S1098D
DU2	P65C	ES1	ES1	FO32R	X221	GM1	P1098A	GM4-OR	S1098D
DU2R	P65C	ES1R	ES1R	FO32RAP	H65-P	GM1-OR	H1098A	GM40	P1109
DU3	HR62BZ	ESP1R	1503	FO34	X231	GM1-OR	P1098A	GM40EP	B92-P
DU3	PA91E	ETA1	ET1	FO34AP	H70-P	GM10	L98AS	GM41	S1105
DU3	R62BZ	ETA1	ET2	FO35	1185FD	GM11	B53	GM4BP	GMD-P
DU3R	H62BZ	ETA1	ET9	FO36BP	1188LN-P	GM11	X143	GM4DP	B51-P
DU3R	PA91F	EV2	EV4	FO37R	S1181FD	GM11P	B53	GM5	P1098E
DU4	1164K	EV3	EVA1	FO38RT3	H72-PT	GM12R	X145	GM5-OR	P1098E
DU4	P64H	EV3R	EVA1R	FO39	1195FD	GM12RP	B55	GM5CP	B44-P
DU4	PA91H	EV4	62EV	FO39CP	H71-P	GM13R	X146	GM6	S1098H
DU4R	H64K	EV4R	R62EV	FO4	1127DP	GM14R	P1098AV	GM6-OR	S1098H
DU4R	P64K	EV5	EV5	FO4	1127FR	GM14RP	P1098AV	GM6DP	B45-P
DU4R	PA91K	EV6R	EV7	FO40R	1196FD	GM15	B61	GM7	P1098J
DV1	DAV10	EZ1	ES1	FO40RBP	H75-P	GM15	MIT1	GM7-OR	P1098J
DWO4RAP	DWO4RAP	FA2AP	NE58	FO5	1127ES	GM15P	MIT1	GM7CP	GMJ-P
DWO4RT5	DWO4RT5	FAB2	X99	FO5	S1127FL	GM16R	S1098WD	GM7CP	P1098J
DWO5AP	DWO5AP	FB1	65CB	FO5	S1127FR	GM17R	P1098WC	GM8	S1098K
DWO5RAP	DWO5RAP	FB1	SK91A	FO5	S1127LC	GM17RP	B64-P	GM8-OR	S1098K
DWO5RT5	DWO5RT5	FB2	65CD	FO5	S1127MU	GM18R	B69	GM8DP	GMK-P
DWO5T5	DWO5T5	FB2	SK91D	FO6	1167FD	GM18R	X180	GM8DP	S1098K
DX1	A1054KD	FB6R	65CE	FO6	1170LN	GM19	B65	GM9	LP98A
DX1	D1054K	FEB2	CF1	FO6	1181FD	GM19	SUZ15	GN1	1033G
DX10R	DXC3	FEB2R	CF2	FO6	1766LN	GM19	X184	GO1R	GL3
DX11R	DXD1	FH1	FTH3	FO6-OR	1167FD	GM19P	B65	GO1R	S62TG
DX12R	DXD2	FH2	FTH4	FO7	X20	GM19P	SUZ15	GO2R	GL1
DX13R	DXD3	FH3	FT1	FO8	BR20	GM1AP	GMA-P	GP1	GIP91
DX14R	DXB4	FH6	FTH5	FO9	CE6	GM1CP	B48-P	GS4R	D1098B
DX15R	DXC4	FH7	FTH6	FOT1	62KT	GM2	H1098C	GT10	NE57
DX16R	DXD4	FID1	C172F	FOT1	FT4	GM2	L1098C	GT10BT5	GT10BT5
DX17R	DXG5	FL1	Z4	FOT2	FT5	GM2	P1098C	GT12A	GT3
DX18R	54GM	FN2	1054WC	FOT2	KL2	GM2-OR	P1098C	GT12A	LN2
DX19R	54CM	FN3	A1054WC	FOT2	VW77	GM20	X143	GT12B	GT4
DX20R	54DM	FN4	A1054WD	FOT3	FT7	GM20P	B53	GT13A	GT1
DX21R	54B1	FN6	1054WD	FOT3	H62FD	GM21R	P1098CV	GT13A	LN1
DX21R	DXB10	FNA1	1552	FOT3R	FT7R	GM21RP	B63-P	GT13A	WA1
DX22R	DXB30	FO10	X86	FOT3R	HR62FD	GM22R	B72	GT13A	WA3
DX23R	DXC10	FO10AP	FC7-P	FOT3R	V32	GM22R	X192	GT13B	GT2
DX24R	DXC20	FO10P	FC7-P	FOT3R	X53	GM22RP	B72	GT15RAP	GT15RAP
DX25R	DXC30	FO11	FC9	FOT4	FT9	GM23P	DC3	GT15RBT2	GT15RBT2
DX26R	DXD10	FO11X	FC9	FOT4	HF22	GM24R	B74	GT15RT2	GT15RT2
DX27R	DXD20	FO12	FC8	FOT4R	FT9R	GM24R	X198	GT16AP	SP25A-P
DX28R	DXD30	FO13	FC7	FOT4R	HF23	GM24RP	B74-P	GT16T2	GT16T2
DX29R	D1098X	FO14R	S1167FD	FOT5	FT10	GM25R	K1994	GT2AP	S10LAA-P
DX3	D1054KA	FO14R	S1170LN	FOT5	YM14	GM25R	P1100	GT4	LN4
DX4R	DXB1	FO14R	S1181FD	FOT5R	FT10R	GM25R	P1108	GT5	NE54
DX5R	DXB2	FO14R	S1766LN	FOT5R	YM15	GM25RP	B76-P	GT5	X167
DX6R	DXB20	FO14R-OR	S1167FD	FOT6	X22	GM25RP	B88-P	GT5BP	NE54
DX7R	DXB3	FO14RP	S1186TS-P	FOT6R	X21	GM26R	P1098EV	GT5P	YU2
DX8R	DXC1	FO15	1127DU	FOT6R	YS1	GM26RP	B77-P	GT5YP	X167
DX9R	DXC2	FO16	FF1	FRT1	L1054G	GM27R	P1098WE	GT5YP	YU2
EF3R	EC12	FO17P	P1127C	FRT2R	ML54G	GM27RP	B78-P	GT6R	FT46
EF4R	EC14	FO17R	S1167C	FRT3R	M54G	GM28R	S1098WH	GT6R	NE59
EF5R	EC16	FO18	1184FD	FS1	FAS1	GM29	P1099	GT6R	X152
EF6R	EC18	FO18-OR	1184FD	FS1R	ST1	GM29P	B68-P	GT6RAP	FT46
EG1	1014F	FO18P	1186TS-P	FT4C	FH4	GM2AP	GMC-P	GT6RBP	X152-P
EG1	X1014F	FO19P	S3FD-P	FT500	FT45	GM2CP	B50-P	GT6RGP	NE54
EG2	01014P	FO20P	S33FD-P	GAS1R	1098GX	GM3	O1098B	GT8	NE55
EG2R	O1014S	FO21P	S30FD-P	GB1	GA91	GM3	S1098B	GYA	999GA
EG3R	1014	FO22R	X202	GB2	GA1	GM3-OR	S1098B	GYA	Y1GA
EG4R	O1014J	FO22RBP	X202	GB2	GAS91	GM30	X225	GYA6	998GA
EG5R	O1014JS	FO22RP	H59-P	GB5	ZE91G	GM30AP	B80-P	GYA7	H998GA
EG6	O1014P	FO22RP	MZ16	GB5R	R62K	GM31	P1101	GYB	999GB
EGO1R	EE1	FO24	1186TS	GD2	191A	GM31P	B84-P	GYB6	998GB
EL1	ELZ1	FO26	1190LN	GE1	GE5	GM32R	1098GM	GYB7	H998GB
ELG10	S1096G	FO26-OR	1184FD	GE17	GE2	GM33R	1098L	GYC	999GC
ELG1R	L1096CN	FO26T3	H73-PT	GE17R	GE4	GM34R	H1098DB	GYC6	998GC

SILCA	ILCO	SILCA	ILCO	SILCA	ILCO	SILCA	ILCO	SILCA	ILCO
GYC7	H998GC	HON2R	HO61S	HON46RAP	HD89	HU12	HF4	HU33	HF38
GYD	999GD	HON2R	R67K	HON46RAP	HD95	HU12	MB13	HU34	MB18
GYD6	998GD	HON3	HO61TR	HON47	X181	HU12R	HF3	HU34P	MB18-P
GYD7	H998GD	HON31	HD58	HON47P	HD83-P	HU12R	HF7	HU35	HF43
GYE	999GE	HON31	X138	HON47P	HD90-P	HU12R	MB14	HU36	MB41
GYE6	998GE	HON31AP	HD58	HON48	HD86	HU13	63W	HU36	X82
GYE7	H998GE	HON31AP	HD75	HON48	HD94	HU13R	R63W	HU36P	MB41-P
GYF	999GF	HON31AP	HON31AP	HON48	X190	HU14	HF6	HU37	MB38
GYF6	998GF	HON31BP	HD75	HON48AP	HD86	HU14	HF9	HU37P	MB38
GYF7	H998GF	HON31BP	HON31BP	HON48AP	HD94	HU14	MB11	HU38	HF46
GYG	999GG	HON31P	HD58	HON49	HD70U	HU14	R63K	HU39P	S48HF-P
GYG6	998GG	HON31P	HD75	HON49	X71	HU14	R63TK	HU4	A62VN
GYG7	H998GG	HON31P	HON31P	HON49P	HD70U-P	HU14R	63K	HU40P	S49HF-P
GYH	999GH	HON31R	X84	HON4R	HD5	HU14R	HF16	HU41AP	S50HF-P
GYH6	998GH	HON31RAP	HD63	HON5	HD13	HU14R	HF5	HU41P	S50HF-P
GYH7	H998GH	HON31RAP	HD74	HON5	HD61	HU14R	MB12	HU42P	HF52-P
GYK	999GK	HON31RAP	HON31RAP	HON50	HD42	HU15	OP60H	HU43	HF56
GYK	Y1GK	HON31RBP	HD63	HON50	HD59	HU15R	DK91S	HU43P	HU43P
GYK6	998GK	HON31RBP	HON31RBP	HON51R	X193	HU15R	R62PE	HU43T2	HU43T2
GYK7	H998GK	HON31RP	HD63	HON51RP	HD96-P	HU16	OP42	HU44AP	S53HF-P
GYP7	H998	HON31RP	HON31RP	HON52R	HD95	HU17	62WB	HU45P	HF55-P
GYP7R	H998R	HON32	HD70	HON52R	X194	HU17	AUBS3	HU46	HF59
H74-PT	H74-PT	HON32P	HD70	HON52RP	HD97	HU18	AUCS1	HU46	X168
H82-PT	H82-PT	HON32P	HON32P	HON53	HD84	HU18	R62WA	HU46P	X168
H86-PT	H86-PT	HON33	HD71	HON53	X183	HU18R	62WA	HU46T2	HU46T2
HAW1	1597	HON33P	HD71	HON53	X208	HU18R	AUDS2	HU47	73VB
HAW2	1598	HON34	HD68	HON53AP	HD101-P	HU19	62DP	HU49	V35
HD1	1098GX	HON34R	HD65	HON53P	HD84-P	HU19	62PD	HU49	V37
HD107-PT5	HD107-PT5	HON35	HD67	HON53P	HD92-P	HU19	HR62DP	HU49	X203
HD2R	1003M	HON35R	HD66	HON54	HD102	HU19	OP1D	HU49AT2	HU49AT2
HD3	1512	HON37	HD83	HON54	HD85	HU19	OP60H	HU49BP	V35-P
HD4R	1561	HON37	HD84	HON54	X189	HU19R	H62DP	HU49CP	V35
HD5R	1562	HON37P	HD83-P	HON54	X209	HU19R	OP61	HU49CP	V35-P
HD6R	1563	HON37P	HD84-P	HON54AP	HD102-P	HU19R	R62DP	HU49P	V37-P
HD7R	1564	HON38	HD82	HON54P	HD102-P	HU1R	S62DW	HU49T1	HU49T1
HEN1	HN2	HON38	X129	HON54P	HD85	HU2	BO5	HU5	HF1
HG2	HG3	HON38P	HD82-P	HON54P	HD93	HU2	LR62VB	HU5	HF14
HM1	BU4	HON38R	X130	HON55R	X195	HU2	R62VP	HU5	MB10
HM1R	BU4R	HON38RP	X130	HON55R	X214	HU20	H62VP	HU5	R62VN
HO2R	HS1	HON39	HD63	HON55RDP	HD98-P	HU20	O79JB	HU50	BMW3
HOL1R	1170B	HON39	HD74	HON56R	X204	HU20	OP19	HU50	X144
HON1	67J	HON39P	HD63	HON56REP	HD99-P	HU20	U62VP	HU50AP	BMW3-P
HON10	HD8	HON39P	HD69	HON57R	HD100	HU20R	HF21	HU55P	S34YS-P
HON11	HD10	HON39P	HD74	HON57R	X205	HU20R	O79JE	HU56RP	S60HF-P
HON11R	HD12	HON39P	HON39P	HON57RP	HD100-P	HU20R	OP1EE	HU58AP	S7BW-P
HON12	HD14	HON39R	HD58	HON58R	X214	HU20R	UR62VP	HU59	S6BW
HON12R	67LC	HON39R	HD75	HON58RDP	HD103-P	HU21	HF10	HU6	G1
HON12R	HD11	HON39RP	HD58	HON58RT5	HD106-PT5	HU21	O79JC	HU6	VW1
HON13	HD15	HON39RP	HD75	HON59R	X215	HU21	OP11	HU60R	B59
HON13R	HD11	HON39RP	HON39RP	HON5R	67LB	HU21R	HF11	HU60R	X162
HON14	HD7	HON3R	HO61T	HON5R	H76G	HU21R	O79JD	HU61AP	S34YS-P
HON15	HD31	HON4	HD14	HON5R	HD60	HU21R	OP1DD	HU64P	S34YS-P
HON16	HD29	HON4	HD5R	HON61RBP	HON61RBP	HU22	MB15	HU65AP	S58HF-P
HON17	HD23	HON40	HD85	HON63FP	X265	HU22P	MB15-P	HU66AT6	HU66AT6
HON18	HD33	HON40	HD86	HON64BP	HON64BP	HU23	MB18	HU66T5	HU66T5
HON19	HD35	HON40AP	HD85	HON64RBP	HON64RBP	HU23P	MB18-P	HU66T6	HU66T6
HON1R	HD24	HON40AP	HD86	HON66T14	HO03-PT	HU24	OP9	HU6R	R62VA
HON1R	HO61P	HON40P	HD85	HON66T27	HD113-PT	HU25	OP14	HU6R	Z2
HON1R	HO61Q	HON40P	HD86	HON66T5	HO01T5	HU25	YM25	HU7	G2L
HON2	67K	HON41	HON41	HON7	HD4	HU25R	OP35	HU7	L62VA
HON20	HD34	HON42AP	HON42AP	HON7R	HD18	HU25R	YM27	HU7R	LR62VA
HON21	HD32	HON43R	HD88	HON8	HD20	HU26	HF47	HU7R	ZM91
HON22	HD30	HON43R	X172	HON8R	HD19	HU26	HF50	HU9	63Y
HON23	HD45	HON43RP	HD88-P	HOV01T5	HOV01T5	HU26	OP13	HU9	BM1
HON23R	X44	HON44R	HD89	HRC1	1014C	HU26R	HF49	HU9	HF13
HON24	HD40	HON44R	X173	HRD1R	1536R	HU26R	OP36	HU9	HU3
HON24	HON24	HON44RAP	HD89	HRD2	1529	HU27	62VG	HU9	1041E
HON24	X57	HON45R	HD88	HT1	VA2	HU29	HF37	HW1	HRD3
HON24P	HD40	HON45R	HD91	HT1R	62H	HU29	NS6	HW2	X100
HON24P	HD72	HON45R	HD98	HT2	VA1	HU2R	61VW	HW2	X226
HON24R	HO41	HON45R	X182	HU10	FT1	HU2R	62VB	HY11R	X234
HON24R	X58	HON45RP	HD88-P	HU10	G63Y	HU2R	62VW	HY1R	X93
HON24RP	HD73	HON45RP	HD91-P	HU10	R63TY	HU2R	L62VB	HY2	X126
HON24RP	HO41	HON45RP	HD98-P	HU11	FT1L	HU3	A62VN	HY2R	X127
HON24RP	HON24RP	HON46R	HD89	HU11	HF12	HU30	BM5	HY3	X101
HON26	HD49	HON46R	HD95	HU11	R63Y	HU30	HF41	HY3R	X102
HON27	67LD	HON46R	X191	HU12	HF15	HU32	AU15	HY4	X125

SILCA	ILCO	SILCA	ILCO	SILCA	ILCO	SILCA	ILCO	SILCA	ILCO
HY4R	HYD5	JOW6	JU2	KS1	1063KW-BR	LF26	LF9	LW12R	24B-AUS
HY5	X95	JS1	J12R	KS1	1176	LF27	C209	LW13	24CL
HY5R	X94	JS1R	J12	KS1	S1176	LF27R	C209R	LW14	24A
HY6	X96	JS3	J11R	KS1FT	S1176	LF28R	LF8	LW15	DL91
HY6R	HY6R	JS3R	J11	KS2	A1176	LF3	LF4	LW16	RD1
HY7	X97	JU1	JN58	KW1	KA2	LF3	R81F	LW17	RD2
HY7R	X98	JU2	JN2	KW1	YH6	LF31R	LF18	LW18	GR9
HY8R	HD51	JW1	JU1D	KW11	KA13	LF35	WB2	LW1R	1004R
HY9	HY9	JW1	WA91C	KW12	X103	LF35	WB3	LW20	1004
HYN1	X161	JW1R	BR91C	KW12P	KA14	LF35P	WB2	LW20R	1004R
HYN10	X235	JW4	JU4R	KW13	X103	LF37	C209L	LW21R	LK21
HYN10BP	HY13-P	JW4R	JU4	KW13P	KA14	LF39	C218	LW23	1004A
HYN11	X236	JW5	JU3	KW14P	KW14P	LF3P	BR19	LW25	A1015M
HYN11CP	HY14-P	JW5R	JU3R	KW14R	KW14R	LF3P	LF4	LW3	24
HYN1P	X161	JW6	JU2	KW1R	KA1	LF4	LF19	LW4	4
HYN2R	X160	JW6R	JU2R	KW3	KA12	LF4	LF5	LW4R	4R
HYN2RP	HY2-P	JW7	JU5	KW4	YH25	LF43R	LF25	LW5	LK1
HYN4	X187	JW7R	JU5R	KW4R	YH26	LF5	CE3	LW5R	LK2
HYN4P	HY4-P	KA1	KAB1	KW5	KA5	LF5	L62FD	LW6	LK5
HYN5R	X196	KA2	KAB2	KW6	X41	LF6R	LF1	LW7	LK8
HYN5RP	HY5-P	KA5	KA5-SI	KW6R	X34	LF9R	WB1	LW8	LK7
HYN6	X216	KE3	KE3-SI	KW7	KA14	LF9RP	WB1	LW9	LK4
HYN6P	HY6-P	KE4	S13KE	KW8	KA15	LH1	LE1	LYA	999LA
HYN7R	X232	KEI1R	1079B	KW8R	KA11	LK1R	1180S	LYA	Y1LA
HYN7RAP	HY12-P	KEI2R	1079	KW9	X106	LL1	RD4	LYA6	998LA
IDS1R	IS1	KEY1	1635K	KW9	X90	LMP1	LM1	LYB	999LB
IF1	IF1R	KEY1R	1635L	KW9R	X105	LMP1	RT17	LYB6	998LB
IF2	IF3S	KF1	KFV1	KW9R	X91	LMP2	RT19	LYC	999LC
IF3	IF3L	KI1	61PS	LA1	LM2	LMP3	LM3	LYC6	998LC
IF4	IF2	KI1	S91S	LA2	LA91S	LMP4	NE47	LYD	999LD
IF4R	IF2R	KI1	S91W	LA3	LA4	LMP5	NE45	LYD6	998LD
IL1	IG1R	KI10	KM2	LA3R	LA13	LP11	KS1	LYE	999LE
IL1R	IG1	KI10	RC2	LA4	LA3	LP12	LP27	LYE6	998LE
ILC1	X1054K	KI10R	KM10	LAP1	63L	LP12R	LP6	LYF	999LF
ILC10	K1054B	KI10R	SM9C	LAP1	DK91F	LP13	LP1R	LYF6	998LF
ILC11	L1054B	KI11	64R	LAP2	LAP2	LP13R	LP1	LYG	999LG
ILC12	1054K	KI11	RK4R	LAP3	LAP1	LP14	LP32R	LYG6	998LG
ILC13R	X1054GF	KI11R	RK4	LAP4R	63	LP14R	LP32	LYH	999LH
ILC2	1054MT	KI12	63H	LAP4R	63L	LP15	LP31R	LYH6	998LH
ILC2	X1053	KI12	PJH	LB10	LS10	LP15R	LP31	LYK	999LK
ILC3	1054FN	KI12R	PJE	LB11	LS11	LP16	LP30	LYK	K1LK
ILC4R	X1054F	KI12R	R63H	LB18	LS18	LP16R	LP30R	LYK6	998LK
ILC5	1054TW	KI13	KM6	LB19	LS19	LP17R	LP5	MAZ1	X4
ILC6	1054UN	KI13	PJP	LB22	LS22	LP18R	LP2	MAZ12BP	MZ16-P
ILC7	1054DL	KI14	L1TL	LB23	LS23	LP18R	LPBS	MAZ13	MZ17
ILC8	1054	KI15	L1S	LB29	LS29	LP19R	LPDS	MAZ13	X188
ILC9	1054LB	KI15R	L1T	LB32	LS32	LP2	LP29R	MAZ13	X201
IN1	1041H	KI16	L2EX	LB33	LS33	LP20R	LP26S	MAZ13AP	MZ17
IN10	1043E	KI1R	PA91	LB34	LS34	LP2R	LP29	MAZ13BP	MZ17
IN11	1043G	KI3	KM3	LB35	LS35	LP3	LP7	MAZ13DP	MZ19
IN2	S1042Z	KI3	PJM	LC1	LC1	LP36R	LP2	MAZ13DP	MZ19-P
IN3	S1042ZS	KI4	NR63G	LC1R	LC2	LP38R	LP26	MAZ13EP	MAZ13EP
IN4	S1042ZM	KI4R	N63G	LC2	S1096G	LP3R	LP7R	MAZ14	MZ20
IN5	1041W	KI5	KM5	LC2R	LC8	LP5	LP24	MAZ14	X199
IN7	1043B	KI5R	KM7	LC3	LC5	LP7	LP39	MAZ15	MZ22
IN8	1043C	KI6	L3TX	LC3R	LC5R	LP7R	LP28S	MAZ15	X200
IN9	1043D	KI7	L3XY	LC4	LC4	LP8	R62QB	MAZ17	X178
INS1	D62SA	KI8	PG4	LC5	LC3	LP8R	LP28	MAZ17AP	MZ16-P
INS1	INS1	KI8R	PA1	LC6	S1096D	LP9	LP21W	MAZ17BP	MZ16-P
IS1	IGS1	KI8R	S91WR	LEG1	62LG	LP9R	LP21R	MAZ19	MZ25
ISP2	63SP	KI9	L63G	LF1	HR62DG	LP9R	LP6	MAZ19	X206
ISP2	ISP2	KI9	SM3	LF1	LR62DG	LR1R	X1014L	MAZ19FP	MZ25-P
ISP3	B57	KI9R	LR63G	LF10	X157	LS1	KM8	MAZ1BP	MZ3
ISP3P	B57	KI9R	SM4	LF10P	LF17	LS11	L4RM	MAZ1BP	MZ4
ISU1	SZ4	KIA1R	X233	LF11	LF14	LS13	L6S	MAZ1P	MZ7
ISU3	X158	KIA1RAP	KK1-P	LF12	S1771CR	LS14	L6FM	MAZ1R	X5
ISU3P	B57	KIA2R	X240	LF13	LF6	LS15	PN3	MAZ1RBP	MZ2
ISU4	SZ3	KIA3R	X253	LF15R	LF16	LS1R	KM9	MAZ1RBP	MZ5
ISU5	X275	KIA3RAP	KK3-P	LF17	LF10	LS8	L5CR	MAZ1RP	MZ8
JC1	1046	KIA5	X269	LF19	LF24	LS8R	L5RC	MAZ2	MZ9
JC2R	1046A	KN1R	1557	LF2	LF7	LS9	L4A1	MAZ2	X26
JG1R	HH1	KN2	1565	LF20	LF23	LSA1	1522	MAZ20R	X222
JOW1	JUR62X	KO1	63VN	LF21R	WB3	LT1	LT1	MAZ20RGP	MZ27-P
JOW1	R62X	KO1	VW63	LF21R	X169	LT2	LT3	MAZ24REH	MAZ24R-EKB
JOW1R	JO1	KO1L	VW63	LF21RCP	WB3	LW1	1004N	MAZ24REH2	MAZ24R-EK
JOW1R	JO91	KO3	VW63	LF24	LF20	LW10	LK3	MAZ24RT5	MAZ24RT5
JOW4R	JO91C	KS1	1063KW	LF25	LF20S	LW11	LK6	MAZ25R	X249



SILCA	ILCO	SILCA	ILCO	SILCA	ILCO	SILCA	ILCO	SILCA	ILCO
MAZ2P	MZ9-P	MS12	MA3	NE21P	NE27	NE9B	FTA2R	PR2	DK91E
MAZ2R	MZ10	MS13R	1092H	NE22	Z3H	NF1	NF2	PR2R	DK91C
MAZ2R	X27	MS14	1092VR	NE23	NE26	NF1R	NF1	PR3	DK91B
MAZ2RP	MZ10-P	MS15	MD1054K	NE23	NE34	NH2	1098GM	PR3R	DK91J
MAZ3	MZ11	MS16	1092VA	NE23	X116	NH2	H1098M	PR5	A63L
MAZ3	X36	MS17	1092-7000	NE23AP	RN24	NI01T	NI01T	PW1P	PO5-P
MAZ4	MZ15	MS18	1092-6000	NE23BP	RN24P	NI02T	NI02T	PW2	PO6
MAZ5	MZ14	MS2	1092	NE23DP	RN24-P	NS1	63VO	PW2P	PO6
MAZ5	X60	MS3	1092N	NE23EP	RN24	NS1	P91N	PW3	PO7
MAZ6	X131	MS3R	1092NR	NE23P	RN24	NS3	BM11	PW3P	PO7
MAZ7	X131	MS4R	1092VM	NE24	NE20	NS3	HF26	PZ1	PZ1
MAZ7AP	MZ13-P	MS6	1092D	NE25	NE22	NS4	HF29	PZ2	PZ2
MAZ7BP	MZ13	MS7	1092B	NE25	X12	NS4	NS4	RB1	1098NR
MAZ7BP	MZ13-P	MS8	1092J	NE26	X30	NSN11	X210	RB1	H1098NR
MAZ7R	MZ13R	MS9R	1092V	NE27	VO73	NSN11	X243	RB1	H1098X
MAZ9	MZ13	MTK1	MTK1	NE27	X29	NSN11BP	DA31-P	RB2	RN27
MAZ9R	MZ13R	MTK2P	MTK2P	NE27P	VO73	NSN11BP	DA38-P	RB2	X150
MB1	MB1	MTR1	MR1	NE28	NE40	NSN11T2	NSN11T2	RB2-OR	1584
MC1R	MCM1	MTR2	MR2	NE3	63M	NSN12	DA32	RB2-OR	1970AM
MC2	MCM2	MTR3	M64	NE3	RE61N	NSN12	X227	RB3	S1970AM
MC2R	MCM2R	NAS1	1177N	NE3	RT3	NSN12BP	DA32-P	RB3-OR	S1970AM
MC3	MCM3	NCR1	X1000FR	NE31	Y16	NSN13	DA33	RC2	CNA2
MD10R	1517	NCR10	1069LC	NE32	NE29	NSN13	X228	RD2	C219
MD4	A1515	NCR11R	N1069B	NE33S	NE33	NSN14	X237	RG1	RG1
MD6	1542	NCR12	S1069G	NE34	NE30	NSN14CP	DA34-P	RIC1	RC1
MD7	1515	NCR13	S1069H	NE35	NE41	NSN14EH	NSN14-EKB	RIQ1	GU4
MD9R	A1517	NCR14	S1069M	NE36	NE43	NSN14EH2	NSN14-EK	RIQ1R	GU4R
MEC1	ME11	NCR15	1028NR	NE37	NE42	NSN14T14	NI04T	RIQ2	GU91F
MER1	ME2	NCR16R	1069B	NE38	NE48	NSN15	X238	RIQ3	GU91G
MER27	ME7	NCR17	1069C	NE38AP	NE48	NSN16R	X242	RIQ4	GU91B
MER4	ME3	NCR18	1069E	NE38CP	NE48	NSN16RBP	DA37-P	RIQ4R	GU3
MER5	ME1	NCR19	1069G	NE38P	NE48	NSN19	X251	RIQ4R	GU91
MER6	ME6	NCR1R	X1000F	NE4	RT3	NSN4	DT3	RIQ5	S65G
MET1	MO1	NCR2	1069	NE40	VL6	NSN4R	DT2	RIQ5R	RS65G
MG1	MG91C	NCR20	1069-5Y	NE40	X80	NSN8R	SR6	RIQ7	LR65G
MG1R	MG91N	NCR21	1069-5X	NE40P	VL6-P	NSN9P	INF90	RIQ7R	L65G
MG2	MG91P	NCR22	1069-5Z	NE42	NE36	NW1	R1064D	RIQ8	LR65Y
MG2R	MG91S	NCR23	1065D	NE42	RN25	NW2R	1064D	RIQ8R	L65Y
MIT11R	X224	NCR3	1069G	NE42	X92	OAL1	OA91R	RO1	62Z
MIT11REH	MIT11R-EKB	NCR4	R1064E	NE42AP	NE36	OAL1R	OA91	RO1	C2
MIT11REH2	MIT11R-EK	NCR5	1069	NE42AP	RN25	OAL2	OA91P	RO10	C3
MIT11RT19	MIT14-PT	NCR6	1069N	NE43	PN2	OAL3	OA91S	RO10	L62UC
MIT12R	X229	NCR7	1069LB	NE49	NE36	OAL4R	OA91D	RO10	SMS8
MIT15AP	MIT15AP	NCR8	1069FL	NE5	N2M	OAL1	ALP9	RO11	62U
MIT1R	DC1	NCR9	1069M	NE5	SR61N	OP1	1171P	RO11	SM1
MIT1R	SZ5	NE1	62BM	NE51	X140	PB1	PE1	RO11R	62R
MIT1R	X54	NE1	NE1	NE51AP	VL8-P	PB1P	PE1	RO11R	SM2
MIT2	TR33	NE1	Z91	NE51P	VL8-P	PC1	PO1	RO12	63P
MIT2P	TR33-P	NE10	NE44	NE52DP	NE48	PC1R	PL2	RO14	62RS
MIT2R	DC3	NE10	V80P	NE55	X147	PD1	PU3	RO14	SM5
MIT2R	X121	NE10	VO6	NE55AP	RN30	PE1R	1016	RO15	H61P
MIT2RP	DC3-P	NE11	BM2	NE55DP	RN30	PE2R	1016N	RO15	SM6
MIT8	X176	NE11	H61N	NE55FP	RN30	PF070	PR91	RO15R	HR61P
MIT8-PT	MIT8-PT	NE13	H61VO	NE55P	RN30	PF071	PR91MS	RO15R	SM7
MIT8AP	MIT4-P	NE14	H61VM	NE57	RN30	PF072	SIC1	RO1R	C1
MIT8EH	MIT8-EK	NE15	BO3	NE57	X147	PF073	PR91M	RO1R	R62Z
MIT8EH2	MIT8-EKB	NE15	BO6	NE6	NE9	PF092S	PR91C	RO2	61P
MIT8P	MIT1-P	NE15	NE5	NE6	RE61XR	PF208	PR91SA	RO20	7DC
MIT8T19	MIT12-PT	NE16	NE14	NE63	RN31	PF209	PR91NS	RO20	PG2
MIT9-PT	MIT9-PT	NE16	RT7	NE63	X171	PF210	PR91N	RO20R	C91
MIT9R	FU2	NE17	NE13	NE64	X170	PF211	PR91A	RO20R	R7DC
MIW2	MIW2	NE17	RT6	NE64DP	NE48	PF212	PR91SA	RO21	HV61
MLM1	MLM1	NE18	NE16	NE66P	S66NN-P	PF213	PR91NS	RO21R	HVR61
MM1	F91EH	NE18	RT16	NE67AP	S67NN-P	PF214	PR91L	RO22	PJ1
MM1R	F91FH	NE19	X51	NE6NP	NE11	PF2S	PR91CS	RO22R	PJ11
MM2	F91GH	NE19AP	AA2	NE6P	RE61XR	PF4R	PR91S	RO23	LN1
MM2R	F91HH	NE19P	AA2	NE7	H63M	PHL1R	A1	RO24	PJ2
MN6	MG91	NE2	63JA	NE7	MB6	PJ2	PN1	RO24R	PJ12
MN6R	MG91R	NE2	MB9	NE71R	NE71R	PK1	OM10	RO26	PJ3
MON1R	MON1	NE20	BL11	NE71RDP	NE71RDP	POR1	64K	RO27	LN3
MP101	61B	NE20	NE31	NE75EP	RV4-P	POR1	PO3	RO28	RT8
MP102	B62B	NE20	RE61XR	NE8	H63M	POR2	DM4	RO29	NE17
MP103	R62B	NE20AP	BL11	NE8	MB59	POR2	VW1CZ	RO2R	R61P
MP104	62BA	NE20P	RE61XR	NE9	NE2	POR5	KP1	RO2R	S91
MP105	R62BA	NE21	NE18	NE9	VO62	POR5	PO4	RO31	61PC
MS1	1092	NE21	RT10	NE9A	H61VR	PR1	AU4	RO31	S91M
MS10	1092DS	NE21P	NE18	NE9A	VW1A	PR1	DK91A	RO33	SMS8

SILCA	ILCO	SILCA	ILCO	SILCA	ILCO	SILCA	ILCO	SILCA	ILCO
RO34	RI5	RW3	A1011PZ	SAR31R	O1007LL	SH9	1145F	STR1	SR3
RO4	V61S	RW30R	1011D1	SAR32	O1007RM	SHW1	62SH	STR2	SR4
RO4R	VR61S	RW31R	1011D2	SAR32R	O1007LM	SIL1R	SIL1R	STR3	SR5
RO5	62UC	RW32R	1011D3	SAR33	O1007RDH	SIP1	NE9	STR4	SR1
RO5	C91CV	RW33R	1011D4	SAR33R	O1007LDH	SIP11	FT43	STR4R	SR2
RO5	C91D	RW34R	1011D12	SAR34	O1007RDM	SIP14	IV1	SV1	ST91F
RO50	RI6	RW35R	1011D34	SAR34R	O1007LDM	SIP14P	IV1	SV1R	ST91V
RO5R	C91PL	RW36R	1011D41	SAR35	O1007RHM	SIP2	F44	SV2R	SV3
RO5R	C91R	RW37	1011PZ	SAR35R	O1007LHM	SIP2	X109	SW1R	SW2
RO5R	R62UC	RW38R	1012	SAR36R	1009	SIP2AP	F44	SW2	SW1
RO6	61PE	RW39	1011GH	SAR37	O1010	SIP2AP	NE23	SW3	SW3
RO7	RN2	RW3R	A1011PZR	SAR38R	O1007CE	SIP2P	NE19	SWL1	1568
RO8	61JD	RW4	A1011-3N	SAR39R	O1007CA	SIP2P	SP9	SX1	C6
RO8R	R61JD	RW4	A1011PC	SAR3R	N1007KMA	SIP3	NE13	SX1	SM2
RO9	RN4R	RW40R	1011M	SAR40	1010	SK1	FB5	SX3	C17
RO9	VA91	RW41R	A1011M	SAR42	O1009	SK11	FB7	SX3	VC30
RO9R	RN4	RW42R	A1011S	SAR5	1007RA	SK14	FB1	SX4	VC31
RR1	62HB	RW43R	N1011M	SAR5R	1007LA	SK2	FB4	SY1	1120D
RR10R	62HG	RW5R	A1011D41	SAR6	1007RB	SK22RT1	SK22RT1	SY2R	1120F
RR2	62HA	RW6R	1011D1	SAR6R	1007LB	SK3	FB3	SZ1	SUZ2
RR2	BR4	RW7R	1011	SAR7	1007RC	SK9	FB6	SZ10R	SUZ12
RR3	62HC	RW8R	1001P	SAR7R	1007LC	SL1	1022	SZ10R	X179
RR4	62JB	RW8R	1011P	SAR8	1007RD	SL2	O1022	SZ10RP	SUZ12
RR5	X28	RW9R	A1011P	SAR8R	1007LD	SM1	SIM2	SZ10RP	SZ10RP
RR6	62HD	RX1	RX2	SAR9	1007RE	SM11	S91P	SZ11R	SUZ17
RR7R	62HF	RX2	RX1	SAR9R	1007LE	SM14R	S91R	SZ11R	X186
RR8R	62HG	SA1	170S	SC1	SC1	SM1R	D1098BM3	SZ11RP	SUZ17-P
RT1	X16	SA2	70S	SC2	STA2	SM1R	SM1R	SZ12	SUZ15
RT1P	P1771CR	SAN1R	SN1	SCY1	SY4	SM2	S91A	SZ12	X185
RT2	CE5	SAR1	1010N	SCY1R	SY1	SM3	S91BV	SZ12P	SUZ15-P
RT2	LF15	SAR10	1007RF	SCY2	SY2	SM4	S91CV	SZ1R	SUZ1
RT2	X50	SAR1031	1028D	SCY2R	SY7	SM5	S91K	SZ2	SUZ3
RT2P	AA3	SAR1032	1068E	SCY3	SY6	SM6	SIM1	SZ2R	SUZ4
RU1	RK1	SAR10R	1007LF	SCY3R	SY3	SM8	SIM8	SZ3	SUZ5
RU2	R67P	SAR11	1007RG	SCY4	SY8	SM9R	SIM9R	SZ4	HD57
RU2R	67P	SAR11R	1007LG	SCY4R	SY5	SNW2	S2-AUS	SZ4	SUZ10
RU3	67Q	SAR12	1007RH	SCY5R	SY9	SNW3	S4-AUS	SZ4P	HD57
RU3R	R67Q	SAR12R	1007LH	SCY6	1559	SO4	SOS91	SZ4P	SUZ10
RU4	67N	SAR13	1007RJ	SD1	EX1	SO5	SO91P	SZ4P	SZ4P
RU4R	R67N	SAR13R	1007LJ	SE1	SM6	SO6	SOS1	SZ4R	HD56
RU5	67U	SAR14	1007RK	SE3	SES91	SO7	R65S	SZ4R	SZ4R
RU5R	RK3	SAR14R	1007LK	SE3R	SR65	SOL8A1	BD1A	SZ4RP	SZ4RP
RU7	RU91C	SAR15	1007RL	SE5	SE91L	SOL8A2	BD2A	SZ5	X87
RW10R	N1011P	SAR15R	1007LL	SE7	SEL91	SOL8A3	BD3A	SZ5P	SZ5P
RW11	A1011-1N	SAR16	1007RM	SE7R	SEL91R	SOL8A4	BD4A	SZ8RP	SZ8RP
RW11	A1011PD	SAR16R	1007LM	SEA1	SE1B	SOL8A5	BD5A	SZ9	SZ9
RW12	A1011-2N	SAR17	N1007RMB	SEA1	SE1C	SOL8B1	BD1B	SZ9P	SZ9P
RW12	A1011PK	SAR17R	N1007KMB	SEA3	F54	SOL8B2	BD2B	TB1	DB1
RW13R	N1011S	SAR18	1007RDH	SF3	X64	SOL8B3	BD3B	TB1R	DB2
RW14	A1011-4N	SAR18R	1007LDH	SF4	X79	SOL8B4	BD4B	TBE1P	S32FJ-P
RW14	A1011PE	SAR19	1007RDM	SF5	SP8	SOL8B5	BD5B	TBE1T5	TBE1T5
RW15	A1011-5N	SAR19R	1007LDM	SG808	SHA-1	SOL8C1	BD1C	TBE2P	S33FJ-P
RW15	A1011PB	SAR2	L1010N	SH1	1307A	SOL8C2	BD2C	TE1	TE1
RW16	A1011-6N	SAR20	1007RHM	SH10	A1145E	SOL8C3	BD3C	TE1R	TE2
RW16	A1011PF	SAR20R	1007LHM	SH11	1145E	SOL8C4	BD4C	TE2	TE4
RW17	A1011-7N	SAR21	O1007RA	SH12	1145G	SOL8C5	BD5C	TE3	TE3
RW17	A1011PG	SAR21R	O1007LA	SH13	1145H	SOL8D1	BD1D	TH1	1148
RW18	A1011-8N	SAR22	O1007RB	SH14	1145J	SOL8D2	BD2D	TK1	66E
RW18	A1011PH	SAR22R	O1007LB	SH15	1145K	SOL8D3	BD3D	TK1R	R66E
RW19	A1011-9N	SAR23	O1007RC	SH16	1145L	SOL8D4	BD4D	TK2	ER10
RW19	A1011PJ	SAR23R	O1007LC	SH17	1145CE	SOL8D5	BD5D	TK2R	ERS3
RW1R	A1011D3	SAR24	O1007RD	SH18	1145FG	SP1	VW1CZ	TK3	ERS6
RW20	A1011-10N	SAR24R	O1007LD	SH19	A1145G	SPU1R	SPU1R	TK3R	ERS5
RW20	A1011PL	SAR25	O1007RE	SH2	1307W	SQ1	192	TK4	ER9
RW21	A1011-11N	SAR25R	O1007LE	SH20	A1145H	SQ2	1192B	TK4R	ERS8
RW21	A1011PM	SAR26	O1007RF	SH21	A1145J	SQ2	192B	TK5R	VL1
RW22	A1011-12N	SAR26R	O1007LF	SH22	A1145K	SR1	SU9	TL6	TR15D
RW22	A1011PN	SAR27	O1007RG	SH23	A1145CE	SR2	SU9S	TN3	TT1
RW23	A1011-13N	SAR27R	O1007LG	SH24	A1145FG	SR2	SX1	TN5	TT91
RW23	A1011PR	SAR28	O1007RH	SH27	SC1247	SR4	SU9L	TO1	TO91
RW24R	A1011S	SAR28R	O1007LH	SH3	1145	SR7	SX3	TO10	TK41
RW25	1011PZ	SAR29	O1007RJ	SH4	A1145L	SR8	SX4	TO3	TK3
RW26R	A1011D2	SAR29R	O1007LJ	SH5	1145A	SRN1R	50	TO4	TK1
RW27R	A1011D4	SAR3	N1007RMA	SH5	A1145C	SS10	1523	TO8X1	TK4
RW28R	A1011D12	SAR30	O1007RK	SH6	A1145EF	ST1	SCH1	TO8X10	TK13
RW29R	A1011D34	SAR30R	O1007LK	SH7	A1145F	STR1	62FE	TO8X12	TK15
RW2R	A1011D1	SAR31	O1007RL	SH8	1145EF	STR1	BR17	TO8X13	TK16

CROSS REFERENCE

SILCA	ILCO	SILCA	ILCO	SILCA	ILCO	SILCA	ILCO	SILCA	ILCO
TO8X14	TK17	TOY41R	X211	UNI25	62DJ	VAC18	H7RD	VO3	62VW
TO8X15	TK18	TOY41RAT4	TOY41RAT4	UNI27	UN5	VAC18R	H7LD	VO3	S62DW
TO8X16	TK19	TOY41RP	TR44-P	UNI28	1033	VAC19	V91LE	VO3	W62VB
TO8X17	TK20	TOY42	X212	UNI28	U180G	VAC19N	H7RE	VO4	HF35
TO8X18	TK21	TOY42P	TR46-P	UNI29	L62DM	VAC2	H10F	VO4	VW77
TO8X2	TK5	TOY43	X217	UNI2R	HR62DG	VAC20	V91LF	VO4R	V27
TO8X3	TK6	TOY43AT4	TOY43AT4	UNI2R	R62DG	VAC20N	H7RF	VO4R	VW67
TO8X4	TK7	TOY43EH	TOY43-EKB	UNI2R	S91RM	VAC20RN	H7LF	VO4RP	V27
TO8X5	TK8	TOY43EH2	TOY43-EK2	UNI3	1033N	VAC21	V91LG	VO4RP	V67
TO8X7	TK10	TOY43P	TR47-P	UNI3	33NO	VAC21N	H7RG	VO4RP	VW67
TO9Y1	TK22	TOY44	X220	UNI30	S33P	VAC21RN	H7LG	VO5	VW67S
TO9Y10	TK31	TOY45R	X219	UNI33	UN51	VAC22	V91LH	VO5P	VW67S
TO9Y11	TK32	TOY46R	X223	UNI33R	UN61	VAC22N	H7RH	VO6	HR62VK
TO9Y12	TK33	TOY46RP	TR53-P	UNI34	UN52	VAC22RN	H7LH	VO6	U61VW
TO9Y13	TK34	TOY48EH	TOY48-EKB	UNI34R	UN52	VAC23	H7RDH	VO6R	H62VK
TO9Y14	TK35	TOY48EH2	TOY48-EK2	UNI35	UN50	VAC23R	H7LDH	VO6R	V61VW
TO9Y16	TK37	TOY4BP	T61C-P	UNI35R	UN60	VAC24	C7	VO7	VW20
TO9Y17	TK38	TOY4R	1771CT	UNI36	UN58	VAC24	VC24	VO8	62VS
TO9Y18	TK39	TOY4RBP	DC1-P	UNI36R	UN68	VAC25	VC28	VO8	A81N
TO9Y2	TK23	TOY4RBP	T61C-P	UNI37	UN53	VAC25R	VC34	VO8	U62VN
TO9Y3	TK24	TOY4RCP	T61C	UNI37R	UN63	VAC26	VC25	VO9	73VB
TO9Y4	TK25	TOY5	P1098V	UNI38	UN54	VAC27	C8	VO9	X9
TO9Y5	TK26	TOY5	T61F	UNI38R	UN64	VAC27	VC26	VO9AP	73VB-P
TO9Y6	TK27	TOY5	T80H	UNI39	UN57	VAC28	C16	VO9BP	73VB-P
TO9Y7	TK28	TOY57-PT	TOY57-PT	UNI39R	UN67	VAC28	VC27	VO9P	73VB-P
TOY1	TA2	TOY5P	P1098V	UNI4	62DM	VAC29	V91N	VYA	999VA
TOY10	TA11	TOY6	T61D	UNI4	BR11	VAC3	H62KB	VYA	BVA1
TOY10R	TA16	TOY7	TA19	UNI40	UN56	VAC30	VCA1	VYA6	998VA
TOY11	TR28	TOY8	TR26	UNI40R	UN66	VAC30R	VCA1R	YB	999VB
TOY11	X37	TOY9	X46	UNI41	UN59	VAC32	H7LDH	VYB6	998VB
TOY11BP	TR28-P	TR1	TO1	UNI41R	UN69	VAC33	VC32	VYC	999VC
TOY12	TA21	TR11R	TR11R	UNI42	MG1	VAC33R	VC33	VYC6	998VC
TOY12	TA26	TR14	TO4	UNI44	UN51L	VAC35	RT18	VYD	999VD
TOY13	TA25	TR15	TO3	UNI44R	UN61L	VAC35	VC29	VYD6	998VD
TOY13	TOY13	TR2	TO2	UNI45	UN52L	VAC47	H62BM	VYE	999VE
TOY14	TR18	TR3	TO5	UNI45R	UN62L	VAC5	VAT1	VYE6	998VE
TOY15	TA15	TR4	TO6	UNI46	UN50L	VAC57	H62CM	VYF6	998VF
TOY16	TA23	TR8	TO8	UNI46R	UN60L	VAC58	H62DM	VYG	999VG
TOY17	TA24	TTL1	A1176T	UNI47	UN58L	VAC59	NE46	VYG6	998VG
TOY18	TR25	TTL2	A1176ST	UNI47R	UN68L	VAC59	RN29	VYH	999VH
TOY18P	TA27	TY1	1141GE	UNI48	UN53L	VAC59	X122	VYH6	998VH
TOY18P	TR25	TY2	1141	UNI48R	UN63L	VAC59P	RN29	VYK6	998VK
TOY19	1519	TY3	H1122M	UNI49	UN54L	VAC6	H7RDH	WA1	WA91WL
TOY19	MS13	UC2	UCM1	UNI49R	UN64L	VAC62	PG5	WA1R	WA91L
TOY1R	TA12	UL050	WA91WL	UNI4R	R62DH	VAC62	X148	WA2	WA91W
TOY2	TA5	UL051	WA91L	UNI4R	R62DM	VAC8	V91E	WA2R	WA91
TOY26	X159	UL052	WA91W	UNI5	62DO	VC1	VEC2	WA4	WA91PP
TOY26P	TR28-P	UL053	WA91	UNI5	BR12	VC1R	VEC1	WA4R	AW91P
TOY27R	X137	UM1R	UM2	UNI50	UN59L	VE1	VE4	WA51	DA20
TOY27RP	TR33-P	UNI1	62DH	UNI50R	UN69L	VEG1	VG2	WAS13RAP	X177
TOY28	TR37	UNI1	BR10	UNI51	UN56L	VG1	VG1	WAS13RP	JA2
TOY28P	TR28-P	UNI1	BR3	UNI51R	UN66L	VI080	VR91	WAS2	WS2
TOY29R	TR33	UNI10	62DP	UNI52	UN57L	VI081	VR91R	WAS2R	WS4
TOY29RP	TR33-P	UNI11	B62DP	UNI52R	UN67L	VI082	VR91S	WAS3	WS3
TOY2R	TA4	UNI11A	62FS	UNI53	62DB	VI083	SR191A	WAS3R	WS1
TOY3	T61A	UNI11A	F70T	UNI56R	S33C	VI084	VR91B	WAS4	DO5
TOY3	TA14	UNI12	S62DP	UNI6	62DN	VI085	VR91BR	WAS4	DO7
TOY30	TR39	UNI13	BR16	UNI6	BR9	VI086	VR91AR	WAS4	WS10
TOY30	X151	UNI13	F70S	UNI6	UN16	VI087	VR91A	WAS4	WS5
TOY30P	TR39	UNI14	62DM	UNI7	H62DP	VI088	VR91CR	WAS5	WS11
TOY32R	TR25	UNI14	B62DR	UNI8	62FT	VI089	VR91C	WB2	NL1
TOY32RP	TR25	UNI15	S62DR	UR1	UR3	VI1	VR1R	WB2	WAR4
TOY34R	T61C	UNI16	BR18	UR1R	UR3R	VI1R	VR1	WB2R	WAR3
TOY34R	TA28	UNI16	H62DR	UR2R	UR2	VO1	VW71A	WC1	WO1
TOY35R	TR25	UNI16R	BR18R	VAC1	VAE1	VO10	VW71	WC2	WO2
TOY38R	X174	UNI17	62DK	VAC10	VC21	VO10P	VW71	WC3	WO3
TOY38RP	TR40-P	UNI17	BR8	VAC102T1	VAC102T1	VO10P	VW71V	WE1	1054WB
TOY39R	TA21	UNI18	UN1	VAC11	V1S	VO11	VW71A	WE1	N1054WB
TOY39R	TR49	UNI19	BR20	VAC12	63PX	VO11P	VW71A	WE110	X1054WA
TOY3R	MS2	UNI19	CE4	VAC12	V91P	VO13	V33	WEI2	A1054WB
TOY3R	T61B	UNI19	MG1	VAC12P	63PX	VO13	X110	WEI4	A1054WC
TOY3R	TA1	UNI19P	MG1	VAC14	VC22	VO13P	V33	WEI5	1054WC
TOY4	T61C	UNI2	62DG	VAC15	H7RA	VO2	FT3F	WEI5	N1054WB
TOY4	T61G	UNI20	UN16	VAC15R	H7LA	VO2	VW63A	WEL1	1123
TOY40AP	LXV90-P	UNI23	62DA	VAC16	H7RB	VO2R	FT3	WH1	1071
TOY40BT4	TOY40BT4	UNI24	62DE	VAC16R	H7LB	VO3	61VW	WH2	1071A
TOY40P	LXP90-P	UNI24	BR14	VAC17	H7RC	VO3	62DW	WH3	1071B

SILCA	ILCO	SILCA	ILCO	SILCA	ILCO	SILCA	ILCO	SILCA	ILCO
WH4R	1071BM	YA17	F1122A	YH15	X63	YH4R	X33	YM5R	YM5
WH5R	1071D	YA17	H1122F	YH15	YM44	YH5	YH28	YM6	62PG
WH6R	1071E	YA17R	F1122AR	YH15R	X76	YH5R	YH27	YM6	OP32
WH7R	1071M	YA17R	H1122FR	YH15R	YM52	YH7	YH29	YM6R	OP31
WI2	VW64T	YA17R	O1122AR	YH16	YM56	YH7R	YH24	YM6R	R62PG
WI3	VW3	YA18	C1041P	YH16R	YM55	YH8	YH37	YM7	OP61B
WI3	W62VE	YA19	E1122A	YH17	YH33	YH8R	YH38	YM7	R62PF
WI3	WT2	YA1E	999	YH17R	YH34	YH9	YH45	YM7R	62FP
WK1	W91C	YA1R	999R	YH1R	YH20	YH9R	YH44	YM7R	OP61A
WK10	WIL1	YA1R	X999R	YH1R	YH22	YM1	DK91H	YM8	62PH
WK11	WK10	YA2	998	YH2	YH9	YM10	OP7	YM8	OP5
WK2	WK7	YA2	998GL	YH20	YH26	YM10	YM7	YM8	YM6
WK25	WK15	YA20	YL5	YH20R	YH25	YM10R	OP7R	YM9	OP6
WK25R	WK16	YA226	14KH	YH21	YH37	YM10R	YM8	YYA	BVA1
WK26	WK12	YA227	H999R	YH21	YM47	YM11	OP10	YYA	BYA1
WK27	WK32	YA28	1764P	YH21R	X77	YM11	YM9	YYA6	998YA
WK28	WK23	YA28	1769CH	YH21R	YM53	YM12	MB16	YYA7	H998YA
WK29	WK20	YA28	1770CH	YH22	YH45	YM12P	MB16	YYB6	998YB
WK3	WK3	YA28	P1770U	YH22	YM54	YM12R	MB16R	YYB7	H998YB
WK30	WK29	YA28-OR	P1770U	YH22R	YH44	YM13	YM16	YYC6	998YB
WK31	WK25	YA29	999B	YH22R	YM43	YM15	MB17	YYC7	H998YC
WK32	WK19	YA2R	998R	YH23	YH35	YM15P	MB17	YYD6	998YD
WK33	WK18	YA3	997D	YH23	YM49	YM16	OP19	YYD7	H998YD
WK34	WK22	YA3	997E	YH23R	YH36	YM16	OP45	YYE6	998YE
WK35	WK24	YA3	KS91P	YH23R	YM48	YM16	YM21	YYE7	H998YE
WK36	WK27	YA3	Y200	YH24	X63	YM16D	OP12	YYF	R9LF
WK37	WK21	YA3	YL9	YH24R	YH24R	X76	OP37	YYF6	998YF
WK38	WK28	YA30	YL6	YH25	YM56	YM16R	OP46	YYF7	H998YF
WK39	WK30	YA31	14KH	YH25R	YM34	YM16R	YM22	YYG6	998YG
WK5	WK26	YA32	997A	YH25R	YM55	YM17	OP39	YYG7	H998YG
WK6	WK17	YA32	O997E	YH26	YH33	YM17	OP48	YYH6	998YH
WK6R	WK14	YA34	999N	YH26	YH51	YM17	YM23	YYH7	H998YH
WK7	WK13	YA35	999N	YH26	YM51	YM17R	OP38	YYK	R9LK
WR1	TS1	YA36	999	YH26	YM56	YM17R	YM24	YYK6	998YK
WR4	WRE2	YA36R	999R	YH26R	Y50	YM18	OP91G	YYK7	H998YK
WS1	1175N	YA3R	997ER	YH26R	YH34	YM19	YM13	ZD2	X47
WS2	1175N	YA3R	DA1	YH26R	YM50	YM2	OP60Y	ZE1	ZE91C
WS3	1175	YA3R	Y204	YH26R	YM55	YM20	OP43	ZE1	ZKN1
WST3	WST3	YA4	O1122	YH27	YH42	YM20	YM28	ZE10	ZK2
WT10	V35	YA4R	O1122R	YH27R	YH41	YM21	YM29	ZE10R	ZK1
WT10	X139	YA5	999A	YH28	X119	YM21P	YM29	ZE12	CN5
WT10P	V35-P	YA5R	Y2R	YH28AP	YH47	YM21R	OP47	ZE13	ZK102
WT4	PA5	YA65	N01122D	YH28BP	YH28BP	YM21R	YM30	ZE13R	ZK100
WT5	AU12	YA66	O1122BER	YH28P	YH28P	YM21RP	YM30	ZE1R	ZE91CR
WT5	WT5	YA66R	O1122BE	YH28R	X120	YM22	X52	ZE1R	ZKN1R
WT6	PA6	YA68	O1122C	YH28RAP	YH46	YM22AP	SAA1-P	ZE1R	ZKN2
WT7	PA8	YA69	O1122BR	YH28RBP	YH28RBP	YM22P	SAA1-P	ZE2	ZE91G
WT7	X88	YA69R	O1122B	YH28RP	YH28RP	YM23	MB39	ZE3	ZIK1
WT7AP	73VB-P	YA7	H997E	YH29	X118	YM23	X83	ZE31-1	60Z1
WT7AP	PA8-P	YA70	998GL	YH29AP	YH49	YM23P	MB39-P	ZE31-10	60Z10
WT7AP	X88	YA70R	998YMK	YH29BP	YH29BP	YM24	MB40	ZE31-100A	ZK70
WT7BP	PA8-P	YA72	998S	YH29P	YH29P	YM24P	MB40	ZE31-100B	ZK71
WT7P	PA8-P	YA74	R1132	YH29P	YH49	YM28	HF59R	ZE31-100C	ZK72
WT9	73VB	YA74R	1132	YH29R	X117	YM3	DK4	ZE31-101	ZK73
WT9	PA8	YA78	L1122A	YH29RAP	YH48	YM3	R63E	ZE31-102	ZK74
XOM1	138	YA79R	1098M	YH29RBP	YH29RBP	YM3	R63KE	ZE31-103	ZK75
XPZ1	XPA1	YA7R	H997ER	YH29RP	YH29RP	YM30P	S32YS-P	ZE31-104	ZK76
XPZ2	XPA2	YA8	997B	YH29RP	YH48	YM30T5	YM30T5	ZE31-105	ZK77
Y160-PT	Y160-PT	YA8	997DB	YH3	YH19	YM31	X166	ZE31-106	ZK78
Y162-PT	Y162-PT	YA8	997EB	YH3	YH39	YM31AP	FT48	ZE31-107	ZK79
Y164-PT	Y164-PT	YA8	YL8	YH3	YH43	YM32R	RN32	ZE31-108	ZK80
YA1	999	YA80R	L1122B	YH30	YH51	YM32R	X175	ZE31-109	ZK81
YA1	X999	YA81R	O1122BE	YH30BP	YH30BP	YM32RP	RN32-P	ZE31-11	60Z11
YA10	1767CH	YA82	997X	YH30P	YH30P	YM3R	63E	ZE31-110	ZK82
YA10	D1707K	YA83	1554	YH30P	YH51	YM3R	MB8	ZE31-111	ZK83
YA11	S1767CH	YA88	YA88	YH30R	YH50	YM3R	YM1	ZE31-112	ZK84
YA12	D1759L	YA8E	997B	YH30RAP	YH50	YM4	M63E	ZE31-113	ZK85
YA12	S1767DP	YA8E	997EB	YH30RBP	YH30RBP	YM4	MB2	ZE31-114	ZK86
YA13	H997EB	YA8E	YL8	YH30RP	YH30RP	YM4	YM3	ZE31-115	ZK87
YA14	HR1132	YA8R	R997EB	YH30RP	YH50	YM4R	MB3	ZE31-116	ZK88
YA14R	1132	YA9	BKZ1	YH31RAP	YH31RAP	YM4R	MR63E	ZE31-117	ZK89
YA14R	H1132	YG1R	X153	YH31RBP	YH31RBP	YM4R	YM4	ZE31-118	ZK90
YA15	YL5	YG1RP	YU1	YH33R	SUZ12	YM5	YM5	ZE31-119	ZK91
YA16	997GX	YH1	YH16	YH35R	X248	YM5	63TV	ZE31-12	60Z12
YA16L	997G	YH1	YH23	YH3R	YH21	YM5	63TW	ZE31-120	ZK92
YA16R	997GXR	YH14	YH35	YH3R	YH40	YM5	MB19	ZE31-121	ZK93
YA16RL	997GR	YH14R	YH36	YH4	X48	YM5R	63TV	ZE31-122	ZK94



SILCA	ILCO	SILCA	ILCO	STAR	ILCO	STAR	ILCO	STAR	ILCO
ZE31-123	ZK95	ZE31-92	ZK60	5HU1	1020	5WR1	X1054WA	7IL2	1004KL
ZE31-124	ZK96	ZE31-93	ZK61	5IL1	1054F	5WR2	1054WB	7LO1	1004AL
ZE31-125	ZK97	ZE31-94	ZK62	5IL11	1054MT	5WR2N	L1054WB	7RU2	1011PAA
ZE31-126	ZK98	ZE31-95	ZK63	5IL2	1054K	5YA1	999	7RU7	B1011D1
ZE31-127	ZK99	ZE31-96	ZK64	5IL3	1054	5YA11	996M	7RU8	B1011D41
ZE31-13	60Z13	ZE31-97	ZK65	5IL4	X1054K	5YA13	999R	7SA3	N1007KMC
ZE31-14	60Z14	ZE31-98	ZK66	5IL6	1004M	5YA1E	999N	7YA8	A998GST
ZE31-16	60Z16	ZE31-98A	ZK67	5IL7	X1054F	5YA2	C999	AD1	PA6
ZE31-17	60Z17	ZE31-98B	ZK68	5IL8	X1054JA	5YA6	997E	AR1	755
ZE31-18	60Z18	ZE31-98C	ZK69	5IL9	1054FN	6AL1	ALP4	BN1	K1122D
ZE31-19	60Z19	ZE3R	Z91KR	5JU2	1046	6AM1	A1045	CB1	1573A
ZE31-2	60Z22	ZE4	ZK1	5KE1	1079B	6AR2	1179A	CB10	1589J
ZE31-3	60Z3	ZE5	Z91K	5KE2	1079	6AR3	A1019M	CB11	1590K
ZE31-4	60Z4	ZE5R	Z91KR	5KW1	1176	6BE1	A1114A	CB12	1591L
ZE31-40A	ZK2	ZE6	ZMK2	5LO1	1004	6BE2	A1114M	CB2	1573B
ZE31-40B	ZK3	ZE6R	ZMK1	5MA3	1092V	6CH2	A1015M	CB3	1573C
ZE31-40C	ZK4	ZN1	ZN1	5MA4	1092VM	6CH4	A1015MR	CB4	1573D
ZE31-41	ZK5			5MA5	1092N	6CO1	1001EG	CB5	1573E
ZE31-42	ZK6	<b>STAR</b>	<b>ILCO</b>	5MA6	1092H	6CO10	X1000F	CB6	1573F
ZE31-43	ZK7	4EA1	1014K	5MA7	1092D	6CO11	A1001EH	CB7	1581G
ZE31-44	ZK8	4EA4	1014DX	5NA1	1177N	6CO12	A1001ABM	CB8	1581H
ZE31-45	ZK9	4ER1	1119S	5NW1	1017B	6CO14	1000FR	CB9	1589I
ZE31-46	ZK10	4MA2	1092B	5NW3	1017	6CO14	X1000FR	CG1	1041G
ZE31-47	ZK11	4MA7	1092DS	5PE1	1016N	6CO16	A1001CDM	CG2	1041GR
ZE31-48	ZK12	4RO2	1064	5PE2	1016	6CO2	1001EA	CG3	100AM
ZE31-49	ZK13	4YA1	999B	5PO1	1034	6CO3	1000AB	CG6	1041GA
ZE31-5	60Z5	4YA15	S7JA	5PO2	1034H	6CO5	R1001EG	CHR93	P1793
ZE31-50	ZK14	4YA6	997X	5PR1	SC1176	6CO6	1000F	CHR94	P1794
ZE31-51	ZK15	5AM1	1045	5RE1	1019	6DE1	A1054KD	CHR95	P1795
ZE31-52	ZK16	5AR2	1179	5RE2	1019D	6DE3	D1054KA	CO7	S1000V
ZE31-53	ZK17	5AU1	1003M	5RO4	R1064D	6EA2	1014A	CP1	X20
ZE31-54	ZK18	5AU2	1069LB	5RO4N	R1064E	6EL4	L1096CN	CP2	X21
ZE31-55	ZK19	5BE1	1114	5RP2	X12	6IL2	X1054KF	CP3	X22
ZE31-56	ZK20	5B01	R1003M	5RP3	X116	6JU2	1046E	CP4	X86
ZE31-57	ZK21	5CG4	1041Y	5RS1	1140G	6KW1	A1176	DA3	X7
ZE31-58	ZK22	5CG5	1041E	5RU1	1011	6LO1	1004A	DA31	X210
ZE31-59	ZK23	5CG7	C1041C	5RU2	1011P	6MA8	1092J	DA34	X237
ZE31-6	60Z6	5CH1	1015C	5RU3	X1000KR	6NW1	1017BA	DA4	X6
ZE31-60	ZK24	5CH2	1015M	5RU4	1011M	6NW2	O1017ML	DA5	X123
ZE31-61	ZK25	5CH3	1015	5RU5	1011PZ	6RE1	1019A	DA6	DA23
ZE31-62	ZK26	5CL1	1023	5RU6	1012	6RU2	A1011P	DA7	X114
ZE31-63	ZK27	5CO1	1001EN	5RU7	1011D1	6RU5	A1011PZ	DE2	D1098X
ZE31-64	ZK28	5CO11	1001EH	5RU8	1011D41	6RU7	A1011D1	EA3	1014J
ZE31-65	ZK29	5CO12	1001ABM	5RU9	N1011M	6RU8	A1011D41	EA5	1014JS
ZE31-66	ZK30	5CO13	1001GH	5SA1	O1010	6RU9	A1011M	EA6	O1014S
ZE31-67	ZK31	5CO2	1001EB	5SA1	1010U	6SA3	N1007KMA	FT2	FT38
ZE31-68	ZK32	5CO3	1000	5SA10	1007LC	6SA6	N1007RMA	FT3	FT37
ZE31-68A	ZK33	5CO4	1001	5SA2	1009	6SA7	L1010N	GM64C	P1098WC
ZE31-68B	ZK34	5CO5	R1001EN	5SA3	N1007KMB	6SA-LA	S22	GM67D	S1098WD
ZE31-68C	ZK35	5CO6	1000G	5SA4	1007	6SE1	1022AB	GM68	P1099
ZE31-7	60Z7	5CO8	X1001KC	5SA5	1010	6SE2	O1022AB	GM78E	P1098WE
ZE31-70A	ZK36	5CO9	R1001EF	5SA6	N1007RMB	6SE4	1022H	GM79H	S1098WH
ZE31-70B	ZK37	5DA1	DA20	5SA7	1010N	6SE5	R1022L	GM86	P1106
ZE31-70C	ZK38	5DA2	X1	5SA9	1007LB	6SH1	1145A	GM89	P1107
ZE31-71	ZK39	5DE1	1054KD	5SA-LA	S22 1/2	6SH3	A1145L	HBR1	H1098M
ZE31-72	ZK40	5DE3	D1054K	5SE1	1022	6SH4	A1145E	HBR10J	P1098J
ZE31-73	ZK41	5DO1	L1054F	5SE2	O1022	6SH5	A1145F	HBR11	1970AM
ZE31-74	ZK42	5DO3	L54K	5SH1	1145	6SH7	A1145G	HBR12A	P1098A
ZE31-75	ZK43	5DO4	P54F	5SH3	1145L	6VL1	VO6	HBR14C	P1098C
ZE31-76	ZK44	5EA1	1014F	5SH4	1145E	6WR2	A1054WB	HBR15A	P1098AV
ZE31-77	ZK45	5EA1	X1014F	5SH5	1145F	6YA1	999A	HBR15C	P1098CV
ZE31-78	ZK46	5EA2	1014	5SH7	1145G	6YA12	998GA	HBR15E	P1098EV
ZE31-79	ZK47	5EL1	1096L	5SN1	1177	6YA14	998YMK	HBR2	H1098LA
ZE31-8	60Z8	5EL2	1096	5SQ1	192	6YA3	998	HBR3	H1098NR
ZE31-80	ZK48	5EL3	C1096LN	5TA1	1141	6YA6	O997E	HBR5	H1098A
ZE31-81	ZK49	5EL4	C1096CN	5TA2	1141E	6YA7	998R	HBR7	H1098C
ZE31-82	ZK50	5ER1	1119	5TA4	1141GE	6YA8	998GST	HBR9E	P1098E
ZE31-83	ZK51	5ES1	1503	5TA5	1141F	6YA9	J997M	HD103	X214
ZE31-84	ZK52	5EX99	EX1	5UN1	1033N	7BE2W	A1114FM	HFD1	1127
ZE31-85	ZK53	5FR1	1073K	5VR1	VR91	7CH2	L1015M	HFD10	1167FD
ZE31-86	ZK54	5FT1	F44	5VR2	VR91R	7CH4	L1015MR	HFD11	1185FD
ZE31-87	ZK55	5HD1	1125	5VR3	VR91AR	7CO1	1001EL	HFD12L	1184FD
ZE31-88	ZK56	5HL1	HL3	5VR4	VR91B	7CO11	L1001EH	HFD2	1125K
ZE31-89	ZK57	5HO1	1170	5WE1	1123	7CO12	L1001ABM	HFD3	1127D
ZE31-9	60Z9	5HO1	1170B	5W1	1071	7CO16	L1001CDM	HFD4	1127DP
ZE31-90	ZK58	5HR1	1014C	5WK1	1175	7CO2	1001E	HFD5	1127MP
ZE31-91	ZK59	5HR2	TE3	5WK1	1175N	7CO5	R1001EL	HFD6	1127DU

# STAR - TAYLOR

STAR	ILCO	STAR	ILCO	TAYLOR	ILCO	TAYLOR	ILCO	TAYLOR	ILCO
HFD62	1191ET	SH2	1307A	66	1015C	111JL	1141JL	12VM	998R
HFD67	1193FD	SH6	1307W	68	1016	111K	1141F	133S	1123S
HFD7	1125H	SL1	1120D	71	1071	111L	1141	135A	1179A
HFD70	X231	SM1	70S	72	1017	111TS	1141H	135D	755
HFD8	1127T	SP1	X143	75	1019	111W	1141W	135E	A1179E
HFD9	1127FD	T146	1270D	77	1047CR	119S	1119S	135F	A1179F
HN1	X51	T23	1270C	78	1068	120D	1120D	135G	A1179G
HN2-3	HD70	T26	1242L	79	1079	120F	1120F	135H	A1179H
HN4	X44	TA3	H1122M	80	1080	120G	1120H	135J	A1179J
HN5	X84	TO1	T61C	92	1092	120H	1120G	135K	A1179K
HN6	X129	TO2	TR26	96	1096	121B	1021B	135L	A1179L
HN90	X181	TO3	X145	102	1022	121BA	1021BA	135M	760
HN95	X191	TO3	X37	111	1141A	123A	1023A	135N	A1179N
HN98	X195	TO37	X159	118	1118	125G	1125G	135P	A1179P
HPL1	X1199G	TO4	X174	119	1119	125H	1125H	135R	A1179R
HPL2	X1199B	TO47	X217	123	1023	127DP	1127DP	135S	A1179S
HPL3	X1199J	UN2	62DP	125	1125	127ES	1127ES	135T	A1179T
HPL6	1706K	UN3	62FS	127	1127	128L	1127T	135U	A1179U
HPL68	1768CH	UN4	MG1	132	1132	12GA	998GA	135V	A1179V
HPL73	1769CH	VW1	62VW	133	1123	12GB	998GB	137A	L1137
HPL89	P1789	VW2	VW67	135	1179	12GC	998GC	137B	1137B
HY5	X196	VW3	VW71	136	757	12GD	998GD	137S	1136S
HYA4	X1199A	VW4	X9	137	1137S	12GE	998GE	13GM	998A
HYA5	X1199AR	VW5	VW71A	138	138	12GF	998GF	140B	1140G
IL10UN	1054UN	YA10	1132	140	1140	12GG	998GG	145A	1145A
IL5	L1054B	YJ1	O1122A	143	1143	12GH	998GH	145CE	A1145CE
IS1	1041H	YJ2	O1122AR	145	1145	12GK	998GK	145E	A1145E
IS2	1043B	YJ3	O1122	147	SC1247	12GM	998	145EF	A1145EF
IS3	1043D	YJ4	O1122B	170	1170B	12GST	998GST	145ES	1145E
JU1	1041C	YJ5	O1122R	171	1171	12LA	998LA	145F	A1145F
KWT	A1176ST	<b>STRATTEC</b>		172	1171B	12LB	998LB	145FG	A1145FG
LC015	1000T	<b>STRATTEC</b>	<b>ILCO</b>	175	1175	12LC	998LC	145FS	1145F
LC07	1000V	598333	H82M-PT	181	170S1	12LD	998LD	145G	A1145G
LDC1	X54	692246	HD106-PT	182	D1098X	12LE	998LE	145GS	1145G
LTO1	X137	692352	Y164-PT	183	D1098B	12LF	998LF	145H	A1145H
LU1	P1098V	692353	Y165-PT	184	62TA	12LG	998LG	145HS	1145H
LU1	T61F	692383	B115-PT	501	3B	12LH	998LH	145J	A1145J
LYJ1	L1122A	692562	MIT16A-PT	502	2B	12LK	998LK	145JS	1145J
M6000	1092-6000	692931	B111-GCPT	502	49B	12LM	998GL	145K	A1145K
M7000	1092-7000	5907552	HO03-PT	503	7B	12PA	998PA	145KS	1145K
MA1	1092	5907793	MIT12-PT	504	504	12PB	998PB	145L	A1145L
MI1	X176	5909874	Y170-PT	505	B6	12PC	998PC	145LS	1145L
MZ1	X26	5910834	TOY44D-PT	506	506	12PD	998PD	14A	999A
MZ13	X131	5912114	B112-PT	507	5B	12PE	998PE	14EN	999T
MZ2	X27	5912557	MIT17A-PT	508	9B	12PF	998PF	14GA	999GA
MZ3	X36	7003526	NI04T	509	17B	12PG	998PG	14GB	999GB
MZ4	X4	7011685	B114R-PT	511	19B	12PH	998PH	14GC	999GC
MZ5	X5	7011685	B111-PT	520	90B	12PK	998PK	14GD	999GD
OBR1	1098M	<b>TAYLOR</b>		521	91B	12SA	998SA	14GE	999GE
OBR10K	S1098K	<b>TAYLOR</b>	<b>ILCO</b>	525	14B	12SB	998SB	14GF	999GF
OBR11	S1970AM	14	999	530	8B	12SC	998SC	14GG	999GG
OBR12B	S1098B	20	1000	533	68M	12SD	998SD	14GH	999GH
OBR14D	S1098D	23	1001	536	66B	12SE	998SE	14GK	999GK
OBR1DB	1098DB	26.5	VA2	539	1B	12SF	998SF	14GM	998S
OBR2	O1098LA	31	1131	544	73M	12SG	998SG	14H	H999R
OBR3	1098NR	35	1004	548	54M	12SH	998SH	14K	14K
OBR4	L1098LA	38	1006	549	14CM	12SK	998SK	14KH	14KH
OBR5	O1098B	40	1040	550	71B	12SM	998SMK	14KR	14KR
OBR7	O1098D	41	C1041R	553	B5A	12TA	998TA	14R	999R
OBR9H	S1098H	42	1042B	574	178SB	12TB	998TB	14YM	C999
OFD10	S1167FD	43	1007	628	628	12TC	998TC	170A	A1170B
OFD2	1125M	44	1042A	637	21B	12TD	998TD	170CB	1170BD
OFD4	1127ES	45	1041W	640	22M	12TE	998TE	170M	1170M
OFD6	M1127A	46	1008	642	22BB	12TF	998TF	171P	1171P
OFD9	S1127FD	47	L1042B	643	23B	12TG	998TG	174B	1069L
OPL1	XO1199G	48	A1008	644	23M	12TH	998TH	174BA	1069LB
OPL2	XO1199B	50	1010	646	84B	12TK	998TK	174BN	1069LA
OPL4	D1759L	52	1010B	651	27B	12TM	998TMK	174D	1064D
OPL5	1759P	53	S1010B	652	34B	12VA	998VA	174E	1069-5X
OPL68	S1768CH	54	1054	669	669	12VB	998VB	174F	1069FN
OPL8	1766S	55	1011	102AB	1022AB	12VC	998VC	174H	1069-5Y
RO1	1069	56	1012	102E	O1022E	12VD	998VD	174HM	1069-5Z
RO3	1069FL	60	1013	111A	TY1	12VE	998VE	174J	1069N
RO5	1069G	61	1014	111B	1141K	12VF	998VF	174K	1069G
RO6	1069N	62	1069	111E	1141E	12VG	998VG	174KM	1069M
RP1	RE61N	63	63	111GE	1141GE	12VH	998VH	174P	N1069B
SAT91	P1108	64	1064	111GS	1141GS	12VK	998VK	174S	1069T

CROSS REFERENCE

TAYLOR	ILCO	TAYLOR	ILCO	TAYLOR	ILCO	TAYLOR	ILCO	TAYLOR	ILCO
175W	1175N	23R34	L1003CD	44A	1041WC	57-15N	A1011-15N	62DHR	R62DM
180E	EX1	23R4	L1003D	47S	L1042A	57-16N	A1011-16N	62DJ	62DK
183M	D1098BM	24WL	1001WL	48A	A1008A	57-17N	A1011-17N	62DK	62DO
183T	TE1	26E	VA1	48KMR	N1007RMB	57-18N	A1011-18N	62DL	62DP
184B	62TC	28N	1028NN	48M	1009M	57-19N	A1011-19N	62DM	62DH
184C	L62TC	307A	1307A	49CA	1007CA	57-1D	1011D1	62DN	62DN
184G	GL1	307W	1307W	49CB	1007CB	57-1H	A1011H1	62E	1069E
184GS	GL3	31R	1131R	49CC	1007CC	57-1N	A1011-1N	62F	1069FNA
184K	184K	35A	1004A	49CD	1007CD	57-20N	A1011-20N	62H	1069HN
185V	185V	35AL	1004AL	49CE	1007CE	57-21N	A1011-21N	62HA	62HA
185VS	VR91AR	35K	1004K	49CF	1007CF	57-22N	A1011-22N	62HB	62HB
191B	VR91B	35M	1004M	49CG	1007CG	57-23N	A1011-23N	62HO	62JB
191C	VR91CR	35N	1004N	49CH	1007CH	57-24N	A1011-24N	62K	N63G
20A	1000A	35RA	1004AR	49CJ	1007CJ	57-25N	A1011-25N	62KE	VAE1
20AB	1000AB	40A	1040A	49CK	1007CK	57-26N	A1011-26N	62KR	SM4
20BP	1000P	40B	1040B	49CL	1007CL	57-27N	A1011-27N	62L	62L
20BPS	S1001JB	40C	1040C	49CM	1007CM	57-2D	1011D2	62LG	62LG
20F	1000F	40E	1040E	49CN	1007CN	57-2H	A1011H2	62R	R62Z
20FR	1000FR	40F	OM10	49D	1049D	57-2N	A1011-2N	62RS	62RS
20FX	1000FX	41B	1041B	49KM	N1007KMB	57-34D	1011D34	62S	62Z
20G	1000G	41C	1041C	49S	1049E	57-3D	1011D3	62T	62R
20H	1000H	41CM	1041CE	501C	79B	57-3H	A1011H3	62VA	62VA
20HL	1000HL	41CO	1041CK	50A	1010A	57-3N	A1011-3N	62VB	62VW
20K	1000K	41DB	1041DB	50M	1010M	57-41D	1011D41	62VC	62VC
20KC	1000KC	41DC	1041DC	51S	1010N	57-4D	1011D4	62VE	62VE
20KS	S1000X	41DE	1041DH	51SA	L1010N	57-4N	A1011-4N	62VG	62VG
20KT	1000X	41DF	1041DV	54B1	DXB10	57-5H	A1011H5	62VM	61N
20T	1000T	41DH	1041DE	54B2	DXB20	57-5N	A1011-5N	62VO	62VO
20TS	S1000T	41F	SC1041R	54B3	DXB30	57-6H	A1011H6	63B	63BG
20V	1000V	41FM	1041FM	54C1	DXC10	57-6N	A1011-6N	63C	61NC
20VS	S1000V	41G	1041G	54C2	DXC20	57-7H	A1011H7	63E	63E
20WX	1000XK	41GA	1041GA	54C3	DXC30	57-7N	A1011-7N	63G	H62VG
21A	1001EA	41GB	1041GB	54D1	DXD10	57-8H	A1011H8	63GK	SB3
21CR	1001CR	41GR	1041GR	54D2	DXD20	57-8N	A1011-8N	63H	R62VN
21E	1001E	41H	1041H	54D3	DXD30	57-9N	A1011-9N	63J	63J
21EB	1001EB	41HN	1041HM	54DR	D1054K	57M	1011PZ	63JA	63JA
21EG	1001EG	41J	1043B	54F	1054F	57MA	A1011PZ	63K	63K
21EL	1001EL	41K	1041K	54FN	1054FN	57MK	1011GJ	63L	63LL
21EN	1001EN	41KA	1043D	54K	1054K	57P	N1011P	63N	RE61N
21R1	S1003A	41L	S1042Z	54KD	1054KD	57PA	A1011P	63P	V61S
21R12	S1003AB	41LB	1043E	54KE	A1054KD	57R	1011GH	63R	61G
21R14	S1003M	41LS	S1042ZS	54KL	1004KL	57SA	A1011S	63S	R63TS
21R2	S1003B	41LSM	S1042ZM	54KS	1176	57T	N1011T	63ST	63ST
21R3	S1003C	41N	1041N	54KT	1176D	57TA	A1011T	63T	7DC
21R34	S1003CD	41NL	C1041DN	54LB	1054LB	58A	SY1	63V	63V
21R4	S1003D	41P	1041P	54MT	1054MT	58AA	SY5-NS	63W	63W
22A1	1001AH	41PB	1043ED	54P	1054P	58B	SY2	63Y	G63Y
22A2	1001FH	41R	1041T	54TW	1054TW	58BA	SY6-NS	64AL	64AL
22AM	1001AM	41RB	1041E	54WA	A1054WB	58C	SY7	64F	LA6
22B	R1003M	41X	1041X	54WAA	L1054WB	58CA	SY3-NS	64K	64KK
22B1	1001BH	41Y	1041Y	54WB	1054WB	58D	SY4	64L	LA10
22B2	1001DH	42Z	1042Z	54WC	N1054WB	58DA	SY8-NS	64LA	LA12
22BM	1001BM	43A	A1007	55-10K	1011K10	58MK	1011MK	64LB	LA11
22C1	1001C1	43LA	1007LA	55-11K	1011K11	58JA	S7JA	64P	64P
22C2	1001C2	43LB	1007LB	55-12K	1011K12	60BF	1013BF	64R	64R
22CL	X1000GR	43LC	1007LC	55-13K	1011K13	60C	1060C	64S	64S
22CM	1001CM	43LD	1007LD	55-1K	1011K1	60DL	1013DL	65B	SB5
22D1	1001D1	43LDH	1007LDH	55-2K	1011K2	60F	1013F	65CA	65CA
22D2	1001D2	43LDM	1007LDM	55-3K	1011K3	61A	1014A	65DL	S62DP
22DM	1001DM	43LE	1007LE	55-4K	1011K4	61D	1014D	65F	65FA
22GM	1001ABM	43LF	1007LF	55-5K	1011K5	61DA	1014DA	65G	65G
22HM	1001CDM	43LG	1007LG	55-6K	1011K6	61DB	1014DB	65K	65K
22R1	1003A	43LH	1007LH	55-7K	1011K7	61DR	1014DR	65M	65M
22R12	1003AB	43LHM	1007LHM	55-8K	1011K8	61DS	1014DS	65TA	65TA
22R14	1003M	43LJ	1007LJ	55-9K	1011K9	61DX	1014DX	65V	V61A
22R2	1003B	43LK	1007LK	55A	1011A	61F	1014F	66A	A1015C
22R3	1003C	43LL	1007LL	55B	1011B	61J	1014J	67M	1015M
22R34	1003CD	43LM	1007LM	55M	1011M	61JS	1014JS	68N	1016N
22R4	1003D	43RA	1007RA	55P	1011P	61K	1014K	68NB	1016NB
22VL	XO1000GR	43RB	1007RB	55PAA	1011PAA	61N	O1014S	6PA	997PA
22Z2	1001EH	43RC	1007RC	55S	1011S	62A	61NA	71A	1071A
23K	1001K	43RE	1007RE	56DM	1012DM	62B	62DB	71B	1071B
23R1	L1003A	43RF	1007RF	57-10N	A1011-10N	62DC	62DC	72A	1017A
23R12	L1003AB	43RG	1007RG	57-11N	A1011-11N	62DE	62DE	72S	1017B
23R14	L1003M	43RJ	1007RJ	57-12D	1011D12	62DF	62DF	72SA	1017BA
23R2	L1003B	43RK	1007RK	57-12N	A1011-12N	62DG	62DG	73BM	1074BM
23R3	L1003C	43RL	1007RL	57-13N	A1011-13N	62DH	62DM	73C	SLA16

TAYLOR	ILCO	TAYLOR	ILCO	TAYLOR	ILCO	TAYLOR	ILCO	TAYLOR	ILCO
73D	SLA17	A22A1	A1001AH	A72BL	A1017BL	C42D	C1041L	F54RA	A1054WR
73E	1074E	A22A2	A1001FH	A72NL	O1017NX	C42E	C1041N	F66A	F38
73EM	S1073DF	A22AM	A1001AM	A72VL	O1017VX	C42F	SC1041YR	F66C	F66C
73F	1074F	A22B1	A1001BH	A72WL	O1017WX	C42G	SC1041S	F66D	F41
73N	1074N	A22B2	A1001DH	A73B	A1074B	C42H	C1041JB	F68B	GT2
75A	1019A	A22BM	A1001BM	A73E	A1074E	C42K	SC1041SR	F68C	F68C
75D	1019D	A22C1	A1001C1	A73F	A1074F	C42L	C1041P	F68XR	UN16
765D	1028	A22C2	A1001C2	A73G	A1074G	C66F	62UC	F68YT	62FT
77A	1047CL	A22CM	A1001CM	A75M	A1019M	C66G	R62UC	F69E	R63SP
79HK	1079B	A22D1	A1001D1	A80M	KL1	C80X	L62UC	F69F	63SP
7DA	997DA	A22D2	A1001D2	A81L	PO7	C81H	VC26	F69G	F91G
7E	997E	A22DM	A1001DM	A81M	PO5	D127M	1127DU	F69H	F91H
7EB	997EB	A22GM	A1001ABM	A81N	A81N	D13GA	H998GA	F70S	F70S
7ER	997ER	A22HM	A1001CDM	A81P	WT5	D13GB	H998GB	F70T	B62DR
7JA	997JA	A22Z2	A1001EH	A81R	PA5	D13GC	H998GC	F72V	F91C8
7JB	997JB	A43LA	L1007LA	A81S	PA6	D13GD	H998GD	F72W	F91CR
7JC	997JC	A43LB	L1007LB	A96C	L1096CN	D13GE	H998GE	F72X	F91C
7JD	997JD	A43LC	L1007LC	B21EF	R1001EE	D13GF	H998GF	F72Y	F91C2
7JE	997JE	A43LD	L1007LD	B21EG	1001MA	D13GG	H998GG	F74T	NE9
7JF	997JF	A43LE	L1007LE	B21EH	1001MB	D13GH	H998GH	F76M	F76M
7JG	997JG	A43LF	L1007LF	B21EM	R1001EM	D13GK	H998GK	F76N	FT6
7JH	997JH	A43LG	L1007LG	B21EP	R1001EK	D180X	64D	F79-1	FT37
7JM	J997M	A43LH	L1007LH	B21FK	A1001MJ	D54F	L1054F	F79-3	FT38
7NX	O1122	A43LJ	L1007LJ	B21HP	A1001HP	D66J	XD63	F79E	SR3
7X	997X	A43LK	L1007LK	B22A1	L1001AH	D66T	63H	F81E	FT6R
92B	1092B	A43LL	L1007LL	B22A2	L1001FH	D67N	R62PE	F81K	BR20
92C	1092C	A43LM	L1007LM	B22AM	L1001AM	D67P	R61N	G190	G190
92D	1092DD	A49CA	L1007CA	B22B1	L1001BH	D68A	DH1	G190A	G190A
92E	1092E	A49CB	L1007CB	B22B2	L1001DH	D71Z	DT3	G190B	G190B
92F	1092DS	A49CC	L1007CC	B22BM	L1001BM	D72D	D72D	G190BA	G190BA
92G	1092D	A49CD	L1007CD	B22C1	L1001C1	D72P	HR62VK	G190C	G190C
92H	1092J	A49CE	L1007CE	B22C2	L1001C2	D72R	L62VB	G190CA	G190CA
92N	1092N	A49CF	L1007CF	B22CM	L1001CM	D72S	H62VK	G190D	G190D
92NR	1092NR	A49CG	L1007CG	B22D1	L1001D1	D72T	LR62VB	G190DA	G190DA
92T	1092H	A49CH	L1007CH	B22D2	L1001D2	D72U	OP60C	G190E	G190E
92V	1092VA	A49CJ	L1007CJ	B22DM	L1001DM	D72Z	D72Z	G190EA	G190EA
92VR	1092VR	A49CK	L1007CK	B22GM	L1001ABM	D73A	DT8	G190F	G190F
96C	1096C	A49CL	L1007CL	B22HM	L1001CDM	D73V	DT5	G190FA	G190FA
96D	LC3	A49CM	L1007CM	B57-12D	B1011D12	D73W	DT4	G190M	G190M
96E	LC4	A49CN	L1007CN	B57-1D	B1011D1	D74E	DT6	G190MA	G190MA
96F	LC5	A49KM	N1007KMC	B57-2D	B1011D2	D74F	DT1	G191	G191
96FL	S1096FL	A54-B1	DXB1	B57-34D	B1011D34	D76F	DT7	G191A	G191A
96FM	S1096FM	A54-B2	DXB2	B57-3D	B1011D3	D79V	DT9	G192	G192
96FR	LC5R	A54-B3	DXB3	B57-41D	B1011D41	D79W	DT10	G192A	G192A
96FS	1096FS	A54-BM	DXB4	B57-4D	B1011D4	D79X	DT11	G193	G193
96G	S1096G	A54-C1	DXC1	B66C	H61G	D79Y	DT12	G193A	G193A
96L	1096L	A54-C2	DXC2	B66D	SP5	D80D	DT13	G194	G194
96LN	C1096LN	A54-C3	DXC3	B69D	NE5	D80E	DT14	G194A	G194A
96P	S1096P	A54-CM	DXC4	B69K	SR61N	D80F	DT15	G195	G195
98DB	1098DB	A54-D1	DXD1	B71F	VW1CZ	D80G	DT16	G195A	G195A
98L	1098L	A54-D2	DXD2	B73T	HF20	D80K	DA20	G196	G196
98M	1098M	A54-D3	DXD3	B76L	X62VK	E14	999N	G196A	G196A
98X	1098X	A54-DM	DXD4	B77U	WT3	E54C	1154C	G197	G197
98XL	1098NR	A54DR	D1054KA	B79K	SR1	F41A	101AM	G198	G198
99A	1970AM	A54-GM	DXG5	B79L	SR2	F41B	102AM	G199	G199
99B	S1970AM	A57-12D	A1011D12	B80N	HF18	F41C	103AM	G200	G200
A114A	FL1	A57-1D	A1011D1	B80NR	BMW1	F41E	104AM	G67J	BU1
A114B	FL2	A57-2D	A1011D2	B96K	EB1096K	F41M	100AM	H111	H1122M
A114C	FL5	A57-34D	A1011D34	C115	1181C	F54	1054WC	H191X	HG1
A114D	FL3	A57-3D	A1011D3	C180Y	CS91E	F54A	A1054WC	H191Z	HG2
A114E	FL4	A57-41D	A1011D41	C184E	R62CA	F54F	1054WF	H199M	H199N
A114F	FL6	A57-4D	A1011D4	C199P	1764P	F54FA	A1054WF	H200	GP1125
A114G	FL7	A67L	A1015L	C199S	1764S	F54G	1054WD	H54B	H1054B
A114H	FL8	A67M	A1015M	C21EF	R1001EF	F54GA	A1054WD	H54S	H1054S
A114J	FL9	A67MA	L1015M	C21EM	R1001CEM	F54H	1054WH	H69T	SR67K
A114M	FL10	A67N	A1015N	C21FM	1001ES	F54HA	A1054WH	H69TR	S67K
A170CB	A1170CB	A67P	A1015P	C21HN	1001GB	F54J	1054WJ	H69U	H67K
A170CC	A1170C	A67Q	A1015Q	C39A	CH3	F54JA	A1054WJ	H69UR	UR67K
A170CD	A1170D	A67R	A1015R	C39B	CH4	F54K	1054WK	H69V	HD3
A170CF	1170CJ	A67S	A1015S	C39C	CH5	F54KA	A1054WK	H69W	HD2
A190	A190	A67T	A1015T	C39D	CH6	F54L	1054WL	H69X	HD1
A191	AG2	A67U	A1015U	C39E	CH7	F54LA	A1054WL	H70H	R67K
A192	A192	A67V	A1015V	C39G	CH8	F54N	1054WN	H70J	HD24
A21EF	A1001MF	A67W	A1015W	C41RB	1096EN	F54NA	A1054WN	H70K	67J
A21EH	A1001MB	A67X	A1015X	C42A	C1041A	F54P	1054WP	H70V	HO61D
A21EJ	1001EJ	A67Y	A1015Y	C42B	1041TR	F54PA	A1054WP	H70W	HO61E
A21HN	1001GA	A68V	BIL1	C42C	C1041J	F54R	1054WR	H70X	H70X



TAYLOR	ILCO	TAYLOR	ILCO	TAYLOR	ILCO	TAYLOR	ILCO	TAYLOR	ILCO
H70Z	H70Z	L20KC	X1001KC	O43LF	O1007LF	P27	1167FD	RB21FM	R1001ET
H71L	HD25	L53	1004L	O43LG	O1007LG	P27E	1181FD	RC21FM	R1001ES
H71T	67H	L54B	L1054B	O43LH	O1007LH	P27FD	1127FD	RM63E	MR63E
H72G	H72G	L54G	L1054G	O43LHM	O1007LHM	P64E	R62BZ	RO102	1022HR
H72H	H72H	L54J	K1054B	O43LJ	O1007LJ	P64H	P64H	RO102A	1022H
H73Z	H73Z	L54K	K1122B	O43LK	O1007LK	P65A	P65A	RO7NX	O1122AR
H74L	E67K	L54L	K1122C	O43LL	O1007LL	P65C	P65C	RS180V	SW4R
H74M	HD22	L54M	L1054M	O43LM	O1007LM	P66E	P66E	S145CE	1145CE
H76G	H76G	L54N	K1122N	O43RA	O1007RA	P67F	63P	S145EF	1145EF
H76H	HD13	L54P	K1122D	O43RB	O1007RB	P68Z	64K	S145FG	1145FG
H76J	HD14	L56K	X1011KR	O43RC	O1007RC	P69A	DM4	S174	1069S
H76K	HD11	L67A	GT1	O43RE	O1007RE	P69B	62VB	S174K	S1069G
H76V	HD17	L67V	LR62VA	O43RF	O1007RF	P69C	U63H	S174L	N1069J
H76VR	HD9	L69L	LA5	O43RG	O1007RG	P69Y	DM2	S174M	1069SM
H76W	HD12	L70L	LA14	O43RJ	O1007RJ	P70C	63VO	S174S	S1069T
H76WR	HD10	L70M	LA4	O43RK	O1007RK	P72	DM3	S179U	SW3
H76X	H76X	L70N	LA13	O43RL	O1007RL	P73U	63PX	S180L	ME1
H76Y	HD4	LF13	LF13	O48	O1009	P73X	H64E	S180U	SW1
H76YR	HD18	LM1	LM1	O48KMR	N1007RMA	P79A	KP1	S180UR	S180UR
H76Z	HD16	LM2	RT19	O49CA	O1007CA	P79B	P79B	S180V	SW4
H76ZR	HD6	LO7NX	L1122A	O49CB	O1007CB	P91A	P1098A	S180W	S180W
H77E	HD20	LR191A	VR91R	O49CC	O1007CC	P91C	P1098C	S180Z	SW2
H77ER	HD19	M174	1064M	O49CD	O1007CD	R102	1022L	S181	S170S1
H77P	H77P	M63B	M63BG	O49CE	O1007CE	R102A	R1022L	S19	S1770U
H77PR	H77PR	M63E	M63E	O49CF	O1007CF	R174B	R1069L	S191A	VR91S
H77R	U67K	M67K	H63M	O49CG	O1007CG	R174D	R1064D	S199L	1766S
H77RR	U67KR	M67L	HR62VG	O49CH	O1007CH	R185V	R185V	S27	S1167FD
H78H	HD5	M68	MB59	O49CJ	O1007CJ	R185VS	VR91A	S27E	S1181FD
H78HR	HD5R	M68E	63C	O49CK	O1007CK	R191B	VR91BR	S27FD	S1127FD
H78KR	H78KR	M68F	YM1	O49CL	O1007CL	R191C	VR91C	S42	S42
H79C	HD42	M68G	YM4	O49CM	O1007CM	R20HL	R1000HL	S50	70S
H79CR	HD43	M68H	63TV	O49CN	O1007CN	R20T	R1000T	S51	170S
H79M	H79M	M68J	YM3	O49CR	O1007CR	R20TS	SR1000T	S54E	SY9
H79MR	H79MR	M68T	RE61XR	O49KM	N1007KMA	R20V	R1000V	S64S	BR6
H7F	H1122F	M70R	HF1	O49NB	O1007NB	R21EG	R1001EG	S66L	AS41
H7FR	H1122FR	M72F	M72F	O50	1010U	R21EL	R1001EL	S67C	R61P
H7W	H1122W	M73J	HF14	O50A	A1010U	R21EN	R1001EN	S67D	61P
H80	HD8	M73K	HF3	O54	O1054	R40C	R1040C	S67E	61PC
H80-1	HD29	M73L	HF15	O63	FV1	R40E	R1040E	S67G	S65CA
H80-2	HD23	M73M	HF16	O67S	62PE	R41DC	R1041DC	S68SK	SB2
H80-3	HD30	M73N	HF9	O67T	L62VJ	R41DF	R1041DV	S70U	SB1
H80-4	HD31	M79S	MB18	O71V	L62VN	R41F	SC1041TR	S71B	62FS
H80-5	HD32	M79T	MB15	O72A	62PG	R61DA	A1014DR	S71W	63L
H80-6	HD33	M79U	MB16	O72BL	1017BL	R62P	SM7	S71X	SB4
H80-7	HD34	M79UR	MB16R	O72NL	O1017NL	R62VB	R62VB	S71Y	U62VA
H80-8	HD35	M81G	MG1	O72WL	O1017WL	R62Y	61H	S72J	61PS
H80A	HD7	M81X	MB17	O73E	62PF	R63E	R63E	S73	SLA15
H98DB	H1098DB	N102	1177N	O73F	62PD	R63K	R63K	S74G	SUZ1
H98L	H1098L	N174D	R1064E	O73G	R62PD	R63R	R61G	S74H	SUZ2
H98LA	H1098LA	N20	1083	O73H	R62PF	R63S	R63ST	S74J	SUZ4
H98M	H1098M	N20C	1083C	O73R	R62PG	R63ST	63TS	S74K	SUZ3
H98X	H1098X	N20H	1083H	O76P	62PH	R63V	R63V	S76S	NE19
H98XL	H1098NR	N20J	1083J	O76R	OP11	R63W	R63W	S77Y	SZ1
HF38	HF38	N20K	1083K	O77J	UR62VP	R63Y	63Y	S7AH	1122D
HF43	HF43	N20L	1083L	O77S	YM6	R64F	LA7	S80L	61PE
HH1	HH1	N20M	1083M	O77T	YM7	R64T	BR7	S91B	S1098B
HN1	HN1	N20N	1083N	O79F	YM8	R65F	R65FA	S91D	S1098D
HRO7NX	H1122AR	N20P	1083P	O79G	YM9	R65G	R65G	S96	170S6
J41	1046	N20R	1083R	O79JB	O79JB	R67M	A1015MR	S96B	S1096B
J41A	1046A	N20S	1083S	O79JC	O79JC	R67Q	A1015QR	SA47	1047
J66M	J66M	N20T	1083T	O79JD	O79JD	R67R	A1015RR	T100	SLA12
J81J	KL2	NE13	NE13	O79JE	O79JE	R67S	A1015SR	T101	SLA13
K22	1001GH	NE15	NE15	O7B	O1122B	R67T	A1015TR	T104	1233M
K22MK	1001MK	NE26	NE26	O7BR	O1122BR	R67U	A1015UR	T104A	633MH
K77L	K77L	NE7	NE7	O7C	O1122C	R67V	A1015VR	T105	T105
K81D	LF7	O102	O1022	O7E	O997E	R67W	A1015WR	T107	T107
K924	K924	O102A	O1022AB	O7G	O997G	R67Y	A1015YR	T108	N1286R
K926	K926	O1S	O1S	O7NV	O1122NV	R68W	HR62DG	T109	1286B
L191	LF10	O20F	XO1000F	O7NX	O1122A	R79N	H61SB	T111	1286
L191A	VR91	O20G	O1000GX	O98B	O1098B	R7NX	O1122R	T112	687W
L191B	LF6	O43LA	O1007LA	O98D	O1098D	R80B	R80B	T113	1239
L192	LF5	O43LB	O1007LB	O98H	S1098H	R80C	NE14	T114	632M
L192M	L192M	O43LC	O1007LC	O98K	S1098K	R81F	R81F	T115	621A
L193	LF14	O43LD	O1007LD	O98LA	O1098LA	RA21HN	R1001GA	T115L	1221AL
L194	L194	O43LDH	O1007LDH	P102	SC1176	RA22A1	1001A1	T116	1215B
L199K	D1707K	O43LDM	O1007LDM	P19	1768CH	RA22A2	1001A2	T120	1427
L199M	1705K	O43LE	O1007LE	P19A	P1770U	RB21FK	A1001MJR	T121	N1286

TAYLOR	ILCO	TAYLOR	ILCO	TAYLOR	ILCO	TAYLOR	ILCO	TAYLOR	ILCO
T122	1286BR	T77	T77	X108	X108	X35	X35	X98J	P1098J
T123	1286C	T77ZL	H62DP	X109	X109	X36	X36	X99	X99
T124	T124	T78L	TA8	X11	X11	X37	X37	XL16	1180S
T126	616	T78M	TR18	X110	X110	X38	X38	XL17	1182
T127	T127	T79P	HF23	X111	X111	X39	X39	XO199G	XO1199G
T129	666	T79PR	HF22	X112	X112	X4	X4	XO199L	1701G
T131	T131	T79R	HR62FD	X113	X113	X40	X40	XO199R	1759P
T132	1225G	T80	T80	X114	X114	X41	X41	Y174A	1069YM
T139	T139	T80J	T80J	X115	DA23	X42	X42	Y68M	YH1
T141	687Y	T80S	T61D	X116	X116	X43	X43	Y68N	YH2
T142	687X	T80U	T61E	X117	X117	X44	X44	Y68P	YH12
T146	1270D	T80V	T61F	X118	X118	X45	X45	Y71H	Y71H
T147	1147	T80W	SR4	X119	X119	X46	X46	Y71J	YH10
T148	1148	T81A	TR25	X12	X12	X48	X48	Y71N	YH4
T153	T153	T81B	TR26	X120	X120	X49	X49	Y71P	YH3
T180K	TK1	T83	1416	X121	X121	X5	X5	Y73C	YH14
T21	O1225N	T84	816A	X122	X122	X50	X50	Y73D	YH17
T22	1417	T86	T86	X123	X123	X51	X51	Y73Y	YH13
T23	1270C	T88	T88	X124	X124	X52	X52	Y76B	Y76B
T25	1225PL	T89	T89	X125	X125	X53	X53	Y76C	Y76C
T26	1242L	T92	T92	X126	X126	X54	X54	Y77B	Y77B
T26S	1033A	T93L	1270	X127	X127	X54F	X1054F	Y77F	YH6
T27	1303	T95	T95	X129	X129	X54K	X1054K	Y77G	YH9
T28	T28	T96	T96	X13	X13	X54W	X1054WA	Y77K	YH7
T30	611	T97	T97	X130	X130	X55	X55	Y80T	YH20
T31	1332S	TS149	TS149	X131	X131	X56	X56	Y80TR	YH16
T32	O1215	TS150	TS150	X132	X132	X57	X57	Z180N	ZKN1
T33	1286E	U180F	1033N	X133	X133	X58	X58	Z185	S60
T34	1214	U180G	U180G	X134	X134	X59	X59	Z185B	60HA
T35	R1286E	U92A	1092V	X135	X135	X6	X6	Z185C	60HB
T37L	T37L	V20S	S1000XK	X136	X136	X60	X60	Z185D	60Z7
T38	1222L	V41	1043V	X137	X137	X61	X61	Z185E	60ZD
T39	T39	V66P	U62VB	X138	X138	X61F	X1014F	Z186A	60UA
T40	T40	V67	U62VN	X139	X139	X61FR	1014C	Z186B	60Z3
T41	T41	V68D	61VW	X14	X999	X62	X62	Z186C	R60ZD
T42	1221L	V68K	W62VE	X140	X140	X63	X63	Z186D	60UF
T42A	O1221L	V68L	V61VW	X141	X141	X64	X64	Z186E	60UG
T44	T44	V68LR	U61VW	X142	X142	X65	X65	<b>WEISER</b>	
T45	T45	V69N	VW63	X143	X143	X66	X66	<b>WEISER</b>	<b>ILCO</b>
T46	T46	V69P	VW63A	X144	X144	X67	X67	1555	1054WB
T49	149	V70A	VL1	X145	X145	X68	X68	1555	N1054WB
T50	T50	V70D	HF17	X146	X146	X69	X69	1559	A1054WB
T51A	1225BL	V70E	63VR	X147	X147	X7	X7	1563	L1054WB
T53	1213A	V71E	S62DW	X148	X148	X70	X70	<b>WELCH</b>	
T54	610BL	V72B	VW64	X14S	999B	X71	X71	<b>WELCH</b>	<b>ILCO</b>
T54A	610B	V72E	V72E	X14S	SX9B	X72	X72	W9803/3K	1123S
T55	1224L	V72L	VW64T	X150	X150	X73	X73	W9805/5K	1123
T55A	1224	V72N	V72N	X151	X151	X74	X74	W9806/6K	1123A
T55B	1224F	V76T	H62DR	X152	X152	X75	X75	<b>WESLOCK</b>	
T57	2714	V77	VO6	X153	X153	X76	X76	<b>WELOCK</b>	<b>ILCO</b>
T60	T60	V77M	BR9	X154	X154	X77	X77	4425	1175
T61	O1223	V77V	VW77	X155	X155	X78	X78	12344	1175N
T61L	O1223L	V78G	VW67S	X157	X157	X79	X79	<b>WILSON-</b>	
T62DL	B62DP	V78J	VW67	X16	X16	X8	X8	<b>BOHANNON</b>	
T62L	1225	V78JK	V27	X17	X17	X80	X80	<b>WIL-BOHAN</b>	<b>ILCO</b>
T63	1412	V79D	VO62	X18	X18	X81	X81	19	WB19
T64	T64	V80P	V80P	X19	X19	X82	X82	20A	1071B
T66	672	V81V	VW71A	X199G	X1199G	X83	X83	20B	1071BD
T66U	TP1	V81W	VW71	X2	X2	X84	X84	20C	1071BE
T66V	TP2	VR1	VR1	X20	X20	X85	X85	20M	1071BM
T66W	TP3	VR1R	VR1R	X20F	X1000F	X86	X86	21A	1071
T66X	TP6	W180M	62RG	X20FR	X1000FR	X87	X87	21B	1071D
T66Y	TP5	W77D	WS5	X21	X21	X88	X88	21C	1071E
T66Z	TP4	W90	W67	X22	X22	X89	X89	21M	1071M
T69R	TA6	WA1	WA1	X23	X23	X9	X9	22A	1071A
T70	T70	WA2	WA2	X24	X24	X90	X90	<b>XL LOCK</b>	
T72	T72	WS11	WS11	X25	X25	X91	X91	<b>XL LOCK</b>	<b>ILCO</b>
T72C	62FE	X1	X1	X26	X26	X92	X92	XL7	1180S
T73	T73	X10	X10	X27	X27	X93	X93	XL5	1182
T74	T74	X100	X100	X28	X28	X94	X94	<b>YALE</b>	
T74U	TA5	X101	X101	X29	X29	X95	X95	<b>YALE</b>	<b>ILCO</b>
T74V	TA16	X102	X102	X3	X3	X96	X96	87	2N
T74W	TA11	X103	X103	X30	X30	X97	X97	88	1
T74X	TA12	X104	X104	X31	X31	X98	X98	88	1N
T74Y	TA2	X105	X105	X32	X32	X98A	H1098A	4551	O1122B
T74Z	TA4	X106	X106	X33	X33	X98C	H1098C	4553	O1122C
T75	T75	X107	X107	X34	X34	X98E	P1098E		

YALE	ILCO	YALE	ILCO	YALE	ILCO
9826	1122D	EN11LE	998LE	EN9LH	998LH
1017B10L	F1122AR	EN11LF	998LF	FN411GA	D998GA
1017B10L	H1122FR	EN11LG	998LG	FN411GA	H998GA
1036B10L	L1122AR	EN11LK	998LK	FN411GA	999GB
12 1/2E3L	O997ER	EN11PA	998PA	FN411GB	D998GB
12 1/2E3R	O997E	EN11PB	998PB	FN411GB	H998GB
12 1/2JA	997JA	EN11PC	998PC	FN411GC	D998GC
12 1/2JB	997JB	EN11PD	998PD	FN411GC	H998GC
12 1/2JC	997JC	EN11PE	998PE	FN411GD	D998GD
12 1/2JD	997JD	EN11PF	998PF	FN411GD	H998GD
12 1/2JE	997JE	EN11PG	998PG	FN411GE	D998GE
12 1/2JF	997JF	EN11PH	998PH	FN411GE	H998GE
12 1/2JG	997JG	EN11PK	998PK	FN411GF	D998GF
12 1/2JH	997JH	EN11SA	998SA	FN411GF	H998GF
12 1/2JK	997JK	EN11SB	998SB	FN411GG	D998GG
12 1/2JMK	J997M	EN11SC	998SC	FN411GG	H998GG
19E1R	SX9B	EN11SD	998SD	FN411GH	D998GH
24 1/2E8R	1132	EN11SE	998SE	FN411GH	H998GH
24 1/2E8R	H1132	EN11SF	998SF	FN411GK	D998GK
421B10R	L1122A	EN11SG	998SG	FN411GK	H998GK
423F8R	L1122B	EN11SH	998SH	FN411GMK	H998
768C-C5R	889A	EN11SK	998SK	FN411VMK	H998R
9278B10R	O1122A	EN11SMK	998SMK	FN411TMK	H998TMK
9E1R	999B	EN11TA	998TA	H7W	O1122
E1019B10L	H1122AR	EN11TB	998TB	TA637B10R	O1122NV
E1019B10L	O1122AR	EN11TC	998TC	X10 1/2E3R	997X
E1019B10R	H122A	EN11TD	998TD	X10 1/2E3R	H997EB
E1019B10R	E1122A	EN11TE	998TE		
E1019F8L	O1122BR	EN11TF	998TF		
E1019F9L	O1122BER	EN11TG	998TG		
E1019F9R	O1122BE	EN11TH	998TH		
E10E3L	R997EB	EN11TK	998TK		
E10E3R	997B	EN11TMK	998TMK		
E10E3R	997EB	EN11VA	998VA		
E10E3R	B997EH	EN11VB	998VB		
E11E1R	999A	EN11VC	998VC		
E13E3L	997ER	EN11VD	998VD		
E13E3L	H997ER	EN11VE	998VE		
E13E3R	YL1	EN11VF	998VF		
E13E3R	Y200	EN11VG	998VG		
E13E3R	997D	EN11VH	998VH		
E13E3R	997E	EN11VK	998VK		
E13E3R	H997E	EN11VMK	998R		
E8E1L	999R	EN13JMK	O997G		
E8E1L	H999R	EN27B10R	O997A		
E8E1R	999	EN27B10R	F1122A		
E8E1R	999N	EN27B10R	H1122F		
E8E1R	999U	EN27B10R	NO1122D		
E8E1R	H999	EN33B10L	R997DA		
E8E1R	X999	EN33B10R	997DA		
E9810B10R	H1122W	EN33B10R	997DB		
EB25E8L	HR1132	EN411E1R	D9		
EB25E8L	R1132	EN8GA	999GA		
EN10JA	S7JA	EN8GC	999GC		
EN10JMK	997GX	EN8GD	999GD		
EN117GMK	998A	EN8GE	999GE		
EN117GST	A998GST	EN8GF	999GF		
EN11C1L	994ARM	EN8GG	999GG		
EN11C1R	994M	EN8GH	999GH		
EN11C4R	Y202	EN8GK	999GK		
EN11C4R	C999	EN8GMK	998S		
EN11GA	998GA	EN8LA	999LA		
EN11GB	998GB	EN8LB	999LB		
EN11GC	998GC	EN8LC	999LC		
EN11GD	998GD	EN8LD	999LD		
EN11GE	998GE	EN8LE	999LE		
EN11GF	998GF	EN8LF	999LF		
EN11GG	998GG	EN8LG	999LG		
EN11GH	998GH	EN8LH	999LH		
EN11GK	998GK	EN8LK	999LK		
EN11GLK	998GL	EN8VA	999VA		
EN11GMK	998	EN8VB	999VB		
EN11GST	998GST	EN8VC	999VC		
EN11LA	998LA	EN8VD	999VD		
EN11LB	998LB	EN8VE	999VE		
EN11LC	998LC	EN8VG	999VG		
EN11LD	998LD	EN8VH	999VH		

# Key News

12-07  
July 2012

These keys are now in inventory

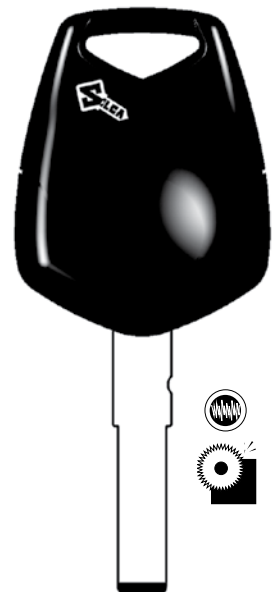
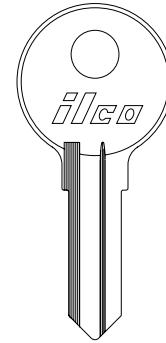
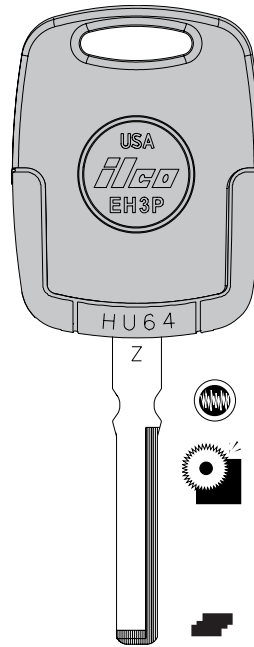
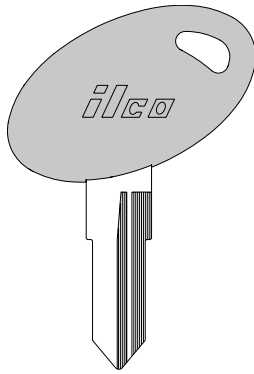

Ilco No.:	<b>BAU4-P</b>	<b>Y172</b>	<b>EB3-Z-HU64 (Blade only)</b>	<b>1678</b>	<b>SIP22EHP-SI</b>
EZ No.	—	—	—	—	—
Used On:	Bauer (RV300)	Chrysler Keyless Go Emergency Key	2007-2011 Dodge Sprinter Vans	Eberhard	Fiat 500
Price Group:	4	Contact Ilco Distributor	6	2	62
Packaged:	5/bag, 25/box	1/bag, 5/box	1/bag, 5/box	10/bag, 50/box	1/bag, 5/box
UPC No.:	036448238507	036448241095	036448241088	036448238491	036448238736
Sales Velocity:	Low	Low	Low	Low	Low



Electronic Key



Special Key Machine Required

**ilco**

A Member of the Kaba Group

Kaba Ilco Corp.

P O Box 2627 (27802)

400 Jeffreys Rd., Rocky Mount, NC 27804

Tel.: (252) 446-3321 • Fax: (252) 446-4702

www.kaba-ilco.com



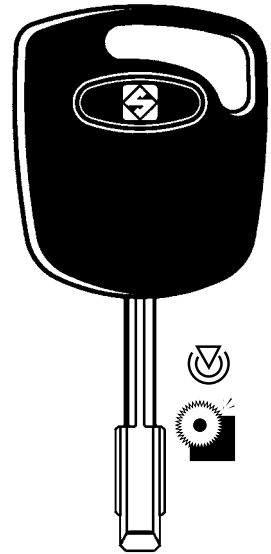
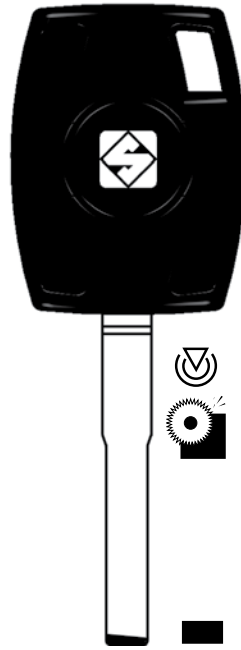
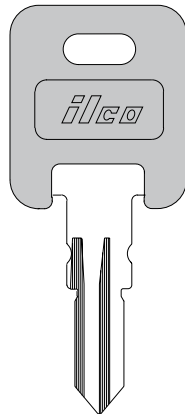
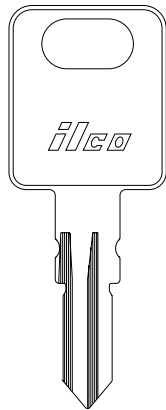

**Ilco No.:** 1681

**FIC3-P**

**HU101T17**

**FO21T17**

**EZ No. Used On:** FIC3  
FIC (85003-00)

—  
FIC (85003-00)  
(BLACK)

—  
2011-2012 Ford Fiesta

—  
Ford Transit

**Price** 3

9

Contact Ilco  
Distributor

Contact Ilco  
Distributor

**Packaged:** 10/bag, 50/box

5/bag, 25/box

1/bag, 5/box

1/bag, 5/box

**UPC No.:** 036448240722

036448240654

036448241071

036448234578

**Sales Velocity:** Low

Low

Low

Low

 *Transponder Key*

 *Special Key Machine Required*

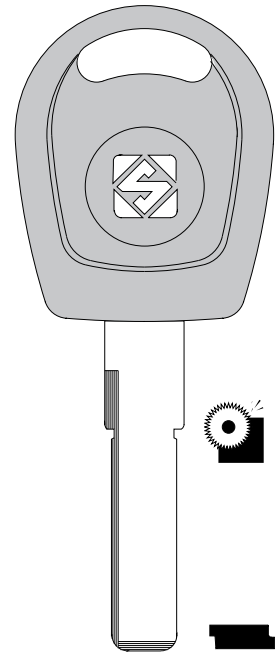
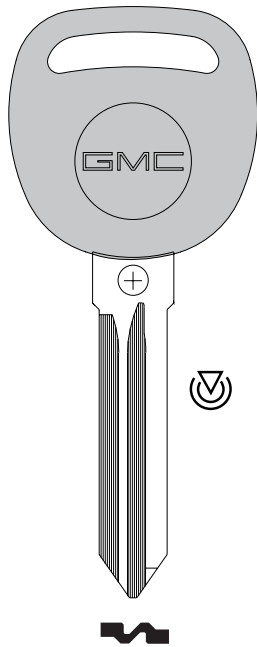

**Iico No.:** B111-GPT

**HON-3B Honda 3  
 Button Shell Complete**

**HON-4B Honda 4 Button  
 Shell  
 Complete**

**HU66-CP**

**EZ No.** —  
**Used On:** Late model GM  
 vehicles

—  
 Honda

—  
 Honda

—  
 Chipless key for  
 various VW models

**Price** Contact Iico  
 Distributor

27

27

61

**Packaged:** 1/bag, 5/box

1/bag, 5/box

1/bag, 5/box

1/bag, 5/box

**UPC No.:** 036448241156

036448241057

036448241064

036448238705

**Sales Velocity:** Low

Low

Low

Low

 *Transponder Key*

 *Special Key Machine Required*

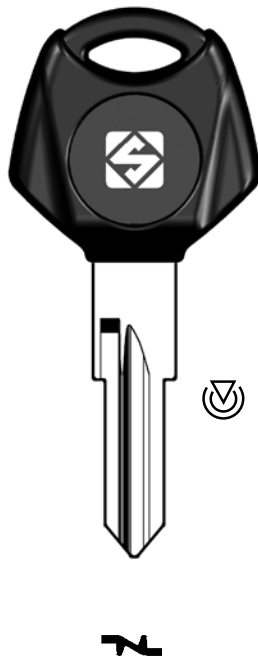
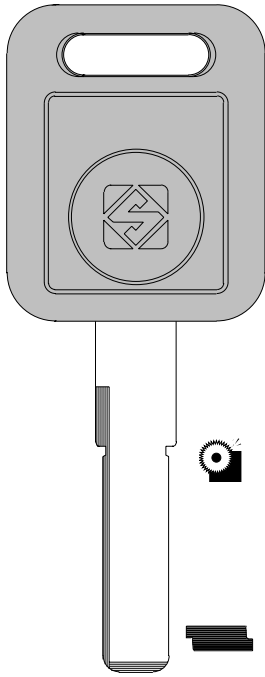

**Ilco No.:** HU66A-CP  
**EZ No.:** —  
**Used On:** Chipless key for  
 Various Audi models

**Ilco No.:** ZD24RAT22-SI

**EZ No.:** —  
**Used On:** Zadi

**Price:** 61

**Price:** Contact Ilco  
 Distributor

**Packaged:** 1/bag, 5/box

**Packaged:** 1/bag, 5/box

**UPC No.:** 036448238712

**UPC No.:** 036448236633

**Sales Velocity:** Low

**Sales Velocity:** Low

 *Transponder Key*

 *Special Key Machine Required*

# Key News

These keys are now in inventory

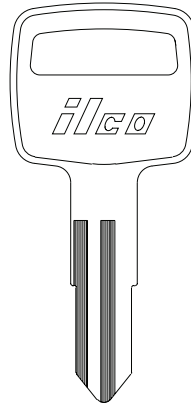
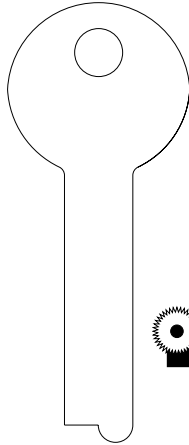
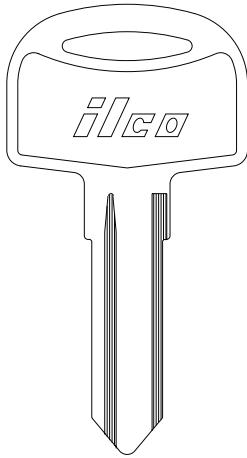

**Ilco No.:** 1679  
**EZ No.:** —  
**Used On:** Cole Hersee

**885BL-060**  
**N/A**  
**Yale**

**YH52**  
—  
Yamaha Outbord

**HU49AT5LT**  
—  
Audi w/o  
transponder)

**Price Group:** 6 5 4 22

**Packaged:** 10/bag, 50/box 10/bag, 50/box 10/bag, 50/box 5/bag, 25/box

**UPC No.:** 036448240043 036448240296 036448238521 036448238279

**Sales Velocity:** Low Low Low Low



Transponder Key



Special Key Machine Required



A Member of the Kaba Group

Kaba Ilco Corp.

P O Box 2627 (27802)

400 Jeffreys Rd., Rocky Mount, NC 27804

Tel.: (252) 446-3321 • Fax: (252) 446-4702

www.kaba-ilco.com

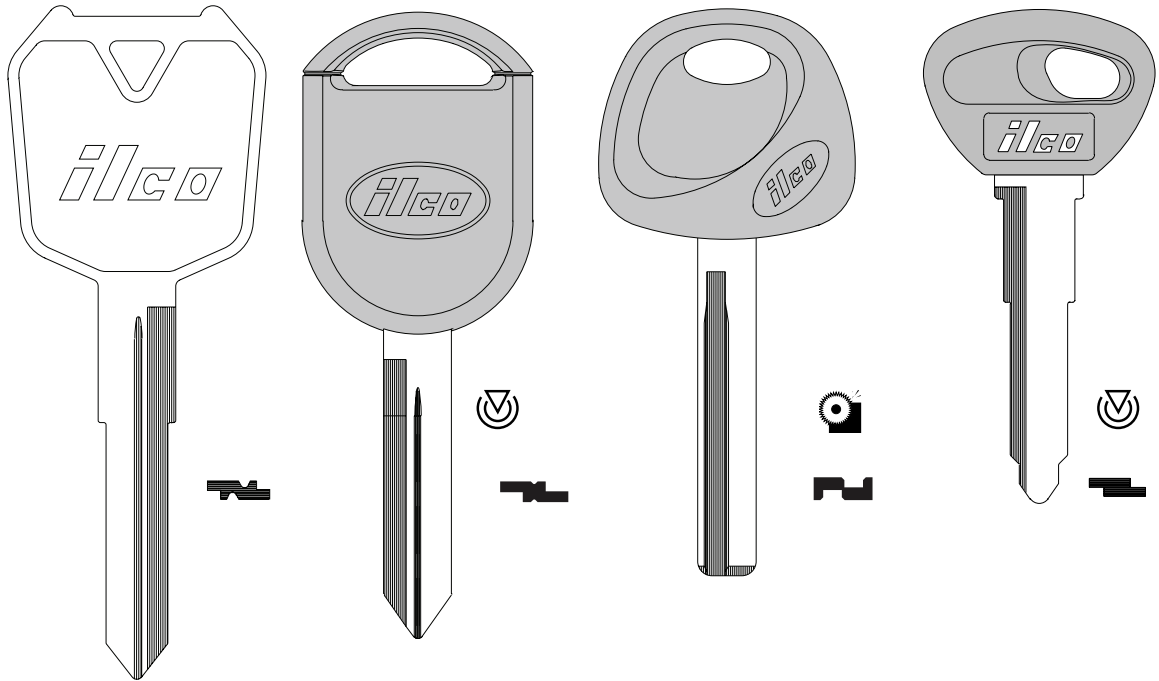

<b>Ilco No.:</b>	<b>X278</b>	<b>H84-PT</b>	<b>HY18-P</b>	<b>MAZ24RT17</b>
<b>EZ No.:</b>	KA33	—	—	—
<b>Used On:</b>	Kawasaki Motorcycle	Many Ford Models	2012 Hyundai Accent & Veloster	Various Mazda CAN Models
<b>Price:</b>	9	Contact Ilco Distributor	21	Contact Ilco Distributor
<b>Packaged:</b>	10/bag, 50/box	1/bag, 5/box	5/bag, 25/box	1/bag, 5/box
<b>UPC No.:</b>	036448238385	036448238750	036448240173	036448238583
<b>Sales Velocity:</b>	Low	High	Low	Low

 *Transponder Key*

 *Special Key Machine Required*

# Key News

12-05  
September 2011

These keys are now in inventory

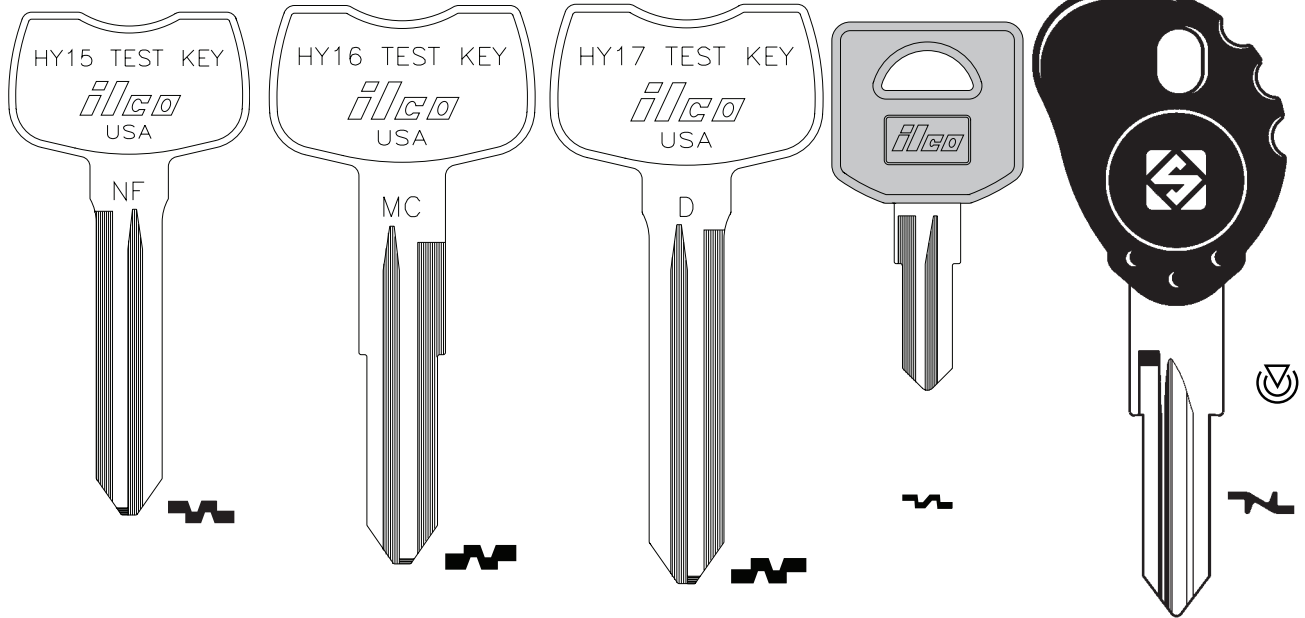

<b>Ilco No.:</b>	<b>HY15 TEST KEY</b>	<b>HY16 TEST KEY</b>	<b>HY17 TEST KEY</b>	<b>FIC1-P</b>	<b>ZD24RT14-SI</b>
<b>EZ No.:</b>	—	—	—	—	—
<b>Used On:</b>	2006 Hyundai Sonata	2006 Hyundai Accent	2007 Hyundai Elantra	FIC 85001-00 (MK9901)	Zadi
<b>Price Group:</b>	9	9	9	9	Contact Ilco Distributor
<b>Packaged:</b>	10/bag, 50/box	10/bag, 50/box	10/bag, 50/box	5/bag, 25/box	1/bag, 5/box
<b>UPC No.:</b>	036448240135	036448240142	036448240159	036448238620	036448236640
<b>Sales Velocity:</b>	Low	Low	Low	Low	Low

 Transponder Key

**ilco**

A Member of the Kaba Group  
Kaba Ilco Corp.  
P O Box 2627 (27802)  
400 Jeffreys Rd., Rocky Mount, NC 27804  
Tel.: (252) 446-3321 • Fax: (252) 446-4702  
www.kaba-ilco.com

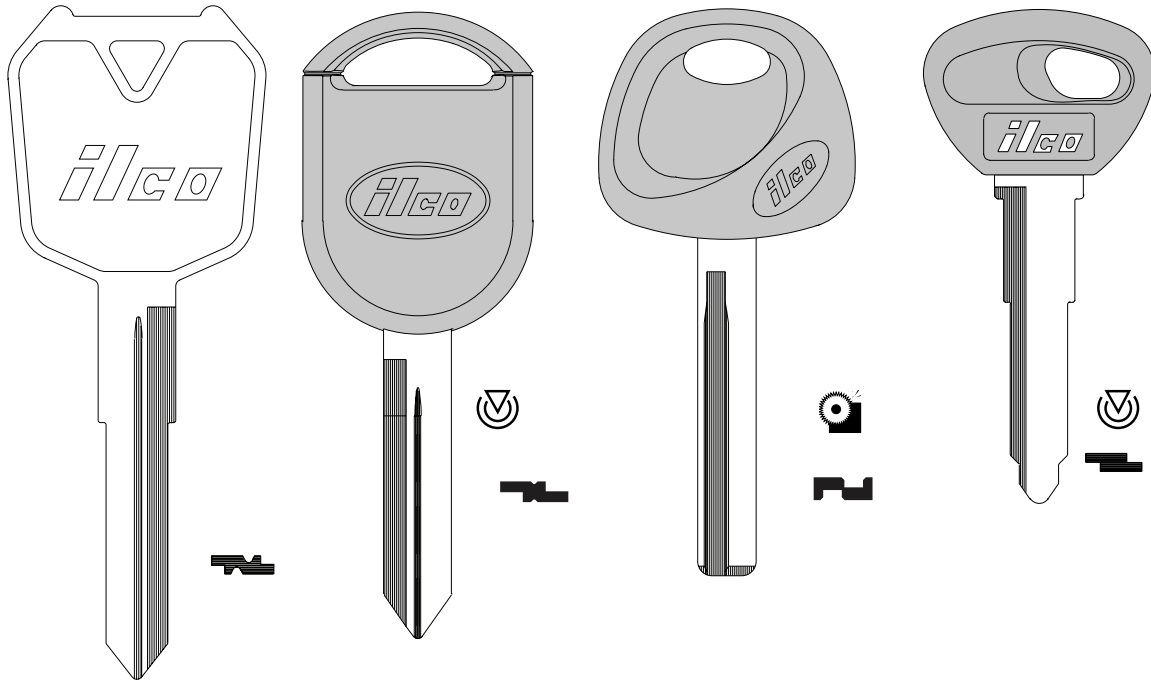

<b>Ilco No.:</b>	<b>X278</b>	<b>H84-PT</b>	<b>HY18-P</b>	<b>MAZ24RT17</b>
<b>EZ No.:</b>	KA33	—	—	—
<b>Used On:</b>	Kawasaki Motorcycle	Many Ford Models	2012 Hyundai Accent	Various Mazda Models
<b>Price:</b>	9	Contact Ilco Distributor	21	Contact Ilco Distributor
<b>Packaged:</b>	10/bag, 50/box	1/bag, 5/box	5/bag, 25/box	1/bag, 5/box
<b>UPC No.:</b>	036448238385	036448238750	036448238743	036448238583
<b>Sales Velocity:</b>	Low	High	Low	Low

 *Transponder Key*

 *Special Key Machine Required*

# Key News

12-04  
July 2011

These keys are now in inventory

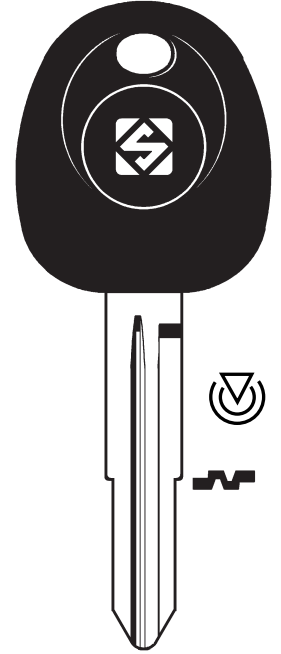
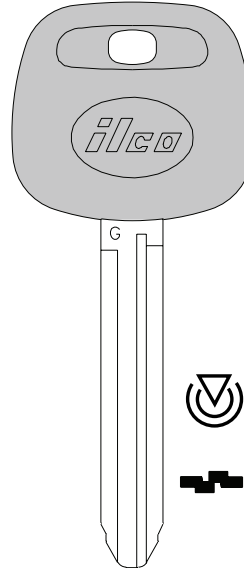

**Ilco No.:** LX40  
**EZ No.:** —  
**Used On:** Lexus 40,000 Series  
Emergency Key

**Ilco No.:** LX80  
**EZ No.:** —  
**Used On:** Lexus Prox  
Lexus 80,000 Series-  
Emergency Key

**Ilco No.:** TOY44G-PT  
**EZ No.:** —  
**Used On:** See Below

**Ilco No.:** HYN6T14  
**EZ No.:** —  
**Used On:** Hyundai/Kia (Canada)

**Price Group:** Contact Ilco  
Distributor

**Price Group:** Contact Ilco  
Distributor

**Price Group:** Contact Ilco  
Distributor

**Price Group:** Contact Ilco  
Distributor

**Packaged:** 1/bag, 5/box

**Packaged:** 1/bag, 5/box

**Packaged:** 1/bag, 5/box

**Packaged:** 1/bag, 5/box

**UPC No.:** 036448238590

**UPC No.:** 036448238248

**UPC No.:** 036448238699

**UPC No.:** 036448236480

**Sales Velocity:** Low

**Sales Velocity:** Low

**Sales Velocity:** Low

**Sales Velocity:** Low

2010-11	Toyota Corolla
2011	Toyota FJ Cruiser
2011	Toyota 4 Runner
2011	Toyota RAV4
2011	Toyota Sequoia
2011	Toyota Sienna
2011	Toyota Tacoma
2011	Toyota Tundra
2011	Toyota Venza

Special Key Machine Required

Transponder Key



A Member of the Kaba Group  
Kaba Ilco Corp.  
P O Box 2627 (27802)  
400 Jeffreys Rd., Rocky Mount, NC 27804  
Tel.: (252) 446-3321 • Fax: (252) 446-4702  
www.kaba-ilco.com



# Key News

12-03  
June 2011

These keys are now in inventory

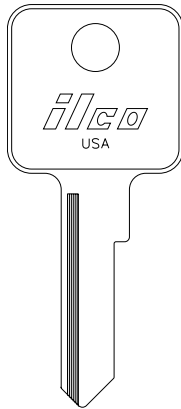

**Ilco No.:** 1092M  
**EZ No.:** M29  
**Used On:** Master

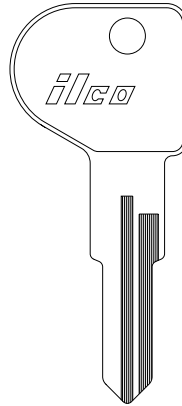

**1669**  
—  
Canada Post

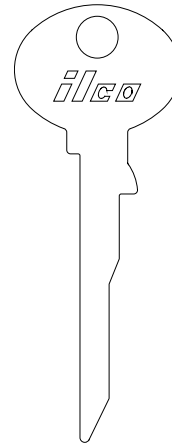

**1673**  
—  
Humane Restraint  
(K100)

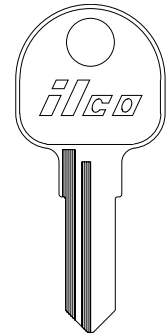

**1670**  
—  
Hafele

<b>Price Group:</b>	4	5	16	4
<b>Packaged:</b>	10/bag, 50/box	10/bag, 50/box	10/bag, 50/box	10/bag, 50/box
<b>UPC No.:</b>	036448236596	036448236534	036448236589	036448236619
<b>Sales Velocity:</b>	Medium	Canada Only	Low	Medium



A Member of the Kaba Group

Kaba Ilco Corp.

P O Box 2627 (27802)

400 Jeffreys Rd., Rocky Mount, NC 27804

Tel.: (252) 446-3321 • Fax: (252) 446-4702

www.kaba-ilco.com

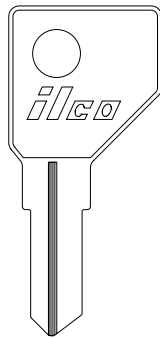

**Ilco No.:** 1671  
**EZ No.:** —  
**Used On:** Hickory /  
First Watch

**Price Group:** 3  
**Packaged:** 10/bag, 50/box  
**UPC No.:** 036448236527

**Sales Velocity:** Low

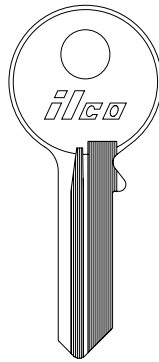

**Ilco No.:** 1672  
**EZ No.:** —  
**Used On:** Guard Security

**Price Group:** 3  
**Packaged:** 10/bag, 50/box  
**UPC No.:** 036448236572

**Sales Velocity:** Low

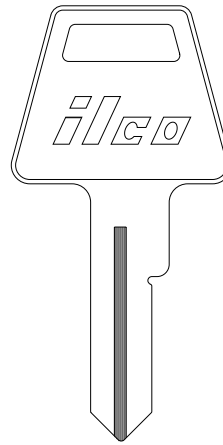

**Ilco No.:** 1045L  
**EZ No.:** AM3L  
**Used On:** American

**Price Group:** 3  
**Packaged:** 10/bag, 50/box  
**UPC No.:** 036448236602

**Sales Velocity:** Medium

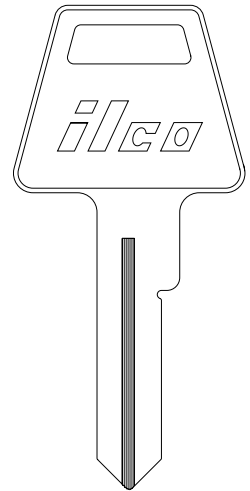

**Ilco No.:** A1045L  
**EZ No.:** —  
**Used On:** American

**Price Group:** 5  
**Packaged:** 10/bag, 50/box  
**UPC No.:** 036448236541

**Sales Velocity:** Medium

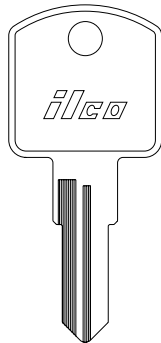

**Ilco No.:** 1675  
**EZ No.:** —  
**Used On:** Armstrong

**Price Group:** 3  
**Packaged:** 10/bag, 50/box  
**UPC No.:** 036448236558

**Sales Velocity:** Low

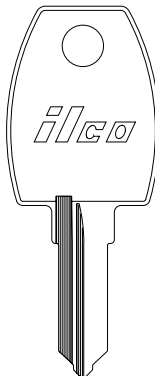

**Ilco No.:** 1674  
**EZ No.:** —  
**Used On:** Wood / Treadway

**Price Group:** 3  
**Packaged:** 10/bag, 50/box  
**UPC No.:** 036448236565

**Sales Velocity:** Low

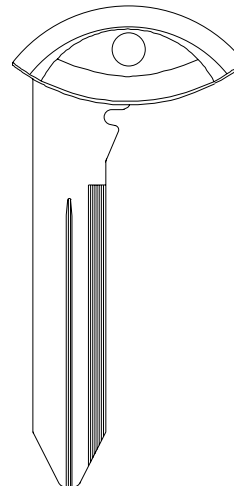

**Ilco No.:** Y171-P  
**EZ No.:** —  
**Used On:** Chrysler Fobik Products

**Price Group:** Contact Ilco Distributor  
**Packaged:** 1/bag, 5/box  
**UPC No.:** 036448235841

**Sales Velocity:** Low

# Key News

12-02  
May 2011

These keys are now in inventory

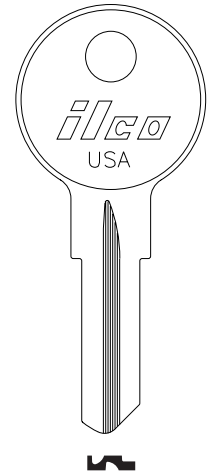
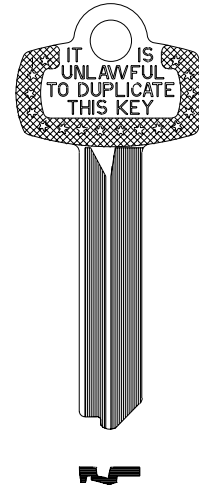
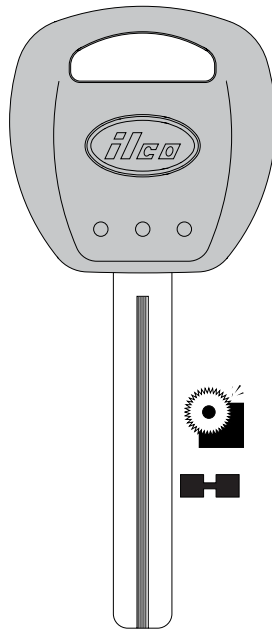

**Ilco No.:** CHRY-4B1  
**EZ No.:** —  
**Used On:** Chrysler 4-Button  
Type 1 Shell Complete

**Ilco No.:** KK10-P  
**EZ No.:** —  
**Used On:** Kia/Hyundai  
(see below)

**Ilco No.:** 1A1N1  
**EZ No.:** —  
**Used On:** Best

**Ilco No.:** 1677  
**EZ No.:** —  
**Used On:** E-Z GO

**Price Group:** 27

19

5

3

**Packaged:** 1/bag

5/bag, 25/box

50/box

10/bag, 50/box

**UPC No.:** 036448236930

036448237234

036448237470

036448238224

**Sales Velocity:** Low

Medium

Low

Low

2011 Hyundai Elantra  
Touring  
2011 Hyundai Sonata  
2011 Kia Rondo

 Special Key Machine Required



A Member of the Kaba Group

Kaba Ilco Corp.

P O Box 2627 (27802)

400 Jeffreys Rd., Rocky Mount, NC 27804

Tel.: (252) 446-3321 • Fax: (252) 446-4702

www.kaba-ilco.com

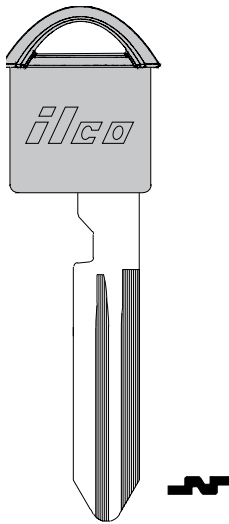

**Ilco No.:** NI06-P  
**EZ No.:** —  
**Used On:** Nissan/Infiniti  
Chipless  
Emergency Key

**Price:** Contact Ilco  
Distributor

**Packaged:** 1/bag, 5/box

**UPC No.:** 036448238255

**Sales Velocity:** Low

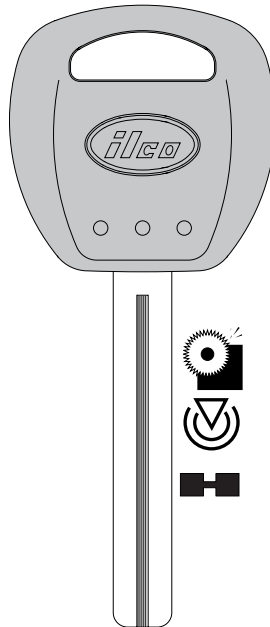

**Ilco No.:** KK9-PT  
**EZ No.:** —  
**Used On:** 2007-09 Kia  
Amanti

**Price:** Contact Ilco  
Distributor

**Packaged:** 1/bag, 5/box

**UPC No.:** 036448238286

**Sales Velocity:** Low

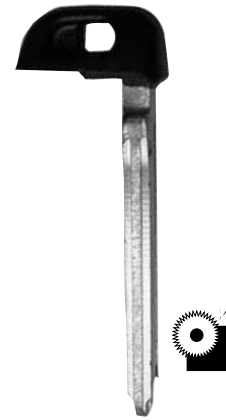

**Ilco No.:** TOY51-P  
**EZ No.:** —  
**Used On:** Toyota Prox  
Emergency Key

**Price:** Contact Ilco  
Distributor

**Packaged:** 1/bag, 5/box

**UPC No.:** 036448238347

**Sales Velocity:** Low

 *Special Key Machine Required*

 *Transponder Key*

# Key News

12-01  
November 2010

These keys are now in inventory

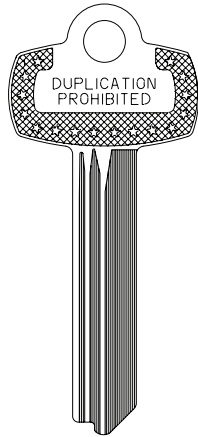

**Ilco No.:** 1A1TB1  
**EZ No.:** —  
**Used On:** Best

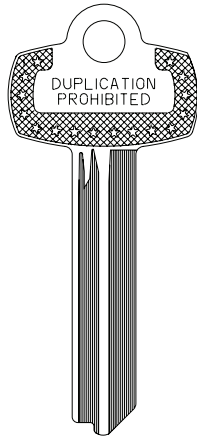

**Ilco No.:** 1A1TC1  
**EZ No.:** —  
**Used On:** Best

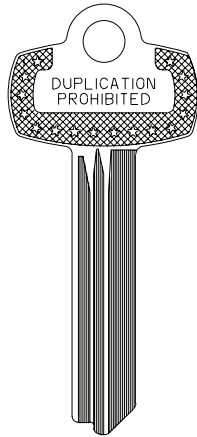

**Ilco No.:** 1A1TD1  
**EZ No.:** —  
**Used On:** Best

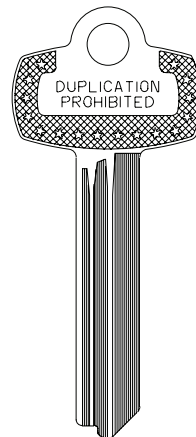

**Ilco No.:** 1A1TE1  
**EZ No.:** —  
**Used On:** Best

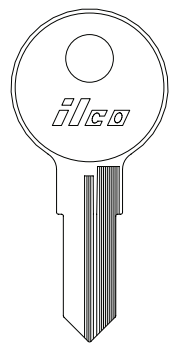

**Ilco No.:** 1676  
**EZ No.:** BAU3  
**Used On:** Bauer

**Price Group:** 5  
**Packaged:** 50/box  
**UPC No.:** 036448236695

**Price Group:** 5  
**Packaged:** 50/box  
**UPC No.:** 036448236817

**Price Group:** 5  
**Packaged:** 50/box  
**UPC No.:** 036448236824

**Price Group:** 5  
**Packaged:** 50/box  
**UPC No.:** 036448236831

**Price Group:** 4  
**Packaged:** 10/bag, 50/box  
**UPC No.:** 036448236701

**Sales Velocity:** Medium

**Sales Velocity:** Medium

**Sales Velocity:** Medium

**Sales Velocity:** Medium

**Sales Velocity:** Medium



A Member of the Kaba Group

Kaba Ilco Corp.

P O Box 2627 (27802)

400 Jeffreys Rd., Rocky Mount, NC 27804

Tel.: (252) 446-3321 • Fax: (252) 446-4702

www.kaba-ilco.com

# Key Blanks

# The Chipless Head

*The latest addition to the Ilco® Modular Key System*



Maximize profits from transponder harvesting with the Ilco Chipless Head.

This unique head design complements the exiting Modular System by utilizing the EB3 blades while enabling you to harvest transponders from miscut, old and/or discarded keys. Transponders are secured in a custom designed carrier that fits into the head.

The  to your success

 A member of the Kaba Group  
[www.kaba-ilco.com](http://www.kaba-ilco.com)

# The Chipless Head

With the Ilco® Modular Key System, harvesting is even more profitable. The EH3C Chipless Head fits all 21 existing Modular Key Blades and one new GM blade (for EH3C head only).

Harvest, recycle, re-chip, recover the transponders (chip or capsule type) from miscut, broken, old and/or discarded keys and place them in the Ilco EH3C head.

By integrating the Chipless Head into the existing Ilco Modular Key System, security professionals can increase the applications of the existing key blades and further reduce their inventory.

The complete Ilco Modular Key System consists of 3 heads and 22 blades. Whether you are cloning, programming or harvesting, the Ilco system covers 95% of the vehicles on the roads today.

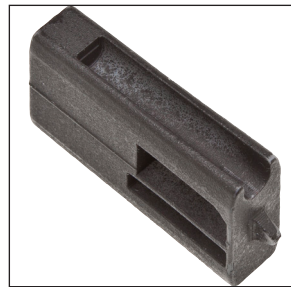
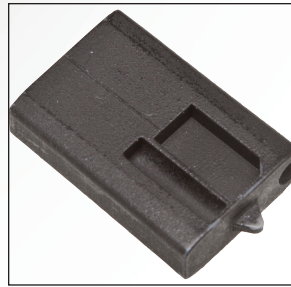

*The Carrier has four custom pockets for specific styles of transponders. This design assures you of accurate positioning of the transponder.*

*EH3C Chipless Head*

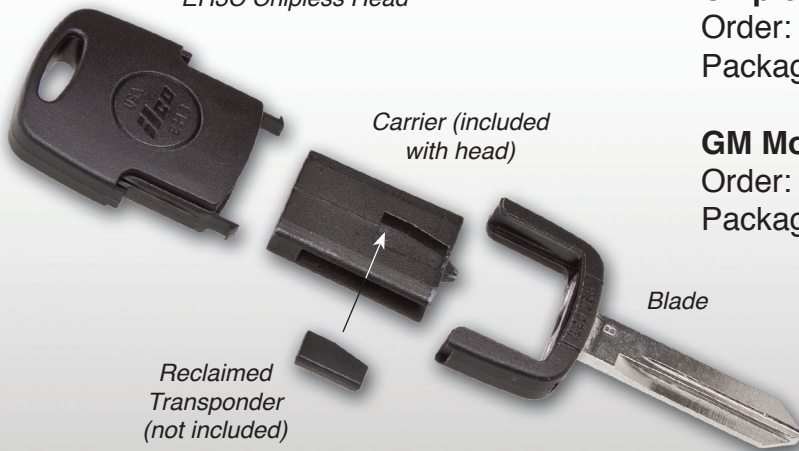

*Carrier (included with head)*

*Blade*

*Reclaimed Transponder (not included)*

## Chipless Head

Order: EH3C

Packaged 5 per bag/25 per box

## GM Modular Chipless Blade (for EH3C only)

Order: EB3-Y-B99 GM Chipless Blade

Packaged 1 per bag/5 per box



Kaba Ilco Corp.  
400 Jeffreys Rd · Rocky Mount, NC 27804  
Phone 800.334.1381 · Fax 252.446.4702  
www.kaba-ilco.com

Form No. 3046/0411



# Llaves Huecas

# Llave con Cabeza Universal

*La Ultima Adición a Sistema  
Modular de Llaves Ilco®*



Maximice sus ganancias utilizando o reutilizando un Transponder en una llave hueca Ilco

El diseño único de la cabeza universal complementa el Sistema Modular utilizando Espadas EB3, permitiéndol evitar desperdicios y ahorrar en caso de un mal corte en la espada, de modo que la Cabeza y el Transponder de una llave nueva o anterior son reutilizables. Incluye una Tableta para los cuatro tipos de Transponder la cual los asegura dentro de la Cabeza Universal.

The  to your success

 A member of the Kaba Group  
[www.kaba-ilco.com](http://www.kaba-ilco.com)



# Cabeza Hueca Universal

Con el Sistema Modular Ilco®, el reutilizar es aún más rentable. La Cabeza Universal EH3C se acopla a las 21 Espadas Modulares y a una nueva espada para aplicaciones GM.

Recupera, recicla o reutiliza los transponders (de tipo chip o capsula) de llaves rotas, mal coradas o desgastadas e insertelos en una Cabeza Universal EH3C.

Con la Adición de la Cabeza Universal al Sistema Modular de Llaves, los profesionales en seguridad tienen más aplicaciones para las espadas existentes, de manera en la que hará más con menos inventario.

El Sistema Modular de Llaves Ilco consiste de 3 cabezas y 22 espadas que le servirán para clonar, programar o reutilizar un transponder. Con el Sistema Ilco podrá cubrir el 95% de los vehículos más comerciales.



*La Tableta contiene cuatro espacios para cada estilo específico de transponder. Su diseño le asegura la correcta posición de cualquiera de los cuatro tipos de transponder*



## Cabeza Universal

Código: EH3C

Empaque 5 por bolsa / 25 por caja

## Espada modular para GM (solo para EH3C)

Código: EB3-Y-B99 GM Chipless Blade

Empaque 1 por bolsa / 5 por caja



Kaba Ilco Corp.  
400 Jeffreys Rd · Rocky Mount, NC 27804  
Phone 800.334.1381 · Fax 252.446.4702  
[www.kaba-ilco.com](http://www.kaba-ilco.com)

Form No. 3046/0411 SP

# Key Blanks

# Ilco<sup>®</sup> Electronic Cloneable Key System



The Ilco<sup>®</sup> Electronic Key system is a modular approach that will accommodate a variety of transponder equipped vehicle applications with a minimum investment. This modular system of a universal head and separate blades offer stock versatility and lower inventory cost.

The  to your success

  
A Member of the Kaba Group  
[www.kaba-ilco.com](http://www.kaba-ilco.com)

# Ilco® Electronic Cloneable Key System

The most expensive component of transponder and electronic keys is the chip or electronics contained in the head. An Ilco electronic key provides the benefit of lower inventory cost. One head, 14 blades covers 17 makes and over 190 models.

- Clone previously “un-cloneable” transponder keys at the counter using Ilco electronic keys and a RW4 or Ilco EZ®-Clone\* equipment (no PC, internet connection, or software purchase required).
- Eliminate the need for two functioning keys that are required for On-Board Programming.
- Key head contains a replaceable, lithium<sup>†</sup> battery (CR1632).
- Mis-cuts, no problem, simply discard the blade, reuse the head.
- Modern, sleek, two-part key design, proportionally sized to original key.
- Made in the USA



Visit the Ilco web site often for the latest references, manuals and guides.

\* RW3 owners will need a PC with Tex Cloning software installed. This will not be required if your RW3 has been “factory upgraded”. RW2 owners must have a Tex-Code Advanced module and a PC with Tex Cloning software installed.

<sup>†</sup>Ilco recommends battery replacement every two years to ensure trouble free operation.



**Electronic Key Cloning Assortment** includes (5) EH3 key heads, (4) A-Y160, (3) B-H72, (4) D-H84, (3) E-TOY43, (1) C-H73, (2) H-NI02, (1) J-MAZ24, (2) K-MIT8, (2) L-MIT9, (2) P-SUB4, and (1) M-MIT14.

Assortment is packed in a plastic case w/ adjustable compartments.

Order no: EKC-1

Ilco Electronic Keys are available “head only”, “blade only” or as a “complete” (head and blade) key.

## **EH3 Universal Head**

Packed 1 per poly bag/5 per box

## **Blades**

Order by key number followed by an “EB” suffix  
Packed 1 per poly bag/5 per box

## **Complete Key (Head & Blade)**

Order by key number followed by “EK3” suffix  
Packed 1 per poly bag, 5 per box

For available blades and complete keys, refer to the latest application guide.



Kaba Ilco Corp.  
400 Jeffreys Road · Rocky Mount, NC 27804  
Phone 800.334.1381 · Fax 252.446.4702  
www.kaba-ilco.com

Form #2954/0908

**Key Blanks**

# EK3 Disassembly Tool



This handy tool disassembles the two-piece electronic keys quickly and easily; without damaging key components. Works with popular two-piece electronic keys featuring the “snap tabs”.

The  to your success

 A member of the Kaba Group  
[www.kaba-ilco.com](http://www.kaba-ilco.com)



# EK3 Disassembly Tool

You no longer have to be concerned about damaging the components of electronic two-part keys while trying to disassemble them. The handy EK3 Disassembly Tool is a compact, affordable tool that will separate the two-piece keys in seconds.

It is currently the only disassembly tool on the market!

- Quickly disassembles two- piece electronic keys having “snap tabs”
- No damage to key components
- Made in the USA
- Makes battery replacement easy



## Specifications:

**Dimensions:** 2.25"L x 2.75"W x 3.25"H  
(5.7cm x 7cm x 8.3cm)

**Weight:** 1 lb. (.45 kg)

**Order No:** EK3 Disassembly Tool

It's as easy as 1-2-3



1. Insert key



2. Tighten knob



3. Flip lever to remove head



Kaba Ilco Corp.  
400 Jeffreys Road · Rocky Mount, NC 27804  
Phone 800.334.1381 · Fax 252.446.4702  
[www.kaba-ilco.com](http://www.kaba-ilco.com)

Form # 2987/0709

# Key Blanks

# Shell Keys



Replacement shells/cases allow you to repair your customer's Chrysler, Toyota or Lexus integrated remote keys. Simply remove the electronics from the customer's existing key and place them in the new shell. Then duplicate the blade and you're done. It is just that easy. Sorry, the electronics are not included.

# Shell Keys

A new integrated remote key is expensive. These shells permit you to offer your customers a much less expensive alternative. You can remove the electronic board from the broken key, place it in this new shell, duplicate the key and have the customer on their way in minutes while saving them big money and adding to your profits.

- Replacement shells cost only a small fraction of what a new key would cost at the dealership
- Replace broken key blades or cracked shells
- No programming is needed as you are using the customer's existing electronic board that you harvest from their damaged key.
- Shells only – no electronics included

Replacement key shells are currently available for the Chrysler, Toyota and Lexus products shown below.



Chrysler  
3-Button Type 1  
Shell Complete

Chrysler  
3-Button Type 2  
Shell Complete

Chrysler  
4-Button Shell  
Complete

Chrysler  
6-Button Shell  
Complete

TOY40 3-button  
Shell Complete

TOY43 3-Button  
Shell Complete

TOY48 3-Button  
Shell Complete



Kaba Ilco Corp.  
400 Jeffreys Road · Rocky Mount, NC 27804  
Phone 800.334.1381 · Fax 252.446.4702  
[www.kaba-ilco.com](http://www.kaba-ilco.com)

Form # 2987/0709

Key Blanks

# Personali-Keys™

A Decorated Key for  
Every Personality



A Personali-Key from Ilco is more than just an ordinary key.

These “cool”, durable chip resistant, enamel decorated keys have proven consumer appeal! Personali-Keys are available in three, top selling residential keys (Kwikset, Schlage & Baldwin and Weiser brands).

The  to your success

 A member of the Kaba Group  
[www.kaba-ilco.com](http://www.kaba-ilco.com)



# Follow these easy steps to order Personali-Keys.

## 1. Select Keyway

KW11 (Kwikset® and Titan® Brand locks)

SC1 (Schlage® and Baldwin® Brand locks)

WR5 (Weiser® Brand locks)

## 2. Select Design

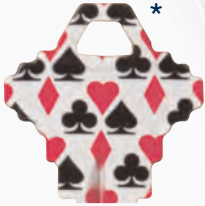

Cards \*



Cherries \*



Clover \*



Flip-Flops \*



Hearts \*



Real Tree



Hibiscus \*



Martini \*



Monkey \*



Music \*



Paw \*



US Flag



CanFlag



Mexico



Puerto Rico



Fleur De Lys



Leopard



Smileys

## 3. How to Order

Personali-Keys are available in complete assortments or as open stock

OPEN STOCK is available two ways: polybags with all of the same design or assorted designs.

- 10 each of the same design and keyway per polybag  
5 polybags (50 keys) per box.

*Ordering Example*

*KW11-SMILEYS (keyway-design)*

- 10 keys, 1 each of 10 designs per polybag. Designs included are noted above with asterisk. 5 polybags (50 keys) per box.

*Ordering Example*

*KW11-7MIX (keyway - MIXED DESIGNS)*

ASSORTMENTS - Each assortment contains 40 keys, a self-standing display board and a colorful POP display backer card.

TA224-7MIX Standard Assortment

Contains 20 each KW11 mixed designs and 20 each SC1 mixed designs.

TA224CN-7MIX Canadian Assortment

Contains 30 each WR5 mixed designs and 10 each SC1 mixed designs.

Custom or Retired Designs are available by special order. Minimums and special pricing may apply to orders. Contact your Ilco distributor for details.

Our unique decorating process produces a finish that is chip resistant during the duplicating process and supplies the consumer with a durable decorative key. Over 100 years of experience goes into the Ilco® key blank line. Made in the USA.



Kaba Ilco Corp.  
400 Jeffreys Road • Rocky Mount, NC 27804  
Phone 800.334.1381 • Fax 252.446.4702  
www.kaba-ilco.com

Form #2915/E/0507

# Key Blanks

# US Armed Forces



These large head keys feature the official authorized emblem of the following U. S. Armed Forces branches: Air Force, Army, Coast Guard, Marines or Navy, PLUS the U. S. Flag. These keys honoring our Armed Forces are sure to be a hit as well as promote patriotism.

The  to your success



A member of the Kaba Group  
[www.kaba-ilco.com](http://www.kaba-ilco.com)

# Follow these easy steps to order Armed Forces Keys.

## 1. Select Keyway

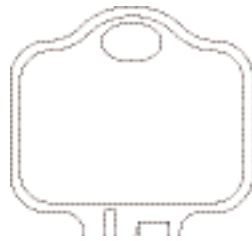

KW11  
(Kwikset® and Titan®  
Brand locks)

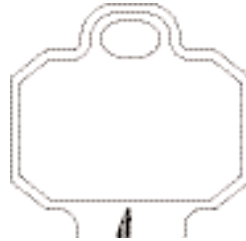

SC1  
(Schlage® and Baldwin®  
Brand locks)

## 2. Select the Design you want.



AIR FORCE



ARMY



COAST GUARD



MARINES



NAVY



FLAG

## 3. How to Order

### POLYBAGS

- 5 each of the same design and keyway per polybag.  
50 keys per box.

*Ordering Example:  
KW-MARINES (keyway-design)*

### ASSORTMENTS

- KW11 and SC1 Keyways (fits Kwikset, Titan, Schlage and Baldwin) Assorted Designs. 5 each of 6 designs in two keyways (60 total keys). Includes acrylic merchandiser with attention grabbing graphics.

Order No. TA224AF-00-8X

Custom Designs are available by special order. Minimums and special pricing may apply to orders. Contact your Ilco distributor for details.

Our unique decorating process produces a finish that is chip resistant during the duplicating process and supplies the consumer with a durable, decorative key. Over 100 years of experience goes into the Ilco® key blank line. Made in the USA.



Kaba Ilco Corp.  
400 Jeffreys Road · Rocky Mount, NC 27804  
Phone 800.334.1381 · Fax 252.446.4702  
www.kaba-ilco.com

Form # 2928/E/0907



Key Blanks

# Critter Keys

Photographic Animal Kingdom  
Keys



Critter Keys appeal to critter lovers everywhere! These keys feature high-resolution photographic images plus a durable finish. An additional feature is the over size bow, making these keys easy to identify and locate on a ring. Critter keys are available in the most popular residential keyways (Kwikset®, Titan®, Baldwin®, Schlage® and Weiser® brands).

The  to your success



A member of the Kaba Group  
[www.kaba-ilco.com](http://www.kaba-ilco.com)

# Follow these easy steps to order Critter Keys.

## 1. Select Keyway

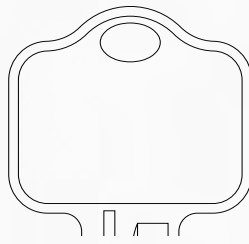

KW11  
(Kwikset® and Titan®  
Brand locks)

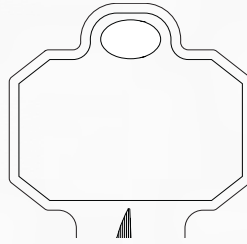

SC1  
(Schlage® and Baldwin®  
Brand locks)

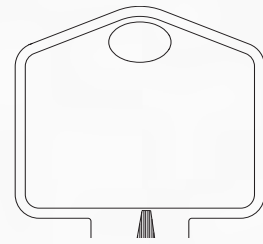

WR5  
(Weiser® Brand locks)

## 2. Select Critter



BIRD



DOG7



DOLPHIN



PANDA



CAT7

## 3. How to Order

### POLYBAGS

- 10 each of the same design and keyway per polybag.  
5 polybags (50 keys) per box.

*Ordering Example:*  
**KW11-DOG (keyway-critter)**

### ASSORTED

- 2 each of five designs per polybag.  
5 polybags (50 keys) per box.

*Ordering Example:*  
**KW11-CRITTERS7 (keyway-CRITTERS7)**

### ASSORTMENTS

- KW11 and SC1 Keyways (fits Kwikset, Titan, Schlage and Baldwin) Assorted Designs. 6 each of 5 Critter designs in Kwikset and 4 each of 5 Critter designs in Schlage (50 total keys). Includes acrylic merchandiser with attention grabbing graphics.

**Order No. TA224-CRITTERS7**

- WR5 and SC1 Keyways (fits Weiser, Schlage and Baldwin) Assorted Designs. 6 each of 5 Critter designs in Weiser and 4 each of 5 Critter designs in Schlage (50 total keys). Includes acrylic merchandiser with attention grabbing graphics.

**Order No. TA224CN-CRITTERS7**

Custom or Retired Designs are available by special order. Minimums and special pricing may apply to orders. Contact your Ilco distributor for details.

Our unique decorating process produces a finish that is chip resistant during the duplicating process and supplies the consumer with a durable, decorative key. Over 100 years of experience goes into the Ilco® key blank line. Made in the USA.



Kaba Ilco Corp.  
400 Jeffreys Road • Rocky Mount, NC 27804  
Phone 800.334.1381 • Fax 252.446.4702  
www.kaba-ilco.com

Form #2914/E/0507

# Keys for the Cause



Combine this universally recognized ribbon shape with a fully functional key, add a long lasting finish and consumers have a unique, symbolic way to show their personal commitment to the cause.



# Keys for the Cause

When you purchase these globally recognized ribbon keys to offer to your customers, Kaba Ilco Corp. donates a portion (25%) of the sales revenue to support representative non-profit organizations.

- **Yellow - U. S. Armed Forces**
- **Pink - Breast Cancer Research**
- **Red - AIDS/Medical Research**

If you would like to receive information regarding our recent contributions, please contact us through our web site.



Ribbon Key is Patent Pending

## Follow these easy steps to order:

### 1. Select Keyway

KW11 (Kwikset® and Titan® Brand locks)  
SC1 (Schlage® and Baldwin® Brand locks)  
WR5 (Weiser® Brand locks)

### 2. Select the Ribbon



Pink Ribbon  
(same both sides)



Red Ribbon  
(same both sides)



Yellow Ribbon  
(each side shown)

### 3. How to Order

OPEN STOCK is available packaged 5 each of the same design and keyway per polybag. 10 polybags (50 keys) per box.

**Ordering Example**  
**KW11-Red Ribbon (keyway-pattern)**

ASSORTMENT- TA224-RIBBONS  
Contains 15 each KW11 and 5 each SC1 Ribbon

Keys of the three designs (60 keys total), plus an attention grabbing Point of Sale display.

TA224CN-RIBBONS Contains 20 each of the Pink and Red ribbon keys in the WR5 keyway and 10 each of the Pink and Red Ribbon Keys in the SC1 keyway (60 keys total), plus an attention grabbing Point of Sale display.

For Your Cause:

Custom ribbon colors or designs are available by special order. Minimums and special pricing may apply to these orders. Contact your Kaba Ilco Corp. distributor for details.

Our unique decorating process produces a finish that is chip resistant during the duplicating process and supplies the consumer with a durable decorative key. Over 100 years of experience goes into the Ilco key blank line. Made in the USA.



Kaba Ilco Corp.  
400 Jeffreys Road · Rocky Mount, NC 27804  
Phone 800.334.1381 · Fax 252.446.4702  
www.kaba-ilco.com

Form # 2911/E/0506 Revised

# Key Blanks

## College Keys

Students, Faculty, Alumni and Fans will sport these keys with pride!



Students, alumni and fans will be thrilled with these college logo/mascot keys. The oversized bow (head) of the key will stand out on their key ring/chain, making it easy to pick out the right key. The decoration is durable and will remind people of their favorite team each time they look at or use their key.

The  to your success

 A member of the Kaba Group  
[www.kaba-ilco.com](http://www.kaba-ilco.com)



# Follow these easy steps to order Collegiate Personal-Keys®.

## 1. Select Keyway

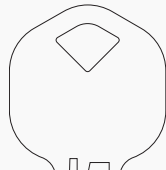

KW  
(Kwikset® and Titan®  
Brand locks)

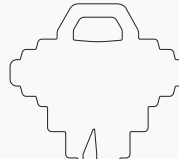

SC1  
(Schlage® and Baldwin®  
Brand locks)

## 2. Select School

Choose from the list of colleges shown. Each key has logo on one side and mascot on the other.

Alabama (Crimson Tide)

Auburn (Tigers)

Clemson (Tigers)

Duke (Blue Devils)

Florida (Gators)

Florida State (Seminoles)

Georgia (Bull Dogs)

Georgia Tech (Yellow Jackets)

Kansas (Jayhawks)

Kansas State (Wildcats)

Kentucky (Wildcats)

Louisville (Cardinals)

Louisiana State University (Tigers)

Maryland (Terrapins)

Miami (Hurricanes)

Michigan (Wolverines)

Michigan State (Spartans)

North Carolina (Tar Heels)

North Carolina State (Wolfpack)

Ohio State (Buckeyes)

Oklahoma (Sooners)

Oregon State (Beavers)

Penn State (Nittany Lions)

Pittsburgh (Panthers)

South Carolina (Gamecocks)

Tennessee (Volunteers)

Texas (Longhorns)

Texas A & M (Aggies)

University of California, LA (Bruins)

University of Southern California (Trojans)

Virginia (Cavaliers)

Virginia Tech (Hokies)

## 3. How to Order

College Keys are available either loose in polybags or individually carded.

### POLYBAGS

- 10 each of the same pattern and keyway per polybag  
5 polybags (50 keys) per box.

*Ordering Example*

*CK-KW-UCLA (CK-keyway-design)*

### MERCHANDISERS (sold separately)

- Collegiate Key Display - acrylic merchandiser with 12 hooks  
Order No. 511-00-8X

### INDIVIDUALLY CARDED

- 1key/card, 5 cards/polybag  
5 polybags (25 keys) per box.

*Ordering Example*

*CK-KCKW-UCLA (CK-KCkeyway-design)*

Our unique decorating process produces a finish that is chip resistant during the duplicating process and supplies the consumer with a durable decorative key. Over 100 years of experience goes into the Ilco® key blank line. Made in the USA.



Kaba Ilco Corp.

400 Jeffreys Road • Rocky Mount, NC 27804

Phone 800.334.1381 • Fax 252.446.4702

www.kaba-ilco.com

Form #2964/0112 REV

# Key Blanks

## Drive Impulse Sales with Carded Personali-Key® Key Blanks



Merchandise an assortment of these popular designs at the key center, near the checkout or the lockset aisle. This decorated key program from Ilco® is sure to get attention and increase impulse sales!

The  to your success

 A member of the Kaba Group  
[www.kaba-ilco.com](http://www.kaba-ilco.com)

This attractive card emphasizes each Personal-Key® key design or pattern, making it more attractive to the consumer. The compact card is the perfect size for creating an extensive assortment of Personal-Key key blanks in a minimum amount of space.

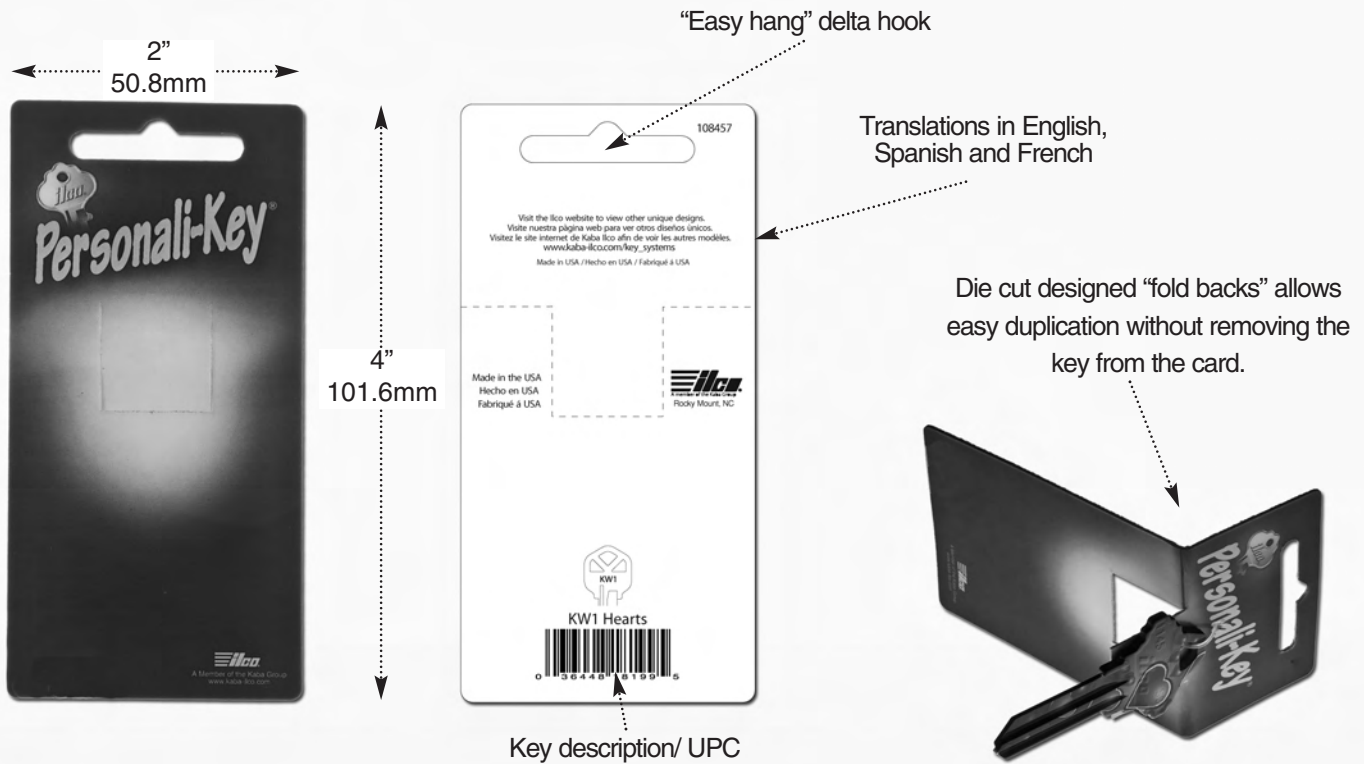

## Follow these easy steps to order:

1. Select the keyway/design
2. Add the prefix "KC" to the product number

**Ordering Example**  
**keyway and design**  
**KW1-SMILEYS**  
**carded versions - add the prefix "KC"**  
**KCKW1-SMILEYS**

This card design is available for non-licensed decorated keys. Licensed products are also available carded however, the graphics and size are specialized to meet license requirements.

Retired and customized designs are available by special order. Minimums and special pricing may apply. Contact your Kaba Ilco Corp. distributor for details.

Our unique decorating process produces a finish that is chip resistant during the duplicating process and supplies the consumer with a durable decorative key. Over 100 years of experience goes into the Ilco® key blank line..



Kaba Ilco Corp.  
 400 Jeffreys Road · Rocky Mount, NC 27804  
 Phone 800.334.1381 · Fax 252.446.4702  
 www.kaba-ilco.com

Form # 2965/0209

Key Blanks

# Canadian Armed Forces Yellow Ribbon Keys



Combine this universally recognized ribbon shape with a fully functional key with a long lasting finish and consumers have a unique, symbolic way to show their personal commitment to the cause.

The  to your success



A member of the Kaba Group  
[www.kaba-ilco.com](http://www.kaba-ilco.com)



# Canadian Armed Forces Yellow Ribbon Keys

In response to consumer demand, these two new sku's have been added to the popular line of ribbon keys..



*Ribbon Key is  
Patent Pending*

Follow these easy steps to order:

## 1. Select Keyway

WR5 (Weiser® Brand locks)

## 2. Select the Version

English or French



Yellow Ribbon (English)  
(each side shown)

WR5-CN-YELLOW RIBBON

Yellow Ribbon (French)  
(each side shown)

WR5-CN-FR-YELLOW RIBBON

*NOTE: Canadian Yellow Ribbon key is currently available  
only in WR5 keyway*

## 3. How to Order

OPEN STOCK is available packaged 5 each of the same design and keyway per polybag. 10 polybags (50 keys) per box.

### *Ordering Example*

*WR5-CN-YELLOW RIBBON(keyway-pattern)*

For Your Cause:

Custom ribbon colors or designs are available by special order. Minimums and special pricing may apply to these orders. Contact your Kaba Ilco Corp. distributor for details.

Our unique decorating process produces a finish that is chip resistant during the duplicating process and supplies the consumer with a durable decorative key. Over 100 years of experience goes into the Ilco key blank line. Made in the USA.



Kaba Ilco Corp.  
400 Jeffreys Road · Rocky Mount, NC 27804  
Phone 800.334.1381 · Fax 252.446.4702  
www.kaba-ilco.com

Form #2948/0608

Key Blanks

# Harley-Davidson® Logo Keys



Whether your target customers are Harley® riders or simply wish they were, offer them house keys that bear the official licensed logo of Harley-Davidson motorcycles.

The  to your success



A member of the Kaba Group  
[www.kaba-ilco.com](http://www.kaba-ilco.com)

# Harley-Davidson® Logo Keys

Harley-Davidson is universally recognized and it is one of the most sought after design accessories in retail merchandise. Promote these in the lockset aisle or at the checkout to increase awareness and your key center profits.



Harley Key

Harley Flame Key

## Follow these easy steps to order:

### 1. Select Keyway

KW (Kwikset® & Titan® brand locks)

SC1 (Schlage® brand locks)

WR5 (Weiser® brand locks)

### 2. How to Order

OPEN STOCK is available packaged 5 polybags/50 keys per box.

INDIVIDUALLY CARDED are available packaged 5 polybags/50 per box. Add the prefix "KC" to item.

#### **PRODUCT NUMBERS**

**KW-HARLEY**

**SC1-HARLEY**

**WR5HARLEY**

**KW-HARLEY FLAME**

**SC1-HARLEY FLAME**

**WR5-HARLEY FLAME**

#### **PRODUCT NUMBERS**

**KCKW-HARLEY**

**KCSC1-HARLEY**

**KCWR5HARLEY**

**KCKW-HARLEY FLAME**

**KCSC1-HARLEY FLAME**

**KCWR5-HARLEY FLAME**

Our unique decorating process produces a finish that is chip resistant during the duplicating process and supplies the consumer with a durable decorative key. Over 100 years of experience goes into the Ilco key blank line. Made in the USA.

Harley-Davidson and Harley are registered trademarks of Harley-Davidson, Inc.  
Ilco is a registered trademark of Kaba Ilco Corp.



Kaba Ilco Corp.  
400 Jeffreys Road · Rocky Mount, NC 27804  
Phone 800.334.1381 · Fax 252.446.4702  
www.kaba-ilco.com

Form #2970/0109

Key Blanks

# MLB TeamKeys®



Show your MLB® team spirit on a house or office key. These "fan pleasing", oversized keys feature the vibrant team colors and logos that will make your statement.

All MLB teams are available and are shown on the reverse side of this flyer.

The  to your success



A member of the Kaba Group  
[www.kaba-ilco.com](http://www.kaba-ilco.com)



# MLB TeamKeys®

Follow these easy steps to order:

## 1. Select Keyway

KW (Kwikset® & Titan® brand locks)

SC1 (Schlage® brand locks)

## 2. Select the Team



ANGELS



ASTROS



ATHLETICS



BRAVES



BREWERS



CARDINALS



CUBS



D BACKS



DODGERS



GIANTS



INDIANS



JAYS



MARINERS



MARLINS



METS



NATIONALS



ORIOLES



PADRES



PHILLIES



PIRATES



RANGERS



RAYS



RED SOX



REDS



ROCKIES



ROYALS



TIGERS



TWINS



WHITE SOX



YANKEES

## 3. How to Order

OPEN STOCK is available packaged 10 each of the same design and keyway per polybag. 5 polybags (50 keys) per box.

**Ordering Example**  
**SC1-MLB-YANKEES( keyway-MLB-team)**

INDIVIDUALLY CARDED are available packaged 5 each of the same design and keyway per polybag. 5 polybags (25 keys) per box. Add the prefix "KC" to item.

**Ordering Example**  
**KCSC1-MLB-YANKEES (keyway-MLB-team)**

Our unique decorating process produces a finish that is chip resistant during the duplicating process and supplies the consumer with a durable decorative key. Over 100 years of experience goes into the Ilco key blank line. Made in the USA.

Ilco is a registered trademark of Kaba Ilco Corp. NFL is a registered trademark of the National Football League. TeamKeys is a registered trademark of United Performance International Marketing Incorporated.



Kaba Ilco Corp.  
400 Jeffreys Road · Rocky Mount, NC 27804  
Phone 800.334.1381 · Fax 252.446.4702  
www.kaba-ilco.com

Form #2982/0609

# Key Blanks

# NBA<sup>®</sup> TeamKeys<sup>®</sup>



NBA<sup>®</sup> fans appreciate these oversize keys for home or office. Team spirit comes alive with vivid team colors and logos. Available NBA<sup>®</sup> teams are shown on the reverse of this flyer.

The  to your success



A member of the Kaba Group  
[www.kaba-ilco.com](http://www.kaba-ilco.com)

# NBA TeamKeys®

Follow these easy steps to order:

## 1. Select Keyway

KW (Kwikset® & Titan® brand locks)

SC1 (Schlage® brand locks)

## 2. Select the Team



CELTICS



BULLS



CAVALIERS



MAVERICKS



NUGGETS



ROCKETS



LAKERS



HEAT



KNICKS



MAGIC



SUNS



SPURS

## 3. How to Order

OPEN STOCK is available packaged 10 each of the same design and keyway per polybag. 5 polybags (50 keys) per box.

**Ordering Example**  
SC1-NBA-CELTICS (keyway-NBA-team)

INDIVIDUALLY CARDED are available packaged 5 each of the same design and keyway per box. Add the prefix "KC" to item.

**Ordering Example**  
KCSC1-NBA-CELTICS (keyway-NBA-team)

Our unique decorating process produces a finish that is chip resistant during the duplicating process and supplies the consumer with a durable decorative key. Over 100 years of experience goes into the Ilco key blank line. Made in the USA.

Ilco is a registered trademark of Kaba Ilco Corp. NBA is a registered trademark of the National Basketball Association. TeamKeys is a registered trademark of United Performance International Marketing Incorporated.



Kaba Ilco Corp.  
400 Jeffreys Road · Rocky Mount, NC 27804  
Phone 800.334.1381 · Fax 252.446.4702  
www.kaba-ilco.com

Form No. 3035/1010



# Key Blanks

# NFL TeamKeys®



Show your NFL® team spirit on a house or office key. These "fan pleasing", oversize keys feature the vibrant team colors and logos that will make your statement.

All NFL teams are available and are shown on the reverse side of this flyer.

The  to your success



A member of the Kaba Group  
[www.kaba-ilco.com](http://www.kaba-ilco.com)

# NFL TeamKeys®

Follow these easy steps to order:

## 1. Select Keyway

KW (Kwikset® & Titan® brand locks)

SC1 (Schlage® brand locks)

## 2. Select the Team



## 3. How to Order

OPEN STOCK is available packaged 10 each of the same design and keyway per polybag. 5 polybags (50 keys) per box.

**Ordering Example**  
**SC1-NFL-COWBOYS (keyway-NHL-team)**

INDIVIDUALLY CARDED are available packaged 5 each of the same design and keyway per polybag. 5 polybags (25 keys) per box. Add the prefix "KC" to item.

**Ordering Example**  
**KCSC1-NFL-COWBOYS (keyway-NHL-team)**

Our unique decorating process produces a finish that is chip resistant during the duplicating process and supplies the consumer with a durable decorative key. Over 100 years of experience goes into the Ilco key blank line. Made in the USA.

Ilco is a registered trademark of Kaba Ilco Corp. NFL is a registered trademark of the National Football League. TeamKeys is a registered trademark of United Performance International Marketing Incorporated.



Kaba Ilco Corp.  
400 Jeffreys Road · Rocky Mount, NC 27804  
Phone 800.334.1381 · Fax 252.446.4702  
www.kaba-ilco.com

Form #2968/0109

# Key Blanks

# NHL TeamKeys®



NHL® fans appreciate these oversize keys for home or office. Team spirit comes alive with vivid team colors and logos. Available NHL teams are shown on the reverse of this flyer.

The  to your success



A member of the Kaba Group  
[www.kaba-ilco.com](http://www.kaba-ilco.com)



# NHL® TeamKeys®

Follow these easy steps to order:

## 1. Select Keyway

WR5 (Weiser® brand locks)

KW (Kwikset® & Titan® brand locks)

SC1 (Schlage® brand locks)

## 2. Select the Team



## 3. How to Order

OPEN STOCK is available packaged 10 each of the same design and keyway per polybag. 5 polybags (50 keys) per box.

**Ordering Example**  
**WR5-NHL-CANADIENS(keyway-NHL-team)**

INDIVIDUALLY CARDED are available packaged 5 each of the same design and keyway per polybag. 5 polybags (25 keys) per box. Add the prefix "KC" to item.

**Ordering Example**  
**KCWR5-NHL-CANADIENS(keyway-NHL-team)**

Our unique decorating process produces a finish that is chip resistant during the duplicating process and supplies the consumer with a durable decorative key. Over 100 years of experience goes into the Ilco key blank line. Made in the USA.

Ilco is a registered trademark of Kaba Ilco Corp. NHL is a registered trademark of the National Hockey League. TeamKeys is a registered trademark of United Performance International Marketing Incorporated.



Kaba Ilco Corp.  
400 Jeffreys Road · Rocky Mount, NC 27804  
Phone 800.334.1381 · Fax 252.446.4702  
www.kaba-ilco.com

Form #2957/0109

# Key Accessories

## The Jacket Auto Remote Cover™

*Protect expensive auto remote  
FOBS with affordable, stylish,  
snug fitting covers*



Automotive fobs are expensive to replace! Protect them with stylish remote fob jackets. Constructed of Silicone rubber, The Jacket Auto Remote Cover™ provides a custom fit for a variety of factory remotes. The affordable price point makes this a perfect choice for consumer impulse purchase.

The  to your success

 A member of the Kaba Group  
[www.kaba-ilco.com](http://www.kaba-ilco.com)



# The Jacket Auto Remote Cover™

The Jacket Auto Remote Cover™ provides protection for expensive automotive remote FOBS from wear, scratches and breaks. Jackets are made of lightweight silicone, much like the protective cell phone covers that are popular with consumers.

Unlike competitive products that are limited to a few generic styles, The Jacket has been designed to provide a “snug”, custom fit for FOBS.

20 different styles are available, each in 3 popular colors (Black, Blue, Pink). The Jacket Auto Remote Cover™ may be purchased individually, in a box containing 6 pieces (same style and color), or choose from three assortments.

## Available Colors



**Ordering Example:**  
**Jacket part number - Color**  
**DDGA55-BLUE**

## OPEN STOCK:

Clam Shell Package, 1 per pack, 6 per carton.



## ASSORTMENTS:

### TA-JKT-00-41 Complete Assortment

Contains 60 total; 3 each (1 black, 1 blue and 1 pink) of 20 styles (foreign and domestic). Includes a 3-sided, rotating acrylic display rack with header.

### TA-JKTD-00-41 Domestic Assortment

Contains 30 total; 3 each (1 black, 1 blue and 1 pink) of 10 styles for various Buick, Cadillac, Chevrolet, Chrysler, Dodge, Ford, GMC, Jeep, Lincoln, Mercury, Mazda, Oldsmobile, Pontiac and Saturn FOB styles. Includes an acrylic display rack with header.

### TA-JKTI-00-41 International Assortment

Contains 30 total; 3 each (1 black, 1 blue and 1 pink) of 10 styles for various Honda, Hyundai, Infiniti, Kia, Lexus, Nissan, Scion and Toyota FOB styles. Includes an acrylic display rack with header.

Application	Style	Part No.	Application	Style	Part No.
Chrysler/Dodge/Jeep	4 Button IRKE	DDGA44	Honda	3 Button IRKE	HNDAD33
Chrysler/Dodge/Jeep	3 Button IRKE	DDGA55	Honda	4 Button IRKE	HNDAD44
Chrysler/Dodge/Jeep	4-7 Button Fobik	DDGA66	Hyundai/Kia	3 Button RKE	HYKIK23
Ford/Lincoln/Mazda/ Mercury	3 Button RKE	FRDB13	Lexus/Toyota	3 Button IRKE	LXUSI23
Ford/Lincoln/Mazda/ Mercury	4 Button IKT	FRDB34	Nissan/Infiniti	3 Button RKE	NSSNF13
Ford/Lincoln/Mercury	4 Button RKE	FRDB24	Nissan/Infiniti	4 Button RKE	NSSNF24
GM-Buick/Cadillac/Chevrolet/ GMC/Hummer/Pontiac/Saturn	3 Button RKE	GMC13	Nissan/Infiniti	4 Button PROX	NSSNF44
GM-Buick/Cadillac/Chevrolet/ GMC/Pontiac/Saturn	4 Button RKE	GMC24	Toyota/Lexus/Pontiac	3 Button RKE	TOYTAG23
GM-Buick/Cadillac/Chevrolet/ GMC/Pontiac/Saturn	4 Button RKE	GMC34	Toyota/Pontiac	4 Button IRKE	TOYTAG64
GM-Buick/Cadillac/Chevrolet/ GMC/Pontiac/Saturn	5 Button RKE	GMC55	Toyota/Scion	2 Button RKE	TOYTAG12

\* RKE = Remote Keyless Entry, IRKE=Integrated Remote Keyless Entry, PROX=Proximity



Kaba Ilico Corp.  
 400 Jeffreys Rd • Rocky Mount, NC 27804  
 Phone 800.334.1381 • Fax 252.446.4702  
 www.kaba-ilico.com

Form No. 3043/0211

# Accesorios

## La Funda de Silicon Cubierta de Controles™

*Proteje los costosos controles  
FOBS con una cubierta estética,  
que se ajusta perfectamente*



¡Los Fobs automotrices son costosos! Protejalos con las fundas de silicon para fobs. Hechas de goma de Silicon, La Funda de silicon cubierta de controles proporciona ajuste adecuado a una variedad de controles. Su precio accesible lo hace una eleccion perfecta para impulsar su compra por el consumidor.

# La Funda de Silicon Cubierta de Controles™

La Cubierta de Controles da protección a los remotos automotrices y Fobs del uso diario, rayones y roturas. Las cubiertas estan hechas de silicon ligero, más resistente que las cubiertas de los celulares que son muy populares para los clientes.

A diferencia de los productos de la competencia competencia que se limitan a pocos modelos, La cubierta fue diseñada para más modelos.

20 estilos diferentes, 3 colores populares (Negro, Azul y Rosa). La cubierta se puede comprar en forma individual, por caja con seis piezas (del mismo estilo y color), o escoger de alguno de los tres surtidos.

## Colores Disponibles



ROSA AZUL NEGRO

**EJEMPLO PARA ORDENAR:**  
Cubierta Numero - Color  
**DDGA55-AZUL**

## PRESENTACIONES

1 por empaque, 6 por caja.



## SURTIDOS

### TA-JKT-00-41 Surtido Completo

Contiene 60 en total; 3 de cada uno (negro, azul y rosa) de 20 estilos (casero e internacional.) Incluye un exhibidor acrilico rotatable con 3 caras.

### TA-JKTD-00-41 Surtido Casero

Contiene 30 en total; 3 de cada uno (negro, azul y rosa) de 10 estilos para los Buick, Cadillac, Chevrolet, Chrysler, Dodge, Ford, GMC, Jeep, Lincoln, Mercury, Mazda, Oldsmobile, Pontiac y Saturn. Incluye un exhibidor acrilico con cabecera.

### TA-JKTI-00-41 Surtido Internacional

Contiene 30 en total; 3 de cada uno (negro, azul y rosa) de 10 estilos para los Honda, Hyundai, Infiniti, Kia, Lexus, Nissan, Scion y Toyota. Incluye un exhibidor acrilico con cabecera.

Application	Style	Part No.	Application	Style	Part No.
Chrysler/Dodge/Jeep	4 Button IRKE	DDGA44	Honda	3 Button IRKE	HNDAD33
Chrysler/Dodge/Jeep	3 Button IRKE	DDGA55	Honda	4 Button IRKE	HNDAD44
Chrysler/Dodge/Jeep	4-7 Button Fobik	DDGA66	Hyundai/Kia	3 Button RKE	HYKIK23
Ford/Lincoln/Mazda/ Mercury	3 Button RKE	FRDB13	Lexus/Toyota	3 Button IRKE	LXUSI23
Ford/Lincoln/Mazda/ Mercury	4 Button IKT	FRDB34	Nissan/Infiniti	3 Button RKE	NSSNF13
Ford/Lincoln/Mercury	4 Button RKE	FRDB24	Nissan/Infiniti	4 Button RKE	NSSNF24
GM-Buick/Cadillac/Chevrolet/ GMC/Hummer/Pontiac/Saturn	3 Button RKE	GMC13	Nissan/Infiniti	4 Button PROX	NSSNF44
GM-Buick/Cadillac/Chevrolet/ GMC/Pontiac/Saturn	4 Button RKE	GMC24	Toyota/Lexus/Pontiac	3 Button RKE	TOYTAG23
GM-Buick/Cadillac/Chevrolet/ GMC/Pontiac/Saturn	4 Button RKE	GMC34	Toyota/Pontiac	4 Button IRKE	TOYTAG64
GM-Buick/Cadillac/Chevrolet/ GMC/Pontiac/Saturn	5 Button RKE	GMC55	Toyota/Scion	2 Button RKE	TOYTAG12

\* RKE = Remote Keyless Entry, IRKE=Integrated Remote Keyless Entry, PROX=Proximity



Kaba Ilco Corp.  
400 Jeffreys Rd · Rocky Mount, NC 27804  
Phone 800.334.1381 · Fax 252.446.4702  
www.kaba-ilco.com

Form No. 3043/0211 (SPANISH)



**Eico**

# The KeyTool™

... keep it handy!

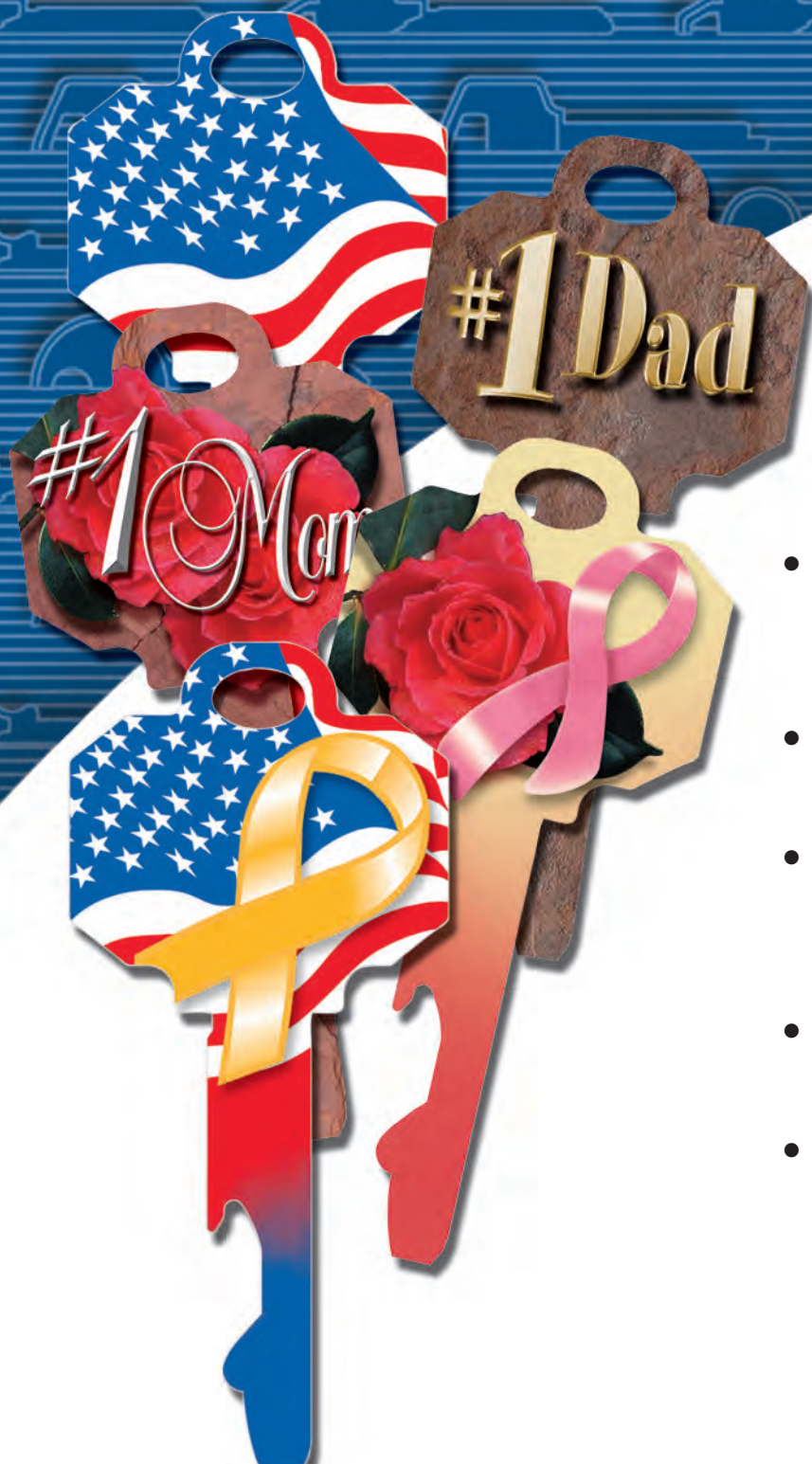

- Combination bottle opener, tab can opener and flat head screwdriver
- Looks like a key, fits on a key ring
- Carded product makes this perfect for generating impulse sales
- Makes a great “gift giving” item
- Available in 5 popular designs

# How To Order



US



PR



DAD



MOM



YR

<i>Design Name</i>	US Flag	Pink Ribbon	#1 Dad	#1 Mom	Yellow Ribbon
<i>Order No.</i>	KTUS	KTPR	KTDAD	KTMOM	KTYR

## OPEN STOCK

KeyTool™ designs are carded, packed 5 per polybag, 25 per box (same design). Order using the numbers above.

## ASSORTMENT

The KeyTool™ assortment contains 2 ea. of 5 stock patterns (10 total) plus a clip strip for merchandising.

Order No.: **KTASST**



## Custom KeyTool™

The KeyTool™ is also a great promotion or premium item. Custom designs are available. Visit our web site at [www.kaba-ilco.com](http://www.kaba-ilco.com) for more information or contact your Ilco Distributor.

# Key Accessories

Identify keys ...  
plus light up the lock

# KeyCaps



KeyCaps may be easily slipped over the head of standard keys to provide easy identification and when pressed, lights up the lock.

Available in four different patterns.

The  to your success



A member of the Kaba Group  
[www.kaba-ilco.com](http://www.kaba-ilco.com)



# KeyCaps™ with LED Light

KeyCaps™ make it easy to quickly and easily identify keys while also providing a bright light to illuminate any lock. The special polymer material provides a snug fit over the head of standard keys.

Holding the KeyCap between the thumb and index finger and squeezing lightly will activate the light. The light will last throughout thousands of uses without failure.

Each cap is carded on an attractive, attention getting package making this a great impulse sale item. A starter assortment is available with an attractive display, backer card and hooks.



*The KeyCap simply slides over any standard key head.*

## How To Order

Key Caps are available in an assortment or as open stock.



### KeyCap Assortment KeyCap-1

Consists of 40 carded KeyCaps (10 each of 4 patterns), acrylic display with colorful backer and 4 peg hooks.

**Open Stock is available in boxes of the same design.**

Packaged: 1per card, 10 per carton per design

Card Measures: 3¾" x 3¾" (95.3 mm x 82.6mm)



USFLAG

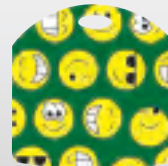

SMILEY



LEOPARD



BURBERRY

*Ordering Example:*

Key Cap - Pattern  
KEYCAP - SMILEY



Kaba Ilco Corp.  
400 Jeffreys Road · Rocky Mount, NC 27804  
Phone 800.334.1381 · Fax 252.446.4702  
www.kaba-ilco.com

Form # 2890/E/1006

# Key Blanks

If your business deals with things that use keys...



Motorcycles



Watercraft



Tool Boxes



Commercial

Office Furniture



Lawn & Garden

Recreational Vehicles



See how our custom programs can earn you additional profits!

The  to your success



A member of the Kaba Group  
[www.kaba-ilco.com](http://www.kaba-ilco.com)



# Here's your opportunity to create a brand new PROFIT CENTER within your core business!

Now you can enjoy the high profit margins of the lucrative key cutting business with Ilco's customized key assortments. We've packaged everything you'll need to be successful selling keys to your existing customers.

We'll set you up with a key cutter and the best-selling keys for your particular market segment.

We offer custom assortments to businesses serving these niche markets:

- Motorcycle Sales & Service
- Watercraft Sales & Service
- Marinas
- Commercial Buildings
- Lawn Mower Sales & Service
- Recreational Vehicles Sales & Service
- Doors and Storm Doors
- Office Furniture & Equipment
- Tool Boxes and Padlocks
- General Keys
- Big Rigs & Heavy Equipment

And you can choose from our two most popular display racks with colorful headers to display your convenient new service.

*Start Generating More Sales Today!*

Flat panel,  
28 hook, black  
acrylic display.  
Order #513-00-41

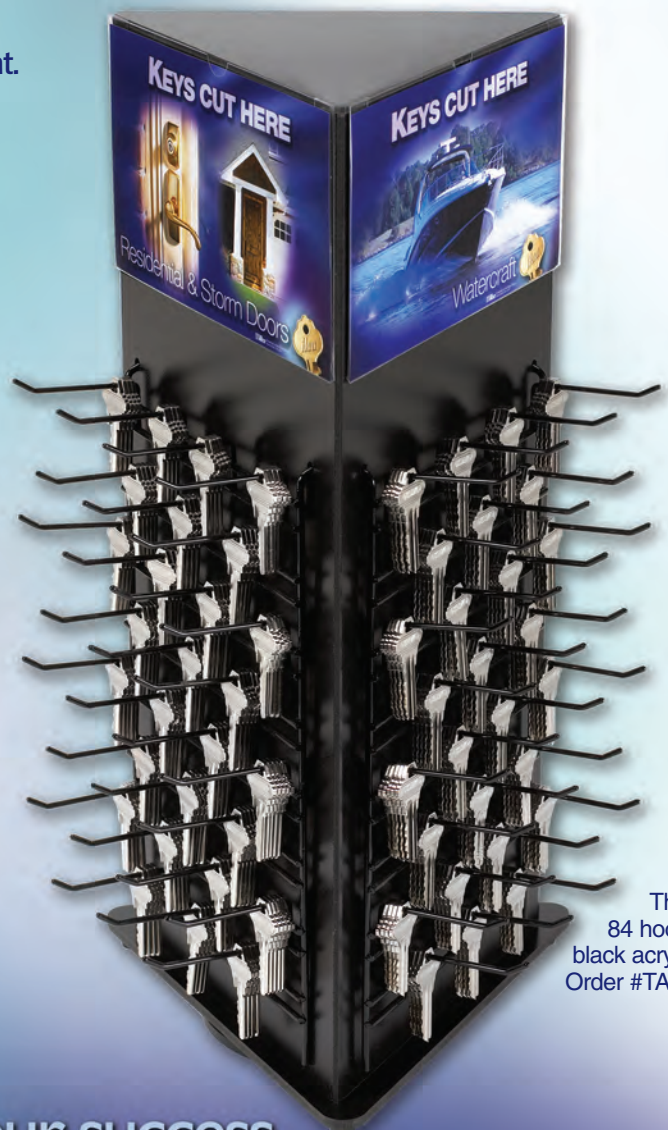

Three-sided  
84 hook, rotating  
black acrylic display.  
Order #TA231-00-83

The  to your success



**KEYS CUT HERE**

**Watercraft**

Member of The Auto Group

**HERE**

**Recreational Vehicles**

Member of The Auto Group

**CUT HERE**

**Motorcycles**

Member of The Auto Group

**CUT HERE**

**Big Rigs**

Member of The Auto Group

**KEYS CUT HERE**

**Big Rigs**

**KEYS CUT HERE**

**Lawn & Garden**

**KEYS CUT HERE**

**Watercraft**

**KEYS CUT HERE**

**Recreational Vehicles**

**KEYS CUT HERE**

**Residential & Storm Doors**

**KEYS CUT HERE**

**Motorcycles**

**KEYS CUT HERE**

**Office Furniture**

**KEYS CUT HERE**

Se certain leaves aqui

**KEYS CUT HERE**

**Commercial**

**KEYS CUT HERE**

**Padlocks & Tool Boxes**



See back page for details



## NICHE ASSORTMENTS

ORDER NUMBER	DESCRIPTION	CONTENTS
159-00-8X	BIG RIGS (Trucks)	6 different keyways - 50 total keys
493-00-8X	CLUB (Steering Column)	15 different keyways - 150 total keys
152-00-8X	COMMERCIAL BUILDINGS	84 different keyways - 840 total keys
149-00-8X	FLAT STEEL & SAFE DEPOSIT	48 different keyways - 480 total keys
145-00-8X	GAS CAPS	6 different keyways - 60 total keys
160-00-8X	GOLF CARTS	10 different keyways - 50 total keys
148-00-8X	HEAVY EQUIPMENT	12 different keyways - 115 total keys
147-00-8X	LAWN & GARDEN	15 different keyways - 150 total keys
151-00-8X	MOTORCYCLE	32 different keyways - 310 total keys
158-00-8X	OFFICE FURNITURE	48 different keyways - 480 total keys
146-00-8X	PADLOCK #1	26 different keyways - 260 total keys
150-00-8X	PADLOCK #2	21 different keyways - 210 total keys
153-00-8X	RESIDENTIAL	48 different keyways - 480 total keys
154-00-8X	RECREATIONAL VEHICLES	36 different keyways - 355 total keys
155-00-8X	SCREEN & STORM DOORS	7 different keyways - 70 total keys
156-00-8X	TOOLBOX	17 different keyways - 170 total keys
157-00-8X	WATERCRAFT	30 different keyways - 300 total keys

## DISPLAYS

ORDER NUMBER	DESCRIPTION	CONTENTS
513-00-41	Flat Panel Display, Black Acrylic	28 hooks, selection of headers - Dimensions: 8" T x 8.75" W x 6.25" D
TA231-00-8X	Rotating Counter Display, Black Acrylic	84 hooks, selection of headers - Dimensions: 21" T x 9" W x 8" D

**KEY DUPLICATING MACHINES** Ilco has several to offer ranging from basic manual machines to fully automatic machines.

ORDER NUMBER	DESCRIPTION
008-110VAC	Mini-Mite, Portable Manual
044-110V	Semi-Automatic (Lever) Operated
045-110VAC	Manual Operation
Bravo III	Heavy Duty, Semi-Automatic (Lever) Operated

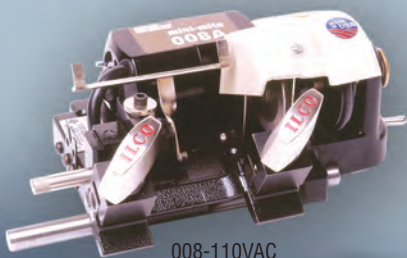

008-110VAC



044-110V



045-110VAC



Bravo II

The  to your success

Kaba Ilco Corp.  
 400 Jeffreys Road - Rocky Mount, NC 27804  
 Phone 800.334.1381 - Fax 252.446.4702  
[www.kaba-ilco.com](http://www.kaba-ilco.com)

Form #2888/0906