

**HOLLOW
METAL
MANUAL**

AMERICAN NATIONAL STANDARD

ANSI/
NAAMM

HMMA 801-12

METAL DOORS & FRAMES



ANSI/NAAMM HMMA 801-12
Nov.30, 2012

GLOSSARY OF TERMS FOR HOLLOW METAL DOORS AND FRAMES

ANSI/NAAMM HMMA 801-12
Nov.30, 2012



METAL DOORS & FRAMES



Approval of an American National Standard requires verification by ANSI that the requirements for due process, consensus, and other criteria for approval have been met by the standards developer.

Consensus is established when, in the judgment of the ANSI Board of Standards Review, directly and materially affected interests have reached substantial agreement. Substantial agreement means much more than a simple majority, but not necessarily unanimity. Consensus requires that all views and objections be considered, and that a concerted effort be made toward their resolution.

The use of American National Standards is completely voluntary; their existence does not in any respect preclude anyone, whether he has approved the standards or not, from manufacturing, marketing, purchasing, or using products, processes, or procedures not conforming to the standards.

The American National Standards Institute does not develop standards and will in no circumstances give an interpretation of any American National Standard. Moreover, no person shall have the right or authority to issue an interpretation of an American National Standard in the name of the American National Standards Institute. Requests for interpretation should be addressed to the sponsor whose name appears on the title page of this standard.

CAUTION NOTICE: This American National Standard may be revised or withdrawn at any time. The procedures of the American National Standards Institute require that action be taken periodically to reaffirm, revise, or withdraw this standard. Purchasers of American National Standards may receive current information on all standards by calling or writing the American National Standards Institute.

This standard was developed by representative members of the Hollow Metal Manufacturers Association Division (HMMA) of the National Association of Architectural Metal Manufacturers (NAAMM) to provide their opinion and guidance on the definition of terms used with hollow metal doors and frames. This standard contains advisory information only and is published as a public service by NAAMM and its HMMA Division. NAAMM and its HMMA Division disclaim all liability of any kind for the use, application, or adaptation of material published in this standard.

NAAMM AND ITS HMMA DIVISION DISCLAIM ALL LIABILITY OF ANY KIND FOR THE USE, APPLICATION, OR ADAPTATION OF MATERIAL PUBLISHED IN THIS STANDARD.

Current information on all NAAMM Standards is available by calling, writing, or visiting the website of the National Association of Architectural Metal Manufacturers, www.namm.org.

National Association of Architectural Metal Manufacturers

800 Roosevelt Road
Bldg. C, Suite 312
Glen Ellyn, Illinois 60137
Phone: (630) 942-6591 Fax: (630) 790-3095
www.naamm.org

Copyright © 1977, 1987, 1998, 2005, 2012

National Association of Architectural Metal Manufacturers

All Rights Reserved

GLOSSARY OF TERMS

For Hollow Metal Doors and Frames

Definitions of terms commonly used in connection with Hollow Metal Work, defined as they apply specifically to hollow metal, may be defined differently by other industries.

ACTIVE DOOR (ACTIVE LEAF): In a pair of doors, the door or doors in which the latching device is installed.

ACTUAL DOOR SIZE: The largest measured width by height of the door leaf as manufactured. Equal to the nominal door size minus design clearance. Also referred to as Net Door Size.

ADJUSTABLE BASE ANCHOR: See **ADJUSTABLE FLOOR ANCHOR**.

ADJUSTABLE FRAME: A frame with profile in two or more pieces to accommodate various wall thickness. Also referred to as an expandable frame or split frame.

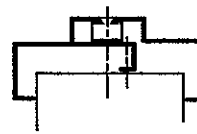

ANCHOR: A metal device provided inside of a jamb, head, sill or mullion used to secure the frame to the adjacent structure, such as wall, ceiling or floor. Also referred to as jamb anchor, wall anchor, floor anchor, etc. See listing;

ADJUSTABLE FLOOR: A metal device used to secure a frame to floor at base which allows the jamb to be positioned at a location in height above floor. Typically used at a depressed slab or unlevel floor condition. Also referred to as Adjustable Base Anchor.

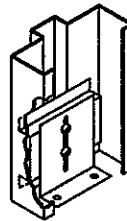

COMPRESSION: An adjustable metal device, used to secure, adjust and square a slip on frame.

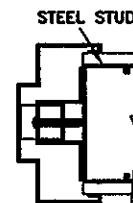

STEEL STUD

WOOD STUD

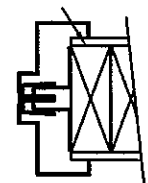

EXISTING WALL: A hole preparation, generally in the soffit of a frame member, with internal reinforcing and/or guide for an expansion bolt, machine bolt, or screw. Used to secure the frame to an existing opening.

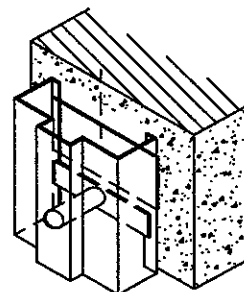

FIXED FLOOR: A metal device attached to the bottom of the frame to secure a frame to the floor. Also referred to as Base Anchor or Sill Anchor.

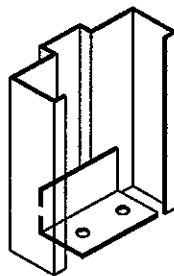

MASONRY STRAP & STIRRUP: A fixed metal device used to secure the frame to new masonry walls.

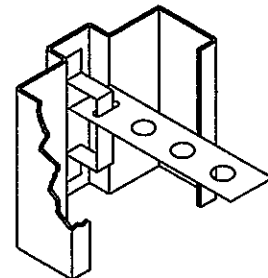

MASONRY "T"-SHAPED: A loose metal device used to secure the frame to new masonry walls.

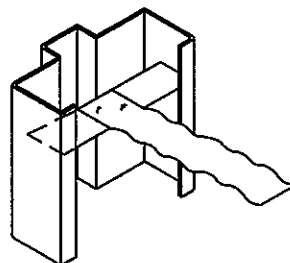

MASONRY WIRE: A loose metal device used to secure the frame to new masonry walls.

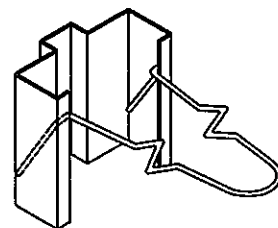

MULLION: A metal clip or angle in either 1 or 2 pieces, secured to the floor in which mullion is then positioned over.

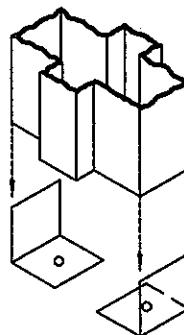

POURED IN PLACE: A metal device used to secure a frame to new concrete pour in place wall.

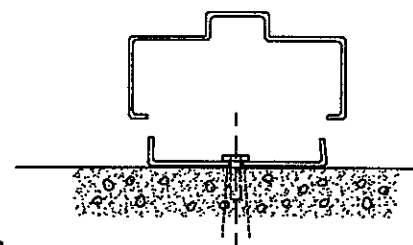

SILL: A metal channel secured to the floor in which the sill section of a hollow metal frame is positioned over.

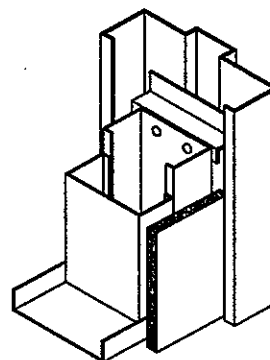

STEEL STUD: A metal device secured in a frame to be used for attachment to a wall built with steel studs.

WOOD STUD: A metal device secured in a frame to be used for attachment in a wall built with wood studs.

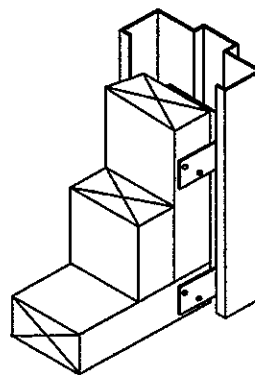

APPLIED STOP: A separate surface mounted channel, typically used on a cased opening section. Creates a rabbeted frame profile.



APPLIED TRIM: A decorative piece mounted to the face of a frame or door.

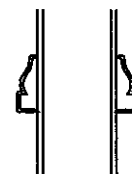
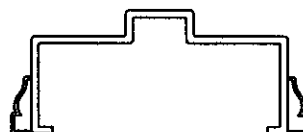

ARMOR PLATE: A plate that can be of various materials and thicknesses applied to a door and /or frame externally, and can extend to the full height and width of the door. Not to be confused with ballistic resistance armor.

ASTRAGAL: A component or combination of components applied to; (a) a single door; (b) one or both doors of a pair at their meeting stiles to cover the door edge clearance; (c) the bottom edge of the flush transom panel; or (d) the bottom of the top leaf of a dutch door. The Astragal closes the clearance gab for the purpose of ensuring privacy; minimizes the passage of light; retard the passage of air, sound, smoke or flame; and provides additional security. Provided by the hollow metal manufacturer, or the hardware supplier.

FLAT SURFACE: A one-piece steel strip attached to one door and overlapping the other door when in the closed position.



INTEGRAL: Either face of a door in a pair, formed at its lock edge to overlap the adjacent leaf.

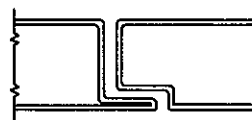

WRAP AROUND: A formed piece of steel attached to one leaf of a pair, and overlapping the other door when in the closed position.

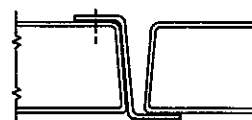

BACKBEND: The element of the frame profile which extends from the return and is formed parallel to the wall, inside the throat. Also referred to as second return, double return or drywall return. See **FRAME ELEMENTS** for additional details.

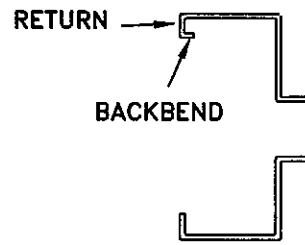

BACKSET: The distance from a cutout or datum line for a hardware preparation from a defined datum a door or frame.

FLUSH BOLT: The distance from the centerline of the lock edge of a door to the centerline of the bolt. Shown on beveled edge door.

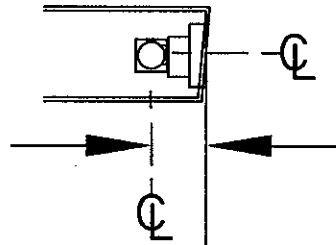

HINGE: On a door, the distance from the push side face sheet to the edge of the hinge cutout. On a frame rabbet, the distance from the stop to the edge of the hinge cutout.

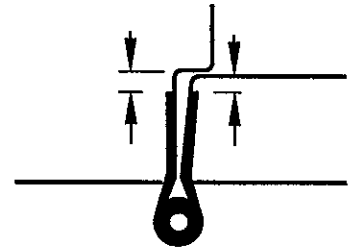

LOCK: The distance from the centerline of the lock edge of a door to the centerline of the lock face prep. Shown on beveled edge door.

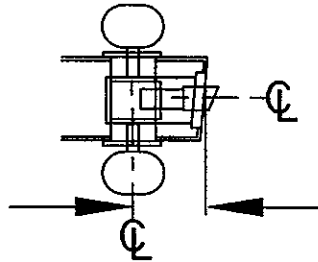

STRIKE: On a frame rabbet, the distance from the stop to the edge of the strike cutout. On the door edge, the distance from the push side face sheet to the edge of the strike cutout.

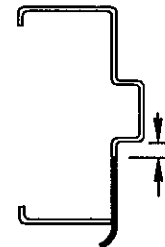

BASE: See **SILL**.

BASE ANCHOR: See **ANCHOR**.

BASE ANCHOR EXTENSION: See **FLOOR ANCHOR EXTENSION**.

BELOW FLOOR: Below the top of the concrete or structural slab. See also Jamb Extension.

BEVELED EDGE: See **EDGE, BEVELED**.

BLANK JAMB: See **JAMB**.

BLAST RESISTANT: Refers to a hollow metal assembly designed and manufactured to resist a specified series of impulse pressures of designated magnitude in pounds-force (Newtons).

BORROWED LIGHT: A glazed opening frame installed in an interior partition prepared for field installation of stationary (fixed) glazing. Mullions may be used to divide individual glazed areas. Similar to **WINDOW**.

BOTTOM CHANNEL: The horizontal stiffener channel secured into the bottom of a door. Also referred to as end channel.

BULL-NOSE: See **EDGE, BULL-NOSE**.

BULL-NOSE TRIM: A radius shaped component applied to the vertical door edge. A typical application would be on double acting doors.

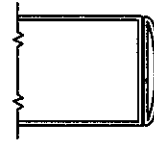

BULLET RESISTANT: A hollow metal assembly designed and manufactured to resist penetration by fire arms projectiles.

BUTT JOINT: Intersection of members, which are not mitered.

BUTTED FRAME: A frame which fits against a wall rather than wrap around it.

CAMLIFT HINGE: A hinge designed and manufactured to provide lifting of the door to a specific height as it is opened through a specific degree of opening. Commonly used on sound retardant door.

CASED OPENING FRAME: A frame without a stop and soffit. See **FRAME PROFILE** for detail.

CEILING STRUT: An adjustable member extending vertically from frame to a rigid support above to hold the frame in place.

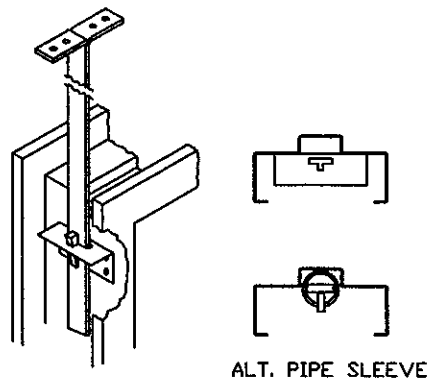

CENTER RAIL: See **RAIL**.

CLASSIFIED: “Products or material of a specific group category that are constructed, inspected, tested and subsequently reinspected in accordance with an established set of requirements.” (Taken directly from NFPA 80.)

CLEARANCE: A term used to define a distance between two items.

FLOOR: The distance between the bottom of the door and the top of the material directly below the door. This varies with applications, such as concrete, any floor covering and/or a threshold. (For additional information, see HMMA TechNote HMMA 810-TN01-03, "Defining Undercuts".)

DESIGN: The distance around a door established by the manufacturer, used to determine the Actual Door Size.

DOOR EDGE: The distance between either the edge of the door and frame rabbet, or the edges of two doors of a pair.

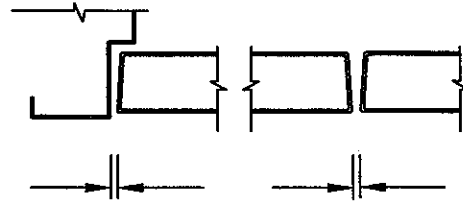

FRAME INSTALLATION, BUTTING

WALL: The distance between a frame and the wall construction where the frames butts against the wall.

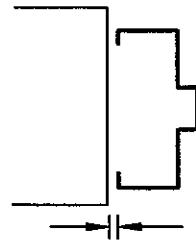

FRAME INSTALLATION, OVERLAPPING

WALL: The distance between the frame return or backband to accommodate irregularities in the thickness in the wall, when the frame is capping the wall.

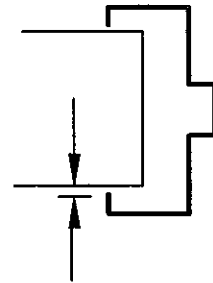

STOP: The distance between the frame stop and the face of the door when the door is in the closed position. Typically equal to the thickness of the silencer.

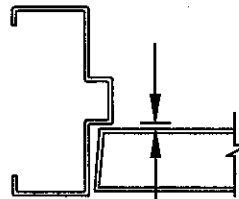

CLOSED SECTION: A frame member without a throat opening such as a mullion or transom bar.

CLOSER REINFORCEMENT: A metal plate or channel in a door or frame to provide additional strength for the attachment of a door closer. Sized and located to accommodate hardware requirements.

PARALLEL ARM: Reinforcing in soffit of frame header or transom mullion.

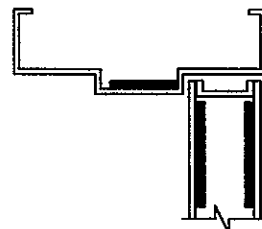

TOP JAMB MOUNT: Reinforcing in push side face of frame header, transom mullion, or panel.

REGULAR ARM: Reinforcing in pull side face of frame header, transom mullion, or panel.

SLEEVE: Reinforcing inside frame header conforming to soffit, rabbet, stop, and face.

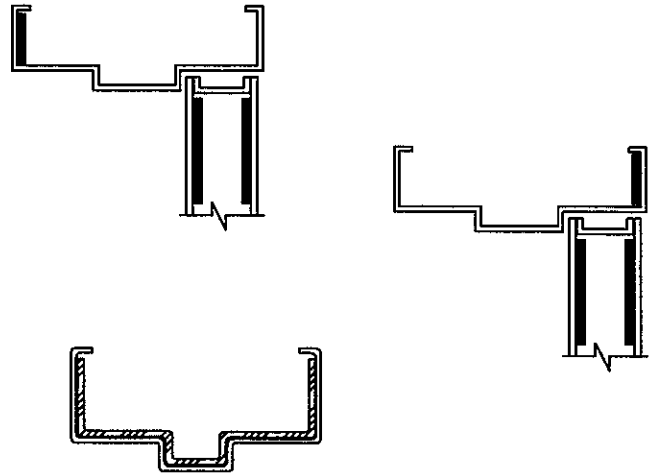

CLOSURE CHANNEL: An additional channel section fitted between the flanges of the top or bottom channel of a door, with its flanges projecting inward and its web in line with the door edge.

COMMERCIAL HOLLOW METAL: Steel door and frame products manufactured for use in office buildings, schools, hospitals, stores and other applications. (See *ANSI/NAAMM HMMA 861 Guide Specification*.)

COMMERCIAL SECURITY HOLLOW METAL: Steel door and frame products designed, tested and manufactured to resist intrusion or forced entry in commercial applications. (See *ANSI/NAAMM HMMA 862 Guide Specification*.)

COMMUNICATING FRAME: Hollow metal frame fabricated such that a door is installed in each rabbet of a double rabbeted frame (2 doors total) to facilitate dual access and control of the opening, i.e. hotel/motel suites, and acoustical applications.

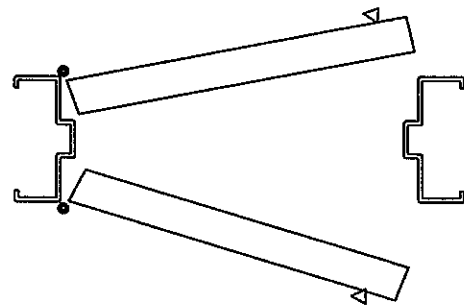

COMPOSITE DOOR: A door consisting of a non-metal core bonded to a metal facing.

CONTINUOUS WELD: See **WELD**.

CONTINUOUSLY WELDED: See **WELDED**.

CONTRA-SWING FRAME: A frame with two doors swinging in opposite direction incorporating a fixed or removable hollow metal mullion between the doors.

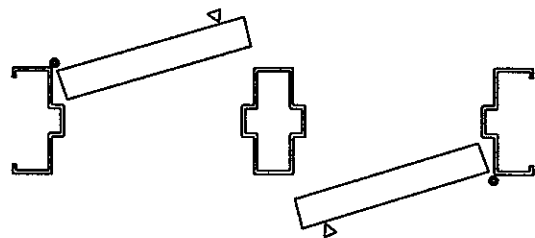

CORE: The material(s) of a hollow metal door or panel.

CORNER CLIP: See **REINFORCING GUSSET**.

CORNER JOINT: The intersection of either the perimeter members of a metal frame product or glass stops.

CORNER GUSSET: See **REINFORCING GUSSET**.

CORNER POST, (CORNER MULLION); A closed section, which facilitates a turn in the hollow metal frame assembly. The angle of the turn may vary, although 45 degree and 90 degree turns are common.

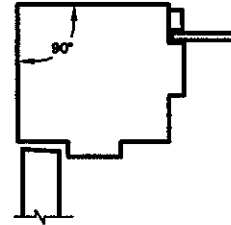

COVER PLATE: A removable piece of metal used to cover the hardware preparation or provide access to the interior of door or frame.

CUT-OFF STOP: The stops and soffit on a jamb or mullion at a door opening that are terminated at a specified distance above the floor, and are closed square or at an angle. To facilitate cleaning the floor. Also referred to as Hospital Stops, Sanitary Base or Terminated Stop.

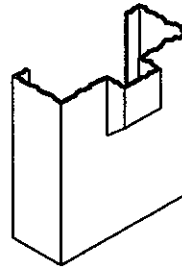

CUTOUT: A hole in the hollow metal door or frame to accommodate hardware, light kits, louvers or other options.

DESIGN CLEARANCE: See **CLEARANCE**.

DETENTION SECURITY HOLLOW METAL: A steel door and frame assembly designed, tested, and manufactured for the containment of individuals to designated areas within detention or correctional facilities. (See also *ANSI/NAAMM HMMA 863 Guide Specifications*).

DOOR CLEARANCE: See **CLEARANCE**.

DOOR EDGE: The vertical surfaces of the door.

HINGE: The vertical edge of a door to which hinges or pivots are attached.

LOCK: The vertical edge of a door in which locking or latching hardware may be installed.

DOOR EDGE SEAM: The connection of face sheets at the vertical edge.

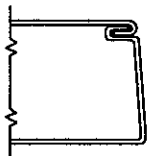

LOCKSEAM:

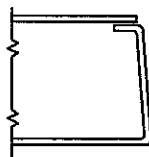

PAN & SKIN

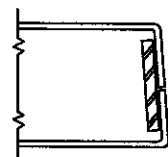
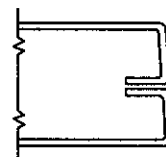

CENTER

DOOR FACE: The exposed surface of the door not including the vertical edges and top and bottom.

DOOR FRAME: An assembly of members surrounding and supporting a door, or doors.

DOOR LIGHT: The provision for glazing material in a door.

DOOR OPENING: The area in a frame product into which a door or doors are installed.

DOOR OPENING HEIGHT: The distance measured vertically between door rabbet and the top of floor or bottom of frame minus jamb extensions. Also referred to as nominal door height. (For additional information, See HMMA TechNote HMMA-810 TN01-03 "Defining Undercuts")

DOOR OPENING WIDTH: The distance measured horizontally between door rabbets. Also referred to as nominal door width.

DOOR RABBET: See RABBET.

DOOR REVEAL: The distance from the face of the door to the face of the frame on the pull side.

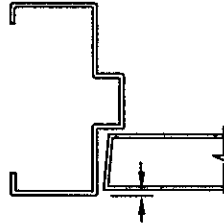

DOOR SCHEDULE: The listing of all door openings on the project by the Architect's/Designer's mark number, including a description of each door opening. The schedule is normally found in the drawings or specifications.

DOOR STOP: That part of a frame profile against which the door closes.

DOUBLE-ACTING DOOR: A door that swings in both directions. May incorporate bull-nose edge[s].

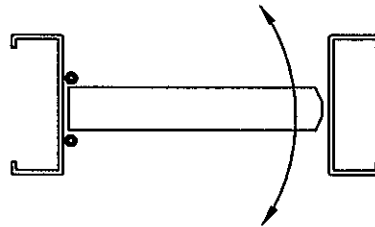

DOUBLE-ACTING FRAME: A frame for double-acting doors.

DOUBLE EGRESS DOORS: A pair of doors swinging in opposite directions, located in the same plane within the frame.

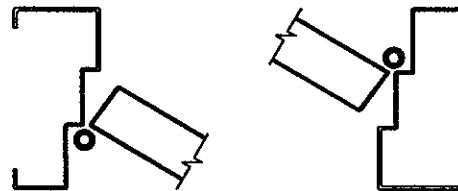

DOUBLE EGRESS FRAME: A frame prepared to receive double egress.

DOUBLE RABBET: A frame provided with two rabbets. See FRAME PROFILE for detail.

DOUBLE RETURN: See BACKBEND.

DOUBLE SWING FRAME: See PAIR FRAME.

DRIP: A head mounted molding designed to reduce rainwater infiltration at top of door.

DRYWALL FRAME: A frame designed for installation in a wall constructed with studs and gypsum wallboard or other dry sheet facing material.

DRYWALL PROFILE: Description of a frame with backbends. Slip-on frames utilize this type of profile.

DRYWALL RETURN: See BACKBEND.

DUST COVER BOX: See **GROUT GUARD**.

DUTCH DOOR: A door consisting of two separate leaves, one above the other. May be provide with shelf at its top edge of the bottom leave.

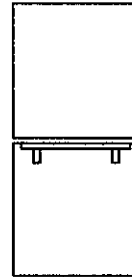

DUTCH DOOR FRAME: A frame prepared for a dutch door.

EDGE PROFILE: Description of the vertical door edge; beveled, bull nosed, rabbeted, or squared. Available on lock and/or hinge edge.

BEVELED: The vertical door edge has a $\frac{1}{8}$ " in 2" (3.1 mm in, 50.8 mm) slope from a plane perpendicular to the door pull side face.

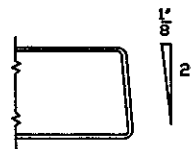

BULL-NOSED: The vertical door edge simulates a $2\text{-}\frac{1}{8}$ " (54 mm) radius.



RABBETED: The vertical door edge which overlaps another door or frame.

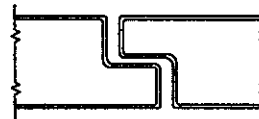

SQUARED: The vertical door edge that is formed 90 degree to the face of the door.

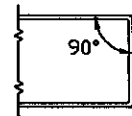

EDGE SEAM: The connection of the face sheet at the vertical edge.

ELEVATION: An orthographic projection of the vertical side of a hollow metal assembly (doors, frames, etc.) usually shown on the architectural plans in conjunction with the vertical side view of a building wall.

EMBOSSSED: Having a raised and/or indented pattern impressed on a surface by means of patterned rolls or stamping dies.

END CHANNEL: See **TOP CHANNEL** and **BOTTOM CHANNEL**.

EXISTING WALL ANCHORS: See **ANCHORS**

EXPANDABLE FRAME: See **ADJUSTABLE FRAME**

FACE WELDED: See **WELDED**.

FIELD SPLICE: A connection of hollow metal frame components accomplished in the field. Also referred to as Shipping Splice.

FILLER PLATE: A metal plate used to fill unused mortise cutouts in a door or frame.

FINISHED FLOOR: See **FLOOR**.

FIRE ENDURANCE RATING: See **FIRE RATING**.

FIRE PROTECTION RATING: See **FIRE RATING**.

FIRE-RATED: A product which has successfully met all conditions of acceptance of the fire test standard specified in the governing model or building code, is “Listed” or “Classified” and eligible for labeling by a recognized testing agency having a factory inspection service.

FIRE RATING: A numeric designation indicating the duration of fire test exposure to which a product has been exposed, and successfully met all acceptance criteria of the standard to which it is tested. For swinging doors and frame products, typical fire ratings include 3, 1-1/2, 1, ¾, and 1/3 hour. Also called Fire Protection Rating.

FIXED STOP: See **STOP**

FLOOR: The top of the concrete or structural slab. Also referred to as finished floor. (*For additional information, see HMMA TechNote HMMA-810 TN01-03 “Defining Undercut.”*)

FLOOR ANCHOR: See **ANCHOR**.

FLOOR CLEARANCE: See **CLEARANCE**.

FLOOR COVERING: Any material applied on top of the floor. (*For additional information, see HMMA TechNote HMMA-810 TN01-03, “Defining Undercuts”*)

FLOOR STILT: A metal device attached to the jamb of a door frame to hold the frame above the finished floor.

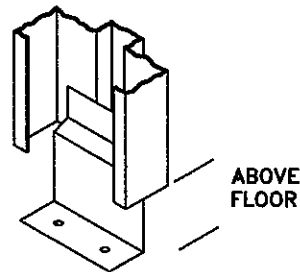

FLUSH DOOR: A door having no glass lights, panels, louvers or grilles.

FRAME: See **DOOR FRAME**.

FRAME CLEARANCE: See **CLEARANCE**.

FRAME FACE: The elements of a frame profile which is visual on the vertical side of a hollow metal assembly. See **FRAME ELEMENTS** for details.

FRAME ELEMENTS: Within a Frame profile, a specific part such as; soffit, stop, rabbets, faces and returns. (*For additional information, see HMMA TechNote HMMA-820 TN 02-03, “Continuously Welded Frame”.*)

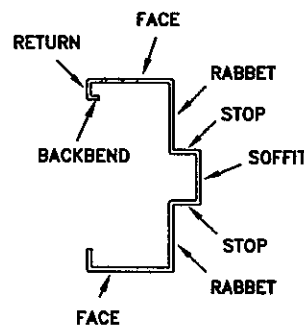

FRAME GASKET: See **GASKETING**.

FRAME JOINT: The intersection of two or more frame members.

FRAME MEMBER: A component in a frame product such as a jamb, head, mullion or sill. (For additional information, see *HMMA TechNote HMMA-820 TN 02-03, "Continuously Welded Frame"*.)

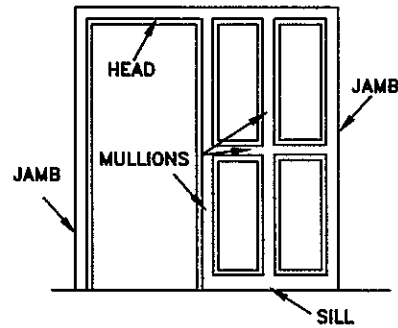

FRAME PROFILE: Visual description of a frame member. Typically referred to as cased opening, single rabbet, double rabbet, and double egress. Refer to individual description for detail.



Cased Opening

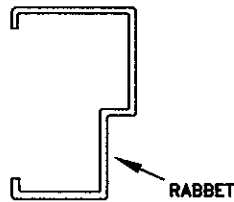

Single Rabbet

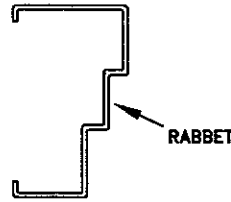

Double Egress

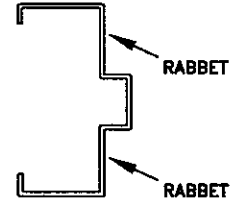

Double Rabbet

FRAME PRODUCTS: Used to describe, as a group, “Frames”, “Transom Frames”, “Sidelight Frames” and “Window Frames”.

FRAME SECTION: Cross cut of a frame member. See **FRAME PROFILE**.

FRAME SILL: The bottom horizontal member of a sidelight or borrowed light frame. Also referred to as Base.

FULL PROFILE WELDED: See **WELDED**

FULL (FULLY) WELDED: See **WELDED**.

FULL (FULLY) WELDED FRAME: See **WELDED**.

FULLY WELDED SEAMLESS DOOR: See **WELDED**.

GAGE (GAUGE): An numeric value used to define the nominal thickness of material. (See *NAAMM/HMMA 803-08 "STEEL TABLES"*)

GASKETING: Material applied around the door or frame to close the clearance opening and minimize or restrict the passage of smoke, light, sound or weather.

GLAZING: The process of installing glazing materials.

GLAZING (GLASS) BEAD: A removable formed metal section used to secure glazing or panel in a door or frame.

GLAZED, (GLASS) LIGHT: In a frame, the light is formed by the assembly of jamb, head, sill and mullion members into a rectangular or shaped opening. The light is equipped with factory installed glazing bead used to retain the glazing that is installed by the glazing contractor. In a door, the light is formed by providing a rectangular or shaped cutout in the door and equipping it with molding and removable bead to receive the glazing.

GLAZING, (GLASS) MOLDING: The portion of the assembly retaining glazing materials or in-fill panels in a hollow metal door which contain the integral stop, and to which a glazing bead is attached. Also referred to as Glazing Stop.

GLAZING MATERIAL: A transparent or translucent material used in door assemblies and windows.

GLAZING STOP: See **GLAZING, (GLASS) MOLDING**

GROUT: A substance used to fill up voids in hollow metal frame cavities. *(For additional information See NAAMM/HMMA 820 TN1-03 Technical Note "Grouting".)*

GROUT GUARD: A metal cover attached to a frame behind reinforcement for mortised or recessed hardware items, to prevent grout from entering the mounting holes. Also referred to as Dust Cover Guard, Masonry Guard, Mortar Guard, or Plaster Guard.

GROUTED FRAME: Frame filled with grout.

HANDING: A term used to designate the direction of door swing.

HARDWARE SCHEDULE: Complete listing of all hardware specified for a project, organized by opening numbers including Door Headings, manufacturers names, template numbers, and special hardware locations. Prepared in accordance with industry standards for or by the Architect/Designer and issued for bid. Once contract is awarded and Hardware Schedule is approved, it becomes part of construction contract.

HARDWARE TEMPLATE: A detailed drawing of the hardware preparation provided by hardware manufacturing for providing preparation of hardware.

HEAD, (HEADER): The horizontal member which forms the top of a frame.

HEAD STIFFENER: A metal angle or channel attached inside the head of a door. Not to be used as a load-carrying member.

HINGE JAMB: See **JAMB**.

HINGE REINFORCEMENT: A metal plate or angle attached to a door or frame to which a hinge is attached.

HINGE SIDE: See **PULL SIDE**:

HOLLOW METAL: A term used to reference to doors, frames, partitions, enclosures and other items, fabricated from metal sheet.

HOSPITAL PROFILE: See **SPLADE STOP**:

HOSPITAL STOP: See **CUT-OFF STOP**

INACTIVE DOOR or LEAF: The leaf of a pair of doors which does not contain a lock but is secured, when closed, by top and/or bottom bolts and contains a strike to receive the latch or bolt of the active leaf.

INFILL PANEL: See **PANEL, INFILL.**

INTEGRAL ASTRAGAL: See **ASTRAGAL.**

INTEGRAL STOP: See **STOP, INTEGRAL.**

INTERGAL TAB and SLOT: Formed as part of the frame profile used to align machined mitered frame corner joints in mechanical alignment construction.

INTERLOCKING SEAM: See **LOCK SEAM DOOR:**

JAMB: The vertical frame member forming the perimeter of a frame.

BLANK: A jamb without mortised hardware preparation.

HINGE: A jamb of a frame prepared for hinges or pivots.

STRIKE: A jamb prepared for a strike.

JAMB ANCHOR : See **ANCHOR.**

JAMB DEPTH / JAMB WIDTH: The dimension of a frame member measured perpendicular to the face from one face to the other.

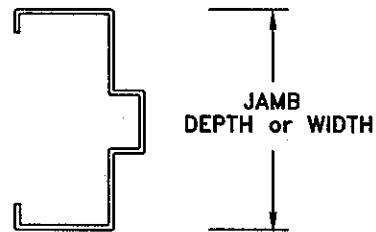

JAMB EXTENSION: That portion of a jamb which extends below the level of the floor. See Also **BELOW FLOOR.** (For additional information, see *HMMA TechNote HMMA-810 TN01-03, "Defining Undercuts."*)

JAMB OPENING: See **DOOR OPENING, WIDTH.**

JAMB WIDTH: See **JAMB DEPTH.**

KERFED FRAME: A frame that is formed with an integral pocket or recess in the area of the stop to receive gasket or seals.

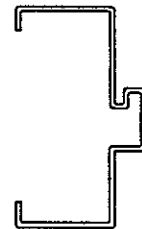

KNOCKED DOWN: A frame product that is shipped disassembled, commonly abbreviated "KD."

LABEL: A metal plate, sticker, or embossment, on a product to indicate a performance level in accordance with a specific standard.

LAMINATED CORE: A door or panel construction utilizing; kraft honeycomb, rigid foam, mineral core or steel stiffeners, in which steel face sheets are bonded.

LEADING EDGE: Intersection of the lock edge and the pull side face of a door.

LEAD-LINED: A door or frame, which is lined with lead to prevent radiation penetration.

LEAF: A single door.

LEAVES: More than one door.

LOCK CENTER CLIP: A part to position a mortised lock inside the center of a door.

LOCK EDGE: See **DOOR EDGE**.

LOCK REINFORCEMENT: A plate attached inside of a door to which a lock is fastened.

LOCK SEAM: Interlocking construction of a door or panel edge.

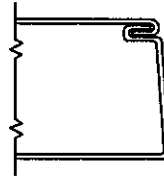

LOUVER: A series of slats, blades, or piercings to allow passage of air through an opening.

LOUVER INSERT: A louver that is fabricated separately and inserted into a preparation in the door or frame.

MASONRY GUARD: See **GROUT GUARD**.

MEETING STILE: The vertical edge of a door, in a pair, which is adjacent to the other door.

MITER JOINT: The intersection of frame members, (typically head and jambs) or frame elements (stops) in which the faces meet at an angle.

MORTAR: See **GROUT**.

MORTAR GUARD: See **GROUT GUARD**.

MORTISE: A recess on a minimum of 3 sides of a hardware item closely surrounding the contour of the item allowing its faceplate to finish flush with the door or frame finished surface.

MORTISE PREPARATION: For hardware, a cutout recessed into a door or frame, which may include, drilling and tapping.

MULLION: A closed member within a frame, separating doors, a door and sidelights, glazed areas or panels. A mullion may be fixed or removable. Typically a double or single rabbeted profile.

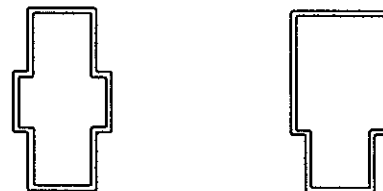

MUNTIN: A bar or formed material supporting and separating panes of glass within a door, sidelight, transom, borrowed light, or window frame.



MUTE: See **SILENCER**.

NAILING FLANGE: A reveal flange in which nail holes are provided.

NARROW SIDE OF DOOR: See **PUSH SIDE OF DOOR**.

NET DOOR SIZE: See **ACTUAL DOOR SIZE**.

NOMINAL DOOR HEIGHT: See **DOOR OPENING HEIGHT**.

NOMINAL DOOR SIZE: (Door opening width) by (door opening height).

NOMINAL DOOR WIDTH: See **DOOR OPENING WIDTH**.

OPENING SIZE: The frame opening measured between the rabbets horizontally and between the header, rabbet and bottom of frame vertically.

OPERABLE TRANSOM: Panel or glass lite above door opening which may be opened for ventilation purposes.

OVERLAPPING ASTRAGAL: See **ASTRAGAL, FLAT SURFACE**.

PANEL, HOLLOW METAL: An assembly made of the same material and construction as a door.

PANEL, INFILL: An assembly comprised of steel sheet secured to each face of a backing material (gypsum or cement board, etc.), installed like glazing materials, in doors, transom, sidelight and window assemblies.

PERIMETER FRAME JOINT: The intersection of two or more frame members that are accessible through the throat or from the unexposed side of the frame member. *(For additional information, See HMMA TechNote HMMA-820 TN02-03, "Continuously Welded Frames.")*

PLANKING: Wood spacers used in storage of doors and frames.

PLASTER GUARD: See **GROUT GUARD**:

PLINTH: A section of sheet metal, usually stainless steel, used as a base for a door frame at the floor. It has the same thickness and profile as the jamb section, and is flush with the jamb on all surfaces.

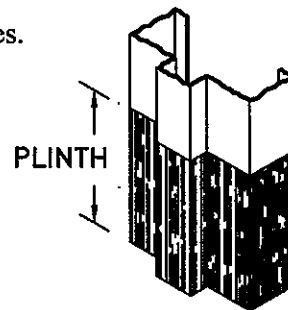

POCKET DOOR: A door designed to slide/recess into a wall cavity to open, and slide out of the wall cavity to close.

POCKET DOOR FRAME: Frame designed to allow a door to slide inside a pocket located within the cavity of a wall.

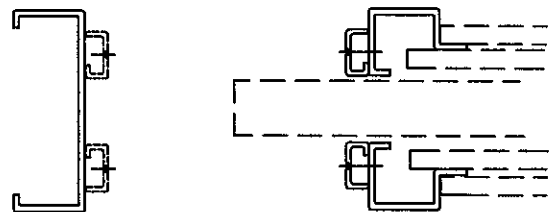

PRESSURE RESISTANT: Refers to a hollow metal assembly designed and manufactured to resist uniform static pressure of a specified magnitude and duration over its exposed surface.

PRIMER / PRIME PAINT: Paint coating used as a base for finish paint.

PULL SIDE OF DOOR: The face of a door opposite the frame stops. Also referred to as Hinge Side or Wide Side.

PUSH SIDE OF DOOR: The face of door, which contacts the frame stops. Also referred to as stop side or narrow side.

RABBET: On a frame, the area that is between the stop and the face, capable of accepting doors, panels or glazing materials. Also referred to as Door Rabbet. See **FRAME ELEMENT** for detail.

RABBETED: Description of a door edge formed to interlock with another door, frame or panel.

RADIATION SHIELDING: Refers to a hollow metal assembly designed and manufactured to resist penetration by a specified type of radiation.

RAIL: The horizontal member forming the top or bottom edge of a door, or separating panels or glazed areas. Referred to as Top Rail, Intermediate Rail or Bottom Rail.

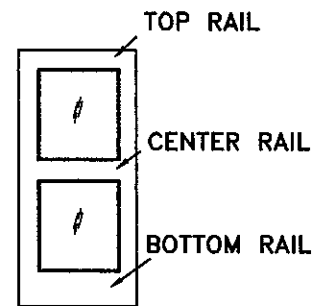

REINFORCING GUSSETT: A flat or formed component at junction of head and jamb used in interlocking of knock-down (K.D.) frames. May be used as an alignment feature on punch mitered frames.

REMOVABLE MULLION: A frame member designed for temporary removal. See **MULLION** for detail.

REMOVABLE STOP: See **STOP**

RETURN: The element of the frame profile, which extends inward from the face to the throat.

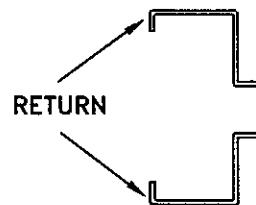

REVEAL FLANGE: The element of the frame profile, which extends from the return. Typically formed parallel to the wall.



REVEAL RETURN: The element of the frame profile, which extends from the reveal flange.

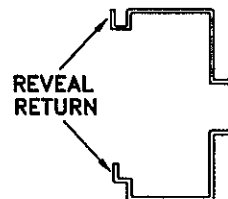

REVERSE BEVEL: Refers to hand of door or lock on outswing doors.

RIB: See **STIFFENER**.

ROUGH BUCK FRAME: An assembly which consists of a finished frame and anchoring channels.

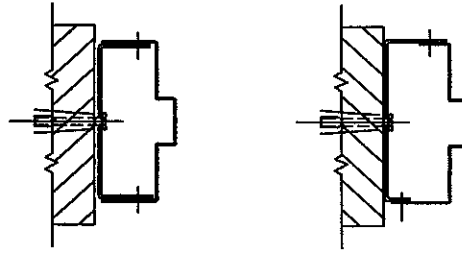

ROUGH OPENING: The size of the wall opening into which a frame is to be installed.

SANITARY BASE: See **CUT-OFF STOP**.

SEAM, INTERLOCKING: See **LOCKSEAM**.

SEAMLESS DOOR: A door having no visible seams on its faces or edges.

SHIPPING BAR: See **SPREADER**.

SHIPPING SPLICE: See **FIELD SPLICE**.

SIDELIGHT: A framed area immediately aside a door opening which may contain fixed glazing, panel or other filler.

SILENCER: A of resilient material attached to the stop on a frame to cushion the closing of a door. Also referred to as Mute.

SILL ANCHOR: See **ANCHOR**.

SILL: The bottom horizontal member of a sidelight or borrowed light frame. Also referred to as Base.

SINGLE-ACTING DOOR: A door which only opens in one direction.

SINGLE RABBET FRAME: A frame having only one rabbet See **FRAME PROFILE**, for detail.

SLIP-ON FRAME: Frame designed to be installed after the wall is erected.

SMOKE CONTROL ASSEMBLY: A door and frame assembly with gasketing (by others) designed to resist the passage of smoke when the door is in the closed position. May or may not be Fire-Rated.

SOFFIT: The element of a door frame; (a) between the stops on a double rabbeted frame, (b) between the stop and face opposite door side of a single rabbeted frame. See **FRAME ELEMENT** for detail.

SOUND RETARDANT: A characteristic of a hollow metal assembly designed and manufactured to resist sound transmission. The Sound Transmission Classification (STC) rating of the assembly indicates the level of resistance to sound transmission.

SPAT: A protective covering, usually of stainless steel, applied over the bottom of jambs to facilitate cleaning and reduce frame damage.

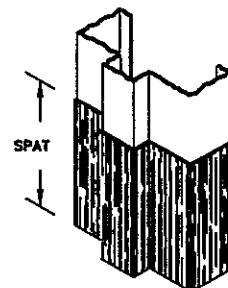

SPLADE PROFILE: A frame member where the transition from stop to opposite face is sloped. Also referred to as Hospital or sloped Profile.

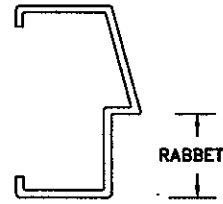

SPLIT FRAME: See **ADJUSTABLE FRAME**.

SPOT WELD: See **WELDING**.

SPREADER (SPREADER BAR): A metal channel or angle temporarily attached to the base of a door frame, extending between jambs, to keep the frame in proper alignment during shipping and handling.

SQUARE-EDGE DOOR: A door having vertical edges that are perpendicular to its face. See **EDGE PROFILE** for detail.

STEEL STUD ANCHOR: See **ANCHOR**.

STIFFENER: An internal formed steel component used to strengthen a door panel or frame member.

STILE: The vertical member which form the edge of a door.

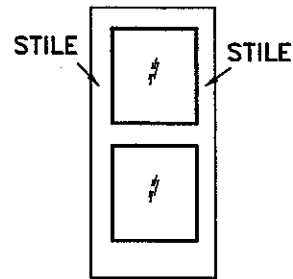

STOP: An element of a frame profile. See also **Door Stop** and **Glazing (Glass) bead**. See **FRAME ELEMENT** for detail.

INTEGRAL: A stop, which is formed as part of the frame profile.

REMOVABLE: Metal channel or angle which is removable to allow installation of glass, panel or door.

STOP SIDE: See **PUSH SIDE OF DOOR**.

STRIKE JAMB: See **JAMB**.

STRIKE REINFORCEMENT: A metal plate or formed unit attached inside a door or frame to attach a strike.

STRUT: See **CEILING STRUT**.

SUB-BUCK or SUB-FRAME: See **ROUGH BUCK FRAME**.

SURFACE HARDWARE REINFORCEMENT: A metal plate attached inside a door or frame to receive surface-mounted hardware applied in the field.

SWING: A term used to describe the operation of a hinged door.

SWINGING DOOR: A door mounted on hinges or pivots.

TEMPERATURE RISE RATED DOOR: A fire rated door designed to limit the transfer of heat over a specified duration to a specified temperature.

TERMINATED STOP: See **CUT-OFF STOP**, also called **Hospital Stops**.

THERMAL BOW: A temporary condition, affecting the operation of an exterior door due to the inside temperature differential. The extent of this condition will vary with environmental conditions, door color, door construction, length of exposure, etc. This condition can often be alleviated by painting the outside surface of the door a light color.

THROAT: The distance between Returns or Backend Returns of a frame profile.

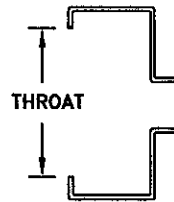

TOLERANCE: Permissible deviation from a nominal or specified dimension or value.

TOP CHANNEL: Horizontal stiffener channel secured into the top of a door. Also referred to as End Channel.

TOP RAIL: See **RAIL**:

TRANSOM: A framed area immediately above a door opening which may contain fixed glazing, an operating sash, panel or other filler.

TRANSOM BAR: See **TRANSOM MULLION**:

TRANSOM FRAME: A frame containing a door opening and transom with or without a transom mullion.

TRANSOM MULLION: The horizontal frame member, which separates the door opening from the transom. Also referred to as transom bar.

TRIM: See **FRAME FACE**.

UNDERCUT: The Distance between the bottom of door and the bottom of the frame. (See *NAAMM/HMMA 810 TN01-03 Technical Note "Determining Undercuts"*.)

VISION LIGHT: A glazed opening in a door.

WEEPHOLE: A opening provided to permit the drainage of moisture.

WELD/WELDING: A process for the joining of metal parts, with the necessary heat being provided by an electric arc struck between an electrode and the metal or between two electrodes. -

WELD, CONTINUOUS: A weld having no gaps or spaces, over its entire length.

WELDED CONTINUOUSLY, DOOR: A door having all joints on its vertical edge continuously welded and finished smooth.

WELDED CONTINUOUSLY, FRAME:
Also called Full or Fully Welded and/or Full Profile Welded. Corner/Perimeter joints shall have all elements of the frame member continuously welded: soffits, stops, rabbet, faces and returns.
(See NAAMM/HMMA 820 TN2-03 Technical Note "Continuously Welded Frames.") for additional information.

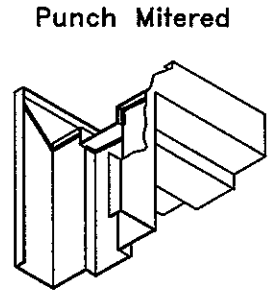
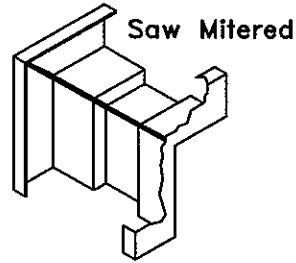

WELDED, FACE, FRAME: Corner/perimeter joints shall have a continuous weld at the faces only.

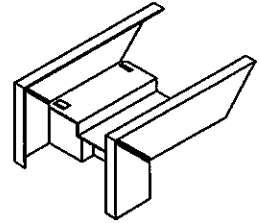
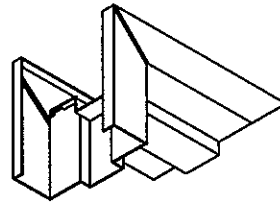

WICKET DOOR: A swinging door within a door.

WIDE SIDE: See **PULL SIDE**.

WINDOW: A glazed opening frame installed in an exterior wall prepared for field installation stationary (fixed) glazing. Mullions may be used to divide individual glazed areas. Similar to **BORROWED LIGHT**.

WOOD STUD ANCHOR: See **ANCHOR**

WRAP-AROUND FRAME: A frame which fits over the wall. The frame throat is nominal 1/8" (3mm) larger than the wall thickness.

RECOMMENDED GUIDE SPECIFICATIONS FOR HOLLOW METAL DOORS AND FRAMES

HMMA 860 - Hollow Metal Doors and Frames

ANSI/NAAMM

HMMA 861 - Commercial Hollow Metal Doors and Frames

ANSI/NAAMM

HMMA 862 - Commercial Security Hollow Metal Doors and Frames

ANSI/NAAMM

HMMA 863 - Detention Security Hollow Metal Doors and Frames

ANSI/NAAMM

HMMA 865 - Sound Control Hollow Metal Door and Frame Assemblies

ANSI/NAAMM

HMMA 866 - Stainless Steel Hollow Metal Doors and Frames

ANSI/NAAMM

HMMA 867 - Commercial Laminated Core Hollow Metal Doors and Frames

RELATED HMMA DOCUMENTS

HMMA 800 - Introduction to Hollow Metal

ANSI/NAAMM

HMMA 801 - Glossary of Terms for Hollow Metal Doors and Frames

HMMA 802 - Manufacturing of Hollow Metal Doors and Frames

HMMA 803 - Steel Tables

HMMA 804 – Quality Control Manual

HMMA 810 - Hollow Metal Doors

HMMA 820 - Hollow Metal Frames

HMMA 830 - Hardware Selection for Hollow Metal Doors and Frames

HMMA 831 - Recommended Hardware Locations for Hollow Metal Doors and Frames

HMMA 840 - Installation and Storage of Hollow Metal Doors and Frames

ANSI/NAAMM

HMMA 841 - Tolerances and Clearances for Commercial Hollow Metal Doors and Frames

HMMA 850 - Fire-Rated Hollow Metal Doors and Frames

HMMA 890 - Technical Summary

HMMA 810-TN01 - Defining Undercuts

HMMA 820-TN01 - Grouting Hollow Metal Frames

HMMA 820-TN02 - Continuously Welded Frames

HMMA 820-TN03 - Guidelines for Glazing Hollow Metal Transoms, Sidelights and Windows

HMMA 840-TN01 - Painting Hollow Metal Products

HMMA 840-TN02 - Maintenance of Installed Hollow Metal Products