

O **ULTRA**
HARDWARE



Full Product Line
Catalog 2012

Table of Contents

Locksets	2-32
Residential	2-29
Commercial	30-32
Commercial Door Hardware	33-39
Builders' Hardware	40-121
Security Hardware.....	40-53
Hinges	54-69
Miniature Solid Brass Hardware.....	70-71
Reinforcement.....	72-74
Organization	75-82
Wire Goods	83-88
Home Hardware	89-102
Gate & Garage Hardware	103-109
Storm & Screen Door Hardware.....	110-117
Window & Patio Door Hardware	118-121
Cabinet Hardware.....	122-143
Fans & Lighting	144-154
Index.....	155-160



ULTRA SECURITY

The Smart Choice For Security & Style

PLUS

CHESTNUT HILL SERIES

- 25 Year limited warranty
- Grade 3
- KW1
- Removable 5 Pin tumbler cylinder
- Reversible, non-handed
- Fits doors 1-3/8" to 1-3/4" thick
- Fits standard 2-1/8" installation hole
- High security 1" throw on all deadbolts
- Double Keyed

(Removable cylinder on both outside & inside knobs)



LOCKSETS



CODE	CUT CASE	FUNCTION	LATCH	PACK	INNER	MASTER
POLISHED BRASS / US3 - CLAMSHELL						
43998	—	Entry KD	4-Way Snap	Clamshell	6◆	24
43999	—	Entry K3	4-Way Snap	Clamshell	6◆	24
43983	—	Entry K6	6-Way Adjustable	Clamshell	6◆	24
44096 NEW	—	Storeroom KD	4-Way Snap	Clamshell	6◆	24
43996	—	Bed/Bath	4-Way Snap	Clamshell	6◆	24
43997	—	Hall/Closet	4-Way Snap	Clamshell	6◆	24
44200	—	Dummy	—	2/Clamshell	6◆	24
43992	—	Combo - Entry & Single Cyl. Deadbolt KD	4-Way Snap	Clamshell	6◆	12
43990	—	Combo - Entry & Single Cyl. Deadbolt K3	4-Way Snap	Clamshell	6◆	12
43403 NEW	—	Double Keyed - Entry KD	2-Way/Radius	Clamshell	6◆	24
43993	—	Combo - Entry & Single Cyl. Deadbolt KD	4-Way Snap	Clamshell	6◆	12
43991 NEW	—	Combo - Entry & Single Cyl. Deadbolt K3	4-Way Snap	Clamshell	6◆	12
ANTIQUE BRASS / US5 - CLAMSHELL						
44196	—	Entry K3	4-Way Snap	Clamshell	6◆	24
44193	—	Bed/Bath	4-Way Snap	Clamshell	6◆	24
44190	—	Hall/Closet	4-Way Snap	Clamshell	6◆	24
44201 NEW	—	Dummy	—	2/Clamshell	6◆	24
44479	—	Combo - Entry & Single Cyl. Deadbolt K3	4-Way Snap	Clamshell	3◆	12
44089 NEW	—	Combo - Entry & Double Cyl. Deadbolt KD	4-Way Snap	Clamshell	3◆	12
43400	—	Double Keyed - Entry KD	2-Way/Radius	Clamshell	6◆	24

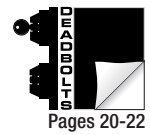

Pages 20-22

ULTRA SECURITY

The Smart Choice For Security & Style

CHESTNUT HILL SERIES Continued

- 25 Year limited warranty
 - Grade 3
 - KW1
 - Removable 5 Pin tumbler cylinder
 - Reversible, non-handed
 - Fits doors 1-3/8" to 1-3/4" thick
 - Fits standard 2-1/8" installation hole
 - High security 1" throw on all deadbolts
 - Double Keyed
- (Removable cylinder on both outside & inside knobs)

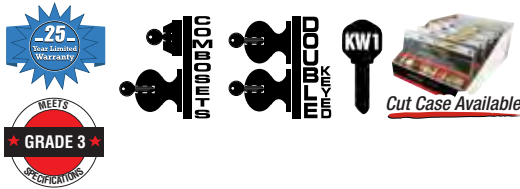

CODE	CUT CASE	FUNCTION	LATCH	PACK	INNER	MASTER
ANTIQUE COPPER / CLAMSHELL						
43404 NEW	—	Entry KD	3	Clamshell	6◆	24
43406 NEW	—	Bed/Bath	2-Way/Radius	Clamshell	6◆	24
43405 NEW	—	Combo - Entry & Single Cyl. Deadbolt KD	2-Way/Radius	Clamshell	6◆	12
43401 NEW	—	Double Keyed - Entry KD	2-Way/Radius	Clamshell	6◆	24
SATIN NICKEL / US15 - CLAMSHELL						
44198	42086	Entry K3	4-Way Snap	Clamshell	6◆	24
44195	42085	Bed/Bath	4-Way Snap	Clamshell	6◆	24
44192	42084	Hall/Closet	4-Way Snap	Clamshell	6◆	24
44204	—	Dummy	—	2/Clamshell	6◆	24
43975	—	Combo - Entry & Single Cyl. Deadbolt K3	4-Way Snap	Clamshell	3◆	12
44086 NEW	—	Combo - Entry & Double Cyl. Deadbolt KD	4-Way Snap	Clamshell	3◆	12
STAINLESS STEEL / US32 - CLAMSHELL						
43987	—	Entry KD	4-Way Snap	Clamshell	6◆	24
43985	—	Entry K3	4-Way Snap	Clamshell	6◆	24
43989	—	Bed/Bath	4-Way Snap	Clamshell	6◆	24
43988	—	Hall/Closet	4-Way Snap	Clamshell	6◆	24
44202	—	Dummy	—	2/Clamshell	6◆	24
43979	—	Combo - Entry & Single Cyl. Deadbolt K3	4-Way Snap	Clamshell	6◆	12
43402	—	Double Keyed - Entry KD	2-Way/Radius	Clamshell	6◆	24

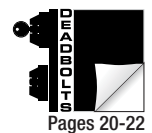

ULTRA SECURITY

The Smart Choice For Security & Style

ULTRA SECURITY SERIES

LOCKSETS

- 25 Year limited warranty
- Grade 3
- KW1 and SC1 Keyways
- Removable 5 Pin tumbler cylinder
- Reversible, non-handed
- Fits doors 1-3/8" to 1-3/4" thick
- Fits standard 2-1/8" installation hole
- High security 1" throw on all deadbolts

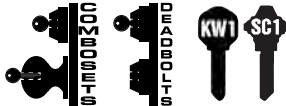

CODE	CUT CASE	FUNCTION	KEYWAY	LATCH	PACK	INNER	MASTER
POLISHED BRASS / US3 - CLAMSHELL							
43960	—	Entry KD	KW1	2-Way/Radius	Clamshell	6◆	24
43952	43264	Entry K3	KW1	2-Way/Radius	Clamshell	6◆	24
44071	43001	Entry K2	KW1	2-Way/Radius	2/Clamshell	6◆	—
95700 NEW	—	Entry K3	SC1	2-Way/Radius	Clamshell	6◆	24
43964	43275	Bed/Bath	—	2-Way/Radius	Clamshell	6◆	24
43962	43286	Hall/Closet	—	2-Way/Radius	Clamshell	6◆	24
43965	—	Combo - Entry & Single Cyl. Deadbolt KD	KW1	2-Way/Radius	Clamshell	6◆	12
43969	43256	Combo - Entry & Single Cyl. Deadbolt K3	KW1	2-Way/Radius	Clamshell	6◆	12
43956	—	Combo - Entry & Double Cyl. Deadbolt KD	KW1	2-Way/Radius	Clamshell	6◆	12
44019	—	Combo - Entry & Double Cyl. Deadbolt K3	KW1	2-Way/Radius	Clamshell	6◆	12
43963	—	Double Combo - Entry & Single Cyl. Deadbolt K2	KW1	2-Way/Radius	2 Combos/Clamshell	3◆	6
95701 NEW	—	Combo - Entry & Single Cyl. Deadbolt K3	SC1	2-Way/Radius	Clamshell	6◆	12
95702 NEW	—	Combo - Entry & Double Cyl. Deadbolt K3	KW1	2-Way/Radius	Clamshell	6◆	12
POLISHED BRASS / US3 - BOX							
43948	—	Entry KD	KW1	Adjustable/Square Corner	Box	6◆	24
43951	—	Entry K3	KW1	Adjustable/Square Corner	Box	6◆	24
43950	—	Bed/Bath	—	Adjustable/Square Corner	Box	6◆	24
43949	—	Hall/Closet	—	Adjustable/Square Corner	Box	6◆	24
43954	—	Combo - Entry & Single Cyl. Deadbolt KD	KW1	Adjustable/Square Corner	Box	6◆	12

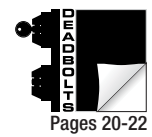

Pages 20-22

ULTRA SECURITY

The Smart Choice For Security & Style

ULTRA SECURITY SERIES Continued

- 25 Year limited warranty
- Grade 3
- KW1
- Removable 5 Pin tumbler cylinder
- Reversible, non-handed
- Fits doors 1-3/8" to 1-3/4" thick
- Fits standard 2-1/8" installation hole
- High security 1" throw on all deadbolts

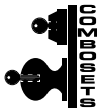

LOCKSETS

CODE	CUT CASE	FUNCTION	KEYWAY	LATCH	PACK	INNER	MASTER
ANTIQUE BRASS / US5 - CLAMSHELL							
43958	—	Entry KD	KW1	2-Way/Radius	Clamshell	6◆	24
43944	43267	Entry K3	KW1	2-Way/Radius	Clamshell	3◆	3◆
43959	43276	Bed/Bath	—	2-Way/Radius	Clamshell	6◆	24
43961	43287	Hall/Closet	—	2-Way/Radius	Clamshell	6◆	24
44061	43257	Combo - Entry & Single Cyl. Deadbolt K3	KW1	2-Way/Radius	Clamshell	6◆	12
43982	—	Combo - Entry & Double Cyl. Deadbolt K3	KW1	2-Way/Radius	Clamshell	3◆	12
STAINLESS STEEL / US32 - CLAMSHELL							
43973	—	Entry KD	KW1	2-Way/Radius	Clamshell	6◆	24
43974	42080	Entry K3	KW1	2-Way/Radius	Clamshell	6◆	24
95703 NEW		Entry K3	SC1	2-Way/Radius	Clamshell	6◆	24
43977	42082	Bed/Bath	—	2-Way/Radius	Clamshell	6◆	24
43976	42081	Hall/Closet	—	2-Way/Radius	Clamshell	6◆	24
43971	42079	Combo - Entry & Single Cyl. Deadbolt K3	KW1	2-Way/Radius	Clamshell	6◆	12
44283 NEW	—	Combo - Entry & Double Cyl. Deadbolt KD	KW1	2-Way/Radius	Clamshell	6◆	12
44158	—	Combo - Entry & Double Cyl. Deadbolt K3	KW1	2-Way/Radius	Clamshell	6◆	12
95704 NEW		Combo - Entry & Single Cyl. Deadbolt K3	SC1	2-Way/Radius	Clamshell	6◆	12
95705 NEW	—	Combo - Entry & Double Cyl. Deadbolt K3	SC1	2-Way/Radius	Clamshell	6◆	12
STAINLESS STEEL / US32 - BOX							
43908	—	Combo - Entry & Single Cyl. Deadbolt K3	KW1	2-Way/Radius	Box	6◆	12

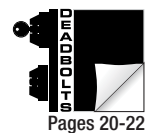

Pages 20-22

ULTRA SECURITY

The Smart Choice For Security & Style

MOBILE HOME LOCKS

- 25 Year limited warranty
- Grade 3
- KW1 Keyway
- Removable 5 Pin tumbler cylinder
- Reversible, non-handed
- Fits standard 2-1/8" installation hole
- High security 1" throw on all deadbolts
- Weather seal protection on entry locks & deadbolts



LOCKSETS

CODE	FUNCTION	LATCH	BACKSET	BODY DIA.	PACK	INNER	MASTER
POLISHED BRASS / US3 - CLAMSHELL							
44260	Entry KD	Drive-In	2-Way Adjustable	1"	Clamshell	6◆	24
44262	Bed/Bath	Drive-In	2-3/8	7/8"	Clamshell	6◆	24
44264	Hall/Closet	Drive-In	2-3/8	7/8"	Clamshell	6◆	24
44266	Combo - Entry & Single Cyl. Deadbolt KD	Drive-In	2-Way Adjustable	1"	Clamshell	6◆	12
STAINLESS STEEL / US32 - CLAMSHELL							
44261	Entry KD	Drive-In	2-Way Adjustable	1"	Clamshell	6◆	24
44263	Bed/Bath	Drive-In	2-3/8	7/8"	Clamshell	6◆	24
44265	Hall/Closet	Drive-In	2-3/8	7/8"	Clamshell	6◆	24

LATCH-DRIVE IN SPRING – FOR BED / BATH & HALL / CLOSET LOCKS

CODE	BACKSET	BODY DIA.	PACK	INNER	MASTER
POLISHED BRASS / US3					
07029	2-3/4	7/8"	Bulk	1	200
06932 NEW	2-3/8	7/8"	Polybag	50	100

DEADBOLTS-MOBILE HOME

CODE	DESCRIPTION	FINISH	LATCH	BACKSET	PACK	INNER	MASTER
POLISHED BRASS / US3 - CLAMSHELL							
44267	Single Cyl. KD	Polished Brass / US3	4-Way	Adjustable	Clamshell	6◆	24
STAINLESS STEEL / US32 - CLAMSHELL							
44268	Single Cyl. KD	Stainless Steel / US32	4-Way	Adjustable	Clamshell	6◆	24

ULTRA SECURITY

The Smart Choice For Security & Style

WYNNEWOOD SERIES

- 25 Year limited warranty
- Grade 3
- KW1 Keyway
- Removable 5 Pin tumbler cylinder
- Reversible, non-handed
- Fits doors 1-3/8" to 1-3/4" thick
- Fits standard 2-1/8" installation hole



LOCKSETS

CODE	FUNCTION	LATCH	PACK	INNER	MASTER
POLISHED BRASS / US3 - CLAMSHELL					
44465	Entry K3	4-Way Snap	Clamshell	6◆	24
44467	Bed/Bath	4-Way Snap	Clamshell	6◆	24
44469	Hall/Closet	4-Way Snap	Clamshell	6◆	24
44471	Dummy	—	2/Clamshell	6◆	24
DULL CHROME / US26D - CLAMSHELL					
44466	Entry K3	4-Way Snap	Clamshell	6◆	24
44468	Bed/Bath	4-Way Snap	Clamshell	6◆	24
44470	Hall/Closet	4-Way Snap	Clamshell	6◆	24
44472	Dummy	—	2/Clamshell	6◆	24



Pages 20-22

ULTRA SECURITY

The Smart Choice For Security & Style

PLUS

LANCASTER SERIES

LOCKSETS

- Limited lifetime warranty
- Grade 3
- KW1
- Removable 5 Pin tumbler cylinder
- Reversible, non-handed
- Fits doors 1-3/8" to 1-3/4" thick
- Fits standard 2-1/8" installation hole
- High security 1" throw throws on deadbolts



CODE	FUNCTION	LATCH	PACK	INNER	MASTER
POLISHED BRASS / US3 - CLAMSHELL					
44051	Entry KD	6-Way Adjustable	Clamshell	6◆	24
44053	Entry K3	6-Way Adjustable	Clamshell	6◆	24
44057	Bed/Bath	6-Way Adjustable	Clamshell	6◆	24
44059	Hall/Closet	6-Way Adjustable	Clamshell	6◆	24
44082	Combo - Entry & Single Cyl. Deadbolt K3	6-Way Adjustable	Clamshell	3◆	12
ANTIQUE BRASS / US5 - CLAMSHELL					
44055	Entry KD	6-Way Adjustable	Clamshell	6◆	24
44073	Entry K3	6-Way Adjustable	Clamshell	6◆	24
44063	Bed/Bath	6-Way Adjustable	Clamshell	6◆	24
44077	Hall/Closet	6-Way Adjustable	Clamshell	6◆	24
STAINLESS STEEL / US32 - CLAMSHELL					
44067	Entry KD	6-Way Adjustable	Clamshell	6◆	24
44069	Entry K3	6-Way Adjustable	Clamshell	6◆	24
44070	Bed/Bath	6-Way Adjustable	Clamshell	6◆	24
44075	Hall/Closet	6-Way Adjustable	Clamshell	6◆	24



Pages 20-22

ULTRA SECURITY PLUS

The Smart Choice For Security & Style

RITTENHOUSE SERIES

- Limited lifetime warranty
- Grade 3
- KW1
- Removable 5 Pin tumbler cylinder
- Reversible, non-handed
- Fits doors 1-3/8" to 1-3/4" thick
- Fits standard 2-1/8" installation hole
- High security 1" throw throws on deadbolts
- Double Combo (2 Entries & 2 Deadbolts KA within pack)

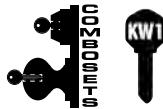

CODE	FUNCTION	LATCH	PACK	INNER	MASTER
POLISHED BRASS / US3 - CLAMSHELL					
44030	Entry KD	6-Way Adjustable	Clamshell	6◆	24
44035	Entry K3	6-Way Adjustable	Clamshell	6◆	24
44045	Bed/Bath	6-Way Adjustable	Clamshell	6◆	24
43927	Bed/Bath (split finish)	6-Way Adjustable	Clamshell	6◆	24
44040	Hall/Closet	6-Way Adjustable	Clamshell	6◆	24
44250	Dummy	—	2/Clamshell	6◆	24
44002	Combo - Entry & Single Cyl. Deadbolt KD	6-Way Adjustable	Clamshell	3◆	12
44000	Combo - Entry & Single Cyl. Deadbolt K3	6-Way Adjustable	Clamshell	3◆	12
44004	Combo - Entry & Double Cyl. Deadbolt KD	6-Way Adjustable	Clamshell	3◆	12
44005	Combo - Entry & Double Cyl. Deadbolt K3	6-Way Adjustable	Clamshell	3◆	12
44007	Double Combo - Entry & Single Cyl. Deadbolt K2	6-Way Adjustable	2 Combos/Clamshell	1	12
POLISHED BRASS / US3 - BOX					
44020	Entry KD	Adjustable	Box	6◆	24
44025	Entry K3	Adjustable	Box	6◆	24
44026	Entry MK	Adjustable	Box	6◆	24
44029	Bed/Bath	2-3/8"/Square Corner	Box	6◆	24
44027	Bed/Bath (split finish)	2-3/8"/Square Corner	Box	6◆	24
44028	Hall/Closet	2-3/8"/Square Corner	Box	6◆	24
44305	Dummy	—	2/Box	6◆	24
44038	Stormroom KD	Adjustable	Box	6◆	24
44049	Bed/Bath	2-3/8"/Square Corner	Box	6◆	24
44048	Hall/Closet	2-3/8"/Square Corner	Box	6◆	24
44015	Combo - Entry & Single Cyl. Deadbolt KD	Adjustable	Box	3◆	12
44010	Combo - Entry & Single Cyl. Deadbolt K3	Adjustable	Box	3◆	12
44011	Combo - Entry & Single Cyl. Deadbolt K2	Adjustable	Box	2◆	12
44001	Combo - Entry & Single Cyl. Deadbolt KDMK	Adjustable	Box	3◆	12



ULTRA SECURITY

The Smart Choice For Security & Style

PLUS

RITTENHOUSE SERIES
Continued

- Limited lifetime warranty
- Grade 3
- KW1
- Removable 5 Pin tumbler cylinder
- Reversible, non-handed
- Fits doors 1-3/8" to 1-3/4" thick
- Fits standard 2-1/8" installation hole
- High security 1" throw throws on deadbolts



LOCKSETS

CODE	FUNCTION	LATCH	PACK	INNER	MASTER
SATIN NICKEL / US15 - CLAMSHELL					
43915	Entry KD	6-Way Adjustable	Clamshell	6◆	24
43916	Entry K3	6-Way Adjustable	Clamshell	6◆	24
43918	Bed/Bath	6-Way Adjustable	Clamshell	6◆	24
43917	Hall/Closet	6-Way Adjustable	Clamshell	6◆	24
43919	Dummy	—	2/Clamshell	6◆	24
44155	Combo - Entry & Single Cyl. Deadbolt K3	6-Way Adjustable	Clamshell	3◆	12
44157	Combo - Entry & Double Cyl. Deadbolt K3	6-Way Adjustable	Clamshell	3◆	12
SATIN NICKEL / US15 - BOX					
43924	Entry KD	6-Way Adjustable	Box	6◆	24
43909	Entry K3	6-Way Adjustable	Box	6◆	24
43925	Bed/Bath	6-Way Adjustable	Box	6◆	24
43926	Hall/Closet	6-Way Adjustable	Box	6◆	24
ANTIQUE BRASS / US5 - CLAMSHELL					
44041	Entry KD	6-Way Adjustable	Clamshell	6◆	24
44042	Entry K3	6-Way Adjustable	Clamshell	6◆	24
44044	Bed/Bath	6-Way Adjustable	Clamshell	6◆	24
44043	Hall/Closet	6-Way Adjustable	Clamshell	6◆	24
44251	Dummy	—	2/Clamshell	6◆	24
44009	Combo - Entry & Single Cyl. Deadbolt K3	6-Way Adjustable	Clamshell	3◆	12
43986	Combo - Entry & Double Cyl. Deadbolt K3	6-Way Adjustable	Clamshell	3◆	12



Pages 20-22

ULTRA SECURITY PLUS

The Smart Choice For Security & Style

RITTENHOUSE SERIES
Continued

- Limited lifetime warranty
- Grade 3
- KW1
- Removable 5 Pin tumbler cylinder
- Reversible, non-handed
- Fits doors 1-3/8" to 1-3/4" thick
- Fits standard 2-1/8" installation hole
- High security 1" throw throws on deadbolts



CODE	FUNCTION	LATCH	PACK	INNER	MASTER
POLISHED CHROME/ US26 - CLAMSHELL					
44031	Entry KD	6-Way Adjustable	Clamshell	6◆	24
44032	Entry K3	6-Way Adjustable	Clamshell	6◆	24
44034	Bed/Bath	6-Way Adjustable	Clamshell	6◆	24
44033	Hall/Closet	6-Way Adjustable	Clamshell	6◆	24
44058	Dummy	—	2/Clamshell	6◆	24
DULL CHROME/ US26D - CLAMSHELL					
43936	Entry KD	6-Way Adjustable	Clamshell	6◆	24
44076	Entry K3	6-Way Adjustable	Clamshell	6◆	24
43947	Bed/Bath	6-Way Adjustable	Clamshell	6◆	24
43946	Hall/Closet	6-Way Adjustable	Clamshell	6◆	24
44252	Dummy	—	2/Clamshell	6◆	24
44017	Combo - Entry & Single Cyl. Deadbolt K3	6-Way Adjustable	Clamshell	3◆	12
44156	Combo - Entry & Double Cyl. Deadbolt K3	6-Way Adjustable	Clamshell	3◆	12
DULL CHROME/ US26D - BOX					
44037	Entry K3	Adjustable	Box	6◆	24
44047	Bed/Bath	2-3/8"/Square Corner	Box	6◆	24
44046	Hall/Closet	2-3/8"/Square Corner	Box	6◆	24



Pages 20-22

ULTRA SECURITY

The Smart Choice For Security & Style

PLUS

STRATHMERE SERIES

- Limited lifetime warranty
- Grade 3
- KW1
- Removable 5 Pin tumbler cylinder
- Reversible, non-handed
- Fits doors 1-3/8" to 1-3/4" thick
- Fits standard 2-1/8" installation hole
- High security 1" throw throws on deadbolts



LOCKSETS

CODE	FUNCTION	LATCH	PACK	INNER	MASTER
POLISHED BRASS / US3 - CLAMSHELL					
44165	Entry KD	6-Way Adjustable	Clamshell	6◆	24
44166	Entry K3	6-Way Adjustable	Clamshell	6◆	24
44167	Bed/Bath	6-Way Adjustable	Clamshell	6◆	24
44168	Hall/Closet	6-Way Adjustable	Clamshell	6◆	24
44169	Dummy	—	2/Clamshell	6◆	24
44175	Combo - Entry & Single Cyl. Deadbolt KD	6-Way Adjustable	Clamshell	3◆	12
SATIN NICKEL / US15 - CLAMSHELL					
44170	Entry KD	6-Way Adjustable	Clamshell	6◆	24
44171	Entry K3	6-Way Adjustable	Clamshell	6◆	24
44172	Bed/Bath	6-Way Adjustable	Clamshell	6◆	24
44173	Hall/Closet	6-Way Adjustable	Clamshell	6◆	24
44174	Dummy	—	2/Clamshell	6◆	24
44176	Combo - Entry & Single Cyl. Deadbolt KD	6-Way Adjustable	Clamshell	3◆	12
OIL RUBBED BRONZE - CLAMSHELL					
44159	Entry KD	6-Way Adjustable	Clamshell	6◆	24
44160	Entry K3	6-Way Adjustable	Clamshell	6◆	24
44161	Bed/Bath	6-Way Adjustable	Clamshell	6◆	24
44162	Hall/Closet	6-Way Adjustable	Clamshell	6◆	24
44164	Dummy	—	2/Clamshell	6◆	24
44177	Combo - Entry & Single Cyl. Deadbolt KD	6-Way Adjustable	Clamshell	3◆	12



Pages 20-22

ULTRA SECURITY

The Smart Choice For Security & Style

PLUS

VALLEY FORGE SERIES

- Limited lifetime warranty
- Grade 3
- KW1
- Removable 5 Pin tumbler cylinder
- Reversible, non-handed
- Fits doors 1-3/8" to 1-3/4" thick
- Fits standard 2-1/8" installation hole
- High security 1" throw throws on deadbolts



Cut Case Available



LOCKSETS

CODE	CUT CASE	FUNCTION	LATCH	PACK	INNER	MASTER
POLISHED BRASS / US3 - CLAMSHELL						
43470	—	Entry KD	6-Way Adjustable	Clamshell	6◆	24
43471	43265	Entry K3	6-Way Adjustable	Clamshell	6◆	24
43472	43277	Bed/Bath	6-Way Adjustable	Clamshell	6◆	24
43473	43288	Hall/Closet	6-Way Adjustable	Clamshell	6◆	24
43474	43258	Combo - Entry & Single Cyl. Deadbolt K3	6-Way Adjustable	Clamshell	3◆	12
43475	—	Combo - Entry & Double Cyl. Deadbolt K3	6-Way Adjustable	Clamshell	3◆	12
ANTIQUE BRASS / US5 - CLAMSHELL						
43486	43266	Entry K3	6-Way Adjustable	Clamshell	6◆	24
43487	43278	Bed/Bath	6-Way Adjustable	Clamshell	6◆	24
43498	43289	Hall/Closet	6-Way Adjustable	Clamshell	6◆	24
43478	43259	Combo - Entry & Single Cyl. Deadbolt K3	6-Way Adjustable	Clamshell	3◆	12
OIL RUBBED BRONZE / US10B - CLAMSHELL						
43494	—	Entry KD	6-Way Adjustable	Clamshell	6◆	24
43495	—	Bed/Bath	6-Way Adjustable	Clamshell	6◆	24
43496	—	Hall/Closet	6-Way Adjustable	Clamshell	6◆	24
43497	—	Dummy	—	2/Clamshell	6◆	24
43453	—	Combo - Entry & Single Cyl. Deadbolt K3	6-Way Adjustable	Clamshell	3◆	12
SATIN NICKEL / US15 - BOX						
43456	—	Entry K3	4-Way Snap	Box	6◆	24
43460	—	Bed/Bath	4-Way Snap	Box	6◆	24
43462	—	Hall/Closet	4-Way Snap	Box	6◆	24
SATIN NICKEL / US15 - CLAMSHELL						
43895	—	Entry K3	6-Way Adjustable	Clamshell	6◆	24
43897	—	Bed/Bath	6-Way Adjustable	Clamshell	6◆	24
43896	—	Hall/Closet	6-Way Adjustable	Clamshell	6◆	24
43898	—	Dummy	—	2/Clamshell	6◆	24
43451	—	Combo - Entry & Single Cyl. Deadbolt K3	6-Way Adjustable	Clamshell	3◆	12



Pages 20-22

ULTRA SECURITY

The Smart Choice For Security & Style

PLUS

STURBRIDGE SERIES

- Limited lifetime warranty
- Grade 3
- KW1 and SC1
- Removable 5 Pin tumbler cylinder
- Reversible, non-handed
- Fits doors 1-3/8" to 1-3/4" thick
- Fits standard 2-1/8" installation hole
- High security 1" throw throws on deadbolts



LOCKSETS

CODE	CUT CASE	FUNCTION	KEYWAY	LATCH	PACK	INNER	MASTER
POLISHED BRASS / US3 - CLAMSHELL							
43046	—	Entry K3	KW1	6-Way Adjustable	Clamshell	6◆	24
43055	—	Entry KD	SC1	6-Way Adjustable	Clamshell	6◆	24
43056	43272	Entry K3	SC1	6-Way Adjustable	Clamshell	6◆	24
43057	43283	Bed/Bath	—	6-Way Adjustable	Clamshell	6◆	24
43058	43294	Hall/Closet	—	6-Way Adjustable	Clamshell	6◆	24
43054	—	Dummy	—	—	2/Clamshell	6◆	24
43059	—	Combo - Entry & Single Cyl. Deadbolt KD	SC1	6-Way Adjustable	Clamshell	3◆	12
43047	42076	Combo - Entry & Single Cyl. Deadbolt K3	SC1	6-Way Adjustable	Clamshell	3◆	12
POLISHED BRASS / US3 - BOX							
43061	—	Entry K3	SC1	6-Way Adjustable	Box	6◆	24
43062	—	Bed/Bath	—	6-Way Adjustable	Box	6◆	24
43063	—	Hall/Closet	—	6-Way Adjustable	Box	6◆	24
43064	—	Combo - Entry & Single Cyl. Deadbolt KD	SC1	Adjustable	Box	3◆	12
43048	—	Combo - Entry & Single Cyl. Deadbolt K3	SC1	Adjustable	Box	3◆	12
OIL RUBBED BRONZE / US10B - CLAMSHELL							
42045	42073	Entry K3	KW1	6-Way Adjustable	Clamshell	6◆	24
44288	—	Entry KD	KW1	6-Way Adjustable	Clamshell	6◆	24
43433	43273	Entry K3	SC1	6-Way Adjustable	Clamshell	6◆	24
43434	43284	Bed/Bath	—	6-Way Adjustable	Clamshell	6◆	24
43435	43295	Hall/Closet	—	6-Way Adjustable	Clamshell	6◆	24
42048	—	Dummy	—	—	2/Clamshell	6◆	24
42049	42074	Combo - Entry & Single Cyl. Deadbolt K3	SC1	6-Way Adjustable	Clamshell	3◆	12
SATIN NICKEL / US15 - CLAMSHELL							
42033	43274	Entry K3	SC1	6-Way Adjustable	Clamshell	6◆	24
42028	42071	Entry K3	KW1	6-Way Adjustable	Clamshell	6◆	24
42038	43285	Bed/Bath	—	6-Way Adjustable	Clamshell	6◆	24
42039	43296	Hall/Closet	—	6-Way Adjustable	Clamshell	6◆	24
42041	—	Dummy	—	—	2/Clamshell	6◆	24
42043	42072	Combo - Entry & Single Cyl. Deadbolt K3	SC1	6-Way Adjustable	Clamshell	3◆	12



ULTRA SECURITY

The Smart Choice For Security & Style

SCARBOROUGH SERIES

PLUS

- Limited lifetime warranty
- Grade 3
- KW1
- Removable 5 Pin tumbler cylinder
- Reversible, non-handed
- Fits doors 1-3/8" to 1-3/4" thick
- Fits standard 2-1/8" installation hole



LOCKSETS

CODE	FUNCTION	LATCH	PACK	INNER	MASTER
POLISHED BRASS / US3 - CLAMSHELL					
44455	Entry KD	4-Way Snap	Clamshell	6◆	24
44454	Entry K3	4-Way Snap	Clamshell	6◆	24
44457	Bed/Bath	4-Way Snap	Clamshell	6◆	24
44456	Hall/Closet	4-Way Snap	Clamshell	6◆	24
44464	Dummy	—	2/Clamshell	6◆	24
SATIN NICKEL/ US15 - CLAMSHELL					
44459	Entry KD	4-Way Snap	Clamshell	6◆	24
44458	Entry K3	4-Way Snap	Clamshell	6◆	24
44462	Bed/Bath	4-Way Snap	Clamshell	6◆	24
44461	Hall/Closet	4-Way Snap	Clamshell	6◆	24
44463	Dummy	—	2/Clamshell	6◆	24
SATIN NICKEL/ US15 - BOX					
44451	Entry KD	4-Way Snap	Box	6◆	24
44453	Bed/Bath	4-Way Snap	Box	6◆	24
44452	Hall/Closet	4-Way Snap	Box	6◆	24

Replacement Cylinder

Fits Kwikset Tylo™* & Other Kwikset™* Locks

- Also Ultra Security (pg. 4), Mobile Home (pg. 6), Rittenhouse (pgs. 9-11, Valley Forge (pgs. 12-13), and Gettysburg (pgs. 18-19)
- Polished brass finish

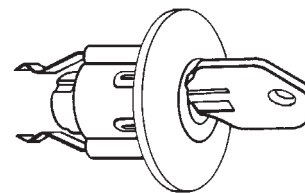

CODE	KEYED	PACK	INNER	MASTER
17025	Different	Box	12◆	288
17026	Master KD	Box	12◆	288

*The following registered trade name or trade mark is not owned, associated with or connected in any way with Ultra Hardware Products LLC and is used herein for illustrative purposes only.



ULTRA SECURITY

The Smart Choice For Security & Style

PLUS

BRIARWOOD SERIES

- Limited lifetime warranty
- Grade 3
- KW1
- Removable 5 Pin tumbler cylinder
- Reversible, non-handed
- Fits doors 1-3/8" to 1-3/4" thick
- Fits standard 2-1/8" installation hole



LOCKSETS

CODE	FUNCTION	LATCH	PACK	INNER	MASTER
POLISHED BRASS / US3 - CLAMSHELL					
44385	Entry KD	4-Way Snap	Clamshell	6◆	24
44391	Entry K3	4-Way Snap	Clamshell	6◆	24
44387	Bed/Bath	4-Way Snap	Clamshell	6◆	24
44389	Hall/Closet	4-Way Snap	Clamshell	6◆	24
44399	Dummy	—	2/Clamshell	6◆	24
SATIN NICKEL/ US15 - CLAMSHELL					
43420	Entry KD	4-Way Snap	Clamshell	6◆	24
44415	Entry K3	4-Way Snap	Clamshell	6◆	24
43421	Bed/Bath	4-Way Snap	Clamshell	6◆	24
43422	Hall/Closet	4-Way Snap	Clamshell	6◆	24
44416	Dummy	—	2/Clamshell	6◆	24
SATIN NICKEL/ US15 - BOX					
44384	Entry KD	4-Way Snap	Box	6◆	24
44383	Bed/Bath	4-Way Snap	Box	6◆	24
44382	Hall/Closet	4-Way Snap	Box	6◆	24
DULL CHROME/ US26D - CLAMSHELL					
44386	Entry KD	4-Way Snap	Clamshell	6◆	24
44392	Entry K3	4-Way Snap	Clamshell	6◆	24
44388	Bed/Bath	4-Way Snap	Clamshell	6◆	24
44390	Hall/Closet	—	2/Clamshell	6◆	24



Pages 20-22

ULTRA SECURITY

The Smart Choice For Security & Style

LEXINGTON SERIES

PLUS

- Limited lifetime warranty
- Grade 3
- KW1 & SC1 Keyways
- Removable 5 Pin tumbler cylinder
- Reversible, non-handed
- Fits doors 1-3/8" to 1-3/4" thick
- Fits standard 2-1/8" installation hole
- High security 1" throw throws on deadbolts

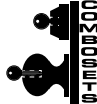

LOCKSETS

CODE	CUT CASE	FUNCTION	KEYWAY	LATCH	PACK	INNER	MASTER
POLISHED BRASS / US3 - CLAMSHELL							
44330	—	Entry KD	KW1	4-Way Snap	Clamshell	6◆	24
44331	42087	Entry K3	KW1	4-Way Snap	Clamshell	6◆	24
95714 NEW	—	Entry K3	SC1	4-Way Snap	Clamshell	6◆	24
44340	42090	Bed/Bath	—	4-Way Snap	Clamshell	6◆	24
44350	42093	Hall/Closet	—	4-Way Snap	Clamshell	6◆	24
44320	—	Dummy	—	—	2/Clamshell	6◆	24
95717 NEW	—	Combo - Entry & Single Cyl. Deadbolt K3	SC1	4-Way Snap	Clamshell	3◆	12
OIL RUBBED BRONZE / US10B - CLAMSHELL							
44334	—	Entry KD	KW1	4-Way Snap	Clamshell	6◆	24
44335	42089	Entry K3	KW1	4-Way Snap	Clamshell	6◆	24
95716 NEW	—	Entry K3	SC1	4-Way Snap	Clamshell	6◆	24
44342	42092	Bed/Bath	—	4-Way Snap	Clamshell	6◆	24
44352	42095	Hall/Closet	—	4-Way Snap	Clamshell	6◆	24
44322	—	Dummy	—	—	2/Clamshell	6◆	24
95719 NEW	—	Combo - Entry & Single Cyl. Deadbolt K3	SC1	4-Way Snap	Clamshell	3◆	12
SATIN NICKEL / US15 - CLAMSHELL							
44332	—	Entry KD	KW1	4-Way Snap	Clamshell	6◆	24
44333	42089	Entry K3	KW1	4-Way Snap	Clamshell	6◆	24
95715 NEW	—	Entry K3	SC1	4-Way Snap	Clamshell	6◆	24
44341	42091	Bed/Bath	—	4-Way Snap	Clamshell	6◆	24
44351	42094	Hall/Closet	—	4-Way Snap	Clamshell	6◆	24
44321	—	Dummy	—	—	2/Clamshell	6◆	24
95718 NEW	—	Combo - Entry & Single Cyl. Deadbolt K3	SC1	4-Way Snap	Clamshell	3◆	12
SATIN NICKEL / US15 - BOX							
44665	—	Entry KD	SC1	4-Way Snap	Box	6◆	24
44666	—	Bed/Bath	—	4-Way Snap	Box	6◆	24
44667	—	Hall/Closet	—	4-Way Snap	Box	6◆	24



Pages 20-22

ULTRA SECURITY

The Smart Choice For Security & Style

PLUS

GETTYSBURG SERIES

- Limited lifetime warranty
- Grade 3
- KW1
- Removable 5 Pin tumbler cylinder
- Reversible, non-handed
- Fits doors 1-3/8" to 1-3/4" thick
- Fits standard 2-1/8" installation hole
- High security 1" throw throws on deadbolts



LOCKSETS

CODE	CUT CASE	FUNCTION	KEYWAY	LATCH	PACK	INNER	MASTER
POLISHED BRASS / US3 - CLAMSHELL							
44485	—	Entry KD	KW1	4-Way Snap	Clamshell	6◆	24
44484	43269	Entry K3	KW1	4-Way Snap	Clamshell	6◆	24
95707 NEW	—	Entry K3	SC1	4-Way Snap	Clamshell	6◆	24
44575	43280	Bed/Bath	—	4-Way Snap	Clamshell	6◆	24
44580	43291	Hall/Closet	—	4-Way Snap	Clamshell	6◆	24
44567	—	Dummy	—	—	2/Clamshell	6◆	24
44552	43261	Combo - Entry & Single Cyl. Deadbolt K3	KW1	4-Way Snap	Clamshell	3◆	12
95711 NEW	—	Combo - Entry & Single Cyl. Deadbolt K3	SC1	4-Way Snap	Clamshell	3◆	12
POLISHED BRASS / US3 - BOX							
44481	—	Entry KD	KW1	4-Way Snap	Box	6◆	24
44578	—	Bed/Bath	—	4-Way Snap	Box	6◆	24
44582	—	Hall/Closet	—	4-Way Snap	Box	6◆	24
44310R1	—	Dummy	—	—	1/Box	6◆	24
ANTIQUE BRASS / US5 - CLAMSHELL							
44097 NEW	—	Entry KD	KW1	4-Way Snap	Clamshell	6◆	24
ANTIQUE BRASS / US5 - BOX							
44594	—	Bed/Bath	—	4-Way Snap	Box	6◆	24
44596	—	Hall/Closet	—	4-Way Snap	Box	6◆	24



Pages 20-22

ULTRA SECURITY

The Smart Choice For Security & Style

PLUS

GETTYSBURG SERIES
Continued

- Limited lifetime warranty
- Grade 3
- KW1
- Removable 5 Pin tumbler cylinder
- Reversible, non-handed
- Fits doors 1-3/8" to 1-3/4" thick
- Fits standard 2-1/8" installation hole
- High security 1" throw throws on deadbolts



LOCKSETS

CODE	CUT CASE	FUNCTION	KEYWAY	LATCH	PACK	INNER	MASTER
OIL RUBBED BRONZE / US10B - CLAMSHELL							
44574	43270	Entry K3	KW1	4-Way Snap	Clamshell	6◆	24
95709 NEW	—	Entry K3	SC1	4-Way Snap	Clamshell	6◆	24
44577	43281	Bed/Bath	—	4-Way Snap	Clamshell	6◆	24
44579	43292	Hall/Closet	—	4-Way Snap	Clamshell	6◆	24
44581	—	Dummy	—	—	Clamshell	6◆	24
44583	43262	Combo - Entry & Single Cyl. Deadbolt K3	KW1	—	2/Clamshell	3◆	12
95713 NEW	—	Combo - Entry & Single Cyl. Deadbolt K3	SC1	4-Way Snap	Clamshell	3◆	12
OIL RUBBED BRONZE / US10B - BOX							
44558	—	Bed/Bath	—	4-Way Snap	Box	6◆	24
44561	—	Hall/Closet	—	4-Way Snap	Box	6◆	24
SATIN NICKEL / US15 - CLAMSHELL							
44487	—	Entry KD	KW1	4-Way Snap	Clamshell	6◆	24
44486	43271	Entry K3	KW1	4-Way Snap	Clamshell	6◆	24
95708 NEW	—	Entry K3	SC1	4-Way Snap	Clamshell	6◆	24
44588	43282	Bed/Bath	—	4-Way Snap	Clamshell	6◆	24
44587	43292	Hall/Closet	—	4-Way Snap	Clamshell	6◆	24
44589	—	Dummy	—	—	2/Clamshell	6◆	24
44569	43263	Combo - Entry & Single Cyl. Deadbolt K3	KW1	4-Way Snap	Clamshell	3◆	12
95712 NEW	—	Combo - Entry & Single Cyl. Deadbolt K3	SC1	4-Way Snap	Clamshell	3◆	12
SATIN NICKEL / US15 - BOX							
44483	—	Entry KD	KW1	4-Way Snap	Box	6◆	24
44557	—	Bed/Bath	—	4-Way Snap	Box	6◆	24
44560	—	Hall/Closet	—	4-Way Snap	Box	6◆	24
44563	—	Dummy	—	4-Way Snap	1/Box	6◆	24
44544	—	Combo - Entry & Single Cyl. Deadbolt K3	KW1	4-Way Snap	Box	3◆	12



Pages 20-22

ULTRA SECURITY

The Smart Choice For Security & Style



LOCKSETS

ULTRA SECURITY DEADBOLTS / KW1



CODE	CUT CASE	FUNCTION	LATCH	PACK	INNER	MASTER
POLISHED BRASS / US3 - CLAMSHELL						
43966	—	Single KD	2-Way Adjustable	Clamshell	6◆	24
43967	43297	Single K3	2-Way Adjustable	Clamshell	6◆	24
43957	—	Double KD	2-Way Adjustable	Clamshell	6◆	24
43968	43301	Double K3	2-Way Adjustable	Clamshell	6◆	24
POLISHED BRASS / US3 - BOX						
43953	—	Single KD	2-Way Adjustable	Box	6◆	24

ANTIQUE BRASS / US5 - CLAMSHELL						
43970	43298	Single K3	2-Way Adjustable	Clamshell	6◆	24
43720	—	Double K3	2-Way Adjustable	Clamshell	6◆	24
44284 NEW	—	Double KD	2-Way Adjustable	Clamshell	6◆	24

STAINLESS STEEL / US32 - CLAMSHELL						
43978	43299	Single K3	2-Way Adjustable	Clamshell	6◆	24
43716	—	Double K3	2-Way Adjustable	Clamshell	6◆	24
44285 NEW	—	Double KD	2-Way Adjustable	Clamshell	6◆	24

ULTRA SECURITY

The Smart Choice For Security & Style

PLUS



STANDARD DUTY DEADBOLTS / KW1



CODE	SERIES	CYLINDER	LATCH	PACK	INNER	MASTER
POLISHED BRASS / US3 - CLAMSHELL						
43600	3000	Single KD	6-Way Adjustable	Clamshell	6◆	24
43605	3000	Single K3	6-Way Adjustable	Clamshell	6◆	24
43700	3000	Double KD	6-Way Adjustable	Clamshell	6◆	24
43705	3000	Double K3	6-Way Adjustable	Clamshell	6◆	24
POLISHED BRASS / US3 - BOX						
43601	3000	Single KD	Adjustable/Radius Corner	Box	6◆	24
43607	3000	Single MK	Adjustable/Radius Corner	Box	6◆	24
43616	3000	Single K3	Adjustable/Radius Corner	Box	3◆	24
43699	3000	Double KD	Adjustable/Radius Corner	Box	6◆	24

ULTRA SECURITY
The Smart Choice For Security & Style
PLUS



Cut Case Available

STANDARD DUTY DEADBOLTS / KW1

CODE	CUT CASE	SERIES	CYLINDER	LATCH	PACK	INNER	MASTER
ANTIQUE BRASS / US5 - CLAMSHELL							
43614	—	3000	Single KD	6-Way Adjustable	Clamshell	6◆	24
43615	—	3000	Single K3	6-Way Adjustable	Clamshell	6◆	24
43714	—	3000	Double KD	6-Way Adjustable	Clamshell	3◆	24
43715	—	3000	Double K3	6-Way Adjustable	Clamshell	6◆	24
ANTIQUE BRASS / US5 - BOX							
43613	—	3000	Single KD	6-Way Adjustable	Box	6◆	24



SATIN NICKEL / US15 - CLAMSHELL							
43617	—	3000	Single KD	6-Way Adjustable	Clamshell	6◆	24
43625	43304	3000	Single K3	6-Way Adjustable	Clamshell	6◆	24
43719	—	3000	Double KD	6-Way Adjustable	Clamshell	3◆	24
43626	—	3000	Double K3	6-Way Adjustable	Clamshell	6◆	24
SATIN NICKEL / US15 - BOX							
43623	—	3000	Single KD	Adjustable/Radius Corner	Box	6◆	24
43611	—	3000	Single K3	6-Way Adjustable	Box	6◆	24



SATIN CHROME / US26 - CLAMSHELL							
43602	—	3000	Single KD	6-Way Adjustable	Clamshell	6◆	24
43717	—	3000	Single K3	6-Way Adjustable	Clamshell	6◆	24



DULL CHROME / US26D - CLAMSHELL							
43627	—	3000	Single KD	6-Way Adjustable	Clamshell	3◆	24
43628	—	3000	Single K3	6-Way Adjustable	Clamshell	3◆	24

STAINLESS STEEL / US32- CLAMSHELL							
43610	—	3000	Single KD	6-Way Adjustable	Clamshell	6◆	24
43612	—	3000	Single K3	6-Way Adjustable	Clamshell	3◆	24
43710	—	3000	Double KD	6-Way Adjustable	Clamshell	6◆	24
43712	—	3000	Double K3	6-Way Adjustable	Clamshell	3◆	24
STAINLESS STEEL / US32 - BOX							
43608	—	3000	Single MK	Adjustable/Radius Corner	Box	6◆	24



LOCKSETS

ULTRA SECURITY

The Smart Choice For Security & Style

PLUS



LOCKSETS

STANDARD DEADBOLTS / SC1



CODE	CUT CASE	SERIES	CYLINDER	LATCH	PACK	INNER	MASTER
POLISHED BRASS/ US3 - CLAMSHELL							
43748	—	4500	Single KD	6-Way Adjustable	Clamshell	6◆	24
42057	43003	4500	Single K3	6-Way Adjustable	Clamshell	6◆	24
42058	—	4500	Double K3	6-Way Adjustable	Clamshell	6◆	24
POLISHED BRASS/ US3 - BOX							
43747	—	4500	Single KD	Adjustable/Square Corner	Box	6◆	24



OIL RUBBED BRONZE/ US10B - CLAMSHELL							
43436	—	4500	Single K3	6-Way Adjustable	Clamshell	6◆	24
43432	—	4500	Double K3	6-Way Adjustable	Clamshell	6◆	24



SATIN NICKEL/ US15 - CLAMSHELL							
42055	—	4500	Single K3	6-Way Adjustable	Clamshell	6◆	24
42056	—	4500	Double K3	6-Way Adjustable	Clamshell	6◆	24
SATIN NICKEL/ US15 - BOX							
43745	—	4500	Single K3	6-Way Adjustable	Box	6◆	24

STAINLESS STEEL / US32 - CLAMSHELL							
95706 NEW	—		Single K3	6-Way Adjustable	Clamshell	3◆	24
95710 NEW	—		Double K3	6-Way Adjustable	Clamshell	3◆	24

CONTEMPORARY STYLE DEADBOLTS / KW1



CODE	CYLINDER	LATCH	PACK	INNER	MASTER
POLISHED BRASS/ US3 - BOX					
43723 NEW	Single K3	2-3/8"/Square	Box	3◆	24
43724 NEW	Double K3	2-3/8"/Square	Box	3◆	24

STAINLESS STEEL / US32 - BOX					
43731 NEW	Single K3	2-3/8"/Square	Box	3◆	24
43732 NEW	Double K3	2-3/8"/Square	Box	3◆	24

ONE SIDED INTERIOR DEADBOLT

Fits doors 1-3/8" to 1-3/4" thick: 1" throw



CODE	BACKSET	PACK	INNER	MASTER
POLISHED BRASS/ US3 - CLAMSHELL				
22111	2-3/8"	Clamshell	6◆	36

ULTRA SECURITY

The Smart Choice For Security & Style

PLUS

CHELTENHAM HANDLE SET

- Limited lifetime warranty
- Grade 3
- KW1
- Removable 5 Pin tumbler cylinder
- Reversible, non-handed
- Fits doors 1-3/8" to 1-3/4" thick
- Fits standard 2-1/8" installation hole
- High security 1" throw throws on deadbolts
- 6-way adjustable latch
- Display window box

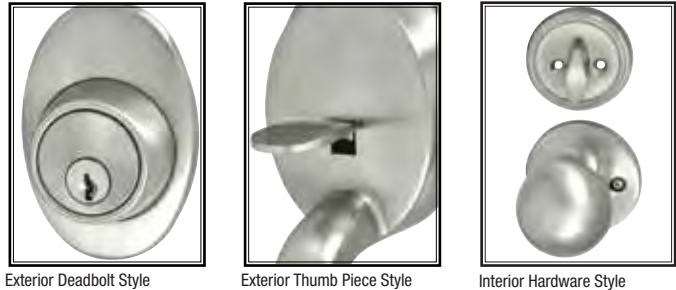

Cheltenham Series

CODE	FUNCTION/CYLINDER	PACK	INNER	MASTER
POLISHED BRASS / US3 - BOX				
45025	Entry & Single Cyl. Deadbolt KD	Box	1	6
45027	Entry & Double Cyl. Deadbolt KD	Box	1	6
POLISHED BRASS — ETERNITY FINISH / US3 EF/PVD				
45024	Entry & Single Cyl. Deadbolt KD	Box	1	6
ANTIQUE BRASS / US5 - BOX				
45035	Entry & Single Cyl. Deadbolt KD	Box	1	6
45028	Entry & Double Cyl. Deadbolt KD	Box	1	6

CODE	FUNCTION/CYLINDER	PACK	INNER	MASTER
OIL RUBBED BRONZE / US10B - BOX				
45046	Entry & Single Cyl. Deadbolt KD	Box	1	6
SATIN NICKEL / US15 - BOX				
45045	Entry & Single Cyl. Deadbolt KD	Box	1	6
POLISHED CHROME / US26 - BOX				
45040	Entry & Single Cyl. Deadbolt KD	Box	1	6
DULL CHROME / US26D - BOX				
45042	Entry & Single Cyl. Deadbolt KD	Box	1	6
45029	Entry & Dbl. Cyl. Deadbolt KD	Box	1	6

ULTRA SECURITY

The Smart Choice For Security & Style

PLUS

GLADWYNE AND STURBRIDGE HANDLE SET

- Limited lifetime warranty
- Grade 3
- KW1
- Removable 5 Pin tumbler cylinder
- Reversible, non-handed
- Fits doors 1-3/8" to 1-3/4" thick
- Fits standard 2-1/8" installation hole
- High security 1" throw throws on deadbolts
- 6-way adjustable latch
- Display window box



LOCKSETS



Gladwyne Series

CODE	FUNCTION/CYLINDER	PACK	INNER	MASTER
POLISHED BRASS — ETERNITY FINISH / US3 EF/PVD				
45030	Entry & Single Cyl. Deadbolt KD	Box	1	6
ANTIQUE BRASS / US5 - BOX				
45031	Entry & Single Cyl. Deadbolt KD	Box	1	6
OIL RUBBED BRONZE / US10B - BOX				
45221	Entry & Single Cyl. Deadbolt KD	Box	1	6
SATIN NICKEL / US15 - BOX				
45055	Entry & Single Cyl. Deadbolt KD	Box	1	6

Sturbridge Series

CODE	FUNCTION/CYLINDER	PACK	INNER	MASTER
POLISHED BRASS — ETERNITY FINISH / US3 EF/PVD				
45090R1	Entry & Single Cyl. Deadbolt KD	Box	1	6
OIL RUBBED BRONZE / US10B - BOX				
45209	Entry & Single Cyl. Deadbolt KD	Box	1	6
SATIN NICKEL / US15 - BOX				
45217	Entry & Single Cyl. Deadbolt KD	Box	1	6

ULTRA SECURITY

The Smart Choice For Security & Style

PLUS

LEXINGTON HANDLE SET

- Limited lifetime warranty
- Grade 3
- KW1
- Removable 5 Pin tumbler cylinder
- Reversible, non-handed
- Fits doors 1-3/8" to 1-3/4" thick
- Fits standard 2-1/8" installation hole
- High security 1" throw throws on deadbolts
- 4-way snap on latch
- Display window box



Polished Brass / US3

Oil Rubbed Bronze / US10B

Satin Nickel / US15t



Exterior Deadbolt Style



Exterior Thumb Piece Style



Interior Hardware Style

Lexington Series

CODE	FUNCTION/CYLINDER	PACK	INNER	MASTER
POLISHED BRASS / US3 - BOX				
42064	Entry & Single Cyl. Deadbolt KD	Box	1	6
OIL RUBBED BRONZE / US10B - BOX				
42066	Entry & Single Cyl. Deadbolt KD	Box	1	6
SATIN NICKEL / US15 - BOX				
42065	Entry & Single Cyl. Deadbolt KD	Box	1	6



- Grade 2
- SC1 Keyway
- Anti-pick resistant pins
- 4-way adjustable latch
- Tubular lock and deadbolt with safety shield



Round Ball

CODE	FUNCTION	LATCH	PACK	INNER	MASTER
POLISHED BRASS / US3 - CLAMSHELL					
44638	Entry KD	4-Way	Clamshell	6◆	24
44647	Privacy	4-Way	Clamshell	6◆	24
44649	Passage	4-Way	Clamshell	6◆	24
SATIN NICKEL / US15 - CLAMSHELL					
44639	Entry KD	4-Way	Clamshell	6◆	24
44648	Privacy	4-Way	Clamshell	6◆	24
44650	Passage	4-Way	Clamshell	6◆	24

Angle Lever

CODE	FUNCTION	LATCH	PACK	INNER	MASTER
SATIN NICKEL / US15 - CLAMSHELL					
44635	Entry KD	4-Way	Clamshell	6◆	24
44636	Privacy	4-Way	Clamshell	6◆	24
44637	Passage	4-Way	Clamshell	6◆	24

Deadbolt

CODE	FUNCTION	LATCH	PACK	INNER	MASTER
POLISHED BRASS / US3 - CLAMSHELL					
44631	Single	4-Way	Clamshell	6◆	24
SATIN NICKEL / US15 - CLAMSHELL					
44632	Single	4-Way	Clamshell	6◆	24



KEYLESS DEADBOLT

- Fits Standard 2-1/8" Installation Hole
- 2 Way Adjustable Backset
- Battery Operated – 4 AA Alkaline or Lithium Batteries (not included)

FEATURES & BENEFITS:

- Rolling code technology
- Easy Installation – only a phillips screwdriver needed
- Tarnish Resistant Finish
- 10 Easy to Program and Change Codes Capacity
- Emergency Key Override
- Illuminated Key Pad
- Security programmer code
- Audible/Visual alarm
- Does not interfere with automobile or garage remotes



Interior

Exterior

No Keys Required!
No Wiring Necessary
Replaces Existing Home Hardware
2 Remote Control Fobs Included

3 ACCESS OPTIONS



CODE	FUNCTION	LATCH	PACK	INNER	MASTER
POLISHED BRASS / US3 - CLAMSHELL IN DISPLAY BOX					
43329	Single Cylinder	2-Way Adjustable	Display Box	1	10
ANTIQUE BRASS / US5 - CLAMSHELL IN DISPLAY BOX					
43328	Single Cylinder	2-Way Adjustable	Display Box	1	10
SATIN NICKEL / US15 - CLAMSHELL IN DISPLAY BOX					
43330	Single Cylinder	2-Way Adjustable	Display Box	1	10
REMOTE/FOB					
43335	Remote Control	—	1/Clamshell	3◆	24

PUSH BUTTON COMBINATION DOOR LOCKS

Heavy duty, keyless security; Standard 2-3/8" backset with 1" throw (2-3/4" option available); Fits all doors 1-3/8" to 1-3/4" thick; Heavy duty construction, precision engineered; Weight: 3 lbs.; Easy to change 5 digit combination

Deadbolt



4 Layer laminated steel throwbolt



Mortise Deadbolt with Interior Turn Knob

CODE	FINISH	PACK	INNER	MASTER
44700	Polished Brass	Box	1	12
44705	Antiqued Brass	Box	1	12
44710	Satin Chrome	Box	1	12

Surface Deadbolt

CODE	FINISH	PACK	INNER	MASTER
44750	Antiqued Brass	Box	1	12

Deadlatch



Spring latch; 2-3/8" Backset; Optional deadbolt available



Mortise Spring Deadlatch with Interior Turn Knob

CODE	FINISH	PACK	INNER	MASTER
44720	Polished Brass	Box	1	12
44725	Antiqued Brass	Box	1	12
44730	Satin Chrome	Box	1	12

Mortise Spring Deadlatch with Interior Lever Handle

CODE	FINISH	PACK	INNER	MASTER
44760	Polished Brass	Box	1	12
44765	Antiqued Brass	Box	1	12
44770	Satin Chrome	Box	1	12

Latchbolts for Push Button Lockset

For mechanical push button door locksets (except surface deadbolt); Stainless steel finish only



CODE	BACKSET	FUNCTION	PACK	INNER	MASTER
06970	2-3/4"	Deadbolt	Bulk	1	100
06972	2-3/4"	Springlatch	Bulk	1	100
06967	2-3/4"	Springlatch	Bulk	1	150

Trim Plate Cover

Rugged ABS plastic construction; Covers standard 2-1/8" installation knob lock holes; For mortise deadbolt, spring latch locks and surface deadbolt; Fits all Ultra push button door locks



CODE	FINISH	PACK	INNER	MASTER
57490	Black	Polybag/1 Pair	1	216

MORTISE LOCKSETS WITH DEADBOLT

- Full 1" throw deadbolt
- Latchbolt cannot retract unless unlocked

Double Cylinder with Rosette

2-1/2" backset, spacing 3-1/4"; Fits all wood or metal doors; Outside knob is locked by a button on the faceplate; Reversible for left or right hand installation; Replacement knob furnished with spindle and screws



CODE	KEYWAY	FINISH	PACK	INNER	MASTER
44630	SC1	Brass	Box	3	12

Replacement Knob Only

CODE	FINISH	PACK	INNER	MASTER
43012	Brass	1 Pair/Box	5	60

Single Cylinder with Escutcheon Plate

Key outside operates both dead and latch bolts; Solid brass faceplate: 1-1/16" x 7-5/8"; Beveled escutcheon plates dimensions: outside: 2-3/4" x 10" insides: 2-1/4" x 7"; Furnished with attached thru bolts for use on fire doors; ASA strike; 2-1/2" Backset; 1/2" Latch throw



CODE	KEYWAY	FINISH	HANDED	KEYED	PACK	INNER	MASTER
96932	SE1	Brass	Right	Different	Box	1	12
96933	SE1	Brass	Left	Different	Box	1	12

Old Time Mortise Lock — Skeleton Key Operated (Bit Key)

Replaces most mortise interior door locks used in the early 1900's; 2-1/4" Diameter round knobs; 2-1/4" W x 7" L Escutcheon plates; Mortise case cutout 3-1/2"H x 3"D; Brass plated; 3/8" Throw spring latch with 1/2" throw deadlock; Edge face plate 7/8" x 5-1/2"; Standard 1/4" square spindle; Reversible for left or right hand application

CODE	TYPE	FINISH	KNOBS	PACK	INNER	MASTER
44609	Entry	Brass Plated	Brass	Clamshell	3♦	24
44610	Bed/Bath	Brass Plated	Steel	Clamshell	3♦	24
44621	Entry	Brass Plated	Glass	Clamshell	3♦	24
44622	Bed/Bath	Brass Plated	Glass	Clamshell	3♦	24
44615 NEW	Entry	Satin Nickel	Glass	Clamshell	3♦	24



Lock Body Only

CODE	TYPE	FINISH	PACK	INNER	MASTER
44623	Entry	Brass Plated	Blister Carded w/2 Skeleton Keys	6♦	24

NARROW STILE STORM DOOR LOCKSET

Heavy duty; Forged solid brass; Fits all doors from 1-3/8" to 1-7/8" thick; Narrow stile backset 1-3/4"; Solid brass face plates 1-1/8" W x 8-1/4" H; Solid brass lever 4-1/2" long; Single unit assembly with reversible latch; Key operated outside-turn knob operated inside; Rekeyable 5 pin tumbler cylinder; Double locking with spring latch & deadbolt; 1-1/2" Posts internally threaded



CODE	KEYWAY	TYPE	FINISH	PACK	INNER	MASTER
44625	SC1	Complete	Brass	Box	1	10
44627	SC1	Body Only	Brass	Box	1	10

LIGHT COMMERCIAL

Cylindrical Ball Lockset

Grade 3; SC4; 6 Pin solid brass cylinder; Cylinder removable for rekeying; Fits all wood or steel doors from 1-3/8" to 1-3/4" thick; Internal mechanism heavy gauge cold rolled steel; Positive push and turn button locking mechanism; 3" Threaded rosette outside; Panic-proof mechanism; Concealed mounting screws



CODE	SERIES	FUNCTION	BACKSET	PACK	INNER	MASTER
POLISHED BRASS / US3 - BOX						
44124	7000	Entry KD	Adjustable	Box	6◆	24
44126	7000	Entry K3	Adjustable	Box	6◆	24
44130	7000	Entry MK	Adjustable	Box	6◆	24
44136	7000	Storeroom KD	Adjustable	Box	6◆	24
44138	7000	Storeroom KA	Adjustable	Box	6◆	24
44147	7000	Privacy	Adjustable	Box	6◆	24
44149	7000	Passage	Adjustable	Box	6◆	24
STAINLESS STEEL / US32 - BOX						
44120	7000	Entry KD	Adjustable	Box	6◆	24
44122	7000	Entry K3	Adjustable	Box	6◆	24
44128	7000	Entry MK	Adjustable	Box	6◆	24
44132	7000	Storeroom KD	Adjustable	Box	6◆	24
44134	7000	Storeroom KA	Adjustable	Box	6◆	24
44140	7000	Storeroom MK	Adjustable	Box	6◆	24
44143	7000	Privacy	Adjustable	Box	6◆	24
44145	7000	Passage	Adjustable	Box	6◆	24

RE-KEYABLE: Will accept the following cylinders*: SCHLAGE™, ARROW™, MARKS™, AWI™, LORI™, FALCON™, ASSA™, & most MEDECO™

Cylindrical Ball Lockset

Heavy duty; KW1; 5 Pin solid brass cylinder; Cylinder removable for rekeying; Fits all wood or steel doors from 1-3/8" to 1-3/4" thick; Internal mechanism heavy gauge cold rolled steel; Reversible for right or left hand doors; Panic-proof mechanism; Concealed mounting screws; ASA strike plate



CODE	SERIES	FUNCTION	BACKSET	PACK	INNER	MASTER
STAINLESS STEEL / US32 - BOX						
43825	7000	Entry KD	2-3/4"	Box	6◆	24
43827	7000	Privacy	2-3/4"	Box	6◆	24
43828	7000	Passage	2-3/4"	Box	6◆	24

*The following registered trade name or trade mark is not owned, associated with or connected in any way with Ultra Hardware Products LLC and is used herein for illustrative purposes only.

COMMERCIAL

Cylindrical Ball Lockset

Heavy duty; Grade 2; 6 Pin solid brass tumbler cylinder; 5 Pins keyed to Arrow* (AR1) or Schlage* (SC1) keyways; Cylinder removable for rekeying; Fits wood or metal doors from 1-3/8" to 1-3/4" thick; Sleeve collar latchbolt option for use on metal doors; Cylindrical lock housing cold rolled steel mechanism, zinc dichromated for corrosion resistance; Reinforced solid brass or stainless steel ball knobs; Concealed mounting screws on 3" threaded roses; Rosettes threaded inside & outside; Standard 2-1/8" hole bore; Deadlocking bolt with 1/2" throw; Panic-proof mechanism; Furnished with 1-1/8" face on latch strike and ASA strike for door jamb; Meets ANSI Specifications



CODE	SERIES	FUNCTION	KEYWAY	BACKSET	STRIKE	PACK	INNER	MASTER
POLISHED BRASS / US3 - BOX								
44220	5200	Entry KD	AR1	2-3/4"	ASA	Box	6◆	24
44225	5200	Entry K3	AR1	2-3/4"	ASA	Box	6◆	24
44235	5200	Storeroom MK	—	2-3/4"	ASA	Box	6◆	24
44245	5200	Privacy	—	2-3/4"	ASA	Box	6◆	24
44240	5200	Passage	—	2-3/4"	ASA	Box	6◆	24
44221	5200	Entry KD	SC1	2-3/4"	ASA	Box	6◆	24
44229	5200	Entry K3	SC1	2-3/4"	ASA	Box	6◆	24
44224	5200	Storeroom KD	SC1	2-3/4"	ASA	Box	6◆	24
STAINLESS STEEL / US32 - CLAMSHELL								
UL 44294	5200	Entry KD	SC1	2-3/4"	ASA	Clamshell	6◆	24
UL 44295	5200	Privacy	—	2-3/4"	ASA	Clamshell	6◆	24
UL 44296	5200	Passage	—	2-3/4"	ASA	Clamshell	6◆	24
STAINLESS STEEL / US32 - BOX								
UL 44222	5200	Entry KD	AR1	2-3/4"	ASA	Box	6◆	24
UL 44234	5200	Entry KD	AR1	2-3/4"	ASA	Box	6◆	24
44227	5200	Entry K3	AR1	2-3/4"	ASA	Box	6◆	24
44232	5200	Entry MK	AR1	2-3/4"	ASA	Box	6◆	24
44237	5200	Storeroom MK	AR1	2-3/4"	ASA	Box	6◆	24
44247	5200	Privacy	—	2-3/4"	ASA	Box	6◆	24
44242	5200	Passage	—	2-3/4"	ASA	Box	6◆	24
44223	5200	Storeroom KD	SC1	2-3/4"	ASA	Box	6◆	24
UL 44236	5200	Entry KD	SC1	2-3/4"	ASA	Box	6◆	24
44228	5200	Entry KD	SC1	2-3/4"	ASA	Box	6◆	24
44226	5200	Storeroom KD	SC1	2-3/4"	ASA	Box	6◆	24



LOCKSETS

RE-KEYABLE: Will accept the following cylinders*: SCHLAGE™, ARROW™, MARKS™, AWI™, LORI™, FALCON™, ASSA™, & most MEDECO™

COMMERCIAL DEADBOLTS

Heavy duty; Grade 2; 6 Pin solid brass cylinder; Cylinder removable for rekeying; Fits wood or metal doors from 1-3/8" to 1-3/4" thick; Heavy duty solid brass tubular construction with heavy gauge steel reinforced plates; Full 1" throw; Heavy gauge strike plates and hardened steel core bar; Tapered collar; Oversize strike plate: 1-1/8" x 2-3/4"(43740 only)



CODE	SERIES	CYLINDER	LATCH	PACK	INNER	MASTER
POLISHED BRASS / US3 - CLAMSHELL						
43735	9800	Single KD	Adjustable / Square	Clamshell	6◆	24
43750	9800	Double KD	Adjustable / Square	Clamshell	6◆	12
POLISHED BRASS / US3 - BOX						
43739	9800	Single MK	Adjustable / Square	Box	6◆	24
STAINLESS STEEL / US32 - CLAMSHELL						
43740	9800	Single KD	Adjustable / Square	Clamshell	6◆	24
43755	9800	Double KD	Adjustable / Square	Clamshell	6◆	12
STAINLESS STEEL / US32 - BOX						
43744	9800	Single MK	Adjustable / Square	Box	6◆	24



CYLINDRICAL LEVER LOCKSETS

Heavy duty; Grade 2; Conforms to Handicap Code ANSI A156.2 Series 4000; Fits wood or metal doors from 1-3/8" to 1-3/4" thick; Furnished with 1-1/8" strike plate; Separate spring mechanism for inside & outside lever prevents arm sag to hold in horizontal position; Designed for barrier free application; 50° Lever travel; Non-handed; 2" Clearance from lever to door surface; return of lever to 3/8" of the face of door; Fits the standard 161 door preparation 2-3/4" backset, 2-1/8" bore; Easy installation; suitable for new construction & retrofit; Special reinforced removable studs prevent twisting or turning of lock rosettes; UL Listed for "A" label (3 hours) single swing doors (4' x 8'); Concealed screw mount; One step rosette; ASA strike plate



ANGLED LEVER



CODE	SERIES	FUNCTION	BACKSET	STRIKE	PACK	INNER	MASTER
POLISHED BRASS / US3 - BOX							
44205	6600	Entry KD	2-3/4" Square	ASA	Box	1◆	12
44211	6600	Storeroom KA	2-3/4" Square	ASA	Box	1◆	12
44208	6600	Privacy	2-3/4" Square	ASA	Box	1◆	12
44209	6600	Passage	2-3/4" Square	ASA	Box	1◆	12
DULL CHROME / US26D - BOX							
44248	6600	Entry KD	2-3/4" Square	ASA	Box	1◆	12
44249	6600	Entry K3	2-3/4" Square	ASA	Box	3◆	12
44253	6600	Entry MK	2-3/4" Square	ASA	Box	1◆	12
44256	6600	Storeroom KA	2-3/4" Square	ASA	Box	1◆	12
44257	6600	Storeroom KD	2-3/4" Square	ASA	Box	1◆	12
44258	6600	Classroom KA	2-3/4" Square	ASA	Box	1◆	12
44259	6600	Classroom KD	2-3/4" Square	ASA	Box	6◆	12
44254	6600	Privacy	2-3/4" Square	ASA	Box	1◆	12
44255	6600	Passage	2-3/4" Square	ASA	Box	1◆	12
DULL CHROME / US26D - CLAMSHELL							
44269	6600	Entry KD	2-3/4" Square	ASA	Clamshell	6◆	12
44270	6600	Privacy	2-3/4" Square	ASA	Clamshell	6◆	12
44271	6600	Passage	2-3/4" Square	ASA	Clamshell	6◆	12

CURVED LEVER



CODE	SERIES	FUNCTION	BACKSET	STRIKE	PACK	INNER	MASTER
DULL CHROME / US26D - BOX							
44216	3600	Entry KD	2-3/4" Square	ASA	Box	1◆	12
44217	3600	Entry KA	2-3/4" Square	ASA	Box	1◆	12
44218	3600	Privacy	2-3/4" Square	ASA	Box	1◆	12
44219	3600	Passage	2-3/4" Square	ASA	Box	1◆	12

RE-KEYABLE: Will accept the following cylinders*: SCHLAGE™, ARROW™, MARKS™, AWI™, LORI™, FALCON™, ASSA™, & most MEDECO™

CLUTCH LEVER LOCKSETS

Patented free-wheeling design rotates lever up & down while lever set stays locked



CODE	SERIES	FUNCTION	BACKSET	STRIKE	PACK	INNER	MASTER
DULL CHROME / US26D - BOX							
44273	6600	Entry KD	2-3/4" Square	ASA	Box	1	12
44276	5200	Storeroom KA	2-3/4" Square	ASA	Box	6◆	12
44277	5200	Classroom KD	2-3/4" Square	ASA	Box	6◆	12

COMMERCIAL DOOR CLOSERS

- Universal application, non-handed for standard, top jamb or parallel arm installation
- Adjustable closing & latching speed by two separate regulating valves
- Rack and pinion mechanism contained in high tensile precision housing
- Surface mount installation

Standard Installation

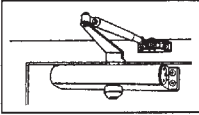

Parallel Installation

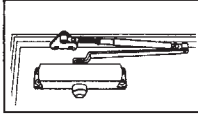

Top Jamb Installation

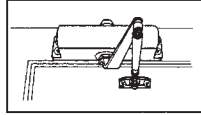

CLOSER SIZE	# 1	# 2	# 3	# 4	# 5
DOOR WEIGHT	33-66 lbs	55-99 lbs	88-143 lbs	121-187 lbs	133-199 lbs

GRADE 1

9000 Series

Meets ANSI 156.4 Grade 1 standards; Heavy duty; Rated for handicap entrance; Adjustable spring power; Standard adjustable-backcheck function; Adjustable delayed action (DA) preset at the factory for approximately 20 seconds, between 70° and 120°; Barrier free; Reduced spring power for handicapped or elderly



Sized 1 thru 4
Factory Preset at 3

Conforms to ADA & ANSI Codes



UL Fire Rated 10C

CODE	SIZE	HOLE CENTERS	FINISH	PACK	INNER	MASTER
16142	#1 - #4	9-1/16" x 3/4"	Aluminum	Box	1	6
16144	#1 - #4	9-1/16" x 3/4"	Bronze	Box	1	6

Recommended operating temperature is between -15° to +40° degrees Celsius, 5° to 104° degrees Fahrenheit; Can be used -20° to +50° degrees Celsius, -4° to 122° Fahrenheit but latching and closing speed should be readjusted

CROSS REFERENCE CHART

ULTRA	S.PARKER*	CAL ROYAL*	TELL*	LCN*	NORTON*	GLOBAL*	DOR.O. MATIC*	YALE*
9000 Series	900	300	600	430	1601	TC201	SC61	51BF

GRADE 2

500S Series

Meets Grade 2 standards; Dual valve; Atlas brand door closer; UL listed; Narrow design; Furnished w/ parallel arm bracket



Parallel Arm Bracket Included



CODE	SIZE	HOLE CENTERS	FINISH	PACK	INNER	MASTER
16122	#2	6-5/8" x 3/4"	Aluminum	Box	1	10
16124	#3	8-3/16" x 3/4"	Aluminum	Box	1	10
16126	#4	9-1/16" x 3/4"	Aluminum	Box	1	10
16137	#5	9-1/16" x 3/4"	Aluminum	Box	1	10
16130	#2	6-5/8" x 3/4"	Bronze	Box	1	10
16132	#3	8-3/16" x 3/4"	Bronze	Box	1	10
16134	#4	9-1/16" x 3/4"	Bronze	Box	1	10
16136	#5	9-1/16" x 3/4"	Bronze	Box	1	10

500BC Series

Meets Grade 2 standards; Triple valve; UL listed; Adjustable back check function 70° to 85° prevents striking wall; Furnished w/parallel arm bracket

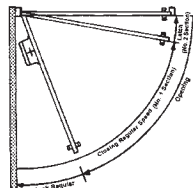

CODE	SIZE	HOLE CENTERS	FINISH	PACK	INNER	MASTER
16146	#3	8-3/16" x 3/4"	Aluminum	Box	1	10
16147	#4	9-1/16" x 3/4"	Aluminum	Box	1	10
16148	#5	9-1/16" x 3/4"	Aluminum	Box	1	10

*The following registered trademark is not owned, associated with or connected in any way with Ultra Hardware Products LLC and is used herein for illustrative purposes only.

RESIDENTIAL GRADE DOOR CLOSERS

- For metal and wood doors up to 150 lbs.
- Non-handed (for left and right swing doors)

Hydraulic Door Closer

Single valve back plate; Aluminum die-cast body construction; Standard top jamb; Heavy duty color plastic casing; Compact design; Furnished w/screws & instructions.



CODE	SIZE	MAX. WIDTH	ARM	FINISH	PACK	INNER	MASTER
16114	#3	38"	Adjustable	Ivory	Clamshell	1	5
16115	#3	38"	Adjustable	Brown	Clamshell	1	5

Mini Door Closers

Heavy duty zinc die cast housing construction; Automatically closes the door; Furnished with 3-1/4" x 7/8" roll plate to prevent damage to door; Adjustable tension rod; Main body fits on door jamb

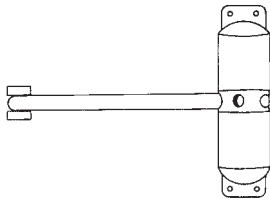

CODE	FINISH	PACK	INNER	MASTER
15990	White	Clamshell	6♦	36
15995	Brown	Clamshell	6♦	36
15999	White	Box	12♦	48
15997	Brown	Box	12♦	48

DOOR CLOSER COMPONENTS

Hold-Open Forearm

Adjustable for any degree of holding within the swing of the door; For closer sizes #1 thru #5 on series 500BC above



CODE	FINISH	PACK	INNER	MASTER
35800	Aluminum	Box	4	24
35805	Bronze	Box	4	24

Flat Drop Bracket

Fits most overhead hydraulic door closers; Used when top door rail or top jamb provides insufficient support area for closer; For closer sizes #4 & #5 only



CODE	SIZE	FINISH	PACK	INNER	MASTER
58007	3-1/2" x 9-3/4"	Aluminum	Box	5♦	30

Closer Bracket

Parallel arm; Fits most overhead hydraulic door closers; Heavy gauge steel construction; Fits all standard arm door closers; For closer sizes #3 thru #5 500BC Series above

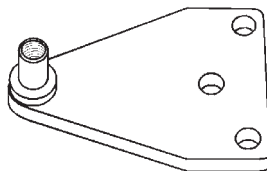

CODE	FINISH	PACK	INNER	MASTER
11010	Aluminum	Polybag	10	100
11012	Bronze	Polybag	10	100

SURFACE MOUNT EXIT BARS

ANSI 156.3 Grade 2; Fits all doors from 30" to 36" in width; 4-1/2" Minimum style; Reversible for all function and trim hex key dog device; Surface mount strike with extra shim; Exterior trim not included; Works with 02058 ball knob and 02059 lever (pg. 37)

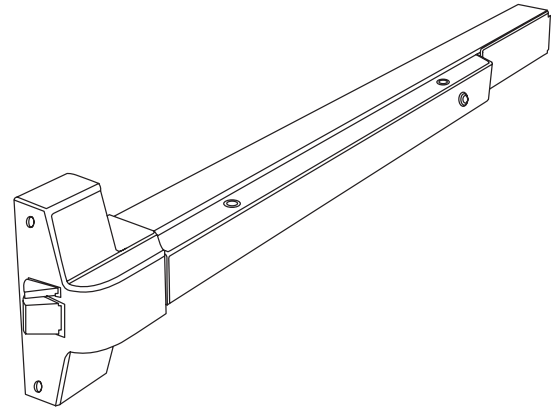

CODE	TYPE	FINISH	PACK	INNER	MASTER
02070	Wide head	Aluminum	Box	1	6



SURFACE MOUNT VERTICAL ROD EXIT DEVICES

- ANSI Grade 1
- Fits all doors from 1-1/2" up to 2" thick
- Surface mount non-handed panic bar
- Wide head touch bar-panic bar for hollow metal or flush wood doors
- Reversible for all functions & trims
- Surface mount strike with extra shim
- Release mechanism activated by simple touch with 8 lbs. of touch pressure
- Furnished with pullman latch top & bottom, with retraction hold in top latch
- Stainless steel latchbolt, top and bottom: 3/4" throw
- No dogging device
- Steel deadbolt; top: 1/2" throw
- Slant design eliminates open space gaps

Fire Rated Exit Devices

Fire rated exit devices meet or exceed standards for "Fire Tests of Door Assemblies", UL10B (UL10B, NFPA 252, ASTM E-152); For use with swinging fire doors of the hollow metal, wood, wood composite and sheet metal; For use on single and double swinging doors rated up to 1-1/2 hours; Fits all doors from 36" to 42" wide & 84" high; Outside cylinder sold separately; Furnished w/ stainless steel sex bolts



CODE	FINISH	PACK	INNER	MASTER
02062	Satin Aluminum	Box	1	4

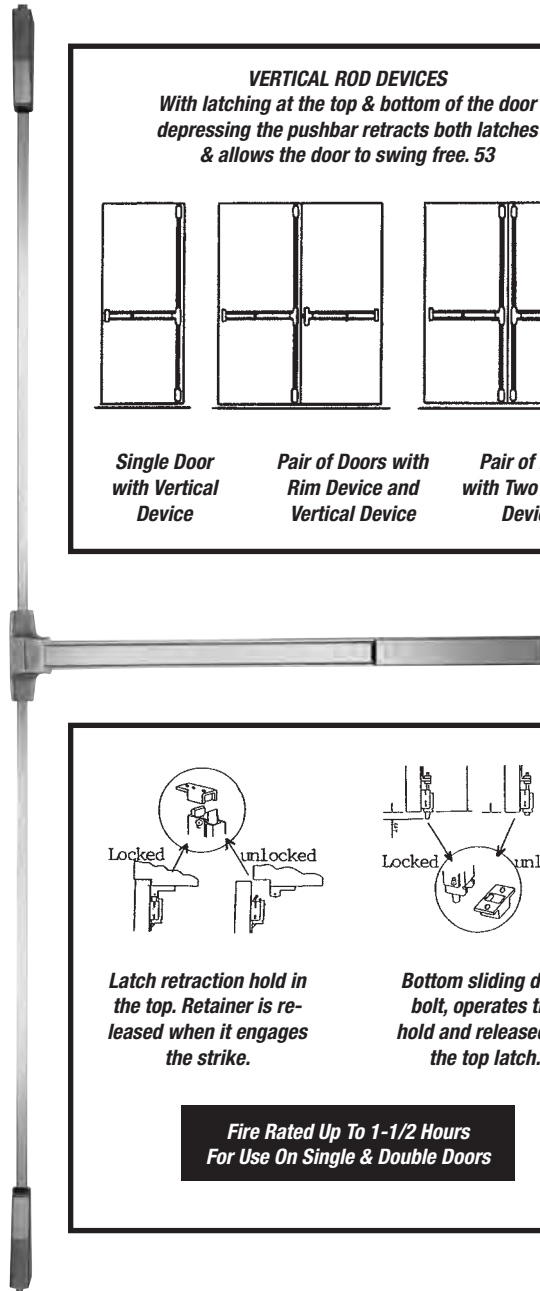

VERTICAL ROD DEVICES
 With latching at the top & bottom of the door depressing the pushbar retracts both latches & allows the door to swing free. 53

Single Door with Vertical Device Pair of Doors with Rim Device and Vertical Device Pair of Doors with Two Vertical Devices

Locked unlocked Locked unlocked

Latch retraction hold in the top. Retainer is released when it engages the strike.

Bottom sliding drop bolt, operates the hold and released by the top latch.

**Fire Rated Up To 1-1/2 Hours
 For Use On Single & Double Doors**

COMMERCIAL DOOR HARDWARE

SURFACE MOUNT EXIT BARS

- Surface mount strike with extra shim
- Fits all doors from 1-1/2" up to 2" thick

- Slant design eliminates open space gaps
- Release mechanism activates at 8 lbs. of touch pressure
- No dogging device

Reversible Rim Fire Exit Device

Fire exit hardware device designed for use with swinging fire doors of hollow metal and sheet metal; Fits all doors from 36" up to 42" in width; Suitable for all wood, steel, glass or aluminum doors; Furnished w/ stainless steel sex bolts; Outside cylinder sold separately

CODE	TYPE	BACK-SET	FINISH	PACK	INNER	MASTER
02054	Wide Head	2-3/4"	Duranodic Bronze	Box	1	6
02055	Wide Head	2-3/4"	Aluminum	Box	1	6

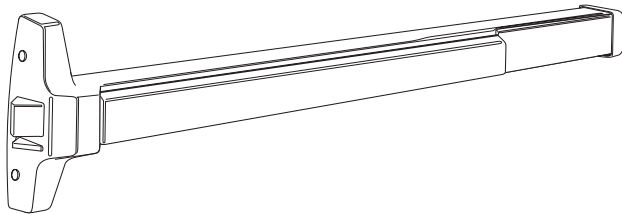

**Fire Rated Up To 1-1/2 Hours
For Use On Single & Double Doors**

COMMERCIAL DOOR HARDWARE

Entry For Wide Head Panic Bars

Exit with key lock; SC-4 keyway; UL listed for fire door assembly

CODE	TYPE	KEYED	FINISH	PACK	INNER	MASTER
02052	Knob	KD	Stainless Steel	Box	1	20
02053	Lever	KD	Stainless Steel	Box	1	20

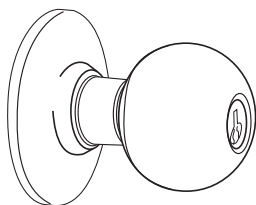

02052

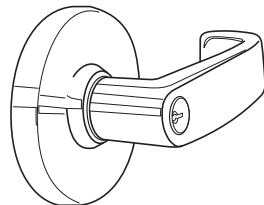

02053



Panic Bar Strike Double Door

Size: 2-1/2" x 3-3/16" x 1/2"; For use with double door with no mul-lion; For use with code numbers 02054 & 02055 only

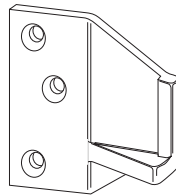

CODE	FINISH	PACK	INNER	MASTER
72062	Stainless Steel	Box	1	100

Panic Bar Components 02052, 02053 and 72062 are for use with surface mount exit bars 02054 and 02055 found above.

Replacement Cylinders

Solid cast brass; 5-Pin Tumbler Schlage Keyway SC-1; 1-3/8" Diameter face plus trim ring; Unlimited key changes; Furnished w/ 2" calibrated spindle; Revers-ible, adjustable construction

CODE	KEYED	FINISH	PACK	INNER	MASTER
17031	KA	Satin Chrome	Box	3◆	81

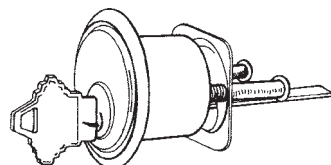

For codes 02047, 02056 (pg. 37), 02054, 02055 above and 02062 (pg. 35)

SURFACE MOUNT EXIT BARS CONTINUED

- ANSI grade 1
- Reversible for all functions & trims
- Surface mount strike with extra shim
- Fits all doors from 1-1/2" up to 2" thick
- Slant design eliminates open space gaps

- Hex key dogging device
- Surface mount non-handed reversible panic bar
- Release mechanism activates at 8 lbs. of touch pressure
- Suitable for all wood, steel, glass or aluminum doors

Reversible Rim 5-Pin Tumbler Cylinder Exit Device

Fits all doors from 29" up to 42" in width; Narrow head designed for all glass, metal & wood doors; Wide head designed for hollow metal or flush wood doors; Fits 1-1/4" narrow style aluminum & glass entry doors

CODE	TYPE	FINISH	KEYED	PACK	INNER	MASTER
02047	Narrow Head	Aluminum	KD	Box	1	6
02056	Wide Head	Aluminum	KD	Box	1	6

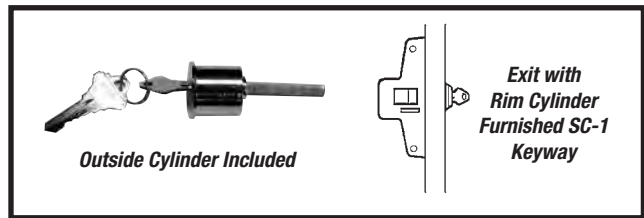

Entry For Wide Head Panic Bars

Exit key lock SC-4 keyway; Can be locked open

CODE	TYPE	KEYED	FINISH	PACK	INNER	MASTER
02058	Knob	KD	Stainless Steel	Box	1	20
02059	Lever	KD	Dull Chrome	Box	1	20

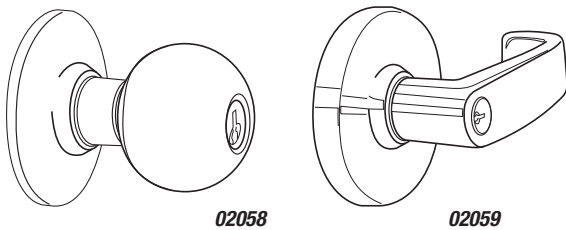

Fits surface mount exit bars 02070 & 02071 pg. 35 and 02047 and 02056 (found above).

Panic Bar Strike Double Door

Size: 2-1/2" x 3-3/16" x 5/8"; For use with double door with no mullion; For use with code numbers 02047 and 02056

CODE	FINISH	PACK	INNER	MASTER
72064	Stainless Steel	Box	1	100

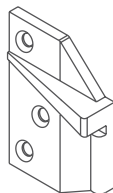

Panic Bar Component 72064 is for use with surface mount exit bars 02047 and 02056 (found above).

PANIC BAR PULL PLATE

Dimensions

- Cylinder diameter: 1-3/16"
- Back plate: 4-1/2"L x 3-1/2"W
- Hole centers: 3-9/16"
- Pull offset: 1"

Furnished with outside cylinder hole; Can be used with any rim cylinder; For exterior application

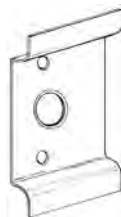

SEX BOLTS

Sold in 8 piece sets: 4 male & 4 female



CODE	FINISH	PACK	INNER	MASTER
59099	Aluminum	Polybag	6♦	48

CODE	FINISH	INNER	MASTER
07040	Aluminum	10♦	200

NARROW STILE DEADLOCKS & LATCHES

Dead Locks

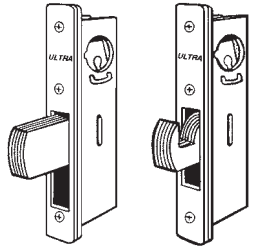

Standard Bolt
Cylinder Sold Separately

Hook Bolt
Cylinder Sold Separately

For installation in narrow stile aluminum doors; 360° turn of key throws or retracts counter balanced bolt; Key can be removed only when bolt is in positive locked or unlocked position; Lock accepts any standard thread mortise cylinder from either or both sides; Weatherstrip face plates

CODE	TYPE	BACKSET	FINISH	PACK	INNER	MASTER
44645	Standard Bolt	31/32"	Aluminum	Box	6◆	36
44646	Standard Bolt	1-1/8"	Aluminum	Box	6◆	36
44655	Hook Bolt	31/32"	Aluminum	Box	6◆	36
44656	Hook Bolt	1-1/8"	Aluminum	Box	6◆	36

Dead Latches

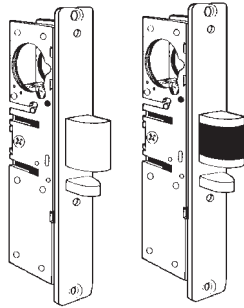

All Zinc Latch

Zinc & Delrin Latch

Can be used with lever handles & paddles; Case size is 1" x 5-13/16"; Standard strike plate furnished is for flat jamb where door closes flush; Latchbolt can be fixed in "hold-open" position with the use of a mortise cylinder key; Latchbolt is 5/8" x 1" W w/ 1/2" throw; Plated zinc alloy with hardened steel internal pins, Delrin plastic insert guarantees quiet strike latching; Non-handed; Furnished with dual strike plate, machine screws and matching face plate; Spring loaded latchbolt will retract by turning key in cylinder or operating inside lever handle or push paddle; The lock accepts any standard thread mortise cylinder from either or both sides

CODE	BACKSET	LATCH	HANDING	PACK	INNER	MASTER
44686	31/32"	Zinc	Left	Box	6◆	36
44687 NEW	31/32"	Zinc	Right	Box	6◆	36
44688	1-1/8"	Zinc	Left	Box	6◆	36
44689 NEW	1-1/8"	Zinc	Right	Box	6◆	36
44690	31/32"	Zinc & Delrin	Left	Box	6◆	36
44391 NEW	31/32"	Zinc & Delrin	Right	Box	6◆	36
44692	1-1/8"	Zinc & Delrin	Left	Box	6◆	36
44693 NEW	1-1/8"	Zinc & Delrin	Right	Box	6◆	36

All Satin Aluminum Finish

NARROW STILE DEADLOCKS & STOREFRONT ACCESSORIES

Lever Handles with Cam Plugs



Heavy duty cast alloy construction; Conforms to building and ADA handicap codes; Fits most makes and models of aluminum narrow stile locks; Reversible for right or left hand doors; Escutcheon plate 1-3/8" x 4"; 1/4" Square spindle that inter-locks with plug; Sag proof heavy duty spring mechanism for lever handle; Lever operates in up or downward positions; Furnished w/ reversible cam plug & screws

CODE	MATERIAL	FINISH	PACK	INNER	MASTER
31618	Cast Alloy	Aluminum	Box	1	50
31619	Cast Alloy	Bronze	Box	10	50



Push or Pull Paddles



Zinc die cast housing hard coat finish; For aluminum doors; Extruded aluminum paddle; Heavy duty compression springs; Reversible non-handed gear blocks; Hardened steel gear wheel; 1/4" Thick solid brass nuts and case hardened steel bolts; Furnished with cam plug

CODE	FINISH	HAND	PACK	INNER	MASTER
54000	Duranodic Bronze	Right	Box	1	20
54005	Duranodic Bronze	Left	Box	1	20
54010	Satin Aluminum	Right	Box	1	20
54015	Satin Aluminum	Left	Box	1	20

JAMB BRACE REINFORCER

Heavy duty theft deterrent system; To be installed w/ grade 2 deadbolts; Strengthens frame; Concealed w/interior door trim; Fits all door types; Furnished w/strike plate screws



CODE	SIZE	PACK	INNER	MASTER
58170	Aluminum	Polybag	1	25

PULL HANDLES

1-1/8" Cylinder hole; Cylinder not included; 1" x 7-1/2" Solid aluminum pull; 7" Hole centers; Fits doors up to 2" thick; Furnished w/studs for thru bolts

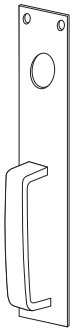

CODE	MATERIAL	SIZE	FINISH	PACK	INNER	MASTER
59096	Aluminum	3-1/2" x 16"	Aluminum	Box	1	40

DOOR PUSH PLATES

Weatherproof; Rustproof; Residential or commercial doors; Furnished w/screws



58060 only



58020 only

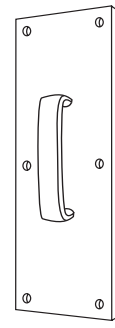

58016

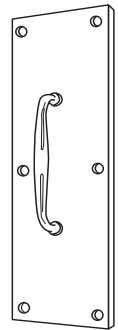

58020
58021

CODE	SIZE	MATERIAL	PACK	INNER	MASTER
58060	3-1/2" x 15"	Solid Brass	Card	10♦	60
58030	3-1/2" x 15"	Aluminum	Card	10♦	100
58050	3" x 12"	Brass	Polybag	12	120

CODE	MATERIAL	GRIP	FINISH	PACK	INNER	MASTER
58020	Solid Brass	6"	Brass	Card	5♦	30
58021	Aluminum	6"	Satin Anodized	Card	5♦	30
58016	Aluminum	7"	Satin Anodized	Card	5♦	30

CRASH CHAIN



Heavy duty commercial door; 2 Rugged compression springs with cast mounting plates; Grey vinyl cover; Furnished w/screws

CODE	SIZE	PACK	INNER	MASTER
15850	30-1/2"	Box	5♦	40

JIMMY PROOF DEADLOCKS

Heavy duty rim-cylinder; For use on 1-3/8" to 2-1/2" thick doors; Reinforced throw-bolt; Overall size: 4-1/2" x 3-1/2"; 5-Pin tumbler, solid brass cylinder; Furnished w/ angle strike bracket

CODE	FINISH	PACK	INNER	MASTER
43315	Antique Brass	Clamshell	6	36

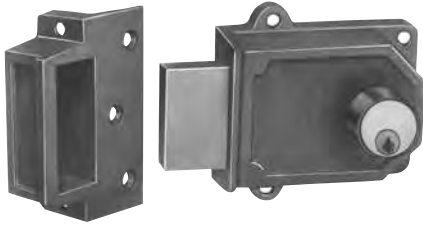

Jimmyproof lock with shutterguard; Fits doors 1-1/4" to 2-1/4" thick; Double cylinder features cylinders both inside and outside for extra protection on glass pane door; Surface installation requires one 1-1/4" diameter hole; Furnished w/ angle strike bracket

CODE	CYLINDER	FINISH	PACK	INNER	MASTER
44860	Single	Brass	Clamshell	5◆	20
44861 NEW	Single	Silver	Clamshell	5◆	20
44850	Double	Brass	Clamshell	5◆	20

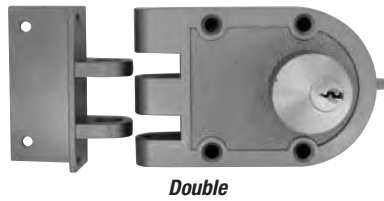
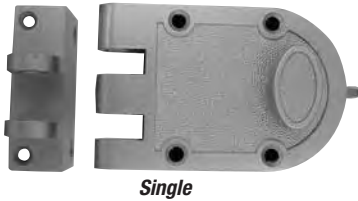

Single cylinder; Die cast housing; For use on 1-3/8" to 2-1/2" thick doors; Twin interlocking drop bolt; 5-Pin tumbler brass cylinders

CODE	KEEPER	FINISH	PACK	INNER	MASTER
44857	Angle	Brass	Box	3◆	24
44858	Flat	Brass	Box	3◆	24

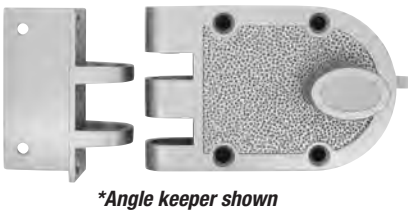

RIM CYLINDER NIGHT LATCH

For doors 1-3/8" to 2-1/2" thick; Requires 1-1/4" diameter hole; Surface installation, no mortising required; Hold back bolt-stop button on 43300; Key outside, turn knob inside; Features exclusive deadlock; Furnished w/ angle strike bracket

CODE	TYPE	KEYWAY	FINISH	PACK	INNER	MASTER
43300	Nightlatch	Y1	Brass	Clamshell	6◆	24
43310	Deadlatch	SE1	Brass	Clamshell	6◆	36

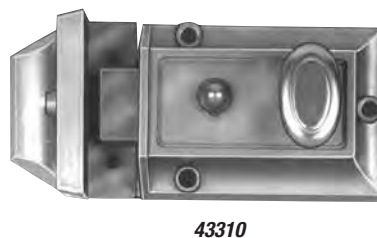
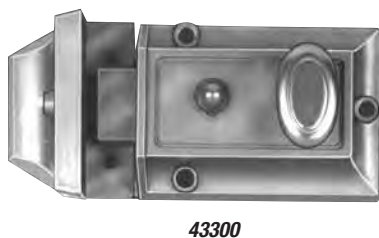

BUILDERS' HARDWARE

DOOR PROTECTORS

One piece construction; Standard installation 2-1/8" hole diameter; Covered with protective PVC film

Single Door Protector

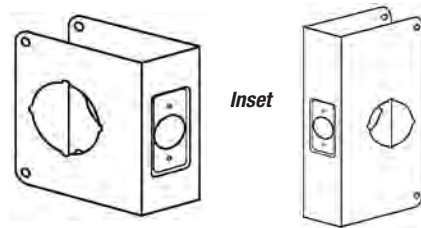
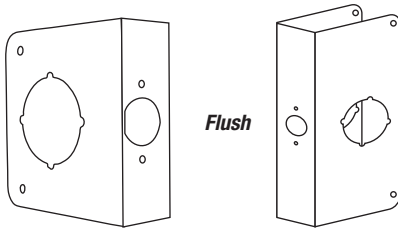

Combo Door Protector

For lockset & deadbolt

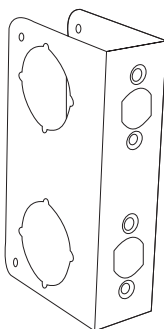

CODE	SIZE	STYLE	BACKSET	THICKNESS	PACK	INNER	MASTER
BRASS FINISH – FLUSH							
59015R1	4-1/2"	Flush	2-3/4"	1-3/4"	Clamshell	6◆	36
59022R1	4-1/2"	Flush	2-3/4"	1-3/8"	Clamshell	6◆	36
59000R1	4-1/2"	Flush	2-3/8"	1-3/4"	Clamshell	6◆	36
59016R1	4-1/2"	Flush	2-3/8"	1-3/8"	Clamshell	6◆	36
59020R1	9"	Flush	2-3/4"	1-3/4"	Clamshell	6◆	36
59025R1	9"	Flush	2-3/4"	1-3/8"	Clamshell	6◆	36
59005R1	9"	Flush	2-3/8"	1-3/4"	Clamshell	6◆	36
59021R1	9"	Flush	2-3/8"	1-3/8"	Clamshell	6◆	36
STAINLESS STEEL FINISH – FLUSH							
59014R1	4-1/2"	Flush	2-3/4"	1-3/4"	Clamshell	6◆	36
59001R1	4-1/2"	Flush	2-3/8"	1-3/4"	Clamshell	6◆	36
59017R1	4-1/2"	Flush	2-3/8"	1-3/8"	Clamshell	6◆	36
59018 NEW	4-1/2"	Flush	2-3/4"	1-3/8"	Clamshell	6◆	36
59019	9"	Flush	2-3/4"	1-3/4"	Clamshell	6◆	36
59029R1	9"	Flush	2-3/4"	1-3/8"	Clamshell	6◆	36
59006R1	9"	Flush	2-3/8"	1-3/4"	Clamshell	6◆	36
59023R1	9"	Flush	2-3/8"	1-3/8"	Clamshell	6◆	36
ANTIQU BRASS FINISH – FLUSH							
59011	9"	Flush	2-3/4"	1-3/4"	Clamshell	6◆	36
59010	9"	Flush	2-3/8"	1-3/4"	Clamshell	6◆	36
59009	9"	Flush	2-3/8"	1-3/8"	Clamshell	6◆	36
PAINTABLE – FLUSH							
59030 NEW	4-1/2"	Flush	2-3/4"	1-3/4"	Clamshell	6◆	36
59031 NEW	9"	Flush	2-3/4"	1-3/4"	Clamshell	6◆	36
STAINLESS STEEL FINISH – INSET							
59027	4-1/2"	Inset	2-3/4"	1-3/8"	Clamshell	6◆	36
BRASS FINISH – INSET							
59002 NEW	9"	Inset	2-3/8"	1-3/4"	Box	10◆	40
59003 NEW	9"	Inset	2-3/8"	1-3/8"	Box	10◆	40
59012 NEW	4-1/2"	Inset	2-3/8"	1-3/4"	Box	10◆	40
59013 NEW	4-1/2"	Inset	2-3/8"	1-3/8"	Box	10◆	40

CODE	SIZE	STYLE	BACKSET	THICKNESS	PACK	INNER	MASTER
BRASS FINISH – FLUSH							
59007 NEW	9"	Flush	2-3/4"	1-3/4"	Clamshell	6◆	36
59032	10-7/8"	Flush	2-3/8"	1-3/4"	Clamshell	4◆	24
ANTIQU BRASS FINISH – FLUSH							
59008 NEW	9"	Flush	2-3/4"	1-3/4"	Clamshell	6◆	36
STAINLESS STEEL FINISH – FLUSH							
59004 NEW	9"	Flush	2-3/4"	1-3/4"	Clamshell	6◆	36
PAINTABLE – BEIGE PRIME – FLUSH							
59026 NEW	9"	Flush	2-3/4"	1-3/4"	Clamshell	6◆	36

BUILDERS' HARDWARE

DOOR GUARDS

Heavy duty; Allows for 4" maximum opening; Furnished w/screws

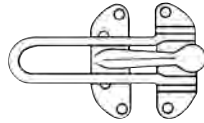

CODE	MATERIAL	FINISH	PACK	INNER	MASTER
60892	Zinc	Brass/US3	Card	5◆	50
29000	Zinc	Brass/US3	Card	12◆	120
29002	Zinc	Chrome/US26	Card	6◆	120
29009	Zinc	Satin Nickel/US15	Card	6◆	120
29017 NEW	Zinc	Oil Rubbed Bronze	Card	6◆	120
29007	Zinc	Chrome/US26	Polybag w/UPC	25◆	100

CHAIN DOOR GUARD

Heavy Duty

Furnished with self tapping screws

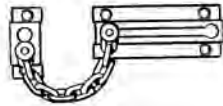

CODE	MATERIAL	FINISH	PACK	INNER	MASTER
29010	Steel	Brass/US3	Card	6◆	144
29012	Steel	Chrome/US26	Card	6◆	144
29011	Steel	Brass/US3	Polybag w/UPC	40◆	120

Light Duty

Furnished with self tapping screws



CODE	MATERIAL	FINISH	PACK	INNER	MASTER
60891	Steel	Brass/US3	Card	5◆	50
29021 NEW	Steel	Satin Nickel/US15	Card	6◆	144
29022 NEW	Steel	Oil Rubbed Bronze/US10B	Card	6◆	144
29020	Steel	Oil Rubbed Bronze/US10B	Polybag w/UPC	20◆	100

Solid Brass

Solid brass; Hardened plated chain; Furnished with self tapping sheet metal screws

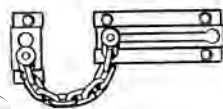

CODE	MATERIAL	FINISH	PACK	INNER	MASTER
29015	Solid Brass	Brass/US3	Card	6◆	144
29014	Solid Brass	Satin Nickel/US15	Card	6◆	144
29016	Solid Brass	Brass/US3	Polybag w/UPC	10◆	150

Key Operated

Key operated chain door guard



CODE	KEYWAY	FINISH	KEY	PACK	INNER	MASTER
44810	IN8	Brass/US3	KD	Card	6◆	96
44811 NEW	IN8	White/US3	KD	Card	6◆	96

FLIP LOCK

Restricts access to closets or rooms for in-swing doors; Easily installs on door jamb



CODE	MATERIAL	FINISH	PACK	INNER	MASTER
58117 NEW	Steel	Brass/US3	Card	5◆	50
58116 NEW	Steel	Antique Brass/US5	Card	5◆	50

DOOR ANCHOR BARS

Jamb plate locks through door frame into wall or studs; Tamperproof design without exposed screws

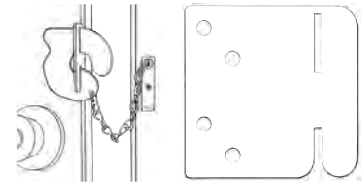

Code 98602
Code 98603

Jamb Plate

This is not a Chain Guard and does not allow for any opening. The bracket and chain only act as a storage hanger when anchor bolt is not in use.

CODE	MATERIAL	FINISH	PACK	INNER	MASTER
06365	Steel	Brass/US3	Card	12◆	60
06360	Steel	White	Card	12◆	60
98603-PP NEW	Steel	Brass	Polybag w/UPC	10◆	80
98602-PP NEW	Steel	White	Polybag w/UPC	10◆	60

BAR HOLDERS

Holds 2" x 4" lumber

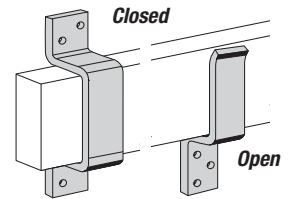

CODE	TYPE	FINISH	PACK	INNER	MASTER
95883	Closed	Zinc/US2	Bulk	10◆	50
95885	Open	Zinc/US2	Bulk	10◆	50

BURGLAR BAR — SECURITY DOOR JAMB

Hard rubber floor pad; Telescoping adjustment; Compact for storage

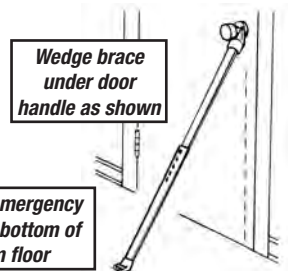

Instant release for emergency situations: Kick the bottom of brace away from floor

CODE	FINISH	PACK	INNER	MASTER
39070	Chrome/US26	Card	6◆	18

BUILDERS' HARDWARE

FILLER PLATE

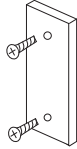

Countersunk holes; Furnished w/screws

CODE	SIZE	FINISH	PACK	INNER	MASTER
58162	2-1/4"H x 1-1/8"W	Brass/US3	Card	6◆	120
58161	2-1/4"H x 1-1/8"W	Grey	Card	6◆	120

HOLE COVER PLATE

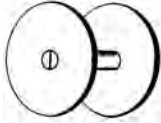

Steel cover plate for standard 2-1/8" diameter bore hole; Male & female plate with thru-bolt; Furnished screws

Code 98677

CODE	DOOR THICKNESS	FINISH	PACK	INNER	MASTER
58159	1-3/8" - 2"	Brass/US3	Card	6◆	120
59169 NEW	1-3/8" - 2"	Satin Nickel/US15	Card	6◆	120
58160	1-3/8" - 2"	Grey	Card	6◆	120
58395	1-3/8" - 1-3/4"	Brass/US3	Polybag w/UPC	6◆	252
58398	1-3/8" - 1-3/4"	Grey	Polybag w/UPC	6◆	252
98677-PP NEW	1-3/8" - 1-3/4"	Satin Chrome	Polybag w/UPC	10◆	120

SCAR COVER PLATES

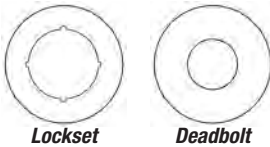

Heavy duty, one-piece construction; Changes 2-3/8" to 2-3/4" backset; Overall diameter 3-1/2"; Lockset 2-1/8" hole; Deadbolt 1-1/2" hole

CODE	TYPE	FINISH	PACK	INNER	MASTER
58393	Lockset	Brass/US3	Card	6◆	120
58399 NEW	Lockset	Satin Nickel/US15	Card	6◆	120
58391	Lockset	Brass/US3	Polybag w/UPC	6◆	720
58392	Lockset	Stainless Steel/US32	Polybag w/UPC	6◆	720
58396	Deadbolt	Brass/US3	Polybag w/UPC	6◆	720
58397	Deadbolt	Stainless Steel/US32	Polybag w/UPC	6◆	720

DUMMY CYLINDER

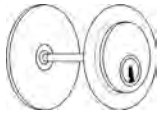

Fits doors up to 2-1/8" thick; Cover plate included

CODE	SIZE	FINISH	PACK	INNER	MASTER
22000	1-7/8" O.D.	Brass/US3	Card	12◆	240

JAMB BRACE REINFORCER



Heavy duty theft deterrent system; To be installed w/ grade 2 deadbolts; Strengthens frame; Concealed w/interior door trim; Fits all door types; Furnished w/strike plate screws

CODE	SIZE	PACK	INNER	MASTER
58170	Aluminum	Polybag	1	25

DOOR LATCH PROTECTORS

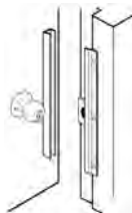

In-swinging door; Tough steel construction; Interlocks door & frame; Furnished w/ 4 Phillips head screws, 3 Security fasteners, 2 Short pan head screws

CODE	SIZE	FINISH	PACK	INNER	MASTER
59044	12"	Brass/US3	Card	3	48
59045	12"	Silver Painted	Card	3	48



Single Door

Outswinging door; Use with key-in-knob and mortise locks; Solid one piece heavy gauge steel; Powder coated weather resistant finish; Furnished w/carriage bolts and cap nuts

CODE	SIZE	MATERIAL	FINISH	PACK	INNER	MASTER
59050	3"W x 11"L	Steel	Aluminum	Polybag w/UPC	3◆	48
59051	3"W x 11"L	Steel	Bronze	Polybag w/UPC	3◆	60

DOOR LATCH PROTECTORS *continued*



Commercial type; 12 Gauge .104 steel; 2-1/8" W x 6"L for key-in-knob locks; 2-1/8" W x 10" L for mortise locks; Concealed welded studs w/fasteners

CODE	MATERIAL	SIZE	FINISH	PACK	INNER	MASTER
59039	Steel	6"	Stainless Steel/US32	Card	3◆	48
59041	Steel	10"	Stainless Steel/US32	Card	12◆	48



Short door latch protectors; 12 Gauge .104 steel; For out-swinging doors; Plastic coated baked on finish; May be used on hollow, metal door frames using ASA strike plate; Furnished w/ washers, carriage bolts and cap nuts

CODE	MATERIAL	SIZE	FINISH	PACK	INNER	MASTER
59042	Steel	3"W x 6"L	Silver	Card	3◆	48
59043	Steel	3"W x 6"L	Duro Bronze	Card	3◆	48



12 Gauge .104 steel; For outswinging doors with key-in-knob sets; Furnished w/washers, carriage bolts and cap nuts

CODE	SIZE	FINISH	PACK	INNER	MASTER
59038	2-3/4"W x 7"L	Polished Brass/US3	Card	3◆	48
59037	2-3/4"W x 7"L	Stainless Steel/US32	Card	3◆	48

STRIKE PLATES

Latchbolt Strike Plates

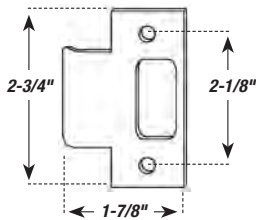

Cylindrical latchbolt "T" strike plates; Furnished w/screws

CODE	FINISH	PACK	INNER	MASTER
58154	Brass/US3	Card	6◆	120
58153	Chrome/US26	Card	6◆	120
72016	Brass/US3	Polybag w/UPC	20◆	200
72018	Stainless Steel/US32	Polybag w/UPC	20◆	200

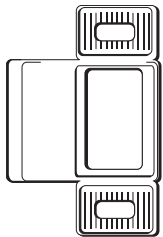

Adjustable latchbolt strike plate; Packed w/ shims and screws

CODE	SIZE	FINISH	PACK	INNER	MASTER
58115	4-7/8" x 1-5/16"	Brass/US3	Card	6◆	120
58111 NEW	2-3/4" x 2"	Brass/US3	Card	6◆	120
58112 NEW	2-3/4" x 2-1/2"	Brass/US3	Card	6◆	120
58118R1 NEW	2-3/4" x 1-5/16"	Brass/US3	Card	6◆	120
58119 NEW	2-3/4" x 1-5/16"	Satin Nickel/US15	Card	6◆	120
58120 NEW	2-3/4" x 1-5/16"	Oil Rubbed Bronze	Card	6◆	120
58105	2-3/4" x 1-5/16"	Brass/US3	Polybag	—	100

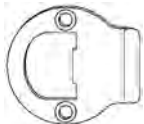

Circular latchbolt strike plate; Packed w/o screws

CODE	FINISH	PACK	INNER	MASTER
58080	Brass/US3	Polybag w/UPC	10◆	2000

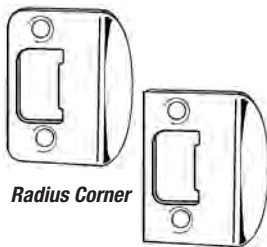

Radius Corner

Square Corner

Universal size latchbolt strike plates; Adjustable tang; Overall dimensions: 2-1/4" H x 1-1/4" W w/o tab; Packed with screws (58102 and 58104 w/o screws)

CODE	CORNER	FINISH	PACK	INNER	MASTER
58100	Square	Brass/US3	Polybag w/UPC	100◆	400
58150R1 NEW	Radius	Brass/US3	2/Blister Card	6◆	120
58169 NEW	Radius	Satin Nickel/US15	2/Blister Card	6◆	120
58104R1 NEW	Radius	Brass/US3	Polybag w/UPC	10◆	600
58102R1 NEW	Radius	Antique Brass/US5	Polybag w/UPC	10◆	600
58113R1 NEW	Radius	Antique Brass/US5	2/Blister Card	6◆	120
58108R1 NEW	Radius	Polished Chrome/US26	2/Blister Card	6◆	120

STRIKE PLATES *continued*



ASA; ANSI prep; ASA
4-7/8" x 1-7/8" x 3/32";
Curved Lip: L to C 1-1/4";
2 Countersunk mounting
holes; Furnished w/screws

CODE	MATERIAL	FINISH	PACK	INNER	MASTER
72010	Steel	Brass/US3	Card	6◆	120
72015	Steel	Satin Chrome/US26	Card	6◆	120

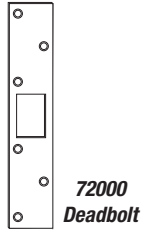

72000
Deadbolt

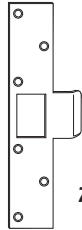

72005 & 58163
Door Lock

CODE	MATERIAL	SIZE	FINISH	PACK	INNER	MASTER
72000R1	Steel	6"H x 1"W	Brass/ US3	Card	6◆	144
58163	Steel	8"H x 1-1/4"W	Brass/ US3	Card	6◆	120
72005	Steel	6"H x 1-3/4"W	Brass/ US3	Card	6◆	144
72001 NEW	Steel	6"H x 1"W	Satin Nickel/ US15	Card	6◆	144



*Square
Corner*



*Radius
Corner*

Countersunk holes;
Furnished w/screws

CODE	CORNER	SIZE	FINISH	PACK	INNER	MASTER
58156	Square	3-5/8"H x 1-1/4"W	Brass/US3	Bli-ster Card	6◆	120
58166 NEW	Square	3-5/8"H x 1-1/4"W	Satin Nickel/ US15	Bli-ster Card	6◆	120
58085R1 NEW	Radius	3-5/8"H x 1-1/4"W	Brass/US3	Bli-ster Card	10◆	600

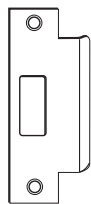

Large lip; Furnished
w/screws

CODE	MATERIAL	FINISH	PACK	INNER	MASTER
58152	Steel	Brass/US3	Card	6◆	120
58151	Steel	Chrome/US26	Card	6◆	120
58164 NEW	Steel	Satin Nickel/US15	Card	6◆	120
58165 NEW	Steel	Oil Rubbed Bronze/ US10B	Card	6◆	120



1-1/4" including the lip
x 3-7/8" long; Furnished
w/screws

CODE	FINISH	PACK	INNER	MASTER
71210	Brass/US3	Card	12◆	120

BOX STRIKE



Heavy duty security;
Countersunk hole;
Furnished w/screws

CODE	SIZE	FINISH	PACK	INNER	MASTER
58155	4-7/8" H x 1-1/4 W	Brass/US3	Bli-ster Card	6◆	120

DEADBOLT STRIKE PLATES

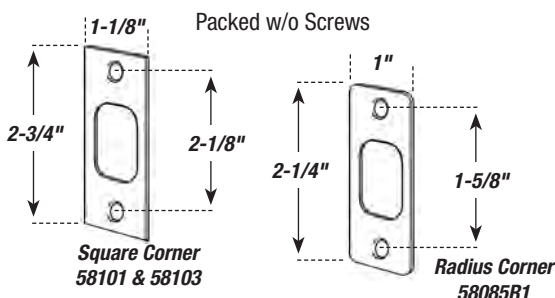

CODE	CORNER	FINISH	PACK	INNER	MASTER
58167 NEW	Radius	Brass/US3	Card	10◆	600
58168 NEW	Radius	Satin Nickel/ US15	Card	10◆	600
58085R1	Radius	Brass/US3	Polybag w/UPC	10◆	600
58103	Square	Brass/US3	Polybag w/UPC	10◆	300
58101	Square	Antique Brass/ US5	Polybag w/UPC	150◆	600

BUILDERS' HARDWARE

REPLACEMENT KNOB SET



2-1/4" Diameter standard round knobs; 2-5/16" Square spindle; Furnished w/ spindle and 2 set screws per knob

CODE	MATERIAL	FINISH	PACK	INNER	MASTER
43010	Solid Brass	Brass/US3	1 Set/Clam	5 ♦	60

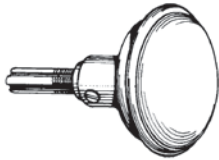

2" Diameter round knob; 5/16" Square spindle; Furnished w/ spindle and set screws
P Code 98677

CODE	MATERIAL	FINISH	PACK	INNER	MASTER
43005	Steel	Brass/US3	1 Set/Clam	10 ♦	60
98615-PP NEW	Steel	Brass/US3	Box	10 ♦	60

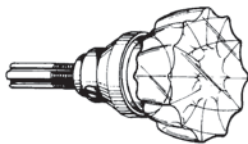

Crystal glass; 2" Diameter faceted glass knobs; 5/16" Square spindle; Furnished w/ spindle and set screws

CODE	FINISH	PACK	INNER	MASTER
43000	Brass/US3	1 Set/Clam	10 ♦	40
43013 NEW	Satin Nickel	1 Set/Clam	10 ♦	40

ROSETTE

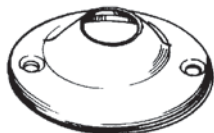

64600, 64602, 64592, 64593

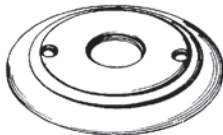

64605

Fits most glass or brass finish door knob sets; Furnished w/screws

CODE	SIZE	FINISH	PACK	INNER	MASTER
64592	2-1/2"	Brass/US3	2/Card	6 ♦	360
64593 NEW	2-1/2"	Satin Nickel/US15	2/Card	6 ♦	360
64602	2-1/2"	White Primed/USP	2/Card	12 ♦	144
64600	2-1/4"	Brass/US3	2/Card	12 ♦	384
64605	2-3/4"	Brass/US3	2/Card	12 ♦	360

SPLIT SPINDLE & SET SCREW

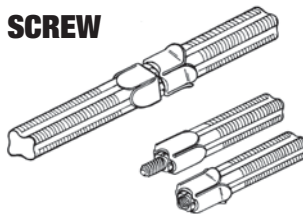

Fits most threaded door knobs; Standard thread; Packed w/o set screw

CODE	MATERIAL	FINISH	PACK	INNER	MASTER
67982	Steel	Zinc/US2	Polybag w/UPC	6 ♦	240

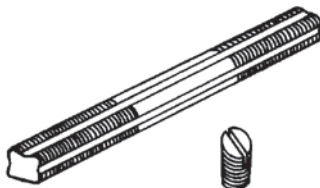

Fits most threaded door knobs; Standard thread

CODE	MATERIAL	PACK	INNER	MASTER
67980	Steel	Card	12 ♦	600

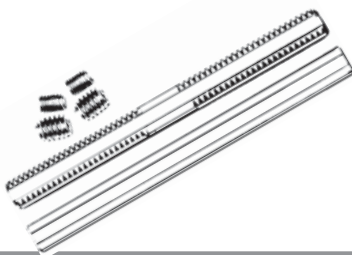

Universal spindle set; 3-1/2" Threaded spindle; 3-1/2" Non-threaded spindle; Standard American thread; Furnished w/screws

CODE	PACK	INNER	MASTER
67981	1 Set/Card	6 ♦	600

BUILDERS' HARDWARE

DECORATIVE SLIP-OVER HANDLES

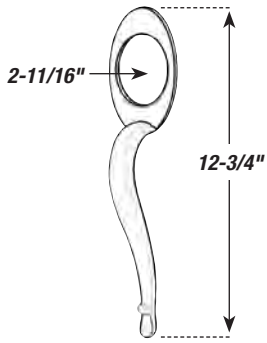

Will fit over most lock rosettes and deadbolts; Furnished w/ screws

ETERNITY

Finish...
 • DOESN'T TARNISH
 • DOESN'T CORRODE
 • DOESN'T DISCOLOR

31617 only



CODE	FINISH	PACK	INNER	MASTER
31625	Brass/US3	Card	6♦	48
31629	Antique Brass/US5	Card	6♦	48
31631	Satin Nickel/US15	Card	6♦	48
31627	Brass/US3	Polybag w/UPC	12♦	48
31652	Brass/US3	Polybag w/UPC	6	48
31641	Antique Brass/US5	Polybag w/UPC	12♦	48
ETERNITY FINISH – PVD				
31617	Brass/US3/PVD	Clamshell	6♦	36

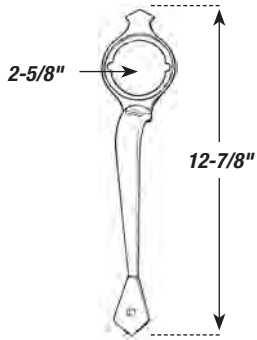

Furnished with plastic spacer

CODE	FINISH	PACK	INNER	MASTER
31624	Brass/US3	Polybag w/UPC	10♦	100

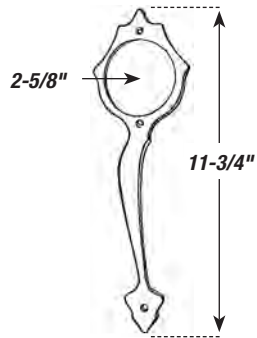

Furnished with plastic spacer

CODE	FINISH	PACK	INNER	MASTER
31628	Brass/US3	Polybag w/UPC	10♦	100

ESCUTCHEON PLATES

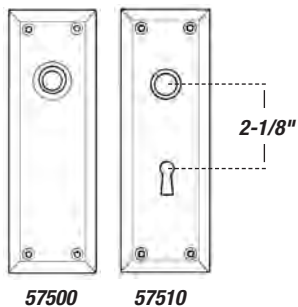

Furnished with solid brass hub & solid brass self tapping screws



CODE	MATERIAL	SIZE	FINISH	PACK	INNER	MASTER
57500	Solid Brass	2-1/4" x 7"	Brass/US3	1/Set Card	3♦	120
57510	Solid Brass	2-1/4" x 7"	Brass/US3	1/Set Card	3♦	120



Inside: Brass plated hub & turn piece; Outside: Brass plated hub & keyhole; Furnished w/screws

CODE	MATERIAL	SIZE	FINISH	PACK	INNER	MASTER
57514	Steel	2-1/4" x 7"	Brass/US3	1/Set Card	3♦	120
57511 NEW	Steel	2-1/4" x 7"	Satin Nickel / US15	1/Set Card	3♦	120

SAFETY HASPS

- Zinc plated—rust resistant
- Galvanized—corrosion resistant

Fixed Staple Safety Hasp

Card and polybag furnished w/screws; Bulk w/o screws

GALVANIZED
All Weather

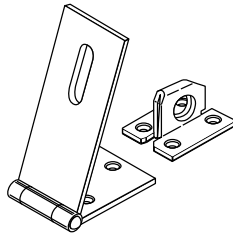

CODE	MATERIAL	SIZE	FINISH	PACK	INNER	MASTER
32000	Steel	2-1/2"	Zinc	Card	10◆	240
32005	Steel	3-1/2"	Zinc	Card	5◆	140
32010	Steel	4-1/2"	Zinc	Card	5◆	140
32015	Steel	6"	Zinc	Card	5◆	60
61040	Steel	2-1/2"	Galvanized	Card	10◆	240
61041	Steel	3-1/2"	Galvanized	Card	5◆	120
61042	Steel	4-1/2"	Galvanized	Card	5◆	120
61043	Steel	6"	Galvanized	Card	5◆	60
96460	Steel	2-1/2"	Zinc	Polybag w/UPC	12◆	600
96461	Steel	3-1/2"	Zinc	Polybag w/UPC	12◆	240
96462	Steel	4-1/2"	Zinc	Polybag w/UPC	12◆	240
96463	Steel	6"	Zinc	Polybag w/UPC	12◆	72
97491	Steel	2-1/2"	Zinc	Bulk	12◆	720
97490	Steel	3-1/2"	Zinc	Bulk	12◆	240
96445	Steel	4-1/2"	Zinc	Bulk	12◆	240
96447	Steel	6"	Zinc	Bulk	12◆	96

Swivel Staple Safety Hasps

Staple swivels a full 360°; Furnished w/ screws



CODE	SIZE	FINISH	PACK	INNER	MASTER
34040	3-1/2"	Zinc	Card	5◆	100
34045	4-1/2"	Zinc	Card	5◆	90
34046	6"	Zinc	Card	12◆	72

Adjustable Staple Safety Hasps

Card and polybag furnished w/screws; Bulk w/o screws

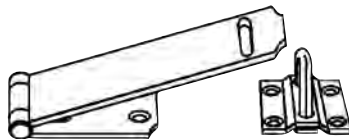

CODE	SIZE	FINISH	PACK	INNER	MASTER
60949	3-1/2"	Zinc	Card	10◆	120
60950	4-1/2"	Zinc	Card	10◆	120
60951	6"	Zinc	Card	5◆	60
96464	3-1/2"	Zinc	Polybag	12◆	240
96465	4-1/2"	Zinc	Polybag	12◆	240
96451	6"	Zinc	Bulk	12◆	96

Extra Heavy Duty Safety Hasp

Square hole for carriage bolt; Furnished w/ carriage bolt, washers and nut

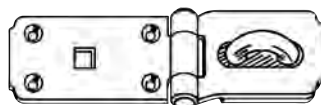

CODE	SIZE	FINISH	PACK	INNER	MASTER
34035	7-1/4"	Zinc	Card	5◆	50
34036	7-1/4"	Zinc	Polybag	6◆	60

SAFETY HASPS *continued*

Heavy Duty Safety Hasp

Pinless hinge for greater security;
Furnished w/screws

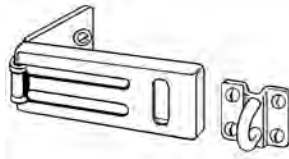

CODE	SIZE	FINISH	PACK	INNER	MASTER
33020	3-1/2"	Zinc	Card	12◆	144
33503	4-1/2"	Zinc	Card	12◆	144
34030	6"	Zinc	Card	6◆	60

Light Duty Safety Hasp

Furnished w/screws

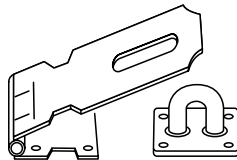

CODE	SIZE	FINISH	PACK	INNER	MASTER
96452	2"	Brass	Card	12◆	144

Hinge Hasp Safety Hasp

Furnished w/screws



CODE	SIZE	FINISH	PACK	INNER	MASTER
60944	3-1/2"	Zinc	Card	5◆	100
60945	4-1/2"	Zinc	Card	5◆	50
60946	6"	Zinc	Card	5◆	50

Double Hinge Safety Hasp

Zinc plated steel; Furnished w/
screws

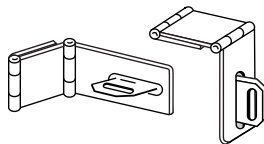

CODE	SIZE	FINISH	PACK	INNER	MASTER
60954	3-1/2"	Zinc	Card	5◆	100

Flexible Link Safety Hasp

For flat, corner or 90°
angle installation; Covered
fixing and staple plate;
Hardened steel; Hardened
laminated links; Furnished
w/ screws and square
shoulder

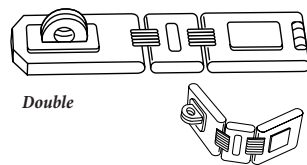
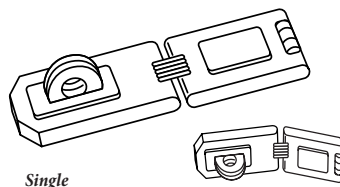

CODE	SIZE	HINGE	FINISH	PACK	INNER	MASTER
34060	6-1/4"	Single	Chrome	Card	6◆	60
96435	4-1/2"	Double	Chrome	Card	6◆	48
34062 NEW	6-1/4"	Single	Chrome	Polybag	6◆	60

Padlock 'n Hasp Combinations

Made of bright chromated steel to pre-
vent rust; Furnished w/screws

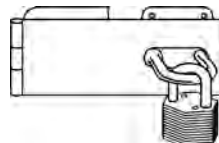

CODE	HASP	PADLOCK	PACK	INNER	MASTER
60947	3-1/2"	1-1/2"	Card	5◆	50
32025	4-1/2"	1-1/2"	Card	5◆	50

Integral bolt; Keyed different; Zinc plated
finish; Brass pin tumbler cylinder; M1
Keyway; Furnished w/ screws and steel
laminated padlock

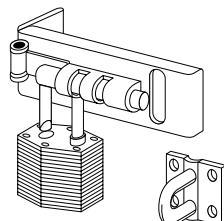

CODE	HASP	PADLOCK	PACK	INNER	MASTER
96475	4-1/2"	1-3/4"	Card	6◆	60

SAFETY HASPS *continued*

Key Cylinder Hasp Lock

Hasp locks w/o use of key; Requires key to unlock; IN8 or L1054B keyway

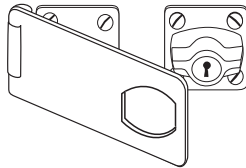

CODE	SIZE	FINISH	PACK	INNER	MASTER
31800	3"	Chrome	Card	6♦	120
31810	4"	Chrome	Card	6♦	96
31815	4-1/2"	Chrome	Card	6♦	96

BARREL BOLTS

Extra Heavy Duty

Padlockable barrel bolts; 2 Types of keepers; Bolt diameter 9/16"; Takes standard padlock from 1" to 2" (padlock not included); Furnished w/ screws

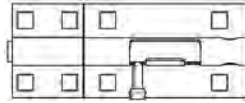

CODE	SIZE	FINISH	PACK	INNER	MASTER
06300	5"	Zinc	Card	5♦	30
06305	8"	Zinc	Card	6♦	36

Steel construction; Long throw for maximum security; Furnished w/screws

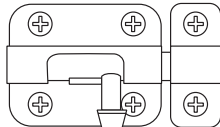

GALVANIZED
All Weather

CODE	SIZE	FINISH	PACK	INNER	MASTER
61097	2-1/2"	Galvanized	Card	5♦	50
61098	3"	Galvanized	Card	5♦	50
61099	4"	Galvanized	Card	5♦	50
61027	5"	Galvanized	Card	5♦	50
61028	6"	Galvanized	Card	5♦	50

Extruded solid brass bolts; long throw for maximum security; furnished w/ screws

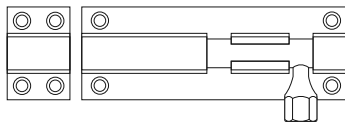

CODE	SIZE	FINISH	PACK	INNER	MASTER
06200	5"	Brass	Card	6♦	72
06205	7"	Brass	Card	6♦	72

Steel construction; Long throw for maximum security; Reversible strike engages at either end of bolt; Carded furnished w/ screws

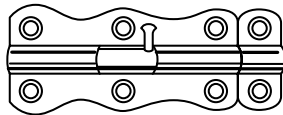

CODE	SIZE	FINISH	PACK	INNER	MASTER
95920	2"	Brass	Card	12♦	144
95921	2-1/2"	Brass	Card	12♦	144
06000	3"	Brass	Card	12♦	144
06005	4"	Brass	Card	12♦	144
06010	5"	Brass	Card	12♦	144
06015	6"	Brass	Card	12♦	120

Heavy Duty

Steel construction barrel bolts; Furnished w/ strike plate and screws

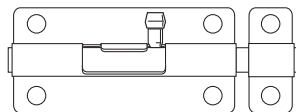

CODE	SIZE	FINISH	PACK	INNER	MASTER
06180	2-1/2"	Satin Brass	B blister Card	10♦	100
06181	4"	Satin Brass	B blister Card	10♦	100
06182	5"	Satin Brass	B blister Card	10♦	100
06183	6"	Satin Brass	B blister Card	5♦	50

BARREL BOLTS *continued*

Standard Duty

Standard steel bolt; Furnished w/ screws and keeper

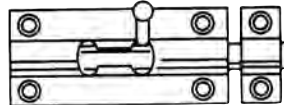

CODE	SIZE	FINISH	PACK	INNER	MASTER
60875	2"	Brass Plated	Card	10◆	240
60876	2-1/2"	Brass Plated	Card	10◆	240
60877	3"	Brass Plated	Card	10◆	120
60879	4"	Brass Plated	Card	10◆	120
60883	5"	Brass Plated	Card	10◆	120
60881	6"	Brass Plated	Card	5◆	120
06029	2"	Zinc Plated	Card	10◆	240
06030	2-1/2"	Zinc Plated	Card	10◆	200
06031	3"	Zinc Plated	Card	10◆	120
06032	4"	Zinc Plated	Card	10◆	120
06033	5"	Zinc Plated	Card	10◆	120
06034	6"	Zinc Plated	Card	5◆	120

Long throw for maximum security; Furnished w/screws

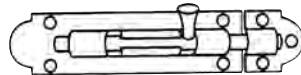

CODE	SIZE	FINISH	PACK	INNER	MASTER
06020	2-1/2"	Brass	Card	12◆	240
06025	3"	Brass	Card	12◆	240
06070	4"	Brass	Card	12◆	240
95916	5"	Brass	Card	12◆	144
95918	6"	Brass	Card	12◆	144
95915	4"	Zinc	Card	12◆	144
95917	5"	Zinc	Card	12◆	144
95919	6"	Zinc	Card	12◆	144

Standard Duty – Solid Brass

Extruded solid brass bolts; Reversible strike engages at either end; Furnished w/ surface and mortise strikes (2) and screws

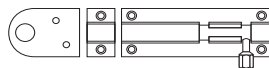

CODE	SIZE	FINISH	PACK	INNER	MASTER
06100	2"	Brass	Card	12◆	240
06105	2-1/2"	Brass	Card	12◆	240
06110	3"	Brass	Card	12◆	240
06115	4"	Brass	Card	12◆	240

Square Spring Bolts

Heavy spring keeps zinc plated bolt in position; Furnished w/ surface and mortise strike and screws

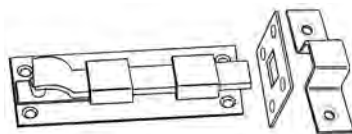

CODE	SIZE	FINISH	PACK	INNER	MASTER
07050	1-3/4" x 6"	Black	Card	6◆	36

SURFACE BOLTS

Solid Brass

Solid brass; Furnished w/ surface and mortise strikes (2) and screws



CODE	SIZE	FINISH	PACK	INNER	MASTER
60885	3"	Brass	Card	10◆	100
60886	4"	Brass	Card	10◆	100
60887	6"	Brass	Card	10◆	100
29025 NEW	4"	Brass	Card	10◆	100
29026 NEW	4"	Satin Nickel	Card	10◆	100
29027 NEW	4"	Oil Rubbed Bronze	Card	10◆	100

Aluminum

Aluminum; Anodized extruded aluminum bolt; Rustproof alloy; Furnished w/ surface and mortise strikes (2) and screws



CODE	SIZE	FINISH	PACK	INNER	MASTER
08005	3"	Brass	Card	12◆	96
08010	4"	Brass	Card	12◆	144
08015	6"	Brass	Card	12◆	144

DUTCH DOOR SURFACE BOLT

Solid brass; Adjustable slide bolt; 7/8" diameter solid brass grip knob; Furnished w/surface jamb and mortise strikes (2) and screws

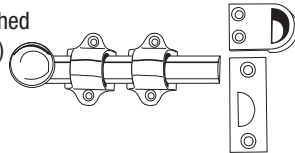

CODE	SIZE	FINISH	PACK	INNER	MASTER
08120	4-1/4" x 1/2"	Brass	Card	10◆	100

MORTISE DOOR BOLT

Zinc die-cast bolt, steel spindle and solid brass casing; Geared tubular mortise bolt; 9/16" Diameter bore; Furnished w/screws

CHAIN BOLT

Heavy duty spring automatically throws bolt when chain is released; Reversible for doors opening in or out; 24" Pull chain with ring; Furnished w/ surface and angle strikes and screws

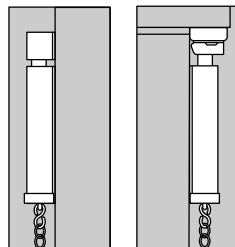
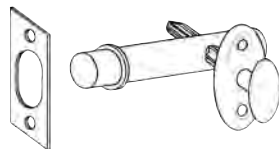

CODE	SIZE	FINISH	PACK	INNER	MASTER
07013	2-1/2"	Brass	Card	3◆	144

CODE	SIZE	FINISH	PACK	INNER	MASTER
60878 NEW	4"	Brass	Card	5◆	50
60871	4"	Zinc	Card	5◆	50
60872	6"	Zinc	Card	5◆	50

FOOT BOLTS

Heavy Duty

Designed for metal or wooden door; Spring motion for easy release; Foot release lever; Furnished w/ strike and screws

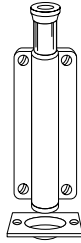

CODE	SIZE	FINISH	PACK	INNER	MASTER
60874	6"	Zinc	Card	5♦	50

MORTISE FLUSH LEVERS

Solid brass construction; Mortise type with steel rod; Spring tension lever action; Face dimensions: 3/4" wide; 1" Rod projection; Furnished w/ keepers and screws



PREMIUM FINISH

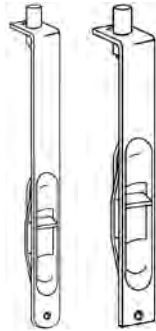

Radius Square

CODE (RADIUS)	CODE (SQUARE)	SIZE	FINISH	PACK	INNER	MASTER
06402	—	6	Brass	Polybag	6♦	240
—	06400	6"	Brass	Polybag	12♦	240
—	06405	6"	Antique Brass	Polybag	12♦	240
06411	—	6"	Oil Rubbed Bronze	Polybag	6♦	240
—	06403	6"	Satin Nickel	Polybag	12♦	240
06408	—	6"	Dull Chrome	Polybag	12♦	240

Solid brass face plate, slide, strike and screws; Steel bolt and bolt case; Mortise type w/ steel rod; Closed side panels; Spring tension lever action; Face dimensions: 3/4" wide; 7/16" High; 5/8" Thick; 1-1/4" Rod projection; Furnished w/ keepers and screws

PREMIUM FINISH



CODE	FINISH	PACK	INNER	MASTER
06425	Brass	Polybag	10♦	100
06431	Antique Brass	Polybag	10♦	120
06432	Oil Rubbed Bronze	Polybag	10♦	120
06426	Chrome	Polybag	10♦	100
06428	Dull Chrome	Polybag	10♦	100
06429	Satin Nickel	Polybag	10♦	100

STRIKES (ONLY)

CODE	FINISH	PACK	INNER	MASTER
58070	Brass	Polybag	100♦	1000
58072	Chrome	Polybag	100♦	1000
58074	Dull Chrome	Polybag	100♦	1000

EXTENSION BOLTS

Solid brass construction; Mortise flush bolt; Face size: 1" x 6-3/4" extruded brass; Solid brass throw 3/4"; Flattened 1/2" round bolt head w/ 1" x 2" brass guide; 12" Steel rod w/ 3/4" rod backset; Steel plated strike 15/16" x 2-1/4"; Furnished w/screws



CODE	SIZE	FINISH	PACK	INNER	MASTER
07025	12" Rod	Brass	Box	6♦	72
07026	12" Rod	Satin Chrome	Box	12♦	72

SQUARE CORNER — PLAIN BEARING BUTT HINGES

Non-Removable Pin

STEEL
HINGES

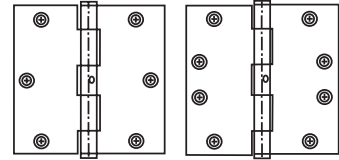

CODE	SIZE	GAUGE	PIN TYPE	FINISH	SCREWS				PACK	INNER	MASTER
					QTY	SIZE	LENGTH	TYPE			
BOX											
35212	3-1/2" x 3-1/2"	2.2mm	NRP SS	Satin/US4	12	#9	0.75	WS T17	2/Box	1	50
35151	4-1/2" x 4-1/2"	3.4mm	NPR SS	Satin Chrome/US26D	24	#12	1.25	WS	3/Box	6◆	12
					24	#12-24	0.5	MS			
35152	4-1/2" x 4-1/2"	3.4mm	NPR SS	Grey Prime/USP	24	#12	1.25	WS	3/Box	6◆	12
					24	#12-24	0.5	MS			

Masonite** hole pattern; Button tip; Furnished w/screws

STEEL
HINGES

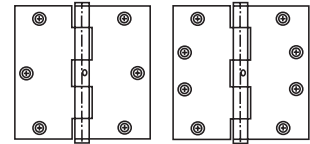

CODE	SIZE	GAUGE	PIN TYPE	FINISH	SCREWS				PACK	INNER	MASTER
					QTY	SIZE	LENGTH	TYPE			
BOX											
35214	4" x 4"	2.2mm	NRP SS	Polished Brass/US4	16	#9	0.75	WS T17	2/Box	1	50
POLYBAG											
61017	3" x 3"	2.2mm	NRP RIV	Zinc/US2	12	#9	0.75	WS T17	2/Poly	5◆	50
61018	3-1/2" x 3-1/2"	2.2mm	NRP RIV	Zinc/US2	12	#9	0.75	WS T17	2/Poly	5◆	50
61019	4" x 4"	2.2mm	NRP RIV	Zinc/US2	16	#9	1	WS T17	2/Poly	5◆	50

Removable Pin

Template hole pattern; Button tip; Furnished w/screws

STEEL
HINGES

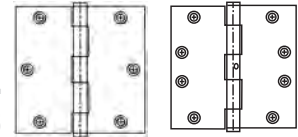

CODE	SIZE	GAUGE	PIN TYPE	FINISH	SCREWS				PACK	INNER	MASTER
					QTY	SIZE	LENGTH	TYPE			
CLAMSHELL											
35061	3-1/2" x 3-1/2"	2.2mm	RP	Brass/US3	6	#9	0.75	WS T17	1/Clam	10◆	100
35062	3-1/2" x 3-1/2"	2.2mm	RP	Chrome/US26	6	#9	0.75	WS T17	1/Clam	10◆	100
35064	3-1/2" x 3-1/2"	2.2mm	RP	Satin Chrome/US26D	6	#9	0.75	WS T17	1/Clam	10◆	100
35063	3-1/2" x 3-1/2"	2.2mm	RP	Oil Rubbed Bronze/US10B	6	#9	0.75	WS T17	1/Clam	10◆	100
35065	3-1/2" x 3-1/2"	2.2mm	RP	Satin Nickel/US15	6	#9	0.75	WS T17	1/Clam	10◆	100
CARD											
60918	3" x 3"	2.0mm	RP	Zinc/US2	6	#9	0.75	WS	1/Card	5◆	60
60906	3" x 3"	2.0mm	RP	Satin Brass/US4	6	#9	0.75	WS	1/Card	5◆	60
60907	3-1/2" x 3-1/2"	2.2mm	RP	Satin Brass/ US4	6	#9	0.75	WS	1/Card	5◆	60
60908	3-1/2" x 3-1/2"	2.2mm	RP	Antique Brass/US5	6	#9	0.75	WS	1/Card	5◆	60
60919	3-1/2" x 3-1/2"	2.2mm	RP	Zinc/US2	6	#9	0.75	WS	1/Card	5◆	60
BOX											
35200	3" x 3"	2.0mm	RP	Satin Brass/US4	12	#9	0.75	WS T17	2/Box	—	25
60802	3-1/2" x 3-1/2"	2.2mm	RP	Bright Brass/US3	12	#9	0.75	WS T17	2/Box	—	25
35210	3-1/2" x 3-1/2"	2.2mm	RP	Satin Brass/US4	12	#9	0.75	WS T17	2/Box	—	25
35251	4-1/2" x 4-1/2"	3.4mm	RP	Dull Chrome/US26D	24	#12	1.25	WS	3/Box	1	12
					24	#12-24	0.5	MS			
35252	4-1/2" x 4-1/2"	3.4mm	RP	Grey Prime/USP	24	#12	1.25	WS	3/Box	6◆	12
					24	#12-24	0.5	MS			

BUILDERS' HARDWARE

SQUARE CORNER — PLAIN BEARING *continued*

Removable Pin

Masonite** hole pattern; Button tip; Furnished w/screws

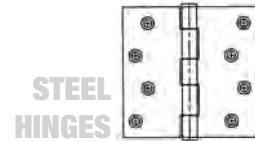

CODE	SIZE	GAUGE	PIN TYPE	FINISH	SCREWS				PACK	INNER	MASTER
					QTY	SIZE	LENGTH	TYPE			
CLAMSHELL											
35066	4" x 4"	2.5mm	RP	Brass/US3	8	#10	1	WS T17	1/Clam	10◆	100
35069	4" x 4"	2.5mm	RP	Satin Chrome/US26D	8	#10	1	WS T17	1/Clam	10◆	100
35070	4" x 4"	2.5mm	RP	Satin Nickel/US15	8	#10	1	WS T17	1/Clam	10◆	100
35071	4" x 4"	2.5mm	RP	Antique Pewter/US17A	8	#10	1	WS T17	1/Clam	10◆	100
CARD											
60909	4" x 4"	2.2mm	RP	Brass/US3	8	#10	1	WS	1/Card	5◆	60
60910	4" x 4"	2.2mm	RP	Antique Brass/US5	8	#10	1	WS	1/Card	5◆	60
60920	4" x 4"	2.2mm	RP	Zinc/US2	8	#10	1	WS	1/Card	5◆	60
BOX											
35215	4" x 4"	2.2mm	RP	Satin Brass/US4	8	#10	0.75	WS T17	2/Box	—	25
60804	4" x 4"	2.2mm	RP	Bright Brass/US3	8	#10	0.75	WS T17	2/Box	—	25

1/4" RADIUS CORNER — PLAIN BEARING

Removable Pin

Masonite** hole pattern; Button tip; Furnished w/screws

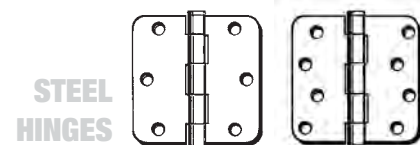

CODE	SIZE	GAUGE	PIN TYPE	FINISH	SCREWS				PACK	INNER	MASTER
					QTY	SIZE	LENGTH	TYPE			
CARD											
61015	3" x 3"	2.2mm	RP	Satin Brass/US4	6	#9	0.75	WS	1/Card	5◆	60
61012	3-1/2" x 3-1/2"	2.2mm	RP	Brass/US3	6	#9	0.75	WS T17	1/Card	5◆	60
61013	4" x 4"	2.2mm	RP	Brass/US3	8	#9	0.75	WS T17	1/Card	5◆	60
BOX											
35217	3-1/2" x 3-1/2"	2.2mm	RP	Satin Brass/US4	12	#9	0.75	WS T17	2/Box	—	25
62134	3-1/2" x 3-1/2"	2.2mm	RP	Oil Rubbed Bronze/US10B	12	#9	0.75	WS T17	2/Box	5◆	50
62130	3-1/2" x 3-1/2"	2.2mm	RP	Satin Nickel/US15	12	#9	0.75	WS T17	2/Box	5◆	50
35219	4" x 4"	2.2mm	RP	Satin Brass/US4	16	#10	0.75	WS T17	2/Box	—	50
62132	4" x 4"	2.2mm	RP	Satin Nickel/US15	16	#10	0.75	WS T17	2/Box	5◆	50

**The following registered trade name or trade mark is not owned, associated with or connected in any way with Ultra Hardware Products LLC and is used herein for illustrative purposes only

5/8" RADIUS CORNER – PLAIN BEARING

Removable Pin

Masonite** hole pattern; Button tip; Furnished w/screws

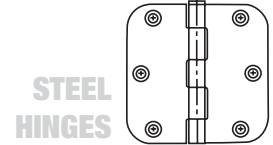

CODE	SIZE	GAUGE	PIN TYPE	FINISH	SCREWS				PACK	INNER	MASTER
					QTY	SIZE	LENGTH	TYPE			
CLAMSHELL											
35107	3-1/2" x 3-1/2"	2.2mm	RP	Brass/US3					1/Clam	10◆	100
35109	3-1/2" x 3-1/2"	2.2mm	RP	Oil Rubbed Bronze/US10B	6	#9	0.75	WS T17	1/Clam	10◆	100
35111	3-1/2" x 3-1/2"	2.2mm	RP	Satin Nickel/US15	6	#9	0.75	WS T17	1/Clam	10◆	100
35106	3-1/2" x 3-1/2"	2.2mm	RP	Antique Pewter/US17A	6	#9	0.75	WS T17	1/Clam	10◆	100
35108	3-1/2" x 3-1/2"	2.2mm	RP	Chrome/US26	6	#9	0.75	WS T17	1/Clam	10◆	100
35110	3-1/2" x 3-1/2"	2.2mm	RP	Satin Chrome/US26D	6	#9	0.75	WS T17	1/Clam	10◆	100
BOX											
96615	3" x 3"	2.0mm	RP	Satin Brass/US4	12	#9	0.75	WS T17	2/Box	1	50
35770	3-1/2" x 3-1/2"	2.2mm	RP	Brass/US3	12	#9	0.75	WS T17	2/Box	1	25
35226	3-1/2" x 3-1/2"	2.2mm	RP	Bright Brass/US3	12	#9	0.75	WS T17	2/Box	1	25
35220	3-1/2" x 3-1/2"	2.2mm	RP	Satin Brass/US4	12	#9	0.75	WS T17	2/Box	1	25
35041	3-1/2" x 3-1/2"	2.2mm	RP	Oil Rubbed Bronze/US10B	12	#9	0.75	WS T17	2/Box	1	25
35054	3-1/2" x 3-1/2"	2.2mm	RP	Nickel/US14	12	#9	0.75	WS T17	2/Box	1	25
35042	3-1/2" x 3-1/2"	2.2mm	RP	Satin Nickel/US15	12	#9	0.75	WS T17	2/Box	1	25
35043	3-1/2" x 3-1/2"	2.2mm	RP	Antique Satin Nickel/US15A	12	#9	0.75	WS T17	2/Box	1	25
35104	3-1/2" x 3-1/2"	2.2mm	RP	Antique Pewter/US17A	12	#9	0.75	WS T17	2/Box	1	25
35229	3-1/2" x 3-1/2"	2.2mm	RP	Flat Black/US19	12	#9	0.75	WS T17	2/Box	1	50
35044	3-1/2" x 3-1/2"	2.2mm	RP	Chrome/US26	12	#9	0.75	WS T17	2/Box	1	25
35045	3-1/2" x 3-1/2"	2.2mm	RP	Stainless Steel/US32D	12	#9	0.75	WS T17	2/Box	1	25
61740	3-1/2" x 3-1/2"	2.2mm	RP	Brass/US3	12	#9	0.75	WS T17	3/Box*	10◆	30
61743	3-1/2" x 3-1/2"	2.2mm	RP	Antique Brass/US5	12	#9	0.75	WS T17	3/Box*	10◆	30
61745	3-1/2" x 3-1/2"	2.2mm	RP	Antique Pewter/US17A	12	#9	0.75	WS T17	3/Box*	10◆	30
61742	3-1/2" x 3-1/2"	2.2mm	RP	Oil Rubbed Bronze/US10B	12	#9	0.75	WS T17	3/Box*	10◆	30
61744	3-1/2" x 3-1/2"	2.2mm	RP	Chrome/US26	12	#9	0.75	WS T17	3/Box*	10◆	30
61741	3-1/2" x 3-1/2"	2.2mm	RP	Satin Nickel/US15	12	#9	0.75	WS T17	3/Box*	10◆	30
61746	3-1/2" x 3-1/2"	2.2mm	RP	White Prime/USP	12	#9	0.75	WS T17	3/Box*	10◆	30

* Packed in cut cases

**The following registered trade name or trade mark is not owned, associated with or connected in any way with Ultra Hardware Products LLC and is used herein for illustrative purposes only

5/8" RADIUS CORNER – PLAIN BEARING *continued*

Removable Pin

Masonite** hole pattern; Button tip; Furnished w/screws

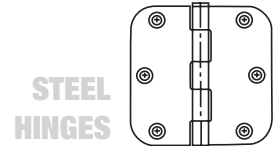

CODE	SIZE	GAUGE	PIN TYPE	FINISH	SCREWS				PACK	INNER	MASTER
					QTY	SIZE	LENGTH	TYPE			
BULK											
35766	3-1/2" x 3-1/2"	2.2mm	RP	Light Bright Brass/US3SP	NONE				Bulk	50 Pairs◆	—
35766KIT1	3-1/2" x 3-1/2"	2.2mm	RP	Light Bright Brass/US3SP	600	#9	0.75	WS T17			
35222	3-1/2" x 3-1/2"	2.2mm	RP	Satin Brass/US4	NONE				Bulk	50 Pairs◆	—
35222KIT1	3-1/2" x 3-1/2"	2.2mm	RP	Satin Brass/US4	600	#9	0.75	WS T17			
35235	3-1/2" x 3-1/2"	2.2mm	RP	Light Brass/US4B	NONE				Bulk	50 Pairs◆	—
35235KIT1	3-1/2" x 3-1/2"	2.2mm	RP	Light Brass/US4B	600	#9	0.75	WS T17			
35224	3-1/2" x 3-1/2"	2.2mm	RP	Antique Brass/US5	NONE				Bulk	50 Pairs◆	—
35224KIT1	3-1/2" x 3-1/2"	2.2mm	RP	Antique Brass/US5	600	#9	0.75	WS T17			
35089	3-1/2" x 3-1/2"	2.2mm	RP	Oil Rubbed Bronze/US10B	600	#9	0.75	WS T17	Bulk	50 Pairs◆	—
35088	3-1/2" x 3-1/2"	2.2mm	RP	Satin Nickel/US15	NONE				Bulk	50 Pairs◆	—
35088KIT1	3-1/2" x 3-1/2"	2.2mm	RP	Satin Nickel/US15	600	#9	0.75	WS T17			
35440	3-1/2" x 3-1/2"	2.2mm	RP	Chrome/US26	NONE				Bulk	50 Pairs◆	—
35440KIT1	3-1/2" x 3-1/2"	2.2mm	RP	Chrome/US26	600	#9	0.75	WS T17			
35437	3-1/2" x 3-1/2"	2.2mm	RP	Satin Chrome/US26D	NONE				Bulk	50 Pairs◆	—
35437KIT1	3-1/2" x 3-1/2"	2.2mm	RP	Satin Chrome/US26D	600	#9	0.75	WS T17			
35223	3-1/2" x 3-1/2"	2.2mm	RP	White Prime/USP	NONE				Bulk	50 Pairs◆	—
35223KIT1	3-1/2" x 3-1/2"	2.2mm	RP	White Prime/USP	600	#9	0.75	WS T17			
35238	3-1/2" x 3-1/2"	2.2mm	RP	Pure White Prime/USP	NONE				Bulk	50 Pairs◆	—
POLYBAG											
61840	3-1/2" x 3-1/2"	2.2mm	RP	Bright Brass/US3	6	#9	0.75	WST17	1/Poly	30◆	90
61843	3-1/2" x 3-1/2"	2.2mm	RP	Antique Brass/US5	6	#9	0.75	WST17	1/Poly	30◆	90
61842	3-1/2" x 3-1/2"	2.2mm	RP	Oil Rubbed Bronze/US10B	6	#9	0.75	WST17	1/Poly	30◆	90
61841	3-1/2" x 3-1/2"	2.2mm	RP	Satin Nickel/US15	6	#9	0.75	WST17	1/Poly	30◆	90
61844	3-1/2" x 3-1/2"	2.2mm	RP	Chrome/US26	6	#9	0.75	WST17	1/Poly	30◆	90
61846	3-1/2" x 3-1/2"	2.2mm	RP	White Prime/USP	6	#9	0.75	WST17	1/Poly	30◆	90

**The following registered trade name or trade mark is not owned, associated with or connected in any way with Ultra Hardware Products LLC and is used herein for illustrative purposes only

BUILDER'S HARDWARE

5/8" RADIUS CORNER – PLAIN BEARING

Removable Pin

Masonite** hole pattern; Button tip; Furnished w/screws

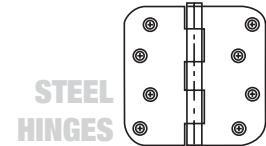

STEEL HINGES

CODE	SIZE	GAUGE	PIN TYPE	FINISH	SCREWS				PACK	INNER	MASTER
					QTY	SIZE	LENGTH	TYPE			
CLAMSHELL											
35112	4" x 4"	2.5mm	RP	Brass/US3	8	#10	1	WS T17	1/Clam	10◆	100
35114	4" x 4"	2.5mm	RP	Oil Rubbed Bronze/US10B	8	#10	1	WS T17	1/Clam	10◆	100
35116	4" x 4"	2.5mm	RP	Satin Nickel/US15	8	#10	1	WS T17	1/Clam	10◆	100
35117	4" x 4"	2.5mm	RP	Antique Pewter/US15A	8	#10	1	WS T17	1/Clam	10◆	100
35113	4" x 4"	2.5mm	RP	Chrome/US26	8	#10	1	WS T17	1/Clam	10◆	100
35115	4" x 4"	2.5mm	RP	Satin Chrome/US26D	8	#10	1	WS T17	1/Clam	10◆	100
BOX											
35228	4" x 4"	2.2mm	RP	Brass/US3	16	#10	1	WS T17	2/Box	1	50
35771	4" x 4"	2.5mm	RP	Brass/US3	16	#10	1	WS T17	2/Box	1	25
35791	4" x 4"	2.5mm	RP	Light Btt3SP	16	#10	1	WS T17	2/Box	1	25
35225	4" x 4"	2.2mm	RP	Satin Brass/US4	16	#10	1	WS T17	2/Box	1	25
35047	4" x 4"	2.5mm	RP	Oil Rubbed Bronze/US10B	16	#10	1	WS T17	2/Box	1	25
35048	4" x 4"	2.5mm	RP	Satin Nickel/US15	16	#10	1	WS T17	2/Box	1	25
35049	4" x 4"	2.5mm	RP	Antique Satin Nickel/US15A	16	#10	1	WS T17	2/Box	1	25
35050	4" x 4"	2.5mm	RP	Polished Chrome/US26	16	#10	1	WS T17	2/Box	1	25
35052	4" x 4"	2.5mm	RP	Satin Chrome/US26D	16	#10	1	WS T17	2/Box	1	25
61750	4" x 4"	2.5mm	RP	Brass/US3	24	#10	1	WS T17	3/Box in cut case	5◆	20
61753	4" x 4"	2.5mm	RP	Antique Brass/US5	24	#10	1	WS T17	3/Box in cut case	5◆	20
61755	4" x 4"	2.5mm	RP	Antique Pewter/US15A	24	#10	1	WS T17	3/Box in cut case	5◆	20
61752	4" x 4"	2.5mm	RP	Oil Rubbed Bronze/US10B	24	#10	1	WS T17	3/Box in cut case	5◆	20
61754	4" x 4"	2.5mm	RP	Chrome/US26	24	#10	1	WS T17	3/Box in cut case	5◆	20
61751	4" x 4"	2.5mm	RP	Satin Nickel/US15	24	#10	1	WS T17	3/Box in cut case	5◆	20
61756	4" x 4"	2.5mm	RP	White	24	#10	1	WS T17	3/Box in cut case	5◆	20
BULK											
35410	4" x 4"	2.5mm	RP	Brass/US3	NONE	—	—	—	Bulk	50 Pairs◆	—
35410KIT1	4" x 4"	2.5mm	RP	Brass/US3	800	#10	0.75	WS T17	Bulk	50 Pairs◆	—
35419	4" x 4"	2.5mm	RP	White Prime/USP	NONE	—	—	—	Bulk	50 Pairs◆	—
35419KIT1	4" x 4"	2.5mm	RP	White Prime/USP	800	#10	0.75	WS T17	Bulk	50 Pairs◆	—
35053	4" x 4"	2.5mm	RP	Brushed Chrome/US26D	800	#10	1	WS T17	Bulk	50 Pairs◆	—
POLYBAG											
61850	4" x 4"	2.5mm	RP	Brass/US3	8	#10	1	WS T17	1/Poly	15◆	60
61853	4" x 4"	2.5mm	RP	Antique Brass/US5	8	#10	1	WS T17	1/Poly	15◆	60
61852	4" x 4"	2.5mm	RP	Oil Rubbed Bronze/US10B	8	#10	1	WS T17	1/Poly	15◆	60
61851	4" x 4"	2.5mm	RP	Satin Nickel/US15	8	#10	1	WS T17	1/Poly	15◆	60
61854	4" x 4"	2.5mm	RP	Chrome/US26	8	#10	1	WS T17	1/Poly	15◆	60

Non-Removable Pin

Masonite** hole pattern

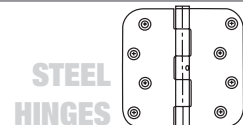

STEEL HINGES

CODE	SIZE	GAUGE	PIN TYPE	FINISH	SCREWS				PACK	INNER	MASTER
					QTY	SIZE	LENGTH	TYPE			
35428KIT1	4" x 4"	2.2mm	NRP	Satin Brass/US4	NONE	#10	.75	WS T17	Bulk	50 Pairs◆	—
35428	4" x 4"	2.2mm	NRP	Satin Brass/US4	NONE	—	—	—	Bulk	50 Pairs◆	—
35425KIT1	4" x 4"	2.2mm	NRP	White Prime/USP	NONE	#10	.75	WS T17	Bulk	50 Pairs◆	—
35425	4" x 4"	2.2mm	NRP	White Prime/USP	NONE	—	—	—	Bulk	50 Pairs◆	—

**The following registered trade name or trade mark is not owned, associated with or connected in any way with Ultra Hardware Products LLC and is used herein for illustrative purposes only

BUILDERS' HARDWARE

5/8" RADIUS & SQUARE CORNER — PLAIN BEARING

Removable Pin

Masonite** hole pattern; Button tip; w/screws

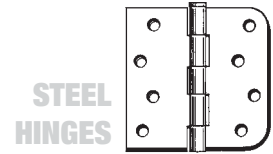

CODE	SIZE	GAUGE	PIN TYPE	FINISH	SCREWS				PACK	INNER	MASTER
					QTY	SIZE	LENGTH	TYPE			
35780	4" x 4-1/4"	2.5mm	RP	Brass/US3/EF/PVD	800	#10	1	WS T17	Bulk	50◆	—

Unassembled

Masonite** hole pattern; Button tip; Furnished w/screws

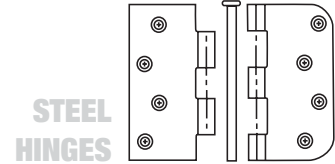

CODE	SIZE	GAUGE	PIN TYPE	FINISH	SCREWS				PACK	INNER	MASTER
					QTY	SIZE	LENGTH	TYPE			
35732	4" x 4"	2.5mm	RP	Oil Rubbed Bronze/US10B	800	#10	1	WS T17	Bulk	50 Pairs◆	—
35733R1	4" x 4"	2.5mm	RP	Satin Nickel/US15	400	#10	1	WS T17	Bulk	50 Pairs◆	—
					400	#10	.75	WST17			
35737	4" x 4"	2.5mm	RP	Chrome/US26	800	#10	1	WS T17	Bulk	50 Pairs◆	—
35776R1	4" x 4-1/4"	2.5mm	RP	Satin Nickel/US15	400	#10	1	WS T17	Bulk	50 Pairs◆	—
					400	#10	.75	WST17			

SECURITY TAB

SQUARE CORNER — PLAIN BEARING

Square Corner — Removable Pin

Masonite** hole pattern; Button tip; Furnished w/screws

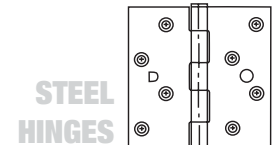

CODE	SIZE	GAUGE	PIN TYPE	FINISH	SCREWS				PACK	INNER	MASTER
					QTY	SIZE	LENGTH	TYPE			
60911	4" x 4"	2.2mm	RP	Brass/US3	8	#10	1	WS T17	1/Card	5◆	50

1/4" RADIUS CORNER — PLAIN BEARING

Removable Pin

Masonite** hole pattern; Button tip; Furnished w/screws

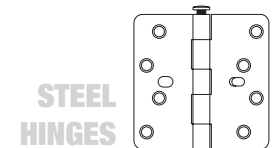

CODE	SIZE	GAUGE	PIN TYPE	FINISH	SCREWS				PACK	INNER	MASTER
					QTY	SIZE	LENGTH	TYPE			
61014	4" x 4"	2.2mm	RP	Brass/US3	8	#10	1	WS T17	1/Card	5◆	60

**The following registered trade name or trade mark is not owned, associated with or connected in any way with Ultra Hardware Products LLC and is used herein for illustrative purposes only

BALL BEARING

SQUARE CORNER — BALL BEARING

Non-Removable Pin

Template hole pattern; Button tip; Furnished w/screws

STEEL HINGES

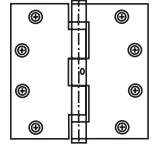

CODE	SIZE	GAUGE	PIN TYPE	FINISH	SCREWS				PACK	INNER	MASTER
					QTY	SIZE	LENGTH	TYPE			
35182	4-1/2" x 4-1/2"	3.4mm	NRP	Satin Chrome/US26D	24	#12	1.25	WS T17	3/Box	6◆	12
					24	#12-24	.5	MS			
35153	4-1/2" x 4-1/2"	3.4mm	NRP	Grey Prime/USP	24	#12	1.25	WS T17	3/Box	6◆	12
					24	#12-24	.5	MS			

Removable Pin

Template hole pattern; Button tip; Furnished w/screws

STEEL HINGES

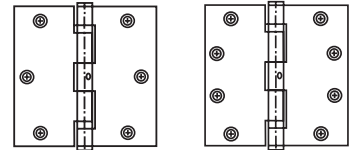

CODE	SIZE	GAUGE	PIN TYPE	FINISH	SCREWS				PACK	INNER	MASTER
					QTY	SIZE	LENGTH	TYPE			
35769	3-1/2" x 3-1/2"	2.2mm	RP	Brass/US3	12	#9	0.75	WS T17	2/Box	1	25
35347	4" x 4"	3.3mm	RP	Brass/US3	16	#12	1	WS T17	2/Box	6◆	24
					16	#12-24	.5	MS			
35282	4-1/2" x 4-1/2"	3.4mm	RP	Satin Chrome//US26D	24	#12	1.25	WS T17	3/Box	6◆	12
					24	#12-24	.5	MS			
35283	4-1/2" x 4-1/2"	3.4mm	RP	PolishedChrome//US26	24	#12	1.25	WS T17	3/Box	6◆	12
					24	#12-24	.5	MS			
35253	4-1/2" x 4-1/2"	3.4mm	RP	Grey Prime/USP	24	#12	1.25	WS T17	3/Box	6◆	12
					24	#12-24	.5	MS			

5/8" RADIUS CORNER — BALL BEARING

Removable Pin

Masonite** hole pattern; Button tip; Furnished w/screws

STEEL HINGES

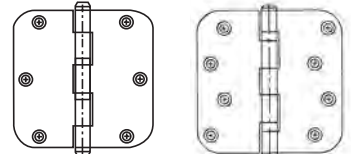

CODE	SIZE	GAUGE	PIN TYPE	FINISH	SCREWS				PACK	INNER	MASTER
					QTY	SIZE	LENGTH	TYPE			
98372 NEW	3-1/2" x 3-1/2"	2.2mm	RP	Satin Brass/US4	12	#9	0.75	WS T17	2/Box	1	25
98373 NEW	3-1/2" x 3-1/2"	2.2mm	RP	Antique Brass/US5	12	#9	0.75	WS T17	2/Box	1	25
98374 NEW	3-1/2" x 3-1/2"	2.2mm	RP	Oil Rubbed Bronze/US10B	12	#9	0.75	WS T17	2/Box	1	25
98375 NEW	3-1/2" x 3-1/2"	2.2mm	RP	Satin Nickel/US15	12	#9	0.75	WS T17	2/Box	1	25
98376 NEW	3-1/2" x 3-1/2"	2.2mm	RP	Chrome/US26	12	#9	0.75	WS T17	2/Box	1	25
98377 NEW	3-1/2" x 3-1/2"	2.2mm	RP	Brush Chrome/US26D	12	#9	0.75	WS T17	2/Box	1	25
98384 NEW	4"x4"	2.5mm	RP	Satin Brass/US4	16	#9	0.75	WS T17	2/Box	1	25
98385 NEW	4"x4"	2.5mm	RP	Antique Brass/US5	16	#9	0.75	WS T17	2/Box	1	25
98386 NEW	4"x4"	2.5mm	RP	Oil Rubbed Bronze/US10B	16	#9	0.75	WS T17	2/Box	1	25
98387 NEW	4"x4"	2.5mm	RP	Satin Nickel/US15	16	#9	0.75	WS T17	2/Box	1	25
98388 NEW	4"x4"	2.5mm	RP	Chrome/US26	16	#9	0.75	WS T17	2/Box	1	25
98389 NEW	4"x4"	2.5mm	RP	Brush Chrome/US26D	16	#9	0.75	WS T17	2/Box	1	25

**The following registered trade name or trade mark is not owned, associated with or connected in any way with Ultra Hardware Products LLC and is used herein for illustrative purposes only

5/8" RADIUS CORNER — BALL BEARING *continued*

Non-Removable Pin

Masonite** hole pattern; Button tip; Furnished w/screws

STEEL HINGES

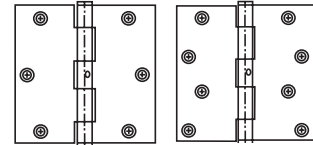

CODE	SIZE	GAUGE	PIN TYPE	FINISH	SCREWS				PACK	INNER	MASTER
					QTY	SIZE	LENGTH	TYPE			
98356 NEW	4" x 4"	2.5mm	NRP	Satin Brass/US4	16	#9	0.75	WS T17	2/Box	1	25
98357 NEW	4" x 4"	2.5mm	NRP	Antique Brass/US5	16	#9	0.75	WS T17	2/Box	1	25
98358 NEW	4" x 4"	2.5mm	NRP	Oil Rubbed Bronze/US10B	16	#9	0.75	WS T17	2/Box	1	25
98359 NEW	4" x 4"	2.5mm	NRP	Satin Nickel/US15	16	#9	0.75	WS T17	2/Box	1	25
98524 NEW	4" x 4"	2.5mm	NRP	Chrome/US26	16	#9	0.75	WS T17	2/Box	1	25
98728 NEW	4" x 4"	2.5mm	NRP	Brush Chrome/US26D	16	#9	0.75	WS T17	2/Box	1	25

SPRING HINGES

SQUARE CORNER — SPRING HINGES

Self Closing — UL Listed

Template hole pattern; Reversible for right and left hand application; Furnished w/adjustable wrench, tension pins and screws

STEEL HINGES

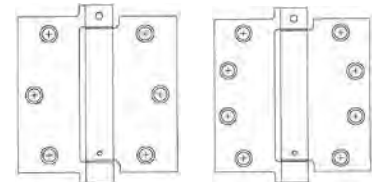

CODE	SIZE	GAUGE	PIN TYPE	FINISH	SCREWS				PACK	INNER	MASTER
					QTY	SIZE	LENGTH	TYPE			
35341R1	3-1/2" x 3-1/2"	2.5mm	NRP	Satin Brass/US4	12	#10	1	WS T17	2/Box	6◆	24
					12	#10-24	.5	MS UH			
35336R1	3-1/2" x 3-1/2"	2.5mm	NRP	Satin Chrome/US26D	12	#10	1	WS T17	2/Box	6◆	24
					12	#10-24	.5	MS UH			
35343R1	4" x 4"	3.3mm	NRP	Brass/US3	16	#12	1	WS T17	2/Box	1	24
					16	#12-24	.5	MS UH			
35342R1	4" x 4"	3.3mm	NRP	Satin Brass/US4	16	#12	1	WS T17	2/Box	6◆	24
					16	#12-24	.5	MS UH			
35337R1	4" x 4"	3.3mm	NRP	Satin Chrome/US26D	16	#12	1	WS T17	2/Box	6◆	24
					16	#12-24	.5	MS UH			
35345R1	4-1/2" x 4-1/2"	3.4mm	NRP	Brass/US3	16	#12	1.25	WS T17	2/Box	6◆	12
					16	#12-24	.5	MS UH			
35344R1	4-1/2" x 4-1/2"	3.4mm	NRP	Satin Brass/US4	16	#12	1.25	WS T17	2/Box	6◆	12
					16	#12-24	.5	MS UH			
35338R1	4-1/2" x 4-1/2"	3.4mm	NRP	Satin Chrome/US26D	16	#12	1.25	WS T17	2/Box	6◆	12
					16	#12-24	.5	MS UH			
35340R1	4-1/2" x 4-1/2"	3.4mm	NRP	Grey Prime Coat/USP	16	#12	1.25	WS T17	2/Box	6◆	12
					16	#12-24	.5	MS UH			
35339 NEW	4-1/2" x 4-1/2"	3.4mm	NRP	Dull Chrome/US26D	24	#12	1.25	WS T17	3/Box	4◆	8
					24	#12-24	.5	MS UH			

**The following registered trade name or trade mark is not owned, associated with or connected in any way with Ultra Hardware Products LLC and is used herein for illustrative purposes only

5/8" RADIUS — SPRING HINGES *continued*

Self Closing — UL Listed

Masonite** hole pattern; Furnished w/adjustable wrench, tension pins and screws

STEEL HINGES

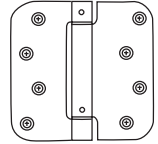

Screws: 8 - #10 x 1", WS T17; 8 - #9 x 1", WS T17; 8 - #10 -24 x .5" MS Under Cut Head; 8 - #10 -24 x .5" MS #9 Flat Under Cut Head

CODE	SIZE	GAUGE	PIN TYPE	FINISH	SCREWS				PACK	INNER	MASTER
					QTY	SIZE	LENGTH	TYPE			
35385R1	4" x 4"	2.5mm	NRP	Brass/US3	Screws Listed in Description				2/Box	6	24
35391R1	4" x 4"	2.5mm	NRP	Oil Rubbed Bronze/US10B					2/Box	6	24
35389R1	4" x 4"	2.5mm	NRP	Satin Nickel/US15					2/Box	6	24
35386R1	4" x 4"	2.5mm	NRP	Satin Chrome/US26D					2/Box	6	24
35356R1	4" x 4"	2.5mm	NRP	White Prime/USP					2/Box	6◆	24
97474R1	4" x 4"	2.5mm	NRP	Gray/USP					2/Box	6◆	24

5/8" RADIUS & SQUARE CORNER — SPRING HINGES

Self Closing — UL Listed

Masonite** hole pattern; Furnished w/adjustable wrench, tension pins and screws

STEEL HINGES

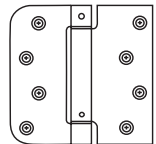

Screws: 8 - #10 x 1", WS T17; 8 - #9 x 1", WS T17; 8 - #10 -24 x .5" MS Under Cut Head; 8 - #10 -24 x .5" MS #9 Flat Under Cut Head

CODE	SIZE	GAUGE	PIN TYPE	FINISH	SCREWS				PACK	INNER	MASTER
					QTY	SIZE	LENGTH	TYPE			
35352R1	4" x 4"	2.5mm	NRP	White Prime/USP	Screws Listed in Description				2/Box	6◆	24

GALVANIZED — ALL WEATHER

5/8" RADIUS — SQUARE CORNER — PLAIN BEARING

Removable Pin

Masonite** hole pattern; Button tip; Furnished w/screws

STEEL HINGES

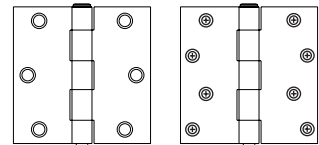

CODE	SIZE	GAUGE	PIN TYPE	FINISH	SCREWS				PACK	INNER	MASTER
					QTY	SIZE	LENGTH	TYPE			
CARD											
61030	3" x 3"	2.0mm	RP	Galvanized/US2H	6	#9	0.75	WS T17	1/Card	5◆	25
61031	3-1/2" x 3-1/2"	2.2mm	RP	Galvanized/US2H	6	#9	0.75	WS T17	1/Card	5◆	25
61032	4" x 4"	2.2mm	RP	Galvanized/US2H	8	#10	0.75	WS T17	1/Card	5◆	25
BOX											
61058	4" x 4"	2.2mm	RP	Galvanized/US2H	16	#10	0.75	WS T17	2/Box	5◆	25

ALUMINUM

SQUARE CORNER — PLAIN BEARING

Stainless steel loose pin; Brass bushings; Furnished w/o screws

ALUMINUM HINGES

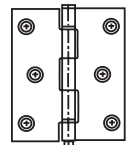

CODE	SIZE	GAUGE	PIN TYPE	FINISH	SCREWS				PACK	INNER	MASTER
					QTY	SIZE	LENGTH	TYPE			
BULK											
35546	3" x 2-1/2"	2	RP	Mill	NONE	—	—	—	Bulk	50 Pairs◆	400

**The following registered trade name or trade mark is not owned, associated with or connected in any way with Ultra Hardware Products LLC and is used herein for illustrative purposes only

STAINLESS STEEL

SQUARE CORNER, PLAIN BEARING

Removable Pin

Template hole pattern; Button tip; Furnished with Screws

STAINLESS
STEEL
HINGES

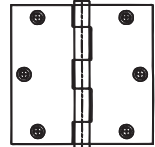

CODE	SIZE	GAUGE	PIN TYPE	FINISH	SCREWS				PACK	INNER	MASTER
					QTY	SIZE	LENGTH	TYPE			
35263	3-1/2" x 3-1/2"	2.5mm	RP	Stainless Steel/US32	12	#9	0.75	WS T17	2/Box	10	30
35264	4" x 4"	3mm	RP	Stainless Steel/US32	16	#8	1.25	WS T17	2/Box	10	20

5/8" RADIUS CORNER, PLAIN BEARING

Removable Pin

Masonite** hole pattern; Button tip; Furnished with Screws

STAINLESS
STEEL
HINGES

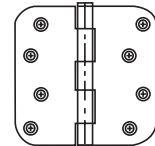

CODE	SIZE	GAUGE	PIN TYPE	FINISH	SCREWS				PACK	INNER	MASTER
					QTY	SIZE	LENGTH	TYPE			
35051	4" x 4"	2.5mm	RP	Stainless Steel/US32	16	#10	1	WS T17	2/Box	1	25

SQUARE CORNER, BALL BEARING

Removable Pin

Template hole pattern; Button tip; Furnished w/screws

STAINLESS
STEEL
HINGES

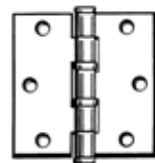

CODE	SIZE	GAUGE	PIN TYPE	FINISH	SCREWS				PACK	INNER	MASTER
					QTY	SIZE	LENGTH	TYPE			
35273	3-1/2" x 3-1/2"	2.5mm	RP	Stainless Steel/US32	12	#8	1.25	WS T17	2/Box	10	40

SPECIALITY HINGES

SINGLE ACTION SPRING HINGES — SQUARE CORNER

Template hole pattern; Standard mortise: 6" x 6" and 7" x 7" flange; 6" x 4-1/2" flange; Furnished w/screws

STEEL
HINGES

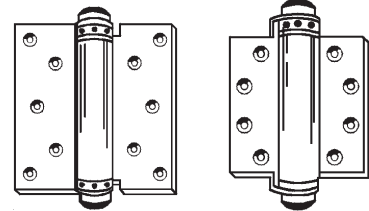

CODE	SIZE	GAUGE	PIN TYPE	FINISH	SCREWS				PACK	INNER	MASTER
					QTY	SIZE	LENGTH	TYPE			
35606	6" x 4-1/2" (4-1/2" Leaves)	2.5mm	NRP	Prime/USP	12	#12	1.125	WS T17	3/Box	1	8
					24	#12	.5	MS			
96738	6" x 4-1/2" (4-1/2" Leaves)	2.5mm	NRP	Prime/USP	8	#12	1.125	WS T17	2/Box	1	12
					16	#12-24	.5	MS			
96739	6" x 6" (6" Leaves)	2.5mm	NRP	Prime/USP	10	#12	1.125	WS T17	2/Box	1	12
					20	#12-24	.5	MS			
96740	7" x 7" (7" Leaves)	3.0mm	NRP	Prime/USP	10	#12	1.125	WS T17	2/Box	1	12
					20	#12-24	.5	MS			

**The following registered trade name or trade mark is not owned, associated with or connected in any way with Ultra Hardware Products LLC and is used herein for illustrative purposes only

DOUBLE ACTION SPRING HINGES — SQUARE CORNER

Template hole pattern; No hanging strip required; Heavy duty for in or out swinging doors; Adjustable tension spring; For doors up to 7/8" thick, use 3" hinge; For doors up to 1-1/8" thick, use 4" hinge; Furnished w/screws

STEEL HINGES

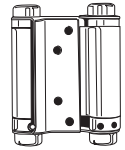

CODE	SIZE	GAUGE	PIN TYPE	FINISH	SCREWS				PACK	INNER	MASTER
					QTY	SIZE	LENGTH	TYPE			
35589	2"	2mm	NRP	Brass/US3	24	#6	0.75	WS T17	3/Box	3◆	24
35590	3"	2mm	NRP	Brass/US3	16	#6	0.75	WS T17	2/Box	3◆	18
35595	4"	2mm	NRP	Brass/US3	16	#6	0.75	WS T17	2/Box	3◆	18
35593	4"	2mm	NRP	Black	16	#6	0.75	WS T17	2/Box	3◆	18
35596	5"	2.2mm	NRP	Brass/US3	20	#8	1.25	WS T17	2/Box	3◆	12
35597	6"	2.5mm	NRP	Brass/US3	20	#10	1.25	WS T17	2/Box	3◆	6
35594	6"	2.5mm	NRP	Black	20	#10	1.25	WS T17	2/Box	3◆	6

WELDABLE HINGE

Heavy duty, Non- removable pin, plain finish

STEEL HINGES

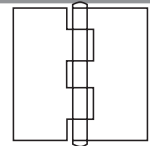

CODE	SIZE	GAUGE	PIN TYPE	FINISH	SCREWS				PACK	INNER	MASTER
					QTY	SIZE	LENGTH	TYPE			
BOX											
35368	4" x 4"	4.5mm		Plain	NONE	—	—	—	2/Box	10◆	20

HINGE SCREWS

All screws sold in bulk box quantities

CODE	DESCRIPTION	BOX QTY.	INNER PACK	INNER	MASTER
FLAT HEAD PHILLIPS DRIVE CASE HARDENED T17 FLY CUT					
64953	# 9 x 3/4" Brass	600	600 Screws per Box	1	20
64952	# 9 x 3/4" Satin Brass	600	600 Screws per Box	1	20
64958	# 9 x 3/4" Antique Brass	600	600 Screws per Box	1	20
98281	#9 x 3/4" Satin Nickel	600	600 Screws per Box	1	20
98282	#9 x 3/4" Oil Rubbed Bronze	600	600 Screws per Box	1	20
64956	# 9 x 3/4" Chrome	600	600 Screws per Box	1	20
64595	# 9 x 3/4" Brushed Chrome	600	600 Screws per Box	1	20
64954	# 9 x 3/4" Zinc Dichromate	600	600 Screws per Box	1	20
64955	# 9 x 3/4" White	600	600 Screws per Box	1	20
65031	# 10 x 3/4" Brass	800	800 Screws per Box	1	10
65030	# 10 x 3/4" Satin Brass	800	800 Screws per Box	1	10
65032	# 10 x 3/4" Zinc Dichromate	800	800 Screws per Box	1	12
65033	# 10 x 3/4" White Prime	800	800 Screws per Box	1	10
65044	# 10 x 3/4" Pure White Prime	800	800 Screws per Box	1	10
65034	# 10 x 1" White Prime	800	800 Screws per Box	1	10
65046	# 10 x 1-1/4" Zinc Dichromate	800	800 Screws per Box	1	10
65036	# 10 x 1-1/4" White Prime	800	800 Screws per Box	1	10
65047	# 10 x 2" Zinc Dichromate	200	4 Polybags, 50 Polybags per Box	1	10
65037	# 10 x 2" White Prime	200	2 Polybags, 100 Polybags per Box	1	20
TRUSS HEAD COMBO DRIVE MACHINE SCREWS					
64609	#8 x 1" Brass	500	500 Screws per Box	1	20
64604	#8 x 1-1/4" Brass	500	500 Screws per Box	1	10
64608	#8 x 1-3/4" Brass	500	500 Screws per Box	1	10
64612	#8-32 x 2" Brass	500	500 Screws per Box	1	10
FLAT HEAD PHILLIPS DRIVE MACHINE SCREWS					
65039	# 10-24 x 1/2" Zinc Dichromate	800	800 Screws per Box	1	20



BUILDERS' HARDWARE

CONTINUOUS HINGES

Drilled with countersunk holes on 2" hole centers;
Shrinkwrap w/screws; bulk w/o screws

STEEL
HINGES

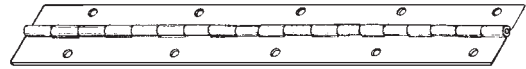

CODE	SIZE	GAUGE	PIN TYPE	FINISH	PACK	INNER	MASTER
35563	1-1/16" x 30"	0.04mm		Brass	Shrink Wrap Header Card	5◆	—
35572	1-1/2" x 30"	0.04mm		Brass	Shrink Wrap Header Card	5◆	—
35578	1-1/16" x 48"	0.04mm		Brass	Shrink Wrap Header Card	5◆	—
35585	1-1/2" x 48"	0.04mm		Brass	Shrink Wrap Header Card	5◆	120
35587	1-1/2" x 72"	0.04mm		Brass	Shrink Wrap Header Card	5◆	—
35550	1-1/16" x 30"	0.04mm		Nickel	Shrink Wrap Header Card	5◆	—
35551	1-1/2" x 30"	0.04mm		Nickel	Shrink Wrap Header Card	5◆	60
35586	1-1/2" x 48"	0.04mm		Nickel	Shrink Wrap Header Card	5◆	—
35581	1-1/16" x 72"	0.04mm		Nickel	Shrink Wrap Header Card	5◆	—
35588	1-1/2" x 72"	0.04mm		Nickel	Shrink Wrap Header Card	5◆	30
35565	1-1/16" x 30"	0.04mm		Brass	Bulk	10◆	—
35569	1-1/2" x 30"	0.04mm		Brass	Bulk	10◆	—
35571	1-1/2" x 72"	0.04mm		Brass	Bulk	10◆	—
35575	2" x 72"	0.04mm		Brass	Bulk	10◆	—
96480	1-1/2" x 72"	0.032mm		Brass	Bulk	50◆	—
35564	1-1/16" x 30"	0.04mm		Nickel	Bulk	10◆	100
35566	1-1/16" x 72"	0.04mm		Nickel	Bulk	10◆	—
35570	1-1/2" x 72"	0.04mm		Nickel	Bulk	10◆	—
35574	2" x 72"	0.04mm		Nickel	Bulk	10◆	—
95626	1-1/2" x 72"	0.04mm		Bronze	Bulk	10◆	—

SEWING MACHINE HINGE

Uses #10 x 1/4" machine screw (not included)

STEEL
HINGES

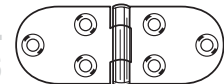

CODE	SIZE	GAUGE	PIN TYPE	FINISH	SCREWS				PACK	INNER	MASTER
					QTY	SIZE	LENGTH	TYPE			
96735	1-3/16" x 3-1/4"	1.6mm	RP	Antique Copper	None				Bulk	100◆	1000

SURFACE MOUNT

Loose pin hinges; For doors & cabinets; No cutting or mortising;
Furnished w/screws

STEEL
HINGES

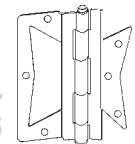

CODE	SIZE	GAUGE	PIN TYPE	FINISH	SCREWS				PACK	INNER	MASTER
					QTY	SIZE	LENGTH	TYPE			
35540	2-1/2"	1.4mm	RP	Brass/US3	10	#4	0.5	WS	2/Card	10◆	240
35542	3"	1.6mm	RP	Brass/US3	12	#6	1	WS	2/Card	12◆	120
35544	3-1/2"	1.8mm	RP	Brass/US3	12	#8	0.75	WS	2/Card	12◆	144
96606	4"	1.9mm	RP	Brass/US3	12	#9	1	WS	2/Card	12◆	96
35543	3"	1.6mm	RP	Zinc/US2C	1500	#6	.76	WS	Bulk	125◆	—

FOLDING SCREEN HINGE

Furnished w/screws

STEEL
HINGES

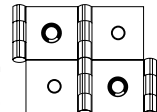

CODE	SIZE	GAUGE	PIN TYPE	FINISH	SCREWS				PACK	INNER	MASTER
					QTY	SIZE	LENGTH	TYPE			
96620	1-1/4" x 2"	1.3mm	RP	Brass	8	#6	0.75	WS	2/Polybag	12◆	180
96622	3/4" x 1-3/4"	1.3mm	RP	Brass	8	#6	0.75	WS	2/Polybag	12◆	300

BUILDERS' HARDWARE

LIGHT DUTY UTILITY

SQUARE CORNER

Removable Pin

Furnished w/screws

STEEL
HINGES

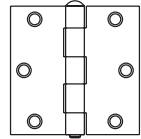

CODE	SIZE	GAUGE	PIN TYPE	FINISH	SCREWS				PACK	INNER	MASTER
					QTY	SIZE	LENGTH	TYPE			
60862	2" x 2"	1.2mm	RP	Brass	12	#4	0.625	WS	2/Card	10◆	100
60916	2" x 2"	1.2mm	RP	Zinc	12	#4	0.625	WS	1/Card	5◆	60
60864	2-1/2" x 2-1/2"	1.2mm	RP	Brass	12	#6	0.625	WS	2/Card	10◆	100
60917	2-1/2" x 2-1/2"	1.2mm	RP	Zinc	12	#6	0.625	WS	1/Card	5◆	60

SQUARE CORNER NARROW HINGE, LIGHT DUTY

Card w/Screws, Polybag & Bulk Pack w/o Screws

Removable Pin

STEEL
HINGES



CODE	SIZE	PIN TYPE	FINISH	SCREWS				PACK	INNER	MASTER
				QTY	SIZE	LENGTH	TYPE			
60928	1" x 3/4"	RP	Zinc/US2C	8	#4	0.5	WS	2/Card	10◆	100
60929	1-1/2" x 1-7/16"	RP	Zinc/US2C	12	#4	0.625	WS	2/Card	10◆	100
60930	2" x 1-9/16"	RP	Zinc/US2C	12	#6	0.75	WS	2/Card	10◆	100
60931	2-1/2" x 1-3/4"	RP	Zinc/US2C	12	#6	0.75	WS	2/Card	10◆	100
60932	3" x 2"	RP	Zinc/US2C	12	#8	0.75	WS	2/Card	10◆	100
96553	1" x 1"	RP	Brass/US3	8	#4	0.5	WS	2/Card	12◆	144
60865	1-1/2" x 1-3/8"	RP	Brass/US3	12	#4	0.625	WS	2/Card	10◆	100
60866	2" x 1-9/16"	RP	Brass/US3	12	#6	0.75	WS	2/Card	10◆	100
60867	2-1/2" x 1-11/16"	RP	Brass/US3	12	#7	0.75	WS	2/Card	10◆	100
60863	2-1/2" x 2"	RP	Brass/US3	12	#8	0.75	WS	2/Card	10◆	100
60868	3" x 2"	RP	Brass/US3	12	#8	0.75	WS	2/Card	10◆	100

POLYBAG

61144	1" x 3/4"	RP	Zinc/US2C	NONE	—	—	—	1/Poly w/UPC	20◆	200
61145	1-1/2" x 1-7/16"	RP	Zinc/US2C	NONE	—	—	—	1/Poly w/UPC	20◆	200
61146	2" x 1-9/16"	RP	Zinc/US2C	NONE	—	—	—	1/Poly w/UPC	20◆	200
61147	2-1/2" x 1-1/4"	RP	Zinc/US2C	NONE	—	—	—	1/Poly w/UPC	20◆	200
61148	3" x 2"	RP	Zinc/US2C	NONE	—	—	—	1/Poly w/UPC	20◆	200
61139	1" x 3/4"	RP	Mill	NONE	—	—	—	1/Poly w/UPC	20◆	200
61140	1-1/2" x 1-7/16"	RP	Mill	NONE	—	—	—	1/Poly w/UPC	20◆	200
61141	2" x 1-9/16"	RP	Mill	NONE	—	—	—	1/Poly w/UPC	20◆	200
61142	2-1/2" x 1-3/4"	RP	Mill	NONE	—	—	—	1/Poly w/UPC	20◆	200
61143	3" x 2"	RP	Mill	NONE	—	—	—	1/Poly w/UPC	20◆	200

BULK

60940	1" x 1"	RP	Zinc/US2C	NONE	—	—	—	Bulk	10 Pair	1000
60941	1-1/2" x 1-1/2"	RP	Zinc/US2C	NONE	—	—	—	Bulk	10 Pair	960
60942	1-5/8" x 2"	RP	Zinc/US2C	NONE	—	—	—	Bulk	10 Pair	600

BUILDERS' HARDWARE

WIDE HINGE

Non-Removable Pin

Furnished w/screws

STEEL HINGES

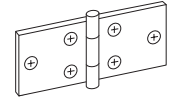

CODE	SIZE	GAUGE	PIN TYPE	FINISH	SCREWS				PACK	INNER	MASTER
					QTY	SIZE	LENGTH	TYPE			
60921	1-7/16" x 3-1/2"	1.9mm	NRP	Zinc/USC2	12	#8	0.75	WS	2/Card	10◆	100
60922	1-7/16" x 3-1/2"	1.9mm	NRP	Brass/US3	12	#8	0.75	WS	2/Card	5◆	50

SQUARE CORNER NARROW HINGE

Card and Polybag w/Screws, Bulk Pack w/o Screws

STEEL HINGES

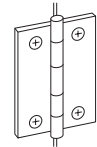

Non-Removable Pin

CODE	SIZE	PIN TYPE	FINISH	SCREWS				PACK	INNER	MASTER
				QTY	SIZE	LENGTH	TYPE			
60923	1" x 3/4"	NRP	Zinc/US2C	8	#4	0.5	WS	2/Card	10◆	100
60924	1-1/2" x 1-1/4"	NRP	Zinc/US2C	12	#4	0.625	WS	2/Card	10◆	100
60925	2" x 1-1/4"	NRP	Zinc/US2C	12	#5	0.75	WS	2/Card	10◆	100
60926	2-1/2" x 1-1/2"	NRP	Zinc/US2C	12	#4	0.625	WS	2/Card	10◆	100
60927	3" x 1-1/2"	NRP	Zinc/US2C	12	#5	0.75	WS	2/Card	10◆	100
35531	1-1/2" x 1-1/8"	NRP	Brass/US3	12	#4	0.625	WS	2/Card	12◆	240
35532	2" x 1-3/8"	NRP	Brass/US3	12	#5	0.75	WS	2/Card	12◆	240
35533	2-1/2" x 1-5/8"	NRP	Brass/US3	12	#6	0.75	WS	2/Card	12◆	240
35534	3" x 2"	NRP	Brass/US3	12	#6	0.75	WS	2/Card	12◆	240
BULK										
61130	1" x 1"	NRP	Zinc/US2C	NONE	—	—	—	Bulk w/UPC	24◆	864
61131	1-1/2" x 1-3/8"	NRP	Zinc/US2C	NONE	—	—	—	Bulk w/UPC	24◆	720
61132	2" x 1-7/16"	NRP	Zinc/US2C	NONE	—	—	—	Bulk w/UPC	24◆	720
61133	2-1/2" x 1-11/16"	NRP	Zinc/US2C	NONE	—	—	—	Bulk w/UPC	24◆	576
61134	3" x 2"	NRP	Zinc/US2C	NONE	—	—	—	Bulk w/UPC	24◆	480
96529	1" x 1"	NRP	Zinc/US2C	NONE	—	—	—	Bulk	12 Pair	432
96531	1-1/2" x 1-3/8"	NRP	Zinc/US2C	NONE	—	—	—	Bulk	12 Pair	360
96533	2" x 1-7/16"	NRP	Zinc/US2C	NONE	—	—	—	Bulk	12 Pair	288
96535	2-1/2" x 1-11/16"	NRP	Zinc/US2C	NONE	—	—	—	Bulk	12 Pair	240
96537	3" x 2"	NRP	Zinc/US2C	NONE	—	—	—	Bulk	12 Pair	240
35090	1-1/2" x 1-1/8"	NRP	Brass/US3	NONE	—	—	—	Bulk	12 Pair	1008
35100	2-1/2" x 1-5/8"	NRP	Brass/US3	NONE	—	—	—	Bulk	12 Pair	300
35105	3" x 2"	NRP	Brass/US3	NONE	—	—	—	Bulk	12 Pair	240
POLYBAG										
61149	1" x 1"	NRP	Plain Steel	NONE	—	—	—	Polybag w/UPC	20	200
61150	1-1/2" x 1-1/2"	NRP	Plain Steel	NONE	—	—	—	Polybag w/UPC	20	200
61151	2" x 1-1/2"	NRP	Plain Steel	NONE	—	—	—	Polybag w/UPC	20	200
61152	2.5" x 1-1/2"	NRP	Plain Steel	NONE	—	—	—	Polybag w/UPC	20	200
61153	3" x 2"	NRP	Plain Steel	NONE	—	—	—	Polybag w/UPC	20	200

SOLID BRASS

SQUARE CORNER, PLAIN BEARING

Removable Pin

Masonite** hole pattern; Button tip; Furnished w/screws



SOLID BRASS HINGES

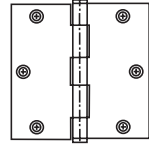

CODE	SIZE	GAUGE	PIN TYPE	FINISH	SCREWS				PACK	INNER	MASTER
					QTY	SIZE	LENGTH	TYPE			
CLAMSHELL											
35072	3-1/2" x 3-1/2"	2.2mm	RP	Brass/US3	6	#9	0.75	WS T17	1/Clam	10◆	100
35074	4" x 4"	2.5mm	RP	Brass/US3	8	#10	0.75	WS T17	1/Clam	10◆	100
BOX											
35265	3-1/2" x 3-1/2"	2.5mm	RP	Brass/US3	8	#10	0.75	WS T17	2/Box	10	20

Threaded Button Tip

Template hole pattern; Removable finial – see page 69 for 2.2mm & 3.1mm hinge finials; Furnished w/screws



SOLID BRASS HINGES

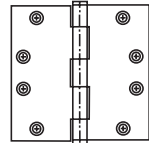

CODE	SIZE	GAUGE	PIN TYPE	FINISH	SCREWS				PACK	INNER	MASTER
					QTY	SIZE	LENGTH	TYPE			
35270	4" x 4"	3.1mm	RP	Brass/US3	8	#10	1.25	WS T17	2/Box	10	20

Threaded Ball Finial

Template hole pattern; Removable finial – see page 69 for 3.1mm hinge finials; Furnished w/screws



SOLID BRASS HINGES

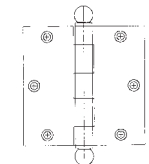

CODE	SIZE	GAUGE	PIN TYPE	FINISH	SCREWS				PACK	INNER	MASTER
					QTY	SIZE	LENGTH	TYPE			
35364	3-1/2" x 3-1/2"	3.1mm	RP	Brass/US3	8	#10	1.25	WS T17	2/Box	10	20
35366	4" x 4"	3.1mm	RP	Brass/US3	8	#10	1.25	WS T17	2/Box	10	20

5/8" RADIUS CORNER, PLAIN BEARING

Non-Removable Pin

Template hole pattern; Threaded button tip; Furnished w/screws



SOLID BRASS HINGES

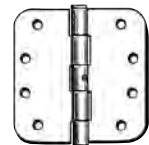

CODE	SIZE	GAUGE	PIN TYPE	FINISH	SCREWS				PACK	INNER	MASTER
					QTY	SIZE	LENGTH	TYPE			
35272	4" x 4"	3.1mm	NRP	Brass/US3	16	#10	1.25	WS T17	2/Box	10	20

**The following registered trade name or trade mark is not owned, associated with or connected in any way with Ultra Hardware Products LLC and is used herein for illustrative purposes only

5/8" RADIUS CORNER, PLAIN BEARING *continued*

Removable Pin

Masonite** hole pattern; Threaded Button Tip; Furnished w/screws



**SOLID
BRASS
HINGES**

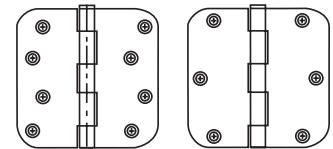

CODE	SIZE	GAUGE	PIN TYPE	FINISH	SCREWS				PACK	INNER	MASTER
					QTY	SIZE	LENGTH	TYPE			
35118	3-1/2" x 3-1/2"	2.2mm		Brass/US3	6	#9	0.75	WS T17	1/Clam	10◆	100
35120	4" x 4"	2.5mm		Brass/US3	8	#10	1	WS T17	1/Clam	10◆	100
BOX											
35288	3-1/2" x 3-1/2"	2.2mm		Brass/US3	12	#8	1	WS T17	2/Box	5◆	20
35289	4" x 4"	2.2mm		Brass/US3	16	#8	1	WS T17	2/Box	5◆	20

SQUARE CORNER, BALL BEARING — SOLID BRASS

Threaded Urn Finial

Masonite** hole pattern; Removable finial – see page below for 3.1mm hinge finials; Furnished w/screws



**SOLID
BRASS
HINGES**

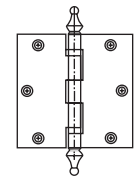

CODE	SIZE	GAUGE	PIN TYPE	FINISH	SCREWS				PACK	INNER	MASTER
					QTY	SIZE	LENGTH	TYPE			
35370	3-1/2" x 3-1/2"	3.1mm		Brass/US3	12	#10	1	WS T17	2/Box	10	20
35375	4" x 4"	3.1mm		Brass/US3	16	#10	1	WS T17	2/Box	10	20

HINGE FINIALS — SOLID BRASS

Solid brass; 3/8"-24 Thread; Decorative brass finial tips are optional and interchangeable



CODE	SIZE	GAUGE	FINISH	PACK	INNER	MASTER
27876	Ball	2.2mm	Brass/US3	Polybag	12◆	840
27890	Pagoda	3.1mm	Brass/US3	Polybag	12◆	840
27879	Steeple	2.2mm	Brass/US3	Polybag	12◆	840



Ball



Pagoda



Steeple

SQUARE HINGE, LIGHT DUTY — SOLID BRASS

Removable Pin

Solid brass removable pin; Button tips; Template hole pattern; Furnished w/screws



**SOLID
BRASS
HINGES**

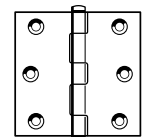

CODE	SIZE	GAUGE	PIN TYPE	FINISH	SCREWS				PACK	INNER	MASTER
					QTY	SIZE	LENGTH	TYPE			
96579	2-1/2" x 2-1/2"	1.3mm	RP	Brass/US3	12	#6	0.75	WS	2/Polybag	12◆	240
96580	3" x 3"	1.3mm	RP	Brass/US3	12	#6	0.75	WS	2/Polybag	12◆	144

**The following registered trade name or trade mark is not owned, associated with or connected in any way with Ultra Hardware Products LLC and is used herein for illustrative purposes only

HINGES

Narrow

For use on small boxes, chest and cabinets; Lacquered to resist tarnishing; Furnished w/screws

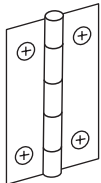

13923 shown

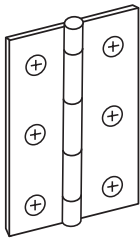

13929 shown

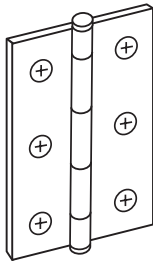

13916 shown

CODE	SIZE	FINISH	HOLES PER LEAF	PACK	INNER	MASTER
Non-Removable Pin						
13922	1" x 13/16"	Brass/US3	2	4/Card	5◆	50
13923	1-1/2" x 1"	Brass/US3	2	2/Card	5◆	50
13924	2" x 1-3/16"	Brass/US3	3	2/Card	5◆	50
13917	3/4" x 11/16"	Antique Brass/US5	2	2/Card	5◆	50
13919	1-1/2" x 1"	Antique Brass/US5	2	2/Card	5◆	50
13925	2" x 1-3/16"	Antique Brass/US5	3	2/Card	5◆	50
13912	3/4" x 5/8"	Brass/US3	2	4/Card	5◆	50
13913	1" x 3/4"	Brass/US3	2	4/Card	5◆	50
13926	1" x 1-1/32"	Brass/US3	2	4/Card	5◆	50
13914	1-1/2" x 7/8"	Brass/US3	2	2/Card	5◆	50
13927	1-1/2" x 1-1/4"	Brass/US3	2	2/Card	5◆	50
13915	2" x 1"	Brass/US3	3	2/Card	5◆	50
13928	2" x 1-3/8"	Brass/US3	3	2/Card	5◆	50
13929	2-1/2" x 1-3/4"	Brass/US3	3	2/Card	5◆	50
13918	1" x 3/4"	Antique Brass/US5	2	2/Card	5◆	50
13930	1" x 1-1/32"	Antique Brass/US5	2	2/Card	5◆	50
13931	1-1/2" x 1-1/4"	Antique Brass/US5	2	2/Card	5◆	50
13920	2" x 1"	Antique Brass/US5	3	2/Card	5◆	50
13932	2" x 1-3/8"	Antique Brass/US5	3	2/Card	5◆	50
13933	2-1/2" x 1-3/4"	Antique Brass/US5	3	2/Card	5◆	50
Removable Button Tip Pin						
13916	2-1/2" x 1-3/4"	Brass/US3	3	2/Card	5◆	50
13921	2-1/2" x 1-3/4"	Antique Brass/US5	3	2/Card	5◆	50

BUILDERS' HARDWARE

Wide

Lacquered to resist tarnishing; Furnished w/screws

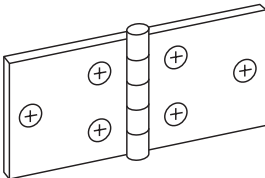

13935 shown

CODE	SIZE	FINISH	HOLES PER LEAF	PACK	INNER	MASTER
Non-Removable Pin						
13935	2" x 3-1/16"	Brass/US3	3	2/Card	5◆	50
13934	1-1/2" x 2"	Brass/US3	3	2/Card	5◆	50

HINGES *continued*



Ornamental

Non-removable pin; Lacquered to resist tarnishing; Furnished w/solid brass screws

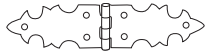

13936 shown

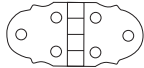

13938 shown

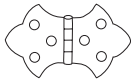

13939 shown

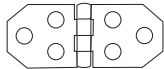

13943 shown

CODE	SIZE	FINISH	PACK	INNER	MASTER
13936	5/8" x 2-11/16"	Brass/US3	2/Card	5◆	50
13937	5/8" x 2-11/16"	Antique Brass/US5	2/Card	5◆	50
13938	1-5/16" x 2-15/16"	Brass/US3	2/Card	5◆	50
13939	1-5/16" x 2-1/4"	Brass/US3	2/Card	5◆	50
13940	1-11/16" x 3-1/16"	Brass/US3	2/Card	5◆	50
13941	1-5/16" x 2-1/4"	Antique Brass/US5	2/Card	5◆	50
13942	1-11/16" x 3-1/16"	Antique Brass/US5	2/Card	5◆	50
13943	3/4" x 1-7/8"	Brass/US3	2/Card	5◆	50

HASPS



Lacquered to resist tarnishing

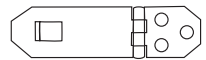

13909 shown

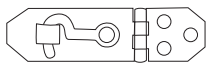

13910 shown



13906 shown

CODE	SIZE	FINISH	PACK	INNER	MASTER
No Hook – Furnished w/fasteners					
13908	3/4" x 2-3/4"	Brass/US3	1/Card	5◆	50
13909	3/4" x 2-3/4"	Antique Brass/US5	1/Card	5◆	50
w/Hook – Furnished w/fasteners					
13910	3/4" x 2-3/4"	Brass/US3	1/Card	5◆	50
13911	3/4" x 2-3/4"	Antique Brass/US5	1/Card	5◆	50
ornamental – Furnished w/nails					
13906	5/8" x 1-7/8"	Brass/US3	1/Card	5◆	50
13907	5/8" x 1-7/8"	Antique Brass/US5	1/Card	5◆	50

LATCH



Ornamental

Lacquered to resist tarnishing; Furnished w/solid brass nails

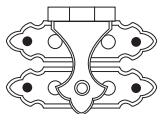

CODE	SIZE	FINISH	PACK	INNER	MASTER
13900	1" x 1-5/16"	Brass/US3	2/Card	5◆	50

BRACES



Corner Braces

Reinforces 90° corners; Lacquered to resist tarnishing; Furnished w/screws

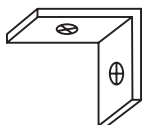

13901 shown

CODE	SIZE	FINISH	PACK	INNER	MASTER
13901	1" x 1/2"	Brass/US3	4/Card	5◆	50
13902	1-1/2" x 1/2"	Brass/US3	4/Card	5◆	50

Corner Brace Plates



Lacquered to resist tarnishing; Furnished w/screws

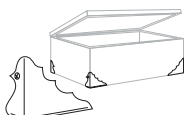

13903 shown

CODE	SIZE	FINISH	PACK	INNER	MASTER
13903	7/16" x 1-1/4"	Brass/US3	4/Card	5◆	50
13904	9/16" x 1-3/4"	Brass/US3	4/Card	5◆	50
13905	7/16" x 1-1/4"	Antique Brass/US5	4/Card	5◆	50

BUILDERS' HARDWARE

REPAIR & REINFORCEMENT PLATES AND BRACES

- Zinc dichromate & zinc plated rust resistant
- Galvanized—corrosion resistant

Corner Braces

Heavy gauge steel construction; Countersunk screw holes; Carded furnished w/screws; Box and bulk w/o screws

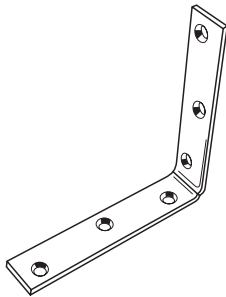

CODE	SIZE	FINISH	PACK	INNER	MASTER
60975	1" x 1/2"	Zinc Dichromate	4/Card	10◆	100
60977	1-1/2" x 1/2"	Zinc Dichromate	4/Card	10◆	100
60979	2" x 5/8"	Zinc Dichromate	4/Card	10◆	100
60981	2-1/2" x 5/8"	Zinc Dichromate	4/Card	10◆	100
60983	3" x 3/4"	Zinc Dichromate	4/Card	5◆	50
16400	1" x 1/2"	Zinc	4/Card	10◆	100
16405	1-1/2" x 1/2"	Zinc	4/Card	10◆	100
16410	2" x 5/8"	Zinc	4/Card	10◆	100
16415	2-1/2" x 5/8"	Zinc	4/Card	10◆	100
16420	3" x 3/4"	Zinc	4/Card	10◆	50
16425	3-1/2" x 3/4"	Zinc	4/Card	6◆	72
16428	4" x 7/8"	Zinc	2/Card	6◆	72
61049	1 x 1/2"	Galvanized	4/Card	10◆	100
61050	1-1/2" x 1/2"	Galvanized	4/Card	10◆	100
61051	2" x 5/8"	Galvanized	4/Card	10◆	100
61052	2-1/2" x 5/8"	Galvanized	4/Card	10◆	100
61053	3" x 3/4"	Galvanized	4/Card	10◆	50
61113	4" x 3/16"	Galvanized	2/Card	10◆	100
95986	10" x 1-1/4"	Zinc	10/Box	1	3
61120	1" x 1/2"	Zinc	Bulk w/UPC	48◆	2160
61121	1-1/2" x 1/2"	Zinc	Bulk w/UPC	48◆	1152
61122	2" x 5/8"	Zinc	Bulk w/UPC	48◆	720
61123	2-1/2" x 5/8"	Zinc	Bulk w/UPC	24◆	432
61124	3" x 3/4"	Zinc	Bulk w/UPC	24◆	288
61125	3-1/2" x 3/4"	Zinc	Bulk w/UPC	24◆	240
60826	4" x 7/8"	Zinc	Bulk w/UPC	10◆	100
60827	5" x 1"	Zinc	Bulk w/UPC	10◆	100
60828	6" x 1-1/8"	Zinc	Bulk w/UPC	10◆	40
60829	8" x 1-1/4"	Zinc	Bulk w/UPC	10◆	40
61062	4" x 7/8"	Galvanized	Bulk w/UPC	10◆	100
61063	6" x 1-1/8"	Galvanized	Bulk w/UPC	10◆	40

REPAIR & REINFORCEMENT PLATES AND BRACES *continued*

- Zinc dichromate & zinc plated rust resistant
- Galvanized — corrosion resistant

Flat Corners

Heavy gauge steel construction; Countersunk screw holes; Carded furnished w/screws; Box and bulk w/o screws

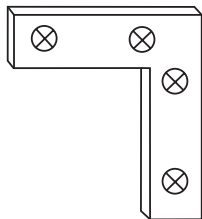

CODE	SIZE	FINISH	PACK	INNER	MASTER
60984	1-1/2" x 3/8"	Zinc Dichromate	4/Card	10◆	100
60986	2" x 3/8"	Zinc Dichromate	4/Card	10◆	100
60989	2-1/2" x 1/2"	Zinc Dichromate	4/Card	10◆	100
60990	3" x 5/8"	Zinc Dichromate	4/Card	10◆	100
60985	1-1/2" x 1/2"	Zinc	4/Card	10◆	100
60987	2" x 3/8"	Zinc	4/Card	10◆	100
60989	2-1/2" x 1/2"	Zinc	4/Card	10◆	100
60991	3" x 5/8"	Zinc	4/Card	10◆	100
96071	4" x 7/8"	Zinc	2/Card	12◆	144
61054	2" x 3/8"	Galvanized	4/Card	10◆	100
61055	2-1/2" x 1/2"	Galvanized	4/Card	10◆	100
61056	3" x 5/8"	Galvanized	4/Card	10◆	100
61112	4" x 7/8"	Galvanized	2/Card	10◆	100
61126	1-1/2" x 1/2"	Zinc	Bulk w/UPC	48◆	2160
61127	2" x 3/8"	Zinc	Bulk w/UPC	48◆	1440
61128	2-1/2" x 1/2"	Zinc	Bulk w/UPC	48◆	768
61129	3" x 5/8"	Zinc	Bulk w/UPC	48◆	480
96053 NEW	3-1/2" x 3/4"	Zinc	Bulk w/UPC	24◆	432
60830	4" x 7/8"	Zinc	Bulk w/UPC	20◆	200
60831	5" x 7/8"	Zinc	Bulk w/UPC	10◆	200
60832	6" x 1-1/8"	Zinc	Bulk w/UPC	10◆	120
61071	6" x 1-1/8"	Galvanized	Bulk w/UPC	10◆	120

Mending Plates

Carded w/screws; Box and bulk w/out screws



CODE	SIZE	FINISH	PACK	INNER	MASTER
60965	2" x 1/2"	Zinc Dichromate	4/Card	10◆	100
60967	2-1/2" x 5/8"	Zinc Dichromate	4/Card	10◆	100
60969	3" x 3/4"	Zinc Dichromate	4/Card	10◆	100
60971	4" x 3/4"	Zinc Dichromate	4/Card	10◆	100
60964	2" x 1/2"	Zinc	4/Card	10◆	100
60966	2-1/2" x 5/8"	Zinc	4/Card	10◆	100
60968	3" x 3/4"	Zinc	4/Card	10◆	100
60970	4" x 3/4"	Zinc	4/Card	10◆	100
61047	2" x 5/8"	Galvanized	4 /Card	10◆	100
61048	3" x 5/8"	Galvanized	4/Card	10◆	100
61114	4" x 5/8"	Galvanized	4/Card	10◆	100
97039	2" x 1/2"	Zinc	48/Box	1	45
97042	2-1/2" x 5/8"	Zinc	48/Box	1	30
97045	3" x 3/4"	Zinc	48/Box	1	15
97048	4" x 3/4"	Zinc	48/Box	1	10
97054	6" x 1-1/8"	Zinc	24/Box	1	6
97036	10" x 1"	Zinc	10/Box	1	5
97062	2-1/2" x 5/8"	Zinc	1000/Box Bulk	1	—
97064	3" x 3/4"	Zinc	700/Box Bulk	1	—
97066	4" x 3/4"	Zinc	500/Box Bulk	1	—
61135	2" x 1/2"	Zinc	Bulk w/UPC	48◆	2160
61136	3" x 5/8"	Zinc	Bulk w/UPC	48◆	720
61137	4" x 5/8"	Zinc	Bulk w/UPC	48◆	480
60821	5" x 1"	Zinc	Bulk w/UPC	20◆	200
60822	6" x 1-1/8"	Zinc	Bulk w/UPC	10◆	40
60823	8" x 1-3/16"	Zinc	Bulk w/UPC	10◆	40
61138	10" x 1"	Zinc	Bulk w/UPC	10◆	50
61067	6" x 1-1/8"	Galvanized	Bulk w/UPC	10◆	40
61068	8" x 1-1/2"	Galvanized	Bulk w/UPC	10◆	40

BUILDERS' HARDWARE

REPAIR & REINFORCEMENT PLATES AND BRACES *continued*

- Zinc dichromate & zinc plated rust resistant
- Galvanized—corrosion resistant

T-BRACE PLATE

Carded w/ screws; Box and bulk w/out screws

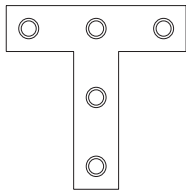

GALVANIZED
All Weather



CODE	SIZE	FINISH	PACK	INNER	MASTER
60972	3"	Zinc	2/Card	10◆	100
97034	3"	Zinc	Bulk w/UPC	48◆	480
97035	4"	Zinc	Bulk w/UPC	48◆	240
60824	3"	Zinc	Bulk w/UPC	20◆	200
60825	4"	Zinc	Bulk w/UPC	20◆	200
61069	3"	Galvanized	Bulk w/UPC	10◆	200

Double Corner Brace Plate

Packed w/o screws

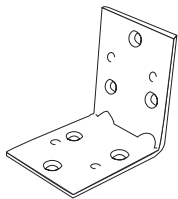

CODE	SIZE	FINISH	PACK	INNER	MASTER
96076	1-1/2"	Zinc	Bulk w/UPC	48◆	480
96077	2"	Zinc	Bulk w/UPC	48◆	480
96078	2-1/2"	Zinc	Bulk w/UPC	48◆	288

Corner Brace Plate

Packed w/o screws

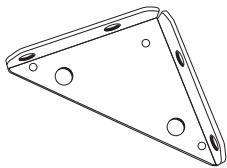

CODE	SIZE	FINISH	PACK	INNER	MASTER
96871	2"	Zinc	Bulk w/UPC	48◆	480
96872	3"	Zinc	Bulk w/UPC	48◆	288
96873	4"	Zinc	Bulk w/UPC	48◆	144

Corner Braces

Use for 90° joints. Side supports for added strength; Elongated screw holes

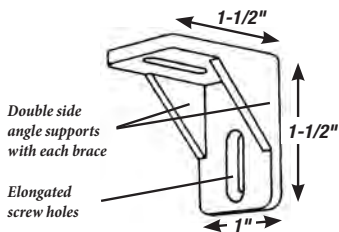

CODE	FINISH	PACK	INNER	MASTER
16492	White Polyethylene	100/Box	1	10

Chair Leg Braces

Card w/screws; Bulk w/o screws

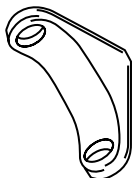

CODE	FINISH	PACK	INNER	MASTER
60973	Zinc	4/Card	10◆	100
95981	Antique Copper	Bulk	500	2000
95982	Brass	Bulk	500	2000
95984	Zinc	Bulk	500	2000

BUILDERS' HARDWARE

MULTI-PURPOSE STORAGE KIT



Ideal for Garages, Storage Sheds, Basements & more!

Heavy Duty Track with Snap-On Hooks

- Place Hooks in Any Location
- Scratch Resistant PVC Coating
- Each track holds up to 220 lbs with proper installation

CODE	DESCRIPTION	PACK	INNER	MASTER
61652	15 Piece	Box	2◆	—
61651	12 Piece	Box	4◆	—
61650	9 Piece	Box	4◆	—



15 Piece



4-24" Track

1- Multi-Purpose Hook

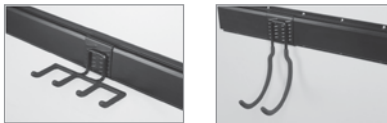

1- Step Ladder

1-Scoop Hook



2 - Single Prong Hooks

1- Hammer Hook



1- Small Loop Hook

1- Large Hook

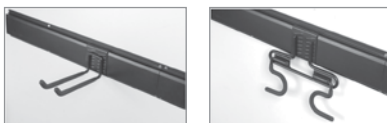

2- Double Prong Hook

1- Two Handle Hook

12 Piece



3- 24" Track

1- Multi Purpose Hook

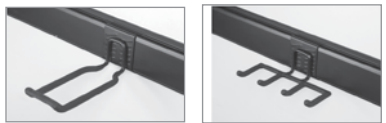

1-Hammer Hook

1-Step Ladder

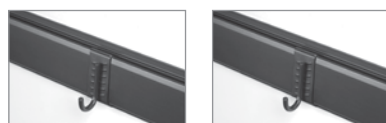

2- Small Loop Hook

1- Large U-Hook

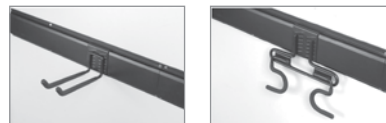

2- Double Prong Hook

1-Two Handle Hook

9 Piece



2-24" Track

2- Multi-Purpose Hook



1- Hammer Hook

1- Small Loop Hook



1- Large Hook

1- Double Prong Hook



1-Two Handle Hook

SUPPORT BRACKETS

Extra Heavy Duty

Combination shelf and rod; Meets BHMA standard 125 lbs. on hook & 150 lbs. on shelf; Holds rods up to 1-3/4" diameter; 11" Projection from wall; One piece steel construction

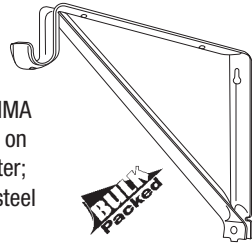

CODE	SIZE	FINISH	PACK	INNER	MASTER
11100	2-1/2"	Painted/White	UPC/Bulk	20◆	—
11104	2-1/2"	Powder Coat/White	UPC/Bulk	20◆	—
11130	3"	Powder Coat/White	UPC/Bulk	20◆	—

Holds up to 1000 pounds per pair

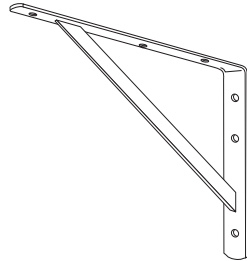

CODE	SIZE	FINISH	PACK	INNER	MASTER
11134	10-1/2" x 7-1/2"	White	UPC/Bulk	10◆	—
11136	16" x 11"	White	Bulk	10◆	—
11138	20" x 13"	White	Bulk	10◆	—

HEAVY DUTY

Meets BHMA standard 150 lbs. on shelf; 10" Projection from wall

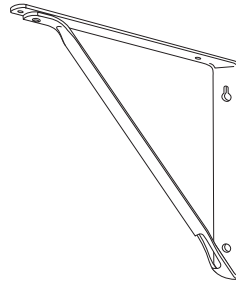

CODE	SIZE	FINISH	PACK	INNER	MASTER
11132	10" Projection	White	Bulk	20◆	—

SHELF BRACKETS

Grey and white enamel finish; Six staggered countersunk screw holes in each bracket; One piece construction; Heavy gauge .0354

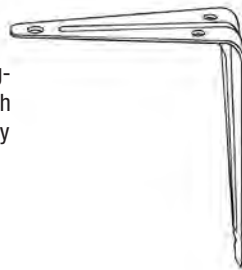

CODE (GREY)	CODE (WHITE)	SIZE	REC. SAFE WORKING LOAD	PACK	INNER	MASTER
96115	96116	3" x 4"	40lbs	Bulk	20◆	200
96117	96118	4" x 5"	40lbs	Bulk	20◆	200
96119	96120	5" x 6"	45lbs	Bulk	20◆	200
96121	96122	6" x 8"	55lbs	Bulk	20◆	200
96123	96124	7" x 9"	55lbs	Bulk	20◆	100
96125	96126	8" x 10"	55lbs	Bulk	20◆	100
96111	96112	10" x 12"	65lbs	Bulk	20◆	60
96113	96114	12" x 14"	75lbs	Bulk	20◆	60

*Open stock items included in merchandising display rack on page 174

FOLDING SHELF BRACKETS

Deluxe Heavy Duty Steel

For drop down shelves from 8" to 24" wide; Automatic safety locking device; Quick release folding mechanism; Solid rivet construction; Polybag furnished w/ screws; Box w/o screws



CODE	SIZE	FINISH	PACK	INNER	MASTER
11030	8" x 8"	White	2/Polybag	3◆	48
11035	12" x 12"	White	2/Polybag	3◆	24
11040	16" x 16"	White	2/Polybag	3◆	12
11045 NEW	8" x 8"	Gray	2/Polybag	5◆	50
11050 NEW	12" x 12"	Gray	2/Polybag	5◆	25
11055 NEW	16" x 16"	Gray	2/Polybag	5◆	15
97217	8" x 8"	Gray	2/Box	1◆	24
97215	12" x 12"	Gray	2/Box	1◆	18
97216	16" x 16"	Gray	2/Box	1◆	18

BUILDERS' HARDWARE

BY-PASS CLOSET DOOR TRACK & HARDWARE SET

Standard Duty Set

For doors 3/4" – 1-3/8" thick; For doors up to 50 lbs. ea.; Hardware for 2 doors. Contents: 1 Length of steel track; Four nylon wheel hangers; 1 Nylon adjustable floor guide; 2 brass finger pulls

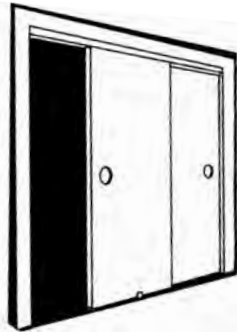

CODE	SIZE	FINISH	PACK	INNER	MASTER
61206	48"	24"	Shrink Wrapped	10◆	—
61207	60"	30"	Shrink Wrapped	10◆	—
61208	72"	36"	Shrink Wrapped	10◆	—
61209	96"	48"	Shrink Wrapped	10◆	—

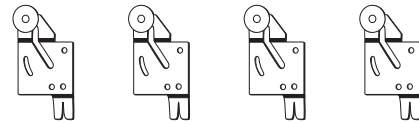
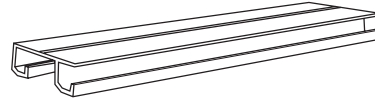

BY-PASS CLOSET DOOR COMPONENTS

Finger Pulls

Solid brass construction; Pull handle stores flush when not in use; Lifetime warranty; Furnished w/ screws



PREMIUM FINISH

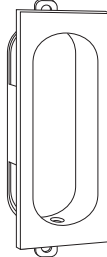

CODE	SIZE	FINISH	PACK	INNER	MASTER
60015	3-1/8" H x 1-5/16" W	Brass	Polybag w/ UPC	10◆	150
60018	3-1/8" H x 1-5/16" W	Satin Nickel	Polybag w/ UPC	10◆	150

Stamped steel construction

PREMIUM FINISH



CODE	SIZE	FINISH	PACK	INNER	MASTER
60005	2-1/8" Dia.	Brass	Polybag w/UPC	50◆	200
60026	2-1/8" Dia.	Dull Chrome	Polybag w/UPC	50◆	200
60027	2-1/8" Dia.	Satin Nickel	Polybag w/UPC	50◆	200
60030 NEW	2-1/8" Dia.	Oil Rubbed Bronze	Polybag w/UPC	50◆	200

3/8" Deep

PREMIUM FINISH



CODE	SIZE	FINISH	PACK	INNER	MASTER
97155	3/4" Dia.	Zinc	Box	200◆	4000
60000	3/4" Dia.	Brass	Box	100◆	5000
60002	3/4" Dia.	Satin Nickel	Box	100◆	5000
60001	3/4" Dia.	Brass	2/Polybag	50◆	2500

SLIDING DOOR COMPONENTS

Sliding Door Track Hangers

Adjustable; Reinforced plated steel; Staggered screw hole location; Smooth glide nylon rollers; Replacement hanger fits most overhead tracks; Furnished w/screws

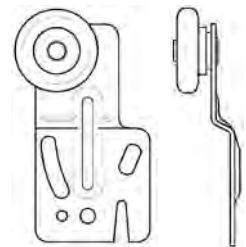

CODE	SIZE	ROLLER DIA.	ROLLERS	PACK	INNER	MASTER
31610	1/2"	7/8"	Plain	1Pr/Polybag	12◆	288
31615 NEW	11/16"	7/8"	Plain	1Pr/Polybag	100◆	—

SLIDING DOOR GUIDE

Adjustable for door thicknesses; For doors from 1-3/8" to 1-3/4" thick

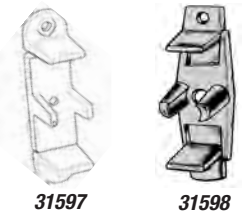

31597

31598

CODE	SIZE	PACK	INNER	MASTER
31597	.8" H x .9"-1.7" W x .7" D	Card	12◆	600
31598	.7" H x 1.55" W x .75" D	Card	12◆	600

For 1-3/8" thick doors; For two or four folding doors

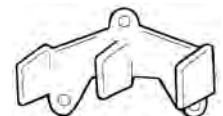

CODE	SIZE	PACK	INNER	MASTER
31591	.75" H x 2.75" W x .75" D	Polybag w/UPC	12◆	720

For 1-3/8" thick doors; Steel plate w/ nylon guides



CODE	SIZE	PACK	INNER	MASTER
31596	.75" H x 2.75" W x .75" D	Card	72◆	240

BUILDERS' HARDWARE

BI-FOLD DOOR TRACK & HARDWARE SET

For doors 7/8" – 1-3/8" thick; For doors up to 20 lbs. each

Contents: Hinges; Pivots & guides; Enameled steel guide track; Heavy duty bracket; Wood knob; Aligners; Spring loaded guide

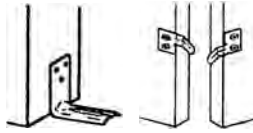

CODE	SIZE	FINISH	PACK	INNER	MASTER
61202	24"/Sets	2	Display Box	5◆	—
61203	48"/Sets	4	Display Box	5◆	—
61204	60"/Sets	4	Display Box	5◆	—
61205	72"/Sets	4	Display Box	5◆	—

BI-FOLD DOOR COMPONENTS

Door Pivots

Spring loaded; For two or four folding doors



CODE	PACK	INNER	MASTER
31593	2/Card	12◆	240

Flag Leaf Hinge

Surface mount; Bright brass plated finish; Nylon bearings with round corners; Countersunk screw holes

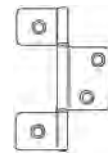

CODE	SIZE	PACK	INNER	MASTER
35400	3-1/2" x 1-1/4"	Bulk	100◆	500

Spring loaded; 3/4" Diameter nylon wheels



CODE	PACK	INNER	MASTER
64500	2/Card	12◆	240

Door Knob

Unfinished wood knob; Furnished w/screw



CODE	SIZE	PACK	INNER	MASTER
41446	1-1/2" Dia.	1/Polybag	25◆	500

BUILDERS' HARDWARE

Aligner

Furnished w/ installation screws

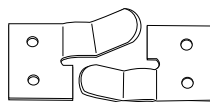

CODE	PACK	INNER	MASTER
10000	1 Pr/Polybag	20◆	—

Top Track Set

Includes: 1 Top pivot bracket; 1 Snugger; 2 Bifold top pivots

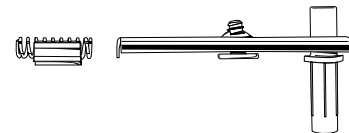

CODE	FINISH	PACK	INNER	MASTER
57022	Zinc	Polybag w/UPC	20◆	—

Hinges

Furnished w/ installation screws

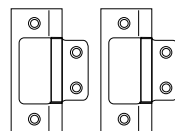

CODE	MATERIAL	PACK	INNER	MASTER
34960	Zinc	1 Pr/Polybag	20◆	—

Bottom Pivot Set

Includes: 1 Bottom pivot; 1 Jamb bracket

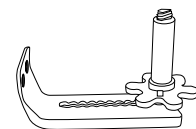

CODE	FINISH	PACK	INNER	MASTER
57024	Zinc	Polybag w/UPC	20◆	—

POCKET DOOR FRAME KIT

Standard Duty

For doors up to 3' wide and up to 6'8" high; For doors 1-3/8" – 1-3/4" thick; Jump-proof track and rollers; Galvanized steel box track; Real wood splint studs, steel encased for rigidity and to prevent fastener penetration into the pocket; Ball bearing hangers; Contents: 1 Header Assembly; 2 Pair Split studs; 2 Heavy Duty Ball Bearing Hangers; 2 Door Mounting Plates; 1 Bumper Stop; 1 Pair Door Guides; 1 Adjusting Wrench



CODE	SIZE	PACK	INNER	MASTER
61215	125lbs.	Display Box	1	—

POCKET DOOR COMPONENTS

Finger Pull

Solid brass construction; Back plate included; Lifetime warranty; Furnished w/screws



CODE	FINISH	TYPE	PACK	INNER	MASTER
60025	3/4" W x 3-7/8" L x 1-7/16" H	Brass	Polybag w/UPC	20◆	200

LID SUPPORT

Steel construction; Furnished w/screws

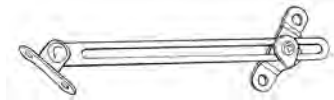

CODE	FINISH	TYPE	PACK	INNER	MASTER
60869	7"	Brass	1 Pr/Card	5◆	50

LID SUPPORT CONT.

Steel construction; Furnished w/screws

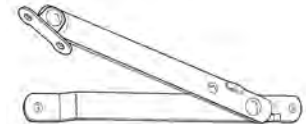

Locks

Overall size: 2-1/2"w by 2-3/4" h; Non-handed; Fits all 1-3/8" to 1-3/4" pocket doors

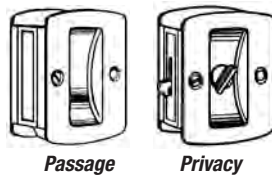

Passage

Privacy



CODE	FINISH	TYPE	PACK	INNER	MASTER
49500	Brass	Passage	Box	6	72
49601 NEW	Satin Nickel	Passage	Card	6◆	72
49602 NEW	Oil Rubbed Bronze	Passage	Card	6◆	72
49505	Brass	Privacy	Box	6	72
49525	Polished Chrome	Privacy	Box	6	72
49606 NEW	Satin Nickel	Privacy	Card	6◆	72
49607 NEW	Oil Rubbed Bronze	Privacy	Card	6◆	72

CODE	SIZE	FINISH	PACK	INNER	MASTER
75592	10"	Brass	1 Pr/Card	12◆	120
60870	10"	Brass	1 Pr/Card	5◆	50

GRAVITY PIVOT HINGE SET

Packed in sets: one set per door; Furnished w/hinges (2) and screws

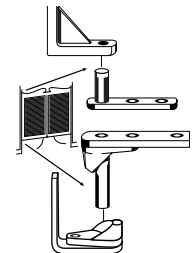

CODE	FINISH	SET QTY.	PACK	INNER	MASTER
60857	Brass	One (1) Door	Card	5◆	50
96623	Brass	Two (2) Doors	Card	10◆	100

CLOSET POLE SOCKETS

For poles or rods up to 1-3/8" O.D.; 2-1/4" base diameter; Single screw mounting; Furnished w/screws



For poles or rods up to 1-9/32" O.D.; 3 Hole installation; Dimensions: 1-5/16" diameter; One-full circle and one-half circle; Furnished w/screws

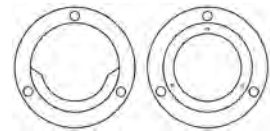

CODE	MATERIAL	FINISH	PACK	INNER	MASTER
69000	ABS	White	1Pr/Polybag	100◆	800

CODE	MATERIAL	FINISH	PACK	INNER	MASTER
69015	Steel	Chrome	1Pr/Polybag	100◆	—

For poles or rods up to 1-1/4" O.D.; Dimensions: 1-11/32" flange; One-full circle & one-half circle; Furnished w/screws

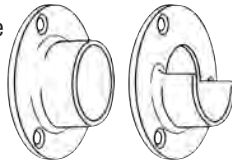

Unfinished; 1-7/16" Inside diameter; 2-1/2" Outside diameter; Furnished w/screws

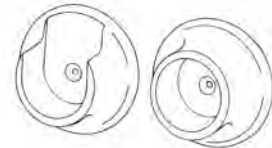

CODE	MATERIAL	FINISH	PACK	INNER	MASTER
68990	Zinc	White	1Pr/Polybag	12◆	60

CODE	MATERIAL	FINISH	PACK	INNER	MASTER
69010	Wood	2-1/2"	1Pr/Polybag	12◆	60

Standard profile; 3 Hole installation; Surface mount screw holes; 7/8" deep; Furnished w/screws

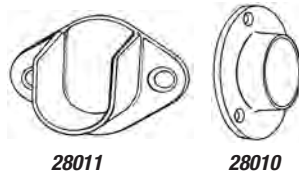

High profile; 2-3/4" long, 1-3/4" wide, 1" deep; 2 Surface mount installation screw holes

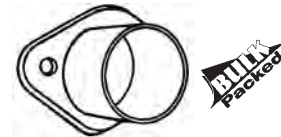

CODE	MATERIAL	TUBE DIA.	FINISH	PACK	INNER	MASTER
28020	Zinc	1-1/8"	Chrome	Polybag w/UPC	12◆	120
28011 NEW	Zinc	1-5/16"*	Chrome	Polybag w/UPC	12◆	240
28010	Zinc	1-1/4"	Chrome	Polybag w/UPC	12◆	240

CODE	MATERIAL	TUBE DIA.	FINISH	PACK	INNER	MASTER
28005	Zinc	1-1/16"	Chrome	Bulk	12◆	240

BUILDERS' HARDWARE

CLOSET RODS

Heavy gauge, no sag construction; Telescoping tubes; Hook flanges; 1" Outside diameter; Furnished w/screws

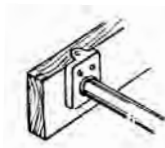

CODE	SIZE	FINISH	PACK	INNER	MASTER
64000	18" to 30"	Zinc	Polybag w/UPC	10◆	—
64005	30" to 48"	Zinc	Polybag w/UPC	10◆	—
64010	48" to 72"	Zinc	Polybag w/UPC	10◆	—
64015	72" to 96"	Zinc	Polybag w/UPC	10◆	—
64020	72" to 120"	Zinc	Polybag w/UPC	10◆	—
64025	96" to 150"	Zinc	Polybag w/UPC	10◆	—

ADJUSTABLE RODS

Spring Tension; Telescoping tubing; Holds up to 33lbs. per rod; Rubber end pads

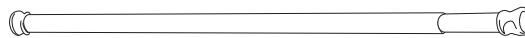

CODE	O.D.	SIZE	FINISH	PACK	INNER	MASTER
64110	1"	36" – 63"	White	Shrink Wrapped	12◆	—
64115	1"	41" – 76"	White	Shrink Wrapped	12◆	—
64120	1"	36" – 63"	Chrome	Shrink Wrapped	12◆	—
64125	1"	41" – 76"	Chrome	Shrink Wrapped	12◆	—

DRIVE-IN BULLET BALL CATCHES

Adjustable tension ball; Bullet catch: 3/4" size; 7/8" Body diameter with fins 1-3/16" body length; 1" Face with lip; 1-3/8" x 2-1/8" Strike plate w/square and radius corners; Furnished w/screws except 07005

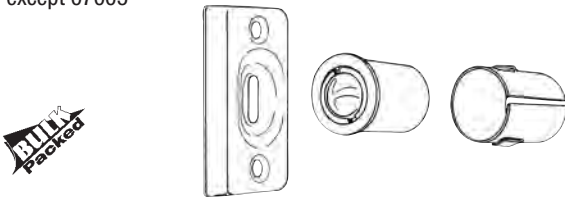

CODE	FINISH	PACK	INNER	MASTER
06981	Brass/US3	Polybag w/UPC	50◆	200
61760	Brass/US3	Polybag w/UPC, Bin Box	30◆	240
61763	Antique Brass/US5	Polybag w/UPC, Bin Box	30◆	240
61765	Ant. Pewter/US17A	Polybag w/UPC, Bin Box	30◆	240
61762	Oil Rubbed Bronze/US10B	Polybag w/UPC, Bin Box	30◆	240
61764	Chrome/US26	Polybag w/UPC, Bin Box	30◆	240
61761	Satin Nickel/US15	Polybag w/UPC, Bin Box	30◆	240
61766	White	Polybag w/UPC, Bin Box	30◆	240
07033	Dull Chrome/US26D	Bulk	100◆	300
07008	Brass/US3	Bulk	300◆	—
BULLET CATCH (ONLY)				
07005	Brass/US3	Bulk	300◆	—
STRIKE PLATES				
58090	Brass/US3	Polybag w/UPC	50◆	500
58079	Oil Rubbed Bronze/US10B	Polybag w/UPC	100◆	500
58071	Satin Nickel/US15	Polybag w/UPC	100◆	500

Furnished w/ strike and nail

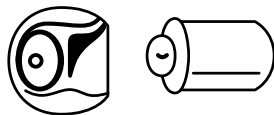

CODE	SIZE	FINISH	PACK	INNER	MASTER
96174	3/8"	Brass	Bulk	144◆	3456

BALL CATCH ADJUSTER TOOL

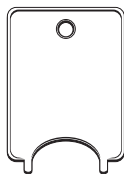

CODE	FINISH	PACK	INNER	MASTER
98545	Zinc	Bulk	1	2500

ROLLER LATCH

Zinc die cast; Adjustable tension; For standard doors 1-3/8" to 1-7/8"; 3/4" Installation hole; Slotted nylon roller; Mortise latchbolt with roller wheel edge; Furnished w/ nylon wheel and keeper; Carded furnished w/screws

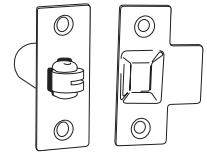

PREMIUM FINISH

CODE	FINISH	PACK	INNER	MASTER
60898	Brass	Card	5◆	100

BULLET CATCHES

Solid brass ball catch; Brass insert and solid brass strike; Radius corners; Threaded adjustable face plate; Furnished w/screws



CODE	SIZE	FINISH	PACK	INNER	MASTER
07017	1"	Brass	Polybag w/UPC	6◆	120

Steel ball roller for positive tension application; Radius corners; Furnished w/screws

PREMIUM FINISH

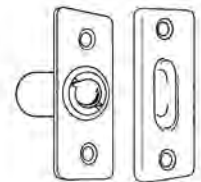

CODE	SIZE	FINISH	PACK	INNER	MASTER
06990	1"	Brass	Polybag w/UPC	50◆	300
06977	1"	Dull Chrome	Polybag w/UPC	50◆	300
06959	1"	Chrome	Polybag w/UPC	50◆	300

BALL CATCH

Solid brass; One pair of spring-loaded ball bearings; Adjustable tension

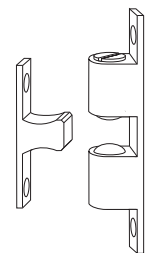

CODE	SIZE	FINISH	PACK	INNER	MASTER
13530	1-5/8"	Brass	Polybag w/Screws	100◆	1200
13535	2"	Brass	Polybag w/Screws	50◆	800
13540	2-1/4"	Brass	Polybag w/Screws	100◆	600
13545	2-3/4"	Brass	Polybag w/Screws	100◆	400
96166	1-3/4"	Brass	Bulk w/o Screws	12◆	1200
97482	2-3/8"	Brass	Bulk w/o Screws	12◆	360
97483	1-3/4"	Nickel	Bulk w/o Screws	12◆	1200
96167	2"	Nickel	Bulk w/o Screws	12◆	600
96170	2-3/4"	Nickel	Bulk w/o Screws	12◆	300

GROMMETS

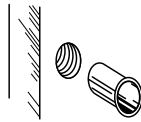

CODE	SIZE	SIZE	PACK	INNER	MASTER
96418	1/4"	Brass	Bulk	1000◆	30,000
96419	1/4"	Nickel	Bulk	1000◆	30,000

CORRUGATED FASTENERS

5" Corrugations; Box pack fasteners bulk; Counter top display includes 10 packs of 100 fasteners



CODE	MATERIAL	PACK	INNER	MASTER
96390	3/8" Deep	50 lb. Box	1	—
96386	1/2" Deep	50 lb. Box	1	—
96395	5/8" Deep	50 lb. Box	1	—
96403	1/2" Deep	Bulk 1000/Counter Top Display	1	10
96405	5/8" Deep	Bulk 1000/Counter Top Display	1	10

SHELF REST SUPPORTS

Steel shelf supports; Push type



CODE	PIN SIZE	FINISH	PACK	INNER	MASTER
97218	1/4"	Brass	Bulk	1000◆	4000
97219	1/4"	Nickel	Bulk	1000◆	4000

Fits all standard 3/16" drilled holes; Push type



CODE	PIN SIZE	PACK	INNER	MASTER
75580	8mm x 4.92mm	100/Polybag	10	50

Push type

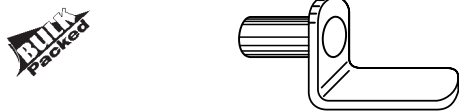

CODE	PIN SIZE	FINISH	PACK	INNER	MASTER
97224	1/4"	Zinc	Box	144◆	2880
97234	1/4"	Brass	Bulk	1000◆	3000
97235	1/4"	Zinc	Bulk	1000◆	3000

Brown vinyl covered; Push type

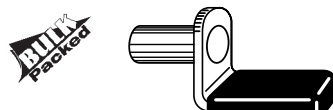

CODE	PIN SIZE	FINISH	PACK	INNER	MASTER
97246	1/4" x .245"	Brass	Bulk	1000◆	4000

FLUSH RING PULLS

Furnished w/screws

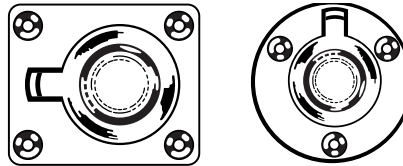

CODE	SIZE	FINISH	PACK	INNER	MASTER
SQUARE					
96410	1-1/4" x 1-1/2"	Brass	Polybag w/UPC	12◆	432
96411	1-1/2" x 1-3/4"	Chrome	Polybag w/UPC	12◆	288
96412	1-1/2" x 1-3/4"	Brass	Polybag w/UPC	12◆	288
95863	1-1/2" x 1-3/4"	Brass	Polybag w/UPC	12◆	240
ROUND					
96407 NEW	1-1/2" Dia.	Chrome	Polybag w/UPC	12◆	288
96408 NEW	1-1/2" Dia.	Brass	Polybag w/UPC	12◆	288

CHEST HANDLE

Furnished w/screws



CODE	PIN SIZE	FINISH	PACK	INNER	MASTER
60818	3-3/4"	Zinc	2/Polybag	5◆	50

MIRROR CLIPS

Ribbed mirror clips; Furnished w/ 6 x 1-1/4" #6 oval head nickel plated wood screws



CODE	SIZE	SIZE	PACK	INNER	MASTER
15293	Clear Plastic	5/8" w x 3/4" l	6/Card	12◆	600

TEAR DROP MIRROR CLIPS

Furnished with 6 x 1-1/4" #6 oval head nickel plated wood screws



CODE	SIZE	SIZE	PACK	INNER	MASTER
15289	Clear Plastic	5/8" w x 1-1/4" l	6/Card	12◆	600

SCREW EYE

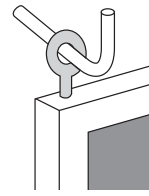
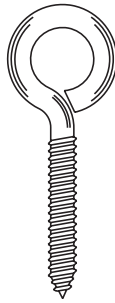

Small Eye

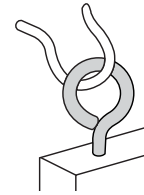

Medium & Large Eye

ZINC PLATED – STEEL

CODE	SIZE	OVERALL LENGTH	INTERIOR DIA. EYE	WIRE DIA.	PACK	INNER	MASTER
SMALL EYE							
61509	#204	1-15/16"	5/16"	.22	4/Card	10◆	100
61316	#206	1-5/8"	17/64"	.192	5/Card	10◆	100
61409	#208	1-3/8"	15/64"	.100	6/Card	10◆	100
61317	#210	1-3/16"	7/32"	.135	8/Card	10◆	100
61092	#212	15/16"	3/16"	.105	10/Card	10◆	100
61318	#212-1/2	3/4"	3/16"	.105	10/Card	10◆	100
61093	#214	13/16"	5/16"	.080	12/Card	10◆	100
61319	#214-1/2	5/8"	5/32"	.080	12/Card	10◆	100
61410	#216	11/16"	9/64"	.06	14/Card	10◆	100
61320	#216-1/2	33/64"	9/64"	.062	14/Card	10◆	100
61436	#217-1/2	15/32"	1/8"	.05	14/Card	10◆	100
MEDIUM EYE							
61311	#104	2-1/16"	31/64"	.225	3/Card	10◆	100
61313	#106	1-13/16"	7/16"	.192	4/Card	10◆	100
61314	#112	1-1/8"	9/32"	.105	10/Card	10◆	100
61315	#114	15/16"	1/4"	.080	12/Card	10◆	100
61090	#108	1-17/32"	25/64"	.162	6/Card	10◆	100
61091	#110	1-5/16"	5/16"	.135	8/Card	10◆	100
LARGE EYE							
61312	#0	2-7/8"	13/16"	.306	2/Card	10◆	100
61307	#2	2-5/8"	23/32"	.262	2/Card	10◆	100
61308	#4	2-3/16"	39/64"	.225	3/Card	10◆	100
61088	#6	1-15/16"	17/32"	.192	4/Card	10◆	100
61309	#8	1-5/8"	15/32"	.162	6/Card	10◆	100
61087	#10	1-3/8"	13/32"	.135	8/Card	10◆	100
61310	#12	1-3/16"	3/8"	.105	10/Card	10◆	100
61413	#14	1-1/16"	11/32"	.08	12/Card	5◆	50
61514	#000	3-7/8"	1"	.36	Bulk w/ UPC	10◆	100
61515	#0	2-7/8"	13/16"	.306	Bulk w/ UPC	20◆	200
61516	#2	2-5/8"	23/32"	.262	Bulk w/ UPC	20◆	200



STAINLESS STEEL

CODE	SIZE	OVERALL LENGTH	INTERIOR DIA. EYE	WIRE DIA.	PACK	INNER	MASTER
LARGE EYE							
61517	#0	2-7/8"	13/16"	.306	Bulk w/ UPC	20◆	200
61474	#2	2-5/8"	23/32"	.262	Bulk w/ UPC	20◆	200
61518	#4	2-3/16"	39/64"	.225	Bulk w/ UPC	20◆	200
61519	#8	1-5/8"	15/32"	.162	Bulk w/ UPC	20◆	200



BRIGHT BRASS – SOLID BRASS

CODE	SIZE	OVERALL LENGTH	INTERIOR DIA. EYE	WIRE DIA.	PACK	INNER	MASTER
SMALL EYE							
61096	#212	15/16"	3/16"	.105	4/Card	10◆	100
61434	#212-1/2	3/4"	3/16"	.105	7/Card	10◆	100
61094	#214	13/16"	5/32"	.080	6/Card	10◆	100
61429	#214-1/2	5/8"	5/32"	.80	7/Card	10◆	100
61422	#216	11/16"	9/64"	.06	7/Card	10◆	100
61430	#216-1/2	17/32"	9/64"	.062	7/Card	10◆	100
61411	#217-1/2	15/32"	1/8"	.05	7/Card	10◆	
LARGE EYE							
61089	#6	1-15/16"	17/32"	.192	4/Card	10◆	100
61443	#8	1-5/8"	15/32"	.162	3/Card	10◆	100
61510	#10	1-3/8"	13/32"	.135	4/Card	10◆	100
61438	#12	1-3/16"	3/8"	.105	5/Card	10◆	100
61431	#14	1-1/16"	1/8"	.05	6/Card	5◆	50

S HOOK



ZINC PLATED – STEEL

CODE	WIRE DIA.	OVERALL LENGTH	STYLE	PACK	INNER	MASTER
LIGHT DUTY						
61304	.08	3/4"	Open	10/Card	10◆	100
61303	.105	1"	Open	8/Card	10◆	100
61417	.092	7/8"	Closed	8/Card	10◆	100
61416	.105	1-1/8"	Closed	6/Card	10◆	100
61415	.125	1-1/4"	Closed	5/Card	10◆	100
61306	.135	1-5/8"	Closed	6/Card	10◆	100
61305	.148	2-1/8"	Closed	4/Card	10◆	100
HEAVY DUTY						
61418	.08	3/4"	Open	8/Card	10◆	100
61419	.105	1"	Open	6/Card	10◆	100
61302	.177	1-1/2"	Open	4/Card	10◆	100
61301	.262	2"	Open	2/Card	10◆	100
61072	.262	2-1/2"	Open	2/Card	10◆	100
61300	.306	3"	Open	2/Card	10◆	100
61530	.262	2"	Open	Bulk w/UPC	30◆	300
61531	.262	2-1/2"	Open	Bulk w/UPC	30◆	300
61486	.306	3"	Open	Bulk w/UPC	30◆	300



STAINLESS STEEL

CODE	WIRE DIA.	OVERALL LENGTH	STYLE	PACK	INNER	MASTER
HEAVY DUTY						
61470	.177	1-1/2"	Open	Bulk w/UPC	20◆	200
61471	.262	2"	Open	Bulk w/UPC	20◆	200
61472	.262	2-1/2"	Open	Bulk w/UPC	20◆	200
61529	.306	3"	Open	Bulk w/UPC	20◆	200



BRIGHT BRASS – SOLID BRASS

CODE	WIRE DIA.	OVERALL LENGTH	STYLE	PACK	INNER	MASTER
LIGHT DUTY						
61512	.092	7/8"	Closed	3/Card	10◆	100
61439	.105	1-1/8"	Closed	2/Card	10◆	100
61511	.125	1-1/4"	Closed	2/Card	10◆	100
HEAVY DUTY						
61441	.08	3/4"	Open	3/Card	10◆	100
61513	.105	1"	Open	3/Card	10◆	100

CLOTHESLINE/SWING HOOK

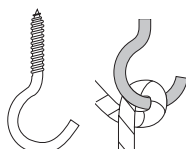

ZINC PLATED – STEEL

CODE	SIZE	WIRE DIA.	PACK	INNER	MASTER
61335	3-3/4"	.283	2/Card	10◆	100

CEILING HOOKS

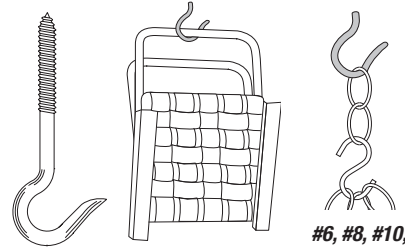

ZINC PLATED – STEEL

CODE	SIZE	OVERALL LENGTH	WIRE DIA.	PACK	INNER	MASTER
61074	#0	4-15/16"	.306	2/Card	10◆	100
61321	#2	4-7/16"	.262	2/Card	10◆	100
61440	#3	4-1/8"	.24	2/Card	10◆	100
61322	#4	3-7/8"	.225	2/Card	10◆	100
61323	#6	3-3/8"	.192	3/Card	10◆	100
61324	#8	2-9/16"	.162	4/Card	10◆	100
61325	#10	2-1/16"	.135	5/Card	10◆	100
61326	#12	1-11/16"	.105	6/Card	10◆	100
61073	#14	1-5/16"	.080	8/Card	10◆	100
61504	#0	4-15/16"	.306	Bulk w/UPC	20◆	200
61407	#2	4-7/16"	.262	Bulk w/UPC	20◆	200
61423	#3	4-1/8"	.24	Bulk w/UPC	20◆	200
61408	#4	3-7/8"	.225	Bulk w/UPC	20◆	200

#0, #2, #4 Size

#6, #8, #10, #12 Size



BRIGHT BRASS – SOLID BRASS

CODE	SIZE	OVERALL LENGTH	WIRE DIA.	PACK	INNER	MASTER
61447	#204	2-9/16"	.16	3/Card	10◆	100
61473	#6	3-3/8"	.192	2/Card	10◆	100
61448	#12	1-11/16"	.105	6/Card	10◆	100

SCREW HOOKS

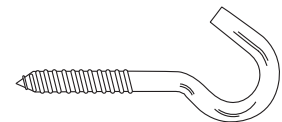

ZINC PLATED – STEEL

CODE	THREAD DIA.	OVERALL LENGTH	PACK	INNER	MASTER
61424	3/8"	4-1/2"	Bulk w/UPC	10◆	100
61425	3/8"	4-7/8"	Bulk w/UPC	10◆	100
61497	3/8"	8"	Bulk w/UPC	10◆	100
61498	3/8"	10"	Bulk w/UPC	10◆	100
61496	5/16"	4-1/2"	Bulk w/UPC	10◆	100
61426	1/4"	4-1/4"	Bulk w/UPC	10◆	100



STAINLESS STEEL

CODE	THREAD DIA.	OVERALL LENGTH	PACK	INNER	MASTER
61488	3/8"	4-7/8"	Bulk w/UPC	10◆	100
61453	1/4"	4-1/4"	Bulk w/UPC	10◆	100

CUP HOOK

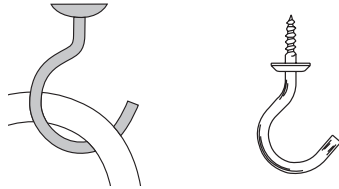

BRASS PLATED – STEEL

CODE	SIZE	WIRE DIA.	PACK	INNER	MASTER
61414	7/8"	.105	2/Card	10◆	100

WHITE VINYL – STEEL

CODE	SIZE	WIRE DIA.	PACK	INNER	MASTER
61420	3/4"	.091	5/card	5◆	50
61421	1-1/2"	.148	2/Card	5◆	50



BRIGHT BRASS – SOLID BRASS

CODE	SIZE	WIRE DIA.	PACK	INNER	MASTER
61329	1/2"	.072	6/Card	10◆	100
61330	5/8"	.080	5/Card	10◆	100
61331	3/4"	.091	5/Card	10◆	100
61332	7/8"	.105	4/Card	10◆	100
61333	1"	.120	4/Card	10◆	100
61334	1-1/2"	.148	2/Card	10◆	100
61076	1-1/4"	.148	2/Card	10◆	100

GATE HOOK AND EYE



ZINC PLATED – STEEL

CODE	SIZE	FINISH	PACK	INNER	MASTER
61428	1"	Zinc	2/Card	10◆	100
61339	1-1/2"	Zinc	3/Card	10◆	100
61338	2"	Zinc	2/Card	10◆	100
61337	2-1/2"	Zinc	2/Card	10◆	100
61336	3"	Zinc	2/Card	10◆	100
35950	6"	Zinc	Clamshell	5◆	40



STAINLESS STEEL

CODE	SIZE	FINISH	PACK	INNER	MASTER
35949	6"	Stainless Steel	Clamshell	5◆	40



BRIGHT BRASS – SOLID BRASS

CODE	SIZE	FINISH	PACK	INNER	MASTER
61435	1"	Brass	2/Card	10◆	100
61508	1-1/2"	Brass	2/Card	10◆	100
61442	2"	Brass	1/Card	10◆	100
61085	2-1/2"	Brass	1/Card	10◆	100
61086	3"	Brass	1/Card	10◆	100

SAFETY GATE HOOK AND EYE

Spring back action



ZINC PLATED – STEEL

CODE	SIZE	PACK	INNER	MASTER
61328	2"	1/Card	10◆	100
61327	2-1/2"	1/Card	10◆	100

Spring backed shield

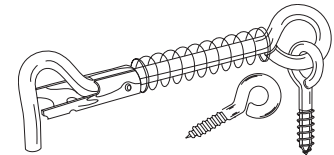

CODE	SIZE	PACK	INNER	MASTER
36930	2-1/2"	2/Card	6◆	72

SHOULDER HOOK

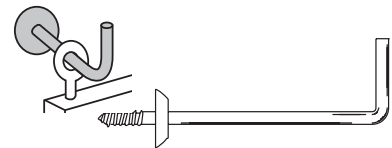

BRIGHT BRASS – SOLID BRASS

CODE	LENGTH OF PROJECTION	WIRE DIA.	PACK	INNER	MASTER
61444	1/2"	.07	5/Card	10◆	100
61445	3/4"	.09	4/Card	10◆	100
61340	1"	.120	3/Card	10◆	100
61446	1-1/4"	.14	2/Card	10◆	100
61095	1-1/2"	.148	2/Card	10◆	100

SQUARE SCREW HOOK

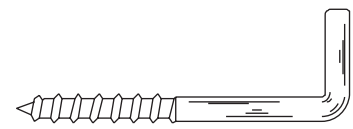
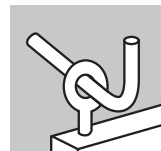

ZINC PLATED – STEEL

CODE	SIZE	OVERALL LENGTH	WIRE DIA.	PACK	INNER	MASTER
61083	#114	1"	.080	10/Card	10◆	100
61341	#112	1-3/8"	.105	8/Card	10◆	100
61343	#110	1-13/16"	.135	6/Card	10◆	100
61082	#108	2-1/4"	.162	4/Card	10◆	100
61081	#106	2-5/8"	.192	3/Card	10◆	100
61080	#104	3"	.225	2/Card	10◆	100



BRIGHT BRASS – SOLID BRASS

CODE	SIZE	OVERALL LENGTH	WIRE DIA.	PACK	INNER	MASTER
61433	#114	1"	.080	5/Card	10◆	100
61432	#112	1-3/8"	.105	5/Card	10◆	100

HOOK BOLT

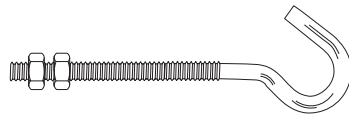

ZINC PLATED – STEEL

CODE	THREAD DIA.	OVERALL LENGTH	PACK	INNER	MASTER
61462	3/8"	7"	Bulk w/UPC	10◆	100
61427	3/8"	10"	Bulk w/UPC	10◆	100
61461	5/16"	5"	Bulk w/UPC	10◆	100



STAINLESS STEEL

CODE	THREAD DIA.	OVERALL LENGTH	PACK	INNER	MASTER
61475	5/16"	5"	Bulk w/UPC	10◆	100

SQUARE U BOLT

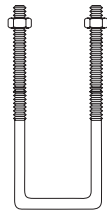

ZINC PLATED – STEEL

CODE	SIZE	THREAD DIA. X LENGTH OF SPREAD X OVERALL LENGTH	PACK	INNER	MASTER
61466	533	5/16" x 2" x 3"	Bulk w/UPC	10◆	100
61489	535	5/16" x 2" x 5"	Bulk w/UPC	10◆	100
61528	657	3/8" x 3" x 7"	Bulk w/UPC	10◆	100
61491	664	3/8" x 3-5/8" x 4"	Bulk w/UPC	5◆	50
61492	665	3/8" x 3-5/8" x 5"	Bulk w/UPC	5◆	50
61493	666	3/8" x 3-5/8" x 6"	Bulk w/UPC	5◆	50
61494	667	3/8" x 3-5/8" x 7"	Bulk w/UPC	5◆	50
61467	673	3/8" x 4" x 3"	Bulk w/UPC	10◆	100
61468	675	3/8" x 4" x 5"	Bulk w/UPC	10◆	100
61490	677	3/8" x 4" x 7"	Bulk w/UPC	10◆	100

U-BOLT PLATE

For Square U-Bolts



ZINC PLATED – STEEL

CODE	SIZE	PACK	INNER	MASTER
61477	5/16" x 2"	Bulk w/UPC	10◆	100
61478	3/8" x 3"	Bulk w/UPC	10◆	100
61495	3/8" x 3-5/8"	Bulk w/UPC	10◆	100
61479	3/8" x 4"	Bulk w/UPC	10◆	100

U BOLT

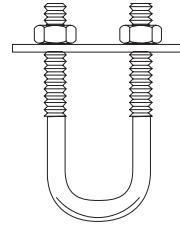

ZINC PLATED – STEEL

CODE	SIZE	THREAD DIA. X LENGTH OF SPREAD X OVERALL LENGTH	PACK	INNER	MASTER
61344	112	1/4" x 3/4" x 2-1/2"	Bulk w/UPC	10◆	100
61476	132	1/4" x 1-1/8" x 2-1/4"	Bulk w/UPC	10◆	100
61345	136	1/4" x 1-1/8" x 3-1/2"	Bulk w/UPC	10◆	100
61353	—	1/4" x 1-3/8" x 3"	Bulk w/UPC	10◆	100
61465	146	1/4" x 1-3/8" x 4"	Bulk w/UPC	10◆	100
61507	512	5/16" x 1-3/8" x 2-1/2"	Bulk w/UPC	10◆	100
61352	516	5/16" x 1-3/8" x 3-3/4"	Bulk w/UPC	10◆	100
61351	522	5/16" x 1-3/4" x 3"	Bulk w/UPC	10◆	100
61350	—	5/16" x 2" x 3"	Bulk w/UPC	10◆	100
61346	546	5/16" x 2-1/2" x 5"	Bulk w/UPC	10◆	100
61347	536	5/16" x 2" x 4-1/2"	Bulk w/UPC	10◆	100
61348	542	5/16" x 2-1/2" x 3-1/2"	Bulk w/UPC	10◆	100
61349	526	5/16" x 1-3/4" x 4-1/4"	Bulk w/UPC	10◆	100
61499	632	3/8" x 2" x 3-1/2"	Bulk w/UPC	10◆	100
61500	642	3/8" x 2" x 4-1/2"	Bulk w/UPC	10◆	100
61501	652	3/8" x 3" x 4-1/2"	Bulk w/UPC	10◆	100
61502	662	3/8" x 3-1/2" x 5-1/4"	Bulk w/UPC	10◆	100



STAINLESS STEEL

CODE	SIZE	THREAD DIA. X LENGTH OF SPREAD X OVERALL LENGTH	PACK	INNER	MASTER
61480	112	1/4" x 3/4" x 2-1/2"	Bulk w/UPC	10◆	100
61481	132	1/4" x 1-1/8" x 2-1/4"	Bulk w/UPC	10◆	100
61482	136	1/4" x 1-1/8" x 3-1/2"	Bulk w/UPC	10◆	100
61469	512	5/16" x 1-3/8" x 2-1/2"	Bulk w/UPC	5◆	50
61483	526	5/16" x 1-3/4" x 4-1/4"	Bulk w/UPC	10◆	100
61484	536	5/16" x 2" x 4-1/2"	Bulk w/UPC	10◆	100
61485	546	5/16" x 2-1/2" x 5"	Bulk w/UPC	10◆	100

EYE BOLT

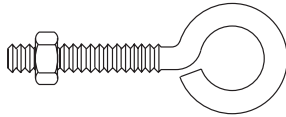

ZINC PLATED – STEEL

CODE	THREAD DIA.	OVERALL LENGTH	PACK	INNER	MASTER
61406	3/16"	1-3/8"	Bulk w/UPC	20◆	200
61520	3/16"	1-1/2"	Bulk w/UPC	20◆	200
61405	3/16"	2"	Bulk w/UPC	20◆	200
61404	3/16"	2-1/2"	Bulk w/UPC	20◆	200
61403	1/4"	2"	Bulk w/UPC	20◆	200
61402	1/4"	2-1/2"	Bulk w/UPC	20◆	200
61396	1/4"	3"	Bulk w/UPC	10◆	100
61397	1/4"	4"	Bulk w/UPC	10◆	100
61398	1/4"	5"	Bulk w/UPC	10◆	100
61399	1/4"	6"	Bulk w/UPC	10◆	100
61400	1/4"	8"	Bulk w/UPC	10◆	100
61454	5/16"	2-1/2"	Bulk w/UPC	10◆	100
61401	5/16"	3-1/4"	Bulk w/UPC	10◆	100
61395	5/16"	4"	Bulk w/UPC	10◆	100
61394	5/16"	5"	Bulk w/UPC	10◆	100
61393	5/16"	6"	Bulk w/UPC	10◆	100
61392	5/16"	8"	Bulk w/UPC	10◆	100
61521	3/8"	3"	Bulk w/UPC	10◆	100
61388	3/8"	4"	Bulk w/UPC	10◆	100
61389	3/8"	5"	Bulk w/UPC	10◆	100
61390	3/8"	6"	Bulk w/UPC	10◆	100
61391	3/8"	8"	Bulk w/UPC	10◆	100
61522	1/2"	4"	Bulk w/UPC	10◆	100
61387	1/2"	6"	Bulk w/UPC	10◆	100
61386	1/2"	8"	Bulk w/UPC	10◆	100
61385	1/2"	10"	Bulk w/UPC	10◆	100
61384	1/2"	12"	Bulk w/UPC	10◆	100



STAINLESS STEEL

CODE	THREAD DIA.	OVERALL LENGTH	PACK	INNER	MASTER
61455	3/16"	1-1/2"	Bulk w/UPC	10◆	100
61456	3/16"	2"	Bulk w/UPC	10◆	100
61457	1/4"	2"	Bulk w/UPC	10◆	100
61458	1/4"	2-1/2"	Bulk w/UPC	10◆	100
61523	1/4"	3"	Bulk w/UPC	10◆	100
61505	1/4"	4"	Bulk w/UPC	10◆	100
61459	5/16"	3-1/4"	Bulk w/UPC	10◆	100
61460	5/16"	4"	Bulk w/UPC	10◆	100
61506	5/16"	5"	Bulk w/UPC	10◆	100
61524	3/8"	4"	Bulk w/UPC	10◆	100
61525	3/8"	5"	Bulk w/UPC	10◆	100
61526	3/8"	6"	Bulk w/UPC	10◆	100
61527	3/8"	8"	Bulk w/UPC	10◆	100

SCREW EYE WITH LAG THREAD

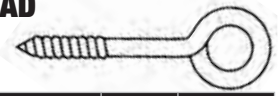

ZINC PLATED – STEEL

CODE	THREAD DIA.	OVERALL LENGTH	PACK	INNER	MASTER
61356	1/4"	3-3/4"	Bulk w/UPC	10◆	100
61355	1/4"	4-1/2"	Bulk w/UPC	10◆	100
61354	1/4"	5"	Bulk w/UPC	10◆	100
61358	5/16"	3-1/4"	Bulk w/UPC	10◆	100
61357	5/16"	4"	Bulk w/UPC	10◆	100
61361	5/16"	4-1/2"	Bulk w/UPC	10◆	100
61360	5/16"	5"	Bulk w/UPC	10◆	100
61359	5/16"	5-1/2"	Bulk w/UPC	10◆	100
61362	5/16"	6"	Bulk w/UPC	10◆	100
61363	3/8"	4"	Bulk w/UPC	10◆	100
61487	3/8"	4-1/2"	Bulk w/UPC	10◆	100
61364	3/8"	5"	Bulk w/UPC	10◆	100
61365	3/8"	5-1/2"	Bulk w/UPC	10◆	100
61366	3/8"	6"	Bulk w/UPC	10◆	100
61367	3/8"	8"	Bulk w/UPC	10◆	100
61449	7/16"	5-1/4"	Bulk w/UPC	10◆	100



STAINLESS STEEL

CODE	THREAD DIA.	OVERALL LENGTH	PACK	INNER	MASTER
61503	1/4"	3-3/4"	Bulk w/UPC	10◆	100
61450	1/4"	5"	Bulk w/UPC	10◆	100
61451	5/16"	4"	Bulk w/UPC	10◆	100
61452	3/8"	4-1/2"	Bulk w/UPC	10◆	100

TURNBUCKLE



Hook to Eye

ZINC PLATED – STEEL

CODE	THREAD DIA.	OVERALL LENGTH	PACK	INNER	MASTER
61374	5/32"	4-3/8"	Bulk w/UPC	10◆	100
61375	3/16"	5-5/8"	Bulk w/UPC	10◆	100
61372	7/32"	6-3/8"	Bulk w/UPC	10◆	100
61373	1/4"	7-3/8"	Bulk w/UPC	10◆	100
61370	5/16"	8-7/8"	Bulk w/UPC	10◆	100
61371	3/8"	10-5/8"	Bulk w/UPC	10◆	100
61369	3/8"	16"	Bulk w/UPC	10◆	100
61368	1/2"	19-1/2"	Bulk w/UPC	1	5

EYE TO EYE

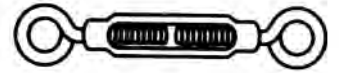

ZINC PLATED – STEEL

CODE	THREAD DIA.	OVERALL LENGTH	PACK	INNER	MASTER
61382	5/32"	4-3/8"	Bulk w/UPC	10◆	100
61383	3/16"	5-5/8"	Bulk w/UPC	10◆	100
61380	7/32"	6-3/8"	Bulk w/UPC	10◆	100
61381	1/4"	7-3/8"	Bulk w/UPC	10◆	100
61378	5/16"	8-7/8"	Bulk w/UPC	10◆	100
61379	3/8"	10-5/8"	Bulk w/UPC	10◆	100
61377	3/8"	16"	Bulk w/UPC	10◆	100
61463	1/2"	17"	Bulk w/UPC	5◆	25
61376	1/2"	19-1/2"	Bulk w/UPC	1	5

WIRE HOOK

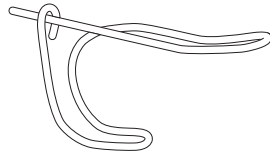

CODE	FINISH	PACK	INNER	MASTER
60850	Brass	2/Card	5◆	50
61009	Zinc	2/Card	10◆	100
60849	Zinc	Polybag w/UPC	100◆	400

STORAGE HOOKS

Bicycle hook; Red vinyl coated

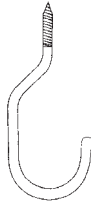

CODE	SIZE	GAUGE	PACK	INNER	MASTER
37025	6" x 2-3/4"	6.7 mm	2/Card	12u	72
60838	6" x 2-3/4"	6.7 mm	Bulk w/UPC	50u	—

Utility hook; Red vinyl coated



CODE	PACK	INNER	MASTER
60839	Bulk w/UPC	50◆	—

Garden tool and utility hook; Red vinyl coated

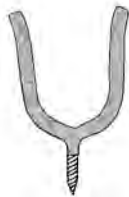

CODE	SIZE	GAUGE	PACK	INNER	MASTER
60840	4" x 2-1/2"	6.5 mm	Bulk w/UPC	50◆	—

Ladder hook; Red vinyl coated



CODE	PACK	INNER	MASTER
60841	Bulk w/UPC	50◆	—

ROPE BINDING HOOK

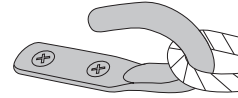

ZINC PLATED – STEEL

CODE	OVERALL LENGTH	WIRE DIA.	PACK	INNER	MASTER
61077	2-1/4"	.212	2/Card	10◆	100
61342	3-3/8"	.306	2/Card	10◆	100

ROPE CLEAT



ZINC PLATED – STEEL

CODE	OVERALL LENGTH	WIRE DIA.	PACK	INNER	MASTER
61078	4-1/2"	.306	2/Card	10◆	100

HAMMOCK HOOK

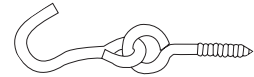

CODE	OVERALL LENGTH	WIRE DIA.	INTERIOR DIA. HOOK	PACK	INNER	MASTER
61079	5-3/4"	.306	15/16"	2/Card	10◆	100

PEG HOOKS

One piece; All metal construction; Scanning plate: 2-1/8" W x 1-3/16"H; Fits standard peg board holes

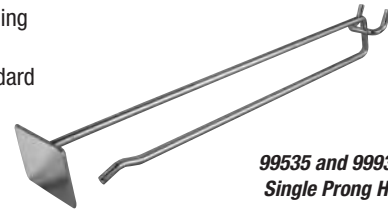

99535 and 99936
Single Prong Hook

CODE	LENGTH	DUTY	PACK	INNER	MASTER
SINGLE PRONG HOOK					
99535	10"	Heavy .212"	Bulk	50◆	100
99936	14"	Extra Heavy .250"	Bulk	50◆	100

DOOR STOPS

Spring Door Stops

Flexible; Cushion bumper tip;
3" Projection



CODE	FINISH	PACK	INNER	MASTER
69999	Brass/US3	2/Card	12◆	144
70084	Antique Brass/US5	2/Card	12◆	50
70085	Chrome/US26	2/Card	12◆	50
95748	Nickel/US14	1/Card	12◆	144
70030	Brass/US3	Polybag w/UPC	10◆	800
70031	Antique Brass/US5	Polybag w/UPC	10◆	800
70000	Brass/US3	Polybag w/UPC	100◆	1000
70001	Antique Brass/US5	Polybag w/UPC	100◆	1000
70026	Satin Nickel/US15	Polybag w/UPC	100◆	1000
70002	Dull Chrome/US26D	Polybag w/UPC	100◆	1000
61700	Brass/US3	Polybag w/UPC, Cut case	50◆	750
61703	Antique Brass/US5	Polybag w/UPC, Cut case	50◆	750
61702	Oil Rubbed Bronze/US10B	Polybag w/UPC, Cut case	50◆	750
61701	Satin Nickel/US15	Polybag w/UPC, Cut case	50◆	750
61705	Chrome/US26	Polybag w/UPC, Cut case	50◆	750
61704	Antique Pewter/US17A	Polybag w/UPC, Cut case	50◆	750
61706	White/USP	Polybag w/UPC, Cut case	50◆	750

Flexible; Cushion bumper tip; Separate screw & base plate; 3" projection; 70051 4" Projection

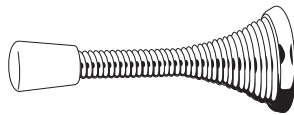

CODE	FINISH	PACK	INNER	MASTER
60998	Brass/US3	2/Card	12◆	144
60997	Antique Brass/US5	2/Card	12◆	50
70088	Oil Rubbed Bronze/US10B	2/Card	12◆	50
70086	White/USP	2/Card	12◆	144
70038	Brass/US3	Polybag w/UPC	10◆	800
70044	Antique Brass/US5	Polybag w/UPC	10◆	800
70032	Satin Nickel/US15	Polybag w/UPC	100◆	1000
70051	Brass/US3	Polybag w/UPC	100◆	1000
70033	Oil Rubbed Bronze/US10B	Polybag w/UPC	100◆	1000
70010	Brass/US3	Bulk	100◆	1000
70050	Satin Nickel/US15	Bulk	50◆	750
70034	Antique Pewter/US17A	Bulk	50◆	750
70055	Chrome/US26	Bulk	50◆	750
70013	White/USP	Bulk	50◆	750

Rigid Door Stops

Angle floor door stop; Hex base; Zinc; Cushion bumper tip; 1" Projection

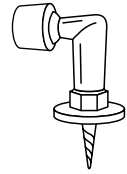

CODE	FINISH	PACK	INNER	MASTER
60993	Brass/US3	2/Card	10◆	100
60994	Antique Brass/US5	2/Card	10◆	100
60842	Brass/US3	Bulk	200◆	—

Heavy duty; Hex base; Zinc; Cushion bumper tip; 4" Projection

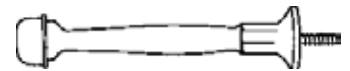

CODE	FINISH	PACK	INNER	MASTER
70006	Brass/US3	Polybag w/UPC	25◆	600
70019	White/USP	Polybag w/UPC	25◆	600
70035	Brass/US3	Polybag w/UPC	10◆	600
70036	Dull Chrome/US26D	Polybag w/UPC	10◆	600

Heavy duty; Hex head; Cushion bumper tip; 3" Projection

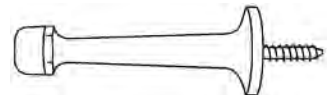

(70009 only)

CODE	FINISH	PACK	INNER	MASTER
70009	Brass/US3	1/Card	12◆	120
70100	Brass/US3	2/Card	5◆	240
70080	Satin Nickel/US15	2/Card	5◆	240
70079	Pewter/US17	2/Card	5◆	240
70078	Chrome/US26	2/Card	5◆	240
70077	White/USP	2/Card	5◆	240

Extra Heavy duty; Zinc Cushion bumper tip; 3" Projection



CODE	FINISH	PACK	INNER	MASTER
60996	Brass/US3	2/Card	10◆	100
60995	Antique Brass/US5	2/Card	5◆	120
70012	Brass/US3	Polybag w/UPC	50◆	400
70052	Satin Nickel/US15	Polybag w/UPC	50◆	400

DOOR STOPS *CONTINUED*

Rigid Door Stops

Heavy duty; Zinc; Cushion bumper tip;
3" Projection

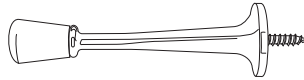

PREMIUM FINISH

CODE	FINISH	PACK	INNER	MASTER
70069	Brass/US3	1/Card	5◆	50
70076	Antique Brass/US5	1/Card	5◆	50
70072	Oil Rubbed Bronze/US10B	1/Card	5◆	50
70073	Satin Nickel/US15	1/Card	5◆	50
70074	Pewter/US17	1/Card	5◆	50
70071	White/USP	1/Card	5◆	50

Hex base; Zinc; Cushion bumper tip; 3" Projection

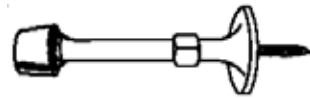

PREMIUM FINISH

BULKY PACKED

CODE	FINISH	PACK	INNER	MASTER
69996	Brass/US3	2/Card	12◆	144
70076	Antique Brass/US5	2/Card	5◆	50
70005	Brass/US3	Polybag w/UPC	50◆	750
70003	Antique Brass/US5	Polybag w/UPC	50◆	500
70025	Satin Nickel/US15	Polybag w/UPC	50◆	750
70024	Dull Chrome/US26D	Polybag w/UPC	50◆	750
61710	Brass/US3	Polybag w/UPC, Cut case	50◆	750
61713	Antique Brass/US5	Polybag w/UPC, Cut case	50◆	750
61712	Oil Rubbed Bronze/US10B	Polybag w/UPC, Cut case	50◆	750
61711	Satin Nickel/US15	Polybag w/UPC, Cut case	50◆	750
61715	Antique Brass/US5	Polybag w/UPC, Cut case	50◆	750
61714	Chrome/US26	Polybag w/UPC, Cut case	50◆	750
61716	White/USP	Polybag w/UPC, Cut case	50◆	750
96351	Nickel/US14	Bulk	25◆	1000

Soft Jam Door Stop



CODE	SIZE	COLOR	PACK	INNER	MASTER
70082	3"	White	2/Card	5◆	50
70083	3"	Almond	2/Card	5◆	50

Wedge Type Door Stop

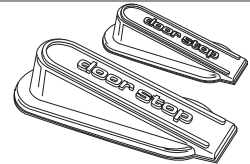

CODE	SIZE	COLOR	PACK	INNER	MASTER
36100	4-1/2"	Brown	2/Card	12◆	192
70097	5"	Brown	2/Card	5◆	500
70098	6"	Grey	1/Card	3◆	90
01013	4-3/4"	Brown	Polybag w/UPC	10◆	100
70093	4"	Brown	Bulk	20◆	500
70094	5"	Brown	Bulk	20◆	500
70095	6"	Grey	Bulk	10◆	200

Door Stop With Holder

Rigid door stop



CODE	SIZE	FINISH	PACK	INNER	MASTER
70067	3"	Brass Plated	1/Card	12◆	50
70068	3"	Chrome	1/Card	5◆	50

Hinge Pin Door Stops

Adjustable; Heavy duty; Zinc; Cushion bumper tips

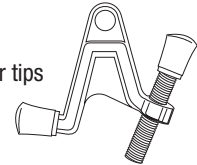

PREMIUM FINISH

CODE	FINISH	PACK	INNER	MASTER
70063	Brass/US3	1/Card	5◆	50
70064	Antique Brass/US5	1/Card	5◆	50
70066	Chrome/US26	1/Card	5◆	50
70065	White/USP	1/Card	5◆	50
70016	Brass/US3	Polybag w/UPC	20◆	480
70099	Antique Brass/US5	Polybag w/UPC	15◆	150
70049	Oil Rubbed Bronze/US10B	Polybag w/UPC	20◆	480
70048	Satin Nickel/US15	Polybag w/UPC	20◆	480
70053	Antique Pewter/US17A	Polybag w/UPC	20◆	480
70020	White/USP	Polybag w/UPC	20◆	480

Adjustable; Deluxe heavy duty steel; Cushion bumper tip

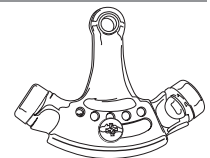

CODE	FINISH	PACK	INNER	MASTER
70021	Brass/US3	Polybag w/UPC	6◆	240

BUILDERS' HARDWARE

HINGE PIN DOOR STOPS *CONTINUED*

Super strong alloy design; Patented

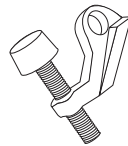

PREMIUM FINISH

CODE	FINISH	PACK	INNER	MASTER
01212	Brass/US3	Polybag w/UPC	50	500
01211	Antique Brass/US5	Polybag w/UPC	50	500
01216	Oil Rubbed Bronze/US10B	Polybag w/UPC	50	500
01214	Satin Nickel/US15	Polybag w/UPC	50	500
01213	Chrome/US26	Polybag w/UPC	50	500

Adjustable; Standard duty; Zinc; Cushion bumper tip

PREMIUM FINISH

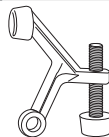

CODE	FINISH	PACK	INNER	MASTER
70057	Brass/US3	1/Card	5◆	50
70062	Oil Rubbed Bronze/US10B	1/Card	5◆	50
70061	Satin Nickel/US15	1/Card	5◆	50
70060	Pewter/US17	1/Card	5◆	50
70059	Chrome/US26	1/Card	5◆	50
70058	White/USP	1/Card	5◆	50
70015	Brass/US3	Polybag w/UPC	60◆	600
70014	Antique Brass/US5	Polybag w/UPC	60◆	600
70040	Oil Rubbed Bronze/US10B	Polybag w/UPC	60◆	600
70039	Satin Nickel/US15	Polybag w/UPC	6◆	600
70042	Antique Pewter/US17A	Polybag w/UPC	60◆	600
70023	Dull Chrome/US26D	Polybag w/UPC	60◆	600
61720	Brass/US3	Polybag w/UPC*	50◆	500
61723	Antique Brass/US5	Polybag w/UPC*	50◆	500
61722	Oil Rubbed Bronze/US10B	Polybag w/UPC*	50◆	500
61721	Satin Nickel/US15	Polybag w/UPC*	50◆	500
61725	Antique Pewter/US17A	Polybag w/UPC*	50◆	500
61724	Chrome/US26	Polybag w/UPC*	50◆	500
61726	White/USP	Polybag w/UPC*	50◆	500

* In Bin Box

Adjustable; Extra heavy duty; Zinc; Cushion bumper tip

PREMIUM FINISH

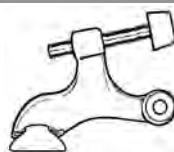

CODE	FINISH	PACK	INNER	MASTER
61000	Brass/US3	1/Card	10◆	100
60999	Antique Brass/US5	1/Card	10◆	100
70017	Brass/US3	Polybag w/UPC	50◆	200
70054	Satin Nickel/US15	Polybag w/UPC	50◆	200

DROP DOWN DOOR HOLDERS

Aluminum; 3 Hole bracket; Replaceable rubber foot (code 87005 pg. 93); Furnished w/screws



CODE	SIZE	FINISH	PACK	INNER	MASTER
35995	4"	Brass/US3	Polybag w/UPC	6◆	120

Heavy duty die cast; 3 Hole bracket; Replaceable rubber foot (code 87005 pg. 93); Furnished w/screws

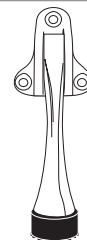

CODE	SIZE	FINISH	PACK	INNER	MASTER
36002	4"	Chrome/US26	Card	6◆	96
36007	4"	Brass/US3	Card	5◆	50
36009	4"	Bronze/US10	Card	6◆	96
96340	4"	Aluminum/US28	Card	10◆	120

Solid brass; 4 Hole bracket; Replaceable rubber tip (code 87007 pg. 93); Furnished w/screws



CODE	SIZE	FINISH	PACK	INNER	MASTER
36015	5"	Brass/US3	Card	6◆	60

Zinc die cast; 4 Hole bracket; Replaceable rubber tip (code 87005 pg. 93); Furnished w/screws



CODE	SIZE	FINISH	PACK	INNER	MASTER
36005	5"	Brass/US3	Card	6◆	60
36000	5"	Aluminum/US28	Card	6◆	60
36010	5"	Bronze/US10	Card	6◆	60
36008	4"	Brass/US3	Polybag w/UPC	6◆	60
36006	4"	Chrome/US26	Polybag w/UPC	6◆	60

BUILDERS' HARDWARE

ROLLER BUMPER DOOR STOP

Zinc; Rubber wheel;
Furnished w/ screws

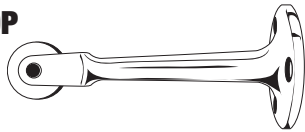

CODE	SIZE	FINISH	PACK	INNER	MASTER
70056	4" Projection	Brass/US3	Polybag w/UPC	12◆	144

FLOOR MOUNT DOOR STOPS

Heavy duty aluminum; 2-1/8" Base diameter;
Furnished with anchors & screws



CODE	SIZE	FINISH	PACK	INNER	MASTER
71017	3" Projection	Dull Brass/US4B	Box	6◆	60
71019	3" Projection	Satin Aluminum/US28	Box	6◆	60

Heavy duty aluminum; 2-1/8" base plate;
3 Hole surface mount; Furnished with spindle, keeper and screws



CODE	SIZE	FINISH	PACK	INNER	MASTER
71016	3-5/8"	Aluminum/US28	Box	6◆	60
71018	3-5/8"	Dull Brass/US4B	Box	10	60

WALL MOUNT DOOR STOPS

Cast aluminum; 2-1/2" Base flange;
3 Hole surface mount; Furnished with screws

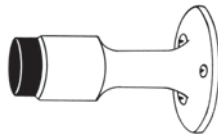

CODE	SIZE	FINISH	PACK	INNER	MASTER
71027	3-1/2"	Dull Brass/US4B	Box	6◆	60
71029	3-1/2"	Satin Aluminum/US28	Box	6◆	60

Cast aluminum; 2-1/2" Base plate; 3 Hole surface mount; Furnished with spindle, keeper and screws and screws

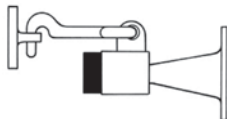

CODE	SIZE	FINISH	PACK	INNER	MASTER
71024	3-1/2"	Aluminum/US28	Box	6◆	60
71026	3-1/2"	Dull Brass/US4B	Box	6◆	60

TELESCOPIC DOOR HOLDER

Extra heavy duty; Foot operated telescopic spring; Furnished w/screws



CODE	SIZE	FINISH	PACK	INNER	MASTER
36030	8"	Aluminum/US28	Box	6◆	36
36035	8"	Bronze/US4B	Box	6◆	36

DOOR STOP REPLACEMENT RUBBER TIPS

For drop down door stop replacement;
Furnished w/screws



CODE	FITS CODE #	COLOR	PACK	INNER	MASTER
87020	Fits codes 36030, 36035	Black	Polybag w/UPC	5◆	200
87005	Fits codes 35995, 36005, 36006, 36008, 36010, 36000, 36002, 36007, 36009, 96340	Brown	Polybag w/UPC	10◆	1000
87007	For code 36015	Brown	Polybag w/UPC	10◆	250

For fit spring, or rigid stops; White rubber; cushion bumper tip



CODE	PACK	INNER	MASTER
87002	50 per Polybag w/UPC	10◆	100

DOOR BUMPERS

Fits most pre-punched metal door jambs;
Virgin rubber; Grey

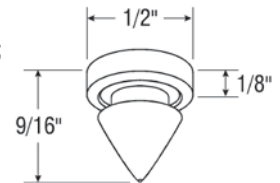

CODE	PACK	INNER	MASTER
12055	1,000 per polybag/Bulk	5	25

DOMED DOOR STOPS

Solid brass; Concealed screw mount;
Vinyl bumper; Furnished w/ anchor and screw

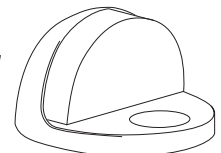

CODE	SIZE	OFFSET	FINISH	PACK	INNER	MASTER
71005	1-3/4" OD	1/8"	Brass/US3	Card	6◆	96
71007	1-3/4" OD	1/8"	Satin Chrome/US26D	Card	6◆	96
71010	1-3/4" OD	1/2"	Brass/US3	Card	6◆	96
71020	1-3/4" OD	1/2"	Satin Chrome/US26D	Card	12◆	120

BUILDERS' HARDWARE

DOME DOOR STOPS *CONTINUED*

Deluxe zinc; Concealed screw mount; Vinyl bumper; Furnished w/ anchor and screw

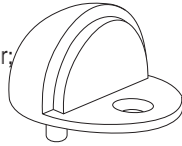

CODE	SIZE	OFFSET	FINISH	PACK	INNER	MASTER
71035	1-3/4" OD	3/16"	Brass/US3	Polybag w/UPC	12◆	240
71040	1-3/4" OD	3/16"	Satin Chrome/US26D	Polybag w/UPC	12◆	240

Zinc; 1-3/8" High, 1-3/4" Base, 1/2" Clearance



CODE	SIZE	OFFSET	FINISH	PACK	INNER	MASTER
96367	1-3/4" OD	1/2"	Dull Chrome/US26D	Card	12◆	144

Aluminum; Vinyl bumper; Furnished with anchor and screws

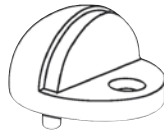

CODE	SIZE	OFFSET	FINISH	PACK	INNER	MASTER
71022	1-5/8" OD	1/2"	Dull Chrome/US26D	Polybag w/UPC	20◆	300

WALL MOUNT DOOR KNOB BUMPERS

Concave face; Grey vinyl bumper; Lacquered finish; Furnished with anchor and screw

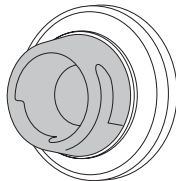

CODE	SIZE	FINISH	PACK	INNER	MASTER
71000	1-7/8" OD	Brass/US3	Card	6◆	192
71006	1-7/8" OD	Satin Chrome/US26D	Card	6◆	192

Deluxe concave face; Grey vinyl bumper; Lacquered finish; Furnished with anchor and screw

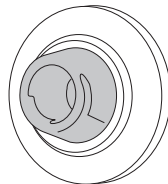

CODE	SIZE	FINISH	PACK	INNER	MASTER
71001	2-3/8" OD	Brass/US3	Card	6◆	96
71003	2-3/8" OD	Satin Chrome/US26	Card	6◆	96
71025	2-1/2" OD	Brass/US3	Polybag w/UPC	12◆	192
71030	2-1/2" OD	Dull Chrome/US26D	Polybag w/UPC	12◆	192
71031	2-1/2" OD	Satin Nickel/US15	Polybag w/UPC	12◆	192

WALL MOUNT DOOR KNOB BUMPERS *CONTINUED*

Convex face; Grey vinyl bumper insert; Die cast base; Furnished w/ anchor and screw

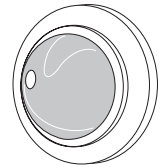

CODE	SIZE	FINISH	PACK	INNER	MASTER
71028	2-1/2" OD	Brass/US3	Polybag w/UPC	12◆	192

Convex face; Vinyl bumper; Stainless steel base; Furnished w/ anchor and screws

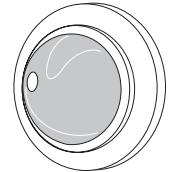

CODE	SIZE	FINISH	PACK	INNER	MASTER
71036	2-1/2" OD	Dull Chrome/US26D	Polybag w/UPC	20◆	200

Convex face; Vinyl cushion; self stick adhesive backing; furnished with screws

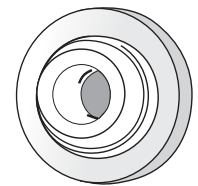

CODE	SIZE	COLOR	PACK	INNER	MASTER
71044	2-1/8" OD	Clear	Card	12◆	240
71042	2-1/8" OD	Clear	Polybag w/UPC	25◆	500
71043	2-1/8" OD	White	Polybag w/UPC	25◆	500

DOOR HOLDERS

Magnetic Door Holder

Heavy full circle magnet; 3-1/8" Diameter projection; 1-3/4" Diameter attach bracket; 2" Diameter base; Dark brown

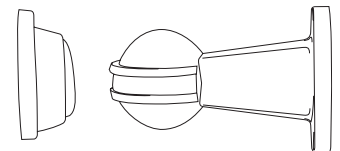

CODE	MATERIAL	PACK	INNER	MASTER
35900	ABS	Box	10◆	60

Plastic Door Stop

2-1/4" overall diameter; 1" height, self-adhesive



CODE	COLOR	PACK	INNER	MASTER
70090	White	2/Card	5◆	50
70091	Almond	2/Card	5◆	50
71043	Brown	2/Card	5◆	50

HINGE PIN DOOR CLOSER

For interior doors up to 60 lbs.;
Spring tension adjustable with wrench;
Fits 3" and 3-1/2" hinges

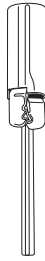

CODE	FINISH	PACK	INNER	MASTER
16165	Brass/US3	Card	10◆	100

WALL PROTECTOR PLATE

Self stick adhesive foam back;
4-1/4" diameter

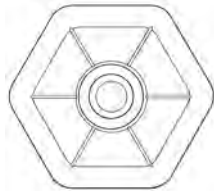

CODE	COLOR	PACK	INNER	MASTER
69909	White	1/Card	5◆	50
69908	Almond	1/Card	5◆	50
69905	Off White	Bulk	50◆	600

Self stick adhesive foam back;
Beveled edge; Neutral white
paintable finish; Hole Templates
included; Self-Adhesive Ring

Self-Adhesive
Ring

Hole Templates
Included

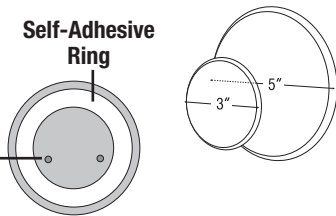

CODE	DIAMETER	FINISH	PACK	INNER	MASTER
57700	3-1/4"	Smooth	Card	10◆	1000
57705	5"	Smooth	Card	10◆	400
69911	3-1/4"	Texture	Card	10◆	1000
69910	5"	Texture	Card	10◆	400
57701	3"	Smooth	Bulk	100◆	1000
57706	5"	Smooth	Bulk	80◆	480

HAND RAIL BRACKETS

Heavy Duty

2-piece zinc construction;
Furnished w/screws



CODE	FINISH	PACK	INNER	MASTER
11036	Satin Nickel/US15	Card	5◆	50
11037	Oil Rubbed Bronze/ US10B	Card	5◆	50
11008	Brass/US3	Polybag w/UPC	25◆	200
11011	Satin Nickel/US15	Polybag w/UPC	25◆	200

HAND RAIL BRACKETS *CONTINUED*

Standard Duty

2-piece zinc construction; Steel under side strap
bracket; Furnished w/screws

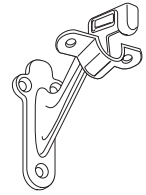

CODE	FINISH	PACK	INNER	MASTER
61005	Brass/US3	Card	5◆	50
61006	Antique Brass/US5	Card	5◆	50
11000R2	Brass/US3	Polybag w/UPC	50◆	200
11006	Antique Brass/US5	Polybag w/UPC	50◆	200
11018	Dull Chrome/ US26D	Polybag w/UPC	50◆	200
61730	Brass/US3	Polybag w/UPC, Cut Case	30◆	180
61733	Antique Brass/US5	Polybag w/UPC, Cut Case	30◆	180
61735	Antique Pewter/US17A	Polybag w/UPC, Cut Case	30◆	180
61732	Oil Rubbed Bronze/US10B	Polybag w/UPC, Cut Case	30◆	180
61734	Chrome/US26	Polybag w/UPC, Cut Case	30◆	180
61731	Satin Nickel/US15	Polybag w/UPC, Cut Case	30◆	180
61736	White	Polybag w/UPC, Cut Case	30◆	180

1 piece zinc construction; For
commercial or residential use;
Furnished w/screws

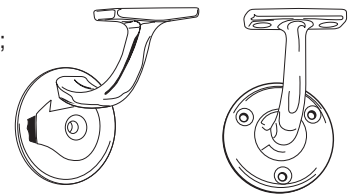

CODE	HOLE	FINISH	PACK	INNER	MASTER
11022	One	Brass/US3	Polybag w/UPC	10◆	100
11001	Three	Brass/US3	Polybag w/UPC	10◆	240
11003	Three	Grey Enamel	Polybag w/UPC	10◆	200
11004	Three	Polished Chrome/ US26	Polybag w/UPC	10◆	240
11007	Three	Dull Chrome/US26D	Polybag w/UPC	10◆	240
11009	Three	Satin Nickel/US15	Polybag w/UPC	10◆	240
11016	Three	Oil Rubbed	Polybag w/UPC	10◆	240

BUILDERS' HARDWARE

DOOR KNOCKERS

Deluxe Solid Brass

- Solid brass door viewer
- Lacquered finish
- Furnished with thru bolts



Overall size 3-1/2" x 8"; w/160° viewer



CODE	FINISH	PACK	INNER	MASTER
43097	Brass/US3	Card	12	72
43098	Brass/US3	Box	25◆	25

Overall size 3-1/2" x 7-5/8"; w/o viewer



CODE	FINISH	PACK	INNER	MASTER
43090	Brass/US3	Card	3◆	72

Overall size 3-3/4" x 7-1/4"; w/160° viewer



PREMIUM FINISH



CODE	FINISH	PACK	INNER	MASTER
43116	Satin Nickel/US15	Card	3◆	48

Overall size 3-1/4" x 6-1/2"; w/o viewer



CODE	FINISH	PACK	INNER	MASTER
43211	Brass/US3	Card	6◆	60

Overall size 3-1/4" x 6-1/2"; w/160° viewer



PREMIUM FINISH



CODE	FINISH	PACK	INNER	MASTER
43217	Satin Nickel/US15	Clamshell	3◆	48
43212	Brass/US3	Card	6◆	60

Zinc Die Cast

- Lacquered finish
- Engraveable
- 1/2" Diameter plastic lens viewer where noted

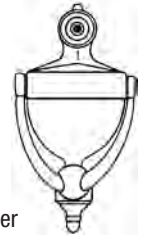

Overall size 3" x 5-1/2"; w/160° viewer; solid brass viewer

CODE	FINISH	PACK	INNER	MASTER
43210	Brass/US3	Card	12◆	120

Overall size 2-1/8" x 4-3/4"; 43100 w/160° viewer; 43103 w/o viewer; 2" by 5/8" name plate



CODE	FINISH	PACK	INNER	MASTER
43100	Brass/US3	Card	12◆	120
43103	Brass/US3	Card	12◆	192

Overall size 2" x 4"; w/160° viewer



CODE	FINISH	PACK	INNER	MASTER
43200	Brass/US3	Card	12◆	192

Overall size 2-3/4" x 5-1/2"; w/180° viewer; solid brass viewer



CODE	FINISH	PACK	INNER	MASTER
43231	Satin Nickel/US15	Card	12◆	120
43230	Brass/US3	Card	12◆	120
43235	Antique Brass/US5	Card	12◆	120
43201	Oil Rubbed Bronze/US10B	Polybag w/UPC	12◆	120

DOOR VIEWERS

Plastic lens; Fits doors 1-5/8" to 2-11/16" thick (42mm - 68mm)

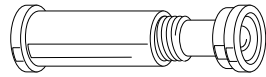

Plastic lens; Viewer fits doors 1-1/2" to 2-1/4"

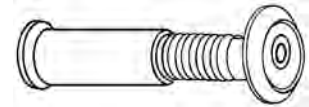

PREMIUM FINISH

CODE	LENS ANGLE	INSTALLATION HOLE	FINISH	PACK	INNER	MASTER
94017	160°	1/2"	Brass/US3	Box	25◆	300

CODE	LENS ANGLE	INSTALLATION HOLE	FINISH	PACK	INNER	MASTER
94005	180°	9/16"	Brass/US3	Card	12◆	600
94010	180°	9/16"	Chrome/US26	Card	12◆	600
94006	180°	9/16"	Brass/US3	Box	12◆	600
94028	180°	1/2"	Brass/US3	Box	12◆	600
94026	180°	9/16"	Oil Rubbed Bronze/US10B	Box	5◆	600
94001	180°	9/16"	Satin Nickel/US15	Box	12◆	600

One-way door viewer; Plastic lens; Fits doors 1-3/8" to 2-1/4" thick

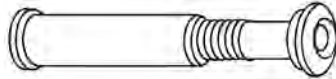

PREMIUM FINISH

CODE	LENS ANGLE	INSTALLATION HOLE	FINISH	PACK	INNER	MASTER
60914	160°	1/2"	Brass/US3	Card	5◆	100
94000	160°	1/2"	Brass/US3	Card	6◆	600
94002	160°	1/2"	Satin Nickel/US15	Card	6◆	600
94003	160°	1/2"	Brass/US3	Box	12◆	600
94016	160°	1/2"	Oil Rubbed Bronze/US10B	Box	5◆	600

Plastic lens; Adjusts for doors from 1-3/8" to 2-3/8"

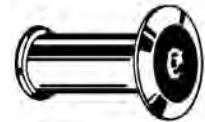

CODE	LENS ANGLE	INSTALLATION HOLE	FINISH	PACK	INNER	MASTER
60915	200°	5/8"	Brass/US3	Card	5◆	100
94025	200°	5/8"	Brass/US3	Card	12◆	480
94030	200°	5/8"	Chrome/US26	Card	12◆	480
94027	200°	5/8"	Brass/US3	Box	24◆	336

Solid brass; Fire door application; One glass and two resin lenses; Adjusts for doors from 1-3/8" to 2"



PREMIUM FINISH

CODE	LENS ANGLE	INSTALLATION HOLE	FINISH	PACK	INNER	MASTER
94031	160°	1/2"	Satin Nickel/US15	Box	10◆	600
94014	200°	9/16"	Brass/US3	Box	12◆	480

Zinc; Plastic lens; Fits doors 1-1/2" to 2-1/4"



CODE	LENS ANGLE	INSTALLATION HOLE	FINISH	PACK	INNER	MASTER
94007	180°	9/16"	Brass/US3	Card	12◆	600
94024	180°	9/16"	Oil Rubbed Bronze/US10B	Card	5◆	600
94022	180°	9/16"	Satin Nickel/US15	Card	5◆	600
94009	180°	9/16"	Chrome/US26	Card	12◆	600
94021	180°	9/16"	Dull Chrome/US26D	Card	5◆	600
94008	180°	9/16"	Brass/US3	Box	12◆	600
94027	180°	9/16"	Chrome/US26	Box	12◆	600

Solid brass; One-way door viewer; Viewer fits doors 1-3/8" to 2"; One glass & two resin lenses

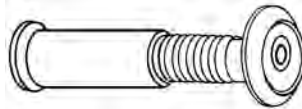

CODE	LENS ANGLE	INSTALLATION HOLE	FINISH	PACK	INNER	MASTER
94012	160°	1/2"	Satin Chrome/US26D	Box	12◆	600

Solid brass; Glass lens; Privacy plate; 7/8" Diameter viewer; Adjusts for doors from 1-3/8" to 2-3/8"

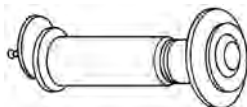

CODE	LENS ANGLE	INSTALLATION HOLE	FINISH	PACK	INNER	MASTER
94020	160°	7/8"	Brass/US3	Box	6◆	240

PROJECTION DOOR VIEWERS

Wide angle; High quality optical plastic lens; Fits doors from 1-3/4" to 2" thickness; One-way door viewing; Large 2" projection screen on inside of door



CODE	INSTALLATION HOLE	FINISH	PACK	INNER	MASTER
94044	1-1/2"	White	Clamshell	10	60
94046	1-1/2"	Bronze	Clamshell	10	60

DOOR CHIME & VIEWER

Non-Electric; White body; 180° Lens Angle; One-way door viewer; Two note mechanical audible door chime; Inside safety shutter mechanism

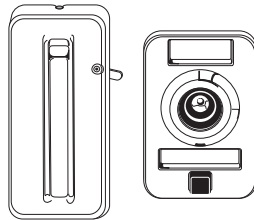

No Wiring No Batteries No Electricity

CODE	FINISH	DOOR SIZE	PACK	INNER	MASTER
97476	Brass/US3	1-1/8" x 2"	Display Box	1	24
97477	Dull Chrome/US26D	1-1/8" x 2"	Display Box	1	24

DOORBELL

Non-Electric

Thumb turn door bell; Fits all doors: 1-3/8" to 2" thick; 5/16" Square connecting shaft; Installs with a 5/16" hole; Outside plate surface mounts with two screws; Specifications: Outside turn plate: 1-5/8" x 3-3/4" Inside bell diameter: 3"

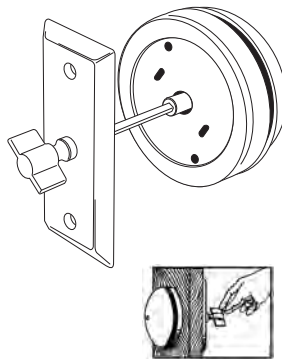

CODE	FINISH	PACK	INNER	MASTER
03200	Brass/US3	Card	6♦	48

MAILBOXES

Heavy gauge black plastic body; Top loading waterproof flap; Hasp eye for use with padlock (padlock not included); Furnished w/screws

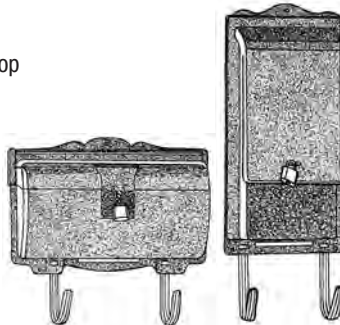

CODE	MATERIAL	SIZE	PACK	INNER	MASTER
10215	Plastic	6" W x 12-1/2" H	Box	1	12
10225	Plastic	12" W x 7-7/8" H	Box	1	6

MAILBOX LOCKS

Steel construction; Cylinder 1/8" offset; Overall length of tongue equals; 1/2" & retracts to 1/4"; 1-5/16" High; Flat steel key blank (T-146)

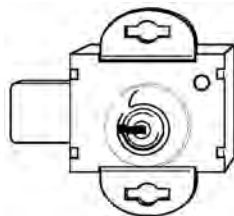

CODE	FINISH	KEYED	PACK	INNER	MASTER
44602	Brass/US3	KD	Polybag w/UPC	24♦	576

DISC TUMBLER CAM LOCKS

- For apartment house type mailboxes;
- 90° Open cam turn
- Adjustable thumb nut



Key removable in locked positions only; Furnished w/3 different offset cams and 2 keys

CODE	SIZE	FINISH	KEYED	PACK	INNER	MASTER
44603	3/4"	Chrome/US26	KD	Card	12♦	240
44604	3/4"	Chrome/US26	KD	Polybag w/UPC	12♦	240

Zinc; Furnished w/ 2 different offset cams and 2 keys

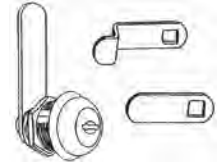

CODE	SIZE	FINISH	KEYED	PACK	INNER	MASTER
43800	5/8"	Nickel/US14	KD	Card	12♦	120
43805	5/8"	Nickel/US14	KA	Card	12♦	120
43813	7/8"	Nickel/US14	KD	Card	12♦	240
43807	5/8"	Nickel/US14	KA	Polybag w/UPC	12♦	360
43810	5/8"	Nickel/US14	KD	Polybag w/UPC	12♦	360
43812	7/8"	Nickel/US14	KD	Polybag w/UPC	12♦	240

Zinc alloy pin tumbler; Furnished w/5 different offset cams and 2 keys HL1

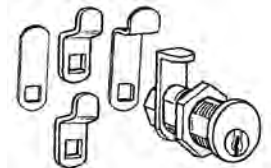

CODE	SIZE	FINISH	KEYED	PACK	INNER	MASTER
44606	3/4"	Chrome/US26	KD	Card	12♦	240
44607	3/4"	Chrome/US26	KD	Polybag w/UPC	12♦	240

Zinc alloy pin tumbler; Furnished w/ 5 different offset cams and 2 keys HL1

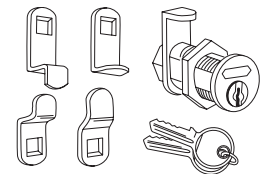

CODE	SIZE	FINISH	KEYED	PACK	INNER	MASTER
97492	Multi	Brass/US3	KD	Polybag w/UPC	12♦	240
96930	Multi	Dull Chrome/US26D	KD	Polybag w/UPC	12♦	240

Steel construction; Overall size: 1-1/2" W x 1-3/4" H; Furnished w/2 keys; T146 key blank

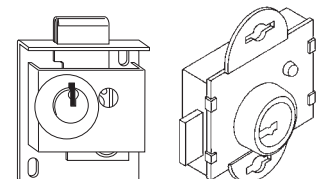

CODE	FINISH	KEYED	PACK	INNER	MASTER
44605	Brass/US3	KD	Card	12♦	300
96929	Brass/US3	KD	Box	12♦	300
44600	Brass/US3	KD	Card	12♦	300

LETTER SLOTS

Screen & Storm Doors



Push-in spring loaded flap; Outside: 8-1/4" x 2-5/8"; Inside: 6-1/4" x 1-1/2"; Meets postal regulations; Furnished w/ nuts & bolts

CODE	MATERIAL	FINISH	PACK	INNER	MASTER
67040	Aluminum	Anodized	Polybag w/UPC	6◆	288
67045	Aluminum	White	Polybag w/UPC	6◆	288
67050	Aluminum	Black	Polybag w/UPC	6◆	288



Full hinged spring loaded single gravity flap; Outside: 3" x 13"; Inside opening: 1-5/8" x 11-1/2"

CODE	MATERIAL	FINISH	PACK	INNER	MASTER
67107	Aluminum	Brass/US3	Box	5◆	25
67108	Aluminum	Satin	Box	5◆	25

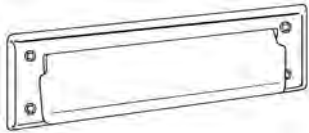

Spring loaded flap opening; Outside: 3" x 10"; Inside opening: 1-5/8" x 7-3/4" Polished brass finish; Openings conform to postal regulations; Furnished w/matching inside trim plate and screws

CODE	MATERIAL	FINISH	PACK	INNER	MASTER
SINGLE FLAP: OUTSIDE					
67100	Steel	Brass/US3	Polybag w/UPC	6◆	72
DOUBLE FLAP: INSIDE & OUTSIDE					
67105	Steel	Brass/US3	Polybag w/UPC	6◆	48
67104	Steel	Brass/US3	Polybag w/UPC	3◆	36

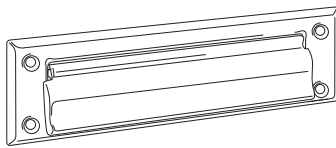

Solid brass magazine slot; Includes covered backplate; Polybag pack w/o screws; Card Pack w/screws



CODE	SIZE	OPENING	FINISH	PACK	INNER	MASTER
67030	3-1/2" x 13"	2-1/2" x 11"	Brass/US3	Polybag w/UPC	6	24
67031	3-1/2" x 13"	2-1/2" x 11"	Antique Brass/US5	Polybag w/UPC	6	24
67041	3-1/2" x 13"	3-1/2" x 13"	Oil Rubbed Brass/US10B	Clam	5◆	30

BUILDERS' HARDWARE



Deluxe solid brass; Fully hinged spring loaded single or double gravity flap; Openings conform to postal regulations; Furnished w/screws



CODE	MATERIAL	FINISH	PACK	INNER	MASTER
3" X 10" OUTSIDE FLAP WITH INSIDE FRAME					
67022	Solid Brass	Brass/US3	Box	3◆	48
3" X 10" OUTSIDE & INSIDE FLAPS					
67023	Solid Brass	Brass/US3	Box	3	36
67024	Solid Brass	Antique Brass/US5	Box	3	45
67021	Solid Brass	Satin Nickel/US15	Box	3	48
2-7/8" X 8-3/4" OUTSIDE FLAP WITH INSIDE FRAME					
67029	Solid Brass	Brass/US3	Card	5◆	30
2-5/16" X 13" OUTSIDE FLAP WITH INSIDE FRAME					
67027	Solid Brass	Brass/US3	Box	3◆	24
67034	Solid Brass	Satin Nickel/US15	Card	5◆	30

DOOR SLEEVE

Furnished w/screws



CODE	MATERIAL	SIZE	PACK	INNER	MASTER
67060	Stainless Steel	8-1/8" x 2"	Box	5◆	25
67062	Stainless Steel	11-3/8" x 2-5/8"	Box	5◆	25

HOUSE NUMBERS

Solid brass; Anti-tarnish lacquer finish; Furnished w/ solid brass screws



HOUSE #	SIZE	BRASS/US3	PACK	INNER	MASTER
0	4"	53000	Card	6♦	198
1	4"	53005	Card	6♦	198
2	4"	53010	Card	6♦	198
3	4"	53015	Card	6♦	198
4	4"	53020	Card	6♦	198
5	4"	53025	Card	6♦	198
6	4"	53030	Card	6♦	198
7	4"	53035	Card	6♦	198
8	4"	53040	Card	6♦	198
9	4"	53045	Card	6♦	198

HOUSE #	SIZE	SATIN NICKEL/US15	POLISHED CHROME/US26	PACK	INNER	MASTER
0	4"	53130	53110	Card	5♦	100
1	4"	53131	53111	Card	5♦	100
2	4"	53132	53112	Card	5♦	100
3	4"	53133	53113	Card	5♦	100
4	4"	53134	53114	Card	5♦	100
5	4"	53135	53115	Card	5♦	100
6	4"	53136	53116	Card	5♦	100
7	4"	53137	53117	Card	5♦	100
8	4"	53138	53118	Card	5♦	100
9	4"	53139	53119	Card	5♦	100

Zinc; Rustproof, weatherproof; Furnished w/ brass nails



HOUSE #	SIZE	BRASS PLATED/US3	PACK	INNER	MASTER
0	4"	52000	Card	12♦	600
1	4"	52005	Card	12♦	600
2	4"	52010	Card	12♦	600
3	4"	52015	Card	12♦	600
4	4"	52020	Card	12♦	600
5	4"	52025	Card	12♦	600
6	4"	52030	Card	12♦	600
7	4"	52035	Card	12♦	600
8	4"	52040	Card	12♦	600
9	4"	52045	Card	12♦	600

HOUSE #	SIZE	BLACK PAINTED	PACK	INNER	MASTER
0	4"	51900	Polybag w/UPC	12♦	600
1	4"	51905	Polybag w/UPC	12♦	600
2	4"	51910	Polybag w/UPC	12♦	600
3	4"	51915	Polybag w/UPC	12♦	600
4	4"	51920	Polybag w/UPC	12♦	600
5	4"	51925	Polybag w/UPC	12♦	600
6	4"	51930	Polybag w/UPC	12♦	600
7	4"	51935	Polybag w/UPC	12♦	600
8	4"	51940	Polybag w/UPC	12♦	600
9	4"	51945	Polybag w/UPC	12♦	600

BUILDERS' HARDWARE

KICKPLATES

For commercial or residential door use; Protection for all types of surfaces; Heavy gauge .040 thick material; Furnished with sheet metal screws

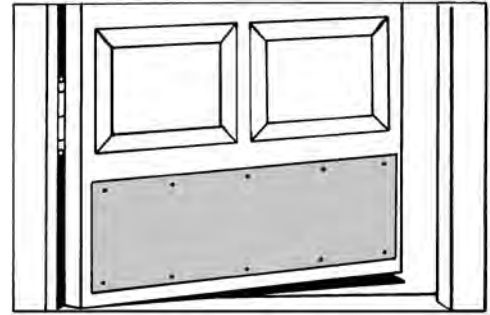

Solid Brass

Stainless Steel

SIZE	BRASS/ US3	ANTIQU BRASS/US5	SOIL RUBBED BRONZE/US10B	SATIN NICKEL/ US15	DULL CHROME/ US26D	STAINLESS STEEL/US32	PACK	INNER
6" x 30"	57828						Polybag w/UPC	3◆
6" x 32"	57830						Polybag w/UPC	3◆
6" x 34"	57835				57849		Polybag w/UPC	3◆
6" x 36"	57840						Polybag w/UPC	3◆
8" x 30"	57843						Polybag w/UPC	3◆
8" x 32"	57845						Polybag w/UPC	3◆
8" x 34"	57850	57852			57859		Polybag w/UPC	3◆
8" x 36"	57855						Polybag w/UPC	3◆
6" x 34"	57834			57832			Box	3◆
8" x 34"	57851		57854	57833		57875	Box	3◆

Aluminum

SIZE	SATIN ANODIZED*	GOLD ANODIZED*	PACK	INNER
6" x 30"	57867	57862	Polybag w/UPC	3◆
6" x 32"	57800		Polybag w/UPC	3◆
6" x 34"	57805	57860	Polybag w/UPC	3◆
6" x 36"	57810		Polybag w/UPC	3◆
8" x 30"	57813		Polybag w/UPC	3◆
8" x 32"	57815		Polybag w/UPC	3◆
8" x 34"	57820	57865	Polybag w/UPC	3◆
8" x 36"	57825		Polybag w/UPC	3◆

BUILDERS' HARDWARE

MULTI-HOOK WALL MOUNTS

Heavy duty zinc hooks; 10" Overall length wood board; 3-3/4" Projection; 4-1/2" Overall hook length; Furnished w/screws

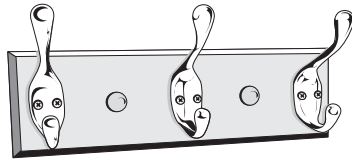

CODE	HOOK FINISH	WOOD FINISH	PACK	INNER	MASTER
37072	Brass/US3	Oak	Card	3◆	30
37073	Chrome/US26	Natural Maple	Card	3◆	30
37071	Satin Nickel/US15	White Board	Card	3◆	30

Zinc hooks; 16" Overall length wood board; 1-1/2" Projection; 2-7/8" Overall hook length; Furnished w/screws

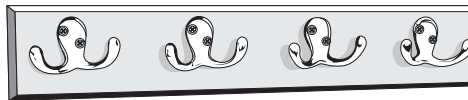

CODE	HOOK FINISH	WOOD FINISH	PACK	INNER	MASTER
37075	Brass/US3	Oak	Card	3◆	30
37076	Chrome/US26	Natural Maple	Card	3◆	30
37074	Satin Nickel/US15	White Board	Card	3◆	30

WARDROBE HOOKS

Solid brass construction; Single hook, 1-1/4" W x 1-5/8" projection; Double hook 2-7/8" W x 1-1/2" projection; Furnished w/screws

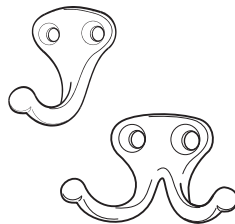

CODE	MATERIAL	FINISH	PACK	INNER	MASTER
38066	Brass/US3	Single	Polybag w/UPC	20◆	300
38058	Chrome/US26	Single	Polybag w/UPC	20◆	300
38068	Brass/US3	Double	Polybag w/UPC	20◆	300
38064	Chrome/US26	Double	Polybag w/UPC	20◆	300

1-1/2" Projection; 1-1/2" Wide; Furnished w/screws

PREMIUM FINISH



CODE	MATERIAL	FINISH	PACK	INNER	MASTER
37106	Zinc	Brass/US3	2/Card	5◆	200
37100	Zinc	Oil Rubbed Bronze/US10B	2/Card	5◆	200
37099	Zinc	Satin Nickel/US15	2/Card	5◆	200
37111	Zinc	Pewter/US17	2/Card	5◆	200
37109	Zinc	Chrome/US26	2/Card	5◆	200
37108	Zinc	White	2/Card	5◆	200
37004	Zinc	Brass/US3	Polybag w/UPC	25◆	800

WARDROBE HOOKS CONTINUED

1-1/4" Projection; 2-1/4" Wide; Furnished w/screws

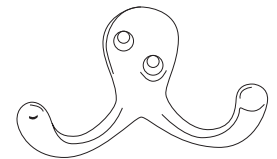

PREMIUM FINISH

CODE	MATERIAL	FINISH	PACK	INNER	MASTER
37113	Zinc	Brass/US3	2/Card	5◆	100
37119	Zinc	ORB/US10B	2/Card	5◆	100
37118	Zinc	Satin Nickel/US15	2/Card	5◆	100
37114	Zinc	Nickel	2/Card	5◆	100
37115	Zinc	White	2/Card	5◆	100
37066	Zinc	Brass/US3	Polybag w/UPC	60◆	600
37068	Zinc	Satin Nickel/US15	Polybag w/UPC	60◆	600
37067	Zinc	Chrome/US26	Polybag w/UPC	60◆	600
37112	Zinc	Nickel/US15A	Polybag w/UPC	10◆	250

COAT & HAT HOOKS

Solid brass; Lacquered finish; 3-1/4" Projection; Furnished w/screws

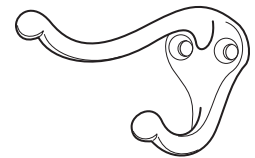

CODE	FINISH	PACK	INNER	MASTER
37005	Brass/US3	Card	6◆	120

Heavy duty; Zinc; 2-7/8" Projection; Furnished w/screws

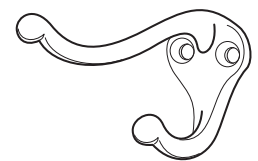

CODE	FINISH	PACK	INNER	MASTER
61007	Brass/US3	2/Card	5◆	50
61008	Antique Brass/US5	2/Card	5◆	50
37006	Brass/US3	Polybag w/UPC	25◆	300
38056	Chrome/US26	Polybag w/UPC	20◆	300

COAT & HAT HOOKS *CONTINUED*

Light duty; Zinc; 3" Projection;
Furnished w/screws

PREMIUM FINISH



Light duty; Zinc; 3" Projection;
Furnished w/screws

PREMIUM FINISH

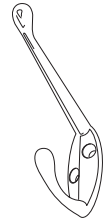

CODE	FINISH	PACK	INNER	MASTER
37015	Antique Brass/US5	2/Card	5◆	50
37018	White	2/Card	5◆	50
37019	Chrome/US26	2/Card	5◆	50
37022	Satin Nickel/US15	2/Card	5◆	50
37014	Brass/US3	2/Card	5◆	50
37016	Satin Nickel/US15	2/Card	5◆	50
96797	Chrome/US26	Polybag w/UPC	20◆	1000
37000	Brass/US3	Polybag w/UPC	50◆	1000
60848	Brass/US3	Polybag w/UPC	100◆	1000
37001	Antique Brass/US5	Polybag w/UPC	100◆	1000
37003	White	Polybag w/UPC	50◆	1000
37009	Satin Nickel/US15	Polybag w/UPC	50◆	1000
37013	Oil Rubbed Bronze/US10B	Polybag w/UPC	50◆	100
37002	Nickel	Polybag w/UPC	5◆	200

CODE	FINISH	PACK	INNER	MASTER
37036	Brass/US3	1/Card	5◆	200
37047	Oil Rubbed Bronze/US10B	1/Card	5◆	200
37046	Chrome/US26	1/Card	5◆	200
37030	Nickel	1/Card	5◆	200
37037	White/USP	1/Card	5◆	200
37055	Brass/US3	Polybag w/UPC	60◆	360
37060	White	Polybag w/UPC	20◆	360
37056	Brass/US3	Polybag w/UPC	50◆	360
37057	Chrome/US26	Polybag w/UPC	50◆	300

Heavy duty; Zinc; Projection: 37007 - 3-3/4", 37088 - 3-9/16";
Furnished w/screws

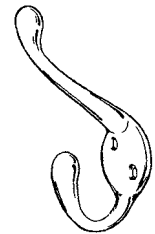

Zinc; 3-9/16" projection; Furnished
w/ screws



CODE	FINISH	PACK	INNER	MASTER
37120	Brass/US3	1/Card	5◆	200
37121	White/USP	1/Card	5◆	200

CODE	SIZE	FINISH	PACK	INNER	MASTER
37101	4-1/2" OD	Brass/US3	1/Card	5◆	50
37093	4-1/2" OD	Satin Nickel/US15	1/Card	5◆	50
37103	4-1/2" OD	Chrome/US26	1/Card	5◆	50
37102	4-1/2" OD	White	1/Card	5◆	50
37088	4-1/2" OD	Nickel/US15	Card	5◆	50

Heavy duty; Zinc; 3-1/4" Projection;
1-1/4" by 2" Base; Furnished w/
screws

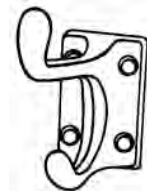

CODE	FINISH	PACK	INNER	MASTER
37008	Brass/US3	Polybag	30◆	300

STRAP HINGES

Extra Heavy Duty

Tight pin; Standard hole pattern

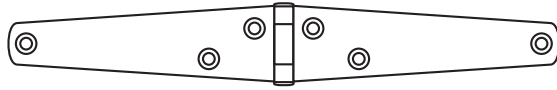

CODE	SIZE	MATERIAL	FINISH	PACK	INNER	MASTER
35735	4"	Steel	Zinc	Box	6 Pair◆	96
35745	6"	Steel	Zinc	Box	3 Pair◆	36
35750	8"	Steel	Zinc	Box	2 Pair◆	20

Heavy Duty

Carded w/screws; Bulk w/o screws

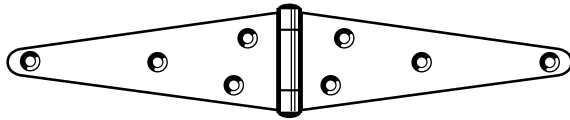

CODE	SIZE	FINISH	PACK	INNER	MASTER
96643	5"	Zinc	2/Card	2◆	24
96644	6"	Zinc	2/Card	2◆	24
96645	8"	Zinc	2/Card	2◆	24
60807R1	4"	Zinc	Bulk w/UPC	10◆	100
60808R1	5"	Zinc	Bulk w/UPC	10◆	50
60809R1	6"	Zinc	Bulk w/UPC	10◆	50
60810R1	8"	Zinc	Bulk w/UPC	5◆	30
60806R1	10"	Zinc	Bulk w/UPC	5◆	20
60631	12"	Zinc	Bulk w/UPC	5◆	20
96639	6"	Zinc	Bulk	3 Pair◆	48

Corrosion resistant finish; Carded w/ screws; Box and bulk w/o screws



GALVANIZED
All Weather

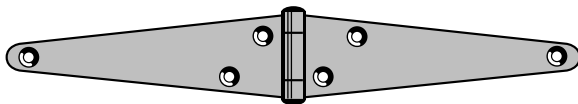

CODE	SIZE	MATERIAL	FINISH	PACK	INNER	MASTER
35758	4"	Steel	Galvanized	Box	3 Pair◆	60
61106	5"	Steel	Galvanized	2/Card	2 Pair◆	24
35757	6"	Steel	Galvanized	Box	3 Pair◆	30
61066	8"	Steel	Galvanized	Bulk w/UPC	5◆	20

Heavy Duty *continued*

Furnished w/ lag screws



CODE	SIZE	MATERIAL	FINISH	PACK	INNER	MASTER
35951 NEW	6"	Stainless Steel	SS	1/Clamshell	5◆	40
35914 NEW	8"	Stainless Steel	SS	1/Clamshell	5◆	40
35915 NEW	8"	Steel	Black	1/Clamshell	5◆	40
89355	4"	Steel	Black	1/Polybag	10◆	100
89360	6"	Steel	Black	1/Polybag	10◆	100
89365R1	8"	Steel	Black	2/Polybag	5◆	20

Light Duty

Carded w/screws; Bulk w/o screws

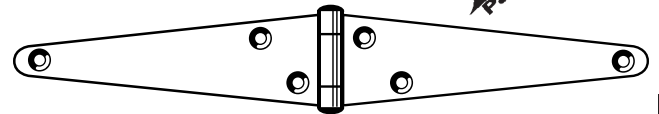

CODE	SIZE	FINISH	PACK	INNER	MASTER
60933	2"	Zinc	2/Card	10◆	100
60934	3"	Zinc	2/Card	10◆	100
60935	4"	Zinc	2/Card	10◆	100
60936	5"	Zinc	2/Card	10◆	100
61020	6"	Zinc	2/Card	10◆	100
60798	2"	Zinc	Bulk w/UPC	10◆	240
60799	3"	Zinc	Bulk w/UPC	10◆	240
60797	4"	Zinc	Bulk w/UPC	10◆	240
60801	5"	Zinc	Bulk w/UPC	10◆	240
60805R1	6"	Zinc	Bulk w/UPC	50◆	100
96666	2"	Zinc	Bulk	12 Pair◆	288
96668	3"	Zinc	Bulk	12 Pair◆	240

Corrosion resistant finish; Non-removable pin; Standard hole pattern; Furnished w/screws

GALVANIZED
All Weather

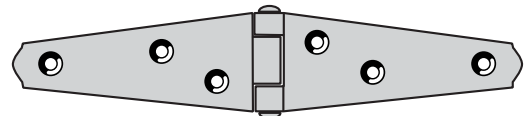

CODE	SIZE	FINISH	PACK	INNER	MASTER
61033	2"	Galvanized	2/Card	10◆	100
61034	3"	Galvanized	2/Card	10◆	100
61035	4"	Galvanized	2/Card	10◆	100
61107	5"	Galvanized	2/Card	10◆	100
61108	6"	Galvanized	2/Card	10◆	100

T-HINGES

Extra Heavy Duty

Tight pin; Carded w/screws;
Box and bulk w/o screws

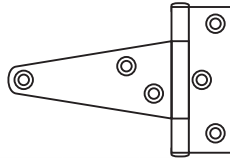

CODE	SIZE	MATERIAL	FINISH	PACK	INNER	MASTER
96770	5"	Steel	Zinc	2/Card	2◆	24
96771	6"	Steel	Zinc	2/Card	2◆	24
96772	8"	Steel	Zinc	2/Card	2◆	12
35952 NEW	6"	Stainless Steel	SS	Clamshell	5◆	40
35916 NEW	8"	Stainless Steel	SS	Clamshell	5◆	40
35953 NEW	6"	Steel	Black	Clamshell	5◆	40
35917 NEW	8"	Steel	Black	Clamshell	5◆	40
96758	10"	Steel	Zinc	Bulk w/UPC	15 Pair◆	—
60625	12"	Steel	Zinc	Bulk w/UPC	5◆	20

Heavy Duty

Carded w/screws; Box
and bulk w/o screws

GALVANIZED
All Weather

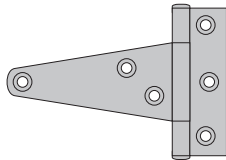

CODE	SIZE	MATERIAL	FINISH	PACK	INNER	MASTER
61105	5"	Steel	Galvanized	2/Card	2◆	24
35754	4"	Steel	Galvanized	Box	3 Pair◆	60
35753	6"	Steel	Galvanized	Box	3 Pair◆	30
35752	8"	Steel	Galvanized	Box	2 Pair◆	20
61059	4"	Steel	Galvanized	Bulk w/UPC	10◆	120
61060	6"	Steel	Galvanized	Bulk w/UPC	5◆	30
61061	8"	Steel	Galvanized	Bulk w/UPC	5◆	20
60812R1	4"	Steel	Zinc	Bulk w/UPC	10◆	100
60813R1	5"	Steel	Zinc	Bulk w/UPC	10◆	50
60814R1	6"	Steel	Zinc	Bulk w/UPC	10◆	50
60815R1	8"	Steel	Zinc	Bulk w/UPC	5◆	30
60811R1	10"	Steel	Zinc	Bulk w/UPC	5◆	20

Standard Duty

Tight pin; Furnished w/screws;
Polybag w/header card

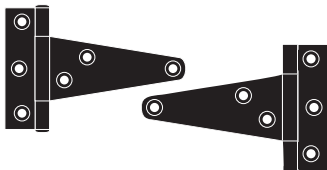

CODE	SIZE	FINISH	PACK	INNER	MASTER
35700	3"	Zinc	2/Card	12◆	144
35705	4"	Zinc	2/Card	12◆	144
35710	5"	Zinc	2/Card	12◆	144
35716	4"	Black Enamel	2/Polybag	6◆	120
35717	5"	Black Enamel	2/Polybag	12◆	72
35718	6"	Black Enamel	2/Polybag	3◆	60
35719	8"	Black Enamel	2/Polybag	3◆	48

Light Duty

Carded w/screws; Bulk
w/o screws

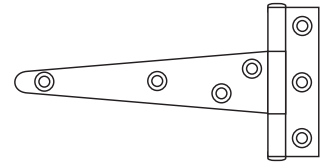

CODE	SIZE	FINISH	PACK	INNER	MASTER
60937	2"	Zinc	2/Card	5◆	120
60938	3"	Zinc	2/Card	5◆	120
60939	4"	Zinc	2/Card	10◆	120
61021	5"	Zinc	2/Card	10◆	120
61022	6"	Zinc	2/Card	10◆	80
96657	2"	Zinc	Bulk w/UPC	10◆	280
96658	3"	Zinc	Bulk w/UPC	10◆	280
96659	4"	Zinc	Bulk w/UPC	10◆	280
96660	5"	Zinc	Bulk w/UPC	10◆	280
96661	6"	Zinc	Bulk w/UPC	10◆	280

Corrosion resistant finish; Non-removable pin;
Standard hole pattern; Furnished w/screws

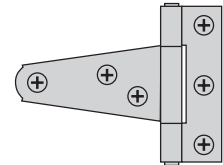

GALVANIZED
All Weather

CODE	SIZE	FINISH	PACK	INNER	MASTER
61036	2"	Galvanized	2/Card	5◆	120
61037	3"	Galvanized	2/Card	5◆	120
61038	4"	Galvanized	2/Card	5◆	120
61109	5"	Galvanized	2/Card	10◆	120
61110	6"	Galvanized	2/Card	10◆	80

D-HINGE

1 hinge per pack



CODE	SIZE	MATERIAL	FINISH	PACK	INNER	MASTER
35912 NEW	3-1/2"	Stainless Steel	SS	Clamshell	5◆	40
35913 NEW	3-1/2"	Black Finish	Steel	Clamshell	5◆	40

AUTO CLOSING GATE HINGE SET

Includes one spring T-hinge and one regular
T-hinge



CODE	SIZE	MATERIAL	FINISH	PACK	INNER	MASTER
35910 NEW	3-1/2"	Stainless Steel	SS	Clamshell	5◆	20
35911 NEW	3-1/2"	Black Finish	Steel	Clamshell	5◆	20

BUILDERS' HARDWARE

T-HINGES *continued*

Heavy duty

Reversible



CODE	SIZE	MATERIAL	FINISH	PACK	INNER	MASTER
35919 NEW	8"	Steel	Black	2/Clamshell	5◆	15

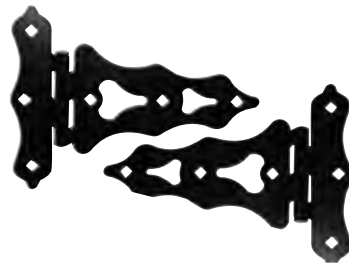

CODE	SIZE	MATERIAL	FINISH	PACK	INNER	MASTER
35918 NEW	8"	Steel	Black	2/Clamshell	5◆	15

SPRING T-HINGE KIT

Closes gate automatically for increased security and safety



CODE	MATERIAL	FINISH	PACK	INNER	MASTER
35921 NEW	Steel	Black	Clamshell	5◆	15

T-HINGE KITS

Decorative gate kit with self adjusting gate latch

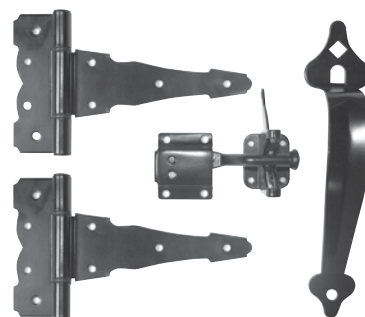

CODE	MATERIAL	FINISH	PACK	INNER	MASTER
35923 NEW	Steel	Black	Clamshell	5◆	20

ALUMINUM GATE KITS

For narrow mounting construction gates

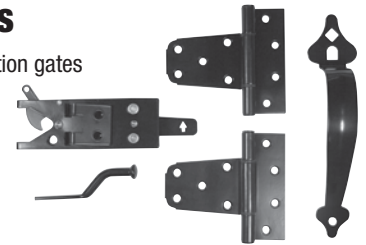

CODE	MATERIAL	FINISH	PACK	INNER	MASTER
35924 NEW	Steel	White	Clamshell	5◆	15
35925 NEW	Steel	Black	Clamshell	5◆	15

TEE SPRING HINGE

Heavy duty; 2" Strap width at joint; 7-5/8" x 1-3/8" Pad; Furnished w/latch screws and adjustable wrench pin

PP Code 905260

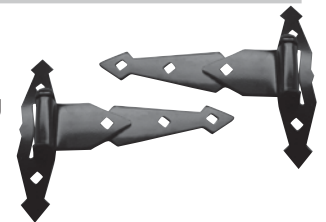

CODE	SIZE	MATERIAL	FINISH	PACK	INNER	MASTER
35920 NEW	8"	Steel	Black	2/Clamshell	5◆	20
905260-PP NEW	8"	Steel	Black	2/Polybag	5◆	20

STRAP HINGE

Heavy duty; Hammered black wrought iron finish; Full or half surface mounting; Non-removable tight pin; 30 lb. Weight per hinge; Furnished w/screws



CODE	SIZE	MATERIAL	FINISH	PACK	INNER	MASTER
35760	13-1/2"	Steel	Black	Polybag	6◆	60

Heavy duty, reversible; 8"; 1 pair per pack



CODE	SIZE	MATERIAL	FINISH	PACK	INNER	MASTER
35909 NEW	8"	Steel	Black	2/Clamshell	5◆	15

Thumb Latches

Includes: Pull: 10-3/8" length; Grip: 5-3/8" length; Latch Bar: 7" length; 2-7/8" projection; Furnished w/lag bolts, hex nuts, washers and screws

 Code 905785



CODE	MATERIAL	FINISH	PACK	INNER	MASTER
35926 NEW	Steel	Black	Clamshell	5◆	20
905785-PP NEW	Steel	Black	Polybag	5◆	20

Includes: thumb piece, strike, handle guide, bar, screws & bushings



CODE	MATERIAL	FINISH	PACK	INNER	MASTER
41948	Steel	Black	Polybag	10◆	100

GATE PULL HANDLE

Furnished w/lag screws



CODE	SIZE	MATERIAL	FINISH	PACK	INNER	MASTER
35927 NEW	11"	Stainless Steel	SS	Clamshell	5◆	40
35928 NEW	11"	Steel	Black	Clamshell	5◆	40

POST LATCH

Heavy duty; 7-3/8"L x 2-7/16"W latch base; 13/16" x 6" Bar; 11" Lever; Furnished w/screws

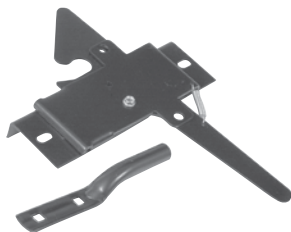

CODE	MATERIAL	FINISH	PACK	INNER	MASTER
35929 NEW	Stainless Steel	SS	Clamshell	5◆	20
35930 NEW	Steel	Black	Clamshell	5◆	20

DOOR & GATE LATCH

For sliding or swinging doors or gates; Furnished w/ surface and mortise strikes; Padlockable; Square holes allow mounting w/ carriage bolts

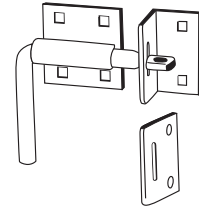

CODE	MATERIAL	FINISH	PACK	INNER	MASTER
89486	Steel	Zinc Plated	Polybag w/UPC	5◆	40

SLIDE BOLT

Heavy duty; Double action, double locking; Padlockable; Two-way keeper for 90° angle locking; Furnished w/carriage bolts, hex nuts, washers & screws



 Code 907546

GALVANIZED
All Weather

Code 61104

CODE	MATERIAL	FINISH	PACK	INNER	MASTER
35931 NEW	Stainless Steel	SS	Clamshell	5◆	20
35932 NEW	Steel	Black	Clamshell	5◆	20
61104	Steel	Galvanized	Card	10◆	50
43255	Steel	Black	Polybag	6◆	48
89485R1	Steel	Zinc	Polybag	10◆	50
907546-PP NEW	Steel	Zinc	Polybag	10◆	50

GRAVITY LATCH

Self-Locking

Easily opened from other side when string or wire is attached; Padlockable; Furnished w/screws

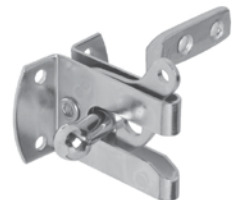

 Code 905720

CODE	MATERIAL	FINISH	PACK	INNER	MASTER
43250	Steel	Zinc	Polybag w/header card	10◆	160
905720-PP NEW	Steel	Zinc	Polybag	10◆	120

Self locking; Corrosion resistant finish; Padlockable; Furnished w/screws

GALVANIZED
All Weather

Code 61039R1

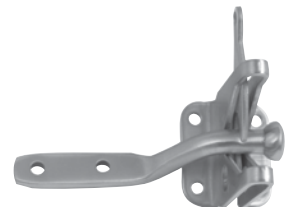

CODE	MATERIAL	FINISH	PACK	INNER	MASTER
35937	Stainless Steel	SS	Clamshell	5◆	40
35938	Steel	Black	Clamshell	5◆	40
61039R1	Steel	Galvanized	Card	10◆	120

BUILDERS' HARDWARE

GATE LATCHES *continued*

Gravity Latch

Self locking; Heavy duty gate latch; Furnish w/ screws

 Code 905311



CODE	MATERIAL	FINISH	PACK	INNER	MASTER
905311-PP NEW	Steel	Zinc	Polybag	10◆	20

Auto Adjust

Offset strike; Base: 1-5/8" L x 1-3/8" W; Furnished w/straight arm strike and screws

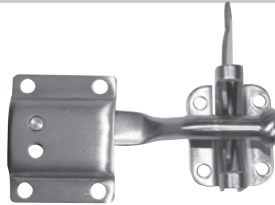

CODE	MATERIAL	FINISH	PACK	INNER	MASTER
35941 NEW	Stainless Steel	SS	Clamshell	5◆	40
35942 NEW	Steel	Black	Clamshell	5◆	40
89445R1 NEW	Steel	Zinc	Polybag	10◆	50

Offset Strike Base

Heavy duty, includes straight and offset arm

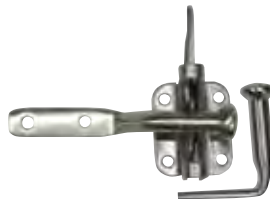

CODE	MATERIAL	FINISH	PACK	INNER	MASTER
35939 NEW	Stainless Steel	SS	Clamshell	5◆	40
35940 NEW	Steel	Black	Clamshell	5◆	40

SCREW HOOK & STRAP HINGE

Heavy duty; 2" Strap at joint; 1/2" x 4" Hook; Furnished w/lag screws



CODE	SIZE	MATERIAL	FINISH	PACK	INNER	MASTER
89370	8"	Steel	Black	2/Polybag w/UPC	5◆	20

LAG SCREWS

Heavy duty, 6 per pack



CODE	MATERIAL	FINISH	PACK	INNER	MASTER
35947 NEW	Stainless Steel	SS	Clamshell	5◆	40
35948 NEW	Steel	Black	Clamshell	5◆	40

SCREW HOOK & EYE HINGE

Heavy duty; 1/2" x 4" Hook dimension; 1/2" x 4" Eye dimension



CODE	FINISH	PACK	INNER	MASTER
89385	Black	2/Polybag	5◆	20

BLIND HINGE

Furnished w/screws

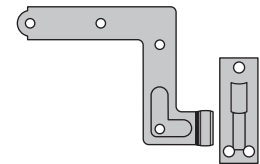

GALVANIZED
All Weather



CODE	MATERIAL	FINISH	PACK	INNER	MASTER
96523	1-1/16"	Black	Bulk	2 Pair◆	48
96526	2-1/8"	Black	Bulk	2 Pair◆	48
96524	1-1/16"	Galvanized	Bulk	2 Pair◆	48
96527	2-1/8"	Galvanized	Bulk	2 Pair◆	48

CANE BOLTS

Heavy Duty

Maximum throw 2-1/4"; Furnished w/surface and mortise keepers; Furnished w/screws



CODE	SIZE	MATERIAL	FINISH	PACK	INNER	MASTER
35936 NEW	Steel	18" x 5/8" Dia.	Zinc	Clamshell	5◆	20
35935 NEW	Steel	18" x 5/8" Dia.	Black	Clamshell	5◆	20

Standard

Furnished w/surface and mortise keepers; Furnished w/screws



CODE	SIZE	MATERIAL	FINISH	PACK	INNER	MASTER
35933 NEW	Steel	12" x 5/8" Dia.	Black	Clamshell	5◆	20
35934 NEW	Steel	12" x 5/8" Dia.	Zinc	Clamshell	5◆	20

ANTI SAG GATE KIT

Includes: 2 corner brackets, 4 cable clamps, 1 hook and eye turnbuckle; Furnished w/carriage bolts, hex nuts, washers and screws



CODE	MATERIAL	FINISH	PACK	INNER	MASTER
35944 NEW	Stainless Steel	SS	Clamshell	5◆	40
35943 NEW	Steel	Zinc	Clamshell	5◆	40

GATE & DOOR SPRING

Light Duty

Adjustable tension; Furnished w/attaching hooks



CODE	SIZE	FINISH	PACK	INNER	MASTER
68400	16"	Zinc	Card	6◆	120

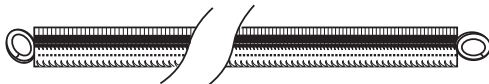

CODE	SIZE	FINISH	PACK	INNER	MASTER
60833	#3	Zinc	Polybag	10◆	40
60834	#4	Zinc	Polybag	10◆	40
60835	#5	Zinc	Polybag	10◆	40

Heavy Duty

Adjustable tension; Furnished w/screws and tension lug

35945, 35946

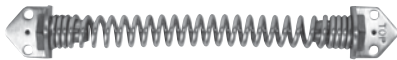

68425



68420, 68426, 68427
905395



97270



CODE	MATERIAL	LENGTH	FINISH	PACK	INNER	MASTER
35945 NEW	Stainless Steel	11"	SS	Clamshell	5◆	40
35946 NEW	Steel	11"	Steel	Clamshell	5◆	40
97270	Steel	9"	Black	Card	12◆	96
68420	Steel	11-5/8"	Black	Card	6◆	36
68425	Steel	15"	Black	Card	6◆	48
905395-PP NEW	Steel	10-1/2"	Black	Polybag	10◆	20

SHUTTER "S" HOLDER

Black hammered wrought iron; Furnished w/cotter pins, flat washers and lag bolts



CODE	SIZE	PACK	INNER	MASTER
97479	7"	2/Card	—	50

HOOK AND EYE



CODE	MATERIAL	FINISH	PACK	INNER	MASTER
35949 NEW	Stainless Steel	SS	Clamshell	5◆	40
35950 NEW	Steel	Zinc	Clamshell	5◆	40

GARAGE LOCK

T-Handle w/ Key Cylinder

For right and left hand doors, 90° turn; 4" Long by 5/16" square shaft; Keyed different; Furnished w/2 keys

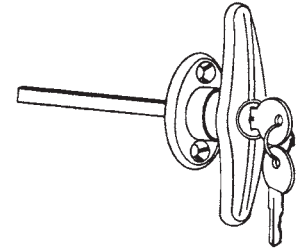

Code 905750

CODE	MATERIAL	FINISH	PACK	INNER	MASTER
49000	Zinc	Chrome	Card	6◆	72
49005	Zinc	Chrome	Polybag	12◆	120
905750-PP NEW	Zinc	Chrome	Polybag	10◆	40

Lever Handle w/ Key Cylinder

Universal design fits most garage doors; 4-1/4" handle w/ 5/16" spindle; Includes: Extension spring for doorside position; 2 keys; Furnished w/ mounting screws



CODE	MATERIAL	FINISH	PACK	INNER	MASTER
905760-PP NEW	Zinc	Chrome	Polybag	10◆	40

BUILDERS' HARDWARE

GARAGE LOCK *continued*

Deadbolt w/ Key Cylinder

6-Pin tumbler cast cylinder;
Hold-back feature for one-handed
operation; Spring bolt automatic
release; Y1 Keyway; Keyed different

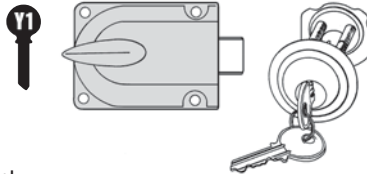

PP Code 905745

CODE	FINISH	PACK	INNER	MASTER
44835	Grey Enamel	Box	12◆	72
905745-PP NEW	Grey Enamel	Polybag	10◆	40

GARAGE DOOR PULLS

Furnished w/screws



CODE	SIZE	FINISH	PACK	INNER	MASTER
60961	5-3/4"	Brass	Card	5◆	100
60956	5-3/4"	Black	Card	5◆	100
60957	5-3/4"	Zinc	Card	5◆	100
60958	6-1/2"	Brass	Card	5◆	100
60959	6-1/2"	Black	Card	5◆	100
60960	6-1/2"	Zinc	Card	5◆	100
97153	6-1/2"	Zinc	Polybag	12◆	144

Heavy duty; One piece stamped
steel; Card w/screws; Polybag
w/o screws

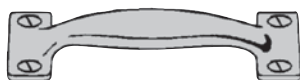

GALVANIZED
All Weather

CODE	SIZE	FINISH	PACK	INNER	MASTER
61044	5-3/4"	Galvanized	Card	10◆	240
61045	6-1/2"	Galvanized	Card	10◆	240

DOOR PULLS

Heavy duty door pull handles; One-piece
construction; Furnished w/screws



CODE	SIZE	MATERIAL	FINISH	PACK	INNER	MASTER
59502	Zinc	5-3/4"	Brass	1/Polybag	12◆	240
59503	Zinc	5-3/4"	Black	1/Polybag	12◆	240
59504	Zinc	5-3/4"	Chrome	1/Polybag	12◆	240
59505	Steel	6-1/2"	Brass	1/Polybag	12◆	240
59510	Steel	6-1/2"	Black	1/Polybag	12◆	240
59511	Steel	6-1/2"	Chrome	1/Polybag	12◆	240

Solid one-piece construction; 2-1/4"
Projection; Furnished w/screws



CODE	MATERIAL	SIZE	FINISH	PACK	INNER	MASTER
59400	Aluminum	7-1/2"	Aluminum	Card	6◆	60
59405	Aluminum	7-1/2"	Bronze	Card	6◆	60

Heavy duty; Solid one-piece construction;
Sizes: 1-7/8" mounting bracket, 1-1/2"
clearance; Furnished w/screws



CODE	MATERIAL	SIZE	FINISH	PACK	INNER	MASTER
59410	Zinc	5-3/4"	Brass	Card	6◆	96
59415	Zinc	5-3/4"	Chrome	Card	6◆	96

EZ GLIDE™ DOOR CLOSER

- Smooth door closing everytime
- Includes Touch 'n Hold™ technology
- Rust and Tarnish resistant
- Retrofits to most existing door closers
- Twin pack recommended for full view doors



Oversized Button



CODE	DESCRIPTION	COLOR	PACK	INNER
16200	Single	White	Clamshell	5♦
16202	Single	Black	Clamshell	5♦
16201	Twin Pack	White	Clamshell	5♦
16203	Twin Pack	Black	Clamshell	5♦

DOOR CLOSER AND HANDLE COMBO SET

Pneumatic Door Closer

Adjustable closing speed control valve, provides 90° opening for outswinging doors; Tube permanently lubricated and factory sealed; Internal shock absorbing spring.

Push button Latch

For outswinging door 7/8" to 1-1/4" thick; Zinc die cast; Installs in three 1/4" holes



CODE	COLOR	PACK	INNER
16208	White	Clamshell	10♦
16209	Black	Clamshell	10♦

BUILDERS' HARDWARE

DOOR CLOSERS

- Adjustable closing speed control valve
- Provides 90° opening for outswinging doors
- Tube permanently lubricated & factory sealed

PRODUCT COMPARISON CHART

ULTRA CODE	INTERNATIONAL*	WRIGHT*	STANLEY*
16000	0832	N/A	CD1708
16005	0882	N/A	CD1700
16027	N/A	N/A	CD1758
16036	0842	V-150	N/A
16057	0850	V-170	CD1764

PNEUMATIC DOOR CLOSERS

*The following registered trade name or trade mark is not owned, associated with or connected in any way with Ultra Hardware Products LLC and is used herein for illustrative purposes only.

Standard

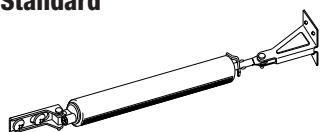

Internal shock absorber spring; Screen/glass panel adjustable.

CODE	FINISH	PACK	INNER	MASTER
16001	Aluminum	Card	5♦	20
16000	Black	Card	5♦	20
16002	White	Card	5♦	20

Heavy Duty

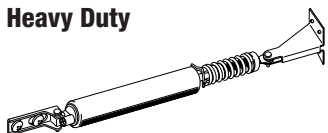

External spring for shock absorbing opening; Screen/glass panel adjustable

CODE	FINISH	PACK	INNER	MASTER
16005	Aluminum	Card	5♦	20
16006	Black	Card	5♦	20

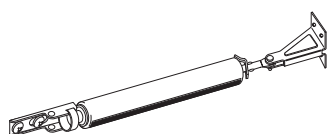

Extra internal spring for shock absorbing; Lifetime sealed unit with positive mechanism

CODE	FINISH	PACK	INNER	MASTER
16027	Aluminum	Card	10♦	20
16028	White	Card	10♦	20
16029	Black	Card	10♦	20



Internal shock absorbing spring; Super power check door control; Piston action door control; For heavy combination storm doors

CODE	FINISH	PACK	INNER	MASTER
16036	Aluminum	Card	5♦	20
16038	Black	Card	5♦	20



For wood or metal doors; Two hole end plug for adjustable latching power

CODE	FINISH	PACK	INNER	MASTER
16060	Black	Card	5♦	20

Extra Heavy Duty



Super torsion; Torsion bar reinforces door frame; Smooth, silent positive closing speed

CODE	FINISH	PACK	INNER	MASTER
16057	Aluminum	Card	5♦	20
16065	Black	Card	5♦	20

HYDRAULIC DOOR CLOSERS



Internal shock absorber spring; Screen/glass panel adjustable

CODE	FINISH	PACK	INNER	MASTER
16050	Aluminum	Card	5♦	20
16048	Black	Card	5♦	20

PUSH-BUTTON LOCKSET

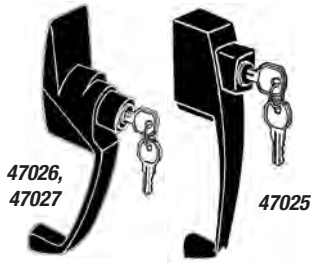

Fits outswinging doors 7/8" to 1-1/4" thick; Heavy duty zinc die cast; Anti-lockout feature; Double-coated baked-on electrostatic black enamel; Installs in three 1/4" holes; Locking unit furnished w/calibrated metal spindle & spring; Furnished w/ resilient strike

CODE	HOLE CENTER	FINISH	PACK	INNER	MASTER
47026	1-1/2"	Black	Card	5◆	40
47027	1-3/4"	Black	Card	5◆	40
47025	1-3/4"	Black	Card	5◆	40

PITCHER HANDLE LOCKS



Fits outswinging doors 7/8" to 1-1/4" thick; Heavy duty; Solid strike w/ resilient inside handle; Anti-lockout feature; 7-1/2" Overall height; Button pin on handle; Push button unit furnished w/ calibrated metal spindle and spring

CODE	HOLE CENTER	KEYLOCK	FINISH	PACK	INNER	MASTER
47030	1-3/4"	With	Black	Card	10	40
47028	1-3/4"	Without	Black	Card	5◆	60

PUSH BUTTON LATCH

Resilient Strike

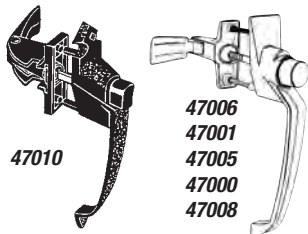

Fits outswinging doors 7/8" to 1-1/4" thick; Installs in three 1/4" holes; Anti-lockout feature; Converts to key locking set with key lock unit (excluding 47010)

CODE	HOLE CENTER	FINISH	PACK	INNER	MASTER
47006	1-1/2"	Black	Card	5◆	40
47001	1-1/2"	Aluminum	Card	5◆	40
47008	1-1/2"	White	Card	5◆	40
47005	1-3/4"	Black	Card	5◆	40
47000	1-3/4"	Aluminum	Card	5◆	40
47010	1-3/4"	Black	Card	5◆	40

Solid Strike

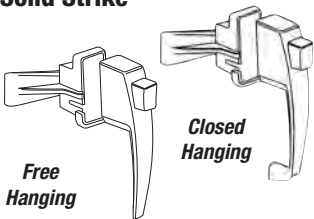

Fits outswinging doors 7/8" to 1-1/4" thick; Zinc die cast; Installs in three 1/4" holes; Anti-lockout feature; Converts to key locking set with key lock unit

CODE	HOLE CENTER	TYPE	FINISH	PACK	INNER	MASTER
47015	1-3/4"	Closed Handle	Aluminum	Card	5◆	60
47020	1-3/4"	Closed Handle	Black	Card	5◆	60
47016	1-3/4"	Closed Handle	White	Card	5◆	50
47012	1-3/4"	Free Hanging	Black	Card	5◆	60
47011	1-3/4"	Free Hanging	Aluminum	Card	5◆	60
47013 NEW	1-3/4"	Free Hanging	White	Card	5◆	60

PUSH-BUTTON KEY PLUGS

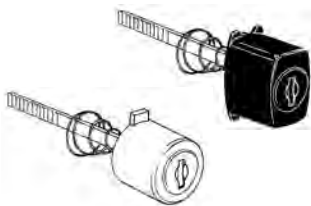

Fits most storm door locks of same shape push button; Furnished w/calibrated metal spindle and spring; Fits Ideal*, Wright*, Luster* & Ultra Locks

CODE	STYLE	KEYED	FINISH	PACK	INNER	MASTER
58400	Round	KD	Black	Card	5◆	120
58405	Round	KD	Aluminum	Card	5◆	120
58401	Round	KD	Black	Polybag	12◆	192
58410	Rectangular	KA	Black	Card	5◆	120

PRODUCT COMPARISON CHART

ULTRA CODE	INTERNATIONAL*	WRIGHT*	STANLEY*
47000	0223	N/A	CD1704
47001	0203	N/A	CD1780
47026	N/A	VK-398x3	N/A

*The following registered trade name or trade mark is not owned, associated with or connected in any way with Ultra Hardware Products LLC and is used herein for illustrative purposes only.

BUILDERS' HARDWARE

STORM DOOR LATCHES

Fits all outswinging doors 5/8" to 1-1/4" thick; Zinc die cast; Installs in three 1/4" holes; Anti-lockout feature



CODE	KEYLOCK	FINISH	PACK	INNER	MASTER
47037	1-3/4"	Black	Box	5◆	40
47039	1-3/4"	Aluminum	Box	5◆	40

Fits 1" to 1-1/4" screen and storm doors; Heavy duty zinc die cast construction; Resilient strike keeper

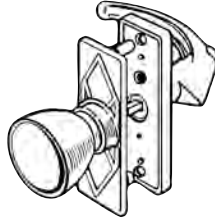

CODE	FINISH	PACK	INNER	MASTER
47035	Aluminum	Card	5◆	40

Fits 7/8" to 1-1/4" thick doors; For in and outswinging wooden doors; 1-3/4" Backset; Mortise lock

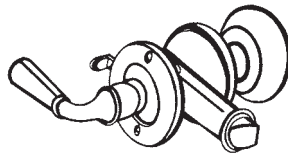

CODE	KEYLOCK	FINISH	PACK	INNER	MASTER
46500	With	Brass	Clamshell	3◆	72
46501	With	Brass	Box	10◆	100

Push-Pull Latches

Fits doors 3/4" to 1-1/4" thick; Zinc die cast; Furnished w/resilient strike plate and screws

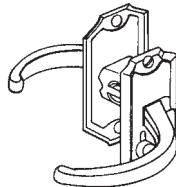

CODE	SWING	HOLE CENTER	FINISH	PACK	INNER	MASTER
47042	Out	1"	Aluminum	Card	10◆	40

Fits doors 3/4" to 1-1/4" thick; Furnished w/resilient strike plate and screws

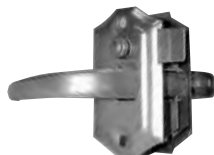

CODE	SWING	HOLE CENTER	FINISH	PACK	INNER	MASTER
47073	In	1"	Aluminum	Card	10◆	40
47077	In	1"	Bronze	Card	10◆	40
47074	Out	1"	White	Card	10◆	40
47075	In	1"	White	Card	10◆	40
47076	Out	1"	Bronze	Card	10◆	40

STORM DOOR LOCKSET

Lever Handle Lockset

For outswinging aluminum, vinyl and wood doors 7/8" to 1-1/4" thick; Polished brass finish (outside); Painted finish (inside); 1-3/4" Hole centers; Thumbturn inside

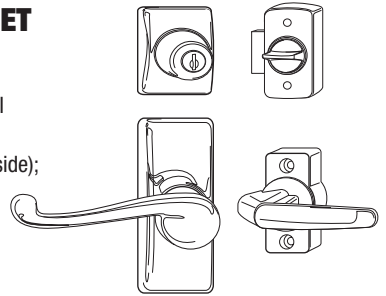

43550, 43552

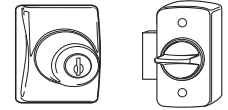

22164

CODE	SIZE	TYPE	KEYED	FINISH	PACK	INNER	MASTER
43550	7/8" x 1-1/4"	Set	KA	White/Brass	Box	10	20
43552	7/8" x 1-3/4"	Set	N/A	Black/Brass	Box	1	20
22164	7/8" x 1-1/4"	Lever/Dead-bolt	KD	Black/Brass	Box	5◆	15

TULIP KNOB LOCKSET

Fits all screen and storm doors 1" to 1-1/4" thick; Heavy duty zinc die cast; Single 1-1/4" hole installation

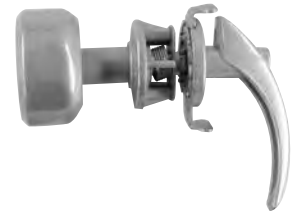

CODE	FINISH	PACK	INNER	MASTER
47040	Aluminum	Card	5◆	40

Fits doors 7/8" to 1-1/8" thick; For outswinging wood or metal doors; Installs with spring loaded strike plate; Key lock extra security



CODE	FINISH	PACK	INNER	MASTER
47033	Aluminum	Card	5◆	40

PRODUCT COMPARISON CHART

ULTRA CODE	INTERNATIONAL*	WRIGHT*	STANLEY*
47035	0423	V-666	CD1703
47040	0441	V-501	CD1772
47042	N0491A	V-1000	CD1280

*The following registered trade name or trade mark is not owned, associated with or connected in any way with Ultra Hardware Products LLC and is used herein for illustrative purposes only.

STORM DOOR HARDWARE KIT

Deluxe; High quality closer, chain and push button lock; Furnished w/ resilient strike latch keeper

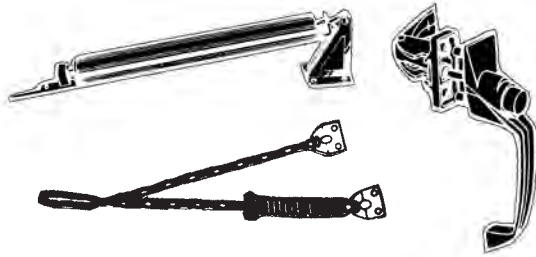

CODE	MOUNT HOLE	TYPE	STRIKE	FINISH	PACK	INNER	MASTER
41120	1-1/2"	Standard Duty	Standard	Black	Box	1	10
41121	1-3/4"	Standard Duty	Standard	Black	Box	1	10
41123	1-1/2"	Heavy Duty	High	Black	Box	1	10

Heavy duty; Key cylinder; Keyed different



SPECIAL ORDER ITEM

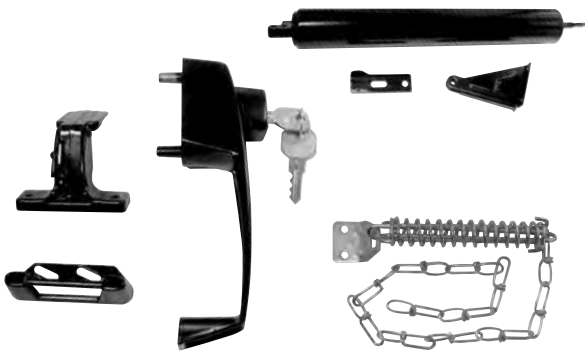

CODE	KEYLOCK	FINISH	PACK	INNER	MASTER
41085	1-3/4"	Black	Bulk	1	500

SCREEN DOOR CATCH

Soft rubber roller; Furnished w/screws

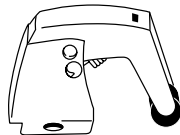

CODE	MATERIAL	FINISH	PACK	INNER	MASTER
96214	Steel	Zinc	Card	12◆	144

INSIDE STORM DOOR LOCK

Resilient Keeper

Standard latch for resilient strike keeper



CODE	HOLE CENTER	FINISH	PACK	INNER	MASTER
31602	1-1/2"	Aluminum	Card	5◆	120
31603	1-1/2"	Black	Card	5◆	120
31600	1-3/4"	Aluminum	Card	5◆	120
31601	1-3/4"	Black	Card	5◆	120

Solid Keeper

Moveable latch for solid strike keeper; Furnished w/screws

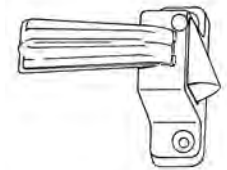

CODE	HOLE CENTER	FINISH	PACK	INNER	MASTER
31604	1-3/4"	Aluminum	Card	5◆	120
31605	1-3/4"	Black	Card	6◆	120
31611	1-3/4"	Black	Polybag	12◆	120

RESILIENT STRIKE KEEPERS

Fits all make storm door locks; Furnished w/screws



CODE	FINISH	PACK	INNER	MASTER
41000	Aluminum	Card	6◆	120
41001	White	Card	6◆	120
41005	Black	Card	6◆	120

Fits all make storm door locks; High strike offset; Furnished w/screws

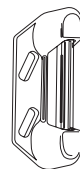

CODE	FINISH	PACK	INNER	MASTER
41010	Aluminum	Card	12◆	120
41015	Black	Card	12◆	120
41017	Black	Polybag	12◆	288

BUILDERS' HARDWARE

SPRING HINGES

Full Surface

For wood screen doors; Right or left handed applications; Furnished w/screws

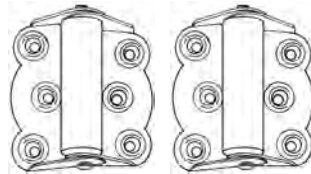

CODE	MATERIAL	FINISH	PACK	INNER	MASTER
60852	Steel	Zinc Dichromate	2/Card	5◆	50
60853	Steel	Zinc	2/Card	5◆	50

Furnished w/screws

GALVANIZED
All Weather

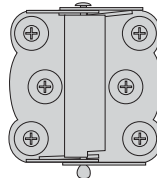

CODE	FINISH	PACK	INNER	MASTER
61023	Galvanized	2/Card	5◆	50

Adjustable Full Surface

Furnished w/screws

GALVANIZED
All Weather

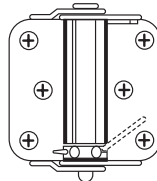

CODE	FINISH	PACK	INNER	MASTER
61010	Zinc Dichromate	2/Card	5◆	50
61011	Zinc	2/Card	5◆	50
61103	Galvanized	2/Card	5◆	50

Adjustable Half Surface

Furnished w/screws

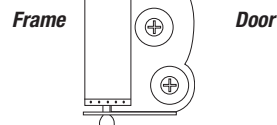

CODE	FINISH	PACK	INNER	MASTER
60837	Zinc	2/Card	5◆	50

SCREEN DOOR HINGES

Full surface; 1/4" Radius corner; Loose pin; Furnished w/screws

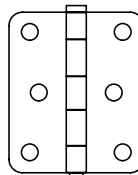

CODE	SIZE	FINISH	PACK	INNER	MASTER
60855	2" x 3"	Zinc Dichromate	2/Card	10◆	100
60856	2" x 3"	Zinc	2/Card	10◆	100

SCREEN DOOR SETS

For wood screen doors; Right or left handed applications

GALVANIZED
All Weather

Code 61101

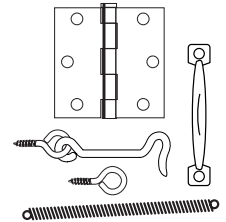

CODE	MATERIAL	FINISH	PACK	INNER	MASTER
61002	Steel	Zinc Dichromate	Card	5◆	50
61003	Steel	Zinc	Card	5◆	50
61101	Steel	Galvanized	Card	5◆	50

SPRING HINGE SET

For use on wood screen doors; Right or left handed applications; Furnished w/screws

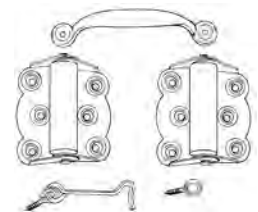

CODE	MATERIAL	FINISH	PACK	INNER	MASTER
60859	Steel	Zinc Dichromate	Card	5◆	50
60858	Steel	Zinc	Card	5◆	50

WING DOOR CLOSER

Butterfly spring; Fits on all door butt hinge pins; Keeps all doors closed; Rubber sleeves on wing

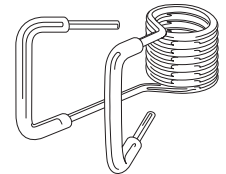

CODE	O.L.	FINISH	PACK	INNER	MASTER
68405	5-1/4"	Zinc	Card	12◆	144

SCREEN BRACE

Furnished w/screws

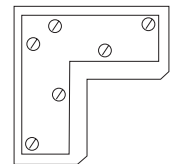

CODE	FINISH	PACK	INNER	MASTER
61004	Zinc	4/Card	5◆	50

CRASH CHAINS

Heavy duty commercial door; 2 Rugged compression springs with cast mounting plates; Grey vinyl cover; Furnished w/screws



CODE	SIZE	PACK	INNER	MASTER
15850	30-1/2"	Box	5◆	40

BUILDERS' HARDWARE

CRASH CHAINS

Single spring; Vinyl covered chain;
Furnished w/screws

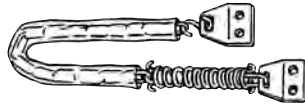

CODE	SIZE	FINISH	PACK	INNER	MASTER
96222	28"	Zinc	Polybag	12◆	144

Single spring door chain with
hold-up spring and nail; Fur-
nished w/"S" hooks & screws

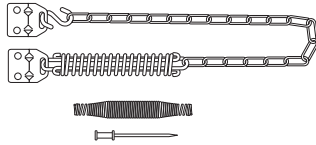

CODE	MATERIAL	FINISH	PACK	INNER	MASTER
15001	Steel	Zinc	Card	6◆	96
15000	Steel	Zinc	Polybag	25◆	100

REPLACEMENT CLIPS AND SCREWS

Offset Door Insert Clips

Threaded thumb clip;
Furnished w/knurled
screws

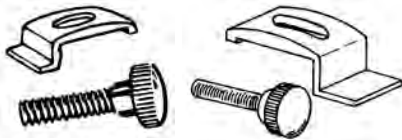

CODE	SIZE	FINISH	PACK	INNER	MASTER
15386	3/8"	Mill	8/Card	6◆	240
15387	3/8"	White	8/Card	6◆	240

Threaded Clips

Packed w/(8) screws



CODE	REACH	SCREWS	FINISH	PACK	INNER	MASTER
15391	Standard	Knurled	Mill	8/Card	6◆	240
15392	Standard	Knurled	White	8/Card	6◆	240
15396	Deep	Threaded	Mill	8/Card	6◆	240
15397	Deep	Threaded	White	8/Card	6◆	240

TURN BUTTONS

Furnished w/screws



GALVANIZED
All Weather

CODE	SIZE	FINISH	PACK	INNER	MASTER
60890	1-3/4"	Zinc	4/Card	10◆	100
61029	1-3/4"	Galvanized	4/Card	10◆	100

TURN BUTTONS

Furnished w/screws

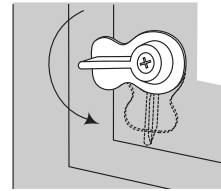

GALVANIZED
All Weather

CODE	FINISH	PACK	INNER	MASTER
60889	Zinc	4/Card	10◆	100
61102	Galvanized	4/Card	10◆	100

STRIKE PLATE SHIMS

Resilient; 15/16" W x 2-5/8"
L x 1/16" thick; Individually
polybagged

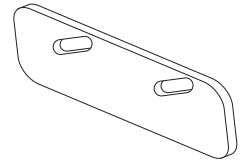

CODE	FINISH	PACK	INNER	MASTER
65200	Aluminum	Bulk	100◆	2000
65201	Black	Bulk	100◆	5000

SPRING FASTENER

Snap-On; Furnished w/fasteners
& (4) screws

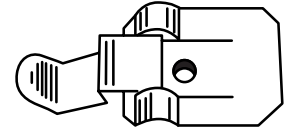

GALVANIZED
All Weather

CODE	FINISH	PACK	INNER	MASTER
61118	Zinc	4/Card	5◆	200
61116	Galvanized	4/Card	10	200

DOOR PULLS

Card and polybag w/screws;
Box w/o screws



GALVANIZED
All Weather

Code 59647 &
61046

CODE	SIZE	FINISH	PACK	INNER	MASTER
97125	4-3/4"	Brass	Card	12◆	144
60962	4-3/4"	Zinc Dichromate	Card	5◆	50
60963	4-3/4"	Zinc	Card	5◆	50
61046	4-3/4"	Galvanized	Card	5◆	50
59647	4-3/4"	Galvanized Stamped Steel	Box	6◆	480

Heavy duty; Furnished
w/screws



CODE	SIZE	FINISH	PACK	INNER	MASTER
60800	6-1/2"	Zinc	Polybag	5◆	50

SCREEN DOOR BRACES

Prevents sagging; Furnished w/screws

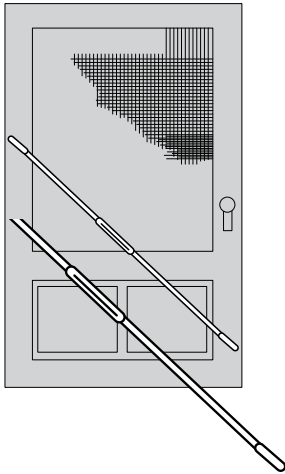

CODE	SIZE	FINISH	PACK	INNER	MASTER
60860	42"	Zinc	Card	10◆	100
60861	50"	Zinc	Card	10◆	60

MESH DOOR GRILLS

Aluminum main frame with breakaway tabs; Adjustable to fit 32" to 36" screen doors; Expanded aluminum mesh; Triple riveted corner construction; Furnished with screws

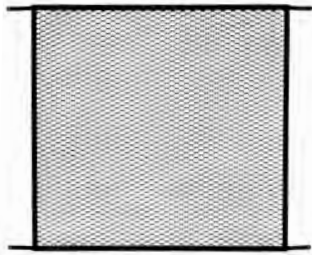

CODE	SIZE	FINISH	PACK	INNER	MASTER
28536 NEW	24" H x 26-1/2" W, 34"-3/4" Tip to Tip Tabs	White	Polybag	1	5
28537 NEW	24" H x 26-1/2" W, 34"-3/4" Tip to Tip Tabs	Bronze	Polybag	1	5

SASH LOCKS

Clamp Style

Furnished w/screws



CODE	MATERIAL	FINISH	PACK	INNER	MASTER
60903	Steel	Brass	Card	10◆	10
60902	Steel	Antique Brass	Card	10◆	100
96953	Steel	Brass	Polybag	50◆	500

Spring Action

Furnished w/screws

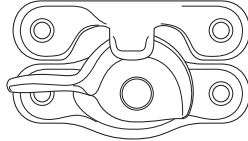

CODE	MATERIAL	FINISH	PACK	INNER	MASTER
46000	Zinc	Brass	Polybag	50◆	500

Furnished w/screws

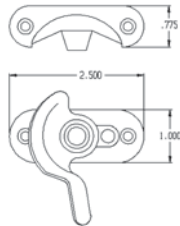

CODE	MATERIAL	FINISH	PACK	INNER	MASTER
46005	Steel	Brass	Polybag	50◆	400
46009-PP New	Steel	Brass	4/Polybag	12◆	96

Solid brass; Furnished w/screws

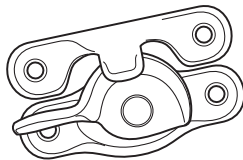

CODE	MATERIAL	FINISH	PACK	INNER	MASTER
46176	Solid Brass	Brass	Polybag	20◆	160
46175	Solid Brass	Polished Chrome	Polybag	20◆	160

Safety Tab

Squeeze locking tab; Furnished w/ screws

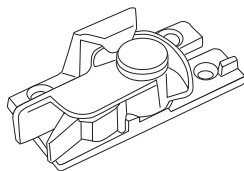

CODE	FINISH	PACK	INNER	MASTER
58157	Brass	Blister Card	12◆	120
58158	White	Blister Card	12◆	120

Cam-Action

Furnished w/screws

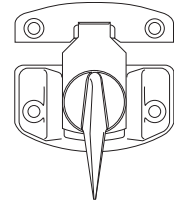

CODE	MATERIAL	FINISH	PACK	INNER	MASTER
60901	Steel	Brass	Card	10◆	100
46010	Steel	Brass	Polybag	50◆	250

Sweep Style

Latch engages the fixed rail to lock window.



CODE	MATERIAL	FINISH	PACK	INNER	MASTER
46093-PP New	Metal	Black	2/Polybag	50◆	—

WINDOW LOCKS

Key Operated

Furnished w/screws

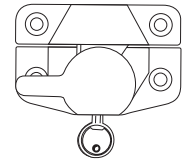

CODE	FINISH	KEYED	PACK	INNER	MASTER
46015	Brass	KA	Card	12◆	120

Window "Safe" Lock

Furnished w/screws

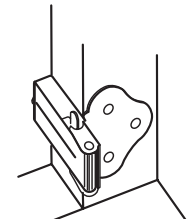

CODE	FINISH	PACK	INNER	MASTER
96980	Brass	Polybag	25◆	600

CASEMENT WINDOW FASTENERS

Full 360° swivel handle; Overall plate size: 1-1/8"W x 2"H; 9/16" Throw; Furnished w/ two keepers, one surface, one mortise & screws

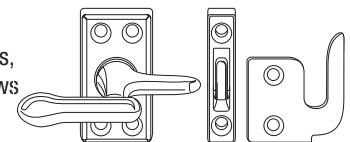

CODE	MATERIAL	FINISH	PACK	INNER	MASTER
27100	Zinc	Brass	Polybag	5◆	200
98609-PP New	Zinc	Brass	2/Polybag	1◆	100

JALOUSIE OPERATORS

Fits all jalousie windows and doors; 4" Standard aluminum link arm; Hardened precision gears; 3-7/8" & 4-3/4" mounting hole centers; Staked on operating T-handle; Furnished w/screws

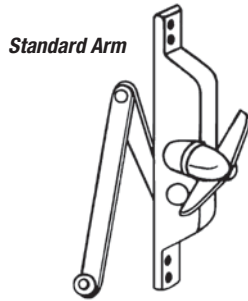

CODE	MATERIAL	FINISH	PACK	INNER	MASTER
53400	Zinc	White	Polybag	24◆	96
53401	Zinc	Aluminum	Polybag	6◆	96

JALOUSIE OPERATOR KIT

For all jalousie type windows & doors; Kit Includes: 1 Universal operator with attached T-handle, 4 Machine screws, 4 Nuts, 1 Calibrated arm for lengths of 3", 3-1/2", 4" & 4-1/2", 1 Link screw, 1 Shoulder screw, 1 Nylon bushing, 4 Sheet metal screws

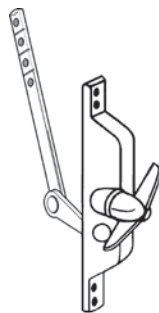

CODE	MATERIAL	FINISH	PACK	INNER	MASTER
41100	Zinc	Aluminum	Card	6◆	48
41105	Zinc	White	Card	6◆	198

AWNING WINDOW OPERATORS

Replaces most popular type operators; 3/8" Gear bore & 3-1/2" link arm; Furnished w/ connecting link, crank handle, & screws

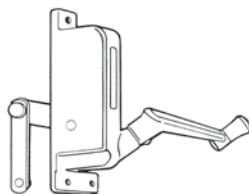

Left Hand shown

CODE	MATERIAL	FINISH	HAND	PACK	INNER	MASTER
53450	Zinc	Aluminum	Left	Card	6◆	36
53455	Zinc	Aluminum	Right	Card	6◆	36

CASEMENT WINDOW ADJUSTERS

Heavy gauge; Knurled thumb turn locking mechanism; 3/8" Thick arm with swivel end bracket; Adjustable openings up to 90°; Furnished w/ installation screws

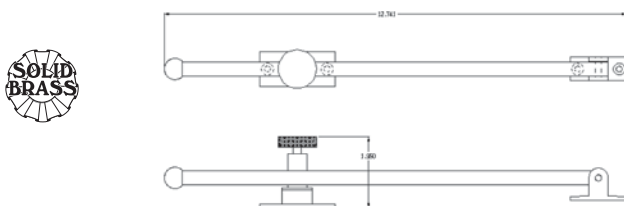

CODE	MATERIAL	SIZE	FINISH	PACK	INNER	MASTER
01790	Solid Brass	10"	Brass	Polybag	3◆	48
01795	Solid Brass	12-1/4"	Brass	Polybag	12◆	48

CASEMENT WINDOW OPERATORS

Arm movement of 105° arc; Hardened gear casing; Rustproof steel 9" long operating arm; Furnished w/ screws

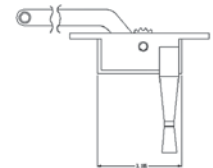

CODE	MATERIAL	FINISH	HAND	PACK	INNER	MASTER
53500	Zinc	Bronze	Left	Card	6◆	48
53505	Zinc	Bronze	Right	Card	6◆	48

WINDOW TILT LATCH

2-5/16" hole Center; one pair per polybag; packed w/o screws



CODE	MATERIAL	FINISH	PACK	INNER	MASTER
41971-PP New	Nylon Plastic	White	Polybag	10◆	500

WINDOW LIFT

2-Hole screw mount; Overall size: 1-11/16" x 1-5/16"; Furnished w/screws

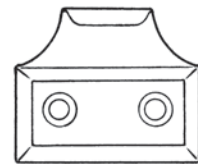

CODE	MATERIAL	FINISH	PACK	INNER	MASTER
43314	Solid Brass	Brass	Polybag	50◆	400

CODE	FINISH	PACK	INNER	MASTER
60900	Brass	Polybag	5◆	50

SASH LIFT

4 Hole screw mount; Furnished w/screws

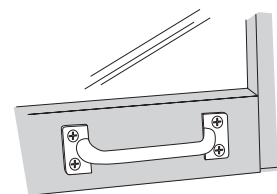

CODE	MATERIAL	SIZE	FINISH	PACK	INNER	MASTER
60904	Zinc	4"	Brass	Card	5◆	100
60905	Zinc	4"	Antique Brass	Card	5◆	100

SOLID BAR PULL HANDLE — OR SASH LIFT

Features 4-hole screw mounting; Furnished w/screws

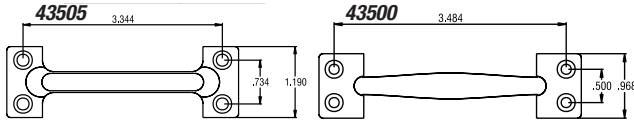

CODE	MATERIAL	FINISH	HAND	PACK	INNER	MASTER
43500	Zinc	4"	Brass	Polybag	25◆	600
43505	Zinc	4"	Brass	Polybag	50	400

SLIDING DOOR FLUSH PULLEY

Face plate overall size: 4-1/2" L x 1" W; Wheel diameter: 2-1/32"



CODE	MATERIAL	FINISH	PACK	INNER	MASTER
97168	Steel	Zinc	Bulk	20◆	200

WINDOW SASH TENSION SPRING

For double hung windows; Rust resistant heavy gauge steel; Replaces broken sash cord



CODE	MATERIAL	FINISH	PACK	INNER	MASTER
68500	Steel	Zinc	Card	12◆	240

SECURITY NIGHT LOCK PINS

For sliding aluminum patio doors; 1/4" Diameter knurled head; Case hardened; Furnished w/ 7-1/2" nickel plated link chain, hanger, bracket, retainer cap and screw; Overall length: 3-3/8"



CODE	FINISH	PACK	INNER	MASTER
57000	Nickel	Polybag	100◆	1200
57002	Nickel	Card	6◆	240

SHUTTER HARDWARE

4 Panel Shutters Hardware Set

Set includes 4 mounting hinges, 36 screws, 1 latch with 2 screws, 2 knobs with 2 screws, 4 interpanel hinges, hook/eye & pull knob

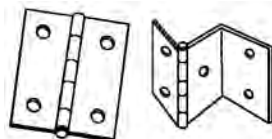

(Qty. 4)

(Qty. 4)

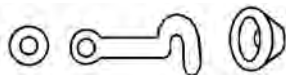

(Qty. 1)

(Qty. 2)

CODE	FINISH	PACK	INNER	MASTER
66000	Brass	Polybag	6◆	96

Shutter Hinges

Furnished w/screws; Sold in pairs

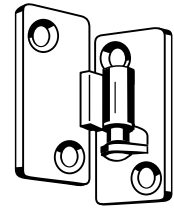

CODE	FINISH	PACK	INNER	MASTER
96737	Zinc	—	12◆	120

TRACK LOCKS

Fits all sliding metal door and window frames; Thumb screw locking

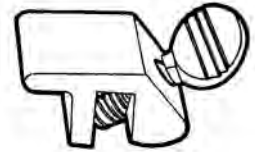

CODE	FINISH	PACK	INNER	MASTER
48000	Aluminum Mill	Bulk	100◆	1200
48001	White	Blister Card	6◆	288

Vinyl Lining

Contains wear resistant vinyl to prevent scratching

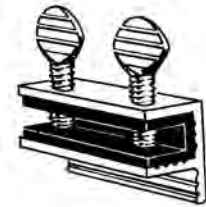

CODE	FINISH	PACK	INNER	MASTER
46103	Aluminum	Card	12◆	288

Vice-Like Grip

Vise-like grip prevents prying window or door open

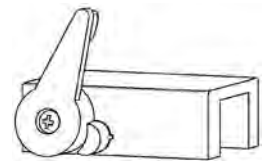

CODE	FINISH	PACK	INNER	MASTER
48002	Aluminum	Card	12◆	96

Plunger Type

Push button cylinder locking operation; 3/8" Hole required for bolt; Easily locked by pushing in cylinder; Furnished w/screws



CODE	MATERIAL	FINISH	PACK	INNER	MASTER
44913	KA	Aluminum	Card	6◆	120

SLIDING DOOR BAR LOCKS

Makes all sliding glass doors jimmyproof; Self-storing; Fits up to 48" wide; Swings 90° & folds out-of-the way when not in use; Overall length 48" long with end cap; 5/8" Square extruded aluminum tubing; Easily cut with hacksaw to fit narrow doors & windows; Furnished w/ installation hardware pack and hinge bracket

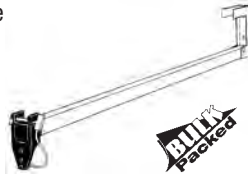

CODE	MATERIAL	FINISH	PACK	INNER	MASTER
44900	Aluminum	Satin	Blister Card	12	—
44905	Aluminum	White	Blister Card	12	—
44910	Aluminum	Bronze	Blister Card	12	—
44901	Aluminum	Satin	Bulk	24◆	—

REPLACEMENT KIT

99095	Aluminum	—	Polybag	1	500
-------	----------	---	---------	---	-----

SCREEN DOOR LOCK

Outside pull, inside lock and keeper



CODE	MATERIAL	FINISH	PACK	INNER	MASTER
45006	1-3/4" W x 3" L	Black	Card	12◆	96

PATIO DOOR LOCKS

Flush mount; 7-1/4" L x 7/8" W with 6-5/8" hole centers; Fits 7" cut-out; Outside with knock-out plug; Furnished w/ installation screws & standard lock keeper; 2 Keys w/ keyplug



CODE	MATERIAL	TYPE	FINISH	PACK	INNER	MASTER
NITE LATCH						
44871	Zinc	w/o Keyplug	Chrome	Box	1	96
44881	Zinc	w/ Keyplug	Chrome	Box	1	96
44878	Zinc	w/ Keyplug	Black	Box	1	96
NO LATCH						
44873	Zinc	w/o Keyplug	Chrome	Box	1	96
44870	Zinc	w/Keyplug	Chrome	Box	1	96

KEY PLUG CYLINDER

Fits sliding door locks: Codes 44873, 44871, 44881, 44878, & 44870; Tailpiece: 1/8" diameter; Wafer cylinder; Furnished w/ 2 keys



CODE	KEYED	KEYWAY	O.D.	PACK	INNER	MASTER
58420	KD	B-1	1"	Polybag	10◆	750
58422	KD	B-1	1-1/8"	Polybag	10◆	750

SLIDING PATIO DOOR FOOT LOCK

Step-lock; Locks in open position

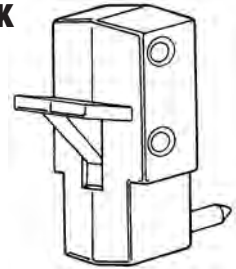

CODE	MATERIAL	FINISH	PACK	INNER	MASTER
45000	Zinc	Aluminum	Card	12	192

PATIO DOOR LOCK KEEPER

Fits most patio locks; Adjustable with elongated holes; 2-3/4" long x 3/4" wide; Furnished w/screws



CODE	MATERIAL	FINISH	PACK	INNER	MASTER
41021	Zinc	Chrome	Polybag	50◆	1000

MORTISE BODY LOCK

Backset 0.10"; Furnished w/screws and strikes

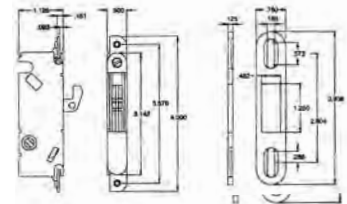

CODE	MATERIAL	FINISH	PACK	INNER	MASTER
44624	Steel	Zinc	Bulk	50◆	100

SLIDING DOOR PULLS

Zinc die cast mounting brackets; Weather resistant finish; Fits most patio doors; Furnished w/ installation screws

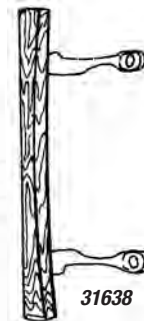

CODE	HANDLE	O.L.	HOLE CENTER	PACK	INNER	MASTER
31621	Teakwood	9"	6-5/8"	Polybag	12◆	96
31638	Teakwood	10"	6-5/8"	Polybag	10◆	60
31626	Teakwood	11"	6-5/8"	Polybag	10◆	60
31622	Chrome	10"	6-5/8"	Polybag	12◆	96

DESIGNER'S EDGE™

SATIN NICKEL



59991	3" C.C./ Overall 5-3/8"	Pack 12◆
59875	3-3/4" C.C. / Overall 7"	Pack 12◆
59876	7" C.C. / Overall 10"	Pack 12◆
59877	9-3/4" C.C. / Overall 13"	Pack 12◆
59878	15-1/4" C.C. / Overall 18-1/4"	Pack 10◆
59879	17-5/8" C.C. / Overall 20-3/4"	Pack 10◆
59992	23-1/4" C.C. / Overall 26"	Pack 10◆



41713R1
1-3/8" Dia.
Satin Nickel
Pack 25◆



41711R1
1-3/16" Dia.
Satin Nickel
Pack 25◆



59899
1-1/4" Dia.
Satin Nickel
Pack 12◆



59888*
1 1/16" Dia.
Satin Nickel
Pack 25◆



59411
2-1/2" C.C.
Satin Nickel
Pack 25◆



59933
3" C.C.
Satin Nickel
Pack 25◆



59216R1
3" C.C.
Satin Nickel
Pack 10◆



41502
1-1/8" Dia.
Satin Nickel
Pack 25◆



59424
5" C.C.
Satin Nickel
Pack 12◆



59416
3-3/4" C.C.
Satin Nickel
Pack 25◆

59419
5" C.C.
Satin Nickel
Pack 12◆



59917
1-1/4" Dia.
Satin Nickel
Pack 25◆



59438
5" C.C.
Satin Nickel
Pack 12◆

CABINET HARDWARE

SATIN NICKEL



41915
1-1/2" Dia.
Satin Nickel
Pack 25◆



41912 2-3/8" Dia. Pack 25◆
41913 2-7/8" Dia. Pack 25◆



59729
3" C.C.
Satin Nickel
Pack 25◆



41543R1
1-1/4" Dia.
Satin Nickel
Pack 25◆



41661R1
1-1/4" Dia.
Satin Nickel
Pack 12◆



41906
1-1/4" Dia.
Satin Nickel
Pack 25◆



41772R1
1-1/4" Dia.
Satin Nickel
Pack 12◆



41737
1-1/4" Dia.
Satin Nickel
Pack 12◆



41776R1
1-1/4" Dia.
Satin Nickel
Pack 25◆



41779R1
1-1/4" Dia.
Satin Nickel
Pack 25◆



41766
1-1/4" Dia.
Satin Nickel
Pack 25◆



41359
1-1/2" Dia.
Satin Nickel
Pack 25◆



41407
1-5/32" Dia.
Satin Nickel
Pack 25◆



41753R1
1-1/4" Dia.
Satin Nickel
Pack 12◆



41649R1
1-1/8" Dia.
Satin Nickel
Pack 12◆



59472
1-1/4" Dia.
Satin Nickel
Pack 25◆



59599R1
3" C.C.
Satin Nickel
Pack 25◆



59219R1
3" C.C.
Satin Nickel
Pack 10◆



41542R1
1-1/4" Dia.
Satin Nickel
Pack 25◆



41527
1-1/4" Dia.
Satin Nickel
Pack 25◆



59967
3" C.C.
Satin Nickel
Pack 25◆

SATIN NICKEL



41840
1-1/4" Dia.
Satin Nickel
Pack 12◆



59883
3" C.C.
Satin Nickel
Pack 12◆



59587R1 **N** 3" C.C. Pack 25◆
59575R1 3-1/2" C.C. Pack 25◆



59613R1 3" C.C. Pack 25◆
59615R1 3-1/2" C.C. Pack 25◆
59501 4" C.C. Pack 25◆



41685
1-3/8" Dia.
Satin Nickel
Pack 25◆



59657
3" C.C.
Satin Nickel
Pack 25◆



41652
1-1/2" Dia.
Satin Nickel
Pack 25◆



59648
3" C.C.
Satin Nickel
Pack 25◆



41459
1-1/4" Dia.
Satin Nickel
Pack 25◆



41529
1-3/16" Dia.
Satin Nickel
Pack 25◆



41841
1-1/2" Dia.
Satin Nickel
Pack 25◆



41851
1-1/4" Dia.
Satin Nickel
Pack 25◆



41929
1-1/4" Dia.
Satin Nickel
Pack 25◆



59147
3" C.C.
Satin Nickel
Pack 25◆



59600
3" C.C.
Satin Nickel
Pack 25◆



59884
3-3/4" C.C.
Satin Nickel
Pack 12◆

STAINLESS STEEL



59990 3" C.C. Pack 12◆
59880 3-3/4" C.C. Pack 12◆
59881 7" C.C. Pack 12◆
59882 9-3/4" C.C. Pack 12◆
59983 15-1/4" C.C. Pack 10◆
59984 17-5/8" C.C. Pack 10◆
59985 23-1/4" C.C. Pack 10◆

BRUSHED NICKEL



41596
1-3/4" Dia.
Brushed Nickel
Pack 10◆



41592
1-1/8" Dia.
Brushed Nickel
Pack 25◆



59757
3-3/4" C.C.
Brushed Nickel
Pack 25◆



59759
3-3/4" C.C.
Brushed Nickel
Pack 25◆



59760
5" C.C.
Brushed Nickel
Pack 25◆



59751
3-3/4" C.C.
Brushed Nickel
Pack 25◆



59752
5" C.C.
Brushed Nickel
Pack 25◆



59761
3-3/4" C.C.
Brushed Nickel
Pack 25◆



59772 3-3/4" C.C. Pack 25◆
59773 5" C.C. Pack 12◆
59774 6-1/4" C.C. Pack 12◆



41639
1-1/8" Dia.
Brushed Nickel
Pack 25◆



59232
3" C.C.
Brushed Nickel
Pack 25◆



59229
3" C.C.
Brushed Nickel
Pack 25◆



59456
3" C.C.
Brushed Nickel
Pack 25◆



59464
3" C.C.
Brushed Nickel
Pack 25◆



41793R1
1-1/4" Dia.
Brushed Nickel
Pack 25◆



59769
2-1/2" C.C.
Brushed Nickel
Pack 25◆



59981
5" C.C.
Brushed Nickel
Pack 25◆

POLISHED NICKEL



41812
1-3/8" Dia.
Polished Nickel
Pack 25◆



41813
1-3/16" Dia.
Polished Nickel
Pack 25◆



59474
1-1/4" Dia.
Polished Nickel
Pack 25◆

SATIN CHROME



41584
1-1/8" DIA.
SATIN CHROME
PACK 25◆



41765
1-1/4" DIA.
SATIN CHROME
PACK 25◆



41775R1
1-1/4" DIA.
SATIN CHROME
PACK 25◆



41778R1
1-1/4" DIA.
SATIN CHROME
PACK 25◆



41654R1
1-1/4" DIA.
SATIN CHROME
PACK 12◆



41648
1-1/8" DIA.
SATIN CHROME
PACK 12◆



59243
3" C.C.
SATIN CHROME
PACK 10◆



59149
3" C.C.
SATIN CHROME
PACK 25◆



59135R1 3-1/2" C.C. Pack 25◆
59140R1 4" C.C. Pack 25◆



41665
2" DIA.
SATIN CHROME
PACK 25◆



41666
2-3/4" DIA.
SATIN CHROME
PACK 25◆



41662
2-1/4" WIDE
SATIN CHROME
PACK 25◆

CABINET HARDWARE

BRUSHED CHROME



59927
1-1/4" DIA.
BRUSHED CHROME
PACK 25◆



59479
1-1/4" DIA.
BRUSHED CHROME
PACK 25◆



59908
1-1/4" DIA.
BRUSHED CHROME
PACK 25◆



59184
3-1/2" C.C.
DULL CHROME
PACK 25◆

ALUMINUM



59965
3" C.C.
BRUSHED CHROME
PACK 25◆



59911
5" C.C.
BRUSHED CHROME
PACK 12◆



41905R1 **N**
1-1/4" DIA.
BRUSHED CHROME
PACK 25◆



59693 3" C.C. ALUMINUM PACK 25◆
59692 3-1/2" C.C. ALUMINUM PACK 25◆
97100 4" C.C. ALUMINUM PACK 25◆

POLISHED CHROME



59926
1-1/4" DIA.
POLISHED CHROME
PACK 25◆



59423
5" C.C.
POLISHED CHROME
PACK 12◆



59915
1-1/4" DIA.
POLISHED CHROME
PACK 25◆



59970
3" C.C.
POLISHED CHROME
PACK 25◆



59923
5" C.C.
POLISHED CHROME
PACK 12◆



59909
1-1/4" DIA.
POLISHED CHROME
PACK 25◆



41544R1
1-1/4" DIA.
POLISHED CHROME
PACK 25◆



41570R1
1-1/4" DIA.
POLISHED CHROME
PACK 25◆



41553R1
1-1/4" DIA.
POLISHED CHROME
PACK 12◆



41358
1-1/2" DIA.
POLISHED CHROME
PACK 25◆



59533R1
3" C.C.
POLISHED CHROME
PACK 25◆



59596
3" C.C.
POLISHED CHROME
PACK 25◆



59245R1
3" C.C.
POLISHED CHROME
PACK 10◆



41574R2
1-1/8" DIA.
POLISHED CHROME
PACK 25◆



41443
1-1/4" DIA.
POLISHED CHROME/ WHITE
PORCELAIN
PACK 25◆



41523
1" DIA.
POLISHED CHROME
PACK 50◆



41607
1-1/4" DIA.
POLISHED CHROME
PACK 25◆



59115R1 3" C.C. Pack 25◆
59120R1 3-1/2" C.C. Pack 25◆
59125R1 4" C.C. Pack 25◆



59668
3" C.C.
POLISHED CHROME W/ BRASS LEGS
PACK 25◆



41616
1-1/4" DIA.
POLISHED CHROME/ WHITE
PLASTIC
PACK 25◆



41513
1-1/4" DIA.
POLISHED CHROME/ WHITE
PLASTIC
PACK 25◆



59523
3" C.C.
POLISHED CHROME/ WHITE
PLASTIC
PACK 25◆

POLISHED CHROME



41669 1-3/8" Dia. Pack 25◆



96843 1-1/2" Dia.
POLISHED CHROME
PACK 50◆



41598 1-1/4" Dia.
POLISHED CHROME
PACK 25◆



41525 1" Dia.
POLISHED CHROME
PACK 50◆



57603 2-3/4" Dia.
POLISHED CHROME
PACK 200◆



59553 3" C.C.
POLISHED CHROME
PACK 25◆



59562 3" C.C.
POLISHED CHROME
PACK 25◆



59558 3" C.C.
POLISHED CHROME
PACK 25◆



59150 3" C.C.
POLISHED CHROME
PACK 25◆

ANTIQUE IRON



41875 1-1/2" Dia.
ANTIQUE IRON
PACK 25◆



41878 1-3/8" Dia.
ANTIQUE IRON
PACK 25◆



59469 3" C.C.
ANTIQUE IRON
PACK 25◆

ANTIQUE STEEL



41532 1-1/8" Dia.
ANTIQUE STEEL
PACK 25◆



41709 1-5/16" Dia.
ANTIQUE STEEL
PACK 25◆



59213 3" C.C.
ANTIQUE STEEL
PACK 25◆

ANTIQUE NICKEL



41531 1-1/4" Dia.
ANTIQUE NICKEL
PACK 25◆



59963 3" C.C.
ANTIQUE NICKEL
PACK 25◆



59941 5" C.C.
ANTIQUE NICKEL
PACK 25◆



59422 5" C.C.
ANTIQUE NICKEL
PACK 12◆

ANTIQUE PEWTER



41732
1-1/2" DIA.
ANTIQUE PEWTER
PACK 25◆



41730
2-3/8" DIA.
ANTIQUE PEWTER
PACK 25◆



59709
3-1/2" C.C.
ANTIQUE PEWTER
PACK 25◆

PEWTER



41777
1-1/4" DIA.
PEWTER
PACK 25◆



59569R1
3-1/2" C.C.
PEWTER
PACK 25◆

ANTIQUE SILVER



41689R1
1-1/4" DIA.
ANTIQUE SILVER
PACK 25◆



59617R1
3" C.C.
ANTIQUE SILVER
PACK 10◆



41697
1-1/4" DIA.
ANTIQUE SILVER
PACK 12◆



41692R1
1-1/4" DIA.
ANTIQUE SILVER
PACK 25◆

BLACK



41640
1" DIA.
MATT BLACK
PACK 50◆



41643
1-1/8" DIA.
MATT BLACK
PACK 25◆



59412
3" C.C.
MATT BLACK
PACK 25◆



59413
3" C.C.
MATT BLACK
PACK 25◆



59225
3" C.C.
BLACK
PACK 25◆



41536
1-1/8" DIA.
BLACK
PACK 25◆



59221
3-1/4" C.C.
BLACK
PACK 25◆

BLACK NICKEL



41546R1
1-1/4" DIA.
BLACK NICKEL
PACK 12◆



59482
1-1/4" DIA.
BLACK NICKEL
PACK 12◆



41591
1-1/8" DIA.
BLACK NICKEL
PACK 25◆



59554
3" C.C.
BLACK NICKEL
PACK 25◆



59188 3" C.C. Pack 25◆
59192 4" C.C. Pack 25◆

EUROPEAN BRONZE



59480R1
1-1/4" DIA.
EUROPEAN BRONZE
PACK 25◆



59481R1
1-1/4" DIA.
EUROPEAN BRONZE
PACK 12◆



59484
1-1/4" DIA.
EUROPEAN BRONZE
PACK 12◆



41850
1-1/4" DIA.
ORB
PACK 25◆



59476
1-1/4" DIA.
EUROPEAN BRONZE
PACK 25◆



59549
3" C.C.
EUROPEAN BRONZE
PACK 10◆



59508R1 3" C.C. Pack 25◆

59509R1 3-1/2" C.C. Pack 25◆



59570
1-5/32" DIA.
EUROPEAN BRONZE
PACK 25◆



59890
1-1/4" DIA.
EUROPEAN BRONZE
PACK 12◆



59948R1
3" C.C.
EUROPEAN BRONZE
PACK 25◆



59891
4" C.C.
EUROPEAN BRONZE
PACK 25◆



59916
1-1/4" DIA.
EUROPEAN BRONZE
PACK 25◆



59971
3" C.C.
EUROPEAN BRONZE
PACK 25◆



59954
1-1/4" DIA.
EUROPEAN BRONZE
PACK 25◆



59924
5" C.C.
EUROPEAN BRONZE
PACK 12◆

CABINET HARDWARE

OIL RUBBED BRONZE



41876
1-1/2" DIA.
ORB (DARK)
PACK 25◆



59914
1-1/4" DIA.
ORB (DARK)
PACK 25◆



59892
1-3/8" DIA.
ORB (DARK)
PACK 25◆



41727
1-1/4" DIA.
ORB (DARK)
PACK 12◆



41593R1
1-1/4" DIA.
ORB (DARK)
PACK 25◆



41798
1-1/4" DIA.
ORB (DARK)
PACK 25◆



41911
1-1/4" DIA.
ORB (DARK)
PACK 25◆



41575R1
1-1/4" DIA.
ORB (DARK)
PACK 25◆



41755
1-1/4" DIA.
ORB (DARK)
PACK 12◆



59945
3" C.C.
ORB (DARK)
PACK 25◆



59450
3" C.C.
ORB (DARK)
PACK 25◆



59905
3" C.C.
ORB (DARK)
PACK 10◆



41754
1-1/4" DIA.
ORB (DARK)
PACK 25◆



59925
5" C.C.
ORB (DARK)
PACK 12◆



41774R1
1-1/4" DIA.
ORB (DARK)
PACK 25◆



41780
1-1/4" DIA.
ORB (DARK)
PACK 12◆



59969
3" C.C.
ORB (DARK)
PACK 25◆



59626R1
3" C.C.
ORB (DARK)
PACK 25◆



59244R1
3" C.C.
ORB (DARK)
PACK 10◆



59937
3" C.C.
ORB (MEDIUM)
PACK 25◆

RUST



41769R1
1-1/4" Dia.
RUST
PACK 25◆



41773R1
1-1/4" Dia.
RUST
PACK 12◆



59250
3" C.C.
RUST
PACK 25◆



41726
1-1/4" Dia.
RUST
PACK 12◆



41695R1
1-1/4" Dia.
RUST
PACK 25



59962
3" C.C.
RUST
PACK 25◆



41724R1
1-1/4" Dia.
RUST
PACK 12◆



59946
3" C.C.
RUST
PACK 25◆



59514
4" C.C.
RUST
PACK 25◆



59893
1-3/8" Dia.
RUST
PACK 25◆



59906
3" C.C.
RUST
PACK 10◆



41612
1-1/2" Dia.
RUST
PACK 25◆



59255
3" C.C.
RUST
PACK 25◆

POLISHED ANTIQUE COPPER



41549R1
1-1/4" DIA.
POLISHED ANTIQUE COPPER
PACK 12◆



41752
1-1/4" DIA.
POLISHED ANTIQUE COPPER
PACK 25◆



59653R1
3" C.C.
POLISHED ANTIQUE COPPER
PACK 25◆



59885
3-3/4" C.C.
POLISHED ANTIQUE COPPER
PACK 12◆



59483
1-1/4" DIA.
POLISHED ANTIQUE COPPER
PACK 12◆



41545
1-5/32" DIA.
POLISHED ANTIQUE COPPER
PACK 25◆



41843
1" DIA.
POLISHED ANTIQUE COPPER
PACK 12◆



59491
3-1/2" C.C.
POLISHED ANTIQUE COPPER
PACK 25◆

ANTIQUA COPPER



41688R1
1-1/4" DIA.
ANTIQUA COPPER
PACK 25◆



59616
3" C.C.
ANTIQUA COPPER
PACK 10◆



41782
1-1/4" DIA.
ANTIQUA COPPER
PACK 12◆



59448
3" C.C.
ANTIQUA COPPER
PACK 25◆



41696
1-1/4" DIA.
ANTIQUA COPPER
PACK 12◆



59961
3" C.C.
ANTIQUA COPPER
PACK 25◆



41910R1
1-1/4" DIA.
ANTIQUA COPPER
PACK 25◆



41656
1-3/8" DIA.
ANTIQUA COPPER
PACK 25◆



41869
3" C.C.
ANTIQUA COPPER
PACK 25◆



59506R1 3" C.C. Pack 25◆

59622R1 3-1/2" C.C. Pack 25◆

ANTIQUE ENGLISH



59898
1-1/4" DIA.
ANTIQUE ENGLISH
PACK 25◆



59901
1-1/4" DIA.
ANTIQUE ENGLISH
PACK 12◆



59953
1-1/4" DIA.
ANTIQUE ENGLISH
PACK 25◆



41702R1
1-1/4" DIA.
ANTIQUE ENGLISH
PACK 12◆



41693
1-1/4" DIA.
ANTIQUE ENGLISH
PACK 12◆



41706
1-5/16" DIA.
ANTIQUE ENGLISH
PACK 25◆



59947
3" C.C.
ANTIQUE ENGLISH
PACK 25◆



41653
1" DIA.
ANTIQUE ENGLISH
PACK 50◆

ANTIQUE BRASS



41708
1-5/16" DIA.
ANTIQUE BRASS
PACK 25◆



41657
1-1/4" DIA.
ANTIQUE BRASS
PACK 25◆



41655
1-3/8" DIA.
ANTIQUE BRASS
PACK 25◆



41610
1-1/2" DIA.
ANTIQUE BRASS
PACK 25◆



59708
3" C.C.
ANTIQUE BRASS
PACK 25◆



59537
3" C.C.
ANTIQUE BRASS
PACK 25◆



59227
3" C.C.
ANTIQUE BRASS
PACK 25◆



59568
3" C.C.
ANTIQUE BRASS
PACK 25◆



59212
3" C.C.
ANTIQUE BRASS
PACK 25◆



59527
3" C.C.
ANTIQUE BRASS
PACK 25◆



59542
3" C.C.
ANTIQUE BRASS
PACK 25◆



59530
3" C.C.
ANTIQUE BRASS
PACK 25◆

ANTIQUE BRASS



41611*
1" DIA.
ANTIQUE BRASS
PACK 25◆



41620
1-3/16" DIA.
ANTIQUE BRASS
PACK 25◆

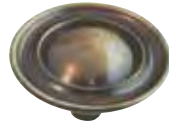

41622
1-7/16" DIA.
ANTIQUE BRASS
PACK 25◆



41658
1-1/8" DIA.
ANTIQUE BRASS
PACK 50◆



41660
1-1/4" DIA.
ANTIQUE BRASS
PACK 25◆

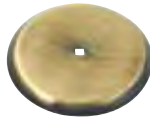

95878
3" DIA.
ANTIQUE BRASS
PACK 100◆



59621
3" C.C.
ANTIQUE BRASS
PACK 25◆



59565
3" C.C.
ANTIQUE BRASS
PACK 25◆



59524
3" C.C.
ANTIQUE BRASS
PACK 25◆



59155
3" C.C.
ANTIQUE BRASS
PACK 25◆



41873
1-1/4" DIA.
ANTIQUE BRASS/ OAK
PACK 25◆



59519
3" C.C.
ANTIQUE BRASS/ OAK
PACK 25◆



41628
1-1/4" DIA.
ANTIQUE BRASS/CLEAR
PACK 25◆



59525
3" C.C.
ANTIQUE BRASS
PACK 25◆

POLISHED BRASS



41568R1
1-1/4" DIA.
POLISHED BRASS
PACK 25◆



41550R1
1-1/4" DIA.
POLISHED BRASS
PACK 25◆



41510R1
1-1/4" DIA.
POLISHED BRASS
PACK 25◆



41606
1-1/4" DIA.
POLISHED BRASS
PACK 25◆



41579
1-1/4" DIA.
POLISHED BRASS
PACK 25◆



41564*
1-1/2" DIA.
POLISHED BRASS
PACK 12◆



41572R1
1-1/8" DIA.
POLISHED BRASS
PACK 25◆



41365
1-1/4" DIA.
POLISHED BRASS
PACK 25◆



41535
1-1/4" DIA.
POLISHED BRASS
PACK 25◆



59100R1 3" C.C. Pack 25◆
59105R1 3-1/2" C.C. Pack 25◆
59110R1 4" C.C. Pack 25◆



59534R1 3" C.C. Pack 25◆
59543 3-1/2" C.C. Pack 25◆



59541
3" C.C.
POLISHED BRASS
PACK 25◆



41433
1-1/4" DIA.
POLISHED BRASS/ WHITE
PORCELAIN
PACK 25◆



41434
1-1/4" DIA.
POLISHED BRASS/ WHITE
PORCELAIN
PACK 25◆



59636
3" C.C.
POLISHED BRASS/ WHITE
PORCELAIN
PACK 25◆

POLISHED BRASS



41519
1" DIA.
POLISHED BRASS
PACK 50◆



41520
1-1/4" DIA.
POLISHED BRASS
PACK 25◆



41522
1" DIA.
POLISHED BRASS
PACK 25◆



41521
1-1/4" DIA.
POLISHED BRASS
PACK 25◆



96844
1" DIA.
POLISHED BRASS
PACK 50◆



41600
1-3/8" DIA.
POLISHED BRASS
PACK 50◆



97484
1-7/8" DIA.
POLISHED BRASS
PACK 50◆



41605
1-3/4" DIA.
POLISHED BRASS
PACK 50◆

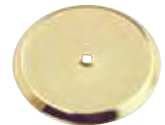

57600
2-3/4" DIA.
POLISHED BRASS
PACK 50◆



59612
3" C.C.
POLISHED BRASS
PACK 25◆



59614
3" C.C.
POLISHED BRASS
PACK 25◆



59551
3" C.C.
POLISHED BRASS
PACK 25◆



59620
3" C.C.
POLISHED BRASS
PACK 25◆



59145
3" C.C.
POLISHED BRASS
PACK 25◆



41617
1-1/4" DIA.
POLISHED BRASS/ OAK
PACK 25◆



59517
3" C.C.
POLISHED BRASS/ OAK
PACK 25◆



59604
3" C.C.
POLISHED BRASS/ OAK
PACK 25◆



41497
1-1/4" DIA.
POLISHED BRASS/CLEAR
PACK 25◆



41499
1" DIA.
POLISHED BRASS/CLEAR
PACK 25◆



41615
1-1/4" DIA.
POLISHED BRASS/ WHITE
PLASTIC
PACK 25◆



41514
1-1/4" DIA.
POLISHED BRASS/ WHITE
PLASTIC
PACK 25◆



59522
3" C.C.
POLISHED BRASS/ WHITE
PLASTIC
PACK 25◆



59602
3" C.C.
POLISHED BRASS/ WHITE
PLASTIC
PACK 25◆

RESIN



41746
1-1/4" DIA.
SOCCERBALL
PACK 25◆



41745
1-1/4" DIA.
BASEBALL
PACK 25◆



41748
1-1/4" DIA.
BASKETBALL
PACK 25◆



41747
1-1/4" LENGTH
FOOTBALL
PACK 25◆



41749
1-1/4" DIA.
SUNFLOWER
PACK 25◆



41744
1-1/4" DIA.
ROSE
PACK 25◆

UNFINISHED WOOD



41445
1-1/4" DIA.
UNFINISHED BEECH
PACK 25◆



41442
1-1/2" DIA.
UNFINISHED BEECH
PACK 25◆



41446
1-1/2" DIA.
UNFINISHED BEECH
PACK 25◆



41447
1-3/4" DIA.
UNFINISHED BEECH
PACK 25◆



41448
2" DIA.
UNFINISHED BEECH
PACK 25◆



41461
1-1/4" DIA.
UNFINISHED BEECH
PACK 25◆



41457
1-1/4" DIA.
UNFINISHED BEECH
PACK 25◆



41458
1-1/2" DIA.
UNFINISHED BEECH
PACK 25◆



59656
3" C.C.
UNFINISHED BEECH
PACK 25◆



59651
3" C.C.
UNFINISHED OAK
PACK 25◆



59654
3-3/4" C.C.
UNFINISHED OAK
PACK 25◆

PORCELAIN



41378*
1-1/4" DIA.
WHITE PORCELAIN
PACK 25◆



41627
1-1/2" DIA.
WHITE PORCELAIN
PACK 25◆

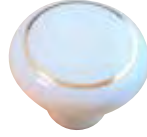

41425
1-1/4" DIA.
WHITE PORCELAIN
PACK 25◆



41435
1-1/4" DIA.
WHITE PORCELAIN
PACK 25◆



41377
1-1/4" DIA.
WHITE PORCELAIN
PACK 25◆



41376
1-1/2" DIA.
WHITE PORCELAIN
PACK 25◆



41437
1-1/4" DIA.
BLACK PORCELAIN
PACK 25◆



41427
1-1/2" DIA.
BLACK PORCELAIN
PACK 25◆

CERAMIC



41633
1" DIA.
WHITE CERAMIC
PACK 25◆



41634
1-1/4" DIA.
WHITE CERAMIC
PACK 25◆



41635
1-1/2" DIA.
WHITE CERAMIC
PACK 25◆



41671
1-1/4" DIA.
WHITE PLASTIC
PACK 25◆



41410
1-1/4" DIA.
WHITE PLASTIC
PACK 25◆



41619
1-3/8" DIA.
WHITE CERAMIC
PACK 25◆



41518
1-1/2" DIA.
WHITE CERAMIC
PACK 25◆



41518
1-1/2" DIA.
WHITE CERAMIC
PACK 25◆



41673
1-1/2" DIA.
WHITE PLASTIC
PACK 25◆



59196 3" C.C. Pack 25◆
59485 4" C.C. Pack 50◆

STEEL



41835R1
1-1/4" DIA.
HOLLOW STEEL
PACK 25◆

VALUE PACK

Clamshell value pack in traditional mushroom style knob and 3" center to center pull. Both available in Satin Nickel, Oil Rubbed Bronze (Med.) and Polished Chrome finishes, 10 pieces per pack



CODE	DESCRIPTION	SIZE	FINISH	INNER
59159	Knob	1-1/4" Dia.	Polished Chrome	5◆
59160	Knob	1-1/4" Dia.	Satin Nickel	5◆
59161	Knob	1-1/4" Dia.	Oil Rubbed Bronze (Medium)	5◆
59157	Pull	3" C.C.	Polished Chrome	5◆
59156	Pull	3" C.C.	Satin Nickel	5◆
59158	Pull	3" C.C.	Oil Rubbed Bronze (Medium)	5◆

CONCEALED HINGES



CODE	DESCRIPTION	CABINET TYPE	OPENING	CC	PACK	INNER
34840	Soft Close - Full Overlay	Frameless	100°	1-7/8" CC	2/Poly	10◆
34841	Soft Close - Half Overlay	Frameless	100°	1-7/8" CC	2/Poly	10◆
34842	Soft Close - Inset	Frameless	100°	1-7/8" CC	2/Poly	10◆
34866	FULL OVERLAY	Frameless	110°	1-7/8" CC	2/Poly	20◆
34868	HALF OVERLAY	Frameless	120°	1-3/4" CC	2/Poly	20◆
34885	INSET	Frameless	105°	1-3/4" CC	2/Poly	10◆
34890	HALF OVERLAY	Frameless	105°	1-3/4" CC	2/Poly	10◆
34895	FULL OVERLAY	Frameless	105°	1-3/4" CC	2/Poly	10◆
34865	INSET	Frameless	165°	1-3/4" CC	1/Poly	10◆
34850	HALF OVERLAY	Framed	100°	1-7/8" CC	2/Poly	10◆
34867	FULL OVERLAY	Framed	105°	1-3/4" CC	2/Poly	20◆
34870	INSET	Framed	105°	1-3/4" CC	2/Poly	10◆
34875	HALF OVERLAY	Framed	105°	1-3/4" CC	2/Poly	10◆
34880	FULL OVERLAY	Framed	105°	1-3/4" CC	2/Poly	10◆
13950R1 NEW	Concealed Hinge Mounting Kit					5◆

CABINET HARDWARE

SELF-CLOSING HINGES

Flush Type Hinges



3/8" Inset Hinges



CODE	FINISH	INNER
FLUSH TYPE HINGES		
34900R1	Antique Brass	25◆
34901R1	Oil Rubbed Bronze	25◆
34902R1	Antique Copper	25◆
34903R1	Antique Pewter	25◆
34904R1	Satin Nickel	25◆
34910R1	Polished Brass	25◆
34920R1	Chrome Plated	25◆
34912R1	White	25◆
INSET HINGES		
34905R1	Antique Brass	25◆
34906R1	Satin Nickel	25◆
34908R1	Oil Rubbed Bronze	25◆
34909R1	Antique Pewter	25◆
34911R1	Antique Copper	25◆
34915R1	Polished Brass	25◆
34918R1	White	25◆
34921R1	Chrome Plated	25◆
Polybagged in Pairs with Screws		

H HINGES



CODE	TYPE	SIZE	FINISH	INNER
35080	Flush	3-1/2" Length	Black	25◆
35082	Flush	3-1/2" Length	Antique Brass	25◆
35084	Offset	3-1/2" Length	Black	25◆
35085	Offset	3-1/2" Length	Antique Copper	25◆
35086	Offset	3-1/2" Length	Antique Brass	25◆
Polybagged in Pairs				

WRAP HINGES

Partial Wrap



CODE	FINISH	INNER
34922	Antique Brass	25◆
34923	Brass Plated	25◆
Polybagged in Pairs with Screws		

ORNAMENTAL HINGE



CODE	SIZE	FINISH	INNER
60854	2-3/8" x 2-3/16"	Brass Plated	10◆
Carded in Pairs with Screws			

Full Wrap



CODE	FINISH	INNER
34924	Antique Brass	25◆
Polybagged in Pairs with Screws		

GLASS DOOR HINGE



CODE	FINISH	INNER
34555	Chrome Plated	20
34560	Brass Plated	20
Individually Polybagged with Screws		

ROLLER CATCHES

Single Roller Catches

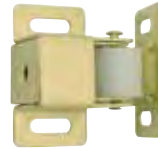

CODE	SIZE	STRIKE	WHEEL	FINISH	INNER
13525	1-3/8"x 1-7/8"	1-5/8"x 7/8"	5/8"x 5/8"	Brass Plated	12◆
13550	1"x 1-3/8"	1-3/8"x 5/8"	3/8"x 3/8"	Zinc Plated	100◆
Polybagged with Screws					

CODE	FINISH	INNER
96211	Zinc Plated	25◆
Polybagged with Screws		

DOUBLE ROLLER CATCHES



FRICTION CATCHES

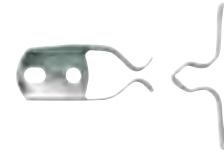

CODE	FINISH	INNER
13505	Zinc Plated	100◆
13510	Antique Copper	100◆
13515	Polished Brass	100◆
Polybagged with Screws		

CODE	FINISH	INNER
60897	Zinc Plated	10◆
Carded with Screws		

CODE	FINISH	INNER
60894	Nickel Plated	10◆
Carded with Screws		

MAGNETIC CATCHES

Magnetic Catch with Strikes

- 2" x 1"



Heavy Duty — Magnetic Catches

- 2-3/8" x 5/8"



CODE	TYPE	CASE	SIZE	INNER
60895	Single	Brown Plastic	2"x 1"	10◆
Carded with Screws				
13492	Single	Brown Plastic	2"x 1"	25◆
13496	Single	Aluminum	2"x 1"	20◆

CODE	TYPE	CASE	SIZE	INNER
13497	Single	Aluminum	2-1/4"x 1"	20◆
13498	Double	Aluminum	2-1/4"x 1"	20◆
Polybagged with Screws				

CODE	SIZE	FINISH	INNER
13503	2-3/8"x 5/8"	White	50◆
13504	2-3/8" x 5/8"	Brown	50◆
Polybagged with Screws			

Plastic — Magnetic Catches



Metal Oversized — Magnetic Catch

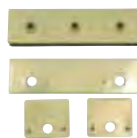

Plastic Oversized — Magnetic Catch



CODE	SIZE	FINISH	INNER
13500	1-3/4"x 1/2"	Brown	50◆
13502	1-3/4"x 1/2"	White	50◆
Polybagged with Screws			

CODE	SIZE	INNER
96200	3"	25◆
Polybagged with Screws		

CODE	SIZE	INNER
13494	2-3/8"x 3/8"	25◆
Polybagged with Screws		

CABINET HARDWARE

MAGNETIC LATCHES

Touch Latches



CODE	FINISH	INNER
96874	Brown	50◆
96875	White	50◆
Polybagged with Screws		

Mini Touch Latch



CODE	FINISH	INNER
96880	Brass Plated	50◆
96881	Nickel Plated	50◆
Polybagged with Screws		

MAGNETIC CATCHES

Mini Touch Latch

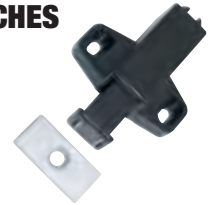

CODE	TYPE	FINISH	INNER
SINGLE			
13605 NEW	Round	Black	25◆
13600	Round	White	50
13615	Square	Black	50
DOUBLE			
13620	Round	White	50
Polybagged with Screws			

LATCHES

Bar Latch



CODE	SIZE	FINISH	INNER
60899	2-1/2"	Brass Plated	10◆
Carded with Screws			

Spring Bolt Latch



CODE	FINISH	INNER
41952	Brass Plated	12◆
Carded with Screws		

Spring Bolt Latch



CODE	FINISH	INNER
41950	Nickel Plated	12◆
60893	Brass Plated	5◆
Carded with Screws		

CABINET & DRAWER LOCKS



CODE	FINISH	KEYED	INNER
44819	Brass Plated	Alike	12◆
Polybagged with Screws			



CODE	FINISH	FINISH
44830	Brass Plated	12◆
Carded with Screws		



CODE	FINISH	KEYED	INNER
44826	Brass Plated	Different	12◆
44825	Brass Plated	Alike	12◆
Carded with Screws			
44821	Brass Plated	Different	12◆
44823	Chrome Plated	Alike	12◆
44824	Chrome Plated	Different	12◆
Boxed with Screws			

DRAWER SLIDES & SOCKETS

Bottom Mounted – Self Closing



CODE	SIZE	FINISH	INNER
66095	14"	White	25◆
66100	16"	White	25◆
66105	18"	White	25◆
66110	20"	White	25◆
66115	22"	White	25◆
Bulk Packed in Pairs with Screws			

Side Mounted



CODE	SIZE	FINISH	INNER
66050R1	16"	Zinc Plated	10
66055R1	18"	Zinc Plated	10
66060R1	20"	Zinc Plated	10
66065R1	22"	Zinc Plated	10
Bulk Packed in Pairs without Screws			

Rear Mounting Sockets



CODE	FINISH	INNER
69020	White Plastic	25◆
Polybagged in Pairs without Screws		

CEILING FANS WITH LIGHTS

- ° *Ceiling Mounted*
- ° *Frosted Ribbed Glass Lights*
- ° *Reversible Blades with 2 wood color options*
- ° *UL Safety Listed*
- ° *Standard 60W Bulb Usage (Bulbs not included)*
- ° *Accepts up to 13w Energy Saver CFL Bulbs*
- ° *Installation Instructions and Hardware Kit Included*



Code	Size	Sockets	Blades	Finish	Blade	Pack	INNER
74001 New	42"	1	4	Satin Nickel	Oak/Walnut	Box	1
74000 New	42"	1	4	Polished Brass	Oak/Walnut	Box	1
74004 New	42"	3	5	Oil Rubbed Bronze	Oak/Walnut	Box	1



Code	Size	Sockets	Blades	Finish	Blade	Pack	INNER
74002 New	52"	3	5	White/Polished Brass	White/Wash Oak	Box	1
74003 New	52"	3	5	Antique Brass	Oak/Walnut	Box	1
74005 New	52"	3	5	Oil Rubbed Bronze	Oak/Walnut	Box	1

COLLECTIONS

- *Installation Instructions and Hardware Included*
- *UL Listed*
- *Bulbs not included*

Alabaster Glass with Pearl Mist Finish



74115



74113



74110

Code	Type	Size	Bulb Capacity	Pack
74110 New	Ceiling Flush Mount	8" W x 4-1/2" H	1/60W	1
74113 New	Wall Mount	18-1/2" W x 6-1/2" H x 6-1/2" Extension	3/60W	1
74115 New	Wall Mount	24" W x 6-1/2" H x 6-1/2" Extension	4/60W	1

Alabaster Glass with Brush Nickel Finish



74114



74111



74129

Code	Type	Size	Bulb Capacity	Pack
74129 New	Ceiling Flush Mount	12-1/4" W x 5-3/4" H	1/60W	1
74111 New	Wall Mount	18-1/2" W x 6-1/2" H x 6-1/2" Extension	3/60W	1
74114 New	Wall Mount	24" W x 6-1/2" H x 6-1/2" Extension	4/60W	1

Alabaster Glass with Silver Mist Finish



74117



74124
74125



74123

Code	Type	Size	Bulb Capacity	Pack
74123 New	Ceiling Flush Mount	8" W x 4-1/2" H	1/60W	1
74124 New	Ceiling Flush Mount	11" W x 6-1/2" H	1/75W	1
74125 New	Ceiling Flush Mount	13" W x 7" H	2/60W	1
74117 New	Wall Mount	5-1/2" W x 7-1/2" H x 6-1/2" Extension	1/60W	1

*Opal Glass with
Polished Chrome Finish*



74152



74150



74149

Code	Type	Size	Bulb Capacity	Pack
74149 New	Wall Mount	13" W x 8" H x 8" Extension	2/60W	1
74150 New	Wall Mount	16-1/4" W x 8-1/2"H x 8-3/4" Extension	3/60W	1
74152 New	Wall Mount	18" W x 6" H x 6" Extension	3/60W	1

*Amber Glass with
Burnished Antique
Bronze Finish*



74116



74112

Code	Type	Size	Bulb Capacity	Pack
74112 New	Wall Mount	18-1/2" W x 6-1/2"H x 6-1/2" Extension	3/60W	1
74116 New	Wall Mount	24" W x 6-1/2" H x 6-1/2" Extension	4/60W	1

*Bronze Satin Glass with
Burnished Antique
Bronze Finish*



74148

Code	Type	Size	Bulb Capacity	Pack
74148 New	Wall Mount	18-1/2" W x 6-1/2"H x 6-1/2" Extension	3/60W	1

CEILING LIGHTS



74119



74126



74130

Code	Glass	Finish	Size	Bulb Capacity	Pack
74119 New	Alabaster Glass	Antique Pewter	11" W x 6-1/2" H	2/60W	1
74126 New	Alabaster Glass	Antique Brass	11" W x 6-1/2" H	2/60W	1
74130 New	Alabaster Glass	Chocolate Bronze	12-1/4" W x 5-3/4" H	1/60W	1



74136



74159



74162

Code	Glass	Finish	Size	Bulb Capacity	Pack
74136 New	Alabaster Swirl Glass	Jade Mist	13" W x 7" H	2/60W	1
74159 New	Etched Glass With Clear Floral	Antique Pewter	13" W x 7" H	2/60W	1
74162 New	Etched Glass with Clear Floral	Antique Brass	13" W x 7" H	2/60W	1



74131



74121



74133

Code	Glass	Finish	Size	Bulb Capacity	Pack
74131 New	Satin Opal Twist-On Glass	Brushed Nickel	16-1/2" W x 6" H	3/60W	1
74121 New	Ribbed Stain Swirl Glass	Textured White	11" W x 6-1/2" H	1/75W	1
74133 New	Pearlescent Glass	Textured White	13" W x 7" H	2/60W	1



74134



74137



74120

Code	Glass	Finish	Size	Bulb Capacity	Pack
74134 New	Ribbed Clear Glass	Polished Brass	8" W x 4-1/2" H	1/60W	1
74137 New	Ribbed Clear Swirl Glass	Polished Brass	13" W x 7" H	2/60W	1
74120 New	Ribbed Swirl Glass	Polished Brass	11" W x 6-1/2" H	1/75W	1



74132



74140



74135

Code	Glass	Finish	Size	Bulb Capacity	Pack
74132 New	Ribbed Clear Swirl Glass	Polished Brass	11" W x 6-1/2" H	1/75W	1
74140 New	White Prismatic Glass	Chrome	8-3/4" W x 4-3/4" H	2/60W	1
74135 New	White Prismatic Glass	Chrome	6" W x 4-3/4" H	1/60W	1



74128



74141



74122

Code	Glass	Finish	Size	Bulb Capacity	Pack
74128 New	Clear Ribbed Glass	Polished Brass	6" W x 8" H	1/60W	1
74141 New	Clear Dimpled Glass	Polished Brass	5-1/4" W x 6-1/2" H	1/60W	1
74122 New	Clear Dimpled Glass	Polished Brass	5" W x 7" H	1/60W	1

CEILING LIGHTS



74158



74147



74161



74160

Code	Glass	Finish	Size	Bulb Capacity	Pack
74158 New	White Glass	White	7-1/4" W x 4-1/4" H	1/60W	1
74147 New	Opal White Glass	White	6" W x 7" H	1/60W	1
74161 New	Cased Opal Mushroom Glass	Polished Brass	9-1/2" W x 5-1/4" H	2/60W	1
74160 New	Cased Opal Glass	Polished Brass	6" W x 8" H	1/60W	1



74157



74127



74163

Code	Glass	Finish	Size	Bulb Capacity	Pack
74157 New	Frosted Etched Glass	White	7-1/2" W x 4-1/2" H	1/60W	1
74127 New	White Drum Glass	White	8" W x 5" H	2/60W	1
74163 New	Textured Floral White Glass	White	12" W x 5-3/4" H	2/60W	1

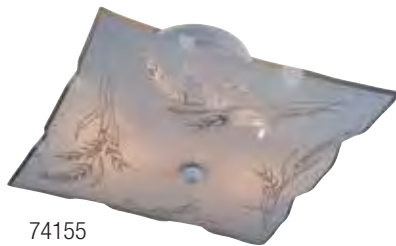

74155

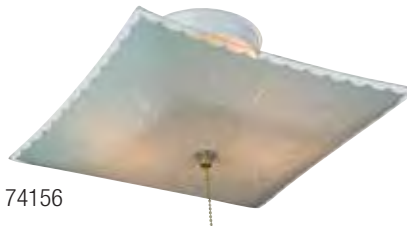

74156

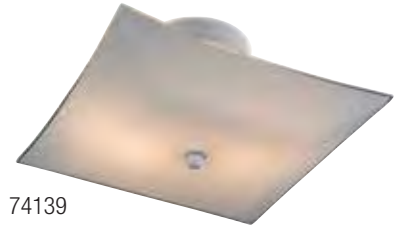

74139

Code	Glass	Finish	Size	Bulb Capacity	Pack
74155 New	White Glass With Wheat	White	12" W x 5" H	2/60W	1
74156 New	Floral White Glass	White	12" W x 5-3/4" H	2/60W	1
74139 New	Frosted Glass	White	12" W x 5-3/4" H	2/60W	1

Twin Pack



- ° *Alabaster glass dome with button finial*
- ° *UL Safety Listed*
- ° *Standard 60W Bulb Usage (Bulbs not included)*
- ° *Accepts up to 13w Energy Saver CFL Bulb*
- ° *Installation Instructions and Hardware Kit Included*



74108



74101



74102



74100

Code	Size	Sockets	Finish	Pack	INNER
74100 New	11"	1	White	2/Box	4◆
74101 New	11"	1	Brushed Nickel	2/Box	4◆
74102 New	11"	1	Polished Brass	2/Box	4◆
74108 New	11"	1	Oil Rubbed Bronze	2/Box	4◆
74103 New	13"	2	White	2/Box	2◆
74104 New	13"	2	Brushed Nickel	2/Box	2◆
74105 New	13"	2	Polished Brass	2/Box	2◆
74109 New	13"	2	Oil Rubbed Bronze	2/Box	2◆

WALL FIXTURE



74143
with Receptacle Outlet



74144



74142

Code	Glass	Finish	Size	Bulb Capacity	Pack
74143 New	Frosted Etched Glass	Polished Brass	4-1/2" W x 7-1/2" H	1/100W	1
74144 New	Frosted Etched Glass	Polished Brass	4-1/2" W x 7-1/2" H	1/100W	1
74142 New	Amber Glass	Polished Brass	4-1/2" W x 7-1/2" H	1/100W	1



74151



74118



74145

Code	Glass	Finish	Size	Bulb Capacity	Pack
74151 New	Clear Ribbed Scalloped Glass	Chrome	13" W x 8" H x 8" Extension	2/60W	1
74118 New	Satin bell Glass	Brushed Nickel	16" W x 9" H x 7" Extension	2/60W	1
74145 New	Clear Etched Glass	Chrome	5-1/4" W x 4-3/4" H	1/60W	1



74153



74154



74146

Code	Glass	Finish	Size	Bulb Capacity	Pack
74153 New	N/A	N/A	18" W x 4-1/4" H x 5" Extension	3 G-25 60W	1
74154 New	N/A	N/A	24" W x 4-1/4" H x 5" Extension	4 G-25 60W	1
74146 New	White Glass	White	4-1/4" W x 7-1/2" H	1/60W	1

OUTDOOR FIXTURE



74213



74215



74214
with Photocell



74216
with Photocell

Code	Glass	Material	Finish	Size	Bulb Capacity	Pack
74213 New	Clear Beveled Glass	Aluminum	Textured Black	6-1/2" W x 17" H x 8" Extension	1/100W	1
74215 New	Clear Beveled Glass	Aluminum	Textured Black	6-1/2" W x 17" H x 8" Extension	1/100W	2
74214 New	Clear Beveled Glass	Aluminum	Textured Black	6-1/2" W x 17" H x 8" Extension	1/100W	1
74216 New	Clear Beveled Glass	Aluminum	Textured Black	6-1/2" W x 17" H x 8" Extension	1/100W	2



74217



74219



74218
with Photocell



74220
with Photocell

Code	Glass	Material	Finish	Size	Bulb Capacity	Pack
74217 New	Clear Beveled Glass	Aluminum	Textured White	6-1/2" W x 17" H x 8" Extension	1/100W	1
74219 New	Clear Beveled Glass	Aluminum	Textured White	6-1/2" W x 17" H x 8" Extension	1/100W	2
74218 New	Clear Beveled Glass	Aluminum	Textured White	6-1/2" W x 17" H x 8" Extension	1/100W	1
74220 New	Clear Beveled Glass	Aluminum	Textured White	6-1/2" W x 17" H x 8" Extension	1/100W	2



74210



74212



74209



74211

Code	Glass	Material	Finish	Size	Bulb Capacity	Pack
74210 New	Clear Beveled Glass	Steel	Textured Black	5-1/2" W x 16-1/4" H x 6" Extension	1/60W	1
74212 New	Clear Glass	Steel	Chocolate Bronze	4-1/2" W x 13-1/2" H x 5-3/4" Extension	1/60W	1
74209 New	Clear Glass	Aluminum	Textured White	7" W x 14" H x 8" Extension	1/60W	1
74211 New	Clear Glass	Steel	Textured White	4-1/2" W x 13-1/2" H x 5-3/4" Extension	1/60W	1

*Photocell - Dusk to dawn sensor

OUTDOOR FIXTURE



74208



74200
with Photocell



74201

Code	Glass	Material	Finish	Size	Bulb Capacity	Pack
74208 New	Clear Glass	Aluminum	Textured Black	7" W x 14" H x 9" Extension	1/60W	1
74200 New	Clear Beveled Glass	Aluminum	Textured Black	6-3/8" W x 16" H x 7-1/2" Extension	1/100W	1
74201 New	Clear Beveled Glass	Aluminum	Weathered Bronze	6-3/8" W x 16" H x 7-1/2" Extension	1/100W	1



74203



74202



74206

Code	Glass	Material	Finish	Size	Bulb Capacity	Pack
74203 New	Clear Glass	Solid Brass	Polished Solid Brass	4-1/8" W x 8" H x 5-3/4" Extension	1/60W	1
74202 New	Clear Glass	Stainless Steel	Brushed Nickel	4-1/8" W x 8" H x 5-3/4" Extension	1/60W	1
74206 New	Clear Beveled Glass	Aluminum	Textured White	4-1/2" W x 8-1/2" H x 5-3/4" Extension	1/60W	1



74205



74204



74207



74138

Code	Glass	Material	Finish	Size	Bulb Capacity	Pack
74207 New	Clear Beveled Glass	Aluminum	Weathered Bronze	4-1/2" W x 8-1/2" H x 5-3/4" Extension	1/60W	1
74205 New	Clear Beveled Glass	Aluminum	Textured Black	4-1/2" W x 8-1/2" H x 5-3/4" Extension	1/60W	1
74204 New	Clear Beveled Glass	Aluminum	Weathered Antique Bronze	4-1/2" W x 8-1/2" H x 5-3/4" Extension	1/60W	1
74138 New	Ribbed Clear Glass	Metal	Black	4-1/2" W x 6-1/2" H x 5-1/2" Extension	1/60W	1

*Photocell - Dusk to dawn sensor

01013.....	90	11007.....	94	13939.....	71	29010.....	42	34911R1.....	141	35253.....	60
01211.....	91	11008.....	94	13940.....	71	29011.....	42	34912R1.....	141	35263.....	63
01212.....	91	11009.....	94	13941.....	71	29012.....	42	34915R1.....	141	35264.....	63
01213.....	91	11010.....	34	13942.....	71	29014.....	42	34918R1.....	141	35265.....	68
01214.....	91	11011.....	94	13943.....	71	29015.....	42	34920R1.....	141	35273.....	63
01216.....	91	11012.....	34	13950R1.....	140	29016.....	42	34921R1.....	141	35270.....	68
01790.....	119	11016.....	94	15000.....	116	29017.....	42	34922.....	141	35272.....	68
01795.....	119	11018.....	94	15001.....	116	29020.....	42	34923.....	141	35282.....	60
02047.....	37	11022.....	94	15289.....	82	29021.....	42	34924.....	141	35283.....	60
02052.....	36	11030.....	76	15293.....	82	29022.....	42	35041.....	56	35288.....	69
02053.....	36	11035.....	76	15386.....	116	29025.....	52	35042.....	56	35289.....	69
02054.....	36	11036.....	94	15387.....	116	29026.....	52	35043.....	56	35336R1.....	61
02055.....	36	11037.....	94	15391.....	116	29027.....	52	35044.....	56	35337R1.....	61
02056.....	37	11040.....	76	15392.....	116	31591.....	77	35045.....	56	35338R1.....	61
02058.....	37	11045.....	76	15396.....	116	31593.....	78	35047.....	58	35339.....	61
02059.....	37	11050.....	76	15397.....	116	31596.....	77	35048.....	58	35340R1.....	61
02062.....	35	11055.....	76	15850.....	39	31597.....	77	35049.....	58	35341R1.....	61
02070.....	35	11100.....	76	15850.....	115	31598.....	77	35050.....	58	35342R1.....	61
02071.....	35	11104.....	76	15990.....	34	31600.....	114	35052.....	58	35343R1.....	61
03200.....	97	11130.....	76	15995.....	34	31601.....	114	35054.....	56	35344R1.....	61
06000.....	50	11132.....	76	15997.....	34	31602.....	114	35053.....	58	35345R1.....	61
06005.....	50	11134.....	76	15999.....	34	31603.....	114	35051.....	63	35347.....	60
06010.....	50	11136.....	76	16000.....	111	31604.....	114	35061.....	54	35352R1.....	62
06015.....	50	11138.....	76	16001.....	111	31605.....	114	35062.....	54	35356R1.....	62
06020.....	51	12055.....	92	16002.....	111	31610.....	77	35063.....	54	35364.....	68
06025.....	51	13492.....	142	16005.....	111	31611.....	114	35064.....	54	35366.....	68
06029.....	51	13494.....	142	16006.....	111	31615.....	77	35065.....	54	35370.....	69
06030.....	51	13496.....	142	16027.....	111	31617.....	47	35066.....	55	35375.....	69
06031.....	51	13497.....	142	16028.....	111	31618.....	38	35069.....	55	35385R1.....	62
06032.....	51	13498.....	142	16029.....	111	31619.....	38	35070.....	55	35386R1.....	62
06033.....	51	13500.....	142	16036.....	111	31621.....	121	35071.....	55	35389R1.....	62
06034.....	51	13502.....	142	16048.....	111	31622.....	121	35072.....	68	35391R1.....	62
06070.....	51	13503.....	142	16050.....	111	31626.....	121	35074.....	68	35410.....	58
06100.....	51	13504.....	142	16057.....	111	31624.....	47	35080.....	141	35410KIT1.....	58
06105.....	51	13505.....	142	16060.....	111	31625.....	47	35082.....	141	35419.....	58
06110.....	51	13510.....	142	16065.....	111	31627.....	47	35084.....	141	35419KIT1.....	58
06115.....	51	13515.....	142	16114.....	34	31628.....	47	35085.....	141	35400.....	78
06180.....	50	13525.....	142	16115.....	34	31629.....	47	35086.....	141	35425.....	58
06181.....	50	13530.....	81	16122.....	33	31631.....	47	35088.....	57	35425KIT1.....	58
06182.....	50	13535.....	81	16124.....	33	31638.....	121	35088KIT1.....	57	35428.....	58
06183.....	50	13540.....	81	16126.....	33	31641.....	47	35089.....	57	35428KIT1.....	58
06200.....	50	13545.....	81	16130.....	33	31652.....	47	35090.....	67	35437.....	57
06205.....	50	13550.....	142	16132.....	33	31800.....	50	35104.....	56	35437KIT1.....	57
06300.....	50	13600.....	143	16134.....	33	31810.....	50	35105.....	67	35440.....	57
06305.....	50	13605.....	143	16136.....	33	31815.....	50	35106.....	56	35440KIT1.....	57
06360.....	42	13615.....	143	16137.....	33	32000.....	48	35107.....	56	35531.....	67
06365.....	42	13620.....	143	16142.....	33	32005.....	48	35108.....	56	35532.....	67
06402.....	53	13900.....	71	16144.....	33	32010.....	48	35109.....	56	35533.....	67
06408.....	53	13901.....	71	16146.....	33	32015.....	48	35110.....	56	35534.....	67
06411.....	53	13902.....	71	16147.....	33	32025.....	49	35100.....	67	35540.....	65
06425.....	53	13903.....	71	16148.....	33	33503.....	49	35111.....	56	35542.....	65
06426.....	53	13904.....	71	16165.....	94	34030.....	49	35112.....	58	35543.....	65
06428.....	53	13905.....	71	16200.....	110	34035.....	48	35113.....	58	35544.....	65
06429.....	53	13906.....	71	16201.....	110	34036.....	48	35114.....	58	35546.....	62
06431.....	53	13907.....	71	16202.....	110	34040.....	48	35115.....	58	35550.....	65
06432.....	53	13908.....	71	16203.....	110	34045.....	48	35116.....	58	35551.....	65
06932.....	6	13909.....	71	16208.....	110	34046.....	48	35117.....	58	35563.....	65
06967.....	28	13910.....	71	16209.....	110	34060.....	49	35118.....	69	35564.....	65
06970.....	28	13911.....	71	16400.....	72	34062.....	49	35120.....	69	35565.....	65
06972.....	28	13912.....	70	16405.....	72	34555.....	141	35151.....	54	35566.....	65
06959.....	81	13913.....	70	16410.....	72	34560.....	141	35152.....	54	35569.....	65
06977.....	81	13914.....	70	16415.....	72	34840.....	140	35153.....	60	35570.....	65
06981.....	81	13915.....	70	16420.....	72	34841.....	140	35182.....	60	35571.....	65
06990.....	81	13916.....	70	16425.....	72	34842.....	140	35200.....	54	35572.....	65
07005.....	81	13917.....	70	16428.....	72	34850.....	140	35210.....	54	35574.....	65
07008.....	81	13918.....	70	16492.....	74	34865.....	140	35212.....	54	35575.....	65
07013.....	52	13919.....	70	17025.....	15	34866.....	140	35214.....	54	35578.....	65
07017.....	81	13920.....	70	17026.....	15	34867.....	140	35215.....	55	35581.....	65
07025.....	53	13921.....	70	17031.....	36	34868.....	140	35217.....	55	35585.....	65
07026.....	53	13922.....	70	22000.....	43	34870.....	140	35219.....	55	35586.....	65
07029.....	6	13923.....	70	22111.....	22	34875.....	140	35220.....	56	35587.....	65
07033.....	81	13924.....	70	22164.....	113	34880.....	140	35222.....	57	35588.....	65
07040.....	37	13925.....	70	27100.....	118	34885.....	140	35222KIT1.....	57	35589.....	64
07050.....	51	13926.....	70	27876.....	69	34890.....	140	35223.....	57	35590.....	64
08005.....	52	13927.....	70	27879.....	69	34895.....	140	35223KIT1.....	57	35593.....	64
08010.....	52	13928.....	70	27890.....	69	34960.....	78	35224.....	57	35594.....	64
08015.....	52	13929.....	70	28005.....	80	34900R1.....	141	35224KIT1.....	57	35595.....	64
08120.....	52	13930.....	70	28010.....	80	34901R1.....	141	35226.....	56	35596.....	64
10000.....	78	13931.....	70	28011.....	80	34902R1.....	141	35225.....	58	35597.....	64
10215.....	97	13932.....	70	28020.....	80	34903R1.....	141	35229.....	56	35606.....	63
10225.....	97	13933.....	70	28536.....	117	34904R1.....	141	35228.....	58	35732.....	59
11000R2.....	94	13934.....	70	28537.....	117	34905R1.....	141	35235.....	57	35733R1.....	59
11001.....	94	13935.....	70	29000.....	42	34906R1.....	141	35235KIT1.....	57	35737.....	59
11003.....	94	13936.....	71	29002.....	42	34908R1.....	141	35238.....	57	35700.....	104
11004.....	94	13937.....	71	29007.....	42	34909R1.....	141	35251.....	54	35705.....	104
11006.....	94	13938.....	71	29009.....	42	34910R1.....	141	35252.....	54	35710.....	104

35716.....104	37002.....102	41443.....127	41671.....139	42065.....25	43335.....27
35717.....104	37003.....102	41442.....138	41673.....139	42066.....25	43400.....2
35718.....104	37004.....101	41445.....138	41685.....124	42071.....14	43401.....3
35719.....104	37005.....101	41446.....138	41688R1.....133	42072.....14	43402.....3
35735.....103	37006.....101	41447.....138	41689R1.....129	42073.....14	43403.....2
35745.....103	37008.....102	41448.....138	41692R1.....129	42074.....14	43404.....3
35750.....103	37009.....102	41459.....124	41693.....134	42076.....14	43405.....3
35752.....104	37013.....102	41457.....138	41695R1.....132	42079.....5	43406.....3
35753.....104	37014.....102	41458.....138	41696.....133	42080.....5	43420.....16
35754.....104	37015.....102	41461.....138	41697.....129	42081.....5	43421.....16
35757.....103	37016.....102	41497.....137	41702R1.....134	42082.....5	43422.....16
35758.....103	37018.....102	41499.....137	41706.....134	42087.....17	43432.....22
35760.....105	37019.....102	41502.....122	41708.....134	42089.....17	43433.....14
35766.....57	37022.....102	41510R1.....136	41709.....128	42090.....17	43434.....14
35766KIT1.....57	37025.....88	41513.....127	41711R1.....122	42092.....17	43435.....14
35769.....60	37030.....102	41514.....137	41713R1.....122	42093.....17	43436.....22
35770.....56	37036.....102	41518.....139	41724R1.....132	42095.....17	43451.....13
35771.....58	37037.....102	41519.....137	41726.....132	43000.....46	43453.....13
35776R1.....59	37046.....102	41520.....137	41727.....131	43001.....4	43456.....13
35780.....59	37047.....102	41521.....137	41730.....129	43003.....22	43460.....13
35791.....58	37055.....102	41522.....137	41732.....129	43005.....46	43462.....13
35800.....34	37056.....102	41523.....127	41737.....123	43010.....46	43470.....13
35805.....34	37057.....102	41527.....123	41744.....138	43012.....29	43471.....13
35900.....93	37060.....102	41525.....128	41745.....138	43013.....46	43472.....13
35909.....105	37066.....101	41529.....124	41746.....138	43046.....14	43473.....13
35910.....104	37067.....101	41531.....128	41747.....138	43047.....14	43474.....13
35911.....104	37068.....101	41532.....128	41748.....138	43048.....14	43475.....13
35912.....104	37071.....101	41535.....136	41749.....138	43054.....14	43478.....13
35913.....104	37072.....101	41536.....129	41752.....133	43055.....14	43486.....13
35914.....103	37073.....101	41542R1.....123	41753R1.....123	43056.....14	43487.....13
35915.....103	37074.....101	41543R1.....123	41754.....131	43057.....14	43494.....13
35916.....104	37075.....101	41544R1.....127	41755.....131	43058.....14	43495.....13
35917.....104	37076.....101	41545.....133	41766.....123	43059.....14	43496.....13
35918.....105	37088.....102	41546R1.....129	41765.....126	43061.....14	43497.....13
35919.....105	37093.....102	41549R1.....133	41769R1.....132	43062.....14	43498.....13
35920.....105	37099.....101	41550R1.....136	41772R1.....123	43063.....14	43500.....120
35921.....105	37100.....101	41553R1.....127	41775R1.....126	43064.....14	43505.....120
35923.....105	37101.....102	41564.....136	41773R1.....132	43090.....95	43550.....113
35924.....105	37102.....102	41568R1.....136	41774R1.....131	43097.....95	43552.....113
35925.....105	37103.....102	41570R1.....127	41776R1.....123	43098.....95	43600.....20
35926.....106	37106.....101	41572R1.....136	41777.....129	43100.....95	43601.....20
35927.....106	37108.....101	41574R2.....127	41778R1.....126	43103.....95	43602.....21
35928.....106	37109.....101	41575R1.....131	41779R1.....123	43116.....95	43605.....20
35929.....106	37111.....101	41579.....136	41780.....131	43200.....95	43607.....20
35949.....85	37112.....101	41584.....126	41782.....133	43201.....95	43608.....21
35950.....85	37113.....101	41591.....129	41793R1.....125	43210.....95	43610.....21
35930.....106	37114.....101	41592.....125	41798.....131	43211.....95	43611.....21
35931.....106	37115.....101	41596.....125	41812.....125	43212.....95	43612.....21
35932.....106	37118.....101	41593R1.....131	41813.....125	43217.....95	43613.....21
35933.....107	37119.....101	41598.....128	41835R1.....139	43230.....95	43614.....21
35934.....107	37120.....102	41600.....137	41840.....124	43231.....95	43615.....21
35935.....107	37121.....102	41605.....137	41841.....124	43235.....95	43616.....20
35936.....107	38056.....101	41606.....136	41843.....133	43250.....106	43617.....21
35937.....106	38058.....101	41607.....127	41851.....124	43255.....106	43623.....21
35938.....106	38064.....101	41610.....134	41850.....130	43256.....4	43625.....21
35939.....107	38066.....101	41611.....135	41869.....133	43257.....5	43626.....21
35940.....107	38068.....101	41612.....132	41873.....135	43262.....19	43627.....21
35941.....107	39070.....42	41615.....137	41875.....128	43263.....19	43628.....21
35942.....107	41000.....114	41616.....127	41876.....131	43264.....4	43699.....20
35943.....108	41001.....114	41617.....137	41878.....128	43267.....5	43700.....20
35944.....108	41005.....114	41619.....139	41905R1.....126	43270.....19	43705.....20
35945.....108	41010.....114	41620.....135	41906.....123	43271.....19	43710.....21
35946.....108	41015.....114	41622.....135	41910R1.....133	43272.....14	43712.....21
35947.....107	41017.....114	41627.....139	41911.....131	43273.....14	43714.....21
35948.....107	41021.....121	41628.....135	41912.....123	43274.....14	43715.....21
35949.....108	41085.....114	41633.....139	41913.....123	43275.....4	43716.....20
35950.....108	41100.....119	41634.....139	41915.....123	43276.....5	43717.....21
35951.....103	41105.....119	41635.....139	41929.....124	43281.....19	43719.....21
35952.....104	41120.....114	41639.....125	41948.....106	43282.....19	43720.....20
35953.....104	41121.....114	41640.....129	41950.....143	43283.....14	43723.....22
35995.....91	41123.....114	41643.....129	41952.....143	43284.....14	43724.....22
36000.....91	41359.....123	41648.....126	41971.....119	43285.....14	43731.....22
36002.....91	41358.....127	41649R1.....123	42028.....14	43286.....4	43732.....22
36005.....91	41365.....136	41652.....124	42033.....14	43287.....5	43735.....31
36006.....91	41376.....139	41653.....134	42038.....14	43292.....19	43739.....31
36007.....91	41377.....139	41654R1.....126	42039.....14	43294.....14	43740.....31
36008.....91	41378.....139	41661R1.....123	42041.....14	43295.....14	43744.....31
36009.....91	41446.....78	41662.....126	42043.....14	43296.....14	43745.....22
36010.....91	41407.....123	41655.....134	42045.....14	43300.....40	43747.....22
36015.....91	41410.....139	41656.....133	42048.....14	43304.....21	43748.....22
36030.....92	41425.....139	41657.....134	42049.....14	43310.....40	43750.....31
36035.....92	41427.....139	41665.....126	42055.....22	43314.....119	43755.....31
36100.....90	41433.....136	41666.....126	42056.....22	43315.....40	43800.....97
36930.....85	41434.....136	41658.....135	42057.....22	43328.....27	43825.....30
37000.....102	41435.....139	41660.....135	42058.....22	43329.....27	43827.....30
37001.....102	41437.....139	41669.....128	42064.....25	43330.....27	43828.....30

43805.....97	44029.....9	44204.....3	44415.....16	44667.....17	47027.....112
43807.....97	44030.....9	44205.....32	44416.....16	44686.....38	47028.....112
43810.....97	44031.....11	44208.....32	44451.....15	44687.....38	47030.....112
43812.....97	44032.....11	44209.....32	44452.....15	44688.....38	47033.....113
43813.....97	44033.....11	44211.....32	44453.....15	44689.....38	47035.....113
43895.....13	44034.....11	44216.....32	44454.....15	44690.....38	47037.....113
43896.....13	44035.....9	44217.....32	44455.....15	44692.....38	47039.....113
43897.....13	44037.....11	44218.....32	44456.....15	44693.....38	47040.....113
43898.....13	44038.....9	44219.....32	44457.....15	44700.....28	47042.....113
43908.....5	44040.....9	44220.....31	44458.....15	44705.....28	47073.....113
43909.....10	44041.....10	44221.....31	44459.....15	44710.....28	47074.....113
43915.....10	44042.....10	44222.....31	44461.....15	44720.....28	47075.....113
43916.....10	44043.....10	44223.....31	44462.....15	44725.....28	47076.....113
43917.....10	44044.....10	44224.....31	44463.....15	44730.....28	47077.....113
43918.....10	44045.....9	44225.....31	44464.....15	44750.....28	48000.....120
43919.....10	44046.....11	44226.....31	44465.....7	44760.....28	48001.....120
43924.....10	44047.....11	44227.....31	44466.....7	44765.....28	48002.....120
43925.....10	44048.....9	44228.....31	44467.....7	44770.....28	49000.....108
43926.....10	44049.....9	44229.....31	44468.....7	44810.....42	49005.....108
43927.....9	44051.....8	44232.....31	44469.....7	44811.....42	49500.....79
43936.....11	44053.....8	44234.....31	44470.....7	44819.....143	49501.....79
43944.....5	44055.....8	44235.....31	44471.....7	44821.....143	49505.....79
43946.....11	44057.....8	44236.....31	44472.....7	44823.....143	49525.....79
43947.....11	44058.....11	44237.....31	44479.....2	44824.....143	49601.....79
43948.....4	44059.....8	44240.....31	44481.....18	44825.....143	49602.....79
43949.....4	44061.....5	44242.....31	44483.....19	44826.....143	49606.....79
43950.....4	44063.....8	44245.....31	44484.....18	44830.....143	49607.....79
43951.....4	44067.....8	44247.....31	44485.....18	44835.....109	51900.....99
43952.....4	44069.....8	44248.....32	44486.....19	44850.....40	51905.....99
43953.....20	44070.....8	44249.....32	44487.....19	44857.....40	51910.....99
43954.....4	44071.....4	44250.....9	44544.....19	44858.....40	51915.....99
43956.....4	44073.....8	44251.....10	44552.....18	44860.....40	51920.....99
43957.....20	44075.....8	44252.....11	44557.....19	44861.....40	51925.....99
43958.....5	44077.....8	44253.....32	44558.....19	44870.....121	51930.....99
43959.....5	44076.....11	44254.....32	44560.....19	44871.....121	51935.....99
43960.....4	44082.....8	44255.....32	44561.....19	44873.....121	51940.....99
43961.....5	44086.....3	44256.....32	44563.....19	44878.....121	51945.....99
43962.....4	44089.....2	44257.....32	44567.....18	44881.....121	52000.....99
43963.....4	44096.....2	44258.....32	44569.....19	44900.....121	52005.....99
43964.....4	44097.....18	44259.....32	44574.....19	44901.....121	52010.....99
43965.....4	44120.....30	44260.....6	44575.....18	44905.....121	52015.....99
43966.....20	44122.....30	44261.....6	44577.....19	44910.....121	52020.....99
43967.....20	44124.....30	44262.....6	44578.....18	44913.....120	52025.....99
43968.....20	44126.....30	44263.....6	44579.....19	45000.....121	52030.....99
43969.....4	44128.....30	44264.....6	44580.....18	45006.....121	52035.....99
43970.....20	44130.....30	44265.....6	44581.....19	45024.....23	52040.....99
43971.....5	44132.....30	44266.....6	44582.....18	45025.....23	52045.....99
43973.....5	44134.....30	44267.....6	44583.....19	45027.....23	53000.....99
43974.....5	44155.....10	44268.....6	44587.....19	45028.....23	53005.....99
43975.....3	44136.....30	44269.....32	44588.....19	45029.....23	53010.....99
43976.....5	44156.....11	44270.....32	44589.....19	45030.....24	53015.....99
43977.....5	44157.....10	44271.....32	44594.....18	45031.....24	53020.....99
43978.....20	44138.....30	44273.....32	44596.....18	45035.....23	53025.....99
43979.....3	44140.....30	44276.....32	44600.....97	45040.....23	53030.....99
43982.....5	44143.....30	44277.....32	44602.....97	45042.....23	53035.....99
43983.....2	44145.....30	44283.....5	44603.....97	45045.....23	53040.....99
43985.....3	44158.....5	44284.....20	44604.....97	45046.....23	53045.....99
43986.....10	44159.....12	44285.....20	44605.....97	45055.....24	53110.....99
43987.....3	44160.....12	44288.....14	44606.....97	45090.....24	53111.....99
43988.....3	44161.....12	44294.....31	44607.....97	45209.....24	53112.....99
43989.....3	44162.....12	44295.....31	44609.....29	45217.....24	53113.....99
43990.....2	44164.....12	44296.....31	44610.....29	45221.....24	53114.....99
43991.....2	44147.....30	44305.....9	44621.....29	46000.....118	53115.....99
43992.....2	44165.....12	44310R1.....18	44622.....29	46005.....118	53116.....99
43993.....2	44166.....12	44320.....17	44623.....29	46009.....118	53117.....99
43996.....2	44149.....30	44322.....17	44624.....121	46010.....118	53118.....99
43997.....2	44167.....12	44330.....17	44625.....29	46015.....118	53119.....99
43998.....2	44168.....12	44331.....17	44627.....29	46093.....118	53130.....99
43999.....2	44169.....12	44334.....17	44630.....29	46103.....120	53131.....99
44000.....9	44170.....12	44335.....17	44631.....26	46175.....118	53132.....99
44001.....9	44171.....12	44340.....17	44632.....26	46176.....118	53133.....99
44002.....9	44172.....12	44342.....17	44635.....26	46500.....113	53134.....99
44004.....9	44173.....12	44350.....17	44636.....26	46501.....113	53135.....99
44005.....9	44174.....12	44352.....17	44637.....26	47000.....112	53136.....99
44007.....9	44175.....12	44382.....16	44638.....26	47001.....112	53137.....99
44009.....10	44176.....12	44383.....16	44639.....26	47005.....112	53138.....99
44010.....9	44177.....12	44384.....16	44645.....38	47006.....112	53139.....99
44011.....9	44190.....2	44385.....16	44646.....38	47008.....112	53400.....119
44015.....9	44192.....3	44386.....16	44647.....26	47010.....112	53401.....119
44017.....11	44193.....3	44387.....16	44648.....26	47011.....112	53450.....119
44019.....4	44195.....2	44388.....16	44649.....26	47012.....112	53455.....119
44020.....9	44196.....2	44389.....16	44650.....26	47015.....112	53500.....119
44025.....9	44198.....3	44390.....16	44655.....38	47016.....112	53505.....119
44026.....9	44200.....2	44391.....38	44656.....38	47020.....112	54000.....38
44027.....9	44201.....2	44392.....16	44665.....17	47025.....112	54005.....38
44028.....9	44202.....3	44399.....16	44666.....17	47026.....112	54010.....38

54015.....38	58163.....45	59184.....126	59602.....137	59983.....124	60878.....52
57000.....120	58164.....45	59188.....129	59615R1.....124	59984.....124	60879.....51
57002.....78	58165.....45	59192.....129	59604.....137	59985.....124	60881.....51
57022.....78	58166.....45	59196.....139	59617R1.....129	59991.....122	60883.....51
57024.....78	58167.....45	59212.....134	59612.....137	59990.....124	60885.....52
57490.....28	58168.....45	59213.....128	59616.....133	59992.....122	60886.....52
57500.....47	58169.....44	59216R1.....122	59614.....137	60000.....77	60887.....52
57510.....47	58170.....43	59219R1.....123	59622R1.....133	60001.....77	60889.....116
57511.....47	58157.....118	59221.....129	59621.....135	60002.....77	60890.....116
57514.....47	58158.....118	59225.....129	59620.....137	60005.....77	60891.....42
57603.....128	58391.....43	59227.....134	59626R1.....131	60015.....77	60892.....42
57600.....137	58392.....43	59232.....125	59647.....116	60018.....77	60893.....143
57700.....94	58393.....43	59243.....126	59636.....136	60026.....77	60894.....142
57701.....94	58396.....43	59244R1.....131	59648.....124	60025.....79	60895.....142
57705.....94	58397.....43	59245R1.....127	59657.....124	60027.....77	60897.....142
57706.....94	58398.....43	59250.....132	59653R1.....133	60029.....77	60898.....81
57800.....100	58399.....43	59255.....132	59651.....138	60625.....104	60899.....143
57805.....100	58400.....112	59400.....109	59654.....138	60631.....103	60900.....119
57810.....100	58401.....112	59405.....109	59656.....138	60797.....103	60901.....118
57813.....100	58405.....112	59410.....109	59668.....127	60798.....103	60902.....118
57815.....100	58410.....112	59411.....122	59692.....126	60799.....103	60903.....118
57820.....100	58420.....121	59415.....109	59693.....126	60800.....116	60904.....119
57825.....100	58422.....121	59416.....122	59709.....129	60801.....103	60905.....119
57828.....100	59000R1.....41	59419.....122	59708.....134	60802.....54	60906.....54
57830.....100	59001R1.....41	59413.....129	59729.....123	60804.....55	60907.....54
57832.....100	59002.....41	59424.....122	59751.....125	60805.....103	60908.....54
57833.....100	59003.....41	59422.....128	59752.....125	60806RI.....103	60909.....55
57834.....100	59004.....41	59423.....127	59757.....125	60807RI.....103	60910.....55
57835.....100	59005R1.....41	59438.....122	59759.....125	60808RI.....103	60911.....59
57840.....100	59006R1.....41	59448.....133	59760.....125	60809RI.....103	60914.....96
57843.....100	59007.....41	59450.....131	59761.....125	60810RI.....103	60915.....96
57845.....100	59008.....41	59456.....125	59769.....125	60811RI.....104	60916.....66
57849.....100	59009AB.....41	59464.....125	59772.....125	60812RI.....104	60917.....66
57850.....100	59010AB.....41	59472.....123	59773.....125	60813RI.....104	60918.....54
57851.....100	59011AB.....41	59469.....128	59774.....125	60814RI.....104	60919.....54
57852.....100	59012.....41	59474.....125	59875.....122	60815RI.....104	60920.....55
57854.....100	59013.....41	59479.....126	59876.....122	60818.....82	60921.....67
57855.....100	59014R1.....41	59476.....130	59877.....122	60821.....73	60922.....67
57859.....100	59015R1.....41	59480R1.....130	59878.....122	60822.....73	60923.....67
57860.....100	59016R1.....41	59502.....109	59879.....122	60823.....73	60924.....67
57862.....100	59017R1.....41	59481R1.....130	59880.....124	60824.....74	60925.....67
57865.....100	59018.....41	59482.....129	59881.....124	60825.....74	60926.....67
57867.....100	59019.....41	59503.....109	59882.....124	60826.....72	60927.....67
57875.....100	59020R1.....41	59504.....109	59883.....124	60827.....72	60928.....66
58007.....34	59021R1.....41	59505.....109	59884.....124	60828.....72	60929.....66
58016.....39	59022R1.....41	59484.....130	59885.....133	60829.....72	60930.....66
58020.....39	59023R1.....41	59483.....133	59888.....122	60830.....73	60931.....66
58021.....39	59025R1.....41	59510.....109	59890.....130	60831.....73	60932.....66
58030.....39	59026.....41	59511.....109	59891.....130	60832.....73	60933.....103
58050.....39	59027.....41	59485.....139	59892.....131	60833.....108	60934.....103
58060.....39	59029R1.....41	59491.....133	59893.....132	60834.....108	60935.....103
58070.....53	59030.....41	59501.....124	59898.....134	60835.....108	60936.....103
58071.....81	59031.....41	59508R1.....130	59899.....122	60837.....115	60937.....104
58072.....53	59032.....41	59506R1.....133	59901.....134	60838.....88	60938.....104
58074.....53	59037.....44	59509R1.....130	59905.....131	60839.....88	60939.....104
58079.....81	59038.....44	59514.....132	59906.....132	60840.....88	60940.....66
58080.....44	59039.....44	59523.....127	59908.....126	60841.....88	60941.....66
58085RI.....45	59041.....44	59517.....137	59909.....127	60842.....89	60942.....66
58090.....81	59042.....44	59519.....135	59911.....126	60849.....88	60944.....49
58100.....44	59043.....44	59522.....137	59914.....131	60848.....102	60945.....49
58101.....45	59044.....43	59524.....135	59915.....127	60850.....88	60946.....49
58102RI.....44	59045.....43	59525.....135	59916.....130	60852.....115	60947.....49
58103.....45	59050.....43	59533R1.....127	59917.....122	60853.....115	60949.....48
58104RI.....44	59051.....43	59527.....134	59923.....127	60854.....141	60950.....48
58105.....44	59096.....39	59530.....134	59926.....127	60855.....115	60951.....48
58108.....44	59099.....37	59534R1.....136	59927.....126	60856.....115	60954.....49
58111.....44	59100R1.....136	59537.....134	59924.....130	60857.....79	60956.....109
58113RI.....44	59105R1.....136	59542.....134	59925.....131	60858.....115	60957.....109
58115.....44	59115R1.....127	59541.....136	59933.....122	60859.....115	60958.....109
58116.....42	59110R1.....136	59543.....136	59937.....131	60860.....117	60959.....109
58117.....42	59120R1.....127	59549.....130	59941.....128	60861.....117	60960.....109
58118RI.....44	59125R1.....127	59553.....128	59945.....131	60862.....66	60961.....109
58119.....44	59135R1.....126	59554.....129	59946.....132	60863.....66	60962.....116
58120.....44	59140R1.....126	59558.....128	59947.....134	60864.....66	60963.....116
58121.....44	59147.....124	59551.....137	59948R1.....130	60865.....66	60964.....73
58150RI.....44	59149.....126	59562.....128	59953.....134	60866.....66	60965.....73
58151.....45	59150.....128	59569R1.....129	59954.....130	60867.....66	60966.....73
58152.....45	59145.....137	59575R1.....124	59961.....133	60868.....66	60967.....73
58153.....44	59155.....135	59565.....135	59962.....132	60869.....79	60968.....73
58154.....44	59156.....140	59570.....130	59963.....128	60870.....79	60969.....73
58155.....45	59157.....140	59568.....134	59965.....126	60871.....52	60970.....73
58156.....45	59158.....140	59587R1.....124	59967.....123	60872.....52	60971.....73
58159.....43	59159.....140	59599R1.....123	59969.....131	60874.....53	60972.....74
58160.....43	59160.....140	59596.....127	59970.....127	60875.....51	60973.....74
58161.....43	59161.....140	59600.....124	59971.....130	60876.....51	60975.....72
58162.....43	59169.....43	59613R1.....124	59981.....125	60877.....51	60977.....72

60979.....72	61081.....85	61310.....83	61396.....87	61485.....86	61751.....58
60981.....72	61082.....85	61311.....83	61397.....87	61486.....84	61752.....58
60983.....72	61083.....85	61312.....83	61398.....87	61487.....87	61753.....58
60984.....73	61085.....85	61313.....83	61399.....87	61488.....84	61754.....58
60985.....73	61086.....85	61314.....83	61400.....87	61489.....86	61756.....58
60986.....73	61087.....83	61315.....83	61401.....87	61490.....86	61760.....81
60987.....73	61088.....83	61316.....83	61402.....87	61491.....86	61761.....81
60989.....73	61089.....83	61317.....83	61403.....87	61492.....86	61762.....81
60990.....73	61090.....83	61318.....83	61404.....87	61493.....86	61763.....81
60991.....73	61091.....83	61319.....83	61407.....84	61494.....86	61764.....81
60993.....89	61092.....83	61320.....83	61405.....87	61495.....86	61765.....81
60994.....89	61093.....83	61321.....84	61408.....84	61496.....84	61766.....81
60995.....89	61094.....83	61322.....84	61409.....83	61497.....84	61840.....57
60996.....89	61095.....85	61323.....84	61406.....87	61498.....84	61841.....57
60997.....89	61096.....83	61324.....84	61410.....83	61499.....86	61842.....57
60998.....89	61097.....50	61325.....84	61411.....83	61500.....86	61843.....57
60999.....91	61098.....50	61326.....84	61413.....83	61501.....86	61844.....57
61000.....91	61099.....50	61327.....85	61414.....85	61502.....86	61846.....58
61002.....115	61104.....106	61328.....85	61415.....84	61503.....87	61850.....57
61003.....115	61105.....104	61329.....85	61416.....84	61504.....84	61851.....58
61004.....115	61106.....103	61330.....85	61417.....84	61505.....87	61852.....58
61005.....94	61107.....103	61331.....85	61418.....84	61506.....87	61853.....58
61006.....94	61108.....103	61332.....85	61419.....84	61507.....86	61854.....58
61007.....101	61109.....104	61333.....85	61420.....85	61508.....85	62130.....55
61008.....101	61112.....73	61334.....85	61422.....83	61509.....83	62132.....55
61009.....88	61113.....72	61335.....84	61421.....85	61510.....83	62134.....55
61010.....115	61114.....73	61336.....85	61423.....84	61511.....84	64000.....80
61011.....115	61120.....72	61337.....85	61424.....84	61512.....84	64005.....80
61012.....55	61121.....72	61338.....85	61425.....84	61513.....84	64010.....80
61013.....55	61122.....72	61339.....85	61426.....84	61514.....83	64015.....80
61014.....59	61123.....72	61340.....85	61429.....83	61515.....83	64020.....80
61015.....55	61124.....72	61341.....85	61427.....86	61516.....83	64025.....80
61017.....54	61125.....72	61343.....85	61428.....85	61517.....83	64110.....80
61018.....54	61126.....73	61342.....88	61430.....83	61518.....83	64115.....80
61019.....54	61127.....73	61344.....86	61431.....83	61519.....83	64120.....80
61020.....103	61128.....73	61345.....86	61432.....85	61520.....87	64125.....80
61021.....104	61129.....73	61346.....86	61434.....83	61521.....87	64500.....78
61022.....104	61130.....67	61347.....86	61433.....85	61522.....87	64592.....46
61023.....115	61131.....67	61348.....86	61436.....83	61523.....87	64593.....46
61027.....50	61132.....67	61349.....86	61435.....85	61524.....87	64595.....64
61028.....50	61133.....67	61350.....86	61438.....83	61525.....87	64600.....46
61029.....116	61134.....67	61351.....86	61439.....84	61526.....87	64602.....46
61030.....62	61135.....73	61352.....86	61440.....84	61527.....87	64604.....64
61031.....62	61136.....73	61353.....86	61441.....84	61528.....86	64605.....46
61032.....62	61137.....73	61354.....87	61443.....83	61529.....84	64608.....64
61033.....103	61138.....73	61355.....87	61442.....85	61530.....84	64609.....64
61034.....103	61139.....66	61356.....87	61444.....85	61531.....84	64612.....64
61035.....103	61140.....66	61357.....87	61445.....85	61650.....75	64952.....64
61036.....104	61141.....66	61358.....87	61446.....85	61651.....75	64953.....64
61037.....104	61142.....66	61359.....87	61447.....84	61652.....75	64954.....64
61038.....104	61143.....66	61360.....87	61448.....84	61700.....89	64955.....64
61039.....106	61144.....66	61361.....87	61449.....87	61701.....89	64956.....64
61040.....48	61145.....66	61362.....87	61450.....87	61702.....89	64958.....64
61041.....48	61146.....66	61363.....87	61451.....87	61703.....89	65030.....64
61042.....48	61147.....66	61364.....87	61452.....87	61704.....89	65031.....64
61043.....48	61110.....104	61365.....87	61453.....84	61705.....89	65032.....64
61044.....109	61148.....66	61366.....87	61454.....87	61706.....89	65033.....64
61045.....116	61149.....67	61367.....87	61455.....87	61710.....90	65034.....64
61047.....73	61101.....115	61368.....87	61456.....87	61711.....90	65036.....64
61048.....73	61150.....67	61369.....87	61457.....87	61712.....90	65037.....64
61049.....72	61151.....67	61370.....87	61458.....87	61713.....90	65039.....64
61050.....72	61102.....116	61371.....87	61459.....87	61714.....90	65044.....64
61051.....72	61103.....115	61372.....87	61460.....87	61715.....90	65046.....64
61052.....72	61152.....67	61373.....87	61461.....86	61716.....90	65047.....64
61053.....72	61153.....67	61374.....87	61462.....86	61720.....91	65200.....116
61054.....73	61116.....116	61375.....87	61463.....87	61721.....91	65201.....116
61055.....73	61118.....116	61376.....87	61465.....86	61722.....91	66000.....120
61056.....73	61202.....78	61377.....87	61466.....86	61723.....91	66050R1.....143
61058.....62	61203.....78	61378.....87	61467.....86	61724.....91	66055R1.....143
61059.....104	61204.....78	61379.....87	61468.....86	61725.....91	66060R1.....143
61060.....104	61205.....78	61380.....87	61469.....86	61726.....91	66065R1.....143
61061.....104	61206.....77	61381.....87	61470.....84	61730.....94	66095.....143
61062.....72	61207.....77	61382.....87	61471.....84	61731.....94	66100.....143
61063.....72	61208.....77	61383.....87	61472.....84	61732.....94	66105.....143
61066.....103	61209.....77	61384.....87	61473.....84	61733.....94	66110.....143
61067.....73	61215.....79	61385.....87	61474.....83	61734.....94	66115.....143
61068.....73	61300.....84	61386.....87	61475.....86	61735.....94	67022.....98
61069.....74	61301.....84	61387.....87	61476.....86	61736.....94	67023.....98
61071.....73	61302.....84	61388.....87	61477.....86	61740.....56	67024.....98
61072.....84	61303.....84	61389.....87	61478.....86	61741.....56	67027.....98
61073.....84	61304.....84	61390.....87	61479.....86	61742.....56	67029.....98
61074.....84	61305.....84	61391.....87	61480.....86	61743.....56	67030.....98
61076.....85	61306.....84	61392.....87	61481.....86	61744.....56	67031.....98
61077.....88	61307.....83	61393.....87	61482.....86	61745.....56	67034.....98
61079.....88	61308.....83	61394.....87	61483.....86	61746.....56	67040.....98
61080.....85	61309.....83	61395.....87	61484.....86	61750.....58	67041.....98

67045.....98	70076.....90	74123.....146	94012.....96	96419.....82	97217.....76
67050.....98	70077.....89	74124.....146	94014.....96	96435.....49	97218.....82
67060.....98	70078.....89	74122.....149	94016.....96	96445.....48	97219.....82
67062.....98	70079.....89	74125.....146	94017.....96	96447.....48	97224.....82
67100.....98	70082.....90	74126.....148	94020.....96	96451.....48	97234.....82
67104.....98	70083.....90	74129.....146	94021.....96	96452.....49	97235.....82
67105.....98	70084.....89	74127.....150	94022.....96	96460.....48	97246.....82
67107.....98	70085.....89	74128.....149	94024.....96	96461.....48	97270.....108
67108.....98	70086.....89	74130.....148	94025.....96	96462.....48	97474R1.....62
67980.....46	70088.....89	74131.....148	94026.....96	96463.....48	97476.....97
67981.....46	70090.....93	74132.....149	94027.....96	96464.....48	97477.....97
67982.....46	70091.....93	74133.....148	94028.....96	96465.....48	97479.....108
68400.....108	70093.....90	74134.....149	94030.....96	96475.....49	97482.....81
68405.....115	70094.....90	74135.....149	94031.....96	96480.....65	97483.....81
68420.....108	70095.....90	74136.....148	94044.....96	96523.....107	97484.....137
68425.....108	70097.....90	74137.....149	94046.....96	96524.....107	97490.....48
68500.....120	70098.....90	74138.....154	95626.....65	96526.....107	97491.....48
68990.....80	70099.....90	74139.....150	95700.....4	96527.....107	97492.....97
69000.....80	70100.....89	74140.....149	95701.....4	96529.....67	97499.....48
69010.....80	71000.....93	74141.....149	95702.....4	96531.....67	97491.....48
69015.....80	71001.....93	74142.....152	95703.....5	96533.....67	97492.....97
69020.....143	71003.....93	74143.....152	95704.....5	96535.....67	98281.....64
69905.....94	71005.....92	74144.....152	95705.....5	96537.....67	98282.....64
69908.....94	71006.....93	74145.....152	95707.....18	96553.....66	98356.....61
69909.....94	71007.....92	74146.....152	95708.....19	96555.....67	98357.....61
69996.....90	71010.....92	74147.....150	95706.....22	96579.....69	98358.....61
69999.....89	71016.....92	74148.....147	95709.....19	96580.....69	98359.....61
70000.....89	71017.....92	74149.....147	95710.....22	96606.....65	98372.....60
70001.....89	71018.....92	74150.....147	95711.....18	96615.....56	98373.....60
70002.....89	71019.....92	74151.....152	95712.....19	96620.....65	98374.....60
70003.....90	71020.....92	74152.....147	95713.....19	96622.....65	98375.....60
70005.....90	71022.....93	74153.....152	95714.....17	96623.....79	98376.....60
70006.....89	71024.....92	74154.....152	95715.....17	96639.....103	98377.....60
70009.....89	71025.....93	74155.....150	95716.....17	96643.....103	98384.....60
70010.....89	71026.....92	74156.....150	95717.....17	96644.....103	98385.....60
70012.....89	71027.....92	74157.....150	95718.....17	96645.....103	98386.....60
70013.....89	71028.....93	74158.....150	95719.....17	96657.....104	98387.....60
70014.....91	71029.....92	74159.....148	95748.....89	96658.....104	98388.....60
70015.....91	71030.....93	74160.....150	95748.....89	96659.....104	98389.....60
70016.....90	71031.....93	74161.....150	95863.....82	96660.....104	98524.....61
70017.....91	71035.....93	74162.....148	95878.....135	96661.....104	98545.....81
70019.....89	71036.....93	74163.....150	95883.....42	96666.....103	98602.....42
70020.....90	71040.....93	74200.....154	95885.....42	96668.....103	98603.....42
70021.....90	71042.....93	74201.....154	95915.....51	96735.....65	98615.....46
70023.....91	71043.....93	74202.....154	95916.....51	96738.....63	98677.....43
70024.....90	71044.....93	74203.....154	95917.....51	96739.....63	98609.....118
70025.....90	71210.....45	74204.....154	95918.....51	96740.....63	98728.....61
70026.....89	72000RI.....45	74205.....154	95919.....51	96743.....63	99535.....88
70030.....89	72001.....45	74206.....154	95920.....50	96744.....63	99936.....88
70031.....89	72005.....45	74207.....154	95921.....50	96747.....120	905260.....105
70032.....89	72010.....45	74208.....154	95981.....74	96758.....104	905745.....109
70033.....89	72015.....45	74209.....153	95982.....74	96770.....104	905750.....108
70034.....89	72016.....44	74210.....153	95984.....74	96771.....104	905760.....108
70035.....89	72018.....44	74211.....153	95986.....72	96772.....104	905785.....106
70036.....89	72047.....37	74212.....153	96053.....73	96797.....102	905720.....106
70038.....89	72056.....37	74214.....153	96071.....73	96871.....74	907546.....106
70039.....91	72058.....37	74215.....153	96078.....74	96872.....74	905311.....107
70040.....91	72059.....37	74216.....153	96111.....76	96873.....74	
70042.....91	72062.....36	74217.....153	96113.....76	96932.....29	
70044.....89	72064.....37	74218.....153	96115.....76	96933.....29	
70048.....90	74000.....144	74219.....153	96117.....76	96842.....128	
70049.....90	74001.....144	74220.....153	96119.....76	96843.....128	
70050.....89	74002.....145	75580.....82	96121.....76	96844.....137	
70051.....89	74003.....145	75592.....79	96123.....76	96874.....143	
70052.....89	74004.....144	87002.....92	96125.....76	96875.....143	
70053.....90	74005.....145	87005.....92	96166.....81	96880.....143	
70055.....89	74100.....151	87007.....92	96167.....81	96881.....143	
70054.....91	74101.....151	87020.....92	96170.....81	96929.....97	
70056.....92	74102.....151	89355.....103	96174.....81	96930.....97	
70057.....91	74103.....151	89360.....103	96214.....114	96953.....118	
70058.....91	74104.....151	89365RI.....103	96222.....116	96980.....118	
70059.....91	74105.....151	89370.....107	96200.....142	97034.....74	
70060.....91	74108.....151	89385.....107	96211.....142	97035.....74	
70061.....91	74109.....151	89445RI.....107	96340.....91	97036.....73	
70062.....91	74110.....146	89485RI.....106	96351.....90	97039.....73	
70063.....90	74111.....146	89486.....106	96367.....93	97042.....73	
70064.....90	74112.....147	94000.....96	96386.....82	97045.....73	
70065.....90	74113.....146	94001.....96	96390.....82	97048.....73	
70066.....90	74114.....146	94002.....96	96395.....82	97054.....73	
70067.....90	74115.....146	94003.....96	96403.....82	97062.....73	
70068.....90	74116.....147	94005.....96	96405.....82	97064.....73	
70069.....90	74117.....146	94006.....96	96407.....82	97066.....73	
70071.....90	74118.....152	94007.....96	96408.....82	97100.....126	
70072.....90	74119.....148	94008.....96	96410.....82	97125.....116	
70073.....90	74120.....149	94009.....96	96411.....82	97153.....109	
70074.....90	74121.....148	94010.....96	96412.....82	97155.....77	
			96418.....82	97168.....120	
				97215.....76	
				97216.....76	

Ultra Hardware Products
Howard Berger Co. LLC
324A Half Acre Road
Cranbury, NJ 08512
Change Service Requested

ULTRA HARDWARE PRODUCTS

Howard Berger Co. LLC
324A Half Acre Road, Cranbury, NJ 08527

800.523.1268
609.860.9990
PHONE

609.860.9991
FAX

www.ultrahardware.com
www.hberger.com