

DOOR HARDWARE 2014 PRICE BOOK

NEW IN THIS BOOK

EMTouch™ Classic Style Electronic Keypad Locksets

Sandcast Bronze Electronic Keypad Entry Set

UL LISTED Mortise Entry Sets, Knob by Knob and Lever by Lever Handlesets

Mormont Stainless Steel Mortise Entry Set

Mormont, Artemis, and Charleston Mortise Knob by Knob and Lever by Lever Handlesets

Sandcast Bronze Hailey Mortise Knob by Knob and Lever by Lever Handlesets

Brass Franklin, Adams, and Jefferson Tubular Entry Sets

Brass Albany Mortise & Wilmington Tubular Entry Sets

Sandcast Bronze Ridgemont, Logan,
and Brighton Tubular Entry Sets

Polished Nickel, Polished White Bronze,
and Tumbled White Bronze Finishes

Sandcast Bronze #4 Key-in Rosette

Stainless Steel Hanover Key-in Lockset

Brass Quincy Deadbolt

Brass Delaware Sideplate Locksets

Sandcast Bronze Missoula Sideplate Locksets

Brass STRETTO Narrow Style Sideplate Locksets

Brass Modern Rectangular Rosette

Brass Quincy Rosette

Sandcast Bronze #6 Rosette

Modern Disc Crystal, Modern Square Crystal
and Providence Crystal Knobs

12" & 18" Appliance Pulls, Stainless Steel Door Pull,
and Rustic Modern Bronze Door Pull

Heavy Duty Steel & Stainless Steel Hinges

Dutch Door Bolts, Concealed Screws Surface Bolts, and more



HANDING

Determining handing for door hardware is different than determining handing for carpentry (ordering and hanging doors). If you follow the standard carpentry rules for handing door hardware, instead of following the diagram below, there is good chance you may end up with a lock that is handed incorrectly. Please refer to the diagram below and if you have any questions, call Customer Service at (800) 356-2741.

HANDING OF DOOR IS ALWAYS DETERMINED FROM THE OUTSIDE

In-Swing Doors



Out-Swing Doors



Handing is required for all items EXCEPT for the followings:

- Leversets with Round Rosettes: Dummy Function
- Keyed Leversets with Sideplates: Dummy Function
- CF Mechanism, except for Knob by Lever and Split Finish
- Entry sets with Inside Knob
- Knobsets: Any Function

FINISH OPTIONS



Polished Brass (US3)



French Antique (US7)



Oil Rubbed Bronze (US10B)



Polished Nickel (US14)



Satin Nickel (US15)



Pewter (US15A)



Flat Black (US19)



Polished Chrome (US26)



PVD-Lifetime



Deep Burgundy Patina (DB)



Flat Black Patina (FB)



Medium Bronze Patina (MB)



Polished White Bronze (WB)



Tumbled White Bronze (TWB)



Flat Black (FB)



Satin Steel



Brushed Stainless Steel (SS)



UNLACQUERED BRASS in US3 & US7

All brass products in Polished Brass finish, except Hinges are now available in unlacquered finish with additional \$14 NET upcharge.

OPTIONS

LATCHES

- Mortise (Standard)
- Drive-In (On Request)

BACKSETS

- 2 3/8" (Standard)
- 2 3/4" (On Request)

STRIKE PLATES

- Full Lip Square Corner (Standard)
- 1/4" Radius (On Request)
- Extended (On Request)
- T Strike (On Request)

FACE PLATES

- Square Corner (Standard)
- 1/4" Radius (On Request)

TABLE OF CONTENTS

ELECTRONIC LOCKSETS

Electronic Keypad Entrance Handlesets	7 - 8
Electronic Keypad Deadbolts	9
Electronic Keypad Leversets	10 - 11

ENTRY SETS

Mortise Entrance Handlesets	
Brass Mortise Handlesets	13 - 20
Sandcast Bronze Mortise Handlesets	21 - 24
Lost Wax Cast Bronze Mortise Handlesets	25
Stainless Steel Mortise Handlesets	26
Wrought Steel Mortise Handlesets	27
Mortise Knob by knob, Lever by Lever Entrance Locksets	28 - 35
Single Point & Two Point Locksets	36
Tubular Entrance Handlesets	
Brass Tubular Handlesets	37 - 45
Sandcast Bronze Tubular Handlesets	46 - 49
Lost Wax Cast Bronze Tubular Handlesets	50 - 51
Stainless Steel Tubular Handlesets	52
Wrought Steel Tubular Handlesets	53 - 54
Grip By Grip Entrance Handlesets	55 - 58
Key-in-Knob & Key-in-Lever Locksets	59 - 64

DEADBOLTS

Brass Deadbolts	65 - 67
Sandcast Bronze Deadbolts	68
Lost Wax Cast Bronze Deadbolts	69 - 70
Stainless Steel Deadbolts	70
Wrought Steel Deadbolts	71
Single Sided Deadbolts	72 - 73

DECORATIVE PLATE LOCKS

Brass Sideplate Locksets	74 - 80
Sandcast Bronze Sideplate Locksets	81 - 83
Lost Wax Cast Bronze Sideplate Locksets	84
Stainless Steel Sideplate Locksets	85
Wrought Steel Sideplate Locksets	85
STRETTO Narrow Style Sideplate Locksets	86 - 87
Thumbturn Privacy Locksets	88 - 89

PASSAGE & PRIVACY SETS

Brass Modern Leversets & Knobsets	90 - 93
Brass Leversets & Knobsets	94 - 101
Sandcast Bronze Leversets & Knobsets	102 - 103
Lost Wax Cast Leversets & Knobsets	104 - 105
Stainless Steel Leversets & Knobsets	106
Wrought Steel Leversets & Knobsets	107 - 108
Brass Arts & Crafts Leversets & Knobsets	109
Porcelain & Crystal Knobsets	110 - 113
Door Knobs with Threaded Spindles	114

DOOR PULLS & ACCESSORIES

Appliance and Door Pulls	115 - 122
Accessories	
Dutch Door Bolts, Surface Bolts	123
Security Door Guards	123
Flush Bolts, Concealed Screw Surface Bolts	124
Pocket Door Locks, Flush Pulls	125
Pocket Door Mortise Locks	126
Edge Pull, Roller & Ball Catches	127
Door Stops, Door Bumpers	128 - 129
Window Utility Pulls, Screen Door Locks	130 - 131
House Numbers	132 - 133
Door Bell Plates & Buttons	134 - 135
Switch Plates	136 - 138
Door Knockers, Mail Slot, Door Viewer	139

HINGES

Solid Brass Hinges	140 - 142
Ball & Steeple Tip Sets for Brass Hinges, Pivot Stop	143
Steel Hinges	144 - 146
Ball & Steeple Tip Sets for Steel Hinges	147
Stainless Steel Hinges	148 - 149
Spring Hinges	150

Parts & Options	151 - 153
Product Index	154 - 156
Sample Order Form	157
Terms & Conditions	158
Lifetime Limited Warranty	159

Solid Brass

Cortina Lever (C)	Coventry Lever (CV)	Elan Lever (EN)	Lafayette Brass Lever (LB)	Milano Lever (M)	Ribbon & Reed Lever (RBL)		
Rope Lever (RL)	Rustic Lever (R)	Santa Fe Lever (SF)	Turino Lever (T)	Wembley Lever (WM)			
Beaded Egg Knob (BE)	Belmont Knob (BT)	Egg Knob (E)	Lancaster Knob (LN)	Melon Knob (MN)	Norwich Knob (NW)		
Providence Knob (P)	Ribbon & Reed Knob (RBK)	Rope Knob (RK)	Victoria Knob (V)	Waverly Knob (W)			
#8 Rosette	Lancaster Rosette	Oval Rosette	Rectangular Rosette	Regular Rosette	Ribbon & Reed Rosette	Rope Rosette	Quincy Rosette

Brass Modern

Athena Lever (ATN)	Aireon Lever (A)	Basel Lever (BA)	Geneva Lever (GV)	Helios Lever (HLO)	Hercules Lever (HEC)
Hermes Lever (HER)	Kiel Lever (KIE)	Luzern Lever (LU)	Mercury Lever (MC)	Poseidon Lever (POS)	Sion Lever (SIO)
Stuttgart Lever (STU)	Triton Lever (TRT)				
Bern Knob (BN)	Octagon Knob (OCT)	Orb Knob (OR)	Round Knob (ROU)	Square Knob (SQU)	
Disk Rosette	Modern Rectangular Rosette	Modern Rosette	Neos Rosette	Square Rosette	

Arts & Crafts Brass

Arts & Crafts Lever (AC)	Hammered Knob (HE)	Hammered Lever (HM)	Arts & Crafts Rectangular Rosette	Hammered Rosette

Crystal

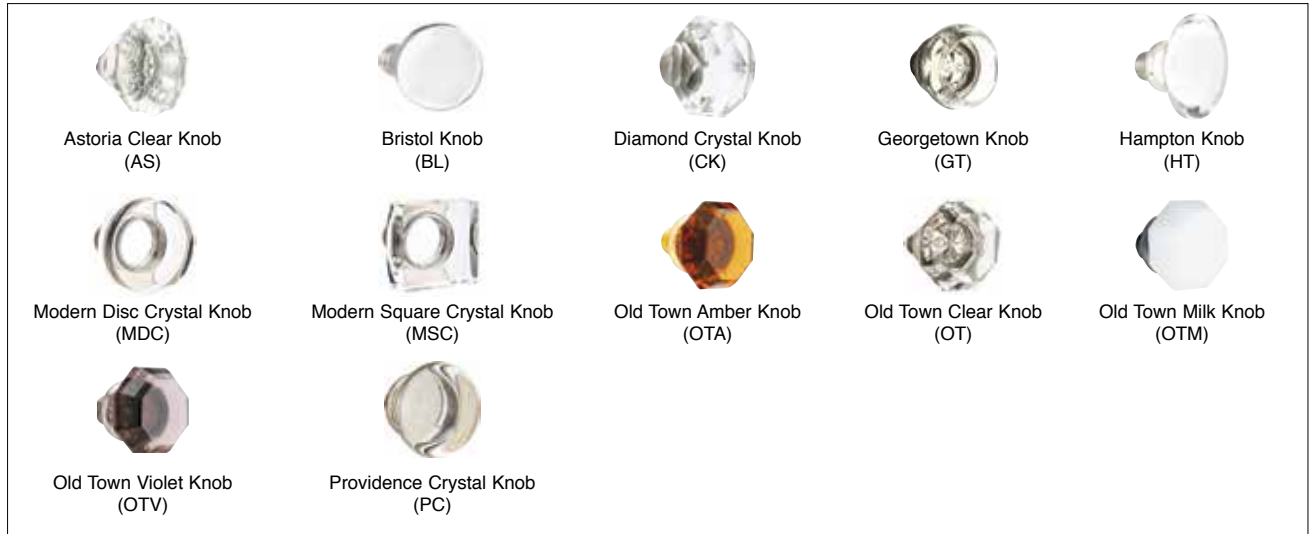

Porcelain





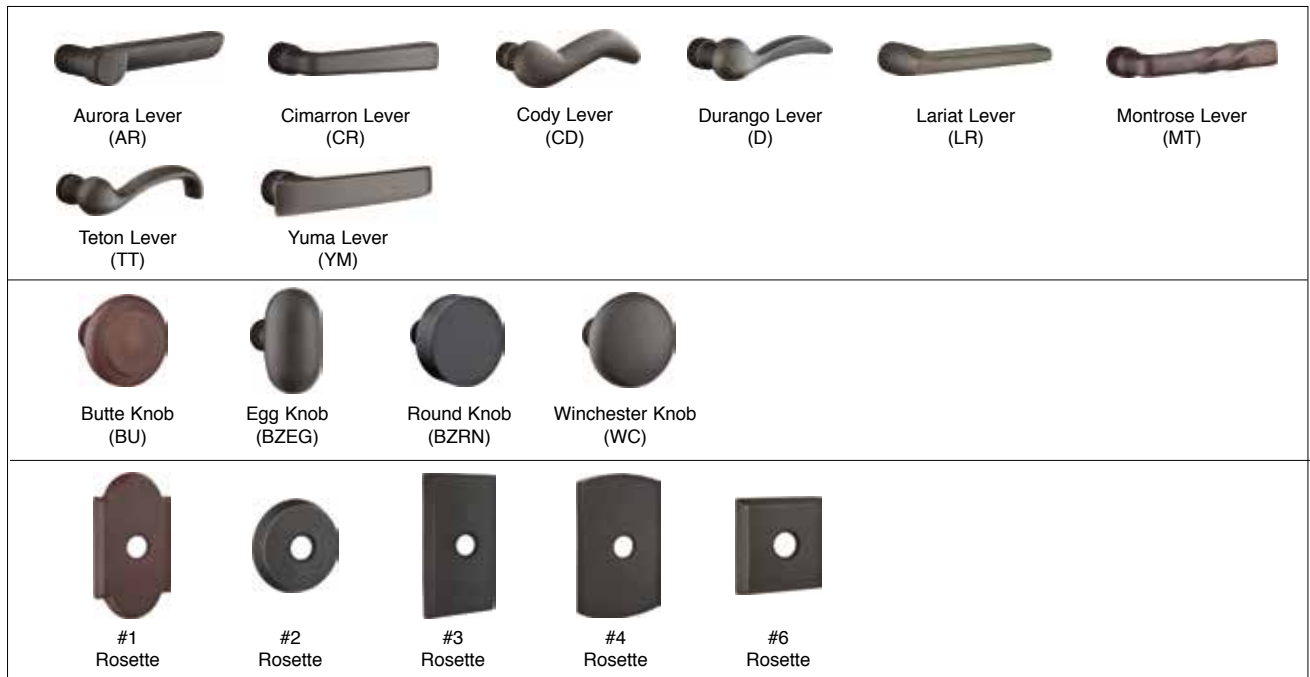











Sandcast Bronze



Lost Wax Cast Bronze



Stainless Steel

 Athena Lever (AT)	 Cologne Lever (CO)	 Dresden Lever (DD)	 Helios Lever (HL)	 Hercules Lever (HS)	 Hermes Lever (HE)
 Kiel Lever (KL)	 Poseidon Lever (PO)	 Stuttgart Lever (ST)			
 Octagon Knob (OK)	 Round Knob (RNK)				
 Beveled (01) Rosette	 Disk (02) Rosette	 Square (03) Rosette			

Wrought Steel

 Lafayette Lever (L)	 Normandy Lever (N)	 San Carlos Lever (SC)			
 Jamestown Knob (J)	 Savannah Knob (SV)	Porcelain Knobs with Wrought Steel Stems			
		 Madison Black Knob (MB)	 Madison Ivory Knob (MI)	 Madison Brown Swirl Knob (MS)	
 #1 Rosette	 #2 Rosette	 #3 Rosette			

EMTouch™ Electronic Keypad Entry Set



Order any Brass knob or lever for the inside trim.

EMTouch™ Classic Style Electronic Keypad Entry Set



Order any Brass knob or lever for the inside trim.

EMTouch™ Electronic Keypad Entry Set

Description	Product Code	Knob or Lever Style for Inside Trim	Finish	List Price
Single Cylinder	E4827	<i>See Page 4 for Brass Knob & Lever Options.</i> <i>See Page 5 for Brass Crystal & Porcelain Knob Options.</i>	Oil Rubbed Bronze (US10B) Satin Nickel (US15) Flat Black (US19) Polished Chrome (US26)	\$400.00

EMTouch™ Classic Style Electronic Keypad Entry Set

Description	Product Code	Knob or Lever Style for Inside Trim	Finish	List Price
Single Cylinder	E4410	<i>See Page 4 for Brass Knob & Lever Options.</i> <i>See Page 5 for Brass Crystal & Porcelain Knob Options.</i>	Oil Rubbed Bronze (US10B) Satin Nickel (US15) PVD-Lifetime	\$400.00

- >> Specify by adding "W" to the beginning of Product Code for Weiser® (WR5) Keyway (For example: WE4827HLO US15). No upcharge for cylinder substitution. Can be keyed into existing Weiser® system.
- >> Matching Dummy Entry Set may be ordered at the List Price shown above.

Product Features for EMTEK Electronic Keypad Locksets:

- Factory programmed with 2 unique, secure user codes for use right out of the box.
- Can be programmed with up to 20 user codes of your choice.
- Emtek's standard mechanical and finish warranties along with a 2 year warranty on electronic components.

Handing Required if Lever Used on Inside. Fits any door between 1 3/4" to 2 1/4" thick with a 2 1/8" bore standard door prep. Standard latch is for 2 3/8" backset. Specify 2 3/4" backset if required. Complete Set Includes Latch and Strike Plate.

ELECTRONIC HANDLESETS - KEYPAD ENTRY SETS

KEYPAD

Modern Style Electronic Keypad Entry Set



Order any Brass knob or lever for the inside trim.

Sandcast Bronze Style Electronic Keypad Entry Set



Order any Bronze knob or lever for the inside trim.

Modern Style Electronic Keypad Entry Set

Description	Product Code	Knob or Lever Style for Inside Trim	Finish	List Price
Single Cylinder	E4817	<i>See Page 4 for Brass Knob & Lever Options. See Page 5 for Brass Crystal & Porcelain Knob Options.</i>	Oil Rubbed Bronze (US10B) Satin Nickel (US15) Flat Black (US19) Polished Chrome (US26)	\$376.00

Sandcast Bronze Style Electronic Keypad Entry Set

Description	Product Code	Knob or Lever Style for Inside Trim	Finish	List Price
Single Cylinder	E451211	<i>See Page 5 for Sandcast Bronze Knob & Lever Options</i>	Deep Burgundy (DB) Flat Black (FB) Medium Bronze (MB)	\$476.00

- >> Specify by adding "W" to the beginning of Product Code for Weiser® (WR5) Keyway (For example: WE4817HLO US15).
No upcharge for cylinder substitution. Can be keyed into existing Weiser® system.
- >> Matching Dummy Entry Set may be ordered at the List Price shown above.

Standard with Keypad Deadbolt Locks

- Schlage® C Keyway
- Standard Door Prep and Installation
- Solid Brass Cylinder, Housing, Collar and Rosette
- Hardened Steel Bolt
- Heavy Gauge Steel Understrike and Brass Trim Strike Shipped with Every Deadbolt



EMTouch™ Electronic Keypad Deadbolt

Product Code	Finish	List Price
E3020	Oil Rubbed Bronze (US10B) Satin Nickel (US15) Flat Black (US19) Polished Chrome (US26)	\$216.00

**To order Adaptor for thin door (1 3/8" - 1 5/8"), add product code KEYDBEXT and list price \$16.*



EMTouch™ Classic Style Electronic Keypad Deadbolt

Product Code	Finish	List Price
E3002	Oil Rubbed Bronze (US10B) Satin Nickel (US15) PVD-Lifetime	\$216.00

**To order Adaptor for thin door (1 3/8" - 1 5/8"), add product code KEYDBEXT and list price \$16.*



Modern Style Electronic Keypad Deadbolt

Product Code	Finish	List Price
E1020	Oil Rubbed Bronze (US10B) Satin Nickel (US15) Flat Black (US19) Polished Chrome (US26)	\$192.00

**To order Adaptor for thin door (1 3/8" - 1 5/8"), add product code KEYDBEXT and list price \$16.*



Classic Style Electronic Keypad Deadbolt

Product Code	Finish	List Price
E1000	Oil Rubbed Bronze (US10B) Satin Nickel (US15) PVD-Lifetime	\$168.00

**To order Adaptor for thin door (1 3/8" - 1 5/8"), add product code KEYDBEXT and list price \$16.*



Sandcast Bronze Style Keypad Deadbolt

Product Code	Finish	List Price
E1001	Deep Burgundy (DB) Flat Black (FB) Medium Bronze (MB)	\$204.00

Adaptor **NOT** available.

>> Specify by adding "W" to the beginning of Product Code for Weiser® (WR5) Keyway (For example: WE1001 MB).
No upcharge for cylinder substitution. Can be keyed into existing Weiser® system.

Fits any door between 1 3/4" to 2 1/4" thick with a 2 1/8" bore standard door prep. Standard latch is for 2 3/8" backset. Specify 2 3/4" backset if required. Complete Set Includes Latch and Strike Plate.

ELECTRONIC LOCKSETS - LEVERSETS

KEYPAD

EMTouch™ Electronic Keypad Leverset
with Triton Lever



EMTouch™ Classic Style Electronic Keypad Leverset
with Milano Lever



EMTouch™ Electronic Keypad Leverset

Description	Product Code	Lever Style	Finish	List Price
Keypad Leverset	E4020	<i>See Page 4 for Brass Lever Options.</i>	Oil Rubbed Bronze (US10B) Satin Nickel (US15)	\$252.00
Keypad Leverset with Storeroom/Gate Function	E4220		Flat Black (US19) Polished Chrome (US26)	\$252.00

**To order Adaptor for thin door (1 3/8" - 1 5/8"), add product code KEYLVREXT and list price \$16.*

EMTouch™ Classic Style Electronic Keypad Leverset

Description	Product Code	Lever Style	Finish	List Price
Keypad Leverset	E4002	<i>See Page 4 for Brass Lever Options.</i>	Oil Rubbed Bronze (US10B) Satin Nickel (US15)	\$252.00
Keypad Leverset with Storeroom/Gate Function	E4202		PVD-Lifetime	\$252.00

**To order Adaptor for thin door (1 3/8" - 1 5/8"), add product code KEYLVREXT and list price \$16.*

Modern Style Electronic Keypad Leverset
with Helios Lever



Modern Style Electronic Keypad Leverset

Description	Product Code	Lever Style	Finish	List Price
Keypad Leverset	E2020	<i>See Page 4 for Brass Lever Options.</i>	Oil Rubbed Bronze (US10B) Satin Nickel (US15)	\$228.00
Keypad Leverset with Storeroom/Gate Function	E2220		Flat Black (US19) Polished Chrome (US26)	\$228.00

**To order Adaptor for thin door (1 3/8" - 1 5/8"), add product code KEYLVREXT and list price \$16.*

Handing Required for Leversets. Fits any door between 1 3/4" to 2 1/4" thick with a 2 1/2" bore standard door prep. Standard latch is for 2 3/8" backset. Specify 2 3/4" backset if required. Complete Set Includes Latch and Strike Plate.

Classic Style Electronic Keypad Leverset
with Cortina Lever



Sandcast Bronze Style Electronic Keypad Leverset
with Durango Lever



Classic Style Electronic Keypad Leverset

Description	Product Code	Lever Style	Finish	List Price
Brass Keypad Leverset	E2000	<i>See Page 4 for Brass Lever Options.</i>	Oil Rubbed Bronze (US10B) Satin Nickel (US15) PVD-Lifetime	\$216.00
Brass Keypad Leverset with Storeroom/Gate Function	E2200		\$216.00	

**To order Adaptor for thin door (1 3/8" - 1 5/8"), add product code KEYLVREXT and list price \$16.*

Sandcast Bronze Style Electronic Keypad Leverset

Description	Product Code	Lever Style	Finish	List Price
Classic Bronze Keypad Leverset	E2001	<i>See Page 5 for Sandcast Bronze Lever Options.</i>	Deep Burgundy (DB) Flat Black (FB) Medium Bronze (MB)	\$240.00
Classic Bronze Keypad Leverset with Storeroom/Gate Function	E2201		\$240.00	

Adaptor **NOT** available.



Passage Function in Locked Mode

- Outside lever always locked
- Entry by code or key only
- Inside lever always free

Passage Function in Passage Mode

- Outside lever always free
- Entry by operating lever, no code or key require
- Inside lever always free

Storeroom Function

- Outside lever always locked
- Entry by code or key only
- Inside lever always free

>> Specify by adding "W" to the beginning of Product Code for Weiser® (WR5) Keyway (For example: **WE2001D MB**).
No upcharge for cylinder substitution. Can be keyed into existing Weiser® system.

Handing Required for Leversets. Fits any door between 1 3/4" to 2 1/4" thick with a 2 1/8" bore standard door prep. Standard latch is for 2 3/8" backset. Specify 2 3/4" backset if required. Complete Set Includes Latch and Strike Plate.

Emtek's standard mortise lock body is an **ANSI F20** function



- Deadbolt operated by key outside, thumbturn inside
- When outside is locked, latch bolt and deadbolt are operated by key outside
- When deadbolt is projected, outside thumb press/knob/lever is automatically locked
- Latch bolt retracted by thumb press/knob/lever either side, except when outside thumb press/knob/lever is locked by stopbutton
- Operating inside knob/lever retracts latch bolt and deadbolt simultaneously with outside thumb press/knob/lever remaining locked
- Deadlocking latch bolt
- Deadbolt has saw-proof inserts
- Standard Mortise Door Prep ANSI A115.1

Available option is an **ANSI F13 UL LISTED** mortise lock body

- Deadbolt operated by key outside, thumbturn inside
- When deadbolt is projected, outside thumb press/knob/lever is automatically locked
- Latch bolt retracted by thumb press/knob/lever either side
- Operating inside knob/lever retracts latch bolt and deadbolt simultaneously, automatically unlocking outside thumb press/knob/lever
- Deadlocking latch bolt
- Deadbolt has saw-proof inserts
- Grade 1
- UL180 minute fire rating

HOW TO ORDER

To form an item number, add the letter **UL** to the Product Code, Backset, Lever or Knob, Handing and Finish. For Example:

UL 3347 234 BN RH US10B

Function (Entry Set)	2-3/4" Backset	Inside Knob	Handing	Finish
-------------------------	-------------------	----------------	---------	--------



BRASS MORTISE - ENTRANCE HANDLESETS

Mormont Mortise

Lugano Mortise

UL LISTED
Lugano Mortise



Order any Brass Knob or Lever for the Inside Trim.

ENTRY SETS

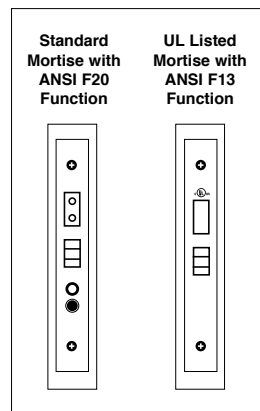

Mormont Mortise Style *Complete Lockset*

Description	UL LISTED	Product Code	Backset	Knob or Lever Style for Inside Trim	Finish	Standard ANSI F20 List Price	UL LISTED ANSI F13 List Price
Entry Set	UL	3347	2 1/2" or 2 3/4"	<i>See Page 4 for Brass Knob & Lever Options.</i>	Oil Rubbed Bronze (US10B) Satin Nickel (US15) Flat Black (US19) Polished Chrome (US26)	\$466.00	\$582.00
Dummy	UL	3047	N/A			<i>See Page 5 for Crystal & Porcelain Knob Options.</i>	\$282.00

Lugano Mortise Style *Complete Lockset*

Description	UL LISTED	Product Code	Backset	Knob or Lever Style for Inside Trim	Finish	Standard ANSI F20 List Price	UL LISTED ANSI F13 List Price
Entry Set	UL	3348	2 1/2" or 2 3/4"	<i>See Page 4 for Brass Knob & Lever Options.</i>	Oil Rubbed Bronze (US10B) Satin Nickel (US15) Flat Black (US19) Polished Chrome (US26)	\$510.00	\$626.00
Dummy	UL	3048	N/A			<i>See Page 5 for Crystal & Porcelain Knob Options.</i>	\$326.00

Handing is Required for All Mortise Locks. Standard door thickness of 1 3/4", specify if thicker. 2 1/2" or 2 3/4" Backsets. Locks for in-swing doors are standard, for out-swing doors please specify.

ENTRANCE HANDLESETS - BRASS MORTISE

Zeus Mortise

Artemis Mortise

Hera Mortise

UL LISTED
Hera Mortise



Order any Brass Knob or Lever for the Inside Trim.

ENTRY SETS

Zeus Mortise Style *Complete Lockset*

Description	UL LISTED	Product Code	Backset	Knob or Lever Style for Inside Trim	Finish	Standard ANSI F20 List Price	UL LISTED ANSI F13 List Price
Entry Set	UL	3346	2½" or 2¾"	<i>See Page 4 for Brass Knob & Lever Options.</i>	Oil Rubbed Bronze (US10B) Satin Nickel (US15) Polished Chrome (US26)	\$466.00	\$582.00
Dummy	UL	3046	N/A	<i>See Page 5 for Crystal & Porcelain Knob Options.</i>		\$282.00	\$282.00

Artemis Mortise Style *Complete Lockset*

Description	UL LISTED	Product Code	Backset	Knob or Lever Style for Inside Trim	Finish	Standard ANSI F20 List Price	UL LISTED ANSI F13 List Price
Entry Set	UL	3344	2½" or 2¾"	<i>See Page 4 for Brass Knob & Lever Options.</i>	Oil Rubbed Bronze (US10B) Satin Nickel (US15) Flat Black (US19) Polished Chrome (US26)	\$466.00	\$582.00
Dummy	UL	3044	N/A	<i>See Page 5 for Crystal & Porcelain Knob Options.</i>		\$282.00	\$282.00

Hera Mortise Style *Complete Lockset*

Description	UL LISTED	Product Code	Backset	Knob or Lever Style for Inside Trim	Finish	Standard ANSI F20 List Price	UL LISTED ANSI F13 List Price
Entry Set	UL	3345	2½" or 2¾"	<i>See Page 4 for Brass Knob & Lever Options.</i>	Oil Rubbed Bronze (US10B) Satin Nickel (US15) Flat Black (US19) Polished Chrome (US26)	\$510.00	\$626.00
Dummy	UL	3045	N/A	<i>See Page 5 for Crystal & Porcelain Knob Options.</i>		\$326.00	\$326.00

BRASS MORTISE - ENTRANCE HANDLESETS

Salem Mortise

Memphis Mortise

UL LISTED
Memphis Mortise



ENTRY SETS

Order any Brass Knob or Lever for the Inside Trim.

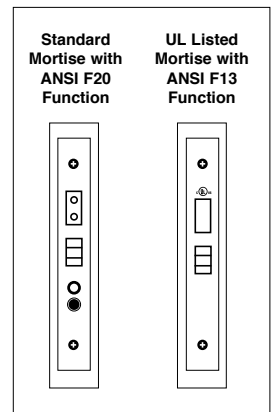

Salem Mortise Style *Complete Lockset*

Description	UL LISTED	Product Code	Backset	Knob or Lever Style for Inside Trim	Finish	Standard ANSI F20 List Price	UL LISTED ANSI F13 List Price
Entry Set	UL	3301	2 1/2" or 2 3/4"	<i>See Page 4 for Brass Knob & Lever Options.</i>	French Antique (US7) Oil Rubbed Bronze (US10B) Satin Nickel (US15) Pewter (US15A) Polished Chrome (US26) PVD-Lifetime	\$430.00	\$546.00
Dummy	UL	3001	N/A				

Memphis Mortise Style *Complete Lockset*

Description	UL LISTED	Product Code	Backset	Knob or Lever Style for Inside Trim	Finish	Standard ANSI F20 List Price	UL LISTED ANSI F13 List Price
Entry Set	UL	3302	2 1/2" or 2 3/4"	<i>See Page 4 for Brass Knob & Lever Options.</i>	French Antique (US7) Oil Rubbed Bronze (US10B) Satin Nickel (US15) Pewter (US15A) Polished Chrome (US26) PVD-Lifetime	\$466.00	\$582.00
Dummy	UL	3002	N/A				

Handing is Required for All Mortise Locks. Standard door thickness of 1 3/4", specify if thicker. 2 1/2" or 2 3/4" Backsets. Locks for in-swing doors are standard, for out-swing doors please specify.

ENTRANCE HANDLESETS - BRASS MORTISE

Charleston Mortise

Albany Mortise

UL LISTED
Albany Mortise



Order any Brass Knob or Lever for the Inside Trim.

ENTRY SETS

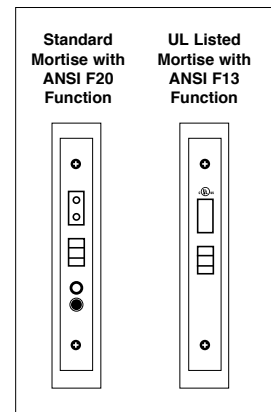

Charleston Mortise Style *Complete Lockset*

Description	UL Listed	Product Code	Backset	Knob or Lever Style for Inside Trim	Finish	Standard ANSI F20 List Price	UL LISTED ANSI F13 List Price
Entry Set	UL	3343	2½" or 2¾"	<i>See Page 4 for Brass Knob & Lever Options.</i>	French Antique (US7) Oil Rubbed Bronze (US10B) Satin Nickel (US15) Pewter (US15A) Polished Chrome (US26) PVD-Lifetime	\$466.00	\$582.00
Dummy	UL	3043	N/A	<i>See Page 5 for Crystal & Porcelain Knob Options.</i>		\$282.00	\$282.00

Albany Mortise Style *Complete Lockset*

Description	UL Listed	Product Code	Backset	Knob or Lever Style for Inside Trim	Finish	Standard ANSI F20 List Price	UL LISTED ANSI F13 List Price
Entry Set	UL	3350	2½" or 2¾"	<i>See Page 4 for Brass Knob & Lever Options.</i>	French Antique (US7) Oil Rubbed Bronze (US10B) Satin Nickel (US15) Pewter (US15A) Polished Chrome (US26) PVD-Lifetime	\$510.00	\$626.00
Dummy	UL	3050	N/A	<i>See Page 5 for Crystal & Porcelain Knob Options.</i>		\$326.00	\$326.00

BRASS MORTISE - ENTRANCE HANDLESETS

Mills Mortise



Manhattan Mortise



Melrose Mortise



UL LISTED Melrose Mortise



Order any Brass Knob or Lever for the Inside Trim.

ENTRY SETS

Mills Mortise Style *Complete Lockset*

Description	UL Listed	Product Code	Backset	Knob or Lever Style for Inside Trim	Finish	Standard ANSI F20 List Price	UL LISTED ANSI F13 List Price
Entry Set	UL	3310	2 1/2" or 2 3/4"	See Page 4 for Brass Knob & Lever Options. See Page 5 for Crystal & Porcelain Knob Options.	French Antique (US7) Oil Rubbed Bronze (US10B) Satin Nickel (US15) Pewter (US15A) Polished Chrome (US26) PVD-Lifetime	\$430.00	\$546.00
Dummy	UL	3010	N/A			\$246.00	\$246.00

Manhattan Mortise Style *Complete Lockset*

Description	UL Listed	Product Code	Backset	Knob or Lever Style for Inside Trim	Finish	Standard ANSI F20 List Price	UL LISTED ANSI F13 List Price
Entry Set	UL	3306	2 1/2" or 2 3/4"	See Page 4 for Brass Knob & Lever Options. See Page 5 for Crystal & Porcelain Knob Options.	French Antique (US7) Oil Rubbed Bronze (US10B) Satin Nickel (US15) Pewter (US15A) Polished Chrome (US26) PVD-Lifetime	\$466.00	\$582.00
Dummy	UL	3006	N/A			\$282.00	\$282.00

Melrose Mortise Style *Complete Lockset*

Description	UL Listed	Product Code	Backset	Knob or Lever Style for Inside Trim	Finish	Standard ANSI F20 List Price	UL LISTED ANSI F13 List Price
Entry Set	UL	3305	2 1/2" or 2 3/4"	See Page 4 for Brass Knob & Lever Options. See Page 5 for Crystal & Porcelain Knob Options.	French Antique (US7) Oil Rubbed Bronze (US10B) Satin Nickel (US15) Pewter (US15A) Polished Chrome (US26) PVD-Lifetime	\$510.00	\$626.00
Dummy	UL	3005	N/A			\$326.00	\$326.00

Handing is Required for All Mortise Locks. Standard door thickness of 1 3/4", specify if thicker. 2 1/2" or 2 3/4" Backsets. Locks for in-swing doors are standard, for out-swing doors please specify.

ENTRANCE HANDLESETS - BRASS MORTISE

**Hamilton
Mortise**

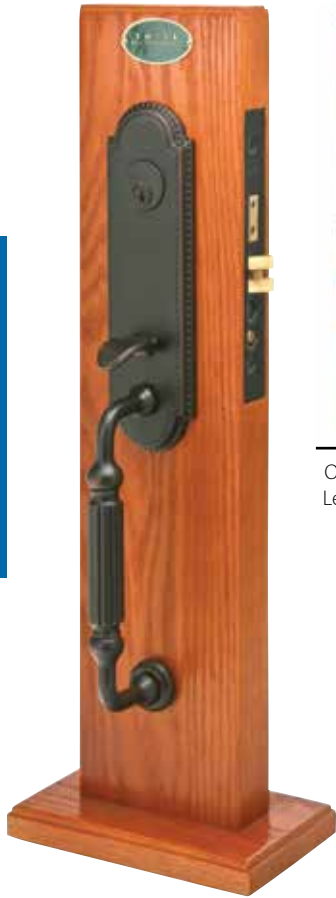

**Oval Ribbon & Reed
Mortise**



Order any Brass Knob or Lever for the Inside Trim.

**UL LISTED
Oval Ribbon & Reed
Mortise**



Order any Brass Knob or Lever for the Inside Trim.

ENTRY SETS

Hamilton Mortise Style *Complete Lockset*

Description	UL Listed	Product Code	Backset	Knob or Lever Style for Inside Trim	Finish	Standard ANSI F20 List Price	UL LISTED ANSI F13 List Price
Entry Set	UL	3304	2 1/2" or 2 3/4"	<i>See Page 4 for Brass Knob & Lever Options.</i>	French Antique (US7) Oil Rubbed Bronze (US10B) Satin Nickel (US15) Pewter (US15A)	\$466.00	\$582.00
Dummy	UL	3004	N/A	<i>See Page 5 for Crystal & Porcelain Knob Options.</i>	Polished Chrome (US26) PVD-Lifetime	\$282.00	\$282.00

Oval Ribbon & Reed Mortise Style *Complete Lockset*

Description	UL Listed	Product Code	Backset	Knob or Lever Style for Inside Trim	Finish	Standard ANSI F20 List Price	UL LISTED ANSI F13 List Price
Entry Set	UL	3342	2 1/2" or 2 3/4"	<i>See Page 4 for Brass Knob & Lever Options.</i>	French Antique (US7) Oil Rubbed Bronze (US10B) Satin Nickel (US15) Pewter (US15A)	\$466.00	\$582.00
Dummy	UL	3042	N/A	<i>See Page 5 for Crystal & Porcelain Knob Options.</i>	Polished Chrome (US26) PVD-Lifetime	\$282.00	\$282.00

BRASS MORTISE - ENTRANCE HANDLESETS

Regency Mortise



Versailles Mortise



UL LISTED Versailles Mortise



Order any Brass Knob or Lever for the Inside Trim.

ENTRY SETS

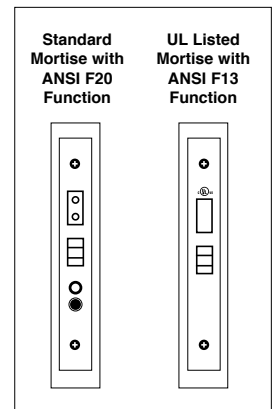

Regency Mortise Style *Complete Lockset*

Description	UL Listed	Product Code	Backset	Knob or Lever Style for Inside Trim	Finish	Standard ANSI F20 List Price	UL LISTED ANSI F13 List Price
Entry Set	UL	3307	2½" or 2¾"	<i>See Page 4 for Brass Knob & Lever Options.</i>	French Antique (US7) Oil Rubbed Bronze (US10B) Satin Nickel (US15) Pewter (US15A) Polished Chrome (US26) PVD-Lifetime	\$466.00	\$582.00
Dummy	UL	3007	N/A	<i>See Page 5 for Crystal & Porcelain Knob Options.</i>		\$282.00	\$282.00

Versailles Mortise Style *Complete Lockset*

Description	UL Listed	Product Code	Backset	Knob or Lever Style for Inside Trim	Finish	Standard ANSI F20 List Price	UL LISTED ANSI F13 List Price
Entry Set	UL	3309	2½" or 2¾"	<i>See Page 4 for Brass Knob & Lever Options.</i>	French Antique (US7) Oil Rubbed Bronze (US10B) Satin Nickel (US15) Pewter (US15A) Polished Chrome (US26) PVD-Lifetime	\$510.00	\$626.00
Dummy	UL	3009	N/A	<i>See Page 5 for Crystal & Porcelain Knob Options.</i>		\$326.00	\$326.00

Handing is Required for All Mortise Locks. Standard door thickness of 1¾", specify if thicker. 2½" or 2¾" Backsets. Locks for in-swing doors are standard, for out-swing doors please specify.

ENTRANCE HANDLESETS - BRASS MORTISE

Craftsman Mortise

Craftsman Full Length Mortise

UL LISTED
Craftsman Full Length Mortise



Order any Brass Knob or Lever for the Inside Trim.

ENTRY SETS

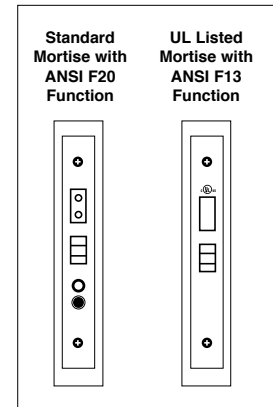

Craftsman Mortise Style *Complete Lockset*

Description	UL Listed	Product Code	Backset	Knob or Lever Style for Inside Trim	Finish	Standard ANSI F20 List Price	UL LISTED ANSI F13 List Price
Entry Set	UL	3308	2½" or 2¾"	<i>See Page 4 for Brass Knob & Lever Options.</i>	Oil Rubbed Bronze (US10B) Satin Nickel (US15) Flat Black (US19)	\$466.00	\$582.00
Dummy	UL	3008	N/A	<i>See Page 5 for Crystal & Porcelain Knob Options.</i>		\$282.00	\$282.00

Craftsman Full Length Mortise Style *Complete Lockset*

Description	UL Listed	Product Code	Backset	Knob or Lever Style for Inside Trim	Finish	Standard ANSI F20 List Price	UL LISTED ANSI F13 List Price
Entry Set	UL	3349	2½" or 2¾"	<i>See Page 4 for Brass Knob & Lever Options.</i>	Oil Rubbed Bronze (US10B) Satin Nickel (US15) Flat Black (US19)	\$510.00	\$626.00
Dummy	UL	3049	N/A	<i>See Page 5 for Crystal & Porcelain Knob Options.</i>		\$326.00	\$326.00

SANDCAST BRONZE MORTISE - ENTRANCE HANDLESETS

Denver Mortise

Cheyenne Mortise

Topeka Mortise

UL LISTED Topeka Mortise



Order any Sandcast Bronze Knob or Lever for the Inside Trim.

ENTRY SETS

Denver Mortise Style *Complete Lockset*

Description	UL Listed	Product Code	Backset	Knob or Lever Style for Inside Trim	Finish	Standard ANSI F20 List Price	UL LISTED ANSI F13 List Price
Entry Set	UL	3323	2 1/2" or 2 3/4"	<i>See Page 5 for Sandcast Bronze Knob & Lever Options.</i>	Deep Burgundy (DB) Flat Black (FB) Medium Bronze (MB)	\$470.00	\$586.00
Dummy	UL	3023	N/A			\$286.00	\$286.00

Cheyenne Mortise Style *Complete Lockset*

Description	UL Listed	Product Code	Backset	Knob or Lever Style for Inside Trim	Finish	Standard ANSI F20 List Price	UL LISTED ANSI F13 List Price
Entry Set	UL	3321	2 1/2" or 2 3/4"	<i>See Page 5 for Sandcast Bronze Knob & Lever Options.</i>	Deep Burgundy (DB) Flat Black (FB) Medium Bronze (MB)	\$512.00	\$628.00
Dummy	UL	3021	N/A			\$328.00	\$328.00

Topeka Mortise Style *Complete Lockset*

Description	UL Listed	Product Code	Backset	Knob or Lever Style for Inside Trim	Finish	Standard ANSI F20 List Price	UL LISTED ANSI F13 List Price
Entry Set	UL	3322	2 1/2" or 2 3/4"	<i>See Page 5 for Sandcast Bronze Knob & Lever Options.</i>	Deep Burgundy (DB) Flat Black (FB) Medium Bronze (MB)	\$562.00	\$678.00
Dummy	UL	3022	N/A			\$378.00	\$378.00

Handing is Required for All Mortise Locks. Standard door thickness of 1 3/4", specify if thicker. 2 1/2" or 2 3/4" Backsets. Locks for in-swing doors are standard, for out-swing doors please specify.

ENTRANCE HANDLESETS - SANDCAST BRONZE MORTISE

ENTRY SETS

Sonoma Mortise



Longmont Mortise



UL LISTED Longmont Mortise



Order any Sandcast Bronze Knob or Lever for the Inside Trim.

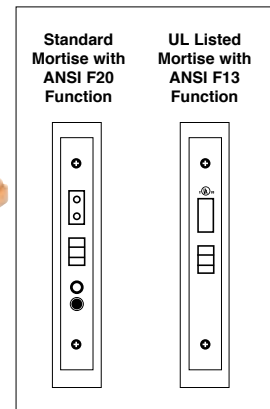

Sonoma Mortise Style *Complete Lockset*

Description	UL Listed	Product Code	Backset	Knob or Lever Style for Inside Trim	Finish	Standard ANSI F20 List Price	UL LISTED ANSI F13 List Price
Entry Set	UL	3329	2½" or 2¾"	<i>See Page 5 for Sandcast Bronze Knob & Lever Options.</i>	Flat Black (FB) Medium Bronze (MB)	\$512.00	\$628.00
Dummy	UL	3029	N/A		\$328.00	\$328.00	

Longmont Mortise Style *Complete Lockset*

Description	UL Listed	Product Code	Backset	Knob or Lever Style for Inside Trim	Finish	Standard ANSI F20 List Price	UL LISTED ANSI F13 List Price
Entry Set	UL	3330	2½" or 2¾"	<i>See Page 5 for Sandcast Bronze Knob & Lever Options.</i>	Flat Black (FB) Medium Bronze (MB)	\$562.00	\$678.00
Dummy	UL	3030	N/A		\$378.00	\$378.00	

22 **Handing is Required for All Mortise Locks.** Standard door thickness of 1¾", specify if thicker. 2½" or 2¾" Backsets. Locks for in-swing doors are standard, for out-swing doors please specify.

SANDCAST BRONZE MORTISE - ENTRANCE HANDLESETS

Rectangular Sectional Mortise

Rectangular Monolithic Mortise

Rectangular Full Length Mortise

UL LISTED Rectangular Full Length Mortise



ENTRY SETS

Rectangular Sectional Mortise Style *Complete Lockset*

Description	UL Listed	Product Code	Backset	Knob or Lever Style for Inside Trim	Finish	Standard ANSI F20 List Price	UL LISTED ANSI F13 List Price
Entry Set	UL	3324	2½" or 2¾"	<i>See Page 5 for Sandcast Bronze Knob & Lever Options.</i>	Deep Burgundy (DB) Flat Black (FB) Medium Bronze (MB)	\$470.00	\$586.00
Dummy	UL	3024	N/A			\$286.00	\$286.00

Rectangular Monolithic Mortise Style *Complete Lockset*

Description	UL Listed	Product Code	Backset	Knob or Lever Style for Inside Trim	Finish	Standard ANSI F20 List Price	UL LISTED ANSI F13 List Price
Entry Set	UL	3325	2½" or 2¾"	<i>See Page 5 for Sandcast Bronze Knob & Lever Options.</i>	Deep Burgundy (DB) Flat Black (FB) Medium Bronze (MB)	\$512.00	\$628.00
Dummy	UL	3025	N/A			\$328.00	\$328.00

Rectangular Full Length Mortise Style *Complete Lockset*

Description	UL Listed	Product Code	Backset	Knob or Lever Style for Inside Trim	Finish	Standard ANSI F20 List Price	UL LISTED ANSI F13 List Price
Entry Set	UL	3326	2½" or 2¾"	<i>See Page 5 for Sandcast Bronze Knob & Lever Options.</i>	Deep Burgundy (DB) Flat Black (FB) Medium Bronze (MB)	\$562.00	\$678.00
Dummy	UL	3026	N/A			\$378.00	\$378.00

Handing is Required for All Mortise Locks. Standard door thickness of 1¾", specify if thicker. 2½" or 2¾" Backsets. Locks for in-swing doors are standard, for out-swing doors please specify.

ENTRANCE HANDLESETS - SANDCAST BRONZE MORTISE

**Morgan
Mortise**

**Rockford
Mortise**

**UL LISTED
Rockford Mortise**



Order any Sandcast Bronze Knob or Lever for the Inside Trim.

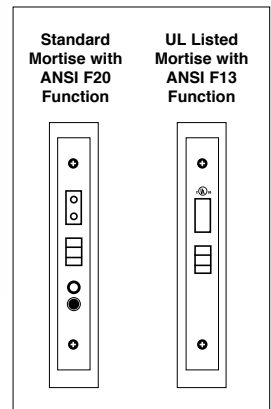

ENTRY SETS



Morgan Mortise Style *Complete Lockset*

Description	UL Listed	Product Code	Backset	Knob or Lever Style for Inside Trim	Finish	Standard ANSI F20 List Price	UL LISTED ANSI F13 List Price
Entry Set	UL	3327	2 1/2" or 2 3/4"	<i>See Page 5 for Sandcast Bronze Knob & Lever Options.</i>	Deep Burgundy (DB) Flat Black (FB) Medium Bronze (MB)	\$512.00	\$628.00
Dummy	UL	3027	N/A			\$328.00	\$328.00

Rockford Mortise Style *Complete Lockset*

Description	UL Listed	Product Code	Backset	Knob or Lever Style for Inside Trim	Finish	Standard ANSI F20 List Price	UL LISTED ANSI F13 List Price
Entry Set	UL	3328	2 1/2" or 2 3/4"	<i>See Page 5 for Sandcast Bronze Knob & Lever Options.</i>	Deep Burgundy (DB) Flat Black (FB) Medium Bronze (MB)	\$562.00	\$678.00
Dummy	UL	3028	N/A			\$378.00	\$378.00

LOST WAX CAST BRONZE MORTISE - ENTRANCE HANDLESETS

Art Nouveau Mortise

Left Hand Grip



Order any Lost Wax Cast Bronze Knob or Lever for the Inside Trim.



Left Right

Grip Options

Octagon Mortise



Order any Lost Wax Cast Bronze Knob or Lever for the Inside Trim.

Da Vinci Mortise

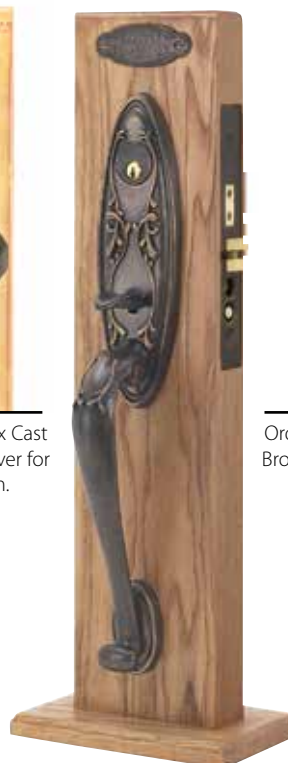

Order any Lost Wax Cast Bronze Knob or Lever for the Inside Trim.

ENTRY SETS

Art Nouveau Mortise Style *Complete Lockset*

Description	UL Listed	Product Code	Backset	Knob or Lever Style for Inside Trim	Finish	Standard ANSI F20 List Price	UL LISTED ANSI F13 List Price
Entry Set	UL	3332	2 1/2" or 2 3/4"	<i>See Page 5 for Lost Wax Cast Bronze Knob & Lever Options.</i>	Deep Burgundy (DB) Flat Black (FB) Medium Bronze (MB)	\$512.00	\$628.00
Dummy	UL	3032	N/A		\$328.00	\$328.00	

Octagon Mortise Style *Complete Lockset*

Description	UL Listed	Product Code	Backset	Knob or Lever Style for Inside Trim	Finish	Standard ANSI F20 List Price	UL LISTED ANSI F13 List Price
Entry Set	UL	3333	2 1/2" or 2 3/4"	<i>See Page 5 for Lost Wax Cast Bronze Knob & Lever Options.</i>	Deep Burgundy (DB) Flat Black (FB) Medium Bronze (MB)	\$512.00	\$628.00
Dummy	UL	3033	N/A		\$328.00	\$328.00	

Da Vinci Mortise Style *Complete Lockset*

Description	UL Listed	Product Code	Backset	Knob or Lever Style for Inside Trim	Finish	Standard ANSI F20 List Price	UL LISTED ANSI F13 List Price
Entry Set	UL	3331	2 1/2" or 2 3/4"	<i>See Page 5 for Lost Wax Cast Bronze Knob & Lever Options.</i>	Deep Burgundy (DB) Flat Black (FB) Medium Bronze (MB)	\$512.00	\$628.00
Dummy	UL	3031	N/A		\$328.00	\$328.00	

Handing is Required for All Mortise Locks. Standard door thickness of 1 3/4", specify if thicker. 2 1/2" or 2 3/4" Backsets. Locks for in-swing doors are standard, for out-swing doors please specify.

ENTRANCE HANDLESETS - STAINLESS STEEL MORTISE

Mormont
Stainless Steel Mortise

UL LISTED
Mormont
Stainless Steel Mortise



Order any Stainless Steel Knob or Lever for the Inside Trim.

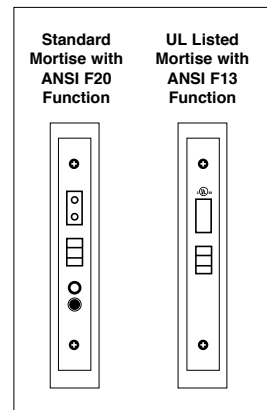

Mormont Stainless Steel Mortise Style *Complete Lockset*

Description	UL Listed	Product Code	Backset	Knob or Lever Style for Inside Trim	Finish	Standard ANSI F20 List Price	UL LISTED ANSI F13 List Price
Entry Set	UL	S3301	2 1/2" or 2 3/4"	<i>See Page 6 for Stainless Steel Knob & Lever Options.</i>	Brushed Stainless Steel (SS)	\$504.00	\$620.00
Dummy	UL	S3001	N/A			\$320.00	\$320.00

WROUGHT STEEL MONOLITHIC MORTISE - ENTRANCE HANDLESETS

**Wrought Steel
Monolithic Mortise
Lafayette Grip**



**UL LISTED
Wrought Steel
Monolithic Mortise
San Carlos Grip**



Order any Wrought Steel
Knob or Lever for the
Inside Trim.



Lafayette Grip San Carlos Grip Normandy Grip

Grip Options

ENTRY SETS

Lafayette Monolithic Mortise Style *Complete Lockset*

Description	UL Listed	Product Code	Backset	Knob or Lever Style for Inside Trim	Finish	Standard ANSI F20 List Price	UL LISTED ANSI F13 List Price
Entry Set	UL	3311	2 1/2" or 2 3/4"	<i>See Page 6 for Wrought Steel Knob & Lever Options.</i>	Flat Black (FB) Satin Steel	\$466.00	\$582.00
Dummy	UL	3011	N/A			\$282.00	\$282.00

San Carlos Monolithic Mortise Style *Complete Lockset*

Description	UL Listed	Product Code	Backset	Knob or Lever Style for Inside Trim	Finish	Standard ANSI F20 List Price	UL LISTED ANSI F13 List Price
Entry Set	UL	3312	2 1/2" or 2 3/4"	<i>See Page 6 for Wrought Steel Knob & Lever Options.</i>	Flat Black (FB) Satin Steel	\$466.00	\$582.00
Dummy	UL	3012	N/A			\$282.00	\$282.00

Normandy Monolithic Mortise Style *Complete Lockset*

Description	UL Listed	Product Code	Backset	Knob or Lever Style for Inside Trim	Finish	Standard ANSI F20 List Price	UL LISTED ANSI F13 List Price
Entry Set	UL	3313	2 1/2" or 2 3/4"	<i>See Page 6 for Wrought Steel Knob & Lever Options.</i>	Flat Black (FB) Satin Steel	\$466.00	\$582.00
Dummy	UL	3013	N/A			\$282.00	\$282.00

Handing is Required for All Mortise Locks. Standard door thickness of 1 3/4", specify if thicker. 2 1/2" or 2 3/4" Backsets. Locks for in-swing doors are standard, for out-swing doors please specify.

ENTRANCE LOCKSETS - BRASS KNOB BY KNOB & LEVER BY LEVER MORTISE

Mormont Mortise

Artemis Mortise

Charleston Mortise

UL LISTED Charleston Mortise

ENTRY SETS



Interior Trim View

Mormont Mortise Style

Description	UL Listed	Product Code	Backset	Knob or Lever Style	Finish	Standard ANSI F20 List Price	UL LISTED ANSI F13 List Price
Entry Set	UL	3545	2½" or 2¾"	<i>See Page 4 for Brass Knob & Lever Options.</i> <i>See Page 5 for Crystal & Porcelain Knob Options.</i>	Oil Rubbed Bronze (US10B) Satin Nickel (US15) Flat Black (US19) Polished Chrome (US26)	\$454.00	\$570.00
Dummy	UL	3145	N/A				

Artemis Mortise Style

Description	UL Listed	Product Code	Backset	Knob or Lever Style	Finish	Standard ANSI F20 List Price	UL LISTED ANSI F13 List Price
Entry Set	UL	3544	2½" or 2¾"	<i>See Page 4 for Brass Knob & Lever Options.</i> <i>See Page 5 for Crystal & Porcelain Knob Options.</i>	Oil Rubbed Bronze (US10B) Satin Nickel (US15) Flat Black (US19) Polished Chrome (US26)	\$454.00	\$570.00
Dummy	UL	3144	N/A				

Charleston Mortise Style

Description	UL Listed	Product Code	Backset	Knob or Lever Style	Finish	Standard ANSI F20 List Price	UL LISTED ANSI F13 List Price
Entry Set	UL	3543	2½" or 2¾"	<i>See Page 4 for Brass Knob & Lever Options.</i> <i>See Page 5 for Crystal & Porcelain Knob Options.</i>	French Antique (US7) Oil Rubbed Bronze (US10B) Satin Nickel (US15) Pewter (US15A) Polished Chrome (US26) PVD-Lifetime	\$454.00	\$570.00
Dummy	UL	3143	N/A				

Manhattan Mortise

Hamilton Mortise

Memphis Mortise



Interior Trim View

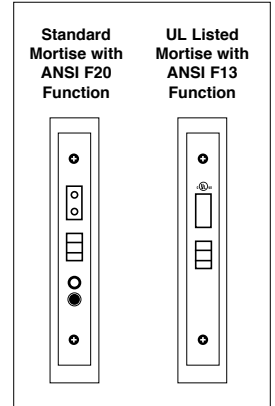

ENTRY SETS

Manhattan Mortise Style

Description	UL Listed	Product Code	Backset	Knob or Lever Style	Finish	Standard ANSI F20 List Price	UL LISTED ANSI F13 List Price
Entry Set	UL	3506	2 1/2" or 2 3/4"	<i>See Page 4 for Brass Knob & Lever Options.</i> <i>See Page 5 for Crystal & Porcelain Knob Options.</i>	French Antique (US7) Oil Rubbed Bronze (US10B) Satin Nickel (US15) Pewter (US15A) Polished Chrome (US26) PVD-Lifetime	\$454.00	\$570.00
Dummy	UL	3106	N/A			\$270.00	\$270.00

Hamilton Mortise Style

Description	UL Listed	Product Code	Backset	Knob or Lever Style	Finish	Standard ANSI F20 List Price	UL LISTED ANSI F13 List Price
Entry Set	UL	3504	2 1/2" or 2 3/4"	<i>See Page 4 for Brass Knob & Lever Options.</i> <i>See Page 5 for Crystal & Porcelain Knob Options.</i>	French Antique (US7) Oil Rubbed Bronze (US10B) Satin Nickel (US15) Pewter (US15A) Polished Chrome (US26) PVD-Lifetime	\$454.00	\$570.00
Dummy	UL	3104	N/A			\$270.00	\$270.00

Memphis Mortise Style

Description	UL Listed	Product Code	Backset	Knob or Lever Style	Finish	Standard ANSI F20 List Price	UL LISTED ANSI F13 List Price
Entry Set	UL	3502	2 1/2" or 2 3/4"	<i>See Page 4 for Brass Knob & Lever Options.</i> <i>See Page 5 for Crystal & Porcelain Knob Options.</i>	French Antique (US7) Oil Rubbed Bronze (US10B) Satin Nickel (US15) Pewter (US15A) Polished Chrome (US26) PVD-Lifetime	\$454.00	\$570.00
Dummy	UL	3102	N/A			\$270.00	\$270.00

Handing is Required for All Mortise Locks. Standard door thickness of 1 3/4", specify if thicker. 2 1/2" or 2 3/4" Backsets. Locks for in-swing doors are standard, for out-swing doors please specify.

ENTRANCE LOCKSETS - BRASS KNOB BY KNOB & LEVER BY LEVER MORTISE

ENTRY SETS



Oval Ribbon & Reed Mortise Style

Description	UL Listed	Product Code	Backset	Knob or Lever Style	Finish	Standard ANSI F20 List Price	UL LISTED ANSI F13 List Price
Entry Set	UL	3542	2 1/2" or 2 3/4"	<i>See Page 4 for Brass Knob & Lever Options.</i>	French Antique (US7) Oil Rubbed Bronze (US10B) Satin Nickel (US15) Pewter (US15A) Polished Chrome (US26) PVD-Lifetime	\$454.00	\$570.00
Dummy	UL	3142	N/A				

Regency Mortise Style

Description	UL Listed	Product Code	Backset	Knob or Lever Style	Finish	Standard ANSI F20 List Price	UL LISTED ANSI F13 List Price
Entry Set	UL	3507	2 1/2" or 2 3/4"	<i>See Page 4 for Brass Knob & Lever Options.</i>	French Antique (US7) Oil Rubbed Bronze (US10B) Satin Nickel (US15) Pewter (US15A) Polished Chrome (US26) PVD-Lifetime	\$454.00	\$570.00
Dummy	UL	3107	N/A				

Craftsman Mortise Style

Description	UL Listed	Product Code	Backset	Knob or Lever Style	Finish	Standard ANSI F20 List Price	UL LISTED ANSI F13 List Price
Entry Set	UL	3508	2 1/2" or 2 3/4"	<i>See Page 4 for Brass Knob & Lever Options.</i>	Oil Rubbed Bronze (US10B) Satin Nickel (US15) Flat Black (US19)	\$454.00	\$570.00
Dummy	UL	3108	N/A				

**Rectangular
Monolithic Mortise**

**Cheyenne
Mortise**

**Hailey
Mortise**

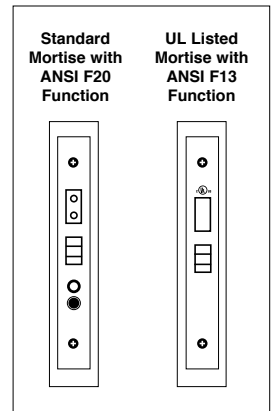

**ENTRANCE
SETS**

Rectangular Monolithic Mortise Style

Description	UL Listed	Product Code	Backset	Knob or Lever Style	Finish	Standard ANSI F20 List Price	UL LISTED ANSI F13 List Price
Entry Set	UL	3525	2 1/2" or 2 3/4"	<i>See Page 5 for Sandcast Bronze Knob & Lever Options.</i>	Deep Burgundy (DB) Flat Black (FB) Medium Bronze (MB)	\$498.00	\$614.00
Dummy	UL	3125	N/A			\$314.00	\$314.00

Cheyenne Mortise Style

Description	UL Listed	Product Code	Backset	Knob or Lever Style	Finish	Standard ANSI F20 List Price	UL LISTED ANSI F13 List Price
Entry Set	UL	3521	2 1/2" or 2 3/4"	<i>See Page 5 for Sandcast Bronze Knob & Lever Options.</i>	Deep Burgundy (DB) Flat Black (FB) Medium Bronze (MB)	\$498.00	\$614.00
Dummy	UL	3121	N/A			\$314.00	\$314.00

Hailey Mortise Style

Description	UL Listed	Product Code	Backset	Knob or Lever Style	Finish	Standard ANSI F20 List Price	UL LISTED ANSI F13 List Price
Entry Set	UL	3534	2 1/2" or 2 3/4"	<i>See Page 5 for Sandcast Bronze Knob & Lever Options.</i>	Flat Black (FB) Medium Bronze (MB)	\$498.00	\$614.00
Dummy	UL	3134	N/A			\$314.00	\$314.00

Handing is Required for All Mortise Locks. Standard door thickness of 1 3/4"; specify if thicker. 2 1/2" or 2 3/4" Backsets. Locks for in-swing doors are standard, for out-swing doors please specify.

ENTRANCE LOCKSETS - LOST WAX CAST KNOB BY KNOB & LEVER BY LEVER MORTISE

Da Vinci
UL Mortise

Octagon
UL Mortise

Art Nouveau
UL Mortise

UL LISTED
Art Nouveau
UL Mortise



Interior Trim View

ENTRY SETS

Da Vinci Mortise Style

Description	UL Listed	Product Code	Backset	Knob or Lever Style	Finish	Standard ANSI F20 List Price	UL LISTED ANSI F13 List Price
Entry Set	UL	3531	2½" or 2¾"	<i>See Page 5 for Lost Wax Cast Bronze Knob & Lever Options.</i>	Deep Burgundy (DB) Flat Black (FB) Medium Bronze (MB)	\$498.00	\$614.00
Dummy	UL	3131	N/A			\$314.00	\$314.00

Octagon Mortise Style

Description	UL Listed	Product Code	Backset	Knob or Lever Style	Finish	Standard ANSI F20 List Price	UL LISTED ANSI F13 List Price
Entry Set	UL	3533	2½" or 2¾"	<i>See Page 5 for Lost Wax Cast Bronze Knob & Lever Options.</i>	Deep Burgundy (DB) Flat Black (FB) Medium Bronze (MB)	\$498.00	\$614.00
Dummy	UL	3133	N/A			\$314.00	\$314.00

Art Nouveau Mortise Style

Description	UL Listed	Product Code	Backset	Knob or Lever Style	Finish	Standard ANSI F20 List Price	UL LISTED ANSI F13 List Price
Entry Set	UL	3532	2½" or 2¾"	<i>See Page 5 for Lost Wax Cast Bronze Knob & Lever Options.</i>	Deep Burgundy (DB) Flat Black (FB) Medium Bronze (MB)	\$498.00	\$614.00
Dummy	UL	3132	N/A			\$314.00	\$314.00

Mormont Stainless Steel Mortise Trim Knob by Knob

Mormont Stainless Steel Mortise Trim Lever by Lever



Interior Trim View

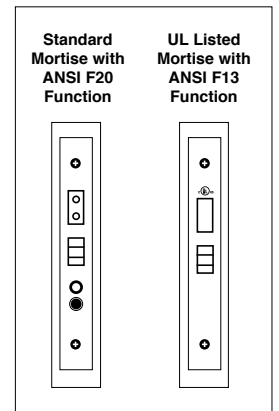

ENTRY SETS

Mormont Stainless Steel Mortise Style

Description	UL Listed	Product Code	Backset	Knob or Lever Style	Finish	Standard ANSI F20 List Price	UL LISTED ANSI F13 List Price
Entry Set	UL	S3501	2 1/2" or 2 3/4"	<i>See Page 6 for Stainless Steel Knob & Lever Options.</i>	Brushed Stainless Steel (SS)	\$504.00	\$620.00
Dummy	UL	S3101	N/A			\$320.00	\$320.00

ENTRANCE LOCKSETS - REPLACEMENT PARTS FOR STANDARD MORTISE LOCKS



Steel Understrike
Supplied with all
Mortise Locks



Brass **Standard** Strike Plate
1 7/8" wide x 4 7/8" high
Supplied with **Mortise Locks**
unless door thickness is specified
as 2" or greater



Brass **Flat** Strike Plate
1 7/8" wide x 4 7/8" high
Supplied with
Mortise Locks
when requested



Brass **Extended** Strike Plate
2 1/2" wide x 4 7/8" high
Supplied with **Mortise Locks**
when door thickness is specified
as 2" or greater

Strike plates are supplied with **STANDARD** Mortise Locks as described above. Additional strike plates may be ordered using the part number shown below.

	Product Code	Finish	Standard List Price
Brass Standard Strike Plate with understrike and screws	86147	French Antique (US7) Oil Rubbed Bronze (US10B) Satin Nickel (US15)	\$16.00
Brass Flat Strike Plate with understrike and screws	86148	Pewter (US15A) Polished Chrome (US26) PVD-Lifetime	\$16.00
Brass Extended Strike Plate with understrike and screws	86149	Deep Burgundy (DB) Flat Black (FB) Medium Bronze (MB) Satin Steel	\$16.00

* **Standard Mortise Strike Plates are NOT compatible with any EMTEK UL Listed mortise locks.**

Standard Mortise Lock Box Only

Includes Face Plate, Trimplate and Strike Plate. **Cylinder Not Included.**

Description	Product Code	Backset	Finish	Standard List Price
Thumb by Lever or Knob	3300	2 1/2" or 2 3/4"	French Antique (US7) Oil Rubbed Bronze (US10B) Satin Nickel (US15) Pewter (US15A) Polished Chrome (US26) PVD-Lifetime	\$184.00
Knob by Knob & Lever by Lever	3380	2 1/2" or 2 3/4"	Deep Burgundy (DB) Flat Black (FB) Medium Bronze (MB) Satin Steel	\$184.00



**ANSI F20
EMTEK Standard Mortise
Lock Box**

Cylinder Only *Threaded Mortise Type*

Product Code	Length	Finish	Standard List Price
CY5-ThrdMrt1375	1 3/8"	Oil Rubbed Bronze (US10B) Polished Chrome (US26)	\$24.00
CY5-ThrdMrt150	1 1/2"	PVD-Lifetime	\$24.00
CY5-ThrdMrt175	1 3/4"		\$24.00

* **Standard Mortise Strike Plates are NOT compatible with any EMTEK UL Listed mortise locks.**



Steel Understrike
Supplied with all
UL LISTED Mortise
Locks



Brass **Standard** Strike Plate
1 7/8" wide x 4 7/8" high
Supplied with **UL LISTED Mortise**
Locks unless door thickness
is specified as 2" or greater



Brass **Flat** Strike Plate
1 7/8" wide x 4 7/8" high
Supplied with
UL LISTED Mortise Locks
when requested



Brass **Extended** Strike Plate
2 1/2" wide x 4 7/8" high
Supplied with **UL LISTED Mortise**
Locks when door thickness
is specified as 2" or greater

Strike plates are supplied with **UL LISTED Mortise Locks** as described above. Additional strike plates may be ordered using the part number shown below.

	Product Code	Finish	List Price
Brass Standard Strike Plate with understrike and screws	UL86147	French Antique (US7) Oil Rubbed Bronze (US10B) Satin Nickel (US15)	\$30.00
Brass Flat Strike Plate with understrike and screws	UL86148	Pewter (US15A) Polished Chrome (US26) PVD-Lifetime	\$30.00
Brass Extended Strike Plate with understrike and screws	UL86149	Deep Burgundy (DB) Flat Black (FB) Medium Bronze (MB) Satin Steel	\$30.00

* **UL LISTED Mortise Strike Plates are NOT compatible with any EMTEK standard mortise locks.**

UL LISTED Mortise Lock Box Only

Includes Face Plate, Trimplate and Strike Plate. **Cylinder Not Included.**

Description	Product Code	Backset	Finish	List Price
Thumb by Lever or Knob	UL3300	2 1/2" or 2 3/4"	French Antique (US7) Oil Rubbed Bronze (US10B) Satin Nickel (US15) Pewter (US15A) Polished Chrome (US26) PVD-Lifetime	\$300.00
Knob by Knob & Lever by Lever	UL3380	2 1/2" or 2 3/4"	Deep Burgundy (DB) Flat Black (FB) Medium Bronze (MB) Satin Steel	\$300.00

Cylinder Only *Threaded UL LISTED Mortise Type*

Product Code	Length	Finish	List Price
ULCY51375	1 3/8"	Oil Rubbed Bronze (US10B)	\$26.00
ULCY5150	1 1/2"	Polished Chrome (US26) PVD-Lifetime	\$26.00
ULCY5175	1 3/4"		\$26.00

* **UL LISTED Mortise Strike Plates are NOT compatible with any EMTEK standard mortise locks.**



ANSI F13
UL LISTED Mortise
Lock Box

ENTRANCE LOCKSETS - SINGLE & TWO POINT

ENTRY SETS

Single Point Lock
Key in Handle
5300



Key in Lever, Cortina with Trenton Plate (Outside)



Key in Knob, Providence with Trenton Plate (Inside)

Single Point Lock
Key in Handle, Dummy
5350



Key in Lever, Dummy Cortina with Trenton Plate (Outside)



Key in Lever, Dummy Cortina with Trenton Plate (Inside)

Two Point Lock
Single Cylinder
5310



Two Point Lock, Providence with Trenton Plate (Outside)



Two Point Lock, Providence with Trenton Plate (Inside)

Two Point Lock
Double Cylinder
5320



Two Point Lock, Cortina with Trenton Plate (Outside)



Two Point Lock, Cortina with Trenton Plate (Inside)

>> Cross Reference: Key & Non-keyed Knob & Leversets with Trenton Plates.

Knobsets with Decorative Plates

Description	Product Code	Knob Style	Finish	List Price
Key in Knob with Decorative Plate	5300	Egg Knob (E)	French Antique (US7)	\$190.00
Key in Knob with Decorative Plate, Dummy	5350	Providence Knob (P)	Oil Rubbed Bronze (US10B)	
Two Point Lock, Single Cylinder	5310	Rope Knob (RK)	Satin Nickel (US15)	\$190.00
Two Point Lock, Double Cylinder	5320	Round Knob (ROU)*	Pewter (US15A)	
		Waverly Knob (W)	Polished Chrome (US26)	\$220.00
			PVD-Lifetime	\$224.00

* Round knob NOT available in French Antique (US7), Pewter (US15A), and PVD-Lifetime.

Leversets with Decorative Plates

Description	Product Code	Lever Style	Finish	List Price
Key in Lever with Decorative Plate	5300	Cortina Lever (C)	French Antique (US7)	\$190.00
Key in Lever with Decorative Plate, Dummy	5350	Luzern Lever (LU)*	Oil Rubbed Bronze (US10B)	
Two Point Lock, Single Cylinder	5310	Rope Lever (RL)	Satin Nickel (US15)	\$190.00
Two Point Lock, Double Cylinder	5320		Pewter (US15A)	
			Polished Chrome (US26)	\$220.00
			PVD-Lifetime	\$224.00

* Luzern lever NOT available in French Antique (US7), Pewter (US15A), and PVD-Lifetime.

>> Specify by adding "W" to the beginning of Product Code for Weiser® (WR5) Keyway (For example: W5300C US7). No upcharge for cylinder substitution. Can be keyed into existing Weiser® system.

BRASS TUBULAR - ENTRANCE HANDLESETS

ENTRY SETS

Baden Trim



Order any Brass Knob or Lever for the Inside Trim.

Davos Trim

Door Prep 5 1/2" Center to Center



Order any Brass Knob or Lever for the Inside Trim.

Lausanne Trim

Door Prep 5 1/2" Center to Center



Interconnect Device Available for Most Brass Tubular Handlesets

Standard with Tubular Locks

- Standard 2 1/8" Door Prep
- Solid Forged Brass Trim
- Schlage® C Keyway

Baden Style

Description	Product Code	Knob or Lever Style for Inside Trim	Finish	List Price
Single Cylinder	4820	<i>See Page 4 for Brass Knob & Lever Options. See Page 5 for Crystal & Porcelain Knob Options.</i>	Oil Rubbed Bronze (US10B)	\$240.00
Double Cylinder	4830		Satin Nickel (US15)	\$240.00
Dummy	4810		Flat Black (US19)	\$240.00
			Polished Chrome (US26)	

Davos Style

Description	Product Code	Knob or Lever Style for Inside Trim	Finish	List Price
Single Cylinder	4818	<i>See Page 4 for Brass Knob & Lever Options. See Page 5 for Crystal & Porcelain Knob Options.</i>	Oil Rubbed Bronze (US10B)	\$274.00
Double Cylinder	4828		Satin Nickel (US15)	\$274.00
Dummy	4808		Flat Black (US19)	\$274.00
			Polished Chrome (US26)	

Lausanne Style

Description	Product Code	Knob or Lever Style for Inside Trim	Finish	List Price
Single Cylinder	4819	<i>See Page 4 for Brass Knob & Lever Options. See Page 5 for Crystal & Porcelain Knob Options.</i>	Oil Rubbed Bronze (US10B)	\$324.00
Double Cylinder	4829		Satin Nickel (US15)	\$324.00
Dummy	4809		Flat Black (US19)	\$324.00
			Polished Chrome (US26)	

Interconnect Device Not Available for Double Cylinder.

Available for Davos & Lausanne Styles	Product Code: 443	List Price: \$58.00
---------------------------------------	-------------------	----------------------------

>> Specify by adding "W" to the beginning of Product Code for Weiser® (WR5) Keyway (For example: **W**4819GV US10B). No upcharge for cylinder substitution. Can be keyed into existing Weiser® system.

ENTRANCE HANDLESETS - BRASS TUBULAR

Ares Trim



Order any Brass Knob or Lever for the Inside Trim.

Apollo Trim

Door Prep 5½" Center to Center



Orion Trim

Door Prep 5½" Center to Center



Order any Brass Knob or Lever for the Inside Trim.

ENTRY SETS

Standard with Tubular Locks

- Standard 2½" Door Prep
- Solid Forged Brass Trim
- Schlage® C Keyway

Ares Style

Description	Product Code	Knob or Lever Style for Inside Trim	Finish	List Price
Single Cylinder	4817	<i>See Page 4 for Brass Knob & Lever Options. See Page 5 for Crystal & Porcelain Knob Options.</i>	Oil Rubbed Bronze (US10B)	\$240.00
Double Cylinder	4827		Satin Nickel (US15)	\$240.00
Dummy	4807		Flat Black (US19)	\$240.00
			Polished Chrome (US26)	

Apollo Style

Description	Product Code	Knob or Lever Style for Inside Trim	Finish	List Price
Single Cylinder	4815	<i>See Page 4 for Brass Knob & Lever Options. See Page 5 for Crystal & Porcelain Knob Options.</i>	Oil Rubbed Bronze (US10B)	\$274.00
Double Cylinder	4825		Satin Nickel (US15)	\$274.00
Dummy	4805		Flat Black (US19)	\$274.00
			Polished Chrome (US26)	

Orion Style

Description	Product Code	Knob or Lever Style for Inside Trim	Finish	List Price
Single Cylinder	4816	<i>See Page 4 for Brass Knob & Lever Options. See Page 5 for Crystal & Porcelain Knob Options.</i>	Oil Rubbed Bronze (US10B)	\$324.00
Double Cylinder	4826		Satin Nickel (US15)	\$324.00
Dummy	4806		Flat Black (US19)	\$324.00
			Polished Chrome (US26)	

Interconnect Device Not Available for Double Cylinder.

Available for Apollo & Orion Styles	Product Code: 443	List Price: \$58.00
-------------------------------------	-------------------	----------------------------

>> Specify by adding "W" to the beginning of Product Code for Weiser® (WR5) Keyway (For example: **W**4816ATN US10B).
No upcharge for cylinder substitution. Can be keyed into existing Weiser® system.

BRASS TUBULAR - ENTRANCE HANDLESETS

Zeus Trim

Door Prep 5 1/2" Center to Center



Order any Brass Knob or Lever for the Inside Trim.

Arts & Crafts Trim

Door Prep 5 1/2" Center to Center



Arts & Crafts Full Length Trim

Door Prep 5 1/2" Center to Center



Order any Brass Knob or Lever for the Inside Trim.

Standard with Tubular Locks

- Standard 2 1/8" Door Prep
- Solid Forged Brass Trim
- Schlage® C Keyway

Zeus Style

Description	Product Code	Knob or Lever Style for Inside Trim	Finish	List Price
Single Cylinder	4814	<i>See Page 4 for Brass Knob & Lever Options. See Page 5 for Crystal & Porcelain Knob Options.</i>	Oil Rubbed Bronze (US10B)	\$274.00
Double Cylinder	4824		Satin Nickel (US15)	\$274.00
Dummy	4804		Polished Chrome (US26)	\$274.00

Arts & Crafts Style

Description	Product Code	Knob or Lever Style for Inside Trim	Finish	List Price
Single Cylinder	4811	<i>See Page 4 for Brass Knob & Lever Options. See Page 5 for Crystal & Porcelain Knob Options.</i>	Oil Rubbed Bronze (US10B)	\$274.00
Double Cylinder	4821		Satin Nickel (US15)	\$274.00
Dummy	4801		Flat Black (US19)	\$274.00

Arts & Crafts Full Length Style

Description	Product Code	Knob or Lever Style for Inside Trim	Finish	List Price
Single Cylinder	4812	<i>See Page 4 for Brass Knob & Lever Options. See Page 5 for Crystal & Porcelain Knob Options.</i>	Oil Rubbed Bronze (US10B)	\$324.00
Double Cylinder	4822		Satin Nickel (US15)	\$324.00
Dummy	4802		Flat Black (US19)	\$324.00

Interconnect Device Not Available for Double Cylinder.

Available for Above Styles	Product Code: 443	List Price: \$58.00
----------------------------	-------------------	----------------------------

>> Specify by adding "W" to the beginning of Product Code for Weiser® (WR5) Keyway (For example: **W**4812HE US10B). No upcharge for cylinder substitution. Can be keyed into existing Weiser® system.

Handing Required if Lever Used on Inside or if Interconnect Device is Specified. Standard latch is for 2 3/8" backset. Specify 2 3/4" backset if required. 28° Latch Not Available for Use with Tubular Entrance Handlesets.

ENTRY SETS

ENTRANCE HANDLESETS - BRASS TUBULAR

ENTRY SETS

Hamden Trim



Order any Brass Knob or Lever for the Inside Trim.

Wilshire Trim

Door Prep 5 1/2" Center to Center



Melrose Trim

Door Prep 5 1/2" Center to Center



Order any Brass Knob or Lever for the Inside Trim.

Standard with Tubular Locks

- Standard 2 1/8" Door Prep
- Solid Forged Brass Trim
- Schlage® C Keyway

Hamden Style

Description	Product Code	Knob or Lever Style for Inside Trim	Finish	List Price
Single Cylinder	4213	<i>See Page 4 for Brass Knob & Lever Options. See Page 5 for Crystal & Porcelain Knob Options.</i>	French Antique (US7) Oil Rubbed Bronze (US10B) Satin Nickel (US15) Pewter (US15A) Flat Black (US19) Polished Chrome (US26) PVD-Lifetime	\$240.00
Double Cylinder	4223		\$240.00	
Dummy	4203		\$240.00	

Wilshire Style

Description	Product Code	Knob or Lever Style for Inside Trim	Finish	List Price
Single Cylinder	4211	<i>See Page 4 for Brass Knob & Lever Options. See Page 5 for Crystal & Porcelain Knob Options.</i>	French Antique (US7) Oil Rubbed Bronze (US10B) Satin Nickel (US15) Pewter (US15A) Flat Black (US19) Polished Chrome (US26) PVD-Lifetime	\$274.00
Double Cylinder	4221		\$274.00	
Dummy	4201		\$274.00	

Melrose Style

Description	Product Code	Knob or Lever Style for Inside Trim	Finish	List Price
Single Cylinder	4212	<i>See Page 4 for Brass Knob & Lever Options. See Page 5 for Crystal & Porcelain Knob Options.</i>	French Antique (US7) Oil Rubbed Bronze (US10B) Satin Nickel (US15) Pewter (US15A) Flat Black (US19) Polished Chrome (US26) PVD-Lifetime	\$324.00
Double Cylinder	4222		\$324.00	
Dummy	4202		\$324.00	

Interconnect Device Not Available for Double Cylinder.

Available for Wilshire & Melrose Styles	Product Code: 443	List Price: \$58.00
---	-------------------	----------------------------

>> Specify by adding "W" to the beginning of Product Code for Weiser® (WR5) Keyway (For example: **W**4212BT US7). No upcharge for cylinder substitution. Can be keyed into existing Weiser® system.

BRASS TUBULAR - ENTRANCE HANDLESETS

Franklin Trim



Order any Brass Knob or Lever for the Inside Trim.

Adams Trim

Door Prep 5 1/2" Center to Center



Jefferson Trim

Door Prep 5 1/2" Center to Center



Order any Brass Knob or Lever for the Inside Trim.

Standard with Tubular Locks

- Standard 2 1/8" Door Prep
- Solid Forged Brass Trim
- Schlage® C Keyway

ENTRY SETS

Franklin Style

Description	Product Code	Knob or Lever Style for Inside Trim	Finish	List Price
Single Cylinder	4413	<i>See Page 4 for Brass Knob & Lever Options. See Page 5 for Crystal & Porcelain Knob Options.</i>	French Antique (US7) Oil Rubbed Bronze (US10B) Satin Nickel (US15) Pewter (US15A) Flat Black (US19) Polished Chrome (US26) PVD-Lifetime	\$240.00
Double Cylinder	4423		\$240.00	
Dummy	4403		\$240.00	

Adams Style

Description	Product Code	Knob or Lever Style for Inside Trim	Finish	List Price
Single Cylinder	4414	<i>See Page 4 for Brass Knob & Lever Options. See Page 5 for Crystal & Porcelain Knob Options.</i>	French Antique (US7) Oil Rubbed Bronze (US10B) Satin Nickel (US15) Pewter (US15A) Flat Black (US19) Polished Chrome (US26) PVD-Lifetime	\$274.00
Double Cylinder	4424		\$274.00	
Dummy	4404		\$274.00	

Jefferson Style

Description	Product Code	Knob or Lever Style for Inside Trim	Finish	List Price
Single Cylinder	4415	<i>See Page 4 for Brass Knob & Lever Options. See Page 5 for Crystal & Porcelain Knob Options.</i>	French Antique (US7) Oil Rubbed Bronze (US10B) Satin Nickel (US15) Pewter (US15A) Flat Black (US19) Polished Chrome (US26) PVD-Lifetime	\$324.00
Double Cylinder	4425		\$324.00	
Dummy	4405		\$324.00	

Interconnect Device Not Available for Double Cylinder.

Available for Adams & Jefferson Styles	Product Code: 443	List Price: \$58.00
--	-------------------	----------------------------

>> Specify by adding "W" to the beginning of Product Code for Weiser® (WR5) Keyway (For example: **W**4415A US15).
No upcharge for cylinder substitution. Can be keyed into existing Weiser® system.

ENTRANCE HANDLESETS - BRASS TUBULAR

Saratoga Trim



Order any Brass Knob or Lever for the Inside Trim.

Marietta Trim

Door Prep 5½" Center to Center



Order any Brass Knob or Lever for the Inside Trim.

ENTRY SETS

Standard with Tubular Locks

- Standard 2½" Door Prep
- Solid Forged Brass Trim
- Schlage® C Keyway

Saratoga Style

Description	Product Code	Knob or Lever Style for Inside Trim	Finish	List Price
Single Cylinder	4410	<i>See Page 4 for Brass Knob & Lever Options. See Page 5 for Crystal & Porcelain Knob Options.</i>	French Antique (US7) Oil Rubbed Bronze (US10B) Satin Nickel (US15)	\$240.00
Double Cylinder	4420		Pewter (US15A) Flat Black (US19)	\$240.00
Dummy	4400		Polished Chrome (US26) PVD-Lifetime	\$240.00

Marietta Style

Description	Product Code	Knob or Lever Style for Inside Trim	Finish	List Price
Single Cylinder	4411	<i>See Page 4 for Brass Knob & Lever Options. See Page 5 for Crystal & Porcelain Knob Options.</i>	French Antique (US7) Oil Rubbed Bronze (US10B) Satin Nickel (US15)	\$274.00
Double Cylinder	4421		Pewter (US15A) Flat Black (US19)	\$274.00
Dummy	4401		Polished Chrome (US26) PVD-Lifetime	\$274.00

Interconnect Device Not Available for Double Cylinder.

Available for Marietta Style	Product Code: 443	List Price: \$58.00
------------------------------	-------------------	----------------------------

>> Specify by adding "W" to the beginning of Product Code for Weiser® (WR5) Keyway (For example: **W**4411C US7). No upcharge for cylinder substitution. Can be keyed into existing Weiser® system.

BRASS TUBULAR - ENTRANCE HANDLESETS

Nashville Trim



Order any Brass Knob or Lever for the Inside Trim.

Richmond Trim

Door Prep 5 1/2" Center to Center



Wilmington

Door Prep 5 1/2" Center to Center



Order any Brass Knob or Lever for the Inside Trim.

Standard with Tubular Locks

- Standard 2 1/8" Door Prep
- Solid Forged Brass Trim
- Schlage® C Keyway

ENTRY SETS

Nashville Style

Description	Product Code	Knob or Lever Style for Inside Trim	Finish	List Price
Single Cylinder	4312	<i>See Page 4 for Brass Knob & Lever Options.</i>	French Antique (US7) Oil Rubbed Bronze (US10B) Satin Nickel (US15) Pewter (US15A) Flat Black (US19) Polished Chrome (US26) PVD-Lifetime	\$240.00
Double Cylinder	4322			\$240.00
Dummy	4302			\$240.00

Richmond Style

Description	Product Code	Knob or Lever Style for Inside Trim	Finish	List Price
Single Cylinder	4313	<i>See Page 4 for Brass Knob & Lever Options.</i>	French Antique (US7) Oil Rubbed Bronze (US10B) Satin Nickel (US15) Pewter (US15A) Flat Black (US19) Polished Chrome (US26) PVD-Lifetime	\$274.00
Double Cylinder	4323			\$274.00
Dummy	4303			\$274.00

Wilmington Style

Description	Product Code	Knob or Lever Style for Inside Trim	Finish	List Price
Single Cylinder	4314	<i>See Page 4 for Brass Knob & Lever Options.</i>	French Antique (US7) Oil Rubbed Bronze (US10B) Satin Nickel (US15) Pewter (US15A) Flat Black (US19) Polished Chrome (US26) PVD-Lifetime	\$324.00
Double Cylinder	4324			\$324.00
Dummy	4304			\$324.00

Interconnect Device Not Available for Double Cylinder.

Available for Richmond & Wilmington Styles	Product Code: 443	List Price: \$58.00
--	-------------------	----------------------------

>> Specify by adding "W" to the beginning of Product Code for Weiser® (WR5) Keyway (For example: **W**4314NW US15).
No upcharge for cylinder substitution. Can be keyed into existing Weiser® system.

ENTRANCE HANDLESETS - BRASS TUBULAR

Knoxville Trim



Order any Brass Knob or Lever for the Inside Trim.

Orleans Trim

Door Prep 5 1/2" Center to Center



Order any Brass Knob or Lever for the Inside Trim.

Standard with Tubular Locks

- Standard 2 1/4" Door Prep
- Solid Forged Brass Trim
- Schlage® C Keyway

ENTRY SETS

Knoxville Style

Description	Product Code	Knob or Lever Style for Inside Trim	Finish	List Price
Single Cylinder	4310	<i>See Page 4 for Brass Knob & Lever Options. See Page 5 for Crystal & Porcelain Knob Options.</i>	French Antique (US7)	\$240.00
Double Cylinder	4320		Oil Rubbed Bronze (US10B)	
Dummy	4300		Satin Nickel (US15)	\$240.00
			Pewter (US15A)	
			Polished Chrome (US26)	\$240.00
			PVD-Lifetime	

Orleans Style

Description	Product Code	Knob or Lever Style for Inside Trim	Finish	List Price
Single Cylinder	4311	<i>See Page 4 for Brass Knob & Lever Options. See Page 5 for Crystal & Porcelain Knob Options.</i>	French Antique (US7)	\$274.00
Double Cylinder	4321		Oil Rubbed Bronze (US10B)	
Dummy	4301		Satin Nickel (US15)	\$274.00
			Pewter (US15A)	
			Polished Chrome (US26)	\$274.00
			PVD-Lifetime	

Interconnect Device Not Available for Double Cylinder.

Available for Orleans Style	Product Code: 443	List Price: \$58.00
-----------------------------	-------------------	----------------------------

>> Specify by adding "W" to the beginning of Product Code for Weiser® (WR5) Keyway (For example: **W**4311LB US7). No upcharge for cylinder substitution. Can be keyed into existing Weiser® system.

BRASS TUBULAR - ENTRANCE HANDLESETS

Oval Ribbon & Reed Trim

Door Prep 5½" Center to Center



Order any Brass Knob or Lever for the Inside Trim.

Ribbon & Reed Trim

Door Prep 5½" Center to Center



Imperial Trim

Door Prep 5½" Center to Center



Order any Brass Knob or Lever for the Inside Trim.

Standard with Tubular Locks

- Standard 2½" Door Prep
- Solid Forged Brass Trim
- Schlage® C Keyway

ENTRY SETS

Oval Ribbon & Reed Style

Description	Product Code	Knob or Lever Style for Inside Trim	Finish	List Price
Single Cylinder	4714	<i>See Page 4 for Brass Knob & Lever Options. See Page 5 for Crystal & Porcelain Knob Options.</i>	French Antique (US7)	\$274.00
Double Cylinder	4724		Oil Rubbed Bronze (US10B)	\$274.00
Dummy	4704		Satin Nickel (US15) Pewter (US15A) Polished Chrome (US26) PVD-Lifetime	\$274.00

Ribbon & Reed Style

Description	Product Code	Knob or Lever Style for Inside Trim	Finish	List Price
Single Cylinder	4711	<i>See Page 4 for Brass Knob & Lever Options. See Page 5 for Crystal & Porcelain Knob Options.</i>	French Antique (US7)	\$274.00
Double Cylinder	4721		Oil Rubbed Bronze (US10B)	\$274.00
Dummy	4701		Satin Nickel (US15) Pewter (US15A) Polished Chrome (US26) PVD-Lifetime	\$274.00

Imperial Style

Description	Product Code	Knob or Lever Style for Inside Trim	Finish	List Price
Single Cylinder	4911	<i>See Page 4 for Brass Knob & Lever Options. See Page 5 for Crystal & Porcelain Knob Options.</i>	French Antique (US7)	\$324.00
Double Cylinder	4921		Oil Rubbed Bronze (US10B)	\$324.00
Dummy	4901		Satin Nickel (US15) Pewter (US15A) Polished Chrome (US26) PVD-Lifetime	\$324.00

Interconnect Device Not Available for Double Cylinder.

Available for Above Styles	Product Code: 443	List Price: \$58.00
----------------------------	-------------------	----------------------------

>> Specify by adding "W" to the beginning of Product Code for Weiser® (WR5) Keyway (For example: **W**4911EN US7). No upcharge for cylinder substitution. Can be keyed into existing Weiser® system.

Handing Required if Lever Used on Inside or if Interconnect Device is Specified. Standard latch is for 2¾" backset. Specify 2¾" backset if required. 28° Latch Not Available for Use with Tubular Entrance Handlesets.

ENTRANCE HANDLESETS - SANDCAST BRONZE TUBULAR

Ridgemont Trim



Order any Sandcast Bronze Knob or Lever for the Inside Trim.

Logan Trim

Door Prep 5 1/2" Center to Center



Brighton Trim

Door Prep 5 1/2" Center to Center



Order any Sandcast Bronze Knob or Lever for the Inside Trim.

ENTRY SETS

Standard with Tubular Locks

- Standard 2 1/8" Door Prep
- Schlage® C Keyway

Ridgemont Style

Description	Product Code	Knob or Lever Style for Inside Trim	Finish	List Price
Single Cylinder	451721	<i>See Page 5 for Sandcast Bronze Knob & Lever Options.</i>	Flat Black (FB)	\$332.00
Double Cylinder	452721		Medium Bronze (MB)	\$332.00
Dummy	450721		Polished White Bronze (WB)	\$332.00
			Tumbled White Bronze (TWB)	

Logan Style

Description	Product Code	Knob or Lever Style for Inside Trim	Finish	List Price
Single Cylinder	451822	<i>See Page 5 for Sandcast Bronze Knob & Lever Options.</i>	Flat Black (FB)	\$366.00
Double Cylinder	452822		Medium Bronze (MB)	\$366.00
Dummy	450822		Polished White Bronze (WB)	\$366.00
			Tumbled White Bronze (TWB)	

Brighton Style

Description	Product Code	Knob or Lever Style for Inside Trim	Finish	List Price
Single Cylinder	451923	<i>See Page 5 for Sandcast Bronze Knob & Lever Options.</i>	Flat Black (FB)	\$416.00
Double Cylinder	452923		Medium Bronze (MB)	\$416.00
Dummy	450923		Polished White Bronze (WB)	\$416.00
			Tumbled White Bronze (TWB)	

Interconnect Device Not Available for Double Cylinder.

Available for Logan & Brighton Styles	Product Code: 443	List Price: \$58.00
---------------------------------------	-------------------	----------------------------

>> Specify by adding "W" to the beginning of Product Code for Weiser® (WR5) Keyway (For example: **W**451923D MB).
No upcharge for cylinder substitution. Can be keyed into existing Weiser® system.

SANDCAST BRONZE TUBULAR - ENTRANCE HANDLESETS

Laramie Trim

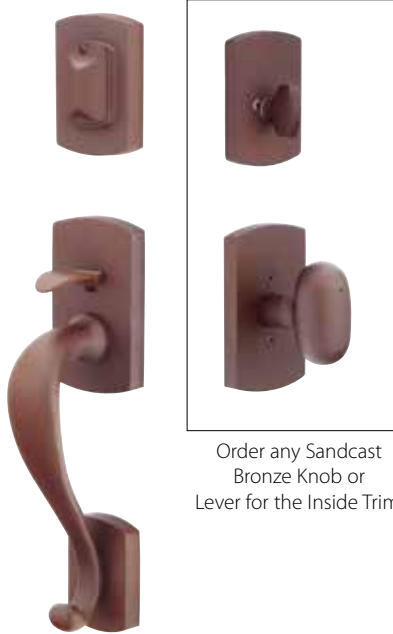

Order any Sandcast Bronze Knob or Lever for the Inside Trim.

Sheridan Trim

Door Prep 5 1/2" Center to Center



Creston Trim

Door Prep 5 1/2" Center to Center



Order any Sandcast Bronze Knob or Lever for the Inside Trim.

Standard with Tubular Locks

- Standard 2 1/8" Door Prep
- Schlage® C Keyway

ENTRY SETS

Laramie Style

Description	Product Code	Knob or Lever Style for Inside Trim	Finish	List Price
Single Cylinder	451711	<i>See Page 5 for Sandcast Bronze Knob & Lever Options.</i>	Deep Burgundy (DB) Flat Black (FB) Medium Bronze (MB)	\$332.00
Double Cylinder	452711			\$332.00
Dummy	450711			\$332.00

Sheridan Style

Description	Product Code	Knob or Lever Style for Inside Trim	Finish	List Price
Single Cylinder	451812	<i>See Page 5 for Sandcast Bronze Knob & Lever Options.</i>	Deep Burgundy (DB) Flat Black (FB) Medium Bronze (MB)	\$366.00
Double Cylinder	452812			\$366.00
Dummy	450812			\$366.00

Creston Style

Description	Product Code	Knob or Lever Style for Inside Trim	Finish	List Price
Single Cylinder	451913	<i>See Page 5 for Sandcast Bronze Knob & Lever Options.</i>	Deep Burgundy (DB) Flat Black (FB) Medium Bronze (MB)	\$416.00
Double Cylinder	452913			\$416.00
Dummy	450913			\$416.00

Interconnect Device Not Available for Double Cylinder.

Available for Sheridan & Creston Styles	Product Code: 443	List Price: \$58.00
---	-------------------	----------------------------

>> Specify by adding "W" to the beginning of Product Code for Weiser® (WR5) Keyway (For example: **W**451913D DB).
No upcharge for cylinder substitution. Can be keyed into existing Weiser® system.

ENTRANCE HANDLESETS - SANDCAST BRONZE TUBULAR

Denver Trim



Order any Sandcast Bronze Knob or Lever for the Inside Trim.

Remington Trim

Door Prep 5½" Center to Center



Greeley Trim

Door Prep 5½" Center to Center



Order any Sandcast Bronze Knob or Lever for the Inside Trim.

Standard with Tubular Locks

- Standard 2½" Door Prep
- Schlage® C Keyway

Denver Style

Description	Product Code	Knob or Lever Style for Inside Trim	Finish	List Price
Single Cylinder	451211	<i>See Page 5 for Sandcast Bronze Knob & Lever Options.</i>	Deep Burgundy (DB)	\$332.00
Double Cylinder	452211		Flat Black (FB)	\$332.00
Dummy	450211		Medium Bronze (MB)	\$332.00
			Polished White Bronze (WB)	
			Tumbled White Bronze (TWB)	\$332.00

Remington Style

Description	Product Code	Knob or Lever Style for Inside Trim	Finish	List Price
Single Cylinder	451112	<i>See Page 5 for Sandcast Bronze Knob & Lever Options.</i>	Deep Burgundy (DB)	\$366.00
Double Cylinder	452112		Flat Black (FB)	\$366.00
Dummy	450112		Medium Bronze (MB)	\$366.00
			Polished White Bronze (WB)	
			Tumbled White Bronze (TWB)	\$366.00

Greeley Style

Description	Product Code	Knob or Lever Style for Inside Trim	Finish	List Price
Single Cylinder	451332	<i>See Page 5 for Sandcast Bronze Knob & Lever Options.</i>	Deep Burgundy (DB)	\$416.00
Double Cylinder	452332		Flat Black (FB)	\$416.00
Dummy	450332		Medium Bronze (MB)	\$416.00
			Polished White Bronze (WB)	
			Tumbled White Bronze (TWB)	\$416.00

Interconnect Device Not Available for Double Cylinder.

Available for Remington & Greeley Styles	Product Code: 443	List Price: \$58.00
--	-------------------	----------------------------

>> Specify by adding "W" to the beginning of Product Code for Weiser® (WR5) Keyway (For example: **W**451332MT DB). No upcharge for cylinder substitution. Can be keyed into existing Weiser® system.

SANDCAST BRONZE TUBULAR - ENTRANCE HANDLESETS

Rectangular Sectional Trim



Order any Sandcast Bronze Knob or Lever for the Inside Trim.

Rectangular Monolithic Trim

Door Prep 5 1/2" Center to Center



Rectangular Full Length

Door Prep 5 1/2" Center to Center



Order any Sandcast Bronze Knob or Lever for the Inside Trim.

Standard with Tubular Locks

- Standard 2 1/8" Door Prep
- Schlage® C Keyway

ENTRY SETS

Rectangular Sectional Style

Description	Product Code	Knob or Lever Style for Inside Trim	Finish	List Price
Single Cylinder	451411	<i>See Page 5 for Sandcast Bronze Knob & Lever Options.</i>	Deep Burgundy (DB)	\$332.00
Double Cylinder	452411		Flat Black (FB)	
Dummy	450411		Medium Bronze (MB) Polished White Bronze (WB) Tumbled White Bronze (TWB)	

Rectangular Monolithic Style

Description	Product Code	Knob or Lever Style for Inside Trim	Finish	List Price
Single Cylinder	451512	<i>See Page 5 for Sandcast Bronze Knob & Lever Options.</i>	Deep Burgundy (DB)	\$366.00
Double Cylinder	452512		Flat Black (FB)	
Dummy	450512		Medium Bronze (MB) Polished White Bronze (WB) Tumbled White Bronze (TWB)	

Rectangular Full Length Style

Description	Product Code	Knob or Lever Style for Inside Trim	Finish	List Price
Single Cylinder	451613	<i>See Page 5 for Sandcast Bronze Knob & Lever Options.</i>	Deep Burgundy (DB)	\$416.00
Double Cylinder	452613		Flat Black (FB)	
Dummy	450613		Medium Bronze (MB) Polished White Bronze (WB) Tumbled White Bronze (TWB)	

Interconnect Device Not Available for Double Cylinder.

Available for Monolithic & Full Length Styles	Product Code: 443	List Price: \$58.00
---	-------------------	----------------------------

>> Specify by adding "W" to the beginning of Product Code for Weiser® (WR5) Keyway (For example: **W**451613CR DB). No upcharge for cylinder substitution. Can be keyed into existing Weiser® system.

ENTRANCE HANDLESETS - LOST WAX CAST BRONZE TUBULAR

Tuscany Sectional Trim



Order any Lost Wax Cast Bronze Knob or Lever for the Inside Trim.

Tuscany Monolithic Trim

Door Prep 5½" Center to Center



Order any Lost Wax Cast Bronze Knob or Lever for the Inside Trim.

Standard with Tubular Locks

- Standard 2½" Door Prep
- Schlage® C Keyway

Tuscany Sectional Style

Description	Product Code	Knob or Lever Style for Inside Trim	Finish	List Price
Single Cylinder	471224	<i>See Page 5 for Lost Wax Cast Bronze Knob & Lever Options.</i>	Deep Burgundy (DB) Flat Black (FB) Medium Bronze (MB)	\$332.00
Double Cylinder	472224			\$332.00
Dummy	470224			\$332.00

Tuscany Monolithic Style

Description	Product Code	Knob or Lever Style for Inside Trim	Finish	List Price
Single Cylinder	471112	<i>See Page 5 for Lost Wax Cast Bronze Knob & Lever Options.</i>	Deep Burgundy (DB) Flat Black (FB) Medium Bronze (MB)	\$366.00
Double Cylinder	472112			\$366.00
Dummy	470112			\$366.00

Interconnect Device Not Available for Double Cylinder.

Available for Tuscany Monolithic Style	Product Code: 443	List Price: \$58.00
--	-------------------	----------------------------

>> Specify by adding "W" to the beginning of Product Code for Weiser® (WR5) Keyway (For example: **W**471112PA DB).
No upcharge for cylinder substitution. Can be keyed into existing Weiser® system.

LOST WAX CAST BRONZE TUBULAR - ENTRANCE HANDLESETS

Art Nouveau Trim

Door Prep 5½" Center to Center



Left Hand Grip

Right Hand Grip



Order any Lost Wax Cast Bronze Knob or Lever for the Inside Trim.

Octagon Trim

Door Prep 5½" Center to Center



Order any Lost Wax Cast Bronze Knob or Lever for the Inside Trim.

Standard with Tubular Locks

- Standard 2½" Door Prep
- Schlage® C Keyway

ENTRY SETS

Art Nouveau Style

Description	Product Code	Specify LH/RH Grip	Knob or Lever Style for Inside Trim	Finish	List Price	
Single Cylinder	471333		<i>See Page 5 for Lost Wax Cast Bronze Knob & Lever Options.</i>		Deep Burgundy (DB)	\$366.00
Double Cylinder	472333				Flat Black (FB)	\$366.00
Dummy	470333				Medium Bronze (MB)	\$366.00

Octagon Style

Description	Product Code	Knob or Lever Style for Inside Trim	Finish	List Price
Single Cylinder	471222	<i>See Page 5 for Lost Wax Cast Bronze Knob & Lever Options.</i>	Deep Burgundy (DB)	\$366.00
Double Cylinder	472222		Flat Black (FB)	\$366.00
Dummy	470222		Medium Bronze (MB)	\$366.00

Interconnect Device Not Available for Double Cylinder.

Available for Above Styles	Product Code: 443	List Price: \$58.00
----------------------------	-------------------	----------------------------

>> Specify by adding "W" to the beginning of Product Code for Weiser® (WR5) Keyway (For example: **W**471222OCL DB).
 No upcharge for cylinder substitution. Can be keyed into existing Weiser® system.

Handing Required if Lever Used on Inside or if Interconnect Device is Specified. Standard latch is for 2¾" backset. Specify 2¾" backset if required.
 28° Latch Not Available for Use with Tubular Entrance Handlesets.

ENTRANCE HANDLESETS - STAINLESS STEEL TUBULAR

ENTRY SETS

Davos Trim

Door Prep 5½" Center to Center



Order any Stainless Steel Knob or Lever for the Inside Trim.

Zeus Trim

Door Prep 5½" Center to Center



Order any Stainless Steel Knob or Lever for the Inside Trim.

Davos Style

Description	Product Code	Knob or Lever Style for Inside Trim	Finish	List Price
Single Cylinder	S40101	<i>See Page 6 For Stainless Steel Knob & Lever Options.</i>	Brushed Stainless Steel (SS)	\$316.00
Dummy	S40100			\$316.00

Zeus Style

Description	Product Code	Knob or Lever Style for Inside Trim	Finish	List Price
Single Cylinder	S40001	<i>See Page 6 For Stainless Steel Knob & Lever Options.</i>	Brushed Stainless Steel (SS)	\$316.00
Double Cylinder	S40002			\$316.00
Dummy	S40000			\$316.00

Interconnect Device Not Available for Double Cylinder.

Available for Above Styles	Product Code: 443	List Price: \$58.00
----------------------------	-------------------	----------------------------

>> Specify by adding "W" to the beginning of Product Code for Weiser® (WR5) Keyway (For example: **WS40101HL SS**).
 No upcharge for cylinder substitution. Can be keyed into existing Weiser® system.

WROUGHT STEEL TUBULAR - ENTRANCE HANDLESETS

Sectional Trim
Lafayette Grip



Sectional Trim
San Carlos Grip



Sectional Trim
Normandy Grip



Order any Wrought Steel Knob or Lever for the Inside Trim.

Standard with Tubular Locks

- Standard 2 1/8" Door Prep
- Schlage® C Keyway

ENTRY SETS

Sectional Style with Lafayette Grip

Description	Product Code	Knob or Lever Style for Inside Trim	Finish	List Price
Single Cylinder	461212	<i>See Page 6 for Wrought Steel Knob & Lever Options.</i>	Flat Black (FB) Satin Steel	\$240.00
Double Cylinder	462212			\$240.00
Dummy	460212			\$240.00

Sectional Style with San Carlos Grip

Description	Product Code	Knob or Lever Style for Inside Trim	Finish	List Price
Single Cylinder	461222	<i>See Page 6 for Wrought Steel Knob & Lever Options.</i>	Flat Black (FB) Satin Steel	\$240.00
Double Cylinder	462222			\$240.00
Dummy	460222			\$240.00

Sectional Style with Normandy Grip

Description	Product Code	Knob or Lever Style for Inside Trim	Finish	List Price
Single Cylinder	461232	<i>See Page 6 for Wrought Steel Knob & Lever Options.</i>	Flat Black (FB) Satin Steel	\$240.00
Double Cylinder	462232			\$240.00
Dummy	460232			\$240.00

>> Specify by adding "W" to the beginning of Product Code for Weiser® (WR5) Keyway (For example: **W**461232N FB).
No upcharge for cylinder substitution. Can be keyed into existing Weiser® system.

Handing Required if Lever Used on Inside. Standard latch is for 2 3/8" backset. Specify 2 3/4" backset if required.
28° Latch Not Available for Use with Tubular Entrance Handlesets.

ENTRANCE HANDLESETS - WROUGHT STEEL TUBULAR

Monolithic Trim

Lafayette Grip

Door Prep 5½" Center to Center



Monolithic Trim

San Carlos Grip

Door Prep 5½" Center to Center



Monolithic Trim

Normandy Grip

Door Prep 5½" Center to Center



Order any Wrought Steel Knob or Lever for the Inside Trim.

Standard with Tubular Locks

- Standard 2½" Door Prep
- Schlage® C Keyway

ENTRY SETS

Monolithic Style with Lafayette Grip

Description	Product Code	Knob or Lever Style for Inside Trim	Finish	List Price
Single Cylinder	461111	<i>See Page 6 for Wrought Steel Knob & Lever Options.</i>	Flat Black (FB) Satin Steel	\$274.00
Double Cylinder	462111			\$274.00
Dummy	460111			\$274.00

Monolithic Style with San Carlos Grip

Description	Product Code	Knob or Lever Style for Inside Trim	Finish	List Price
Single Cylinder	461121	<i>See Page 6 for Wrought Steel Knob & Lever Options.</i>	Flat Black (FB) Satin Steel	\$274.00
Double Cylinder	462121			\$274.00
Dummy	460121			\$274.00

Monolithic Style with Normandy Grip

Description	Product Code	Knob or Lever Style for Inside Trim	Finish	List Price
Single Cylinder	461131	<i>See Page 6 for Wrought Steel Knob & Lever Options.</i>	Flat Black (FB) Satin Steel	\$274.00
Double Cylinder	462131			\$274.00
Dummy	460131			\$274.00

Interconnect Device Not Available for Double Cylinder.

Available for Above Styles	Product Code: 443	List Price: \$58.00
----------------------------	-------------------	----------------------------

>> Specify by adding "W" to the beginning of Product Code for Weiser® (WR5) Keyway (For example: **W**461131SV FB). No upcharge for cylinder substitution. Can be keyed into existing Weiser® system.



ENTRY SETS

Double sided handlesets, also known as grip-by-grip, have a full length trim on both the interior and exterior sides of the door. They are available in three functions: single cylinder, double cylinder, and dummy. The single cylinder configuration has a thumbturn which unlocks the door from the inside; while the double cylinder has keyed cylinders on both sides of the door. The dummy does not include a thumbturn, instead it only features matching trim on either side of the door with no locking functionality.

Grip By Grip now available in Brass. Call us for pricing. See page 37 - 45 for styles.



GRIP BY GRIP ENTRANCE HANDLESETS - SANDCAST BRONZE

Ridgemont Trim



Logan Trim
Door Prep 5 1/2"
Center to Center



Brighton Trim
Door Prep 5 1/2"
Center to Center



Rectangular Sectional Trim





Rectangular Monolithic Trim
Door Prep 5 1/2"
Center to Center





Rectangular Full Length Trim
Door Prep 5 1/2"
Center to Center



ENTRY SETS

	Description	Product Code	Finish	List Price
Ridgemont Style 	Single Cylinder	453727	Flat Black (FB)	\$536.00
	Double Cylinder	454727	Medium Bronze (MB)	\$536.00
	Dummy	455727	Polished White Bronze (WB) Tumbled White Bronze (TWB)	\$536.00
Logan Style 	Single Cylinder	453828	Flat Black (FB)	\$580.00
	Double Cylinder	454828	Medium Bronze (MB)	\$580.00
	Dummy	455828	Polished White Bronze (WB) Tumbled White Bronze (TWB)	\$580.00
Brighton Style 	Single Cylinder	453929	Flat Black (FB)	\$638.00
	Double Cylinder	454929	Medium Bronze (MB)	\$638.00
	Dummy	455929	Polished White Bronze (WB) Tumbled White Bronze (TWB)	\$638.00

	Description	Product Code	Finish	List Price
Rectangular Sectional Style 	Single Cylinder	453414	Deep Burgundy (DB)	\$536.00
	Double Cylinder	454414	Flat Black (FB)	\$536.00
	Dummy	455414	Medium Bronze (MB) Polished White Bronze (WB) Tumbled White Bronze (TWB)	\$536.00
Rectangular Monolithic Style 	Single Cylinder	453515	Deep Burgundy (DB)	\$580.00
	Double Cylinder	454515	Flat Black (FB)	\$580.00
	Dummy	455515	Medium Bronze (MB) Polished White Bronze (WB) Tumbled White Bronze (TWB)	\$580.00
Rectangular Full Length Style 	Single Cylinder	453636	Deep Burgundy (DB)	\$638.00
	Double Cylinder	454636	Flat Black (FB)	\$638.00
	Dummy	455636	Medium Bronze (MB) Polished White Bronze (WB) Tumbled White Bronze (TWB)	\$638.00

>> Specify by adding "W" to the beginning of Product Code for Weiser® (WR5) Keyway (For example: **W**453414 DB).
No upcharge for cylinder substitution. Can be keyed into existing Weiser® system.

SANDCAST BRONZE - GRIP BY GRIP ENTRANCE HANDLESETS



Laramie Trim

Sheridan Trim
Door Prep 5½"
Center to Center

Creston Trim
Door Prep 5½"
Center to Center



Denver Trim



Remington Trim
Door Prep 5½"
Center to Center

Greeley Trim
Door Prep 5½"
Center to Center



ENTRY SETS

	Description	Product Code	Finish	List Price
Laramie Style 	Single Cylinder	453717	Deep Burgundy (DB) Flat Black (FB) Medium Bronze (MB)	\$536.00
	Double Cylinder	454717		\$536.00
	Dummy	455717		\$536.00
Sheridan Style 	Single Cylinder	453818	Deep Burgundy (DB) Flat Black (FB) Medium Bronze (MB)	\$580.00
	Double Cylinder	454818		\$580.00
	Dummy	455818		\$580.00
Creston Style 	Single Cylinder	453919	Deep Burgundy (DB) Flat Black (FB) Medium Bronze (MB)	\$638.00
	Double Cylinder	454919		\$638.00
	Dummy	455919		\$638.00

	Description	Product Code	Finish	List Price
Denver Style 	Single Cylinder	453212	Deep Burgundy (DB) Flat Black (FB) Medium Bronze (MB) Polished White Bronze (WB) Tumbled White Bronze (TWB)	\$536.00
	Double Cylinder	454212		\$536.00
	Dummy	455212		\$536.00
Remington Style 	Single Cylinder	453111	Deep Burgundy (DB) Flat Black (FB) Medium Bronze (MB) Polished White Bronze (WB) Tumbled White Bronze (TWB)	\$580.00
	Double Cylinder	454111		\$580.00
	Dummy	455111		\$580.00
Greeley Style 	Single Cylinder	453333	Deep Burgundy (DB) Flat Black (FB) Medium Bronze (MB) Polished White Bronze (WB) Tumbled White Bronze (TWB)	\$638.00
	Double Cylinder	454333		\$638.00
	Dummy	455333		\$638.00

>> Specify by adding "W" to the beginning of Product Code for Weiser® (WR5) Keyway (For example: **W**453212 FB).
No upcharge for cylinder substitution. Can be keyed into existing Weiser® system.

Sets Fit Standard Door Thickness of 1¾"; Specify if Thicker. Standard latch is for 2¾" backset. Specify 2¾" backset if required.



GRIP BY GRIP ENTRANCE HANDLESETS - LOST WAX CAST BRONZE

Tuscany Sectional Trim

Tuscany Trim
Door Prep 5 1/2"
Center to Center



Octagon Trim
Door Prep 5 1/2"
Center to Center



Art Nouveau Trim
Left Hand Grip
Door Prep 5 1/2" Center to Center

Art Nouveau Trim
Right Hand Grip
Door Prep 5 1/2" Center to Center



ENTRY SETS

	Description	Product Code	Finish	List Price
Tuscany Sectional Style 	Single Cylinder	473444	Deep Burgundy (DB) Flat Black (FB) Medium Bronze (MB)	\$536.00
	Double Cylinder	474444		\$536.00
	Dummy	475444		\$536.00
Tuscany Style 	Single Cylinder	473111	Deep Burgundy (DB) Flat Black (FB) Medium Bronze (MB)	\$580.00
	Double Cylinder	474111		\$580.00
	Dummy	475111		\$580.00
Octagon Style 	Single Cylinder	473222	Deep Burgundy (DB) Flat Black (FB) Medium Bronze (MB)	\$580.00
	Double Cylinder	474222		\$580.00
	Dummy	475222		\$580.00

	Description	Product Code	Finish	List Price
Art Nouveau Style  Left Hand Grip (Outside)	Single Cylinder	473333LH	Deep Burgundy (DB) Flat Black (FB) Medium Bronze (MB)	\$580.00
	Double Cylinder	474333LH		\$580.00
	Dummy	475333LH		\$580.00
Art Nouveau Style  Right Hand Grip (Outside)	Single Cylinder	473333RH	Deep Burgundy (DB) Flat Black (FB) Medium Bronze (MB)	\$580.00
	Double Cylinder	474333RH		\$580.00
	Dummy	475333RH		\$580.00

>> Specify by adding "W" to the beginning of Product Code for Weiser® (WR5) Keyway (For example: **W**473333LH MB).
No upcharge for cylinder substitution. Can be keyed into existing Weiser® system.

BRASS KEY IN LEVERSETS - ENTRANCE LOCKSETS

ENTRY SETS

Luzern Lever
with Square Rosette



Cortina Lever
with Regular Rosette



Cortina Lever
with #8 Rosette



Cortina Lever
with Rectangular Rosette



Rope Lever
with Rope Rosette



Rosette	Description	Product Code	Lever Style	Finish	List Price
 <p>Square</p>	Key in Lever	5122	Cortina Lever (C) Luzern Lever (LU) Rope Lever (RL)	Oil Rubbed Bronze (US10B) Satin Nickel (US15) Flat Black (US19)* Polished Chrome (US26)	\$158.00
	Dummy Key in Lever	5022			\$158.00
 <p>Regular</p>	Key in Lever	5100	Cortina Lever (C) Luzern Lever (LU) Rope Lever (RL)	French Antique (US7)** Oil Rubbed Bronze (US10B) Satin Nickel (US15) Pewter (US15A)** Flat Black (US19)* Polished Chrome (US26) PVD-Lifetime**	\$158.00
	Dummy Key in Lever	5150			\$158.00
 <p>#8</p>	Key in Lever	5108	Cortina Lever (C) Luzern Lever (LU) Rope Lever (RL)	French Antique (US7)** Oil Rubbed Bronze (US10B) Satin Nickel (US15) Pewter (US15A)** Flat Black (US19)* Polished Chrome (US26) PVD-Lifetime**	\$158.00
	Dummy Key in Lever	5158			\$158.00
 <p>Rectangular</p>	Key in Lever	5121	Cortina Lever (C) Luzern Lever (LU) Rope Lever (RL)	French Antique (US7)** Oil Rubbed Bronze (US10B) Satin Nickel (US15) Pewter (US15A)** Flat Black (US19)* Polished Chrome (US26) PVD-Lifetime**	\$158.00
	Dummy Key in Lever	5021			\$158.00
 <p>Rope</p>	Key in Lever	5101	Cortina Lever (C) Luzern Lever (LU) Rope Lever (RL)	French Antique (US7)** Oil Rubbed Bronze (US10B) Satin Nickel (US15) Pewter (US15A)** Polished Chrome (US26) PVD-Lifetime**	\$158.00
	Dummy Key in Lever	5151			\$158.00

* Rope Lever NOT available in Flat Black (US19).

** Luzern Lever NOT available in French Antique (US7), Pewter (US15A), and PVD-Lifetime.

>> Specify by adding "W" to the beginning of Product Code for Weiser® (WR5) Keyway (For example: **W5101C US7**).
No upcharge for cylinder substitution. Can be keyed into existing Weiser® system.

Handing is Required for Leversets. Standard latch is for 2 3/8" backset. Specify 2 3/4" backset if required.

ENTRANCE LOCKSETS - BRASS KEY IN KNOBSETS

Round Knob
with Square Rosette



Waverly Knob
with Regular Rosette



Providence Knob
with #8 Rosette



Egg Knob
with Rectangular Rosette



Rope Knob
with Rope Rosette



Standards for Key In Locks

- Schlage® C Keyway
- Standard Door Prep and Installation
- Includes Latch and Strike Plate

ENTRY SETS

Rosette	Description	Product Code	Knob Style	Finish	List Price
Square 	Key in Knob	5122	Egg Knob (E) Providence Knob (P) Rope Knob (RK)	Oil Rubbed Bronze (US10B) Satin Nickel (US15)	\$158.00
	Dummy Key in Knob	5022	Round Knob (ROU) Waverly Knob (W)	Flat Black (US19)* Polished Chrome (US26)	\$158.00
Regular 	Key in Knob	5100	Egg Knob (E) Providence Knob (P) Rope Knob (RK)	French Antique (US7)** Oil Rubbed Bronze (US10B) Satin Nickel (US15)	\$158.00
	Dummy Key in Knob	5150	Round Knob (ROU) Waverly Knob (W)	Pewter (US15A)** Flat Black (US19)* Polished Chrome (US26) PVD-Lifetime**	\$158.00
#8 	Key in Knob	5108	Egg Knob (E) Providence Knob (P) Rope Knob (RK)	French Antique (US7)** Oil Rubbed Bronze (US10B) Satin Nickel (US15)	\$158.00
	Dummy Key in Knob	5158	Round Knob (ROU) Waverly Knob (W)	Pewter (US15A)** Flat Black (US19)* Polished Chrome (US26) PVD-Lifetime**	\$158.00
Rectangular 	Key in Knob	5121	Egg Knob (E) Providence Knob (P) Rope Knob (RK)	French Antique (US7)** Oil Rubbed Bronze (US10B) Satin Nickel (US15)	\$158.00
	Dummy Key in Knob	5021	Round Knob (ROU) Waverly Knob (W)	Pewter (US15A)** Flat Black (US19)* Polished Chrome (US26) PVD-Lifetime**	\$158.00
Rope 	Key in Knob	5101	Egg Knob (E) Providence Knob (P) Rope Knob (RK)	French Antique (US7)** Oil Rubbed Bronze (US10B) Satin Nickel (US15)	\$158.00
	Dummy Key in Knob	5151	Round Knob (ROU) Waverly Knob (W)	Pewter (US15A)** Polished Chrome (US26) PVD-Lifetime**	\$158.00

* Rope knob NOT available in Flat Black (US19).

** Round knob NOT available in French Antique (US7), Pewter (US15A), and PVD-Lifetime.

>> Specify by adding "W" to the beginning of Product Code for Weiser® (WR5) Keyway (For example: W5101E US7).
No upcharge for cylinder substitution. Can be keyed into existing Weiser® system.

SANDCAST BRONZE KEY IN KNOBSETS - ENTRANCE LOCKSETS

Winchester Knob
with #1 Rosette



Winchester Knob
with #2 Rosette



Winchester Knob
with #3 Rosette



Winchester Knob
with #4 Rosette



Standards for Key In Locks

- Schlage® C Keyway
- Standard Door Prep and Installation
- Includes Latch and Strike Plate

Rosette	Description	Product Code	Knob Style	Finish	List Price
<p>#1</p> 	Key in Knob	5104	Winchester Knob (WC)	Deep Burgundy (DB) Flat Black (FB) Medium Bronze (MB)	\$174.00
	Dummy Key in Knob	5154			\$174.00
<p>#2</p> 	Key in Knob	5102	Winchester Knob (WC)	Deep Burgundy (DB) Flat Black (FB) Medium Bronze (MB)	\$174.00
	Dummy Key in Knob	5152			\$174.00
<p>#3</p> 	Key in Knob	5103	Winchester Knob (WC)	Deep Burgundy (DB) Flat Black (FB) Medium Bronze (MB)	\$174.00
	Dummy Key in Knob	5153			\$174.00
<p>#4</p> 	Key in Knob	5114	Winchester Knob (WC)	Flat Black (FB) Medium Bronze (MB)	\$174.00
	Dummy Key in Knob	5164			\$174.00

>> Specify by adding "W" to the beginning of Product Code for Weiser® (WR5) Keyway (For example: **W**5114WC FB).
No upcharge for cylinder substitution. Can be keyed into existing Weiser® system.

Handing Not Required for Knobsets. Standard latch is for 2¾" backset. Specify 2¾" backset if required.

ENTRANCE LOCKSETS - SANDCAST BRONZE KEY IN LEVERSETS

Durango Lever
with #1 Rosette



Durango Lever
with #2 Rosette



Durango Lever
with #3 Rosette







Durango Lever
with #4 Rosette



Standards for Key In Locks

- Schlage® C Keyway
- Standard Door Prep and Installation
- Includes Latch and Strike Plate

ENTRY SETS

Rosette	Description	Product Code	Lever Style	Finish	List Price
#1 	Key in Lever	5104	Durango Lever (D)	Deep Burgundy (DB) Flat Black (FB) Medium Bronze (MB)	\$174.00
	Dummy Key in Lever	5154			\$174.00
#2 	Key in Lever	5102	Durango Lever (D)	Deep Burgundy (DB) Flat Black (FB) Medium Bronze (MB)	\$174.00
	Dummy Key in Lever	5152			\$174.00
#3 	Key in Lever	5103	Durango Lever (D)	Deep Burgundy (DB) Flat Black (FB) Medium Bronze (MB)	\$174.00
	Dummy Key in Lever	5153			\$174.00
#4 	Key in Lever	5114	Durango Lever (D)	Flat Black (FB) Medium Bronze (MB)	\$174.00
	Dummy Key in Lever	5164			\$174.00

>> Specify by adding "W" to the beginning of Product Code for Weiser® (WR5) Keyway (For example: **W**5114D FB).
No upcharge for cylinder substitution. Can be keyed into existing Weiser® system.

LOST WAX CAST BRONZE KEY IN KNOBSETS & LEVERSETS - ENTRANCE LOCKSETS

Petal Knob
with #11 Rosette



Petal Knob
with #12 Rosette





Petal Knob
with #14 Rosette



Standards for Key In Locks

- Schlage® C Keyway
- Standard Door Prep and Installation
- Includes Latch and Strike Plate

Rosette	Description	Product Code	Knob Style	Finish	List Price
	Key in Knob	54011	Petal Knob (PT)	Deep Burgundy (DB) Flat Black (FB) Medium Bronze (MB)	\$174.00
	Dummy Key in Knob	54511			\$174.00
	Key in Knob	54012	Petal Knob (PT)	Deep Burgundy (DB) Flat Black (FB) Medium Bronze (MB)	\$174.00
	Dummy Key in Knob	54512			\$174.00
	Key in Knob	54014	Petal Knob (PT)	Deep Burgundy (DB) Flat Black (FB) Medium Bronze (MB)	\$174.00
	Dummy Key in Knob	54514			\$174.00

Siena Lever
with #11 Rosette





Siena Lever
with #12 Rosette



Siena Lever
with #14 Rosette



Rosette	Description	Product Code	Lever Style	Finish	List Price
	Key in Lever	54011	Siena Lever (SN)	Deep Burgundy (DB) Flat Black (FB) Medium Bronze (MB)	\$174.00
	Dummy Key in Lever	54511			\$174.00
	Key in Lever	54012	Siena Lever (SN)	Deep Burgundy (DB) Flat Black (FB) Medium Bronze (MB)	\$174.00
	Dummy Key in Lever	54512			\$174.00
	Key in Lever	54014	Siena Lever (SN)	Deep Burgundy (DB) Flat Black (FB) Medium Bronze (MB)	\$174.00
	Dummy Key in Lever	54514			\$174.00

>> Specify by adding "W" to the beginning of Product Code for Weiser® (WR5) Keyway (For example: **W**54014SN DB). No upcharge for cylinder substitution. Can be keyed into existing Weiser® system.

Handing is Required for Leversets. Standard latch is for 2 3/8" backset. Specify 2 3/4" backset if required.

ENTRY SETS

ENTRANCE LOCKSETS - STAINLESS STEEL KEY IN LEVERSETS

Hanover Lever with Disc Rosette



Standards for Key In Locks

- Schlage® C Keyway
- Standard Door Prep and Installation
- Includes Latch and Strike Plate

Rosette	Description	Product Code	Lever Style	Finish	List Price
	Key in Lever	S901	Hanover Lever (HN)	Brushed Stainless Steel (SS)	\$168.00
	Dummy Key in Lever	S951			\$168.00

>> Specify by adding "W" to the beginning of Product Code for Weiser® (WR5) Keyway (For example: **WS901HNSS**).
No upcharge for cylinder substitution. Can be keyed into existing Weiser® system.

SOLID BRASS - DEADBOLTS

Standard with Brass Deadbolt Locks

- Schlage® C Keyway
- Standard Door Prep and Installation
- Solid Brass Cylinder, Housing, Collar and Rosette
- Hardened Steel Bolt
- Heavy Gauge Steel Understrike and Brass Trim Strike Shipped with Every Deadbolt

Square Deadbolt *Includes Extension Collar for Thin Door Applications*



Description	Product Code	Finish	List Price
Single Cylinder Deadbolt	8469	Oil Rubbed Bronze (US10B) Satin Nickel (US15) Flat Black (US19) Polished Chrome (US26)	\$56.00
Double Cylinder Deadbolt	8369		

Neos Deadbolt *Includes Extension Collar for Thin Door Applications*



Description	Product Code	Finish	List Price
Single Cylinder Deadbolt	8475	Oil Rubbed Bronze (US10B) Satin Nickel (US15) Flat Black (US19) Polished Chrome (US26)	\$56.00
Double Cylinder Deadbolt	8375		

Modern Deadbolt *Includes Extension Collar for Thin Door Applications*



Description	Product Code	Finish	List Price
Single Cylinder Deadbolt	8467	Oil Rubbed Bronze (US10B) Satin Nickel (US15) Flat Black (US19) Polished Chrome (US26)	\$56.00
Double Cylinder Deadbolt	8367		

Quincy Deadbolt *Includes Extension Collar for Thin Door Applications*



Description	Product Code	Finish	List Price
Single Cylinder Deadbolt	8478	Polished Brass (US3) French Antique (US7) Oil Rubbed Bronze (US10B) Satin Nickel (US15)	\$56.00
Double Cylinder Deadbolt	8378	Pewter (US15A) Flat Black (US19) Polished Chrome (US26) PVD-Lifetime	

>> Specify by adding "W" to the beginning of Product Code for Weiser® (WR5) Keyway (For example: **W**8478 US10B).
 No upcharge for cylinder substitution. Can be keyed into existing Weiser® system.

DEADBOLTS

DEADBOLTS - SOLID BRASS

Standard with Brass Deadbolt Locks

- Schlage® C Keyway
- Standard Door Prep and Installation
- Solid Brass Cylinder, Housing, Collar and Rosette
- Hardened Steel Bolt
- Heavy Gauge Steel Understrike and Brass Trim Strike Shipped with Every Deadbolt

Regular Deadbolt



Description	Product Code	Finish	List Price
Single Cylinder Deadbolt	8450	Polished Brass (US3) French Antique (US7) Oil Rubbed Bronze (US10B) Satin Nickel (US15)	\$46.00
Double Cylinder Deadbolt	8350	Pewter (US15A) Flat Black (US19) Polished Chrome (US26) PVD-Lifetime	\$50.00

Low Profile Deadbolt



Description	Product Code	Finish	List Price
Single Cylinder Deadbolt	8455	Polished Brass (US3) French Antique (US7) Oil Rubbed Bronze (US10B) Satin Nickel (US15)	\$46.00
Double Cylinder Deadbolt	8355	Pewter (US15A) Flat Black (US19) Polished Chrome (US26) PVD-Lifetime	\$50.00

Rope Deadbolt *Includes Extension Collar for Thin Door Applications*



Description	Product Code	Finish	List Price
Single Cylinder Deadbolt	8464	Polished Brass (US3) French Antique (US7) Oil Rubbed Bronze (US10B) Satin Nickel (US15)	\$56.00
Double Cylinder Deadbolt	8364	Pewter (US15A) Polished Chrome (US26) PVD-Lifetime	\$60.00

Arts & Crafts Deadbolt *Includes Extension Collar for Thin Door Applications*



Description	Product Code	Finish	List Price
Single Cylinder Deadbolt	8454	Oil Rubbed Bronze (US10B) Satin Nickel (US15) Flat Black (US19)	\$56.00
Double Cylinder Deadbolt	8354		\$60.00

>> Specify by adding "W" to the beginning of Product Code for Weiser® (WR5) Keyway (For example: **W**8454 US10B).
No upcharge for cylinder substitution. Can be keyed into existing Weiser® system.

#8 Deadbolt *Includes Extension Collar for Thin Door Applications*



Description	Product Code	Finish	List Price
Single Cylinder Deadbolt	8466	Polished Brass (US3) French Antique (US7) Oil Rubbed Bronze (US10B) Satin Nickel (US15)	\$56.00
Double Cylinder Deadbolt	8366	Pewter (US15A) Flat Black (US19) Polished Chrome (US26) PVD-Lifetime	\$60.00

Rectangular Deadbolt *Includes Extension Collar for Thin Door Applications*



Description	Product Code	Finish	List Price
Single Cylinder Deadbolt	8468	Polished Brass (US3) French Antique (US7) Oil Rubbed Bronze (US10B) Satin Nickel (US15)	\$56.00
Double Cylinder Deadbolt	8368	Pewter (US15A) Flat Black (US19) Polished Chrome (US26) PVD-Lifetime	\$60.00

Saratoga Deadbolt *Includes Extension Collar for Thin Door Applications*



Description	Product Code	Finish	List Price
Single Cylinder Deadbolt	8458	French Antique (US7) Oil Rubbed Bronze (US10B) Satin Nickel (US15) Pewter (US15A)	\$56.00
Double Cylinder Deadbolt	8358	Flat Black (US19) Polished Chrome (US26) PVD-Lifetime	\$60.00

Knoxville Deadbolt *Includes Extension Collar for Thin Door Applications*



Description	Product Code	Finish	List Price
Single Cylinder Deadbolt	8459	French Antique (US7) Oil Rubbed Bronze (US10B) Satin Nickel (US15) Pewter (US15A)	\$56.00
Double Cylinder Deadbolt	8359	Polished Chrome (US26) PVD-Lifetime	\$60.00

DEADBOLTS

>> Specify by adding "W" to the beginning of Product Code for Weiser® (WR5) Keyway (For example: **W**8459 US7).
 No upcharge for cylinder substitution. Can be keyed into existing Weiser® system.

DEADBOLTS - SANDCAST BRONZE

Standard with Sandcast Bronze Deadbolt Locks

- Schlage® C Keyway
- Standard Door Prep and Installation
- Solid Brass Cylinder
- Sandcast Bronze Collar and Inside Rosette
- Hardened Steel Bolt
- Heavy Gauge Steel Understrike and Brass Trim Strike Shipped with Every Deadbolt

Regular Deadbolt



Description	Product Code	Finish	List Price
Single Cylinder Deadbolt	8450	Deep Burgundy (DB) Flat Black (FB)	\$60.00
Double Cylinder Deadbolt	8350	Medium Bronze (MB) Polished White Bronze (WB) Tumbled White Bronze (TWB)	\$64.00

#1 Style Plate Deadbolt with Flap



Description	Product Code	Finish	List Price
Single Cylinder Deadbolt	8457	Deep Burgundy (DB) Flat Black (FB)	\$60.00
Double Cylinder Deadbolt	8357	Medium Bronze (MB) Polished White Bronze (WB) Tumbled White Bronze (TWB)	\$64.00

#3 Style Plate Deadbolt with Flap



Description	Product Code	Finish	List Price
Single Cylinder Deadbolt	8465	Deep Burgundy (DB) Flat Black (FB)	\$60.00
Double Cylinder Deadbolt	8365	Medium Bronze (MB) Polished White Bronze (WB) Tumbled White Bronze (TWB)	\$64.00

#4 Style Plate Deadbolt with Flap



Description	Product Code	Finish	List Price
Single Cylinder Deadbolt	8474	Deep Burgundy (DB) Flat Black (FB)	\$60.00
Double Cylinder Deadbolt	8374	Medium Bronze (MB)	\$64.00

Ridgemont Plate Deadbolt with Flap



Description	Product Code	Finish	List Price
Single Cylinder Deadbolt	8476	Flat Black (FB) Medium Bronze (MB)	\$60.00
Double Cylinder Deadbolt	8376	Polished White Bronze (WB) Tumbled White Bronze (TWB)	\$64.00

>> Specify by adding "W" to the beginning of Product Code for Weiser® (WR5) Keyway (For example: **W**8474 DB).
No upcharge for cylinder substitution. Can be keyed into existing Weiser® system.

LOST WAX CAST BRONZE - DEADBOLTS

Standard with Lost Wax Cast Deadbolt Locks

- Schlage® C Keyway
- Standard Door Prep and Installation
- Solid Brass Cylinder
- Lost Wax Cast Bronze Collar and Inside Rosette
- Hardened Steel Bolt
- Heavy Gauge Steel Understrike and Brass Trim Strike Shipped with Every Deadbolt

Tuscany Deadbolt



Description	Product Code	Finish	List Price
Single Cylinder Deadbolt	8456	Deep Burgundy (DB) Flat Black (FB)	\$60.00
Double Cylinder Deadbolt	8356	Medium Bronze (MB)	\$64.00

Tuscany Classic Deadbolt



Description	Product Code	Finish	List Price
Single Cylinder Deadbolt	8471	Deep Burgundy (DB) Flat Black (FB)	\$60.00
Double Cylinder Deadbolt	8371	Medium Bronze (MB)	\$64.00

Octagon Deadbolt



Description	Product Code	Finish	List Price
Single Cylinder Deadbolt	8460	Deep Burgundy (DB) Flat Black (FB)	\$60.00
Double Cylinder Deadbolt	8360	Medium Bronze (MB)	\$64.00

#11 Style Deadbolt

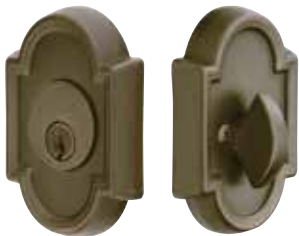

Description	Product Code	Finish	List Price
Single Cylinder Deadbolt	8472	Deep Burgundy (DB) Flat Black (FB)	\$60.00
Double Cylinder Deadbolt	8372	Medium Bronze (MB)	\$64.00

#14 Style Deadbolt



Description	Product Code	Finish	List Price
Single Cylinder Deadbolt	8473	Deep Burgundy (DB) Flat Black (FB)	\$60.00
Double Cylinder Deadbolt	8373	Medium Bronze (MB)	\$64.00

>> Specify by adding "W" to the beginning of Product Code for Weiser® (WR5) Keyway (For example: **W**8460 DB).
No upcharge for cylinder substitution. Can be keyed into existing Weiser® system.

Standard door thickness of 1¾", specify if thicker. Standard latch is for 2¾" backset. Specify 2¾" backset if required.

DEADBOLTS

DEADBOLTS - LOST WAX CAST BRONZE & STAINLESS STEEL

Standard with Lost Wax Cast Deadbolt Locks

- Schlage® C Keyway
- Standard Door Prep and Installation
- Solid Brass Cylinder
- Lost Wax Cast Bronze Collar and Inside Rosette
- Hardened Steel Bolt
- Heavy Gauge Steel Understrike and Brass Trim Strike Shipped with Every Deadbolt

Art Nouveau Deadbolt



Description	Product Code	Finish	List Price
Single Cylinder Deadbolt	8470	Deep Burgundy (DB) Flat Black (FB)	\$60.00
Double Cylinder Deadbolt	8370	Medium Bronze (MB)	\$64.00

>> Specify by adding "W" to the beginning of Product Code for Weiser® (WR5) Keyway (For example: **W**8470 DB).
No upcharge for cylinder substitution. Can be keyed into existing Weiser® system.

Standard with Stainless Steel Deadbolt Locks

- Schlage® C Keyway
- Standard Door Prep and Installation
- Solid Brass Cylinder
- Stainless Steel Collar and Inside Rosette
- Hardened Steel Bolt
- Heavy Gauge Steel Understrike and Stainless Steel Trim Strike Shipped with Every Deadbolt

Round Deadbolts



Description	Product Code	Finish	List Price
Single Cylinder Deadbolt	S50001	Brushed Stainless Steel (SS)	\$64.00
Double Cylinder Deadbolt	S50002		\$68.00

Square Deadbolts



Description	Product Code	Finish	List Price
Single Cylinder Deadbolt	S50003	Brushed Stainless Steel (SS)	\$64.00
Double Cylinder Deadbolt	S50023		\$68.00

>> Specify by adding "W" to the beginning of Product Code for Weiser® (WR5) Keyway (For example: **W**S50003 SS).
No upcharge for cylinder substitution. Can be keyed into existing Weiser® system.

Standard with Wrought Steel Deadbolt Locks

- Schlage® C Keyway
- Standard Door Prep and Installation
- Solid Brass Cylinder
- Wrought Steel Collar and Inside Rosette
- Hardened Steel Bolt
- Heavy Gauge Steel Understrike and Brass Trim Strike Shipped with Every Deadbolt



Wrought Steel #1 Style Deadbolt

Description	Product Code	Finish	List Price
Single Cylinder Deadbolt	8461	Flat Black (FB) Satin Steel	\$56.00
Double Cylinder Deadbolt	8361		\$60.00



Wrought Steel #2 Style Deadbolt

Description	Product Code	Finish	List Price
Single Cylinder Deadbolt	8452	Flat Black (FB) Satin Steel	\$56.00
Double Cylinder Deadbolt	8350		\$60.00



Wrought Steel #3 Style Deadbolt

Description	Product Code	Finish	List Price
Single Cylinder Deadbolt	8463	Flat Black (FB) Satin Steel	\$56.00
Double Cylinder Deadbolt	8363		\$60.00

>> Specify by adding "W" to the beginning of Product Code for Weiser® (WR5) Keyway (For example: **W8463** FB).
No upcharge for cylinder substitution. Can be keyed into existing Weiser® system.

SINGLE SIDED DEADBOLTS

Operated by Thumbturn from Inside Only. No Cylinder.

Rope



Knoxville



Standard with Single Sided Deadbolt Locks

- Includes Deadbolt Mechanism and Strikeplate
- **For Inside Installation and Appearance**
- No Cylinder or Collar
- Hardened Steel Bolt
- Fits Door Thickness 1⁵/₈" to 2³/₈"

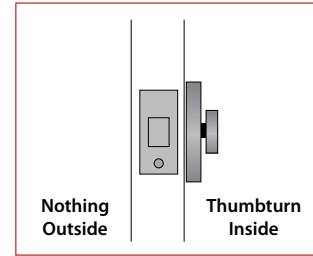

	Description	Product Code	Finish	List Price
Rope Style	Single Sided Deadbolt	8564	Polished Brass (US3)* French Antique (US7) Oil Rubbed Bronze (US10B) Satin Nickel (US15)	\$40.00
Knoxville Style	Single Sided Deadbolt	8559	Pewter (US15A) Polished Chrome (US26) PVD-Lifetime	\$40.00

*Not available for Knoxville Style.

Regular



#8



Rectangular



Saratoga



Quincy



	Description	Product Code	Finish	List Price
Regular Style	Single Sided Deadbolt	8550	Polished Brass (US3)* French Antique (US7)	\$40.00
#8 Style	Single Sided Deadbolt	8566	Oil Rubbed Bronze (US10B) Satin Nickel (US15)	\$40.00
Rectangular Style	Single Sided Deadbolt	8568	Pewter (US15A) Flat Black (US19)	\$40.00
Saratoga Style	Single Sided Deadbolt	8558	Polished Chrome (US26) PVD-Lifetime	\$40.00
Quincy Style	Single Sided Deadbolt	8578		\$40.00

*Not available for Saratoga Style.

Arts & Crafts



Modern



Square



Neos



	Description	Product Code	Finish	List Price
Arts & Crafts Style	Single Sided Deadbolt	8554	Oil Rubbed Bronze (US10B) Satin Nickel (US15) Flat Black (US19)	\$40.00
Modern Style	Single Sided Deadbolt	8567	Oil Rubbed Bronze (US10B) Satin Nickel (US15)	\$40.00
Square Style	Single Sided Deadbolt	8569	Flat Black (US19)	\$40.00
Neos Style	Single Sided Deadbolt	8575	Polished Chrome (US26)	\$40.00

DEADBOLTS

SINGLE SIDED DEADBOLTS

Operated by Thumbturn from Inside Only. No Cylinder.

Sandcast Bronze #1



Sandcast Bronze #2



Sandcast Bronze #3



Sandcast Bronze #4

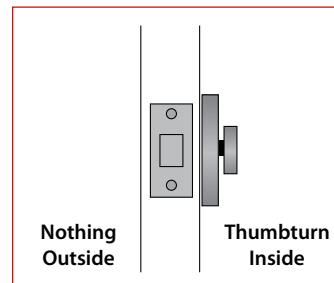

	Description	Product Code	Finish	List Price
Sandcast Bronze #1 Style	Single Sided Deadbolt	8557	Deep Burgundy (DB)	\$42.00
Sandcast Bronze #2 Style	Single Sided Deadbolt	8550	Flat Black (FB)	\$42.00
Sandcast Bronze #3 Style	Single Sided Deadbolt	8565	Medium Bronze (MB)	\$42.00
Sandcast Bronze #4 Style	Single Sided Deadbolt	8574	Polished White Bronze (WB)* Tumbled White Bronze (TWB)*	\$42.00

*Not available for Sandcast Bronze #2 Style.

Tuscany



Octagon



Lost Wax Cast Bronze #11



Lost Wax Cast Bronze #14



Art Nouveau



	Description	Product Code	Finish	List Price
Tuscany Style	Single Sided Deadbolt	8556	Deep Burgundy (DB)	\$42.00
Octagon Style	Single Sided Deadbolt	8560	Flat Black (FB)	\$42.00
Lost Wax Cast Bronze #11	Single Sided Deadbolt	8572	Medium Bronze (MB)	\$42.00
Lost Wax Cast Bronze #14	Single Sided Deadbolt	8573		\$42.00
Art Nouveau Style	Single Sided Deadbolt	8570		\$42.00

Round



Square



Wrought Steel #1



Wrought Steel #2



Wrought Steel #3



	Description	Product Code	Finish	List Price
Stainless Steel Round Style	Single Sided Deadbolt	S52005	Brushed Stainless Steel (SS)	\$48.00
Stainless Steel Square Style	Single Sided Deadbolt	S52006		\$48.00
Wrought Steel #1 Style	Single Sided Deadbolt	8551	Flat Black (FB) Satin Steel	\$40.00
Wrought Steel #2 Style	Single Sided Deadbolt	8552		\$40.00
Wrought Steel #3 Style	Single Sided Deadbolt	8553		\$40.00

Fits Door Thickness 1 5/8" to 2 3/8", specify if thicker. Standard latch is for 2 3/8" backset. Specify 2 3/4" backset if required.

DEADBOLTS

SIDEPLATE LOCKSETS - DECORATIVE BRASS

Modern Non-Keyed Style

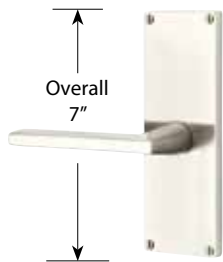

Description	Product Code	Knob or Lever Style	Finish	List Price
Passage	8111	<i>See Page 4 for Brass Knob & Lever Options.</i>	Oil Rubbed Bronze (US10B) Satin Nickel (US15) Flat Black (US19) Polished Chrome (US26)	\$144.00
Privacy	8211			\$144.00
Dummy Pair	8011			\$144.00

- Helios Lever with Non-Keyed Modern Plate
- Standard 2 1/8" Door Prep

Modern 3 5/8" Center to Center Keyed Style



Description	Product Code	Knob or Lever Style	Finish	List Price
Passage/Single Keyed	8112	<i>See Page 4 for Brass Knob & Lever Options.</i>	Oil Rubbed Bronze (US10B) Satin Nickel (US15) Flat Black (US19) Polished Chrome (US26)	\$160.00
Passage/Double Keyed	8212			\$160.00
Dummy Pair	8012			\$160.00

- Bern Knob with Keyed Modern Plate
- Two Standard 2 1/8" Door Preps, 3 5/8" Center to Center Hole Spacing
- Schlage® C Keyway

Modern Non-Keyed Style



Description	Product Code	Knob or Lever Style	Finish	List Price
Passage	8113	<i>See Page 4 for Brass Knob & Lever Options.</i>	Oil Rubbed Bronze (US10B) Satin Nickel (US15) Flat Black (US19) Polished Chrome (US26)	\$144.00
Privacy	8213			\$144.00
Dummy Pair	8013			\$144.00

- Bern Knob with Non-Keyed Modern Plate
- Standard 2 1/8" Door Prep

Modern 5 1/2" Center to Center Keyed Style



Description	Product Code	Knob or Lever Style	Finish	List Price
Passage/Single Keyed	8114	<i>See Page 4 for Brass Knob & Lever Options.</i>	Oil Rubbed Bronze (US10B) Satin Nickel (US15) Flat Black (US19) Polished Chrome (US26)	\$160.00
Passage/Double Keyed	8214			\$160.00
Dummy Pair	8014			\$160.00

- Geneva Lever with Keyed Modern Plate
- Two Standard 2 1/8" Door Preps, 5 1/2" Center to Center Hole Spacing
- Schlage® C Keyway

Interconnect Device Not Available for Double Cylinder. 28° Latch Not Available for Use with Interconnect Device.

Available for 5 1/2" C-to-C Keyed Modern Plate	Product Code: 443	List Price: \$58.00
--	-------------------	----------------------------

>> Specify by adding "W" to the beginning of Product Code for Weiser® (WR5) Keyway (For example: **W**8114GV US3).
No upcharge for cylinder substitution. Can be keyed into existing Weiser® system.

Handing Required for Leversets or if Interconnect Device is Specified. Standard latch is for 2 3/8" backset.
Specify 2 3/4" backset if required. To order 28° Rotation Latch with any Sideplate, add product code **Latch28** and list price **\$10**.

Quincy Non-Keyed Style



Description	Product Code	Knob or Lever Style	Finish	List Price
Passage	8104	<i>See Page 4 for Brass Knob & Lever Options.</i>	Polished Brass (US3) French Antique (US7) Oil Rubbed Bronze (US10B)	\$144.00
Privacy	8204		Satin Nickel (US15) Pewter (US15A)	\$144.00
Dummy Pair	8054		Flat Black (US19) Polished Chrome (US26)	\$144.00

- Norwich Knob with Non-Keyed Quincy Plate
- Standard 2 1/8" Door Prep

Quincy 3 5/8" Center to Center Keyed Style



Description	Product Code	Knob or Lever Style	Finish	List Price
Passage/Single Keyed	8080	<i>See Page 4 for Brass Knob & Lever Options.</i>	Polished Brass (US3) French Antique (US7) Oil Rubbed Bronze (US10B)	\$160.00
Passage/Double Keyed	8081		Satin Nickel (US15) Pewter (US15A)	\$160.00
Dummy Pair	8085		Flat Black (US19) Polished Chrome (US26)	\$160.00

- Egg Knob with Keyed Quincy Plate
- Two Standard 2 1/8" Door Preps, 3 5/8" Center to Center Hole Spacing
- Schlage® C Keyway

Quincy Non-Keyed Style



Description	Product Code	Knob or Lever Style	Finish	List Price
Passage	8704	<i>See Page 4 for Brass Knob & Lever Options.</i>	Polished Brass (US3) French Antique (US7) Oil Rubbed Bronze (US10B)	\$144.00
Privacy	8804		Satin Nickel (US15) Pewter (US15A)	\$144.00
Dummy Pair	8854		Flat Black (US19) Polished Chrome (US26)	\$144.00

- Cortina Lever with Non-Keyed Quincy Plate
- Standard 2 1/8" Door Prep

Quincy 5 1/2" Center to Center Keyed Style



Description	Product Code	Knob or Lever Style	Finish	List Price
Passage/Single Keyed	8980	<i>See Page 4 for Brass Knob & Lever Options.</i>	Polished Brass (US3) French Antique (US7) Oil Rubbed Bronze (US10B)	\$160.00
Passage/Double Keyed	8981		Satin Nickel (US15) Pewter (US15A)	\$160.00
Dummy Pair	8985		Flat Black (US19) Polished Chrome (US26)	\$160.00

- Milano Lever with Keyed Quincy Plate
- Two Standard 2 1/8" Door Preps, 5 1/2" Center to Center Hole Spacing
- Schlage® C Keyway

Interconnect Device Not Available for Double Cylinder. 28° Latch Not Available for Use with Interconnect Device.

Available for 5 1/2" C-to-C Keyed Quincy Plate	Product Code: 443	List Price: \$58.00
--	-------------------	----------------------------

>> Specify by adding "W" to the beginning of Product Code for Weiser® (WR5) Keyway (For example: **W**8980M US3).
No upcharge for cylinder substitution. Can be keyed into existing Weiser® system.

Handing Required for Leversets or if Interconnect Device is Specified. Standard latch is for 2 3/8" backset.
Specify 2 3/4" backset if required. To order 28° Rotation Latch with any Sideplate, add product code **Latch28** and list price **\$10**.

SIDEPLATE LOCKSETS - DECORATIVE BRASS

Delaware Non-Keyed Style



Description	Product Code	Knob or Lever Style	Finish	List Price
Passage	8016	<i>See 2012 Page 4 for Brass Knob & Lever Options.</i>	Polished Brass (US3)	\$144.00
Privacy	8026		French Antique (US7)	
Dummy Pair	8006		Oil Rubbed Bronze (US10B)	\$144.00
			Satin Nickel (US15)	\$144.00
			Pewter (US15A)	
			Flat Black (US19)	\$144.00
			Polished Chrome (US26)	

- Norwich Knob with Non-Keyed Delaware Plate
- Standard 2 1/8" Door Prep

Delaware 3 5/8" Center to Center Keyed Style



Description	Product Code	Knob or Lever Style	Finish	List Price
Passage/Single Keyed	8066	<i>See 2012 Page 4 for Brass Knob & Lever Options.</i>	Polished Brass (US3)	\$160.00
Passage/Double Keyed	8166		French Antique (US7)	
Dummy Pair	8061		Oil Rubbed Bronze (US10B)	\$160.00
			Satin Nickel (US15)	\$160.00
			Pewter (US15A)	
			Flat Black (US19)	\$160.00
			Polished Chrome (US26)	

- Providence Crystal Knob with Keyed Delaware Plate
- Two Standard 2 1/8" Door Preps, 3 5/8" Center to Center Hole Spacing
- Schlage® C Keyway

Delaware Non-Keyed Style



Description	Product Code	Knob or Lever Style	Finish	List Price
Passage	8716	<i>See 2012 Page 4 for Brass Knob & Lever Options.</i>	Polished Brass (US3)	\$144.00
Privacy	8816		French Antique (US7)	
Dummy Pair	8998		Oil Rubbed Bronze (US10B)	\$144.00
			Satin Nickel (US15)	\$144.00
			Pewter (US15A)	
			Flat Black (US19)	\$144.00
			Polished Chrome (US26)	

- Cortina Lever with Non-Keyed Delaware Plate
- Standard 2 1/8" Door Prep

Delaware 5 1/2" Center to Center Keyed Style



Description	Product Code	Knob or Lever Style	Finish	List Price
Passage/Single Keyed	8996	<i>See 2012 Page 4 for Brass Knob & Lever Options.</i>	Polished Brass (US3)	\$160.00
Passage/Double Keyed	8997		French Antique (US7)	
Dummy Pair	8856		Oil Rubbed Bronze (US10B)	\$160.00
			Satin Nickel (US15)	\$160.00
			Pewter (US15A)	
			Flat Black (US19)	\$160.00
			Polished Chrome (US26)	

- Waverly Knob with Keyed Delaware Plate
- Two Standard 2 1/8" Door Preps, 5 1/2" Center to Center Hole Spacing
- Schlage® C Keyway

Interconnect Device Not Available for Double Cylinder. 28° Latch Not Available for Use with Interconnect Device.

Available for 5 1/2" C-to-C Keyed Delaware Plate	Product Code: 443	List Price: \$58.00
--	-------------------	----------------------------

>> Specify by adding "W" to the beginning of Product Code for Weiser® (WR5) Keyway (For example: **W8996PC** US10B).
 No upcharge for cylinder substitution. Can be keyed into existing Weiser® system.

Handing Required for Leversets or if Interconnect Device is Specified. Standard latch is for 2 3/8" backset.
 Specify 2 3/4" backset if required. To order 28° Rotation Latch with any Sideplate, add product code **Latch28** and list price **\$10**.

Colonial Non-Keyed Style



Description	Product Code	Knob or Lever Style	Finish	List Price
Passage	8010	<i>See Page 4 for Brass Knob & Lever Options.</i>	Polished Brass (US3) French Antique (US7) Oil Rubbed Bronze (US10B) Satin Nickel (US15) Pewter (US15A) Flat Black (US19) Polished Chrome (US26)	\$144.00
Privacy	8020			\$144.00
Dummy Pair	8001			\$144.00

- Cortina Lever with Non-Keyed Colonial Plate
- Standard 2 1/8" Door Prep

Colonial 3 5/8" Center to Center Keyed Style



Description	Product Code	Knob or Lever Style	Finish	List Price
Passage/Single Keyed	8060	<i>See Page 4 for Brass Knob & Lever Options.</i>	Polished Brass (US3) French Antique (US7) Oil Rubbed Bronze (US10B) Satin Nickel (US15) Pewter (US15A) Flat Black (US19) Polished Chrome (US26)	\$160.00
Passage/Double Keyed	8160			\$160.00
Dummy Pair	8065			\$160.00

- Waverly Knob with Keyed Colonial Plate
- Two Standard 2 1/8" Door Preps, 3 5/8" Center to Center Hole Spacing
- Schlage® C Keyway

Colonial Non-Keyed Style

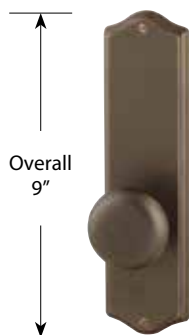

Description	Product Code	Knob or Lever Style	Finish	List Price
Passage	8711	<i>See Page 4 for Brass Knob & Lever Options.</i>	Polished Brass (US3) French Antique (US7) Oil Rubbed Bronze (US10B) Satin Nickel (US15) Pewter (US15A) Flat Black (US19) Polished Chrome (US26)	\$144.00
Privacy	8811			\$144.00
Dummy Pair	8851			\$144.00

- Providence Knob with Non-Keyed Colonial Plate
- Standard 2 1/8" Door Prep

Colonial 5 1/2" Center to Center Keyed Style



Description	Product Code	Knob or Lever Style	Finish	List Price
Passage/Single Keyed	8990	<i>See Page 4 for Brass Knob & Lever Options.</i>	Polished Brass (US3) French Antique (US7) Oil Rubbed Bronze (US10B) Satin Nickel (US15) Pewter (US15A) Flat Black (US19) Polished Chrome (US26)	\$160.00
Passage/Double Keyed	8991			\$160.00
Dummy Pair	8995			\$160.00

- Egg Knob with Keyed Colonial Plate
- Two Standard 2 1/8" Door Preps, 5 1/2" Center to Center Hole Spacing
- Schlage® C Keyway

Interconnect Device *Not Available for Double Cylinder. 28° Latch Not Available for Use with Interconnect Device.*

Available for 5 1/2" C-to-C Keyed Colonial Plate	Product Code: 443	List Price: \$58.00
--	-------------------	----------------------------

>> Specify by adding "W" to the beginning of Product Code for Weiser® (WR5) Keyway (For example: **W**8990E US3).
No upcharge for cylinder substitution. Can be keyed into existing Weiser® system.

Handing Required for Leversets or if Interconnect Device is Specified. Standard latch is for 2 3/8" backset.
Specify 2 3/4" backset if required. To order 28° Rotation Latch with any Sideplate, add product code **Latch28** and list price **\$10**.

SIDEPLATES

SIDEPLATE LOCKSETS - DECORATIVE BRASS

Rope Non-Keyed Style



Description	Product Code	Knob or Lever Style	Finish	List Price
Passage	7109	<i>See Page 4 for Brass Knob & Lever Options.</i>	Polished Brass (US3) French Antique (US7) Oil Rubbed Bronze (US10B) Satin Nickel (US15)	\$144.00
Privacy	7209			\$144.00
Dummy Pair	7059			\$144.00

- Rope Knob with Non-Keyed Rope Plate
- Standard 2 1/8" Door Prep

Rope 3 5/8" Center to Center Keyed Style



Description	Product Code	Knob or Lever Style	Finish	List Price
Passage/Single Keyed	7090	<i>See Page 4 for Brass Knob & Lever Options.</i>	Polished Brass (US3) French Antique (US7) Oil Rubbed Bronze (US10B) Satin Nickel (US15)	\$160.00
Passage/Double Keyed	7091			\$160.00
Dummy Pair	7095			\$160.00

- Rope Lever with Keyed Rope Plate
- Two Standard 2 1/8" Door Preps, 3 5/8" Center to Center Hole Spacing
- Schlage® C Keyway

Rope Non-Keyed Style

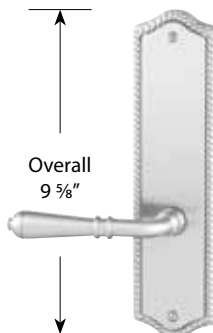

Description	Product Code	Knob or Lever Style	Finish	List Price
Passage	7710	<i>See Page 4 for Brass Knob & Lever Options.</i>	Polished Brass (US3) French Antique (US7) Oil Rubbed Bronze (US10B) Satin Nickel (US15)	\$144.00
Privacy	7810			\$144.00
Dummy Pair	7850			\$144.00

- Turino Lever with Non-Keyed Rope Plate
- Standard 2 1/8" Door Prep

Rope 5 1/2" Center to Center Keyed Style



Description	Product Code	Knob or Lever Style	Finish	List Price
Passage/Single Keyed	7990	<i>See Page 4 for Brass Knob & Lever Options.</i>	Polished Brass (US3) French Antique (US7) Oil Rubbed Bronze (US10B) Satin Nickel (US15)	\$160.00
Passage/Double Keyed	7991			\$160.00
Dummy Pair	7995			\$160.00

- Rope Knob with Keyed Rope Plate
- Two Standard 2 1/8" Door Preps, 5 1/2" Center to Center Hole Spacing
- Schlage® C Keyway

Interconnect Device Not Available for Double Cylinder. 28° Latch Not Available for Use with Interconnect Device.

Available for 5 1/2" C-to-C Keyed Rope Plate	Product Code: 443	List Price: \$58.00
--	-------------------	----------------------------

>> Specify by adding "W" to the beginning of Product Code for Weiser® (WR5) Keyway (For example: **W**7990RK US3).
No upcharge for cylinder substitution. Can be keyed into existing Weiser® system.

Oval Beaded Non-Keyed Style



Description	Product Code	Knob or Lever Style	Finish	List Price
Passage	8105	<i>See Page 4 for Brass Knob & Lever Options.</i>	Polished Brass (US3)	\$144.00
Privacy	8205		French Antique (US7) Oil Rubbed Bronze (US10B) Satin Nickel (US15)	
Dummy Pair	8055		<i>See Page 5 for Crystal & Porcelain Knob Options.</i>	\$144.00

- Astoria Knob with Non-Keyed Oval Beaded Plate
- Standard 2 1/8" Door Prep

Oval Beaded 3 5/8" Center to Center Keyed Style



Description	Product Code	Knob or Lever Style	Finish	List Price
Passage/Single Keyed	6010	<i>See Page 4 for Brass Knob & Lever Options.</i>	Polished Brass (US3)	\$160.00
Passage/Double Keyed	6011		French Antique (US7) Oil Rubbed Bronze (US10B) Satin Nickel (US15)	
Dummy Pair	6015		<i>See Page 5 for Crystal & Porcelain Knob Options.</i>	\$160.00

- Beaded Egg Knob with Keyed Oval Beaded Plate
- Two Standard 2 1/8" Door Preps, 3 5/8" Center to Center Hole Spacing
- Schlage® C Keyway

Trenton Non-Keyed Style



Description	Product Code	Knob or Lever Style	Finish	List Price
Passage	8109	<i>See Page 4 for Brass Knob & Lever Options.</i>	Polished Brass (US3)	\$144.00
Privacy	8209		French Antique (US7) Oil Rubbed Bronze (US10B) Satin Nickel (US15)	
Dummy Pair	8059		<i>See Page 5 for Crystal & Porcelain Knob Options.</i>	Pewter (US15A) Polished Chrome (US26)

- Hampton Knob with Non-Keyed Trenton Plate
- Standard 2 1/8" Door Prep

Trenton 5 1/2" Center to Center Keyed Style



Description	Product Code	Knob or Lever Style	Finish	List Price
Passage/Single Keyed	6030	<i>See Page 4 for Brass Knob & Lever Options.</i>	Polished Brass (US3)	\$160.00
Passage/Double Keyed	6031		French Antique (US7) Oil Rubbed Bronze (US10B) Satin Nickel (US15)	
Dummy Pair	6035		<i>See Page 5 for Crystal & Porcelain Knob Options.</i>	Pewter (US15A) Polished Chrome (US26)

- Rope Lever with Keyed Trenton Plate
- Two Standard 2 1/8" Door Preps, 5 1/2" Center to Center Hole Spacing
- Schlage® C Keyway

Interconnect Device

Not Available for Double Cylinder. 28° Latch Not Available for Use with Interconnect Device.

Available for 5 1/2" C-to-C Keyed Trenton Plate	Product Code: 443	List Price: \$58.00
---	-------------------	----------------------------

>> Specify by adding "W" to the beginning of Product Code for Weiser® (WR5) Keyway (For example: **W6030RL US3**).
No upcharge for cylinder substitution. Can be keyed into existing Weiser® system.

Handing Required for Leversets or if Interconnect Device is Specified. Standard latch is for 2 3/8" backset.
Specify 2 3/4" backset if required. To order 28° Rotation Latch with any Sideplate, add product code **Latch28** and list price **\$10**.

SIDEPLATES

SIDEPLATE LOCKSETS - DECORATIVE BRASS

Belmont Non-Keyed Style



Description	Product Code	Knob or Lever Style	Finish	List Price
Passage	8102	<i>See Page 4 for Brass Knob & Lever Options. See Page 5 for Crystal & Porcelain Knob Options.</i>	Polished Brass (US3) French Antique (US7) Oil Rubbed Bronze (US10B) Satin Nickel (US15)	\$144.00
Privacy	8202			\$144.00
Dummy Pair	8052			\$144.00

- Georgetown Crystal Knob with Non-Keyed Belmont Plate
- Standard 2 1/8" Door Prep

Belmont 3 5/8" Center to Center Keyed Style



Description	Product Code	Knob or Lever Style	Finish	List Price
Passage/Single Keyed	8070	<i>See Page 4 for Brass Knob & Lever Options. See Page 5 for Crystal & Porcelain Knob Options.</i>	Polished Brass (US3) French Antique (US7) Oil Rubbed Bronze (US10B) Satin Nickel (US15)	\$160.00
Passage/Double Keyed	8071			\$160.00
Dummy Pair	8075			\$160.00

- Belmont Knob with Keyed Belmont Plate
- Two Standard 2 1/8" Door Preps, 3 5/8" Center to Center Hole Spacing
- Schlage® C Keyway

Victoria Non-Keyed Style



Description	Product Code	Knob or Lever Style	Finish	List Price
Passage	8103	<i>See Page 4 for Brass Knob & Lever Options. See Page 5 for Crystal & Porcelain Knob Options.</i>	Polished Brass (US3) French Antique (US7) Oil Rubbed Bronze (US10B) Satin Nickel (US15)	\$144.00
Privacy	8203			\$144.00
Dummy Pair	8053			\$144.00

- Victoria Knob with Non-Keyed Victoria Plate
- Standard 2 1/8" Door Prep

Victoria 3 5/8" Center to Center Keyed Style



Description	Product Code	Knob or Lever Style	Finish	List Price
Passage/Single Keyed	8090	<i>See Page 4 for Brass Knob & Lever Options. See Page 5 for Crystal & Porcelain Knob Options.</i>	Polished Brass (US3) French Antique (US7) Oil Rubbed Bronze (US10B) Satin Nickel (US15)	\$160.00
Passage/Double Keyed	8091			\$160.00
Dummy Pair	8095			\$160.00

- Victoria Knob with Keyed Victoria Plate
- Two Standard 2 1/8" Door Preps, 3 5/8" Center to Center Hole Spacing
- Schlage® C Keyway

SIDEPLATES

>> Specify by adding "W" to the beginning of Product Code for Weiser® (WR5) Keyway (For example: **W8090V** US3).
No upcharge for cylinder substitution. Can be keyed into existing Weiser® system.

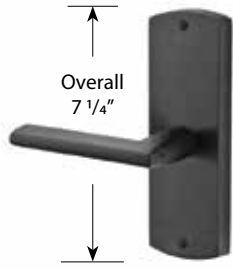

Missoula Style Non-Keyed

Description	Product Code	Knob or Lever Style	Finish	List Price
Passage	71023	<i>See 2012 EMTEK Price Book Page 5 for Sandcast Bronze Knob & Lever Options.</i>	Flat Black (FB) Medium Bronze (MB)	\$158.00
Privacy	72023			\$158.00
Dummy Pair	70063			\$158.00

- Lariat Lever with Non-Keyed Missoula Plate
- Standard 2 1/8" Door Prep



Missoula Style 3 5/8" Center to Center Keyed

Description	Product Code	Knob or Lever Style	Finish	List Price
Passage/Single Keyed	7370	<i>See 2012 EMTEK Price Book Page 5 for Sandcast Bronze Knob & Lever Options.</i>	Flat Black (FB) Medium Bronze (MB)	\$176.00
Passage/Double Keyed	7371			\$176.00
Dummy Pair	7375			\$176.00

- Winchester Knob with Keyed Missoula Plate
- Two Standard 2 1/8" Door Preps, 3 5/8" Center to Center Hole Spacing
- Schlage® C Keyway

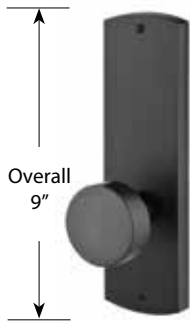

Missoula Style Non-Keyed

Description	Product Code	Knob or Lever Style	Finish	List Price
Passage	7522	<i>See 2012 EMTEK Price Book Page 5 for Sandcast Bronze Knob & Lever Options.</i>	Flat Black (FB) Medium Bronze (MB)	\$158.00
Privacy	7622			\$158.00
Dummy Pair	7562			\$158.00

- Bronze Round Knob with Non-Keyed Missoula Plate
- Standard 2 1/8" Door Prep



Missoula Style 5 1/2" Center to Center Keyed

Description	Product Code	Knob or Lever Style	Finish	List Price
Passage/Single Keyed	7570	<i>See Page 5 for Sandcast Bronze Knob & Lever Options.</i>	Flat Black (FB) Medium Bronze (MB)	\$176.00
Passage/Double Keyed	7571			\$176.00
Dummy Pair	7575			\$176.00

- Yuma Lever with Keyed Missoula Plate
- Two Standard 2 1/8" Door Preps, 5 1/2" Center to Center Hole Spacing
- Schlage® C Keyway

Interconnect Device *Not Available for Double Cylinder. 28° Latch Not Available for Use with Interconnect Device.*

Available for 5 1/2" C-to-C Keyed Missoula Style Plates	Product Code: 443	List Price: \$58.00
---	-------------------	----------------------------

>> Specify by adding "W" to the beginning of Product Code for Weiser® (WR5) Keyway (For example: **W**7570YM MB).
 No upcharge for cylinder substitution. Can be keyed into existing Weiser® system.

Handing Required for Leversets or if Interconnect Device is Specified. Standard latch is for 2 3/8" backset.
 Specify 2 3/4" backset if required. To order 28° Rotation Latch with any Sideplate, add product code **Latch28** and list price **\$10**.

SIDEPLATES

SIDEPLATE LOCKSETS - SANDCAST BRONZE

Rectangular Non-Keyed Style



Description	Product Code	Knob or Lever Style	Finish	List Price
Passage	71013	<i>See Page 5 for Sandcast Bronze Knob & Lever Options.</i>	Deep Burgundy (DB) Flat Black (FB) Medium Bronze (MB)	\$158.00
Privacy	72013			\$158.00
Dummy Pair	70053			\$158.00

- Bronze Egg Knob with Non-Keyed Rectangular Sandcast Bronze Plate
- Standard 2 1/8" Door Prep

Rectangular 3 5/8" Center to Center Keyed Style



Description	Product Code	Knob or Lever Style	Finish	List Price
Passage/Single Keyed	7360	<i>See Page 5 for Sandcast Bronze Knob & Lever Options.</i>	Deep Burgundy (DB) Flat Black (FB) Medium Bronze (MB)	\$176.00
Passage/Double Keyed	7361			\$176.00
Dummy Pair	7365			\$176.00

- Montrose Lever with Keyed Rectangular Sandcast Bronze Plate
- Two Standard 2 1/8" Door Preps, 3 5/8" Center to Center Hole Spacing
- Schlage® C Keyway

Rectangular Non-Keyed Style



Description	Product Code	Knob or Lever Style	Finish	List Price
Passage	7512	<i>See Page 5 for Sandcast Bronze Knob & Lever Options.</i>	Deep Burgundy (DB) Flat Black (FB) Medium Bronze (MB)	\$158.00
Privacy	7612			\$158.00
Dummy Pair	7552			\$158.00

- Teton Lever with Non-Keyed Rectangular Sandcast Bronze Plate
- Standard 2 1/8" Door Prep

Rectangular 5 1/2" Center to Center Keyed Style



Description	Product Code	Knob or Lever Style	Finish	List Price
Passage/Single Keyed	7560	<i>See Page 5 for Sandcast Bronze Knob & Lever Options.</i>	Deep Burgundy (DB) Flat Black (FB) Medium Bronze (MB)	\$176.00
Passage/Double Keyed	7561			\$176.00
Dummy Pair	7565			\$176.00

- Butte Knob with Keyed Rectangular Sandcast Bronze Plate
- Two Standard 2 1/8" Door Preps, 5 1/2" Center to Center Hole Spacing
- Schlage® C Keyway

Interconnect Device Not Available for Double Cylinder. 28° Latch Not Available for Use with Interconnect Device.

Available for 5 1/2" C-to-C Keyed Rectangular Plate	Product Code: 443	List Price: \$58.00
---	-------------------	----------------------------

>> Specify by adding "W" to the beginning of Product Code for Weiser® (WR5) Keyway (For example: **W**7560BU DB).
No upcharge for cylinder substitution. Can be keyed into existing Weiser® system.

Handing Required for Leversets or if Interconnect Device is Specified. Standard latch is for 2 3/8" backset.
Specify 2 3/4" backset if required. To order 28° Rotation Latch with any Sideplate, add product code **Latch28** and list price **\$10**.

#5 Style Non-Keyed



Description	Product Code	Knob or Lever Style	Finish	List Price
Passage	7107	<i>See Page 5 for Sandcast Bronze Knob & Lever Options.</i>	Deep Burgundy (DB) Flat Black (FB) Medium Bronze (MB)	\$158.00
Privacy	7207			\$158.00
Dummy Pair	7057			\$158.00

- Cody Lever with Non-Keyed #5 Sandcast Bronze Plate
- Standard 2 1/8" Door Prep

#5 Style 3 5/8" Center to Center Keyed



Description	Product Code	Knob or Lever Style	Finish	List Price
Passage/Single Keyed	7070	<i>See Page 5 for Sandcast Bronze Knob & Lever Options.</i>	Deep Burgundy (DB) Flat Black (FB) Medium Bronze (MB)	\$176.00
Passage/Double Keyed	7071			\$176.00
Dummy Pair	7075			\$176.00

- Butte Knob with Keyed #5 Sandcast Bronze Plate
- Two Standard 2 1/8" Door Preps, 3 5/8" Center to Center Hole Spacing
- Schlage® C Keyway

#5 Style Non-Keyed



Description	Product Code	Knob or Lever Style	Finish	List Price
Passage	7707	<i>See Page 5 for Sandcast Bronze Knob & Lever Options.</i>	Deep Burgundy (DB) Flat Black (FB) Medium Bronze (MB)	\$158.00
Privacy	7807			\$158.00
Dummy Pair	7757			\$158.00

- Butte Knob with Non-Keyed #5 Sandcast Bronze Plate
- Standard 2 1/8" Door Prep

#5 Style 5 1/2" Center to Center Keyed



Description	Product Code	Knob or Lever Style	Finish	List Price
Passage/Single Keyed	7670	<i>See Page 5 for Sandcast Bronze Knob & Lever Options.</i>	Deep Burgundy (DB) Flat Black (FB) Medium Bronze (MB)	\$176.00
Passage/Double Keyed	7671			\$176.00
Dummy Pair	7675			\$176.00

- Cody Lever with Keyed #5 Sandcast Bronze Plate
- Two Standard 2 1/8" Door Preps, 5 1/2" Center to Center Hole Spacing
- Schlage® C Keyway

Interconnect Device *Not Available for Double Cylinder. 28° Latch Not Available for Use with Interconnect Device.*

Available for 5 1/2" C-to-C Keyed #5 Style Plate	Product Code: 443	List Price: \$58.00
--	-------------------	----------------------------

>> Specify by adding "W" to the beginning of Product Code for Weiser® (WR5) Keyway (For example: W7670D DB). No upcharge for cylinder substitution. Can be keyed into existing Weiser® system.

Handing Required for Leversets or if Interconnect Device is Specified. Standard latch is for 2 3/8" backset. Specify 2 3/4" backset if required. To order 28° Rotation Latch with any Sideplate, add product code **Latch28** and list price **\$10**.

SIDEPLATES

SIDEPLATE LOCKSETS - LOST WAX CAST BRONZE

#16 Style Non-Keyed



Description	Product Code	Knob or Lever Style	Finish	List Price
Passage	6102	<i>See Page 5 for Lost Wax Cast Bronze Knob & Lever Options.</i>	Deep Burgundy (DB) Flat Black (FB) Medium Bronze (MB)	\$158.00
Privacy	6202			\$158.00
Dummy Pair	6052			\$158.00

- Parma Knob with Non-Keyed #16 Lost Wax Cast Bronze Plate
- Standard 2 1/8" Door Prep

#16 Style 3 5/8" Center to Center Keyed



Description	Product Code	Knob or Lever Style	Finish	List Price
Passage/Single Keyed	6020	<i>See Page 5 for Lost Wax Cast Bronze Knob & Lever Options.</i>	Deep Burgundy (DB) Flat Black (FB) Medium Bronze (MB)	\$176.00
Passage/Double Keyed	6021			\$176.00
Dummy Pair	6025			\$176.00

- Napoli Lever with Keyed #16 Lost Wax Cast Bronze Plate
- Two Standard 2 1/8" Door Preps, 3 5/8" Center to Center Hole Spacing
- Schlage® C Keyway

#16 Style Non-Keyed



Description	Product Code	Knob or Lever Style	Finish	List Price
Passage	6702	<i>See Page 5 for Lost Wax Cast Bronze Knob & Lever Options.</i>	Deep Burgundy (DB) Flat Black (FB) Medium Bronze (MB)	\$158.00
Privacy	6802			\$158.00
Dummy Pair	6752			\$158.00

- Medici Lever with Non-Keyed #16 Lost Wax Cast Bronze Plate
- Standard 2 1/8" Door Prep

#16 Style 5 1/2" Center to Center Keyed



Description	Product Code	Knob or Lever Style	Finish	List Price
Passage/Single Keyed	6620	<i>See Page 5 for Lost Wax Cast Bronze Knob & Lever Options.</i>	Deep Burgundy (DB) Flat Black (FB) Medium Bronze (MB)	\$176.00
Passage/Double Keyed	6621			\$176.00
Dummy Pair	6625			\$176.00

- Art Nouveau Lever with Keyed #16 Lost Wax Cast Bronze Plate
- Two Standard 2 1/8" Door Preps, 5 1/2" Center to Center Hole Spacing
- Schlage® C Keyway

Interconnect Device *Not Available for Double Cylinder. 28° Latch Not Available for Use with Interconnect Device.*

Available for 5 1/2" C-to-C #16 Style Keyed Plate	Product Code: 443	List Price: \$58.00
---	-------------------	----------------------------

>> Specify by adding "W" to the beginning of Product Code for Weiser® (WR5) Keyway (For example: **W6620ANL DB**).
No upcharge for cylinder substitution. Can be keyed into existing Weiser® system.

Handing Required for Leversets or if Interconnect Device is Specified. Standard latch is for 2 3/8" backset.
Specify 2 3/4" backset if required. To order 28° Rotation Latch with any Sideplate, add product code **Latch28** and list price **\$10**.

STAINLESS STEEL & WROUGHT STEEL - SIDEPLATE LOCKSETS



Stainless Steel Non-Keyed

Description	Product Code	Knob or Lever Style	Finish	List Price
Passage	S801	<i>See Page 6 For Stainless Steel Knob & Lever Options.</i>	Brushed Stainless Steel (SS)	\$168.00
Privacy	S802			\$168.00
Dummy, Pair	S800			\$168.00

- Hercules Lever with Non-Keyed Modern Plate
- Standard 2 1/8" Door Prep

>> Specify by adding "W" to the beginning of Product Code for Weiser® (WR5) Keyway (For example: **WS801HS SS**). No upcharge for cylinder substitution. Can be keyed into existing Weiser® system.

#5 Style Non-Keyed



Description	Product Code	Knob or Lever Style	Finish	List Price
Passage	7105	<i>See Page 6 for Wrought Steel Knob & Lever Options.</i>	Flat Black (FB) Satin Steel	\$144.00
Privacy	7205			\$144.00
Dummy Pair	7055			\$144.00

- Madison Ivory Knob with Non-Keyed #5 Wrought Steel Plate
- Standard 2 1/8" Door Prep

#5 Style 3 5/8" Center to Center Keyed

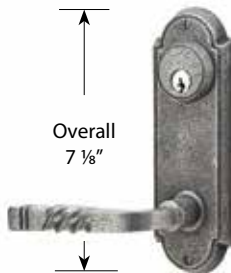

Description	Product Code	Knob or Lever Style	Finish	List Price
Passage/Single Keyed	7010	<i>See Page 6 for Wrought Steel Knob & Lever Options.</i>	Flat Black (FB) Satin Steel	\$160.00
Passage/Double Keyed	7011			\$160.00
Dummy Pair	7015			\$160.00

- San Carlos Lever with Keyed #5 Wrought Steel Plate
- Two Standard 2 1/8" Door Preps, 3 5/8" Center to Center Hole Spacing
- Schlage® C Keyway

>> Specify by adding "W" to the beginning of Product Code for Weiser® (WR5) Keyway (For example: **W7010HL FB**). No upcharge for cylinder substitution. Can be keyed into existing Weiser® system.

SIDEPLATES

SIDEPLATE LOCKSETS - STRETTO NARROW TRIM

STRETTO uses a tubular latch and is available for order in passage, thumb-turn privacy, keyed entry, and dummy functions. It can be paired with any brass Emtek knob or lever. The sleek design of the STRETTO requires a 1 1/4" diameter bore hole and a 2-hole door preparation for privacy thumb-turn and keyed configurations. Additional specifications for this truly unique design include:

- 28 Degree latch Standard. Available in 2 3/8" or 2 3/4" backsets
- Available in Oil Rubbed Bronze (US10B), Satin Nickel (US15), and Polished Chrome (US26) finishes - also available in split finishes
- Trim sizes available are 2" x 10" or 1 1/2" x 11"

STRETTO KEYED ENTRY STYLES



STRETTO NON-KEYED PASSAGE STYLES

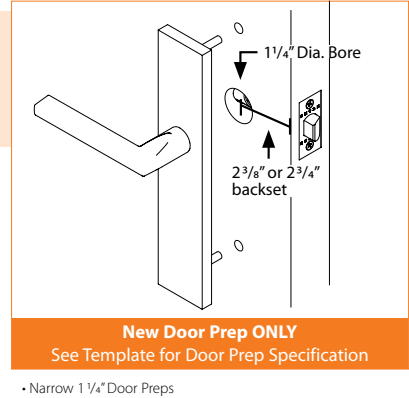

STRETTO THUMBTURN PRIVACY STYLES

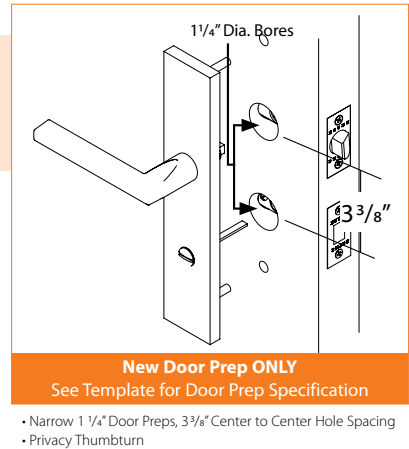

STRETTO DUMMY PAIR STYLES

Available in both 10" and 11"

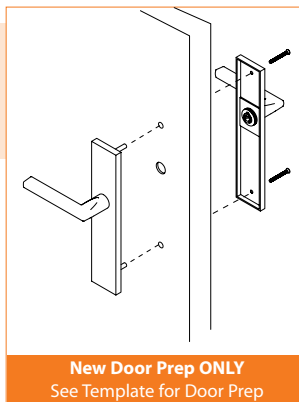

STRETTO DUMMY SINGLE SIDED STYLES

Available in both 10" and 11"

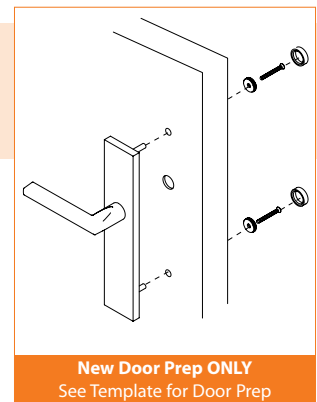

10" STRETTO
Keyed Entry Set

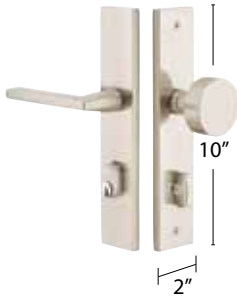

2" x 10" STRETTO Keyed Style

Description	Product Code	Knob or Lever Style	Finish	List Price
Passage/Single Keyed	8442	<i>See Page 4 for Brass Knob & Lever Options.</i>	Oil Rubbed Bronze (US10B) Satin Nickel (US15) Polished Chrome (US26)	\$170.00
Dummy Pair	8042			\$170.00

>> Specify by adding "W" to the beginning of Product Code for Weiser® (WR5) Keyway (For example: **W8442SQU** US10B). No upcharge for cylinder substitution. Can be keyed into existing Weiser® system.

10" STRETTO
Thumbturn Privacy Set



2" x 10" STRETTO Non-Keyed Style

Description	Product Code	Knob or Lever Style	Finish	List Price
Passage	8141	<i>See Page 4 for Brass Knob & Lever Options.</i> <i>See Page 5 for Crystal & Porcelain Knob Options.</i>	Oil Rubbed Bronze (US10B) Satin Nickel (US15) Polished Chrome (US26)	\$154.00
Thumbturn Privacy	8241			\$154.00
Dummy, Pair	8045			\$154.00
Dummy, Single Sided	8041			\$82.00

11" STRETTO
Keyed Entry Set



1 1/2" x 11" STRETTO Keyed Style

Description	Product Code	Knob or Lever Style	Finish	List Price
Passage/Single Keyed	8444	<i>See Page 4 for Brass Knob & Lever Options.</i>	Oil Rubbed Bronze (US10B) Satin Nickel (US15) Polished Chrome (US26)	\$170.00
Dummy Pair	8044			\$170.00

>> Specify by adding "W" to the beginning of Product Code for Weiser® (WR5) Keyway (For example: **W8444HT** US10B). No upcharge for cylinder substitution. Can be keyed into existing Weiser® system.

11" STRETTO
Non-Keyed Passage Set



1 1/2" x 11" STRETTO Non-Keyed Style

Description	Product Code	Knob or Lever Style	Finish	List Price
Passage	8143	<i>See Page 4 for Brass Knob & Lever Options.</i> <i>See Page 5 for Crystal & Porcelain Knob Options.</i>	Oil Rubbed Bronze (US10B) Satin Nickel (US15) Polished Chrome (US26)	\$154.00
Thumbturn Privacy	8243			\$154.00
Dummy, Pair	8046			\$154.00
Dummy, Single Sided	8043			\$82.00

SIDEPLATES

SIDEPLATE LOCKSETS - BRASS THUMBTURN PRIVACY

**Delaware Plates
with Providence Crystal Knobs**



Exterior Interior

**Colonial Plates
with Cortina Levers**



Exterior Interior

**Quincy Plates
with Egg Knobs**

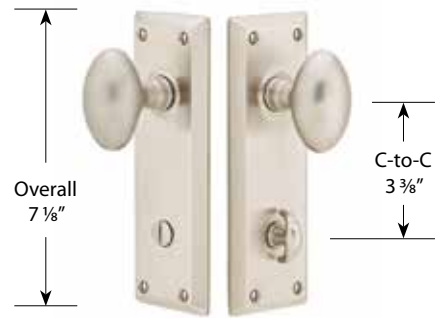

Exterior Interior

Thumbturn Privacy, Non-Keyed Style

Description	Product Code	Knob or Lever Style	Finish	List Price
Delaware Plate 3 3/8" Center to Center	8228	<i>See Page 4 for Brass Knob & Lever Options. See Page 5 for Crystal & Porcelain Knob Options.</i>	Polished Brass (US3) French Antique (US7) Oil Rubbed Bronze (US10B) Satin Nickel (US15) Pewter (US15A) Flat Black (US19) Polished Chrome (US26)	\$156.00
Colonial Plate 3 3/8" Center to Center	8022			\$156.00
Quincy Plate 3 3/8" Center to Center	8226			\$156.00

**Belmont Plates
with Belmont Knobs**



Exterior Interior

**Victoria Plates
with Elan Levers**



Exterior Interior

Thumbturn Privacy, Non-Keyed Style

Description	Product Code	Knob or Lever Style	Finish	List Price
Belmont Plate 3 3/8" Center to Center	8224	<i>See Page 4 for Brass Knob & Lever Options. See Page 5 for Crystal & Porcelain Knob Options.</i>	Polished Brass (US3) French Antique (US7) Oil Rubbed Bronze (US10B) Satin Nickel (US15)	\$156.00
Victoria Plate 3 3/8" Center to Center	8225			\$156.00

BRASS THUMBTURN PRIVACY - SIDEPLATE LOCKSETS

Rope Plates with Rope Levers



Exterior Interior

Oval Beaded Plates with Georgetown Knobs



Exterior Interior

Thumbturn Privacy, Non-Keyed Style

Description	Product Code	Knob or Lever Style	Finish	List Price
Rope Plate 3 3/8" Center to Center	7211	<i>See Page 4 for Brass Knob & Lever Options. See Page 5 for Crystal & Porcelain Knob Options.</i>	Polished Brass (US3) French Antique (US7) Oil Rubbed Bronze (US10B) Satin Nickel (US15)	\$156.00
Oval Beaded Plate 3 3/8" Center to Center	8227			\$156.00

THUMBTURN PRIVACY LOCKSETS - USE WITH BRASS PASSAGE

Cortina Leverset with Thumbturn Privacy Set
Exterior



Cortina Leverset with Thumbturn Privacy Set
Interior



Standard with Thumbturn Privacy Locksets

Thumbturn Privacy can be used with any Emtek Brass Passage Lockset. See Page 90 -101 for Lever & Knob styles.

Description	Product Code	Finish	List Price
Thumbturn Privacy Set	828TP	Polished Brass (US3) French Antique (US7) Oil Rubbed Bronze (US10B) Satin Nickel (US15) Pewter (US15A) Flat Black (US19) Polished Chrome (US26) PVD-Lifetime	\$22.00

Handing Required for Leversets. Standard latch is for 2 3/8" backset. Specify 2 3/4" backset if required. To order 28° Rotation Latch with any Sideplate, add product code **Latch28** and list price **\$10**.

LEVERSETS - BRASS MODERN

Athena Lever
with Neos Rosette



Helios Lever
with Disk Rosette



Hercules Lever
with Square Rosette



Sion Lever
with Disk Rosette



Stuttgart Lever
with Square Rosette



Triton Lever
with Modern Rectangular Rosette



Rosette	Description	CF	Product Code	Lever Style	Finish	Standard List Price	CF Mechanism List Price
Modern 	Passage Set	C	5107	Athena Lever (ATN) Helios Lever (HLO)	Oil Rubbed Bronze (US10B) Satin Nickel (US15)	\$108.00	\$144.00
	Privacy Set	C	5207	Hercules Lever (HEC) Triton Lever (TRT)	Flat Black (US19) Polished Chrome (US26)	\$108.00	\$144.00
	Dummy, Pair	C	5057			\$108.00	\$108.00
Disk 	Passage Set	C	5109	Athena Lever (ATN) Helios Lever (HLO)	Oil Rubbed Bronze (US10B) Polished Nickel (US14)**	\$108.00	\$144.00
	Privacy Set	C	5209	Hercules Lever (HEC) Sion Lever (SIO)*	Satin Nickel (US15) Flat Black (US19)	\$108.00	\$144.00
	Dummy, Pair	C	5059	Stuttgart Lever (STU)* Triton Lever (TRT)	Polished Chrome (US26)	\$108.00	\$108.00
Square 	Passage Set	C	5110	Athena Lever (ATN) Helios Lever (HLO)	Oil Rubbed Bronze (US10B) Polished Nickel (US14)**	\$108.00	\$144.00
	Privacy Set	C	5210	Hercules Lever (HEC) Sion Lever (SIO)*	Satin Nickel (US15) Flat Black (US19)	\$108.00	\$144.00
	Dummy, Pair	C	5050	Stuttgart Lever (STU)* Triton Lever (TRT)	Polished Chrome (US26)	\$108.00	\$108.00
Neos 	Passage Set	C	5111	Athena Lever (ATN) Helios Lever (HLO)	Oil Rubbed Bronze (US10B) Satin Nickel (US15)	\$108.00	\$144.00
	Privacy Set	C	5211	Hercules Lever (HEC) Sion Lever (SIO)*	Flat Black (US19) Polished Chrome (US26)	\$108.00	\$144.00
	Dummy, Pair	C	5051	Stuttgart Lever (STU)* Triton Lever (TRT)		\$108.00	\$108.00
Modern Rectangular 	Passage Set	C	5112	Athena Lever (ATN) Helios Lever (HLO)	Oil Rubbed Bronze (US10B) Satin Nickel (US15)	\$108.00	\$144.00
	Privacy Set	C	5212	Hercules Lever (HEC) Sion Lever (SIO)*	Flat Black (US19) Polished Chrome (US26)	\$108.00	\$144.00
	Dummy, Pair	C	5052	Stuttgart Lever (STU)* Triton Lever (TRT)		\$108.00	\$108.00

* Sion & Stuttgart levers do not fit into Modern rosette. ** Polished Nickel (US14) available only for Helios and Stuttgart levers.

>> **Modern Leversets may be ordered with any Brass rosette at the list price shown above.**
(See page 94-95 for Brass rosette options)

Handing Required For Leversets. Standard latch is for 2³/₈" backset. Specify 2³/₄" backset if required. Maximum door thickness for CF Mechanism is 2¹/₄". Complete set includes Latch and Strike Plate. To order 28° Rotation Latch with any standard Knobset or Leverset, add product code **Latch28** and list price **\$10**.

BRASS MODERN - LEVERSETS

Basel Lever
with Disk Rosette



Aireon Lever
with Modern Rosette



Geneva Lever
with Neos Rosette



Geneva Lever
with Modern Rectangular Rosette



Luzern Lever
with Square Rosette



Mercury Lever
with Square Rosette



Rosette	Description	CF	Product Code	Lever Style	Finish	Standard List Price	CF Mechanism List Price
Modern 	Passage Set	C	5107	Aireon (A) Basel Lever (BA)	Oil Rubbed Bronze (US10B) Satin Nickel (US15)	\$108.00	\$144.00
	Privacy Set	C	5207	Geneva Lever (GV) Luzern Lever (LU)	Flat Black (US19) Polished Chrome (US26)	\$108.00	\$144.00
	Dummy, Pair	C	5057	Mercury Lever (MC)		\$108.00	\$108.00
Disk 	Passage Set	C	5109	Aireon (A) Basel Lever (BA)	Oil Rubbed Bronze (US10B) Polished Nickel (US14)**	\$108.00	\$144.00
	Privacy Set	C	5209	Geneva Lever (GV) Luzern Lever (LU)	Satin Nickel (US15) Flat Black (US19)	\$108.00	\$144.00
	Dummy, Pair	C	5059	Mercury Lever (MC)	Polished Chrome (US26)	\$108.00	\$108.00
Square 	Passage Set	C	5110	Aireon (A) Basel Lever (BA)	Oil Rubbed Bronze (US10B) Polished Nickel (US14)**	\$108.00	\$144.00
	Privacy Set	C	5210	Geneva Lever (GV) Luzern Lever (LU)	Satin Nickel (US15) Flat Black (US19)	\$108.00	\$144.00
	Dummy, Pair	C	5050	Mercury Lever (MC)	Polished Chrome (US26)	\$108.00	\$108.00
Neos 	Passage Set	C	5111	Aireon (A) Basel Lever (BA)	Oil Rubbed Bronze (US10B) Satin Nickel (US15)	\$108.00	\$144.00
	Privacy Set	C	5211	Geneva Lever (GV) Luzern Lever (LU)	Flat Black (US19) Polished Chrome (US26)	\$108.00	\$144.00
	Dummy, Pair	C	5051	Mercury Lever (MC)		\$108.00	\$108.00
Modern Rectangular 	Passage Set	C	5112	Aireon (A) Basel Lever (BA)	Oil Rubbed Bronze (US10B) Satin Nickel (US15)	\$108.00	\$144.00
	Privacy Set	C	5212	Geneva Lever (GV) Luzern Lever (LU)	Flat Black (US19) Polished Chrome (US26)	\$108.00	\$144.00
	Dummy, Pair	C	5052	Mercury Lever (MC)		\$108.00	\$108.00

** Polished Nickel (US14) available only for Geneva lever.

>> **Modern Leversets may be ordered with any Brass rosette at the list price shown above.**
(See page 94-95 for Brass rosette options)

Handing Required For Leversets. Standard latch is for 23/8" backset. Specify 23/4" backset if required. Maximum door thickness for CF Mechanism is 2 1/4". Complete set includes Latch and Strike Plate. To order 28° Rotation Latch with any standard Knobset or Leverset, add product code **Latch28** and list price **\$10**.

PASSAGE & PRIVACY SETS

LEVERSETS - BRASS MODERN

Hermes Lever
with Neos Rosette



Kiel Lever
with Disk Rosette



Poseidon Lever
with Disk Rosette



Poseidon Lever
with Square Rosette



Hermes Lever
with Modern Rosette



Kiel Lever
with Square Rosette



Rosette	Description	CF	Product Code	Lever Style	Finish	Standard List Price	CF Mechanism List Price
Modern 	Passage Set	C	5107	Hermes Lever (HER) Poseidon Lever (POS)	Oil Rubbed Bronze (US10B) Satin Nickel (US15) Polished Chrome (US26)	\$108.00	\$144.00
	Privacy Set	C	5207			\$108.00	\$144.00
	Dummy, Pair	C	5057			\$108.00	\$108.00
Disk 	Passage Set	C	5109	Hermes Lever (HER) Kiel Lever (KIE)* Poseidon Lever (POS)	Oil Rubbed Bronze (US10B) Satin Nickel (US15) Polished Chrome (US26)	\$108.00	\$144.00
	Privacy Set	C	5209			\$108.00	\$144.00
	Dummy, Pair	C	5059			\$108.00	\$108.00
Square 	Passage Set	C	5110	Hermes Lever (HER) Kiel Lever (KIE)* Poseidon Lever (POS)	Oil Rubbed Bronze (US10B) Satin Nickel (US15) Polished Chrome (US26)	\$108.00	\$144.00
	Privacy Set	C	5210			\$108.00	\$144.00
	Dummy, Pair	C	5050			\$108.00	\$108.00
Neos 	Passage Set	C	5111	Hermes Lever (HER) Kiel Lever (KIE)* Poseidon Lever (POS)	Oil Rubbed Bronze (US10B) Satin Nickel (US15) Polished Chrome (US26)	\$108.00	\$144.00
	Privacy Set	C	5211			\$108.00	\$144.00
	Dummy, Pair	C	5051			\$108.00	\$108.00
Modern Rectangular 	Passage Set	C	5112	Hermes Lever (HER) Kiel Lever (KIE)* Poseidon Lever (POS)	Oil Rubbed Bronze (US10B) Satin Nickel (US15) Polished Chrome (US26)	\$108.00	\$144.00
	Privacy Set	C	5212			\$108.00	\$144.00
	Dummy, Pair	C	5052			\$108.00	\$108.00

* Kiel lever does not fit into Modern rosette.

>> **Modern Leversets may be ordered with any Brass rosette at the list price shown above.**
(See page 94-95 for Brass rosette options)

Handing Required For Leversets. Standard latch is for 2³/₈" backset. Specify 2³/₄" backset if required. Maximum door thickness for CF Mechanism is 2¹/₄". Complete set includes Latch and Strike Plate. To order 28° Rotation Latch with any standard Knobset or Leverset, add product code **Latch28** and list price **\$10**.

Bern Knob
with Square Rosette



Square Knob
with Modern Rectangular Rosette



Orb Knob
with Disk Rosette



Round Knob
with Square Rosette



Octagon Knob
with Modern Rosette



Rosette	Description	CF	Product Code	Knob Style	Finish	Standard List Price	CF Mechanism List Price
Modern 	Passage Set	C	5107	Bern Knob (BN) Octagon Knob (OCT)	Oil Rubbed Bronze (US10B) Satin Nickel (US15)	\$112.00	\$148.00
	Privacy Set	C	5207	Orb Knob (OR) Round Knob (ROU)	Flat Black (US19)** Polished Chrome (US26)	\$112.00	\$148.00
	Dummy, Pair	C	5057	Square Knob (SQU)		\$112.00	\$112.00
Disk 	Passage Set	C	5109	Bern Knob (BN) Octagon Knob (OCT)	Oil Rubbed Bronze (US10B) Polished Nickel (US14)*	\$112.00	\$148.00
	Privacy Set	C	5209	Orb Knob (OR) Round Knob (ROU)	Satin Nickel (US15) Flat Black (US19)**	\$112.00	\$148.00
	Dummy, Pair	C	5059	Square Knob (SQU)	Polished Chrome (US26)	\$112.00	\$112.00
Square 	Passage Set	C	5110	Bern Knob (BN) Octagon Knob (OCT)	Oil Rubbed Bronze (US10B) Polished Nickel (US14)*	\$112.00	\$148.00
	Privacy Set	C	5210	Orb Knob (OR) Round Knob (ROU)	Satin Nickel (US15) Flat Black (US19)**	\$112.00	\$148.00
	Dummy, Pair	C	5050	Square Knob (SQU)	Polished Chrome (US26)	\$112.00	\$112.00
Neos 	Passage Set	C	5111	Bern Knob (BN) Octagon Knob (OCT)	Oil Rubbed Bronze (US10B) Satin Nickel (US15)	\$112.00	\$148.00
	Privacy Set	C	5211	Orb Knob (OR) Round Knob (ROU)	Flat Black (US19)** Polished Chrome (US26)	\$112.00	\$148.00
	Dummy, Pair	C	5051	Square Knob (SQU)		\$112.00	\$112.00
Modern Rectangular 	Passage Set	C	5112	Bern Knob (BN) Octagon Knob (OCT)	Oil Rubbed Bronze (US10B) Satin Nickel (US15)	\$112.00	\$148.00
	Privacy Set	C	5212	Orb Knob (OR) Round Knob (ROU)	Flat Black (US19)** Polished Chrome (US26)	\$112.00	\$148.00
	Dummy, Pair	C	5052	Square Knob (SQU)		\$112.00	\$112.00

* Polished Nickel (US14) available only for Round knob. ** Flat Black (US19) NOT available for Octagon knob.

>> **Modern Knobsets may be ordered with any Brass rosette at the list price shown above.**
(See page 96-97 for Brass rosette options)

Handing Not Required For Knobsets. Standard latch is for 2 3/8" backset. Specify 2 3/4" backset if required. Maximum door thickness for CF Mechanism is 2 1/4". Complete set includes Latch and Strike Plate. To order 28° Rotation Latch with any standard Knobset or Leverset, add product code **Latch28** and list price **\$10**.

PASSAGE & PRIVACY SETS

LEVERSETS - BRASS CLASSIC

Cortina Lever
with Regular Rosette



Milano Lever
with #8 Rosette



Cortina Lever
with Ribbon & Reed Rosette



Rustic Lever
with Oval Rosette



Turino Lever
with Oval Rosette



Rustic Lever
with Rope Rosette



Rosette	Description	CF	Product Code	Lever Style	Finish	Standard List Price	CF Mechanism List Price
Regular 	Passage Set	C	8100	Cortina Lever (C) Milano Lever (M) Rope Lever (RL) Rustic Lever (R) Turino Lever (T)	Polished Brass (US3) French Antique (US7) Oil Rubbed Bronze (US10B)	\$86.00	\$122.00
	Privacy Set	C	8200	Rustic Lever (R) Turino Lever (T)	Polished Nickel (US14)* Satin Nickel (US15) Pewter (US15A) Flat Black (US19)** Polished Chrome (US26) PVD-Lifetime	\$86.00	\$122.00
	Dummy, Pair	C	8050			\$86.00	\$86.00
Rope 	Passage Set	C	8101	Cortina Lever (C) Milano Lever (M) Rope Lever (RL) Rustic Lever (R) Turino Lever (T)	Polished Brass (US3) French Antique (US7) Oil Rubbed Bronze (US10B)	\$86.00	\$122.00
	Privacy Set	C	8201	Rustic Lever (R) Turino Lever (T)	Satin Nickel (US15) Pewter (US15A) Polished Chrome (US26) PVD-Lifetime	\$86.00	\$122.00
	Dummy, Pair	C	8051			\$86.00	\$86.00
Lancaster 	Passage Set	C	8106	Cortina Lever (C) Milano Lever (M) Rope Lever (RL) Rustic Lever (R) Turino Lever (T)	Polished Brass (US3) French Antique (US7) Oil Rubbed Bronze (US10B)	\$86.00	\$122.00
	Privacy Set	C	8206	Rustic Lever (R) Turino Lever (T)	Satin Nickel (US15) Pewter (US15A) Polished Chrome (US26)	\$86.00	\$122.00
	Dummy, Pair	C	8056			\$86.00	\$86.00
Ribbon & Reed 	Passage Set	C	8107	Cortina Lever (C) Milano Lever (M) Rope Lever (RL) Rustic Lever (R) Turino Lever (T)	Polished Brass (US3) French Antique (US7) Oil Rubbed Bronze (US10B)	\$86.00	\$122.00
	Privacy Set	C	8207	Rustic Lever (R) Turino Lever (T)	Satin Nickel (US15) Pewter (US15A) Polished Chrome (US26) PVD-Lifetime	\$86.00	\$122.00
	Dummy, Pair	C	8057			\$86.00	\$86.00

* Polished Nickel (US14) available only for Cortina and Turino levers. ** Flat Black (US19) NOT available for Rope and Rustic levers.

>> **Classic Leversets may be ordered with any Modern rosette at the list price shown above.**
(See page 90 for Modern rosette options)

Handing Required For Leversets. Standard latch is for 2³/₈" backset. Specify 2³/₄" backset if required. Maximum door thickness for CF Mechanism is 2¹/₄". Complete set includes Latch and Strike Plate. To order 28° Rotation Latch with any standard Knobset or Leverset, add product code **Latch28** and list price **\$10**. Polished Brass (US3) and French Antique (US7) are available in Unlacquered finish with additional \$14 NET upcharge.

Turino Lever
with Quincy Rosette



Cortina Lever
with #8 Rosette



Milano Lever
with Rectangular Rosette



Rope Lever
with Rope Rosette





Turino Lever
with Lancaster Rosette



Rope Lever
with Regular Rosette



Rosette	Description	CF	Product Code	Lever Style	Finish	Standard List Price	CF Mechanism List Price
#8 	Passage Set	C	8108	Cortina Lever (C) Milano Lever (M) Rope Lever (RL)	Polished Brass (US3) French Antique (US7) Oil Rubbed Bronze (US10B)	\$86.00	\$122.00
	Privacy Set	C	8208	Rustic Lever (R) Turino Lever (T)	Polished Nickel (US14)* Satin Nickel (US15) Pewter (US15A)	\$86.00	\$122.00
	Dummy, Pair	C	8058		Flat Black (US19)** Polished Chrome (US26) PVD-Lifetime	\$86.00	\$86.00
Oval 	Passage Set	C	8120	Cortina Lever (C) Milano Lever (M) Rope Lever (RL)	Polished Brass (US3) French Antique (US7) Oil Rubbed Bronze (US10B)	\$86.00	\$122.00
	Privacy Set	C	8220	Rustic Lever (R) Turino Lever (T)	Satin Nickel (US15) Pewter (US15A)	\$86.00	\$122.00
	Dummy, Pair	C	8520		Flat Black (US19)** Polished Chrome (US26) PVD-Lifetime	\$86.00	\$86.00
Rectangular 	Passage Set	C	8121	Cortina Lever (C) Milano Lever (M) Rope Lever (RL)	Polished Brass (US3) French Antique (US7) Oil Rubbed Bronze (US10B)	\$86.00	\$122.00
	Privacy Set	C	8221	Rustic Lever (R) Turino Lever (T)	Polished Nickel (US14)* Satin Nickel (US15) Pewter (US15A)	\$86.00	\$122.00
	Dummy, Pair	C	8521		Flat Black (US19)** Polished Chrome (US26)	\$86.00	\$86.00
Quincy 	Passage Set	C	8131	Cortina Lever (C) Milano Lever (M) Rope Lever (RL)	Polished Brass (US3) French Antique (US7) Oil Rubbed Bronze (US10B)	\$86.00	\$122.00
	Privacy Set	C	8231	Rustic Lever (R) Turino Lever (T)	Satin Nickel (US15) Pewter (US15A)	\$86.00	\$122.00
	Dummy, Pair	C	8531		Flat Black (US19)** Polished Chrome (US26) PVD-Lifetime	\$86.00	\$86.00

* Polished Nickel (US14) available only for Cortina and Turino levers. ** Flat Black (US19) NOT available for Rope and Rustic levers.

>> **Classic Leversets may be ordered with any Modern rosette at the list price shown above.**
(See page 90 for Modern rosette options)

Handing Required For Leversets. Standard latch is for 2³/₈" backset. Specify 2³/₄" backset if required. Maximum door thickness for CF Mechanism is 2¹/₄". Complete set includes Latch and Strike Plate. To order 28° Rotation Latch with any standard Knobset or Leverset, add product code **Latch28** and list price **\$10**. Polished Brass (US3) and French Antique (US7) are available in Unlacquered finish with additional \$14 NET upcharge.

KNOBSETS - BRASS CLASSIC

Waverly Knob
with Quincy Rosette



Providence Knob
with Regular Rosette



Egg Knob
with Rectangular Rosette



Rope Knob
with #8 Rosette



Egg Knob
with Oval Rosette



Norwich Knob
with #8 Rosette



Rosette	Description	CF	Product Code	Knob Style	Finish	Standard List Price	CF Mechanism List Price
Regular 	Passage Set	C	8100	Egg Knob (E) Norwich Knob (NW) Providence Knob (P)	Polished Brass (US3)* French Antique (US7) Oil Rubbed Bronze (US10B)	\$96.00	\$132.00
	Privacy Set	C	8200	Rope Knob (RK) Waverly Knob (W)	Polished Nickel (US14)** Satin Nickel (US15) Pewter (US15A) Flat Black (US19)*** Polished Chrome (US26) PVD-Lifetime	\$96.00	\$132.00
	Dummy, Pair	C	8050			\$96.00	\$96.00
Rope 	Passage Set	C	8101	Egg Knob (E) Norwich Knob (NW) Providence Knob (P)	Polished Brass (US3)* French Antique (US7) Oil Rubbed Bronze (US10B)	\$96.00	\$132.00
	Privacy Set	C	8201	Rope Knob (RK) Waverly Knob (W)	Satin Nickel (US15) Pewter (US15A) Polished Chrome (US26) PVD-Lifetime	\$96.00	\$132.00
	Dummy, Pair	C	8051			\$96.00	\$96.00
Lancaster 	Passage Set	C	8106	Egg Knob (E) Norwich Knob (NW) Providence Knob (P)	Polished Brass (US3)* French Antique (US7) Oil Rubbed Bronze (US10B)	\$96.00	\$132.00
	Privacy Set	C	8206	Rope Knob (RK) Waverly Knob (W)	Satin Nickel (US15) Pewter (US15A) Polished Chrome (US26)	\$96.00	\$132.00
	Dummy, Pair	C	8056			\$96.00	\$96.00
Ribbon & Reed 	Passage Set	C	8107	Egg Knob (E) Norwich Knob (NW) Providence Knob (P)	Polished Brass (US3)* French Antique (US7) Oil Rubbed Bronze (US10B)	\$96.00	\$132.00
	Privacy Set	C	8207	Rope Knob (RK) Waverly Knob (W)	Satin Nickel (US15) Pewter (US15A) Polished Chrome (US26) PVD-Lifetime	\$96.00	\$132.00
	Dummy, Pair	C	8057			\$96.00	\$96.00

*Polished Brass (US3) NOT available for Norwich knob. ** Polished Nickel (US14) NOT available for Rope knob.
*** Flat Black (US19) NOT available for Norwich & Rope knobs.

>> **Classic Knobsets may be ordered with any Modern rosette at the list price shown above.**
(See page 93 for Modern rosette options)

Handing Not Required For Knobsets. Standard latch is for 2³/₈" backset. Specify 2³/₄" backset if required. Maximum door thickness for CF Mechanism is 2¹/₄". Complete set includes Latch and Strike Plate. To order 28° Rotation Latch with any standard Knobset or Leverset, add product code **Latch28** and list price **\$10**. Polished Brass (US3) and French Antique (US7) are available in Unlacquered finish with additional \$14 NET upcharge.

Egg Knob
with Regular Rosette



Waverly Knob
with Rope Rosette



Norwich Knob
with Regular Rosette



Rope Knob
with Rope Rosette



Egg Knob
with Lancaster Rosette



Providence Knob
with Quincy Rosette



Rosette	Description	CF	Product Code	Knob Style	Finish	Standard List Price	CF Mechanism List Price		
#8 	Passage Set	C	8108	Egg Knob (E) Norwich Knob (NW) Providence Knob (P)	Polished Brass (US3)* French Antique (US7) Oil Rubbed Bronze (US10B)	\$96.00	\$132.00		
	Privacy Set	C	8208	Rope Knob (RK) Waverly Knob (W)	Polished Nickel (US14)** Satin Nickel (US15) Pewter (US15A)			\$96.00	\$132.00
	Dummy, Pair	C	8058		Flat Black (US19)*** Polished Chrome (US26) PVD-Lifetime			\$96.00	\$96.00
Oval 	Passage Set	C	8120	Egg Knob (E) Norwich Knob (NW) Providence Knob (P)	Polished Brass (US3)* French Antique (US7) Oil Rubbed Bronze (US10B)	\$96.00	\$132.00		
	Privacy Set	C	8220	Rope Knob (RK) Waverly Knob (W)	Satin Nickel (US15) Pewter (US15A)			\$96.00	\$132.00
	Dummy, Pair	C	8520		Flat Black (US19)*** Polished Chrome (US26) PVD-Lifetime			\$96.00	\$96.00
Rectangular 	Passage Set	C	8121	Egg Knob (E) Norwich Knob (NW) Providence Knob (P)	Polished Brass (US3)* French Antique (US7) Oil Rubbed Bronze (US10B)	\$96.00	\$132.00		
	Privacy Set	C	8221	Rope Knob (RK) Waverly Knob (W)	Polished Nickel (US14)** Satin Nickel (US15) Pewter (US15A)			\$96.00	\$132.00
	Dummy, Pair	C	8521		Flat Black (US19)*** Polished Chrome (US26)			\$96.00	\$96.00
Quincy 	Passage Set	C	8131	Egg Knob (E) Norwich Knob (NW) Providence Knob (P)	Polished Brass (US3)* French Antique (US7) Oil Rubbed Bronze (US10B)	\$96.00	\$132.00		
	Privacy Set	C	8231	Rope Knob (RK) Waverly Knob (W)	Satin Nickel (US15) Pewter (US15A)			\$96.00	\$132.00
	Dummy, Pair	C	8531		Flat Black (US19)*** Polished Chrome (US26) PVD-Lifetime			\$96.00	\$96.00

*Polished Brass (US3) NOT available for Norwich knob. ** Polished Nickel (US14) NOT available for Rope knob.

*** Flat Black (US19) NOT available for Norwich & Rope knobs.

>> **Classic Knobsets may be ordered with any Modern rosette at the list price shown above.**
(See page 93 for Modern rosette options)

Handing Not Required For Knobsets. Standard latch is for 2³/₈" backset. Specify 2³/₄" backset if required. Maximum door thickness for CF Mechanism is 2¹/₄". Complete set includes Latch and Strike Plate. To order 28° Rotation Latch with any standard Knobset or Leverset, add product code **Latch28** and list price **\$10**. Polished Brass (US3) and French Antique (US7) are available in Unlacquered finish with additional \$14 NET upcharge.

LEVERSETS - BRASS DESIGNER

Coventry Lever
with Regular Rosette



Ribbon & Reed Lever
with Ribbon & Reed Rosette



Lafayette Brass Lever
with Rope Style Rosette



Elan Lever
with #8 Rosette



Elan Lever
with Oval Rosette



Wembley Lever
with Regular Rosette



Rosette	Description	CF	Product Code	Lever Style	Finish	Standard List Price	CF Mechanism List Price
Regular 	Passage Set	C	8100	Coventry Lever (CV) Elan Lever (EN) Lafayette Brass Lever (LB)	Polished Brass (US3)* French Antique (US7) Oil Rubbed Bronze (US10B)	\$114.00	\$150.00
	Privacy Set	C	8200	Ribbon & Reed Lever (RBL) Santa Fe Lever (SF) Wembley Lever (WM)	Satin Nickel (US15) Pewter (US15A) Flat Black (US19)** Polished Chrome (US26) PVD-Lifetime	\$114.00	\$150.00
	Dummy, Pair	C	8050			\$114.00	\$114.00
Rope 	Passage Set	C	8101	Coventry Lever (CV) Elan Lever (EN) Lafayette Brass Lever (LB)	Polished Brass (US3)* French Antique (US7) Oil Rubbed Bronze (US10B)	\$114.00	\$150.00
	Privacy Set	C	8201	Ribbon & Reed Lever (RBL) Santa Fe Lever (SF) Wembley Lever (WM)	Satin Nickel (US15) Pewter (US15A) Polished Chrome (US26) PVD-Lifetime	\$114.00	\$150.00
	Dummy, Pair	C	8051			\$114.00	\$114.00
Lancaster 	Passage Set	C	8106	Coventry Lever (CV) Elan Lever (EN) Lafayette Brass Lever (LB)	Polished Brass (US3)* French Antique (US7) Oil Rubbed Bronze (US10B)	\$114.00	\$150.00
	Privacy Set	C	8206	Ribbon & Reed Lever (RBL) Santa Fe Lever (SF) Wembley Lever (WM)	Satin Nickel (US15) Pewter (US15A) Polished Chrome (US26)	\$114.00	\$150.00
	Dummy, Pair	C	8056			\$114.00	\$114.00
Ribbon & Reed 	Passage Set	C	8107	Coventry Lever (CV) Elan Lever (EN) Lafayette Brass Lever (LB)	Polished Brass (US3)* French Antique (US7) Oil Rubbed Bronze (US10B)	\$114.00	\$150.00
	Privacy Set	C	8207	Ribbon & Reed Lever (RBL) Santa Fe Lever (SF) Wembley Lever (WM)	Satin Nickel (US15) Pewter (US15A) Polished Chrome (US26) PVD-Lifetime	\$114.00	\$150.00
	Dummy, Pair	C	8057			\$114.00	\$114.00

* Polished Brass (US3) NOT available for Coventry lever. ** Flat Black (US19) available for Elan and Wembley levers only.

>> **Designer Leversets may be ordered with any Modern rosette at the list price shown above.**
(See page 90 for Modern rosette options)

Handing Required For Leversets. Standard latch is for 2³/₈" backset. Specify 2³/₄" backset if required. Maximum door thickness for CF Mechanism is 2¹/₄". Complete set includes Latch and Strike Plate. To order 28° Rotation Latch with any standard Knobset or Leverset, add product code **Latch28** and list price **\$10**. Polished Brass (US3) and French Antique (US7) are available in Unlacquered finish with additional \$14 NET upcharge.

Ribbon & Reed Lever
with Quincy Rosette



Lafayette Brass Lever
with #8 Rosette



Wembley Lever
with Ribbon & Reed Rosette



Coventry Lever
with Quincy Rosette



Santa Fe Lever
with Rope Rosette



Elan Lever
with Regular Rosette



Rosette	Description	CF	Product Code	Lever Style	Finish	Standard List Price	CF Mechanism List Price
#8 	Passage Set	C	8108	Coventry Lever (CV) Elan Lever (EN) Lafayette Brass Lever (LB)	Polished Brass (US3)* French Antique (US7) Oil Rubbed Bronze (US10B)	\$114.00	\$150.00
	Privacy Set	C	8208	Ribbon & Reed Lever (RBL) Santa Fe Lever (SF) Wembley Lever (WM)	Satin Nickel (US15) Pewter (US15A) Flat Black (US19)**	\$114.00	\$150.00
	Dummy, Pair	C	8058		Polished Chrome (US26) PVD-Lifetime	\$114.00	\$114.00
Oval 	Passage Set	C	8120	Coventry Lever (CV) Elan Lever (EN) Lafayette Brass Lever (LB)	Polished Brass (US3)* French Antique (US7) Oil Rubbed Bronze (US10B)	\$114.00	\$150.00
	Privacy Set	C	8220	Ribbon & Reed Lever (RBL) Santa Fe Lever (SF)	Satin Nickel (US15) Flat Black (US19)**	\$114.00	\$150.00
	Dummy, Pair	C	8520	Wembley Lever (WM)	Pewter (US15A) Polished Chrome (US26) PVD-Lifetime	\$114.00	\$114.00
Rectangular 	Passage Set	C	8121	Coventry Lever (CV) Elan Lever (EN) Lafayette Brass Lever (LB)	Polished Brass (US3)* French Antique (US7) Oil Rubbed Bronze (US10B)	\$114.00	\$150.00
	Privacy Set	C	8221	Ribbon & Reed Lever (RBL) Santa Fe Lever (SF)	Satin Nickel (US15) Flat Black (US19)**	\$114.00	\$150.00
	Dummy, Pair	C	8521	Wembley Lever (WM)	Pewter (US15A) Polished Chrome (US26)	\$114.00	\$114.00
Quincy 	Passage Set	C	8131	Coventry Lever (CV) Elan Lever (EN) Lafayette Brass Lever (LB)	Polished Brass (US3)* French Antique (US7) Oil Rubbed Bronze (US10B)	\$114.00	\$150.00
	Privacy Set	C	8231	Ribbon & Reed Lever (RBL) Santa Fe Lever (SF)	Satin Nickel (US15) Flat Black (US19)**	\$114.00	\$150.00
	Dummy, Pair	C	8531	Wembley Lever (WM)	Polished Chrome (US26) PVD-Lifetime	\$114.00	\$114.00

* Polished Brass (US3) NOT available for Coventry lever. ** Flat Black (US19) available for Elan and Wembley levers only.

>> **Designer Leversets may be ordered with any Modern rosette at the list price shown above.**
(See page 90 for Modern rosette options)

Handing Required For Leversets. Standard latch is for 2³/₈" backset. Specify 2³/₄" backset if required. Maximum door thickness for CF Mechanism is 2¹/₄". Complete set includes Latch and Strike Plate. To order 28° Rotation Latch with any standard Knobset or Leverset, add product code **Latch28** and list price **\$10**. Polished Brass (US3) and French Antique (US7) are available in Unlacquered finish with additional \$14 NET upcharge.

PASSAGE & PRIVACY SETS

Beaded Egg Knob
with Regular Rosette



Belmont Knob
with Rope Rosette



Melon Knob
with Regular Rosette



Melon Knob
with Quincy Rosette



Victoria Knob
with Oval Rosette



Ribbon & Reed Knob
with #8 Rosette



Rosette	Description	CF	Product Code	Knob Style	Finish	Standard List Price	CF Mechanism List Price
Regular 	Passage Set	C	8100	Beaded Egg Knob (BE)* Belmont Knob (BT)* Lancaster Knob (LN)*	Polished Brass (US3) French Antique (US7) Oil Rubbed Bronze (US10B)	\$118.00	\$154.00
	Privacy Set	C	8200	Melon Knob (MN) Ribbon & Reed Knob (RBK) Victoria Knob (V)*	Satin Nickel (US15) Pewter (US15A) Flat Black (US19)** Polished Chrome (US26) PVD-Lifetime	\$118.00	\$154.00
	Dummy, Pair	C	8050			\$118.00	\$118.00
Rope 	Passage Set	C	8101	Beaded Egg Knob (BE)* Belmont Knob (BT)* Lancaster Knob (LN)*	Polished Brass (US3) French Antique (US7) Oil Rubbed Bronze (US10B)	\$118.00	\$154.00
	Privacy Set	C	8201	Melon Knob (MN) Ribbon & Reed Knob (RBK) Victoria Knob (V)*	Satin Nickel (US15) Pewter (US15A) Polished Chrome (US26) PVD-Lifetime	\$118.00	\$154.00
	Dummy, Pair	C	8051			\$118.00	\$118.00
Lancaster 	Passage Set	C	8106	Beaded Egg Knob (BE)* Belmont Knob (BT)* Lancaster Knob (LN)*	Polished Brass (US3) French Antique (US7) Oil Rubbed Bronze (US10B)	\$118.00	\$154.00
	Privacy Set	C	8206	Melon Knob (MN) Ribbon & Reed Knob (RBK) Victoria Knob (V)*	Satin Nickel (US15) Pewter (US15A) Polished Chrome (US26)	\$118.00	\$154.00
	Dummy, Pair	C	8056			\$118.00	\$118.00
Ribbon & Reed 	Passage Set	C	8107	Beaded Egg Knob (BE)* Belmont Knob (BT)* Lancaster Knob (LN)*	Polished Brass (US3) French Antique (US7) Oil Rubbed Bronze (US10B)	\$118.00	\$154.00
	Privacy Set	C	8207	Melon Knob (MN) Ribbon & Reed Knob (RBK) Victoria Knob (V)*	Satin Nickel (US15) Pewter (US15A) Polished Chrome (US26) PVD-Lifetime	\$118.00	\$154.00
	Dummy, Pair	C	8057			\$118.00	\$118.00

* Beaded Egg, Belmont, Lancaster, and Victoria knobs are available in US3, US7, US10B, US15 only. ** Flat Black (US19) available for Melon knob only.

>> **Designer Knobsets may be ordered with any Modern rosette at the list price shown above.**
(See page 93 for Modern rosette options)

Handing Not Required For Knobsets. Standard latch is for 2³/₈" backset. Specify 2³/₄" backset if required. Maximum door thickness for CF Mechanism is 2¹/₄". Complete set includes Latch and Strike Plate. To order 28° Rotation Latch with any standard Knobset or Leverset, add product code **Latch28** and list price **\$10**. Polished Brass (US3) and French Antique (US7) are available in Unlacquered finish with additional \$14 NET upcharge.

Beaded Egg Knob
with Oval Rosette



Belmont Knob
with Quincy Rosette



Lancaster Knob
with #8 Rosette



Lancaster Knob
with Lancaster Rosette



Ribbon & Reed Knob
with Ribbon & Reed Rosette



Victoria Knob
with Rope Rosette



Rosette	Description	CF	Product Code	Knob Style	Finish	Standard List Price	CF Mechanism List Price
#8 	Passage Set	C	8108	Beaded Egg Knob (BE)* Belmont Knob (BT)* Lancaster Knob (LN)*	Polished Brass (US3) French Antique (US7) Oil Rubbed Bronze (US10B)	\$118.00	\$154.00
	Privacy Set	C	8208	Melon Knob (MN) Ribbon & Reed Knob (RBK) Victoria Knob (V)*	Satin Nickel (US15) Pewter (US15A) Flat Black (US19)** Polished Chrome (US26) PVD-Lifetime	\$118.00	\$154.00
	Dummy, Pair	C	8058			\$118.00	\$118.00
Oval 	Passage Set	C	8120	Beaded Egg Knob (BE)* Belmont Knob (BT)* Lancaster Knob (LN)*	Polished Brass (US3) French Antique (US7) Oil Rubbed Bronze (US10B)	\$118.00	\$154.00
	Privacy Set	C	8220	Melon Knob (MN) Ribbon & Reed Knob (RBK) Victoria Knob (V)*	Satin Nickel (US15) Pewter (US15A) Flat Black (US19)** Polished Chrome (US26) PVD-Lifetime	\$118.00	\$154.00
	Dummy, Pair	C	8520			\$118.00	\$118.00
Rectangular 	Passage Set	C	8121	Beaded Egg Knob (BE)* Belmont Knob (BT)* Lancaster Knob (LN)*	Polished Brass (US3) French Antique (US7) Oil Rubbed Bronze (US10B)	\$118.00	\$154.00
	Privacy Set	C	8221	Melon Knob (MN) Ribbon & Reed Knob (RBK) Victoria Knob (V)*	Satin Nickel (US15) Pewter (US15A) Flat Black (US19)** Polished Chrome (US26)	\$118.00	\$154.00
	Dummy, Pair	C	8521			\$118.00	\$118.00
Quincy 	Passage Set	C	8131	Beaded Egg Knob (BE)* Belmont Knob (BT)* Lancaster Knob (LN)*	Polished Brass (US3) French Antique (US7) Oil Rubbed Bronze (US10B)	\$118.00	\$154.00
	Privacy Set	C	8231	Melon Knob (MN) Ribbon & Reed Knob (RBK) Victoria Knob (V)*	Satin Nickel (US15) Pewter (US15A) Flat Black (US19)** Polished Chrome (US26) PVD-Lifetime	\$118.00	\$154.00
	Dummy, Pair	C	8531			\$118.00	\$118.00

* Beaded Egg, Belmont, Lancaster, and Victoria knobs are available in US3, US7, US10B, US15 only. ** Flat Black (US19) available for Melon knob only.

>> **Designer Knobsets may be ordered with any Modern rosette at the list price shown above.**
(See page 93 for Modern rosette options)

Handing Not Required For Knobsets. Standard latch is for 2³/₈" backset. Specify 2³/₄" backset if required. Maximum door thickness for CF Mechanism is 2¹/₄". Complete set includes Latch and Strike Plate. To order 28° Rotation Latch with any standard Knobset or Leverset, add product code **Latch28** and list price **\$10**. Polished Brass (US3) and French Antique (US7) are available in Unlacquered finish with additional \$14 NET upcharge.

LEVERSETS - SANDCAST BRONZE

Yuma Lever
with #6 Rosette



Teton Lever
with #4 Rosette



Montrose Lever
with #3 Rosette



Cody Lever
with #2 Rosette



Lariat Lever
with #4 Rosette



Durango Lever
with #1 Rosette







Cimarron Lever
with #2 Rosette



Aurora Lever
with #6 Rosette



Rosette	Description	CF	Product Code	Lever Style	Finish	Standard List Price	CF Mechanism List Price
	Passage Set	C	7108	Aurora Lever (AR) Cimarron Lever (CR) Cody Lever (CD)	Deep Burgundy (DB) Flat Black (FB) Medium Bronze (MB)	\$126.00	\$162.00
	Privacy Set	C	7208	Durango Lever (D) Lariat Lever (LR)*	Polished White Bronze (WB) Tumbled White Bronze (TWB)	\$126.00	\$162.00
	Dummy, Pair	C	7058	Montrose Lever (MT) Teton Lever (TT) Yuma Lever (YM)*		\$126.00	\$126.00
	Passage Set	C	7106	Aurora Lever (AR) Cimarron Lever (CR) Cody Lever (CD)	Deep Burgundy (DB) Flat Black (FB) Medium Bronze (MB)	\$126.00	\$162.00
	Privacy Set	C	7206	Durango Lever (D) Lariat Lever (LR)*	Polished White Bronze (WB) Tumbled White Bronze (TWB)	\$126.00	\$162.00
	Dummy, Pair	C	7056	Montrose Lever (MT) Teton Lever (TT) Yuma Lever (YM)*		\$126.00	\$126.00
	Passage Set	C	7104	Aurora Lever (AR) Cimarron Lever (CR) Cody Lever (CD)	Deep Burgundy (DB) Flat Black (FB) Medium Bronze (MB)	\$126.00	\$162.00
	Privacy Set	C	7204	Durango Lever (D) Lariat Lever (LR)*	Polished White Bronze (WB) Tumbled White Bronze (TWB)	\$126.00	\$162.00
	Dummy, Pair	C	7054	Montrose Lever (MT) Teton Lever (TT) Yuma Lever (YM)*		\$126.00	\$126.00
	Passage Set	C	7100	Aurora Lever (AR) Cimarron Lever (CR) Cody Lever (CD)	Deep Burgundy (DB) Flat Black (FB) Medium Bronze (MB)	\$126.00	\$162.00
	Privacy Set	C	7200	Durango Lever (D) Lariat Lever (LR)*	Polished White Bronze (WB) Tumbled White Bronze (TWB)	\$126.00	\$162.00
	Dummy, Pair	C	7050	Montrose Lever (MT) Teton Lever (TT) Yuma Lever (YM)*		\$126.00	\$126.00
	Passage Set	C	7111	Aurora Lever (AR) Cimarron Lever (CR) Cody Lever (CD)	Flat Black (FB) Medium Bronze (MB)	\$126.00	\$162.00
	Privacy Set	C	7211	Durango Lever (D) Lariat Lever (LR)*	Polished White Bronze (WB) Tumbled White Bronze (TWB)	\$126.00	\$162.00
	Dummy, Pair	C	7061	Montrose Lever (MT) Teton Lever (TT) Yuma Lever (YM)*		\$126.00	\$126.00

* Lariat and Yuma levers are NOT available in Deep Burgundy (DB) finish.

Handing Required For Leversets. Standard latch is for 2³/₈" backset. Specify 2³/₄" backset if required. Maximum door thickness for CF Mechanism is 2¹/₄". Complete set includes Latch and Strike Plate. To order 28° Rotation Latch with any standard Knobset or Leverset, add product code **Latch28** and list price **\$10**.

SANDCAST BRONZE - KNOBSETS

Butte Knob
with #4 Rosette



Round Knob
with #6 Rosette



Winchester Knob
with #3 Rosette



Egg Knob
with #6 Rosette



Providence Crystal Knob
with #4 Rosette



Hampton Knob
with #1 Rosette



Bristol Knob
with #2 Rosette



Round Knob
with #6 Rosette



Rosette	Description	CF	Product Code	Knob Style	Finish	Standard List Price	CF Mechanism List Price
	Passage Set	C	7108	Bristol Knob (BL) Butte Knob (BU)	Deep Burgundy (DB) Flat Black (FB)	\$130.00	\$166.00
	Privacy Set	C	7208	Egg Knob (BZEG) Hampton Knob (HT)	Medium Bronze (MB) Polished White Bronze (WB)	\$130.00	\$166.00
	Dummy, Pair	C	7058	Providence Crystal Knob (PC) Winchester Knob (WC) Round Knob (BZRN)*	Tumbled White Bronze (TWB)	\$130.00	\$130.00
	Passage Set	C	7106	Bristol Crystal Knob (BL) Butte Knob (BU)	Deep Burgundy (DB) Flat Black (FB)	\$130.00	\$166.00
	Privacy Set	C	7206	Egg Knob (BZEG) Hampton Crystal Knob (HT)	Medium Bronze (MB) Polished White Bronze (WB)	\$130.00	\$166.00
	Dummy, Pair	C	7056	Providence Crystal Knob (PC) Winchester Knob (WC) Round Knob (BZRN)*	Tumbled White Bronze (TWB)	\$130.00	\$130.00
	Passage Set	C	7104	Bristol Crystal Knob (BL) Butte Knob (BU)	Deep Burgundy (DB) Flat Black (FB)	\$130.00	\$166.00
	Privacy Set	C	7204	Egg Knob (BZEG) Hampton Crystal Knob (HT)	Medium Bronze (MB) Polished White Bronze (WB)	\$130.00	\$166.00
	Dummy, Pair	C	7054	Providence Crystal Knob (PC) Winchester Knob (WC) Round Knob (BZRN)*	Tumbled White Bronze (TWB)	\$130.00	\$130.00
	Passage Set	C	7100	Bristol Crystal Knob (BL) Butte Knob (BU)	Deep Burgundy (DB) Flat Black (FB)	\$130.00	\$166.00
	Privacy Set	C	7200	Egg Knob (BZEG) Hampton Crystal Knob (HT)	Medium Bronze (MB) Polished White Bronze (WB)	\$130.00	\$166.00
	Dummy, Pair	C	7050	Providence Crystal Knob (PC) Winchester Knob (WC) Round Knob (BZRN)*	Tumbled White Bronze (TWB)	\$130.00	\$130.00
	Passage Set	C	7111	Bristol Crystal Knob (BL) Butte Knob (BU)	Flat Black (FB) Medium Bronze (MB)	\$130.00	\$166.00
	Privacy Set	C	7211	Egg Knob (BZEG) Hampton Crystal Knob (HT)	Polished White Bronze (WB) Tumbled White Bronze (TWB)	\$130.00	\$166.00
	Dummy, Pair	C	7061	Providence Crystal Knob (PC) Winchester Knob (WC) Round Knob (BZRN)*		\$130.00	\$130.00

* Round knob is NOT available in Deep Burgundy (DB) finish.

Handing Not Required For Knobsets. Standard latch is for 2³/₈" backset. Specify 2³/₄" backset if required. Maximum door thickness for CF Mechanism is 2¹/₄". Complete set includes Latch and Strike Plate. To order 28° Rotation Latch with any standard Knobset or Lever set, add product code **Latch28** and list price **\$10**.

PASSAGE & PRIVACY SETS

LEVERSETS - LOST WAX CAST BRONZE

Art Nouveau Lever

with #17 Rosette



Medici Lever

with #14 Rosette



Napoli Lever

with #12 Rosette



Padua Lever

with #11 Rosette



Octagon Lever

with #15 Rosette



Rosette	Description	CF	Product Code	Lever Style	Finish	Standard List Price	CF Mechanism List Price
#11 	Passage Set	C	71011	Art Nouveau Lever (ANL) Medici Lever (MDI)	Deep Burgundy (DB) Flat Black (FB) Medium Bronze (MB)	\$126.00	\$162.00
	Privacy Set	C	72011	Napoli Lever (NA) Octagon Lever (OCL) Padua Lever (PD)		\$126.00	\$162.00
	Dummy, Pair	C	70511			\$126.00	\$126.00
#12 	Passage Set	C	71012	Art Nouveau Lever (ANL) Medici Lever (MDI)	Deep Burgundy (DB) Flat Black (FB) Medium Bronze (MB)	\$126.00	\$162.00
	Privacy Set	C	72012	Napoli Lever (NA) Octagon Lever (OCL) Padua Lever (PD)		\$126.00	\$162.00
	Dummy, Pair	C	70512			\$126.00	\$126.00
#14 	Passage Set	C	71014	Art Nouveau Lever (ANL) Medici Lever (MDI)	Deep Burgundy (DB) Flat Black (FB) Medium Bronze (MB)	\$126.00	\$162.00
	Privacy Set	C	72014	Napoli Lever (NA) Octagon Lever (OCL) Padua Lever (PD)		\$126.00	\$162.00
	Dummy, Pair	C	70514			\$126.00	\$126.00
#15 	Passage Set	C	71015	Art Nouveau Lever (ANL) Medici Lever (MDI)	Deep Burgundy (DB) Flat Black (FB) Medium Bronze (MB)	\$126.00	\$162.00
	Privacy Set	C	72015	Napoli Lever (NA) Octagon Lever (OCL) Padua Lever (PD)		\$126.00	\$162.00
	Dummy, Pair	C	70515			\$126.00	\$126.00
#17 	Passage Set	C	71017	Art Nouveau Lever (ANL) Medici Lever (MDI)	Deep Burgundy (DB) Flat Black (FB) Medium Bronze (MB)	\$126.00	\$162.00
	Privacy Set	C	72017	Napoli Lever (NA) Octagon Lever (OCL) Padua Lever (PD)		\$126.00	\$162.00
	Dummy, Pair	C	70517			\$126.00	\$126.00

Handing Required For Leversets. Standard latch is for 2³/₈" backset. Specify 2³/₄" backset if required. Maximum door thickness for CF Mechanism is 2¹/₄". Complete set includes Latch and Strike Plate. To order 28° Rotation Latch with any standard Knobset or Leverset, add product code **Latch28** and list price **\$10**.

LOST WAX CAST BRONZE - KNOBSETS

Art Nouveau Knob
with #17 Rosette



Octagon Knob
with #11 Rosette



Parma Knob
with #14 Rosette



Octagon Knob
with #15 Rosette







Parma Knob
with #12 Rosette



Petal Knob
with #11 Rosette



Rosette	Description	CF	Product Code	Knob Style	Finish	Standard List Price	CF Mechanism List Price
#11 	Passage Set	C	71011	Art Nouveau Knob (ANK) Octagon Knob (OCK)	Deep Burgundy (DB) Flat Black (FB) Medium Bronze (MB)	\$130.00	\$166.00
	Privacy Set	C	72011	Parma Knob (PA) Petal Knob (PT)		\$130.00	\$166.00
	Dummy, Pair	C	70511			\$130.00	\$130.00
#12 	Passage Set	C	71012	Art Nouveau Knob (ANK) Octagon Knob (OCK)	Deep Burgundy (DB) Flat Black (FB) Medium Bronze (MB)	\$130.00	\$166.00
	Privacy Set	C	72012	Parma Knob (PA) Petal Knob (PT)		\$130.00	\$166.00
	Dummy, Pair	C	70512			\$130.00	\$130.00
#14 	Passage Set	C	71014	Art Nouveau Knob (ANK) Octagon Knob (OCK)	Deep Burgundy (DB) Flat Black (FB) Medium Bronze (MB)	\$130.00	\$166.00
	Privacy Set	C	72014	Parma Knob (PA) Petal Knob (PT)		\$130.00	\$166.00
	Dummy, Pair	C	70514			\$130.00	\$130.00
#15 	Passage Set	C	71015	Art Nouveau Knob (ANK) Octagon Knob (OCK)	Deep Burgundy (DB) Flat Black (FB) Medium Bronze (MB)	\$130.00	\$166.00
	Privacy Set	C	72015	Parma Knob (PA) Petal Knob (PT)		\$130.00	\$166.00
	Dummy, Pair	C	70515			\$130.00	\$130.00
#17 	Passage Set	C	71017	Art Nouveau Knob (ANK) Octagon Knob (OCK)	Deep Burgundy (DB) Flat Black (FB) Medium Bronze (MB)	\$130.00	\$166.00
	Privacy Set	C	72017	Parma Knob (PA) Petal Knob (PT)		\$130.00	\$166.00
	Dummy, Pair	C	70517			\$130.00	\$130.00

Handing Not Required For Knobsets. Standard latch is for 2³/₈" backset. Specify 2³/₄" backset if required. Maximum door thickness for CF Mechanism is 2¹/₄". Complete set includes Latch and Strike Plate. To order 28° Rotation Latch with any standard Knobset or Leverset, add product code **Latch28** and list price **\$10**.

LEVERSETS & KNOBSETS - STAINLESS STEEL

Cologne Lever
with Disk Rosette



Dresden Lever
with Disk Rosette



Kiel Lever
with Beveled Rosette



Stuttgart Lever
with Disk Rosette



Tubular Stainless Steel Leversets

Description	CF	Product Code	Rosette Style	Lever Style	Finish	Standard List Price	CF Mechanism List Price
Passage Set	C	S100	Beveled (01) Disk (02) Square (03)	Cologne Lever (CO)	Brushed Stainless Steel (SS)	\$84.00	\$120.00
Privacy Set	C	S200		Dresden Lever (DD)		\$84.00	\$120.00
Dummy, Pair	C	S300		Kiel Lever (KL) Stuttgart Lever (ST)		\$84.00	\$84.00

Athena Lever
with Square Rosette



Hercules Lever
with Disk Rosette



Hermes Lever
with Beveled Rosette



Poseidon Lever
with Square Rosette



Helios Lever
with Square Rosette



Cast Stainless Steel Leversets

Description	CF	Product Code	Rosette Style	Lever Style	Finish	Standard List Price	CF Mechanism List Price
Passage Set	C	S100	Beveled (01) Disk (02) Square (03)	Athena Lever (AT)	Brushed Stainless Steel (SS)	\$126.00	\$162.00
Privacy Set	C	S200		Hercules Lever (HS) Helios Lever (HL)		\$126.00	\$162.00
Dummy, Pair	C	S300		Hermes Lever (HE) Poseidon Lever (PO)		\$126.00	\$126.00

Octagon Knob
with Disk Rosette



Round Knob
with Beveled Rosette



Octagon Knob
with Square Rosette



Cast Stainless Steel Knobsets

Description	CF	Product Code	Rosette Style	Knob Style	Finish	Standard List Price	CF Mechanism List Price
Passage Set	C	S100	Beveled (01) Disk (02) Square (03)	Octagon Knob (OK)	Brushed Stainless Steel (SS)	\$132.00	\$168.00
Privacy Set	C	S200		Round Knob (RNK)		\$132.00	\$168.00
Dummy, Pair	C	S300				\$132.00	\$132.00

San Carlos Lever
with #2 Rosette



Normandy Lever
with #2 Rosette



San Carlos Lever
with #3 Rosette



Lafayette Lever
with #1 Rosette





San Carlos Lever
with #1 Rosette



Lafayette Lever
with #3 Rosette



Rosette	Description	Product Code	Lever Style	Finish	Standard List Price
	Passage Set	7101	Lafayette Lever (L) Normandy Lever (N) San Carlos Lever (SC)	Flat Black (FB) Satin Steel	\$86.00
	Privacy Set	7201			\$86.00
	Dummy, Pair	7051			\$86.00
	Passage Set	7102	Lafayette Lever (L) Normandy Lever (N) San Carlos Lever (SC)	Flat Black (FB) Satin Steel	\$86.00
	Privacy Set	7202			\$86.00
	Dummy, Pair	7052			\$86.00
	Passage Set	7103	Lafayette Lever (L) Normandy Lever (N) San Carlos Lever (SC)	Flat Black (FB) Satin Steel	\$86.00
	Privacy Set	7203			\$86.00
	Dummy, Pair	7053			\$86.00

>> CF Mechanism NOT available for Wrought Steel products.

KNOBSETS - WROUGHT STEEL

Savannah Knob
with #3 Rosette



Madison Ivory Knob
with #1 Rosette



Jamestown Knob
with #1 Rosette



Jamestown Knob
with #3 Rosette





Savannah Knob
with #1 Rosette



Madison Black Knob
with #2 Rosette



Rosette	Description	Product Code	Knob Style	Finish	Standard List Price
	Passage Set	7101	Jamestown Knob (J) Madison Black Knob (MB) Madison Ivory Knob (MI) Madison Brown Swirl Knob (MS) Savannah Knob (SV)	Flat Black (FB) Satin Steel	\$96.00
	Privacy Set	7201			\$96.00
	Dummy, Pair	7051			\$96.00
	Passage Set	7102	Jamestown Knob (J) Madison Black Knob (MB) Madison Ivory Knob (MI) Madison Brown Swirl Knob (MS) Savannah Knob (SV)	Flat Black (FB) Satin Steel	\$96.00
	Privacy Set	7202			\$96.00
	Dummy, Pair	7052			\$96.00
	Passage Set	7103	Jamestown Knob (J) Madison Black Knob (MB) Madison Ivory Knob (MI) Madison Brown Swirl Knob (MS) Savannah Knob (SV)	Flat Black (FB) Satin Steel	\$96.00
	Privacy Set	7203			\$96.00
	Dummy, Pair	7053			\$96.00

>> CF Mechanism NOT available for Wrought Steel products.

ARTS & CRAFTS - LEVERSETS & KNOBSETS

Arts & Crafts Lever

with Arts & Crafts Rectangular Rosette



Hammered Lever

with Hammered Rosette



Hammered Egg Knob

with Arts & Crafts Rectangular Rosette



Arts & Crafts Lever

with Hammered Rosette



Hammered Lever

with Arts & Crafts Rectangular Rosette



Hammered Egg Knob

with Hammered Rosette



Arts & Crafts Rosette Style

Rosette	Description	CF	Product Code	Lever or Knob Style	Finish	Standard List Price	CF Mechanism List Price
	Passage Set	C	5105	Arts & Crafts Lever (AC) Hammered Lever (HM)	Oil Rubbed Bronze (US10B) Satin Nickel (US15) Flat Black (US19)	\$118.00	\$154.00
	Privacy Set	C	5205	Hammered Egg Knob (HE)		\$118.00	\$154.00
	Dummy, Pair	C	5055			\$118.00	\$118.00

Hammered Rosette Style

Rosette	Description	CF	Product Code	Lever or Knob Style	Finish	Standard List Price	CF Mechanism List Price
	Passage Set	C	5106	Arts & Crafts Lever (AC) Hammered Lever (HM)	Oil Rubbed Bronze (US10B) Satin Nickel (US15) Flat Black (US19)	\$118.00	\$154.00
	Privacy Set	C	5206	Hammered Egg Knob (HE)		\$118.00	\$154.00
	Dummy, Pair	C	5056			\$118.00	\$118.00

Handing Required For Leversets. Standard latch is for 2³/₈" backset. Specify 2³/₄" backset if required. Maximum door thickness for CF Mechanism is 2¹/₄". Complete set includes Latch and Strike Plate. To order 28° Rotation Latch with any standard Knobset or Leverset, add product code **Latch28** and list price **\$10**.

KNOBSETS - PORCELAIN

Almond Knob
with Regular Rosette



Bedford Knob
with Porcelain Rosette



Courtney Knob
with #8 Rosette



Devonshire Knob
with Regular Rosette



Ebony Knob
with #8 Brass Rosette



Ice White Knob
with Oval Rosette



Stoneware Knob
with Rectangular Rosette



Porcelain Knobs with Porcelain Style Rosettes *Finish is for Center Ring in Rosette*

Rosette	Description	Product Code	Knob Style	Finish	Standard List Price
	Passage Set	8030	Almond Knob (AL) Bedford Knob (BD) Courtney Knob (CTY)	Polished Brass (US3) French Antique (US7)	\$96.00
	Privacy Set	8040	Devonshire Knob (DV) Ebony Knob (EB) Ice White Knob (IW)	Oil Rubbed Bronze (US10B) Satin Nickel (US15) Pewter (US15A)	\$96.00
	Dummy, Pair	8003	Stoneware Knob (ST)	Polished Chrome (US26)	\$96.00

>> **CF Mechanism NOT available for Porcelain Style Rosettes.**

Porcelain Knobs with Brass Regular Style Rosettes

Description	CF	Product Code	Knob Style	Finish	Standard List Price	CF Mechanism List Price
Passage Set	C	8100	Almond Knob (AL) Bedford Knob (BD) Courtney Knob (CTY)	Polished Brass (US3) French Antique (US7)	\$96.00	\$132.00
Privacy Set	C	8200	Devonshire Knob (DV) Ebony Knob (EB) Ice White Knob (IW)	Oil Rubbed Bronze (US10B) Polished Nickel (US14) Satin Nickel (US15) Pewter (US15A)	\$96.00	\$132.00
Dummy, Pair	C	8050	Stoneware Knob (ST)	Flat Black (US19) Polished Chrome (US26)	\$96.00	\$96.00

>> **Porcelain Knobs may be ordered with any Brass rosettes. Please refer to page 96-97 for the product codes. List prices are the same as shown above. Choose from these Brass Rosettes:**



Regular Rosette



Rope Rosette



Lancaster Rosette



Ribbon & Reed Rosette



#8 Rosette



Oval Rosette



Rectangular Rosette



Quincy Rosette

Handing Not Required For Knobsets. Standard latch is for 2³/₈" backset. Specify 2³/₄" backset if required. Maximum door thickness for CF Mechanism is 2¹/₄". Complete set includes Latch and Strike Plate. To order 28° Rotation Latch with any standard Knobset or Leverset, add product code **Latch28** and list price **\$10**. Polished Brass (US3) and French Antique (US7) are available in Unlacquered finish with additional \$14 NET upcharge.

Bristol Knob
with Square Rosette



Modern Disc Crystal Knob
with Modern Rectangular Rosette



Modern Square Crystal Knob
with Disk Rosette



Modern Square Crystal Knob
with Modern Rectangular Rosette





Modern Disc Crystal Knob
with Disk Rosette



Hampton Knob
with Neos Rosette



Rosette	Description	CF	Product Code	Knob Style	Finish	Standard List Price	CF Mechanism List Price
Modern 	Passage Set	C	5107	Bristol Knob (BL) Hampton Knob (HT)	Oil Rubbed Bronze (US10B) Satin Nickel (US15)	\$118.00	\$152.00
	Privacy Set	C	5207	Modern Disc Crystal (MDC) Modern Square Crystal (MSC)	Flat Black (US19) Polished Chrome (US26)	\$118.00	\$152.00
	Dummy, Pair	C	5057			\$118.00	\$118.00
Disk 	Passage Set	C	5109	Bristol Knob (BL) Hampton Knob (HT)	Oil Rubbed Bronze (US10B) Polished Nickel (US14)	\$118.00	\$152.00
	Privacy Set	C	5209	Modern Disc Crystal (MDC) Modern Square Crystal (MSC)	Satin Nickel (US15) Flat Black (US19)	\$118.00	\$152.00
	Dummy, Pair	C	5059		Polished Chrome (US26)	\$118.00	\$118.00
Square 	Passage Set	C	5110	Bristol Knob (BL) Hampton Knob (HT)	Oil Rubbed Bronze (US10B) Polished Nickel (US14)	\$118.00	\$152.00
	Privacy Set	C	5210	Modern Disc Crystal (MDC) Modern Square Crystal (MSC)	Satin Nickel (US15) Flat Black (US19)	\$118.00	\$152.00
	Dummy, Pair	C	5050		Polished Chrome (US26)	\$118.00	\$118.00
Neos 	Passage Set	C	5111	Bristol Knob (BL) Hampton Knob (HT)	Oil Rubbed Bronze (US10B) Satin Nickel (US15)	\$118.00	\$152.00
	Privacy Set	C	5211	Modern Disc Crystal (MDC) Modern Square Crystal (MSC)	Flat Black (US19) Polished Chrome (US26)	\$118.00	\$152.00
	Dummy, Pair	C	5051			\$118.00	\$118.00
Modern Rectangular 	Passage Set	C	5112	Bristol Knob (BL) Hampton Knob (HT)	Oil Rubbed Bronze (US10B) Satin Nickel (US15)	\$118.00	\$152.00
	Privacy Set	C	5212	Modern Disc Crystal (MDC) Modern Square Crystal (MSC)	Flat Black (US19) Polished Chrome (US26)	\$118.00	\$152.00
	Dummy, Pair	C	5052			\$118.00	\$118.00

>> **Crystal Knobs may be ordered with any Brass rosette at the list price shown above.**
(See page 112-113 for Brass rosette options)

Handing Not Required For Knobsets. Standard latch is for 2³/₈" backset. Specify 2³/₄" backset if required. Maximum door thickness for CF Mechanism is 2¹/₄". Complete set includes Latch and Strike Plate. To order 28° Rotation Latch with any standard Knobset or Leverset, add product code **Latch28** and list price **\$10**.

KNOBSETS - CRYSTAL

Old Town Milk Knob

with Regular Rosette



Diamond Crystal Knob

with Lancaster Rosette



Old Town Amber Knob

with Ribbon & Reed Rosette



Astoria Clear Knob

with Rope Rosette



Georgetown Knob

with Lancaster Rosette



Providence Crystal Knob

with Quincy Rosette



Rosette	Description	CF	Product Code	Knob Style	Finish	Standard List Price	CF Mechanism List Price
Regular 	Passage Set	C	8100	Astoria Clear Knob (AS) Bristol Knob (BL) Diamond Crystal Knob (CK)	Polished Brass (US3) French Antique (US7) Oil Rubbed Bronze (US10B)	\$118.00	\$152.00
	Privacy Set	C	8200	Georgetown Knob (GT) Hampton Knob (HT) Old Town Amber Knob (OTA)	Polished Nickel (US14) Satin Nickel (US15) Pewter (US15A)	\$118.00	\$152.00
	Dummy, Pair	C	8050	Old Town Clear Knob (OT) Old Town Milk Knob (OTM) Old Town Violet Knob (OTV) Providence Crystal Knob (PC)	Flat Black (US19) Polished Chrome (US26)	\$118.00	\$118.00
Rope 	Passage Set	C	8101	Astoria Clear Knob (AS) Bristol Knob (BL) Diamond Crystal Knob (CK)	Polished Brass (US3) French Antique (US7) Oil Rubbed Bronze (US10B)	\$118.00	\$152.00
	Privacy Set	C	8201	Georgetown Knob (GT) Hampton Knob (HT) Old Town Amber Knob (OTA)	Satin Nickel (US15) Pewter (US15A) Polished Chrome (US26)	\$118.00	\$152.00
	Dummy, Pair	C	8051	Old Town Clear Knob (OT) Old Town Milk Knob (OTM) Old Town Violet Knob (OTV) Providence Crystal Knob (PC)		\$118.00	\$118.00
Lancaster 	Passage Set	C	8106	Astoria Clear Knob (AS) Bristol Knob (BL) Diamond Crystal Knob (CK)	Polished Brass (US3) French Antique (US7) Oil Rubbed Bronze (US10B)	\$118.00	\$152.00
	Privacy Set	C	8206	Georgetown Knob (GT) Hampton Knob (HT) Old Town Amber Knob (OTA)	Satin Nickel (US15) Pewter (US15A) Polished Chrome (US26)	\$118.00	\$152.00
	Dummy, Pair	C	8056	Old Town Clear Knob (OT) Old Town Milk Knob (OTM) Old Town Violet Knob (OTV) Providence Crystal Knob (PC)		\$118.00	\$118.00
Ribbon & Reed 	Passage Set	C	8107	Astoria Clear Knob (AS) Bristol Knob (BL) Diamond Crystal Knob (CK)	Polished Brass (US3) French Antique (US7) Oil Rubbed Bronze (US10B)	\$118.00	\$152.00
	Privacy Set	C	8207	Georgetown Knob (GT) Hampton Knob (HT) Old Town Amber Knob (OTA)	Satin Nickel (US15) Pewter (US15A) Polished Chrome (US26)	\$118.00	\$152.00
	Dummy, Pair	C	8057	Old Town Clear Knob (OT) Old Town Milk Knob (OTM) Old Town Violet Knob (OTV) Providence Crystal Knob (PC)		\$118.00	\$118.00

Handing Not Required For Knobsets. Standard latch is for 2³/₈" backset. Specify 2³/₄" backset if required. Maximum door thickness for CF Mechanism is 2¹/₄". Complete set includes Latch and Strike Plate. To order 28° Rotation Latch with any standard Knobset or Leverset, add product code **Latch28** and list price **\$10**. Polished Brass (US3) and French Antique (US7) are available in Unlacquered finish with additional \$14 NET upcharge.

Old Town Clear Knob
with #8 Rosette



Bristol Knob
with Rectangular Rosette







Hampton Knob
with #8 Rosette



Old Town Violet Knob
with Rectangular Rosette



Rosette	Description	CF	Product Code	Knob Style	Finish	Standard List Price	CF Mechanism List Price
#8 	Passage Set	C	8108	Astoria Clear Knob (AS) Bristol Knob (BL) Diamond Crystal Knob (CK)	Polished Brass (US3) French Antique (US7) Oil Rubbed Bronze (US10B)	\$118.00	\$152.00
	Privacy Set	C	8208	Georgetown Knob (GT) Hampton Knob (HT) Old Town Amber Knob (OTA)	Polished Nickel (US14) Satin Nickel (US15) Pewter (US15A)	\$118.00	\$152.00
	Dummy, Pair	C	8058	Old Town Clear Knob (OT) Old Town Milk Knob (OTM) Old Town Violet Knob (OTV) Providence Crystal Knob (PC)	Flat Black (US19) Polished Chrome (US26)	\$118.00	\$118.00
Oval 	Passage Set	C	8120	Astoria Clear Knob (AS) Bristol Knob (BL) Diamond Crystal Knob (CK)	Polished Brass (US3) French Antique (US7) Oil Rubbed Bronze (US10B)	\$118.00	\$152.00
	Privacy Set	C	8220	Georgetown Knob (GT) Hampton Knob (HT) Old Town Amber Knob (OTA)	Satin Nickel (US15) Pewter (US15A) Flat Black (US19)	\$118.00	\$152.00
	Dummy, Pair	C	8520	Old Town Clear Knob (OT) Old Town Milk Knob (OTM) Old Town Violet Knob (OTV) Providence Crystal Knob (PC)	Polished Chrome (US26)	\$118.00	\$118.00
Rectangular 	Passage Set	C	8121	Astoria Clear Knob (AS) Bristol Knob (BL) Diamond Crystal Knob (CK)	Polished Brass (US3) French Antique (US7) Oil Rubbed Bronze (US10B)	\$118.00	\$152.00
	Privacy Set	C	8221	Georgetown Knob (GT) Hampton Knob (HT) Old Town Amber Knob (OTA)	Polished Nickel (US14) Satin Nickel (US15) Pewter (US15A)	\$118.00	\$152.00
	Dummy, Pair	C	8521	Old Town Clear Knob (OT) Old Town Milk Knob (OTM) Old Town Violet Knob (OTV) Providence Crystal Knob (PC)	Flat Black (US19) Polished Chrome (US26)	\$118.00	\$118.00
Quincy 	Passage Set	C	8131	Astoria Clear Knob (AS) Bristol Knob (BL) Diamond Crystal Knob (CK)	Polished Brass (US3) French Antique (US7) Oil Rubbed Bronze (US10B)	\$118.00	\$152.00
	Privacy Set	C	8231	Georgetown Knob (GT) Hampton Knob (HT) Old Town Amber Knob (OTA)	Satin Nickel (US15) Pewter (US15A) Flat Black (US19)	\$118.00	\$152.00
	Dummy, Pair	C	8531	Old Town Clear Knob (OT) Old Town Milk Knob (OTM) Old Town Violet Knob (OTV) Providence Crystal Knob (PC)	Polished Chrome (US26)	\$118.00	\$118.00

>> **Crystal Knobs may be ordered with any Modern rosette at the list price shown above.**
(See page 111 for Modern rosette options)

Handing Not Required For Knobsets. Standard latch is for 2³/₈" backset. Specify 2³/₄" backset if required. Maximum door thickness for CF Mechanism is 2¹/₄". Complete set includes Latch and Strike Plate. To order 28° Rotation Latch with any standard Knobset or Leverset, add product code **Latch28** and list price **\$10**. Polished Brass (US3) and French Antique (US7) are available in Unlacquered finish with additional \$14 NET upcharge.

PASSAGE & PRIVACY SETS

DOOR KNOB WITH THREADED SPINDLE - CRYSTAL & PORCELAIN

Threaded Rod
with Old Town Clear Knobs



Threaded Rod
with Diamond Crystal Knobs



Threaded Rod
with Astoria Clear Knobs



Threaded Rod
with Georgetown Knobs



Threaded Rod
with Providence Crystal Knobs



Threaded Rod
with Bristol Knobs



Threaded Rod
with Hampton Knobs



Threaded Rod
with Ice White
Porcelain Knobs



Threaded Rod
with Modern Disc Crystal Knobs



Threaded Rod
with Modern Square Crystal Knobs

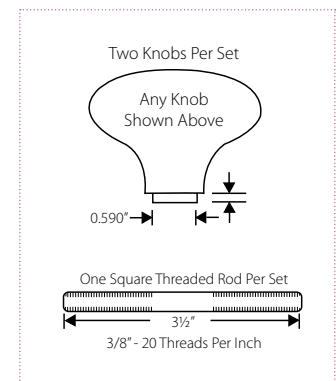

Crystal Style

Description	Product Code	Knob Style	Finish	List Price
Set of Crystal Knobs with Threaded Rod	8000	Astoria Clear Knob (AS) Bristol Knob (BL) Diamond Crystal Knob (CK) Georgetown Knob (GT) Hampton Knob (HT) Modern Disc Crystal Knob (MDC) Modern Square Crystal Knob (MSC) Old Town Amber Knob (OTA) Old Town Clear Knob (OT) Old Town Milk Knob (OTM) Old Town Violet Knob (OTV) Providence Crystal Knob (PC)	Polished Brass (US3) French Antique (US7) Oil Rubbed Bronze (US10B) Polished Nickel (US14) Satin Nickel (US15) Pewter (US15A) Flat Black (US19) Polished Chrome (US26)	\$90.00

Porcelain Style

Description	Product Code	Knob Style	Finish	List Price
Set of Porcelain Knobs with Threaded Rod	8000	Almond Knob (AL) Bedford Knob (BD) Courtney Knob (CTY) Devonshire Knob (DV) Ebony Knob (EB) Ice White Knob (IW) Stoneware Knob (ST)	Polished Brass (US3) French Antique (US7) Oil Rubbed Bronze (US10B) Satin Nickel (US15) Polished Chrome (US26)	\$90.00

BRASS & BRONZE - APPLIANCE PULLS

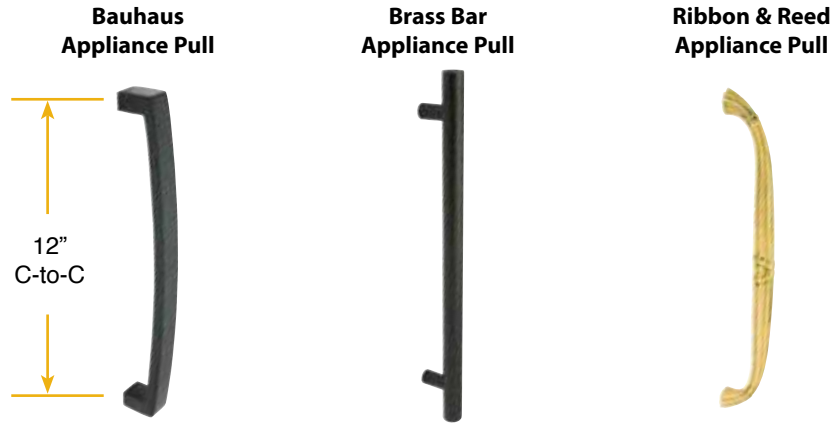

- Drilled and Tapped with 1/4"-20 Thread
Supplied with:
- Both 1/4"-20 Screws and #10-32 Screws
 - Adapter for #10-32 Thread
 - 2 Threaded Washers
 - 2 Decorative Caps
 - Two 2" #10-32 Machine Screws

12" & 18" Brass Appliance Pulls

Description	Product Code	Finish	List Price
Bauhaus 12" Appliance Pull	86345	Oil Rubbed Bronze (US10B) Satin Nickel (US15)	\$124.00
Bauhaus 18" Appliance Pull	86346	Flat Black (US19) Polished Chrome (US26)	\$180.00
Brass Bar 12" Appliance Pull	86351	Oil Rubbed Bronze (US10B) Satin Nickel (US15)	\$124.00
Brass Bar 18" Appliance Pull	86352	Polished Chrome (US26)	\$180.00
Ribbon & Reed 12" Appliance Pull	86355	Polished Brass (US3) French Antique (US7) Oil Rubbed Bronze (US10B)	\$146.00
Ribbon & Reed 18" Appliance Pull	86356	Satin Nickel (US15) Pewter (US15A) Polished Chrome (US26)	\$216.00

DOOR ACCESSORIES

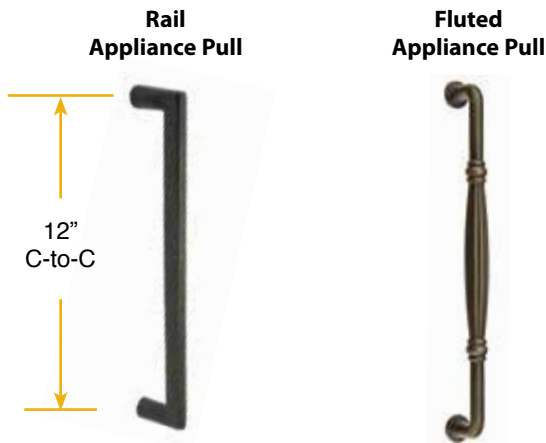

- Drilled and Tapped with 1/4"-20 Thread
Supplied with:
- Both 1/4"-20 Screws and #10-32 Screws
 - Adapter for #10-32 Thread
 - 2 Threaded Washers
 - 2 Decorative Caps
 - Two 2" #10-32 Machine Screws

12" & 18" Bronze Appliance Pulls

Description	Product Code	Finish	List Price
Rail Sandcast Bronze 12" Appliance Pull	86349	Deep Burgundy (DB) Flat Black (FB)	\$136.00
Rail Sandcast Bronze 18" Appliance Pull	86350	Medium Bronze (MB)	\$190.00
Fluted Lost Wax Cast Bronze 12" Appliance Pull	86347	Deep Burgundy (DB) Flat Black (FB)	\$158.00
Fluted Lost Wax Cast Bronze 18" Appliance Pull	86348	Medium Bronze (MB)	\$228.00

DOOR PULLS - SOLID BRASS & STAINLESS STEEL

DOOR ACCESSORIES



Drilled and Tapped with 1/4"-20 Thread
 Supplied with:

- Both 1/4"-20 Screws and #10-32 Screws
- Adapter for #10-32 Thread
- 2 Threaded Washers
- 2 Decorative Caps
- Two 2" #10-32 Machine Screws

Brass 8" Pulls *May Be Used Separately or With Pull Plates*

Description	Product Code	Finish	List Price
Knoxville 8" Pull	86077	French Antique (US7) Oil Rubbed Bronze (US10B)	\$88.00
Wilshire 8" Pull	86078	Satin Nickel (US15) Pewter (US15A)	\$88.00
Ribbon & Reed 8" Pull	86080	Polished Chrome (US26) PVD-Lifetime	\$88.00
Arts & Crafts 8" Pull	86079	Oil Rubbed Bronze (US10B) Satin Nickel (US15) Flat Black (US19)	\$88.00
Zeus 8" Pull	86183	Oil Rubbed Bronze (US10B) Satin Nickel (US15) Flat Black (US19)*	\$88.00
Baden 8" Pull	86184	Polished Chrome (US26)	\$88.00
Stainless Steel Zeus 8" Pull	S86001	Brushed Stainless Steel (SS)	\$88.00
Stainless Steel Baden 8" Pull	S86002		\$88.00

* Flat Black (US19) NOT available in Zeus 8" Pull.

Modern Push Plate



Modern Pull Plate (Plate Only)

Drilled to accept 8" pull

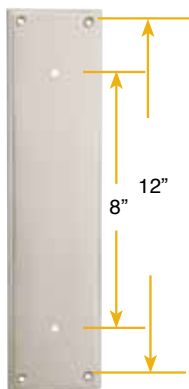

Example:
Combination of 8" Baden Pull and 3" x 12" Modern Pull Plate

- 3"W x 12"H
- Supplied with 4 Wood Screws
- Pull Plates and Pulls Must Be Ordered Separately

Baden Push and Pull Plates

Description	Product Code	Finish	List Price
Modern Push Plate	86436	Oil Rubbed Bronze (US10B) Satin Nickel (US15) Flat Black (US19)	\$66.00 <i>(Plate Only)</i>
Modern Pull Plate	86437	Polished Chrome (US26)	\$66.00 <i>(Plate Only)</i>

Knoxville Push Plate



Knoxville Pull Plate (Plate Only)

Drilled to accept 8" pull

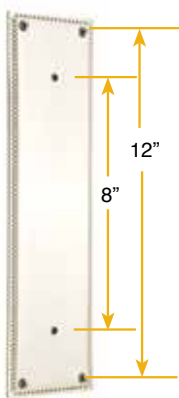

Example:
Combination of 8" Knoxville Pull and 3" x 12" Knoxville Pull Plate

- 3"W x 12"H
- Supplied with 4 Wood Screws
- Pull Plates and Pulls Must Be Ordered Separately

Knoxville Push and Pull Plates

Description	Product Code	Finish	List Price
Knoxville Push Plate	86081	French Antique (US7) Oil Rubbed Bronze (US10B) Satin Nickel (US15)	\$66.00 <i>(Plate Only)</i>
Knoxville Pull Plate	86082	Pewter (US15A) Polished Chrome (US26) PVD-Lifetime	\$66.00 <i>(Plate Only)</i>

DOOR ACCESSORIES

DOOR PULLS - SOLID BRASS

DOOR ACCESSORIES



- Drilled and Tapped with 1/4"-20 Thread
Supplied with:
- Both 1/4"-20 Screws and #10-32 Screws
 - Adapter for #10-32 Thread
 - 2 Threaded Washers
 - 2 Decorative Caps
 - Two 2" #10-32 Machine Screws

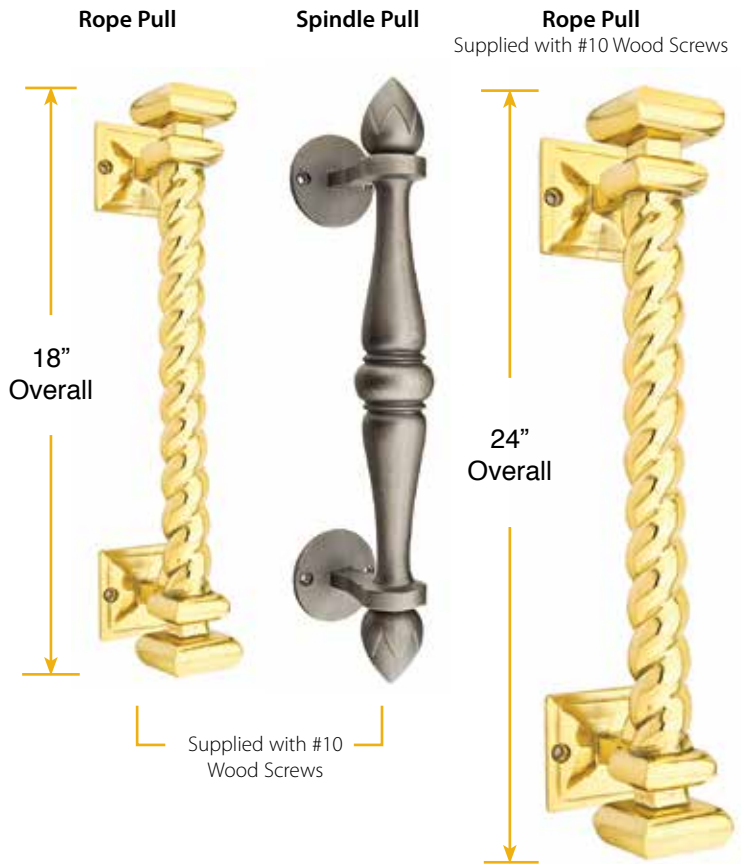

Solid Brass 12" Pulls

Description	Product Code	Finish	List Price
Knoxville 12" Pull	86177	French Antique (US7) Oil Rubbed Bronze (US10B) Satin Nickel (US15)	\$124.00
Wilshire 12" Pull	86178	Pewter (US15A) Polished Chrome (US26) PVD-Lifetime	\$124.00
Arts & Crafts 12" Pull	86179	Oil Rubbed Bronze (US10B) Satin Nickel (US15) Flat Black (US19)	\$124.00

Solid Brass 18" & 24" Pulls

Description	Product Code	Finish	List Price
Rope 18" Pull	86064	Polished Brass (US3) Oil Rubbed Bronze (US10B)* Pewter (US15A)	\$212.00
Spindle 18" Pull	86065	Pewter (US15A)	\$212.00
Rope 24" Pull	86083	Polished Brass (US3) Oil Rubbed Bronze (US10B) Pewter (US15A)	\$238.00

* Oil Rubbed Bronze (US10B) **NOT** available in Spindle 18" Pull.

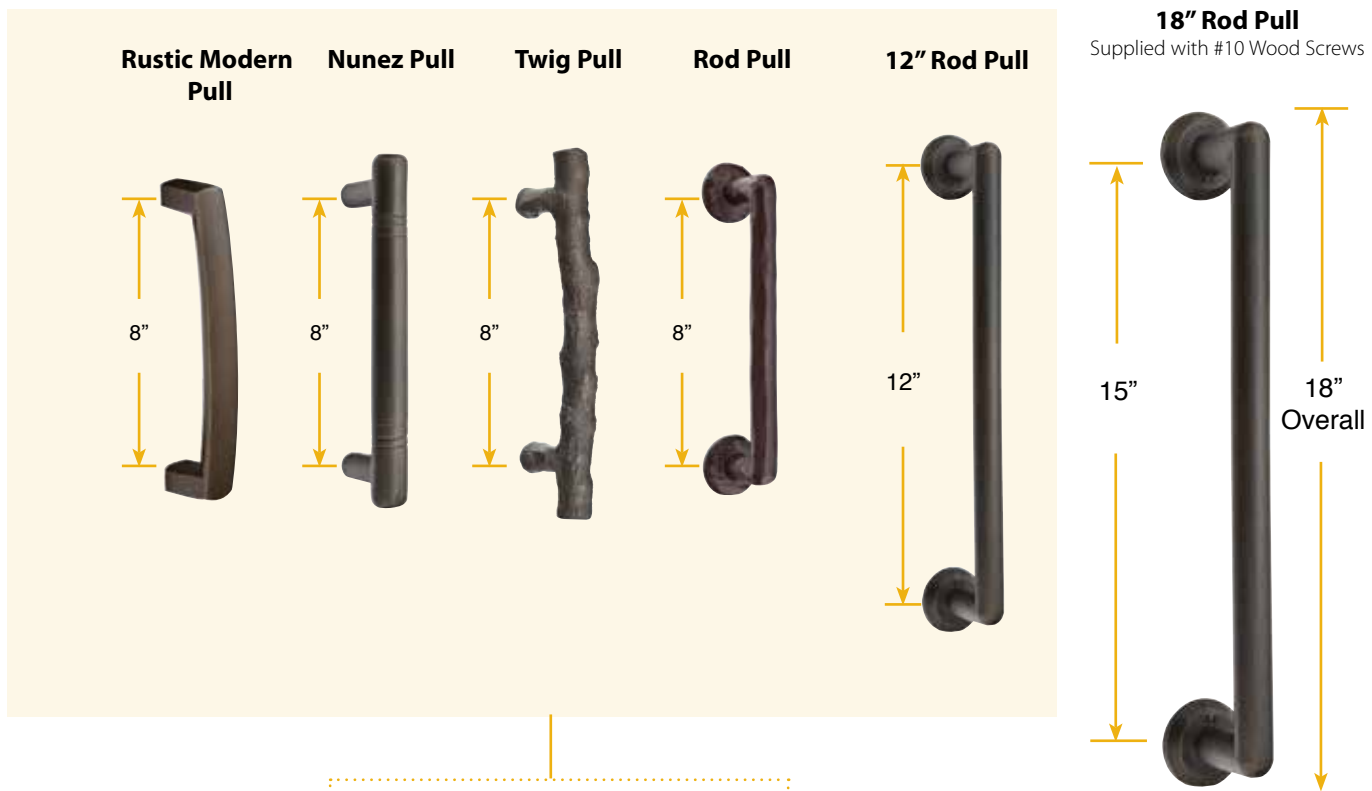

Supplied with:

- Both ¼"-20" and #10-32 Machine Screws
- 2 Threaded Washers
- 2 Decorative Caps
- Two 2" #10-32 Machine Screws

Sandcast Bronze 8", 12", and 18" Pulls

Description	Product Code	Finish	List Price
Rustic Modern Bronze 8" Pull	86439	Flat Black (FB) Medium Bronze (MB) Polished White Bronze (WB) Tumbled White Bronze (TWB)	\$114.00
Nunez Bronze 8" Pull	86160	Deep Burgundy (DB) Flat Black (FB)	\$114.00
Twig Bronze 8" Pull	86090	Medium Bronze (MB)	\$114.00
Rod Bronze 8" Pull	86088		\$114.00
Rod Bronze 12" Pull	86068	Deep Burgundy (DB) Flat Black (FB) Medium Bronze (MB)	\$138.00
Rod Bronze 18" Pull	86089	Deep Burgundy (DB) Flat Black (FB) Medium Bronze (MB)	\$216.00

DOOR PULLS - LOST CAST WAX BRONZE

DOOR ACCESSORIES

Twist Pull

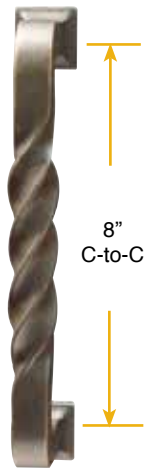

Column Pull

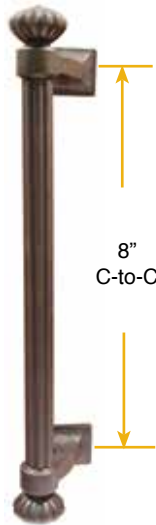

Palermo Pull

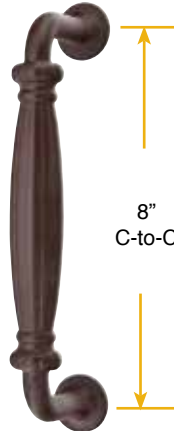

Recoleta Pull



Art Nouveau Pulls

Left Hand Right Hand

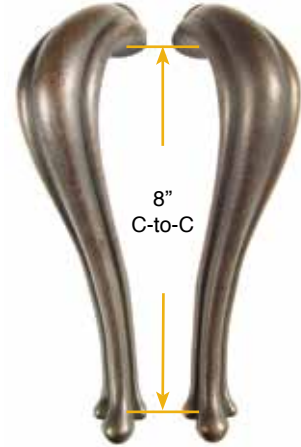

- Supplied with:
- Both 1/4"-20" and #10-32 Machine Screws
 - 2 Threaded Washers
 - 2 Decorative Caps
 - Two 2" #10-32 Machine Screws

Lost Cast Wax Bronze 8" Door Pulls *May Be Used Separately or With Pull Plates*

Description	Product Code	Finish	List Price
Twist 8" Pull	86069	Deep Burgundy (DB) Flat Black (FB) Medium Bronze (MB)	\$114.00
Column 8" Pull	86156		\$114.00
Palermo 8" Pull	86167		\$114.00
Recoleta 8" Pull	86168		\$114.00
Art Nouveau 8" Pull (Left Hand)	86144LH		\$114.00
Art Nouveau 8" Pull (Right Hand)	86144RH		\$114.00

Petal Pull Plate Petal Push Plate

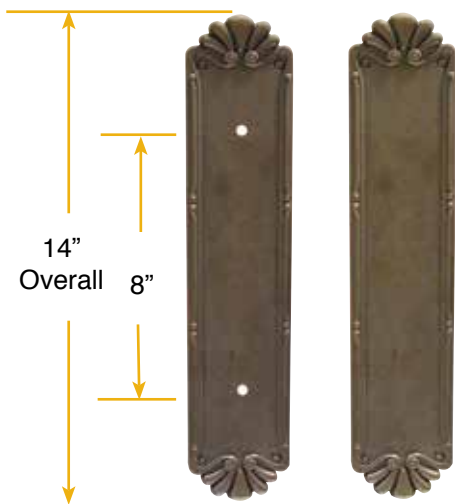

- Supplied with:
- 3"W x 12"H
 - Supplied with 4 Wood Screws
 - Pull Plates and Pulls Must Be Ordered Separately

Lost Cast Wax Bronze Petal Push & Pull Plates

Description	Product Code	Finish	List Price
Petal Push Plate	86181	Deep Burgundy (DB) Flat Black (FB) Medium Bronze (MB)	\$110.00
Petal Pull Plate	86182		\$110.00

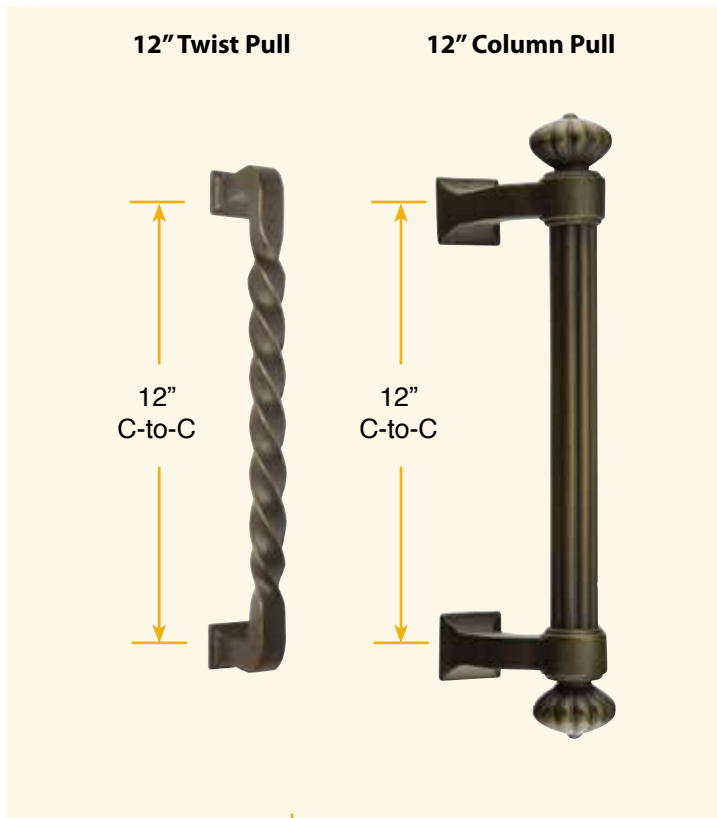

18" Column Pull
Supplied with #10 Wood Screws



24" Column Pull
Supplied with #10 Wood Screws



DOOR ACCESSORIES

Supplied with:

- Both 1/4"-20" and #10-32 Machine Screws
- 2 Threaded Washers
- 2 Decorative Caps
- Two 2" #10-32 Machine Screws

Lost Cast Wax Bronze 12" Door Pulls

Description	Product Code	Finish	List Price
Twist 12" Pull	86169	Deep Burgundy (DB) Flat Black (FB) Medium Bronze (MB)	\$138.00
Column 12" Pull	86159		\$200.00

Lost Cast Wax Bronze 18" & 24" Column Pulls

Description	Product Code	Finish	List Price
Column 18" Pull	86157	Deep Burgundy (DB) Flat Black (FB) Medium Bronze (MB)	\$340.00
Column 24" Pull	86158		\$400.00

DOOR PULLS - WROUGHT STEEL

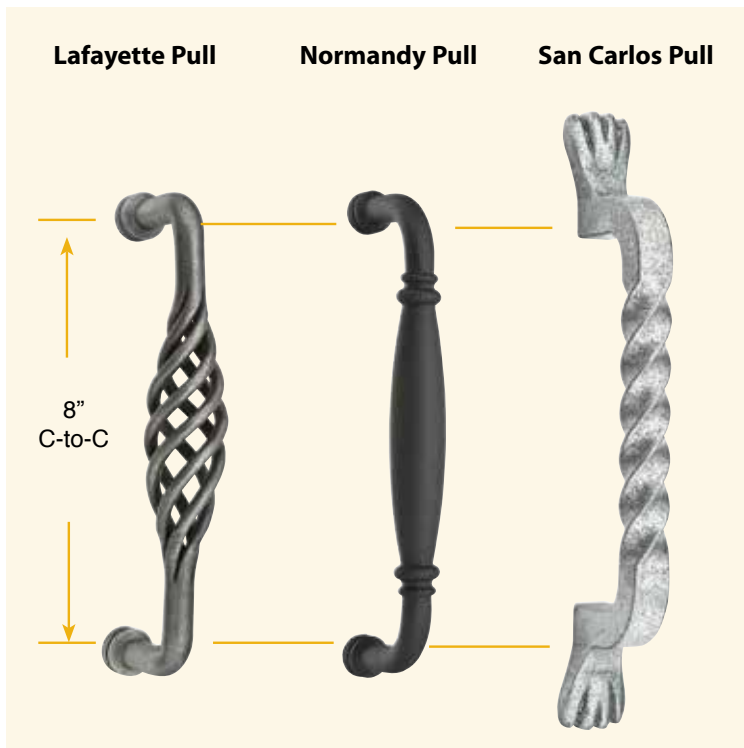

18" San Carlos Pull
Supplied with #10 Wood Screws



24" San Carlos Pull
Supplied with #10 Wood Screws



- Drilled and Tapped with 1/4"-20 Thread
Supplied with:
- Both 1/4"-20 Screws and #10-32 Screws
 - Adapter for #10-32 Thread
 - 2 Threaded Washers
 - 2 Decorative Caps
 - Two 2" #10-32 Machine Screws

Wrought Steel 8", 18", and 24" Pulls

Description	Product Code	Finish	List Price
Lafayette 8" Pull	76030	Flat Black (FB) Satin Steel	\$88.00
Normandy 8" Pull	76031		\$88.00
San Carlos 8" Pull	76028		\$88.00
San Carlos 18" Pull	76029	Flat Black (FB) Satin Steel	\$140.00
San Carlos 24" Pull	76041	Flat Black (FB) Satin Steel	\$180.00

4" Dutch Door Bolts



4" Dutch Door Bolts

Description	Product Code	Finish	List Price
4" Dutch Door Bolt	8516	Polished Brass (US3) French Antique (US7) Oil Rubbed Bronze (US10B) Satin Nickel (US15) Pewter (US15A) Polished Chrome (US26)	\$26.00

Solid Brass Surface Bolts



Solid Brass Surface Bolts

Description	Product Code	Finish	List Price
6" Surface Bolt	8511	French Antique (US7) Oil Rubbed Bronze (US10B) Satin Nickel (US15) Pewter (US15A)	\$46.00
8" Surface Bolt	8515	Polished Chrome (US26) PVD-Lifetime Deep Burgundy (DB) Flat Black (FB)	\$54.00
12" Surface Bolt	8512	Medium Bronze (MB) Satin Steel	\$60.00
18" Surface Bolt	8513		\$74.00
24" Surface Bolt	8514		\$88.00

DOOR ACCESSORIES

>> Supplied with 3 Types of Strike Plates and Screws. Strikes & Screws are NOT sold separately.



Security Door Guards



Security Door Guards

Description	Product Code	Finish	List Price
4" x 2½" Security Door Guard	2074	Polished Brass (US3) French Antique (US7) Oil Rubbed Bronze (US10B) Satin Nickel (US15)	\$24.00
5" x 2½" Security Door Guard	2075	Pewter (US15A) Polished Chrome (US26)	\$26.00

Flush Bolts

Square & Radius Corners



Flush Bolts *Supplied with Strike Plates & Screws*

Description	Product Code	Finish	List Price
4" Brass Flush Bolt with Square Corners	8505	Polished Brass (US3) French Antique (US7) Oil Rubbed Bronze (US10B)	\$10.00
4" Brass Flush Bolt with 5/8" Radius Corners	8506	Satin Nickel (US15) Pewter (US15A) Polished Chrome (US26)	\$10.00
6" Brass Flush Bolt with Square Corners	8501	Polished Brass (US3) French Antique (US7) Oil Rubbed Bronze (US10B)	\$12.00
6" Brass Flush Bolt with 5/8" Radius Corners	8502	Satin Nickel (US15) Pewter (US15A) Polished Chrome (US26)	\$12.00
12" Brass Flush Bolt with Square Corners	8503	Polished Brass (US3) French Antique (US7) Oil Rubbed Bronze (US10B)	\$24.00
12" Brass Flush Bolt with 5/8" Radius Corners	8504	Satin Nickel (US15) Pewter (US15A) Polished Chrome (US26)	\$24.00

>> Strikes & Screws are **NOT** sold separately.

Concealed Screw Surface Bolts



Concealed Screw Surface Bolts

Description	Product Code	Finish	List Price
4" Concealed Screw Surface Bolt	8527	Polished Brass (US3) French Antique (US7) Oil Rubbed Bronze (US10B)	\$12.00
6" Concealed Screw Surface Bolt	8528	Satin Nickel (US15) Pewter (US15A) Polished Chrome (US26)	\$15.00
8" Concealed Screw Surface Bolt	8529		\$18.00
12" Concealed Screw Surface Bolt	8530		\$21.00

>> **Supplied with 3 Types of Strike Plates and Screws.** Strikes & Screws are **NOT** sold separately.



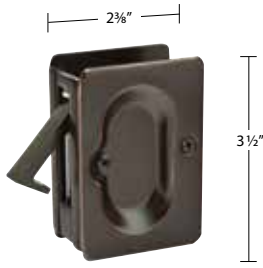

Passage Function

- Fits door thickness 1 3/8" to 1 3/4"
- Standard rectangular door prep 3 3/8" x 1 3/4"



Privacy Function

- Fits door thickness 1 3/8" to 1 3/4"
- Standard rectangular door prep 3 3/8" x 1 3/4"
- Complete with strikeplate
- (Strikes & Screws are NOT sold separately)

Rectangular Flush Pull



Round Flush Pull



>> Installs into 2 1/8" hole.

Pocket Door Locks

Description	Product Code	Finish	List Price
Passage	2101	Polished Brass (US3) French Antique (US7) Oil Rubbed Bronze (US10B) Satin Nickel (US15) Pewter (US15A) Polished Chrome (US26) Deep Burgundy (DB) Flat Black (FB) Medium Bronze (MB) Satin Steel	\$26.00

Description	Product Code	Finish	List Price
Privacy	2102	Polished Brass (US3) French Antique (US7) Oil Rubbed Bronze (US10B) Satin Nickel (US15) Pewter (US15A) Polished Chrome (US26) Deep Burgundy (DB) Flat Black (FB) Medium Bronze (MB) Satin Steel	\$34.00

>> Available in split finish.

Rectangular Flush Pull

Product Code	Finish	List Price
2201	French Antique (US7) Oil Rubbed Bronze (US10B) Satin Nickel (US15) Pewter (US15A) Polished Chrome (US26) PVD-Lifetime Deep Burgundy (DB) Flat Black (FB) Medium Bronze (MB) Satin Steel	\$14.00

Round Flush Pull

Product Code	Finish	List Price
2211	Polished Brass (US3) French Antique (US7) Oil Rubbed Bronze (US10B) Satin Nickel (US15) Pewter (US15A) Polished Chrome (US26) Deep Burgundy (DB) Flat Black (FB) Medium Bronze (MB) Satin Steel	\$14.00



Pocket Door Mortise Locks

Description	Product Code	Finish	List Price
Keyed Pocket Door Mortise Lock*	2103	Polished Brass (US3) Oil Rubbed Bronze (US10B)	\$162.00
Passage Pocket Door Mortise Lock	2104	Satin Nickel (US15)	\$132.00
Privacy Pocket Door Mortise Lock	2105	Polished Chrome (US26) Medium Bronze (MB)	\$158.00
Dummy Pocket Door Mortise Lock	2106		\$132.00

>> **Must Specify Door Thickness.** Plates are 1/8" Thick. Not available in split finish.

Keyed

Door Mortise Lock

Supplied with:

- Mortise Lock Body with 2 Keys
- Complete with Strikeplates and Screws

Privacy

Door Mortise Lock

Supplied with:

- Mortise Lock Body
- Complete with Strikeplates and Screws

Passage

Door Mortise Lock

Supplied with:

- Mortise Edge Pull
- Complete with Strikeplates and Screws

Dummy

Door Mortise Lock

Supplied with:

- Dummy Mortise Box
- Complete with Strikeplates and Screws

Edge Pull with Screws



Edge Pull *with Screws*

Product Code	Finish	List Price
2221	Polished Brass (US3) French Antique (US7) Oil Rubbed Bronze (US10B) Satin Nickel (US15) Pewter (US15A) Polished Chrome (US26) Deep Burgundy (DB) Flat Black (FB) Medium Bronze (MB) Satin Steel	\$12.00

Roller Catch with Strike & Screws



Roller Catch *with Strikes & Screws*

Product Code	Finish	List Price
8801	French Antique (US7) Oil Rubbed Bronze (US10B) Satin Nickel (US15) Pewter (US15A) Polished Chrome (US26) PVD-Lifetime Deep Burgundy (DB) Flat Black (FB) Medium Bronze (MB) Satin Steel	\$30.00

>> Strikes & Screws are **NOT** sold separately.

Ball Catch with Strike & Screws



Ball Catch *with Strikes & Screws*

Product Code	Finish	List Price
8802	Polished Brass (US3) French Antique (US7) Oil Rubbed Bronze (US10B) Satin Nickel (US15) Pewter (US15A) Polished Chrome (US26) Deep Burgundy (DB) Flat Black (FB) Medium Bronze (MB)	\$16.00

>> Strikes & Screws are **NOT** sold separately.

ACCESSORIES

Kickdown Door Holders

4" and 5"



Kickdown Door Holders *with Screws*

Description	Product Code	Finish	List Price
4" Kickdown Door Holder	2264	Polished Brass (US3) French Antique (US7) Oil Rubbed Bronze (US10B) Satin Nickel (US15)	\$20.00
5" Kickdown Door Holder	2265	Pewter (US15A) Polished Chrome (US26)	\$22.00

Magnetic Door Stop & Holder

3"



3" Magnetic Door Stop & Holder *with Screw*

Product Code	Finish	List Price
2256	Polished Brass (US3) French Antique (US7) Oil Rubbed Bronze (US10B) Satin Nickel (US15) Pewter (US15A) Polished Chrome (US26)	\$24.00

Extendable Baseboard Door Bumper



>> Includes 3", 1", and 1/2" base with 2" screw

Extendable Baseboard Door Bumper *with Screw*

Product Code	Finish	List Price
2233	Oil Rubbed Bronze (US10B) Satin Nickel (US15) Flat Black (US19) Polished Chrome (US26)	\$16.00

Door Stops with Screw

3" and 4"



Door Stops *with Screw*

Description	Product Code	Finish	List Price
3" Door Stop with Screw	2232	Polished Brass (US3) French Antique (US7) Oil Rubbed Bronze (US10B) Satin Nickel (US15) Pewter (US15A) Polished Chrome (US26)	\$10.00
4" Door Stop with Screw	2231	PVD-Lifetime Deep Burgundy (DB) Flat Black (FB) Medium Bronze (MB) Satin Steel	\$12.00

Floor Door Bumper



Floor Door Bumper *with Screw*

Product Code	Finish	List Price
2254	Polished Brass (US3) French Antique (US7) Oil Rubbed Bronze (US10B) Satin Nickel (US15) Pewter (US15A) Polished Chrome (US26)	\$10.00

Door Stops *with Screws*

Half Dome
Door Stop



Goose Style
Door Stop



Description	Product Code	Finish	List Price
Half Dome Door Stop	2251	Polished Brass (US3) French Antique (US7) Oil Rubbed Bronze (US10B) Satin Nickel (US15) Pewter (US15A) Polished Chrome (US26)	\$12.00
Goose Style Door Stop	2253	Deep Burgundy (DB) Flat Black (FB) Medium Bronze (MB) Satin Steel	\$22.00

Cylinder Floor Bumpers
1½" and 2"



Cylinder Floor Bumpers *with Screws*

Description	Product Code	Finish	List Price
1½" Cylinder Floor Bumper	2257	Oil Rubbed Bronze (US10B) Satin Nickel (US15) Flat Black (US19) Polished Chrome (US26)	\$16.00
2" Cylinder Floor Bumper	2258		\$18.00

Cylinder Floor Bumpers with Dome Cap
1½" and 2"



Cylinder Floor Bumpers with Dome Cap *with Screws*

Description	Product Code	Finish	List Price
1½" Cylinder Floor Bumper with Dome Cap	2259	Oil Rubbed Bronze (US10B) Satin Nickel (US15) Flat Black (US19) Polished Chrome (US26)	\$16.00
2" Cylinder Floor Bumper with Dome Cap	2260		\$18.00

Brass Wall Bumper
with Regular Rosette



Sandcast Bronze Wall Bumper
with #2 Rosette



Wrought Steel Wall Bumper
with #2 Rosette



Wall Bumpers *with Screws*

Description	Product Code	Finish	List Price
Brass Regular Rosette Style	2255	Polished Brass (US3) French Antique (US7) Oil Rubbed Bronze (US10B) Polished Nickel (US14) Satin Nickel (US15) Pewter (US15A) Flat Black (US19) Polished Chrome (US26) PVD-Lifetime	\$12.00
Sandcast Bronze #2 Rosette Style	2255	Deep Burgundy (DB) Flat Black (FB) Medium Bronze (MB) Polished White Bronze (WB) Tumbled White Bronze (TWB)	\$12.00
Wrought Steel #2 Rosette Style	2255	Flat Black (FB) Satin Steel	\$12.00

ACCESSORIES

Window, Utility Pulls



Window, Utility Pulls *with Screws*

Description	Product Code	Finish	List Price
4" Window, Utility Pulls	2244	Polished Brass (US3) French Antique (US7) Oil Rubbed Bronze (US10B)	\$8.00
6" Window, Utility Pulls	2246	Satin Nickel (US15) Pewter (US15A) Polished Chrome (US26)	\$24.00

Casement Latch

Standard Size

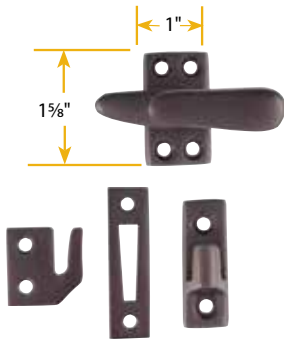

Casement Latch Standard Size *with 3 Strikes & Screws*

Product Code	Finish	List Price
8703	Polished Brass (US3) French Antique (US7) Oil Rubbed Bronze (US10B) Satin Nickel (US15) Pewter (US15A) Polished Chrome (US26)	\$18.00

>> Strikes & Screws are **NOT** sold separately.

Casement Latch

Large Size

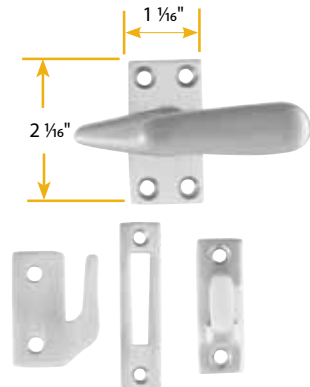

Casement Latch Large Size *with 3 Strikes & Screws*

Product Code	Finish	List Price
8713	Polished Brass (US3) French Antique (US7) Oil Rubbed Bronze (US10B) Satin Nickel (US15) Pewter (US15A) Polished Chrome (US26)	\$28.00

>> Strikes & Screws are **NOT** sold separately.

Keyed Patio Door Bolts



Keyed Patio Door Bolts

Product Code	Finish	List Price
206011	Silver	\$16.00
206012	Bronze	\$16.00
206016	White	\$16.00
206017	Black	\$16.00

Non-Keyed Patio Door Bolts



Non-Keyed Patio Door Bolts

Product Code	Finish	List Price
206511	Silver	\$12.00
206512	Bronze	\$12.00
206516	White	\$12.00

Solid Brass
with Arch Style

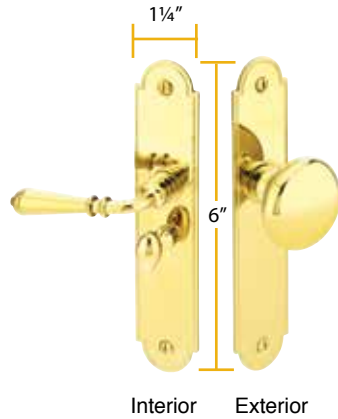

Sandcast Bronze
with Arch Style



Screen Door Locks - Arch Style

Description	Product Code	Finish	List Price
Solid Brass Screen Door Lock with Arch Style	2290	Oil Rubbed Bronze (US10B) Satin Nickel (US15) PVD-Lifetime	\$120.00
Sandcast Bronze Screen Door Lock with Arch Style	2290	Medium Bronze (MB)	\$120.00

>> **Handing Required for Screen Door Locks.**

Solid Brass
with Rectangular Style



Sandcast Bronze
with Rectangular Style

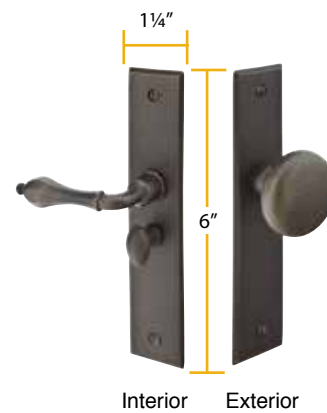

Screen Door Locks - Rectangular Style

Description	Product Code	Finish	List Price
Solid Brass Screen Door Lock with Rectangular Style	2291	Oil Rubbed Bronze (US10B) Satin Nickel (US15) PVD-Lifetime	\$120.00
Sandcast Bronze Screen Door Lock with Rectangular Style	2291	Medium Bronze (MB)	\$120.00

>> **Handing Required for Screen Door Locks.**

ACCESSORIES

Brass House Numbers
4"

Brass House Numbers
5½"



DOOR ACCESSORIES

Brass 4" House Numbers with Matching Screws

Description	Product Code	Finish	List Price
House Number Digit '0'	2810	Oil Rubbed Bronze (US10B) Satin Nickel (US15)	\$10.00
House Number Digit '1'	2811		\$10.00
House Number Digit '2'	2812		\$10.00
House Number Digit '3'	2813		\$10.00
House Number Digit '4'	2814		\$10.00
House Number Digit '5'	2815		\$10.00
House Number Digit '6'	2816		\$10.00
House Number Digit '7'	2817		\$10.00
House Number Digit '8'	2818		\$10.00
House Number Digit '9'	2819		\$10.00

Brass 5½" House Numbers with Matching Screws

Description	Product Code	Finish	List Price
House Number Digit '0'	2820	Oil Rubbed Bronze (US10B) Satin Nickel (US15)	\$14.00
House Number Digit '1'	2821		\$14.00
House Number Digit '2'	2822		\$14.00
House Number Digit '3'	2823		\$14.00
House Number Digit '4'	2824		\$14.00
House Number Digit '5'	2825		\$14.00
House Number Digit '6'	2826		\$14.00
House Number Digit '7'	2827		\$14.00
House Number Digit '8'	2828		\$14.00
House Number Digit '9'	2829		\$14.00

Bronze House Numbers
4"

Bronze House Numbers
6"



Bronze 4" House Numbers *with Matching Screws*

Description	Product Code	Finish	List Price
House Number Digit '0'	2810	Flat Black (FB) Medium Bronze (MB)	\$14.00
House Number Digit '1'	2811		\$14.00
House Number Digit '2'	2812		\$14.00
House Number Digit '3'	2813		\$14.00
House Number Digit '4'	2814		\$14.00
House Number Digit '5'	2815		\$14.00
House Number Digit '6'	2816		\$14.00
House Number Digit '7'	2817		\$14.00
House Number Digit '8'	2818		\$14.00
House Number Digit '9'	2819		\$14.00

Bronze 6" House Numbers *with Matching Screws*

Description	Product Code	Finish	List Price
House Number Digit '0'	2820	Flat Black (FB) Medium Bronze (MB)	\$20.00
House Number Digit '1'	2821		\$20.00
House Number Digit '2'	2822		\$20.00
House Number Digit '3'	2823		\$20.00
House Number Digit '4'	2824		\$20.00
House Number Digit '5'	2825		\$20.00
House Number Digit '6'	2826		\$20.00
House Number Digit '7'	2827		\$20.00
House Number Digit '8'	2828		\$20.00
House Number Digit '9'	2829		\$20.00

DOOR ACCESSORIES

ACCESSORIES

Regular



Oval



Rectangular



#8



Rope



Lancaster



Ribbon & Reed



Quincy



Arts & Crafts



Hammered



Modern



Neos



Square



Modern Rectangular



Disk



Small #1 Style



Small Oval Style



Brass Doorbell with Plates & Buttons

Description	Product Code	Finish	List Price
Doorbell Button with Regular Rosette	2400	Polished Brass (US3) French Antique (US7) Oil Rubbed Bronze (US10B)	\$32.00
Doorbell Button with Oval Rosette	2402	Satin Nickel (US15) Pewter (US15A) Flat Black (US19)	\$32.00
Doorbell Button with Rectangular Rosette	2403	Polished Chrome (US26) PVD-Lifetime	\$32.00
Doorbell Button with #8 Rosette	2408		\$32.00
Doorbell Button with Quincy Rosette	2409		\$32.00
Doorbell Button with Rope Rosette	2401	Polished Brass (US3) French Antique (US7) Oil Rubbed Bronze (US10B)	\$32.00
Doorbell Button with Lancaster Rosette	2406	Satin Nickel (US15) Pewter (US15A) Polished Chrome (US26)	\$32.00
Doorbell Button with Ribbon & Reed Rosette	2407	PVD-Lifetime*	\$32.00
Doorbell Button with Arts & Crafts Rosette	2451	Oil Rubbed Bronze (US10B) Satin Nickel (US15) Flat Black (US19)	\$32.00
Doorbell Button with Hammered Rosette	2452		\$32.00
Doorbell Button with Modern Rosette	2457	Oil Rubbed Bronze (US10B) Satin Nickel (US15) Flat Black (US19)	\$32.00
Doorbell Button with Disk Rosette	2458	Polished Chrome (US26)	\$32.00
Doorbell Button with Square Rosette	2459		\$32.00
Doorbell Button with Neos Rosette	2460		\$32.00
Doorbell Button with Modern Rectangular Rosette	2463		\$32.00
Doorbell Button with Small #1 Style Rosette	2461	French Antique (US7) Oil Rubbed Bronze (US10B) Satin Nickel (US15) Pewter (US15A)	\$32.00
Doorbell Button with Small Oval Style Rosette	2462	Polished Chrome (US26) PVD-Lifetime Deep Burgundy (DB) Flat Black (FB) Medium Bronze (MB) Satin Steel	\$32.00

* PVD-Lifetime not available for Lancaster Rosette.

>> Supplied with Matching Screws & Lighted Button.



Sandcast Bronze Doorbell with Plates & Buttons

Description	Product Code	Finish	List Price
Doorbell Button with #1 Rosette	2421	Deep Burgundy (DB) Flat Black (FB) Medium Bronze (MB) Polished White Bronze (WB) Tumbled White Bronze (TWB)	\$34.00
Doorbell Button with #2 Rosette*	2422		\$34.00
Doorbell Button with #3 Rosette	2423		\$34.00
Doorbell Button with #4 Rosette	2424		\$34.00
Doorbell Button with #6 Rosette	2425		\$34.00

* Polished White Bronze & Tumbled White Bronze not available for #2 Rosette.

>> Supplied with Matching Screws & Lighted Button.



Lost Wax Cast Bronze Doorbell with Plates & Buttons

Description	Product Code	Finish	List Price
Doorbell Button with #11 Rosette	2411	Deep Burgundy (DB) Flat Black (FB) Medium Bronze (MB)	\$34.00
Doorbell Button with #12 Rosette	2412		\$34.00
Doorbell Button with #14 Rosette	2414		\$34.00
Doorbell Button with #15 Rosette	2415		\$34.00
Doorbell Button with #17 Rosette	2417		\$34.00

>> Supplied with Matching Screws & Lighted Button.



Wrought Steel Doorbell with Plates & Buttons

Description	Product Code	Finish	List Price
Doorbell Button with #1 Rosette	2431	Flat Black (FB) Satin Steel	\$32.00
Doorbell Button with #2 Rosette	2432		\$32.00
Doorbell Button with #3 Rosette	2433		\$32.00

>> Supplied with Matching Screws & Lighted Button.

ACCESSORIES

Forged Brass Switch Plates with Colonial Design



Description	Product Code	Finish	List Price
Toggle 1, Colonial Switch Plate	29111	Oil Rubbed Bronze (US10B)	\$16.00
Toggle 2, Colonial Switch Plate	29112	Satin Nickel (US15)	\$22.00
Toggle 3, Colonial Switch Plate	29113	PVD-Lifetime	\$28.00
Toggle 4, Colonial Switch Plate	29114		\$38.00



Description	Product Code	Finish	List Price
Rocker 1, Colonial Switch Plate	29121	Oil Rubbed Bronze (US10B)	\$16.00
Rocker 2, Colonial Switch Plate	29122	Satin Nickel (US15)	\$22.00
Rocker 3, Colonial Switch Plate	29123	PVD-Lifetime	\$28.00
Rocker 4, Colonial Switch Plate	29124		\$38.00

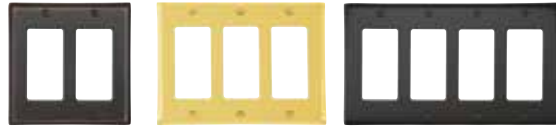

Description	Product Code	Finish	List Price
Duplex 1, Colonial Switch Plate	29131	Oil Rubbed Bronze (US10B)	\$16.00
Duplex 2, Colonial Switch Plate	29132	Satin Nickel (US15)	\$22.00
		PVD-Lifetime	\$28.00



Description	Product Code	Finish	List Price
Toggle 1, Duplex 1 Colonial Switch Plate	29141	Oil Rubbed Bronze (US10B)	\$22.00
Toggle 2, Duplex 1 Colonial Switch Plate	29142	Satin Nickel (US15)	\$28.00
Rocker 1, Duplex 1 Colonial Switch Plate	29143	PVD-Lifetime	\$22.00



Description	Product Code	Finish	List Price
Colonial Blank Plate	29151	Oil Rubbed Bronze (US10B) Satin Nickel (US15) PVD-Lifetime	\$16.00
Colonial Cable Plate	29161		\$16.00

DOOR ACCESSORIES

Forged Brass Switch Plates with Rope Design



Description	Product Code	Finish	List Price
Toggle 1, Rope Switch Plate	29211	Oil Rubbed Bronze (US10B)	\$16.00
Toggle 2, Rope Switch Plate	29212	Satin Nickel (US15)	\$22.00
Toggle 3, Rope Switch Plate	29213	PVD-Lifetime	\$28.00
Toggle 4, Rope Switch Plate	29214		\$38.00



Description	Product Code	Finish	List Price
Rocker 1, Rope Switch Plate	29221	Oil Rubbed Bronze (US10B)	\$16.00
Rocker 2, Rope Switch Plate	29222	Satin Nickel (US15)	\$22.00
Rocker 3, Rope Switch Plate	29223	PVD-Lifetime	\$28.00
Rocker 4, Rope Switch Plate	29224		\$38.00

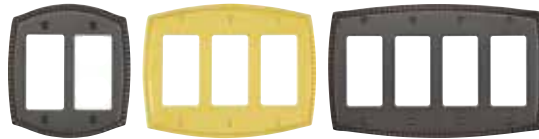

Description	Product Code	Finish	List Price
Duplex 1, Rope Switch Plate	29231	Oil Rubbed Bronze (US10B)	\$16.00
Duplex 2, Rope Switch Plate	29232	Satin Nickel (US15)	\$22.00
		PVD-Lifetime	\$28.00



Description	Product Code	Finish	List Price
Toggle 1, Duplex 1 Rope Switch Plate	29241	Oil Rubbed Bronze (US10B)	\$22.00
Toggle 2, Duplex 1 Rope Switch Plate	29242	Satin Nickel (US15)	\$28.00
Rocker 1, Duplex 1 Rope Switch Plate	29243	PVD-Lifetime	\$22.00

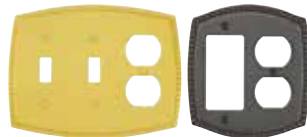

Description	Product Code	Finish	List Price
Rope Blank Plate	29251	Oil Rubbed Bronze (US10B) Satin Nickel (US15) PVD-Lifetime	\$16.00
Rope Cable Plate	29261		\$16.00

ACCESSORIES

Lost Wax Cast Bronze Switch Plates



Description	Product Code	Finish	List Price
Toggle 1, Bronze Switch Plate	29311	Deep Burgundy (DB)	\$18.00
Toggle 2, Bronze Switch Plate	29312	Flat Black (FB)	\$28.00
Toggle 3, Bronze Switch Plate	29313	Medium Bronze (MB)	\$34.00
Toggle 4, Bronze Switch Plate	29314		\$46.00



Description	Product Code	Finish	List Price
Rocker 1, Bronze Switch Plate	29321	Deep Burgundy (DB)	\$18.00
Rocker 2, Bronze Switch Plate	29322	Flat Black (FB)	\$28.00
Rocker 3, Bronze Switch Plate	29323	Medium Bronze (MB)	\$34.00
Rocker 4, Bronze Switch Plate	29324		\$46.00



Description	Product Code	Finish	List Price
Duplex 1, Bronze Switch Plate	29331	Deep Burgundy (DB)	\$18.00
Duplex 2, Bronze Switch Plate	29332	Flat Black (FB)	\$28.00
		Medium Bronze (MB)	\$34.00



Description	Product Code	Finish	List Price
Toggle 1, Duplex 1 Bronze Switch Plate	29341	Deep Burgundy (DB)	\$28.00
Toggle 2, Duplex 1 Bronze Switch Plate	29342	Flat Black (FB)	\$34.00
Rocker 1, Duplex 1 Bronze Switch Plate	29343	Medium Bronze (MB)	\$28.00



Description	Product Code	Finish	List Price
Bronze Blank Plate	29351	Deep Burgundy (DB) Flat Black (FB) Medium Bronze (MB)	\$18.00
Bronze Cable Plate	29361		\$18.00

DOOR ACCESSORIES

Urn Style



Narrow Style



Solid Brass Door Knockers

Description	Product Code	Finish	List Price
Urn Style	2620	Polished Brass (US3) Oil Rubbed Bronze (US10B) Satin Nickel (US15)	\$40.00
Narrow Style	2621	Oil Rubbed Bronze (US10B) Satin Nickel (US15) PVD-Lifetime	\$40.00

>> Note: We recommend that US3 finish be selected for those who intend to have the door knocker engraved. Emtek does not offer engraving services at this time.

Bronze Door Knocker
3"



Bronze Door Knocker
4"



Bronze Door Knockers

Description	Product Code	Finish	List Price
3" Bronze Door Knocker with Ring Pull	86059	Deep Burgundy (DB) Flat Black (FB) Medium Bronze (MB)	\$44.00
4" Bronze Door Knocker with Ring Pull	86060		\$52.00

Solid Brass Mail Slot



Solid Brass Mail Slot

Product Code	Finish	List Price
2280	Oil Rubbed Bronze (US10B) Satin Nickel (US15) PVD-Lifetime	\$78.00

>> Complete set includes both exterior & interior trims and wood screws.

Solid Brass Door Viewer



Solid Brass Door Viewer

Product Code	Finish	List Price
2610	Oil Rubbed Bronze (US10B) Satin Nickel (US15) PVD-Lifetime	\$16.00

>> 200 Degree wide viewing angle. Fits door thickness from 1 3/8" to 2". Hole Diameter 5/8".

SOLID BRASS HINGES - RESIDENTIAL DUTY, PLAIN BEARING, EXTRUDED

3 1/2" x 3 1/2", 4" x 4"

**3 1/2" x 3 1/2" Residential Duty
Square Corners**



**3 1/2" x 3 1/2" Residential Duty
1/4" Radius Corners**



**3 1/2" x 3 1/2" Residential Duty
5/8" Radius Corners**



Residential Duty Hinges - Solid Extruded Brass Plain Bearing, 0.096" - 0.098" Thick

Description	Product Code	Finish	Hinges Per Case	List Price (Per Pair) Broken Case	List Price (Per Pair) 1-5 Cases	List Price (Per Pair) 6+ Cases
3 1/2" x 3 1/2" with Square Corners	96113	French Antique (US7) Oil Rubbed Bronze (US10B) Polished Nickel (US14) Satin Nickel (US15) Pewter (US15A) Polished Chrome (US26) PVD-Lifetime	50 (Pair)	\$30.00	\$25.00	\$22.00
4" x 4" with Square Corners	96114		50 (Pair)	\$33.00	\$27.00	\$24.00
3 1/2" x 3 1/2" with 1/4" Radius Corners	96123		50 (Pair)	\$30.00	\$25.00	\$22.00
4" x 4" with 1/4" Radius Corners	96124		50 (Pair)	\$33.00	\$27.00	\$24.00
3 1/2" x 3 1/2" with 5/8" Radius Corners	96133		50 (Pair)	\$30.00	\$25.00	\$22.00
4" x 4" with 5/8" Radius Corners	96134		50 (Pair)	\$33.00	\$27.00	\$24.00

>> See page 143 for Decorative Tip Sets for Solid Brass Hinges.

Prices Are Per Pair. All Hinges Supplied with Screws.
Non-Removable Pin (NRP) is available for additional \$4.00 per pair (List Price).

HEAVY DUTY, PLAIN BEARING, EXTRUDED - **SOLID BRASS HINGES**
 3 1/2" x 3 1/2", 4" x 4", 4 1/2" x 4 1/2"

**4 1/2" x 4 1/2" Heavy Duty
Square Corners**



**3 1/2" x 3 1/2" Heavy Duty
1/4" Radius Corners**



**4" x 4" Heavy Duty
5/8" Radius Corners**



Heavy Duty Hinges - Solid Extruded Brass Plain Bearing, 0.130" - 0.132" Thick

Description	Product Code	Finish	Hinges Per Case	List Price (Per Pair) Broken Case	List Price (Per Pair) 1-5 Cases	List Price (Per Pair) 6+ Cases
3 1/2" x 3 1/2" with Square Corners	96213	French Antique (US7) Oil Rubbed Bronze (US10B) Polished Nickel (US14)	24 (Pair)	\$33.00	\$29.00	\$26.00
4" x 4" with Square Corners	96214	Satin Nickel (US15) Pewter (US15A) Polished Chrome (US26)	24 (Pair)	\$37.00	\$33.00	\$29.00
4 1/2" x 4 1/2" with Square Corners	96215	PVD-Lifetime	24 (Pair)	\$42.00	\$38.00	\$34.00
3 1/2" x 3 1/2" with 1/4" Radius Corners	96223		24 (Pair)	\$33.00	\$29.00	\$26.00
4" x 4" with 1/4" Radius Corners	96224		24 (Pair)	\$37.00	\$33.00	\$29.00
4 1/2" x 4 1/2" with 1/4" Radius Corners	96225		24 (Pair)	\$42.00	\$38.00	\$34.00
3 1/2" x 3 1/2" with 5/8" Radius Corners	96233		24 (Pair)	\$33.00	\$29.00	\$26.00
4" x 4" with 5/8" Radius Corners	96234		24 (Pair)	\$37.00	\$33.00	\$29.00

>> See page 143 for Decorative Tip Sets for Solid Brass Hinges.

Prices Are Per Pair. All Hinges Supplied with Screws.
 Non-Removable Pin (NRP) is available for additional \$4.00 per pair (List Price).

HINGES

SOLID BRASS HINGES - HEAVY DUTY BALL BEARING, EXTRUDED

3 1/2" x 3 1/2", 4" x 4", 4 1/2" x 4 1/2", 5" x 5"

**3 1/2" x 3 1/2" Ball Bearing
Square Corners**



**4 1/2" x 4 1/2" Ball Bearing
1/4" Radius Corners**



Heavy Duty Ball Bearing Hinges - Solid Extruded Brass Ball Bearing, 0.122" - 0.134" Thick

Description	Product Code	Finish	Hinges Per Case	List Price (Per Pair) Broken Case	List Price (Per Pair) 1-5 Cases	List Price (Per Pair) 6+ Cases
3 1/2" x 3 1/2" with Square Corners	96413	French Antique (US7) Oil Rubbed Bronze (US10B) Polished Nickel (US14)	24 (Pair)	\$36.00	\$32.00	\$29.00
4" x 4" with Square Corners	96414	Satin Nickel (US15) Pewter (US15A) Polished Chrome (US26) PVD-Lifetime	24 (Pair)	\$42.00	\$38.00	\$35.00
4 1/2" x 4 1/2" with Square Corners	96415		24 (Pair)	\$48.00	\$44.00	\$40.00
5" x 5" with Square Corners	96416		24 (Pair)	\$52.00	\$48.00	\$44.00
4 1/2" x 4 1/2" with 1/4" Radius Corners	96425		24 (Pair)	\$48.00	\$44.00	\$40.00

>> See page 143 for Decorative Tip Sets for Solid Brass Hinges.

Prices Are Per Pair. All Hinges Supplied with Screws.
Non-Removable Pin (NRP) is available for additional \$4.00 per pair (List Price).

DECORATIVE TIPS FOR SOLID BRASS HINGES

Ball Tip Sets *4 tips per set*

Ball Tip
for 3 1/2" Hinges



Ball Tip
for 4 1/2" Hinges



Description	Product Code	Finish	List Price
3 1/2" x 3 1/2" Residential Duty Hinges	97203	French Antique (US7) Oil Rubbed Bronze (US10B) Polished Nickel (US14)	\$14.00
4" x 4" Residential Duty Hinges	97204	Satin Nickel (US15) Pewter (US15A) Polished Chrome (US26) PVD-Lifetime	\$14.00
3 1/2" x 3 1/2" Heavy Duty Plain or Ball Bearing Hinges	97303		\$14.00
4" x 4" Heavy Duty Plain or Ball Bearing Hinges	97304		\$14.00
4 1/2" x 4 1/2" Heavy Duty Plain or Ball Bearing Hinges*	97305		\$14.00

* Also fits 5" x 5" Heavy Duty Ball Bearing Brass Hinges.

Steeple Tip
for 3 1/2" Hinges



Steeple Tip
for 4" Hinges



Steeple Tip Sets *4 tips per set*

Description	Product Code	Finish	List Price
3 1/2" x 3 1/2" Residential Duty Hinges	97213	French Antique (US7) Oil Rubbed Bronze (US10B) Polished Nickel (US14)	\$14.00
4" x 4" Residential Duty Hinges	97214	Satin Nickel (US15) Pewter (US15A) Polished Chrome (US26) PVD-Lifetime	\$14.00
3 1/2" x 3 1/2" Heavy Duty Hinges or Ball Bearing Hinges	97313		\$14.00
4" x 4" Heavy Duty Hinges or Ball Bearing Hinges	97314		\$14.00
4 1/2" x 4 1/2" or 5" x 5" Heavy Duty Hinges or Ball Bearing Hinges	97315		\$14.00

>> **Prices Are Per Pair.** All Hinges Supplied with Screws, and Stainless Steel Pins.
Non-Removable Pin (NRP) is available for additional \$4.00 per pair (List Price).



Hinges Pivot Stop



Extended Button Tip

Product Code	Finish	List Price
2241	Polished Brass (US3) French Antique (US7) Oil Rubbed Bronze (US10B) Polished Nickel (US14) Satin Nickel (US15) Pewter (US15A) Polished Chrome (US26) Deep Burgundy (DB) Flat Black (FB) Medium Bronze (MB) Satin Steel	\$8.00

Product Code	Finish	List Price
2242	Polished Brass (US3) French Antique (US7) Oil Rubbed Bronze (US10B) Polished Nickel (US14) Satin Nickel (US15) Pewter (US15A) Polished Chrome (US26)	\$4.00

>> **Can not be used with Steel Residential Duty Hinges.**
Required Extended Button Tip when used with Solid Brass Hinges.

>> **Used with Hinge Pivot Stop on Solid Brass Hinge.**

PLATED STEEL HINGES - RESIDENTIAL DUTY, PLAIN BEARING

3 1/2" x 3 1/2", 4" x 4"

4" x 4" Residential Duty Square Corners



3 1/2" x 3 1/2" Residential Duty 1/4" Radius Corners



4" x 4" Residential Duty 5/8" Radius Corners



Residential Duty Hinges Plain Bearing, Plated Steel 0.084" - 0.090" Thick

Description	Product Code	Finish	Hinges Per Case	List Price (Per Pair) Broken Case	List Price (Per Pair) 1-5 Cases	List Price (Per Pair) 6+ Cases
3 1/2" x 3 1/2" with Square Corners*	91013	Polished Brass (US3) French Antique (US7) Oil Rubbed Bronze (US10B)	24 (Pair)	\$9.50	\$8.50	\$8.00
4" x 4" with Square Corners**	91014	Polished Nickel (US14) Satin Nickel (US15) Pewter (US15A) Polished Chrome (US26) Satin Chrome (US26D)	24 (Pair)	\$11.00	\$9.00	\$8.50
3 1/2" x 3 1/2" with 1/4" Radius Corners*	91023	Flat Black (FB) Medium Bronze (MB)	24 (Pair)	\$9.50	\$8.50	\$8.00
4" x 4" with 1/4" Radius Corners**	91024		24 (Pair)	\$11.00	\$9.00	\$8.50
3 1/2" x 3 1/2" with 5/8" Radius Corners*	91033		24 (Pair)	\$9.50	\$8.50	\$8.00
4" x 4" with 5/8" Radius Corners**	91034		24 (Pair)	\$11.00	\$9.00	\$8.50

* 3 1/2" x 3 1/2" Hinges have 6 screwholes per hinge in an "Arc" pattern. ** 4" x 4" Hinges have 8 screwholes per hinge in a "Zig-Zag" pattern.

>> **Decorative Tips are NOT available with Residential Duty, Plain Bearing Hinges.**

Prices Are Per Pair. All Hinges Supplied with Screws.
Non-Removable Pin (NRP) is available for additional \$4.00 per pair (List Price).

HEAVY DUTY, PLAIN BEARING - PLATED STEEL HINGES

3 1/2" x 3 1/2", 4" x 4", 4 1/2" x 4 1/2"

**4 1/2" x 4 1/2" Heavy Duty
Square Corners**



**4" x 4" Heavy Duty
1/4" Radius Corners**



**3 1/2" x 3 1/2" Heavy Duty
5/8" Radius Corners**



Heavy Duty Hinges *Plain Bearing, Plated Steel 0.118" - 0.126" Thick*

Description	Product Code	Finish	Hinges Per Case	List Price (Per Pair) Broken Case	List Price (Per Pair) 1-5 Cases	List Price (Per Pair) 6+ Cases
3 1/2" x 3 1/2" with Square Corners	92013	Polished Brass (US3) French Antique (US7) Oil Rubbed Bronze (US10B) Polished Nickel (US14) Satin Nickel (US15) Pewter (US15A) Polished Chrome (US26) Satin Chrome (US26D) Flat Black (FB) Medium Bronze (MB)	24 (Pair)	\$15.00	\$13.00	\$12.00
4" x 4" with Square Corners	92014		24 (Pair)	\$18.00	\$15.00	\$14.00
4 1/2" x 4 1/2" with Square Corners	92015		24 (Pair)	\$22.00	\$18.00	\$17.00
3 1/2" x 3 1/2" with 1/4" Radius Corners	92023		24 (Pair)	\$15.00	\$13.00	\$12.00
4" x 4" with 1/4" Radius Corners	92024		24 (Pair)	\$18.00	\$15.00	\$14.00
4 1/2" x 4 1/2" with 1/4" Radius Corners	92025		24 (Pair)	\$22.00	\$18.00	\$17.00
3 1/2" x 3 1/2" with 5/8" Radius Corners	92033		24 (Pair)	\$15.00	\$13.00	\$12.00
4" x 4" with 5/8" Radius Corners	92034		24 (Pair)	\$18.00	\$15.00	\$14.00

>> See page 147 for Decorative Tip Sets for Steel Hinges.

Prices Are Per Pair. All Hinges Supplied with Screws.
Non-Removable Pin (NRP) is available for additional \$4.00 per pair (List Price).

HINGES

PLATED STEEL HINGES - HEAVY DUTY, BALL BEARING

3 1/2" x 3 1/2", 4" x 4", 4 1/2" x 4 1/2"

**3 1/2" x 3 1/2" Ball Bearing
Square Corners**



**3 1/2" x 3 1/2" Ball Bearing
1/4" Radius Corners**



**4 1/2" x 4 1/2" Ball Bearing
5/8" Radius Corners**



Heavy Duty Ball Bearing Hinges *Plated Steel 0.126" Thick*

Description	Product Code	Finish	Hinges Per Case	List Price (Per Pair) Broken Case	List Price (Per Pair) 1-5 Cases	List Price (Per Pair) 6+ Cases
3 1/2" x 3 1/2" with Square Corners	94013	Polished Brass (US3) French Antique (US7) Oil Rubbed Bronze (US10B) Polished Nickel (US14) Satin Nickel (US15) Pewter (US15A) Polished Chrome (US26) Satin Chrome (US26D) Flat Black (FB) Medium Bronze (MB)	24 (Pair)	\$24.00	\$23.00	\$22.00
4" x 4" with Square Corners	94014		24 (Pair)	\$26.00	\$24.00	\$23.00
4 1/2" x 4 1/2" with Square Corners	94015		24 (Pair)	\$34.00	\$29.00	\$28.00
3 1/2" x 3 1/2" with 1/4" Radius Corners	94023		24 (Pair)	\$24.00	\$23.00	\$22.00
4" x 4" with 1/4" Radius Corners	94024		24 (Pair)	\$26.00	\$24.00	\$23.00
4 1/2" x 4 1/2" with 1/4" Radius Corners	94025		24 (Pair)	\$34.00	\$29.00	\$28.00
3 1/2" x 3 1/2" with 5/8" Radius Corners	94033		24 (Pair)	\$24.00	\$23.00	\$22.00
4" x 4" with 5/8" Radius Corners	94034		24 (Pair)	\$26.00	\$24.00	\$23.00

>> See page 147 for Decorative Tip Sets for Steel Hinges.

Prices Are Per Pair. All Hinges Supplied with Screws.
Non-Removable Pin (NRP) is available for additional \$4.00 per pair (List Price).

DECORATIVE TIPS FOR PLATED STEEL HINGES

Ball Tip Sets *2 pins and 4 tips per set*

Ball Tip



Description	Product Code	Finish	List Price
3 1/2"	94103	Polished Brass (US3) French Antique (US7) Oil Rubbed Bronze (US10B) Polished Nickel (US14) Satin Nickel (US15)	\$12.00
4"	94104	Pewter (US15A) Polished Chrome (US26) Satin Chrome (US26D) Flat Black (FB)	\$12.00
4 1/2"	94105	Medium Bronze (MB)	\$12.00

>> **These tip sets cannot be used with Hinge Pivot Stop.**

Steeple Tip Sets *2 pins and 4 tips per set*

Steeple Tip



Description	Product Code	Finish	List Price
3 1/2"	94113	Polished Brass (US3) French Antique (US7) Oil Rubbed Bronze (US10B) Polished Nickel (US14) Satin Nickel (US15)	\$12.00
4"	94114	Pewter (US15A) Polished Chrome (US26) Satin Chrome (US26D) Flat Black (FB)	\$12.00
4 1/2"	94115	Medium Bronze (MB)	\$12.00

>> **These tip sets cannot be used with Hinge Pivot Stop.**

Each set includes tip, and threaded pins for one pair of hinges.

Compatible with Heavy Duty and Ball Bearing Hinges. Not compatible with Residential Duty Hinges.

STAINLESS STEEL HINGES - RESIDENTIAL DUTY, PLAIN BEARING

3 1/2" x 3 1/2", 4" x 4"

3 1/2" x 3 1/2" Residential Duty
Square Corners



4" x 4" Residential Duty
1/4" Radius Corners



4" x 4" Residential Duty
5/8" Radius Corners



Residential Hinges *Plain Bearing, 304 Grade, 0.093" - 0.096" Thick*

Description	Product Code	Finish	Hinges Per Case	List Price (Per Pair) Broken Case	List Price (Per Pair) 1-5 Cases	List Price (Per Pair) 6+ Cases
3 1/2" x 3 1/2" with Square Corners	9811332D	Stainless Steel (SS)	50 (Pair)	\$20.00	\$18.00	\$17.00
4" x 4" with Square Corners	9811432D		50 (Pair)	\$24.00	\$22.00	\$21.00
3 1/2" x 3 1/2" with 1/4" Radius Corners	9812332D	Stainless Steel (SS)	50 (Pair)	\$20.00	\$18.00	\$17.00
4" x 4" with 1/4" Radius Corners	9812432D		50 (Pair)	\$24.00	\$22.00	\$21.00
3 1/2" x 3 1/2" with 5/8" Radius Corners	9813332D	Stainless Steel (SS)	50 (Pair)	\$20.00	\$18.00	\$17.00
4" x 4" with 5/8" Radius Corners	9813432D		50 (Pair)	\$24.00	\$22.00	\$21.00

>> **Decorative Tips are NOT available with Stainless Steel Hinges.**

Prices Are Per Pair. All Hinges Supplied with Screws, and Stainless Steel Pins. Non-Removable Pin (NRP) is available for additional \$4.00 per pair (List Price).

HEAVY DUTY, PLAIN & BALL BEARING - STAINLESS STEEL HINGES

3 1/2" x 3 1/2", 4" x 4", 4 1/2" x 4 1/2"

**3 1/2" x 3 1/2" Heavy Duty
Square Corners**

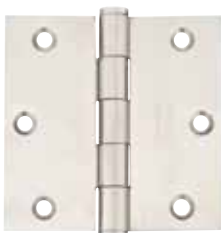

**4" x 4" Heavy Duty
1/4" Radius Corners**



**4" x 4" Heavy Duty
5/8" Radius Corners**



Heavy Duty Hinges *Plain Bearing, 304 Grade, 0.113" - 0.135" Thick*

Description	Product Code	Finish	Hinges Per Case	List Price (Per Pair) Broken Case	List Price (Per Pair) 1-5 Cases	List Price (Per Pair) 6+ Cases
3 1/2" x 3 1/2" with Square Corners	9821332D	Stainless Steel (SS)	24 (Pair)	\$22.00	\$20.00	\$19.00
4" x 4" with Square Corners	9821432D		24 (Pair)	\$28.00	\$26.00	\$25.00
4 1/2" x 4 1/2" with Square Corners	9821532D		24 (Pair)	\$34.00	\$32.00	\$31.00
3 1/2" x 3 1/2" with 1/4" Radius Corners	9822332D		24 (Pair)	\$22.00	\$20.00	\$19.00
4" x 4" with 1/4" Radius Corners	9822432D		24 (Pair)	\$28.00	\$26.00	\$25.00
3 1/2" x 3 1/2" with 5/8" Radius Corners	9823332D		24 (Pair)	\$22.00	\$20.00	\$19.00
4" x 4" with 5/8" Radius Corners	9823432D		24 (Pair)	\$28.00	\$26.00	\$25.00

**4" x 4" Heavy Duty
Square Corners**



**4" x 4" Heavy Duty
1/4" Radius Corners**

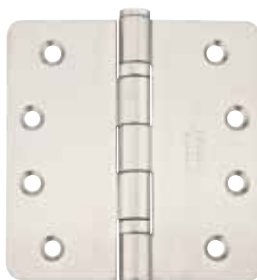

**3 1/2" x 3 1/2" Heavy Duty
5/8" Radius Corners**



Heavy Duty Hinges *Ball Bearing, 304 Grade, 0.113" - 0.132" Thick*

Description	Product Code	Finish	Hinges Per Case	List Price (Per Pair) Broken Case	List Price (Per Pair) 1-5 Cases	List Price (Per Pair) 6+ Cases
3 1/2" x 3 1/2" with Square Corners	9841332D	Stainless Steel (SS)	24 (Pair)	\$24.00	\$22.00	\$21.00
4" x 4" with Square Corners	9841432D		24 (Pair)	\$32.00	\$30.00	\$29.00
4 1/2" x 4 1/2" with Square Corners	9841532D		24 (Pair)	\$38.00	\$36.00	\$35.00
3 1/2" x 3 1/2" with 1/4" Radius Corners	9842332D		24 (Pair)	\$24.00	\$22.00	\$21.00
4" x 4" with 1/4" Radius Corners	9842432D		24 (Pair)	\$32.00	\$30.00	\$29.00
3 1/2" x 3 1/2" with 5/8" Radius Corners	9843332D		24 (Pair)	\$24.00	\$22.00	\$21.00
4" x 4" with 5/8" Radius Corners	9843432D		24 (Pair)	\$32.00	\$30.00	\$29.00

Prices Are Per Pair. All Hinges Supplied with Screws, and Stainless Steel Pins. Non-Removable Pin (NRP) is available for additional \$4.00 per pair (List Price).

HINGES

SPRING HINGES - UL LISTED

3 1/2" x 3 1/2", 4" x 4"

3 1/2" x 3 1/2" Spring Hinge
1/4" Radius Corner



4" x 4" Spring Hinge
5/8" Radius Corner



Spring Hinges, UL Listed Plated Steel 0.110" Thick

Description	Product Code	Finish	Hinges Per Case	List Price (Per Pair) Broken Case	List Price (Per Pair) 1-5 Cases	List Price (Per Pair) 6+ Cases
3 1/2" x 3 1/2" with 1/4" Radius Corners	95023	Polished Brass (US3) French Antique (US7) Oil Rubbed Bronze (US10B) Polished Nickel (US14)	24 (Pair)	\$26.00	\$24.00	\$23.00
4" x 4" with 1/4" Radius Corners	95024	Satin Nickel (US15) Pewter (US15A) Polished Chrome (US26) Satin Chrome (US26D)	24 (Pair)	\$26.00	\$24.00	\$23.00
3 1/2" x 3 1/2" with 5/8" Radius Corners	95033	Deep Burgundy (DB) Flat Black (FB) Medium Bronze (MB)	24 (Pair)	\$26.00	\$24.00	\$23.00
4" x 4" with 5/8" Radius Corners	95034		24 (Pair)	\$26.00	\$24.00	\$23.00

Prices Are Per Pair. All Hinges Supplied with Screws.

Standard Latches



Standard Latches

Description	Finish	List Price
Passage Latch, 2 3/8" backset	Polished Brass (US3) French Antique (US7)	\$8.00
Privacy Latch, 2 3/8" backset	Oil Rubbed Bronze (US10B) Satin Nickel (US15)	\$8.00
Passage Latch, 2 3/4" backset	Pewter (US15A) Polished Chrome (US26)	\$8.00
Privacy Latch, 2 3/4" backset	Flat Black (FB)	\$8.00

>> Please specify if faceplate and screws are required. If required, specify finish and square or 1/4" radius corner condition for faceplate.

Drive-in Latches



Description	List Price
Drive-in Passage Latch, 2 3/8" backset	\$8.00
Drive-in Privacy Latch, 2 3/8" backset	\$8.00
Drive-in Passage Latch, 2 3/4" backset	\$8.00
Drive-in Privacy Latch, 2 3/4" backset	\$8.00

>> Please specify Brass or Chrome nose bolt.

Deadbolt Latches



Description	Finish	List Price
Deadbolt Latch, 2 3/8" backset	Polished Brass (US3) French Antique (US7)	\$8.00
Deadbolt Latch, 2 3/4" backset	Oil Rubbed Bronze (US10B) Satin Nickel (US15) Pewter (US15A) Polished Chrome (US26) Flat Black (FB)	\$8.00

>> Latches are included with EMTEK locks. Latches come standard with square corner face plates. Radius corner face plates may be substituted at no extra charge.

28° Rotation Latch



28° Rotation Latch

Product Code	Description	List Price
Latch28	28° rotation latch is designed to work with a corresponding door mechanism and cannot be retrofitted. Replacement use only.	\$18.00

Lever operated with 28° Rotation Latch



Lever operated with Standard Latch



* Knobsets, leversets and platesets ordered with 28° Rotation Latches are assembled with internal components specifically designed for use with our 28° Rotation Latch.

PARTS & OPTIONS

Heavy Duty
Deadbolt Strike Plate



Heavy Duty Full Lip
Deadbolt Strike Plate



Standard with Deadbolt Strike Plates

- Supplied with 4 Screws:
- (2) #10, 2 1/2" Wood Screws
- (2) #10, 3/4" Wood Screws

	Description	Product Code	Finish	List Price
Heavy Duty Deadbolt Strike Plate with 4 Wood Screws	1 1/4" x 3 5/8", 3/4" Fits Kwikset® Type Jamb Prep	932233	Polished Brass	\$4.00
		932237	French Antique	\$4.00
		9322310B	Oil Rubbed Bronze	\$4.00
		9322315	Satin Nickel	\$4.00
		9322315A	Pewter	\$4.00
		932236	Polished Chrome	\$4.00
		93223DB	Deep Burgundy	\$4.00
Heavy Duty Full Lip Deadbolt Strike Plate with 4 Wood Screws	1 7/8" x 3 5/8", 3/4" Full Lip Deadbolt Strike	932243	Polished Brass	\$4.00
		932247	French Antique	\$4.00
		9322410B	Oil Rubbed Bronze	\$4.00
		9322415	Satin Nickel	\$4.00
		9322415A	Pewter	\$4.00
		932246	Polished Chrome	\$4.00
		93224DB	Deep Burgundy	\$4.00

>> These strike plates must be purchased separately. If ordered along with deadbolts they will be packed into the deadbolt boxes. In that case deadbolts will be packed with both normal strikes and heavy duty strikes.

Full Lip Strike
Square Corner



Full Lip Strike
1/4" Radius Corner



Extended Lip Strike
Square Corner



T Strike
Square Corner



Strike Plates For Passage and Privacy Sets

Description	Product Code	Finish	List Price
Full Lip Strike, Square Corners	86084	Polished Brass (US3) French Antique (US7)	\$6.00
Full Lip Strike, 1/4" Radius Corners	86085	Oil Rubbed Bronze (US10B) Satin Nickel (US15)	\$6.00
Extended Lip Strike, Square Corners	86086	Pewter (US15A) Polished Chrome (US26)	\$6.00
T Strike	86087	Flat Black (FB)	\$6.00

>> All Brass Strike Plates supplied with 2 screws. Strike plates are included with EMTEK locks.

Square corner strike plates are standard. Radius corner, extended and T strike plates may be substituted at no extra charge.



UL LISTED Knobsets and Deadbolts - Add the below product codes and prices to standard items to obtain UL LISTED versions of EMTEK Knobsets and Deadbolts

Knobsets with UL LISTING-USL, 60 Minute Fire Rating		Add On List Price
Passage Set 81UL	Add Product Code, Knob Style, Rosette Style*, and Finish.	\$20.00

* Available only in Round Rosettes for UL.

Deadbolts with UL LISTING-USL, 60 Minute Fire Rating		Add On List Price
Single Cylinder Deadbolt 84UL	Add Material (Low Profile Brass (8455), Sandcast Bronze (8450), or Wrought Steel #2 (8452)) and Add Finish.	\$20.00

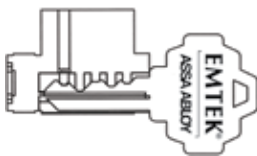
Construction Keying

	
Construction devices used on one or all of last four positions.	Dimples drilled in plug in this position.

Standard with Construction Keying Services

- Lost ball system
- Last four pin locations drilled for lost ball application
- Master key wafers used for code variability
- Construction keys and owner keys sent separately
- Order by indicating "Construction Keyed, House #_" next to applicable locks

Charge for Construction Keying - \$2 (NET)

Locks that are both construction keyed and keyed alike will be charged a total of \$4.00 (NET) per cylinder.

Charge for Re-Keying - \$2 (NET)

Locks that are keyed to code or keyed alike will be charged \$2.00 (NET) per cylinder.

Keying to Code

- Order by indicating "Key Code XXXXX" next to applicable locks.

Keying Alike

- Order by indicating "Keyed Alike" next to applicable locks if only one keyed alike group is wanted.
- If ordering multiple groups (houses) indicate "Keyed Alike House #_" next to applicable locks.

Key Blanks Schlage® C Keyway / Weiser® (WR5) Keyway	List Price: \$1.00 / \$2.00
--	------------------------------------

PRODUCT INDEX

Product#	Page	Product#	Page	Product#	Page	Product#	Page	Product#	Page	Product#	Page	Product#	Page
443	37-54, 74-79, 81-84	2452	134	3043	16	3350	16	4704	45	5114	61,62	7091	78
		2457	134	3044	14	3380	34	4711	45	5121	59,60	7095	78
		2458	134	3045	14	3502	29	4714	45	5122	59,60	7100	102,103
2074	123	2459	134	3046	14	3504	29	4721	45	5150	59,60	7101	107,108
2075	123	2460	134	3047	13	3506	29	4724	45	5151	59,60	7102	107,108
2101	125	2461	134	3048	13	3507	30	4801	39	5152	61,62	7103	107,108
2102	125	2462	134	3049	20	3508	30	4802	39	5153	61,62	7104	102,103
2103	126	2463	134	3050	16	3521	31	4804	39	5154	61,62	7105	85
2104	126	2610	139	3102	29	3525	31	4805	38	5158	59,60	7106	102,103
2105	126	2620	139	3104	29	3531	32	4806	38	5164	61,62	7107	83
2106	126	2621	139	3106	29	3532	32	4807	38	5205	109	7108	102,103
2201	125	2810	132,133	3107	30	3533	32	4808	37	5206	109	7109	78
2211	125	2811	132,133	3108	30	3534	31	4809	37	5207	90-93,111	7111	102,103
2221	127	2812	132,133	3121	31	3542	30	4810	37	5209	90-93,111	7200	102,103
2231	128	2813	132,133	3125	31	3543	28	4811	39	5210	90-93,111	7201	107,108
2232	128	2814	132,133	3131	32	3544	28	4812	39	5211	90-93,111	7202	107,108
2233	128	2815	132,133	3132	32	3545	28	4814	39	5212	90-93,111	7203	107,108
2241	143	2816	132,133	3133	32	4201	40	4815	38	5300	36	7204	102,103
2242	143	2817	132,133	3134	31	4202	40	4816	38	5310	36	7205	85
2244	130	2818	132,133	3142	30	4203	40	4817	38	5320	36	7206	102,103
2246	130	2819	132,133	3143	28	4211	40	4818	37	5350	36	7207	83
2251	129	2820	132,133	3144	28	4212	40	4819	37	6010	79	7208	102,103
2253	129	2821	132,133	3145	28	4213	40	4820	37	6011	79	7209	78
2254	128	2822	132,133	3300	34	4221	40	4821	39	6015	79	7211	89,102,103
2255	129	2823	132,133	3301	15	4222	40	4822	39	6020	84	7360	82
2256	128	2824	132,133	3302	15	4223	40	4824	39	6021	84	7361	82
2257	129	2825	132,133	3304	18	4300	44	4825	38	6025	84	7365	82
2258	129	2826	132,133	3305	17	4301	44	4826	38	6030	79	7370	81
2259	129	2827	132,133	3306	17	4302	43	4827	38	6031	79	7371	81
2260	129	2828	132,133	3307	19	4303	43	4828	37	6035	79	7375	81
2264	128	2829	132,133	3308	20	4304	43	4829	37	6052	84	7512	82
2265	128	3001	15	3309	19	4310	44	4830	37	6102	84	7522	81
2280	139	3002	15	3310	17	4311	44	4901	45	6202	84	7552	82
2290	131	3004	18	3311	27	4312	43	4911	45	6620	84	7560	82
2291	131	3005	17	3312	27	4313	43	4921	45	6621	84	7561	82
2400	134	3006	17	3313	27	4314	43	5021	59,60	6625	84	7562	81
2401	134	3007	19	3321	21	4320	44	5022	59,60	6702	84	7565	82
2402	134	3008	20	3322	21	4321	44	5050	90-93,111	6752	84	7570	81
2403	134	3009	19	3323	21	4322	43	5051	90-93,111	6802	84	7571	81
2406	134	3010	17	3324	23	4323	43	5052	90-93,111	7010	85	7575	81
2407	134	3011	27	3325	23	4324	43	5055	109	7011	85	7612	82
2408	134	3012	27	3326	23	4400	42	5056	109	7015	85	7622	81
2409	134	3013	27	3327	24	4401	42	5057	90-93,111	7050	102,103	7670	83
2411	135	3021	21	3328	24	4403	41	5059	90-93,111	7051	107,108	7671	83
2412	135	3022	21	3329	22	4404	41	5100	59,60	7052	107,108	7675	83
2414	135	3023	21	3330	22	4405	41	5101	59,60	7053	107,108	7707	83
2415	135	3024	23	3331	25	4410	42	5102	61,62	7054	102,103	7710	78
2417	135	3025	23	3332	25	4411	42	5103	61,62	7055	85	7757	83
2421	135	3026	23	3333	25	4413	41	5104	61,62	7056	102,103	7807	83
2422	135	3027	24	3342	18	4414	41	5105	109	7057	83	7810	78
2423	135	3028	24	3343	16	4415	41	5106	109	7058	102,103	7850	78
2424	135	3029	22	3344	14	4420	42	5107	90-93,111	7059	78	7990	78
2425	135	3030	22	3345	14	4421	42	5108	59,60	7061	102,103	7991	78
2431	135	3031	25	3346	14	4423	41	5109	90-93,111	7070	83	7995	78
2432	135	3032	25	3347	13	4424	41	5110	90-93,111	7071	83	8000	114
2433	135	3033	25	3348	13	4425	41	5111	90-93,111	7075	83	8001	77
2451	134	3042	18	3349	20	4701	45	5112	90-93,111	7090	78	8003	110

Product#	Page	Product#	Page	Product#	Page	Product#	Page	Product#	Page	Product#	Page
8006	76	8102	80		113	8470	70	8704	75	29323	138
8010	77	8103	80	8221	95,97,99,	8471	69	8711	77	29324	138
8011	74	8104	75		101,110,	8472	69	8713	130	29331	138
8012	74	8105	79		113	8473	69	8716	76	29332	138
8013	74	8106	94,96,98,	8224	88	8474	68	8801	127	29341	138
8014	74		100,110,	8225	88	8475	65	8802	127	29342	138
8016	76		112	8226	88	8476	68	8804	75	29343	138
8020	77	8107	95,97,99,	8227	89	8478	65	8811	77	29351	138
8022	88		101,110,	8228	88	8501	124	8816	76	29361	138
8026	76		113	8231	95,97,99,	8502	124	8851	77	54011	63
8030	110	8108	95,97,99,		101,110,	8503	124	8854	75	54012	63
8040	110		101,110,		113	8504	124	8856	76	54014	63
8041	87		113	8241	87	8505	124	8980	75	54511	63
8042	87	8109	79	8243	87	8506	124	8981	75	54512	63
8043	87	8111	74	8350	66,68,71	8511	123	8985	75	54514	63
8044	87	8112	74	8354	66	8512	123	8990	77	70053	82
8045	87	8113	74	8355	66	8513	123	8991	77	70063	81
8046	87	8114	74	8356	69	8514	123	8995	77	70511	104,105
8050	94,96,98,	8120	95,97,99,	8357	68	8515	123	8996	76	70512	104,105
	100,110,		101,110,	8358	67	8516	123	8997	76	70514	104,105
	112		113	8359	67	8520	95,97,99,	8998	76	70515	104,105
8051	94,96,98,	8121	95,97,99,	8360	69		101,110,	29111	136	70517	104,105
	100,110,		101,110,	8361	71		113	29112	136	71011	104,105
	112		113	8363	71	8521	95,97,99,	29113	136	71012	104,105
8052	80	8131	95,97,99,	8364	66		101,110,	29114	136	71013	82
8053	80		101,110,	8365	68		113	29121	136	71014	104,105
8054	75		113	8366	67	8527	124	29122	136	71015	104,105
8055	79	8141	87	8367	65	8528	124	29123	136	71017	104,105
8056	94,96,98,	8143	87	8368	67	8529	124	29124	136	71023	81
	100,110,	8160	77	8369	65	8530	124	29131	136	72011	104,105
	112	8166	76	8370	70	8531	95,97,99,	29132	136	72012	104,105
8057	94,96,98,	8200	94,96,98,	8371	69		101,110,	29141	136	72013	82
	100,110,		100,110,	8372	69		113	29142	136	72014	104,105
	112		112	8373	69	8550	72	29143	136	72015	104,105
8058	95,97,99,	8201	94,96,98,	8374	68	8550	73	29151	136	72017	104,105
	101,110,		100,110,	8375	65	8551	73	29161	136	72023	81
	113		112	8376	68	8552	73	29211	137	76028	122
8059	79	8202	80	8378	65	8553	73	29212	137	76029	122
8060	77	8203	80	8442	87	8554	72	29213	137	76030	122
8061	76	8204	75	8444	87	8556	73	29214	137	76031	122
8065	77	8205	79	8450	66,68	8557	73	29221	137	76041	122
8066	76	8206	94,96,98,	8452	71	8558	72	29222	137	86059	139
8070	80		100,110,	8454	66	8559	72	29223	137	86060	139
8071	80		112	8455	66	8560	73	29224	137	86064	118
8075	80	8207	94,96,98,	8456	69	8564	72	29231	137	86065	118
8080	75		100,110,	8457	68	8565	73	29232	137	86068	119
8081	75		112	8458	67	8566	72	29241	137	86069	120
8085	75	8208	95,97,99,	8459	67	8567	72	29242	137	86077	116
8090	80		101,110,	8460	69	8568	72	29243	137	86078	116
8091	80		113	8461	71	8569	72	29251	137	86079	116
8095	80	8209	79	8463	71	8570	73	29261	137	86080	116
8100	94,96,98,	8211	74	8464	66	8572	73	29311	138	86081	117
	100,110,	8212	74	8465	68	8573	73	29312	138	86082	117
	112	8213	74	8466	67	8574	73	29313	138	86083	118
8101	94,96,98,	8214	74	8467	65	8575	72	29314	138	86084	152
	100,110,	8220	95,97,99,	8468	67	8578	72	29321	138	86085	152
	112		101,110,	8469	65	8703	130	29322	138	86086	152

PRODUCT INDEX

Product#	Page	Product#	Page	Product#	Page	Product#	Page	Product#	Page	Product#	Page
86087	152	94103	147	450923	46	455818	57	828TP	89	S3001	26
86088	119	94104	147	451112	48	455828	56	86144LH	120	S3101	33
86089	119	94105	147	451211	48	455919	57	86144RH	120	S3301	26
86090	119	94113	147	451332	48	455929	56	9322310B	152	S3501	33
86147	34	94114	147	451411	49	460111	54	9322315A	152	S40000	52
86148	34	94115	147	451512	49	460121	54	93223DB	152	S40001	52
86149	34	95023	150	451613	49	460131	54	9322410B	152	S40002	52
86156	120	95024	150	451711	47	460212	53	9322415A	152	S40100	52
86157	121	95033	150	451721	46	460222	53	93224DB	152	S40101	52
86158	121	95034	150	451812	47	460232	53	9611332D	148	S50001	70
86159	121	96113	140	451822	46	461111	54	9611432D	148	S50002	70
86160	119	96114	140	451913	47	461121	54	9612332D	148	S50003	70
86167	120	96123	140	451923	46	461131	54	9612432D	148	S50023	70
86168	120	96124	140	452112	48	461212	53	9613332D	148	S52005	73
86169	121	96133	140	452211	48	461222	53	9613432D	148	S52006	73
86177	118	96134	140	452332	48	461232	53	9821332D	149	S800	85
86178	118	96213	141	452411	49	462111	54	9821432D	149	S801	85
86179	118	96214	141	452512	49	462121	54	9821532D	149	S802	85
86181	120	96215	141	452613	49	462131	54	9822332D	149	S86001	116
86182	120	96223	141	452711	47	462212	53	9822432D	149	S86002	116
86183	116	96224	141	452721	46	462222	53	9823332D	149	S901	64
86184	116	96225	141	452812	47	462232	53	9823432D	149	S951	64
86345	115	96233	141	452822	46	470112	50	9841332D	149	ULCY5150	35
86346	115	96234	141	452913	47	470222	51	9841432D	149	ULCY51375	35
86347	115	96413	142	452923	46	470224	50	9841532D	149	ULCY5175	35
86348	115	96414	142	453111	57	470333	51	9842332D	149		
86349	115	96415	142	453212	57	471112	50	9842432D	149		
86350	115	96416	142	453333	57	471222	51	9843332D	149		
86351	115	96425	142	453414	56	471224	50	9843432D	149		
86352	115	97203	143	453515	56	471333	51	CY5-ThrdMrt1375	34		
86355	115	97204	143	453636	56	472112	50	CY5-ThrdMrt150	34		
86356	115	97213	143	453717	57	472222	51	CY5-ThrdMrt175	34		
86436	117	97214	143	453727	56	472224	50	E1000	9		
86437	117	97303	143	453818	57	472333	51	E1001	9		
86439	119	97304	143	453828	56	473111	58	E1020	9		
91013	144	97305	143	453919	57	473222	58	E2000	11		
91014	144	97313	143	453929	56	473444	58	E2001	11		
91023	144	97314	143	454111	57	474111	58	E2020	10		
91024	144	97315	143	454212	57	474222	58	E2200	11		
91033	144	206011	130	454333	57	474444	58	E2201	11		
91034	144	206012	130	454414	56	475111	58	E2220	10		
92013	145	206016	130	454515	56	475222	58	E3002	9		
92014	145	206017	130	454636	56	475444	58	E3020	9		
92015	145	206511	130	454717	57	932233	152	E4002	10		
92023	145	206512	130	454727	56	932236	152	E4020	10		
92024	145	206516	130	454818	57	932237	152	E4202	10		
92025	145	450112	48	454828	56	932243	152	E4220	10		
92033	145	450211	48	454919	57	932246	152	E4410	7		
92034	145	450332	48	454929	56	932247	152	E451211	8		
94013	146	450411	49	455111	57	9322315	152	E4817	8		
94014	146	450512	49	455212	57	9322415	152	E4827	7		
94015	146	450613	49	455333	57	473333LH	58	Latch28	74-85,		
94023	146	450711	47	455414	56	473333RH	58		88-89,		
94024	146	450721	46	455515	56	474333LH	58		90-113		
94025	146	450812	47	455636	56	474333RH	58	S100	106		
94033	146	450822	46	455717	57	475333LH	58	S200	106		
94034	146	450913	47	455727	56	475333RH	58	S300	106		

Door Hardware Order Form



Billing Information

Company Name

Address

City State, Zip

Telephone

Shipping Address

Company Name

Address

City State, Zip

Telephone

<input type="text" value="PO#"/>	<input type="text" value="Note"/>
----------------------------------	-----------------------------------

QTY	Product / Rosette Code	Backset	Handle Style	Handing (LH / RH)	Door Thickness	Finish	Extension / Comments

**Please Fax Order Form to (800) 577-5771
or Email to orders@emtek.com**

HOW TO ORDER

To form an item number for a passage set, combine Product Code, Rosette, Handle, and Finish. For Example:



To form an item number for **CF Mechanism** Passage Set, add the letter **C** to the Product Code, Rosette, Handle, and Finish. For Example:

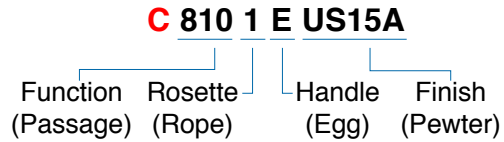

Privacy & Passage Set Sample Views



TERMS AND CONDITIONS OF SALE

Terms:

Net 30 Days on established credit.

Shipping:

EMTEK builds all products to order and ships most orders within 48 hours. EMTEK pays the freight on all orders using 3 Day shipping service. To shorten the transit time, shipments can be upgraded to 2nd Day service or Next Day service for a fee. All shipping services are from the time the order is shipped.

Returned Goods:

Merchandise may be returned only with approval from the factory. A copy of the factory issued RGA must accompany all returns. All returns must be sent freight prepaid. Returned goods are subject to a minimum 25% handling charge. Factory issued RGA's expire 90 days from the date they are issued.

Minimum Order:

There is no minimum order quantity. A \$10.00 net handling charge will be added to orders valued at less than \$50.00 net.

Patina Finishes:

Sandcast & Lost Wax Cast Bronze products have patina finishes that will gracefully age showing highlights of the underlying bronze over time.

Prices:

Prices are subject to change without prior notice.

EMTEK TECHNICAL REFERENCE MANUAL

Available at the Emtek website at www.emtek.com. Select Resources and then Technical Specifications.

LIFETIME LIMITED WARRANTY

Subject to the terms and conditions of this warranty, Emtek Products, Inc. ("Company") extends a lifetime limited warranty to the original consumer user ("Original User") of our product ("Product") against defects in material and workmanship, as long as the Original User occupies the residential premises upon which the Product was originally installed.

This warranty only applies to the Original User of the Products. This warranty is not transferable. This warranty applies to all products sold on or after April 2, 2012.

Original User: The Original User will return the defective Product to the Company, free and clear of all liens and encumbrances, transportation prepaid, accompanied by a statement of defects and proof of purchase.

What Emtek will do: Upon return of the defective Product to Emtek, Emtek's sole obligation, at its option, is to either repair or replace the Product, or refund the original purchase price in exchange for the Product.

THE COMPANY MAKES NO OTHER WARRANTY OTHER THAN AS EXPRESSLY STATED HEREIN, AND ALL IMPLIED WARRANTIES, INCLUDING ANY WARRANTY OF MERCHANTABILITY OR FITNESS FOR A PARTICULAR PURPOSE, ARE HEREBY EXCLUDED.

THE COMPANY'S MAXIMUM LIABILITY HEREUNDER IS LIMITED TO THE PURCHASE PRICE OF THE PRODUCT. IN NO EVENT SHALL THE COMPANY BE LIABLE FOR ANY CONSEQUENTIAL, INDIRECT, INCIDENTAL OR SPECIAL AND/OR PUNITIVE DAMAGES OF ANY NATURE ARISING FROM THE SALE OR USE OF THE PRODUCT, WHETHER BASED ON CONTRACT, WARRANTY, TORT, STRICT LIABILITY, PATENT INFRINGEMENT, OR OTHERWISE, EVEN IF ADVISED OF THE POSSIBILITY OF SUCH DAMAGES. Some local laws do not allow the exclusion or limitation of incidental or consequential damages, so the above exclusion or limitation may not apply to you. This warranty gives specific legal rights and a buyer may also have other rights which may vary from state to state.

WHAT IS NOT COVERED: THE FOLLOWING COSTS, EXPENSES AND DAMAGES ARE NOT COVERED BY THE PROVISIONS OF THIS LIMITED WARRANTY: (I) LABOR COSTS INCLUDING, BUT NOT LIMITED TO, SUCH COSTS AS THE REMOVAL AND RE-INSTALLATION OF PRODUCT; AND (II) SHIPPING AND FREIGHT EXPENSES REQUIRED TO RETURN PRODUCT TO EMTEK.

THE PROVISIONS OF THIS WARRANTY DO NOT APPLY TO PRODUCTS: (I) USED IN COMMERCIAL APPLICATIONS; (II) USED IN COMMON AREA APPLICATIONS; (III) USED FOR PURPOSES FOR WHICH THEY ARE NOT DESIGNED OR INTENDED; (IV) WHICH HAVE BEEN SUBJECTED TO ALTERATION, ABUSE, MISUSE, NEGLIGENCE OR ACCIDENT; (V) WHICH HAVE BEEN IMPROPERLY STORED, INSTALLED, MAINTAINED OR OPERATED; (VI) WHICH HAVE BEEN USED IN VIOLATION OF WRITTEN INSTRUCTIONS PROVIDED BY EMTEK; (VII) WHICH HAVE BEEN SUBJECTED TO IMPROPER TEMPERATURE, HUMIDITY OR OTHER ENVIRONMENTAL CONDITIONS; OR (VIII) WHICH, BASED ON EMTEK'S EXAMINATION, DO NOT DISCLOSE TO EMTEK'S SATISFACTION NON-CONFORMANCE TO THE WARRANTY. Additionally, this warranty DOES NOT COVER scratches, abrasions, or deterioration due to the use of paints, solvents or other chemicals.

Finish Warranty: PVD finish carries a lifetime limited finish warranty. There is no finish warranty on Deep Burgundy, Medium Bronze, Flat Black Patina, Silver Patina, Rust, Polished White Bronze, and Tumbled White Bronze finishes. All other finishes carry a five year finish warranty.

Warranty claims: For warranty service and shipping instructions contact customer service at:

EMTEK Products, Inc.
15250 E. Stafford Street
City of Industry, CA 91744
Tel: (626) 961-0413



Scan this code to
visit our website



follow us on

facebook.com/EmtekAssaAbloy

youtube.com/user/EMTEKproducts

twitter.com/emtek_assaabloy

pinterest.com/emtekassaabloy

EMTEK[®]
ASSA ABLOY

EMTEK Products, Inc.
15250 E. Stafford Street
City of Industry • CA 91744
Tel: 800-356-2741 • 626-961-0413
Fax: 800-577-5771 • 626-336-2812
www.emtek.com

BX4-MAINPRICEBK2014
JANUARY 2014

