

2017

DOOR HARDWARE

PRICE BOOK







CONTEMPORARY COLOR COLLECTION

Tubular Handleset, Deadbolts, Passage & Privacy Leversets 20

ELECTRONIC LOCKSETS

Liscio Electronic Keypad Leverset with Bluetooth® Programming 22

Electronic Keypad Entrance Handlesets, Deadbolts, Leversets 23

ENTRY SETS

Mortise Entrance Handlesets 28

Mortise Knob by Knob, Lever by Lever Entrance Locksets 42

Tubular Entrance Handlesets 48

Grip by Grip Entrance Handlesets 65

Key in Knob & Key in Lever Locksets 69

SINGLE AND TWO-POINT LOCKSETS

Brass Single and Two-Point Locksets 76

DEADBOLTS

Single Cylinder, Double Cylinder Deadbolts 78

Single Sided Deadbolts 84

SIDEPLATE LOCKSETS

Keyed and Non-Keyed Sideplate Locksets 86

Thumbturn Privacy Sideplate Locksets 98

STRETTO NARROW TRIM LOCKSETS

2" x 10", 1.5" x 11" STRETTO Narrow Trim Locksets 100

1.5" x 5" STRETTO Narrow Trim Passage & Privacy Sets 107

PASSAGE & PRIVACY SETS

Leversets & Knobsets 108

Thumbturn Privacy for Passage & Privacy 124

Door Knobs with Threaded Spindles 125

DOOR PULLS & ACCESSORIES

Appliance Pulls / Back to Back Pulls 135

Door Pulls 138

Door Accessories 144

HINGES

Square Barrel Solid Brass Hinges 164

Solid Brass Hinges 165

Steel Hinges 170

Stainless Steel Hinges 174

Spring Hinges 177

Hinge Screws 178

PARTS & OPTIONS

Replacement Parts 179

Index by Collection 183

Product Index 187

Order Form 194

Lifetime Limited Warranty 195

SOLID BRASS

CLASSIC						
	Cortina Lever (C)	Milano Lever (M)	Rustic Lever (R)	Turino Lever (T)		
DESIGNER						
	Coventry Lever (CV)	Elan Lever (EN)	Merrimack Lever (ME)	Ribbon & Reed Lever (RBL)	Rope Lever (RL)	Santa Fe Lever (SF)
CLASSIC						
	Egg Knob (E)	Melon Knob (MN)	Norwich Knob (NW)	Providence Knob (P)	Waverly Knob (W)	
DESIGNER						
	Beaded Egg Knob (BE)	Belmont Knob (BT)	Lancaster Knob (LN)	Ribbon & Reed Knob (RBK)	Rope Knob (RK)	Victoria Knob (V)
CLASSIC						
	#8 Rosette	Oval Rosette	Rectangular Rosette	Regular Rosette	Quincy Rosette	Wilshire Rosette
DESIGNER						
	Lancaster Rosette	Ribbon & Reed Rosette	Rope Rosette			

BRASS MODERN

CLASSIC							
	Aireon Lever (A)	Argos Lever (AG)	Athena Lever (ATN)	Basel Lever (BA)	Geneva Lever (GV)	Helios Lever (HLO)	Hercules Lever (HEC)
DESIGNER							
	Hermes Lever (HER)	Luzern Lever (LU)	Mercury Lever (MC)	Poseidon Lever (POS)	Sion Lever (SIO)	Stuttgart Lever (STU)	Triton Lever (TRT)
CLASSIC							
	Bern Knob (BN)	Octagon Knob (OCT)	Orb Knob (OR)	Round Knob (ROU)	Square Knob (SQU)		
DESIGNER							
	Disk Rosette	Modern Rectangular Rosette	Modern Rosette	Neos Rosette	Square Rosette		

ARTS & CRAFTS BRASS



Arts & Crafts Lever
(AC)



Hammered Lever
(HM)



Hammered Egg Knob
(HE)



Arts & Crafts
Rectangular Rosette



Hammered
Rosette

CRYSTAL



Astoria Clear Knob
(AS)



Bristol Knob
(BL)



Diamond Crystal Knob
(CK)



Georgetown Knob
(GT)



Hampton Knob
(HT)



Lowell Crystal Knob
(LW)



Modern Disc Crystal Knob
(MDC)



Modern Square Crystal Knob
(MSC)



Old Town Clear Knob
(OT)



Providence Crystal Knob
(PC)



Windsor Crystal Knob
(WS)

PORCELAIN



Ebony Knob
(EB)



Ice White Knob
(IW)



Porcelain
Rosette

SANDCAST BRONZE



Aurora Lever
(AR)



Cimarron Lever
(CR)



Cody Lever
(CD)



Durango Lever
(D)



Lariat Lever
(LR)



Montrose Lever
(MT)



Teton Lever
(TT)



Yuma Lever
(YM)



Butte Knob
(BU)



Egg Knob
(BZEG)



Round Knob
(BZRN)



Winchester Knob
(WC)



#1
Rosette



#2
Rosette



#3
Rosette



#4
Rosette



#6
Rosette

LOST WAX CAST BRONZE



Medici Lever
(MDI)



Napoli Lever
(NA)



Octagon Lever
(OCL)



Padua Lever
(PD)



Octagon Knob
(OCK)



Parma Knob
(PA)



Petal Knob
(PT)



#11
Rosette



#12
Rosette



#14
Rosette



#15
Rosette

WROUGHT STEEL



Lafayette Lever
(L)



Normandy Lever
(N)



San Carlos Lever
(SC)

Porcelain Knobs with Wrought Steel Stems



Jamestown Knob
(J)



Savannah Knob
(SV)



Madison Black Knob
(MB)



Madison Ivory Knob
(MI)



#1
Rosette



#2
Rosette



#3
Rosette

STAINLESS STEEL



Athena Lever
(AT)



Cologne Lever
(CO)



Dresden Lever
(DD)



Helios Lever
(HL)



Hercules Lever
(HS)



Hermes Lever
(HES)



Kiel Lever
(KL)



Poseidon Lever
(PO)



Stuttgart Lever
(STT)



Octagon Knob
(OK)



Round Knob
(RNK)



Beveled (01)
Rosette



Disk (02)
Rosette



Square (03)
Rosette



Polished Brass (US3)



Polished Brass - Lifetime (US3)



Satin Brass (US4)



French Antique (US7)



Oil Rubbed Bronze (US10B)



Polished Nickel (US14)



Polished Nickel - Lifetime (US14)



Satin Nickel (US15)



Pewter (US15A)



Flat Black (US19)



Polished Chrome (US26)

Bronze Patina is a living finish that will gracefully age, revealing the underlying bronze over time. Because of this characteristic, no finish warranty is offered on bronze patina products.



Flat Black Bronze Patina (FB)



Medium Bronze Patina (MB)



Tumbled White Bronze (TWB)



Flat Black Steel (FBS)



Satin Steel (SWS)



Brushed Stainless Steel (SS)

Unlacquered Brass (US3NL) is a custom, made-to-order finish. It is available with an upcharge, per item and requires an additional 2-3 day lead time. This living finish will gracefully age and evolve in appearance over time. Because of this characteristic, no finish warranty is offered on unlacquered brass products.



Unlacquered Brass (US3NL)

CLASSIC

Cortina Lever (C) Milano Lever (M) Rustic Lever (R) Turino Lever (T)

DESIGNER

Coventry Lever (CV) Elan Lever (EN) Merrimack Lever (ME) Ribbon & Reed Lever (RBL) Rope Lever (RL) Santa Fe Lever (SF) Wembley Lever (WM)

CLASSIC

Egg Knob (E) Melon Knob (MN) Norwich Knob (NW) Providence Knob (P) Waverly Knob (W)

DESIGNER

Beaded Egg Knob (BE) Belmont Knob (BT) Lancaster Knob (LN) Ribbon & Reed Knob (RBK) Rope Knob (RK) Victoria Knob (V)

CLASSIC

#8 Rosette Oval Rosette Rectangular Rosette Regular Rosette Quincy Rosette Wilshire Rosette

DESIGNER

Lancaster Rosette Ribbon & Reed Rosette Rope Rosette

US3 Lifetime US7 US10B US14 Lifetime US15 US15A US19 US26 US3NL*

		US3 Lifetime	US7	US10B	US14 Lifetime	US15	US15A	US19	US26	US3NL*
Classic Brass Levers	Cortina Lever (C)	•	•	•	•	•	•	•	•	•
	Milano Lever (M)	•	•	•	•	•	•	•	•	•
	Rustic Lever (R)	•	•	•		•	•	•	•	•
	Turino Lever (T)	•	•	•	•	•	•	•	•	•
Designer Brass Levers	Coventry Lever (CV)	•	•	•		•	•		•	•
	Elan Lever (EN)	•	•	•		•	•		•	•
	Merrimack Lever (ME)	•	•	•	•	•	•		•	•
	Ribbon & Reed Lever (RBL)	•	•	•		•	•		•	•
	Rope Lever (RL)	•	•	•		•	•		•	•
	Santa Fe Lever (SF)	•	•	•		•	•		•	•
	Wembley Lever (WM)	•	•	•		•	•		•	•
Classic Brass Knobs	Egg Knob (E)	•	•	•	•	•	•	•	•	•
	Melon Knob (MN)	•	•	•		•	•	•	•	•
	Norwich Knob (NW)	•	•	•	•	•	•	•	•	•
	Providence Knob (P)	•	•	•	•	•	•	•	•	•
	Waverly Knob (W)	•	•	•	•	•	•	•	•	•
Designer Brass Knobs	Beaded Egg Knob (BE)	•	•	•		•	•		•	•
	Belmont Knob (BT)	•	•	•		•	•		•	•
	Lancaster Knob (LN)	•	•	•		•	•		•	•
	Ribbon & Reed Knob (RBK)	•	•	•		•	•		•	•
	Rope Knob (RK)	•	•	•		•	•		•	•
	Victoria Knob (V)	•	•	•		•	•		•	•
Classic Brass Rosettes	#8 Rosette	•	•	•	•	•	•	•	•	•
	Oval Rosette	•	•	•		•	•	•	•	•
	Rectangular Rosette	•	•	•	•	•	•	•	•	•
	Regular Rosette	•	•	•	•	•	•	•	•	•
	Quincy Rosette	•	•	•		•	•	•	•	•
	Wilshire Rosette	•	•	•	•	•	•	•	•	•
Designer Brass Rosettes	Lancaster Rosette	•	•	•		•	•		•	•
	Ribbon & Reed Rosette	•	•	•		•	•		•	•
	Rope Rosette	•	•	•		•	•		•	•

***Unlacquered Brass (US3NL)** is a custom, made-to-order finish. It is available with an upcharge, per item and requires an additional 2-3 day lead time. This living finish will gracefully age and evolve in appearance over time. Because of this characteristic, no finish warranty is offered on unlacquered brass products.



Aireon Lever
(A)



Argos Lever
(AG)



Athena Lever
(ATN)



Basel Lever
(BA)



Geneva Lever
(GV)



Helios Lever
(HLO)



Hercules Lever
(HEC)



Hermes Lever
(HER)



Luzern Lever
(LU)



Mercury Lever
(MC)



Poseidon Lever
(POS)



Sion Lever
(SIO)



Stuttgart Lever
(STU)



Triton Lever
(TRT)



Bern Knob
(BN)



Octagon Knob
(OCT)



Orb Knob
(OR)



Round Knob
(ROU)



Square Knob
(SQU)



Disk
Rosette



Modern Rectangular
Rosette



Modern
Rosette



Neos
Rosette



Square
Rosette

US4

US10B

US14
Lifetime

US15

US19

US26

US3NL*

	US4	US10B	US14 Lifetime	US15	US19	US26	US3NL*
Modern Brass Levers							
Aireon Lever (A)	•	•		•	•	•	•
Argos Lever (AG)	•	•	•	•	•	•	•
Athena Lever (ATN)	•	•		•	•	•	•
Basel Lever (BA)	•	•		•	•	•	•
Geneva Lever (GV)	•	•	•	•	•	•	•
Helios Lever (HLO)	•	•	•	•	•	•	•
Hercules Lever (HEC)	•	•	•	•	•	•	•
Hermes Lever (HER)	•	•		•	•	•	•
Luzern Lever (LU)	•	•	•	•	•	•	•
Mercury Lever (MC)	•	•		•	•	•	•
Poseidon Lever (POS)	•	•		•	•	•	•
Sion Lever (SIO)	•	•		•	•	•	•
Stuttgart Lever (STU)	•	•	•	•	•	•	•
Triton Lever (TRT)	•	•		•	•	•	•
Modern Brass Knobs							
Bern Knob (BN)	•	•		•	•	•	•
Octagon Knob (OCT)	•	•		•	•	•	•
Orb Knob (OR)	•	•		•	•	•	•
Round Knob (ROU)	•	•	•	•	•	•	•
Square Knob (SQU)	•	•		•	•	•	•
Modern Brass Rosettes							
Disk Rosette	•	•	•	•	•	•	•
Modern Rectangular Rosette	•	•	•	•	•	•	•
Modern Rosette	•	•		•	•	•	•
Neos Rosette	•	•		•	•	•	•
Square Rosette	•	•	•	•	•	•	•

***Unlacquered Brass (US3NL)** is a custom, made-to-order finish. It is available with an upcharge, per item and requires an additional 2-3 day lead time. This living finish will gracefully age and evolve in appearance over time. Because of this characteristic, no finish warranty is offered on unlacquered brass products.

CRYSTAL



PORCELAIN



		US3 Lifetime	US4	US7	US10B	US14 Lifetime	US15	US15A	US19	US26	US3NL*	FB	MB	TWB
Crystal Knobs	Astoria Clear Knob (AS)	•		•	•	•	•	•	•	•	•	•	•	•
	Bristol Knob (BL)	•	•	•	•	•	•	•	•	•	•	•	•	•
	Diamond Knob (CK)	•		•	•	•	•	•	•	•	•	•	•	•
	Georgetown Knob (GT)	•		•	•	•	•	•	•	•	•	•	•	•
	Hampton Knob (HT)	•	•	•	•	•	•	•	•	•	•	•	•	•
	Lowell Knob (LW)	•		•	•	•	•	•	•	•	•	•	•	•
	Modern Disc Knob (MDC)	•	•	•	•	•	•	•	•	•	•	•	•	•
	Modern Square Knob (MSC)	•	•	•	•	•	•	•	•	•	•	•	•	•
	Old Town Clear Knob (OT)	•		•	•	•	•	•	•	•	•	•	•	•
	Providence Knob (PC)	•		•	•	•	•	•	•	•	•	•	•	•
	Windsor Knob (WS)	•	•	•	•	•	•	•	•	•	•	•	•	•
Classic Brass Rosettes	#8 Rosette	•		•	•	•	•	•	•	•				
	Oval Rosette	•		•	•		•	•	•	•				
	Rectangular Rosette	•		•	•	•	•	•	•	•				
	Regular Rosette	•		•	•	•	•	•	•	•				
	Quincy Rosette	•		•	•		•	•	•	•				
	Wilshire Rosette	•		•	•	•	•	•	•	•				
Designer Brass Rosettes	Lancaster Rosette	•		•	•		•	•		•	•			
	Ribbon & Reed Rosette	•		•	•		•	•		•	•			
	Rope Rosette	•		•	•		•	•		•	•			
Modern Brass Rosettes	Disk Rosette		•		•	•	•		•	•	•			
	Modern Rectangular Rosette		•		•	•	•		•	•	•			
	Modern Rosette		•		•		•		•	•	•			
	Neos Rosette		•		•		•		•	•	•			
	Square Rosette		•		•	•	•		•	•	•			
Sandcast Bronze Rosettes	#1 Rosette											•	•	•
	#2 Rosette											•	•	•
	#3 Rosette											•	•	•
	#4 Rosette											•	•	•
	#6 Rosette											•	•	•
Porcelain Knobs & Rosette	Ebony Porcelain Knob (EB)	•		•	•		•	•	•	•	•			
	Ice White Porcelain Knob (IW)	•		•	•		•	•	•	•	•			
	Porcelain Rosette	•		•	•		•	•	•	•				

***Unlacquered Brass (US3NL)** is a custom, made-to-order finish. It is available with an upcharge, per item and requires an additional 2-3 day lead time. This living finish will gracefully age and evolve in appearance over time. Because of this characteristic, no finish warranty is offered on unlacquered brass products.

SANDCAST BRONZE



Aurora Lever
(AR)



Cimarron Lever
(CR)



Cody Lever
(CD)



Durango Lever
(D)



Lariat Lever
(LR)



Montrose Lever
(MT)



Teton Lever
(TT)



Yuma Lever
(YM)



Butte Knob
(BU)



Egg Knob
(BZEG)



Round Knob
(BZRN)



Winchester Knob
(WC)



#1
Rosette



#2
Rosette



#3
Rosette



#4
Rosette



#6
Rosette

LOST WAX CAST BRONZE



Medici Lever
(MDI)



Napoli Lever
(NA)



Octagon Lever
(OCL)



Padua Lever
(PD)



Octagon Knob
(OCK)



Parma Knob
(PA)



Petal Knob
(PT)



#11
Rosette



#12
Rosette



#14
Rosette



#15
Rosette

FB

MB

TWB

		FB	MB	TWB
Sandcast Bronze Levers	Aurora Lever (AR)	•	•	•
	Cimarron Lever (CR)	•	•	•
	Cody Lever (CD)	•	•	•
	Durango Lever (D)	•	•	•
	Lariat Lever (LR)	•	•	•
	Montrose Lever (MT)	•	•	•
	Teton Lever (TT)	•	•	•
	Yuma Lever (YM)	•	•	•
Sandcast Bronze Knobs	Butte Knob (BU)	•	•	•
	Egg Knob (BZEG)	•	•	•
	Round Knob (BZRN)	•	•	•
	Winchester Knob (WC)	•	•	•
Sandcast Bronze Rosettes	#1 Rosette	•	•	•
	#2 Rosette	•	•	•
	#3 Rosette	•	•	•
	#4 Rosette	•	•	•
	#6 Rosette	•	•	•
Lost Wax Cast Bronze Levers	Medici Lever (MDI)		•	•
	Napoli Lever (NA)		•	•
	Octagon Lever (OCL)		•	•
	Padua Lever (PD)		•	•
Lost Wax Cast Bronze Knobs	Octagon Knob (OCK)		•	•
	Parma Knob (PA)		•	•
	Petal Knob (PT)		•	•
Lost Wax Cast Bronze Rosettes	#11 Rosette		•	•
	#12 Rosette		•	•
	#14 Rosette		•	•
	#15 Rosette		•	•

WROUGHT STEEL



Lafayette Lever
(L)



Normandy Lever
(N)



San Carlos Lever
(SC)



Jamestown Knob
(J)



Savannah Knob
(SV)



Madison Black Knob
(MB)



Madison Ivory Knob
(MI)



#1
Rosette



#2
Rosette



#3
Rosette

STAINLESS STEEL



Athena Lever
(AT)



Cologne Lever
(CO)



Dresden Lever
(DD)



Helios Lever
(HL)



Hercules Lever
(HS)



Hermes Lever
(HES)



Kiel Lever
(KL)



Poseidon Lever
(PO)



Stuttgart Lever
(STT)



Octagon Knob
(OK)



Round Knob
(RNK)



Beveled (01)
Rosette



Disk (02)
Rosette



Square (03)
Rosette



		FBS	SWS
Wrought Steel Levers	Lafayette Lever (L)	•	•
	Normandy Lever (N)	•	•
	San Carlos Lever (SC)	•	•
Wrought Steel Knobs	Jamestown Knob (J)	•	•
	Savannah Knob (SV)	•	•
	Madison Black Knob (MB)	•	•
	Madison Ivory Knob (MI)	•	•
Wrought Steel Rosettes	#1 Rosette	•	•
	#2 Rosette	•	•
	#3 Rosette	•	•

		SS
Stainless Steel Levers	Athena Lever (AT)	•
	Cologne Lever (CO)	•
	Dresden Lever (DD)	•
	Helios Lever (HL)	•
	Hercules Lever (HS)	•
	Hermes Lever (HES)	•
	Kiel Lever (KL)	•
	Poseidon Lever (PO)	•
	Stuttgart Lever (STT)	•
Stainless Steel Knobs	Octagon Knob (OK)	•
	Round Knob (RNK)	•
Stainless Steel Rosettes	Beveled (01) Rosette	•
	Disk (02) Rosette	•
	Square (03) Rosette	•

Terms:

Net 30 Days on established credit.

Prices:

Prices are subject to change without prior notice. All prices listed are in U.S. funds.

Minimum Order:

There is no minimum order quantity.

Shipping:

Emtek assembles all products to order in City of Industry, California. Orders typically ship within two business days. For shipments to customers located in the U.S. or Canada, Emtek ships freight prepaid via 3 day service. For shipments to customers located in Mexico, Emtek ships freight prepaid via UPS ground. For shipments to customers located outside of North America, Emtek ships freight prepaid to the U.S. location of the customer's freight forwarder via 3 day service.

If a reduced transit time is needed, shipments can be upgraded to 2nd Day Service or Next Day Service for a fee. Orders not shipping to the customer's place of business must ship via 2nd Day or Next Day Service, and additional charges will apply for shipments to a residential address. Emtek cannot use a customer's freight account for shipping charges.

Returned Goods:

For your convenience, dealers can now process returns directly from the Emtek website. Go to www.emtek.com, click on "Dealer Site", and then select "Return Goods". Fill out the RGA form, and follow the link to generate a UPS call tag (terms and conditions apply – see the website for details). A completed RGA form must accompany all packages for returned goods. Returns can only be accepted from, and any refunds made to, the Emtek dealer who originally purchased the product being returned. All returned goods are subject to a minimum 25% handling charge.

Living Finishes:

Unlacquered Brass and Bronze Patina finishes will gracefully age and evolve in appearance over time. Because of this characteristic, no finish warranty is offered on these products.

Technical Specifications and Door Thickness Reference Manual:

Available on the Emtek website. Select Resources and then Technical Specifications.

<http://emtek.com/technical-specifications.php>

**Minimum Advertised Price Policy
Effective February 6, 2017**

Emtek has determined that in order to better compete against existing competitors it must exercise a greater degree of control over the distribution of its products. Therefore, all sales of Emtek products will be subject to this Policy. This Policy has been unilaterally adopted and will be enforced strictly and uniformly.

Although resellers remain free to establish their own resale prices, to the extent that any customer elects to advertise products of Emtek in any manner, that is in print, in electronic media, on its website, etc., and provides price information for such products, that price information must be no less than List Price less 20%, this is the Minimum Advertised Price (MAP). Advertisements and offers to sell that do not include a particular price, but require further action that implies a price that is lower than the Minimum Advertised Price violate the MAP Policy. Examples of such unauthorized advertisements include "drop in cart" pricing, "add to cart" pricing, "click to see" pricing, and discount coupon pricing. Also prohibited are advertisements that indicate that discounts may be available when a customer takes specific action that goes beyond buying the product, such as "special price option" or "name your price."

To assure fair business practices, we will strictly enforce this policy. Violations of this MAP Policy will include termination of our business relationship with a customer. On the first offense there will be a written notice counseling any customer that disregards this policy. Any customer who violates the policy a second time, within one year of receiving a written notice of a first violation, will be terminated.

Emtek will not discuss any conditions of acceptance related to this Policy, as it is non-negotiable and will not be altered for any dealer. In addition, Emtek neither solicits, nor will it accept, any assurance of compliance with this Policy. Nothing in this Policy shall constitute an agreement between Emtek and any reseller that the reseller will comply with this Policy.

Determining handing for door hardware is different than determining handing for carpentry (ordering and hanging doors). If you follow the standard carpentry rules for handing door hardware, instead of following the diagram below, there is good chance you may end up with a lock that is handed incorrectly. Please refer to the diagram below and if you have any questions, call Customer Service at (800) 356-2741.

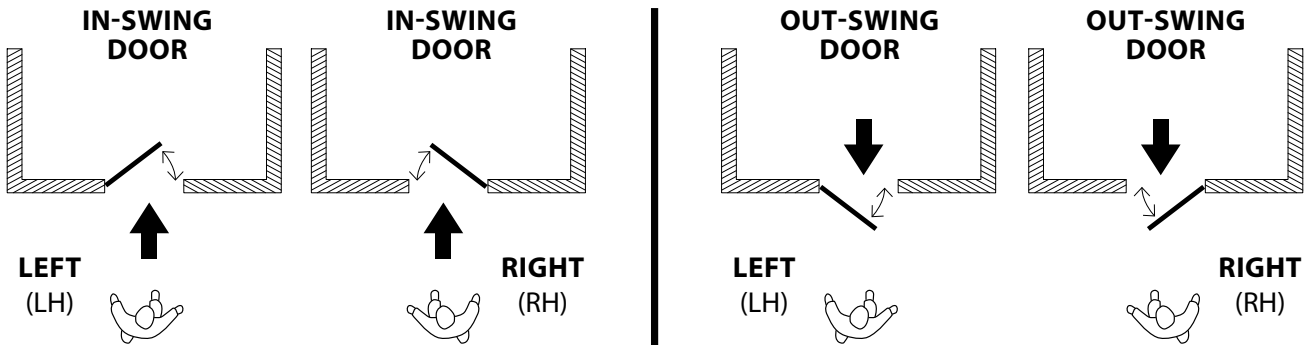

HANDING OF DOOR IS ALWAYS DETERMINED FROM THE OUTSIDE

- The outside of an exterior door is the street or entrance side.
- The outside of a room door is the hall side.
- The outside of a closet door is the room or hall side.
- The outside of a single communicating door is the side from which the hinges are not visible when the door is closed.

	Standard	On Request (at no charge)
Latches	Mortise	Drive-in
Backsets	2-3/8"	2-3/4"
Strike Plates	Full Lip Square Corner	1/4" Radius, Extended, T-Strike
Face Plates	Square Corner	1/4" Radius

Passage & Privacy Set Sample Views



Martinique Trim



Color Insert Options



FEATURES AND TECHNICAL SPECIFICATIONS:

- Choose from seven different colored inserts
- Use all one color or your own creative combination (For example: Caribbean Blue for exterior trim / Graphite Grey for interior trim)
- Color inserts are permanently affixed to the hardware once ordered
- Contemporary Color Collection hardware cannot be combined with other Emtek knob, lever or rosette
- Contemporary Color Collection hardware may be ordered with other Emtek products if each product is on opposite side of the door (For example: Standard Emtek tubular entry set for exterior trim* / Contemporary Color Collection for interior trim)

MARTINIQUE TUBULAR ENTRY SET	Product Code	Lever Style for Inside Trim	Color Insert	List Price
Single Cylinder	L4820	Aruba Lever (AB) Cayman Lever (CM)	Caribbean Blue (BE) Onyx Black (BK) Sea Glass Green (GN) Graphite Grey (GY) Hibiscus Red (RD) Calypso Silver (SR) Pearl White (WE)	\$180.00
Double Cylinder	L4830			\$180.00
Dummy	L4810			\$180.00

* See Page 48 - 55 for product codes and list prices. The price of the higher cost item will be charged.

Handing Required For Orders

- Standard latch is for 2 3/8" backset. Specify 2 3/4" backset if required.
- Complete set includes latch and strike plate.
- 28° Rotation latch **NOT** available for use with Contemporary Color Collection products.

Weiser® (WR5) Keyway

- Specify by adding "W" to the beginning of product code.
- No upcharge for cylinder substitution.
- Can be keyed into existing Weiser® system.



MARTINIQUE DEADBOLT	Product Code	Color Insert	List Price
Single Cylinder Deadbolt	L8469	Caribbean Blue (BE) Onyx Black (BK)	\$42.00
Double Cylinder Deadbolt	L8369	Sea Glass Green (GN) Graphite Grey (GY) Hibiscus Red (RD) Calypso Silver (SR) Pearl White (WE)	\$46.00

Weiser® (WR5) Keyway

- Specify by adding "W" to the beginning of product code.
- No upcharge for cylinder substitution.
- Can be keyed into existing Weiser® system.

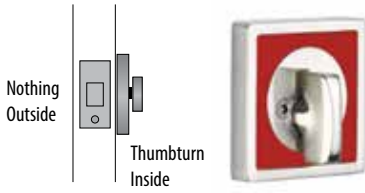

MARTINIQUE SINGLE SIDED DEADBOLT	Product Code	Color Insert	List Price
Single Sided Deadbolt	L8569	Caribbean Blue (BE) Onyx Black (BK) Sea Glass Green (GN) Graphite Grey (GY) Hibiscus Red (RD) Calypso Silver (SR) Pearl White (WE)	\$32.00

Handing NOT Required.

- Standard door thickness of 1¾". Specify if thicker.
- Standard latch is for 2¾" backset. Specify 2¾" backset if required.
- Complete set includes latch and strike plate.

To order: **(W) Product Code + Backset + Color Insert + Add Door Thickness to Comments**

Cayman Lever
with Sea Glass Green Color Insert
Trinidad Rosette



Cayman Lever
with Graphite Grey Color Insert
Trinidad Rosette



Cayman Lever
with Calypso Silver Color Insert
Trinidad Rosette



Aruba Lever
with Caribbean Blue Color Insert
Trinidad Rosette



Aruba Lever
with Hibiscus Red Color Insert
Trinidad Rosette



TRINIDAD	Description	Product Code	Lever Style	Color Insert	List Price
	Passage Set	L5110	Aruba Lever (AB) Cayman Lever (CM)	Caribbean Blue (BE) Onyx Black (BK)	\$60.00
	Privacy Set	L5210		Sea Glass Green (GN) Graphite Grey (GY)	\$60.00
	Dummy, Pair	L5050		Hibiscus Red (RD) Calypso Silver (SR) Pearl White (WE)	\$60.00

Handing Required For Leversets

- Standard latch is for 2¾" backset. Specify 2¾" backset if required.
- Complete set includes latch and strike plate.
- 28° Rotation latch **NOT** available for use with Contemporary Color Collection products.

To order: **Product Code + Backset + Lever Style + Handing + Color Insert + Add Door Thickness to Comments**

ELECTRONIC LOCKSET - LISCIO ELECTRONIC KEYPAD LEVERSET WITH BLUETOOTH® PROGRAMMING



>> Liscio cannot be used in conjunction with a deadbolt for standard 5½" center-to-center door preparation. Deadbolt dimensions vary, please verify door preparation based on actual deadbolt measurements.

Order any brass lever for the inside trim.

Features and Technical Specifications:

- Includes a key cylinder on the exterior for backup access
- Ready-to-use with two codes pre-programmed in the lock
- Available in either standard or storeroom/gate functions
- Weatherproofed for use on exterior doors
- Low battery indicator lets you know when to change the battery
- Standard 9-volt battery (included) is housed in the interior trim
- Supplied with both interior and exterior gaskets

LISCIO ELECTRONIC KEYPAD LEVERSET WITH BLUETOOTH® PROGRAMMING	Product Code	Lever Style for Inside Trim	Finish	List Price
Keypad Leverset	E6000	See Page 4 for Brass Lever Options.	Oil Rubbed Bronze (US10B) Satin Nickel (US15) Polished Chrome (US26)	\$240.00
Keypad Leverset with Storeroom/Gate Function	E6200		\$240.00	



Emtek App Overview:

- Program and manage user codes for the lock using our free app
- Easy-to-use app wizard walks you through step-by-step setup for Bluetooth®
- Add, edit, and delete user codes from your device
- The activity log will show you the date, time and user who opened the lock
- If you replace your phone or tablet, communicate existing data to your new device easily
- Communicate with multiple locks using one Bluetooth® device
- Apple® iPad® 3rd Gen/iPhone® 4S and later using iOS 6.1 and newer
- Android™ devices using 4.3 or later



Handing Required for Leversets

- Fits standard door thickness of 1¾". Specify if thicker.
- Standard door prep 2½" bore. Standard latch is for 2¾" backset. Specify 2¾" backset if required.
- Complete set includes latch, strike plate and a 9-volt battery.

Weiser® (WR5) Keyway

- Specify by adding "W" to the beginning of product code.
- No upcharge for cylinder substitution.
- Can be keyed into existing Weiser® system.

EMTouch™ Electronic Keypad Handleset



Order any brass knob or lever for the inside trim.

EMTouch™ Classic Style Electronic Keypad Handleset



Order any brass knob or lever for the inside trim.

EMTOUCH™ ELECTRONIC KEYPAD HANDLESET	Product Code	Knob or Lever Style for Inside Trim	Finish	List Price
Single Cylinder	E4827	See Page 4 for Brass Knob & Lever Options.	Oil Rubbed Bronze (US10B) Satin Nickel (US15)	\$402.00
Dummy	E4027	See Page 5 for Crystal & Porcelain Knob Options.	Flat Black (US19) Polished Chrome (US26)	\$402.00

EMTOUCH™ CLASSIC STYLE ELECTRONIC KEYPAD HANDLESET	Product Code	Knob or Lever Style for Inside Trim	Finish	List Price
Single Cylinder	E4410	See Page 4 for Brass Knob & Lever Options.	Polished Brass - Lifetime (US3) Oil Rubbed Bronze (US10B) Satin Nickel (US15)	\$402.00
Dummy	E4010	See Page 5 for Crystal & Porcelain Knob Options.		\$402.00

Product Features for Emtek Electronic Keypad Locksets:

- Factory programmed with 2 unique, secure user codes for use right out of the box.
- Can be programmed with up to 20 user codes of your choice.
- Emtek's standard mechanical and finish warranties along with a 2 year warranty on electronic components.

EMTouch™ and all Emtek Keypad Locksets are covered by the following patents:

Canadian patents	U.S. patents
2,698,041	8,176,761
2,789,278	8,141,400
2,789,280	

Handing Required if Lever Used on Inside

- Fits standard door thickness of 1¾". Specify if thicker.
- Standard door prep 2½" bore. Standard latch is for 2¾" backset. Specify 2¾" backset if required.
- Complete set includes latch, strike plate and a 9-volt battery.

Weiser® (WR5) Keyway

- Specify by adding "W" to the beginning of product code.
- No upcharge for cylinder substitution.
- Can be keyed into existing Weiser® system.

Modern Style Electronic Keypad Handleset



Order any brass knob or lever for the inside trim.

Sandcast Bronze Style Electronic Keypad Handleset



Order any sandcast bronze knob or lever for the inside trim.

MODERN STYLE ELECTRONIC KEYPAD HANDLESET	Product Code	Knob or Lever Style for Inside Trim	Finish	List Price
Single Cylinder	E4817	See Page 4 for Brass Knob & Lever Options. See Page 5 for Crystal & Porcelain Knob Options.	Oil Rubbed Bronze (US10B) Satin Nickel (US15) Flat Black (US19) Polished Chrome (US26)	\$378.00
Dummy	E4017		\$378.00	

SANDCAST BRONZE STYLE ELECTRONIC KEYPAD HANDLESET	Product Code	Knob or Lever Style for Inside Trim	Finish	List Price
Single Cylinder	E451211	See Page 5 for Sandcast Bronze Knob & Lever Options. See Page 5 for Crystal & Porcelain Knob Options.	Flat Black Bronze (FB) Medium Bronze (MB)	\$476.00
Dummy	E401211		\$476.00	

Handing Required if Lever Used on Inside

- Fits standard door thickness of 1¾". Specify if thicker.
- Standard door prep 2½" bore. Standard latch is for 2¾" backset. Specify 2¾" backset if required.
- Complete set includes latch, strike plate and a 9-volt battery.

Weiser® (WR5) Keyway

- Specify by adding "W" to the beginning of product code.
- No upcharge for cylinder substitution.
- Can be keyed into existing Weiser® system.



EMTOUCH™	Product Code	Finish	List Price
Electronic Keypad Deadbolt	E3020	Oil Rubbed Bronze (US10B) Satin Nickel (US15) Flat Black (US19) Polished Chrome (US26)	\$216.00

* To order Adaptor for thin door (1 3/8" - 1 1/2"), add product code **KEYDBEXT** and list price \$16.



EMTOUCH™ CLASSIC	Product Code	Finish	List Price
Electronic Keypad Deadbolt	E3002	Polished Brass - Lifetime (US3) Oil Rubbed Bronze (US10B) Satin Nickel (US15)	\$216.00

* To order Adaptor for thin door (1 3/8" - 1 1/2"), add product code **KEYDBEXT** and list price \$16.



MODERN	Product Code	Finish	List Price
Electronic Keypad Deadbolt	E1020	Oil Rubbed Bronze (US10B) Satin Nickel (US15) Flat Black (US19) Polished Chrome (US26)	\$192.00

* To order Adaptor for thin door (1 3/8" - 1 1/2"), add product code **KEYDBEXT** and list price \$16.



CLASSIC	Product Code	Finish	List Price
Electronic Keypad Deadbolt	E1000	Polished Brass - Lifetime (US3) Oil Rubbed Bronze (US10B) Satin Nickel (US15)	\$168.00

* To order Adaptor for thin door (1 3/8" - 1 1/2"), add product code **KEYDBEXT** and list price \$16.



SANDCAST BRONZE	Product Code	Finish	List Price
Electronic Keypad Deadbolt	E1001	Flat Black Bronze (FB) Medium Bronze (MB)	\$204.00

* Adaptor NOT available.

STANDARD WITH KEYPAD DEADBOLT LOCKSETS	
- Schlage® C Keyway	- Hardened Steel Bolt
- Standard Door Prep and Installation	- Brass Trim Strike
- Solid Brass Cylinder, Housing, Collar and Rosette	- Heavy Gauge Steel Understrike

Handing Not Required

- Fits standard door thickness of 1 3/4". Specify if thicker.
- Standard door prep 2 1/8" bore. Standard latch is for 2 3/8" backset. Specify 2 3/4" backset if required.
- Complete set includes latch, strike plate and a 9-volt battery.

Weiser® (WR5) Keyway

- Specify by adding "W" to the beginning of product code.
- No upcharge for cylinder substitution.
- Can be keyed into existing Weiser® system.

ELECTRONIC LOCKSETS - LEVERSETS



EMTOUCH™	Product Code	Lever Style	Finish	List Price
Keypad Leverset	E4020	See Page 4 for Brass Lever Options.	Oil Rubbed Bronze (US10B) Satin Nickel (US15)	\$252.00
Keypad Leverset with Storeroom/Gate Function	E4220		Flat Black (US19) Polished Chrome (US26)	\$252.00

* To order Adaptor for thin door (1 3/8" - 1 5/8"), add product code **KEYLVREXT** and list price \$16.



EMTOUCH™ CLASSIC	Product Code	Lever Style	Finish	List Price
Keypad Leverset	E4002	See Page 4 for Brass Lever Options.	Polished Brass - Lifetime (US3) Oil Rubbed Bronze (US10B)	\$252.00
Keypad Leverset with Storeroom/Gate Function	E4202		Satin Nickel (US15)	\$252.00

* To order Adaptor for thin door (1 3/8" - 1 5/8"), add product code **KEYLVREXT** and list price \$16.



MODERN	Product Code	Lever Style	Finish	List Price
Keypad Leverset	E2020	See Page 4 for Brass Lever Options.	Oil Rubbed Bronze (US10B) Satin Nickel (US15)	\$228.00
Keypad Leverset with Storeroom/Gate Function	E2220		Flat Black (US19) Polished Chrome (US26)	\$228.00

* To order Adaptor for thin door (1 3/8" - 1 5/8"), add product code **KEYLVREXT** and list price \$16.



CLASSIC	Product Code	Lever Style	Finish	List Price
Keypad Leverset	E2000	See Page 4 for Brass Lever Options.	Polished Brass - Lifetime (US3) Oil Rubbed Bronze (US10B)	\$216.00
Keypad Leverset with Storeroom/Gate Function	E2200		Satin Nickel (US15)	\$216.00

* To order Adaptor for thin door (1 3/8" - 1 5/8"), add product code **KEYLVREXT** and list price \$16.



SANDCAST BRONZE	Product Code	Lever Style	Finish	List Price
Keypad Leverset	E2001	See Page 5 for Sandcast Bronze Lever Options.	Flat Black Bronze (FB) Medium Bronze (MB)	\$240.00
Keypad Leverset with Storeroom/Gate Function	E2201		\$240.00	

*Adaptor NOT available.



Passage Function in Locked Mode

- Outside lever always locked
- Entry by code or key only
- Inside lever always free



Passage Function in Passage Mode

- Outside lever always free
- Entry by operating lever, no code or key require
- Inside lever always free



Storeroom Function

- Outside lever always locked
- Entry by code or key only
- Inside lever always free

Handing Required for Leversets

- Fits standard door thickness of 1 3/4". Specify if thicker.
- Standard door prep 2 1/8" bore. Standard latch is for 2 3/8" backset. Specify 2 3/4" backset if required.
- Complete set includes latch, strike plate and a 9-volt battery.

Weiser® (WR5) Keyway

- Specify by adding "W" to the beginning of product code.
- No upcharge for cylinder substitution.
- Can be keyed into existing Weiser® system.

HEAVY DUTY MORTISE LOCK BODY WITH ANSI F20 UL LISTED FUNCTION

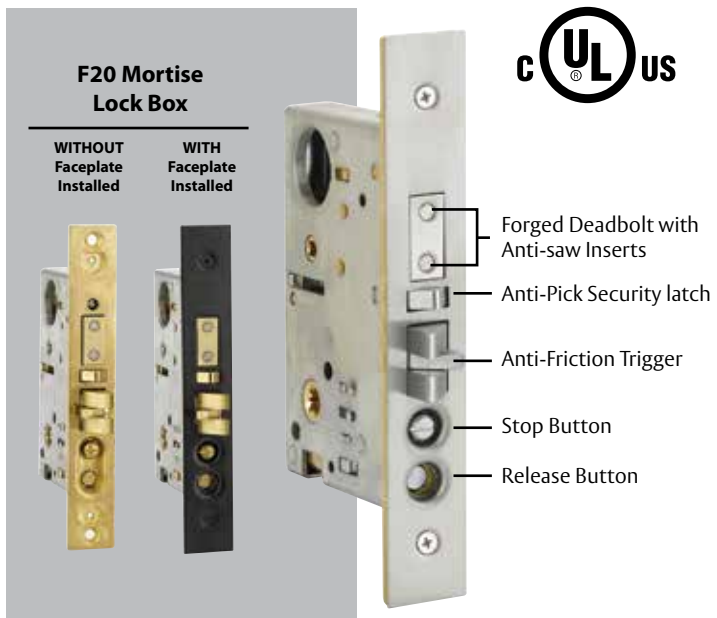

- Deadbolt operated by key outside, thumbturn inside
- When locked outside, latch bolt and deadbolt are operated by key outside
- When deadbolt is engaged, outside thumb press/knob/lever is automatically locked
- Latch bolt retracted by thumb press/knob/lever either side, except when outside thumb press/knob/lever is locked by stop button
- Operating inside knob/lever retracts latch bolt and deadbolt simultaneously with outside thumb press/knob/lever remaining locked
- Deadlocking latch bolt
- Deadbolt has saw-proof inserts
- UL Listed Mortise Door Prep ANSI A115.1
- UL180 minute fire rating

HOW TO ORDER

Add **FUNCTION** to the Product Code, Backset, Lever / Knob, Handing and Finish. For example:

F20 3347 50 HLO RH US10B

Function Entry Set 2-1/2" Backset Inside Lever Handing Finish

ALSO AVAILABLE IN ANSI F13 UL LISTED FUNCTION MORTISE LOCK BODY

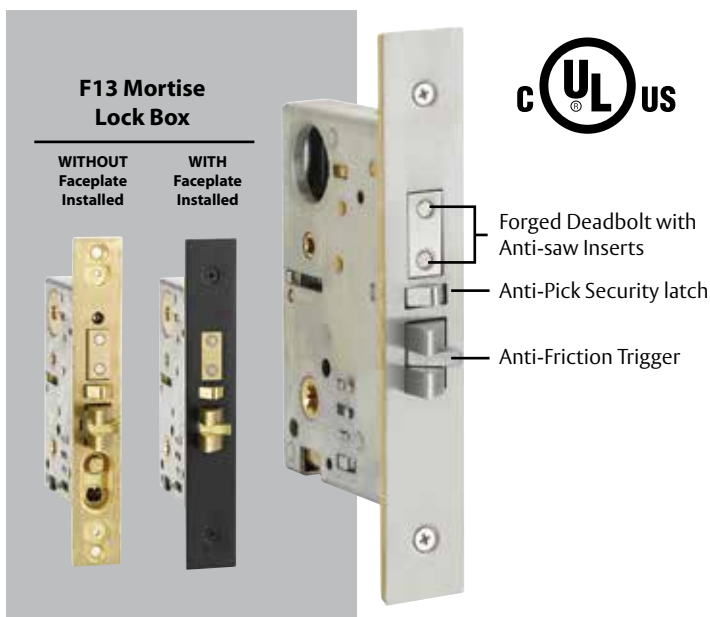

- Deadbolt operated by key outside, thumbturn inside
- When deadbolt is engaged, outside thumb press/knob/lever is automatically locked
- Latch bolt retracted by thumb press/knob/lever either side
- Operating inside knob/lever retracts latch bolt and deadbolt simultaneously, automatically unlocking outside thumb press/knob/lever
- Deadlocking latch bolt
- Deadbolt has saw-proof inserts
- UL Listed Mortise Door Prep ANSI A115.1
- UL180 minute fire rating

HOW TO ORDER

Add **FUNCTION** to the Product Code, Backset, Lever / Knob, Handing and Finish. For example:

F13 3347 75 HLO RH US10B

Function Entry Set 2-3/4" Backset Inside Lever Handing Finish

Mormont Mortise

Lugano Mortise

ANSI F13
Lugano Mortise



Order any brass knob or lever for the inside trim.

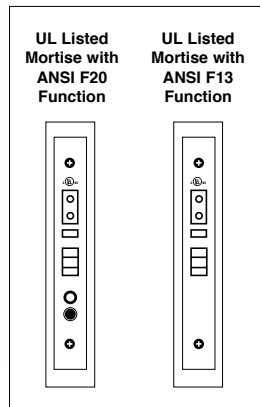

MORMONT MORTISE		Product Code	Backset	Knob or Lever Style for Inside Trim	Handing	Finish	List Price
Entry Set	Specify F20/F13 Function	3347	2½" or 2¾"	See Page 4 for Brass Knob & Lever Options. See Page 5 for Crystal & Porcelain Knob Options.	LH/RH	Satin Brass (US4) Oil Rubbed Bronze (US10B) Satin Nickel (US15) Flat Black (US19) Polished Chrome (US26) Unlacquered Brass (US3NL)*	\$500.00
Dummy	N/A	3047	N/A				\$316.00

LUGANO MORTISE		Product Code	Backset	Knob or Lever Style for Inside Trim	Handing	Finish	List Price
Entry Set	Specify F20/F13 Function	3348	2½" or 2¾"	See Page 4 for Brass Knob & Lever Options. See Page 5 for Crystal & Porcelain Knob Options.	LH/RH	Satin Brass (US4) Oil Rubbed Bronze (US10B) Satin Nickel (US15) Flat Black (US19) Polished Chrome (US26) Unlacquered Brass (US3NL)*	\$550.00
Dummy	N/A	3048	N/A				\$366.00

Handing is Required for All Mortise Locks

- Standard door thickness of 1¾". Specify if thicker.
- Locks for in-swing doors are standard, for out-swing doors please specify.

*Unlacquered Brass (US3NL) finish available for a \$50 List Price upcharge per item.

Zeus Mortise



Artemis Mortise



Hera Mortise

ANSI F13
Hera Mortise

Order any brass knob or lever
for the inside trim.

ZEUS MORTISE		Product Code	Backset	Knob or Lever Style for Inside Trim	Handing	Finish	List Price
Entry Set	Specify F20/F13 Function	3346	2½" or 2¾"	See Page 4 for Brass Knob & Lever Options.	LH/RH	Oil Rubbed Bronze (US10B) Satin Nickel (US15) Flat Black (US19) Polished Chrome (US26) Unlacquered Brass (US3NL)*	\$500.00
Dummy	N/A	3046	N/A	See Page 5 for Crystal & Porcelain Knob Options.			\$316.00

ARTEMIS MORTISE		Product Code	Backset	Knob or Lever Style for Inside Trim	Handing	Finish	List Price
Entry Set	Specify F20/F13 Function	3344	2½" or 2¾"	See Page 4 for Brass Knob & Lever Options.	LH/RH	Satin Brass (US4) Oil Rubbed Bronze (US10B) Satin Nickel (US15) Flat Black (US19) Polished Chrome (US26) Unlacquered Brass (US3NL)*	\$500.00
Dummy	N/A	3044	N/A	See Page 5 for Crystal & Porcelain Knob Options.			\$316.00

HERA MORTISE		Product Code	Backset	Knob or Lever Style for Inside Trim	Handing	Finish	List Price
Entry Set	Specify F20/F13 Function	3345	2½" or 2¾"	See Page 4 for Brass Knob & Lever Options.	LH/RH	Satin Brass (US4) Oil Rubbed Bronze (US10B) Satin Nickel (US15) Flat Black (US19) Polished Chrome (US26) Unlacquered Brass (US3NL)*	\$550.00
Dummy	N/A	3045	N/A	See Page 5 for Crystal & Porcelain Knob Options.			\$366.00

Handing is Required for All Mortise Locks

- Standard door thickness of 1¾". Specify if thicker.
- Locks for in-swing doors are standard, for out-swing doors please specify.

*Unlacquered Brass (US3NL) finish available for a \$50 List Price upcharge per item.

Harrison Mortise



Middleton Mortise



ANSI F13 Middleton Mortise



Order any brass knob or lever for the inside trim.

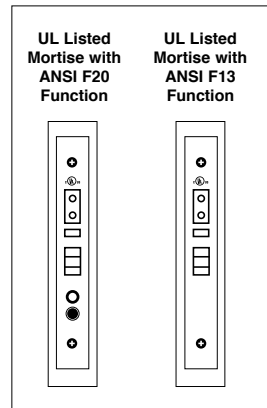

HARRISON MORTISE		Product Code	Backset	Knob or Lever Style for Inside Trim	Handing	Finish	List Price
Entry Set	Specify F20/F13 Function	3351	2½" or 2¾"	See Page 4 for Brass Knob & Lever Options. See Page 5 for Crystal & Porcelain Knob Options.	LH/RH	Polished Brass - Lifetime (US3) French Antique (US7) Oil Rubbed Bronze (US10B) Satin Nickel (US15) Pewter (US15A) Flat Black (US19) Polished Chrome (US26) Unlacquered Brass (US3NL)*	\$500.00
Dummy	N/A	3051	N/A				\$316.00

MIDDLETON MORTISE		Product Code	Backset	Knob or Lever Style for Inside Trim	Handing	Finish	List Price
Entry Set	Specify F20/F13 Function	3352	2½" or 2¾"	See Page 4 for Brass Knob & Lever Options. See Page 5 for Crystal & Porcelain Knob Options.	LH/RH	Polished Brass - Lifetime (US3) French Antique (US7) Oil Rubbed Bronze (US10B) Satin Nickel (US15) Pewter (US15A) Flat Black (US19) Polished Chrome (US26) Unlacquered Brass (US3NL)*	\$550.00
Dummy	N/A	3052	N/A				\$366.00

Handing is Required for All Mortise Locks

- Standard door thickness of 1¾". Specify if thicker.
- Locks for in-swing doors are standard, for out-swing doors please specify.

*Unlacquered Brass (US3NL) finish available for a \$50 List Price upcharge per item.

Salem Mortise



Memphis Mortise

ANSI F13
Memphis Mortise

Order any brass knob or lever
for the inside trim.

SALEM MORTISE		Product Code	Backset	Knob or Lever Style for Inside Trim	Handing	Finish	List Price
Entry Set	Specify F20/F13 Function	3301	2½" or 2¾"	See Page 4 for Brass Knob & Lever Options. See Page 5 for Crystal & Porcelain Knob Options.	LH/RH	Polished Brass - Lifetime (US3) French Antique (US7) Oil Rubbed Bronze (US10B) Satin Nickel (US15) Pewter (US15A) Flat Black (US19) Polished Chrome (US26) Unlacquered Brass (US3NL)*	\$460.00
Dummy	N/A	3001	N/A				\$276.00

MEMPHIS MORTISE		Product Code	Backset	Knob or Lever Style for Inside Trim	Handing	Finish	List Price
Entry Set	Specify F20/F13 Function	3302	2½" or 2¾"	See Page 4 for Brass Knob & Lever Options. See Page 5 for Crystal & Porcelain Knob Options.	LH/RH	Polished Brass - Lifetime (US3) French Antique (US7) Oil Rubbed Bronze (US10B) Satin Nickel (US15) Pewter (US15A) Flat Black (US19) Polished Chrome (US26) Unlacquered Brass (US3NL)*	\$500.00
Dummy	N/A	3002	N/A				\$316.00

Handing is Required for All Mortise Locks

- Standard door thickness of 1¾". Specify if thicker.
- Locks for in-swing doors are standard, for out-swing doors please specify.

*Unlacquered Brass (US3NL) finish available for a \$50 List Price upcharge per item.

To order: **Function + Product Code + Backset + Knob/Lever Style + Handing + Finish** + Add Door Thickness to Comments

Charleston Mortise



Albany Mortise



ANSI F13
Albany Mortise



Order any brass knob or lever for the inside trim.

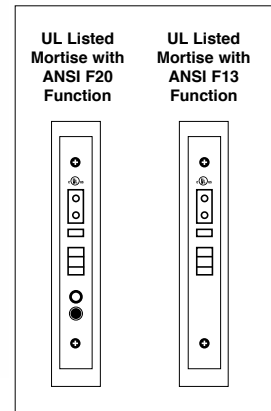

CHARLESTON MORTISE		Product Code	Backset	Knob or Lever Style for Inside Trim	Handing	Finish	List Price
Entry Set	Specify F20/F13 Function	3343	2½" or 2¾"	See Page 4 for Brass Knob & Lever Options. See Page 5 for Crystal & Porcelain Knob Options.	LH/RH	Polished Brass - Lifetime (US3) French Antique (US7) Oil Rubbed Bronze (US10B) Satin Nickel (US15) Pewter (US15A) Flat Black (US19) Polished Chrome (US26) Unlacquered Brass (US3NL)*	\$500.00
Dummy	N/A	3043	N/A				\$316.00

ALBANY MORTISE		Product Code	Backset	Knob or Lever Style for Inside Trim	Handing	Finish	List Price
Entry Set	Specify F20/F13 Function	3350	2½" or 2¾"	See Page 4 for Brass Knob & Lever Options. See Page 5 for Crystal & Porcelain Knob Options.	LH/RH	Polished Brass - Lifetime (US3) French Antique (US7) Oil Rubbed Bronze (US10B) Satin Nickel (US15) Pewter (US15A) Flat Black (US19) Polished Chrome (US26) Unlacquered Brass (US3NL)*	\$550.00
Dummy	N/A	3050	N/A				\$366.00

Handing is Required for All Mortise Locks

- Standard door thickness of 1¾". Specify if thicker.
- Locks for in-swing doors are standard, for out-swing doors please specify.

*Unlacquered Brass (US3NL) finish available for a \$50 List Price upcharge per item.

**Mills
Mortise****Manhattan
Mortise****Melrose
Mortise****ANSI F13
Melrose Mortise**

Order any brass knob or lever
for the inside trim.

MILLS MORTISE		Product Code	Backset	Knob or Lever Style for Inside Trim	Handing	Finish	List Price
Entry Set	Specify F20/F13 Function	3310	2½" or 2¾"	See Page 4 for Brass Knob & Lever Options. See Page 5 for Crystal & Porcelain Knob Options.	LH/RH	Polished Brass - Lifetime (US3) French Antique (US7) Oil Rubbed Bronze (US10B) Satin Nickel (US15) Pewter (US15A) Flat Black (US19) Polished Chrome (US26) Unlacquered Brass (US3NL)*	\$460.00
Dummy	N/A	3010	N/A				\$276.00

MANHATTAN MORTISE		Product Code	Backset	Knob or Lever Style for Inside Trim	Handing	Finish	List Price
Entry Set	Specify F20/F13 Function	3306	2½" or 2¾"	See Page 4 for Brass Knob & Lever Options. See Page 5 for Crystal & Porcelain Knob Options.	LH/RH	Polished Brass - Lifetime (US3) French Antique (US7) Oil Rubbed Bronze (US10B) Satin Nickel (US15) Pewter (US15A) Flat Black (US19) Polished Chrome (US26) Unlacquered Brass (US3NL)*	\$500.00
Dummy	N/A	3006	N/A				\$316.00

MELROSE MORTISE		Product Code	Backset	Knob or Lever Style for Inside Trim	Handing	Finish	List Price
Entry Set	Specify F20/F13 Function	3305	2½" or 2¾"	See Page 4 for Brass Knob & Lever Options. See Page 5 for Crystal & Porcelain Knob Options.	LH/RH	Polished Brass - Lifetime (US3) French Antique (US7) Oil Rubbed Bronze (US10B) Satin Nickel (US15) Pewter (US15A) Flat Black (US19) Polished Chrome (US26) Unlacquered Brass (US3NL)*	\$550.00
Dummy	N/A	3005	N/A				\$366.00

Handing is Required for All Mortise Locks

- Standard door thickness of 1¾". Specify if thicker.
- Locks for in-swing doors are standard, for out-swing doors please specify.

*Unlacquered Brass (US3NL) finish available for a \$50 List Price upcharge per item.

To order: **Function + Product Code + Backset + Knob/Lever Style + Handing + Finish + Add Door Thickness to Comments**

Hamilton Mortise

Regency Mortise

Versailles Mortise

ANSI F13 Versailles Mortise



Order any brass knob or lever for the inside trim.

Order any brass knob or lever for the inside trim.

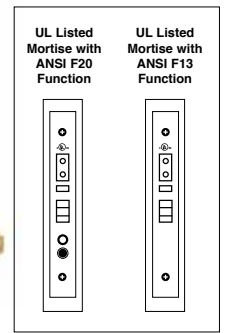

HAMILTON MORTISE		Product Code	Backset	Knob or Lever Style for Inside Trim	Handing	Finish	List Price
Entry Set	Specify F20/F13 Function	3304	2½" or 2¾"	See Page 4 for Brass Knob & Lever Options. See Page 5 for Crystal & Porcelain Knob Options.	LH/RH	Polished Brass - Lifetime (US3) French Antique (US7) Oil Rubbed Bronze (US10B) Satin Nickel (US15) Pewter (US15A) Polished Chrome (US26) Unlacquered Brass (US3NL)*	\$500.00
Dummy	N/A	3004	N/A				\$316.00

REGENCY MORTISE		Product Code	Backset	Knob or Lever Style for Inside Trim	Handing	Finish	List Price
Entry Set	Specify F20/F13 Function	3307	2½" or 2¾"	See Page 4 for Brass Knob & Lever Options. See Page 5 for Crystal & Porcelain Knob Options.	LH/RH	Polished Brass - Lifetime (US3) French Antique (US7) Oil Rubbed Bronze (US10B) Satin Nickel (US15) Pewter (US15A) Polished Chrome (US26) Unlacquered Brass (US3NL)*	\$500.00
Dummy	N/A	3007	N/A				\$316.00

VERSAILLES MORTISE		Product Code	Backset	Knob or Lever Style for Inside Trim	Handing	Finish	List Price
Entry Set	Specify F20/F13 Function	3309	2½" or 2¾"	See Page 4 for Brass Knob & Lever Options. See Page 5 for Crystal & Porcelain Knob Options.	LH/RH	Polished Brass - Lifetime (US3) French Antique (US7) Oil Rubbed Bronze (US10B) Satin Nickel (US15) Pewter (US15A) Polished Chrome (US26) Unlacquered Brass (US3NL)*	\$550.00
Dummy	N/A	3009	N/A				\$366.00

Handing is Required for All Mortise Locks

- Standard door thickness of 1¾". Specify if thicker.
- Locks for in-swing doors are standard, for out-swing doors please specify.

*Unlacquered Brass (US3NL) finish available for a \$50 List Price upcharge per item.

Craftsman Mortise



Craftsman Full Length Mortise



ANSI F13
Craftsman Full Length Mortise



Order any brass knob or lever for the inside trim.

CRAFTSMAN MORTISE		Product Code	Backset	Knob or Lever Style for Inside Trim	Handing	Finish	List Price
Entry Set	Specify F20/F13 Function	3308	2½" or 2¾"	See Page 4-5 for Brass Knob & Lever Options. See Page 5 for Crystal & Porcelain Knob Options.	LH/RH	Oil Rubbed Bronze (US10B) Satin Nickel (US15) Flat Black (US19) Unlacquered Brass (US3NL)*	\$500.00
Dummy	N/A	3008	N/A				\$316.00

CRAFTSMAN FULL LENGTH MORTISE		Product Code	Backset	Knob or Lever Style for Inside Trim	Handing	Finish	List Price
Entry Set	Specify F20/F13 Function	3349	2½" or 2¾"	See Page 4-5 for Brass Knob & Lever Options. See Page 5 for Crystal & Porcelain Knob Options.	LH/RH	Oil Rubbed Bronze (US10B) Satin Nickel (US15) Flat Black (US19) Unlacquered Brass (US3NL)*	\$550.00
Dummy	N/A	3049	N/A				\$366.00

Handing is Required for All Mortise Locks

- Standard door thickness of 1¾". Specify if thicker.
- Locks for in-swing doors are standard, for out-swing doors please specify.

*Unlacquered Brass (US3NL) finish available for a \$50 List Price upcharge per item.

To order: **Function + Product Code + Backset + Knob/Lever Style + Handing + Finish + Add Door Thickness to Comments**

Sonoma Mortise



Longmont Mortise



ANSI F13 Longmont Mortise



Order any sandcast bronze knob or lever for the inside trim.

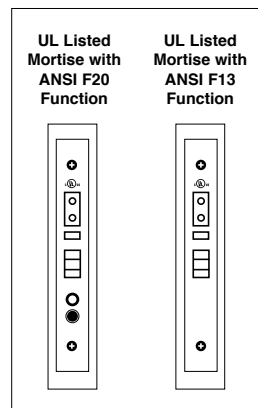

SONOMA MORTISE		Product Code	Backset	Knob or Lever Style for Inside Trim	Handing	Finish	List Price
Entry Set	Specify F20/F13 Function	3329	2½" or 2¾"	See Page 5 for Sandcast Bronze Knob & Lever Options.	LH/RH	Flat Black Bronze (FB) Medium Bronze (MB) Tumbled White Bronze (TWB)	\$550.00
Dummy	N/A	3029	N/A	See Page 5 for Crystal & Porcelain Knob Options.			\$366.00

LONGMONT MORTISE		Product Code	Backset	Knob or Lever Style for Inside Trim	Handing	Finish	List Price
Entry Set	Specify F20/F13 Function	3330	2½" or 2¾"	See Page 5 for Sandcast Bronze Knob & Lever Options.	LH/RH	Flat Black Bronze (FB) Medium Bronze (MB) Tumbled White Bronze (TWB)	\$600.00
Dummy	N/A	3030	N/A	See Page 5 for Crystal & Porcelain Knob Options.			\$416.00

Handing is Required for All Mortise Locks

- Standard door thickness of 1¾". Specify if thicker.
- Locks for in-swing doors are standard, for out-swing doors please specify.

Denver Mortise

Cheyenne Mortise

Topeka Mortise

ANSI F13 Topeka Mortise



Order any sandcast bronze knob or lever for the inside trim.

DENVER MORTISE		Product Code	Backset	Knob or Lever Style for Inside Trim	Handing	Finish	List Price
Entry Set	Specify F20/F13 Function	3323	2½" or 2¾"	See Page 5 for Sandcast Bronze Knob & Lever Options.	LH/RH	Flat Black Bronze (FB) Medium Bronze (MB) Tumbled White Bronze (TWB)	\$510.00
Dummy	N/A	3023	N/A				See Page 5 for Crystal & Porcelain Knob Options.

CHEYENNE MORTISE		Product Code	Backset	Knob or Lever Style for Inside Trim	Handing	Finish	List Price
Entry Set	Specify F20/F13 Function	3321	2½" or 2¾"	See Page 5 for Sandcast Bronze Knob & Lever Options.	LH/RH	Flat Black Bronze (FB) Medium Bronze (MB) Tumbled White Bronze (TWB)	\$550.00
Dummy	N/A	3021	N/A				See Page 5 for Crystal & Porcelain Knob Options.

TOPEKA MORTISE		Product Code	Backset	Knob or Lever Style for Inside Trim	Handing	Finish	List Price
Entry Set	Specify F20/F13 Function	3322	2½" or 2¾"	See Page 5 for Sandcast Bronze Knob & Lever Options.	LH/RH	Flat Black Bronze (FB) Medium Bronze (MB) Tumbled White Bronze (TWB)	\$600.00
Dummy	N/A	3022	N/A				See Page 5 for Crystal & Porcelain Knob Options.

Handing is Required for All Mortise Locks

- Standard door thickness of 1¾". Specify if thicker.
- Locks for in-swing doors are standard, for out-swing doors please specify.

To order: **Function + Product Code + Backset + Knob/Lever Style + Handing + Finish + Add Door Thickness to Comments**

Rectangular Sectional Mortise



Rectangular Monolithic Mortise



Rectangular Full Length Mortise



ANSI F13 Rectangular Full Length Mortise



Order any sandcast bronze knob or lever for the Inside trim.

RECTANGULAR SECTIONAL MORTISE		Product Code	Backset	Knob or Lever Style for Inside Trim	Handing	Finish	List Price
Entry Set	Specify F20/F13 Function	3324	2½" or 2¾"	See Page 5 for Sandcast Bronze Knob & Lever Options. See Page 5 for Crystal & Porcelain Knob Options.	LH/RH	Flat Black Bronze (FB) Medium Bronze (MB) Tumbled White Bronze (TWB)	\$510.00
Dummy	N/A	3024	N/A				\$326.00

RECTANGULAR MONOLITHIC MORTISE		Product Code	Backset	Knob or Lever Style for Inside Trim	Handing	Finish	List Price
Entry Set	Specify F20/F13 Function	3325	2½" or 2¾"	See Page 5 for Sandcast Bronze Knob & Lever Options. See Page 5 for Crystal & Porcelain Knob Options.	LH/RH	Flat Black Bronze (FB) Medium Bronze (MB) Tumbled White Bronze (TWB)	\$550.00
Dummy	N/A	3025	N/A				\$366.00

RECTANGULAR FULL LENGTH MORTISE		Product Code	Backset	Knob or Lever Style for Inside Trim	Handing	Finish	List Price
Entry Set	Specify F20/F13 Function	3326	2½" or 2¾"	See Page 5 for Sandcast Bronze Knob & Lever Options. See Page 5 for Crystal & Porcelain Knob Options.	LH/RH	Flat Black Bronze (FB) Medium Bronze (MB) Tumbled White Bronze (TWB)	\$600.00
Dummy	N/A	3026	N/A				\$416.00

Handing is Required for All Mortise Locks

- Standard door thickness of 1¾". Specify if thicker.
- Locks for in-swing doors are standard, for out-swing doors please specify.

Morgan Mortise



Rockford Mortise



ANSI F13 Rockford Mortise



Order any sandcast bronze knob or lever for the inside trim.

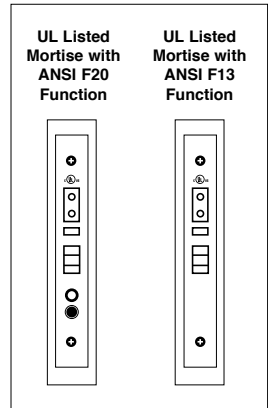

MORGAN MORTISE		Product Code	Backset	Knob or Lever Style for Inside Trim	Handing	Finish	List Price
Entry Set	Specify F20/F13 Function	3327	2½" or 2¾"	See Page 5 for Sandcast Bronze Knob & Lever Options.	LH/RH	Flat Black Bronze (FB) Medium Bronze (MB) Tumbled White Bronze (TWB)	\$550.00
Dummy	N/A	3027	N/A				See Page 5 for Crystal & Porcelain Knob Options.

ROCKFORD MORTISE		Product Code	Backset	Knob or Lever Style for Inside Trim	Handing	Finish	List Price
Entry Set	Specify F20/F13 Function	3328	2½" or 2¾"	See Page 5 for Sandcast Bronze Knob & Lever Options.	LH/RH	Flat Black Bronze (FB) Medium Bronze (MB) Tumbled White Bronze (TWB)	\$600.00
Dummy	N/A	3028	N/A				See Page 5 for Crystal & Porcelain Knob Options.

Handing is Required for All Mortise Locks

- Standard door thickness of 1¾". Specify if thicker.
- Locks for in-swing doors are standard, for out-swing doors please specify.

To order: **Function + Product Code + Backset + Knob/Lever Style + Handing + Finish + Add Door Thickness to Comments**

Octagon Mortise



Da Vinci Mortise



ANSI F13
Da Vinci
Mortise



Order any lost wax cast bronze knob or lever for the inside trim.



Order any lost wax cast bronze knob or lever for the inside trim.

OCTAGON MORTISE		Product Code	Backset	Knob or Lever Style for Inside Trim	Handing	Finish	List Price
Entry Set	Specify F20/F13 Function	3333	2½" or 2¾"	See Page 6 for Lost Wax Cast Bronze Knob & Lever Options.	LH/RH	Flat Black Bronze (FB) Medium Bronze (MB)	\$550.00
Dummy	N/A	3033	N/A				See Page 5 for Crystal & Porcelain Knob Options.

DA VINCI MORTISE		Product Code	Backset	Knob or Lever Style for Inside Trim	Handing	Finish	List Price
Entry Set	Specify F20/F13 Function	3331	2½" or 2¾"	See Page 6 for Lost Wax Cast Bronze Knob & Lever Options.	LH/RH	Flat Black Bronze (FB) Medium Bronze (MB)	\$550.00
Dummy	N/A	3031	N/A				See Page 5 for Crystal & Porcelain Knob Options.

Handing is Required for All Mortise Locks

- Standard door thickness of 1¾". Specify if thicker.
- Locks for in-swing doors are standard, for out-swing doors please specify.

Mormont
Stainless Steel
Mortise

ANSI F13
Mormont
Stainless Steel
Mortise



Order any stainless steel knob or lever for the inside trim.

UL Listed Mortise with ANSI F20 Function UL Listed Mortise with ANSI F13 Function



MORMONT STAINLESS STEEL MORTISE		Product Code	Backset	Knob or Lever Style for Inside Trim	Handing	Finish	List Price
Entry Set	Specify F20/F13 Function	S3301	2½" or 2¾"	See Page 6 for Stainless Steel Knob & Lever Options.	LH/RH	Brushed Stainless Steel (SS)	\$500.00
Dummy	N/A	S3001	N/A				\$316.00

Handing is Required for All Mortise Locks

- Standard door thickness of 1¾". Specify if thicker.
- Locks for in-swing doors are standard, for out-swing doors please specify.

To order: **Function + Product Code + Backset + Knob/Lever Style + Handing + Finish + Add Door Thickness to Comments**



MORMONT MORTISE		Product Code	Backset	Knob or Lever Style	Handing	Finish	List Price
Entry Set	Specify F20/F13 Function	3545	2 1/2" or 2 3/4"	See Page 4 for Brass Knob & Lever Options. See Page 5 for Crystal & Porcelain Knob Options.	LH/RH	Satin Brass (US4) Oil Rubbed Bronze (US10B) Satin Nickel (US15) Flat Black (US19) Polished Chrome (US26) Unlacquered Brass (US3NL)*	\$460.00
Dummy	N/A	3145	N/A				\$276.00

ARTEMIS MORTISE		Product Code	Backset	Knob or Lever Style	Handing	Finish	List Price
Entry Set	Specify F20/F13 Function	3544	2 1/2" or 2 3/4"	See Page 4 for Brass Knob & Lever Options. See Page 5 for Crystal & Porcelain Knob Options.	LH/RH	Satin Brass (US4) Oil Rubbed Bronze (US10B) Satin Nickel (US15) Flat Black (US19) Polished Chrome (US26) Unlacquered Brass (US3NL)*	\$460.00
Dummy	N/A	3144	N/A				\$276.00

HARRISON MORTISE		Product Code	Backset	Knob or Lever Style	Handing	Finish	List Price
Entry Set	Specify F20/F13 Function	3551	2 1/2" or 2 3/4"	See Page 4 for Brass Knob & Lever Options. See Page 5 for Crystal & Porcelain Knob Options.	LH/RH	Polished Brass - Lifetime (US3) French Antique (US7) Oil Rubbed Bronze (US10B) Satin Nickel (US15) Pewter (US15A) Flat Black (US19) Polished Chrome (US26) Unlacquered Brass (US3NL)*	\$460.00
Dummy	N/A	3151	N/A				\$276.00

Handing is Required for All Mortise Locks

- Standard door thickness of 1 3/4". Specify if thicker.
- Locks for in-swing doors are standard, for out-swing doors please specify.

*Unlacquered Brass (US3NL) finish available for a \$50 List Price upcharge per item.

**Manhattan
Mortise**

**Charleston
Mortise**

**Memphis
Mortise**



Interior trim view

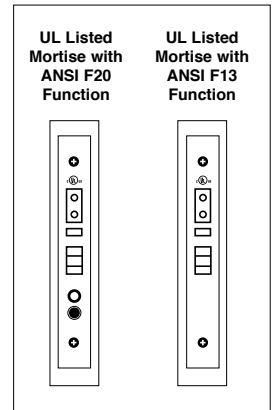

MANHATTAN MORTISE		Product Code	Backset	Knob or Lever Style	Handing	Finish	List Price
Entry Set	Specify F20/F13 Function	3506	2 1/2" or 2 3/4"	See Page 4 for Brass Knob & Lever Options. See Page 5 for Crystal & Porcelain Knob Options.	LH/RH	Polished Brass - Lifetime (US3) French Antique (US7) Oil Rubbed Bronze (US10B) Satin Nickel (US15) Pewter (US15A) Flat Black (US19) Polished Chrome (US26) Unlacquered Brass (US3NL)*	\$460.00
Dummy	N/A	3106	N/A				\$276.00

CHARLESTON MORTISE		Product Code	Backset	Knob or Lever Style	Handing	Finish	List Price
Entry Set	Specify F20/F13 Function	3543	2 1/2" or 2 3/4"	See Page 4 for Brass Knob & Lever Options. See Page 5 for Crystal & Porcelain Knob Options.	LH/RH	Polished Brass - Lifetime (US3) French Antique (US7) Oil Rubbed Bronze (US10B) Satin Nickel (US15) Pewter (US15A) Flat Black (US19) Polished Chrome (US26) Unlacquered Brass (US3NL)*	\$460.00
Dummy	N/A	3143	N/A				\$276.00

MEMPHIS MORTISE		Product Code	Backset	Knob or Lever Style	Handing	Finish	List Price
Entry Set	Specify F20/F13 Function	3502	2 1/2" or 2 3/4"	See Page 4 for Brass Knob & Lever Options. See Page 5 for Crystal & Porcelain Knob Options.	LH/RH	Polished Brass - Lifetime (US3) French Antique (US7) Oil Rubbed Bronze (US10B) Satin Nickel (US15) Pewter (US15A) Flat Black (US19) Polished Chrome (US26) Unlacquered Brass (US3NL)*	\$460.00
Dummy	N/A	3102	N/A				\$276.00

Handing is Required for All Mortise Locks

- Standard door thickness of 1 3/4". Specify if thicker.
- Locks for in-swing doors are standard, for out-swing doors please specify.

*Unlacquered Brass (US3NL) finish available for a \$50 List Price upcharge per item.

Hamilton Mortise



Regency Mortise



Craftsman Mortise



ANSI F13 Craftsman Mortise



Interior Trim View

HAMILTON MORTISE		Product Code	Backset	Knob or Lever Style	Handing	Finish	List Price
Entry Set	Specify F20/F13 Function	3504	2 1/2" or 2 3/4"	See Page 4 for Brass Knob & Lever Options. See Page 5 for Crystal & Porcelain Knob Options.	LH/RH	Polished Brass - Lifetime (US3) French Antique (US7) Oil Rubbed Bronze (US10B) Satin Nickel (US15) Pewter (US15A) Polished Chrome (US26) Unlacquered Brass (US3NL)*	\$460.00
Dummy	N/A	3104	N/A				\$276.00

REGENCY MORTISE		Product Code	Backset	Knob or Lever Style	Handing	Finish	List Price
Entry Set	Specify F20/F13 Function	3507	2 1/2" or 2 3/4"	See Page 4 for Brass Knob & Lever Options. See Page 5 for Crystal & Porcelain Knob Options.	LH/RH	Polished Brass - Lifetime (US3) French Antique (US7) Oil Rubbed Bronze (US10B) Satin Nickel (US15) Pewter (US15A) Polished Chrome (US26) Unlacquered Brass (US3NL)*	\$460.00
Dummy	N/A	3107	N/A				\$276.00

CRAFTSMAN MORTISE		Product Code	Backset	Knob or Lever Style	Handing	Finish	List Price
Entry Set	Specify F20/F13 Function	3508	2 1/2" or 2 3/4"	See Page 4-5 for Brass Knob & Lever Options. See Page 5 for Crystal & Porcelain Knob Options.	LH/RH	Oil Rubbed Bronze (US10B) Satin Nickel (US15) Flat Black (US19) Unlacquered Brass (US3NL)*	\$460.00
Dummy	N/A	3108	N/A				\$276.00

Handing is Required for All Mortise Locks

- Standard door thickness of 1 3/4". Specify if thicker.
- Locks for in-swing doors are standard, for out-swing doors please specify.

*Unlacquered Brass (US3NL) finish available for a \$50 List Price upcharge per item.

Rectangular Mortise

Cheyenne Mortise

Hailey Mortise

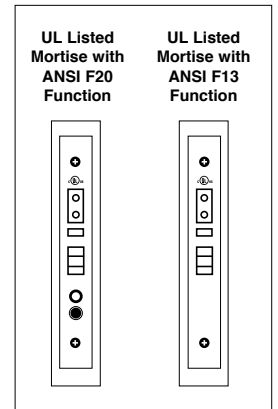

Interior Trim View

RECTANGULAR MORTISE		Product Code	Backset	Knob or Lever Style	Handing	Finish	List Price
Entry Set	Specify F20/F13 Function	3525	2 1/2" or 2 3/4"	See Page 5 for Sandcast Bronze Knob & Lever Options.	LH/RH	Flat Black Bronze (FB) Medium Bronze (MB) Tumbled White Bronze (TWB)	\$510.00
Dummy	N/A	3125	N/A				See Page 5 for Crystal & Porcelain Knob Options.

CHEYENNE MORTISE		Product Code	Backset	Knob or Lever Style	Handing	Finish	List Price
Entry Set	Specify F20/F13 Function	3521	2 1/2" or 2 3/4"	See Page 5 for Sandcast Bronze Knob & Lever Options.	LH/RH	Flat Black Bronze (FB) Medium Bronze (MB) Tumbled White Bronze (TWB)	\$510.00
Dummy	N/A	3121	N/A				See Page 5 for Crystal & Porcelain Knob Options.

HAILEY MORTISE		Product Code	Backset	Knob or Lever Style	Handing	Finish	List Price
Entry Set	Specify F20/F13 Function	3534	2 1/2" or 2 3/4"	See Page 5 for Sandcast Bronze Knob & Lever Options.	LH/RH	Flat Black Bronze (FB) Medium Bronze (MB) Tumbled White Bronze (TWB)	\$510.00
Dummy	N/A	3134	N/A				See Page 5 for Crystal & Porcelain Knob Options.

Handing is Required for All Mortise Locks

- Standard door thickness of 1 3/4". Specify if thicker.
- Locks for in-swing doors are standard, for out-swing doors please specify.

Da Vinci Mortise

Octagon Mortise

Mormont Stainless Steel Mortise

ANSI F13 Mormont Stainless Steel Mortise



Interior Trim View

DA VINCI MORTISE		Product Code	Backset	Knob or Lever Style	Handing	Finish	List Price
Entry Set	Specify F20/F13 Function	3531	2 1/2" or 2 3/4"	See Page 6 for Lost Wax Cast Bronze Knob & Lever Options. See Page 5 for Crystal & Porcelain Knob Options.	LH/RH	Flat Black Bronze (FB) Medium Bronze (MB)	\$510.00
Dummy	N/A	3131	N/A				\$326.00

OCTAGON MORTISE		Product Code	Backset	Knob or Lever Style	Handing	Finish	List Price
Entry Set	Specify F20/F13 Function	3533	2 1/2" or 2 3/4"	See Page 6 for Lost Wax Cast Bronze Knob & Lever Options. See Page 5 for Crystal & Porcelain Knob Options.	LH/RH	Flat Black Bronze (FB) Medium Bronze (MB)	\$510.00
Dummy	N/A	3133	N/A				\$326.00

MORMONT STAINLESS STEEL MORTISE		Product Code	Backset	Knob or Lever Style	Handing	Finish	List Price
Entry Set	Specify F20/F13 Function	S3501	2 1/2" or 2 3/4"	See Page 6 for Stainless Steel Knob & Lever Options.	LH/RH	Brushed Stainless Steel (SS)	\$460.00
Dummy	N/A	S3101	N/A				\$276.00

Handing is Required for All Mortise Locks

- Standard door thickness of 1 3/4". Specify if thicker.
- Locks for in-swing doors are standard, for out-swing doors please specify.



Steel Understrike
Supplied with all
Mortise Locks



Brass **Standard** Strike Plate
1 7/8" wide x 4 7/8" high
Supplied with **Mortise Locks**
unless door thickness is specified
as 2" or greater



Brass **Flat** Strike Plate
1 7/8" wide x 4 7/8" high
Supplied with
Mortise Locks
when requested



Brass **Extended** Strike Plate
2 1/2" wide x 4 7/8" high
Supplied with **Mortise Locks**
when door thickness is specified
as 2" or greater

ADDITIONAL STRIKE PLATES (F20/F13)	Product Code	Finish	List Price
Brass Standard Strike Plate with understrike and screws	86147	Polished Brass - Lifetime (US3) French Antique (US7) Oil Rubbed Bronze (US10B)	\$16.00
Brass Flat Strike Plate with understrike and screws	86148	Satin Nickel (US15) Pewter (US15A) Flat Black (US19) Polished Chrome (US26)	\$16.00
Brass Extended Strike Plate with understrike and screws	86149	Medium Bronze (MB) Tumbled White Bronze (TWB) Unlacquered Brass (US3NL)*	\$16.00

MORTISE LOCK BOX ONLY Includes Face Plate, Trimplate and Strike Plate. Cylinder Not Included.		Product Code	Backset	Handing	Finish	List Price
Thumb by Lever or Knob	Specify F20/F13 Function	3300	2 1/2" or 2 3/4"	LH/RH	Polished Brass - Lifetime (US3) French Antique (US7) Oil Rubbed Bronze (US10B) Satin Nickel (US15) Pewter (US15A) Flat Black (US19)	\$184.00
Knob by Knob & Lever by Lever		3380	2 1/2" or 2 3/4"	LH/RH	Polished Chrome (US26) Medium Bronze (MB) Tumbled White Bronze (TWB) Unlacquered Brass (US3NL)*	\$184.00

CYLINDER ONLY	Product Code	Length	Finish	List Price
Threaded Mortise	CY5-ThrdMrt1375	1 3/8"	Polished Brass - Lifetime (US3) Oil Rubbed Bronze (US10B)	\$24.00
	CY5-ThrdMrt150	1 1/2"	Polished Chrome (US26) Unlacquered Brass (US3NL)*	\$24.00
	CY5-ThrdMrt175	1 3/4"		\$24.00

Handing is Required for All Mortise Locks

- Standard door thickness of 1 3/4". Specify if thicker.
- Locks for in-swing doors are standard, for out-swing doors please specify.

*Unlacquered Brass (US3NL) finish available for a \$20 List Price upcharge per item.

ENTRANCE HANDLESETS - BRASS TUBULAR

Baden



Order any brass knob or lever for the inside trim.

Davos



Order any brass knob or lever for the inside trim.

Lausanne



Interconnect device available for most brass tubular handlesets

BADEN	Product Code	Knob or Lever Style for Inside Trim	Finish	List Price
Single Cylinder	4820	See Page 4 for Brass Knob & Lever Options. See Page 5 for Crystal & Porcelain Knob Options.	Satin Brass (US4)	\$246.00
Double Cylinder	4830		Oil Rubbed Bronze (US10B)	\$246.00
Dummy	4810		Polished Nickel - Lifetime (US14)	\$246.00
			Satin Nickel (US15)	
			Flat Black (US19)	
			Polished Chrome (US26)	
			Unlacquered Brass (US3NL)*	

DAVOS (5½" Center to Center Door Prep)	Product Code	Knob or Lever Style for Inside Trim	Finish	List Price
Single Cylinder	4818	See Page 4 for Brass Knob & Lever Options. See Page 5 for Crystal & Porcelain Knob Options.	Satin Brass (US4)	\$282.00
Double Cylinder	4828		Oil Rubbed Bronze (US10B)	\$282.00
Dummy	4808		Polished Nickel - Lifetime (US14)	\$282.00
			Satin Nickel (US15)	
			Flat Black (US19)	
			Polished Chrome (US26)	
			Unlacquered Brass (US3NL)*	

LAUSANNE (5½" Center to Center Door Prep)	Product Code	Knob or Lever Style for Inside Trim	Finish	List Price
Single Cylinder	4819	See Page 4 for Brass Knob & Lever Options. See Page 5 for Crystal & Porcelain Knob Options.	Satin Brass (US4)	\$334.00
Double Cylinder	4829		Oil Rubbed Bronze (US10B)	\$334.00
Dummy	4809		Polished Nickel - Lifetime (US14)	\$334.00
			Satin Nickel (US15)	
			Flat Black (US19)	
			Polished Chrome (US26)	
			Unlacquered Brass (US3NL)*	

INTERCONNECT DEVICE	Product Code		List Price
Davos & Lausanne Styles	443	Not Available for Double Cylinder.	\$58.00

*Unlacquered Brass (US3NL) finish available for a \$50 List Price upcharge per item.

Handing Required if Lever Used on Inside or if Interconnect Device is Specified

- Fits standard door thickness of 1¾". Specify if thicker.
- Standard 2½" door prep. Standard latch is for 2¾" backset. Specify 2¾" backset if required.
- 28° Rotation latch not available for use with Tubular Entrance Handlesets.

Weiser® (WR5) Keyway

- Specify by adding "W" to the beginning of product code.
- No upcharge for cylinder substitution. • Can be keyed into existing Weiser® system.

Ares



Order any brass knob or lever for the inside trim.

Apollo



Orion



Order any brass knob or lever for the inside trim.

ARES	Product Code	Knob or Lever Style for Inside Trim	Finish	List Price
Single Cylinder	4817	See Page 4 for Brass Knob & Lever Options. See Page 5 for Crystal & Porcelain Knob Options.	Satin Brass (US4)	\$246.00
Double Cylinder	4827		Oil Rubbed Bronze (US10B)	\$246.00
Dummy	4807		Satin Nickel (US15) Flat Black (US19) Polished Chrome (US26) Unlacquered Brass (US3NL)*	\$246.00

APOLLO (5½" Center to Center Door Prep)	Product Code	Knob or Lever Style for Inside Trim	Finish	List Price
Single Cylinder	4815	See Page 4 for Brass Knob & Lever Options. See Page 5 for Crystal & Porcelain Knob Options.	Satin Brass (US4)	\$282.00
Double Cylinder	4825		Oil Rubbed Bronze (US10B)	\$282.00
Dummy	4805		Satin Nickel (US15) Flat Black (US19) Polished Chrome (US26) Unlacquered Brass (US3NL)*	\$282.00

ORION (5½" Center to Center Door Prep)	Product Code	Knob or Lever Style for Inside Trim	Finish	List Price
Single Cylinder	4816	See Page 4 for Brass Knob & Lever Options. See Page 5 for Crystal & Porcelain Knob Options.	Satin Brass (US4)	\$334.00
Double Cylinder	4826		Oil Rubbed Bronze (US10B)	\$334.00
Dummy	4806		Satin Nickel (US15) Flat Black (US19) Polished Chrome (US26) Unlacquered Brass (US3NL)*	\$334.00

INTERCONNECT DEVICE	Product Code		List Price
Apollo & Orion Styles	443	Not Available for Double Cylinder.	\$58.00

*Unlacquered Brass (US3NL) finish available for a \$50 List Price upcharge per item.

Handing Required if Lever Used on Inside or if Interconnect Device is Specified

- Fits standard door thickness of 1¾". Specify if thicker.
- Standard 2½" door prep. Standard latch is for 2¾" backset. Specify 2¾" backset if required.
- 28° Rotation latch not available for use with Tubular Entrance Handlesets.

Weiser® (WR5) Keyway

- Specify by adding "W" to the beginning of product code.
- No upcharge for cylinder substitution. • Can be keyed into existing Weiser® system.

To order: (W) Product Code + Knob/Lever Style + Handing + Finish + Add Door Thickness to Comments

Zeus



Order any brass knob or lever for the inside trim.

Arts & Crafts



Arts & Crafts Full Length



Order any brass knob or lever for the inside trim.

ZEUS (5½" Center to Center Door Prep)	Product Code	Knob or Lever Style for Inside Trim	Finish	List Price
Single Cylinder	4814	See Page 4 for Brass Knob & Lever Options. See Page 5 for Crystal & Porcelain Knob Options.	Oil Rubbed Bronze (US10B) Satin Nickel (US15) Flat Black (US19) Polished Chrome (US26) Unlacquered Brass (US3NL)*	\$282.00
Double Cylinder	4824		\$282.00	
Dummy	4804		\$282.00	

ARTS & CRAFTS (5½" Center to Center Door Prep)	Product Code	Knob or Lever Style for Inside Trim	Finish	List Price
Single Cylinder	4811	See Page 4-5 for Brass Knob & Lever Options. See Page 5 for Crystal & Porcelain Knob Options.	Oil Rubbed Bronze (US10B) Satin Nickel (US15) Flat Black (US19) Unlacquered Brass (US3NL)*	\$282.00
Double Cylinder	4821		\$282.00	
Dummy	4801		\$282.00	

ARTS & CRAFTS FULL LENGTH (5½" Center to Center Door Prep)	Product Code	Knob or Lever Style for Inside Trim	Finish	List Price
Single Cylinder	4812	See Page 4-5 for Brass Knob & Lever Options. See Page 5 for Crystal & Porcelain Knob Options.	Oil Rubbed Bronze (US10B) Satin Nickel (US15) Flat Black (US19) Unlacquered Brass (US3NL)*	\$334.00
Double Cylinder	4822		\$334.00	
Dummy	4802		\$334.00	

INTERCONNECT DEVICE	Product Code		List Price
Available for Above Styles	443	Not Available for Double Cylinder.	\$58.00

*Unlacquered Brass (US3NL) finish available for a \$50 List Price upcharge per item.

Handing Required if Lever Used on Inside or if Interconnect Device is Specified

- Fits standard door thickness of 1¾". Specify if thicker.
- Standard 2½" door prep. Standard latch is for 2¾" backset. Specify 2¾" backset if required.
- 28° Rotation latch not available for use with Tubular Entrance Handlesets.

Weiser® (WR5) Keyway

- Specify by adding "W" to the beginning of product code.
- No upcharge for cylinder substitution. • Can be keyed into existing Weiser® system.

Franklin



Order any brass knob or lever for the inside trim.

Adams



Jefferson



Order any brass knob or lever for the inside trim.

FRANKLIN	Product Code	Knob or Lever Style for Inside Trim	Finish	List Price
Single Cylinder	4413	See Page 4 for Brass Knob & Lever Options. See Page 5 for Crystal & Porcelain Knob Options.	Polished Brass - Lifetime (US3) French Antique (US7) Oil Rubbed Bronze (US10B) Satin Nickel (US15) Pewter (US15A) Flat Black (US19) Polished Chrome (US26) Unlacquered Brass (US3NL)*	\$246.00
Double Cylinder	4423			\$246.00
Dummy	4403			\$246.00

ADAMS (5½" Center to Center Door Prep)	Product Code	Knob or Lever Style for Inside Trim	Finish	List Price
Single Cylinder	4414	See Page 4 for Brass Knob & Lever Options. See Page 5 for Crystal & Porcelain Knob Options.	Polished Brass - Lifetime (US3) French Antique (US7) Oil Rubbed Bronze (US10B) Satin Nickel (US15) Pewter (US15A) Flat Black (US19) Polished Chrome (US26) Unlacquered Brass (US3NL)*	\$282.00
Double Cylinder	4424			\$282.00
Dummy	4404			\$282.00

JEFFERSON (5½" Center to Center Door Prep)	Product Code	Knob or Lever Style for Inside Trim	Finish	List Price
Single Cylinder	4415	See Page 4 for Brass Knob & Lever Options. See Page 5 for Crystal & Porcelain Knob Options.	Polished Brass - Lifetime (US3) French Antique (US7) Oil Rubbed Bronze (US10B) Satin Nickel (US15) Pewter (US15A) Flat Black (US19) Polished Chrome (US26) Unlacquered Brass (US3NL)*	\$334.00
Double Cylinder	4425			\$334.00
Dummy	4405			\$334.00

INTERCONNECT DEVICE	Product Code		List Price
Adams & Jefferson Styles	443	Not Available for Double Cylinder.	\$58.00

*Unlacquered Brass (US3NL) finish available for a \$50 List Price upcharge per item.

Handing Required if Lever Used on Inside or if Interconnect Device is Specified

- Fits standard door thickness of 1¾". Specify if thicker.
- Standard 2½" door prep. Standard latch is for 2¾" backset. Specify 2¾" backset if required.
- 28° Rotation latch not available for use with Tubular Entrance Handlesets.

Weiser® (WR5) Keyway

- Specify by adding "W" to the beginning of product code.
- No upcharge for cylinder substitution. • Can be keyed into existing Weiser® system.

To order: (W) Product Code + Knob/Lever Style + Handing + Finish + Add Door Thickness to Comments

ENTRANCE HANDLESETS - BRASS TUBULAR

Hamden



Order any brass knob or lever for the inside trim.

Wilshire



Melrose



Order any brass knob or lever for the inside trim.

HAMDEN	Product Code	Knob or Lever Style for Inside Trim	Finish	List Price
Single Cylinder	4213	See Page 4 for Brass Knob & Lever Options. See Page 5 for Crystal & Porcelain Knob Options.	Polished Brass - Lifetime (US3) French Antique (US7) Oil Rubbed Bronze (US10B)	\$246.00
Double Cylinder	4223		Polished Nickel - Lifetime (US14) Satin Nickel (US15) Pewter (US15A)	\$246.00
Dummy	4203		Flat Black (US19) Polished Chrome (US26) Unlacquered Brass (US3NL)*	\$246.00

WILSHIRE (5½" Center to Center Door Prep)	Product Code	Knob or Lever Style for Inside Trim	Finish	List Price
Single Cylinder	4211	See Page 4 for Brass Knob & Lever Options. See Page 5 for Crystal & Porcelain Knob Options.	Polished Brass - Lifetime (US3) French Antique (US7) Oil Rubbed Bronze (US10B)	\$282.00
Double Cylinder	4221		Polished Nickel - Lifetime (US14) Satin Nickel (US15) Pewter (US15A)	\$282.00
Dummy	4201		Flat Black (US19) Polished Chrome (US26) Unlacquered Brass (US3NL)*	\$282.00

MELROSE (5½" Center to Center Door Prep)	Product Code	Knob or Lever Style for Inside Trim	Finish	List Price
Single Cylinder	4212	See Page 4 for Brass Knob & Lever Options. See Page 5 for Crystal & Porcelain Knob Options.	Polished Brass - Lifetime (US3) French Antique (US7) Oil Rubbed Bronze (US10B)	\$334.00
Double Cylinder	4222		Polished Nickel - Lifetime (US14) Satin Nickel (US15) Pewter (US15A)	\$334.00
Dummy	4202		Flat Black (US19) Polished Chrome (US26) Unlacquered Brass (US3NL)*	\$334.00

INTERCONNECT DEVICE	Product Code		List Price
Wilshire & Melrose Styles	443	Not Available for Double Cylinder.	\$58.00

*Unlacquered Brass (US3NL) finish available for a \$50 List Price upcharge per item.

Handing Required if Lever Used on Inside or if Interconnect Device is Specified

- Fits standard door thickness of 1¾". Specify if thicker.
- Standard 2⅞" door prep. Standard latch is for 2⅝" backset. Specify 2¾" backset if required.
- 28° Rotation latch not available for use with Tubular Entrance Handlesets.

Weiser® (WR5) Keyway

- Specify by adding "W" to the beginning of product code.
- No upcharge for cylinder substitution.
- Can be keyed into existing Weiser® system.

Nashville

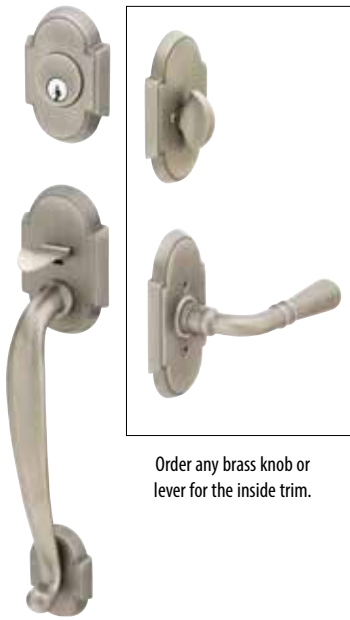

Order any brass knob or lever for the inside trim.

Richmond



Wilmington



Order any brass knob or lever for the inside trim.

NASHVILLE	Product Code	Knob or Lever Style for Inside Trim	Finish	List Price
Single Cylinder	4312	See Page 4 for Brass Knob & Lever Options. See Page 5 for Crystal & Porcelain Knob Options.	Polished Brass - Lifetime (US3) French Antique (US7) Oil Rubbed Bronze (US10B) Satin Nickel (US15) Pewter (US15A) Flat Black (US19) Polished Chrome (US26) Unlacquered Brass (US3NL)*	\$246.00
Double Cylinder	4322			\$246.00
Dummy	4302			\$246.00

RICHMOND (5½" Center to Center Door Prep)	Product Code	Knob or Lever Style for Inside Trim	Finish	List Price
Single Cylinder	4313	See Page 4 for Brass Knob & Lever Options. See Page 5 for Crystal & Porcelain Knob Options.	Polished Brass - Lifetime (US3) French Antique (US7) Oil Rubbed Bronze (US10B) Satin Nickel (US15) Pewter (US15A) Flat Black (US19) Polished Chrome (US26) Unlacquered Brass (US3NL)*	\$282.00
Double Cylinder	4323			\$282.00
Dummy	4303			\$282.00

WILMINGTON (5½" Center to Center Door Prep)	Product Code	Knob or Lever Style for Inside Trim	Finish	List Price
Single Cylinder	4314	See Page 4 for Brass Knob & Lever Options. See Page 5 for Crystal & Porcelain Knob Options.	Polished Brass - Lifetime (US3) French Antique (US7) Oil Rubbed Bronze (US10B) Satin Nickel (US15) Pewter (US15A) Flat Black (US19) Polished Chrome (US26) Unlacquered Brass (US3NL)*	\$334.00
Double Cylinder	4324			\$334.00
Dummy	4304			\$334.00

INTERCONNECT DEVICE	Product Code		List Price
Richmond & Wilmington Styles	443	Not Available for Double Cylinder.	\$58.00

*Unlacquered Brass (US3NL) finish available for a \$50 List Price upcharge per item.

Handing Required if Lever Used on Inside or if Interconnect Device is Specified

- Fits standard door thickness of 1¾". Specify if thicker.
- Standard 2½" door prep. Standard latch is for 2¾" backset. Specify 2¾" backset if required.
- 28° Rotation latch not available for use with Tubular Entrance Handlesets.

Weiser® (WR5) Keyway

- Specify by adding "W" to the beginning of product code.
- No upcharge for cylinder substitution.
- Can be keyed into existing Weiser® system.

To order: (W) Product Code + Knob/Lever Style + Handing + Finish + Add Door Thickness to Comments

ENTRANCE HANDLESETS - BRASS TUBULAR

Saratoga



Order any brass knob or lever for the inside trim.

Marietta



Order any brass knob or lever for the inside trim.

Knoxville



Order any brass knob or lever for the inside trim.

SARATOGA	Product Code	Knob or Lever Style for Inside Trim	Finish	List Price
Single Cylinder	4410	See Page 4 for Brass Knob & Lever Options. See Page 5 for Crystal & Porcelain Knob Options.	Polished Brass - Lifetime (US3) French Antique (US7) Oil Rubbed Bronze (US10B) Satin Nickel (US15) Pewter (US15A) Flat Black (US19) Polished Chrome (US26) Unlacquered Brass (US3NL)*	\$246.00
Double Cylinder	4420			\$246.00
Dummy	4400			\$246.00

MARIETTA (5½" Center to Center Door Prep)	Product Code	Knob or Lever Style for Inside Trim	Finish	List Price
Single Cylinder	4411	See Page 4 for Brass Knob & Lever Options. See Page 5 for Crystal & Porcelain Knob Options.	Polished Brass - Lifetime (US3) French Antique (US7) Oil Rubbed Bronze (US10B) Satin Nickel (US15) Pewter (US15A) Flat Black (US19) Polished Chrome (US26) Unlacquered Brass (US3NL)*	\$282.00
Double Cylinder	4421			\$282.00
Dummy	4401			\$282.00

KNOXVILLE	Product Code	Knob or Lever Style for Inside Trim	Finish	List Price
Single Cylinder	4310	See Page 4 for Brass Knob & Lever Options. See Page 5 for Crystal & Porcelain Knob Options.	Polished Brass - Lifetime (US3) French Antique (US7) Oil Rubbed Bronze (US10B) Satin Nickel (US15) Pewter (US15A) Polished Chrome (US26) Unlacquered Brass (US3NL)*	\$246.00
Double Cylinder	4320			\$246.00
Dummy	4300			\$246.00

INTERCONNECT DEVICE	Product Code		List Price
Marietta Style	443	Not Available for Double Cylinder.	\$58.00

*Unlacquered Brass (US3NL) finish available for a \$50 List Price upcharge per item.

Handing Required if Lever Used on Inside or if Interconnect Device is Specified

- Fits standard door thickness of 1¾". Specify if thicker.
- Standard 2½" door prep. Standard latch is for 2¾" backset. Specify 2¾" backset if required.
- 28° Rotation latch not available for use with Tubular Entrance Handlesets.

Weiser® (WR5) Keyway

- Specify by adding "W" to the beginning of product code.
- No upcharge for cylinder substitution.
- Can be keyed into existing Weiser® system.

Orleans



Order any brass knob or lever for the inside trim.

Ribbon & Reed



Imperial



Order any brass knob or lever for the inside trim.

ORLEANS (5½" Center to Center Door Prep)	Product Code	Knob or Lever Style for Inside Trim	Finish	List Price
Single Cylinder	4311	See Page 4 for Brass Knob & Lever Options. See Page 5 for Crystal & Porcelain Knob Options.	Polished Brass - Lifetime (US3) French Antique (US7) Oil Rubbed Bronze (US10B) Satin Nickel (US15) Pewter (US15A) Polished Chrome (US26) Unlacquered Brass (US3NL)*	\$282.00
Double Cylinder	4321			\$282.00
Dummy	4301			\$282.00

RIBBON & REED (5½" Center to Center Door Prep)	Product Code	Knob or Lever Style for Inside Trim	Finish	List Price
Single Cylinder	4711	See Page 4 for Brass Knob & Lever Options. See Page 5 for Crystal & Porcelain Knob Options.	Polished Brass - Lifetime (US3) French Antique (US7) Oil Rubbed Bronze (US10B) Satin Nickel (US15) Pewter (US15A) Polished Chrome (US26) Unlacquered Brass (US3NL)*	\$282.00
Double Cylinder	4721			\$282.00
Dummy	4701			\$282.00

IMPERIAL (5½" Center to Center Door Prep)	Product Code	Knob or Lever Style for Inside Trim	Finish	List Price
Single Cylinder	4911	See Page 4 for Brass Knob & Lever Options. See Page 5 for Crystal & Porcelain Knob Options.	Polished Brass - Lifetime (US3) French Antique (US7) Oil Rubbed Bronze (US10B) Satin Nickel (US15) Pewter (US15A) Polished Chrome (US26) Unlacquered Brass (US3NL)*	\$334.00
Double Cylinder	4921			\$334.00
Dummy	4901			\$334.00

INTERCONNECT DEVICE	Product Code		List Price
Available for Above Styles	443	Not Available for Double Cylinder.	\$58.00

*Unlacquered Brass (US3NL) finish available for a \$50 List Price upcharge per item.

Handing Required if Lever Used on Inside or if Interconnect Device is Specified

- Fits standard door thickness of 1¾". Specify if thicker.
- Standard 2½" door prep. Standard latch is for 2¾" backset. Specify 2¾" backset if required.
- 28° Rotation latch not available for use with Tubular Entrance Handlesets.

Weiser® (WR5) Keyway

- Specify by adding "W" to the beginning of product code.
- No upcharge for cylinder substitution.
- Can be keyed into existing Weiser® system.

To order: (W) Product Code + Knob/Lever Style + Handing + Finish + Add Door Thickness to Comments

ENTRANCE HANDLESETS - SANDCAST BRONZE TUBULAR

Ridgmont



Logan



Brighton



RIDGEMONT	Product Code	Knob or Lever Style for Inside Trim	Finish	List Price
Single Cylinder	451721	See Page 5 for Sandcast Bronze Knob & Lever Options. See Page 5 for Crystal & Porcelain Knob Options.	Flat Black Bronze (FB) Medium Bronze (MB) Tumbled White Bronze (TWB)	\$340.00
Double Cylinder	452721			\$340.00
Dummy	450721			\$340.00

LOGAN (5½" Center to Center Door Prep)	Product Code	Knob or Lever Style for Inside Trim	Finish	List Price
Single Cylinder	451822	See Page 5 for Sandcast Bronze Knob & Lever Options. See Page 5 for Crystal & Porcelain Knob Options.	Flat Black Bronze (FB) Medium Bronze (MB) Tumbled White Bronze (TWB)	\$376.00
Double Cylinder	452822			\$376.00
Dummy	450822			\$376.00

BRIGHTON (5½" Center to Center Door Prep)	Product Code	Knob or Lever Style for Inside Trim	Finish	List Price
Single Cylinder	451923	See Page 5 for Sandcast Bronze Knob & Lever Options. See Page 5 for Crystal & Porcelain Knob Options.	Flat Black Bronze (FB) Medium Bronze (MB) Tumbled White Bronze (TWB)	\$428.00
Double Cylinder	452923			\$428.00
Dummy	450923			\$428.00

INTERCONNECT DEVICE	Product Code		List Price
Logan & Brighton Styles	443	Not Available for Double Cylinder.	\$58.00

Handing Required if Lever Used on Inside or if Interconnect Device is Specified

- Fits standard door thickness of 1¾". Specify if thicker.
- Standard 2½" door prep. Standard latch is for 2¾" backset. Specify 2¾" backset if required.
- 28° Rotation latch not available for use with Tubular Entrance Handlesets.

Weiser® (WR5) Keyway

- Specify by adding "W" to the beginning of product code.
- No upcharge for cylinder substitution.
- Can be keyed into existing Weiser® system.

Laramie

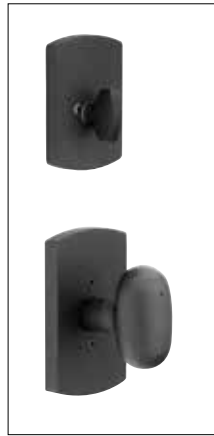

Order any sandcast bronze knob or lever for the inside trim.

Sheridan



Creston



Order any sandcast bronze knob or lever for the inside trim.

LARAMIE	Product Code	Knob or Lever Style for Inside Trim	Finish	List Price
Single Cylinder	451711	See Page 5 for Sandcast Bronze Knob & Lever Options. See Page 5 for Crystal & Porcelain Knob Options.	Flat Black Bronze (FB) Medium Bronze (MB) Tumbled White Bronze (TWB)	\$340.00
Double Cylinder	452711			\$340.00
Dummy	450711			\$340.00

SHERIDAN (5½" Center to Center Door Prep)	Product Code	Knob or Lever Style for Inside Trim	Finish	List Price
Single Cylinder	451812	See Page 5 for Sandcast Bronze Knob & Lever Options. See Page 5 for Crystal & Porcelain Knob Options.	Flat Black Bronze (FB) Medium Bronze (MB) Tumbled White Bronze (TWB)	\$376.00
Double Cylinder	452812			\$376.00
Dummy	450812			\$376.00

CRESTON (5½" Center to Center Door Prep)	Product Code	Knob or Lever Style for Inside Trim	Finish	List Price
Single Cylinder	451913	See Page 5 for Sandcast Bronze Knob & Lever Options. See Page 5 for Crystal & Porcelain Knob Options.	Flat Black Bronze (FB) Medium Bronze (MB) Tumbled White Bronze (TWB)	\$428.00
Double Cylinder	452913			\$428.00
Dummy	450913			\$428.00

INTERCONNECT DEVICE	Product Code		List Price
Sheridan & Creston Styles	443	Not Available for Double Cylinder.	\$58.00

Handing Required if Lever Used on Inside or if Interconnect Device is Specified

- Fits standard door thickness of 1¾". Specify if thicker.
- Standard 2½" door prep. Standard latch is for 2¾" backset. Specify 2¾" backset if required.
- 28° Rotation latch not available for use with Tubular Entrance Handlesets.

Weiser® (WR5) Keyway

- Specify by adding "W" to the beginning of product code.
- No upcharge for cylinder substitution.
- Can be keyed into existing Weiser® system.

To order: **(W) Product Code + Knob/Lever Style + Handing + Finish + Add Door Thickness to Comments**

ENTRANCE HANDLESETS - SANDCAST BRONZE TUBULAR

Denver



Order any sandcast bronze knob or lever for the inside trim.

Remington



Greeley



Order any sandcast bronze knob or lever for the inside trim.

DENVER	Product Code	Knob or Lever Style for Inside Trim	Finish	List Price
Single Cylinder	451211	See Page 5 for Sandcast Bronze Knob & Lever Options. See Page 5 for Crystal & Porcelain Knob Options.	Flat Black Bronze (FB) Medium Bronze (MB) Tumbled White Bronze (TWB)	\$340.00
Double Cylinder	452211			\$340.00
Dummy	450211			\$340.00

REMINGTON (5½" Center to Center Door Prep)	Product Code	Knob or Lever Style for Inside Trim	Finish	List Price
Single Cylinder	451112	See Page 5 for Sandcast Bronze Knob & Lever Options. See Page 5 for Crystal & Porcelain Knob Options.	Flat Black Bronze (FB) Medium Bronze (MB) Tumbled White Bronze (TWB)	\$376.00
Double Cylinder	452112			\$376.00
Dummy	450112			\$376.00

GREELEY (5½" Center to Center Door Prep)	Product Code	Knob or Lever Style for Inside Trim	Finish	List Price
Single Cylinder	451332	See Page 5 for Sandcast Bronze Knob & Lever Options. See Page 5 for Crystal & Porcelain Knob Options.	Flat Black Bronze (FB) Medium Bronze (MB) Tumbled White Bronze (TWB)	\$428.00
Double Cylinder	452332			\$428.00
Dummy	450332			\$428.00

INTERCONNECT DEVICE	Product Code		List Price
Remington & Greeley Styles	443	Not Available for Double Cylinder.	\$58.00

Handing Required if Lever Used on Inside or if Interconnect Device is Specified

- Fits standard door thickness of 1¾". Specify if thicker.
- Standard 2½" door prep. Standard latch is for 2¾" backset. Specify 2¾" backset if required.
- 28° Rotation latch not available for use with Tubular Entrance Handlesets.

Weiser® (WR5) Keyway

- Specify by adding "W" to the beginning of product code.
- No upcharge for cylinder substitution.
- Can be keyed into existing Weiser® system.

To order: (W) Product Code + Knob/Lever Style + Handing + Finish + Add Door Thickness to Comments

Rectangular Sectional



Order any sandcast bronze knob or lever for the inside trim.

Rectangular Monolithic



Rectangular Full Length



Order any sandcast bronze knob or lever for the inside trim.

RECTANGULAR SECTIONAL	Product Code	Knob or Lever Style for Inside Trim	Finish	List Price
Single Cylinder	451411	See Page 5 for Sandcast Bronze Knob & Lever Options. See Page 5 for Crystal & Porcelain Knob Options.	Flat Black Bronze (FB) Medium Bronze (MB) Tumbled White Bronze (TWB)	\$340.00
Double Cylinder	452411			\$340.00
Dummy	450411			\$340.00

RECTANGULAR MONOLITHIC <small>(5½" Center to Center Door Prep)</small>	Product Code	Knob or Lever Style for Inside Trim	Finish	List Price
Single Cylinder	451512	See Page 5 for Sandcast Bronze Knob & Lever Options. See Page 5 for Crystal & Porcelain Knob Options.	Flat Black Bronze (FB) Medium Bronze (MB) Tumbled White Bronze (TWB)	\$376.00
Double Cylinder	452512			\$376.00
Dummy	450512			\$376.00

RECTANGULAR FULL LENGTH <small>(5½" Center to Center Door Prep)</small>	Product Code	Knob or Lever Style for Inside Trim	Finish	List Price
Single Cylinder	451613	See Page 5 for Sandcast Bronze Knob & Lever Options. See Page 5 for Crystal & Porcelain Knob Options.	Flat Black Bronze (FB) Medium Bronze (MB) Tumbled White Bronze (TWB)	\$428.00
Double Cylinder	452613			\$428.00
Dummy	450613			\$428.00

INTERCONNECT DEVICE	Product Code		List Price
Rectangular Monolithic & Full Length Styles	443	Not Available for Double Cylinder.	\$58.00

Handing Required if Lever Used on Inside or if Interconnect Device is Specified

- Fits standard door thickness of 1¾". Specify if thicker.
- Standard 2½" door prep. Standard latch is for 2¾" backset. Specify 2¾" backset if required.
- 28° Rotation latch not available for use with Tubular Entrance Handlesets.

Weiser® (WR5) Keyway

- Specify by adding "W" to the beginning of product code.
- No upcharge for cylinder substitution.
- Can be keyed into existing Weiser® system.

To order: **(W) Product Code + Knob/Lever Style + Handing + Finish + Add Door Thickness to Comments**

ENTRANCE HANDLESETS - LOST WAX CAST BRONZE TUBULAR

Tuscany Sectional



Order any lost wax cast bronze knob or lever for the inside trim.

Tuscany Monolithic



Order any lost wax cast bronze knob or lever for the inside trim.

TUSCANY SECTIONAL	Product Code	Knob or Lever Style for Inside Trim	Finish	List Price
Single Cylinder	471224	See Page 6 for Lost Wax Cast Bronze Knob & Lever Options. See Page 5 for Crystal & Porcelain Knob Options.	Flat Black Bronze (FB) Medium Bronze (MB)	\$340.00
Double Cylinder	472224			\$340.00
Dummy	470224			\$340.00

TUSCANY MONOLITHIC <small>(5½" Center to Center Door Prep)</small>	Product Code	Knob or Lever Style for Inside Trim	Finish	List Price
Single Cylinder	471112	See Page 6 for Lost Wax Cast Bronze Knob & Lever Options. See Page 5 for Crystal & Porcelain Knob Options.	Flat Black Bronze (FB) Medium Bronze (MB)	\$376.00
Double Cylinder	472112			\$376.00
Dummy	470112			\$376.00

INTERCONNECT DEVICE	Product Code		List Price
Tuscany Monolithic Style	443	Not Available for Double Cylinder.	\$58.00

Handing Required if Lever Used on Inside or if Interconnect Device is Specified

- Fits standard door thickness of 1¾". Specify if thicker.
- Standard 2½" door prep. Standard latch is for 2¾" backset. Specify 2¾" backset if required.
- 28° Rotation latch not available for use with Tubular Entrance Handlesets.

Weiser® (WR5) Keyway

- Specify by adding "W" to the beginning of product code.
- No upcharge for cylinder substitution.
- Can be keyed into existing Weiser® system.

Art Nouveau



Left Hand Grip

Right Hand Grip



Order any lost wax cast bronze knob or lever for the inside trim.

Octagon



Order any lost wax cast bronze knob or lever for the inside trim.

ART NOUVEAU (5½" Center to Center Door Prep)	Product Code	Specify LH/RH Grip	Knob or Lever Style for Inside Trim	Finish	List Price
Single Cylinder	471333		See Page 6 for Lost Wax Cast Bronze Knob & Lever Options. See Page 5 for Crystal & Porcelain Knob Options.	Flat Black Bronze (FB) Medium Bronze (MB)	\$376.00
Double Cylinder	472333				\$376.00
Dummy	470333				\$376.00

OCTAGON (5½" Center to Center Door Prep)	Product Code	Knob or Lever Style for Inside Trim	Finish	List Price
Single Cylinder	471222	See Page 6 for Lost Wax Cast Bronze Knob & Lever Options. See Page 5 for Crystal & Porcelain Knob Options.	Flat Black Bronze (FB) Medium Bronze (MB)	\$376.00
Double Cylinder	472222			\$376.00
Dummy	470222			\$376.00

INTERCONNECT DEVICE	Product Code		List Price
Available for Above Styles	443	Not Available for Double Cylinder.	\$58.00

Handing Required if Lever Used on Inside or if Interconnect Device is Specified

- Fits standard door thickness of 1¾". Specify if thicker.
- Standard 2½" door prep. Standard latch is for 2¾" backset. Specify 2¾" backset if required.
- 28° Rotation latch not available for use with Tubular Entrance Handlesets.

Weiser® (WR5) Keyway

- Specify by adding "W" to the beginning of product code.
- No upcharge for cylinder substitution.
- Can be keyed into existing Weiser® system.

Sectional
with Lafayette Grip



Sectional
with San Carlos Grip



Sectional
with Normandy Grip

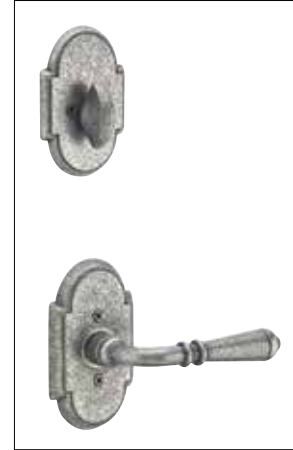

Order any wrought steel knob or lever for the inside trim.

SECTIONAL WITH LAFAYETTE GRIP	Product Code	Knob or Lever Style for Inside Trim	Finish	List Price
Single Cylinder	461212	See Page 6 for Wrought Steel Knob & Lever Options.	Flat Black Steel (FBS) Satin Steel (SWS)	\$246.00
Double Cylinder	462212			\$246.00
Dummy	460212			\$246.00

SECTIONAL WITH SAN CARLOS GRIP	Product Code	Knob or Lever Style for Inside Trim	Finish	List Price
Single Cylinder	461222	See Page 6 for Wrought Steel Knob & Lever Options.	Flat Black Steel (FBS) Satin Steel (SWS)	\$246.00
Double Cylinder	462222			\$246.00
Dummy	460222			\$246.00

SECTIONAL WITH NORMANDY GRIP	Product Code	Knob or Lever Style for Inside Trim	Finish	List Price
Single Cylinder	461232	See Page 6 for Wrought Steel Knob & Lever Options.	Flat Black Steel (FBS) Satin Steel (SWS)	\$246.00
Double Cylinder	462232			\$246.00
Dummy	460232			\$246.00

Handing Required if Lever Used on Inside or if Interconnect Device is Specified

- Fits standard door thickness of 1¾". Specify if thicker.
- Standard 2½" door prep. Standard latch is for 2¾" backset. Specify 2¾" backset if required.
- 28° Rotation latch not available for use with Tubular Entrance Handlesets.

Weiser® (WR5) Keyway

- Specify by adding "W" to the beginning of product code.
- No upcharge for cylinder substitution.
- Can be keyed into existing Weiser® system.

Monolithic
with Lafayette Grip



Monolithic
with San Carlos Grip



Monolithic
with Normandy Grip



Order any wrought steel knob or lever for the inside trim.

MONOLITHIC WITH LAFAYETTE GRIP (5½" Center to Center Door Prep)	Product Code	Knob or Lever Style for Inside Trim	Finish	List Price
Single Cylinder	461111	See Page 6 for Wrought Steel Knob & Lever Options.	Flat Black Steel (FBS) Satin Steel (SWS)	\$282.00
Double Cylinder	462111			\$282.00
Dummy	460111			\$282.00

MONOLITHIC WITH SAN CARLOS GRIP (5½" Center to Center Door Prep)	Product Code	Knob or Lever Style for Inside Trim	Finish	List Price
Single Cylinder	461121	See Page 6 for Wrought Steel Knob & Lever Options.	Flat Black Steel (FBS) Satin Steel (SWS)	\$282.00
Double Cylinder	462121			\$282.00
Dummy	460121			\$282.00

MONOLITHIC WITH NORMANDY GRIP (5½" Center to Center Door Prep)	Product Code	Knob or Lever Style for Inside Trim	Finish	List Price
Single Cylinder	461131	See Page 6 for Wrought Steel Knob & Lever Options.	Flat Black Steel (FBS) Satin Steel (SWS)	\$282.00
Double Cylinder	462131			\$282.00
Dummy	460131			\$282.00

INTERCONNECT DEVICE	Product Code		List Price
Available for Above Styles	443	Not Available for Double Cylinder.	\$58.00

Handing Required if Lever Used on Inside or if Interconnect Device is Specified

- Fits standard door thickness of 1¾". Specify if thicker.
- Standard 2¾" door prep. Standard latch is for 2¾" backset. Specify 2¾" backset if required.
- 28° Rotation latch not available for use with Tubular Entrance Handlesets.

Weiser® (WR5) Keyway

- Specify by adding "W" to the beginning of product code.
- No upcharge for cylinder substitution.
- Can be keyed into existing Weiser® system.

To order: **(W) Product Code + Knob/Lever Style + Handing + Finish** + Add Door Thickness to Comments

ENTRANCE HANDLESETS - STAINLESS STEEL TUBULAR

Davos
Stainless Steel



Order any stainless steel knob or lever for the inside trim.

Zeus
Stainless Steel



Order any stainless steel knob or lever for the inside trim.

DAVOS STAINLESS STEEL (5½" Center to Center Door Prep)		Product Code	Knob or Lever Style for Inside Trim	Finish	List Price
Single Cylinder	S40101	See Page 6 For Stainless Steel Knob & Lever Options.	Brushed Stainless Steel (SS)	\$282.00	
Dummy	S40100			\$282.00	

ZEUS STAINLESS STEEL (5½" Center to Center Door Prep)		Product Code	Knob or Lever Style for Inside Trim	Finish	List Price
Single Cylinder	S40001	See Page 6 For Stainless Steel Knob & Lever Options.	Brushed Stainless Steel (SS)	\$282.00	
Double Cylinder	S40002			\$282.00	
Dummy	S40000			\$282.00	

INTERCONNECT DEVICE		Product Code	List Price
Available for Above Styles	443	Not Available for Double Cylinder.	\$58.00

Handing Required if Lever Used on Inside or if Interconnect Device is Specified

- Fits standard door thickness of 1¾". Specify if thicker.
- Standard 2½" door prep. Standard latch is for 2¾" backset. Specify 2¾" backset if required.
- 28° Rotation latch not available for use with Tubular Entrance Handlesets.

Weiser® (WR5) Keyway

- Specify by adding "W" to the beginning of product code.
- No upcharge for cylinder substitution.
- Can be keyed into existing Weiser® system.



Exterior

Profile

Interior



Double sided handlesets, also known as grip by grip, have a full length trim on both the interior and exterior sides of the door. They are available in three functions: single cylinder, double cylinder, and dummy. The single cylinder configuration has a thumbturn which unlocks the door from the inside; while the double cylinder has keyed cylinders on both sides of the door. The dummy does not include a thumbturn, instead it only features matching trim on either side of the door with no locking functionality.

Grip by Grip is a custom function made to order and requires an additional 2-3 day lead time. Also available in Brass handlesets, see page 48-55 for styles - Please call for pricing.

Ridgemont

Logan



Brighton



Rectangular
Sectional

Rectangular
Monolithic

Rectangular
Full Length



GRIP BY GRIP ENTRY SETS	Description	Product Code	Finish	List Price
 RIDGEMONT	Single Cylinder	453727	Flat Black Bronze (FB) Medium Bronze (MB) Tumbled White Bronze (TWB)	\$544.00
	Double Cylinder	454727		\$544.00
	Dummy	455727		\$544.00
 LOGAN Door Prep 5½" Center to Center	Single Cylinder	453828	Flat Black Bronze (FB) Medium Bronze (MB) Tumbled White Bronze (TWB)	\$590.00
	Double Cylinder	454828		\$590.00
	Dummy	455828		\$590.00
 BRIGHTON Door Prep 5½" Center to Center	Single Cylinder	453929	Flat Black Bronze (FB) Medium Bronze (MB) Tumbled White Bronze (TWB)	\$652.00
	Double Cylinder	454929		\$652.00
	Dummy	455929		\$652.00

GRIP BY GRIP ENTRY SETS	Description	Product Code	Finish	List Price
 RECTANGULAR SECTIONAL	Single Cylinder	453414	Flat Black Bronze (FB) Medium Bronze (MB) Tumbled White Bronze (TWB)	\$544.00
	Double Cylinder	454414		\$544.00
	Dummy	455414		\$544.00
 RECTANGULAR MONOLITHIC Door Prep 5½" Center to Center	Single Cylinder	453515	Flat Black Bronze (FB) Medium Bronze (MB) Tumbled White Bronze (TWB)	\$590.00
	Double Cylinder	454515		\$590.00
	Dummy	455515		\$590.00
 RECTANGULAR FULL LENGTH Door Prep 5½" Center to Center	Single Cylinder	453636	Flat Black Bronze (FB) Medium Bronze (MB) Tumbled White Bronze (TWB)	\$652.00
	Double Cylinder	454636		\$652.00
	Dummy	455636		\$652.00

Handing Not Required

- Standard door thickness of 1¾". Specify if thicker.
- Standard latch is for 2¾" backset. Specify 2¾" backset if required.

Weiser® (WR5) Keyway

- Specify by adding "W" to the beginning of product code.
- No upcharge for cylinder substitution. Can be keyed into existing Weiser® system.



GRIP BY GRIP ENTRY SETS	Description	Product Code	Finish	List Price
LARAMIE	Single Cylinder	453717	Flat Black Bronze (FB) Medium Bronze (MB) Tumbled White Bronze (TWB)	\$544.00
	Double Cylinder	454717		\$544.00
	Dummy	455717		\$544.00
SHERIDAN Door Prep 5½" Center to Center	Single Cylinder	453818	Flat Black Bronze (FB) Medium Bronze (MB) Tumbled White Bronze (TWB)	\$590.00
	Double Cylinder	454818		\$590.00
	Dummy	455818		\$590.00
CRESTON Door Prep 5½" Center to Center	Single Cylinder	453919	Flat Black Bronze (FB) Medium Bronze (MB) Tumbled White Bronze (TWB)	\$652.00
	Double Cylinder	454919		\$652.00
	Dummy	455919		\$652.00

GRIP BY GRIP ENTRY SETS	Description	Product Code	Finish	List Price
DENVER	Single Cylinder	453212	Flat Black Bronze (FB) Medium Bronze (MB) Tumbled White Bronze (TWB)	\$544.00
	Double Cylinder	454212		\$544.00
	Dummy	455212		\$544.00
REMINGTON Door Prep 5½" Center to Center	Single Cylinder	453111	Flat Black Bronze (FB) Medium Bronze (MB) Tumbled White Bronze (TWB)	\$590.00
	Double Cylinder	454111		\$590.00
	Dummy	455111		\$590.00
GREELEY Door Prep 5½" Center to Center	Single Cylinder	453333	Flat Black Bronze (FB) Medium Bronze (MB) Tumbled White Bronze (TWB)	\$652.00
	Double Cylinder	454333		\$652.00
	Dummy	455333		\$652.00

Handing Not Required

- Standard door thickness of 1¾". Specify if thicker.
- Standard latch is for 2¾" backset. Specify 2¾" backset if required.



Weiser® (WRS) Keyway



- Specify by adding "W" to the beginning of product code.
- No upcharge for cylinder substitution. Can be keyed into existing Weiser® system.

To order: **(W) Product Code + Finish + Add Door Thickness to Comments**

GRIP BY GRIP ENTRANCE HANDLESETS - LOST WAX CAST BRONZE



GRIP BY GRIP ENTRY SETS	Description	Product Code	Finish	List Price
 TUSCANY SECTIONAL	Single Cylinder	473444	Flat Black Bronze (FB) Medium Bronze (MB)	\$544.00
	Double Cylinder	474444		\$544.00
	Dummy	475444		\$544.00
 TUSCANY MONOLITHIC Door Prep 5½" Center to Center	Single Cylinder	473111	Flat Black Bronze (FB) Medium Bronze (MB)	\$590.00
	Double Cylinder	474111		\$590.00
	Dummy	475111		\$590.00
 OCTAGON Door Prep 5½" Center to Center	Single Cylinder	473222	Flat Black Bronze (FB) Medium Bronze (MB)	\$590.00
	Double Cylinder	474222		\$590.00
	Dummy	475222		\$590.00

GRIP BY GRIP ENTRY SETS	Description	Product Code	Finish	List Price
 ART NOUVEAU Left Hand Grip (Outside) Door Prep 5½" Center to Center	Single Cylinder	473333LH	Flat Black Bronze (FB) Medium Bronze (MB)	\$590.00
	Double Cylinder	474333LH		\$590.00
	Dummy	475333LH		\$590.00
 ART NOUVEAU Right Hand Grip (Outside) Door Prep 5½" Center to Center	Single Cylinder	473333RH	Flat Black Bronze (FB) Medium Bronze (MB)	\$590.00
	Double Cylinder	474333RH		\$590.00
	Dummy	475333RH		\$590.00

Handing Not Required

- Standard door thickness of 1¾". Specify if thicker.
- Standard latch is for 2¾" backset. Specify 2¾" backset if required.

Weiser® (WR5) Keyway

- Specify by adding "W" to the beginning of product code.
- No upcharge for cylinder substitution. Can be keyed into existing Weiser® system.

Round Knob
with Square Rosette





Round Knob
with Disk Rosette



Round Knob
with Modern Rectangular Rosette



KEY IN KNOBSETS		Description	Product Code	Key In Knob Style	Finish	List Price
Square 	Key in Knob	5122	Round Knob (ROU)	Satin Brass (US4) Oil Rubbed Bronze (US10B) Polished Nickel - Lifetime (US14) Satin Nickel (US15) Flat Black (US19) Polished Chrome (US26) Unlacquered Brass (US3NL)*	\$158.00	
	Dummy, Key in Knob	5022			\$158.00	
Disk 	Key in Knob	5115	Round Knob (ROU)	Satin Brass (US4) Oil Rubbed Bronze (US10B) Satin Nickel (US15) Flat Black (US19) Polished Chrome (US26) Unlacquered Brass (US3NL)*	\$158.00	
	Dummy, Key in Knob	5015			\$158.00	
Modern Rectangular 	Key in Knob	5123	Round Knob (ROU)	Satin Brass (US4) Oil Rubbed Bronze (US10B) Satin Nickel (US15) Flat Black (US19) Polished Chrome (US26) Unlacquered Brass (US3NL)*	\$158.00	
	Dummy, Key in Knob	5023			\$158.00	

Hanover Lever
with Square Rosette





Helios Lever
with Modern Rectangular Rosette



Luzern Lever
with Square Rosette



KEY IN LEVERSETS		Description	Product Code	Key In Lever Style	Finish	List Price
Square 	Key in Lever	5122	Hanover Lever (HN) Helios Lever (HLO) Luzern Lever (LU)	Satin Brass (US4) Oil Rubbed Bronze (US10B) Satin Nickel (US15) Flat Black (US19) Polished Chrome (US26) Unlacquered Brass (US3NL)*	\$158.00	
	Dummy, Key in Lever	5022			\$158.00	
Disk 	Key in Lever	5115	Hanover Lever (HN) Helios Lever (HLO) Luzern Lever (LU)	Satin Brass (US4) Oil Rubbed Bronze (US10B) Satin Nickel (US15) Flat Black (US19) Polished Chrome (US26) Unlacquered Brass (US3NL)*	\$158.00	
	Dummy, Key in Lever	5015			\$158.00	
Modern Rectangular 	Key in Lever	5123	Hanover Lever (HN) Helios Lever (HLO) Luzern Lever (LU)	Satin Brass (US4) Oil Rubbed Bronze (US10B) Satin Nickel (US15) Flat Black (US19) Polished Chrome (US26) Unlacquered Brass (US3NL)*	\$158.00	
	Dummy, Key in Lever	5023			\$158.00	

*Unlacquered Brass (US3NL) finish available for a \$40 List Price upcharge per item.

Handing is Required for Leversets

- Standard latch is for 2 3/4" backset. Specify 2 3/4" backset if required. Complete set includes latch and strike plate.
- Brass Modern Key In knobsets and leversets may be ordered with any Brass Key In rosette at the list price shown above. See page 70 - 71 for Brass Key In rosette options.

Weiser® (WR5) Keyway

- Specify by adding "W" to the beginning of product code.
- No upcharge for cylinder substitution.
- Can be keyed into existing Weiser® system.

Waverly Knob
with Regular Rosette



Providence Knob
with #8 Rosette



Egg Knob
with Rectangular Rosette



Rope Knob
with Rope Rosette



KEY IN KNOBSETS	Description	Product Code	Key In Knob Style	Finish	List Price
Regular 	Key in Knob	5100	Egg Knob (E) Providence Knob (P) Rope Knob (RK) Waverly Knob (W)	Polished Brass - Lifetime (US3) French Antique (US7) Oil Rubbed Bronze (US10B) Polished Nickel - Lifetime (US14)** Satin Nickel (US15) Pewter (US15A) Flat Black (US19)*** Polished Chrome (US26) Unlacquered Brass (US3NL)*	\$158.00
	Dummy, Key in Knob	5150			\$158.00
#8 	Key in Knob	5108	Egg Knob (E) Providence Knob (P) Rope Knob (RK) Waverly Knob (W)	Polished Brass - Lifetime (US3) French Antique (US7) Oil Rubbed Bronze (US10B) Satin Nickel (US15) Pewter (US15A) Flat Black (US19)*** Polished Chrome (US26) Unlacquered Brass (US3NL)*	\$158.00
	Dummy, Key in Knob	5158			\$158.00
Rectangular 	Key in Knob	5121	Egg Knob (E) Providence Knob (P) Rope Knob (RK) Waverly Knob (W)	Polished Brass - Lifetime (US3) French Antique (US7) Oil Rubbed Bronze (US10B) Polished Nickel - Lifetime (US14)** Satin Nickel (US15) Pewter (US15A) Flat Black (US19)*** Polished Chrome (US26) Unlacquered Brass (US3NL)*	\$158.00
	Dummy, Key in Knob	5021			\$158.00
Rope 	Key in Knob	5101	Egg Knob (E) Providence Knob (P) Rope Knob (RK) Waverly Knob (W)	Polished Brass - Lifetime (US3) French Antique (US7) Oil Rubbed Bronze (US10B) Satin Nickel (US15) Pewter (US15A) Polished Chrome (US26) Unlacquered Brass (US3NL)*	\$158.00
	Dummy, Key in Knob	5151			\$158.00

***Unlacquered Brass (US3NL)** finish available for a **\$40 List Price** upcharge per item. **Polished Nickel - Lifetime (US14) available only for Waverly Key In Knob.

***Flat Black (US19) NOT available for Rope Knob.

Handing Not Required for Knobsets

- Standard latch is for 2³/₈" backset. Specify 2³/₄" backset if required. Complete set includes latch and strike plate.
 - Brass Key In Knobsets may be ordered with any Brass Modern Key In rosette at the list price shown above.
- See page 69 for Brass Modern Key In rosette options.

Weiser® (WR5) Keyway

- Specify by adding "W" to the beginning of product code.
- No upcharge for cylinder substitution.
- Can be keyed into existing Weiser® system.

Cortina Lever
with Regular RosetteCortina Lever
with #8 RosetteCortina Lever
with Rectangular RosetteRope Lever
with Rope Rosette

KEY IN LEVERSETS	Description	Product Code	Key In Lever Style	Finish	List Price
Regular 	Key in Lever	5100	Cortina Lever (C) Rope Lever (RL)	Polished Brass - Lifetime (US3) French Antique (US7) Oil Rubbed Bronze (US10B) Satin Nickel (US15) Pewter (US15A) Flat Black (US19)*** Polished Chrome (US26) Unlacquered Brass (US3NL)*	\$158.00
	Dummy, Key in Lever	5150			\$158.00
#8 	Key in Lever	5108	Cortina Lever (C) Rope Lever (RL)	Polished Brass - Lifetime (US3) French Antique (US7) Oil Rubbed Bronze (US10B) Satin Nickel (US15) Pewter (US15A) Flat Black (US19)*** Polished Chrome (US26) Unlacquered Brass (US3NL)*	\$158.00
	Dummy, Key in Lever	5158			\$158.00
Rectangular 	Key in Lever	5121	Cortina Lever (C) Rope Lever (RL)	Polished Brass - Lifetime (US3) French Antique (US7) Oil Rubbed Bronze (US10B) Satin Nickel (US15) Pewter (US15A) Flat Black (US19)*** Polished Chrome (US26) Unlacquered Brass (US3NL)*	\$158.00
	Dummy, Key in Lever	5021			\$158.00
Rope 	Key in Lever	5101	Cortina Lever (C) Rope Lever (RL)	Polished Brass - Lifetime (US3) French Antique (US7) Oil Rubbed Bronze (US10B) Satin Nickel (US15) Pewter (US15A) Polished Chrome (US26) Unlacquered Brass (US3NL)*	\$158.00
	Dummy, Key in Lever	5151			\$158.00

***Unlacquered Brass (US3NL)** finish available for a **\$40 List Price** upcharge per item. ***Flat Black (US19) NOT available for Rope Key In Lever.

Handing is Required for Leversets





- Standard latch is for 2 $\frac{3}{4}$ " backset. Specify 2 $\frac{3}{4}$ " backset if required. Complete set includes latch and strike plate.
 - Brass Key In leversets may be ordered with any Brass Modern Key In rosette at the list price shown above.
- See page 69 for Brass Modern Key In rosette options.

Weiser® (WR5) Keyway

- Specify by adding "W" to the beginning of product code.
- No upcharge for cylinder substitution.
- Can be keyed into existing Weiser® system.

ENTRANCE LOCKSETS - SANDCAST BRONZE KEY IN KNOBSETS

Winchester Knob
with #1 RosetteWinchester Knob
with #2 RosetteWinchester Knob
with #3 RosetteWinchester Knob
with #4 Rosette

KEY IN KNOBSETS	Description	Product Code	Key In Knob Style	Finish	List Price
#1 	Key in Knob	5104	Winchester Knob (WC)	Flat Black Bronze (FB) Medium Bronze (MB) Tumbled White Bronze (TWB)	\$174.00
	Dummy, Key in Knob	5154			\$174.00
#2 	Key in Knob	5102	Winchester Knob (WC)	Flat Black Bronze (FB) Medium Bronze (MB) Tumbled White Bronze (TWB)	\$174.00
	Dummy, Key in Knob	5152			\$174.00
#3 	Key in Knob	5103	Winchester Knob (WC)	Flat Black Bronze (FB) Medium Bronze (MB) Tumbled White Bronze (TWB)	\$174.00
	Dummy, Key in Knob	5153			\$174.00
#4 	Key in Knob	5114	Winchester Knob (WC)	Flat Black Bronze (FB) Medium Bronze (MB) Tumbled White Bronze (TWB)	\$174.00
	Dummy, Key in Knob	5164			\$174.00

Handing Not Required for Knobsets

- Standard latch is for 2 $\frac{3}{8}$ " backset. Specify 2 $\frac{3}{4}$ " backset if required.
- Complete set includes latch and strike plate.

Weiser® (WR5) Keyway

- Specify by adding "W" to the beginning of product code.
- No upcharge for cylinder substitution. • Can be keyed into existing Weiser® system.

Durango Lever with #1 Rosette



Durango Lever with #2 Rosette





Durango Lever with #3 Rosette



Durango Lever with #4 Rosette



KEY IN LEVERSETS	Description	Product Code	Key In Lever Style	Finish	List Price
#1 	Key in Lever	5104	Durango Lever (D)	Flat Black Bronze (FB) Medium Bronze (MB) Tumbled White Bronze (TWB)	\$174.00
	Dummy, Key in Lever	5154			\$174.00
#2 	Key in Lever	5102	Durango Lever (D)	Flat Black Bronze (FB) Medium Bronze (MB) Tumbled White Bronze (TWB)	\$174.00
	Dummy, Key in Lever	5152			\$174.00
#3 	Key in Lever	5103	Durango Lever (D)	Flat Black Bronze (FB) Medium Bronze (MB) Tumbled White Bronze (TWB)	\$174.00
	Dummy, Key in Lever	5153			\$174.00
#4 	Key in Lever	5114	Durango Lever (D)	Flat Black Bronze (FB) Medium Bronze (MB) Tumbled White Bronze (TWB)	\$174.00
	Dummy, Key in Lever	5164			\$174.00

Handing is Required for Leversets

- Standard latch is for 2¾" backset. Specify 2¾" backset if required.
- Complete set includes latch and strike plate.

Weiser® (WR5) Keyway

- Specify by adding "W" to the beginning of product code.
- No upcharge for cylinder substitution. • Can be keyed into existing Weiser® system.

ENTRANCE LOCKSETS - LOST WAX CAST BRONZE KEY IN KNOBSETS & LEVERSETS

**Petal Knob
with #11 Rosette**





**Petal Knob
with #12 Rosette**



**Petal Knob
with #14 Rosette**



KEY IN KNOBSETS	Description	Product Code	Key In Knob Style	Finish	List Price
	Key in Knob	54011	Petal Knob (PT)	Flat Black Bronze (FB) Medium Bronze (MB)	\$174.00
	Dummy, Key in Knob	54511			\$174.00
	Key in Knob	54012	Petal Knob (PT)	Flat Black Bronze (FB) Medium Bronze (MB)	\$174.00
	Dummy, Key in Knob	54512			\$174.00
	Key in Knob	54014	Petal Knob (PT)	Flat Black Bronze (FB) Medium Bronze (MB)	\$174.00
	Dummy, Key in Knob	54514			\$174.00

**Siena Lever
with #11 Rosette**





**Siena Lever
with #12 Rosette**



**Siena Lever
with #14 Rosette**



KEY IN LEVERSETS	Description	Product Code	Key In Lever Style	Finish	List Price
	Key in Lever	54011	Siena Lever (SN)	Flat Black Bronze (FB) Medium Bronze (MB)	\$174.00
	Dummy, Key in Lever	54511			\$174.00
	Key in Lever	54012	Siena Lever (SN)	Flat Black Bronze (FB) Medium Bronze (MB)	\$174.00
	Dummy, Key in Lever	54512			\$174.00
	Key in Lever	54014	Siena Lever (SN)	Flat Black Bronze (FB) Medium Bronze (MB)	\$174.00
	Dummy, Key in Lever	54514			\$174.00

Handing is Required for Leversets

- Standard latch is for 2 3/8" backset. Specify 2 3/4" backset if required.
- Complete set includes latch and strike plate.

Weiser® (WR5) Keyway

- Specify by adding "W" to the beginning of product code.
- No upcharge for cylinder substitution. • Can be keyed into existing Weiser® system.

**Hanover Lever
with Disc Rosette**
Stainless Steel



KEY IN LEVERSETS	Description	Product Code	Key In Lever Style	Finish	List Price
Disc 	Key in Lever	S901	Hanover Lever (HN)	Brushed Stainless Steel (SS)	\$158.00
	Dummy, Key in Lever	S951			\$158.00

Handing is Required for Leversets

- Standard latch is for 2 $\frac{3}{8}$ " backset. Specify 2 $\frac{3}{4}$ " backset if required.
- Complete set includes latch and strike plate.

Weiser® (WR5) Keyway

- Specify by adding "W" to the beginning of product code.
- No upcharge for cylinder substitution. • Can be keyed into existing Weiser® system.

**Modern Rectangular
Single Point with Round Key In Knobs**

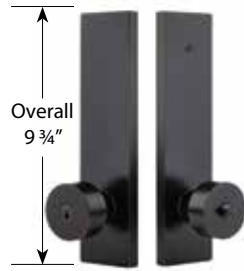

**Modern Rectangular
Dummy with Round Key In Knobs**



MODERN RECTANGULAR SINGLE POINT LOCKSET	Product Code	Key In Knob / Lever Style	Finish	List Price
Key in Knob/Lever	5302	Round Knob (ROU) Hanover Lever (HN)	Oil Rubbed Bronze (US10B) Satin Nickel (US15) Flat Black (US19)	\$200.00
Dummy, Pair	5352	Helios Lever (HLO) Luzern Lever (LU)	Polished Chrome (US26) Unlacquered Brass (US3NL)*	\$200.00

**Modern Rectangular
Two-Point, Single Cylinder
with Helios Key In Levers**

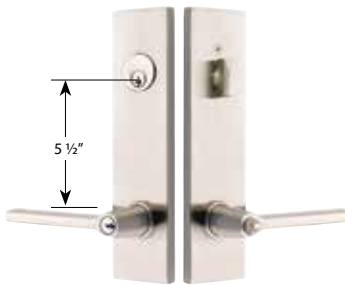

**Modern Rectangular
Two-Point, Double Cylinder
with Luzern Key In Levers**



**Modern Rectangular
Two-Point, Dummy
with Hanover Key In Levers**



MODERN RECTANGULAR TWO-POINT LOCKSET	Product Code	Key In Knob / Lever Style	Finish	List Price
Single Cylinder	5312	Round Knob (ROU) Hanover Lever (HN)	Oil Rubbed Bronze (US10B) Satin Nickel (US15) Flat Black (US19)	\$220.00
Double Cylinder	5322	Helios Lever (HLO) Luzern Lever (LU)	Polished Chrome (US26) Unlacquered Brass (US3NL)*	\$220.00
Dummy, Pair	5362			\$220.00

*Unlacquered Brass (US3NL) finish available for a \$40 List Price upcharge per item.

Handing Required for Leversets

- Standard latch is for 2 3/8" backset. Specify 2 3/4" backset if required
- Complete set includes latch and strike plate.
- Any Key In Knob / Lever style options listed on this page can be used with Annapolis trim style.

Weiser® (WR5) Keyway

- Specify by adding "W" to the beginning of product code.
- No upcharge for cylinder substitution.
- Can be keyed into existing Weiser® system.

Annapolis
Single Point with Providence Key In Knobs



Annapolis
Dummy with Egg Key In Knobs



ANNAPOLIS SINGLE POINT LOCKSET	Product Code	Key In Knob / Lever Style	Finish	List Price
Key in Knob/Lever	5308	Egg Knob (E) Providence Knob (P)	Polished Brass - Lifetime (US3) French Antique (US7) Oil Rubbed Bronze (US10B)	\$200.00
Dummy, Pair	5358	Rope Knob (RK) Waverly Knob (W) Cortina Lever (C) Rope Lever (RL)	Satin Nickel (US15) Pewter (US15A) Flat Black (US19)** Polished Chrome (US26) Unlacquered Brass (US3NL)*	\$200.00

Annapolis
Two-Point, Single Cylinder
with Waverly Key In Knobs

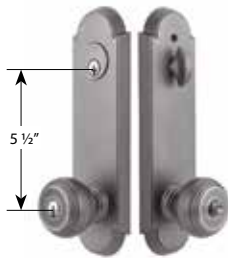

Annapolis
Two-Point, Double Cylinder
with Cortina Key In Levers



Annapolis
Two-Point, Dummy
with Cortina Key In Levers



ANNAPOLIS TWO-POINT LOCKSET	Product Code	Key In Knob / Lever Style	Finish	List Price
Single Cylinder	5318	Egg Knob (E) Providence Knob (P)	Polished Brass - Lifetime (US3) French Antique (US7) Oil Rubbed Bronze (US10B)	\$220.00
Double Cylinder	5328	Rope Knob (RK) Waverly Knob (W) Cortina Lever (C)	Satin Nickel (US15) Pewter (US15A) Flat Black (US19)** Polished Chrome (US26)	\$220.00
Dummy, Pair	5368	Rope Lever (RL)	Unlacquered Brass (US3NL)*	\$220.00

*Unlacquered Brass (US3NL) finish available for a \$40 List Price upcharge per item. **Flat Black (US19) NOT available for Rope Key In Knob/Lever.

Handing Required for Leversets

- Standard latch is for 2 3/8" backset. Specify 2 3/4" backset if required
- Complete set includes latch and strike plate.
- Any Key In Knob / Lever style options listed on this page can be used with Modern Rectangular trim style.

Weiser® (WR5) Keyway

- Specify by adding "W" to the beginning of product code.
- No upcharge for cylinder substitution.
- Can be keyed into existing Weiser® system.

STANDARD WITH BRASS DEADBOLTS

- Schlage® C Keyway
- Standard Door Prep and Installation
- Solid Brass Cylinder, Housing, Collar, Thumbturn, and Rosette
- Hardened Steel Bolt
- Heavy Gauge Steel Understrike
- Brass Trim Strike Shipped with Every Deadbolt



SQUARE DEADBOLT	Product Code	Finish	List Price
Single Cylinder <i>Includes extension collar for thin doors</i>	8469	Satin Brass (US4) Oil Rubbed Bronze (US10B) Polished Nickel - Lifetime (US14) Satin Nickel (US15) Flat Black (US19)	\$60.00
Double Cylinder	8369	Polished Chrome (US26) Unlacquered Brass (US3NL)*	



MODERN DEADBOLT	Product Code	Finish	List Price
Single Cylinder <i>Includes extension collar for thin doors</i>	8467	Satin Brass (US4) Oil Rubbed Bronze (US10B) Polished Nickel - Lifetime (US14) Satin Nickel (US15) Flat Black (US19)	\$60.00
Double Cylinder	8367	Polished Chrome (US26) Unlacquered Brass (US3NL)*	



NEOS DEADBOLT	Product Code	Finish	List Price
Single Cylinder <i>Includes extension collar for thin doors</i>	8475	Satin Brass (US4) Oil Rubbed Bronze (US10B) Satin Nickel (US15) Flat Black (US19)	\$60.00
Double Cylinder	8375	Polished Chrome (US26) Unlacquered Brass (US3NL)*	



QUINCY DEADBOLT	Product Code	Finish	List Price
Single Cylinder <i>Includes extension collar for thin doors</i>	8478	Polished Brass - Lifetime (US3) French Antique (US7) Oil Rubbed Bronze (US10B) Satin Nickel (US15) Pewter (US15A) Flat Black (US19)	\$60.00
Double Cylinder	8378	Polished Chrome (US26) Unlacquered Brass (US3NL)*	

*Unlacquered Brass (US3NL) finish available for a \$40 List Price upcharge per item.

Handing Not Required

- Standard door thickness of 1¾". Specify if thicker.
- Standard latch is for 2¾" backset. Specify 2¾" backset if required.

Weiser® (WR5) Keyway

- Specify by adding "W" to the beginning of product code.
- No upcharge for cylinder substitution. Can be keyed into existing Weiser® system.



REGULAR DEADBOLT Includes Extension Collar for Thin Doors	Product Code	Finish	List Price
Single Cylinder	8450	Polished Brass - Lifetime (US3) French Antique (US7) Oil Rubbed Bronze (US10B) Polished Nickel - Lifetime (US14) Satin Nickel (US15) Pewter (US15A) Flat Black (US19) Polished Chrome (US26) Unlacquered Brass (US3NL)*	\$50.00
Double Cylinder	8350		\$54.00



LOW PROFILE DEADBOLT Includes Extension Collar for Thin Doors	Product Code	Finish	List Price
Single Cylinder	8455	Polished Brass - Lifetime (US3) French Antique (US7) Oil Rubbed Bronze (US10B) Polished Nickel - Lifetime (US14) Satin Nickel (US15) Pewter (US15A) Flat Black (US19) Polished Chrome (US26) Unlacquered Brass (US3NL)*	\$50.00
Double Cylinder	8355		\$54.00



WILSHIRE DEADBOLT	Product Code	Finish	List Price
Single Cylinder <i>Includes extension collar for thin doors</i>	8479	Polished Brass - Lifetime (US3) French Antique (US7) Oil Rubbed Bronze (US10B) Polished Nickel - Lifetime (US14) Satin Nickel (US15) Pewter (US15A) Flat Black (US19) Polished Chrome (US26) Unlacquered Brass (US3NL)*	\$60.00
Double Cylinder	8379		\$64.00



ROPE DEADBOLT	Product Code	Finish	List Price
Single Cylinder <i>Includes extension collar for thin doors</i>	8464	Polished Brass - Lifetime (US3) French Antique (US7) Oil Rubbed Bronze (US10B) Satin Nickel (US15) Pewter (US15A) Polished Chrome (US26) Unlacquered Brass (US3NL)*	\$60.00
Double Cylinder	8364		\$64.00



ARTS & CRAFTS DEADBOLT	Product Code	Finish	List Price
Single Cylinder <i>Includes extension collar for thin doors</i>	8454	Oil Rubbed Bronze (US10B) Satin Nickel (US15) Flat Black (US19) Unlacquered Brass (US3NL)*	\$60.00
Double Cylinder	8354		\$64.00

*Unlacquered Brass (US3NL) finish available for a \$40 List Price upcharge per item.

Handing Not Required

- Standard door thickness of 1¾". Specify if thicker.
- Standard latch is for 2¾" backset. Specify 2¾" backset if required.

Weiser® (WR5) Keyway

- Specify by adding "W" to the beginning of product code.
- No upcharge for cylinder substitution. Can be keyed into existing Weiser® system.

DEADBOLTS - BRASS



#8 DEADBOLT	Product Code	Finish	List Price
Single Cylinder <i>Includes extension collar for thin doors</i>	8466	Polished Brass - Lifetime (US3) French Antique (US7) Oil Rubbed Bronze (US10B) Polished Nickel - Lifetime (US14) Satin Nickel (US15)	\$60.00
Double Cylinder	8366	Pewter (US15A) Flat Black (US19) Polished Chrome (US26) Unlacquered Brass (US3NL)*	



RECTANGULAR DEADBOLT	Product Code	Finish	List Price
Single Cylinder <i>Includes extension collar for thin doors</i>	8468	Polished Brass - Lifetime (US3) French Antique (US7) Oil Rubbed Bronze (US10B) Polished Nickel - Lifetime (US14) Satin Nickel (US15)	\$60.00
Double Cylinder	8368	Pewter (US15A) Flat Black (US19) Polished Chrome (US26) Unlacquered Brass (US3NL)*	



SARATOGA DEADBOLT	Product Code	Finish	List Price
Single Cylinder <i>Includes extension collar for thin doors</i>	8458	Polished Brass - Lifetime (US3) French Antique (US7) Oil Rubbed Bronze (US10B) Satin Nickel (US15)	\$60.00
Double Cylinder	8358	Pewter (US15A) Flat Black (US19) Polished Chrome (US26) Unlacquered Brass (US3NL)*	



KNOXVILLE DEADBOLT	Product Code	Finish	List Price
Single Cylinder <i>Includes extension collar for thin doors</i>	8459	Polished Brass - Lifetime (US3) French Antique (US7) Oil Rubbed Bronze (US10B) Satin Nickel (US15)	\$60.00
Double Cylinder	8359	Pewter (US15A) Polished Chrome (US26) Unlacquered Brass (US3NL)*	

*Unlacquered Brass (US3NL) finish available for a \$40 List Price upcharge per item.

Handing Not Required

- Standard door thickness of 1¾". Specify if thicker.
- Standard latch is for 2¾" backset. Specify 2¾" backset if required.

Weiser® (WR5) Keyway

- Specify by adding "W" to the beginning of product code.
- No upcharge for cylinder substitution. Can be keyed into existing Weiser® system.

STANDARD WITH SANDCAST BRONZE DEADBOLTS

- Schlage® C Keyway
- Standard Door Prep and Installation
- Solid Brass Cylinder
- Sandcast Bronze Collar and Rosette
- Hardened Steel Bolt
- Heavy Gauge Steel Understrike
- Brass Trim Strike Shipped with Every Deadbolt



REGULAR SANDCAST BRONZE DEADBOLT	Product Code	Finish	List Price
Single Cylinder	8450	Flat Black Bronze (FB)	\$68.00
Double Cylinder	8350	Medium Bronze (MB) Tumbled White Bronze (TWB)	\$72.00



#1 SANDCAST BRONZE DEADBOLT WITH FLAP	Product Code	Finish	List Price
Single Cylinder	8457	Flat Black Bronze (FB)	\$68.00
Double Cylinder	8357	Medium Bronze (MB) Tumbled White Bronze (TWB)	\$72.00



#3 SANDCAST BRONZE DEADBOLT WITH FLAP	Product Code	Finish	List Price
Single Cylinder	8465	Flat Black Bronze (FB)	\$68.00
Double Cylinder	8365	Medium Bronze (MB) Tumbled White Bronze (TWB)	\$72.00



#4 SANDCAST BRONZE DEADBOLT WITH FLAP	Product Code	Finish	List Price
Single Cylinder	8474	Flat Black Bronze (FB)	\$68.00
Double Cylinder	8374	Medium Bronze (MB) Tumbled White Bronze (TWB)	\$72.00



RIDGEMONT SANDCAST BRONZE DEADBOLT WITH FLAP	Product Code	Finish	List Price
Single Cylinder	8476	Flat Black Bronze (FB)	\$68.00
Double Cylinder	8376	Medium Bronze (MB) Tumbled White Bronze (TWB)	\$72.00

Handing Not Required

- Standard door thickness of 1¾". Specify if thicker.
- Standard latch is for 2¾" backset. Specify 2¾" backset if required.

Weiser® (WR5) Keyway

- Specify by adding "W" to the beginning of product code.
- No upcharge for cylinder substitution. Can be keyed into existing Weiser® system.

STANDARD WITH TUSCANY BRONZE DEADBOLTS

- Schlage® C Keyway
- Standard Door Prep and Installation
- Solid Brass Cylinder
- Lost Wax Cast Bronze Collar and Rosette
- Hardened Steel Bolt
- Heavy Gauge Steel Understrike
- Brass Trim Strike Shipped with Every Deadbolt



TUSCANY BRONZE DEADBOLT	Product Code	Finish	List Price
Single Cylinder	8456	Flat Black Bronze (FB) Medium Bronze (MB)	\$68.00
Double Cylinder	8356		\$72.00



CLASSIC TUSCANY BRONZE DEADBOLT	Product Code	Finish	List Price
Single Cylinder	8471	Flat Black Bronze (FB) Medium Bronze (MB)	\$68.00
Double Cylinder	8371		\$72.00



OCTAGON TUSCANY BRONZE DEADBOLT	Product Code	Finish	List Price
Single Cylinder	8460	Flat Black Bronze (FB) Medium Bronze (MB)	\$68.00
Double Cylinder	8360		\$72.00



#11 TUSCANY BRONZE DEADBOLT	Product Code	Finish	List Price
Single Cylinder	8472	Flat Black Bronze (FB) Medium Bronze (MB)	\$68.00
Double Cylinder	8372		\$72.00



#14 TUSCANY BRONZE DEADBOLT	Product Code	Finish	List Price
Single Cylinder	8473	Flat Black Bronze (FB) Medium Bronze (MB)	\$68.00
Double Cylinder	8373		\$72.00

Handing Not Required

- Standard door thickness of 1¾". Specify if thicker.
- Standard latch is for 2¾" backset. Specify 2¾" backset if required.

Weiser® (WR5) Keyway

- Specify by adding "W" to the beginning of product code.
- No upcharge for cylinder substitution. Can be keyed into existing Weiser® system.

STANDARD WITH WROUGHT STEEL DEADBOLTS

- Schlage® C Keyway
- Standard Door Prep and Installation
- Solid Brass Cylinder
- Wrought Steel Collar and Rosette
- Hardened Steel Bolt
- Heavy Gauge Steel Understrike
- Brass Trim Strike Shipped with Every Deadbolt



WROUGHT STEEL #1 STYLE DEADBOLT	Product Code	Finish	List Price
Single Cylinder	8461	Flat Black Steel (FBS) Satin Steel (SWS)	\$60.00
Double Cylinder	8361		\$64.00



WROUGHT STEEL #2 STYLE DEADBOLT	Product Code	Finish	List Price
Single Cylinder	8452	Flat Black Steel (FBS) Satin Steel (SWS)	\$60.00
Double Cylinder	8350		\$64.00



WROUGHT STEEL #3 STYLE DEADBOLT	Product Code	Finish	List Price
Single Cylinder	8463	Flat Black Steel (FBS) Satin Steel (SWS)	\$60.00
Double Cylinder	8363		\$64.00

STANDARD WITH STAINLESS STEEL DEADBOLTS

- Schlage® C Keyway
- Standard Door Prep and Installation
- Solid Brass Cylinder
- Stainless Steel Collar and Rosette
- Hardened Steel Bolt
- Heavy Gauge Steel Understrike
- Stainless Steel Trim Strike Shipped with Every Deadbolt



STAINLESS STEEL ROUND DEADBOLTS	Product Code	Finish	List Price
Single Cylinder	S50001	Brushed Stainless Steel (SS)	\$60.00
Double Cylinder	S50002		\$64.00



STAINLESS STEEL SQUARE DEADBOLTS	Product Code	Finish	List Price
Single Cylinder	S50003	Brushed Stainless Steel (SS)	\$60.00
Double Cylinder	S50023		\$64.00

Handing Not Required

- Standard door thickness of 1¾". Specify if thicker.
- Standard latch is for 2¾" backset. Specify 2¾" backset if required.

Weiser® (WR5) Keyway

- Specify by adding "W" to the beginning of product code.
- No upcharge for cylinder substitution. Can be keyed into existing Weiser® system.

SINGLE SIDED DEADBOLTS

Operated by Thumbturn from Inside Only. No Cylinder.

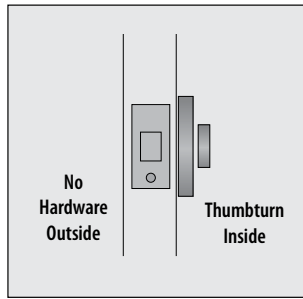

STANDARD WITH SINGLE SIDED DEADBOLTS

- Includes Deadbolt Mechanism and Strikeplate
- For Inside Installation and Appearance
- No Cylinder or Collar
- Hardened Steel Bolt

SINGLE SIDED DEADBOLTS	Product Code	Finish	List Price
Modern	8567	Satin Brass (US4) Oil Rubbed Bronze (US10B)	\$42.00
Square	8569	Polished Nickel - Lifetime (US14)** Satin Nickel (US15)	
Neos	8575	Flat Black (US19) Polished Chrome (US26) Unlacquered Brass (US3NL)*	

SINGLE SIDED DEADBOLTS	Product Code	Finish	List Price
Regular	8550	Polished Brass - Lifetime (US3) French Antique (US7)	\$42.00
#8	8566	Oil Rubbed Bronze (US10B) Polished Nickel - Lifetime (US14)	
Rectangular	8568	Satin Nickel (US15) Pewter (US15A)	\$42.00
Wilshire	8579	Flat Black (US19) Polished Chrome (US26) Unlacquered Brass (US3NL)*	

SINGLE SIDED DEADBOLTS	Product Code	Finish	List Price
Saratoga	8558	Polished Brass - Lifetime (US3) French Antique (US7)	\$42.00
Quincy	8578	Oil Rubbed Bronze (US10B) Satin Nickel (US15)	
Rope	8564	Pewter (US15A) Flat Black (US19)***	\$42.00
Knoxville	8559	Polished Chrome (US26) Unlacquered Brass (US3NL)*	

SINGLE SIDED DEADBOLTS	Product Code	Finish	List Price
Arts & Crafts	8554	Oil Rubbed Bronze (US10B) Satin Nickel (US15) Flat Black (US19) Unlacquered Brass (US3NL)*	\$42.00

*Unlacquered Brass (US3NL) finish available for a \$20 List Price upcharge per item.
 Polished Nickel - Lifetime (US14) **NOT available for Neos Style.
 ***Flat Black (US19) **NOT** available for Rope and Knoxville Styles.



Handing Not Required

- Standard door thickness of 1 3/4". Specify if thicker.
- Standard latch is for 2 3/8" backset. Specify 2 3/4" backset if required.

Operated by Thumbturn from Inside Only. No Cylinder.

#1
Sandcast
Bronze



#2
Sandcast
Bronze



#3
Sandcast
Bronze



#4
Sandcast
Bronze



SINGLE SIDED DEADBOLTS	Product Code	Finish	List Price
#1 Sandcast Bronze	8557	Flat Black Bronze (FB) Medium Bronze (MB) Tumbled White Bronze (TWB)	\$44.00
#2 Sandcast Bronze	8550		
#3 Sandcast Bronze	8565		
#4 Sandcast Bronze	8574		

Tuscany



Octagon



#11
Tuscany



#14
Tuscany



SINGLE SIDED DEADBOLTS	Product Code	Finish	List Price
Tuscany Bronze	8556	Flat Black Bronze (FB) Medium Bronze (MB)	\$44.00
Octagon	8560		
#11 Tuscany Bronze	8572		
#14 Tuscany Bronze	8573		

#1
Wrought Steel



#2
Wrought Steel



#3
Wrought Steel



SINGLE SIDED DEADBOLTS	Product Code	Finish	List Price
#1 Wrought Steel	8551	Flat Black Steel (FBS) Satin Steel (SWS)	\$42.00
#2 Wrought Steel	8552		
#3 Wrought Steel	8553		

Round
Stainless Steel



Square
Stainless Steel



SINGLE SIDED DEADBOLTS	Product Code	Finish	List Price
Round Stainless Steel	S52005	Brushed Stainless Steel (SS)	\$42.00
Square Stainless Steel	S52006		

Handing Not Required

- Standard door thickness of 1¾". Specify if thicker.
- Standard latch is for 2¾" backset. Specify 2¾" backset if required.

SIDEPLATE LOCKSETS - BRASS TUBULAR

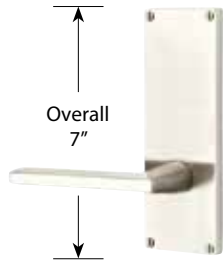

- Helios Lever with Non-Keyed Modern Plate
- Standard 2 1/8" door prep

MODERN 7" NON-KEYED	Product Code	Knob or Lever Style	Finish	List Price
Passage	8111	See Page 4 for Brass Knob & Lever Options.	Satin Brass (US4)	\$148.00
Privacy	8211		Oil Rubbed Bronze (US10B)	
Dummy, Pair	8011	See Page 5 for Crystal & Porcelain Knob Options.	Satin Nickel (US15)	\$148.00
			Flat Black (US19)	
			Polished Chrome (US26)	\$148.00
			Unlacquered Brass (US3NL)*	



- Bern Knob with Keyed Modern Plate
- Two standard 2 1/8" door preps
- 3 3/8" Center to Center hole spacing

MODERN 3 5/8" C-TO-C KEYED	Product Code	Knob or Lever Style	Finish	List Price
Passage/Single Keyed	8112	See Page 4 for Brass Knob & Lever Options.	Satin Brass (US4)	\$172.00
Passage/Double Keyed	8212		Oil Rubbed Bronze (US10B)	
Dummy, Pair	8012	See Page 5 for Crystal & Porcelain Knob Options.	Satin Nickel (US15)	\$172.00
			Flat Black (US19)	
			Polished Chrome (US26)	\$172.00
			Unlacquered Brass (US3NL)*	



- Bern Knob with Non-Keyed Modern Plate
- Standard 2 1/8" door prep

MODERN 9" NON-KEYED	Product Code	Knob or Lever Style	Finish	List Price
Passage	8113	See Page 4 for Brass Knob & Lever Options.	Satin Brass (US4)	\$154.00
Privacy	8213		Oil Rubbed Bronze (US10B)	
Dummy, Pair	8013	See Page 5 for Crystal & Porcelain Knob Options.	Satin Nickel (US15)	\$154.00
			Flat Black (US19)	
			Polished Chrome (US26)	\$154.00
			Unlacquered Brass (US3NL)*	



- Geneva Lever with Keyed Modern Plate
- Two standard 2 1/8" door preps
- 5 1/2" Center to Center hole spacing

MODERN 5 1/2" C-TO-C KEYED	Product Code	Knob or Lever Style	Finish	List Price
Passage/Single Keyed	8114	See Page 4 for Brass Knob & Lever Options.	Satin Brass (US4)	\$178.00
Passage/Double Keyed	8214		Oil Rubbed Bronze (US10B)	
Dummy, Pair	8014	See Page 5 for Crystal & Porcelain Knob Options.	Satin Nickel (US15)	\$178.00
			Flat Black (US19)	
			Polished Chrome (US26)	\$178.00
			Unlacquered Brass (US3NL)*	

INTERCONNECT DEVICE	Product Code		List Price
Modern 5 1/2" C-to-C Keyed	443	Not Available for Double Cylinder. 28° Latch Not Available for Use with Interconnect Device.	\$58.00

*Unlacquered Brass (US3NL) finish available for a \$40 List Price upcharge per item.

Handing Required if Keyed Leversets or if Interconnect Device is Specified

- Standard 2 1/8" door prep. Standard latch is for 2 3/8" backset. Specify 2 3/4" backset if required.
- To order 28° Rotation latch, add product code **Latch28** and list price **\$4**.

Weiser® (WR5) Keyway

- Specify by adding "W" to the beginning of product code.
- No upcharge for cylinder substitution. Can be keyed into existing Weiser® system.



• Norwich Knob with Non-Keyed Quincy Plate
• Standard 2 1/8" door prep

QUINCY 7 1/8" NON-KEYED	Product Code	Knob or Lever Style	Finish	List Price
Passage	8104	See Page 4 for Brass Knob & Lever Options. See Page 5 for Crystal & Porcelain Knob Options.	Polished Brass - Lifetime (US3) French Antique (US7) Oil Rubbed Bronze (US10B) Satin Nickel (US15) Pewter (US15A) Flat Black (US19) Polished Chrome (US26) Unlacquered Brass (US3NL)*	\$148.00
Privacy	8204			\$148.00
Dummy, Pair	8054			\$148.00



• Egg Knob with Keyed Quincy Plate
• Two standard 2 1/8" door preps
• 3 5/8" Center to Center hole spacing

QUINCY 3 5/8" C-TO-C KEYED	Product Code	Knob or Lever Style	Finish	List Price
Passage/Single Keyed	8080	See Page 4 for Brass Knob & Lever Options. See Page 5 for Crystal & Porcelain Knob Options.	Polished Brass - Lifetime (US3) French Antique (US7) Oil Rubbed Bronze (US10B) Satin Nickel (US15) Pewter (US15A) Flat Black (US19) Polished Chrome (US26) Unlacquered Brass (US3NL)*	\$172.00
Passage/Double Keyed	8081			\$172.00
Dummy, Pair	8085			\$172.00



• Cortina Lever with Non-Keyed Quincy Plate
• Standard 2 1/8" door prep

QUINCY 9" NON-KEYED	Product Code	Knob or Lever Style	Finish	List Price
Passage	8704	See Page 4 for Brass Knob & Lever Options. See Page 5 for Crystal & Porcelain Knob Options.	Polished Brass - Lifetime (US3) French Antique (US7) Oil Rubbed Bronze (US10B) Satin Nickel (US15) Pewter (US15A) Flat Black (US19) Polished Chrome (US26) Unlacquered Brass (US3NL)*	\$154.00
Privacy	8804			\$154.00
Dummy, Pair	8854			\$154.00



• Milano Lever with Keyed Quincy Plate
• Two standard 2 1/8" door preps
• 5 1/2" Center to Center hole spacing

QUINCY 5 1/2" C-TO-C KEYED	Product Code	Knob or Lever Style	Finish	List Price
Passage/Single Keyed	8980	See Page 4 for Brass Knob & Lever Options. See Page 5 for Crystal & Porcelain Knob Options.	Polished Brass - Lifetime (US3) French Antique (US7) Oil Rubbed Bronze (US10B) Satin Nickel (US15) Pewter (US15A) Flat Black (US19) Polished Chrome (US26) Unlacquered Brass (US3NL)*	\$178.00
Passage/Double Keyed	8981			\$178.00
Dummy, Pair	8985			\$178.00

INTERCONNECT DEVICE	Product Code	Knob or Lever Style	List Price
Quincy 5 1/2" C-to-C Keyed	443	Not Available for Double Cylinder. 28° Latch Not Available for Use with Interconnect Device.	\$58.00

*Unlacquered Brass (US3NL) finish available for a \$40 List Price upcharge per item.

Handing Required if Keyed Leversets or if Interconnect Device is Specified

- Standard 2 1/8" door prep. Standard latch is for 2 3/8" backset. Specify 2 3/4" backset if required.
- To order 28° Rotation latch, add product code **Latch28** and list price **\$4**.

Weiser® (WRS) Keyway

- Specify by adding "W" to the beginning of product code.
- No upcharge for cylinder substitution. Can be keyed into existing Weiser® system.

SIDEPLATE LOCKSETS - BRASS TUBULAR



Overall
7 1/8"

- Norwich Knob with Non-Keyed Delaware Plate
- Standard 2 1/8" door prep

DELAWARE 7 1/8" NON-KEYED	Product Code	Knob or Lever Style	Finish	List Price
Passage	8016	See Page 4 for Brass Knob & Lever Options.	Polished Brass - Lifetime (US3) French Antique (US7)	\$148.00
Privacy	8026			\$148.00
Dummy, Pair	8006	See Page 5 for Crystal & Porcelain Knob Options.	Oil Rubbed Bronze (US10B) Satin Nickel (US15) Pewter (US15A) Flat Black (US19) Polished Chrome (US26) Unlacquered Brass (US3NL)*	\$148.00



Overall
7 1/8"

- Providence Crystal Knob with Keyed Delaware Plate
- Two standard 2 1/8" door preps
- 3 5/8" Center to Center hole spacing

DELAWARE 3 5/8" C-TO-C KEYED	Product Code	Knob or Lever Style	Finish	List Price
Passage/Single Keyed	8066	See Page 4 for Brass Knob & Lever Options.	Polished Brass - Lifetime (US3) French Antique (US7)	\$172.00
Passage/Double Keyed	8166			\$172.00
Dummy, Pair	8061	See Page 5 for Crystal & Porcelain Knob Options.	Satin Nickel (US15) Pewter (US15A) Flat Black (US19) Polished Chrome (US26) Unlacquered Brass (US3NL)*	\$172.00



Overall
9"

- Cortina Lever with Non-Keyed Delaware Plate
- Standard 2 1/8" door prep

DELAWARE 9" NON-KEYED	Product Code	Knob or Lever Style	Finish	List Price
Passage	8716	See Page 4 for Brass Knob & Lever Options.	Polished Brass - Lifetime (US3) French Antique (US7)	\$154.00
Privacy	8816			\$154.00
Dummy, Pair	8998	See Page 5 for Crystal & Porcelain Knob Options.	Satin Nickel (US15) Pewter (US15A) Flat Black (US19) Polished Chrome (US26) Unlacquered Brass (US3NL)*	\$154.00

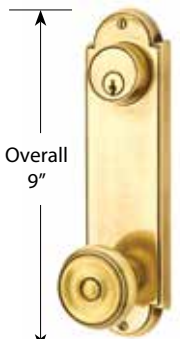

Overall
9"

- Waverly Knob with Keyed Delaware Plate
- Two standard 2 1/8" door preps
- 5 1/2" Center to Center hole spacing

DELAWARE 5 1/2" C-TO-C KEYED	Product Code	Knob or Lever Style	Finish	List Price
Passage/Single Keyed	8996	See Page 4 for Brass Knob & Lever Options.	Polished Brass - Lifetime (US3) French Antique (US7)	\$178.00
Passage/Double Keyed	8997			\$178.00
Dummy, Pair	8856	See Page 5 for Crystal & Porcelain Knob Options.	Oil Rubbed Bronze (US10B) Satin Nickel (US15) Pewter (US15A) Flat Black (US19) Polished Chrome (US26) Unlacquered Brass (US3NL)*	\$178.00

INTERCONNECT DEVICE	Product Code		List Price
Delaware 5 1/2" C-to-C Keyed	443	Not Available for Double Cylinder. 28° Latch Not Available for Use with Interconnect Device.	\$58.00

*Unlacquered Brass (US3NL) finish available for a \$40 List Price upcharge per item.

Handing Required if Keyed Leversets or if Interconnect Device is Specified

- Standard 2 1/8" door prep. Standard latch is for 2 3/4" backset. Specify 2 3/4" backset if required.
- To order 28° Rotation latch, add product code **Latch28** and list price \$4.

Weiser® (WR5) Keyway

- Specify by adding "W" to the beginning of product code.
- No upcharge for cylinder substitution. Can be keyed into existing Weiser® system.



- Cortina Lever with Non-Keyed Colonial Plate
- Standard 2 1/8" door prep

COLONIAL 7 1/8" NON-KEYED	Product Code	Knob or Lever Style	Finish	List Price
Passage	8010	See Page 4 for Brass Knob & Lever Options. See Page 5 for Crystal & Porcelain Knob Options.	Polished Brass - Lifetime (US3) French Antique (US7) Oil Rubbed Bronze (US10B) Satin Nickel (US15) Pewter (US15A) Flat Black (US19) Polished Chrome (US26) Unlacquered Brass (US3NL)*	\$148.00
Privacy	8020			\$148.00
Dummy, Pair	8001			\$148.00



- Waverly Knob with Keyed Colonial Plate
- Two standard 2 1/8" door preps
- 3 3/8" Center to Center hole spacing

COLONIAL 3 5/8" C-TO-C KEYED	Product Code	Knob or Lever Style	Finish	List Price
Passage/Single Keyed	8060	See Page 4 for Brass Knob & Lever Options. See Page 5 for Crystal & Porcelain Knob Options.	Polished Brass - Lifetime (US3) French Antique (US7) Oil Rubbed Bronze (US10B) Satin Nickel (US15) Pewter (US15A) Flat Black (US19) Polished Chrome (US26) Unlacquered Brass (US3NL)*	\$172.00
Passage/Double Keyed	8160			\$172.00
Dummy, Pair	8065			\$172.00



- Providence Knob with Non-Keyed Colonial Plate
- Standard 2 1/8" door prep

COLONIAL 9" NON-KEYED	Product Code	Knob or Lever Style	Finish	List Price
Passage	8711	See Page 4 for Brass Knob & Lever Options. See Page 5 for Crystal & Porcelain Knob Options.	Polished Brass - Lifetime (US3) French Antique (US7) Oil Rubbed Bronze (US10B) Satin Nickel (US15) Pewter (US15A) Flat Black (US19) Polished Chrome (US26) Unlacquered Brass (US3NL)*	\$154.00
Privacy	8811			\$154.00
Dummy, Pair	8851			\$154.00



- Egg Knob with Keyed Colonial Plate
- Two standard 2 1/8" door preps
- 5 1/2" Center to Center hole spacing

COLONIAL 5 1/2" C-TO-C KEYED	Product Code	Knob or Lever Style	Finish	List Price
Passage/Single Keyed	8990	See Page 4 for Brass Knob & Lever Options. See Page 5 for Crystal & Porcelain Knob Options.	Polished Brass - Lifetime (US3) French Antique (US7) Oil Rubbed Bronze (US10B) Satin Nickel (US15) Pewter (US15A) Flat Black (US19) Polished Chrome (US26) Unlacquered Brass (US3NL)*	\$178.00
Passage/Double Keyed	8991			\$178.00
Dummy, Pair	8995			\$178.00

INTERCONNECT DEVICE	Product Code		List Price
Colonial 5 1/2" C-to-C Keyed	443	Not Available for Double Cylinder. 28° Latch Not Available for Use with Interconnect Device.	\$58.00

*Unlacquered Brass (US3NL) finish available for a \$40 List Price upcharge per item.

Handing Required if Keyed Leversets or if Interconnect Device is Specified

- Standard 2 1/8" door prep. Standard latch is for 2 3/8" backset. Specify 2 3/4" backset if required.
- To order 28° Rotation latch, add product code **Latch28** and list price **\$4**.

Weiser® (WR5) Keyway

- Specify by adding "W" to the beginning of product code.
- No upcharge for cylinder substitution. Can be keyed into existing Weiser® system.

SIDEPLATE LOCKSETS - BRASS TUBULAR



- Rope Knob with Non-Keyed Rope Plate
- Standard 2 1/8" door prep

ROPE 7 1/2" NON-KEYED	Product Code	Knob or Lever Style	Finish	List Price
Passage	7109	See Page 4 for Brass Knob & Lever Options.	Polished Brass - Lifetime (US3) French Antique (US7)	\$148.00
Privacy	7209			\$148.00
Dummy, Pair	7059	See Page 5 for Crystal & Porcelain Knob Options.	Unlacquered Brass (US3NL)*	\$148.00



- Rope Lever with Keyed Rope Plate
- Two standard 2 1/8" door preps
- 3 3/8" Center to Center hole spacing

ROPE 3 5/8" C-TO-C KEYED	Product Code	Knob or Lever Style	Finish	List Price
Passage/Single Keyed	7090	See Page 4 for Brass Knob & Lever Options.	Polished Brass - Lifetime (US3) French Antique (US7)	\$172.00
Passage/Double Keyed	7091			\$172.00
Dummy, Pair	7095	See Page 5 for Crystal & Porcelain Knob Options.	Unlacquered Brass (US3NL)*	\$172.00

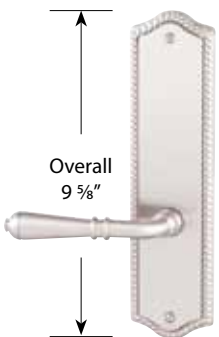

- Turino Lever with Non-Keyed Rope Plate
- Standard 2 1/8" door prep

ROPE 9 5/8" NON-KEYED	Product Code	Knob or Lever Style	Finish	List Price
Passage	7710	See Page 4 for Brass Knob & Lever Options.	Polished Brass - Lifetime (US3) French Antique (US7)	\$154.00
Privacy	7810			\$154.00
Dummy, Pair	7850	See Page 5 for Crystal & Porcelain Knob Options.	Unlacquered Brass (US3NL)*	\$154.00



- Rope Knob with Keyed Rope Plate
- Two standard 2 1/8" door preps
- 5 1/2" Center to Center hole spacing

ROPE 5 1/2" C-TO-C KEYED	Product Code	Knob or Lever Style	Finish	List Price
Passage/Single Keyed	7990	See Page 4 for Brass Knob & Lever Options.	Polished Brass - Lifetime (US3) French Antique (US7)	\$178.00
Passage/Double Keyed	7991			\$178.00
Dummy, Pair	7995	See Page 5 for Crystal & Porcelain Knob Options.	Unlacquered Brass (US3NL)*	\$178.00

INTERCONNECT DEVICE	Product Code		List Price
Rope 5 1/2" C-to-C Keyed	443	Not Available for Double Cylinder. 28° Latch Not Available for Use with Interconnect Device.	\$58.00

*Unlacquered Brass (US3NL) finish available for a \$40 List Price upcharge per item.

Handing Required if Keyed Leversets or if Interconnect Device is Specified

- Standard 2 1/8" door prep. Standard latch is for 2 3/8" backset. Specify 2 3/4" backset if required.
- To order 28° Rotation latch, add product code **Latch28** and list price **\$4**.

Weiser® (WRS) Keyway

- Specify by adding "W" to the beginning of product code.
- No upcharge for cylinder substitution. Can be keyed into existing Weiser® system.



• Astoria Knob with Non-Keyed Oval Beaded Plate
• Standard 2 1/8" door prep

OVAL BEADED 7" NON-KEYED	Product Code	Knob or Lever Style	Finish	List Price
Passage	8105	See Page 4 for Brass Knob & Lever Options.	Polished Brass - Lifetime (US3) French Antique (US7)	\$148.00
Privacy	8205		Oil Rubbed Bronze (US10B) Satin Nickel (US15)	\$148.00
Dummy, Pair	8055	See Page 5 for Crystal & Porcelain Knob Options.	Unlacquered Brass (US3NL)*	\$148.00



• Beaded Egg Knob with Keyed Oval Beaded Plate
• Two standard 2 1/8" door preps
• 3/8" Center to Center hole spacing

OVAL BEADED 3 5/8" C-TO-C KEYED	Product Code	Knob or Lever Style	Finish	List Price
Passage/Single Keyed	6010	See Page 4 for Brass Knob & Lever Options.	Polished Brass - Lifetime (US3) French Antique (US7)	\$172.00
Passage/Double Keyed	6011		Oil Rubbed Bronze (US10B) Satin Nickel (US15)	\$172.00
Dummy, Pair	6015	See Page 5 for Crystal & Porcelain Knob Options.	Unlacquered Brass (US3NL)*	\$172.00



• Hampton Knob with Non-Keyed Trenton Plate
• Standard 2 1/8" door prep

TRENTON 10 3/4" NON-KEYED	Product Code	Knob or Lever Style	Finish	List Price
Passage	8109	See Page 4 for Brass Knob & Lever Options.	Polished Brass - Lifetime (US3) French Antique (US7)	\$154.00
Privacy	8209		Oil Rubbed Bronze (US10B) Satin Nickel (US15)	\$154.00
Dummy, Pair	8059	See Page 5 for Crystal & Porcelain Knob Options.	Pewter (US15A) Polished Chrome (US26) Unlacquered Brass (US3NL)*	\$154.00



• Rope Lever with Keyed Trenton Plate
• Two standard 2 1/8" door preps
• 5/2" Center to Center hole spacing

TRENTON 5 1/2" C-TO-C KEYED	Product Code	Knob or Lever Style	Finish	List Price
Passage/Single Keyed	6030	See Page 4 for Brass Knob & Lever Options.	Polished Brass - Lifetime (US3) French Antique (US7)	\$178.00
Passage/Double Keyed	6031		Oil Rubbed Bronze (US10B) Satin Nickel (US15)	\$178.00
Dummy, Pair	6035	See Page 5 for Crystal & Porcelain Knob Options.	Pewter (US15A) Polished Chrome (US26) Unlacquered Brass (US3NL)*	\$178.00

INTERCONNECT DEVICE	Product Code	Knob or Lever Style	List Price
Trenton 5 1/2" C-to-C Keyed	443	Not Available for Double Cylinder. 28° Latch Not Available for Use with Interconnect Device.	\$58.00

*Unlacquered Brass (US3NL) finish available for a \$40 List Price upcharge per item.

Handing Required if Keyed Leversets or if Interconnect Device is Specified

- Standard 2 1/8" door prep. Standard latch is for 2 3/8" backset. Specify 2 3/4" backset if required.
- To order 28° Rotation latch, add product code **Latch28** and list price **\$4**.

Weiser® (WR5) Keyway

- Specify by adding "W" to the beginning of product code.
- No upcharge for cylinder substitution. Can be keyed into existing Weiser® system.

SIDEPLATE LOCKSETS - BRASS TUBULAR



- Georgetown Crystal Knob with Non-Keyed Belmont Plate
- Standard 2 1/8" door prep

BELMONT 7 1/2" NON-KEYED	Product Code	Knob or Lever Style	Finish	List Price
Passage	8102	See Page 4 for Brass Knob & Lever Options.	Polished Brass - Lifetime (US3) French Antique (US7)	\$148.00
Privacy	8202			\$148.00
Dummy, Pair	8052	See Page 5 for Crystal & Porcelain Knob Options.	Unlacquered Brass (US3NL)*	\$148.00



- Belmont Knob with Keyed Belmont Plate
- Two standard 2 1/8" door preps
- 3 5/8" Center to Center hole spacing

BELMONT 3 5/8" C-TO-C KEYED	Product Code	Knob or Lever Style	Finish	List Price
Passage/Single Keyed	8070	See Page 4 for Brass Knob & Lever Options.	Polished Brass - Lifetime (US3) French Antique (US7)	\$172.00
Passage/Double Keyed	8071			\$172.00
Dummy, Pair	8075	See Page 5 for Crystal & Porcelain Knob Options.	Unlacquered Brass (US3NL)*	\$172.00



- Victoria Knob with Non-Keyed Victoria Plate
- Standard 2 1/8" door prep

VICTORIA 7 3/4" NON-KEYED	Product Code	Knob or Lever Style	Finish	List Price
Passage	8103	See Page 4 for Brass Knob & Lever Options.	Polished Brass - Lifetime (US3) French Antique (US7)	\$148.00
Privacy	8203			\$148.00
Dummy, Pair	8053	See Page 5 for Crystal & Porcelain Knob Options.	Unlacquered Brass (US3NL)*	\$148.00



- Victoria Knob with Keyed Victoria Plate
- Two standard 2 1/8" door preps
- 3 5/8" Center to Center hole spacing

VICTORIA 3 5/8" C-TO-C KEYED	Product Code	Knob or Lever Style	Finish	List Price
Passage/Single Keyed	8090	See Page 4 for Brass Knob & Lever Options.	Polished Brass - Lifetime (US3) French Antique (US7)	\$178.00
Passage/Double Keyed	8091			\$178.00
Dummy, Pair	8095	See Page 5 for Crystal & Porcelain Knob Options.	Unlacquered Brass (US3NL)*	\$178.00

*Unlacquered Brass (US3NL) finish available for a \$40 List Price upcharge per item.

Handing Required if Keyed Leversets or if Interconnect Device is Specified

- Standard 2 1/8" door prep. Standard latch is for 2 3/8" backset. Specify 2 3/4" backset if required.
- To order 28° Rotation latch, add product code **Latch28** and list price **\$4**.

Weiser® (WR5) Keyway

- Specify by adding "W" to the beginning of product code.
- No upcharge for cylinder substitution. Can be keyed into existing Weiser® system.

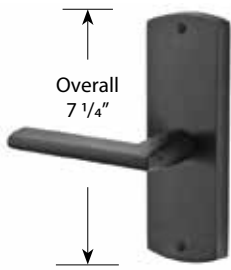

- Lariat Lever with Non-Keyed Missoula Plate
- Standard 2 1/8" door prep

MISSOULA 7 1/4" NON-KEYED	Product Code	Knob or Lever Style	Finish	List Price
Passage	71023	See Page 5 for Sandcast Bronze Knob & Lever, Crystal & Porcelain Knob Options.	Flat Black Bronze (FB) Medium Bronze (MB) Tumbled White Bronze (TWB)	\$164.00
Privacy	72023			\$164.00
Dummy, Pair	70063			\$164.00



- Winchester Knob with Keyed Missoula Plate
- Two standard 2 1/8" door preps
- 3 3/8" Center to Center hole spacing

MISSOULA 3 5/8" C-TO-C KEYED	Product Code	Knob or Lever Style	Finish	List Price
Passage/Single Keyed	7370	See Page 5 for Sandcast Bronze Knob & Lever, Crystal & Porcelain Knob Options.	Flat Black Bronze (FB) Medium Bronze (MB) Tumbled White Bronze (TWB)	\$192.00
Passage/Double Keyed	7371			\$192.00
Dummy, Pair	7375			\$192.00

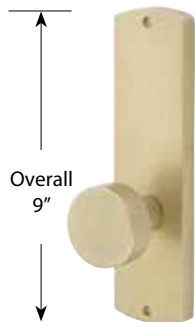

- Bronze Round Knob with Non-Keyed Missoula Plate
- Standard 2 1/8" door prep

MISSOULA 9" NON-KEYED	Product Code	Knob or Lever Style	Finish	List Price
Passage	7522	See Page 5 for Sandcast Bronze Knob & Lever, Crystal & Porcelain Knob Options.	Flat Black Bronze (FB) Medium Bronze (MB) Tumbled White Bronze (TWB)	\$172.00
Privacy	7622			\$172.00
Dummy, Pair	7562			\$172.00



- Yuma Lever with Keyed Missoula Plate
- Two standard 2 1/8" door preps
- 5 1/2" Center to Center hole spacing

MISSOULA 5 1/2" C-TO-C KEYED	Product Code	Knob or Lever Style	Finish	List Price
Passage/Single Keyed	7570	See Page 5 for Sandcast Bronze Knob & Lever, Crystal & Porcelain Knob Options.	Flat Black Bronze (FB) Medium Bronze (MB) Tumbled White Bronze (TWB)	\$200.00
Passage/Double Keyed	7571			\$200.00
Dummy, Pair	7575			\$200.00

INTERCONNECT DEVICE	Product Code	Knob or Lever Style	Finish	List Price
Missoula 5 1/2" C-to-C Keyed	443	Not Available for Double Cylinder. 28° Latch Not Available for Use with Interconnect Device.		\$58.00

Handing Required if Keyed Leversets or if Interconnect Device is Specified

- Standard 2 1/8" door prep. Standard latch is for 2 3/8" backset. Specify 2 3/4" backset if required.
- To order 28° Rotation latch, add product code **Latch28** and list price **\$4**.

Weiser® (WR5) Keyway

- Specify by adding "W" to the beginning of product code.
- No upcharge for cylinder substitution. Can be keyed into existing Weiser® system.

SIDEPLATE LOCKSETS - SANDCAST BRONZE TUBULAR



- Bronze Egg Knob with Non-Keyed Rectangular Plate
- Standard 2 1/8" door prep

RECTANGULAR 7" NON-KEYED	Product Code	Knob or Lever Style	Finish	List Price
Passage	71013	See Page 5 for Sandcast Bronze Knob & Lever, Crystal & Porcelain Knob Options.	Flat Black Bronze (FB) Medium Bronze (MB) Tumbled White Bronze (TWB)	\$164.00
Privacy	72013			\$164.00
Dummy, Pair	70053			\$164.00

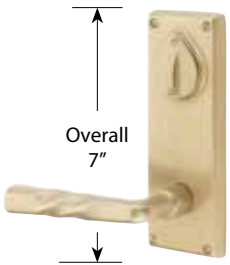

- Montrose Lever with Keyed Rectangular Plate
- Two standard 2 1/8" door preps
- 3 5/8" Center to Center hole spacing

RECTANGULAR 3 5/8" C-TO-C KEYED	Product Code	Knob or Lever Style	Finish	List Price
Passage/Single Keyed	7360	See Page 5 for Sandcast Bronze Knob & Lever, Crystal & Porcelain Knob Options.	Flat Black Bronze (FB) Medium Bronze (MB) Tumbled White Bronze (TWB)	\$192.00
Passage/Double Keyed	7361			\$192.00
Dummy, Pair	7365			\$192.00



- Teton Lever with Non-Keyed Rectangular Plate
- Standard 2 1/8" door prep

RECTANGULAR 8 7/8" NON-KEYED	Product Code	Knob or Lever Style	Finish	List Price
Passage	7512	See Page 5 for Sandcast Bronze Knob & Lever, Crystal & Porcelain Knob Options.	Flat Black Bronze (FB) Medium Bronze (MB) Tumbled White Bronze (TWB)	\$172.00
Privacy	7612			\$172.00
Dummy, Pair	7552			\$172.00



- Butte Knob with Keyed Rectangular Plate
- Two standard 2 1/8" door preps
- 5 1/2" Center to Center hole spacing

RECTANGULAR 5 1/2" C-TO-C KEYED	Product Code	Knob or Lever Style	Finish	List Price
Passage/Single Keyed	7560	See Page 5 for Sandcast Bronze Knob & Lever, Crystal & Porcelain Knob Options.	Flat Black Bronze (FB) Medium Bronze (MB) Tumbled White Bronze (TWB)	\$200.00
Passage/Double Keyed	7561			\$200.00
Dummy, Pair	7565			\$200.00

INTERCONNECT DEVICE	Product Code	Knob or Lever Style	Finish	List Price
Rectangular 5 1/2" C-to-C Keyed	443	Not Available for Double Cylinder. 28° Latch Not Available for Use with Interconnect Device.		\$58.00

Handing Required if Keyed Leversets or if Interconnect Device is Specified

- Standard 2 1/8" door prep. Standard latch is for 2 3/8" backset. Specify 2 3/4" backset if required.
- To order 28° Rotation latch, add product code **Latch28** and list price **\$4**.

Weiser® (WRS) Keyway

- Specify by adding "W" to the beginning of product code.
- No upcharge for cylinder substitution. Can be keyed into existing Weiser® system.



• Cody Lever with Non-Keyed #5 Plate
• Standard 2 1/8" door prep

#5 7 1/4" NON-KEYED	Product Code	Knob or Lever Style	Finish	List Price
Passage	7107	See Page 5 for Sandcast Bronze Knob & Lever, Crystal & Porcelain Knob Options.	Flat Black Bronze (FB) Medium Bronze (MB) Tumbled White Bronze (TWB)	\$164.00
Privacy	7207			\$164.00
Dummy, Pair	7057			\$164.00



• Butte Knob with Keyed #5 Plate
• Two standard 2 1/8" door preps
• 3 5/8" Center to Center hole spacing

#5 3 5/8" C-TO-C KEYED	Product Code	Knob or Lever Style	Finish	List Price
Passage/Single Keyed	7070	See Page 5 for Sandcast Bronze Knob & Lever, Crystal & Porcelain Knob Options.	Flat Black Bronze (FB) Medium Bronze (MB) Tumbled White Bronze (TWB)	\$192.00
Passage/Double Keyed	7071			\$192.00
Dummy, Pair	7075			\$192.00



• Butte Knob with Non-Keyed #5 Plate
• Standard 2 1/8" door prep

#5 9 1/4" NON-KEYED	Product Code	Knob or Lever Style	Finish	List Price
Passage	7707	See Page 5 for Sandcast Bronze Knob & Lever, Crystal & Porcelain Knob Options.	Flat Black Bronze (FB) Medium Bronze (MB) Tumbled White Bronze (TWB)	\$172.00
Privacy	7807			\$172.00
Dummy, Pair	7757			\$172.00

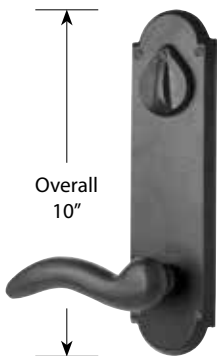

• Cody Lever with Keyed #5 Plate
• Two standard 2 1/8" door preps
• 5 1/2" Center to Center hole spacing

#5 5 1/2" C-TO-C KEYED	Product Code	Knob or Lever Style	Finish	List Price
Passage/Single Keyed	7670	See Page 5 for Sandcast Bronze Knob & Lever, Crystal & Porcelain Knob Options.	Flat Black Bronze (FB) Medium Bronze (MB) Tumbled White Bronze (TWB)	\$200.00
Passage/Double Keyed	7671			\$200.00
Dummy, Pair	7675			\$200.00

INTERCONNECT DEVICE	Product Code		List Price
#5 5 1/2" C-to-C Keyed	443	Not Available for Double Cylinder. 28° Latch Not Available for Use with Interconnect Device.	\$58.00

Handing Required if Keyed Leversets or if Interconnect Device is Specified

- Standard 2 1/8" door prep. Standard latch is for 2 3/8" backset. Specify 2 3/4" backset if required.
- To order 28° Rotation latch, add product code **Latch28** and list price **\$4**.

Weiser® (WR5) Keyway

- Specify by adding "W" to the beginning of product code.
- No upcharge for cylinder substitution. Can be keyed into existing Weiser® system.

SIDEPLATE LOCKSETS - LOST WAX CAST BRONZE TUBULAR



- Parma Knob with Non-Keyed #16 Plate
- Standard 2 1/8" door prep

#16 8 1/4" NON-KEYED	Product Code	Knob or Lever Style	Finish	List Price
Passage	6102	See Page 6 for Lost Wax Cast Bronze Knob & Lever.	Flat Black Bronze (FB) Medium Bronze (MB)	\$164.00
Privacy	6202			\$164.00
Dummy, Pair	6052	See Page 5 for Crystal & Porcelain Knob Options.		\$164.00



- Napoli Lever with Keyed #16 Plate
- Two standard 2 1/8" door preps
- 3 5/8" Center to Center hole spacing

#16 3 5/8" C-TO-C KEYED	Product Code	Knob or Lever Style	Finish	List Price
Passage/Single Keyed	6020	See Page 6 for Lost Wax Cast Bronze Knob & Lever.	Flat Black Bronze (FB) Medium Bronze (MB)	\$192.00
Passage/Double Keyed	6021			\$192.00
Dummy, Pair	6025	See Page 5 for Crystal & Porcelain Knob Options.		\$192.00



- Medici Lever with Non-Keyed #16 Plate
- Standard 2 1/8" door prep

#16 10 1/8" NON-KEYED	Product Code	Knob or Lever Style	Finish	List Price
Passage	6702	See Page 6 for Lost Wax Cast Bronze Knob & Lever.	Flat Black Bronze (FB) Medium Bronze (MB)	\$172.00
Privacy	6802			\$172.00
Dummy, Pair	6752	See Page 5 for Crystal & Porcelain Knob Options.		\$172.00



- Octagon Lever with Keyed #16 Plate
- Two standard 2 1/8" door preps
- 5 1/2" Center to Center hole spacing

#16 5 1/2" C-TO-C KEYED	Product Code	Knob or Lever Style	Finish	List Price
Passage/Single Keyed	6620	See Page 6 for Lost Wax Cast Bronze Knob & Lever.	Flat Black Bronze (FB) Medium Bronze (MB)	\$200.00
Passage/Double Keyed	6621			\$200.00
Dummy, Pair	6625	See Page 5 for Crystal & Porcelain Knob Options.		\$200.00

INTERCONNECT DEVICE	Product Code		List Price
#16 5 1/2" C-to-C Keyed	443	Not Available for Double Cylinder. 28° Latch Not Available for Use with Interconnect Device.	\$58.00

Handing Required if Keyed Leversets or if Interconnect Device is Specified

- Standard 2 1/8" door prep. Standard latch is for 2 3/8" backset. Specify 2 3/4" backset if required.
- To order 28° Rotation latch, add product code **Latch28** and list price **\$4**.

Weiser® (WR5) Keyway

- Specify by adding "W" to the beginning of product code.
- No upcharge for cylinder substitution. Can be keyed into existing Weiser® system.



- Madison Ivory Knob with Non-Keyed #5 Wrought Steel Plate
- Standard 2 1/8" door prep

#5 WROUGHT STEEL 7 1/8" NON-KEYED	Product Code	Knob or Lever Style	Finish	List Price
Passage	7105	See Page 6 for Wrought Steel Knob & Lever Options.	Flat Black Steel (FBS) Satin Steel (SWS)	\$148.00
Privacy	7205			\$148.00
Dummy, Pair	7055			\$148.00

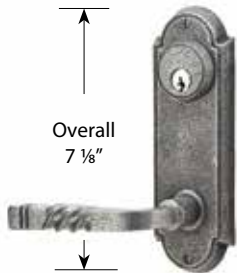

- San Carlos Lever with Keyed #5 Wrought Steel Plate
- Two standard 2 1/8" door preps
- 3 5/8" Center to Center hole spacing

#5 WROUGHT STEEL 3 5/8" C-TO-C KEYED	Product Code	Knob or Lever Style	Finish	List Price
Passage/Single Keyed	7010	See Page 6 for Wrought Steel Knob & Lever Options.	Flat Black Steel (FBS) Satin Steel (SWS)	\$172.00
Passage/Double Keyed	7011			\$172.00
Dummy, Pair	7015			\$172.00



- Hercules Lever with Non-Keyed Stainless Steel Plate
- Standard 2 1/8" door prep

STAINLESS STEEL 8" NON-KEYED	Product Code	Knob or Lever Style	Finish	List Price
Passage	S801	See Page 6 For Stainless Steel Knob & Lever Options.	Brushed Stainless Steel (SS)	\$154.00
Privacy	S802			\$154.00
Dummy, Pair	S800			\$154.00



- Helios Lever with Keyed Stainless Steel Plate
- Two standard 2 1/8" door preps
- 5 1/2" Center to Center hole spacing

STAINLESS STEEL 5 1/2" C-TO-C KEYED	Product Code	Knob or Lever Style	Finish	List Price
Passage/Single Keyed	S811	See Page 6 For Stainless Steel Knob & Lever Options.	Brushed Stainless Steel (SS)	\$178.00
Passage/Double Keyed	S812			\$178.00
Dummy, Pair	S810			\$178.00

INTERCONNECT DEVICE	Product Code		List Price
Stainless Steel 5 1/2" C-to-C Keyed	443	Not Available for Double Cylinder. 28° Latch Not Available for Use with Interconnect Device.	\$58.00

Handing Required if Keyed Leversets or if Interconnect Device is Specified

- Standard 2 1/8" door prep. Standard latch is for 2 3/8" backset. Specify 2 3/4" backset if required.
- To order 28° Rotation latch, add product code **Latch28** and list price **\$4**.

Weiser® (WRS) Keyway

- Specify by adding "W" to the beginning of product code.
- No upcharge for cylinder substitution. Can be keyed into existing Weiser® system.

To order: **(W) Product Code + Knob/Lever Style + Handing + Finish + Add Door Thickness to Comments**

**Modern Plates
with Round Knobs**



Exterior Interior

THUMBTURN PRIVACY NON-KEYED STYLE	Product Code	Knob / Lever Style	Finish	List Price
Modern Plate 3 3/8" Center to Center	8229	See Page 4 for Brass Knob & Lever Options. See Page 5 for Crystal & Porcelain Knob Options.	Satin Brass (US4) Oil Rubbed Bronze (US10B) Satin Nickel (US15) Flat Black (US19) Polished Chrome (US26) Unlacquered Brass (US3NL)*	\$160.00

**Delaware Plates
with Providence Crystal Knobs**



Exterior Interior

**Colonial Plates
with Cortina Levers**



Exterior Interior

**Quincy Plates
with Egg Knobs**

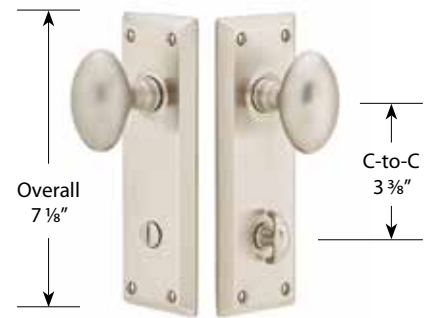

Exterior Interior

THUMBTURN PRIVACY NON-KEYED STYLE	Product Code	Knob / Lever Style	Finish	List Price
Delaware Plate 3 3/8" Center to Center	8228	See Page 4 for Brass Knob & Lever Options. See Page 5 for Crystal & Porcelain Knob Options.	Polished Brass - Lifetime (US3) French Antique (US7) Oil Rubbed Bronze (US10B) Satin Nickel (US15) Pewter (US15A) Flat Black (US19) Polished Chrome (US26) Unlacquered Brass (US3NL)*	\$160.00
Colonial Plate 3 3/8" Center to Center	8022			\$160.00
Quincy Plate 3 3/8" Center to Center	8226			\$160.00

*Unlacquered Brass (US3NL) finish available for a \$40 List Price upcharge per item.

Handing Required for Leversets

- Standard 2 1/8" door prep. Standard latch is for 2 3/8" backset. Specify 2 3/4" backset if required.
- To order 28° Rotation latch, add product code **Latch28** and list price \$4.

Belmont Plates with Belmont Knobs



Exterior Interior

Victoria Plates with Elan Levers



Exterior Interior

THUMBTURN PRIVACY NON-KEYED STYLE	Product Code	Knob / Lever Style	Finish	List Price
Belmont Plate 3 ³ / ₈ " Center to Center	8224	See Page 4 for Brass Knob & Lever Options.	Polished Brass - Lifetime (US3) French Antique (US7) Oil Rubbed Bronze (US10B) Satin Nickel (US15)	\$160.00
Victoria Plate 3 ³ / ₈ " Center to Center	8225	See Page 5 for Crystal & Porcelain Knob Options.	Unlacquered Brass (US3NL)*	\$160.00

Rope Plates with Rope Levers



Exterior Interior

Oval Beaded Plates with Georgetown Knobs



Exterior Interior

THUMBTURN PRIVACY NON-KEYED STYLE	Product Code	Knob / Lever Style	Finish	List Price
Rope Plate 3 ³ / ₈ " Center to Center	8223	See Page 4 for Brass Knob & Lever Options.	Polished Brass - Lifetime (US3) French Antique (US7) Oil Rubbed Bronze (US10B) Satin Nickel (US15)	\$160.00
Oval Beaded Plate 3 ³ / ₈ " Center to Center	8227	See Page 5 for Crystal & Porcelain Knob Options.	Unlacquered Brass (US3NL)*	\$160.00

*Unlacquered Brass (US3NL) finish available for a \$40 List Price upcharge per item.

Handing Required for Leversets

- Standard 2¹/₈" door prep. Standard latch is for 2³/₈" backset. Specify 2³/₄" backset if required.
- To order 28° Rotation latch, add product code **Latch28** and list price **\$4**.

STRETTO NARROW TRIM LOCKSETS - 2" x 10", 1 1/2" x 11"

STRETTO uses a tubular latch and is available for order in passage, thumb-turn privacy, keyed entry, and dummy functions. It can be paired with any Emtek knob or lever. The sleek design of the STRETTO requires a 1 1/4" diameter bore hole and a 2-hole door preparation for privacy thumb-turn and keyed configurations. Additional specifications for this truly unique design include:

- Supplied with a 28° Rotation latch. Available in 2 3/8" or 2 3/4" backset
- Trim sizes available are 2" x 10" or 1 1/2" x 11"

STRETTO NON-KEYED PASSAGE STYLES

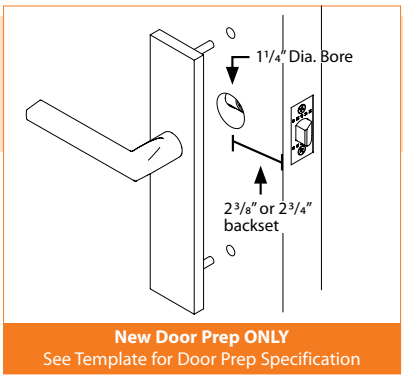

• Narrow 1 1/4" Door Preps

STRETTO THUMBTURN PRIVACY STYLES

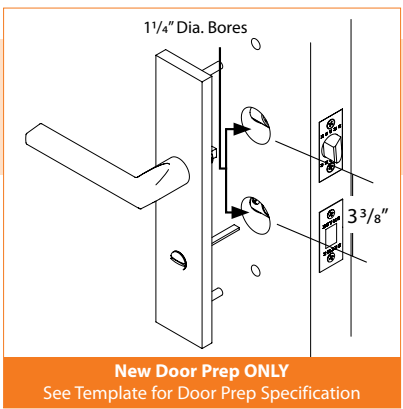

• Narrow 1 1/4" Door Preps, 3 3/8" Center to Center Hole Spacing
• Privacy Thumbturn

STRETTO DUMMY PAIR STYLES

Available in both 10" and 11"

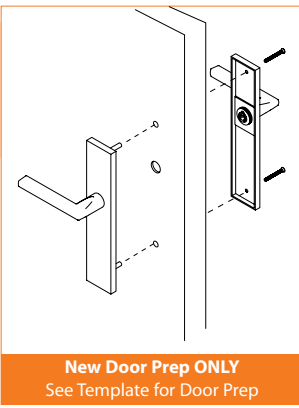

STRETTO DUMMY SINGLE SIDED STYLES

Available in both 10" and 11"

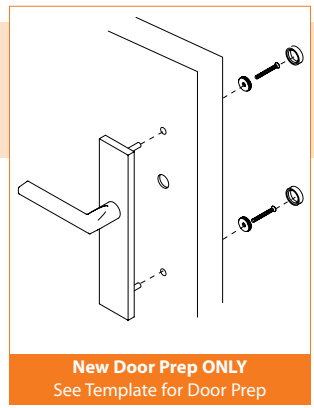

STRETTO KEYED ENTRY STYLES

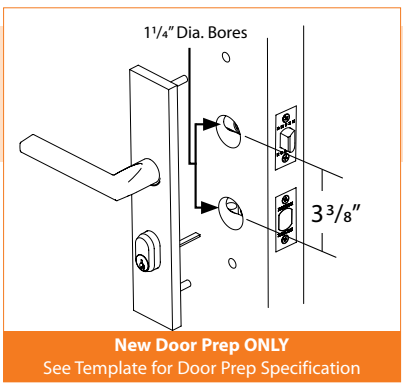
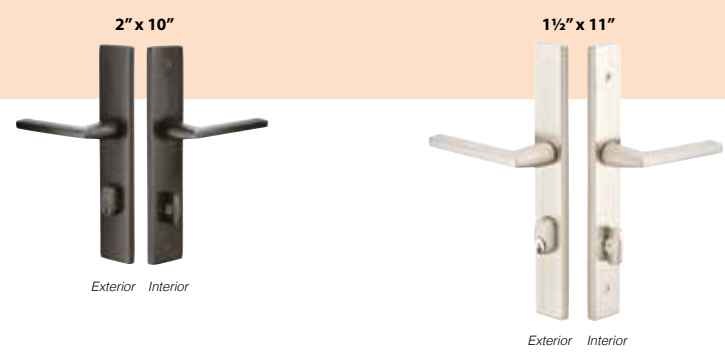

• Narrow 1 1/4" Door Preps, 3 3/8" Center to Center Hole Spacing
• Schlage® C Keyway (Available in Weiser® Keyway)

10" STRETTO
Thumbturn Privacy Set

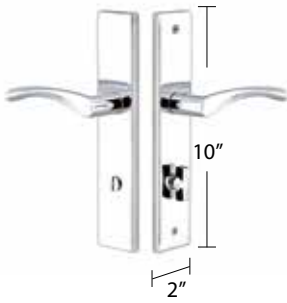

2" x 10" MODERN RECTANGULAR NON-KEYED	Product Code	Knob or Lever Style	Finish	List Price
Passage	8141	See Page 4 for Brass Knob & Lever Options.	Satin Brass (US4) Oil Rubbed Bronze (US10B) Satin Nickel (US15) Flat Black (US19)	\$156.00
Thumbturn Privacy	8241			\$156.00
Dummy, Pair	8045	See Page 5 for Crystal & Porcelain Knob Options.	Polished Chrome (US26) Unlacquered Brass (US3NL)*	\$156.00
Dummy, Single Sided	8041			\$78.00

10" STRETTO
Keyed Entry Set



2" x 10" MODERN RECTANGULAR KEYED	Product Code	Knob or Lever Style	Finish	List Price
Passage/Single Keyed	8442	See Page 4 for Brass Knob & Lever Options.	Satin Brass (US4) Oil Rubbed Bronze (US10B) Satin Nickel (US15) Flat Black (US19)	\$172.00
Dummy, Pair	8042			Polished Chrome (US26) Unlacquered Brass (US3NL)*

11" STRETTO
Non-Keyed Passage Set

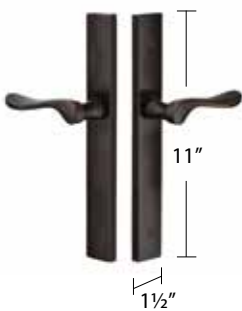

1 1/2" x 11" MODERN RECTANGULAR NON-KEYED	Product Code	Knob or Lever Style	Finish	List Price
Passage	8143	See Page 4 for Brass Knob & Lever Options.	Satin Brass (US4) Oil Rubbed Bronze (US10B) Satin Nickel (US15) Flat Black (US19)	\$156.00
Thumbturn Privacy	8243			\$156.00
Dummy, Pair	8046	See Page 5 for Crystal & Porcelain Knob Options.	Polished Chrome (US26) Unlacquered Brass (US3NL)*	\$156.00
Dummy, Single Sided	8043			\$78.00

11" STRETTO
Keyed Entry Set



1 1/2" x 11" MODERN RECTANGULAR KEYED	Product Code	Knob or Lever Style	Finish	List Price
Passage/Single Keyed	8444	See Page 4 for Brass Knob & Lever Options.	Satin Brass (US4) Oil Rubbed Bronze (US10B) Satin Nickel (US15) Flat Black (US19)	\$172.00
Dummy, Pair	8044			Polished Chrome (US26) Unlacquered Brass (US3NL)*

*Unlacquered Brass (US3NL) finish available for a \$40 List Price upcharge per item.

Handing Required for Leversets

- Supplied with 28° Rotation latch.
- Standard backset is 2 3/8". Specify 2 3/4" backset if required.

Weiser® (WR5) Keyway

- Specify by adding "W" to the beginning of product code.
- No upcharge for cylinder substitution. Can be keyed into existing Weiser® system.

To order: (W) Product Code + Knob/Lever Style + Handing + Finish + Add Door Thickness to Comments

STRETTO NARROW TRIM LOCKSETS - BRASS CONCORD

10" STRETTO
Non-Keyed Passage Set

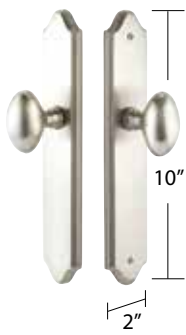

2" x 10" CONCORD NON-KEYED	Product Code	Knob or Lever Style	Finish	List Price
Passage	7141	See Page 4 for Brass Knob & Lever Options. See Page 5 for Crystal & Porcelain Knob Options.	Polished Brass - Lifetime (US3) French Antique (US7) Oil Rubbed Bronze (US10B) Satin Nickel (US15) Pewter (US15A) Flat Black (US19) Polished Chrome (US26) Unlacquered Brass (US3NL)*	\$156.00
Thumbturn Privacy	7241			\$156.00
Dummy, Pair	7045			\$156.00
Dummy, Single Sided	7041			\$78.00

10" STRETTO
Keyed Entry Set



2" x 10" CONCORD KEYED	Product Code	Knob or Lever Style	Finish	List Price
Passage/Single Keyed	7442	See Page 4 for Brass Knob & Lever Options. See Page 5 for Crystal & Porcelain Knob Options.	Polished Brass - Lifetime (US3) French Antique (US7) Oil Rubbed Bronze (US10B) Satin Nickel (US15) Pewter (US15A) Flat Black (US19) Polished Chrome (US26) Unlacquered Brass (US3NL)*	\$172.00
Dummy, Pair	7042			\$172.00

11" STRETTO
Thumbturn Privacy Set



1 1/2" x 11" CONCORD NON-KEYED	Product Code	Knob or Lever Style	Finish	List Price
Passage	7143	See Page 4 for Brass Knob & Lever Options. See Page 5 for Crystal & Porcelain Knob Options.	Polished Brass - Lifetime (US3) French Antique (US7) Oil Rubbed Bronze (US10B) Satin Nickel (US15) Pewter (US15A) Flat Black (US19) Polished Chrome (US26) Unlacquered Brass (US3NL)*	\$156.00
Thumbturn Privacy	7243			\$156.00
Dummy, Pair	7046			\$156.00
Dummy, Single Sided	7043			\$78.00

11" STRETTO
Keyed Entry Set



1 1/2" x 11" CONCORD KEYED	Product Code	Knob or Lever Style	Finish	List Price
Passage/Single Keyed	7444	See Page 4 for Brass Knob & Lever Options. See Page 5 for Crystal & Porcelain Knob Options.	Polished Brass - Lifetime (US3) French Antique (US7) Oil Rubbed Bronze (US10B) Satin Nickel (US15) Pewter (US15A) Flat Black (US19) Polished Chrome (US26) Unlacquered Brass (US3NL)*	\$172.00
Dummy, Pair	7044			\$172.00

*Unlacquered Brass (US3NL) finish available for a \$40 List Price upcharge per item.

Handing Required for Leversets
 • Supplied with 28° Rotation latch.
 • Standard backset is 2 3/8". Specify 2 3/4" backset if required.

Weiser® (WR5) Keyway
 • Specify by adding "W" to the beginning of product code.
 • No upcharge for cylinder substitution. Can be keyed into existing Weiser® system.

10" STRETTO
Non-Keyed Passage Set

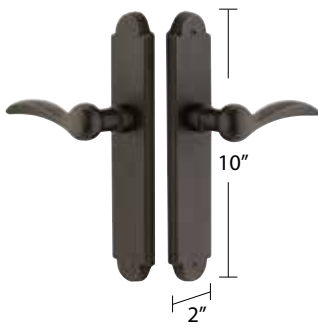

2" x 10" ARCHED NON-KEYED	Product Code	Knob or Lever Style	Finish	List Price
Passage	4141	See Page 5 for Sandcast Bronze Knob & Lever, Crystal & Porcelain Knob Options.	Flat Black Bronze (FB) Medium Bronze (MB) Tumbled White Bronze (TWB)	\$172.00
Thumbturn Privacy	4241			\$172.00
Dummy, Pair	4045			\$172.00
Dummy, Single Sided	4041			\$86.00

10" STRETTO
Keyed Entry Set



2" x 10" ARCHED KEYED	Product Code	Knob or Lever Style	Finish	List Price
Passage/Single Keyed	4442	See Page 5 for Sandcast Bronze Knob & Lever, Crystal & Porcelain Knob Options.	Flat Black Bronze (FB) Medium Bronze (MB) Tumbled White Bronze (TWB)	\$192.00
Dummy, Pair	4042			\$192.00

11" STRETTO
Thumbturn Privacy Set

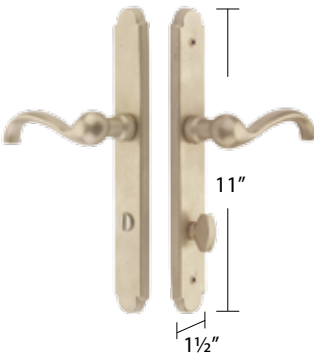

1 1/2" x 11" ARCHED NON-KEYED	Product Code	Knob or Lever Style	Finish	List Price
Passage	4143	See Page 5 for Sandcast Bronze Knob & Lever, Crystal & Porcelain Knob Options.	Flat Black Bronze (FB) Medium Bronze (MB) Tumbled White Bronze (TWB)	\$172.00
Thumbturn Privacy	4243			\$172.00
Dummy, Pair	4046			\$172.00
Dummy, Single Sided	4043			\$86.00

11" STRETTO
Keyed Entry Set



1 1/2" x 11" ARCHED KEYED	Product Code	Knob or Lever Style	Finish	List Price
Passage/Single Keyed	4444	See Page 5 for Sandcast Bronze Knob & Lever, Crystal & Porcelain Knob Options.	Flat Black Bronze (FB) Medium Bronze (MB) Tumbled White Bronze (TWB)	\$192.00
Dummy, Pair	4044			\$192.00

Handing Required for Leversets

- Supplied with 28° Rotation latch.
- Standard backset is 2 3/8". Specify 2 3/4" backset if required.

Weiser® (WR5) Keyway

- Specify by adding "W" to the beginning of product code.
- No upcharge for cylinder substitution. Can be keyed into existing Weiser® system.

To order: (W) Product Code + Knob/Lever Style + Handing + Finish + Add Door Thickness to Comments

STRETTO NARROW TRIM LOCKSETS - SANDCAST BRONZE RECTANGULAR

10" STRETTO
Thumbturn Privacy Set

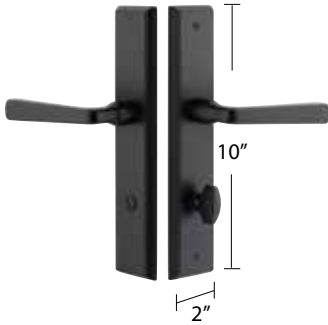

2" x 10" RECTANGULAR NON-KEYED	Product Code	Knob or Lever Style	Finish	List Price
Passage	5141	See Page 5 for Sandcast Bronze Knob & Lever, Crystal & Porcelain Knob Options.	Flat Black Bronze (FB) Medium Bronze (MB) Tumbled White Bronze (TWB)	\$172.00
Thumbturn Privacy	5241			\$172.00
Dummy, Pair	5045			\$172.00
Dummy, Single Sided	5041			\$86.00

10" STRETTO
Keyed Entry Set



2" x 10" RECTANGULAR KEYED	Product Code	Knob or Lever Style	Finish	List Price
Passage/Single Keyed	5442	See Page 5 for Sandcast Bronze Knob & Lever, Crystal & Porcelain Knob Options.	Flat Black Bronze (FB) Medium Bronze (MB) Tumbled White Bronze (TWB)	\$192.00
Dummy, Pair	5042			\$192.00

11" STRETTO
Non-Keyed Passage Set

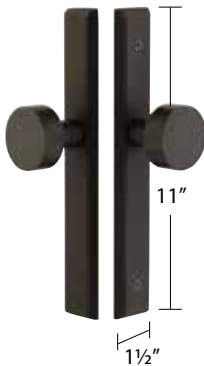

1 1/2" x 11" RECTANGULAR NON-KEYED	Product Code	Knob or Lever Style	Finish	List Price
Passage	5143	See Page 5 for Sandcast Bronze Knob & Lever, Crystal & Porcelain Knob Options.	Flat Black Bronze (FB) Medium Bronze (MB) Tumbled White Bronze (TWB)	\$172.00
Thumbturn Privacy	5243			\$172.00
Dummy, Pair	5046			\$172.00
Dummy, Single Sided	5043			\$86.00

11" STRETTO
Keyed Entry Set



1 1/2" x 11" RECTANGULAR KEYED	Product Code	Knob or Lever Style	Finish	List Price
Passage/Single Keyed	5444	See Page 5 for Sandcast Bronze Knob & Lever, Crystal & Porcelain Knob Options.	Flat Black Bronze (FB) Medium Bronze (MB) Tumbled White Bronze (TWB)	\$192.00
Dummy, Pair	5044			\$192.00

Handing Required for Leversets

- Supplied with 28° Rotation latch.
- Standard backset is 2 3/8". Specify 2 3/4" backset if required.

Weiser® (WR5) Keyway

- Specify by adding "W" to the beginning of product code.
- No upcharge for cylinder substitution. Can be keyed into existing Weiser® system.

10" STRETTO
Non-Keyed Passage Set

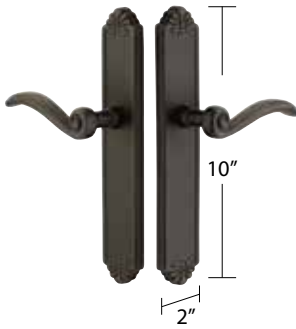

2" x 10" TUSCANY NON-KEYED	Product Code	Knob or Lever Style	Finish	List Price
Passage	6141	See Page 6 for Lost Wax Cast Bronze Knob & Lever Options.	Flat Black Bronze (FB) Medium Bronze (MB)	\$172.00
Thumbturn Privacy	6241			\$172.00
Dummy, Pair	6045	See Page 5 for Crystal & Porcelain Knob Options.		\$172.00
Dummy, Single Sided	6041			\$86.00

10" STRETTO
Keyed Entry Set



2" x 10" TUSCANY KEYED	Product Code	Knob or Lever Style	Finish	List Price
Passage/Single Keyed	6442	See Page 6 for Lost Wax Cast Bronze Knob & Lever Options.	Flat Black Bronze (FB) Medium Bronze (MB)	\$192.00
Dummy, Pair	6042			See Page 5 for Crystal & Porcelain Knob Options.

11" STRETTO
Thumbturn Privacy Set

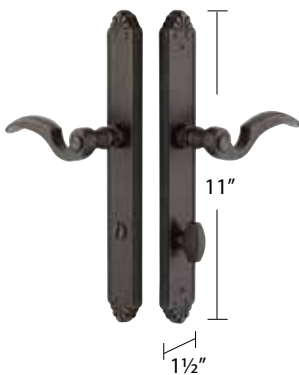

1 1/2" x 11" TUSCANY NON-KEYED	Product Code	Knob or Lever Style	Finish	List Price
Passage	6143	See Page 6 for Lost Wax Cast Bronze Knob & Lever Options.	Flat Black Bronze (FB) Medium Bronze (MB)	\$172.00
Thumbturn Privacy	6243			\$172.00
Dummy, Pair	6046	See Page 5 for Crystal & Porcelain Knob Options.		\$172.00
Dummy, Single Sided	6043			\$86.00

11" STRETTO
Keyed Entry Set



1 1/2" x 11" TUSCANY KEYED	Product Code	Knob or Lever Style	Finish	List Price
Passage/Single Keyed	6444	See Page 6 for Lost Wax Cast Bronze Knob & Lever Options.	Flat Black Bronze (FB) Medium Bronze (MB)	\$192.00
Dummy, Pair	6044			See Page 5 for Crystal & Porcelain Knob Options.

Handing Required for Leversets

- Supplied with 28° Rotation latch.
- Standard backset is 2 3/8". Specify 2 3/4" backset if required.

Weiser® (WR5) Keyway

- Specify by adding "W" to the beginning of product code.
- No upcharge for cylinder substitution. Can be keyed into existing Weiser® system.

To order: (W) Product Code + Knob/Lever Style + Handing + Finish + Add Door Thickness to Comments

STRETTO NARROW TRIM LOCKSETS - STAINLESS STEEL

10" STRETTO
Thumbturn Privacy Set

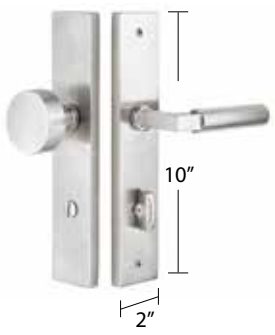

2" x 10" STAINLESS STEEL NON-KEYED	Product Code	Knob or Lever Style	Finish	List Price
Passage	9141	See Page 6 for Stainless Steel Knob & Lever Options.	Brushed Stainless Steel (SS)	\$156.00
Thumbturn Privacy	9241			\$156.00
Dummy, Pair	9045			\$156.00
Dummy, Single Sided	9041			\$78.00

10" STRETTO
Keyed Entry Set



2" x 10" STAINLESS STEEL KEYED	Product Code	Knob or Lever Style	Finish	List Price
Passage/Single Keyed	9442	See Page 6 for Stainless Steel Knob & Lever Options.	Brushed Stainless Steel (SS)	\$172.00
Dummy, Pair	9042			\$172.00

11" STRETTO
Non-Keyed Passage Set

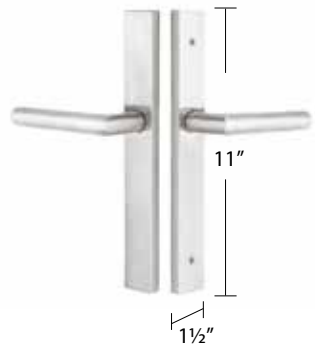

1 1/2" x 11" STAINLESS STEEL NON-KEYED	Product Code	Knob or Lever Style	Finish	List Price
Passage	9143	See Page 6 for Stainless Steel Knob & Lever Options.	Brushed Stainless Steel (SS)	\$156.00
Thumbturn Privacy	9243			\$156.00
Dummy, Pair	9046			\$156.00
Dummy, Single Sided	9043			\$78.00

11" STRETTO
Keyed Entry Set



1 1/2" x 11" STAINLESS STEEL KEYED	Product Code	Knob or Lever Style	Finish	List Price
Passage/Single Keyed	9444	See Page 6 for Stainless Steel Knob & Lever Options.	Brushed Stainless Steel (SS)	\$172.00
Dummy, Pair	9044			\$172.00

Handing Required for Leversets

- Supplied with 28° Rotation latch.
- Standard backset is 2 3/8". Specify 2 3/4" backset if required.

Weiser® (WR5) Keyway

- Specify by adding "W" to the beginning of product code.
- No upcharge for cylinder substitution. Can be keyed into existing Weiser® system.

1½" x 5" STRETTO
with Helios Levers
Passage Set



1½" x 5" STRETTO
with Hercules Levers
Privacy Set



1½" x 5" STRETTO
with Stuttgart Levers
Dummy Set



1½" x 5" STRETTO
with Modern Square Crystal Knobs
Passage Set



1½" x 5" STRETTO
with Round Knobs
Privacy Set



1½" x 5" STRETTO
with Modern Disc Crystal Knobs
Dummy Set



1½" x 5" STRETTO	Product Code	Knob or Lever Style	Finish	List Price
Passage	5507	See Page 4 for Brass Knob & Lever Options. See Page 5 for Crystal & Porcelain Knob Options.	Satin Brass (US4)	\$116.00
Thumbturn Privacy	5607		Oil Rubbed Bronze (US10B)	
Dummy, Pair	5007		Satin Nickel (US15)	\$116.00
Dummy, Single Sided	5005		Flat Black (US19)	
			Polished Chrome (US26)	\$116.00
			Unlacquered Brass (US3NL)*	\$58.00

*Unlacquered Brass (US3NL) finish available for a \$40 List Price upcharge per item.

IMPORTANT DOOR PREP INFORMATION

New Door Prep Only

- Cannot be combined with other rosette designs on opposite side of the door.
- Handing is required for Knob by Lever and split finish products.

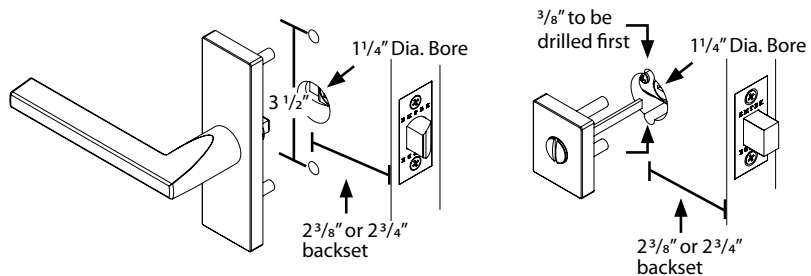

Handing Required for Leversets

- Requires a 1¼" diameter bore hole and 2-hole door preparation for privacy thumbturn.
- Standard backset is 2¾". Specify 2¾" backset if required.
- Supplied with 28° Rotation latch. Complete set includes latch and strike plate.

Geneva Lever
with Modern Rectangular Rosette



Helios Lever
with Disk Rosette



Hercules Lever
with Square Rosette



Luzern Lever
with Square Rosette







Argos Lever
with Modern Rectangular Rosette



Stuttgart Lever
with Square Rosette



ROSETTE	Description	CF	Product Code	Lever Style	Finish	Standard List Price	CF List Price
	Passage Set	C	5107	Argos Lever (AG) Geneva Lever (GV)	Satin Brass (US4) Oil Rubbed Bronze (US10B)	\$114.00	\$150.00
	Privacy Set	C	5207	Helios Lever (HLO) Hercules Lever (HEC)	Satin Nickel (US15) Flat Black (US19) Polished Chrome (US26)	\$114.00	\$150.00
	Dummy, Pair		5057	Luzern Lever (LU) Stuttgart Lever (STU)	Unlacquered Brass (US3NL)*	\$114.00	
	Passage Set	C	5109	Argos Lever (AG) Geneva Lever (GV)	Satin Brass (US4) Oil Rubbed Bronze (US10B)	\$114.00	\$150.00
	Privacy Set	C	5209	Helios Lever (HLO) Hercules Lever (HEC)	Polished Nickel - Lifetime (US14) Satin Nickel (US15) Flat Black (US19) Polished Chrome (US26)	\$114.00	\$150.00
	Dummy, Pair		5059	Luzern Lever (LU) Stuttgart Lever (STU)	Unlacquered Brass (US3NL)*	\$114.00	
	Passage Set	C	5110	Argos Lever (AG) Geneva Lever (GV)	Satin Brass (US4) Oil Rubbed Bronze (US10B)	\$114.00	\$150.00
	Privacy Set	C	5210	Helios Lever (HLO) Hercules Lever (HEC)	Polished Nickel - Lifetime (US14) Satin Nickel (US15) Flat Black (US19) Polished Chrome (US26)	\$114.00	\$150.00
	Dummy, Pair		5050	Luzern Lever (LU) Stuttgart Lever (STU)	Unlacquered Brass (US3NL)*	\$114.00	
	Passage Set	C	5111	Argos Lever (AG) Geneva Lever (GV)	Satin Brass (US4) Oil Rubbed Bronze (US10B)	\$114.00	\$150.00
	Privacy Set	C	5211	Helios Lever (HLO) Hercules Lever (HEC)	Satin Nickel (US15) Flat Black (US19) Polished Chrome (US26)	\$114.00	\$150.00
	Dummy, Pair		5051	Luzern Lever (LU) Stuttgart Lever (STU)	Unlacquered Brass (US3NL)*	\$114.00	
	Passage Set	C	5112	Argos Lever (AG) Geneva Lever (GV)	Satin Brass (US4) Oil Rubbed Bronze (US10B)	\$114.00	\$150.00
	Privacy Set	C	5212	Helios Lever (HLO) Hercules Lever (HEC)	Polished Nickel - Lifetime (US14) Satin Nickel (US15) Flat Black (US19) Polished Chrome (US26)	\$114.00	\$150.00
	Dummy, Pair		5052	Luzern Lever (LU) Stuttgart Lever (STU)	Unlacquered Brass (US3NL)*	\$114.00	

*Unlacquered Brass (US3NL) finish available for a \$40 List Price upcharge per item.

Handing Required For Leversets

- Standard latch is for 2¾" backset. Specify 2¾" backset if required. Complete set includes latch and strike plate.
 - To order 28° Rotation latch with any standard leverset, add product code **Latch28** and list price **\$4**.
 - Modern leversets may also be ordered with any Brass rosette at the list price shown above.
- See page 112-113 for Brass rosette options.

Concealed Fastener (CF) Mechanism

- Rosettes have no exposed screws.
- Handing not required, except for Knob by Lever and split finish products.
- Door thickness for CF Mechanism is 1¾" to 1⅝". Specify if thicker.
- Supplied with a 28° Rotation latch.

Basel Lever
with Disk RosetteTriton Lever
with Modern Rectangular RosetteAireon Lever
with Modern RosettePoseidon Lever
with Modern Rectangular RosetteSion Lever
with Disk RosetteAthena Lever
with Neos RosetteMercury Lever
with Square RosetteHermes Lever
with Modern Rosette

ROSETTE	Description	CF	Product Code	Lever Style	Finish	Standard List Price	CF List Price
Modern 	Passage Set	C	5107	Aireon Lever (A) Athena Lever (ATN) Basel Lever (BA)	Satin Brass (US4) Oil Rubbed Bronze (US10B)	\$114.00	\$150.00
	Privacy Set	C	5207	Hermes Lever (HER) Mercury Lever (MC)	Satin Nickel (US15) Flat Black (US19)	\$114.00	\$150.00
	Dummy, Pair		5057	Poseidon Lever (POS) Sion Lever (SIO) Triton Lever (TRT)	Polished Chrome (US26) Unlacquered Brass (US3NL)*	\$114.00	
Disk 	Passage Set	C	5109	Aireon Lever (A) Athena Lever (ATN) Basel Lever (BA)	Satin Brass (US4) Oil Rubbed Bronze (US10B)	\$114.00	\$150.00
	Privacy Set	C	5209	Hermes Lever (HER) Mercury Lever (MC)	Satin Nickel (US15) Flat Black (US19)	\$114.00	\$150.00
	Dummy, Pair		5059	Poseidon Lever (POS) Sion Lever (SIO) Triton Lever (TRT)	Polished Chrome (US26) Unlacquered Brass (US3NL)*	\$114.00	
Square 	Passage Set	C	5110	Aireon Lever (A) Athena Lever (ATN) Basel Lever (BA)	Satin Brass (US4) Oil Rubbed Bronze (US10B)	\$114.00	\$150.00
	Privacy Set	C	5210	Hermes Lever (HER) Mercury Lever (MC)	Satin Nickel (US15) Flat Black (US19)	\$114.00	\$150.00
	Dummy, Pair		5050	Poseidon Lever (POS) Sion Lever (SIO) Triton Lever (TRT)	Polished Chrome (US26) Unlacquered Brass (US3NL)*	\$114.00	
Neos 	Passage Set	C	5111	Aireon Lever (A) Athena Lever (ATN) Basel Lever (BA)	Satin Brass (US4) Oil Rubbed Bronze (US10B)	\$114.00	\$150.00
	Privacy Set	C	5211	Hermes Lever (HER) Mercury Lever (MC)	Satin Nickel (US15) Flat Black (US19)	\$114.00	\$150.00
	Dummy, Pair		5051	Poseidon Lever (POS) Sion Lever (SIO) Triton Lever (TRT)	Polished Chrome (US26) Unlacquered Brass (US3NL)*	\$114.00	
Modern Rectangular 	Passage Set	C	5112	Aireon Lever (A) Athena Lever (ATN) Basel Lever (BA)	Satin Brass (US4) Oil Rubbed Bronze (US10B)	\$114.00	\$150.00
	Privacy Set	C	5212	Hermes Lever (HER) Mercury Lever (MC)	Satin Nickel (US15) Flat Black (US19)	\$114.00	\$150.00
	Dummy, Pair		5052	Poseidon Lever (POS) Sion Lever (SIO) Triton Lever (TRT)	Polished Chrome (US26) Unlacquered Brass (US3NL)*	\$114.00	

*Unlacquered Brass (US3NL) finish available for a \$40 List Price upcharge per item.

Handing Required For Leversets

- Standard latch is for 2¾" backset. Specify 2¾" backset if required. Complete set includes latch and strike plate.
 - To order 28° Rotation latch with any standard leverset, add product code **Latch28** and list price **\$4**.
 - Modern leversets may also be ordered with any Brass rosette at the list price shown above.
- See page 112-113 for Brass rosette options.

Concealed Fastener (CF) Mechanism

- Rosettes have no exposed screws.
- Handing not required, except for Knob by Lever and split finish products.
- Door thickness for CF Mechanism is 1¾" to 1⅝". Specify if thicker.
- Supplied with a 28° Rotation latch.

**Bern Knob
with Square Rosette**



**Square Knob
with Modern Rectangular Rosette**



**Orb Knob
with Disk Rosette**







**Round Knob
with Square Rosette**



**Octagon Knob
with Modern Rosette**



ROSETTE	Description	CF	Product Code	Knob Style	Finish	Standard List Price	CF List Price
 Modern	Passage Set	C	5107	Bern Knob (BN) Octagon Knob (OCT)	Satin Brass (US4) Oil Rubbed Bronze (US10B)	\$114.00	\$150.00
	Privacy Set	C	5207	Orb Knob (OR) Round Knob (ROU)	Satin Nickel (US15) Flat Black (US19)	\$114.00	\$150.00
	Dummy, Pair		5057	Square Knob (SQU)	Polished Chrome (US26) Unlacquered Brass (US3NL)*	\$114.00	
 Disk	Passage Set	C	5109	Bern Knob (BN) Octagon Knob (OCT)	Satin Brass (US4) Oil Rubbed Bronze (US10B)	\$114.00	\$150.00
	Privacy Set	C	5209	Orb Knob (OR) Round Knob (ROU)	Polished Nickel - Lifetime (US14)** Satin Nickel (US15)	\$114.00	\$150.00
	Dummy, Pair		5059	Square Knob (SQU)	Flat Black (US19) Polished Chrome (US26) Unlacquered Brass (US3NL)*	\$114.00	
 Square	Passage Set	C	5110	Bern Knob (BN) Octagon Knob (OCT)	Satin Brass (US4) Oil Rubbed Bronze (US10B)	\$114.00	\$150.00
	Privacy Set	C	5210	Orb Knob (OR) Round Knob (ROU)	Polished Nickel - Lifetime (US14)** Satin Nickel (US15)	\$114.00	\$150.00
	Dummy, Pair		5050	Square Knob (SQU)	Flat Black (US19) Polished Chrome (US26) Unlacquered Brass (US3NL)*	\$114.00	
 Neos	Passage Set	C	5111	Bern Knob (BN) Octagon Knob (OCT)	Satin Brass (US4) Oil Rubbed Bronze (US10B)	\$114.00	\$150.00
	Privacy Set	C	5211	Orb Knob (OR) Round Knob (ROU)	Satin Nickel (US15) Flat Black (US19)	\$114.00	\$150.00
	Dummy, Pair		5051	Square Knob (SQU)	Polished Chrome (US26) Unlacquered Brass (US3NL)*	\$114.00	
 Modern Rectangular	Passage Set	C	5112	Bern Knob (BN) Octagon Knob (OCT)	Satin Brass (US4) Oil Rubbed Bronze (US10B)	\$114.00	\$150.00
	Privacy Set	C	5212	Orb Knob (OR) Round Knob (ROU)	Polished Nickel - Lifetime (US14)** Satin Nickel (US15)	\$114.00	\$150.00
	Dummy, Pair		5052	Square Knob (SQU)	Flat Black (US19) Polished Chrome (US26) Unlacquered Brass (US3NL)*	\$114.00	

*Unlacquered Brass (US3NL) finish available for a \$40 List Price upcharge per item. **Polished Nickel - Lifetime (US14) available only for Round Knob.

Handing Not Required For Knobsets

- Standard latch is for 2¾" backset. Specify 2¾" backset if required. Complete set includes latch and strike plate.
 - To order 28° Rotation latch with any standard knobset, add product code **Latch28** and list price **\$4**.
 - Modern knobsets may also be ordered with any Brass rosette at the list price shown above.
- See page 114-115 for Brass rosette options.

Concealed Fastener (CF) Mechanism

- Rosettes have no exposed screws.
- Handing not required, except for Knob by Lever and split finish products.
- Door thickness for CF Mechanism is 1¾" to 1⅝". Specify if thicker.
- Supplied with a 28° Rotation latch.

**Bristol Knob
with Square Rosette**



**Modern Disc Crystal Knob
with Modern Rectangular Rosette**



**Modern Square Crystal Knob
with Disk Rosette**



**Windsor Crystal Knob
with Modern Rectangular Rosette**





**Modern Disc Crystal Knob
with Disk Rosette**



**Hampton Knob
with Neos Rosette**



ROSETTE	Description	CF	Product Code	Knob Style	Finish	Standard List Price	CF List Price
 Modern	Passage Set	C	5107	Bristol Crystal Knob (BL) Hampton Crystal Knob (HT)	Satin Brass (US4) Oil Rubbed Bronze (US10B)	\$118.00	\$154.00
	Privacy Set	C	5207	Modern Disc Crystal Knob (MDC) Modern Square Crystal Knob (MSC)	Satin Nickel (US15) Flat Black (US19)	\$118.00	\$154.00
	Dummy, Pair		5057	Windsor Crystal Knob (WS)	Polished Chrome (US26) Unlacquered Brass (US3NL)*	\$118.00	
 Disk	Passage Set	C	5109	Bristol Crystal Knob (BL) Hampton Crystal Knob (HT)	Satin Brass (US4) Oil Rubbed Bronze (US10B)	\$118.00	\$154.00
	Privacy Set	C	5209	Modern Disc Crystal Knob (MDC) Modern Square Crystal Knob (MSC)	Polished Nickel - Lifetime (US14) Satin Nickel (US15)	\$118.00	\$154.00
	Dummy, Pair		5059	Windsor Crystal Knob (WS)	Flat Black (US19) Polished Chrome (US26) Unlacquered Brass (US3NL)*	\$118.00	
 Square	Passage Set	C	5110	Bristol Crystal Knob (BL) Hampton Crystal Knob (HT)	Satin Brass (US4) Oil Rubbed Bronze (US10B)	\$118.00	\$154.00
	Privacy Set	C	5210	Modern Disc Crystal Knob (MDC) Modern Square Crystal Knob (MSC)	Polished Nickel - Lifetime (US14) Satin Nickel (US15)	\$118.00	\$154.00
	Dummy, Pair		5050	Windsor Crystal Knob (WS)	Flat Black (US19) Polished Chrome (US26) Unlacquered Brass (US3NL)*	\$118.00	
 Neos	Passage Set	C	5111	Bristol Crystal Knob (BL) Hampton Crystal Knob (HT)	Satin Brass (US4) Oil Rubbed Bronze (US10B)	\$118.00	\$154.00
	Privacy Set	C	5211	Modern Disc Crystal Knob (MDC) Modern Square Crystal Knob (MSC)	Satin Nickel (US15) Flat Black (US19)	\$118.00	\$154.00
	Dummy, Pair		5051	Windsor Crystal Knob (WS)	Polished Chrome (US26) Unlacquered Brass (US3NL)*	\$118.00	
 Modern Rectangular	Passage Set	C	5112	Bristol Crystal Knob (BL) Hampton Crystal Knob (HT)	Satin Brass (US4) Oil Rubbed Bronze (US10B)	\$118.00	\$154.00
	Privacy Set	C	5212	Modern Disc Crystal Knob (MDC) Modern Square Crystal Knob (MSC)	Polished Nickel - Lifetime (US14) Satin Nickel (US15)	\$118.00	\$154.00
	Dummy, Pair		5052	Windsor Crystal Knob (WS)	Flat Black (US19) Polished Chrome (US26) Unlacquered Brass (US3NL)*	\$118.00	

*Unlacquered Brass (US3NL) finish available for a \$40 List Price upcharge per item.

Handing Not Required For Knobsets

- Standard latch is for 2 3/8" backset. Specify 2 3/4" backset if required. Complete set includes latch and strike plate.
- To order 28° Rotation latch with any standard knobset, add product code **Latch28** and list price **\$4**.
- Modern Crystal knobsets may also be ordered with any Brass rosette at the list price shown above. See page 114-115 for Brass rosette options.

Concealed Fastener (CF) Mechanism

- Rosettes have no exposed screws.
- Handing not required, except for Knob by Lever and split finish products.
- Door thickness for CF Mechanism is 1 3/8" to 1 1/2". Specify if thicker.
- Supplied with a 28° Rotation latch.

To order: (C) Product Code + Knob Style + Finish + Add Door Thickness to Comments

Cortina Lever
with #8 Rosette



Milano Lever
with Rectangular Rosette







Rustic Lever
with Oval Rosette



Turino Lever
with Quincy Rosette



ROSETTE	Description	CF	Product Code	Lever Style	Finish	Standard List Price	CF List Price
	Passage Set	C	8108	Cortina Lever (C) Milano Lever (M)	Polished Brass - Lifetime (US3) French Antique (US7) Oil Rubbed Bronze (US10B) Polished Nickel - Lifetime (US14)** Satin Nickel (US15) Pewter (US15A) Flat Black (US19) Polished Chrome (US26) Unlacquered Brass (US3NL)*	\$86.00	\$122.00
	Privacy Set	C	8208	Rustic Lever (R) Turino Lever (T)		\$86.00	\$122.00
	Dummy, Pair		8058			\$86.00	
	Passage Set	C	8120	Cortina Lever (C) Milano Lever (M)	Polished Brass - Lifetime (US3) French Antique (US7) Oil Rubbed Bronze (US10B) Satin Nickel (US15) Pewter (US15A) Flat Black (US19) Polished Chrome (US26) Unlacquered Brass (US3NL)*	\$86.00	\$122.00
	Privacy Set	C	8220	Rustic Lever (R) Turino Lever (T)		\$86.00	\$122.00
	Dummy, Pair		8520			\$86.00	
	Passage Set	C	8100	Cortina Lever (C) Milano Lever (M)	Polished Brass - Lifetime (US3) French Antique (US7) Oil Rubbed Bronze (US10B) Polished Nickel - Lifetime (US14)** Satin Nickel (US15) Pewter (US15A) Flat Black (US19) Polished Chrome (US26) Unlacquered Brass (US3NL)*	\$86.00	\$122.00
	Privacy Set	C	8200	Rustic Lever (R) Turino Lever (T)		\$86.00	\$122.00
	Dummy, Pair		8050			\$86.00	
	Passage Set	C	8121	Cortina Lever (C) Milano Lever (M)	Polished Brass - Lifetime (US3) French Antique (US7) Oil Rubbed Bronze (US10B) Polished Nickel - Lifetime (US14)** Satin Nickel (US15) Pewter (US15A) Flat Black (US19) Polished Chrome (US26) Unlacquered Brass (US3NL)*	\$86.00	\$122.00
	Privacy Set	C	8221	Rustic Lever (R) Turino Lever (T)		\$86.00	\$122.00
	Dummy, Pair		8521			\$86.00	
	Passage Set	C	8131	Cortina Lever (C) Milano Lever (M)	Polished Brass - Lifetime (US3) French Antique (US7) Oil Rubbed Bronze (US10B) Satin Nickel (US15) Pewter (US15A) Flat Black (US19) Polished Chrome (US26) Unlacquered Brass (US3NL)*	\$86.00	\$122.00
	Privacy Set	C	8231	Rustic Lever (R) Turino Lever (T)		\$86.00	\$122.00
	Dummy, Pair		8531			\$86.00	

*Unlacquered Brass (US3NL) finish available for a \$40 List Price upcharge per item.

**Polished Nickel - Lifetime (US14) available only for Cortina, Milano and Turino Levers.





Handing Required For Leversets

- Standard latch is for 2¾" backset. Specify 2¾" backset if required. Complete set includes latch and strike plate.
- To order 28° Rotation latch with any standard leverset, add product code **Latch28** and list price **\$4**.
- Classic leversets may also be ordered with any Modern rosette at the list price shown above. See page 108 for Modern rosette options.

Concealed Fastener (CF) Mechanism

- Rosettes have no exposed screws.
- Handing not required, except for Knob by Lever and split finish products.
- Door thickness for CF Mechanism is 1¾" to 1⅝". Specify if thicker.
- Supplied with a 28° Rotation latch.

Cortina Lever
with Regular RosetteTurino Lever
with Lancaster RosetteCortina Lever
with Ribbon & Reed RosetteTurino Lever
with Oval RosetteMilano Lever
with Wilshire RosetteRustic Lever
with Rope Rosette

ROSETTE	Description	CF	Product Code	Lever Style	Finish	Standard List Price	CF List Price
	Passage Set	C	8161	Cortina Lever (C) Milano Lever (M)	Polished Brass - Lifetime (US3) French Antique (US7) Oil Rubbed Bronze (US10B) Polished Nickel - Lifetime (US14)** Satin Nickel (US15) Pewter (US15A) Flat Black (US19) Polished Chrome (US26) Unlacquered Brass (US3NL)*	\$86.00	\$122.00
	Privacy Set	C	8261	Rustic Lever (R) Turino Lever (T)		\$86.00	\$122.00
	Dummy, Pair		8561			\$86.00	
	Passage Set	C	8101	Cortina Lever (C) Milano Lever (M)	Polished Brass - Lifetime (US3) French Antique (US7) Oil Rubbed Bronze (US10B) Satin Nickel (US15) Pewter (US15A) Polished Chrome (US26) Unlacquered Brass (US3NL)*	\$86.00	\$122.00
	Privacy Set	C	8201	Rustic Lever (R) Turino Lever (T)		\$86.00	\$122.00
	Dummy, Pair		8051			\$86.00	
	Passage Set	C	8106	Cortina Lever (C) Milano Lever (M)	Polished Brass - Lifetime (US3) French Antique (US7) Oil Rubbed Bronze (US10B) Satin Nickel (US15) Pewter (US15A) Polished Chrome (US26) Unlacquered Brass (US3NL)*	\$86.00	\$122.00
	Privacy Set	C	8206	Rustic Lever (R) Turino Lever (T)		\$86.00	\$122.00
	Dummy, Pair		8056			\$86.00	
	Passage Set	C	8107	Cortina Lever (C) Milano Lever (M)	Polished Brass - Lifetime (US3) French Antique (US7) Oil Rubbed Bronze (US10B) Satin Nickel (US15) Pewter (US15A) Polished Chrome (US26) Unlacquered Brass (US3NL)*	\$86.00	\$122.00
	Privacy Set	C	8207	Rustic Lever (R) Turino Lever (T)		\$86.00	\$122.00
	Dummy, Pair		8057			\$86.00	

*Unlacquered Brass (US3NL) finish available for a \$40 List Price upcharge per item.

**Polished Nickel - Lifetime (US14) available only for Cortina, Milano and Turino Levers.

Handing Required For Leversets

- Standard latch is for 2 $\frac{3}{8}$ " backset. Specify 2 $\frac{3}{4}$ " backset if required. Complete set includes latch and strike plate.
- To order 28° Rotation latch with any standard leverset, add product code **Latch28** and list price \$4.
- Classic leversets may also be ordered with any Modern rosette at the list price shown above. See page 108 for Modern rosette options.

Concealed Fastener (CF) Mechanism

- Rosettes have no exposed screws.
- Handing not required, except for Knob by Lever and split finish products.
- Door thickness for CF Mechanism is 1 $\frac{3}{8}$ " to 1 $\frac{1}{2}$ ". Specify if thicker.
- Supplied with a 28° Rotation latch.

To order: (C) Product Code + Lever Style + Handing + Finish + Add Door Thickness to Comments

**Egg Knob
with Regular Rosette**



**Providence Knob
with Quincy Rosette**







**Norwich Knob
with #8 Rosette**



**Egg Knob
with Rectangular Rosette**



ROSETTE	Description	CF	Product Code	Knob Style	Finish	Standard List Price	CF List Price
	Passage Set	C	8108	Egg Knob (E) Melon Knob (MN)	Polished Brass - Lifetime (US3) French Antique (US7) Oil Rubbed Bronze (US10B) Polished Nickel - Lifetime (US14)** Satin Nickel (US15) Pewter (US15A) Flat Black (US19) Polished Chrome (US26) Unlacquered Brass (US3NL)*	\$96.00	\$132.00
	Privacy Set	C	8208	Norwich Knob (NW) Providence Knob (P)		\$96.00	\$132.00
	Dummy, Pair		8058	Waverly Knob (W)		\$96.00	
	Passage Set	C	8120	Egg Knob (E) Melon Knob (MN)	Polished Brass - Lifetime (US3) French Antique (US7) Oil Rubbed Bronze (US10B) Satin Nickel (US15) Pewter (US15A) Flat Black (US19) Polished Chrome (US26) Unlacquered Brass (US3NL)*	\$96.00	\$132.00
	Privacy Set	C	8220	Norwich Knob (NW) Providence Knob (P)		\$96.00	\$132.00
	Dummy, Pair		8520	Waverly Knob (W)		\$96.00	
	Passage Set	C	8100	Egg Knob (E) Melon Knob (MN)	Polished Brass - Lifetime (US3) French Antique (US7) Oil Rubbed Bronze (US10B) Polished Nickel - Lifetime (US14)** Satin Nickel (US15) Pewter (US15A) Flat Black (US19) Polished Chrome (US26) Unlacquered Brass (US3NL)*	\$96.00	\$132.00
	Privacy Set	C	8200	Norwich Knob (NW) Providence Knob (P)		\$96.00	\$132.00
	Dummy, Pair		8050	Waverly Knob (W)		\$96.00	
	Passage Set	C	8121	Egg Knob (E) Melon Knob (MN)	Polished Brass - Lifetime (US3) French Antique (US7) Oil Rubbed Bronze (US10B) Polished Nickel - Lifetime (US14)** Satin Nickel (US15) Pewter (US15A) Flat Black (US19) Polished Chrome (US26) Unlacquered Brass (US3NL)*	\$96.00	\$132.00
	Privacy Set	C	8221	Norwich Knob (NW) Providence Knob (P)		\$96.00	\$132.00
	Dummy, Pair		8521	Waverly Knob (W)		\$96.00	
	Passage Set	C	8131	Egg Knob (E) Melon Knob (MN)	Polished Brass - Lifetime (US3) French Antique (US7) Oil Rubbed Bronze (US10B) Satin Nickel (US15) Pewter (US15A) Flat Black (US19) Polished Chrome (US26) Unlacquered Brass (US3NL)*	\$96.00	\$132.00
	Privacy Set	C	8231	Norwich Knob (NW) Providence Knob (P)		\$96.00	\$132.00
	Dummy, Pair		8531	Waverly Knob (W)		\$96.00	

*Unlacquered Brass (US3NL) finish available for a \$40 List Price upcharge per item. **Polished Nickel - Lifetime (US14) NOT available for Melon Knob.

Handing Not Required For Knobsets

- Standard latch is for 2¾" backset. Specify 2¾" backset if required. Complete set includes latch and strike plate.
- To order 28° Rotation latch with any standard knobset, add product code **Latch28** and list price **\$4**.
- Classic knobsets may also be ordered with any Modern rosette at the list price shown above. See page 110 for Modern rosette options.

Concealed Fastener (CF) Mechanism

- Rosettes have no exposed screws.
- Handing not required, except for Knob by Lever and split finish products.
- Door thickness for CF Mechanism is 1¾" to 1½". Specify if thicker.
- Supplied with a 28° Rotation latch.

**Waverly Knob
with Quincy Rosette**



**Norwich Knob
with Wilshire Rosette**



**Providence Knob
with Regular Rosette**



**Egg Knob
with Oval Rosette**



**Waverly Knob
with Lancaster Rosette**



**Melon Knob
with Rope Rosette**



ROSETTE	Description	CF	Product Code	Knob Style	Finish	Standard List Price	CF List Price
Wilshire 	Passage Set	C	8161	Egg Knob (E) Melon Knob (MN)	Polished Brass - Lifetime (US3) French Antique (US7) Oil Rubbed Bronze (US10B) Polished Nickel - Lifetime (US14)** Satin Nickel (US15) Pewter (US15A) Flat Black (US19) Polished Chrome (US26) Unlacquered Brass (US3NL)*	\$96.00	\$132.00
	Privacy Set	C	8261	Norwich Knob (NW) Providence Knob (P)		\$96.00	\$132.00
	Dummy, Pair		8561	Waverly Knob (W)		\$96.00	
Rope 	Passage Set	C	8101	Egg Knob (E) Melon Knob (MN)	Polished Brass - Lifetime (US3) French Antique (US7) Oil Rubbed Bronze (US10B) Satin Nickel (US15) Pewter (US15A) Polished Chrome (US26) Unlacquered Brass (US3NL)*	\$96.00	\$132.00
	Privacy Set	C	8201	Norwich Knob (NW) Providence Knob (P)		\$96.00	\$132.00
	Dummy, Pair		8051	Waverly Knob (W)		\$96.00	
Lancaster 	Passage Set	C	8106	Egg Knob (E) Melon Knob (MN)	Polished Brass - Lifetime (US3) French Antique (US7) Oil Rubbed Bronze (US10B) Satin Nickel (US15) Pewter (US15A) Polished Chrome (US26) Unlacquered Brass (US3NL)*	\$96.00	\$132.00
	Privacy Set	C	8206	Norwich Knob (NW) Providence Knob (P)		\$96.00	\$132.00
	Dummy, Pair		8056	Waverly Knob (W)		\$96.00	
Ribbon & Reed 	Passage Set	C	8107	Egg Knob (E) Melon Knob (MN)	Polished Brass - Lifetime (US3) French Antique (US7) Oil Rubbed Bronze (US10B) Satin Nickel (US15) Pewter (US15A) Polished Chrome (US26) Unlacquered Brass (US3NL)*	\$96.00	\$132.00
	Privacy Set	C	8207	Norwich Knob (NW) Providence Knob (P)		\$96.00	\$132.00
	Dummy, Pair		8057	Waverly Knob (W)		\$96.00	

*Unlacquered Brass (US3NL) finish available for a \$40 List Price upcharge per item. **Polished Nickel - Lifetime (US14) NOT available for Melon Knob.

Handing Not Required For Knobsets

- Standard latch is for 2¾" backset. Specify 2¾" backset if required. Complete set includes latch and strike plate.
- To order 28° Rotation latch with any standard knobset, add product code **Latch28** and list price **\$4**.
- Classic knobsets may also be ordered with any Modern rosette at the list price shown above. See page 110 for Modern rosette options.

Concealed Fastener (CF) Mechanism

- Rosettes have no exposed screws.
- Handing not required, except for Knob by Lever and split finish products.
- Door thickness for CF Mechanism is 1⅜" to 1⅞". Specify if thicker.
- Supplied with a 28° Rotation latch.

Elan Lever
with #8 Rosette



Wembley Lever
with Lancaster Rosette







Merrimack Lever
with Rectangular Rosette



Coventry Lever
with Regular Rosette



ROSETTE	Description	CF	Product Code	Lever Style	Finish	Standard List Price	CF List Price
	Passage Set	C	8108	Coventry Lever (CV) Elan Lever (EN)	Polished Brass - Lifetime (US3) French Antique (US7)	\$118.00	\$154.00
	Privacy Set	C	8208	Merrimack Lever (ME) Ribbon & Reed Lever (RBL)	Oil Rubbed Bronze (US10B) Polished Nickel - Lifetime (US14)**	\$118.00	\$154.00
	Dummy, Pair		8058	Rope Lever (RL) Santa Fe Lever (SF) Wembley Lever (WM)	Satin Nickel (US15) Pewter (US15A) Polished Chrome (US26) Unlacquered Brass (US3NL)*	\$118.00	
	Passage Set	C	8120	Coventry Lever (CV) Elan Lever (EN)	Polished Brass - Lifetime (US3) French Antique (US7)	\$118.00	\$154.00
	Privacy Set	C	8220	Merrimack Lever (ME) Ribbon & Reed Lever (RBL)	Oil Rubbed Bronze (US10B) Satin Nickel (US15)	\$118.00	\$154.00
	Dummy, Pair		8520	Rope Lever (RL) Santa Fe Lever (SF) Wembley Lever (WM)	Pewter (US15A) Polished Chrome (US26) Unlacquered Brass (US3NL)*	\$118.00	
	Passage Set	C	8100	Coventry Lever (CV) Elan Lever (EN)	Polished Brass - Lifetime (US3) French Antique (US7)	\$118.00	\$154.00
	Privacy Set	C	8200	Merrimack Lever (ME) Ribbon & Reed Lever (RBL)	Oil Rubbed Bronze (US10B) Polished Nickel - Lifetime (US14)**	\$118.00	\$154.00
	Dummy, Pair		8050	Rope Lever (RL) Santa Fe Lever (SF) Wembley Lever (WM)	Satin Nickel (US15) Pewter (US15A) Polished Chrome (US26) Unlacquered Brass (US3NL)*	\$118.00	
	Passage Set	C	8121	Coventry Lever (CV) Elan Lever (EN)	Polished Brass - Lifetime (US3) French Antique (US7)	\$118.00	\$154.00
	Privacy Set	C	8221	Merrimack Lever (ME) Ribbon & Reed Lever (RBL)	Oil Rubbed Bronze (US10B) Polished Nickel - Lifetime (US14)**	\$118.00	\$154.00
	Dummy, Pair		8521	Rope Lever (RL) Santa Fe Lever (SF) Wembley Lever (WM)	Satin Nickel (US15) Pewter (US15A) Polished Chrome (US26) Unlacquered Brass (US3NL)*	\$118.00	
	Passage Set	C	8131	Coventry Lever (CV) Elan Lever (EN)	Polished Brass - Lifetime (US3) French Antique (US7)	\$118.00	\$154.00
	Privacy Set	C	8231	Merrimack Lever (ME) Ribbon & Reed Lever (RBL)	Oil Rubbed Bronze (US10B) Satin Nickel (US15)	\$118.00	\$154.00
	Dummy, Pair		8531	Rope Lever (RL) Santa Fe Lever (SF) Wembley Lever (WM)	Pewter (US15A) Polished Chrome (US26) Unlacquered Brass (US3NL)*	\$118.00	

*Unlacquered Brass (US3NL) finish available for a \$40 List Price upcharge per item. **Polished Nickel - Lifetime (US14) available only for Merrimack Lever.

Handing Required For Leversets

- Standard latch is for 2¾" backset. Specify 2¾" backset if required. Complete set includes latch and strike plate.
- To order 28° Rotation latch with any standard leverset, add product code **Latch28** and list price **\$4**.
- Designer leversets may also be ordered with any Modern rosette at the list price shown above. See page 108 for Modern rosette options.

Concealed Fastener (CF) Mechanism

- Rosettes have no exposed screws.
- Handing not required, except for Knob by Lever and split finish products.
- Door thickness for CF Mechanism is 1¾" to 1⅝". Specify if thicker.
- Supplied with a 28° Rotation latch.

Rope Lever
with Rope RosetteMerrimack Lever
with Quincy RosetteRibbon & Reed Lever
with Ribbon & Reed RosetteElan Lever
with Oval RosetteSanta Fe Lever
with Wilshire RosetteElan Lever
with Regular Rosette

ROSETTE	Description	CF	Product Code	Lever Style	Finish	Standard List Price	CF List Price
Wilshire 	Passage Set	C	8161	Coventry Lever (CV) Elan Lever (EN)	Polished Brass - Lifetime (US3) French Antique (US7)	\$118.00	\$154.00
	Privacy Set	C	8261	Merrimack Lever (ME) Ribbon & Reed Lever (RBL)	Oil Rubbed Bronze (US10B) Polished Nickel - Lifetime (US14)**	\$118.00	\$154.00
	Dummy, Pair		8561	Rope Lever (RL) Santa Fe Lever (SF) Wembley Lever (WM)	Satin Nickel (US15) Pewter (US15A) Polished Chrome (US26) Unlacquered Brass (US3NL)*	\$118.00	
Rope 	Passage Set	C	8101	Coventry Lever (CV) Elan Lever (EN)	Polished Brass - Lifetime (US3) French Antique (US7)	\$118.00	\$154.00
	Privacy Set	C	8201	Merrimack Lever (ME) Ribbon & Reed Lever (RBL)	Oil Rubbed Bronze (US10B) Satin Nickel (US15)	\$118.00	\$154.00
	Dummy, Pair		8051	Rope Lever (RL) Santa Fe Lever (SF) Wembley Lever (WM)	Pewter (US15A) Polished Chrome (US26) Unlacquered Brass (US3NL)*	\$118.00	
Lancaster 	Passage Set	C	8106	Coventry Lever (CV) Elan Lever (EN)	Polished Brass - Lifetime (US3) French Antique (US7)	\$118.00	\$154.00
	Privacy Set	C	8206	Merrimack Lever (ME) Ribbon & Reed Lever (RBL)	Oil Rubbed Bronze (US10B) Satin Nickel (US15)	\$118.00	\$154.00
	Dummy, Pair		8056	Rope Lever (RL) Santa Fe Lever (SF) Wembley Lever (WM)	Pewter (US15A) Polished Chrome (US26) Unlacquered Brass (US3NL)*	\$118.00	
Ribbon & Reed 	Passage Set	C	8107	Coventry Lever (CV) Elan Lever (EN)	Polished Brass - Lifetime (US3) French Antique (US7)	\$118.00	\$154.00
	Privacy Set	C	8207	Merrimack Lever (ME) Ribbon & Reed Lever (RBL)	Oil Rubbed Bronze (US10B) Satin Nickel (US15)	\$118.00	\$154.00
	Dummy, Pair		8057	Rope Lever (RL) Santa Fe Lever (SF) Wembley Lever (WM)	Pewter (US15A) Polished Chrome (US26) Unlacquered Brass (US3NL)*	\$118.00	

*Unlacquered Brass (US3NL) finish available for a \$40 List Price upcharge per item. **Polished Nickel - Lifetime (US14) available only for Merrimack Lever.

Handing Required For Leversets

- Standard latch is for 2¾" backset. Specify 2¾" backset if required. Complete set includes latch and strike plate.
 - To order 28° Rotation latch with any standard leverset, add product code **Latch28** and list price \$4.
 - Designer leversets may also be ordered with any Modern rosette at the list price shown above.
- See page 108 for Modern rosette options.

Concealed Fastener (CF) Mechanism

- Rosettes have no exposed screws.
- Handing not required, except for Knob by Lever and split finish products.
- Door thickness for CF Mechanism is 1⅝" to 1⅞". Specify if thicker.
- Supplied with a 28° Rotation latch.

**Beaded Egg Knob
with Regular Rosette**



**Lancaster Knob
with Lancaster Rosette**







**Ribbon & Reed Knob
with Rectangular Rosette**



**Victoria Knob
with Oval Rosette**



ROSETTE	Description	CF	Product Code	Knob Style	Finish	Standard List Price	CF List Price
	Passage Set	C	8108	Beaded Egg Knob (BE) Belmont Knob (BT)	Polished Brass - Lifetime (US3) French Antique (US7) Oil Rubbed Bronze (US10B) Satin Nickel (US15) Pewter (US15A) Polished Chrome (US26) Unlacquered Brass (US3NL)*	\$118.00	\$154.00
	Privacy Set	C	8208	Lancaster Knob (LN) Ribbon & Reed Knob (RBK)		\$118.00	\$154.00
	Dummy, Pair		8058	Rope Knob (RK) Victoria Knob (V)		\$118.00	
	Passage Set	C	8120	Beaded Egg Knob (BE) Belmont Knob (BT)	Polished Brass - Lifetime (US3) French Antique (US7) Oil Rubbed Bronze (US10B) Satin Nickel (US15) Pewter (US15A) Polished Chrome (US26) Unlacquered Brass (US3NL)*	\$118.00	\$154.00
	Privacy Set	C	8220	Lancaster Knob (LN) Ribbon & Reed Knob (RBK)		\$118.00	\$154.00
	Dummy, Pair		8520	Rope Knob (RK) Victoria Knob (V)		\$118.00	
	Passage Set	C	8100	Beaded Egg Knob (BE) Belmont Knob (BT)	Polished Brass - Lifetime (US3) French Antique (US7) Oil Rubbed Bronze (US10B) Satin Nickel (US15) Pewter (US15A) Polished Chrome (US26) Unlacquered Brass (US3NL)*	\$118.00	\$154.00
	Privacy Set	C	8200	Lancaster Knob (LN) Ribbon & Reed Knob (RBK)		\$118.00	\$154.00
	Dummy, Pair		8050	Rope Knob (RK) Victoria Knob (V)		\$118.00	
	Passage Set	C	8121	Beaded Egg Knob (BE) Belmont Knob (BT)	Polished Brass - Lifetime (US3) French Antique (US7) Oil Rubbed Bronze (US10B) Satin Nickel (US15) Pewter (US15A) Polished Chrome (US26) Unlacquered Brass (US3NL)*	\$118.00	\$154.00
	Privacy Set	C	8221	Lancaster Knob (LN) Ribbon & Reed Knob (RBK)		\$118.00	\$154.00
	Dummy, Pair		8521	Rope Knob (RK) Victoria Knob (V)		\$118.00	
	Passage Set	C	8131	Beaded Egg Knob (BE) Belmont Knob (BT)	Polished Brass - Lifetime (US3) French Antique (US7) Oil Rubbed Bronze (US10B) Satin Nickel (US15) Pewter (US15A) Polished Chrome (US26) Unlacquered Brass (US3NL)*	\$118.00	\$154.00
	Privacy Set	C	8231	Lancaster Knob (LN) Ribbon & Reed Knob (RBK)		\$118.00	\$154.00
	Dummy, Pair		8531	Rope Knob (RK) Victoria Knob (V)		\$118.00	

*Unlacquered Brass (US3NL) finish available for a \$40 List Price upcharge per item.

Handing Not Required For Knobsets

- Standard latch is for 2¾" backset. Specify 2¾" backset if required. Complete set includes latch and strike plate.
- To order 28° Rotation latch with any standard knobset, add product code **Latch28** and list price **\$4**.
- Designer knobsets may also be ordered with any Modern rosette at the list price shown above. See page 110 for Modern rosette options.

Concealed Fastener (CF) Mechanism

- Rosettes have no exposed screws.
- Handing not required, except for Knob by Lever and split finish products.
- Door thickness for CF Mechanism is 1⅜" to 1⅝". Specify if thicker.
- Supplied with a 28° Rotation latch.

**Rope Knob
with Rope Rosette**



**Belmont Knob
with Quincy Rosette**



**Lancaster Knob
with #8 Rosette**



**Belmont Knob
with Wilshire Rosette**





**Beaded Egg Knob
with Oval Rosette**



**Ribbon & Reed Knob
with Ribbon & Reed Rosette**



ROSETTE	Description	CF	Product Code	Knob Style	Finish	Standard List Price	CF List Price
Wilshire 	Passage Set	C	8161	Beaded Egg Knob (BE) Belmont Knob (BT)	Polished Brass - Lifetime (US3) French Antique (US7) Oil Rubbed Bronze (US10B) Satin Nickel (US15) Pewter (US15A) Polished Chrome (US26) Unlacquered Brass (US3NL)*	\$118.00	\$154.00
	Privacy Set	C	8261	Lancaster Knob (LN) Ribbon & Reed Knob (RBK)		\$118.00	\$154.00
	Dummy, Pair		8561	Rope Knob (RK) Victoria Knob (V)		\$118.00	
Rope 	Passage Set	C	8101	Beaded Egg Knob (BE) Belmont Knob (BT)	Polished Brass - Lifetime (US3) French Antique (US7) Oil Rubbed Bronze (US10B) Satin Nickel (US15) Pewter (US15A) Polished Chrome (US26) Unlacquered Brass (US3NL)*	\$118.00	\$154.00
	Privacy Set	C	8201	Lancaster Knob (LN) Ribbon & Reed Knob (RBK)		\$118.00	\$154.00
	Dummy, Pair		8051	Rope Knob (RK) Victoria Knob (V)		\$118.00	
Lancaster 	Passage Set	C	8106	Beaded Egg Knob (BE) Belmont Knob (BT)	Polished Brass - Lifetime (US3) French Antique (US7) Oil Rubbed Bronze (US10B) Satin Nickel (US15) Pewter (US15A) Polished Chrome (US26) Unlacquered Brass (US3NL)*	\$118.00	\$154.00
	Privacy Set	C	8206	Lancaster Knob (LN) Ribbon & Reed Knob (RBK)		\$118.00	\$154.00
	Dummy, Pair		8056	Rope Knob (RK) Victoria Knob (V)		\$118.00	
Ribbon & Reed 	Passage Set	C	8107	Beaded Egg Knob (BE) Belmont Knob (BT)	Polished Brass - Lifetime (US3) French Antique (US7) Oil Rubbed Bronze (US10B) Satin Nickel (US15) Pewter (US15A) Polished Chrome (US26) Unlacquered Brass (US3NL)*	\$118.00	\$154.00
	Privacy Set	C	8207	Lancaster Knob (LN) Ribbon & Reed Knob (RBK)		\$118.00	\$154.00
	Dummy, Pair		8057	Rope Knob (RK) Victoria Knob (V)		\$118.00	

*Unlacquered Brass (US3NL) finish available for a \$40 List Price upcharge per item.

Handing Not Required For Knobsets

- Standard latch is for 2 $\frac{3}{8}$ " backset. Specify 2 $\frac{3}{4}$ " backset if required. Complete set includes latch and strike plate.
- To order 28° Rotation latch with any standard knobset, add product code **Latch28** and list price **\$4**.
- Designer knobsets may also be ordered with any Modern rosette at the list price shown above. See page 110 for Modern rosette options.

Concealed Fastener (CF) Mechanism

- Rosettes have no exposed screws.
- Handing not required, except for Knob by Lever and split finish products.
- Door thickness for CF Mechanism is 1 $\frac{3}{8}$ " to 1 $\frac{5}{8}$ ". Specify if thicker.
- Supplied with a 28° Rotation latch.

**Old Town Clear Knob
with #8 Rosette**



**Bristol Knob
with Rectangular Rosette**







**Old Town Clear Knob
with Wilshire Rosette**



**Providence Crystal Knob
with Quincy Rosette**



ROSETTE	Description	CF	Product Code	Knob Style	Finish	Standard List Price	CF List Price
	Passage Set	C	8108	Astoria Clear Knob (AS) Bristol Knob (BL)	Polished Brass - Lifetime (US3) French Antique (US7)	\$118.00	\$154.00
	Privacy Set	C	8208	Diamond Crystal Knob (CK) Georgetown Knob (GT)	Oil Rubbed Bronze (US10B) Polished Nickel - Lifetime (US14)	\$118.00	\$154.00
	Dummy, Pair		8058	Hampton Knob (HT) Lowell Crystal Knob (LW) Old Town Clear Knob (OT) Providence Crystal Knob (PC) Windsor Crystal Knob (WS)	Satin Nickel (US15) Pewter (US15A) Flat Black (US19) Polished Chrome (US26) Unlacquered Brass (US3NL)*	\$118.00	
	Passage Set	C	8120	Astoria Clear Knob (AS) Bristol Knob (BL)	Polished Brass - Lifetime (US3) French Antique (US7)	\$118.00	\$154.00
	Privacy Set	C	8220	Diamond Crystal Knob (CK) Georgetown Knob (GT)	Oil Rubbed Bronze (US10B) Satin Nickel (US15)	\$118.00	\$154.00
	Dummy, Pair		8520	Hampton Knob (HT) Lowell Crystal Knob (LW) Old Town Clear Knob (OT) Providence Crystal Knob (PC) Windsor Crystal Knob (WS)	Pewter (US15A) Flat Black (US19) Polished Chrome (US26) Unlacquered Brass (US3NL)*	\$118.00	
	Passage Set	C	8100	Astoria Clear Knob (AS) Bristol Knob (BL)	Polished Brass - Lifetime (US3) French Antique (US7)	\$118.00	\$154.00
	Privacy Set	C	8200	Diamond Crystal Knob (CK) Georgetown Knob (GT)	Oil Rubbed Bronze (US10B) Polished Nickel - Lifetime (US14)	\$118.00	\$154.00
	Dummy, Pair		8050	Hampton Knob (HT) Lowell Crystal Knob (LW) Old Town Clear Knob (OT) Providence Crystal Knob (PC) Windsor Crystal Knob (WS)	Satin Nickel (US15) Pewter (US15A) Flat Black (US19) Polished Chrome (US26) Unlacquered Brass (US3NL)*	\$118.00	
	Passage Set	C	8121	Astoria Clear Knob (AS) Bristol Knob (BL)	Polished Brass - Lifetime (US3) French Antique (US7)	\$118.00	\$154.00
	Privacy Set	C	8221	Diamond Crystal Knob (CK) Georgetown Knob (GT)	Oil Rubbed Bronze (US10B) Polished Nickel - Lifetime (US14)	\$118.00	\$154.00
	Dummy, Pair		8521	Hampton Knob (HT) Lowell Crystal Knob (LW) Old Town Clear Knob (OT) Providence Crystal Knob (PC) Windsor Crystal Knob (WS)	Satin Nickel (US15) Pewter (US15A) Flat Black (US19) Polished Chrome (US26) Unlacquered Brass (US3NL)*	\$118.00	
	Passage Set	C	8131	Astoria Clear Knob (AS) Bristol Knob (BL)	Polished Brass - Lifetime (US3) French Antique (US7)	\$118.00	\$154.00
	Privacy Set	C	8231	Diamond Crystal Knob (CK) Georgetown Knob (GT)	Oil Rubbed Bronze (US10B) Satin Nickel (US15)	\$118.00	\$154.00
	Dummy, Pair		8531	Hampton Knob (HT) Lowell Crystal Knob (LW) Old Town Clear Knob (OT) Providence Crystal Knob (PC) Windsor Crystal Knob (WS)	Pewter (US15A) Flat Black (US19) Polished Chrome (US26) Unlacquered Brass (US3NL)*	\$118.00	

*Unlacquered Brass (US3NL) finish available for a **\$40 List Price** upcharge per item.

Handing Not Required For Knobsets

- Standard latch is for 2¾" backset. Specify 2¾" backset if required. Complete set includes latch and strike plate.
 - To order 28° Rotation latch with any standard knobset, add product code **Latch28** and list price **\$4**.
 - Crystal knobsets may also be ordered with any Modern rosette at the list price shown above.
- See page 111 for Modern rosette options.

Concealed Fastener (CF) Mechanism

- Rosettes have no exposed screws.
- Handing not required, except for Knob by Lever and split finish products.
- Door thickness for CF Mechanism is 1¾" to 1½". Specify if thicker.
- Supplied with a 28° Rotation latch.

Astoria Clear Knob with Rope Rosette



Georgetown Knob with Wilshire Rosette



Hampton Knob with #8 Rosette



Diamond Crystal Knob with Lancaster Rosette



Lowell Crystal Knob with Quincy Rosette



Windsor Crystal Knob with Rectangular Rosette



ROSETTE	Description	CF	Product Code	Knob Style	Finish	Standard List Price	CF List Price
	Passage Set	C	8161	Astoria Clear Knob (AS) Bristol Knob (BL)	Polished Brass - Lifetime (US3) French Antique (US7)	\$118.00	\$154.00
	Privacy Set	C	8261	Diamond Crystal Knob (CK) Georgetown Knob (GT)	Oil Rubbed Bronze (US10B) Polished Nickel - Lifetime (US14)	\$118.00	\$154.00
	Dummy, Pair		8561	Hampton Knob (HT) Lowell Crystal Knob (LW) Old Town Clear Knob (OT) Providence Crystal Knob (PC) Windsor Crystal Knob (WS)	Satin Nickel (US15) Pewter (US15A) Flat Black (US19) Polished Chrome (US26) Unlacquered Brass (US3NL)*	\$118.00	
	Passage Set	C	8101	Astoria Clear Knob (AS) Bristol Knob (BL)	Polished Brass - Lifetime (US3) French Antique (US7)	\$118.00	\$154.00
	Privacy Set	C	8201	Diamond Crystal Knob (CK) Georgetown Knob (GT)	Oil Rubbed Bronze (US10B) Satin Nickel (US15)	\$118.00	\$154.00
	Dummy, Pair		8051	Hampton Knob (HT) Lowell Crystal Knob (LW) Old Town Clear Knob (OT) Providence Crystal Knob (PC) Windsor Crystal Knob (WS)	Pewter (US15A) Polished Chrome (US26) Unlacquered Brass (US3NL)*	\$118.00	
	Passage Set	C	8106	Astoria Clear Knob (AS) Bristol Knob (BL)	Polished Brass - Lifetime (US3) French Antique (US7)	\$118.00	\$154.00
	Privacy Set	C	8206	Diamond Crystal Knob (CK) Georgetown Knob (GT)	Oil Rubbed Bronze (US10B) Satin Nickel (US15)	\$118.00	\$154.00
	Dummy, Pair		8056	Hampton Knob (HT) Lowell Crystal Knob (LW) Old Town Clear Knob (OT) Providence Crystal Knob (PC) Windsor Crystal Knob (WS)	Pewter (US15A) Polished Chrome (US26) Unlacquered Brass (US3NL)*	\$118.00	
	Passage Set	C	8107	Astoria Clear Knob (AS) Bristol Knob (BL)	Polished Brass - Lifetime (US3) French Antique (US7)	\$118.00	\$154.00
	Privacy Set	C	8207	Diamond Crystal Knob (CK) Georgetown Knob (GT)	Oil Rubbed Bronze (US10B) Satin Nickel (US15)	\$118.00	\$154.00
	Dummy, Pair		8057	Hampton Knob (HT) Lowell Crystal Knob (LW) Old Town Clear Knob (OT) Providence Crystal Knob (PC) Windsor Crystal Knob (WS)	Pewter (US15A) Polished Chrome (US26) Unlacquered Brass (US3NL)*	\$118.00	

*Unlacquered Brass (US3NL) finish available for a \$40 List Price upcharge per item.

Handing Not Required For Knobsets

- Standard latch is for 2¾" backset. Specify 2¾" backset if required. Complete set includes latch and strike plate.
 - To order 28° Rotation latch with any standard knobset, add product code **Latch28** and list price **\$4**.
 - Crystal knobsets may also be ordered with any Modern rosette at the list price shown above.
- See page 111 for Modern rosette options.

Concealed Fastener (CF) Mechanism

- Rosettes have no exposed screws.
- Handing not required, except for Knob by Lever and split finish products.
- Door thickness for CF Mechanism is 1¾" to 1½". Specify if thicker.
- Supplied with a 28° Rotation latch.

To order: (C) Product Code + Knob Style + Finish + Add Door Thickness to Comments

Ice White Knob
with Porcelain Rosette



Ebony Knob
with Porcelain Rosette



PORCELAIN KNOBS WITH PORCELAIN ROSETTE		Description	Product Code	Knob Style	Finish (for Center Ring in Rosette)	Standard List Price
	Passage Set	8030	Ebony Knob (EB) Ice White Knob (IW)	Polished Brass - Lifetime (US3) French Antique (US7) Oil Rubbed Bronze (US10B) Satin Nickel (US15) Pewter (US15A) Flat Black (US19) Polished Chrome (US26)	\$96.00	
	Privacy Set	8040			\$96.00	
	Dummy, Pair	8003			\$96.00	

>> CF Mechanism NOT available for Porcelain Style Rosettes.

Ebony Knob
with Ribbon & Reed Rosette



Ice White Knob
with Oval Rosette



Ebony Knob
with #8 Brass Rosette



PORCELAIN KNOBS WITH BRASS ROSETTES		CF	Product Code	Knob Style	Finish	Standard List Price	CF List Price
Passage Set	C	See page 110 for Brass Modern Rosette product codes.	Ebony Knob (EB) Ice White Knob (IW)	Polished Brass - Lifetime (US3) French Antique (US7) Oil Rubbed Bronze (US10B) Satin Nickel (US15) Pewter (US15A) Flat Black (US19) Polished Chrome (US26) Unlacquered Brass (US3NL)*	\$96.00	\$132.00	
Privacy Set	C				\$96.00	\$132.00	
Dummy, Pair		See page 114-115 for Brass Rosette product codes.			\$96.00		

*Unlacquered Brass (US3NL) finish available for a \$40 List Price upcharge per item.

Handing Not Required For Knobsets

- Standard latch is for 2¾" backset. Specify 2¾" backset if required.
- To order 28° Rotation latch with any standard knobset, add product code **Latch28** and list price **\$4**.
- Complete set includes latch and strike plate.

Concealed Fastener (CF) Mechanism

- Rosettes have no exposed screws.
- Handing not required, except for Knob by Lever and split finish products.
- Door thickness for CF Mechanism is 1¾" to 1 1/8". Specify if thicker.
- Supplied with a 28° Rotation latch.

Arts & Crafts Lever
with Arts & Crafts
Rectangular Rosette



Hammered Lever
with Hammered Rosette



Hammered Egg Knob
with Arts & Crafts
Rectangular Rosette



Arts & Crafts Lever
with Hammered Rosette





Hammered Lever
with Arts & Crafts
Rectangular Rosette



Hammered Egg Knob
with Hammered Rosette



ROSETTE	Description	CF	Product Code	Knob / Lever Style	Finish	Standard List Price	CF List Price
	Passage Set	C	5105	Hammered Egg Knob (HE) Arts & Crafts Lever (AC) Hammered Lever (HM)	Oil Rubbed Bronze (US10B) Satin Nickel (US15) Flat Black (US19) Unlacquered Brass (US3NL)*	\$118.00	\$154.00
	Privacy Set	C	5205			\$118.00	\$154.00
	Dummy, Pair		5055			\$118.00	
	Passage Set	C	5106	Hammered Egg Knob (HE) Arts & Crafts Lever (AC) Hammered Lever (HM)	Oil Rubbed Bronze (US10B) Satin Nickel (US15) Flat Black (US19) Unlacquered Brass (US3NL)*	\$118.00	\$154.00
	Privacy Set	C	5206			\$118.00	\$154.00
	Dummy, Pair		5056			\$118.00	

*Unlacquered Brass (US3NL) finish available for a \$40 List Price upcharge per item.

Handing Required For Leversets

- Standard latch is for 2¾" backset. Specify 2¾" backset if required. Complete set includes latch and strike plate.
- To order 28° Rotation latch with any standard knobset/leverset, add product code **Latch28** and list price **\$4**.
- Arts & Crafts leversets/knobsets may also be ordered with any Modern or Brass rosette at the list price shown above. See page 108, 110, 116-117, 118-119 for Modern or Brass rosette options.

Concealed Fastener (CF) Mechanism

- Rosettes have no exposed screws.
- Handing not required, except for Knob by Lever and split finish products.
- Door thickness for CF Mechanism is 1⅜" to 1⅝". Specify if thicker.
- Supplied with a 28° Rotation latch.

THUMBTURN PRIVACY LOCKSETS - USE WITH BRASS PASSAGE SET

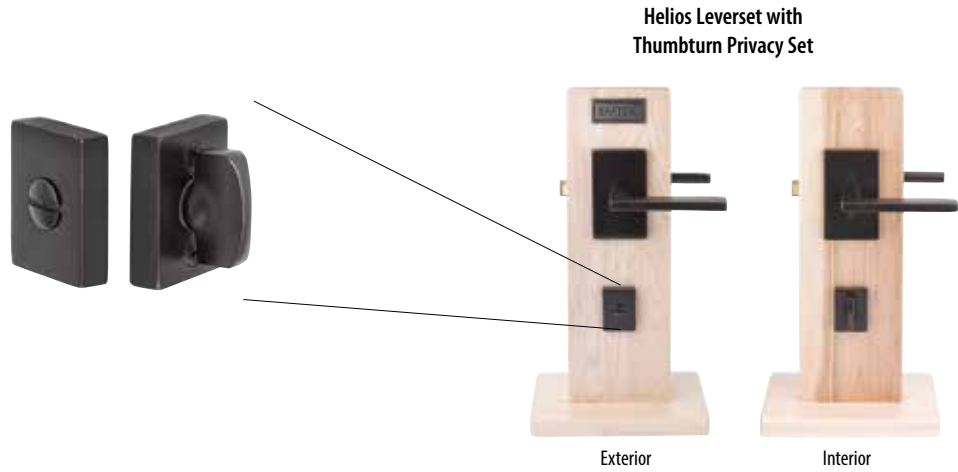

MODERN THUMBTURN PRIVACY LOCKSET	Product Code	Finish	List Price
Use with any Brass Modern passage set	818TP	Satin Brass (US4) Oil Rubbed Bronze (US10B) Polished Nickel - Lifetime (US14) Satin Nickel (US15) Flat Black (US19) Polished Chrome (US26) Unlacquered Brass (US3NL)*	\$22.00

>> Knob/Lever Lockset sold separately.

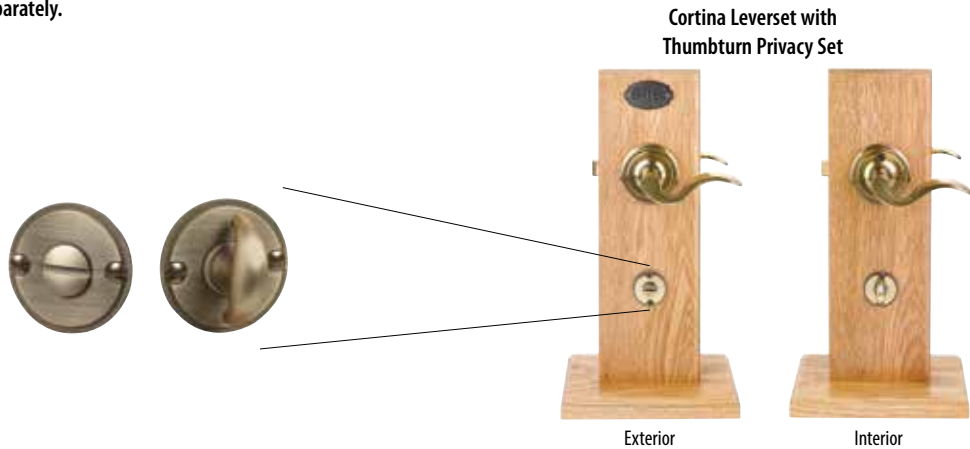

CLASSIC THUMBTURN PRIVACY LOCKSET	Product Code	Finish	List Price
Use with any Brass Classic or Brass Designer passage set	828TP	Polished Brass - Lifetime (US3) French Antique (US7) Oil Rubbed Bronze (US10B) Polished Nickel - Lifetime (US14) Satin Nickel (US15) Pewter (US15A) Flat Black (US19) Polished Chrome (US26) Unlacquered Brass (US3NL)*	\$22.00

>> Knob/Lever Lockset sold separately.

Handing Required for Leversets

- Standard latch is for 2³/₈" backset. Specify 2³/₄" backset if required.
- Complete set includes latch and strike plate.
- Thumbturn Privacy can be used with any Brass passage set.

*Unlacquered Brass (US3NL) finish available for a \$20 List Price upcharge per item.

Threaded Rod with Old Town Clear Knobs



Threaded Rod with Diamond Crystal Knobs



Threaded Rod with Astoria Clear Knobs



Threaded Rod with Georgetown Knobs



Threaded Rod with Providence Crystal Knobs



Threaded Rod with Bristol Knobs



Threaded Rod with Hampton Knobs



Threaded Rod with Ice White Porcelain Knobs



Threaded Rod with Modern Disc Crystal Knobs



Threaded Rod with Modern Square Crystal Knobs

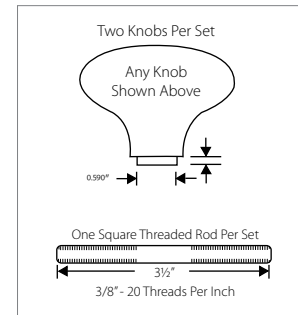

CRYSTAL KNOBS WITH THREADED ROD	Product Code	Knob Style	Finish	Standard List Price
Two Knobs Per Set	8000	Astoria Clear Knob (AS) Bristol Knob (BL) Diamond Crystal Knob (CK) Georgetown Knob (GT) Hampton Knob (HT) Lowell Crystal Knob (LW) Modern Disc Crystal Knob (MDC) Modern Square Crystal Knob (MSC) Old Town Clear Knob (OT) Providence Crystal Knob (PC) Windsor Crystal Knob (WS)	Polished Brass - Lifetime (US3) Satin Brass (US4)** French Antique (US7) Oil Rubbed Bronze (US10B) Polished Nickel - Lifetime (US14) Satin Nickel (US15) Pewter (US15A) Flat Black (US19) Polished Chrome (US26) Unlacquered Brass (US3NL)*	\$90.00

** Satin Brass (US4) available for select Modern Crystal knobs.

PORCELAIN KNOBS WITH THREADED ROD	Product Code	Knob Style	Finish	Standard List Price
Two Knobs Per Set	8000	Ebony Knob (EB) Ice White Knob (IW)	Polished Brass - Lifetime (US3) French Antique (US7) Oil Rubbed Bronze (US10B) Satin Nickel (US15) Pewter (US15A) Flat Black (US19) Polished Chrome (US26) Unlacquered Brass (US3NL)*	\$90.00

*Unlacquered Brass (US3NL) finish available for a \$20 List Price upcharge per item.

LEVERSETS - SANDCAST BRONZE

Yuma Lever
with #6 Rosette



Durango Lever
with #1 Rosette



Montrose Lever
with #3 Rosette



Cody Lever
with #2 Rosette



Lariat Lever
with #4 Rosette



Teton Lever
with #4 Rosette



Cimarron Lever
with #2 Rosette



Aurora Lever
with #6 Rosette



ROSETTE	Description	CF	Product Code	Lever Style	Finish	Standard List Price	CF List Price
	Passage Set	C	7108	Aurora Lever (AR) Cimarron Lever (CR)	Flat Black Bronze (FB) Medium Bronze (MB) Tumbled White Bronze (TWB)	\$134.00	\$170.00
	Privacy Set	C	7208	Cody Lever (CD) Durango Lever (D)		\$134.00	\$170.00
	Dummy, Pair		7058	Lariat Lever (LR) Montrose Lever (MT) Teton Lever (TT) Yuma Lever (YM)		\$134.00	
	Passage Set	C	7106	Aurora Lever (AR) Cimarron Lever (CR)	Flat Black Bronze (FB) Medium Bronze (MB) Tumbled White Bronze (TWB)	\$134.00	\$170.00
	Privacy Set	C	7206	Cody Lever (CD) Durango Lever (D)		\$134.00	\$170.00
	Dummy, Pair		7056	Lariat Lever (LR) Montrose Lever (MT) Teton Lever (TT) Yuma Lever (YM)		\$134.00	
	Passage Set	C	7104	Aurora Lever (AR) Cimarron Lever (CR)	Flat Black Bronze (FB) Medium Bronze (MB) Tumbled White Bronze (TWB)	\$134.00	\$170.00
	Privacy Set	C	7204	Cody Lever (CD) Durango Lever (D)		\$134.00	\$170.00
	Dummy, Pair		7054	Lariat Lever (LR) Montrose Lever (MT) Teton Lever (TT) Yuma Lever (YM)		\$134.00	
	Passage Set	C	7100	Aurora Lever (AR) Cimarron Lever (CR)	Flat Black Bronze (FB) Medium Bronze (MB) Tumbled White Bronze (TWB)	\$134.00	\$170.00
	Privacy Set	C	7200	Cody Lever (CD) Durango Lever (D)		\$134.00	\$170.00
	Dummy, Pair		7050	Lariat Lever (LR) Montrose Lever (MT) Teton Lever (TT) Yuma Lever (YM)		\$134.00	
	Passage Set	C	7111	Aurora Lever (AR) Cimarron Lever (CR)	Flat Black Bronze (FB) Medium Bronze (MB) Tumbled White Bronze (TWB)	\$134.00	\$170.00
	Privacy Set	C	7211	Cody Lever (CD) Durango Lever (D)		\$134.00	\$170.00
	Dummy, Pair		7061	Lariat Lever (LR) Montrose Lever (MT) Teton Lever (TT) Yuma Lever (YM)		\$134.00	

Handing Required For Leversets

- Standard latch is for 2 3/8" backset. Specify 2 3/4" backset if required.
- To order 28° Rotation latch with any standard leverset, add product code **Latch28** and list price **\$4**.
- Complete set includes latch and strike plate.

Concealed Fastener (CF) Mechanism

- Rosettes have no exposed screws.
- Handing not required, except for Knob by Lever and split finish products.
- Door thickness for CF Mechanism is 1 3/8" to 1 3/4". Specify if thicker.
- Supplied with a 28° Rotation latch.

Butte Knob
with #4 Rosette



Round Knob
with #6 Rosette



Winchester Knob
with #3 Rosette



Egg Knob
with #2 Rosette



Butte Knob
with #1 Rosette



Winchester Knob
with #2 Rosette







Egg Knob
with #4 Rosette



Round Knob
with #6 Rosette



ROSETTE	Description	CF	Product Code	Knob Style	Finish	Standard List Price	CF List Price
	Passage Set	C	7108	Butte Knob (BU) Egg Knob (BZEG)	Flat Black Bronze (FB) Medium Bronze (MB) Tumbled White Bronze (TWB)	\$134.00	\$170.00
	Privacy Set	C	7208	Round Knob (BZRN) Winchester Knob (WC)		\$134.00	\$170.00
	Dummy, Pair		7058			\$134.00	
	Passage Set	C	7106	Butte Knob (BU) Egg Knob (BZEG)	Flat Black Bronze (FB) Medium Bronze (MB) Tumbled White Bronze (TWB)	\$134.00	\$170.00
	Privacy Set	C	7206	Round Knob (BZRN) Winchester Knob (WC)		\$134.00	\$170.00
	Dummy, Pair		7056			\$134.00	
	Passage Set	C	7104	Butte Knob (BU) Egg Knob (BZEG)	Flat Black Bronze (FB) Medium Bronze (MB) Tumbled White Bronze (TWB)	\$134.00	\$170.00
	Privacy Set	C	7204	Round Knob (BZRN) Winchester Knob (WC)		\$134.00	\$170.00
	Dummy, Pair		7054			\$134.00	
	Passage Set	C	7100	Butte Knob (BU) Egg Knob (BZEG)	Flat Black Bronze (FB) Medium Bronze (MB) Tumbled White Bronze (TWB)	\$134.00	\$170.00
	Privacy Set	C	7200	Round Knob (BZRN) Winchester Knob (WC)		\$134.00	\$170.00
	Dummy, Pair		7050			\$134.00	
	Passage Set	C	7111	Butte Knob (BU) Egg Knob (BZEG)	Flat Black Bronze (FB) Medium Bronze (MB) Tumbled White Bronze (TWB)	\$134.00	\$170.00
	Privacy Set	C	7211	Round Knob (BZRN) Winchester Knob (WC)		\$134.00	\$170.00
	Dummy, Pair		7061			\$134.00	

Handing Not Required For Knobsets

- Standard latch is for 2¾" backset. Specify 2¾" backset if required.
- To order 28° Rotation latch with any standard knobset, add product code **Latch28** and list price **\$4**.
- Complete set includes latch and strike plate.

Concealed Fastener (CF) Mechanism

- Rosettes have no exposed screws.
- Handing not required, except for Knob by Lever and split finish products.
- Door thickness for CF Mechanism is 1¾" to 1⅝". Specify if thicker.
- Supplied with a 28° Rotation latch.

To order: **(C) Product Code + Knob Style + Finish + Add Door Thickness to Comments**

**Hampton Knob
with #1 Rosette**



**Lowell Crystal Knob
with #4 Rosette**



**Astoria Knob
with #6 Rosette**



**Diamond Crystal Knob
with #3 Rosette**







**Georgetown Knob
with #4 Rosette**



**Bristol Knob
with #2 Rosette**



ROSETTE	Description	CF	Product Code	Knob Style	Finish	Standard List Price	CF List Price
	Passage Set	C	7108	Astoria Clear Knob (AS) Bristol Knob (BL)	Flat Black Bronze (FB) Medium Bronze (MB) Tumbled White Bronze (TWB)	\$134.00	\$170.00
	Privacy Set	C	7208	Diamond Crystal Knob (CK) Georgetown Knob (GT)		\$134.00	\$170.00
	Dummy, Pair		7058	Hampton Knob (HT) Lowell Crystal Knob (LW)		\$134.00	
	Passage Set	C	7106	Astoria Clear Knob (AS) Bristol Knob (BL)	Flat Black Bronze (FB) Medium Bronze (MB) Tumbled White Bronze (TWB)	\$134.00	\$170.00
	Privacy Set	C	7206	Diamond Crystal Knob (CK) Georgetown Knob (GT)		\$134.00	\$170.00
	Dummy, Pair		7056	Hampton Knob (HT) Lowell Crystal Knob (LW)		\$134.00	
	Passage Set	C	7104	Astoria Clear Knob (AS) Bristol Knob (BL)	Flat Black Bronze (FB) Medium Bronze (MB) Tumbled White Bronze (TWB)	\$134.00	\$170.00
	Privacy Set	C	7204	Diamond Crystal Knob (CK) Georgetown Knob (GT)		\$134.00	\$170.00
	Dummy, Pair		7054	Hampton Knob (HT) Lowell Crystal Knob (LW)		\$134.00	
	Passage Set	C	7100	Astoria Clear Knob (AS) Bristol Knob (BL)	Flat Black Bronze (FB) Medium Bronze (MB) Tumbled White Bronze (TWB)	\$134.00	\$170.00
	Privacy Set	C	7200	Diamond Crystal Knob (CK) Georgetown Knob (GT)		\$134.00	\$170.00
	Dummy, Pair		7050	Hampton Knob (HT) Lowell Crystal Knob (LW)		\$134.00	
	Passage Set	C	7111	Astoria Clear Knob (AS) Bristol Knob (BL)	Flat Black Bronze (FB) Medium Bronze (MB) Tumbled White Bronze (TWB)	\$134.00	\$170.00
	Privacy Set	C	7211	Diamond Crystal Knob (CK) Georgetown Knob (GT)		\$134.00	\$170.00
	Dummy, Pair		7061	Hampton Knob (HT) Lowell Crystal Knob (LW)		\$134.00	

Handing Not Required For Knobsets

- Standard latch is for 2¾" backset. Specify 2¾" backset if required.
- To order 28° Rotation latch with any standard knobset, add product code **Latch28** and list price **\$4**.
- Complete set includes latch and strike plate.

Concealed Fastener (CF) Mechanism

- Rosettes have no exposed screws.
- Handing not required, except for Knob by Lever and split finish products.
- Door thickness for CF Mechanism is 1¾" to 1⅝". Specify if thicker.
- Supplied with a 28° Rotation latch.

Providence Crystal Knob
with #2 Rosette



Modern Disc Crystal Knob
with #6 Rosette



Old Town Clear Crystal Knob
with #1 Rosette



Windsor Crystal Knob
with #1 Rosette







Providence Crystal Knob
with #3 Rosette



Modern Square Crystal Knob
with #3 Rosette



ROSETTE	Description	CF	Product Code	Knob Style	Finish	Standard List Price	CF List Price
	Passage Set	C	7108	Modern Disc Crystal Knob (MDC) Modern Square Crystal Knob (MSC) Old Town Clear Knob (OT) Providence Crystal Knob (PC) Windsor Crystal Knob (WS)	Flat Black Bronze (FB) Medium Bronze (MB) Tumbled White Bronze (TWB)	\$134.00	\$170.00
	Privacy Set	C	7208			\$134.00	\$170.00
	Dummy, Pair		7058			\$134.00	
	Passage Set	C	7106	Modern Disc Crystal Knob (MDC) Modern Square Crystal Knob (MSC) Old Town Clear Knob (OT) Providence Crystal Knob (PC) Windsor Crystal Knob (WS)	Flat Black Bronze (FB) Medium Bronze (MB) Tumbled White Bronze (TWB)	\$134.00	\$170.00
	Privacy Set	C	7206			\$134.00	\$170.00
	Dummy, Pair		7056			\$134.00	
	Passage Set	C	7104	Modern Disc Crystal Knob (MDC) Modern Square Crystal Knob (MSC) Old Town Clear Knob (OT) Providence Crystal Knob (PC) Windsor Crystal Knob (WS)	Flat Black Bronze (FB) Medium Bronze (MB) Tumbled White Bronze (TWB)	\$134.00	\$170.00
	Privacy Set	C	7204			\$134.00	\$170.00
	Dummy, Pair		7054			\$134.00	
	Passage Set	C	7100	Modern Disc Crystal Knob (MDC) Modern Square Crystal Knob (MSC) Old Town Clear Knob (OT) Providence Crystal Knob (PC) Windsor Crystal Knob (WS)	Flat Black Bronze (FB) Medium Bronze (MB) Tumbled White Bronze (TWB)	\$134.00	\$170.00
	Privacy Set	C	7200			\$134.00	\$170.00
	Dummy, Pair		7050			\$134.00	
	Passage Set	C	7111	Modern Disc Crystal Knob (MDC) Modern Square Crystal Knob (MSC) Old Town Clear Knob (OT) Providence Crystal Knob (PC) Windsor Crystal Knob (WS)	Flat Black Bronze (FB) Medium Bronze (MB) Tumbled White Bronze (TWB)	\$134.00	\$170.00
	Privacy Set	C	7211			\$134.00	\$170.00
	Dummy, Pair		7061			\$134.00	

Handing Not Required For Knobsets

- Standard latch is for 2 3/8" backset. Specify 2 3/4" backset if required.
- To order 28° Rotation latch with any standard knobset, add product code **Latch28** and list price **\$4**.
- Complete set includes latch and strike plate.

Concealed Fastener (CF) Mechanism

- Rosettes have no exposed screws.
- Handing not required, except for Knob by Lever and split finish products.
- Door thickness for CF Mechanism is 1 3/8" to 1 3/4". Specify if thicker.
- Supplied with a 28° Rotation latch.

To order: **(C) Product Code + Knob Style + Finish + Add Door Thickness to Comments**

Medici Lever
with #14 Rosette



Napoli Lever
with #12 Rosette



Octagon Lever
with #11 Rosette



Padua Lever
with #11 Rosette



Octagon Lever
with #15 Rosette



Medici Lever
with #12 Rosette



ROSETTE	Description	CF	Product Code	Lever Style	Finish	Standard List Price	CF List Price
	Passage Set	C	71011	Medici Lever (MDI) Napoli Lever (NA) Octagon Lever (OCL) Padua Lever (PD)	Flat Black Bronze (FB) Medium Bronze (MB)	\$134.00	\$170.00
	Privacy Set	C	72011			\$134.00	\$170.00
	Dummy, Pair		70511			\$134.00	
	Passage Set	C	71012	Medici Lever (MDI) Napoli Lever (NA) Octagon Lever (OCL) Padua Lever (PD)	Flat Black Bronze (FB) Medium Bronze (MB)	\$134.00	\$170.00
	Privacy Set	C	72012			\$134.00	\$170.00
	Dummy, Pair		70512			\$134.00	
	Passage Set	C	71014	Medici Lever (MDI) Napoli Lever (NA) Octagon Lever (OCL) Padua Lever (PD)	Flat Black Bronze (FB) Medium Bronze (MB)	\$134.00	\$170.00
	Privacy Set	C	72014			\$134.00	\$170.00
	Dummy, Pair		70514			\$134.00	
	Passage Set	C	71015	Medici Lever (MDI) Napoli Lever (NA) Octagon Lever (OCL) Padua Lever (PD)	Flat Black Bronze (FB) Medium Bronze (MB)	\$134.00	\$170.00
	Privacy Set	C	72015			\$134.00	\$170.00
	Dummy, Pair		70515			\$134.00	

Handing Required For Leversets

- Standard latch is for 2¾" backset. Specify 2¼" backset if required.
- To order 28° Rotation latch with any standard leverset, add product code **Latch28** and list price **\$4**.
- Complete set includes latch and strike plate.

Concealed Fastener (CF) Mechanism

- Rosettes have no exposed screws.
- Handing not required, except for Knob by Lever and split finish products.
- Door thickness for CF Mechanism is 1¾" to 1½". Specify if thicker.
- Supplied with a 28° Rotation latch.

**Petal Knob
with #12 Rosette**



**Octagon Knob
with #11 Rosette**



**Parma Knob
with #14 Rosette**



**Octagon Knob
with #15 Rosette**



**Parma Knob
with #12 Rosette**



**Petal Knob
with #11 Rosette**



ROSETTE	Description	CF	Product Code	Knob Style	Finish	Standard List Price	CF List Price
	Passage Set	C	71011	Octagon Knob (OCK) Parma Knob (PA)	Flat Black Bronze (FB) Medium Bronze (MB)	\$134.00	\$170.00
	Privacy Set	C	72011	Petal Knob (PT)		\$134.00	\$170.00
	Dummy, Pair		70511			\$134.00	
	Passage Set	C	71012	Octagon Knob (OCK) Parma Knob (PA)	Flat Black Bronze (FB) Medium Bronze (MB)	\$134.00	\$170.00
	Privacy Set	C	72012	Petal Knob (PT)		\$134.00	\$170.00
	Dummy, Pair		70512			\$134.00	
	Passage Set	C	71014	Octagon Knob (OCK) Parma Knob (PA)	Flat Black Bronze (FB) Medium Bronze (MB)	\$134.00	\$170.00
	Privacy Set	C	72014	Petal Knob (PT)		\$134.00	\$170.00
	Dummy, Pair		70514			\$134.00	
	Passage Set	C	71015	Octagon Knob (OCK) Parma Knob (PA)	Flat Black Bronze (FB) Medium Bronze (MB)	\$134.00	\$170.00
	Privacy Set	C	72015	Petal Knob (PT)		\$134.00	\$170.00
	Dummy, Pair		70515			\$134.00	

Handing Not Required For Knobsets

- Standard latch is for 2 3/8" backset. Specify 2 3/4" backset if required.
- To order 28° Rotation latch with any standard knobset, add product code **Latch28** and list price **\$4**.
- Complete set includes latch and strike plate.

Concealed Fastener (CF) Mechanism

- Rosettes have no exposed screws.
- Handing not required, except for Knob by Lever and split finish products.
- Door thickness for CF Mechanism is 1 3/8" to 1 1/2". Specify if thicker.
- Supplied with a 28° Rotation latch.

To order: **(C) Product Code + Knob Style + Finish + Add Door Thickness to Comments**

San Carlos Lever
with #2 Rosette



Normandy Lever
with #2 Rosette



San Carlos Lever
with #3 Rosette



Lafayette Lever
with #1 Rosette



San Carlos Lever
with #1 Rosette



Lafayette Lever
with #3 Rosette



ROSETTE	Description	Product Code	Lever Style	Finish	Standard List Price
<p>#1</p> 	Passage Set	7101	Lafayette Lever (L) Normandy Lever (N) San Carlos Lever (SC)	Flat Black Steel (FBS) Satin Steel (SWS)	\$86.00
	Privacy Set	7201			\$86.00
	Dummy, Pair	7051			\$86.00
<p>#2</p> 	Passage Set	7102	Lafayette Lever (L) Normandy Lever (N) San Carlos Lever (SC)	Flat Black Steel (FBS) Satin Steel (SWS)	\$86.00
	Privacy Set	7202			\$86.00
	Dummy, Pair	7052			\$86.00
<p>#3</p> 	Passage Set	7103	Lafayette Lever (L) Normandy Lever (N) San Carlos Lever (SC)	Flat Black Steel (FBS) Satin Steel (SWS)	\$86.00
	Privacy Set	7203			\$86.00
	Dummy, Pair	7053			\$86.00

Handing Required For Leversets

- Standard latch is for 2 3/8" backset. Specify 2 3/4" backset if required.
- To order 28° Rotation latch with any standard leverset, add product code **Latch28** and list price **\$4**.
- Complete set includes latch and strike plate.

CF Mechanism NOT available for Wrought Steel products.

Savannah Knob
with #3 Rosette



Madison Ivory Knob
with #1 Rosette



Jamestown Knob
with #1 Rosette



Jamestown Knob
with #3 Rosette



Savannah Knob
with #1 Rosette



Madison Black Knob
with #2 Rosette



ROSETTE	Description	Product Code	Knob Style	Finish	Standard List Price
#1 	Passage Set	7101	Jamestown Knob (J)	Flat Black Steel (FBS) Satin Steel (SWS)	\$96.00
	Privacy Set	7201	Madison Black Knob (MB) Madison Ivory Knob (MI) Savannah Knob (SV)		\$96.00
	Dummy, Pair	7051			\$96.00
#2 	Passage Set	7102	Jamestown Knob (J)	Flat Black Steel (FBS) Satin Steel (SWS)	\$96.00
	Privacy Set	7202	Madison Black Knob (MB) Madison Ivory Knob (MI) Savannah Knob (SV)		\$96.00
	Dummy, Pair	7052			\$96.00
#3 	Passage Set	7103	Jamestown Knob (J)	Flat Black Steel (FBS) Satin Steel (SWS)	\$96.00
	Privacy Set	7203	Madison Black Knob (MB) Madison Ivory Knob (MI) Savannah Knob (SV)		\$96.00
	Dummy, Pair	7053			\$96.00

Handing Not Required For Knobsets

- Standard latch is for 23/8" backset. Specify 23/4" backset if required.
- To order 28° Rotation latch with any standard knobset, add product code **Latch28** and list price **\$4**.
- Complete set includes latch and strike plate.

CF Mechanism NOT available for Wrought Steel products.

LEVERSETS & KNOBSETS - STAINLESS STEEL

Cologne Lever with Disk Rosette



Dresden Lever with Square Rosette



Kiel Lever with Beveled Rosette



Stuttgart Lever with Disk Rosette



TUBULAR STAINLESS STEEL LEVERSETS	CF	Product Code	Rosette Style	Lever Style	Finish	Standard List Price	CF List Price
Passage Set	C	S100	Beveled (01) Disk (02) Square (03)	Cologne Lever (CO)	Brushed Stainless Steel (SS)	\$86.00	\$118.00
Privacy Set	C	S200		Dresden Lever (DD)		\$86.00	\$118.00
Dummy, Pair		S300		Kiel Lever (KL) Stuttgart Lever (STT)		\$86.00	

Athena Lever with Square Rosette



Hercules Lever with Disk Rosette



Hermes Lever with Beveled Rosette



Poseidon Lever with Disk Rosette



Helios Lever with Square Rosette



CAST STAINLESS STEEL LEVERSETS	CF	Product Code	Rosette Style	Lever Style	Finish	Standard List Price	CF List Price
Passage Set	C	S100	Beveled (01) Disk (02) Square (03)	Athena Lever (AT)	Brushed Stainless Steel (SS)	\$124.00	\$156.00
Privacy Set	C	S200		Hercules Lever (HS)		\$124.00	\$156.00
Dummy, Pair		S300		Helios Lever (HL) Hermes Lever (HES) Poseidon Lever (PO)		\$124.00	

Octagon Knob with Beveled Rosette



Round Knob with Disk Rosette



Octagon Knob with Square Rosette



CAST STAINLESS STEEL KNOBSETS	CF	Product Code	Rosette Style	Knob Style	Finish	Standard List Price	CF List Price
Passage Set	C	S100	Beveled (01) Disk (02) Square (03)	Octagon Knob (OK)	Brushed Stainless Steel (SS)	\$124.00	\$156.00
Privacy Set	C	S200		Round Knob (RNK)		\$124.00	\$156.00
Dummy, Pair		S300				\$124.00	

Handing Required For Leversets

- Standard latch is for 2 3/8" backset. Specify 2 3/4" backset if required.
- Supplied with a 28° Rotation latch.
- Complete set includes latch and strike plate.

Concealed Fastener (CF) Mechanism

- Rosettes have no exposed screws.
- Handing not required, except for Knob by Lever and split finish products.
- Door thickness for CF Mechanism is 1 3/8" to 1 5/8". Specify if thicker.
- Supplied with a 28° Rotation latch.



Standard Appliance and Door Pulls

Appliance/Door pulls are drilled and tapped for $\frac{3}{8}$ "-16 thread to accommodate thread adapters.

Supplied with:

- Two- Thread adapter for $\frac{1}{4}$ -20 thread
- Two- $\frac{1}{4}$ -20 Flat head machine screws x 1" long
- Two- Thread adapters for 10-32 thread
- Two- 10-32 Flat head machine screws x 1" long
- Two- 10-32 Flat head machine screws x 2" long
- Two- Threaded Washers
- Two- Decorative Caps



Back to Back Appliance and Door Pulls

Most standard appliance pulls and door pulls are available in Back to Back function. Fits door thickness from $1\frac{3}{8}$ " to $2\frac{1}{4}$ ". Specify if thicker.

Supplied with:

- One grip with 10-32 threads in the stem
- One mating grip with $\frac{3}{8}$ " diameter hole in the stem
- Two $\frac{3}{8}$ " diameter bevel head screws with 10-32 shaft by $3\frac{1}{4}$ " long
- Two 10-32 set screws

HOW TO ORDER

Add **FUNCTION** to the Product Code, and Finish. For example:

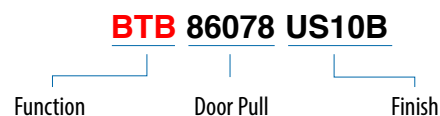



12" & 18" APPLIANCE PULLS		Back To Back	Product Code	Finish	List Price	Back To Back List Price
Bauhaus	12" Appliance Pull	BTB	86345	Satin Brass (US4) Oil Rubbed Bronze (US10B) Polished Nickel (US14) Satin Nickel (US15) Flat Black (US19) Polished Chrome (US26) Unlacquered Brass (US3NL)*	\$124.00	\$248.00
	18" Appliance Pull	BTB	86346		\$180.00	\$360.00
Trail	12" Appliance Pull	BTB	86440		\$124.00	\$248.00
	18" Appliance Pull	BTB	86441		\$180.00	\$360.00
Trinity**	12" Appliance Pull	BTB	86444		\$124.00	\$248.00
	18" Appliance Pull	BTB	86445		\$180.00	\$360.00
Bar	12" Appliance Pull	BTB	86351		\$124.00	\$248.00
	18" Appliance Pull	BTB	86352		\$180.00	\$360.00
Alexander**	12" Appliance Pull	BTB	86442		\$124.00	\$248.00
	18" Appliance Pull	BTB	86443		\$180.00	\$360.00

*Unlacquered Brass (US3NL) finish available for a \$20 List Price upcharge per Door/Appliance pull. Back to Back pulls are available for a \$40 List Price upcharge per pair.

**Unlacquered Brass (US3NL) NOT available for Trinity and Alexander Appliance pulls.



12" & 18" APPLIANCE PULLS		Back To Back	Product Code	Finish	List Price	Back To Back List Price
Spindle	12" Appliance Pull	BTB	86343	Polished Brass (US3) French Antique (US7)	\$124.00	\$248.00
	18" Appliance Pull	BTB	86344	Oil Rubbed Bronze (US10B) Polished Nickel (US14) Satin Nickel (US15) Pewter (US15A) Flat Black (US19) Polished Chrome (US26) Unlacquered Brass (US3NL)*	\$180.00	\$360.00
Rail Sandcast Bronze	12" Appliance Pull	BTB	86349	Flat Black Bronze (FB) Medium Bronze (MB)	\$136.00	\$272.00
	18" Appliance Pull	BTB	86350	Tumbled White Bronze (TWB)	\$190.00	\$380.00
Fluted Lost Wax Cast Bronze	12" Appliance Pull	BTB	86347	Flat Black Bronze (FB) Medium Bronze (MB)	\$136.00	\$272.00
	18" Appliance Pull	BTB	86348		\$190.00	\$380.00

*Unlacquered Brass (US3NL) finish available for a \$20 List Price upcharge per Door/Appliance pull. Back to Back pulls are available for a \$40 List Price upcharge per pair.

DOOR PULLS - SOLID BRASS & STAINLESS STEEL



BRASS & STAINLESS STEEL 8" DOOR PULLS May Be Used Separately or With Pull Plates		Back To Back	Product Code	Finish	List Price	Back To Back List Price
Wilshire 8" Door Pull	BTB	86078	Polished Brass - Lifetime (US3) French Antique (US7) Oil Rubbed Bronze (US10B) Polished Nickel - Lifetime (US14) Satin Nickel (US15) Pewter (US15A) Flat Black (US19) Polished Chrome (US26) Unlacquered Brass (US3NL)*	\$88.00	\$176.00	
Knoxville 8" Door Pull	BTB	86077	Polished Brass - Lifetime (US3) French Antique (US7) Oil Rubbed Bronze (US10B) Satin Nickel (US15) Pewter (US15A) Polished Chrome (US26) Unlacquered Brass (US3NL)*	\$88.00	\$176.00	
Ribbon & Reed 8" Door Pull	BTB	86080	Polished Brass - Lifetime (US3) French Antique (US7) Oil Rubbed Bronze (US10B) Satin Nickel (US15) Pewter (US15A) Polished Chrome (US26) Unlacquered Brass (US3NL)*	\$88.00	\$176.00	
Arts & Crafts 8" Door Pull	BTB	86079	Oil Rubbed Bronze (US10B) Satin Nickel (US15) Flat Black (US19) Unlacquered Brass (US3NL)*	\$88.00	\$176.00	
Baden 8" Door Pull	BTB	86184	Satin Brass (US4)** Oil Rubbed Bronze (US10B) Polished Nickel - Lifetime (US14)**	\$88.00	\$176.00	
Zeus 8" Door Pull	BTB	86183	Satin Nickel (US15) Flat Black (US19) Polished Chrome (US26) Unlacquered Brass (US3NL)*	\$88.00	\$176.00	
Baden Stainless Steel 8" Door Pull	BTB	S86002	Brushed Stainless Steel (SS)	\$88.00	\$176.00	
Zeus Stainless Steel 8" Door Pull	BTB	S86001		\$88.00	\$176.00	

*Unlacquered Brass (US3NL) finish available for a \$20 List Price upcharge per Door/Appliance Pull. Back to Back pulls are available for a \$40 List Price upcharge per pair.

**Polished Nickel - Lifetime (US14) and Satin Brass (US4) are available only for Baden Door Pull.

Modern Push Plate



Modern Pull Plate (Plate Only)
Drilled to accept 8" pull

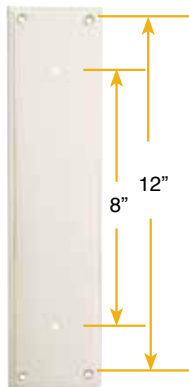

Example:
Combination of 8" Baden Pull
and 3"W x 12"H Modern Pull Plate



MODERN PUSH & PULL PLATES Supplied with 4 Wood Screws		Product Code	Finish	List Price
Modern Push Plate	86436	86437	Satin Brass (US4) Oil Rubbed Bronze (US10B) Polished Nickel - Lifetime (US14) Satin Nickel (US15) Flat Black (US19) Polished Chrome (US26) Unlacquered Brass (US3NL)*	\$66.00 (Plate Only)
Modern Pull Plate				\$66.00 (Plate Only)

Knoxville Push Plate



Knoxville Pull Plate (Plate Only)
Drilled to accept 8" pull

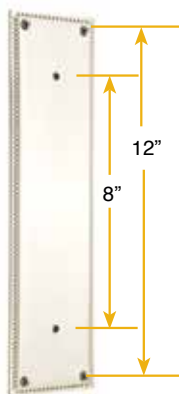

Example:
Combination of 8" Knoxville Pull
and 3"W x 12"H Knoxville Pull Plate



KNOXVILLE PUSH & PULL PLATES Supplied with 4 Wood Screws		Product Code	Finish	List Price
Knoxville Push Plate	86081	86082	Polished Brass - Lifetime (US3) French Antique (US7) Oil Rubbed Bronze (US10B) Satin Nickel (US15) Pewter (US15A) Polished Chrome (US26) Unlacquered Brass (US3NL)*	\$66.00 (Plate Only)
Knoxville Pull Plate				\$66.00 (Plate Only)

*Unlacquered Brass (US3NL) finish available for a \$20 List Price upcharge per item. Pull plates and pulls must be ordered separately.

DOOR PULLS - SANDCAST BRONZE

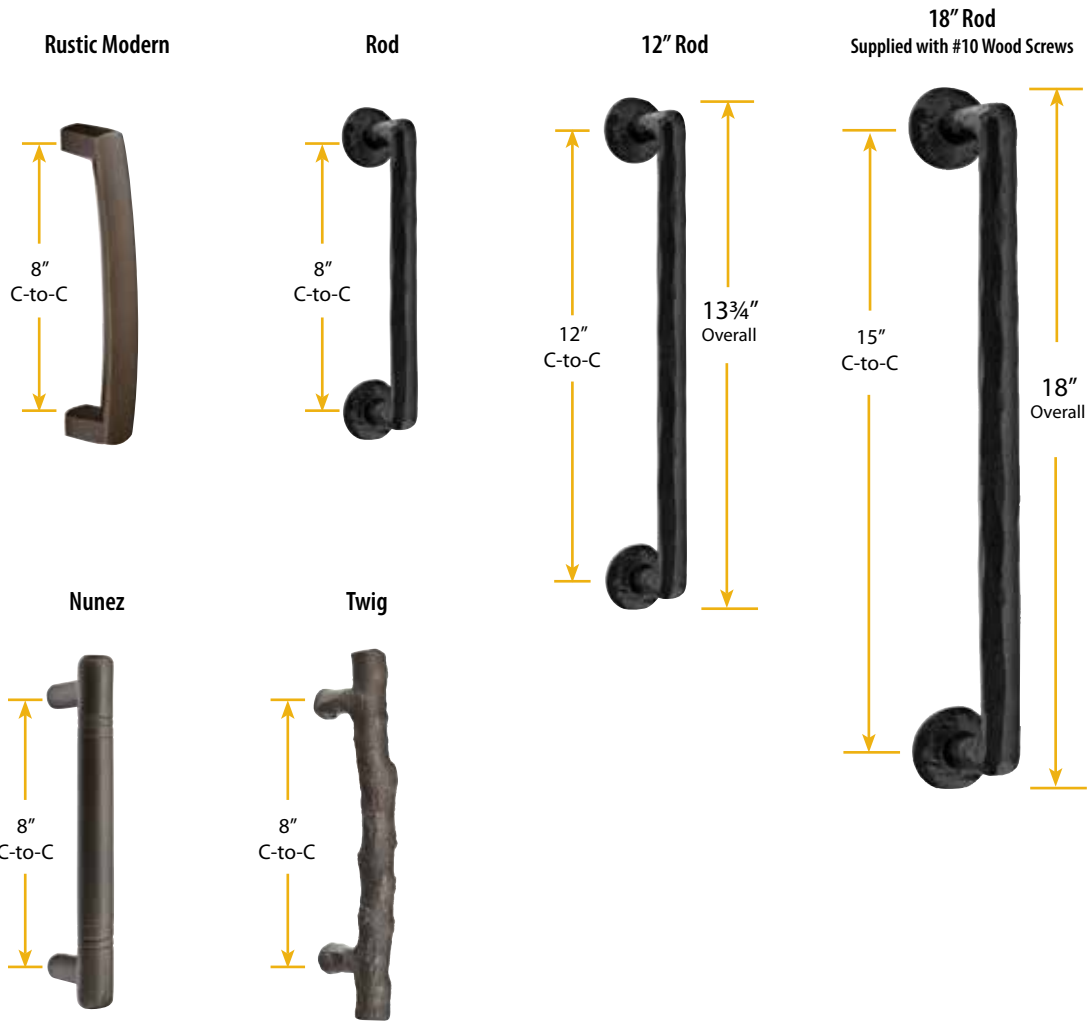

SANDCAST BRONZE DOOR PULLS 8", 12", and 18"		Back To Back	Product Code	Finish	List Price	Back To Back List Price
Rustic Modern Bronze 8" Pull	BTB	86439	Flat Black Bronze (FB) Medium Bronze (MB) Tumbled White Bronze (TWB)		\$114.00	\$228.00
Nunez Bronze 8" Pull	BTB	86160			\$114.00	\$228.00
Twig Bronze 8" Pull	BTB	86090			\$114.00	\$228.00
Rod Bronze 8" Pull	BTB	86088			\$114.00	\$228.00
Rod Bronze 12" Pull	BTB	86068			\$138.00	\$276.00
Rod Bronze 18" Pull		86089			\$216.00	

Twist

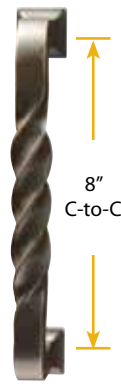

Palermo

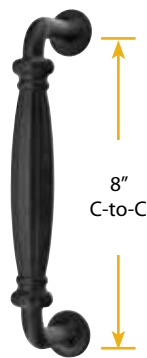

Art Nouveau
Supplied with 1-1/16" Threaded Tube

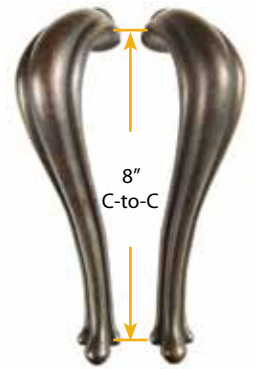

Left Hand Right Hand

Column

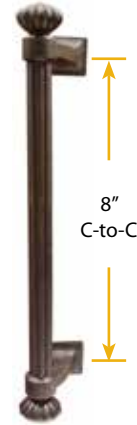

Recoleta

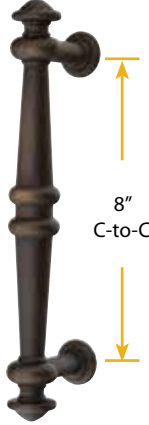

LOST WAX CAST BRONZE 8" DOOR PULLS May Be Used Separately or With Pull Plates	Back To Back	Product Code	Finish	List Price	Back To Back List Price
Twist 8" Pull	BTB	86069	Flat Black Bronze (FB) Medium Bronze (MB)	\$114.00	\$228.00
Column 8" Pull	BTB	86156		\$114.00	\$228.00
Palermo 8" Pull	BTB	86167		\$114.00	\$228.00
Recoleta 8" Pull	BTB	86168		\$114.00	\$228.00
Art Nouveau 8" Pull (Left Hand)		86144LH		\$114.00	
Art Nouveau 8" Pull (Right Hand)		86144RH		\$114.00	

Petal Pull Plate

Petal Push Plate
3" W x 12" H

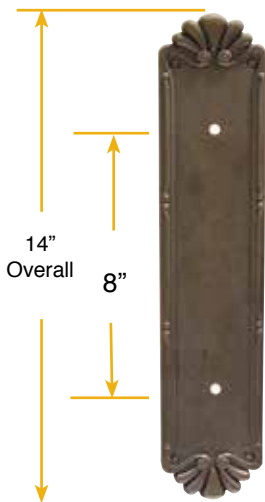

PETAL PUSH & PULL PLATES Supplied with 4 Wood Screws	Product Code	Finish	List Price
Petal Push Plate	86181	Flat Black Bronze (FB) Medium Bronze (MB)	\$110.00 <i>Plate Only</i>
Petal Pull Plate	86182		\$110.00 <i>Plate Only</i>

>> Pull plates and pulls must be ordered separately.

DOOR PULLS - LOST WAX CAST BRONZE

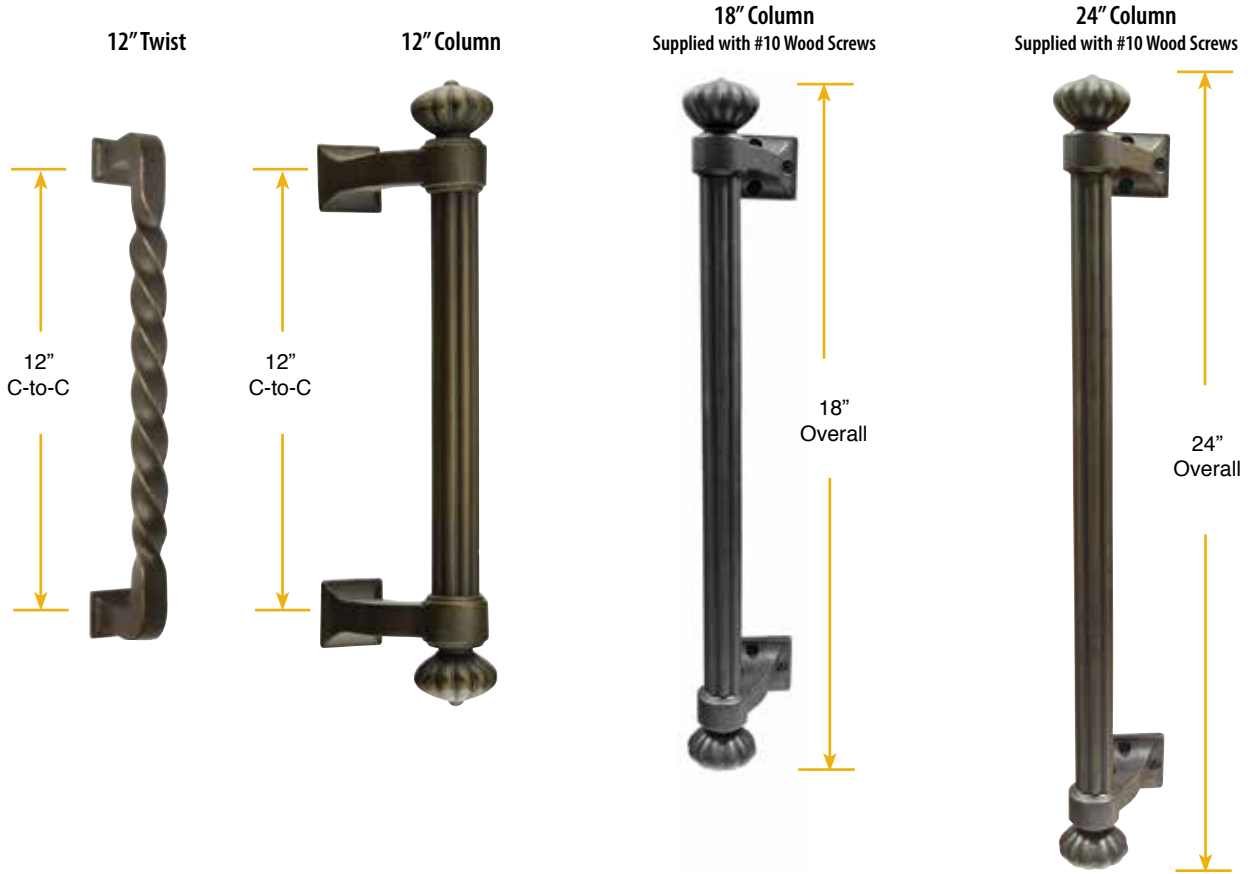

LOST WAX CAST BRONZE DOOR PULLS 12", 18", and 24"		Back To Back	Product Code	Finish	List Price	Back To Back List Price
Twist 12" Pull	BTB	86169	Flat Black Bronze (FB) Medium Bronze (MB)		\$138.00	\$276.00
Column 12" Pull	BTB	86159			\$200.00	\$400.00
Column 18" Pull		86157			\$340.00	
Column 24" Pull		86158			\$400.00	

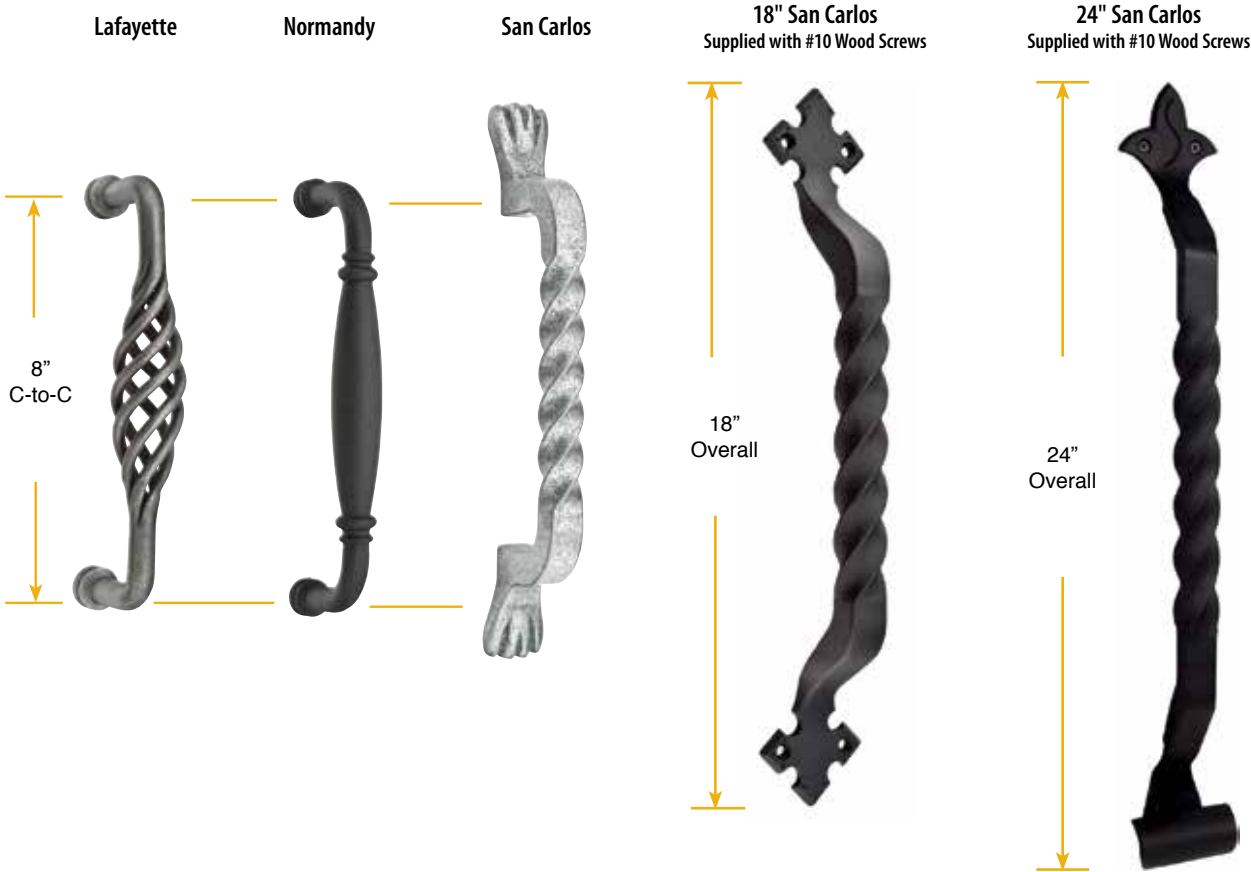

WROUGHT STEEL DOOR PULLS 8", 18", and 24"		Back To Back	Product Code	Finish	List Price	Back To Back List Price
Lafayette 8" Pull	BTB	76030	Flat Black Steel (FBS) Satin Steel (SWS)		\$88.00	\$176.00
Normandy 8" Pull	BTB	76031			\$88.00	\$176.00
San Carlos 8" Pull	BTB	76028			\$88.00	\$176.00
San Carlos 18" Pull		76029			\$140.00	
San Carlos 24" Pull		76041			\$180.00	

4" Dutch Door Bolt



DUTCH DOOR BOLT	Product Code	Finish	List Price
4"	8516	Polished Brass (US3) Satin Brass (US4) French Antique (US7) Oil Rubbed Bronze (US10B) Polished Nickel (US14) Satin Nickel (US15) Pewter (US15A) Flat Black (US19) Polished Chrome (US26) Medium Bronze (MB) Tumbled White Bronze (TWB) Unlacquered Brass (US3NL)*	\$26.00

>> Supplied with 2 types of strike plates and finish matching screws.



Lip Strike

Mortise Strike

Solid Brass Surface Bolts



SOLID BRASS SURFACE BOLTS	Product Code	Finish	List Price
6"	8511	Polished Brass - Lifetime (US3) Satin Brass (US4) French Antique (US7)	\$46.00
8"	8515	Oil Rubbed Bronze (US10B) Polished Nickel - Lifetime (US14) Satin Nickel (US15)	\$54.00
12"	8512	Pewter (US15A) Flat Black (US19) Polished Chrome (US26)	\$60.00
18"	8513	Medium Bronze (MB) Tumbled White Bronze (TWB) Unlacquered Brass (US3NL)*	\$74.00
24"	8514		\$88.00

>> Supplied with 3 types of strike plates and finish matching screws.



Lip Strike

Mortise Strike

Angle Strike

*Unlacquered Brass (US3NL) finish available for a \$20 List Price upcharge per item.

Concealed Screw Surface Bolts



CONCEALED SCREW SURFACE BOLTS	Product Code	Finish	List Price
4"	8527	Polished Brass (US3) Satin Brass (US4) French Antique (US7)	\$12.00
6"	8528	Oil Rubbed Bronze (US10B) Polished Nickel (US14) Satin Nickel (US15)	\$15.00
8"	8529	Pewter (US15A) Flat Black (US19) Polished Chrome (US26)	\$18.00
12"	8530	Unlacquered Brass (US3NL)*	\$21.00

>> Supplied with 3 types of strike plates and finish matching screws.



Flush Bolts Square & Radius Corners



FLUSH BOLTS	Product Code	Finish	List Price
4" with Square Corners	8505	Polished Brass - Lifetime (US3) Satin Brass (US4) French Antique (US7)	\$10.00
4" with 5/8" Radius Corners	8506	Oil Rubbed Bronze (US10B) Polished Nickel - Lifetime (US14) Satin Nickel (US15)	\$10.00
6" with Square Corners	8501	Pewter (US15A) Flat Black (US19) Polished Chrome (US26)	\$12.00
6" with 5/8" Radius Corners	8502	Medium Bronze (MB) Tumbled White Bronze (TWB) Unlacquered Brass (US3NL)*	\$12.00
12" with Square Corners	8503		\$24.00
12" with 5/8" Radius Corners	8504		\$24.00

*Unlacquered Brass (US3NL) finish available for a \$20 List Price upcharge per item.

Modern Brass Double Hook with Rosette



MODERN BRASS DOUBLE HOOK WITH ROSETTE	Product Code	Finish	List Price
See Page 4 for available Modern Brass Rosette options.	2809	Satin Brass (US4) Oil Rubbed Bronze (US10B) Polished Nickel - Lifetime (US14) Satin Nickel (US15) Flat Black (US19) Polished Chrome (US26) Unlacquered Brass (US3NL)*	\$36.00

Solid Brass Double Hook with Rosette



SOLID BRASS DOUBLE HOOK WITH ROSETTE	Product Code	Finish	List Price
See Page 4 for available Classic & Designer Brass Rosette options.	2609	Polished Brass - Lifetime (US3) French Antique (US7) Oil Rubbed Bronze (US10B) Polished Nickel - Lifetime (US14) Satin Nickel (US15) Pewter (US15A) Flat Black (US19) Polished Chrome (US26) Unlacquered Brass (US3NL)*	\$28.00

Solid Brass Double Hook



SOLID BRASS DOUBLE HOOK	Product Code	Finish	List Price
Height: 1¾" Projection: 2⅞"	2607	Polished Brass - Lifetime (US3) French Antique (US7) Oil Rubbed Bronze (US10B) Polished Nickel - Lifetime (US14) Satin Nickel (US15) Pewter (US15A) Polished Chrome (US26) Unlacquered Brass (US3NL)*	\$16.00

Solid Brass Robe Hook



SOLID BRASS ROBE HOOK	Product Code	Finish	List Price
Height: 4" Projection: 2⅞"	2606	Polished Brass - Lifetime (US3) Satin Brass (US4) French Antique (US7) Oil Rubbed Bronze (US10B) Polished Nickel - Lifetime (US14) Satin Nickel (US15) Pewter (US15A) Flat Black (US19) Polished Chrome (US26) Unlacquered Brass (US3NL)*	\$16.00

*Unlacquered Brass (US3NL) finish available for a \$20 List Price upcharge per item.

Solid Brass Single Hook



SOLID BRASS SINGLE HOOK	Product Code	Finish	List Price
See Page 4 for available Classic & Designer Brass Rosette options.	2608	Polished Brass - Lifetime (US3) French Antique (US7) Oil Rubbed Bronze (US10B) Polished Nickel - Lifetime (US14) Satin Nickel (US15) Pewter (US15A) Flat Black (US19) Polished Chrome (US26) Unlacquered Brass (US3NL)*	\$26.00

*Unlacquered Brass (US3NL) finish available for a \$20 List Price upcharge per item.

Sandcast Bronze 3 Hooks with Rectangular Plate



SANDCAST BRONZE 3 HOOKS WITH RECTANGULAR PLATE	Product Code	Finish	List Price
9½" x 2" Projection: 2½"	2307	Flat Black (FB) Medium Bronze (MB) Tumbled White Bronze (TWB)	\$62.00

Sandcast Bronze Double Hook



SANDCAST BRONZE DOUBLE HOOK	Product Code	Finish	List Price
Height: 1½" Projection: 2"	2306	Flat Black (FB) Medium Bronze (MB) Tumbled White Bronze (TWB)	\$20.00

Sandcast Bronze Robe Hook



SANDCAST BRONZE ROBE HOOK	Product Code	Finish	List Price
Height: 4" Projection: 3¾"	86106	Flat Black (FB) Medium Bronze (MB) Tumbled White Bronze (TWB)	\$20.00

Sandcast Bronze Single Hook



SANDCAST BRONZE SINGLE HOOK	Product Code	Finish	List Price
See Page 5 for available Sandcast Bronze Rosette options.	2308	Flat Black Bronze (FB) Medium Bronze (MB) Tumbled White Bronze (TWB)	\$26.00

Tuscany Bronze Robe Hook



TUSCANY BRONZE ROBE HOOK	Product Code	Finish	List Price
Height: 1¾" Projection: 2½"	2707	Flat Black Bronze (FB) Medium Bronze (MB)	\$26.00

Tuscany Bronze Single Hook



TUSCANY BRONZE SINGLE HOOK	Product Code	Finish	List Price
See Page 6 for available Tuscany Bronze Rosette options.	2706	Flat Black Bronze (FB) Medium Bronze (MB)	\$26.00

Wrought Steel Robe Hook



WROUGHT STEEL ROBE HOOK	Product Code	Finish	List Price
Height: 3¾" Projection: 3"	25050	Flat Black Steel (FBS) Satin Steel (SWS)	\$8.00

Stainless Steel Single Hook



STAINLESS STEEL SINGLE HOOK	Product Code	Finish	List Price
Projection: 2½"	S71001	Brushed Stainless Steel	\$30.00

Window Utility Pulls



WINDOW UTILITY PULLS	Product Code	Finish	List Price
4"	2244	Polished Brass (US3) French Antique (US7) Oil Rubbed Bronze (US10B)	\$8.00
6"	2246	Satin Nickel (US15) Pewter (US15A) Flat Black (US19) Polished Chrome (US26) Unlacquered Brass (US3NL)*	\$24.00

*Unlacquered Brass (US3NL) finish available for a \$20 List Price upcharge per item.

Security Door Guard



SECURITY DOOR GUARD	Product Code	Finish	List Price
4" x 2½"	2074	Polished Brass (US3) French Antique (US7) Oil Rubbed Bronze (US10B)	\$24.00
5" x 2½"	2075	Satin Nickel (US15) Pewter (US15A) Polished Chrome (US26) Unlacquered Brass (US3NL)*	\$26.00

Roller Catch



Ball Catch



DOOR CATCH	Product Code	Finish	List Price
Roller Catch	8801	Polished Brass (US3) Satin Brass (US4) French Antique (US7) Oil Rubbed Bronze (US10B)	\$30.00
Ball Catch	8802	Polished Nickel (US14) Satin Nickel (US15) Pewter (US15A) Flat Black (US19) Polished Chrome (US26) Medium Bronze (MB) Tumbled White Bronze (TWB) Unlacquered Brass (US3NL)*	\$16.00

>> Supplied with strike plates and finish matching screws.

Casement Latch



CASEMENT LATCH	Product Code	Finish	List Price
Standard Size 1" x 1⅝"	8703	Polished Brass (US3) French Antique (US7) Oil Rubbed Bronze (US10B)	\$18.00
Large Size 1⅞" x 2⅞"	8713	Satin Nickel (US15) Pewter (US15A) Flat Black (US19) Polished Chrome (US26) Unlacquered Brass (US3NL)*	\$28.00

>> Supplied with 3 types of strike plates and finish matching screws.

***Unlacquered Brass (US3NL)** finish available for a \$20 List Price upcharge per item.

Kickdown Door Holders
4" and 5"



KICKDOWN DOOR HOLDERS	Product Code	Finish	List Price
4"	2264	Polished Brass (US3) French Antique (US7) Oil Rubbed Bronze (US10B)	\$20.00
5"	2265	Satin Nickel (US15) Pewter (US15A) Polished Chrome (US26) Unlacquered Brass (US3NL)*	

3" Magnetic Door Stop
& Holder



MAGNETIC DOOR STOP & HOLDER	Product Code	Finish	List Price
3"	2256	Polished Brass (US3) French Antique (US7) Oil Rubbed Bronze (US10B) Satin Nickel (US15) Pewter (US15A) Polished Chrome (US26) Unlacquered Brass (US3NL)*	\$24.00

Extendable Baseboard
Door Bumper



EXTENDABLE BASEBOARD DOOR BUMPER	Product Code	Finish	List Price
3½" or 4½"	2233	Satin Brass (US4) Oil Rubbed Bronze (US10B) Polished Nickel (US14) Satin Nickel (US15) Flat Black (US19) Polished Chrome (US26) Unlacquered Brass (US3NL)*	\$16.00

>> Includes 3", 1", and ½" base with 2" screws.

Door Stops
3" and 4"



DOOR STOPS	Product Code	Finish	List Price
3"	2232	Polished Brass (US3) Satin Brass (US4) French Antique (US7)	\$10.00
4"	2231	Oil Rubbed Bronze (US10B) Polished Nickel (US14) Satin Nickel (US15) Pewter (US15A) Flat Black (US19) Polished Chrome (US26) Medium Bronze (MB) Tumbled White Bronze (TWB) Unlacquered Brass (US3NL)*	

Floor Door Bumper



FLOOR DOOR BUMPER	Product Code	Finish	List Price
1¾" x 1¼"	2254	Polished Brass (US3) French Antique (US7) Oil Rubbed Bronze (US10B) Satin Nickel (US15) Pewter (US15A) Polished Chrome (US26) Unlacquered Brass (US3NL)*	\$10.00

*Unlacquered Brass (US3NL) finish available for a \$20 List Price upcharge per item.

Half Dome Door Stop



Goose Style Door Stop



DOOR STOPS	Product Code	Finish	List Price
Half Dome	2251	Polished Brass (US3) Satin Brass (US4) French Antique (US7)	\$12.00
Goose Style	2253	Oil Rubbed Bronze (US10B) Polished Nickel (US14) Satin Nickel (US15) Pewter (US15A) Flat Black (US19) Polished Chrome (US26) Medium Bronze (MB) Tumbled White Bronze (TWB) Unlacquered Brass (US3NL)*	\$22.00

Cylinder Floor Bumpers
1½" and 2"



CYLINDER FLOOR BUMPERS	Product Code	Finish	List Price
1½" Cylinder	2257	Satin Brass (US4) Oil Rubbed Bronze (US10B) Polished Nickel - Lifetime (US14)	\$16.00
2" Cylinder	2258	Satin Nickel (US15) Flat Black (US19) Polished Chrome (US26) Unlacquered Brass (US3NL)*	\$18.00

Cylinder Floor Bumpers
with Dome Cap
1½" and 2"



CYLINDER FLOOR BUMPERS WITH DOME CAP	Product Code	Finish	List Price
1½" Cylinder Dome Cap	2259	Oil Rubbed Bronze (US10B) Satin Nickel (US15) Flat Black (US19)	\$16.00
2" Cylinder Dome Cap	2260	Polished Chrome (US26) Unlacquered Brass (US3NL)*	\$18.00

Wall Bumper
with #8 Rosette



Wall Bumper
with Square Rosette



Wall Bumper
with Regular Rosette



Wall Bumper
with #2 Rosette



WALL BUMPERS	Product Code	Finish	List Price
Available for All Rosettes	2255	See Page 8 - 17 for available Rosette Styles and Finish options.	\$12.00

*Unlacquered Brass (US3NL) finish available for a \$20 List Price upcharge per item.

DOOR ACCESSORIES



MODERN RECTANGULAR POCKET DOOR MORTISE LOCKS	Product Code	Finish	List Price
Keyed Pocket Door Mortise Lock**	2113	Polished Brass - Lifetime (US3) Satin Brass (US4) French Antique (US7) Oil Rubbed Bronze (US10B)	\$186.00
Passage Pocket Door Mortise Lock	2114	Polished Nickel - Lifetime (US14) Satin Nickel (US15) Pewter (US15A)	\$166.00
Privacy Pocket Door Mortise Lock	2115	Flat Black (US19) Polished Chrome (US26) Unlacquered Brass (US3NL)*	\$166.00
Dummy Pocket Door Mortise Lock	2116		\$166.00

*Unlacquered Brass (US3NL) finish available for a \$40 List Price upcharge per item.

Keyed
Door Mortise Lock

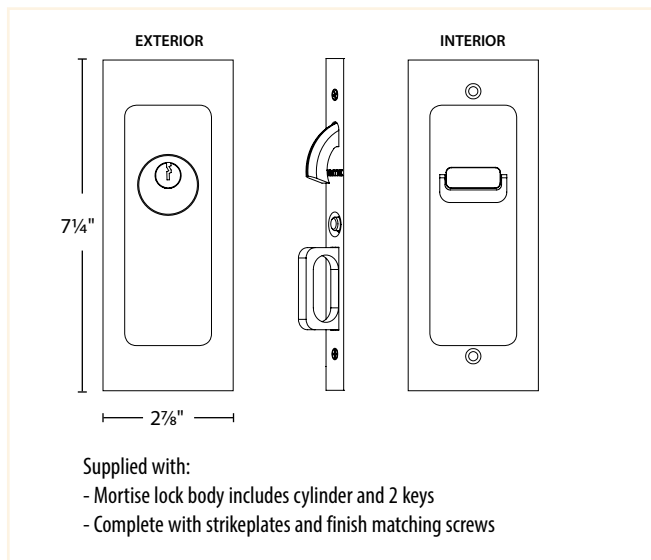

Privacy
Door Mortise Lock

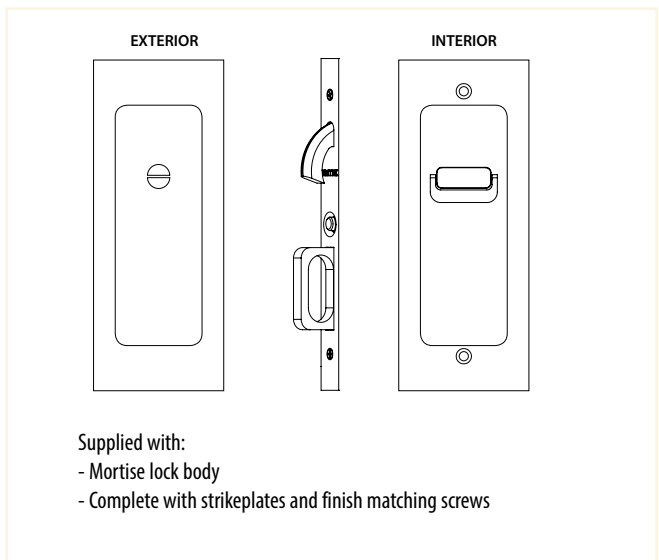

Passage
Door Mortise Lock

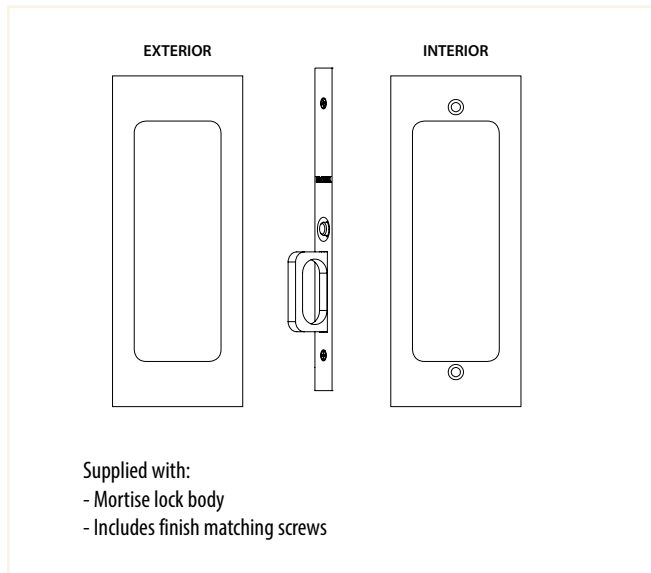

Dummy
Door Mortise Lock

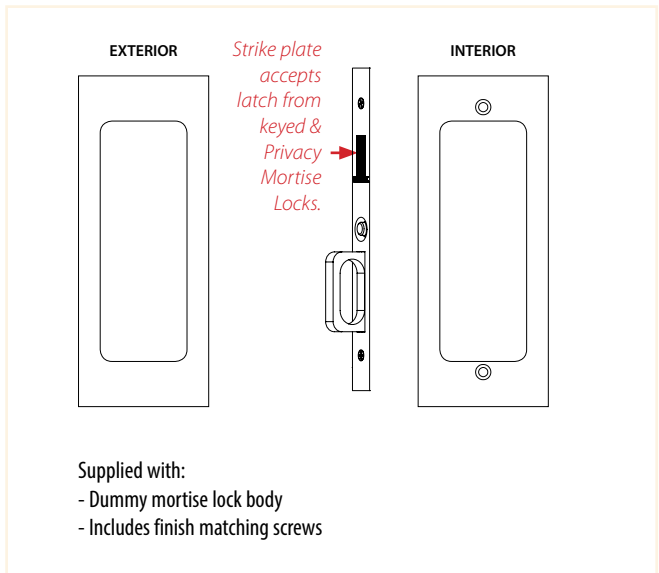

Handing Required for Split Finish

- Must specify door thickness for keyed and privacy functions.
- Trim plates are 1/16" thick.

** Emtek pocket door mortise locks can be keyed alike with each other, but may not be keyed alike with any other Emtek products.



CLASSIC POCKET DOOR MORTISE LOCKS	Product Code	Finish	List Price
Keyed Pocket Door Mortise Lock**	2103	Polished Brass (US3) Oil Rubbed Bronze (US10B)	\$186.00
Passage Pocket Door Mortise Lock	2104	Satin Nickel (US15) Polished Chrome (US26)	\$166.00
Privacy Pocket Door Mortise Lock	2105	Medium Bronze (MB) Tumbled White Bronze (TWB)	\$166.00
Dummy Pocket Door Mortise Lock	2106	Unlacquered Brass (US3NL)*	\$166.00

*Unlacquered Brass (US3NL) finish available for a \$40 List Price upcharge per item.

**Keyed
Door Mortise Lock**

Supplied with:

- Mortise lock body includes cylinder and 2 keys
- Complete with strikeplates and finish matching screws

**Privacy
Door Mortise Lock**

Supplied with:

- Mortise lock body
- Complete with strikeplates and finish matching screws

**Passage
Door Mortise Lock**

Supplied with:

- Mortise lock body
- Includes finish matching screws

**Dummy
Door Mortise Lock**

Supplied with:

- Dummy mortise lock body
- Includes finish matching screws

Handing Required for Split Finish

- Must specify door thickness for keyed and privacy functions.
- Trim plates are 1/8" thick.

** Emtek pocket door mortise locks can be keyed alike with each other, but may not be keyed alike with any other Emtek products.

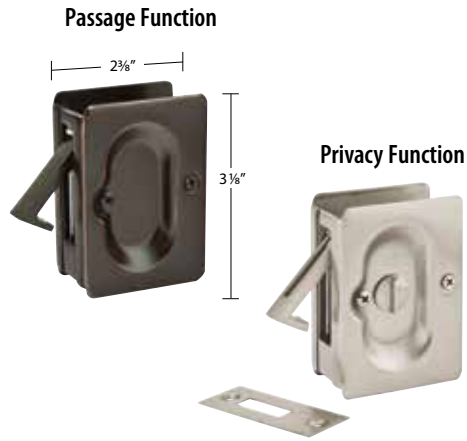

POCKET DOOR LOCKS	Product Code	Finish	List Price
Passage	2101	Polished Brass (US3) Satin Brass (US4) French Antique (US7)	\$26.00
Privacy	2102	Oil Rubbed Bronze (US10B) Polished Nickel (US14) Satin Nickel (US15) Pewter (US15A) Flat Black (US19) Polished Chrome (US26) Medium Bronze (MB) Tumbled White Bronze (TWB) Unlacquered Brass (US3NL)*	\$34.00

>> Fits door thickness 1 3/8" to 1 3/4". Supplied with finish matching screws.

Edge Pull



EDGE PULL	Product Code	Finish	List Price
3/4" x 4"	2221	Polished Brass (US3) Satin Brass (US4) French Antique (US7) Oil Rubbed Bronze (US10B) Polished Nickel (US14) Satin Nickel (US15) Pewter (US15A) Flat Black (US19) Polished Chrome (US26) Medium Bronze (MB) Tumbled White Bronze (TWB) Unlacquered Brass (US3NL)*	\$12.00

>> Supplied with finish matching screws.

Keyed Patio Door Bolts



Non-Keyed Patio Door Bolts



PATIO DOOR BOLTS	Product Code	Finish	List Price
Keyed	206011	Silver	\$16.00
	206012	Bronze	\$16.00
	206016	White	\$16.00
	206017	Black	\$16.00
Non-Keyed	206511	Silver	\$12.00
	206512	Bronze	\$12.00
	206516	White	\$12.00

*Unlacquered Brass (US3NL) finish available for a \$20 List Price upcharge per item.

Round Flush Pull



Rectangular Flush Pull



FLUSH PULLS	Product Code	Finish	List Price
Round 2½" Dia. <i>Fits standard 2½" door prep</i>	2211	Polished Brass (US3) Satin Brass (US4) French Antique (US7) Oil Rubbed Bronze (US10B) Polished Nickel (US14) Satin Nickel (US15)	\$14.00
Rectangular 1¾" x 4"	2201	Pewter (US15A) Flat Black (US19) Polished Chrome (US26) Medium Bronze (MB) Tumbled White Bronze (TWB) Unlacquered Brass (US3NL)*	\$14.00

Modern Rectangular Flush Pull
2⅞" x 7¼"



FLUSH PULL	Product Code	Finish	List Price
Modern Rectangular 2⅞" x 7¼"	2215	Polished Brass - Lifetime (US3) Satin Brass (US4) French Antique (US7) Oil Rubbed Bronze (US10B) Polished Nickel - Lifetime (US14) Satin Nickel (US15) Pewter (US15A) Flat Black (US19) Polished Chrome (US26) Unlacquered Brass (US3NL)*	\$30.00

>> Supplied with finish matching screws.

Classic Rectangular Flush Pull
2½" x 7½"



FLUSH PULL	Product Code	Finish	List Price
Classic Rectangular 2½" x 7½"	2216	Polished Brass (US3) Oil Rubbed Bronze (US10B) Satin Nickel (US15) Polished Chrome (US26) Medium Bronze (MB) Tumbled White Bronze (TWB) Unlacquered Brass (US3NL)*	\$30.00

>> Supplied with finish matching screws.

*Unlacquered Brass (US3NL) finish available for a \$20 List Price upcharge per item.

DOOR ACCESSORIES

Solid Brass
with Arch Style



Interior Exterior

Sandcast Bronze
with Arch Style



Interior Exterior

SCREEN DOOR LOCKS - ARCH STYLE	Product Code	Handing	Finish	List Price
Solid Brass 1¼" x 6"	2290	LH/RH	Polished Brass - Lifetime (US3) Oil Rubbed Bronze (US10B) Satin Nickel (US15) Flat Black (US19) Unlacquered Brass (US3NL)*	\$120.00
Sandcast Bronze 1¼" x 6"	2290	LH/RH	Medium Bronze (MB)	\$120.00

Solid Brass
with Rectangular Style



Interior Exterior

Sandcast Bronze
with Rectangular Style



Interior Exterior

SCREEN DOOR LOCKS - RECTANGULAR STYLE	Product Code	Handing	Finish	List Price
Solid Brass 1¼" x 6"	2291	LH/RH	Polished Brass - Lifetime (US3) Oil Rubbed Bronze (US10B) Satin Nickel (US15) Flat Black (US19) Unlacquered Brass (US3NL)*	\$120.00
Sandcast Bronze 1¼" x 6"	2291	LH/RH	Medium Bronze (MB)	\$120.00

*Unlacquered Brass (US3NL) finish available for a \$20 List Price upcharge per item.

Handing Required for Screen Door Locks.

- Supplied with strike plates and finish matching screws.
- **NOT** available knob by knob, lever by lever. **NOT** available in split finish.

Bronze Door Knocker
3"



Bronze Door Knocker
4"



BRONZE DOOR KNOCKERS	Product Code	Finish	List Price
3" with Ring Pull	86059	Flat Black Bronze (FB) Medium Bronze (MB) Tumbled White Bronze (TWB)	\$44.00
4" with Ring Pull	86060		\$52.00

Urn Style



Narrow Style



SOLID BRASS DOOR KNOCKERS	Product Code	Finish	List Price
Urn	2620	Polished Brass (US3) Oil Rubbed Bronze (US10B) Satin Nickel (US15) Flat Black (US19) Unlacquered Brass (US3NL)*	\$40.00
Narrow	2621	Polished Brass - Lifetime (US3) Oil Rubbed Bronze (US10B) Satin Nickel (US15) Flat Black (US19) Unlacquered Brass (US3NL)*	\$40.00

>> We recommend that US3 finish be selected for those who intend to have the door knocker engraved. Emtek does not offer engraving services at this time.

Solid Brass Mail Slot



SOLID BRASS MAIL SLOT	Product Code	Finish	List Price
3 3/8" x 13 1/16"	2280	Polished Brass - Lifetime (US3) Oil Rubbed Bronze (US10B) Satin Nickel (US15) Unlacquered Brass (US3NL)*	\$78.00

>> Complete set includes both interior and exterior trims. Supplied with wood screws. Not available in split finish.

Solid Brass Door Viewer



SOLID BRASS DOOR VIEWER	Product Code	Finish	List Price
Hole Diameter 5/8"	2610	Polished Brass - Lifetime (US3) Oil Rubbed Bronze (US10B) Satin Nickel (US15) Unlacquered Brass (US3NL)*	\$16.00

>> 200 Degree wide viewing angle. Fits door thickness from 1 3/8" to 2". Not available in split finish.

***Unlacquered Brass (US3NL)** finish available for a \$20 List Price upcharge per item.

Brass House Numbers
4"



Brass House Numbers
5½"



4" BRASS HOUSE NUMBERS	Product Code	Finish	List Price
House Number Digit '0'	2810	Oil Rubbed Bronze (US10B) Satin Nickel (US15)	\$10.00
House Number Digit '1'	2811	Unlacquered Brass (US3NL)*	\$10.00
House Number Digit '2'	2812		\$10.00
House Number Digit '3'	2813		\$10.00
House Number Digit '4'	2814		\$10.00
House Number Digit '5'	2815		\$10.00
House Number Digit '6'	2816		\$10.00
House Number Digit '7'	2817		\$10.00
House Number Digit '8'	2818		\$10.00
House Number Digit '9'	2819		\$10.00

5½" BRASS HOUSE NUMBERS	Product Code	Finish	List Price
House Number Digit '0'	2820	Oil Rubbed Bronze (US10B) Satin Nickel (US15)	\$14.00
House Number Digit '1'	2821	Unlacquered Brass (US3NL)*	\$14.00
House Number Digit '2'	2822		\$14.00
House Number Digit '3'	2823		\$14.00
House Number Digit '4'	2824		\$14.00
House Number Digit '5'	2825		\$14.00
House Number Digit '6'	2826		\$14.00
House Number Digit '7'	2827		\$14.00
House Number Digit '8'	2828		\$14.00
House Number Digit '9'	2829		\$14.00

*Unlacquered Brass (US3NL) finish available for a \$20 List Price upcharge per item.

Bronze House Numbers
4"



Bronze House Numbers
6"



4" BRONZE HOUSE NUMBERS	Product Code	Finish	List Price
House Number Digit '0'	2810	Flat Black Bronze (FB) Medium Bronze (MB) Tumbled White Bronze (TWB)	\$14.00
House Number Digit '1'	2811		\$14.00
House Number Digit '2'	2812		\$14.00
House Number Digit '3'	2813		\$14.00
House Number Digit '4'	2814		\$14.00
House Number Digit '5'	2815		\$14.00
House Number Digit '6'	2816		\$14.00
House Number Digit '7'	2817		\$14.00
House Number Digit '8'	2818		\$14.00
House Number Digit '9'	2819		\$14.00

6" BRONZE HOUSE NUMBERS	Product Code	Finish	List Price
House Number Digit '0'	2820	Flat Black Bronze (FB) Medium Bronze (MB) Tumbled White Bronze (TWB)	\$20.00
House Number Digit '1'	2821		\$20.00
House Number Digit '2'	2822		\$20.00
House Number Digit '3'	2823		\$20.00
House Number Digit '4'	2824		\$20.00
House Number Digit '5'	2825		\$20.00
House Number Digit '6'	2826		\$20.00
House Number Digit '7'	2827		\$20.00
House Number Digit '8'	2828		\$20.00
House Number Digit '9'	2829		\$20.00



BRASS DOORBELL WITH PLATE & BUTTON		Product Code	Finish	List Price
Doorbell Button with Regular Rosette	2400	Polished Brass - Lifetime (US3) French Antique (US7) Oil Rubbed Bronze (US10B)	\$32.00	
Doorbell Button with Oval Rosette	2402	Polished Nickel - Lifetime (US14)** Satin Nickel (US15) Pewter (US15A)		
Doorbell Button with Rectangular Rosette	2403	Flat Black (US19) Polished Chrome (US26) Unlacquered Brass (US3NL)*		
Doorbell Button with #8 Rosette	2408			
Doorbell Button with Quincy Rosette	2409			
Doorbell Button with Wilshire Rosette	2404			
Doorbell Button with Rope Rosette	2401	Polished Brass - Lifetime (US3) French Antique (US7) Oil Rubbed Bronze (US10B)		
Doorbell Button with Lancaster Rosette	2406	Satin Nickel (US15) Pewter (US15A) Polished Chrome (US26)		
Doorbell Button with Ribbon & Reed Rosette	2407	Unlacquered Brass (US3NL)*		
Doorbell Button with Arts & Crafts Rosette	2451	Oil Rubbed Bronze (US10B) Satin Nickel (US15) Flat Black (US19)		
Doorbell Button with Hammered Rosette	2452	Unlacquered Brass (US3NL)*	\$32.00	
Doorbell Button with Modern Rosette	2457	Satin Brass (US4) Oil Rubbed Bronze (US10B)		
Doorbell Button with Disk Rosette	2458	Polished Nickel - Lifetime (US14)** Satin Nickel (US15) Flat Black (US19)	\$32.00	
Doorbell Button with Square Rosette	2459	Polished Chrome (US26) Unlacquered Brass (US3NL)*		
Doorbell Button with Neos Rosette	2460		\$32.00	
Doorbell Button with Modern Rectangular Rosette	2463			

*Unlacquered Brass (US3NL) finish available for a \$20 List Price upcharge per item.

Polished Nickel - Lifetime (US14) **NOT available for Oval, Quincy, Modern, and Neos Rosettes.



SMALL DOORBELL WITH PLATE & BUTTON	Product Code	Finish	List Price
Doorbell Button with Small #1 Rosette	2461	Polished Brass - Lifetime (US3) Satin Brass (US4) French Antique (US7)	\$32.00
Doorbell Button with Small Oval Rosette	2462	Oil Rubbed Bronze (US10B) Polished Nickel - Lifetime (US14) Satin Nickel (US15)	\$32.00
Doorbell Button with Small Rectangular Rosette	2464	Pewter (US15A) Flat Black (US19) Polished Chrome (US26) Medium Bronze (MB) Tumbled White Bronze (TWB) Unlacquered Brass (US3NL)*	\$32.00

*Unlacquered Brass (US3NL) finish available for a \$20 List Price upcharge per item.

SANDCAST BRONZE DOORBELL WITH PLATE & BUTTON	Product Code	Finish	List Price
Doorbell Button with #1 Rosette	2421	Flat Black Bronze (FB) Medium Bronze (MB) Tumbled White Bronze (TWB)	\$34.00
Doorbell Button with #2 Rosette	2422		\$34.00
Doorbell Button with #3 Rosette	2423		\$34.00
Doorbell Button with #4 Rosette	2424		\$34.00
Doorbell Button with #6 Rosette	2425		\$34.00

TUSCANY BRONZE DOORBELL WITH PLATE & BUTTON	Product Code	Finish	List Price
Doorbell Button with #11 Rosette	2411	Flat Black Bronze (FB) Medium Bronze (MB)	\$34.00
Doorbell Button with #12 Rosette	2412		\$34.00
Doorbell Button with #14 Rosette	2414		\$34.00
Doorbell Button with #15 Rosette	2415		\$34.00

WROUGHT STEEL DOORBELL WITH PLATE & BUTTON	Product Code	Finish	List Price
Doorbell Button with #1 Rosette	2431	Flat Black Steel (FBS) Satin Steel (SWS)	\$32.00
Doorbell Button with #2 Rosette	2432		\$32.00
Doorbell Button with #3 Rosette	2433		\$32.00

DOOR ACCESSORIES - FORGED BRASS SWITCH PLATES



FORGED BRASS SWITCH PLATES	Product Code	Finish	List Price
Toggle 1, Colonial Switch Plate	29111	Polished Brass - Lifetime (US3)	\$16.00
Toggle 2, Colonial Switch Plate	29112	Oil Rubbed Bronze (US10B)	\$22.00
Toggle 3, Colonial Switch Plate	29113	Satin Nickel (US15)	\$28.00
Toggle 4, Colonial Switch Plate	29114	Flat Black (US19) Medium Bronze (MB) Tumbled White Bronze (TWB) Unlacquered Brass (US3NL)*	\$38.00



FORGED BRASS SWITCH PLATES	Product Code	Finish	List Price
Rocker 1, Colonial Switch Plate	29121	Polished Brass - Lifetime (US3)	\$16.00
Rocker 2, Colonial Switch Plate	29122	Oil Rubbed Bronze (US10B)	\$22.00
Rocker 3, Colonial Switch Plate	29123	Satin Nickel (US15)	\$28.00
Rocker 4, Colonial Switch Plate	29124	Flat Black (US19) Medium Bronze (MB) Tumbled White Bronze (TWB) Unlacquered Brass (US3NL)*	\$38.00

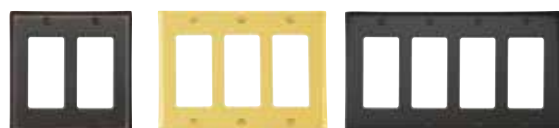

FORGED BRASS SWITCH PLATES	Product Code	Finish	List Price
Duplex 1, Colonial Switch Plate	29131	Polished Brass - Lifetime (US3)	\$16.00
Duplex 2, Colonial Switch Plate	29132	Oil Rubbed Bronze (US10B) Satin Nickel (US15) Flat Black (US19) Medium Bronze (MB) Tumbled White Bronze (TWB) Unlacquered Brass (US3NL)*	\$22.00



FORGED BRASS SWITCH PLATES	Product Code	Finish	List Price
Toggle 1, Duplex 1 Colonial Switch Plate	29141	Polished Brass - Lifetime (US3)	\$22.00
Toggle 2, Duplex 1 Colonial Switch Plate	29142	Oil Rubbed Bronze (US10B)	\$28.00
Rocker 1, Duplex 1 Colonial Switch Plate	29143	Satin Nickel (US15) Flat Black (US19) Medium Bronze (MB) Tumbled White Bronze (TWB) Unlacquered Brass (US3NL)*	\$22.00



FORGED BRASS SWITCH PLATES	Product Code	Finish	List Price
Colonial Blank Plate	29151	Polished Brass - Lifetime (US3)	\$16.00
Colonial Cable Plate	29161	Oil Rubbed Bronze (US10B) Satin Nickel (US15) Flat Black (US19) Medium Bronze (MB) Tumbled White Bronze (TWB) Unlacquered Brass (US3NL)*	\$16.00

*Unlacquered Brass (US3NL) finish available for a \$20 List Price upcharge per item.



FORGED BRASS SWITCH PLATES	Product Code	Finish	List Price
Toggle 1, Rope Switch Plate	29211	Polished Brass - Lifetime (US3)	\$16.00
Toggle 2, Rope Switch Plate	29212	Oil Rubbed Bronze (US10B)	\$22.00
Toggle 3, Rope Switch Plate	29213	Satin Nickel (US15)	\$28.00
Toggle 4, Rope Switch Plate	29214	Unlacquered Brass (US3NL)*	\$38.00



FORGED BRASS SWITCH PLATES	Product Code	Finish	List Price
Rocker 1, Rope Switch Plate	29221	Polished Brass - Lifetime (US3)	\$16.00
Rocker 2, Rope Switch Plate	29222	Oil Rubbed Bronze (US10B)	\$22.00
Rocker 3, Rope Switch Plate	29223	Satin Nickel (US15)	\$28.00
Rocker 4, Rope Switch Plate	29224	Unlacquered Brass (US3NL)*	\$38.00



FORGED BRASS SWITCH PLATES	Product Code	Finish	List Price
Duplex 1, Rope Switch Plate	29231	Polished Brass - Lifetime (US3)	\$16.00
Duplex 2, Rope Switch Plate	29232	Oil Rubbed Bronze (US10B)	\$22.00
		Satin Nickel (US15)	\$28.00
		Unlacquered Brass (US3NL)*	\$38.00



FORGED BRASS SWITCH PLATES	Product Code	Finish	List Price
Toggle 1, Duplex 1 Rope Switch Plate	29241	Polished Brass - Lifetime (US3)	\$22.00
Toggle 2, Duplex 1 Rope Switch Plate	29242	Oil Rubbed Bronze (US10B)	\$28.00
Rocker 1, Duplex 1 Rope Switch Plate	29243	Satin Nickel (US15)	\$22.00
		Unlacquered Brass (US3NL)*	\$38.00



FORGED BRASS SWITCH PLATES	Product Code	Finish	List Price
Rope Blank Plate	29251	Polished Brass - Lifetime (US3)	\$16.00
Rope Cable Plate	29261	Oil Rubbed Bronze (US10B)	\$16.00
		Satin Nickel (US15)	\$28.00
		Unlacquered Brass (US3NL)*	\$38.00

*Unlacquered Brass (US3NL) finish available for a \$20 List Price upcharge per item.

SOLID BRASS HINGES - HEAVY DUTY, SQUARE BARREL

3 1/2" x 3 1/2"
Square Barrel



4 1/2" x 4 1/2"
Square Barrel



4" x 4"
Square Barrel



SQUARE BARREL HEAVY DUTY HINGES - SOLID BRASS Thickness: 0.180"		Product Code	Finish	List Price (Per Pair) Broken Case	List Price (Per Pair) 1 or More Cases	Hinges Per Case
3 1/2" x 3 1/2"	96513	Polished Brass - Lifetime (US3) Satin Brass (US4) French Antique (US7)	\$48.00	\$44.00	24 (Pair)	
4" x 4"	96514	Oil Rubbed Bronze (US10B) Polished Nickel (US14) Satin Nickel (US15)	\$54.00	\$50.00	24 (Pair)	
4 1/2" x 4 1/2"	96515	Pewter (US15A) Flat Black (US19) Polished Chrome (US26) Unlacquered Brass (US3NL)*	\$60.00	\$56.00	24 (Pair)	

*Unlacquered Brass (US3NL) finish available for a \$40 List Price upcharge per pair.

>> Decorative Tips are NOT available for Square Barrel Heavy Duty Hinges. See page 178 for Hinge Screw Pack Options.

4" x 4" Residential Duty
1/4" Radius Corners



3 1/2" x 3 1/2" Residential Duty
1/4" Radius Corners



3 1/2" x 3 1/2" Residential Duty
5/8" Radius Corners



RESIDENTIAL DUTY HINGES - SOLID BRASS Plain Bearing, Thickness: 0.096" - 0.098"		Product Code	Finish	List Price (Per Pair) Broken Case	List Price (Per Pair) 1 or More Cases	Hinges Per Case
3 1/2" x 3 1/2" with Square Corners	96113	Polished Brass - Lifetime (US3) Satin Brass (US4) French Antique (US7) Oil Rubbed Bronze (US10B) Polished Nickel (US14) Satin Nickel (US15) Pewter (US15A) Flat Black (US19) Polished Chrome (US26) Unlacquered Brass (US3NL)*		\$30.00	\$25.00	24 (Pair)
4" x 4" with Square Corners	96114			\$33.00	\$28.00	24 (Pair)
3 1/2" x 3 1/2" with 1/4" Radius Corners	96123			\$30.00	\$25.00	24 (Pair)
4" x 4" with 1/4" Radius Corners	96124			\$33.00	\$28.00	24 (Pair)
3 1/2" x 3 1/2" with 5/8" Radius Corners	96133			\$30.00	\$25.00	24 (Pair)
4" x 4" with 5/8" Radius Corners	96134			\$33.00	\$28.00	24 (Pair)

*Unlacquered Brass (US3NL) finish available for a \$40 List Price upcharge per pair.
>> See page 168-169 for Decorative Tip Sets for Solid Brass Hinges and page 178 for Hinge Screw Pack Options.

SOLID BRASS HINGES - HEAVY DUTY, PLAIN BEARING

4 1/2" x 4 1/2" Heavy Duty
Square Corners3 1/2" x 3 1/2" Heavy Duty
1/4" Radius Corners4" x 4" Heavy Duty
5/8" Radius Corners

HEAVY DUTY HINGES - SOLID BRASS Plain Bearing, Thickness: 0.130" - 0.132"		Product Code	Finish	List Price (Per Pair) Broken Case	List Price (Per Pair) 1 or More Cases	Hinges Per Case
3 1/2" x 3 1/2" with Square Corners	96213	Polished Brass - Lifetime (US3) Satin Brass (US4) French Antique (US7) Oil Rubbed Bronze (US10B) Polished Nickel (US14) Satin Nickel (US15) Pewter (US15A) Flat Black (US19) Polished Chrome (US26) Unlacquered Brass (US3NL)*		\$36.00	\$32.00	24 (Pair)
4" x 4" with Square Corners	96214			\$42.00	\$38.00	24 (Pair)
4 1/2" x 4 1/2" with Square Corners	96215			\$48.00	\$44.00	24 (Pair)
3 1/2" x 3 1/2" with 1/4" Radius Corners	96223			\$36.00	\$32.00	24 (Pair)
4" x 4" with 1/4" Radius Corners	96224			\$42.00	\$38.00	24 (Pair)
4 1/2" x 4 1/2" with 1/4" Radius Corners	96225			\$48.00	\$44.00	24 (Pair)
3 1/2" x 3 1/2" with 5/8" Radius Corners	96233			\$36.00	\$32.00	24 (Pair)
4" x 4" with 5/8" Radius Corners	96234			\$42.00	\$38.00	24 (Pair)

*Unlacquered Brass (US3NL) finish available for a \$40 List Price upcharge per pair.

>> See page 168-169 for Decorative Tip Sets for Solid Brass Hinges and page 178 for Hinge Screw Pack Options.

**3 ½" x 3 ½" Heavy Duty
Square Corners**



**4 ½" x 4 ½" Heavy Duty
¼" Radius Corners**



HEAVY DUTY HINGES - SOLID BRASS Ball Bearing, Thickness: 0.122" - 0.134"		Product Code	Finish	List Price (Per Pair) Broken Case	List Price (Per Pair) 1 or More Cases	Hinges Per Case
3 ½" x 3 ½" with Square Corners	96413	Polished Brass - Lifetime (US3) Satin Brass (US4) French Antique (US7) Oil Rubbed Bronze (US10B) Polished Nickel (US14) Satin Nickel (US15) Pewter (US15A) Flat Black (US19) Polished Chrome (US26) Unlacquered Brass (US3NL)*		\$40.00	\$36.00	24 (Pair)
4" x 4" with Square Corners	96414			\$46.00	\$42.00	24 (Pair)
4 ½" x 4 ½" with Square Corners	96415			\$52.00	\$48.00	24 (Pair)
5" x 5" with Square Corners	96416			\$58.00	\$54.00	24 (Pair)
4 ½" x 4 ½" with ¼" Radius Corners	96425			\$52.00	\$48.00	24 (Pair)

***Unlacquered Brass (US3NL)** finish available for a \$40 List Price upcharge per pair.
 >> See page 168-169 for Decorative Tip Sets for Solid Brass Hinges and page 178 for Hinge Screw Pack Options.

DECORATIVE TIPS FOR SOLID BRASS HINGES

Ball Tip
for 3 1/2" Hinges



Ball Tip
for 4 1/2" Hinges



BALL TIP SETS 4 tips per set	Product Code	Finish	List Price
for 3 1/2" x 3 1/2" Residential Duty Hinges	97203	Polished Brass - Lifetime (US3) Satin Brass (US4) French Antique (US7) Oil Rubbed Bronze (US10B) Polished Nickel (US14) Satin Nickel (US15) Pewter (US15A) Flat Black (US19) Polished Chrome (US26)	\$14.00
for 4" x 4" Residential Duty Hinges	97204	Polished Nickel (US14) Satin Nickel (US15) Pewter (US15A) Flat Black (US19) Polished Chrome (US26)	\$14.00
for 3 1/2" x 3 1/2" Heavy Duty Plain or Ball Bearing Hinges	97303	Unlacquered Brass (US3NL)*	\$14.00
for 4" x 4" Heavy Duty Plain or Ball Bearing Hinges	97304		\$14.00
for 4 1/2" x 4 1/2" or 5" x 5" Heavy Duty Plain or Ball Bearing Hinges	97305		\$14.00

*Unlacquered Brass (US3NL) finish available for a \$20 List Price upcharge per pair.

Steeple Tip
for 3 1/2" Hinges



Steeple Tip
for 4" Hinges



STEEPLE TIP SETS 4 tips per set	Product Code	Finish	List Price
for 3 1/2" x 3 1/2" Residential Duty Hinges	97213	Polished Brass - Lifetime (US3) Satin Brass (US4) French Antique (US7) Oil Rubbed Bronze (US10B) Polished Nickel (US14) Satin Nickel (US15) Pewter (US15A) Flat Black (US19) Polished Chrome (US26)	\$14.00
for 4" x 4" Residential Duty Hinges	97214	Polished Nickel (US14) Satin Nickel (US15) Pewter (US15A) Flat Black (US19) Polished Chrome (US26)	\$14.00
for 3 1/2" x 3 1/2" Heavy Duty Plain or Ball Bearing Hinges	97313	Unlacquered Brass (US3NL)*	\$14.00
for 4" x 4" Heavy Duty Plain or Ball Bearing Hinges	97314		\$14.00
for 4 1/2" x 4 1/2" or 5" x 5" Heavy Duty Plain or Ball Bearing Hinges	97315		\$14.00

*Unlacquered Brass (US3NL) finish available for a \$20 List Price upcharge per pair.

Button Tip
for 3 1/2" Hinges



Button Tip
for 4" Hinges



BUTTON TIP SETS 4 tips per set	Product Code	Finish	List Price
for 3 1/2" x 3 1/2" Residential Duty Hinges	97223	Polished Brass - Lifetime (US3) Satin Brass (US4) French Antique (US7) Oil Rubbed Bronze (US10B)	\$14.00
for 4" x 4" Residential Duty Hinges	97224	Polished Nickel (US14) Satin Nickel (US15) Pewter (US15A) Flat Black (US19)	\$14.00
for 3 1/2" x 3 1/2" Heavy Duty Plain or Ball Bearing Hinges	97323	Polished Chrome (US26) Unlacquered Brass (US3NL)*	\$14.00
for 4" x 4" Heavy Duty Plain or Ball Bearing Hinges	97324		\$14.00
for 4 1/2" x 4 1/2" or 5" x 5" Heavy Duty Plain or Ball Bearing Hinges	97325		\$14.00

*Unlacquered Brass (US3NL) finish available for a \$20 List Price upcharge per pair.

Extended
Button Tip



EXTENDED BUTTON TIP	Product Code	Finish	List Price
Used with Hinge Pivot Stop on Solid Brass Hinge.	2242	Polished Brass (US3) Satin Brass (US4) French Antique (US7) Oil Rubbed Bronze (US10B) Polished Nickel (US14) Satin Nickel (US15) Pewter (US15A) Flat Black (US19) Polished Chrome (US26) Unlacquered Brass (US3NL)*	\$4.00 ea

*Unlacquered Brass (US3NL) finish available for a \$20 List Price upcharge per item.

Hinges
Pivot Stop



HINGES PIVOT STOP		
Product Code	Finish	List Price
2241	Polished Brass (US3) Satin Brass (US4) French Antique (US7) Oil Rubbed Bronze (US10B) Polished Nickel (US14) Satin Nickel (US15) Pewter (US15A) Flat Black (US19) Polished Chrome (US26) Medium Bronze (MB) Tumbled White Bronze (TWB) Unlacquered Brass (US3NL)*	\$8.00

*Unlacquered Brass (US3NL) finish available for a \$20 List Price upcharge per pair.

Hinge Pivot with
Solid Brass Hinge

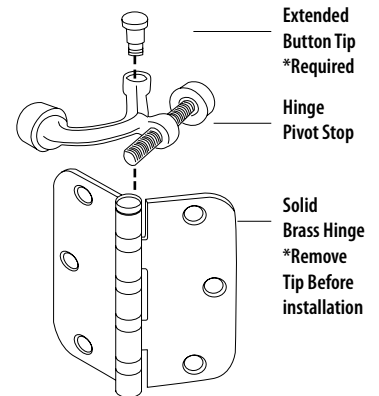

>> Required Extended Button Tip when used with Solid Brass Hinges. Not compatible with Steel Residential Duty Hinges.

STEEL HINGES - RESIDENTIAL DUTY, PLAIN BEARING

4" x 4" Residential Duty
Square Corners



3 1/2" x 3 1/2" Residential Duty
1/4" Radius Corners



4" x 4" Residential Duty
5/8" Radius Corners



RESIDENTIAL DUTY HINGES - STEEL Plain Bearing, Thickness: 0.084" - 0.090"		Product Code	Finish	List Price (Per Pair) Broken Case	List Price (Per Pair) 1 or More Cases	Hinges Per Case
3 1/2" x 3 1/2" with Square Corners*	91013	Polished Brass (US3) French Antique (US7) Oil Rubbed Bronze (US10B) Polished Nickel (US14) Satin Nickel (US15) Pewter (US15A) Flat Black (US19) Polished Chrome (US26) Satin Chrome (US26D) Medium Bronze (MB) Tumbled White Bronze (TWB)	\$9.50	\$8.50	24 (Pair)	
4" x 4" with Square Corners**	91014					\$11.00
3 1/2" x 3 1/2" with 1/4" Radius Corners*	91023		\$9.50	\$8.50	24 (Pair)	
4" x 4" with 1/4" Radius Corners**	91024		\$11.00	\$9.00	24 (Pair)	
3 1/2" x 3 1/2" with 5/8" Radius Corners*	91033		\$9.50	\$8.50	24 (Pair)	
4" x 4" with 5/8" Radius Corners**	91034		\$11.00	\$9.00	24 (Pair)	

* 3 1/2" x 3 1/2" Hinges have 6 screwholes per hinge in an "Arc" pattern. ** 4" x 4" Hinges have 8 screwholes per hinge in a "Zig-Zag" pattern.

>> Decorative Tips are NOT available for Residential Duty, Plain Bearing Steel Hinges. See page 178 for Hinge Screw Pack Options.

4 1/2" x 4 1/2" Heavy Duty
Square Corners



4" x 4" Heavy Duty
1/4" Radius Corners



3 1/2" x 3 1/2" Heavy Duty
5/8" Radius Corners



HEAVY DUTY HINGES - STEEL Plain Bearing, Thickness: 0.118" - 0.126"		Product Code	Finish	List Price (Per Pair) Broken Case	List Price (Per Pair) 1 or More Cases	Hinges Per Case
3 1/2" x 3 1/2" with Square Corners	92013	Polished Brass (US3) French Antique (US7) Oil Rubbed Bronze (US10B) Polished Nickel (US14) Satin Nickel (US15) Pewter (US15A) Flat Black (US19) Polished Chrome (US26) Satin Chrome (US26D) Medium Bronze (MB) Tumbled White Bronze (TWB)		\$14.00	\$12.00	24 (Pair)
4" x 4" with Square Corners	92014			\$16.00	\$14.00	24 (Pair)
4 1/2" x 4 1/2" with Square Corners	92015			\$18.00	\$16.00	24 (Pair)
3 1/2" x 3 1/2" with 1/4" Radius Corners	92023			\$14.00	\$12.00	24 (Pair)
4" x 4" with 1/4" Radius Corners	92024			\$16.00	\$14.00	24 (Pair)
4 1/2" x 4 1/2" with 1/4" Radius Corners	92025			\$18.00	\$16.00	24 (Pair)
3 1/2" x 3 1/2" with 5/8" Radius Corners	92033			\$14.00	\$12.00	24 (Pair)
4" x 4" with 5/8" Radius Corners	92034			\$16.00	\$14.00	24 (Pair)

>> See page 173 for Decorative Tip Sets for Steel Hinges and page 178 for Hinge Screw Pack Options.

Hinges are available in 1/2 pair (1 hinge) for 50% of the list price. Please use quantity (.5) when ordering.
All hinges supplied with screws. Non-Removable Pin (NRP) is available for additional \$3.00 Per pair (NET price).

STEEL HINGES - HEAVY DUTY, BALL BEARING

3 1/2" x 3 1/2" Heavy Duty
Square Corners



3 1/2" x 3 1/2" Heavy Duty
1/4" Radius Corners



4" x 4" Heavy Duty
5/8" Radius Corners



HEAVY DUTY HINGES - STEEL			List Price (Per Pair) Broken Case	List Price (Per Pair) 1 or More Cases	Hinges Per Case
Ball Bearing, Thickness: 0.118" - 0.126"		Product Code			
3 1/2" x 3 1/2" with Square Corners	94013	Polished Brass (US3) French Antique (US7) Oil Rubbed Bronze (US10B) Polished Nickel (US14) Satin Nickel (US15) Pewter (US15A) Flat Black (US19) Polished Chrome (US26) Satin Chrome (US26D) Medium Bronze (MB) Tumbled White Bronze (TWB)	\$22.00	\$20.00	24 (Pair)
4" x 4" with Square Corners	94014		\$24.00	\$22.00	24 (Pair)
4 1/2" x 4 1/2" with Square Corners	94015		\$26.00	\$24.00	24 (Pair)
3 1/2" x 3 1/2" with 1/4" Radius Corners	94023		\$22.00	\$20.00	24 (Pair)
4" x 4" with 1/4" Radius Corners	94024		\$24.00	\$22.00	24 (Pair)
4 1/2" x 4 1/2" with 1/4" Radius Corners	94025		\$26.00	\$24.00	24 (Pair)
3 1/2" x 3 1/2" with 5/8" Radius Corners	94033		\$22.00	\$20.00	24 (Pair)
4" x 4" with 5/8" Radius Corners	94034		\$24.00	\$22.00	24 (Pair)

>> See page 173 for Decorative Tip Sets for Steel Hinges and page 178 for Hinge Screw Pack Options.

Ball Tip



BALL TIP SETS 2 pins and 4 tips per set		Product Code	Finish	List Price
3 1/2"	94103	Polished Brass (US3) French Antique (US7) Oil Rubbed Bronze (US10B)		\$12.00
4"	94104			Polished Nickel (US14) Satin Nickel (US15) Pewter (US15A) Flat Black (US19)
4 1/2"	94105	Polished Chrome (US26) Satin Chrome (US26D) Medium Bronze (MB) Tumbled White Bronze (TWB)		\$12.00

>> Tip sets cannot be used with Hinge Pivot Stop. Not compatible with Residential Duty Hinges.

Steeple Tip



STEEPLE TIP SETS 2 pins and 4 tips per set		Product Code	Finish	List Price
3 1/2"	94113	Polished Brass (US3) French Antique (US7) Oil Rubbed Bronze (US10B)		\$12.00
4"	94114			Polished Nickel (US14) Satin Nickel (US15) Pewter (US15A) Flat Black (US19)
4 1/2"	94115	Polished Chrome (US26) Satin Chrome (US26D) Medium Bronze (MB) Tumbled White Bronze (TWB)		\$12.00

>> Tip sets cannot be used with Hinge Pivot Stop. Not compatible with Residential Duty Hinges.

Tip Sets are available in 1/2 Pair (1 pin and 2 tips) for 50% of the List Price. Please use quantity (.5) when ordering. Compatible with Heavy Duty and Ball Bearing Hinges only. Not compatible with Residential Duty Hinges.

STAINLESS STEEL HINGES - RESIDENTIAL DUTY, PLAIN BEARING

3 1/2" x 3 1/2" Residential Duty
Square Corners

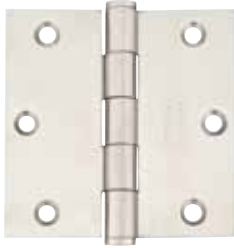

4" x 4" Residential Duty
1/4" Radius Corners



4" x 4" Residential Duty
5/8" Radius Corners



RESIDENTIAL DUTY HINGES - STAINLESS STEEL Plain Bearing, 304 Grade, Thickness: 0.093" - 0.096"		Product Code	Finish	List Price (Per Pair) Broken Case	List Price (Per Pair) 1 or More Cases	Hinges Per Case
3 1/2" x 3 1/2" with Square Corners	9811332D	Brushed Stainless Steel (SS)		\$20.00	\$18.00	24 (Pair)
4" x 4" with Square Corners	9811432D			\$24.00	\$22.00	24 (Pair)
3 1/2" x 3 1/2" with 1/4" Radius Corners	9812332D			\$20.00	\$18.00	24 (Pair)
4" x 4" with 1/4" Radius Corners	9812432D			\$24.00	\$22.00	24 (Pair)
3 1/2" x 3 1/2" with 5/8" Radius Corners	9813332D			\$20.00	\$18.00	24 (Pair)
4" x 4" with 5/8" Radius Corners	9813432D			\$24.00	\$22.00	24 (Pair)

>> Decorative Tips are NOT available for Stainless Steel Hinges. See page 178 for Hinge Screw Pack Options.

3 1/2" x 3 1/2" Heavy Duty
Square Corners

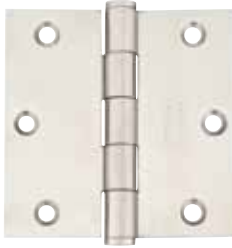

4" x 4" Heavy Duty
1/4" Radius Corners



4" x 4" Heavy Duty
5/8" Radius Corners



HEAVY DUTY HINGES - STAINLESS STEEL Plain Bearing, 304 Grade, Thickness: 0.113" - 0.135"		Product Code	Finish	List Price (Per Pair) Broken Case	List Price (Per Pair) 1 or More Cases	Hinges Per Case
3 1/2" x 3 1/2" with Square Corners	9821332D	Brushed Stainless Steel (SS)		\$22.00	\$20.00	24 (Pair)
4" x 4" with Square Corners	9821432D			\$28.00	\$26.00	24 (Pair)
4 1/2" x 4 1/2" with Square Corners	9821532D			\$34.00	\$32.00	24 (Pair)
3 1/2" x 3 1/2" with 1/4" Radius Corners	9822332D			\$22.00	\$20.00	24 (Pair)
4" x 4" with 1/4" Radius Corners	9822432D			\$28.00	\$26.00	24 (Pair)
3 1/2" x 3 1/2" with 5/8" Radius Corners	9823332D			\$22.00	\$20.00	24 (Pair)
4" x 4" with 5/8" Radius Corners	9823432D			\$28.00	\$26.00	24 (Pair)

>> Decorative Tips are NOT available for Stainless Steel Hinges. See page 178 for Hinge Screw Pack Options.

STAINLESS STEEL HINGES - HEAVY DUTY, BALL BEARING

4" x 4" Heavy Duty
Square Corners4" x 4" Heavy Duty
1/4" Radius Corners3 1/2" x 3 1/2" Heavy Duty
5/8" Radius Corners

HEAVY DUTY HINGES - STAINLESS STEEL Ball Bearing, 304 Grade, Thickness: 0.113" - 0.132"		Product Code	Finish	List Price (Per Pair) Broken Case	List Price (Per Pair) 1 or More Cases	Hinges Per Case
3 1/2" x 3 1/2" with Square Corners	9841332D	Brushed Stainless Steel (SS)		\$24.00	\$22.00	24 (Pair)
4" x 4" with Square Corners	9841432D			\$32.00	\$30.00	24 (Pair)
4 1/2" x 4 1/2" with Square Corners	9841532D			\$38.00	\$36.00	24 (Pair)
3 1/2" x 3 1/2" with 1/4" Radius Corners	9842332D			\$24.00	\$22.00	24 (Pair)
4" x 4" with 1/4" Radius Corners	9842432D			\$32.00	\$30.00	24 (Pair)
3 1/2" x 3 1/2" with 5/8" Radius Corners	9843332D			\$24.00	\$22.00	24 (Pair)
4" x 4" with 5/8" Radius Corners	9843432D			\$32.00	\$30.00	24 (Pair)

>> Decorative Tips are NOT available for Stainless Steel Hinges. See page 178 for Hinge Screw Pack Options

3 1/2" x 3 1/2" Spring Hinge
1/4" Radius Corners



4" x 4" Spring Hinge
Square Corners



4" x 4" Spring Hinge
5/8" Radius Corners



SPRING HINGES, UL LISTED - STEEL Plated Steel, Thickness: 0.110"	Product Code	Finish	List Price (Per Pair) Broken Case	List Price (Per Pair) 1 or More Cases	Hinges Per Case
3 1/2" x 3 1/2" with Square Corners	95013	Polished Brass (US3) French Antique (US7) Oil Rubbed Bronze (US10B)	\$24.00	\$22.00	24 (Pair)
4" x 4" with Square Corners	95014	Polished Nickel (US14) Satin Nickel (US15) Pewter (US15A)	\$26.00	\$24.00	24 (Pair)
3 1/2" x 3 1/2" with 1/4" Radius Corners	95023	Flat Black (US19) Polished Chrome (US26) Satin Chrome (US26D)	\$24.00	\$22.00	24 (Pair)
4" x 4" with 1/4" Radius Corners	95024	Medium Bronze (MB) Tumbled White Bronze (TWB)	\$26.00	\$24.00	24 (Pair)
3 1/2" x 3 1/2" with 5/8" Radius Corners	95033		\$24.00	\$22.00	24 (Pair)
4" x 4" with 5/8" Radius Corners	95034		\$26.00	\$24.00	24 (Pair)

>> Decorative Tips are NOT available for Spring Hinges. See page 178 for Hinge Screw Pack Options

HINGE SCREWS

Flat Head Wood Screw
#9 X 3/4"



FLAT HEAD WOOD SCREW - STEEL #9 x 3/4"		Finish	List Price	Pack Qty
Hinge Product Code Reference: 9812432D 9813432D 9821432D 9822432D 9823432D 9841432D		Polished Brass (US3) Satin Brass (US4) French Antique (US7) Oil Rubbed Bronze (US10B) Polished Nickel (US14) Satin Nickel (US15) Pewter (US15A) Flat Black (US19) Polished Chrome (US26) Satin Chrome (US26D) Medium Bronze (MB) Tumbled White Bronze (TWB)	\$11.00	100

Flat Head Wood Screw
#10 x 1"



FLAT HEAD WOOD SCREW - STEEL #10 x 1"		Finish	List Price	Pack Qty
Hinge Product Code Reference: 91013 94025 96513 91023 94033 9811332D 91033 95023 9812332D 92013 95033 9813332D 92015 96113 9821332D 92023 96123 9822332D 92025 96133 9823332D 92033 96213 9841332D 94013 96223 9842332D 94015 96233 9843332D 94023 96413		Polished Brass (US3) Satin Brass (US4) French Antique (US7) Oil Rubbed Bronze (US10B) Polished Nickel (US14) Satin Nickel (US15) Pewter (US15A) Flat Black (US19) Polished Chrome (US26) Satin Chrome (US26D) Medium Bronze (MB) Tumbled White Bronze (TWB)	\$12.00	100

Flat Head Wood Screw
#12 x 1 1/4"



FLAT HEAD WOOD SCREW - STEEL #12 x 1 1/4"		Finish	List Price	Pack Qty
Hinge Product Code Reference: 91014 96114 96514 91024 96124 96515 91034 96134 9811432D 92014 96214 9821532D 92024 96215 9841532D 92034 96224 94014 96225 94024 96234 94034 96414 95024 96415 95034 96425		Polished Brass (US3) Satin Brass (US4) French Antique (US7) Oil Rubbed Bronze (US10B) Polished Nickel (US14) Satin Nickel (US15) Pewter (US15A) Flat Black (US19) Polished Chrome (US26) Satin Chrome (US26D) Medium Bronze (MB) Tumbled White Bronze (TWB)	\$14.00	100

Drive-in Latch



DRIVE-IN LATCHES		List Price
Passage Latch, 2 $\frac{3}{8}$ " backset	Please specify Brass or Chrome nose bolt.	\$8.00
Privacy Latch, 2 $\frac{3}{8}$ " backset		\$8.00
Passage Latch, 2 $\frac{3}{4}$ " backset		\$8.00
Privacy Latch, 2 $\frac{3}{4}$ " backset		\$8.00

Deadbolt Latch



DEADBOLT LATCHES	Finish	List Price
2 $\frac{3}{8}$ " backset	Polished Brass (US3) Satin Brass (US4) French Antique (US7) Oil Rubbed Bronze (US10B) Polished Nickel (US14) Satin Nickel (US15) Pewter (US15A) Flat Black (US19) Polished Chrome (US26) Medium Bronze (MB) Tumbled White Bronze (TWB) Unlacquered Brass (US3NL)*	\$8.00
2 $\frac{3}{4}$ " backset		\$8.00

Key In Latch



KEY IN LATCHES	Finish	List Price
2 $\frac{3}{8}$ " backset	Polished Brass (US3) Satin Brass (US4) French Antique (US7) Oil Rubbed Bronze (US10B) Polished Nickel (US14) Satin Nickel (US15) Pewter (US15A) Flat Black (US19) Polished Chrome (US26) Medium Bronze (MB) Tumbled White Bronze (TWB) Unlacquered Brass (US3NL)*	\$8.00
2 $\frac{3}{4}$ " backset		\$8.00

Thumbturn Privacy Latch



THUMBTURN PRIVACY LATCHES	Finish	List Price
Privacy Latch, 2 $\frac{3}{8}$ " backset	Polished Brass (US3) Satin Brass (US4) French Antique (US7) Oil Rubbed Bronze (US10B) Polished Nickel (US14) Satin Nickel (US15) Pewter (US15A) Flat Black (US19) Polished Chrome (US26) Unlacquered Brass (US3NL)*	\$8.00
Privacy Latch, 2 $\frac{3}{4}$ " backset		\$8.00

*Unlacquered Brass (US3NL) finish available for a \$20 List Price upcharge per item.

Standard Latch



STANDARD LATCHES		List Price
Passage Latch, 2¾" backset	Please specify Brass or Chrome nose bolt.	\$8.00
Privacy Latch, 2¾" backset		\$8.00
Passage Latch, 2¾" backset		\$8.00
Privacy Latch, 2¾" backset		\$8.00

>> If faceplate and screws are required. Please specify square or ¼" radius corner for the faceplate, and finish.

28° Rotation Latch



28 DEGREE ROTATION LATCHES		List Price
Passage Latch, 2¾" backset	Please specify Brass or Chrome nose bolt.	\$12.00
Privacy Latch, 2¾" backset		\$12.00
Passage Latch, 2¾" backset		\$12.00
Privacy Latch, 2¾" backset		\$12.00

- 28° rotation latch is designed to work with a corresponding door mechanism and cannot be retrofitted.
- If faceplate and screws are required. Please specify square or ¼" radius corners for the faceplate, and finish.

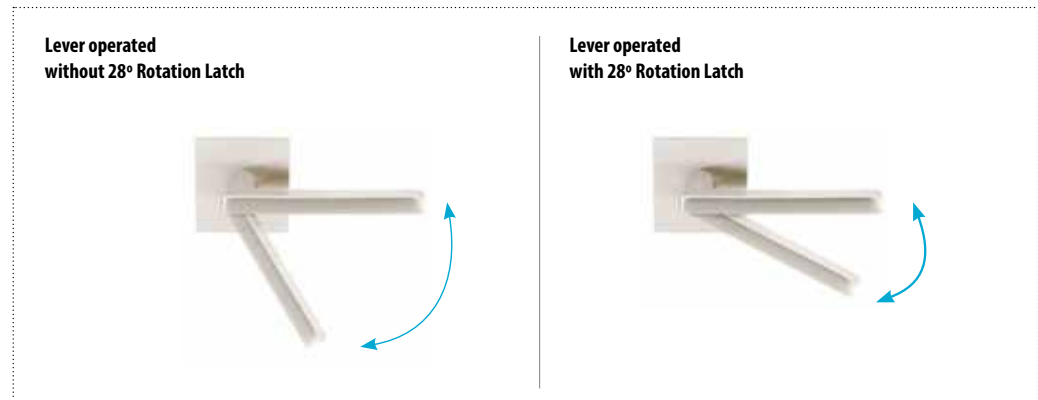

* Knobsets, leversets and platesets ordered with 28° Rotation Latches are assembled with internal components specifically designed for use **ONLY** with our 28° Rotation latch.

*Unlacquered Brass (US3NL) finish available for a \$20 List Price upcharge per item.

**Heavy Duty
Deadbolt Strike Plate**



**Heavy Duty Full Lip
Deadbolt Strike Plate**



HEAVY DUTY DEADBOLT STRIKE PLATE			
Supplied with 4 Screws: (2) #10, 2 1/2" Wood Screws (2) #10, 3/4" Wood Screws			
Product Code	Finish	List Price	
Standard 1 1/4" x 3 5/8", 3/4" Fits Kwikset® Type Jamb Prep	93223	Polished Brass (US3) Satin Brass (US4) French Antique (US7) Oil Rubbed Bronze (US10B)	\$6.00
Full Lip 1 7/8" x 3 5/8", 3/4" Full Lip Deadbolt Strike	93224	Polished Nickel (US14) Satin Nickel (US15) Pewter (US15A) Flat Black (US19) Polished Chrome (US26) Medium Bronze (MB) Tumbled White Bronze (TWB) Unlacquered Brass (US3NL)*	

>> Strike plates must be purchased separately. If ordered along with deadbolts they will be packed into the deadbolt boxes. In that case deadbolts will be packed with both normal strikes and heavy duty strikes.

**Full Lip Strike
Square Corner**

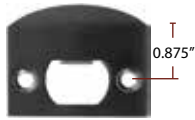

**Full Lip Strike
1/4" Radius Corner**



**Extended Lip Strike
Square Corner**

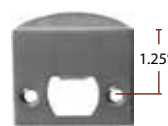

**T Strike
Square Corner**



STRIKE PLATES For Key In and Passage & Privacy Sets			
Product Code	Finish	List Price	
Full Lip Strike, Square Corners	86084	Polished Brass (US3) Satin Brass (US4) French Antique (US7) Oil Rubbed Bronze (US10B)	\$6.00
Full Lip Strike, 1/4" Radius Corners	86085	Polished Nickel (US14) Satin Nickel (US15) Pewter (US15A) Flat Black (US19)	
Extended Lip Strike, Square Corners	86086	Polished Chrome (US26) Medium Bronze (MB) Tumbled White Bronze (TWB) Unlacquered Brass (US3NL)*	\$6.00
T Strike, Square Corners	86087		\$6.00

>> Square corner strike plates are standard. Full Lip Strike and T-Strike plates may be substituted at no extra charge. Extended Lip Strike and T-Strike plates **NOT** available with radius corners.

*Unlacquered Brass (US3NL) finish available for a \$20 List Price upcharge per item.

UL LISTED Knobsets and Deadbolts

Add the below product codes and prices to standard items to obtain UL LISTED versions of Emtek Knobsets and Deadbolts

Knobsets with UL LISTING-USL, 60 Minute Fire Rating		Add On List Price
Passage Set 81UL	Add Product Code, Knob Style, Rosette Style*, and Finish.	\$20.00

* Available only in Round Rosettes for UL.

Deadbolts with UL LISTING-USL, 60 Minute Fire Rating		Add On List Price
Single Cylinder Deadbolt 84UL	Add Material (Low Profile Brass (8455), Sandcast Bronze (8450), or Wrought Steel #2 (8452)) and Add Finish.	\$20.00

CONSTRUCTION KEYING

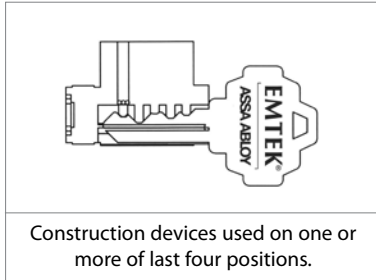

Construction devices used on one or more of last four positions.

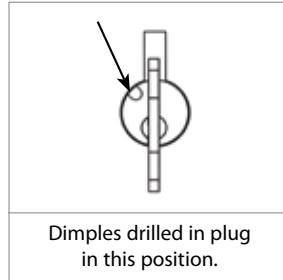

Dimples drilled in plug in this position.

Charge for Construction Keying - \$3 (NET)

Locks that are both construction keyed and keyed alike will be charged a total of \$5.00 (NET) per cylinder.

Charge for Re-Keying - \$2 (NET)

Locks that are keyed to code or keyed alike will be charged \$2.00 (NET) per cylinder.

Keying to Code

• Order by indicating "Key Code XXXXX" next to applicable locks.

Standard with Construction Keying Services

- Lost ball system
- Last four pin locations drilled for lost ball application
- Master key wafers used for code variability
- Construction keys and owner keys sent separately
- Order by indicating "Construction Keyed, House #_" next to applicable locks

Keying Alike

- Order by indicating "Keyed Alike" next to applicable locks if only one keyed alike group is wanted.
- If ordering multiple groups (houses) indicate "Keyed Alike House #_" next to applicable locks.



Thru-Bore Dummy Mounting Kit

8900	List Price: \$12.00
Thru-Bore Dummy Mounting Kit	

>> Specify Lever/Knob and Rosette styles when ordered.

CY4	List Price: \$12.00
Tubular Cylinder (Each)	

>> Specify function and finish.

Key Blanks	
MS4-KEYBLKC Schlage® C Keyway	List Price: \$2.00
MS4-WEISERKYBLKC Weiser® (WR5) Keyway	List Price: \$2.00

COLLECTION PAGE

**CONTEMPORARY
COLOR COLLECTION**

Martinique	20, 21
Cayman	21
Aruba	21

ELECTRONIC

Classic	25, 26
EMTouch™	23, 25, 26
EMTouch™ Classic	23, 25, 26
Liscio	22
Modern	24, 25, 26
Sandcast Bronze	24, 25, 26

MORTISE ENTRY SETS

Albany	32
Artemis	29
Charleston	32
Cheyenne	37
Craftsman	35
Craftsman Full Length	35
Da Vinci	40
Denver	37
Hamilton	34
Harrison	30
Hera	29
Longmont	36
Lugano	28
Manhattan	33
Melrose	33
Memphis	31
Middleton	30
Mills	33
Morgan	39
Mormont	28
Mormont - Stainless Steel	41
Octagon	40
Rectangular Full Length	38
Rectangular Monolithic	38
Rectangular Sectional	38
Regency	34
Rockford	39
Salem	31
Sonoma	36
Topeka	37
Versailles	34
Zeus	29

**MORTISE KNOB BY KNOB,
LEVER BY LEVER ENTRY SETS**

Artemis	42
Charleston	43
Cheyenne	45
Craftsman	44
Da Vinci	46
Hailey	45

COLLECTION PAGE

Hamilton	44
Harrison	42
Manhattan	43
Memphis	43
Mormont	42
Mormont - Stainless Steel	46
Octagon	46
Rectangular	45
Regency	44

TUBULAR ENTRY SETS

Adams	51
Apollo	49
Ares	49
Art Nouveau	61
Arts & Crafts	50
Arts & Crafts Full Length	50
Baden	48
Brighton	56
Creston	57
Davos	48
Davos - Stainless Steel	64
Denver	58
Franklin	51
Greeley	58
Hamden	52
Imperial	55
Jefferson	51
Knoxville	54
Laramie	57
Lausanne	48
Logan	56
Marietta	54
Melrose	52
Monolithic with Lafayette Grip	63
Monolithic with Normandy Grip	63
Monolithic with San Carlos Grip	63
Nashville	53
Octagon	61
Orion	49
Orleans	55
Rectangular Full Length	59
Rectangular Monolithic	59
Rectangular Sectional	59
Remington	58
Ribbon & Reed	55
Richmond	53
Ridgemont	56
Saratoga	54
Sectional with Lafayette Grip	62
Sectional with Normandy Grip	62
Sectional with San Carlos Grip	62
Sheridan	57
Tuscany Monolithic	60
Tuscany Sectional	60
Wilmington	53
Wilshire	52

COLLECTION	PAGE
Zeus	50
Zeus - Stainless Steel	64

GRIP BY GRIP ENTRY SETS

Art Nouveau	68
Brighton	66
Creston	67
Denver	67
Greeley	67
Laramie	67
Logan	66
Octagon	68
Rectangular Full Length	66
Rectangular Monolithic	66
Rectangular Sectional	66
Remington	67
Ridgemont	66
Sheridan	67
Tuscany Monolithic	68
Tuscany Sectional	68

KEY IN ENTRY SETS

Cortina Key in Lever	71
Durango Key in Lever	73
Egg Key in Knob	70
Hanover Key In Lever	69
Hanover Key in Lever - Stainless Steel	75
Helios Key In Lever	69
Luzern Key in Lever	69
Petal Key in Knob	74
Providence Key in Knob	70
Rope Key in Knob	70
Rope Key in Lever	71
Round Key in Knob	69
Siena Key in Lever	74
Waverly Key in Knob	70
Winchester Key in Knob	72

SINGLE AND TWO POINT LOCKSETS

Annapolis	77
Modern Rectangular	76

DEADBOLTS

#8	80
Arts & Crafts	79
Knoxville	80
Low Profile	79
Modern	78
Neos	78
Quincy	78
Rectangular	80
Regular	79
Rope	79
Sandcast Bronze #1	81
Sandcast Bronze #3	81
Sandcast Bronze #4	81
Sandcast Bronze Regular	81

COLLECTION	PAGE
Sandcast Bronze Ridgemont	81
Saratoga	80
Square	78
Stainless Steel Round	83
Stainless Steel Square	83
Tuscany Bronze	82
Tuscany Bronze #11	82
Tuscany Bronze #14	82
Tuscany Bronze Classic	82
Tuscany Bronze Octagon	82
Wilshire	79
Wrought Steel #1	83
Wrought Steel #2	83
Wrought Steel #3	83

SIDEPLATE LOCKSETS

Belmont	92
Colonial	89
Delaware	88
Missoula	93
Modern	86
Oval Beaded	91
Quincy	87
Rope	90
Sandcast Bronze #5	95
Sandcast Bronze Rectangular	94
Stainless Steel	97
Trenton	91
Tuscany Bronze #16	96
Victoria	92
Wrought Steel #5	97

THUMBTURN PRIVACY LOCKSETS

Belmont	99
Colonial	98
Delaware	98
Modern	98
Oval Beaded	99
Quincy	98
Rope	99
Victoria	99

STRETTO NARROW TRIM LOCKSETS

1.5" x 5" Passage & Privacy	107
Concord	102
Modern Rectangular	101
Sandcast Bronze Arched	103
Sandcast Bronze Rectangular	104
Stainless Steel	106
Tuscany Bronze	105

PASSAGE/PRIVACY LEVERSETS

Aireon	109
Argos	108
Arts & Crafts	123
Athena	109
Athena - Stainless Steel	134

COLLECTION	PAGE
Aurora	126
Basel	109
Cimarron	126
Cody	126
Cologne - Stainless Steel	134
Cortina	112,113
Coventry	116,117
Dresden - Stainless Steel	134
Durango	126
Elan	116,117
Geneva	108
Hammered	123
Helios	108
Helios - Stainless Steel	134
Hercules	108
Hercules - Stainless Steel	134
Hermes	109
Hermes - Stainless Steel	134
Kiel - Stainless Steel	134
Lafayette	132
Lariat	126
Luzern	108
Medici	130
Mercury	109
Merrimack	116,117
Milano	112,113
Montrose	126
Napoli	130
Normandy	132
Octagon	130
Padua	130
Poseidon	109
Poseidon - Stainless Steel	134
Ribbon & Reed	116,117
Rope	116,117
Rustic	112,113
San Carlos	132
Santa Fe	116,117
Sion	109
Stuttgart	108
Stuttgart - Stainless Steel	134
Teton	126
Triton	109
Turino	112,113
Wembley	116,117
Yuma	126
PASSAGE/PRIVACY KNOBSSETS	
Astoria Clear Crystal	120,121,128
Beaded Egg	118,119
Belmont	118,119
Bern	110
Bristol Crystal	111,120,121,128
Butte	127
Diamond Crystal	120,121,128
Ebony Porcelain	122
Egg	114,115

COLLECTION	PAGE
Egg - Sandcast Bronze	127
Georgetown Crystal	120,121,128
Hammered Egg	123
Hampton	111,120,121,128
Ice White Porcelain	122
Jamestown	133
Lancaster	118,119
Lowell	120,121,128,129
Madison Black	133
Madison Ivory	133
Melon	114,115
Modern Disc Crystal	111,129
Modern Square Crystal	111,129
Norwich	114,115
Octagon	110
Octagon - Lost Wax Cast Bronze	131
Octagon - Stainless Steel	134
Old Town Clear Crystal	111,120,121,129
Orb	110
Parma	131
Petal	131
Providence	114,115
Providence Crystal	120,121,128,129
Ribbon & Reed	118,119
Rope	118,119
Round	110
Round - Sandcast Bronze	127
Round - Stainless Steel	134
Savannah	133
Square	110
Victoria	118,119
Waverly	114,115
Winchester	127
Windsor	111,120,121,129

THUMBTURN PRIVACY FOR PASSAGE SETS

Modern	124
Classic	124

BACK TO BACK/ APPLIANCE PULLS

Alexander	136
Bauhaus	136
Bar	136
Fluted Lost Wax Cast Bronze	137
Rail Sandcast Bronze	137
Spindle	137
Trail	136
Trinity	136

BACK TO BACK/ DOOR PULLS

8" Art Nouveau	141
8" Arts & Crafts	138
8" Baden	138

COLLECTION	PAGE	COLLECTION	PAGE
8" Baden - Stainless Steel	138	Magnetic Door Stop & Holder	150
8" Column	141	Mail Slot	157
8" Knoxville	138	Patio Door Bolt	154
8" Lafayette	143	Pocket Door Lock	154
8" Normandy	143	Pocket Door Mortise Lock - Classic	153
8" Nunez	140	Pocket Door Mortise Lock - Modern Rectangular	152
8" Palermo	141	Rectanuglar Flush Pull	155
8" Recoleta	141	Rectanuglar Flush Pull - Classic	155
8" Ribbon & Reed	138	Rectanuglar Flush Pull - Modern	155
8" Rod	140	Robe Hook - Sandcast Bronze	147
8" Rustic Modern	140	Robe Hook - Solid Brass	146
8" San Carlos	143	Robe Hook - Wrought Steel	148
8" Twig	140	Roller Catch	149
8" Twist	141	Round Flush Pull	155
8" Wilshire	138	Screen Door Lock	156
8" Zeus	138	Security Door Guard	149
8" Zeus - Stainless Steel	138	Single Hook - Sandcast Bronze	147
12" Column	142	Single Hook - Solid Brass	147
12" Rod	140	Single Hook - Stainless Steel	148
12" Twist	142	Single Hook - Tuscany Bronze	148
18" Column	142	Surface Bolt	144
18" Rod	140	Switch Plate	162,163
18" San Carlos	143	Wall Bumper	151
24" Column	142	Window Utility Pull	148
24" San Carlos	143		
Knoxville Push/Pull Plate	139		
Modern Push/Pull Plate	139		
Petal Push/Pull Plate	141		
DOOR ACCESSORIES		HINGES	
3 Hooks with Sandcast Bronze	147	Ball Tip for Solid Brass Hinges	168
Rectangular Plate		Ball Tip for Steel Hinges	173
Ball Catch	149	Button Tip for Solid Brass Hinges	169
Casement Latch	149	Extended Button Tip	169
Concealed Screw Surface Bolt	145	Hinge Screws	178
Cylinder Floor Bumper	151	Hinges Pivot Stop	169
Cylinder Floor Bumper with Dome Cap	151	Steel Hinges	170,171,172
Door Knocker - Bronze	157	Solid Brass Hinges	165,166,167
Door Knocker - Solid Brass	157	Spring Hinges	177
Door Stop	150	Square Barrel Hinges	164
Door Stop - Goose Style	151	Stainless Steel Hinges	174,175,176
Door Stop - Half Dome	151	Steeple Tip Set for Solid Brass Hinges	168
Door Viewer	157	Steeple Tip Set for Steel Hinges	173
Doorbell	160,161		
Double Hook - Sandcast Bronze	147		
Double Hook - Solid Brass	146		
Double Hook - Tuscany Bronze	148		
Double Hook with Rosette - Modern Brass	146		
Double Hook with Rosette - Solid Brass	146		
Dutch Door Bolt	144		
Edge Pull	154		
Extendable Base Board Door Bumper	150		
Floor Door Bumper	150		
Flush Bolt	145		
House Number	158,159		
Kickdown Door Holder	150		

PRODUCT CODE	PAGE	PRODUCT CODE	PAGE	PRODUCT CODE	PAGE
443	48-61, 63-64, 86-91, 93, 94-96, 97	2411	161	3001	31
818TP	124	2412	161	3002	31
828TP	124	2414	161	3004	34
2074	149	2415	161	3005	33
2075	149	2421	161	3006	33
2101	154	2422	161	3007	34
2102	154	2423	161	3008	35
2103	153	2424	161	3009	34
2104	153	2425	161	3010	33
2105	153	2431	161	3021	37
2106	153	2432	161	3022	37
2113	152	2433	161	3023	37
2114	152	2451	160	3024	38
2115	152	2452	160	3025	38
2116	152	2457	160	3026	38
2201	155	2458	160	3027	39
2211	155	2459	160	3028	39
2215	155	2460	160	3029	36
2216	155	2461	161	3030	36
2221	154	2462	161	3031	40
2232	150	2463	160	3033	40
2233	150	2464	161	3043	32
2241	169	2606	146	3044	29
2242	169	2607	146	3045	29
2244	148	2608	147	3046	29
2246	148	2609	146	3047	28
2251	151	2610	157	3048	28
2253	151	2620	157	3049	35
2254	150	2621	157	3050	32
2255	151	2621	157	3102	43
2256	150	2706	148	3104	44
2257	151	2707	148	3106	43
2258	151	2809	146	3107	44
2259	151	2810	158, 159	3108	44
2260	151	2811	158, 159	3121	45
2264	150	2812	158, 159	3125	45
2265	150	2813	158, 159	3131	46
2280	157	2814	158, 159	3133	46
2290	156	2815	158, 159	3134	45
2291	156	2816	158, 159	3143	43
2306	147	2817	158, 159	3144	42
2307	147	2818	158, 159	3145	42
2308	147	2819	158, 159	3151	42
2400	160	2820	158, 159	3300	47
2401	160	2821	158, 159	3301	31
2402	160	2822	158, 159	3302	31
2403	160	2823	158, 159	3304	34
2404	160	2824	158, 159	3305	33
2406	160	2825	158, 159	3306	33
2407	160	2826	158, 159	3307	34
2408	160	2827	158, 159	3308	35
2409	160	2828	158, 159	3309	34
		2829	158, 159	3310	33

PRODUCT CODE	PAGE	PRODUCT CODE	PAGE	PRODUCT CODE	PAGE
3321	37	4243	103	4820	48
3322	37	4300	54	4821	50
3323	37	4301	55	4822	50
3324	38	4302	53	4824	50
3325	38	4303	53	4825	49
3326	38	4304	53	4826	49
3327	39	4310	54	4827	49
3328	39	4311	55	4828	48
3329	36	4312	53	4829	48
3330	36	4313	53	4830	48
3331	40	4314	53	4901	55
3333	40	4320	54	4911	55
3343	32	4321	55	4921	55
3344	29	4322	53	5005	107
3345	29	4323	53	5007	107
3346	29	4324	53	5015	69
3347	28	4400	54	5021	70, 71
3348	28	4401	54	5022	69
3349	35	4403	51	5023	69
3350	32	4404	51	5041	104
3380	47	4405	51	5042	104
3502	43	4410	54	5043	104
3504	44	4411	54	5044	104
3506	43	4413	51	5045	104
3507	44	4414	51	5046	104
3508	44	4415	51	5050	108-111,122
3521	45	4420	54	5051	108-111,122
3525	45	4421	54	5052	108-111,122
3531	46	4423	51	5055	123
3533	46	4424	51	5056	123
3534	45	4425	51	5057	108-111,122
3543	43	4442	103	5059	108-111,122
3544	42	4444	103	5100	70, 71
3545	42	4701	55	5101	70, 71
3551	42	4711	55	5102	72, 73
4041	103	4721	55	5103	72, 73
4042	103	4801	50	5104	72, 73
4043	103	4802	50	5105	123
4044	103	4804	50	5106	123
4045	103	4805	49	5107	108-111,122
4046	103	4806	49	5108	70, 71
4141	103	4807	49	5109	108-111,122
4143	103	4808	48	5110	108-111,122
4201	52	4809	48	5111	108-111,122
4202	52	4810	48	5112	108-111,122
4203	52	4811	50	5114	72, 73
4211	52	4812	50	5115	69
4212	52	4814	50	5121	70, 71
4213	52	4815	49	5122	69
4221	52	4816	49	5123	69
4222	52	4817	49	5141	104
4223	52	4818	48	5143	104
4241	103	4819	48	5150	70, 71

PRODUCT CODE	PAGE	PRODUCT CODE	PAGE	PRODUCT CODE	PAGE
5151	70, 71	6620	96	7208	126, 127, 128, 129
5152	72, 73	6621	96	7209	90
5153	72, 73	6625	96	7211	126, 127, 128, 129
5154	72, 73	6702	96	7241	102
5158	70, 71	6752	96	7243	102
5164	72, 73	6802	96	7360	94
5205	123	7010	97	7361	94
5206	123	7011	97	7365	94
5207	108-111,122	7015	97	7370	93
5209	108-111,122	7041	102	7371	93
5210	108-111,122	7042	102	7375	93
5211	108-111,122	7043	102	7442	102
5212	108-111,122	7044	102	7444	102
5241	104	7045	102	7512	94
5243	104	7046	102	7522	93
5302	76	7050	126, 127, 128, 129	7552	94
5308	77	7051	132, 133	7560	94
5312	76	7052	132, 133	7561	94
5318	77	7053	132, 133	7562	93
5322	76	7054	126, 127, 128, 129	7565	94
5328	77	7055	97	7570	93
5352	76	7056	126, 127, 128, 129	7571	93
5358	77	7057	95	7575	93
5362	76	7058	126, 127, 128, 129	7612	94
5368	77	7059	90	7622	93
5442	104	7061	126, 127, 128, 129	7670	95
5444	104	7070	95	7671	95
5507	107	7071	95	7675	95
5607	107	7075	95	7707	95
6010	91	7090	90	7710	90
6011	91	7091	90	7757	95
6015	91	7095	90	7807	95
6020	96	7100	126, 127, 128, 129	7810	90
6021	96	7101	132, 133	7850	90
6025	96	7102	132, 133	7990	90
6030	91	7103	132, 133	7991	90
6031	91	7104	126, 127, 128, 129	7995	90
6035	91	7105	97	8000	125
6041	105	7106	126, 127, 128, 129	8001	89
6042	105	7107	95	8003	122
6043	105	7108	126, 127, 128, 129	8006	88
6044	105	7109	90	8010	89
6045	105	7111	126, 127, 128, 129	8011	86
6046	105	7141	102	8012	86
6052	96	7143	102	8013	86
6102	96	7200	126, 127, 128, 129	8014	86
6141	105	7201	132, 133	8016	88
6143	105	7202	132, 133	8020	89
6202	96	7203	132, 133	8022	98
6241	105	7204	126, 127, 128, 129	8026	88
6243	105	7205	97	8030	122, 125
6442	105	7206	126, 127, 128, 129		
6444	105	7207	95		

PRODUCT CODE	PAGE	PRODUCT CODE	PAGE	PRODUCT CODE	PAGE
8040	122	8114	86	8357	81
8041	101	8120	112, 114, 116, 118, 120, 122	8358	80
8042	101	8121	112, 114, 116, 118, 120, 122	8359	80
8043	101	8131	112, 114, 116, 118, 120, 122	8360	82
8044	101	8141	101	8361	83
8045	101	8143	101	8363	83
8046	101	8160	89	8364	79
8050	112, 114, 116, 118, 120, 122	8161	113, 115, 117, 119, 121, 122	8365	81
8051	113, 115, 117, 119, 121, 122	8200	112, 114, 116, 118, 120, 122	8366	80
8052	92	8201	113, 115, 117, 119, 121, 122	8367	78
8053	92	8202	92	8368	80
8054	87	8203	92	8369	78
8055	91	8204	87	8371	82
8056	113, 115, 117, 119, 121, 122	8205	91	8372	82
8057	113, 115, 117, 119, 121, 122	8206	113, 115, 117, 119, 121, 122	8373	82
8058	112, 114, 116, 118, 120, 122	8207	113, 115, 117, 119, 121, 122	8374	81
8059	91	8208	112, 114, 116, 118, 120, 122	8375	78
8060	89	8209	91	8376	81
8061	88	8211	86	8378	78
8065	89	8212	86	8379	79
8066	88	8213	86	8442	101
8070	92	8214	86	8444	101
8071	92	8220	112, 114, 116, 118, 120, 122	8450	79, 81
8075	92	8221	112, 114, 116, 118, 120, 122	8452	83
8080	87	8223	99	8454	79
8081	87	8224	99	8455	79
8085	87	8225	99	8456	82
8090	92	8226	98	8457	81
8091	92	8227	99	8458	80
8095	92	8228	98	8459	80
8100	112, 114, 116, 118, 120, 122	8229	98	8460	82
8101	113, 115, 117, 119, 121, 122	8231	112, 114, 116, 118, 120, 122	8461	83
8102	92	8241	101	8463	83
8103	92	8243	101	8464	79
8104	87	8261	113, 115, 117, 119, 121, 122	8465	81
8105	91	8350	79, 81, 83	8466	80
8106	113, 115, 117, 119, 121, 122	8354	79	8467	78
8107	113, 115, 117, 119, 121, 122	8355	79	8468	80
8108	112, 114, 116, 118, 120, 122	8356	82	8469	78
8109	91			8471	82
8111	86			8472	82
8112	86			8473	82
8113	86			8474	81
				8475	78
				8476	81
				8478	78
				8479	79
				8501	145
				8502	145
				8503	145
				8504	145
				8505	145
				8506	145

PRODUCT CODE	PAGE	PRODUCT CODE	PAGE	PRODUCT CODE	PAGE
8511	144	8900	182	54011	74
8512	144	8980	87	54012	74
8513	144	8981	87	54014	74
8514	144	8985	87	54511	74
8515	144	8990	89	54512	74
8516	144	8991	89	54514	74
8520	112, 114, 116, 118, 120, 122	8995	89	70053	94
8521	112, 114, 116, 118, 120, 122	8996	88	70063	93
8527	145	8997	88	70511	130, 131
8528	145	8998	88	70512	130, 131
8529	145	9041	106	70514	130, 131
8530	145	9042	106	70515	130, 131
8531	112, 114, 116, 118, 120, 122	9043	106	71011	130, 131
8550	84, 85	9044	106	71012	130, 131
8551	85	9045	106	71013	94
8552	85	9046	106	71014	130, 131
8553	85	9141	106	71015	130, 131
8554	84	9143	106	71023	93
8556	85	9241	106	72011	130, 131
8557	85	9243	106	72012	130, 131
8558	84	9442	106	72013	94
8559	84	9444	106	72014	130, 131
8560	85	25050	148	72015	130, 131
8564	84	29111	162	72023	93
8565	85	29112	162	76028	143
8566	84	29113	162	76029	143
8567	84	29114	162	76030	143
8568	84	29121	162	76031	143
8569	84	29122	162	76041	143
8572	85	29123	162	86059	157
8573	85	29124	162	86060	157
8574	85	29131	162	86068	140
8575	84	29132	162	86069	141
8578	84	29141	162	86077	138
8579	84	29142	162	86078	138
8561	113, 115, 117, 119, 121, 122	29143	162	86079	138
8703	149	29151	162	86080	138
8704	87	29161	162	86081	139
8711	89	29211	163	86082	139
8713	149	29212	163	86084	181
8716	88	29213	163	86085	181
8801	149	29214	163	86086	181
8802	149	29221	163	86087	181
8804	87	29222	163	86088	140
8811	89	29223	163	86089	140
8816	88	29224	163	86090	140
8851	89	29231	163	86106	147
8854	87	29232	163	86144LH	141
8856	88	29241	163	86144RH	141
		29242	163	86147	47
		29243	163	86148	47
		29251	163	86149	47
		29261	163	86156	141

PRODUCT CODE	PAGE	PRODUCT CODE	PAGE	PRODUCT CODE	PAGE
86157	142	94034	172, 178	206017	154
86158	142	94103	173, 178	206512	154
86159	142	94104	173, 178	206516	154
86160	140	94105	173, 178	450112	58
86167	141	94113	173, 178	450211	58
86168	141	94114	173, 178	450332	58
86169	142	94115	173, 178	450411	59
86181	141	95013	177, 178	450512	59
86182	141	95014	177, 178	450613	59
86183	138	95023	177, 178	450711	57
86184	138	95024	177, 178	450721	56
86343	137	95033	177, 178	450812	57
86344	137	95034	177, 178	450822	56
86345	136	96113	165, 178	450913	57
86346	136	96114	165, 178	450923	56
86347	137	96123	165, 178	451112	58
86348	137	96124	165, 178	451211	58
86349	137	96133	165, 178	451332	58
86350	137	96134	165, 178	451411	59
86351	136	96213	166, 178	451512	59
86352	136	96214	166, 178	451613	59
86436	139	96215	166, 178	451711	57
86437	139	96223	166, 178	451721	56
86439	140	96224	166, 178	451812	57
86440	136	96225	166, 178	451822	56
86441	136	96233	166, 178	451913	57
86442	136	96234	166, 178	451923	56
86443	136	96413	167, 178	452112	58
86444	136	96414	167, 178	452211	58
86445	136	96415	167, 178	452332	58
91013	170, 178	96416	167, 178	452411	59
91014	170, 178	96425	167, 178	452512	59
91023	170, 178	96513	164, 178	452613	59
91024	170, 178	96514	164, 178	452711	57
91033	170, 178	96515	164, 178	452721	56
91034	170, 178	97203	168	452812	57
92013	171, 178	97204	168	452822	56
92014	171, 178	97213	168	452913	57
92015	171, 178	97214	168	452923	56
92023	171, 178	97223	169	453111	67
92024	171, 178	97224	169	453212	67
92025	171, 178	97303	168	453333	67
92033	171, 178	97304	168	453414	66
92034	171, 178	97305	168	453515	66
93223	181	97313	168	453636	66
93224	181	97314	168	453717	67
94013	172, 178	97315	168	453727	66
94014	172, 178	97323	169	453818	67
94015	172, 178	97324	169	453828	66
94023	172, 178	97325	169	453919	67
94024	172, 178	206011	154	453929	66
94025	172, 178	206012	154	454111	67
94033	172, 178	206016	154	454212	67

PRODUCT CODE	PAGE	PRODUCT CODE	PAGE	PRODUCT CODE	PAGE
454333	67	473333LH	68	E4220	26
454414	66	473333RH	68	E4410	23
454515	66	473444	68	E4817	24
454636	66	474111	68	E4827	23
454717	67	474222	68	E6000	22
454727	66	474333LH	68	E6200	22
454818	67	474333RH	68	E401211	24
454828	66	474444	68	E451211	24
454919	67	475111	68	KEYDBEXT	25
454929	66	475222	68	KEYLVREXT	26
455111	67	475333LH	68	Latch28	86-99, 108-123, 126-133
455212	67	475333RH	68		
455333	67	475444	68		
455414	66	9811332D	174, 178	L4810	20
455515	66	9811432D	174, 178	L4820	20
455636	66	9812332D	174, 178	L4830	20
455717	67	9812432D	174, 178	L5050	21
455727	66	9813332D	174, 178	L5110	21
455818	67	9813432D	174, 178	L5210	21
455828	66	9821332D	175, 178	L8369	21
455919	67	9821432D	175, 178	L8469	21
455929	66	9821532D	175, 178	L8569	21
460111	63	9822332D	175, 178	S100	134
460121	63	9822432D	175, 178	S200	134
460131	63	9823332D	175, 178	S300	134
460212	62	9823432D	175, 178	S800	97
460222	62	9841332D	176, 178	S801	97
460232	62	9841432D	176, 178	S802	97
461111	63	9841532D	176, 178	S810	97
461121	63	9842332D	176, 178	S811	97
461131	63	9842432D	176, 178	S812	97
461212	62	9843332D	176, 178	S901	75
461222	62	9843432D	176, 178	S951	75
461232	62	CY4	182	S3001	41
462111	63	CY5-ThrdMrt150	47	S3101	46
462121	63	CY5-ThrdMrt175	47	S3301	41
462131	63	CY5-ThrdMrt1375	47	S3501	46
462212	62	E1000	25	S40000	64
462222	62	E1001	25	S40001	64
462232	62	E1020	25	S40002	64
470112	60	E2000	26	S40100	64
470222	61	E2001	26	S40101	64
470224	60	E2020	26	S50001	83
470333	61	E2200	26	S50002	83
471112	60	E2201	26	S50003	83
471222	61	E2220	26	S50023	83
471224	60	E3002	25	S52005	85
471333	61	E3020	25	S52006	85
472112	60	E4002	26	S71001	148
472222	61	E4010	23	S86001	138
472224	60	E4017	24	S86002	138
472333	61	E4020	26		
473111	68	E4027	23		
473222	68	E4202	26		

Door Hardware Order Form

Acct# _____



Order Placed By _____

Date _____

Billing Information

Company Name

Address

City State, Zip

Telephone

Shipping Address

Company Name

Address

City State, Zip

Telephone

PO# _____	Note _____
-----------	------------

QTY	Product / Rosette Code	Backset	Handle Style	Handing <small>(LH / RH)</small>	Door Thickness	Finish	Extension / Comments

EMTEK Products, Inc.
 15250 E Stafford Street
 City of Industry, CA 91744
 Tel: 800-356-2741 626-961-0413
 Fax: 800-577-5771 626-336-2812
 www.emtek.com

**Please Fax Order Form to (800) 577-5771
 or Email to orders@emtek.com**

LIFETIME LIMITED WARRANTY

Subject to the terms and conditions of this warranty, Emtek Products, Inc. ("Company") extends a lifetime limited warranty to the original consumer user ("Original User") of our product ("Product") against defects in material and workmanship, as long as the Original User occupies the residential premises upon which the Product was originally installed.

This warranty only applies to the Original User of the Products. This warranty is not transferable. This warranty applies to all products sold on or after April 2, 2012.

Original User: The Original User will return the defective Product to the Company, free and clear of all liens and encumbrances, transportation prepaid, accompanied by a statement of defects and proof of purchase.

What Emtek will do: Upon return of the defective Product to Emtek, Emtek's sole obligation, at its option, is to either repair or replace the Product, or refund the original purchase price in exchange for the Product.

THE COMPANY MAKES NO OTHER WARRANTY OTHER THAN AS EXPRESSLY STATED HEREIN, AND ALL IMPLIED WARRANTIES, INCLUDING ANY WARRANTY OF MERCHANTABILITY OR FITNESS FOR A PARTICULAR PURPOSE, ARE HEREBY EXCLUDED.

THE COMPANY'S MAXIMUM LIABILITY HEREUNDER IS LIMITED TO THE PURCHASE PRICE OF THE PRODUCT. IN NO EVENT SHALL THE COMPANY BE LIABLE FOR ANY CONSEQUENTIAL, INDIRECT, INCIDENTAL OR SPECIAL AND/OR PUNITIVE DAMAGES OF ANY NATURE ARISING FROM THE SALE OR USE OF THE PRODUCT, WHETHER BASED ON CONTRACT, WARRANTY, TORT, STRICT LIABILITY, PATENT INFRINGEMENT, OR OTHERWISE, EVEN IF ADVISED OF THE POSSIBILITY OF SUCH DAMAGES. Some local laws do not allow the exclusion or limitation of incidental or consequential damages, so the above exclusion or limitation may not apply to you. This warranty gives specific legal rights and a buyer may also have other rights which may vary from state to state.

WHAT IS NOT COVERED: THE FOLLOWING COSTS, EXPENSES AND DAMAGES ARE NOT COVERED BY THE PROVISIONS OF THIS LIMITED WARRANTY: (I) LABOR COSTS INCLUDING, BUT NOT LIMITED TO, SUCH COSTS AS THE REMOVAL AND RE-INSTALLATION OF PRODUCT; AND (II) SHIPPING AND FREIGHT EXPENSES REQUIRED TO RETURN PRODUCT TO EMTEK.

THE PROVISIONS OF THIS WARRANTY DO NOT APPLY TO PRODUCTS: (I) USED IN COMMERCIAL APPLICATIONS; (II) USED IN COMMON AREA APPLICATIONS; (III) USED FOR PURPOSES FOR WHICH THEY ARE NOT DESIGNED OR INTENDED; (IV) WHICH HAVE BEEN SUBJECTED TO ALTERATION, ABUSE, MISUSE, NEGLIGENCE OR ACCIDENT; (V) WHICH HAVE BEEN IMPROPERLY STORED, INSTALLED, MAINTAINED OR OPERATED; (VI) WHICH HAVE BEEN USED IN VIOLATION OF WRITTEN INSTRUCTIONS PROVIDED BY EMTEK; (VII) WHICH HAVE BEEN SUBJECTED TO IMPROPER TEMPERATURE, HUMIDITY OR OTHER ENVIRONMENTAL CONDITIONS; OR (VIII) WHICH, BASED ON EMTEK'S EXAMINATION, DO NOT DISCLOSE TO EMTEK'S SATISFACTION NON-CONFORMANCE TO THE WARRANTY. Additionally, this warranty DOES NOT COVER scratches, abrasions, or deterioration due to the use of paints, solvents or other chemicals.

Finish Warranty: Door Hardware in Polished Brass-Lifetime and Polished Nickel-Lifetime finishes carry a lifetime limited finish warranty. There is no finish warranty on Deep Burgundy, Flat Black Patina, Medium Bronze Patina, Polished White Bronze, Rust, Silver Patina, Tumbled White Bronze, and Unlacquered Brass finishes. All other finishes carry a five year finish warranty.

Warranty claims: For warranty service and shipping instructions contact customer service at:

EMTEK Products, Inc.
15250 E. Stafford Street
City of Industry, CA 91744
Tel: (626) 961-0413

ASSA ABLOY is the global leader in door opening solutions, dedicated to satisfying end-user needs for security, safety and convenience

EMTEK[®]
ASSA ABLOY

EMTEK Products, Inc.
15250 E. Stafford Street
City of Industry • CA 91744
Tel: 800-356-2741 • 626-961-0413
Fax: 800-577-5771 • 626-336-2812
emtek.com

