

2016

DOOR HARDWARE

PRICE BOOK



NEW Satin Brass on Select Modern Styles



NEW Tumbled White Bronze Finish Available for Sandcast Bronze Mortise Handlesets. See Pages 26-29, 35



NEW Square Barrel Heavy Duty Solid Brass Hinges. See Page 146

What's New in This Book

Wilshire Collection Expansion

- Deadbolt, Rosette, and Doorbell

Argos Modern Brass Lever

Lowell and Windsor Crystal Knobs

Polished Nickel - Lifetime (US14) Finish Expansion

- Hercules, Luzern, Merrimack, Milano Levers
- Modern Rectangular Rosette
- Bauhaus and Bar Appliance Pulls

Modern Rectangular Pocket Door Mortise Locks

Small Modern Rectangular Doorbell

Door Accessories Finish Expansion

- Polished Nickel - Lifetime (US14)
- Flat Black (US19)
- Tumbled White Bronze (TWB)

Button Tip Sets for Solid Brass Hinges

UL Listed Spring Hinges with Square Corners



NEW Lowell & Windsor Crystal Knobs. See Pages 115-119

CONTEMPORARY COLOR COLLECTION

Tubular Handleset, Deadbolts, Passage & Privacy Leversets	10 - 11
---	---------

ELECTRONIC LOCKSETS

Liscio Electronic Keypad Leverset with Bluetooth® Programming	12
Electronic Keypad Entrance Handlesets	13 - 14
Electronic Keypad Deadbolts	15
Electronic Keypad Leversets	16

ENTRY SETS

Mortise Entrance Handlesets	17
Brass Mortise Handlesets	18 -25
Sandcast Bronze Mortise Handlesets	26 - 29
Lost Wax Cast Bronze Mortise Handlesets	30
Stainless Steel Mortise Handlesets	31
Mortise Knob by knob, Lever by Lever Entrance Locksets	32 -37
Tubular Entrance Handlesets	
Brass Tubular Handlesets	38 - 45
Sandcast Bronze Tubular Handlesets	46 - 49
Lost Wax Cast Bronze Tubular Handlesets	50 - 51
Stainless Steel Tubular Handlesets	52
Wrought Steel Tubular Handlesets	53 - 54
Grip By Grip Entrance Handlesets	55 - 58
Key-in-Knob & Key-in-Lever Locksets	59 - 65

SINGLE AND TWO-POINT LOCKSETS

Brass Single and Two-Point Locksets	66 - 67
-------------------------------------	---------

DEADBOLTS

Brass Deadbolts	68 -70
Sandcast Bronze Deadbolts	71
Lost Wax Cast Bronze Deadbolts	72
Stainless Steel Deadbolts	73
Wrought Steel Deadbolts	73
Single Sided Deadbolts	74 - 75

SIDEPLATE LOCKSETS

Brass Sideplate Locksets	76 - 82
Sandcast Bronze Sideplate Locksets	83 - 85
Lost Wax Cast Bronze Sideplate Locksets	86
Stainless Steel Sideplate Locksets	87
Wrought Steel Sideplate Locksets	87
Thumbturn Privacy Locksets	88 - 89
STRETTO Narrow Trim Sideplate Locksets	90
Brass STRETTO Narrow Trim Sideplate Locksets	91 - 92
Sandcast Bronze STRETTO Narrow Trim Sideplate Locksets	93 - 94
Lost Wax Cast Bronze STRETTO Narrow Trim Sideplate Locksets	95
Stainless Steel STRETTO Narrow Trim Sideplate Locksets	96

PASSAGE & PRIVACY SETS

Brass Modern Leversets & Knobsets	97 - 99
Brass Classic & Designer Leversets & Knobsets	100 - 107
Sandcast Bronze Leversets & Knobsets	108 - 109
Lost Wax Cast Bronze Leversets & Knobsets	110 - 111
Stainless Steel Leversets & Knobsets	112
Wrought Steel Leversets & Knobsets	113 - 114
Brass Arts & Crafts Leversets & Knobsets	115
Porcelain Knobsets	116
Crystal Knobsets	117 - 121
Door Knobs with Threaded Spindles	122

DOOR PULLS & ACCESSORIES

Appliance Pulls	123
Door Pulls	124 - 129
Accessories	
Dutch Door Bolts, Surface Bolts	130
Security Door Guards	130
Flush Bolts, Concealed Screw Surface Bolts, Edge Pull	131
Pocket Door Mortise Locks	132 - 133
Door Stops, Door Bumpers	134 - 135
Pocket Door Locks, Flush Pulls	136
Roller & Ball Catches	136
Window Utility Pulls	137
Screen Door Locks	138
Door Knockers, Mail Slot, Door Viewer	139
House Numbers	140 - 141
Door Bell Plates & Buttons	142 - 143
Switch Plates	144 - 145

HINGES

Square Barrel Hinges	146
Solid Brass Hinges	147 - 149
Ball & Steeple Tip Sets for Brass Hinges	150
Button Tip Sets for Brass Hinges, Hinge Pivot Stop	151
Steel Hinges	152 - 154
Ball & Steeple Tip Sets for Steel Hinges	155
Stainless Steel Hinges	155 - 158
Spring Hinges	159
Parts & Options	160 - 163
Index by Collection	164 - 165
Product Index	166 - 169
Order Form	170
Lifetime Limited Warranty	171

Solid Brass

CLASSIC	Cortina Lever (C)	Milano Lever (M)	Rustic Lever (R)	Turino Lever (T)		
DESIGNER	Coventry Lever (CV)	Elan Lever (EN)	Merrimack Lever (ME)	Ribbon & Reed Lever (RBL)	Rope Lever (RL)	Santa Fe Lever (SF)
CLASSIC	Egg Knob (E)	Melon Knob (MN)	Norwich Knob (NW)	Providence Knob (P)	Waverly Knob (W)	
DESIGNER	Beaded Egg Knob (BE)	Belmont Knob (BT)	Lancaster Knob (LN)	Ribbon & Reed Knob (RBK)	Rope Knob (RK)	Victoria Knob (V)
CLASSIC	#8 Rosette	Oval Rosette	Rectangular Rosette	Regular Rosette	Quincy Rosette	Wilshire Rosette
DESIGNER	Lancaster Rosette	Ribbon & Reed Rosette	Rope Rosette			

Brass Modern

Aireon Lever (A)	Argos Lever (AG)	Athena Lever (ATN)	Basel Lever (BA)	Geneva Lever (GV)	Helios Lever (HLO)	Hercules Lever (HEC)
Hermes Lever (HER)	Luzern Lever (LU)	Mercury Lever (MC)	Poseidon Lever (POS)	Sion Lever (SIO)	Stuttgart Lever (STU)	Triton Lever (TRT)
Bern Knob (BN)	Octagon Knob (OCT)	Orb Knob (OR)	Round Knob (ROU)	Square Knob (SQU)		
Disk Rosette	Modern Rectangular Rosette	Modern Rosette	Neos Rosette	Square Rosette		

Arts & Crafts Brass



Arts & Crafts Lever
(AC)



Hammered Lever
(HM)



Hammered Egg Knob
(HE)



Arts & Crafts
Rectangular Rosette



Hammered
Rosette

Crystal



Astoria Clear Knob
(AS)



Bristol Knob
(BL)



Diamond Crystal Knob
(CK)



Georgetown Knob
(GT)



Hampton Knob
(HT)



Lowell Crystal Knob
(LW)



Modern Disc Crystal Knob
(MDC)



Modern Square Crystal Knob
(MSC)



Old Town Clear Knob
(OT)



Providence Crystal Knob
(PC)



Windsor Crystal Knob
(WS)

Porcelain



Ebony Knob
(EB)



Ice White Knob
(IW)



Porcelain
Rosette

Sandcast Bronze



Aurora Lever
(AR)



Cimarron Lever
(CR)



Cody Lever
(CD)



Durango Lever
(D)



Lariat Lever
(LR)



Montrose Lever
(MT)



Teton Lever
(TT)



Yuma Lever
(YM)



Butte Knob
(BU)



Egg Knob
(BZEG)



Round Knob
(BZRN)



Winchester Knob
(WC)



#1
Rosette



#2
Rosette



#3
Rosette



#4
Rosette



#6
Rosette

Lost Wax Cast Bronze



Medici Lever
(MDI)



Napoli Lever
(NA)



Octagon Lever
(OCL)



Padua Lever
(PD)



Octagon Knob
(OCK)



Parma Knob
(PA)



Petal Knob
(PT)



#11
Rosette



#12
Rosette



#14
Rosette



#15
Rosette

Stainless Steel



Athena Lever
(AT)



Cologne Lever
(CO)



Dresden Lever
(DD)



Helios Lever
(HL)



Hercules Lever
(HS)



Hermes Lever
(HES)



Kiel Lever
(KL)



Poseidon Lever
(PO)



Stuttgart Lever
(STT)



Octagon Knob
(OK)



Round Knob
(RNK)



Beveled (01)
Rosette



Disk (02)
Rosette



Square (03)
Rosette

Wrought Steel



Lafayette Lever
(L)



Normandy Lever
(N)



San Carlos Lever
(SC)

Porcelain Knobs with Wrought Steel Stems



Jamestown Knob
(J)



Savannah Knob
(SV)



Madison Black Knob
(MB)



Madison Ivory Knob
(MI)



#1
Rosette



#2
Rosette



#3
Rosette



Polished Brass (US3)



Polished Brass - Lifetime (US3)



French Antique (US7)



Oil Rubbed Bronze (US10B)



Polished Nickel (US14)



Polished Nickel - Lifetime (US14)



Satin Nickel (US15)



Pewter (US15A)



Flat Black (US19)



Polished Chrome (US26)

Bronze Patina finishes are living patina, designed to wear over time and change in appearance. The distressed appearance is what gives our bronze its character. Finish discoloration is not applicable to the warranty.



Flat Black Bronze Patina (FB)



Medium Bronze Patina (MB)



Tumbled White Bronze (TWB)



Brushed Stainless Steel (SS)

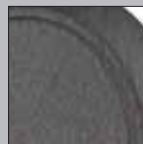

Flat Black Steel (FBS)



Satin Steel (SWS)

Custom Finishes

Unlacquered Brass is available for any brass products that are currently offered in standard Polished Brass (US3) or French Antique (US7), for additional \$18 NET upcharge.

Satin Brass is available for select Modern Brass products. This custom finish is produced locally in our California manufacturing facility and requires an additional 1-2 days to create.



Unlacquered Brass



Satin Brass (US4)

Terms:

Net 30 Days on established credit.

Shipping:

Emtek assembles all products to order in City of Industry, California. Orders typically ship within two business days. For shipments to customers located in the U.S. or Canada, Emtek ships freight prepaid via 3 day service. For shipments to customers located in Mexico, Emtek ships freight prepaid via UPS ground. For shipments to customers located outside of North America, Emtek ships freight prepaid to the U.S. location of the customer's freight forwarder via 3 day service.

If a reduced transit time is needed, shipments can be upgraded to 2nd Day Service or Next Day Service for a fee. Orders not shipping to the customer's place of business must ship via 2nd Day or Next Day Service, and additional charges will apply for shipments to a residential address. Emtek cannot use a customer's freight account for shipping charges.

Returned Goods:

For your convenience, dealers can now process returns directly from the Emtek website. Go to www.emtek.com, click on "Dealer Site", and then select "Return Goods". Fill out the RGA form, and follow the link to generate a UPS call tag (terms and conditions apply – see the web site for details). A completed RGA form must accompany all packages for returned goods. Returns can only be accepted from, and any refunds made to, the Emtek dealer who originally purchased the product being returned. All returned goods are subject to a minimum 25% handling charge.

Minimum Order:

There is no minimum order quantity. A \$10.00 net handling charge will be added to orders valued at less than \$50.00 net.

Patina Finishes:

Sandcast & Lost Wax Cast Bronze products have patina finishes that will gracefully age showing highlights of the underlying bronze over time.

Prices:

Prices are subject to change without prior notice. All prices listed are in U.S. funds.

EMTEK TECHNICAL REFERENCE MANUAL

Available at the Emtek website at www.emtek.com. Select Resources and then Technical Specifications.

Determining handing for door hardware is different than determining handing for carpentry (ordering and hanging doors). If you follow the standard carpentry rules for handing door hardware, instead of following the diagram below, there is good chance you may end up with a lock that is handed incorrectly. Please refer to the diagram below and if you have any questions, call Customer Service at **(800) 356-2741**.

HANDING OF DOOR IS ALWAYS DETERMINED FROM THE OUTSIDE

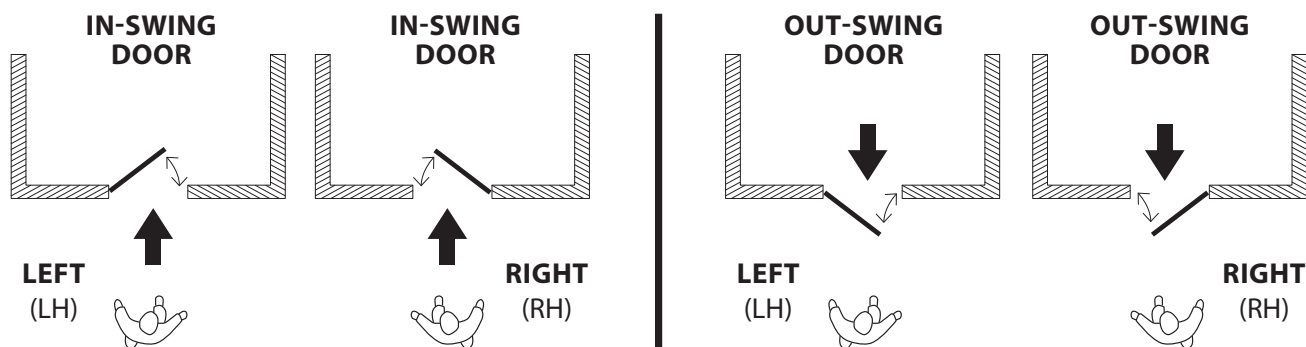

Handing is required for all products **EXCEPT** for the following*:

ENTRY SETS • Interior Trim with Knob	CF MECHANISM • Lever-by-Lever • Knob-by-Knob
ALL DUMMY FUNCTION SETS (Handing is required for ½ dummy levers, Handleset with Lever, and STRETTO)	KNOB SETS • All Functions

* Split finish of items listed may require handing

	Standard	On Request (at no charge)
Latches	Mortise	Drive-in
Backsets	2-3/8"	2-3/4"
Strike Plates	Full Lip Square Corner	1/4" Radius, Extended, T-Strike
Face Plates	Square Corner	1/4" Radius

Passage & Privacy Set Sample Views



Martinique Trim



Color Insert Options



FEATURES AND TECHNICAL SPECIFICATIONS:

- Choose from seven different colored inserts
- Use all one color or your own creative combination (e.g. Caribbean Blue for exterior trim / Graphite Grey for interior trim)
- Color inserts are permanently affixed to the hardware once ordered
- Contemporary Color Collection hardware cannot be mixed with any other Emtek knob, lever or rosette
- Contemporary Color Collection hardware may be ordered with other Emtek products if each product is on opposite sides of the door (e.g. Standard Emtek tubular entry set for exterior trim* / Contemporary Color Collection for interior trim).

MARTINIQUE TUBULAR ENTRY SET	Product Code	Lever Style for Inside Trim	Color Insert	List Price
Single Cylinder	L4820	Cayman Lever (CM) Aruba Lever (AB)	Onyx Black (BK) Caribbean Blue (BE) Pearl White (WE) Graphite Grey (GY) Calypso Silver (SR) Hibiscus Red (RD) Sea Glass Green (GN)	\$180.00
Double Cylinder	L4830		\$180.00	
Dummy	L4810		\$180.00	

* See Page 38 - 54 for product codes and list prices. The price of the higher cost item will be charged.

Handing Required For Orders. Standard latch is for 2 3/8" backset. Specify 2 3/4" backset if required. Complete set includes Latch and Strike Plate. 28° Rotation Latch NOT available for use with Contemporary Color Collection products. **Weiser® (WR5) Keyway:** Specify by adding "W" to the beginning of Product Code. No upcharge for cylinder substitution. Can be keyed into existing Weiser® system.



MARTINIQUE DEADBOLT	Product Code	Color Insert	List Price
Single Cylinder Deadbolt	L8469	Onyx Black (BK) Caribbean Blue (BE)	\$42.00
Double Cylinder Deadbolt	L8369	Pearl White (WE) Graphite Grey (GY) Calypso Silver (SR) Hibiscus Red (RD) Sea Glass Green (GN)	

Weiser® (WR5) Keyway: Specify by adding "W" to the beginning of Product Code. No upcharge for cylinder substitution. Can be keyed into existing Weiser® system.

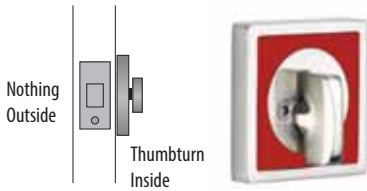

MARTINIQUE SINGLE SIDED DEADBOLT	Product Code	Color Insert	List Price
Single Sided Deadbolt	L8569	Onyx Black (BK) Caribbean Blue (BE) Pearl White (WE) Graphite Grey (GY) Calypso Silver (SR) Hibiscus Red (RD) Sea Glass Green (GN)	\$32.00

Handing NOT Required. Standard latch is for 2³/₈" backset. Specify 2³/₄" backset if required. Complete set includes Latch and Strike Plate. Standard door thickness of 1³/₄", specify if thicker.

To order: **(W) Product Code + Backset + Color Insert + Add Door Thickness to Comments**

Cayman Lever
with Sea Glass Green Color Insert
Trinidad Rosette



Cayman Lever
with Graphite Grey Color Insert
Trinidad Rosette



Cayman Lever
with Calypso Silver Color Insert
Trinidad Rosette



Aruba Lever
with Caribbean Blue Color Insert
Trinidad Rosette



Aruba Lever
with Hibiscus Red Color Insert
Trinidad Rosette



TRINIDAD	Description	Product Code	Lever Style	Color Insert	List Price
	Passage Set	L5110	Cayman Lever (CM) Aruba Lever (AB)	Onyx Black (BK) Caribbean Blue (BE)	\$60.00
	Privacy Set	L5210		Pearl White (WE) Graphite Grey (GY)	
	Dummy, Pair	L5050		Calypso Silver (SR) Hibiscus Red (RD) Sea Glass Green (GN)	

Handing Required For Leversets. Standard latch is for 2³/₈" backset. Specify 2³/₄" backset if required. Complete set includes Latch and Strike Plate. 28° Rotation Latch & CF Mechanism are NOT available for use with Contemporary Color Collection products.

To order: **Product Code + Backset + Lever Style + Handing + Color Insert + Add Door Thickness to Comments**

ELECTRONIC LOCKSET - LISCIO ELECTRONIC KEYPAD LEVERSET WITH BLUETOOTH® PROGRAMMING



>> Liscio cannot be used in conjunction with a deadbolt for standard 5½" center-to-center door preparation. Deadbolt dimensions vary, please verify door preparation based on actual deadbolt measurements.

Order any Brass lever for the inside trim.

Features and Technical Specifications:

- Includes a key cylinder on the exterior for backup access
- Ready-to-use with two codes pre-programmed in the lock
- Available in either standard or storeroom/gate functions
- Adjustable latch for 2¾" or 2¾" backset
- Requires standard 2⅞" dia. tubular door prep
- Fits door thickness from 1¾" to 2¼"
- Low battery indicator lets you know when to change the battery
- Weatherproofed for use on exterior doors
- Standard 9-Volt battery is housed in the interior trim
- Supplied with both interior and exterior gaskets

LISCIO ELECTRONIC KEYPAD LEVERSET WITH BLUETOOTH® PROGRAMMING	Product Code	Lever Style for Inside Trim	Finish	List Price
Keypad Leverset	E6000	See Page 4 for Brass Lever Options.	Oil Rubbed Bronze (US10B)	\$240.00
Keypad Leverset with Storeroom/Gate Function	E6200		Satin Nickel (US15) Polished Chrome (US26)	



Emtek App Overview:

- Program and manage user codes for the lock using our free app
- Easy-to-use app wizard walks you through step-by-step setup for Bluetooth®
- Add, edit, and delete user codes from your device
- The activity log will show you the date, time and user who opened the lock
- If you replace your phone or tablet, communicate existing data to your new device easily
- Communicate with multiple locks using one Bluetooth® device
- Apple® iPad® 3rd Gen/iPhone® 4S and later using iOS 6.1 and newer
- Android™ devices using 4.3 or later



Handing Required for Leversets. Fits any door between 1¾" to 2¼" thick with a 2⅞" bore standard door prep. **Supplied with Adjustable Latch to fit 2¾" or 2¾" backset.** Complete Set Includes Latch and Strike Plate. **Weiser® (WR5) Keyway:** Specify by adding "W" to the beginning of Product Code. No upcharge for cylinder substitution. Can be keyed into existing Weiser® system.

EMTouch™ Electronic Keypad Handleset



Order any Brass knob or lever for the inside trim.

EMTouch™ Classic Style Electronic Keypad Handleset



Order any Brass knob or lever for the inside trim.

EMTOUCH™ ELECTRONIC KEYPAD HANDLESET	Product Code	Knob or Lever Style for Inside Trim	Finish	List Price
Single Cylinder	E4827	See Page 4 for Brass Knob & Lever Options. See Page 5 for Crystal & Porcelain Knob Options.	Oil Rubbed Bronze (US10B) Satin Nickel (US15)	\$400.00
Dummy	E4027		Flat Black (US19) Polished Chrome (US26)	\$400.00

EMTOUCH™ CLASSIC STYLE ELECTRONIC KEYPAD HANDLESET	Product Code	Knob or Lever Style for Inside Trim	Finish	List Price
Single Cylinder	E4410	See Page 4 for Brass Knob & Lever Options. See Page 5 for Crystal & Porcelain Knob Options.	Polished Brass - Lifetime (US3) Oil Rubbed Bronze (US10B)	\$400.00
Dummy	E4010		Satin Nickel (US15)	\$400.00

Product Features for EMTEK Electronic Keypad Locksets:

- Factory programmed with 2 unique, secure user codes for use right out of the box.
- Can be programmed with up to 20 user codes of your choice.
- Emtek's standard mechanical and finish warranties along with a 2 year warranty on electronic components.

EMTouch™ and all Emtek Keypad Locksets are covered by the following patents:	
Canadian patents	U.S. patents
2,698,041	8,176,761
2,789,278	8,141,400
2,789,280	

Handing Required if Lever Used on Inside. Keypad Deadbolt: fits door between 1 3/4" to 2 1/4". Handleset Grip: fits door between 1 3/4" to 2 1/4". Standard door prep 2 1/2" bore. Standard latch is for 2 3/8" backset. Specify 2 3/4" backset if required. Complete Set Includes Latch and Strike Plate. **Weiser® (WR5) Keyway:** Specify by adding "W" to the beginning of Product Code. No upcharge for cylinder substitution. Can be keyed into existing Weiser® system.

ELECTRONIC HANDLESETS

Modern Style Electronic
Keypad Handleset

Order any Brass knob
or lever for the inside trim.

Sandcast Bronze Style
Electronic Keypad Handleset

Order any Bronze knob
or lever for the inside trim.

MODERN STYLE ELECTRONIC KEYPAD HANDLESET	Product Code	Knob or Lever Style for Inside Trim	Finish	List Price
Single Cylinder	E4817	See Page 4 for Brass Knob & Lever Options. See Page 5 for Crystal & Porcelain Knob Options.	Oil Rubbed Bronze (US10B) Satin Nickel (US15) Flat Black (US19) Polished Chrome (US26)	\$376.00
Dummy	E4017		\$376.00	

SANDCAST BRONZE STYLE ELECTRONIC KEYPAD HANDLESET	Product Code	Knob or Lever Style for Inside Trim	Finish	List Price
Single Cylinder	E451211	See Page 5 for Sandcast Bronze Knob & Lever Options. See Page 5 for Crystal & Porcelain Knob Options.	Flat Black Bronze (FB) Medium Bronze (MB)	\$476.00
Dummy	E401211		\$476.00	

Handing Required if Lever Used on Inside. Keypad Deadbolt: fits door between 1 $\frac{3}{4}$ " to 2 $\frac{1}{4}$ ". Handleset Grip: fits door between 1 $\frac{3}{4}$ " to 2 $\frac{1}{8}$ ". Standard door prep 2 $\frac{1}{8}$ " bore. Standard latch is for 2 $\frac{3}{8}$ " backset. Specify 2 $\frac{3}{4}$ " backset if required. Complete Set Includes Latch and Strike Plate. **Weiser® (WR5) Keyway:** Specify by adding "W" to the beginning of Product Code. No upcharge for cylinder substitution. Can be keyed into existing Weiser® system.



EMTOUCH™	Product Code	Finish	List Price
Electronic Keypad Deadbolt	E3020	Oil Rubbed Bronze (US10B) Satin Nickel (US15) Flat Black (US19) Polished Chrome (US26)	\$216.00

* To order Adaptor for thin door (1 3/8" - 1 5/8"), add product code **KEYDBEXT** and list price \$16.



EMTOUCH™ CLASSIC	Product Code	Finish	List Price
Electronic Keypad Deadbolt	E3002	Polished Brass - Lifetime (US3) Oil Rubbed Bronze (US10B) Satin Nickel (US15)	\$216.00

* To order Adaptor for thin door (1 3/8" - 1 5/8"), add product code **KEYDBEXT** and list price \$16.



MODERN	Product Code	Finish	List Price
Electronic Keypad Deadbolt	E1020	Oil Rubbed Bronze (US10B) Satin Nickel (US15) Flat Black (US19) Polished Chrome (US26)	\$192.00

* To order Adaptor for thin door (1 3/8" - 1 5/8"), add product code **KEYDBEXT** and list price \$16.



CLASSIC	Product Code	Finish	List Price
Electronic Keypad Deadbolt	E1000	Polished Brass - Lifetime (US3) Oil Rubbed Bronze (US10B) Satin Nickel (US15)	\$168.00

* To order Adaptor for thin door (1 3/8" - 1 5/8"), add product code **KEYDBEXT** and list price \$16.



SANDCAST BRONZE	Product Code	Finish	List Price
Electronic Keypad Deadbolt	E1001	Flat Black Bronze (FB) Medium Bronze (MB)	\$204.00

* Adaptor NOT available.

STANDARD WITH KEYPAD DEADBOLT LOCKSETS	
- Schlage® C Keyway	- Hardened Steel Bolt
- Standard Door Prep and Installation	- Brass Trim Strike
- Solid Brass Cylinder, Housing, Collar and Rosette	- Heavy Gauge Steel Understrike

Fits any door between 1 3/4" to 2 1/4" thick with a 2 1/8" bore standard door prep. Standard latch is for 2 3/8" backset. Specify 2 3/4" backset if required. Complete Set Includes Latch and Strike Plate.
Weiser® (WR5) Keyway: Specify by adding "W" to the beginning of Product Code. No upcharge for cylinder substitution. Can be keyed into existing Weiser® system.

ELECTRONIC LOCKSETS - LEVERSETS



EMTOUCH™	Product Code	Lever Style	Finish	List Price
Keypad Leverset	E4020	See Page 4 for Brass Lever Options.	Oil Rubbed Bronze (US10B) Satin Nickel (US15)	\$252.00
Keypad Leverset with Storeroom/Gate Function	E4220		Flat Black (US19) Polished Chrome (US26)	\$252.00

* To order Adaptor for thin door (1 $\frac{3}{8}$ " - 1 $\frac{5}{8}$ "), add product code **KEYLVREXT** and list price \$16.



EMTOUCH™ CLASSIC	Product Code	Lever Style	Finish	List Price
Keypad Leverset	E4002	See Page 4 for Brass Lever Options.	Polished Brass - Lifetime (US3) Oil Rubbed Bronze (US10B)	\$252.00
Keypad Leverset with Storeroom/Gate Function	E4202		Satin Nickel (US15)	\$252.00

* To order Adaptor for thin door (1 $\frac{3}{8}$ " - 1 $\frac{5}{8}$ "), add product code **KEYLVREXT** and list price \$16.



MODERN	Product Code	Lever Style	Finish	List Price
Keypad Leverset	E2020	See Page 4 for Brass Lever Options.	Oil Rubbed Bronze (US10B) Satin Nickel (US15)	\$228.00
Keypad Leverset with Storeroom/Gate Function	E2220		Flat Black (US19) Polished Chrome (US26)	\$228.00

* To order Adaptor for thin door (1 $\frac{3}{8}$ " - 1 $\frac{5}{8}$ "), add product code **KEYLVREXT** and list price \$16.



CLASSIC	Product Code	Lever Style	Finish	List Price
Keypad Leverset	E2000	See Page 4 for Brass Lever Options.	Polished Brass - Lifetime (US3) Oil Rubbed Bronze (US10B)	\$216.00
Keypad Leverset with Storeroom/Gate Function	E2200		Satin Nickel (US15)	\$216.00

* To order Adaptor for thin door (1 $\frac{3}{8}$ " - 1 $\frac{5}{8}$ "), add product code **KEYLVREXT** and list price \$16.



SANDCAST BRONZE	Product Code	Lever Style	Finish	List Price
Keypad Leverset	E2001	See Page 5 for Sandcast Bronze Lever Options.	Flat Black Bronze (FB) Medium Bronze (MB)	\$240.00
Keypad Leverset with Storeroom/Gate Function	E2201			\$240.00

*Adaptor NOT available.



Passage Function in Locked Mode

- Outside lever always locked
- Entry by code or key only
- Inside lever always free



Passage Function in Passage Mode

- Outside lever always free
- Entry by operating lever, no code or key require
- Inside lever always free



Storeroom Function

- Outside lever always locked
- Entry by code or key only
- Inside lever always free

Handing Required for Leversets. Fits any door between 1 $\frac{3}{4}$ " to 2 $\frac{1}{4}$ " thick with a 2 $\frac{1}{8}$ " bore standard door prep. Supplied with Adjustable Latch to fit 2 $\frac{3}{8}$ " or 2 $\frac{3}{4}$ " backset. Complete Set Includes Latch and Strike Plate. **Weiser® (WR5) Keyway:** Specify by adding "W" to the beginning of Product Code. No upcharge for cylinder substitution. Can be keyed into existing Weiser® system.

EMTEK'S HEAVY DUTY MORTISE LOCK BODY WITH ANSI F20 UL LISTED FUNCTION



- Deadbolt operated by key outside, thumbturn inside
- When locked outside, latch bolt and deadbolt are operated by key outside
- When deadbolt is engaged, outside thumb press/knob/lever is automatically locked
- Latch bolt retracted by thumb press/knob/lever either side, except when outside thumb press/knob/lever is locked by stop button
- Operating inside knob/lever retracts latch bolt and deadbolt simultaneously with outside thumb press/knob/lever remaining locked
- Deadlocking latch bolt
- Deadbolt has saw-proof inserts
- UL Listed Mortise Door Prep ANSI A115.1
- UL180 minute fire rating

HOW TO ORDER

To form an item number, add **FUNCTION** to the Product Code, Backset, Lever / Knob, Handing and Finish. For Example:

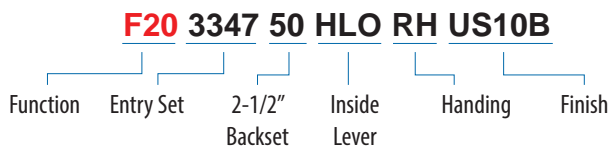

ALSO AVAILABLE IN ANSI F13 UL LISTED FUNCTION MORTISE LOCK BODY



- Deadbolt operated by key outside, thumbturn inside
- When deadbolt is engaged, outside thumb press/knob/lever is automatically locked
- Latch bolt retracted by thumb press/knob/lever either side
- Operating inside knob/lever retracts latch bolt and deadbolt simultaneously, automatically unlocking outside thumb press/knob/lever
- Deadlocking latch bolt
- Deadbolt has saw-proof inserts
- UL Listed Mortise Door Prep ANSI A115.1
- UL180 minute fire rating

HOW TO ORDER

To form an item number, add **FUNCTION** to the Product Code, Backset, Lever / Knob, Handing and Finish. For Example:

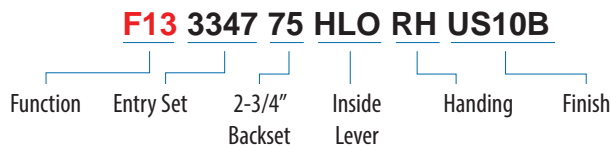

ENTRANCE HANDLESETS - BRASS MORTISE

Mormont Mortise

Lugano Mortise

ANSI F13
Lugano Mortise



Order any Brass Knob or Lever for the Inside Trim.

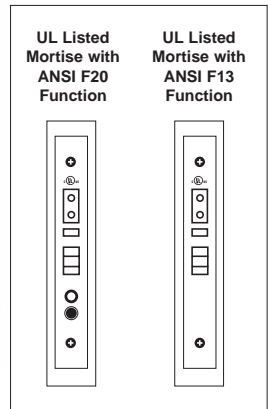

MORMONT MORTISE		Product Code	Backset	Knob or Lever Style for Inside Trim	Handing	Finish	List Price
Entry Set	Specify F20/F13 Function	3347	2 1/2" or 2 3/4"	See Page 4 for Brass Knob & Lever Options. See Page 5 for Crystal & Porcelain Knob Options.	LH/RH	Satin Brass (US4) Oil Rubbed Bronze (US10B) Satin Nickel (US15) Flat Black (US19) Polished Chrome (US26)	\$480.00
Dummy	N/A	3047	N/A				\$296.00

LUGANO MORTISE		Product Code	Backset	Knob or Lever Style for Inside Trim	Handing	Finish	List Price
Entry Set	Specify F20/F13 Function	3348	2 1/2" or 2 3/4"	See Page 4 for Brass Knob & Lever Options. See Page 5 for Crystal & Porcelain Knob Options.	LH/RH	Satin Brass (US4) Oil Rubbed Bronze (US10B) Satin Nickel (US15) Flat Black (US19) Polished Chrome (US26)	\$530.00
Dummy	N/A	3048	N/A				\$346.00

Handing is Required for All Mortise Locks. Standard door thickness of 1 3/4", specify if thicker. Available in 2 1/2" or 2 3/4" Backset. Locks for in-swing doors are standard, for out-swing doors please specify.

Zeus Mortise



Artemis Mortise



Hera Mortise



ANSI F13
Hera Mortise



Order any Brass Knob or Lever for the Inside Trim.

ZEUS MORTISE		Product Code	Backset	Knob or Lever Style for Inside Trim	Handing	Finish	List Price
Entry Set	Specify F20/F13 Function	3346	2½" or 2¾"	See Page 4 for Brass Knob & Lever Options. See Page 5 for Crystal & Porcelain Knob Options.	LH/RH	Oil Rubbed Bronze (US10B) Satin Nickel (US15) Flat Black (US19) Polished Chrome (US26)	\$480.00
Dummy	N/A	3046	N/A				\$296.00

ARTEMIS MORTISE		Product Code	Backset	Knob or Lever Style for Inside Trim	Handing	Finish	List Price
Entry Set	Specify F20/F13 Function	3344	2½" or 2¾"	See Page 4 for Brass Knob & Lever Options. See Page 5 for Crystal & Porcelain Knob Options.	LH/RH	Satin Brass (US4) Oil Rubbed Bronze (US10B) Satin Nickel (US15) Flat Black (US19) Polished Chrome (US26)	\$480.00
Dummy	N/A	3044	N/A				\$296.00

HERA MORTISE		Product Code	Backset	Knob or Lever Style for Inside Trim	Handing	Finish	List Price
Entry Set	Specify F20/F13 Function	3345	2½" or 2¾"	See Page 4 for Brass Knob & Lever Options. See Page 5 for Crystal & Porcelain Knob Options.	LH/RH	Satin Brass (US4) Oil Rubbed Bronze (US10B) Satin Nickel (US15) Flat Black (US19) Polished Chrome (US26)	\$530.00
Dummy	N/A	3045	N/A				\$346.00

Handing is Required for All Mortise Locks. Standard door thickness of 1¾", specify if thicker. Available in 2½" or 2¾" Backset. Locks for in-swing doors are standard, for out-swing doors please specify.

Harrison Mortise



Middleton Mortise



ANSI F13 Middleton Mortise



Order any Brass Knob or Lever for the Inside Trim.

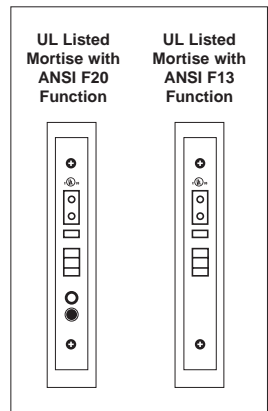

HARRISON MORTISE		Product Code	Backset	Knob or Lever Style for Inside Trim	Handing	Finish	List Price
Entry Set	Specify F20/F13 Function	3351	2½" or 2¾"	See Page 4 for Brass Knob & Lever Options. See Page 5 for Crystal & Porcelain Knob Options.	LH/RH	Polished Brass - Lifetime (US3) French Antique (US7) Oil Rubbed Bronze (US10B) Satin Nickel (US15) Pewter (US15A) Flat Black (US19) Polished Chrome (US26)	\$480.00
Dummy	N/A	3051	N/A				\$296.00

MIDDLETON MORTISE		Product Code	Backset	Knob or Lever Style for Inside Trim	Handing	Finish	List Price
Entry Set	Specify F20/F13 Function	3352	2½" or 2¾"	See Page 4 for Brass Knob & Lever Options. See Page 5 for Crystal & Porcelain Knob Options.	LH/RH	Polished Brass - Lifetime (US3) French Antique (US7) Oil Rubbed Bronze (US10B) Satin Nickel (US15) Pewter (US15A) Flat Black (US19) Polished Chrome (US26)	\$530.00
Dummy	N/A	3052	N/A				\$346.00

Handing is Required for All Mortise Locks. Standard door thickness of 1¾", specify if thicker. Available in 2½" or 2¾" Backset. Locks for in-swing doors are standard, for out-swing doors please specify.

Salem Mortise



Memphis Mortise



ANSI F13
Memphis Mortise



Order any Brass Knob or Lever for the Inside Trim.

SALEM MORTISE		Product Code	Backset	Knob or Lever Style for Inside Trim	Handing	Finish	List Price
Entry Set	Specify F20/F13 Function	3301	2½" or 2¾"	See Page 4 for Brass Knob & Lever Options. See Page 5 for Crystal & Porcelain Knob Options.	LH/RH	Polished Brass - Lifetime (US3) French Antique (US7) Oil Rubbed Bronze (US10B) Satin Nickel (US15) Pewter (US15A) Polished Chrome (US26)	\$440.00
Dummy	N/A	3001	N/A				\$256.00

MEMPHIS MORTISE		Product Code	Backset	Knob or Lever Style for Inside Trim	Handing	Finish	List Price
Entry Set	Specify F20/F13 Function	3302	2½" or 2¾"	See Page 4 for Brass Knob & Lever Options. See Page 5 for Crystal & Porcelain Knob Options.	LH/RH	Polished Brass - Lifetime (US3) French Antique (US7) Oil Rubbed Bronze (US10B) Satin Nickel (US15) Pewter (US15A) Polished Chrome (US26)	\$480.00
Dummy	N/A	3002	N/A				\$296.00

Handing is Required for All Mortise Locks. Standard door thickness of 1¾", specify if thicker. Available in 2½" or 2¾" Backset. Locks for in-swing doors are standard, for out-swing doors please specify.

ENTRANCE HANDLESETS - BRASS MORTISE

Charleston Mortise



Albany Mortise



ANSI F13
Albany Mortise



Order any Brass Knob or Lever for the Inside Trim.

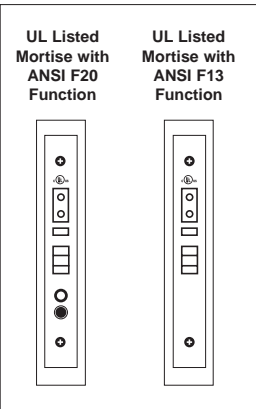

CHARLESTON MORTISE		Product Code	Backset	Knob or Lever Style for Inside Trim	Handing	Finish	List Price
Entry Set	Specify F20/F13 Function	3343	2½" or 2¾"	See Page 4 for Brass Knob & Lever Options. See Page 5 for Crystal & Porcelain Knob Options.	LH/RH	Polished Brass - Lifetime (US3) French Antique (US7) Oil Rubbed Bronze (US10B) Satin Nickel (US15) Pewter (US15A) Polished Chrome (US26)	\$480.00
Dummy	N/A	3043	N/A				\$296.00

ALBANY MORTISE		Product Code	Backset	Knob or Lever Style for Inside Trim	Handing	Finish	List Price
Entry Set	Specify F20/F13 Function	3350	2½" or 2¾"	See Page 4 for Brass Knob & Lever Options. See Page 5 for Crystal & Porcelain Knob Options.	LH/RH	Polished Brass - Lifetime (US3) French Antique (US7) Oil Rubbed Bronze (US10B) Satin Nickel (US15) Pewter (US15A) Polished Chrome (US26)	\$530.00
Dummy	N/A	3050	N/A				\$346.00

Handing is Required for All Mortise Locks. Standard door thickness of 1¾", specify if thicker. Available in 2½" or 2¾" Backset. Locks for in-swing doors are standard, for out-swing doors please specify.

Mills Mortise



Manhattan Mortise



Melrose Mortise



ANSI F13 Melrose Mortise



Order any Brass Knob or Lever for the Inside Trim.

MILLS MORTISE		Product Code	Backset	Knob or Lever Style for Inside Trim	Handing	Finish	List Price
Entry Set	Specify F20/F13 Function	3310	2½" or 2¾"	See Page 4 for Brass Knob & Lever Options. See Page 5 for Crystal & Porcelain Knob Options.	LH/RH	Polished Brass - Lifetime (US3) French Antique (US7) Oil Rubbed Bronze (US10B) Satin Nickel (US15) Pewter (US15A) Polished Chrome (US26)	\$440.00
Dummy	N/A	3010	N/A				\$256.00

MANHATTAN MORTISE		Product Code	Backset	Knob or Lever Style for Inside Trim	Handing	Finish	List Price
Entry Set	Specify F20/F13 Function	3306	2½" or 2¾"	See Page 4 for Brass Knob & Lever Options. See Page 5 for Crystal & Porcelain Knob Options.	LH/RH	Polished Brass - Lifetime (US3) French Antique (US7) Oil Rubbed Bronze (US10B) Satin Nickel (US15) Pewter (US15A) Polished Chrome (US26)	\$480.00
Dummy	N/A	3006	N/A				\$296.00

MELROSE MORTISE		Product Code	Backset	Knob or Lever Style for Inside Trim	Handing	Finish	List Price
Entry Set	Specify F20/F13 Function	3305	2½" or 2¾"	See Page 4 for Brass Knob & Lever Options. See Page 5 for Crystal & Porcelain Knob Options.	LH/RH	Polished Brass - Lifetime (US3) French Antique (US7) Oil Rubbed Bronze (US10B) Satin Nickel (US15) Pewter (US15A) Polished Chrome (US26)	\$530.00
Dummy	N/A	3005	N/A				\$346.00

Handing is Required for All Mortise Locks. Standard door thickness of 1¾", specify if thicker. Available in 2½" or 2¾" Backset. Locks for in-swing doors are standard, for out-swing doors please specify.

ENTRANCE HANDLESETS - BRASS MORTISE

Hamilton Mortise



Regency Mortise



Versailles Mortise



ANSI F13 Versailles Mortise



Order any Brass Knob or Lever for the Inside Trim.

Order any Brass Knob or Lever for the Inside Trim.

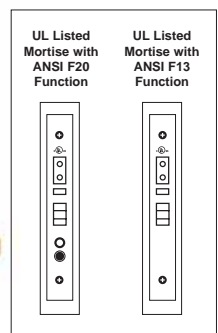

HAMILTON MORTISE		Product Code	Backset	Knob or Lever Style for Inside Trim	Handing	Finish	List Price
Entry Set	Specify F20/F13 Function	3304	2½" or 2¾"	See Page 4 for Brass Knob & Lever Options. See Page 5 for Crystal & Porcelain Knob Options.	LH/RH	Polished Brass - Lifetime (US3) French Antique (US7) Oil Rubbed Bronze (US10B) Satin Nickel (US15) Pewter (US15A) Polished Chrome (US26)	\$480.00
Dummy	N/A	3004	N/A				\$296.00

REGENCY MORTISE		Product Code	Backset	Knob or Lever Style for Inside Trim	Handing	Finish	List Price
Entry Set	Specify F20/F13 Function	3307	2½" or 2¾"	See Page 4 for Brass Knob & Lever Options. See Page 5 for Crystal & Porcelain Knob Options.	LH/RH	Polished Brass - Lifetime (US3) French Antique (US7) Oil Rubbed Bronze (US10B) Satin Nickel (US15) Pewter (US15A) Polished Chrome (US26)	\$480.00
Dummy	N/A	3007	N/A				\$296.00

VERSAILLES MORTISE		Product Code	Backset	Knob or Lever Style for Inside Trim	Handing	Finish	List Price
Entry Set	Specify F20/F13 Function	3309	2½" or 2¾"	See Page 4 for Brass Knob & Lever Options. See Page 5 for Crystal & Porcelain Knob Options.	LH/RH	Polished Brass - Lifetime (US3) French Antique (US7) Oil Rubbed Bronze (US10B) Satin Nickel (US15) Pewter (US15A) Polished Chrome (US26)	\$530.00
Dummy	N/A	3009	N/A				\$346.00

Handing is Required for All Mortise Locks. Standard door thickness of 1¾", specify if thicker. Available in 2½" or 2¾" Backset. Locks for in-swing doors are standard, for out-swing doors please specify.

Craftsman Mortise



Craftsman Full Length Mortise



ANSI F13 Craftsman Full Length Mortise



Order any Brass Knob or Lever for the Inside Trim.

CRAFTSMAN MORTISE		Product Code	Backset	Knob or Lever Style for Inside Trim	Handing	Finish	List Price
Entry Set	Specify F20/F13 Function	3308	2½" or 2¾"	See Page 5 for Brass Knob & Lever Options.	LH/RH	Oil Rubbed Bronze (US10B) Satin Nickel (US15) Flat Black (US19)	\$480.00
Dummy	N/A	3008	N/A	See Page 5 for Crystal & Porcelain Knob Options.			\$296.00

CRAFTSMAN FULL LENGTH MORTISE		Product Code	Backset	Knob or Lever Style for Inside Trim	Handing	Finish	List Price
Entry Set	Specify F20/F13 Function	3349	2½" or 2¾"	See Page 5 for Brass Knob & Lever Options.	LH/RH	Oil Rubbed Bronze (US10B) Satin Nickel (US15) Flat Black (US19)	\$530.00
Dummy	N/A	3049	N/A	See Page 5 for Crystal & Porcelain Knob Options.			\$346.00

Handing is Required for All Mortise Locks. Standard door thickness of 1¾", specify if thicker. Available in 2½" or 2¾" Backset. Locks for in-swing doors are standard, for out-swing doors please specify.

ENTRANCE HANDLESETS - SANDCAST BRONZE MORTISE

Sonoma Mortise

Longmont Mortise

ANSI F13 Longmont Mortise



Order any Sandcast Bronze Knob or Lever for the Inside Trim.

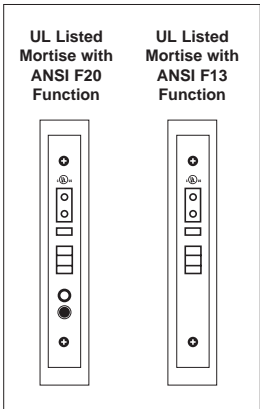

SONOMA MORTISE		Product Code	Backset	Knob or Lever Style for Inside Trim	Handing	Finish	List Price
Entry Set	Specify F20/F13 Function	3329	2½" or 2¾"	See Page 5 for Sandcast Bronze Knob & Lever Options.	LH/RH	Flat Black Bronze (FB) Medium Bronze (MB) Tumbled White Bronze (TWB)	\$530.00
Dummy	N/A	3029	N/A	See Page 5 for Crystal & Porcelain Knob Options.			\$346.00

LONGMONT MORTISE		Product Code	Backset	Knob or Lever Style for Inside Trim	Handing	Finish	List Price
Entry Set	Specify F20/F13 Function	3330	2½" or 2¾"	See Page 5 for Sandcast Bronze Knob & Lever Options.	LH/RH	Flat Black Bronze (FB) Medium Bronze (MB) Tumbled White Bronze (TWB)	\$580.00
Dummy	N/A	3030	N/A	See Page 5 for Crystal & Porcelain Knob Options.			\$396.00

Handing is Required for All Mortise Locks. Standard door thickness of 1¾", specify if thicker. Available in 2½" or 2¾" Backset. Locks for in-swing doors are standard, for out-swing doors please specify.

Denver Mortise

Cheyenne Mortise

Topeka Mortise

ANSI F13 Topeka Mortise



Order any Sandcast Bronze Knob or Lever for the Inside Trim.

DENVER MORTISE		Product Code	Backset	Knob or Lever Style for Inside Trim	Handing	Finish	List Price
Entry Set	Specify F20/F13 Function	3323	2½" or 2¾"	See Page 5 for Sandcast Bronze Knob & Lever Options.	LH/RH	Flat Black Bronze (FB) Medium Bronze (MB) Tumbled White Bronze (TWB)	\$490.00
Dummy	N/A	3023	N/A				See Page 5 for Crystal & Porcelain Knob Options.

CHEYENNE MORTISE		Product Code	Backset	Knob or Lever Style for Inside Trim	Handing	Finish	List Price
Entry Set	Specify F20/F13 Function	3321	2½" or 2¾"	See Page 5 for Sandcast Bronze Knob & Lever Options.	LH/RH	Flat Black Bronze (FB) Medium Bronze (MB) Tumbled White Bronze (TWB)	\$530.00
Dummy	N/A	3021	N/A				See Page 5 for Crystal & Porcelain Knob Options.

TOPEKA MORTISE		Product Code	Backset	Knob or Lever Style for Inside Trim	Handing	Finish	List Price
Entry Set	Specify F20/F13 Function	3322	2½" or 2¾"	See Page 5 for Sandcast Bronze Knob & Lever Options.	LH/RH	Flat Black Bronze (FB) Medium Bronze (MB) Tumbled White Bronze (TWB)	\$580.00
Dummy	N/A	3022	N/A				See Page 5 for Crystal & Porcelain Knob Options.

Handing is Required for All Mortise Locks. Standard door thickness of 1¾", specify if thicker. Available in 2½" or 2¾" Backset. Locks for in-swing doors are standard, for out-swing doors please specify.

ENTRANCE HANDLESETS - SANDCAST BRONZE MORTISE

Rectangular Sectional Mortise



Rectangular Monolithic Mortise



Rectangular Full Length Mortise



ANSI F13 Rectangular Full Length Mortise



Order any Sandcast Bronze Knob or Lever for the Inside Trim.

RECTANGULAR SECTIONAL MORTISE		Product Code	Backset	Knob or Lever Style for Inside Trim	Handing	Finish	List Price
Entry Set	Specify F20/F13 Function	3324	2½" or 2¾"	See Page 5 for Sandcast Bronze Knob & Lever Options. See Page 5 for Crystal & Porcelain Knob Options.	LH/RH	Flat Black Bronze (FB) Medium Bronze (MB) Tumbled White Bronze (TWB)	\$490.00
Dummy	N/A	3024	N/A				\$306.00

RECTANGULAR MONOLITHIC MORTISE		Product Code	Backset	Knob or Lever Style for Inside Trim	Handing	Finish	List Price
Entry Set	Specify F20/F13 Function	3325	2½" or 2¾"	See Page 5 for Sandcast Bronze Knob & Lever Options. See Page 5 for Crystal & Porcelain Knob Options.	LH/RH	Flat Black Bronze (FB) Medium Bronze (MB) Tumbled White Bronze (TWB)	\$530.00
Dummy	N/A	3025	N/A				\$346.00

RECTANGULAR FULL LENGTH MORTISE		Product Code	Backset	Knob or Lever Style for Inside Trim	Handing	Finish	List Price
Entry Set	Specify F20/F13 Function	3326	2½" or 2¾"	See Page 5 for Sandcast Bronze Knob & Lever Options. See Page 5 for Crystal & Porcelain Knob Options.	LH/RH	Flat Black Bronze (FB) Medium Bronze (MB) Tumbled White Bronze (TWB)	\$580.00
Dummy	N/A	3026	N/A				\$396.00

Handing is Required for All Mortise Locks. Standard door thickness of 1¾", specify if thicker. Available in 2½" or 2¾" Backset. Locks for in-swing doors are standard, for out-swing doors please specify.

Morgan
Mortise

Rockford
Mortise

ANSI F13
Rockford Mortise



Order any Sandcast Bronze Knob or Lever for the Inside Trim.

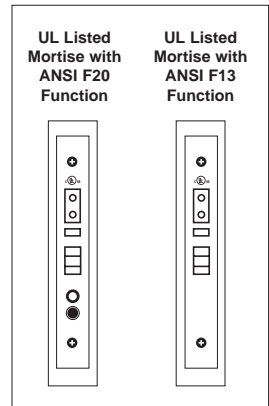

MORGAN MORTISE		Product Code	Backset	Knob or Lever Style for Inside Trim	Handing	Finish	List Price
Entry Set	Specify F20/F13 Function	3327	2½" or 2¾"	See Page 5 for Sandcast Bronze Knob & Lever Options.	LH/RH	Flat Black Bronze (FB) Medium Bronze (MB) Tumbled White Bronze (TWB)	\$530.00
Dummy	N/A	3027	N/A				See Page 5 for Crystal & Porcelain Knob Options.

ROCKFORD MORTISE		Product Code	Backset	Knob or Lever Style for Inside Trim	Handing	Finish	List Price
Entry Set	Specify F20/F13 Function	3328	2½" or 2¾"	See Page 5 for Sandcast Bronze Knob & Lever Options.	LH/RH	Flat Black Bronze (FB) Medium Bronze (MB) Tumbled White Bronze (TWB)	\$580.00
Dummy	N/A	3028	N/A				See Page 5 for Crystal & Porcelain Knob Options.

Handing is Required for All Mortise Locks. Standard door thickness of 1¾", specify if thicker. Available in 2½" or 2¾" Backset. Locks for in-swing doors are standard, for out-swing doors please specify.

ENTRANCE HANDLESETS - LOST WAX CAST BRONZE MORTISE

Octagon Mortise



Da Vinci Mortise



ANSI F13
Da Vinci
Mortise



Order any Lost Wax Cast Bronze Knob or Lever for the Inside Trim.



Order any Lost Wax Cast Bronze Knob or Lever for the Inside Trim.

OCTAGON MORTISE		Product Code	Backset	Knob or Lever Style for Inside Trim	Handing	Finish	List Price
Entry Set	Specify F20/F13 Function	3333	2½" or 2¾"	See Page 6 for Lost Wax Cast Bronze Knob & Lever Options.	LH/RH	Flat Black Bronze (FB) Medium Bronze (MB)	\$530.00
Dummy	N/A	3033	N/A				See Page 5 for Crystal & Porcelain Knob Options.

DA VINCI MORTISE		Product Code	Backset	Knob or Lever Style for Inside Trim	Handing	Finish	List Price
Entry Set	Specify F20/F13 Function	3331	2½" or 2¾"	See Page 6 for Lost Wax Cast Bronze Knob & Lever Options.	LH/RH	Flat Black Bronze (FB) Medium Bronze (MB)	\$530.00
Dummy	N/A	3031	N/A				See Page 5 for Crystal & Porcelain Knob Options.

Handing is Required for All Mortise Locks. Standard door thickness of 1¾", specify if thicker. Available in 2½" or 2¾" Backset. Locks for in-swing doors are standard, for out-swing doors please specify.

Mormont
Stainless Steel
Mortise



ANSI F13
Mormont
Stainless Steel
Mortise



Order any Stainless Steel Knob or Lever for the Inside Trim.

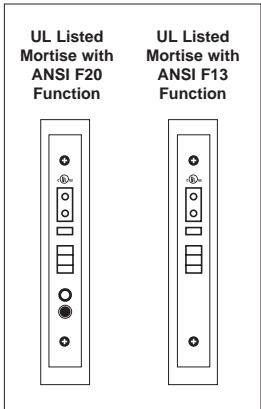

MORMONT STAINLESS STEEL MORTISE		Product Code	Backset	Knob or Lever Style for Inside Trim	Handing	Finish	List Price
Entry Set	Specify F20/F13 Function	S3301	2½" or 2¾"	See Page 6 for Stainless Steel Knob & Lever Options.	LH/RH	Brushed Stainless Steel (SS)	\$480.00
Dummy	N/A	S3001	N/A				\$296.00

Handing is Required for All Mortise Locks. Standard door thickness of 1¾", specify if thicker. Available in 2½" or 2¾" Backset. Locks for in-swing doors are standard, for out-swing doors please specify.

ENTRANCE LOCKSETS - BRASS KNOB BY KNOB & LEVER BY LEVER MORTISE



MORMONT MORTISE		Product Code	Backset	Knob or Lever Style	Handing	Finish	List Price
Entry Set	Specify F20/F13 Function	3545	2 1/2" or 2 3/4"	See Page 4 for Brass Knob & Lever Options. See Page 5 for Crystal & Porcelain Knob Options.	LH/RH	Satin Brass (US4) Oil Rubbed Bronze (US10B) Satin Nickel (US15) Flat Black (US19) Polished Chrome (US26)	\$460.00
Dummy	N/A	3145	N/A				\$276.00

ARTEMIS MORTISE		Product Code	Backset	Knob or Lever Style	Handing	Finish	List Price
Entry Set	Specify F20/F13 Function	3544	2 1/2" or 2 3/4"	See Page 4 for Brass Knob & Lever Options. See Page 5 for Crystal & Porcelain Knob Options.	LH/RH	Satin Brass (US4) Oil Rubbed Bronze (US10B) Satin Nickel (US15) Flat Black (US19) Polished Chrome (US26)	\$460.00
Dummy	N/A	3144	N/A				\$276.00

HARRISON MORTISE		Product Code	Backset	Knob or Lever Style	Handing	Finish	List Price
Entry Set	Specify F20/F13 Function	3551	2 1/2" or 2 3/4"	See Page 4 for Brass Knob & Lever Options. See Page 5 for Crystal & Porcelain Knob Options.	LH/RH	Polished Brass - Lifetime (US3) French Antique (US7) Oil Rubbed Bronze (US10B) Satin Nickel (US15) Pewter (US15A) Flat Black (US19) Polished Chrome (US26)	\$460.00
Dummy	N/A	3151	N/A				\$276.00

Handing is Required for All Mortise Locks. Standard door thickness of 1 3/4", specify if thicker. Available in 2 1/2" or 2 3/4" Backset. Locks for in-swing doors are standard, for out-swing doors please specify.

Manhattan Mortise



Charleston Mortise



Memphis Mortise



Interior Trim View

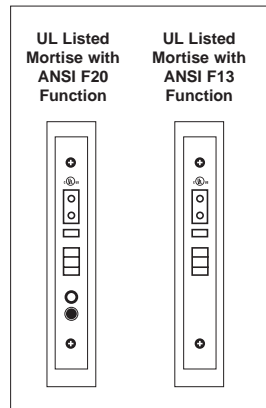

MANHATTAN MORTISE		Product Code	Backset	Knob or Lever Style	Handing	Finish	List Price
Entry Set	Specify F20/F13 Function	3506	2 1/2" or 2 3/4"	See Page 4 for Brass Knob & Lever Options. See Page 5 for Crystal & Porcelain Knob Options.	LH/RH	Polished Brass - Lifetime (US3) French Antique (US7) Oil Rubbed Bronze (US10B) Satin Nickel (US15) Pewter (US15A) Polished Chrome (US26)	\$460.00
Dummy	N/A	3106	N/A				\$276.00

CHARLESTON MORTISE		Product Code	Backset	Knob or Lever Style	Handing	Finish	List Price
Entry Set	Specify F20/F13 Function	3543	2 1/2" or 2 3/4"	See Page 4 for Brass Knob & Lever Options. See Page 5 for Crystal & Porcelain Knob Options.	LH/RH	Polished Brass - Lifetime (US3) French Antique (US7) Oil Rubbed Bronze (US10B) Satin Nickel (US15) Pewter (US15A) Polished Chrome (US26)	\$460.00
Dummy	N/A	3143	N/A				\$276.00

MEMPHIS MORTISE		Product Code	Backset	Knob or Lever Style	Handing	Finish	List Price
Entry Set	Specify F20/F13 Function	3502	2 1/2" or 2 3/4"	See Page 4 for Brass Knob & Lever Options. See Page 5 for Crystal & Porcelain Knob Options.	LH/RH	Polished Brass - Lifetime (US3) French Antique (US7) Oil Rubbed Bronze (US10B) Satin Nickel (US15) Pewter (US15A) Polished Chrome (US26)	\$460.00
Dummy	N/A	3102	N/A				\$276.00

Handing is Required for All Mortise Locks. Standard door thickness of 1 3/4", specify if thicker. Available in 2 1/2" or 2 3/4" Backset. Locks for in-swing doors are standard, for out-swing doors please specify.

ENTRANCE LOCKSETS - BRASS KNOB BY KNOB & LEVER BY LEVER MORTISE

Hamilton
MortiseRegency
MortiseCraftsman
MortiseANSI F13
Craftsman
Mortise

Interior Trim View

HAMILTON MORTISE		Product Code	Backset	Knob or Lever Style	Handing	Finish	List Price
Entry Set	Specify F20/F13 Function	3504	2 1/2" or 2 3/4"	See Page 4 for Brass Knob & Lever Options. See Page 5 for Crystal & Porcelain Knob Options.	LH/RH	Polished Brass - Lifetime (US3) French Antique (US7) Oil Rubbed Bronze (US10B) Satin Nickel (US15) Pewter (US15A) Polished Chrome (US26)	\$460.00
Dummy	N/A	3104	N/A				\$276.00

REGENCY MORTISE		Product Code	Backset	Knob or Lever Style	Handing	Finish	List Price
Entry Set	Specify F20/F13 Function	3507	2 1/2" or 2 3/4"	See Page 4 for Brass Knob & Lever Options. See Page 5 for Crystal & Porcelain Knob Options.	LH/RH	Polished Brass - Lifetime (US3) French Antique (US7) Oil Rubbed Bronze (US10B) Satin Nickel (US15) Pewter (US15A) Polished Chrome (US26)	\$460.00
Dummy	N/A	3107	N/A				\$276.00

CRAFTSMAN MORTISE		Product Code	Backset	Knob or Lever Style	Handing	Finish	List Price
Entry Set	Specify F20/F13 Function	3508	2 1/2" or 2 3/4"	See Page 5 for Brass Knob & Lever Options. See Page 5 for Crystal & Porcelain Knob Options.	LH/RH	Oil Rubbed Bronze (US10B) Satin Nickel (US15) Flat Black (US19)	\$460.00
Dummy	N/A	3108	N/A				\$276.00

Handing is Required for All Mortise Locks. Standard door thickness of 1 3/4", specify if thicker. Available in 2 1/2" or 2 3/4" Backset. Locks for in-swing doors are standard, for out-swing doors please specify.

Rectangular Mortise



Cheyenne Mortise



Hailey Mortise

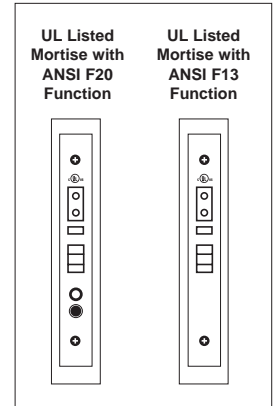

RECTANGULAR MORTISE		Product Code	Backset	Knob or Lever Style	Handing	Finish	List Price
Entry Set	Specify F20/F13 Function	3525	2 1/2" or 2 3/4"	See Page 5 for Sandcast Bronze Knob & Lever Options.	LH/RH	Flat Black Bronze (FB) Medium Bronze (MB) Tumbled White Bronze (TWB)	\$510.00
Dummy	N/A	3125	N/A				See Page 5 for Crystal & Porcelain Knob Options.

CHEYENNE MORTISE		Product Code	Backset	Knob or Lever Style	Handing	Finish	List Price
Entry Set	Specify F20/F13 Function	3521	2 1/2" or 2 3/4"	See Page 5 for Sandcast Bronze Knob & Lever Options.	LH/RH	Flat Black Bronze (FB) Medium Bronze (MB) Tumbled White Bronze (TWB)	\$510.00
Dummy	N/A	3121	N/A				See Page 5 for Crystal & Porcelain Knob Options.

HAILEY MORTISE		Product Code	Backset	Knob or Lever Style	Handing	Finish	List Price
Entry Set	Specify F20/F13 Function	3534	2 1/2" or 2 3/4"	See Page 5 for Sandcast Bronze Knob & Lever Options.	LH/RH	Flat Black Bronze (FB) Medium Bronze (MB) Tumbled White Bronze (TWB)	\$510.00
Dummy	N/A	3134	N/A				See Page 5 for Crystal & Porcelain Knob Options.

Handing is Required for All Mortise Locks. Standard door thickness of 1 3/4", specify if thicker. Available in 2 1/2" or 2 3/4" Backset. Locks for in-swing doors are standard, for out-swing doors please specify.

ENTRANCE LOCKSETS - LOST WAX CAST BRONZE & STAINLESS STEEL KNOB BY KNOB & LEVER BY LEVER MORTISE

Da Vinci
MortiseOctagon
MortiseMormont
Stainless Steel MortiseANSI F13
Mormont
Stainless Steel Mortise



Interior Trim View

DA VINCI MORTISE		Product Code	Backset	Knob or Lever Style	Handing	Finish	List Price
Entry Set	Specify F20/F13 Function	3531	2 1/2" or 2 3/4"	See Page 6 for Lost Wax Cast Bronze Knob & Lever Options. See Page 5 for Crystal & Porcelain Knob Options.	LH/RH	Flat Black Bronze (FB) Medium Bronze (MB)	\$510.00
Dummy	N/A	3131	N/A				\$326.00

OCTAGON STEEL MORTISE		Product Code	Backset	Knob or Lever Style	Handing	Finish	List Price
Entry Set	Specify F20/F13 Function	3533	2 1/2" or 2 3/4"	See Page 6 for Lost Wax Cast Bronze Knob & Lever Options. See Page 5 for Crystal & Porcelain Knob Options.	LH/RH	Flat Black Bronze (FB) Medium Bronze (MB)	\$510.00
Dummy	N/A	3133	N/A				\$326.00

MORMONT STAINLESS STEEL MORTISE		Product Code	Backset	Knob or Lever Style	Handing	Finish	List Price
Entry Set	Specify F20/F13 Function	S3501	2 1/2" or 2 3/4"	See Page 6 for Stainless Steel Knob & Lever Options.	LH/RH	Brushed Stainless Steel (SS)	\$460.00
Dummy	N/A	S3101	N/A				\$276.00

Handing is Required for All Mortise Locks. Standard door thickness of 1 3/4", specify if thicker. Available in 2 1/2" or 2 3/4" Backset. Locks for in-swing doors are standard, for out-swing doors please specify.

			
<p>Steel Understrike Supplied with all Mortise Locks</p>	<p>Brass Standard Strike Plate 1 7/8" wide x 4 7/8" high Supplied with Mortise Locks unless door thickness is specified as 2" or greater</p>	<p>Brass Flat Strike Plate 1 7/8" wide x 4 7/8" high Supplied with Mortise Locks when requested</p>	<p>Brass Extended Strike Plate 2 1/2" wide x 4 7/8" high Supplied with Mortise Locks when door thickness is specified as 2" or greater</p>

ADDITIONAL STRIKE PLATES (F20/F13)	Product Code	Finish	List Price
Brass Standard Strike Plate with understrike and screws	86147	Polished Brass - Lifetime (US3) French Antique (US7) Oil Rubbed Bronze (US10B)	\$16.00
Brass Flat Strike Plate with understrike and screws	86148	Satin Nickel (US15) Pewter (US15A) Flat Black (US19) Polished Chrome (US26)	\$16.00
Brass Extended Strike Plate with understrike and screws	86149	Medium Bronze (MB) Tumbled White Bronze (TWB)	\$16.00

MORTISE LOCK BOX ONLY Includes Face Plate, Trimplate and Strike Plate. Cylinder Not Included.		Product Code	Backset	Handing	Finish	List Price
Thumb by Lever or Knob	Specify F20/F13 Function	3300	2 1/2" or 2 3/4"	LH/RH	Polished Brass - Lifetime (US3) French Antique (US7) Oil Rubbed Bronze (US10B) Satin Nickel (US15) Pewter (US15A) Flat Black (US19)	\$184.00
Knob by Knob & Lever by Lever		3380	2 1/2" or 2 3/4"	LH/RH	Polished Chrome (US26) Medium Bronze (MB) Tumbled White Bronze (TWB)	\$184.00

CYLINDER ONLY	Product Code	Length	Finish	List Price
Threaded Mortise	CY5-ThrdMrt1375	1 3/8"	Polished Brass - Lifetime (US3) Oil Rubbed Bronze (US10B)	\$24.00
	CY5-ThrdMrt150	1 1/2"	Polished Chrome (US26)	\$24.00
	CY5-ThrdMrt175	1 3/4"		\$24.00

Handing is Required for All Mortise Locks. Standard door thickness of 1 3/4", specify if thicker. Available in 2 1/2" or 2 3/4" Backset. Locks for in-swing doors are standard, for out-swing doors please specify.

ENTRANCE HANDLESETS - BRASS TUBULAR

Baden



Order any Brass Knob or Lever for the Inside Trim.

Davos



Order any Brass Knob or Lever for the Inside Trim.

Lausanne



Interconnect Device Available for Most Brass Tubular Handlesets

BADEN	Product Code	Knob or Lever Style for Inside Trim	Finish	List Price
Single Cylinder	4820	See Page 4 for Brass Knob & Lever Options. See Page 5 for Crystal & Porcelain Knob Options.	Satin Brass (US4)	\$240.00
Double Cylinder	4830		Oil Rubbed Bronze (US10B)	
Dummy	4810		Polished Nickel - Lifetime (US14)	\$240.00
			Satin Nickel (US15)	\$240.00
			Flat Black (US19)	
			Polished Chrome (US26)	\$240.00

DAVOS (5½" Center to Center Door Prep)	Product Code	Knob or Lever Style for Inside Trim	Finish	List Price
Single Cylinder	4818	See Page 4 for Brass Knob & Lever Options. See Page 5 for Crystal & Porcelain Knob Options.	Satin Brass (US4)	\$274.00
Double Cylinder	4828		Oil Rubbed Bronze (US10B)	
Dummy	4808		Polished Nickel - Lifetime (US14)	\$274.00
			Satin Nickel (US15)	\$274.00
			Flat Black (US19)	
			Polished Chrome (US26)	\$274.00

LAUSANNE (5½" Center to Center Door Prep)	Product Code	Knob or Lever Style for Inside Trim	Finish	List Price
Single Cylinder	4819	See Page 4 for Brass Knob & Lever Options. See Page 5 for Crystal & Porcelain Knob Options.	Satin Brass (US4)	\$324.00
Double Cylinder	4829		Oil Rubbed Bronze (US10B)	
Dummy	4809		Polished Nickel - Lifetime (US14)	\$324.00
			Satin Nickel (US15)	\$324.00
			Flat Black (US19)	
			Polished Chrome (US26)	\$324.00

INTERCONNECT DEVICE	Product Code		List Price
Davos & Lausanne Styles	443	Not Available for Double Cylinder.	\$58.00

Handing Required if Lever Used on Inside or if Interconnect Device is Specified. Standard 2½" Door Prep. Standard latch is for 2¾" backset. Specify 2¾" backset if required. 28° Latch Not Available for Use with Tubular Entrance Handlesets. **Weiser® (WRS) Keyway:** Specify by adding "W" to the beginning of Product Code. No upcharge for cylinder substitution. Can be keyed into existing Weiser® system.



Order any Brass Knob or Lever for the Inside Trim.

Order any Brass Knob or Lever for the Inside Trim.

ARES	Product Code	Knob or Lever Style for Inside Trim	Finish	List Price
Single Cylinder	4817	See Page 4 for Brass Knob & Lever Options. See Page 5 for Crystal & Porcelain Knob Options.	Satin Brass (US4)	\$240.00
Double Cylinder	4827		Oil Rubbed Bronze (US10B)	
Dummy	4807		Satin Nickel (US15)	Flat Black (US19)
		Polished Chrome (US26)		

APOLLO (5½" Center to Center Door Prep)	Product Code	Knob or Lever Style for Inside Trim	Finish	List Price
Single Cylinder	4815	See Page 4 for Brass Knob & Lever Options. See Page 5 for Crystal & Porcelain Knob Options.	Satin Brass (US4)	\$274.00
Double Cylinder	4825		Oil Rubbed Bronze (US10B)	
Dummy	4805		Satin Nickel (US15)	Flat Black (US19)
		Polished Chrome (US26)		

ORION (5½" Center to Center Door Prep)	Product Code	Knob or Lever Style for Inside Trim	Finish	List Price
Single Cylinder	4816	See Page 4 for Brass Knob & Lever Options. See Page 5 for Crystal & Porcelain Knob Options.	Satin Brass (US4)	\$324.00
Double Cylinder	4826		Oil Rubbed Bronze (US10B)	
Dummy	4806		Satin Nickel (US15)	Flat Black (US19)
		Polished Chrome (US26)		

INTERCONNECT DEVICE	Product Code		List Price
Apollo & Orion Styles	443	Not Available for Double Cylinder.	\$58.00

Handing Required if Lever Used on Inside or if Interconnect Device is Specified. Standard 2½" Door Prep. Standard latch is for 2¾" backset. Specify 2¾" backset if required. 28° Latch Not Available for Use with Tubular Entrance Handlesets. **Weiser® (WRS) Keyway:** Specify by adding "W" to the beginning of Product Code. No upcharge for cylinder substitution. Can be keyed into existing Weiser® system.

ENTRANCE HANDLESETS - BRASS TUBULAR

Zeus



Order any Brass Knob or Lever for the Inside Trim.

Arts & Crafts



Arts & Crafts Full Length



Order any Brass Knob or Lever for the Inside Trim.

ZEUS (5½" Center to Center Door Prep)	Product Code	Knob or Lever Style for Inside Trim	Finish	List Price
Single Cylinder	4814	See Page 4 for Brass Knob & Lever Options.	Oil Rubbed Bronze (US10B)	\$274.00
Double Cylinder	4824		Satin Nickel (US15)	\$274.00
Dummy	4804	See Page 5 for Crystal & Porcelain Knob Options.	Flat Black (US19)	\$274.00
			Polished Chrome (US26)	\$274.00

ARTS & CRAFTS (5½" Center to Center Door Prep)	Product Code	Knob or Lever Style for Inside Trim	Finish	List Price
Single Cylinder	4811	See Page 5 for Brass Knob & Lever Options.	Oil Rubbed Bronze (US10B)	\$274.00
Double Cylinder	4821		Satin Nickel (US15)	\$274.00
Dummy	4801	See Page 5 for Crystal & Porcelain Knob Options.	Flat Black (US19)	\$274.00

ARTS & CRAFTS FULL LENGTH (5½" Center to Center Door Prep)	Product Code	Knob or Lever Style for Inside Trim	Finish	List Price
Single Cylinder	4812	See Page 5 for Brass Knob & Lever Options.	Oil Rubbed Bronze (US10B)	\$324.00
Double Cylinder	4822		Satin Nickel (US15)	\$324.00
Dummy	4802	See Page 5 for Crystal & Porcelain Knob Options.	Flat Black (US19)	\$324.00

INTERCONNECT DEVICE	Product Code		List Price
Available for Above Styles	443	Not Available for Double Cylinder.	\$58.00

Handing Required if Lever Used on Inside or if Interconnect Device is Specified. Standard 2¾" Door Prep. Standard latch is for 2¾" backset. Specify 2¾" backset if required. 28° Latch Not Available for Use with Tubular Entrance Handlesets. **Weiser® (WR5) Keyway:** Specify by adding "W" to the beginning of Product Code. No upcharge for cylinder substitution. Can be keyed into existing Weiser® system.

Franklin



Order any Brass Knob or Lever for the Inside Trim.

Adams



Jefferson



Order any Brass Knob or Lever for the Inside Trim.

FRANKLIN	Product Code	Knob or Lever Style for Inside Trim	Finish	List Price
Single Cylinder	4413	See Page 4 for Brass Knob & Lever Options. See Page 5 for Crystal & Porcelain Knob Options.	Polished Brass - Lifetime (US3)	\$240.00
Double Cylinder	4423		French Antique (US7)	
Dummy	4403		Oil Rubbed Bronze (US10B)	\$240.00
			Satin Nickel (US15)	\$240.00
			Pewter (US15A)	
			Flat Black (US19)	
			Polished Chrome (US26)	

ADAMS (5½" Center to Center Door Prep)	Product Code	Knob or Lever Style for Inside Trim	Finish	List Price
Single Cylinder	4414	See Page 4 for Brass Knob & Lever Options. See Page 5 for Crystal & Porcelain Knob Options.	Polished Brass - Lifetime (US3)	\$274.00
Double Cylinder	4424		French Antique (US7)	
Dummy	4404		Oil Rubbed Bronze (US10B)	\$274.00
			Satin Nickel (US15)	\$274.00
			Pewter (US15A)	
			Flat Black (US19)	
			Polished Chrome (US26)	

JEFFERSON (5½" Center to Center Door Prep)	Product Code	Knob or Lever Style for Inside Trim	Finish	List Price
Single Cylinder	4415	See Page 4 for Brass Knob & Lever Options. See Page 5 for Crystal & Porcelain Knob Options.	Polished Brass - Lifetime (US3)	\$324.00
Double Cylinder	4425		French Antique (US7)	
Dummy	4405		Oil Rubbed Bronze (US10B)	\$324.00
			Satin Nickel (US15)	\$324.00
			Pewter (US15A)	
			Flat Black (US19)	
			Polished Chrome (US26)	

INTERCONNECT DEVICE	Product Code		List Price
Adams & Jefferson Styles	443	Not Available for Double Cylinder.	\$58.00

Handing Required if Lever Used on Inside or if Interconnect Device is Specified. Standard 2½" Door Prep. Standard latch is for 2¾" backset. Specify 2¾" backset if required. 28° Latch Not Available for Use with Tubular Entrance Handlesets. **Weiser® (WRS) Keyway:** Specify by adding "W" to the beginning of Product Code. No upcharge for cylinder substitution. Can be keyed into existing Weiser® system.

ENTRANCE HANDLESETS - BRASS TUBULAR

Hamden



Order any Brass Knob or Lever for the Inside Trim.

Wilshire



Melrose



Order any Brass Knob or Lever for the Inside Trim.

HAMDEN	Product Code	Knob or Lever Style for Inside Trim	Finish	List Price
Single Cylinder	4213	See Page 4 for Brass Knob & Lever Options. See Page 5 for Crystal & Porcelain Knob Options.	Polished Brass - Lifetime (US3) French Antique (US7) Oil Rubbed Bronze (US10B)	\$240.00
Double Cylinder	4223		Polished Nickel - Lifetime (US14) Satin Nickel (US15)	\$240.00
Dummy	4203		Pewter (US15A) Flat Black (US19) Polished Chrome (US26)	\$240.00

WILSHIRE (5½" Center to Center Door Prep)	Product Code	Knob or Lever Style for Inside Trim	Finish	List Price
Single Cylinder	4211	See Page 4 for Brass Knob & Lever Options. See Page 5 for Crystal & Porcelain Knob Options.	Polished Brass - Lifetime (US3) French Antique (US7) Oil Rubbed Bronze (US10B)	\$274.00
Double Cylinder	4221		Polished Nickel - Lifetime (US14) Satin Nickel (US15)	\$274.00
Dummy	4201		Pewter (US15A) Flat Black (US19) Polished Chrome (US26)	\$274.00

MELROSE (5½" Center to Center Door Prep)	Product Code	Knob or Lever Style for Inside Trim	Finish	List Price
Single Cylinder	4212	See Page 4 for Brass Knob & Lever Options. See Page 5 for Crystal & Porcelain Knob Options.	Polished Brass - Lifetime (US3) French Antique (US7) Oil Rubbed Bronze (US10B)	\$324.00
Double Cylinder	4222		Polished Nickel - Lifetime (US14) Satin Nickel (US15)	\$324.00
Dummy	4202		Pewter (US15A) Flat Black (US19) Polished Chrome (US26)	\$324.00

INTERCONNECT DEVICE	Product Code		List Price
Wilshire & Melrose Styles	443	Not Available for Double Cylinder.	\$58.00

Handing Required if Lever Used on Inside or if Interconnect Device is Specified. Standard 2½" Door Prep. Standard latch is for 2¾" backset. Specify 2¾" backset if required. 28° Latch Not Available for Use with Tubular Entrance Handlesets. **Weiser® (WRS) Keyway:** Specify by adding "W" to the beginning of Product Code. No upcharge for cylinder substitution. Can be keyed into existing Weiser® system.

Nashville



Order any Brass Knob or Lever for the Inside Trim.

Richmond



Wilmington



Order any Brass Knob or Lever for the Inside Trim.

NASHVILLE	Product Code	Knob or Lever Style for Inside Trim	Finish	List Price
Single Cylinder	4312	See Page 4 for Brass Knob & Lever Options. See Page 5 for Crystal & Porcelain Knob Options.	Polished Brass - Lifetime (US3) French Antique (US7) Oil Rubbed Bronze (US10B) Satin Nickel (US15) Pewter (US15A) Flat Black (US19) Polished Chrome (US26)	\$240.00
Double Cylinder	4322			\$240.00
Dummy	4302			\$240.00

RICHMOND (5½" Center to Center Door Prep)	Product Code	Knob or Lever Style for Inside Trim	Finish	List Price
Single Cylinder	4313	See Page 4 for Brass Knob & Lever Options. See Page 5 for Crystal & Porcelain Knob Options.	Polished Brass - Lifetime (US3) French Antique (US7) Oil Rubbed Bronze (US10B) Satin Nickel (US15) Pewter (US15A) Flat Black (US19) Polished Chrome (US26)	\$274.00
Double Cylinder	4323			\$274.00
Dummy	4303			\$274.00

WILMINGTON (5½" Center to Center Door Prep)	Product Code	Knob or Lever Style for Inside Trim	Finish	List Price
Single Cylinder	4314	See Page 4 for Brass Knob & Lever Options. See Page 5 for Crystal & Porcelain Knob Options.	Polished Brass - Lifetime (US3) French Antique (US7) Oil Rubbed Bronze (US10B) Satin Nickel (US15) Pewter (US15A) Flat Black (US19) Polished Chrome (US26)	\$324.00
Double Cylinder	4324			\$324.00
Dummy	4304			\$324.00

INTERCONNECT DEVICE	Product Code		List Price
Richmond & Wilmington Styles	443	Not Available for Double Cylinder.	\$58.00

Handing Required if Lever Used on Inside or if Interconnect Device is Specified. Standard 2½" Door Prep. Standard latch is for 2¾" backset. Specify 2¾" backset if required. 28° Latch Not Available for Use with Tubular Entrance Handlesets. **Weiser® (WRS) Keyway:** Specify by adding "W" to the beginning of Product Code. No upcharge for cylinder substitution. Can be keyed into existing Weiser® system.

ENTRANCE HANDLESETS - BRASS TUBULAR

Saratoga



Order any Brass Knob or Lever for the Inside Trim.

Marietta



Order any Brass Knob or Lever for the Inside Trim.

Knoxville



Order any Brass Knob or Lever for the Inside Trim.

SARATOGA	Product Code	Knob or Lever Style for Inside Trim	Finish	List Price
Single Cylinder	4410	See Page 4 for Brass Knob & Lever Options. See Page 5 for Crystal & Porcelain Knob Options.	Polished Brass - Lifetime (US3) French Antique (US7) Oil Rubbed Bronze (US10B) Satin Nickel (US15) Pewter (US15A) Flat Black (US19) Polished Chrome (US26)	\$240.00
Double Cylinder	4420			\$240.00
Dummy	4400			\$240.00

MARIETTA (1/2" Center to Center Door Prep)	Product Code	Knob or Lever Style for Inside Trim	Finish	List Price
Single Cylinder	4411	See Page 4 for Brass Knob & Lever Options. See Page 5 for Crystal & Porcelain Knob Options.	Polished Brass - Lifetime (US3) French Antique (US7) Oil Rubbed Bronze (US10B) Satin Nickel (US15) Pewter (US15A) Flat Black (US19) Polished Chrome (US26)	\$274.00
Double Cylinder	4421			\$274.00
Dummy	4401			\$274.00

KNOXVILLE	Product Code	Knob or Lever Style for Inside Trim	Finish	List Price
Single Cylinder	4310	See Page 4 for Brass Knob & Lever Options. See Page 5 for Crystal & Porcelain Knob Options.	Polished Brass - Lifetime (US3) French Antique (US7) Oil Rubbed Bronze (US10B) Satin Nickel (US15) Pewter (US15A) Polished Chrome (US26)	\$240.00
Double Cylinder	4320			\$240.00
Dummy	4300			\$240.00

INTERCONNECT DEVICE	Product Code		List Price
Marietta Style	443	Not Available for Double Cylinder.	\$58.00

Handing Required if Lever Used on Inside or if Interconnect Device is Specified. Standard 2 1/8" Door Prep. Standard latch is for 2 3/8" backset. Specify 2 3/4" backset if required. 28° Latch Not Available for Use with Tubular Entrance Handlesets. **Weiser® (WRS) Keyway:** Specify by adding "W" to the beginning of Product Code. No upcharge for cylinder substitution. Can be keyed into existing Weiser® system.

Orleans



Order any Brass Knob or Lever for the Inside Trim.

Ribbon & Reed



Imperial



Order any Brass Knob or Lever for the Inside Trim.

ORLEANS (5½" Center to Center Door Prep)	Product Code	Knob or Lever Style for Inside Trim	Finish	List Price
Single Cylinder	4311	See Page 4 for Brass Knob & Lever Options. See Page 5 for Crystal & Porcelain Knob Options.	Polished Brass - Lifetime (US3) French Antique (US7) Oil Rubbed Bronze (US10B) Satin Nickel (US15) Pewter (US15A) Polished Chrome (US26)	\$274.00
Double Cylinder	4321			\$274.00
Dummy	4301			\$274.00

RIBBON & REED (5½" Center to Center Door Prep)	Product Code	Knob or Lever Style for Inside Trim	Finish	List Price
Single Cylinder	4711	See Page 4 for Brass Knob & Lever Options. See Page 5 for Crystal & Porcelain Knob Options.	Polished Brass - Lifetime (US3) French Antique (US7) Oil Rubbed Bronze (US10B) Satin Nickel (US15) Pewter (US15A) Polished Chrome (US26)	\$274.00
Double Cylinder	4721			\$274.00
Dummy	4701			\$274.00

IMPERIAL (5½" Center to Center Door Prep)	Product Code	Knob or Lever Style for Inside Trim	Finish	List Price
Single Cylinder	4911	See Page 4 for Brass Knob & Lever Options. See Page 5 for Crystal & Porcelain Knob Options.	Polished Brass - Lifetime (US3) French Antique (US7) Oil Rubbed Bronze (US10B) Satin Nickel (US15) Pewter (US15A) Polished Chrome (US26)	\$324.00
Double Cylinder	4921			\$324.00
Dummy	4901			\$324.00

INTERCONNECT DEVICE	Product Code		List Price
Available for Above Styles	443	Not Available for Double Cylinder.	\$58.00

Handing Required if Lever Used on Inside or if Interconnect Device is Specified. Standard 2½" Door Prep. Standard latch is for 2¾" backset. Specify 2¾" backset if required. 28° Latch Not Available for Use with Tubular Entrance Handlesets. **Weiser® (WR5) Keyway:** Specify by adding "W" to the beginning of Product Code. No upcharge for cylinder substitution. Can be keyed into existing Weiser® system.

ENTRANCE HANDLESETS - SANDCAST BRONZE TUBULAR

Ridgemont



Order any Sandcast Bronze Knob or Lever for the Inside Trim.

Logan



Brighton



Order any Sandcast Bronze Knob or Lever for the Inside Trim.

RIDGEMONT	Product Code	Knob or Lever Style for Inside Trim	Finish	List Price
Single Cylinder	451721	See Page 5 for Sandcast Bronze Knob & Lever Options. See Page 5 for Crystal & Porcelain Knob Options.	Flat Black Bronze (FB) Medium Bronze (MB) Tumbled White Bronze (TWB)	\$332.00
Double Cylinder	452721			\$332.00
Dummy	450721			\$332.00

LOGAN (5½" Center to Center Door Prep)	Product Code	Knob or Lever Style for Inside Trim	Finish	List Price
Single Cylinder	451822	See Page 5 for Sandcast Bronze Knob & Lever Options. See Page 5 for Crystal & Porcelain Knob Options.	Flat Black Bronze (FB) Medium Bronze (MB) Tumbled White Bronze (TWB)	\$366.00
Double Cylinder	452822			\$366.00
Dummy	450822			\$366.00

BRIGHTON (5½" Center to Center Door Prep)	Product Code	Knob or Lever Style for Inside Trim	Finish	List Price
Single Cylinder	451923	See Page 5 for Sandcast Bronze Knob & Lever Options. See Page 5 for Crystal & Porcelain Knob Options.	Flat Black Bronze (FB) Medium Bronze (MB) Tumbled White Bronze (TWB)	\$416.00
Double Cylinder	452923			\$416.00
Dummy	450923			\$416.00

INTERCONNECT DEVICE	Product Code		List Price
Logan & Brighton Styles	443	Not Available for Double Cylinder.	\$58.00

Handing Required if Lever Used on Inside or if Interconnect Device is Specified. Standard 2½" Door Prep. Standard latch is for 2¾" backset. Specify 2¾" backset if required. 28° Latch Not Available for Use with Tubular Entrance Handlesets. **Weiser® (WR5) Keyway:** Specify by adding "W" to the beginning of Product Code. No upcharge for cylinder substitution. Can be keyed into existing Weiser® system.

Laramie

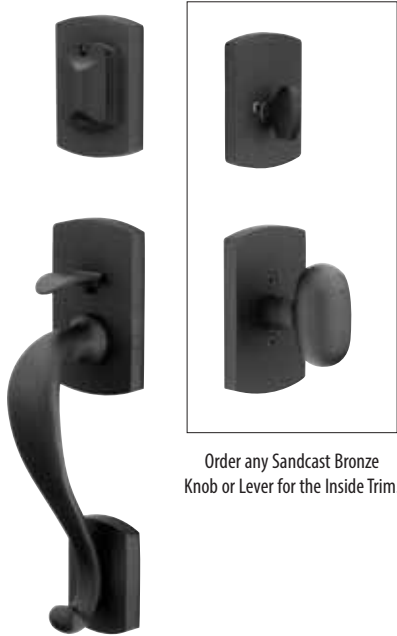

Order any Sandcast Bronze Knob or Lever for the Inside Trim.

Sheridan



Creston



Order any Sandcast Bronze Knob or Lever for the Inside Trim.

LARAMIE	Product Code	Knob or Lever Style for Inside Trim	Finish	List Price
Single Cylinder	451711	See Page 5 for Sandcast Bronze Knob & Lever Options. See Page 5 for Crystal & Porcelain Knob Options.	Flat Black Bronze (FB) Medium Bronze (MB) Tumbled White Bronze (TWB)	\$332.00
Double Cylinder	452711			\$332.00
Dummy	450711			\$332.00

SHERIDAN (5½" Center to Center Door Prep)	Product Code	Knob or Lever Style for Inside Trim	Finish	List Price
Single Cylinder	451812	See Page 5 for Sandcast Bronze Knob & Lever Options. See Page 5 for Crystal & Porcelain Knob Options.	Flat Black Bronze (FB) Medium Bronze (MB) Tumbled White Bronze (TWB)	\$366.00
Double Cylinder	452812			\$366.00
Dummy	450812			\$366.00

CRESTON (5½" Center to Center Door Prep)	Product Code	Knob or Lever Style for Inside Trim	Finish	List Price
Single Cylinder	451913	See Page 5 for Sandcast Bronze Knob & Lever Options. See Page 5 for Crystal & Porcelain Knob Options.	Flat Black Bronze (FB) Medium Bronze (MB) Tumbled White Bronze (TWB)	\$416.00
Double Cylinder	452913			\$416.00
Dummy	450913			\$416.00

INTERCONNECT DEVICE	Product Code		List Price
Sheridan & Creston Styles	443	Not Available for Double Cylinder.	\$58.00

Handing Required if Lever Used on Inside or if Interconnect Device is Specified. Standard 2½" Door Prep. Standard latch is for 2¾" backset. Specify 2¾" backset if required. 28° Latch Not Available for Use with Tubular Entrance Handlesets. **Weiser® (WRS) Keyway:** Specify by adding "W" to the beginning of Product Code. No upcharge for cylinder substitution. Can be keyed into existing Weiser® system.

ENTRANCE HANDLESETS - SANDCAST BRONZE TUBULAR

Denver



Order any Sandcast Bronze Knob or Lever for the Inside Trim.

Remington



Greeley



Order any Sandcast Bronze Knob or Lever for the Inside Trim.

DENVER	Product Code	Knob or Lever Style for Inside Trim	Finish	List Price
Single Cylinder	451211	See Page 5 for Sandcast Bronze Knob & Lever Options. See Page 5 for Crystal & Porcelain Knob Options.	Flat Black Bronze (FB) Medium Bronze (MB) Tumbled White Bronze (TWB)	\$332.00
Double Cylinder	452211			\$332.00
Dummy	450211			\$332.00

REMINGTON (5½" Center to Center Door Prep)	Product Code	Knob or Lever Style for Inside Trim	Finish	List Price
Single Cylinder	451112	See Page 5 for Sandcast Bronze Knob & Lever Options. See Page 5 for Crystal & Porcelain Knob Options.	Flat Black Bronze (FB) Medium Bronze (MB) Tumbled White Bronze (TWB)	\$366.00
Double Cylinder	452112			\$366.00
Dummy	450112			\$366.00

GREELEY (5½" Center to Center Door Prep)	Product Code	Knob or Lever Style for Inside Trim	Finish	List Price
Single Cylinder	451332	See Page 5 for Sandcast Bronze Knob & Lever Options. See Page 5 for Crystal & Porcelain Knob Options.	Flat Black Bronze (FB) Medium Bronze (MB) Tumbled White Bronze (TWB)	\$416.00
Double Cylinder	452332			\$416.00
Dummy	450332			\$416.00

INTERCONNECT DEVICE	Product Code		List Price
Remington & Greeley Styles	443	Not Available for Double Cylinder.	\$58.00

Handing Required if Lever Used on Inside or if Interconnect Device is Specified. Standard 2½" Door Prep. Standard latch is for 2¾" backset. Specify 2¾" backset if required. 28° Latch Not Available for Use with Tubular Entrance Handlesets. **Weiser® (WR5) Keyway:** Specify by adding "W" to the beginning of Product Code. No upcharge for cylinder substitution. Can be keyed into existing Weiser® system.

To order: **(W) Product Code + Knob/Lever Style + Handing + Finish + Add Door Thickness to Comments**

Rectangular Sectional



Order any Sandcast Bronze Knob or Lever for the Inside Trim.

Rectangular Monolithic



Rectangular Full Length



Order any Sandcast Bronze Knob or Lever for the Inside Trim.

RECTANGULAR SECTIONAL	Product Code	Knob or Lever Style for Inside Trim	Finish	List Price
Single Cylinder	451411	See Page 5 for Sandcast Bronze Knob & Lever Options. See Page 5 for Crystal & Porcelain Knob Options.	Flat Black Bronze (FB) Medium Bronze (MB) Tumbled White Bronze (TWB)	\$332.00
Double Cylinder	452411			\$332.00
Dummy	450411			\$332.00

RECTANGULAR MONOLITHIC <small>(5½" Center to Center Door Prep)</small>	Product Code	Knob or Lever Style for Inside Trim	Finish	List Price
Single Cylinder	451512	See Page 5 for Sandcast Bronze Knob & Lever Options. See Page 5 for Crystal & Porcelain Knob Options.	Flat Black Bronze (FB) Medium Bronze (MB) Tumbled White Bronze (TWB)	\$366.00
Double Cylinder	452512			\$366.00
Dummy	450512			\$366.00

RECTANGULAR FULL LENGTH <small>(5½" Center to Center Door Prep)</small>	Product Code	Knob or Lever Style for Inside Trim	Finish	List Price
Single Cylinder	451613	See Page 5 for Sandcast Bronze Knob & Lever Options. See Page 5 for Crystal & Porcelain Knob Options.	Flat Black Bronze (FB) Medium Bronze (MB) Tumbled White Bronze (TWB)	\$416.00
Double Cylinder	452613			\$416.00
Dummy	450613			\$416.00

INTERCONNECT DEVICE	Product Code		List Price
Rectangular Monolithic & Full Length Styles	443	Not Available for Double Cylinder.	\$58.00

Handing Required if Lever Used on Inside or if Interconnect Device is Specified. Standard 2½" Door Prep. Standard latch is for 2¾" backset. Specify 2¾" backset if required. 28° Latch Not Available for Use with Tubular Entrance Handlesets. **Weiser® (WR5) Keyway:** Specify by adding "W" to the beginning of Product Code. No upcharge for cylinder substitution. Can be keyed into existing Weiser® system.

To order: **(W) Product Code + Knob/Lever Style + Handing + Finish + Add Door Thickness to Comments**

ENTRANCE HANDLESETS - LOST WAX CAST BRONZE TUBULAR

Tuscany Sectional



Order any Lost Wax Cast Bronze Knob or Lever for the Inside Trim.

Tuscany Monolithic



Order any Lost Wax Cast Bronze Knob or Lever for the Inside Trim.

TUSCANY SECTIONAL	Product Code	Knob or Lever Style for Inside Trim	Finish	List Price
Single Cylinder	471224	See Page 6 for Lost Wax Cast Bronze Knob & Lever Options. See Page 5 for Crystal & Porcelain Knob Options.	Flat Black Bronze (FB) Medium Bronze (MB)	\$332.00
Double Cylinder	472224			\$332.00
Dummy	470224			\$332.00

TUSCANY MONOLITHIC (5½" Center to Center Door Prep)	Product Code	Knob or Lever Style for Inside Trim	Finish	List Price
Single Cylinder	471112	See Page 6 for Lost Wax Cast Bronze Knob & Lever Options. See Page 5 for Crystal & Porcelain Knob Options.	Flat Black Bronze (FB) Medium Bronze (MB)	\$366.00
Double Cylinder	472112			\$366.00
Dummy	470112			\$366.00

INTERCONNECT DEVICE	Product Code		List Price
Tuscany Monolithic Style	443	Not Available for Double Cylinder.	\$58.00

Handing Required if Lever Used on Inside or if Interconnect Device is Specified. Standard 2½" Door Prep. Standard latch is for 2¾" backset. Specify 2¾" backset if required. 28° Latch Not Available for Use with Tubular Entrance Handlesets. **Weiser® (WRS) Keyway:** Specify by adding "W" to the beginning of Product Code. No upcharge for cylinder substitution. Can be keyed into existing Weiser® system.

Art Nouveau



Left Hand Grip

Right Hand Grip



Order any Lost Wax Cast Bronze Knob or Lever for the Inside Trim.

Octagon



Order any Lost Wax Cast Bronze Knob or Lever for the Inside Trim.

ART NOUVEAU (5½" Center to Center Door Prep)	Product Code	Specify LH/RH Grip	Knob or Lever Style for Inside Trim	Finish	List Price
Single Cylinder	471333		See Page 6 for Lost Wax Cast Bronze Knob & Lever Options. See Page 5 for Crystal & Porcelain Knob Options.	Flat Black Bronze (FB) Medium Bronze (MB)	\$366.00
Double Cylinder	472333				\$366.00
Dummy	470333				\$366.00

OCTAGON (5½" Center to Center Door Prep)	Product Code	Knob or Lever Style for Inside Trim	Finish	List Price
Single Cylinder	471222	See Page 6 for Lost Wax Cast Bronze Knob & Lever Options. See Page 5 for Crystal & Porcelain Knob Options.	Flat Black Bronze (FB) Medium Bronze (MB)	\$366.00
Double Cylinder	472222			\$366.00
Dummy	470222			\$366.00

INTERCONNECT DEVICE	Product Code		List Price
Available for Above Styles	443	Not Available for Double Cylinder.	\$58.00

Handing Required if Lever Used on Inside or if Interconnect Device is Specified. Standard 2½" Door Prep. Standard latch is for 2¾" backset. Specify 2¾" backset if required. 28° Latch Not Available for Use with Tubular Entrance Handlesets. **Weiser® (WRS) Keyword:** Specify by adding "W" to the beginning of Product Code. No upcharge for cylinder substitution. Can be keyed into existing Weiser® system.

ENTRANCE HANDLESETS - STAINLESS STEEL TUBULAR

Davos
Stainless Steel



Order any Stainless Steel Knob or Lever for the Inside Trim.

Zeus
Stainless Steel



Order any Stainless Steel Knob or Lever for the Inside Trim.

DAVOS STAINLESS STEEL (5½" Center to Center Door Prep)	Product Code	Knob or Lever Style for Inside Trim	Finish	List Price
Single Cylinder	S40101	See Page 6 For Stainless Steel Knob & Lever Options.	Brushed Stainless Steel (SS)	\$274.00
Dummy	S40100			\$274.00

ZEUS STAINLESS STEEL (5½" Center to Center Door Prep)	Product Code	Knob or Lever Style for Inside Trim	Finish	List Price
Single Cylinder	S40001	See Page 6 For Stainless Steel Knob & Lever Options.	Brushed Stainless Steel (SS)	\$274.00
Double Cylinder	S40002			\$274.00
Dummy	S40000			\$274.00

INTERCONNECT DEVICE	Product Code		List Price
Available for Above Styles	443	Not Available for Double Cylinder.	\$58.00

Handing Required if Lever Used on Inside or if Interconnect Device is Specified. Standard 2½" Door Prep. Standard latch is for 2¾" backset. Specify 2¾" backset if required. 28° Latch Not Available for Use with Tubular Entrance Handlesets. **Weiser® (WRS) Keyword:** Specify by adding "W" to the beginning of Product Code. No upcharge for cylinder substitution. Can be keyed into existing Weiser® system.

Sectional
with Lafayette Grip



Sectional
with San Carlos Grip



Sectional
with Normandy Grip



Order any Wrought Steel
Knob or Lever for the Inside Trim.

SECTIONAL WITH LAFAYETTE GRIP	Product Code	Knob or Lever Style for Inside Trim	Finish	List Price
Single Cylinder	461212	See Page 6 for Wrought Steel Knob & Lever Options.	Flat Black Steel (FBS) Satin Steel (SWS)	\$240.00
Double Cylinder	462212			\$240.00
Dummy	460212			\$240.00

SECTIONAL WITH SAN CARLOS GRIP	Product Code	Knob or Lever Style for Inside Trim	Finish	List Price
Single Cylinder	461222	See Page 6 for Wrought Steel Knob & Lever Options.	Flat Black Steel (FBS) Satin Steel (SWS)	\$240.00
Double Cylinder	462222			\$240.00
Dummy	460222			\$240.00

SECTIONAL WITH NORMANDY GRIP	Product Code	Knob or Lever Style for Inside Trim	Finish	List Price
Single Cylinder	461232	See Page 6 for Wrought Steel Knob & Lever Options.	Flat Black Steel (FBS) Satin Steel (SWS)	\$240.00
Double Cylinder	462232			\$240.00
Dummy	460232			\$240.00

Handing Required if Lever Used on Inside. Standard 2 1/8" Door Prep. Standard latch is for 2 3/8" backset. Specify 2 3/4" backset if required. 28° Latch Not Available for Use with Tubular Entrance Handlesets. **Weiser® (WR5) Keyway:** Specify by adding "W" to the beginning of Product Code. No upcharge for cylinder substitution. Can be keyed into existing Weiser® system.

ENTRANCE HANDLESETS - WROUGHT STEEL TUBULAR

Monolithic
with Lafayette Grip



Monolithic
with San Carlos Grip



Monolithic
with Normandy Grip



Order any Wrought Steel
Knob or Lever for the Inside Trim.

MONOLITHIC WITH LAFAYETTE GRIP (5½" Center to Center Door Prep)	Product Code	Knob or Lever Style for Inside Trim	Finish	List Price
Single Cylinder	461111	See Page 6 for Wrought Steel Knob & Lever Options.	Flat Black Steel (FBS) Satin Steel (SWS)	\$274.00
Double Cylinder	462111			\$274.00
Dummy	460111			\$274.00

MONOLITHIC WITH SAN CARLOS GRIP (5½" Center to Center Door Prep)	Product Code	Knob or Lever Style for Inside Trim	Finish	List Price
Single Cylinder	461121	See Page 6 for Wrought Steel Knob & Lever Options.	Flat Black Steel (FBS) Satin Steel (SWS)	\$274.00
Double Cylinder	462121			\$274.00
Dummy	460121			\$274.00

MONOLITHIC WITH NORMANDY GRIP (5½" Center to Center Door Prep)	Product Code	Knob or Lever Style for Inside Trim	Finish	List Price
Single Cylinder	461131	See Page 6 for Wrought Steel Knob & Lever Options.	Flat Black Steel (FBS) Satin Steel (SWS)	\$274.00
Double Cylinder	462131			\$274.00
Dummy	460131			\$274.00

INTERCONNECT DEVICE	Product Code		List Price
Available for Above Styles	443	Not Available for Double Cylinder.	\$58.00

Handing Required if Lever Used on Inside or if Interconnect Device is Specified. Standard 2½" Door Prep. Standard latch is for 2¾" backset. Specify 2¾" backset if required. 28° Latch Not Available for Use with Tubular Entrance Handlesets. **Weiser® (WR5) Keyway:** Specify by adding "W" to the beginning of Product Code. No upcharge for cylinder substitution. Can be keyed into existing Weiser® system.



Exterior

Profile

Interior



Double sided handlesets, also known as grip-by-grip, have a full length trim on both the interior and exterior sides of the door. They are available in three functions: single cylinder, double cylinder, and dummy. The single cylinder configuration has a thumbturn which unlocks the door from the inside; while the double cylinder has keyed cylinders on both sides of the door. The dummy does not include a thumbturn, instead it only features matching trim on either side of the door with no locking functionality.

Grip By Grip also available in Brass. Call us for pricing. See pages 38 - 45 for styles.

GRIP BY GRIP ENTRANCE HANDLESETS - SANDCAST BRONZE

Ridgemont









Logan



Brighton

Rectangular
SectionalRectangular
MonolithicRectangular
Full Length

GRIP BY GRIP ENTRY SETS	Description	Product Code	Finish	List Price
 RIDGEMONT	Single Cylinder	453727	Flat Black Bronze (FB) Medium Bronze (MB) Tumbled White Bronze (TWB)	\$536.00
	Double Cylinder	454727		\$536.00
	Dummy	455727		\$536.00
 LOGAN Door Prep 5½" Center to Center	Single Cylinder	453828	Flat Black Bronze (FB) Medium Bronze (MB) Tumbled White Bronze (TWB)	\$580.00
	Double Cylinder	454828		\$580.00
	Dummy	455828		\$580.00
 BRIGHTON Door Prep 5½" Center to Center	Single Cylinder	453929	Flat Black Bronze (FB) Medium Bronze (MB) Tumbled White Bronze (TWB)	\$638.00
	Double Cylinder	454929		\$638.00
	Dummy	455929		\$638.00

GRIP BY GRIP ENTRY SETS	Description	Product Code	Finish	List Price
 RECTANGULAR SECTIONAL	Single Cylinder	453414	Flat Black Bronze (FB) Medium Bronze (MB) Tumbled White Bronze (TWB)	\$536.00
	Double Cylinder	454414		\$536.00
	Dummy	455414		\$536.00
 RECTANGULAR MONOLITHIC Door Prep 5½" Center to Center	Single Cylinder	453515	Flat Black Bronze (FB) Medium Bronze (MB) Tumbled White Bronze (TWB)	\$580.00
	Double Cylinder	454515		\$580.00
	Dummy	455515		\$580.00
 RECTANGULAR FULL LENGTH Door Prep 5½" Center to Center	Single Cylinder	453636	Flat Black Bronze (FB) Medium Bronze (MB) Tumbled White Bronze (TWB)	\$638.00
	Double Cylinder	454636		\$638.00
	Dummy	455636		\$638.00

Sets Fit Standard Door Thickness of 1¾", Specify if Thicker. Standard latch is for 2¾" backset. Specify 2¾" backset if required. **Weiser® (WR5) Keyway:** Specify by adding "W" to the beginning of Product Code. No upcharge for cylinder substitution. Can be keyed into existing Weiser® system.



Laramie

Sheridan

Creston

Denver

Remington

Greeley



GRIP BY GRIP ENTRY SETS	Description	Product Code	Finish	List Price
LARAMIE	Single Cylinder	453717	Flat Black Bronze (FB) Medium Bronze (MB) Tumbled White Bronze (TWB)	\$536.00
	Double Cylinder	454717		\$536.00
	Dummy	455717		\$536.00
SHERIDAN Door Prep 5½" Center to Center	Single Cylinder	453818	Flat Black Bronze (FB) Medium Bronze (MB) Tumbled White Bronze (TWB)	\$580.00
	Double Cylinder	454818		\$580.00
	Dummy	455818		\$580.00
CRESTON Door Prep 5½" Center to Center	Single Cylinder	453919	Flat Black Bronze (FB) Medium Bronze (MB) Tumbled White Bronze (TWB)	\$638.00
	Double Cylinder	454919		\$638.00
	Dummy	455919		\$638.00

GRIP BY GRIP ENTRY SETS	Description	Product Code	Finish	List Price
DENVER	Single Cylinder	453212	Flat Black Bronze (FB) Medium Bronze (MB) Tumbled White Bronze (TWB)	\$536.00
	Double Cylinder	454212		\$536.00
	Dummy	455212		\$536.00
REMINGTON Door Prep 5½" Center to Center	Single Cylinder	453111	Flat Black Bronze (FB) Medium Bronze (MB) Tumbled White Bronze (TWB)	\$580.00
	Double Cylinder	454111		\$580.00
	Dummy	455111		\$580.00
GREELEY Door Prep 5½" Center to Center	Single Cylinder	453333	Flat Black Bronze (FB) Medium Bronze (MB) Tumbled White Bronze (TWB)	\$638.00
	Double Cylinder	454333		\$638.00
	Dummy	455333		\$638.00

Sets Fit Standard Door Thickness of 1¾", Specify if Thicker. Standard latch is for 2¾" backset. Specify 2¾" backset if required. **Weiser® (WR5) Keyway:** Specify by adding "W" to the beginning of Product Code. No upcharge for cylinder substitution. Can be keyed into existing Weiser® system.

GRIP BY GRIP ENTRANCE HANDLESETS - LOST WAX CAST BRONZE



GRIP BY GRIP ENTRY SETS	Description	Product Code	Finish	List Price
TUSCANY SECTIONAL	Single Cylinder	473444	Flat Black Bronze (FB) Medium Bronze (MB)	\$536.00
	Double Cylinder	474444		\$536.00
	Dummy	475444		\$536.00
TUSCANY Door Prep 5½" Center to Center	Single Cylinder	473111	Flat Black Bronze (FB) Medium Bronze (MB)	\$580.00
	Double Cylinder	474111		\$580.00
	Dummy	475111		\$580.00
OCTAGON Door Prep 5½" Center to Center	Single Cylinder	473222	Flat Black Bronze (FB) Medium Bronze (MB)	\$580.00
	Double Cylinder	474222		\$580.00
	Dummy	475222		\$580.00

GRIP BY GRIP ENTRY SETS	Description	Product Code	Finish	List Price
ART NOUVEAU Left Hand Grip (Outside) Door Prep 5½" Center to Center	Single Cylinder	473333LH	Flat Black Bronze (FB) Medium Bronze (MB)	\$580.00
	Double Cylinder	474333LH		\$580.00
	Dummy	475333LH		\$580.00
ART NOUVEAU Right Hand Grip (Outside) Door Prep 5½" Center to Center	Single Cylinder	473333RH	Flat Black Bronze (FB) Medium Bronze (MB)	\$580.00
	Double Cylinder	474333RH		\$580.00
	Dummy	475333RH		\$580.00



Sets Fit Standard Door Thickness of 1¾"; Specify if Thicker. Standard latch is for 2¾" backset. Specify 2¾" backset if required. **Weiser® (WR5) Keyway:** Specify by adding "W" to the beginning of Product Code. No upcharge for cylinder substitution. Can be keyed into existing Weiser® system.

Round Knob with Square Rosette



Round Knob with Disk Rosette



KEY IN KNOBSETS	Description	Product Code	Key In Knob Style	Finish	List Price
Square 	Key in Knob	5122	Round Knob (ROU)	Oil Rubbed Bronze (US10B) Polished Nickel - Lifetime (US14) Satin Nickel (US15) Flat Black (US19) Polished Chrome (US26)	\$158.00
	Dummy, Key in Knob	5022			\$158.00
Disk 	Key in Knob	5115	Round Knob (ROU)	Oil Rubbed Bronze (US10B) Satin Nickel (US15) Flat Black (US19) Polished Chrome (US26)	\$158.00
	Dummy, Key in Knob	5015			\$158.00

Hanover Lever with Square Rosette





Hanover Lever with Disk Rosette



Luzern Lever with Square Rosette



KEY IN LEVERSETS	Description	Product Code	Key In Lever Style	Finish	List Price
Square 	Key in Lever	5122	Hanover (HN) Luzern Lever (LU)	Oil Rubbed Bronze (US10B) Satin Nickel (US15) Flat Black (US19) Polished Chrome (US26)	\$158.00
	Dummy, Key in Lever	5022			\$158.00
Disk 	Key in Lever	5115	Hanover (HN) Luzern Lever (LU)	Oil Rubbed Bronze (US10B) Satin Nickel (US15) Flat Black (US19) Polished Chrome (US26)	\$158.00
	Dummy, Key in Lever	5015			\$158.00

Handing is Required for Leversets. Standard Door Prep and Installation. Supplied with Strike Plate and Adjustable Latch to fit 2³/₈" or 2³/₄" backset. **Weiser® (WR5) Keyway:** Specify by adding "W" to the beginning of Product Code. No upcharge for cylinder substitution. Can be keyed into existing Weiser® system. **Modern Brass Key In Knobsets and Leversets may be ordered with any Brass Key In rosette at the list price shown above.** (See pages 60 - 61 for Brass Key In rosette options)

ENTRANCE LOCKSETS - BRASS KEY IN KNOBSETS

Waverly Knob
with Regular RosetteProvidence Knob
with #8 RosetteEgg Knob
with Rectangular RosetteRope Knob
with Rope Rosette

KEY IN KNOBSETS	Description	Product Code	Key In Knob Style	Finish	List Price
Regular 	Key in Knob	5100	Egg Knob (E) Providence Knob (P) Rope Knob (RK) Waverly Knob (W)	Polished Brass - Lifetime (US3) French Antique (US7) Oil Rubbed Bronze (US10B)	\$158.00
	Dummy, Key in Knob	5150		Polished Nickel - Lifetime (US14)* Satin Nickel (US15) Pewter (US15A) Flat Black (US19)** Polished Chrome (US26)	\$158.00
#8 	Key in Knob	5108	Egg Knob (E) Providence Knob (P) Rope Knob (RK) Waverly Knob (W)	Polished Brass - Lifetime (US3) French Antique (US7) Oil Rubbed Bronze (US10B)	\$158.00
	Dummy, Key in Knob	5158		Satin Nickel (US15) Pewter (US15A) Flat Black (US19)** Polished Chrome (US26)	\$158.00
Rectangular 	Key in Knob	5121	Egg Knob (E) Providence Knob (P) Rope Knob (RK) Waverly Knob (W)	Polished Brass - Lifetime (US3) French Antique (US7) Oil Rubbed Bronze (US10B)	\$158.00
	Dummy, Key in Knob	5021		Polished Nickel - Lifetime (US14)* Satin Nickel (US15) Pewter (US15A) Flat Black (US19)** Polished Chrome (US26)	\$158.00
Rope 	Key in Knob	5101	Egg Knob (E) Providence Knob (P) Rope Knob (RK) Waverly Knob (W)	Polished Brass - Lifetime (US3) French Antique (US7) Oil Rubbed Bronze (US10B)	\$158.00
	Dummy, Key in Knob	5151		Satin Nickel (US15) Pewter (US15A) Polished Chrome (US26)	\$158.00

* Polished Nickel - Lifetime (US14) available only for Waverly knob. ** Flat Black (US19) NOT available for Rope knob.

Handing Not Required for Knobsets. Standard Door Prep and Installation. Supplied with Strike Plate and Adjustable Latch to fit 2³/₈" or 2³/₄" backset. **Weiser® (WR5) Keyway:** Specify by adding "W" to the beginning of Product Code. No upcharge for cylinder substitution. Can be keyed into existing Weiser® system. **Brass Key In Knobsets may be ordered with any Modern Brass Key In rosette at the list price shown above.** (See page 59 for Modern Brass Key In rosette options)

Cortina Lever
with Regular Rosette



Cortina Lever
with #8 Rosette



Cortina Lever
with Rectangular Rosette



Rope Lever
with Rope Rosette



KEY IN LEVERSETS	Description	Product Code	Key In Lever Style	Finish	List Price
Regular 	Key in Lever	5100	Cortina Lever (C) Rope Lever (RL)	Polished Brass - Lifetime (US3) French Antique (US7) Oil Rubbed Bronze (US10B) Satin Nickel (US15) Pewter (US15A) Flat Black (US19)* Polished Chrome (US26)	\$158.00
	Dummy, Key in Lever	5150			\$158.00
#8 	Key in Lever	5108	Cortina Lever (C) Rope Lever (RL)	Polished Brass - Lifetime (US3) French Antique (US7) Oil Rubbed Bronze (US10B) Satin Nickel (US15) Pewter (US15A) Flat Black (US19)* Polished Chrome (US26)	\$158.00
	Dummy, Key in Lever	5158			\$158.00
Rectangular 	Key in Lever	5121	Cortina Lever (C) Rope Lever (RL)	Polished Brass - Lifetime (US3) French Antique (US7) Oil Rubbed Bronze (US10B) Satin Nickel (US15) Pewter (US15A) Flat Black (US19)* Polished Chrome (US26)	\$158.00
	Dummy, Key in Lever	5021			\$158.00
Rope 	Key in Lever	5101	Cortina Lever (C) Rope Lever (RL)	Polished Brass - Lifetime (US3) French Antique (US7) Oil Rubbed Bronze (US10B) Satin Nickel (US15) Pewter (US15A) Polished Chrome (US26)	\$158.00
	Dummy, Key in Lever	5151			\$158.00

* Rope In Lever NOT available in Flat Black (US19).

Handing is Required for Leversets. Standard Door Prep and Installation. Supplied with Strike Plate and Adjustable Latch to fit 2³/₈" or 2³/₄" backset. **Weiser® (WR5) Keyway:** Specify by adding "W" to the beginning of Product Code. No upcharge for cylinder substitution. Can be keyed into existing Weiser® system. Brass Key In Knobsets may be ordered with any Modern Brass Key In rosette at the list price shown above. (See page 59 for Modern Brass Key In rosette options)

ENTRANCE LOCKSETS - SANDCAST BRONZE KEY IN KNOBSETS

Winchester Knob
with #1 RosetteWinchester Knob
with #2 RosetteWinchester Knob
with #3 RosetteWinchester Knob
with #4 Rosette

KEY IN KNOBSETS	Description	Product Code	Key In Knob Style	Finish	List Price
#1 	Key in Knob	5104	Winchester Knob (WC)	Flat Black Bronze (FB) Medium Bronze (MB) Tumbled White Bronze (TWB)	\$174.00
	Dummy, Key in Knob	5154			\$174.00
#2 	Key in Knob	5102	Winchester Knob (WC)	Flat Black Bronze (FB) Medium Bronze (MB) Tumbled White Bronze (TWB)	\$174.00
	Dummy, Key in Knob	5152			\$174.00
#3 	Key in Knob	5103	Winchester Knob (WC)	Flat Black Bronze (FB) Medium Bronze (MB) Tumbled White Bronze (TWB)	\$174.00
	Dummy, Key in Knob	5153			\$174.00
#4 	Key in Knob	5114	Winchester Knob (WC)	Flat Black Bronze (FB) Medium Bronze (MB) Tumbled White Bronze (TWB)	\$174.00
	Dummy, Key in Knob	5164			\$174.00

Handing Not Required for Knobsets. Standard Door Prep and Installation. Supplied with Strike Plate and Adjustable Latch to fit 2³/₈" or 2³/₄" backset. **Weiser® (WR5) Keyway:** Specify by adding "W" to the beginning of Product Code. No upcharge for cylinder substitution. Can be keyed into existing Weiser® system.

Durango Lever with #1 Rosette



Durango Lever with #2 Rosette







Durango Lever with #3 Rosette



Durango Lever with #4 Rosette





KEY IN LEVERSETS	Description	Product Code	Key In Lever Style	Finish	List Price
#1 	Key in Lever	5104	Durango Lever (D)	Flat Black Bronze (FB) Medium Bronze (MB) Tumbled White Bronze (TWB)	\$174.00
	Dummy, Key in Lever	5154			\$174.00
#2 	Key in Lever	5102	Durango Lever (D)	Flat Black Bronze (FB) Medium Bronze (MB) Tumbled White Bronze (TWB)	\$174.00
	Dummy, Key in Lever	5152			\$174.00
#3 	Key in Lever	5103	Durango Lever (D)	Flat Black Bronze (FB) Medium Bronze (MB) Tumbled White Bronze (TWB)	\$174.00
	Dummy, Key in Lever	5153			\$174.00
#4 	Key in Lever	5114	Durango Lever (D)	Flat Black Bronze (FB) Medium Bronze (MB) Tumbled White Bronze (TWB)	\$174.00
	Dummy, Key in Lever	5164			\$174.00



Handing is Required for Leversets. Standard Door Prep and Installation. Supplied with Strike Plate and Adjustable Latch to fit 2³/₈" or 2³/₄" backset. **Weiser® (WR5) Keyway:** Specify by adding "W" to the beginning of Product Code. No upcharge for cylinder substitution. Can be keyed into existing Weiser® system.

ENTRANCE LOCKSETS - LOST WAX CAST BRONZE KEY IN KNOBSETS & LEVERSETS

Petal Knob
with #11 RosettePetal Knob
with #12 RosettePetal Knob
with #14 Rosette

KEY IN KNOBSETS		Description	Product Code	Key In Knob Style	Finish	List Price
#11		Key in Knob	54011	Petal Knob (PT)	Flat Black Bronze (FB) Medium Bronze (MB)	\$174.00
		Dummy, Key in Knob	54511			\$174.00
#12		Key in Knob	54012	Petal Knob (PT)	Flat Black Bronze (FB) Medium Bronze (MB)	\$174.00
		Dummy, Key in Knob	54512			\$174.00
#14		Key in Knob	54014	Petal Knob (PT)	Flat Black Bronze (FB) Medium Bronze (MB)	\$174.00
		Dummy, Key in Knob	54514			\$174.00

Siena Lever
with #11 RosetteSiena Lever
with #12 RosetteSiena Lever
with #14 Rosette

KEY IN LEVERSETS		Description	Product Code	Key In Lever Style	Finish	List Price
#11		Key in Lever	54011	Siena Lever (SN)	Flat Black Bronze (FB) Medium Bronze (MB)	\$174.00
		Dummy, Key in Lever	54511			\$174.00
#12		Key in Lever	54012	Siena Lever (SN)	Flat Black Bronze (FB) Medium Bronze (MB)	\$174.00
		Dummy, Key in Lever	54512			\$174.00
#14		Key in Lever	54014	Siena Lever (SN)	Flat Black Bronze (FB) Medium Bronze (MB)	\$174.00
		Dummy, Key in Lever	54514			\$174.00

Handing is Required for Leversets. Standard Door Prep and Installation. Supplied with Strike Plate and Adjustable Latch to fit 2³/₈" or 2³/₄" backset. **Weiser® (WR5) Keyway:** Specify by adding "W" to the beginning of Product Code. No upcharge for cylinder substitution. Can be keyed into existing Weiser® system.

Hanover Lever
with Disc Rosette



KEY IN LEVERSETS	Description	Product Code	Key In Lever Style	Finish	List Price
Disc 	Key in Lever	S901	Hanover Lever (HN)	Brushed Stainless Steel (SS)	\$158.00
	Dummy, Key in Lever	S951			\$158.00

Handing is Required for Leversets. Standard Door Prep and Installation. Supplied with Strike Plate and Adjustable Latch to fit 2³/₈" or 2³/₄" backset. **Weiser® (WR5) Keyway:** Specify by adding "W" to the beginning of Product Code. No upcharge for cylinder substitution. Can be keyed into existing Weiser® system.

SINGLE & TWO-POINT LOCKSETS - BRASS TUBULAR

Modern Rectangular
Single Point with Round Key In Knobs

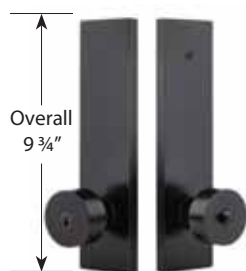

Modern Rectangular
Dummy with Round Key In Knobs



MODERN RECTANGULAR SINGLE POINT	Product Code	Key In Knob / Lever Style	Finish	List Price
Key in Knob/Lever	5302	Round Knob (ROU) Hanover Lever (HN) Luzern Lever (LU)	Oil Rubbed Bronze (US10B) Satin Nickel (US15) Flat Black (US19) Polished Chrome (US26)	\$200.00
Dummy, Pair	5352			\$200.00

Modern Rectangular
Two-Point, Single Cylinder
with Hanover Key In Levers

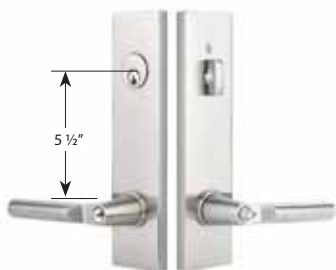

Modern Rectangular
Two-Point, Double Cylinder
with Luzern Key In Levers



Modern Rectangular
Two-Point, Dummy
with Hanover Key In Levers



MODERN RECTANGULAR TWO-POINT	Product Code	Key In Knob / Lever Style	Finish	List Price
Single Cylinder	5312	Round Knob (ROU) Hanover Lever (HN) Luzern Lever (LU)	Oil Rubbed Bronze (US10B) Satin Nickel (US15) Flat Black (US19) Polished Chrome (US26)	\$220.00
Double Cylinder	5322			\$220.00
Dummy, Pair	5362			\$220.00

Handing Required for Leversets. Standard Door Prep and Installation. **Supplied with Strike Plate and Adjustable Latch to fit 2³/₈" or 2³/₄" backset.** **Weiser® (WRS) Keyway:** Specify by adding "W" to the beginning of Product Code. No upcharge for cylinder substitution. Can be keyed into existing Weiser® system. **Any Key In Knob / Lever Style Options listed on this page can be used with Annapolis Trim Style.**

Annapolis
Single Point with Providence Key In Knobs



Annapolis
Dummy with Egg Key In Knobs



ANNAPOLIS SINGLE POINT	Product Code	Key In Knob / Lever Style	Finish	List Price
Key in Knob/Lever	5308	Egg Knob (E) Providence Knob (P)	Polished Brass - Lifetime (US3) French Antique (US7) Oil Rubbed Bronze (US10B)	\$200.00
Dummy, Pair	5358	Rope Knob (RK) Waverly Knob (W) Cortina Lever (C) Rope Lever (RL)	Satin Nickel (US15) Pewter (US15A) Flat Black (US19) Polished Chrome (US26)	\$200.00

Annapolis
Two-Point, Single Cylinder
with Waverly Key In Knobs

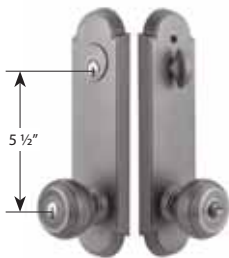

Annapolis
Two-Point, Double Cylinder
with Cortina Key In Levers



Annapolis
Two-Point, Dummy
with Cortina Key In Levers



ANNAPOLIS TWO-POINT	Product Code	Key In Knob / Lever Style	Finish	List Price
Single Cylinder	5318	Egg Knob (E) Providence Knob (P)	Polished Brass - Lifetime (US3) French Antique (US7) Oil Rubbed Bronze (US10B)	\$220.00
Double Cylinder	5328	Rope Knob (RK) Waverly Knob (W) Cortina Lever (C) Rope Lever (RL)	Satin Nickel (US15) Pewter (US15A) Flat Black (US19) Polished Chrome (US26)	\$220.00
Dummy, Pair	5368			\$220.00

Handing Required for Leversets. Standard Door Prep and Installation. **Supplied with Strike Plate and Adjustable Latch to fit 2 3/8" or 2 3/4" backset.** **Weiser® (WRS) Keyway:** Specify by adding "W" to the beginning of Product Code. No upcharge for cylinder substitution. Can be keyed into existing Weiser® system. Any Key In Knob / Lever Style Options listed on this page can be used with Modern Rectangular Trim Style.

DEADBOLTS - BRASS



SQUARE DEADBOLT Includes Extension Collar for Thin Doors		Product Code	Finish	List Price
Single Cylinder	8469	Satin Brass (US4) Oil Rubbed Bronze (US10B)	\$58.00	
Double Cylinder	8369	Polished Nickel - Lifetime (US14) Satin Nickel (US15) Flat Black (US19) Polished Chrome (US26)		



NEOS DEADBOLT Includes Extension Collar for Thin Doors		Product Code	Finish	List Price
Single Cylinder	8475	Satin Brass (US4) Oil Rubbed Bronze (US10B)	\$58.00	
Double Cylinder	8375	Satin Nickel (US15) Flat Black (US19) Polished Chrome (US26)		



MODERN DEADBOLT Includes Extension Collar for Thin Doors		Product Code	Finish	List Price
Single Cylinder	8467	Satin Brass (US4) Oil Rubbed Bronze (US10B)	\$58.00	
Double Cylinder	8367	Polished Nickel - Lifetime (US14) Satin Nickel (US15) Flat Black (US19) Polished Chrome (US26)		



QUINCY DEADBOLT Includes Extension Collar for Thin Doors		Product Code	Finish	List Price
Single Cylinder	8478	Polished Brass - Lifetime (US3) French Antique (US7)	\$58.00	
Double Cylinder	8378	Oil Rubbed Bronze (US10B) Satin Nickel (US15) Pewter (US15A) Flat Black (US19) Polished Chrome (US26)		

STANDARD WITH BRASS DEADBOLTS

- Schlage® C Keyway
- Standard Door Prep and Installation
- Solid Brass Cylinder, Housing, Collar and Rosette
- Hardened Steel Bolt
- Heavy Gauge Steel Understrike
- Brass Trim Strike Shipped with Every Deadbolt

Handing Not Required. Standard door thickness of 1¾", specify if thicker. Standard latch is for 2¾" backset. Specify 2¾" backset if required. **Weiser® (WR5) Keyway:** Specify by adding "W" to the beginning of Product Code. No upcharge for cylinder substitution. Can be keyed into existing Weiser® system.



WILSHIRE DEADBOLT Includes Extension Collar for Thin Doors		Product Code	Finish	List Price
Single Cylinder	8479	Polished Brass - Lifetime (US3) French Antique (US7) Oil Rubbed Bronze (US10B)	\$58.00	
Double Cylinder	8379	Polished Nickel - Lifetime (US14) Satin Nickel (US15) Pewter (US15A) Flat Black (US19) Polished Chrome (US26)		



REGULAR DEADBOLT Includes Extension Collar for Thin Doors		Product Code	Finish	List Price
Single Cylinder	8450	Polished Brass - Lifetime (US3) French Antique (US7) Oil Rubbed Bronze (US10B)	\$48.00	
Double Cylinder	8350	Polished Nickel - Lifetime (US14) Satin Nickel (US15) Pewter (US15A) Flat Black (US19) Polished Chrome (US26)		



LOW PROFILE DEADBOLT Includes Extension Collar for Thin Doors		Product Code	Finish	List Price
Single Cylinder	8455	Polished Brass - Lifetime (US3) French Antique (US7) Oil Rubbed Bronze (US10B)	\$48.00	
Double Cylinder	8355	Polished Nickel - Lifetime (US14) Satin Nickel (US15) Pewter (US15A) Flat Black (US19) Polished Chrome (US26)		



ROPE DEADBOLT Includes Extension Collar for Thin Doors		Product Code	Finish	List Price
Single Cylinder	8464	Polished Brass - Lifetime (US3) French Antique (US7) Oil Rubbed Bronze (US10B)	\$58.00	
Double Cylinder	8364	Satin Nickel (US15) Pewter (US15A) Polished Chrome (US26)		



ARTS & CRAFTS DEADBOLT Includes Extension Collar for Thin Doors		Product Code	Finish	List Price
Single Cylinder	8454	Oil Rubbed Bronze (US10B) Satin Nickel (US15)	\$58.00	
Double Cylinder	8354	Flat Black (US19)		

Handing Not Required. Standard door thickness of 1 $\frac{3}{4}$ ", specify if thicker. Standard latch is for 2 $\frac{3}{8}$ " backset. Specify 2 $\frac{3}{4}$ " backset if required. **Weiser® (WR5) Keyway:** Specify by adding "W" to the beginning of Product Code. No upcharge for cylinder substitution. Can be keyed into existing Weiser® system.

DEADBOLTS - BRASS



#8 DEADBOLT Includes Extension Collar for Thin Doors	Product Code	Finish	List Price
Single Cylinder	8466	Polished Brass - Lifetime (US3) French Antique (US7) Oil Rubbed Bronze (US10B)	\$58.00
Double Cylinder	8366	Polished Nickel - Lifetime (US14) Satin Nickel (US15) Pewter (US15A) Flat Black (US19) Polished Chrome (US26)	\$62.00



RECTANGULAR DEADBOLT Includes Extension Collar for Thin Doors	Product Code	Finish	List Price
Single Cylinder	8468	Polished Brass - Lifetime (US3) French Antique (US7) Oil Rubbed Bronze (US10B)	\$58.00
Double Cylinder	8368	Polished Nickel - Lifetime (US14) Satin Nickel (US15) Pewter (US15A) Flat Black (US19) Polished Chrome (US26)	\$62.00



SARATOGA DEADBOLT Includes Extension Collar for Thin Doors	Product Code	Finish	List Price
Single Cylinder	8458	Polished Brass - Lifetime (US3) French Antique (US7) Oil Rubbed Bronze (US10B)	\$58.00
Double Cylinder	8358	Satin Nickel (US15) Pewter (US15A) Flat Black (US19) Polished Chrome (US26)	\$62.00



KNOXVILLE DEADBOLT Includes Extension Collar for Thin Doors	Product Code	Finish	List Price
Single Cylinder	8459	Polished Brass - Lifetime (US3) French Antique (US7) Oil Rubbed Bronze (US10B)	\$58.00
Double Cylinder	8359	Satin Nickel (US15) Pewter (US15A) Polished Chrome (US26)	\$62.00

Handing Not Required. Standard door thickness of 1 3/4", specify if thicker. Standard latch is for 2 3/8" backset. Specify 2 3/4" backset if required. **Weiser® (WR5) Keyway:** Specify by adding "W" to the beginning of Product Code. No upcharge for cylinder substitution. Can be keyed into existing Weiser® system.



REGULAR SANDCAST BRONZE DEADBOLT	Product Code	Finish	List Price
Single Cylinder	8450	Flat Black Bronze (FB) Medium Bronze (MB)	\$64.00
Double Cylinder	8350	Tumbled White Bronze (TWB)	\$68.00



#1 SANDCAST BRONZE DEADBOLT WITH FLAP	Product Code	Finish	List Price
Single Cylinder	8457	Flat Black Bronze (FB) Medium Bronze (MB)	\$64.00
Double Cylinder	8357	Tumbled White Bronze (TWB)	\$68.00



#3 SANDCAST BRONZE DEADBOLT WITH FLAP	Product Code	Finish	List Price
Single Cylinder	8465	Flat Black Bronze (FB) Medium Bronze (MB)	\$64.00
Double Cylinder	8365	Tumbled White Bronze (TWB)	\$68.00



#4 SANDCAST BRONZE DEADBOLT WITH FLAP	Product Code	Finish	List Price
Single Cylinder	8474	Flat Black Bronze (FB) Medium Bronze (MB)	\$64.00
Double Cylinder	8374	Tumbled White Bronze (TWB)	\$68.00



RIDGEMONT SANDCAST BRONZE DEADBOLT WITH FLAP	Product Code	Finish	List Price
Single Cylinder	8476	Flat Black Bronze (FB) Medium Bronze (MB)	\$64.00
Double Cylinder	8376	Tumbled White Bronze (TWB)	\$68.00

STANDARD WITH SANDCAST BRONZE DEADBOLTS

- Schlage® C Keyway
- Standard Door Prep and Installation
- Solid Brass Cylinder
- Sandcast Bronze Collar and Inside Rosette
- Hardened Steel Bolt
- Heavy Gauge Steel Understrike
- Brass Trim Strike Shipped with Every Deadbolt

Handing Not Required. Standard door thickness of 1¾", specify if thicker. Standard latch is for 2¾" backset. Specify 2¾" backset if required. **Weiser® (WR5) Keyway:** Specify by adding "W" to the beginning of Product Code. No upcharge for cylinder substitution. Can be keyed into existing Weiser® system.

DEADBOLTS - LOST WAX CAST BRONZE



TUSCANY BRONZE DEADBOLT	Product Code	Finish	List Price
Single Cylinder	8456	Flat Black Bronze (FB) Medium Bronze (MB)	\$64.00
Double Cylinder	8356		\$68.00



CLASSIC TUSCANY BRONZE DEADBOLT	Product Code	Finish	List Price
Single Cylinder	8471	Flat Black Bronze (FB) Medium Bronze (MB)	\$64.00
Double Cylinder	8371		\$68.00



OCTAGON TUSCANY BRONZE DEADBOLT	Product Code	Finish	List Price
Single Cylinder	8460	Flat Black Bronze (FB) Medium Bronze (MB)	\$64.00
Double Cylinder	8360		\$68.00



#11 TUSCANY BRONZE DEADBOLT	Product Code	Finish	List Price
Single Cylinder	8472	Flat Black Bronze (FB) Medium Bronze (MB)	\$64.00
Double Cylinder	8372		\$68.00



#14 TUSCANY BRONZE DEADBOLT	Product Code	Finish	List Price
Single Cylinder	8473	Flat Black Bronze (FB) Medium Bronze (MB)	\$64.00
Double Cylinder	8373		\$68.00

STANDARD WITH TUSCANY BRONZE DEADBOLTS	
<ul style="list-style-type: none"> • Schlage® C Keyway • Standard Door Prep and Installation • Solid Brass Cylinder • Lost Wax Cast Bronze Collar and Inside Rosette 	<ul style="list-style-type: none"> • Hardened Steel Bolt • Heavy Gauge Steel Understrike • Brass Trim Strike Shipped with Every Deadbolt

Handing Not Required. Standard door thickness of 1¾", specify if thicker. Standard latch is for 2¾" backset. Specify 2¾" backset if required. **Weiser® (WR5) Keyway:** Specify by adding "W" to the beginning of Product Code. No upcharge for cylinder substitution. Can be keyed into existing Weiser® system.



STAINLESS STEEL ROUND DEADBOLTS	Product Code	Finish	List Price
Single Cylinder	S50001	Brushed Stainless Steel (SS)	\$58.00
Double Cylinder	S50002		\$62.00



STAINLESS STEEL SQUARE DEADBOLTS	Product Code	Finish	List Price
Single Cylinder	S50003	Brushed Stainless Steel (SS)	\$58.00
Double Cylinder	S50023		\$62.00

STANDARD WITH STAINLESS STEEL DEADBOLTS

- Schlage® C Keyway
- Standard Door Prep and Installation
- Solid Brass Cylinder
- Stainless Steel Collar and Inside Rosette
- Hardened Steel Bolt
- Heavy Gauge Steel Understrike
- Stainless Steel Trim Strike Shipped with Every Deadbolt

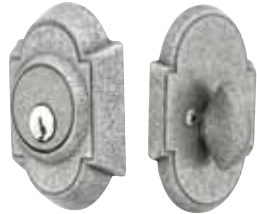

WROUGHT STEEL #1 STYLE DEADBOLT	Product Code	Finish	List Price
Single Cylinder	8461	Flat Black Steel (FBS) Satin Steel (SWS)	\$58.00
Double Cylinder	8361		\$62.00



WROUGHT STEEL #2 STYLE DEADBOLT	Product Code	Finish	List Price
Single Cylinder	8452	Flat Black Steel (FBS) Satin Steel (SWS)	\$58.00
Double Cylinder	8350		\$62.00



WROUGHT STEEL #3 STYLE DEADBOLT	Product Code	Finish	List Price
Single Cylinder	8463	Flat Black Steel (FBS) Satin Steel (SWS)	\$58.00
Double Cylinder	8363		\$62.00

STANDARD WITH WROUGHT STEEL DEADBOLTS

- Schlage® C Keyway
- Standard Door Prep and Installation
- Solid Brass Cylinder
- Wrought Steel Collar and Inside Rosette
- Hardened Steel Bolt
- Heavy Gauge Steel Understrike
- Brass Trim Strike Shipped with Every Deadbolt

Handing Not Required. Standard door thickness of 1¾", specify if thicker. Standard latch is for 2¾" backset. Specify 2¾" backset if required. **Weiser® (WR5) Keyway:** Specify by adding "W" to the beginning of Product Code. No upcharge for cylinder substitution. Can be keyed into existing Weiser® system.

SINGLE SIDED DEADBOLTS

Operated by Thumbturn from Inside Only. No Cylinder.

Modern



Square



Neos



Regular



#8



Rectangular



Wilshire



Saratoga



Quincy



Rope



Knoxville



Arts & Crafts



SINGLE SIDED DEADBOLTS	Product Code	Finish	List Price
Modern	8567	Satin Brass (US4) Oil Rubbed Bronze (US10B)	\$42.00
Square	8569	Polished Nickel - Lifetime (US14)* Satin Nickel (US15)	
Neos	8575	Flat Black (US19) Polished Chrome (US26)	

* Polished Nickel - Lifetime (US14) Not available for Neos Style.

SINGLE SIDED DEADBOLTS	Product Code	Finish	List Price
Regular	8550	Polished Brass - Lifetime (US3) French Antique (US7)	\$42.00
#8	8566	Oil Rubbed Bronze (US10B) Polished Nickel - Lifetime (US14)	
Rectangular	8568	Satin Nickel (US15) Pewter (US15A)	
Wilshire	8579	Flat Black (US19) Polished Chrome (US26)	

SINGLE SIDED DEADBOLTS	Product Code	Finish	List Price
Saratoga	8558	Polished Brass - Lifetime (US3) French Antique (US7)	\$42.00
Quincy	8578	Oil Rubbed Bronze (US10B) Satin Nickel (US15)	
Rope	8564	Pewter (US15A) Flat Black (US19)*	
Knoxville	8559	Polished Chrome (US26)	

* Flat Black (US19) Not available for Rope and Knoxville Styles.

SINGLE SIDED DEADBOLTS	Product Code	Finish	List Price
Arts & Crafts	8554	Oil Rubbed Bronze (US10B) Satin Nickel (US15) Flat Black (US19)	\$42.00

STANDARD WITH SINGLE SIDED DEADBOLTS

- Includes Deadbolt Mechanism and Strikeplate
- For Inside Installation and Appearance
- No Cylinder or Collar
- Hardened Steel Bolt
- Fits Door Thickness 1⁵/₈" to 2³/₈"

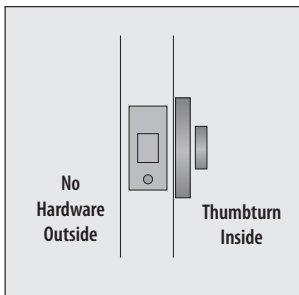

Standard door thickness of 1³/₄", specify if thicker. Standard latch is for 2³/₈" backset. Specify 2³/₄" backset if required.

Operated by Thumbturn from Inside Only. No Cylinder.

#1
Sandcast
Bronze



#2
Sandcast
Bronze



#3
Sandcast
Bronze



#4
Sandcast
Bronze



Tuscany



Octagon



#11
Tuscany



#14
Tuscany



Round
Stainless Steel



Square
Stainless Steel



#1
Wrought Steel



#2
Wrought Steel



#3
Wrought Steel



SINGLE SIDED DEADBOLTS	Product Code	Finish	List Price
#1 Sandcast Bronze	8557	Flat Black Bronze (FB) Medium Bronze (MB) Tumbled White Bronze (TWB)	\$44.00
#2 Sandcast Bronze	8550		
#3 Sandcast Bronze	8565		
#4 Sandcast Bronze	8574		

SINGLE SIDED DEADBOLTS	Product Code	Finish	List Price
Tuscany Bronze	8556	Flat Black Bronze (FB) Medium Bronze (MB)	\$44.00
Octagon	8560		
#11 Tuscany Bronze	8572		
#14 Tuscany Bronze	8573		

SINGLE SIDED DEADBOLTS	Product Code	Finish	List Price
Round Stainless Steel	S52005	Brushed Stainless Steel (SS)	\$42.00
Square Stainless Steel	S52006		

SINGLE SIDED DEADBOLTS	Product Code	Finish	List Price
#1 Wrought Steel	8551	Flat Black Steel (FBS) Satin Steel (SWS)	\$42.00
#2 Wrought Steel	8552		
#3 Wrought Steel	8553		

STANDARD WITH SINGLE SIDED DEADBOLTS

- Includes Deadbolt Mechanism and Strikeplate
- For Inside Installation and Appearance
- No Cylinder or Collar
- Hardened Steel Bolt
- Fits Door Thickness 1⁵/₈" to 2³/₈"

Standard door thickness of 1³/₄", specify if thicker. Standard latch is for 2³/₈" backset. Specify 2³/₄" backset if required.

SIDEPLATE LOCKSETS - BRASS TUBULAR

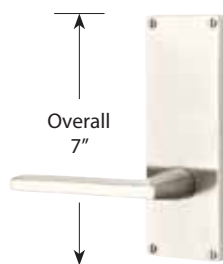

- Helios Lever with Non-Keyed Modern Plate
- Standard 2 1/8" Door Prep

MODERN 7" NON-KEYED	Product Code	Knob or Lever Style	Finish	List Price
Passage	8111	See Page 4 for Brass Knob & Lever Options. See Page 5 for Crystal & Porcelain Knob Options.	Satin Brass (US4) Oil Rubbed Bronze (US10B)	\$148.00
Privacy	8211		Satin Nickel (US15) Flat Black (US19)	\$148.00
Dummy, Pair	8011		Polished Chrome (US26)	\$148.00



- Bern Knob with Keyed Modern Plate
- Two Standard 2 1/8" Door Preps
- 3 5/8" Center to Center Hole Spacing

MODERN 3 5/8" C-TO-C KEYED	Product Code	Knob or Lever Style	Finish	List Price
Passage/Single Keyed	8112	See Page 4 for Brass Knob & Lever Options. See Page 5 for Crystal & Porcelain Knob Options.	Satin Brass (US4) Oil Rubbed Bronze (US10B)	\$168.00
Passage/Double Keyed	8212		Satin Nickel (US15) Flat Black (US19)	\$168.00
Dummy, Pair	8012		Polished Chrome (US26)	\$168.00



- Bern Knob with Non-Keyed Modern Plate
- Standard 2 1/8" Door Prep

MODERN 9" NON-KEYED	Product Code	Knob or Lever Style	Finish	List Price
Passage	8113	See Page 4 for Brass Knob & Lever Options. See Page 5 for Crystal & Porcelain Knob Options.	Satin Brass (US4) Oil Rubbed Bronze (US10B)	\$148.00
Privacy	8213		Satin Nickel (US15) Flat Black (US19)	\$148.00
Dummy, Pair	8013		Polished Chrome (US26)	\$148.00



- Geneva Lever with Keyed Modern Plate
- Two Standard 2 1/8" Door Preps
- 5 1/2" Center to Center Hole Spacing

MODERN 5 1/2" C-TO-C KEYED	Product Code	Knob or Lever Style	Finish	List Price
Passage/Single Keyed	8114	See Page 4 for Brass Knob & Lever Options. See Page 5 for Crystal & Porcelain Knob Options.	Satin Brass (US4) Oil Rubbed Bronze (US10B)	\$168.00
Passage/Double Keyed	8214		Satin Nickel (US15) Flat Black (US19)	\$168.00
Dummy, Pair	8014		Polished Chrome (US26)	\$168.00

INTERCONNECT DEVICE	Product Code	Knob or Lever Style	List Price
Modern 5 1/2" C-to-C Keyed	443	Not Available for Double Cylinder. 28° Latch Not Available for Use with Interconnect Device.	\$58.00

Handing Required if Keyed Leversets or if Interconnect Device is Specified. Standard 2 1/8" Door Prep. Standard latch is for 2 3/8" backset. Specify 2 3/4" backset if required. To order 28° Rotation Latch with any Sideplate, add product code **Latch28** and list price **\$4**. **Weiser® (WR5) Keyword:** Specify by adding "W" to the beginning of Product Code. No upcharge for cylinder substitution. Can be keyed into existing Weiser® system.



• Norwich Knob with Non-Keyed Quincy Plate
• Standard 2 1/8" Door Prep

QUINCY 7 1/8" NON-KEYED	Product Code	Knob or Lever Style	Finish	List Price
Passage	8104	See Page 4 for Brass Knob & Lever Options. See Page 5 for Crystal & Porcelain Knob Options.	Polished Brass - Lifetime (US3)	\$148.00
Privacy	8204		French Antique (US7)	
Dummy, Pair	8054		Oil Rubbed Bronze (US10B)	\$148.00
			Satin Nickel (US15)	\$148.00
			Pewter (US15A)	
			Flat Black (US19)	
			Polished Chrome (US26)	



• Egg Knob with Keyed Quincy Plate
• Two Standard 2 1/8" Door Preps
• 3 3/8" Center to Center Hole Spacing

QUINCY 3 5/8" C-TO-C KEYED	Product Code	Knob or Lever Style	Finish	List Price
Passage/Single Keyed	8080	See Page 4 for Brass Knob & Lever Options. See Page 5 for Crystal & Porcelain Knob Options.	Polished Brass - Lifetime (US3)	\$168.00
Passage/Double Keyed	8081		French Antique (US7)	
Dummy, Pair	8085		Oil Rubbed Bronze (US10B)	\$168.00
			Satin Nickel (US15)	\$168.00
			Pewter (US15A)	
			Flat Black (US19)	
			Polished Chrome (US26)	



• Cortina Lever with Non-Keyed Quincy Plate
• Standard 2 1/8" Door Prep

QUINCY 9" NON-KEYED	Product Code	Knob or Lever Style	Finish	List Price
Passage	8704	See Page 4 for Brass Knob & Lever Options. See Page 5 for Crystal & Porcelain Knob Options.	Polished Brass - Lifetime (US3)	\$148.00
Privacy	8804		French Antique (US7)	
Dummy, Pair	8854		Oil Rubbed Bronze (US10B)	\$148.00
			Satin Nickel (US15)	\$148.00
			Pewter (US15A)	
			Flat Black (US19)	
			Polished Chrome (US26)	



• Milano Lever with Keyed Quincy Plate
• Two Standard 2 1/8" Door Preps
• 5 1/2" Center to Center Hole Spacing

QUINCY 5 1/2" C-TO-C KEYED	Product Code	Knob or Lever Style	Finish	List Price
Passage/Single Keyed	8980	See Page 4 for Brass Knob & Lever Options. See Page 5 for Crystal & Porcelain Knob Options.	Polished Brass - Lifetime (US3)	\$168.00
Passage/Double Keyed	8981		French Antique (US7)	
Dummy, Pair	8985		Oil Rubbed Bronze (US10B)	\$168.00
			Satin Nickel (US15)	\$168.00
			Pewter (US15A)	
			Flat Black (US19)	
			Polished Chrome (US26)	

INTERCONNECT DEVICE	Product Code	Knob or Lever Style	Finish	List Price
Quincy 5 1/2" C-to-C Keyed	443	Not Available for Double Cylinder. 28° Latch Not Available for Use with Interconnect Device.		\$58.00

Handing Required if Keyed Leversets or if Interconnect Device is Specified. Standard 2 1/8" Door Prep. Standard latch is for 2 3/8" backset. Specify 2 3/4" backset if required. To order 28° Rotation Latch with any Sideplate, add product code **Latch28** and list price \$4. **Weiser® (WRS) Keyway:** Specify by adding "W" to the beginning of Product Code. No upcharge for cylinder substitution. Can be keyed into existing Weiser® system. **Unlacquered Brass** finish available with additional \$18 NET upcharge.

SIDEPLATE LOCKSETS - BRASS TUBULAR



- Norwich Knob with Non-Keyed Delaware Plate
- Standard 2 1/8" Door Prep

DELAWARE 7 1/8" NON-KEYED	Product Code	Knob or Lever Style	Finish	List Price
Passage	8016	See Page 4 for Brass Knob & Lever Options. See Page 5 for Crystal & Porcelain Knob Options.	Polished Brass - Lifetime (US3) French Antique (US7) Oil Rubbed Bronze (US10B) Satin Nickel (US15) Pewter (US15A) Flat Black (US19) Polished Chrome (US26)	\$148.00
Privacy	8026			\$148.00
Dummy, Pair	8006			\$148.00



- Providence Crystal Knob with Keyed Delaware Plate
- Two Standard 2 1/8" Door Preps
- 3 5/8" Center to Center Hole Spacing

DELAWARE 3 5/8" C-TO-C KEYED	Product Code	Knob or Lever Style	Finish	List Price
Passage/Single Keyed	8066	See Page 4 for Brass Knob & Lever Options. See Page 5 for Crystal & Porcelain Knob Options.	Polished Brass - Lifetime (US3) French Antique (US7) Oil Rubbed Bronze (US10B) Satin Nickel (US15) Pewter (US15A) Flat Black (US19) Polished Chrome (US26)	\$168.00
Passage/Double Keyed	8166			\$168.00
Dummy, Pair	8061			\$168.00



- Cortina Lever with Non-Keyed Delaware Plate
- Standard 2 1/8" Door Prep

DELAWARE 9" NON-KEYED	Product Code	Knob or Lever Style	Finish	List Price
Passage	8716	See Page 4 for Brass Knob & Lever Options. See Page 5 for Crystal & Porcelain Knob Options.	Polished Brass - Lifetime (US3) French Antique (US7) Oil Rubbed Bronze (US10B) Satin Nickel (US15) Pewter (US15A) Flat Black (US19) Polished Chrome (US26)	\$148.00
Privacy	8816			\$148.00
Dummy, Pair	8998			\$148.00



- Waverly Knob with Keyed Delaware Plate
- Two Standard 2 1/8" Door Preps
- 5 1/2" Center to Center Hole Spacing

DELAWARE 5 1/2" C-TO-C KEYED	Product Code	Knob or Lever Style	Finish	List Price
Passage/Single Keyed	8996	See Page 4 for Brass Knob & Lever Options. See Page 5 for Crystal & Porcelain Knob Options.	Polished Brass - Lifetime (US3) French Antique (US7) Oil Rubbed Bronze (US10B) Satin Nickel (US15) Pewter (US15A) Flat Black (US19) Polished Chrome (US26)	\$168.00
Passage/Double Keyed	8997			\$168.00
Dummy, Pair	8856			\$168.00

INTERCONNECT DEVICE	Product Code		List Price
Delaware 5 1/2" C-to-C Keyed	443	Not Available for Double Cylinder. 28° Latch Not Available for Use with Interconnect Device.	\$58.00

Handing Required if Keyed Leversets or if Interconnect Device is Specified. Standard 2 1/8" Door Prep. Standard latch is for 2 3/8" backset. Specify 2 3/4" backset if required. To order 28° Rotation Latch with any Sideplate, add product code **Latch28** and list price \$4. **Weiser® (WRS) Keyway:** Specify by adding "W" to the beginning of Product Code. No upcharge for cylinder substitution. Can be keyed into existing Weiser® system. **Unlacquered Brass** finish available with additional \$18 NET upcharge.



• Cortina Lever with Non-Keyed Colonial Plate
• Standard 2 1/8" Door Prep

COLONIAL 7 1/8" NON-KEYED	Product Code	Knob or Lever Style	Finish	List Price
Passage	8010	See Page 4 for Brass Knob & Lever Options. See Page 5 for Crystal & Porcelain Knob Options.	Polished Brass - Lifetime (US3) French Antique (US7)	\$148.00
Privacy	8020		Oil Rubbed Bronze (US10B) Satin Nickel (US15)	\$148.00
Dummy, Pair	8001		Pewter (US15A) Flat Black (US19) Polished Chrome (US26)	\$148.00



• Waverly Knob with Keyed Colonial Plate
• Two Standard 2 1/8" Door Preps
• 3 3/8" Center to Center Hole Spacing

COLONIAL 3 5/8" C-TO-C KEYED	Product Code	Knob or Lever Style	Finish	List Price
Passage/Single Keyed	8060	See Page 4 for Brass Knob & Lever Options. See Page 5 for Crystal & Porcelain Knob Options.	Polished Brass - Lifetime (US3) French Antique (US7)	\$168.00
Passage/Double Keyed	8160		Oil Rubbed Bronze (US10B) Satin Nickel (US15)	\$168.00
Dummy, Pair	8065		Pewter (US15A) Flat Black (US19) Polished Chrome (US26)	\$168.00



• Providence Knob with Non-Keyed Colonial Plate
• Standard 2 1/8" Door Prep

COLONIAL 9" NON-KEYED	Product Code	Knob or Lever Style	Finish	List Price
Passage	8711	See Page 4 for Brass Knob & Lever Options. See Page 5 for Crystal & Porcelain Knob Options.	Polished Brass - Lifetime (US3) French Antique (US7)	\$148.00
Privacy	8811		Oil Rubbed Bronze (US10B) Satin Nickel (US15)	\$148.00
Dummy, Pair	8851		Pewter (US15A) Flat Black (US19) Polished Chrome (US26)	\$148.00



• Egg Knob with Keyed Colonial Plate
• Two Standard 2 1/8" Door Preps
• 5 1/2" Center to Center Hole Spacing

COLONIAL 5 1/2" C-TO-C KEYED	Product Code	Knob or Lever Style	Finish	List Price
Passage/Single Keyed	8990	See Page 4 for Brass Knob & Lever Options. See Page 5 for Crystal & Porcelain Knob Options.	Polished Brass - Lifetime (US3) French Antique (US7)	\$168.00
Passage/Double Keyed	8991		Oil Rubbed Bronze (US10B) Satin Nickel (US15)	\$168.00
Dummy, Pair	8995		Pewter (US15A) Flat Black (US19) Polished Chrome (US26)	\$168.00

INTERCONNECT DEVICE	Product Code		List Price
Colonial 5 1/2" C-to-C Keyed	443	Not Available for Double Cylinder. 28° Latch Not Available for Use with Interconnect Device.	\$58.00

Handing Required if Keyed Leversets or if Interconnect Device is Specified. Standard 2 1/8" Door Prep. Standard latch is for 2 3/8" backset. Specify 2 3/4" backset if required. To order 28° Rotation Latch with any Sideplate, add product code **Latch28** and list price **\$4**. **Weiser® (WRS) Keyway:** Specify by adding "W" to the beginning of Product Code. No upcharge for cylinder substitution. Can be keyed into existing Weiser® system. **Unlacquered Brass** finish available with additional **\$18 NET** upcharge.

SIDEPLATE LOCKSETS - BRASS TUBULAR



- Rope Knob with Non-Keyed Rope Plate
- Standard 2 1/8" Door Prep

ROPE 7 1/2" NON-KEYED	Product Code	Knob or Lever Style	Finish	List Price
Passage	7109	See Page 4 for Brass Knob & Lever Options.	Polished Brass - Lifetime (US3) French Antique (US7)	\$148.00
Privacy	7209			\$148.00
Dummy, Pair	7059	See Page 5 for Crystal & Porcelain Knob Options.	Satin Nickel (US15)	\$148.00



- Rope Lever with Keyed Rope Plate
- Two Standard 2 1/8" Door Preps
- 3 5/8" Center to Center Hole Spacing

ROPE 3 5/8" C-TO-C KEYED	Product Code	Knob or Lever Style	Finish	List Price
Passage/Single Keyed	7090	See Page 4 for Brass Knob & Lever Options.	Polished Brass - Lifetime (US3) French Antique (US7)	\$168.00
Passage/Double Keyed	7091			\$168.00
Dummy, Pair	7095	See Page 5 for Crystal & Porcelain Knob Options.	Satin Nickel (US15)	\$168.00

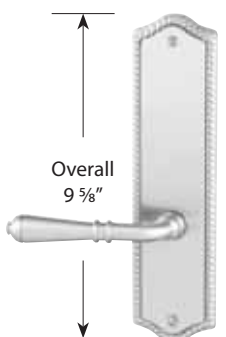

- Turino Lever with Non-Keyed Rope Plate
- Standard 2 1/8" Door Prep

ROPE 9 5/8" NON-KEYED	Product Code	Knob or Lever Style	Finish	List Price
Passage	7710	See Page 4 for Brass Knob & Lever Options.	Polished Brass - Lifetime (US3) French Antique (US7)	\$148.00
Privacy	7810			\$148.00
Dummy, Pair	7850	See Page 5 for Crystal & Porcelain Knob Options.	Satin Nickel (US15)	\$148.00



- Rope Knob with Keyed Rope Plate
- Two Standard 2 1/8" Door Preps
- 5 1/2" Center to Center Hole Spacing

ROPE 5 1/2" C-TO-C KEYED	Product Code	Knob or Lever Style	Finish	List Price
Passage/Single Keyed	7990	See Page 4 for Brass Knob & Lever Options.	Polished Brass - Lifetime (US3) French Antique (US7)	\$168.00
Passage/Double Keyed	7991			\$168.00
Dummy, Pair	7995	See Page 5 for Crystal & Porcelain Knob Options.	Satin Nickel (US15)	\$168.00

INTERCONNECT DEVICE	Product Code		List Price
Rope 5 1/2" C-to-C Keyed	443	Not Available for Double Cylinder. 28° Latch Not Available for Use with Interconnect Device.	\$58.00

Handing Required if Keyed Leversets or if Interconnect Device is Specified. Standard 2 1/8" Door Prep. Standard latch is for 2 3/8" backset. Specify 2 3/4" backset if required. To order 28° Rotation Latch with any Sideplate, add product code **Latch28** and list price \$4. **Weiser® (WR5) Keyway:** Specify by adding "W" to the beginning of Product Code. No upcharge for cylinder substitution. Can be keyed into existing Weiser® system. **Unlacquered Brass** finish available with additional \$18 NET upcharge.



• Astoria Knob with Non-Keyed Oval Beaded Plate
• Standard 2 1/8" Door Prep

OVAL BEADED 7" NON-KEYED	Product Code	Knob or Lever Style	Finish	List Price
Passage	8105	See Page 4 for Brass Knob & Lever Options.	Polished Brass - Lifetime (US3) French Antique (US7)	\$148.00
Privacy	8205			Oil Rubbed Bronze (US10B) Satin Nickel (US15)
Dummy, Pair	8055	See Page 5 for Crystal & Porcelain Knob Options.		\$148.00

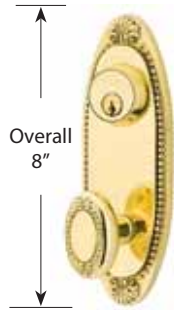

• Beaded Egg Knob with Keyed Oval Beaded Plate
• Two Standard 2 1/8" Door Preps
• 3 3/8" Center to Center Hole Spacing

OVAL BEADED 3 5/8" C-TO-C KEYED	Product Code	Knob or Lever Style	Finish	List Price
Passage/Single Keyed	6010	See Page 4 for Brass Knob & Lever Options.	Polished Brass - Lifetime (US3) French Antique (US7) Oil Rubbed Bronze (US10B) Satin Nickel (US15)	\$168.00
Passage/Double Keyed	6011			\$168.00
Dummy, Pair	6015	See Page 5 for Crystal & Porcelain Knob Options.		\$168.00



• Hampton Knob with Non-Keyed Trenton Plate
• Standard 2 1/8" Door Prep

TRENTON 10 3/4" NON-KEYED	Product Code	Knob or Lever Style	Finish	List Price
Passage	8109	See Page 4 for Brass Knob & Lever Options.	Polished Brass - Lifetime (US3) French Antique (US7) Oil Rubbed Bronze (US10B) Satin Nickel (US15)	\$148.00
Privacy	8209			\$148.00
Dummy, Pair	8059	See Page 5 for Crystal & Porcelain Knob Options.	Pewter (US15A) Polished Chrome (US26)	\$148.00



• Rope Lever with Keyed Trenton Plate
• Two Standard 2 1/8" Door Preps
• 5 1/2" Center to Center Hole Spacing

TRENTON 5 1/2" C-TO-C KEYED	Product Code	Knob or Lever Style	Finish	List Price
Passage/Single Keyed	6030	See Page 4 for Brass Knob & Lever Options.	Polished Brass - Lifetime (US3) French Antique (US7) Oil Rubbed Bronze (US10B) Satin Nickel (US15)	\$168.00
Passage/Double Keyed	6031			\$168.00
Dummy, Pair	6035	See Page 5 for Crystal & Porcelain Knob Options.	Pewter (US15A) Polished Chrome (US26)	\$168.00

INTERCONNECT DEVICE	Product Code		List Price
Trenton 5 1/2" C-to-C Keyed	443	Not Available for Double Cylinder. 28° Latch Not Available for Use with Interconnect Device.	\$58.00

Handing Required if Keyed Leversets or if Interconnect Device is Specified. Standard 2 1/8" Door Prep. Standard latch is for 2 3/8" backset. Specify 2 3/4" backset if required. To order 28° Rotation Latch with any Sideplate, add product code **Latch28** and list price **\$4**. **Weiser® (WR5) Keyway:** Specify by adding "W" to the beginning of Product Code. No upcharge for cylinder substitution. Can be keyed into existing Weiser® system. **Unlacquered Brass** finish available with additional **\$18 NET** upcharge.

SIDEPLATE LOCKSETS - BRASS TUBULAR



• Georgetown Crystal Knob with Non-Keyed Belmont Plate
• Standard 2 1/8" Door Prep

BELMONT 7 1/2" NON-KEYED	Product Code	Knob or Lever Style	Finish	List Price
Passage	8102	See Page 4 for Brass Knob & Lever Options. See Page 5 for Crystal & Porcelain Knob Options.	Polished Brass - Lifetime (US3) French Antique (US7) Oil Rubbed Bronze (US10B) Satin Nickel (US15)	\$148.00
Privacy	8202			\$148.00
Dummy, Pair	8052			\$148.00



• Belmont Knob with Keyed Belmont Plate
• Two Standard 2 1/8" Door Preps
• 3 5/8" Center to Center Hole Spacing

BELMONT 3 5/8" C-TO-C KEYED	Product Code	Knob or Lever Style	Finish	List Price
Passage/Single Keyed	8070	See Page 4 for Brass Knob & Lever Options. See Page 5 for Crystal & Porcelain Knob Options.	Polished Brass - Lifetime (US3) French Antique (US7) Oil Rubbed Bronze (US10B) Satin Nickel (US15)	\$168.00
Passage/Double Keyed	8071			\$168.00
Dummy, Pair	8075			\$168.00



• Victoria Knob with Non-Keyed Victoria Plate
• Standard 2 1/8" Door Prep

VICTORIA 7 3/4" NON-KEYED	Product Code	Knob or Lever Style	Finish	List Price
Passage	8103	See Page 4 for Brass Knob & Lever Options. See Page 5 for Crystal & Porcelain Knob Options.	Polished Brass - Lifetime (US3) French Antique (US7) Oil Rubbed Bronze (US10B) Satin Nickel (US15)	\$148.00
Privacy	8203			\$148.00
Dummy, Pair	8053			\$148.00



• Victoria Knob with Keyed Victoria Plate
• Two Standard 2 1/8" Door Preps
• 3 5/8" Center to Center Hole Spacing

VICTORIA 3 5/8" C-TO-C KEYED	Product Code	Knob or Lever Style	Finish	List Price
Passage/Single Keyed	8090	See Page 4 for Brass Knob & Lever Options. See Page 5 for Crystal & Porcelain Knob Options.	Polished Brass - Lifetime (US3) French Antique (US7) Oil Rubbed Bronze (US10B) Satin Nickel (US15)	\$168.00
Passage/Double Keyed	8091			\$168.00
Dummy, Pair	8095			\$168.00

Handing Required for Keyed Leversets. Standard 2 1/8" Door Prep. Standard latch is for 2 3/8" backset. Specify 2 3/4" backset if required. To order 28° Rotation Latch with any Sideplate, add product code **Latch28** and list price \$4. **Weiser® (WR5) Keyway:** Specify by adding "W" to the beginning of Product Code. No upcharge for cylinder substitution. Can be keyed into existing Weiser® system. **Unlacquered Brass** finish available with additional \$18 NET upcharge.

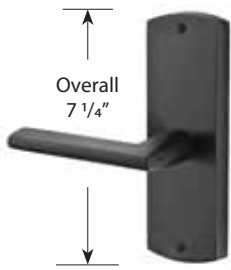

Overall
7 1/4"

- Lariat Lever with Non-Keyed Missoula Plate
- Standard 2 1/8" Door Prep

MISSOULA 7 1/4" NON-KEYED	Product Code	Knob or Lever Style	Finish	List Price
Passage	71023	See Page 5 for Sandcast Bronze Knob & Lever, Crystal & Porcelain Knob Options.	Flat Black Bronze (FB) Medium Bronze (MB) Tumbled White Bronze (TWB)	\$162.00
Privacy	72023			\$162.00
Dummy, Pair	70063			\$162.00



Overall
7 1/4"

- Winchester Knob with Keyed Missoula Plate
- Two Standard 2 1/8" Door Preps
- 3 3/8" Center to Center Hole Spacing

MISSOULA 3 5/8" C-TO-C KEYED	Product Code	Knob or Lever Style	Finish	List Price
Passage/Single Keyed	7370	See Page 5 for Sandcast Bronze Knob & Lever, Crystal & Porcelain Knob Options.	Flat Black Bronze (FB) Medium Bronze (MB) Tumbled White Bronze (TWB)	\$184.00
Passage/Double Keyed	7371			\$184.00
Dummy, Pair	7375			\$184.00

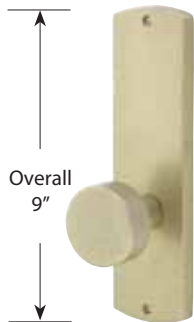

Overall
9"

- Bronze Round Knob with Non-Keyed Missoula Plate
- Standard 2 1/8" Door Prep

MISSOULA 9" NON-KEYED	Product Code	Knob or Lever Style	Finish	List Price
Passage	7522	See Page 5 for Sandcast Bronze Knob & Lever, Crystal & Porcelain Knob Options.	Flat Black Bronze (FB) Medium Bronze (MB) Tumbled White Bronze (TWB)	\$162.00
Privacy	7622			\$162.00
Dummy, Pair	7562			\$162.00



Overall
9"

- Yuma Lever with Keyed Missoula Plate
- Two Standard 2 1/8" Door Preps
- 5 1/2" Center to Center Hole Spacing

MISSOULA 5 1/2" C-TO-C KEYED	Product Code	Knob or Lever Style	Finish	List Price
Passage/Single Keyed	7570	See Page 5 for Sandcast Bronze Knob & Lever, Crystal & Porcelain Knob Options.	Flat Black Bronze (FB) Medium Bronze (MB) Tumbled White Bronze (TWB)	\$184.00
Passage/Double Keyed	7571			\$184.00
Dummy, Pair	7575			\$184.00

INTERCONNECT DEVICE	Product Code	Knob or Lever Style	Finish	List Price
Missoula 5 1/2" C-to-C Keyed	443	Not Available for Double Cylinder. 28° Latch Not Available for Use with Interconnect Device.		\$58.00

Handing Required if Keyed Leversets or if Interconnect Device is Specified. Standard 2 1/8" Door Prep. Standard latch is for 2 3/8" backset. Specify 2 3/4" backset if required. To order 28° Rotation Latch with any Sideplate, add product code **Latch28** and list price \$4. **Weiser® (WR5) Keyword:** Specify by adding "W" to the beginning of Product Code. No upcharge for cylinder substitution. Can be keyed into existing Weiser® system.

SIDEPLATE LOCKSETS - SANDCAST BRONZE TUBULAR



- Bronze Egg Knob with Non-Keyed Rectangular Plate
- Standard 2 1/8" Door Prep

RECTANGULAR 7" NON-KEYED	Product Code	Knob or Lever Style	Finish	List Price
Passage	71013	See Page 5 for Sandcast Bronze Knob & Lever, Crystal & Porcelain Knob Options.	Flat Black Bronze (FB) Medium Bronze (MB) Tumbled White Bronze (TWB)	\$162.00
Privacy	72013			\$162.00
Dummy, Pair	70053			\$162.00

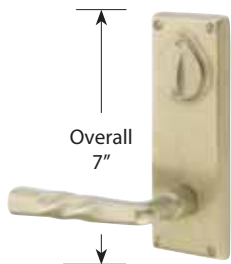

- Montrose Lever with Keyed Rectangular Plate
- Two Standard 2 1/8" Door Preps
- 3 5/8" Center to Center Hole Spacing

RECTANGULAR 3 5/8" C-TO-C KEYED	Product Code	Knob or Lever Style	Finish	List Price
Passage/Single Keyed	7360	See Page 5 for Sandcast Bronze Knob & Lever, Crystal & Porcelain Knob Options.	Flat Black Bronze (FB) Medium Bronze (MB) Tumbled White Bronze (TWB)	\$184.00
Passage/Double Keyed	7361			\$184.00
Dummy, Pair	7365			\$184.00



- Teton Lever with Non-Keyed Rectangular Plate
- Standard 2 1/8" Door Prep

RECTANGULAR 8 7/8" NON-KEYED	Product Code	Knob or Lever Style	Finish	List Price
Passage	7512	See Page 5 for Sandcast Bronze Knob & Lever, Crystal & Porcelain Knob Options.	Flat Black Bronze (FB) Medium Bronze (MB) Tumbled White Bronze (TWB)	\$162.00
Privacy	7612			\$162.00
Dummy, Pair	7552			\$162.00



- Butte Knob with Keyed Rectangular Plate
- Two Standard 2 1/8" Door Preps
- 5 1/2" Center to Center Hole Spacing

RECTANGULAR 5 1/2" C-TO-C KEYED	Product Code	Knob or Lever Style	Finish	List Price
Passage/Single Keyed	7560	See Page 5 for Sandcast Bronze Knob & Lever, Crystal & Porcelain Knob Options.	Flat Black Bronze (FB) Medium Bronze (MB) Tumbled White Bronze (TWB)	\$184.00
Passage/Double Keyed	7561			\$184.00
Dummy, Pair	7565			\$184.00

INTERCONNECT DEVICE	Product Code	Knob or Lever Style	Finish	List Price
Rectangular 5 1/2" C-to-C Keyed	443	Not Available for Double Cylinder. 28° Latch Not Available for Use with Interconnect Device.		\$58.00

Handing Required if Keyed Leversets or if Interconnect Device is Specified. Standard 2 1/8" Door Prep. Standard latch is for 2 3/8" backset. Specify 2 3/4" backset if required. To order 28° Rotation Latch with any Sideplate, add product code **Latch28** and list price **\$4**. **Weiser® (WR5) Keyword:** Specify by adding "W" to the beginning of Product Code. No upcharge for cylinder substitution. Can be keyed into existing Weiser® system.



Overall
7 1/4"

- Cody Lever with Non-Keyed #5 Plate
- Standard 2 1/8" Door Prep

#5 7 1/4" NON-KEYED	Product Code	Knob or Lever Style	Finish	List Price
Passage	7107	See Page 5 for Sandcast Bronze Knob & Lever, Crystal & Porcelain Knob Options.	Flat Black Bronze (FB) Medium Bronze (MB) Tumbled White Bronze (TWB)	\$162.00
Privacy	7207			\$162.00
Dummy, Pair	7057			\$162.00



Overall
8 1/8"

- Butte Knob with Keyed #5 Plate
- Two Standard 2 1/8" Door Preps
- 3 5/8" Center to Center Hole Spacing

#5 3 5/8" C-TO-C KEYED	Product Code	Knob or Lever Style	Finish	List Price
Passage/Single Keyed	7070	See Page 5 for Sandcast Bronze Knob & Lever, Crystal & Porcelain Knob Options.	Flat Black Bronze (FB) Medium Bronze (MB) Tumbled White Bronze (TWB)	\$184.00
Passage/Double Keyed	7071			\$184.00
Dummy, Pair	7075			\$184.00



Overall
9 1/4"

- Butte Knob with Non-Keyed #5 Plate
- Standard 2 1/8" Door Prep

#5 9 1/4" NON-KEYED	Product Code	Knob or Lever Style	Finish	List Price
Passage	7707	See Page 5 for Sandcast Bronze Knob & Lever, Crystal & Porcelain Knob Options.	Flat Black Bronze (FB) Medium Bronze (MB) Tumbled White Bronze (TWB)	\$162.00
Privacy	7807			\$162.00
Dummy, Pair	7757			\$162.00

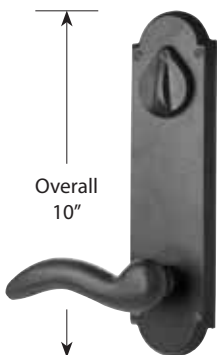

Overall
10"

- Cody Lever with Keyed #5 Plate
- Two Standard 2 1/8" Door Preps
- 5 1/2" Center to Center Hole Spacing

#5 5 1/2" C-TO-C KEYED	Product Code	Knob or Lever Style	Finish	List Price
Passage/Single Keyed	7670	See Page 5 for Sandcast Bronze Knob & Lever, Crystal & Porcelain Knob Options.	Flat Black Bronze (FB) Medium Bronze (MB) Tumbled White Bronze (TWB)	\$184.00
Passage/Double Keyed	7671			\$184.00
Dummy, Pair	7675			\$184.00

INTERCONNECT DEVICE	Product Code			List Price
#5 5 1/2" C-to-C Keyed	443	Not Available for Double Cylinder. 28° Latch Not Available for Use with Interconnect Device.		\$58.00

Handing Required if Keyed Leversets or if Interconnect Device is Specified. Standard 2 1/8" Door Prep. Standard latch is for 2 3/8" backset. Specify 2 3/4" backset if required. To order 28° Rotation Latch with any Sideplate, add product code **Latch28** and list price \$4. **Weiser® (WR5) Keyword:** Specify by adding "W" to the beginning of Product Code. No upcharge for cylinder substitution. Can be keyed into existing Weiser® system.

SIDEPLATE LOCKSETS - LOST WAX CAST BRONZE TUBULAR



Overall
8 1/4"

- Parma Knob with Non-Keyed #16 Plate
- Standard 2 1/8" Door Prep

#16 8 1/4" NON-KEYED	Product Code	Knob or Lever Style	Finish	List Price
Passage	6102	See Page 6 for Lost Wax Cast Bronze Knob & Lever. See Page 5 for Crystal & Porcelain Knob Options.	Flat Black Bronze (FB) Medium Bronze (MB)	\$162.00
Privacy	6202			\$162.00
Dummy, Pair	6052			\$162.00



Overall
8 1/4"

- Napoli Lever with Keyed #16 Plate
- Two Standard 2 1/8" Door Preps
- 3 3/8" Center to Center Hole Spacing

#16 3 5/8" C-T-O-C KEYED	Product Code	Knob or Lever Style	Finish	List Price
Passage/Single Keyed	6020	See Page 6 for Lost Wax Cast Bronze Knob & Lever. See Page 5 for Crystal & Porcelain Knob Options.	Flat Black Bronze (FB) Medium Bronze (MB)	\$184.00
Passage/Double Keyed	6021			\$184.00
Dummy, Pair	6025			\$184.00



Overall
10 1/8"

- Medici Lever with Non-Keyed #16 Plate
- Standard 2 1/8" Door Prep

#16 10 1/8" NON-KEYED	Product Code	Knob or Lever Style	Finish	List Price
Passage	6702	See Page 6 for Lost Wax Cast Bronze Knob & Lever. See Page 5 for Crystal & Porcelain Knob Options.	Flat Black Bronze (FB) Medium Bronze (MB)	\$162.00
Privacy	6802			\$162.00
Dummy, Pair	6752			\$162.00



Overall
10 1/8"

- Octagon Lever with Keyed #16 Plate
- Two Standard 2 1/8" Door Preps
- 5 1/2" Center to Center Hole Spacing

#16 5 1/2" C-T-O-C KEYED	Product Code	Knob or Lever Style	Finish	List Price
Passage/Single Keyed	6620	See Page 6 for Lost Wax Cast Bronze Knob & Lever. See Page 5 for Crystal & Porcelain Knob Options.	Flat Black Bronze (FB) Medium Bronze (MB)	\$184.00
Passage/Double Keyed	6621			\$184.00
Dummy, Pair	6625			\$184.00

INTERCONNECT DEVICE	Product Code			List Price
#16 5 1/2" C-to-C Keyed	443	Not Available for Double Cylinder. 28° Latch Not Available for Use with Interconnect Device.		\$58.00

Handing Required if Keyed Leversets or if Interconnect Device is Specified. Standard 2 1/8" Door Prep. Standard latch is for 2 3/8" backset. Specify 2 3/4" backset if required. To order 28° Rotation Latch with any Sideplate, add product code **Latch28** and list price \$4. **Weiser® (WR5) Keyway:** Specify by adding "W" to the beginning of Product Code. No upcharge for cylinder substitution. Can be keyed into existing Weiser® system.



- Hercules Lever with Non-Keyed Stainless Steel Plate
- Standard 2 1/8" Door Prep

STAINLESS STEEL 8" NON-KEYED	Product Code	Knob or Lever Style	Finish	List Price
Passage	S801	See Page 6 For Stainless Steel Knob & Lever Options.	Brushed Stainless Steel (SS)	\$148.00
Privacy	S802			\$148.00
Dummy, Pair	S800			\$148.00



- Helios Lever with Keyed Stainless Steel Plate
- Two Standard 2 1/8" Door Preps
- 5 1/2" Center to Center Hole Spacing

STAINLESS STEEL 5 1/2" C-TO-C KEYED	Product Code	Knob or Lever Style	Finish	List Price
Passage/Single Keyed	S811	See Page 6 For Stainless Steel Knob & Lever Options.	Brushed Stainless Steel (SS)	\$168.00
Passage/Double Keyed	S812			\$168.00
Dummy, Pair	S810			\$168.00

INTERCONNECT DEVICE	Product Code	Knob or Lever Style	Finish	List Price
Stainless Steel 5 1/2" C-to-C Keyed	443	Not Available for Double Cylinder. 28° Latch Not Available for Use with Interconnect Device.		\$58.00



- Madison Ivory Knob with Non-Keyed #5 Wrought Steel Plate
- Standard 2 1/8" Door Prep

#5 WROUGHT STEEL 7 1/8" NON-KEYED	Product Code	Knob or Lever Style	Finish	List Price
Passage	7105	See Page 6 for Wrought Steel Knob & Lever Options.	Flat Black Steel (FBS) Satin Steel (SWS)	\$148.00
Privacy	7205			\$148.00
Dummy, Pair	7055			\$148.00

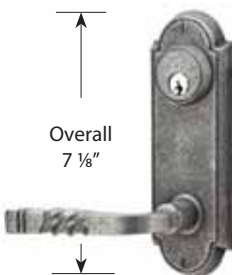

- San Carlos Lever with Keyed #5 Wrought Steel Plate
- Two Standard 2 1/8" Door Preps
- 3 5/8" Center to Center Hole Spacing

#5 WROUGHT STEEL 3 5/8" C-TO-C KEYED	Product Code	Knob or Lever Style	Finish	List Price
Passage/Single Keyed	7010	See Page 6 for Wrought Steel Knob & Lever Options.	Flat Black Steel (FBS) Satin Steel (SWS)	\$168.00
Passage/Double Keyed	7011			\$168.00
Dummy, Pair	7015			\$168.00

Handing Required if Keyed Leversets or if Interconnect Device is Specified. Standard 2 1/8" Door Prep. Standard latch is for 2 3/8" backset. Specify 2 3/4" backset if required. To order 28° Rotation Latch with any Sideplate, add product code **Latch28** and list price \$4. **Weiser® (WRS) Keyword:** Specify by adding "W" to the beginning of Product Code. No upcharge for cylinder substitution. Can be keyed into existing Weiser® system.

SIDEPLATE LOCKSETS - BRASS THUMBTURN PRIVACY

Delaware Plates
with Providence Crystal Knobs



Exterior Interior

Colonial Plates
with Cortina Levers



Exterior Interior

Quincy Plates
with Egg Knobs

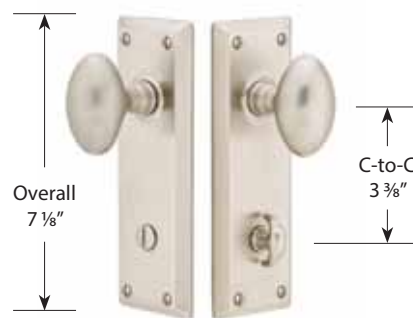

Exterior Interior

THUMBTURN PRIVACY NON-KEYED STYLE	Product Code	Knob / Lever Style	Finish	List Price
Delaware Plate 3 3/8" Center to Center	8228	See Page 4 for Brass Knob & Lever Options. See Page 5 for Crystal & Porcelain Knob Options.	Polished Brass - Lifetime (US3) French Antique (US7) Oil Rubbed Bronze (US10B) Satin Nickel (US15) Pewter (US15A) Flat Black (US19) Polished Chrome (US26)	\$156.00
Colonial Plate 3 3/8" Center to Center	8022			\$156.00
Quincy Plate 3 3/8" Center to Center	8226			\$156.00

Belmont Plates
with Belmont Knobs



Exterior Interior

Victoria Plates
with Elan Levers



Exterior Interior

THUMBTURN PRIVACY NON-KEYED STYLE	Product Code	Knob / Lever Style	Finish	List Price
Belmont Plate 3 3/8" Center to Center	8224	See Page 4 for Brass Knob & Lever Options. See Page 5 for Crystal & Porcelain Knob Options.	Polished Brass - Lifetime (US3) French Antique (US7) Oil Rubbed Bronze (US10B) Satin Nickel (US15)	\$156.00
Victoria Plate 3 3/8" Center to Center	8225			\$156.00

Handing Required for Leversets. Standard latch is for 2 3/8" backset. Specify 2 3/4" backset if required. To order 28° Rotation Latch with any Sideplate, add product code **Latch28** and list price \$4.

Rope Plates
with Rope Levers



Oval Beaded Plates
with Georgetown Knobs



THUMBTURN PRIVACY NON-KEYED STYLE	Product Code	Knob / Lever Style	Finish	List Price
Rope Plate 3 $\frac{3}{8}$ " Center to Center	8223	See Page 4 for Brass Knob & Lever Options.	Polished Brass - Lifetime (US3) French Antique (US7) Oil Rubbed Bronze (US10B) Satin Nickel (US15)	\$156.00
Oval Beaded Plate 3 $\frac{3}{8}$ " Center to Center	8227	See Page 5 for Crystal & Porcelain Knob Options.		\$156.00

USE WITH BRASS PASSAGE - THUMBTURN PRIVACY LOCKSETS

Cortina Leverset with
Thumbturn Privacy Set
Exterior



THUMBTURN PRIVACY LOCKSETS	Product Code	Finish	List Price
Use with Brass Passage	828TP	Polished Brass - Lifetime (US3) French Antique (US7) Oil Rubbed Bronze (US10B) Polished Nickel - Lifetime (US14) Satin Nickel (US15) Pewter (US15A) Flat Black (US19) Polished Chrome (US26)	\$22.00

>> Knob/Lever Lockset sold separately.

Cortina Leverset with
Thumbturn Privacy Set
Interior



STANDARD WITH THUMBTURN PRIVACY LOCKSETS

Thumbturn Privacy can be used with any Emtek Brass Passage Lockset.
See Pages 100 -107, 115 -116, 118-119 for Lever & Knob styles.

Handing Required for Leversets. Standard latch is for 2 $\frac{3}{8}$ " backset. Specify 2 $\frac{3}{4}$ " backset if required. To order 28° Rotation Latch with any Sideplate, add product code **Latch28** and list price **\$4**.

SIDEPLATE LOCKSETS - STRETTO NARROW TRIM

STRETTO uses a tubular latch and is available for order in passage, thumb-turn privacy, keyed entry, and dummy functions. It can be paired with any Emtek knob or lever. The sleek design of the STRETTO requires a 1 1/4" diameter bore hole and a 2-hole door preparation for privacy thumb-turn and keyed configurations. Additional specifications for this truly unique design include:

- Supplied with a 28° rotation latch. Available in 2 3/8" or 2 3/4" backset
- Trim sizes available are 2" x 10" or 1 1/2" x 11"

STRETTO NON-KEYED PASSAGE STYLES

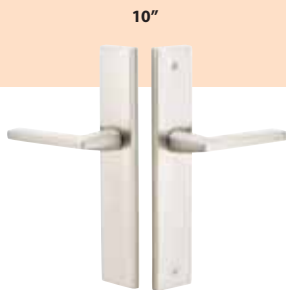

Exterior Interior

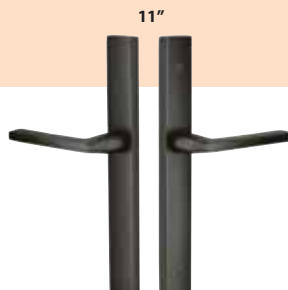

Exterior Interior

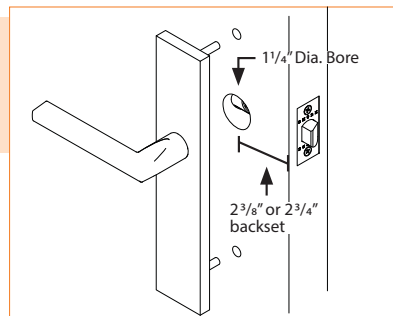

New Door Prep ONLY
See Template for Door Prep Specification

- Narrow 1 1/4" Door Preps

STRETTO THUMBTURN PRIVACY STYLES

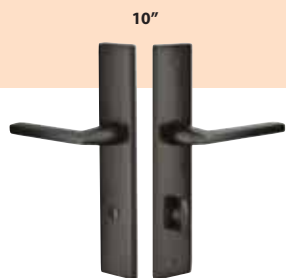

Exterior Interior



Exterior Interior

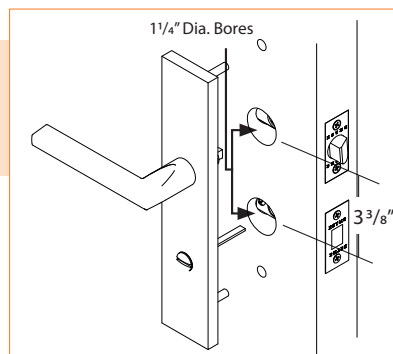

New Door Prep ONLY
See Template for Door Prep Specification

- Narrow 1 1/4" Door Preps, 3 3/8" Center to Center Hole Spacing
- Privacy Thumbturn

STRETTO DUMMY PAIR STYLES

Available in both 10" and 11"



Exterior Interior

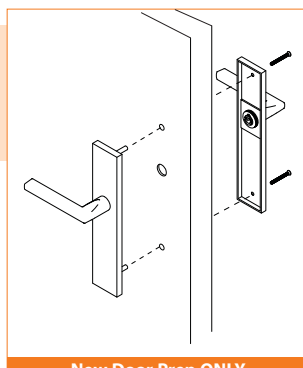

New Door Prep ONLY
See Template for Door Prep

STRETTO DUMMY SINGLE SIDED STYLES

Available in both 10" and 11"



Exterior

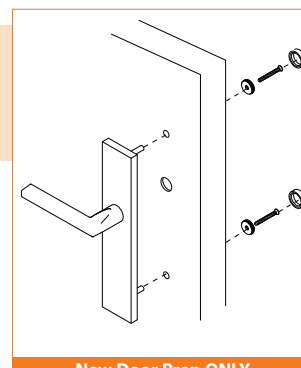

New Door Prep ONLY
See Template for Door Prep

STRETTO KEYED ENTRY STYLES

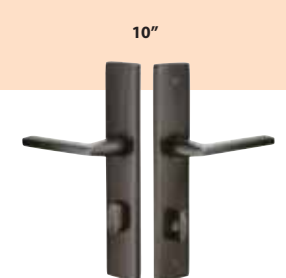

Exterior Interior



Exterior Interior

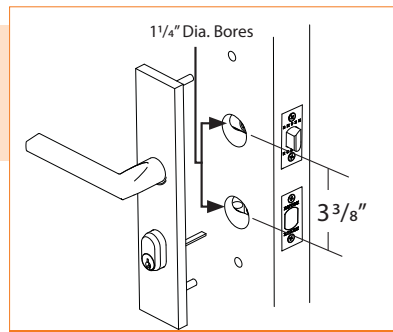

New Door Prep ONLY
See Template for Door Prep Specification

- Narrow 1 1/4" Door Preps, 3 3/8" Center to Center Hole Spacing
- Schlage® C Keyway (Available in Weiser® Keyway)

10" STRETTO
Thumbturn Privacy Set

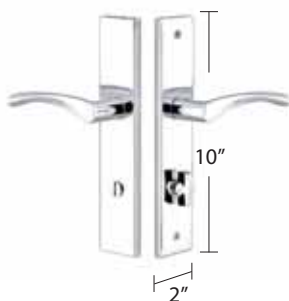

2" x 10" MODERN RECTANGULAR NON-KEYED	Product Code	Knob or Lever Style	Finish	List Price
Passage	8141	See Page 4 for Brass Knob & Lever Options. See Page 5 for Crystal & Porcelain Knob Options.	Satin Brass (US4) Oil Rubbed Bronze (US10B) Satin Nickel (US15) Flat Black (US19) Polished Chrome (US26)	\$154.00
Thumbturn Privacy	8241			\$154.00
Dummy, Pair	8045			\$154.00
Dummy, Single Sided	8041			\$82.00

10" STRETTO
Keyed Entry Set



2" x 10" MODERN RECTANGULAR KEYED	Product Code	Knob or Lever Style	Finish	List Price
Passage/Single Keyed	8442	See Page 4 for Brass Knob & Lever Options. See Page 5 for Crystal & Porcelain Knob Options.	Satin Brass (US4) Oil Rubbed Bronze (US10B) Satin Nickel (US15) Flat Black (US19) Polished Chrome (US26)	\$172.00
Dummy, Pair	8042			\$172.00

11" STRETTO
Non-Keyed Passage Set

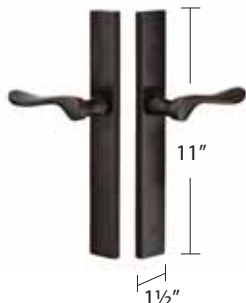

1 1/2" x 11" MODERN RECTANGULAR NON-KEYED	Product Code	Knob or Lever Style	Finish	List Price
Passage	8143	See Page 4 for Brass Knob & Lever Options. See Page 5 for Crystal & Porcelain Knob Options.	Satin Brass (US4) Oil Rubbed Bronze (US10B) Satin Nickel (US15) Flat Black (US19) Polished Chrome (US26)	\$154.00
Thumbturn Privacy	8243			\$154.00
Dummy, Pair	8046			\$154.00
Dummy, Single Sided	8043			\$82.00

11" STRETTO
Keyed Entry Set



1 1/2" x 11" MODERN RECTANGULAR KEYED	Product Code	Knob or Lever Style	Finish	List Price
Passage/Single Keyed	8444	See Page 4 for Brass Knob & Lever Options. See Page 5 for Crystal & Porcelain Knob Options.	Satin Brass (US4) Oil Rubbed Bronze (US10B) Satin Nickel (US15) Flat Black (US19) Polished Chrome (US26)	\$172.00
Dummy, Pair	8044			\$172.00

Handing Required for Leversets. Supplied with 28° rotation latch. Standard latch is for 2 3/8" backset. Specify 2 3/4" backset if required. **Weiser® (WR5) Keyway:** Specify by adding "W" to the beginning of Product Code. No upcharge for cylinder substitution. Can be keyed into existing Weiser® system.

SIDEPLATE LOCKSETS - BRASS STRETTO NARROW TRIM

10" STRETTO
Non-Keyed Passage Set

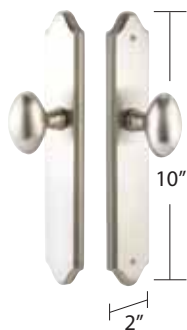

2" x 10" CONCORD NON-KEYED	Product Code	Knob or Lever Style	Finish	List Price
Passage	7141	See Page 4 for Brass Knob & Lever Options. See Page 5 for Crystal & Porcelain Knob Options.	Polished Brass - Lifetime (US3) French Antique (US7) Oil Rubbed Bronze (US10B) Satin Nickel (US15) Pewter (US15A) Flat Black (US19) Polished Chrome (US26)	\$154.00
Thumbturn Privacy	7241			\$154.00
Dummy, Pair	7045			\$154.00
Dummy, Single Sided	7041			\$82.00

10" STRETTO
Keyed Entry Set



2" x 10" CONCORD KEYED	Product Code	Knob or Lever Style	Finish	List Price
Passage/Single Keyed	7442	See Page 4 for Brass Knob & Lever Options. See Page 5 for Crystal & Porcelain Knob Options.	Polished Brass - Lifetime (US3) French Antique (US7) Oil Rubbed Bronze (US10B) Satin Nickel (US15) Pewter (US15A) Flat Black (US19) Polished Chrome (US26)	\$172.00
Dummy, Pair	7042			\$172.00

11" STRETTO
Thumbturn Privacy Set



1 1/2" x 11" CONCORD NON-KEYED	Product Code	Knob or Lever Style	Finish	List Price
Passage	7143	See Page 4 for Brass Knob & Lever Options. See Page 5 for Crystal & Porcelain Knob Options.	Polished Brass - Lifetime (US3) French Antique (US7) Oil Rubbed Bronze (US10B) Satin Nickel (US15) Pewter (US15A) Flat Black (US19) Polished Chrome (US26)	\$154.00
Thumbturn Privacy	7243			\$154.00
Dummy, Pair	7046			\$154.00
Dummy, Single Sided	7043			\$82.00

11" STRETTO
Keyed Entry Set



1 1/2" x 11" CONCORD KEYED	Product Code	Knob or Lever Style	Finish	List Price
Passage/Single Keyed	7444	See Page 4 for Brass Knob & Lever Options. See Page 5 for Crystal & Porcelain Knob Options.	Polished Brass - Lifetime (US3) French Antique (US7) Oil Rubbed Bronze (US10B) Satin Nickel (US15) Pewter (US15A) Flat Black (US19) Polished Chrome (US26)	\$172.00
Dummy, Pair	7044			\$172.00

Handing Required for Leversets. Supplied with 28° rotation latch. Standard latch is for 2 3/8" backset. Specify 2 3/4" backset if required. **Weiser® (WRS) Keyway:** Specify by adding "W" to the beginning of Product Code. No upcharge for cylinder substitution. Can be keyed into existing Weiser® system. **Unlacquered Brass** finish available with additional **\$18 NET** upcharge.

10" STRETTO
Non-Keyed Passage Set

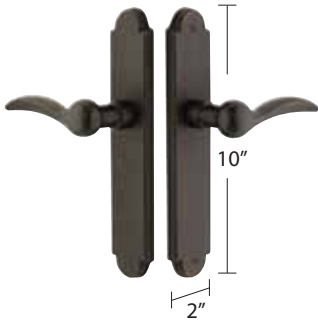

2" x 10" ARCHED NON-KEYED	Product Code	Knob or Lever Style	Finish	List Price
Passage	4141	See Page 5 for Sandcast Bronze Knob & Lever, Crystal & Porcelain Knob Options.	Flat Black Bronze (FB) Medium Bronze (MB) Tumbled White Bronze (TWB)	\$168.00
Thumbturn Privacy	4241			\$168.00
Dummy, Pair	4045			\$168.00
Dummy, Single Sided	4041			\$86.00

10" STRETTO
Keyed Entry Set



2" x 10" ARCHED KEYED	Product Code	Knob or Lever Style	Finish	List Price
Passage/Single Keyed	4442	See Page 5 for Sandcast Bronze Knob & Lever, Crystal & Porcelain Knob Options.	Flat Black Bronze (FB) Medium Bronze (MB) Tumbled White Bronze (TWB)	\$188.00
Dummy, Pair	4042			\$188.00

11" STRETTO
Thumbturn Privacy Set

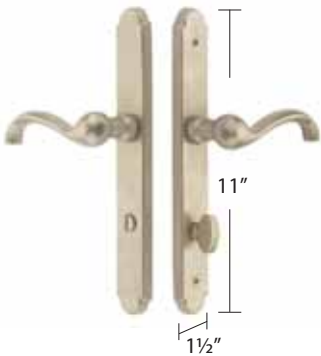

1 1/2" x 11" ARCHED NON-KEYED	Product Code	Knob or Lever Style	Finish	List Price
Passage	4143	See Page 5 for Sandcast Bronze Knob & Lever, Crystal & Porcelain Knob Options.	Flat Black Bronze (FB) Medium Bronze (MB) Tumbled White Bronze (TWB)	\$168.00
Thumbturn Privacy	4243			\$168.00
Dummy, Pair	4046			\$168.00
Dummy, Single Sided	4043			\$86.00

11" STRETTO
Keyed Entry Set



1 1/2" x 11" ARCHED KEYED	Product Code	Knob or Lever Style	Finish	List Price
Passage/Single Keyed	4444	See Page 5 for Sandcast Bronze Knob & Lever, Crystal & Porcelain Knob Options.	Flat Black Bronze (FB) Medium Bronze (MB) Tumbled White Bronze (TWB)	\$188.00
Dummy, Pair	4044			\$188.00

Handing Required for Leversets. Supplied with 28° rotation latch. Standard latch is for 2 3/8" backset. Specify 2 3/4" backset if required. **Weiser® (WR5) Keyway:** Specify by adding "W" to the beginning of Product Code. No upcharge for cylinder substitution. Can be keyed into existing Weiser® system.

SIDEPLATE LOCKSETS - SANDCAST BRONZE STRETTO NARROW TRIM

10" STRETTO
Thumbturn Privacy Set

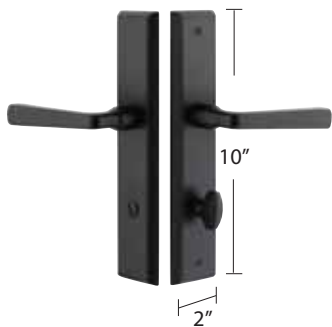

2" x 10" RECTANGULAR NON-KEYED	Product Code	Knob or Lever Style	Finish	List Price
Passage	5141	See Page 5 for Sandcast Bronze Knob & Lever, Crystal & Porcelain Knob Options.	Flat Black Bronze (FB) Medium Bronze (MB) Tumbled White Bronze (TWB)	\$168.00
Thumbturn Privacy	5241			\$168.00
Dummy, Pair	5045			\$168.00
Dummy, Single Sided	5041			\$86.00

10" STRETTO
Keyed Entry Set



2" x 10" RECTANGULAR KEYED	Product Code	Knob or Lever Style	Finish	List Price
Passage/Single Keyed	5442	See Page 5 for Sandcast Bronze Knob & Lever, Crystal & Porcelain Knob Options.	Flat Black Bronze (FB) Medium Bronze (MB) Tumbled White Bronze (TWB)	\$188.00
Dummy, Pair	5042			\$188.00

11" STRETTO
Non-Keyed Passage Set



1 1/2" x 11" RECTANGULAR NON-KEYED	Product Code	Knob or Lever Style	Finish	List Price
Passage	5143	See Page 5 for Sandcast Bronze Knob & Lever, Crystal & Porcelain Knob Options.	Flat Black Bronze (FB) Medium Bronze (MB) Tumbled White Bronze (TWB)	\$168.00
Thumbturn Privacy	5243			\$168.00
Dummy, Pair	5046			\$168.00
Dummy, Single Sided	5043			\$86.00

11" STRETTO
Keyed Entry Set



1 1/2" x 11" RECTANGULAR KEYED	Product Code	Knob or Lever Style	Finish	List Price
Passage/Single Keyed	5444	See Page 5 for Sandcast Bronze Knob & Lever, Crystal & Porcelain Knob Options.	Flat Black Bronze (FB) Medium Bronze (MB) Tumbled White Bronze (TWB)	\$188.00
Dummy, Pair	5044			\$188.00

Handing Required for Leversets. Supplied with 28° rotation latch. Standard latch is for 2 3/8" backset. Specify 2 3/4" backset if required. **Weiser® (WRS) Keyway:** Specify by adding "W" to the beginning of Product Code. No upcharge for cylinder substitution. Can be keyed into existing Weiser® system.

10" STRETTO
Non-Keyed Passage Set

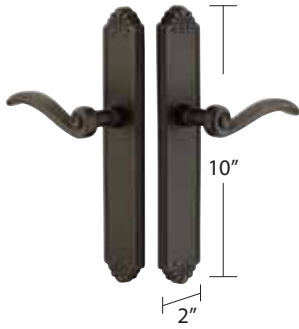

2" x 10" TUSCANY NON-KEYED	Product Code	Knob or Lever Style	Finish	List Price
Passage	6141	See Page 6 for Lost Wax Cast Bronze Knob & Lever Options. See Page 5 for Crystal & Porcelain Knob Options.	Flat Black Bronze (FB) Medium Bronze (MB)	\$168.00
Thumbturn Privacy	6241			\$168.00
Dummy, Pair	6045			\$168.00
Dummy, Single Sided	6041			\$86.00

10" STRETTO
Keyed Entry Set



2" x 10" TUSCANY KEYED	Product Code	Knob or Lever Style	Finish	List Price
Passage/Single Keyed	6442	See Page 6 for Lost Wax Cast Bronze Knob & Lever Options. See Page 5 for Crystal & Porcelain Knob Options.	Flat Black Bronze (FB) Medium Bronze (MB)	\$188.00
Dummy, Pair	6042			\$188.00

11" STRETTO
Thumbturn Privacy Set

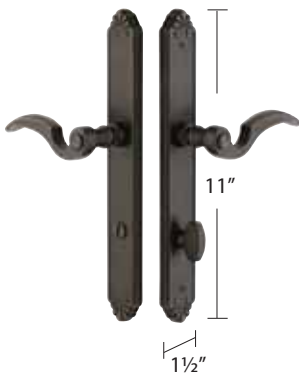

1 1/2" x 11" TUSCANY NON-KEYED	Product Code	Knob or Lever Style	Finish	List Price
Passage	6143	See Page 6 for Lost Wax Cast Bronze Knob & Lever Options. See Page 5 for Crystal & Porcelain Knob Options.	Flat Black Bronze (FB) Medium Bronze (MB)	\$168.00
Thumbturn Privacy	6243			\$168.00
Dummy, Pair	6046			\$168.00
Dummy, Single Sided	6043			\$86.00

11" STRETTO
Keyed Entry Set



1 1/2" x 11" TUSCANY KEYED	Product Code	Knob or Lever Style	Finish	List Price
Passage/Single Keyed	6444	See Page 6 for Lost Wax Cast Bronze Knob & Lever Options. See Page 5 for Crystal & Porcelain Knob Options.	Flat Black Bronze (FB) Medium Bronze (MB)	\$188.00
Dummy, Pair	6044			\$188.00

Handing Required for Leversets. Supplied with 28° rotation latch. Standard latch is for 2 3/4" backset. Specify 2 3/4" backset if required. **Weiser® (WR5) Keyway:** Specify by adding "W" to the beginning of Product Code. No upcharge for cylinder substitution. Can be keyed into existing Weiser® system.

SIDEPLATE LOCKSETS - STAINLESS STEEL STRETTO NARROW TRIM

10" STRETTO
Thumbturn Privacy Set



2" x 10" STAINLESS STEEL NON-KEYED	Product Code	Knob or Lever Style	Finish	List Price
Passage	9141	See Page 6 for Stainless Steel Knob & Lever Options.	Brushed Stainless Steel (SS)	\$154.00
Thumbturn Privacy	9241			\$154.00
Dummy, Pair	9045			\$154.00
Dummy, Single Sided	9041			\$82.00

10" STRETTO
Keyed Entry Set



2" x 10" STAINLESS STEEL KEYED	Product Code	Knob or Lever Style	Finish	List Price
Passage/Single Keyed	9442	See Page 6 for Stainless Steel Knob & Lever Options.	Brushed Stainless Steel (SS)	\$172.00
Dummy, Pair	9042			\$172.00

11" STRETTO
Non-Keyed Passage Set

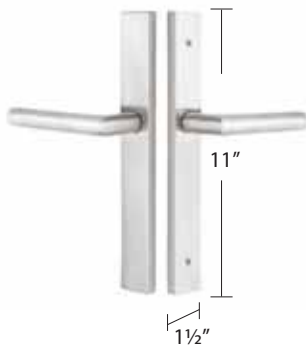

1 1/2" x 11" STAINLESS STEEL NON-KEYED	Product Code	Knob or Lever Style	Finish	List Price
Passage	9143	See Page 6 for Stainless Steel Knob & Lever Options.	Brushed Stainless Steel (SS)	\$154.00
Thumbturn Privacy	9243			\$154.00
Dummy, Pair	9046			\$154.00
Dummy, Single Sided	9043			\$82.00





11" STRETTO
Keyed Entry Set



1 1/2" x 11" STAINLESS STEEL KEYED	Product Code	Knob or Lever Style	Finish	List Price
Passage/Single Keyed	9444	See Page 6 for Stainless Steel Knob & Lever Options.	Brushed Stainless Steel (SS)	\$172.00
Dummy, Pair	9044			\$172.00

Handing Required for Leversets. Supplied with 28° rotation latch. Standard latch is for 2 3/8" backset. Specify 2 3/4" backset if required. **Weiser® (WR5) Keyway:** Specify by adding "W" to the beginning of Product Code. No upcharge for cylinder substitution. Can be keyed into existing Weiser® system.

Geneva Lever
with Modern Rectangular RosetteHelios Lever
with Disk RosetteHercules Lever
with Square RosetteLuzern Lever
with Square RosetteArgos Lever
with Modern Rectangular RosetteStuttgart Lever
with Square Rosette

ROSETTE	Description	CF	Product Code	Lever Style	Finish	Standard List Price	CF List Price
Modern 	Passage Set	C	5107	Argos Lever (AG) Geneva Lever (GV)	Satin Brass (US4) Oil Rubbed Bronze (US10B)	\$112.00	\$148.00
	Privacy Set	C	5207	Helios Lever (HLO) Hercules Lever (HEC)	Satin Nickel (US15) Flat Black (US19)	\$112.00	\$148.00
	Dummy, Pair		5057	Luzern Lever (LU) Stuttgart Lever (STU)	Polished Chrome (US26)	\$112.00	
Disk 	Passage Set	C	5109	Argos Lever (AG) Geneva Lever (GV)	Satin Brass (US4) Oil Rubbed Bronze (US10B)	\$112.00	\$148.00
	Privacy Set	C	5209	Helios Lever (HLO) Hercules Lever (HEC)	Polished Nickel - Lifetime (US14)* Satin Nickel (US15)	\$112.00	\$148.00
	Dummy, Pair		5059	Luzern Lever (LU) Stuttgart Lever (STU)	Flat Black (US19) Polished Chrome (US26)	\$112.00	
Square 	Passage Set	C	5110	Argos Lever (AG) Geneva Lever (GV)	Satin Brass (US4) Oil Rubbed Bronze (US10B)	\$112.00	\$148.00
	Privacy Set	C	5210	Helios Lever (HLO) Hercules Lever (HEC)	Polished Nickel - Lifetime (US14)* Satin Nickel (US15)	\$112.00	\$148.00
	Dummy, Pair		5050	Luzern Lever (LU) Stuttgart Lever (STU)	Flat Black (US19) Polished Chrome (US26)	\$112.00	
Neos 	Passage Set	C	5111	Argos Lever (AG) Geneva Lever (GV)	Satin Brass (US4) Oil Rubbed Bronze (US10B)	\$112.00	\$148.00
	Privacy Set	C	5211	Helios Lever (HLO) Hercules Lever (HEC)	Satin Nickel (US15) Flat Black (US19)	\$112.00	\$148.00
	Dummy, Pair		5051	Luzern Lever (LU) Stuttgart Lever (STU)	Polished Chrome (US26)	\$112.00	
Modern Rectangular 	Passage Set	C	5112	Argos Lever (AG) Geneva Lever (GV)	Satin Brass (US4) Oil Rubbed Bronze (US10B)	\$112.00	\$148.00
	Privacy Set	C	5212	Helios Lever (HLO) Hercules Lever (HEC)	Polished Nickel - Lifetime (US14)* Satin Nickel (US15)	\$112.00	\$148.00
	Dummy, Pair		5052	Luzern Lever (LU) Stuttgart Lever (STU)	Flat Black (US19) Polished Chrome (US26)	\$112.00	

Handing Required For Leversets. Standard latch is for 2³/₈" backset. Specify 2³/₄" backset if required. To order 28° Rotation Latch with any standard Leverset, add product code **Latch28** and list price \$4. Complete set includes Latch and Strike Plate. **CF Mechanism:** Handing not required, except for Knob by Lever and Split Finish products. Maximum door thickness for CF Mechanism is 2¹/₄". Supplied with a 28° Rotation Latch. Modern Leversets may also be ordered with any Brass rosette at the list price shown above. (See pages 100-101 for Brass rosette options)

LEVERSETS - BRASS MODERN

Basel Lever
with Disk Rosette



Triton Lever
with Modern Rectangular Rosette



Aireon Lever
with Modern Rosette



Poseidon Lever
with Modern Rectangular Rosette



Sion Lever
with Disk Rosette



Athena Lever
with Neos Rosette



Mercury Lever
with Square Rosette







Hermes Lever
with Modern Rosette



ROSETTE	Description	CF	Product Code	Lever Style	Finish	Standard List Price	CF List Price
Modern 	Passage Set	C	5107	Aireon Lever (A) Athena Lever (ATN) Basel Lever (BA) Hermes Lever (HER) Mercury Lever (MC) Poseidon Lever (POS) Sion Lever (SIO) Triton Lever (TRT)	Satin Brass (US4) Oil Rubbed Bronze (US10B) Satin Nickel (US15) Flat Black (US19) Polished Chrome (US26)	\$112.00	\$148.00
	Privacy Set	C	5207			\$112.00	\$148.00
	Dummy, Pair		5057			\$112.00	
Disk 	Passage Set	C	5109	Aireon Lever (A) Athena Lever (ATN) Basel Lever (BA) Hermes Lever (HER) Mercury Lever (MC) Poseidon Lever (POS) Sion Lever (SIO) Triton Lever (TRT)	Satin Brass (US4) Oil Rubbed Bronze (US10B) Satin Nickel (US15) Flat Black (US19) Polished Chrome (US26)	\$112.00	\$148.00
	Privacy Set	C	5209			\$112.00	\$148.00
	Dummy, Pair		5059			\$112.00	
Square 	Passage Set	C	5110	Aireon Lever (A) Athena Lever (ATN) Basel Lever (BA) Hermes Lever (HER) Mercury Lever (MC) Poseidon Lever (POS) Sion Lever (SIO) Triton Lever (TRT)	Satin Brass (US4) Oil Rubbed Bronze (US10B) Satin Nickel (US15) Flat Black (US19) Polished Chrome (US26)	\$112.00	\$148.00
	Privacy Set	C	5210			\$112.00	\$148.00
	Dummy, Pair		5050			\$112.00	
Neos 	Passage Set	C	5111	Aireon Lever (A) Athena Lever (ATN) Basel Lever (BA) Hermes Lever (HER) Mercury Lever (MC) Poseidon Lever (POS) Sion Lever (SIO) Triton Lever (TRT)	Satin Brass (US4) Oil Rubbed Bronze (US10B) Satin Nickel (US15) Flat Black (US19) Polished Chrome (US26)	\$112.00	\$148.00
	Privacy Set	C	5211			\$112.00	\$148.00
	Dummy, Pair		5051			\$112.00	
Modern Rectangular 	Passage Set	C	5112	Aireon Lever (A) Athena Lever (ATN) Basel Lever (BA) Hermes Lever (HER) Mercury Lever (MC) Poseidon Lever (POS) Sion Lever (SIO) Triton Lever (TRT)	Satin Brass (US4) Oil Rubbed Bronze (US10B) Satin Nickel (US15) Flat Black (US19) Polished Chrome (US26)	\$112.00	\$148.00
	Privacy Set	C	5212			\$112.00	\$148.00
	Dummy, Pair		5052			\$112.00	

Handing Required For Leversets. Standard latch is for 2³/₈" backset. Specify 2³/₄" backset if required. To order 28° Rotation Latch with any standard Leverset, add product code **Latch28** and list price **\$4**. Complete set includes Latch and Strike Plate. **CF Mechanism:** Handing not required, except for Knob by Lever and Split Finish products. Maximum door thickness for CF Mechanism is 2¹/₄". Supplied with a 28° Rotation Latch. Modern Leversets may also be ordered with any Brass rosette at the list price shown above. (See pages 100-101 for Brass rosette options)

Bern Knob
with Square RosetteSquare Knob
with Modern Rectangular RosetteOrb Knob
with Disk RosetteRound Knob
with Square RosetteOctagon Knob
with Modern Rosette

ROSETTE	Description	CF	Product Code	Knob Style	Finish	Standard List Price	CF List Price
	Passage Set	C	5107	Bern Knob (BN)** Octagon Knob (OCT)	Satin Brass (US4) Oil Rubbed Bronze (US10B)	\$112.00	\$148.00
	Privacy Set	C	5207	Orb Knob (OR) Round Knob (ROU)	Satin Nickel (US15) Flat Black (US19)	\$112.00	\$148.00
	Dummy, Pair		5057	Square Knob (SQU)	Polished Chrome (US26)	\$112.00	
	Passage Set	C	5109	Bern Knob (BN)** Octagon Knob (OCT)	Satin Brass (US4) Oil Rubbed Bronze (US10B)	\$112.00	\$148.00
	Privacy Set	C	5209	Orb Knob (OR) Round Knob (ROU)	Polished Nickel - Lifetime (US14)* Satin Nickel (US15)	\$112.00	\$148.00
	Dummy, Pair		5059	Square Knob (SQU)	Flat Black (US19) Polished Chrome (US26)	\$112.00	
	Passage Set	C	5110	Bern Knob (BN)** Octagon Knob (OCT)	Satin Brass (US4) Oil Rubbed Bronze (US10B)	\$112.00	\$148.00
	Privacy Set	C	5210	Orb Knob (OR) Round Knob (ROU)	Polished Nickel - Lifetime (US14)* Satin Nickel (US15)	\$112.00	\$148.00
	Dummy, Pair		5050	Square Knob (SQU)	Flat Black (US19) Polished Chrome (US26)	\$112.00	
	Passage Set	C	5111	Bern Knob (BN)** Octagon Knob (OCT)	Satin Brass (US4) Oil Rubbed Bronze (US10B)	\$112.00	\$148.00
	Privacy Set	C	5211	Orb Knob (OR) Round Knob (ROU)	Satin Nickel (US15) Flat Black (US19)	\$112.00	\$148.00
	Dummy, Pair		5051	Square Knob (SQU)	Polished Chrome (US26)	\$112.00	
	Passage Set	C	5112	Bern Knob (BN)** Octagon Knob (OCT)	Satin Brass (US4) Oil Rubbed Bronze (US10B)	\$112.00	\$148.00
	Privacy Set	C	5212	Orb Knob (OR) Round Knob (ROU)	Polished Nickel - Lifetime (US14)* Satin Nickel (US15)	\$112.00	\$148.00
	Dummy, Pair		5052	Square Knob (SQU)	Flat Black (US19) Polished Chrome (US26)	\$112.00	

* Polished Nickel - Lifetime (US14) available only for Round knob. ** Bern Knob **NOT** available in Satin Brass (US4) finish.

Handing Not Required For Knobsets. Standard latch is for 2³/₈" backset. Specify 2³/₄" backset if required. To order 28° Rotation Latch with any standard Knobset, add product code **Latch28** and list price \$4. Complete set includes Latch and Strike Plate. **CF Mechanism:** Handing not required, except for Knob by Lever and Split Finish products. Maximum door thickness for CF Mechanism is 2¹/₄". Supplied with a 28° Rotation Latch. Modern Knobsets may also be ordered with any Brass rosette at the list price shown above. (See pages 102-103 for Brass rosette options)

LEVERSETS - BRASS CLASSIC

**Cortina Lever
with #8 Rosette**



**Milano Lever
with Rectangular Rosette**







**Rustic Lever
with Oval Rosette**



**Turino Lever
with Quincy Rosette**



ROSETTE	Description	CF	Product Code	Lever Style	Finish	Standard List Price	CF List Price
	Passage Set	C	8108	Cortina Lever (C) Milano Lever (M) Rustic Lever (R) Turino Lever (T)	Polished Brass - Lifetime (US3) French Antique (US7) Oil Rubbed Bronze (US10B) Polished Nickel - Lifetime (US14)* Satin Nickel (US15) Pewter (US15A) Flat Black (US19) Polished Chrome (US26)	\$86.00	\$122.00
	Privacy Set	C	8208			\$86.00	\$122.00
	Dummy, Pair		8058			\$86.00	
	Passage Set	C	8120	Cortina Lever (C) Milano Lever (M) Rustic Lever (R) Turino Lever (T)	Polished Brass - Lifetime (US3) French Antique (US7) Oil Rubbed Bronze (US10B) Satin Nickel (US15) Pewter (US15A) Flat Black (US19) Polished Chrome (US26)	\$86.00	\$122.00
	Privacy Set	C	8220			\$86.00	\$122.00
	Dummy, Pair		8520			\$86.00	
	Passage Set	C	8100	Cortina Lever (C) Milano Lever (M) Rustic Lever (R) Turino Lever (T)	Polished Brass - Lifetime (US3) French Antique (US7) Oil Rubbed Bronze (US10B) Polished Nickel - Lifetime (US14)* Satin Nickel (US15) Pewter (US15A) Flat Black (US19) Polished Chrome (US26)	\$86.00	\$122.00
	Privacy Set	C	8200			\$86.00	\$122.00
	Dummy, Pair		8050			\$86.00	
	Passage Set	C	8121	Cortina Lever (C) Milano Lever (M) Rustic Lever (R) Turino Lever (T)	Polished Brass - Lifetime (US3) French Antique (US7) Oil Rubbed Bronze (US10B) Polished Nickel - Lifetime (US14)* Satin Nickel (US15) Pewter (US15A) Flat Black (US19) Polished Chrome (US26)	\$86.00	\$122.00
	Privacy Set	C	8221			\$86.00	\$122.00
	Dummy, Pair		8521			\$86.00	
	Passage Set	C	8131	Cortina Lever (C) Milano Lever (M) Rustic Lever (R) Turino Lever (T)	Polished Brass - Lifetime (US3) French Antique (US7) Oil Rubbed Bronze (US10B) Satin Nickel (US15) Pewter (US15A) Flat Black (US19) Polished Chrome (US26)	\$86.00	\$122.00
	Privacy Set	C	8231			\$86.00	\$122.00
	Dummy, Pair		8531			\$86.00	

* Polished Nickel - Lifetime (US14) available only for Cortina, Milano and Turino levers.

Handing Required For Leversets. Standard latch is for 2³/₈" backset. Specify 2³/₄" backset if required. To order 28° Rotation Latch with any standard Leverset, add product code **Latch28** and list price **\$4**. Complete set includes Latch and Strike Plate. **CF Mechanism:** Handing not required, except for Knob by Lever and Split Finish products. Maximum door thickness for CF Mechanism is 2¹/₄". Supplied with a 28° Rotation Latch. **Unlacquered Brass** finish available with additional **\$18 NET** upcharge. Classic Leversets may also be ordered with any Modern rosette at the list price shown above. (See page 97 for Modern rosette options)

Cortina Lever
with Regular RosetteTurino Lever
with Lancaster RosetteCortina Lever
with Ribbon & Reed RosetteTurino Lever
with Oval RosetteMilano Lever
with Wilshire RosetteRustic Lever
with Rope Rosette

ROSETTE	Description	CF	Product Code	Lever Style	Finish	Standard List Price	CF List Price
Wilshire 	Passage Set	C	8161	Cortina Lever (C) Milano Lever (M) Rustic Lever (R) Turino Lever (T)	Polished Brass - Lifetime (US3) French Antique (US7) Oil Rubbed Bronze (US10B) Polished Nickel - Lifetime (US14)* Satin Nickel (US15) Pewter (US15A) Flat Black (US19) Polished Chrome (US26)	\$86.00	\$122.00
	Privacy Set	C	8261			\$86.00	\$122.00
	Dummy, Pair		8561			\$86.00	
Rope 	Passage Set	C	8101	Cortina Lever (C) Milano Lever (M) Rustic Lever (R) Turino Lever (T)	Polished Brass - Lifetime (US3) French Antique (US7) Oil Rubbed Bronze (US10B) Satin Nickel (US15) Pewter (US15A) Polished Chrome (US26)	\$86.00	\$122.00
	Privacy Set	C	8201			\$86.00	\$122.00
	Dummy, Pair		8051			\$86.00	
Lancaster 	Passage Set	C	8106	Cortina Lever (C) Milano Lever (M) Rustic Lever (R) Turino Lever (T)	Polished Brass - Lifetime (US3) French Antique (US7) Oil Rubbed Bronze (US10B) Satin Nickel (US15) Pewter (US15A) Polished Chrome (US26)	\$86.00	\$122.00
	Privacy Set	C	8206			\$86.00	\$122.00
	Dummy, Pair		8056			\$86.00	
Ribbon & Reed 	Passage Set	C	8107	Cortina Lever (C) Milano Lever (M) Rustic Lever (R) Turino Lever (T)	Polished Brass - Lifetime (US3) French Antique (US7) Oil Rubbed Bronze (US10B) Satin Nickel (US15) Pewter (US15A) Polished Chrome (US26)	\$86.00	\$122.00
	Privacy Set	C	8207			\$86.00	\$122.00
	Dummy, Pair		8057			\$86.00	

* Polished Nickel - Lifetime (US14) available only for Cortina, Milano and Turino levers.

Handing Required For Leversets. Standard latch is for 2³/₈" backset. Specify 2³/₄" backset if required. To order 28° Rotation Latch with any standard Leverset, add product code **Latch28** and list price \$4. Complete set includes Latch and Strike Plate. **CF Mechanism:** Handing not required, except for Knob by Lever and Split Finish products. Maximum door thickness for CF Mechanism is 2¹/₄". Supplied with a 28° Rotation Latch. **Unlacquered Brass** finish available with additional \$18 NET upcharge. Classic Leversets may also be ordered with any Modern rosette at the list price shown above. (See page 97 for Modern rosette options)

KNOBSETS - BRASS CLASSIC

**Egg Knob
with Regular Rosette**



**Providence Knob
with Quincy Rosette**







**Norwich Knob
with #8 Rosette**



**Egg Knob
with Rectangular Rosette**



ROSETTE	Description	CF	Product Code	Knob Style	Finish	Standard List Price	CF List Price
#8 	Passage Set	C	8108	Egg Knob (E) Melon Knob (MN) Norwich Knob (NW) Providence Knob (P) Waverly Knob (W)	Polished Brass - Lifetime (US3) French Antique (US7) Oil Rubbed Bronze (US10B) Polished Nickel - Lifetime (US14)* Satin Nickel (US15) Pewter (US15A) Flat Black (US19) Polished Chrome (US26)	\$96.00	\$132.00
	Privacy Set	C	8208			\$96.00	\$132.00
	Dummy, Pair		8058			\$96.00	
Oval 	Passage Set	C	8120	Egg Knob (E) Melon Knob (MN) Norwich Knob (NW) Providence Knob (P) Waverly Knob (W)	Polished Brass - Lifetime (US3) French Antique (US7) Oil Rubbed Bronze (US10B) Satin Nickel (US15) Pewter (US15A) Flat Black (US19) Polished Chrome (US26)	\$96.00	\$132.00
	Privacy Set	C	8220			\$96.00	\$132.00
	Dummy, Pair		8520			\$96.00	
Regular 	Passage Set	C	8100	Egg Knob (E) Melon Knob (MN) Norwich Knob (NW) Providence Knob (P) Waverly Knob (W)	Polished Brass - Lifetime (US3) French Antique (US7) Oil Rubbed Bronze (US10B) Polished Nickel - Lifetime (US14)* Satin Nickel (US15) Pewter (US15A) Flat Black (US19) Polished Chrome (US26)	\$96.00	\$132.00
	Privacy Set	C	8200			\$96.00	\$132.00
	Dummy, Pair		8050			\$96.00	
Rectangular 	Passage Set	C	8121	Egg Knob (E) Melon Knob (MN) Norwich Knob (NW) Providence Knob (P) Waverly Knob (W)	Polished Brass - Lifetime (US3) French Antique (US7) Oil Rubbed Bronze (US10B) Polished Nickel - Lifetime (US14)* Satin Nickel (US15) Pewter (US15A) Flat Black (US19) Polished Chrome (US26)	\$96.00	\$132.00
	Privacy Set	C	8221			\$96.00	\$132.00
	Dummy, Pair		8521			\$96.00	
Quincy 	Passage Set	C	8131	Egg Knob (E) Melon Knob (MN) Norwich Knob (NW) Providence Knob (P) Waverly Knob (W)	Polished Brass - Lifetime (US3) French Antique (US7) Oil Rubbed Bronze (US10B) Satin Nickel (US15) Pewter (US15A) Flat Black (US19) Polished Chrome (US26)	\$96.00	\$132.00
	Privacy Set	C	8231			\$96.00	\$132.00
	Dummy, Pair		8531			\$96.00	

* Polished Nickel - Lifetime (US14) NOT available for Melon knob.

Handing Not Required For Knobsets. Standard latch is for 2³/₈" backset. Specify 2³/₄" backset if required. To order 28° Rotation Latch with any standard Knobset, add product code **Latch28** and list price \$4. Complete set includes Latch and Strike Plate. **CF Mechanism:** Handing not required, except for Knob by Lever and Split Finish products. Maximum door thickness for CF Mechanism is 2¹/₄". Supplied with a 28° Rotation Latch. **Unlacquered Brass** finish available with additional \$18 NET upcharge. Classic Knobsets may also be ordered with any Modern rosette at the list price shown above. (See page 99 for Modern rosette options)

Waverly Knob
with Quincy RosetteNorwich Knob
with Wilshire RosetteProvidence Knob
with Regular RosetteEgg Knob
with Oval RosetteWaverly Knob
with Lancaster RosetteMelon Knob
with Rope Rosette

ROSETTE	Description	CF	Product Code	Knob Style	Finish	Standard List Price	CF List Price
Wilshire 	Passage Set	C	8161	Egg Knob (E)	Polished Brass - Lifetime (US3)	\$96.00	\$132.00
	Privacy Set	C	8261	Melon Knob (MN)	French Antique (US7)	\$96.00	\$132.00
	Dummy, Pair		8561	Norwich Knob (NW) Providence Knob (P) Waverly Knob (W)	Oil Rubbed Bronze (US10B) Polished Nickel - Lifetime (US14)* Satin Nickel (US15) Pewter (US15A) Flat Black (US19) Polished Chrome (US26)	\$96.00	
Rope 	Passage Set	C	8101	Egg Knob (E)	Polished Brass - Lifetime (US3)	\$96.00	\$132.00
	Privacy Set	C	8201	Melon Knob (MN)	French Antique (US7)	\$96.00	\$132.00
	Dummy, Pair		8051	Norwich Knob (NW) Providence Knob (P) Waverly Knob (W)	Oil Rubbed Bronze (US10B) Satin Nickel (US15) Pewter (US15A) Polished Chrome (US26)	\$96.00	
Lancaster 	Passage Set	C	8106	Egg Knob (E)	Polished Brass - Lifetime (US3)	\$96.00	\$132.00
	Privacy Set	C	8206	Melon Knob (MN)	French Antique (US7)	\$96.00	\$132.00
	Dummy, Pair		8056	Norwich Knob (NW) Providence Knob (P) Waverly Knob (W)	Oil Rubbed Bronze (US10B) Satin Nickel (US15) Pewter (US15A) Polished Chrome (US26)	\$96.00	
Ribbon & Reed 	Passage Set	C	8107	Egg Knob (E)	Polished Brass - Lifetime (US3)	\$96.00	\$132.00
	Privacy Set	C	8207	Melon Knob (MN)	French Antique (US7)	\$96.00	\$132.00
	Dummy, Pair		8057	Norwich Knob (NW) Providence Knob (P) Waverly Knob (W)	Oil Rubbed Bronze (US10B) Satin Nickel (US15) Pewter (US15A) Polished Chrome (US26)	\$96.00	

* Polished Nickel - Lifetime (US14) NOT available for Melon knob.

Handing Not Required For Knobsets. Standard latch is for 2³/₈" backset. Specify 2³/₄" backset if required. To order 28° Rotation Latch with any standard Knobset, add product code **Latch28** and list price \$4. Complete set includes Latch and Strike Plate. **CF Mechanism:** Handing not required, except for Knob by Lever and Split Finish products. Maximum door thickness for CF Mechanism is 2¹/₄". Supplied with a 28° Rotation Latch. **Unlacquered Brass** finish available with additional \$18 NET upcharge. Classic Knobsets may also be ordered with any Modern rosette at the list price shown above. (See page 99 for Modern rosette options)

LEVERSETS - BRASS DESIGNER

Elan Lever
with #8 Rosette



Wembley Lever
with Lancaster Rosette







Merrimack Lever
with Rectangular Rosette



Coventry Lever
with Regular Rosette



ROSETTE	Description	CF	Product Code	Lever Style	Finish	Standard List Price	CF List Price
	Passage Set	C	8108	Coventry Lever (CV) Elan Lever (EN)	Polished Brass - Lifetime (US3) French Antique (US7)	\$118.00	\$154.00
	Privacy Set	C	8208	Merrimack Lever (ME) Ribbon & Reed Lever (RBL)	Oil Rubbed Bronze (US10B) Polished Nickel - Lifetime (US14)*	\$118.00	\$154.00
	Dummy, Pair		8058	Rope Lever (RL) Santa Fe Lever (SF) Wembley Lever (WM)	Satin Nickel (US15) Pewter (US15A) Polished Chrome (US26)	\$118.00	
	Passage Set	C	8120	Coventry Lever (CV) Elan Lever (EN)	Polished Brass - Lifetime (US3) French Antique (US7)	\$118.00	\$154.00
	Privacy Set	C	8220	Merrimack Lever (ME) Ribbon & Reed Lever (RBL)	Oil Rubbed Bronze (US10B) Satin Nickel (US15)	\$118.00	\$154.00
	Dummy, Pair		8520	Rope Lever (RL) Santa Fe Lever (SF) Wembley Lever (WM)	Pewter (US15A) Polished Chrome (US26)	\$118.00	
	Passage Set	C	8100	Coventry Lever (CV) Elan Lever (EN)	Polished Brass - Lifetime (US3) French Antique (US7)	\$118.00	\$154.00
	Privacy Set	C	8200	Merrimack Lever (ME) Ribbon & Reed Lever (RBL)	Oil Rubbed Bronze (US10B) Polished Nickel - Lifetime (US14)*	\$118.00	\$154.00
	Dummy, Pair		8050	Rope Lever (RL) Santa Fe Lever (SF) Wembley Lever (WM)	Satin Nickel (US15) Pewter (US15A) Polished Chrome (US26)	\$118.00	
	Passage Set	C	8121	Coventry Lever (CV) Elan Lever (EN)	Polished Brass - Lifetime (US3) French Antique (US7)	\$118.00	\$154.00
	Privacy Set	C	8221	Merrimack Lever (ME) Ribbon & Reed Lever (RBL)	Oil Rubbed Bronze (US10B) Polished Nickel - Lifetime (US14)*	\$118.00	\$154.00
	Dummy, Pair		8521	Rope Lever (RL) Santa Fe Lever (SF) Wembley Lever (WM)	Satin Nickel (US15) Pewter (US15A) Polished Chrome (US26)	\$118.00	
	Passage Set	C	8131	Coventry Lever (CV) Elan Lever (EN)	Polished Brass - Lifetime (US3) French Antique (US7)	\$118.00	\$154.00
	Privacy Set	C	8231	Merrimack Lever (ME) Ribbon & Reed Lever (RBL)	Oil Rubbed Bronze (US10B) Satin Nickel (US15)	\$118.00	\$154.00
	Dummy, Pair		8531	Rope Lever (RL) Santa Fe Lever (SF) Wembley Lever (WM)	Pewter (US15A) Polished Chrome (US26)	\$118.00	

* Polished Nickel - Lifetime (US14) available only for Merrimack lever.

Handing Required For Leversets. Standard latch is for 2³/₈" backset. Specify 2³/₄" backset if required. To order 28° Rotation Latch with any standard Leverset, add product code **Latch28** and list price **\$4**. Complete set includes Latch and Strike Plate. **CF Mechanism:** Handing not required, except for Knob by Lever and Split Finish products. Maximum door thickness for CF Mechanism is 2¹/₄". Supplied with a 28° Rotation Latch. **Unlacquered Brass** finish available with additional **\$18 NET** upcharge. Designer Leversets may also be ordered with any Modern rosette at the list price shown above. (See page 97 for Modern rosette options)

Rope Lever
with Rope RosetteMerrimack Lever
with Quincy RosetteRibbon & Reed Lever
with Ribbon & Reed RosetteElan Lever
with Oval RosetteSanta Fe Lever
with Wilshire RosetteElan Lever
with Regular Rosette

ROSETTE	Description	CF	Product Code	Lever Style	Finish	Standard List Price	CF List Price
	Passage Set	C	8161	Coventry Lever (CV) Elan Lever (EN)	Polished Brass - Lifetime (US3) French Antique (US7)	\$118.00	\$154.00
	Privacy Set	C	8261	Merrimack Lever (ME) Ribbon & Reed Lever (RBL)	Oil Rubbed Bronze (US10B) Polished Nickel - Lifetime (US14)*	\$118.00	\$154.00
	Dummy, Pair		8561	Rope Lever (RL) Santa Fe Lever (SF) Wembley Lever (WM)	Satin Nickel (US15) Pewter (US15A) Polished Chrome (US26)	\$118.00	
	Passage Set	C	8101	Coventry Lever (CV) Elan Lever (EN)	Polished Brass - Lifetime (US3) French Antique (US7)	\$118.00	\$154.00
	Privacy Set	C	8201	Merrimack Lever (ME) Ribbon & Reed Lever (RBL)	Oil Rubbed Bronze (US10B) Satin Nickel (US15)	\$118.00	\$154.00
	Dummy, Pair		8051	Rope Lever (RL) Santa Fe Lever (SF) Wembley Lever (WM)	Pewter (US15A) Polished Chrome (US26)	\$118.00	
	Passage Set	C	8106	Coventry Lever (CV) Elan Lever (EN)	Polished Brass - Lifetime (US3) French Antique (US7)	\$118.00	\$154.00
	Privacy Set	C	8206	Merrimack Lever (ME) Ribbon & Reed Lever (RBL)	Oil Rubbed Bronze (US10B) Satin Nickel (US15)	\$118.00	\$154.00
	Dummy, Pair		8056	Rope Lever (RL) Santa Fe Lever (SF) Wembley Lever (WM)	Pewter (US15A) Polished Chrome (US26)	\$118.00	
	Passage Set	C	8107	Coventry Lever (CV) Elan Lever (EN)	Polished Brass - Lifetime (US3) French Antique (US7)	\$118.00	\$154.00
	Privacy Set	C	8207	Merrimack Lever (ME) Ribbon & Reed Lever (RBL)	Oil Rubbed Bronze (US10B) Satin Nickel (US15)	\$118.00	\$154.00
	Dummy, Pair		8057	Rope Lever (RL) Santa Fe Lever (SF) Wembley Lever (WM)	Pewter (US15A) Polished Chrome (US26)	\$118.00	

* Polished Nickel - Lifetime (US14) available only for Merrimack lever.

Handing Required For Leversets. Standard latch is for 2³/₈" backset. Specify 2³/₄" backset if required. To order 28° Rotation Latch with any standard Leverset, add product code **Latch28** and list price **\$4**. Complete set includes Latch and Strike Plate. **CF Mechanism:** Handing not required, except for Knob by Lever and Split Finish products. Maximum door thickness for CF Mechanism is 2¹/₄". Supplied with a 28° Rotation Latch. **Unlacquered Brass** finish available with additional **\$18 NET** upcharge. Designer Leversets may also be ordered with any Modern rosette at the list price shown above. (See page 97 for Modern rosette options)

**Beaded Egg Knob
with Regular Rosette**



**Lancaster Knob
with Lancaster Rosette**







**Ribbon & Reed Knob
with Rectangular Rosette**



**Victoria Knob
with Oval Rosette**



ROSETTE	Description	CF	Product Code	Knob Style	Finish	Standard List Price	CF List Price
	Passage Set	C	8108	Beaded Egg Knob (BE) Belmont Knob (BT)	Polished Brass - Lifetime (US3) French Antique (US7)	\$118.00	\$154.00
	Privacy Set	C	8208	Lancaster Knob (LN) Ribbon & Reed Knob (RBK)	Oil Rubbed Bronze (US10B) Satin Nickel (US15)	\$118.00	\$154.00
	Dummy, Pair		8058	Rope Knob (RK) Victoria Knob (V)	Pewter (US15A) Polished Chrome (US26)	\$118.00	
	Passage Set	C	8120	Beaded Egg Knob (BE) Belmont Knob (BT)	Polished Brass - Lifetime (US3) French Antique (US7)	\$118.00	\$154.00
	Privacy Set	C	8220	Lancaster Knob (LN) Ribbon & Reed Knob (RBK)	Oil Rubbed Bronze (US10B) Satin Nickel (US15)	\$118.00	\$154.00
	Dummy, Pair		8520	Rope Knob (RK) Victoria Knob (V)	Pewter (US15A) Polished Chrome (US26)	\$118.00	
	Passage Set	C	8100	Beaded Egg Knob (BE) Belmont Knob (BT)	Polished Brass - Lifetime (US3) French Antique (US7)	\$118.00	\$154.00
	Privacy Set	C	8200	Lancaster Knob (LN) Ribbon & Reed Knob (RBK)	Oil Rubbed Bronze (US10B) Satin Nickel (US15)	\$118.00	\$154.00
	Dummy, Pair		8050	Rope Knob (RK) Victoria Knob (V)	Pewter (US15A) Polished Chrome (US26)	\$118.00	
	Passage Set	C	8121	Beaded Egg Knob (BE) Belmont Knob (BT)	Polished Brass - Lifetime (US3) French Antique (US7)	\$118.00	\$154.00
	Privacy Set	C	8221	Lancaster Knob (LN) Ribbon & Reed Knob (RBK)	Oil Rubbed Bronze (US10B) Satin Nickel (US15)	\$118.00	\$154.00
	Dummy, Pair		8521	Rope Knob (RK) Victoria Knob (V)	Pewter (US15A) Polished Chrome (US26)	\$118.00	
	Passage Set	C	8131	Beaded Egg Knob (BE) Belmont Knob (BT)	Polished Brass - Lifetime (US3) French Antique (US7)	\$118.00	\$154.00
	Privacy Set	C	8231	Lancaster Knob (LN) Ribbon & Reed Knob (RBK)	Oil Rubbed Bronze (US10B) Satin Nickel (US15)	\$118.00	\$154.00
	Dummy, Pair		8531	Rope Knob (RK) Victoria Knob (V)	Pewter (US15A) Polished Chrome (US26)	\$118.00	

Handing Not Required For Knobsets. Standard latch is for 2³/₈" backset. Specify 2³/₄" backset if required. To order 28° Rotation Latch with any standard Knobset, add product code **Latch28** and list price **\$4**. Complete set includes Latch and Strike Plate. **CF Mechanism:** Handing not required, except for Knob by Lever and Split Finish products. Maximum door thickness for CF Mechanism is 2¹/₄". Supplied with a 28° Rotation Latch. **Unlacquered Brass** finish available with additional **\$18 NET** upcharge. Designer Knobsets may also be ordered with any Modern rosette at the list price shown above. (See page 99 for Modern rosette options)

Rope Knob
with Rope RosetteBelmont Knob
with Quincy RosetteLancaster Knob
with #8 RosetteBelmont Knob
with Wilshire RosetteBeaded Egg Knob
with Oval RosetteRibbon & Reed Knob
with Ribbon & Reed Rosette

ROSETTE	Description	CF	Product Code	Knob Style	Finish	Standard List Price	CF List Price
Wilshire 	Passage Set	C	8161	Beaded Egg Knob (BE) Belmont Knob (BT) Lancaster Knob (LN) Ribbon & Reed Knob (RBK) Rope Knob (RK) Victoria Knob (V)	Polished Brass - Lifetime (US3) French Antique (US7) Oil Rubbed Bronze (US10B) Satin Nickel (US15) Pewter (US15A) Polished Chrome (US26)	\$118.00	\$154.00
	Privacy Set	C	8261			\$118.00	\$154.00
	Dummy, Pair		8561			\$118.00	
Rope 	Passage Set	C	8101	Beaded Egg Knob (BE) Belmont Knob (BT) Lancaster Knob (LN) Ribbon & Reed Knob (RBK) Rope Knob (RK) Victoria Knob (V)	Polished Brass - Lifetime (US3) French Antique (US7) Oil Rubbed Bronze (US10B) Satin Nickel (US15) Pewter (US15A) Polished Chrome (US26)	\$118.00	\$154.00
	Privacy Set	C	8201			\$118.00	\$154.00
	Dummy, Pair		8051			\$118.00	
Lancaster 	Passage Set	C	8106	Beaded Egg Knob (BE) Belmont Knob (BT) Lancaster Knob (LN) Ribbon & Reed Knob (RBK) Rope Knob (RK) Victoria Knob (V)	Polished Brass - Lifetime (US3) French Antique (US7) Oil Rubbed Bronze (US10B) Satin Nickel (US15) Pewter (US15A) Polished Chrome (US26)	\$118.00	\$154.00
	Privacy Set	C	8206			\$118.00	\$154.00
	Dummy, Pair		8056			\$118.00	
Ribbon & Reed 	Passage Set	C	8107	Beaded Egg Knob (BE) Belmont Knob (BT) Lancaster Knob (LN) Ribbon & Reed Knob (RBK) Rope Knob (RK) Victoria Knob (V)	Polished Brass - Lifetime (US3) French Antique (US7) Oil Rubbed Bronze (US10B) Satin Nickel (US15) Pewter (US15A) Polished Chrome (US26)	\$118.00	\$154.00
	Privacy Set	C	8207			\$118.00	\$154.00
	Dummy, Pair		8057			\$118.00	

Handing Not Required For Knobsets. Standard latch is for 2³/₈" backset. Specify 2³/₄" backset if required. To order 28° Rotation Latch with any standard Knobset, add product code **Latch28** and list price \$4. Complete set includes Latch and Strike Plate. **CF Mechanism:** Handing not required, except for Knob by Lever and Split Finish products. Maximum door thickness for CF Mechanism is 2¹/₄". Supplied with a 28° Rotation Latch. **Unlacquered Brass** finish available with additional \$18 NET upcharge. Designer Knobsets may also be ordered with any Modern rosette at the list price shown above. (See page 99 for Modern rosette options)

LEVERSETS - SANDCAST BRONZE

Yuma Lever
with #6 Rosette



Durango Lever
with #1 Rosette



Montrose Lever
with #3 Rosette



Cody Lever
with #2 Rosette



Lariat Lever
with #4 Rosette



Teton Lever
with #4 Rosette







Cimarron Lever
with #2 Rosette



Aurora Lever
with #6 Rosette



ROSETTE	Description	CF	Product Code	Lever Style	Finish	Standard List Price	CF List Price
	Passage Set	C	7108	Aurora Lever (AR) Cimarron Lever (CR)	Flat Black Bronze (FB) Medium Bronze (MB) Tumbled White Bronze (TWB)	\$130.00	\$166.00
	Privacy Set	C	7208	Cody Lever (CD) Durango Lever (D)		\$130.00	\$166.00
	Dummy, Pair		7058	Lariat Lever (LR) Montrose Lever (MT) Teton Lever (TT) Yuma Lever (YM)		\$130.00	
	Passage Set	C	7106	Aurora Lever (AR) Cimarron Lever (CR)	Flat Black Bronze (FB) Medium Bronze (MB) Tumbled White Bronze (TWB)	\$130.00	\$166.00
	Privacy Set	C	7206	Cody Lever (CD) Durango Lever (D)		\$130.00	\$166.00
	Dummy, Pair		7056	Lariat Lever (LR) Montrose Lever (MT) Teton Lever (TT) Yuma Lever (YM)		\$130.00	
	Passage Set	C	7104	Aurora Lever (AR) Cimarron Lever (CR)	Flat Black Bronze (FB) Medium Bronze (MB) Tumbled White Bronze (TWB)	\$130.00	\$166.00
	Privacy Set	C	7204	Cody Lever (CD) Durango Lever (D)		\$130.00	\$166.00
	Dummy, Pair		7054	Lariat Lever (LR) Montrose Lever (MT) Teton Lever (TT) Yuma Lever (YM)		\$130.00	
	Passage Set	C	7100	Aurora Lever (AR) Cimarron Lever (CR)	Flat Black Bronze (FB) Medium Bronze (MB) Tumbled White Bronze (TWB)	\$130.00	\$166.00
	Privacy Set	C	7200	Cody Lever (CD) Durango Lever (D)		\$130.00	\$166.00
	Dummy, Pair		7050	Lariat Lever (LR) Montrose Lever (MT) Teton Lever (TT) Yuma Lever (YM)		\$130.00	
	Passage Set	C	7111	Aurora Lever (AR) Cimarron Lever (CR)	Flat Black Bronze (FB) Medium Bronze (MB) Tumbled White Bronze (TWB)	\$130.00	\$166.00
	Privacy Set	C	7211	Cody Lever (CD) Durango Lever (D)		\$130.00	\$166.00
	Dummy, Pair		7061	Lariat Lever (LR) Montrose Lever (MT) Teton Lever (TT) Yuma Lever (YM)		\$130.00	

Handing Required For Leversets. Standard latch is for 2³/₈" backset. Specify 2³/₄" backset if required. To order 28° Rotation Latch with any standard Leverset, add product code **Latch28** and list price **\$4**. Complete set includes Latch and Strike Plate. **CF Mechanism:** Handing not required, except for Knob by Lever and Split Finish products. Maximum door thickness for CF Mechanism is 2¹/₄". Supplied with a 28° Rotation Latch.

Butte Knob with #4 Rosette



Round Knob with #6 Rosette



Winchester Knob with #3 Rosette



Egg Knob with #2 Rosette



Butte Knob with #1 Rosette



Winchester Knob with #2 Rosette







Egg Knob with #4 Rosette



Round Knob with #6 Rosette



ROSETTE	Description	CF	Product Code	Knob Style	Finish	Standard List Price	CF List Price
	Passage Set	C	7108	Butte Knob (BU) Egg Knob (BZEG) Round Knob (BZRN) Winchester Knob (WC)	Flat Black Bronze (FB) Medium Bronze (MB) Tumbled White Bronze (TWB)	\$130.00	\$166.00
	Privacy Set	C	7208			\$130.00	\$166.00
	Dummy, Pair		7058			\$130.00	
	Passage Set	C	7106	Butte Knob (BU) Egg Knob (BZEG) Round Knob (BZRN) Winchester Knob (WC)	Flat Black Bronze (FB) Medium Bronze (MB) Tumbled White Bronze (TWB)	\$130.00	\$166.00
	Privacy Set	C	7206			\$130.00	\$166.00
	Dummy, Pair		7056			\$130.00	
	Passage Set	C	7104	Butte Knob (BU) Egg Knob (BZEG) Round Knob (BZRN) Winchester Knob (WC)	Flat Black Bronze (FB) Medium Bronze (MB) Tumbled White Bronze (TWB)	\$130.00	\$166.00
	Privacy Set	C	7204			\$130.00	\$166.00
	Dummy, Pair		7054			\$130.00	
	Passage Set	C	7100	Butte Knob (BU) Egg Knob (BZEG) Round Knob (BZRN) Winchester Knob (WC)	Flat Black Bronze (FB) Medium Bronze (MB) Tumbled White Bronze (TWB)	\$130.00	\$166.00
	Privacy Set	C	7200			\$130.00	\$166.00
	Dummy, Pair		7050			\$130.00	
	Passage Set	C	7111	Butte Knob (BU) Egg Knob (BZEG) Round Knob (BZRN) Winchester Knob (WC)	Flat Black Bronze (FB) Medium Bronze (MB) Tumbled White Bronze (TWB)	\$130.00	\$166.00
	Privacy Set	C	7211			\$130.00	\$166.00
	Dummy, Pair		7061			\$130.00	

Handing Not Required For Knobsets. Standard latch is for 2³/₈" backset. Specify 2³/₄" backset if required. To order 28° Rotation Latch with any standard Knobset, add product code **Latch28** and list price \$4. Complete set includes Latch and Strike Plate. **CF Mechanism:** Handing not required, except for Knob by Lever and Split Finish products. Maximum door thickness for CF Mechanism is 2¹/₄". Supplied with a 28° Rotation Latch.

To order: (C) Product Code + Knob Style + Finish + Add Door Thickness to Comments

LEVERSETS - LOST WAX CAST BRONZE

Medici Lever
with #14 Rosette



Napoli Lever
with #12 Rosette



Octagon Lever
with #11 Rosette



Padua Lever
with #11 Rosette



Octagon Lever
with #15 Rosette



Medici Lever
with #12 Rosette



ROSETTE	Description	CF	Product Code	Lever Style	Finish	Standard List Price	CF List Price
	Passage Set	C	71011	Medici Lever (MDI) Napoli Lever (NA)	Flat Black Bronze (FB) Medium Bronze (MB)	\$130.00	\$166.00
	Privacy Set	C	72011	Octagon Lever (OCL) Padua Lever (PD)		\$130.00	\$166.00
	Dummy, Pair		70511			\$130.00	
	Passage Set	C	71012	Medici Lever (MDI) Napoli Lever (NA)	Flat Black Bronze (FB) Medium Bronze (MB)	\$130.00	\$166.00
	Privacy Set	C	72012	Octagon Lever (OCL) Padua Lever (PD)		\$130.00	\$166.00
	Dummy, Pair		70512			\$130.00	
	Passage Set	C	71014	Medici Lever (MDI) Napoli Lever (NA)	Flat Black Bronze (FB) Medium Bronze (MB)	\$130.00	\$166.00
	Privacy Set	C	72014	Octagon Lever (OCL) Padua Lever (PD)		\$130.00	\$166.00
	Dummy, Pair		70514			\$130.00	
	Passage Set	C	71015	Medici Lever (MDI) Napoli Lever (NA)	Flat Black Bronze (FB) Medium Bronze (MB)	\$130.00	\$166.00
	Privacy Set	C	72015	Octagon Lever (OCL) Padua Lever (PD)		\$130.00	\$166.00
	Dummy, Pair		70515			\$130.00	

Handing Required For Leversets. Standard latch is for 2³/₈" backset. Specify 2³/₄" backset if required. To order 28° Rotation Latch with any standard Leverset, add product code **Latch28** and list price \$4. Complete set includes Latch and Strike Plate. **CF Mechanism:** Handing not required, except for Knob by Lever and Split Finish products. Maximum door thickness for CF Mechanism is 2¹/₄". Supplied with a 28° Rotation Latch.

Petal Knob
with #12 Rosette



Octagon Knob
with #11 Rosette



Parma Knob
with #14 Rosette



Octagon Knob
with #15 Rosette



Parma Knob
with #12 Rosette



Petal Knob
with #11 Rosette



ROSETTE	Description	CF	Product Code	Knob Style	Finish	Standard List Price	CF List Price
	Passage Set	C	71011	Octagon Knob (OCK) Parma Knob (PA) Petal Knob (PT)	Flat Black Bronze (FB) Medium Bronze (MB)	\$130.00	\$166.00
	Privacy Set	C	72011			\$130.00	\$166.00
	Dummy, Pair		70511			\$130.00	
	Passage Set	C	71012	Octagon Knob (OCK) Parma Knob (PA) Petal Knob (PT)	Flat Black Bronze (FB) Medium Bronze (MB)	\$130.00	\$166.00
	Privacy Set	C	72012			\$130.00	\$166.00
	Dummy, Pair		70512			\$130.00	
	Passage Set	C	71014	Octagon Knob (OCK) Parma Knob (PA) Petal Knob (PT)	Flat Black Bronze (FB) Medium Bronze (MB)	\$130.00	\$166.00
	Privacy Set	C	72014			\$130.00	\$166.00
	Dummy, Pair		70514			\$130.00	
	Passage Set	C	71015	Octagon Knob (OCK) Parma Knob (PA) Petal Knob (PT)	Flat Black Bronze (FB) Medium Bronze (MB)	\$130.00	\$166.00
	Privacy Set	C	72015			\$130.00	\$166.00
	Dummy, Pair		70515			\$130.00	

Handing Not Required For Knobsets. Standard latch is for 2³/₈" backset. Specify 2³/₄" backset if required. To order 28° Rotation Latch with any standard Knobset, add product code **Latch28** and list price \$4. Complete set includes Latch and Strike Plate. **CF Mechanism:** Handing not required, except for Knob by Lever and Split Finish products. Maximum door thickness for CF Mechanism is 2¹/₄". Supplied with a 28° Rotation Latch.

LEVERSETS & KNOBSETS - STAINLESS STEEL

Cologne Lever
with Disk Rosette



Dresden Lever
with Square Rosette



Kiel Lever
with Beveled Rosette



Stuttgart Lever
with Disk Rosette



TUBULAR STAINLESS STEEL LEVERSETS	CF	Product Code	Rosette Style	Lever Style	Finish	Standard List Price	CF List Price
Passage Set	C	S100	Beveled (01) Disk (02) Square (03)	Cologne Lever (CO)	Brushed Stainless Steel (SS)	\$84.00	\$116.00
Privacy Set	C	S200		Dresden Lever (DD)		\$84.00	\$116.00
Dummy, Pair		S300		Kiel Lever (KL) Stuttgart Lever (STT)		\$84.00	

Athena Lever
with Square Rosette



Hercules Lever
with Disk Rosette



Hermes Lever
with Beveled Rosette



Poseidon Lever
with Disk Rosette



Helios Lever
with Square Rosette



CAST STAINLESS STEEL LEVERSETS	CF	Product Code	Rosette Style	Lever Style	Finish	Standard List Price	CF List Price
Passage Set	C	S100	Beveled (01) Disk (02) Square (03)	Athena Lever (AT)	Brushed Stainless Steel (SS)	\$124.00	\$156.00
Privacy Set	C	S200		Hercules Lever (HS)		\$124.00	\$156.00
Dummy, Pair		S300		Helios Lever (HL) Hermes Lever (HES) Poseidon Lever (PO)		\$124.00	

Octagon Knob
with Beveled Rosette



Round Knob
with Disk Rosette



Octagon Knob
with Square Rosette



CAST STAINLESS STEEL KNOBSETS	CF	Product Code	Rosette Style	Knob Style	Finish	Standard List Price	CF List Price
Passage Set	C	S100	Beveled (01) Disk (02) Square (03)	Octagon Knob (OK)	Brushed Stainless Steel (SS)	\$124.00	\$156.00
Privacy Set	C	S200		Round Knob (RNK)		\$124.00	\$156.00
Dummy, Pair		S300				\$124.00	

Handing Required For Leversets. Standard latch is for 2³/₈" backset. Specify 2³/₄" backset if required. Complete set includes Latch and Strike Plate. Supplied with a 28° Rotation Latch.
CF Mechanism: Handing not required. Maximum door thickness is 2¹/₄".

San Carlos Lever
with #2 Rosette



Normandy Lever
with #2 Rosette



San Carlos Lever
with #3 Rosette



Lafayette Lever
with #1 Rosette



San Carlos Lever
with #1 Rosette



Lafayette Lever
with #3 Rosette



ROSETTE	Description	Product Code	Lever Style	Finish	Standard List Price
	Passage Set	7101	Lafayette Lever (L) Normandy Lever (N) San Carlos Lever (SC)	Flat Black Steel (FBS) Satin Steel (SWS)	\$86.00
	Privacy Set	7201			\$86.00
	Dummy, Pair	7051			\$86.00
	Passage Set	7102	Lafayette Lever (L) Normandy Lever (N) San Carlos Lever (SC)	Flat Black Steel (FBS) Satin Steel (SWS)	\$86.00
	Privacy Set	7202			\$86.00
	Dummy, Pair	7052			\$86.00
	Passage Set	7103	Lafayette Lever (L) Normandy Lever (N) San Carlos Lever (SC)	Flat Black Steel (FBS) Satin Steel (SWS)	\$86.00
	Privacy Set	7203			\$86.00
	Dummy, Pair	7053			\$86.00

>> CF Mechanism NOT available for Wrought Steel products.

Handing Required For Leversets. Standard latch is for 2³/₈" backset. Specify 2³/₄" backset if required. Complete set includes Latch and Strike Plate. To order 28° Rotation Latch with any standard Leverset, add product code **Latch28** and list price **\$4**.

KNOBSETS - WROUGHT STEEL

**Savannah Knob
with #3 Rosette**



**Madison Ivory Knob
with #1 Rosette**



**Jamestown Knob
with #1 Rosette**



**Jamestown Knob
with #3 Rosette**





**Savannah Knob
with #1 Rosette**



**Madison Black Knob
with #2 Rosette**



ROSETTE	Description	Product Code	Knob Style	Finish	Standard List Price
	Passage Set	7101	Jamestown Knob (J) Madison Black Knob (MB)	Flat Black Steel (FBS) Satin Steel (SWS)	\$96.00
	Privacy Set	7201	Madison Ivory Knob (MI) Savannah Knob (SV)		\$96.00
	Dummy, Pair	7051			\$96.00
	Passage Set	7102	Jamestown Knob (J) Madison Black Knob (MB)	Flat Black Steel (FBS) Satin Steel (SWS)	\$96.00
	Privacy Set	7202	Madison Ivory Knob (MI) Savannah Knob (SV)		\$96.00
	Dummy, Pair	7052			\$96.00
	Passage Set	7103	Jamestown Knob (J) Madison Black Knob (MB)	Flat Black Steel (FBS) Satin Steel (SWS)	\$96.00
	Privacy Set	7203	Madison Ivory Knob (MI) Savannah Knob (SV)		\$96.00
	Dummy, Pair	7053			\$96.00

>> **CF Mechanism NOT available for Wrought Steel products.**

Handing Not Required for Knobsets. Standard latch is for 2³/₈" backset. Specify 2³/₄" backset if required. Complete set includes Latch and Strike Plate. To order 28° Rotation Latch with any standard Leverset, add product code **Latch28** and list price **\$4**.

Arts & Crafts Lever
with Arts & Crafts
Rectangular Rosette



Hammered Lever
with Hammered Rosette



Hammered Egg Knob
with Arts & Crafts
Rectangular Rosette



Arts & Crafts Lever
with Hammered Rosette





Hammered Lever
with Arts & Crafts
Rectangular Rosette



Hammered Egg Knob
with Hammered Rosette



ROSETTE	Description	CF	Product Code	Knob / Lever Style	Finish	Standard List Price	CF List Price
	Passage Set	C	5105	Hammered Egg Knob (HE) Arts & Crafts Lever (AC) Hammered Lever (HM)	Oil Rubbed Bronze (US10B) Satin Nickel (US15) Flat Black (US19)	\$118.00	\$154.00
	Privacy Set	C	5205			\$118.00	\$154.00
	Dummy, Pair		5055			\$118.00	
	Passage Set	C	5106	Hammered Egg Knob (HE) Arts & Crafts Lever (AC) Hammered Lever (HM)	Oil Rubbed Bronze (US10B) Satin Nickel (US15) Flat Black (US19)	\$118.00	\$154.00
	Privacy Set	C	5206			\$118.00	\$154.00
	Dummy, Pair		5056			\$118.00	

Handing Required For Leversets. Standard latch is for 2³/₈" backset. Specify 2³/₄" backset if required. To order 28° Rotation Latch with any standard Leverset or Knobset, add product code **Latch28** and list price \$4. Complete set includes Latch and Strike Plate. **CF Mechanism:** Handing not required, except for Knob by Lever and Split Finish products. Maximum door thickness for CF Mechanism is 2¹/₄". Supplied with a 28° Rotation Latch.

**Ebony Knob
with Ribbon & Reed Rosette**



**Ice White Knob
with Oval Rosette**



**Ebony Knob
with #8 Brass Rosette**



**Ice White Knob
with Porcelain Rosette**



PORCELAIN KNOBS WITH PORCELAIN ROSETTES	Product Code	Knob Style	Finish (for Center Ring in Rosette)	Standard List Price
Passage Set	8030	Ebony Knob (EB) Ice White Knob (IW)	Polished Brass - Lifetime (US3) French Antique (US7) Oil Rubbed Bronze (US10B) Satin Nickel (US15) Pewter (US15A) Flat Black (US19) Polished Chrome (US26)	\$96.00
Privacy Set	8040			\$96.00
Dummy, Pair	8003			\$96.00

>> **CF Mechanism NOT available for Porcelain Style Rosettes.**

PORCELAIN KNOBS WITH BRASS ROSETTES	CF	Product Code	Knob Style	Finish	Standard List Price	CF List Price
Passage Set	C	8100	Ebony Knob (EB) Ice White Knob (IW)	Polished Brass - Lifetime (US3) French Antique (US7) Oil Rubbed Bronze (US10B) Satin Nickel (US15) Pewter (US15A) Flat Black (US19) Polished Chrome (US26)	\$96.00	\$132.00
Privacy Set	C	8200			\$96.00	\$132.00
Dummy, Pair		8050			\$96.00	

>> Porcelain Knobs may also be ordered with any Brass rosettes. Please refer to pages 102 - 103 for the product codes. List prices are the same as shown above. Choose from these Brass Classic & Designer Rosettes:



#8 Rosette



Oval Rosette



Regular Rosette



Rectangular Rosette



Quincy Rosette



Wilshire Rosette



Rope Rosette



Lancaster Rosette



Ribbon & Reed Rosette

Handing Not Required For Knobsets. Standard latch is for 2³/₈" backset. Specify 2³/₄" backset if required. To order 28° Rotation Latch with any standard Knobset, add product code **Latch28** and list price **\$4**. Complete set includes Latch and Strike Plate. **CF Mechanism:** Handing not required, except for Knob by Lever and Split Finish products. Maximum door thickness for CF Mechanism is 2¹/₄". Supplied with a 28° Rotation Latch. **Unlacquered Brass** finish available with additional **\$18 NET** upcharge.

Bristol Knob with Square Rosette



Modern Disc Crystal Knob with Modern Rectangular Rosette



Modern Square Crystal Knob with Disk Rosette



Windsor Crystal Knob with Modern Rectangular Rosette







Modern Disc Crystal Knob with Disk Rosette



Hampton Knob with Neos Rosette



ROSETTE	Description	CF	Product Code	Knob Style	Finish	Standard List Price	CF List Price
	Passage Set	C	5107	Bristol Knob (BL) Hampton Knob (HT)	Satin Brass (US4) Oil Rubbed Bronze (US10B)	\$118.00	\$154.00
	Privacy Set	C	5207	Modern Disc Crystal Knob (MDC) Modern Square Crystal Knob (MSC)	Satin Nickel (US15) Flat Black (US19)	\$118.00	\$154.00
	Dummy, Pair		5057	Windsor Crystal Knob (WS)	Polished Chrome (US26)	\$118.00	
	Passage Set	C	5109	Bristol Knob (BL) Hampton Knob (HT)	Satin Brass (US4) Oil Rubbed Bronze (US10B)	\$118.00	\$154.00
	Privacy Set	C	5209	Modern Disc Crystal Knob (MDC) Modern Square Crystal Knob (MSC)	Polished Nickel - Lifetime (US14) Satin Nickel (US15)	\$118.00	\$154.00
	Dummy, Pair		5059	Windsor Crystal Knob (WS)	Flat Black (US19) Polished Chrome (US26)	\$118.00	
	Passage Set	C	5110	Bristol Knob (BL) Hampton Knob (HT)	Satin Brass (US4) Oil Rubbed Bronze (US10B)	\$118.00	\$154.00
	Privacy Set	C	5210	Modern Disc Crystal Knob (MDC) Modern Square Crystal Knob (MSC)	Polished Nickel - Lifetime (US14) Satin Nickel (US15)	\$118.00	\$154.00
	Dummy, Pair		5050	Windsor Crystal Knob (WS)	Flat Black (US19) Polished Chrome (US26)	\$118.00	
	Passage Set	C	5111	Bristol Knob (BL) Hampton Knob (HT)	Satin Brass (US4) Oil Rubbed Bronze (US10B)	\$118.00	\$154.00
	Privacy Set	C	5211	Modern Disc Crystal Knob (MDC) Modern Square Crystal Knob (MSC)	Satin Nickel (US15) Flat Black (US19)	\$118.00	\$154.00
	Dummy, Pair		5051	Windsor Crystal Knob (WS)	Polished Chrome (US26)	\$118.00	
	Passage Set	C	5112	Bristol Knob (BL) Hampton Knob (HT)	Satin Brass (US4) Oil Rubbed Bronze (US10B)	\$118.00	\$154.00
	Privacy Set	C	5212	Modern Disc Crystal Knob (MDC) Modern Square Crystal Knob (MSC)	Polished Nickel - Lifetime (US14) Satin Nickel (US15)	\$118.00	\$154.00
	Dummy, Pair		5052	Windsor Crystal Knob (WS)	Flat Black (US19) Polished Chrome (US26)	\$118.00	

Handing Not Required For Knobsets. Standard latch is for 2³/₈" backset. Specify 2³/₄" backset if required. To order 28° Rotation Latch with any standard Knobset, add product code **Latch28** and list price \$4. Complete set includes Latch and Strike Plate. **CF Mechanism:** Handing not required, except for Knob by Lever and Split Finish products. Maximum door thickness for CF Mechanism is 2¹/₄". Supplied with a 28° Rotation Latch. Crystal Knobs may also be ordered with any Brass Classic and Designer rosette at the list price shown above. (See pages 118 - 119 for Brass Classic and Designer rosette options)

Old Town Clear Knob with #8 Rosette



Bristol Knob with Rectangular Rosette







Old Town Clear Knob with Wilshire Rosette



Providence Crystal Knob with Quincy Rosette



ROSETTE	Description	CF	Product Code	Knob Style	Finish	Standard List Price	CF List Price
	Passage Set	C	8108	Astoria Clear Knob (AS) Bristol Knob (BL)	Polished Brass - Lifetime (US3) French Antique (US7)	\$118.00	\$154.00
	Privacy Set	C	8208	Diamond Crystal Knob (CK) Georgetown Knob (GT)	Oil Rubbed Bronze (US10B) Polished Nickel - Lifetime (US14)	\$118.00	\$154.00
	Dummy, Pair		8058	Hampton Knob (HT) Lowell Crystal Knob (LW) Old Town Clear Knob (OT) Providence Crystal Knob (PC) Windsor Crystal Knob (WS)	Satin Nickel (US15) Pewter (US15A) Flat Black (US19) Polished Chrome (US26)	\$118.00	
	Passage Set	C	8120	Astoria Clear Knob (AS) Bristol Knob (BL)	Polished Brass - Lifetime (US3) French Antique (US7)	\$118.00	\$154.00
	Privacy Set	C	8220	Diamond Crystal Knob (CK) Georgetown Knob (GT)	Oil Rubbed Bronze (US10B) Satin Nickel (US15)	\$118.00	\$154.00
	Dummy, Pair		8520	Hampton Knob (HT) Lowell Crystal Knob (LW) Old Town Clear Knob (OT) Providence Crystal Knob (PC) Windsor Crystal Knob (WS)	Pewter (US15A) Flat Black (US19) Polished Chrome (US26)	\$118.00	
	Passage Set	C	8100	Astoria Clear Knob (AS) Bristol Knob (BL)	Polished Brass - Lifetime (US3) French Antique (US7)	\$118.00	\$154.00
	Privacy Set	C	8200	Diamond Crystal Knob (CK) Georgetown Knob (GT)	Oil Rubbed Bronze (US10B) Polished Nickel - Lifetime (US14)	\$118.00	\$154.00
	Dummy, Pair		8050	Hampton Knob (HT) Lowell Crystal Knob (LW) Old Town Clear Knob (OT) Providence Crystal Knob (PC) Windsor Crystal Knob (WS)	Satin Nickel (US15) Pewter (US15A) Flat Black (US19) Polished Chrome (US26)	\$118.00	
	Passage Set	C	8121	Astoria Clear Knob (AS) Bristol Knob (BL)	Polished Brass - Lifetime (US3) French Antique (US7)	\$118.00	\$154.00
	Privacy Set	C	8221	Diamond Crystal Knob (CK) Georgetown Knob (GT)	Oil Rubbed Bronze (US10B) Polished Nickel - Lifetime (US14)	\$118.00	\$154.00
	Dummy, Pair		8521	Hampton Knob (HT) Lowell Crystal Knob (LW) Old Town Clear Knob (OT) Providence Crystal Knob (PC) Windsor Crystal Knob (WS)	Satin Nickel (US15) Pewter (US15A) Flat Black (US19) Polished Chrome (US26)	\$118.00	
	Passage Set	C	8131	Astoria Clear Knob (AS) Bristol Knob (BL)	Polished Brass - Lifetime (US3) French Antique (US7)	\$118.00	\$154.00
	Privacy Set	C	8231	Diamond Crystal Knob (CK) Georgetown Knob (GT)	Oil Rubbed Bronze (US10B) Satin Nickel (US15)	\$118.00	\$154.00
	Dummy, Pair		8531	Hampton Knob (HT) Lowell Crystal Knob (LW) Old Town Clear Knob (OT) Providence Crystal Knob (PC) Windsor Crystal Knob (WS)	Pewter (US15A) Flat Black (US19) Polished Chrome (US26)	\$118.00	

Handing Not Required For Knobsets. Standard latch is for 2³/₈" backset. Specify 2³/₄" backset if required. To order 28° Rotation Latch with any standard Knobset, add product code **Latch28** and list price \$4. Complete set includes Latch and Strike Plate. **CF Mechanism:** Handing not required, except for Knob by Lever and Split Finish products. Maximum door thickness for CF Mechanism is 2¹/₄". Supplied with a 28° Rotation Latch. **Unlacquered Brass** finish available with additional \$18 NET upcharge. Classic Knobsets may also be ordered with any Modern rosette at the list price shown above. (See page 117 for Modern rosette options)

Astoria Clear Knob with Rope Rosette



Georgetown Knob with Wilshire Rosette



Hampton Knob with #8 Rosette



Diamond Crystal Knob with Lancaster Rosette







Lowell Crystal Knob with Quincy Rosette



Windsor Crystal Knob with Rectangular Rosette



ROSETTE	Description	CF	Product Code	Knob Style	Finish	Standard List Price	CF List Price
 <p>Wilshire</p>	Passage Set	C	8161	Astoria Clear Knob (AS) Bristol Knob (BL)	Polished Brass - Lifetime (US3) French Antique (US7)	\$118.00	\$154.00
	Privacy Set	C	8261	Diamond Crystal Knob (CK) Georgetown Knob (GT)	Oil Rubbed Bronze (US10B) Polished Nickel - Lifetime (US14)	\$118.00	\$154.00
	Dummy, Pair		8561	Hampton Knob (HT) Lowell Crystal Knob (LW) Old Town Clear Knob (OT) Providence Crystal Knob (PC) Windsor Crystal Knob (WS)	Satin Nickel (US15) Pewter (US15A) Flat Black (US19) Polished Chrome (US26)	\$118.00	
 <p>Rope</p>	Passage Set	C	8101	Astoria Clear Knob (AS) Bristol Knob (BL)	Polished Brass - Lifetime (US3) French Antique (US7)	\$118.00	\$154.00
	Privacy Set	C	8201	Diamond Crystal Knob (CK) Georgetown Knob (GT)	Oil Rubbed Bronze (US10B) Satin Nickel (US15)	\$118.00	\$154.00
	Dummy, Pair		8051	Hampton Knob (HT) Lowell Crystal Knob (LW) Old Town Clear Knob (OT) Providence Crystal Knob (PC) Windsor Crystal Knob (WS)	Pewter (US15A) Polished Chrome (US26)	\$118.00	
 <p>Lancaster</p>	Passage Set	C	8106	Astoria Clear Knob (AS) Bristol Knob (BL)	Polished Brass - Lifetime (US3) French Antique (US7)	\$118.00	\$154.00
	Privacy Set	C	8206	Diamond Crystal Knob (CK) Georgetown Knob (GT)	Oil Rubbed Bronze (US10B) Satin Nickel (US15)	\$118.00	\$154.00
	Dummy, Pair		8056	Hampton Knob (HT) Lowell Crystal Knob (LW) Old Town Clear Knob (OT) Providence Crystal Knob (PC) Windsor Crystal Knob (WS)	Pewter (US15A) Polished Chrome (US26)	\$118.00	
 <p>Ribbon & Reed</p>	Passage Set	C	8107	Astoria Clear Knob (AS) Bristol Knob (BL)	Polished Brass - Lifetime (US3) French Antique (US7)	\$118.00	\$154.00
	Privacy Set	C	8207	Diamond Crystal Knob (CK) Georgetown Knob (GT)	Oil Rubbed Bronze (US10B) Satin Nickel (US15)	\$118.00	\$154.00
	Dummy, Pair		8057	Hampton Knob (HT) Lowell Crystal Knob (LW) Old Town Clear Knob (OT) Providence Crystal Knob (PC) Windsor Crystal Knob (WS)	Pewter (US15A) Polished Chrome (US26)	\$118.00	

Handing Not Required For Knobsets. Standard latch is for 2³/₈" backset. Specify 2³/₄" backset if required. To order 28° Rotation Latch with any standard Knobset, add product code **Latch28** and list price **\$4**. Complete set includes Latch and Strike Plate. **CF Mechanism:** Handing not required, except for Knob by Lever and Split Finish products. Maximum door thickness for CF Mechanism is 2¹/₄". Supplied with a 28° Rotation Latch. **Unlacquered Brass** finish available with additional **\$18 NET** upcharge. Classic Knobsets may also be ordered with any Modern rosette at the list price shown above. (See page 117 for Modern rosette options)

KNOBSETS - CRYSTAL

**Hampton Knob
with #1 Rosette**



**Providence Crystal Knob
with #3 Rosette**



**Astoria Knob
with #6 Rosette**



**Diamond Crystal Knob
with #3 Rosette**







**Georgetown Knob
with #4 Rosette**



**Bristol Knob
with #2 Rosette**



ROSETTE	Description	CF	Product Code	Knob Style	Finish	Standard List Price	CF List Price
	Passage Set	C	7108	Astoria Clear Knob (AS) Bristol Knob (BL)	Flat Black Bronze (FB) Medium Bronze (MB) Tumbled White Bronze (TWB)	\$130.00	\$166.00
	Privacy Set	C	7208	Diamond Crystal Knob (CK) Georgetown Knob (GT)		\$130.00	\$166.00
	Dummy, Pair		7058	Hampton Knob (HT) Lowell Crystal Knob (LW)		\$130.00	
	Passage Set	C	7106	Astoria Clear Knob (AS) Bristol Knob (BL)	Flat Black Bronze (FB) Medium Bronze (MB) Tumbled White Bronze (TWB)	\$130.00	\$166.00
	Privacy Set	C	7206	Diamond Crystal Knob (CK) Georgetown Knob (GT)		\$130.00	\$166.00
	Dummy, Pair		7056	Hampton Knob (HT) Lowell Crystal Knob (LW)		\$130.00	
	Passage Set	C	7104	Astoria Clear Knob (AS) Bristol Knob (BL)	Flat Black Bronze (FB) Medium Bronze (MB) Tumbled White Bronze (TWB)	\$130.00	\$166.00
	Privacy Set	C	7204	Diamond Crystal Knob (CK) Georgetown Knob (GT)		\$130.00	\$166.00
	Dummy, Pair		7054	Hampton Knob (HT) Lowell Crystal Knob (LW)		\$130.00	
	Passage Set	C	7100	Astoria Clear Knob (AS) Bristol Knob (BL)	Flat Black Bronze (FB) Medium Bronze (MB) Tumbled White Bronze (TWB)	\$130.00	\$166.00
	Privacy Set	C	7200	Diamond Crystal Knob (CK) Georgetown Knob (GT)		\$130.00	\$166.00
	Dummy, Pair		7050	Hampton Knob (HT) Lowell Crystal Knob (LW)		\$130.00	
	Passage Set	C	7111	Astoria Clear Knob (AS) Bristol Knob (BL)	Flat Black Bronze (FB) Medium Bronze (MB) Tumbled White Bronze (TWB)	\$130.00	\$166.00
	Privacy Set	C	7211	Diamond Crystal Knob (CK) Georgetown Knob (GT)		\$130.00	\$166.00
	Dummy, Pair		7061	Hampton Knob (HT) Lowell Crystal Knob (LW)		\$130.00	

Handing Not Required For Knobsets. Standard latch is for 2³/₈" backset. Specify 2³/₄" backset if required. To order 28° Rotation Latch with any standard Knobset, add product code **Latch28** and list price \$4. Complete set includes Latch and Strike Plate. **CF Mechanism:** Handing not required, except for Knob by Lever and Split Finish products. Maximum door thickness for CF Mechanism is 2¹/₄". Supplied with a 28° Rotation Latch.

Providence Crystal Knob
with #2 Rosette



Modern Disc Crystal Knob
with #6 Rosette



Old Town Clear Crystal Knob
with #1 Rosette



Lowell Crystal Knob
with #4 Rosette







Modern Square Crystal Knob
with #3 Rosette



Windsor Crystal Knob
with #1 Rosette



ROSETTE	Description	CF	Product Code	Knob Style	Finish	Standard List Price	CF List Price
	Passage Set	C	7108	Modern Disc Crystal Knob (MDC)	Flat Black Bronze (FB) Medium Bronze (MB) Tumbled White Bronze (TWB)	\$130.00	\$166.00
	Privacy Set	C	7208	Modern Square Crystal Knob (MSC)		\$130.00	\$166.00
	Dummy, Pair		7058	Old Town Clear Knob (OT) Providence Crystal Knob (PC) Windsor Crystal Knob (WS)		\$130.00	
	Passage Set	C	7106	Modern Disc Crystal Knob (MDC)	Flat Black Bronze (FB) Medium Bronze (MB) Tumbled White Bronze (TWB)	\$130.00	\$166.00
	Privacy Set	C	7206	Modern Square Crystal Knob (MSC)		\$130.00	\$166.00
	Dummy, Pair		7056	Old Town Clear Knob (OT) Providence Crystal Knob (PC) Windsor Crystal Knob (WS)		\$130.00	
	Passage Set	C	7104	Modern Disc Crystal Knob (MDC)	Flat Black Bronze (FB) Medium Bronze (MB) Tumbled White Bronze (TWB)	\$130.00	\$166.00
	Privacy Set	C	7204	Modern Square Crystal Knob (MSC)		\$130.00	\$166.00
	Dummy, Pair		7054	Old Town Clear Knob (OT) Providence Crystal Knob (PC) Windsor Crystal Knob (WS)		\$130.00	
	Passage Set	C	7100	Modern Disc Crystal Knob (MDC)	Flat Black Bronze (FB) Medium Bronze (MB) Tumbled White Bronze (TWB)	\$130.00	\$166.00
	Privacy Set	C	7200	Modern Square Crystal Knob (MSC)		\$130.00	\$166.00
	Dummy, Pair		7050	Old Town Clear Knob (OT) Providence Crystal Knob (PC) Windsor Crystal Knob (WS)		\$130.00	
	Passage Set	C	7111	Modern Disc Crystal Knob (MDC)	Flat Black Bronze (FB) Medium Bronze (MB) Tumbled White Bronze (TWB)	\$130.00	\$166.00
	Privacy Set	C	7211	Modern Square Crystal Knob (MSC)		\$130.00	\$166.00
	Dummy, Pair		7061	Old Town Clear Knob (OT) Providence Crystal Knob (PC) Windsor Crystal Knob (WS)		\$130.00	

Handing Not Required For Knobsets. Standard latch is for 2³/₈" backset. Specify 2³/₄" backset if required. To order 28° Rotation Latch with any standard Knobset, add product code **Latch28** and list price \$4. Complete set includes Latch and Strike Plate. **CF Mechanism:** Handing not required, except for Knob by Lever and Split Finish products. Maximum door thickness for CF Mechanism is 2¹/₄". Supplied with a 28° Rotation Latch.

DOOR KNOB WITH THREADED SPINDLE - CRYSTAL & PORCELAIN

Threaded Rod with Old Town Clear Knobs



Threaded Rod with Diamond Crystal Knobs



Threaded Rod with Astoria Clear Knobs



Threaded Rod with Georgetown Knobs



Threaded Rod with Providence Crystal Knobs



Threaded Rod with Bristol Knobs



Threaded Rod with Hampton Knobs



Threaded Rod with Ice White Porcelain Knobs



Threaded Rod with Modern Disc Crystal Knobs



Threaded Rod with Modern Square Crystal Knobs

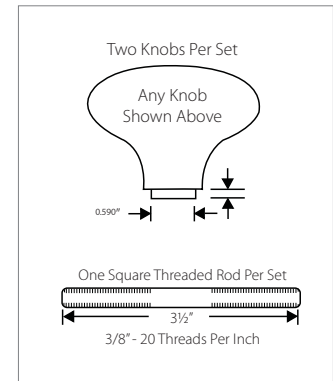

CRYSTAL KNOBS WITH THREADED ROD	Product Code	Knob Style	Finish	Standard List Price
Two Knobs Per Set	8000	Astoria Clear Knob (AS) Bristol Knob (BL) Diamond Crystal Knob (CK) Georgetown Knob (GT) Hampton Knob (HT) Lowell Crystal Knob (LLW) Modern Disc Crystal Knob (MDC) Modern Square Crystal Knob (MSC) Old Town Clear Knob (OT) Providence Crystal Knob (PC) Windsor Crystal Knob (WS)	Polished Brass - Lifetime (US3) French Antique (US7) Oil Rubbed Bronze (US10B) Polished Nickel - Lifetime (US14) Satin Nickel (US15) Pewter (US15A) Flat Black (US19) Polished Chrome (US26)	\$90.00

PORCELAIN KNOBS WITH THREADED ROD	Product Code	Knob Style	Finish	Standard List Price
Two Knobs Per Set	8000	Ebony Knob (EB) Ice White Knob (IW)	Polished Brass (US3) French Antique (US7) Oil Rubbed Bronze (US10B) Satin Nickel (US15) Polished Chrome (US26)	\$90.00

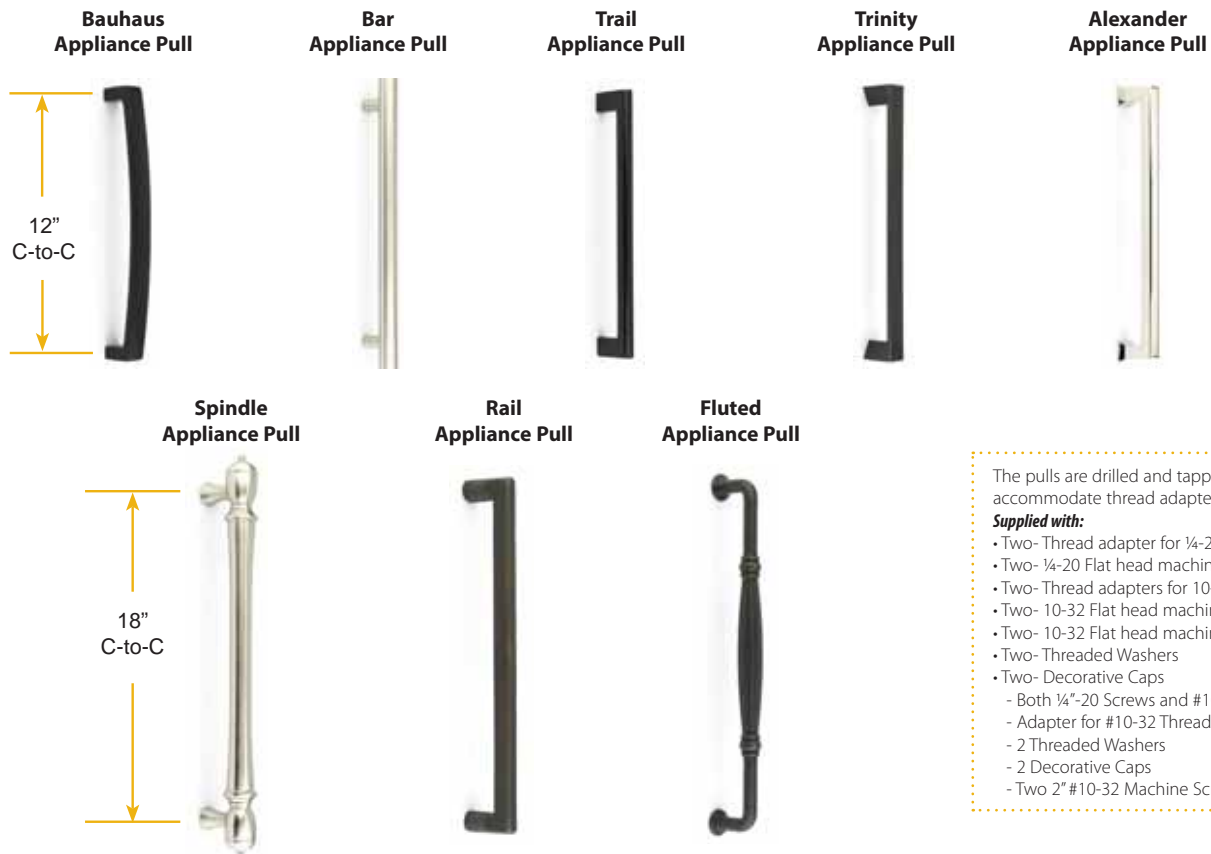

The pulls are drilled and tapped for 3/8"-16 thread to accommodate thread adapters.

Supplied with:

- Two- Thread adapter for 1/4-20 thread
- Two- 1/4-20 Flat head machine Screws x 1" long
- Two- Thread adapters for 10-32 thread
- Two- 10-32 Flat head machine screws x 1" long
- Two- 10-32 Flat head machine screws x 2" long
- Two- Threaded Washers
- Two- Decorative Caps
 - Both 1/4"-20 Screws and #10-32 Screws
 - Adapter for #10-32 Thread
 - 2 Threaded Washers
 - 2 Decorative Caps
 - Two 2" #10-32 Machine Screws

12" & 18" APPLIANCE PULLS		Product Code	Finish	List Price
Bauhaus	12" Appliance Pull	86345	Oil Rubbed Bronze (US10B)	\$124.00
	18" Appliance Pull	86346	Polished Nickel (US14)	\$180.00
Trail	12" Appliance Pull	86440	Satin Nickel (US15)	\$124.00
	18" Appliance Pull	86441	Flat Black (US19)	\$180.00
Trinity	12" Appliance Pull	86444	Polished Chrome (US26)	\$124.00
	18" Appliance Pull	86445		\$180.00
Alexander	12" Appliance Pull	86442		\$124.00
	18" Appliance Pull	86443		\$180.00
Bar	12" Appliance Pull	86351	Oil Rubbed Bronze (US10B)	\$124.00
	18" Appliance Pull	86352	Polished Nickel (US14)	\$180.00
Spindle	12" Appliance Pull	86343	Satin Nickel (US15)	\$146.00
	18" Appliance Pull	86344	Polished Brass (US3)	\$216.00
Rail Sandcast Bronze	12" Appliance Pull	86349	French Antique (US7)	\$136.00
	18" Appliance Pull	86350	Oil Rubbed Bronze (US10B)	\$190.00
Fluted Lost Wax Cast Bronze	12" Appliance Pull	86347	Medium Bronze (MB)	\$158.00
	18" Appliance Pull	86348	Tumbled White Bronze (TWB)	\$228.00

DOOR PULLS - SOLID BRASS & STAINLESS STEEL

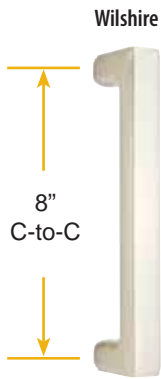

The pulls are drilled and tapped for 3/8"-16 thread to accommodate thread adapters.

Supplied with:

- Two- Thread adapter for 1/4-20 thread
- Two- 1/4-20 Flat head machine Screws x 1" long
- Two- Thread adapters for 10-32 thread
- Two- 10-32 Flat head machine screws x 1" long
- Two- 10-32 Flat head machine screws x 2" long
- Two- Threaded Washers
- Two- Decorative Caps
 - Both 1/4"-20 Screws and #10-32 Screws
 - Adapter for #10-32 Thread
 - 2 Threaded Washers
 - 2 Decorative Caps
- Two 2" #10-32 Machine Screws

BRASS & STAINLESS STEEL 8" DOOR PULLS May Be Used Separately or With Pull Plates			
	Product Code	Finish	List Price
Wilshire 8" Door Pull	86078	Polished Brass - Lifetime (US3) French Antique (US7) Oil Rubbed Bronze (US10B) Polished Nickel - Lifetime (US14) Satin Nickel (US15) Pewter (US15A) Flat Black (US19) Polished Chrome (US26)	\$88.00
Knoxville 8" Door Pull	86077	Polished Brass - Lifetime (US3) French Antique (US7) Oil Rubbed Bronze (US10B) Satin Nickel (US15) Pewter (US15A) Polished Chrome (US26)	\$88.00
Ribbon & Reed 8" Door Pull	86080	Polished Brass - Lifetime (US3) French Antique (US7) Oil Rubbed Bronze (US10B) Satin Nickel (US15) Pewter (US15A) Polished Chrome (US26)	\$88.00
Arts & Crafts 8" Door Pull	86079	Oil Rubbed Bronze (US10B) Satin Nickel (US15) Flat Black (US19)	\$88.00
Zeus 8" Door Pull	86183	Satin Brass (US4)* Oil Rubbed Bronze (US10B) Polished Nickel - Lifetime (US14)* Satin Nickel (US15) Flat Black (US19) Polished Chrome (US26)	\$88.00
Baden 8" Door Pull	86184	Satin Brass (US4)* Oil Rubbed Bronze (US10B) Polished Nickel - Lifetime (US14)* Satin Nickel (US15) Flat Black (US19) Polished Chrome (US26)	\$88.00
Zeus Stainless Steel 8" Door Pull	S86001	Brushed Stainless Steel (SS)	\$88.00
Baden Stainless Steel 8" Door Pull	S86002	Brushed Stainless Steel (SS)	\$88.00

* Polished Nickel - Lifetime (US14) and Satin Brass (US4) are available only for Baden Door Pull.

Modern Push Plate



Modern Pull Plate
(Plate Only)
Drilled to accept 8" pull

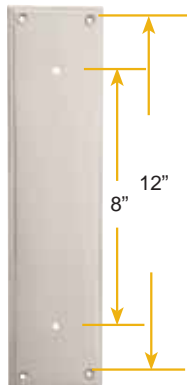

Example:
Combination of 8" Baden Pull
and 3"W x 12" H Modern Pull Plate



MODERN PUSH & PULL PLATES Supplied with 4 Wood Screws		Product Code	Finish	List Price
Modern Push Plate	86436	Oil Rubbed Bronze (US10B) Satin Nickel (US15) Flat Black (US19) Polished Chrome (US26)	\$66.00 <i>(Plate Only)</i>	
Modern Pull Plate	86437			

Knoxville Push Plate



Knoxville Pull Plate
(Plate Only)
Drilled to accept 8" pull

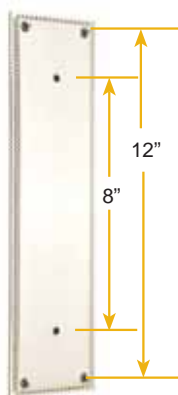

Example:
Combination of 8" Knoxville Pull
and 3"W x 12"H Knoxville Pull Plate



KNOXVILLE PUSH & PULL PLATES Supplied with 4 Wood Screws		Product Code	Finish	List Price
Knoxville Push Plate	86081	Polished Brass - Lifetime (US3) French Antique (US7) Oil Rubbed Bronze (US10B) Satin Nickel (US15) Pewter (US15A) Polished Chrome (US26)	\$66.00 <i>(Plate Only)</i>	
Knoxville Pull Plate	86082			

DOOR PULLS - SANDCAST BRONZE

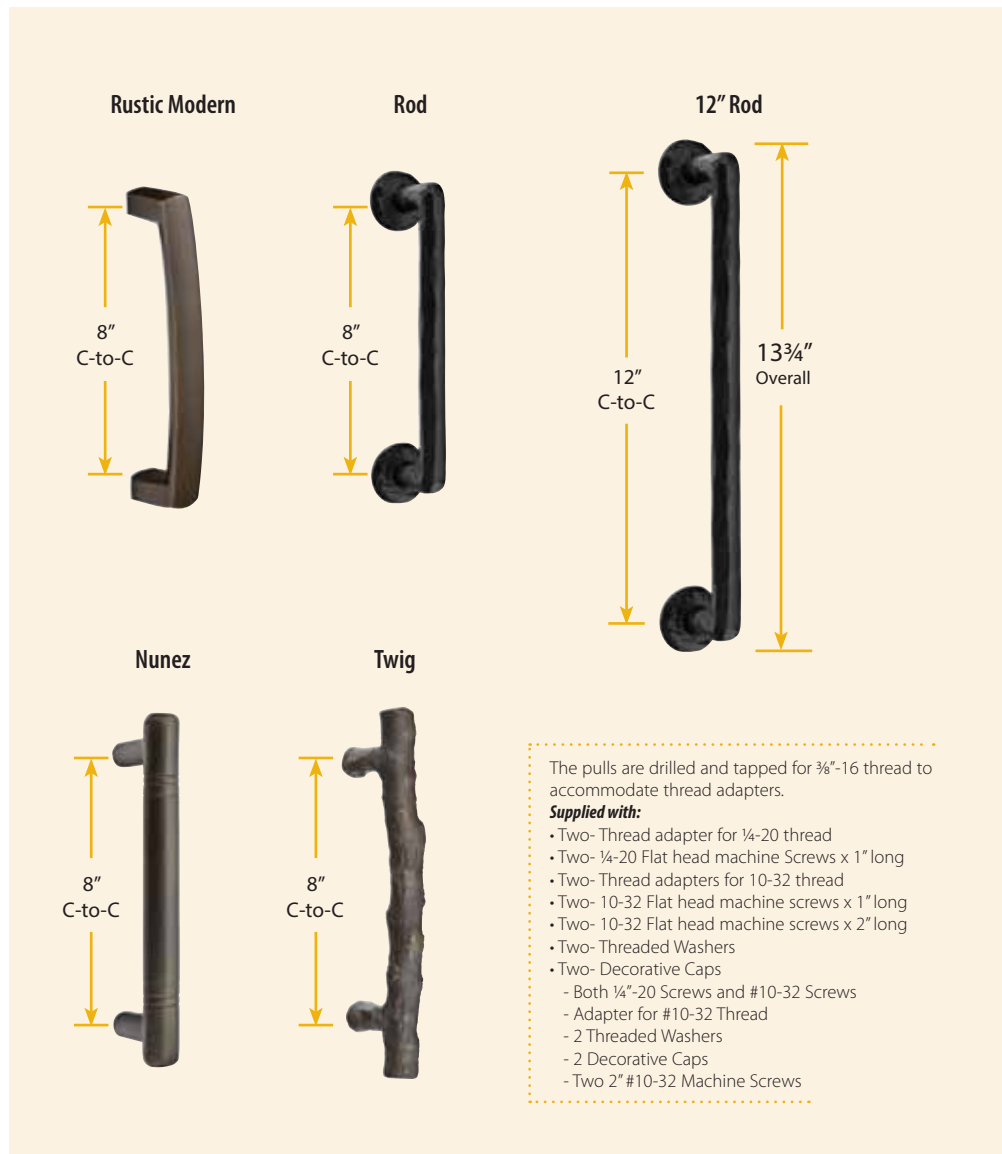

18" Rod
Supplied with #10 Wood Screws

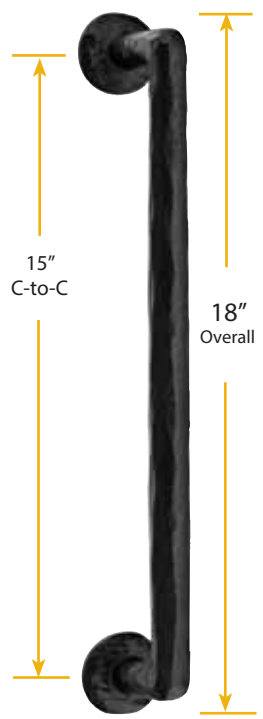

The pulls are drilled and tapped for 3/8"-16 thread to accommodate thread adapters.

Supplied with:

- Two- Thread adapter for 1/4-20 thread
- Two- 1/4-20 Flat head machine Screws x 1" long
- Two- Thread adapters for 10-32 thread
- Two- 10-32 Flat head machine screws x 1" long
- Two- 10-32 Flat head machine screws x 2" long
- Two- Threaded Washers
- Two- Decorative Caps
 - Both 1/4"-20 Screws and #10-32 Screws
 - Adapter for #10-32 Thread
 - 2 Threaded Washers
 - 2 Decorative Caps
 - Two 2" #10-32 Machine Screws

SANDCAST BRONZE DOOR PULLS 8", 12", and 18"			
	Product Code	Finish	List Price
Rustic Modern Bronze 8" Pull	86439	Flat Black Bronze (FB) Medium Bronze (MB) Tumbled White Bronze (TWB)	\$114.00
Nunez Bronze 8" Pull	86160		\$114.00
Twig Bronze 8" Pull	86090		\$114.00
Rod Bronze 8" Pull	86088		\$114.00
Rod Bronze 12" Pull	86068		\$138.00
Rod Bronze 18" Pull	86089		\$216.00

Twist



Palermo



Art Nouveau
Supplied with 1-1/16" Threaded Tube

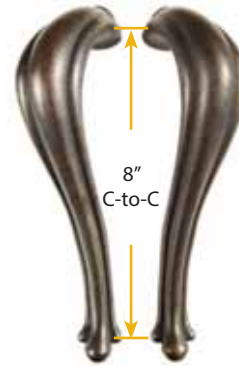

Left Hand Right Hand

Column

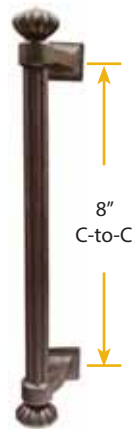

Recoleta

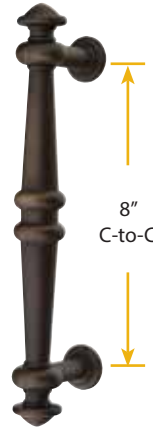

The pulls are drilled and tapped for 3/8"-16 thread to accommodate thread adapters.

Supplied with:

- Two- Thread adapter for 1/4"-20 thread
- Two- 1/4"-20 Flat head machine Screws x 1" long
- Two- Thread adapters for 10-32 thread
- Two- 10-32 Flat head machine screws x 1" long
- Two- 10-32 Flat head machine screws x 2" long
- Two- Threaded Washers
- Two- Decorative Caps
 - Both 1/4"-20 Screws and #10-32 Screws
 - Adapter for #10-32 Thread
 - 2 Threaded Washers
 - 2 Decorative Caps
 - Two 2" #10-32 Machine Screws

LOST WAX CAST BRONZE 8" DOOR PULLS May Be Used Separately or With Pull Plates	Product Code	Finish	List Price
Twist 8" Pull	86069	Flat Black Bronze (FB) Medium Bronze (MB)	\$114.00
Column 8" Pull	86156		\$114.00
Palermo 8" Pull	86167		\$114.00
Recoleta 8" Pull	86168		\$114.00
Art Nouveau 8" Pull (Left Hand)	86144LH		\$114.00
Art Nouveau 8" Pull (Right Hand)	86144RH		\$114.00

Petal Pull Plate

Petal Push Plate
3" W x 12" H

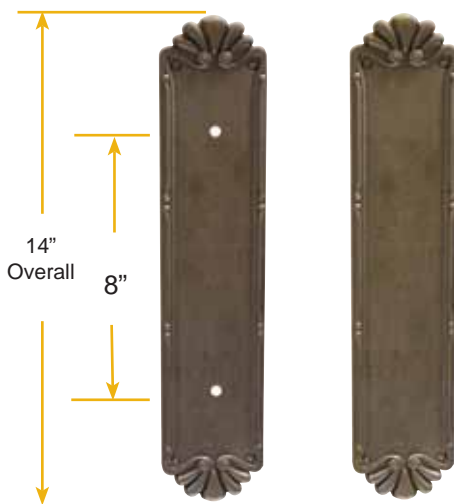

PETAL PUSH & PULL PLATES Supplied with 4 Wood Screws	Product Code	Finish	List Price
Petal Push Plate	86181	Flat Black Bronze (FB) Medium Bronze (MB)	\$110.00 (Plate Only)
Petal Pull Plate	86182		\$110.00 (Plate Only)

DOOR PULLS - LOST WAX CAST BRONZE

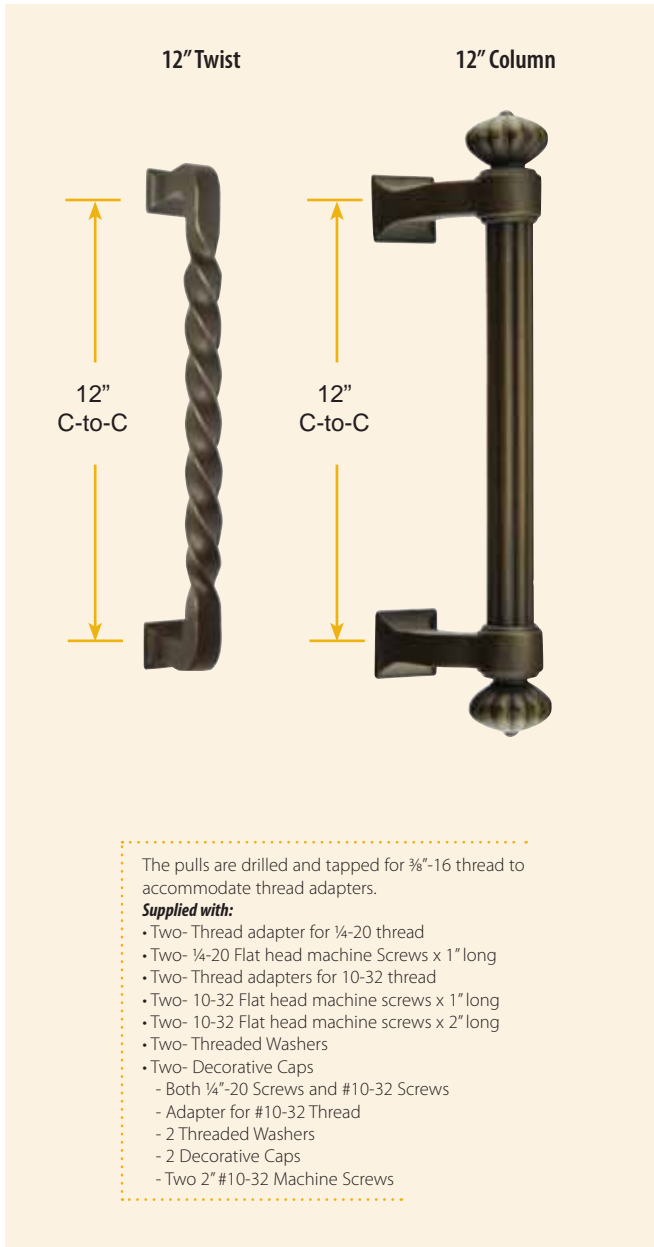

18" Column
Supplied with #10 Wood Screws



24" Column
Supplied with #10 Wood Screws



LOST WAX CAST BRONZE DOOR PULLS 12", 18", and 24"	Product Code	Finish	List Price
Twist 12" Pull	86169	Flat Black Bronze (FB) Medium Bronze (MB)	\$138.00
Column 12" Pull	86159		\$200.00
Column 18" Pull	86157		\$340.00
Column 24" Pull	86158		\$400.00

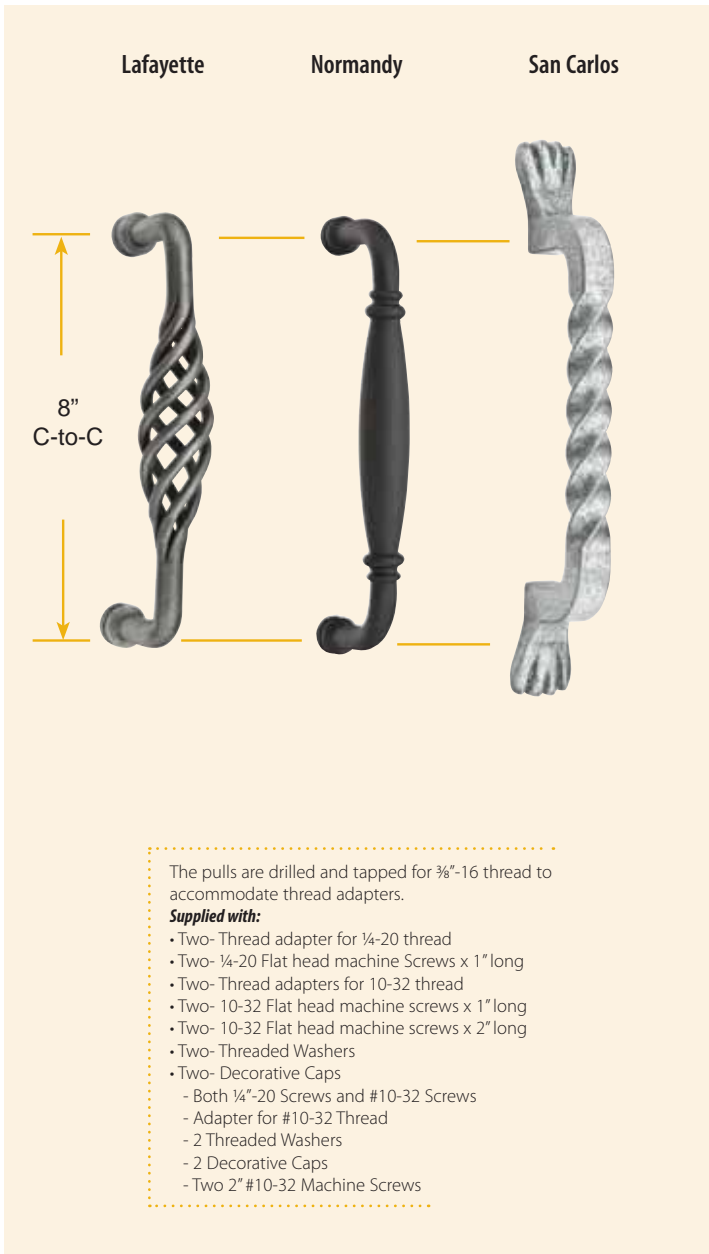

WROUGHT STEEL DOOR PULLS 8", 18", and 24"			
	Product Code	Finish	List Price
Lafayette 8" Pull	76030	Flat Black Steel (FBS) Satin Steel (SWS)	\$88.00
Normandy 8" Pull	76031		\$88.00
San Carlos 8" Pull	76028		\$88.00
San Carlos 18" Pull	76029		\$140.00
San Carlos 24" Pull	76041		\$180.00

DOOR ACCESSORIES

4" Dutch Door Bolt



DUTCH DOOR BOLT	Product Code	Finish	List Price
4"	8516	Polished Brass (US3) French Antique (US7) Oil Rubbed Bronze (US10B) Satin Nickel (US15) Pewter (US15A) Flat Black (US19) Polished Chrome (US26)	\$26.00

>> Supplied with 2 Types of Strike Plates and Screws.



Solid Brass Surface Bolts



SOLID BRASS SURFACE BOLTS	Product Code	Finish	List Price
6"	8511	Polished Brass - Lifetime (US3) French Antique (US7) Oil Rubbed Bronze (US10B)	\$46.00
8"	8515	Satin Nickel (US15) Pewter (US15A) Flat Black (US19)	\$54.00
12"	8512	Polished Chrome (US26) Medium Bronze (MB)	\$60.00
18"	8513	Satin Steel (SWS) Tumbled White Bronze (TWB)	\$74.00
24"	8514		\$88.00

>> Supplied with 3 Types of Strike Plates and Screws.



Security Door Guards



SECURITY DOOR GUARDS	Product Code	Finish	List Price
4" x 2½"	2074	Polished Brass (US3) French Antique (US7) Oil Rubbed Bronze (US10B)	\$24.00
5" x 2½"	2075	Satin Nickel (US15) Pewter (US15A) Polished Chrome (US26)	\$26.00

Flush Bolts
Square & Radius Corners



FLUSH BOLTS	Product Code	Finish	List Price
4" with Square Corners	8505	Polished Brass - Lifetime (US3) French Antique (US7) Oil Rubbed Bronze (US10B)	\$10.00
4" with 5/8" Radius Corners	8506	Satin Nickel (US15) Pewter (US15A) Flat Black (US19)	\$10.00
6" with Square Corners	8501	Polished Chrome (US26) Medium Bronze (MB)	\$12.00
6" with 5/8" Radius Corners	8502	Satin Steel (SWS) Tumbled White Bronze (TWB)	\$12.00
12" with Square Corners	8503		\$24.00
12" with 5/8" Radius Corners	8504		\$24.00

>> Supplied with Strike Plates and Screws.

Concealed Screw Surface Bolts



CONCEALED SCREW SURFACE BOLTS	Product Code	Finish	List Price
4"	8527	Polished Brass (US3) French Antique (US7) Oil Rubbed Bronze (US10B)	\$12.00
6"	8528	Satin Nickel (US15) Pewter (US15A) Flat Black (US19)	\$15.00
8"	8529	Polished Chrome (US26)	\$18.00
12"	8530		\$21.00

>> Supplied with 3 Types of Strike Plates and Screws.



Edge Pull



EDGE PULL	Product Code	Finish	List Price
4" x 3/4"	2221	Polished Brass (US3) French Antique (US7) Oil Rubbed Bronze (US10B) Polished Nickel (US14) Satin Nickel (US15) Pewter (US15A) Flat Black (US19) Polished Chrome (US26) Medium Bronze (MB) Satin Steel (SWS) Tumbled White Bronze (TWB)	\$12.00

DOOR ACCESSORIES



MODERN RECTANGULAR POCKET DOOR MORTISE LOCKS	Product Code	Finish	List Price
Keyed Pocket Door Mortise Lock*	2113	Polished Brass - Lifetime (US3) French Antique (US7)	\$186.00
Passage Pocket Door Mortise Lock	2114	Oil Rubbed Bronze (US10B) Polished Nickel - Lifetime (US14)	\$166.00
Privacy Pocket Door Mortise Lock	2115	Satin Nickel (US15) Pewter (US15A)	\$166.00
Dummy Pocket Door Mortise Lock	2116	Flat Black (US19) Polished Chrome (US26)	\$166.00

>> Must Specify Door Thickness for Keyed and Privacy Functions. Plates are 1/16" Thick.

**Keyed
Door Mortise Lock**

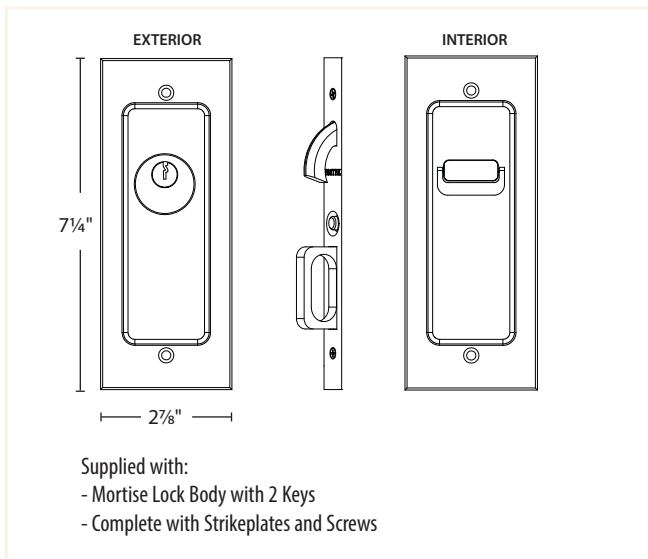

**Privacy
Door Mortise Lock**

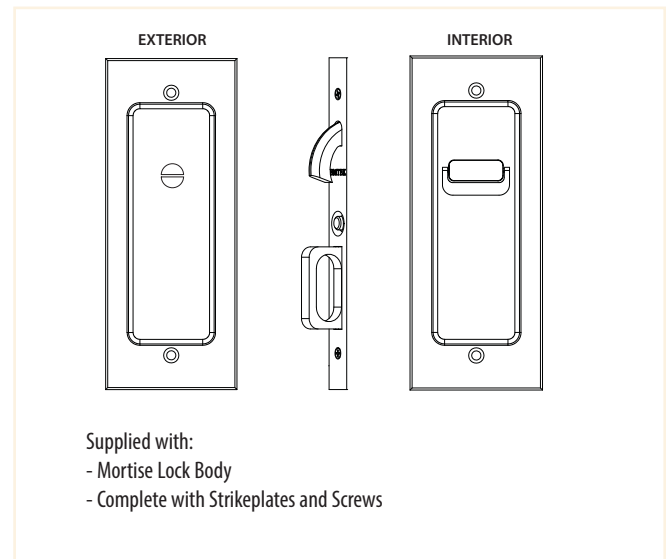

**Passage
Door Mortise Lock**

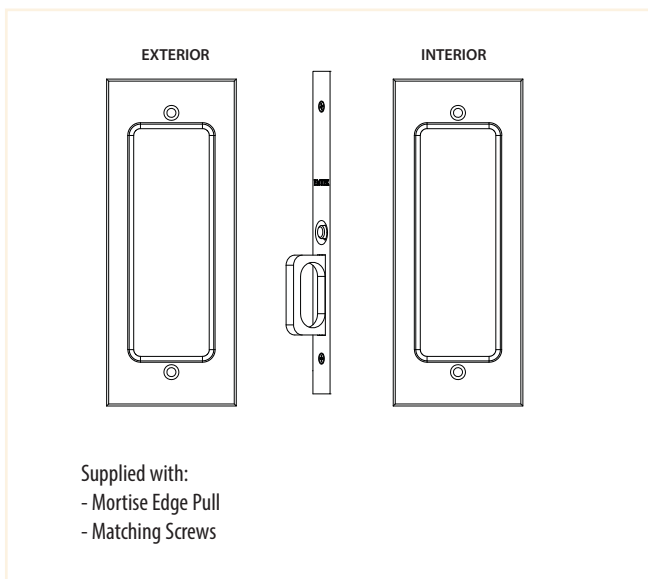

**Dummy
Door Mortise Lock**

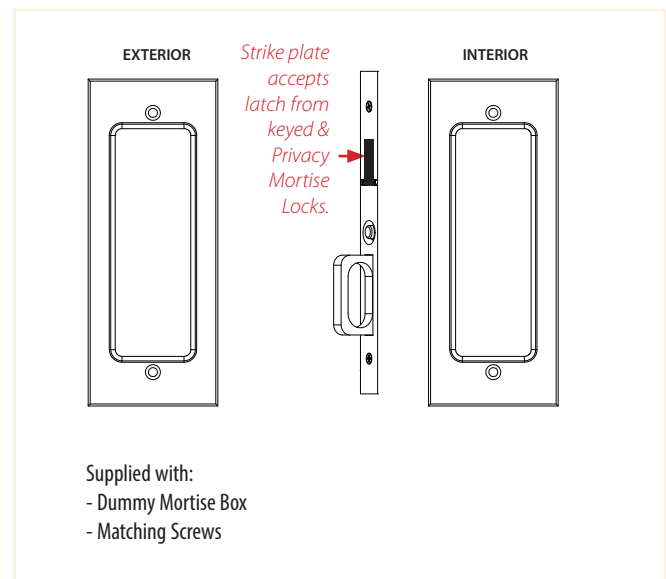

* Multiple Emtek pocket door mortise locks can be keyed alike with each other, but may not be keyed alike with any other Emtek products.



CLASSIC POCKET DOOR MORTISE LOCKS	Product Code	Finish	List Price
Keyed Pocket Door Mortise Lock*	2103	Polished Brass (US3) Oil Rubbed Bronze (US10B)	\$186.00
Passage Pocket Door Mortise Lock	2104	Satin Nickel (US15) Polished Chrome (US26)	\$166.00
Privacy Pocket Door Mortise Lock	2105	Medium Bronze (MB) Tumbled White Bronze (TWB)	\$166.00
Dummy Pocket Door Mortise Lock	2106		\$166.00

>> Must Specify Door Thickness for Keyed and Privacy Functions. Plates are 1/16" Thick.

Keyed
Door Mortise Lock

EXTERIOR

INTERIOR

Supplied with:

- Mortise Lock Body with 2 Keys
- Complete with Strikeplates and Screws

Privacy
Door Mortise Lock

EXTERIOR

INTERIOR

Supplied with:

- Mortise Lock Body
- Complete with Strikeplates and Screws

Passage
Door Mortise Lock

EXTERIOR

INTERIOR

Supplied with:

- Mortise Edge Pull
- Matching Screws

Dummy
Door Mortise Lock

EXTERIOR

INTERIOR

Strike plate accepts latch from keyed & Privacy Mortise Locks.

Supplied with:

- Dummy Mortise Box
- Matching Screws

* Multiple Emtek pocket door mortise locks can be keyed alike with each other, but may not be keyed alike with any other Emtek products.

DOOR ACCESSORIES

Kickdown Door Holders
4" and 5"

KICKDOWN DOOR HOLDERS	Product Code	Finish	List Price
4"	2264	Polished Brass (US3) French Antique (US7) Oil Rubbed Bronze (US10B)	\$20.00
5"	2265	Satin Nickel (US15) Pewter (US15A) Polished Chrome (US26)	\$22.00

3" Magnetic Door Stop
& Holder

MAGNETIC DOOR STOP & HOLDER	Product Code	Finish	List Price
3"	2256	Polished Brass (US3) French Antique (US7) Oil Rubbed Bronze (US10B) Satin Nickel (US15) Pewter (US15A) Polished Chrome (US26)	\$24.00

Extendable Baseboard
Door Bumper

EXTENDABLE BASEBOARD DOOR BUMPER	Product Code	Finish	List Price
4½"	2233	Oil Rubbed Bronze (US10B) Satin Nickel (US15) Flat Black (US19) Polished Chrome (US26)	\$16.00

>> Includes 3", 1", and ½" base with 2" screws.

Door Stops
3" and 4"

DOOR STOPS	Product Code	Finish	List Price
3"	2232	Polished Brass (US3) French Antique (US7) Oil Rubbed Bronze (US10B)	\$10.00
4"	2231	Polished Nickel (US14) Satin Nickel (US15) Pewter (US15A) Flat Black (US19) Polished Chrome (US26) Medium Bronze (MB) Satin Steel (SWS) Tumbled White Bronze (TWB)	\$12.00

Floor Door Bumper



FLOOR DOOR BUMPER	Product Code	Finish	List Price
1⅜" x 1¼"	2254	Polished Brass (US3) French Antique (US7) Oil Rubbed Bronze (US10B) Satin Nickel (US15) Pewter (US15A) Polished Chrome (US26)	\$10.00

Half Dome Door Stop



Goose Style Door Stop



DOOR STOPS	Product Code	Finish	List Price
Half Dome	2251	Polished Brass (US3) French Antique (US7) Oil Rubbed Bronze (US10B)	\$12.00
Goose Style	2253	Satin Nickel (US15) Pewter (US15A) Flat Black (US19) Polished Chrome (US26) Medium Bronze (MB) Satin Steel (SWS) Tumbled White Bronze (TWB)	\$22.00

Cylinder Floor Bumpers
1½" and 2"



CYLINDER FLOOR BUMPERS	Product Code	Finish	List Price
1½" Cylinder	2257	Oil Rubbed Bronze (US10B) Polished Nickel - Lifetime (US14) Satin Nickel (US15)	\$16.00
2" Cylinder	2258	Flat Black (US19) Polished Chrome (US26)	\$18.00

Cylinder Floor Bumpers
with Dome Cap
1½" and 2"



CYLINDER FLOOR BUMPERS WITH DOME CAP	Product Code	Finish	List Price
1½" Cylinder Dome Cap	2259	Oil Rubbed Bronze (US10B) Satin Nickel (US15) Flat Black (US19)	\$16.00
2" Cylinder Dome Cap	2260	Polished Chrome (US26)	\$18.00

Brass Wall Bumper
with Regular Rosette



Brass
Wall Bumper
with #8 Rosette



Brass
Wall Bumper
with Square Rosette



Wrought Steel
Wall Bumper
with #2 Rosette



Sandcast Bronze
Wall Bumper
with #2 Rosette



WALL BUMPERS	Product Code	Finish	List Price
Available for All Rosettes (See Page 4 and 5 for Rosette Styles)	2255	Polished Brass - Lifetime (US3) Satin Brass (US4) French Antique (US7) Oil Rubbed Bronze (US10B) Polished Nickel - Lifetime (US14) Satin Nickel (US15) Pewter (US15A) Flat Black (US19) Polished Chrome (US26) Flat Black Bronze (FB) Medium Bronze (MB) Tumbled White Bronze (TWB) Flat Black Steel (FBS) Satin Steel (SWS)	\$12.00

DOOR ACCESSORIES

Passage Function



Privacy Function

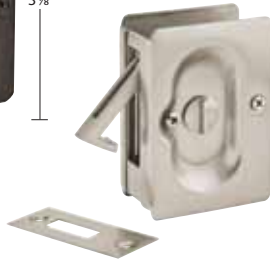

POCKET DOOR LOCKS	Product Code	Finish	List Price
Passage	2101	Polished Brass (US3) French Antique (US7) Oil Rubbed Bronze (US10B)	\$26.00
Privacy	2102	Polished Nickel (US14) Satin Nickel (US15) Pewter (US15A) Flat Black (US19) Polished Chrome (US26) Medium Bronze (MB) Satin Steel (SWS) Tumbled White Bronze (TWB)	\$34.00

>> Fits door thickness 1 3/8" to 1 3/4".

Rectangular Flush Pull



Round Flush Pull



FLUSH PULLS	Product Code	Finish	List Price
Rectangular	2201	Polished Brass (US3) French Antique (US7) Oil Rubbed Bronze (US10B)	\$14.00
Round	2211	Polished Nickel (US14) Satin Nickel (US15) Pewter (US15A) Flat Black (US19) Polished Chrome (US26) Medium Bronze (MB) Satin Steel (SWS) Tumbled White Bronze (TWB)	\$14.00

>> Installs into 2 3/8" hole.

Roller Catch



Ball Catch



DOOR CATCHES	Product Code	Finish	List Price
Roller Catch	8801	Polished Brass (US3) French Antique (US7) Oil Rubbed Bronze (US10B)	\$30.00
Ball Catch	8802	Polished Nickel (US14) Satin Nickel (US15) Pewter (US15A) Flat Black (US19) Polished Chrome (US26) Medium Bronze (MB) Tumbled White Bronze (TWB)	\$16.00

>> Supplied with Strike Plates and Screws.

Window Utility Pulls



WINDOW UTILITY PULLS	Product Code	Finish	List Price
4"	2244	Polished Brass (US3) French Antique (US7) Oil Rubbed Bronze (US10B)	\$8.00
6"	2246	Satin Nickel (US15) Pewter (US15A) Polished Chrome (US26)	\$24.00

Casement Latch
Standard Size

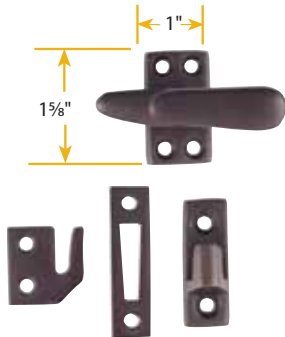

CASEMENT LATCHES	Product Code	Finish	List Price
Standard Size	8703	Polished Brass (US3) French Antique (US7) Oil Rubbed Bronze (US10B)	\$18.00
Large Size	8713	Satin Nickel (US15) Pewter (US15A) Flat Black (US19) Polished Chrome (US26)	\$28.00

Casement Latch
Large Size

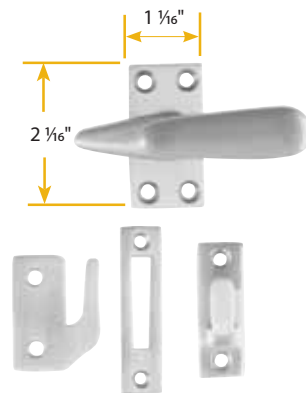

>> Supplied with 3 Types of Strike Plates and Screws.

Keyed Patio Door Bolts



Non-Keyed Patio
Door Bolts



PATIO DOOR BOLTS	Product Code	Finish	List Price
Keyed	206011	Silver	\$16.00
	206012	Bronze	\$16.00
	206016	White	\$16.00
	206017	Black	\$16.00
Non-Keyed	206511	Silver	\$12.00
	206512	Bronze	\$12.00
	206516	White	\$12.00

DOOR ACCESSORIES

**Solid Brass
with Arch Style**

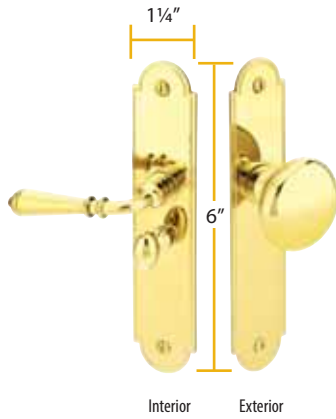

**Sandcast Bronze
with Arch Style**



SCREEN DOOR LOCKS - ARCH STYLE	Product Code	Handing	Finish	List Price
Solid Brass	2290	LH/RH	Polished Brass - Lifetime (US3) Oil Rubbed Bronze (US10B) Satin Nickel (US15) Flat Black (US19)	\$120.00
Sandcast Bronze	2290	LH/RH	Medium Bronze (MB) Tumbled White Bronze (TWB)	\$120.00

**Solid Brass
with Rectangular Style**



**Sandcast Bronze
with Rectangular Style**

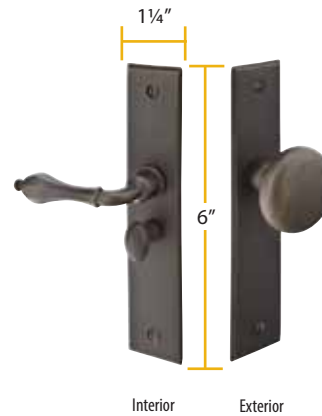

SCREEN DOOR LOCKS - RECTANGULAR STYLE	Product Code	Handing	Finish	List Price
Solid Brass	2291	LH/RH	Polished Brass - Lifetime (US3) Oil Rubbed Bronze (US10B) Satin Nickel (US15) Flat Black (US19)	\$120.00
Sandcast Bronze	2291	LH/RH	Medium Bronze (MB) Tumbled White Bronze (TWB)	\$120.00

Handing Required for Screen Door Locks. Not available in split finish.

Urn Style



Narrow Style



SOLID BRASS DOOR KNOCKERS	Product Code	Finish	List Price
Urn	2620	Polished Brass (US3) Oil Rubbed Bronze (US10B) Satin Nickel (US15) Flat Black (US19)	\$40.00
Narrow	2621	Polished Brass - Lifetime (US3) Oil Rubbed Bronze (US10B) Satin Nickel (US15) Flat Black (US19)	\$40.00

>> We recommend that Polished Brass (US3) finish be selected for those who intend to have the door knocker engraved. Emtex does not offer engraving services at this time.

Bronze Door Knocker 3"



Bronze Door Knocker 4"



BRONZE DOOR KNOCKERS	Product Code	Finish	List Price
3" with Ring Pull	86059	Flat Black Bronze (FB) Medium Bronze (MB) Tumbled White Bronze (TWB)	\$44.00
4" with Ring Pull	86060		\$52.00

Solid Brass Mail Slot



SOLID BRASS MAIL SLOT	Product Code	Finish	List Price
3 3/8" x 13 1/16"	2280	Polished Brass - Lifetime (US3) Oil Rubbed Bronze (US10B) Satin Nickel (US15)	\$78.00

>> Complete set includes both exterior & interior trims and wood screws. Not available in split finish.

Solid Brass Door Viewer



SOLID BRASS DOOR VIEWER	Product Code	Finish	List Price
Hole Diameter 5/8"	2610	Polished Brass - Lifetime (US3) Oil Rubbed Bronze (US10B) Satin Nickel (US15)	\$16.00

>> 200 Degree wide viewing angle. Fits door thickness from 1 3/8" to 2". Not available in split finish.

DOOR ACCESSORIES - BRASS HOUSE NUMBERS

Brass House Numbers
4"



Brass House Numbers
5½"



4" BRASS HOUSE NUMBERS	Product Code	Finish	List Price
House Number Digit '0'	2810	Oil Rubbed Bronze (US10B) Satin Nickel (US15)	\$10.00
House Number Digit '1'	2811		\$10.00
House Number Digit '2'	2812		\$10.00
House Number Digit '3'	2813		\$10.00
House Number Digit '4'	2814		\$10.00
House Number Digit '5'	2815		\$10.00
House Number Digit '6'	2816		\$10.00
House Number Digit '7'	2817		\$10.00
House Number Digit '8'	2818		\$10.00
House Number Digit '9'	2819		\$10.00

5½" BRASS HOUSE NUMBERS	Product Code	Finish	List Price
House Number Digit '0'	2820	Oil Rubbed Bronze (US10B) Satin Nickel (US15)	\$14.00
House Number Digit '1'	2821		\$14.00
House Number Digit '2'	2822		\$14.00
House Number Digit '3'	2823		\$14.00
House Number Digit '4'	2824		\$14.00
House Number Digit '5'	2825		\$14.00
House Number Digit '6'	2826		\$14.00
House Number Digit '7'	2827		\$14.00
House Number Digit '8'	2828		\$14.00
House Number Digit '9'	2829		\$14.00

Bronze House Numbers
4"



Bronze House Numbers
6"



4" BRONZE HOUSE NUMBERS	Product Code	Finish	List Price
House Number Digit '0'	2810	Flat Black Bronze (FB) Medium Bronze (MB) Tumbled White Bronze (TWB)	\$14.00
House Number Digit '1'	2811		\$14.00
House Number Digit '2'	2812		\$14.00
House Number Digit '3'	2813		\$14.00
House Number Digit '4'	2814		\$14.00
House Number Digit '5'	2815		\$14.00
House Number Digit '6'	2816		\$14.00
House Number Digit '7'	2817		\$14.00
House Number Digit '8'	2818		\$14.00
House Number Digit '9'	2819		\$14.00

6" BRONZE HOUSE NUMBERS	Product Code	Finish	List Price
House Number Digit '0'	2820	Flat Black Bronze (FB) Medium Bronze (MB) Tumbled White Bronze (TWB)	\$20.00
House Number Digit '1'	2821		\$20.00
House Number Digit '2'	2822		\$20.00
House Number Digit '3'	2823		\$20.00
House Number Digit '4'	2824		\$20.00
House Number Digit '5'	2825		\$20.00
House Number Digit '6'	2826		\$20.00
House Number Digit '7'	2827		\$20.00
House Number Digit '8'	2828		\$20.00
House Number Digit '9'	2829		\$20.00

DOOR ACCESSORIES - DOORBELLS



BRASS DOORBELL WITH PLATE & BUTTON		Product Code	Finish	List Price
Doorbell Button with Regular Rosette	2400	Polished Brass - Lifetime (US3) French Antique (US7) Oil Rubbed Bronze (US10B)	\$32.00	
Doorbell Button with Oval Rosette	2402	Polished Nickel - Lifetime (US14)* Satin Nickel (US15) Pewter (US15A)		
Doorbell Button with Rectangular Rosette	2403	Flat Black (US19) Polished Chrome (US26)		
Doorbell Button with #8 Rosette	2408			
Doorbell Button with Quincy Rosette	2409			
Doorbell Button with Wilshire Rosette	2404			
Doorbell Button with Rope Rosette	2401	Polished Brass - Lifetime (US3) French Antique (US7) Oil Rubbed Bronze (US10B)		
Doorbell Button with Lancaster Rosette	2406	Satin Nickel (US15) Pewter (US15A) Polished Chrome (US26)		
Doorbell Button with Ribbon & Reed Rosette	2407			
Doorbell Button with Arts & Crafts Rosette	2451	Oil Rubbed Bronze (US10B) Satin Nickel (US15) Flat Black (US19)		
Doorbell Button with Hammered Rosette	2452		\$32.00	
Doorbell Button with Modern Rosette	2457	Oil Rubbed Bronze (US10B) Polished Nickel - Lifetime (US14)* Satin Nickel (US15)	\$32.00	
Doorbell Button with Disk Rosette	2458	Flat Black (US19) Polished Chrome (US26)		
Doorbell Button with Square Rosette	2459			
Doorbell Button with Neos Rosette	2460		\$32.00	
Doorbell Button with Modern Rectangular Rosette	2463		\$32.00	

* Polished Nickel - Lifetime (US14) **NOT** available for Oval, Quincy, Modern, and Neos Rosettes.



SMALL DOORBELL WITH PLATE & BUTTON	Product Code	Finish	List Price
Doorbell Button with Small #1 Rosette	2461	Polished Brass - Lifetime (US3) French Antique (US7) Oil Rubbed Bronze (US10B)	\$32.00
Doorbell Button with Small Oval Rosette	2462	Satin Nickel (US15) Pewter (US15A) Flat Black (US19)	\$32.00
Doorbell Button with Small Rectangular Rosette	2464	Polished Chrome (US26) Medium Bronze (MB) Satin Steel (SWS) Tumbled White Bronze (TWB)	\$32.00

SANDCAST BRONZE DOORBELL WITH PLATE & BUTTON	Product Code	Finish	List Price
Doorbell Button with #1 Rosette	2421	Flat Black Bronze (FB) Medium Bronze (MB) Tumbled White Bronze (TWB)	\$34.00
Doorbell Button with #2 Rosette	2422		\$34.00
Doorbell Button with #3 Rosette	2423		\$34.00
Doorbell Button with #4 Rosette	2424		\$34.00
Doorbell Button with #6 Rosette	2425		\$34.00

TUSCANY BRONZE DOORBELL WITH PLATE & BUTTON	Product Code	Finish	List Price
Doorbell Button with #11 Rosette	2411	Flat Black Bronze (FB) Medium Bronze (MB)	\$34.00
Doorbell Button with #12 Rosette	2412		\$34.00
Doorbell Button with #14 Rosette	2414		\$34.00
Doorbell Button with #15 Rosette	2415		\$34.00

WROUGHT STEEL DOORBELL WITH PLATE & BUTTON	Product Code	Finish	List Price
Doorbell Button with #1 Rosette	2431	Flat Black Steel (FBS) Satin Steel (SWS)	\$32.00
Doorbell Button with #2 Rosette	2432		\$32.00
Doorbell Button with #3 Rosette	2433		\$32.00

DOOR ACCESSORIES - FORGED BRASS SWITCH PLATES



FORGED BRASS SWITCH PLATES	Product Code	Finish	List Price
Toggle 1, Colonial Switch Plate	29111	Polished Brass - Lifetime (US3)	\$16.00
Toggle 2, Colonial Switch Plate	29112	Oil Rubbed Bronze (US10B)	\$22.00
Toggle 3, Colonial Switch Plate	29113	Satin Nickel (US15)	\$28.00
Toggle 4, Colonial Switch Plate	29114	Flat Black (US19)	\$28.00
		Medium Bronze (MB)	\$38.00
		Tumbled White Bronze (TWB)	



FORGED BRASS SWITCH PLATES	Product Code	Finish	List Price
Rocker 1, Colonial Switch Plate	29121	Polished Brass - Lifetime (US3)	\$16.00
Rocker 2, Colonial Switch Plate	29122	Oil Rubbed Bronze (US10B)	\$22.00
Rocker 3, Colonial Switch Plate	29123	Satin Nickel (US15)	\$28.00
Rocker 4, Colonial Switch Plate	29124	Flat Black (US19)	\$28.00
		Medium Bronze (MB)	\$38.00
		Tumbled White Bronze (TWB)	

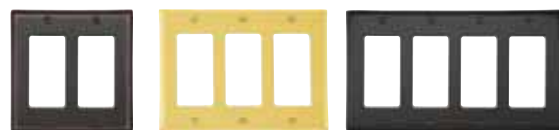

FORGED BRASS SWITCH PLATES	Product Code	Finish	List Price
Duplex 1, Colonial Switch Plate	29131	Polished Brass - Lifetime (US3)	\$16.00
Duplex 2, Colonial Switch Plate	29132	Oil Rubbed Bronze (US10B)	\$22.00
		Satin Nickel (US15)	\$22.00
		Flat Black (US19)	
		Medium Bronze (MB)	
		Tumbled White Bronze (TWB)	



FORGED BRASS SWITCH PLATES	Product Code	Finish	List Price
Toggle 1, Duplex 1 Colonial Switch Plate	29141	Polished Brass - Lifetime (US3)	\$22.00
Toggle 2, Duplex 1 Colonial Switch Plate	29142	Oil Rubbed Bronze (US10B)	\$28.00
Rocker 1, Duplex 1 Colonial Switch Plate	29143	Satin Nickel (US15)	\$28.00
		Flat Black (US19)	
		Medium Bronze (MB)	\$22.00
		Tumbled White Bronze (TWB)	



FORGED BRASS SWITCH PLATES	Product Code	Finish	List Price
Colonial Blank Plate	29151	Polished Brass - Lifetime (US3)	\$16.00
Colonial Cable Plate	29161	Oil Rubbed Bronze (US10B)	\$16.00
		Satin Nickel (US15)	
		Flat Black (US19)	
		Medium Bronze (MB)	
		Tumbled White Bronze (TWB)	



FORGED BRASS SWITCH PLATES	Product Code	Finish	List Price
Toggle 1, Rope Switch Plate	29211	Polished Brass - Lifetime (US3)	\$16.00
Toggle 2, Rope Switch Plate	29212	Oil Rubbed Bronze (US10B)	\$22.00
Toggle 3, Rope Switch Plate	29213	Satin Nickel (US15)	\$28.00
Toggle 4, Rope Switch Plate	29214		\$38.00



FORGED BRASS SWITCH PLATES	Product Code	Finish	List Price
Rocker 1, Rope Switch Plate	29221	Polished Brass - Lifetime (US3)	\$16.00
Rocker 2, Rope Switch Plate	29222	Oil Rubbed Bronze (US10B)	\$22.00
Rocker 3, Rope Switch Plate	29223	Satin Nickel (US15)	\$28.00
Rocker 4, Rope Switch Plate	29224		\$38.00

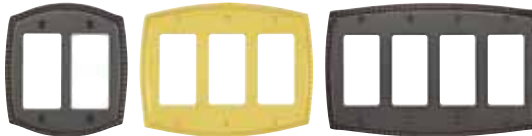

FORGED BRASS SWITCH PLATES	Product Code	Finish	List Price
Duplex 1, Rope Switch Plate	29231	Polished Brass - Lifetime (US3)	\$16.00
Duplex 2, Rope Switch Plate	29232	Oil Rubbed Bronze (US10B) Satin Nickel (US15)	\$22.00



FORGED BRASS SWITCH PLATES	Product Code	Finish	List Price
Toggle 1, Duplex 1 Rope Switch Plate	29241	Polished Brass - Lifetime (US3)	\$22.00
Toggle 2, Duplex 1 Rope Switch Plate	29242	Oil Rubbed Bronze (US10B) Satin Nickel (US15)	\$28.00
Rocker 1, Duplex 1 Rope Switch Plate	29243		\$22.00



FORGED BRASS SWITCH PLATES	Product Code	Finish	List Price
Rope Blank Plate	29251	Polished Brass - Lifetime (US3)	\$16.00
Rope Cable Plate	29261	Oil Rubbed Bronze (US10B) Satin Nickel (US15)	\$16.00

SOLID BRASS HINGES - HEAVY DUTY, SQUARE BARREL

3 1/2" x 3 1/2" Heavy Duty Square Barrel



4 1/2" x 4 1/2" Heavy Duty Square Barrel



4" x 4" Heavy Duty Square Barrel



SQUARE BARREL HEAVY DUTY HINGES Solid Extruded Brass, Thickness: 0.180"		Product Code	Finish	Hinges Per Case	List Price (Per Pair) Broken Case	List Price (Per Pair) 1 or More Cases
3 1/2" x 3 1/2"	96513	Polished Brass - Lifetime (US3) Satin Brass (US4) French Antique (US7)	24 (Pair)	\$48.00	\$44.00	
4" x 4"	96514	Oil Rubbed Bronze (US10B) Polished Nickel (US14) Satin Nickel (US15)				
4 1/2" x 4 1/2"	96515	Pewter (US15A) Flat Black (US19) Polished Chrome (US26)	24 (Pair)	\$60.00	\$56.00	

>> Decorative Tips are NOT available for Square Barrel Heavy Duty Hinges.

3 1/2" x 3 1/2" Residential Duty
Square Corners



3 1/2" x 3 1/2" Residential Duty
1/4" Radius Corners



3 1/2" x 3 1/2" Residential Duty
5/8" Radius Corners



RESIDENTIAL DUTY HINGES - SOLID BRASS Plain Bearing, Thickness: 0.096" - 0.098"		Product Code	Finish	Hinges Per Case	List Price (Per Pair) Broken Case	List Price (Per Pair) 1 or More Cases
3 1/2" x 3 1/2" with Square Corners	96113	Polished Brass - Lifetime (US3) Satin Brass (US4) French Antique (US7) Oil Rubbed Bronze (US10B) Polished Nickel (US14) Satin Nickel (US15) Pewter (US15A) Flat Black (US19) Polished Chrome (US26)		50 (Pair)	\$30.00	\$25.00
4" x 4" with Square Corners	96114			50 (Pair)	\$33.00	\$28.00
3 1/2" x 3 1/2" with 1/4" Radius Corners	96123			50 (Pair)	\$30.00	\$25.00
4" x 4" with 1/4" Radius Corners	96124			50 (Pair)	\$33.00	\$28.00
3 1/2" x 3 1/2" with 5/8" Radius Corners	96133			50 (Pair)	\$30.00	\$25.00
4" x 4" with 5/8" Radius Corners	96134			50 (Pair)	\$33.00	\$28.00

>> See pages 150-151 for Decorative Tip Sets for Solid Brass Hinges.

SOLID BRASS HINGES - HEAVY DUTY, PLAIN BEARING

4 ½" x 4 ½" Heavy Duty
Square Corners3 ½" x 3 ½" Heavy Duty
¼" Radius Corners4" x 4" Heavy Duty
⅝" Radius Corners

HEAVY DUTY HINGES - SOLID BRASS Plain Bearing, Thickness: 0.130" - 0.132"	Product Code	Finish	Hinges Per Case	List Price (Per Pair) Broken Case	List Price (Per Pair) 1 or More Cases
3 ½" x 3 ½" with Square Corners	96213	Polished Brass - Lifetime (US3) Satin Brass (US4) French Antique (US7)	24 (Pair)	\$36.00	\$32.00
4" x 4" with Square Corners	96214	Oil Rubbed Bronze (US10B) Polished Nickel (US14) Satin Nickel (US15)	24 (Pair)	\$42.00	\$38.00
4 ½" x 4 ½" with Square Corners	96215	Pewter (US15A) Flat Black (US19) Polished Chrome (US26)	24 (Pair)	\$48.00	\$44.00
3 ½" x 3 ½" with ¼" Radius Corners	96223		24 (Pair)	\$36.00	\$32.00
4" x 4" with ¼" Radius Corners	96224		24 (Pair)	\$42.00	\$38.00
4 ½" x 4 ½" with ¼" Radius Corners	96225		24 (Pair)	\$48.00	\$44.00
3 ½" x 3 ½" with ⅝" Radius Corners	96233		24 (Pair)	\$36.00	\$32.00
4" x 4" with ⅝" Radius Corners	96234		24 (Pair)	\$42.00	\$38.00

>> See pages 150-151 for Decorative Tip Sets for Solid Brass Hinges.

**3 ½" x 3 ½" Heavy Duty
Square Corners**

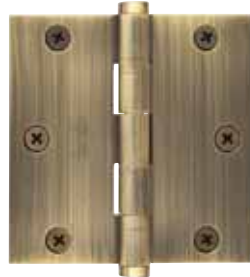

**4 ½" x 4 ½" Heavy Duty
¼" Radius Corners**



HEAVY DUTY HINGES - SOLID BRASS Ball Bearing, Thickness: 0.122" - 0.134"		Product Code	Finish	Hinges Per Case	List Price (Per Pair) Broken Case	List Price (Per Pair) 1 or More Cases
3 ½" x 3 ½" with Square Corners	96413	Polished Brass - Lifetime (US3) Satin Brass (US4) French Antique (US7)	24 (Pair)	\$40.00	\$36.00	
4" x 4" with Square Corners	96414	Oil Rubbed Bronze (US10B) Polished Nickel (US14) Satin Nickel (US15)	24 (Pair)	\$46.00	\$42.00	
4 ½" x 4 ½" with Square Corners	96415	Pewter (US15A) Flat Black (US19) Polished Chrome (US26)	24 (Pair)	\$52.00	\$48.00	
5" x 5" with Square Corners	96416		24 (Pair)	\$58.00	\$54.00	
4 ½" x 4 ½" with ¼" Radius Corners	96425		24 (Pair)	\$52.00	\$48.00	

>> See pages 150-151 for Decorative Tip Sets for Solid Brass Hinges.

DECORATIVE TIPS FOR SOLID BRASS HINGES

Ball Tip
for 3 1/2" Hinges



Ball Tip
for 4" Hinges



BALL TIP SETS 4 tips per set	Product Code	Finish	List Price
for 3 1/2" x 3 1/2" Residential Duty Hinges	97203	Polished Brass - Lifetime (US3) Satin Brass (US4) French Antique (US7) Oil Rubbed Bronze (US10B)	\$14.00
for 4" x 4" Residential Duty Hinges	97204	Polished Nickel (US14) Satin Nickel (US15) Pewter (US15A) Flat Black (US19) Polished Chrome (US26)	\$14.00
for 3 1/2" x 3 1/2" Heavy Duty Plain or Ball Bearing Hinges	97303		\$14.00
for 4" x 4" Heavy Duty Plain or Ball Bearing Hinges	97304		\$14.00
for 4 1/2" x 4 1/2" or 5" x 5" Heavy Duty Plain or Ball Bearing Hinges	97305		\$14.00

Steeple Tip
for 3 1/2" Hinges



Steeple Tip
for 4" Hinges



STEEPLE TIP SETS 4 tips per set	Product Code	Finish	List Price
for 3 1/2" x 3 1/2" Residential Duty Hinges	97213	Polished Brass - Lifetime (US3) Satin Brass (US4) French Antique (US7) Oil Rubbed Bronze (US10B)	\$14.00
for 4" x 4" Residential Duty Hinges	97214	Polished Nickel (US14) Satin Nickel (US15) Pewter (US15A) Flat Black (US19) Polished Chrome (US26)	\$14.00
for 3 1/2" x 3 1/2" Heavy Duty Plain or Ball Bearing Hinges	97313		\$14.00
for 4" x 4" Heavy Duty Plain or Ball Bearing Hinges	97314		\$14.00
for 4 1/2" x 4 1/2" or 5" x 5" Heavy Duty Plain or Ball Bearing Hinges	97315		\$14.00

Button Tip
for 3 1/2" Hinges



Button Tip
for 4" Hinges



BUTTON TIP SETS 4 tips per set		Product Code	Finish	List Price
for 3 1/2" x 3 1/2" Residential Duty Hinges	97223	Polished Brass - Lifetime (US3) Satin Brass (US4) French Antique (US7) Oil Rubbed Bronze (US10B)	\$14.00	
for 4" x 4" Residential Duty Hinges	97224	Polished Nickel (US14) Satin Nickel (US15) Pewter (US15A) Flat Black (US19) Polished Chrome (US26)		
for 3 1/2" x 3 1/2" Heavy Duty Plain or Ball Bearing Hinges	97323			
for 4" x 4" Heavy Duty Plain or Ball Bearing Hinges	97324			
for 4 1/2" x 4 1/2" or 5" x 5" Heavy Duty Plain or Ball Bearing Hinges	97325			

Extended
Button Tip



EXTENDED BUTTON TIP		
Product Code	Finish	List Price
2242	Polished Brass (US3) Satin Brass (US4) French Antique (US7) Oil Rubbed Bronze (US10B) Polished Nickel (US14) Satin Nickel (US15) Pewter (US15A) Flat Black (US19) Polished Chrome (US26)	\$4.00 ea

>> Used with Hinge Pivot Stop on Solid Brass Hinge.

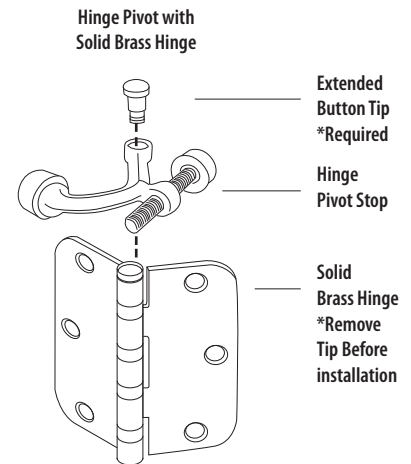

Hinges
Pivot Stop



HINGES PIVOT STOP		
Product Code	Finish	List Price
2241	Polished Brass (US3) Satin Brass (US4) French Antique (US7) Oil Rubbed Bronze (US10B) Polished Nickel (US14) Satin Nickel (US15) Pewter (US15A) Flat Black (US19) Polished Chrome (US26) Medium Bronze (MB) Tumbled White Bronze (TWB)	\$8.00

>> Required Extended Button Tip when used with Solid Brass Hinges.
Not compatible with Steel Residential Duty Hinges.

STEEL HINGES - RESIDENTIAL DUTY, PLAIN BEARING

4" x 4" Residential Duty
Square Corners3 1/2" x 3 1/2" Residential Duty
1/4" Radius Corners4" x 4" Residential Duty
5/8" Radius Corners

RESIDENTIAL DUTY HINGES - STEEL Plain Bearing, Thickness: 0.084" - 0.090"	Product Code	Finish	Hinges Per Case	List Price (Per Pair) Broken Case	List Price (Per Pair) 1 or More Cases
3 1/2" x 3 1/2" with Square Corners*	91013	Polished Brass (US3) French Antique (US7) Oil Rubbed Bronze (US10B)	24 (Pair)	\$9.50	\$8.50
4" x 4" with Square Corners**	91014	Polished Nickel (US14) Satin Nickel (US15) Pewter (US15A)	24 (Pair)	\$11.00	\$9.00
3 1/2" x 3 1/2" with 1/4" Radius Corners*	91023	Flat Black (US19) Polished Chrome (US26) Satin Chrome (US26D)	24 (Pair)	\$9.50	\$8.50
4" x 4" with 1/4" Radius Corners**	91024	Medium Bronze (MB) Tumbled White Bronze (TWB)	24 (Pair)	\$11.00	\$9.00
3 1/2" x 3 1/2" with 5/8" Radius Corners*	91033		24 (Pair)	\$9.50	\$8.50
4" x 4" with 5/8" Radius Corners**	91034		24 (Pair)	\$11.00	\$9.00

>> Decorative Tips are NOT available for Residential Duty, Plain Bearing Steel Hinges.

* 3 1/2" x 3 1/2" Hinges have 6 screwholes per hinge in an "Arc" pattern.

** 4" x 4" Hinges have 8 screwholes per hinge in a "Zig-Zag" pattern.

4 1/2" x 4 1/2" Heavy Duty
Square Corners



4" x 4" Heavy Duty
1/4" Radius Corners



3 1/2" x 3 1/2" Heavy Duty
5/8" Radius Corners



HEAVY DUTY HINGES - STEEL Plain Bearing, Thickness: 0.118" - 0.126"	Product Code	Finish	Hinges Per Case	List Price (Per Pair) Broken Case	List Price (Per Pair) 1 or More Cases
3 1/2" x 3 1/2" with Square Corners	92013	Polished Brass (US3) French Antique (US7) Oil Rubbed Bronze (US10B)	24 (Pair)	\$14.00	\$12.00
4" x 4" with Square Corners	92014	Polished Nickel (US14) Satin Nickel (US15) Pewter (US15A)	24 (Pair)	\$16.00	\$14.00
4 1/2" x 4 1/2" with Square Corners	92015	Flat Black (US19) Polished Chrome (US26) Satin Chrome (US26D)	24 (Pair)	\$18.00	\$16.00
3 1/2" x 3 1/2" with 1/4" Radius Corners	92023	Medium Bronze (MB) Tumbled White Bronze (TWB)	24 (Pair)	\$14.00	\$12.00
4" x 4" with 1/4" Radius Corners	92024		24 (Pair)	\$16.00	\$14.00
4 1/2" x 4 1/2" with 1/4" Radius Corners	92025		24 (Pair)	\$18.00	\$16.00
3 1/2" x 3 1/2" with 5/8" Radius Corners	92033		24 (Pair)	\$14.00	\$12.00
4" x 4" with 5/8" Radius Corners	92034		24 (Pair)	\$16.00	\$14.00

>> See page 155 for Decorative Tip Sets for Steel Hinges.

STEEL HINGES - HEAVY DUTY, BALL BEARING

3 1/2" x 3 1/2" Heavy Duty
Square Corners3 1/2" x 3 1/2" Heavy Duty
1/4" Radius Corners4" x 4" Heavy Duty
5/8" Radius Corners

HEAVY DUTY HINGES - STEEL Ball Bearing, Thickness: 0.118" - 0.126"	Product Code	Finish	Hinges Per Case	List Price (Per Pair) Broken Case	List Price (Per Pair) 1 or More Cases
3 1/2" x 3 1/2" with Square Corners	94013	Polished Brass (US3) French Antique (US7) Oil Rubbed Bronze (US10B)	24 (Pair)	\$22.00	\$20.00
4" x 4" with Square Corners	94014	Polished Nickel (US14) Satin Nickel (US15) Pewter (US15A)	24 (Pair)	\$24.00	\$22.00
4 1/2" x 4 1/2" with Square Corners	94015	Flat Black (US19) Polished Chrome (US26) Satin Chrome (US26D)	24 (Pair)	\$26.00	\$24.00
3 1/2" x 3 1/2" with 1/4" Radius Corners	94023	Medium Bronze (MB) Tumbled White Bronze (TWB)	24 (Pair)	\$22.00	\$20.00
4" x 4" with 1/4" Radius Corners	94024		24 (Pair)	\$24.00	\$22.00
4 1/2" x 4 1/2" with 1/4" Radius Corners	94025		24 (Pair)	\$26.00	\$24.00
3 1/2" x 3 1/2" with 5/8" Radius Corners	94033		24 (Pair)	\$22.00	\$20.00
4" x 4" with 5/8" Radius Corners	94034		24 (Pair)	\$24.00	\$22.00

>> See page 155 for Decorative Tip Sets for Steel Hinges.

Ball Tip



BALL TIP SETS 2 pins and 4 tips per set	Product Code	Finish	List Price
3 1/2"	94103	Polished Brass (US3) French Antique (US7) Oil Rubbed Bronze (US10B)	\$12.00
4"	94104	Polished Nickel (US14) Satin Nickel (US15) Pewter (US15A) Flat Black (US19)	\$12.00
4 1/2"	94105	Polished Chrome (US26) Satin Chrome (US26D) Medium Bronze (MB) Tumbled White Bronze (TWB)	\$12.00

>> Tip sets cannot be used with Hinge Pivot Stop. Not compatible with Residential Duty Hinges.

Steeple Tip



STEEPLE TIP SETS 2 pins and 4 tips per set	Product Code	Finish	List Price
3 1/2"	94113	Polished Brass (US3) French Antique (US7) Oil Rubbed Bronze (US10B)	\$12.00
4"	94114	Polished Nickel (US14) Satin Nickel (US15) Pewter (US15A) Flat Black (US19)	\$12.00
4 1/2"	94115	Polished Chrome (US26) Satin Chrome (US26D) Medium Bronze (MB) Tumbled White Bronze (TWB)	\$12.00

>> Tip sets cannot be used with Hinge Pivot Stop. Not compatible with Residential Duty Hinges.

STAINLESS STEEL HINGES - RESIDENTIAL DUTY, PLAIN BEARING

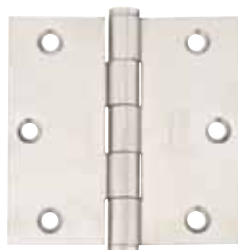
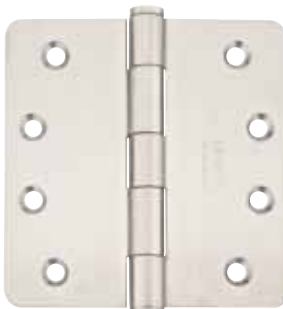
3 1/2" x 3 1/2" Residential Duty
Square Corners4" x 4" Residential Duty
1/4" Radius Corners4" x 4" Residential Duty
5/8" Radius Corners

RESIDENTIAL DUTY HINGES - STAINLESS STEEL Plain Bearing, 304 Grade, Thickness: 0.093" - 0.096"	Product Code	Finish	Hinges Per Case	List Price (Per Pair) Broken Case	List Price (Per Pair) 1 or More Cases
3 1/2" x 3 1/2" with Square Corners	9811332D	Brushed Stainless Steel (SS)	50 (Pair)	\$20.00	\$18.00
4" x 4" with Square Corners	9811432D		50 (Pair)	\$24.00	\$22.00
3 1/2" x 3 1/2" with 1/4" Radius Corners	9812332D		50 (Pair)	\$20.00	\$18.00
4" x 4" with 1/4" Radius Corners	9812432D		50 (Pair)	\$24.00	\$22.00
3 1/2" x 3 1/2" with 5/8" Radius Corners	9813332D		50 (Pair)	\$20.00	\$18.00
4" x 4" with 5/8" Radius Corners	9813432D		50 (Pair)	\$24.00	\$22.00

>> Decorative Tips are NOT available for Stainless Steel Hinges.

3 1/2" x 3 1/2" Heavy Duty
Square Corners



4" x 4" Heavy Duty
1/4" Radius Corners



4" x 4" Heavy Duty
5/8" Radius Corners



HEAVY DUTY HINGES - STAINLESS STEEL Plain Bearing, 304 Grade, Thickness: 0.113" - 0.135"		Product Code	Finish	Hinges Per Case	List Price (Per Pair) Broken Case	List Price (Per Pair) 1 or More Cases
3 1/2" x 3 1/2" with Square Corners	9821332D	Brushed Stainless Steel (SS)	24 (Pair)	\$22.00	\$20.00	
4" x 4" with Square Corners	9821432D			\$28.00	\$26.00	
4 1/2" x 4 1/2" with Square Corners	9821532D			\$34.00	\$32.00	
3 1/2" x 3 1/2" with 1/4" Radius Corners	9822332D			\$22.00	\$20.00	
4" x 4" with 1/4" Radius Corners	9822432D			\$28.00	\$26.00	
3 1/2" x 3 1/2" with 5/8" Radius Corners	9823332D			\$22.00	\$20.00	
4" x 4" with 5/8" Radius Corners	9823432D			\$28.00	\$26.00	

>> Decorative Tips are NOT available for Stainless Steel Hinges.

STAINLESS STEEL HINGES - HEAVY DUTY, BALL BEARING

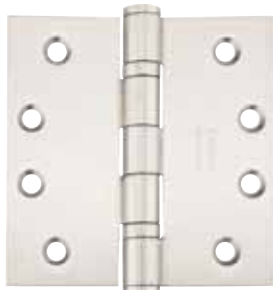
4" x 4" Heavy Duty
Square Corners4" x 4" Heavy Duty
1/4" Radius Corners3 1/2" x 3 1/2" Heavy Duty
5/8" Radius Corners

HEAVY DUTY HINGES - STAINLESS STEEL Ball Bearing, 304 Grade, Thickness: 0.113" - 0.132"		Product Code	Finish	Hinges Per Case	List Price (Per Pair) Broken Case	List Price (Per Pair) 1 or More Cases
3 1/2" x 3 1/2" with Square Corners	9841332D	Brushed Stainless Steel (SS)	24 (Pair)	\$24.00	\$22.00	
4" x 4" with Square Corners	9841432D			\$32.00	\$30.00	
4 1/2" x 4 1/2" with Square Corners	9841532D			\$38.00	\$36.00	
3 1/2" x 3 1/2" with 1/4" Radius Corners	9842332D			\$24.00	\$22.00	
4" x 4" with 1/4" Radius Corners	9842432D			\$32.00	\$30.00	
3 1/2" x 3 1/2" with 5/8" Radius Corners	9843332D			\$24.00	\$22.00	
4" x 4" with 5/8" Radius Corners	9843432D			\$32.00	\$30.00	

>> Decorative Tips are NOT available for Stainless Steel Hinges.

3 1/2" x 3 1/2" Spring Hinge
1/4" Radius Corners



4" x 4" Spring Hinge
Square Corners



4" x 4" Spring Hinge
5/8" Radius Corners



SPRING HINGES, UL LISTED Plated Steel, Thickness: 0.110"	Product Code	Finish	Hinges Per Case	List Price (Per Pair) Broken Case	List Price (Per Pair) 1 or More Cases
3 1/2" x 3 1/2" with Square Corners	95013	Polished Brass (US3) French Antique (US7) Oil Rubbed Bronze (US10B)	24 (Pair)	\$24.00	\$22.00
4" x 4" with Square Corners	95014	Polished Nickel (US14) Satin Nickel (US15) Pewter (US15A)	24 (Pair)	\$26.00	\$24.00
3 1/2" x 3 1/2" with 1/4" Radius Corners	95023	Flat Black (US19) Polished Chrome (US26) Satin Chrome (US26D)	24 (Pair)	\$24.00	\$22.00
4" x 4" with 1/4" Radius Corners	95024	Medium Bronze (MB) Tumbled White Bronze (TWB)	24 (Pair)	\$26.00	\$24.00
3 1/2" x 3 1/2" with 5/8" Radius Corners	95033		24 (Pair)	\$24.00	\$22.00
4" x 4" with 5/8" Radius Corners	95034		24 (Pair)	\$26.00	\$24.00

LATCHES

Adjustable Latch



ADJUSTABLE LATCHES	Finish	List Price
Fit Both 2 ³ / ₈ " & 2 ³ / ₄ " backsets	Polished Brass (US3) French Antique (US7) Oil Rubbed Bronze (US10B) Polished Nickel (US14) Satin Nickel (US15) Pewter (US15A) Flat Black (US19) Polished Chrome (US26) Medium Bronze (MB) Tumbled White Bronze (TWB)	\$8.00

Drive-in Latch



DRIVE-IN LATCHES		List Price
Passage Latch, 2 ³ / ₈ " backset	Please specify Brass or Chrome nose bolt.	\$8.00
Privacy Latch, 2 ³ / ₈ " backset		\$8.00
Passage Latch, 2 ³ / ₄ " backset		\$8.00
Privacy Latch, 2 ³ / ₄ " backset		\$8.00

Deadbolt Latch



DEADBOLT LATCHES	Finish	List Price
2 ³ / ₈ " backset	Polished Brass (US3) French Antique (US7) Oil Rubbed Bronze (US10B) Polished Nickel (US14) Satin Nickel (US15) Pewter (US15A) Flat Black (US19) Polished Chrome (US26) Medium Bronze (MB) Tumbled White Bronze (TWB)	\$8.00
2 ³ / ₄ " backset		\$8.00

Thumbturn Privacy Latch



THUMBTURN PRIVACY LATCHES	Finish	List Price
Privacy Latch, 2 ³ / ₈ " backset	Polished Brass (US3) French Antique (US7) Oil Rubbed Bronze (US10B) Polished Nickel (US14) Satin Nickel (US15) Pewter (US15A) Flat Black (US19) Polished Chrome (US26)	\$8.00
Privacy Latch, 2 ³ / ₄ " backset		\$8.00

28° Rotation Latch



28 DEGREE ROTATION LATCHES	Finish	List Price
Passage Latch, 2 ³ / ₈ " backset	Polished Brass (US3) French Antique (US7)	\$12.00
Privacy Latch, 2 ³ / ₈ " backset	Oil Rubbed Bronze (US10B) Polished Nickel (US14)	
Passage Latch, 2 ³ / ₄ " backset	Satin Nickel (US15) Pewter (US15A)	\$12.00
Privacy Latch, 2 ³ / ₄ " backset	Flat Black (US19) Polished Chrome (US26) Medium Bronze (MB) Tumbled White Bronze (TWB)	

>> 28° rotation latch is designed to work with a corresponding door mechanism and cannot be retrofitted. Replacement use only. Please specify function and finish when ordering.

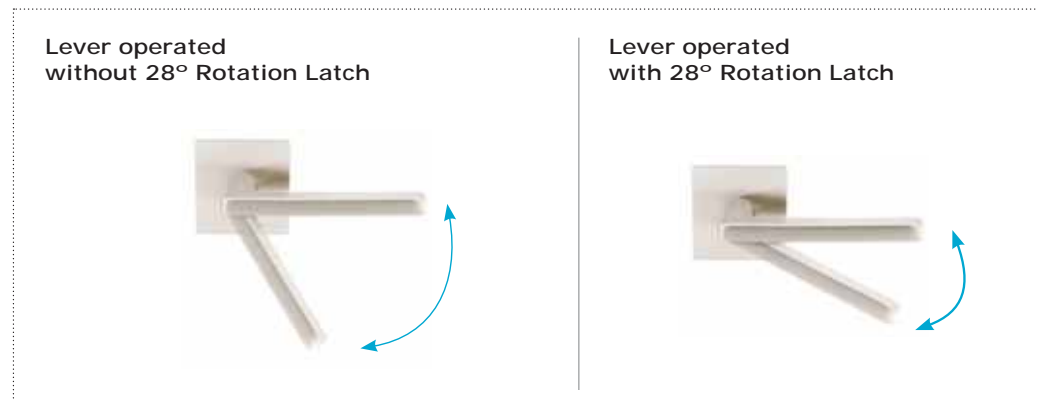

* Knobsets, leversets and platesets ordered with 28° Rotation Latches are assembled with internal components specifically designed for use **ONLY** with our 28° Rotation Latch.

Standard Latch



STANDARD LATCHES	Finish	List Price
Passage Latch, 2 ³ / ₈ " backset	Polished Brass (US3) French Antique (US7)	\$8.00
Privacy Latch, 2 ³ / ₈ " backset	Oil Rubbed Bronze (US10B) Polished Nickel (US14)	
Passage Latch, 2 ³ / ₄ " backset	Satin Nickel (US15) Pewter (US15A)	\$8.00
Privacy Latch, 2 ³ / ₄ " backset	Flat Black (US19) Polished Chrome (US26) Medium Bronze (MB) Tumbled White Bronze (TWB)	

>> Please specify if faceplate and screws are required. If required, specify finish and square or 1/4" radius corner condition for faceplate.

STRIKE PLATES

**Heavy Duty
Deadbolt Strike Plate**



**Heavy Duty Full Lip
Deadbolt Strike Plate**



HEAVY DUTY DEADBOLT STRIKE PLATE			
Supplied with 4 Screws: (2) #10, 2 1/2" Wood Screws (2) #10, 3/4" Wood Screws			
	Product Code	Finish	List Price
Standard 1 1/4" x 3 3/8", 3/4" Fits Kwikset® Type Jamb Prep	93223	Polished Brass (US3) French Antique (US7) Oil Rubbed Bronze (US10B) Polished Nickel (US14)	\$4.00
Full Lip 1 7/8" x 3 3/8", 3/4" Full Lip Deadbolt Strike	93224	Satin Nickel (US15) Pewter (US15A) Flat Black (US19) Polished Chrome (US26) Medium Bronze (MB) Tumbled White Bronze (TWB)	\$4.00

>> Strike plates must be purchased separately. If ordered along with deadbolts they will be packed into the deadbolt boxes. In that case deadbolts will be packed with both normal strikes and heavy duty strikes.

**Full Lip Strike
Square Corner**



**Full Lip Strike
1/4" Radius Corner**



**Extended Lip Strike
Square Corner**



**T Strike
Square Corner**



STRIKE PLATES For Passage and Privacy Sets			
	Product Code	Finish	List Price
Full Lip Strike, Square Corners	86084	Polished Brass (US3) French Antique (US7) Oil Rubbed Bronze (US10B) Polished Nickel (US14)	\$6.00
Full Lip Strike, 1/4" Radius Corners	86085	Satin Nickel (US15) Pewter (US15A)	\$6.00
Extended Lip Strike, Square Corners	86086	Flat Black (US19) Polished Chrome (US26)	\$6.00
T Strike	86087	Medium Bronze (MB) Tumbled White Bronze (TWB)	\$6.00

>> All Brass Strike Plates supplied with 2 screws. Strike plates are included with EMTEK locks. Square corner strike plates are standard. Full Lip Strike and T-Strike plates may be substituted at no extra charge. Extended Lip Strike and T-Strike plates not available with radius corners.

UL LISTED Knobsets and Deadbolts

Add the below product codes and prices to standard items to obtain UL LISTED versions of EMTEK Knobsets and Deadbolts

Knobsets with UL LISTING-USL, 60 Minute Fire Rating		Add On List Price
Passage Set 81UL	Add Product Code, Knob Style, Rosette Style*, and Finish.	\$20.00

* Available only in Round Rosettes for UL.

Deadbolts with UL LISTING-USL, 60 Minute Fire Rating		Add On List Price
Single Cylinder Deadbolt 84UL	Add Material (Low Profile Brass (8455), Sandcast Bronze (8450), or Wrought Steel #2 (8452)) and Add Finish.	\$20.00

CONSTRUCTION KEYING

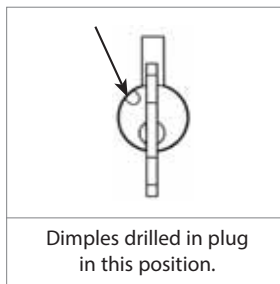
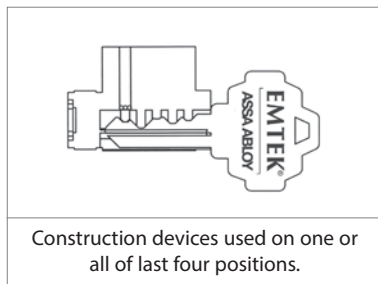

Charge for Construction Keying - \$3 (NET)

Locks that are both construction keyed and keyed alike will be charged a total of \$5.00 (NET) per cylinder.

Charge for Re-Keying - \$2 (NET)

Locks that are keyed to code or keyed alike will be charged \$2.00 (NET) per cylinder.

Keying to Code

• Order by indicating "Key Code XXXXX" next to applicable locks.

Standard with Construction Keying Services

- Lost ball system
- Last four pin locations drilled for lost ball application
- Master key wafers used for code variability
- Construction keys and owner keys sent separately
- Order by indicating "Construction Keyed, House #_" next to applicable locks

Keying Alike

- Order by indicating "Keyed Alike" next to applicable locks if only one keyed alike group is wanted.
- If ordering multiple groups (houses) indicate "Keyed Alike House #_" next to applicable locks.



Thru-Bore Dummy Mounting Kit

8900	List Price: \$12.00
Thru-Bore Dummy Mounting Kit	

>> Specify Lever/Knob and Rosette styles when ordered.

CY4	List Price: \$12.00
Tubular Cylinder (Each)	

>> Specify function and finish.

MS4-KEYBLKC	List Price: \$1.00
Key Blanks (Schlage® C Keyway / Weiser® (WR5) Keyway)	

COLLECTION PAGE**CONTEMPORARY
COLOR COLLECTION**

Martinique	10
Cayman	11
Aruba	11

ELECTRONIC

Classic	15, 16
EMTouch™	13, 15, 16
EMTouch™ Classic	13, 15, 16
Liscio	12
Modern	14, 15, 16
Sandcast Bronze	14, 15, 16

MORTISE ENTRY SETS

Albany	22
Artemis	19
Charleston	22
Cheyenne	27
Craftsman	25
Craftsman Full Length	25
Da Vinci	30
Denver	27
Hamilton	24
Harrison	20
Hera	19
Longmont	26
Lugano	18
Manhattan	23
Melrose	23
Memphis	21
Middleton	20
Mills	23
Morgan	29
Mormont	18
Mormont Stainless Steel	31
Octagon	30
Rectangular Full Length	28
Rectangular Monolithic	28
Rectangular Sectional	28
Regency	24
Rockford	29
Salem	21
Sonoma	26
Topeka	27
Versailles	24
Zeus	19

**MORTISE KNOB BY KNOB,
LEVER BY LEVER ENTRY SETS**

Artemis	32
Charleston	33
Cheyenne	35
Craftsman	34
Da Vinci	36
Hailey	35
Hamilton	34
Harrison	32
Manhattan	33
Memphis	33
Mormont	32
Mormont Stainless Steel	36
Octagon	36
Rectangular	35
Regency	34

TUBULAR ENTRY SETS

Adams	41
Apollo	39

Ares	39
Art Nouveau	51
Arts & Crafts	40
Arts & Crafts Full Length	40
Baden	38
Brighton	46
Creston	47
Davos	38
Davos Stainless Steel	52
Denver	48
Franklin	41
Greeley	48
Hamden	42
Imperial	45
Jefferson	41
Knoxville	44
Laramie	47
Lausanne	38
Logan	46
Marietta	44
Melrose	42
Monolithic with Lafayette Grip	54
Monolithic with Normandy Grip	54
Monolithic with San Carlos Grip	54
Nashville	43
Octagon	51
Orion	39
Orleans	45
Rectangular Full Length	49
Rectangular Monolithic	49
Rectangular Sectional	49
Remington	48
Ribbon & Reed	45
Richmond	43
Ridgmont	46
Saratoga	44
Sectional with Lafayette Grip	53
Sectional with Normandy Grip	53
Sectional with San Carlos Grip	53
Sheridan	47
Tuscany Monolithic	50
Tuscany Sectional	50
Wilmington	43
Wilshire	42
Zeus	40
Zeus Stainless Steel	52

GRIP BY GRIP ENTRY SETS

Art Nouveau	58
Brighton	56
Creston	57
Denver	57
Greeley	57
Laramie	57
Logan	56
Octagon	59
Rectangular Full Length	56
Rectangular Monolithic	56
Rectangular Sectional	56
Remington	57
Ridgmont	56
Sheridan	57
Tuscany Monolithic	58
Tuscany Sectional	58

KEY IN ENTRY SETS

Cortina Key in Lever	61
Durango Key in Lever	63
Egg Key in Knob	60
Hanover Key In Lever	59
Hanover Stainless Steel Key in Lever	65

Luzern Key in Lever	59
Petal Key in Knob	64
Providence Key in Knob	60
Rope Key in Knob	60
Rope Key in Lever	61
Round Key in Knob	59
Siena Key in Lever	64
Waverly Key in Knob	60
Winchester Key in Knob	62

**SINGLE AND TWO POINT
LOCKSETS**

Annapolis	67
Modern Rectangular	68

DEADBOLTS

#8	70
Arts & Crafts	69
Knoxville	70
Low Profile	69
Modern	68
Neos	68
Quincy	68
Rectangular	70
Regular	69
Rope	69
Sandcast Bronze #1	71
Sandcast Bronze #3	71
Sandcast Bronze #4	71
Sandcast Bronze Regular	71
Sandcast Bronze Ridgemont	71
Saratoga	70
Square	68
Stainless Steel Round	73
Stainless Steel Square	73
Tuscany Bronze	72
Tuscany Bronze #11	72
Tuscany Bronze #14	72
Tuscany Bronze Classic	72
Tuscany Bronze Octagon	72
Wilshire	69
Wrought Steel #1	73
Wrought Steel #2	73
Wrought Steel #3	73

SIDEPLATE LOCKSETS

Belmont	82
Colonial	79
Delaware	78
Missoula	83
Modern	76
Oval Beaded	81
Quincy	77
Rope	80
Sandcast Bronze #5	85
Sandcast Bronze Rectangular	84
Stainless Steel	87
Trenton	81
Tuscany Bronze #16	86
Victoria	82
Wrought Steel #5	87

**THUMBTURN PRIVACY
LOCKSETS**

Belmont	88
Colonial	88
Delaware	88
Oval Beaded	89
Quincy	88
Rope	89
Victoria	88

COLLECTION **PAGE****STRETTO NARROW TRIM****SIDEPLATE LOCKSETS**

Concord	92
Modern Rectangular	91
Sandcast Bronze Arched	93
Sandcast Bronze Rectangular	94
Stainless Steel	96
Tuscany Bronze	95

PASSAGE/PRIVACY**LEVERSETS**

Aireon	98
Argos	97
Arts & Crafts	115
Athena	98
Athena - Stainless Steel	112
Aurora	108
Basel	98
Cimarron	108
Cody	108
Cologne - Stainless Steel	112
Cortina	100, 101
Coventry	104, 105
Dresden - Stainless Steel	112
Durango	108
Elan	104, 105
Geneva	97
Hammered	115
Helios	97
Helios - Stainless Steel	112
Hercules	97
Hercules - Stainless Steel	112
Hermes	98
Hermes - Stainless Steel	112
Kiel - Stainless Steel	112
Lafayette	113
Lariat	108
Luzern	97
Medici	110
Mercury	98
Merrimack	104, 105
Milano	100, 101
Montrose	108
Napoli	110
Normandy	113
Octagon	110
Padua	110
Poseidon	98
Poseidon - Stainless Steel	112
Ribbon & Reed	104, 105
Rope	104, 105
Rustic	100, 101
San Carlos	113
Santa Fe	104, 105
Sion	98
Stuttgart	97
Stuttgart - Stainless Steel	112
Teton	108
Triton	98
Turino	100, 101
Wembley	104, 105
Yuma	108

PASSAGE/PRIVACY**KNOBSETS**

Astoria Clear Crystal	118, 119, 120, 121, 122
Beaded Egg	106, 107
Belmont	106, 107

Bern	99
Bristol Crystal	117, 118, 119, 120, 121, 122
Butte	109
Diamond Crystal	118, 119, 120, 121, 122
Ebony Porcelain	116, 122
Egg	102, 103
Egg - Sandcast Bronze	109
Georgetown	118, 119
Hammered Egg	115
Hampton	117, 118, 119, 120, 121, 122
Ice White Porcelain	116, 122
Jamestown	114
Lancaster	106, 107
Lowell	118, 119, 120, 121, 122
Madison Black	114
Madison Ivory	114
Melon	102, 103
Modern Disc Crystal	117, 121, 122
Modern Square Crystal	117, 121, 122
Norwich	102, 103
Octagon	99
Octagon - Lost Wax Cast Bronze	111
Octagon - Stainless Steel	112
Old Town Clear Crystal	118, 119, 120, 121, 122
Orb	99
Parma	111
Petal	111
Providence	102, 103
Providence Crystal	118, 119, 120, 121, 122
Ribbon & Reed	106, 107
Rope	106, 107
Round	99
Round - Sandcast Bronze	109
Round - Stainless Steel	112
Savannah	114
Square	99
Victoria	106, 107
Waverly	102, 103
Winchester	109
Windsor	117, 118, 119, 120, 121, 122

APPLIANCE PULLS

Alexander	123
Bauhaus	123
Brass Bar	123
Fluted Lost Wax Cast Bronze	123
Rail Sandcast Bronze	123
Spindle	123
Trail	123
Trinity	123

DOOR PULLS

8" Art Nouveau	127
8" Arts & Crafts	124
8" Baden	124
8" Baden Stainless Steel	124
8" Column	127
8" Knoxville	124
8" Lafayette	129
8" Normandy	129
8" Nunez	126
8" Palermo	127
8" Recoleta	127
8" Ribbon & Reed	124

8" Rod	126
8" Rustic Modern	126
8" San Carlos	129
8" Twig	126
8" Twist	127
8" Wilshire	124
8" Zeus	124
8" Zeus Stainless Steel	124
12" Column	128
12" Rod	126
12" Twist	128
18" Column	128
18" Rod	126
18" San Carlos	129
24" Column	128
24" San Carlos	129
Knoxville Push/Pull Plate	125
Modern Push/Pull Plate	125
Petal Push/Pull Plate	127

DOOR ACCESSORIES

Ball Tip	150, 155
Ball Catch	136
Button Tip	151
Casement Latch	137
Classic Pocket Door Mortise Lock	133
Concealed Screw Surface Bolt	131
Cylinder Floor Bumper	135
Cylinder Floor Bumper with Dome Cap	135
Door Knocker	139
Door Stop	134
Door Stop - Goose Style	135
Door Stop - Half Dome	135
Door Viewer	139
Doorbell	142, 143
Dutch Door Bolt	130
Edge Pull	131
Extendable Base Board Door Bumper	134
Extended Button Tip	151
Floor Door Bumper	134
Flush Bolt	131
Hinges - Plated Steel	152, 153, 154
Hinges - Solid Brass	147, 148, 149
Hinges - Square Barrel	146
Hinges - Stainless Steel	156, 157, 158
Hinges Pivot Stop	151
House Number	140, 141
Kickdown Door Holder	134
Magnetic Door Stop & Holder	134
Mail Slot	139
Patio Door Bolt	137
Pocket Door Lock	136
Modern Rectangular Pocket Door Mortise Lock	132
Rectangular Flush Pull	136
Roller Catch	136
Round Flush Pull	136
Screen Door Lock	138
Security Door Guard	130
Spring Hinges	159
Steeple Tip Set	150, 155
Surface Bolt	130
Switch Plate	144, 145
Wall Bumper	135
Window Utility Pull	137

PRODUCT CODE	PAGE										
		2463	142	3107	34	4041	93	4806	39	5109	97, 98,
		2464	143	3108	34	4042	93	4807	39		99, 117
443	38-52,	2610	139	3121	35	4043	93	4808	38	5110	97, 98,
	54, 76-	2620	139	3125	35	4044	93	4809	38		99, 117
	81 83-87	2810	140, 141	3131	36	4045	93	4810	38	5111	97, 98,
828TP	89	2811	140, 141	3133	36	4046	93	4811	40		99, 117
2074	130	2812	140, 141	3134	35	4141	93	4812	40	5112	97, 98,
2103	133	2813	140, 141	3143	33	4143	93	4814	40		99, 117
2104	133	2814	140, 141	3144	32	4201	42	4815	39	5114	62, 63
2105	133	2815	140, 141	3145	32	4202	42	4816	39	5115	59
2106	133	2816	140, 141	3151	32	4203	42	4817	39	5121	60, 61
2113	132	2817	140, 141	3300	37	4211	42	4818	38	5122	59
2114	132	2818	140, 141	3301	21	4212	42	4819	38	5141	94
2115	132	2819	140, 141	3302	21	4213	42	4820	38	5143	94
2116	132	2820	140, 141	3304	24	4221	42	4821	40	5150	60, 61
2201	136	2821	140, 141	3305	23	4222	42	4822	40	5151	60, 61
2232	134	2822	140, 141	3306	23	4223	42	4824	40	5152	62, 63
2233	134	2823	140, 141	3307	24	4241	93	4825	39	5153	62, 63
2241	151	2824	140, 141	3308	25	4243	93	4826	39	5154	62, 63
2242	151	2825	140, 141	3309	24	4300	44	4827	39	5158	60, 61
2244	137	2826	140, 141	3310	23	4301	45	4828	38	5164	62, 63
2246	137	2827	140, 141	3321	27	4302	43	4829	38	5205	115
2251	135	2828	140, 141	3322	27	4303	43	4830	38	5206	115
2253	135	2829	140, 141	3323	27	4304	43	4901	45	5207	97, 98,
2254	134	3001	21	3324	28	4310	44	4911	45		99, 117
2255	135	3002	21	3325	28	4311	45	4921	45	5209	97, 98,
2256	134	3004	24	3326	28	4312	43	5015	59		99, 117
2257	135	3005	23	3327	29	4313	43	5021	60, 61	5210	97, 98,
2258	135	3006	23	3328	29	4314	43	5022	59		99, 117
2259	135	3007	24	3329	26	4320	44	5041	94	5211	97, 98,
2260	135	3008	25	3330	26	4321	45	5042	94		99, 117
2280	139	3009	24	3331	30	4322	43	5043	94	5212	97, 98,
2290	138	3010	23	3333	30	4323	43	5044	94		99, 117
2291	138	3021	27	3343	22	4324	43	5045	94	5241	94
2400	142	3022	27	3344	19	4400	44	5046	94	5243	94
2401	142	3023	27	3345	19	4401	44	5050	97, 98,	5302	66
2402	142	3024	28	3346	19	4403	41		99, 117	5308	67
2403	142	3025	28	3347	18	4404	41	5051	97, 98,	5312	66
2404	142	3026	28	3348	18	4405	41		99, 117	5318	67
2406	142	3027	29	3349	25	4410	44	5052	97, 98,	5322	66
2407	142	3028	29	3350	22	4411	44		99, 117	5328	67
2408	142	3029	26	3351	20	4413	41	5055	115	5352	66
2409	142	3030	26	3352	20	4414	41	5056	115	5358	67
2411	143	3031	30	3380	37	4415	41	5057	97, 98,	5362	66
2412	143	3033	30	3502	33	4420	44		99, 117	5368	67
2414	143	3043	22	3504	34	4421	44	5059	97, 98,	5442	94
2415	143	3044	19	3506	33	4423	41		99, 117	5444	94
2421	143	3045	19	3507	34	4424	41	5100	60, 61	6010	81
2422	143	3046	19	3508	34	4425	41	5101	60, 61	6011	81
2423	143	3047	18	3521	35	4442	93	5102	62, 63	6015	81
2424	143	3048	18	3525	35	4444	93	5103	62, 63	6020	86
2425	143	3049	25	3531	36	4701	45	5104	62, 63	6021	86
2431	143	3050	22	3533	36	4711	45	5105	115	6025	86
2432	143	3051	20	3534	35	4721	45	5106	115	6030	81
2452	142	3052	20	3543	33	4801	40	5107	97, 98,	6031	81
2458	142	3102	33	3544	32	4802	40		99, 117	6035	81
2459	142	3104	34	3545	32	4804	40	5108	60, 61	6041	95
2460	142	3106	33	3551	32	4805	39			6042	95

PRODUCT CODE	PAGE								
			120, 121	7670	85	8071	82	8206	101, 103,
6043	95	7105	87	7671	85	8075	82		105, 107,
6044	95	7106	108,	7675	85	8080	77		119
6045	95		109,	7707	85	8081	77	8207	101, 103,
6046	95		120, 121	7710	80	8085	77		105, 107,
6052	86	7107	85	7757	85	8090	82		119
6102	86	7108	108,	7807	85	8091	82	8208	100, 102,
6141	95		109,	7810	80	8095	82		104, 106,
6143	95		120, 121	7850	80	8100	100, 102,		118
6202	86	7109	80	7990	80		104, 106,	8209	81
6241	95	7111	108,	7991	80		116, 118	8211	76
6243	95		109,	7995	80	8101	101, 103,	8212	76
6442	95		120, 121	8000	122		105, 107,	8213	76
6444	95	7141	92	8001	79		119	8214	76
6620	86	7143	92	8003	116	8102	82	8220	100, 102,
6621	86	7200	108,	8006	78	8103	82		104, 106,
6625	86		109,	8010	79	8104	77		118
6702	86		120, 121	8011	76	8105	81	8221	100, 102,
6752	86	7201	113, 114	8012	76	8106	101, 103,		104, 106,
6802	86	7202	113, 114	8013	76		105, 107,		118
7010	87	7203	113, 114	8014	76		119	8223	89
7011	87	7204	108,	8016	78	8107	101, 103,	8226	88
7015	87		109,	8020	79		105, 107,	8227	89
7041	92		120, 121	8022	88		119	8228	88
7042	92	7205	87	8026	78	8108	100, 102,	8231	100, 102,
7043	92	7206	108,	8030	116		104, 106,		104, 106,
7044	92		109,	8040	116		118		118
7045	92		120, 121	8041	91	8109	81	8241	91
7046	92	7207	85	8042	91	8111	76	8243	91
7050	108, 109,	7208	108,	8043	91	8112	76	8261	101, 103,
	120, 121		109,	8044	91	8113	76		105, 107,
7051	113, 114		120, 121	8045	91	8114	76		119
7052	113, 114	7209	80	8046	91	8120	100, 102,	8350	69, 71, 73
7053	113, 114	7211	108,	8050	100, 102,		104, 106,	8354	69
7054	108, 109,		109,		104, 106,		118	8355	69
	120, 121		120, 121		116, 118	8121	100, 102,	8356	72
7055	87	7241	92	8051	101, 103,		104, 106,	8357	71
7056	108, 109,	7243	92		105, 107,		118	8358	70
	120, 121	7360	84		119	8131	100, 102,	8359	70
7057	85	7361	84	8052	82		104, 106,	8360	72
7058	108, 109,	7365	84	8053	82		118	8361	73
	120, 121	7370	83	8054	77	8141	91	8363	73
7059	80	7371	83	8055	81	8143	91	8364	69
7061	108, 109,	7375	83	8056	101, 103,	8160	79	8365	71
	120, 121	7442	92		105, 107,	8161	101, 103,	8366	70
7070	85	7444	92		119		105, 107,	8367	68
7071	85	7512	84	8057	101, 103,		119	8368	70
7075	85	7522	83		105, 107,	8166	78	8369	68
7090	80	7552	84		119	8200	100, 102,	8371	72
7091	80	7560	84	8058	100, 102,		104, 106,	8372	72
7095	80	7561	84		104, 106,		116, 118	8373	72
7100	108, 109,	7562	83		118	8201	101, 103,	8374	71
	120, 121	7565	84	8059	81		105, 107,	8375	68
7101	113, 114	7570	83	8060	79		119	8376	71
7102	113, 114	7571	83	8061	78	8202	82	8378	68
7103	113, 114	7575	83	8065	79	8203	82	8379	69
7104	108, 109,	7612	84	8066	78	8204	77	8442	91
		7622	83	8070	82	8205	81	8444	91

PRODUCT CODE	PAGE								
8450	69, 71	8564	74	29142	144	86084	162	93224	162
8452	73	8565	75	29143	144	86085	162	94013	154
8454	69	8566	74	29151	144	86086	162	94014	154
8455	69	8567	74	29161	144	86087	162	94015	154
8456	72	8568	74	29211	145	86088	126	94023	154
8457	71	8569	74	29212	145	86090	126	94024	154
8458	70	8572	75	29213	145	86144LH	127	94025	154
8459	70	8573	75	29214	145	86144RH	127	94033	154
8460	72	8574	75	29221	145	86147	37	94034	154
8461	73	8575	74	29222	145	86148	37	94103	155
8463	73	8578	74	29223	145	86149	37	94104	155
8464	69	8579	74	29224	145	86156	127	94105	155
8465	71	8703	137	29231	145	86157	128	94113	155
8466	70	8704	77	29232	145	86158	128	94114	155
8467	68	8711	79	29241	145	86159	128	94115	155
8468	70	8716	78	29242	145	86160	126	95013	159
8469	68	8801	136	29243	145	86167	127	95014	159
8471	72	8802	136	29251	145	86168	127	95023	159
8472	72	8804	77	29261	145	86169	128	95024	159
8473	72	8811	79	54011	64	86181	127	95033	159
8474	71	8816	78	54012	64	86182	127	95034	159
8475	68	8851	79	54014	64	86183	124	95033	159
8476	71	8854	77	54511	64	86184	124	95034	159
8478	68	8856	78	54512	64	86343	123	96113	147
8479	69	8900	163	54514	64	86344	123	96114	147
8503	131	8980	77	70053	84	86345	123	96123	147
8504	131	8981	77	70063	83	86346	123	96124	147
8505	131	8985	77	70511	110, 111	86347	123	96133	147
8511	130	8990	79	70512	110, 111	86348	123	96134	147
8512	130	8991	79	70514	110, 111	86349	123	96213	148
8513	130	8995	79	70515	110, 111	86350	123	96214	148
8516	130	8996	78	71011	110, 111	86351	123	96215	148
8520	100, 102, 104, 106, 118	8997	78	71012	110, 111	86352	123	96223	148
8521	100, 102, 104, 106, 118	8998	78	71013	84	86436	125	96224	148
8527	131	9041	96	71014	110, 111	86437	125	96225	148
8531	100, 102, 104, 106, 118	9042	96	71015	110, 111	86439	126	96233	148
8550	74, 75	9043	96	71023	83	86440	123	96234	148
8551	75	9044	96	72011	110, 111	86441	123	96413	149
8552	75	9045	96	72012	110, 111	86442	123	96414	149
8553	75	9046	96	72013	84	86443	123	96415	149
8554	74	9141	96	72014	110, 111	86444	123	96416	149
8556	75	9143	96	72015	110, 111	86445	123	96425	149
8557	75	9241	96	72023	83	91013	152	96513	146
8558	74	9243	96	76028	129	91014	152	96514	146
8559	74	9442	96	76029	129	91023	152	96515	146
8560	75	9444	96	76030	129	91024	152	97203	150
8561	101, 103, 105, 107, 119	29111	144	76031	129	91033	152	97204	150
		29112	144	76041	129	91034	152	97303	150
		29113	144	86059	139	92013	153	97304	150
		29114	144	86068	126	92014	153	97305	150
		29121	144	86069	127	92015	153	97213	150
		29122	144	86077	124	92023	153	97214	150
		29123	144	86078	124	92024	153	97313	150
		29124	144	86079	124	92025	153	97314	150
		29131	144	86080	124	92033	153	97315	150
		29132	144	86081	125	92034	153	97223	151
		29141	144	86082	125	93223	162	97224	151

97323	151	454111	57	473333RH	58	E6000	12
97324	151	454212	57	473444	58	E6200	12
97325	151	454333	57	474111	58	E401211	14
206011	137	454414	56	474222	58	E451211	14
206012	137	454515	56	474333LH	58	KEYDBEXT	15
206016	137	454636	56	474333RH	58	KEYLVREXT	16
206017	137	454717	57	474444	58	MS4-KEYBLKC	163
206512	137	454727	56	475111	58	Latch28	76-90, 98-107, 114-121
206516	137	454818	57	475222	58	L4820	10
450112	48	454828	56	475333LH	58	L4830	10
450211	48	454919	57	475333RH	58	L4810	10
450332	48	454929	56	475444	58	L5050	11
450411	49	455111	57	9811332D	156	L5110	11
450512	49	455212	57	9811432D	156	L5210	11
450613	49	455333	57	9812332D	156	L8469	11
450711	47	455414	56	9812432D	156	L8369	11
450721	46	455515	56	9813332D	156	L8569	11
450812	47	455636	56	9813432D	156	S100	112
450822	46	455717	57	9821332D	157	S200	112
450913	47	455727	56	9821432D	157	S300	112
450923	46	455818	57	9821532D	157	S800	87
451112	48	455828	56	9822332D	157	S801	87
451211	48	455919	57	9822432D	157	S802	87
451332	48	455929	56	9823332D	157	S810	87
451411	49	460111	54	9823432D	157	S811	87
451512	49	460121	54	9841332D	158	S812	87
451613	49	460131	54	9841432D	158	S901	65
451711	47	460212	53	9841532D	158	S951	65
451721	46	460222	53	9842332D	158	S3001	31
451812	47	460232	53	9842432D	158	S3101	36
451822	46	461111	54	9843332D	158	S3301	31
451913	47	461121	54	9843432D	158	S3501	36
451923	46	461131	54	CY4	163	S40000	52
452112	48	461212	53	CY5-ThrdMrt150	37	S40001	52
452211	48	461222	53	CY5-ThrdMrt175	37	S40002	52
452332	48	461232	53	CY5-ThrdMrt1375	37	S40100	52
452411	49	462111	54	E1000	15	S40101	52
452512	49	462121	54	E1001	15	S50001	73
452613	49	462131	54	E1020	15	S50002	73
452711	47	462212	53	E2000	16	S50003	73
452721	46	462222	53	E2001	16	S50023	73
452812	47	462232	53	E2020	16	S52005	75
452822	46	470112	50	E2200	16	S52006	75
452913	47	470222	51	E2201	16	S86001	124
452923	46	470224	50	E2220	16	S86002	124
453111	57	470333	51	E3002	15		
453212	57	471112	50	E3020	15		
453333	57	471222	51	E4002	16		
453414	56	471224	50	E4010	13		
453515	56	471333	51	E4017	14		
453636	56	472112	50	E4020	16		
453717	57	472222	51	E4027	13		
453727	56	472224	50	E4202	16		
453818	57	472333	51	E4220	16		
453828	56	473111	58	E4410	13		
453919	57	473222	58	E4817	14		
453929	56	473333LH	58	E4827	13		

LIFETIME LIMITED WARRANTY

Subject to the terms and conditions of this warranty, Emtek Products, Inc. ("Company") extends a lifetime limited warranty to the original consumer user ("Original User") of our product ("Product") against defects in material and workmanship, as long as the Original User occupies the residential premises upon which the Product was originally installed.

This warranty only applies to the Original User of the Products. This warranty is not transferable. This warranty applies to all products sold on or after April 2, 2012.

Original User: The Original User will return the defective Product to the Company, free and clear of all liens and encumbrances, transportation prepaid, accompanied by a statement of defects and proof of purchase.

What Emtek will do: Upon return of the defective Product to Emtek, Emtek's sole obligation, at its option, is to either repair or replace the Product, or refund the original purchase price in exchange for the Product.

THE COMPANY MAKES NO OTHER WARRANTY OTHER THAN AS EXPRESSLY STATED HEREIN, AND ALL IMPLIED WARRANTIES, INCLUDING ANY WARRANTY OF MERCHANTABILITY OR FITNESS FOR A PARTICULAR PURPOSE, ARE HEREBY EXCLUDED.

THE COMPANY'S MAXIMUM LIABILITY HEREUNDER IS LIMITED TO THE PURCHASE PRICE OF THE PRODUCT. IN NO EVENT SHALL THE COMPANY BE LIABLE FOR ANY CONSEQUENTIAL, INDIRECT, INCIDENTAL OR SPECIAL AND/OR PUNITIVE DAMAGES OF ANY NATURE ARISING FROM THE SALE OR USE OF THE PRODUCT, WHETHER BASED ON CONTRACT, WARRANTY, TORT, STRICT LIABILITY, PATENT INFRINGEMENT, OR OTHERWISE, EVEN IF ADVISED OF THE POSSIBILITY OF SUCH DAMAGES. Some local laws do not allow the exclusion or limitation of incidental or consequential damages, so the above exclusion or limitation may not apply to you. This warranty gives specific legal rights and a buyer may also have other rights which may vary from state to state.

WHAT IS NOT COVERED: THE FOLLOWING COSTS, EXPENSES AND DAMAGES ARE NOT COVERED BY THE PROVISIONS OF THIS LIMITED WARRANTY: (I) LABOR COSTS INCLUDING, BUT NOT LIMITED TO, SUCH COSTS AS THE REMOVAL AND RE-INSTALLATION OF PRODUCT; AND (II) SHIPPING AND FREIGHT EXPENSES REQUIRED TO RETURN PRODUCT TO EMTEK.

THE PROVISIONS OF THIS WARRANTY DO NOT APPLY TO PRODUCTS: (I) USED IN COMMERCIAL APPLICATIONS; (II) USED IN COMMON AREA APPLICATIONS; (III) USED FOR PURPOSES FOR WHICH THEY ARE NOT DESIGNED OR INTENDED; (IV) WHICH HAVE BEEN SUBJECTED TO ALTERATION, ABUSE, MISUSE, NEGLIGENCE OR ACCIDENT; (V) WHICH HAVE BEEN IMPROPERLY STORED, INSTALLED, MAINTAINED OR OPERATED; (VI) WHICH HAVE BEEN USED IN VIOLATION OF WRITTEN INSTRUCTIONS PROVIDED BY EMTEK; (VII) WHICH HAVE BEEN SUBJECTED TO IMPROPER TEMPERATURE, HUMIDITY OR OTHER ENVIRONMENTAL CONDITIONS; OR (VIII) WHICH, BASED ON EMTEK'S EXAMINATION, DO NOT DISCLOSE TO EMTEK'S SATISFACTION NON-CONFORMANCE TO THE WARRANTY. Additionally, this warranty DOES NOT COVER scratches, abrasions, or deterioration due to the use of paints, solvents or other chemicals.

Finish Warranty: Door Hardware in Polished Brass-Lifetime and Polished Nickel-Lifetime finishes carry a lifetime limited finish warranty. There is no finish warranty on Deep Burgundy, Medium Bronze Patina, Flat Black Patina, Silver Patina, Rust, Polished White Bronze, Tumbled White Bronze, and Unlacquered Brass finishes. All other finishes carry a five year finish warranty.

Warranty claims: For warranty service and shipping instructions contact customer service at:

EMTEK Products, Inc.
15250 E. Stafford Street
City of Industry, CA 91744
Tel: (626) 961-0413

ASSA ABLOY is the global leader in door opening solutions, dedicated to satisfying end-user needs for security, safety and convenience

EMTEK[®]

ASSA ABLOY

EMTEK Products, Inc.
15250 E. Stafford Street
City of Industry • CA 91744
Tel: 800-356-2741 • 626-961-0413
Fax: 800-577-5771 • 626-336-2812
emtek.com



Scan this code to visit our website

follow us on



facebook.com/EmtekAssaAbloy



youtube.com/user/EMTEKproducts



twitter.com/emtek_assaabloy



pinterest.com/emtekassaabloy

BX4-MAINPRICEBK2016
FEBRUARY 2016