

Applications:

For Fine Residential and Commercial Entrances, matching door knockers and bell buttons are available for many designs. They can be used to achieve an authentic "period effect" or provide distinctive styling for any type of entry way design.

Door Range: 1 $\frac{5}{8}$ " to 1 $\frac{7}{8}$ " Standard

Specify Door Thickness { 1 $\frac{3}{8}$ " to 2 $\frac{1}{4}$ " Regular parts available for assembly to order

Backsets: 2 $\frac{3}{8}$ " Standard

Specify to Order { 2 $\frac{3}{4}$ " Regular latches available

Grip Handles Outside Trim:

Cast brass or bronze. All other exposed parts are wrought, brass or bronze.

Designs:

All "A" series knobs are available for inside trim. See Handcrafted catalog for the outstanding selection of Grip Handles, matching Bell Buttons, Door Knockers and inside trim.

Mechanism:

Cold rolled steel corrosion treated for normal atmospheric conditions.

Keying:

5 or 6 pin tumbler cylinders with 2 nickel silver keys per lock. Stock locks are keyed 5 pin.

Door and Jamb Preparation: See Templates

	Wood	Hollow Metal
E51PD, E193	E569	E570
Strike	S454	S455, ANSI S568

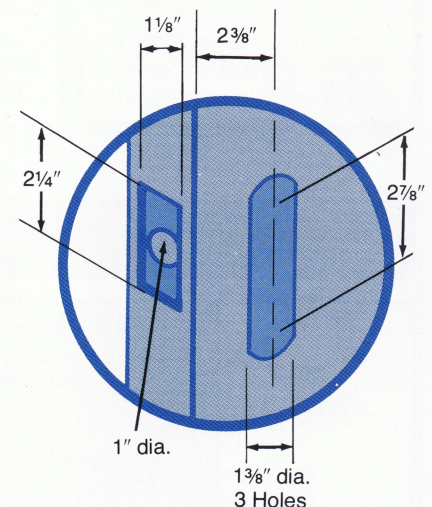



Designs/Finishes

Relative Design Price Index (P/I)

For assistance in design selection, the approximate cost differential is expressed by percentage of increase over Plymouth design.

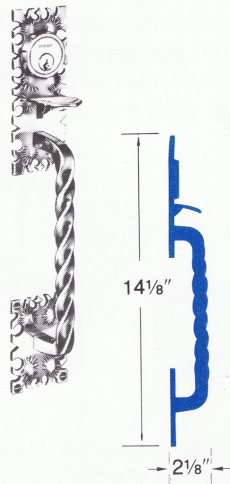
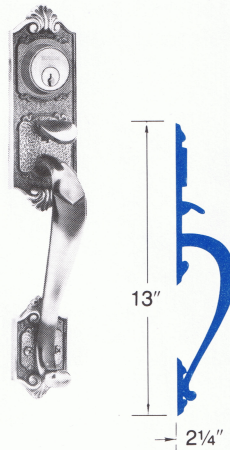
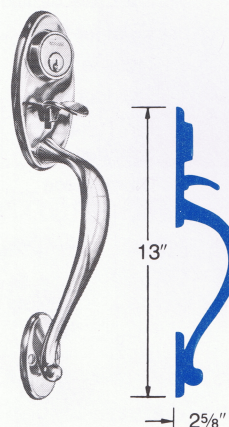
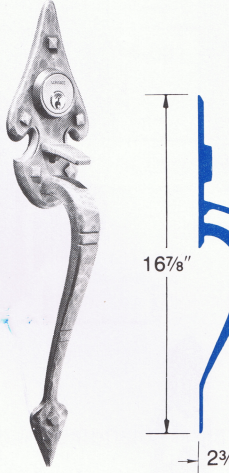
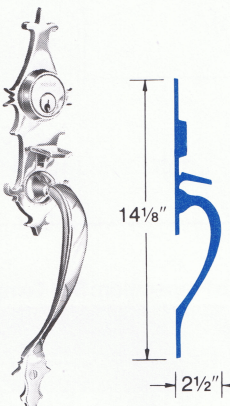
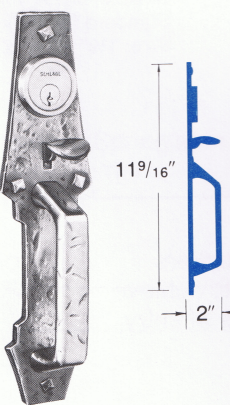
SCHLAGE E/Locks

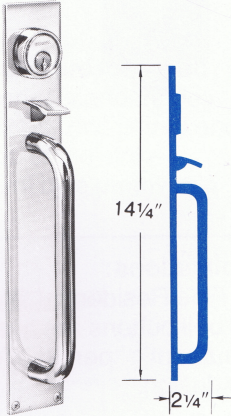
<p>Castile P/I: 122</p>  <p>Handle: $2\frac{5}{16}'' \times 14\frac{1}{8}''$ Finish: 610</p>	<p>Parthenon P/I: 104</p>  <p>Handle: $2\frac{7}{16}'' \times 13''$ Finish: 610</p>	<p>Plymouth P/I: 100</p>  <p>Handle: $2\frac{5}{8}'' \times 13''$ Finish: 605</p>	<p>Sussex P/I: 98</p>  <p>Handle: $3\frac{9}{16}'' \times 16\frac{7}{8}''$ Finish: 616, 621, 622</p>
<p>Waverly P/I: 112</p>  <p>Handle: $2\frac{13}{16}'' \times 14\frac{1}{8}''$ Finish: 605</p>	<p>Weymouth P/I: 104</p>  <p>Handle: $3'' \times 11\frac{9}{16}''$ Finish: 621</p>	<p>Bowman P/I: 192</p>  <p>Handle: $3\frac{3}{8}'' \times 17''$ Finish: 605</p>	<p>Murchison P/I: 112</p>  <p>Handle: $2\frac{3}{8}'' \times 14\frac{1}{4}''$ Finish: 605, 613</p>

SCHLAGE NO.	DESCRIPTION
-------------	-------------

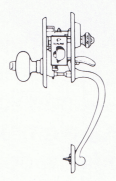
<p>E51PD</p> 	<p>ENTRANCE LOCK</p> <p>Entrance Doors for residential, apartment or commercial by key from outside when thumbpiece is locked by inside knob turn-button.</p> <p>For Door Push/Pull operation: Latch-bolt can also be held in retracted position by depressing thumbpiece and turning button to horizontal position.</p>
---	---

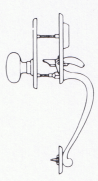
<p>E193</p> 	<p>OUTSIDE AND INSIDE DUMMY TRIM</p> <p>Fixed thumbpiece and inside knob dummy cylinder thru-bolts.</p>
--	--

Functions

SCHLAGE E/Locks

Deadlatches

Standard "E" series deadlatches have self-adjusting faceplates for flat or beveled doors and are reversible for right or left-handed doors. Faceplates are furnished in compatible brass, bronze or chrome finishes.

Numbers for ordering separately or with locks are listed below.

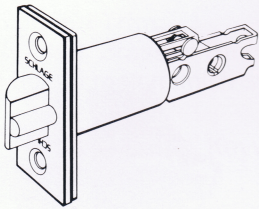

12-100
Standard Deadlatch
Square Corner Front
1 1/8" Square Front
1" Housing 9/16" throw

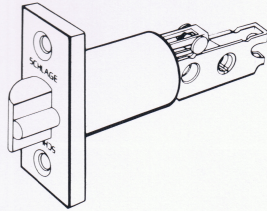

12-102
Deadlatch
1/2" Rabbeted
1 1/8" Flat Front
1" Housing 9/16"

BACKSET	FACEPLATE WIDTH, DESCRIPTION	NUMBER
2 3/8"	1 1/8", Square Corner Standard	12-100
	1 1/8", Flat, 1/2" Rabbeted	12-102
2 3/4"	1 1/8", Square Corner	12-103
	1 1/8", Flat, 1/2" Rabbeted	12-105

Strikes

All Schlage strikes are reversible and are furnished complete with screws. The "E" Series standard box strike has a 1 1/8" lip and wrought steel, zinc plated and dichromated box. The finished side of the strike is masked against scratches and paint by a removable protective coating.

10-001 Standard
"T" Strike
Square Corner
1 1/8" x 2 3/4" x 3/32"

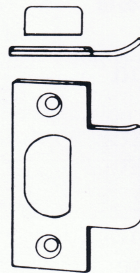

For strike options and lip length variations see pages 46-48.

NUMBER	LIP LENGTH	DESCRIPTION
10-001	1 1/8"	1 1/8" x 2 3/4", Standard
10-003	1 1/8"	1 1/8" x 2 3/4", 1/2" Rabbeted
10-025	1 3/16"	1 1/4" x 4 7/8", A.N.S.I.
10-058	—	1 3/4" Circular, Adjustable

Options and Auxiliary Items

37-016 Strike/Frame Reinforcer

Zinc Plated Dichromate Steel

"E" series locks are normally furnished with 37-016 strike reinforcing units.

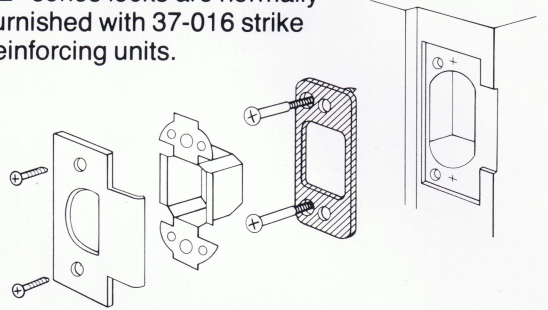

This unique device significantly strengthens a wood door jamb against "kick-in" attack and greatly increases the security effectiveness of the lock. The reinforcer is concealed under the strike and is anchored to the jamb with two 3" long screws.

Inside Knob and Rose Designs

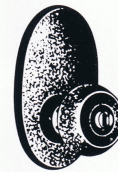

Clarendon



Georgian



Plymouth



Tulip

Inside Rose Dimension: 2 1/2" x 4 5/8"

All "A" lock knob designs and finishes are available for "E" lock inside trim. Knob designs not shown will be found in the "A" lock catalog section. When ordering "E" locks specify outside and inside designs and finishes.



36-074
Cylinder Ring
For standard "E" Pin
Tumbler Cylinders



Spacer
For use with 6 pin
"E" cylinder unit.