



Locks

Cylinders,
Keys & Keying

Exit Devices

Electronic
Access Control
Components

Low Energy
Operators

Surface
Closers

Fire/Life
Safety

Concealed
Closers/Pivots

Stops/
Holders

Sliding
Systems

Architectural
Pulls &
Handles

Service Parts

PRICE LIST 26



Architectural Hardware
February 1, 2016

TABLE OF CONTENTS

	Terms of Sale	iv
	Freight Policy	v
	Limited Warranty Policy	vi
	Finishes Cross Reference	vii
Locks	DORMA Locks Product Guide	1
	Select Service Quick Ship	3
	M9000 Grade 1 Mortise Series	9
	D900 Grade 1 Mortise Dead Bolt Series	21
	T900 Tubular Series	25
	C800 Grade 1 Cylindrical Series	31
	D800 Grade 1 Dead Bolt Series	41
	CL700 / CK700 Grade 2 Cylindrical Series	47
	C500 Grade 2 Cylindrical Series	55
	DB600 Grade 2 Dead Bolt Series	59
	C300 Grade 2 Cylindrical Series	63
	J300 Grade 2 Interconnected Series	65
Cylinders, Keys, and Keying	Cylinders, Keys, and Keying Product Guide	67
	Master Keying/DORMA SKC Policy	68
	Mortise Cylinders	69
	Rim Cylinders	74
	Key-in-Knob/Lever Cylinders	76
	Hotel Cylinders	77
	Small Format Interchangeable Cores	79
	Large Format Interchangeable Cores	80
	Retrofit Cylinder Housings	81
	Tailpieces	82
	Keys and Key Blanks	83
	SFIC Padlocks	85
	Service Parts	86
	Labeling and Cylinder Marking	88
	Merchandising Aids	89
Exit Devices	DORMA Exit Device Product Guide	91
	Select Service Quick Ship	93
	9000 Series	97
	9000 Series Wide Stile Exits	98
	9000 Series Wide Stile Trim	109
	9000 Series Narrow Stile Exits	126
	9000 Series Narrow Stile Trim	135
	8000 Series	145
	8000 Series Exits	146
	8000 Series Trim	152
	Mullions	161
Electronic Access Control Components	Select Service Quick Ship	163
	DORMA / Kaba E-Plex and Powerplex	166
	PS Series	169

	ES Series	173
	EML Series	177
	EMLSG Series	185
	EMSL Series	187
	EMDE Series	189
	AC Series	191
	PB Series	193
	39 Series	197
	KS Series	199
	Accessories	202
Low Energy Operators	Select Service Quick Ship	205
	ED900 Series	207
Surface Closers	DORMA Surface Closers Product Guide	211
	Select Service Quick Ship	213
	TS93 Series	217
	8900 Series	221
	8600 Series	227
	7400 Series	231
	U1500 Series	235
	7300 Series	237
	STA Series	241
	GSR Series	243
	Modular Packaging	245
Fire/Life Safety	DORMA Fire/Life Safety Product Guide	247
	Select Service Quick Ship	249
	EMR/EMF Series	251
	1800 Series	255
	EM Series	259
Concealed Closers/Pivots	DORMA Concealed Door Closers Product Guide	261
	Select Service Quick Ship	263
	BTS80 Series	267
	BTS80 EMB Series	273
	BTS75V Series	279
	ITS96 Series	285
	RTS88 Series	287
	LM Series Heavy-Duty Pivots	293
	LM Series Extra Heavy-Duty Pivots	297
Stops/ HOLDERS	900/700 Series	301
Sliding Systems	MUTO Comfort — Coming Soon	305
Architectural Pulls & Handles	Finishes Cross Reference	307
	TG 138 Locking & Non-Locking Ladder Pulls	307
	TG 9387 Non-Locking Ladder Pulls	311
	MANET Non-Locking Ladder Pulls	314
	TG Decorative Pulls	316
	ARCOS & BEYOND Decorative Pulls	318
	Economy Pulls	319



TERMS OF SALE

(Effective February 1, 2016)

Prices – The price list in effect on the date the customer order is received will determine billing price. Orders requiring price protection must be clearly indicated and received prior to the effective date of the price list increase. Delivery of price-protected orders will only be honored for immediate shipment. Orders requiring delivery in excess of three (3) months will be billed at prices in effect at time of shipment, unless otherwise quoted in writing by DORMA. Prices and availability subject to change without notice.

Terms – 1% -10 days; Net - 30.

Orders – We reserve the right to decline the whole or part of orders in which price, finishes, or quantity of goods or credit status of the buyer is not satisfactory to us. We reserve the right to discontinue items or change specifications at any time without notice and without incurring any obligations. DORMA cannot be held liable for extended delivery dates that may result in the cancellation of an order.

Acknowledgements – Acknowledgements are exact copies of the manufacturing order and should be checked upon receipt. If incorrect, please notify us immediately.

Cancellations – While DORMA will attempt to comply with customer's telephone or written change orders and/or cancellations, we cannot guarantee that they can be accomplished before shipment. Appropriate handling charges on returns will be exercised if the order has been shipped before processing a change order request. **A cancellation or change charge will apply if any costs for material or labor have been incurred prior to notification by customer of the change.**

Shipments – Shipment dates are contingent upon conditions at the time of order acknowledgement and can be subject to delays caused by shortages of materials, strikes, or other labor problems, equipment failure, fire, flood or other acts of God, or causes beyond our control. DORMA will not be liable under any circumstances for consequential damages arising from any delays.

Claims – All claims, whether referring to errors in prices, in filling orders, or for defective goods, must be submitted IN WRITING within 30 days after receipt of shipment. Requests for tracing of all lost shipments must be submitted IN WRITING within 30 days or the liability and risk is placed on the purchaser. All issued documents by a carrier confirming receipt of a shipment must be honored by the purchaser.

Return Goods – Returned goods will not be accepted unless authorized by a Return Goods Authorization (RGA) in writing within 120 days of invoice date. An RGA becomes void 30 days after its issue date. Credit will be given for products that are current production, new, unused, and in undamaged condition as received at the DORMA facility. A minimum 35% restock charge will apply. Exit devices should be shipped to DORMA USA, Inc. Returns Department, 1003 West Main Street, Steeleville, Illinois 62288. All other products should be shipped to DORMA USA, Inc. Returns Department, Dorma Drive, Reamstown, PA 17567. Returned material must be freight prepaid. Any exceptions to this policy will be noted on the RGA document.

To protect our customers from liability, do not sign the delivery receipt until shipment has been inspected thoroughly.

Customer is responsible to make necessary notations on the delivery receipt after inspection. Failure to note damaged items and/or shortages on the receipt releases DORMA from all liability; therefore, customer is responsible for any replacement costs. If damage or shortage is noted, please notify your DORMA customer service representative within 48 hours of receiving your shipment.

Product Modifications – Unauthorized modifications to DORMA USA, Inc. (DORMA) products by a third party will void the factory limited warranty. For a full description, please refer to the LIMITED WARRANTY POLICY. Any listings and/or certifications, such as Underwriters Laboratory, ANSI/ BHMA certification, and other similar listings, do not apply to products modified outside DORMA's U.S. plants. Any modified product cannot be advertised, promoted or sold as a DORMA product. The party, or parties, modifying DORMA products bear sole and complete responsibility for the modified product.

FREIGHT POLICY

(Effective February 1, 2016)

Freight Policy for Consignees within Contiguous United States

Customer orders that exceed \$5,000 (USD) in net value (before tax and freight) will be shipped by a carrier selected by DORMA, freight prepaid as a single shipment to a single business destination within the contiguous United States. Other terms apply to Alaska, Hawaii, Puerto Rico, and export orders. When a customer requests either multiple destinations or multiple shipments to the same destination, the \$5,000 minimum will apply to each shipment requested. Items backordered from an order qualifying for prepaid shipping charges will be shipped prepaid.

Orders less than \$5000 in net value will be shipped by a carrier selected by DORMA, with shipping and handling charges added to the customer's invoice.

All charges resulting from customer designated carrier, air freight, special handling, special routing or other freight services requested by the customer will be prepaid and added to the customers invoice.

All goods ship F.O.B. factory. Title and risk of loss pass to the customer upon tender of shipment to the carrier. If product is damaged in transit, consignee must file claim with the carrier.

Freight Policy for Consignees in Alaska, Hawaii, Puerto Rico, and Destinations Outside the Contiguous United States

Customer orders that exceed \$5,000 (USD) in net value (before tax and freight) will be shipped by a carrier selected by DORMA, freight prepaid to a U.S. airport or port of exit for single shipment orders. When a customer requests either multiple destinations or multiple shipments to the same destination, the \$5,000 minimum will apply to each shipment requested. Items backordered from an order qualifying for prepaid shipping charges will be shipped prepaid as Buyer's exclusive remedy.

At DORMA's option, this freight policy may be subject to special terms and conditions for certain export orders.

Orders less than \$5000 in net value will be shipped to a US airport or port of exit by a carrier selected by DORMA, with shipping and handling charges added to the customer's invoice.

All charges resulting from customer designated carrier, air freight, special handling, special routing, or other freight services requested by the customer will be prepaid and added to the customer's invoice.

All goods ship F.O.B. factory. Customer shall be responsible for obtaining insurance. Title and risk of loss for products shall pass when made available to customer on delivery to carrier in the United States; provided that if payment has not been made at the time of shipment, DORMA shall retain title (but not risk of loss) until payment has been made. If product is damaged in transit, customer must file claim exclusively with airline, carrier, vessel and/or insurance company; provided, however, that if DORMA has not received payment in full at the time the product is damaged in transit, DORMA shall have the right to file claim exclusively with airline, carrier, vessel and/or insurance company.



LIMITED WARRANTY POLICY

(Effective February 1, 2016)

For projects located in the United States and Canada, all products sold are warranted to be free from defects in workmanship and materials for the periods listed in the table below, from the date of manufacture. THIS COMPRISES SELLER'S SOLE AND EXCLUSIVE WARRANTY AND IS MADE EXPRESSLY IN LIEU OF ALL OTHER WARRANTIES, WRITTEN OR ORAL, EXPRESSED OR IMPLIED, STATUTORY OR OTHERWISE CONCERNING THE PRODUCTS, AND ALL OTHER WARRANTIES, INCLUDING, WITHOUT LIMITATION, WARRANTIES OF MERCHANTABILITY OR FITNESS FOR INTENDED PURPOSE, ARE HEREBY DISCLAIMED AND EXPRESSLY EXCLUDED. SELLER DOES NOT WARRANT AGAINST UNITED STATES PATENT INFRINGEMENT BY WAY OF THE USE OF PRODUCTS IN COMBINATION WITH OTHER PRODUCTS.

Limited warranty period (years) by product (from date of manufacture)		Mechanical	Electrical
Door Controls	TS93, 8900, 8600, 7400, 7300, BTS75V, BTS80	25	N/A
	U1500	10	N/A
	ITS, RTS	5	N/A
	EMR, EMF, 1800, GSR	25	2
	EMB, EM, EAC, ED900	2	2
	LM, 900, 700	2	N/A
Exit Devices	9000	10	2
	8000	5	2
Mullions		2	N/A
Locks	M9000, D900, T900, C800, D800	10	2
	CL/CK700, J300, DB600	5	N/A
	C500	3	N/A
	C300	1	N/A
	SKC Keys	Lifetime	N/A
Sliding Systems	MUTO Comfort	2	N/A
All other products not listed		2	1

For projects located outside the United States or Canada, the limited warranty period for all products is 1 year from the date of manufacture. DORMA regional businesses located outside the United States or Canada may offer different warranty periods. "United States and Canada" is defined as the several states of the United States, the District of Columbia, the commonwealths, territories and possessions of the United States and the provinces and territories of Canada.

None of the warranties set forth herein shall extend to any products or parts thereof that have been subjected to improper installation, lack of, or improper, maintenance, improper storage, shipping and handling, ordinary wear and tear, misuse, neglect, accident, unauthorized service, use of unauthorized parts, or performance of repairs, modifications or attachment to other products outside of Seller's plant. These warranties shall neither extend to nor cover any labor charges for replacement of products or parts, adjustments, or repairs, or any other work, which costs shall be the sole responsibility of Buyer. These warranties are extended only to Seller's distributors of products and the first user who purchases products for purposes other than resale (collectively, "Buyer").

Buyer's sole and exclusive remedy against Seller for any claim, whether in contract, tort or otherwise, arising out of, or resulting from the purchase of the products shall be limited to the repair or replacement of any product or part thereof, which is proved to be other than as warranted, or, at the sole option of Seller, to the issuance of a credit in an amount not to exceed the cost of the repair or replacement. In no event shall Seller be liable to Buyer or any other party for, and Buyer waives, any and all other damages, including, without limitation, incidental, special, indirect, collateral, punitive or consequential damages, including, without limitation, loss of profits, or loss of use damages or downtime costs. If a product is claimed to be other than as warranted, Seller, upon notice promptly given, will either examine the goods at Buyer's site or issue shipping instructions for return of product to the Seller (transportation costs prepaid by Buyer and all cost associated with the removal and reinstallation of such product to be the sole responsibility of Buyer).

Any representations, warranties or promises inconsistent with, or in addition to, the warranties contained herein are unauthorized and shall not be binding upon Seller. Because Seller has no control over the conditions under which its products are used, Seller specifically does not warrant the adequacy or sufficiency of any advice or recommendations given to Buyer. Nor does Seller warrant that every Seller product complies with every code, standard or regulation in every community except as specifically stated in a published Seller catalog or in writing signed by an officer of Seller. Seller shall not be bound by the terms of any agreements between a Buyer and third parties.

DORMA FINISHES CROSS REFERENCE

(Effective February 1, 2016)

Finish Description	Finish Appearance	DORMA/BHMA Code	Nearest U.S. Equivalent
Brass	Bright	605	US3
	Satin	606	US4
Bronze	Polished	611	US9
	Satin	612	US10
	Oil Rubbed/Dark Satin	613	US10B
Nickel	Bright	618	US14
	Satin	619	US15
Chrome	Bright	625	US26
	Satin	626	US26D
Stainless	Bright	629	US32
	Satin	630	US32D
Aluminum	Satin Anodized	628	US28
Dark Oxidized Bronze	Satin Anodized	710	US10B
Flat Black	Anodized	711	US19
Aluminum	Painted or Powder Coated	689	US28
Dark (Statuary) Bronze	Painted or Powder Coated	690	US20
Light (Dull) Bronze	Painted or Powder Coated	691	US10
Black	Painted or Powder Coated	693	Black Anodized
Dark (Duronodic) Bronze	Painted or Powder Coated	695	Dark Bronze Anodized
Satin Brass (Gold)	Painted or Powder Coated	696	US4
Primed	Painted or Powder Coated	600	USP
Custom	Painted or Powder Coated	Custom	RAL Pallet
Designer	Painted	Designer	Sample Match

Reference: ANSI A156.18 American National Standard for Materials & Finishes

DORMA 600 Series Plated Finishes designate the appearance of the finish, regardless of the base material.

For example, 605 defines a polished brass material, but DORMA 605 can be any base material, like steel or stainless, that is finished to provide the appearance of polished brass.

Standard sprayed finishes are shown above.

For a **Custom Color**, refer to the DORMA Custom Color Pallet. For Door Controls, a \$100.00 net setup fee per purchase order, per color will be charged. For exits and trim, a \$110.00 net setup fee per purchase order, per color will be charged. For a copy of the DORMA Custom Color Pallet, please contact your DORMA Representative or our Customer Service Department. Locks are NOT included in the Custom Color program.

For a **Designer Color**, custom matched to a supplied sample, three (3) each 2" x 3" color chip samples are required. For Door Controls, a non-refundable fee of \$250.00 net is required per color match request prior to processing. For exits and trim, non-refundable \$400.00 net fee is required per color match request prior to processing. Allow six (6) weeks for designer color development. If a match can not be made to the customer's satisfaction after three (3) attempts, DORMA reserves the right to decline the order. Metallic colors are difficult to duplicate and may be rejected. Locks are NOT included in the Designer Color program.

Please contact our Sales Service Department, or your local sales representative for further information.



DORMA LOCKS

How to Determine Hand of Door

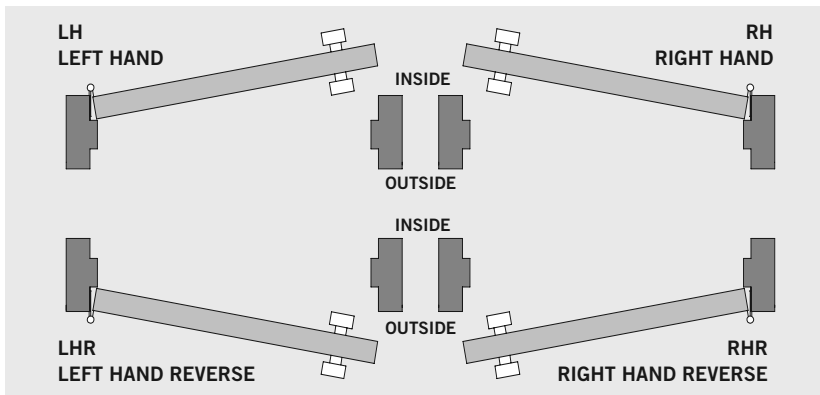

How to Determine Handed Levers

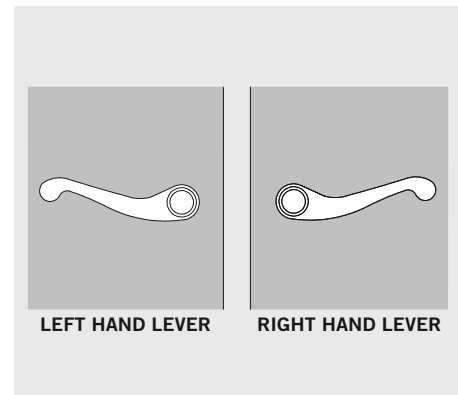

Product Guide

	Description	ANSI BHMA	Fire Rated	Standard Cylinder	SFIC	Schlage Style LFC
M9000 Lock	GR1 Mortise Lock	●	●	●	●	●
T900 Lock	GR2 Decorative Tubular Lock (M9000 Trim)	●	▨	○	○	○
D900 Dead Bolt	GR1 Small Case Mortise Dead Bolt	●	●	●	●	●
C800 Lever Lock	GR1 Cylindrical Lever Lock	●	●	●	●	●
C800 Knob Lock	GR1 Cylindrical Knob Lock	●	●	●	●	○
D800 Dead Bolt	GR1 Tubular Dead Bolt	●	●	●	●	●
CL700 Lever Lock	GR2 Cylindrical Lever Lock	●	●	●	●	○
CK700 Knob Lock	GR2 Cylindrical Knob Lock	●	●	●	●	○
DB600 Dead Bolt	GR2 Tubular Dead Bolt	●	●	●	●	○
C500 Lever Lock	GR2 Cylindrical Lever Lock	●	●	●	●	○
C300 Lever Lock	GR2 Cylindrical Lever Lock	●	▨	●	○	○
J300 Interconnected Lock	GR2 Interconnected Lock	●	●	●	●	○

SELECT SERVICE QUICK SHIP

Locks

Select service should be used for small quantities of popular DORMA products that require shipment within 24 hours. The program includes locks, exit devices, door closers, magnets, electronic access control, and low energy operators. Warehouses have been set up in the east and west for faster delivery nationwide. (Customer responsible for shipping costs FOB.)

Subject to Availability

Next Business Day Service (Shipment when Purchase Order is received prior to 4:00 PM EST).

Examples: DORMA receives P.O. at 3:59 PM on Monday, order will ship by close of business on Tuesday.

DORMA receives P.O. at 3:59 PM on Friday, order will ship by close of business on the following Monday.

Notes:

- Standard freight and discount schedules and terms of sale apply. Please refer to the current price list for full details.
- DORMA reserves the right to limit quantities or decline an order if the credit status of the buyer is not satisfactory to DORMA.
- Orders cannot be cancelled.
- Select Service Quick Ship available only in the United States.
- All prices are in U.S. dollars.
- Products and prices are subject to change without notice.
- Some of the available products have quantity per order limits and will be noted accordingly.

Key

N	"New" to Select Service, Available in East and West Coast Warehouse
■	Available in East and West Coast Warehouse
E	Available only in East Coast Warehouse



- Locks
- Cylinders, Keys & Keying
- Exit Devices
- Electronic Access Control Components
- Low Energy Operators
- Surface Closers
- Fire/Life Safety
- Concealed Closers/Pivots
- Stops/ Holders
- Sliding Systems
- Architectural Pulls & Handles
- Service Parts



C800 Series Grade 1 Cylindrical Lever Locks

PN #		Product	Lever	Rose	Latch	Strike	Finish	Keying	List \$
626 Finish									
33800001	■	C801 Single Dummy	LR	E	2-3/4" – 1-1/8" Face	ANSI 4-7/8"	626	—	155
33800002	■	C810 Passage	LR	E	2-3/4" – 1-1/8" Face	ANSI 4-7/8"	626	—	361
33800003	■	C840 Privacy	LR	E	2-3/4" – 1-1/8" Face	ANSI 4-7/8"	626	—	414
33800004	■	C853D Entry	LR	E	2-3/4" – 1-1/8" Face	ANSI 4-7/8"	626	SCKD	481
33800005	■	C853J Entry	LR	E	2-3/4" – 1-1/8" Face	ANSI 4-7/8"	626	IC	481
33800006	■	C870D Classroom	LR	E	2-3/4" – 1-1/8" Face	ANSI 4-7/8"	626	SCKD	481
33800007	■	C870J Classroom	LR	E	2-3/4" – 1-1/8" Face	ANSI 4-7/8"	626	IC	481
33800008	■	C880D Storeroom	LR	E	2-3/4" – 1-1/8" Face	ANSI 4-7/8"	626	SCKD	481
33800009	■	C880J Storeroom	LR	E	2-3/4" – 1-1/8" Face	ANSI 4-7/8"	626	IC	481
33800054	☐	C801 Single Dummy	LC	E	2-3/4" – 1-1/8" Face	ANSI 4-7/8"	626	—	155
33800055	☐	C810 Passage	LC	E	2-3/4" – 1-1/8" Face	ANSI 4-7/8"	626	—	361
33800056	☐	C840 Privacy	LC	E	2-3/4" – 1-1/8" Face	ANSI 4-7/8"	626	—	414
33800057	☐	C853D Entry	LC	E	2-3/4" – 1-1/8" Face	ANSI 4-7/8"	626	SCKD	481
33800058	☐	C853J Entry	LC	E	2-3/4" – 1-1/8" Face	ANSI 4-7/8"	626	IC	481
33800059	☐	C870D Classroom	LC	E	2-3/4" – 1-1/8" Face	ANSI 4-7/8"	626	SCKD	481
33800060	☐	C870J Classroom	LC	E	2-3/4" – 1-1/8" Face	ANSI 4-7/8"	626	IC	481
33800061	☐	C880D Storeroom	LC	E	2-3/4" – 1-1/8" Face	ANSI 4-7/8"	626	SCKD	481
33800062	☐	C880J Storeroom	LC	E	2-3/4" – 1-1/8" Face	ANSI 4-7/8"	626	IC	481
Strikes									
33800010	■	C800 Strike	—	—	—	T Strike	626	—	9
33800011	■	C800 Strike	—	—	—	FL Square	626	—	9





CL700 Series Grade 2 Cylindrical Lever Locks

PN #		Product	Lever	Rose	Latch	Strike	Finish	Keying	List \$
626 Finish									
33800012	■	CL701 Single Dummy	LR	E	2-3/4" – 1-1/8" Face	ANSI 4-7/8"	626	—	93
33800013	■	CL710 Passage	LR	E	2-3/4" – 1-1/8" Face	ANSI 4-7/8"	626	—	163
33800014	■	CL740 Privacy	LR	E	2-3/4" – 1-1/8" Face	ANSI 4-7/8"	626	—	185
33800015	■	CL753D Entry	LR	E	2-3/4" – 1-1/8" Face	ANSI 4-7/8"	626	SC KD	238
33800016	■	CL753J Entry	LR	E	2-3/4" – 1-1/8" Face	ANSI 4-7/8"	626	IC	238
33800017	■	CL770D Classroom	LR	E	2-3/4" – 1-1/8" Face	ANSI 4-7/8"	626	SC KD	238
33800018	■	CL770J Classroom	LR	E	2-3/4" – 1-1/8" Face	ANSI 4-7/8"	626	IC	238
33800019	■	CL780D Storeroom	LR	E	2-3/4" – 1-1/8" Face	ANSI 4-7/8"	626	SC KD	238
33800020	■	CL780J Storeroom	LR	E	2-3/4" – 1-1/8" Face	ANSI 4-7/8"	626	IC	238
33800063	ⓔ	CL701 Single Dummy	LC	E	2-3/4" – 1-1/8" Face	ANSI 4-7/8"	626	—	93
33800064	ⓔ	CL710 Passage	LC	E	2-3/4" – 1-1/8" Face	ANSI 4-7/8"	626	—	163
33800065	ⓔ	CL740 Privacy	LC	E	2-3/4" – 1-1/8" Face	ANSI 4-7/8"	626	—	185
33800066	ⓔ	CL753D Entry	LC	E	2-3/4" – 1-1/8" Face	ANSI 4-7/8"	626	SCKD	238
33800067	ⓔ	CL770D Classroom	LC	E	2-3/4" – 1-1/8" Face	ANSI 4-7/8"	626	SCKD	238
33800068	ⓔ	CL780D Storeroom	LC	E	2-3/4" – 1-1/8" Face	ANSI 4-7/8"	626	SCKD	238
613 Finish									
33800069	ⓔ	CL701 Single Dummy	LR	E	2-3/4" – 1-1/8" Face	ANSI 4-7/8"	613	—	106
33800070	ⓔ	CL710 Passage	LR	E	2-3/4" – 1-1/8" Face	ANSI 4-7/8"	613	—	187
33800071	ⓔ	CL740 Privacy	LR	E	2-3/4" – 1-1/8" Face	ANSI 4-7/8"	613	—	209
33800072	ⓔ	CL753D Entry	LR	E	2-3/4" – 1-1/8" Face	ANSI 4-7/8"	613	SCKD	262
33800073	ⓔ	CL770D Classroom	LR	E	2-3/4" – 1-1/8" Face	ANSI 4-7/8"	613	SCKD	262
33800074	ⓔ	CL780D Storeroom	LR	E	2-3/4" – 1-1/8" Face	ANSI 4-7/8"	613	SCKD	262
Strikes									
33800022	■	Strike	—	—	—	T	—	626	9
33800076	ⓔ	Strike	—	—	—	T	—	613	9
33800011	■	Strike	—	—	—	FL Square	—	626	9
33800077	ⓔ	Strike	—	—	—	FL Square	—	613	9

- Locks
- Cylinders, Keys & Keying
- Exit Devices
- Electronic Access Control Components
- Low Energy Operators
- Surface Closers
- Fire/Life Safety
- Concealed Closers/Pivots
- Stops/ Holders
- Sliding Systems
- Architectural Pulls & Handles
- Service Parts





C500 Series Economy Grade 2 Cylindrical Lever Locks

PN #	Product	Lever	Rose	Latch	Strike	Finish	Keying	List \$
626 Finish								
33800024	■ C501 Single Dummy	LR	C	2-3/4" – 1" Face with Filler	ANSI 4-7/8"	626	—	60
33800025	■ C510 Passage	LR	C	2-3/4" – 1" Face with Filler	ANSI 4-7/8"	626	—	102
33800026	■ C540 Privacy	LR	C	2-3/4" – 1" Face with Filler	ANSI 4-7/8"	626	—	104
33800027	■ C553D Entry	LR	C	2-3/4" – 1" Face with Filler	ANSI 4-7/8"	626	SCKD	112
33800028	■ C553J Entry	LR	C	2-3/4" – 1" Face with Filler	ANSI 4-7/8"	626	IC	112
33800029	■ C570D Classroom	LR	C	2-3/4" – 1" Face with Filler	ANSI 4-7/8"	626	SCKD	112
33800030	■ C570J Classroom	LR	C	2-3/4" – 1" Face with Filler	ANSI 4-7/8"	626	IC	112
33800031	■ C580D Storeroom	LR	C	2-3/4" – 1" Face with Filler	ANSI 4-7/8"	626	SCKD	112
33800032	■ C580J Storeroom	LR	C	2-3/4" – 1" Face with Filler	ANSI 4-7/8"	626	SCKD	112
33800033	■ C501 Single Dummy	LC	C	2-3/4" – 1" Face with Filler	ANSI 4-7/8"	626	—	60
33800034	■ C510 Passage	LC	C	2-3/4" – 1" Face with Filler	ANSI 4-7/8"	626	—	102
33800035	■ C540 Privacy	LC	C	2-3/4" – 1" Face with Filler	ANSI 4-7/8"	626	—	104
33800036	■ C553D Entry	LC	C	2-3/4" – 1" Face with Filler	ANSI 4-7/8"	626	SCKD	112
33800037	■ C580D Storeroom	LC	C	2-3/4" – 1" Face with Filler	ANSI 4-7/8"	626	SCKD	112
613 Finish								
33800038	■ C510 Passage	LR	C	2-3/4" – 1" Face with Filler	ANSI 4-7/8"	613	—	114
33800039	■ C540 Privacy	LR	C	2-3/4" – 1" Face with Filler	ANSI 4-7/8"	613	—	116
33800040	■ C553D Entry	LR	C	2-3/4" – 1" Face with Filler	ANSI 4-7/8"	613	SCKD	124
33800041	■ C580D Storeroom	LR	C	2-3/4" – 1" Face with Filler	ANSI 4-7/8"	613	SCKD	124
33800078	☐ C510 Passage	LC	C	2-3/4" – 1" Face with Filler	ANSI 4-7/8"	613	—	114
33800079	☐ C540 Privacy	LC	C	2-3/4" – 1" Face with Filler	ANSI 4-7/8"	613	—	116
33800080	☐ C553D Entry	LC	C	2-3/4" – 1" Face with Filler	ANSI 4-7/8"	613	SCKD	124
33800081	☐ C580D Storeroom	LC	C	2-3/4" – 1" Face with Filler	ANSI 4-7/8"	613	SCKD	124
Strikes								
33800022	■ Strike	—	—	—	T	626	—	9
33800076	☐ Strike	—	—	—	T	613	—	9
33800011	■ Strike	—	—	—	FL Square	626	—	9
33800077	☐ Strike	—	—	—	FL Square	613	—	9





C300/J300 Series Grade 2 Cylindrical & Interconnected Locks

PN #	Product	Function	Lever	Latch	Strike	Finish	Keying	List \$
626 Finish								
33800105	■ C301	Single Dummy	LR	—	—	626	—	30
33800108	■ C310	Passage	LR	234N 118S	Full Lip Radius	626	—	60
33800109	■ C310	Passage	LC	234N 118S	Full Lip Radius	626	—	60
33800113	■ C330	Patio	LR	234F 118S	Full Lip Radius	626	—	69
33800116	■ C340	Privacy	LR	234N 118S	Full Lip Radius	626	—	64
33800117	■ C340	Privacy	LC	234N 118S	Full Lip Radius	626	—	64
33800121	■ C353	Keyed Entry	LR	234F 118S	Full Lip Radius	626	SCKD	79
33800122	■ C353	Keyed Entry	LC	234F 118S	Full Lip Radius	626	SCKD	79
33800126	■ J310	Entry, Single Cylinder	LR	234F 118S	T Strike	626	SCKD	313
33800127	■ J310	Entry, Single Cylinder	LC	234F 118S	T Strike	626	SCKD	313
626/619 Finish								
33800130	■ Latch	C310/C340	—	238N 100S	—	626/619	—	15
33800131	■ Latch	C353/J310	—	238F 100S	—	626/619	—	20
33800132	■ Latch	C330	—	238F 100S	—	626/619	—	20
619 Finish								
33800106	■ C301	Single Dummy	LS	—	—	619	—	32
33800107	■ C301	Single Dummy	LS	—	—	619	—	32
33800111	■ C310	Passage	LS	234N 118S	Full Lip Radius	619	—	62
33800112	■ C310	Passage	LS	234N 118S	Full Lip Radius	619	—	62
33800114	■ C330	Patio	LS	234F 118S	Full Lip Radius	619	—	71
33800115	■ C330	Patio	LS	234F 118S	Full Lip Radius	619	—	71
33800119	■ C340	Privacy	LS	234N 118S	Full Lip Radius	619	—	66
33800120	■ C340	Privacy	LS	234N 118S	Full Lip Radius	619	—	66
33800124	■ C353	Keyed Entry	LS	234F 118S	Full Lip Radius	619	SCKD	82
33800125	■ C353	Keyed Entry	LS	234F 118S	Full Lip Radius	619	SCKD	82
33800128	■ J310	Entry, Single Cylinder	LS	234F 118S	T Strike	619	SCKD	325
33800129	■ J310	Entry, Single Cylinder	LS	234F 118S	T Strike	619	SCKD	325
613 Finish								
33800110	■ C310	Passage	LC	234N 118S	Full Lip Radius	613	—	62
33800118	■ C340	Privacy	LC	234N 118S	Full Lip Radius	613	—	66
33800123	■ C353	Keyed Entry	LC	234F 118S	Full Lip Radius	613	SCKD	82
33800133	■ Latch	C310/C340	—	238N 100S	—	613	—	15
33800134	■ Latch	C353/J310	—	238F 100S	—	613	—	20



- Locks
- Cylinders, Keys & Keying
- Exit Devices
- Electronic Access Control Components
- Low Energy Operators
- Surface Closers
- Fire/Life Safety
- Concealed Closers/Pivots
- Stops/Holders
- Sliding Systems
- Architectural Pulls & Handles
- Service Parts

Deadbolts

PN #	Product	Latch	Finish	Keying	List \$
630 Finish					
33800052 ■	DB660D Cylindrical × Turn	Adj, 1" Face with Filler	630	SCKD	73
33800053 ■	DB660J Cylindrical × Turn	Adj, 1" Face with Filler	630	IC	73
33800104 ☒	DB662D Cylindrical × Turn	Adj, 1" Face with Filler	630	SCKD	94
626 Finish					
33800050 ■	DB660D Cylindrical × Turn	Adj, 1" Face with Filler	626	SCKD	73
33800051 ■	DB660J Cylindrical × Turn	Adj, 1" Face with Filler	626	IC	73
33800103 ☒	DB662D Cylindrical × Turn	Adj, 1" Face with Filler	626	SCKD	94



M9000 SERIES

Ordering Guide

Function*

Privacy w/DB & Indicator	996
Faculty Restroom/Hotel w/DB & Indicator	986
Storeroom w/DB Single Cylinder	980
Classroom Intruder w/DB	974
Dormitory w/DB (F21)	973
Intruder Dead Bolt (F33)	968
Intruder Dead Bolt (F34)	967
Storeroom w/DB (F14)	966
Storeroom w/DB (F35)	958
Dormitory w/DB (F11)	957
Corridor w/DB (F13)	956
Entry w/DB (F20)	953
Privacy w/DB (F19)	940
Institution (F30)	082
Electrically Unlocked/Locked w/Double Locking	082EU/EL
Electrically Unlocked/Locked	080EU/EL
Storeroom (F07)	080
Classroom Intruder Latch Bolt (F32)	071
Classroom (F05)	070
Apartment (F09)	060
Office/Entry (Alt F04)	053
Office/Entry (F04)	050
Privacy w/Indicator	046
Privacy w/Coin Turn	042
Privacy, Bedroom or Bath (F22)	040
Exit/Communicating Passage (F31)	025
Passage/Closet (F01)	010
Dummy Trim Two Sides	002
Dummy Trim One Side	001

Lever Design

Premium Lever	PREMIUM
Lever	LT
Lever	LR
Lever	LN
Lever	LG
Lever	LD
Lever	LC

Finish¹

630	Satin Stainless
629	Bright Stainless
626	Satin Chrome
625	Bright Chrome
619 PVD	Satin Nickel
613 PVD	Dark Oxidized Satin Bronze
612 PVD	Satin Bronze
606 PVD	Satin Brass
605 PVD	Bright Brass

- For split finishes or finishes not shown, consult factory. Special order finishes require extended lead times.
- Available on lever designs in 626/630 finishes only. Consult factory for other finishes.
- Example shows default values. Refer to Lock Options section for full details.
- Standard door thickness is 1-3/4" (44 mm). Requirements for doors 1-13/16" (46 mm) and thicker can vary by trim and function. Consult factory for these special applications.

Product Family

Heavy Duty Grade 1 Mortise Lockset	M9
Temporary SFIC	953
SFIC (Less Core)	J
SFIC (With Core)	C
Less Cylinder	L
Conventional Cylinder	D
Schlage FSIC (Less Core)	R

Cylinder Type

Keying Options Field

A	2-1/4" Dia. Rose
B	2-9/16" Dia. Rose
H	2-1/8" x 8-9/16" Escutcheon
M	2-1/2" x 8" Escutcheon
D	2-9/16" Dia. Decorative Rose

Rose/Escutcheon Design

Door Hand

RH	Right Hand
RHR	Right Hand Reverse
LH	Left Hand
LHR	Left Hand Reverse

Security Screws

AM	Antimicrobial Coating ²
TX	Security Screws

Door Thickness^{3,4}

Strike Options³

Lip Length³

Keying Options Field

RH	Right Hand
RHR	Right Hand Reverse
LH	Left Hand
LHR	Left Hand Reverse

Keying Options Field

134	5006	114	XXXX
-----	------	-----	------

- Locks
- Cylinders, Keys & Keying
- Exit Devices
- Electronic Access Control Components
- Low Energy Operators
- Surface Closers
- Fire/Life Safety
- Concealed Closers/Pivots
- Stops/ Holders
- Sliding Systems
- Architectural Pulls & Handles
- Service Parts

TRIM OPTIONS

Finish Group A

Available Finishes—626, 625, 605, 606, 612, 613, 619

Standard

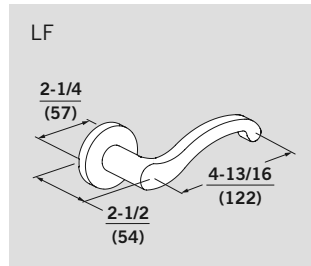
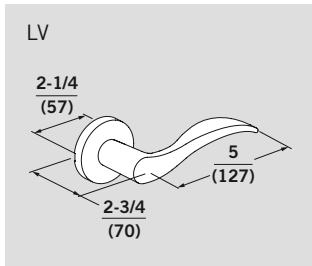
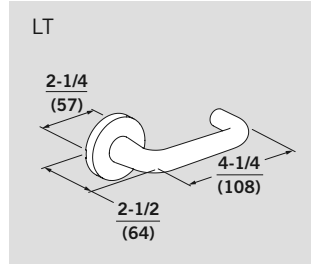
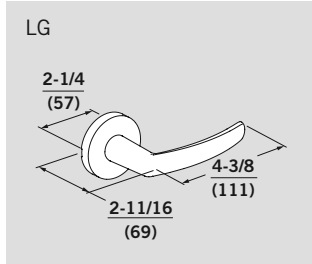
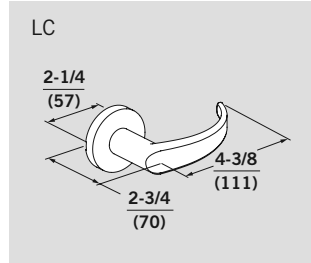
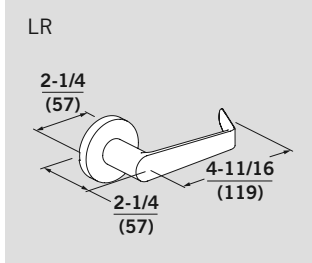

Premium

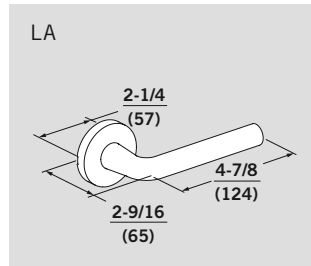
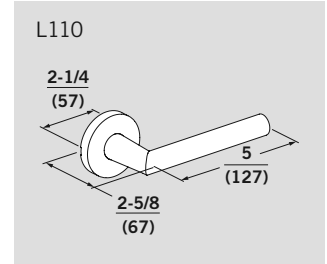
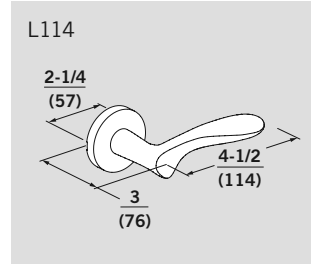
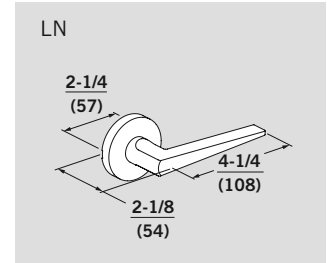
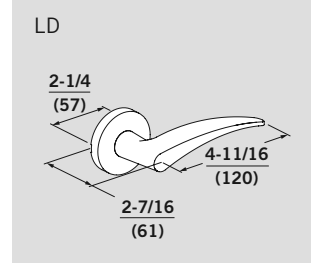

Finish Group B

Available Finishes—630, 606, 612, 613, 619 / L117 also available in 605 and 629

Standard

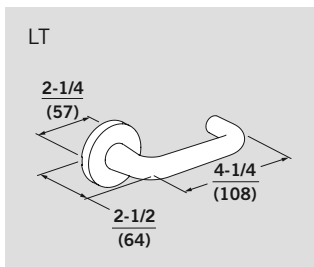
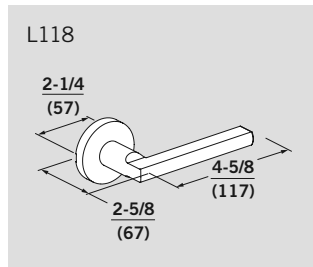
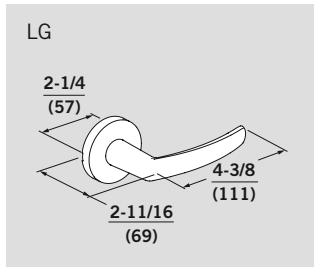
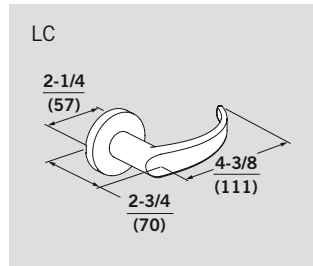
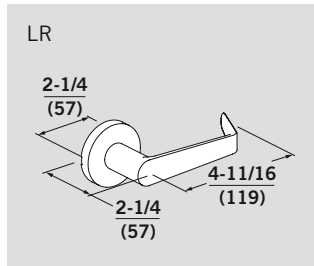

Premium

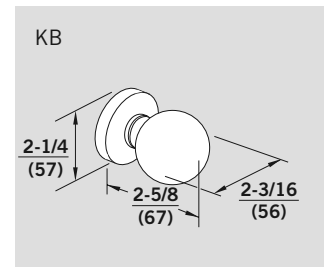
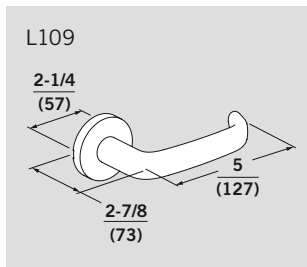
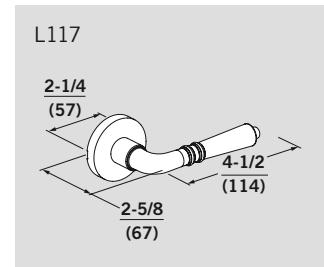
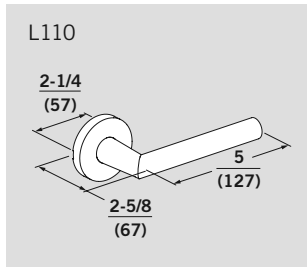
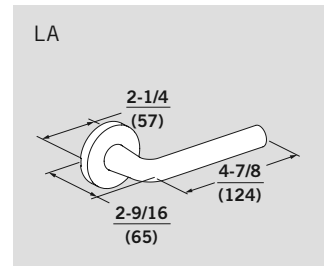
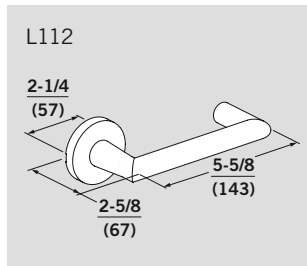

Finish Groups A & B

All Finishes

Wrought Roses

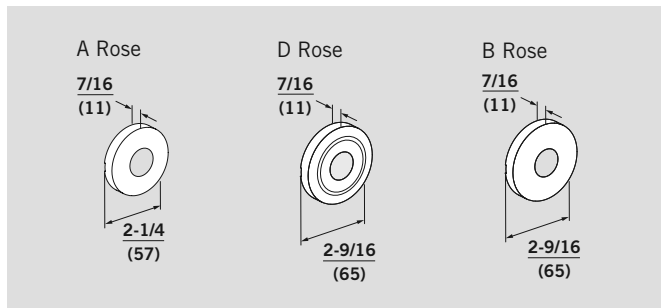

Escutcheons

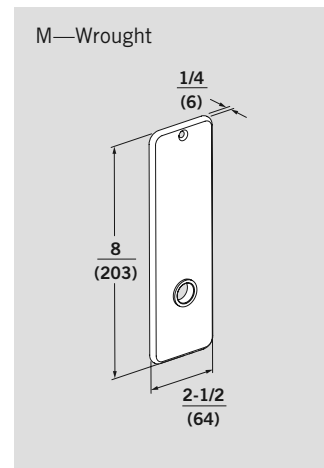
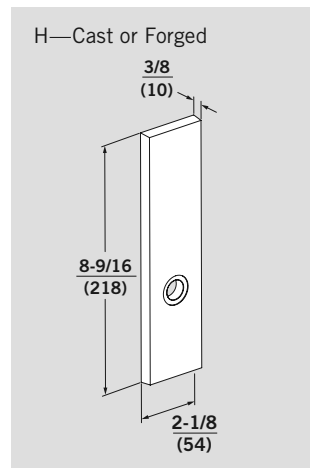

- Locks
- Cylinders, Keys & Keying
- Exit Devices
- Electronic Access Control Components
- Low Energy Operators
- Surface Closers
- Fire/Life Safety
- Concealed Closers/Pivots
- Stops/ Holders
- Sliding Systems
- Architectural Pulls & Handles
- Service Parts



STANDARD LEVERS

Roses: A, B, D / Levers: LG, LC, LR, LT, LF, LV, L118

Finish availability determined by finish group A/B

A,B,D Rose	
626	605, 606, 612, 613, 619, 625, 630

ANSI #	Function	Description	List \$	
Non-Keyed				
—	M9001 (w/out lock case)	Single dummy	190	217
—	M9002 (w/out lock case)	Double dummy	407	438
—	M9003 (w/lock case)	Single dummy	300	317
—	M9004 (w/lock case)	Double dummy	495	526
F01	M9010	Passage/closet	533	593
F31	M9025	Exit/communicating passage	614	677
F22	M9040	Privacy, bedroom or bath	614	677
—	M9042	Privacy w/coin turn	655	721
—	M9046	Privacy w/indicator	740	772
F19	M9940	Privacy w/dead bolt	740	772
—	M9942	Privacy w/dead bolt and coin turn	784	815
Keyed, Single Cylinder				
F04	M9050	Office/Entry	682	749
F04	M9053	Office/Entry	682	749
—	M9056	Office/Entry w/automatic unlocking	744	813
F05	M9070	Classroom	682	749
F06	M9076	Holdback	682	749
F07	M9080	Storeroom	682	749
—	M9080EL	Electrically locked (Fail Safe)	1,030	1,061
—	M9080EU	Electrically unlocked (Fail Secure)	1,030	1,061
—	M9080ELRX	Electrically locked (Fail Safe) w/request to exit switch	1,186	1,217
—	M9080EURX	Electrically unlocked (Fail Secure) w/request to exit switch	1,186	1,217
F20	M9953	Entry w/dead bolt	703	772
—	M9954	Security entrance w/dead bolt	703	772
F13	M9956	Corridor w/dead bolt	703	772
F12	M9959	Dormitory/Exit w/dead bolt	703	772
F21	M9973	Dormitory w/dead bolt	703	772
—	M9980	Storeroom w/dead bolt	703	772
F15	M9985	Faculty restroom/hotel w/dead bolt	744	813
—	M9986	Faculty restroom/hotel w/dead bolt/indicator	802	876
—	M9996	Privacy w/dead bolt/indicator	802	876
Keyed, Double Cylinder				
F09	M9060	Apartment	749	820
F32	M9071	Intruder latch bolt	749	820
—	M9077	Holdback double cylinder	749	820
F30	M9082	Institution lock	749	820
—	M9082EL	Electrically locked (Fail Safe) w/double locking	1,088	1,119
—	M9082EU	Electrically unlocked (Fail Secure) w/double locking	1,088	1,119
F11	M9957	Dormitory w/dead bolt	788	820
F35	M9958	Storeroom w/dead bolt	788	820
F14	M9966	Storeroom w/dead bolt	788	820
F34	M9967	Intruder w/dead bolt	788	820
—	M9974	Classroom intruder w/dead bolt	788	820
Deadbolt Only				
F17	M9960	Deadbolt Only – Cylinder × Turn (No Trim)	354	370
F18	M9961	Deadbolt Only – Cylinder × Blank (No Trim)	291	308
F16	M9962	Deadbolt Only – Cylinder × Cylinder (No Trim)	428	445
F29	M9963	Deadbolt Only – Classroom (No Trim)	428	445



STANDARD LEVERS

Escutcheons: H, M / Levers: LG, LC, LR, LT, LF, LV, L118

Finish availability determined by finish group A/B

H Escutcheon		M Escutcheon	
626	605, 606, 612, 613, 619, 625, 630	626, 630	605, 606, 612, 613, 619, 625

ANSI #	Function	Description	List \$			
Non-Keyed						
—	M9001 (w/out lock case)	Single dummy	237	254	196	223
—	M9002 (w/out lock case)	Double dummy	440	471	417	448
—	M9003 (w/lock case)	Single dummy	334	350	305	328
—	M9004 (w/lock case)	Double dummy	531	563	505	537
F01	M9010	Passage/closet	597	628	544	603
F31	M9025	Exit/communicating passage	NA	NA	NA	NA
F22	M9040	Privacy, bedroom or bath	682	713	624	687
—	M9042	Privacy w/coin turn	725	756	665	731
—	M9046	Privacy w/indicator	NA	NA	NA	NA
F19	M9940	Privacy w/dead bolt	776	804	751	782
—	M9942	Privacy w/dead bolt and coin turn	820	850	794	826
Keyed, Single Cylinder						
F04	M9050	Office/Entry	752	783	692	759
F04	M9053	Office/Entry	752	783	692	759
—	M9056	Office/Entry w/automatic unlocking	786	817	754	824
F05	M9070	Classroom	752	783	692	759
F06	M9076	Holdback	752	783	692	759
F07	M9080	Storeroom	752	783	692	759
—	M9080EL	Electrically locked (Fail Safe)	1,068	1,099	1,040	1,071
—	M9080EU	Electrically unlocked (Fail Secure)	1,068	1,099	1,040	1,071
—	M9080ELRX	Electrically locked (Fail Safe) w/request to exit switch	1,224	1,255	1,196	1,227
—	M9080EURX	Electrically unlocked (Fail Secure) w/request to exit switch	1,224	1,255	1,196	1,227
F20	M9953	Entry w/dead bolt	775	806	713	782
—	M9954	Security entrance w/dead bolt	775	806	713	782
F13	M9956	Corridor w/dead bolt	775	806	713	782
F12	M9959	Dormitory/Exit w/dead bolt	775	806	713	782
F21	M9973	Dormitory w/dead bolt	775	806	713	782
—	M9980	Storeroom w/dead bolt	775	806	713	782
F15	M9985	Faculty restroom/hotel w/dead bolt	806	837	754	824
—	M9986	Faculty restroom/hotel w/dead bolt/indicator	NA	NA	NA	NA
—	M9996	Privacy w/dead bolt/indicator	NA	NA	NA	NA
Keyed, Double Cylinder						
F09	M9060	Apartment	822	853	759	830
F32	M9071	Intruder latch bolt	822	853	759	830
—	M9077	Holdback double cylinder	822	853	759	830
F30	M9082	Institution lock	822	853	759	830
—	M9082EL	Electrically locked (Fail Safe) w/double locking	1,122	1,153	1,098	1,130
—	M9082EU	Electrically unlocked (Fail Secure) w/double locking	1,122	1,153	1,098	1,130
F11	M9957	Dormitory w/dead bolt	822	853	798	830
F35	M9958	Storeroom w/dead bolt	822	853	798	830
F14	M9966	Storeroom w/dead bolt	822	853	798	830
F34	M9967	Intruder w/dead bolt	822	853	798	830
—	M9974	Classroom intruder w/dead bolt	822	853	798	830
Deadbolt Only						
F17	M9960	Deadbolt Only – Cylinder x Turn (No Trim)	354	370	—	—
F18	M9961	Deadbolt Only – Cylinder x Blank (No Trim)	291	308	—	—
F16	M9962	Deadbolt Only – Cylinder x Cylinder (No Trim)	428	445	—	—
F29	M9963	Deadbolt Only – Classroom (No Trim)	428	445	—	—

- Locks
- Cylinders, Keys & Keying
- Exit Devices
- Electronic Access Control Components
- Low Energy Operators
- Surface Closers
- Fire/Life Safety
- Concealed Closers/Pivots
- Stops/ Holders
- Sliding Systems
- Architectural Pulls & Handles
- Service Parts



PREMIUM LEVERS

Roses: A, B, D / Levers: LA, L109,
L110, L112, L114, L117, KB, LD, LN

Finish availability determined
by finish group A/B

A ,B, D Rose	
626	605, 606, 612, 613, 619, 625, 630

ANSI #	Function	Description	List \$	
Non-Keyed				
—	M9001 (w/out lock case)	Single dummy	202	230
—	M9002 (w/out lock case)	Double dummy	430	461
—	M9003 (w/lock case)	Single dummy	314	332
—	M9004 (w/lock case)	Double dummy	520	553
F01	M9010	Passage/closet	560	621
F31	M9025	Exit/communicating passage	643	708
F22	M9040	Privacy, bedroom or bath	643	708
—	M9042	Privacy w/coin turn	685	753
—	M9046	Privacy w/indicator	773	805
F19	M9940	Privacy w/dead bolt	773	805
—	M9942	Privacy w/dead bolt and coin turn	819	851
Keyed, Single Cylinder				
F04	M9050	Office/Entry	713	782
F04	M9053	Office/Entry	713	782
—	M9056	Office/Entry w/automatic unlocking	777	849
F05	M9070	Classroom	713	782
F06	M9076	Holdback	713	782
F07	M9080	Storeroom	713	782
—	M9080EL	Electrically locked (Fail Safe)	1,071	1,103
—	M9080EU	Electrically unlocked (Fail Secure)	1,071	1,103
—	M9080ELRX	Electrically locked (Fail Safe) w/request to exit switch	1,232	1,264
—	M9080EURX	Electrically unlocked (Fail Secure) w/request to exit switch	1,232	1,264
F20	M9953	Entry w/dead bolt	734	805
—	M9954	Security entrance w/dead bolt	734	805
F13	M9956	Corridor w/dead bolt	734	805
F12	M9959	Dormitory/Exit w/dead bolt	734	805
F21	M9973	Dormitory w/dead bolt	734	805
—	M9980	Storeroom w/dead bolt	734	805
F15	M9985	Faculty restroom/hotel w/dead bolt	777	849
—	M9986	Faculty restroom/hotel w/dead bolt/indicator	836	913
—	M9996	Privacy w/dead bolt/indicator	836	913
Keyed, Double Cylinder				
F09	M9060	Apartment	782	855
F32	M9071	Intruder latch bolt	782	855
—	M9077	Holdback double cylinder	782	855
F30	M9082	Institution lock	782	855
—	M9082EL	Electrically locked (Fail Safe) w/double locking	1,131	1,163
—	M9082EU	Electrically unlocked (Fail Secure) w/double locking	1,131	1,163
F11	M9957	Dormitory w/dead bolt	823	855
F35	M9958	Storeroom w/dead bolt	823	855
F14	M9966	Storeroom w/dead bolt	823	855
F34	M9967	Intruder w/dead bolt	823	855
—	M9974	Classroom intruder w/dead bolt	823	855
Deadbolt Only				
F17	M9960	Deadbolt Only – Cylinder x Turn (No Trim)	365	381
F18	M9961	Deadbolt Only – Cylinder x Blank (No Trim)	300	317
F16	M9962	Deadbolt Only – Cylinder x Cylinder (No Trim)	441	458
F29	M9963	Deadbolt Only – Classroom (No Trim)	441	458



PREMIUM LEVERS

Escutcheons: H, M / Levers: LA, L109, L110, L112, L114, L117, KB, LD, LN

Finish availability determined by finish group A/B

H Escutcheon		M Escutcheon	
626	605, 606, 612, 613, 619, 625, 630	626, 630	605, 606, 612, 613, 619, 625,

ANSI #	Function	Description	List \$			
Non-Keyed						
—	M9001 (w/out lock case)	Single dummy	249	267	207	235
—	M9002 (w/out lock case)	Double dummy	464	496	440	473
—	M9003 (w/lock case)	Single dummy	349	366	320	343
—	M9004 (w/lock case)	Double dummy	558	528	531	563
F01	M9010	Passage/closet	625	658	571	632
F31	M9025	Exit/communicating passage	—	—	—	—
F22	M9040	Privacy, bedroom or bath	714	746	653	719
—	M9042	Privacy w/coin turn	757	789	696	764
—	M9046	Privacy w/indicator	—	—	—	—
F19	M9940	Privacy w/dead bolt	810	838	784	816
—	M9942	Privacy w/dead bolt and coin turn	855	887	829	861
Keyed, Single Cylinder						
F04	M9050	Office/Entry	785	818	723	793
F04	M9053	Office/Entry	785	818	723	793
—	M9056	Office/Entry w/automatic unlocking	821	853	787	859
F05	M9070	Classroom	785	818	723	793
F06	M9076	Holdback	785	818	723	793
F07	M9080	Storeroom	785	818	723	793
—	M9080EL	Electrically locked (Fail Safe)	1,110	1,143	1,082	1,114
—	M9080EU	Electrically unlocked (Fail Secure)	1,110	1,143	1,082	1,114
—	M9080ELRX	Electrically locked (Fail Safe) w/request to exit switch	1,271	1,304	1,242	1,275
—	M9080EURX	Electrically unlocked (Fail Secure) w/request to exit switch	1,271	1,304	1,242	1,275
F20	M9953	Entry w/dead bolt	809	840	746	816
—	M9954	Security entrance w/dead bolt	809	840	746	816
F13	M9956	Corridor w/dead bolt	809	840	746	816
F12	M9959	Dormitory/Exit w/dead bolt	809	840	746	816
F21	M9973	Dormitory w/dead bolt	809	840	746	816
—	M9980	Storeroom w/dead bolt	809	840	746	816
F15	M9985	Faculty restroom/hotel w/dead bolt	840	873	787	859
—	M9986	Faculty restroom/hotel w/dead bolt/indicator	—	—	—	—
—	M9996	Privacy w/dead bolt/indicator	—	—	—	—
Keyed, Double Cylinder						
F09	M9060	Apartment	867	900	793	865
F32	M9071	Intruder latch bolt	867	900	793	865
—	M9077	Holdback double cylinder	867	900	793	865
F30	M9082	Institution lock	867	900	793	865
—	M9082EL	Electrically locked (Fail Safe) w/double locking	1,176	1,209	1,142	1,172
—	M9082EU	Electrically unlocked (Fail Secure) w/double locking	1,176	1,209	1,142	1,172
F11	M9957	Dormitory w/dead bolt	867	900	833	865
F35	M9958	Storeroom w/dead bolt	867	900	833	865
F14	M9966	Storeroom w/dead bolt	867	900	833	865
F34	M9967	Intruder w/dead bolt	867	900	833	865
—	M9974	Classroom intruder w/dead bolt	867	900	833	865
Deadbolt Only						
F17	M9960	Deadbolt Only – Cylinder x Turn (No Trim)	365	381	—	—
F18	M9961	Deadbolt Only – Cylinder x Blank (No Trim)	300	317	—	—
F16	M9962	Deadbolt Only – Cylinder x Cylinder (No Trim)	441	458	—	—
F29	M9963	Deadbolt Only – Classroom (No Trim)	441	458	—	—

- Locks
- Cylinders, Keys & Keying
- Exit Devices
- Electronic Access Control Components
- Low Energy Operators
- Surface Closers
- Fire/Life Safety
- Concealed Closers/Pivots
- Stops/ Holders
- Sliding Systems
- Architectural Pulls & Handles
- Service Parts



CYLINDER TYPES, KEYING OPTIONS & KEYWAYS

Cylinder	Option	Description	Example:	List Add/Deduct \$
Conventional Cylinders (non-interchangeable core)				
D		Conventional cylinder	Example: M9070D	N/C
	KD	Keyed differently to a random combination; SC keyway with 2 keys (default)		N/C
	KA2	Keyed alike in pairs to a random combination; SC keyway with 2 keys		N/C
	KA4	Keyed alike in sets of 4 to a random combination; SC keyway with 2 keys		N/C
	0-Bit	Operated by 1 bit cut key for easy rekeying; SC, SE keyway with 2 keys		N/C
	0-Bit	Operated by 1 bit cut key for easy rekeying; D100 keyway — ⊗ Keys sold separately		N/C
	0-Bit	Operated by 1 bit cut key for easy rekeying; AA, CA, CB, CC, CD, CE, RA, RB, GA, SF, WA, YA, YG keyways with 2 keys		12
	NSK	Non-stock keyed — KA quantities other than KA2/KA4; SC keyway with 2 keys		12
	MKD	Master keyed or SKD, SC, SE, or D100 keyway — ⊗ Keys sold separately		12
	NS2	Non-stock keyed double cylinder locks; SC keyway with 2 keys		24
	MK2	Master keyed or SKD double cylinder lock; SC, SE, or D100 keyway — ⊗ Keys sold separately		24
	CMK	Construction master keyed single cylinder locks — ⊗ Keys sold separately		13
	CM2	Construction master keyed double cylinder locks — ⊗ Keys sold separately		26
L		Lock less conventional cylinder and collar	Example: M9070L	Deduct 30
Small Format Interchangeable Core Cylinders				
J		Lock with disposable plastic SFIC construction core	Example: M9070J	N/C
T		Lock with keyed temporary SFIC construction core (Core may be returned for a full refund) — ⊗ Keys sold separately	Example: M9070T	40
C		Lock with combined SFIC core installed at the factory ¹ ; BA (default), BB, BC, BD, BE, BF, BG, BH, BJ, BK, BL, BM, BQ, D100 keyway — ⊗ Keys sold separately	Example: M9070C	45
R		Housing prepared for Schlage FSIC	M9070R	8

1. For uncombined cores, UNC, cores must be ordered separately, see Cylinders, Keys, and Keying.

Locks will be supplied w/plastic construction core, Option J.

⊗ Denotes keys must be ordered separately.

Cut Keys Ordered Separately

Part #	Description	List \$
45101	Change key, master key, construction master key, or control key; BA, BB, BC, BD, BE, BF BG, BH, BJ, BK, BL, BM, BQ, SC, SE section	6
45401	Change key, master key, or control key; SKC selections - D100 etc.	10
45103	Emergency key for M9985C or M9986C; BA section	20
45403	Emergency key for M9985C or M9986C; SKC selections - D100 etc.	20
45404	1 bit cut key for operating 1 bit cylinders	4

NOTES:

- M9985D and M9986D are available MKD, CMK, or 0-bit only.
- Emergency keys for M9985D and M9986D are 45101 or 45401.
- D100 keyway is restricted. See TERMS OF SALE section for DORMA SKC policies.
- 1 bit cylinder comes with (2) uncut keys and will require a 1 bit cut key to operate cylinder.

CONFIGURATION OPTIONS

Description: Grade 1 Mortise Locks Less Components (Use LRA trim design and specified finish for base list price.)	List Deduct \$
Less outside lever and rose Example: M9953D LLL × LRA 626 RH 134 5006 114; includes mortise less trim kit 76007272	Deduct 36
Less inside lever and rose Example: M9953D LRA × LLL 626 RH 134 5006 114; includes mortise less trim kit 76007272	Deduct 36
Less strike Example: M9953D LRA 626 RH 134 LLL	Deduct 2

NOTES:

- For other configurations, consult factory.
- Mortise locks not available less trim both sides.

Strikes

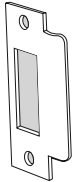

Part #	Description	List Add \$
5006 – ANSI Strike for Mortise Lock (*see below for usage)		
5006-114	1-1/4" × 4-7/8", 1-1/4" lip length, square corner, curved lip	N/C
5006-078	1-1/4" × 4-7/8", 7/8" lip length, square corner, straight lip	18
5006-112	1-1/4" × 4-7/8", 1-1/2" lip length, square corner, curved lip	18
5006-134	1-1/4" × 4-7/8", 1-3/4" lip length, square corner, curved lip	18
5006-200	1-1/4" × 4-7/8", 2" lip length, square corner, curved lip	18

* Default non-handed strike shown in bold for all M9000 functions.

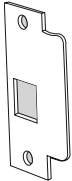

Part #	Description	List Add \$
5007 – ANSI Strike for Mortise Lock (*see below for usage)		
5007-114	1-1/4" × 4-7/8", 1-1/4" lip length, square corner (specify hand)	10

* Optional handed strike available for M9000 functions without dead bolts. Only available in 1-1/4" lip length. Specify hand.

Antimicrobial Coating

Description of Components Coated	List Add \$
Available on 626 and 630 finishes. Specify AM. Example: 626AM or 630AM	
Rose Trim A, B, or D	Inside: lever, rose, and thumbturn Outside: Lever and rose
Escutcheon Trim H or M	Inside: lever, escutcheon, and thumbturn Outside: Lever and escutcheon
	38
	38

NOTE: Extended leadtime, consult factory.





- Locks
- Cylinders, Keys & Keying
- Exit Devices
- Electronic Access Control Components
- Low Energy Operators
- Surface Closers
- Fire/Life Safety
- Concealed Closers/Pivots
- Stops/ Holders
- Sliding Systems
- Architectural Pulls & Handles
- Service Parts

SPECIAL APPLICATION OPTIONS

Lead Lined Lock Case

Part #	Description	List Add \$
660001	Lead lining plate for M9000 Series Mortise Locks	193

Occupancy Indicators

	Part #	Description	List Add \$
	79019	Occupancy indicator for rose trim used w/cylinder, reading OCCUPIED/VACANT or SECURED/UNSECURED. Both readings supplied. Specify finish.	74
		Optional RG – Solid red/green indicator insert, Specify "79019 630 RG"	5
	79020	Occupancy indicator for rose trim used without cylinder, emergency access, reading OCCUPIED/VACANT. Specify finish.	74
	79021	Occupancy indicator for rose trim used without cylinder, reading SECURED/UNSECURED. No emergency access. Used on inside of door with 79019 on outside.	74
	79022	Occupancy indicator w/cointurn for rose trim used without cylinder, reading OCCUPIED/VACANT. Specify finish.	74

NOTES:

- 1-3/4"-2-1/8" thick doors.
- Specify finish. Example: 79019 626.
- Indicators will work on the following functions but may have unexpected operation on lock sets that remain locked when the dead bolt is retracted: M9046, 9056, 9940, 9942, 9953, 9956, 9957, 9959, 9960, 9961, 9962, 9966, 9967, 9968, 9973, 9974, 9980, 9985, 9986, 9996

Thumbturns

Part #	Description	List Add \$
79014	Thumbturn & rose, M9040/9042/9940/9942	62

NOTE: Specify finish. Example: 79014 626.

Tactile Markings

Part #	Description	List Add \$
660002	Knurled or grooved lever (LR, LT, and LG desings only)	50
660003	Abrasive coated lever or knob (all designs)	40

NOTE: Tactile marking is applied to outside knob or lever only, unless otherwise specified. Prices shown per single lever or knob.



Request to Exit/Latch Monitoring

Suffix	Description	List Add \$
RX	Request to exit, M9010/ 9025/ 9050/ 9080. Specify RX. Example: M9010RX.	150
LM	Latch Monitoring, M9010/ 9025/ 9050/ 9053/ 9070/ 9080/ 9082/ 9080EL/ 9080EU/ 9080ELRX/ 9080EURX/ 9082EL/ 9082EU. Specify LM. Example: M9080EURXLM.	150
RXLM	Request to Exit & Latch Monitoring, M9010/ 9025/ 9050/ 9080/ 9080EL/ 9080EU. Specify RXLM. Example: M9010RXLM.	300

Security Screws

Specify	Description	List Add \$
TX A/B/D	Security screws for all exposed fasteners (sectional trim and dead bolts only).	16
TX H	Security screws for all exposed fasteners (H escutcheon only).	18
TX M	Security screws for all exposed fasteners (M escutcheon only).	18

Mounting Kit for Trim One Side Only

Part #	Description	List \$
76007272	Less outside trim attachment kit – installed with LLL x XXXX	16

Special Strikes (Non-Standard Lip Lengths)

NOTE: Non-standard items are considered to be *special request* items and have an extended lead time. Consult factory for more information.

Part #	Description	List Add \$
5006-214	1-1/4" x 4-7/8", 2-1/4" lip length square corner, curved lip	24
5006-XXX	1-1/4" x 4-7/8", special lip length (other than 7/8", 1-1/4", 1-1/2", 1-3/4", 2", or 2-1/4"). Specify lip length.	80

- Locks
- Cylinders, Keys & Keying
- Exit Devices
- Electronic Access Control Components
- Low Energy Operators
- Surface Closers
- Fire/Life Safety
- Concealed Closers/Pivots
- Stops/ Holders
- Sliding Systems
- Architectural Pulls & Handles
- Service Parts

Non-Standard Door Thickness

IMPORTANT – Prices shown below **DO NOT** include additional charges for special strike or cylinder applications. See **Cylinders, Keys, and Keying** for cylinder limitations and additional charges.

Description	List Add \$
All Functions	N/C
Doors 1-3/4" to 2-1/4" thick extended inside (EI), extended outside, (EO) extended equally (EE)	
All Functions^{1,2}	70
Doors 2-1/4" to 4" thick extended inside (EI)	
Example: 2-1/2" door, 1-3/4" door extended 3/4" inside only	
Doors 2-1/4" to 4" thick extended outside (EO)	70
Example: 2-1/2" door, 1-3/4" door extended 3/4" outside only	
Doors 2-1/4" to 4" thick extended equally (EE)	70
Example: 2-1/2" door extended equally	
Doors 2-1/4" to 4" thick extended differently (ED)	70
Example: 2-1/2" door, 1-3/4" door extended 1/2" outside and 1/4" inside	

NOTES:

1. Locks are furnished extended equally (EE) unless otherwise specified.
2. Strikes are NOT included in the prices shown.

Required Information

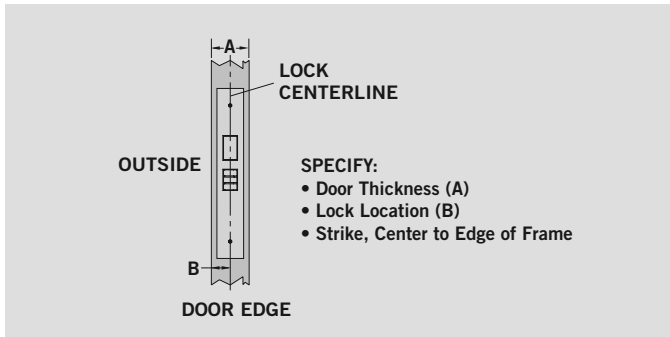

NOTE:
Non-standard items are considered to be **special request** items and have an extended lead time. Consult factory for more information.

Special Requests:
Customized products may be available to solve unusual functions or applications. Contact DORMA Technical Services for assistance.

D900 SERIES

Ordering Guide

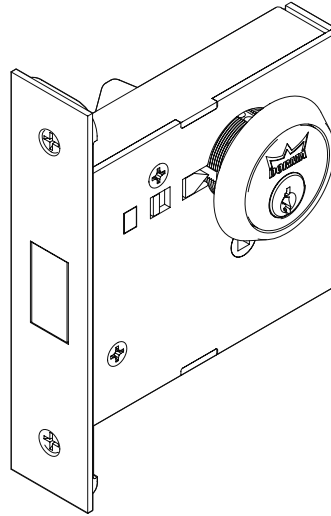

Function

- Turn Only — **81**
- Indicator x Turn — **71**
- Cylinder x Classroom — **63**
- Cylinder x Cylinder — **62**
- Cylinder x Blank — **61**
- Cylinder x Turn — **60**

Antimicrobial Coating — **AM** Security Screws — **TX**

Keying Options Field

Strike Options

Product Family — **D9** **60** **626** **RH** **134** **5301** **D** **XXXX**

Grade 1 Small Case Mortise Dead Bolt

Satin Stainless — **630** Right Hand/Right Hand Reverse — **RH** **134** — 1-3/4"–2-1/4" **T** — Temporary SFIC

Bright Stainless — **629** Left Hand/Left Hand Reverse — **LH** **Door Thickness** **J** — SFIC (Less Core)

Satin Chrome — **626** **Handing (D963 only)** **C** — SFIC

Bright Chrome — **625** **R** — Conventional Cylinder

Satin Nickel — **619 PVD** **Cylinder Type** **R** — Schlage LFIC (Less Core)

Dark Oxidized Satin Bronze — **613 PVD**

Satin Bronze — **612 PVD**

Satin Brass — **606 PVD**

Bright Brass — **605 PVD**

* D963 function available in 613, 619, 626, and 630 finish only.

ANSI #	Function	Description	List \$	
E06071	D960	Cylinder x Turn	275	291
E06061	D962	Cylinder x Cylinder	315	331
E06091	D963	Cylinder x Classroom	315	331
E06081	D961	Cylinder x Blank	260	276
—	D971	Cylinder Indicator x Turn	315	331
E06181	D981	Turn Only	205	215

- Locks
- Cylinders, Keys & Keying
- Exit Devices
- Electronic Access Control Components
- Low Energy Operators
- Surface Closers
- Fire/Life Safety
- Concealed Closers/Pivots
- Stops/ Holders
- Sliding Systems
- Architectural Pulls & Handles
- Service Parts



CYLINDER TYPES, KEYING OPTIONS & KEYWAYS

Cylinder	Option	Description	Example:	List Add/Deduct \$
Conventional Cylinders (non-interchangeable core)				
D		Conventional cylinder	Example: D960D	N/C
	KD	Keyed differently to a random combination; SC keyway with 2 keys (default)		N/C
	KA2	Keyed alike in pairs to a random combination; SC keyway with 2 keys		N/C
	KA4	Keyed alike in sets of 4 to a random combination; SC keyway with 2 keys		N/C
	0-Bit	Operated by 1 bit cut key for easy rekeying; SC, SE keyway with 2 keys		N/C
	0-Bit	Operated by 1 bit cut key for easy rekeying; D100 keyway — ⊗ Keys sold separately		N/C
	0-Bit	Operated by 1 bit cut key for easy rekeying; AA, CA, CB, CC, CD, CE, RA, RB, GA, SF, WA, YA, YG keyways with 2 keys		12
	NSK	Non-stock keyed — KA quantities other than KA2/KA4; SC keyway with 2 keys		12
	MKD	Master keyed or SKD, SC, SE, or D100 keyway — ⊗ Keys sold separately		12
	NS2	Non-stock keyed double cylinder locks; SC keyway with 2 keys		24
	MK2	Master keyed or SKD double cylinder lock; SC, SE, or D100 keyway — ⊗ Keys sold separately		24
	CMK	Construction master keyed single cylinder locks — ⊗ Keys sold separately		13
	CM2	Construction master keyed double cylinder locks — ⊗ Keys sold separately		26
L		Lock less conventional cylinder and collar	Example: D960L	Deduct 30
Small Format Interchangeable Core Cylinders				
J		Lock with disposable plastic SFIC construction core	Example: D960J	N/C
T		Lock with keyed temporary SFIC construction core (Core may be returned for a full refund) — ⊗ Keys sold separately	Example: D960T	40
C		Lock with combined SFIC core installed at the factory ¹ ; BA (default), BB, BC, BD, BE, BF, BG, BH, BJ, BK, BL, BM, BQ, D100 keyway — ⊗ Keys sold separately	Example: D960C	45
R		Housing prepared for Schlage FSIC	Example: D960R	8

1. For uncombined cores, UNC, cores must be ordered separately, see Cylinders, Keys, and Keying.

Locks will be supplied w/plastic construction core, Option J.

⊗ Denotes keys must be ordered separately.

Cut Keys Ordered Separately

Part #	Description	List \$
45101	Change key, master key, construction master key, or control key; BA, BB, BC, BD, BE, BF, BG, BH, BJ, BK, BL, BM, BQ, SC, SE section	6
45401	Change key, master key, or control key; SKC selections - D100 etc.	10
45404	1 bit cut key for operating 1 bit cylinders	4

NOTES:

- D100 keyway is restricted. See TERMS OF SALE section for DORMA SKC policies.
- 1 bit cylinder comes with (2) uncut keys and will require a 1 bit cut key to operate cylinder.



D900 ACCESSORIES

Antimicrobial Coating

Description of Components Coated		List \$
Available on 626 and 630 finished. Specify AM. Example 626AM or 630AM.		
Inside	Thumb Turn and Rose if applicable to function	15
Outside	No coating	15

Security Screws

Specify	Description	List \$
TX	Security Screws for Strike, Armor Plate, Thumb Turn	16

Locks

Cylinders,
Keys & Keying

Exit Devices

Electronic
Access Control
Components

Low Energy
Operators

Surface
Closers

Fire/Life
Safety

Concealed
Closers/Pivots

Stops/
Holders

Sliding
Systems

Architectural
Pulls &
Handles

Service Parts



T900 SERIES

Ordering Guide

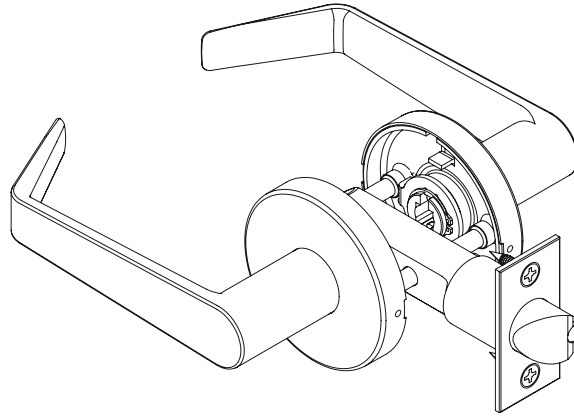

Function		Rose Design		Finish ²		Fire-Rated		Latch Bolt ⁴		Strike Options ⁴		Lip Length ⁴	
Privacy, Bedroom or Bath	40	2-9/16" Dia.	D	630	Satin Stainless								
Exit/Communicating Passage	25	Decorative		629	Bright Stainless								
Passage/Closet	10			626	Satin Chrome								
Double Dummy	02			625	Bright Chrome								
Single Dummy, Through-Bolted	01	2-9/16" Dia.	B	619 PVD	Satin Nickel								
				613 PVD	Dark Oxidized Satin Bronze								
				612 PVD	Satin Bronze								
				606 PVD	Satin Brass								
				605 PVD	Bright Brass								

T9	10	LR	B	626	AM	RH	F	90202	134	5101	118
Product Family Grade 2 Tubular Lockset		LC — Lever			AM — Antimicrobial Coating ³	RH — Right Hand			134 — 1-3/8"–1-3/4"		
		LD — Lever, Handed				LH — Left Hand			Door Thickness^{4,5}		
		LG — Lever									
		LN — Lever									
		LR — Lever									
		LT — Lever									
		PREMIUM — Premium Lever									

Lever Design¹

1. Select premium levers not available in 625 or 626. Use 629 or 630 as an alternative.
2. For split finishes, available on levers only, consult factory. Specify hand.
3. Available on 626/630 finishes only. Consult factory for other finishes.
4. Example shows default values. Refer to Lock Options section for full details.
5. Standard door thickness is 1-3/8"-1-3/4". Contact factory for other thicknesses.
6. Fire rated latch available on T910 and T925 only.

TRIM OPTIONS

Finish Group A

Available Finishes—626, 625, 605, 606, 612, 613, 619

Standard

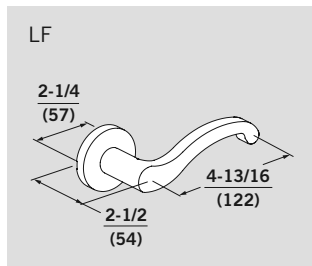
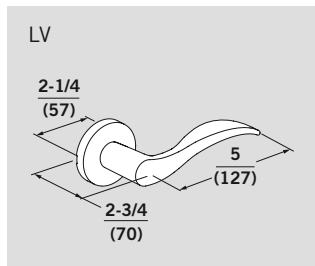
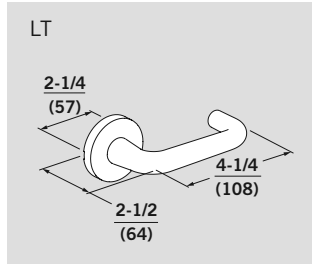
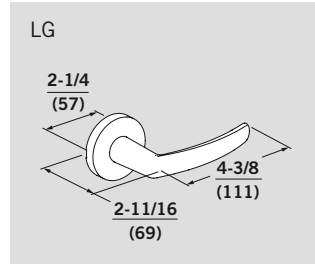
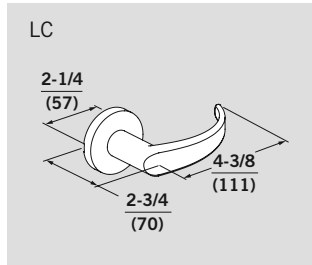
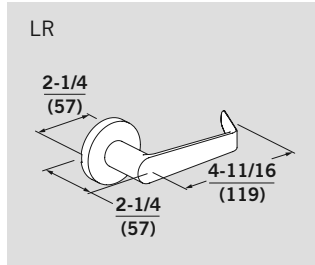

Premium

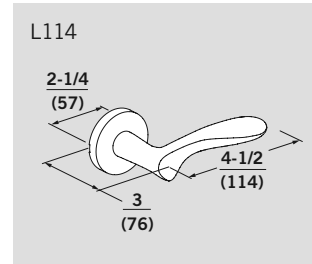
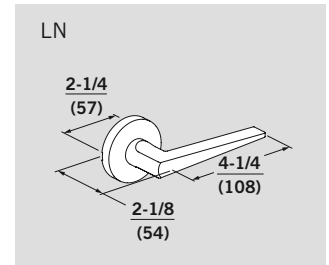
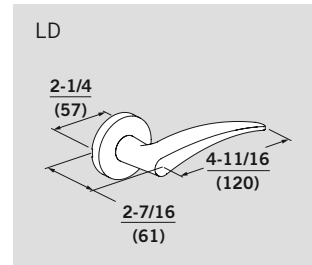

Finish Group B

Available Finishes—630, 606, 612, 613, 619 / L117 also available in 605 and 629

Standard

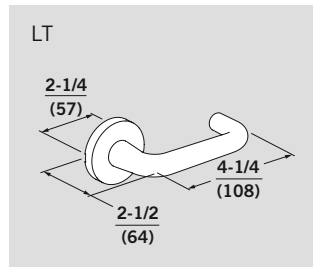
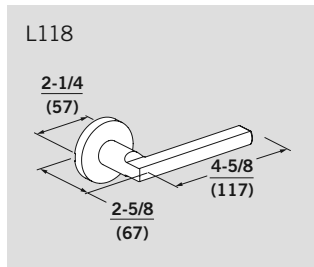
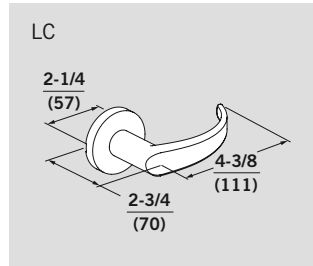
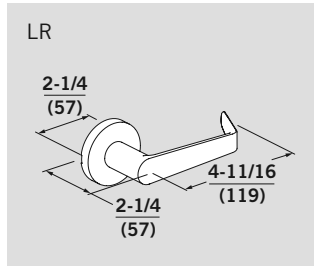

Wrought Roses

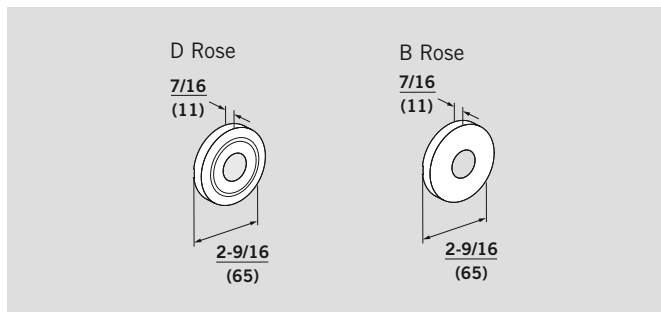

Premium

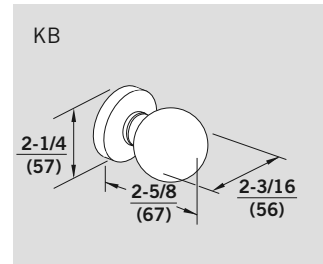
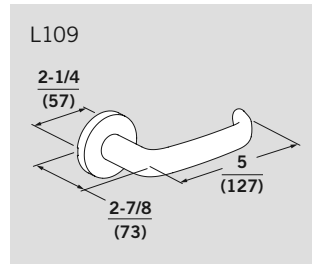
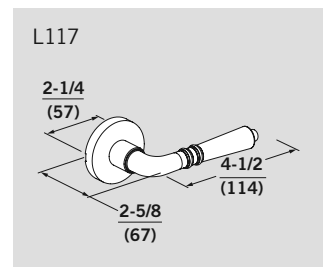
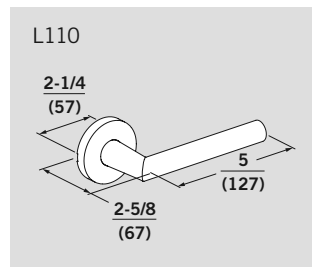
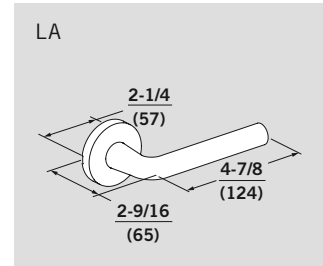
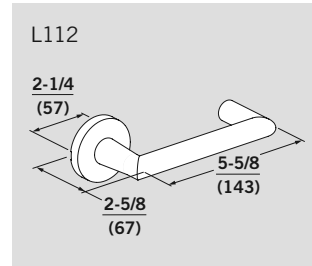

- Locks
- Cylinders, Keys & Keying
- Exit Devices
- Electronic Access Control Components
- Low Energy Operators
- Surface Closers
- Fire/Life Safety
- Concealed Closers/Pivots
- Stops/ Holders
- Sliding Systems
- Architectural Pulls & Handles
- Service Parts

T900 SERIES

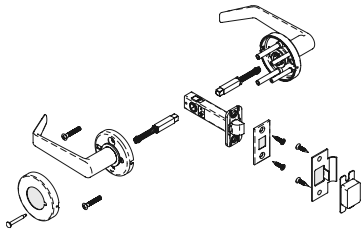

Standard Levers

Finish availability determined by lever group A/B	626	605PVD, 606PVD, 612PVD, 619PVD, 622, 625, 613PVD, 629, 630
--	-----	---

ANSI #	Function	Description	List \$	
Keyless				
—	T901	Single dummy, surface mounted	126	133
—	T902	Double dummy	174	186
F75	T910	Passage/closet	210	222
F111	T925	Exit/communicating	210	222
F76	T940	Privacy, bedroom or bath	223	236

Premium Levers

Finish availability determined by lever group A/B	626	605PVD, 606PVD, 612PVD, 619PVD, 622, 625, 613PVD, 629, 630
--	-----	---

ANSI #	Function	Description	List \$	
Keyless				
—	T901	Single dummy, surface mounted	138	145
—	T902	Double dummy	193	206
F75	T910	Passage/closet	231	244
F111	T925	Exit/communicating	231	244
F76	T940	Privacy, bedroom or bath	245	258

CONFIGURATION OPTIONS

Non-Fire Latch Bolts

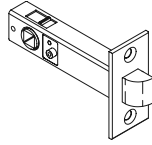

Part #	Backset	Description	List Add \$
90202	2-3/4"	1-1/8" faceplate, passage, square corner, non Fire	N/C
90232	2-3/4"	1-1/8" faceplate, privacy, square corner, non Fire	N/C
90200	2-3/4"	1" faceplate, passage, square corner, non Fire	N/C
90230	2-3/4"	1" faceplate, privacy, square corner, non Fire	N/C
90100	2-3/8"	1" faceplate, passage, square corner, non Fire	N/C
90101	2-3/8"	1" faceplate, passage, 1/4" radius corner, non Fire	N/C
90130	2-3/8"	1" faceplate, privacy, square corner, non Fire	N/C
90131	2-3/8"	1" faceplate, privacy, 1/4" radius corner, non Fire	N/C

Fire Rated Latch Bolts

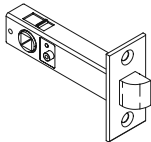

Part #	Backset	Description	List Add \$
91202	2-3/4"	1-1/8" faceplate, passage, square corner, 90 min Fire Rated	12
91200	2-3/4"	1" faceplate, passage, square corner, 90 min Fire Rated	12
91100	2-3/8"	1" faceplate, passage, square corner, 90 min Fire Rated	12
91101	2-3/8"	1" faceplate, passage, 1/4" radius corner, 90 min Fire Rated	12

IMPORTANT: Ordering a fire rated latch only is not possible as trim is different for fire rated locksets

Strikes

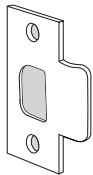

Part #	Description	List Add \$
5101	T Strike with Dust Box	
5101-118	1-1/8" x 2-3/4", 1-1/8" lip length, square corner	N/C
5101-112	1-1/8" x 2-3/4", 1-1/2" lip length, square corner	18

NOTE: Default strike shown in bold.

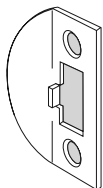

Part #	Description	List Add \$
5201, 5202	Full Lip Strike	
5201-118	1-5/8" x 2-1/4", 1-1/8" lip length, square corner	N/C
5202-118	1-5/8" x 2-1/4", 1-1/8" lip length, 1/4" radius corner	N/C

Strikes Continued

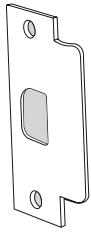

Part #	Description	List Add \$
5001 – ANSI Strike, includes Dust Box		
5001-1316	1-1/4" × 4-7/8", 1-3/16 lip length, square corner	N/C
5001-112	1-1/4" × 4-7/8", 1-1/2 lip length, square corner	18
5001-078	1-1/4" × 4-7/8", 7/8 lip length	18

SPECIAL APPLICATION OPTIONS

Antimicrobial Coating

Available on 626 and 630 finish. Specify AM. Example: 626AM

Description of Components Coated	List Add \$
Lever trim Inside: Lever and rose Outside: lever and rose	28

NOTE: Extended leadtime, consult factory.

Tactile Markings Lever

Part #	Description	List Add \$
660002	Knurled or grooved lever (LR, LT and LG designs only)	50
660003	Abrasive coated lever or knob (All Designs)	40

NOTE: Tactile marking is applied to outside lever only, unless otherwise specified. Prices shown per single lever.

Special Strikes (Non-Standard Lip Lengths)

Part #	Description	List Add \$
5001 – ANSI Strike with Tubular Lock Cutout, includes Dust Box		
5001-XXX	1-1/4" × 4-7/8", special lip length (other than 7/8", 1-3/16", or 1-1/2"). Specify length.	80

NOTE: Non-standard items are considered to be special request items and have an extended lead time. Consult factory for more information.

C800 SERIES

Ordering Guide

Function		Cylinder Type		Finish ⁴	
F93 – Faculty Restroom/Hotel ¹	85	A	Corbin/Ruswin 6-pin FSIC (less core)	630	Satin Stainless (Knob Designs)
F87 – Asylum	82	M	Medeco FSIC 32 Series (less core)	626	Satin Chrome
Electrically Unlocked (Fail Secure)	80EU	N	Sargent 6300 FSIC (less core)	625	Bright Chrome
Electrically Locked (Fail Safe)	80EL	Y	Yale 1210/Medeco 31 Series 6-pin FSIC (less core)	619 PVD	Satin Nickel
F86 – Storeroom	80	E	Corbin Russwin 2000 series 6-Pin KIL (Less Cylinder)	613 PVD	Dark Oxidized Satin Bronze
F110 – Classroom Intruder	77	S	Sargent 10 Line KIL (less cylinder)	612 PVD	Satin Bronze
F90 – Corridor/Dormitory	73	D	Conventional Cylinder	606 PVD	Satin Brass
F80 – Communicating	72	L	Less Cylinder	605 PVD	Bright Brass (Lever Designs)
F84 – Classroom	70	C	SFIC (With Core)	605	Bright Brass (Knob Designs)
F91 – Store Door	66	J	SFIC (Less Core)		
F113 – Exit/Communicating Classroom	65	T	Temporary SFIC		
F88 – Apartment	60	R	Schlage FSIC ⁸ (Less Core)		
F92 – Service Station	55				
F109 – Entry	53				
F82 – Entry/Office	50				
F112 – Exit/Communicating Storeroom	48				
Hospital Privacy	44				
F76A – Privacy, Bedroom or Bath	40				
F77A – Patio	30				
F111 – Exit/Communicating Passage	25				
F89 – Exit	12				
F75 – Passage/Closet	10				
Double Dummy	02				
Single Dummy	01				

Product Family	Lever/Knob Design	Rose Design ³	Security Screws	Antimicrobial Coating ⁵	Door Hand	Door Thickness ⁶	Keying Options Field
Heavy-Duty Grade 1 Cylindrical Lockset	Lever — LR	B — 3" Dia.	AM	TX	RH — Right Hand	134 — 1-3/4"–2-1/4"	1316 XXXX
	Lever — LC	C — 3-1/2" Dia.			LH — Left Hand	138 — 1-3/8"–1-5/8"	
	Lever — LG	D — 3-1/2" Dia. stamped, LOCK					
	Lever — LT	E — 3-1/2" Dia. stepped rose					
	Lever, Handed — LF	F — 3-1/2" Dia. stepped rose stamped, LOCK					
	Lever, Handed — LV						
Knob — KB							

- Locks
- Cylinders, Keys & Keying
- Exit Devices
- Electronic Access Control Components
- Low Energy Operators
- Surface Closers
- Fire/Life Safety
- Concealed Closers/Pivots
- Stops/Holders
- Sliding Systems
- Architectural Pulls & Handles
- Service Parts

1. Faculty restroom/hotel function available in SC and SE keyway only. Not available in SFIC or prepared for competitor cylinders.
2. Request to exit option only available on lever locks. Refer to pages 7–9 for available functions.
3. Rose B applicable to knob designs only. Roses C, D, E, and F applicable to lever designs only. Split design roses not available.
4. Split finishes, available on levers only, consult factory. Specify hand.

5. Available on lever trim, 626 finish only. Consult factory for other finishes.
6. Door thickness range:
Lever locks 1-3/4"–2-1/4" without spacers, 1-3/8"– 1-5/8" with spacers.
Knob locks 1-3/8"–2" without spacers or special tools.
7. Consult factory for other cylinder options.
8. Available LR Lever only.

Lever Designs

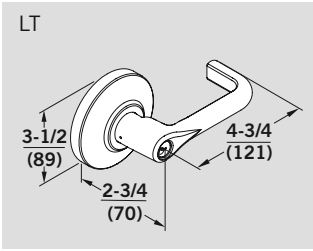
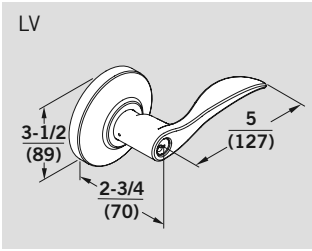
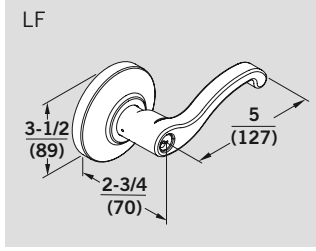
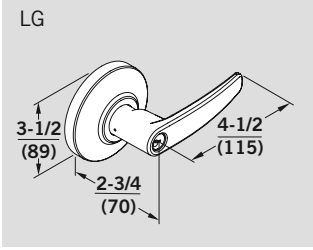
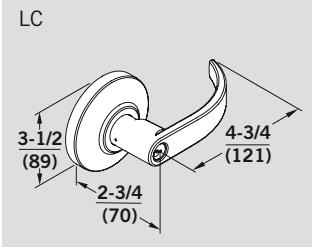
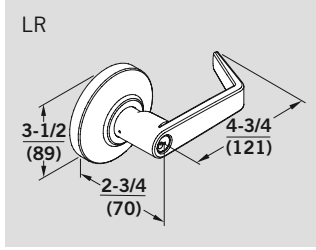

Rose Designs

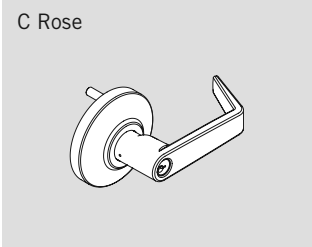
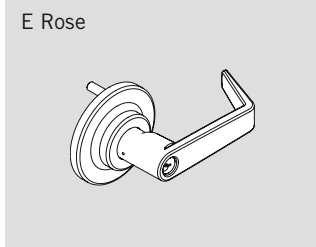

LEVER LOCKS

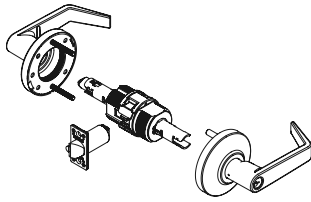

ANSI #	Function	Description	Lever Locks	
			626	605 PVD, 606 PVD, 612 PVD, 619 PVD, 625,613 PVD
			List \$	
Keyless				
F75	C810	Passage/closet	361	391
F89	C812	Exit	361	391
F111	C825	Exit/communicating passage	361	391
F77A	C830	Patio	428	459
F76A	C840	Privacy, bedroom or bath	414	445
—	C844	Hopital privacy	414	445
—	C801	Single dummy	155	170
—	C802	Double dummy	299	330
Keyed, Single Cylinder				
F112	C848	Exit/communicating storeroom	481	521
F82	C850	Entry/Office	481	521
F109	C853	Entry	481	521
F84	C870	Classroom	481	521
F92	C855	Service station	481	521
F113	C865	Exit/communicating classroom	481	521
F86	C880	Storeroom	481	521
F90	C873	Corridor/Dormitory	496	527
F93	C885 ¹	Faculty restroom/hotel	562	593
—	C880EL	Electrically locked (Fail Safe)	656	687
—	C880EU	Electrically unlocked (Fail Secure)	656	687
Keyed, Double Cylinder				
F80	C872	Communicating	583	614
F87	C882	Asylum	583	614
F88	C860 ²	Apartment	583	614
F91	C866	Store door	583	614
F110	C877 ²	Classroom intruder	583	614

* Split finishes priced at highest list price. Available on levers only — No Knobs

NOTES:

1. Faculty restroom/hotel fuction available in SC and SE keyway only. Not available in SFIC or prepared for competitor cylinders.
2. Optional rose stamped **LOCK** available for inside rose. Specify D or F rose.

- Locks
- Cylinders, Keys & Keying
- Exit Devices
- Electronic Access Control Components
- Low Energy Operators
- Surface Closers
- Fire/Life Safety
- Concealed Closers/Pivots
- Stops/ Holders
- Sliding Systems
- Architectural Pulls & Handles
- Service Parts

KNOB LOCKS

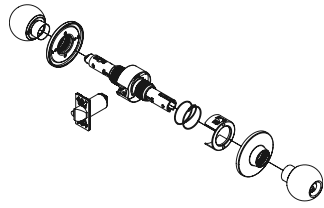

ANSI #	Function	Description	Knob Locks	
			630	605
			List \$	
Keyless				
F75	C810	Passage/closet	370	382
F76A	C840	Privacy, bedroom or bath	460	472
—	C801	Single dummy	168	174
Keyed, Single Cylinder				
F109	C853	Entry	535	547
F84	C870	Classroom	535	547
F86	C880	Storeroom	535	547
F90	C873	Corridor	540	552

NOTES:

- List prices for keyed locks include standard DORMA (D) cylinder, keyed different (KD) with two (2) nickel silver keys.
- Split finishes not available on knobs.
- For functions not shown, consult factory. Special order functions require extended lead times.
- Knob locks not available prepared for competitor cylinder options.



CYLINDER TYPES, KEYING OPTIONS & KEYWAYS

Cylinder	Option	Description	List Add/Deduct \$
Conventional Cylinders (non-interchangeable core)			
D		Conventional cylinder	Example: C853D N/C
	KD	Keyed differently to a random combination; SC keyway with 2 keys (default)	N/C
	KA2	Keyed alike in pairs to a random combination; SC keyway with 2 keys	N/C
	KA4	Keyed alike in sets of 4 to a random combination; SC keyway with 2 keys	N/C
	O-Bit	Operated by 1 bit cut key for easy rekeying; SC, SE keyway with 2 keys	N/C
	O-Bit	Operated by 1 bit cut key for easy rekeying; D100 keyway — ⊗ Keys sold separately	N/C
	O-Bit	Operated by 1 bit cut key for easy rekeying; AA, CA, CB, CC, CD, CE, RA, RB, GA, SF, WA, YA, YG keyways with 2 keys	12
	NSK	Non-stock keyed — KA quantities other than KA2/KA4; SC keyway with 2 keys	12
	MKD	Master keyed or SKD, SC, SE, or D100 keyway — ⊗ Keys sold separately	12
	NS2	Non-stock keyed double cylinder locks; SC keyway with 2 keys	24
	MK2	Master keyed or SKD double cylinder lock; SC, SE, or D100 keyway — ⊗ Keys sold separately	24
	CMK	Construction master keyed single cylinder locks — ⊗ Keys sold separately	13
	CM2	Construction master keyed double cylinder locks — ⊗ Keys sold separately	26

Competitor Cylinder Types

A/M/N/Y		Other manufacturer IC core prep, less core	100
E		Lock prepared for Corbin/Ruswin 2000 Series 6-pin KIL cylinder, less cylinder (all designs)	Example: C853E N/C
S		Lock prepared for Sargent 10 line KIL, less cylinder (all designs)	Example: C853S N/C
L		Lock less conventional cylinder	Example: C853L Deduct 30

Interchangeable Core Cylinders

J		Lock with disposable plastic SFIC construction core	Example: C853J N/C
T		Lock with keyed temporary SFIC construction core (cores may be returned for a full refund) — ⊗ Keys sold separately	Example: C853T 40
C		Lock with combined SFIC core installed at the factory ¹ ; BA (default), BB, BC, BD, BE, BF, BG, BH, BJ, BK, BL, BM, BQ, D100 keyway — ⊗ Keys sold separately	45
R		Lock prepared for Schlage full size IC core, less core (LR Lever Only)	Example: C853R 8

1. For uncombined cores, UNC, cores must be ordered separately, see Cylinders, Keys, and Keying.
Locks will be supplied w/plastic construction core, Option J.

⊗ Denotes keys must be ordered separately.

Cut Keys Ordered Separately

Part #	Description	List \$
45101	Change key, master key, construction master key, or control key; BA, BB, BC, BD, BE, BF, BG, BH, BJ, BK, BL, BM, BQ, SC, SE section	6
45401	Change key, master key, or control key; SKC sections - D100 etc.	10
45102	Emergency key for C885D; SC or SE section	20
45404	1 bit cut key for operating 1 bit cylinders	4

NOTES:

- C885D is available MKD, CMK, or O-bit only. Not available prepared for competitor cylinders.
- D100 keyway is restricted. See TERMS OF SALE section for DORMA SKC policies.
- 1 bit cylinder comes with (2) uncut keys and will require a 1 bit cut key to operate cylinder.

- Locks
- Cylinders, Keys & Keying
- Exit Devices
- Electronic Access Control Components
- Low Energy Operators
- Surface Closers
- Fire/Life Safety
- Concealed Closers/Pivots
- Stops/ Holders
- Sliding Systems
- Architectural Pulls & Handles
- Service Parts

CONFIGURATION OPTIONS

Latch Bolts

1/2" Throw, 2-3/4" Backset			List Add \$
Part #	Description		
For 810, 840, and 844 Locks			
10202	1-1/8" x 2-1/4" front, 1" diameter, square corner		N/C
For All Other Locks			
10252	1-1/8" x 2-1/4" front, 1" diameter, square corner		N/C

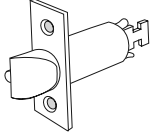

1/2" Throw, 2-3/8" Backset			List Add \$
Part #	Description		
For 810, 840, and 844 Locks			
10100	1" x 2-1/4" front, 7/8" diameter, square corner		9
10101	1" x 2-1/4" front, 7/8" diameter, 1/4" radius corner		9
10102	1-1/8" x 2-1/4" front, 7/8" diameter, square corner		9
For All Other Locks			
10150	1" x 2-1/4" front, 7/8" diameter, square corner		9
10151	1" x 2-1/4" front, 7/8" diameter, 1/4" radius corner		9
10152	1-1/8" x 2-1/4" front, 7/8" diameter, square corner		9

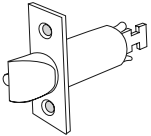

1/2" Throw, 3-3/4" Backset			List Add \$
Part #	Description		
For 810, 840, and 844 Locks			
10302	1-1/8" x 2-1/4" front, 1" diameter, square corner		11
For All Other Locks			
10352	1-1/8" x 2-1/4" front, 1" diameter, square corner		11

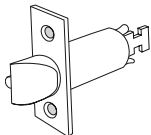

5" Backset Link			List Add \$
Part #	Description		
For All Locks			
76016008	5" Backset Link		19

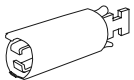

NOTE: Use with 2-3/4" backset latch

Latch Bolts (continued)

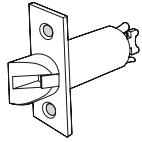

3/4" Throw, 2-3/4" Backset		
Part #	Description	List Add \$
For All 800 Locks (605 and 626 finishes only) (non-restoring)		
18262	1-1/8" x 2-1/4" front, 1" diameter, square corner. Available in 605 or 626 only.	95

Strikes

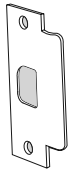

Part #	Description	List Add \$
5001 – ANSI Strike Includes Dust Box		
5001-1316	1-1/4" x 4-7/8", 1-3/16" lip length, square corner	N/C
5001-112	1-1/4" x 4-7/8", 1-1/2" lip length, square corner	18
5001-078	1-1/4" x 4-7/8", 7/8" lip length	18

NOTE: Default strike shown in bold.

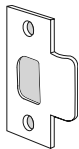

Part #	Description	List Add \$
5101 – T Strike with Dust Box		
5101-118	1-1/8" x 2-3/4", 1-1/8" lip length, square corner	N/C
5101-112	1-1/8" x 2-3/4", 1-1/2" lip length, square corner	18

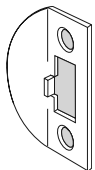

Part #	Description	List Add \$
5201, 5202 – Full Lip Strike		
5201-118	1-5/8" x 2-1/4", 1-1/8" lip length, square corner	N/C
5202-118	1-5/8" x 2-1/4", 1-1/8" lip length, 1/4" radius corner	N/C

Antimicrobial Coating

Available on 626 finish. Specify AM. Example: 626AM

Description of Components Coated	List Add \$
Lever trim Inside: Lever and rose Outside: lever and rose	28

NOTE: Extended leadtime, consult factory.

- Locks
- Cylinders, Keys & Keying
- Exit Devices
- Electronic Access Control Components
- Low Energy Operators
- Surface Closers
- Fire/Life Safety
- Concealed Closers/Pivots
- Stops/ Holders
- Sliding Systems
- Architectural Pulls & Handles
- Service Parts

SPECIAL APPLICATION OPTIONS

Knurled Knob and Levers (Tactile Markings)

Part #	Description	List Add \$
660002	Knurled or grooved lever (LR or LG designs only)	50
660003	Abrasive coated lever or knob (all designs)	40

NOTE: Tactile marking is applied to outside knob or lever only, unless otherwise specified. Prices shown are for one lever only.

Lead Lining Plate

Part #	Description	List Add \$
660004	Lead lining plate for C800, CL700	160

Lock Spacers for 1-3/8" Doors, C800 Series

Part #	Description	605, 606, 612, 613, 625, 626 List \$
138	Spacers for thin door, 1 pair (2 spacers) 1-3/8" door – Specify finish (Ref. # 660005)	36

Security Screws

Part #	Description	List Add \$
TX	Security screws for latch and strike.	14

Special Strikes (Non-Standard Lip Lengths)

Part #	Description	List Add \$
5001-XXX	1-1/4" x 4-7/8", special lip length (other than 7/8", 1-3/16", or 1-1/2"). Specify length.	80

NOTE: Non-standard items are considered to be *special request* items and have an extended lead time. Consult factory for more information.

NON-STANDARD DOOR THICKNESS

Description	List Add \$
Doors 2" to 4" thick extended inside (EI) Example: 2-1/2" door, 1-3/4" door extended 3/4" inside only	235
Doors 2" to 4" thick extended outside (EO) Example: 2-1/2" door, 1-3/4" door extended 3/4" outside only	235
Doors over 2-5/16 to 4" thick extended equally (EE)	395

NOTE: Non-standard items are considered to be special request items and have an extended lead time. Consult factory for more information.

Required Information

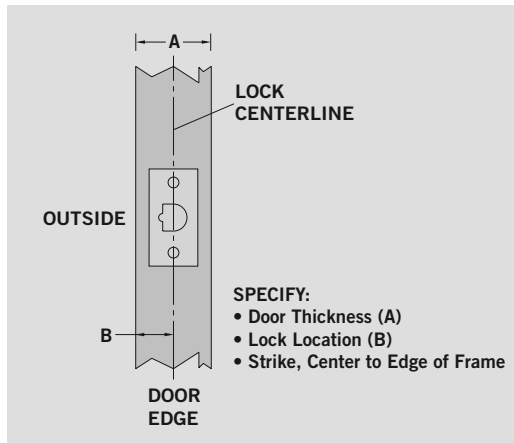

Special Requests:

Customize products may be available to solve unusual functions or applications. Contact DORMA Technical Services for assistance.

Request to Exit

Specify	Description	List Add \$
RX	Request to exit, available on C800 lever models: 853, 870, 880, 880EL, 880EU	140

Stamped Rose



Specify	Description	List Add \$
D Rose*	Stamped LOCK on inside rose (specify finish)	N/C
F Rose*	Stepped, stamped LOCK on inside rose (specify finish)	N/C

* Available on inside of double cylinder functions C860 and C877.

Boring Jig

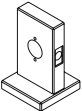
Part #	Description	List \$
 76004795	Boring Jig for C800 and CL700 Locksets	10
 640003	Mount, C800 lever, CL700, and C500 Series — 1-1/8" x 2-1/4" faceplate	90

D800 SERIES

Ordering Guide

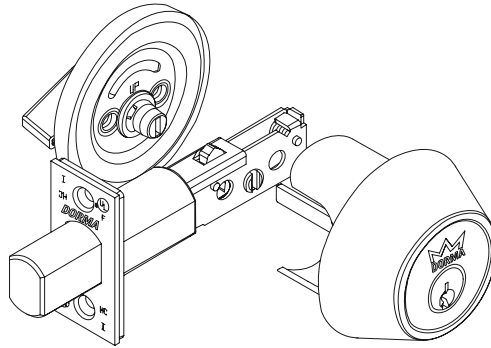

Function		Cylinder Type ¹		Security Screws		Door Thickness ^{3,5}	
Turn x Turn	82						
Turn only	81						
Turn x Blank Plate	80						
Turn x Occupancy Indicator	71	R	Schlage FSIC (Less Core)				
Cylinder x Classroom	63	D	Conventional Cylinder				
Cylinder x Cylinder	62	C	SFIC (With Core)				
Cylinder x Blank Plate	61	J	SFIC (Less Core)				
Cylinder x Turn	60	T	Temporary SFIC	TX	Latch Bolt ³		
						182	1-13/16"-2"
						134	1-3/8"-1-3/4"
D 8 60 D 626 AM 28752 134 5103 XXXX							
Product Type		Finish ²		Antimicrobial Coating ⁴		Strike Options ³	
Dead Bolt — D		Bright Brass — 605					
		Satin Brass — 606					
		Satin Bronze ⁶ — 612					
		Dark Oxidized Satin Bronze — 613					
		Satin Nickel ⁶ — 619					
		Bright Chrome ⁶ — 625					
		Satin Chrome — 626					
Heavy-Duty Grade 1 Tubular Dead Bolt							
Product Family						Keying Options Field	

1. The Less Conventional Cylinder option is not available for the D800 Series.
2. For split finishes, consult factory.
3. Example shows default values. Refer to Configuration Options section for full details.
4. Available on 626 finish only. Consult factory for other finishes.
5. Door range — 1-3/8"-1-3/4" default (1-13/16"-2" optional). Consult factory for applications over 2".
6. Special Order Finish — May require additional lead time.

- Locks
- Cylinders, Keys & Keying
- Exit Devices
- Electronic Access Control Components
- Low Energy Operators
- Surface Closers
- Fire/Life Safety
- Concealed Closers/Pivots
- Stops/ Holders
- Sliding Systems
- Architectural Pulls & Handles
- Service Parts

D800 SERIES

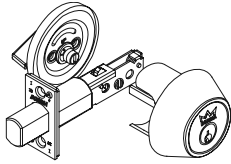

ANSI #	Function	Description	626	605, 606, 612, 619, 625, 613
Keyless			List \$	
E21111	D880	Thumb turn × blank plate	134	149
E2191	D881	Thumb turn only	127	142
—	D882	Thumb turn × thumb turn (windstorm)	160	175
—	D871	Thumb turn × occupancy indicator w/coin turn	130	145
Keyed, Single Cylinder				
E2151	D860	Cylinder × turn	160	175
E2161	D861	Cylinder × blank	160	175
E2171	D863	Cylinder × classroom turn	167	182
Keyed, Double Cylinder**				
E2141	D862	Cylinder × cylinder	205	220

**** CAUTION:** Double cylinder locks used on residences and any door in a structure which is used for egress are a life safety hazard in times of emergency and their use is not recommended. Installation should be in accordance with existing codes only.

NOTE: List prices for keyed locks include standard DORMA (D) cylinder, keyed different (KD) with two (2) nickel silver keys.



CYLINDER TYPES, KEYING OPTIONS & KEYWAYS

Cylinder	Option	Description	List Add/Deduct \$
Conventional Cylinders (non-interchangeable core)			
D		Conventional cylinder	Example: D860D N/C
	KD	Keyed differently to a random combination; SC keyway with 2 keys (default)	N/C
	KA2	Keyed alike in pairs to a random combination; SC keyway with 2 keys	N/C
	KA4	Keyed alike in sets of 4 to a random combination; SC keyway with 2 keys	N/C
	O-Bit	Operated by 1 bit cut key for easy rekeying; SC, SE keyway with 2 keys	N/C
	O-Bit	Operated by 1 bit cut key for easy rekeying; D100 keyway — ⊗ Keys sold separately	N/C
	O-Bit	Operated by 1 bit cut key for easy rekeying; AA, CA, CB, CC, CD, CE, RA, RB, GA, SF, WA, YA, YG keyways with 2 keys	12
	NSK	Non-stock keyed — KA quantities other than KA2/KA4; SC keyway with 2 keys	12
	MKD	Master keyed or SKD, SC, SE, or D100 keyway — ⊗ Keys sold separately	12
	NS2	Non-stock keyed double cylinder locks; SC keyway with 2 keys	24
	MK2	Master keyed or SKD double cylinder lock; SC, SE, or D100 keyway — ⊗ Keys sold separately	24
	CMK	Construction master keyed single cylinder locks — ⊗ Keys sold separately	13
	CM2	Construction master keyed double cylinder locks — ⊗ Keys sold separately	26
Interchangeable Core Cylinders			
J		Lock with disposable plastic SFIC construction core	Example: D860J N/C
T		Lock with keyed temporary SFIC construction core (cores may be returned for a full refund) — ⊗ Keys sold separately	Example: D860T 40
C		Lock with combined SFIC core installed at the factory ¹ ; BA (default), BB, BC, BD, BE, BF, BG, BH, BJ, BK, BL, BM, BQ, D100 keyway — ⊗ Keys sold separately	Example: D860C 45
R		Lock prepared for Schlage FSIC (less core), single cylinder housing	Example: D860R 8
		Lock prepared for Schlage FSIC (less core), double cylinder housing	Example: D862R 16

* The Less Cylinder option is not available for the D800 Series.

1. For uncombined cores, UNC, cores must be ordered separately, see Cylinders, Keys, and Keying.
Locks will be supplied w/plastic construction core, Option J.

⊗ Denotes keys must be ordered separately.

Cut Keys Ordered Separately

Part #	Description	List \$
45101	Change key, master key, construction master key, or control key; BA, BB, BC, BD, BE, BF BG, BH, BJ, BK, BL, BM, BQ, SC, SE section	6
45401	Change key, master key, or control key; SKC sections - D100 etc.	10
45404	1 bit cut key for operating 1 bit cylinders	4

NOTES:

- D100 keyway is restricted. See TERMS OF SALE section for DORMA SKC policies.
- 1 bit cylinder comes with (2) uncut keys and will require a 1 bit cut key to operate cylinder.

- Locks
- Cylinders, Keys & Keying
- Exit Devices
- Electronic Access Control Components
- Low Energy Operators
- Surface Closers
- Fire/Life Safety
- Concealed Closers/Pivots
- Stops/ Holders
- Sliding Systems
- Architectural Pulls & Handles
- Service Parts

CONFIGURATION OPTIONS

Dead Bolts

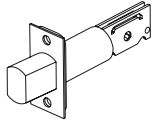

1" Throw

Part #	Description	List Add \$
28752	1-1/8" x 2-1/4" faceplate, 2-3/4" backset, square corner	N/C
28652	1-1/8" x 2-1/4" faceplate, 2-3/8" backset, square corner	N/C

NOTE: Default configuration shown above in bold.

Strikes

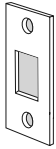

Part #	Description	List Add \$
5103	Standard Strike for Dead Bolt	
5103	1-1/8" x 2-3/4", no lip, square corner	N/C

NOTE: Default strike shown above in bold.

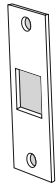

Part #	Description	List Add \$
5004	ANSI Strike with Dead Bolt Cutout	
5004	1-1/4" x 4-7/8", no lip, square corner	5

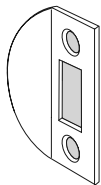

Part #	Description	List Add \$
5203	Full Lip Strike with Dead Bolt Cutout	
5203-118	1-5/8" x 2-1/4", 1-1/8" lip length, square corner	N/C

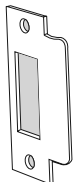

Part #	Description	List Add \$
5006	ANSI Strike with Lip and Dead Bolt Cutout	
5006-114	1-1/4" x 4-7/8", 1-1/4" lip length, square corner	7
5006-112	1-1/4" x 4-7/8", 1-1/2" lip length, square corner	18

Antimicrobial Coating

Description of Components Coated	List Add \$
---	--------------------

Available on 626 finish. Specify AM. Example: 626AM

Inside: thumbturn, rose, or same as outside for double cylinder 28

Outside: trim ring and cylinder faceplate

NOTE: Extended leadtime, consult factory.

Security Screws

Specify	Description	List Add \$
----------------	--------------------	--------------------

TX	Security screws for all exposed fasteners.	18
----	--	----

Non-Standard Door Thickness

Cylinder Type	List Add \$			
	1-3/8"-1-3/4" Door Thickness	To 2-1/2" Door Thickness	To 3" Door Thickness	Over 3" Door Thickness
Standard	Standard	25	Consult Factory	Consult Factory
SFIC	Standard	25	25	Consult Factory
LFIC	Standard	25	25	Consult Factory

Required Information

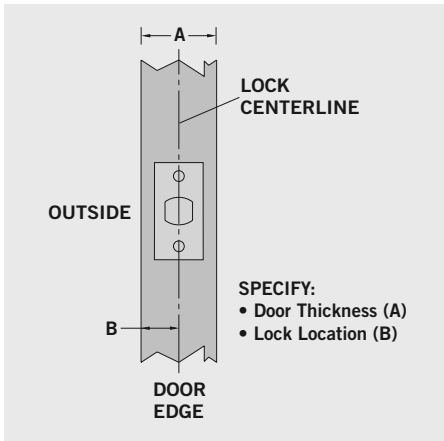

- Locks
- Cylinders, Keys & Keying
- Exit Devices
- Electronic Access Control Components
- Low Energy Operators
- Surface Closers
- Fire/Life Safety
- Concealed Closers/Pivots
- Stops/ Holders
- Sliding Systems
- Architectural Pulls & Handles
- Service Parts

CL700/CK700 SERIES

Ordering Guide

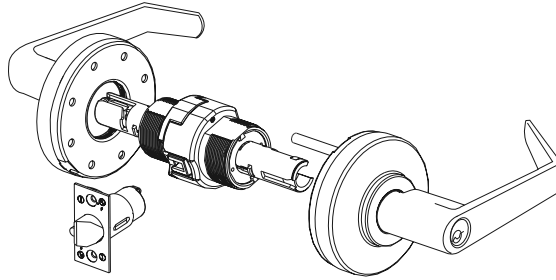

Function		Cylinder Type		Finish ³		Door Thickness		Strike Options ²		Lip Length ²	
Storeroom	80			630	Satin Stainless (Knob only)						
Classroom	70			626	Satin Chrome (Levers only)						
Entry	53			625	Bright Chrome (Levers only)						
Entry/Office	50			613	Dark Oxidized Satin Bronze (Levers only)						
Privacy, Bedroom or Bath	40	D	Conventional Cylinder	612	Satin Bronze (Levers only)						
Patio	30	L	Less Cylinder	606	Satin Brass (Levers only)						
Exit/Communicating Passage	25	C	SFIC (With Core)	605	Bright Brass						
Exit	12	J	SFIC (Less Core)								
Passage/Closet	10	T	Construction Core SFIC								
Dummy Trim One Side	01										

Knob Trim	CK	Lever	LR	Rose Design ¹	B	3" Dia. Rose	TX	Latch Bolt ²	17252	134	5001	1316	XXXX
Lever Trim	CL	Lever	LC		E	3-7/16" Dia. Rose				134			
		Lever	LG										
		Knob	KB										

Product Type: CL 7 53 D LR E 626 TX 17252 134 5001 1316 XXXX

Product Family: Grade 2 Cylindrical Lockset

Lever/Knob Design: LR, LC, LG, KB

Security Screws: TX

Keying Options Field: XXXX

- Rose B is applicable to knob lock only. Rose E is applicable to lever lock designs only.
- Example shows default values. Refer to Lock Options section for full details.
- For split finishes, consult factory.

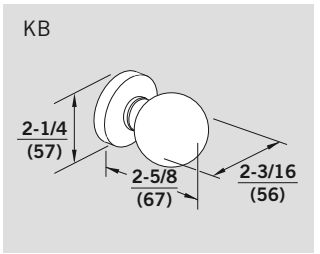
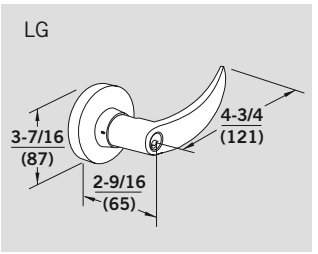
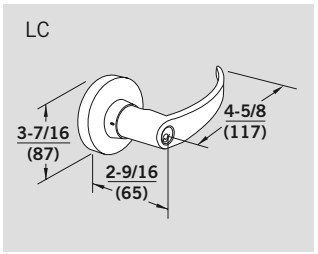
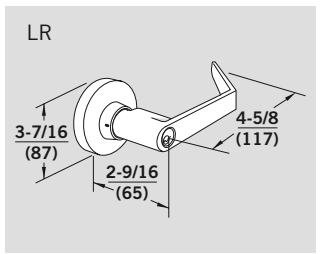

- Locks
- Cylinders, Keys & Keying
- Exit Devices
- Electronic Access Control Components
- Low Energy Operators
- Surface Closers
- Fire/Life Safety
- Concealed Closers/Pivots
- Stops/ Holders
- Sliding Systems
- Architectural Pulls & Handles
- Service Parts

LEVER LOCKS

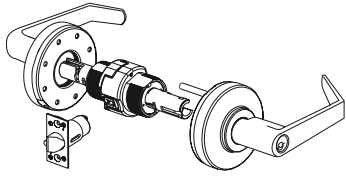

Lever Locks

626	605, 606, 612, 625, 613
------------	--

ANSI #	Function	Description	List \$	
Keyless				
F75	CL710	Passage/closet	163	187
F89	CL712	Exit	180	204
F111	CL725	Exit/communicating passage	180	204
F77A	CL730	Patio	185	209
F76A	CL740	Privacy, bedroom or bath	185	209
—	CL701	Single dummy	93	106
Keyed, Single Cylinder				
F82	CL750	Entry/Office	238	262
F109	CL753	Entry	238	262
F84	CL770	Classroom	238	262
F86	CL780	Storeroom	238	262

KNOB LOCKS

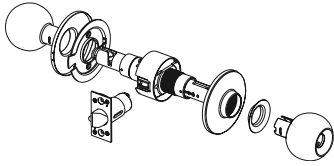

ANSI #	Function	Description	Knob Lock	
			630	605
			List \$	
Keyless				
F75	CK710	Passage/closet	105	117
F77A	CK730	Patio	141	153
F76A	CK740	Privacy, bedroom or bath	110	122
—	CK701	Single dummy	60	66
Keyed, Single Cylinder				
F109	CK753	Entry	190	202
F84	CK770	Classroom	190	202
F86	CK780	Storeroom	190	202

NOTES:

- List prices for keyed locks include standard DORMA (D) cylinder, keyed different (KD) with two (2) nickel silver keys.
- Split finishes will be priced at the highest finish list price.
- Split trim not available.

- Locks
- Cylinders, Keys & Keying
- Exit Devices
- Electronic Access Control Components
- Low Energy Operators
- Surface Closers
- Fire/Life Safety
- Concealed Closers/Pivots
- Stops/ Holders
- Sliding Systems
- Architectural Pulls & Handles
- Service Parts



CYLINDER TYPES, KEYING OPTIONS & KEYWAYS

Cylinder	Option	Description	List Add/Deduct	\$
Conventional Cylinders (non-interchangeable core)				
D		Conventional cylinder	Example: CL753D	N/C
	KD	Keyed differently to a random combination; SC keyway with 2 keys (default)		N/C
	KA2	Keyed alike in pairs to a random combination; SC keyway with 2 keys		N/C
	KA4	Keyed alike in sets of 4 to a random combination; SC keyway with 2 keys		N/C
	O-Bit	Operated by 1 bit cut key for easy rekeying; SC, SE keyway with 2 keys		N/C
	O-Bit	Operated by 1 bit cut key for easy rekeying; D100 keyway — ⊗ Keys sold separately		N/C
	O-Bit	Operated by 1 bit cut key for easy rekeying; AA, CA, CB, CC, CD, CE, RA, RB, GA, SF, WA, YA, YG keyways with 2 keys		12
	NSK	Non-stock keyed — KA quantities other than KA2/KA4; SC keyway with 2 keys		12
	MKD	Master keyed or SKD, SC, SE, or D100 keyway — ⊗ Keys sold separately		12
	NS2	Non-stock keyed double cylinder locks; SC keyway with 2 keys		24
	MK2	Master keyed or SKD double cylinder lock; SC, SE, or D100 keyway — ⊗ Keys sold separately		24
	CMK	Construction master keyed single cylinder locks — ⊗ Keys sold separately		13
	CM2	Construction master keyed double cylinder locks — ⊗ Keys sold separately		26
L		Lock less conventional cylinder	Example: CL753L	Deduct 30
Small Format Interchangeable Core Cylinders				
J		Lock with disposable plastic SFIC construction core	Example: CL753J	N/C
T		Lock with keyed temporary SFIC construction core (cores may be returned for a full refund) — ⊗ Keys sold separately	Example: CL753T	40
C		Lock with combined SFIC core installed at the factory ¹ ; BA (default), BB, BC, BD, BE, BF, BG, BH, BJ, BK, BL, BM, BQ, D100 keyway — ⊗ Keys sold separately	Example: CL753C	45

1. For uncombined cores, UNC, cores must be ordered separately, see Cylinders, Keys, and Keying.
Locks will be supplied w/plastic construction core, Option J.

⊗ Denotes keys must be ordered separately.

Cut Keys Ordered Separately

Part #	Description	List \$
45101	Change key, master key, construction master key, or control key; BA, BB, BC, BD, BE, BF, BG, BH, BJ, BK, BL, BM, BQ, SC, SE section	6
45401	Change key, master key, or control key; SKC sections - D100 etc.	10
45404	1 bit cut key for operating 1 bit cylinders	4

NOTES:

- D100 keyway is restricted. See TERMS OF SALE section for DORMA SKC policies.
- 1 bit cylinder comes with (2) uncut keys and will require a 1 bit cut key to operate cylinder.

CONFIGURATION OPTIONS

Latch Bolts

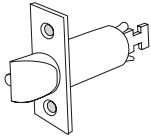

1/2" Throw, 2-3/8" Backset

Part #	Description	List Add \$
For 710 Locks		
17100	1" x 2-1/4" front, 7/8" diameter, square corner	N/C
17101	1" x 2-1/4" front, 7/8" diameter, 1/4" radius corner	N/C
17102	1-1/8" x 2-1/4" front, 1" diameter, square corner	N/C
For 725, 750, 753, 770, or 780 Locks		
17150	1" x 2-1/4" front, 7/8" diameter, square corner	N/C
17151	1" x 2-1/4" front, 7/8" diameter, 1/4" radius corner	N/C
17152	1-1/8" x 2-1/4" front, 1" diameter, square corner	N/C
For 730 Locks		
17180	1" x 2-1/4" front, 7/8" diameter, square corner	N/C
17181	1" x 2-1/4" front, 7/8" diameter, 1/4" radius corner	N/C
17182	1-1/8" x 2-1/4" front, 1" diameter, square corner	N/C
For 740 Locks		
17130	1" x 2-1/4" front, 7/8" diameter, square corner	N/C
17131	1" x 2-1/4" front, 7/8" diameter, 1/4" radius corner	N/C
17132	1-1/8" x 2-1/4" front, 1" diameter, square corner	N/C

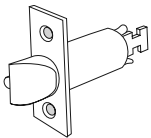

1/2" Throw, 2-3/4" Backset

Part #	Description	List Add \$
For 710 Locks		
17200	1" x 2-1/4" front, 7/8" diameter, square corner	N/C
17201	1" x 2-1/4" front, 7/8" diameter, 1/4" radius corner	N/C
17202	1-1/8" x 2-1/4" front, 1" diameter, square corner	N/C
For 725, 750, 753, 770, or 780 Locks		
17250	1" x 2-1/4" front, 7/8" diameter, square corner	N/C
17251	1" x 2-1/4" front, 7/8" diameter, 1/4" radius corner	N/C
17252	1-1/8" x 2-1/4" front, 1" diameter, square corner	N/C
For 730 Locks		
17280	1" x 2-1/4" front, 7/8" diameter, square corner	N/C
17281	1" x 2-1/4" front, 7/8" diameter, 1/4" radius corner	N/C
17282	1-1/8" x 2-1/4" front, 1" diameter, square corner	N/C
For 740 Locks		
17230	1" x 2-1/4" front, 7/8" diameter, square corner	N/C
17231	1" x 2-1/4" front, 7/8" diameter, 1/4" radius corner	N/C
17232	1-1/8" x 2-1/4" front, 1" diameter, square corner	N/C

NOTE: Default configurations for CL700 shown above in bold.

Latch Bolts (continued)

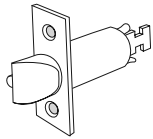

1/2" Throw, 3-3/4" Backset		
Part #	Description	List Add \$
For 710 Locks		
17300	1" x 2-1/4" front, 7/8" diameter, square corner	9
17301	1" x 2-1/4" front, 7/8" diameter, 1/4" radius corner	9
17302	1-1/8" x 2-1/4" front, 1" diameter, square corner	9
For 725, 750, 753, 770, or 780 Locks		
17350	1" x 2-1/4" front, 7/8" diameter, square corner	9
17351	1" x 2-1/4" front, 7/8" diameter, 1/4" radius corner	9
17352	1-1/8" x 2-1/4" front, 1" diameter, square corner	9
For 730 Locks		
17380	1" x 2-1/4" front, 7/8" diameter, square corner	9
17381	1" x 2-1/4" front, 7/8" diameter, 1/4" radius corner	9
17382	1-1/8" x 2-1/4" front, 1" diameter, square corner	9
For 740 Locks		
17330	1" x 2-1/4" front, 7/8" diameter, square corner	9
17331	1" x 2-1/4" front, 7/8" diameter, 1/4" radius corner	9
17332	1-1/8" x 2-1/4" front, 1" diameter, square corner	9

5" Backset Link

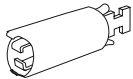

Part #	Description	List Add \$
For 710, 725, 750, 753, 770 and 780 Locks		
76008115	5" Backset Link, non-restoring	17
For 740		
76008106	5" Backset Link, restoring	17

NOTE: Use with 2-3/8" backset latch

Strikes

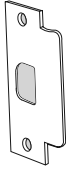

Part #	Description	List Add \$
5001	ANSI Strike with Cylindrical Lock Cutout	
5001-1316	1-1/4" x 4-7/8", 1-3/16" lip length, square corner	N/C
5001-112	1-1/4" x 4-7/8", 1-1/2" lip length, square corner	18

NOTE: Default strike for CL700 lock shown above in bold.

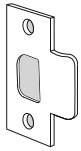

Part #	Description	List Add \$
5101	T Strike with Dust Box	
5101-118	1-1/8" x 2-3/4", 1-1/8" lip length, square corner	N/C
5101-112	1-1/8" x 2-3/4", 1-1/2" lip length, square corner	18

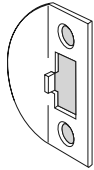

Part #	Description	List Add \$
5201, 5202	Full Lip Strike	
5201-118	1-5/8" x 2-1/4", 1-1/8" lip length, square corner	N/C
5202-118	1-5/8" x 2-1/4", 1-1/8" lip length, 1/4" radius corner	N/C

Locks

Cylinders,
Keys & Keying

Exit Devices

Electronic
Access Control
Components

Low Energy
Operators

Surface
Closers

Fire/Life
Safety

Concealed
Closers/Pivots

Stops/
Holders

Sliding
Systems

Architectural
Pulls &
Handles

Service Parts

SPECIAL APPLICATION OPTIONS

Abrasive Coated Knobs and Levers (Tactile Markings)

Part #	Description	List Add \$
660003	Abrasive coated lever or knob (all designs)	40

NOTE: Tactile marking is applied to outside knob or lever only, unless otherwise specified.

Lead Lining Plate

Part #	Description	List Add \$
660004	Lead lining plate for CL800, CL700	160

Security Screws

Specify	Description	List Add \$
TX	Security screws for latch and strike. 626 Finish Only	14

Special Strikes (Non-Standard Lip Lengths)

Part #	Description	List Add \$
5001-078	1-1/4" × 4-7/8", 7/8" lip length	N/C
5001-XXX	1-1/4" × 4-7/8", special lip length (other than 7/8", 1-3/16", or 1-1/2"). Specify length.	80

Boring Jig

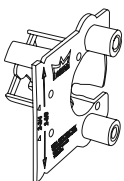
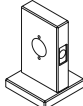
	Part #	Description	List \$
	76004795	Boring jig for CL800 and CL700 locksets	10
	640003	Mount, C800 lever, CL700, and C500 Series — 1-1/8" × 2-1/4" faceplate	90

C500 SERIES

Finish Availability Chart

	613	619	626	605	606	625
LR	•	•	•	•	•	•
LC	•	•	•	•	•	•
LG	•	•	•	—	—	—

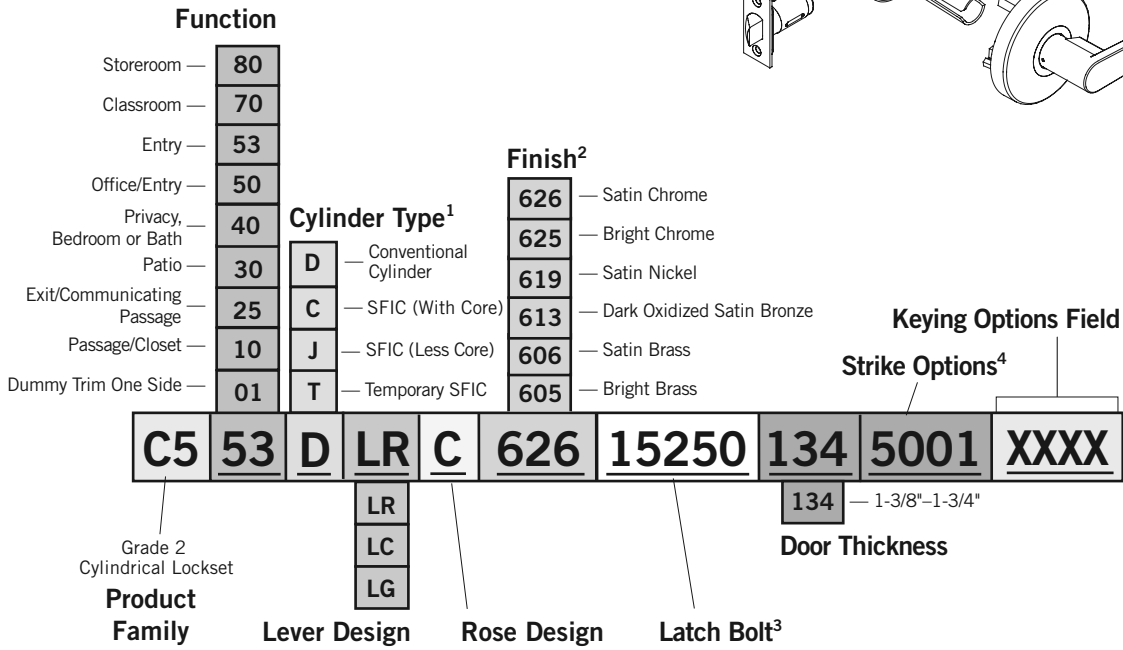
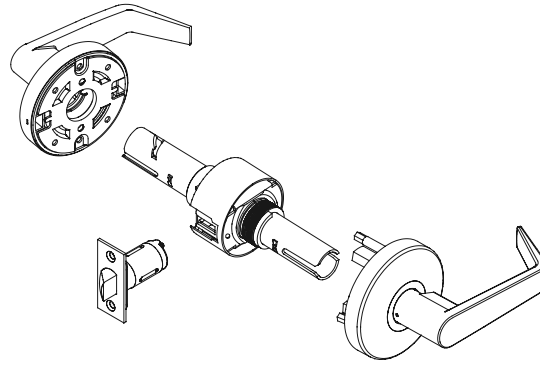

- The C500 is not available less conventional cylinder. All keyed functions are available with or without SFIC cores.
- For split finishes, consult factory.
- Example shows default values. Refer to Lock Options section for full details.

NOTE: SFIC available on LR and LC lever designs only, not available on LG lever.

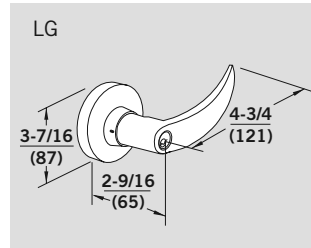
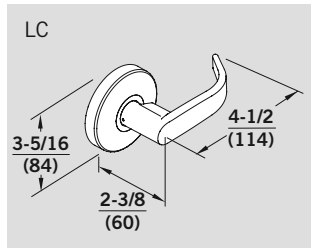
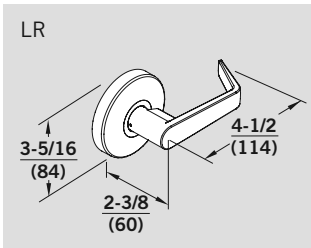

- Locks
- Cylinders, Keys & Keying
- Exit Devices
- Electronic Access Control Components
- Low Energy Operators
- Surface Closers
- Fire/Life Safety
- Concealed Closers/Pivots
- Stops/ Holders
- Sliding Systems
- Architectural Pulls & Handles
- Service Parts



LEVER LOCKS

			Lever Locks	
			626	605, 606, 613, 619, 625
ANSI #	Function	Description	List \$	
Keyless				
F75	C510	Passage/closet	102	114
F111	C525	Exit/Communicating passage	102	114
F77A	C530	Patio	104	116
F76A	C540	Privacy, bedroom or bath	104	116
—	C501	Single dummy	60	66
Keyed, Single Cylinder				
F82A	C550	Entry/Office	112	124
F109	C553	Entry	112	124
F84	C570	Classroom	112	124
F86	C580	Storeroom	112	124

NOTE: Consult factory for split finish. Additional charges may apply.

Cylinder Types, Keying Options & Keyways

Cylinder	Option	Description	List Add/Deduct \$
Conventional Cylinders (non-interchangeable core)			
D	Conventional cylinder	Example: C553D	N/C
	KD	Keyed differently to a random combination; SC keyway with 2 keys (default)	N/C
	O-Bit	Operated by 1 bit cut key for easy rekeying; D100 keyway — Keys sold separately	N/C
	O-Bit	Operated by 1 bit cut key for easy rekeying; SC, SE, AA, CA, CB, CC, CD, CE, RA, RB, GA, SF, WA, YA, YG keyways with 2 keys	12
	MKD	Master keyed or CMK, SKD, KA, SC, SE, or D100 keyway — Keys sold separately	12
	CMK	Construction master keyed single cylinder locks — Keys sold separately	13
Small Format Interchangeable Core Cylinders			
J		SFIC core sold separately (see Cylinders & Keying) Example: C553J	N/C
T		Temporary SFIC construction core Example: C553T	40
		(Cores may be returned for a full refund) — Keys sold separately	
C		Lock with combinated SFIC core; BA (default). Shipped separately Example: C553C	45
		BB, BC, BD, BE, BF, BG, BH, BJ, BK, BL, BM, BQ, D100 keyway — Keys sold separately	

1. For uncombined cores, UNC, cores must be ordered separately, see Cylinders, Keys, and Keying.

⊗ Denotes keys must be ordered separately.

Cut Keys Ordered Separately

Part #	Description	List \$
45101	Change key, master key, construction master key, or control key; BA, BB, BC, BD, BE, BF, BG, BH, BJ, BK, BL, BM, BQ, SC, SE section	6
45401	Change key, master key, or control key; SKC sections - D100 etc.	10
45404	1 bit cut key for operating 1 bit cylinders	4

NOTES:

- D100 keyway is restricted. See TERMS OF SALE section for DORMA SKC policies.
- 1 bit cylinder comes with (2) uncut keys and will require a 1 bit cut key to operate cylinder.

CONFIGURATION OPTIONS

Latch Bolts

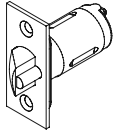

1/2" Throw, 2-3/8" Backset

Part #	Description	Add List \$
For 510 or 540 Locks		
15130	1" x 2-1/4" front, 7/8" diameter, square corner	N/C
15131	1" x 2-1/4" front, 7/8" diameter, 1/4" radius corner	N/C
For 525, 550, 553, 570, or 580 Locks		
15150	1" x 2-1/4" front, 7/8" diameter, square corner	N/C
15151	1" x 2-1/4" front, 7/8" diameter, 1/4" radius corner	N/C
For 530 Locks		
15180	1" x 2-1/4" front, 7/8" diameter, square corner	N/C
15181	1" x 2-1/4" front, 7/8" diameter, 1/4" radius corner	N/C

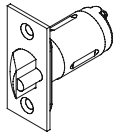

1/2" Throw, 2-3/4" Backset

Part #	Description	List Add \$
For 510 or 540 Locks		
15230	1" x 2-1/4" front, 7/8" diameter, square corner	N/C
15231	1" x 2-1/4" front, 7/8" diameter, 1/4" radius corner	N/C
15232	1-1/8" x 2-1/4" front, 7/8" diameter, square corner	N/C
For 525, 550, 553, 570, or 580 Locks		
15250	1" x 2-1/4" front, 7/8" diameter, square corner	N/C
15251	1" x 2-1/4" front, 7/8" diameter, 1/4" radius corner	N/C
15252	1-1/8" x 2-1/4" front, 7/8" diameter, square corner	N/C
For 530 Locks		
15280	1" x 2-1/4" front, 7/8" diameter, square corner	N/C
15281	1" x 2-1/4" front, 7/8" diameter, 1/4" radius corner	N/C
15282	1-1/8" x 2-1/4" front, 7/8" diameter, square corner	N/C

NOTE: Default configurations for C500 shown above in bold.

Locks

Cylinders,
Keys & Keying

Exit Devices

Electronic
Access Control
Components

Low Energy
Operators

Surface
Closers

Fire/Life
Safety

Concealed
Closers/Pivots

Stops/
Holders

Sliding
Systems

Architectural
Pulls &
Handles

Service Parts

SPECIAL APPLICATION OPTIONS

Boring Jig

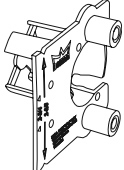
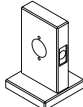
	Part #	Description	List \$
	76004795	Boring jig for CL800 and CL700 locksets	10
	640003	Mount, C800 lever, CL700, and C500 Series — 1-1/8" × 2-1/4" faceplate	90

Strikes

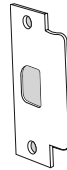
	Part #	Description	List Add \$
	5001 – ANSI Strike with Cylindrical Lock Cutout		
	5001-1316	1-1/4" × 4-7/8", 1-3/16" lip length, square corner	N/C
	5001-112	1-1/4" × 4-7/8", 1-1/2" lip length, square corner	18

NOTE: Default strike for C500 lock shown above in bold.

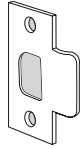
	Part #	Description	List Add \$
	5101, 5102 – "T" Strike with Dust Box		
	5101-118	1-1/8" × 2-3/4", 1-1/8" lip length, square corner	N/C
	5101-112	1-1/8" × 2-3/4", 1-1/2" lip length, square corner	18
	5102-118	1-1/8" × 2-3/4", 1-1/8" lip length, 1/4" radius corner	N/C
	5102-112	1-1/8" × 2-3/4", 1-1/2" lip length, 1/4" radius corner	18

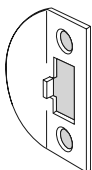
	Part #	Description	List Add \$
	5201, 5202 – Full Lip Strike		
	5201-118	1-5/8" × 2-1/4", 1-1/8" lip length, square corner	N/C
	5202-118	1-5/8" × 2-1/4", 1-1/8" lip length, 1/4" radius corner	N/C

Abrasive Coated Levers (Tactile Markings)

Part #	Description	List Add \$
660003	Abrasive coated lever (all designs)	40

NOTE: Tactile marking is applied to outside lever only, unless otherwise specified.

DB600 SERIES

Ordering Guide

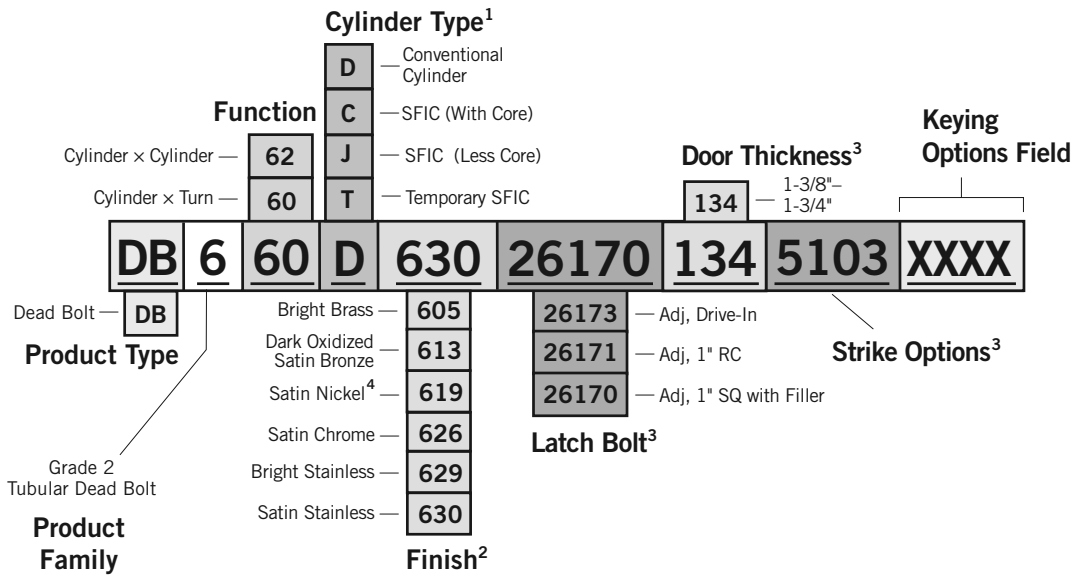
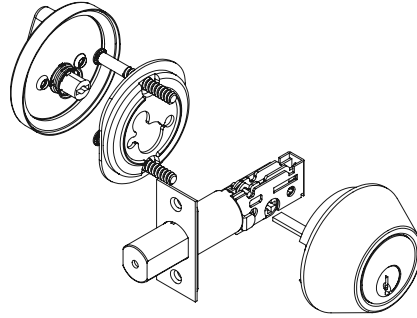

1. The Less Conventional Cylinder option is not available for the DB600 Series.
2. For split finishes, consult factory.
3. Example shows default values. Refer to Configuration Options section for full details.
4. 619 finish available standard cylinder only.

- Locks
- Cylinders, Keys & Keying
- Exit Devices
- Electronic Access Control Components
- Low Energy Operators
- Surface Closers
- Fire/Life Safety
- Concealed Closers/Pivots
- Stops/ Holders
- Sliding Systems
- Architectural Pulls & Handles
- Service Parts



DB600 SERIES

ANSI #	Function	Description	List \$	
			626, 630	605, 613, 619* 629
E2152	DB660	Cylinder × turn	73	79
E2142	DB662	Cylinder × cylinder	94	101

* 619 finish available standard cylinder only.

NOTES:

- List prices for keyed locks include standard DORMA (D) cylinder, keyed different (KD) with two (2) nickel silver keys.
- Split finishes will be priced at the highest finish list price.

Cylinder Types, Keying Options & Keyways

Cylinder	Option	Description	List Add/Deduct \$
Conventional Cylinders (non-interchangeable core)			
D	Conventional cylinder	Example: DB660D	N/C
	KD	Keyed differently to a random combination; SC keyway with 2 keys (default)	N/C
	KA2	Keyed alike in pairs to a random combination; SC keyway with 2 keys	10
	KA4	Keyed alike in sets of 4 to a random combination; SC keyway with 2 keys	10
	0-Bit	Operated by 1 bit cut key for easy rekeying; D100 keyway — ⊗ Keys sold separately	10
	0-Bit	Operated by 1 bit cut key for easy rekeying; SC, SE, AA, CA, CB, CC, CD, CE, RA, RB, GA, SF, WA, YA, YG keyways with 2 keys. Price per cylinder (DB662 requires 2 cylinders).	12
	NSK	Non-stock keyed — KA quantities other than KA2/KA4; SC keyway with 2 keys	12
	MKD	Master keyed or SKD, SC, SE, or D100 keyway — ⊗ Keys sold separately	12
	NS2	Non-stock keyed double cylinder locks; SC keyway with 2 keys	24
	MK2	Master keyed or SKD double cylinder lock; SC, SE, or D100 keyway — ⊗ Keys sold separately	24
	CMK	Construction master keyed single cylinder locks — ⊗ Keys sold separately	13
	CM2	Construction master keyed double cylinder locks — ⊗ Keys sold separately	26
Small Format Interchangeable Core Cylinders			
J	SFIC core sold separately	Example: DB660J	N/C
T	Locks with keyed temporary SFIC construction cores (Cores may be returned for a full refund) — ⊗ Keys sold separately	Example: DB660T	40
C	Lock with combined SFIC core Shipped Separately BA (default), BB, BC, BD, BE, BF, BG, BH, BJ, BK, BL, BM, BQ, D100 keyway — ⊗ Keys sold separately	Example: DB660C	45

* The Less Cylinder option is not available for the DB600 Series.

1. For uncombined cores, UNC, cores must be ordered separately, see Cylinders, Keys, and Keying.

⊗ Denotes keys must be ordered separately.

Cut Keys Ordered Separately

Part #	Description	List \$
45101	Change key, master key, construction master key, or control key; BA, BB, BC, BD, BE, BF BG, BH, BJ, BK, BL, BM, BQ, SC, SE section	6
45401	Change key, master key, or control key; SKC sections - D100 etc.	10
45404	1 bit cut key for operating 1 bit cylinders	4

NOTES:

- D100 keyway is restricted. See TERMS OF SALE section for DORMA SKC policies.
- 1 bit cylinder comes with (2) uncut keys and will require a 1 bit cut key to operate cylinder.

CONFIGURATION OPTIONS

Dead Bolts

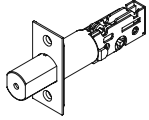

1" Throw, 2-3/8" – 2-3/4" Adjustable Backset

Part #	Description	List Add \$
26170	1" × 2-1/4" faceplate, square corner (1-1/8" wide w/filler)	N/C
26171	1" × 2-1/4" Faceplate, Radius Corner	N/C
26173	1" diameter, drive in (626 Finish only)	N/C

NOTE: Default configuration shown above in bold.

Strikes

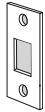

Part #	Description	List Add \$
5103	Standard Strike for Dead Bolt	
5103	1-1/8" × 2-3/4", no lip, square corner	N/C

NOTE: Default strike shown above in bold.

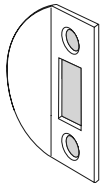

Part #	Description	List Add \$
5203	Full Lip Strike with Dead Bolt Cutout	
5203-118	1-5/8" × 2-1/4", 1-1/8" lip length, square corner	N/C

C300 SERIES

Finish Availability Chart				
	626	613	619	605
LR	•	•		
LC	•	•		•
LG	•	•	•	
LS		•	•	•

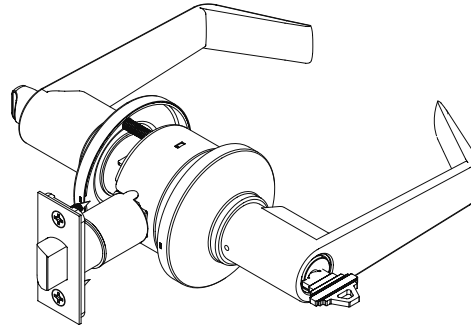

Lever		Backset		Strike		Cylinder Type		Keying
Lever Handed	LSB	2-3/8" Fire	238F	ANSI Strike, Square Corner	5001	D	Standard Cylinder	
Lever	LGB	2-3/4" Fire	234F	T Strike, Square Corner	5101			
Lever	LCB	2-3/8" Non-Fire*	238N	Full Lip, Square Corner	5201			
Lever	LRB	2-3/4" Non-Fire*	234N	Full Lip, Radius Corner	5202			

Function	Code	Finish	Code	Faceplate	Code	Handing	Code	Keyway
Single Dummy	301		626	Satin Chrome	100S	RH	SC	SC Keyway
Passage	310		613	Dark Bronze	118S	LH	D100	DORMA SKC D100 Keyway
Patio	330		619	Satin Nickel	100R			
Privacy	340		605	Bright Brass	DRIV			
Entry	353							

*C353 and C330 only available with fire rated latch.

Levers

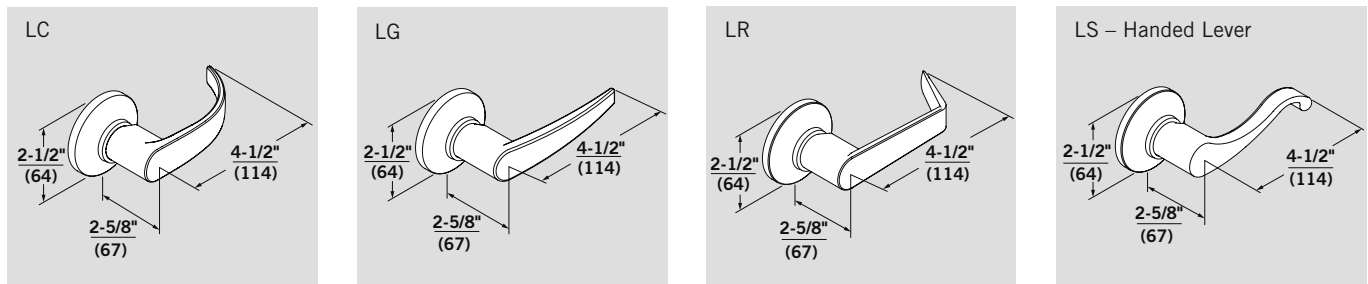

Strikes

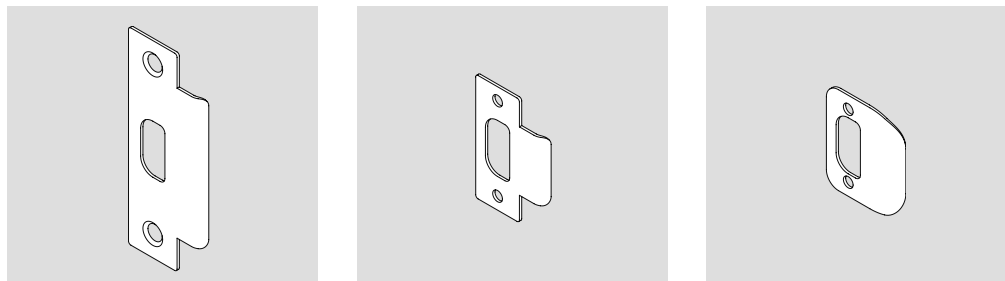

ANSI Strike

T Strike

Full Lip

- Locks
- Cylinders, Keys & Keying
- Exit Devices
- Electronic Access Control Components
- Low Energy Operators
- Surface Closers
- Fire/Life Safety
- Concealed Closers/Pivots
- Stops/ Holders
- Sliding Systems
- Architectural Pulls & Handles
- Service Parts



ANSI #	Function	Description	626	605, 613, 619
			List \$	
—	C301	Single dummy	30	32
F75	C310	Passage/closet	60	62
F77A	C330	Patio	69	71
F76A	C340	Privacy, bedroom, or bath	64	66
F109	C353	Entry	79	82

Strikes

Option	Description	List \$
5202	Full lip strike, radius corner – default	N/C
5001	ANSI strike	7
5101	T strike, square corner	N/C
5201	Full lip strike, square corner	N/C

Latches

Option	Description	List \$
C310/C340 Latches		
234N	2-3/4" Backset non-fire, default latch	N/C
238N	2-3/8" Backset non-fire, optional latch	N/C
234F	2-3/4" Backset fire rated, optional latch	8
238F	2-3/8" Backset fire rated, optional latch	8
C330/C353 Latches		
234F	2-3/4" Backset fire rated	N/C
238F	2-3/8" Backset fire rated	N/C

Keying

Option	Description	List \$
KD	Keyed different, default for SC keyway – default	N/C
KA	Keyed alike, available in SC keyway	10
MKD	Master keyed — ☒ Keys sold separately	12
CMK	Construction master keyed — ☒ Keys sold separately	13
0-BIT	Operated by 1 bit cut key for easy re-keying, SC keyway — ☒ Keys sold separately	10
0-BIT	Operated by 1 bit cut key for easy re-keying, D100 keyway — ☒ Keys sold separately	10

NOTE: Less Cylinder option is not available on the C300 series.

☒ Denotes keys must be ordered separately.

Keys

Part #	Description	List \$
45101	SC change key, master key, construction master key	6
45401	D100 change key, master key, construction master key	10
45404	1 bit cut key for operating 1 bit cylinders	4

NOTES:

- D100 keyway is restricted. See TERMS OF SALE section for DORMA SKC policies.
- 1 bit cylinder comes with (2) uncut keys and will require a 1 bit cut key to operate cylinder.

J300 SERIES

	626	613	619	605
LR	•	•		
LC	•	•		•
LG	•	•	•	
LS		•	•	•

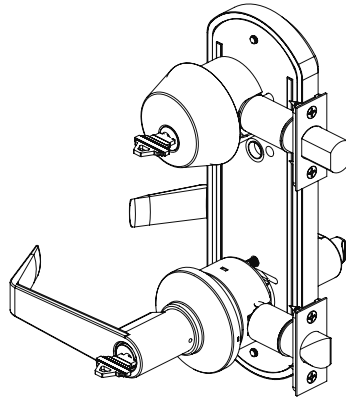

Lever		Backset		Handing		Cylinder Type	
Lever (Handed)	LSB	2-3/8" Fire	238F	Left Hand/Left Hand Reverse	LH	T	Temporary SFIC
Lever	LGB	2-3/4" Fire	234F	Right Hand/Right Hand Reverse	RH	C	SFIC (With Core)
Lever	LCB					J	SFIC (Less Core)
Lever	LRB					D	Standard Cylinder

Function	Finish	Faceplate	Strike	Keying
Entry – Single Cylinder	626	100S	5701	J
Entry – Double Cylinder	613	118S	5703	310
	619	100R	5704	353
	605		5705	
			5706	

310 — (1) T Strike Square, (1) No Lip Square
353 — (1) Full Lip Square, (1) No Lip Square
626 — (1) Full Lip Radiused, (1) No Lip Radiused
613 — (1) Full Lip Square, (1) Full Lip Square
619 — (1) Full Lip Square, (1) Full Lip Square
605 — (1) Full Lip Radiused, (1) Full Lip Radiused

NOTE: SFIC Core on C353 function available with LR lever only.

Levers

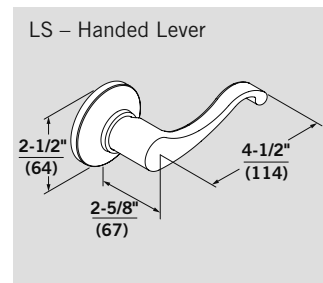
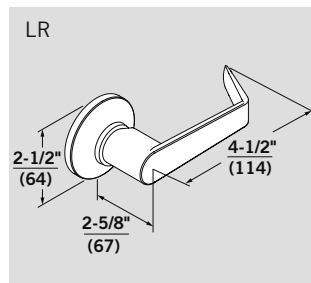
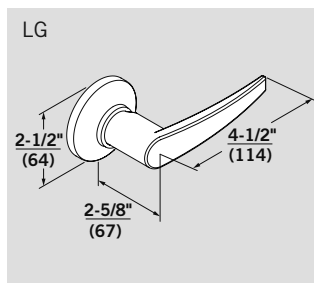
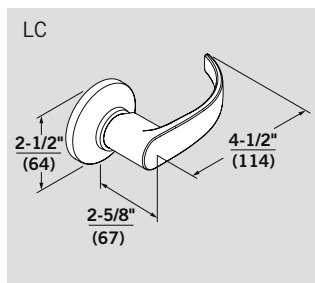

Strikes

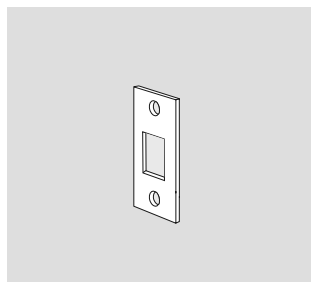
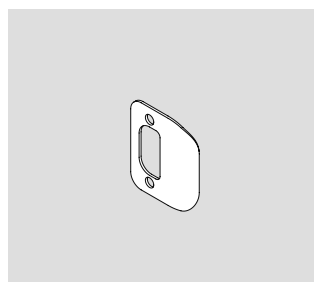
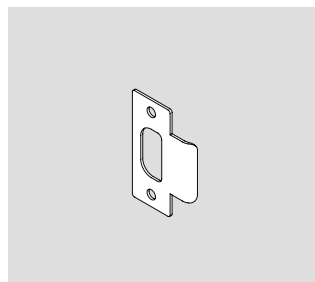

T Strike

Full Lip

No Lip, Deadbolt Strike

- Locks
- Cylinders, Keys & Keying
- Exit Devices
- Electronic Access Control Components
- Low Energy Operators
- Surface Closers
- Fire/Life Safety
- Concealed Closers/Pivots
- Stops/ Holders
- Sliding Systems
- Architectural Pulls & Handles
- Service Parts



All Levers—Per Chart

ANSI #	Function	Description	All Levers—Per Chart	
			626	605, 613, 619
F95	J310	Entrance, Single Locking	313	325
F97	J353	Entrance, Double Locking	390	402

Strikes

Option	Description	List \$
5701	Lock – T strike square / Deadbolt – no lip square (default)	N/C
5703	Lock – full lip square / Deadbolt – no lip square	N/C
5704	Lock – full lip radiused / Deadbolt – no lip radiused	N/C
5705	Lock – full lip square / Deadbolt – full lip square	N/C
5706	Lock – full lip radiused / Deadbolt – full lip radiused	N/C
Description		
Split Finish		20

Cylinder Types, Keying Options & Keyways

Cylinder	Option	Description	List Add/Deduct \$
Conventional Cylinders (non-interchangeable core)			
D		Conventional cylinder	
	KD	Keyed differently to a random combination; SC keyway with 2 keys (default)	N/C
	KA2	Keyed alike in pairs to a random combination; SC keyway with 2 keys	N/C
	KA4	Keyed alike in sets of 4 to a random combination; SC keyway with 2 keys	N/C
	O-Bit	Operated by 1 bit cut key for easy rekeying; SC, SE keyway with 2 keys	N/C
	O-Bit	Operated by 1 bit cut key for easy rekeying; D100 keyway — ⊗ Keys sold separately	N/C
	O-Bit	Operated by 1 bit cut key for easy rekeying; AA, CA, CB, CC, CD, CE, RA, RB, GA, SF, WA, YA, YG keyways with 2 keys	12
	NSK	Non-stock keyed — KA quantities other than KA2/KA4; SC keyway with 2 keys	12
	MK	Master keyed; SC, SE, or D100 keyway — ⊗ Keys sold separately	12
	MK2	Master keyed double cylinder lock; SC, SE, or D100 keyway — ⊗ Keys sold separately	24
	CMK	Construction master keyed single cylinder locks — ⊗ Keys sold separately	13
	CM2	Construction master keyed double cylinder locks — ⊗ Keys sold separately	26
L		Lock less conventional cylinder, per cylinder	Example: J310L Deduct 30
Small Format Interchangeable Core Cylinders			
J		Lock with disposable plastic SFIC construction core	Example: J353J N/C
T		Lock with keyed temporary SFIC construction core, per cylinder (cores may be returned for a full refund) — ⊗ Keys sold separately	Example: J310T 40
C		Lock with combined SFIC core installed at the factory ¹ ; BA (default), BB, BC, BD, BE, BF, BG, BH, BJ, BK, BL, BM, BQ, D100 keyway — ⊗ Keys sold separately	Example: J310C 45

⊗ Denotes keys must be ordered separately.

Cut Keys Ordered Separately

Part #	Description	List \$
45101	Change key, master key, construction master key, or control key; BA, BB, BC, BD, BE, BF, BG, BH, BJ, BK, BL, BM, BQ, SC, SE section	6
45401	Change key, master key, or control key; SKC sections - D100 etc.	10
45404	1 bit cut key for operating 1 bit cylinders	4

NOTE: 1 bit cylinder comes with (2) uncut keys and will require a 1 bit cut key to operate cylinder.



DORMA CYLINDERS, KEYS & KEYING

Product Guide

CYLINDER AVAILABILITY	Conventional	Interchangeable Core 6-Pin	Interchangeable Core 7-Pin	Conventional Hotel	Interchangeable Core Hotel
Mortise Cylinder	90	96	97	95	98
Rim Cylinder	80	86	87	—	—
KIL Cylinder	70	—	—	75	—
KIK Cylinder	71	—	—	—	—
Small Format Interchangeable Core	—	76	77	—	—

KEYWAY AVAILABILITY ● Yes ○ No	SC Keyway	SE Keyway	Retrofit Keyways AA, CA, CB, CC, CD, CE, RA, RB, GA, SF, WA, YA, YG	SFIC Keyways BA, BB, BC, BD, BE, BF, BG, BH, BJ, BK, BL, BM, BQ	DORMA SKC Keyways D100
KD Keyed different to a random combination	●	○	○	○	○
KA2 Keyed alike in pairs to a random combination	●	○	○	○	○
KA4 Keyed alike in sets of 4 to a random combination	●	○	○	○	○
NSK Keyed alike in sets of other than 2 or 4	●	○	○	○	○
MKD Master keyed or keyed to a specific combination	●	●	○	●	●
CMK Construction master keyed	●	●	○	○	● (Not available SFIC)



MASTER KEYING

DORMA master keying charges do not include keys. Always order and price keys as a separate line item.

A completed DORMA Key System Specification Form is required for every new master key system ordered. Orders and keying schedules must use BHMA/ANSI Standard Key Coding Symbols. See ANSI 156.28 for reference.

Keying capacity varies greatly with product and system architecture. Check keying requirements prior to selecting product. Expressions like "Plan for maximum expansion" have no meaning. The table below is a very general guide and can be misinterpreted. For more information, please contact DORMA.

Cylinder/Core Mechanism	Theoretical Number of Changes Under the Top Master Key	System Capacity	Example of Theoretical Keying Capacity in Three Levels of Keying (Grand Master, Master and Changes)
SC Keyway with Construction Keying	$4^5 = 1,024$	Smaller Projects	GMK and 16 Masters of 64 Changes Each
SC Keyway without Construction Keying	$4^6 = 4,096$	Medium Projects	GMK and 16 Masters of 256 Changes Each
77BA, BB etc. SFIC only	$4^7 = 16,384$	Larger Projects	GMK and 64 Masters of 256 Changes Each
DORMA SKC with Construction keying	$6 \times 4^6 = 24,576$	Very Large Projects	GMK and 96 Masters of 256 Changes Each
DORMA SKC without Construction Keying	$6 \times 4^7 = 98,304$	Extremely Large Projects	GMK and 384 Masters of 256 Changes Each

DORMA SKC

DORMA SKC (Shown in the price list as D100 keyway) are restricted. Possession of a price list does not constitute authorization to purchase DORMA SKC. Contact your local DORMA representative for information about authorization to purchase DORMA SKC. DORMA SKC may only be used in the USA and Canada.

CONVENTIONAL (NON-IC) MORTISE CYLINDERS

Ordering Guide

Cylinder Type
 Conventional Mortise — **90** **X**

Cylinder Ring (List Add)
90 **X** **10** **SC** **118** **626** **KD**

Length

300	— 3"
212	— 2-1/2"
214	— 2-1/4"
200	— 2"
134	— 1-3/4"
158	— 1-5/8"
112	— 1-1/2"
138	— 1-3/8"
114	— 1-1/4"
118	— 1-1/8"

Keying

OBIT	— O-Bitted (Pinned 1 Bit, Uncut Keys)
CMK	— Construction Master Keyed
MKD	— Master Keyed
NSK	— Non-Stock Keyed
KA4	— Keyed Alike, Sets of 4
KA2	— Keyed Alike, Sets of 2
KD	— Keyed Different

Cam

01	Adams Rite & DORMA 1340KR Key Removable Mullion
02	Adams Rite 4070
09	DORMA 9600, 9700 & 9800 Exit Z Trim w/09 or 12 Functions
10	DORMA M9050, 9080 & 9082 (2) Mortise Locks; DORMA 9100, 9300, 9400 & 9500 Exit Y Trim/Options & Other Straight Cam Applications
11	DORMA M9056, 9080EL/EU, 9080ELRX/EURX 9082EL/EU & M9900 Mortise Locks w/Dead Bolts
12	DORMA M9053, 9070, 9071 (2), 9076, 9077 (2) & 9060 Insider Cylinder Mortise Locks
13	DORMA M9060 Outside Cylinder Mortise Locks; DORMA 9600, 9700 & 9800 Exit Z Trim w/08 or 11 Functions
15	Schlage Style Clover (L)
16	DORMA 5000 Series Exit J Trim, Sargent & Yale Narrow
19	Best & CorbinRusswin Style Clover
30	Falcon Dead Bolt Style Clover
31	CorbinRusswin DL4000 Style

Keyway

SC	— Schlage C
SE	— Schlage E
D100	— DORMA SKC
AA	— Arrow A
CA	— Corbin 60
CB	— Corbin 67
CC	— Corbin 77
CD	— Corbin 59A1
CE	— CorbinRusswin L4
RA	— Russwin 981
RB	— Russwin D1
GA	— Sargent LA
SF	— Schlage F
WA	— Weiser E
YA	— Yale 8
YG	— Yale GA

Finish

605	— Bright Brass
606	— Satin Brass
612	— Satin Bronze
613	— Dark Oxidized Satin Bronze
625	— Bright Chrome
626	— Satin Chrome
630	— Satin Stainless (also for use with 619)

Length Includes Cam

Option	Keyway	Example	Keys	All Finishes \$
KD (standard)/KA2/KA4	SC	90X10 SC 118 626 KD	2 keys ea.	46
NSK (KA other than KA2/KA4)	SC	90X10 SC 118 626 NSK KA31	2 keys ea.	Add 20
Master keyed	SC, SE, D100	90X10 SC 118 626 MKD	⊗ Keys sold separately	Add 20
Construction master keyed	SC, SE, D100	90X10 SC 118 626 CMK	⊗ Keys sold separately	Add 25
O-Bit	SC, SE	90X10 SC 118 626 OBIT	2 keys ea.	46
O-Bit	D100	90X10 D100 118 626 OBIT	⊗ Keys sold separately	46
O-Bit	Retro	90X10 RB 118 626 OBIT	2 keys ea.	46
138, 112, 158, or 134 length		90X10 SC 112 626 KD		Add 25
200 or 214 length (extended leadtime)		90B10 SC 200 626 KD		Add 200
212 or 300 length (extended leadtime)		90B10 SC 212 626 KD		Add 250

⊗ Denotes keys must be ordered separately.

Keys Ordered Separately for MKD, CMK, and SKC

Part #	Description	List \$
45101	Cut key — change key, master key, construction key; SC, SE keyway	6
45401	Cut key — change key, master key, construction key; SKC sections - D100 etc.	10
45404	1 bit cut key for operating 1 bit cylinders	4

NOTES:

- D100 keyway cylinders must be ordered O-bitted or MKD; keys sold separately.
- Other restrictions apply. See TERMS OF SALE section for DORMA SKC policies.
- 1 bit cylinder comes with (2) uncut keys and will require a 1 bit cut key to operate cylinder.

SMALL FORMAT INTERCHANGEABLE CORE MORTISE HOUSINGS

Ordering Guide

Cylinder Type		Cylinder Ring (List Add)	Length		Finish	
For 7 Pin Core	97		300	3"	605	Bright Brass
For 6 Pin Core	96	X	212	2-1/2"	606	Satin Brass
			214	2-1/4"	612	Satin Bronze
			200	2"	613	Dark Oxidized Satin Bronze
			134	1-3/4"	625	Bright Chrome
			138	1-3/8"	626	Satin Chrome
					630	Satin Stainless (also for use with 619)
97 X 10 138 626						
Adams Rite & DORMA 1340KR Key Removable Mullion	01					
Adams Rite 4070	02					
DORMA 9600, 9700 & 9800 Exit Z Trim w/09 or 12 Functions	09					
DORMA M9050, 9080 & 9082 (2) Mortise Locks; DORMA 9100, 9300, 9400 & 9500 Exit Y Trim/Options & Other Straight Cam Applications	10					
DORMA M9056, 9080EL/EU, 9080ELRX/EURX 9082EL/EU & M9900 Mortise Locks w/Dead Bolts	11					
DORMA M9053, 9070, 9071 (2), 9076, 9077 (2) & 9060 Inside Cylinder Mortise Locks	12					
DORMA M9060 Outside Cylinder Mortise Locks; DORMA 9600, 9700 & 9800 Exit Z Trim w/08 or 11 Functions	13					
Schlage Style Clover (L)	15					
DORMA 5000 Series Exit J Trim, Sargent & Yale Narrow	16					
Best & CorbinRusswin Style Clover	19					
Falcon Dead Bolt Style Clover	30					
CorbinRusswin DL4000 Style	31					

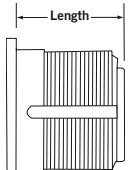

Length Includes Cam

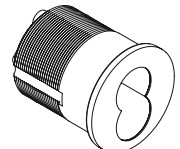

SFIC Mortise Housing

NOTE: To order cores, refer to page 79.

Description	Example	All Finishes \$
Housing less core	97X10 00 138 626	43
Housing less core — 200 or 214 length (extended leadtime)	97X10 00 200 626	Add 200
Housing less core — 212 or 300 length (extended leadtime)	97X10 00 212 626	Add 250

DUMMY & THUMBTURN CYLINDERS

Ordering Guide

Cylinder Ring (List Add)

Cylinder Type

Dummy — 91 X

91 X 118 626

1-1/8" — 118

1-1/4" — 114

Length

Finish

605 — Bright Brass

606 — Satin Brass

612 — Satin Bronze

613 — Dark Oxidized Satin Bronze

625 — Bright Chrome

626 — Satin Chrome

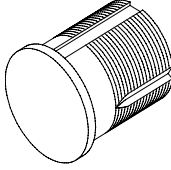

Dummy Cylinder

Cylinder Ring (List Add)

Cylinder Type

Thumbturn — 92 X

92 X 10 118 626

Adams Rite & DORMA 1340KR Key Removable Mullion — 01

Adams Rite 4070 — 02

DORMA M9050, 9080 & 9082 (2) Mortise Locks; DORMA 9100, 9300, 9400 & 9500 Exit Y Trim/Options & Other Straight Cam Applications — 10

DORMA M9056, 9080EL/EU, 9080ELRX/EURX 9082EL/EU & M9900 Mortise Locks w/Dead Bolts — 11

DORMA M9053, 9070, 9071 (2), 9076, 9077 (2) & 9060 Insider Cylinder Mortise Locks — 12

Best & CorbinRusswin Style Clover — 19

Cam

Finish

626 — Satin Chrome

625 — Bright Chrome

613 — Dark Oxidized Satin Bronze

612 — Satin Bronze

606 — Satin Brass

605 — Bright Brass

Length

114 — 1-1/4"

118 — 1-1/8"

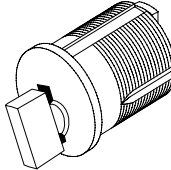

Thumbturn Cylinder

NOTE: For special arm applications, consult DORMA Technical Services.

Description	Example	All Finishes \$
91 Series dummy cylinder	91X 118 626	46
92 Series thumbturn cylinder	92X 10 118 626	60

NOTE: For cylinders over 1-1/4" long, contact the factory.



MORTISE CYLINDER CAMS FOR DORMA PRODUCTS

Ordering Guide

Product Type	Pattern	
Mortise Cylinder Cam — 63	C — DORMA SFIC Screw-On DORMA 93R Housing for Schlage FSIC	
	D — DORMA Conventional	
63	10	D
DORMA Key Removable Mullion & Adams Rite — 01		
Adams Rite 4070 & Amarlite: Baldwin Mortise Locks, Miscellaneous Non-DORMA Straight Cam Applications — 02	(Not available in SFIC)	
DORMA 9600, 9700 & 9800 Exit Z Trim w/09 or 12 Functions — 09		
DORMA M9050, 9080 & 9082 (2) Mortise Locks; DORMA 9100, 9300, 9400 & 9500 Exit Y Trim/Options & Other Straight Cam Applications — 10		
DORMA M9056, 9080EL/EU, 9080ELRX/EURX 9082EL/EU & M9900 Mortise Locks w/Dead Bolts — 11		
DORMA M9053, 9070, 9071 (2), 9076, 9077 (2) & 9060 Insider Cylinder Mortise Locks — 12		
DORMA M9060 Outside Cylinder Mortise Locks; DORMA 9600, 9700 & 9800 Exit Z Trim w/08 or 11 Functions — 13		
Schlage Style Clover (L) — 15		
DORMA 5000 Series Exit J Trim, Sargent & Yale Narrow — 16		
Best & CorbinRusswin Style Clover — 19		
	Cam	

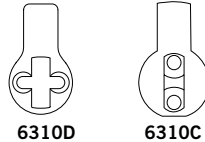

6310D **6310C**
SFIC cams have mounting screw holes at 12 and 6 o'clock

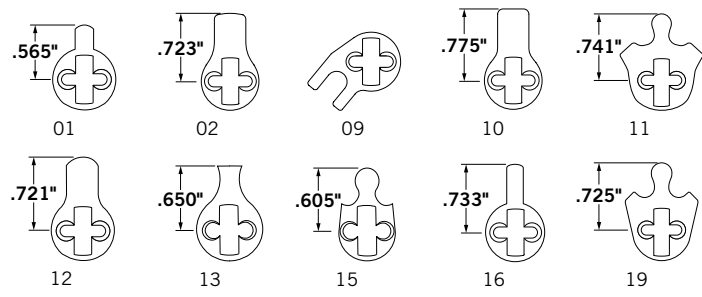

Description	List \$
Cams — 6301D, 6302D, 6309D, 6310D, 6311D, 6312D, 6313D, 6315D, 6316D, 6319D	3
Cams — 6301C, 6309C, 6310C, 6311C, 6312C, 6313C, 6315C, 6316C	4

NOTE: Cams, conventional & SFIC/Schlage FSIC sold in multiples of 10 only unless indicated otherwise.

RETROFIT MORTISE CYLINDER CAMS

Ordering Guide For other manufacturers' cylinders when used in DORMA M9000 Series Locks

Product Type

Mortise Cylinder Cam — **63**

DORMA 9600, 9700 & 9800 Exit Z Trim w/09 or 12 Functions — **09¹**

DORMA M9056, 9080EL/EU, 9080ELRX/EURX 9082EL/EU & M9900 Mortise Locks w/Dead Bolts — **11**

DORMA M9053, 9070, 9071 (2), 9076, 9077 (2) & 9060 Insider Cylinder Mortise Locks — **12**

DORMA M9060 Outside Cylinder Mortise Locks; DORMA 9600, 9700 & 9800 Exit Z Trim w/08 or 11 Functions — **13**

Cam

Pattern

SG — Arrow and Sargent Conventional Cylinders

CR — CorbinRusswin Conventional Cylinders

6311SG **6311CR**

1. 09 cam required for DORMA Z09 & Z12 exit trim. For this, or any other application not shown, contact DORMA Technical Services.

Retrofit cams are configured to fit non-DORMA cylinders. Use of incorrect cams can cause lockouts.

Description	List \$
Cams — 6311CR, 6312CR, 6313CR	8
Cams — 6311SG, 6312SG, 6313SG	8

NOTE: Cams, conventional sold in multiples of 10 only unless indicated otherwise.

MORTISE CYLINDER RINGS

Ordering Guide

Product Type

Mortise Cylinder Ring — **64**

64 **J** **626**

Cylinder with Blocking Ring Cylinder with Tapered Ring

Cylinder Ring

H — 13/16" Tapered Ring raises cylinder 5/8" off door

G — 11/16" Tapered Ring raises cylinder 1/2" off door

K — 17/32" Tapered Ring raises cylinder 7/16" off door

J — 7/16" Tapered Ring raises cylinder 1/4" off door

A — 9/32" Tapered Ring raises cylinder 3/32" off door

D — 1/4" Blocking Ring

C — 1/8" Blocking Ring

Finish

605 — Bright Brass

606 — Satin Brass

612 — Satin Bronze

613 — Dark Oxidized Satin Bronze

625 — Bright Chrome

626 — Satin Chrome

629 — Bright Stainless

630 — Satin Stainless (also for use with 619)

Description	List \$	
Blocking rings — 64C, 64D	4	5
Tapered rings — 64A, 64J, 64K (includes wave washer)	9	11
Tapered rings — 64G, 64H (includes wave washer)	10	12
Wave washer (sold in multiples of 25 only)	.60 each	

Example: 64J 626

- Locks
- Cylinders, Keys & Keying
- Exit Devices
- Electronic Access Control Components
- Low Energy Operators
- Surface Closers
- Fire/Life Safety
- Concealed Closers/Pivots
- Stops/ Holders
- Sliding Systems
- Architectural Pulls & Handles
- Service Parts



CONVENTIONAL (NON-IC) RIM CYLINDERS

Ordering Guide

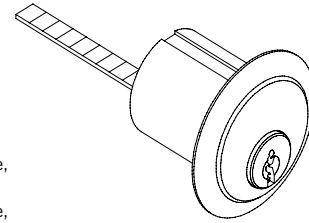
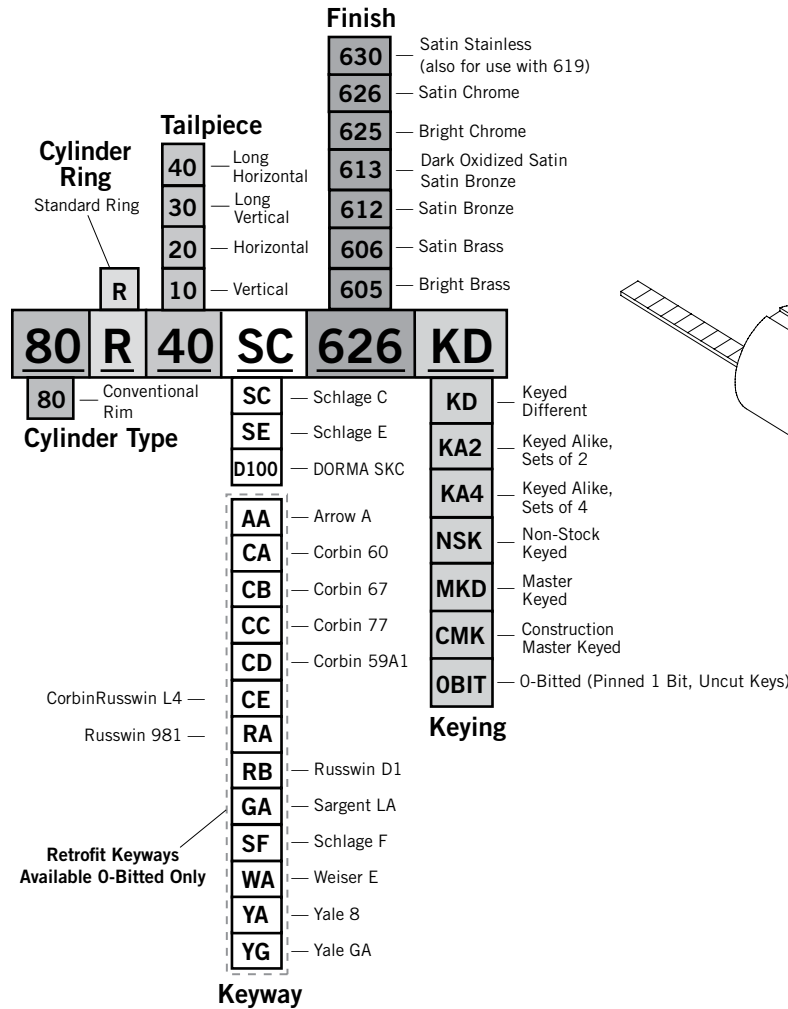

Option	Keyway	Example	Keys	All Finishes \$
KD (standard)/KA2/KA4	SC	80R40 SC 626 KD	2 keys ea.	46
NSK (KA other than KA2/KA4)	SC	80R40 SC 626 NSK KA31	2 keys ea.	Add 20
Master keyed	SC, SE, D100	80R40 SC 626 MKD	⊗ Keys sold separately	Add 20
Construction master keyed	SC, SE, D100	80R40 SC 626 CMK	⊗ Keys sold separately	Add 25
O-Bit	SC, SE	80R40 SC 626 OBIT	2 keys ea.	46
O-Bit	D100	80R40 D100 626 OBIT	⊗ Keys sold separately	46
O-Bit	Retro	80R40 RB 626 OBIT	2 keys ea.	46

⊗ Denotes keys must be ordered separately.

Keys Ordered Separately for MKD, CMK, and SKC

Part #	Description	List \$
45101	Cut key — change key, master key, construction key; SC, SE keyway	6
45401	Cut key — change key, master key, construction key; SKC sections - D100 etc.	10
45404	1 bit cut key for operating 1 bit cylinders	4

NOTES:

- D100 keyway cylinders must be ordered O-bitted or MKD; keys sold separately.
- Other restrictions apply. See TERMS OF SALE section for DORMA SKC policies.
- 1 bit cylinder comes with (2) uncut keys and will require a 1 bit cut key to operate cylinder.

SMALL FORMAT INTERCHANGEABLE CORE RIM HOUSINGS

Ordering Guide

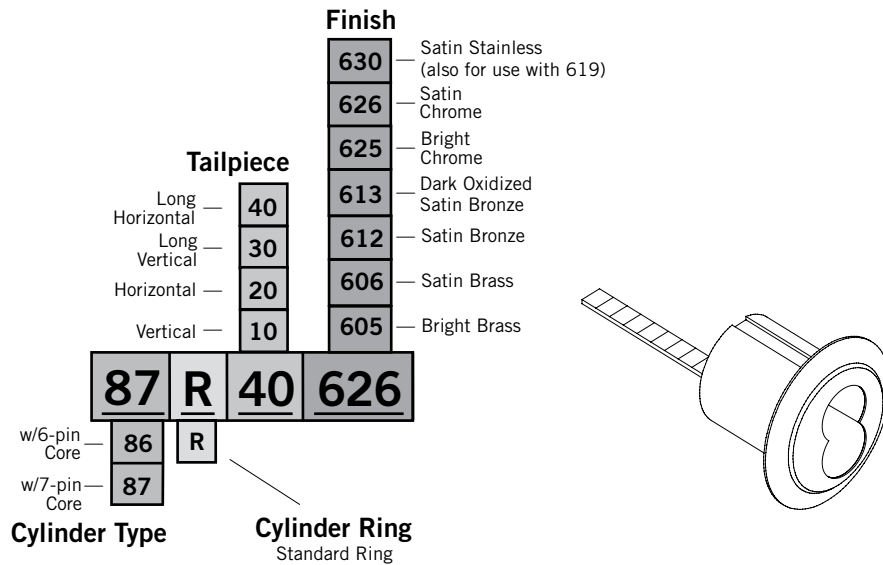

NOTE: To order cores, refer to page 79.

Description	Example	All Finishes \$
Housing less core	87R40 00 626	43

- Locks
- Cylinders, Keys & Keying**
- Exit Devices
- Electronic Access Control Components
- Low Energy Operators
- Surface Closers
- Fire/Life Safety
- Concealed Closers/Pivots
- Stops/ Holders
- Sliding Systems
- Architectural Pulls & Handles
- Service Parts



CONVENTIONAL (NON-IC) KEY-IN-KNOB/LEVER CYLINDERS

Ordering Guide (Except Hotel Function)

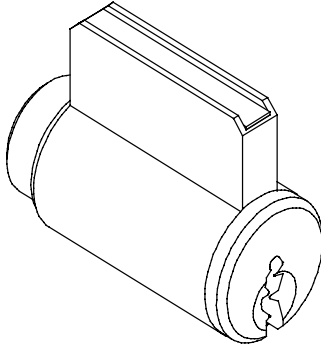

Tailpiece		Keyway		Retrofit Keyways Available O-Bitted Only
C873 Lever Only	28			
All C800 Levers except C873 & 885	27			
D860 & 863 1-13/16"-2" Door	26	YG	Yale GA	
C570	25	YA	Yale 8	
C550, 553, 555, 580	24	WA	Weiser E	
J210 & J253 Upper Cylinder	23	SF	Schlage F	
J253 Lower Cylinder	22	GA	Sargent LA	
D862 1-13/16"-2" Door	21	RB	Russwin D1	
D862 1-3/8"-1-3/4" Door	20	RA	Russwin 981	
D860 & 863 1-3/8"-1-3/4" Door	19	CE	CorbinRusswin L4	
D861	18	CD	Corbin 59A1	
DB662	17	CC	Corbin 77	
DB660	16	CB	Corbin 67	
RO8 Trim	13	CA	Corbin 60	
CL700 Levers	13	AA	Arrow A	
CK700 Knobs	12	D100	DORMA SKC	
		SE	Schlage E	
		SC	Schlage C	
				Keying
				OBIT — O-Bitted (Pinned 1Bit, Uncut Keys)
				CMK — Construction Master Keyed
				MKD — Master Keyed
				NSK — Non-Stock Keyed
				KA4 — Keyed Alike, Sets of 4
				KA2 — Keyed Alike, Sets of 2
				KD — Keyed Different
		70	10	SC
				626
				KD
Lever Designs	70	Satin Brass	606	
Knob Designs	71	Satin Chrome	626	
		Lock Type		Finish

NOTE: To order tailpiece only, refer to page 82.

Option	Keyway	ExampleKeys	Keys	All Finishes \$
KD (standard)/KA2/KA4	SC	7010 SC 626 KD2 keys ea.	2 keys ea.	41
NSK (KA other than KA2/KA4)	SC	7010 SC 626 NSK KA31	2 keys ea.	Add 20
Master keyed	SC, SE, D100	7010 SC 626 MKD	⊗ Keys sold separately	Add 20
Construction master keyed	SC, SE, D100	7010 SC 626 CMK	⊗ Keys sold separately	Add 25
O-Bit	SC, SE	7010 SC 626 OBIT	2 keys ea.	41
O-Bit	D100	7010 D100 626 OBIT	⊗ Keys sold separately	41
O-Bit	Retro	7010 RB 626 OBIT	2 keys ea.	41

NOTE: For locksets in 619, 625, 626, 629, and 630 finish, order cylinders in 626. For locksets in 605, 606, 612, and 613, order in 606.

⊗ Denotes keys must be ordered separately.

Keys Ordered Separately for MKD, CMK, and SKC

Part #	Description	List \$
45101	Cut key — change key, master key, construction key; SC, SE keyway	6
45401	Cut key — change key, master key, construction key; SKC sections - D100 etc.	10
45404	1 bit cut key for operating 1 bit cylinders	4

NOTES:

- D100 keyway cylinders must be ordered O-bitted or MKD; keys sold separately.
- Other restrictions apply. See TERMS OF SALE section for DORMA SKC policies.
- 1 bit cylinder comes with (2) uncut keys and will require a 1 bit cut key to operate cylinder.

CONVENTIONAL (NON-IC) HOTEL CYLINDERS

Ordering Guides

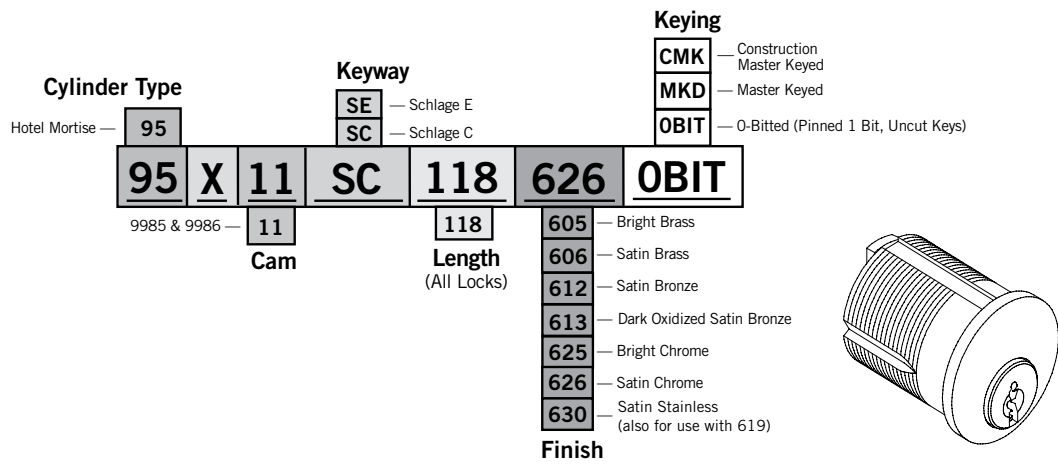
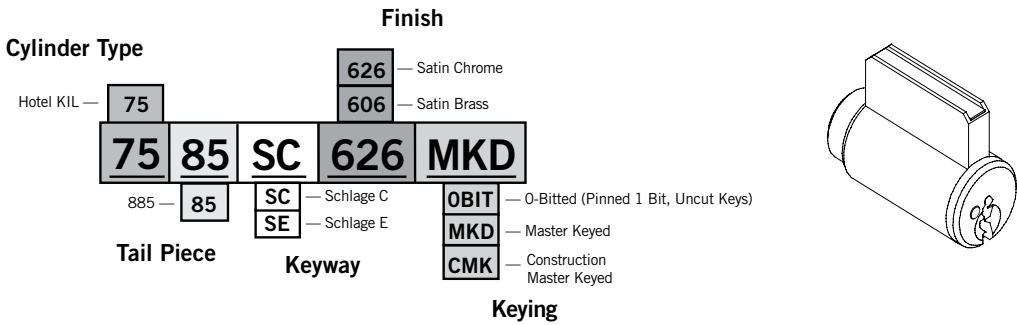

Description	Example	All Finishes \$
Key-in-Lever Cylinders		
Key-in-lever hotel cylinder	7585 SC 626 OBIT	66
Key-in-lever master keyed cylinder — Keys sold separately	7585 SC 626 MKD	Add 20
Key-in-lever construction keyed cylinder — Keys sold separately	7585 SC 626 CMK	Add 25
Mortise Cylinders		
Mortise hotel cylinder	95B10 SC 118 626 OBIT	71
Mortise master keyed cylinder — Keys sold separately	95B10 SC 118 626 MKD	Add 20
Mortise construction master keyed cylinder — Keys sold separately	95B10 SC 118 626 CMK	Add 25

NOTES:

- For key-in-lever locksets in 619, 625, and 626 finish, order cylinders in 626. For key-in-lever locksets in 605, 606, 612, and 613, order in 606.
- Key-in-lever hotel cylinders are not available in D100 keyway.

⊗ Denotes keys must be ordered separately.

Keys Ordered Separately for MKD and CMK cylinders

Part #	Description	List \$
45101	Cut key — change key, master key, construction key, emergency key 95 Cyl; SC, SE keyway	6
45401	Cut key — change key, master key, construction key, emergency key 95 Cyl; SKC sections - D100 etc.	10
45102	Emergency key 75CYL; SC, SE keyway	20

NOTES:

- D100 keyway cylinders must be ordered 0-bitted or MKD; keys sold separately.
- Other restrictions apply. See TERMS OF SALE section for DORMA SKC policies.

- Locks
- Cylinders, Keys & Keying
- Exit Devices
- Electronic Access Control Components
- Low Energy Operators
- Surface Closers
- Fire/Life Safety
- Concealed Closers/Pivots
- Stops/Holders
- Sliding Systems
- Architectural Pulls & Handles
- Service Parts

SMALL FORMAT INTERCHANGEABLE CORE HOTEL CYLINDER

Ordering Guide

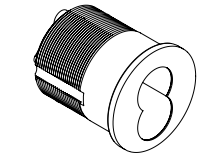
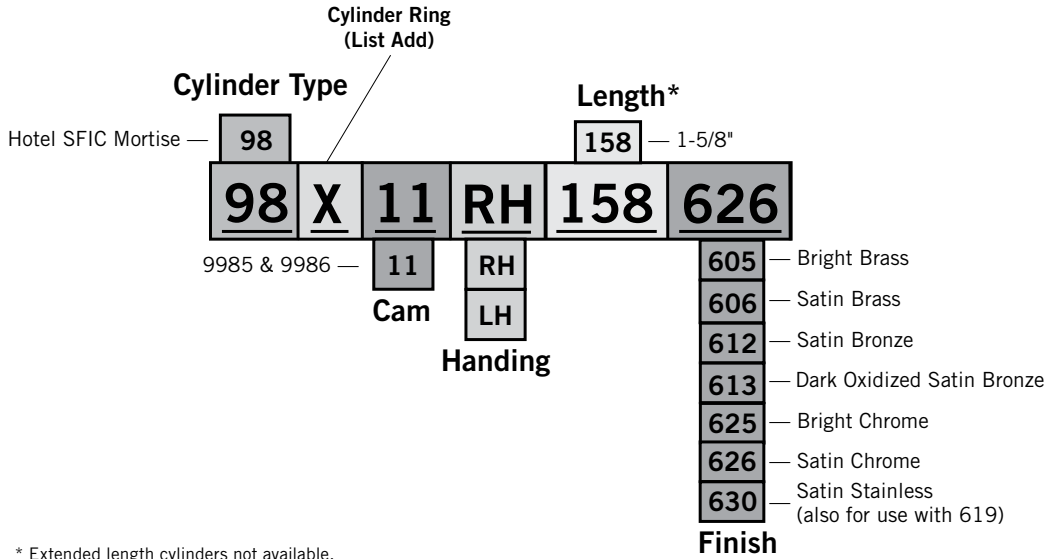

Cylinder without Ring

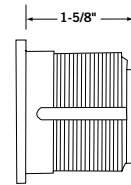

Length Includes Cam

* Extended length cylinders not available.

NOTE: To order cores only, refer to page 79.

Description	Example	All Finishes \$
Housing less core	98H11 00 158 626	57

1. For uncombined cores, UNC, cores must be ordered separately.



SMALL FORMAT INTERCHANGEABLE CORES

Ordering Guide

Core Length

7-Pin Core — **77**

6-Pin Core — **76**

Finish

626 — Satin Chrome

606 — Satin Brass

77 BA 606 MKD

Keying

BA — Best A

BB — Best B

BC — Best C

BD — Best D

BE — Best E

BF — Best F

BG — Best G

BH — Best H

BJ — Best J

BK — Best K

BL — Best L

BM — Best M

TB — Best TB

BQ — Best Q

D100 — DORMA SKC (supplied standard with DORMA logo - 7-pin Core only)

BLK — Black Construction Core

BLU — Blue Construction Core

GRN — Green Construction Core

MKD — Combined (Master Keyed)

UNC — Uncombined

TMP — Temporary Construction Core

NOTE: To order tailpiece only, refer to page 82.

Specify Color If Required to Match Existing Project

Description	Example	All Finishes \$
Uncombined core — Keys sold separately	77 BA 606 UNC	30
76 or 77 Series core, combined — Keys sold separately	77 BA 606 MKD	Add 15
Temporary construction core — Keys sold separately	77 XX 606 TMP	40

Cores may be returned for a full refund

NOTES:

- For locksets in 619, 625, 626, 629, and 630 finish, order cores in 626. For locksets in 605, 606, 612, and 613, order cores in 606.
- SFIC cores are not available 0-Bitted.

Denotes keys must be ordered separately.

Keys Ordered Separately

Part #	Description	List \$
45101	Cut key — change key, master key, control key; "B" keyways	6
45401	Cut key — change key, master key, control key; SKC sections - D100 etc.	10
45103	Emergency key for M9985C "B" keyways	20
45403	Emergency key for M9985C D100 keyway	20

NOTES:

- D100 keyway cylinders must be ordered UNC or MKD; keys sold separately.
- Other restrictions apply. See TERMS OF SALE section for DORMA SKC policies.

Service Items

Part #	Description	List \$
860051	Plastic construction core	4



LARGE FORMAT INTERCHANGEABLE CORE CYLINDER

Ordering Guide

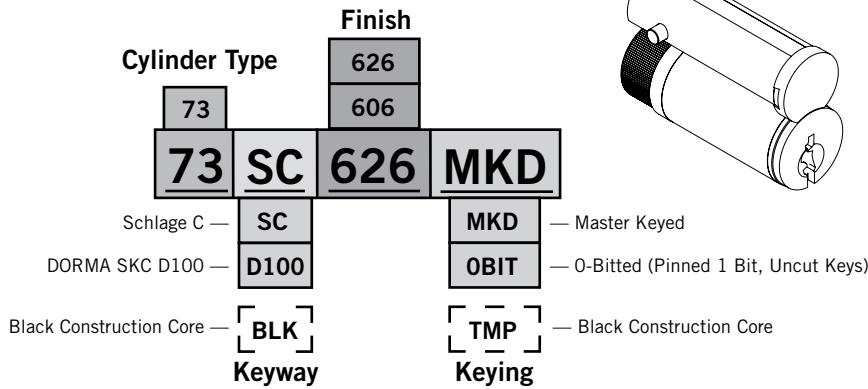

Description	Keyway	All Finishes \$
73 Schlage style LFIC Core — ☒ Keys sold separately	D100	45
73 Schlage style LFIC Core — ☒ Keys sold separately	SC	45
73 Schlage style temporary construction core — ☒ Keys sold separately		55

☒ Denotes keys must be ordered separately.

Keying	Example	List \$
MKD—Master Keyed — ☒ Keys sold separately	73 D100 626 MKD	Add 20
OBIT—O Bitted — ☒ Keys sold separately	73 D100 626 OBIT	N/C

☒ Denotes keys must be ordered separately.

Keying		List \$
Cut Key SC	Change key, master key, control key; SC Keyway	6
Cut Key D100	Change key, master key, control key; D100 Keyway	10

Part #	Description	List \$
45404	1 bit cut key for operating 1 bit cylinders	4
45405	1 bit cut control key for inserting/removing 1 bit Large Format core	4

NOTE: 1 bit cylinder comes with (2) uncut keys and will require a 1 bit cut key to operate cylinder.

RETROFIT INTERCHANGEABLE CORE CYLINDER HOUSINGS

Ordering Guides

Cylinder Type
Rim Cylinder Housing — **83** **R** **R** **40** **00** **626**

Cylinder Ring
Standard Ring

Tailpiece
40 — Long Horizontal
30 — Long Vertical

Retrofit Type
X7 — Sargent XC 11-P-7300B, Arrow Choice Plus CP7S, Arrow Choice Flex C7FS, Arrow Choice Base C7S
X6 — Arrow Choice Plus CP6S, Arrow Choice Flex C6FS, Arrow Choice Base C6S
R — Schlage FSIC

Finish
605 — Bright Brass
606 — Satin Brass
612 — Satin Bronze
613 — Dark Oxidized Satin Bronze
625 — Bright Chrome
626 — Satin Chrome
630 — Satin Stainless (also for use with 619)

1. Interchangeable cores not available from DORMA for these rim cylinder housings.

Cylinder Type
Mortise Cylinder Housing — **93** **R** **X** **10** **00** **112** **626**

Retrofit Type
X6 — Arrow Choice Plus CP6S, Arrow Choice Flex C6FS, Arrow Choice Base C6S
X7 — Sargent XC 11-P-7300B, Arrow Choice Plus CP7S, Arrow Choice Flex C7FS, Arrow Choice Base C7S
R — Schlage FSIC

Cylinder Ring (List Add)
X

Length
112 — 1-1/2" (R only)
134 — 1-3/4" (X7, X6 only)
138 — 1-3/8" (X7, X6 only)

Finish
605 — Bright Brass
606 — Satin Brass
612 — Satin Bronze
613 — Dark Oxidized Satin Bronze
625 — Bright Chrome
626 — Satin Chrome
630 — Satin Stainless (also for use with 619)

01 — DORMA 1340KR Key Removable Mullion
09 — DORMA 9600, 9700 & 9800 Exit Z Trim w/09 or 12 Functions
10 — DORMA M9050, 9080 & 9082 (2) Mortise Locks; DORMA 9100, 9300, 9400 & 9500 Exit Y Trim/Options & Other Straight Cam Applications
11 — DORMA M9056, 9080EL/EU, 9080ELRX/EURX, 9082EL/EU & M9900 Mortise Locks w/Dead Bolts
12 — DORMA M9053, 9070, 9071 (2), 9076, 9077 (2) & 9060 Insider Cylinder Mortise Locks
13 — DORMA M9060 Outside Cylinder Mortise Locks; DORMA 9600, 9700 & 9800 Exit Z Trim w/08 or 11 Functions
16 — DORMA 5000 Series Exit J Trim

Retrofit	Description	Cam	Example	All Finishes \$
Full Size Interchangeable Core Housing—Less Core				
R	1. Interchangeable cores not available from DORMA for these mortise cylinder housings. Housing prepared for Schlage FSIC	00	83 R R 40 00 626 or 93 R G 10 00 112 626	51
Small Format Interchangeable Core Housings—Less Core				
X7 ¹	Housing prepared for Sargent XC 7P and Arrow Choice 7P		83 X7 R 40 00 626 or 93 X7 G 10 00 112 626	51
X6 ¹	Housing prepared for Arrow Choice 6P		83 X6 R 40 00 626 or 93 X6 G 10 00 112 626	51

NOTE: If temporary construction cores are required, consult DORMA technical services. SFIC housings X6 require 6-pin temporary cores; X7 require 7-pin temporary cores.

DORMA TAILPIECES

C800 Lever	Tailpiece	Cylinder Type	Application	List \$
	6727D	Standard	All functions but C873, C885	4
	6728D	Standard	C873 function only	4
	6785D	Standard	C885 function only (hotel)	5
	6727C	SFIC	All functions but C873, C885	4
	6728C	SFIC	C873 function only	4
	6727R	R (Schlage FSIC)	All functions but C873	5
	6728R	R (Schlage FSIC)	C873 function only	5
	6727A	A (Corbin FSIC)	All functions but C873	5
	6728A	A (Corbin FSIC)	C873 function only	5
	6727M	M (Medeco 32 FSIC)	All functions but C873	5
	6728M	M (Medeco 32 FSIC)	C873 function only	5
	6727E	E (Corbin 2000 KIL)	All functions but C873	5
	6728E	E (Corbin 2000 KIL)	C873 function only	5
	6727N	N (Sargent 6300 FSIC)	All functions but C873	5
	6728N	N (Sargent 6300 FSIC)	C873 function only	5
	6727S	S (Sargent 10 Line KIL)	All functions but C873	4
	6728S	S (Sargent 10 Line KIL)	C873 function only	4
	6727Y	Y (Yale 1210/Medeco 31 FSIC)	All functions but C873	5
	6728Y	Y (Yale 1210/Medeco 31 FSIC)	C873 function only	5
C800 Knob				
	6727D	Standard	All functions but C873	4
	6728D	Standard	C873 function only	4
	6712C	SFIC	All functions but C873	3
	6729C	SFIC	C873 function only	3
CL700 Lever				
	6713D	Standard	All functions	3
	6713C	SFIC	All functions	3
CK700 Knob				
	6712D	Standard	All functions	3
	6712C	SFIC	All functions	3
C500 Tailpieces				
	6724D	Standard	All functions except C570	3
	6725D	Standard	C570 function only	3
	6724C	SFIC	All functions except C570	3
	6725C	SFIC	C570 function only	3
J300 Tailpieces				
	6732D	Standard	J353 (lever)	3
	6733D	Standard	All functions (deadbolt)	4
	6733C	SFIC	All functions (deadbolt)	4
	6734C	SFIC	J353 (lever)	3
C300 Tailpieces				
	6732D	Standard	C353	3



D800 Tailpieces	Tailpiece	Cylinder Type	Application	List \$
	6718D	Standard	D861	3
	6719D	Standard	D860/D863	3
	6720D	Standard	D862	3
	6718C	SFIC	D861	3
	6720C	SFIC	D862	3
DB600 Tailpieces				
	6716D	Standard	D660	3
	6717D	Standard	D662	3
	6716C	SFIC	D660	3
	6717C	SFIC	D662	3

CONVENTIONAL & INTERCHANGEABLE TAILPIECES

Description (sold in multiples of 10 unless otherwise specified)	List \$
DORMA tailpieces 6727D, 6728D (include white spacer for Schlage OEM cylinder)	4
DORMA tailpieces 6727C, 6728C, 6729C	4
DORMA tailpieces 6712D, 6712C, 6713D, 6713C, 6716D, 6716C, 6717D, 6717C, 6718D, 6718C, 6719D, 6719C, 6720D, 6720C, 6721D, 6721C, 6722D, 6722C, 6723D, 6723C, 6724D, 6724C, 6725D, 6725C, 6726D, 6726C, 6730D	3
DORMA tailpiece 6785D (sold in multiples of 5 only)	5
Retrofit tailpieces 6727A, 6727E, 6727N, 6727S, 6728A, 6728E, 6728N, 6728S	4
Retrofit tailpieces 6727R, 6727M, 6727Y, 6728R, 6728M, 6728Y, 6731R	5
76009468—SFIC tailpiece spacer for use with 6-pin cores (except C800C Series) (sold in multiples of 25 only)	1

NOTE: 6727C & 6728C tailpieces for C800C accommodate both 6 & 7-pin cores.

KEYS & KEY BLANKS

Key Blanks

Part #	Description	List \$
44101SC	SC section 6-pin (order in multiples of 50), w/ DORMA logo	1.60
44101SE	SE section 6-pin (order in multiples of 50), w/ DORMA logo	1.60
44101BA	BA section 7-pin (order in multiples of 50), w/ DORMA logo and stamped DO NOT DUPLICATE	1.80
44401D100	D100 section 7-pin (order in multiples of 50), w/ DORMA logo and stamped DO NOT DUPLICATE	4
44102SC	SC section emergency blank for C885D	17
44102SE	SE section emergency blank for C885D	17
44103BA	BA section emergency blank for M9985C and M9986C	20
44403D100	D100 section emergency blank for M9985C and M9986C	20

NOTE: D100 keys and blanks are restricted. See TERMS OF SALE section for DORMA SKC policies.

- Locks
- Cylinders, Keys & Keying
- Exit Devices
- Electronic Access Control Components
- Low Energy Operators
- Surface Closers
- Fire/Life Safety
- Concealed Closers/Pivots
- Stops/Holders
- Sliding Systems
- Architectural Pulls & Handles
- Service Parts



Cut Keys

Use cut key for master keys, change keys, control keys, construction keys, and emergency key for M9985 and M9986

Part #	Description	List \$
45101	Cut key SC, SE, or B sections	6
45401D100	Cut key D100 section	10
45102SC	SC section emergency key for C885D	20
45102SE	SE section emergency key for C885D	20
45103	Emergency keys for SFIC, M9985C, and M9986C (specify B keyway)	20
45403D100	D100 section emergency key for M9985C and M9986C	20

NOTE: D100 keys and blanks are restricted. See TERMS OF SALE section for DORMA SKC policies.

Key Stamping

Part #	Description	List Add \$
—	Alpha-numeric non-standard key symbols, up to 6 characters	4
—	Do not duplicate or US Property Do Not Duplicate	4

NOTE: BB through BQ section key stamped DUPLICATION PROHIBITED

HOW TO ORDER SFIC PADLOCKS

Cylinder Type

Shackle Length	T — SFIC, Temporary Core	Keying	
2" Shackle — 20	C — SFIC, with Core	TMP — Temporary Construction Core	
1" Shackle — 10	J — SFIC, Less Core	MKD — Combined (Master Keyed)	

SFIC Heavy Duty Padlock — **P1 10 J 626 BA MKD**

Satin Chrome — **626**

Finish

BA — Best A
BB — Best B
BC — Best C
BD — Best D
BE — Best E
BF — Best F
BG — Best G
BH — Best H
BJ — Best J
BK — Best K
BL — Best L
BM — Best M
BQ — Best Q
TB — Best TB
D100 — DORMA SKC 7-Pin Only

Black Construction Core — **BLK**

Blue Construction Core — **BLU**

Green Construction Core — **GRN**

Keyway

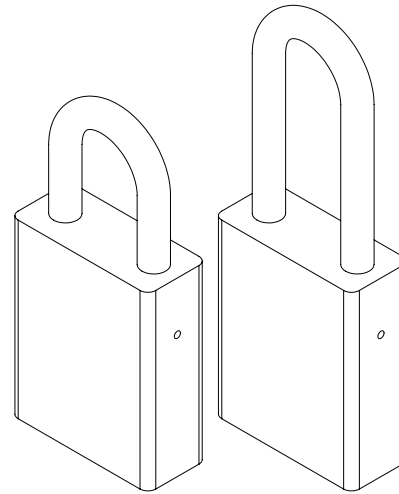

- Locks
- Cylinders, Keys & Keying**
- Exit Devices
- Electronic Access Control Components
- Low Energy Operators
- Surface Closers
- Fire/Life Safety
- Concealed Closers/Pivots
- Stops/ Holders
- Sliding Systems
- Architectural Pulls & Handles
- Service Parts



Description	List \$
P110 J 626—SFIC Padlock with 1" shackle, less core	46
P120 J 626—SFIC Padlock with 2" shackle, less core	52

Small Format Interchangeable Cores	List Add \$
J SFIC Core sold separately	N/C
T Temporary construction core—Cores may be returned for a full refund	40
C Padlock with combined SFIC core; BA (default). Shipped separately BB, BC, BD, BE, BF, BG, BH, BJ, BK, BL, BM, BQ, D100 Keyway — Keys sold separately	45

Cut Keys Ordered Separately

Part #	Description	List \$
45101	Change key, master key, construction master key or control key; BA, BB, BC, BD, BE, BF, BG, BH, BJ, BK, BL, BM, BQ, SC, SE section	6
45401	Change key, master key or control key; SKC sections — D100 etc.	10

SERVICE PARTS

Pin Kits

Part #	Description	List \$
76006942	Pin kit for SC and SE keyway conventional cylinders (0.015 dia. pins)	135
76006943	Pin kit for DORMA small format IC (BA, BB, etc., A2 system; 0.108 dia. pins)	135
76007399	Pin kit for DORMA SKC (D100) SFIC and conventional cylinders (A2 system)	319

NOTE: 7-pin kit for DORMA SKC also pins B keyway SFIC.

Key Machine

Part #	Description	List \$
76007932	Code key machine for originating DORMA SKC keys, 120 VAC 60 Hz. 4 week lead time.	4190
76007934	Code key machine for originating DORMA SKC keys, 220 VAC 60 Hz. 4 week lead time.	4400
76007936	Replacement cutter for DORMA key machines	400
76007938	Replacement belt for DORMA key machines	63
76010077	DORMA SKC code card for HPC1200/Ilco Universal code machines	24



IC Capping Equipment

Part #	Description	List \$
76007939	Capsaver press for DORMA D100	1650
76010091	Manual capping set for DORMA D100 & B keyways (capping block and capping tool)	180
76010076	SFIC decombining block and ejector tool (for B keyways only)	160
76010074	Capping tool for manual capping	42
76010075	Ejector tool for decombining	24
76010068	Capping strips (pack of 50)	60
76010069	Individual caps for manual capping (pack of 500)	18

Tools and Service Items

Part #	Description	List \$
76010070	Small format IC housing installation wrench	84
76010071	Pin tumbler tweezers	34
76010073	Cylinder and core lubricant	26
76010072	Cylinder shims (pack of 25; for servicing conventional cylinders)	12
76007846	Follower (for servicing all DORMA conventional cylinders)	10
76010246	DORMA SKC sample set	124
76010534	BA sample set, 626	60
76010535	BA sample set, 606	60

Manual Capping Set

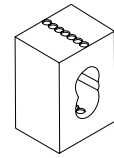

Capping Block



Capping Tool



Ejector Tool

REPLACEMENT PINS, A2 SYSTEM

Part #	Description (Order in multiples of 100) — Price is per pin	List \$
76007952	SKC Spring	0.10
76007953	SKC full size 0 bottom pin .185"	0.22
76007954	SKC full size 1 bottom pin .1975"	0.22
76007955	SKC full size 2 bottom pin .210"	0.22
76007956	SKC full size 3 bottom pin .2225"	0.22
76007957	SKC full size 4 bottom pin .235"	0.22
76007958	SKC full size 5 bottom pin .2475"	0.22
76007959	SKC full size 6 bottom pin .260"	0.22
76007960	SKC full size 7 bottom pin .2725"	0.22
76007961	SKC full size 8 bottom pin .285"	0.22
76007962	SKC full size 9 bottom pin .2975"	0.22
76007963	SKC full size A top pin .200"	0.22
76007964	SKC full size B top pin .235"	0.22
76007965	SKC full size C top pin .285"	0.22
76007966	SKC full size D top pin .2975"	0.22
76010031	SFIC/SKC size 2 top .025"	0.12
76010032	SFIC/SKC size 3 top .0375"	0.12
76010033	SFIC/SKC size 4 top .050"	0.12
76010034	SFIC/SKC size 5 top .0625"	0.12
76010035	SFIC/SKC size 6 top .075"	0.12
76010036	SFIC/SKC size 7 top .0875"	0.12
76010037	SFIC/SKC size 8 top .100"	0.12

Part #	Description (Order in multiples of 100) — Price is Per Pin	List \$
76010038	SFIC/SKC size 9 top .1125"	0.12
76010039	SFIC/SKC size 10 top .125"	0.12
76010040	SFIC/SKC size 11 top .1375"	0.12
76010041	SFIC/SKC size 12 top .150"	0.12
76010042	SFIC/SKC size 13 top .1625"	0.12
76010043	SFIC/SKC size 14 top .175"	0.12
76010044	SFIC/SKC size 15 top .1875"	0.12
76010045	SFIC/SKC size 16 top .200"	0.12
76010046	SFIC/SKC size 17 top .2125"	0.12
76010047	SFIC/SKC size 18 top .225"	0.12
76010048	SFIC/SKC size 19 top .2375"	0.12
76010049	SFIC/SKC size 0 bottom pin .110"	0.12
76010050	SFIC/SKC size 1 bottom pin .1225"	0.12
76010051	SFIC/SKC size 2 bottom pin .135"	0.12
76010052	SFIC/SKC size 3 bottom pin .1475"	0.12
76010053	SFIC/SKC size 4 bottom pin .160"	0.12
76010054	SFIC/SKC size 5 bottom pin .1725"	0.12
76010055	SFIC/SKC size 6 bottom pin .185"	0.12
76010056	SFIC/SKC size 7 bottom pin .1975"	0.12
76010057	SFIC/SKC size 8 bottom pin .210"	0.12
76010058	SFIC/SKC size 9 bottom pin .2225"	0.12

LABELING & CYLINDER MARKING

Each product on a contract order is automatically labeled with door number, keying information, and hardware set information. This information is placed on a special secondary label. **There is no extra charge for this service.**

In addition to the secondary label, DORMA marks cylinders with their key symbol in a concealed location using a water-resistant marker. If the cylinder needs to be rekeyed, the marking can be rubbed off without damaging the cylinder.

We do not recommend permanent marking for cylinders, but if required, we can mark the cylinder in a concealed location with up to six characters, or in a visible location (plug or core face) with up to four characters.

Permanent marking voids the warranty with regards to finish and adds \$5 list to the price of each cylinder.

Visible Cylinder Marking Locations

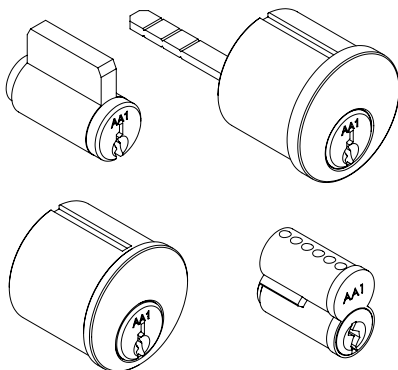

Concealed Cylinder Marking Locations

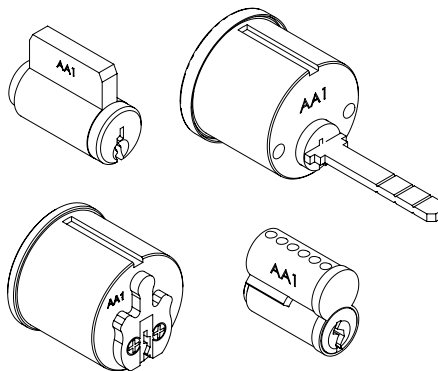

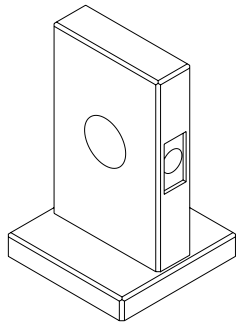

640002

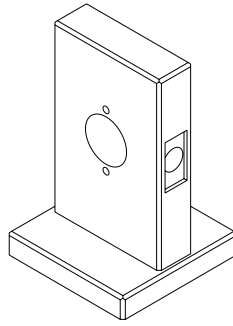

640003

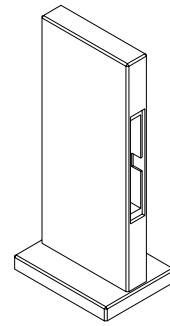

640004

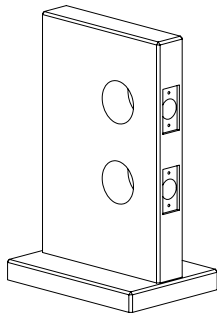

640007

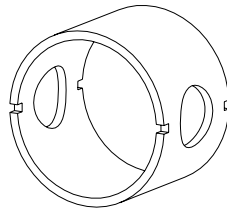

640005

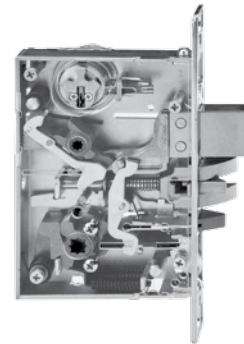

19075 RH 630

Lock Display Mounts

Part #	Description	Size	List \$
Solid Maple Mounts (all bored mounts are 2-3/4" backset)			
640002	Mount, C300, CK700, C800 knob, DB600, and D800 Series — 1-1/8" x 2-1/4" faceplate	6" x 9-1/2"	90
640003	Mount, C800 lever, CL700, and C500 Series — 1-1/8" x 2-1/4" faceplate	6" x 9-1/2"	90
640004	Mount, M9000 lever & knob	8" x 13"	115
640007	Mount, J300 Series — 1-1/8" x 2-1/4" faceplate	8" x 13"	110
640008	Mount, D900 Series small case mortise deadbolt	8" x 13"	115

NOTE: Price does not include lock.

Part #	Description	Size	List \$
Clear Plastic Ring Mount			
640005	Mount, Plastic Ring	2-1/2" dia.	30

Mortise Lock Chassis with Cover

Part #	Description	List \$
19075 RH 630	Chassis, M9953 with clear cover installed	299

- Locks
- Cylinders, Keys & Keying
- Exit Devices
- Electronic Access Control Components
- Low Energy Operators
- Surface Closers
- Fire/Life Safety
- Concealed Closers/Pivots
- Stops/ Holders
- Sliding Systems
- Architectural Pulls & Handles
- Service Parts





DORMA EXIT DEVICES

Product Guide (1 of 2)

GRADE 1 EXIT DEVICES	Concealed Vertical Rod	Rim	Surface Vertical Rod	Mortise
Architectural Wide Stile 9000 Series Panic and Fire Rated	9100	9300	9400	9500
Architectural Narrow Stile 9000 Series Panic and Fire Rated	9600	9700	9800	—
Wide Stile 8000 Series Panic and Fire Rated	—	8300	8400	—

Architectural Mullions 1300 Series Panic/Fire Rated	Aluminum 1-5/8" x 2-5/8" 1310 Panic Rated	Steel 1-1/2" x 2-1/2" 1330 Panic Rated	Steel 2" x 3" 1300 Panic/Fire Rated	Steel 2" x 3" HC1300 Hurricane Rated	Steel 2" x 3" 1340 Key Removable Panic/Fire Rated
--	--	---	--	---	---

Locks

Cylinders, Keys & Keying

Exit Devices

Electronic Access Control Components

Low Energy Operators

Surface Closers

Fire/Life Safety

Concealed Closers/Pivots

Stops/ Holders

Sliding Systems

Architectural Pulls & Handles

Service Parts

DORMA EXIT DEVICES

Product Guide (1 of 2)

<input checked="" type="radio"/> Yes <input type="radio"/> No	A156.3 Grade 1	EN1125 Grade 1	5 Mil Extended Cycle Test	Latch Bolt Load Rated	Hurricane Rated	Plated Finishes	Powder Coat Finishes	Fire Rated	Panic Rated	Escutcheon Trim	Sectional Trim	Plate and Pull Trim	Electric Latch Retraction	Delayed Egress
8300 Rim Wide Stile	●	○	○	○	●	○	●	●	●	●	●	●	●	○
8400 SVR Wide Stile	●	○	○	○	●	○	●	●	●	●	●	●	●	○
9300 Rim Wide Stile	●	○	●	●	●	●	●	●	●	●	●	●	●	●
9100 CVR Wide Stile	●	○	●	○	○	●	●	●	●	●	●	●	●	●
9400 SVR Wide Stile	●	○	●	○	●	●	●	●	●	●	●	●	●	○
9500 Mortise Wide Stile	●	○	●	○	●	●	●	●	●	●	●	●	●	●
9700 Rim Narrow Stile	●	●	●	●	○	●	●	●	●	●	●	●	●	●
9600 CVR Narrow Stile	●	●	●	○	○	●	●	●	●	●	●	●	●	●
9800 SVR Narrow Stile	●	●	●	○	○	●	●	●	●	●	●	●	●	○

Handing

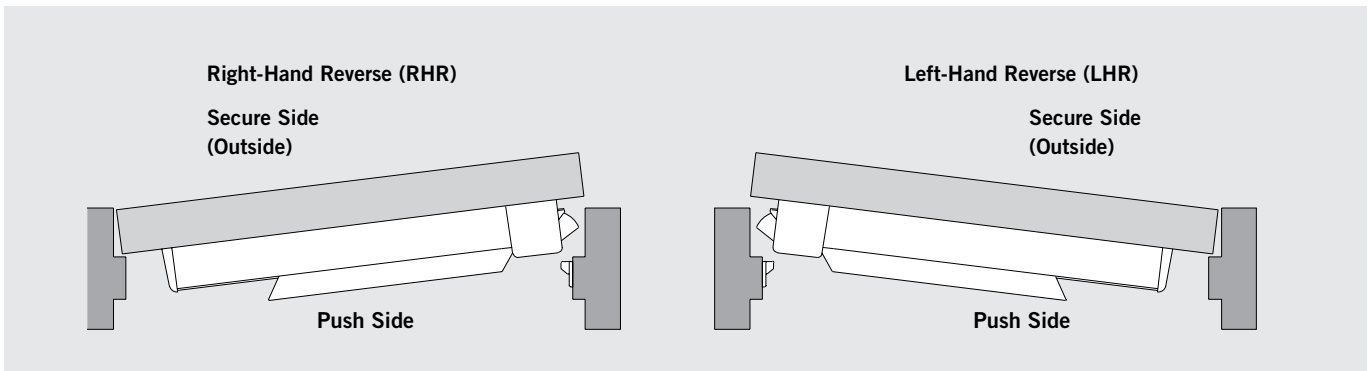



SELECT SERVICE QUICK SHIP

Exit Devices

Select service should be used for small quantities of popular DORMA products that require shipment within 24 hours. The program includes locks, exit devices, door closers, magnets, electronic access control, and low energy operators. Warehouses have been set up in the east and west for faster delivery nationwide. (Customer responsible for shipping costs FOB.)

Subject to Availability

Next Business Day Service (Shipment when Purchase Order is received prior to 4:00 PM EST).

Examples: DORMA receives P.O. at 3:59 PM on Monday, order will ship by close of business on Tuesday.

DORMA receives P.O. at 3:59 PM on Friday, order will ship by close of business on the following Monday.

Notes:

- Standard freight and discount schedules and terms of sale apply. Please refer to the current price list for full details.
- DORMA reserves the right to limit quantities or decline an order if the credit status of the buyer is not satisfactory to DORMA.
- Orders cannot be cancelled.
- Select Service Quick Ship available only in the United States.
- All prices are in U.S. dollars.
- Products and prices are subject to change without notice.
- Some of the available products have quantity per order limits and will be noted accordingly.

Key

N "New" to Select Service, Available in East and West Coast Warehouse

■ Available in East and West Coast Warehouse

E Available only in East Coast Warehouse





9000 Series Grade 1 Wide Stile Exit Devices

PN #	Product	Length	Height	Hand	Strike	Finish	List \$
11913920	■ 9300	B	—	—	463	689	741
11900100	■ 9300	B	—	—	463	630	1,173
11910310	■ 9300	A	—	—	463	630	1,173
11913937	☒ F9300	B	—	—	463	689	888
11900104	■ F9300	B	—	—	463	630	1,317
11910311	■ F9300	A	—	—	463	630	1,317
11900108	☒ 9400	B	7'	RHR	426/439	630	1,710
11900107	☒ 9400	B	7'	LHR	426/439	630	1,710
11900112	■ F9400	B	7'	RHR	426/439	630	1,875
11900111	■ F9400	B	7'	LHR	426/439	630	1,875
11914010	☒ LB9400 (Less bottom rod)	B	7'	RHR	426	630	1,710
11914009	☒ LB9400 (Less bottom rod)	B	7'	LHR	426	630	1,710
11913922	☒ LBF9400	B	7'	RHR	426	630	1,875
11913921	☒ LBF9400	B	7'	LHR	426	630	1,875
11900116	☒ 9500 *(08)	B	—	RHR	465	630	1,642
11900115	☒ 9500 *(08)	B	—	LHR	465	630	1,642

9000 Series Wide Stile Trim

PN #	Product	Cylinder	Keying	Finish	List \$
95006897	■ HRT05	D	SC KD	630	265
95008560	■ PRT02	—	—	630	173
95008617	☒ PRT03	—	—	630	252
95009803	☒ YC08	D	SC KD	630	512
95010417	■ YR08	D	SC KD	630	512
34000001	■ YR08	L	—	630	482
95010372	☒ YR08M	D	SC KD	630	512
95010711	☒ YT08	D	SC KD	630	512
95009951	■ YC23	—	—	630	410
95010564	■ YR23	—	—	630	410

NOTE: * For E0, 02, 08, 23 functions use 08 device





9000 Series Grade 1 Narrow Stile Exit Devices

PN #	Product	Length	Height	Hand	Strike	Finish	List \$
95058062	9600	BB	7'	RHR	418/439 NS	630	1,980
95058061	9600	BB	7'	LHR	418/439 NS	630	1,980
95058066	F9600	BB	7'	RHR	418/439	630	2,145
95058065	F9600	BB	7'	LHR	418/439	630	2,145
95058069	9700	BB	—	—	430	630	1,418
95058070	F9700	BB	—	—	463	630	1,562
95058072	9800	BB	7'	RHR	426/439	630	1,864
95058071	9800	BB	7'	LHR	426/439	630	1,864
95058074	F9800	BB	7'	RHR	426/439	630	2,029
95058073	F9800	BB	7'	LHR	426/439	630	2,029

9000 Series Narrow Stile Trim

PN #	Product	Cylinder	Keying	Finish	List \$
95058077	ZP02	—	—	630	304
95058078	ZP03	D	SC KD	630	437
95058079	ZC08	D	SC KD	630	512
95058081	ZG08	D	SC KD	630	512
95058082	ZR08	D	SC KD	630	512
95058080	ZT08	D	SC KD	630	512

8000 Series Grade 1 Standard Exit Devices

PN #	Product	Length	Height	Hand	Strike	Finish	List \$
11800008	8300	B	—	—	463	689	441
11800194	8300	A	—	—	463	689	441
11800208	F8300	B	—	—	463	689	604
11800006	8400	B	7'	RHR	426/439	689	730
34000009	8400	B	7'	LHR	426/439	689	730
11800216	F8400	B	7'	RHR	426/439	689	929
34000002	F8400	B	7'	LHR	426/439	689	929



- Locks
- Cylinders, Keys & Keying
- Exit Devices
- Electronic Access Control Components
- Low Energy Operators
- Surface Closers
- Fire/Life Safety
- Concealed Closers/Pivots
- Stops/ Holders
- Sliding Systems
- Architectural Pulls & Handles
- Service Parts

8000 Series Trim

PN #	Product	Cylinder	Keying	Finish	List \$
95052308	8PDT	—	—	689	80
95052326	8P03	D	SC KD	689	133
34000005	8R08	D	SC KD	689	308
34000004	8R08	D	SC KD	626	345
34000003	8R08J	J	—	689	308
34000010	8R08J	J	—	626	345
95008957	8R23	—	—	689	251
34000006	8R23	—	—	626	286

Mullions

PN #	Product	Finish	List \$
95041980	1330-8 (Steel mullion)	600	428
95005018	F1300-8 (Fire listed steel mullion)	600	717
34000007	F1340 KR-8 (Fire listed key removable mullion)	600	1103

Accessories and Service Items

PN #	Product	Finish	List \$
95009070	SNB Sex Nuts	630	13
95044866	320 Strike — RIM	693	58
95046951	463 Strike — RIM (Fire-rated & NON)	693	60
95046248	426 Strike — SVR	693	38
95004861	ETR — Top Rod Extension Kit (9400 or 9800 series, for doors 8' to 10')	630	97
95004847	ETR — Top Rod Extension Kit (9600 series, doors from 7'6" to 10')	689	49
95006734	GK9000 (for 9000 series only)	630	73
95006729	GK8000 (for 8000 series only)	693	73
95008528	Popper (for fire rated LB vert. rod)	N/A	66
95002640	8DRKIT (Dogging repair kit) (for 8000 series only)	N/A	80
95052775	9DRKIT (Dogging repair kit) (for 5000 or 9000 series only)	N/A	80
95052779	9GALD (Alum. door bracket & screws) (for 9100 series only)	N/A	102
95001851	BPA-KIT Specify Bar (for 9000 series only)	630	590
95002388	CD-KIT Specify Bar (for 9000 series only)	630	170



DORMA 9000 SERIES EXIT DEVICES

How to Order

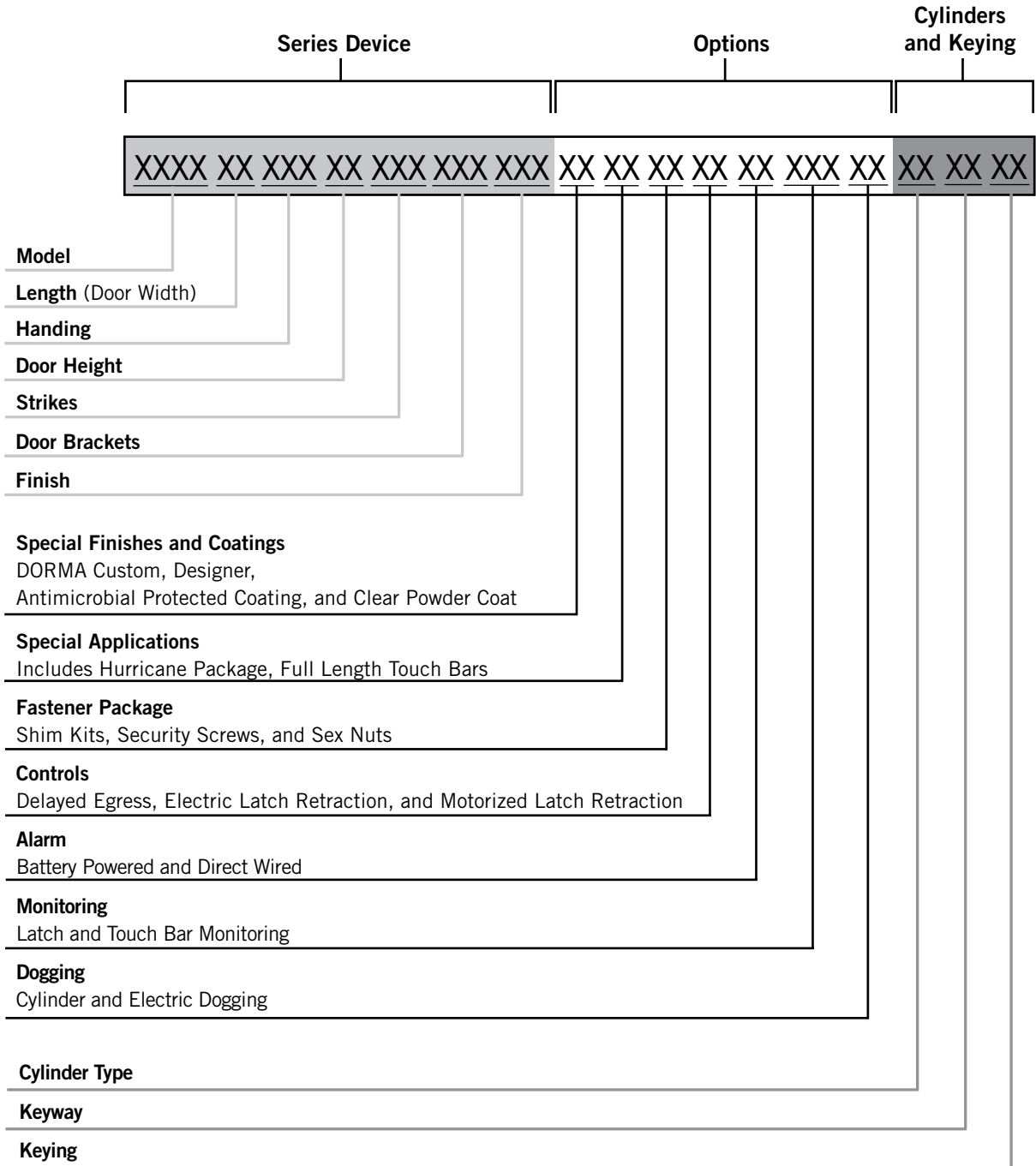

- Locks
- Cylinders, Keys & Keying
- Exit Devices
- Electronic Access Control Components
- Low Energy Operators
- Surface Closers
- Fire/Life Safety
- Concealed Closers/Pivots
- Stops/ Holders
- Sliding Systems
- Architectural Pulls & Handles
- Service Parts



9100 SERIES

Wide Stile Concealed Vertical Rod Exit Device

9100 Series Device								Options (Specify)							Cylinders and Keying			
Device	Length	Touchbar	Handing	Door Height	Top Strike	Bottom Strike	Finish	Special Finish Coating	Bottom Latch	Alum Door Latch Brackets	Fastener Package	Control	Alarm	Monitoring	Dogging	Cylinder Type	Keyway	Keying
9100	B		RHR	7	418	439	630									DSC	KD	
F9100	A	FL	RHR	7	418	340	605	AM	LB	ALD	SK	DE	BPA	LM	CD	C	CA	KD
9100	B		LHR	8	419	431	606	P	PB		SNB	DE30	BPAR	MS	LD	D	CD	KA2
	C			9		439	611		SB		TX	ES	DWA	LMMS	MD	J	CE	KA4
	SPCL			10			612				SKTX	DECBC		LMMSBP		L	*D100	NSK
				SPCL			613				SKSNB	ESB				T	GA	MKD
							619				TXSNB	MLR				R	RA	CMK
							625				SKTXSNB					X6	RB	SKD
							626									X7	SC	OBIt
							628										SE	
							629										SF	
							630										WA	
							689										YA	
							691										YG	
							693											
							695											
							696											
							Custom											
							Designer											

— Default

— Supplied with Standard KD Cylinder

***Patented Key Control**

D100 is the keyway for DORMA's patented SKC serialized key control system. SKC is internet based and provides added layers of security. For more information, contact your local DORMA sales representative or DORMA Technical Service at 800-523-8483.

9000 Series – Wide Stile Applications

Device Length	All Device Options (except BPA, DWA, or DE)		BPA or DWA Device Options	DE Device Option
	Maximum Door Width ¹	Minimum Door Width ²	Minimum Door Width ²	Minimum Door Width ²
A	48" (1220 mm)	34" (864 mm)	39" (991 mm)	41" (1042 mm)
B	36" (915 mm)	28" (712 mm)	33" (839 mm)	35" (889 mm)
C	30" (762 mm)	25" (635 mm)	30" (762 mm)	N/A

- As delivered from factory, device will fit doors of this width. For other widths, consult DORMA Technical Services.
- Touch bar and rail assembly can be shortened at time of installation to fit doors down to this width.

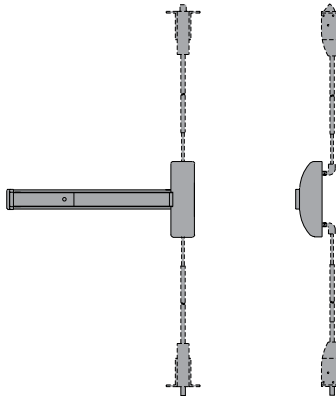

Available Finishes \$

Function	Description	Device, Exit Only	689, 691, 693, 695, 696	630	606, 612, 613, 619	605, 611, 625, 626, 629**
01	Panic	9100 Concealed vertical rod	1,517	1,826	1,844	1,962
01	Fire	F9100 Concealed vertical rod	1,685	1,990	2,010	2,122

Typical Options

Item	Description	List Add \$
CD	Cylinder dogging (Includes cylinder)	80
LD	Less dogging (Standard with fire rated device)	N/C
AM	Antimicrobial coating	71
SNB	Sex nuts (Included with F and HC Options)	14
TX	Security screws	30
HC	Hurricane (Includes SNB)	150
FL	Full length touchbar (Not Available DE)	N/C
LB	Less bottom rod	N/C
PB	Pullman bottom latch	48
SB	Slide bolt (Default)	N/C
Up to 8'	7' to 8' Adjustable	N/C
Up to 10'	Door Heights over 8' to 10'	49 97 97

** For 629 finish, please allow 4 week lead time.

NOTES:

- Prices shown apply to A, B, or C length devices.
- Specify door width and handing. If not specified, Size B, RHR is the standard default.
- List price includes default strikes. For optional strikes, specify strike number and adjust list price accordingly.
- List price for the device does not include trim.
- Devices include wood and machine screws standard.
- Fire and hurricane rated devices include SNB sex nuts standard.
- For options requiring a cylinder, the option list price includes the default cylinder.
- Device includes precut and drilled rods for 7' to 8' doors.
 - For 9' doors, device includes precut and drilled rods for a 7' door and a 2' rod extension for the top rod. Specify 9' on order.
 - For 10' doors, device includes precut and drilled rods for an 8' door and a 2' rod extension for the top rod. Specify 10' on order.
- See Device Options for pricing information.
- For special lengths and/or door heights over 10', consult DORMA Technical Service.
- All standard devices and trim are designed for 1-3/4"-2-1/4" thick doors. For door thickness greater than 2-1/4", consult DORMA Technical Service.
- ALD for Wide and Narrow Stile aluminum.

- Locks
- Cylinders, Keys & Keying
- Exit Devices
- Electronic Access Control Components
- Low Energy Operators
- Surface Closers
- Fire/Life Safety
- Concealed Closers/Pivots
- Stops/ Holders
- Sliding Systems
- Architectural Pulls & Handles
- Service Parts



9300 SERIES

Wide Stile Rim Exit Device

9300 Series Device					Options (Specify)							Cylinders and Keying		
Device	Length	Touchbar	Strike	Finish	Special Finish Coating	Special Application Package	Fastener Package	Control	Alarm	Monitoring	Dogging	Cylinder Type	Keyway	Keying
9300	B		463	630								DSC	KD	
F9300	A	FL	320	605	AM	HC	SK	DE	BPA	LM	CD	C	CA	KD
9300	B		430	606	P		SNB	DE30	BPAR	MS	LD	D	CD	KA2
	C		463	611			TX	ES	DWA	LMMS	MD	J	CE	KA4
	SPCL		486	612			SKTX	DECBC		LMMSBP		L	D100	NSK
				613			SKSNB	ESB				T	GA	MKD
				619			TXSNB	MLR				R	RA	CMK
				625			SKTXSNB					X6	RB	SKD
				626								X7	SC	OBit
				629									SE	
				630									SF	
				689									WA	
				691									YA	
				693									YG	
				695										
				696										
				Custom										
				Designer										

— Default
 — Supplied with Standard KD Cylinder

***Patented Key Control**
D100 is the keyway for DORMA's patented **SKC** serialized key control system. **SKC** is internet based and provides added layers of security. For more information, contact your local DORMA sales representative or DORMA Technical Service at 800-523-8483.

9000 Series – Wide Stile Applications

Device Length	All Device Options (except BPA, DWA, or DE)		BPA or DWA Device Options	DE Device Option
	Maximum Door Width ¹	Minimum Door Width ²	Minimum Door Width ²	Minimum Door Width ²
A	48" (1220 mm)	34" (864 mm)	39" (991 mm)	41" (1042 mm)
B	36" (915 mm)	28" (712 mm)	33" (839 mm)	35" (889 mm)
C	30" (762 mm)	25" (635 mm)	30" (762 mm)	N/A

- As delivered from factory, device will fit doors of this width. For other widths, consult DORMA Technical Services.
- Touch bar and rail assembly can be shortened at time of installation to fit doors down to this width.

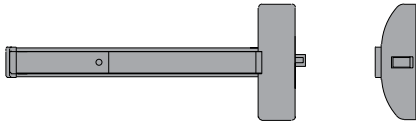

Function	Description	Device, Exit Only	Available Finishes \$			
			689, 691, 693, 695, 696	630	606, 612, 613, 619	605, 611, 625, 626, 629**
01	Panic	9300 Rim	741	1,173	1,184	1,274
01	Fire	F9300 Rim	888	1,317	1,330	1,414

Typical Options

Item	Description	List Add \$
CD	Cylinder dogging (Includes cylinder)	80
LD	Less dogging (Standard with fire rated device)	N/C
AM	Antimicrobial coating	71
SNB	Sex nuts (Included with F and HC Options)	14
TX	Security screws	30
HC	Hurricane (Includes SNB)	150
FL	Full length touchbar (Not Available DE)	N/C

** For 629 finish, please allow 4 week lead time.

NOTES:

- Prices shown apply to A, B, or C length devices.
- Specify door width. If not specified, Size B is the standard default.
- List price includes default strikes. For optional strikes, specify strike number and adjust list price accordingly.
- List price for the device does not include trim.
- Devices include wood and machine screws standard.
- Fire and hurricane rated devices include 463 rim strike and SNB sex nuts standard.
- For options requiring a cylinder, the option list price includes the default cylinder.
- For special lengths, consult DORMA Technical Service.
- All standard devices and trim are designed for 1-3/4"-2-1/4" thick doors. For door thickness greater than 2-1/4", consult DORMA Technical Service.



9400 SERIES

Wide Stile Surface Vertical Rod Exit Device

9400 Series Device							Options (Specify)										Cylinders and Keying		
Device	Length	Touchbar	Handing	Door Height	Top Strike	Bottom Strike	Finish	Special Finish Coating	Bottom Latch	Special Application Package	Fastener Package	Control	Alarm	Monitoring	Dogging	Cylinder Type	Keyway	Keying	
9400	B		RHR	7	426	439	630									D	S	CD	KD
F9400	A	FL	RHR	7	426	340	605	AM	LB	HC	SK	ES	BPA	LM	CD	C	CA	KD	
9400	B		LHR	8	426A	416V	606	P	PB		SNB	ESB	BP	MS	LD	D	CD	KA2	
	C			9		431	611		SB		TX	MLR	DWA	LMMS	MD	J	CE	KA4	
	SPCL			10		439	612				SKTX			LMMSBP		L	*D100	NSK	
				SPCL			613				SKSNB					T	GA	MKD	
							619				TXSNB					R	RA	CMK	
							625				SKTXSNB					X6	RB	SKD	
							626									X7	SC	OBit	
							629										SE		
							630										SF		
							689										WA		
							691										YA		
							693										YG		
							695												
							696												
							Custom												
							Designer												

— Default

— Supplied with Standard KD Cylinder

***Patented Key Control**
 D100 is the keyway for DORMA's patented SKC serialized key control system. SKC is internet based and provides added layers of security. For more information, contact your local DORMA sales representative or DORMA Technical Service at 800-523-8483.

9000 Series – Wide Stile Applications

Device Length	All Device Options (except BPA, DWA, or DE)		BPA or DWA Device Options
	Maximum Door Width ¹	Minimum Door Width ²	Minimum Door Width ²
A	48" (1220 mm)	34" (864 mm)	39" (991 mm)
B	36" (915 mm)	28" (712 mm)	33" (839 mm)
C	30" (762 mm)	25" (635 mm)	30" (762 mm)

- As delivered from factory, device will fit doors of this width. For other widths, consult DORMA Technical Services.
- Touch bar and rail assembly can be shortened at time of installation to fit doors down to this width.

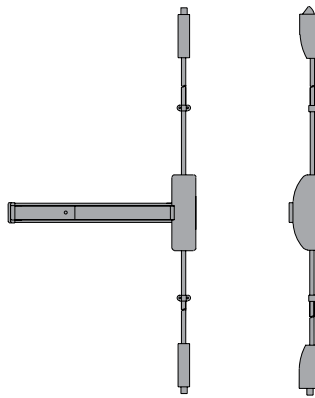

Available Finishes \$

Function	Description	Device, Exit Only	689, 691, 693, 695, 696	630	606, 612, 613, 619	605, 611, 625, 626, 629**
01	Panic	9400 Surface vertical rod	1,483	1,710	1,726	1,862
01	Fire	F9400 Surface vertical rod	1,651	1,875	1,893	2,022

Typical Options

Item	Description	List Add \$
CD	Cylinder dogging (Includes Cylinder)	80
LD	Less dogging (Standard with fire rated device)	N/C
AM	Antimicrobial coating	71
SNB	Sex nuts (included with F and HC options)	14
TX	Security screws	30
HC	Hurricane (Includes SNB)	150
FL	Full length touchbar (Not Available DE)	N/C
LB	Less bottom rod	N/C
PB	Pullman bottom latch	48
SB	Slide bolt (Default)	N/C
Up to 8'	7' Default	N/C
Up to 10'	Door Heights over 8' to 10'	49 97 97

** For 629 finish, please allow 4 week lead time.

NOTES:

- Prices shown apply to A, B, or C length devices.
- Specify door width and handing. If not specified, Size B, RHR is the standard default.
- List price includes default strikes. For optional strikes, specify strike number and adjust list price accordingly.
- List price for the device does not include trim.
- Devices include wood and machine screws standard.
- Fire and hurricane rated devices include SNB sex nuts standard.
- For options requiring a cylinder, the option list price includes the default cylinder.
- Device includes precut and drilled rods for 7' or 8' doors as specified on order.
 - For 9' doors, device includes precut and drilled rods for a 7' door and a 2' rod extension for the top rod.
 - For 10' doors, device includes precut and drilled rods for an 8' door and a 2' rod extension for the top rod.
 See Device Options for pricing information.
- For special lengths and/or door heights over 10', consult DORMA Technical Service.
- All standard devices and trim are designed for 1-3/4"-2-1/4" thick doors. For door thickness greater than 2-1/4", consult DORMA Technical Service.



9500 SERIES

Wide Stile Mortise Exit Device

9500 Series Device							Options (Specify)							Cylinders and Keying				
Device	Length	Touchbar	Function	Handing	Strike	Finish	Special Finish Coating	Special Application Package	Fastener Package	Electric Locking	Control	Alarm	Monitoring	Dogging	Cylinder Type	Keyway	Keying	
9500	B		08	RHR	465	630									D	S	C	KD
F9500	A	FL	01	RHR	465	605	AM	HC	SK	LFSC	DE	BPA	LM	CD	C	CA	KD	
9500	B		03	LHR	565	606	P		SNB	LFSF	DE30	BPAR	MS	LD	D	CD	KA2	
	C		05			611			TX		DECBC	DWA	LMMS	MD	J	CE	KA4	
	SPCL		08			612			SKTX		MLR		LMMSBP		L	D100	NSK	
			23			613			SKSNB						T	GA	MKD	
						619			TXSNB						R	RA	CMK	
						625			SKTXSNB						X6	RB	SKD	
						626									X7	SC	OBit	
						629										SE		
						630										SF		
						689										WA		
						691										YA		
						693										YG		
						695												
						696												
						Custom												
						Designer												

— Default

— Supplied with Standard KD Cylinder

***Patented Key Control**
D100 is the keyway for DORMA's patented **SKC** serialized key control system. **SKC** is internet based and provides added layers of security. For more information, contact your local DORMA sales representative or DORMA Technical Service at 800-523-8483.

9000 Series – Wide Stile Applications

Device Length	All Device Options (except BPA, DWA, or DE)		BPA or DWA Device Options	DE Device Option
	Maximum Door Width ¹	Minimum Door Width ²	Minimum Door Width ²	Minimum Door Width ²
A	48" (1220 mm)	34" (864 mm)	39" (991 mm)	41" (1042 mm)
B	36" (915 mm)	28" (712 mm)	33" (839 mm)	35" (889 mm)
C	30" (762 mm)	25" (635 mm)	30" (762 mm)	N/A

- As delivered from factory, device will fit doors of this width. For other widths, consult DORMA Technical Services.
- Touch bar and rail assembly can be shortened at time of installation to fit doors down to this width.

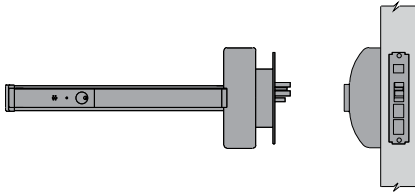

Function	Description	Device, Exit Only	Available Finishes \$			
			689, 691, 693, 695, 696	630	606, 612, 613, 619	605, 611, 625, 626, 629**
01	Panic	9500 Mortise	1,326	1,642	1,659	1,734
01	Fire	F9500 Mortise	1,473	1,787	1,804	1,874

Typical Options

Item	Description	List Add \$
CD	Cylinder dogging (Includes Cylinder)	80
LD	Less dogging (Standard with fire rated device)	N/C
AM	Antimicrobial coating	71
SNB	Sex nuts (Included with F and HC options)	14
TX	Security screws	30
HC	Hurricane (Includes SNB)	150
FL	Full length touchbar (Not Available DE)	N/C
LFSF	Fail safe, electric locking of mortise lock (requires PS610RF power supply and ES105 power transfer)	924
LFSC	Fail secure, electric unlocking of mortise lock (requires PS610RF power supply and ES105 power transfer)	924

** For 629 finish, please allow 4 week lead time.

NOTES:

- Prices shown apply to A, B, or C length devices.
- Specify door width and handing. If not specified, Size B, RHR is the standard default.
- List price includes default strikes. For optional strikes, specify strike number and adjust list price accordingly.
- List price for the device does not include trim.
- Devices include wood and machine screws standard.
- Fire and hurricane rated devices include SNB sex nuts standard.
- For options requiring a cylinder, the option list price includes the default cylinder.
- For special lengths, consult DORMA Technical Service.
- All standard devices and trim are designed for 1-3/4"-2-1/4" thick doors. For door thickness greater than 2-1/4", consult DORMA Technical Service.

- Locks
- Cylinders, Keys & Keying
- Exit Devices
- Electronic Access Control Components
- Low Energy Operators
- Surface Closers
- Fire/Life Safety
- Concealed Closers/Pivots
- Stops/ Holders
- Sliding Systems
- Architectural Pulls & Handles
- Service Parts



WIDE STILE DUMMY BARS

Item	Description	Available Finishes \$			
		689, 691, 693, 695, 696	630	606, 612, 613, 619	605, 611, 625, 626, 629**
Dummy Touchbars					
9030	Rigid dummy touchbar	495	722	748	748
9030MS	Dummy touchbar w/microswitch	733	925	935	935
9035	Rigid touchbar	495	722	748	748
9036	Moveable touchbar	495	722	748	748
9036MS	Moveable touchbar w/microswitch	733	925	935	935

** For 629 finish, please allow 4 week lead time.

NOTE: Dummy touchbars available in all rail sizes: A, B or C

OPTIONS

Option Code	Description	List Add \$
Strikes		
9100, 9400 Concealed and Surface Vertical Rods		
340	Flat slide bolt bottom strike (9100 and 9400 Series)	N/C
416V	Surface bottom strike for pullman latch (9400)	N/C
418	Standard top strike (9100 Series)	N/C
419	Wood frame top strike (9100 Series)	14
426	Standard top strike (9400 Series)	N/C
426A	Top strike w/angle (9400 Series)	25
431	Recessed bottom strike for pullman latch (9100 and 9400 Series)	25
439	Standard slide bolt bottom strike (9100 and 9400 Series)	N/C
9300 Rim Devices		
320	Overlap strike	25
430	Rim box strike	39
463	Standard rim strike (default/no charge for 9300/F9300)	63
486	Roller strike	14
9500 Mortise		
465	Standard mortise strike	N/C
565	Open back strike	25
Special Finishes and Coatings		
AM	Antimicrobial protected coating	71
P	Clear powder coat	71
Custom Color	Custom painted finish selected from DORMA RAL color pallet book. For details, see DORMA Finishes Cross Reference , page vii.	
	Per order, setup charge (Net)	110
	per exit device only, list add	55
	per trim only, list add	55
Designer Color	Designer painted color matched to supplied samples. Three (3) each 2" x 3" color chip samples required. For details, see DORMA Finishes Cross Reference , page vii.	
	per order, non-refundable development/setup charge (Net)	400
	per exit device only, list add	55
	per trim only, list add	55
Bottom Latches for 9100 Concealed Vertical Rods & 9400 Surface Vertical Rods		
LB	Less bottom rod	N/C
PB	Pullman bottom latch	48
SB	Slide bolt (Default)	N/C
Door Height Designation		
9100 Concealed Vertical Rods		
7 or 8	Door heights from 7' to 8' adjustable	N/C
9 or 10	Door heights over 8', up to 10'	49
Over 10'	Contact DORMA Technical Service for assistance	
9400 Surface Vertical Rods		
7 or 8	Door heights from 7' to 8' (7' Default)	N/C
9 or 10	Door heights over 8', up to 10'	
	For 689, 691, 693, 695, 696 finishes	49
	For 605, 606, 611, 612, 613, 619, 625, 626, 630 finishes	97
Over 10'	Consult DORMA Technical Service	
Door Latch Brackets		
ALD	Wide Stile aluminum door bracket (9100 Series)	N/C

Option Code	Description	List Add \$
Special Application Packages		
HC	Hurricane (9300, 9400, and 9500 Series only) Includes SNB	150
FL	Full length touchbar (Not Available DE)	N/C
Fastener Package		
SK	Shim kit	79
SNB	Sex nuts	14
TX	Security screws	30
SKTX	Shim kit and security screws	126
SKSNB	Shim kit and sex nuts	93
TXSNB	Security screws and sex nuts	61
SKTXSNB	Shim kit, security screws, and sex nuts	140
Electronic Controls		
DE*	Delayed egress (requires ES100 power supply and ES105 power transfer)	1,473
DE30*	Delayed egress, 30 second (requires special approval from authority having jurisdiction)	1,824
DECBC*	Delayed egress, CBC compliant	1,824
MLR	Motorized Latch Retraction/dogging (use PS610RF or PS532RF power supply—2 MLR's)	825
ES	Electric latch retraction (requires PS501 power supply and ES105 power transfer)	794
ESB	Electric latch retraction option for battery back-up power supply (requires PS406BB or PS426BB power supply and ES105 power transfer)	910
IMPORTANT NOTE: ESB can not be used with any other power supplies.		
Alarm		
BPA*	Battery powered alarm	550
BPAR*	Battery powered alarm, 4 minute reset	587
DWA*	Direct wired alarm	550
Monitoring		
LM	Latch bolt monitoring	216
MS	Monitor switch in touchbar	216
LMMS	Latch bolt and touchbar monitor	432
LMMSBP*	Latch bolt and touchbar monitor with bypass	432
Dogging		
CD*	Cylinder dogging (panic devices only)	80
LD	Less dogging (panic devices only)	N/C
MD	Electric dogging (requires PS610RF power supply)	725
Power Supplies, Power Transfers, Power Modules		
AD100	Export power supply for up to 2 ES devices, 110 VAC. Powers 1 DE device.	641
ES101	Delay module	118
ES103	Relay module	74
ES100	Power supply for DE devices and LFSC/LFSF trims. Powers 1 DE device or 2 trims.	545
ES105	Power transfer (recommended for ES, DE & MLR options)	181
PS501	Power supply for ES9000 devices. Powers up to 2 devices.	641
PS501220	Export power supply, 220 VAC. Powers up to 2 ES9000 devices.	641
ES2	Power supply card for PS501. Powers an additional 2 devices.	349
PS610RF	Power supply for MD, 9500 LFSC/LFSF, or MLR. Powers 1 device.	395
PS615RF	Power supply for MD, 9500 LFSC/LFSF powers 2 devices (will also power 1 MLR device).	495
PS532RF	Power supply for MLR. Powers 2 devices.	638
PS406BB	Power supply with battery back-up for ESB solenoid electric latch retraction option.	915
PS426BB	Power supply with battery back-up for ESB solenoid electric latch retraction option.	915
IMPORTANT NOTE: PS406BB and PS426BB can only be used with ESB electric latch retraction option		

* List price includes default cylinder.

DORMA 9000 SERIES EXIT TRIM

How to Order

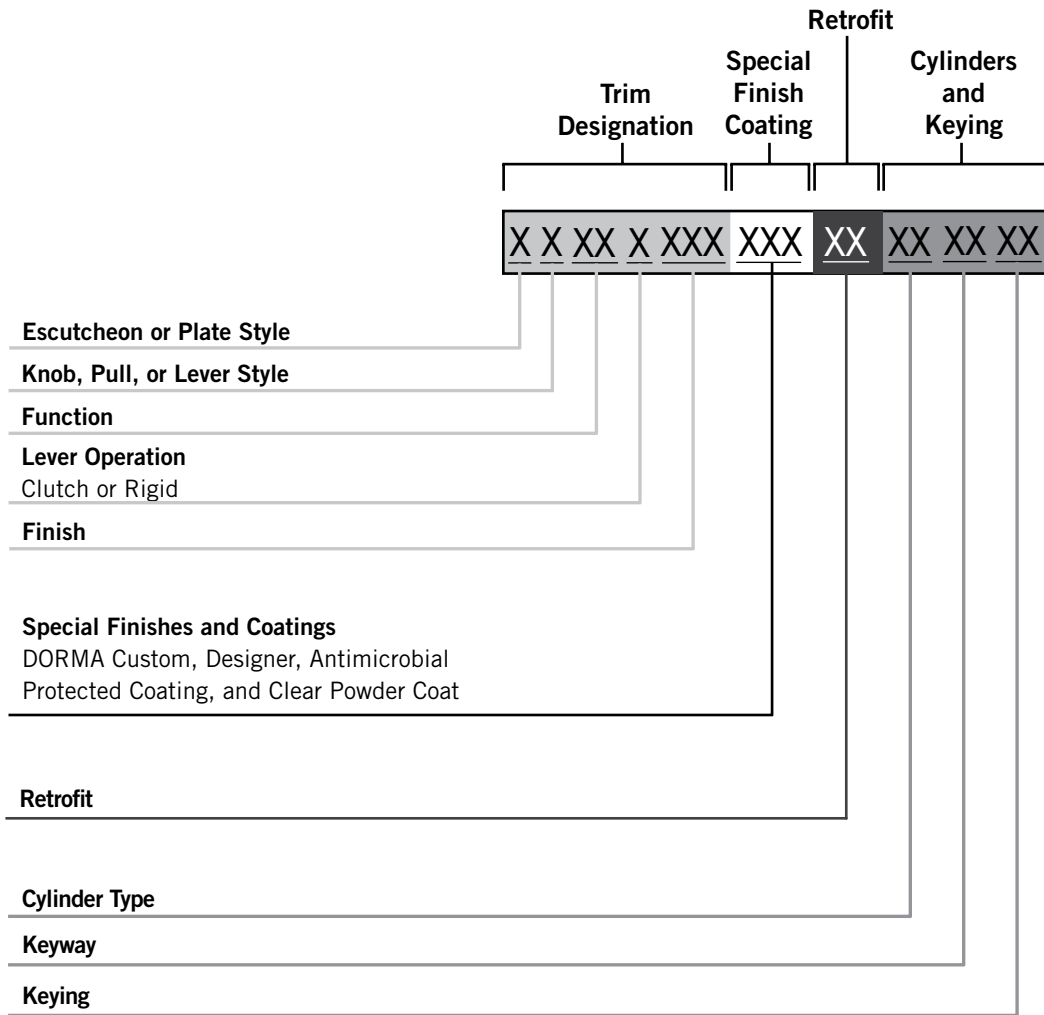

- Locks
- Cylinders, Keys & Keying
- Exit Devices**
- Electronic Access Control Components
- Low Energy Operators
- Surface Closers
- Fire/Life Safety
- Concealed Closers/Pivots
- Stops/ Holders
- Sliding Systems
- Architectural Pulls & Handles
- Service Parts

LEVER & KNOB STYLES

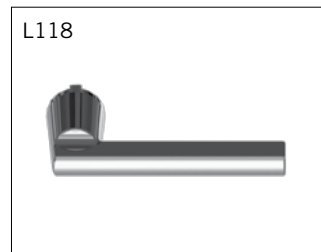
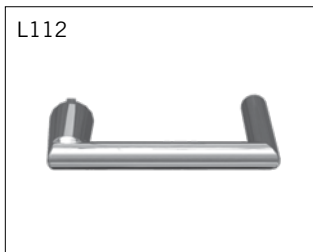
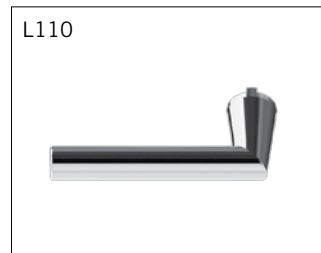
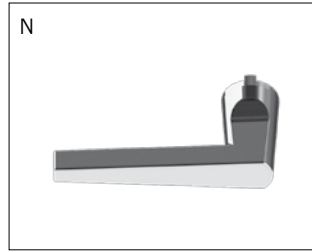
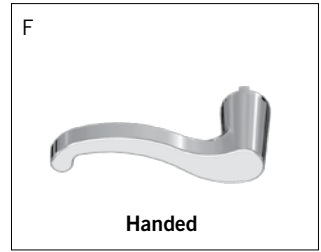
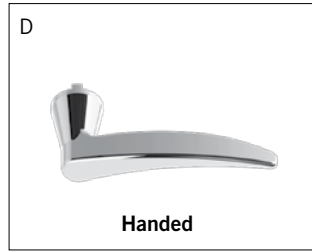

ANSI Function	Description	Y Series Raised Escutcheon 2-3/4" W x 8-1/2" H x 15/16" D	Sectional Trim 3-3/8" Diameter Rose	Plate 2" W x 16" H	Plate 3" W x 16" H	Pulls
DT	Dummy trim					
02	Entrance by trim when touchbar is dogged					
03	Entrance by trim when latch bolt is retracted by key. Key removable only when trim is locked.					
04	Entrance by trim when latch bolt is retracted by key or set in a retracted position by key.					
05	Entrance by thumbpiece. Key locks or unlocks thumbpiece.					
06	Entrance by thumbpiece only when released by key. Key removable only when locked.					
08	Entrance by lever or knob. Key locks or unlocks lever or knob.					
08C w/ clutch (Handed)	Entrance by lever with clutch option. Key locks or unlocks lever.					
0808 Double Cylinder	Entrance by knob or lever. Outside or inside key locks or unlocks knob or lever. (9300 only)					
09	Entrance by lever or knob only when unlocked by key. Key removable only when locked.					
09C w/ clutch (Handed)	Entrance by lever with clutch option trim unlocked by key. Key removable only when locked.					
11	Entrance by thumbturn and pull. Key locks or unlocks thumbturn.					
12	Entrance by thumbturn and pull only when released by key. Key removable only when locked.					
22	Entrance by thumbpiece (no cylinder). Thumbpiece always active.					
23	Entrance by lever or knob (no cylinder). Lever or knob always active.					
25	Entrance by thumbturn and pull (no cylinder). Thumbturn always active.					

- Locks
- Cylinders, Keys & Keying
- Exit Devices
- Electronic Access Control Components
- Low Energy Operators
- Surface Closers
- Fire/Life Safety
- Concealed Closers/Pivots
- Stops/ Holders
- Sliding Systems
- Architectural Pulls & Handles
- Service Parts

9000 SERIES WIDE STILE Y ESCUTCHEON TRIM

Y Series Trim (Specify)					Door Thickness	Retrofit	Special Finish Coating	Cylinders and Keying			
Escutcheon	Knob, Pull, or Lever	Function	Handing	Electric Locking**	Finish			Cylinder Type	Keyway	Keying	
					630			DSC	KD		
Y	A	DT	RHR	LFSC	605	Ext3	AM	R1	C	CA	KD
	C	02R	LHR	LFSF	606	Ext4	P		D	CD	KA2
Handed	D	03			611				J	CE	KA4
	K	03R			612				L	D100	NSK
Handed	F	03MR			613				T	GA	MKD
	G	08			619				R	RA	CMK
	R	08M			625				x6	RB	SKD
	T	08C	— Handed		626				x7	SC	OBit
	O	08MC	— Handed		629**					SE	
	P	0808	— Double Cylinder 9300		630					SF	
Handed	N	09			689					WA	
	V	09C	— Handed		691					YA	
	L109	23			693					YG	
	L110				695						
	L112				696						
Handed	L114				Custom						
	L117				Designer						
	L118										

Suffix **M** required for 9500 mortise
 Suffix **C** and **LHR/RHR** required for clutch
 Suffix **R** required for rigid lever

□ — Default



***Patented Key Control**
D100 is the keyway for DORMA's patented **SKC** serialized key control system. **SKC** is internet based and provides added layers of security. For more information, contact your local DORMA sales representative or DORMA Technical Service at 800-523-8483.

** For 629 finish, please allow 4 week lead time.
 *** LFSC/LFSF only on 09/09C Functions



ANSI Function	Description	Concealed Vertical Rod	Rim	Surface Vertical Rod	Mortise	Available Finishes \$		
		9100 F9100	9300 F9300	9400 F9400	9500 F9500	689, 691, 693, 695, 696	630	605, 606, 611, 612, 613, 619, 625, 626, 629**
DT	Dummy trim	YODT				119	173	200
02	Entrance by trim when touchbar is dogged.	YPO2, YK02R, Yx02R				252	370	410
03	Entrance by trim when latch bolt is retracted by key. Key removable only when trim is locked.	Y003*			Y003M*	186	252	265
		YPO3, YK03R, Yx03R			YPO3M YK03R Yx3MR	331	437	476
04	Entrance by trim when latch bolt is retracted by key or set in a retracted position by key.	Y003*			Y003M*	186	252	265
		YPO3, Yx03R			YPO3M Yx3MR	331	437	476
08	Entrance by lever or knob. Key locks or unlocks lever or knob.	YK08, Yx08			YK08M Yx08M	437	512	588
08 w/clutch	Entrance by lever with clutch option. Key locks or unlocks lever. (Handed)	Yx08C			Yx08MC	621	727	767
0808 (9300)	Entrance by lever. Outside or inside key locks or unlocks lever.	—	Yx0808	—	—	768	879	912
09	Entrance by lever or knob only when unlocked by key. Key removable only when locked.	YK09, Yx09			—	437	512	588
09 w/clutch	Entrance by lever with clutch option trim unlocked by key. Key removable only when locked. (Handed)	Yx09C			—	621	727	767
11	Entrance by thumbturn. Key locks or unlocks thumbturn.	YP11			—	413	501	517
12	Entrance by thumbturn when unlocked by key. Key removable only when locked.	YP12			—	413	501	517
11	Entrance by thumbturn. Key locks or unlocks thumbturn.	Y011			—	360	468	483
12	Entrance by thumbturn when unlocked by key. Key removable only when locked.	Y012			—	360	468	483
23	Entrance by lever or knob (no cylinder). Lever or knob always active.	YK23, Yx23			YK23M Yx23M	290	410	437

* Requires Pull by Others

** For 629 finish, please allow 4 week lead time.

NOTES:

- Where x appears above, x = lever styles A, C, D, F, G, N, R, T, V, L109, L110, L112, L114, L117 or L118. (Handed Levers — D, F, V, L114)
- List price includes the default cylinder.

- Locks
- Cylinders, Keys & Keying
- Exit Devices
- Electronic Access Control Components
- Low Energy Operators
- Surface Closers
- Fire/Life Safety
- Concealed Closers/Pivots
- Stops/ Holders
- Sliding Systems
- Architectural Pulls & Handles
- Service Parts

9000 SERIES WIDE STILE SECTIONAL TRIM

Sectional Trim (Specify)		Special Finish Coating	Cylinders and Keying
Knob or Lever	Function	Finish	Cylinder Type Keyway Keying
		626	D S C K D
9C	02	605	AM C CA KD
9G	03	606	P D CD KA2
9K	04	611	J J CE KA4
9R	08	612	L *D100 NSK
Specify J for SFIC Core	08J	613	T GA MKD
	23	619	RA CMK
		625	RB SKD
		626	SC OBit
		630	SE
		689	SF <input type="checkbox"/> — Default
		691	WA
		693	YA
		695	YG
		696	
		Custom	
		Designer	



***Patented Key Control**
D100 is the keyway for DORMA's patented **SKC** serialized key control system. **SKC** is internet based and provides added layers of security. For more information, contact your local DORMA sales representative or DORMA Technical Service at 800-523-8483.



		Concealed Vertical Rod	Rim	Surface Vertical Rod	Mortise	Available Finishes \$	
		9100 F9100	9300 F9300	9400 F9400	9500 F9500	689, 691, 693, 695, 696	630 605, 606, 611, 612, 613, 619, 625, 626
ANSI Function	Description						
02	Entrance by trim when touchbar is dogged.		9C02R 9G02R 9K02R 9R02R		—	279	— 317
03	Entrance by trim when latch bolt is retracted by key. Key removable only when trim is locked.		9C03 9G03 9K03 9R03		—	342	— 385
04	Entrance by trim when latch bolt is retracted by key or set in a retracted position by key.		9C03 9G03 9K03 9R03		—	342	— 385
08	Entrance by lever or knob. Key locks or unlocks lever or knob.		9C08 9G08 9K08 9R08		—	342	— 385
23	Entrance by lever or knob (no cylinder). Lever or knob always active.		9C23 9G23 9K23 9R23		—	279	— 317

NOTE: List price includes the default cylinder.

- Locks
- Cylinders, Keys & Keying
- Exit Devices
- Electronic Access Control Components
- Low Energy Operators
- Surface Closers
- Fire/Life Safety
- Concealed Closers/Pivots
- Stops/ Holders
- Sliding Systems
- Architectural Pulls & Handles
- Service Parts

9000 SERIES WIDE STILE 3" PLATE TRIM

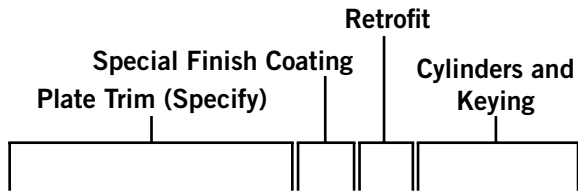

Plate Type	Function	Finish		Retrofit	Cylinder Type	Keyway	Keying
		630			D	S	CD
					C	A	KD
HRT	DT	630	AM	R1	C	CA	KD
HTT	DTCV	689	P		D	CD	KA2
NPT	02	691			J	CE	KA4
PRT	02CV	693			L	D100	NSK
PTT	03	695			T	GA	MKD
80	03CV	696			R	RA	CMK
	03M	Custom			X6	RB	SKD
	04	Designer			X7	SC	OBit
	05					SE	
	05CV					SF	
	05M					WA	
	06					YA	
	06CV					YG	
	22						
	22CV						
	22M						

Suffix **CV** required for 9100 CVR
 Suffix **M** required for 9500 mortise

— Default

***Patented Key Control**
D100 is the keyway for DORMA's patented **SKC** serialized key control system. **SKC** is internet based and provides added layers of security. For more information, contact your local DORMA sales representative or DORMA Technical Service at 800-523-8483.





		Concealed Vertical Rod	Rim	Surface Vertical Rod	Mortise	Available Finishes \$		
		9100 F9100	9300 F9300	9400 F9400	9500 F9500	689, 691, 693, 695, 696	630 605, 606, 611, 612, 613, 619, 625, 626	
ANSI Function	Description							
DT	Dummy Trim	NPTDTCV	NPTDT			106	146	159
02	Entrance by trim when touchbar is dogged.	NPTDTCV	PRT02 PTT02	PRT02M PTT02M		119	173	200
03	Entrance by trim when latch bolt is retracted by key. Key removable only when trim is locked.	NPT03CV* PRT03CV PTT03CV	NPT03* PRT03 PTT03	NPT03M* PRT03M PTT03M		186	252	265
04	Entrance by trim when latch bolt is retracted by key or set in a retracted position by key.	NPT03CV* PRT03CV PTT03CV	NPT03* PRT03 PTT03	NPT03M* PRT03M PTT03M		186	252	265
05	Entrance by thumbpiece. Key locks or unlocks thumbpiece.	HRT05CV HTT05CV	HRT05 HTT05	HRT05M HTT05M		212	265	290
06	Entrance by thumbpiece only when released by key. Key removable only when locked.	HRT06CV HTT06CV	HRT06 HTT06	—		212	265	290
22	Entrance by thumbpiece (no cylinder). Thumb-piece always active.	HRT22CV HTT22CV	HRT22 HTT22	HRT22M HTT22M		173	212	239

* Requires Pull by Others

NOTES:

- List price includes the default cylinder.

- Locks
- Cylinders, Keys & Keying
- Exit Devices
- Electronic Access Control Components
- Low Energy Operators
- Surface Closers
- Fire/Life Safety
- Concealed Closers/Pivots
- Stops/ Holders
- Sliding Systems
- Architectural Pulls & Handles
- Service Parts

9000 SERIES WIDE STILE 2" PLATE TRIM

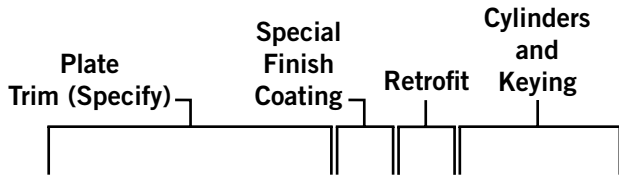

Plate Type	Function	Finish			Cylinder Type	Keyway	Keying
		630			D	S	C
VO	DT	605	AM	R1	C	CA	KD
V1	DTCV	606	P		D	CD	KA2
V3	02	611			J	CE	KA4
	02CV	612			L	*D100	NSK
	03	613			T	GA	MKD
	03CV	619			R	RA	CMK
	03M	625			x6	RB	SKD
		626			x7	SC	OBit
		630				SE	
		689				SF	
		691				WA	
		693				YA	
		695				YG	
		696					
		Custom					
		Designer					

Suffix **CV** required for 9100 CVR
 Suffix **M** required for 9500 mortise

— Default

***Patented Key Control**
D100 is the keyway for DORMA's patented **SKC** serialized key control system. **SKC** is internet based and provides added layers of security. For more information, contact your local DORMA sales representative or DORMA Technical Service at 800-523-8483.





		Concealed Vertical Rod	Rim	Surface Vertical Rod	Mortise	Available Finishes \$		
		9100 F9100	9300 F9300	9400 F9400	9500 F9500	689, 691, 693 695, 696	630	605, 606, 611, 612, 613, 619, 625, 626
ANSI Function	Description							
DT	Dummy Trim	VODTCV		VODT	—	106	119	159
02	Entrance by trim when touchbar is dogged.	V102CV V302CV		V102 V302	—	119	159	200
03	Entrance by trim when latch bolt is retracted by key. Key removable only when trim is locked.	V003CV* V103CV V303CV		V003* V103 V303	V003M* V103M V303M	186	225	265
04	Entrance by trim when latch bolt is retracted by key or set in a retracted position by key.	V003CV V103CV V303CV		V003 V103 V303	V003M V103M V303M	186	225	265

* Requires Pull by Others

NOTE: List price includes the default cylinder.

- Locks
- Cylinders, Keys & Keying
- Exit Devices**
- Electronic Access Control Components
- Low Energy Operators
- Surface Closers
- Fire/Life Safety
- Concealed Closers/Pivots
- Stops/ Holders
- Sliding Systems
- Architectural Pulls & Handles
- Service Parts

9000 SERIES WIDE STILE PULL TRIM

Pulls (Specify)			Special Finish Coating	Cylinders and Keying
Pull Type	Function	Handing	Finish	Cylinder Type Keyway Keying
			630	D S C K D
OP	02	RHR	605	AM C CA KD
POF	03HDA	LHR	606	P D CD KA2
VRF	02SPM		611	L CE KA4
	03SPM		612	T D100 NSK
			613	R GA MKD
			619	x6 RA CMK
			625	x7 RB SKD
			626	SC OBit
			630	SE
			689	SF
			691	WA
			693	YA
			695	YG
			696	
			Custom	
			Designer	

— Default



***Patented Key Control**
D100 is the keyway for DORMA's patented **SKC** serialized key control system. **SKC** is internet based and provides added layers of security. For more information, contact your local DORMA sales representative or DORMA Technical Service at 800-523-8483.



ANSI Function	Description	Concealed Vertical Rod	Rim	Surface Vertical Rod	Mortise	Available Finishes \$		
		9100 F9100	9300 F9300	9400 F9400	9500 F9500	689, 691, 693, 695, 696	630	605, 606, 611, 612, 613, 619 625, 626
02	Entrance by trim when touchbar is dogged.	OP02			106	133	159	
		—	VRF02SPM	—	—	—	543	—
03	Entrance by trim when latch bolt is retracted by key. Key removable only when trim is locked.	—	POF03HDA	—	—	—	767	—
		—	VRF03SPM	—	—	—	543	—
04	Entrance by trim when latch bolt is retracted by key or set in a retracted position by key.	—	POF03HDA	—	—	—	767	—
		—	VRF03SPM	—	—	—	543	—

NOTE: List price includes the default cylinder.

- Locks
- Cylinders, Keys & Keying
- Exit Devices
- Electronic Access Control Components
- Low Energy Operators
- Surface Closers
- Fire/Life Safety
- Concealed Closers/Pivots
- Stops/ Holders
- Sliding Systems
- Architectural Pulls & Handles
- Service Parts

TRIM OPTIONS

Option Code	Description	List Add \$
Special Finishes and Coatings		
AM	Antimicrobial protected coating	71
P	Clear powder coat	71
Custom Color	Custom painted finish selected from DORMA RAL color pallet book. For details, see DORMA Finishes Cross Reference , page vii.	
	Per order, setup charge (Net)	110
	per exit device only, list add	55
	per trim only, list add	55
Designer Color	Designer painted color matched to supplied samples. Three (3) each 2" x 3" color chip samples required. For details, see DORMA Finishes Cross Reference , page vii.	
	per order, non-refundable development/setup charge (Net)	400
	per exit device only, list add	55
	per trim only, list add	55
Electric Locking Trim for 9100 Concealed Vertical Rods, 9300 Rim & 9400 Surface Vertical Rods		
LFSC	Fail secure (requires DORMA ES100 power supply)	528
LFSF	Fail safe (requires DORMA ES100 power supply)	528
Retrofit		
R1	Von Duprin® retrofit. For Y series trim, wide and narrow plate trim only.	N/C
Door Thickness (includes extended spindle and fasteners)		
Ext3	Door thickness from 2-1/4"-3-1/4" (57 mm to 83 mm)	74
Ext4	Door thickness from 3-1/4"-4-1/4" (83 mm to 108 mm)	74

CYLINDERS

Rim Cylinders

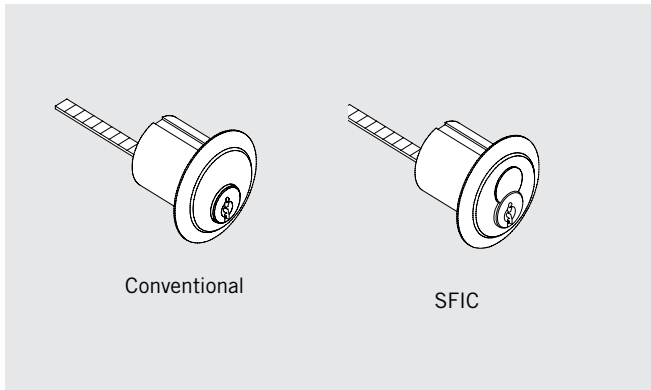

Mortise Cylinders

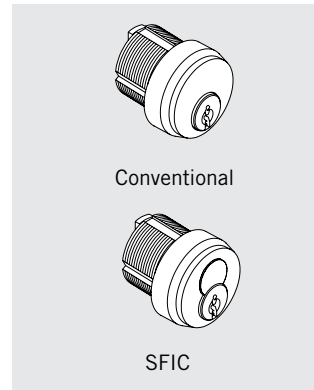



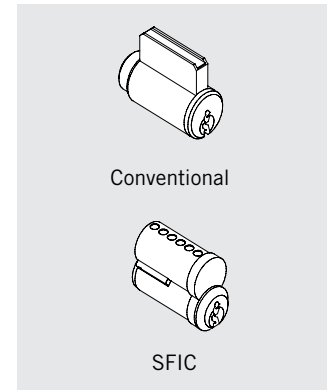

Key-in-Lever Cylinders



Wide Stile

Application	ANSI Function	Cylinder Type	Conventional (Default)	Cam	SFIC 7-Pin
Cylinders for 9100/F9100 Concealed Vertical Rod, 9300/F9300 Rim, and 9400/F9400 Surface Vertical Rod Wide Stile Devices					
Sectional Trim (Key-in-Lever)	03, 04, 08	Key-in-lever	7013SC	NA	77BA
Wide Plate Trim	03, 04	Rim	80R20SC	NA	87R20BA
Wide Plate Trim	05, 06	Mortise	90A10BA118	#10	97A10BA138
Narrow Plate Trim	03, 04	Rim	80R20SC	NA	87R20BA
Y Escutcheon Trim	03, 04	Rim	80R20SC	NA	87R20BA
Y Escutcheon Trim	08	Mortise	90×10SC118	#10	97D10BA138
Y Escutcheon Trim	09	Mortise	90×10SC118	#9	97D10BA138
Cylinders for 9500/F9500 Mortise Devices shipped prior to 11/14					
Wide Plate Trim	03, 05	Mortise	90A10SC118	#10	97B10BA138
Wide Plate Trim	03	Mortise	90A10SC118	#10	97B10BA138
Y Escutcheon Trim	03, 08	Mortise	90×10SC158	#10	97D10BA134
Cylinders for 9500/F9500 Mortise Devices shipped 11/14 or after					
Wide Plate Trim	03	Mortise	90A13SC118	#13	97B13BA138
Wide Plate Trim	05	Mortise	90A12SC118	#12	97B12BA138
Narrow Plate Trim	03	Mortise	90A13SC118	#13	97B13BA138
Y Escutcheon Trim	03	Mortise	90×13SC118	#13	97C13BA138
Y Escutcheon Trim	05, 08	Mortise	90×12SC118	#12	97C12BA138
Cylinders for Device Options					
CD, BPA, BPAR, DE, DE30, DECBC, DWA, LMMSBP	—	Mortise	90×10SC118	#10	97D10BA138

CYLINDER TYPES, KEYING OPTIONS & KEYWAYS FOR REMOVABLE MULLIONS & EXIT DEVICES

Cylinder	Option	Description	List Add/Deduct \$
Conventional Cylinders (non-interchangeable core)			
D		Keying for exit device or removable mullions with conventional cylinder (default)	N/C
	KD	Keyed differently to a random combination; SC keyway with 2 keys (default)	N/C
	KA2	Keyed alike in pairs to a random combination; SC keyway with 2 keys	N/C
	KA4	Keyed alike in sets of 4 to a random combination; SC keyway with 2 keys	N/C
	O-Bit	Operated by a key blank for easy rekeying; SC, SE keyway with 2 key	N/C
	O-Bit	Operated by a key blank for easy rekeying; D100 keyway —  Keys sold separately	N/C
	O-Bit	Operated by a key blank for easy rekeying; CA, CD, CE, RA, RB, GA, SF, WA, YA, YG keyways with 2 keys	12
	NSK	Non-stock keyed — KA quantities other than KA2/KA4; SC keyway with 2 keys	12
	MKD	Master keyed or SKD, SC, SE, or D100 keyway —  Keys sold separately	12
	CMK	Construction master keyed single cylinder locks —  Keys sold separately	13
L		Keying for exit device or removable mullions less conventional cylinder	Deduct 30
Small Format Interchangeable Core Cylinders			
J		Keying for exit device or removable mullions with disposable plastic SFIC construction core	N/C
T		Keying for exit device or removable mullions with keyed temporary SFIC construction core Keying for exit trim with keyed temporary SFIC construction core (cores may be returned for a full refund) —  Keys sold separately	40
C		Keying for exit device or removable mullions with combined SFIC core installed at factory ¹ Keying for exit trim with combined core installed at factory; BA (default), BB, BC, BD, BE, BF, BG, BH, BJ, BK, BL, BM, BQ, D100 keyway —  Keys sold separately	45
Cylinder Housings Less Cores			
R		Housing prepared for Schlage FSIC	8
X7		Housing prepared for Sargent XC 7P & Arrow Choice 7P SFIC	8
X6		Housing prepared for Arrow Choice 6P SFIC	8

1. For uncombined cores, **UNC**, cores must be ordered separately, see **Cylinders, Keys, and Keying**. Exits/trim will be supplied w/ plastic construction core, Option J.

 Denotes keys must be ordered separately.

Cut Keys Ordered Separately

Part #	Description	List \$
45101	Change key, master key, construction master key, or control key; BA, BB, BC, BD, BE, BF BG, BH, BJ, BK, BL, BM, BQ, SC, SE section	6
45401	Change key, master key, or control key; D100 section	10

NOTES:

- D100 keyway is restricted. See TERMS OF SALE section for DORMA SKC policies.
- For additional information, please refer to Cylinders, Keys, and Keying

MULLIONS

Item	Description	List \$
Aluminum Mullions × 628 (clear anodized), 1-5/8" × 2-5/8"		
1310-8	8'	856
1310-8 × 443	8', recessed strike	996
WS1310-8	8', weatherstrip	910
WS1310-8 × 443	8', weatherstrip and recessed strike	1006
1310-10	10'	910
1310-10 × 443	10', recessed strike	1092
WS1310-10	10', weatherstrip	996
WS1310-10 × 443	10', weatherstrip and recessed strike	1156
Aluminum Mullions × 695 (painted), 1-5/8" × 2-5/8"		
1310-8	8'	1038
1310-8 × 443	8', recessed strike	1177
WS1310-8	8', weatherstrip	1092
WS1310-8 × 443	8', weatherstrip and recessed strike	1243
1310-10	10'	1124
1310-10 × 443	10', recessed strike	1274
WS1310-10	10', weatherstrip	1199
WS1310-10 × 443	10', weatherstrip and recessed strike	1210
Steel Mullions × 600 (primed for paint), 1-1/2" × 2-1/2"		
1330-8	8'	428
1330-10	10'	450
Steel Mullions × 600 (primed for paint), 2" × 3"		
1300-8	8'	557
F1300-8	8', fire-rated	717
1340KR-8	8', key removable (includes standard cylinder using 01 cam)	942
F1340KR-8	8', fire-rated mullion, key removable (includes standard cylinder using 01 cam)	1103
1300-10	10'	642
1340KR-EL	8', key removable, electrified mullion	1092
1340KR-10	10', key removable (includes standard cylinder using 01 cam)	996
HC1300-8	8', design pressure rated 80PSF for openings up to 8' × 8' with HC9300 device.	1038
Mullion Storage Kit		
1340SK	Storage kit for 1340/F1340 Series key removable mullion.	279

Cylinders for 1340KR/F1340KR Mullions and 1340SK Storage Kit

Type	Standard	7-pin IC	Cam
Mortise	90X01SC118	97D01BA138	01 (AR)



9600 SERIES

Narrow Stile Concealed Vertical Rod Exit Device

9600 Series Device									Options (Specify)							Cylinders and Keying		
Device	Length	Touchbar	Handing	Door Height	Top Strike	Bottom Strike	Door Latch Brackets	Finish	Special Finish Coating	Bottom Latch	Fastener Package	Control	Alarm	Monitoring	Dogging	Cylinder Type	Keyway	Keying
9600	BB		RHR	7	418	439	NS	630								D	SC	KD
F9600	AA	FL	RHR	7	418	340	NS	605	AM	LB	SK	DE	BPA	LM	CD	C	CA	KD
9600	BB		LHR	8	419	431	ALD	606	P	PB	SNB	DE30	BPAR	MS	LD	D	CD	KA2
	CC			9		439	WD	611		SB	TX	ES	DWA	LMMS	MD	J	CE	KA4
	SPCL			10				612			SKTX	DECBC	LMMSP			L	D100	NSK
				SPCL				613			SKSNB	ESB				T	GA	MKD
								619			TXSNB	MLR				R	RA	CMK
								625			SKTXSNB					x6	RB	SKD
								626			METRIC					x7	SC	OBIt
								629									SE	
								630									SF	
								689									WA	
								691									YA	
								693									YG	
								695										
								696										
								Custom										
								Designer										

— Default

— Supplied with Standard KD Cylinder

***Patented Key Control**

D100 is the keyway for DORMA's patented SKC serialized key control system. SKC is internet based and provides added layers of security. For more information, contact your local DORMA sales representative or DORMA Technical Service at 800-523-8483.

9000 Series – Narrow Stile Applications

Device Length	All Device Options (except BPA, DWA, or DE)		BPA or DWA Device Options	DE Device Option
	Maximum Door Width ¹	Minimum Door Width ²	Minimum Door Width ²	Minimum Door Width ²
AA	48" (1220 mm)	32-1/2" (826 mm)	41" (1042 mm)	40" (1016 mm)
BB	36" (915 mm)	27" (686 mm)	35" (889 mm)	32" (812.8 mm)
CC	30" (762 mm)	23-1/2" (597 mm)	N/A	N/A

9000 Series – Narrow Stile with Full Length Touchbar Applications

Device Length	All Device Options (except BPA, DWA, or DE)		BPA or DWA Device Options
	Maximum Door Width ¹	Minimum Door Width ²	Minimum Door Width ²
AA	48" (1220 mm)	33" (839 mm)	34" (837 mm)
BB	36" (915 mm)	27" (686 mm)	28" (711 mm)
CC	36" (915 mm)	24" (610 mm)	25" (635 mm)

- As delivered from factory, device will fit doors of this width. For other widths, consult DORMA Technical Services.
- Touch bar and rail assembly can be shortened at time of installation to fit doors down to this width. Varies by installations.

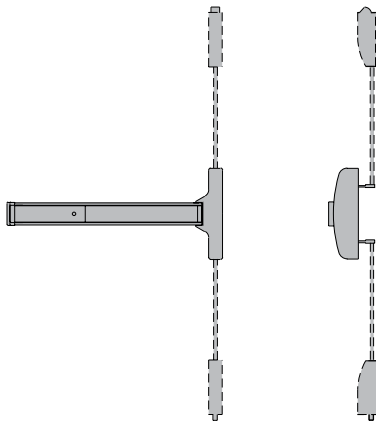

Available Finishes \$

Function	Description	Device, Exit Only	689, 691, 693, 695, 696	630	606, 612, 613, 619	605, 611, 625, 626, 629**
01	Panic	9600 Concealed vertical rod	1,675	1,980	1,999	2,112
01	Fire	F9600 Concealed vertical rod	1,842	2,145	2,166	2,272

Typical Options

Item	Description	List Add \$
CD	Cylinder dogging (includes cylinder)	80
LD	Less dogging (Standard with fire rated device)	N/C
AM	Antimicrobial coating	71
SNB	Sex nuts (Included with F and HC options)	14
TX	Security screws	30
HC	Hurricane (Includes SNB)	150
FL	Full length touchbar (Not Available DE)	N/C
LB	Less bottom rod	N/C
PB	Pullman bottom latch	48
SB	Slide Bolt (Default)	N/C
Up to 8'	7' to 8' adjustable	N/C
Up to 10'	Door heights over 8' to 10'	49 97 97

** For 629 finish, please allow 4 week lead time.

NOTES:

- Prices shown apply to AA, BB, or CC length devices.
- Specify door width and handing. If not specified, Size BB, RHR is the standard default.
- List price includes default strikes. For optional strikes, specify strike number and adjust list price accordingly.
- List price for the device does not include trim.
- Devices include wood and machine screws standard.
- Specify door latch brackets: **NS** (default) for 2-1/8" narrow stile aluminum, **ALD** for Wide Stile aluminum, or **WD** for wood or hollow steel.
- Fire rated devices include SNB sex nuts standard.
- For options requiring a cylinder, the option list price includes the default cylinder.
- Device includes precut and drilled rods for 7' to 8' doors as specified on order
 - For 9' doors, device includes precut and drilled rods for a 7' door and a 2' rod extension for the top rod. Specify 9' on order.
 - For 10' doors, device includes precut and drilled rods for an 8' door and a 2' rod extension for the top rod. Specify 10' on order.
 - See Device Options for pricing information.
- For special lengths and/or door heights over 10', consult DORMA Technical Service.
- All standard devices and trim are designed for 1-3/4"-2-1/4" thick doors. For door thickness greater than 2-1/4", consult DORMA Technical Service.
- FL (full length touchbar) and **METRIC** (metric installation fasteners) must be specified when ordered and included in the model number.

Example: 9600 BB FL RHR 430 630 METRIC
- Full length touchbar not available with DE. CD option on FL devices supplied with U.S. mortise cylinder.
- ALD wide stile aluminum door bracket (9100 and 9600 Series) N/C
- NS 2-1/8" narrow stile aluminum door bracket (9600 Series only) N/C
- WD narrow stile wood or hollow steel door bracket (9600 Series only) N/C

- Locks
- Cylinders, Keys & Keying
- Exit Devices
- Electronic Access Control Components
- Low Energy Operators
- Surface Closers
- Fire/Life Safety
- Concealed Closers/Pivots
- Stops/ Holders
- Sliding Systems
- Architectural Pulls & Handles
- Service Parts



9700 SERIES

Narrow Stile Rim Exit Device

9700 Series Device					Options (Specify)							Cylinders and Keying		
Device	Length	Touch Bar	Strike	Finish	Special Finish Coating	Special Applications Package	Fastener Package	Control	Alarm	Monitoring	Dogging	Cylinder Type	Keyway	Keying
9700	BB		430	630								D	S	CKD
F9700	AA	FL	320	605	AM	HC	SK	DE	BPA	LM	CD	C	CA	KD
9700	BB		430	606	P		SNB	DE30	BPAR	MS	LD	D	CD	KA2
	CC		463	611			TX	ES	DWA	LMMS	MD	J	CE	KA4
	SPCL		486	612			SKTX	DECBC		LMMSBP		L	D100	NSK
				613			SKSNB	ESB				T	GA	MKD
				619			TXSNB	MLR				R	RA	CMK
				625			SKTXSNB					X6	RB	SKD
				626			METRIC					X7	SC	OBit
				629									SE	
				630									SF	
				689									WA	
				691									YA	
				693									YG	
				695										
				696										
				Custom										
				Designer										

— Default

— Supplied with Standard KD Cylinder

***Patented Key Control**

D100 is the keyway for DORMA's patented **SKC** serialized key control system. **SKC** is internet based and provides added layers of security. For more information, contact your local DORMA sales representative or DORMA Technical Service at 800-523-8483.

9000 Series – Narrow Stile Applications

Device Length	All Device Options (except BPA, DWA, or DE)		BPA or DWA Device Options
	Maximum Door Width ¹	Minimum Door Width ²	Minimum Door Width ²
AA	48" (1220 mm)	32-1/2" (826 mm)	41" (1042 mm)
BB	36" (915 mm)	27" (686 mm)	35" (889 mm)
CC	30" (762 mm)	23-1/2" (597 mm)	N/A

9000 Series – Narrow Stile with Full Length Touchbar Applications

Device Length	All Device Options (except BPA, DWA, or DE)		BPA or DWA Device Options
	Maximum Door Width ¹	Minimum Door Width ²	Minimum Door Width ²
AA	48" (1220 mm)	33" (839 mm)	34" (837 mm)
BB	36" (915 mm)	27" (686 mm)	28" (711 mm)
CC	36" (915 mm)	24" (610 mm)	25" (635 mm)

- As delivered from factory, device will fit doors of this width. For other widths, consult DORMA Technical Services.
- Touch bar and rail assembly can be shortened at time of installation to fit doors down to this width.

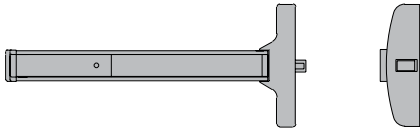

Function	Description	Device, Exit Only	Available Finishes \$			
			689, 691, 693, 695, 696	630	606, 612, 613, 619	605, 611, 625, 626, 629**
01	Panic	9700 Rim	899	1,418	1,432	1,676
01	Fire	F9700 Rim	1,045	1,562	1,577	1,816

Typical Options

Item	Description	List Add \$
CD	Cylinder dogging (Includes cylinder)	80
LD	Less dogging (Standard with fire rated device)	N/C
AM	Antimicrobial coating	71
SNB	Sex nuts (Included with F and HC options)	14
TX	Security screws	30
HC	Hurricane (Includes SNB)	150
FL	Full length touchbar (Not Available DE)	N/C

** For 629 finish, please allow 4 week lead time.

NOTES:

- Prices shown apply to AA, BB, or CC length devices.
- Specify door width. If not specified, Size BB is the standard default.
- List price includes default strikes. For optional strikes, specify strike number and adjust list price accordingly.
- List price for the device does not include trim.
- Devices include wood and machine screws standard.
- Fire and hurricane rated devices include 463 rim strike and SNB sex nuts standard.
- For options requiring a cylinder, the option list price includes the default cylinder.
- All standard devices and trim are designed for 1-3/4"-2-1/4" thick doors. For door thickness greater than 2-1/4", consult DORMA Technical Service.
- FL** (full length touchbar) and **METRIC** (metric installation fasteners) must be specified when ordered and included in the model number.
Example: 9700 BB FL RHR 430 630 METRIC
- For special lengths, consult DORMA Technical Service.
- Full length touchbar not available with DE. CD option on FL devices supplied with U.S. mortise cylinder.

- Locks
- Cylinders, Keys & Keying
- Exit Devices
- Electronic Access Control Components
- Low Energy Operators
- Surface Closers
- Fire/Life Safety
- Concealed Closers/Pivots
- Stops/ Holders
- Sliding Systems
- Architectural Pulls & Handles
- Service Parts



9800 SERIES

Narrow Stile Surface Vertical Rod Exit Device

9800 Series Device								Options (Specify)								Cylinders and Keying		
Device	Length	Touch Bar	Handing	Door Height	Top Strike	Bottom Strike	Finish	Special Finish Coating	Special Applications Package	Bottom Latch	Fastener Package	Control	Alarm	Monitoring	Dogging	Cylinder Type	Keyway	Keying
9800	BB		RHR	7	426	439	630									D	SC	KD
F9800	AA	FL	RHR	7	426	340	605	AM	HC	LB	SK	ES	BPA	LM	CD	C	CA	KD
9800	BB		LHR	8	426A	416V	606	P	TGD	PB	SNB	ESB	BPAR	MS	LD	D	CD	KA2
	CC			9		431	611			SB	TX	MLR	DWA	LMMS	MD	J	CE	KA4
	SPCL			10		439	612				SKTX			LMMSBP		L	D100	NSK
				SPCL			613				SKSNB					T	GA	MKD
							619				TXSNB					R	RA	CMK
							625				SKTXSNB					x6	RB	SKD
							626				METRIC					x7	SC	OBIt
							629										SE	
							630										SF	
							689										WA	
							691										YA	
							693										YG	
							695											
							696											
							Custom											
							Designer											

— Default

— Supplied with Standard KD Cylinder

***Patented Key Control**
D100 is the keyway for DORMA's patented **SKC** serialized key control system. **SKC** is internet based and provides added layers of security. For more information, contact your local DORMA sales representative or DORMA Technical Service at 800-523-8483.

9000 Series – Narrow Stile Applications

Device Length	All Device Options (except BPA, DWA, or DE)		BPA or DWA Device Options	DE Device Option
	Maximum Door Width ¹	Minimum Door Width ²	Minimum Door Width ²	Minimum Door Width ²
AA	48" (1220 mm)	32-1/2" (826 mm)	41" (1042 mm)	40" (1016 mm)
BB	36" (915 mm)	27" (686 mm)	35" (889 mm)	32" (812.8mm)
CC	30" (762 mm)	23-1/2" (597 mm)	N/A	N/A

9000 Series – Narrow Stile with Full Length Touchbar Applications

Device Length	All Device Options (except BPA, DWA, or DE)		BPA or DWA Device Options
	Maximum Door Width ¹	Minimum Door Width ²	Minimum Door Width ²
AA	48" (1220 mm)	33" (839 mm)	34" (837 mm)
BB	36" (915 mm)	27" (686 mm)	28" (711 mm)
CC	36" (915 mm)	24" (610 mm)	25" (635 mm)

- As delivered from factory, device will fit doors of this width. For other widths, consult DORMA Technical Services.
- Touch bar and rail assembly can be shortened at time of installation to fit doors down to this width. Varies by installation.

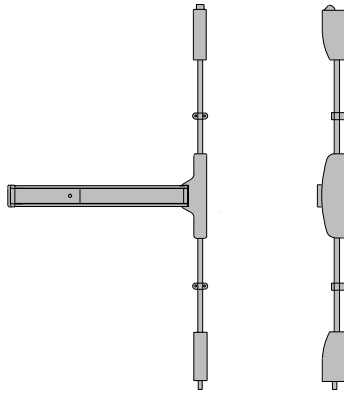

Available Finishes \$

Function	Description	Device, Exit Only	689, 691, 693, 695, 696	630	606, 612, 613, 619	605, 611, 625, 626, 629**
01	Panic	9800 Surface vertical rod	1,641	1,864	1,882	2,012
01	Fire	F9800 Surface vertical rod	1,809	2,029	2,048	2,172

Typical Options

Item	Description	List Add \$
CD	Cylinder dogging (Includes Cylinder)	80
LD	Less dogging (Standard with fire rated device)	N/C
AM	Antimicrobial coating	71
SNB	Sex nuts (Included with F and HC options)	14
TX	Security screws	30
HC	Hurricane (Includes SNB)	150
FL	Full length touchbar (Not available DE)	N/C
LB	Less bottom rod	N/C
PB	Pullman bottom latch	48
SB	Slide bolt (Default)	N/C
TGD	Tempered glass doors—9800 only	— 631 —
Up to 8'	7' Default	N/C
Up to 10'	Door Heights over 8' to 10'	49 97 97

** For 629 finish, please allow 4 week lead time.

NOTES:

- Prices shown apply to AA, BB, or CC length devices.
- Specify door width and handing. If not specified, Size BB, RHR is the standard default.
- List price includes default strikes. For optional strikes, specify strike number and adjust list price accordingly.
- List price for the device does not include trim.
- Devices include wood and machine screws standard.
- Fire and hurricane rated devices include SNB sex nuts standard.
- For options requiring a cylinder, the option list price includes the default cylinder.
- Device includes precut and drilled rods for 7' or 8' doors as specified on order.
 - For 9' doors, device includes precut and drilled rods for a 7' door and a 2' rod extension for the top rod.
 - For 10' doors, device includes precut and drilled rods for an 8' door and a 2' rod extension for the top rod.
 See Device Options for pricing information.
- For special lengths and/or door heights over 10', consult DORMA Technical Service.
- All standard devices and trim are designed for 1-3/4"-2-1/4" thick doors. For door thickness greater than 2-1/4", consult DORMA Technical Service.
- FL (full length touchbar) and METRIC (metric installation fasteners) must be specified when ordered and included in the model number.
 - Example: 9800 BB FL RHR 430 630 METRIC
- Full length touchbar not available with DE. CD option on FL devices supplied with U.S. mortise cylinder.



NARROW STILE DUMMY BARS

Item	Description	Available Finishes \$			
		689, 691, 693, 695, 696	630	606, 612, 613, 619	605, 611, 625, 626, 629**
Dummy Touchbars					
9230	Rigid dummy touchbar	495	722	748	748
9230MS	Dummy touchbar with microswitch	733	925	935	935
9235	Rigid touchbar	495	722	748	748
9236	Moveable touchbar	495	722	748	748
9236MS	Moveable touchbar with microswitch	733	925	935	935

** For 629 finish, please allow 4 week lead time.

NOTE: Dummy touchbars available in all rail sizes: AA, BB or CC

OPTIONS

Option Code	Description	List Add \$
Strikes		
9600, and 9800 Concealed and Surface Vertical Rods		
340	Flat slide bolt bottom strike (9600, and 9800 Series)	N/C
416V	Surface bottom strike for pullman latch (9800 Series)	N/C
418	Standard top strike (9600 Series)	N/C
419	Wood frame top strike (9600 Series)	14
426	Standard top strike (9800 Series)	N/C
426A	Top strike w/angle (9800 Series)	25
431	Recessed bottom strike for pullman latch (9600, and 9800 Series)	25
439	Standard slide bolt bottom strike (9600, and 9800 Series)	N/C
9700 Rim Devices		
320	Overlap strike	25
430	Rim box strike (default/no charge for 9700 Series panic devices)	39
463	Standard rim strike (default/no charge for F9700 devices)	63
486	Roller strike	14
Special Finishes and Coatings		
AM	Antimicrobial protected coating	71
P	Clear powder coat	71
Custom Color	Custom painted finish selected from DORMA RAL color pallet book. For details, see DORMA Finishes Cross Reference , page vii.	
	Per order, setup charge (Net)	110
	per exit device only, list add	55
	per trim only, list add	55
Designer Color	Designer painted color matched to supplied samples. Three (3) each 2" x 3" color chip samples required. For details, see DORMA Finishes Cross Reference , page vii.	
	per order, non-refundable development/setup charge (Net)	400
	per exit device only, list add	55
	per trim only, list add	55
Bottom Latches for 9600 Concealed Vertical Rods & 9800 Surface Vertical Rods		
LB	Less bottom rod	N/C
PB	Pullman bottom latch	48
SB	Slide bolt (Default)	N/C
Door Height Designation		
9600 Concealed Vertical Rods		
7 or 8	Door heights from 7' to 8' adjustable	N/C
9 or 10	Door heights over 8', up to 10'	49
Over 10'	Contact DORMA Technical Service for assistance	
9800 Surface Vertical Rods		
7 or 8	Door heights from 7' to 8' (7' Default)	N/C
9 or 10	Door heights over 8', up to 10'	
	For 689, 691, 693, 695, 696 finishes	49
	For 605, 606, 611, 612, 613, 619, 625, 626, 630 finishes	97
Over 10'	Consult DORMA Technical Service	
Door Latch Brackets		
ALD	Wide Stile aluminum door bracket (9600 Series)	N/C
NS	2-1/8" narrow stile aluminum door bracket (9600 Series only)	N/C
WD	Narrow stile wood or hollow steel door bracket (9600 Series only)	N/C
Special Application Packages		
HC	Hurricane (9700 and 9800 Series only) Includes SNB	150

Option Code	Description	List Add \$
FL	Full length touchbar (Not Available DE)	N/C
Fastener Package		
SK	Shim kit	79
SNB	Sex nuts	14
TX	Security screws	30
SKTX	Shim kit and security screws	126
SKSNB	Shim kit and sex nuts	93
TXSNB	Security screws and sex nuts	61
SKTXSNB	Shim kit, security screws, and sex nuts	140
METRIC	Metric installation fasteners (9600, 9700, and 9800 Series only)	N/C
Tempered Glass Door Applications (9800 Series Only)		
TGD	Tempered glass doors in 630 finish	631
Electronic Controls		
DE*	Delayed egress (requires ES100 power supply and ES105 power transfer)	1,473
DE30*	Delayed egress, 30 second (requires special approval from authority having jurisdiction)	1,824
DECBC*	Delayed egress, CBC compliant	1,824
MLR	Motorized Latch Retraction/dogging (use PS610RF or PS532RF power supply—2 MLR's)	825
ES	Electric latch retraction (requires PS501 power supply and ES105 power transfer)	794
ESB	Electric latch retraction option for battery back-up power supply (requires PS406BB or PS426BB power supply and ES105 power transfer)	910
IMPORTANT NOTE: ESB can not be used with any other power supplies.		
Alarm		
BPA*	Battery powered alarm	550
BPAR*	Battery powered alarm, 4 minute reset	587
DWA*	Direct wired alarm	550
Monitoring		
LM	Latch bolt monitoring	216
MS	Monitor switch in touchbar	216
LMMS	Latch bolt and touchbar monitor	432
LMMSBP*	Latch bolt and touchbar monitor with bypass	432
Dogging		
CD*	Cylinder dogging (panic devices only)	80
LD	Less dogging (panic devices only)	N/C
MD	Electric dogging (requires PS502RF power supply)	725
Power Supplies, Power Transfers, Power Modules		
AD100	Export power supply for up to 2 ES devices, 110 VAC. Powers 1 DE device.	641
ES101	Delay module	118
ES103	Relay module	74
ES100	Power supply for DE devices and LFSC/LFSF trims. Powers 1 DE device or 2 trims.	545
ES105	Power transfer (recommended for ES, DE & MLR options)	181
PS501	Power supply for ES9000 devices. Powers up to 2 devices.	641
PS501220	Export power supply, 220 VAC. Powers up to 2 ES9000 devices.	641
ES2	Power supply card for PS501. Powers an additional 2 devices.	349
PS610RF	Power supply for MD, 9500 LFSC/LFSF, or MLR. Powers 1 device.	395
PS615RF	Power supply for MD, 9500 LFSC/LFSF powers 2 devices (will also power 1 MLR device).	495
PS532RF	Power supply for MLR. Powers 2 devices.	638
PS406BB	Power supply with battery back-up for ESB solenoid electric latch retraction option.	915
PS426BB	Power supply with battery back-up for ESB solenoid electric latch retraction option.	915
IMPORTANT NOTE: PS406BB and PS426BB can only be used with ESB electric latch retraction option		

* List price includes default cylinder.

DORMA 9000 SERIES EXIT TRIM

How to Order

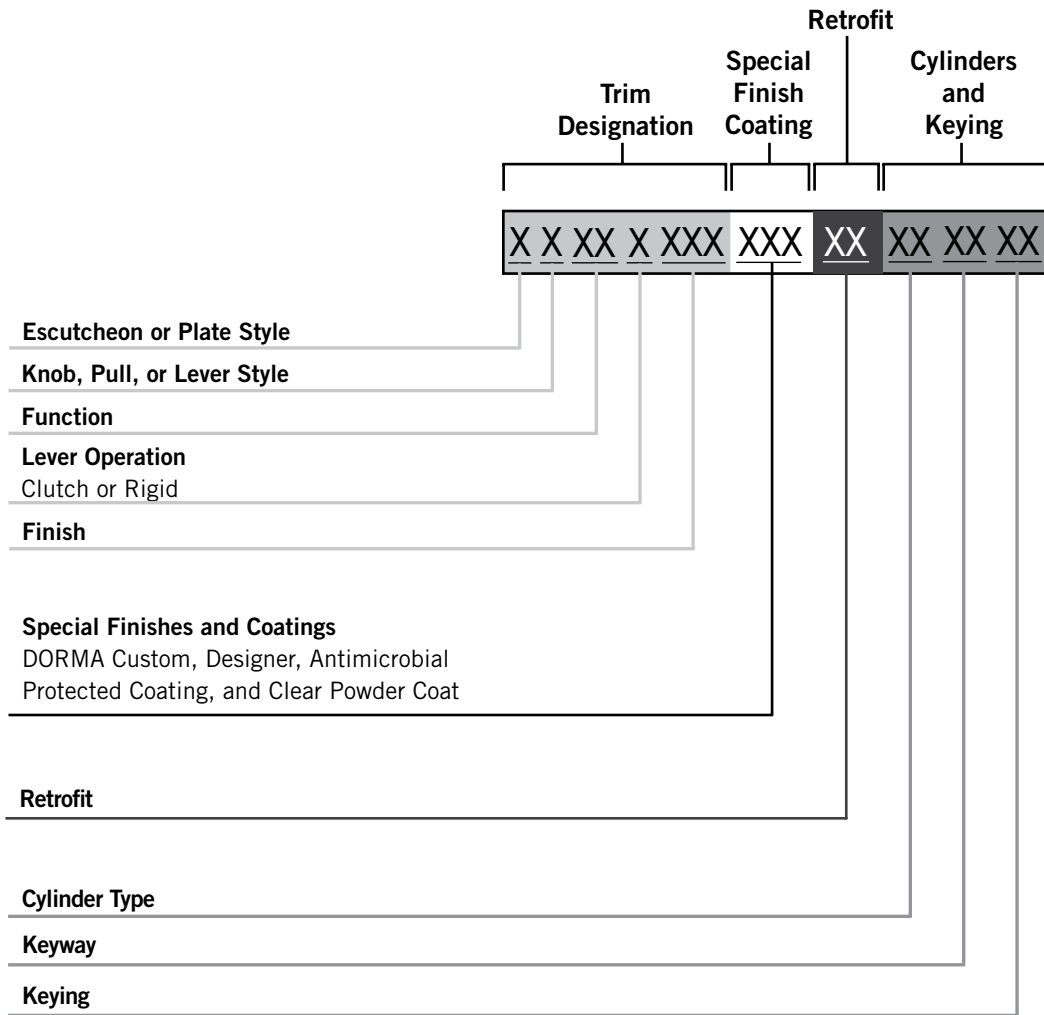

- Locks
- Cylinders, Keys & Keying
- Exit Devices**
- Electronic Access Control Components
- Low Energy Operators
- Surface Closers
- Fire/Life Safety
- Concealed Closers/Pivots
- Stops/ Holders
- Sliding Systems
- Architectural Pulls & Handles
- Service Parts

LEVER & KNOB STYLES

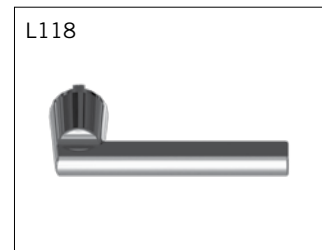
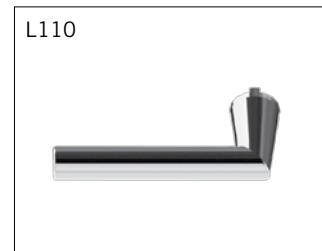
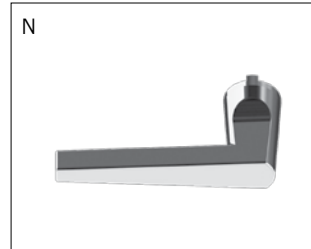
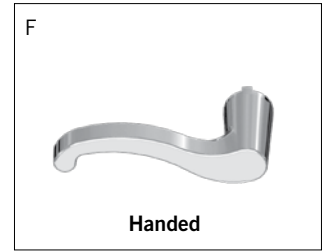

ANSI Function	Description	Z Series Raised Escutcheon 1-5/8" W x 8-1/2" H x 15/16" D
DT	Dummy trim	
02	Entrance by trim when touchbar is dogged	
03	Entrance by trim when latch bolt is retracted by key. Key removable only when trim is locked.	
04	Entrance by trim when latch bolt is retracted by key or set in a retracted position by key.	
08	Entrance by lever or knob. Key locks or unlocks lever or knob.	
08C w/ clutch (Handed)	Entrance by lever with clutch option. Key locks or unlocks lever.	
09	Entrance by lever or knob only when unlocked by key. Key removable only when locked.	
09C w/ clutch (Handed)	Entrance by lever with clutch option trim unlocked by key. Key removable only when locked.	
11	Entrance by thumbturn and pull. Key locks or unlocks thumbturn.	
12	Entrance by thumbturn and pull only when released by key. Key removable only when locked.	
23	Entrance by lever or knob (no cylinder). Lever or knob always active.	
25	Entrance by thumbturn and pull (no cylinder). Thumbturn always active.	

- Locks
- Cylinders, Keys & Keying
- Exit Devices
- Electronic Access Control Components
- Low Energy Operators
- Surface Closers
- Fire/Life Safety
- Concealed Closers/Pivots
- Stops/ Holders
- Sliding Systems
- Architectural Pulls & Handles
- Service Parts

9000 SERIES NARROW STILE Z TRIM

Z Series Trim (Specify)				Door Thickness		Special Finish Coating					Special Application Package Cylinders and Keying			
Escutcheon	Knob, Pull, or Lever	Function	Handing	Finish				Cylinder Type	Keyway	Keying				
				630				D	S	C	K	D		
Z	A	DT	RHR	605	Ext3	AM	TGD	C	CA	KD				
	C	02	LHR	606	Ext4	P		D	CD	KA2				
Handed	D	02R		611				J	CE	KA4				
Handed	K	03		612				L	D100	NSK				
	F	03R		613				T	GA	MKD				
	G	08		619				EP	RA	CMK				
	R	08C	Handed	625				R	RB	SKD				
	T	09		626				X6	SC	OBit				
	O	09C	Handed	629				X7	SE					
	P	11		630					SF					
Handed	N	12		689					WA					
	V	23		691					YA					
	L109	25		693					YG					
	L110	Suffix C and LH/RH required for clutch		695										
	L112	Suffix R required for rigid lever		696										
Handed	L114			Custom										
	L117			Designer										
	L118													



— Default

***Patented Key Control**
D100 is the keyway for DORMA's patented **SKC** serialized key control system. **SKC** is internet based and provides added layers of security. For more information, contact your local DORMA sales representative or DORMA Technical Service at 800-523-8483.



ANSI Function	Description	Concealed Vertical Rod	Rim	Surface Vertical Rod	Available Finishes \$		
		9600 F9600	9700 F9700	9800 F9800	689, 691, 693 695, 696	630	605, 606, 611, 612, 613, 619, 625, 626, 629**
DT	Dummy trim		ZODT		119	173	200
02	Entrance by trim when touchbar is dogged.		ZP02		225	304	343
			ZK02R, Zx02R		167	273	333
03	Entrance by trim when latch bolt is retracted by key. Key removable only when trim is locked.		Z003		186	252	265
			ZP03, ZK03R, Zx03R		331	437	476
04	Entrance by trim when latch bolt is retracted by key or set in a retracted position by key.		Z003		186	252	265
			ZP03, ZK03R, Zx03R		331	437	476
08	Entrance by lever or knob. Key locks or unlocks lever or knob.		ZK08, Zx08		437	512	588
08 w/ clutch (Handed)	Entrance by lever with clutch option. Key locks or unlocks lever.		Zx08C		621	727	767
09	Entrance by lever or knob only when unlocked by key. Key removable only when locked.		ZK09, Zx09		437	512	588
09 w/ clutch (Handed)	Entrance by lever with clutch option trim unlocked by key. Key removable only when locked.		Zx09C		621	727	767
11	Entrance by thumbturn. Key locks or unlocks thumbturn		Z011		360	468	483
12	Entrance by thumbturn when unlocked by key. Key removable only when locked.		Z012		360	468	483
11	Entrance by thumbturn. Key locks or unlocks thumbturn		ZP11		413	501	517
12	Entrance by thumbturn when unlocked by key. Key removable only when locked.		ZP12		413	501	517
23	Entrance by lever or knob (no cylinder). Lever or knob always active.		ZK23, Zx23		290	410	437
25	Entrance by thumbturn and pull (no cylinder). Thumbturn always active.		ZP25		358	441	539

** For 629 finish, please allow 4 week lead time.

NOTES:

- Where x appears above, x = lever styles A, C, D, F, G, N, R, T, V, L109, L110, L112, L114, L117 or L118. (Handed — D, F, V, L114)
- List price includes the default cylinder.

- Locks
- Cylinders, Keys & Keying
- Exit Devices
- Electronic Access Control Components
- Low Energy Operators
- Surface Closers
- Fire/Life Safety
- Concealed Closers/Pivots
- Stops/ Holders
- Sliding Systems
- Architectural Pulls & Handles
- Service Parts

9000 SERIES NARROW STILE PULL TRIM

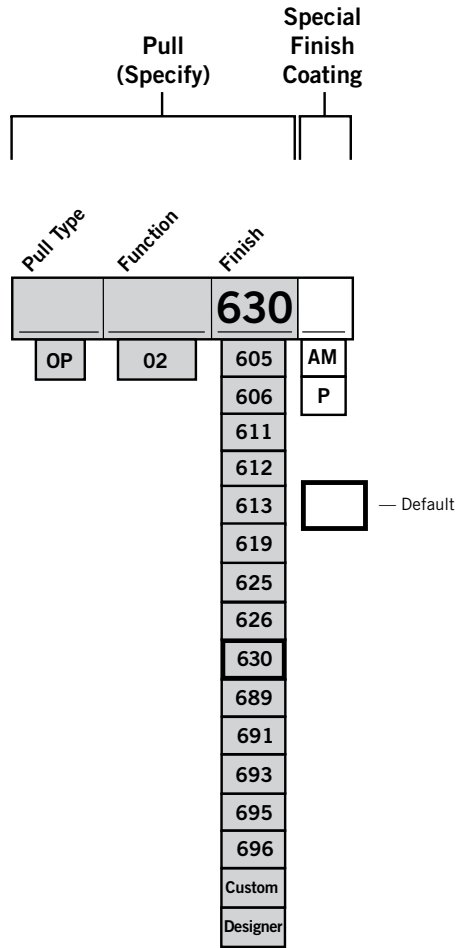

Concealed Vertical Rod	Rim	Surface Vertical Rod	Available Finishes \$			
9600 F9600	9700 F9700	9800 F9800	689, 691, 693, 695, 696	606, 612	630	605, 611, 613, 619, 625, 626

ANSI Function	Description					
02	Entrance by trim when touchbar is dogged.	OP02	95	131	119	142

NOTE: List price includes the default cylinder.

TRIM OPTIONS

Option Code	Description	List Add \$
Special Finishes and Coatings		
AM	Antimicrobial protected coating	71
P	Clear powder coat	71
Custom Color	Custom painted finish selected from DORMA RAL color pallet book. For details, see DORMA Finishes Cross Reference , page vii.	
	Per order, setup charge (Net)	110
	per exit device only, list add	55
	per trim only, list add	55
Designer Color	Designer painted color matched to supplied samples. Three (3) each 2" x 3" color chip samples required. For details, see DORMA Finishes Cross Reference , page vii.	
	per order, non-refundable development/setup charge (Net)	400
	per exit device only, list add	55
	per trim only, list add	55
Tempered Glass Door Applications		
TGD	Tempered glass doors (Z series trim only), available in 630 finish only	37
Door Thickness (includes extended spindle and fasteners)		
Ext3	Door thickness from 2-1/4"-3-1/4" (57 mm to 83 mm)	74
Ext4	Door thickness from 3-1/4"-4-1/4" (83 mm to 108 mm)	74

CYLINDERS

Rim Cylinders

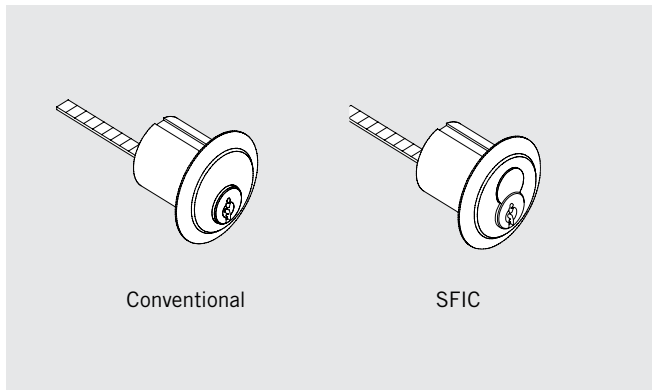

Mortise Cylinders

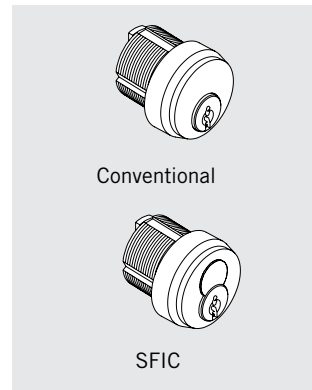

Key-in-Lever Cylinders

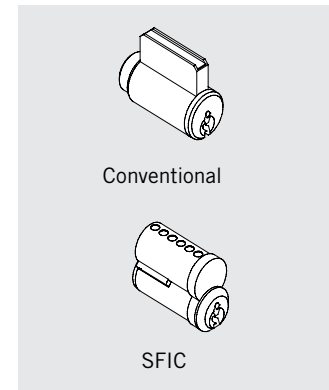





Narrow Stile

Application	ANSI Function	Cylinder Type	Conventional (Default)	Cam	SFIC 7-Pin
Cylinders for 9600/F9600 Concealed Vertical Rod, 9700/F9700 Rim, and 9800/F9800 Surface Vertical Rod Narrow Stile Devices					
Z Escutcheon Trim	03, 04	Rim	80R20SC	NA	87R20BA
Z Escutcheon Trim	08, 11	Mortise	90x13SC118	#13	97C13BA138
Z Escutcheon Trim	09, 12	Mortise	90x09SC118	#9	97C09BA138
Cylinders for Device Options					
CD, BPA, BPAR, DE, DE30, DECBC, DWA, LMMSBP	—	Mortise	90x10SC118	#10	97D10BA138

NOTE: For additional information, please refer to Cylinders, Keys, and Keying.

CYLINDER TYPES, KEYING OPTIONS & KEYWAYS FOR REMOVABLE MULLIONS & EXIT DEVICES

Cylinder	Option	Description	List Add/Deduct \$
Conventional Cylinders (non-interchangeable core)			
D		Keying for exit device or removable mullions with conventional cylinder (default)	N/C
	KD	Keyed differently to a random combination; SC keyway with 2 keys (default)	N/C
	KA2	Keyed alike in pairs to a random combination; SC keyway with 2 keys	N/C
	KA4	Keyed alike in sets of 4 to a random combination; SC keyway with 2 keys	N/C
	O-Bit	Operated by a key blank for easy rekeying; SC, SE keyway with 2 key	N/C
	O-Bit	Operated by a key blank for easy rekeying; D100 keyway —  Keys sold separately	N/C
	O-Bit	Operated by a key blank for easy rekeying; CA, CD, CE, RA, RB, GA, SF, WA, YA, YG keyways with 2 keys	12
	NSK	Non-stock keyed — KA quantities other than KA2/KA4; SC keyway with 2 keys	12
	MKD	Master keyed or SKD, SC, SE, or D100 keyway —  Keys sold separately	12
	CMK	Construction master keyed single cylinder locks —  Keys sold separately	13
L		Keying for exit device or removable mullions less conventional cylinder	Deduct 30
Small Format Interchangeable Core Cylinders			
J		Keying for exit device or removable mullions with disposable plastic SFIC construction core	N/C
T		Keying for exit device or removable mullions with keyed temporary SFIC construction core Keying for exit trim with keyed temporary SFIC construction core (cores may be returned for a full refund) —  Keys sold separately	40
C		Keying for exit device or removable mullions with combined SFIC core installed at factory ¹ Keying for exit trim with combined core installed at factory; BA (default), BB, BC, BD, BE, BF, BG, BH, BJ, BK, BL, BM, BQ, D100 keyway —  Keys sold separately	45
Cylinder Housings Less Cores			
EP		Euro profile half cylinder housing	N/C
R		Housing prepared for Schlage FSIC	8
X7		Housing prepared for Sargent XC 7P & Arrow Choice 7P SFIC	8
X6		Housing prepared for Arrow Choice 6P SFIC	8

1. For uncombined cores, **UNC** cores must be ordered separately, see **Cylinders, Keys, and Keying**. Exits/trim will be supplied w/ plastic construction core, Option J.

 Denotes keys must be ordered separately.

Cut Keys Ordered Separately

Part #	Description	List \$
45101	Change key, master key, construction master key, or control key; BA, BB, BC, BD, BE, BF BG, BH, BJ, BK, BL, BM, BQ, SC, SE section	6
45401	Change key, master key, or control key; D100 section	10

NOTES:

- D100 keyway is restricted. See TERMS OF SALE section for DORMA SKC policies.
- For additional information, please refer to Cylinders, Keys, and Keying

MULLIONS

Item	Description	List \$
Aluminum Mullions × 628 (clear anodized), 1-5/8" × 2-5/8"		
1310-8	8'	856
1310-8 × 443	8', recessed strike	996
WS1310-8	8', weatherstrip	910
WS1310-8 × 443	8', weatherstrip and recessed strike	1006
1310-10	10'	910
1310-10 × 443	10', recessed strike	1092
WS1310-10	10', weatherstrip	996
WS1310-10 × 443	10', weatherstrip and recessed strike	1156
Aluminum Mullions × 695 (painted), 1-5/8" × 2-5/8"		
1310-8	8'	1038
1310-8 × 443	8', recessed strike	1177
WS1310-8	8', weatherstrip	1092
WS1310-8 × 443	8', weatherstrip and recessed strike	1243
1310-10	10'	1124
1310-10 × 443	10', recessed strike	1274
WS1310-10	10', weatherstrip	1199
WS1310-10 × 443	10', weatherstrip and recessed strike	1210
Steel Mullions × 600 (primed for paint), 1-1/2" × 2-1/2"		
1330-8	8'	428
1330-10	10'	450
Steel Mullions × 600 (primed for paint), 2" × 3"		
1300-8	8'	557
F1300-8	8', fire-rated	717
1340KR-8	8', key removable (includes standard cylinder using 01 cam)	942
F1340KR-8	8', fire-rated mullion, key removable (includes standard cylinder using 01 cam)	1103
1300-10	10'	642
1340KR-EL	8', key removable, electrified mullion	1092
1340KR-10	10', key removable (includes standard cylinder using 01 cam)	996
HC1300-8	8', design pressure rated 80PSF for openings up to 8' × 8' with HC9300 device.	1038
Mullion Storage Kit		
1340SK	Storage kit for 1340/F1340 Series key removable mullion.	279

Cylinders for 1340KR/F1340KR Mullions and 1340SK Storage Kit

Type	Standard	7-pin IC	Cam
Mortise	90X01SC118	97D01BA138	01 (AR)



DORMA 8000 SERIES EXIT DEVICES

How to Order

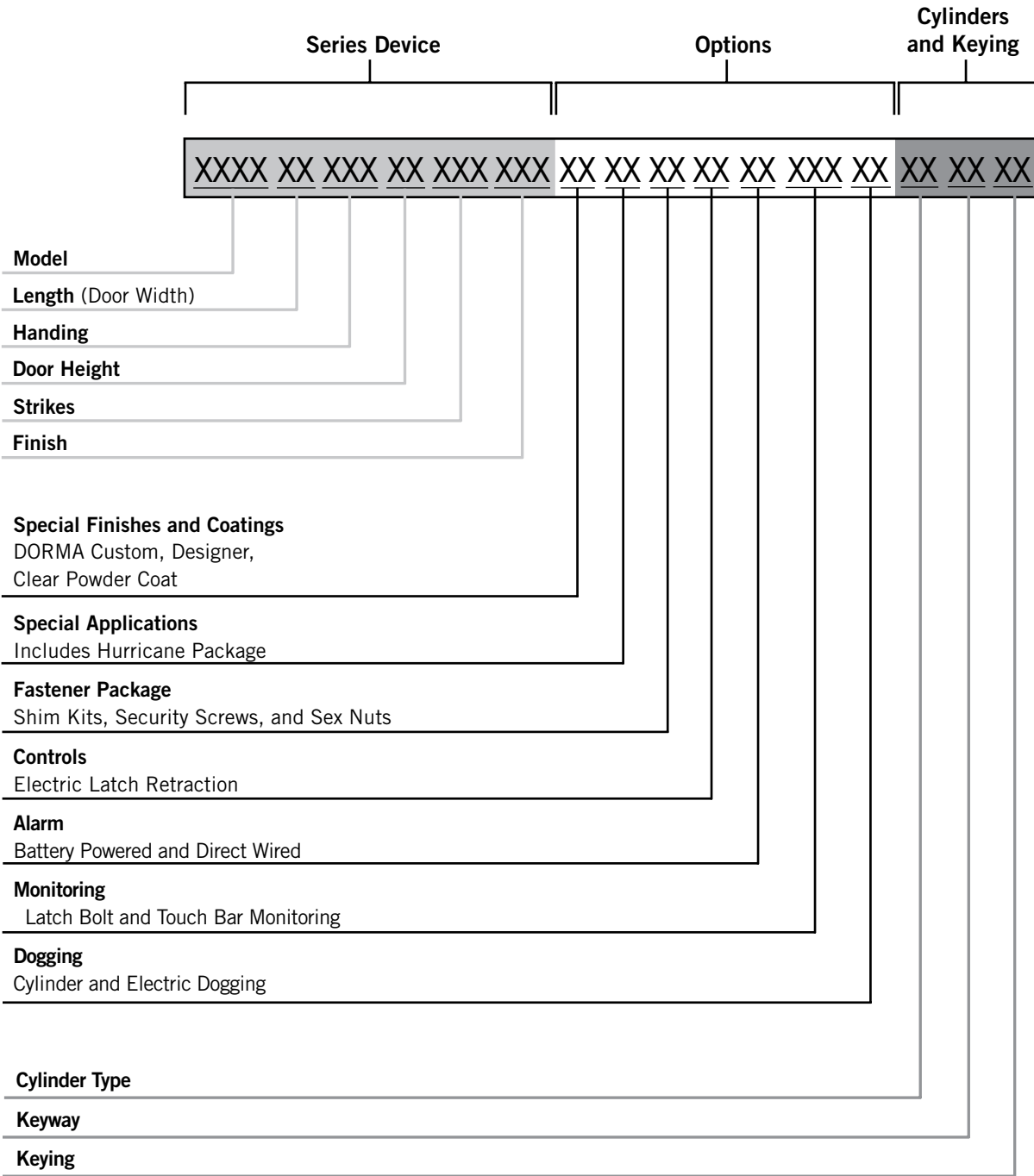

- Locks
- Cylinders, Keys & Keying
- Exit Devices**
- Electronic Access Control Components
- Low Energy Operators
- Surface Closers
- Fire/Life Safety
- Concealed Closers/Pivots
- Stops/ Holders
- Sliding Systems
- Architectural Pulls & Handles
- Service Parts

8300 SERIES

Rim Exit Device

8300 Series Device				Options (Specify)							Cylinders and Keying		
Device	Length	Strike	Finish	Special Finish Coating	Special Application Package	Fastener Package	Control	Alarm	Monitoring	Dogging	Cylinder Type	Keyway	Keying
8300	B	463	689								DSC	KD	
F8300	A	320	689	P	HC	SK	ES	BPA	LM	CD	C	CA	KD
8300	B	430	689			SNB		BPAR	MS	LD	D	CD	KA2
	C	463	630TB			TX		DWA	LMMS		J	CE	KA4
	SPCL	486	691			SKTX					L	D100	NSK
			693			SKSNB					T	GA	MKD
			695			TXSNB					R	RA	CMK
			696			SKTXSNB					X6	RB	SKD
			Custom								X7	SC	OBit
			Designer									SE	
												SF	
												WA	
												YA	
												YG	

***Patented Key Control**
D100 is the keyway for DORMA's patented **SKC** serialized key control system. **SKC** is internet based and provides added layers of security. For more information, contact your local DORMA sales representative or DORMA Technical Service at 800-523-8483.

— Default

— Supplied with Standard KD Cylinder

8000 Series – Wide Stile Applications

Device Length	All Device Options (except BPA, DWA, or DE)		BPA or DWA Device Options
	Maximum Door Width ¹	Minimum Door Width ²	Minimum Door Width ²
A	48" (1220 mm)	34" (864 mm)	39" (991 mm)
B	36" (915 mm)	28" (712 mm)	33" (839 mm)
C	36" (915 mm)	22" (559 mm)	22" (559 mm)

- As delivered from factory, device will fit doors of this width. For other widths, consult DORMA Technical Services.
- Touch bar and rail assembly can be shortened at time of installation to fit doors down to this width.



Function	Description	Device, Exit Only	Available Finishes \$	
			689, 691, 693, 695, 696	689 w/ 630 TB
01	Panic	8300 Rim	441	666
01	Fire	F8300 Rim	604	830

Typical Options

Item	Description	List Add \$
CD	Cylinder dogging (includes cylinder)	80
LD	Less dogging (Standard with fire rated device)	N/C
SNB	Sex nuts (Included with F and H options)	14
TX	Security screws	30
HC	Hurricane (includes SNB)	150

NOTES:

- Prices shown apply to A, B, or C length devices.
- Specify door width. If not specified, Size B is the standard default.
- List price includes default strikes. For optional strikes, specify strike number and adjust list price accordingly.
- List price for the device does not include trim.
- Devices include wood and machine screws standard.
- Fire and hurricane rated devices include SNB sex nuts standard.
- For options requiring a cylinder, the option list price includes the default cylinder.
- For special lengths, consult DORMA Technical Service.
- All standard devices and trim are designed for 1-3/4"-2-1/4" thick doors. For door thickness greater than 2-1/4", consult DORMA Technical Service.

- Locks
- Cylinders, Keys & Keying
- Exit Devices
- Electronic Access Control Components
- Low Energy Operators
- Surface Closers
- Fire/Life Safety
- Concealed Closers/Pivots
- Stops/ Holders
- Sliding Systems
- Architectural Pulls & Handles
- Service Parts



8400 SERIES

Surface Vertical Rod Exit Device

8400 Series Device							Options (Specify)							Cylinders and Keying			
Device	Length	Handing	Door Height	Top Strike	Bottom Strike	Finish	Special Finish Coating	Bottom Latch	Special Application Package	Fastener Package	Control	Alarm	Monitoring	Dogging	Cylinder Type	Keyway	Keying
8400	B	RHR	7	426	439	689									D	SC	KD
F8400	A	RHR	7	426	340	689	P	LB	HC	SK	ES	BPA	LM	CD	C	CA	KD
8400	B	LHR	8	426A	416V	689 630TB		PB		SNB		BPAR	MS	LD	D	CD	KA2
	C		9		431	691		SB		TX		DWA	LMMS		J	CE	KA4
	SPCL		10		439	693				SKTX					L	D100	NSK
			SPCH			695				SKSNB					T	GA	MKD
						696				TXSNB					R	RA	CMK
						Custom				SKTXSNB					X6	RB	SKD
						Designer									X7	SC	OBit
																SE	
																SF	
																WA	
																YA	
																YG	

— Default
 — Supplied with Standard KD Cylinder

***Patented Key Control**
D100 is the keyway for DORMA's patented **SKC** serialized key control system. **SKC** is internet based and provides added layers of security. For more information, contact your local DORMA sales representative or DORMA Technical Service at 800-523-8483.

8000 Series – Wide Stile Applications

Device Length	All Device Options (except BPA, DWA, or DE)		BPA or DWA Device Options
	Maximum Door Width ¹	Minimum Door Width ²	Minimum Door Width ²
A	48" (1220 mm)	34" (864 mm)	39" (991 mm)
B	36" (915 mm)	28" (712 mm)	33" (839 mm)
C	36" (915 mm)	22" (559 mm)	22" (559 mm)

- As delivered from factory, device will fit doors of this width. For other widths, consult DORMA Technical Services.
- Touch bar and rail assembly can be shortened at time of installation to fit doors down to this width.

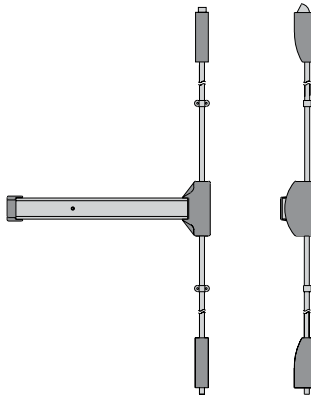

Available Finishes \$

689, 691, 693, 695, 696	689 w/ 630 TB
----------------------------	---------------

Function	Description	Device, Exit Only	689, 691, 693, 695, 696	689 w/ 630 TB
01	Panic	8400 Surface vertical rod	730	965
01	Fire	F8400 Surface vertical rod	929	1,162

Typical Options

Item	Description	List Add \$
CD	Cylinder dogging (Includes cylinder)	80
LD	Less dogging (Standard with fire rated device)	N/C
SNB	Sex nuts (Included with F and HC options)	14
TX	Security screws	30
HC	Hurricane (Includes SNB)	150
LB	Less bottom rod	N/C
PB	Pullman bottom latch	48
SB	Slide bolt (Default)	N/C
Up to 8'	7' default	N/C
Up to 10'	Door heights over 8' to 10'	47

NOTES:

- Prices shown apply to A, B, or C length devices.
- Specify door width and handing. If not specified, Size B, RHR is the standard default.
- List price includes default strikes. For optional strikes, specify strike number and adjust list price accordingly.
- List price for the device does not include trim.
- Devices include wood and machine screws standard.
- Fire and hurricane rated devices include SNB sex nuts standard.
- For options requiring a cylinder, the option list price includes the default cylinder.
- Device includes precut and drilled rods for 7' or 8' doors as specified on order.
 - For 9' doors, device includes precut and drilled rods for a 7' door and a 2' rod extension for the top rod.
 - For 10' doors, device includes precut and drilled rods for an 8' door and a 2' rod extension for the top rod.
 See Device Options for pricing information.
- For special lengths and/or door heights over 10', consult DORMA Technical Service.
- All standard devices and trim are designed for 1-3/4"-2-1/4" thick doors. For door thickness greater than 2-1/4", consult DORMA Technical Service.

- Locks
- Cylinders, Keys & Keying
- Exit Devices
- Electronic Access Control Components
- Low Energy Operators
- Surface Closers
- Fire/Life Safety
- Concealed Closers/Pivots
- Stops/ Holders
- Sliding Systems
- Architectural Pulls & Handles
- Service Parts

OPTIONS

Option Code	Description	List Add \$
Strikes		
8400 Concealed and Surface Vertical Rods		
340	Flat slide bolt bottom strike	N/C
416V	Surface bottom strike for pullman latch	N/C
426	Standard top strike	N/C
426A	Top strike w/angle	25
431	Recessed bottom strike for pullman latch	25
439	Standard slide bolt bottom strike	N/C
8300 Rim		
320	Overlap strike	25
430	Rim box strike	39
463	Standard rim strike	N/C
486	Roller strike	14
Special Finishes and Coatings		
P	Clear powder coat	71
Custom Color	Custom painted finish selected from DORMA RAL color pallet book. For details, see DORMA Finishes Cross Reference , page vii.	
	Per order, setup charge (Net)	110
	per exit device only, list add	55
	per trim only, list add	55
Designer Color	Designer painted color matched to supplied samples. Three (3) each 2" x 3" color chip samples required. For details, see DORMA Finishes Cross Reference , page vii.	
	per order, non-refundable development/setup charge (Net)	400
	per exit device only, list add	55
	per trim only, list add	55
Bottom Latches for 8400 Surface Vertical Rods		
LB	Less bottom rod	N/C
PB	Pullman bottom latch	48
SB	Slide bolt (Default)	N/C
Door Height Designation		
8400 Surface Vertical Rods		
7 or 8	Door heights from 7' to 8'	N/C
9 or 10	Door heights over 8', up to 10' (689, 691, 693, 695, 696 finishes)	47
Over 10'	Consult DORMA Technical Service	
Special Application Packages		
HC	Hurricane	150
Fastener Package		
SK	Shim kit	79
SNB	Sex nuts	14
TX	Security screws	30
SKTX	Shim kit and security screws	126
SKSNB	Shim kit and sex nuts	93
TXSNB	Security screws and sex nuts	61
SKTXSNB	Shim kit, security screws, and sex nuts	140
Controls		
ES	Electric latch retraction (requires ES100 power supply and ES105 power transfer)	794



Alarm		
BPA*	Battery powered alarm	550
BPAR*	Battery powered alarm, 4 minute reset	587
DWA*	Direct wired alarm	550
Monitoring		
LM	Latch bolt monitoring	216
MS	Monitor switch in touchbar	216
LMMS	Latch bolt and touchbar monitor	432
Dogging		
CD*	Cylinder dogging (panic devices only) kit	80
LD	Less dogging (panic devices only)	N/C
Power Supplies, Power Transfers, Power Modules		
ES101	Delay module	118
ES103	Relay module	74
ES100	Power supply for DE devices and LFSC/LFSF trims. Powers up to 1 device or 2 trims.	545
ES105	Power transfer for DE or ES devices	181

- Locks
- Cylinders, Keys & Keying
- Exit Devices
- Electronic Access Control Components
- Low Energy Operators
- Surface Closers
- Fire/Life Safety
- Concealed Closers/Pivots
- Stops/ Holders
- Sliding Systems
- Architectural Pulls & Handles
- Service Parts

DORMA 8000 SERIES EXIT TRIM

How to Order

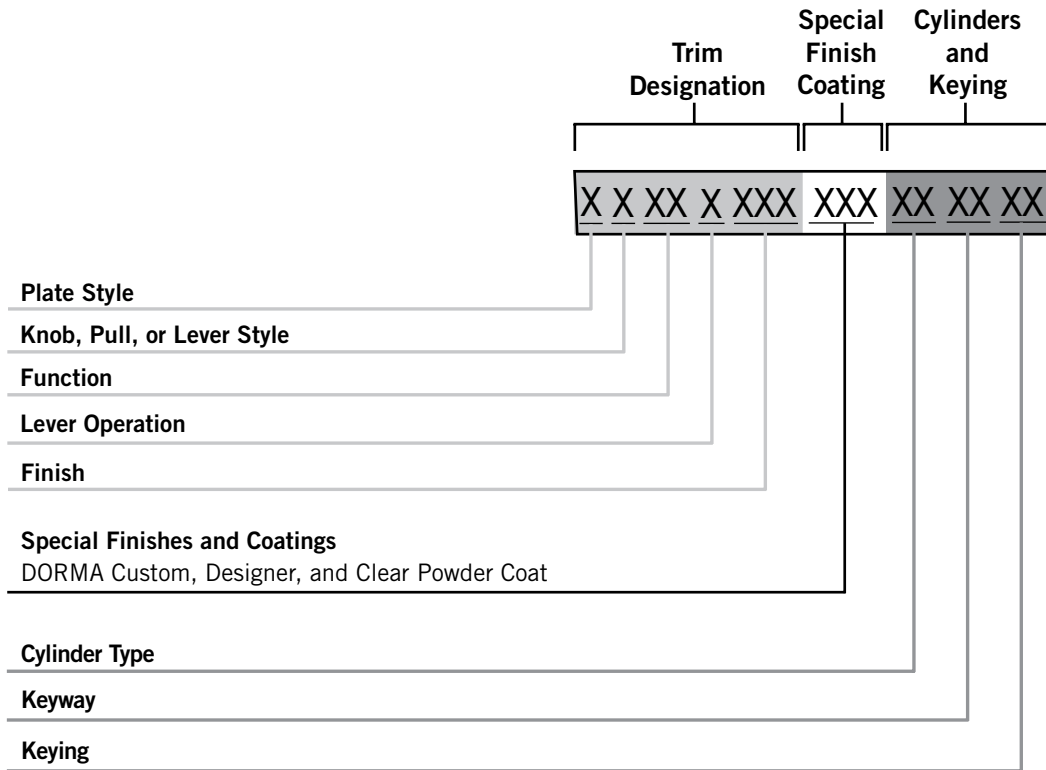

LEVER & KNOB STYLES

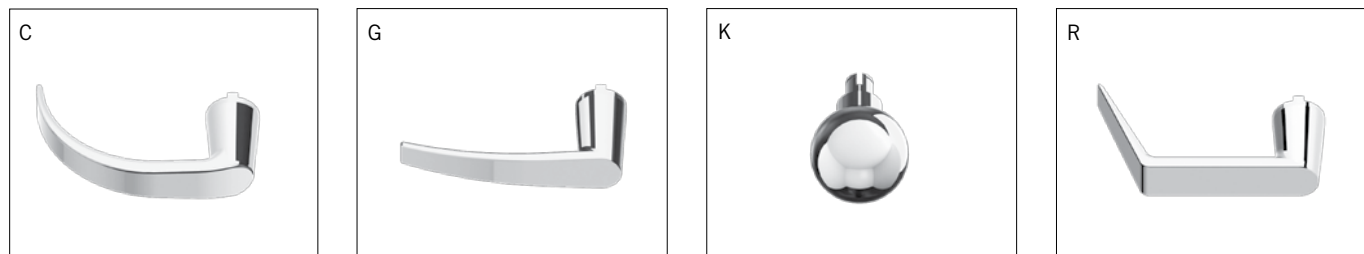

ANSI Function	Description	Sectional 3-3/8" Diameter Rose	Wide Plate 3" W x 16" H	Pulls
DT	Dummy trim			
02	Entrance by trim when touchbar is dogged			
03	Entrance by trim when latch bolt is retracted by key. Key removable only when trim is locked.			
04	Entrance by trim when latch bolt is retracted by key or set in a retracted position by key.			
05	Entrance by thumbpiece. Key locks or unlocks thumbpiece.			
06	Entrance by thumbpiece only when released by key. Key removable only when locked.			
08	Entrance by lever or knob. Key locks or unlocks lever or knob.			
22	Entrance by thumbpiece (no cylinder). Thumbpiece always active.			
23	Entrance by lever or knob (no cylinder). Lever or knob always active.			

- Locks
- Cylinders, Keys & Keying
- Exit Devices
- Electronic Access Control Components
- Low Energy Operators
- Surface Closers
- Fire/Life Safety
- Concealed Closers/Pivots
- Stops/ Holders
- Sliding Systems
- Architectural Pulls & Handles
- Service Parts

8000 SERIES SECTIONAL TRIM

Sectional Trim (Specify)		Special Finish Coating	Cylinders and Keying
Knob or Lever	Function	Finish	Cylinder Type Keyway Keying
		689	DSC KD
8C	02	626	P C CA KD
8G	03	689	D CD KA2
8K	04	691	J CE KA4
8R	08	693	L D100 NSK
	23	695	T GA MKD
		696	RA CMK
		Custom	RB SKD
		Designer	SC OBit
			SE
			SF
			WA
			YA
			YG

— Default



***Patented Key Control**
D100 is the keyway for DORMA's patented **SKC** serialized key control system. **SKC** is internet based and provides added layers of security. For more information, contact your local DORMA sales representative or DORMA Technical Service at 800-523-8483.



		Rim	Surface Vertical Rod	Available Finishes \$	
		8300 F8300	8400 F8400	689, 691, 693 695, 696	626
ANSI Function	Description				
02	Entrance by trim when touchbar is dogged.	8C02R 8G02R 8K02R 8R02R		251	286
03	Entrance by trim when latch bolt is retracted by key. Key removable only when trim is locked.	8C03 8G03 8K03 8R03		308	345
04	Entrance by trim when latch bolt is retracted by key or set in a retracted position by key.	8C03 8G03 8K03 8R03		308	345
08	Entrance by lever or knob. Key locks or unlocks lever or knob.	8C08 8G08 8K08 8R08		308	345
23	Entrance by lever or knob (no cylinder). Lever or knob always active.	8C23 8G23 8K23 8R23		251	286

NOTE: List price includes the default cylinder.

- Locks
- Cylinders, Keys & Keying
- Exit Devices
- Electronic Access Control Components
- Low Energy Operators
- Surface Closers
- Fire/Life Safety
- Concealed Closers/Pivots
- Stops/ Holders
- Sliding Systems
- Architectural Pulls & Handles
- Service Parts

8000 SERIES WIDE PLATE TRIM

Wide Plate Trim (Specify)		Special Finish Coating	Cylinders and Keying
Plate Type	Function	Finish	Cylinder Type Keyway Keying
		630	D S C K D
HRS	DT	630	P C CA KD
HTS	02	689	D CD KA2
NPS	03	691	J CE KA4
PRS	04	693	L D100 NSK
PTS	05	695	T GA MKD
80	06	696	R RA CMK
	08	Custom	X6 RB SKD
	22	Designer	X7 SC OBit
			SE
			SF
			WA
			YA
			YG

— Default



***Patented Key Control**
D100 is the keyway for DORMA's patented **SKC** serialized key control system. **SKC** is internet based and provides added layers of security. For more information, contact your local DORMA sales representative or DORMA Technical Service at 800-523-8483.



		Rim	Surface Vertical Rod	Available Finishes \$	
		8300 F8300	8400 F8400	689, 691, 693 695, 696	630
ANSI Function	Description				
DT	Dummy Trim	NPSDT		106	149
		80DT		65	—
02	Entrance by trim when touchbar is dogged.	PRS02 PTS02		149	186
03	Entrance by trim when latch bolt is retracted by key. Key removable only when trim is locked.	NPS03		149	200
		PRS03 PTS03		186	239
04	Entrance by trim when latch bolt is retracted by key or set in a retracted position by key.	NPS03		149	200
		PRS03 PTS03		186	239
05	Entrance by thumbpiece. Key locks or unlocks thumbpiece.	HRS05 HTS05		212	279
06	Entrance by thumbpiece only when released by key. Key removable only when locked.	HRS06 HTS06		212	279
22	Entrance by thumbpiece (no cylinder). Thumbpiece always active.	HRS22 HTS22		174	212

NOTE: List price includes the default cylinder.

- Locks
- Cylinders, Keys & Keying
- Exit Devices**
- Electronic Access Control Components
- Low Energy Operators
- Surface Closers
- Fire/Life Safety
- Concealed Closers/Pivots
- Stops/ Holders
- Sliding Systems
- Architectural Pulls & Handles
- Service Parts

8000 SERIES PULL TRIM

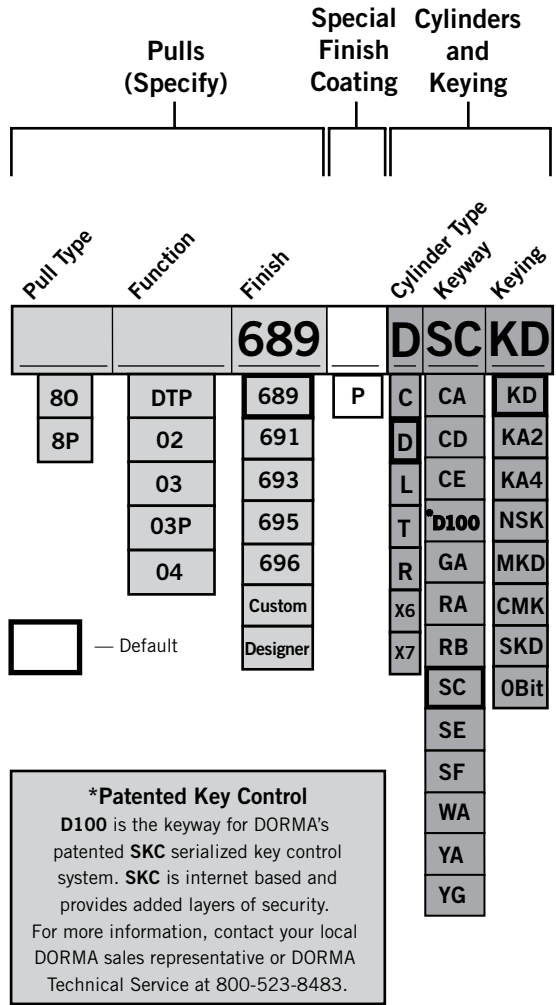

Rim	Surface Vertical Rod	Available Finishes \$
8300 F8300	8400 F8400	689, 691, 693 695, 696

ANSI Function	Description		
02	Entrance by trim when touchbar is dogged.	8P02	212
		80DTP	147
		8PDT	80
03	Entrance by trim when latch bolt is retracted by key. Key removable only when trim is locked.	8003P	200
		8003	106
		8P03	133
04	Entrance by trim when latch bolt is retracted by key or set in a retracted position by a key.	8003P	200
		8003	106
		8P03	133

NOTE: List price includes the default cylinder.

TRIM OPTIONS

Option Code	Description	List Add \$
Special Finishes and Coatings		
P	Clear powder coat	71
Custom Color	Custom painted finish selected from DORMA RAL color pallet book. For details, see DORMA Finishes Cross Reference , page vii.	
	Per order, setup charge (Net)	110
	per exit device only, list add	55
	per trim only, list add	55
Designer Color	Designer painted color matched to supplied samples. Three (3) each 2" x 3" color chip samples required. For details, see DORMA Finishes Cross Reference , page vii.	
	per order, non-refundable development/setup charge (Net)	400
	per exit device only, list add	55
	per trim only, list add	55

CYLINDERS

Rim Cylinders

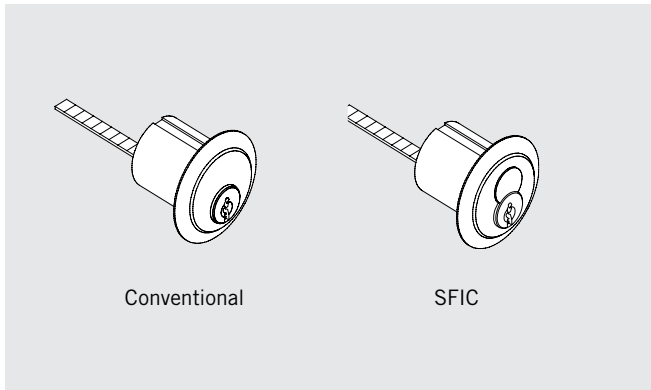

Mortise Cylinders

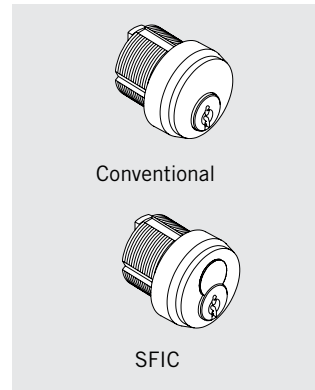

Key-in-Lever Cylinders

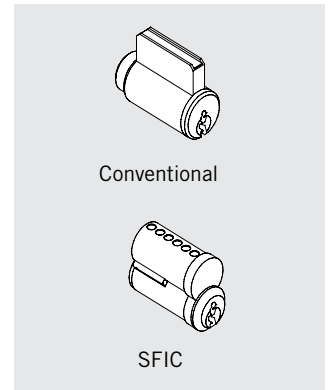





Application	ANSI Function	Cylinder Type	Conventional (Default)	SFIC 7-Pin
Trim				
Sectional Trim (Key-in-Lever)	03, 04, 08	Key-in-lever	70135C	77
3" Wide Plate Trim	03, 04	Rim	80R20SC	87A20
3" Wide Plate Trim	05, 06	Mortise	90X10SC118	97C10138
Pulls	03, 04	Rim	80R20SC	87A20
Device Options				
CD, BPA, BPAR,		Mortise	90X10SC118	97D10138

NOTE: For additional information, please refer to Cylinders, Keys, and Keying.

- Locks
- Cylinders, Keys & Keying
- Exit Devices
- Electronic Access Control Components
- Low Energy Operators
- Surface Closers
- Fire/Life Safety
- Concealed Closers/Pivots
- Stops/ Holders
- Sliding Systems
- Architectural Pulls & Handles
- Service Parts

CYLINDER TYPES, KEYING OPTIONS & KEYWAYS FOR REMOVABLE MULLIONS & EXIT DEVICES

Cylinder	Option	Description	List Add/Deduct \$
Conventional Cylinders (non-interchangeable core)			
D		Keying for exit device or removable mullions with conventional cylinder (default)	N/C
	KD	Keyed differently to a random combination; SC keyway with 2 keys (default)	N/C
	KA2	Keyed alike in pairs to a random combination; SC keyway with 2 keys	N/C
	KA4	Keyed alike in sets of 4 to a random combination; SC keyway with 2 keys	N/C
	O-Bit	Operated by a key blank for easy rekeying; SC, SE keyway with 2 key	N/C
	O-Bit	Operated by a key blank for easy rekeying; D100 keyway —  Keys sold separately	N/C
	O-Bit	Operated by a key blank for easy rekeying; CA, CD, CE, RA, RB, GA, SF, WA, YA, YG keyways with 2 keys	12
	NSK	Non-stock keyed — KA quantities other than KA2/KA4; SC keyway with 2 keys	12
	MKD	Master keyed or SKD, SC, SE, or D100 keyway —  Keys sold separately	12
	CMK	Construction master keyed single cylinder locks —  Keys sold separately	13
L		Keying for exit device or removable mullions less conventional cylinder	Deduct 30
Small Format Interchangeable Core Cylinders			
J		Keying for exit device or removable mullions with disposable plastic SFIC construction core	N/C
T		Keying for exit device or removable mullions with keyed temporary SFIC construction core Keying for exit trim with keyed temporary SFIC construction core (cores may be returned for a full refund) —  Keys sold separately	40
C		Keying for exit device or removable mullions with combined SFIC core installed at factory ¹ Keying for exit trim with combined core installed at factory; BA (default), BB, BC, BD, BE, BF, BG, BH, BJ, BK, BL, BM, BQ, D100 keyway —  Keys sold separately	45
Cylinder Housings Less Cores			
R		Housing prepared for Schlage FSIC	8
X7		Housing prepared for Sargent XC 7P & Arrow Choice 7P SFIC	8
X6		Housing prepared for Arrow Choice 6P SFIC	8

1. For uncombined cores, **UNC** cores must be ordered separately, see **Cylinders, Keys, and Keying**. Exits/trim will be supplied w/ plastic construction core, Option J.

 Denotes keys must be ordered separately.

Cut Keys Ordered Separately

Part #	Description	List \$
45101	Change key, master key, construction master key, or control key; BA, BB, BC, BD, BE, BF BG, BH, BJ, BK, BL, BM, BQ, SC, SE section	6
45401	Change key, master key, or control key; D100 section	10

NOTES:

- D100 keyway is restricted. See TERMS OF SALE section for DORMA SKC policies.
- For additional information, please refer to Cylinders, Keys, and Keying

MULLIONS

Item	Description	List \$
Aluminum Mullions × 628 (clear anodized), 1-5/8" × 2-5/8"		
1310-8	8'	856
1310-8 × 443	8', recessed strike	996
WS1310-8	8', weatherstrip	910
WS1310-8 × 443	8', weatherstrip and recessed strike	1006
1310-10	10'	910
1310-10 × 443	10', recessed strike	1092
WS1310-10	10', weatherstrip	996
WS1310-10 × 443	10', weatherstrip and recessed strike	1156
Aluminum Mullions × 695 (painted), 1-5/8" × 2-5/8"		
1310-8	8'	1038
1310-8 × 443	8', recessed strike	1177
WS1310-8	8', weatherstrip	1092
WS1310-8 × 443	8', weatherstrip and recessed strike	1243
1310-10	10'	1124
1310-10 × 443	10', recessed strike	1274
WS1310-10	10', weatherstrip	1199
WS1310-10 × 443	10', weatherstrip and recessed strike	1210
Steel Mullions × 600 (primed for paint), 1-1/2" × 2-1/2"		
1330-8	8'	428
1330-10	10'	450
Steel Mullions × 600 (primed for paint), 2" × 3"		
1300-8	8'	557
F1300-8	8', fire-rated	717
1340KR-8	8', key removable (includes standard cylinder using O1 cam)	942
F1340KR-8	8', fire-rated mullion, key removable (includes standard cylinder using O1 cam)	1103
1300-10	10'	642
1340KR-EL	8', key removable, electrified mullion	1092
1340KR-10	10', key removable (includes standard cylinder using O1 cam)	996
HC1300-8	8', design pressure rated 80PSF for openings up to 8' × 8' with HC9300 device.	1038
Mullion Storage Kit		
1340SK	Storage kit for 1340/F1340 Series key removable mullion.	279

Cylinders for 1340KR/F1340KR Mullions and 1340SK Storage Kit

Type	Standard	7-pin IC	Cam
Mortise	90X01SC118	97D01BA138	O1 (AR)



Locks

Cylinders,
Keys & Keying

Exit Devices

Electronic
Access Control
Components

Low Energy
Operators

Surface
Closers

Fire/Life
Safety

Concealed
Closers/Pivots

Stops/
Holders

Sliding
Systems

Architectural
Pulls &
Handles

Service Parts



SELECT SERVICE QUICK SHIP

Electronic Access Control Components

Select service should be used for small quantities of popular DORMA products that require shipment within 24 hours. The program includes locks, exit devices, door closers, magnets, electronic access control, and low energy operators. Warehouses have been set up in the east and west for faster delivery nationwide. (Customer responsible for shipping costs FOB.)

Subject to Availability

Next Business Day Service (Shipment when Purchase Order is received prior to 4:00 PM EST).

Examples: DORMA receives P.O. at 3:59 PM on Monday, order will ship by close of business on Tuesday.

DORMA receives P.O. at 3:59 PM on Friday, order will ship by close of business on the following Monday.

Notes:

- Standard freight and discount schedules and terms of sale apply. Please refer to the current price list for full details.
- DORMA reserves the right to limit quantities or decline an order if the credit status of the buyer is not satisfactory to DORMA.
- Orders cannot be cancelled.
- Select Service Quick Ship available only in the United States.
- All prices are in U.S. dollars.
- Products and prices are subject to change without notice.
- Some of the available products have quantity per order limits and will be noted accordingly.

Key



N	"New" to Select Service, Available in East and West Coast Warehouse
■	Available in East and West Coast Warehouse
E	Available only in East Coast Warehouse





- Locks
- Cylinders, Keys & Keying
- Exit Devices
- Electronic Access Control Components**
- Low Energy Operators
- Surface Closers
- Fire/Life Safety
- Concealed Closers/Pivots
- Stops/ Holders
- Sliding Systems
- Architectural Pulls & Handles
- Service Parts

Electronic Access Control Magnetic Locks



1,500 lb Magnetic Locks

PN #	Product	Description	Finish	List \$
33400014	 EML310 BA DP 628	Magnetic lock, single door, 1500 lb holding	628	570
33400015	 EML310 BA DP 630	Magnetic lock, single door, 1500 lb holding	693	651

Electric Strikes

PN #	Product	Description	Dual Voltage	Finish	List \$
33400016	 ES62F FSV 630	Electric strike, fire rated, surface rim	12 or 24 VDC	630	525
33400017	 ES96F FSV 630	Electric strike, fire rated, modular mortise/cylindrical	12 or 24 VDC	630	495
33400025	 ES0563 630	Electric strike, 1/2" surface rim	12 or 24 VDC	630	475

Power Supplies & Accessories

PN #	Product	Description	Dual Voltage	List \$
33400018	 PS610RF	1.0 A @ 24 VDC filter/reg, class 2 selectable output, fire panel interface standard	12 or 24 VDC	395
33400019	 PS532RF CR	2.0 A @ 24 VDC filter/reg, class 2 selectable output, CR fire panel interface standard	12 or 24 VDC	638





Keypads

PN #	Product	Description	Finish	List \$
33400020	AC225 630	12 button, 480 user exterior keypad, (flat black w/630 face plate)	711/630	776
33400021	AC228 701	12 button, 480 user interior keypad, (satin chrome faceplate)	701	342

Key Switches, Push Buttons

PN #	Product	Description	Finish	List \$
33400022	KS801 D 628	Key switch, single gang, maintained, SPDT, standard cylinder – KD, satin aluminum	628	145
33400023	KS802 D 628	Key switch, single gang, momentary, SPDT, standard cylinder – less core, satin aluminum	628	145

Key Switches, Push Buttons and Controls Consoles

PN #	Product	Description	Finish	List \$
33400026	PB73 1 MO 630	Push button, single gang, 2" square illuminated exit, momentary, satin stainless	630	82



- Locks
- Cylinders, Keys & Keying
- Exit Devices
- Electronic Access Control Components
- Low Energy Operators
- Surface Closers
- Fire/Life Safety
- Concealed Closers/Pivots
- Stops/ Holders
- Sliding Systems
- Architectural Pulls & Handles
- Service Parts

DORMA/KABA E-PLEX & POWERPLEX

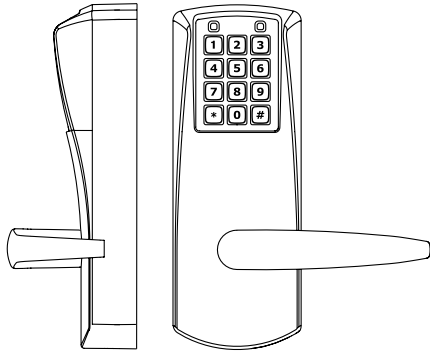

Stock Item Numbers

Use when no special keying or configuration is required.

E-Plex 2000 Cylindrical Lock — Battery Powered

Cylindrical Lockset

Item #	Description	List \$
76019774	EPLEX, E2031 LR 626 J 626 Finish, LR Lever, 2-3/4" Backset, 1-1/8" Faceplate, ANSI & T Strike, SFIC, Less Core	668
76019775	EPLEX, E2031 LR 626 D SC 626 Finish, LR Lever, 2-3/4" Backset, 1-1/8" Faceplate, ANSI & T Strike, Schlage C, Keyed Different	668
76019780	EPLEX, E2031 LR 613 J 613 Finish, LR Lever, 2-3/4" Backset, 1-1/8" Faceplate, ANSI & T Strike, SFIC, Less Core	737
76019781	EPLEX, E2031 LR 613 D SC 626 Finish, LR Lever, 2-3/4" Backset, 1-1/8" Faceplate, ANSI & T Strike, Schlage C, Keyed Different	737

E-Plex 2000 Exit Trim — Battery Powered

9300 Series Exit Trim

Item #	Description	List \$
76019776	EPLEX, E201U LR 626 J 626 Finish, LR Lever, SFIC, Less Core	794
76019777	EPLEX, E201U LR 626 D SC 626 Finish, LR Lever, Schlage C, Keyed Different	794
76019782	EPLEX, E201U LR 613 J 613 Finish, LR Lever, SFIC, Less Core	864
76019783	EPLEX, E201U LR 613 D SC 613 Finish, LR Lever, Schlage C, Keyed Different	864

Powerplex 2000 Cylindrical Lock — Self Powered

Cylindrical Lockset

Item #	Description	List \$
76019778	PPLEX, P2031 LR 626 J 626 Finish, LR Lever, 2-3/4" Backset, 1-1/8" Faceplate, ANSI & T Strike, SFIC	728
76019779	PPLEX, P 2031 LR 626 D SC 626 Finish, LR Lever, 2-3/4" Backset, 1-1/8" Faceplate, ANSI & T Strike, Schlage C, Keyed Different	728



Configured Item Numbers
Use when special keying or configuration is required.

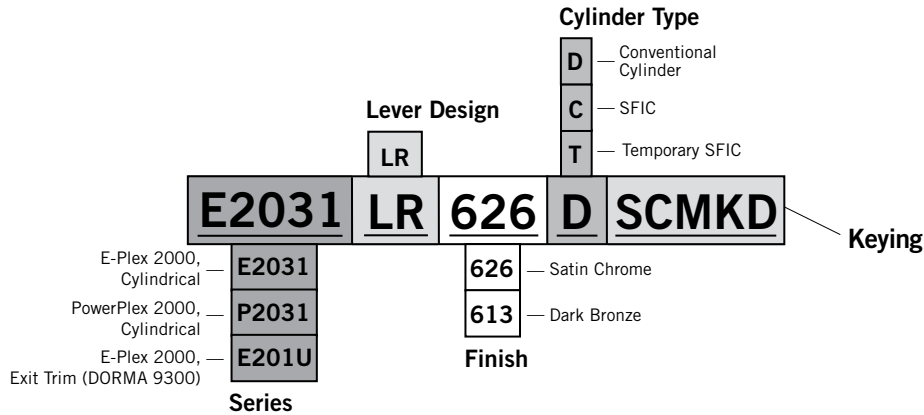

Cylinder Types, Keying Options & Keyways

Cylinder	Option	Description	List Add/Deduct \$
Conventional Cylinders (non-interchangeable core)			
D	Conventional cylinder	Example: C553D	N/C
KD	Keyed differently to a random combination; SC keyway with 2 keys (default)		N/C
0-Bit	Operated by 1 bit cut key for easy rekeying; D100 keyway — Keys sold separately		N/C
0-Bit	Operated by 1 bit cut key for easy rekeying; SC, SE, AA, CA, CB, CC, CD, CE, RA, RB, GA, SF, WA, YA, YG keyways with 2 keys		12
MKD	Master keyed or CMK, SKD, KA, SC, SE, or D100 keyway — Keys sold separately		12
CMK	Construction master keyed single cylinder locks — Keys sold separately		13
Small Format Interchangeable Core Cylinders			
J	SFIC core sold separately (see Cylinders & Keying)	Example: C553J	N/C
T	Temporary SFIC construction core (Cores may be returned for a full refund) — Keys sold separately	Example: C553T	40
C	Lock with combinated SFIC core; BA (default). Shipped separately BB, BC, BD, BE, BF, BG, BH, BJ, BK, BL, BM, BQ, D100 keyway — Keys sold separately	Example: C553C	45

1. For uncombined cores, UNC, cores must be ordered separately, see Cylinders, Keys, and Keying.

⊗ Denotes keys must be ordered separately.

Cut Keys Ordered Separately

Part #	Description	List \$
45101	Change key, master key, construction master key, or control key; BA, BB, BC, BD, BE, BF BG, BH, BJ, BK, BL, BM, BQ, SC, SE section	6
45401	Change key, master key, or control key; SKC sections - D100 etc.	10
45404	1 bit cut key for operating 1 bit cylinders	4

NOTES:

- D100 keyway is restricted. See TERMS OF SALE section for DORMA SKC policies.
- 1 bit cylinder comes with (2) uncut keys and will require a 1 bit cut key to operate cylinder.

PS5 SERIES

PS5 Series Ordering Guide

Model		Optional Accessories
Selectable 12/24 V, 6 A output, 110 VAC	36RF	Programmable Controller, 2 Doors — UR2-4
Selectable 12/24 V, 4 A output, 110 VAC	34RF	1-120 s Delay — TD
Selectable 12/24 V, 2 A output, 110 VAC	32RF	Fused Terminal Board, 4 Fused Outputs — FB4
Selectable 12/24 V, 1.0 A output, 220 VAC	02RF-220V	4 Ah Battery (1 @ 12V, 2 @ 24 V) — RB12V4
		7 Ah Battery (1 @ 12V, 2 @ 24 V) — RB12V7
		x4 Relay Model — CR4

PS5	34RF	
------------	-------------	--

PS5 — General Purpose Power Supplies, Heavy Duty

PS1 — On/Off Inside Cabinet

MR — Manual Reset, Fire Release

KL — Key Lockable

Cabinet Options



PS5 Series General Purpose Power Supplies

Item	Description	List \$
PS532RF	110 V / 2.0 A @ 24 VDC filter/reg, class 2 selectable output	638
PS534RF	110 V / 4.0 A @ 24 VDC filter/reg, class 2 selectable output, (2) 2.0 A or (1) 4.0 A	958
PS536RF	110 V / 6.0 A @ 24 VDC filter/reg, class 2 selectable output, (3) 2.0 A or (1) 6.0 A	1,118
PS502RF-220	220 V / 1.0 A @ 24 VDC filter/reg, class 2 selectable output	486

PS5 Series Options

Item	Description	List \$
PS1	On/off inside cabinet	58
MR	Manual reset, fire release	58
KL	Key lockable cabinet	58
FB4	4 output distribution board (fused)	65
TD	1-120 sec delay board	193
RB12V4	4 Ahr Battery Backup (1 each @ 12 V / 2 each @ 24 V)	65
RB12V7	7 Ahr Battery Backup (1 each @ 12 V / 2 each @ 24 V)	96
CR4	Control relay x 4	130
UR 2-4	Universal door control module—2 door—Requires MOV for solenoid products	360
UR 4-8	Universal door control module—4 door—Requires MOV for solenoid products	500

PS6 SERIES

PS6 Series Ordering Guide

Optional Accessories

BB24-7	7 Ah Battery Backup (24 V)
BB24-4	4.5 Ah Battery Backup (24 V)
BB12-7	7 Ah Battery Backup (12 V)
BB12-4	4.5 Ah Battery Backup (12 V)
PDM-4	Non-Selectable 4 Output Distribution Board (Fused)
PDM-8	Non-Selectable 8 Output Distribution Board (Fused)

Selectable 12/24 V, 1.5 A output, 110 VAC	Model
	15RF
Selectable 12/24 V, 1.0 A output, 110 VAC	10RF

PS6	10RF	
------------	-------------	--

PS6 — General Purpose Power Supplies, Medium Duty
Series

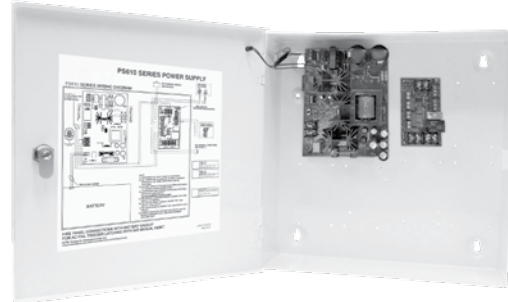

PS610RF

PS6 Series General Purpose Power Supplies

Item	Description	List \$
PS610RF	110 V / 1.0 A @ 24 VDC filter/reg, class 2 selectable output	375
PS615RF	110 V / 1.5 A @ 24 VDC filter/reg, class 2 selectable output	470

PS6 Series Options

Item	Description	List \$
PDM-4	4 output distribution board (fused)	75
PDM-8	8 output distribution board (fused)	90
BB12-4	4.5 Ahr battery backup for 12 V	45
BB12-7	7 Ahr battery backup for 12 V	70
BB24-4	4.5 Ahr battery backup for 24 V	90
BB24-7	7 Ahr battery backup for 24 V	140

Power Supplies for Use with Exit Devices

Item	Description	List \$
ES100	110 V / 24 VDC, 6 A surge, 0.65 A continuous per zone. Use with delayed egress (DE) exit device or LFSC/LFSF electrified exit device trim.	545
PS501	110 V / 36 VDC, 14-18 A surge, 2 A continuous per zone. Use with solenoid latch retraction (ES) exit devices (UL requirement)	641
AD100	220 V / 24 VDC, 6 A surge, 0.65 A continuous per zone. Use with solenoid latch retraction (ES) exit devices (UL requirement)	641
PS406BB*	Power supply with battery backup for ESB solenoid latch retraction	915
PS426BB*	Power supply with battery backup for ESB solenoid latch retraction	915

Note: PS406BB and PS426BB can only be used with ESB latch retraction option

Power Supply Options for Use with Exit Devices

Item	Description	List \$
ES101	Delay module (ES100 only)	118
ES103	Relay module (ES100 only)	74
ES105	Power transfer (recommended for ES and DE option)	181
ES2	Power card (PS501 only), powers an additional 2 devices (4 total)	349



ELECTRIC STRIKES

ES62 Ordering Guide

Application – Rim Exit Device

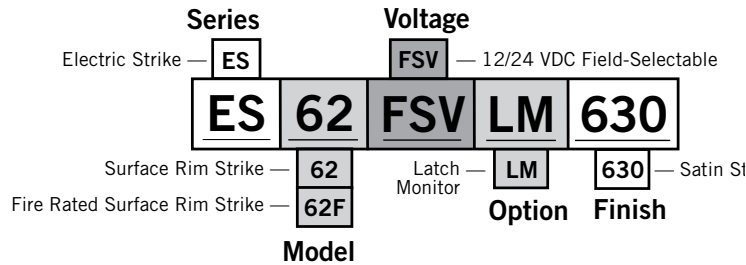

ES62

NOTE: Fail secure only.

ES62 Electric Strikes

Item	Description	List \$
ES62 FSV 630	Surface mount rim exit strike, UL 1034 (CVXY), 12/24 V	475
ES62F FSV 630	3 Hour fire rated surface mount rim exit strike, UL 1034 (CVXY), 12/24 V	525
ES62 FSV LM 630	Surface mount rim exit strike with Latch Monitor switch, UL 1034 (CVXY), 12/24 V	570
ES62F FSV LM 630	Fire rated surface mount rim exit strike with Latch Monitor switch, UL 1034 (CVXY), 12/24 V	592

ES62 Accessories

DPH62	Door pair housing, ES62, 628 finish only	155
MSK62	Shim mounting kit, ES62	12

DORMA/RCI 0563 1/2" Ordering Guide

Application – Rim Exit Strike

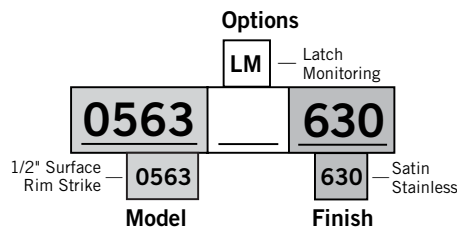

0563

Available Items

0563 Electric Strikes

Item	Description	List \$
0563 630	1/2" surface mount rim exit strike, UL 1034 (CVXY), 12/24 V	475
0563 LM 630	1/2" surface mount rim exit strike with Latch Monitor switch, UL 1034 (CVXY), 12/24 V	525

0563 Accessories

0563DDH	Door pair housing, 0563	155
---------	-------------------------	-----



ES96F Ordering Guide

Application – Mortise Lock / Cylindrical Lock

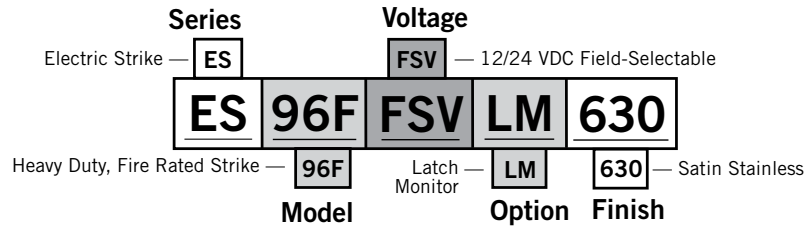

ES96F

NOTE: Fail secure only.

ES96F Electric Strikes

Item	Description	List \$
ES96F FSV 630	Heavy duty, fire rated mortise strike, 12/24 V, 3 hr	520
ES96F FSV LM 630	Heavy duty, fire rated mortise strike with Latch Monitor switch, 12/24 V, 3 hr	565

ES96F Accessories

96LM	Latch monitor switch, ES96F	45
------	-----------------------------	----

ES72F Ordering Guide

Application – Fire Rated Cylindrical Lock

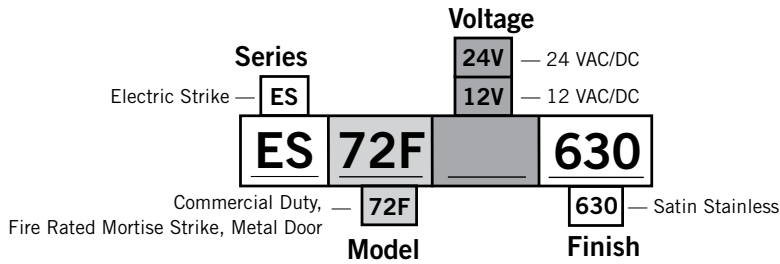

ES72F

NOTE: Fail secure only.

ES72F Electric Strikes

Item	Description	List \$
ES72F 12V 630	Commercial duty, fire rated cylindrical strike, 12 V, 90 minute fire rated	400
ES72F 24V 630	Commercial duty, fire rated cylindrical strike, 24 V, 90 minute fire rated	400



ES84/86 Ordering Guide

Application – Non-Fire Rated Cylindrical Lock

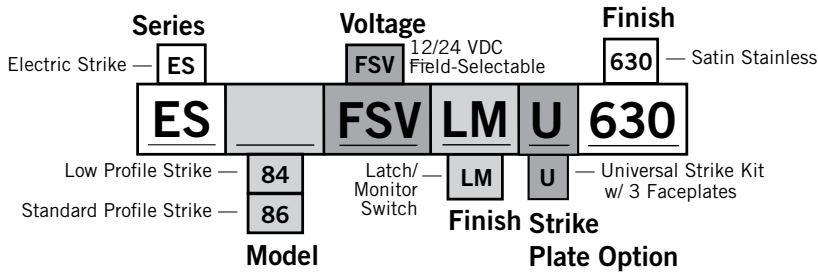

NOTE: Field Selectable. Fail safe/ fail secure.

ES84/86 Electric Strikes

Item	Description	List \$
ES84 FSV U 630	Low profile, commercial duty cylindrical strike, 12/24 V	200
ES84 FSV LM U 630	Low profile, commercial duty cylindrical strike with Latch Monitor switch, 12/24 V	250
ES86 FSV U 630	Standard profile, commercial duty cylindrical strike, 12/24 V	200
ES86 FSV LM U 630	Standard profile, commercial duty cylindrical strike with Latch Monitor strike, 12/24 V	250

Strike Plate Options (ES84/86, 630 finish)

Option	Description	List \$
U	Universal strike kit standard with ES84/86 electric strikes includes (3) face plates S4, S4S, and S7	N/C
S4*	1-1/4" × 4-7/8" with radius corners	-5
S4S*	1-1/4" × 4-7/8" with square corners	-5
S5	1-1/8" × 5-7/8" with radius corners	-5
S6	1-1/4" × 6-7/8" with radius corners	-5
S7*	1-7/16" × 7-15/16" with radius corners	-5

* Included with "U" kit

- Locks
- Cylinders, Keys & Keying
- Exit Devices
- Electronic Access Control Components
- Low Energy Operators
- Surface Closers
- Fire/Life Safety
- Concealed Closers/Pivots
- Stops/ Holders
- Sliding Systems
- Architectural Pulls & Handles
- Service Parts

ES84/86 Accessories

Item	Description	List \$
84LE1	1" Lip extension, ES84	60
84LE2	2" Lip extension, ES84	70
84LE3	3" Lip extension, ES84	80
86LE1	1" Lip extension, ES86	60
86LE2	2" Lip extension, ES86	70
86LE3	3" Lip extension, ES86	80
84JIG	Frame prep jig, ES84	80
86JIG	Frame prep jig, ES86	80
84TP5	Trim plate, ES84	25
86TP5	Trim plate, ES86	25
86LG	Latch guard, ES84/86	25
84/86HK	Mounting hardware kit, ES84/86	75

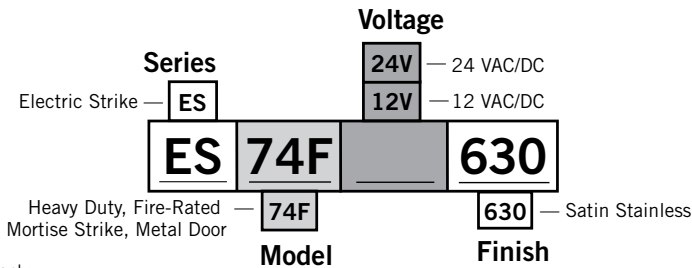
ES74F Ordering Guide
Application – Heavy Duty Fire Rated Cylindrical Lock - BHMA Listed

NOTE: Fail secure only.

ES74F Electric Strikes

Item	Description	List \$
ES74F 12V 630	Heavy duty, fire rated cylindrical strike, 12 V, 90 minute fire rated	375
ES74F 24V 630	Heavy duty, fire rated cylindrical strike, 24 V, 90 minute fire rated	375

ELECTROMAGNETIC LOCKS

EML310/320 Ordering Guide

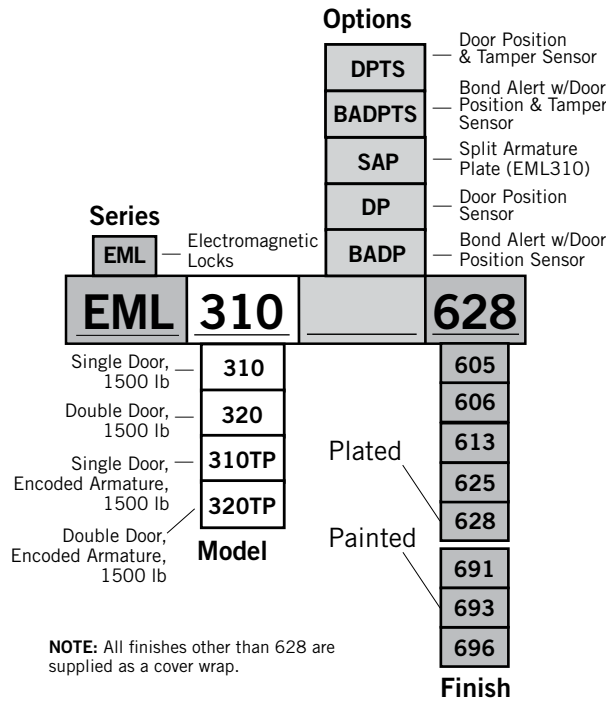

EML310



EML320

EML310/320 Electromagnetic Locks

Item	Description	628 Finish \$	Painted Finishes \$	Plated Finishes \$
EML310 Series Single Door, 1500 lb Holding Force				
EML310	Single lock	430	511	546
EML310 DP	Single lock w/ DP sensor	500	582	616
EML310 BA DP	Single lock w/ BA sensor, DP sensor	570	651	686
EML310TP Series Single Door, 1500 lb Holding Force				
EML310TP	Single lock w/ encoded armature	600	—	—
EML320 Series Double Door, 1500 lb Holding Force				
EML320	Double lock	820	915	958
EML320 DP	Double lock w/ DP sensor	953	1048	1091
EML320 BA DP	Double lock w/ BA sensor, DP sensor	1080	1175	1218
EML320TP Series Double Door, 1500 lb Holding Force				
EML320TP	Double lock w/ encoded armature	1200	—	—

EML310/320 Options

Item	Description	628 List Add \$	695 List Add \$
Angle Brackets			
AB11	1"H x 1"W x 10-1/2"L, EML310	42	50
AB12	1-1/2"H x 1"W x 10-1/2"L, EML310	44	52
AB13	1-1/2"H x 1-1/4"W x 10-1/2"L, EML310	46	54
AB20	1"H x 1"W x 21"L, EML320	60	76
AB21	1-1/2"H x 1"W x 21"L, EML320	68	86
AB22	1-1/2"H x 1-1/2"W x 21"L, EML320	76	92
L Brackets			
LB10	2-1/2"H x 2"W x 10-1/2"L, EML310	75	—
LB20	2-1/2"H x 2"W x 21"L, EML320	150	—
Filler Bars			
FB11	1/8"H x 3/4"W x 10-1/2"L, EML310	30	—
FB12	1/4"H x 3/4"W x 10-1/2"L, EML310	32	36
FB14N	1/2"H x 5/8"W x 10-1/2"L, EML310	40	44
FB14	1/2"H x 3/4"W x 10-1/2"L, EML310	36	40
FB15	5/8"H x 3/4"W x 10-1/2"L, EML310	38	42
FB21	1/8"H x 3/4"W x 21"L, EML320	44	—
FB22	1/4"H x 3/4"W x 21"L, EML320	44	50
FB24N	1/2"H x 5/8"W x 21"L, EML320	52	58
FB24	1/2"H x 3/4"W x 21"L, EML320	48	54
FB25	5/8"H x 3/4"W x 21"L, EML320	50	56
Blade Stop Spacers			
BSS14	1/2"H x 1-1/2"W x 10-1/2"L, EML310	45	54
BSS15	5/8"H x 1-1/2"W x 10-1/2"L, EML310	49	58
BSS24	1/2"H x 1-1/2"W x 10-1/2"L, EML320	90	108
BSS25	5/8"H x 1-1/2"W x 10-1/2"L, EML320	98	116

Item	Description	628 List Add \$	695 List Add \$
Top Jam Brackets			
TJ10	Top jamb bracket, EML310	135	145
TJ20	Top jamb bracket, EML320	270	290
Armature Plate Holders			
APH10	Armature plate holder, EML310	75	80
APH15	Armature plate holder, EML310 with DP function	50	55
APH20	Armature plate holder, EML320	150	155
APH25	Armature plate holder, EML320 with DP function	100	105
Armature Mounting Bolts			
AMB225	Extended length for doors 1-3/4" to 2-1/4" thick	9	—
AMB275	Extended length for doors 2-1/4" to 2-3/4" thick	9	—
AMB300	Extended length for doors 2-3/4" to 3" thick	9	—

Glass Door Brackets

Item	Description	629 List Add \$
GDB14	1/2" thick glass, EML310	169
GDB16	3/4" thick glass, EML310	169
GDB24	1/2" thick glass, EML320	320
GDB26	3/4" thick glass, EML320	320

Split Armature Plate

Item	Description	List Add \$
SAP	Split armature plate, EML310	99

EML310/320 Accessories

Item	Description	Painted Finishes \$	Plated Finishes \$
MCW310	Cover wrap for EML310	80	115
MCW320	Cover wrap for EML320	100	140
MCW310TP	Cover wrap for EML310TP	80	115

EML371/372 Ordering Guide

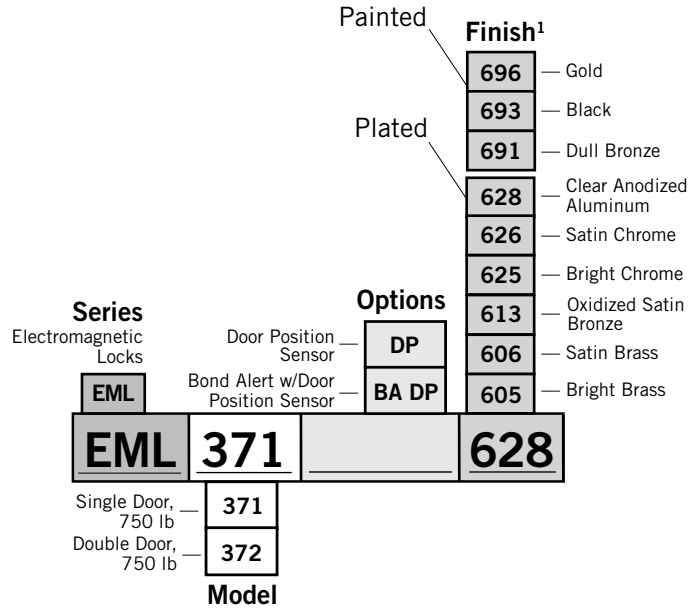

EML371



EML372

EML371/372 Electromagnetic Locks

Item	Description	628 Finish \$	Painted Finishes \$	Plated Finishes \$
EML371 Single Door, 750 lb Holding Force				
EML371	Single lock	330	400	425
EML371 DP	Single lock w/ DP sensor	385	455	481
EML371 BA DP	Single lock w/ BA sensor, DP sensor	445	515	541
EML372 Double Door, 750 lb Holding Force				
EML372	Single lock	660	745	783
EML372 DP	Single lock w/ DP sensor	770	855	893
EML372 BA DP	Single lock w/ BA sensor, DP sensor	890	975	1013

EML371/372 Options

Item	Description	628 List Add \$	695 List Add \$
Angle Brackets			
AB710	1"H x 1"W x 9-3/8"L, EML371	42	46
AB711	1-1/2"H x 1"W x 9-3/8"L, EML371	44	48
AB712	1-1/2"H x 1-1/2"W x 9-3/8"L, EML371	46	50
AB713	1-1/2"H x 2"W x 9-3/8"L, EML371	48	52
AB720	1"H x 1"W x 18-3/4"L, EML372	66	74
AB721	1-1/2"H x 1"W x 18-3/4"L, EML372	68	76
AB722	1-1/2"H x 1-1/2"W x 18-3/4"L, EML372	70	78
AB723	1-1/2"H x 2"W x 18-3/4"L, EML372	72	80
Filler Bars			
FB712	1/4"H x 3/4"W x 9"L, EML371	32	36
FB713	3/8"H x 3/4"W x 9"L, EML371	34	38
FB714	1/2"H x 3/4"W x 9"L, EML371	36	40
FB715	5/8"H x 3/4"W x 9"L, EML371	38	42
FB722	1/4"H x 3/4"W x 18-3/4"L, EML372	44	50
FB724	1/2"H x 3/4"W x 18-3/4"L, EML372	46	52
FB725	5/8"H x 3/4"W x 18-3/4"L, EML372	50	56
Blade Stop Spacers			
BSS714	1/2"H x 1"W x 9-3/8"L, EML371	40	49
BSS715	5/8"H x 1"W x 9-3/8"L, EML371	44	53
BSS724	1/2"H x 1"W x 18-3/4"L, EML372	80	98
BSS725	5/8"H x 1"W x 18-3/4"L, EML372	88	106
Top Jam Brackets			
TJ71	Top jamb bracket, EML371	135	145
TJ72	Top jamb bracket, EML372	270	290
Conduit Mounting Bracket			
CMB110	1"H x 2-1/4"W x 10-9/16"L, EML371	75	—



Item	Description	628 List Add \$	695 List Add \$
Armature Plate Holders			
APH71	Armature plate holder, EML371	75	80
Armature Mounting Bolts			
AMB225	Extended length for doors 1-3/4" to 2-1/4" thick	9	—
AMB275	Extended length for doors 2-1/4" to 2-3/4" thick	9	—
AMB300	Extended length for doors 2-3/4" to 3" thick	9	—
APH72	Armature plate holder, EML372	150	155

Glass Door Brackets

Item	Description	629 List Add \$
GDB714	1/2" thick glass, EML371	160
GDB716	3/4" thick glass, EML371	160
GDB724	1/2" thick glass, EML372	320
GDB726	3/4" thick glass, EML372	320

EML371/372 Accessories

Item	Description	Painted Finishes \$	Plated Finishes \$
MCW371	Cover wrap for EML371	75	100
MCW372	Cover wrap for EML372	90	130

EML375 Ordering Guide

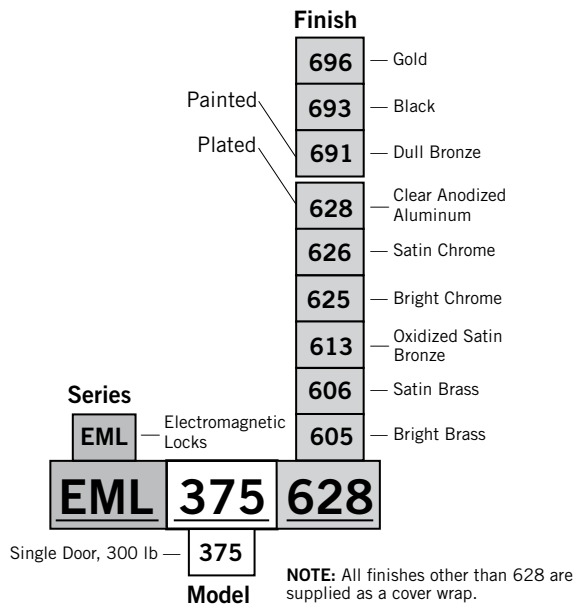

EML375 Electromagnetic Locks

Item	Description	628 Finish \$	Painted Finishes \$	Plated Finishes \$
EML375 Single Door, 300 lb Holding Force				
EML375	Single lock	220	305	330

EML375 Options

Item	Description	628 List Add \$	695 List Add \$
Blade Stop Spacers			
BSS752	1/4"H x 13/16"W x 6-9/16"L, EML375	45	—
Top Jam Brackets			
TJ75	Top jamb bracket, EML375	120	125
Armature Plate Holders			
APH75	Armature plate holder, EML375	75	80
Armature Mounting Bolts			
AMB225	Extended length for doors 1-3/4" to 2-1/4" thick	9	—
AMB275	Extended length for doors 2-1/4" to 2-3/4" thick	9	—
AMB300	Extended length for doors 2-3/4" to 3" thick	9	—

Glass Door Brackets

Item	Description	629 List Add \$
GDB754	1/2" thick glass, EML375	160
GDB756	3/4" thick glass, EML375	160

EML375 Accessories

Item	Description	Painted Finishes \$	Plated Finishes \$
MCW375	Cover wrap for EML375	90	130

Locks

Cylinders,
Keys & Keying

Exit Devices

Electronic
Access Control
ComponentsLow Energy
OperatorsSurface
ClosersFire/Life
SafetyConcealed
Closers/PivotsStops/
HoldersSliding
SystemsArchitectural
Pulls &
Handles

Service Parts



SPECIALIZED ELECTROMAGNETIC LOCKS

EMLSG360/365 Ordering Guide



EMLSG360



EMLSG365

EMLSG380 Ordering Guide

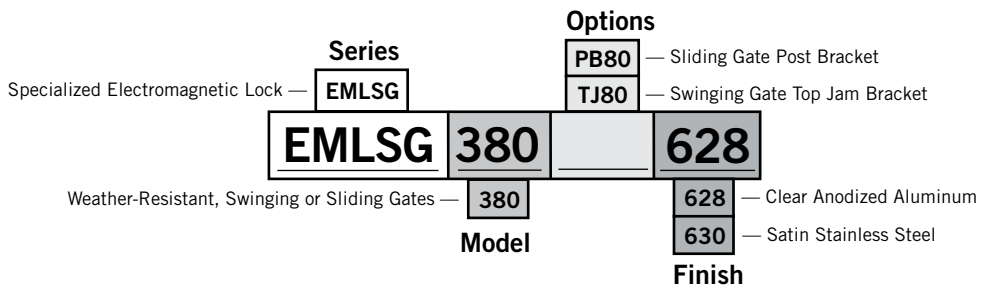

EMLSG380



EMLSG Series Specialized Electromagnetic Locks

Item	Description	628 Finish \$	630 Finish \$
EMLSG360	Mortise lock for sliding doors, 750 lb	439	—
EMLSG365	Mortise lock for sliding drawers, 300 lb	260	—
EMLSG380	Weather-resistant gate lock with stainless steel housing	—	439

EMLSG Options

Item	Description	List Add \$
TJ80	Top jamb bracket, EMLSG380	115
PB80	Post bracket, EMLSG380	75

SHEAR LOCKS

EMSL Ordering Guide

Series		Options			Finish
Shear Lock, Concealed, 2700 lb Holding Force	EMSL2700	Wood Door Reinforcement Box (2700-65, 2700-66)	WDRB	External LED	628 — Satin Aluminum (2061S & 2061TJ Surface Series only)
Micro Shear Lock, Concealed, 2000 lb Holding Force	EMSL2000	Wood Door Reinforcement Box (2000-61, 2000-62)	WDRBM	Door Position Switch	
				Bond Alert Sensor	
				Top Rail Bracket	
		65	AC		
Micro Shear Lock Built-In Auto Re-Lock and Time Delay		61	AC	Mounting Kit - Aluminum Doors (suffix "M" for Micro Shear Locks)	
Micro Shear Lock Surface, Push Side		61S			
Micro Shear Lock Surface, Pull Side		61TJ	FC	Mounting Kit - Flush Steel Doors (suffix "M" for Micro Shear Locks)	
Micro Shear Lock Built-In Auto Re-Lock and External Time Delay		62			
Micro Shear Lock Semi-Concealed, Push Side		62SC	AHC	Mounting Kit - Wood or Metal Doors w/7/8" to 1-1/8" Web (suffix "M" for Micro Shear Locks)	
Micro Shear Lock Semi-Concealed with Glass Door Bracket (**)		6SC x GBRKT	Mounting Kit Options		
Built-In Auto Re-Lock and Time Delay (EMSL2700 only)		65			
Built-In Auto Re-Lock and External Time Delay (EMSL2700 only)		66			
		Function			

(**) Specify 1/2" or 3/4" for glass thickness



EMSL2000-61



EMSL2000-62



EMSL2700-65



EMSL2700-66

EMSL Series Micro Shear Locks (2,000 lb Holding Force)

Item	Description	List \$
EMSL2000-61	Concealed mount with integral time delay. 1-5/8" projection (fits 1-3/4"-2" frame).	1079
EMSL2000-61S	Surface mount push side of door	1498
EMSL2000-61TJ	Surface mount pull side of door	1498
EMSL2000-62	Concealed mount with external time delay. 1-1/4" projection (fits 1-1/4"-1-3/4" frame).	1079
EMSL2000-62SC	Semi-concealed push side of door. Lock is mortised.	1274
EMSL2000-62SC-GDBKT1/2	Semi-concealed w/glass door bracket, 1/2" glass. Lock is mortise	1573
EMSL2000-62SC-GDBKT3/4	Semi-concealed w/glass door bracket, 3/4" glass. Lock is mortised	1573

* Specify mounting kit for all locks (see options below).

EMSL Series High Shear Locks (2,700 lb Holding Force)

Item	Description	List \$
EML2700-65	Built-in auto re-lock and time delay to ensure alignment before re-locking. 1-5/8" projection (fits 1-3/4"-2" frame).	1169
EMSL2700-66	Built-in auto re-lock and external time delay. 1-1/4" projection (fits 1-1/4"-1-1/2" frame).	1169

* Specify mounting kit for all locks (see options below).

EMSL Series Options

Item	Description	List Add \$
*AHC	Standard mounting armature kit for aluminum and hollow metal doors w/ 7/8" to 1-1/8" deep top channels, wood doors, and factory prepared hollow metal flush edge doors	N/C
*FC	Mounting kit for field prepared horizontal mounting in hollow metal doors w/flush edge	N/C
*AC	Mounting kit for aluminum doors with 1-15/16" web (1 pack of two 1" shims)	N/C
Must specify one of the above options for every shear lock ordered. Add Suffix "M" for Micro Shear Lock Armatures: i.e. AHCM		
ATR	Aluminum top rail armature bracket for leading edge adjustments	510
BA	Bond sensor (Not available on 2062 or 2766)	165
DPS	Door position switch	75
L3	External LED. Mounted separately through the frame 	24
WDRBM	Wood door reinforcement box (Micro-shear)	60
WDRB	Wood door reinforcement box (High-shear)	60

 L3 option may use one, two, or three colors.

DELAYED EGRESS ELECTROMAGNETIC LOCKS

EMDE Series Ordering Guide

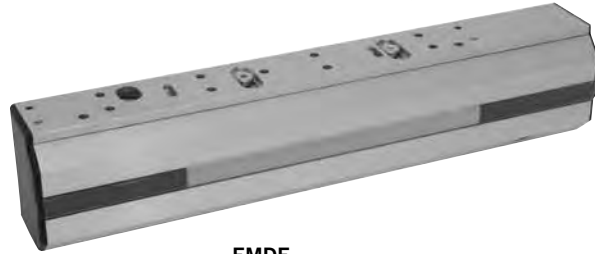
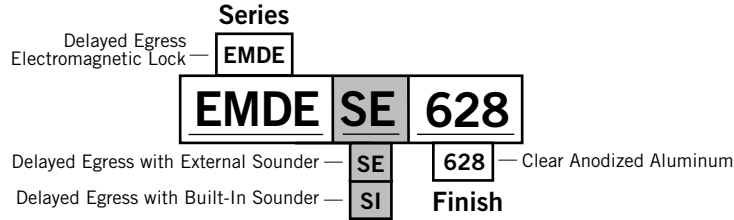

EMDE

EMDE Series Delayed Egress Magnetic Locks

Item	Description	628 Finish \$
EMDE SE	Lock with external remote, 1200 lb	1050
EMDE SI	Lock with integral sounder, 1200 lb	1200

Locks

Cylinders,
Keys & Keying

Exit Devices

Electronic
Access Control
Components

Low Energy
Operators

Surface
Closers

Fire/Life
Safety

Concealed
Closers/Pivots

Stops/
Holders

Sliding
Systems

Architectural
Pulls &
Handles

Service Parts



AC SERIES

Available Items

AC200 Electric Strikes

Item	Description	List \$
AC217 630	Keypad, Indoor 120 user code, satin stainless face plate	375
AC217 605	Keypad, Indoor 120 user code, bright brass face plate	480
AC225 630	Keypad, Outdoor, 480 user code, satin stainless face plate	545
AC228 626	Keypad, Indoor, 480 user code, satin chrome face plate	274



AC217



AC225



AC228

Locks

Cylinders,
Keys & Keying

Exit Devices

**Electronic
Access Control
Components**

Low Energy
Operators

Surface
Closers

Fire/Life
Safety

Concealed
Closers/Pivots

Stops/
Holders

Sliding
Systems

Architectural
Pulls &
Handles

Service Parts



RED MUSHROOM PUSH BUTTONS

Available Items

Item	Color	Label	Diameter	Faceplate	Switch	Faceplate Finish	List \$
PB RE2 MA 628	Red	Exit	1-9/16"	Narrow	Maintained	Brushed Aluminum	130
PB RE2 MO 628	Red	Exit	1-9/16"	Narrow	Momentary	Brushed Aluminum	130
PB RE2 MA 710	Red	Exit	1-9/16"	Narrow	Maintained	Dark Bronze	130
PB RE2 MO 710	Red	Exit	1-9/16"	Narrow	Momentary	Dark Bronze	130
PB EP2 PA 630	Red	Push to exit	1-5/8"	Narrow	Momentary with pneumatic time delay	Satin Stainless	390
PB RE3 MA 628	Red	Exit	1-9/16"	Single Gang	Maintained	Brushed Aluminum	130
PB RE3 MO 628	Red	Exit	1-9/16"	Single Gang	Momentary	Brushed Aluminum	130
PB RE3 MA 710	Red	Exit	1-9/16"	Single Gang	Maintained	Dark Bronze	130
PB RE3 MO 710	Red	Exit	1-9/16"	Single Gang	Momentary	Dark Bronze	130
PB E03 MA 628	Red	Exit	2-3/8"	Single Gang	Maintained	Brushed Aluminum	150
PB E03 MO 628	Red	Exit	2-3/8"	Single Gang	Momentary	Brushed Aluminum	150
PB E03 MA 710	Red	Exit	2-3/8"	Single Gang	Maintained	Dark Bronze	150
PB E03 MO 710	Red	Exit	2-3/8"	Single Gang	Momentary	Dark Bronze	150
PB EP3 PA 630	Red	Push to exit	1-5/8"	Single Gang	Momentary with pneumatic time delay	Satin Stainless	360

Accessories

Item	Description	
TD-ADJ	Field Selectable Timer—0–30 seconds—wire inline	80
TD-FIX	Fixed Timer—30 seconds—wire inline	80
SBX	Surface mounting box, single gang—PBBH2 MO 630 SBX	53

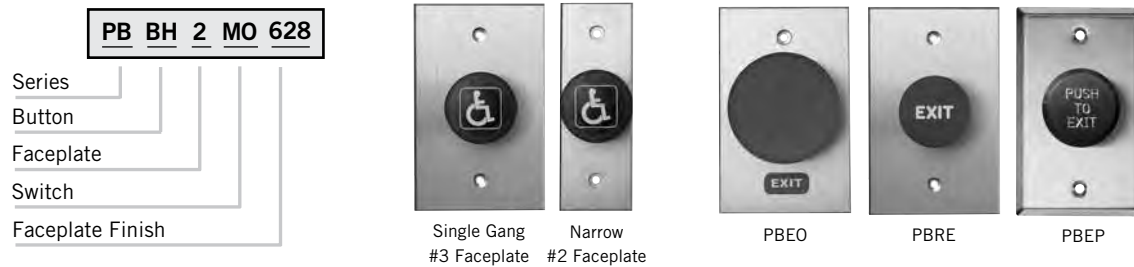

- Locks
- Cylinders, Keys & Keying
- Exit Devices
- Electronic Access Control Components
- Low Energy Operators
- Surface Closers
- Fire/Life Safety
- Concealed Closers/Pivots
- Stops/ Holders
- Sliding Systems
- Architectural Pulls & Handles
- Service Parts

BLUE MUSHROOM PUSH BUTTONS

Available Items

Item	Color	Label	Diameter	Faceplate	Switch	Faceplate Finish	List \$
PB BH2 MA 628	Blue	Handicap	1-9/16"	Narrow	Maintained	Brushed Aluminum	130
PB BH2 MO 628	Blue	Handicap	1-9/16"	Narrow	Momentary	Brushed Aluminum	130
PB BH2 MA 710	Blue	Handicap	1-9/16"	Narrow	Maintained	Dark Bronze	130
PB BH2 MO 710	Blue	Handicap	1-9/16"	Narrow	Momentary	Dark Bronze	130
PB HP2 PA 630	Blue	Handicap	1-5/8"	Narrow	Momentary with pneumatic time delay	Satin Stainless	390
PB BH3 MA 628	Blue	Handicap	1-9/16"	Single Gang	Maintained	Brushed Aluminum	130
PB BH3 MO 628	Blue	Handicap	1-9/16"	Single Gang	Momentary	Brushed Aluminum	130
PB BH3 MA 710	Blue	Handicap	1-9/16"	Single Gang	Maintained	Dark Bronze	130
PB BH3 MO 710	Blue	Handicap	1-9/16"	Single Gang	Momentary	Dark Bronze	130
PB HO3 MA 628	Blue	Handicap	2-3/8"	Single Gang	Maintained	Brushed Aluminum	150
PB HO3 MO 628	Blue	Handicap	2-3/8"	Single Gang	Momentary	Brushed Aluminum	150
PB HO3 MA 710	Blue	Handicap	2-3/8"	Single Gang	Maintained	Dark Bronze	150
PB HO3 MO 710	Blue	Handicap	2-3/8"	Single Gang	Momentary	Dark Bronze	150
PB HP3 PA 630	Blue	Handicap	1-5/8"	Single Gang	Momentary with pneumatic time delay	Satin Stainless	360

Accessories

Item	Description	
TD-ADJ	Field Selectable Timer—0–30 seconds—wire inline	80
TD-FIX	Fixed Timer—30 seconds—wire inline	80
SBX	Surface mounting box, single gang—PBBH2 MO 630 SBX	53

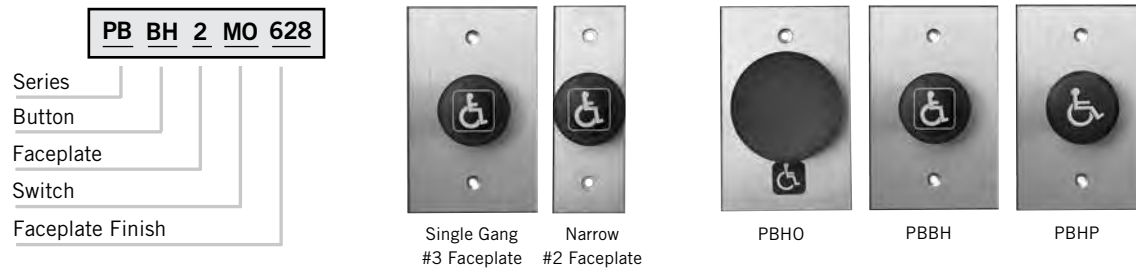



ILLUMINATED PUSH BUTTONS

Available Items

Item	Button	Faceplate	Switch	Faceplate Finish	List \$
PB 731 MO 630	2" x 2" LED	Single Gang	Momentary	Brushed Stainless	100
PB 752 MO 628	1" x 1" LED	Narrow	Momentary	Brushed Aluminum	160
PB 752 MO 710	1" x 1" LED	Narrow	Momentary	Dark Bronze	160

Accessories

Item	Description	List \$
TD-ADJ	Field Selectable Timer—0–30 seconds—wire inline	80
TD-FIX	Fixed Timer—30 seconds—wire inline	80
SBX	Surface mounting box, single gang—PB731 MO 630 SBX	53

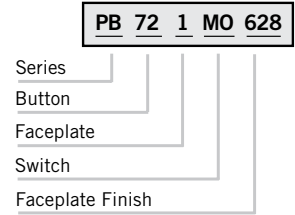

Locks

Cylinders,
Keys & Keying

Exit Devices

**Electronic
Access Control
Components**

Low Energy
Operators

Surface
Closers

Fire/Life
Safety

Concealed
Closers/Pivots

Stops/
Holders

Sliding
Systems

Architectural
Pulls &
Handles

Service Parts



Rotary/Key Release Switches Ordering Guide

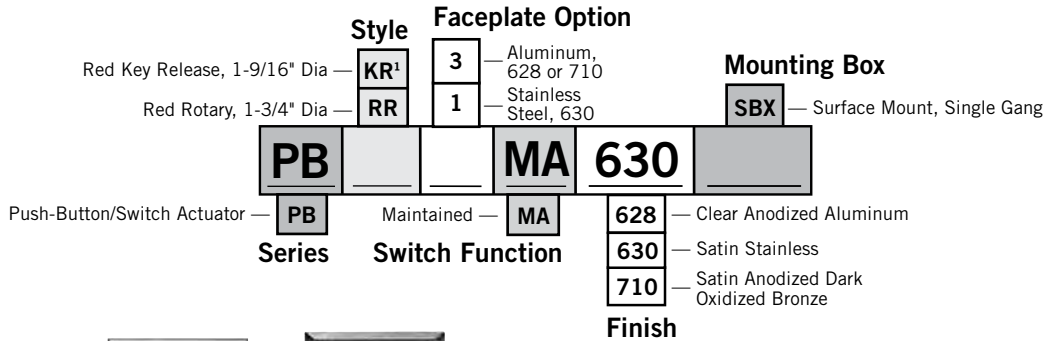

PBRR



PBKR

1. PBKR Key Switch uses a disc tumbler style cylinder. This style cylinder can **NOT** be configured into the building master key system.

Item	Description	630 Finish \$	628 Finish \$	710 Finish \$
Red Rotary/Key Release Switches, 12/24 VDC				
PBRR	1-3/4" Dia MA, 2A SPDT, rotary release, single gang aluminum	—	165	165
PBKR	1-9/16" Dia MA, 2A SPDT, key release, single gang stainless steel	205	—	—

MOUNTING BOX OPTIONS FOR PB SERIES

Item	Description	List \$
SBX	Surface Mount	53

39 SERIES SOUNDERS

Ordering Guide

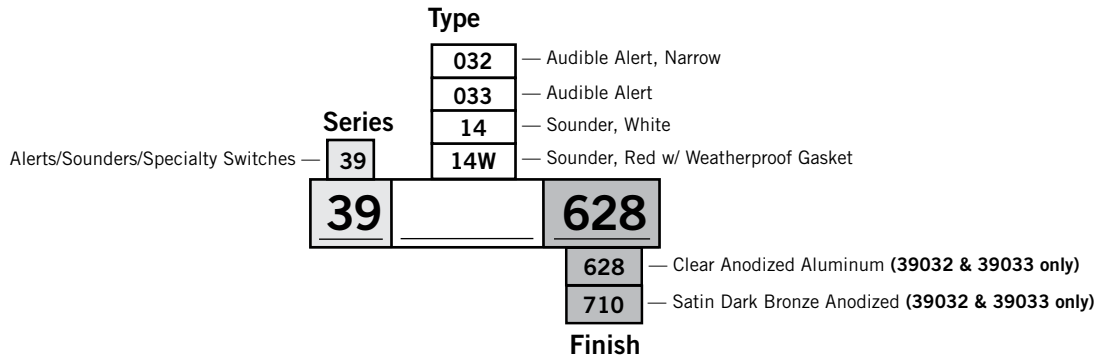

39 SERIES ALERTS/SOUNDERS/SPECIALTY SWITCHES

Item	Description	List \$	628 Finish \$	710 Finish \$
Alerts				
39032	Audible alert, narrow	—	155	155
39033	Audible alert	—	155	155
Sounders				
3914	Sounder, red w/ weatherproof gasket	99	—	—
3914W	Sounder, white	140	—	—



KS SERIES

Ordering Guide

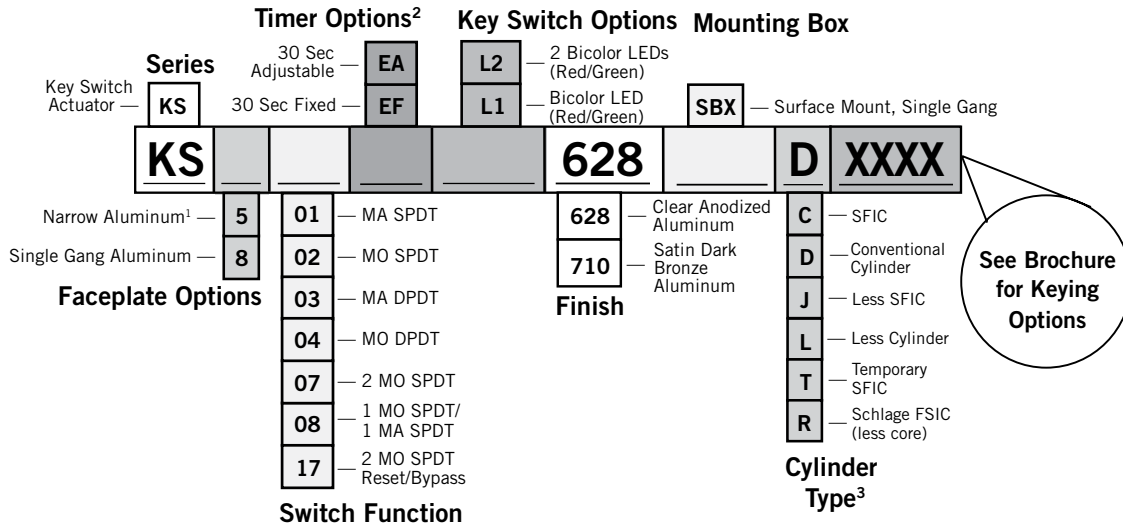

1. Faceplate option 5 only available with switch functions 01 and 02.
2. Timer options only available with switch function 02.
3. List price includes default conventional cylinder.



KS8 Single Gang Aluminum



KS5 Narrow Aluminum

KS SERIES KEY SWITCHES

Item	Description	List \$
KS800 Series Single Gang Aluminum		
KS801	MA SPDT	145
KS802	MO SPDT	145
KS 802 EA	MO SPDT, electronic timer, 1–30 sec adjustable	225
KS 802 EF	MO SPDT, electronic timer, 30 sec fixed	225
KS 803	MA DPDT	145
KS 804	MO DPDT	145
KS 503	MA DPDT	145
KS 504	MA DPDT	145
KS807	MO (2) SPDT	185
KS808	MO SPDT/MA SPDT	185
KS817	MO (2) SPDT, labeled Reset/Bypass	185
KS500 Series Narrow Aluminum		
KS501	MA SPDT	145
KS502	MO SPDT	145
KS502 EA	MO SPDT, electronic timer, 1–30 sec adjustable	225
KS502 EF	MO SPDT, electronic timer, 30 sec fixed	225
KS 502 PA	(2) SPDT, pneumatic timer, 2–60 sec adjustable	400

NOTE: Highlighted items are available from Select Service. Refer to **Select Service Price List** for specific model details.

OPTIONS

Item	Description	List Add \$
Key Switch Options		
L1	One (1) bicolor (red/green) LED added to faceplate	18
Mounting Box Options		
SBX	Surface mount, single gang	53

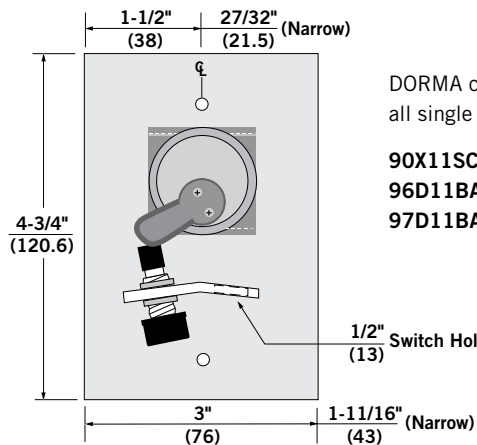

DORMA cylinders for use with all single key switches:

90X11SC118 - 6-pin mortise

96D11BA138 - 6-pin SFIC mortise

97D11BA138 - 7-pin SFIC mortise

CYLINDER, KEYING & KEYWAY OPTIONS FOR KS SERIES

Cylinder	Option	Description	Examples	List Add/Deduct \$
Conventional Cylinders (non-interchangeable core)				
		Keying with conventional cylinder (default)	KS02628	N/C
	KD	Keyed differently to a random combination; SC keyway with 2 keys (default SPDT)		N/C
	KA2	Keyed alike in pairs to a random combination; SC keyway with 2 keys		N/C
	KA4	Keyed alike in sets of 4 to a random combination; SC keyway with 2 keys		N/C
	1-Bit	Operated by 1 bit cut key for easy rekeying; SC, SE keyway with 2 keys		N/C
	1-Bit	Operated by 1 bit cut key for easy rekeying; D100 keyway — ⊗ Keys sold separately		N/C
	1-Bit	Operated by 1 bit cut key for easy rekeying; AA, CA, CB, CC, CD, CE, RA, RB, GA, SF, WA, YA, YG keyways with 2 keys		12
	NSK	Non-stock keyed — KA quantities other than KA2/KA4; SC keyway with 2 keys		12
	MKD	Master keyed or SKD, SC, SE, or D100 keyway — ⊗ Keys sold separately		12
	CMK	Construction master keyed single cylinder locks — ⊗ Keys sold separately		13
L		Keying less conventional cylinder	KS02628L	Deduct 30
Small Format Interchangeable Core Cylinders				
J		Less Core with disposable plastic SFIC construction core	KS02628J	N/C
T		Keying for temporary SFIC construction core (cores may be returned for a full refund) — ⊗ Keys sold separately	KS02628T	40
C		Keying with combined SFIC core installed at factory1; BA (default), BB, BC, BD, BE, BF, BG, BH, BJ, BK, BL, BM, BQ, D100 keyway — ⊗ Keys sold separately	KS02628C	45

1. For uncombined cores, **UNC**, cores must be ordered separately.

⊗ Denotes keys must be ordered separately

Cylinder Housings Less Cores

Housing	Description	List Add \$
R	Housing prepared for Schlage FSIC – Less Core	8
X7	Housing prepared for Sargent XC 7P & Arrow Choice 7P SFIC – Less Core	8
X6	Housing prepared for Arrow Choice 6P SFIC – Less Core	8

Cut Keys Ordered Separately

Item	Description	List \$
45101	Change key, master key, construction master key, or control key; BA, BB, BC, BD, BE, BF, BG, BH, BJ, BK, BL, BM, BQ, SC, SE section	6
45401	Change key, master key, or control key; D100 section	10

NOTE: D100 keyway is restricted, See TERMS OF SALE section for DORMA SKC policies

ACCESSORIES

Available Items

Item	Description	List \$
Power Transfer		
ES105	Power transfer conduit—satin chrome finish	181
Flex Loops		
3118 628	Loop, 18", surface mount flex, satin aluminum finish	33
3118 695	Loop, 18" flex, surface mount, less wires, dark bronze painted	49
3118 714	Loop, 18" flex, surface mount, less wires, white painted	49
3218 630	Loop, 18" flex, heavy duty, less wires, satin stainless	65
Wired Hinges		STD/DPS
PTH4 626 / PTH4 DPS 626	Hinge, 4 wire power transfer, 4-1/2" × 4-1/2", satin chrome finish	241/321
PTH4 613 / PTH4 DPS 613	Hinge, 4 wire power transfer, 4-1/2" × 4-1/2", dark bronze finish	241/321
PTH4 605 / PTH4 DPS 605	Hinge, 4 wire power transfer, 4-1/2" × 4-1/2", bright brass finish	241/321
PTH6 626 / PTH6 DPS 626	Hinge, 6 wire power transfer, 4-1/2" × 4-1/2", satin chrome finish	382/362
PTH6 613 / PTH6 DPS 613	Hinge, 6 wire power transfer, 4-1/2" × 4-1/2", dark bronze finish	382/362
PTH6 605 / PTH6 DPS 605	Hinge, 6 wire power transfer, 4-1/2" × 4-1/2", bright brass finish	382/362
PTH10 626 / PTH10 DPS 626	Hinge, 10 wire power transfer, 4-1/2" × 4-1/2", satin chrome finish	321/402
PTH10 613 / PTH10 DPS 613	Hinge, 10 wire power transfer, 4-1/2" × 4-1/2", dark bronze finish	321/402
PTH10 605 / PTH10 DPS 605	Hinge, 10 wire power transfer, 4-1/2" × 4-1/2", bright brass finish	321/402
Wired Pivots		
75200 626 (standard)	Pivot, 3/4" offset intermediate, electrified, 8 wire, satin chrome finish	446
75200 605	Pivot, 3/4" offset intermediate, electrified, 8 wire, bright brass finish	446
75200 606	Pivot, 3/4" offset intermediate, electrified, 8 wire, satin brass finish	446
75200 611	Pivot, 3/4" offset intermediate, electrified, 8 wire, bright bronze finish	446
75200 612	Pivot, 3/4" offset intermediate, electrified, 8 wire, satin bronze finish	446
75200 613	Pivot, 3/4" offset intermediate, electrified, 8 wire, dark bronze finish	446
75200 619	Pivot, 3/4" offset intermediate, electrified, 8 wire, satin nickel finish	446
75200 625	Pivot, 3/4" offset intermediate, electrified, 8 wire, bright chrome finish	446
E80622 630 / E80624 630 (Standard)	Pivot, center hung top, electrified, 8 wire, satin chrome finish	488
E80622 605 / E80624 605	Pivot, center hung top, electrified, 8 wire, bright brass finish	488
E80622 606 / E80624 606	Pivot, center hung top, electrified, 8 wire, satin brass finish	488
E80622 611 / E80624 611	Pivot, center hung top, electrified, 8 wire, bright bronze finish	488
E80622 612 / E80624 612	Pivot, center hung top, electrified, 8 wire, satin bronze finish	488
E80622 613 / E80624 613	Pivot, center hung top, electrified, 8 wire, dark bronze finish	488
E80622 619 / E80624 619	Pivot, center hung top, electrified, 8 wire, satin nickel finish	488
E80622 629 / E80624 629	Pivot, center hung top, electrified, 8 wire, bright stainless finish	488
E80622 689 / E80624 689	Pivot, center hung top, electrified, 8 wire, aluminum painted finish	488
E80622 695 / E80624 695	Pivot, center hung top, electrified, 8 wire, dark bronze painted finish	488

Request to Exit Touch Bars (No latch assembly)

		628, 711	605, 629, 630
Item	Description	Standard Finish \$	Plated Finish \$
MSD550	Exit touch bar with mechanical switch (power transfer required), 628 or 711 finish standard, optional plated finishes 605, 629, 630	331	528

Timers/Relays

Item	Description	List \$
14-2	7-day programmable timer with memory and battery back-up. Specify 12 or 24 V	360
TD-ADJ	0-30 second adjustable timer	80
TD-FIX	30 second fixed timer	80
TDM	Time delay module sequencer relay	218

Desk Switches

Item	Description	List \$
PD15-1	MA SPDT	156
PD15-2	MO SPDT	106
PD15-3	MA SPDT (Toggle)	187

Desk Top Models for One or Two Doors

Item	Description	List \$
CC401DTM	One Momentary (MO) switch and one LED	313
CC402DTM	Two Momentary (MO) switches and two LEDs	391
CC403DTM	One Momentary (MO) & one Maintained (MA) switch and two LEDs	469
CC402DTMA	Two Maintained (MA) switches and two LEDs	391

Specialty Switches

Item	Description	List \$
3909S MA	Rocker switch, maintained	56
3909S MO	Rocker switch, momentary	56
39043B	Emergency pull station, blue with red pull	160
39043Y	Emergency pull station, yellow with red pull	180

Door Position Sensors (SPDT)

Item	Description	List \$
DPS11	Adjustable ball type SPDT, 5 amp	63
DPS112	Adjustable ball type 2 SPDT, 5 amp	95
MC4	Recessed magnetic	38
MC4M	Recessed magnetic mounted on plate	122
MC7	Biased high security recessed magnetic	95

Passive Infrared Egress Control

Item	Description	List \$
MS1RV1	Motion sensor (Requires PS1 RMT)	320
PS1RMT	Remote control for motion sensor	53
MD31DOW	Motion sensor with time delay — off white	320
MD31DB	Motion sensor with time delay — black	320

Monitor Strikes

Item	Description	List \$
MS12	Cylindrical latch monitor, 2-3/4" SPDT	176
MS12D	Cylindrical latch monitor, 2-3/4" DPDT	225
MS14	Cylindrical latch monitor, 4-7/8" SPDT	176
MS14D	Cylindrical latch monitor, 4-7/8" DPDT	225
MS16	Mortise lock latch monitor SPDT	176
MS16D	Mortise lock latch monitor DPDT	225
MS18	Mortise lock dead bolt monitor SPDT	176
MS18D	Mortise lock dead bolt monitor DPDT	240
MS20	Mortise lock latch and bolt monitor SPDT	225
MS20D	Mortise lock latch and bolt monitor DPDT	300



SELECT SERVICE QUICK SHIP

Low Energy Operators

Select service should be used for small quantities of popular DORMA products that require shipment within 24 hours. The program includes patch fittings, DRS rails, headers, concealed closers and pivots, handles, locks, exit devices, surface door closers, magnets, electronic access control, and low energy operators. Warehouses have been set up in the east and west for faster delivery nationwide. (Customer responsible for shipping costs FOB.)

Subject to Availability

Next Business Day Service (Shipment when Purchase Order is received prior to 4:00 PM EST).

Examples: DORMA receives P.O. at 3:59 PM on Monday, order will ship by close of business on Tuesday.

DORMA receives P.O. at 3:59 PM on Friday, order will ship by close of business on the following Monday.

Notes:

- Standard freight and discount schedules and terms of sale apply. Please refer to the current price list for full details.
- DORMA reserves the right to limit quantities or decline an order if the credit status of the buyer is not satisfactory to DORMA.
- Orders cannot be cancelled.
- All prices are in U.S. dollars.
- Products and prices are subject to change without notice.
- Some of the available products have quantity per order limits and will be noted accordingly.

Key

N	"New" to Select Service, Available in East and West Coast Warehouse
■	Available in East and West Coast Warehouse
E	Available only in East Coast Warehouse





Power Door Operator

ED900

PN #		Product	Arm	Finish	List \$
33700001	■	ED900	J8	689	4,893
33700002	■	ED900	T	689	4,893
33700003	■	RFR 433 Receiver	—	—	280
08108210	■	WS1 Wall Switch	—	—	248
33700004	■	WSRFT1 433 Wireless Wall Switch, 6" Square	—	—	399



ED900 SERIES

Ordering Guide

Low Energy Swing Door Operator		Model 900		T — Pull Side Track Mount	Options	
				J8 — Push Side Top Jab Mount, 0-8"	PC — Power Cord	
				J12 — Push Side Top Jamb Mount, 8-12" Reveal	CB — Conduit Box	
Power Door Operator	ED	Pair of Doors 2 ED900s	PR	SW	600	Remote Key switch (628 finish) less cylinder
Series	ED 900			SW — Standard Width	689 — Aluminum	
				FWS — Full Width, Sgl. Door, Seamless Cover	690 — Statuary Bronze	
				FW2 — Full Width, Sgl. Doors 2 piece cover	691 — Dull Bronze	
				FWPRS — Full Width, Pair of Doors, Seamless Cover	693 — Black	
				FWPR3 — Full Width, Pair of Doors, 3-Piece	695 — Dark Duranodic Bronze	
					696 — Gold	
					Custom — Custom Painted Finish	
					Designer — Designer Painted Finish	
				Cover	Finish	

SW
Standard Width 27"; Single Door

FWS
Seamless Full Width Cover, Single Door, From 29" (737 mm) to 48" (1219 mm)

FW2
Full Width Cover, 2-Pieces, Includes 27" SW Cover and extension cover up to 21" (533 mm).

FWPRS
Seamless Full Width Cover for Pair of Doors, From 56" (1422 mm) to 96" (2438 mm)

FWPR3
Full Width Pair of Doors, includes two 27" Standard Width Covers, and extension cover to fill remaining opening, up to 35" (889 mm).

Painted



ED900 SERIES LOW ENERGY OPERATORS

Single Door Applications

Model	Arm	Mounting	List Add Painted \$
ED900	T	Pull-side regular mount, track arm	4,893
ED900	J8	Push-side, top jamb mount, 0"-8" reveal, mechanical arm stop	4,893
ED900	J12	Push-side, top jamb mount, 8"-12" reveal, mechanical arm stop	5,026
Covers			
SW		Standard width cover, 27", included with ED900	N/C
FWS		Full width cover for single door (door widths from 29"-48"), double mode switch and cable included.	227
FW2		A 27" standard cover, with field cut cover and mounting plate, (door width up to 48"), seam concealer, double mode switch and cable included.	227

Pair of Door Applications (Includes two ED900 Operators)

Model	Arm	Arm Mounting	List Add Painted \$
ED900PR	T	Two ED900 operators, pull-side mount with track arms, for pairs of doors	9,785
ED900PR	J8	Two ED900 operators, push-side, top jamb mount arms, 0"-8" reveal, for pairs of doors	9,785
ED900PR	J12	Two ED900 operators, push-side, top jamb mount arms, 8"-19" reveal, for pairs of doors	10,058
Covers			
SW		Two standard width covers, 27", for two ED900 operators	N/C
FWPRS		Seamless full width cover for pair of doors (door widths from 56"-96"), includes center mounting plate, control switch wiring harness, synchronizing cable, mode switch with cable, and power harness jumper.	453
FWPR3		Two 27" standard covers with field cut cover and mounting plate (door widths from 56"-96"), with seam concealers, control switch wiring harness, synchronizing cable, mode switch with cable, and power harness jumper.	453

NOTE: ED900 T, J8, J12 and ED900PR T, J8, J12 models include all axle extension 5/16" (9mm), 3/4" (20mm), 1-1/8" (30mm), and 2-3/8" (60mm).



OPTIONS

Item	Description	List Add \$
Special Finishes		
Custom Color	Custom painted finish selected from DORMA RAL color pal book. For details, see DORMA Finishes Cross Reference, page vii.	
	Per operator, set-up charge (Net)	56
	Per operator, list add	54
Designer Color	Designer painted color matched to supplied samples. Three (3) each, 2" x 2" color chip samples required. For details, see DORMA Finishes Cross Reference, page vii.	
	Per operator, non-refundable development/set-up charge (Net)	220
	Per operator, list add	67
Electrical Connection Options		
CB	Conduit box (only)	57
PC	Power cord (includes conduit box and power cord)	110

ACCESSORIES

Item	Description	List \$
Hard Wired Switches and Accessories		
WS1	Wall Switch – RF 6" square	248
WS 1 LOGO	Wall switch – RF with wheelchair logo only, 6" square	248
WS 1 SQ4	Wall switch, 4-1/2" square	275
WS 1 RND4	Wall switch, 4-1/2" round	275
WSTLS	Wall switch, touch-less sensor (available in white, gray, black)	424
FS 1	Frame switch, 1-3/4" x 4-1/2"	169
FS 1 LOGO	Frame switch with wheelchair logo only, 1-3/4" x 4-1/2"	169
UMB	Universal mounting box, for surface mounting WS-1, where no junction box is supplied	109
UMBFR	Universal mounting box flush mount ring, dress ring for WS-1	71
UMBRFT	Universal mounting box only, for 6" square WS/RFT 1 type switches (includes circuit board)	253

Locks

Cylinders,
Keys & Keying

Exit Devices

Electronic
Access Control
Components

Low Energy
Operators

Surface
Closers

Fire/Life
Safety

Concealed
Closers/Pivots

Stops/
Holders

Sliding
Systems

Architectural
Pulls &
Handles

Service Parts



Item	Description	List \$
RF Switches and Accessories		
WSRFT 1	Wall switch – RF 300 MHz, 6" square	408
WSRFT 1 LOGO	Wall switch – RF 300 MHz, 6" square, with wheelchair logo only	408
WSRFT 1 433	Wall switch – RF 433 MHz, 6" square	399
WSRFT 1 433 SQ4	Wall switch – RF 433 MHz, 4-1/2" square	399
WSRFT 1 43 RND4	Wall switch – RF 433 MHz, 4-1/2" round	399
RFR	RF receiver, 300 MHz, 12 or 24 AC/DC (can be powered from ED900)	280
RFR 433	RF receiver, 433 MHz, 12 or 24 VAC/DC, 24AC (can be powered from ED900)	199
HHRFT 1 433	Hand held transmitter, 433 MHz	121
HHRFT 2 433	Hand held dual transmitter, 433 MHz	165
HHRFT 4 433	Hand held four button transmitter, 433 MHz	209
KCRFT 2 433	Key chain dual transmitter, 433 MHz	109
Miscellaneous Accessories		
SP1	Axle adaptor, zero extension	59
SP2	Axle adaptor, 3/4" (20mm) extension	59
SP3	Axle adaptor, 1-1/8" (30mm) extension	59
SP6	Axle adaptor, 2-3/8" (60mm) extension	70
SCRPK, ED900 Track	ED900 track arm, screwpack	11
970	Angle bracket	235
SCRPK900970	ED900 970 bracket, screwpack	11
930	Drop plate for arm shoe	60
SCRPK900930	930 drop plate, screwpack	11
BSTP25	Bumper/stop (1/4" thick plate)	65
BSTP50	Bumper/stop (1/2" thick plate)	65
BSTPSHM25	Bumper/stop shim, 1/4" thick	65
BSTPSHM50	Bumper/stop shim, 1/2" thick	65
BUMPER BLK	Bumper only	22
HEXKEY T	Hex key, 5mm, T-handle	16
DECAL ED900	Decal, ED900 door set	43
PRCONKIT96	Pair connection kit up to 96" opening width	165
TERMCONBD	Terminal Connection Board	73
T	Pull side track mount arm	240
J8	Push side top jamb mount arm, 0"–8" reveal	240
J12	Push side top jamb mount arm, 8"–12" reveal	374
CAPSCOVS	Plastic endcaps/pinion cover	21

NOTE: DORMA offers safety and motion sensors for use with the ED900. Please contact customer service for ordering support



DORMA SURFACE CLOSERS

Product Guide (1 of 2)

SURFACE MOUNTED CLOSERS	Full Cover	Slimline Cover	No Cover
Grade 1 — Cam Action Fully Adjustable (Power) Size	TS93	—	—
Grade 1 — Heavy Duty Fully Adjustable (Power) Size	8900	—	—
	STA8900	—	—
Grade 1 — Fully Adjustable (Power) Size	8600 × FC	8600 × COV	—
	STA8600 × FC	STA8600 × COV	—
Grade 1 — Adjustable (Power) Size	7400 × FC	7400 × COV	7400
	STA7400 × FC	STA7400 × COV	STA7400
	—	U1500 × COV	U1500
Grade 1 — Sized (Power) per Application	—	7300 × COV	7300

- Locks
- Cylinders, Keys & Keying
- Exit Devices
- Electronic Access Control Components
- Low Energy Operators
- Surface Closers**
- Fire/Life Safety
- Concealed Closers/Pivots
- Stops/ Holders
- Sliding Systems
- Architectural Pulls & Handles
- Service Parts



DORMA SURFACE CLOSERS

Product Guide (2 of 2)

<input checked="" type="radio"/> Yes <input type="radio"/> No	A156.4 Grade 1	UL10C	Advanced Cam & Roller Design	Rack & Pinion Design	Stainless	Plated or Decorative Finishes	Standard Painted Finishes	Custom Painted Finishes	Adjustable Power	Fixed Power
TS93	<input checked="" type="radio"/>	<input checked="" type="radio"/>	<input checked="" type="radio"/>	<input type="radio"/>	<input type="radio"/>	<input checked="" type="radio"/>	<input checked="" type="radio"/>	<input checked="" type="radio"/>	<input checked="" type="radio"/>	<input type="radio"/>
8900	<input checked="" type="radio"/>	<input checked="" type="radio"/>	<input type="radio"/>	<input checked="" type="radio"/>	<input type="radio"/>	<input checked="" type="radio"/>	<input checked="" type="radio"/>	<input checked="" type="radio"/>	<input checked="" type="radio"/>	<input type="radio"/>
STA8900	<input checked="" type="radio"/>	<input checked="" type="radio"/>	<input type="radio"/>	<input checked="" type="radio"/>	<input checked="" type="radio"/>	<input checked="" type="radio"/>	<input checked="" type="radio"/>	<input checked="" type="radio"/>	<input checked="" type="radio"/>	<input type="radio"/>
8600	<input checked="" type="radio"/>	<input checked="" type="radio"/>	<input type="radio"/>	<input checked="" type="radio"/>	<input type="radio"/>	<input checked="" type="radio"/>	<input checked="" type="radio"/>	<input checked="" type="radio"/>	<input checked="" type="radio"/>	<input type="radio"/>
STA8600	<input checked="" type="radio"/>	<input checked="" type="radio"/>	<input type="radio"/>	<input checked="" type="radio"/>	<input checked="" type="radio"/>	<input checked="" type="radio"/>	<input checked="" type="radio"/>	<input checked="" type="radio"/>	<input checked="" type="radio"/>	<input type="radio"/>
7400	<input checked="" type="radio"/>	<input checked="" type="radio"/>	<input type="radio"/>	<input checked="" type="radio"/>	<input type="radio"/>	<input checked="" type="radio"/>	<input checked="" type="radio"/>	<input checked="" type="radio"/>	<input checked="" type="radio"/>	<input type="radio"/>
U1500	<input checked="" type="radio"/>	<input checked="" type="radio"/>	<input type="radio"/>	<input checked="" type="radio"/>	<input type="radio"/>	<input type="radio"/>	<input checked="" type="radio"/> *	<input type="radio"/>	<input checked="" type="radio"/>	<input type="radio"/>
7300	<input checked="" type="radio"/>	<input checked="" type="radio"/>	<input type="radio"/>	<input checked="" type="radio"/>	<input type="radio"/>	<input type="radio"/>	<input checked="" type="radio"/>	<input checked="" type="radio"/>	<input type="radio"/>	<input checked="" type="radio"/>
GSR	<input checked="" type="radio"/>	<input checked="" type="radio"/>	<input checked="" type="radio"/>	<input type="radio"/>	<input type="radio"/>	<input checked="" type="radio"/>	<input checked="" type="radio"/>	<input checked="" type="radio"/>	<input checked="" type="radio"/>	<input type="radio"/>

* 689 and 695 only.



SELECT SERVICE QUICK SHIP

Surface Closers

Select service should be used for small quantities of popular DORMA products that require shipment within 24 hours. The program includes locks, exit devices, door closers, magnets, electronic access control, and low energy operators. Warehouses have been set up in the east and west for faster delivery nationwide. (Customer responsible for shipping costs FOB.)

Subject to Availability

Next Business Day Service (Shipment when Purchase Order is received prior to 4:00 PM EST).

Examples: DORMA receives P.O. at 3:59 PM on Monday, order will ship by close of business on Tuesday.

DORMA receives P.O. at 3:59 PM on Friday, order will ship by close of business on the following Monday.

Notes:

- Standard freight and discount schedules and terms of sale apply. Please refer to the current price list for full details.
- DORMA reserves the right to limit quantities or decline an order if the credit status of the buyer is not satisfactory to DORMA.
- Orders cannot be cancelled.
- Select Service Quick Ship available only in the United States.
- All prices are in U.S. dollars.
- Products and prices are subject to change without notice.
- Some of the available products have quantity per order limits and will be noted accordingly.

Key

N	"New" to Select Service, Available in East and West Coast Warehouse
■	Available in East and West Coast Warehouse
E	Available only in East Coast Warehouse



- Locks
- Cylinders, Keys & Keying
- Exit Devices
- Electronic Access Control Components
- Low Energy Operators
- Surface Closers**
- Fire/Life Safety
- Concealed Closers/Pivots
- Stops/ Holders
- Sliding Systems
- Architectural Pulls & Handles
- Service Parts

Surface Door Closers

TS93 Series

PN #		Product	Arm	Cover	Fastener	Finish	List \$
93000706	■	TS9315 (Cam & roller technology)	T	FMC	SN3	689	471
93000709	■	TS9315 (Cam & roller technology)	PT	FMC	SN3	689	471
33400001	■	TS9315 (Cam & roller technology)	ST	FMC	SN3	689	680
33400002	■	TS9315 (Cam & roller technology)	SPT	FMC	SN3	689	680

8900 Series

PN #		Body	Arm	Cover	Fastener	Finish	List \$
30000050	■	8916	AF89P	FC	SN1	689	442
30001450	□	8916	AF89P	FMC	SN1	689	448
30001310	■	8916	SPA	FC	SN1	689	460
30000054	■	8916	DS	FC	SN1	689	491
30001076	□	8916	DST	FC	SN1	689	533
30001727	■	8916	SDS	FC	SN1	689	620
30001728	■	8916	SDST	FC	SN1	689	662
30001729	□	8916	SIS	FC	SN1	689	680

8600 Series

PN #		Body	Arm	Cover	Fastener	Finish	List \$
28003500	■	8616	AF86P	COV	SNB1	689	330
28003520	□	8616	AF86P	FC	SNB1	689	333
28003460	■	8616	ARP	COV	SNB1	689	319
28003550	□	8616	ARP	FC	SNB1	689	324
28010180	■	8616	FHP	COV	SNB1	689	370
28003730	■	8616	DS	COV	SNB1	689	387
28010150	■	8616	DST	COV	SNB1	689	432

7400 Series

PN #		Body	Arm	Fastener	Finish	List \$
33400003	■	7436	ARP	COMBO	689	218
33400004	■	7414	ARP	COMBO	689	218
28003480	■	7436	ARP	SNB1	689	224
28001860	■	7414	ARP	SNB1	689	224
28010200	□	7436	FHP	SNB1	689	273
28010210	□	7414	FHP	SNB1	689	273





Surface Closer Accessories & Service Items

PN #		Product	Finish	List \$
08032860	■	P86	689	16
33400005	■	BSHD	689	25
08098830	■	BP89	689	30
08205660	□	BP86	689	30
08205670	□	BP86FC	689	30
08098800	■	BP74	689	30
08211960	■	BP640C	689	5
08096920	■	DP89	689	30
08098820	■	DP86	689	30
08205680	□	DP86FC	689	30
08098810	■	DP74	689	30
08205590	■	AF89P	689	83
08205613	□	AF86P	695	78
33400007	■	AF86	689	70
08205630	□	ARP	689	67
33400008	■	AR	689	60
08112030	■	A08P	689	67
33400009	■	FHP	689	114
08091470	□	SR48	689	28
08098860	□	SB48	689	29
33400006	■	FC	689	22
08098840	■	COV	689	17
08111320	■	DPK89	689	9
08211160	■	DPK86	689	9
08081290	■	SN1	689	5
08098850	■	SNB1	689	7
08205690	□	SN3	689	5

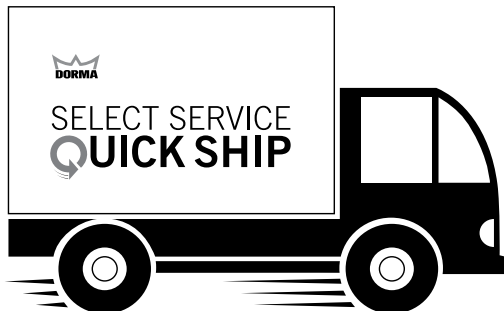

- Locks
- Cylinders, Keys & Keying
- Exit Devices
- Electronic Access Control Components
- Low Energy Operators
- Surface Closers
- Fire/Life Safety
- Concealed Closers/Pivots
- Stops/ Holders
- Sliding Systems
- Architectural Pulls & Handles
- Service Parts



TS93 SERIES

Ordering Guide

Arm Type	
171°-180° Pocket Mount	TPKT180
120°-170° Pocket Mount	TPKT170
90°-119° Pocket Mount	TPKT119
90° Pocket Mount	TPKT90
Spring Stop Track Hold Open (Pull)	STH
Push Side Track Hold	PTH
Pull Side Track Hold	TH
Spring Stop Track (Push)	SPT
Spring Stop Track (Pull)	ST
Push Side Track	PT
Pull Side Track	T

Fastener Pack	
SN4	Sex Nuts for 1-3/8" Door
SN3	Sex Nuts for 1-3/4" Door

Painted	
PNT	Special Sprayed Finish (must specify)
696	Gold
695	Dark Duranodic Bronze
693	Black
691	Dull Bronze
690	Statuary Bronze
689	Aluminum
600	Primed

Plated	
605	Bright Brass
630	Satin Stainless

Options	
CS*	Cushion Stop

Architectural	
630	Satin Stainless

Spring Size	
15	Size 1-5
56	Size 5-6

Model	
TS93	Model

Ordering Code Example				
TS93	15	T	SN3	689

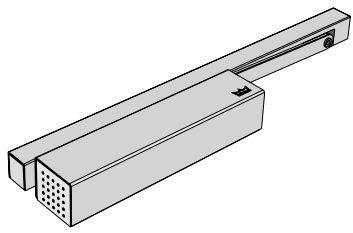

*Available for use with T, TH, PT, PTH arms only.

NOTES:

- All combinations of features and options are not available for all models.
- Please refer to TS93 Series product brochure for details.

- Locks
- Cylinders, Keys & Keying
- Exit Devices
- Electronic Access Control Components
- Low Energy Operators
- Surface Closers**
- Fire/Life Safety
- Concealed Closers/Pivots
- Stops/ Holders
- Sliding Systems
- Architectural Pulls & Handles
- Service Parts



Body	Arm	Mounting	Painted Finish \$	605/630 \$
Slide Track Non-Hold Open				
TS9315/TS9356	T	Door mounted (pull side)	471	782
	PT	Soffit mounted (push side)	471	782
Slide Track Hold Open				
TS9315/TS9356	TH	Door mounted (pull side)	494	805
	PTH	Soffit mounted (push side)	494	805
Slide Track Non-Hold Open w/Spring Dead Stop				
TS9315/TS9356	ST	Door mounted w/stop (pull side)	680	1,025
	SPT	Soffit mounted w/stop (push side)	680	1,025
Slide Track Hold Open w/Spring Dead Stop				
TS9315/TS9356	STH	Door mounted w/stop (pull side)	703	1,050

NOTE: S-track (stop) units ordered in 630 finish are furnished as a combination of 619 and 630 finish components.

NOTE: Highlighted items are available from Select Service, 689 finish only.

Body	Arm	Mounting	Painted Finish \$
90° Slide Track/Pocket Pivot Applications			
TS9356	TPKT90	90° track application less pocket pivots For nonfire-rated applications, order (3 ea.) plated finish 75520 pocket pivots, separately For 3-hour fire-rated applications, order (3 ea.) plated finish 75523 pocket pivots, separately	506
90°-180° Slide Track/Pocket Pivot Applications			
TS9356	TPKT119	90° to 119°, offset pivots or hinges, closer on door, track in pocket. Order EM504 electromagnet separately.	611
	TPKT170	120° to 170°, closer on wall in pocket, track on door. Order EM504 electromagnet separately.	645
	TPKT180	171° to 180°, closer on wall in pocket, track on door. Order EM504 electromagnet separately.	677



OPTIONS

(List Price 'add' when ordered with complete closer)

Item	Description	List Add/Deduct \$
CS	Cushion stop/bumper to help slow door in normal opening cycle (for T, TH, PT, PTH arms only)	32
SN4	(4) each 10-32 aluminum sex nuts for 1-3/8" door	N/C
LSN	Less sex nuts (less SN3 pack)	Deduct 5
Custom Color	Custom painted finish selected from DORMA RAL color pallet book. For details, see DORMA Finishes Cross Reference , page vii.	
	per order, setup charge (Net)	100
	per closer, list add	25
Designer Color	Designer painted color matched to supplied samples. Three (3) each 2" x 3" color chip samples required. For details, see DORMA Finishes Cross Reference , page vii.	
	per order, non-refundable development/ setup charge (Net)	250
	per closer, list add	31

NOTES:

- Painted finish price includes full metal cover with plastic end caps.
- Specify closer and arm designation and finish when ordering
- TS93 packaged (2) units per master carton.
- SN3 sex nuts and (DA) delayed action is standard with all TS93 closers.

- Locks
- Cylinders, Keys & Keying
- Exit Devices
- Electronic Access Control Components
- Low Energy Operators
- Surface Closers**
- Fire/Life Safety
- Concealed Closers/Pivots
- Stops/ Holders
- Sliding Systems
- Architectural Pulls & Handles
- Service Parts





8900 SERIES

Ordering Guide

Spring Size		Body Cover		Accessory Plates*		Other Accessories*	
Fixed size 2 for TEL	02	Full Plastic	FC	Drop Plate	DPXX	AB89	Angle Bracket
Adjustable 1-6	16	Full Plastic Slotted	FCSL	Back Plate	BPXX	NFHD	Narrow Frame Bracket, Heavy Duty
Fixed Size 7	07	Telephone Booth Closer	TEL			FTHD	Flush Transom Bracket, Heavy Duty
Adjustable 5-6	56	Delay	DA	Full Metal Cover*	FMC	BS	Blade Stop Spacer
						BSHD	Blade Stop Heavy Duty
89	16	AF89	FC	SN1		689	
Series 8900	Flat Form Non-Hold Open, Tri-Pack	AF89P	PFT	TX89	Plated Torx Security Pack Sex Nuts 1-3/8" Sex Nuts 1-3/4" Std. and Self-Drilling Self-Drilling Std. and Self-Tapping Self-Tapping	605	Polished Brass
	Flat Form Non-Hold Open, TJ 4"-8" Reveal	AF89J	PD	SN2		606	Satin Brass
	Flat Form Non-Hold Open, Reg./TJ 0"-4" Reveal	AF89	MJ	SN1		611	Polished Bronze
	Friction Hold Open, Tri-Pack	FHP	PA Bracket	SNDPK		612	Satin Bronze
	Friction Hold Open, TJ 4"-8" Reveal	FHJ		DPK89		613	Oxidized Satin Oil Rubbed Bronze
	Friction Hold Open, Reg./TJ 0"-4" Reveal	FH		SNTPK		618	Polished Nickel
	Plunger Hold Open, Parallel Arm (TJ 1-1/2"-3-1/2" Reveal)	PHP		TPK89		619	Satin Nickel
	Plunger Hold Open, Reg./TJ 0"-1-1/2" Reveal	PH		Fastener Pack		625	Polished Chrome
	Door Saver Parallel Cushion Arm	DS				626	Satin Chrome
	Door Saver Parallel Cushion Arm Thumb Turn Hold Open	DST				630	Stainless Satin* (SIS/SISJ arm assembly only)
	Spring Door Saver Parallel Dead Stop	DSK	Door Saver Parallel Cushion Arm Hex e y Turn Hold Open		600	Primed	
	Cushion IS Arm Reg./TJ 0"-3-1/2" Reveal	SDS			689	Aluminum	
	Spring Stop IS Reg./TJ 0"-3-1/2" Reveal	SDST	Spring Door Saver Parallel Dead Stop Thumb Turn Hold Open		690	Statuary Bronze	
	Cushion IS Arm Hold Open, 0"-3-1/2" Reveal (Not Available on 8956 or 8907)	IS			691	Dull Bronze	
	Spring Stop IS Hold Open, Reg./TJ 0"-3-1/2" Reveal (Not Available on 8956 or 8907)	ISH			693	Black	
	Cushion IS Arm Top Jamb 3-1/2"-6-1/2" Reveal	SIS	Spring Stop IS Arm Hold Open, Top Jamb 3-1/2"-6-1/2" Reveal		695	Dark Duranodic Bronze	
	Spring Stop IS Top Jamb 3-1/2"-6-1/2" Reveal	SISH			696	Gold	
	Cushion IS Arm Top Jamb 3-1/2"-6-1/2" Reveal	ISJ	Spring Stop IS Arm Hold Open, Top Jamb 3-1/2"-6-1/2" Reveal		PNT	Special sprayed finish (must specify)**	
	Spring Stop IS Top Jamb 3-1/2"-6-1/2" Reveal	ISJH					
	Super Parallel Arm	SISJ					
	Super Parallel Arm Thumb Turn Hold Open	SISJH					
	Super Parallel Arm Hex e y Hold Open	SPA					
	Track, Pull Side Door Mounted	SPAT					
	Jamb Track, Pull Side Frame Face Mounted	SPAK					
	Push Track, Push Side Soffit Mounted	T					
	Track Double Egress, Pull Side Transom Mounted	JT					
	Track Hold Open, Pull Side Door Mounted	JT					
	Track Hold Open, Pull Side Door Mounted	PT					
	Track Double Egress, Pull Side Transom Mounted	TDE					
	Track Hold Open, Pull Side Door Mounted	FT	Flush Track, Push Side Transom Mounted				
	Track Hold Open, Pull Side Door Mounted	TH					
	Track Hold Open, Pull Side Door Mounted	JTH	Jamb Track Hold Open, Pull Side Frame Face Mounted				
	Track Hold Open, Pull Side Door Mounted	PTH					
	Track Hold Open, Pull Side Door Mounted	TDEH	Track Double Egress Hold Open, Pull Side Frame Face Mounted				
	Track Hold Open, Pull Side Door Mounted	FTH					
	Track Application, 90 Pocket Door Includes 3 ea. 75520 Pocket Pivots (8956 only)	TPKT90	Track Application, 90 Pocket Door (8956 only)				
	Track Application, 90 Pocket Fire Door Includes 3 ea. 75523 Pocket Pivots	TPKT90/P					
	Track Application, 90 Pocket Fire Door Includes 3 ea. 75523 Pocket Pivots	T PKT90/PF					
	Double Lever Flat Form Arm, 90 Pocket Door (8907 only)	AFPKT90					
	Double Lever Flat Form, 180 Pocket Door (8907 only)	AFPKT180					

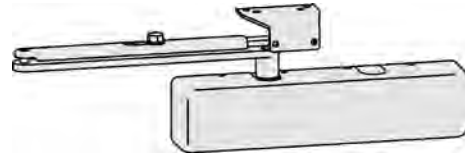

NOTES:

- All combinations of features and options are not available for all models. Please refer to 8900 product brochure for details.
- Non-fire rated, 90TPK (90° pocket) applications require (3 ea.) 75520 pocket pivots, ordered separately.
- Fire rated, 90 TPK (90° pocket) applications require (3 ea.) 75523 pocket pivots, ordered separately.

*Stainless steel base material with satin finish.
 **For optional DORMA custom color or designer Color Finishes, contact Customer Service.

- Locks
- Cylinders, Keys & Keying
- Exit Devices
- Electronic Access Control Components
- Low Energy Operators
- Surface Closers
- Fire/Life Safety
- Concealed Closers/Pivots
- Stops/ Holders
- Sliding Systems
- Architectural Pulls & Handles
- Service Parts

Body	Arm	Mounting	Painted Finish \$	Plated Finish \$
Non-Hold Open				
8916, 8956	AF89P	PA, REG & TJ for reveals to 4" (flat)	442	741
	AF89J	TJ for reveals 4" to 8" (flat)	438	689
	AF89	REG or TJ for reveals to 4" (flat)	434	684
	RRA	REG, rigid regular mount arm (flat)	488	—
Dead Stop or Cushion Arms				
8916, 8956	DS	Door saver parallel arm (Cushion Arm)	491	793
	DST	w/thumb turn hold open	533	831
	DSK	w/hex key turn hold open	533	831
	SDS	Spring assist dead stop parallel arm	620	998
	SDST	w/thumb turn hold open	662	1,040
	IS	Integra cushion arm, REG and TJ for 0" to 3-1/2" reveal	611	891
	ISH	Integra cushion arm, w/ hold open REG and TJ for 0" to 3-1/2" reveal (not available on 8956 or 8907)	655	—
	SIS	Spring integra stop arm, REG and TJ for 0" to 3-1/2" reveal	655	*1,013
	SISH	w/hold open, REG and TJ for 0" to 3-1/2" reveal (not available on 8956 or 8907)	724	—
	ISJ	Integra cushion arm, TJ for 3-1/2" to 6-1/2" reveal	633	909
	ISJH	Integra cushion arm w/hold open, TJ for 3-1/2" to 6-1/2" reveal (not available on 8956 or 8907)	676	—
	SISJ	Spring integra stop arm, TJ for 3-1/2" to 6-1/2" reveal	702	*1,035
	SISJH	w/hold open, TJ for 3-1/2" to 6-1/2" reveal (not available on 8956 or 8907)	744	—
Heavy Duty PA				
8916, 8956	SPA	Super parallel arm	460	758
	SPAT	w/thumb turn hold open	502	793
	SPAK	w/hex key turn hold open	502	787
Hold Open				
8916, 8956	FHP	Friction PA, REG & TJ for reveals to 4"	475	—
	FHJ	TJ for reveals 4" to 8"	471	—
	FH	REG or TJ for reveals to 4"	467	—
	PHP	Plunger PA & TJ for reveals 1-1/4" to 3-1/4"	547	841
	PH	REG or TJ for reveals 0" to 1-1/4"	543	784

* Available in 630 finish only and not intended for corrosive environments.

NOTE: Highlighted items are available from Select Service, and only available in 689 Finish.

NOTE: Standard arm configuration is indicated in **bold**.



Body	Arm	Mounting	Painted Finish \$	Plated Finish \$
Slide Track				
8916, 8956	T	Door mounted (pull side)	471	758
	JT	Frame mounted (pull side)	471	758
	FT	Flush transom mounted (push side)	471	758
	PT	Soffit mounted (push side)	471	758
	TDE	Frame mounted double egress frame (pull side)	525	812
Track Hold Open				
8916, 8956	TH	Door mounted (pull side)	493	781
	JTH	Frame mounted (pull side)	493	781
	FTH	Flush transom mounted (push side)	493	781
	PTH	Soffit mounted (push side)	493	781
	TDEH	Frame mounted double egress frame (pull side)	546	836
Pocket Applications				
8956	TPKT90	Track application, 90 degree pocket door	471	758
8907	AFPKT90	Double lever flat form arm, 90 degree pocket door	471	769
	AFPKT180	Double lever flat form arm, 180 degree pocket door	471	806

- Locks
- Cylinders, Keys & Keying
- Exit Devices
- Electronic Access Control Components
- Low Energy Operators
- Surface Closers**
- Fire/Life Safety
- Concealed Closers/Pivots
- Stops/ Holders
- Sliding Systems
- Architectural Pulls & Handles
- Service Parts

OPTIONS

Item	Description	List Add/Deduct \$
DA	Adjustable delayed action (suffix to model)	33
TEL	Telephone booth closer (size 2 spring only, holds door ajar, suffix to model)	32
FCSL	Full plastic slotted cover (low ceiling conditions)	N/C
FMC	Full metal cover (handed for TJ or JT [FMCL/FMCR])	6
FMCLL	Full metal cover, lead lined. Handed & non-handed.	109
SN2	(4) each 1/4-20 aluminum sex nuts for 1-3/8" thick door	N/C
LSN	Less sex nuts (less SN1 pack)	Deduct 5
DPK89	All fasteners to be self-drilling (in lieu of standard fasteners)	N/C
SNDPK	Standard fasteners and DPK89	11
TPK89	All fasteners to be self-tapping (in lieu of standard fasteners)	N/C
SNTPK	Standard fasteners and TPK89	11
TX89	All exposed fasteners to be Torx security fasteners (n/a with track applications)	26
TANDEM	Dual closer body system for extra heavy or wide doors or doors with difficult air handling conditions 8916 or 8956 (select one). SPA, FMC.	528
TANDEM	Dual closer body system for extra heavy or wide doors or doors with difficult air handling conditions. 8907, SPA, FML.	553
Decorative Finish Options (specify 605, 606, 611, 612, 613, 618, 619, 625, or 626 finish)		
Back or Drop Plates	Decorative plated finish, back plates, drop plates or non-standard PA brackets (BP**/DP**/AB**/PFT/PD/MJ/BSHD/NFHD/FTHD)	83
Custom Color	Custom painted finish selected from DORMA RAL color pallet book. For details, see DORMA Finishes Cross Reference , page vii.	
	per order, setup charge (Net)	100
	per closer, list add	25
Designer Color	Designer painted color matched to supplied samples. Three (3) each 2" x 3" color chip samples required. For details, see DORMA Finishes Cross Reference , page vii.	
	per order, non-refundable development/setup charge (Net)	250
	per closer, list add	31

NOTE: Highlighted items are available from Select Service.

NOTES:

- All painted components w/plated line item will be painted complementary finish.
 - Example:** For a line item ordered w/plated 626 FMC only, all other components will be 689.
- Painted finish price includes full plastic cover.
- Plated finish price includes optional full metal cover.
- Specify closer and arm designation, hand (when required), finish, and options when ordering.
 - All dead stop, heavy-duty PA, tracks, and top jamb (J) configurations packaged (4) units per master carton.
- All others are packaged (6) units per master carton.
- FMC is only cover available in plated finishes.
- Sex nuts for 1-3/4" door (SN1) furnished standard with all 8900 and included in price. Specify (SN2) for 1-3/8" door.



ACCESSORIES

Item	Description	List \$
BP89	Backplate for top jamb with frame < 2-7/8" wide	30
DP89	Drop plate for PA where top rail is < 5-3/4"	30
AB89	Angle bracket for closer with full plastic cover	55
PFT	Parallel flush transom bracket	24
PD	Parallel drop bracket, non-hold open arms (AF89 only)	32
MJ 	Mortised jamb bracket, non-hold open arms (AF89 only)	22
BS	Blade stop spacer (P89, PHB, and PD)	22
BSHD	Blade stop spacer for use with heavy duty door saver and super parallel arms	25
NFHD	Narrow frame bracket for use with heavy duty door saver and super parallel arms	25
FTHD	Flush transom bracket for use with heavy duty door saver and super parallel arms	46

 When used with flat form non-hold open arms, the MJ bracket must be used with a special length arm. Specify AF8MJ for 8600 or 8900 Series closers.

NOTE: Highlighted items are available from Select Service, and only available in 689 Finish.

Locks

Cylinders,
Keys & Keying

Exit Devices

Electronic
Access Control
Components

Low Energy
Operators

Surface
Closers

Fire/Life
Safety

Concealed
Closers/Pivots

Stops/
Holders

Sliding
Systems

Architectural
Pulls &
Handles

Service Parts





8600 SERIES

Ordering Guide

Series	8600	16	Delay	DA	Spring Size	Adjustable	1-6	Cover	Fastener Pack
	86	16			AF86P	COV	SNB1	689	
					AF86P	PFT	NFHD	605	LSN — Less Sex Nuts
					AF86J	PD	FTHD	606	METRIC — All Metric Fasteners
					AF86	MJ	BP86C	611	AWS — All Wood Screws
					ARP	P86		612	TX86 — Torx Security Pack
					ARNP	PHB		613	SNTPK — Std. and Self-Tapping
					ARJ			618	TPK86 — Self-Tapping
					AR			619	SNDPK — Std. and Self-Drilling
					A08P			625	DPK86 — Self-Drilling
					A08			626	SNB2 — Sex Nuts and Machine Screws, 1-3/8"
					FHP			630	SNB1 — Sex Nuts and Machine Screws, 1-3/4"
					FHJ			600	COMBO — Wood/Machine Screw Combination
					FH			689	
					PHP			690	
					PH			691	
					DS			693	
					DST			695	
					DSK			696	
					SDS			PNT	
					SDST				
					IS				
					ISH				
					SIS				
					SISH				
					ISJ				
					ISJH				
					SISJ				
					SISJH				
					SPA				
					SPAT				
					SPAK				
					T				
					JT				
					PT				
					TDE				
					FT				
					TH				
					JTH				
					PTH				
					TDEH				
					FTH				

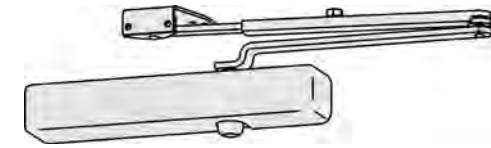

* Stainless steel base material with Satin Finish.

- NOTES:**
- All combinations of features and options are not available for all models. Please refer to 8600 Series product brochure for details.
 - To simplify initial installation, a range of back plates (BPxx), drop plates (DPxx), brackets, and spacers are listed under 8600 Accessories in this section. Refer to 8600 Series product brochure for details.

- Locks
- Cylinders, Keys & Keying
- Exit Devices
- Electronic Access Control Components
- Low Energy Operators
- Surface Closers
- Fire/Life Safety
- Concealed Closers/Pivots
- Stops/ Holders
- Sliding Systems
- Architectural Pulls & Handles
- Service Parts

Body	Arm	Mounting	Painted Finish \$	Plated Finish \$
Non-Hold Open				
8616	AF86P	PA, REG & TJ for reveals to 4" (flat)	330	643
	AF86J	TJ for reveals 4" to 8" (flat)	319	584
	AF86	REG or TJ for reveals to 4" (flat)	316	575
	ARP	PA, REG & TJ for reveals to 4" (round)	318	611
	ARNP	Narrow profile, REG or TJ for reveals to 4" (round)	305	554
	ARJ	TJ for reveals 4" to 8" (round)	309	558
	AR	REG or TJ for reveals to 4" (round)	305	554
	A08P	PA, REG & TJ secured elbow for reveals to 4" (round)	318	—
	A08	REG or TJ secured elbow for reveals to 4" (round)	314	—
Dead Stop or Cushion Arms				
8616	DS	Door saver parallel arm (cushion arm)	386	685
	DST	w/thumb turn hold open	432	728
	DSK	w/hex key turn hold open	420	728
	SDS	Spring assist dead stop parallel arm	506	895
	SDST	w/thumb turn hold open	549	938
	IS	Integra cushion arm, REG and TJ for 0" to 3-1/2" reveal	499	775
	ISH	Integra cushion arm w/hold open, REG and TJ for 0" to 3-1/2" reveal	542	—
	SIS	Spring integra stop arm, REG and TJ for 0" to 3-1/2" reveal	568	*908
	SISH	w/hold open, REG and TJ for 0" to 3-1/2" reveal	610	—
	ISJ	Integra cushion arm, TJ for 3-1/2" to 6-1/2" reveal	520	804
	ISJH	Integra cushion arm w/hold open, TJ for 3-1/2" to 6-1/2" reveal	563	—
	SISJ	Spring integra stop arm, TJ for 3-1/2" to 6-1/2" reveal	589	*931
	S-ISJH	w/hold open, TJ for 3-1/2" to 6-1/2" reveal	631	—
Heavy Duty PA				
8616	SPA	Super parallel arm	346	655
	SPAT	w/thumb turn hold open	389	699
	SPAK	w/hex key turn hold open	389	699
Hold Open				
8616	FHP	Friction PA, REG & TJ for reveals to 4"	370	—
	FHJ	TJ for reveals 4" to 8"	358	—
	FH	REG or TJ for reveals to 4"	354	—
	PHP	Plunger PA & TJ for reveals 1-1/2" to 3-1/2"	435	739
	PH	REG or TJ for reveals 0" to 1-1/2"	431	692
Slide Track				
8616	T	Door mounted (pull side)	358	645
	JT	Frame mounted (pull side)	358	645
	FT	Flush transom mounted (push side)	358	645
	PT	Soffit mounted (push side)	358	645
	TDE	Frame mounted double egress frame (pull side)	412	701

* Available in 630 finish only and not intended for corrosive environments.

* FMC is the only cover available in 630 finish

NOTE: Standard arm configuration is indicated in **bold**.

NOTE: Highlighted items are available from Select Service, and only available in 689 Finish.

Body	Arm	Mounting	Painted Finish \$	Plated Finish \$
Track Hold Open				
8616	TH	Door mounted (pull side),	380	666
	JTH	Frame mounted (pull side)	380	666
	FTH	Flush transom mounted (push side)	380	666
	PTH	Soffit mounted (push side)	380	666
	TDEH	Frame mounted double egress frame (pull side),	433	723

OPTIONS

(List Price 'add' when ordered with complete closer)

Item	Description	List Add/Deduct \$
DA	Adjustable delayed action (suffix to model)	34
LCOV	Less slim plastic cover, Deduct	Deduct 15
FC	Full plastic cover	6
FCSL	Full plastic slotted cover (low ceiling conditions)	6
FMC	Full metal cover (handed for TJ or JT [FMCL/FMCR])	11
FMCLL	Full metal cover, lead lined. Handed & non-handed.	109
SNB2	(4) each 1/4-20 aluminum sex nuts and bolts for 1-3/8" door	N/C
LSN	Less sex nuts (less SN1 pack)	Deduct 5
AWS	All wood screws	9
DPK86	All fasteners to be self-drilling (in lieu of standard fasteners)	N/C
SNDPK	Standard fasteners and DPK86	11
TPK86	All fasteners to be self-tapping (in lieu of standard fasteners)	N/C
SNTPK	Standard fasteners and TPK86,	11
METRIC	All metric fasteners	N/C
TX86	All exposed fasteners to be Torx security fasteners (n/a with track applications)	26

NOTE: Highlighted items are available from Select Service, and only available in 689 Finish.

Locks

Cylinders,
Keys & Keying

Exit Devices

Electronic
Access Control
ComponentsLow Energy
OperatorsSurface
ClosersFire/Life
SafetyConcealed
Closers/PivotsStops/
HoldersSliding
SystemsArchitectural
Pulls &
Handles

Service Parts

Item	Description	List Add/Deduct \$
Decorative Finish Options (specify 605, 606, 611, 612, 613, 618, 619, 625, or 626 finish)		
Back or Drop Plates	Decorative plated finish, back plates, drop plates or non-standard PA brackets (BP**/DP**/AB**/PFT/PD/MJ/BSHD/NFHD/FTHD)	83
Custom Color	Custom painted finish selected from DORMA RAL color pallet book. For details, see DORMA Finishes Cross Reference , page vii.	
	per order, setup charge (Net)	100
	per closer, list add	25
Designer Color	Designer painted color matched to supplied samples. Three (3) each 2" x 3" color chip samples required. For details, see DORMA Finishes Cross Reference , page vii.	
	per order, non-refundable development/setup charge (Net)	250
	per closer, list add	31

NOTES:

- All painted components w/plated line item will be painted complementary finish.
Example: For a line item ordered w/plated 626 FMC only, all other components will be 689.
- Painted finish price includes slim plastic cover.
- Plated finish price includes optional full metal cover.
- Specify closer and arm designation, hand (when required), and finish when ordering.
- All dead stop, heavy-duty PA, tracks, and top jamb (J) configurations packaged (4) units per master carton.
- All others are packaged (6) units per master carton.
- FMC is only cover available in plated finishes.
- All 8600 closers standard with SNB1.
- T, TH, FT, FTH include backplate standard.
- 8600 Series closer prepared standard to accept COV, FC, FCSL, or FMC.

ACCESSORIES

Item	Description	List \$
BP86	Backplate for closer with slim cover	30
BP86FC	Backplate for closer with full cover	30
BP86T	Backplate for slide track closer with slim cover	30
BP86TFC	Backplate for slide track closer with full cover	30
BP86FTFC	Backplate for flush transom slide track closer w/wo/cover or full cover	30
DP86	Drop plate for closer with slim cover	30
DP86FC	Drop plate for closer with full cover	30
BP86C	Backplate for conversion of 7600 Series to 8600 Series	30
AB86	Angle bracket for closer with slim cover	55
PFT	Parallel flush transom bracket	24
PD	Parallel drop bracket, non-hold open arms (AF86, AR, A08 only)	32
MJ 	Mortised jamb bracket, non-hold open arms (AF86, AR, A08 only)	22
BS	Blade stop spacer (P86, PHB, and PD)	23
BSHD	Blade stop spacer for use with heavy duty door saver and super parallel arms	25
NFHD	Narrow frame bracket for use with heavy duty door saver and super parallel arms	25
FTHD	Flush transom bracket for use with heavy duty door saver and super parallel arms	46

 When used with flat form non-hold open arms, the MJ bracket must be used with a special length arm. Specify AF8MJ for 8600 or 8900 Series closers.

NOTE: Highlighted items are available from Select Service, and only available in 689 Finish.

7400 SERIES

Ordering Guide

Series	Spring Size			Cover			Accessory Plates*			Other Accessories*					
	7400	14	36	COV	FC	FCSL	DPXX	BPXX	ABXX	XXHD	PFT	PD	MJ	BS	BSHD
	Adjustable 1-4	Adjustable 3-6	Delay	Slim Cover	Full Plastic	Full Plastic Slotted	Drop Plate	Back Plate	Angle Bracket	Heavy Duty Bracket	PA Transom Bracket	PA Drop Bracket	Mortise Jamb Bracket	Blade Stop Spacer	Blade Stop Heavy Duty
	74	14	DA	ARP			COMBO								
	Round Arm Non-Hold Open, Tri-Pack			ARP			COMBO		600						
	Round Arm Non-Hold Open, TJ 4"-8" Reveal			ARJ			SNB1		689						
	Round Arm Non-Hold Open, TJ 0"-4" Reveal			AR			SNB2		690						
	Round Arm Secure Non-Hold Open, Tri-Pack			A08P			DPK86		691						
	Round Arm Secure Non-Hold Open, Reg./TJ 0"-4" Reveal			A08			CMBDPK		693						
	Friction Hold Open, Tri-Pack			FHP			TPK86		695						
	Friction Hold Open, TJ 4"-8" Reveal			FHJ			CMBTPK		696						
	Friction Hold Open, Reg./TJ 0"-4" Reveal			FH			TX86		PNT						
	Door Saver Parallel Cushion Arm			DS			AWS		Finish						
	Door Saver Parallel Cushion Arm Thumb Turn Hold Open			DST											
	Door Saver Parallel Cushion Arm Hex Key Turn Hold Open			DSK											
	Spring Door Saver Parallel Dead Stop			SDS											
	Spring DS Parallel Dead Stop Thumb Turn Hold Open			SDST											
	Integra Cushion Arm Reg./TJ 0"-3-1/2" Reveal			IS											
	Spring Integra Stop Reg./TJ 0"-3-1/2" Reveal			ISH											
	Integra Cushion Arm Top Jamb 3-1/2"-6-1/2" Reveal			SIS											
	Spring Integra Stop Hold Open, Reg./TJ 0"-3-1/2" Reveal			SISH											
	Integra Cushion Arm Top Jamb 3-1/2"-6-1/2" Reveal			ISJ											
	Spring Integra Stop Hold Open, Top Jamb 3-1/2"-6-1/2" Reveal			ISJH											
	Spring Integra Stop Hold Open, Top Jamb 3-1/2"-6-1/2" Reveal			SISJ											
	Spring Integra Stop Hold Open, Top Jamb 3-1/2"-6-1/2" Reveal			SISJH											
	Super Parallel Arm			SPA											
	Super Parallel Arm Thumb Turn Hold Open			SPAT											
	Track, Pull Side Door Mounted			T											
	Jamb Track, Pull Side Frame Face Mounted			JT											
	Push Track, Push Side Soffit Mounted			PT											
	Track Double Egress, Pull Side Transom Mounted (7436 only)			TDE											
	Flush Track, Push Side Transom Mounted			FT											
	Track Hold Open, Pull Side Door Mounted			TH											
	Push Track Hold Open, Push Side Soffit Mounted			JTH											
	Track Double Egress Hold Open, Pull Side Frame Face Mounted (7436 only)			PTH											
	Flush Track Hold Open, Pull Side Frame Face Mounted			TDEH											
				FTH											

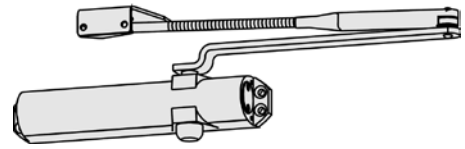

NOTES:
 All combinations of features and options are not available for all models. Please refer to 7400 Series product brochure for details.

To simplify initial installation, a range of back plates (BPxx), drop plates (DPxx), brackets, and spacers are listed under 7400 Accessories in this section. Refer to 7400 Series product brochure for details.

- Locks
- Cylinders, Keys & Keying
- Exit Devices
- Electronic Access Control Components
- Low Energy Operators
- Surface Closers
- Fire/Life Safety
- Concealed Closers/Pivots
- Stops/ Holders
- Sliding Systems
- Architectural Pulls & Handles
- Service Parts

Body	Arm	Mounting	Painted Finish \$
Non-Hold Open			
7414, 7436	ARP	PA, REG & TJ for reveals to 4" (round)	221
	ARJ	TJ for reveals 4" to 8" (round)	216
	AR	REG or TJ for reveals to 4" (round)	212
	A08P	PA, REG & TJ secured elbow for reveals to 4" (round)	222
	A08	REG or TJ secured elbow for reveals to 4" (round)	212
Dead Stop or Cushion Stop			
7414, 7436	DS	Door saver parallel arm (cushion arm)	287
	DST	w/thumb turn hold open	331
	DSK	w/hex key turn hold open	331
	SDS	Spring assist dead stop parallel arm	418
	SDST	w/thumb turn hold open	461
Integra Stop			
7414, 7436	IS	Integra cushion arm, REG and TJ for 0" to 3-1/2" reveal	411
	ISH	Integra cushion arm w/hold open, REG and TJ for 0" to 3-1/2" reveal	454
	SIS	Spring integra stop arm, REG and TJ for 0" to 3-1/2" reveal	480
	SISH	w/hold open, REG and TJ for 0" to 3-1/2" reveal	524
	ISJ	Integra cushion arm, TJ for 3-1/2" to 6-1/2" reveal	432
	ISJH	Integra cushion arm w/hold open, TJ for 3-1/2" to 6-1/2" reveal	476
	SISJ	Spring integra stop arm, TJ for 3-1/2" to 6-1/2" reveal	502
	SISJH	w/hold open, TJ for 3-1/2" to 6-1/2" reveal	546
Heavy Duty PA			
7436	SPA	Super parallel arm	255
	SPAT	w/thumb turn hold open	298
	SPAK	w/hex key turn hold open	298
Friction Hold Open			
7414, 7436	FHP	PA, REG & TJ for reveals to 4"	278
	FHJ	TJ for reveals 4" to 8"	267
	FH	REG or TJ for reveals to 4"	263
Slide Track			
7436	T	Door mounted (pull side)	267
	JT	Frame mounted (pull side)	267
	FT	Flush transom mounted (push side)	267
	PT	Soffit mounted (push side)	267
Track Hold Open			
7436	TH	Door mounted (pull side)	289
	JTH	Frame mounted (pull side)	289
	FTH	Flush transom mounted (push side)	289
	PTH	Soffit mounted (push side)	289

NOTE: Standard arm configuration is indicated in **bold**.

NOTE: Highlighted items are available from Select Service, and only available in 689 Finish. Items include SNB1 standard. Add \$4.00 to list price.



OPTIONS

(List Price 'add' when ordered with complete closer)

Item	Description	List Add \$
DA	Adjustable delayed action (suffix to model number)	33
COV	Slim plastic cover	17
FC	Full plastic cover	22
FCSL	Full plastic slotted cover (low ceiling conditions)	22
SNB1	(4) each 1/4-20 sex nuts and machine screws for 1-3/4" door	7
SNB2	(4) each 1/4-20 sex nuts and machine screws for 1-3/8" door	7
AWS	All wood screws	9
DPK86	All fasteners to be self-drilling fasteners (In lieu of combo screws)	N/C
CMBDPK	Standard and DPK86 fasteners	11
TPK86	All fasteners to be self-tapping fasteners (In lieu of combo screws)	N/C
CMBTPK	Standard and TPK86 fasteners	11
TX86	All exposed fasteners to be Torx security fasteners (n/a with track applications)	26
Custom Color	Custom painted finish selected from DORMA RAL color pallet book. For details, see DORMA Finishes Cross Reference , page vii.	
	per order, setup charge (Net)	100
	per closer, list add	25
Designer Color	Designer painted color matched to supplied samples. Three (3) each 2" x 3" colorchip samples required. For details, see DORMA Finishes Cross Reference , page vii.	
	per order, non-refundable development/setup charge (Net)	250
	per closer, list add	31

NOTE: Highlighted items are available from Select Service, and only available in 689 Finish.

NOTES:

- Standard price does not include cover.
- Specify closer and arm designation, hand (when required), and finish when ordering.
- All dead stop, heavy-duty PA, tracks, and top jamb (J) configurations packaged (4) units per master carton.
- All others are packaged (6) units per master carton.
- T, TH, FT, FTH include backplate standard.
- 7400 closers are not furnished to accept FC or FCSL unless specified at time of order.
- Sex nuts and bolts standard with cushion or dead stop arms and included in list price.

- Locks
- Cylinders, Keys & Keying
- Exit Devices
- Electronic Access Control Components
- Low Energy Operators
- Surface Closers
- Fire/Life Safety
- Concealed Closers/Pivots
- Stops/ Holders
- Sliding Systems
- Architectural Pulls & Handles
- Service Parts

ACCESSORIES

Item	Description	List \$
BP74	Backplate for 7400	30
BP74T	Backplate for 7400 slide track closer without cover	30
BP640C	Back plate to retrofit 9 1/16" hole spacing with 7400. Examples: DORMA 640, Norton 1600 or Yale 50.	5
BP86	Backplate for closer with slim cover	30
BP86T	Backplate for 7400 slide track closer with slim cover	30
BP86FC	Backplate for closer with full cover	30
DP74	Drop plate for 7400	30
DP86	Drop plate for closer with slim cover	30
DP86FC	Drop plate for closer with full cover	30
AB74	Angle bracket for 7400 without cover	55
AB86	Angle bracket for 7400 with slim cover	55
PFT	Parallel flush transom bracket	24
PD	Parallel drop bracket, non-hold open arms (AR, A08 only)	32
MJ	Mortised jamb bracket, non-hold open arms (AR, A08 only)	22
BS	Blade stop spacer (P86, PHB, and PD)	22
BSHD	Blade stop spacer for use with heavy duty door saver and super parallel arms	25
NFHD	Narrow frame bracket for use with heavy duty door saver and super parallel arms	25
FTHD	Flush transom bracket for use with heavy duty door saver and super parallel arms	46

NOTE: Highlighted items are available from Select Service, and only available in 689 Finish.

U1500 SERIES

Ordering Guide

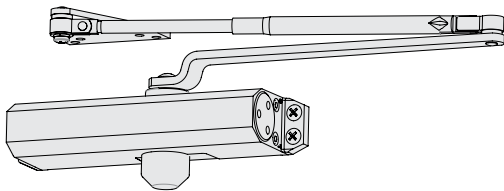
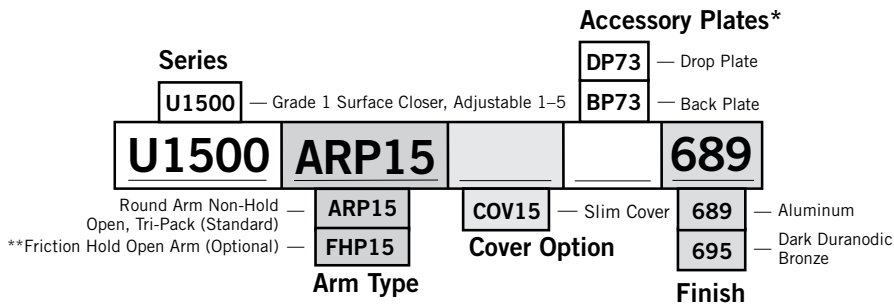

NOTE:

▪ All combinations of features and options are not available for all models.

* To simplify initial installation, back plate (BP73) or drop plate (DP73) are listed under U1500 Accessories in this section.

** Supplied in addition to non-hold open arm.

- Locks
- Cylinders, Keys & Keying
- Exit Devices
- Electronic Access Control Components
- Low Energy Operators
- Surface Closers**
- Fire/Life Safety
- Concealed Closers/Pivots
- Stops/ Holders
- Sliding Systems
- Architectural Pulls & Handles
- Service Parts

Body	U/M	Arm	Mounting	Painted Finish \$
Non-Hold Open				689/695
U1500 1-5	Ea.	ARP15	PA, REG & TJ for reveals to 4" (round)	165

NOTES:

- Standard arm configuration is indicated in **bold**.
- Minimum order quantity of 1 case (6 each units) required per purchase order.
- Case quantity discounts available below.

OPTIONS

(List Price 'add' when ordered with complete closer)

Item	U/M	Description	List Add \$
FHP15	Ea.	Friction hold open arm and bracket. Can be used in the field in place of standard non-hold open arm configuration.	65
COV15	Ea.	Slim plastic cover U1500	13

NOTES:

- Standard price does not include cover.
- Specify finish when ordering.
- Standard configuration includes non-hold open tri-pack arm and parallel arm bracket assembly in cases of six.

ACCESSORIES

Item	Description	List \$
P15	Parallel arm soffit bracket, U1500 non-hold open (689/695 only)	13
PH15	Parallel arm soffit bracket, U1500 friction hold open (689/695 only)	13
COV15	Slim plastic cover, U1500 (689/695 only)	13
CAP15	Dust cap to cover exposed pinion of U1500 (689/695 only)	3
ARP15	Arm, round U1500 complete tri-pack, NHO 10 mm rod with P15 bracket, 0"-4" reveal (689/695 only)	50
FHP15	Friction hold open arm complete U1500 tri-pack, 0"-4" reveal (689/695 only)	65
U15NHPK	All wood and machine fasteners required to install one each U1500 non-hold open closer (689/695 only)	6
U15HPK	All wood and machine fasteners required to install one each U1500 friction hold open closer (689/695 only)	6
SN1	(4) each 1/4-20 sex nuts for 1-3/4" door	5
SN2	(4) each 1/4-20 sex nuts for 1-3/8" door	5
TPK15	All self-tapping fasteners to install U1500 NHO/FHO	6
BP73	Backplate for U1500 or 7300	30
DP73	Drop plate for U1500 or 7300	30

U1500 Quantity Discount Program

- Case quantities of 18-35 receive a 3% additional discount, quantities of 36-71 receive a 4% additional discount, case quantities >72 receive a 5% additional discount.
- Tiered discounts apply to entire quantity once tier quantity is reached. Example: 40 cases receives 4%.
- Orders must be on one purchase order for one ship to location to qualify for the quantity discount.
- Freight policy and other standard terms and conditions apply. See intro for details. Visit go.dorma.com/terms for details.
- Quantity discounts apply only to U1500 closers and do not apply to accessories.
- Qualified orders must be placed in case quantity (6 each units per case).
- This promotional program is subject to change without notice.

7300 SERIES

Ordering Guide

Series	Spring Size			Cover	Fastener Pack	Finish
	7300	05 — ANSI Size 5	04 — ANSI Size 4			
73	04	ARP		COMBO	689	
Round Arm Non-Hold Open, Tri-Pack		ARP		COMBO		— Default Fastener Pack
Round Arm Non-Hold Open, TJ 4"-8" Reveal		ARJ		SNB1		— Sex Nuts and Machine Screws, 1-3/4"
Round Arm Non-Hold Open, TJ 0"-4" Reveal		AR		SNB2		— Sex Nuts and Machine Screws, 1-3/8"
Round Arm Secure Non-Hold Open, Tri-Pack		AO8P		DPK86		— Self-Drilling
Round Arm Secure Non-Hold Open, Reg./TJ 0"-4" Reveal		AO8		CMBDPK		— Std. and Self-Drilling
Friction Hold Open, Tri-Pack		FHP		TPK86		— Self-Tapping
Friction Hold Open, TJ 4"-8" Reveal		FHJ		CMBTPK		— Std. and Self-Tapping
Friction Hold Open, Reg./TJ 0"-4" Reveal		FH		TX86		— Torx Security Pack
Door Saver Parallel Cushion Arm		DS		AWS		— All Wood Screws
Door Saver Parallel Cushion Arm Thumb Turn Hold Open		DST				
Door Saver Parallel Cushion Arm Hex Key Turn Hold Open		DSK				
Spring Door Saver Parallel Dead Stop		SDS				
Spring DS Parallel Dead Stop Thumb Turn Hold Open		SDST				
Integra Cushion Arm Reg./TJ 0"-3-1/2" Reveal		S				
		SH				— Integra Cushion Arm Hold Open, 0"-3-1/2" Reveal
Spring Integra Stop Reg./TJ 0"-3-1/2" Reveal		S S				
		S SH				— Spring Integra Stop Hold Open, Reg./TJ 0"-3-1/2" Reveal
Integra Cushion Arm Top Jamb 3-1/2"-6-1/2" Reveal		SJ				
		SJH				— Integra Cushion Arm Hold Open, Top Jamb 3-1/2"-6-1/2" Reveal
Spring Integra Stop Top Jamb 3-1/2"-6-1/2" Reveal		S SJ				
		S SJH				— Spring Integra Stop Hold Open, Top Jamb 3-1/2"-6-1/2" Reveal
Super Parallel Arm		SPA				
Super Parallel Arm Thumb Turn Hold Open		SPAT				
Super Parallel Arm Key Hold Open		SPAK				
Track, Pull Side Door Mounted		T				
Jamb Track, Pull Side Frame Face Mounted		JT				
Push Track, Push Side Soffit Mounted		PT				
Flush Track, Push Side Transom Mounted		FT				
Track Hold Open, Pull Side Door Mounted		TH				
		JTH				— Jamb Track Hold Open, Pull Side Frame Face Mounted
Push Track Hold Open, Push Side Soffit Mounted		PTH				
		FTH				— Flush Track Hold Open, Pull Side Frame Face Mounted

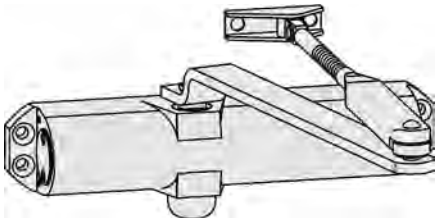

NOTES:

- All combinations of features and options are not available for all models. Please refer to 7300 Series product brochure for details.
- To simplify initial installation, a range of back plates (BPxx), drop plates (DPxx), brackets, and spacers are listed under 7300 Accessories in this section. Refer to 7300 Series product brochure for details.

- Locks
- Cylinders, Keys & Keying
- Exit Devices
- Electronic Access Control Components
- Low Energy Operators
- Surface Closers
- Fire/Life Safety
- Concealed Closers/Pivots
- Stops/ Holders
- Sliding Systems
- Architectural Pulls & Handles
- Service Parts

Body	Arm	Mounting	Painted Finish \$
Non-Hold Open			
7303, 7304,	ARP	PA, REG & TJ for reveals to 4" (round)	224
7305	ARJ	TJ for reveals 4" to 8" (round)	218
	AR	REG or TJ for reveals to 4" (round)	214
	A08P	PA, REG & TJ secured elbow for reveals to 4" (round)	224
	A08	REG or TJ secured elbow for reveals to 4" (round)	214
Dead Stop or Cushion Arms			
7305	DS	Door saver parallel arm (cushion arm)	289
	DST	w/thumb turn hold open	334
	DSK	w/hex key turn hold open	334
	SDS	Spring assist dead stop parallel arm	422
	SDST	w/thumb turn hold open	465
Integra Stop			
7303, 7304,	IS	Integra cushion arm, REG and TJ for 0" to 3-1/2" reveal	414
7305	ISH	Integra cushion arm w/hold open, REG and TJ for 0" to 3-1/2" reveal	458
	SIS	Spring integra stop arm, REG and TJ for 0" to 3-1/2" reveal	484
	SISH	w/hold open, REG and TJ for 0" to 3-1/2" reveal	529
	ISJ	Integra cushion arm, TJ for 3-1/2" to 6-1/2" reveal	436
	ISJH	Integra cushion arm w/hold open, TJ for 3-1/2" to 6-1/2" reveal	480
	SISJ	Spring integra stop arm, TJ for 3-1/2" to 6-1/2" reveal	507
	SISJH	w/hold open, TJ for 3-1/2" to 6-1/2" reveal	551
Heavy Duty PA			
7305	SPA	Super parallel arm	257
	SPAT	w/thumb turn hold open	301
	SPAK	w/hex key turn hold open	301
Friction Hold Open			
7303, 7304,	FHP	PA, REG & TJ for reveals to 4"	273
7305	FHJ	TJ for reveals 4" to 8"	269
	FH	REG or TJ for reveals to 4"	265
Track Units			
7305	T	Door mounted (pull side)	269
	JT	Frame mounted (pull side)	269
	FT	Flush transom mounted (push side)	269
	PT	Soffit mounted (push side)	269
	TH	Door mounted (pull side)	291
	JTH	Frame mounted (pull side)	291
	FTH	Flush transom mounted (push side)	291
	PTH	Soffit mounted (push side)	291

NOTE: Standard arm configuration is indicated in **bold**.



OPTIONS

(List Price 'add' when ordered with complete closer)

Item	Description	List Add \$
COV	Slim plastic cover	17
SNB1	(4) each 1/4-20 sex nuts and machine screws for 1-3/4" door	7
SNB2	(4) each 1/4-20 sex nuts and machine screws for 1-3/8" door	7
AWS	All wood screws	9
DPK86	All fasteners to be self-drilling fasteners (In lieu of combo screws)	N/C
CMBDPK	Standard and DPK86 fasteners	11
TPK86	All fasteners to be self-tapping fasteners (In lieu of combo screws)	N/C
CMBTPK	Standard and TPK86 fasteners	11
TX86	All exposed fasteners to be Torx security fasteners (n/a with track applications)	26
Custom Color	Custom painted finish selected from DORMA RAL color pallet book. For details, see DORMA Finishes Cross Reference , page vii.	
	per order, setup charge (Net)	100
	per closer, list add	25
Designer Color	Designer painted color matched to supplied samples. Three (3) each 2" x 3" color chip samples required. For details, see DORMA Finishes Cross Reference , page vii.	
	per order, non-refundable development/setup charge (Net)	250
	per closer, list add	31

NOTE: Highlighted items are available from Select Service, and only available in 689 Finish.

NOTES:

- Standard price does not include cover.
- Specify closer and arm designation, hand (when required), and finish when ordering.
- All dead stop, heavy-duty PA, tracks, and top jamb (J) configurations packaged (4) units per master carton.
- All others are packaged (6) units per master carton.

- Locks
- Cylinders, Keys & Keying
- Exit Devices
- Electronic Access Control Components
- Low Energy Operators
- Surface Closers**
- Fire/Life Safety
- Concealed Closers/Pivots
- Stops/ Holders
- Sliding Systems
- Architectural Pulls & Handles
- Service Parts

ACCESSORIES

Item	Description	List \$
BP73	Backplate for 7300	30
BP73T	Backplate for 7300 slide track closer without cover	30
BP86	Backplate for closer with slim cover	30
BP86T	Backplate for 7300 slide track closer with slim cover	30
DP73	Drop plate for 7300	30
DP86	Drop plate for closer with slim cover	30
AB73	Angle bracket for 7300 without cover	55
AB86	Angle bracket for 7300 with slim cover	55
PFT	Parallel flush transom bracket	24
PD	Parallel drop bracket, non-hold open arms (AR, A08 only)	32
MJ	Mortised jamb bracket, non-hold open arms (AR, A08 only)	22
BS	Blade stop spacer (P86, PHB, and PD)	22
BSHD	Blade stop spacer for use with heavy duty door saver and super parallel arms	25
NFHD	Narrow frame bracket for use with heavy duty door saver and super parallel arms	25
FTHD	Flush transom bracket for use with heavy duty door saver and super parallel arms	45

NOTE: Highlighted items are available from Select Service.

STA SERIES

Ordering Guide

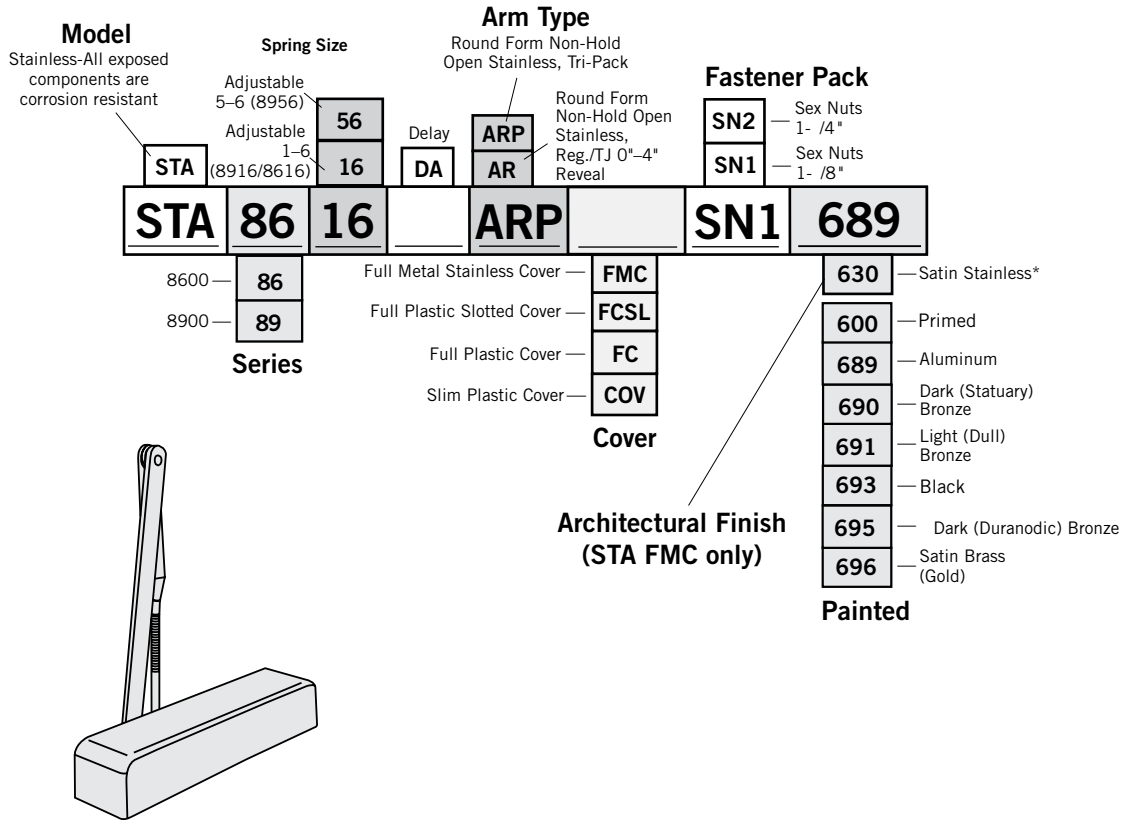

* Stainless steel base material with Satin Finish.

NOTE: Because STA is specified in the beginning of the model description, it does not need to be specified at the component level.

Example: **STA8616 ARP FC SN1 689**

***XX** indicates specific accessory model designation required.

Refer to product brochure for applicable models.

Locks

Cylinders, Keys & Keying

Exit Devices

Electronic Access Control Components

Low Energy Operators

Surface Closers

Fire/Life Safety

Concealed Closers/Pivots

Stops/ Holders

Sliding Systems

Architectural Pulls & Handles

Service Parts



Body	Arm	Mounting	Painted Finish \$	630 \$
STA 8900				
STA 8916/8956	ARP	PA, REG & TJ for reveals to 4" (painted price w/FC)	800	1,143
	AR	REG or TJ for reveals to 4" (painted price w/FC)	746	1,060
STA 8600				
STA 8616	ARP	PA, REG & TJ for reveals to 4" (painted price w/COV)	686	1,077
	AR	REG or TJ for reveals to 4" (painted price w/COV)	630	993

OPTIONS

(List Price 'add' when ordered with complete closer)

Item	Model	Description	List Add/Deduct \$
DA	8000	Adjustable delayed action (suffix to model number) (Only for 8616, 8916, and 8966)	33
LSN	8000	Less sex nuts (less SN1 pack)	Deduct 5
SN2	8000	(4) each 1/4-20 aluminum sex nuts for 1-3/8" door	N/C
LCOV	8600	Less slim plastic cover for 8600	Deduct 11
FC or FCSL	8600	Full plastic cover for 8600(FC standard w/8900)	6
FCSL	8900	Full plastic slotted cover for 8900	N/C
Custom Color		Custom painted finish selected from DORMA RAL color pallet book. For details, see DORMA Finishes Cross Reference , page vii.	
		per order, setup charge (Net)	100
		per closer, list add	25
Designer Color		Designer painted color matched to supplied samples. Three (3) each 2" x 3" color chip samples required. For details, see DORMA Finishes Cross Reference , page vii.	
		per order, non-refundable development/setup charge (Net)	250
		per closer, list add	31

NOTES:

- Architectural finish price (630) includes optional full stainless metal cover.
- Specify closer and arm designation and finish when ordering.
- All STA Series closers are packaged (6) units per master.
- STA full metal cover (FMC) is the only cover available in architectural finish 630.
- STA closers are supplied standard with SN1. Specify LSN for less SN1 deduct.
- STA 8900 standard with FC, 8600 standard with COV.

GSR SERIES

Ordering Guide

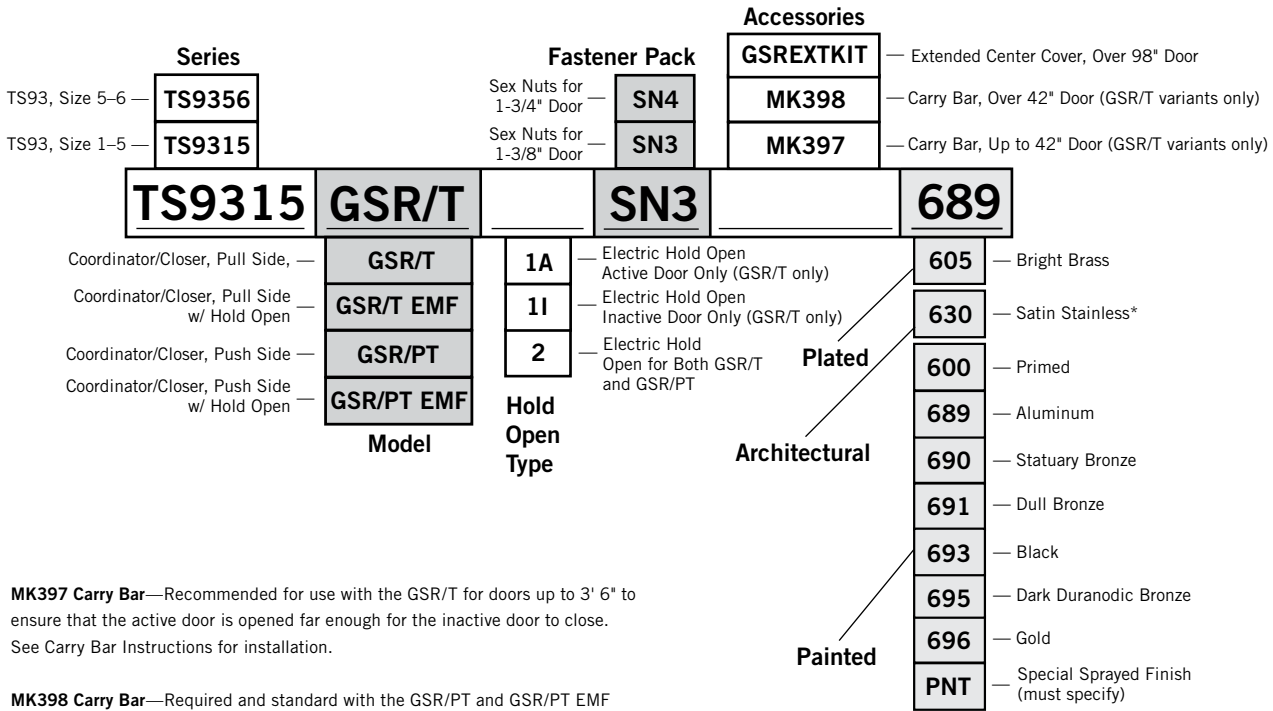

MK397 Carry Bar—Recommended for use with the GSR/T for doors up to 3' 6" to ensure that the active door is opened far enough for the inactive door to close. See Carry Bar Instructions for installation.

MK398 Carry Bar—Required and standard with the GSR/PT and GSR/PT EMF units. Recommended for use with GSR/T for doors 3' 6" and wider to ensure that the active door is opened far enough for the inactive door to close. See Carry Bar Instructions for installation.

* Stainless steel base material with Satin Finish

NOTES:

- All combinations and options are not available for all models.
- Please refer to EMR/EMF Series Product Brochure for details.
- EMR/EMF accepts 24 VAC/DC.
- Transformer must be purchased if power source is 120 VAC.

- Locks
- Cylinders, Keys & Keying
- Exit Devices
- Electronic Access Control Components
- Low Energy Operators
- Surface Closers
- Fire/Life Safety
- Concealed Closers/Pivots
- Stops/ Holders
- Sliding Systems
- Architectural Pulls & Handles
- Service Parts

Body	Arm	Mounting	Painted Finish \$	605/630
TS93 Coordinators				
TS9315, TS9356	GSR/T	Door closer/coordinator system only (pull side)	1,232	2,035
TS9315, TS9356	GSR/PT	Door closer/coordinator system only (push side)	1,644	2,741
	GSR/T EMF/1A	Electromagnetic holder/release device (active door) closer/coordinator system (pull)	1,794	2,517
	GSR/T EMF/1I	Electromagnetic holder/release device (inactive door) with door closer/coordinator system (pull)	1,794	2,517
	GSR/T EMF/2	Electromagnetic holder/release device (both doors) with door closer/coordinator system (pull)	2,303	3,024
	GSR/PT EMF/2	Electromagnetic holder/release device (both doors) with door closer/coordinator system (push)	3,036	4,036

NOTE: Standard GSR is packaged for installation on openings 53" to 98" wide. For narrower or wider openings, contact the factory. Opening size is derived from measuring centerline of hinge on one door to centerline of hinge on second door.

OPTIONS

(List Price 'add' when ordered with complete closer)

Item	Description	Painted Finish \$	605/630
SN4	(4) each 10–32 sex nuts for 1-3/8" door	N/C	—
LSN	Less sex nuts (less SN3 pack)	Deduct 3	—
MK397	Carry bar – up to 3' 6" wide doors (included with GSR/PT variants option for GRS/PT variants)	38	78
MK398	Carry bar – 3' 6" and wider doors (included with GSR/PT variants option for GRS/PT variants)	42	92
Custom Color	Custom painted finish selected from DORMA RAL color pallet book. For details, see DORMA Finishes Cross Reference , page vii.		
	per order, setup charge (Net)	100	—
	per closer, list add	25	—
Designer Color	Designer painted color matched to supplied samples. Three (3) Color each 2" × 3" colorchip samples required. For details, see DORMA Finishes Cross Reference , page vii.		
	per order, non-refundable development/setup charge (Net)	250	—
	per closer, list add	31	—

NOTES:

- Specify body and arm designation, centerline to centerline of hinge or hanging means (indicate type), hand of active door, and finish, when ordering.
- Closer cover and/or track main arm only are electroplated when specified. Frame unit cover and closer cover caps are furnished primed or in complementing color.

8900/8600/7400

Closer Bodies



Item	Description	Painted Finish \$
MOD, 8916 FC××	Closer body × full plastic cover & mounting screws	338
MOD, 8916 FCSL	Closer body × slotted full plastic cover & mounting screws	338
MOD, 8916 FMC	Closer body × full metal cover & mounting screws	343
MOD, 8916DA FC	Delay closer body × full plastic cover & mounting screws	372
MOD, 8916DA FCSL	Delay closer body × slotted full plastic cover & mounting screws	372
MOD, 8916DA FMC	Delay closer body × full metal cover & mounting screws	378
MOD, 8956 FC	Closer body × full plastic cover & mounting screws	338
MOD, 8956 FCSL	Closer body × slotted full plastic cover & mounting screws	338
MOD, 8956 FMC	Closer body × full metal cover & mounting screws	343
MOD, 8956DA FC	Delay closer body × full plastic cover & mounting screws	372
MOD, 8956DA FCSL	Delay closer body × slotted full plastic cover & mounting screws	372
MOD, 8956DA FMC	Delay closer body × full metal cover & mounting screws	378
MOD, 8616 COV	Closer body × slim plastic cover & mounting screws	226
MOD, 8616 FC	Closer body × full plastic cover & mounting screws	231
MOD, 8616 FCSL	Closer body × slotted full plastic cover & mounting screws	231
MOD, 8616 FMC	Closer body × full metal cover & mounting screws	234
MOD, 8616DA COV	Delay closer body × slim plastic cover & mounting screws	260
MOD, 8616DA FC	Delay closer body × full plastic cover & mounting screws	265
MOD, 8616DA FCSL	Delay closer body × slotted full plastic cover & mounting screws	265
MOD, 8616 DA FMC	Delay closer body × full metal cover and mounting screws	271
MOD, 7414	Closer body & mounting screws	133
MOD, 7414 COV	Closer body × slim plastic cover & mounting screws	150
MOD, 7414 FC	Closer body × full plastic cover & mounting screws	155
MOD, 7414 FCSL	Closer body × slotted full plastic cover & mounting screws	155
MOD, 7414DA	Delay closer body & mounting screws	166
MOD, 7414DA COV	Delay closer body × slim plastic cover & mounting screws	183
MOD, 7414DA FC	Delay closer body × full plastic cover & mounting screws	188
MOD, 7414DA FCSL	Delay closer body × slotted full plastic cover & mounting screws	188
MOD, 7436	Closer body & mounting screws	133
MOD, 7436 COV	Closer body × slim plastic cover & mounting screws	150
MOD, 7436 FC	Closer body × full plastic cover & mounting screws	155
MOD, 7436 FCSL	Closer body × slotted full plastic cover & mounting screws	155
MOD, 7436DA	Delay closer body & mounting screws	166
MOD, 7436DA COV	Delay closer body × slim plastic cover & mounting screws	183
MOD, 7436DA FC	Delay closer body × full plastic cover & mounting screws	188
MOD, 7436DA FCSL	Delay closer body × slotted full plastic cover & mounting screws	188

Arms (All arms include "all" mounting screws and installation instructions)

Item	Description	Painted Finish \$
MOD, AF89P (8900 only)	Arm, flat tri-pack NHO w/P89 bracket	103
MOD, AF89J (8900 only)	Arm, flat NHO TJ 4" to 8" reveal	99
MOD, AF89 (8900 only)	Arm, flat NHO Reg./TJ 0" to 4" reveal	95
MOD, AF86P (8600 only)	Arm, flat tri-pack NHO w/P86 bracket	98
MOD, AF86J (8600 only)	Arm, flat NHO TJ 4" to 8" reveal	94
MOD, AF86 (8600 only)	Arm, flat NHO Reg./TJ 0" to 4" reveal	90
MOD, ARP (8600/7400)	Arm, round tri-pack NHO w/P86 bracket	88
MOD, ARJ (8600/7400)	Arm, round NHO TJ 4" to 8" reveal	83
MOD, AR (8600/7400)	Arm, round NHO Reg./TJ 0" to 4" reveal	78
MOD, A08P (8600/7400)	Arm, round secure tri-pack NHO w/P86 bracket	93
MOD, A08 (8600/7400)	Arm, round secure Reg./TJ 0" to 4" reveal	89
MOD, DS	Arm, parallel heavy duty cushion (Door Saver)	151
MOD, DST	Arm, parallel heavy duty cushion thumb turn hold open (Door Saver)	195
MOD, DSK	Arm, parallel heavy duty cushion hex key turn hold open (Door Saver)	195
MOD, SDS	Arm, parallel heavy duty spring assisted dead stop mount	280
MOD, SDST	Arm, parallel heavy duty spring assisted dead stop mount w/hold open	323
MOD, FHP	Arm, friction hold open w/PHB bracket (0" to 4" reveal)	137
MOD, FHJ	Arm, friction hold open TJ 4" to 8" reveal	132
MOD, FH	Arm, friction hold open Reg./TJ 0" to 4" reveal	128
MOD, IS	Arm, heavy duty cushioned stop Reg./TJ 0" to 3-1/2" reveal (Integra Stop)	273
MOD, ISH	Arm, hold open heavy duty cushioned stop Reg./TJ 0" to 3-1/2" reveal (Integra Stop)	315
MOD, SIS	Arm, heavy duty dead stop w/bumper (Spring Integra Stop)	341
MOD, SISH	Arm, heavy duty dead stop hold open w/bumper (Spring Integra Stop)	384
MOD, ISJ	Arm, heavy duty cushioned stop TJ 3-1/2" to 6-1/2" reveal (Integra Stop)	295
MOD, ISJH	Arm, hold open heavy duty cushioned stop TJ 3-1/2" to 6-1/2" reveal (Integra Stop)	337
MOD, SISJ	Arm, heavy duty dead stop w/bumper, top jamb and mount for 3-1/2" to 6-1/2" reveal (Spring Integra Stop)	363
MOD, SISJH	Arm, heavy duty dead stop w/bumper, top jamb and mount for 3-1/2" to 6-1/2" reveal w/hold open (Spring Integra Stop)	406
MOD, PHP	Arm, plunger hold open w/P89 bracket 1-1/2" to 3-1/2"	208
MOD, PH	Arm, plunger hold open Reg. 0" to 1-1/2" reveal	204
MOD, SPA	Arm, parallel heavy duty (Super Parallel Arm)	121
MOD, SPAT	Arm, parallel heavy duty thumb turn hold open (Super Parallel Arm)	164
MOD, SPAK	Arm, parallel heavy duty hex key turn hold open (Super Parallel Arm)	164
MOD, T	Arm, track (T, JT and FT)	132
MOD, TH	Arm, track hold open (TH, JTH and FTH)	153
MOD, TDE	Arm, track double egress	185
MOD, TDEH	Arm, track double egress hold open	207

NOTE: MOD, 8600 Series includes SNB1 standard. Deduct \$4.00 list when ordering MOD, 8600 Series less SNB1.

NOTE: Modular packaging is designed to save you, our valued DORMA stocking distributor up to 15% on your inventory dollars. Instead of stocking all door closer requirements in complete units in various arm types, DORMA produces a packaging option to allow a mixed stockof closer body combinations and arm types in separate packaging that easily combine later in the stocking distributor warehouse.

Determine the arm type required to be packaged with a particular closer body, place the closer body package inside the arm pack, mark the appropriate check list on the carton label and deliver the product. It's that simple.

DORMA recommends that the 80% usage items such as 8916 AF89P FC SN1 689 and 8616 AF86P COV 689 be packaged complete and the remainder of inventory be packaged in modular packaged items. This allows the 20% mixed variations to be handled with much less inventory. Arm mix inventory can be cut in half since the majority of arms can be used with the 8900, 8600, or 7400 Series closer.



DORMA FIRE/LIFE SAFETY

Product Guide (1 of 2)

FIRE/LIFE SAFETY CLOSER/HOLDERS	Surface Mount	Floor-Mount	Wall-Mount
Closer/Holder Only	TS93 EMF	—	
	8900 EMF	—	
	8600 EMF	—	
Closer/Holder with Integral Smoke Detector	TS93 EMR	—	
	8900 EMR	—	
	8600 EMR	—	
	1800 Series	—	
Electromagnetic Door Holders	—	EM501	EM504
	—	EM502	EM505
	—	—	EM508
	—	—	EM509

- Locks
- Cylinders, Keys & Keying
- Exit Devices
- Electronic Access Control Components
- Low Energy Operators
- Surface Closers
- Fire/Life Safety**
- Concealed Closers/Pivots
- Stops/ Holders
- Sliding Systems
- Architectural Pulls & Handles
- Service Parts



DORMA FIRE/LIFE SAFETY

Product Guide (2 of 2)

<input checked="" type="radio"/> Yes <input type="radio"/> No	A156.15	UL10C	Includes Smoke Detector	No Smoke Detector	Advanced Cam & Roller Design	Rack & Pinion Design	Plated Finishes	Custom Painted Finishes	Adjustable Power
TS93 EMF	<input checked="" type="radio"/>	<input checked="" type="radio"/>	<input type="radio"/>	<input checked="" type="radio"/>	<input checked="" type="radio"/>	<input type="radio"/>	<input checked="" type="radio"/>	<input checked="" type="radio"/>	<input checked="" type="radio"/>
8900 EMF	<input checked="" type="radio"/>	<input checked="" type="radio"/>	<input type="radio"/>	<input checked="" type="radio"/>	<input type="radio"/>	<input type="radio"/>	<input checked="" type="radio"/>	<input checked="" type="radio"/>	<input checked="" type="radio"/>
8600 EMF	<input checked="" type="radio"/>	<input checked="" type="radio"/>	<input type="radio"/>	<input checked="" type="radio"/>	<input type="radio"/>	<input type="radio"/>	<input checked="" type="radio"/>	<input checked="" type="radio"/>	<input checked="" type="radio"/>
TS93 EMR	<input checked="" type="radio"/>	<input checked="" type="radio"/>	<input checked="" type="radio"/>	<input type="radio"/>	<input checked="" type="radio"/>	<input type="radio"/>	<input checked="" type="radio"/>	<input checked="" type="radio"/>	<input checked="" type="radio"/>
8900 EMR	<input checked="" type="radio"/>	<input checked="" type="radio"/>	<input checked="" type="radio"/>	<input type="radio"/>	<input type="radio"/>	<input type="radio"/>	<input checked="" type="radio"/>	<input checked="" type="radio"/>	<input checked="" type="radio"/>
8600 EMR	<input checked="" type="radio"/>	<input checked="" type="radio"/>	<input checked="" type="radio"/>	<input type="radio"/>	<input type="radio"/>	<input type="radio"/>	<input checked="" type="radio"/>	<input checked="" type="radio"/>	<input checked="" type="radio"/>
1800 SD	<input checked="" type="radio"/>	<input checked="" type="radio"/>	<input checked="" type="radio"/>	<input type="radio"/>	<input type="radio"/>	<input checked="" type="radio"/>	<input checked="" type="radio"/>	<input checked="" type="radio"/>	<input checked="" type="radio"/>
1800	<input checked="" type="radio"/>	<input checked="" type="radio"/>	<input type="radio"/>	<input checked="" type="radio"/>	<input type="radio"/>	<input checked="" type="radio"/>	<input checked="" type="radio"/>	<input checked="" type="radio"/>	<input checked="" type="radio"/>



SELECT SERVICE QUICK SHIP

Fire/Life Safety

Select service should be used for small quantities of popular DORMA products that require shipment within 24 hours. The program includes locks, exit devices, door closers, magnets, electronic access control, and low energy operators. Warehouses have been set up in the east and west for faster delivery nationwide. (Customer responsible for shipping costs FOB.)

Subject to Availability

Next Business Day Service (Shipment when Purchase Order is received prior to 4:00 PM EST).

Examples: DORMA receives P.O. at 3:59 PM on Monday, order will ship by close of business on Tuesday.

DORMA receives P.O. at 3:59 PM on Friday, order will ship by close of business on the following Monday.

Notes:

- Standard freight and discount schedules and terms of sale apply. Please refer to the current price list for full details.
- DORMA reserves the right to limit quantities or decline an order if the credit status of the buyer is not satisfactory to DORMA.
- Orders cannot be cancelled.
- Select Service Quick Ship available only in the United States.
- All prices are in U.S. dollars.
- Products and prices are subject to change without notice.
- Some of the available products have quantity per order limits and will be noted accordingly.

Key

N	"New" to Select Service, Available in East and West Coast Warehouse
■	Available in East and West Coast Warehouse
E	Available only in East Coast Warehouse



- Locks
- Cylinders, Keys & Keying
- Exit Devices
- Electronic Access Control Components
- Low Energy Operators
- Surface Closers
- Fire/Life Safety
- Concealed Closers/Pivots
- Stops/ Holders
- Sliding Systems
- Architectural Pulls & Handles
- Service Parts



Electromagnetic Door Holders

EM Series

PN #	Package	Finish	List \$
33400011 ■	EM504	689	348
33400010 ■	EM508	689	348

EM Accessories & Service Items

PN #	Product	Finish	List \$
33400013 ■	ER1.5 (1-1/2" extension rod)	689	58
33400012 ■	ER2.0 (2" extension rod)	689	66



EMR/EMF SERIES

Ordering Guide

Series		Arm		Hand		Options		Finish	
TS93	Double Egress Pull Side Track	TDE	RH	Specify for Right Handed Units (TDE only)	120 VAC to 24 VAC External Transformer	BYP	PNT	Special Sprayed Finish (must specify)	Gold
89	Push Side Track	PT	LH	Specify for Left Handed Units (TDE only)	Preparation for Exposed Wiring Connection	TRANSF	696		Dark Duranodic Bronze
86	Pull Side Track	T				EXP	693		Black
							691		Dull Bronze
							690		Statuary Bronze
							689		Aluminum
							600		Primed
89	16	EMR	T		24V	FC		695	
Size 1-5 (TS9315)	15	EMR	Detected	24 VAC/DC EMF Unit	24V	COV	8600		
Size 1-6 (8900)	16	EMF	Non-Detected			FC	8900 or 8600		
Size 5-6 (TS9356, 8900, or 8600)	56					FMC	8600 or 8600		
Spring Size		Electrical Specifications (EMR 24V only)				Cover Options			

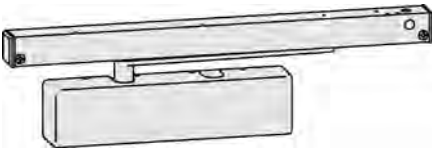

NOTES:

- All combinations of features and options are not available for all models.
- Please refer to EMR/EMF Series product brochure for details.

- Locks
- Cylinders, Keys & Keying
- Exit Devices
- Electronic Access Control Components
- Low Energy Operators
- Surface Closers
- Fire/Life Safety
- Concealed Closers/Pivots
- Stops/ Holders
- Sliding Systems
- Architectural Pulls & Handles
- Service Parts



EMF Series (with Detector)

Body	Arm	Mounting	Painted Finish \$
Premium Electromagnetic Slide Track Holder/Closing Device with Detector – 24 VAC/DC			
TS9315, TS9356	EMR/T	Frame mounted (pull side)	1,848
	EMR/PT	Soffit mounted (push side)	1,848
	EMR/TDE	Frame mounted (pull side; double egress), handed	1,901
Heavy-Duty Electromagnetic Slide Track Holder/Closing Device with Detector – 24 VAC/DC			
8916, 8956	EMR/T	Frame mounted (pull side)	1,821
	EMR/PT	Soffit mounted (push side)	1,821
	EMR/TDE	Frame mounted (pull side; double egress), handed	1,875
Electromagnetic Slide Track Holder/Closing Device with Detector – 24 VAC/DC			
8656	EMR/T	Frame mounted (pull side)	1,703
	EMR/PT	Soffit mounted (push side)	1,703
	EMR/TDE	Frame mounted (pull side; double egress), handed	1,756

EMF Series (No Detector)

Body	Arm	Mounting	Painted Finish \$
Premium Electromagnetic Slide Track Holder/Closing Device. Transformer required if power source is 120 VAC.			
TS9315, TS9356	EMF/T	Frame mounted, (pull side)	824
	EMF/PT	Soffit mounted (push side)	824
	EMF/TDE	Frame mounted (pull side; double egress), handed	878
Heavy-Duty Electromagnetic Slide Track Holder/Closing Device. Transformer required if power source is 120 VAC.			
8916, 8956	EMF/T	Frame mounted, (pull side)	797
	EMF/PT	Soffit mounted (push side)	797
	EMF/TDE	Frame mounted (pull side; double egress), handed	851
Electromagnetic Slide Track Holder/Closing Device – 24 VAC/DC. Transformer required if power source is 120 VAC.			
8656	EMF/T	Frame mounted (pull side)	680
	EMF/PT	Soffit mounted (push side)	680
	EMF/TDE	Frame mounted (pull side; double egress), handed	733



OPTIONS

(List Price 'add' when ordered with complete closer)

Item	Description	List Add \$
FC	Full plastic closer body cover, 8600	6
FMC	Full metal closer body cover (Handed), used w/8900	6
FMC	Full metal closer body cover (Handed), used w/8600	11
BYP	Concealed switch to bypass hold open function	49
TRANSF	120 VAC to 24 VAC transformer (installed separately)	55
EXP	Exposed wiring preparation	23
Custom Color	Custom painted finish selected from DORMA RAL color pallet book. For details, see DORMA Finishes Cross Reference , page vii.	
	per order, setup charge (Net)	100
	per closer, list add	25
Designer Color	Designer painted color matched to supplied samples. Three (3) each 2" x 3" colorchip samples required. For details, see DORMA Finishes Cross Reference , page vii.	
	per order, non-refundable development/setup charge (Net)	250
	per closer, list add	31

NOTES:

- Specify body and arm designation, voltage, hand (when required), and finish when ordering.
- EMR Series in 120 VAC requires optional "external" 120 VAC to 24 VAC transformer (TRANSF).
- MF Series unit must be ordered 24 V when used as a companion to an EMR Series unit.

ACCESSORIES

Item	Series	Applicable Description	List \$
COV	8600	Slim plastic closer body cover	17
FC	8900/8600	Full plastic closer body cover	22
FMC	8900/8600	Full metal closer body cover (specify hand)	27
SN1	8900	(4) each 1/4-20 sex nuts for 1-3/4" door	5
SN3	TS93	(4) each 10-32 sex nuts for 1-3/4" door	5
SNB1	8600	(4) each 1/4-20 sex nuts and machine screws for 1-3/4" door	7
SD2	EMR	Replacement detector module	433
RFR	All	Radio frequency receiver for wireless release of hold open 272	281
HHRFT1	All	Hand held transmitter for wireless release of hold open	139
TRANSF	All	120 VAC to 24 VAC Transformer (External)	55
SCRPKEMRDET	EMR	Standoff for SD-2 Detector Replacement (EMR)	3

NOTE: Highlighted items are available from Select Service.

- Locks
- Cylinders, Keys & Keying
- Exit Devices
- Electronic Access Control Components
- Low Energy Operators
- Surface Closers
- Fire/Life Safety
- Concealed Closers/Pivots
- Stops/ Holders
- Sliding Systems
- Architectural Pulls & Handles
- Service Parts



1800 SERIES

Ordering Guide

Series			Arm		Hand		Finish	
			Push Side Top Jamb Mount	J	RH	Specify for Right Handed Units	PNT	Special Sprayed Finish (must specify)
			Pull Side Track Mount	T	LH	Specify for Left Handed Units	696	Gold
18							695	Dark Duranodic Bronze
							693	Black
							691	Dull Bronze
							690	Statuary Bronze
							689	Aluminum
							600	Primed
18	16	H	J	RH	SD		689	
Size 1-6	16	H				24V	BYP	Bypass Switch
Size 5-6	56	SF				120V	EXP	Preparation for Exposed Wiring Connection
Spring Size		Arm				SD	Options	

Electrical Specifications

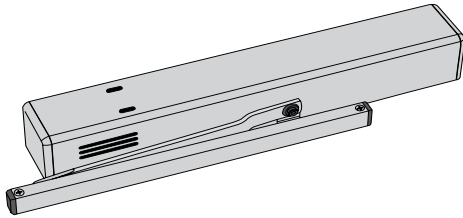

NOTES:

- All combinations of features and options are not available for all models.
- Please refer to 1800 Series product brochure for details.

- Locks
- Cylinders, Keys & Keying
- Exit Devices
- Electronic Access Control Components
- Low Energy Operators
- Surface Closers
- Fire/Life Safety
- Concealed Closers/Pivots
- Stops/ Holders
- Sliding Systems
- Architectural Pulls & Handles
- Service Parts



1800 SD Series (with Detector)

Body	Arm	Mounting	Painted Finish \$
Electromagnetic Holder/Closing Device with Integral Smoke Detector – 24 VAC/DC and 120 VAC			
1856	HT SD	Frame mounted slide track (pull side)	2,121
1816	HJ SD	Frame mounted top jamb (push side)	2,121
Electromagnetic Swing Free/Closing Device with Integral Smoke Detector – 24 VAC/DC and 120 VAC			
1856	SFT SD	Frame mounted slide track (pull side)	2,163
1816	SFJ SD	Frame mounted top jamb (push side)	2,163

1800 Series (No Detector)

Body	Arm	Mounting	Painted Finish \$
Electromagnetic Holder/Closing Device – 24VAC/DC and 120VAC			
1856	HT	Frame mounted slide track (pull side)	1,071
1816	HJ	Frame mounted top jamb (push side)	1,071
Electromagnetic Swing Free/Closing Device – 24VAC/DC and 120VAC			
1856	SFT	Frame mounted slide track (pull side)	1,113
1816	SFJ	Frame mounted top jamb (push side)	1,113

NOTES:

- Specify body, arm, hand, and finish for all units.
- Specify if less than 2" frame face for (T) track mounted units. Specify <2" (no additional charge).
- Specify **DROP** for top jamb drop applications (no additional charge if noted at time of order).
- 1800 Series can be used as a companion to the 1800 SD Series, bypass 120 VAC transformer
- when making wiring connections or order less transformer for deduct.



OPTIONS

(List Price 'add' when ordered with complete closer)

Item	Description	List Add/Deduct \$
LTRANSF	1800 Less 120 VAC transformer (deduct)	Deduct 29
<2"	T mount <2" frame face	N/C
DROP	Top jamb drop applications (configure at factory)	N/C
BYP	Concealed switch to bypass hold open function	49
EXP	Exposed wiring preparation	23
AR	Complete arm for top jamb 0"-4" reveal	Deduct 3
Custom Color	Custom painted finish selected from DORMA RAL color pallet book. For details, see DORMA Finishes Cross Reference , page vii.	
	per order, setup charge (Net)	100
	per closer, list add	25
Designer Color	Designer painted color matched to supplied samples. Three (3) each 2" x 3" color chip samples required. For details, see DORMA Finishes Cross Reference , page vii.	
	per order, non-refundable development/setup charge (Net)	250
	per closer, list add	31

ACCESSORIES

Item	Applicable Description	List \$
SN1	(4) each 1/4-20 sex nuts for 1-3/4" door	5
SNB1	(4) each 1/4-20 sex nuts and machine screws for 1-3/4" door	6
EXPKIT	Exposed wiring bracket	30
SFKIT	Swing free kit	42
SOL1800	1800 replacement solenoid 24 VAC/DC	292
SD2	Replacement detector module	433
RFR	Radio frequency receiver for wireless release of hold open	281
HHRFT1	Hand held transmitter for wireless release of hold open	139
CAMDRIVE	Replacement Hold Open Cam/Cam Drive	18
TRANSF	120 VAC to 24 VAC Transformer	55

NOTE: Highlighted items are available from Select Service.

- Locks
- Cylinders, Keys & Keying
- Exit Devices
- Electronic Access Control Components
- Low Energy Operators
- Surface Closers
- Fire/Life Safety
- Concealed Closers/Pivots
- Stops/ Holders
- Sliding Systems
- Architectural Pulls & Handles
- Service Parts



EM SERIES

Ordering Guide

Series		Options (Packaged Separately)			Finish	
		2-5/8" Catch Plate —	CP LONG			
		2" Catch Plate —	CP SHORT			
		8-3/8" to 12" Adjustable Extension —	ER 12			
		6-3/8" to 8" Adjustable Extension —	ER 7			
		2" Extension —	ER 2.0	696 —	Satin Brass Painted	
		1-1/2" Extension —	ER 1.5	695 —	Dark Duranodic Bronze Powder Coated	
				689 —	Aluminum Powder Coated	
EM	504	24120		689		
Single Floor —	501	24120 —	Dual Voltage 24 VDC, 120 VAC			
Double Floor —	502	Electrical Specification				
Semi-Flush, Long Catch —	504					
Semi-Flush, Short Catch —	505					
Surface —	508					
Completely Flush —	509					
Application						

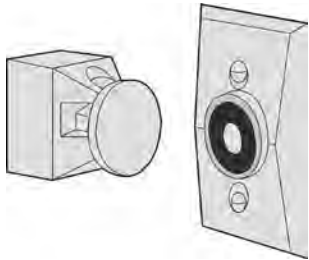

NOTES:

- All combinations of features and options are not available for all models.
- Please refer to EM Series product brochure for details.

- Locks
- Cylinders, Keys & Keying
- Exit Devices
- Electronic Access Control Components
- Low Energy Operators
- Surface Closers
- Fire/Life Safety**
- Concealed Closers/Pivots
- Stops/ Holders
- Sliding Systems
- Architectural Pulls & Handles
- Service Parts

Body	Mounting	689/695 Finish \$	696 Finish \$
Electromagnetic Floor Mounted Holder – 24 VDC, 24 VAC, or 120 VAC			
EM 501-24120	Floor mount, single unit	648	690
EM 502-24120	Floor mount, double unit	809	851
Electromagnetic Wall Mounted Holder – 24 VDC, 24 VAC, or 120 VAC			
EM 504-24120	Semi-flush mount, (recessed) long catch plate	348	390
EM 505-24120	Semi-flush mount, (recessed) short catch plate	348	390
EM 508-24120	Surface mount	369	412
EM 509-24120*	Completely flush mount	369	412

NOTE: Highlighted items are available from Select Service.

* The EM509 is shipped with a 630 faceplate when ordered in 689 finish.

OPTIONS

Item	Description	689/695 Finish \$	696 Finish \$
ER1.5**	1-1/2" extension rod	58	—
ER2.0**	2" extension rod	66	—
ER7**	6-3/8"–8" adjustable extension rod	74	—
ER12**	8-3/8"–12" adjustable extension rod	82	—

** ER extension rods available in 689 finish only.

ACCESSORIES

Item	Description	689/695 Finish \$	696 Finish \$
CPSHORT	2" projection catch plate (door portion)	85	98
CPLONG	2-5/8" projection catch plate (door portion)	97	111
EMDPPK**	Door plate pack, (plate, bracket & fasteners)	32	—
EMSCRPK**	Universal fastener pack for all EM models	21	—
EMSURFPK**	Surface mount box and fastener pack for EM 509	75	—
EMFACEPLTPK**	Brackets and fastener pack for all EM face plates	20	—

** Available in 689 finish only.



DORMA CONCEALED DOOR CLOSERS

Product Guide (1 of 2)

CONCEALED DOOR CLOSERS	CONCEALED IN THE FLOOR	CONCEALED IN THE FRAME	CONCEALED IN THE DOOR
Grade 1 Heavy-Duty Sized (Power) per Application	BTS80	—	—
Grade 1 Heavy-Duty Sized (Power) per Application Hold Open	BTS80 EMB	—	—
Grade 1 Commercial Adjustable (Power) Size	BTS75V	ITS96	ITS96
Commercial Sized (Power) per Application	—	RTS88	—

- Locks
- Cylinders, Keys & Keying
- Exit Devices
- Electronic Access Control Components
- Low Energy Operators
- Surface Closers
- Fire/Life Safety
- Concealed Closers/Pivots**
- Stops/ Holders
- Sliding Systems
- Architectural Pulls & Handles
- Service Parts



DORMA CONCEALED DOOR CLOSERS

Product Guide (2 of 2)

<input checked="" type="radio"/> Yes <input type="radio"/> No	A156.4 Grade 1	A156.4 Grade 3	UL10C UBC 7-2	Advanced Cam & Roller Design	Plated Finishes	Standard Painted Finishes	Custom Painted Finishes	Adjustable Power	Fixed Power
BTS75V	<input checked="" type="radio"/>	<input type="radio"/>	<input checked="" type="radio"/>	<input checked="" type="radio"/>	<input checked="" type="radio"/>	<input checked="" type="radio"/>	<input checked="" type="radio"/>	<input checked="" type="radio"/>	<input type="radio"/>
BTS80	<input checked="" type="radio"/>	<input type="radio"/>	<input checked="" type="radio"/>	<input checked="" type="radio"/>	<input checked="" type="radio"/>	<input checked="" type="radio"/>	<input checked="" type="radio"/>	<input type="radio"/>	<input checked="" type="radio"/>
BTS80 EMB	<input checked="" type="radio"/>	<input type="radio"/>	<input checked="" type="radio"/>	<input checked="" type="radio"/>	<input checked="" type="radio"/>	<input checked="" type="radio"/>	<input checked="" type="radio"/>	<input type="radio"/>	<input checked="" type="radio"/>
ITS96	<input type="radio"/>	<input checked="" type="radio"/>	<input checked="" type="radio"/>	<input checked="" type="radio"/>	<input checked="" type="radio"/>	<input checked="" type="radio"/>	<input checked="" type="radio"/>	<input checked="" type="radio"/>	<input type="radio"/>
RTS88	<input type="radio"/>	<input type="radio"/>	<input type="radio"/>	<input checked="" type="radio"/>	<input checked="" type="radio"/>	<input checked="" type="radio"/>	<input checked="" type="radio"/>	<input type="radio"/>	<input checked="" type="radio"/>



SELECT SERVICE QUICK SHIP

Concealed Closers/Pivots

Select service should be used for small quantities of popular DORMA products that require shipment within 24 hours. The program includes locks, exit devices, door closers, magnets, electronic access control, and low energy operators. Warehouses have been set up in the east and west for faster delivery nationwide. (Customer responsible for shipping costs FOB.)

Subject to Availability

Next Business Day Service (Shipment when Purchase Order is received prior to 4:00 PM EST).

Examples: DORMA receives P.O. at 3:59 PM on Monday, order will ship by close of business on Tuesday.

DORMA receives P.O. at 3:59 PM on Friday, order will ship by close of business on the following Monday.

Notes:

- Standard freight and discount schedules and terms of sale apply. Please refer to the current price list for full details.
- DORMA reserves the right to limit quantities or decline an order if the credit status of the buyer is not satisfactory to DORMA.
- Orders cannot be cancelled.
- Select Service Quick Ship available only in the United States.
- All prices are in U.S. dollars.
- Products and prices are subject to change without notice.
- Some of the available products have quantity per order limits and will be noted accordingly.

Key

N "New" to Select Service, Available in East and West Coast Warehouse

■ Available in East and West Coast Warehouse

E Available only in East Coast Warehouse



Locks

Cylinders,
Keys & Keying

Exit Devices

Electronic
Access Control
Components

Low Energy
Operators

Surface
Closers

Fire/Life
Safety

Concealed
Closers/Pivots

Stops/
Holders

Sliding
Systems

Architectural
Pulls &
Handles

Service Parts



Concealed Door Closers

ITS Series

PN #	Body	Description	NHO/HO	Finish	List \$
33600001	■ ITS9613		NHO	689	436
33600002	■ THKIT	(ITS HO Kit)	—	—	57

RTS Series

PN #	Package	Spring	Stop	NHO/HO	Extension	List \$
33600003	■ RTS88	SZ3	105°	NHO	5 mm	364
33600004	■ RTS88	SZ3	105°	HO	5 mm	364
33600005	■ RTS88	SZ3	90°	NHO	5 mm	364
33600006	■ RTS88	SZ3	90°	HO	5 mm	364
33600007	■ RTS88	BFI	105°	NHO	5 mm	364
33600008	■ RTS88	BFI	105°	HO	5 mm	364
33600009	■ RTS88	BFE	105°	NHO	5 mm	364
33600010	■ RTS88	BFE	105°	HO	5 mm	364
33600047	■ RTS88	SZ3	105°	NHO	—	364
33600048	■ RTS88	SZ3	105°	HO	—	364
33600050	■ RTS88	SZ3	90°	NHO	—	364
33600051	■ RTS88	BFE	105°	NHO	—	364
33600052	■ RTS88	BFI	105°	NHO	—	364

NOTE: RTS88 Body only prices above (include mounting brackets)





RTS Accessories & Service Items

PN #	Model	Description	Finish	List \$
33600011	■ CRNR BRKT	Header to side Jamb 1" web	—	7
33600012	■ 8835	End load arm 7/8" web	—	98
33600013	■ 8836	End load arm 5/8" web	—	98
33600014	■ 8837	End load arm 3/4" web	—	98
33600015	■ 8838	End load arm	—	98
33600016	■ 8812	Offset arm	—	145
33600017	■ 8852	Short floor pivot	—	67
33600018	■ 8853	Tall floor pivot	—	67
33600019	■ 8855	Short threshold pivot	—	67
33600020	■ 8575	Cover, steel	626	144
33600021	■ 8563	Cover, aluminum	689	62
33600022	■ 8532	Steel frame mounting channel	—	52
33600023	■ 8521E	2-5/16" (add-on) spindle extension	—	52
33600024	■ 8820J	Conversion bracket, Jackson to RTS (use with standard RTS CRNR BRKT)	—	16

BTS Series

PN #	Package	Spring	Top Pivot	Bottom Pivot	Cover	Hand	Spindle	HO/HNO	Finish	List \$
33600025	■ BTS80B	Sz4	Sz4	8062	7410		74010	HO/NHO	626	1,354
33600027	■ BTS80D	Sz4	Sz4	75120	7410	RH	74010	HO/NHO	626	1,431
33600026	■ BTS80D	Sz4	Sz4	75120	7410	LH	74010	HO/NHO	626	1,431

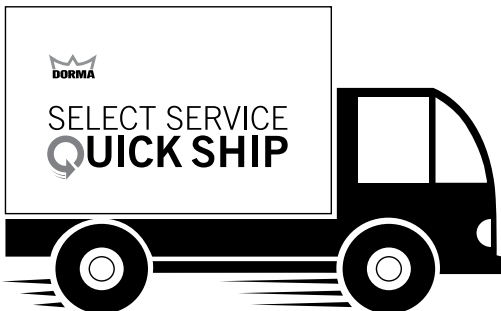

- Locks
- Cylinders, Keys & Keying
- Exit Devices
- Electronic Access Control Components
- Low Energy Operators
- Surface Closers
- Fire/Life Safety
- Concealed Closers/Pivots**
- Stops/ Holders
- Sliding Systems
- Architectural Pulls & Handles
- Service Parts



BTS Accessories & Service Items

PN #	Product	Hand	Finish	List \$
33600028	■ BTS80 Sz. 3	—	(no finish)	971
33600029	■ BTS80 Sz. 4	—	(no finish)	971
33600030	■ BTS80 Sz. 6	—	(no finish)	971
33600031	■ BTS75V NHO 1-4	—	(no finish)	888
33600032	■ BTS75V BF NHO 1-4	—	(no finish)	888
33600033	■ BTS75V 90 HO 1-4	—	(no finish)	941
33600034	■ 74003 (Spindle insert)	—	(no finish)	67
33600035	■ 74005 (Spindle insert)	—	(no finish)	67
33600036	■ 74007 (Spindle insert)	—	(no finish)	67
33600037	■ 74010 (Spindle insert)	—	(no finish)	67
33600038	■ 74015 (Spindle insert)	—	(no finish)	88
33600039	■ 74020 (Spindle insert)	—	(no finish)	88
33600040	■ 74025 (Spindle insert)	—	(no finish)	88
33600041	■ 80010 (3° Spindle insert)	LH	(no finish)	67
33600042	■ 80010 (3° Spindle insert)	RH	(no finish)	67
33600043	■ 7410 (BTS80 cover plate)	—	630	108
33600044	■ 7410 (BTS80 cover plate)	—	613	108
33600045	■ 7510 (BTS75V cover plate)	—	630	108
33600046	■ 7510 (BTS75V cover plate)	—	613	108

Pivots

LM Series Pivot Sets & Pivot Hardware

PN #	Package	Finish	List \$
33500001	■ CP440	626/630	303
33500002	■ OP440 RH	626	379
33500003	■ OP440 LH	626	379

LM Pivot Accessories & Service Items

PN #	Product	Finish	List \$
33500004	■ 75220 RH (3/4" offset intermediate)	626	256
33500005	■ 75220 LH (3/4" offset intermediate)	626	256
33500006	■ 75523 3 Hour Rated Pocket Pivot	626	408





BTS80 SERIES

Ordering Guide

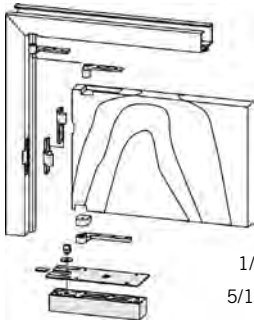

1/2" Pre-Loaded Spindle	80005
5/16" Pre-Loaded Spindle	80003
2-5/16" Spindle	74050
2-1/16" Spindle	74045
1-7/8" Spindle	74040
1-11/16" Spindle	74035
1-1/2" Spindle	74030
1-5/16" Spindle	74025
1-1/8" Spindle	74020
7/8" Spindle	74015
13/16" Spindle	74012
3/4" Spindle	74010
5/8" Spindle	74007
1/2" Spindle	74005
5/16" Spindle	74003

Spindle

80030	1-1/2" Pre-Loaded Spindle
80025	1-5/16" Pre-Loaded Spindle
80020	1-1/8" Pre-Loaded Spindle
80015	7/8" Pre-Loaded Spindle
80010	3/4" Pre-Loaded Spindle
3 h Intermediate Pivot for 1-1/2" Offset	15233
Through Wire Intermediate Pivot for 1-1/2" Offset	15222
20 min Intermediate Pivot for Lead Lined 3/4" Offset (see note*)	75243
20 min Intermediate Pivot for 3/4" Offset	75242
Intermediate Pivot for Lead Lined 3/4" Offset (see note*)	75240
Intermediate Pivot for 3/4" Offset	75233
Intermediate Pivot for 3/4" Offset	75222
Intermediate Pivot for 3/4" Offset	75220

Optional Accessories

E80624	Through Wire CH Top Pivot (4 wire)
E80622	Through Wire CH Top Pivot (2 wire)
HD8062	Heavy Duty CH Top Pivot
75200	Through Wire Intermediate Pivot for 3/4" Offset
15233	20 min Intermediate Pivot for 1-1/2" Offset
15222	3 h Intermediate Pivot for Lead Lined 3/4" Offset (see note*)
75243	Intermediate Pivot for Lead Lined 3/4" Offset (see note*)
75242	3 h Intermediate Pivot for 3/4" Offset
75240	Intermediate Pivot for 3/4" Offset
75233	Intermediate Pivot for 3/4" Offset
75222	Intermediate Pivot for 3/4" Offset
75220	Intermediate Pivot for 3/4" Offset
SC2	Sealing Compound
TP80 CH	Terrazo Pan CH and 1-1/2" Offset
TP80	Terrazo Pan for 3/4" Offset

Hand

LH	Specify for Left Handed Units
RH	Specify for Right Handed Units

Deducts

LBX	Less Cement Box
LFP	Less Floor Plate
LTP	Less Top Pivot

Series	BTS80	D	74010	RH	AMS	626
---------------	--------------	----------	--------------	-----------	------------	------------

CH Double Acting, Aluminum Door and Frame	A
CH Double Acting, Wood or Steel Door and Frame	B
1-1/2" Offset, Handed	C
1-1/2" Offset, 20 min Rated Handed	C-E
1-1/2" Offset, 3 h Rated Handed	C-F
CH Single Acting, Aluminum Door and Frame	D
CH Single Acting, Wood or Steel Door and Frame	E
Independent Hung, Non-Handed	F
Independent Hung, Up to 3 h Rated, Non-Handed	G
3/4" Offset Lead Lined, Handed*	H
3/4" Offset Lead Lined, 20 min Rated Handed*	I
3/4" Offset Lead Lined, 3 h Rated Handed*	IF
Independent Hung On Pocket Pivots, Non-Handed	L
	L-E
	L-F
	P
	PF

3	Size 3, Light Opening Force, No Backcheck
4	Size 4, No Need to Specify
5	Size 5, for use w/Fire Pkgs, No Delay, No Hold Open
6	Size 6, Strong

Spring Size

D	3/4" Offset, Handed
E	3/4" Offset, 20 min Rated Handed
F	3/4" Offset, 3 h Rated Handed

AMS	All Metal Screws
W2	All Wood Screws
W1	1/2 Wood Screws
AMSAWS	All Metal Screws All Wood Screws

Fastener Packs

600	Primed
689	Aluminum
690	Statuary Bronze
691	Dull Bronze
693	Black
695	Dark Duranodic Bronze
696	Gold
PNT	Special Sprayed Finish (must specify)

Painted

Bright Brass	605
Satin Brass	606
Bright Bronze	611
Satin Bronze	612
Oxidized Satin Oil Rubbed	613
Bright Nickel	618
Satin Nickel	619
Bright Chrome	625
Satin Chrome	626

Plated

* "L" Package Door Thickness Note:
The standard door thickness is 1-3/4", and is the default unless otherwise specified.

Other alternative sizes are

-2
-2-1/4
-2-1/2
-3

Examples: L-E-2-1/2....75242-2-1/2
Example above 20 min. lead lined package for 2-1/2" thick door.

Package

NOTES:

- All combinations of features and options are not available for all models.
- Please refer to BTS80 Series product brochure for details.
- When replacing standard package hardware with optional hardware, adjust list price accordingly.

Locks

Cylinders, Keys & Keying

Exit Devices

Electronic Access Control Components

Low Energy Operators

Surface Closers

Fire/Life Safety

Concealed Closers/Pivots

Stops/ Holders

Sliding Systems

Architectural Pulls & Handles

Service Parts



Package	Description	Painted Finish \$	Plated Finish \$
Center Hung, Double Acting, Aluminum Door and Frame (Non-Handed)			
BTS80A	Complete package BTS80-4, 74010, 7410, 7422, 8062	—	1,381
BTS80/A LFP	Complete package, less floor plate	—	1,268
Center Hung, Double Acting, Wood or Steel Door and Frame (Non-Handed)			
BTS80B	Complete package BTS80-4, 74010, 7410, 7421, 8062	—	1,354
BTS80/B LFP	Complete package, less floor plate	—	1,241
1-1/2" Offset, Single Acting, Wood, Steel or Aluminum Door and Frame (Specify Hand)			
BTS80C	Complete package BTS80-4, 74010, 7410, 15323, 15120	—	1,683
BTS80C LFP	Complete package, less floor plate	—	1,570
1-1/2" Offset, Single Acting, 20 Minute Rated Fire Door and Frame (Specify Hand)			
BTS80CE	Complete package BTS80 F-5, 74010, 7410, 15323, 15122	1,737	1,737
BTS80CE LFP	Complete package, less floor plate	1,624	1,624
1-1/2" Offset, Single Acting, 3 Hour Rated Fire Door and Frame (Specify Hand)			
BTS80CF	Complete package BTS80 F-5, 74010, 7410, 15323, 15133	1,763	2,037
BTS80CF LFP	Complete package, less floor plate	1,650	1,924
3/4" Offset, Single Acting, Wood, Steel or Aluminum Door and Frame (Specify Hand)			
BTS80D	Complete package BTS80-4, 74010, 7410, 75323, 75120	—	1,431
BTS80D LFP	Complete package, less floor plate	—	1,318
3/4" Offset, Single Acting, 20 Minute Rated Fire Door and Frame (Specify Hand)			
BTS80E	Complete Package BTS80 F-5, 74010, 7410, 75323, 75122	1,471	1,471
BTS80E LFP	Complete package, less floor plate	1,358	1,358
3/4" Offset, Single Acting, 3 Hour Rated Fire Door and Frame (Specify Hand)			
BTS80F	Complete package BTS80 F-5, 74010, 7410, 75323, 75133	1,509	1,709
BTS80F LFP	Complete package, less floor plate	1,396	1,596
Center Hung, Single Acting, Aluminum Door and Frame (Specify Hand)			
BTS80G	Complete package BTS80-4, 80010, 7410, 7422, 8062	—	1,381
BTS80G LFP	Complete package, less floor plate	—	1,268
Center Hung, Single Acting, Wood or Steel Door and Frame (Specify Hand)			
BTS80H	Complete package BTS80-4, 80010, 7410, 7421, 8062	—	1,354
BTS80H LFP	Complete package, less floor plate	—	1,241

NOTE: See BTS80 Accessories for intermediate pivots. See BTS Accessories for individual component list prices.

NOTE: Highlighted items are available from Select Service.



Package	Description	Painted Finish \$	Plated Finish \$
Independent Hung, on Hinges, etc. (Non-Handed)			
BTS80I	Complete package BTS80-4, 74003, 7410, 7451N-A**	1,355	1,461
BTS80I LFP	Complete package, less floor plate	1,242	1,348
Independent Hung, 3 Hour Rated Steel, 1-1/2 hour Rated Wood Fire Doors Hung on Hinges, etc. (Specify Hand)			
BTS80IF	Complete package BTS80 F-5, 74003, 7410, 7451N	1,377	1,581
BTS80IF LFP	Complete package, less floor plate	1,264	1,468
3/4" Offset, Single Acting, Wood or Steel Lead Lined Door and Frame (Specify Hand)			
BTS80L	Complete package BTS80-4, 74010, 7410, 75343, 75140	—	1,808
BTS80L LFP	Complete package, less floor plate	—	1,695
3/4" Offset, Single Acting, Lead Lined 20 Minute Rated Fire Door and Frame (Specify Hand)			
BTS80LE	Complete package BTS80 F-5, 74010, 7410, 75343, 75142	1,851	1,851
BTS80LE LFP	Complete package, less floor plate	1,738	1,738
3/4" Offset, Single Acting, Lead Lined 3 Hour Rated Fire Door and Frame (Specify Hand)			
BTS80LF	Complete package BTS80 F-5, 74010, 7410, 75343, 75143	1,895	2,038
BTS80LF LFP	Complete package, less floor plate	1,782	1,925
Independent Hung, on Pocket Pivots (Non-Handed)			
BTS80P	Complete package (priced w/ 3 pivots) BTS80-4, 74003, 7410, 7451N-A, 75520	2,519	2,858
BTS80P LFP	Complete package, less floor plate (priced w/ 3 pivots)	2,406	2,745
Independent Hung, 3 Hour Rated Steel, 1-1/2 Hour Rated Wood Fire Doors Hung on Pocket Pivots (Specify Hand)			
BTS80PF	Complete package (priced w/ 3 pivots) BTS80 F-5, 74003, 7410, 7451N, 75523	2,622	3,059
BTS80PF LFP	Complete package, less floor plate (priced w/ 3 pivots)	2,509	2,946

* Floor closer is painted black only. Cement case is galvanized steel.

Spindle is available in zinc plated finish only.

Center hung bottom arms are available in zinc plated finish only (7421/7422).

Floor plate is only available in plated finishes.

** Bottom arm for painted finish would be 7451N.

See BTS80 Accessories for intermediate pivots. See BTS Accessories for individual component list prices.

See **Options** for **Less Cement Box**.

- Locks
- Cylinders, Keys & Keying
- Exit Devices
- Electronic Access Control Components
- Low Energy Operators
- Surface Closers
- Fire/Life Safety
- Concealed Closers/Pivots
- Stops/ Holders
- Sliding Systems
- Architectural Pulls & Handles
- Service Parts



OPTIONS

(List Price 'add' when ordered with complete closer)

Item	Description	Painted Add \$	Plated Add \$
<u>3</u>	ANSI size 3, light opening force, non-fire rated doors (previously BFE)	N/C	—
<u>6</u>	ANSI size 6, spring for up to 4'0" exterior or 4'6" interior non-fire rated doors (previously Sz 3)	N/C	—
AMS	All metal screws	N/C	—
AMSAWS	All metal screws, all wood screws	9	13
W1	Half wood screws	3	4
W2	All wood screws	5	7
<u>74003, 74005, 74007, 74010</u>	5/16", 1/2", 5/8", or 3/4" clearance spindle	N/C	—
<u>74012, 74015, 74020</u>	13/16", 7/8", or 1-1/8" clearance spindle	21	—
<u>74025, 74030, 74035</u>	1-5/16", 1-1/2", or 1-11/16" clearance spindle	21	—
<u>74040, 74045, 74050</u>	1-7/8", 2-1/16", or 2-5/16" clearance spindle	21	—
TP80	▲ Terrazo pan for BTS 80, 80 F, 80 EMB – 3/4" offset (handed)	—	488
TP80CH	▲ Terrazo pan for BTS 80, 80 F, 80 EMB – Center hung or 1-1/2" offset	—	443
SC2	Sealing compound	67	—
LBX	Less cement box	Deduct 24	—
Custom Color	Custom painted finish selected from DORMA RAL color pallet book. For details, see DORMA Finishes Cross Reference , page vii.		
	per order, setup charge (Net)	100	—
	per closer, list add	50	—
Designer Color	Designer painted color matched to supplied samples. Three (3) each 2" x 3" colorchip samples required. For details, see DORMA Finishes Cross Reference , page vii.		
	per order, non-refundable development/ setup charge (Net)	250	—
	per closer, list add	62	—

Spindle Inserts for Center Hung Single Acting Packages

Item	Description	Painted Add \$	Plated Add \$
80003, 80005, <u>80010</u>	5/16", 1/2" or 3/4" clearance spindle (specify hand)	N/C	—
80015, 80020, 80025, 80030	7/8", 1-1/8", 1-5/16" or 1-1/2" clearance spindle (specify hand)	21	—

▲ **NOTE:** Terrazo pans are available stainless steel only.

NOTE: Highlighted items are available from Select Service.



ACCESSORIES

Pivots

Item	Description	Painted Finish \$	Plated Finish \$
3/4" Offset Hung Intermediate Pivots**			
75220	Full mortise standard intermediate pivot	256	256
75222	Full mortise intermediate pivot – 20 minute rated fire door	273	273
75233	Full mortise intermediate pivot – 3 hour rated fire door	288	556
75240	Full mortise intermediate pivot – 1-3/4" lead lined doors	385	385
75242	Full mortise intermediate pivot – 20 minute rated, 1-3/4" lead-lined doors	407	407
75243	Full mortise intermediate pivot – 3 hour rated, 1-3/4" lead-lined doors	417	809
1-1/2" Offset Hung Intermediate Pivots**			
15220	Full mortise standard intermediate pivot	385	385
15222	Full mortise intermediate pivot – 20 minute rated fire door	417	417
15233	Full mortise intermediate pivot – 3 hour rated fire door	428	750
Power Transfer Pivots			
75200	Through-wire 3/4" offset intermediate pivot – 8 wire**	477	477
E80622	Through-wire center hung top pivot (2 wire)	522	522
E80624	Through-wire center hung top pivot (4 wire)	522	522

** NOTE: All intermediate pivots are handed.

NOTE: Highlighted items are available from Select Service.

NOTES:

- Only packages with an "E" or "F" designation in the package description are available in painted finishes.
- Specify package designation, hand (when required), finish, and options or accessories when ordering.
- Complete package prices are indicated in bold.
- When ordering a package "less components," deduct the list price for the component removed.
- Cover plate not available in painted finish. Cover plate will be plated to match when ordering with painted finishes.
- All packages furnished with all machine screws standard (AMS).
- Lead-lined packages shown are for 1-3/4" thick doors. For lead-lined doors from 2" up to 3" thick, add \$88.00 list to the package price. Example, specify: BTS80L-3 for a 3" thick door.
- Lead-lined packages are designed for doors with lead in center of door thickness.
- Package price for P or PF packages includes 3 pocket pivots.

- Locks
- Cylinders, Keys & Keying
- Exit Devices
- Electronic Access Control Components
- Low Energy Operators
- Surface Closers
- Fire/Life Safety
- Concealed Closers/Pivots**
- Stops/ Holders
- Sliding Systems
- Architectural Pulls & Handles
- Service Parts





BTS80 EMB SERIES

Ordering Guide

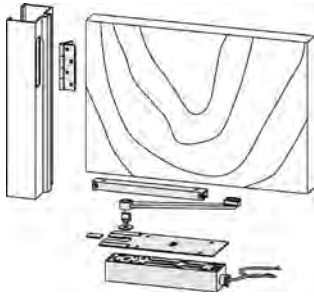

Spindle	
1/2" Pre-Loaded Spindle	80030
5/16" Pre-Loaded Spindle	80025
2-5/16" Spindle	74050
2-1/16" Spindle	74045
1-7/8" Spindle	74040
1-11/16" Spindle	74035
1-1/2" Spindle	74030
1-5/16" Spindle	74025
1-1/8" Spindle	74020
7/8" Spindle	74015
13/16" Spindle	74012
3/4" Spindle	74010
5/8" Spindle	74007
1/2" Spindle	74005
5/16" Spindle	74003

Optional Accessories

E80624	Through Wire CH Top Pivot (4 wire)
E80622	Through Wire CH Top Pivot (2 wire)
HD8062	Heavy Duty CH Top Pivot
75200	Through Wire Intermediate Pivot for 3/4" Offset
15233	20 min Intermediate Pivot for 1-1/2" Offset
15222	20 min Intermediate Pivot for 1-1/2" Offset
15220	Intermediate Pivot for 1-1/2" Offset
75243	3 h Intermediate Pivot for Lead Lined 3/4" Offset (see note*)
75242	Intermediate Pivot for Lead Lined 3/4" Offset (see note*)
75240	Intermediate Pivot for Lead Lined 3/4" Offset (see note*)
75233	3 h Intermediate Pivot for 3/4" Offset
75222	20 min Intermediate Pivot for 3/4" Offset
75220	Intermediate Pivot for 3/4" Offset
SC2	Sealing Compound
TP80 CH	Terrazo Pan CH and 1-1/2" Offset
TP80	Terrazo Pan for 3/4" Offset

Deducts

LBX	Less Cement Box
LFP	Less Floor Plate
LTP	Less Top Pivot

Hand	
LH	Specify for Left Handed Units
RH	Specify for Right Handed Units

Series

BTS80EMB

BTS80EMB	D	5	74010	RH	AMS	626
-----------------	----------	----------	--------------	-----------	------------	------------

C	1-1/2" Offset, Handed
C-E	1-1/2" Offset, 20 min Rated Handed
C-F	1-1/2" Offset, 3 h Rated Handed
D	3/4" Offset, Handed
E	3/4" Offset, 20 min Rated Handed
F	3/4" Offset, 3 h Rated Handed
G	CH Single Acting, Wood or Steel Door and Frame
H	CH Single Acting, Aluminum Door and Frame
I	Independent Hung, Non-Handed
IF	Independent Hung, Up to 3 h Rated, Non-Handed
L	3/4" Offset Lead Lined, Handed*
L-E	3/4" Offset Lead Lined, 20 min Rated Handed*
L-F	3/4" Offset Lead Lined, 3 h Rated Handed*

Package

*** "L" Package Door Thickness Note:**
The standard door thickness is 1-3/4", and is the default unless otherwise specified.

Other alternative sizes are

- 2
- 2-1/4
- 2-1/2
- 3

Examples: L-E-2-1/2...75242-2-1/2

Example above 20 min. lead lined package for 2-1/2" thick door.

Fastener Packs

AMS	All Metal Screws
W2	All Wood Screws
W1	1/2 Wood Screws
AMSAWS	All Metal Screws All Wood Screws

Painted

600	Primed
689	Aluminum
690	Statuary Bronze
691	Dull Bronze
693	Black
695	Dark Duranodic Bronze
696	Gold
PNT	Special Sprayed Finish (must specify)
605	Bright Brass
606	Satin Brass
611	Bright Bronze
612	Satin Bronze
613	Oxidized Satin Oil Rubbed
618	Bright Nickel
619	Satin Nickel
625	Bright Chrome
626	Satin Chrome

Plated

- NOTES:**
- All combinations of features and options are not available for all models.
 - Please refer to BTS80 EMB Series product brochure for details.

Locks
Cylinders, Keys & Keying
Exit Devices
Electronic Access Control Components
Low Energy Operators
Surface Closers
Fire/Life Safety
Concealed Closers/Pivots
Stops/ Holders
Sliding Systems
Architectural Pulls & Handles
Service Parts



Package	Description	Painted Finish \$	Plated Finish \$
1-1/2" Offset, Single Acting, Wood, Steel or Aluminum Door and Frame (Specify Hand)			
BTS80 EMBC	Complete package 80 EMB-5, 74010, 7410, 15323, 15120	—	3,234
BTS80 EMBC LFP	Complete package, less floor plate	—	3,121
1-1/2" Offset, Single Acting, 20 Minute Rated Fire Door and Frame (Specify Hand)			
BTS80 EMBCE	Complete package 80 EMB-5, 74010, 7410, 15323, 15122	3,267	3,267
BTS80 EMBCE LFP	Complete package, less floor plate	3,154	3,154
1-1/2" Offset, Single Acting, 3 Hour Rated Fire Door and Frame (Specify Hand)			
BTS80 EMBCF	Complete package 80 EMB-5, 74010, 7410, 15323, 15133	3,294	3,567
BTS80 EMBCF LFP	Complete package, less floor plate	3,181	3,454
3/4" Offset, Single Acting, Wood, Steel or Aluminum Door and Frame (Specify Hand)			
BTS80 EMBD	Complete package 80 EMB-5, 74010, 7410, 75323, 75120	—	2,982
BTS80 EMBD LFP	Complete package, less floor plate	—	2,869
3/4" Offset, Single Acting, 20 Minute Rated Fire Door and Frame (Specify Hand)			
BTS80 EMBE	Complete package 80 EMB-5, 74010, 7410, 75323, 75122	3,001	3,001
BTS80 EMBE LFP	Complete package, less floor plate	2,888	2,888
3/4" Offset, Single Acting, 3 Hour Rated Fire Door and Frame (Specify Hand)			
BTS80 EMBF	Complete package 80 EMB-5, 74010, 7410, 75323, 75133	3,039	3,209
BTS80 EMBF LFP	Complete package, less floor plate	2,926	3,096
Center Hung, Single Acting, Aluminum Door and Frame (Specify Hand)			
BTS80 EMBG	Complete package 80 EMB-5, 80010, 7410, 7422, 8062	—	2,932
BTS80 EMBG LFP	Complete package, less floor plate	—	2,819
Center Hung, Single Acting, Wood or Steel Door and Frame (Specify Hand)			
BTS80 EMBH	Complete package 80 EMB-5, 80010, 7410, 7421, 8062	—	2,906
BTS80 EMBH LFP	Complete package, less floor plate	—	2,793
Independent Hung, on Hinges, etc. (Specify Hand)			
BTS80 EMBI	Complete package 80 EMB-5, 74003, 7410, 7451N-A	2,907	3,012
BTS80 EMBI LFP	Complete package, less floor plate	2,794	2,899
Independent Hung, 3 Hour Rated Steel, 1-1/2 Hour Rated Wood Fire Door Hung on Hinges, etc. (Specify Hand)			
BTS80 EMBIF	Complete package 80 EMB-5, 74003, 7410, 7451N**	2,907	3,111
BTS80 EMBIF LFP	Complete package, less floor plate	2,794	2,998

NOTE: See BTS80 EMB Accessories for intermediate pivots. See BTS Accessories for individual component list prices.



Package	Description	Painted Finish \$	Plated Finish \$
3/4" Offset, Single Acting, Lead Lined, Wood, or Steel Door and Frame (Specify Hand)			
BTS80 EMBL	Complete package 80 EMB-5, 74010, 7410, 75343, 75140	—	3,359
BTS80 EMBL LFP	Complete package, less floor plate	—	3,246
3/4" Offset, Single Acting, Lead Lined 20 Minute Rated Fire Door and Frame (Specify Hand)			
BTS80 EMBL-E	Complete package 80 EMB-5, 74010, 7410, 75343, 75142	3,380	3,380
BTS80 EMBLE LFP	Complete package, less floor plate	3,267	3,267
3/4" Offset, Single Acting, Lead Lined 3 Hour Rated Fire Door and Frame (Specify Hand)			
BTS80 EMBL-F	Complete package 80 EMB-5, 74010, 7410, 75343,75143	3,425	3,568
BTS80 EMBLF LFP	Complete package, less floor plate	3,312	3,455

* Floor closer is painted black only. Cement case is galvanized steel.
 Spindle is available in zinc plated finish only.
 Center hung bottom arms are available in zinc plated finish only (7421/7422).
 Floor plate is only available in plated finishes.
 ** Bottom arm for painted finish would be 7451N.
 See BTS80 EMB Accessories for intermediate pivots. See BTS Accessories for individual component list prices.
 See Options for Less Cement Box.

- Locks
- Cylinders, Keys & Keying
- Exit Devices
- Electronic Access Control Components
- Low Energy Operators
- Surface Closers
- Fire/Life Safety
- Concealed Closers/Pivots**
- Stops/ Holders
- Sliding Systems
- Architectural Pulls & Handles
- Service Parts



OPTIONS

(List Price 'add' when ordered with complete closer)

Item	Description	Painted Add \$	Plated Add \$
AMS	All metal screws	N/C	—
AMSAWS	All metal screws, all wood screws	9	13
W1	Half wood screws	3	9
W2	All wood screws	5	7
74003, 74005, 74007, 74010	5/16", 1/2", 5/8", or 3/4" clearance spindle	N/C	—
74012, 74015, 74020	13/16", 7/8", or 1-1/8" clearance spindle	21	—
74025, 74030, 74035	1-5/16", 1-1/2", or 1-11/16" clearance spindle	21	—
74040, 74045, 74050	1-7/8", 2-1/16", or 2-5/16" clearance spindle	21	—
TP80	▲ Terrazo pan for BTS 80, 80 F, 80 EMB - 3/4" offset (handed)	—	488
TP80 CH	▲ Terrazo pan for BTS 80, 80 F, 80 EMB - Center hung or 1-1/2" offset	—	443
SC2	Sealing compound	67	—
LBX	Less cement box	Deduct 24	—
Custom Color	Custom painted finish selected from DORMA RAL color pallet book. For details, see DORMA Finishes Cross Reference , page vii.		
	per order, setup charge (Net)	100	—
	per closer, list add	50	—
Designer Color	Designer painted color matched to supplied samples. Three (3) each 2" x 3" colorchip samples required. For details, see DORMA Finishes Cross Reference , page vii.		
	per order, non-refundable development/ setup charge (Net)	250	—
	per closer, list add	62	—

Spindle Inserts for Center Hung Single Acting Packages

Item	Description	Painted Add \$	Plated Add \$
80003, 80005, 80010	5/16", 1/2" or 3/4" clearance spindle (specify hand)	N/C	—
80015, 80020, 80025, 80030	7/8", 1-1/8", 1-5/16" or 1-1/2" clearance spindle (specify hand)	21	—

▲ **NOTE:** Terrazo pans are available stainless steel only.
NOTE: Highlighted items are available from Select Service.



ACCESSORIES

Pivots

Item	Description	Painted Finish \$	Plated Finish \$
3/4" Offset Hung Intermediate Pivots**			
75220	Full mortise standard intermediate pivot	256	256
75222	Full mortise intermediate pivot – 20 minute rated fire door	273	273
75233	Full mortise intermediate pivot – 3 hour rated fire door	288	556
75240	Full mortise intermediate pivot – 1-3/4" lead-lined doors	385	385
75242	Full mortise intermediate pivot – 20 minute rated, 1-3/4" lead-lined doors	407	407
1-1/2" Offset Hung Intermediate Pivots**			
15220	Full mortise standard intermediate pivot	385	385
15222	Full mortise intermediate pivot – 20 minute rated fire door	417	417
15233	Full mortise intermediate pivot – 3 hour rated fire door	428	750
Power Transfer Pivots			
75200	Through-wire 3/4" offset intermediate pivot – 8 wire**	477	477
E80622	Through-wire center hung top pivot (2 wire)	522	522
E80624	Through-wire center hung top pivot (4 wire)	522	522

**NOTE: All intermediate pivots are handed.

Miscellaneous

Item	Description	List \$
TP80	▲ Terrazo pan for BTS 80, 80 F, 80 EMB – 3/4" offset (Handed)	506
TP80CH	Terrazo pan for BTS 80, 80 F, 80 EMB – Center hung or 1-1/2" offset	460
SC2	Sealing compound	67

▲ NOTE: Terrazo pans are available stainless steel only.

NOTES:

- Only packages with an "E" or "F" designation in the package description are available in painted finishes.
- Specify package designation, hand (when required), finish, and options or accessories when ordering.
- Complete package prices are indicated in bold.
- When ordering a package "less components," deduct the list price for the component removed.
- Cover plate not available in painted finish. Cover plate will be plated to match when ordering with painted finishes.
- All packages furnished with all machine screws standard (AMS).
- Lead-lined packages shown are for 1-3/4" thick doors. For lead-lined doors from 2" up to 3" thick, add \$88.00 list to the package price. Example, specify: BTS80/L-3 for a 3" door.

Locks

Cylinders, Keys & Keying

Exit Devices

Electronic Access Control Components

Low Energy Operators

Surface Closers

Fire/Life Safety

Concealed Closers/Pivots

Stops/ Holders

Sliding Systems

Architectural Pulls & Handles

Service Parts





BTS75V SERIES

Ordering Guide

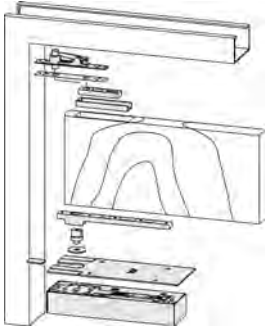

Spindle	
1-1/2" Pre-Loaded Spindle	80030
1-5/16" Pre-Loaded Spindle	80025
1-1/8" Pre-Loaded Spindle	80020
7/8" Pre-Loaded Spindle	80015
3/4" Pre-Loaded Spindle	80010
1/2" Pre-Loaded Spindle	80005
5/16" Pre-Loaded Spindle	80003
2-5/16" Spindle	74050
2-1/16" Spindle	74045
1-7/8" Spindle	74040
1-11/16" Spindle	74035
1-1/2" Spindle	74030
1-5/16" Spindle	74025
1-1/8" Spindle	74020
7/8" Spindle	74015
13/16" Spindle	74012
3/4" Spindle	74010
5/8" Spindle	74007
1/2" Spindle	74005
5/16" Spindle	74003

Hold Open	
150° Hold Open (BF Not Available)	105
90° Hold Open	90
Non-Hold Open	NHO

Optional Accessories (multiple options can be ordered)

E80624	Through Wire CH Top Pivot (4 wire)
E80622	Through Wire CH Top Pivot (2 wire)
HD8062	Heavy Duty CH Top Pivot
75200	Through Wire Intermediate Pivot for 3/4" Offset
15233	Through Wire Intermediate Pivot for 1-1/2" Offset
15222	20 min Intermediate Pivot for 1-1/2" Offset
15220	20 min Intermediate Pivot for 3/4" Offset
75233	3 h Intermediate Pivot for 3/4" Offset
75222	Intermediate Pivot for 3/4" Offset
75220	Intermediate Pivot for 3/4" Offset
SC2	Sealing Compound
TP75 CH	Terrazo Pan CH and 1-1/2" Offset
TP75	Terrazo Pan for 3/4" Offset

Deducts	
LBX	Less Cement Box
LFP	Less Floor Plate
LTP	Less Top Pivot

Series	BTS75V	D	NHO	74010	RH	AMS	626
---------------	---------------	----------	------------	--------------	-----------	------------	------------

CH Double Acting, Aluminum Door and Frame	A	Std.	No Need to Specify Size 1-4, No Delay	LH	AMS	All Metal Screws	600	Primed					
CH Double Acting, Wood or Steel Door and Frame	B	BF	Size 1-4, No Backcheck	RH	W2	All Wood Screws	689	Aluminum					
1-1/2" Offset, Handed	C-E	Spring Size	Hand	Specify for Left Handed Units	Specify for Right Handed Units	W1	1/2 Wood Screws	690	Statuary Bronze				
1-1/2" Offset, 20 min Rated Handed	C-F									AMS	All Metal Screws All Wood Screws	691	Dull Bronze
1-1/2" Offset, 3 h Rated Handed	D									3/4" Offset, Handed	693	Black	
	E	3/4" Offset, 20 min Rated Handed	695	Dark Duranodic Bronze									
	F	3/4" Offset, 3 h Rated Handed	696	Gold Special Sprayed Finish (must specify)									
	G	CH Single Acting, Aluminum Door and Frame	PNT										
	H	CH Single Acting, Wood or Steel Door and Frame	Bright Brass	605									
	I	Independent Hung, Non-Handed	Satin Brass	606									
	IF	Independent Hung, Up to 3 h Rated, Non-Handed	Bright Bronze	611									
	P	Independent Hung On Pocket Pivots, Non-Handed	Satin Bronze	612									
	PF	Independent Hung On Pocket Pivots, Up to 3 h Rated, Non-Handed	Oxidized Satin Oil Rubbed	613									
			Bright Nickel	618									
			Satin Nickel	619									
			Bright Chrome	625									
			Satin Chrome	626									

Package

NOTES:

- All combinations of features and options are not available for all models.
- Please refer to BTS75V Series product brochure for details.



Package	Description	Painted Finish \$	Plated Finish \$
Center Hung, Double Acting, Aluminum Door and Frame (Non-Handed)			
BTS75VA	Complete package BTS75V NHO, 74010, 7510, 7422, 8062	—	1,298
BTS75VA LFP	Complete package, less floor plate	—	1,185
Center Hung, Double Acting, Wood or Steel Door and Frame (Non-handed)			
BTS75VB	Complete Package BTS75V NHO, 74010, 7510, 7421, 8062	—	1,271
BTS75VB LFP	Complete package, less floor plate	—	1,158
1-1/2" Offset, Single Acting, Wood, Steel, or Aluminum Door and Frame (Specify Hand)			
BTS75VC	Complete package BTS75V NHO, 74010, 7510, 15323, 15120	—	1,600
BTS75VC LFP	Complete package, less floor plate	—	1,487
1-1/2" Offset, Single Acting, 20 Minute Rated Fire Door and Frame (Specify Hand)			
BTS75VCE	Complete package BTS75V NHO, 74010, 7510, 15323, 15122	1,632	1,632
BTS75VCE LFP	Complete package, less floor plate	1,519	1,519
1-1/2" Offset, Single Acting, 3 Hour Rated Fire Door and Frame (Specify Hand)			
BTS75VCF	Complete package BTS75V NHO, 74010, 7510, 15323, 15133	1,658	1,932
BTS75VCF LFP	Complete package, less floor plate	1,545	1,819
3/4" Offset, Single Acting, Wood, Steel, or Aluminum Door and Frame (Specify Hand)			
BTS75VD	Complete Package BTS75V NHO, 74010, 7510, 75323, 75120	—	1,347
BTS75VD LFP	Complete package, less floor plate	—	1,234
3/4" Offset, Single Acting, 20 Minute Rated Fire Door and Frame (Specify Hand)			
BTS75VE	Complete package BTS75V NHO, 74010, 7510, 75323, 75122	1,367	1,367
BTS75VE LFP	Complete package, less floor plate	1,254	1,254
3/4" Offset, Single Acting, 3 Hour Rated Fire Door and Frame (Specify Hand)			
BTS75VF	Complete package BTS75V NHO, 74010, 7510, 75323, 75133	1,404	1,575
BTS75VF LFP	Complete package, less floor plate	1,291	1,462
Center Hung, Single Acting, Aluminum Door and Frame (Specify Hand)			
BTS75VG	Complete package BTS75V NHO, 80010, 7510, 7422, 8062	—	1,298
BTS75VG LFP	Complete package, less floor plate	—	1,185
Center Hung, Single Acting, Wood or Steel Door and Frame (Specify Hand)			
BTS75VH	Complete package BTS75V NHO, 80010, 7510, 7421, 8062	—	1,271
BTS75VH LFP	Complete package, less floor plate	—	1,158

NOTE: See BTS75V Accessories for intermediate pivots. See BTS Accessories for individual component list prices.



Package	Description	Painted Finish \$	Plated Finish \$
Independent Hung, on Hinges, etc. (Non-Handed)			
BTS75VI	Complete package BTS75V NHO, 74003, 7510, 7451N-A**	1,272	1,377
BTS75VI LFP	Complete package, less floor plate	1,159	1,264
Independent Hung, 3 Hour Rated Steel and 1-1/2 Hour Rated Wood Fire Doors Hung on Hinges, etc. (Non-Handed)			
BTS75VIF	Complete package BTS75V NHO, 74003, 7510, 7451N	1,272	1,476
BTS75VIF LFP	Complete package, less floor plate	1,159	1,363
Independent Hung, on Pocket Pivots (Non-Handed)			
BTS 75VP	Complete package (priced w/ 3 pivots) BTS75V NHO, 74003, 7510, 7451N-A, 75520	2,435	2,775
BTS75VP LFP	Complete package, less floor plate	2,322	2,662
Independent Hung, 3 Hour Rated Steel and 1-1/2 Hour Rated Wood Fire Doors Hung on Pocket Pivots (Specify Hand)			
BTS75VPF	Complete package (priced w/ 3 pivots) BTS75V NHO, 74003, 7510, 7451N, 75523	2,497	2,954
BTS75VPF LFP	Complete package, less floor plate	2,384	2,841

* Floor closer is painted black only. Cement case is galvanized steel.

Spindle is available in zinc plated finish only.

Center hung bottom arms are available in zinc plated finish only (7421/7422).

Floor plate is only available in plated finishes.

** Bottom arm for painted finish would be 7451N.

See BTS Accessories for individual component list prices.

See Options for Less Cement Box.

- Locks
- Cylinders, Keys & Keying
- Exit Devices
- Electronic Access Control Components
- Low Energy Operators
- Surface Closers
- Fire/Life Safety
- Concealed Closers/Pivots**
- Stops/ Holders
- Sliding Systems
- Architectural Pulls & Handles
- Service Parts



OPTIONS

(List Price 'add' when ordered with complete closer)

Item	Description	Painted Add \$	Plated Add \$
90	90° hold open	52	—
105	105° hold open	52	—
BF, BF 90	Barrier free for non-fire doors only	N/C	—
AMS	All metal screws	N/C	—
AMSAWS	All metal screws, all wood screws	9	13
W1	Half wood screws	3	4
W2	All wood screws	5	7
74003, 74005, 74007, 74010	5/16", 1/2", 5/8", or 3/4" clearance spindle	N/C	—
74012, 74015, 74020	13/16", 7/8", or 1-1/8" clearance spindle	21	—
74025, 74030, 74035	1-5/16", 1-1/2", or 1-11/16" clearance spindle	21	—
74040, 74045, 74050	1-7/8", 2-1/16", or 2-5/16" clearance spindle	21	—
TP75	▲ Terrazo pan for BTS 75V – 3/4" offset (Handed)	—	464
TP75CH	▲ Terrazo pan for BTS 75V – Center hung or 1-1/2" offset	—	422
SC2	Sealing compound	67	—
LBX	Less cement box	Deduct 24	—
Custom Color	Custom painted finish selected from DORMA RAL color pallet book. For details, see DORMA Finishes Cross Reference , page vii		
	per order, setup charge (Net)	100	—
	per closer, list add	50	—
Designer Color	Designer painted color matched to supplied samples. Three (3) each 2" × 3" colorchip samples required. For details, see DORMA Finishes Cross Reference , page vii.		
	per order, non-refundable development/ setup charge (Net)	250	—
	per closer, list add	62	—

** NOTE: All intermediate pivots are handed.

▲ NOTE: Terrazo pans are available stainless steel only.

NOTE: Highlighted items are available from Select Service.

Spindle Inserts for Center Hung Single Acting Packages

Item	Description	Painted Add \$	Plated Add \$
80003, 80005, 80010	5/16", 1/2", or 3/4" clearance spindle (specify hand)	N/C	—
80015, 80020, 80025, 80030	7/8", 1-1/8", 1-5/16", or 1-1/2" clearance spindle (specify hand)	21	—

NOTE: Highlighted items are available from Select Service.



ACCESSORIES

Pivots

Item	Description	Painted Finish \$	Plated Finish \$
3/4" Offset Hung Intermediate Pivots**			
75220	Full mortise standard intermediate pivot	256	256
75222	Full mortise intermediate pivot – 20 minute rated fire door	273	273
75233	Full mortise intermediate pivot – 3 hour rated fire door	288	556
1-1/2" Offset Hung Intermediate Pivots **			
15220	Full mortise standard intermediate pivot	385	385
15222	Full mortise intermediate pivot – 20 minute rated fire door	417	417
15233	Full mortise intermediate pivot – 3 hour rated fire door	428	750
Power Transfer Pivots			
75200	Through-wire 3/4" offset intermediate pivot – 8 wire**	477	477
E80622	Through-wire center hung top pivot (2 wire)	522	522
E80624	Through-wire center hung top pivot (4 wire)	522	522

** All intermediate pivots are handed.

NOTES:

- Only packages with an "E" or "F" designation in the package description are available in painted finishes.
- Specify package designation, hand (when required), finish, and options or accessories when ordering.
- Complete package prices are indicated in bold.
- When ordering a package "less components, deduct the list price of the removed component.
- Cover plate not available in painted finish. Cover plate will be plated to match when ordering with painted finishes.
- All packages furnished with all machine screws standard (AMS).
- Package price for P or PF packages includes 3 pocket pivots.
- When BTS75D Package is ordered through Select Service, the BF closer is supplied as the default, unless specified otherwise.

- Locks
- Cylinders, Keys & Keying
- Exit Devices
- Electronic Access Control Components
- Low Energy Operators
- Surface Closers
- Fire/Life Safety
- Concealed Closers/Pivots**
- Stops/ Holders
- Sliding Systems
- Architectural Pulls & Handles
- Service Parts

ITS96 SERIES

Ordering Guide

Application		Mounting Kit Options		Painted	
Inverted (closer in frame)	INV	Steel Frame Mounting Kit	BRKTMD	PNT	— Special Sprayed Finish (must specify)
Standard		Wood Frame Mount Kit	BRKTWD	696	— Gold
ITS96				695	— Dark Duranodic Bronze
	13	NHO		693	— Black
Series	Size 1-3	HO		691	— Dull Bronze
	Size 2-5	NHO		690	— Statuary Bronze
	13			689	— Aluminum
	25			600	— Primed
				605	— Bright Brass
				606	— Satin Brass
				611	— Bright Bronze
				612	— Satin Bronze
				613	— Oxidized Satin Oil Rubbed Bronze
				618	— Bright Nickel
				619	— Satin Nickel
				625	— Bright Chrome
				626	— Satin Chrome
					Plated

NOTES:

- All combinations of features and options are not available for all models.
- Please refer to ITS96 Series product brochure for details.



Body	Mounting	Painted Finish \$	Plated Finish \$
Non-Hold Open			
ITS9613	Concealed in door (size 1–3)	436	541
ITS9625	Concealed in door (size 2–5)	520	648
Hold Open			
ITS9613 HO	Concealed in door w/hold open (size 1–3)	495	600
ITS9625 HO	Concealed in door w/hold open (size 2–5)	580	707

NOTE: Highlighted items are available from Select Service.

OPTIONS

(List Price 'add' when ordered with complete closer)

Item	Description	Painted Add \$	Plated Add \$
INV	Inverted ITS96 (closer in header)	16	31
BRKT ITS WOOD	Wood frame mounting kit	27	—
BRKT ITS METAL	Steel frame mounting kit	27	—
Custom Color	Custom painted finish selected from DORMA RAL color pallet book. For details, see DORMA Finishes Cross Reference , page vii.		
	per order, setup charge (Net)	100	—
	per closer, list add	25	—
Designer Color	Designer painted color matched to supplied samples. Three (3) each 2" × 3" color chip samples required. For details, see DORMA Finishes Cross Reference , page vii.		
	per order, non-refundable development/setup charge (Net)	250	—
	per closer, list add	31	—

NOTES:

- Standard configuration is painted arm with track channel to match (shown in bold); closer and closer mounting plate are one finish only.
- Plated finish price includes arm plated and track sprayed with complementary finish.
- Minimum door thickness for ITS9625 is 2" when concealed in the door.
For 1-3/4" thick doors, install ITS9625 in the header (i.e. ITS9625 INV).



RTS88 SERIES

Ordering Guide

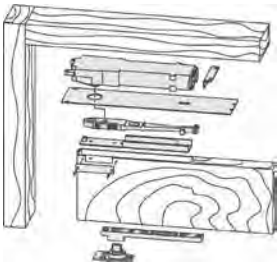

Adds or Deducts

LBA	Less Bottom Arm
LTA	Less Top Arm
LBP	Less Bottom Pivot
5MM	W/ 5mm Extended Spindle
LMC	Less Mounting Channel
8563	Cover Plate for Aluminum Frame Application

Fastener Packs

All Metal Screws	All Wood Screws	AMSAWS
1/2 Wood Screws		W1
All Wood Screws		W2
All Metal Screws		AMS

Accessories

8836S	Closer Arm for 7/8" Top Rail Glass Shoe
8820J	Conversion Bracket for Jackson OHC
8521E	1-5/16" Spindle Extension

Hold Open

Non-Hold Open	NHO	All Wood Screws
Hold Open	HO	All Metal Screws

Series	RTS	03	105	NHO	Sz3	AMS	626
--------	-----	----	-----	-----	-----	-----	-----

CH Side, Aluminum	01	105	105° Cushion	Sz2	Light Opening Force	600	Primed
CH Side, Aluminum	02	90	90° Cushion	Sz3	Standard Closing Force	689	Aluminum
CH Side, Steel	03	Cushion		Sz4	Strongest Closing Force	690	Statuary Bronze
CH Side, Wood Door, Steel Frame	04			BFE	Light Opening Force for Exterior Doors	691	Dull Bronze
CH Side, Wood Door, Aluminum Frame	05		CH Side, Wood	BFI	Lightest Opening Force for Interior	693	Black
	06			Spring Size		695	Dark Duranodic Bronze
	07		CH End, Aluminum			696	Gold
	08		CH End, Aluminum			PNT	Special Sprayed Finish (must specify)
	09		CH End, Aluminum			Painted	
	10		CH End, Aluminum			Bright Brass	605
	11		CH End, Aluminum			Satin Brass	606
	12		CH End, Aluminum			Bright Bronze	611
	13		CH End, Aluminum			Satin Bronze	612
	14		CH End, Aluminum			Oxidized Satin Oil Rubbed	613
	15		CH End, Aluminum			Bright Nickel	618
	16		CH End, Aluminum			Satin Nickel	619
	17		CH End, Aluminum			Bright Chrome	625
	18		CH End, Aluminum			Satin Chrome	626
	19		CH End, Aluminum			Plated	
	20		CH End, Aluminum				
	21		CH End, Aluminum				
	22		CH End, Aluminum				
	25		Hinge Hung, Aluminum				
	26		3/4" Offset, Aluminum				
	27		Hinge or 3/4" Offset, Steel				
	28		Hinge or 3/4" Offset, Wood Door, Steel Frame				
	29		Hinge or 3/4" Offset, Wood				
	30		Hinge, Wood Door, Aluminum Frame				
	31		3/4" Offset, Wood Door, Aluminum Frame				

Package

NOTES:

- All combinations of features and options are not available for all models.
- Please refer to RTS88 Series product brochure for details.



Package	Description	Painted Finish \$	Plated Finish \$
Center Hung Side Load, Double or Single Acting, Aluminum Door and Frame (Non-Handed)			
RTS01	Complete package RTS88, 8831, 8572	525	—
RTS01 × 8563	Complete package, including 8563 frame cover plate	590	—
Center Hung Side Load, Double or Single Acting, Aluminum Door and Frame (Non-Handed)			
RTS02	Complete package RTS88, 8831, 8570	547	—
RTS02 × 8563	Complete package, including 8563 frame cover plate	611	—
Center Hung Side Load, Double or Single Acting, Steel Door and Frame (Non-Handed)			
RTS03	Complete package RTS88, 8831, 7471K, 7421, 8575, 8532**	758	844
RTS03 LMC	Complete package, less mounting channel	705	790
Center Hung Side Load, Double or Single Acting, Wood Door and Steel Frame (Non-Handed)			
RTS04	Complete package RTS88, 8832, 7471K, 7421, 8575, 8532**, W1	830	917
RTS04 LMC	Complete package, less mounting channel	777	861
Center Hung Side Load, Double or Single Acting, Wood Door and Frame (Non-Handed)			
RTS05	Complete package RTS88, 8832, 7471K, 7421, 8561, W2	777	866
Center Hung Side Load, Double or Single Acting, Wood Door and Aluminum Frame (Non-Handed)			
RTS06	Complete package RTS88, 8832, 7471K, 7421, W1	712	713
RTS06 × 8563	Complete package, including 8563 frame cover plate	777	863
Center Hung End Load, Double or Single Acting, Aluminum Door and Frame (Non-Handed)			
RTS07	Complete package RTS88, 8835, 8857	536	—
RTS07 × 8563	Complete package, including 8563 frame cover plate	599	—
Center Hung End Load, Double or Single Acting, Aluminum Door and Frame (Non-Handed)			
RTS08	Complete package RTS88, 8835, 8853	536	—
RTS08 × 8563	Complete package, including 8563 frame cover plate	599	—
Center Hung End Load, Double or Single Acting, Aluminum Door and Frame (Non-Handed)			
RTS09	Complete package RTS88, 8835, 8855	536	—
RTS09 × 8563	Complete package, including 8563 frame cover plate	599	—
Center Hung End Load, Double or Single Acting, Aluminum Door and Frame (Non-Handed)			
RTS10	Complete package RTS88, 8835, 8852	536	—
RTS10 × 8563	Complete package, including 8563 frame cover plate	599	—

NOTE: See RTS88 Accessories for individual component list prices.

NOTE: Highlighted items are available from Select Service.



Package	Description	Painted Finish \$	Plated Finish \$
Center Hung End Load, Double or Single Acting, Aluminum Door and Frame (Non-Handed)			
RTS11	Complete package RTS88, 8836, 8857	536	—
RTS11 × 8563	Complete package, including 8563 frame cover plate	599	—
Center Hung End Load, Double or Single Acting, Aluminum Door and Frame (Non-Handed)			
RTS12	Complete package RTS88, 8836, 8853	536	—
RTS12 × 8563	Complete package, including 8563 frame cover plate	599	—
Center Hung End Load, Double or Single Acting, Aluminum Door and Frame (Non-Handed)			
RTS13	Complete package RTS88, 8836, 8855	536	—
RTS13 × 8563	Complete package, including 8563 frame cover plate	599	—
Center Hung End Load, Double or Single Acting, Aluminum Door and Frame (Non-Handed)			
RTS14	Complete package RTS88, 8836, 8852	536	—
RTS14 × 8563	Complete package, including 8563 frame cover plate	599	—
Center Hung End Load, Double or Single Acting, Aluminum Door and Frame (Non-Handed)			
RTS15	Complete package RTS88, 8838, 8857	536	—
RTS15 × 8563	Complete package, including 8563 frame cover plate	599	—
Center Hung End Load, Double or Single Acting, Aluminum Door and Frame (Non-Handed)			
RTS16	Complete package RTS88, 8838, 8853	536	—
RTS16 × 8563	Complete package, including 8563 frame cover plate	599	—
Center Hung End Load, Double or Single Acting, Aluminum Door and Frame (Non-Handed)			
RTS17	Complete package RTS88, 8838, 8855	536	—
RTS17 × 8563	Complete package, including 8563 frame cover plate	599	—
Center Hung End Load, Double or Single Acting, Aluminum Door and Frame (Non-Handed)			
RTS18	Complete package RTS88, 8838, 8852	536	—
RTS18 × 8563	Complete package, including 8563 frame cover plate	599	—
Center Hung End Load, Double or Single Acting, Aluminum Door and Frame (Non-Handed)			
RTS19	Complete package RTS88, 8837, 8857	536	—
RTS19 × 8563	Complete package, including 8563 frame cover plate	599	—
Center Hung End Load, Double or Single Acting, Aluminum Door and Frame (Non-Handed)			
RTS20	Complete package RTS88, 8837, 8853	536	—
RTS20 × 8563	Complete package, including 8563 frame cover plate	599	—

NOTE: See RTS88 Accessories for individual component list prices.

- Locks
- Cylinders, Keys & Keying
- Exit Devices
- Electronic Access Control Components
- Low Energy Operators
- Surface Closers
- Fire/Life Safety
- Concealed Closers/Pivots
- Stops/ Holders
- Sliding Systems
- Architectural Pulls & Handles
- Service Parts



Package	Description	Painted Finish \$	Plated Finish \$
Center Hung End Load, Double or Single Acting, Aluminum Door and Frame (Non-Handed)			
RTS21	Complete package RTS88, 8837, 8855	536	—
RTS21 × 8563	Complete package, including 8563 frame cover plate	599	—
Center Hung End Load, Double or Single Acting, Aluminum Door and Frame (Non-Handed)			
RTS22	Complete package RTS88, 8837, 8852	536	—
RTS22 × 8563	Complete package, including 8563 frame cover plate	599	—
Hinge Hung, Single Acting, Aluminum Door and Frame (Non-Handed)			
RTS25	Complete package RTS88, 8812	536	—
RTS25 × 8563	Complete package, including 8563 frame cover plate	599	—
3/4" Offset Pivot Hung, Single Acting, Aluminum Door and Frame (Non-Handed)			
RTS26	Complete package RTS88, 8812	536	—
RTS26 × 8563	Complete package, including 8563 frame cover plate	599	—
Hinge or 3/4" Offset Pivot Hung, Single Acting, Steel Door and Frame (Non-Handed)			
RTS27	Complete package RTS88, 8812, 8575, 8532**	632	718
RTS27 LMC	Complete package, less mounting channel	579	664
Hinge or 3/4" offset Pivot Hung, Single Acting, Wood Door and Steel Frame (Non-Handed)			
RTS28	Complete package RTS88, 8812, 8575, 8532**, W1	634	721
RTS28 LMC	Complete package, less mounting channel	581	667
Hinge or 3/4" Offset Pivot Hung, Single Acting, Wood Door and Frame (Non-Handed)			
RTS29	Complete package RTS88, 8812, 8561, W2	583	672
Hinge Hung, Single Acting, Wood Door and Aluminum Frame (Non-Handed)			
RTS30	Complete package RTS88, 8812, W1	517	—
RTS30 × 8563	Complete package, including 8563 frame cover plate	581	—
3/4" Offset Pivot Hung, Single Acting, Wood Door and Aluminum Frame (Non-Handed)			
RTS31	Complete package RTS88, 8812, W1	517	—
RTS31 × 8563	Complete package, including 8563 frame cover plate	581	—

NOTE: Highlighted items are available from Select Service.

NOTE: See RTS88 Accessories for individual component list prices.

NOTE: RTS closer body is always painted aluminum.

Bottom arm and closer arm are always zinc plated finish.

Frame mounting channel is always unfinished.

8563 cover plate is available painted only.

** No. 8532 steel header mounting channel is specifically designed to install the RTS closer into open-throat steel header sections. Typical practice would be to install the mounting channel in the header prior to shipment to the job site.



OPTIONS

(List Price 'add' when ordered with complete closer)

Item	Description	Painted Add \$	Plated Add \$
AMS	All metal screws	N/C	—
AMSAWS	All metal screws, all wood screws	9	13
W1	Half wood screws	3	4
W2	All wood screws	5	7
105° NHO Sz 3, 4, BFI, BFE	Closer with 105° bumper without hold open	N/C	—
105° HO Sz 3, 4, BFI, BFE	Closer with 105° bumper and 105° hold open	N/C	—
90° NHO Sz 2, 3, or 4	Closer with 90° bumper without hold open	N/C	—
90° HO Sz 2, 3 or 4	Closer with 90° bumper and 90° hold open	N/C	—
5 mm EXT	3/16" (5 mm) extended spindle (integral part of pinion)	N/C	—
Custom Color	Custom painted finish selected from DORMA RAL color pallet book. For details, see DORMA Finishes Cross Reference , page vii.		
	per order, setup charge (Net)	100	—
	per closer, list add	50	—
Designer Color	Designer painted color matched to supplied samples. Three (3) each 2" x 3" color chip samples required. For details, see DORMA Finishes Cross Reference , page vii.		
	per order, non-refundable development/ setup charge (Net)	250	—
	per closer, list add	62	—

NOTES:

- Specify package designation, hand (when required), finish, and options or accessories when ordering.
- RTS packages furnished standard with 105° NHO, size 3 closer.
- Complete package prices are indicated in bold.
- When ordering a package "less components," deduct the list price of the component removed.
- Auxiliary limiting stop required for all RTS88 installations, especially those doors experiencing unusual conditions, e.g. excessive wind pressure or abuse.

ACCESSORIES

Item	Description	List \$
8836S	Closer arm, 7/8" top rail glass door shoe (zinc plated finish only)	169
8511	Slide arm, (8812) cover/applied stop (specify hand and finish)	232
8521E	Add-on 1-5/16" spindle extension (finish not required)	52
8532	Steel header closer mounting channel (finish not required)	52
8820J	Conversion bracket kit to replace Jackson OH closer with RTS88 (Finish not required)	16

NOTE: Highlighted items are available from Select Service.

Locks

Cylinders, Keys & Keying

Exit Devices

Electronic Access Control Components

Low Energy Operators

Surface Closers

Fire/Life Safety

Concealed Closers/Pivots

Stops/ Holders

Sliding Systems

Architectural Pulls & Handles

Service Parts





LM SERIES, HEAVY-DUTY

Ordering Guide

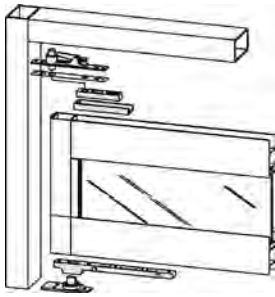

Series	Hand	Fastener Packs	Spindle Extensions	Deducts
Center Pivot — CP	Specify for Right Handed Units — RH	All Metal Screws — AMSAWS	50mm — 50 mm Extended Spindle	LCP — Less Cover Plate
Offset Pivot — OP	Specify for Left Handed Units — LH	All Wood Screws — W1	45mm — 45 mm Extended Spindle	LA — Less Arm
		1/2 Wood Screws — W2	40mm — 40 mm Extended Spindle	LBP — Less Bottom Pivot
		All Wood Screws — AMS	35mm — 35 mm Extended Spindle	LTP — Less Top Pivot
		All Metal Screws — AMS	30mm — 30 mm Extended Spindle	
			25mm — 25 mm Extended Spindle	
			20mm — 20 mm Extended Spindle	
			15mm — 15 mm Extended Spindle	
			10mm — 10 mm Extended Spindle	
			5mm — 5 mm Extended Spindle	

OP	440	RH	AMS	626
-----------	------------	-----------	------------	------------

Up to 440 lb, CH Aluminum —	A440	Intermediate Pivot for 3/4" Offset —	75220	605 — Bright Brass
Up to 440 lb, CH or 3/4" Offset —	440	20 min Intermediate Pivot for 3/4" Offset —	75222	606 — Satin Brass
Up to 440 lb, 20 min Fire Door, 3/4" Offset —	440E	3 h Intermediate Pivot for 3/4" Offset —	75233	611 — Bright Bronze
Up to 440 lb, Up to 3 h Fire Door, 3/4" Offset —	440F	Intermediate Pivot for Lead Lined 3/4" Offset (see note*) —	75240	612 — Satin Bronze
Up to 350 lb, Jamb Mount, 3/4" Offset —	J350	20 min Intermediate Pivot for Lead Lined 3/4" Offset (see note*) —	75242	613 — Oxidized Satin Oil Rubbed Bronze
Up to 440 lb, Lead Lined 3/4" Offset (see note*) —	L440	3 h Intermediate Pivot for Lead Lined 3/4" Offset (see note*) —	75243	618 — Bright Nickel
Up to 440 lb, 20 min Fire Door, Lead Lined 3/4" Offset (see note*) —	L440E	Intermediate Pivot for 1-1/2" Offset —	15220	619 — Satin Nickel
Up to 440 lb, 3 h Fire Door, Lead Lined 3/4" Offset (see note*) —	L440F	20 min Intermediate Pivot for 1-1/2" Offset —	15222	625 — Bright Chrome
Up to 200 lb, 1-1/2" Offset —	15200	3 h Intermediate Pivot for 3/4" Offset —	15233	626 — Satin Chrome
Up to 200 lb, 20 min Fire Door, 1-1/2" Offset —	15200E	Through Wire Intermediate Pivot for 3/4" Offset —	75200	600 — Primed
Up to 200 lb, 3 h Fire Door, 1-1/2" Offset —	15200F	Through Wire CH Top Pivot (2 wire) —	E80622	689 — Aluminum
		Through Wire CH Top Pivot (4 wire) —	E80624	690 — Statuary Bronze

Package

Pivot Accessories

Painted

Plated

*** "L" Package Door Thickness Note:**
 The standard door thickness is 1-3/4", and is the default unless otherwise specified.

Other alternative sizes are

-2
-2-1/4
-2-1/2
-3

Examples: L-E-2-1/2....75242-2-1/2

Example above 20 min. lead lined package for 2-1/2" thick door.

NOTES:

- All combinations of features and options are not available for all models.
- Please refer to LM Heavy-Duty Series product brochure for details.

- Locks
- Cylinders, Keys & Keying
- Exit Devices
- Electronic Access Control Components
- Low Energy Operators
- Surface Closers
- Fire/Life Safety
- Concealed Closers/Pivots
- Stops/ Holders
- Sliding Systems
- Architectural Pulls & Handles
- Service Parts



PACKAGES FOR DOORS WEIGHING UP TO 440 LB

Center Hung Packages

Package	Description	Painted Finish \$	Plated Finish \$
Double or Single Acting, Aluminum Door and Frame (Non-handed)			
CPA440	Complete package 7471K, 7422, 8062	330	330
Double or Single Acting, Wood or Steel Door and Frame (Non-handed)			
CP440	Complete package 7471K, 7421, 8062	303	303

NOTE: Bottom arms are available in zinc plated finish only.

NOTE: Highlighted items are available from Select Service.

3/4" Offset Packages

Package	Description	Painted Finish \$	Plated Finish \$
Single Acting, Wood, Steel, or Aluminum Door and Frame (Specify Hand)			
OP440	Complete package 7471K, 75323, 75120	379	379
Single Acting, 20 Minute Rated Fire Door and Frame (Specify Hand)			
OP440E	Complete package 7471K, 75323, 75122	398	398
Single Acting, 3 Hour Rated Fire Door and Frame (Specify Hand)			
OP440F	Complete package 7471K, 75323, 75133	436	607
Single Acting, Wood or Steel Door and Frame (Specify Hand)			
OPJ350	Complete package 75320, 75120	521	521
Single Acting, Lead-Lined Door and Frame, 1-3/4" Thick Door (Specify Hand)			
OPL440	Complete package 7471K, 75343, 75140	756	756
Single Acting, Lead-Lined, 20 Minute Rated Fire Door and Frame, 1-3/4" Thick Door (Specify Hand)			
OPL440E	Complete package 7471K, 75343, 75142	778	778
Single Acting, Lead-Lined, 3 Hour Rated Fire Door and Frame, 1-3/4" Thick Door (Specify Hand)			
OPL440F	Complete package 7471K, 75343, 75143	822	782

NOTE: See LM Heavy Duty Accessories for intermediate pivots. See LM Accessories for individual component list prices.

NOTE: Highlighted items are available from Select Service.



1-1/2" Offset Packages

Package	Description	Painted Finish \$	Plated Finish \$
Single Acting, Wood, Steel, or Aluminum Door and Frame (Specify Hand)			
OP15200	Complete package 7471K, 15323, 15120	631	631
Single Acting, 20 Minute Rated Fire Door and Frame (Specify Hand)			
OP15200E	Complete package 7471K, 15323, 15122	663	663
Single Acting, 3 Hour Rated Fire Door and Frame (Specify Hand)			
OP15200F	Complete package 7471K, 15323, 15133	690	964

NOTE: See LM Heavy Duty Accessories for intermediate pivots. See LM Accessories for individual component list prices.

OPTIONS

(List Price 'add' when ordered with complete closer)

Item	Description	Painted Finish \$	Plated Finish \$
AMS	All metal screws	N/C	—
AMSAWS	All wood screws, all metal screws	9	13
W1	Half wood screws	3	4
W2	All wood screws	5	7
EXT	Extended spindles available in 5 mm increments from 5 mm–50 mm in height (specify height)	37	—

ACCESSORIES

(Center Hung Pivot)

Item	Description	Painted Finish \$	Plated Finish \$
HD8062	Heavy-duty complete top pivot	388	388
E80622	Through-wire center hung top pivot (2 wire) fire door	522	522
E80624	Through-wire center hung top pivot (4 wire)	522	522

- Locks
- Cylinders, Keys & Keying
- Exit Devices
- Electronic Access Control Components
- Low Energy Operators
- Surface Closers
- Fire/Life Safety
- Concealed Closers/Pivots**
- Stops/ Holders
- Sliding Systems
- Architectural Pulls & Handles
- Service Parts



3/4" Offset Hung Intermediate Pivots **

Item	Description	Painted Finish \$	Plated Finish \$
75220	Full mortise standard intermediate pivot	256	256
75222	Full mortise intermediate pivot – 20 minute rated fire door	273	273
75233	Full mortise intermediate pivot – 3 hour rated fire door	288	556
75240	Full mortise intermediate pivot – 1-3/4" lead-lined doors	385	385
75242	Full mortise intermediate pivot – 20 minute rated 1-3/4" lead-lined doors	407	407
75243	Full mortise intermediate pivot – 3 hour rated 1-3/4" lead-lined doors	417	809
75200	Through-wire 3/4" offset intermediate pivot – 8 wire**	477	477

** All intermediate pivots are handed.

NOTE: Highlighted items are available from Select Service.

1/2" Offset Hung Intermediate Pivots **

Item	Description	Painted Finish \$	Plated Finish \$
15220	Full mortise standard intermediate pivot	385	385
15222	Full mortise intermediate pivot – 20 minute rated fire door	417	417
15233	Full mortise intermediate pivot – 3 hour rated fire door	428	750

** All intermediate pivots are handed.

NOTES:

- Specify package designation, hand (when required), finish, and options or accessories when ordering.
- Complete package prices are indicated in bold.
- When ordering a package "less components," deduct the list price of the component removed.
- Lead-lined packages shown are for 1-3/4" thick non-fire rated doors. For lead-lined doors up to 3" thick, add \$88.00 list to the package price. Example: OPL800 - 2-1/2. Others available are 2", 2-1/4", and 3".
- Consult factory for quotes on lead-lined, fire-rated packages for various door thicknesses.
- All pivots furnished with all machine screws standard (AMS).



LM SERIES, EXTRA HEAVY-DUTY

Ordering Guide

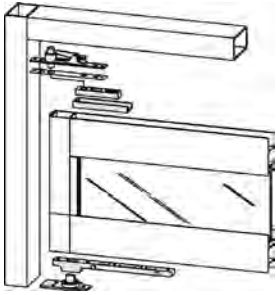

Series	Hand	Fastener Packs	Spindle	Deducts
Center Pivot — CP	Specify for Right Handed Units — RH	All Metal Screws — AMSAWS	74030 — 1-3/4" Spindle	LCP — Less Cover Plate
Offset Pivot — OP	Specify for Left Handed Units — LH	All Wood Screws — W1	74025 — 1-9/16" Spindle	LA — Less Arm
		1/2 Wood Screws — W2	74020 — 1-3/8" Spindle	LBP — Less Bottom Pivot
		All Wood Screws — W2	74015 — 1-1/8" Spindle	LTP — Less Top Pivot
		All Metal Screws — AMS	74012 — 1-1/16" Spindle	
			74010 — 1" Spindle	
			74007 — 7/8" Spindle	
			74005 — 3/4" Spindle	
			74003 — 9/16" Spindle	

Package	Options	Options	Options	Options
OP	H750	RH	AMS	74005
Up to 660 lb, CH — 660	Intermediate Pivot for 3/4" Offset — 75220	605 — Bright Brass		626
Up to 1000 lb, CH — 1000	20 min Intermediate Pivot for 3/4" Offset — 75222	606 — Satin Brass		
Up to 750 lb, 3/4" Offset — H750	3 h Intermediate Pivot for 3/4" Offset — 75233	611 — Bright Bronze		
Up to 750 lb, 20 min Fire Door, 3/4" Offset — H750E	Intermediate Pivot for Lead Lined 3/4" Offset (see note*) — 75240	612 — Satin Bronze		
Up to 750 lb, Up to 3 h Fire Door, 3/4" Offset — H750F	20 min Intermediate Pivot for Lead Lined 3/4" Offset (see note*) — 75242	613 — Oxidized Satin Oil Rubbed Bronze		
Up to 800 lb, Lead Lined 3/4" Offset (see note*) — L800	3 h Intermediate Pivot for Lead Lined 3/4" Offset (see note*) — 75243	618 — Bright Nickel		
Up to 800 lb, 20 min Fire Door, Lead Lined 3/4" Offset (see note*) — L800E	Intermediate Pivot for 1-1/2" Offset — 15220	619 — Satin Nickel		
Up to 800 lb, 3 h Fire Door, Lead Lined 3/4" Offset (see note*) — L800F	20 min Intermediate Pivot for 1-1/2" Offset — 15222	625 — Bright Chrome		
Up to 500 lb, 1-1/2" Offset — 15500	3 h Intermediate Pivot for 3/4" Offset — 15233	626 — Satin Chrome		
Up to 500 lb, 20 min Fire Door, 1-1/2" Offset — 15500E	Through Wire Intermediate Pivot for 3/4" Offset — 75200	600 — Primed		
Up to 500 lb, 3 h Fire Door, 1-1/2" Offset — 15500F	Through Wire CH Top Pivot (2 wire) — E80622	689 — Aluminum		
	Through Wire CH Top Pivot (4 wire) — E80624	690 — Statuary Bronze		

Options	Options
691 — Dull Bronze	693 — Black
695 — Dark Duranodic Bronze	696 — Gold
PNT — Special Sprayed Finish (must specify)	

*** "L" Package Door Thickness Note:**
 The standard door thickness is 1-3/4", and is the default unless otherwise specified.

Other alternative sizes are

- 2
- 2-1/4
- 2-1/2
- 3

Examples: L-E-2-1/2....75242-2-1/2

Example above 20 min. lead lined package for 2-1/2" thick door.

NOTES:

- All combinations of features and options are not available for all models.
- Please refer to LM Heavy-Duty Series product brochure for details.

- Locks
- Cylinders, Keys & Keying
- Exit Devices
- Electronic Access Control Components
- Low Energy Operators
- Surface Closers
- Fire/Life Safety
- Concealed Closers/Pivots
- Stops/ Holders
- Sliding Systems
- Architectural Pulls & Handles
- Service Parts



PACKAGES FOR DOORS WEIGHING OVER 440 LB. TO 1,000 LB.

Center Hung Packages

Package	Description	Painted Finish \$	Plated Finish \$
Double or Single Acting, Wood or Steel Door and Frame (Non-handed)			
CP660	Complete package 7471HD/74005, 7421, 8062	736	736
Double or Single Acting, Wood or Steel Door and Frame (Non-handed)			
CP1000	Complete package 7471HD/74005, 7421, HD8062	999	999

3/4" Offset Packages

Package	Description	Painted Finish \$	Plated Finish \$
Single Acting, Wood, Steel, or Aluminum Door and Frame (Specify Hand)			
OPH750	Complete package 7471HD/74005, 75323, 75120	813	813
Single Acting, 20 Minute Rated Fire Door and Frame (Specify Hand)			
OPH750E	Complete package 7471HD/74005, 75323, 75122	832	832
Single Acting, 3 Hour Rated Fire Door and Frame (Specify Hand)			
OPH750F	Complete package 7471HD/74005, 75323, 75133	869	1,040
Single Acting, Lead-Lined Door and Frame, 1-3/4" Thick Door (Specify Hand)			
OPL800	Complete package 7471HD/74005, 75343, 75140	1,190	1,190
Single Acting, Lead-Lined, 20 Minute Rated Fire Door and Frame, 1-3/4" Thick Door (Specify Hand)			
OPL800E	Complete package 7471HD/74005, 75343, 75142	1,211	1,211
Single Acting, Lead-Lined, 3 Hour Rated Fire Door and Frame, 1-3/4" Thick Door (Specify Hand)			
OPL800F	Complete package 7471HD/74005, 75343, 75143	1,256	1,399



1-1/2" Offset Packages

Package	Description	Painted Finish \$	Plated Finish \$
Single Acting, Wood, Steel, or Aluminum Door and Frame (Specify Hand)			
OP15500	Complete package 7471HD/74005, 15323, 15120	1,065	1,065
Single Acting, 20 Minute Rated Fire Door and Frame (Specify Hand)			
OP15500E	Complete package 7471HD/74005, 15323, 15122	1,098	1,098
Single Acting, 3 Hour Rated Fire Door and Frame (Specify Hand)			
OP15500F	Complete package 7471HD/74005, 15323, 15133	1,125	1,398

NOTE: See LM Extra-Heavy Duty Accessories for intermediate pivots. See LM Accessories for individual component list prices.

NOTE: Center hung bottom arms are available in zinc plated finish only.

NOTE: 7471HD floor bearings not available in painted finish.

7471HD is plated to match when ordering with painted finishes.

See LM Extra Heavy-Duty Accessories for intermediate pivots. See LM Accessories for individual component list prices.

OPTIONS

(List Price 'add' when ordered with complete set)

Item	Description	Painted Add \$	Plated Add \$
AMS	All metal screws	N/C	—
AMSAWS	All metal screws, all wood screws	9	13
W1	Half wood screws	3	4
W2	All wood screws	5	7
74003	9/16" clearance spindle (when used w/7471HD)	N/C	—
74007	7/8" clearance spindle (when used w/7471HD)	N/C	—
74010	1" clearance spindle (when used w/7471HD)	N/C	—
74012	1-1/16" clearance spindle (when used w/7471HD)	21	—
74015	1-1/8" clearance spindle (when used w/7471HD)	21	—
74020	1-3/8" clearance spindle (when used w/7471HD)	21	—
74025	1-9/16" clearance spindle (when used w/7471HD)	21	—
74030	1-3/4" clearance spindle (when used w/7471HD)	21	—

NOTE: Highlighted items are available from Select Service.

- Locks
- Cylinders, Keys & Keying
- Exit Devices
- Electronic Access Control Components
- Low Energy Operators
- Surface Closers
- Fire/Life Safety
- Concealed Closers/Pivots
- Stops/ Holders
- Sliding Systems
- Architectural Pulls & Handles
- Service Parts



ACCESSORIES

(Center Hung Pivot)

Item	Description	Painted Finish \$	Plated Finish \$
HD8062	Heavy-duty complete top pivot	388	388
E80622	Through-wire center hung top pivot (2 wire) fire door	522	522
E80624	Through-wire center hung top pivot (4 wire)	522	522

3/4" Offset Hung Intermediate Pivots **

Item	Description	Painted Finish \$	Plated Finish \$
75220	Full mortise standard intermediate pivot	256	256
75222	Full mortise intermediate pivot – 20 minute rated fire door	273	273
75233	Full mortise intermediate pivot – 3 hour rated fire door	288	556
75240	Full mortise intermediate pivot – 1-3/4" lead lined doors	385	385
75242	Full mortise intermediate pivot – 20 minute rated 1-3/4" lead-lined doors	407	407
75243	Full mortise intermediate pivot – 3 hour rated 1-3/4" lead-lined doors	417	809
75200	Through-wire 3/4" offset intermediate pivot – 8 wire**	477	477

** All intermediate pivots are handed.

NOTE: Highlighted items are available from Select Service.

1-1/2" Offset Hung Intermediate Pivots **

Item	Description	Painted Finish \$	Plated Finish \$
15220	Full mortise standard intermediate pivot	385	381
15222	Full mortise intermediate pivot – 20 minute rated fire door	417	417
15233	Full mortise intermediate pivot – 3 hour rated fire door	428	750

** All intermediate pivots are handed.

90° Pocket Pivots

Item	Description	Painted Finish \$	Plated Finish \$
75520	Standard pocket pivot	387	466
75523	3 hour rated pocket pivot	408	492

NOTE: Highlighted items are available from Select Service.

NOTES:

- Specify package designation, hand (when required), finish, and options or accessories when ordering.
- Complete package prices are indicated in bold.
- When ordering a package "less components," deduct the list price of the component removed.
- Lead-lined packages shown are for 1-3/4" thick non-fire rated doors. For lead-lined doors up to 3" thick, add \$88.00 list to the package price. Example: OPL800 - 2-1/2. Others available are 2", 2-1/4", and 3".
- Consult factory for quotes on lead-lined, fire-rated packages for various door thicknesses.
- All pivots furnished with all machine screws standard (AMS).

900/700 SERIES

Ordering Guide

Series		Optional Brackets (Use with RTS Closers)		Painted	
Heavy Duty Surface	90	Push Side Mounting Bracket Used w/903 & RTS Offset Hung	903RTSOFF	PNT	— Special Sprayed Finish (must specify)
Heavy Duty Concealed	91	Push Side Mounting Bracket Used w/902 & RTS Offset Hung	902RTSOFF	696	— Gold
Standard Surface	70	Push Side Mounting Bracket Used w/RTS Center Hung	900RTSCH	695	— Dark Duranodic Bronze
Standard Concealed	71	Pull Side Mounting Bracket	7090	693	— Black
				691	— Dull Bronze
				690	— Statuary Bronze
				689	— Aluminum
				600	— Primed
	90	2	S	626	
	1	S	— Stop Only	605	— Bright Brass
	2	H	— Stop/Hold	606	— Satin Brass
	3	F	— Friction Stop (700 only)	611	— Bright Bronze
			Function	612	— Satin Bronze
			Door Size	613	— Oxidized Satin Oil Rubbed Bronze
			Refer to 700/900 Series Brochure; varies by Model and Mount.	618	— Bright Nickel
				619	— Satin Nickel
				625	— Bright Chrome
				626	— Satin Chrome
				Plated	

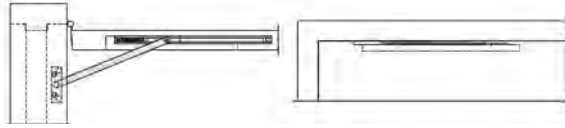

- NOTES:**
- All combinations of features and options are not available for all models.
 - Please refer to 700/900 Series product brochure for details.

- Locks
- Cylinders, Keys & Keying
- Exit Devices
- Electronic Access Control Components
- Low Energy Operators
- Surface Closers
- Fire/Life Safety
- Concealed Closers/Pivots
- Stops/ Holders**
- Sliding Systems
- Architectural Pulls & Handles
- Service Parts



700 SERIES

Standard Duty Surface

Item	Description	Painted Finish \$	Plated Finish \$
701S	Stop only	109	215
702S	Stop only	109	215
703S	Stop only	109	215
701F	Friction stop	109	215
702F	Friction stop	109	215
703F	Friction stop	109	215
701H	Stop/hold	109	215
702H	Stop/hold	109	215
703H	Stop/hold	109	215

Standard Duty Concealed

Item	Description	Painted Finish \$	Plated Finish \$
711S	Stop only	105	193
712S	Stop only	105	193
713S	Stop only	105	193
711F	Friction stop	105	193
712F	Friction stop	105	193
713F	Friction stop	105	193
711H	Stop/hold	105	193
712H	Stop/hold	105	193
713H	Stop/hold	105	193

900 SERIES

Heavy Duty Surface

Item	Description	Painted Finish \$	Plated Finish \$
901S	Stop only	224	366
902S	Stop only	224	366
903S	Stop only	224	366
901H	Stop/hold	224	366
902H	Stop/hold	224	366
903H	Stop/hold	224	366

Heavy Duty Concealed

Item	Description	Painted Finish \$	Plated Finish \$
911S	Stop only	263	343
912S	Stop only	263	343
913S	Stop only	263	343
911H	Stop/hold	263	343
912H	Stop/hold	263	343
913H	Stop/hold	263	343

OPTIONS

(List Price 'add')

Item	Description	Painted Finish \$	Plated Finish \$
7090	Pull side mounting bracket (900/700)	47	101
900RTSCH	Push side mounting bracket for use with RTS center hung closer. Provides mount for surface applied stop mount plate to prevent screws from damaging RTS closer body.	47	101
902RTSOFF	Push side mounting bracket for 902 stop/holder, used with offset pivots when RTS closer is installed in the header.	47	101
903RTSOFF	Push side mounting bracket for 903 stop/holder, used with offset pivots and an RTS closer installed in the header.	47	101
Custom Color	Custom painted finish selected from DORMA RAL color pallet book. For details, see DORMA Finishes Cross Reference , page vii.		
	per order, setup charge (Net)	100	—
	per closer, list add	25	—
Designer Color	Designer painted color matched to supplied samples. Three (3) Color each 2" x 3" colorchip samples required. For details, see DORMA Finishes Cross Reference , page vii.		
	per order, non-refundable development/setup charge (Net)	250	—
	per closer, list add	31	—

NOTE: Standard screw pack includes wood and machine screws for the soffit bracket, and sex nuts for the door, as required.



MUTO COMFORT

Coming Soon.

Please call Customer Service for availability — 800-523-8483

Locks

Cylinders,
Keys & Keying

Exit Devices

Electronic
Access Control
Components

Low Energy
Operators

Surface
Closers

Fire/Life
Safety

Concealed
Closers/Pivots

Stops/
Holders

**Sliding
Systems**

Architectural
Pulls &
Handles

Service Parts



DORMA PULL FINISHES CROSS REFERENCE

	DORMA GMBH Finish #	Closest BHMA Equivalent
Anodized Aluminum Parts		
Clear	101	628
Similar to Stainless Steel	107	670
Dark Bronze	108	710
Black	109	711
Aluminum Color	114	718
Brass		
Polished Brass without Lacquer	503	—
Satin Brass without Lacquer	599	728
Steel or Stainless Steel		
Satin Stainless Steel	700	630
Polished Stainless Steel	701	629
Bronze		
Satin Bronze without Lacquer	600	612
Polished Bronze without Lacquer	601	611
Custom Finish		
	999	—

TG 138 LADDER PULLS

Ordering Guide

		Function				Screwpack Options	
		Locking — L					SNUT — Sex Nut, up to 3-5/16"
		Non-Locking — NL					BLIND — 1-3/4" wood door, not through door
				Door Thickness			
				134 — Wood Door Screw Pack			B2B80 — Back-to-back up to 3-5/16" thick door
TG 138	NL	B2B	STD	49	B2B12	700	XXXX
Model	Back-To-Back — B2B	49" Length — 49			Satin Stainless — 700		
	Single Sided — SNG	60" Length — 60			Custom Polished finish — 701		
	Pull Type	72" Length — 72			Custom Paint or Powder — 999		
		84" Length — 84			Keying Options Field		
		XX* (Specify) Length — Custom			Finish		
			(L) Length				

- Locks
- Cylinders, Keys & Keying
- Exit Devices
- Electronic Access Control Components
- Low Energy Operators
- Surface Closers
- Fire/Life Safety
- Concealed Closers/Pivots
- Stops/ Holders
- Sliding Systems
- Architectural Pulls & Handles
- Service Parts

TG 138 LOCKING & NON-LOCKING LADDER PULLS

Locking Ladder Pull Configurations Single and Back-To-Back Locking and Non-Locking Pulls					Standard Finish \$	Custom Finish \$	
Model	Ref. #	U/M	No. Of Fixing Posts	Description	700	701	999
Back-to-Back Locking Ladder Pull with Small Format Interchangeable Core (SFIC) Cylinder, Less Core (00)					3	SO	SO
	926.933	Set	3F	L B2B STD 84" 700	1,425	1,853	—
	926.932	Set	3F	L B2B STD 72" 700	1,388	1,804	—
	926.936	Set	3F	L B2B STD 60" 700	1,354	1,760	—
	926.930	Set	2F	L B2B STD 49" 700	1,298	1,687	—
Single Sided Locking Ladder Pull with (CYL) Cylinder (SFIC), Less Core (00), or Thumb-Turn (TT)							
	926.934	Ea.	2F	L SNG STD 49" CYL 700	720	936	—
	926.935	Ea.	2F	L SNG STD 49" TT 700	720	936	—
NOTE: Cylinder or Thumb-Turn are Top Mounted							
Back-to-Back Non-Locking Ladder Pull					3	SO	SO
	926.923	2 Ea.	3F	NL B2B STD 84" 700	622	809	822
	926.922	2 Ea.	3F	NL B2B STD 72" 700	588	764	788
	926.924	2 Ea.	3F	NL B2B STD 60" 700	551	716	751
	926.920	2 Ea.	2F	NL B2B STD 49" 700	495	644	695
NOTE: Specify 2 Ea. for a back-to-back set,							
Single Sided Non-Locking Ladder Pull							
	926.923	Ea.	3F	NL SNG STD 84" 700	361	469	481
	926.922	Ea.	3F	NL SNG STD 72" 700	341	443	461
	926.924	Ea.	3F	NL SNG STD 60" 700	320	416	440
	926.920	Ea.	2F	NL SNG STD 49" 700	287	373	407
NOTE: Customer must specify Fixing Pack and adjust List Price accordingly for Non-Locking Single Ladder Pulls and all door panel thicknesses greater than 1/2".							



NOTES:

- Default cylinder for TG 138 L pulls uses "87" Small Format Interchangeable Core (SFIC) cylinder, less core (00).
- Other cylinder and keying options available, see **Cylinder Types, Keying Options & Keyways**.
- 999 Finish is Custom Paint and Powder only, not available on locking pulls.

SO Special Fabricated/Finish or Special Order; lead time up to 9 weeks.

3 Standard or Non-Standard Fabricated; lead time up to 3 business days.

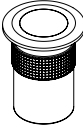
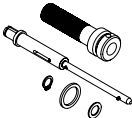
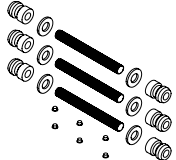
TG 138 LOCKING & NON-LOCKING LADDER PULLS ACCESSORIES

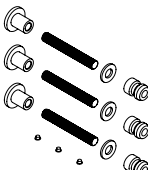
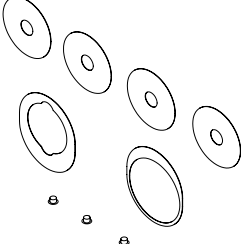
Mounting	Ref. #	Description	Door Thickness	List \$
	926.937	Strike, Dustproof, Standard 1-1/8" (29 mm)		37
	926.890	Locking Post Mounting Pack, Back-to-back, (Non-Locking Post Fasteners not included)	1-3/4" (44 mm)	202
	926.909	Mounting Pack, Back-to-back Non-Locking Post	1-3/8" (34 mm) – 1-3/4" (44 mm)	53
	926.910	Mounting Pack, SNG Blind, 3 each in pack (Will not project through door)	min. 1-3/4" (44 mm)	25
	926.908	Mounting Pack, Single Non-Locking x Sex Nut	3/4" (19 mm) – 3-1/8" (80 mm)	56
	926.939	Washer Pack	—	14

NOTE: Default cylinder for Locking Ladder pulls uses **87** Small Format Interchangeable Core (SFIC) cylinder, less core (00).

Other cylinder and keying options available, see next page.

(SO) Special Fabricated/Finish or Special Order; lead time up to 9 weeks.

Locks

Cylinders,
Keys & Keying

Exit Devices

Electronic
Access Control
Components

Low Energy
Operators

Surface
Closers

Fire/Life
Safety

Concealed
Closers/Pivots

Stops/
Holders

Sliding
Systems

Architectural
Pulls &
Handles

Service Parts



TG 138 CYLINDER TYPES, KEYING OPTIONS & KEYWAYS

Cylinder Option	Description	List Add \$
Conventional Cylinders (non-interchangeable core)		
D	Conventional cylinder; Example: CML9070D	N/C
KD	Keyed differently to a random combination; SC keyway with 2 keys (default)	N/C
KA2	Keyed alike in pairs to a random combination; SC keyway with 2 keys	N/C
KA4	Keyed alike in sets of 4 to a random combination; SC keyway with 2 keys	N/C
0-Bit	Operated by a key blank for easy rekeying; SC, SE keyway with 2 keys	N/C
0-Bit	Operated by a key blank for easy rekeying; D100 keyway — ⊗ Keys sold separately	N/C
0-Bit	Operated by a key blank for easy rekeying; AA, CA, CB, CC, CD, CE, RA, RB, GA, SF, WA, YA, YG keyways with 2 keys	12
NSK	Non-stock keyed – KA quantities other than KA2/KA4; SC keyway with 2 keys	12
MKD	Master keyed or SKD, SC, SE, or D100 keyway — ⊗ Keys sold separately	12
NS2	Non-stock keyed double cylinder locks; SC keyway with 2 keys	24
MK2	Master keyed or SKD double cylinder lock; SC, SE, or D100 keyway — ⊗ Keys sold separately	24
CMK	Construction master keyed single cylinder locks — ⊗ Keys sold separately	13
CM2	Construction master keyed double cylinder locks — ⊗ Keys sold separately	26
L	Lock less conventional cylinder and collar Small Format Interchangeable Core Cylinders; Example: CML9070L	Deduct 30
J	Lock with disposable plastic SFIC construction core; Example: CML9070J	N/C
T	Lock with keyed temporary SFIC construction core; Example: CML9070T (Core may be returned for a full refund) — ⊗ Keys sold separately;	40
C	Lock with combined SFIC core installed at the factory ¹ ; BA (default), BB, BC, BD, BE, BF, BG, BH, BJ, BK, BL, BM, BQ, D100 keyway; Example: CML9070C — ⊗ Keys sold separately	45
R	Housing prepared for Schlage FSIC; Example: CML9070R	8

Ladder Pulls will be supplied w/plastic construction core, Option J.

⊗ Denotes keys must be ordered separately.

Cut Keys Ordered Separately

Part #	Description	List \$
45101	Change key, master key, construction master key, or control key; BA, BB, BC, BD, BE, BF, BG, BH, BJ, BK, BL, BM, BQ, SC, SE section	6
45401	Change key, master key, or control key; SKC selections – D100 etc.	10

NOTE: D100 keyway is restricted. Call customer service for DORMA SKC policies.



TG 9387 LADDER PULLS

Ordering Guide

		Door Material		Door Thickness		SNG Mounting Type	
		WD — Wood Door		134 — Wood Door Screw Pack		ROSE — Screw-on-Rose	
		BLIND — Concealed					
S-TG 9387	WD	SNG	134	18	BLIND	700	
S-TG 9387	Single Sided — SNG	12" Length — 12	DORMA 700/ BHMA 630		700		
Model	Back-To-Back — B2B	18" Length — 18	Finish				
	Pull Type	36" Length — 36					
		42" Length — 42					
		60" Length — 60					
		(L) Length					

Locks

Cylinders, Keys & Keying

Exit Devices

Electronic Access Control Components

Low Energy Operators

Surface Closers

Fire/Life Safety

Concealed Closers/Pivots

Stops/ Holders

Sliding Systems

Architectural Pulls & Handles

Service Parts

STOCK TG 9387 STANDARD SIZE NON-LOCKING LADDER PULLS, WITH STRAIGHT FIXING POSTS

Stock Pull Handles for Commercial Doors						Finish \$
Model	Ref. #	U/M	No. Of Fixing Posts	Description		700
Back-to-Back 1-1/4" (32 mm) Diameter						3
	B2B.905.370	Set	3F	L = 60" CTC = 37-1/2"		245
	B2B.905.371	Set	2F	L = 42" CTC = 26-1/4"		168
	B2B.905.372	Set	2F	L = 36" CTC = 22-1/2"		152
	B2B.905.373	Set	2F	L = 18" CTC = 11-1/4"		122
	B2B.905.374	Set	2F	L = 12" CTC = 7-1/2"		114
Single Sided 1-1/4" (32 mm) Diameter						3
	SNG.905.370	Ea.	3F	L = 60" CTC = 37-1/2"		125
	SNG.905.371	Ea.	2F	L = 42" CTC = 26-1/4"		85
	SNG.905.372	Ea.	2F	L = 36" CTC = 22-1/2"		77
	SNG.905.373	Ea.	2F	L = 18" CTC = 11-1/4"		62
	SNG.905.374	Ea.	2F	L = 12" CTC = 7-1/2"		58
						List \$
POWDER All Custom powder coated orders will include a net charge per purchase order.						200

NOTES:

- Prefix Ref. # with (SNG) single or (B2B) back-to-back. Specify part number, pull height, door material, and door thickness. For single pull on wood door, specify roses or blind fasteners.
- Inserts and mounting hardware included in stock pull TG 9387, list price as shown.
- Mounting hardware also available as multi-pack service packs and priced separately following pulls.

Model Accessories	Ref. #	U/M	Description	List \$
	905.390	Set	Service inserts, reduces post thread from 8 mm–6 mm, used for every mounting post. Bulk pack of 6. Used as service item.	7
	905.388	Set	Service mounting pack with finished mounting ROSE used for SNG WOOD mount 1-3/8"–2" (40 mm–51 mm). Bulk pack of 6. Used as service item.	33
	905.386	Set	Service mounting pack used for BACK-TO-BACK WOOD mount 1-3/8"–2" (40 mm–51 mm). Bulk pack of 6. Used as service item.	17
	905.389	Set	Service mounting pack with BLIND (concealed) fasteners. Used for SNG WOOD mount ≥ 1-3/8" (40 mm). Bulk pack of 6. Used as service item.	17

øG	1-1/4" (32)				
øS	1" (25)				
H	3-3/8" (85)				
3 fixings required	60" (1,524)				
(CTC) Center-to-Center	37-1/2" (953)	26-1/4" (667)	22-1/2" (571)	11-1/4" (286)	7-1/2" (191)
L (Length)	60" (1,524)	42" (1,067)	36" (914)	18" (457)	12" (305)

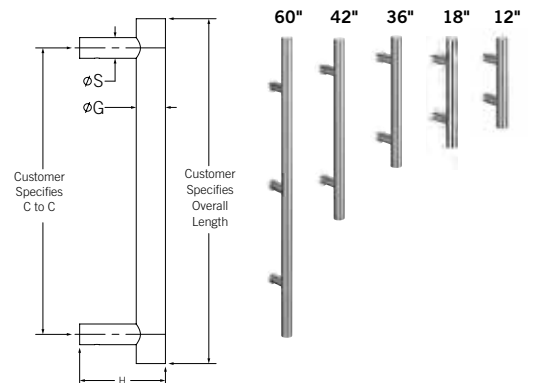

TG 9387 CUSTOM SIZE NON-LOCKING LADDER PULLS, WITH STRAIGHT FIXING POSTS

Pull Handles for Commercial Doors					Standard Finish \$		Custom Finish \$
Model	Ref. #	U/M	No. Of Fixing Posts	Description	700	701	999
Back-to-Back 1-1/4" (32 mm) Diameter					(SO)	(SO)	(SO)
	905.568	Ea.	3F	L = 94-1/2" through 110-3/16"	1,091	1,200	1,491
	905.567	Ea.	3F	L = 74-13/16" through 94-7/16"	944	1,038	1,344
	905.566	Ea.	2F	L = 59-1/16" through 74-3/4"	797	877	1,197
	905.565	Ea.	2F	L = 43-5/16" through 59"	650	715	950
	905.564	Ea.	2F	L = 27-9/16" through 43-1/4"	503	553	803
	905.563	Ea.	2F	L = 11-13/16" through 27-1/2"	355	391	655
Single Sided 1-1/4" (32 mm) Diameter					(SO)	(SO)	(SO)
	905.368	Ea.	3F	L = 94-1/2" through 110-3/16"	645	710	845
	905.367	Ea.	3F	L = 74-13/16" through 94-7/16"	565	622	765
	905.366	Ea.	2F	L = 59-1/16" through 74-3/4"	485	534	685
	905.365	Ea.	2F	L = 43-5/16" through 59"	405	446	555
	905.364	Ea.	2F	L = 27-9/16" through 43-1/4"	325	358	475
	905.363	Ea.	2F	L = 11-13/16" through 27-1/2"	244	268	394
Back-to-Back 1" (25 mm) Diameter					(SO)	(SO)	(SO)
	905.527	Ea.	3F	L = 94-1/2" through 110-3/16"	950	1,045	1,350
	905.526	Ea.	3F	L = 74-13/16" through 94-7/16"	845	930	1,245
	905.525	Ea.	3F	L = 59-1/16" through 74-3/4"	740	814	1,140
	905.524	Ea.	2F	L = 43-5/16" through 59"	635	699	935
	905.523	Ea.	2F	L = 27-9/16" through 43-1/4"	530	583	830
	905.522	Ea.	2F	L = 11-13/16" through 27-1/2"	425	468	725
Single Sided 1" (25 mm) Diameter					(SO)	(SO)	(SO)
	905.327	Ea.	3F	L = 94-1/2" through 110-3/16"	616	678	816
	905.326	Ea.	3F	L = 74-13/16" through 94-7/16"	549	604	749
	905.325	Ea.	3F	L = 59-1/16" through 74-3/4"	482	530	682
	905.324	Ea.	2F	L = 43-5/16" through 59"	415	457	565
	905.323	Ea.	2F	L = 27-9/16" through 43-1/4"	348	383	498
	905.322	Ea.	2F	L = 11-13/16" through 27-1/2"	280	308	430

Net Add \$
POWDER All Custom powder coated orders will include a net charge per purchase order.

200

NOTE: Specify door thickness to acquire appropriate mounting screwpack.

ϕG	1" (25)	1-1/4" (32)
ϕS	11/16" (18)	1" (25)
H	2-15/16" (75)	3-3/8" (85)
3 fixings required	59-1/16" (1,500)	59-1/16" (1,500)

NOTES:

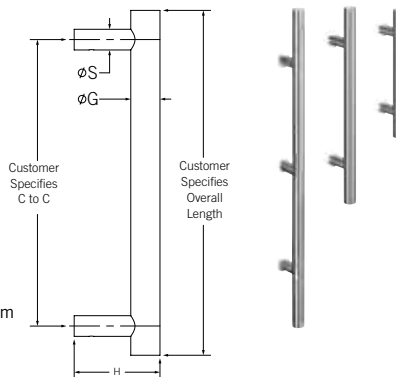

- When required, 3rd fixing post is centered on L dimension unless otherwise requested. Center distance can be specifically tailored to your requirements.
- Specify door thickness and desired screwpack.
- Top and bottom post location is preset at factory unless specified custom by customer.



(SO) Special Fabricated/Finish or Special Order; lead time up to 5 weeks.

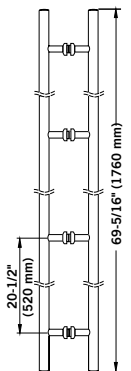
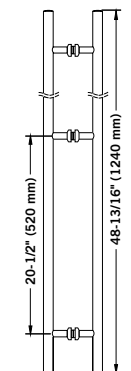

MANET NON-LOCKING LADDER PULLS, WITH STRAIGHT FIXING POSTS & MANET CLAMPING DISKS

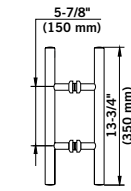
Pull Handles for Commercial Doors, Back-to-Back (B2B) or Single Sided					Standard Finish \$	Custom Finish \$
Model	Ref. #	U/M	No. Of Fixing Posts	Description	700	999
Back-to-Back					①	SO
	821.276	Ea.	4F	20-1/2" (520 mm) Center-to-Center Length 69-5/16" (1760 mm)	607	1,162
	821.273	Ea.	3F	20-1/2" (520 mm) Center-to-Center Length 48-13/16" (1240 mm)	505	1,068
	821.270	Ea.	2F	20-1/2" (520 mm) Center-to-Center Length 28-3/8" (720 mm)	379	679
	821.267	Ea.	2F	5-7/8" (150 mm) Center-to-Center Length 13-3/4" (350 mm)	294	594

Net Add \$

POWDER All Custom powder coated orders will include a net charge per purchase order. 200

NOTES:

- Specify door thickness and either wood or glass door material.
- Specify Ref. # 829.991 for 1-3/4" (44 mm) wood door fasteners, no additional charge.

① Non-Fabricated item, ships in 1 business day.

SO Special Fabricated/Finish or Special Order; lead time up to 5 weeks.

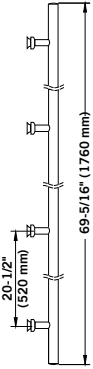
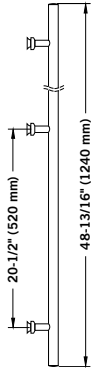
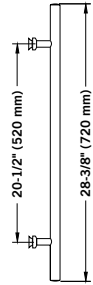
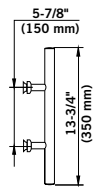

Pull Handles for Commercial Doors					Standard Finish \$	Custom Finish \$
Model	Ref. #	U/M	No. Of Fixing Posts	Description	700	999
Single Sided					(S0)	(S0)
	821.243	Ea.	4F	20-1/2" (520 mm) Center-to-Center Length 69-5/16" (1760 mm)	474	674
	821.242	Ea.	3F	20-1/2" (520 mm) Center-to-Center Length 48-13/16" (1240 mm)	385	585
	821.241	Ea.	2F	20-1/2" (520 mm) Center-to-Center Length 28-3/8" (720 mm)	267	417
	821.240	Ea.	2F	5-7/8" (150 mm) Center-to-Center Length 13-3/4" (350 mm)	219	369

Net Add \$

POWDER All Custom powder coated orders will include a net charge per purchase order. 200

NOTES:

- Specify door thickness and either wood or glass door material.
- Specify Ref. # 829.991 for 1-3/4" (44 mm) wood door fasteners, no additional charge.

(S0) Special Fabricated/Finish or Special Order; lead time up to 5 weeks.

- Locks
- Cylinders, Keys & Keying
- Exit Devices
- Electronic Access Control Components
- Low Energy Operators
- Surface Closers
- Fire/Life Safety
- Concealed Closers/Pivots
- Stops/ Holders
- Sliding Systems
- Architectural Pulls & Handles
- Service Parts



TG 9335 DECORATIVE PULLS, STRAIGHT PULL WITH MITERED CORNERS/POSTS

Pull Handles for Commercial Doors					Standard Finish \$		Custom Finish \$
Model	Ref. #	U/M	No. Of Fixing Posts	Description	700	701	999
Back-to-Back 1-1/4" (32 mm) Diameter					(SO)	(SO)	(SO)
	905.545	Ea.	3F	CTC = 94-1/2" through 110-3/16"	1,002	1,102	1,402
	905.544	Ea.	3F	CTC = 74-13/16" through 94-7/16"	862	948	1,262
	905.543	Ea.	3F	CTC = 59-1/16" through 74-3/4"	722	794	1,122
	905.542	Ea.	2F	CTC = 43-5/16" through 59"	582	640	882
	905.541	Ea.	2F	CTC = 27-9/16" through 43-1/4"	442	486	742
	905.540	Ea.	2F	CTC = 7-7/8" through 27-1/2"	302	332	602
Single Sided 1-1/4" (32 mm) Diameter					(SO)	(SO)	(SO)
	905.345	Ea.	3F	CTC = 94-1/2" through 110-3/16"	601	661	801
	905.344	Ea.	3F	CTC = 74-13/16" through 94-7/16"	524	576	724
	905.343	Ea.	3F	CTC = 59-1/16" through 74-3/4"	447	492	647
	905.342	Ea.	2F	CTC = 43-5/16" through 59"	370	407	520
	905.341	Ea.	2F	CTC = 27-9/16" through 43-1/4"	293	322	443
	905.340	Ea.	2F	CTC = 7-7/8" through 27-1/2"	218	240	368
Back-to-Back 1" (25 mm) Diameter					(SO)	(SO)	(SO)
	905.506	Ea.	3F	CTC = 94-1/2" through 110-3/16"	1,265	1,392	1,665
	905.505	Ea.	3F	CTC = 74-13/16" through 94-7/16"	1,120	1,232	1,520
	905.504	Ea.	3F	CTC = 59-1/16" through 74-3/4"	975	1,073	1,375
	905.503	Ea.	2F	CTC = 43-5/16" through 59"	830	913	1,130
	905.502	Ea.	2F	CTC = 27-9/16" through 43-1/4"	685	754	985
	905.501	Ea.	2F	CTC = 8-1/4" through 27-1/2"	540	594	840
Single Sided 1" (25 mm) Diameter					(SO)	(SO)	(SO)
	905.306	Ea.	3F	CTC = 94-1/2" through 110-3/16"	742	816	942
	905.305	Ea.	3F	CTC = 74-13/16" through 94-7/16"	661	727	861
	905.304	Ea.	3F	CTC = 59-1/16" through 74-3/4"	580	638	780
	905.303	Ea.	2F	CTC = 43-5/16" through 59"	499	549	649
	905.302	Ea.	2F	CTC = 27-9/16" through 43-1/4"	418	460	568
	905.301	Ea.	2F	CTC = 8-1/4" through 27-1/2"	337	371	487

Net Add \$

POWDER All Custom powder coated orders will include a net charge per purchase order.

200

NOTES:

- When required, 3rd fixing post is centered on **CTC** dimension unless otherwise requested.
- CTC=Center to center of mounting posts.
- Specify door thickness and desired screwpack. See following page for options.

(SO) Special Fabricated/Finish or Special Order; lead time up to 5 weeks.



TG DECORATIVE PULLS

Pull Handles for Commercial Doors				Standard Finish \$		Custom Finish \$	
Model	Ref. #	U/M	Description	700	701	999	
TG 9830 Bowed Pull, 13-3/4" (349 mm) Center-to-Center				(SO)	(SO)	(SO)	
	905.530	Set	Back-to-Back	597	657	797	
	905.330	Ea.	Single Sided	366	403	516	
TG 9304 Curved Pull, Radius Standoff, 1-1/4" (32 mm) Diameter, 13-3/4" (349 mm) Center-to-Center				(SO)	(SO)	(SO)	
	905.569	Set	Back-to-Back	302	332	502	
	905.369	Ea.	Single Sided	197	217	347	
				Ø 1-1/4" (32 mm)			
				R 1-3/4" (44 mm)			
				R1 6-7/8" (175 mm)			
				B 8-11/16" (220 mm)			
			H 3-3/8" (85 mm)				
			CTC 13-3/4" (350 mm)				
TG 9306 Curved Pull, Sharp/Straight Standoff, 1-9/16" (40 mm) Diameter, 13-3/4" (349 mm) Center-to-Center				(SO)	(SO)	(SO)	
	905.611	Set	Back-to-Back	669	736	869	
	905.411	Ea.	Single Sided	401	441	551	
				ØGS 1-9/16" (40 mm)			
				R 6-7/8" (175 mm)			
				B 8-3/16" (205 mm)			
				H 3-15/16" (100 mm)			
			M 1" (24 mm)				
Fixings for TG Handles to Glass Doors 1-3/8" (35 mm)–3-15/16" (100 mm) Thick				701	999		
				(SO)	(SO)		
	905.901	Ea.	Back-to-Back – M6	24	26		
	905.903	Ea.	Back-to-Back – M8	24	26		
	905.907	Ea.	Single Sided – M6	42	46		
	905.906	Ea.	Single Sided – M8	42	46		
Rose Options for TG Pulls							
	905.971	Ea.	1-9/16" (40 mm) Rose – M6	10	12		
	905.972	Ea.	1-3/4" (44 mm) Rose – M8	10	12		

Net Add \$
POWDER All Custom powder coated orders will include a net charge per purchase order. 200

(SO) Special Fabricated/Finish or Special Order; lead time up to 5 weeks.

ARCOS & BEYOND DECORATIVE PULLS

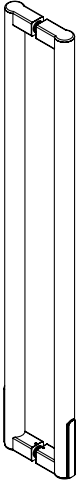
Pulls for Commercial Doors					Standard Finish \$	Custom Finish \$
Model	Ref. #	U/M	No. Of Fixing Posts	Description	114	999
ARCOS 15-11/16" (398 mm) Length					(SO)	(SO)
	826.500	Set	2F	13-3/4" (350 mm) Center-to-Center	340	540
ARCOS 32-1/16" (824 mm) Length					(SO)	(SO)
	826.510	Set	2F	29-1/2" (750 mm) Center-to-Center	401	801
					107	999
BEYOND, Specify Door Thickness					(SO)	(SO)
	830.300	Set	2F	17-3/4" (450 mm) Center-to-Center 3/8" (10 mm) or 1/2" (12 mm)	815	1,015
	830.305	Set	2F	23-5/8" (600 mm) Center-to-Center 3/8" (10 mm) or 1/2" (12 mm)	945	1,145
	830.310	Set	2F	35-7/16" (900 mm) Center-to-Center 3/8" (10 mm) or 1/2" (12 mm)	1,128	1,528
						Net Add \$
POWDER	All Custom powder coated orders will include a net charge per purchase order.					200

NOTE: Specify door thickness and either wood or glass door material.

(SO) Special Fabricated/Finish or Special Order; lead time up to 5 weeks.

SOLID & TUBULAR PULL HANDLES FOR COMMERCIAL DOORS

Model	Ref. #	U/M	Description	Finishes \$						
				101	108	109	503/599	600/ 601	700	701
Solid and Tubular, Back-to-Back, 10" & 12" (Center-to-Center) Handles				①	①	SO	SO	SO	①	SO
	926.001	Set	10" (254 mm) Solid	58	61	61	—	250	132	132
	926.601	Set	10" (254 mm) Tubular	—	—	—	106	—	70	70
	926.004	Set	12" (305 mm) Solid	61	65	65 ①	179	450	146	146 ①
	926.604	Set	12" (305 mm) Tubular	—	—	—	112	—	73	73 ①
Solid and Tubular, Single Sided, 10" & 12" (Center-to-Center) Handles				SO	SO	SO	SO	SO	SO	SO
	926.012	Ea.	10" (254 mm) Solid	35	40	40	—	—	—	—
	926.612	Ea.	10" (254 mm) Tubular	—	—	—	—	—	44	44
	926.016	Ea.	12" (305 mm) Solid	45	48	48	—	—	—	—
	926.616	Ea.	12" (305 mm) Tubular	—	—	—	—	—	48	48
Solid and Tubular, Back-to-Back Offset, 10" & 12" (Center-to-Center) Handles				SO	SO	SO	SO	SO	SO	SO
	926.022	Set	10" (254 mm) Solid	66	—	—	—	—	—	—
	926.622	Set	10" (254 mm) Tubular	—	—	—	—	—	88	88
	926.009	Set	12" (305 mm) Solid	70	77	77	—	—	—	—
	926.609	Set	12" (305 mm) Tubular	—	—	—	143	—	95 ①	95 ①
Solid and Tubular, Back-to-Back, 10" & 12" (Center-to-Center) × 27-3/4" Handles				SO	SO	SO	SO	SO	SO	SO
	926.002	Set	10" × 27-3/4" (254 × 705 mm) Solid	80	90	90	—	—	—	—
	926.602	Set	10" × 27-3/4" (254 × 705 mm) Tubular	—	—	—	—	—	113	113
	926.005	Set	12" × 27-3/4" (305 × 705 mm) Solid	77 ①	86 ①	86	—	—	247 ①	247 ①
	926.605	Set	12" × 27-3/4" (305 × 705 mm) Tubular	—	—	—	152	—	121 ①	121 ①

NOTES:

- Tubular handles include a 1-1/4" (32 mm) washer.
- Specify door thickness and either wood or glass door material.

① Non-Fabricated item, 2-day lead time.

SO Special Fabricated/Finish or Special Order; lead time up to 5 weeks.







DORMA USA
Tel: 800-523-8483
Fax: 800-274-9724
www.dorma.com
dahorders@dorma-usa.com