

# DON-JO MFG., INC.

## ARCHITECTURAL HARDWARE & ACCESSORIES



Seattle, Washington

# LATCH PROTECTORS

DON-JO MFG., INC.  
P.O. Box 929  
Sterling, MA 01564

PHONE: 978.422.3377  
FAX: 978.422.3467  
WATS: 800.628.8389  
WATS FAX: 800.278.8202

WEB: [www.don-jo.com](http://www.don-jo.com)  
E-mail: [info@don-jo.com](mailto:info@don-jo.com)  
Section G, Version 1



# INDEX

Item#	Page#	Item#	Page#	Item#	Page#	Item#	Page#
9211	2g	GLP-307-RHR	1g	LP-312P	6g	OSLP-110-EBF	5g
9211-EBF	2g	ILP-206	1g	LP-312P-EBF	6g	OSLP-207	5g
AL-211	6g	ILP-212	1g	LP-2878	6g	OSLP-207-EBF	5g
ALP-206	3g	KLP-110-LHR	4g	MELP-210	5g	OSLP-210	5g
ALP-210	3g	KLP-110-RHR	4g	MELP-210-EBF	5g	OSLP-210-EBF	5g
BLP-107	4g	LELP-208	5g	MLP-111	2g	PLP-111	2g
BLP-110	4g	LELP-208-EBF	5g	MLP-111-EBF	2g	PLP-111-EBF	2g
BLP-207	4g	LP-107	3g	MLP-211	2g	PLP-211	2g
BLP-210	4g	LP-107-EBF	3g	MLP-211-EBF	2g	PLP-211-EBF	2g
CLP-106	3g	LP-207	3g	NLP-106	4g	PMLP-111	3g
CLP-110	3g	LP-207-EBF	3g	NLP-110	4g	PMLP-111-EBF	3g
ELP-208	5g	LP-111	2g	NLP-206	4g	PMLP-211	3g
ELP-208-EBF	5g	LP-111-EBF	2g	NLP-210	4g	PMLP-211-EBF	3g
ELP-208P	5g	LP-211	2g	OLP-2650	1g	SLP-106	5g
ELP-208P-EBF	5g	LP-211-EBF	2g	OLP-2651	1g	SLP-106-EBF	5g
FLP-111	6g	LP-307	1g	OSLP-107	5g	SLP-206	5g
FLP-211	6g	LP-312	6g	OSLP-107-EBF	5g	SLP-206-EBF	5g
GLP-307-LHR	1g	LP-312-EBF	6g	OSLP-110	5g		

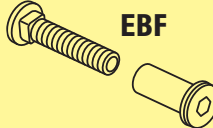

**EBF**

- \* Special Fasteners to prevent interference with the frame
- \* Available on selected Latch Protectors as an option

# FASTENERS

Product	Fastening Type
ILP-206 & ILP-212	3 ea. #10 x 1 1/4" one way screws, 3 ea. #8 x 1 1/4" WS Flat Head
LP-307 GLP-307, OLP-2650, OLP-2651	1 ea. 5/16-18 x 2 1/4" Carriage bolt w/Acorn nut & washer 1 ea. Drive in Rivet
LP-111 & LP-211	4 ea. 5/16-18 x 2 1/4" Carriage bolts w/Acorn nuts & washers
MLP-111 & MLP-211, PLP-111 & PLP-211, PMLP-111 & PMLP-211, LP-107 & LP-207, ELP-208 & ELP-208P, LELP-208, MELP-210, SLP-106-SLP-206, OSLP-107 & OSLP-207, OSLP-110 & OSLP-210, LP-312 & LP-312P	2 ea. 5/16-18 x 2 1/4" Carriage bolts w/Acorn nuts & washers
CLP-106 & CLP-110, NLP-106 & NLP-206, NLP-110 & NLP-210, BLP-107 & BLP-207, BLP-110 & BLP-210, KLP-110, FLP-111 & FLP-211, LP-2878	2 ea. 1/4-20 x 1 3/4" Flat Head MS w/Finish Washer
ALP-206 & ALP-210	4 ea. #10-1 1/2 Phillips SMS

The **INTERLOCK** for inswinging doors

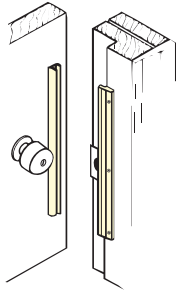

**ILP-206**  
**ILP-212**

NUMBER	DIMENSIONS	MATERIAL
ILP-206	6"	Steel
ILP-212	12"	

**SHELF PACK:** 10      **Display Package Size** - 4" x 12" and 4" x 16"  
**GAUGE:** 14 (.075)  
**FEATURES:** • 6" version for use with key-in-knob and deadbolt locks  
 • 12" version for use with Mortise Locks, Simplex 1000 series, Alarm Lock DL-2500, DL-2700 & 3000, Card Access Systems, etc.  
**FINISHES:** BP (Brass Plated), CP (Chrome Plated), DU (Duro Coated), SL (Silver Coated)

For **ALUMINUM ENTRANCE** doors

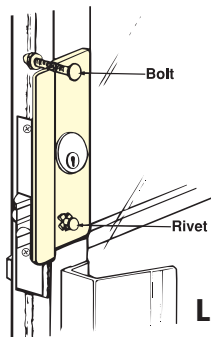

**LP-307**

NUMBER	DIMENSIONS	MATERIAL
LP-307	2 5/8" x 7"	Steel Stainless Steel

**SHELF PACK:** 10      **Polybagged / Display Package Size** 4" x 12"  
**GAUGE:** 12 (.104)  
**FEATURES:** • Reversible • Fits over cylinder - lock removal NOT required  
 • Hand carriage bolt and rivet supplied • No specific tools required  
 • 3/8" offset  
**FINISHES:** 630, DU (Duro Coated), SL (Silver Coated)

For **ALUMINUM ENTRANCE** doors- solves pull handle interference

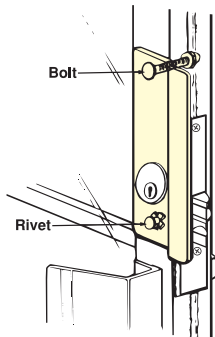

**GLP-307**  
**LHR SHOWN**

NUMBER	DIMENSIONS	MATERIAL
GLP-307 LHR	2 5/8" x 7"	Steel Stainless Steel
GLP-307 RHR	2 5/8" x 7"	

**SHELF PACK:** 10      **Polybagged**  
**GAUGE:** 12 (.104)  
**FEATURES:** • Fits over cylinder - lock removal NOT required  
 • Hand carriage bolt and rivet supplied • No specific tools required  
 • 3/8" offset  
 • Center of cylinder hole is 2 1/2" from end of plate  
**FINISHES:** 630, DU (Duro Coated), SL (Silver Coated)

For use with **CENTER HUNG OUTSWINGING ALUMINUM** doors

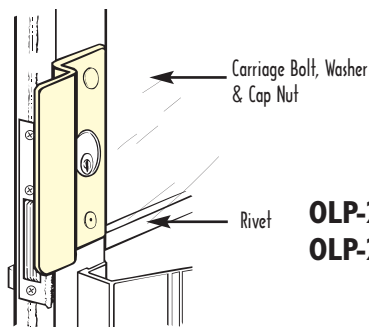

**OLP-2650**  
**OLP-2651**

NUMBER	DIMENSIONS	MATERIAL
OLP-2650	2 5/8" x 6 1/2"	Steel
OLP-2651	2 5/8" x 6 1/2"	

**SHELF PACK:** 10      **Polybagged**  
**GAUGE:** 12 (.104)  
**FEATURES:** • (OLP-2650) available in 1 1/8" offset  
 • (OLP-2651) available in 1 3/8" offset  
**FINISHES:** DU (Duro Coated), SL (Silver Coated)



**EBF Fasteners available with selected Latch Protectors.**

America's favorite for **OUTSWINGING DOORS** - completely covers the strike plate

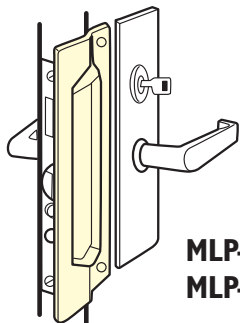

**MLP-III  
MLP-2II**

NUMBER	DIMENSIONS	MATERIAL
MLP-111	3" x 11"	Stainless Steel
MLP-211	3" x 11"	Steel
MLP-111-EBF	3" x 11"	Stainless Steel
MLP-211-EBF	3" x 11"	Steel

**SHELF PACK:** 10 Polybagged

**GAUGE:** 12 (.104)

**FEATURES:** (MLP-111, MLP-211) Furnished with carriage bolts, washers & acorn cap nuts for safety and strength  
(MLP-111-EBF, MLP-211-EBF) Furnished w/carriage bolt & sex nut

**FINISHES:** (MLP-111) 630  
(MLP-211) BP (Brass Plated), CP (Chrome Plated), DU (Duro Coated), SL (Silver Coated)

America's favorite for **OUTSWINGING DOORS** - completely covers the strike plate

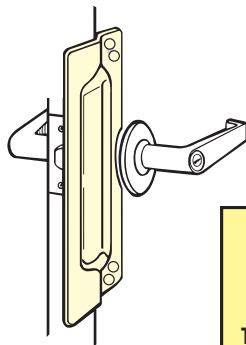

**LP-III  
LP-2II  
92II**

**SAVE \$!**  
Product available polybagged  
To order, replace "LP" with "9". (i.e., LP-2II will become 92II)

NUMBER	DIMENSIONS	MATERIAL
LP-111	3" x 11"	Stainless Steel
LP-211	3" x 11"	Steel
9211 (*Polybagged)	3" x 11"	Steel
LP-111-EBF	3" x 11"	Stainless Steel
LP-211-EBF	3" x 11"	Steel
9211 (*Polybagged)-EBF	3" x 11"	Steel

**SHELF PACK:** 10 Display Package Size - 4" x 16" (9211, LP-111) Polybagged

**GAUGE:** 12 (.104)

**FEATURES:** • Furnished with carriage bolts, washers & acorn cap nuts for safety and strength  
• Fits 2 3/4" and 2 3/8" backsets

**FINISHES:** (LP-111) 630  
(LP-211) BP (Brass Plated), CP (Chrome Plated), DU (Duro Coated), PC (Prime Coated), SL (Silver Coated)

Pin Latch protectors for **OUTSWINGING DOORS**

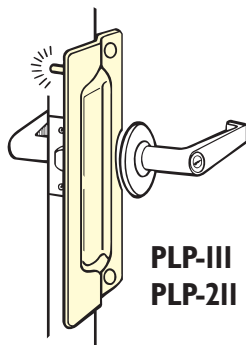

**PLP-III  
PLP-2II**

NUMBER	DIMENSIONS	MATERIAL
PLP-111	3" x 11"	Stainless Steel
PLP-211	3" x 11"	Steel
PLP-111-EBF	3" x 11"	Stainless Steel
PLP-211-EBF	3" x 11"	Steel

**SHELF PACK:** 10 Polybagged

**GAUGE:** 12 (.104)

**FEATURES:** • Solid steel pin prevents spreading of door from frame  
• Pin is welded on back leaving no visible point of attack from outside  
• Fits 2 3/4" and 2 3/8" backsets

**FINISHES:** (PLP-111) 630  
(PLP-211) 626, BP (Brass Plated), CP (Chrome Plated), DU (Duro Coated), SL (Silver Coated),

 **EBF Fasteners available with selected Latch Protectors.**

Pin Latch protectors for **OUTSWINGING DOORS**

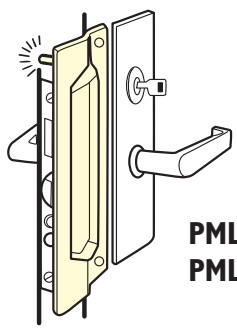

**PMLP-111**  
**PMLP-211**

NUMBER	DIMENSIONS	MATERIAL
PMLP-111	3" x 11"	Stainless Steel
PMLP-211	3" x 11"	Steel
PMLP-111-EBF	3" x 11"	Stainless Steel
PMLP-211-EBF	3" x 11"	Steel

**SHELF PACK:** 10 Polybagged  
**GAUGE:** 12 (.104)  
**FEATURES:** • Solid steel pin prevents spreading of door from frame  
 • Pin is welded on back leaving no visible point of attack from outside  
**FINISHES:** (PMLP-111) 630  
 (PMLP-211) BP (Brass Plated), CP (Chrome Plated), DU (Duro Coated), SL (Silver Coated)

For **Outswinging doors**

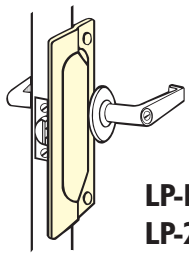

**LP-107**  
**LP-207**

NUMBER	DIMENSIONS	MATERIAL
LP-107	2 3/4" x 7"	Stainless Steel
LP-207	2 3/4" x 7"	Steel
LP-107-EBF	2 3/4" x 7"	Stainless Steel
LP-207-EBF	2 3/4" x 7"	Steel

**SHELF PACK:** 10 Display Package Size - 4" x 12"  
**GAUGE:** 12 (.104)  
**FEATURES:** Furnished with carriage bolts, washers & acorn cap nuts for safety and strength  
**FINISHES:** (LP-107) 630  
 (LP-207) BP (Brass Plated), CP (Chrome Plated), DU (Duro Coated), SL (Silver Coated)

**COMMERCIAL TYPE** for outswinging doors

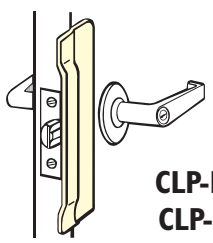

**CLP-106**  
**CLP-110**

NUMBER	DIMENSIONS	MATERIAL
CLP-106	2 1/8" x 6"	Stainless Steel
CLP-110	2 1/8" x 10"	

**SHELF PACK:** 10 Polybagged  
**GAUGE:** 12 (.104)  
**FEATURES:** • 6" for key-in-knobs • 10" for Mortise Locks  
 • Architectural design • Concealed welded studs with fasteners  
**FINISHES:** 630

**ANGLE TYPE** for outswinging doors

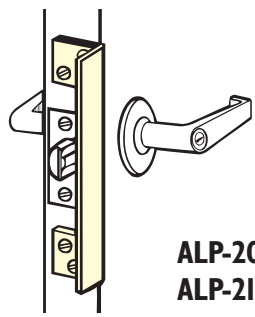

**ALP-206**  
**ALP-210**

NUMBER	DIMENSIONS	MATERIAL
ALP-206	6"	Steel
ALP-210	10"	

**SHELF PACK:** 10 Polybagged  
**GAUGE:** 10 (.134)  
**FEATURES:** • 6" for key-in-knobs  
 • 10" for Mortise Locks  
 • 1 1/2" sheet metal screws for wood or metal  
**FINISHES:** BC (Brass Coated), DU (Duro Coated), SL (Silver Coated)



**NARROW COMMERCIAL TYPE** for outswinging doors

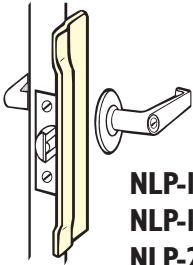

**NLP-106**  
**NLP-110**  
**NLP-206**  
**NLP-210**

NUMBER	DIMENSIONS	MATERIAL
NLP-106	1 1/2" x 6"	Stainless Steel
NLP-110	1 1/2" x 10"	
NLP-206	1 1/2" x 6"	Steel
NLP-210	1 1/2" x 10"	

**SHELF PACK:** 10 Polybagged  
**GAUGE:** 12 (.104)  
**FEATURES:** • 6" for key-in-knobs • 10" for Mortise Locks  
 • Narrow type for outswinging doors  
**FINISHES:** (NLP-106, NLP-110) 630  
 (NLP-206, NLP-210) DU (Duro Coated), PC (Prime Coated), SL (Silver Coated)

For **KEY-IN-LEVER** Locks with up to 3 3/4" ESCUTCHEON

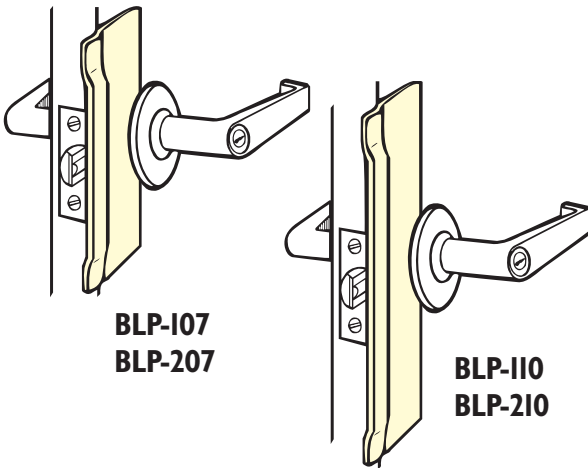

**BLP-107**  
**BLP-207**

**BLP-110**  
**BLP-210**

NUMBER	DIMENSIONS	MATERIAL
BLP-107	3 1/4" x 7"	Stainless Steel
BLP-110	3 1/4" x 10"	
BLP-207	3 1/4" x 7"	Steel
BLP-210	3 1/4" x 10"	

**SHELF PACK:** 10 Polybagged  
**GAUGE:** 12 (.104)  
**FEATURES:** • Works with up to 3 3/4" rose  
 • Concealed welded studs with fasteners  
**FINISHES:** (BLP-107, BLP-110) 630  
 (BLP-207, BLP-210) BP (Brass Plated), DU (Duro Coated), SL (Silver Coated)

For **ELECTRONIC** Locks

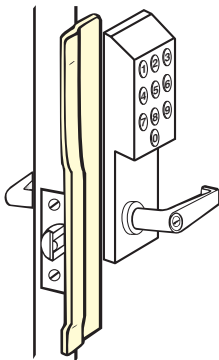

**"RHR" SHOWN**

**KLP-110-LHR**  
**KLP-110-RHR**

NUMBER	DIMENSIONS	MATERIAL
KLP-110-LHR	1 1/2" x 10"	Stainless Steel
KLP-110-RHR	1 1/2" x 10"	

**SHELF PACK:** 10 Polybagged  
**GAUGE:** 12 (.104)  
**FEATURES:** • Works with ILCO 1000, 4000  
 • Alarm Lock Trilogy Locks  
 • Mas-Hamilton Power Levers  
 • Schlage Cobra  
 • Marks I-Q  
**FINISHES:** 630

 **EBF Fasteners available with selected Latch Protectors.**

**SHORT TYPE** for outswinging doors

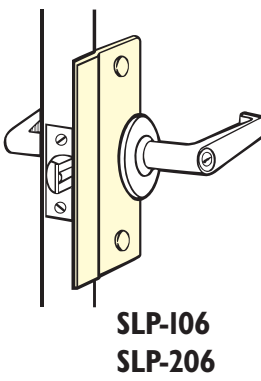

**SLP-106**  
**SLP-206**

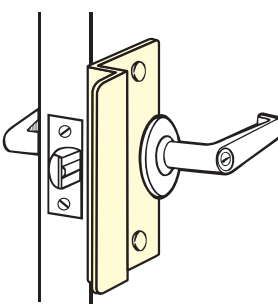

**OSLP-110**  
**OSLP-210**

NUMBER	DIMENSIONS	MATERIAL
SLP-106	2 5/8" x 6"	Stainless Steel
SLP-206	2 5/8" x 6"	Steel
OSLP-107	2 5/8" x 7"	Stainless Steel
OSLP-207	2 5/8" x 7"	Steel
OSLP-110	2 5/8" x 10"	Stainless Steel
OSLP-210	2 5/8" x 10"	Steel
SLP-106-EBF	2 5/8" x 6"	Stainless Steel
SLP-206-EBF	2 5/8" x 6"	Steel
OSLP-107-EBF	2 5/8" x 7"	Stainless Steel
OSLP-207-EBF	2 5/8" x 7"	Steel
OSLP-110-EBF	2 5/8" x 10"	Stainless Steel
OSLP-210-EBF	2 5/8" x 10"	Steel

**SHELF PACK:** 10 **Display Package Size - 4" x 12"**  
**GAUGE:** 12 (.104)  
**FEATURES:**

- (SLP) Display Packaged
- (OSLP) Polybagged
- Furnished with carriage bolts, washers & acorn cap nuts for safety and strength
- May be used on hollow metal door/frame using ANSI strike
- Works with up to 3 3/4" rose
- SLP - 3/8" offset / OSLP - 3/4" offset

**FINISHES:** (SLP-106, OSLP-107, OSLP-110) 630  
 (SLP-206, OSLP-207, OSLP-210) BP (Brass Plated), CP (Chrome Plated), DU (Duro Coated), SL (Silver Coated),

For use with **ELECTRIC STRIKES**

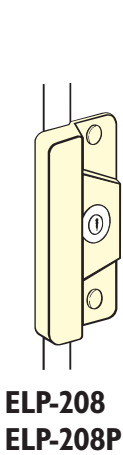

**ELP-208**  
**ELP-208P**

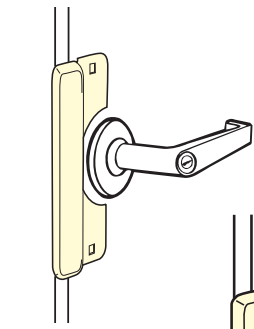

**LELP-208**  
Fits up to 3 3/4" Rose

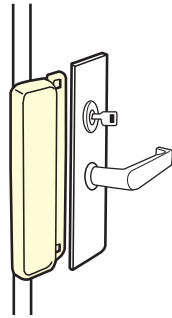

**MELP 210**

NUMBER	DIMENSIONS	MATERIAL
ELP-208	3 1/2" x 8"	Steel
ELP-208P	3 1/2" x 8"	
LELP-208	3 1/2" x 8"	
MELP-210	2 5/8" x 10"	
ELP-208-EBF	3 1/2" x 8"	
ELP-208P-EBF	3 1/2" x 8"	
LELP-208-EBF	3 1/2" x 8"	
MELP-210-EBF	2 5/8" x 10"	

**SHELF PACK:** 10 **Polybagged**  
**GAUGE:** 12 (.104)  
**FEATURES:**

- Available with or without cylinder hole
- Designed to fit most electric strikes
- Completely encases the keeper for maximum protection
- Use with Mortise, Keyless Locks & Exit Devices
- ELP-208P No Cylinder Hole

**FINISHES:** DU (Duro Coated), SL (Silver Coated)



**EBF Fasteners available with selected Latch Protectors.**

Fits FOLGER ADAMS ELECTRIC STRIKE for outswinging doors

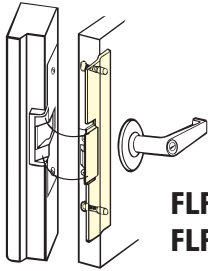

**FLP-111  
FLP-211**

NUMBER	DIMENSIONS	MATERIAL
FLP-111	1 3/4" x 11 1/4"	Stainless Steel
FLP-211	1 3/4" x 11 1/4"	Steel

**SHELF PACK:** 10 Polybagged  
**GAUGE:** 12 (.104)  
**FEATURES:** Works with Folger Adams 310 & 710 models  
**FINISHES:** (FLP-111) 630  
 (FLP-211) BP (Brass Plated), DU (Duro Coated)

For outswinging ALUMINUM ENTRANCE DOORS

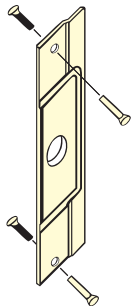

**AL-211**

NUMBER	DIMENSIONS	MATERIAL
AL-211	3 1/2" x 12"	Steel

**SHELF PACK:** 10 Polybagged  
**GAUGE:** 12 (.104)  
**FINISHES:** DU (Duro Coated), SL (Silver Coated)  
**FEATURES:** Sex nuts and bolts for secure mounting and professional appearance

Fits ADAMS RITE LATCH LOCK for outswinging doors

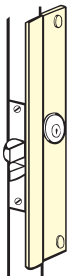

**LP-312  
LP-312P**

NUMBER	DIMENSIONS	MATERIAL
LP-312	2 5/8" x 12"	Steel
LP-312P	2 5/8" x 12"	
LP-312-EBF	2 5/8" x 12"	
LP-312P-EBF	2 5/8" x 12"	

**SHELF PACK:** 10 Polybagged  
**GAUGE:** 12 (.104)  
**FEATURES:** • Reversible  
 • 3/8" offset - 1 7/16" hole - 1 1/8" backset  
 • LP-312P No Center Hole  
**FINISHES:** DU (Duro Coated), SL (Silver Coated)

SLIMLINE for outswinging doors

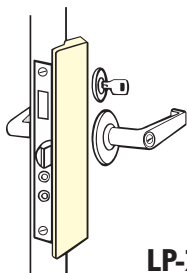

**LP-2878**

NUMBER	DIMENSIONS	MATERIAL
LP-2878	1 1/2" x 8 7/8"	Steel

**SHELF PACK:** 10 Polybagged  
**GAUGE:** 5/16" thick (.3125)  
**FEATURES:** Sleek appearance  
**FINISHES:** DU (Duro Coated), PC (Prime Coated), SL (Silver Coated)