

DON-JO MFG., INC.

ARCHITECTURAL HARDWARE & ACCESSORIES



Minneapolis, Minnesota

DOOR STOPS, HOLDERS & BUMPERS

DON-JO MFG., INC.
P.O. Box 929
Sterling, MA 01564

PHONE: 978.422.3377
FAX: 978.422.3467
WATS: 800.628.8389
WATS FAX: 800.278.8202

WEB: www.don-jo.com
E-mail: info@don-jo.com
Section C, Version 1



INDEX

Item#	Page#	Item#	Page#	Item#	Page#	Item#	Page#
1400	1c	1448	3c	1471	3c	1503	8c
1401	1c	1449	3c	1472	3c	1504	7c
1402	1c	1449P	3c	1473	3c	1505	8c
1406	1c	1450	4c	1474	3c	1506	7c
1407	1c	1452	4c	1475	3c	1508	8c
1410	1c	1453	4c	1476	3c	1509	8c
1412	1c	1455	5c	1477	3c	1510	8c
1413	1c	1457	6c	1478	3c	1511	8c
1420	9c	1458	6c	1480	3c	1514	7c
1430	9c	1462	5c	1486	4c	1517	7c
1432	9c	1463	5c	1487	4c	1520	6c
1440	2c	1464	5c	1488	4c	1521	6c
1442	2c	1465	5c	1490	7c	1522	6c
1443	2c	1466	5c	1492	7c	1523	6c
1444	2c	1467	5c	1500	8c	1608	8c
1445	2c	1468	5c	1501	7c	1609	8c
1446	2c	1469	5c	1502	8c	1610	8c



WROUGHT WALL BUMPERS



1400

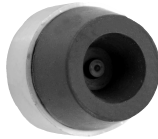

1402



1406



1407

NUMBER	TYPE	PROJ.	DIA.	ANSI A156.16	MATERIAL
1400	Convex	1/2"	1"	L02101	Brass
1402	Concave	1 1/8"	1 1/2"	-	Solid Brass
1406	Convex	1 1/8"	2 1/2"	L22101, L52101	Wrought
1407	Concave	1"	2 1/2"	L22251, L52251	Wrought

SHELF PACK: (1400, 1406, 1407) 50 Polybagged
(1402) 10

FASTENERS: (1400) 1 ea. #8 x 1" SMS, 1 ea. Brad Nail, 1 ea. Plastic Anchor
(1402) 1 ea. #10 x 1 1/4" SMS, 1 ea. Plastic Anchor & Plastic Drywall Anchor
(1406, 1407) 1 ea. #8 x 1 1/4" SMS, 1 ea. Plastic Anchor & Plastic Drywall Anchor

FINISHES: (1400) 605, 606, 613, 625, 626
(1402) 626

(1406) 605, 606, 612, 613, 619, 620, 625, 626, 630
(1407) 605, 606, 612, 613, 619, 620, 625, 626, 630

CAST WALL BUMPERS



1412



1413



1410

NUMBER	TYPE	PROJ.	DIA.	ANSI A156.16	MATERIAL
1410	Convex	7/8"	3 7/8"	-	Cast Brass
1412	Convex	1"	2 1/2"	L12101	Cast Brass
1413	Concave	1"	2 1/2"	L12251	Cast Brass

SHELF PACK: 10 Polybagged

FASTENERS: (1412, 1413) 1 ea. #10 x 1 1/4" SMS, 1 ea. Plastic Anchor & Plastic Drywall Anchor
(1410) 1 ea. 1/4-20 x 1 1/4" MS, 3 ea. #8-32 x 1/4" MS, 1 ea. Lead Expansion Shield

FINISHES: (1412, 1413) 605, 606, 612, 613, 626
(1410) 626

OPTIONS: (1410) Torx screws available

RUBBER WALL BUMPERS



1401

NUMBER	TYPE	PROJ.	DIA.	MATERIAL
1401	Concave	9/16"	1 13/16"	Rubber

SHELF PACK: 10 Polybagged

FASTENER: Adhesive

FINISHES: White & Gray

Proj. = Projection, Dia. = Diameter



FLOOR STOPS



1440



1442

NUMBER	HEIGHT	BASE	ANSI A156.16	MATERIAL
1440	1"	1/8" x 1 3/4"	L12141	Cast Brass
1442	1 1/4"	3/8" x 1 3/4"	L12161	Cast Brass

SHELF PACK: (1440, 1442) 20 Polybagged
FASTENERS: (1440, 1442) 1 ea. 1/4-20 x 1 1/4" MS, 1 ea. 1/4" x 1 1/4" SMS,
 1 ea. Plastic Anchor and 1 ea. Lead Expansion Shield
FINISHES: (1440, 1442) 605, 606, 612, 613, 619, 620, 625, 626

RISERS



1446

NUMBER	HEIGHT	BASE	MATERIAL
1446	1/2"	1 3/4"	Cast Brass

SHELF PACK: 50 Polybagged
FINISHES: 605, 612, 613, 625, 626

FLOOR STOPS



1445

NUMBER	HEIGHT	BASE	MATERIAL
1445	1 1/2"	5/8" x 1 3/4"	Cast Brass

SHELF PACK: 20 Polybagged
FASTENERS: 1 ea. 1/4-20 x 1 1/4" MS, 1 ea. 1/4" x 1 1/4" SMS,
 1 ea. Plastic Anchor and 1 ea. Lead Expansion Shield
FEATURES: 1445 is made by combining the 1440 & 1446
FINISHES: 605, 612, 613, 625, 626

FLOOR STOPS



1443



1444

NUMBER	HEIGHT	BASE	MATERIAL
1443	1"	1/8" x 4"	Cast Brass
1444	1 3/8"	1/2" x 4"	Cast Brass

SHELF PACK: (1443, 1444) 10 Polybagged
FASTENERS: (1443, 1444) 2 ea. 1/4-20 x 1 1/4" MS, 2 ea. 1/4" x 1 1/4" SMS,
 2 ea. Plastic Anchor and 2 ea. Lead Expansion Shield
FINISHES: (1443, 1444) 605, 613, 626



DOOR STOPS



**1471 (shown),
1472**



**1473 (shown)
1474**

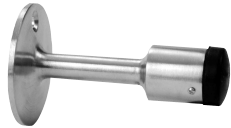

**1475 (shown),
1476**



**1477 (shown)
1478**

NUMBER	HEIGHT	BASE	ANSI A156.16	MATERIAL
1471	3 1/8"	2 1/4"	L12131	Cast Brass
1472	3 1/8"	2 1/4"	L12121	Cast Brass
1473	3 7/8"	2 1/4"	L11371	Cast Brass
1474	3 7/8"	2 1/4"	L11361	Cast Brass
1475	3 7/8"	2 1/4"	L12021	Cast Brass
1476	3 7/8"	2 1/4"	L12011	Cast Brass
1477	3 1/2"	2 1/4"	L11351	Cast Brass
1478	3 1/2"	2 1/4"	L11341	Cast Brass

SHELF PACK: 10

Polybagged

FASTENERS: (1471, 1475) 1 ea. 5/16-18 x 2 5/8" MS Stud, 1 ea. 1/16-18 x 2 5/8" SMS Stud, 1 ea. #10 x 1" SMS, 1 ea. Plastic Anchor, 1 ea. Lead Expansion Shield
 (1472, 1476) 3 ea. #10 x 1" SMS, 3 ea. Plastic Anchors
 (1473, 1477) 1 ea. 5/16-18 x 2 5/8" MS Stud, 1 ea. 5/16-18 x 2 5/8" SMS Stud, 3 ea. #10 x 1" SMS, 3 ea. Plastic Anchors, 1 ea. Lead Expansion Shield
 (1474, 1478) 5 ea. #10 x 1" SMS, 3 ea. Plastic Anchors

FEATURES:

(1471, 1473, 1475, 1477) concealed mounting
 (1472, 1474, 1476, 1478) surface mounting

FINISHES:

(1471, 1477) 605, 613, 626
 (1472, 1474, 1476, 1478) 626
 (1473, 1475) 605, 613, 626

ANGLE STOP



1480

NUMBER	BASE	RUBBER	
		HEIGHT	WIDTH
1480	2 1/2" x 1"	2 5/8"	1 1/2"

SHELF PACK: 10

Polybagged

FASTENERS: 2 ea. 1/4" x 1 1/2" SMS, 2 ea. Plastic Anchors
FINISHES: 626

DOOR STOPS



1448



1449



1449P

NUMBER	HEIGHT	BASE	MATERIAL
1448	1 5/8"	2 1/4" x 1 5/8"	Cast Brass
1449	2 1/2"	2 1/4" x 1 5/8"	Cast Brass
1449P	3 3/4"	2 11/16" dia.	Cast Aluminum

SHELF PACK: 10

Polybagged

FASTENERS: (1448, 1449) 3 ea. 8/32 x 1" MS, 3 ea. #8 x 1 1/4" SMS, 3 ea. Plastic Anchors, 3 ea. Lead Expansion Shields
FINISHES: (1448, 1449) 605, 613, 626
 (1449P) 628



DON-JO MFG., INC.

DOOR STOPS



I450



I452



I453

NUMBER	HEIGHT	BASE	ANSI A156.16	MATERIAL
I450	2 1/8"	2 5/8" x 1 5/8"	L12131	Cast Brass
I452	2 3/4"	2 1/2" x 1 1/2"	L12131	Cast Brass
I453	3"	2 1/2" x 1 1/2"	L13171	Cast Brass

SHELF PACK: 10 Polybagged
FASTENERS: (I450, I452) 1 ea. 5/16-18 x 2 5/8" MS Stud, 1 ea. 5/16-18 x 2 5/8" SMS Stud, 1 ea. #10 x 1" SMS, 1 ea. Plastic Anchor, 1 ea. Lead Expansion Shield
 (I453) 1 ea. 5/16-18 x 2 5/8" MS Stud, 1 ea. 5/16-18 x 2 5/8" SMS Stud, 2 ea. #8 x 1" SMS, 1 ea. 14-20 x 1 1/4" MS, 1 ea. 1/4 x 1 1/2" SMS, 3 ea. Plastic Anchors, 1 ea. Lead Expansion Shields
FINISHES: (I450, I452) 605, 613, 619, 620, 626
 (I453) 605, 613, 626

ROLLER BUMPERS



I486



I487



I488

NUMBER	BASE	PROJECTION	ANSI A156.16	MATERIAL
I486	2" dia.	4 1/2"	L12191	Cast Brass
I487	2" dia.	6"	L12201	Cast Brass
I488	1 5/8" x 2 1/4"	2 3/4"	L12211	Cast Brass

SHELF PACK: 10 Polybagged
FASTENERS: 3 ea. #10 x 1" SMS, 3 ea. Plastic Anchors
FINISHES: 605, 613, 626

I488

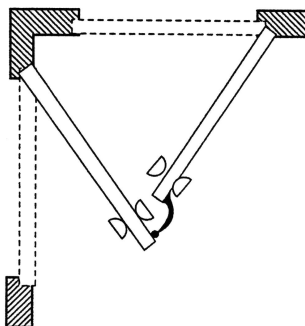

I486 & I487

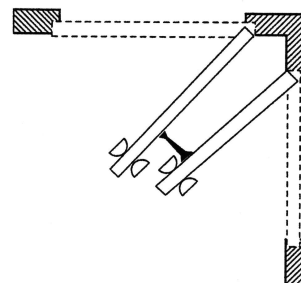



DETENTION STOP

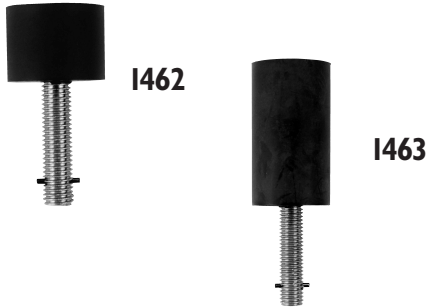

NUMBER	HEIGHT	BASE	MOUNTING BOLT
1462	4 1/2"	1 1/2 x 2"	1/2" x 3"
1463	6"	3 1/2 x 2"	1/2" x 2 1/2"

SHELF PACK: (1462) 20, (1463) 10
FINISH: Black

Polybagged

DOOR HOLDERS



NUMBER	PROJECTION	ANSI A156.16	MATERIAL
1455	4"	L11382	Cast Aluminum
1464	4"	L11382	Solid Brass
1465	4"	L11382	Solid Brass
1466	4"	-	Cast Iron
1467	5"	L11382	Solid Brass
1468	-	-	Rubber
1469	-	-	Rubber

SHELF PACK: 10 Polybagged

FASTENERS: (1455) 3 ea. #8 x 1" SMS
(1464, 1465, 1466, 1467) 4 ea. #8 x 1" SMS
(1469) 1 ea. #8-32 x 7/8" MS

FINISHES: (1455) 626, BP (Brass Plated), BZ (Bronze Sprayed), CP (Chrome Plated), DU (Duro Coated)
(1465) 605, 613, 625, 626
(1466) Sprayed Brass, Sprayed Bronze, Sprayed Aluminum, Sprayed Durocoat
(1464) (1467) 605, 613, 626
(1468) Gray Rubber
(1469) Gray Rubber

PLUNGER STOP



1457



1458

NUMBER	PROJECTION	BASE	ANSI A156.16	MATERIAL
1457	1 1/4"	6 3/16" x 1 7/16"	L11401	Cast Aluminum
1458	1 7/8"	1 3/8" x 5 3/8"	L01411	Brass

SHELF PACK: 10 Polybagged

FASTENERS: (1457) 2 ea. #8 x 1" SMS
(1458) 3 ea. #10 x 3/4" OHSMS

FINISH: (1457) 628
(1458) 626

DOOR HOLDER



NUMBER	DOOR TO FLOOR CLEARANCE	HOLDER DIMENSIONS	ANSI A156.16	MATERIAL
1520	1/2" or less	3" W x 3 1/2" H	L11301	Cast Brass
1521	9/16" - 1 1/16"	3" W x 3 1/2" H	L11301	Cast Brass
1522	1 1/8" - 1 9/16"	3" W x 3 1/2" H	L11301	Cast Brass
1523	1 5/8" - 2 1/16"	3" W x 3 1/2" H	L11301	Cast Brass

SHELF PACK: 1

Box Pack

FASTENERS: 3 ea. 1/4-20 x 3/4" MS, 3 ea. 1/4 x 1 1/4" SMS, 4 ea. #12-24 x 1" MS,
4 ea. #12 x 1" SMS, 3 ea. Lead Expansion Shields

FINISH: 626

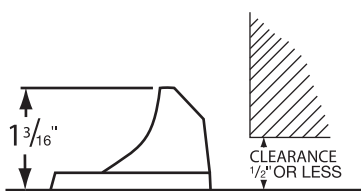

1520

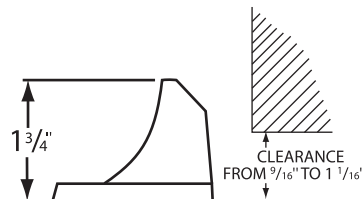

1521

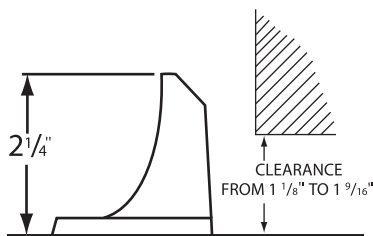

1522

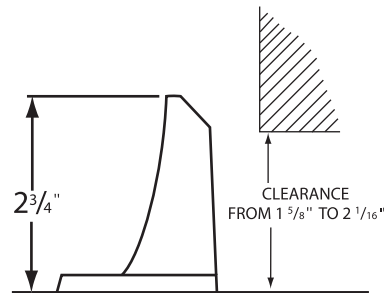

1523



DOOR HOLDER



1517

NUMBER	HEIGHT	BASE DIMENSIONS	ANSI A156.16	MATERIAL
1517	3 1/2"	2" x 3 1/2"	L11241	Brass

SHELF PACK: 1 Polybagged
FASTENERS: 2 ea. Plastic Anchors, 1 ea. 1/2-13" x 3 1/4" Stud, 1 ea. Lead Anchor, 2 ea. 1/4 x 1 1/2" FHSMS, 1 ea. 1/4-20 x 1 1/4" FHMS, 1 ea. Lead Anchor
FINISH: 626

DOOR HOLDER



1514

NUMBER	PROJECTION	HOLDER DIMENSIONS	ANSI A156.16	MATERIAL
1514	3 1/2"	2 1/2"H x 2 1/4"W	L11291	Cast Brass

SHELF PACK: 10 Polybagged
FASTENERS: 2 ea. #10-24 x 1 1/4" MS, 5 ea. #10 x 1" SMS, 3 ea. Plastic Anchors
FINISH: 626

DOOR STOPS



1490



1492

NUMBER	HEIGHT	LENGTH	MATERIAL
1490	3"	3 3/4"	Cast Brass
1492	3"	3 3/4"	Cast Brass

SHELF PACK: 10 Polybagged
FASTENERS: (1490) 3 ea. 1/4-20 x 3/4" MS, 3 ea. 1/4 x 1 1/2" SMS, 3 ea. Plastic Anchors, 3 ea. Lead Expansion Shield
 (1492) 1 ea. 5/16-18 x 2 5/8" SMS Stud, 1 ea. 1/4 x 1 1/2" SMS, 1 ea. Plastic Anchor, 1 ea. Lead Expansion Shield
FINISHES: 626

RIGID BASE STOPS



1501



1504



1506

NUMBER	BASE	PROJECTION	ANSI A156.16	MATERIAL
1501	3/4"	3"	L32031	Cast Zinc
1504	1"	3"	L32031	Cast Aluminum
1506	1"	3 1/4"	L12031	Cast Brass

SHELF PACK: (1501) 50 Polybagged
 (1504, 1506) 10
FASTENERS: #10 SMS
FINISHES: (1501) 605, 609, 625
 (1504, 1506) 605, 609, 613, 619, 620, 622, 625, 626



DON-JO MFG., INC.

SPRING BASE STOPS



1508



1509
1510
1511

NUMBER	BASE	PROJECTION	MATERIAL
1508	3/4"	3"	Spring Steel
1509	1"	3 1/8"	Spring Steel
1510	1"	3 3/4"	Spring Steel
1511	1"	3 1/8"	Spring Steel

SHELF PACK: 50 Polybagged
FASTENERS: (1508) #8 SMS
 (1509, 1510) #8 x 1" SMS
 (1511) #8 x 1 1/4" SMS
FINISHES: 605, 609, 613, 619, 620, 625, 626

HINGE STOP



1500



1502



1503



1505

NUMBER	DOOR OPEN ADJ.	MATERIAL
1500	70° - 100°	Cast Zinc
1502	70° - 100°	Steel
1503	70° - 100°	Cast Brass
1505	70° - 100°	Cast Zinc

SHELF PACK: (1500) 100, (1502, 1503, 1505) 20 Polybagged
FINISHES: (1500) 605, 619, 620, 625
 (1502) 605, 613, 619, 620, 626
 (1503) 605, 609, 619, 620, 625
 (1505) 605, 609, 613, 619, 620, 622, 626
FEATURES: Works w/ 1/4" hinge pins only!

DOOR SILENCERS



1608

For metal frame



1609

For wood frame



1610

Adhesive mounting

NUMBER	ANSI A156.16
1608	L03011
1609	L03021
1610	-

SHELF PACK: 100 Polybagged
FINISHES: Gray Rubber
 (1610 also available in clear)



DOOR STOPS



1430



1432

NUMBER	HEIGHT	BASE	ANSI A156.16	MATERIAL
1430	1 5/16"	1 1/4"	–	Cast Brass
1432	1 5/16"	1 1/4"	L32181	Cast Aluminum

SHELF PACK: 10 Polybagged
FASTENERS: (1430) #8 x 1 SMS
 (1432) 2 ea. #8 x 3/4" SMS
FINISHES: 605, 613, 619, 620, 626

APPLIED STOP



1420

NUMBER	WIDTH	HEIGHT	LENGTH
1420	1 1/2"	3/4"	3 1/2"

SHELF PACK: 10 Polybagged
FASTENERS: 2 ea. #12 x 1 1/2" FHWS and
 2 ea. 12-24 x 3/4" FHWS

FEATURES:

- For use with single or double doors without stops
- Supplied with machine & wood screws

FINISHES: 605, 613, 626

www.don-jo.com

- 📁 CATALOG
- 📁 ORDERING
- 📁 NEW PRODUCTS
- 📁 REPRESENTATIVES
- 📁 CONTACT US
- 📁 ABOUT DON-JO
- 📁 WARRANTY



Architectural
Hardware & Accessories

[Click Here To Download Our 2008 Suggested List Price List](#)



Copyright © 2008, Don-Jo Mfg., Inc.

Check out our website at www.don-jo.com
to take advantage of these great conveniences:

- ▶ On-line Ordering
- ▶ Checking Status of Open Orders
- ▶ Templates
- ▶ Plus Many Other Features

Please contact DON-JO for a username and password
to access all of these features on the DON-JO website.

info@don-jo.com • 1.800.628.8389 • 1.800.278.8202 fax