

# **DON-JO** MFG., INC.

## ARCHITECTURAL HARDWARE & ACCESSORIES



Philadelphia, Pennsylvania

# ACCESSORY HARDWARE

DON-JO MFG., INC.  
P.O. Box 929  
Sterling, MA 01564

PHONE: 978.422.3377  
FAX: 978.422.3467  
WATS: 800.628.8389  
WATS FAX: 800.278.8202

WEB: [www.don-jo.com](http://www.don-jo.com)  
E-mail: [info@don-jo.com](mailto:info@don-jo.com)  
Section J, Version 1



# INDEX

Item #	Page #	Item #	Page #	Item #	Page #	Item #	Page #
104	5j	AP-34	3j	DV-180	3j	RP-13515	2j
106	5j	BN-4	6j	EM-2	5j	RP-13515-2	2j
125	4j	BN-6	6j	EM-4	5j	RP-13545	2j
130	4j	C5-1	6j	PBDSP-135	1j	RP-13545-2	2j
135	4j	C5-2	6j	PBSP-135	1j	RPE2000-14	2j
300	4j	C6-1	6j	PDL-100	1j	RPK-109	2j
302	4j	C6-2	6j	PDL-101	1j	SP-135	1j
350	5j	CC-100	5j	RHP-100	4j	ULDV-90	3j
1590	3j	CHP-100	4j	RP-14-2	2j	ULDV-180	3j
1603	3j	CR-1-F	6j	RP-15	2j	WB-112	4j
1604	3j	CR-2-NR	6j	RP-18	2j	WP-34	3j
1607	3j	CR-3-NF	6j	RP-27	2j		
1611	6j	DSP-135	1j	RP-13509	2j		
1613	6j	DV-90	3j	RP-13509-2	2j		

# FASTENERS

Product	Fastening Type
PDL-100, PDL-101	2 ea. #6 x 1" OHSMS, 2 ea. #6 x 1/2" OHSMS
RP-13509, RP-13509-2, RP-13515, RP-13515-2, RP-13545, RP-13545-2, RP-14-2, RP-15, RP-18, RP-27, RP-28, RP-109	4 ea. #8 x 3/4" Truss Head SMS
130, 135	3 ea. #10 x 1 1/2" SMS
1603, 1604	2 ea. #6 x 3/4" SMS, 2 ea. #8 x 1" SMS
1607	6 ea. #8 x 1" SMS
1590	4 ea. #5 x 3/4" SMS
300, 302	2 ea. #6 x 5/8" SMS
EM-2, EM-4	4 ea. #8 x 3/4" Truss Head SMS
CC-100	4 ea. #8 x 3/4" SMS
104, 106	2 ea. #6 x 3/4" SMS
BN-4, BN-6	2 ea. #8 x 1" SMS
1611, 1613	2 ea. #8-32 x 2" SMS
350	2 ea. #6 x 5/8" SMS

**POCKET DOOR LOCKS**



**PDL-100**  
Passage

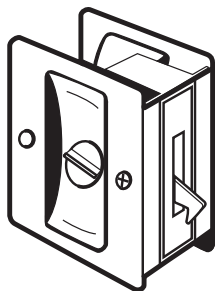

**PDL-101**  
Privacy

NUMBER	DIMENSIONS	ANSI
PDL-100	2 1/2" x 2 3/4"	D082 I
PDL-101	2 1/2" x 2 3/4"	D083 I

SHELF PACK: 10

Box Pack

- FEATURES:
- Field Reversible
  - Adjustable for various door thickness
  - Includes pin & screws for 1 3/4" door width
- FINISHES: 605, 609, 613, 619, 620, 622, 625, 626, 605x625

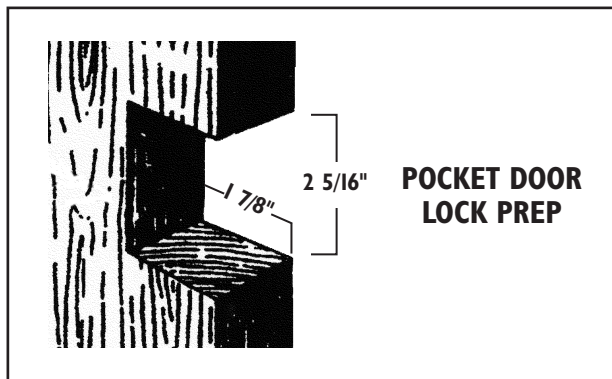

**SCAR PLATES** used to convert 2 3/8" to 2 3/4" backset

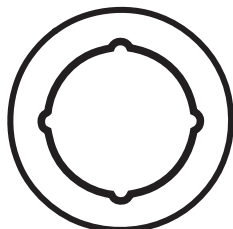

**SP-135**

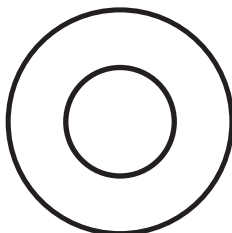

**DSP-135**

NUMBER	DIMENSIONS
SP-135	3 1/2" O.D. - 2 1/8" I.D.
DSP-135	3 1/2" O.D. - 1 1/2" I.D.
PBSP-135	3 1/2" O.D. - 2 1/8" I.D.
PBDSP-135	3 1/2" O.D. - 1 1/2" I.D.

SHELF PACK: 10      Display Package Size - 5 1/4" x 6 1/2"

- FEATURES:
- SP-135 fits under rose of key-in-knob or deadbolt locks
  - DSP-135 fits under deadbolt collars
  - SPs & DSPs are display packed
  - PBSPs & PBDSPs are polybagged

FINISHES: 605, 609, 612, 630

**SAVE \$!**  
Product available polybagged  
To order, add prefix "PB".  
(i.e., SP-135 will become PBSP-135)



REMODELER PLATES for modernizing or decorating

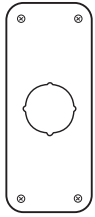

**RP-13509**

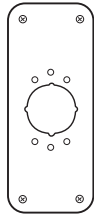

**RP-13509-2**

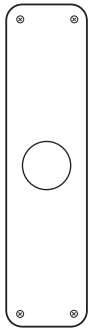

**RP-13515**

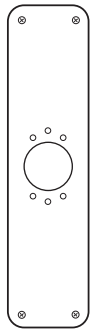

**RP-13515-2**

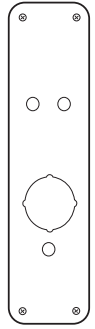

**RP-E2000-14**

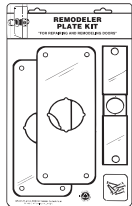

**RPK-109**

Kit Contains:  
 (2) RP-13509  
 (1) CV-86-C &  
 all fasteners

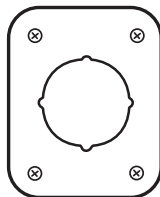

**RP-13545**

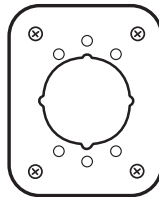

**RP-13545-2**

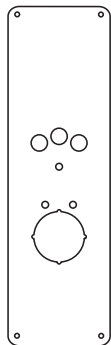

**RP-18**

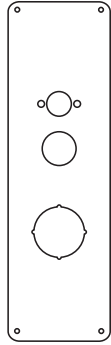

**RP-15**

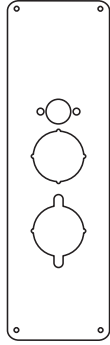

**RP-27**

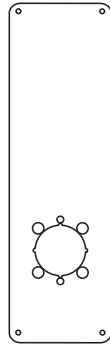

**RP-14-2**

NUMBER	DIMENSIONS
RP-13509	3 1/2" x 9"
RP-13509-2	3 1/2" x 9"
RP-13515	3 1/2" x 15"
RP-13515-2	3 1/2" x 15"
RP-13545	3 1/2" x 4 1/2"
RP-13545-2	3 1/2" x 4 1/2"
RPK-109	3 1/2" x 9"
RPE2000-14	5" x 14"
RP-15	5" x 14"
RP-18	5" x 14"
RP-27	5" x 14"
RP-14-2	5" x 14"

**SHELF PACK: 10** Polybagged  
**RPK-109 Display Packaged Size - 7 1/2" x 13"**

**GAUGE: .032 thick**

**FINISHES:** (RP-13509, RP-13509-2, RP-13545, RP-13545-2)

**605, 609, 612, 630**

(RP-13515, RP-13515-2, RP-109, RPE2000-14,

RP-15, RP-18, RP-27, RP-14-2) **605, 630**



**DOOR VIEWERS**

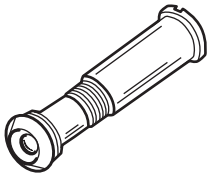

**DV-90  
ULDV-90**

1/2" installation hole

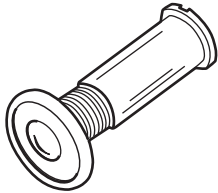

**DV-180  
ULDV-180**

9/16" installation hole

NUMBER	VIEW DIMENS.	ANSI
DV-90	160 Degrees	L21372
DV-180	180 Degrees	L21371
ULDV-90	160 Degrees	L23222
ULDV-180	180 Degrees	L23221



**SHELF PACK:** 10 Polybagged  
**FEATURES:** • For doors 1 3/8" to 2" thickness  
 • DV-90 and DV-180 with plastic lens  
 • ULDV-90 and ULDV-180 with glass lens are UL rated  
**FINISHES:** 605, 626

**DOOR FLIP GUARDS**

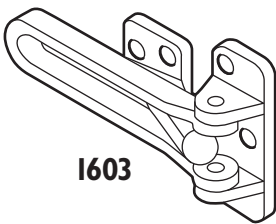

**I603**

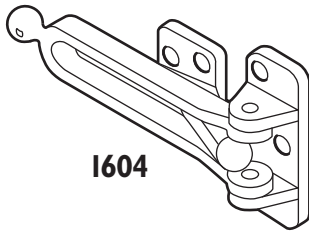

**I604**



**AP-34**  
1" x 1" x 1/2"



**WP-34**  
1" x 1"

NUMBER	ANSI	MATERIAL
I603	L33042	Aluminum
I604	L13042	Brass
AP-34	-	-
WP-34	-	-

**SHELF PACK:** (I603, I604) 10 Polybagged  
 (AP-34, WP-34) 100  
**FEATURES:** • Black rubber shim available for I603 and I604  
 • AP-34 included with item I604  
 • Both models feature Ball Bearing Design  
**FINISHES:** (I603, I604) 605, 606, 613, 625, 626  
 (AP-34) 605, 606, 625, 626  
 (WP-34) 605, 606, 625, 626, Clear

**CHAIN GUARD**

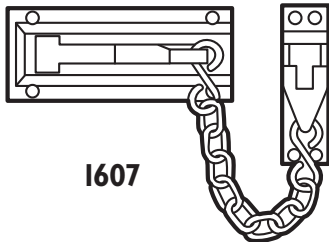

**I607**

NUMBER	MATERIAL
I607	Cast Brass

**SHELF PACK:** 20 Polybagged  
**FINISHES:** 605, 625, 626

**ELBOW CATCH**

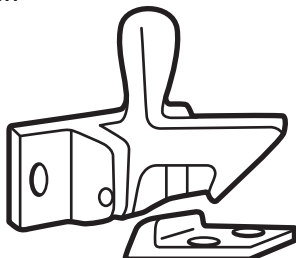

**I590**

NUMBER	MATERIAL
I590	Cast

**SHELF PACK:** 10 Polybagged  
**FINISHES:** 605, 613, 625, 626



**HANDRAIL BRACKETS**

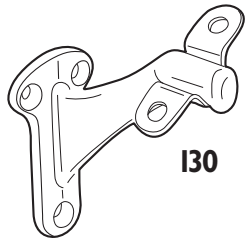

130

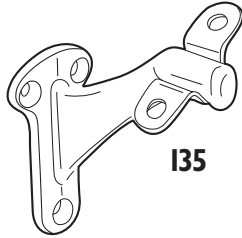

135

NUMBER	ANSI	MATERIAL
130	L33061	Cast Aluminum
135	L13061	Solid Brass

**SHELF PACK:** (130) 20, (135) 10 **Polybagged**  
**FEATURES:** (130) Base 2 13/16" x 1 1/2"  
 (135) Base 2 1/4" x 1 1/4"  
**FINISHES:** (130): 605, 609, 613, 619, 620, 625, 626  
 (135): 605, 613, 619, 620, 626

**HINGE PINS/WINDOW BOLTS**

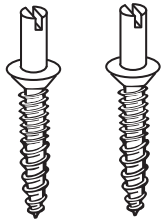

CHP-100  
RHP-100

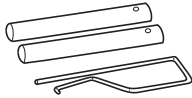

WB-112

NUMBER	DIMENSIONS
CHP-100	#12 Head
RHP-100	#10 Head
WB-112	Contains: 8 Bolts, 4 Tools

**SHELF PACK:** (CHP-100, RHP-100) 10 pack of 2 each **Polybagged**  
 (WB-112) 10  
**FINISHES:** (CHP-100, RHP-100) BP (Brass Plated), CP (Chrome Plated)  
 (WB-112) ZINC

**COAT HOOKS**

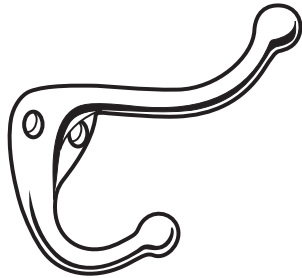

300

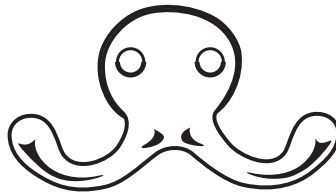

302

NUMBER	MATERIAL
300	Die Cast
302	Die Cast

**SHELF PACK:** 20 **Polybagged**  
**FINISHES:** 605, 613, 619, 620, 625, 626

**FINGER PULL**

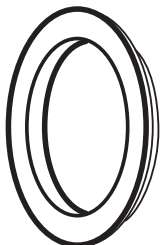

125

NUMBER	DIMENSIONS	MATERIAL
125	2 1/8"	Zinc

**SHELF PACK:** 50 **Polybagged**  
**FINISHES:** 605, 609, 613, 619, 620, 625, 626, Black



SCAR PLATE for door damaged by prying

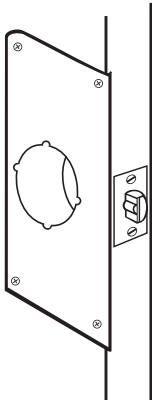

EM-2  
EM-4

NUMBER	DIMENSIONS
EM-2	9" x 4" x 2 3/8"
EM-4	9" x 4 1/4" x 2 3/4"

SHELF PACK: 10 Polybagged  
 FEATURES: • Fits one side of door with curved lip  
 • Fits under key-in-knob  
 FINISHES: 605, 630

CRASH CHAIN

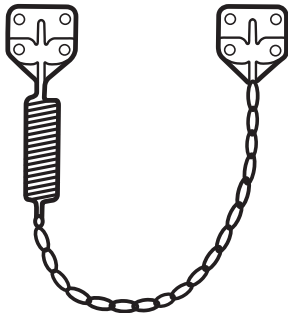

CC-100

NUMBER	LENGTH
CC-100	21 3/4"

SHELF PACK: 20 Polybagged  
 FEATURE: Vinyl Cover  
 FINISHES: Zinc

EDGE PULLS

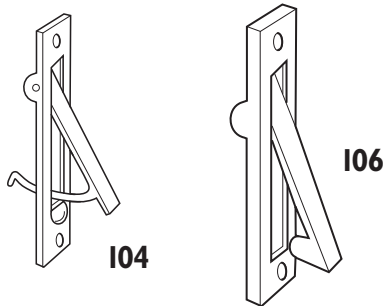

104

106

NUMBER	DIMENSIONS
104	3 7/8" x 3/4"
106	6" x 1 1/4"

SHELF PACK: 10 Polybagged  
 FINISHES: 605, 613, 619, 620, 626

WINDOW LOCK

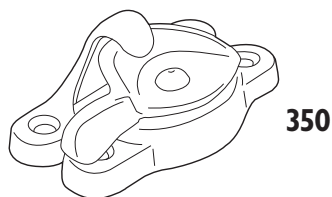

350

NUMBER	DIMENSIONS		MATERIAL
	BASE	STRIKE	
350	15/16" x 2 5/8"	5/8" x 2 5/8"	Steel

SHELF PACK: 10 Polybagged  
 FINISHES: 605, 613, 619, 626



NUMBERS/DOOR KNOCKERS

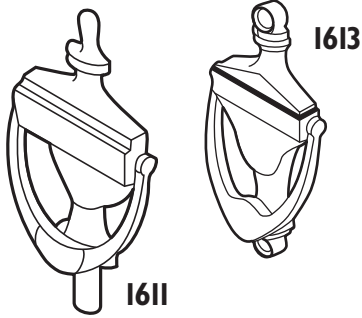

**378**

**BN4 (shown)  
- BN6**

**How to Order:  
eg: BN4-2-605**

NUMBER	DIMENSIONS	ANSI
1611	6 7/8" x 3 1/2"	L13151
1613	3 7/8" x 2 1/4"	L13151
BN4	4"	-
BN6	6"	-

**SHELF PACK: 10** Polybagged  
**FEATURE: Forged Brass**  
**FINISHES: 605**

CYLINDER GUARDS

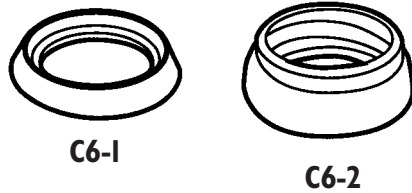

NUMBER	DIAMETER	THICKNESS	MATERIAL
C6-1	1 1/8"	1/4"	Steel
C6-2	1 1/8"	3/8"	Steel

**SHELF PACK: 10** Polybagged  
**FINISHES: BP, CP, DU**

CYLINDER RINGS

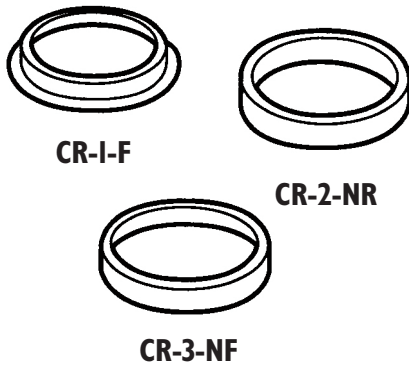

NUMBER	DIAMETER	THICKNESS	MATERIAL
CR-1-F	1 1/4"	1/4"	Aluminum
CR-2-NR	1 1/8"	1/4"	Aluminum
CR-3-NF	1 1/8"	1/4"	Brass

**SHELF PACK: 10** Polybagged  
**FINISHES: BP, CP, DU**

CYLINDER RINGS

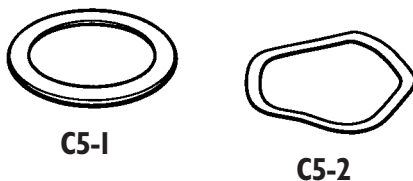

NUMBER	DIAMETER	THICKNESS	MATERIAL
C5-1	1 1/8"	1/16"	Plastic
C5-2	1 1/8"	3/16"	Brass

**SHELF PACK: 10** Polybagged  
**FINISHES: Clear plastic, 605**