



Insulated Foam Cups, Containers, Bowls, & Lids

Dart is the world's leading manufacturer of foam foodservice products and coordinating lids. Foam preserves the integrity of food and beverages by maintaining proper serving temperatures, hot or cold. Whether it's fountain drinks, coffee, soups or ice cream, we have a style and stock print to fit your needs—and your budget.



Insulated Foam Buyer's Guide

J cup® Features

Fill line

Etched line inside mouth of cup that indicates level at which cup should be filled

Lip

Provides comfort while drinking and gives additional strength to cup

Print area

1/4" below lip and above pedestal-allows cup to become a promotional tool to increase sales and awareness of your business

Sidewall

Provides insulation, preserving beverage integrity

Lip stack

Allows easy separation and increases the speed of the operator

Pedestal

Raises bottom of cup to allow it to rest steadily on flat surface



Insulated Foam Buyer's Guide

Drink Cups



| Stock Number | Approximate Capacity | Packing Bag | Packing Case | Case Cube (ft ³) | Case Weight (lbs) | Lids |
|--------------|----------------------|-------------|--------------|------------------------------|-------------------|-------------------|
| 4J4 | 4oz | 50 | 1000 | 2.3 | 4.8 | 4JL |
| 6J6 | 6oz | 25 | 1000 | 2.9 | 5.6 | Any 6 series lid |
| 8J8 | 8oz | 25 | 1000 | 3.6 | 6.8 | Any 8 series lid |
| 8KY8* | 8oz | 25 | 1000 | 4.7 | 7.5 | |
| 10FJ8 | 10oz** | 25 | 1000 | 4.6 | 8.6 | |
| 10J10 | 10oz | 25 | 1000 | 4.3 | 8.1 | Any 10 series lid |
| 10KY10* | 10oz | 25 | 1000 | 5.7 | 8.9 | Any 12 series lid |
| 10J12 | 10oz | 25 | 1000 | 4.7 | 9.1 | |
| 12J12 | 12oz | 25 | 1000 | 5.0 | 9.4 | |
| 12J16 | 12oz | 25 | 1000 | 5.7 | 10.2 | Any 16 series lid |



| Stock Number | Approximate Capacity | Packing Bag | Packing Case | Case Cube (ft ³) | Case Weight (lbs) | Lids |
|---------------------|----------------------|-------------|--------------|------------------------------|-------------------|-------------------|
| 14J12 | 14oz | 25 | 1000 | 8.3 | 12.6 | Any 12 series lid |
| 14FJ12 | 14oz** | 25 | 1000 | 5.9 | 11.0 | |
| 14J16 | 16oz | 25 | 1000 | 7.6 | 12.5 | Any 16 series lid |
| 16J16 | 16oz | 25 | 1000 | 8.7 | 14.0 | |
| 20J16 | 20oz | 25 | 500 | 5.5 | 8.6 | |
| 24J16 | 24oz | 20 | 500 | 7.2 | 10.4 | |
| 24J24 | 24oz | 25 | 500 | 6.3 | 10.0 | 24SL05 |
| 30AJ20 | 30oz** | 16 | 400 | 7.8 | 10.3 | Any 20 series lid |
| 32AJ20 | 32oz** | 16 | 400 | 7.9 | 10.9 | |
| 30AJ26 ⁺ | 30oz | 15 | 300 | 6.5 | 8.2 | Any 26 series lid |
| 42AJ26 ⁺ | 42oz | 15 | 300 | 8.5 | 10.5 | |
| 32AJ32 | 32oz** | 25 | 500 | 7.7 | 13.0 | Any 32 series lid |
| 32TJ32 | 32oz | 25 | 500 | 8.5 | 12.8 | |
| 44TJ32 | 44oz | 20 | 300 | 7.0 | 9.6 | |
| 44AJ32 | 44oz** | 15 | 300 | 7.7 | 10.6 | |
| 60AJ32 ⁺ | 60oz** | 8 | 160 | 7.9 | 9.0 | |

*May not be available in all sales areas
** Flush fill

+Only available custom or stock printed
*UPC and GTIN information can be found at www.dartcontainer.com

*Available in custom print only

Insulated Foam Buyer's Guide



Features

Great lid programs and combinability

Multiple cups fit one common lid size across multiple stock prints lowering the number of SKU's you have to carry in inventory

Printed with UV inks

For brighter colors and excellent print quality

Large selection of sizes

8oz to 60oz with capacity printed on most cups

Dual usage
For hot or cold

Color coded by size
for easy size identification



Impulse®



Impulse®



Horizon®



Café G®



Uptown™



RPM®



Coca-Cola®



Ice Cup

Insulated Foam Buyer's Guide

Stock Prints

| Stock Number | Approximate Capacity | Print Colors | Packing Bag | Packing Case | Case Cube (ft ³) | Case Weight (lbs) | Lids |
|--------------------------------|----------------------|--|-------------|--------------|------------------------------|-------------------|-------------------|
| Horizon* | | | | | | | |
| 8J8H | 8 oz | Dark Red | 25 | 1000 | 3.6 | 6.8 | Any 8 series lid |
| 10FJ8H* | 10 oz** | Plum | 25 | 1000 | 4.6 | 8.6 | Any 8 series lid |
| 10J10H* | 10 oz | Plum | 25 | 1000 | 4.3 | 8.1 | Any 10 series lid |
| 12J16H | 12 oz | Forest Green | 25 | 1000 | 5.7 | 10.2 | Any 16 series lid |
| 16J16H | 16 oz | Cranberry | 25 | 1000 | 8.7 | 14.0 | Any 16 series lid |
| 20J16H | 20 oz | Blueberry | 25 | 500 | 5.5 | 8.6 | Any 16 series lid |
| 24J16H | 24 oz | Mauve | 20 | 500 | 7.2 | 10.4 | Any 16 series lid |
| 30AJ20H* | 30 oz | Teal | 16 | 400 | 7.8 | 10.3 | Any 20 series lid |
| 32AJ20H | 32 oz** | Teal | 16 | 400 | 7.9 | 10.9 | Any 20 series lid |
| 32AJ32H* | 32 oz** | Teal | 25 | 500 | 7.7 | 13.0 | Any 32 series lid |
| 32TJ32H | 32 oz | Teal | 25 | 500 | 8.5 | 12.8 | Any 32 series lid |
| 44AJ32H | 44 oz** | Ocean Blue | 15 | 300 | 7.7 | 10.6 | Any 32 series lid |
| 44TJ32H | 44 oz | Ocean Blue | 20 | 300 | 7.0 | 9.6 | Any 32 series lid |
| 60AJ32H* | 60 oz** | Forest Green | 8 | 160 | 7.9 | 9.0 | Any 32 series lid |
| Impulse* | | | | | | | |
| 8J8E | 8 oz | Red & Gray | 25 | 1000 | 3.6 | 6.8 | Any 8 series lid |
| 12J16E | 12 oz | Green & Gray | 25 | 1000 | 5.7 | 10.2 | Any 16 series lid |
| 16J16E | 16 oz | Orange & Gray | 25 | 1000 | 8.7 | 14.0 | Any 16 series lid |
| 20J16E | 20 oz | Purple & Gray | 25 | 500 | 5.5 | 8.6 | Any 16 series lid |
| 24J16E | 24 oz | Green & Gray | 20 | 500 | 7.2 | 10.4 | Any 16 series lid |
| 30AJ20E* | 30 oz | Blue & Gray | 16 | 400 | 7.8 | 10.3 | Any 20 series lid |
| 32AJ20E | 32 oz** | Blue & Gray | 16 | 400 | 7.9 | 10.9 | Any 20 series lid |
| 32AJ32E* | 32 oz** | Blue & Gray | 25 | 500 | 7.7 | 13.0 | Any 32 series lid |
| 32TJ32E | 32 oz | Blue & Gray | 25 | 500 | 8.5 | 12.8 | Any 32 series lid |
| 44AJ32E | 44 oz** | Green & Gray | 15 | 300 | 7.7 | 10.6 | Any 32 series lid |
| 44TJ32E | 44 oz | Green & Gray | 20 | 300 | 7.0 | 9.6 | Any 32 series lid |
| 60AJ32E* | 60 oz** | Blue & Gray | 8 | 160 | 7.9 | 9.0 | Any 32 series lid |
| Impulse Food Containers | | | | | | | |
| 8SJ20E* | 8 oz | Green & Gray | 50 | 1000 | 4.4 | 8.1 | Any 20 series lid |
| 12SJ20E* | 12 oz | Purple & Gray | 25 | 500 | 3.1 | 5.6 | Any 20 series lid |
| 16MJ20E* | 16 oz | Orange & Gray | 25 | 500 | 4.1 | 6.5 | Any 20 series lid |
| Café G* | | | | | | | |
| 4J4G | 4 oz | Red, Brown & Black | 50 | 1000 | 2.3 | 4.7 | 4JL |
| 8X8G | 8 oz** | Green, Brown & Black | 25 | 1000 | 4.2 | 7.2 | Any 8 series lid |
| 12X12G | 12 oz** | Red, Brown & Black | 20 | 1000 | 6.2 | 10.7 | Any 12 series lid |
| 12X16G | 12 oz** | Red, Brown & Black | 20 | 1000 | 6.1 | 10.7 | Any 16 series lid |
| 16X16G | 16 oz** | Green, Brown & Black | 25 | 1000 | 8.6 | 13.8 | Any 16 series lid |
| 20X16G | 20 oz** | Red, Brown & Black | 20 | 500 | 6.5 | 9.6 | Any 16 series lid |
| 24X16G | 24 oz** | Green, Brown & Black | 20 | 500 | 7.9 | 11.2 | Any 16 series lid |
| 8X8GWRAP | 8 oz** | Green, Brown & Black; Individually Wrapped | 1 | 900 | 4.9 | 8.4 | Any 8 series lid |
| 10X10GWRAP | 10 oz** | Green, Brown & Black; Individually Wrapped | 1 | 900 | 6.1 | 9.7 | Any 10 series lid |
| Uptown™ | | | | | | | |
| 8X8TWN | 8 oz** | Red, Black & Gray | 25 | 1000 | 4.2 | 7.2 | Any 8 series lid |
| 12X16TWN | 12 oz** | Blue, Black & Gray | 20 | 1000 | 6.1 | 10.7 | Any 16 series lid |
| 16X16TWN | 16 oz** | Green, Black & Gray | 25 | 1000 | 8.6 | 13.8 | Any 16 series lid |
| 20X16TWN | 20 oz** | Red, Black & Gray | 20 | 500 | 6.5 | 9.6 | Any 16 series lid |
| 24X16TWN | 24 oz** | Blue, Black & Gray | 20 | 500 | 7.9 | 11.2 | Any 16 series lid |
| RPM* | | | | | | | |
| 12J16RPM* | 12 oz | Green, Blue, Yellow & Black | 25 | 1000 | 5.7 | 10.2 | Any 16 series lid |
| 16J16RPM* | 16 oz | Red, Blue, Yellow & Black | 25 | 1000 | 8.7 | 14.0 | Any 16 series lid |
| 20J16RPM* | 20 oz | Purple, Blue, Yellow & Black | 25 | 500 | 5.5 | 8.6 | Any 16 series lid |
| 24J16RPM* | 24 oz | Green, Blue, Yellow & Black | 20 | 500 | 7.2 | 10.4 | Any 16 series lid |
| 30AJ20RPM* | 30 oz** | Red, Blue, Yellow & Black | 16 | 400 | 7.8 | 10.3 | Any 20 series lid |
| 32AJ20RPM* | 32 oz** | Red, Blue, Yellow & Black | 16 | 400 | 7.9 | 10.9 | Any 20 series lid |
| 32AJ32RPM* | 32 oz** | Red, Blue, Yellow & Black | 25 | 500 | 7.7 | 13.0 | Any 32 series lid |
| 44AJ32RPM* | 44 oz** | Purple, Blue, Yellow & Black | 15 | 300 | 7.7 | 10.6 | Any 32 series lid |
| 60AJ32RPM* | 60 oz** | Green, Blue, Yellow & Black | 8 | 160 | 7.9 | 9.0 | Any 32 series lid |
| Coca-Cola† | | | | | | | |
| 16J16C | 16 oz | Red | 25 | 1000 | 8.7 | 14.0 | Any 16 series lid |
| 20J16C | 20 oz | Red | 25 | 500 | 5.5 | 8.6 | Any 16 series lid |
| 24J16C | 24 oz | Red | 20 | 500 | 7.2 | 10.4 | Any 16 series lid |
| 32AJ20C | 32 oz** | Red | 16 | 400 | 7.9 | 10.9 | Any 20 series lid |
| 32TJ32C | 32 oz | Red | 25 | 500 | 8.5 | 12.8 | Any 32 series lid |
| 44AJ32C | 44 oz** | Red | 15 | 300 | 7.7 | 10.6 | Any 32 series lid |
| Ice Cup | | | | | | | |
| 14J16I* | 16 oz** | Blue & Teal | 25 | 1000 | 7.6 | 12.5 | Any 16 series lid |

*May not be available in all sales areas †Coca-Cola® and the Contour Bottle® design are registered trademarks of The Coca-Cola Company. All rights reserved

**Flush Fill *UPC and GTIN information can be found at www.dartcontainer.com

Insulated Foam Buyer's Guide



Features

Strong sidewall
Provides insulation from hot or cold contents while preventing container from collapsing

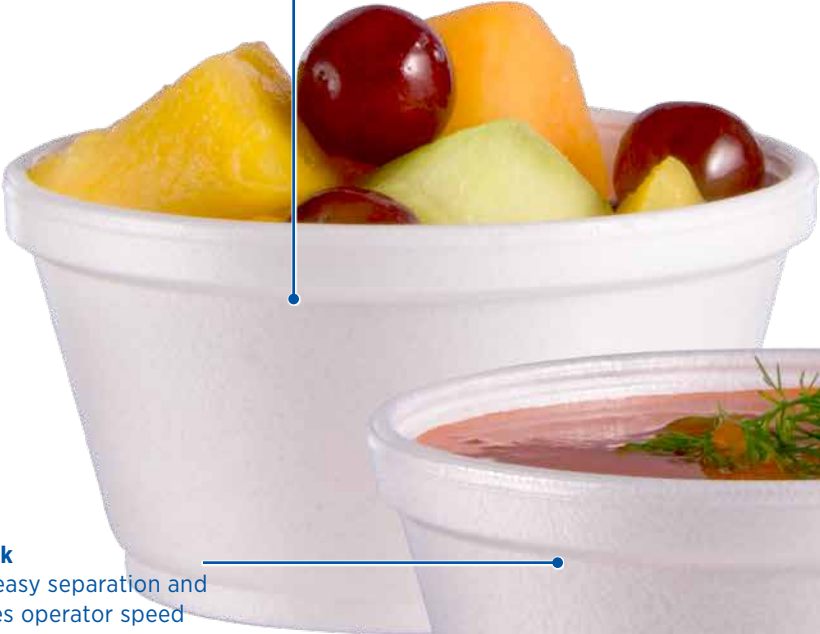

Fill line
Etched line inside mouth of containers and bowls indicates fill levels

Lip stack
Allows easy separation and increases operator speed

Pedestal
Raises bottom of bowl to allow it to rest steadily on flat surface

Insulated Foam Buyer's Guide

Bowls



| Stock Number | Approximate Capacity | Packing Bag | Packing Case | Case Cube (ft ³) | Case Weight (lbs) | Lids |
|--------------|----------------------|-------------|--------------|------------------------------|-------------------|-------------------|
| 5B20 | 5oz | 50 | 1000 | 4.4 | 6.2 | Any 20 series lid |
| 6B12 | 6oz | 50 | 1000 | 3.3 | 5.8 | Any 12 series lid |
| 6B20 | 6oz | 50 | 1000 | 4.2 | 6.6 | Any 20 series lid |
| 8B20 | 8oz | 50 | 1000 | 4.5 | 7.4 | Any 20 series lid |
| 10B20 | 10oz | 50 | 1000 | 4.7 | 8.0 | Any 20 series lid |
| 12B32 | 12oz | 50 | 1000 | 6.5 | 10.4 | Any 32 series lid |

Containers

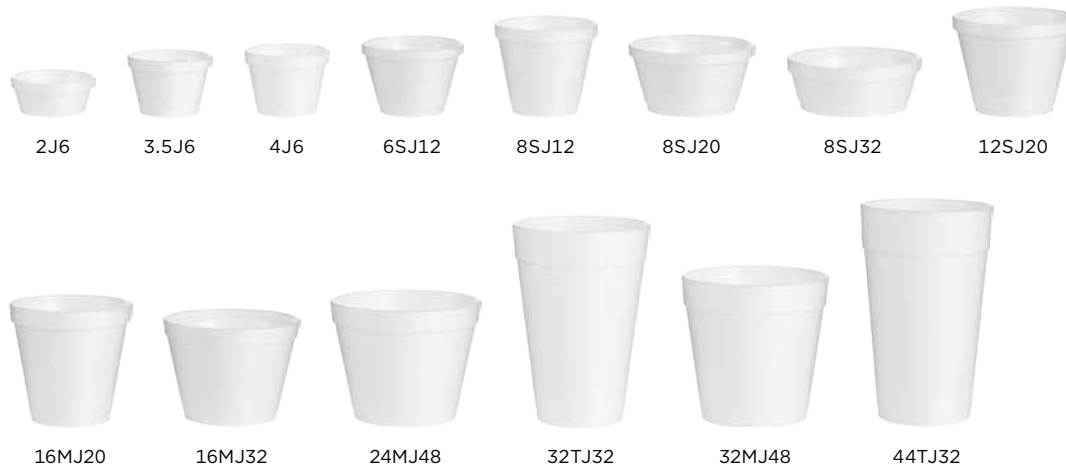

| Stock Number | Approximate Capacity | Packing Bag | Packing Case | Case Cube (ft ³) | Case Weight (lbs) | Lids |
|--------------|----------------------|-------------|--------------|------------------------------|-------------------|-------------------|
| 2J6* | 2oz | 50 | 1000 | 2.1 | 3.6 | Any 6 series lid |
| 3.5J6 | 3½oz | 50 | 1000 | 2.2 | 4.5 | Any 6 series lid |
| 4J6 | 4oz | 50 | 1000 | 2.5 | 4.8 | Any 6 series lid |
| 6SJ12 | 6oz | 50 | 1000 | 2.9 | 5.9 | Any 12 series lid |
| 8SJ12 | 8oz | 50 | 1000 | 3.8 | 7.1 | Any 12 series lid |
| 8SJ20 | 8oz | 50 | 1000 | 4.4 | 8.1 | Any 20 series lid |
| 8SJ32 | 8oz | 25 | 500 | 3.4 | 5.4 | Any 32 series lid |
| 12SJ20 | 12oz | 25 | 500 | 3.1 | 5.6 | Any 20 series lid |
| 16MJ20 | 16oz | 25 | 500 | 4.1 | 6.5 | Any 20 series lid |
| 16MJ32 | 16oz | 25 | 500 | 4.4 | 7.0 | Any 32 series lid |
| 24MJ48 | 24oz | 25 | 500 | 6.6 | 10.1 | 48JL |
| 32TJ32 | 32oz | 25 | 500 | 8.5 | 12.8 | Any 32 series lid |
| 32MJ48 | 32oz | 25 | 500 | 9.0 | 12.7 | 48JL |
| 44TJ32 | 44oz | 20 | 300 | 7.0 | 9.6 | Any 32 series lid |

*May not be available in all sales areas

*UPC and GTIN information can be found at www.dartcontainer.com

Insulated Foam Buyer's Guide

Features

Clear, high dome
Increases impulse sales of pre-packaged items. Tops off sundaes, fruit salads, or other mounded desserts

Foam vented
Perfect for hot soup or frozen yogurt. Combine with a foam cup or container for an exceptionally insulated package

Cappuccino
Elevated platform reduces the chance of spills. Perfect upscale complement to carryout gourmet coffee



Insulated Foam Buyer's Guide



Optima® Reclosable Lid

Reclosable tab provides leak-resistant seal. The ideal solution for gourmet coffee on the go

Sip Thru® Cup Lid

No tearing or pulling; reduces chance of drips or spills. Allows easy sipping of soft drinks, coffee, tea, or juice

Dart® Dome Lid - Clear

Exceptional clarity provides excellent product visibility. Ideal for root beer floats, fruit smoothies, "slushie" style drinks, or iced coffee beverages with whipped cream

Lift 'n' Lock™ Cup Lid

Closing tab helps avoid spills. Great for coffee, soft drinks, shakes, juice, tea, or water



Insulated Foam Buyer's Guide

Lid Matching Guide

| Cup, Container, Bowl, & Lid Matching Guide | | | | | | | | | | | | | | | | | | | | | | | | | | | | | | | | | |
|--|-----|-----------------------------|------|-------|-----------------------------|--|-------|-------|-----------------------------|--------|-------|--|-------|-----------------------------|-------|-----------------------------|--|--------|--------|-----------------------------------|--------|--------|--------|--------|--------|--------|--|--------|--|--------|--|--------|--|
| 4J4 | 6J6 | 8J8 | 8KY8 | 10FJ8 | 10J10 | 10KY10 | 10J12 | 12J12 | 14J12 | 14FJ12 | 12J16 | 14J16 | 16J16 | 20J16 | 24J16 | 24J24 | 30AJ26 | 42AJ26 | 30AJ20 | 32AJ20 | 32AJ32 | 32TJ32 | 44AJ32 | 44TJ32 | 60AJ32 | | | | | | | | |
| 1 Lid Size Fits 1 Cup Size | | 1 Lid Size Fits 3 Cup Sizes | | | 1 Lid Size Fits 4 Cup Sizes | | | | 1 Lid Size Fits 5 Cup Sizes | | | | | 1 Lid Size Fits 2 Cup Sizes | | 1 Lid Size Fits 5 Cup Sizes | | | | | | | | | | | | | | | | | |
| 2J6* | | 3.5J6 | | 4J6 | | 6S12 | | 8S12 | | 6B12 | | 8S120 | | | | | 12S120 | | 16M120 | | 8S132 | | | 16M132 | | 32T132 | | 44T132 | | 24MJ48 | | 32MJ48 | |
| 1 Lid Size Fits 3 Container Sizes | | | | | | 1 Lid Size Fits 2 Container/Bowl Sizes | | | | | | 1 Lid Size Fits 7 Container/Bowl Sizes | | | | | 1 Lid Size Fits 5 Container/Bowl Sizes | | | 1 Lid Size Fits 2 Container Sizes | | | | | | | | | | | | | |

| Lids | 4J4 | 6J6 | 8J8 | 8KY8 | 10FJ8 | 10J10 | 10KY10 | 10J12 | 12J12 | 14J12 | 14FJ12 | 12J16 | 14J16 | 16J16 | 20J16 | 24J16 | 24J24 | 30AJ26 | 42AJ26 | 30AJ20 | 32AJ20 | 32AJ32 | 32TJ32 | 44AJ32 | 44TJ32 | 60AJ32 |
|--------------------------------|-----|-----|-----|------|-------|-------|--------|-------|-------|-------|--------|-------|-------|-------|-------|-------|-------|--------|--------|--------|--------|--------|--------|--------|--------|--------|
| Flat, Vented | ■ | ■ | ■ | ■ | ■ | ■ | ■ | ■ | ■ | ■ | ■ | ■ | ■ | ■ | ■ | ■ | ○ | ○ | ■ | ■ | ■ | ■ | ■ | ■ | ■ | ■ |
| Flat, No Vent | ○ | ■ | ○ | ○ | ○ | ○ | ○ | ○ | ○ | ○ | ○ | ○ | ○ | ○ | ○ | ○ | ○ | ○ | ○ | ■ | ■ | ■ | ■ | ○ | ○ | ○ |
| Flat, Straw Slot | ○ | ○ | ■ | ■ | ■ | ■ | ■ | ■ | ■ | ■ | ■ | ■ | ■ | ■ | ■ | ■ | ○ | ○ | ■ | ■ | ■ | ■ | ○ | ○ | ○ | ○ |
| Flat, Sip Thru* | ○ | ○ | ■ | ■ | ■ | ■ | ■ | ■ | ■ | ■ | ■ | ■ | ■ | ■ | ■ | ○ | ○ | ○ | ○ | ○ | ○ | ○ | ○ | ○ | ○ | ○ |
| Lift 'n' Lock™ | ○ | ○ | ■ | ■ | ■ | ■ | ■ | ■ | ■ | ■ | ■ | ■ | ■ | ■ | ■ | ○ | ○ | ○ | ○ | ○ | ○ | ○ | ○ | ○ | ○ | ○ |
| Lift 'n' Lock™ with Straw Slot | ○ | ○ | ○ | ○ | ○ | ○ | ○ | ■ | ■ | ■ | ■ | ■ | ■ | ■ | ○ | ○ | ○ | ○ | ○ | ○ | ○ | ○ | ○ | ○ | ○ | ○ |
| Pour Spout | ○ | ○ | ○ | ○ | ○ | ○ | ○ | ○ | ○ | ○ | ○ | ○ | ○ | ○ | ○ | ○ | ○ | ○ | ○ | ○ | ○ | ○ | ■ | ○ | ○ | ○ |
| Foam, Vented | ○ | ○ | ○ | ○ | ○ | ○ | ○ | ○ | ○ | ○ | ○ | ○ | ○ | ○ | ○ | ○ | ○ | ○ | ○ | ○ | ○ | ■ | ■ | ○ | ○ | ○ |
| Dome, No Vent | ○ | ○ | ○ | ○ | ○ | ○ | ○ | ○ | ○ | ○ | ○ | ○ | ○ | ○ | ○ | ○ | ○ | ○ | ○ | ○ | ○ | ○ | ○ | ○ | ○ | ○ |
| Dome, Vented | ○ | ○ | ○ | ○ | ○ | ○ | ○ | ○ | ○ | ○ | ○ | ○ | ○ | ○ | ○ | ○ | ○ | ○ | ○ | ○ | ○ | ○ | ○ | ○ | ○ | ○ |
| Cappuccino | ○ | ○ | ■ | ■ | ■ | ■ | ■ | ■ | ■ | ■ | ■ | ■ | ■ | ■ | ○ | ○ | ○ | ○ | ○ | ○ | ○ | ○ | ○ | ○ | ○ | ○ |
| Optima* | ○ | ○ | ○ | ○ | ○ | ○ | ○ | ○ | ○ | ○ | ○ | ○ | ○ | ○ | ○ | ○ | ○ | ○ | ○ | ○ | ○ | ○ | ○ | ○ | ○ | ○ |
| High Dome | ○ | ○ | ○ | ○ | ○ | ○ | ○ | ■ | ■ | ■ | ■ | ○ | ○ | ○ | ○ | ○ | ○ | ○ | ○ | ○ | ○ | ○ | ○ | ○ | ○ | ○ |
| Dome | ○ | ○ | ○ | ○ | ○ | ○ | ○ | ○ | ○ | ○ | ○ | ○ | ○ | ○ | ○ | ○ | ○ | ○ | ○ | ○ | ○ | ○ | ○ | ○ | ○ | ○ |
| Dome with Hole | ○ | ○ | ○ | ○ | ○ | ○ | ○ | ○ | ○ | ○ | ○ | ○ | ○ | ○ | ○ | ○ | ○ | ○ | ○ | ○ | ○ | ○ | ○ | ○ | ○ | ○ |



Insulated Foam Buyer's Guide

Lids



| Stock Number | Color | Packing Bag | Packing Case | Case Cube (ft ³) | Case Weight (lbs) | Cups |
|-------------------------|-------------|-------------|--------------|------------------------------|-------------------|---|
| Flat, Vented Lid | | | | | | |
| 4JL | Translucent | 100 | 1000 | 0.7 | 3.1 | 4J4 |
| 6JL | White | 100 | 1000 | 0.8 | 3.5 | 6J6, 3.5J6, 4J6 |
| 8JL | White | 100 | 1000 | 0.9 | 4.0 | 8J8, 8KY8, 10FJ8, 8X8, 3.5B8 |
| 10JL | White | 100 | 1000 | 1.0 | 4.2 | 10J10, 10KY10 |
| 12JL | White | 100 | 1000 | 1.1 | 4.8 | 10J12, 12J12, 14J12, 14FJ12, 12X12, 6SJ12, 8SJ12, 6B12 |
| 16JL | Translucent | 100 | 1000 | 1.2 | 5.4 | 12J16, 14J16, 16J16, 20J16, 24J16, 12X16, 16X16, 20X16, 24X16 |
| 20JL | Translucent | 100 | 1000 | 1.6 | 8.1 | 32AJ20, 8SJ20, 12SJ20, 16MJ20, 5B20, 6B20, 8B20, 10B20 |
| 32JL | Translucent | 100 | 500 | 1.0 | 4.9 | 32AJ32, 32TJ32, 44AJ32, 44TJ32, 60AJ32, 8SJ32, 16MJ32, 12B32 |
| 48JL | Translucent | 100 | 500 | 1.2 | 6.4 | 24MJ48, 32MJ48 |



| | | | | | | |
|-----------------------------|-------------|-----|------|-----|-----|--|
| Flat, Not Vented Lid | | | | | | |
| 6JLNV | Translucent | 100 | 1000 | 0.8 | 3.9 | 6J6, 3.5J6, 4J6 |
| 20JLNV | Translucent | 100 | 1000 | 1.6 | 8.1 | 32AJ20, 8SJ20, 12SJ20, 16MJ20, 5B20, 6B20, 8B20, 10B20 |
| 6CLR | Clear | 100 | 1000 | 0.8 | 4.2 | 6J6, 3.5J6, 4J6 |
| 12CLR | Clear | 100 | 1000 | 1.2 | 5.8 | 10J12, 12J12, 14J12, 14FJ12, 12X12, 6SJ12, 8SJ12, 6B12 |
| 20CLR | Clear | 100 | 1000 | 1.6 | 7.8 | 32AJ20, 8SJ20, 12SJ20, 16MJ20, 5B20, 6B20, 8B20, 10B20 |
| 32CLR | Clear | 100 | 500 | 1.0 | 5.1 | 32AJ32, 32TJ32, 44AJ32, 44TJ32, 60AJ32, 8SJ32, 16MJ32, 12B32 |



| | | | | | | |
|--------------------------------|-------------|-----|------|-------|------|---|
| Flat, Straw-Slotted Lid | | | | | | |
| 8SL | Translucent | 100 | 1000 | 0.9 | 4.1 | 8J8, 8KY8, 10FJ8, 8X8 |
| 10SL | Translucent | 100 | 1000 | 1.0 | 4.2 | 10J10, 10KY10 |
| 12SL | Translucent | 100 | 1000 | 1.1 | 4.9 | 10J12, 12J12, 14J12, 14FJ12, 12X12 |
| 16SL | Translucent | 100 | 1000 | 1.2 | 5.2 | 12J16, 14J16, 16J16, 20J16, 24J16, 12X16, 16X16, 20X16, 24X16 |
| 20SL | Translucent | 100 | 1000 | 1.7 | 8.1 | 32AJ20 |
| 24SL05 | Translucent | 100 | 500 | 0.7 | 3.0 | 24J24 |
| 26SL | Translucent | 100 | 1000 | 1.739 | 8.49 | 32AJ26, 42AJ26 |
| 32SL | Translucent | 100 | 500 | 1.0 | 4.8 | 32AJ32, 32TJ32, 44AJ32, 44TJ32, 60AJ32 |



| | | | | | | |
|---------------------------|-------|-----|------|-----|-----|---|
| Flat, Sip Thru Lid | | | | | | |
| 8UL | White | 100 | 1000 | 1.3 | 5.6 | 8J8, 8KY8, 10FJ8, 8X8 |
| 10UL | White | 100 | 1000 | 1.3 | 6.0 | 10J10, 10KY10 |
| 12UL | White | 100 | 1000 | 1.4 | 6.7 | 10J12, 12J12, 14J12, 14FJ12, 12X12 |
| 16UL | White | 100 | 1000 | 1.6 | 7.0 | 12J16, 14J16, 16J16, 20J16, 24J16, 12X16, 16X16, 20X16, 24X16 |



| | | | | | | |
|---------------------------------|-------|-----|------|-----|-----|---|
| Flat, Lift 'n' Lock™ Lid | | | | | | |
| 8FTL | White | 100 | 1000 | 0.9 | 4.7 | 8J8, 8KY8, 10FJ8, 8X8, 3.5B8 |
| 10FTL | White | 100 | 1000 | 1.0 | 5.2 | 10J10, 10KY10 |
| 12FTL | White | 100 | 1000 | 1.1 | 5.5 | 10J12, 12J12, 14J12, 14FJ12, 12X12, 6SJ12, 8SJ12, 6B12 |
| 16FTL | White | 100 | 1000 | 1.2 | 6.0 | 12J16, 14J16, 16J16, 20J16, 24J16, 12X16, 16X16, 20X16, 24X16 |



| | | | | | | |
|---|-------------|-----|------|-----|-----|---|
| Flat, Lift 'n' Lock™ Lid with Straw Slot | | | | | | |
| 12FTLS | Translucent | 100 | 1000 | 1.1 | 5.5 | 10J12, 12J12, 14J12, 14FJ12, 12X12, 6SJ12, 8SJ12, 6B12 |
| 16FTLS | Translucent | 100 | 1000 | 1.3 | 6.0 | 12J16, 14J16, 16J16, 20J16, 24J16, 12X16, 16X16, 20X16, 24X16 |



| | | | | | | |
|-----------------------------|-------------|-----|-----|-----|-----|--|
| Flat, Pour Spout Lid | | | | | | |
| 32PL | Translucent | 100 | 500 | 1.0 | 5.1 | 32AJ32, 32TJ32, 44AJ32, 44TJ32, 60AJ32, 16MJ32 |



| | | | | | | |
|-------------------------|-------|----|-----|-----|-----|--|
| Foam, Vented Lid | | | | | | |
| 20RL | White | 50 | 500 | 1.9 | 3.3 | 32AJ20, 8SJ20, 12SJ20, 16MJ20, 5B20, 6B20, 8B20, 10B20 |
| 32RL | White | 50 | 500 | 2.2 | 3.6 | 32AJ32, 32TJ32, 44AJ32, 44TJ32, 60AJ32, 8SJ32, 16MJ32, 12B32 |



| | | | | | | |
|-----------------------------|-------|-----|------|-----|-----|---|
| Dome, Cappuccino Lid | | | | | | |
| 8EL | White | 100 | 1000 | 1.1 | 6.8 | 8J8, 8KY8, 10FJ8, 8X8 |
| 8ELBLK | Black | 100 | 1000 | 1.1 | 6.8 | 8J8, 8KY8, 10FJ8, 8X8 |
| 10EL | White | 100 | 1000 | 1.3 | 7.3 | 10J10, 10KY10 |
| 12EL | White | 100 | 1000 | 1.4 | 8.0 | 10J12, 12J12, 14J12, 14FJ12, 12X12 |
| 16EL | White | 100 | 1000 | 1.3 | 9.0 | 12J16, 14J16, 16J16, 20J16, 24J16, 12X16, 16X16, 20X16, 24X16 |
| 16ELBLK | Black | 100 | 1000 | 1.3 | 9.0 | 12J16, 14J16, 16J16, 20J16, 24J16, 12X16, 16X16, 20X16, 24X16 |



| | | | | | | |
|-------------------------------------|-------|-----|------|-----|------|---|
| Dome, Optima® Reclosable Lid | | | | | | |
| 16RCL | White | 100 | 1000 | 1.4 | 10.7 | 12J16, 14J16, 16J16, 20J16, 24J16, 12X16, 16X16, 20X16, 24X16 |
| 16RCLBLK | Black | 100 | 1000 | 1.4 | 10.7 | 12J16, 14J16, 16J16, 20J16, 24J16, 12X16, 16X16, 20X16, 24X16 |



| | | | | | | |
|-----------------------------|-------|-----|------|-----|-----|--|
| Dome, Not Vented Lid | | | | | | |
| 20DLCL | Clear | 100 | 1000 | 1.6 | 8.0 | 32AJ20, 8SJ20, 12SJ20, 16MJ20, 5B20, 6B20, 8B20, 10B20 |



| | | | | | | |
|-------------------------|-------------|-----|------|-----|-----|--|
| Dome, Vented Lid | | | | | | |
| 20DLV | Translucent | 100 | 1000 | 1.6 | 8.0 | 32AJ20, 8SJ20, 12SJ20, 16MJ20, 5B20, 6B20, 8B20, 10B20 |



| | | | | | | |
|----------------------|-------|----|------|-----|------|--|
| High Dome Lid | | | | | | |
| 12HDLC | Clear | 50 | 1000 | 2.2 | 8.6 | 10J12, 12J12, 14J12, 14FJ12, 12X12, 6SJ12, 8SJ12, 6B12 |
| 20HDLC | Clear | 50 | 1000 | 2.6 | 10.4 | 32AJ20, 8SJ20, 12SJ20, 16MJ20, 5B20, 6B20, 8B20, 10B20 |
| 32HDLC | Clear | 50 | 500 | 1.7 | 6.4 | 32AJ32, 32TJ32, 44AJ32, 44TJ32, 60AJ32, 8SJ32, 16MJ32, 12B32 |



| | | | | | | |
|-----------------|-------|----|------|-----|------|---|
| Dome Lid | | | | | | |
| 16LCD | Clear | 50 | 1000 | 2.1 | 10.4 | 12J16, 14J16, 16J16, 20J16, 24J16, 12X16, 16X16, 20X16, 24X16 |

| | | | | | | |
|---------------------------|-------|----|------|-----|------|---|
| Dome Lid with Hole | | | | | | |
| 16LCDH | Clear | 50 | 1000 | 2.2 | 9.9 | 12J16, 14J16, 16J16, 20J16, 24J16, 12X16, 16X16, 20X16, 24X16 |
| 20LCDH | Clear | 50 | 1000 | 2.7 | 11.6 | 12J16, 14J16, 16J16, 20J16, 24J16, 12X16, 16X16, 20X16, 24X16 |

| | | | | | | |
|--------------------------------|-------|----|------|-----|-----|---|
| Dome Lid with 1.9" Hole | | | | | | |
| 16LCDHX | Clear | 50 | 1000 | 2.2 | 9.2 | 12J16, 14J16, 16J16, 20J16, 24J16, 12X16, 16X16, 20X16, 24X16 |

*UPC and GTIN information can be found at www.dartcontainer.com



Foam Foodservice Products and the Environment

- Foam can be recycled
- Dart Container operates foam collection centers in North America, the UK, and Argentina and has capabilities to recycle 12 million pounds of post consumer foam #6 annually
- Foam foodservice products do not “clog” landfills. Polystyrene foam foodservice products constitute less than 1%, by both weight and volume, of landfill waste.
- Dart does not use chlorofluorocarbons (CFCs) in manufacturing foam cups, and never has

Visit www.dartcontainer.com/recycle to learn more about foam recycling.



Accessories

Get the most out of your foam cups! Consider Dart's line of foam cup accessories to add more convenience and efficiency to your operation.

- Plastic malt collars fit Dart 14, 16, and 20 oz foam cups and are compatible with most mixing systems
- Color-coded dessert sleeves are made of heavyweight plastic for maximum support when preparing soft serve treats
- Our white, plastic pitcher handle enhances the versatility of Dart foam cups

Malt Collars



14B/C 14J/C 16C 20C

Dessert Sleeves



BLD12X16 BLD16X16 BLD20X16

Pitcher Handle



32TJ32
32PHW
32PL

| Item | Description | Sleeve | Case Pack | Case Cube (ft ³) | Case Weight (lbs) | Use With |
|--------------------------------------|------------------------|--------|-----------|------------------------------|-------------------|---|
| Malt Collar | | | | | | |
| 14B/C | Malt Mixer Adapter | 1 | 1 | 0.1 | 0.5 | 14J12 |
| 14J/C | Malt Mixer Adapter | 1 | 1 | 0.1 | 0.5 | 14J16 |
| 12B32 | Malt Mixer Adapter | 1 | 1 | 0.1 | 0.5 | 16J16 |
| 12B32 | Malt Mixer Adapter | 1 | 1 | 0.1 | 0.5 | 20J16 |
| Frozen Dessert Sleeve Adapter | | | | | | |
| BLD12X16 | Small - White | 1 | 1 | 0.1 | 0.4 | 12X16, 12J16 |
| BLD16X16 | Medium - Blue | 1 | 1 | 0.1 | 0.4 | 16X16, 14J16, 14X16 |
| BLD20X16 | Large - Red | 1 | 1 | 0.1 | 0.5 | 20X16, 16J16, 20J16, 24J24, 24X24 |
| Pitcher Handle Adapter | | | | | | |
| 32PHW | Pitcher Handle - White | 25 | 500 | 5.6 | 24.3 | 32AJ32, 32TJ32, 44AJ32, 44TJ32, 60AJ32 & 32PL |



For additional information,
contact your Dart representative
or call 1-800-248-5960

www.dartcontainer.com

DART CONTAINER CORPORATION

The Industry Standard of Excellence

Mason, Michigan 48854 U.S.A.

Ph: (800) 248-5960 • Fax: (517) 676-3883

Email: sales@dart.biz • www.dartcontainer.com

PRINTED ON RECYCLED PAPER



Enhance Your Image With Premium Insulated Cups



ThermoGlaze® Insulated Foam Cups

ThermoGlaze® insulated foam cups will help communicate your upscale image with each beverage served. The powerful combination of your distinctive logo printed on ThermoGlaze® cups reminds customers of the quality, value, and satisfaction gained from each visit.

It's no wonder you routinely see Dart® ThermoGlaze® cups in the nation's most visible dining establishments and other quality quick-serve operations.





ThermoGlaze®

Features

Portion control sizing

Based on flush fill volume - which controls beverage cost and increases profitability

Dual-use

For hot and cold

Printed with UV inks

For brighter colors and excellent print quality



Great lid program

5 cups use the same size lid—choose from 12 different designs

Comfortable external temperature

Cups remain comfortable to carry without the need for wraps, jackets, extra napkins or double cupping

Heavy duty single-piece construction

Means no leaky seams

ThermoGlaze® cups

5 Cups / 1 Lid Size



| Stock Number | Description | Packing Bag | Packing Case | Case Cube (ft ³) | Case Weight (lbs) | Use With |
|--------------|-------------|-------------|--------------|------------------------------|-------------------|--|
| 4X4* | 4 oz. | 50 | 1000 | 2.3 | 4.4 | 4JL |
| 8X8 | 8 oz. | 25 | 1000 | 4.2 | 7.2 | 8JL, 8SL, 8UL, 8FTL, 8EL, 8ELBLK |
| 10X10 | 10 oz. | 20 | 1000 | 5.4 | 8.9 | 10JL, 10SL, 10UL, 10FTL, 10EL |
| 12X12 | 12 oz. | 20 | 1000 | 6.3 | 10.7 | 12JL, 12SL, 12UL, 12FTL, 12FTLS, 12EL, 12CLR, 12HDL |
| 12X16 | 12 oz. | 20 | 1000 | 6.2 | 10.7 | 5 cups / 1 lid size 16JL, 16SL, 16FTL, 16FTLS, 16UL, 16 EL, 16ELBLK, 16LCD, 16LCDH, 16LCDHX, 16RCL, 16RCLBLK |
| 14X16* | 14 oz. | 25 | 1000 | 7.3 | 12.0 | |
| 16X16 | 16 oz. | 25 | 1000 | 8.7 | 13.8 | |
| 20X16 | 20 oz. | 20 | 500 | 6.6 | 9.6 | |
| 24X16 | 24 oz. | 20 | 500 | 8.0 | 11.2 | |
| 24X24 | 24 oz. | 20 | 500 | 7.8 | 11.6 | 24SL05 |
| 8X8WRAP | 8 oz. | 25 | 900 | 5.0 | 8.3 | 8JL, 8SL, 8UL, 8FTL, 8EL, 8ELBLK |
| 10X10WRAP | 10 oz. | 25 | 900 | 6.2 | 9.7 | 10JL, 10SL, 10UL, 10FTL, 10EL |

All cup capacities are flush fill
* Not available in all areas



For additional information,
contact your Dart representative
or call (800) 248-5960

www.dartcontainer.com

DART CONTAINER CORPORATION

The Industry Standard of Excellence

Mason, Michigan 48854 U.S.A.

Ph: (800) 248-5960 • Fax: (517) 676-3883

Email: sales@dart.biz • www.dartcontainer.com



PRINTED ON RECYCLED PAPER



Coca-Cola[®]

Brand Stock Printed
Foam Cups by Dart





Brand Stock Printed
Foam Cups by Dart

Serve it cold, keep it cold!

Dart® and Coca-Cola®

Dart foam cups and Coca-Cola®* are an unbeatable combination for delivering long-lasting, cool refreshment. Foam cups keep your favorite Coca-Cola® beverage ice cold and tasting great, with less condensation and longer lasting carbonation than paper cups.

Available in the most popular sizes, Coca-Cola® brand cups manufactured by Dart offer the flexibility of two lid sizes fitting five different cups. This versatility simplifies operations and reduces lid inventory requirements, while taking advantage of the popularity and profitability of larger beverage sizes.



Advantages of Foam

- Foam cups provide superior insulation vs. other drink packaging.
- Fountain beverages increase profitability.
- Five cup sizes use two lids.
- 32AJ20C and 44AJ32C are designed to fit in standard car cupholders.**
- Dart foam cups have never been manufactured with CFCs.
- Dart printed foam cups use UV inks for brighter colors and sharper print definition. UV inks emit no volatile organic compounds into the environment.

3 Cups/1 Lid Means Less Lid Inventory & Simplified Handling



16J16C



20J16C



24J16C



32AJ20C



32TJ32C



44AJ32C

| Stock Number | Approximate Capacity | Packing | | Case Cube | Case Weight | Lids |
|--------------|----------------------|---------|------|-----------|-------------|-------------------|
| | | Bag | Case | | | |
| 16J16C | 16 oz. | 25 | 1000 | 8.7 | 14.0 | Any 16 series lid |
| 20J16C | 20 oz. | 25 | 500 | 5.5 | 8.6 | Any 16 series lid |
| 24J16C | 24 oz. | 20 | 500 | 7.2 | 10.4 | Any 16 series lid |
| 32AJ20C | 32 oz. *** | 16 | 400 | 7.9 | 10.9 | Any 20 series lid |
| 32TJ32C | 32 oz. | 25 | 500 | 8.5 | 12.8 | Any 32 series lid |
| 44AJ32C | 44 oz. *** | 15 | 300 | 7.7 | 10.6 | Any 32 series lid |

* "Coca-Cola" is a registered trademark of The Coca-Cola Company. Technical claims have not been evaluated by The Coca-Cola Company.

** May not fit securely in all makes and models

*** Flush fill capacity

DART CONTAINER CORPORATION

The Industry Standard of Excellence

Mason, Michigan 48854 U.S.A.

Ph: (800) 248-5960 • Fax: (517) 676-3883

Email: sales@dart.biz • www.dartcontainer.com



Put beverage sales
on the fast track

RPM® Stock Printed J cup® Insulated Foam Cups

Accelerate your beverage sales with RPM® stock printed cup's bright, energetic colors and eye-catching graphics. RPM stock printed cups are available in a full range of cup sizes, including 32 oz, 44 oz, and 60 oz pedestal style for use in car cupholders. Color coding by size and a UPC code printed on each cup allows for easy product identification by customers and employees. RPM stock printed cups now include a printed message to help promote the positive environmental aspects of foam cups to your customers.





Features

Environmental message includes a printed message to help promote the positive environmental aspects of foam cups

Color-coded by size for easy identification



Printed with UV inks for brighter colors and excellent print quality

Strong sidewall provides insulation preserving beverage integrity

1 Lid Size Fits 4 Different Cup Sizes



12J16RPM 16J16RPM 20J16RPM 24J16RPM



30AJ20RPM 32AJ20RPM

1 Lid Size Fits 3 Different Cup Sizes



32AJ32RPM 44AJ32RPM 60AJ32RPM

| Item | Approximate Capacity (to lid seat) | Color | Packing Bag | Packing Case | Case Cube (ft ³) | Case Weight (lbs) | Use With |
|--|------------------------------------|-----------------------------|-------------|--------------|------------------------------|-------------------|-------------------|
| RPM® Stock Printed J cup® Insulated Foam Cups | | | | | | | |
| 12J16RPM | 12 oz | Green, Blue, Black, & Gold | 25 | 1000 | 5.7 | 10.2 | Any 16 series lid |
| 16J16RPM | 16 oz | Red, Blue, Black, & Gold | 25 | 1000 | 8.7 | 14.0 | |
| 20J16RPM | 20 oz | Purple, Blue, Black, & Gold | 25 | 500 | 5.5 | 8.6 | |
| 24J16RPM | 24 oz | Green, Blue, Black, & Gold | 20 | 500 | 7.2 | 10.4 | |
| 30AJ20RPM* | 30 oz | Red, Blue, Black, & Gold | 16 | 400 | 7.8 | 10.3 | Any 20 series lid |
| 32AJ20RPM | 32 oz | Red, Blue, Black, & Gold | 16 | 400 | 7.9 | 10.9 | Any 20 series lid |
| 32AJ32RPM | 32 oz | Red, Blue, Black, & Gold | 25 | 500 | 7.7 | 13.0 | Any 32 series lid |
| 44AJ32RPM | 44 oz | Purple, Blue, Black, & Gold | 15 | 300 | 7.7 | 10.6 | |
| 60AJ32RPM* | 60 oz | Green, Blue, Black, & Gold | 8 | 160 | 8.0 | 9.0 | |

* May not be available in all sales areas.



For additional information, contact your Dart representative or call (800) 248-5960

www.dartcontainer.com

DART CONTAINER CORPORATION

The Industry Standard of Excellence

Mason, Michigan 48854 U.S.A.

Ph: (800) 248-5960 • Fax: (517) 676-3883

Email: sales@dart.biz • www.dartcontainer.com



PRINTED ON RECYCLED PAPER

HORIZON® Stock Printed Insulated Foam Cups



A colorful design to brighten your sales

Horizon's design adds a touch of color to any beverage service, while providing an economical alternative to custom print. Suited for hot or cold beverages, Horizon foam cups are color coded by size in attractive, contemporary colors. Lid interchange between the most popular sizes allows you to simplify your operation and minimize inventory requirements.

Horizon foam cups are printed with UV inks for brighter colors and sharper print definition. UV inks emit no volatile organic compounds into the environment.

- Color-coded by size for easy identification
- Ounce capacity is printed on most cups
- Dual use for hot or cold
- Full range of sizes from 8 oz. to 60 oz.
- Two lid programs—one lid four cups and one lid five cups
- Dart foam cups have never been manufactured with CFCs



One Lid Size Fits Four Different Cups

One Lid Size Fits Five Different Cups



8J8H 10FJ8H 10J10H 12J16H 16J16H 20J16H 24J16H 30AJ20H 32AJ20H 32AJ32H 32TJ32H 44AJ32H 44TJ32H 60AJ32H

| Stock Number | Approx. Capacity (to lid seat) | Print Color | Packing Bag/Case | Case Cube | Case Weight | Lids |
|--------------|--------------------------------|--------------|------------------|-----------|-------------|-------------------|
| 8J8H | 8 oz. | Dark Red | 25/1000 | 3.6 | 6.8 | Any 8 series lid |
| 10FJ8H | 10 oz.* | Plum | 25/1000 | 4.6 | 8.6 | Any 8 series lid |
| 10J10H* | 10 oz. | Plum | 25/1000 | 4.3 | 8.1 | Any 10 series lid |
| 12J16H | 12 oz. | Forest Green | 25/1000 | 5.7 | 10.2 | Any 16 series lid |
| 16J16H | 16 oz. | Cranberry | 25/1000 | 8.7 | 14.0 | Any 16 series lid |
| 20J16H | 20 oz. | Blueberry | 25/500 | 5.5 | 8.6 | Any 16 series lid |
| 24J16H | 24 oz. | Mauve | 20/500 | 7.2 | 10.4 | Any 16 series lid |
| 30AJ20H** | 30 oz.* | Teal | 16/400 | 7.8 | 10.3 | Any 20 series lid |
| 32AJ20H** | 32 oz.* | Teal | 16/400 | 7.9 | 10.9 | Any 20 series lid |
| 32AJ32H*** | 32 oz.* | Teal | 25/500 | 7.7 | 13.0 | Any 32 series lid |
| 32TJ32H | 32 oz. | Teal | 25/500 | 8.5 | 12.8 | Any 32 series lid |
| 44AJ32H** | 44 oz.* | Ocean Blue | 15/300 | 7.7 | 10.6 | Any 32 series lid |
| 44TJ32H | 44 oz. | Ocean Blue | 20/300 | 7.0 | 9.6 | Any 32 series lid |
| 60AJ32H** | 60 oz.* | Green | 8/160 | 7.9 | 9.0 | Any 32 series lid |

Dart's Horizon cups are ideally suited for your every need:



*Flush fill capacity. **May not fit securely in all vehicle makes and models. *May not be available in all sales areas.



For additional information, contact your Dart representative or call 800-248-5960

www.dartcontainer.com

DART CONTAINER CORPORATION
The Industry Standard of Excellence

Mason, Michigan 48854 U.S.A.
Ph: (800) 248-5960 • Fax: (517) 676-3883
Email: sales@dart.biz • www.dartcontainer.com



UPTOWN™

Stock Printed
Foam Cups



Upgrade To Uptown

From bustling city streets to small town charm, Uptown is equally at home with its classic yet trendy design. Rich, bold colors accent the cup's subdued streetscape design, making it easy to distinguish between cup sizes for both customers and employees. Behind the print is premium Thermo-Glaze® quality, keeping beverages at their proper serving temperature longer than any alternative cup—critical for discerning coffee drinkers.

Uptown printed cups are available in five sizes and satisfy a full array of beverage options including coffee, tea, and other specialty drinks. Upgrade to Uptown today!

- Combine Uptown with Dart's award winning Optima® lid for the perfect beverage package "to go"
- Available in 5 popular sizes from 8 oz. to 24 oz.
- Four cup sizes use the same lid size
- Color coding by size for easy product identification
- Dual use for hot and cold
- Now includes a printed environmental message to help promote the positive environmental aspects of foam cups to your customers



A single lid fits four different cups.



8X8TWN



12X16TWN



16X16TWN



20X16TWN



24X16TWN

| Stock Number | Approximate Capacity | Packing Bag/Case | Case Cube | Case Weight | Suggested Lid |
|--------------|----------------------|------------------|-----------|-------------|-------------------|
| 8X8TWN | 8 oz. | 25/1000 | 4.1 | 7.1 | Any 8 series lid |
| 12X16TWN | 12 oz. | 20/1000 | 6.1 | 10.7 | Any 16 series lid |
| 16X16TWN | 16 oz. | 25/1000 | 8.6 | 13.8 | Any 16 series lid |
| 20X16TWN | 20 oz. | 20/500 | 6.5 | 9.6 | Any 16 series lid |
| 24X16TWN | 24 oz. | 20/500 | 7.9 | 11.2 | Any 16 series lid |



FOR ENVIRONMENTAL
INFORMATION, VISIT
WWW.DART.BIZ

DART CONTAINER CORPORATION
The Industry Standard of Excellence

Mason, Michigan 48854 U.S.A.

Ph: (800) 248-5960 • Fax: (517) 676-3883

Email: sales@dart.biz • www.dartcontainer.com

©2016 Dart Container Corporation. All rights reserved.
Dart®, the Dart logo, Uptown™, and Thermo-Glaze® are trademarks of Dart Container Corporation.
M419USED_061317



Impulse®

Stock Printed Foam
Cups & Containers



Profitable sales are made on Impulse

Dart's Impulse stock print is sure to increase impulse sales in your business! The updated design and colors were developed to fit comfortably in any environment where hot or cold food or beverages are served—in convenience stores, cafeterias, coffee shops, at special events, and more.

Each Impulse cup and container is color coded to make it easier for customers and employees to ensure the correct size is selected.

See what Impulse can do to energize food and beverage sales in your business.

- Dual use – one cup or container for both hot and cold
- Easy identification – color coded design with capacity printed on most sizes
- Pedestal-style car cups available – for big drinks on-the-go
- Promotes environmental benefits of foam – a message is printed on each cup and container

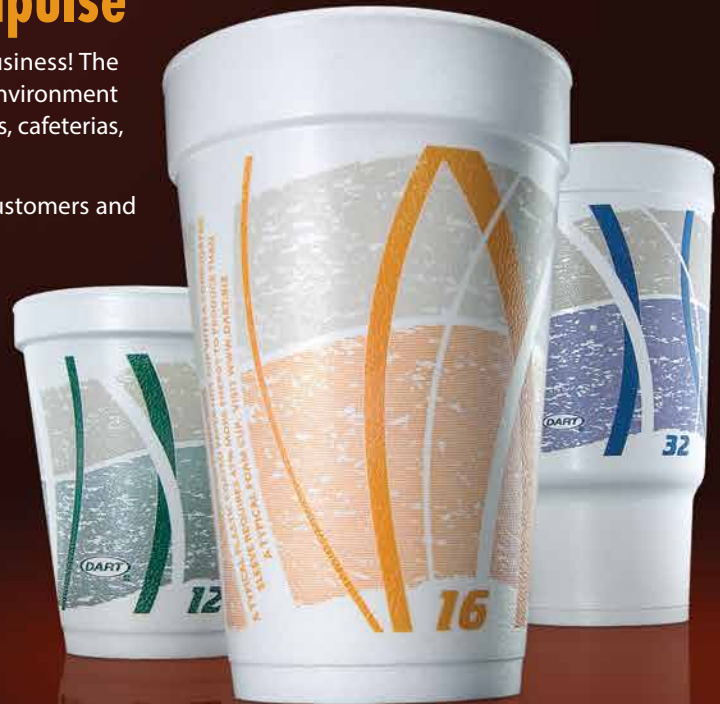

One Lid Size Fits Four Different Cups

Drink Cups



8J8E 12J16E 16J16E 20J16E 24J16E



30AJ20E 32AJ20E 32AJ32E 32TJ32E 44AJ32E 44TJ32E



60AJ32E

Food Containers



8SJ20E 12SJ20E 16MJ20E

| Stock Number | Approx. Capacity (to lid seat) | Print Color | Packing Bag/Case | Case Cube | Case Weight | Lids |
|------------------------|--------------------------------|-------------|------------------|-----------|-------------|-------------------|
| Drink Cups | | | | | | |
| 8J8E | 8 oz. | Red | 25/1000 | 3.6 | 6.8 | Any 8 series lid |
| 12J16E | 12 oz. | Green | 25/1000 | 5.7 | 10.2 | Any 16 series lid |
| 16J16E | 16 oz. | Orange | 25/1000 | 8.7 | 14.0 | Any 16 series lid |
| 20J16E | 20 oz. | Purple | 25/500 | 5.5 | 8.6 | Any 16 series lid |
| 24J16E | 24 oz. | Green | 20/500 | 7.2 | 10.4 | Any 16 series lid |
| 30AJ20E* | 30 oz.** | Blue | 16/400 | 7.8 | 10.3 | Any 20 series lid |
| 32AJ20E | 32 oz.** | Blue | 16/400 | 7.9 | 10.9 | Any 20 series lid |
| 32AJ32E* | 32 oz.** | Blue | 25/500 | 7.7 | 13.0 | Any 32 series lid |
| 32TJ32E | 32 oz. | Blue | 25/500 | 8.5 | 12.8 | Any 32 series lid |
| 44AJ32E | 44 oz.** | Green | 15/300 | 7.7 | 10.6 | Any 32 series lid |
| 44TJ32E | 44 oz. | Green | 20/300 | 7.0 | 9.6 | Any 32 series lid |
| 60AJ32E* | 60 oz.** | Blue | 8/160 | 7.9 | 9.0 | Any 32 series lid |
| Food Containers | | | | | | |
| 8SJ20E* | 8 oz. | Green | 50/1000 | 4.4 | 8.1 | Any 20 series lid |
| 12SJ20E* | 12 oz. | Purple | 25/500 | 3.1 | 5.6 | Any 20 series lid |
| 16MJ20E* | 16 oz. | Orange | 25/500 | 4.1 | 6.5 | Any 20 series lid |

* May not be available in all sales areas.

** Flush fill capacity.

Impulse cups & containers

are ideally suited for
your every need:



FOR ENVIRONMENTAL
INFORMATION, VISIT
WWW.DART.BIZ



Scan this code with your smart
phone for more information.

DART CONTAINER CORPORATION

The Industry Standard of Excellence

Mason, Michigan 48854 U.S.A.
Ph: 800-248-5960 • Fax: 517-676-3883
Email: sales@dart.biz • www.dart.biz



No sleeves or jackets required

Café G® Stock Printed ThermoGlaze® Insulated Foam Cups

Dart's Café G® stock printed insulated foam cups keep hot beverages hot and cold beverages cold while remaining comfortable to the touch. Because this premium line of ThermoGlaze® foam cups keep beverages at their proper serving temperature, coffee will taste fresher longer and there is no need for a sleeve or jacket.





Features

Includes a printed message

Helps promote the positive environmental aspects of foam cups

Printed with UV inks

For brighter colors and excellent print quality



Strong sidewall

Reduces the transfer of heat from the beverage to your hand. No sleeves or jackets required

Color-coded by size

Subtle color coding system in coffee design to help identify correct size



| Stock Number | Approximate Capacity | Packing Bag | Packing Case | Case Cube (ft ³) | Case Weight (lbs) | Suggested Lid |
|--|----------------------|-------------|--------------|------------------------------|-------------------|-------------------|
| Café G® Stock Printed ThermoGlaze® Insulated Foam Cups | | | | | | |
| 4J4G | 4 oz | 50 | 1000 | 2.3 | 4.8 | 4JL |
| 8X8G | 8 oz | 25 | 1000 | 4.1 | 7.1 | Any 8 Series Lid |
| 12X12G | 12 oz | 20 | 1000 | 6.2 | 10.7 | Any 12 Series Lid |
| 12X16G | 12 oz | 20 | 1000 | 6.1 | 10.7 | Any 16 Series Lid |
| 16X16G | 16 oz | 25 | 1000 | 8.6 | 13.8 | Any 16 Series Lid |
| 20X16G | 20 oz | 20 | 500 | 6.5 | 9.6 | Any 16 Series Lid |
| 24X16G | 24 oz | 20 | 500 | 7.9 | 11.2 | Any 16 Series Lid |
| Café G® Stock Printed ThermoGlaze® Individually Wrapped Insulated Foam Cups | | | | | | |
| 8X8GWRAP | 8 oz | 25 | 900 | 4.9 | 8.4 | Any 8 Series Lid |
| 10X10GWRAP | 10 oz | 25 | 900 | 6.1 | 9.7 | Any 10 Series Lid |



For additional information,
contact your Dart representative
or call (800) 248-5960

www.dartcontainer.com

DART CONTAINER CORPORATION

The Industry Standard of Excellence

Mason, Michigan 48854 U.S.A.

Ph: (800) 248-5960 • Fax: (517) 676-3883

Email: sales@dart.biz • www.dartcontainer.com



PRINTED ON RECYCLED PAPER



OPTIMA[®]

RECLOSABLE LID

The solution for people with active lives!



LIFT LOCK & RECLOSE

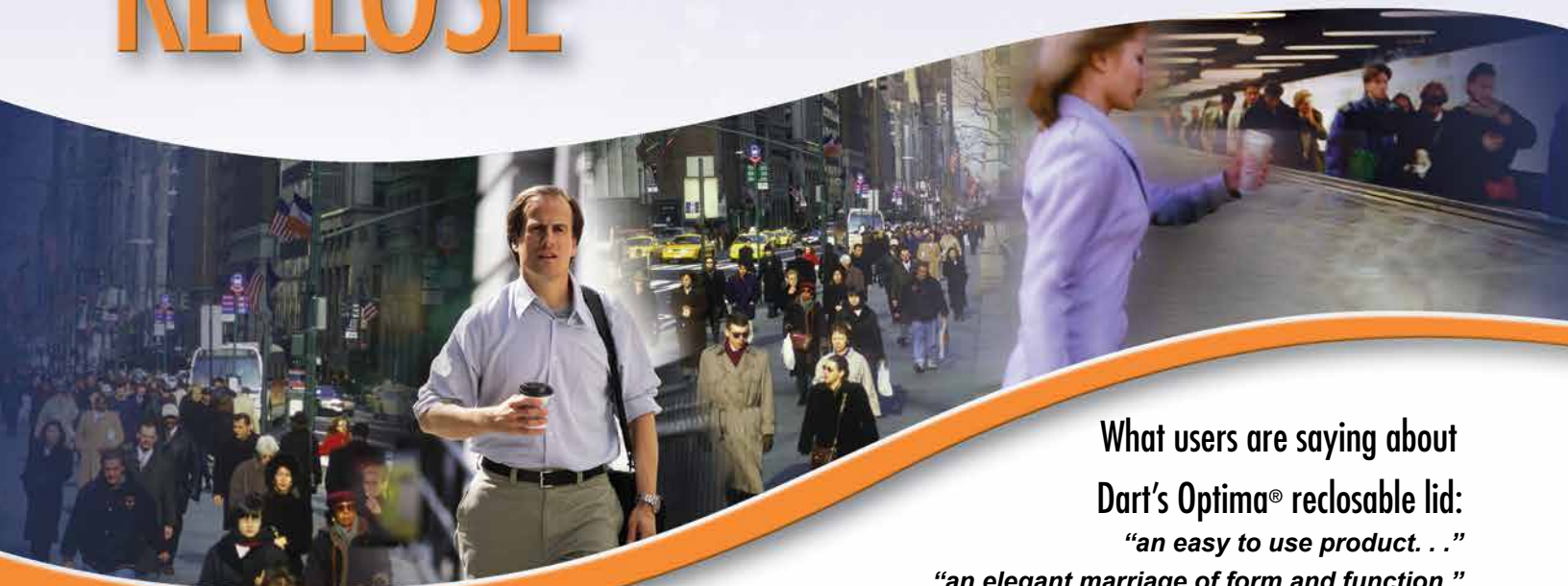

What users are saying about
Dart's Optima[®] reclosable lid:

"an easy to use product. . ."

"an elegant marriage of form and function."

"a startlingly superior to-go coffee lid . . . A++"



The solution for people with active lives!

Optima® offers coffee drinkers a new level of convenience not found in any other cup lid. What makes the Optima lid unique? To start, it provides users with a completely sealed beverage—no open drink hole means less chance of spilling or leaking. When ready to drink, just pull the tab open and lock it back out of the way.

Most notable about Optima, however, is the ability to securely reclose the lid until ready to resume drinking. Not just once, but again and again. Give it a try and we're certain you and your customers will quickly realize that no other lid provides the security, convenience, and quality of the innovative Optima lid from Dart.

Locking Post with Side Latches

Secures tab in the open position

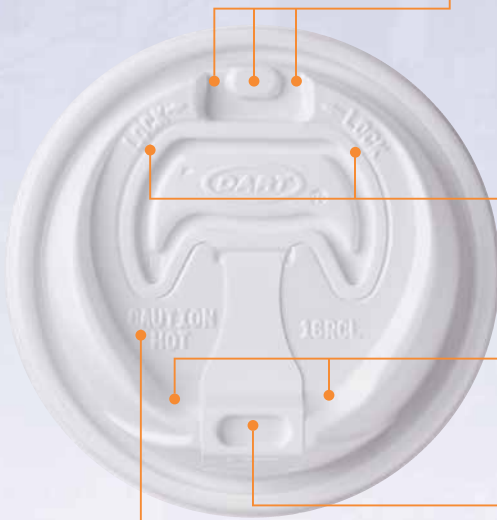

Lock Statement

Identifies where to lock tab in the open position

Contoured Drinking Area

Ergonomically designed drinking spout provides drinking comfort

Drink Well Plug™ on Tab

Provides a leak-resistant seal

Precautionary Statement

Creates beverage temperature awareness



| Stock Number | Style | Packing Bag | Case | Case Cube | Case Weight | For Use With |
|--------------|-------------------|-------------|------|-----------|-------------|----------------------------|
| 16RCL | White, Reclosable | 100 | 1000 | 1.4 | 10.7 | Any 16 lid series foam cup |
| 16RCLBLK | Black, Reclosable | 100 | 1000 | 1.4 | 10.7 | Any 16 lid series foam cup |

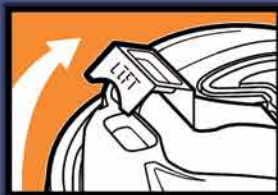

LIFT · LOCK · RECLOSE



For additional information, contact your Dart representative or call 800-248-5960

www.dart.biz

DART CONTAINER CORPORATION

The Industry Standard of Excellence

Mason, Michigan 48854 U.S.A.

Ph: 800-248-5960 • Fax: 517-676-3883

Email: sales@dart.biz • www.dart.biz



Specialty Lids

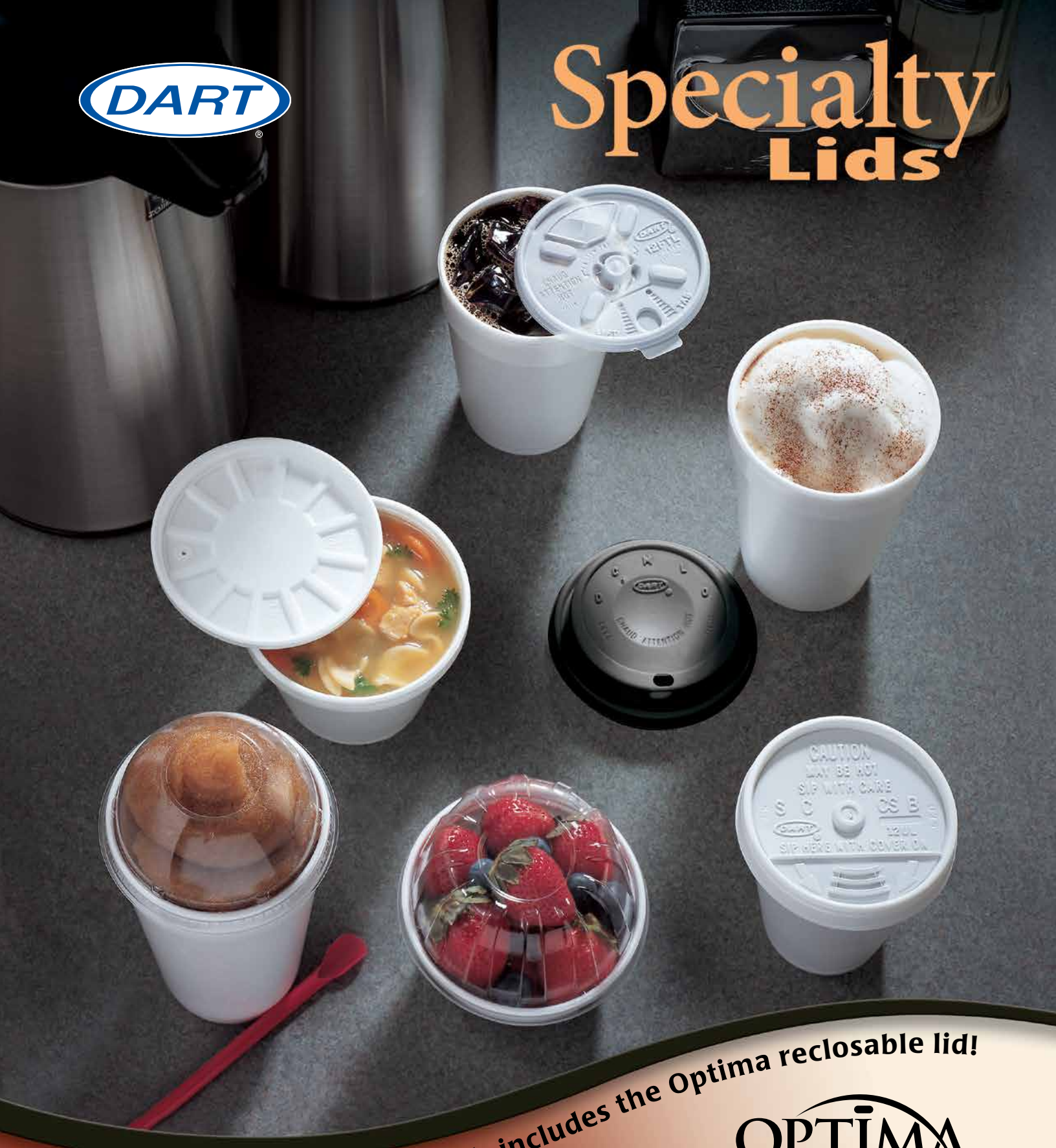

Dart's line-up of specialty lids includes the Optima reclosable lid!

OPTIMA
RECLOSABLE LID

LIFT · LOCK · RECLOSE





- Reclosable tab provides leak-resistant seal
- The ideal solution for gourmet coffee on the go



| Stock Number | Packing | | Case Cube | Case Weight | Use With |
|--------------|---------|------|-----------|-------------|--------------------|
| | Bag | Case | | | |
| 16RCL | 100 | 1000 | 1.4 | 10.7 | 16 lid series cups |
| 16RCLBLK | 100 | 1000 | 1.4 | 10.7 | 16 lid series cups |



- No tearing or pulling; reduces chance of drips or spills
- Allows easy sipping of soft drinks, coffee, tea, or juice



| Stock Number | Packing | | Case Cube | Case Weight | Use With |
|--------------|---------|------|-----------|-------------|--------------------|
| | Bag | Case | | | |
| 8UL | 100 | 1000 | 1.3 | 5.6 | 8 lid series cups |
| 10UL | 100 | 1000 | 1.3 | 6.0 | 10 lid series cups |
| 12UL | 100 | 1000 | 1.5 | 6.7 | 12 lid series cups |
| 16UL | 100 | 1000 | 1.6 | 7.0 | 16 lid series cups |

Clear Dome



- Exceptional clarity provides excellent product visibility
- Ideal for root beer floats, fruit smoothies, "slushie" style drinks, or iced coffee beverages with whipped cream

| Stock Number | Packing | | Case Cube | Case Weight | Use With |
|--------------|---------|------|-----------|-------------|--------------------|
| | Bag | Case | | | |
| 16LCD | 50 | 1000 | 2.2 | 10.4 | 16 lid series cups |
| 16LCDH | 50 | 1000 | 2.2 | 9.9 | 16 lid series cups |
| 16LCDHX | 50 | 1000 | 2.2 | 9.2 | 16 lid series cups |
| 20LCDH | 50 | 1000 | 2.7 | 11.6 | 20 lid series cups |

Clear High Dome

- Increases impulse sales of pre-packaged items
- Tops off sundaes, fruit salads, or other rounded desserts



| Stock Number | Packing | | Case Cube | Case Weight | Use With |
|--------------|---------|------|-----------|-------------|--------------------|
| | Bag | Case | | | |
| 12HDLC | 50 | 1000 | 2.2 | 8.6 | 12 lid series cups |
| 20HDLC | 50 | 1000 | 2.6 | 10.4 | 20 lid series cups |
| 32HDLC | 50 | 500 | 1.7 | 6.4 | 32 lid series cups |

| Cups and Containers | | | | | |
|-----------------------------------|-------------------------------|--|---|---|--|
| 8 Lid Series | 10 Lid Series | 12 Lid Series | 16 Lid Series | 20 Lid Series | 32 Lid Series |
| 6J8, 8J8, 10FJ8, 8X8, 89U8, 8KY8* | 10J10, 12FJ10, 10X10, 10KY10* | 10J12, 12J12, 14J12, 14FJ12, 12X12, 6SJ12, 8SJ12, 6B12 | 12J16, 14J16, 16J16, 20J16, 24J16, 12X16, 14X16*, 16X16, 20X16, 24X16 | 30AJ20*, 32AJ20, 8SJ20, 12SJ20, 16MJ20, 5B20, 6B20, 8B20, 10B20 | 32TJ32, 32AJ32, 44AJ32, 44TJ32, 32X32, 60AJ32*, 8SJ32, 16MJ32, 12B32 |

* Not available in all areas

FOR ENVIRONMENTAL INFORMATION, VISIT WWW.DARTCONTAINER.COM

Specialty Lids

Foam

- Perfect for hot soup or frozen yogurt
- Combine with a foam cup or container for an exceptionally insulated package



| Stock Number | Packing | | Case Cube | Case Weight | Use With |
|--------------|---------|------|-----------|-------------|--------------------|
| | Bag | Case | | | |
| 20RL | 50 | 500 | 1.9 | 3.3 | 20 lid series cups |
| 32RL | 50 | 500 | 2.3 | 3.6 | 32 lid series cups |

Cappuccino

- Elevated platform reduces the chance of spills
- Perfect upscale complement to carryout gourmet coffee



| Stock Number | Packing | | Case Cube | Case Weight | Use With |
|--------------|---------|------|-----------|-------------|--------------------|
| | Bag | Case | | | |
| 8EL | 100 | 1000 | 1.1 | 6.8 | 8 lid series cups |
| 8ELBLK | 100 | 1000 | 1.1 | 6.8 | 8 lid series cups |
| 10EL | 100 | 1000 | 1.3 | 7.3 | 10 lid series cups |
| 12EL | 100 | 1000 | 1.4 | 8.0 | 12 lid series cups |
| 16EL | 100 | 1000 | 1.4 | 9.0 | 16 lid series cups |
| 16ELBLK | 100 | 1000 | 1.4 | 9.0 | 16 lid series cups |



- Closing tab helps avoid spills
- Great for coffee, soft drinks, shakes, juice, tea, or water



| Stock Number | Packing | | Case Cube | Case Weight | Use With |
|--------------|---------|------|-----------|-------------|--------------------|
| | Bag | Case | | | |
| 8FTL | 100 | 1000 | 1.0 | 4.7 | 8 lid series cups |
| 10FTL | 100 | 1000 | 1.1 | 5.2 | 10 lid series cups |
| 12FTL | 100 | 1000 | 1.2 | 5.5 | 12 lid series cups |
| 16FTL | 100 | 1000 | 1.3 | 6.0 | 16 lid series cups |
| 12FTLS | 100 | 1000 | 1.2 | 5.5 | 12 lid series cups |
| 16FTLS | 100 | 1000 | 1.3 | 6.0 | 16 lid series cups |

Lid Compatibility

Understanding cup and container lid compatibility:

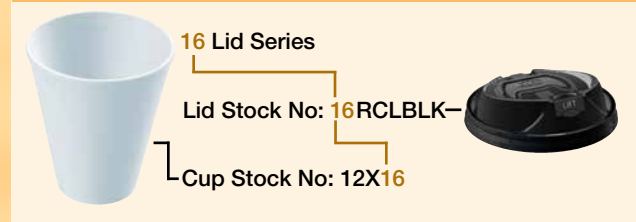

DART CONTAINER CORPORATION
The Industry Standard of Excellence

Mason, Michigan 48854 U.S.A.
Ph: (800) 248-5960 • Fax: (517) 676-3883
Email: sales@dart.biz • www.dartcontainer.com





Custom Print

- Insulated Foam Cups, Bowls, & Containers · Clear Plastic Cups ·
- Transparent Plastic Cups · Translucent Plastic Cups ·
- White Plastic Cups · Plastic Deli Containers & Lids ·



Customize your food and beverage program!



Custom Print

Increase your name recognition with brilliant color!

Dart custom print can boost your sales and profits by increasing the exposure of your business name and message. The quality of Dart products upholds the image of your business, while custom print increases your market visibility.

An added benefit of custom printing is a coordinated look with your other branded items such as menus and signs. Your business will present a unified look which further reinforces your company identity.

Available on both foam and plastic products, Dart custom printing will add color and style to your foodservice program.

Take advantage of these Custom Print features provided by Dart:

- **Ultraviolet inks** for brighter colors and sharper print definition (uv inks emit no volatile organic compounds into the environment)
- **Pantone® color coordination** with other printed items in your business
- Printing available in **up to four spot colors** on foam cups, translucent cold cups, and deli containers
- Printing available in **up to six spot colors** on all clear, transparent, and white plastic cups
- **Low minimum order quantities**



FOR ENVIRONMENTAL
INFORMATION, VISIT
WWW.DART.BIZ

DART CONTAINER CORPORATION
The Industry Standard of Excellence

Mason, Michigan 48854 U.S.A.
Ph: 800-248-5960 • Fax: 517-676-3883
Email: sales@dart.biz • www.dart.biz



Superb graphics and superior insulation



Graphically-Enhanced Insulated Cups

Fusion® cups offer an excellent solution for your upscale, gourmet beverage program. With the most appealing and inviting gourmet beverage package available today, these cups are certain to increase customer satisfaction as well as enhance your business image.

Gourmet coffee customers will appreciate the comfort of using Fusion cups thanks to its unique ThermoThin™ core. ThermoThin offers superior insulation over paper hot cups, creating a cup that isn't too hot to hold. ThermoThin also means less waste and cost by eliminating the need for double-cupping or cup sleeves.





Features

ThermoThin™ Core

Maintains hot and cold beverage serving temperature and taste while keeping cup sidewall comfortable to the touch

Strong Sidewall

Reinforces cup durability and prevents seeps, thereby reducing customer complaints and increasing operator repeat business

4 Cups/1 Lid Size

Stock one lid size to accommodate 4 different Fusion® cups; pair with our award winning Optima® reclosable lid for exceptional performance and style



Molded Rolled Lip

Provides for comfortable drinking and secure lidding

Fotofinish®

Magazine-quality print surface allows for detailed graphics, top-to-bottom coverage, and amazing process printing unlike any other hot cup

Two Attractive Stock Prints

Stock printed designs include a positive environmental message along with "Caution - May Be Hot!" statement in English, French, and Spanish

Foot Stack

Allows for easy one-hand separation of stacked cups

Stock Print



Custom Print

| Stock Number | Product Description | Sleeve | Case Pack | Case Cube ft ³ | Case Weight lb | Use With |
|-----------------------|---------------------|--------|-----------|---------------------------|----------------|-------------------|
| Fusion Steele® | | | | | | |
| 89U8FS | 8 oz | 25 | 1000 | 4.8 | 10.4 | Any 8 series lid |
| 12U16FS | 12 oz | 20 | 1000 | 5.5 | 12.4 | Any 16 series lid |
| 16U16FS | 16 oz | 25 | 1000 | 7.3 | 15.4 | |
| 20U16FS | 20 oz | 20 | 500 | 5.2 | 10.0 | |
| 24U16FS | 24 oz | 20 | 500 | 6.5 | 12.0 | |
| Escape® | | | | | | |
| 89U8ESC | 8 oz | 25 | 1000 | 4.8 | 10.4 | Any 8 series lid |
| 12U16ESC | 12 oz | 20 | 1000 | 5.5 | 12.4 | Any 16 series lid |
| 16U16ESC | 16 oz | 25 | 1000 | 7.3 | 15.4 | |
| 20U16ESC | 20 oz | 20 | 500 | 5.2 | 10.0 | |
| 24U16ESC | 24 oz | 20 | 500 | 6.5 | 12.0 | |
| Custom Print | | | | | | |
| 89U8 | 8 oz | 25 | 1000 | 4.8 | 10.4 | Any 8 series lid |
| 12U16 | 12 oz | 20 | 1000 | 5.5 | 12.4 | Any 16 series lid |
| 16U16 | 16 oz | 25 | 1000 | 7.3 | 15.4 | |
| 20U16 | 20 oz | 20 | 500 | 5.2 | 10.0 | |
| 24U16 | 24 oz | 20 | 500 | 6.5 | 12.0 | |
| 32AU20 | 32 oz | 20 | 400 | 8.0 | 10.8 | Any 20 series lid |
| 44AU32 | 44 oz | 20 | 300 | 7.1 | 10.2 | Any 32 series lid |



For additional information, contact your Dart representative or call (800) 248-5960

www.dartcontainer.com

DART CONTAINER CORPORATION

The Industry Standard of Excellence

Mason, Michigan 48854 U.S.A.

Ph: (800) 248-5960 • Fax: (517) 676-3883

Email: sales@dart.biz • www.dartcontainer.com





ICE CUP



Profits heat up while customers cool down, enjoying their favorite beverage “on the rocks.”

When filled with ice, Dart’s insulated Ice Cup becomes the perfect traveling companion for bottled or canned juices, soft drinks, and teas. Great for convenience stores, quick service restaurants, cafeterias, hospitals, colleges... anywhere cold beverages are enjoyed.

| Feature | | Advantage | | Benefit | | |
|--------------------------------------|----------|--|--------------|---|-------------|-------------------|
| Insulation | | Reduces condensation, maintains beverage temperature and slows ice melt | | Increases customer satisfaction by retaining beverage flavor and enhances overall drinking experience | | |
| Eye-Catching Graphics | | Bright design enhances business image | | No need for custom print | | |
| No Minimum Order Quantity | | Reduces inventory needs and improves inventory turns | | Enhances efficiency by saving space on the counter or in the storage room | | |
| Wide Variety of Lid Styles Available | | Allows for creation of beverage package best suited to product application | | Increases customer satisfaction by offering variety of beverage packages | | |
| Seamless, One-Piece Construction | | Cups won't separate at the seams | | Avoids customer complaints due to leaking or accidents | | |
| Unique Stock Number | | Easy to understand | | Avoids ordering mistakes and prevents out of stocks; thereby increasing operator efficiency | | |
| Stock Number | Capacity | Packing Bag | Packing Case | Case Cube | Case Weight | Use Lid |
| 14J161 | 16 oz. | 25 | 1000 | 7.6 | 12.5 | Any 16 Series Lid |

DART CONTAINER CORPORATION

The Industry Standard of Excellence

Mason, Michigan 48854 U.S.A.
 Ph: 800-248-5960 • Fax: 517-676-3883
 Email: sales@dart.biz • www.dart.biz

FOR ENVIRONMENTAL INFORMATION, VISIT WWW.DART.BIZ



A colorful design to
increase your sales!



Horizon Stock Printed Cups

Horizon LX foam cups stand above all others in customer appeal. The upscale flared lip styling, smooth cup wall, and high luster finish are an unbeatable combination. The Horizon stock printed design adds a touch of color to any beverage service, while providing an economical alternative to custom printing.





Horizon® LX®

Stock Printed Insulated Foam Cups

Features

- Printed with UV Inks**
For brighter colors and excellent print quality
- Great Lid Program**
4 cups use the same size Lid
- Dual Use**
For hot and cold
- Portion Control Sizing**
Increases profitability



- Color Coded by Size**
For easy identification
- Printed Ounce Capacity**
Improves check-out accuracy
- 30AJ20H, 32AJ20H & 44AJ32H**
Fit standard cup holders**

Horizon® LX®



8LX8H

10LX10H

12LX16H

16LX16H

20LX16H

24LX16H

30AJ20H

32AJ20H

32LX32H

44AJ32H

44TJ32H

| Stock Number | Description | Print Color | Packaging per Bag/Case | Case Cube | Case Weight | Lid Stock Number |
|--------------|-------------|--------------|------------------------|-----------|-------------|--|
| 8LX8H | 8 oz. | Dark Red | 25/1000 | 4.1 | 6.9 | 8JL, 8SL, 8FTL, 8UL, 8EL |
| 10LX10H | 10 oz. | Plum | 20/1000 | 5.3 | 8.9 | 10JL, 10SL, 10FTL, 10UL, 10EL |
| 12LX16H | 12 oz. | Forest Green | 20/1000 | 6.1 | 10.4 | 4 cups / 1 lid Choose from eleven lid styles to fit all five cup sizes: 16JL, 16SL, 16FTL, 16FTLS, 16UL, 16 EL, 16ELBLK, 16LCD, 16LCDH, 16RCL, 16RCLBLK |
| 16LX16H | 16 oz. | Cranberry | 25/1000 | 8.6 | 13.3 | |
| 20LX16H | 20 oz. | Blueberry | 20/500 | 6.5 | 9.4 | |
| 24LX16H | 24 oz. | Mauve | 20/500 | 7.9 | 10.9 | |
| 30AJ20H | 30 oz. | Teal | 16/400 | 7.8 | 10.3 | 20SL, 20JLNV, 20CL, 20DLC, 20DLV, 20HDLC |
| 32AJ20H | 32 oz. | Teal | 16/400 | 7.9 | 10.9 | 20SL, 20JLNV, 20CL, 20DLC, 20DLV, 20HDLC |
| 32LX32H | 32 oz. | Teal | 20/500 | 9.2 | 13.1 | 32JL, 32SL, 32CLR, 32PL |
| 44AJ32H | 44 oz. | Ocean Blue | 15/300 | 7.7 | 10.6 | 32JL, 32SL, 32CLR, 32PL |
| 44TJ32H | 44 oz.* | Ocean Blue | 20/300 | 7.0 | 9.6 | 32JL, 32SL, 32CLR, 32PL, 32RL, 32HDLC |

Products listed may not be available in all sales areas
 * Practical Fill Capacity
 ** May not fit securely in all makes and models



For additional information,
 contact your Dart representative
 or call (800) 248-5960
www.dartcontainer.com

DART CONTAINER CORPORATION
The Industry Standard of Excellence
 Mason, Michigan 48854 U.S.A.
 Ph: (800) 248-5960 • Fax: (517) 676-3883
 Email: sales@dart.biz • www.dartcontainer.com

Impulse LX

Stock Printed Foam
Cups & Containers



Profitable sales are made on Impulse

Dart's Impulse stock print is sure to increase impulse sales in your business! The updated design and colors were developed to fit comfortably in any environment where hot or cold food or beverages are served—in convenience stores, cafeterias, coffee shops, at special events, and more.

Each Impulse cup and container is now color coded to make it easier for customers and employees to ensure the correct size is selected. And, with Impulse, you benefit from low minimum order requirements and quick turnaround times, as well as a cost savings when compared to custom printed products.

See what Impulse can do to energize food and beverage sales in your business.

- Dual use – one cup or container for both hot and cold
- Easy identification – color coded design with capacity printed on each size
- Pedestal-style car cups available – for big drinks on-the-go
- Promotes environmental benefits of foam – a message is printed on each cup and container

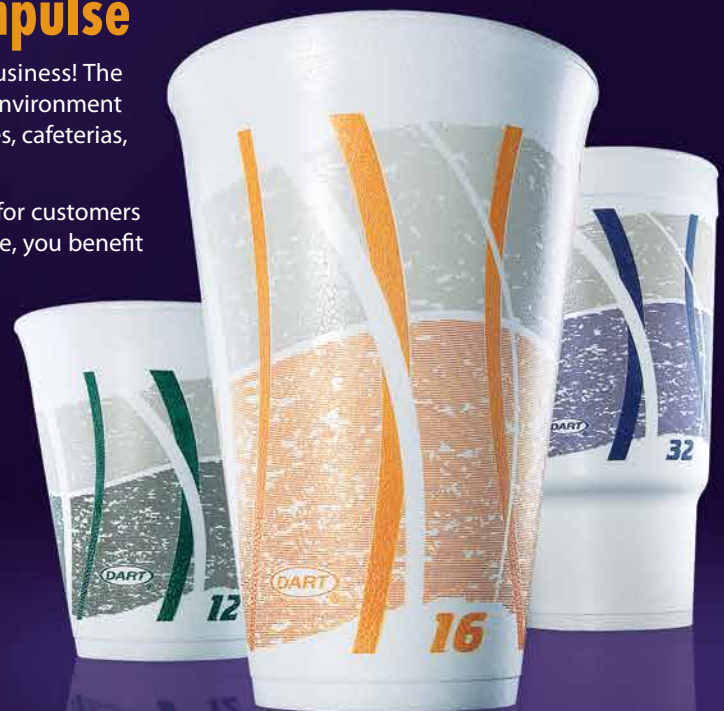

One Lid Size Fits Four Different Cups



| Stock Number | Description | Print Color | Packing Bag/Case | Case Cube | Case Weight | Lids |
|------------------------|-------------|-------------|------------------|-----------|-------------|-------------------|
| Drink Cups | | | | | | |
| 8LX8E | 8 oz. | Red | 25/1000 | 4.1 | 6.9 | Any 8 series lid |
| 12LX16E | 12 oz. | Green | 20/1000 | 6.1 | 10.4 | Any 16 series lid |
| 16LX16E | 16 oz. | Orange | 25/1000 | 8.6 | 13.3 | Any 16 series lid |
| 20LX16E | 20 oz. | Purple | 20/500 | 6.5 | 9.4 | Any 16 series lid |
| 24LX16E | 24 oz. | Green | 20/500 | 7.9 | 10.9 | Any 16 series lid |
| 32AJ20E | 32 oz. | Blue | 16/400 | 7.9 | 10.9 | Any 20 series lid |
| 32AJ32E | 32 oz. | Blue | 25/500 | 7.7 | 13.0 | Any 32 series lid |
| 32LX32E | 32 oz. | Blue | 20/500 | 9.2 | 13.1 | Any 32 series lid |
| 44AJ32E | 44 oz. | Green | 15/300 | 7.7 | 10.6 | Any 32 series lid |
| 44TJ32E | 44 oz.* | Green | 20/300 | 7.0 | 9.6 | Any 32 series lid |
| 60AJ32E | 60 oz.* | Blue | 8/160 | 7.9 | 9.0 | Any 32 series lid |
| Food Containers | | | | | | |
| 8SJ20E | 8 oz.* | Green | 50/1000 | 4.4 | 8.1 | Any 20 series lid |
| 12SJ20E | 12 oz.* | Purple | 25/500 | 3.1 | 5.6 | Any 20 series lid |
| 16MJ20E | 16 oz.* | Orange | 25/500 | 4.1 | 6.5 | Any 20 series lid |

Impulse cups & containers

are ideally suited for
your every need:



* Practical fill capacity. All other items flush fill capacity.

FOR ENVIRONMENTAL
INFORMATION, VISIT
WWW.DART.BIZ

DART CONTAINER CORPORATION

The Industry Standard of Excellence

Mason, Michigan 48854 U.S.A.
Ph: 800-248-5960 • Fax: 517-676-3883
Email: sales@dart.biz • www.dart.biz



Graduated Stock Printed Foam Cup

For All of Your Patient's Bedside Water Service Needs



| | |
|------------------------------|--|
| Item | 16J16GRA |
| Description | 16 oz Graduated Stock Print |
| Packing Bag | 25 |
| Packing Case | 1000 |
| Case Cube (ft ³) | 8.8 |
| Case Weight (lbs) | 14.0 |
| Lids | 16SL - Translucent, Straw-Slotted 16FTLS - Translucent, Straw-Slotted 16FTL - White, Lift 'n' Lock 16UL - White, Sip Thru® 16EL - White, Cappuccino 16RCL - White, Optima® Reclosable Lid |



16FTLS
Straw-Slotted



16FTL
Lift 'n' Lock



16UL
Sip Thru®



16EL
Cappuccino



16RCL
Optima® Reclosable Lid

Graduated Sip System



16SL
Straw-Slotted



875WX-2050
Flexible Straw - Paper
Wrapped, Super Jumbo



16J16GRA
Insulated Foam Cup

Increase patient satisfaction while improving efficiencies

- **Graduation lines** (CC's, ML's, and ounces) help nurses save time charting I's and O's
- **Insulated foam** keeps hot and cold beverages at the proper serving temperature; reduces ice melt and sidewall condensation, minimizes refill trips, and increases overall patient satisfaction
- **Single use cup**, provides an economical and sterile solution to minimize cross contamination
- **Top off with a straw-slot lid and flexible straw (Graduated Sip System)** to provide patients with an easy, no-pour drinking vessel, and minimize spills



For additional information, contact your Dart representative or call (800) 248-5960

www.dartcontainer.com



©2018 Dart Container Corporation. All rights reserved. Dart® and the Dart logo are trademarks of Dart Container Corporation. Solo® and the Solo logo are trademarks of Solo Cup Operating Corporation. Used with permission. MC2514USE_041018



A single cup solution for hot and cold beverages

Trophy® Plus™ Dual Temperature Insulated Cups

- **Cost control** – the efficiency of two cups in one and a common lid streamlines inventory
- **Case and space management** – compact cups nest tightly so more fit in a stack, reducing the frequency of dispenser refills, and a smaller case cube makes transportation more efficient, freeing up storage space
- **Upscale graphics** – top-to-bottom print capability and a glossy finish creates a billboard for custom graphics and branded messaging
- **Built to perform** – a rolled rim tightly secures the lid, increased rigidity provides added strength, and Cozy® Touch™ insulation ensures customer comfort



Features

5 Cup sizes

1 Lid

Lid choices:

Use any of these lids on the 12, 16, 20, 22 and 24 oz Trophy® Plus™ cups!



Lift & Lock Tab w/Straw Slot Translucent



The Gourmet Lid® White



Dome Lid with Hole Clear



The Gourmet Lid® Black

16 oz

20 oz

22 oz



* Only available to the Dallas plant served area



Space efficiency
close nesting for space saving

Enhanced glossy, top-to-bottom graphics
creates an upscale image

Cozy® Touch™
reduces cold drink condensation & heat transfer

Rolled rim
leak-resistant, secure lid fit

True flush fill
allows for cost control

Strong sidewalls



Trophy® Plus™



Jazz®



Mistique®



Symphony®

Hot Beverage Lids



The Gourmet Lid®
White



The Gourmet Lid®
Black



Flat Liftback 'n'
Lock Tab Lid
White

Cold Beverage Lids



Dome Lid
with Hole
Clear



Identification
Straw Slot Lid
Translucent



Lift & Lock Tab Lid
w/Straw Slot
Translucent

Hot & Cold Beverage Lid

| Trophy® Plus™ | 8 oz (Vending) | 8 oz | 9 oz (Indv Wrapped) | 10 oz | 12 oz (Vending) | 12 oz | 16 oz | 20 oz | 22 oz | 24 oz | 33 oz |
|--------------------|----------------|----------|---------------------|------------|-----------------|-----------|------------|------------|------------|-------------|------------|
| Jazz® | V8X-00055 | X8-00055 | WX9-64568 | X10N-00055 | V12TX-00055 | X12-00055 | X16N-00055 | X20N-00055 | X22N-00055 | — | X33N-00055 |
| Mistique® | — | X8-0029 | — | — | — | X12-0029 | X16N-0029 | X20N-0029 | — | XN246-0029 | — |
| Symphony® | — | X8-J8002 | WX9-J8002 | X10N-J8002 | — | X12-J8002 | X16N-J8002 | X20N-J8002 | X22N-J8002 | XN246-J8002 | X33N-J8002 |
| Ti/Hi | 6/3 | 9/4 | 9/4 | 6/3 | 8/3 | 7/3 | 9/3 | 6/3 | 6/3 | 6/3 | 8/3 |
| Tube/Case Quantity | 35/1050 | 100/1000 | 900/900 | 60/1500 | 35/700 | 100/1000 | 50/750 | 30/750 | 30/750 | 24/600 | 40/480 |
| Case Cube (ft3) | 3.7 | 2.8 | 2.8 | 4.7 | 3.3 | 3.9 | 3.5 | 5.3 | 5.4 | 5.8 | 4.2 |
| Case Weight (lbs) | 1.1 | 9.2 | 10.5 | 16.2 | 9.5 | 12.3 | 11.4 | 13.4 | 15.1 | 12.9 | 13.0 |
| Case (in) | | | | | | | | | | | |
| Length | 18.0 | 15.9 | 16.0 | 18.6 | 17.0 | 17.6 | 17.6 | 19.3 | 19.3 | 19.3 | 17.4 |
| Case Width | 15.0 | 13.0 | 13.0 | 15.2 | 13.5 | 14.3 | 10.7 | 15.8 | 15.8 | 15.8 | 13.1 |
| Case Height | 24.0 | 23.2 | 23.0 | 28.6 | 25 | 26.5 | 32.1 | 29.9 | 30.6 | 32.6 | 31.4 |

Hot Beverage Lids

| | | | | | | | | | | | |
|--|---|-------------|-------------|--------------|---|-------------|-------------|-------------|-------------|-------------|---|
| The Gourmet Lid® — White | — | LGX8R1-0007 | LGX8R1-0007 | — | — | LGXW2-0007 | LGXW2-0007 | LGXW2-0007 | LGXW2-0007 | LGXW2-0007 | — |
| The Gourmet Lid® — Black | — | — | — | — | — | LGXBK2-0004 | LGXBK2-0004 | LGXBK2-0004 | LGXBK2-0004 | LGXBK2-0004 | — |
| Flat Liftback 'n' Lock Tab Lid — White | — | DLX8R-00007 | DLX8R-00007 | DLX10R-00007 | — | — | — | — | — | — | — |

Hot & Cold Beverage Lid

| | | | | | | | | | | | |
|---|---|---|---|---|---|--------------|--------------|--------------|--------------|--------------|---|
| Lift & Lock Tab Lid w/ Straw Slot — Translucent | — | — | — | — | — | LX2SBR-00100 | LX2SBR-00100 | LX2SBR-00100 | LX2SBR-00100 | LX2SBR-00100 | — |
|---|---|---|---|---|---|--------------|--------------|--------------|--------------|--------------|---|

Cold Beverage Lids

| | | | | | | | | | | | |
|-------------------------------|---|---|---|---|---|--------------|--------------|--------------|--------------|--------------|-------------|
| Identification Straw Slot Lid | — | — | — | — | — | — | — | — | — | — | LX33BN-0100 |
| Dome Lid with Hole — Clear | — | — | — | — | — | LDAX2N-00090 | LDAX2N-00090 | LDAX2N-00090 | LDAX2N-00090 | LDAX2N-00090 | — |

* Only available to the Dallas plant served area



For additional information,
contact your Dart representative
or call (800) 248-5960
www.dartcontainer.com

DART CONTAINER CORPORATION

The Industry Standard of Excellence

Mason, Michigan 48854 U.S.A.

Ph: (800) 248-5960 • Fax: (517) 676-3883

Email: sales@dart.biz • www.dartcontainer.com



Quality Cups,
Economical Solution

Conex® Galaxy® Translucent Cups

- **Full range of sizes** – From 3 oz to 54 oz
- **Custom print** – Smooth sidewalls are ideal for custom print up to 4 colors
- **Custom print** – Select ribbed cups available for custom print up to 4 colors
- **Beyond translucent** – Select smooth-wall cup sizes also available in red, white, or blue



Perfect Pak® Cases of Conex® Galaxy® Cups



Y5PFTPK



Y7PFTPK



Y10PFTPK



Y12TPFTPK



Y16PFTPK

| Item | Description | Sleeve | Bags Per Case | Items Per Case | Case Cube (ft ³) | Case Weight (lbs) |
|--|---|--------|---------------|----------------|------------------------------|-------------------|
| Perfect Pak® Cases of Conex® Galaxy® Cups | | | | | | |
| Y5PFTPK | 5 oz Perfect Pak® cases of Conex® Galaxy® cups - Translucent | 50 | 15 | 750 | 0.8 | 5.5 |
| Y7PFTPK | 7 oz Perfect Pak® cases of Conex® Galaxy® cups - Translucent | 50 | 15 | 750 | 0.9 | 7.1 |
| Y10PFTPK | 10 oz Perfect Pak® cases of Conex® Galaxy® cups - Translucent | 50 | 10 | 500 | 0.9 | 13.3 |
| Y12TPFTPK | 12 oz Perfect Pak® cases of Conex® Galaxy® cups - Translucent | 25 | 20 | 500 | 1.7 | 8.3 |
| Y16PFTPK | 16 oz Perfect Pak® cases of Conex® Galaxy® cups - Translucent | 25 | 20 | 500 | 1.6 | 10.4 |

Conex® Galaxy® Translucent Cups – Ribbed



| Item | Description | Print Capability | Sleeve | Case Pack | Case Cube (ft ³) | Case Weight (lbs) | Use With |
|--|-----------------------------|------------------|--------|-----------|------------------------------|-------------------|--|
| Conex® Galaxy® Translucent Cups - Ribbed | | | | | | | |
| Y35 | 3.5 oz | ○ | 100 | 2500 | 1.6 | 14.2 | — |
| Y5 | 5 oz | ○ | 100 | 2500 | 2.8 | 18.2 | 605TP |
| 5N25 | 5 oz | ○ | 100 | 2500 | 2.2 | 19.9 | L7N25 |
| 7N25 | 7 oz | ○ | 100 | 2500 | 2.6 | 23.3 | |
| Y7 | 7 oz | ⊙ | 100 | 2500 | 2.5 | 22.8 | PL4TSN, PL4N, DLR685, DNR685 |
| Y9 | 9 oz | ⊙ | 100 | 2500 | 3.0 | 30.5 | 600TS |
| Y10 | 10 oz | ⊙ | 100 | 2500 | 3.5 | 36.2 | |
| Y12T | 12 oz Tall | ⊙ | 50 | 1000 | 2.9 | 16.2 | 640TS, M640S, 640TP, DLR640, DNR640 |
| Y12S | 12 oz Squat | ○ | 50 | 1000 | 2.3 | 16.3 | 695TS |
| Y14 | 14 oz | ⊙ | 50 | 1000 | 2.4 | 17.6 | |
| Y16T | 16 oz Tall | ⊙ | 50 | 1000 | 2.5 | 20.0 | LC16BLR, L16BL-0100, DLR16-0090, DLW16 |
| Y20 | 20 Oz | ⊙ | 50 | 1000 | 3.9 | 29.0 | 624TS |
| Y16S | 16 oz Practical-Fill Squat | ⊙ | 50 | 1000 | 4.0 | 25.6 | 626TS, 626TP, DLR626, DNR626, DLW626 |
| Y24 | 24 oz | ⊙ | 50 | 1000 | 4.8 | 32.6 | |
| Y32 | 32 oz | ⊙ | 50 | 500 | 3.0 | 21.4 | 636TS, DL639 |
| Conex® Galaxy® Individually Wrapped Translucent Cold Cups | | | | | | | |
| Y9WRAP | 9 oz - Individually Wrapped | ⊙ | 50 | 1000 | 1.6 | 15.0 | — |

Print Capability: ○ Not available printed. ⊙ Available printed or unprinted. ● Available printed only

Please note, select lids are interchangeable with other Dart plastic cup lines, portion container lines, and/or paper cold cup lines. Please refer to your Dart sales representative or visit www.dartcontainer.com for confirmation of product compatibility.

Features

Rolled rim

Provides secure lid fit for leak resistance

Contact clarity

Provides easy beverage identification



Flush-fill capacity

Provides portion control*
(*excludes P12S, P16, P32)

Custom print

Most sizes available in up to 4-color printing

Select sizes also available in red, white, or blue



Solo® Party Cups – Smoothwall



| Item | Description | Print Capability | Sleeve | Case Pack | Case Cube (ft ³) | Case Weight (lbs) | Use With |
|--------------------------------------|------------------------------------|------------------|--------|-----------|------------------------------|-------------------|--------------------------------------|
| Solo® Party Cups - Smoothwall | | | | | | | |
| P3A | 3 oz | ○ | 100 | 2500 | 1.5 | 14.1 | |
| P35A | 3.5 oz | ● | 100 | 2500 | 1.7 | 20.7 | |
| TK35 | 3.5 oz – Clear PS | ⊙ | 100 | 2500 | 1.7 | 20.1 | PL200N |
| P5 | 5 oz | ⊙ | 100 | 2500 | 3.7 | 21.7 | 605TP |
| P7 | 7 oz | ● | 100 | 2500 | 3.2 | 29.0 | |
| P7R | 7 oz – Red | ○ | 100 | 2500 | 3.2 | 29.1 | PL4TSN, PL4N, DLR685, DNR685 |
| P9 | 9 oz | ● | 100 | 2500 | 3.2 | 33.0 | |
| P10 | 10 oz | ● | 100 | 2500 | 3.4 | 36.1 | |
| P10R | 10 oz – Red | ○ | 100 | 2500 | 3.4 | 36.2 | 600TS |
| P12T | 12 oz Tall | ● | 50 | 1000 | 2.2 | 18.0 | |
| P12TW | 12 oz Tall – White | ● | 50 | 1000 | 2.2 | 18.0 | 640TS, M640S, 640TP, DLR640, DNR640 |
| P12S | 12 oz Practical-Fill Squat | ● | 50 | 1000 | 3.1 | 21.8 | |
| P12SB | 12 oz Practical-Fill Squat – Blue | ○ | 50 | 1000 | 3.1 | 22.0 | |
| P12SR | 12 oz Practical-Fill Squat – Red | ○ | 50 | 1000 | 3.1 | 22.0 | |
| P12SW | 12 oz Practical-Fill Squat – White | ⊙ | 50 | 1000 | 3.1 | 21.8 | 662TS, 662TP, DLR662, DNR662, DLW662 |
| P20 | 20 oz | ● | 50 | 1000 | 4.3 | 32.6 | |
| P20W | 20 oz – White | ● | 50 | 1000 | 4.3 | 32.6 | |
| P16 | 16 oz Practical-Fill | ⊙ | 50 | 1000 | 3.2 | 26.1 | |
| P16B | 16 oz Practical-Fill – Blue | ○ | 50 | 1000 | 3.2 | 26.1 | |
| P16R | 16 oz Practical-Fill – Red | ⊙ | 50 | 1000 | 3.2 | 26.1 | |
| P16W | 16 oz Practical-Fill – White | ⊙ | 50 | 1000 | 3.2 | 26.1 | 626TS, 626TP, DLR626, DNR626, DLW626 |
| P24 | 24 oz | ● | 50 | 1000 | 4.2 | 41.9 | |
| P24W | 24 oz – White | ● | 50 | 1000 | 4.2 | 41.9 | |
| P32 | 32 oz Practical-Fill | ● | 25 | 300 | 2.4 | 18.6 | 636TS, DL639 |
| CD54W | 54 oz Practical-Fill – White | ● | 20 | 240 | 3.4 | 23.3 | 642TS, 44LCDH |



Lids for Conex® Galaxy® and Solo® Party Cups



Flat Lid
No Straw Slot



Flat Lid
with Straw Slot



Dome Lid
with No Hole



Dome Lid
with Hole



Dome Lid
with Wide Hole

| Item | Description | Sleeve | Case Pack | Case Cube (ft ³) | Case Weight (lbs) | Use With |
|--------------|---------------------------------|--------|-----------|------------------------------|-------------------|---------------------------------------|
| PL200N | Non-Vented Lid | 125 | 2500 | 1.7 | 8.0 | P35A |
| 605TP | Non-Vented Lid | 100 | 2500 | 2.2 | 9.3 | Y5, P5 |
| L7N25 | Non-Vented Translucent | 100 | 2500 | 1.9 | 7.8 | 5N25, 7N25 |
| PL4N | Non-Vented Lid | 125 | 2500 | 2.5 | 12.0 | Y7, P7, P7R |
| PL4TSN | Straw-Slotted Lid | 125 | 2500 | 2.5 | 12.0 | |
| DNR685 | Domed Lid with No Hole | 125 | 2500 | 3.0 | 14.3 | |
| DLR685 | Domed Lid with Hole | 125 | 2500 | 3.0 | 14.5 | |
| 600TS | Straw Slotted Lid | 100 | 2500 | 2.7 | 13.4 | Y9, Y10, P10, P10R |
| 640TP | Non-Vented Lid | 100 | 2500 | 3.2 | 13.9 | Y12T, P12T |
| 640TS | Straw-Slotted Lid - 2500 count | 100 | 2500 | 3.1 | 13.9 | |
| M640S | Straw-Slotted Lid - 1000 count | 100 | 1000 | 1.4 | 5.8 | |
| DNR640 | Domed Lid with No Hole | 100 | 1000 | 1.3 | 7.2 | |
| DLR640 | Domed Lid with Hole | 100 | 1000 | 1.3 | 7.1 | |
| 695TS | Straw-Slotted Lid | 100 | 1000 | 1.6 | 5.8 | Y12S, Y14 |
| 662TP | Non-Vented Lid | 100 | 1000 | 1.8 | 6.9 | P12S, P12SB, P12SR, P12SW, P20, P20W |
| 662TS | Straw-Slotted Lid | 100 | 1000 | 1.8 | 6.9 | |
| DNR662 | Domed Lid with No Hole | 100 | 1000 | 1.8 | 10.7 | |
| DLR662 | Domed Lid with Hole | 100 | 1000 | 1.8 | 9.1 | |
| DLW662 | Domed Lid with Wide Hole | 100 | 1000 | 1.7 | 9.3 | |
| LC16BLR* | Straw-Slotted Lid - Clear | 125 | 2000 | 2.8 | 9.1 | Y16T |
| L16BL-0100** | Straw-Slotted Lid - Translucent | 125 | 2000 | 2.9 | 8.9 | |
| DLR16-0090 | Domed Lid with Hole | 100 | 1000 | 1.5 | 9.1 | |
| DLW16 | Domed Lid with Wide Hole | 100 | 1000 | 1.5 | 8.8 | |
| 626TP | Non-Vented Lid | 100 | 1000 | 1.9 | 7.6 | Y16S, Y24, P16, P16B, P16R, P16W, P24 |
| 626TS | Straw-Slotted Lid | 100 | 1000 | 1.9 | 7.6 | |
| DNR626 | Domed Lid with No Hole | 100 | 1000 | 1.9 | 10.5 | |
| DLR626 | Domed Lid with Hole | 100 | 1000 | 1.9 | 10.1 | |
| DLW626 | Domed Lid with Wide Hole | 100 | 1000 | 1.9 | 8.7 | |
| 624TS | Straw-Slotted Lid | 100 | 1000 | 1.8 | 7.4 | Y20 |
| 636TS | Straw-Slotted Lid | 50 | 500 | 1.5 | 5.6 | Y32, P32 |
| DL639 | Domed Lid with Hole | 25 | 500 | 1.9 | 7.6 | |
| 642TS | Straw-Slotted Lid | 75 | 600 | 1.7 | 7.3 | CD54W |
| 44LCDH | Domed Lid with Hole | 50 | 1000 | 3.5 | 14.8 | |

All lids are made of PET unless noted.

* The LC16BLR is made of clear polystyrene.

** The L16BL-0100 is made of translucent polystyrene.



For additional information,
contact your Dart representative
or call (800) 248-5960

www.dartcontainer.com

DART CONTAINER CORPORATION

The Industry Standard of Excellence

Mason, Michigan 48854 U.S.A.

Ph: (800) 248-5960 • Fax: (517) 676-3883

Email: sales@dart.biz • www.dartcontainer.com



Durable plastic cups to showcase your cold beverages



Conex ClearPro® Clear Polypropylene Cups

Conex ClearPro® cups are perfect for many different applications including fountain beverages, iced coffees, and smoothies. Pair with a dome lid to create Grab 'n' Go items such as salads and donut holes.

Conex ProMotions® White Polypropylene Cups

The white backgrounds of **Conex ProMotions®** cups are an ideal backdrop to make your graphics pop, allowing you to successfully brand your business. Only available printed.



Features

Primarily flush-fill capacity
Provide portion control

Custom printing
Available in up to 10 colors*

Maximized print area
Helps showcase your brand messaging



Lid interchangeability
One lid fits 5 straight-wall cup sizes

Exceptional clarity
Helps stimulate impulse purchases

* Six color standard printing; 7-10 color premium print option. Ask your Dart representative for details.

Conex ClearPro® Clear Polypropylene Cups

1 Lid Size Fits 5 Different Cup Sizes



1 Lid Size Fits 4 Different Cup Sizes



| Item | Description | Print Capability | Packing Bag | Packing Case | Case Cube (ft ³) | Case Weight (lbs) | Use With |
|---|----------------------|------------------|-------------|--------------|------------------------------|-------------------|--------------------------------------|
| Conex ClearPro® Clear Polypropylene Cups | | | | | | | |
| 12PX | 12 oz Practical-Fill | ☉ | 50 | 1000 | 2.6 | 22.3 | 626TS, 626TP, DLR626, DNR626, DLW626 |
| 16FPX | 16 oz | ☉ | 50 | 1000 | 2.9 | 22.6 | |
| 16PX | 16 oz Practical-Fill | ☉ | 50 | 1000 | 3.3 | 27.2 | |
| 20PX | 20 oz | ☉ | 50 | 600 | 2.3 | 18.6 | |
| 24PX | 24 oz | ☉ | 50 | 600 | 2.8 | 20.8 | |
| PXG30 | 30 oz Pedestal | ☉ | 30 | 300 | 2.1 | 14.3 | L32C, L32SL, 20LCDH |
| 32P | 32 oz Pedestal | ☉ | 25 | 500 | 4.1 | 26.0 | |
| 32SP | 32 oz Squat Pedestal | ● | 25 | 500 | 4.1 | 26.2 | L44BN, LC44BN, 642TS, 44LCDH |
| PXG40 | 40 oz Pedestal | ● | 25 | 300 | 2.7 | 19.1 | |
| 42P | 42 oz Pedestal | ● | 25 | 400 | 3.8 | 24.7 | |
| 44P | 44 oz Pedestal | ● | 25 | 400 | 3.8 | 27.0 | |

Print Capability: ☉ Available printed or unprinted. ● Available printed only

Please note, select lids are interchangeable with other Dart plastic cup lines, portion container lines, and/or paper cold cup lines. Please refer to your Dart sales representative or visit www.dartcontainer.com for confirmation of product compatibility.

Features

Primarily flush-fill capacity
Provide portion control

Custom printing
Available in up to 10 colors*

Car compatible
Pedestal cups fit standard car cupholders



Rolled rim
Secure lid fit for leak resistance

Icy Chill™ stock print
Available in 32 and 44 oz sizes

Brilliant white background
Ideal for custom printing

* Six color standard printing; 7-10 color premium print option. Ask your Dart representative for details.

Conex Promotions® White Polypropylene Cups

1 Lid Size Fits 5 Different Cup Sizes



12PXW 16FPXW 16PXW 20PXW 24PXW

1 Lid Size Fits 4 Different Cup Sizes



PXG30W 32PW 32SPW PXG40W 42PW 44PW

| Item | Description | Print Capability | Packing Bag | Packing Case | Case Cube (ft ³) | Case Weight (lbs) | Use With |
|--|---------------------------|------------------|-------------|--------------|------------------------------|-------------------|--------------------------------------|
| Conex ProMotions® White Polypropylene Cups | | | | | | | |
| 12PXW | 12 oz Practical-Fill | ● | 50 | 1000 | 2.6 | 22.3 | 626TS, 626TP, DLR626, DNR626, DLW626 |
| 16FPXW | 16 oz | ● | 50 | 1000 | 3.0 | 22.6 | |
| 16PXW | 16 oz Practical-Fill | ● | 50 | 1000 | 3.3 | 27.1 | |
| 20PXW | 20 oz | ● | 50 | 600 | 2.2 | 18.7 | |
| 24PXW | 24 oz | ● | 50 | 600 | 2.6 | 20.7 | |
| PXG30W | 30 oz Pedestal | ● | 30 | 300 | 2.1 | 14.3 | L32C, L32SL, 20LCDH |
| 32PW | 32 oz Pedestal | ● | 25 | 500 | 4.1 | 26.1 | |
| 32SPW | 32 oz Pedestal | ● | 25 | 500 | 4.1 | 26.2 | L44BN, LC44BN, 642TS, 44LCDH |
| PXG40W | 40 oz Pedestal | ● | 25 | 300 | 2.7 | 17.9 | |
| 42PW | 42 oz Pedestal | ● | 25 | 400 | 3.8 | 26.1 | |
| 44PW | 44 oz Pedestal | ● | 25 | 400 | 3.8 | 27.0 | |
| Icy Chill™ Stock Printed Conex ProMotions® Go Cup® White Polypropylene Cups | | | | | | | |
| 32SPWIC | 32 oz Icy Chill™ Pedestal | — | 25 | 500 | 4.1 | 26.3 | L44BN, LC44BN, 642TS, 44LCDH |
| 44PWIC | 44 oz Icy Chill™ Pedestal | — | 25 | 400 | 3.8 | 27.0 | |

Print Capability: ● Available printed or unprinted. ● Available printed only



Lids for Conex ClearPro® Cups and Conex ProMotions® Cups



| Item | Description | Packing Bag | Packing Case | Case Cube (ft ³) | Case Weight (lbs) | Use With |
|--------|-------------------------------------|-------------|--------------|------------------------------|-------------------|---|
| 626TP | PET Non-Vented Lid - Clear | 100 | 1000 | 1.9 | 7.6 | 12PX, 16FPX, 16PX, 20PX, 24PX, 12PXW, 16FPXW, 16PXW, 20PXW, 24PXW |
| 626TS | PET Straw Slotted Lid - Clear | 100 | 1000 | 1.9 | 7.6 | |
| DNR626 | PET Dome Lid with No Hole - Clear | 100 | 1000 | 1.9 | 10.5 | |
| DLR626 | PET Dome Lid with Hole - Clear | 100 | 1000 | 1.9 | 10.2 | |
| DLW626 | PET Dome Lid with Wide Hole - Clear | 100 | 1000 | 1.9 | 8.8 | |
| L32SL | PS Straw Slotted Lid - Translucent | 50 | 1000 | 1.9 | 7.6 | PXG30, 32P, PXG30W, 32PW |
| L32C | PET Straw Slotted Lid - Clear | 50 | 1000 | 2.2 | 9.1 | |
| 20LCDH | OPS Dome Lid with Hole - Clear | 50 | 1000 | 2.7 | 11.4 | |
| L44BN | PS Straw Slotted Lid - Translucent | 80 | 960 | 3.0 | 9.7 | 32SP, PXG40, 42P, 44P, 32SPW, PXG40W, 42PW, 44PW, 32SPWIC, 44PWIC |
| LC44BN | Straw Slotted Lid - Clear | 80 | 960 | 3.0 | 9.7 | |
| 642TS | PET Straw Slotted Lid - Clear | 75 | 600 | 1.7 | 6.1 | |
| 44LCDH | PET Dome Lid with 1.9" Hole - Clear | 50 | 1000 | 3.5 | 16.1 | |



For additional information,
contact your Dart representative
or call (800) 248-5960

www.dartcontainer.com

DART CONTAINER CORPORATION

The Industry Standard of Excellence

Mason, Michigan 48854 U.S.A.

Ph: (800) 248-5960 • Fax: (517) 676-3883

Email: sales@dart.biz • www.dartcontainer.com



Made with a Minimum of 20%
Post-Consumer Recycled PET



Bare® by Solo® Eco-Forward® RPET Clear Cups

Post-consumer recycled PET is comprised mostly of PET beverage bottles. Each case of Bare® by Solo® cold cups contain an amount of post-consumer recycled PET equal to approximately the following number of 16.9 fl oz water bottles*:

- 9oz cups - 174 bottles/case
- 10oz cups - 194 bottles/case
- 12oz cups - 236 bottles/case
- 16oz cups - 294 bottles/case
- 20oz cups - 222 bottles/case
- 24oz cups - 232 bottles/case

* Based on average weight of 16.9 fl oz water bottles = 10.97 grams.





Bare® by Solo® RPET Clear Cups



| Stock Number Custom Print | Stock Number Bare® Print | Description | Sleeve | Case Pack | Case Cube (ft ³) | Case Weight (lbs) | Use With |
|------------------------------|-----------------------------|----------------------------------|--------|--------------|---------------------------------|----------------------|--------------------------------------|
| RTP9D | RTP9DBARE | 9oz Tall | 50 | 1000 | 1.6 | 23.1 | 610TS, 610TP, DLR610, DNR610, DLW610 |
| RTP10D | RTP10DBARE | 10oz Tall | 50 | 1000 | 1.7 | 24.1 | |
| RTP9R | RTP9RBARE | 9oz Squat | 50 | 1000 | 2.2 | 20.6 | 662TS, 662TP, DLR662, DNR662, DLW662 |
| RTP12 | RTP12BARE | 12oz Squat | 50 | 1000 | 2.9 | 30.2 | |
| RTN20 | RTN20BARE | 20oz Straight Wall | 50 | 1000 | 3.9 | 39.3 | |
| RTP16D | RTP16DBARE | 16oz | 50 | 1000 | 3.2 | 36.3 | 626TS, 626TP, DLR626, DNR626, DLW626 |
| RTP20 | RTP20BARE | 20oz | 50 | 600 | 2.4 | 27.6 | |
| RTD24 | RTD24BARE | 24oz | 50 | 600 | 2.5 | 29.0 | |
| RTP9DW | RTP9DBAREW | 9oz Tall - Individually Wrapped | 25 | 500 | 1.6 | 14.8 | |
| RTP10DW | RTP10DBAREW | 10oz Tall - Individually Wrapped | 25 | 500 | 1.6 | 15.2 | — |

Lids for Bare® by Solo® RPET Cups



| Item | Description | Sleeve | Case Pack | Case Cube (ft ³) | Case Weight (lbs) | Use With |
|--------|--------------------------|--------|--------------|---------------------------------|----------------------|--|
| 610TP | Flat Lid No Straw Slot | 100 | 1000 | 1.0 | 5.3 | RTP9D, RTP10D, RTP9DBARE, RTP10DBARE |
| 610TS | Flat Lid with Straw Slot | 100 | 1000 | 1.0 | 5.3 | |
| DNR610 | Domed Lid with No Hole | 100 | 1000 | 1.2 | 6.8 | |
| DLR610 | Domed Lid with Hole | 100 | 1000 | 1.2 | 6.6 | |
| DLW610 | Domed Lid with Wide Hole | 100 | 1000 | 1.2 | 5.5 | |
| 662TP | Flat Lid No Straw Slot | 100 | 1000 | 1.8 | 6.9 | RTP9R, RTP12, RTN20, RTP9RBARE, RTP12BARE, RTN20BARE |
| 662TS | Flat Lid with Straw Slot | 100 | 1000 | 1.8 | 6.9 | |
| DNR662 | Domed Lid with No Hole | 100 | 1000 | 1.8 | 10.7 | |
| DLR662 | Domed Lid with Hole | 100 | 1000 | 1.8 | 9.1 | |
| DLW662 | Domed Lid with Wide Hole | 100 | 1000 | 1.7 | 9.3 | |
| 626TP | Flat Lid No Straw Slot | 100 | 1000 | 1.9 | 7.6 | RTP16D, RTP20, RTD24, RTP16DBARE, RTP20BARE, RTD24BARE |
| 626TS | Flat Lid with Straw Slot | 100 | 1000 | 1.9 | 7.6 | |
| DNR626 | Domed Lid with No Hole | 100 | 1000 | 1.9 | 10.5 | |
| DLR626 | Domed Lid with Hole | 100 | 1000 | 1.9 | 10.1 | |
| DLW626 | Domed Lid with Wide Hole | 100 | 1000 | 1.9 | 8.7 | |

Please note, select lids are interchangeable with other Dart plastic cup lines, portion container lines, and/or paper cold cup lines. Please refer to your Dart sales representative or visit www.dartcontainer.com for confirmation of product compatibility.



For additional information,
contact your Dart representative
or call (800) 248-5960
www.dartcontainer.com

DART CONTAINER CORPORATION
The Industry Standard of Excellence
Mason, Michigan 48854 U.S.A.
Ph: (800) 248-5960 • Fax: (517) 676-3883
Email: sales@dart.biz • www.dartcontainer.com



Ideally suited for your every need

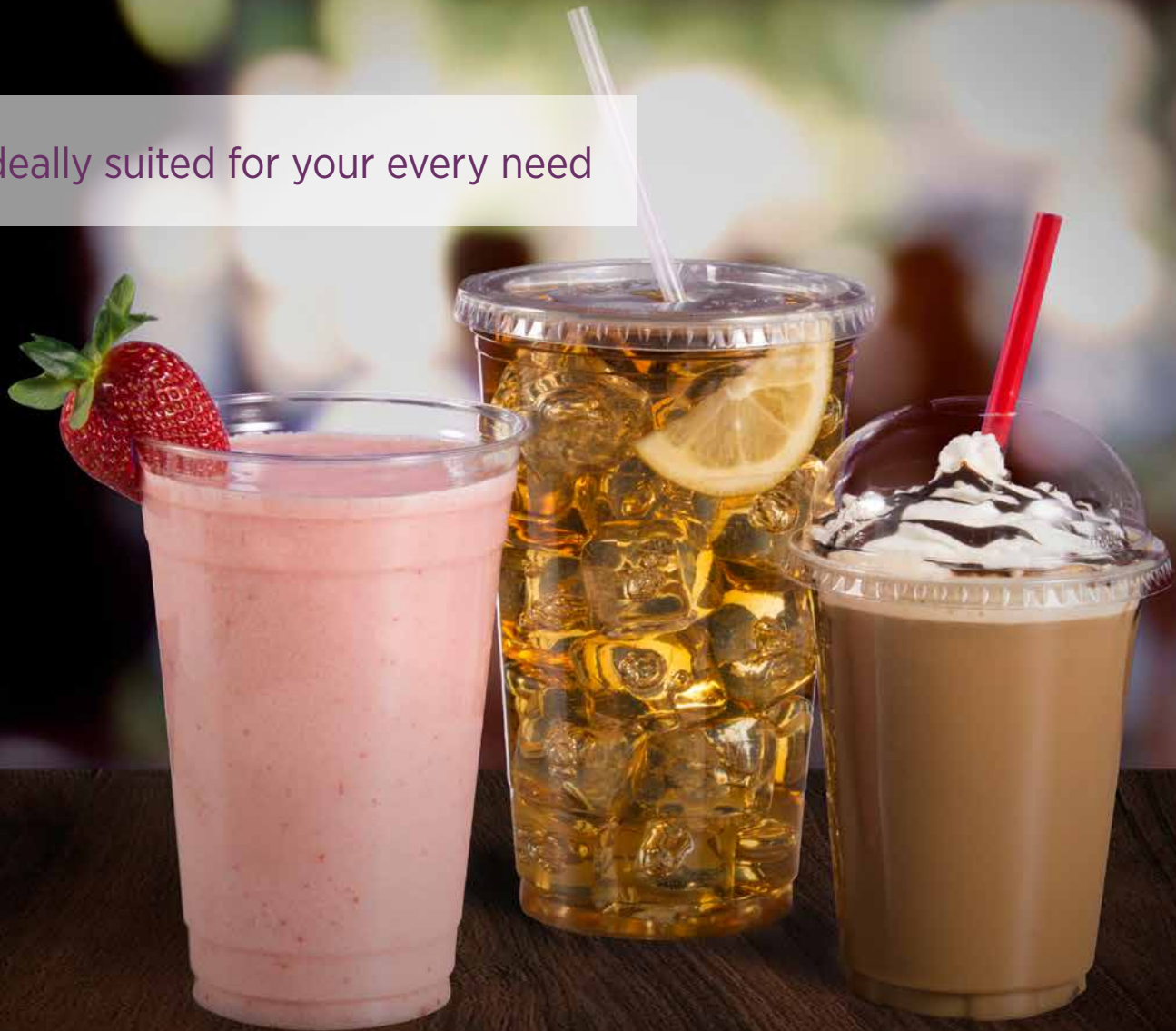

Clear Cups and Lids

Whatever you're serving, Solo® Ultra Clear™ will create an irresistible product presentation. It's not all about show either. Made of crack-resistant PET, you'll find these cups are sturdy yet flexible for countless product applications such as frozen drinks, fruit smoothies, iced coffee, beer, and much more. To add promotional punch to your merchandising efforts, consider having your design custom printed on Solo® Ultra Clear™.



Features

Primarily Flush-fill Capacity
Provide portion control

Custom Printing
Available in up to ten spot colors

Car Compatible
32AC pedestal cup fits
standard car cupholders

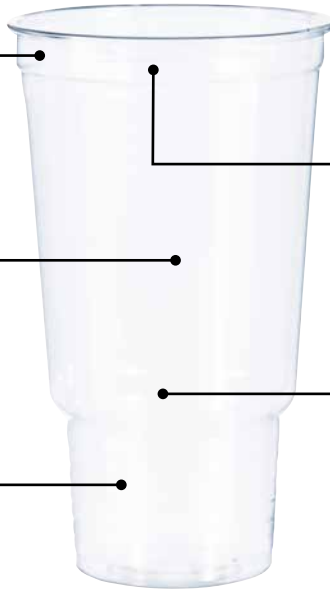

Rolled Rim
Secure lid fit for leak resistance

Exceptional Clarity
Helps stimulate impulse purchases

1 Lid Size Fits Multiple Cup Sizes



Solo® Ultra Clear™ Cups

1 Lid Size Fits 2 Different Cup Sizes



1 Lid Size Fits 5 Different Cup Sizes



1 Lid Size Fits 4 Different Cup Sizes



| Item | Description | Print Capability | Sleeve | Case Pack | Case Cube (ft ³) | Case Weight (lbs) | Use With |
|---|---|------------------|--------|-----------|------------------------------|-------------------|--------------------------------------|
| Solo® Ultra Clear™ Clear Cups | | | | | | | |
| 5C | 5 oz. PET Cup | ⊙ | 100 | 2500 | 2.6 | 35.5 | — |
| TP7 | 7 oz. PET Cup | ⊙ | 50 | 1000 | 1.5 | 19.0 | PL4TSN, PL4N, DLR685, DNR685 |
| TP9D | 9 oz. Tall PET Cup | ⊙ | 50 | 1000 | 1.6 | 23.6 | 610TS, 610TP, DLR610, DNR610, DLW610 |
| TP10D | 10 oz. PET Cup | ⊙ | 50 | 1000 | 1.7 | 24.1 | |
| TP22 | 12 oz. Flush-fill PET Cup | ⊙ | 50 | 1000 | 2.3 | 29.6 | 640TS, M640S, 640TP, DLR640, DNR640 |
| TP9R | 9 oz. Squat PET Cup | ⊙ | 50 | 1000 | 2.2 | 20.7 | 662TS, 662TP, DLR662, DNR662, DLW662 |
| TP12 | 12 oz. Practical-fill PET Cup | ⊙ | 50 | 1000 | 2.8 | 29.6 | |
| TR16 | 16 oz. Flush-fill PET Cup | ⊙ | 50 | 1000 | 3.4 | 36.3 | |
| TN20 | 20 oz. PET Cup | ⊙ | 50 | 1000 | 3.8 | 39.5 | |
| TN22* | 22 oz. PET Cup | ⊙ | 40 | 800 | 3.7 | 38.4 | |
| TP16D | 16 oz. Practical-fill PET Cup | ⊙ | 50 | 1000 | 3.2 | 36.3 | 626TS, 626TP, DLR626, DNR626, DLW626 |
| TP20 | 20 oz. PET Cup | ⊙ | 50 | 600 | 2.4 | 26.4 | |
| TD24 | 24 oz. PET Cup | ⊙ | 50 | 600 | 2.5 | 25.8 | |
| TD26* | 26 oz. PET Cup | ⊙ | 50 | 600 | 2.6 | 28.1 | |
| TC32 | 32 oz. Straight Wall PET Cup | ⊙ | 25 | 300 | 2.4 | 20.7 | 636TS, DL639 |
| 32AC | 32 oz. Pedestal PET Cup | ⊙ | 25 | 500 | 4.6 | 33.7 | L32C, 20LCDH |
| Solo® Ultra Clear™ Individually Wrapped Clear Cups | | | | | | | |
| TP9DW | 9 oz. Tall PET Cup - Individually Wrapped | ⊙ | 50 | 500 | 1.6 | 11.9 | — |
| TP10DW | 10 oz. PET Cup - Individually Wrapped | ⊙ | 25 | 500 | 1.6 | 15.2 | — |
| Solo® Ultra Clear™ Specialty Cups | | | | | | | |
| TP10DGM | 10 oz. PET Graduated Medical Cup | — | 50 | 1000 | 1.7 | 24.1 | — |

*MTO. Print Capability: ⊙ Available printed or unprinted.



Lids for Solo® Ultra Clear™ Cups



Flat Lid
No Straw Slot



Flat Lid
with Straw Slot



Dome Lid
with No Hole



Dome Lid
with Hole



Dome Lid
with Wide Hole

| Item | Description | Sleeve | Case Pack | Case Cube (ft ³) | Case Weight (lbs) | Use With |
|--------|------------------------------|--------|-----------|------------------------------|-------------------|-------------------------------------|
| PL4N | Flat Lid No Straw Slot | 125 | 2500 | 2.5 | 11.9 | TP7 |
| PL4TSN | Flat Lid with Straw Slot | 125 | 2500 | 2.5 | 11.9 | |
| DLR685 | Domed Lid with Hole | 125 | 2500 | 3.0 | 14.5 | |
| DNR685 | Domed Lid with No Hole | 125 | 2500 | 3.0 | 14.3 | |
| 610TP | Flat Lid No Straw Slot | 100 | 1000 | 1.3 | 5.3 | TP9D, TP10D, TP9DW, TP10DW, TP10DGM |
| 610TS | Flat Lid with Straw Slot | 100 | 1000 | 1.0 | 5.3 | |
| DLR610 | Domed Lid with Hole | 100 | 1000 | 1.2 | 6.6 | |
| DNR610 | Domed Lid with No Hole | 100 | 1000 | 1.2 | 6.8 | |
| DLW610 | Domed Lid with Wide Hole | 100 | 1000 | 1.2 | 5.5 | |
| 640TP | Flat Lid No Straw Slot | 100 | 2500 | 3.2 | 13.9 | TP22 |
| 640TS | Flat Lid with Straw Slot | 100 | 2500 | 3.2 | 13.9 | |
| M640S | Flat Lid with Straw Slot | 100 | 1000 | 1.4 | 5.8 | |
| DLR640 | Domed Lid with Hole | 100 | 1000 | 1.3 | 7.1 | |
| DNR640 | Domed Lid with No Hole | 100 | 1000 | 1.3 | 7.2 | |
| 662TP | Flat Lid No Straw Slot | 100 | 1000 | 1.8 | 6.9 | TP9R, TP12, TR16, TN20, TN22 |
| 662TS | Flat Lid with Straw Slot | 100 | 1000 | 1.8 | 6.9 | |
| DLR662 | Domed Lid with Hole | 100 | 1000 | 1.8 | 9.1 | |
| DNR662 | Domed Lid with No Hole | 100 | 1000 | 1.8 | 10.7 | |
| DLW662 | Domed Lid with Wide Hole | 100 | 1000 | 1.7 | 9.3 | |
| 626TP | Flat Lid No Straw Slot | 100 | 1000 | 1.9 | 7.6 | TP16D, TP20, TD24, TD26 |
| 626TS | Flat Lid with Straw Slot | 100 | 1000 | 1.9 | 7.6 | |
| DLR626 | Domed Lid with Hole | 100 | 1000 | 1.9 | 10.1 | |
| DNR626 | Domed Lid with No Hole | 100 | 1000 | 1.9 | 10.5 | |
| DLW626 | Domed Lid with Wide Hole | 100 | 1000 | 1.9 | 8.7 | |
| L32C | Flat Lid with Straw Slot | 50 | 1000 | 2.2 | 9.3 | 32AC |
| 20LCDH | OPS Domed Lid with Wide Hole | 50 | 1000 | 2.7 | 11.6 | |
| 636TS | Flat Lid with Straw Slot | 50 | 500 | 1.5 | 5.6 | TC32 |
| DL639 | Domed Lid with Hole | 25 | 500 | 1.9 | 7.6 | |

Please note, select lids are interchangeable with other Dart plastic cup lines, portion container lines, and/or paper cold cup lines. Please refer to your Dart sales representative or visit www.dartcontainer.com for confirmation of product compatibility.



For additional information,
contact your Dart representative
or call (800) 248-5960
www.dartcontainer.com

DART CONTAINER CORPORATION

The Industry Standard of Excellence

Mason, Michigan 48854 U.S.A.

Ph: (800) 248-5960 • Fax: (517) 676-3883

Email: sales@dart.biz • www.dartcontainer.com



CUTE VS WILD

UNLEASH THE FUN CUPS

NEW CRITTER AND JUNGLE DESIGNS

CUSTOMIZED CREATIONS

SNAP-TIGHT, SPILL-RESISTANT LIDS

SOLO®

KICK UP YOUR KIDS' MENU

CATCH ATTENTION AND KEEP KIDS HAPPY. IT'S EASY WITH SOLO® 12 OZ KIDS' CUPS.



★ COMBO PACK INCLUDES CUPS, LIDS AND FLEXIBLE STRAWS

★ 2 NEW COLORFUL STOCK DESIGNS

★ CUSTOMIZED DESIGNS

★ SNAP-TIGHT LIDS

★ STRONG MULTI-LAYER CONSTRUCTION

JUNGLE CUP COMBO

A Solo® Exclusive

CRITTER CUP COMBO

A Solo® Exclusive

EMBOSSSED SNAP-TIGHT, SPILL-RESISTANT LIDS



YOUR CUSTOM DESIGN

OR CUSTOMIZE A DESIGN TO FIT YOUR OPERATION

80% of parents state that children dominate the decision when choosing where to eat.

80% of families with children 3-8 say a special children's menu is extremely important.

KID CUP COMBOS: CUPS, LIDS, & STRAWS

| PRINT | PRODUCT CODE | CASE QUANTITY | UPC CODE | CASE WT. (lbs) | CASE DIMENSIONS (IN) L x W x H | CASE CUBE (cu. ft) | PALLET TI/HI |
|----------|--------------|-------------------------|--------------------|----------------|--------------------------------|--------------------|--------------|
| JUNGLE | OC12C-J5145 | 250 CUPS, LIDS & STRAWS | 0-00-41165-07374-4 | 9.75 | 21.3125 x 7.9375 x 14.5 | 1.4195 | 10/3 |
| CRITTERS | OC12C-J5146 | 250 CUPS, LIDS & STRAWS | 0-00-41165-07375-1 | 9.75 | 21.3125 x 7.9375 x 14.5 | 1.4195 | 10/3 |





Solo® Paper Hot Cups



Hot cups that heat up sales!

Solo® Paper Hot cups

Lid interchangeability - 5 cups, 1 lid solution for sizes 10oz-24oz reduces storage requirements and increases operational efficiencies

Smooth, rolled rim - Gives rigidity to the cup and ensures secure leak-resistant lid fit

Sustainable alternative - Made with at least 90% plant-based renewable resources. We source fibers under the SFI® chain of custody

Eye-catching graphics - Matte finish and top-to-bottom coverage offers excellent printability for a variety of stock designs or custom graphics to match any decor



Solo® Paper Hot Cups

Features

Rolled rim

Gives rigidity to the cup and ensures secure leak-resistant lid fit

Top-to-bottom graphics

provides more space for custom printing to showcase your brand



Handled hot cups

Available in 4, 6, and 8 oz sizes

Moisture barrier

Cup lined with polyethylene to help prevent leaking



One lid fits 5 cup sizes

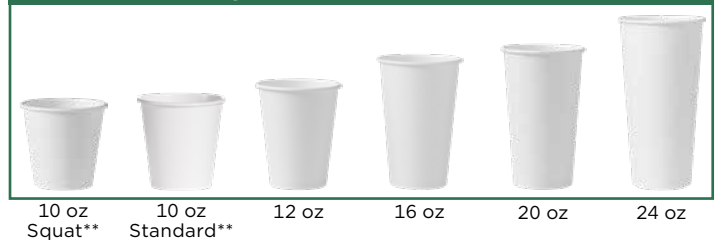

| Item | Description | Packing Bag | Packing Case | Case Weight (lbs) | Case Cube (ft³) | Use With |
|---|----------------|-------------|--------------|-------------------|-----------------|---|
| Solo® Paper Hot Cups - White (Also Available Custom Print) | | | | | | |
| 374W-2050 | 4 oz | 50 | 1000 | 9.1 | 1.1 | VL34R-0007 |
| 374HW-2050 | 4 oz Handled | 50 | 1000 | 8.3 | 1.1 | |
| 376W-2050 | 6 oz | 50 | 1000 | 16.1 | 1.8 | VL36R-0007 |
| 376HW-2050 | 6 oz Handled | 50 | 1000 | 18.5 | 1.8 | |
| 378W-2050 | 8 oz | 50 | 1000 | 18.7 | 2.1 | TL38B2-0004, TL38R2-0007, LB3081-00007 |
| 378HW-2050 | 8 oz Handled | 50 | 1000 | 20.6 | 2.1 | |
| 370W-2050 | 10 oz | 50 | 1000 | 22.4 | 2.6 | TL31B2-0004, TL31R2-0007, LB3101-00007 |
| 410W-2050** | 10 oz Squat | 50 | 1000 | 20.9 | 2.7 | TLB316-0004, TLN316-00013, TLP316-0007, TLP316PP, OPT316, OPT316B, LK316W-0007, LK316B-0004, LB3161-00007 |
| 510W** | 10 oz Standard | 50 | 1000 | 23.2 | 3.6 | |
| 412WN-2050 | 12 oz | 50 | 1000 | 26.6 | 3.2 | |
| 316W-2050 | 16 oz | 50 | 1000 | 32.2 | 3.7 | |
| 420W-2050 | 20 oz | 40 | 600 | 20.6 | 2.7 | |
| 424WN-2050 | 24 oz | 25 | 500 | 25.8 | 3.1 | |

| Bistro® Stock Printed Solo® Paper Hot Cups | | | | | | |
|---|----------------|----|------|------|-----|---|
| 374SI-0041 | 4 oz | 50 | 1000 | 9.1 | 1.1 | VL34R-0007 |
| 374SH-0041 | 4 oz Handled | 50 | 1000 | 8.3 | 1.1 | |
| 376SI-0041 | 6 oz | 50 | 1000 | 16.1 | 1.8 | VL36R-0007 |
| 376SH-0041 | 6 oz Handled | 50 | 1000 | 18.5 | 1.8 | |
| 378SI-0041 | 8 oz | 50 | 1000 | 18.7 | 2.1 | TL38B2-0004, TL38R2-0007, LB3081-00007 |
| 378SH-0041 | 8 oz Handled | 50 | 1000 | 20.6 | 2.1 | |
| 370SI-0041 | 10 oz | 50 | 1000 | 22.4 | 2.6 | TL31B2-0004, TL31R2-0007, LB3101-00007 |
| 410SI-0041** | 10 oz Squat | 50 | 1000 | 20.9 | 2.7 | TLB316-0004, TLN316-00013, TLP316-0007, TLP316PP, OPT316, OPT316B, LK316W-0007, LK316B-0004, LB3161-00007 |
| 510SI** | 10 oz Standard | 50 | 1000 | 23.2 | 3.6 | |
| 412SIN-0041 | 12 oz | 50 | 1000 | 26.6 | 3.2 | |
| 316SI-0041 | 16 oz | 50 | 1000 | 32.2 | 3.7 | |
| 420SI-0041 | 20 oz | 40 | 600 | 20.6 | 2.7 | |
| 424SIN-0041 | 24 oz | 25 | 500 | 25.8 | 3.1 | |

*MTO only **May not be available in all areas. Check for product availability

Stock Prints



White



Bistro®



Jazz®



Mistique®



Symphony®

| Item | Description | Packing Bag | Packing Case | Case Weight (lbs) | Case Cube (ft ³) | Use With |
|---|----------------|-------------|--------------|-------------------|------------------------------|---|
| Jazz® Stock Printed Solo® Paper Hot Cups | | | | | | |
| 374JZ-00055* | 4 oz | 50 | 1000 | 9.1 | 1.1 | VL34R-0007 |
| 374HJZ-00055* | 4 oz Handled | 50 | 1000 | 8.3 | 1.1 | |
| 376JZ-00055 | 6 oz | 50 | 1000 | 16.1 | 1.8 | VL36R-0007 |
| 376HJZ-00055 | 6 oz Handled | 50 | 1000 | 18.5 | 1.8 | |
| 378JZ-00055 | 8 oz | 50 | 1000 | 18.7 | 2.1 | TL38B2-0004, TL38R2-0007, LB3081-00007 |
| 378HJZ-00055 | 8 oz Handled | 50 | 1000 | 20.6 | 2.1 | |
| 370JZ-00055 | 10 oz | 50 | 1000 | 22.4 | 2.6 | TL31B2-0004, TL31R2-0007, LB3101-00007 |
| 410JZ-00055* | 10 oz Squat | 50 | 1000 | 20.9 | 2.7 | |
| 510JZ** | 10 oz Standard | 50 | 1000 | 23.2 | 3.6 | |
| 412JZ-00055 | 12 oz | 50 | 1000 | 26.6 | 3.2 | TLB316-0004, TLN316-00013, TLP316-0007, TLP316PP, OPT316, OPT316B, LK316W-0007, LK316B-0004, LB3161-00007 |
| 316JZ-00055 | 16 oz | 50 | 1000 | 32.2 | 3.7 | |
| 420JZ-00055* | 20 oz | 40 | 600 | 20.6 | 2.7 | |
| 424JZ-00055* | 24 oz | 25 | 500 | 25.8 | 3.1 | |
| Mistique® Stock Printed Solo® Paper Hot Cups | | | | | | |
| 374MS-0029 | 4 oz | 50 | 1000 | 9.1 | 1.1 | VL34R-0007 |
| 374HS-0029 | 4 oz Handled | 50 | 1000 | 8.3 | 1.1 | |
| 376MS-0029 | 6 oz | 50 | 1000 | 16.1 | 1.8 | VL36R-0007 |
| 376HS-0029* | 6 oz Handled | 50 | 1000 | 18.5 | 1.8 | |
| 378MS-0029 | 8 oz | 50 | 1000 | 18.7 | 2.1 | TL38B2-0004, TL38R2-0007, LB3081-00007 |
| 378HS-0029 | 8 oz Handled | 50 | 1000 | 20.6 | 2.1 | |
| 370MS-0029 | 10 oz | 50 | 1000 | 22.4 | 2.6 | TL31B2-0004, TL31R2-0007, LB3101-00007 |
| 410MS-0029** | 10 oz Squat | 50 | 1000 | 20.9 | 2.7 | |
| 510MS** | 10 oz Standard | 50 | 1000 | 23.2 | 3.6 | |
| 412MSN-0029 | 12 oz | 50 | 1000 | 26.6 | 3.2 | TLB316-0004, TLN316-00013, TLP316-0007, TLP316PP, OPT316, OPT316B, LK316W-0007, LK316B-0004, LB3161-00007 |
| 316MS-0029 | 16 oz | 50 | 1000 | 32.2 | 3.7 | |
| 420MS-0029 | 20 oz | 40 | 600 | 20.6 | 2.7 | |
| 424MSN-0029 | 24 oz | 25 | 500 | 25.8 | 3.1 | |
| Symphony® Stock Printed Solo® Paper Hot Cups | | | | | | |
| 374SM-J8000* | 4 oz | 50 | 1000 | 9.1 | 1.1 | VL34R-0007 |
| 374HJSM-J8000* | 4 oz Handled | 50 | 1000 | 8.3 | 1.1 | |
| 376SM-J8000 | 6 oz | 50 | 1000 | 16.1 | 1.8 | VL36R-0007 |
| 376HSM-J8000 | 6 oz Handled | 50 | 1000 | 18.5 | 1.8 | |
| 378SM-J8000 | 8 oz | 50 | 1000 | 18.7 | 2.1 | TL38B2-0004, TL38R2-0007, LB3081-00007 |
| 378HSM-J8000 | 8 oz Handled | 50 | 1000 | 20.6 | 2.1 | |
| 370SM-J8000 | 10 oz | 50 | 1000 | 22.4 | 2.6 | TL31B2-0004, TL31R2-0007, LB3101-00007 |
| 410SM-J8000** | 10 oz Squat | 50 | 1000 | 20.9 | 2.7 | |
| 510SM** | 10 oz Standard | 50 | 1000 | 23.2 | 3.6 | |
| 412SM-J8000 | 12 oz | 50 | 1000 | 26.6 | 3.2 | TLB316-0004, TLN316-00013, TLP316-0007, TLP316PP, OPT316, OPT316B, LK316W-0007, LK316B-0004, LB3161-00007 |
| 316SM-J8000 | 16 oz | 50 | 1000 | 32.2 | 3.7 | |
| 420SM-J8000 | 20 oz | 40 | 600 | 20.6 | 2.7 | |
| 424SM-J8000* | 24 oz | 25 | 500 | 25.8 | 3.1 | |

*MTO only **May not be available in all areas. Check for product availability.



Solo® Paper Hot Cup Lids



Optima® Lids

TraveLock® Lids

Traveler® Lids

Liftback 'n' Lock Tab Lids

Vented Lids

| Item | Description | Packing Bag | Packing Case | Case Weight (lbs) | Case Cube (ft ³) | Use With |
|--|--|-------------|--------------|-------------------|------------------------------|---------------------------------|
| Optima® Reclosable Lids for Solo® Paper Hot Cups | | | | | | |
| OPT316 | Reclosable Dome Hot Cup Lid - White | 100 | 1000 | 10.0 | 1.6 | 410,510,412,316,420, 424 series |
| OPT316B | Reclosable Dome Hot Cup Lid - Black | 100 | 1000 | 10.0 | 1.6 | |
| TraveLock® Reclosable Dome Lids | | | | | | |
| LK316W-0007 | Reclosable Dome Hot Cup Lid - White | 100 | 1000 | 10.1 | 1.8 | 410,510,412,316,420, 424 series |
| LK316B-0004 | Reclosable Dome Hot Cup Lid - Black | 100 | 1000 | 10.1 | 1.8 | |
| Traveler® Cappuccino Style Dome Lids for Solo® Paper Hot Cups | | | | | | |
| TL38B2-0004 | Dome Hot Cup Lid - Black | 100 | 1000 | 6.9 | 1.2 | 378 series |
| TL38R2-0007 | Dome Hot Cup Lid - White | 100 | 1000 | 6.9 | 1.2 | |
| TL31B2-0004 | Dome Hot Cup Lid - Black | 100 | 1000 | 8.5 | 1.4 | 370 series |
| TL31R2-0007 | Dome Hot Cup Lid - White | 100 | 1000 | 8.5 | 1.4 | |
| TLB316-0004 | Dome Hot Cup Lid - Black | 100 | 1000 | 9.6 | 1.6 | 410,510,412,316,420, 424 series |
| TLN316-00013 | Dome Hot Cup Lid - Brown | 100 | 1000 | 10.1 | 1.6 | |
| TLP316-0007 | Dome Hot Cup Lid - White | 100 | 1000 | 9.7 | 1.6 | |
| TLP316PP | Polypropylene Dome Hot Cup Lid - White | 100 | 1000 | 9.4 | 1.6 | |
| Solo® Liftback 'n' Lock Tab Lids | | | | | | |
| LB3081-00007 | Liftback 'n' Lock Tab Lid - White | 100 | 1000 | 4.7 | 1.1 | 378 series |
| LB3101-00007 | Liftback 'n' Lock Tab Lid - White | 100 | 1000 | 5.9 | 1.2 | 370 series |
| LB3161-00007 | Liftback 'n' Lock Tab Lid - White | 100 | 1000 | 6.9 | 1.4 | 410,510,412,316,420,424 series |
| Solo® Vented Lids | | | | | | |
| VL34R-0007 | Vented Lid - White | 100 | 1000 | 4.3 | 1.0 | 374 series |
| VL36R-0007 | Vented Lid - White | 100 | 1000 | 5.7 | 1.4 | 376 series |



For additional information, contact your Dart representative or call (800) 248-5960

www.dartcontainer.com



DART CONTAINER CORPORATION

The Industry Standard of Excellence

Mason, Michigan 48854 U.S.A.

Ph: (800) 248-5960 • Fax: (517) 676-3883

Email: sales@dart.biz • www.dartcontainer.com





Solo® DSP Paper Cold Cups

The standard in cold cups — and not without reason. With superior water resistance, improved portion control, and excellent graphic capabilities, Solo® double-sided polyethylene-coated paper cold cups deliver performance foodservice professionals can count on.

Solo cups offer lid interchangeability with a **single-lid solution for 7 popular sizes** that minimizes storage space while increasing operational efficiencies.





DSP Paper Cold Cups

Features

Lid interchangeability
single-lid solution for 7 most popular sizes minimizes storage space while increasing operational efficiencies

Custom printing
available in up to six spot colors

Double-sided polyethylene (DSP) coating
provides superior moisture resistance and protects the cup walls from weakening

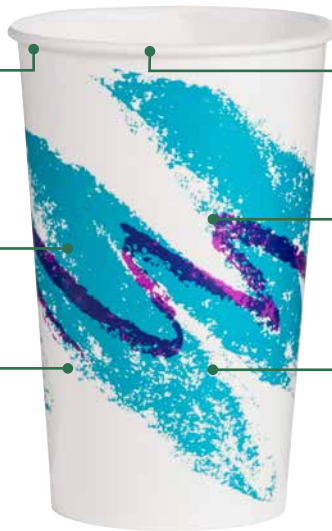

Smooth rolled rim
provides additional strength to cup and allows for a tight lid fit

Glossy sidewall finish
offers superior printing for advertising your brand

Stock prints
available in 4 stock printed designs



Jazz®



Symphony®



Lemonade



Coca-Cola® Branded

Solo® Stock Printed Paper Cold Cups

| Item | Description | Sleeve | Case Pack | Case Cube (ft ³) | Case Weight (lbs) | Use With |
|--|------------------|--------|-----------|------------------------------|-------------------|--|
| Jazz® Stock Printed Paper Cold Cups | | | | | | |
| RP12NP-00055 | 12 oz | 100 | 2000 | 2.9 | 33.0 | LC12B1-0099, L12BLN-0100, LDN12C-0090 |
| RP12SP-00055 | 12 oz Squat | 80 | 2000 | 4.6 | 37.2 | LC16BLR, L16BL-0100, DLR16-0090, DLW16 |
| RSP16P-00055 | 16 oz Squat | 50 | 1000 | 3.3 | 23.9 | |
| RP16P-00055 | 16 oz | 50 | 1000 | 3.3 | 26.3 | |
| RSP21P-00055 | 21 oz | 50 | 1000 | 4.2 | 32.3 | |
| RSP22P-00055 | 22 oz | 50 | 1000 | 3.9 | 32.2 | |
| RP24P-00055 | 24 oz | 50 | 1000 | 4.7 | 36.8 | LC1624-0099, L1624B-0100, DLR24-0090 |
| RP28NP-00055 | 28 oz | 40 | 480 | 3.0 | 22.9 | LC28BNR, L28BNR, LD28CH-0090 |
| RP30-00055* | 30 oz | 40 | 480 | 2.5 | 20.7 | |
| 44TDNP-00055 | 44 oz | 40 | 480 | 4.1 | 29.5 | LC44BN, L44BN |
| Symphony® Stock Printed Paper Cold Cups | | | | | | |
| RP12NP-J8000 | 12 oz | 100 | 2000 | 2.9 | 33.0 | LC12B1-0099, L12BLN-0100, LDN12C-0090 |
| RP12SP-J8000 | 12 oz Squat | 80 | 2000 | 4.6 | 37.2 | LC16BLR, L16BL-0100, DLR16-0090, DLW16 |
| RP16P-J8000 | 16 oz | 50 | 1000 | 3.3 | 26.3 | |
| RSP20P-J8000 | 20 oz | 50 | 1000 | 4.2 | 30.5 | |
| RSP21P-J8000 | 21 oz | 50 | 1000 | 4.2 | 32.3 | |
| RP24P-J8000 | 24 oz | 50 | 1000 | 4.7 | 36.8 | |
| RP28NP-J8000 | 28 oz | 40 | 480 | 3.0 | 22.9 | LC28BNR, L28BNR, LD28CH-0090 |
| RP32NP-J8000 | 32 oz | 40 | 480 | 3.6 | 26.0 | 636TS, L32BNR, DL639 |
| 44TDNP-J8000 | 44 oz | 40 | 480 | 4.1 | 29.5 | LC44BN, L44BN |
| Lemonade Stock Printed Paper Cold Cups | | | | | | |
| 32TDN-98034* | 32 oz Squat | 40 | 480 | 2.8 | 21.5 | LC44BN, L44BN |
| Coca-Cola® Brand Stock Printed Paper Cold Cups* | | | | | | |
| RP2SCB-44044 | 12 oz Squat | 80 | 2000 | 4.8 | 37.6 | LC16BLR, L16BL-0100, DLR16-0090, DLW16 |
| RNP16C-44045 | 16 oz | 50 | 1000 | 2.7 | 23.0 | |
| RNP21C-44046 | 21 oz | 50 | 1000 | 3.3 | 30.8 | |
| RP4TCB-44047 | 24 oz Flush Fill | 50 | 1000 | 4.2 | 36.2 | |
| RN32CB-44048 | 32 oz Flush Fill | 40 | 480 | 3.0 | 22.8 | LC28BNR, L28BNR, LD28CH-0090 |
| TPH445-44049 | 44 oz | 25 | 500 | 5.1 | 30.5 | LC44BN, L44BN |

* MTO only

Solo® Custom Printed Paper Cold Cups

| Item | Description | Minimum Order | Sleeve | Case Pack | Case Cube (ft ³) | Case Weight (lbs) | Use With |
|---|--------------------------|---------------|--------|-----------|------------------------------|-------------------|--|
| Solo® Custom Printed Paper Cold Cups | | | | | | | |
| RP12NP | 12 oz | 138M | 100 | 2000 | 2.9 | 33.0 | LC12B1-0099, L12BLN-0100, LDN12C-0090 |
| RP12SP | 12 oz Squat | 126M | 80 | 2000 | 4.6 | 37.2 | LC16BLR, L16BL-0100, DLR16-0090, DLW16 |
| RSP16P | 16 oz Squat | 113M | 50 | 1000 | 3.3 | 23.9 | |
| RP16P | 16 oz | 111M | 50 | 1000 | 3.3 | 26.3 | |
| RSP20P | 20 oz | 74M | 50 | 1000 | 4.2 | 30.5 | |
| RSP21P | 21 oz | 92M | 50 | 1000 | 4.2 | 32.3 | |
| RSP22P | 22 oz | 89M | 50 | 1000 | 3.9 | 32.2 | |
| RP24T | 24 oz Flush Fill | 90M | 50 | 1000 | 4.2 | 36.3 | |
| RP24P | 24 oz | 63M | 50 | 1000 | 4.7 | 36.8 | LC1624-0099, L1624B-0100, DLR24-0090 |
| RP28NP / RNP32 | 28 oz (32 oz Flush Fill) | 44M | 40 | 480 | 3.0 | 22.9 | LC28BNR, L28BNR, LD28CH-0090 |
| RP30 | 30 oz | 47M | 40 | 480 | 2.5 | 20.7 | |
| RP32NP | 32 oz | 45M | 40 | 480 | 3.6 | 26.0 | 636TS, L32BNR, DL639 |
| 32TDN | 32 oz | 52M | 40 | 480 | 2.8 | 21.5 | LC44BN, L44BN |
| 44TDNP | 44 oz | 42M | 40 | 480 | 4.1 | 29.5 | |

Solo® Paper Cold Cup Lids



Translucent, Straw-Slotted



Clear, Straw-Slotted



Clear Dome with No Hole



Clear Dome with Hole



Clear Dome with Wide Hole

| Item | Description | Sleeve | Case Pack | Case Cube (ft ³) | Case Weight (lbs) | Use With |
|-------------|--|--------|-----------|------------------------------|-------------------|--|
| L12BLN-0100 | Identification Straw Slot PS Lid - Translucent | 125 | 2000 | 2.3 | 7.8 | RP12NP |
| LC12B1-0099 | Identification Straw Slot PS Lid - Clear | 125 | 1000 | 1.2 | 4.0 | |
| LDN12C-0090 | Dome PET Lid No Hole | 50 | 500 | 0.7 | 3.3 | |
| L16BL-0100 | Identification Straw Slot PS Lid - Translucent | 125 | 2000 | 2.9 | 8.9 | RP12SP, RSP16P, RP16P, RSP20P, RSP21P, RSP22P, RP24T |
| LC16BLR | Identification Straw Slot PS Lid - Clear | 125 | 2000 | 2.8 | 9.1 | |
| DLR16-0090 | Dome PS Lid with Hole | 100 | 1000 | 1.5 | 9.1 | |
| DLW16 | Dome PET Lid with Wide Hole | 100 | 1000 | 1.5 | 8.8 | |
| L1624B-0100 | Identification Straw Slot PS Lid - Translucent | 125 | 2000 | 3.7 | 11.5 | RP24P |
| LC1624-0099 | Identification Straw Slot PS Lid - Clear | 125 | 2000 | 3.7 | 11.5 | |
| DLR24-0090 | Dome PET Lid with Hole | 100 | 1000 | 1.7 | 10.1 | |
| L28BNR | Identification Straw Slot PS Lid - Translucent | 120 | 960 | 2.1 | 7.4 | RP28NP, RNP32, RP30NP |
| LC28BNR | Identification Straw Slot PS Lid - Clear | 120 | 960 | 2.1 | 7.4 | |
| LD28CH-0090 | Dome PS Lid with Hole | 50 | 500 | 1.4 | 5.2 | |
| L32BNR | Identification Straw Slot PS Lid - Translucent | 120 | 960 | 2.1 | 7.7 | RP32NP |
| 636TS | Straw Slot PET Lid - Clear | 50 | 500 | 1.5 | 5.6 | |
| DL639 | Dome PET Lid with Hole | 25 | 500 | 1.9 | 7.6 | |
| L44BN | Identification Straw Slot PS Lid - Translucent | 80 | 960 | 3.0 | 9.7 | 32TDN, 44TDNP |
| LC44BN | Identification Straw Slot PS Lid - Clear | 80 | 960 | 3.0 | 9.7 | |

Solo® Paper 32oz cold cups share lids with Conex® Galaxy® PS 32oz translucent ribbed cups.

* Technical claims have not been evaluated by The Coca-Cola Company.

Solo® Paper 12oz squat, 16 oz, 16 oz squat, 20 oz, 21 oz, 22 oz, and 24 oz tall cold cups share lids with Conex® Galaxy® PS 16 oz tall translucent ribbed cups.

| Cup-to-Lid Selection Guide | | | | | | | | | | | | | | | |
|--|--------------|--------------|--------------|--------------|--------------|--------------|--------------|---------------------------------------|-------------|--------------|---------------------------------------|--------------|--------------|--------------|--------------|
| Clear Straw-Slotted Lids | LC1281-0099 | | | | | | | | LC1624-0099 | LC288NR | 6361S | LC44BN | | | |
| Translucent Straw-Slotted Lids with ID Buttons | L128LN-0100 | | | | | | | | L1624B-0100 | L288NR | L328NR | L44BN | | | |
| Clear Dome Lid with No Hole | LDN12C-0090 | - | | | | | | | - | - | - | - | | | |
| Clear Dome Lid with Hole | - | DLR16-0090 | | | | | | | DLR24-0090 | LD28CH-0090 | DL639 | - | | | |
| Clear Dome Lid with Extra Wide Hole | - | DLW16 | | | | | | | - | - | - | - | | | |
| 4 lids share 7 different cup sizes | | | | | | | | 3 lids share 2 different cup sizes | | | 2 lids share 2 different cup sizes | | | | |
| Available Custom Printed | RP12NP | RP12SP | RSP16P | RP16P | RSP20P | RSP21P | RSP22P | RP24T | RP24P | RP28NP RNP32 | RP30NP | RP32NP | 32TDN | 44TDNP | |
| Jazz® | RP12NP-00055 | RP12SP-00055 | RSP16P-00055 | RP16P-00055 | - | RSP21P-00055 | RSP22P-00055 | - | RP24P-00055 | RP28NP-00055 | RP30NP-00055* | - | - | 44TDNP-00055 | |
| Symphony® | RP12NP-J8000 | RP12SP-J8000 | - | RP16P-J8000 | RSP20P-J8000 | RSP21P-J8000 | - | - | RP24P-J8000 | RP28NP-J8000 | - | RP32NP-J8000 | - | 44TDNP-J8000 | |
| Lemonade | - | - | - | - | - | - | - | - | - | - | - | - | 32TDN-98034* | - | |
| Coca-Cola® Branded | - | RP25CB-44044 | - | RNP16C-44045 | - | RNP21C-44046 | - | RP4TCB-44047 | - | RN32CB-44048 | - | - | - | - | TPH445-44049 |

*MTO only

THE MOST FAMOUS HOT CUP IN THE WORLD



- **Two popular sizes**, 8 oz and 10 oz
- **Original iconic print**, popular in NY since the early 1960s
- **Authentic** Greek key design
- **Made from plant-based renewable resources** with a poly lining

Anthora™ Hot Cups



| Item | 378AN | 370AN |
|--------------------------------------|--------------------------------------|--------------------------------------|
| Description | 8 oz Hot Cup - Anthora™ | 10 oz Hot Cup - Anthora™ |
| Case GTIN | 00041594018583 | 00041594018569 |
| Case Quantity | 1000 | 1000 |
| Case Dimensions | 16.3 × 13.1 × 17.2 | 17.1 × 13.8 × 18.8 |
| Case Cube | 2.1 | 2.6 |
| Case Weight | 19 | 23 |
| Sleeve Quantity (20 inners per case) | 50 | 50 |
| Pallet TI/HI | 9/5 | 8/5 |
| Suggested Lids | LB3081-00007 Liftback & Lock Tab™ | LB3101-00007 Liftback & Lock Tab™ |
| | TL38B2-0004 Traveler® Lid-Black | TL31B2-0004 Traveler® Lid-Black |
| | TL38R2-0007 Traveler® Lid-White | TL31R2-0007 Traveler® Lid-White |

Lids



Liftback and Lock Tab™ Lid



Traveler® Lid - Black



Traveler® Lid - White



For additional information,
contact your Dart representative
or call 1-800-248-5960

www.dart.biz



Duo Shield®
Insulated Paper Hot Cups



KEEP THE HEAT. LOSE THE SLEEVE.

- **Air Pocket Insulation** — Eliminates the need for sleeves or double cupping, which reduces serving time and operating expenses for increased operational efficiency
- **Get a Grip!** — Matte finish on overwrap offers superior non-slip grip and better hand-hold feel
- **Top-to-Bottom Graphics** — Print area spans entire length of cup, allowing maximum space for customization to showcase operator brand/logo



Duo Shield® Insulated Paper Hot Cups

KEEP THE HEAT. LOSE THE SLEEVE.

Duo Shield® insulated paper hot cups provide air pocket insulation to keep beverages hot and hands at a comfortable temperature, eliminating the need to add a sleeve or double cup beverages. A poly lining on the inside of the cup acts as a moisture barrier to keep liquid inside the cup and prevent leaking. This dual layer product is made with 95% plant-based renewable resources and is the ideal solution for specialty coffee, lodging, travel, and leisure operations.



Air Pocket Insulation
For perfect hand-hold temperature without a sleeve



Superior Grip
Matte finish surface for non-slip grip



Top-to-Bottom Graphics
Provides more space to showcase your brand



Sustainability Alternative
Made with 95% plant-based renewable resources



Variety
Available in multiple sizes and stock designs

| Item | Description | Inner Qty | Case Qty | Case Cube (cu. ft.) | Case Wt (lbs.) | Corresponding Cup/Lid |
|--|-------------------------------------|-----------|----------|---------------------|----------------|--|
| SYMPHONY® PRINTED DUO SHIELD® INSULATED PAPER HOT CUPS | | | | | | |
| IC8-J8000 | 8 oz. Hot Cup - Symphony® | 50 | 1000 | 3.2 | 32.7 | TL38B2-0004, TL38R2-0007 |
| IC12-J8000 | 12 oz. Hot Cup - Symphony® | 40 | 600 | 3.0 | 26.1 | TLB316-0004, TLP316-0007, TLP316PP, TLN316-00013, LK316W-0007, LK316B-0004 |
| IC16-J8000 | 16 oz. Hot Cup - Symphony® | 35 | 525 | 2.8 | 26.8 | |
| IC20-J8000 | 20 oz. Hot Cup - Symphony® | 35 | 350 | 2.4 | 20.9 | |
| IC24-J8000 | 24 oz. Hot Cup - Symphony® | 25 | 500 | 4.3 | 33.7 | TLB20-0001, TLP20-0007 |
| TUSCAN CAFÉ™ PRINTED DUO SHIELD® INSULATED PAPER HOT CUPS | | | | | | |
| IC8-J7534 | 8 oz. Hot Cup - Tuscan Café™ | 50 | 1000 | 3.2 | 32.7 | TL38B2-0004, TL38R2-0007 |
| IC12-J7534 | 12 oz. Hot Cup - Tuscan Café™ | 40 | 600 | 3.0 | 26.1 | TLB316-0004, TLP316-0007, TLP316PP, TLN316-00013, LK316W-0007, LK316B-0004 |
| IC16-J7534 | 16 oz. Hot Cup - Tuscan Café™ | 35 | 525 | 2.8 | 26.8 | |
| IC20-J7534 | 20 oz. Hot Cup - Tuscan Café™ | 35 | 350 | 2.4 | 20.9 | |
| IC24-J7534 | 24 oz. Hot Cup - Tuscan Café™ | 25 | 500 | 4.3 | 33.7 | TLB20-0001, TLP20-0007 |
| TRAVELER® DOME HOT CUP LIDS | | | | | | |
| TL38B2-0004 | Dome Hot Cup Lid - Black | 100 | 1000 | 1.2 | 6.9 | IC8-J8000, IC8-J7534 |
| TL38R2-0007 | Dome Hot Cup Lid - White | 100 | 1000 | 1.2 | 6.9 | |
| TLB316-0004 | Dome Hot Cup Lid - Black | 100 | 1000 | 1.6 | 9.6 | IC12-J8000, IC12-J7534, IC16-J8000, IC16-J7534 |
| TLP316-0007 | Dome Hot Cup Lid - White | 100 | 1000 | 1.6 | 10.0 | |
| TLP316PP | Dome Hot Cup PP Lid - White | 100 | 1000 | 1.6 | 9.4 | |
| TLN316-00013 | Dome Hot Cup Lid - Brown | 100 | 1000 | 1.6 | 10.1 | |
| TLB20-0001 | Dome Hot Cup Lid - Black | 100 | 1000 | 1.8 | 11.7 | IC20-J8000, IC20-J7534, IC24-J8000, IC24-J7534 |
| TLP20-0007 | Dome Hot Cup Lid - White | 100 | 1000 | 1.8 | 11.1 | |
| TRAVELOCK™ RECLOSABLE DOME HOT CUP LIDS | | | | | | |
| LK316W-0007 | Reclosable Dome Hot Cup Lid - White | 100 | 1000 | 1.8 | 10.0 | IC12-J8000, IC12-J7534, IC16-J8000, IC16-J7534 |
| LK316B-0004 | Reclosable Dome Hot Cup Lid - Black | 100 | 1000 | 1.8 | 10.0 | |
| OPTIMA® RECLOSABLE DOME HOT CUP LIDS | | | | | | |
| OPT316 | Reclosable Dome Hot Cup Lid | 100 | 1000 | 1.6 | 10.0 | IC12-J8000, IC12-J7534, IC16-J8000, IC16-J7534 |
| OPT316B | Reclosable Dome Hot Cup Lid | 100 | 1000 | 1.6 | 10.0 | |

Solo brand paper products are made from paper purchased from manufacturers that at a minimum have either Forest Stewardship Council (FSC) or Sustainable Forestry Initiative (SFI) certified fiber sourcing.



For additional information,
contact your Dart representative
or call (800) 248-5960

www.dartcontainer.com

DART CONTAINER CORPORATION

The Industry Standard of Excellence

Mason, Michigan 48854 U.S.A.

Ph: (800) 248-5960 • Fax: (517) 676-3883

Email: sales@dart.biz • www.dartcontainer.com

PRINTED ON RECYCLED PAPER

©2017 Dart Container Corporation. All rights reserved.
Dart®, the Dart logo and Optima® are trademarks of Dart Container Corporation. Solo®, the Solo logo, Duo Shield®, Symphony®, Tuscan Café™, Traveler®, TraveLock™ and the Traveler lid product configuration are trademarks of Solo Cup Operating Corporation. Used with permission.
MC1237USE_083017

Make the World a
Greener Place



Bare® by Solo® Eco-Forward® Waxed Paper Cold Cups

- Made with plant-based renewable resources
- Commercially compostable alternative to standard, double-sided polyethylene and plastic cold cups*
- Available in custom prints or Bare® stock designs to match any décor
- Wax coating creates firm, durable cup walls for cold beverages
- Secure lid seal prevents messy leaks
- One lid fits two different cup sizes



*Compostable in a commercial compost facility which may not exist in your community. Not suitable for backyard composting. Meets the ASTM standard D6868 for compostability.



Bare® by Solo® Eco-Forward® Waxed Paper Cold Cups



| Item | Description | Color or Design | Packing Bag/Case | Case Cube (ft³) | Case Weight (lbs) | Use With |
|--|----------------|-----------------|------------------|-----------------|-------------------|--|
| Bare® by Solo® Eco-Forward® Treated Paper Cold Cups | | | | | | |
| 44BB-JD110 | 3 oz Treated | Bare® | 100/5000 | 2.7 | 25.4 | |
| 44-2050 | 3 oz Treated | White | 100/5000 | 2.7 | 25.4 | |
| 404-2050 | 4 oz Treated | White | 100/5000 | 2.8 | 27.4 | |
| Bare® by Solo® Eco-Forward® Waxed Paper Cold Cups | | | | | | |
| R53BB-2050 | 5 oz Waxed | White | 100/3000 | 2.3 | 25.6 | |
| R53BB-JD110 | 5 oz Waxed | Bare® | 100/3000 | 2.3 | 25.6 | |
| R7BB-JD110 | 7 oz Waxed | Bare® | 100/2000 | 2.2 | 23.5 | L7N-0100 |
| R9BB-JD110 | 9 oz Waxed | Bare® | 100/2000 | 2.5 | 31.4 | L9N-0100 |
| R10NBB-JD110 | 10 oz Waxed | Bare® | 100/2000 | 2.7 | 34.1 | L10BLN-0100 |
| R12BB-JD110 | 12 oz Waxed | Bare® | 100/2000 | 3.0 | 39.7 | L12BLN-0100, LC12B1-0099, LDN12C-0090 |
| RW16BB-JD110 | 16-18 oz Waxed | Bare® | 50/1000 | 3.8 | 33.6 | L16BL-0100, LC16BL-0099, DLR16-0090, DLW16 |
| RS22BB-JD110 | 22 oz Waxed | Bare® | 50/1000 | 4.1 | 37.9 | |

Lids for Bare® by Solo® Eco-Forward® Waxed Paper Cold Cups



| Item | Description | Color or Design | Packing Bag/Case | Case Cube (ft³) | Case Weight (lbs) | Use With |
|------------------------|--------------------------------|-----------------|------------------|-----------------|-------------------|----------------------------|
| Straw-Slot Lids | | | | | | |
| L7N-0100 | Flat Lids - Straw Slot - PS | Translucent | 100/2000 | 1.6 | 7.3 | R7BB-JD110 |
| L9N-0100 | Flat Lids - Straw Slot - PS | Translucent | 100/2000 | 1.9 | 7.2 | R9BB-JD110 |
| L10BLN-0100 | Flat Lids - ID Straw Slot - PS | Translucent | 100/2000 | 2.0 | 7.0 | R10NBB-JD110 |
| L12BLN-0100 | Flat Lids - ID Straw Slot - PS | Translucent | 125/2000 | 2.3 | 7.8 | R12BB-JD110 |
| L16BL-0100 | Flat Lids - ID Straw Slot - PS | Translucent | 125/2000 | 2.9 | 8.9 | RW16BB-JD110, RS22BB-JD110 |
| LC12B1-0099 | Flat Lids - ID Straw Slot - PS | Clear | 125/1000 | 1.2 | 4.0 | R12BB-JD110 |
| LC16BLR | Flat Lids - ID Straw Slot - PS | Clear | 125/2000 | 2.8 | 9.1 | RW16BB-JD110, RS22BB-JD110 |
| Dome Lids | | | | | | |
| LDN12C-0090 | Dome Lids - No Hole - PETE | Clear | 50/500 | 0.7 | 3.3 | R12BB-JD110 |
| DLR16-0090 | Dome Lids - Hole - PETE | Clear | 100/1000 | 1.5 | 9.1 | RW16BB-JD110, RS22BB-JD110 |
| DLW16 | Dome Lids - Wide Hole - PETE | Clear | 100/1000 | 1.5 | 8.8 | RW16BB-JD110, RS22BB-JD110 |



For additional information,
contact your Dart representative
or call (800) 248-5960
www.dartcontainer.com

DART CONTAINER CORPORATION

The Industry Standard of Excellence

Mason, Michigan 48854 U.S.A.

Ph: (800) 248-5960 • Fax: (517) 676-3883

Email: sales@dart.biz • www.dartcontainer.com



Lock it open to enjoy a sip,
and then reclose it for a safer trip

TraveLock® Reclosable Dome Lid

Conveniently take hot beverages on-the-go with Solo®'s new TraveLock® reclosable dome lids! The perforated tab reduces the chance of liquid splashing out of the cup and helps keep the beverage warm prior to consumption. Once opened, the tab can be locked back into drinking position or it can be pushed through the sip hole again to act as a cover, avoiding splashing during transport. An elevated surface provides more lip room and comfort, enhancing the drinking experience! One lid fits the five most popular hot cup sizes, reducing storage requirements and increasing operational efficiencies — a plus for any business owner!





Features

Dome-style

Accommodates gourmet beverage toppings

Elevated rise design around sip hole

Provides more surface area for the lower lip to enhance drinking comfort

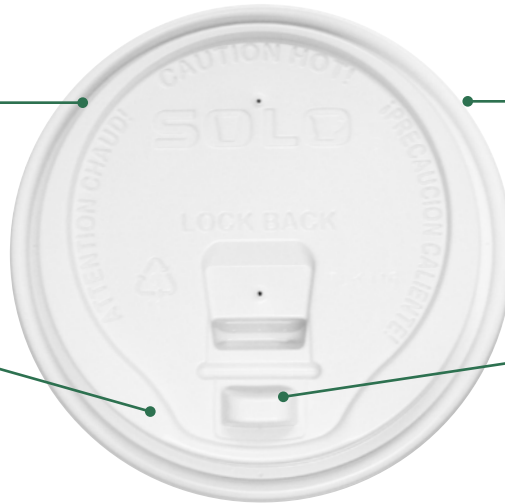

One lid size fits 5 cup sizes

One lid fits the 5 most popular cup sizes for operational efficiency

Reclosable

Reduces the chance of liquid splashing out of the sip hole



LK316W-0007



LK316B-0004

| Stock Number | Description | Color | Packing Bag | Packing Case | Case Cube (ft ³) | Case Weight (lbs) | Use With |
|---|-----------------------------|-------|-------------|--------------|------------------------------|-------------------|----------|
| TravelLock® Reclosable Dome Lids | | | | | | | |
| LK316W-0007 | Reclosable Dome Hot Cup Lid | White | 100 | 1000 | 1.8 | 10.0 | Optional |
| LK316B-0004 | Reclosable Dome Hot Cup Lid | Black | 100 | 1000 | 1.8 | 10.0 | Optional |

| Compatible Hot Cups | | | | | | |
|---|----------------|-------------|-------------|------------|------------|--|
| | 10 oz. | 12 oz. | 16 oz. | 20 oz. | 24 oz. | |
| Solo® Single Sided Poly Paper Hot Cups | 410/510 series | 412 series | 316 series | 420 series | 424 series | |
| Bare® Eco-Forward® Single Sided PLA (SSPLA) Hot Cups | 410/510 series | 412 series | 316 series | 420 series | — | |
| Bare® Eco-Forward® Post-Consumer Fiber (PCF) Hot Cups | 410/510 series | 412 series | 316 series | 420 series | — | |
| Duo Shield® Insulated Paper Hot Cups | — | IC12 series | IC16 series | — | — | |



For additional information,
contact your Dart representative
or call (800) 248-5960

www.dartcontainer.com

DART CONTAINER CORPORATION

The Industry Standard of Excellence

Mason, Michigan 48854 U.S.A.

Ph: (800) 248-5960 • Fax: (517) 676-3883

Email: sales@dart.biz • www.dartcontainer.com



ASEGÚRELA EN POSICIÓN ABIERTA PARA DISFRUTAR DE UN SORBITO, Y VUELVA A CERRARLA PARA MAYOR SEGURIDAD AL ANDAR

- **¡Lleve su bebida vaya donde vaya!** Tapón/orificio para beber resellable reduce los derrames y salpicaduras y mantiene las bebidas calientes
- **¡Diseñado para mayor comodidad al beber!** Superficie elevada adyacente al orificio para beber brinda más espacio para el labio inferior
- **¡Una tapa funciona para cinco tamaños de vasos!** La intercambiabilidad de la tapa reduce los requisitos de almacenamiento y aumenta la eficiencia operativa
- **¡Llénelo!** La tapa estilo domo brinda espacio adicional para agregar espuma u otros ingredientes a bebidas gourmet



TravelLock™

Tapa “Abre/Cierra Seguro” para vasos de papel para bebidas calientes

ASEGÚRELA EN POSICIÓN ABIERTA PARA DISFRUTAR DE UN SORBITO, Y VUELVA A CERRARLA PARA MAYOR SEGURIDAD AL ANDAR

¡Lleve bebidas calientes convenientemente vaya donde vaya con la nueva tapa TravelLock “Abre/Cierra Seguro” de Solo para vasos de papel para bebidas calientes! La solapa perforada disminuye la posibilidad de que el líquido salpique fuera del vaso y ayuda a mantener la bebida caliente antes de ser consumida. Una vez abierta, la solapa puede ser asegurada en posición para beber o puede ser nuevamente insertada en el orificio para beber para actuar como un tapón, evitando salpicaduras durante su transporte. ¡La superficie elevada brinda más espacio para los labios y mayor comodidad, optimizando su experiencia! Una misma tapa funciona para los cinco tamaños de vasos para bebidas calientes más usados frecuentemente, reduciendo los requisitos de almacenamiento y aumentando la eficiencia operativa... ¡una ventaja para todo propietario de negocio!



Abre/Cierra Seguro
Disminuye la posibilidad de que el líquido salpique a través del orificio para beber



Diseño de superficie más alta
Proporciona una superficie de mayor tamaño para el labio inferior, brindando mayor comodidad al beber



Una tapa funciona para 5 tamaños de vasos
Con fines de eficiencia operativa, una tapa funciona para los 5 tamaños de vasos más usados frecuentemente



Estilo domo
Brinda espacio para ingredientes adicionales de bebidas gourmet



| Producto | Descripción | Color o diseño | Cantidad por bolsa | Cantidad por caja | Código UPC | Libras (kg) por caja | Largo de la caja pulgadas (cm) | Ancho de la caja pulgadas (cm) | Alto de la caja pulgadas (cm) | Pies (metros) cúbicos por caja | Paletizado TI/HI |
|--|--|----------------|--------------------|-------------------|--------------|----------------------|--------------------------------|--------------------------------|-------------------------------|--------------------------------|------------------|
| TRAVELLOCK™ “ABRE/CIERRA SEGURO” CON DOMO PARA VASOS PARA BEBIDAS CALIENTES | | | | | | | | | | | |
| LK316W-0007 | Tapa domo “Abre/Cierra Seguro” para vasos para bebidas calientes | Blanca | 100 | 1000 | 041165249286 | 10.0 (4.5) | 18.9 (48.0) | 7.8 (19.8) | 20.9 (53.1) | 1.8 (.051) | 12/4 |
| LK316B-0004 | Tapa domo “Abre/Cierra Seguro” para vasos para bebidas calientes | Negra | 100 | 1000 | 041165249255 | 10.0 (4.5) | 18.9 (48.0) | 7.8 (19.8) | 20.9 (53.1) | 1.8 (.051) | 12/4 |

| VASOS PARA BEBIDAS CALIENTES COMPATIBLES | | | | | |
|--|-----------------|-----------------|-----------------|-----------------|-----------------|
| | 10 oz. (296 ml) | 12 oz. (355 ml) | 16 oz. (473 ml) | 20 oz. (591 ml) | 24 oz. (710 ml) |
| Vasos de papel para bebidas calientes recubiertos de polietileno en un solo lado | Serie 410 | Serie 412 | Serie 316 | Serie 420 | Serie 424 |
| Vasos Bare® Eco-Forward® recubiertos de PLA (SSPLA) para bebidas calientes | Serie 410 | Serie 412 | Serie 316 | Serie 420 | — |
| Vasos aislantes de papel Duo Shield® para bebidas calientes | — | Serie IC12 | Serie IC16 | — | — |



Para más información favor de comunicarse con su representante Solo o llamar al 1-800-367-2877

www.solutionsbysolo.com



An Eco-Forward Thinking Cup

Bare® by Solo® Eco-Forward® PCF Paper Hot Cups

- **Recycled content** — This innovative, first-ever FDA-compliant, PCF paper hot cup contains recycled content that comes from paper collected from school or office recycling programs after consumer use. Less virgin material is used to make PCF paper hot cups, reducing the impact on valuable natural resources
- **Sustainability alternative** — Made from 90% plant-based renewable resources and a minimum of 10% post-consumer recycled fiber. We source fibers certified under the SFI® chain of custody
- **Lid interchangeability** — Four cup, one lid solution for sizes 10 ounce squat–20 ounce reduces storage requirements and increases operational efficiencies
- **Smooth rolled rim** — Gives rigidity to the cup and ensures secure leak-resistant lid fit





Features

Sustainability alternative

Made from 90% plant-based renewable resources and a minimum of 10% post-consumer recycled fiber

Lid interchangeability

One lid fits four popular cup sizes (10 sq – 20 oz) for operational efficiency



Rolled rim

Gives rigidity to the cup and ensures secure, leak-resistant lid fit

Customized design available

Customize with the Bare® co-logo print or custom print to showcase operators' branding and logos

| Item | Description | Packing Bag | Packing Case | Case Cube (ft') | Case Weight (lbs) | Use With Cup/Lid |
|--|--|-------------|--------------|-----------------|-------------------|---|
| Bare® by Solo® Eco-Forward® PCF Paper Hot Cups | | | | | | |
| 374RC-J8484 | 4 oz PCF Hot Cup - Bare® | 50 | 1000 | 1.1 | 9.1 | VL34R-0007 |
| 378RC-J8484 | 8 oz PCF Hot Cup - Bare® | 50 | 1000 | 2.1 | 18.9 | TL38B2-0004, TL38R2-0007, LB3081-00007 |
| 370RC-J8484 | 10 oz PCF Hot Cup - Bare® | 50 | 1000 | 2.6 | 22.7 | TL31B2-0004, TL31R2-0007, LB3101-00007 |
| W370RC-J8484 | 10 oz Wrapped PCF Hot Cup - Bare® | 1 | 480 | 1.4 | 12.3 | |
| 410RC-J8484* | 10 oz Squat PCF Hot Cup - Bare® | 50 | 1000 | 2.7 | 20.8 | |
| 510RC-J8484* | 10 oz Standard PCF Hot Cup - Bare® | 50 | 1000 | 3.2 | 22.6 | OPT316, OPT316B, TLB316-0004, TLN316-00013, TLP316-0007, LB3161-00007, LK316B-0004, LK316W-0007 |
| 412RCN-J8484 | 12 oz PCF Hot Cup - Bare® | 50 | 1000 | 3.2 | 26.1 | |
| 316RC-J8484 | 16 oz PCF Hot Cup - Bare® | 50 | 1000 | 3.7 | 32.8 | |
| 420RC-J8484 | 20 oz PCF Hot Cup - Bare® | 40 | 600 | 2.7 | 22.4 | |
| Optima™ Reclosable Lids For Solo® Paper Hot Cups | | | | | | |
| OPT316 | Reclosable Dome Hot Cup Lid - White | 100 | 1000 | 1.6 | 10.0 | 410, 510, 412, 316, 420 series |
| OPT316B | Reclosable Dome Hot Cup Lid - Black | 100 | 1000 | 1.6 | 10.0 | |
| Traveler® Cappuccino Style Dome Lids For Solo® Paper Hot Cups | | | | | | |
| TL38B2-0004 | Dome Hot Cup Lid - Black | 100 | 1000 | 1.2 | 6.9 | 378 series |
| TL38R2-0007 | Dome Hot Cup Lid - White | 100 | 1000 | 1.2 | 6.9 | |
| TL31B2-0004 | Dome Hot Cup Lid - Black | 100 | 1000 | 1.4 | 8.5 | 370 series |
| TL31R2-0007 | Dome Hot Cup Lid - White | 100 | 1000 | 1.4 | 8.5 | |
| TLB316-0004 | Dome Hot Cup Lid - Black | 100 | 1000 | 1.6 | 9.6 | |
| TLN316-00013 | Dome Hot Cup Lid - Brown | 100 | 1000 | 1.6 | 10.1 | 410, 510, 412, 316, 420 series |
| TLP316-0007 | Dome Hot Cup Lid - White | 100 | 1000 | 1.6 | 9.6 | |
| TLP316PP | Polypropylene Dome Hot Cup Lid - White | 100 | 1000 | 1.6 | 9.4 | |
| TravelLock® Reclosable Dome Lids | | | | | | |
| LK316W-0007 | Reclosable Dome Hot Cup Lid - White | 100 | 1000 | 1.8 | 10.1 | 410, 510, 412, 316, 420 series |
| LK316B-0004 | Reclosable Dome Hot Cup Lid - Black | 100 | 1000 | 1.8 | 10.1 | |
| Solo® Liftback 'n' Lock Tab Lids | | | | | | |
| LB3081-00007 | Liftback and Lock Tab Lid - White | 100 | 1000 | 1.1 | 4.7 | 378 series |
| LB3101-00007 | Liftback and Lock Tab Lid - White | 100 | 1000 | 1.2 | 5.9 | 370 series |
| LB3161-00007 | Liftback and Lock Tab Lid - White | 100 | 1000 | 1.4 | 6.9 | 410, 510, 412, 316, 420 series |
| Solo® Vented Lids | | | | | | |
| VL34R-0007 | Vented Lid - White | 100 | 1000 | 1.0 | 4.3 | 374 series |

* May not be available in all sales areas.



For additional information, contact your Dart representative or call (800) 248-5960
www.dartcontainer.com



DART CONTAINER CORPORATION

The Industry Standard of Excellence

Mason, Michigan 48854 U.S.A.

Ph: (800) 248-5960 • Fax: (517) 676-3883

Email: sales@dart.biz • www.dartcontainer.com



©2018 Dart Container Corporation. All rights reserved. Dart®, the Dart logo and Optima® are trademarks of Dart Container Corporation. Solo®, the Solo logo, Bare®, Eco-Forward®, Traveler®, and TravelLock® are trademarks of Solo Cup Operating Corporation. Used with permission.
 MC1539USE_022618

PRINTED ON RECYCLED PAPER



Bare[®] by Solo[®]
Eco-Forward[®] SSPLA Paper Hot Cups



PLANT MADE. PLANET APPROVED.

- **Compostable in a commercial compost facility** - Appropriate commercial composting facilities may not exist in your community. Please check with your local municipality. Not suitable for backyard composting.
- **Plant-based lining** - cup lined with PLA (polylactic acid), a plant-based resin, acting as a moisture barrier to prevent leaking and replacing the petroleum-based lining typically found in paper hot cups
- **Sustainability alternative** - made from 100% plant-based renewable resources and made with SFI certified paperboard.
- **Third party certifications** - meets the ASTM D6868 standard and certified by the Biodegradable Products Institute (BPI) as compostable in a commercial composting facility



Bare® by Solo® Eco-Forward® SSPLA Paper Hot Cups

PLANT MADE. PLANET APPROVED.

For some food packaging applications, a commercially compostable product is the most environmentally responsible option. Solo's® Bare® SSPLA-lined hot cups are compostable in a commercial compost facility. Appropriate commercial composting facilities may not exist in your community. Please check with your local municipality. Not suitable for backyard composting.



Commercially compostable* paper hot cups made from plant-based renewable resources



Sustainability Alternative
Commercially compostable* and made from 100% plant-based renewable resources



Lid Interchangeability
One lid fits the 4 most popular cup sizes for operational efficiency



Rolled Rim
Gives rigidity to the cup and ensures secure leak-resistant lid fit



Customized Design Available
Customize operator's branding and logos

| Item | Description | Packing Bag | Packing Case | Case Cube (cu. ft.) | Case Wt (lbs.) | Use With |
|---|--|-------------|--------------|---------------------|----------------|---|
| SINGLE SIDED PLA PAPER HOT CUPS | | | | | | |
| 378PLA-J7234 | 8 oz Hot Cup - Bare® | 50 | 1000 | 2.1 | 20.0 | TL38B2-0004, TL38R2-0007, LB3081-00007 |
| 370PLA-J7234 | 10 oz Hot Cup - Bare® | 50 | 1000 | 2.6 | 24.7 | TL31B2-0004, TL31R2-0007, LB3101-00007 |
| 410PLA-J7234 | 10 oz Squat Hot Cup - Bare® | 50 | 1000 | 2.7 | 20.7 | OPT316, OPT316B, TLB316-0004, TLN316-00013, TLP316-0007, LB3161-00007, LK316B-0004, LK316W-0007, TLP316PP |
| 412PLN-J7234 | 12 oz Hot Cup - Bare® | 50 | 1000 | 3.2 | 28.8 | |
| 316PLA-J7234 | 16 oz Hot Cup - Bare® | 50 | 1000 | 3.7 | 33.9 | |
| 420PLA-J7234 | 20 oz Hot Cup - Bare® | 40 | 600 | 2.7 | 22.7 | |
| OPTIMA® RECLOSABLE PAPER HOT CUP LID | | | | | | |
| OPT316 | Reclosable Dome Hot Cup Lid - White | 100 | 1000 | 1.6 | 10.0 | 410, 412, 316, 420 series |
| OPT316B | Reclosable Dome Hot Cup Lid - Black | 100 | 1000 | 1.6 | 10.0 | |
| TRAVELER® CAPPUCCINA STYLE DOME LIDS | | | | | | |
| TL38B2-0004 | Dome Hot Cup Lid - Black | 100 | 1000 | 1.2 | 6.9 | 378 series |
| TL38R2-0007 | Dome Hot Cup Lid - White | 100 | 1000 | 1.2 | 6.9 | |
| TL31B2-0004 | Dome Hot Cup Lid - Black | 100 | 1000 | 1.4 | 8.5 | 370 series |
| TL31R2-0007 | Dome Hot Cup Lid - White | 100 | 1000 | 1.4 | 8.5 | |
| TLB316-0004 | Dome Hot Cup Lid - Black | 100 | 1000 | 1.6 | 9.6 | 410, 412, 316, 420 series |
| TLN316-00013 | Dome Hot Cup Lid - Brown | 100 | 1000 | 1.6 | 10.1 | |
| TLP316-0007 | Dome Hot Cup Lid - White | 100 | 1000 | 1.6 | 10.0 | |
| TLP316PP | Polypropylene Dome Hot Cup Lid - White | 100 | 1000 | 1.6 | 9.4 | |
| TRAVELOCK® RECLOSABLE DOME LIDS | | | | | | |
| LK316W-0007 | Reclosable Dome Hot Cup Lid - White | 100 | 1000 | 1.8 | 10.0 | 410, 412, 316, 420 series |
| LK316B-0004 | Reclosable Dome Hot Cup Lid - Black | 100 | 1000 | 1.8 | 10.0 | |
| SOLO® LIFTBACK 'N' LOCK TAB LIDS | | | | | | |
| LB3081-00007 | Liftback and Lock Tab Lid - White | 100 | 1000 | 1.1 | 5.6 | 378 series |
| LB3101-00007 | Liftback and Lock Tab Lid - White | 100 | 1000 | 1.2 | 5.9 | 370 series |
| LB3161-00007 | Liftback and Lock Tab Lid - White | 100 | 1000 | 1.4 | 6.9 | 410, 412, 316, 420 series |

* Compostable in a commercial composting facility which may not exist in your community. Not suitable for backyard composting. Meets the ASTM standard D6868 for compostability by the Biodegradable Product Institute (BPI).

Bare® Eco-Forward® Product



For additional information,
contact your Dart representative
or call (800) 248-5960
www.dartcontainer.com



COMPOSTABLE
IN INDUSTRIAL FACILITIES
Check locally, as these do not exist in many communities. Not suitable for backyard composting. CERT # 1436995



EXCLUSIVELY
DESIGNED FOR USE WITH

SOLO PAPER HOT CUPS!

Optima® Reclosable Paper Hot Cup Lids

- **Fully reclosable, on-the-go solution** — the Drink Well Plug creates a leak-resistant seal to reduce spills and splashes during transport
- **One lid fits five cup sizes (10 squat-24 oz)** — lid interchangeability reduces storage requirements and increases operational efficiencies
- **Beverage protector** — the Drink Well Plug serves as a protective shield to prevent contamination of the sip hole and the beverage inside the cup, alleviating sanitation concerns
- **Image enhancer** — Upscale your coffee program with the Optima® reclosable lid paired with a Solo® paper hot cup! No other cup/lid combination offers this type of security, outstanding quality and uniqueness





Features

Lock statement

identifies where to lock tab in the open position

Bilingual precautionary statement

creates beverage temperature awareness

Ribbed skirt

provides added strength to maintain integrity of the skirt



Locking post with side latches
secures tab in the open position

Elevated Platform

allows extra room for froth or toppings on gourmet beverages

Contoured drinking area

ergonomically designed drinking spout provides drinking comfort

Drink Well Plug

provides a leak-resistant seal

Lift

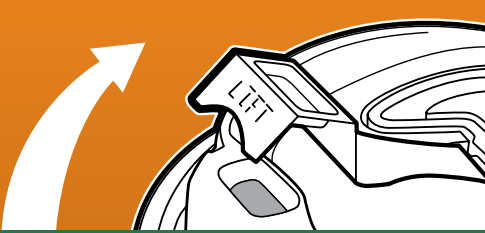

Lock

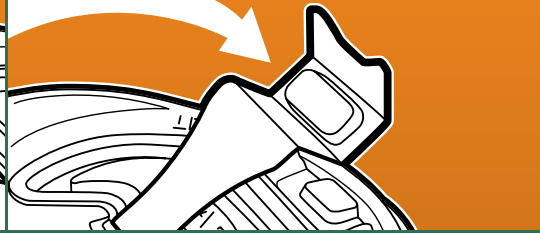

Reclose

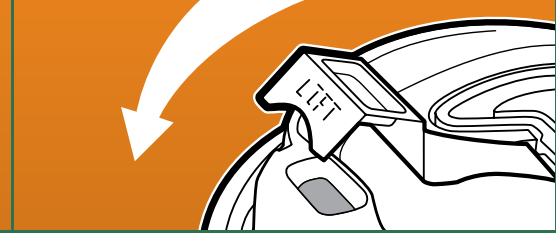

| Item | Description | Color or Design | Inner Qty | Case Qty | Case Cube (ft ³) | Case Wt (lb) |
|--|-----------------------------------|-----------------|-----------|----------|------------------------------|--------------|
| Optima® Reclosable Paper Hot Cup Lids | | | | | | |
| OPT316 | Reclosable Dome Paper Hot Cup Lid | White | 100 | 1000 | 1.6 | 10.0 |
| OPT316B | Reclosable Dome Paper Hot Cup Lid | Black | 100 | 1000 | 1.6 | 10.0 |

| Compatible Solo® Paper Hot Cups | | | | | | |
|--|--|--|---|---|---|---|
| | 10 oz | 12 oz | 16 oz | 20 oz | 24 oz | |
| Solo® Paper Hot Cups |  410/510* series |  412 series |  316 series |  420 series |  424 series | |
| Bare® by Solo® Eco-Forward® SSPLA Paper Hot Cups |  410 series |  412 series |  316 series |  420 series | | — |
| Bare® by Solo® Eco-Forward® PCF Paper Hot Cups |  410/510* series |  412 series |  316 series |  420 series | | — |
| Duo Shield® Insulated Paper Hot Cups | — |  IC12 series |  IC16 series | — | — | — |

* May not be available in all sales areas



For additional information,
contact your Dart representative
or call (800) 248-5960

www.dartcontainer.com

DART CONTAINER CORPORATION

The Industry Standard of Excellence

Mason, Michigan 48854 U.S.A.

Ph: (800) 248-5960 • Fax: (517) 676-3883

Email: sales@dart.biz • www.dartcontainer.com

©2017 Dart Container Corporation. All rights reserved.
Dart®, the Dart logo, and Optima® are trademarks of Dart Container Corporation. Solo®, the Solo logo, Bare® by Solo®, Eco-Forward®, and Duo Shield® are trademarks of Solo Cup Operating Corporation. Used with permission.
MC1546USE_102017

PRINTED ON RECYCLED PAPER



Optima®

Tapa "Abre/Cierra Seguro" para vasos de papel para bebidas calientes

¡EXCLUSIVAMENTE DISEÑADA PARA USO CON

VASOS DE PAPEL PARA BEBIDAS CALIENTES DE **SOLO!**



LEVÁNTELA · ASEGÚRELA · VUÉLVALA A CERRAR ¡LA SOLUCIÓN PARA GENTE EN MOVIMIENTO!

- **Solución portátil totalmente resellable** - El tapón para sellar crea un cierre resistente a goteos para reducir derrames y salpicaduras durante el transporte
- **Una tamaño de tapa para cinco tamaños de vaso (10 bajo - 24 oz)** - La intercambiabilidad de la tapa reduce las necesidades de espacio de almacenaje y aumenta la eficiencia operativa
- **Protector de bebida** - El tapón para sellar sirve como una barrera protectora para prevenir la contaminación del orificio para beber y de la bebida dentro del vaso, reduciendo las preocupaciones en cuanto a higiene
- **Realzador de imagen** - ¡Eleva su programa de café con la tapa Optima "Abre/Cierra Seguro" de Dart en conjunción con un vaso de papel para bebidas calientes de Solo! Ninguna otra combinación de vaso/tapa ofrece este tipo de seguridad, excelente calidad y originalidad



Optima®

Tapa "Abre/Cierra Seguro" para vasos de papel para bebidas calientes*

¡LA SOLUCIÓN PARA GENTE EN MOVIMIENTO!

Optima ofrece a los bebedores de café un nuevo nivel de conveniencia que no se encuentra en ninguna otra tapa para vasos. ¿Qué es lo que hace única a la tapa Optima? Para empezar, brinda a los usuarios una bebida completamente sellada; al no tener un orificio para beber abierto hay menos oportunidades para derrames. Cuando esté listo para beber, simplemente levante la solapa y asegúrela al poste.

Lo más notable de Optima es la capacidad de volver a cerrar la tapa con seguridad hasta que esté listo para volver a beber. No solo una vez, sino una y otra vez. Pruébela y estamos seguros que usted y sus clientes rápidamente se darán cuenta de que ninguna otra tapa brinda la seguridad, conveniencia y calidad de la nueva e innovadora tapa Optima de Dart.

*DISEÑADA EXCLUSIVAMENTE para ser usada con vasos de papel para bebidas calientes de la marca Solo, 10 bajo-24 onzas.

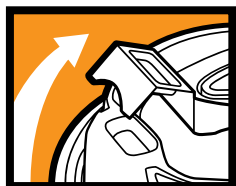

LEVÁNTELA

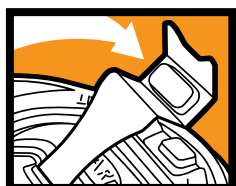

ASEGÚRELA

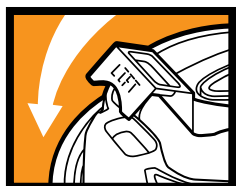

VUÉLVALA A CERRAR

Poste para asegurar con enganches laterales

Asegura la solapa en la posición de abierto

Indicador de enganche

Identifica en dónde asegurar la solapa en la posición de abierto

Plataforma elevada

Brinda espacio adicional para espuma u otros ingredientes en bebidas gourmet

Superficie curvada para beber

Diseño ergonómico que provee comodidad al tomar

Faldón estriado

Brinda mayor resistencia para mantener la integridad del faldón

Tapón para sellar la solapa

Provee un sello resistente a derrames

Aviso de precaución bilingüe

Alerta al consumidor de la temperatura de la bebida



| Artículo | Descripción | Color o diseño | Empaque por bolsa | Empaque por caja | Código UPC | Libras (kg) por caja | Largo de la caja pulg. (cm) | Ancho de la caja pulg. (cm) | Alto de la caja pulg. (cm) | Piés (metros) cúbicos por caja | Tarima Ti/Hi |
|--|---|----------------|-------------------|------------------|--------------|----------------------|-----------------------------|-----------------------------|----------------------------|--------------------------------|--------------|
| TAPAS DOMO OPTIMA "ABRE/CIERRA SEGURO" PARA VASOS DE PAPEL PARA BEBIDAS CALIENTES | | | | | | | | | | | |
| OPT316 | Tapa domo "Abre/Cierra Seguro" para vasos de papel para bebidas calientes | Blanca | 100 | 1000 | 041594326312 | 10.0 (4.5) | 18.9 (48.0) | 7.8 (19.8) | 18.9 (48.0) | 1.6 (.045) | 12/5 |
| OPT316B | Tapa domo "Abre/Cierra Seguro" para vasos de papel para bebidas calientes | Negra | 100 | 1000 | 041594338032 | 10.0 (4.5) | 18.9 (48.0) | 7.8 (19.8) | 18.9 (48.0) | 1.6 (.045) | 12/5 |

VASOS DE PAPEL PARA BEBIDAS CALIENTES SOLO COMPATIBLES

| | 10 oz. (296 ml) | 12 oz. (355 ml) | 16 oz. (473 ml) | 20 oz. (591 ml) | 24 oz. (710 ml) |
|---|-----------------|-----------------|-----------------|-----------------|-----------------|
| Vasos de polipapel para bebidas calientes | Serie 410 | Serie 412 | Serie 316 | Serie 420 | Serie 424 |
| Bare® Eco-Forward® vasos recubiertos de PLA (SSPLA) para bebidas calientes | Serie 410 | Serie 412 | Serie 316 | Serie 420 | — |
| Bare® Eco-Forward® vasos de material reciclado (PCF) para bebidas calientes | Serie 410 | Serie 412 | Serie 316 | Serie 420 | — |
| Vasos aislantes de papel para bebidas calientes Duo Shield® | — | Serie IC12 | Serie IC16 | — | — |



Para más información, favor de comunicarse con su representante de ventas Dart o llamar al 800-248-5960

www.dart.biz

DART CONTAINER CORPORATION

El modelo de excelencia de la industria

Mason, Michigan 48854 E.U.A.
Tel: 800-248-5960 • Fax: 517-676-3883
Email: ventas@dart.biz • www.dart.biz

©2015 Dart Container Corporation. Todos los derechos reservados. Dart®, el logo Dart, Optima® y Drink Well Plug™ son marcas registradas de Dart Container Corporation. Solo®, el logo Solo, Bare®, Eco-Forward® y Duo Shield® son marcas registradas de Solo Cup Operating Corporation. Usado con permiso. GS1546USSD_121115



New from Dart!



Perfect Pak®

Bare® by Solo® Eco-Forward® Recycled Content (PCF) Paper Hot Cups

Good things come in small paks!

| Operator/End-User Challenges | Perfect Pak® Solutions | Office Channel | Cash & Carry | Small Business |
|---|--|----------------|--------------|----------------|
| Limited storage space | Perfect Pak® cases are designed under 21" in height in order to fit in small areas/cabinets in breakrooms and on a retail shelf | X | X | X |
| Breaking cases often necessary for operators to sell smaller quantities | Perfect Pak® reduced case counts eliminate the need for operators to break cases and allow operators to 'turn and earn' | X | X | |
| End users cannot meet distributor minimums as they use less volume in single-use products | Perfect Pak® case counts are up to 50-70% less than standard case counts and are available for purchase in channels such as office and cash & carry where there are no minimum-purchase requirements | X | X | X |
| Need retail-ready packaging | PCF Perfect Pak® cases have attractive four-color outer-case graphics that are eye-catching on the shelf | X | | |
| Reduced cost per case of inventory | Perfect Pak® has a lower price point per case than a standard foodservice pack size | X | X | X |

| Stock Number | Description | Color/Design | Case Count | Sleeve Count | Sleeves Per Case | Case Cube (ft³) | Case Weight (lbs) |
|--------------|------------------------|--------------|------------|--------------|------------------|-----------------|-------------------|
| OF8RC-J8484 | 8oz PCF Paper Hot Cup | Bare® | 500 | 25 | 20 | 1.27 | 10.08 |
| OF10RC-J8484 | 10oz PCF Paper Hot Cup | Bare® | 300 | 25 | 12 | 0.94 | 7.06 |
| OF12RC-J8484 | 12oz PCF Paper Hot Cup | Bare® | 300 | 25 | 12 | 1.19 | 8.16 |
| OF16RC-J8484 | 16oz PCF Paper Hot Cup | Bare® | 300 | 25 | 12 | 1.41 | 10.18 |

Bare® by Solo® Eco-Forward® Recycled Content (PCF) Paper Hot Cups

| FEATURE | ADVANTAGE | BENEFIT |
|--|--|--|
| Made with a minimum of 10% Post-Consumer Recycled Fiber | Paper is diverted from landfills | Supports customer sustainability goals. Reduces impact on valuable natural resources by using less virgin material |
| Uses paper that has been recovered and recycled | Encourages consumer recycling, fueling demand for post-consumer recycled materials | Reduces operator's environmental impact while increasing contribution to a sustainable planet |
| We source fibers certified under the SFI® Chain of Custody | Independent 3rd party certification that enhances supplier credibility | Confidence that paperboard is sourced from sustainably harvested forests alleviating customer/consumer concerns |
| Offered in 8, 10, 12 and 16 oz. | Perfect Paks® offered in the most popular office coffee and retail sizes | Increased business in the office and retail segments |
| Bare® print design | Neutral colors compliment any decor or occasion | Can accommodate any existing operator program |
| Bare® print design | Advertises environmental benefit of cup material | Creates awareness among customers of operator efforts to contribute to a sustainable planet |
| Made with a minimum of 90% plant based renewable resources | Contributes to operator's sustainability goals | Operator confidence of commitment to environment |



We also offer our popular Traveler® Lid in Perfect Paks®!

| Stock Number | Case Count | Case Cube (ft³/cu. m) | Case Weight (lbs/kg) | Pair With |
|--------------|------------|-----------------------|----------------------|----------------------------|
| OFTL31-0007 | 300 | 0.5/0.01 | 2.9/1.3 | OF10RC-J8484 |
| OFTL16-0007 | 300 | 0.5/0.01 | 3.0/1.4 | OF12RC-J8484, OF16RC-J8484 |



For additional information, contact your Dart representative or call 1-800-248-5960

www.dart.biz

DART CONTAINER CORPORATION

The Industry Standard of Excellence

Mason, Michigan 48854 U.S.A.

Ph: 800-248-5960 • Fax: 517-676-3883

Email: sales@dart.biz • www.dart.biz

PRINTED ON RECYCLED PAPER



Traveler®

Exclusively designed for use with

SOLO Paper Hot Cups!

Now available
in polypropylene!

Traveler® Cappuccino Style Dome Polypropylene Lids for Solo® Paper Hot Cups

| | |
|-------------------|--|
| Stock Number | TLP316PP |
| Description | Traveler® Cappuccino Style Dome Polypropylene Lids |
| Color | White |
| Packing Bag | 100 |
| Packing Case | 1000 |
| Case Cube (ft³) | 1.6 |
| Case Weight (lbs) | 9.4 |
| Use With | 410, 510, 412, 316, 420, and 424 Series Solo® Paper Hot Cups |

Fits Solo® 10 oz squat–24 oz single-wall paper hot cups

One lid fits five different cup sizes, reducing storage requirements and increasing operational efficiency



10 oz

10 oz

12 oz

16 oz

20 oz

24 oz

- **Same iconic lid design, offered in recyclable* material** — polypropylene (#5) is a recyclable* material which will support your sustainability goals
- **Polystyrene alternative** — in communities that will not allow solid polystyrene, this lid provides a fully-functional alternative to standard polystyrene (#6) lids

* This product is made with polypropylene resin. Check with your local community to see if it is accepted for recycling.



For additional information,
contact your Dart representative
or call (800) 248-5960

www.dartcontainer.com

©2017 Dart Container Corporation. All rights reserved.
Dart® and the Dart logo are registered trademarks
of Dart Container Corporation. Solo®, the Solo logo,
Traveler®, and the Traveler product configuration are
registered trademarks of Solo Cup Operating Company.
Used with permission.
MC2506USE_112117





New Cup & Lid Sizes Available

Two New Pedestal Cup Sizes 30AJ26 and 42AJ26

For Custom Print Only

With these additions, Dart has the widest selection of pedestal cups available for custom print, up to 4 colors.

2 Cups 1 Lid Program

Available with translucent straw-slotted lid to fit both sizes.

Down-Sizing Trend

These two new sizes are a perfect solution for those customers looking to reduce portions on a current 32oz or 44oz cup.

Flush Fill

30AJ26 30.1 oz
42AJ26 42.3 oz

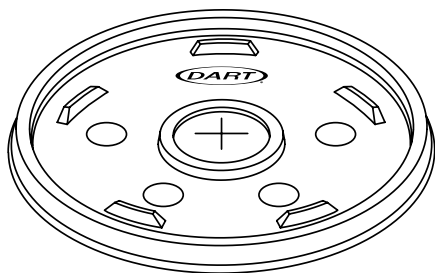

New Straw-Slotted Lid Size Now Available for 26 series Cups!

2 Cups 1 Lid Program

Available with translucent straw-slotted lid to fit both sizes.

| Stock Number | Description | Sleeve | Case Pack | Case Cube (ft ³) | Case Weight (lbs) |
|--------------|-----------------------------|--------|-----------|------------------------------|-------------------|
| 30AJ26 | 30 oz EPS Pedestal Cup | 15 | 300 | 6.544 | 8.249 |
| 42AJ26 | 42 oz EPS Pedestal Cup | 15 | 300 | 8.545 | 10.529 |
| 26SL | 26 Series Straw-Slotted Lid | 100 | 1000 | 1.739 | 8.490 |

*50M minimum print quantity.



For additional information,
contact your Dart representative
or call (800) 248-5960

www.dartcontainer.com

DART CONTAINER CORPORATION

The Industry Standard of Excellence

Mason, Michigan 48854 U.S.A.

Ph: (800) 248-5960 • Fax: (517) 676-3883

Email: sales@dart.biz • www.dartcontainer.com

PRINTED ON RECYCLED PAPER

©2017 Dart Container Corporation. All rights reserved.
Dart® and the Dart logo are registered trademarks of Dart Container Corporation.
Steam® and Symphony® are registered trademarks of Solo Cup Operating Corporation. Used with permission.
MNPIS19USE



New SOLO® Traveler® Lid

Traveler® Cappuccino-Style Dome Lids

Now available in polypropylene!*

Same iconic lid design, offered in recyclable* material — polypropylene (#5) is a recyclable* material which will support customers' sustainability goals

Fits Solo® 10 oz squat-24 oz single-wall paper hot cups — one lid fits five different cup sizes, reducing storage requirements and increasing operational efficiency

Dome lid — allows extra room for froth or toppings on gourmet beverages which communicates an upscale appearance

Polystyrene alternative — in communities that will not allow solid polystyrene, this lid provides a fully-functional alternative to standard polystyrene (#6) lids

Partial plug lid fit — seals inside and out, creating a leak-resistant package which will decrease the likelihood of spillage and associated customer complaints

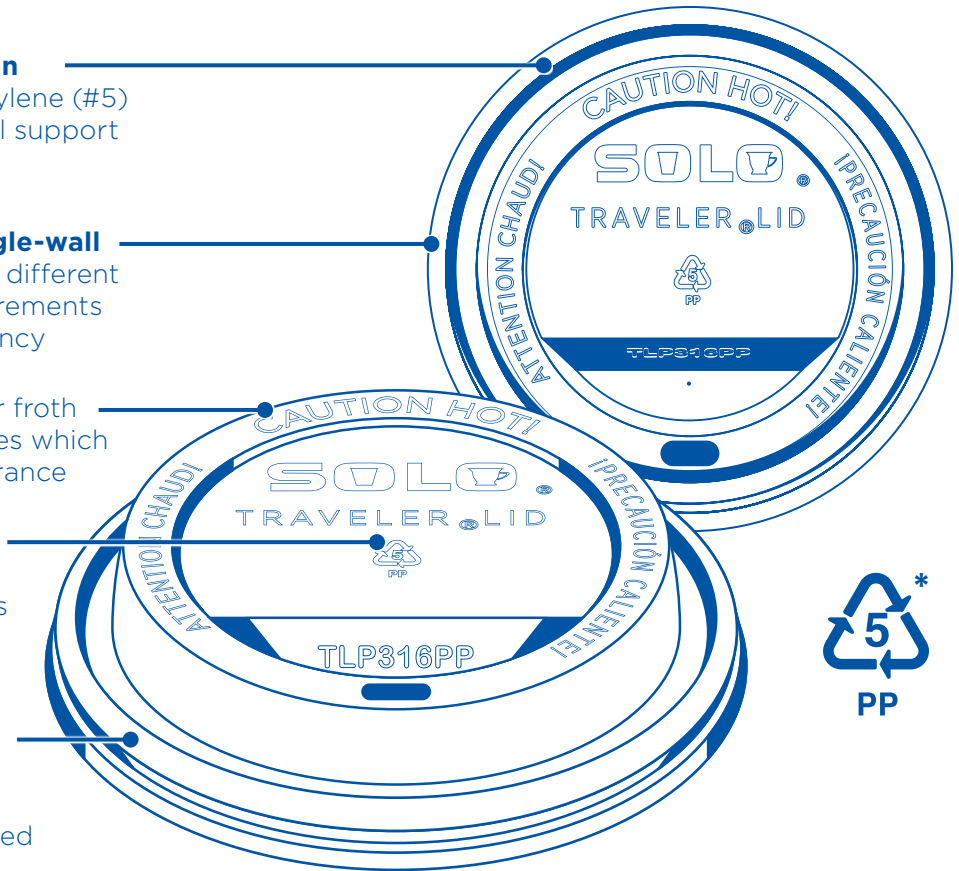

| Stock Number | Description | Sleeve | Case Pack | Case Cube (ft ³) | Case Weight (lbs) |
|--------------|---|--------|-----------|------------------------------|-------------------|
| TLP316PP | Traveler® Polypropylene Cappuccino-Style Dome Lid | 100 | 1000 | 1.6 | 9.4 |

* This product is made with polypropylene resin. Check with your local community to see if it is accepted for recycling.



For additional information,
contact your Dart representative
or call (800) 248-5960

www.dartcontainer.com

DART CONTAINER CORPORATION

The Industry Standard of Excellence

Mason, Michigan 48854 U.S.A.

Ph: (800) 248-5960 • Fax: (517) 676-3883

Email: sales@dart.biz • www.dartcontainer.com

PRINTED ON RECYCLED PAPER

©2017 Dart Container Corporation. All rights reserved.

Dart® and the Dart logo are registered trademarks of Dart Container Corporation. Solo®, the Solo logo, Traveler®, and the Traveler product configuration are registered trademarks of Solo Cup Operating Company. Used with permission. MNPIS116USE_071217



ThermoGuard™ Insulated Paper Hot Cups

- **Custom print only** — customize your cups with your own logo to increase visibility and brand recognition of your business
- **4 Cup/1 Lid program** — ThermoGuard™ sets the industry standard by offering 1 lid that fits 12, 16, 20, and 24 oz cups. Choose from our iconic Traveler® lid, or the one-of-a-kind, fully reclosable Optima® lid
- **“ThermoTouch” insulation** — eliminates the need for a cardboard cup sleeve or wasteful double-cupping, thus saving you money
- **“Full-length” print coverage** — print area fully covers the entire height of the cup, allowing you to make the most of your custom print
- **Made with renewable resources** — ThermoGuard™ is made with renewable resources, which helps to support your customer’s green initiatives





Features

Polyethylene lining
Acts as a moisture barrier keeping contents from leaking

“Full length” print coverage
Allows the customer to use the full length of the sidewall for their custom graphics

Matte sidewall
Offers excellent printability on uncoated sidewalls

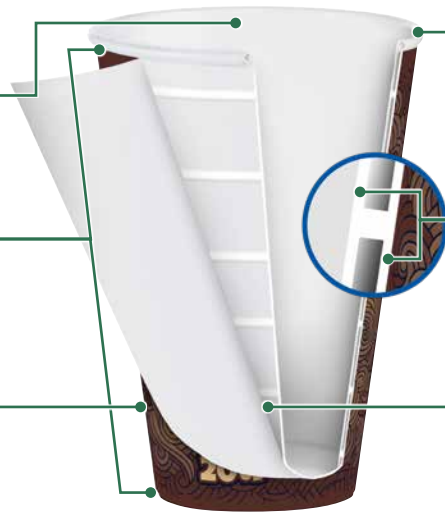

Rolled rim
Provides additional strength to cup and allows for tight lid fit

Double wall construction
Eliminates the need for a cardboard cup sleeve or double-cupping

Insulating air channels
Reduces heat transfer keeping the sidewall cool to the touch

Lids for ThermoGuard™ Insulated Paper Hot Cups



LB3081-00007



TL38R2-0007



TL38B2-0004



OPT1224TG



OPT1224TGB



TL1224TG



TL1224TGB

ThermoGuard™ Insulated Paper Hot Cups



DWTG8



DWTG12



DWTG16



DWTG20



DWTG24

| Stock Code | Approximate Capacity | Color or Design | Minimum Order | Packing Bag | Packing Case | Case Cube ft ³ (m ³) | Case Weight lbs(kg) | Use with |
|--|----------------------|---------------------|---------------|-------------|--------------|---|---------------------|--|
| ThermoGuard™ Insulated Paper Hot Cups | | | | | | | | |
| DWTG8 | 8 oz (236ml) | Custom Printed Only | 154M | 40 | 1000 | 3.9 (.110) | 32.0 (14.5) | LB3081-00007, TL38R2-0007, TL38B2-0004 |
| DWTG12 | 12 oz (354ml) | | 136M | 30 | 600 | 3.2 (.091) | 23.7 (10.8) | TL1224TG, TL1224TGB, OPT1224TG, OPT1224TGB |
| DWTG16 | 16 oz (473ml) | | 112M | 30 | 600 | 3.4 (.096) | 28.0 (12.7) | |
| DWTG20 | 20 oz (591ml) | | 95M | 30 | 600 | 4.2 (.119) | 33.6 (15.2) | |
| DWTG24 | 24 oz (709ml) | | 73M | 25 | 600 | 5.8 (.164) | 40.2 (18.2) | |



For additional information,
contact your Dart representative
or call (800) 248-5960

www.dartcontainer.com

DART CONTAINER CORPORATION

The Industry Standard of Excellence

Mason, Michigan 48854 U.S.A.

Ph: (800) 248-5960 • Fax: (517) 676-3883

Email: sales@dart.biz • www.dartcontainer.com





Wrapped Cup Solutions

Individually Wrapped Paper, Foam, & Plastic Cups

Guest peace of mind
is all wrapped up!

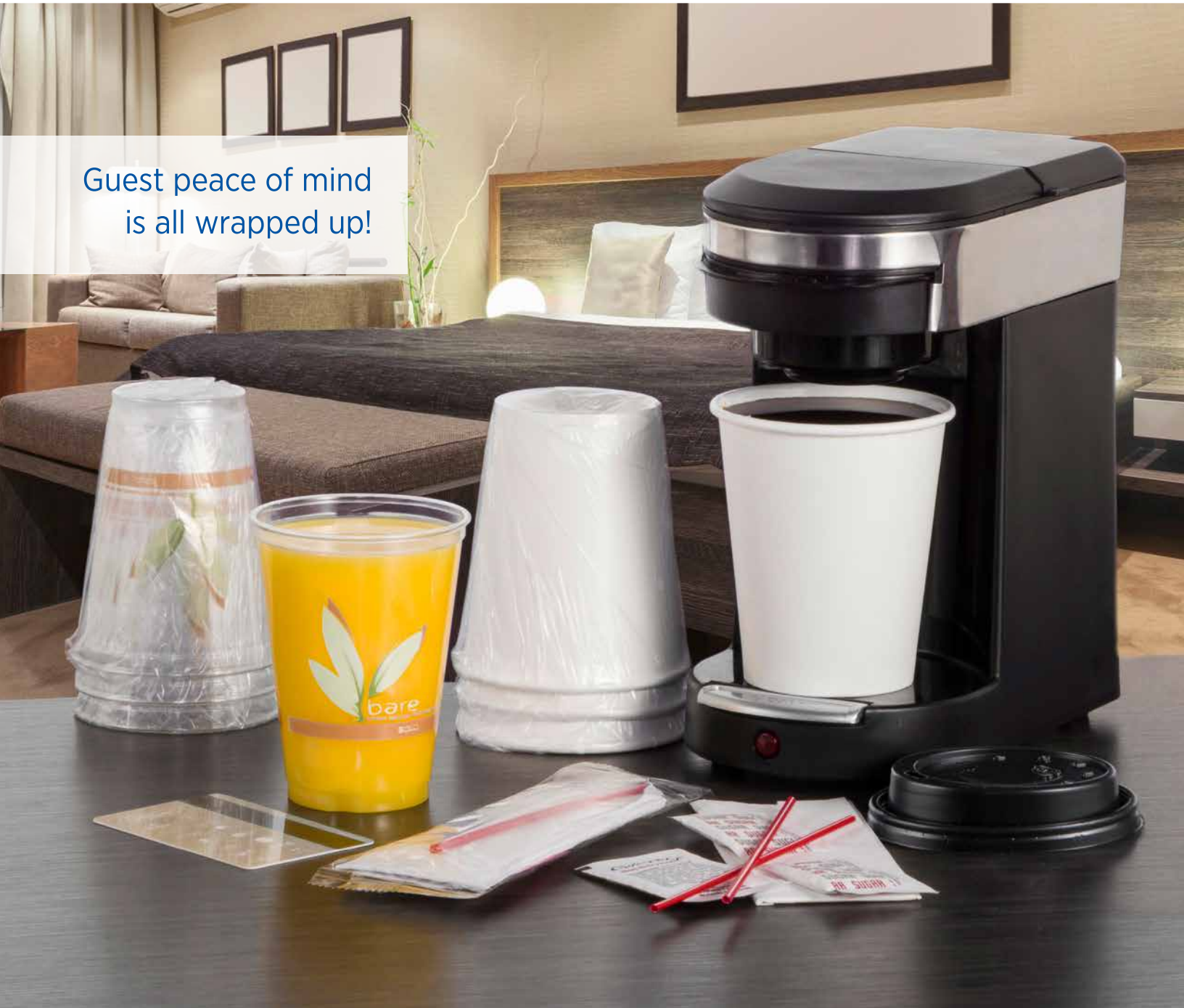

Covering all your wrapped cup needs!

- Boost guest confidence that in-room cups are sanitary
- Operationally efficient to reduce labor and energy cost
- Plastic wrapped cups are more sanitary than glassware
- Variety of wrapped cups available to meet every need



Wrapped Cup Solutions

Individually Wrapped Hot Cups

Features

- **Bare® by Solo® Eco-Forward® PCF Individually Wrapped Paper Hot Cups**
 - First-ever FDA-compliant PCF paper hot cup
 - Made with at least 10% post-consumer recycled fiber and at least 90% renewable resources
 - Custom or co-logo prints available
- **ThermoGlaze® Individually Wrapped Insulated Foam Cups**
 - Hot/cold use
 - Café G® stock or custom print design
- **Trophy® Plus™ Individually Wrapped Dual-Temperature Insulated Cups**
 - Hot/cold use
 - Small case cube
 - Jazz®, Symphony® or custom print designs



W370RC-J8484



W370-2050



8X8GWRAP



10X10GWRAP



WX9-64568



WX9-J8002

| Product Code | Description | Print Capability | Packing Bag/Case | Case Cube (ft ³) | Case Wt. (lbs) | Use With |
|--|----------------|------------------|------------------|------------------------------|----------------|--|
| Solo® Individually Wrapped Paper Hot Cups | | | | | | |
| W370-2050 [†] | 10 oz | ○ | 1/480 | 1.4 | 12.3 | TL31B2-0004, TL31R2-0007, LB3101-00007 |
| Bare® by Solo® Eco-Forward® PCF Individually Wrapped Paper Hot Cups | | | | | | |
| W370RC-J8484 [†] | 10 oz | ● | 1/480 | 1.4 | 12.3 | TL31B2-0004, TL31R2-0007, LB3101-00007 |
| Café G® Individually Wrapped Insulated Foam Cups | | | | | | |
| 8X8GWRAP | 8 oz | ● | 1/900 | 4.9 | 8.4 | 8JL, 8UL, 8FTL, 8EL, 8ELBLK, |
| 10X10GWRAP | 10 oz | ● | 1/900 | 6.1 | 9.7 | 10JL, 10UL, 10FTL, 10EL |
| Trophy® Plus™ Individually Wrapped Dual-Temperature Insulated Cups | | | | | | |
| WX9-64568 | 9 oz Jazz® | ● | 1/900 | 2.8 | 10.5 | LGX8R1-0007, DLX8R-00007 |
| WX9-J8002 | 9 oz Symphony® | ● | 1/900 | 2.8 | 10.5 | |

Print Capability: ● Available printed or unprinted. ○ Available unprinted only. ● Available stock or custom printed only.
[†] SFI-certified.

Wrapped Cup Solutions

Individually Wrapped Cold Cups



Features

- **Bare® by Solo® Eco-Forward® RPET Individually Wrapped Clear Cups**
 - Made with a minimum of 20% post-consumer recycled material
FDA-compliant material
 - Custom or co-logo prints available
- **Individually Wrapped Diamond Tumbler Clear Plastic Cold Cups**
 - Attractive, diamond-cut texture adds a touch of elegance
- **Conex® Galaxy® Individually Wrapped Translucent Cups**
 - Economical alternative that reduces your operating costs
 - Double sidewall ridges for added strength



TP9DW



TP10DW



RTP9DBAREW



RTP10DBAREW



WTC10X-00681



Y9WRAP

| Product Code | Description | Print Capability | Packing Bag/Case | Case Cube (ft ³) | Case Wt. (lbs) | Use With |
|---|-------------|------------------|------------------|------------------------------|----------------|--------------------------------------|
| Solo® Ultra Clear™ Individually Wrapped PET Cold Cups | | | | | | |
| TP9DW | 9 oz | ⊙ | 1/500 | 1.6 | 11.9 | 610TS, 610TP, DLR610, DNR610, DLW610 |
| TP10DW | 10 oz | ⊙ | 1/500 | 1.6 | 13.7 | |
| Bare® by Solo® Eco-Forward® RPET Individually Wrapped Clear Cups | | | | | | |
| RTP9DBAREW | 9 oz | ● | 1/500 | 1.6 | 11.8 | 610TS, 610TP, DLR610, DNR610, DLW610 |
| RTP10DBAREW | 10 oz | ● | 1/500 | 1.6 | 12.3 | |
| Individually Wrapped Diamond Tumbler Clear Plastic Cold Cups | | | | | | |
| WTC10X-00681 | 10 oz | ○ | 1/500 | 1.6 | 12.1 | — |
| Conex® Galaxy® Individually Wrapped Translucent Cups | | | | | | |
| Y9WRAP | 9 oz | ⊙ | 1/1000 | 1.6 | 15.0 | 600TS |

Print Capability: ● Available printed or unprinted. ○ Available unprinted only. ● Available stock or custom printed only.



Wrapped Cup Solutions

Individually Wrapped Paper, Foam, & Plastic Cups

Lids for Cold Cups



Solo® Clear Straw-Slot Lid



Solo® Clear No Slot Lid



Solo® Clear No Hole Dome Lid



Solo® Clear Dome Lid with Hole



Solo® Clear Wide Hole Dome Lid

| Product Code | Description | Packing Bag/Case | Case Cube (ft ³) | Case Weight (lbs) | Use With |
|--|--------------------------------|------------------|------------------------------|-------------------|--|
| Lids Compatible with Individually Wrapped Cold Cups | | | | | |
| 600TS | Solo® Clear Straw-Slot Lid | 100/2500 | 2.7 | 13.4 | Y9WRAP |
| 610TP | Solo® Clear No Slot Lid | 100/1000 | 1.3 | 5.3 | TP9DW, TP10DW, RTP9DBAREW, RTP10DBAREW |
| 610TS | Solo® Clear Straw-Slot Lid | 100/1000 | 1.0 | 5.3 | |
| DNR610 | Solo® Clear No Hole Dome Lid | 100/1000 | 1.2 | 6.8 | |
| DLR610 | Solo® Clear Dome Lid with Hole | 100/1000 | 1.2 | 6.6 | |
| DLW610 | Solo® Clear Wide Hole Dome Lid | 100/1000 | 1.2 | 5.5 | |

Lids for Hot Cups (All lids available in white)



Dart® Vented Lid



Sip Thru® Hot Cup Lid



Lift 'n' Lock Hot Cup Lid



Dart® Cappuccino Lid*



The Gourmet Lid® Cappuccino Style Dome Lid



Solo® Liftback 'n' Lock Tab Lid for Trophy® Plus™



Traveler® Cappuccino Style Dome Lid*



Solo® Liftback 'n' Lock Tab Lid for paper hot cups

* Lid available in white

| Product Code | Description | Packing Bag/Case | Case Cube (ft ³) | Case Weight (lbs) | Use With |
|--|---|------------------|------------------------------|-------------------|-------------------------|
| Lids Compatible with Foam Hot Cups | | | | | |
| 8JL | Dart® Vented Lid | 100/1000 | 1.0 | 4.0 | 8X8GWRAP |
| 8UL | Sip Thru® Hot Cup Lid | 100/1000 | 1.3 | 5.6 | |
| 8FTL | Lift 'n' Lock Hot Cup Lid | 100/1000 | 1.0 | 4.7 | |
| 8ELBLK | Dart® Cappuccino Lid - Black | 100/1000 | 1.1 | 6.8 | |
| 8EL | Dart® Cappuccino Lid - White | 100/1000 | 1.1 | 6.8 | |
| 10JL | Dart® Vented Lid | 100/1000 | 1.1 | 4.2 | 10X10GWRAP |
| 10UL | Sip Thru® Hot Cup Lid | 100/1000 | 1.3 | 6.0 | |
| 10FTL | Lift 'n' Lock Hot Cup Lid | 100/1000 | 1.1 | 5.2 | |
| 10EL | Dart® Cappuccino Lid | 100/1000 | 1.3 | 7.3 | |
| Lids Compatible with Trophy® Plus™ | | | | | |
| LGX8R1-0007 | The Gourmet Lid® Cappuccino Style Dome Lid | 100/1000 | 1.3 | 7.5 | WX9-64568, WX9-J8002 |
| DLX8R-00007 | Solo® Liftback 'n' Lock Tab Lid | 100/2000 | 2.4 | 11.1 | |
| Lids Compatible with Paper Hot Cups | | | | | |
| TL31B2-0004 | Traveler® Cappuccino Style Dome Lid - Black | 100/1000 | 1.4 | 8.5 | W370RC-J8484, W370-2050 |
| TL31R2-0007 | Traveler® Cappuccino Style Dome Lid - White | 100/1000 | 1.4 | 8.5 | |
| LB3101-00007 | Solo® Liftback 'n' Lock Tab Lid | 100/1000 | 1.2 | 5.9 | WX9-64568, WX9-J8002 |



For additional information, contact your Dart representative or call (800) 248-5960
www.dartcontainer.com



DART CONTAINER CORPORATION

The Industry Standard of Excellence

Mason, Michigan 48854 U.S.A.

Ph: (800) 248-5960 • Fax: (517) 676-3883

Email: sales@dart.biz • www.dartcontainer.com



PRINTED ON RECYCLED PAPER

COLD CUPS
BASIC



Double Sided Poly (DSP) Paper*

Features:
1 lid fits 6 cups
Two PE film layers protect paper layer from moisture
Excellent lid fit
Made with renewable materials

Size Range:
12 oz. - 44 oz.



Galaxy® PS Plastic

Features:
Lower-cost option for plastic cups
Ribbed sidewall adds cup strength, safety and convenience
Translucent cup with special print options up to 4 colors

Size Range:
5 oz. - 32 oz.

PREMIUM



Party Plastic Drink Cups

Features:
Smooth wall design ideal for special print
Select sizes available in popular colors (blue, white, red)

Size Range:
7 oz. - 32 oz. straight wall



Reveal® PP Plastic

Features:
Single lid solution reduces lid inventory requirements
True flush fill
Superior custom print capability
Recyclable where available**

Size Range:
12 oz. - 24 oz. straight wall,
30 oz. - 44 oz. Go Cup®



Wet Waxed Paper*

Features:
Made exclusively with renewable resources
Compostable in a commercial compost facility.
Appropriate commercial composting facilities may not exist in your community. Please check with your local municipality. Not suitable for backyard composting
1 lid fits multiple sizes

Size Range:
3 oz. - 22 oz.



SIGNATURE



Bare® Recycled Content (RPET)

Features:
20% post-consumer recycled PET material (FDA compliant)
Superb clarity & crack resistant
Stiffness — ideal for ice cream drinks
Recyclable where available**

Size Range:
9 oz. - 24 oz.



Trophy® Plus™ Dual Temperature Insulated

Features:
1 lid fits 5 cup sizes: 12 oz. - 24 oz.
Tight nesting for smaller cube
Rolled rim for better lid fit
Full custom print capability
Recyclable where available**

Size Range:
6 oz. - 33 oz. straight wall



SOLO® Ultra Clear™ PET Plastic

Features:
Superb clarity
Crack resistant
Stiffness — ideal for ice cream drinks
Superior custom print capability
Recyclable where available**

Size Range:
5 oz. - 32 oz. straight wall

COLD CUP LIDS
PAPER & PLASTIC



Flat Lids

Features:
Available with or without straw slot and/or identification buttons
Available in translucent PS (Basic) and clear PET (Premium)



Dome Lids

Features:
Allows extra space for whipped cream on frozen drinks and shakes
1-lid fits multiple cups
Options include wide hole, narrow hole and no hole



TROPHY® PLUS™



Liftback and Lock Tab Lids for Trophy® Plus™

Features:
Lid stays closed until patron breaks the seal and locks the tab
1-lid fits 5 cups: 10 oz. - 24 oz.
Available in white



* Paper products manufactured by Dart Container are certified by SFI®, which ensures responsible forestation practices.

** Appropriate recycling facilities may not exist in your community. Check with your local municipality.

Contact your Dart representative or call 1-800-248-5960 | www.solutionsbysolo.com



Solo® HOT CUPS & LIDS

PRODUCT FEATURE COMPARISON GUIDE

HOT CUPS

BASIC



Single Sided Poly (SSP)

Features:
1 lid fits 5 cup sizes: 10 oz. Squat - 24 oz.
Consumers see paper as premium material
Rolled rim for optimal lid fit
Made with plant-based renewable resources

Temperature Range:
Up to 205°F
Size Range:
4 oz. - 24 oz.; Solo offers handled SSP options in 4, 6, 8 oz.



PREMIUM



Trophy® Plus™ Dual Temperature Insulated

Features:
1 lid fits 5 cup sizes: 12 - 24 oz.
Tight nesting for smaller cube
Rolled rim for optimal lid fit
Top-to-bottom custom print capability

Temperature Range:
6 oz. - 33 oz.: up to 200°F;
Size Range:
6 oz. - 33 oz.



Bare® Single Sided PLA (SSPLA)

Features:
1 lid fits cup sizes: 10 oz. Squat - 20 oz.
Compostable in a commercial compost facility. Appropriate commercial composting facilities may not exist in your community. Please check with your local municipality. Not suitable for backyard composting
Made from plant-based renewable resources
Custom print capability

Temperature Range:
Up to 205°F
Size Range:
4 - 20 oz.



Bare® Post-Consumer Recycled Fiber (PCF)

Features:
1 lid fits cup sizes:
10 oz. Squat - 20 oz.
Made with 10% post-consumer recycled paper fibers
Custom print capability

Temperature Range:
Up to 205°F
Size Range:
4 - 20 oz.



SIGNATURE



Duo Shield Insulated

Features:
Double-wall construction insulates without sleeves
Matte finish and top-to-bottom print capability for upscale look and full graphic impact
Made with plant-based renewable resources

Temperature Range:
Up to 205°F
Size Range:
8 - 24 oz.



HOT CUP LIDS

PAPER



Optima® Lid for Paper Hot Cups

Features:
Superior on-the-go solution with a fully reclosable leak-resistant seal
Dome allows extra space for froth or whipped cream
1-lid fits 5 cups: 10 squat-24 oz.
Available in white and black



TravelLock®

Features:
Splash-resistant reclosable sip hole for secure transportation
Dome allows extra space for froth or whipped cream
Available in white and black



Traveler®

Features:
Partial plug fit - inner ring reduces pop-off incidents, providing a more secure lid fit and reducing dribble at the rim and cup seam
Dome allows extra space for froth or whipped cream
Available in white, black and brown
1-lid fits 5 cups: 10 squat - 24 oz.



Liftback and Lock Tab

Features:
Lid stays closed until patron breaks the seal and locks the tab
1-lid fits 5 cups: 10 squat - 24 oz.
Available in white

TROPHY® PLUS™



The Gourmet Lid®

Features:
Plug fit - Inner ring reduces pop-off incidents, providing a more secure lid fit and reducing dribble at the rim and cup seam
Dome allows extra space for froth or whipped cream
1-lid fits 4 cups: 12 - 24 oz.
Available in white, black, and green



Liftback and Lock Tab for Trophy®

Features:
Lid stays closed until patron breaks the seal and locks the tab
1-lid fits 4 cups: 12 - 24 oz.
Available in white





Solo® HOT CUPS & LIDS

SEGMENT DRIVERS & FEATURE OVERVIEW

| SEGMENT: | C-STORE | OFFICE COFFEE | LODGING | FOODSERVICE | C&U |
|-------------------------|---|---|---|---|---|
| Key Decision Maker: | Procurement/Buyer | Procurement/Buyer | Procurement/Buyer | Procurement/Buyer | Procurement/Buyer |
| Hot Buttons: | <ul style="list-style-type: none"> Convenient Increase brand awareness Improve consumer perception Desire for fresh and healthy menu Budget keep costs low Beverage service choices are expanding, what is the right packaging choice for me and my customers | <ul style="list-style-type: none"> Convenient Beverage service choices are expanding, what is the right packaging choice for me and my customers Environmental options | <ul style="list-style-type: none"> Personal/customizable Increase brand awareness Improve consumer perception Quality Beverage service choices are expanding, what is the right packaging choice for me and my customers | <ul style="list-style-type: none"> Quality Desire for fresh and healthy menu Branded | <ul style="list-style-type: none"> Reduce cost and spend Environmental options Convenient Fresh and healthy |
| Why choose Solo brands: | | | | | |

| PRODUCT FEATURES | HOT CUPS | | | | |
|---------------------------------------|---|--------------|----------|----------|--------------|
| | SSP | Trophy Plus™ | SSPLA | PCF | Duo Shield™ |
| Insulation (L/M/H) | — | H | — | — | M |
| Price | \$ | \$\$ | \$\$ | \$\$ | \$\$\$ |
| Print Quality (L/M/H) | H | M | H | H | H |
| Size Range | 4-24 oz. | 6-33 oz. | 4-20 oz. | 4-20 oz. | 8, 12-24 oz. |
| True Flush Fill | | 16-24 oz. | | | |
| Printing Customization | Y | Y | Y | Y | Y |
| Degree of Condensation (L/M/H) | — | L | — | — | — |
| Blend-in Capability | N | Y | N | N | N |
| SUSTAINABLE FEATURES | | | | | |
| Cedar Grove Accepted | | | • | | |
| ASTM D6400/D6868 | | | • | | |
| BPI | | | • | | |
| SFI/FSC¹ | • | | • | • | • |
| Bare® by Solo® | | | • | • | |
| Eco-Forward® | | | • | • | |
| Post-Consumer Recycled Content (PCR) | | | • | • | |
| SPI Resin Code | | 6 | | | |
| Commercially Compostable² | | | • | | |
| Made from Renewable Resources | • | | • | • | • |
| HOT LIDS | | | | | |
| The Gourmet Lid® | | • | | | |
| Liftback and lock tab | • | • | • | • | |
| Liftback and lock tab with straw slot | | • | | | |
| Optima® Lid for Paper Hot Cups | • | | • | • | • |
| TravelLock® | • | | • | • | • |
| Traveler® | • | | • | • | • |
| Vented | • | • | • | • | |
| STIRRERS | Solo offers a complete line of top-quality stirrers to cater to all hot beverage needs. Solo cups, lids, and stirrers together create the ultimate beverage solution offering superior performance, easier handling, and leak resistance. | | | | |



¹Solo represents that our Solo brand paper products are made from paper purchased from manufacturers that at a minimum have either Forest Stewardship Council (FSC) or Sustainable Forestry Initiative (SFI) certified fiber sourcing.
 ²Compostable in a commercial compost facility. Appropriate commercial composting facilities may not exist in your community. Please check with your local municipality. Not suitable for backyard composting.

Contact your Dart representative or call 1-800-248-5960 | www.dart.biz



Office Channel



Cash & Carry



Small Business

**PERFECT SIZE WHEN
 SPACE IS AT A PREMIUM**

Up to 70% less than Solo's standard case counts - see the difference!



**Reduce
 Size &
 Increase
 Turns!**

BEVERAGE

HOT CUPS & LIDS



Solo's hot cup offering features single-sided poly paper, insulated and Eco-Forward® options deliver durability and performance in a convenient pack size for operators with space challenges. All Solo hot cups are well engineered with strong sidewalls and smooth, rolled rims for comfort, safety and optimal lid fit.

SINGLE-SIDED POLY (SSP) PAPER HOT CUPS

- Polyethylene lining provides a barrier to liquid penetration
- Available in popular Bistro® design

BARE® ECO-FORWARD® SINGLE SIDED RECYCLED CONTENT (PCF) HOT CUPS

- First-ever, FDA-compliant, PCF paper hot cup
- Made with a minimum of 10% post-consumer recycled fiber
- Made with at least 90% plant-based renewable resources
- Less virgin material used to make PCF hot Cups, reducing the impact on valuable natural resources

TRAVELER® LIDS - Use with SSP or PCF Paper Hot Cups

- Leading-edge design provides optimal fit on Solo paper hot cups
- Inner ring ensures better, tighter fit to reduce dribble, leakage and pop-offs

TROPHY® INSULATED HOT/COLD FOAM CUPS

- Versatile two-cups-in-one are ideal for hot or cold beverages
- Provides superior insulation over paper
- Rolled rim offers a more secure lid fit versus flat foam

INSULATED HOT CUP & LID COMBO PACKS

Comes with cups and lids in one attractive retail pack!

- Trophy® Insulated Foam Cups with The Gourmet Lid® - an upscale option providing superior insulation and lid fit for hot beverages
- Duo Shield® Insulated Hot Cups with Traveler® Lid - premium paper solution that provides air-pocket insulation to help keep drinks hot longer

COLD CUPS



GALAXY® POLYSTYRENE COLD CUPS

- Ideal option for cold beverages
- Double sidewall ridges provide strength and durability to help prevent spills

Up to 70% less than Solo's standard case count, Perfect Pak® by Solo is ideal for limited storage space and lower-volume turnover of single-use products. Solo presents a wide selection to meet operators' specific needs.



Office Channel



Cash & Carry



Small Business

COME IN SMALL PAKS!

MEAL SERVICE

DINNERWARE



Bare® Eco-Forward® products make it easy to provide environmentally responsible dinnerware. Convenient pack size for catered meals.



BARE® ECO-FORWARD® PAPER DINNERWARE

- Compostable in a commercial compost facility. Appropriate commercial composting facilities may not exist in your community. Please check with your local municipality. Not suitable for backyard composting
- Certified compostable by the Biodegradable Products Institute (BPI)
- Made from plant-based renewable resources
- Strong and soak-through resistant

TAKEOUT

TAKEOUT CONTAINERS



Creative Carryouts® hinged packages are designed for hot or cold meals, side dishes and salads to ensure food remains in place during handling and transport. This versatile packaging features clear lids and is microwaveable.

OCTAVIEW® HINGED OCTAGON CARRYOUT PACKAGES

- Keeps operation running efficiently with leak-resistant, attached lid
- Visual attraction turns into customer satisfaction driving impulse sales

| Operator/End-User Challenges | Perfect Pak® Solutions | Office Channel | Cash & Carry | Small Business |
|---|--|----------------|--------------|----------------|
| Limited storage space | Perfect Pak® cases are designed to be under 21" in height in order to fit in small areas/cabinets in breakrooms and on a retail shelf | X | X | X |
| Breaking cases often necessary for operators to sell smaller quantities | Perfect Pak® reduced case counts eliminate the need for operators to break cases and allow operators to "turn and earn" | X | X | |
| End users cannot meet distributor minimums as they use less volume in single-use products | Perfect Pak® case counts are up to 50-70% less than standard case counts and are available for purchase in channels such as office and cash and carry where there are no minimum-purchase requirements | X | X | X |
| Need retail-ready packaging | Most Perfect Pak® cases have attractive, four-color outer-case graphics that are eye-catching on the shelf | X | | |
| Need for convenient grab-n-go, single-use products | Perfect Pak® Combo Packs includes a smaller quantity of cups and lids in one shrink-wrapped retail-ready package | X | | X |
| Reduce cost per case of inventory | Perfect Pak® has a lower price point per case than a standard foodservice pack size | X | X | X |

PERFECT SIZE WHEN SPACE IS AT A PREMIUM

- Reduce size and increase turns
- Cases are under 21" in height to accommodate storage space constraints and fit on a retail shelf
- Retail-ready, attractive outer-case packaging
- Takeout offering features trendy carryout containers that boost grab-n-go sales and increase impulse purchases



| Item # | Description | Inners/ Case | Eaches/ Inner | Case Count | Outer UPC code | Case Wt (lbs.) | Case Dimensions L x W x H (in) | Case Cube (cu. ft.) | Pallet TL/HL | Corresponding Lid / Cup |
|--|---|-----------------|------------------|---------------|-------------------|-------------------|-----------------------------------|------------------------|-----------------|---|
| SINGLE-SIDED POLY (SSP) PAPER HOT CUPS | | | | | | | | | | |
| OF8BI-0041 | 8 oz SSP Paper Hot Cups - Bistro® | 20 | 25 | 500 | 041165159943 | 9.7 | 16.07 x 12.94 x 10.57 | 1.3 | 9/4 | — |
| OF10BI-0041 | 10 oz SSP Paper Hot Cups - Bistro® | 12 | 25 | 300 | 041165159950 | 7.0 | 13.69 x 10.38 x 11.44 | 0.9 | 14/4 | OFTL31-0007 |
| OF12BI-0041 | 12 oz SSP Paper Hot Cups - Bistro® | 12 | 25 | 300 | 041165159967 | 8.1 | 14.50 x 10.94 x 12.94 | 1.2 | 11/3 | OFTL16-0007 |
| OF16BI-0041 | 16 oz SSP Paper Hot Cups - Bistro® | 12 | 25 | 300 | 041165159974 | 9.4 | 14.50 x 10.94 x 15.32 | 1.4 | 11/3 | OFTL16-0007 |
| BARE® ECO-FORWARD® RECYCLED CONTENT (PCF) HOT CUPS | | | | | | | | | | |
| OF8RC-J8484 | 8 oz PCF Hot Cups - Bare® | 20 | 25 | 500 | 041594050460 | 10.1 | 16.07 x 12.94 x 10.57 | 1.3 | 9/4 | — |
| OF10RC-J8484 | 10 oz PCF Hot Cups - Bare® | 12 | 25 | 300 | 041594050484 | 7.7 | 13.69 x 10.38 x 11.44 | 0.9 | 14/4 | OFTL31-0007 |
| OF12RC-J8484 | 12 oz PCF Hot Cups - Bare® | 12 | 25 | 300 | 041594051016 | 8.9 | 14.50 x 10.94 x 12.94 | 1.2 | 11/3 | OFTL16-0007 |
| OF16RC-J8484 | 16 oz PCF Hot Cups - Bare® | 12 | 25 | 300 | 041594051030 | 10.4 | 14.50 x 10.94 x 15.32 | 1.4 | 11/3 | OFTL16-0007 |
| TRAVELER® DOME LIDS | | | | | | | | | | |
| OFTL31-0007 | Traveler® Lids - White (TL31R2) | 5 | 60 | 300 | 041165159998 | 2.9 | 10.57 x 6.69 x 11.50 | 0.5 | 25/4 | OF10BI-0041, OF10RC-J8484 |
| OFTL16-0007 | Traveler® Lids - White (TLP316) | 6 | 50 | 300 | 041165268058 | 3.0 | 11.38 x 7.69 x 9.69 | 0.5 | 22/10 | OF12BI-0041, OF16BI-0041, OF12RC-J8484, OF16RC-J8484 |
| TROPHY® PLUS™ INSULATED HOT/COLD CUPS | | | | | | | | | | |
| OFX8N-J8002 | 8 oz Trophy® Cups - Symphony™ | 6 | 50 | 300 | 041165126495 | 3.3 | 12.94 x 9.94 x 13.13 | 1.0 | 15/3 | N/A |
| OFX10N-J8002 | 10 oz Trophy® Cups - Symphony™ | 6 | 50 | 300 | 041165127447 | 3.7 | 15.07 x 9.82 x 14.25 | 1.2 | 13/3 | N/A |
| OFX12N-J8002 | 12 oz Trophy® Cups - Symphony™ | 6 | 50 | 300 | 041165127461 | 4.1 | 15.94 x 10.07 x 15.13 | 1.4 | 12/3 | N/A |
| TROPHY® PLUS™ INSULATED HOT CUPS & LIDS COMBO PACK | | | | | | | | | | |
| FSX12-0029 | 12 oz Trophy® Combo Pack - Mistique® | 6 | 50 | 300 | 041165001006 | 7.0 | 21.82 x 14.69 x 12.00 | 2.2 | 5/3 | (Lid included LGXBK2-0004) |
| DUO SHIELD® INSULATED PAPER HOT CUPS & LIDS COMBO PACK | | | | | | | | | | |
| FSIC12-J7534 | 12 oz Duo Shield® Combo Pack - Tuscan Cafe™ | 6 | 52 | 312 | 041165122114 | 16.7 | 22.32 x 15.19 x 13.00 | 2.6 | 5/7 | (Lid included TLB316-0004) |
| GALAXY® PLASTIC COLD CUPS | | | | | | | | | | |
| Y5PFTPK | 5 oz Galaxy® Cups - Translucent | 15 | 50 | 750 | 041594056868 | 5.6 | 13.13 x 8.00 x 13.69 | 0.8 | 18/3 | N/A |
| Y7PFTPK | 7 oz Galaxy® Cups - Translucent | 15 | 50 | 750 | 041594056967 | 6.9 | 15.00 x 9.13 x 10.88 | 0.9 | 13/4 | N/A |
| Y10PFTPK | 10 oz Galaxy® Cups - Translucent | 10 | 50 | 500 | 041594056523 | 13.3 | 11.75 x 9.82 x 14.13 | 0.9 | 16/3 | N/A |
| Y12PFTPK | 12 oz Galaxy® Cups - Translucent | 20 | 25 | 500 | 041594056547 | 9.0 | 16.63 x 13.38 x 12.63 | 1.6 | 8/3 | N/A |
| Y16PFTPK | 16 oz Galaxy® Cups - Translucent | 20 | 25 | 500 | 041594056561 | 10.5 | 17.88 x 14.32 x 10.82 | 1.6 | 6/4 | N/A |
| BARE® ECO-FORWARD® PAPER DINNERWARE | | | | | | | | | | |
| OFMP6-J7234 | 6" Paper Plates - Bare® | 4 | 125 | 500 | 041165160048 | 7.1 | 12.50 x 7.75 x 6.57 | 0.4 | 19/7 | N/A |
| OFMP9-J7234 | 8.5" Paper Plates - Bare® | 2 | 125 | 250 | 041165160024 | 8.4 | 10.88 x 8.88 x 9.00 | 0.5 | 18/5 | N/A |
| OFHW12-J7234 | 12 oz Paper Bowls - Bare® | 4 | 125 | 500 | 041165160031 | 12.5 | 12.32 x 11.00 x 12.50 | 1.0 | 12/3 | N/A |
| CREATIVE CARRYOUTS® OCTAVIEW® HINGED CONTAINERS - FOR COLD APPLICATIONS | | | | | | | | | | |
| 862043-PS94 | 6" Deep OctaView® Hinged Containers - Clear/Black | 1 | 50 | 50 | 846280001616 | 3.4 | 13.94 x 9.32 x 7.00 | 0.5 | 12/6 | (Hinged Lid) |
| 864055-PS94 | 9" Deep OctaView® Hinged Containers - Clear/Black | 1 | 50 | 50 | 846280001630 | 7.4 | 19.44 x 9.32 x 10.00 | 1.1 | 10/4 | (Hinged Lid) |
| 865043-PS94 | 7.5" Deep OctaView® Hinged Containers - Clear/Black | 1 | 50 | 50 | 846280001623 | 4.9 | 16.19 x 9.57 x 8.25 | 0.7 | 10/5 | (Hinged Lid) |

= Bare® Eco-Forward® Product



For additional information,
contact your Dart representative
or call 1-800-248-5960

www.dart.biz

DART CONTAINER CORPORATION

The Industry Standard of Excellence

Mason, Michigan 48854 U.S.A.
Ph: 800-248-5960 • Fax: 517-676-3883
Email: sales@dart.biz • www.dart.biz

©2016 Dart Container Corporation. All rights reserved.

Dart® and the Dart logo are trademarks of Dart Container Corporation. Solo®, the Solo logo, Traveler®, Trophy®, The Gourmet Lid®, Eco-Forward®, Bare®, the Bare logo, Perfect Pak®, Creative Carryouts®, Expressions®, OctaView®, Duo Shield®, Bistro®, Symphony™, Galaxy® and Tuscan Cafe™ are trademarks of Solo Cup Operating Corporation. Used with permission.
GS1488USES_030216



Foam Hinged Lid Containers

with **PERFORMER** perforated hinge

Many popular sizes
also available in black



Convenience doesn't have to be a compromise

- Removable lid
- Superior insulation
- Vented to preserve food longer
- Stackable
- Shareable



Foam Hinged Lid Containers

with **PERFORMER** perforated hinge

Hinged Containers with a Removable Lid

The **PERFORMER** is a patented perforated hinge that allows the container's lid to be removed.

The result is a less cluttered dining experience and an additional plate for meal sharing.

1. Grab the lid
2. Hold the base
3. Gently pull apart



Performer's Unrivaled Convenience

In the car

In a crunch, when you are rushed for time, the Performer is the answer. No more cumbersome lid to deal with. Simply tear the lid off and enjoy!

At the office

Can't get away for lunch? The Performer will free up needed space so you can be more productive and still enjoy your meal.

Sharing

At home or in social settings, the versatility of the Performer allows you to "tear and share." Use the lid as an extra plate to make meal sharing convenient anywhere.

Foam Hinged Lid Containers

with **PERFORMER** perforated hinge

Features

Vented to Preserve Food Quality Longer

Vent holes on sidewalls of the lid preserve food quality (i.e. crispiness) by allowing steam to escape. The vented containers come with the Performer perforated hinge.

Secure Closure

These containers feature either a double lock closure or a "knuckle" locking tab intended to prevent accidental openings.

When closed, a perimeter seal keeps food secure, reducing leaks.

Tabs on base ensure containers stay closed when picked up by the lid.



50HT1



60HT1



72HT1



80HT1/80HT1R



80HT3/80HT3R



85HT1/85HT1R



85HT3/85HT3R



90HT1/90HT1R
90HTPF1/90HTPF1R



90HT3/90HT3R
90HTPF3/90HTPF3R



90HTPF1V/90HTPF1VR



90HTPF3V/90HTPF3VR



95HT1/95HT1R
95HTPF1/95HTPF1R



95HT3/95HT3R
95HTPF3/95HTPF3R



99HT1/99HT1R



110HT1



Superior Insulation

All Dart foam hinged lid containers have high insulation properties to keep hot foods hot and cold foods cold. Maintaining proper temperature inside the container keeps food at the right serving temperature, preserving product quality.

Stacking

The recessed lid and platform base increase the stability of multiple stacked containers, allowing for stable and convenient transport.

Present Your Food With Style

Black Foam Hinged Containers are available in many popular sizes and are ideal for a variety of hot and cold foods.

They provide an upscale packaging alternative to enhance the image of any food application, while still providing the performance benefits of traditional Dart Foam Hinged Containers.



110HT3



201HT1



205HT1



205HT2



206HT1/206HT1R



206HT1P/206HT1PR



DT1



DT3



60HTB1



85HTB1/85HTB1R



85HTB3/85HTB3R



90HTB1/90HTB1R
90HTPFB1/90HTPFB1R



90HTB3/90HTB3R
90HTPFB3/90HTPFB3R



95HTB1/95HTB1R
95HTPFB1/95HTPFB1R



95HTB3/95HTB3R
95HTPFB3/95HTPFB3R

Foam Hinged Lid Containers

with **PERFORMER** perforated hinge

| Stock Number | Stock Number Reduced Cube | Description | Hinge Style | Outside Dimensions | Sleeve | Case Pack | Case Cube** Non-R R | Case Weight Non-R R | Ti/Hi Non-R R |
|---|------------------------------|---|----------------|-----------------------|--------|--------------|--------------------------|--------------------------|--------------------|
| White Foam Hinged Lid Containers | | | | | | | | | |
| 50HT1 | — | 5" Medium Sandwich | □ | 5½ × 5¾ × 2⅞ | 125 | 500 | 3.6 — | 6.7 — | 8/3 — |
| 60HT1 | — | 6" Large Sandwich | □ | 5⅞ × 6 × 3 | 125 | 500 | 4.3 — | 8.9 — | 8/3 — |
| 72HT1 | — | Hot Dog | □ | 7⅞ × 3¾ × 2¼ | 125 | 500 | 3.5 — | 7.1 — | 6/3 — |
| — | 80HT1R | Small, Single Compartment | □ | 8 × 7½ × 2¼ | 100 | 200 | — 3.0 | — 6.3 | — 9/3 |
| — | 80HT3R | Small, 3 Compartment | □ | 8 × 7½ × 2¼ | 100 | 200 | — 3.0 | — 6.3 | — 9/3 |
| 85HT1 | 85HT1R | Medium, Single Compartment | ■ | 8⅜ × 7⅞ × 3¼ | 100 | 200 | 3.8 3.3 | 7.1 7.0 | 8/3 9/3 |
| 85HT3 | 85HT3R | Medium, 3 Compartment | ■ | 8⅜ × 7⅞ × 3¼ | 100 | 200 | 3.8 3.3 | 7.1 7.0 | 8/3 9/3 |
| 90HT1 | 90HT1R | Large, Single Compartment | □ | 9⅜ × 9 × 3 | 100 | 200 | 4.8 4.2 | 8.6 8.4 | 8/3 9/3 |
| 90HTPF1 | 90HTPF1R | Large, Single Compartment | ■ | 9⅜ × 9 × 3 | 100 | 200 | 4.8 4.2 | 8.6 8.4 | 8/3 9/3 |
| — | 90HTPF1VR | Large, Single Compartment with Vented Lid | ■ | 9⅜ × 9 × 3 | 100 | 200 | — 4.2 | — 8.4 | — 9/3 |
| 90HT3 | 90HT3R | Large, 3 Compartment | □ | 9⅜ × 9 × 3 | 100 | 200 | 4.8 4.2 | 8.9 8.7 | 8/3 9/3 |
| 90HTPF3 | 90HTPF3R | Large, 3 Compartment | ■ | 9⅜ × 9 × 3 | 100 | 200 | 4.8 4.2 | 8.9 8.7 | 8/3 9/3 |
| — | 90HTPF3VR | Large, 3 Compartment with Vented Lid | ■ | 9⅜ × 9 × 3 | 100 | 200 | — 4.2 | — 8.7 | — 9/3 |
| 95HT1 | 95HT1R | Large, Single Compartment | □ | 9½ × 9¼ × 3 | 100 | 200 | 5.3 4.2 | 9.4 9.1 | 8/3 9/3 |
| 95HTPF1 | 95HTPF1R | Large, Single Compartment | ■ | 9½ × 9¼ × 3 | 100 | 200 | 5.3 4.2 | 9.4 9.1 | 8/3 9/3 |
| 95HT3 | 95HT3R | Large, 3 Compartment | □ | 9½ × 9¼ × 3 | 100 | 200 | 5.3 4.8 | 9.5 9.4 | 8/3 9/3 |
| 95HTPF3 | 95HTPF3R | Large, 3 Compartment | ■ | 9½ × 9¼ × 3 | 100 | 200 | 5.3 4.8 | 9.5 9.4 | 8/3 9/3 |
| — | 99HT1R | Hoagie/All Purpose | ■ | 9¾ × 5¼ × 3¼ | 125 | 500 | — 6.0 | — 14.0 | — 6/2 |
| 110HT1 | — | Extra Large, Single Compartment | ■ | 10¼ × 9½ × 3½ | 100 | 200 | 5.2 — | 10.7 — | 6/3 — |
| 110HT3 | — | Extra Large, 3 Compartment | ■ | 10¼ × 9½ × 3½ | 100 | 200 | 5.2 — | 10.7 — | 6/3 — |
| 201HT1* | — | Multi-Purpose, Single Compartment | □ | 8⅞ × 5⅞ × 2⅞ | 125 | 250 | 3.5 — | 7.4 — | 8/3 — |
| 205HT1 | — | All Purpose, Single Compartment | ■ | 9¼ × 6⅜ × 2⅞ | 100 | 200 | 3.3 — | 6.7 — | 8/3 — |
| 205HT2 | — | All Purpose, 2 Compartment | ■ | 9¼ × 6⅜ × 2⅞ | 100 | 200 | 3.3 — | 7.1 — | 8/3 — |
| — | 206HT1R | All Purpose, Shallow, Single Compartment | ■ | 9¼ × 6⅜ × 2⅞ | 100 | 200 | — 3.3 | — 7.1 | — 8/3 |
| — | 206HT1PR | All Purpose, Shallow, Single Compartment with Embossed Prosperity™ Design | □ | 9¼ × 6⅜ × 2⅞ | 100 | 200 | — 3.3 | — 7.2 | — 8/3 |
| DT1* | DT1R* | Medium, Shallow, Single Compartment with Embossed Design | □ | 8⅞ × 7¾ × 2½ | 100 | 200 | 3.4 3.1 | 7.9 7.7 | 6/3 6/3 |
| DT3* | DT3R* | Medium, Shallow, 3 Compartment with Embossed Design | □ | 8⅞ × 7¾ × 2½ | 100 | 200 | 3.6 3.1 | 8.0 7.7 | 6/3 6/3 |
| Black Foam Hinged Lid Containers | | | | | | | | | |
| 60HTB1 | — | 6" Large Sandwich | □ | 5⅞ × 6 × 3 | 125 | 500 | 4.3 — | 10.1 — | 8/3 — |
| 85HTB1 | 85HTB1R | Medium, Single Compartment | ■ | 8⅜ × 7⅞ × 3¼ | 100 | 200 | 3.8 3.3 | 7.1 7.0 | 8/3 9/3 |
| 85HTB3 | 85HTB3R | Medium, 3 Compartment | ■ | 8⅜ × 7⅞ × 3¼ | 100 | 200 | 3.8 3.3 | 7.1 7.0 | 8/3 9/3 |
| 90HTB1 | 90HTB1R | Large, Single Compartment | □ | 9⅜ × 9 × 3 | 100 | 200 | 4.8 4.2 | 8.6 8.4 | 8/3 9/3 |
| 90HTB3 | 90HTB3R | Large, 3 Compartment | □ | 9⅜ × 9 × 3 | 100 | 200 | 4.8 4.2 | 8.9 8.7 | 8/3 9/3 |
| 90HTPFB1 | 90HTPFB1R | Large, Single Compartment | ■ | 9⅜ × 9 × 3 | 100 | 200 | 4.8 4.2 | 8.6 8.4 | 8/3 9/3 |
| 90HTPFB3 | 90HTPFB3R | Large, 3 Compartment | ■ | 9⅜ × 9 × 3 | 100 | 200 | 4.8 4.2 | 8.9 8.7 | 8/3 9/3 |
| 95HTB1 | 95HTB1R | Large, Single Compartment | □ | 9½ × 9¼ × 3 | 100 | 200 | 5.3 4.2 | 9.4 9.1 | 8/3 9/3 |
| 95HTB3 | 95HTB3R | Large, 3 Compartment | □ | 9½ × 9¼ × 3 | 100 | 200 | 5.3 4.8 | 9.5 9.4 | 8/3 9/3 |
| 95HTPFB1 | 95HTPFB1R | Large, Single Compartment | ■ | 9½ × 9¼ × 3 | 100 | 200 | 5.3 4.2 | 9.4 9.1 | 8/3 9/3 |
| 95HTPFB3 | 95HTPFB3R | Large, 3 Compartment | ■ | 9½ × 9¼ × 3 | 100 | 200 | 5.3 4.8 | 9.5 9.4 | 8/3 9/3 |

Hinge Style: ■ Features the Performer™ Perforated, Hinged Lid □ Non-Perforated, Hinged Lid

*May not be available in all areas. Check for product availability. **Case cube may vary by region. Custom embossing available for qualifying volumes. Contact your Dart representative for details. Stock codes ending in "R" are items available in reduced cube version in certain Dart plant-served areas.



Foam Hinged Lid Containers

with **PERFORMER** perforated hinge

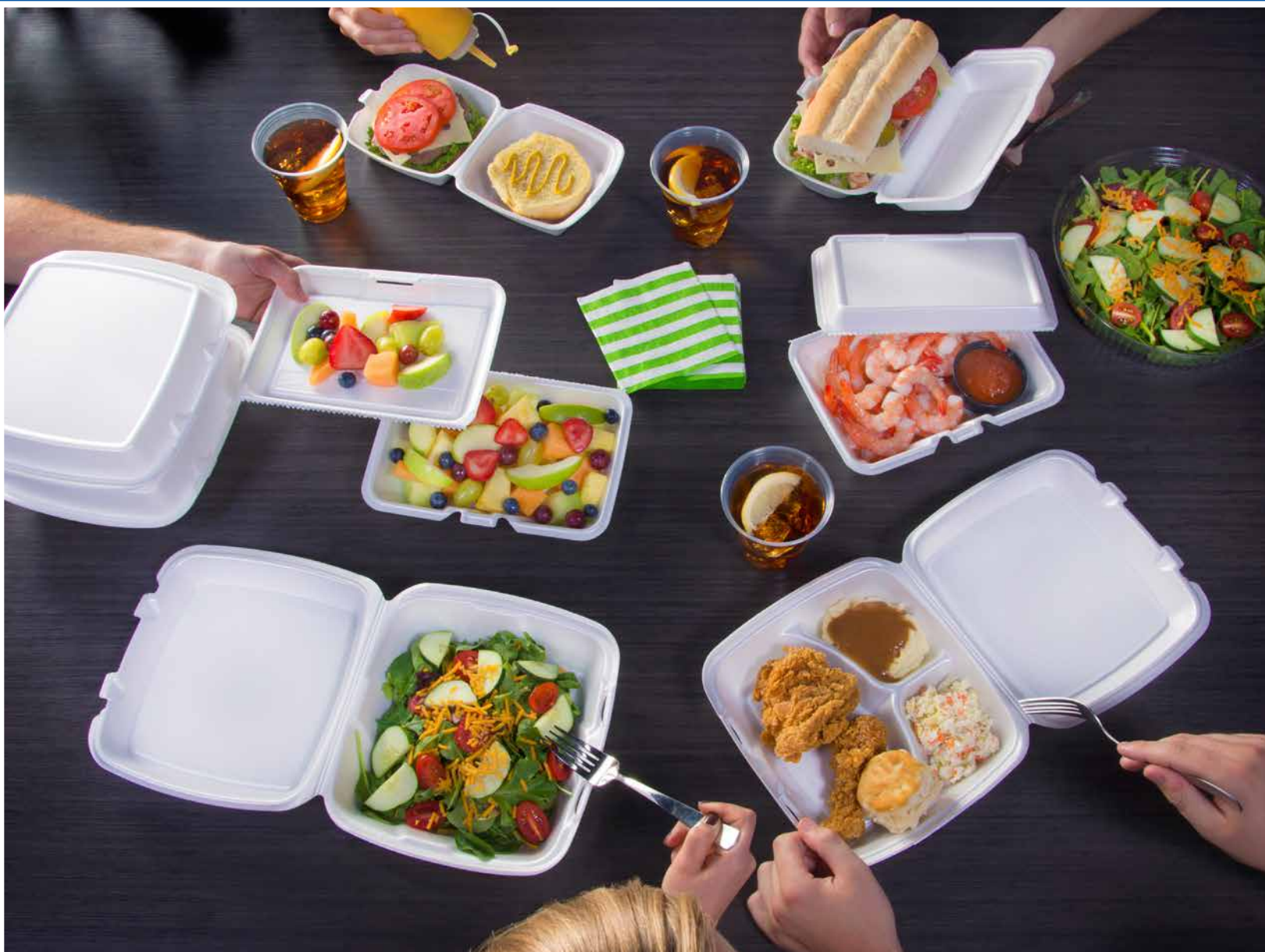

Dart Foam Hinged Lid containers can be recycled through our CARE Program.
Ask your sales representative for details.



For additional information,
contact your Dart representative
or call (800) 248-5960
www.dartcontainer.com

DART CONTAINER CORPORATION

The Industry Standard of Excellence

Mason, Michigan 48854 U.S.A.

Ph: (800) 248-5960 • Fax: (517) 676-3883

Email: sales@dart.biz • www.dartcontainer.com



CLEARPAC®
SAFESEAL



 PETE packaging

Tamper-Resistant, Tamper-Evident Containers

- Specifically designed to inhibit tampering, eliminating the need for shrink bands and wrap labels
- Shrink Band Elimination Spurs Savings!

2¢ - 4¢ per Shrink Band

\$60 - \$140 per Heat Gun

\$2,000 - \$16,000 per Heat Tunnel

\$1,000 - \$1,200/yr in Utility Costs



Look what customers are saying about **SafeSeal**

"We use 16oz ClearPac SafeSeal containers

for black eyed peas and a vented 12oz ClearPac SafeSeal container for sprouted green peas and mung beans. The vented container is perfectly designed to allow the sprouts and mung beans to breathe, thereby **maximizing their shelf life**. ClearPac SafeSeal containers are also **quick and easy to close and effectively showcase our produce.**" - Lee Ewing, President, Sunny Creek Farm

"Using the **Safe-Seal line** of plastic tamper-evident, tamper-resistant containers from Dart has allowed us to offer the same quality bulk candies to our customers, but in a much more **professional, safe** and **attractive** presentation. The **'stackability'** and **clear design** of these containers has allowed us to **profit upon the impulse driven sales** of the retail world, as well as keep our candy **fresher, longer.**" - Matt Costea, Buyer, Somerset Candy



TamperAlert™

Hinge protrudes outward when torn, alerting the customer that the container has been opened. Hinge remains attached to the container, meaning no loose plastic pieces and therefore no littering.

EASY TO CLOSE

Press down on the lid with two hands for an easy ONE STEP closure!



EASY TO OPEN

Pull apart the "Lift" and "Hold" tabs to tear the perforated hinge completely across.



EASY TO RECLOSE

Once the hinge is torn, the container becomes a LEAK RESISTANT two-piece package!

ASK YOUR DART SALES REPRESENTATIVE ABOUT:

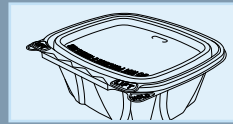

Vented SafeSeal
Minimum order quantity requirements.



Auto Closure Equipment

Made of crack-resistant PET, ClearPac SafeSeal performs exceptionally in cold temperatures and accommodates freezing down to -22°F.

- 1 Leak-Resistant Perimeter Seal** — Maximizes product freshness and prevents messy spills.
- 2 Separation Lugs** — Allows for easy, one-hand separation of nested containers.
- 3 Tamper-Resistant Locking Post on 24oz–64oz Flat Lid Containers** — Further reinforces container tamper-resistance.
- 4 TamperAlert Hinge and "Do Not Purchase If Hinge Is Torn" Message on the Lid** — Alerts the customer to the signs of a tampered container.
- 5 Stacking Platform** — Provides greater stability of merchandising displays.
- 6 Clear Packaging with Minimal Sidewall Ribbing** — Maximizes product visibility.
- 7 Offset Opening Tabs with "Lift" and "Hold" Embossing** — Makes container easier to open.

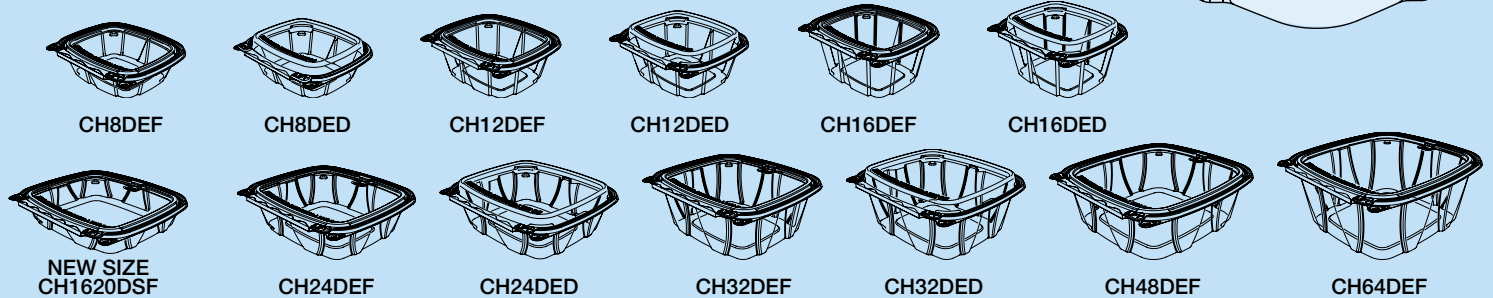
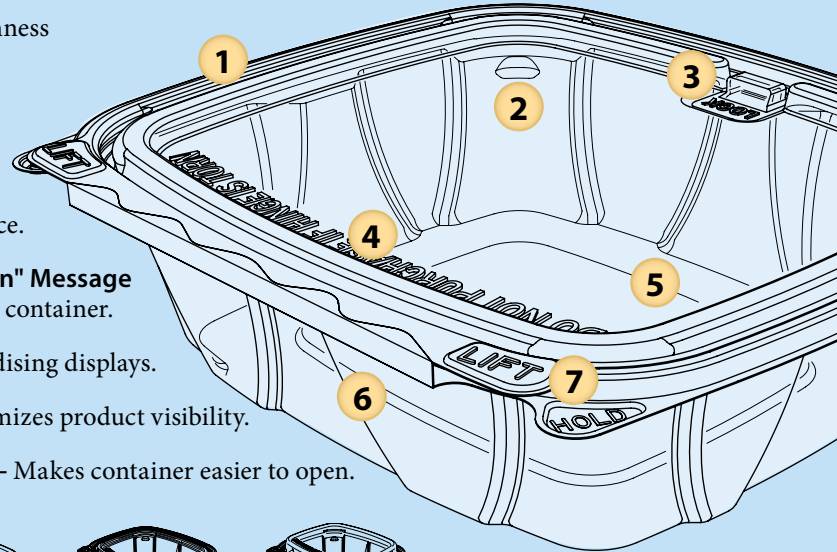

| Stock Number | Description | Container Dimensions | Packing Sleeve/Case | Case Cube | Case Weight |
|--------------------|--|----------------------|---------------------|-----------|-------------|
| CH8DEF | 8 oz. Tamper-Resistant, Tamper-Evident Container with Flat Lid | 5½" x 4⅞" x 1⅜" | 100/200 | 1.6 | 8.4 |
| CH8DED | 8 oz. Tamper-Resistant, Tamper-Evident Container with Dome Lid | 5½" x 4⅞" x 1⅞" | 100/200 | 1.6 | 8.4 |
| CH12DEF | 12 oz. Tamper-Resistant, Tamper-Evident Container with Flat Lid | 5½" x 4⅞" x 2" | 100/200 | 1.6 | 9.3 |
| CH12DED | 12 oz. Tamper-Resistant, Tamper-Evident Container with Dome Lid | 5½" x 4⅞" x 2⅜" | 100/200 | 1.6 | 9.3 |
| CH16DEF | 16 oz. Tamper-Resistant, Tamper-Evident Container with Flat Lid | 5½" x 4⅞" x 2½" | 100/200 | 1.7 | 10.3 |
| CH16DED | 16 oz. Tamper-Resistant, Tamper-Evident Container with Dome Lid | 5½" x 4⅞" x 2⅞" | 100/200 | 1.7 | 10.3 |
| NEW SIZE CH1620DSF | 16 oz./20 oz. Shallow Tamper-Resistant, Tamper-Evident Container with Flat Lid | 7⅞" x 6⅜" x 1⅝" | 100/200 | 2.6 | 14.4 |
| CH24DEF | 24 oz. Tamper-Resistant, Tamper-Evident Container with Flat Lid | 7⅞" x 6⅜" x 1⅞" | 100/200 | 2.7 | 16.5 |
| CH24DED | 24 oz. Tamper-Resistant, Tamper-Evident Container with Dome Lid | 7⅞" x 6⅜" x 2¼" | 100/200 | 2.7 | 16.5 |
| CH32DEF | 32 oz. Tamper-Resistant, Tamper-Evident Container with Flat Lid | 7⅞" x 6⅜" x 2⅝" | 100/200 | 2.8 | 18.3 |
| CH32DED | 32 oz. Tamper-Resistant, Tamper-Evident Container with Dome Lid | 7⅞" x 6⅜" x 2⅞" | 100/200 | 2.8 | 18.3 |
| CH48DEF | 48 oz. Tamper-Resistant, Tamper-Evident Container with Flat Lid | 7¾" x 8⅞" x 2½" | 100/200 | 3.7 | 24.7 |
| CH64DEF | 64 oz. Tamper-Resistant, Tamper-Evident Container with Flat Lid | 7¾" x 8⅞" x 3¼" | 100/200 | 3.9 | 28.5 |

NEW SIZE



DART CONTAINER CORPORATION
The Industry Standard of Excellence

Mason, Michigan 48854 U.S.A.
Ph: (800) 248-5960 • Fax: (517) 676-3883
Email: sales@dart.biz • www.dartcontainer.com

FOR ENVIRONMENTAL INFORMATION, VISIT
WWW.DARTCONTAINER.COM

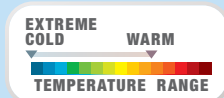

Scan this code with your smart phone for more information.

Keeping your food safe
with ClearPac® is a snap!



ClearPac® Plastic Containers and Lids

- **Large Variety of Sizes** — Great for any application
- **Leak-Resistant Perimeter Seal** — Completely seals tray for maximum freshness
- **Nacho Trays** — For savory concession snacks
- **Flat Lids, Dome Lids, and Combo Packs Available!**





Outstanding Versatility
and Crystal Clarity

PresentaBowls® Clear Bowls and Lids

- Lid interchange reduces storage space and minimizes confusion
- Crystal clarity allows for easy product identification, while the elegant design creates an upscale presentation
- Ideal for a variety of uses including deli, bakery, produce, and specialty items
- Lids create a leak-resistant seal
- Lids are stackable for stable, multi-level merchandising



Clear Bowls



| Stock Number | Description | Packing Bag | Packing Case | Case Cube (ft ³) | Case Weight (lb) | Use with |
|---------------------------------------|-------------|-------------|--------------|------------------------------|------------------|---------------|
| PresentaBowls® Clear OPS Bowls | | | | | | |
| C8B | 8 oz Bowl | 63 | 504 | 2.5 | 7.7 | C16BL, C16BDL |
| C12B | 12 oz Bowl | 63 | 504 | 2.6 | 9.0 | |
| C16B | 16 oz Bowl | 63 | 504 | 2.7 | 11.6 | |
| C24B | 24 oz Bowl | 63 | 252 | 2.3 | 8.7 | C64BL, C64BDL |
| C32B | 32 oz Bowl | 63 | 252 | 2.4 | 10.5 | |
| C48B | 48 oz Bowl | 63 | 252 | 2.5 | 14.1 | |
| C64B | 64 oz Bowl | 63 | 252 | 2.6 | 15.0 | |
| PresentaBowls® Clear PET Bowls | | | | | | |
| PET8B | 8 oz Bowl | 63 | 504 | 2.5 | 9.9 | PET16BDL |
| PET12B | 12 oz Bowl | 63 | 504 | 2.6 | 12.1 | |
| PET16B | 16 oz Bowl | 63 | 504 | 2.7 | 13.8 | |
| PET24B | 24 oz Bowl | 63 | 252 | 2.3 | 10.9 | PET64BDL |
| PET32B | 32 oz Bowl | 63 | 252 | 2.4 | 12.5 | |
| PET48B | 48 oz Bowl | 63 | 252 | 2.5 | 16.9 | |
| PET64B | 64 oz Bowl | 63 | 252 | 2.6 | 19.0 | |

Clear Lids



| Stock Number | Description | Packing Bag | Packing Case | Case Cube (ft ³) | Case Weight (lb) | Use with |
|--|-------------|-------------|--------------|------------------------------|------------------|--------------------------------|
| Clear Lids for PresentaBowls® Clear OPS Bowls | | | | | | |
| C16BL | Flat Lid | 63 | 504 | 2.3 | 7.6 | C8B, C12B, C16B |
| C16BDL | Dome Lid | 63 | 504 | 2.3 | 8.6 | |
| C64BL | Flat Lid | 63 | 252 | 2.0 | 6.8 | C24B, C32B, C48B, C64B |
| C64BDL | Dome Lid | 63 | 252 | 2.1 | 8.1 | |
| Clear Lids for PresentaBowls® Clear PET Bowls | | | | | | |
| PET16BDL | Dome Lid | 63 | 504 | 2.3 | 9.5 | PET8B, PET12B, PET16B |
| PET64BDL | Dome Lid | 63 | 252 | 1.7 | 9.4 | PET24B, PET32B, PET48B, PET64B |

Features

Variety

Choose from a variety of options for all your applications, including:

- PET or OPS
- hinged or 2-piece
- flat or dome lid
- combo pak or bulk

Dome Lid Available

Provides ample room for high-mounded food items

Leak-Resistant Perimeter Seal

Prevents leaks from wet foods such as salad dressings and sauces



Registered Stacking Platform

Provides greater stacking stability ideal for merchandising displays, and reduces falls and spills

Lid Interchange

- OPS: 2 lids fit 7 bowls
- PET: 2 lids fit 5 bowls

Unique Crystal-Cut Design

Provides an upscale appearance and increases sidewall strength

Combo-Paks

| Stock Number | Description | Packing Bag | Packing Case | Case Cube (ft ³) | Case Weight (lb) |
|--|---|----------------------------|------------------------------|------------------------------|------------------|
| PresentaBowls® Clear OPS Combo-Paks | | | | | |
| C8BCD | Combo-Pak with 8 oz Bowl — Contains C8B, C16BDL | C8B: 63 C16BDL: 63 | C8B: 252 C16BDL: 252 | 2.5 | 8.2 |
| C12BCD | Combo-Pak with 12 oz Bowl — Contains C12B, C16BDL | C12B: 63 C16BDL: 63 | C12B: 252 C16BDL: 252 | 2.6 | 8.9 |
| C16BCD | Combo-Pak with 16 oz Bowl — Contains C16B, C16BDL | C16B: 63 C16BDL: 63 | C16B: 252 C16BDL: 252 | 2.7 | 10.2 |
| C24BCD | Combo-Pak with 24 oz Bowl — Contains C24B, C64BDL | C24B: 63 C64BDL: 63 | C24B: 126 C64BDL: 126 | 2.3 | 8.5 |
| C32BCD | Combo-Pak with 32 oz Bowl — Contains C32B, C64BDL | C32B: 63 C64BDL: 63 | C32B: 126 C64BDL: 126 | 2.4 | 9.4 |
| C48BCD | Combo-Pak with 48 oz Bowl — Contains C48B, C64BDL | C48B: 63 C64BDL: 63 | C48B: 126 C64BDL: 126 | 2.5 | 11.2 |
| C64BCD | Combo-Pak with 64 oz Bowl — Contains C64B, C64BDL | C64B: 63 C64BDL: 63 | C64B: 126 C64BDL: 126 | 2.6 | 11.6 |
| PresentaBowls® Clear PET Combo-Paks | | | | | |
| PET8BCD | Combo-Pak with 8 oz Bowl — Contains PET8B, PET16BDL | PET8B: 63 PET16BDL: 63 | PET8B: 252 PET16BDL: 252 | 2.5 | 9.9 |
| PET12BCD | Combo-Pak with 12 oz Bowl — Contains PET12B, PET16BDL | PET12B: 63 PET16BDL: 63 | PET12B: 252 PET16BDL: 252 | 2.6 | 11.0 |
| PET16BCD | Combo-Pak with 16 oz Bowl — Contains PET16B, PET16BDL | PET16B: 63 PET16BDL: 63 | PET16B: 252 PET16BDL: 252 | 2.7 | 11.9 |
| PET24BCD | Combo-Pak with 24 oz Bowl — Contains PET24B, PET64BDL | PET24B: 63 PET64BDL: 63 | PET24B: 126 PET64BDL: 126 | 2.3 | 10.4 |
| PET32BCD | Combo-Pak with 32 oz Bowl — Contains PET32B, PET64BDL | PET32B: 63 PET64BDL: 63 | PET32B: 126 PET64BDL: 126 | 2.4 | 11.2 |



Features

Hinged Lid
Eliminates lidding confusion

Leak Resistant Perimeter Seal
Prevents leaks from wet foods such as salad dressings and sauces



Available with Dome or Flat Lid

Unique Crystal-Cut Design
Provides an upscale appearance and increases sidewall strength

Clear Hinged Lid Bowls



C8HBF



C12HBF



C16HBF



C24HBF



C32HBF



C8HBD



C12HBD



C16HBD



C24HBD



C32HBD

| Stock Number | Description | Packing Bag | Packing Case | Case Cube (ft ³) | Case Weight (lb) |
|--|---------------------------------|-------------|--------------|------------------------------|------------------|
| PresentaBowls® Clear OPS Hinged Lid Bowls | | | | | |
| C8HBF | 8 oz Hinged Bowl with Flat Lid | 75 | 300 | 3.0 | 9.3 |
| C12HBF | 12 oz Hinged Bowl with Flat Lid | 75 | 300 | 3.0 | 10.8 |
| C16HBF | 16 oz Hinged Bowl with Flat Lid | 75 | 300 | 3.2 | 14.5 |
| C24HBF | 24 oz Hinged Bowl with Flat Lid | 75 | 150 | 2.8 | 10.1 |
| C32HBF | 32 oz Hinged Bowl with Flat Lid | 75 | 150 | 2.9 | 12.4 |
| C8HBD | 8 oz Hinged Bowl with Dome Lid | 75 | 300 | 3.0 | 9.3 |
| C12HBD | 12 oz Hinged Bowl with Dome Lid | 75 | 300 | 3.0 | 10.8 |
| C16HBD | 16 oz Hinged Bowl with Dome Lid | 75 | 300 | 3.2 | 14.5 |
| C24HBD | 24 oz Hinged Bowl with Dome Lid | 75 | 150 | 2.8 | 10.1 |
| C32HBD | 32 oz Hinged Bowl with Dome Lid | 75 | 150 | 2.9 | 12.4 |



For additional information,
contact your Dart representative
or call (800) 248-5960

www.dartcontainer.com

DART CONTAINER CORPORATION

The Industry Standard of Excellence

Mason, Michigan 48854 U.S.A.

Ph: (800) 248-5960 • Fax: (517) 676-3883

Email: sales@dart.biz • www.dartcontainer.com



ClearPac® Containers & Snap-On Lids

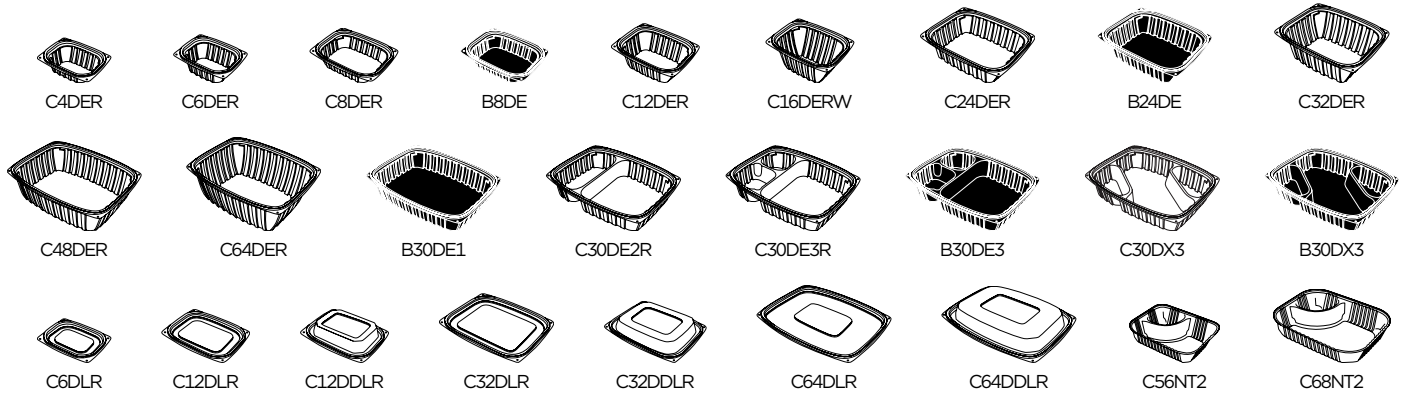

| Stock Numbers | | Description | Packing Bag/Case | | Case Cube (ft ³) | | Case Weight (lbs) | | Use With |
|-------------------------------------|--|--------------------------|----------------------------------|--------|------------------------------|-------|-------------------|-------|---|
| Clear | Black | | Clear | Black | Clear | Black | Clear | Black | |
| Clear & Black Containers | | | | | | | | | |
| C4DER | — | 4 oz | 63/1008 | — | 3.2 | — | 11.0 | — | C6DLR |
| C6DER | — | 6 oz | 63/1008 | — | 3.3 | — | 13.2 | — | |
| C8DER | B8DE | 8 oz | 63/1008 | 63/252 | 4.1 | 1.1 | 17.6 | 4.8 | C12DLR, C12DDL |
| C12DER | — | 12 oz | 63/1008 | — | 4.3 | — | 19.0 | — | |
| C16DERW | — | 16 oz | 63/1008 | — | 4.6 | — | 24.7 | — | C32DLR, C32DDL |
| C24DER | B24DE | 24 oz | 63/504 | 63/252 | 4.2 | 2.1 | 16.5 | 8.6 | |
| C32DER | — | 32 oz | 63/504 | — | 4.3 | — | 19.4 | — | C64DLR, C64DDL |
| C48DER | — | 48 oz | 63/252 | — | 2.8 | — | 12.6 | — | |
| C64DER | — | 64 oz | 63/252 | — | 2.9 | — | 14.7 | — | C64DLR, C64DDL |
| — | B30DE1 | 30 oz | 63/252 | 63/252 | 2.5 | 2.5 | 11.1 | 11.1 | |
| C30DE2R | — | 22.6 oz & 10.2 oz | 63/252 | — | 2.5 | — | 11.1 | — | C64DLR, C64DDL |
| C30DE3R | B30DE3 | 23.0 oz, 4.7 oz & 4.6 oz | 63/252 | 63/252 | 2.5 | 2.5 | 11.1 | 11.1 | |
| C30DX3R | B30DX3 | 20.9 oz, 4.9 oz & 4.9 oz | 63/252 | 63/252 | 2.5 | 2.5 | 11.1 | 11.1 | |
| Clear Snap-On Lids | | | | | | | | | |
| C6DLR | Flat Lid | | 63/1008 | | 2.7 | | 10.9 | | C4DER, C6DER |
| C12DLR | Flat Lid | | 63/1008 | | 3.2 | | 14.9 | | C8DER, B8DE, C12DER, C16DER |
| C12DDL | Dome Lid | | 63/1008 | | 3.3 | | 17.1 | | |
| C32DLR | Flat Lid | | 63/504 | | 3.2 | | 13.6 | | C24DER, B24DE, C32DER |
| C32DDL | Dome Lid | | 63/504 | | 2.9 | | 15.1 | | |
| C64DLR | Flat Lid | | 63/252 | | 1.9 | | 9.5 | | C48DER, C64DER, C30DE2R, C30DE3R, B30DE3, C30DX3R, B30DX3, B30DE1 |
| C64DDL | Dome Lid | | 63/252 | | 2.0 | | 10.3 | | |
| Combo Packs | | | | | | | | | |
| C8DCPR | 8 oz Container with Flat Lid Contains C8DER, C12DLR | | C8DER: 63/252 C12DLR: 63/252 | | 2.1 | | 7.9 | | — |
| C12DCPR | 12 oz Container with Flat Lid Contains C12DER, C12DLR | | C12DER: 63/252 C12DLR: 63/252 | | 2.2 | | 9.0 | | — |
| C16DCPRW | 16 oz Container with Flat Lid Contains C16DER, C12DLR | | C16DER: 63/252 C12DLR: 63/252 | | 2.4 | | 10.0 | | — |
| C24DCPR | 24 oz Container with Flat Lid Contains C24DER, C32DLR | | C24DER: 63/252 C32DLR: 63/252 | | 4.1 | | 14.6 | | — |
| C32DCPR | 32 oz Container with Flat Lid Contains C32DER, C32DLR | | C32DER: 63/252 C32DLR: 63/252 | | 4.3 | | 16.6 | | — |
| Clear Nacho Trays | | | | | | | | | |
| C56NT2 | Small Nacho Tray - Clear | | 125/500 | | 1.1 | | 7.8 | | — |
| C68NT2 | Large Nacho Tray - Clear | | 125/500 | | 1.5 | | 13.0 | | — |



For additional information,
contact your Dart representative
or call (800) 248-5960

www.dartcontainer.com

DART CONTAINER CORPORATION

The Industry Standard of Excellence

Mason, Michigan 48854 U.S.A.

Ph: (800) 248-5960 • Fax: (517) 676-3883

Email: sales@dart.biz • www.dartcontainer.com



PresentaBowls Pro® Square Bowls

Dart's PresentaBowls Pro® bowl line offers incredible versatility for users with its wide array of sizes and ability to accommodate both hot and cold food applications. Made from polypropylene, the bowls resist cracking and breaking and are fully microwaveable. The upscale appearance and crystal-like design enhances the image of food applications.





Features

Polypropylene and PET Lids Available

One base, two lids for maximum versatility

Crystal-Like Design

Gives upscale, table-ready appearance

Microwaveable

Polypropylene base when used with polypropylene lid makes container completely microwaveable



Leak-Resistant Perimeter Seal

Keeps liquids in, reducing customer complaints

Self-Aligning Offset Opening Tabs

Lid fits no matter what direction it's applied

Stackability

Base fits snugly into recessed platform on lids for greater merchandising and stability

PresentaBowls Pro® Square Bowls



PresentaBowls Pro® Square Lids



| Item | Description | Packing Bag | Packing Case | Case Cube (ft ³) | Case Weight (lbs) | Use With |
|--|----------------------------|-------------|--------------|------------------------------|-------------------|----------------------------|
| PresentaBowls Pro® Square Bowls | | | | | | |
| B8SB | 8 oz Black Square Bowl | 63 | 504 | 2.0 | 11.5 | C816BDL, PP816BDL |
| B12SB | 12 oz Black Square Bowl | 63 | 504 | 2.1 | 13.1 | |
| B16SB | 16 oz Black Square Bowl | 63 | 504 | 2.2 | 14.8 | |
| B24SB | 24 oz Black Square Bowl | 63 | 252 | 2.7 | 14.5 | C2464BDL, PP2464BDL |
| B32SB | 32 oz Black Square Bowl | 63 | 252 | 3.1 | 15.2 | |
| B48SB | 48 oz Black Square Bowl | 63 | 252 | 3.1 | 18.7 | |
| B64SB | 64 oz Black Square Bowl | 63 | 252 | 3.5 | 20.8 | |
| PresentaBowls Pro® Square Lids | | | | | | |
| C816BDL | PET Small Clear Square Lid | 63 | 504 | 1.7 | 8.6 | B8SB, B12SB, B16SB |
| PP816BDL | PP Small Vented Square Lid | 63 | 504 | 1.8 | 7.6 | B8SB, B12SB, B16SB |
| C2464BDL | PET Large Clear Square Lid | 63 | 252 | 2.8 | 13.6 | B24SB, B32SB, B48SB, B64SB |
| PP2464BDL | PP Large Vented Square Lid | 63 | 252 | 2.5 | 12.0 | B24SB, B32SB, B48SB, B64SB |



For additional information, contact your Dart representative or call (800) 248-5960

www.dartcontainer.com

DART CONTAINER CORPORATION

The Industry Standard of Excellence

Mason, Michigan 48854 U.S.A.

Ph: (800) 248-5960 • Fax: (517) 676-3883

Email: sales@dart.biz • www.dartcontainer.com



PRINTED ON RECYCLED PAPER



The decision
is CLEAR

ClearSeal® Clear Plastic Hinged Lid Containers

Lock in freshness with ClearSeal®'s perimeter seal designed to maximize product freshness and reduce leaks. Dual barlocks provide a snap-tight secure closure while easily accessible flared gripper tabs simplify opening. ClearSeal, the clear choice for accentuating the full appeal of your food with confidence.





ClearSeal.

Features

Stacking platform

Increases stability for delivery and display

Chamfered corners

Provide extra strength at container corners

Dual bar-locks

provide Audible snap, and confirms secure closing every time



Curved sidewall
Offers reinforced durability in handling

Label window
Offers ideal label or tamper evident seal placement

Slip-resistant gripper tabs
Easy and secure opening

Perimeter seal ensures product freshness and leak-resistance.



ClearSeal



Competitor



ClearSeal



Competitor

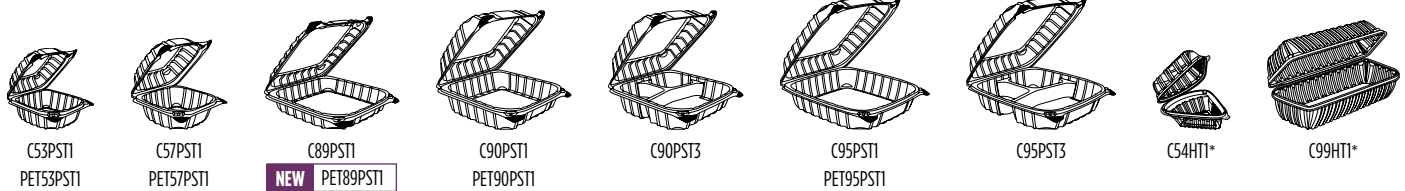

C53PST1
PET53PST1

C57PST1
PET57PST1

C89PST1
NEW PET89PST1

C90PST1
PET90PST1

C90PST3

C95PST1
PET95PST1

C95PST3

C54HT1*

C99HT1*

| Item | Description | Dimensions | Packing Bag/Case | Case Cube (ft ³) | Case Weight (lbs) |
|---|---------------------------------|--------------------|------------------|------------------------------|-------------------|
| ClearSeal® OPS Hinged Lid Containers | | | | | |
| C53PST1 | 5" sandwich container | 5 ¼" × 5 ¾" × 2 ½" | 125/500 | 3.2 | 14.7 |
| C57PST1 | 6" sandwich container | 6" × 5 ¾" × 3" | 125/500 | 4.0 | 19.6 |
| C89PST1 | Medium container, shallow | 8 ¼" × 8 ¼" × 2" | 125/250 | 3.8 | 19.0 |
| C90PST1 | Medium container | 8 ¼" × 8 ¼" × 3" | 125/250 | 3.8 | 19.8 |
| C90PST3 | Medium container, 3-compartment | 8 ¼" × 8 ¼" × 3" | 125/250 | 3.8 | 19.8 |
| C95PST1 | Large container | 8 ¾" × 9 ¾" × 3" | 100/200 | 3.8 | 20.3 |
| C95PST3 | Large container, 3-compartment | 8 ¾" × 9 ¾" × 3" | 100/200 | 3.8 | 20.3 |
| C54HT1* | Pie wedge | 5 ½" × 6 ½" × 3" | 125/250 | 2.7 | 10.1 |
| C99HT1* | Hoagie container | 9 ¾" × 5 ½" × 3 ½" | 100/200 | 3.2 | 13.9 |
| ClearSeal® PET Hinged Lid Containers | | | | | |
| PET53PST1 | 5" sandwich container | 5 ¼" × 5 ¾" × 2 ½" | 125/500 | 3.2 | 21.5 |
| PET57PST1 | 6" sandwich container | 6" × 5 ¾" × 3" | 125/500 | 4.0 | 25.6 |
| PET89PST1 | Medium container, shallow | 8 ¼" × 8 ¼" × 2" | 125/250 | 3.8 | 24.5 |
| PET90PST1 | Medium container | 8 ¼" × 8 ¼" × 3" | 125/250 | 3.8 | 25.6 |
| PET95PST1 | Large container | 8 ¾" × 9 ¾" × 3" | 100/200 | 3.8 | 24.3 |

* Previously part of Dart Showtime clear hinged container line — features may vary



For additional information,
contact your Dart representative
or call (800) 248-5960

www.dartcontainer.com

DART CONTAINER CORPORATION

The Industry Standard of Excellence

Mason, Michigan 48854 U.S.A.

Ph: (800) 248-5960 • Fax: (517) 676-3883

Email: sales@dart.biz • www.dartcontainer.com



A clear choice to drive
home impulse sales!



Superior Product Visibility

Show off your mouth watering baked goods, sandwiches, salads, frozen foods and more with Dart's Staylock® Clear Hinged Lid Containers. Both OPS (Oriented Polystyrene) and PET (Polyethylene Terephthalate) have crystal clarity for superior product visibility as well as being flexible, yet durable to maximize strength and reliability. PET StayLock has exceptional performance in cold temperatures and accommodates freezing down to -22°F.





Features

Registered Stacking Platform

Provides greater stability of merchandising displays

Superior Product Visibility

Show off baked goods, sandwiches, salads, frozen foods and more. Both OPS (Oriented Polystyrene) and PET (Polyethylene Terephthalate) have crystal clarity

Opening Tabs

Makes container easy to open

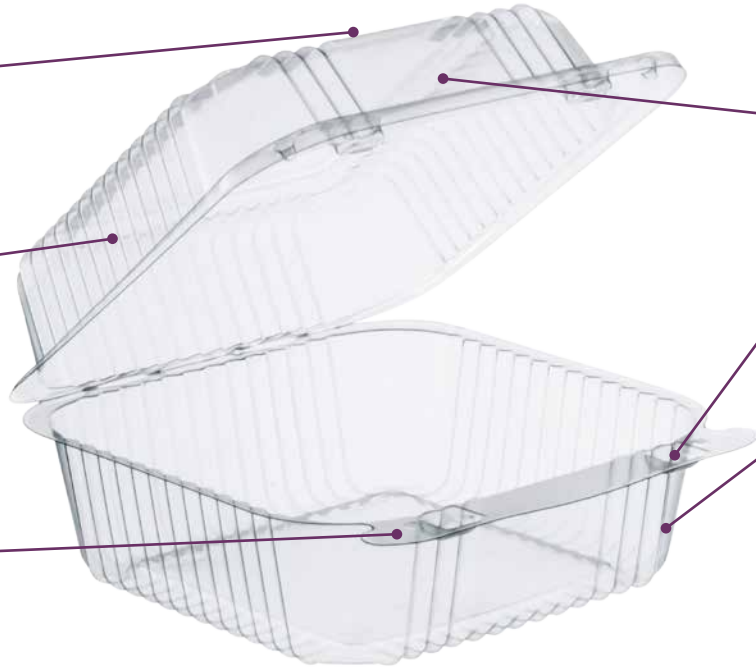

Label Window

For placement of a tamper evident seal

Bowtie Bar Locks

Provides an audible snap and excellent closure multiple times

Chamfered Corners

Provides extra strength at the corners



C18UT1
PET18UT1



C19UT1



C20UT1
PET20UT1



C20UTD
PET20UTD

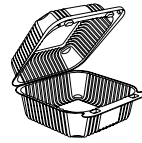

C25UT1
PET25UT1



C26UT1

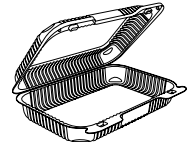

C30UT1
PET30UT1

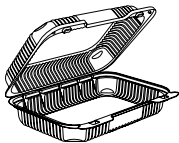

C32UT1
PET32UT1



C35UT1
PET35UT1

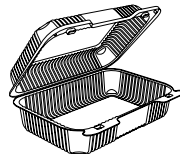

C40UT1
PET40UT1

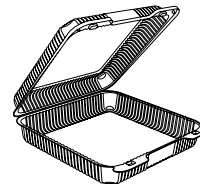

C50UT1

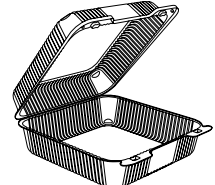

C50UTD

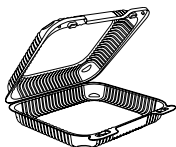

C51UTS

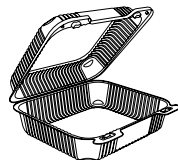

C51UT1
PET51UT1

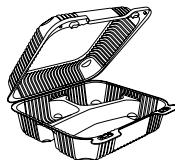

C51UT3

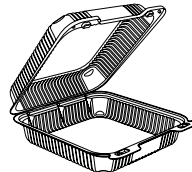

C55UT1
PET55UT1

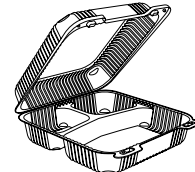

C55UT3

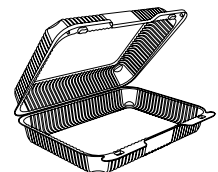

C57UT1

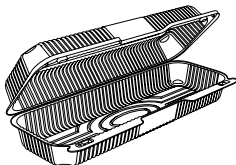

C60UT1
PET60UT1

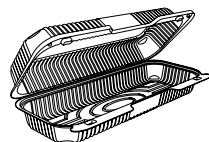

C65UT1

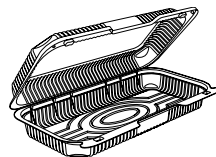

C75UTD

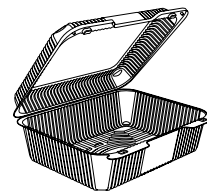

C80UT1

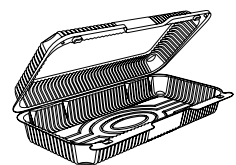

C90UT1
PET90UT1



StayLock®

| OPS Stock Number | PET Stock Number | Description | Outside Dimensions | Capacity (fl oz) of Container Base | Packing Bag/Case | Case Cube OPS/PET | Case Weight OPS/PET |
|------------------|------------------|---------------------------------------|--------------------|------------------------------------|------------------|-------------------|---------------------|
| C18UT1 | PET18UT1 | Small oblong container | 8½ x 4½ x 2½ | 14.9 | 125/250 | 1.5/1.5 | 9.5/11.9 |
| C19UT1 | -- | Small oblong container, high dome | 8½ x 4½ x 3% | 23.9 | 125/250 | 1.8 | 11.3 |
| C20UT1 | PET20UT1 | 5" square container | 5¼ x 5¼ x 2¼ | 15.7 | 125/500 | 2.5/2.5 | 15.5/20.7 |
| C20UTD | PET20UTD | 5" square container, deep base | 5¼ x 5¼ x 3¼ | 18.7 | 125/500 | 2.7/2.5 | 15.6/20.7 |
| C25UT1 | PET25UT1 | 6" square container | 6½ x 6½ x 3¼ | 26.6 | 125/500 | 3.3/3.3 | 20.2/27.4 |
| C26UT1 | -- | 7" small oblong container | 7 x 6 x 2½ | 18.0 | 125/250 | 1.6 | 10.7 |
| C30UT1 | PET30UT1 | Medium oblong container, shallow dome | 9¾ x 6¾ x 2½ | 33.5 | 125/250 | 2.3/2.3 | 15.8/20.1 |
| C32UT1 | PET32UT1 | Medium oblong container, medium dome | 9¾ x 6¾ x 2¾ | 36.3 | 125/250 | 2.7/2.4 | 16.1/20.1 |
| C35UT1 | PET35UT1 | 9" Medium oblong container | 9 x 5¾ x 3½ | 29.7 | 125/250 | 2.1/1.8 | 14.0/17.5 |
| C40UT1 | PET40UT1 | Medium oblong container, high dome | 9¾ x 6¾ x 3¾ | 46.9 | 125/250 | 2.8/2.5 | 18.8/22.2 |
| C50UT1 | -- | 9" square container | 9½ x 9½ x 2½ | 46.4 | 125/250 | 3.6 | 24.3 |
| C50UTD | -- | 9" square container, high dome | 9½ x 9½ x 3¾ | 75.7 | 125/250 | 3.7 | 25.9 |
| C51UTS | -- | Medium container, shallow | 8¾ x 7¾ x 2 | 24.7 | 125/250 | 2.5 | 16.0 |
| C51UT1 | PET51UT1 | Medium container | 8¾ x 7¾ x 3 | 42.5 | 125/250 | 3.0/2.3 | 19.0/23.8 |
| C51UT3 | -- | Medium container, three compartment | 8¾ x 7¾ x 3 | 15.8, 6.1, & 6.1 | 125/250 | 3.0 | 19.0 |
| C55UT1 | PET55UT1 | Large container | 9 x 8½ x 3 | 38.1 | 100/200 | 2.7/2.4 | 18.5/21.9 |
| C55UT3 | -- | Large container, three compartment | 9 x 8½ x 3 | 22.2, 7.4, & 7.4 | 100/200 | 2.7 | 18.5 |
| C57UT1 | -- | 10½" oblong container | 10½ x 8¼ x 2¾ | 48.5 | 125/250 | 3.7 | 26.0 |
| C60UT1 | PET60UT1 | 14" strudel or hoagie container | 14¾ x 5½ x 3½ | 44.4 | 125/250 | 3.0/2.3 | 19.4/26.8 |
| C65UT1 | -- | 12" small strudel container | 12¼ x 5½ x 2¾ | 26.0 | 125/250 | 2.4 | 15.8 |
| C75UTD | -- | 12" strudel container, deep base | 12½ x 6¾ x 2¾ | 35.9 | 125/250 | 2.9 | 19.7 |
| C80UT1 | -- | 10½" oblong container, deep base | 10½ x 8¾ x 3¼ | 93.4 | 100/200 | 3.5 | 21.8 |
| C90UT1 | PET90UT1 | 13" strudel container | 13¾ x 6¾ x 2¾ | 50.2 | 100/200 | 2.8/2.8 | 18.1/24.1 |



StayLock
Clear Hinged Lid Container



PET
STAYLOCK®

EXCEPTIONAL
PERFORMANCE
in
COLD
TEMPERATURES

ACCOMMODATES
FREEZING
DOWN TO
-22°F



For additional information,
contact your Dart representative
or call (800) 248-5960

www.dartcontainer.com

DART CONTAINER CORPORATION

The Industry Standard of Excellence

Mason, Michigan 48854 U.S.A.

Ph: (800) 248-5960 • Fax: (517) 676-3883

Email: sales@dart.biz • www.dartcontainer.com

©2017 Dart Container Corporation. All rights reserved.
Dart® and the Dart logo are trademarks of Dart Container Corporation. Solo® and the Solo logo are trademarks of Solo Cup
Operating Corporation. Used with permission.
MC299USE_030917

PRINTED ON RECYCLED PAPER



We contain your
GOOD REPUTATION

Creative Carryouts® Octaview® Black Base/Clear Lid Hinged Containers

- Elevates merchandising and allows for premium pricing
- Provides superior food presentation
- Drives impulse sales
- Enhances dining experience and generates repeat business
- Provides clear view of contents, reducing order errors at point-of-pickup



- LeakGuard seal helps reduce leaks and extend shelf life
- Textured base and juice well elevate food to extend freshness
- Compartmented lids and bases keep portions contained and prevent food from migrating



Secure stacking ensures stability of stacked containers in a display or take-out bag

| | |
|-------------------------|---------------------------|
| Material | PS |
| Container Sizes | 4.5" - 12" (11.4-30.5 cm) |
| Microwaveable | No |
| Approximate Temp. Range | 14° to 203° F |

**Creative Carryouts®
OctaView® Plastic
Hinged Lid
Containers**



| Container Description | 4.5" Medium | 4.5" Deep | 6" Medium | 6" Deep | 7.5" Medium Low Dome Lid | 7.5" Medium |
|--|----------------|----------------|----------------|----------------|--------------------------|----------------|
| Item Number | 866611-PS94 | 866612-PS94 | 862613-PS94 | 862611-PS94 | 865624-PS94 | 865611-PS94 |
| Approximate Flush Fill Capacity (fl oz) | 7 | 9 | 16 | 21 | 24 | 24 |
| Dimensions (L×W×H) | 4.6"×4.6"×2.4" | 4.6"×4.6"×3.2" | 6.3"×6.3"×2.4" | 6.3"×6.3"×3.2" | 7.5"×7.5"×2.1" | 7.5"×7.5"×2.4" |
| Packing Bag | 300 | 300 | 200 | 200 | 100 | 100 |
| Packing Case | 300 | 300 | 200 | 200 | 100 | 100 |
| Case Cube (ft ³ /m ³) | 1.9/0.06 | 1.9/0.06 | 2.1/0.06 | 2.1/0.06 | 1.5/0.04 | 1.5/0.04 |
| Case Weight (lb/kg) | 10.9/4.9 | 10.9/5.0 | 12.8/5.8 | 12.4/5.6 | 9.6/4.3 | 9.4/4.2 |



Creative Carryouts® OctaView® (Polystyrene) 6" Deep, 7.5" Deep and 9" Deep containers are also available in Perfect Pak®!

- 50% less than standard OctaView® case count
- Cases under 21" in height accommodate storage constraints and fit retail shelves
- Retail-ready, attractive outer-case packaging



**Creative Carryouts®
OctaView® Plastic
Hinged Lid
Containers**



| Container Description | 7.5" Deep | 9" Shallow | 9" Deep | 9" Deep 3-Comp | 12" Deep |
|--|-----------------|-----------------|----------------|-----------------|------------------|
| Item Number | 865612-PS94 | 864611-PS94 | 864612-PS94 | 864628-PS94 | 863611-PS94 |
| Approximate Flush Fill Capacity (fl oz) | 32 | 38 | 45 | 8/8/24 | 80 |
| Dimensions (L×W×H) | 7.5"×7.5"× 3.2" | 9.1"×9.1"× 2.0" | 9.1"×9.1"×3.2" | 9.1"×9.1"× 2.4" | 12.0"×12.1"×3.1" |
| Packing Bag | 100 | 100 | 100 | 100 | 100 |
| Packing Case | 100 | 100 | 100 | 100 | 100 |
| Case Cube (ft ³ /m ³) | 1.5/0.04 | 1.9/0.05 | 1.9/0.05 | 1.9/0.05 | 3.5/0.10 |
| Case Weight (lb/kg) | 9.4/4.3 | 12.9/5.9 | 14.3/6.5 | 14.3/6.5 | 24.1/11.0 |

- Excellent barrier properties extend product shelf life and increase profits
- LeakGuard seal helps reduce leaks and extend shelf life
- Textured base and juice well elevate food to extend freshness
- Secure stacking feature facilitates stability of stacked containers in a display or take-out bag



| | |
|-------------------------|-------------------------|
| Material | PET |
| Container Sizes | 6" - 9" (15.2 -22.9 cm) |
| Microwaveable | No |
| Approximate Temp. Range | -22° to 151° F |

Creative Carryout® OctaView® PET Hinged Lid Containers



| Container Description | 6" Deep | 7.5" Medium | 7.5" Deep | 9" Shallow | 9" Deep |
|--|--------------------|--------------------|--------------------|--------------------|--------------------|
| Item Number | 862044-AP94 | 865045-AP94 | 865044-AP94 | 864057-AP94 | 864056-AP94 |
| Approximate Flush Fill Capacity (fl oz) | 21 | 24 | 32 | 38 | 45 |
| Dimensions (L×W×H) | 6.3" × 6.3" × 3.2" | 7.5" × 7.5" × 2.4" | 7.5" × 7.5" × 3.2" | 9.1" × 9.1" × 2.0" | 9.1" × 9.1" × 3.2" |
| Packing Bag | 200 | 100 | 100 | 100 | 100 |
| Packing Case | 200 | 100 | 100 | 100 | 100 |
| Case Cube (ft ³ /m ³) | 2.1/0.06 | 1.5/0.04 | 1.5/0.04 | 1.9/0.05 | 1.9/0.05 |
| Case Weight (lb/kg) | 12.5/5.7 | 10.9/4.9 | 11.0/5.0 | 14.4/6.5 | 16.1/7.3 |



- Modified Polystyrene (PM): Special PS blend makes containers suitable for hot foods or applications requiring microwave reheating
- LeakGuard seal helps reduce leaks and extends shelf life
- Secure stacking feature facilitates stability of stacked containers in a display or take-out bag
- Anti-fog lids resist fog in hot applications

Creative Carryouts® OctaView® PM containers feature an anti-fog, Tear-Away lid which adds two-piece convenience to a hinged container

| | |
|-------------------------|--|
| Material | PM  |
| Container Sizes | 9" (22.9 cm) |
| Microwarmable | Yes |
| Approximate Temp. Range | 32° to 225° F |

Creative Carryouts® OctaView® Plastic Hinged Lid Containers



| Container Description | 9" Deep 3-Comp | 9" Deep | 9" OctaBowl® |
|---|-----------------|-----------------|-----------------|
| Item Number | 864036-PM94 | 864035-PM94 | 864039-PM94 |
| Approximate Flush Fill Capacity (fl oz) | 8/8/24 | 45 | 51 |
| Dimensions (L×W×H) | 9.1"×9.1"× 2.4" | 9.1"×9.1"× 3.2" | 9.2"×9.2"× 2.5" |
| Packing Bag | 100 | 100 | 100 |
| Packing Case | 100 | 100 | 100 |
| Case Cube (ft³/m³) | 1.9/0.05 | 1.9/0.05 | 2.1/0.06 |
| Case Weight (lb/kg) | 14.2/6.4 | 14.7/6.6 | 14.4/6.5 |

84%
of consumers
purchase meal replacement
solutions!

"84% of U.S. consumers now report that they buy retailer meal solutions at least once per month — up from 79% in 2012."

Technomic (2016) Retail Foodservice Gaining Ground in Food Fight.

- From freezer to microwave to table flexibility
- Vented lids that prevent steam from building up in hot applications
- Tear-Away lid adds two-piece convenience to a hinged container
- LeakGuard seal helps reduce leaks and extend shelf life
- Compartmented lids and bases keep portions contained and prevent food from migrating

EZ Close feature on Creative Carryouts® OctaView® Supreme Containers allows for a fast, secure closure with minimal effort



| | |
|-------------------------|-------------------------|
| Material | PP |
| Container Sizes | 6" – 9" (15.2 -22.9 cm) |
| Microwaveable | Yes |
| Approximate Temp. Range | -4° to 230° F |

OctaView® Supreme Polypropylene Hinged Lid Containers



| Container Description | 6" Medium Supreme | 6" Deep Supreme | 7.5" Medium Supreme | 7.5" Deep Supreme | 9" Deep Low Dome Supreme | 9" Deep Supreme | 9" Deep 3-Comp Supreme |
|--|-------------------|-----------------|---------------------|-------------------|--------------------------|-----------------|------------------------|
| Item Number | 806012-PP94 | 806011-PP94 | 807012-PP94 | 807011-PP94 | 809013-PP94 | 809011-PP94 | 809014-PP94 |
| Approximate Flush Fill Capacity (fl oz) | 17 | 22 | 27 | 34 | 51 | 51 | 7/8/24 |
| Dimensions (L×W×H) | 6.3"× 6.3"×2.4" | 6.3"× 6.3"×3.1" | 7.5"×7.5"×2.4" | 7.5"×7.5"×3.2" | 9.1"×9.1"×2.4" | 9.1"×9.1"×3.1" | 9.1"×9.1"×2.4" |
| Packing Bag | 200 | 200 | 100 | 100 | 50 | 50 | 50 |
| Packing Case | 200 | 200 | 100 | 100 | 100 | 100 | 100 |
| Case Cube (ft ³ /m ³) | 3.5/0.1 | 3.5/0.1 | 2.3/0.06 | 2.3/0.06 | 3.6/0.1 | 3.6/0.1 | 3.6/0.1 |
| Case Weight (lb/kg) | 15.8/7.2 | 15.8/7.2 | 11.5/5.2 | 11.5/5.2 | 15.8/7.2 | 16.6/7.5 | 16.4/7.5 |



- From freezer to microwave to table flexibility
- Anti-fog lids resist fog in hot applications
- Vented lids that prevent steam from building up in hot applications
- Tear-Away lid adds two-piece convenience to a hinged container
- LeakGuard seal helps reduce leaks and extend shelf life

| | |
|-------------------------|-------------------------|
| Material | PP |
| Container Sizes | 6" - 9" (15.2 -22.9 cm) |
| Microwaveable | Yes |
| Approximate Temp. Range | -4° to 230° F |

OctaView® Select Polypropylene Hinged Lid Containers



| Container Description | 6" Medium Select | 6" Deep Select | 7.5" Medium Select | 9" Deep Low Dome Lid Select |
|--|------------------|----------------|--------------------|-----------------------------|
| Item Number | 806015-PP94 | 806016-PP94 | 807015-PP94 | 809015-PP94 |
| Approximate Flush Fill Capacity (fl oz) | 17 | 22 | 26 | 52 |
| Dimensions (L×W×H) | 6.3"×6.3"×2.3" | 6.3"×6.3"×3.1" | 7.5"×7.5"×2.3" | 9.1"×9.1"×2.3" |
| Packing Bag | 100 | 100 | 50 | 50 |
| Packing Case | 200 | 200 | 100 | 100 |
| Case Cube (ft ³ /m ³) | 3.4/0.1 | 3.4/0.1 | 2.3/0.07 | 3.3/0.09 |
| Case Weight (lb/kg) | 13.0/5.9 | 13.0/5.9 | 9.3/4.2 | 13.4/6.1 |

30% increase
in customers choosing prepared food items

"An increasing number of consumers are opting for prepared food items, which are up 30% in the past five years."

NPD Market Research Group, September 2014



OctaView®



| Brand Name | OctaView® | OctaView®/ OctaBowl® | OctaView® | OctaView® Supreme | OctaView® Select |
|------------------------------------|---------------|-------------------------|----------------|----------------------|---------------------|
| Resin/Material | PS | PM | PET | PP | PP |
| Approximate Temperature Range | 14° to 203° F | 32° to 225° F | -22° to 151° F | -4° to 230° F | -4° to 230° F |
| Unique, Octagonal Design | ● | ● | ● | ● | ● |
| Black Bottom, Clear Lid | ● | ● | ● | ● | ● |
| One-Piece Hinge Design | ● | ● | ● | ● | ● |
| Leak Guard Perimeter Seal | ● | ● | ● | ● | ● |
| Off-Set Opening Tabs | ● | ● | ● | ● | ● |
| Registered stacking platform | ● | ● | ● | ● | ● |
| Pebbled/Textured Base | ● | ● | ● | ● | ● |
| Juice Well | ● | ● | ● | ● | ● |
| Microwarmable | ○ | ● | ○ | ○ | ○ |
| Microwavable | ○ | ○ | ○ | ● | ● |
| Smooth Sidewalls | ● | ● | ● | ○ | ○ |
| Ribbed Sidewalls | ○ | ○ | ○ | ● | ● |
| Tear-Away Hinge | ○ | ● | ○ | ● | ● |
| Lid closure = Single-Push EZ Close | ○ | ○ | ○ | ● | ○ |
| Vented Lid | ○ | ○ | ○ | ● | ● |
| Anti-fog Lid | ○ | ● | ○ | ○ | ● |

Customization Options:

Base depths, compartmented bases, lid heights, lid embossing
(note: minimum order quantities apply)



For additional information,
contact your Dart representative
or call (800) 248-5960

www.dartcontainer.com

DART CONTAINER CORPORATION

The Industry Standard of Excellence

Mason, Michigan 48854 U.S.A.

Ph: (800) 248-5960 • Fax: (517) 676-3883

Email: sales@dart.biz • www.dartcontainer.com



We contain your
GOOD REPUTATION

**Black Base/Clear Lid
Hinged Containers**

- Elevates merchandising and allows for premium pricing
- Provides superior food presentation
- Drives impulse sales
- Enhances dining experience and generates repeat business
- Made in the USA



- Available in a variety of sizes and shapes to fit numerous applications and portion sizing requirements
- Textured base and juice well elevate food to extend freshness
- Secure stacking feature facilitates stability of stacked containers in a display or takeout bag
- LeakGuard seal on select sizes helps reduce leaks and extend shelf life



*“Asked to pick the top factors that influence where they purchase take-out, more than one in 10 consumers made a decision on **whether the packaging is high in quality.**”*

Technomic (2012). Packaging Can Make or Break a Takeout Meal.

Creative
Carryouts®

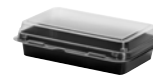

| Container Description | Mini Box Shallow | Snack Box Shallow (Bar Locks) | Snack Box Medium (Bar Locks) | Snack Box Deep (Bar Locks) | Deli Box Medium (Bar Locks) | Deli Box Deep (Bar Locks) |
|--|--------------------|-------------------------------|------------------------------|----------------------------|-----------------------------|---------------------------|
| Resin | PS | PS | PS | PS | PS | PS |
| Item Number | 850618-PS94 | 851012-PS94 | 851611-PS94 | 851013-PS94 | 846612-PS94 | 846622-PS94 |
| Approximate Flush Fill Capacity (fl oz) | 8 | 13 | 18 | 24 | 26 | 31 |
| Dimensions (l×w×h) | 6.0" × 3.8" × 1.6" | 6.2" × 5.7" × 1.8" | 6.2" × 5.7" × 2.1" | 6.2" × 5.7" × 3.2" | 7.8" × 5.7" × 2.3" | 7.8" × 5.7" × 3.0" |
| Packing Bag | 250 | 200 | 200 | 200 | 100 | 100 |
| Packing Case | 500 | 200 | 200 | 200 | 200 | 200 |
| Case Cube (ft ³ /m ³) | 3.6/0.10 | 2.2/0.06 | 2.2/0.06 | 2.2/0.06 | 2.7/0.08 | 2.7/0.08 |
| Case Weight (lbs/kg) | 19.4/8.8 | 14.7/6.7 | 14.0/6.4 | 15.1/6.8 | 18.4/8.4 | 18.5/8.4 |



Creative Carryouts®



| Container Description | 6-8" Hoagie (LeakGuard Seal) | 11" Hoagie (Bar Locks) | 10.5" Hoagie | Lunch Box Shallow, 2-Comp (Bar Locks) | Lunch Box Shallow (Bar Locks) | Lunch Box Medium (Bar Locks) | Larger Lunch Box (EZ Close, Bar Locks) |
|---|---------------------------------|---------------------------|---------------------|---|-------------------------------------|------------------------------------|--|
| Resin | PS | PS | PS | PS | PS | PS | PS |
| Item Number | 836011-PS94 | 888612-PS94 | 848604-PS94 | 878618-PS94 | 878611-PS94 | 878617-PS94 | 872011-PS94 |
| Approximate Flush Fill Capacity (fl oz) | 22 | 24 | 29 | 18/11 | 32 | 37 | 54 |
| Dimensions (l×w×h) | 8.7" × 4.3" × 3.1" | 10.8" × 4.0" × 3.0" | 10.6" × 5.2" × 2.2" | 7.9" × 7.8" × 1.8" | 7.9" × 7.8" × 1.8" | 7.9" × 7.8" × 2.3" | 8.5" × 9.1" × 2.7" |
| Packing Bag | 200 | 100 | 100 | 100 | 100 | 100 | 100 |
| Packing Case | 200 | 200 | 200 | 100 | 100 | 100 | 100 |
| Case Cube (ft ³ /m ³) | 2.1/0.06 | 2.1/0.06 | 2.6/0.07 | 1.9/0.05 | 1.9/0.05 | 1.9/0.05 | 2.2/0.06 |
| Case Weight (lbs/kg) | 15.5/7.0 | 17.0/7.7 | 19.4/8.8 | 12.5/5.7 | 12.9/5.8 | 12.7/5.8 | 14.1/6.4 |



Dinner Boxes

- Made of modified polystyrene (PM), a special polystyrene blend suitable for hot foods or items requiring microwave reheating
- Compartmented lids and bases keep portions contained and prevent food from migrating
- Vented lids prevent steam build up
- Anti-fog lids resist fog in hot applications

EZ Close feature for fast, secure closure with minimal effort

“An increasing number of consumers are opting for prepared food items, which are up 30% in the past five years.”

NPD Group (2014).

Creative Carryouts®



| Container Description | Dinner Box Shallow (Vented, LeakGuard Seal, EZ Close, Anti-Fog) | Dinner Box Medium (Vented, LeakGuard Seal, EZ Close, Anti-Fog) | Dinner Box Deep (Vented, LeakGuard Seal, EZ Close, Anti-Fog) | Dinner Box Medium 2-Comp (Vented, LeakGuard Seal, EZ Close, Anti-Fog) | Dinner Box Medium 3-Comp (Vented, LeakGuard Seal, EZ Close, Anti-Fog) | Dinner Box Medium 4-Comp (Vented, LeakGuard Seal, EZ Close, Anti-Fog) |
|--|--|---|---|--|--|--|
| Resin | PM* | PM* | PM* | PM* | PM* | PM* |
| Item Number | 919023-PM94 | 919017-PM94 | 919021-PM94 | 919018-PM94 | 919019-PM94 | 919020-PM94 |
| Approximate Flush Fill Capacity (fl oz) | 48 | 73 | 73 | 24/35 | 11/12/32 | 4/7/7/29 |
| Dimensions (LxWxH) | 11.5" x 7.9" x 2.3" | 11.5" x 7.9" x 3.0" | 11.5" x 7.9" x 3.7" | 11.5" x 7.9" x 3.0" | 11.5" x 7.9" x 3.0" | 11.5" x 7.9" x 3.0 |
| Packing Bag | 100 | 100 | 100 | 100 | 100 | 100 |
| Packing Case | 100 | 100 | 100 | 100 | 100 | 100 |
| Case Cube (ft ³ /m ³) | 2.7/0.08 | 2.7/0.08 | 2.7/0.08 | 2.7/0.08 | 2.7/0.08 | 2.7/0.08 |
| Case Weight (lbs/kg) | 17.1/7.8 | 17.7/8.0 | 18.0/8.2 | 16.4/7.4 | 17.9/8.1 | 18.0/8.2 |

*Modified Polystyrene (PM): Special PS blend suitable for hot foods or items requiring microwave reheating.

“Packaging is a vital aspect of take-out and more than one-third of consumers consider high-quality packaging an important factor in deciding where to order food.”

QSR Magazine (2014). Put a Lid on It.

The patented IsoBox® design provides a unique, distinctive look to any food display.



Creative Carryouts®



| Container Description | Potato Box (LeakGuard Seal, TearAway Hinge, Anti-Fog) | Deli Box Medium (LeakGuard Seal, Anti-Fog) | Deli Box Medium (LeakGuard Seal) | MonsterBox® (Vented, Bar Locks, EZ Close, Anti-Fog) | IsoBox® Medium (LeakGuard Seal) |
|--|--|--|-------------------------------------|--|------------------------------------|
| Resin | PM* | PM* | PS | PM* | PS |
| Item Number | 861012-PM94 | 844012-PM94 | 844001-PS94 | 839017-PM94 | 891001-PS94 |
| Approximate Flush Fill Capacity (fl oz) | 17 | 22 | 22 | 108 | 26 |
| Dimensions (l×w×h) | 6.7" × 4.9" × 3.2" | 8.7" × 6.0" × 2.2" | 8.7" × 6.0" × 2.2" | 13.1" × 10.9" × 3.4" | 10.6" × 7.5" × 2.2" |
| Packing Bag | 200 | 100 | 100 | 50 | 100 |
| Packing Case | 200 | 200 | 200 | 50 | 100 |
| Case Cube (ft ³ /m ³) | 1.7/0.05 | 2.6/0.07 | 2.6/0.07 | 2.5/0.07 | 2.0/0.06 |
| Case Weight (lbs/kg) | 12.3/5.6 | 22.7/10.3 | 22.5/10.2 | 14.7/6.6 | 12.0/5.4 |

*Modified Polystyrene (PM): Special PS blend suitable for hot foods or items requiring microwave reheating.



BoxLine



Creative Carryouts®

| Grouping/Brand Name Where Applicable | Snack, Deli, Hoagie | Lunch | Dinner | MonsterBox® | IsoBox® |
|---|--------------------------------------|-------------------------------------|-------------------------------------|-------------------------------------|-------------------------------------|
| Resin/Material | PS, PM (Modified PS) Only 2 Sizes | PS | PM (Modified PS) | PM (Modified PS) | PS |
| Approximate Temperature Range | PS: 14 to 203 °F PM: 32 to 225 °F | 14 to 203 °F | 32 to 225 °F | 32 to 225 °F | 14 to 203 °F |
| Black Bottom/Clear Lid | <input checked="" type="checkbox"/> | <input checked="" type="checkbox"/> | <input checked="" type="checkbox"/> | <input checked="" type="checkbox"/> | <input checked="" type="checkbox"/> |
| One-Piece Hinge Design | <input checked="" type="checkbox"/> | <input checked="" type="checkbox"/> | <input checked="" type="checkbox"/> | <input checked="" type="checkbox"/> | <input checked="" type="checkbox"/> |
| Registered Stacking Platform | <input checked="" type="checkbox"/> | <input checked="" type="checkbox"/> | <input checked="" type="checkbox"/> | <input checked="" type="checkbox"/> | <input checked="" type="checkbox"/> |
| Pebbled/Textured Base | <input checked="" type="checkbox"/> | <input checked="" type="checkbox"/> | <input checked="" type="checkbox"/> | <input checked="" type="checkbox"/> | <input checked="" type="checkbox"/> |
| Juice Well | <input checked="" type="checkbox"/> | <input checked="" type="checkbox"/> | <input checked="" type="checkbox"/> | <input checked="" type="checkbox"/> | <input checked="" type="checkbox"/> |
| Minimal to No Sidewall Ribbing | <input checked="" type="checkbox"/> | <input checked="" type="checkbox"/> | <input checked="" type="checkbox"/> | <input checked="" type="checkbox"/> | <input checked="" type="checkbox"/> |
| Good Lid Clarity | <input checked="" type="checkbox"/> | <input checked="" type="checkbox"/> | <input checked="" type="checkbox"/> | <input checked="" type="checkbox"/> | <input checked="" type="checkbox"/> |
| Microwarmable | PM SKUs Only | <input type="checkbox"/> | <input checked="" type="checkbox"/> | <input checked="" type="checkbox"/> | <input type="checkbox"/> |
| LeakGuard Perimeter Seal | PM SKUs, 6"-8" Hoagie | <input type="checkbox"/> | <input checked="" type="checkbox"/> | <input type="checkbox"/> | <input checked="" type="checkbox"/> |
| Off-Set Opening Tabs | Select Sizes | <input checked="" type="checkbox"/> | <input type="checkbox"/> | <input checked="" type="checkbox"/> | <input checked="" type="checkbox"/> |
| Bar Lock Closure | Select Sizes | <input checked="" type="checkbox"/> | <input type="checkbox"/> | <input checked="" type="checkbox"/> | <input type="checkbox"/> |
| TearAway Hinge | Potato Box Only | <input type="checkbox"/> | <input type="checkbox"/> | <input type="checkbox"/> | <input type="checkbox"/> |
| Lid Closure = Single-Push EZ Close | <input type="checkbox"/> | Larger Lunch Box Only | <input checked="" type="checkbox"/> | <input checked="" type="checkbox"/> | <input type="checkbox"/> |
| Vented Lid | <input type="checkbox"/> | <input type="checkbox"/> | <input checked="" type="checkbox"/> | <input checked="" type="checkbox"/> | <input type="checkbox"/> |
| Anti-Fog Lid | Select Sizes | <input type="checkbox"/> | <input checked="" type="checkbox"/> | <input checked="" type="checkbox"/> | <input type="checkbox"/> |

Customization Options:

Base depths, compartmented bases, lid heights, lid embossing
(note: minimum order quantities apply)



For additional information,
contact your Dart representative
or call (800) 248-5960
www.dartcontainer.com

DART CONTAINER CORPORATION

The Industry Standard of Excellence

Mason, Michigan 48854 U.S.A.

Ph: (800) 248-5960 • Fax: (517) 676-3883

Email: sales@dart.biz • www.dartcontainer.com



PRINTED ON RECYCLED PAPER

©2017 Dart Container Corporation. All rights reserved.
Dart® and the Dart logo are trademarks of Dart Container Corporation. Creative Carryouts®, the Creative Carryouts logo, IsoBox®, and MonsterBox® are trademarks of Solo Cup Operating Corporation. Used with permission.
MC1521USE_090117



Scoop up sales with
SoloServe® PET Sundae Cups



SoloServe® PET Sundae Cups

Showcase anything from signature sundaes and desserts to fruit cups. The glass-like clarity and superb lid fit adds an upscale accent to all types of menu offerings.





Lids for SoloServe® PET Sundae



Clear Dome
DNR662,
DNR626,
DNR640



Clear Dome with 1" Hole
DLR662, DLR626,
DLR640



Clear Dome with 1.9" Hole
DLW662



Clear Non-Vented
662TP, 626TP,
640TP



Clear Straw Slotted
662TS, 626TS,
640TS, M640S



Flat Top Domed Lid
SDL58-0090,
SDL12



Tall Flat Top Domed Lid
DLR100-0090

SoloServe® PET Sundae Cups

1 Lid Size Fits 3 Different Cup Sizes



SD35



SD5



TS5R-0090



SD8-0090



TS9



SD12

| Item | Description | Packing Bag/Case | Case Cube (ft ³) | Case Weight (lbs) | TI/HI | Use With |
|-----------------------------------|-------------------|------------------|------------------------------|-------------------|-------|---|
| SoloServe™ PET Sundae Cups | | | | | | |
| SD35 | 3.5 oz | 50/1000 | 1.5 | 12.8 | 8/4 | 640TS, M640S, DLR640, 640TP, DNR640 |
| SD5 | 5 oz | 50/1000 | 1.9 | 17.7 | 6/4 | DLR662, DNR662, DLW662, SDL58-0090, DLR100-0090, 662TS, 662TP |
| TS5R-0090 | 5 oz | 50/1000 | 2.0 | 18.0 | 6/3 | |
| SD8-0090 | 8 oz | 50/1000 | 1.9 | 20.9 | 6/5 | |
| TS9* | 9 oz Tall Parfait | 50/1200 | 4.5 | 26.3 | 7/2 | DL620 |
| SD12 | 12 oz | 50/1000 | 3.1 | 33.1 | 6/4 | 626TP, 626TS, DNR626, DLR626, SDL12 |

* Made from Polystyrene (PS)



For additional information,
contact your Dart representative
or call (800) 248-5960

www.dartcontainer.com

DART CONTAINER CORPORATION

The Industry Standard of Excellence

Mason, Michigan 48854 U.S.A.
Ph: (800) 248-5960 • Fax: (517) 676-3883
Email: sales@dart.biz • www.dartcontainer.com

PRINTED ON RECYCLED PAPER

©2017 Solo Cup Operating Corporation. All rights reserved.
Dart® and the Dart logo are trademark of Dart Container Corporation.
Solo®, Soloserve® and the Solo logo are trademarks of Solo Cup Operating Corporation. Used with permission. MC2413USE_032717



The clear way to go green

Bare® by Solo® Eco-Forward® RPET Deli Containers

Dart's premium Bare® by Solo® RPET deli containers and lids are made with 20% post-consumer recycled content, delivering a sustainable option that environmentally-conscious customers prefer. The superb clarity of the container enhances product appearance and impulse sales. For streamlined operations, a common lid fits five convenient sizes that are easily stackable to reduce storage space.





Features

One lid fits five container sizes

Lid interchangeability reduces storage requirements and increases operational efficiencies

Customized design available

Up to 6 colors on all containers and up to 4 colors on the recessed lids (LG8R and LG8RB only)



Sustainability alternative

Made with a minimum of 20% post-consumer recycled material sourced from recycled soda and water bottles

Built to perform

Made with crack-resistant RPET, a material that holds up well to high-acid and oily foods and has a temperature range of -22–151°F

Clear view

Excellent crystal clarity to enhance product appearance, stimulating impulse sales



| Item | Description | Color | Packing Bag | Packing Case | Case Cube (ft ³) | Case Weight (lbs) | Use With |
|---|------------------------------|-------|-------------|--------------|------------------------------|-------------------|---|
| Bare* by Solo* Eco-Forward* RPET Deli Containers | | | | | | | |
| DM8R-0090 | 8 oz Containers | Clear | 50 | 500 | 2.9 | 15.8 | LG8R-0090, LG8RB-0090, 632DG-0090 |
| DM12R-0090 | 12 oz Containers | Clear | 50 | 500 | 2.9 | 20.0 | |
| DM16R-0090 | 16 oz Containers | Clear | 50 | 500 | 3.0 | 21.0 | |
| DM24R-0090 | 24 oz Containers | Clear | 50 | 500 | 3.2 | 27.9 | |
| DM32R-0090 | 32 oz Containers | Clear | 50 | 500 | 3.3 | 32.0 | |
| Bare* by Solo* Eco-Forward* RPET Deli Container Lids | | | | | | | |
| LG8R-0090 | Embossed Recessed RPET Lid | Clear | 50 | 500 | 2.6 | 7.5 | DM8R-0090, DM12R-0090, DM16R-0090, DM24R-0090, DM32R-0090 |
| LG8RB-0090 | Unembossed Recessed RPET Lid | Clear | 50 | 500 | 2.6 | 7.5 | |
| 632DG-0090 | Overcap PET Lid | Clear | 50 | 500 | 1.9 | 5.5 | |

🌱 = Bare* by Solo* Eco-Forward* Product

* Lower temperatures make the product more brittle. The minimum use temperatures (-22°F/-30°C) are based on the product receiving no impact from shipping, storage and handling during use. If the product is subjected to impact under conditions of use, the minimum use temperature will be higher than the values indicated. Customers should test the product under their conditions of use to confirm it meets their performance requirement.



For additional information,
contact your Dart representative
or call (800) 248-5960

www.dartcontainer.com

DART CONTAINER CORPORATION

The Industry Standard of Excellence

Mason, Michigan 48854 U.S.A.

Ph: (800) 248-5960 • Fax: (517) 676-3883

Email: sales@dart.biz • www.dartcontainer.com



PRINTED ON RECYCLED PAPER



Be Square and
Shape Sales in Style



It's Hip to be Square!

- Trendy square shape makes restaurant takeout a great dining experience at home
- Plate-like design and angled sides provide the convenience of a table-ready presentation and enhance portion size and value perceptions
- Easy closing, leak-resistant lid keeps operation running smoothly while increasing customer satisfaction
- Eye-catching design attracts impulse buyers and creates lasting impressions with repeat sales



Expressions®

Square Plastic Bases & Lids

Features

Trendy square design

Offers a table ready, upscale look and the perception of larger portions

3-compartmented base & lid

maintain food integrity by minimizing migration between compartments

Leak-resistant perimeter seal

Prevents spills while maintaining freshness



Opening tabs

allow for easy consumer handling

Recessed stacking platform (on lid)

provides greater stability when merchandising and transporting

Separation lugs

allow for easy, one-hand separation of nested containers and lids

Expressions®

Hot Food Bases & Lids



| Description | 7 1/2" Black Base | 9" Black Base, Shallow | 9" Black Base, Deep | 9" Black Base, 3-Compartment | 10 1/4" Black Base | 10 1/4" Black Base, 3-Compartment |
|---|-----------------------------|------------------------|------------------------------------|------------------------------|---|-----------------------------------|
| Resin | PM* | PP | PP | PP | PP | PP |
| Stock Number | 972012-PM04* | 974025-PP04 | 974026-PP04 | 974027-PP04 | 976024-PP04 | 976026-PP04 |
| Approximate Flush Fill Capacity (fl oz) | 24 | 32 | 42 | 13/4/4 | 46 | 18/5/5 |
| Dimensions (LxWxH) | 7 1/2" x 7 1/2" x 1" | 9" x 9" x 1" | 9" x 9" x 1 1/8" | 9" x 9" x 1" | 10 1/4" x 10 1/4" x 1 1/4" | 10 1/4" x 10 1/4" x 1" |
| Packing Bag/Case | 300/300 | 150/150 | 150/150 | 150/150 | 130/130 | 130/130 |
| Case Cube (ft ³) | 3.2 | 2.4 | 2.4 | 2.4 | 2.6 | 2.6 |
| Case Wt (lbs) | 14.4 | 10.6 | 14.0 | 13.6 | 15.6 | 14.3 |
| Description | 7 1/2" Clear Non-Vented Lid | 9" Clear Vented Lid | 9" Clear Vented Lid, 3-Compartment | 10 1/4" Clear Vented Lid | 10 1/4" Clear Vented Lid, 3-Compartment | |
| Stock Number | 973010-PS90** ^ | 975018-PP90 | 975019-PP90 | 977020-PP90 | 977021-PP90 | |
| Dimensions (LxWxH) | 7 1/2" x 7 1/2" x 1 1/4" | 9" x 9" x 1 1/4" | 9" x 9" x 1 1/4" | 10 1/4" x 10 1/4" x 1 3/8" | 10 1/4" x 10 1/4" x 1 1/4" | |
| Packing Bag/Case | 300/300 | 150/150 | 150/150 | 130/130 | 130/130 | |
| Case Cube (ft ³) | 3.2 | 2.4 | 2.4 | 2.6 | 2.6 | |
| Case Wt (lbs) | 11.8 | 9.2 | 9.2 | 10.4 | 10.4 | |

*Modified PS, microwarmable

**Lid is not microwaveable/microwarmable

^Non-vented

Expressions®

Square Plastic Bases & Lids



Compostable PLA

Compostable in a commercial composting facility which may not exist in your community. Not suitable for backyard composting. Meets the ASTM standard D6400 for compostability by the Biodegradable Products Institute (BPI)

"The global compostable packaging market is expected to witness a strong growth owing to the increasing consumer awareness about environmentally-friendly products."

<http://www.transparencymarketresearch.com/compostable-packaging-materials-market.html>



Expressions®

Cold Food Bases & Lids

| Description | 7 1/2" Tan Base | 9" Tan Base | 7 1/2" Black Base | 9" Black Base | 10 1/4" Black Base |
|---|-----------------------------|-------------------------|-----------------------------|-------------------------|------------------------------|
| Resin | PLA | PLA | PET | PET | PET |
| Stock Number | 972013-CO33 | 974015-CO33 | 972016-AP04 | 974020-AP04 | 976020-AP04* |
| Approximate Flush Fill Capacity (fl oz) | 24 | 32 | 24 | 32 | 46 |
| Dimensions (L×W×H) | 7 1/2" × 7 1/2" × 1" | 9" × 9" × 1" | 7 1/2" × 7 1/2" × 1" | 9" × 9" × 1" | 10 1/4" × 10 1/4" × 1 1/4" |
| Packing Bag/Case | 300/300 | 150/150 | 300/300 | 150/150 | 130/130 |
| Case Cube (ft³) | 3.2 | 2.4 | 3.2 | 2.4 | 2.6 |
| Case Wt (lbs) | 14.9 | 11.9 | 16.4 | 11 | 12.4 |
| Description | 7 1/2" Clear Non-Vented Lid | 9" Clear Non-Vented Lid | 7 1/2" Clear Non-Vented Lid | 9" Clear Non-Vented Lid | 10 1/4" Clear Non-Vented Lid |
| Stock Number | 973016-PL90 | 975016-PL90 | 973017-AP90 | 975017-AP90 | 977019-AP90 |
| Dimensions (L×W×H) | 7 1/2" × 7 1/2" × 1 1/4" | 9" × 9" × 1 1/4" | 7 1/2" × 7 1/2" × 1 1/4" | 9" × 9" × 1 1/4" | 10 1/4" × 10 1/4" × 1 3/8" |
| Packing Bag/Case | 300/300 | 150/150 | 300/300 | 150/150 | 130/130 |
| Case Cube (ft³) | 3.2 | 2.4 | 3.2 | 2.4 | 2.6 |
| Case Wt (lbs) | 10.7 | 9.3 | 12.3 | 9.4 | 9.9 |



Expressions®

Square Plastic Bases & Lids



2-piece design for ease of operational efficiency

Stackable

Leak-resistant perimeter seal

| Grouping/Brand Name Where Applicable | Expressions® Hot | Expressions® Hot | Expressions® Cold | Eco Expressions® |
|--------------------------------------|--|-------------------------------------|-------------------------------------|-------------------------------------|
| Resin/Material | PM* (base) PS** (lid) | PP | PET | PLA^ |
| Approximate temperature range | PM* -33°F to 225°F PS** -33°F to 212°F | -4°F to 230°F | -22°F to 151°F | 32°F to 110°F |
| Registered stacking platform | <input checked="" type="checkbox"/> | <input checked="" type="checkbox"/> | <input checked="" type="checkbox"/> | <input checked="" type="checkbox"/> |
| No Sidewall Ribbing | <input checked="" type="checkbox"/> | <input checked="" type="checkbox"/> | <input checked="" type="checkbox"/> | <input checked="" type="checkbox"/> |
| Good lid clarity | <input checked="" type="checkbox"/> | <input checked="" type="checkbox"/> | <input checked="" type="checkbox"/> | <input checked="" type="checkbox"/> |
| Microwarmable | <input checked="" type="checkbox"/> (base only) | <input type="checkbox"/> | <input type="checkbox"/> | <input type="checkbox"/> |
| Microwaveable | <input type="checkbox"/> | <input checked="" type="checkbox"/> | <input type="checkbox"/> | <input type="checkbox"/> |
| Leak-resistant perimeter seal | <input checked="" type="checkbox"/> | <input checked="" type="checkbox"/> | <input checked="" type="checkbox"/> | <input checked="" type="checkbox"/> |
| Opening tabs | <input checked="" type="checkbox"/> | <input checked="" type="checkbox"/> | <input checked="" type="checkbox"/> | <input checked="" type="checkbox"/> |
| Vented Lid | <input type="checkbox"/> | <input checked="" type="checkbox"/> | <input type="checkbox"/> | <input type="checkbox"/> |
| Compostable* | <input type="checkbox"/> | <input type="checkbox"/> | <input type="checkbox"/> | <input checked="" type="checkbox"/> |

*Modified PS, microwarmable

**Lid is not microwarmable/microwarmable

^Compostable in a commercial composting facility which may not exist in your community. Not suitable for backyard composting.

Meets the ASTM standard D6400 for compostability by the Biodegradable Products Institute (BPI)



**For additional information,
contact your Dart representative
or call (800) 248-5960**

www.dartcontainer.com

DART CONTAINER CORPORATION

The Industry Standard of Excellence

Mason, Michigan 48854 U.S.A.

Ph: (800) 248-5960 • Fax: (517) 676-3883

Email: sales@dart.biz • www.dartcontainer.com

©2017 Dart Container Corporation. All rights reserved.

Dart® and the Dart logo are trademarks of Dart Container Corporation. Solo®, the Solo logo, and Expressions® are trademarks of Solo Cup Operating Corporation. Used with permission.

MC1522USED_010517

PRINTED ON RECYCLED PAPER



FROM FRIDGE TO MICROWAVE

- **Dual Temperature Usage** - Versatile polypropylene material allows for broad temperature range (32°F - 240°F) to go from refrigerator to microwave
- **One Lid Fits Five Container Sizes** - Lid interchangeability reduces storage requirements and increases operational efficiencies
- **The Eyes Have It** - Excellent contact clarity for exceptional food visibility to increase sales of pre-packaged foods
- **White Sidewall Option** - Minimizes ultra-violet light exposure to keep container contents fresh and extend shelf life



MicroGourmet® Plastic Deli Containers

FROM FRIDGE TO MICROWAVE

Busy operations will appreciate how this versatile line of deli containers allows pre-packaged foods to be refrigerated and microwave-reheated in the same container. Five different container sizes use one common recessed lid to help streamline inventory. Available in contact clear for excellent food visibility or in white to minimize ultra-violet light exposure to keep container contents fresh and extend shelf life. Custom print available on containers only.



Versatile Applications
Serves hot or cold foods



Fridge to Microwave Reheat
Versatile material allows for broad temperature range (32°F - 240°F)



Customized Design Available
Up to 6 colors on all containers



Lid Interchangeability
One recessed lid fits 5 container sizes (8 - 32 oz)



Variety
Available in contact or clear or white



Recessed Tight Fitting Lid
Prevents leaking during transport and handling

| Item | Description | Color/Design | Inner Qty | Case Qty | Case Wt (lbs) | Case Cube (ft³) | Corresponding Lid/Container |
|--|-------------------------|---------------|-----------|----------|---------------|-----------------|-----------------------------|
| MICROGOURMET® POLYPROPYLENE PLASTIC DELI CONTAINERS | | | | | | | |
| MN8-0100 | 8 oz PP Deli Container | Contact Clear | 25 | 500 | 12.7 | 3.6 | NL8RT-7000 NL8WN-0007 |
| 8NW-0007 | 8 oz PP Deli Container | White | 25 | 500 | 12.7 | 3.6 | |
| MN12-0100 | 12 oz PP Deli Container | Contact Clear | 25 | 500 | 15.5 | 3.8 | |
| MN16-0100 | 16 oz PP Deli Container | Contact Clear | 25 | 500 | 17.3 | 3.8 | |
| 16NW-0007 | 16 oz PP Deli Container | White | 25 | 500 | 17.3 | 3.8 | |
| MN24-0100 | 24 oz PP Deli Container | Contact Clear | 25 | 500 | 20.5 | 4.1 | |
| MN32-0100 | 32 oz PP Deli Container | Contact Clear | 25 | 500 | 23.5 | 4.1 | |
| 32NW-0007 | 32 oz PP Deli Container | White | 25 | 500 | 23.5 | 4.1 | |
| RECESSED LID - PP | | | | | | | |
| NL8RT-7000 | Recessed PP Lid | Contact Clear | 50 | 500 | 7.5 | 2.6 | 8-32 oz Containers |
| NL8WN-0007 | Recessed PP Lid | White | 50 | 500 | 7.5 | 2.6 | |



For additional information,
contact your Dart representative
or call 1-800-367-2877

www.dartcontainer.com

DART CONTAINER CORPORATION

The Industry Standard of Excellence

Mason, Michigan 48854 U.S.A.

Ph: (800) 248-5960 • Fax: (517) 676-3883

Email: sales@dart.biz • www.dartcontainer.com

©2015 Dart Container Corporation. All rights reserved.

Dart® and the Dart logo are trademarks of Dart Container Corporation. Solo®, the Solo logo, and MicroGourmet™ are trademarks of Solo Cup Operating Corporation. Used with permission.

GS1550USE_032917



**Versatile grease-resistant containers
for a variety of applications**

- Made of grease-resistant paper to keep hands and clothing clean
- Made from renewable resources
- We source fibers certified under the SFI® chain of custody
- Custom print capable to brand your business



Solo® Grease-Resistant Paper French Fry Cups

- Grease-resistant paper keeps customers' hands and clothes clean, thus increasing customer satisfaction
- Great Fries® stock print design allows an operator to brand their business with no minimum order quantity
- Car cupholder compatible, which increases ease of use and customer satisfaction
- Made with 99% plant-based renewable resources to help promote an operator's sustainability goals

*Compostable in a commercial composting facility**



Solo® Fry Cups

| Item Number | Size | Design/Color | Bag/Case | Case Cube (ft ³) | Weight (lbs) |
|-------------|-------|--------------|----------|------------------------------|--------------|
| GRS9N-00021 | 9 oz | Great Fries® | 100/2000 | 2.5 | 26.4 |
| GRS12-00021 | 12 oz | Great Fries® | 50/1000 | 3.4 | 18.9 |
| GRS16-00021 | 16 oz | Great Fries® | 50/1000 | 3.8 | 20.7 |
| GRS32-00021 | 32 oz | Great Fries® | 50/500 | 3.1 | 18.1 |

*Commercial composting facility may not be available in your community. Not suitable for backyard composting. Meets the ASTM standard D6868 for compostability.

Solo® Paper Popcorn Buckets and Solo® Grease-Resistant Paper Popcorn Cups

- Butter and grease-resistant to keep customer's hands and clothing clean, thus increasing customer satisfaction
- 24oz - 46oz are compostable in a commercial composting facility*, which helps to promote an operator's sustainability goals
- Available in a variety of sizes
- Two popular stock prints available to allow an operator to brand their business with no minimum order quantity

Made with at least 90% plant-based renewable resources



Solo® Popcorn Buckets and Solo® Popcorn Cups

| Item Number | Size | Design/Color | Flush Fill | Bag/Case | Case Cube (ft ³) | Weight (lbs) |
|-------------|--------|--------------|------------|----------|------------------------------|--------------|
| V24-00061 | 24 oz | Popcorn | 26.2 | 50/1000 | 4.7 | 30.2 |
| V32-00061 | 32 oz | Popcorn | 35.6 | 50/500 | 3.2 | 16.3 |
| VB46-00061 | 46 oz | Popcorn | 47.3 | 50/500 | 3.7 | 21.1 |
| VP64-00061 | 64 oz | Popcorn | 64.9 | 30/360 | 4.6 | 23.2 |
| VP85-00061 | 85 oz | Popcorn | 97.9 | 25/150 | 3.4 | 12.2 |
| VP130-00061 | 130 oz | Popcorn | 141.6 | 150/150 | 4.5 | 15.8 |
| VP170-00061 | 170 oz | Popcorn | 185.3 | 150/150 | 5.3 | 18.4 |
| V24-00059 | 24 oz | Premier | 26.2 | 50/1000 | 4.7 | 30.2 |
| V32-00059 | 32 oz | Premier | 35.6 | 50/500 | 3.2 | 16.3 |
| VB46-00059 | 46 oz | Premier | 47.3 | 50/500 | 3.7 | 21.1 |
| VP85-00059 | 85 oz | Premier | 97.9 | 25/150 | 3.4 | 12.2 |
| VP130-00059 | 130 oz | Premier | 141.6 | 150/150 | 4.5 | 15.8 |
| VP170-00059 | 170 oz | Premier | 185.3 | 150/150 | 5.3 | 18.4 |

*Commercial composting facility may not be available in your community. Not suitable for backyard composting. Meets the ASTM standard D6868 for compostability.

Solo® Paper Scoop Cups



- DSP lined paper keeps customers' hands and clothes clean, thus increasing customer satisfaction
- Consistent portioning compared to paper trays for increased operator profits
- Car cupholder compatible, which increases ease of use and customer satisfaction
- Made with 85% plant-based renewable resources to help promote an operator's sustainability goals

Scoopable shape makes for quick and consistent portioning

Solo® Scoop Cups

| Item Number | Size* | Design/Color | Bag/Case | Case Cube (ft3) | Weight (lbs) |
|-------------|--------|--------------|----------|-----------------|--------------|
| GSP49-2050 | 5.5 oz | White | 80/1200 | 2.2 | 17.2 |
| GSP34-83013 | 4 oz | Scoop Fries | 75/1200 | 1.5 | 12.8 |
| GSP49-83013 | 5.5 oz | Scoop Fries | 80/1200 | 2.2 | 17.2 |
| GSP55-83013 | 7.5 oz | Scoop Fries | 50/1000 | 2.6 | 18.6 |
| GSP80-83013 | 9 oz | Scoop Fries | 50/600 | 2.2 | 16.5 |

*Ounce description based on estimated average fried food weights. Will vary.



Great Fries®



Popcorn

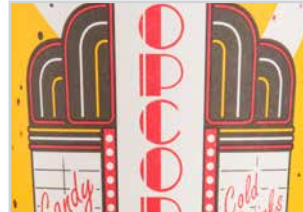

Premier

Solo® Grease-Resistant Paper Munchie Cup® Containers



- Unique self lidding design increases operator efficiency and ease of use
- Made with 99% plant-based renewable resources to help promote an operator's sustainability goals
- Built-in venting allows steam to escape to maintain food integrity and increase customer enjoyment
- Car cupholder compatible, which increases ease of use and customer satisfaction
- Consistent portioning compared to paper trays for increased operator profits
- Built-in, reclosable lid makes for mess-free transportation and increased customer satisfaction

*Compostable in a commercial composting facility**

Solo® Munchie Cup® Containers

| Item Number | Size** | Design/Color | Bag/Case | Case Cube (ft3) | Weight (lbs) |
|-------------|--------|--------------|----------|-----------------|--------------|
| GF24-00645 | 2.4 oz | Munchie® | 50/1000 | 2.6 | 18.2 |
| GF35-00645 | 3.5 oz | Munchie® | 50/1000 | 3.0 | 21.9 |
| GF45-00645 | 4.5 oz | Munchie® | 50/1000 | 3.6 | 25.4 |
| GF90-00645 | 9.0 oz | Munchie® | 50/500 | 3.0 | 20.4 |

*Commercial composting facility may not be available in your community. Not suitable for backyard composting. Meets the ASTM standard D6868 for compostability.

**Ounce description based on estimated average fried food weights. Will vary.

Stock Prints





SOLO Specialty Paper & Popcorn Containers



WHICH WOULD YOU RATHER OFFER TO YOUR CUSTOMERS?

This operator sells fries in a 1 pound paper food tray

- Each tray costs 2 cents
- Each tray holds about 6oz of fries and each ounce of fries costs about 6 cents (6oz * \$0.06 = \$0.36 per portion)
- 100 orders x 2 cents per tray = \$2 per day in paper tray costs
- 100 orders x 36 cents per portion = \$36 per day in fry costs
- \$2 + \$36 = \$38 per day in total costs
- Weekly Cost = \$266
- Monthly Cost = \$1,155

Yearly Cost = \$13,860*

This operator switches to a 5.5oz Solo® Scoop Cups

- Each Solo® scoop cup costs 9 cents
- Each Solo® scoop cup holds 4.2oz of fries and each ounce of fries costs about 6 cents (4.2oz * \$0.06 = \$0.25 per portion)
- 100 orders x 9 cents per Solo® scoop cup = \$9 per day in Solo® scoop cup costs
- 100 orders x 25 cents per portion = \$25 per day in fry costs
- \$9 + \$25 = \$34 per day in total costs
- Weekly Cost = \$238
- Monthly Cost = \$1,034

Yearly Cost = \$12,410*
Total yearly savings using Solo® Scoop Cups instead of paper food trays = \$1,450

*Figures based on average market pricing and may vary.



For additional information,
contact your Dart representative
or call (800) 248-5960
www.dartcontainer.com

DART CONTAINER CORPORATION
The Industry Standard of Excellence
Mason, Michigan 48854 U.S.A.
Ph: (800) 248-5960 • Fax: (517) 676-3883
Email: sales@dart.biz • www.dartcontainer.com



Your secret recipe
deserves nothing less!



**Heavy duty, double-wrapped
construction and an economical price.**

- Made of grease resistant, waxed or non-coated paper for a variety of applications
- Made from renewable resources
- We source fibers certified under the SFI® chain of custody
- Vented lids ideal for packing “to-go” meals
- Custom print capabilities to brand your business





Features

Double wrapped sidewall

Dual layer construction provides increased strength under heavy applications

Top-to-bottom graphics

Custom printable with full print coverage, providing more space to advertise your brand



Grease-Resistant

Sturdy and grease-proof, these containers are ideal for fried chicken and can even withstand heat lamps



| Description | 83 oz Bucket | 83 oz Bucket | 83 oz Bucket | 165 oz Bucket |
|----------------------|--------------|--------------|--------------|---------------|
| Item | 5T1GR-86868 | 5T1GR-02050 | 5T1GR-J8000 | 10TR25-J8000 |
| Design/Color | Chicken | White | Symphony® | Symphony® |
| Sleeve/Case Quantity | 100/100 | 100/100 | 100/100 | 125/125 |
| Case Cube (ft³) | 2.8 | 2.8 | 2.8 | 4.9 |
| Case Weight. (lbs) | 12.8 | 12.8 | 12.8 | 23 |
| Use With | 5VT19S-N1125 | 5VT19S-N1125 | 5VT19S-N1125 | 10V19S-02050 |

SOLO® Double Wrapped Paper Buckets & Lids



Multiple coating options

Create protective barriers against anything from leaking liquids to greasy foods

Sustainable alternative

Made with plant-based, renewable resources and SFI® certified paper board

Waxed

A convenient disposable twist on the classic hotel ice bucket



| Description | 83 oz Bucket | 165 oz Bucket | 83 oz Bucket | 165 oz Bucket |
|------------------------------|--------------|---------------|--------------|---------------|
| Item | 5T3-00069 | 10T3-00069 | 5T3-N0196 | 10T3-N0199 |
| Design/Color | Marble | Marble | White | White |
| Sleeve/Case Quantity | 100/100 | 100/100 | 100/100 | 100/100 |
| Case Cube (ft ³) | 2.8 | 4.3 | 2.8 | 4.3 |
| Case Weight (lbs) | 22.7 | 35.8 | 22.7 | 35.8 |
| Use With | 5VT19S-N1125 | 10V19S-02050 | 5VT19S-N1125 | 10V19S-02050 |



SOLO® Double Wrapped Paper Buckets & Lids

Non-Coated

Great option to serve up dry snack items or non-food applications like mixing paint



| Description | 53 oz Bucket | 83 oz Bucket | 165 oz Bucket | 53 oz Bucket | 83 oz Bucket | 165 oz Bucket |
|------------------------------|--------------|--------------|---------------|--------------|--------------|---------------|
| Item | 3T1-00069 | 5T1-00069 | 10T1-00069 | 3T1-02050 | 5T1-N0195 | 10T1-N0198 |
| Design/Color | Marble | Marble | Marble | White | White | White |
| Sleeve/Case Quantity | 50/300 | 100/100 | 100/100 | 50/300 | 100/100 | 100/100 |
| Case Cube (ft ³) | 5.3 | 2.8 | 4.3 | 5.3 | 2.8 | 4.3 |
| Case Weight (lbs) | 29.5 | 15.3 | 23.9 | 29.5 | 15.3 | 23.9 |
| Use With | 3VT19S-02050 | 5VT19S-N1125 | 10V19S-02050 | 3VT19S-02050 | 5VT19S-N1125 | 10V19S-02050 |

Vented Paper Finger Pull Lids



| Description | Vented Paper Lid Fits - 53 oz Bucket | Vented Paper Lid Fits - 83 oz Bucket | Vented Paper Lid Fits - 165 oz Bucket |
|------------------------------|--------------------------------------|--------------------------------------|---------------------------------------|
| Item | 3VT19S-02050 | 5VT19S-N1125 | 10V19S-02050 |
| Design/Color | White | White | White |
| Sleeve/Case Quantity | 300/600 | 100/100 | 100/100 |
| Case Cube (ft ³) | 0.8 | 0.2 | 0.2 |
| Case Weight (lbs) | 20.7 | 4.7 | 7.5 |
| Use With | 3T1 series | 5T1GR, 5T3, & 5T1 series | 10TR25-J8000, 10T3 & 10T1 series |



For additional information,
contact your Dart representative
or call (800) 248-5960
www.dartcontainer.com



DART CONTAINER CORPORATION
The Industry Standard of Excellence

Mason, Michigan 48854 U.S.A.
Ph: (800) 248-5960 • Fax: (517) 676-3883
Email: sales@dart.biz • www.dartcontainer.com

PRINTED ON RECYCLED PAPER



Bare[®] by Solo[®] Eco-Forward[®] Commercially Compostable VS SSPLA Paper Food Containers



PLANT MADE. PLANET APPROVED.

- **Compostable in a Commercial Compost Facility** – Appropriate commercial composting facilities may not exist in your community. Please check with your local municipality. Not suitable for backyard composting.
- **Plant-Based Lining** – Container lined with PLA (poly-lactic acid), a plant-based resin that acts as a moisture barrier to prevent leaking, replacing the petroleum-based lining typically found in paper food containers.
- **Sustainability Alternative** – Made from 100% plant-based renewable resources and made with fibers certified under the SFI[®] chain of custody.
- **Third Party Certifications** – Meets the ASTM standard D6868 for compostability by the Biodegradable Products Institute (BPI).



Bare® Eco-Forward® Commercially Compostable VS SSPLA Paper Food Containers

PLANT MADE. PLANET APPROVED.

Bare® by Solo® Eco-Forward® VS Single Sided PLA lined food containers are perfect for holding hot foods (with a maximum temperature of 205°F). These versatile containers can also be used with cold food for immediate consumption. The PLA lining on the inside of the container acts as a moisture barrier to prevent leaking, while the matte finish on the outside of the container conducts less heat to your fingertips. The squat profile and wide mouth make this product easy for operators to fill and easy for customers to eat from. These containers are compostable in a commercial composting facility which may not exist in your community. Please check with your local municipality. Not suitable for backyard composting.



Rolled Rim

Gives rigidity to the container and ensures secure leak-resistant lid fit



Versatile Applications

Serves hot or cold foods



Moisture Barrier

Container lined with polylactic acid on the inside to prevent leaking

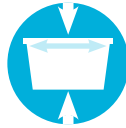

Wide Mouth and Squat Profile

Easy to serve, easy to eat



Sustainability Alternative

Commercially compostable containers made from 100% plant-based renewable resources and made with SFI-certified paperboard



Variety

Containers available in multiple sizes with multiple lid styles made with different materials

| Item # | Description | Color or Design | Sleeve | Case Pack | Case Wt (lbs.) | Case Length (in) | Case Width (in) | Case Height (in) | Case Cube (cu.ft.) | Pallet Ti/Hi | Corresponding Lid/Container |
|---|---|-----------------|--------|-----------|----------------|------------------|-----------------|------------------|--------------------|--------------|--|
| BARE® BY SOLO® ECO-FORWARD® VS SSPLA PAPER FOOD CONTAINERS | | | | | | | | | | | |
| V508PL-JF522 | 8 oz Round Containers | Bare® | 50 | 1000 | 20.0 | 19.4 | 15.6 | 21.9 | 3.8 | 6/4 | DF8-0090, LS8-00090, LVS508-0007, LVP508-0100, 8TFLV-18701 |
| V512PL-JF522 | 12 oz Round Containers | Bare® | 60 | 1200 | 32.5 | 21.4 | 17.3 | 28.6 | 6.1 | 4/3 | DF12-0090, LVS512-0007, LVP512-0100 |
| V516PL-JF522 | 16 oz Round Containers | Bare® | 25 | 500 | 19.7 | 22.9 | 18.4 | 16.0 | 3.9 | 4/6 | DF16-0090, LVS516-00007, LVP516-0100 |
| PLASTIC LIDS FOR FOOD CONTAINERS | | | | | | | | | | | |
| DF8-0090 | Flat Top Dome Lid - PET | Clear | 100 | 1000 | 11.3 | 14.8 | 12.4 | 19.3 | 2.1 | 11/5 | V508PL-JF522 |
| DF12-0090 | Flat Top Dome Lid - PET | Clear | 100 | 1000 | 13.8 | 20.2 | 11.3 | 19.8 | 2.6 | 8/5 | V512PL-JF522 |
| DF16-0090 | Flat Top Dome Lid - PET | Clear | 100 | 500 | 8.1 | 14.4 | 9.3 | 20.6 | 1.6 | 13/5 | V516PL-JF522 |
| LS8-00090 | Non-Vented Lid - PS | Translucent | 125 | 2000 | 11.3 | 16.3 | 16.3 | 23.8 | 3.7 | 6/4 | V508PL-JF522 |
| 8TFLV-18701 | Vented Lid - PS | Translucent | 100 | 2000 | 20.6 | 20.4 | 16.4 | 20.3 | 3.9 | 6/4 | V508PL-JF522 |
| LVS508-0007 | Recessed Vented Lid - PS | White | 100 | 2000 | 19.8 | 26.1 | 16.1 | 20.1 | 4.9 | 4/4 | V508PL-JF522 |
| LVS512-0007 | Recessed Vented Lid - PS | White | 100 | 1200 | 14.0 | 26.1 | 13.3 | 17.8 | 3.6 | 6/5 | V512PL-JF522 |
| LVS516-00007 | Recessed Vented Lid - PS | White | 50 | 1000 | 16.0 | 23.6 | 13.8 | 19.3 | 3.6 | 6/5 | V516PL-JF522 |
| LVP508-0100 | Recessed High Heat Plug Fit Vented Lid - PP | Clear | 100 | 1000 | 10.2 | 20.0 | 16.1 | 14.9 | 2.8 | 6/6 | V508PL-JF522 |
| LVP512-0100 | Recessed High Heat Plug Fit Vented Lid - PP | Clear | 100 | 1000 | 13.2 | 21.9 | 17.6 | 14.1 | 3.1 | 9/3 | V512PL-JF522 |
| LVP516-0100 | Recessed High Heat Plug Fit Vented Lid - PP | Clear | 100 | 1000 | 15.5 | 23.3 | 18.8 | 15.0 | 3.8 | 4/6 | V516PL-JF522 |

Bare® Eco-Forward® Product



For additional information,
contact your Dart representative
or call (800) 248-5960
www.dartcontainer.com



DART CONTAINER CORPORATION
The Industry Standard of Excellence

Mason, Michigan 48854 U.S.A.
Ph: (800) 248-5960 • Fax: (517) 676-3883
Email: sales@dart.biz • www.dartcontainer.com



SOLO® Flat Top Dome PET Plastic Lids

Lid performance that
clearly stacks up



Solo® Flat Top Dome PET Plastic Lids

- Flat top dome lids offer excellent stacking and nesting for operational efficiency, exceptional merchandising, and enhanced takeout convenience
- Crystal-clear PET material showcases all types of mouthwatering frozen creations
- Suitable for a wide range of applications from gelato to ice cream and frozen yogurt





SOLO® Flat Top Dome PET Plastic Lids

Features

Custom Embossing

Is available for enhanced merchandising and brand-building

Stacking Feature

For merchandising and takeout convenience

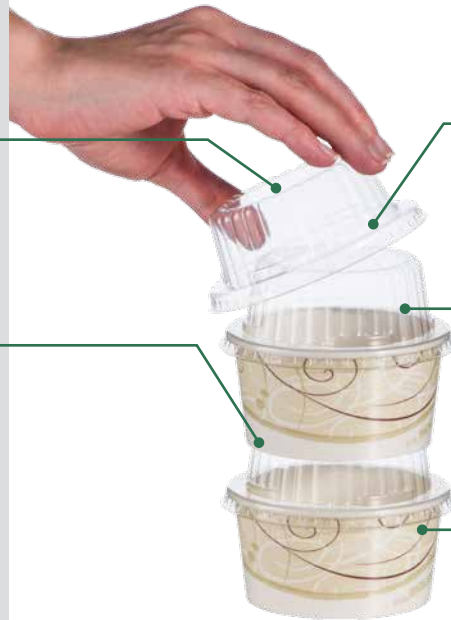

Lids De-Nest Easily

To streamline operations

Crystal Clear PET Lids

For a premium look to drive impulse sales

Popular Sizes

For 3.5 oz to 16 oz containers



DF35-0090



DF5-0090



DF8-0090



DF12-0090



DF16-0090

| Item | Description | Color or Design | Packing Bag | Packing Case | Case Cube (ft ³) | Case Weight (lbs) | Use With |
|---|---|-------------------|-------------|--------------|------------------------------|-------------------|---|
| SOLO® Flat Top Dome PET Plastic Lids | | | | | | | |
| DF35-0090 | Flat Dome Lid for 3.5 oz Container | Clear PET Plastic | 100 | 1000 | 1.1 | 6.3 | VS535, VS635N |
| DF5-0090 | Flat Dome Lid for 5 oz Container | Clear PET Plastic | 100 | 1000 | 1.6 | 9.8 | S605T |
| DF8-0090 | Flat Dome Lid for 6, 8, and 10 oz Container | Clear PET Plastic | 100 | 1000 | 2.1 | 11.3 | VS506X, VS606X, VS508, VS08PL, VS608, VN510 |
| DF12-0090 | Flat Dome Lid for 12 oz Container | Clear PET Plastic | 100 | 1000 | 2.6 | 13.8 | VS512, VS612, V512PL |
| DF16-0090 | Flat Dome Lid for 16 oz Container | Clear PET Plastic | 100 | 500 | 1.6 | 8.1 | VS516, VS616, V516PL |

* This is Legal Copy



For additional information,
contact your Dart representative
or call (800) 248-5960

www.dartcontainer.com

DART CONTAINER CORPORATION

The Industry Standard of Excellence

Mason, Michigan 48854 U.S.A.

Ph: (800) 248-5960 • Fax: (517) 676-3883

Email: sales@dart.biz • www.dartcontainer.com

©2017 Dart Container Corporation. All rights reserved.

Dart® and the Dart logo are trademarks of Dart Container Corporation. Solo® and the Solo logo are trademarks of Solo Cup Operating Corporation. Used with permission.
MCI486USE_041817

PRINTED ON RECYCLED PAPER



Flexstyle® DSP Paper Food Containers and Lids



DURABILITY WITH VERSATILITY

- **Wide-Formed Rim** – Gives excellent rigidity to the container making it durable for heavier foods such as hard-packed ice cream
- **Dual-Temperature Usage** – Multi-purpose, double-sided poly container that can be used for both hot and cold applications with a maximum temperature of 205°F
- **Eye-Catching Graphics** – High-gloss polyethylene coating on the outside of the container allows for exceptional print quality and a smudge-free surface
- **Portion Control** – Flush fill capacity on all sizes, except the 32 oz, to reduce food costs and increase profits
- **Sustainability Alternative** – Made with at least 85% plant-based renewable resources and made with fibers certified under the SFI® chain of custody



Flexstyle® DSP Paper Food Containers and Lids

DURABILITY WITH VERSATILITY

Flexstyle containers are just that – flexible! These durable containers are made with a double-sided polyethylene material so they can be used for either hot or cold food applications! Perfect for hot take-out items like soup or for storing ice cream in the freezer, this multi-purpose container offers something for everyone! Our only paper food container line available with spiral wound paper lids, and in combo packs, for a comprehensive paper solution.



| Stock Number | Description | Packing Bag/Case | Case Wt. (lbs) | Case Cube (ft³) | Use With |
|--|---|------------------|---------------------------|----------------------------------|---|
| FLEXSTYLE® DSP PAPER FOOD CONTAINERS – BULK PACKS | | | | | |
| Jazz® | Symphony® | White | | | |
| H4085-00055* | H4085-J8000 | H4085-2050 | 8 oz Food Container | 25/500 | 12.9 2.2 LPH408-0090, CA8A-4000, CH8A-4000 |
| H4125-00055* | H4125-J8000 | H4125-2050 | 12 oz Food Container | 25/500 | 15.3 2.3 LPH416-0090, CA16A-4000, H16A-4000 |
| H4165-00055* | H4165-J8000 | H4165-2050 | 16 oz Food Container | 25/500 | 18.0 2.9 LPH432-0090, CA32A-4000, H32A-4000 |
| H4325-00055* | H4325-J8000 | H4325-2050 | 32 oz Food Container | 25/500 | 28.4 5.0 CA64A-4000 |
| — | P4643-J8000 | P4643-02050* | 64 oz Food Container | 25/300 | 26.6 6.2 |
| FLEXSTYLE® DSP PAPER FOOD CONTAINER & SPIRAL WOUND VENTED LID COMBOS | | | | | |
| Hearty Soup™ | Symphony® | White | | | |
| KHB8A-86926 | KHB8A-J8000 | KHB8A-2050 | 8 oz Container/Lid Combo | Container: 25/250 Lid: 25/250 | 12.0 2.6 Includes lid CH8A-4000 |
| KHB12A-86926 | KHB12A-J8000 | KHB12A-2050 | 12 oz Container/Lid Combo | Container: 25/250 Lid: 25/250 | 13.2 2.7 Includes lid CH16A-4000 |
| KHB16A-86926 | KHB16A-J8000 | KHB16A-2050 | 16 oz Container/Lid Combo | Container: 25/250 Lid: 25/250 | 14.5 3.1 Includes lid CH32A-4000 |
| KHB32A-86926 | KHB32A-J8000 | KHB32A-2050 | 32 oz Container/Lid Combo | Container: 25/250 Lid: 25/250 | 22.8 5.4 |
| FLEXSTYLE® DSP PAPER FOOD CONTAINER & SPIRAL WOUND VENTED LID COMBOS – MTO ONLY | | | | | |
| Jazz® | Wok Away™ | | | | |
| KHB8A-00055* | — | | 8 oz Container/Lid Combo | Container: 25/250 Lid: 25/250 | 12.0 2.6 Includes lid CH8A-4000 |
| KHB12A-00055* | KHB12A-0356* | | 12 oz Container/Lid Combo | Container: 25/250 Lid: 25/250 | 13.2 2.7 Includes lid CH16A-4000 |
| KHB16A-00055* | KHB16A-0356* | | 16 oz Container/Lid Combo | Container: 25/250 Lid: 25/250 | 14.5 3.1 Includes lid CH32A-4000 |
| KHB32A-00055* | KHB32A-0356* | | 32 oz Container/Lid Combo | Container: 25/250 Lid: 25/250 | 22.8 5.4 |
| SPIRAL-WOUND VENTED PAPER LIDS – WHITE | | | | | |
| CH8A-4000 | Vented Paper Lid — Fits 8 oz, 12 oz | | 25/500 | 11.0 2.3 | H4085, H4125 series |
| CH16A-4000 | Vented Paper Lid — Fits 16 oz | | 25/500 | 11.5 2.7 | H4165 series |
| CH32A-4000 | Vented Paper Lid — Fits 32 oz | | 25/500 | 12.7 3.9 | H4325 series |
| SPIRAL-WOUND NON-VENTED PAPER LIDS – WHITE | | | | | |
| CA8A-4000 | Non-Vented Paper Lid — Fits 8 oz, 12 oz | | 25/500 | 9.0 2.3 | H4085, H4125 series |
| CA16A-4000 | Non-Vented Paper Lid — Fits 16 oz | | 25/500 | 10.0 2.7 | H4165 series |
| CA32A-4000 | Non-Vented Paper Lid — Fits 32 oz | | 25/500 | 12.7 3.9 | H4325 series |
| CA64A-4000 | Non-Vented Paper Lid — Fits 64 oz | | 25/300 | 16.3 6.3 | P4643-J8000 |
| RECESSED HIGH HEAT VENTED PP LIDS – CLEAR | | | | | |
| LPH408-0090 | Vented PP Lid — Fits 8 oz, 12 oz | | 25/500 | 5.2 1.7 | H4085, H4125 series |
| LPH416-0090 | Vented PP Lid — Fits 16 oz | | 25/500 | 6.0 1.9 | H4165 series |
| LPH432-0090 | Vented PP Lid — Fits 32 oz | | 25/1000 | 15.5 5.3 | H4325 series |

* Made-to-Order Only



For additional information,
contact your Dart representative
or call (800) 367-2877

www.dartcontainer.com



DART CONTAINER CORPORATION

The Industry Standard of Excellence

Mason, Michigan 48854 U.S.A.

Ph: (800) 248-5960 • Fax: (517) 676-3883

Email: sales@dart.biz • www.dartcontainer.com



Solo® VS DSP Paper Food Containers

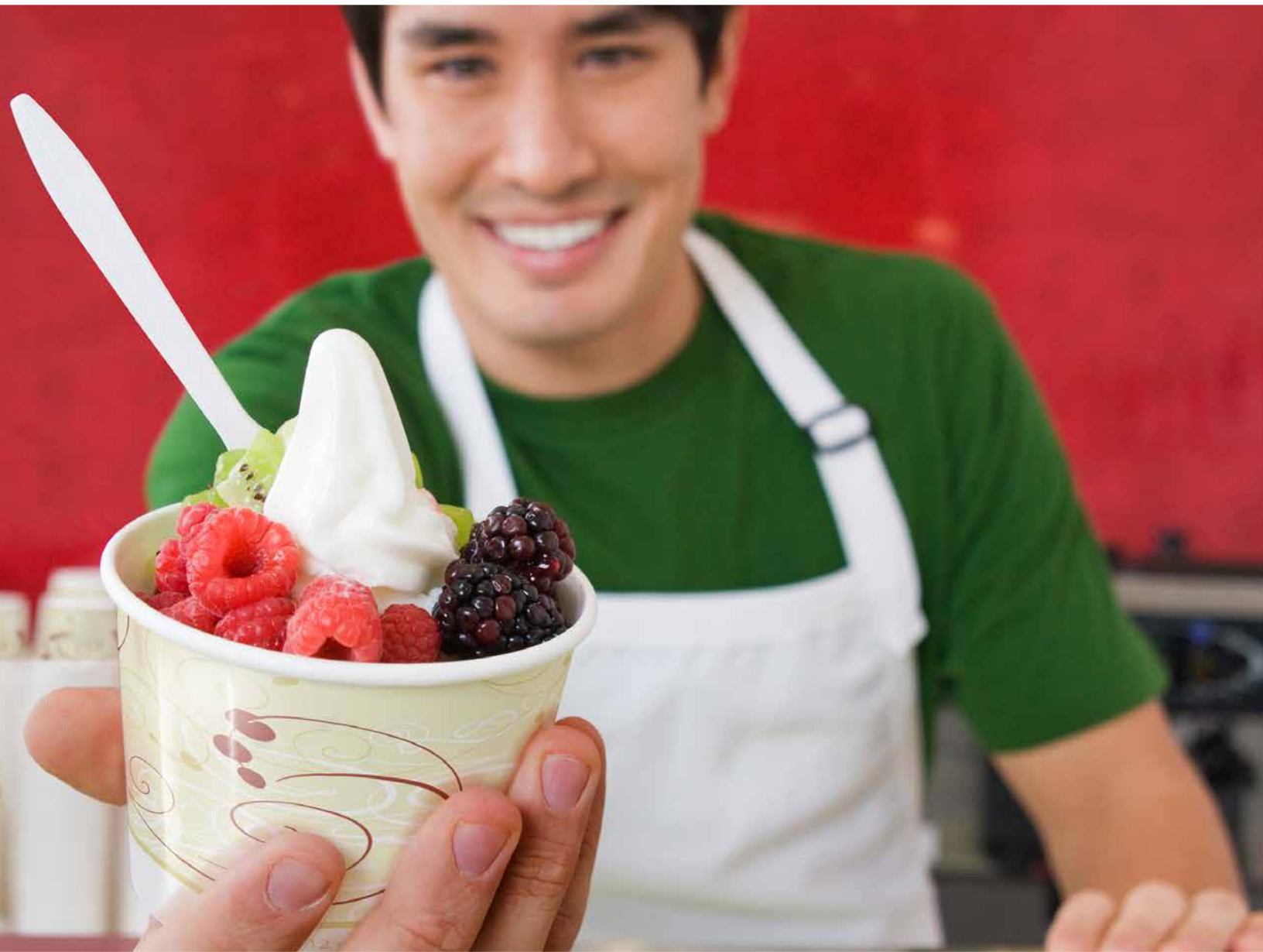

Ready to Serve

The squat profile and wide mouth of our Solo® VS DSP paper food containers makes this product easy for operators to fill and easy for customers to eat! These containers are ideal for cold foods due to the polyethylene coating on the outside of the container which reduces condensation, but can also be used for hot foods due to the temperature maximum of 205°F. A high-gloss finish ensures a smudge-free surface for your stock or custom print to stand out!





Solo® VS DSP Paper Food Containers

Features

Purposeful design

Wide mouth and squat profile make it easier to fill and eat from the container

Rolled rim

Gives rigidity to the container and ensures secure leak-resistant lid fit

Dual-temperature usage

Multi-purpose, double-sided polyethylene-coated container that can be used for both hot and cold applications with a maximum temperature of 205°F



Put a lid on it!

Multiple plastic lid options available in multiple materials to cover all customer needs

Sustainable alternative

Made with at least 85% plant-based renewable resources; we source fibers certified under the SFI® chain of custody

Eye-catching graphics

High-gloss polyethylene coating on the outside of the container allows for exceptional print quality and a smudge-free surface



White



Symphony®



Jazz® (MTO)



Recessed High-Heat Vented PS Lids - White



Recessed High-Heat Plug-Fit Vented PP Lids - Clear



Flat Vented PS Lid - Translucent



Flat Non-Vented PS Lid - Translucent



Flat-Top Dome PET Lids No Hole - Clear

| Items | | | Description | Packing Bag | Packing Case | Case Cube (ft ³) | Case Wt. (lbs) | Use With |
|---|------------------------------------|---------------|-----------------------|-------------|--------------|------------------------------|----------------|---|
| Solo® VS DSP Paper Food Containers | | | | | | | | |
| White | | | | | | | | |
| | Symphony® | Jazz® | | | | | | |
| | VS635N-J8000 | VS635N-00055* | 3.5 oz Food Container | 60 | 2400 | 4.5 | 26.7 | DF35-0090, LVS535-00007 |
| | S605T-J8000 | S605T-00055* | 5 oz Food Container | 50 | 1000 | 2.7 | 12.2 | DF5-0090 |
| VS606X-02050 | VS606X-J8000 | | 6 oz Food Container | 50 | 1000 | 3.9 | 16.0 | 8TFLNV, 8TFLV-18701, DF8-0090, LVS508-0007, LVP508-0100 |
| VS608-02050 | VS608-J8000 | | 8 oz Food Container | 50 | 1000 | 3.8 | 19.6 | DF12-0090, LVS512-0007, LVP512-0100 |
| VS612-02050* | VS612-J8000 | | 12 oz Food Container | 50 | 1000 | 5.2 | 30.5 | DF16-0090, LVS516-0007, LVP516-0100 |
| VS616-02050 | | | 16 oz Food Container | 25 | 500 | 3.9 | 20.1 | |
| Items | | | Description | Packing Bag | Packing Case | Case Cube (ft ³) | Case Wt. (lbs) | Use With |
| Recessed High-Heat Vented PS Lids - White | | | | | | | | |
| LVS535-00007 | Recessed High-Heat Vented Lid | | | 100 | 2400 | 3.2 | 14.7 | VS635N series |
| LVS508-0007 | Recessed High-Heat Vented Lid | | | 100 | 2000 | 4.9 | 19.8 | VS606X & VS608-J8000 series |
| LVS512-0007 | Recessed High-Heat Vented Lid | | | 100 | 1200 | 3.6 | 14.0 | VS612 series |
| LVS516-00007 | Recessed High-Heat Vented Lid | | | 50 | 1000 | 2.7 | 15.2 | VS616 series |
| Recessed High-Heat Plug-Fit Vented PP Lids - Clear | | | | | | | | |
| LVP508-0100 | Recessed High-Heat Plug-Fit PP Lid | | | 100 | 1000 | 2.8 | 10.2 | VS606X & VS608-J8000 series |
| LVP512-0100 | Recessed High-Heat Plug-Fit PP Lid | | | 100 | 1000 | 3.1 | 13.2 | VS612 series |
| LVP516-0100 | Recessed High-Heat Plug-Fit PP Lid | | | 100 | 1000 | 3.8 | 15.5 | VS616 series |
| Flat Vented PS Lid - Translucent | | | | | | | | |
| 8TFLV-18701 | Flat Vented Lid | | | 100 | 2000 | 3.9 | 20.6 | VS606X & VS608-J8000 series |
| Flat Non-Vented PS Lid - Translucent | | | | | | | | |
| 8TFLNV | Flat Non-Vented Lid | | | 100 | 2000 | 3.9 | 19.7 | VS606X & VS608-J8000 series |
| Flat-Top Dome PET Lids No Hole - Clear | | | | | | | | |
| DF35-0090 | Flat-Top Dome PET Plastic Lid | | | 100 | 1000 | 1.1 | 6.3 | VS635N series |
| DF5-0090 | Flat-Top Dome PET Plastic Lid | | | 100 | 1000 | 1.6 | 9.8 | S605T series |
| DF8-0090 | Flat-Top Dome PET Plastic Lid | | | 100 | 1000 | 2.1 | 11.3 | VS606X & VS608-J8000 series |
| DF12-0090 | Flat-Top Dome PET Plastic Lid | | | 100 | 1000 | 2.6 | 13.8 | VS612 series |
| DF16-0090 | Flat-Top Dome PET Plastic Lid | | | 100 | 500 | 1.6 | 8.1 | VS616 series |

* Available as Made To Order only.



For additional information, contact your Dart representative or call (800) 248-5960

www.dartcontainer.com



DART CONTAINER CORPORATION

The Industry Standard of Excellence

Mason, Michigan 48854 U.S.A.

Ph: (800) 248-5960 • Fax: (517) 676-3883

Email: sales@dart.biz • www.dartcontainer.com



©2018 Dart Container Corporation. All rights reserved. Dart® and the Dart logo are trademarks of Dart Container Corporation. Solo®, the Solo logo, Jazz®, and Symphony® are trademarks of Solo Cup Operating Corporation. SFI® and the SFI® logo are registered marks owned by Sustainable Forestry Initiative, Inc. Used with permission. MC1544USE_031318

PRINTED ON RECYCLED PAPER



Solo® VS SSP Paper Food Containers



SERVE IT UP, AND GO!

- **Rolled Rim** – Gives rigidity to the container and ensures leak-resistant lid fit
- **Purposeful Design** – Wide mouth and squat profile make it easier to fill and eat from the container
- **Prevents Leaking** – Single-sided poly coating on the inside of the container acts as a moisture barrier to keep liquid inside
- **Dual-Temperature Usage** – Multi-purpose, single-sided poly container that can be used for both hot and cold applications with a maximum temperature of 205°F
- **Put A Lid On It!** – Multiple plastic lid options available in multiple materials to cover all customer needs



Solo® VS SSP Paper Food Containers

SERVE IT UP AND GO!

A unique offering in our food container line up, Solo® VS SSP paper food containers are perfect for holding hot foods up to 205°F due to the poly coating on the inside of the container, which acts as a moisture barrier to prevent leaking, and the matte finish on the outside of the container, which conducts less heat on your fingertips. These versatile containers can also be used for cold foods with immediate consumption. The squat profile and wide mouth makes this product easy for operators to fill and easy for customers to eat!



White

Jazz®
(MTO item*)

Symphony®

Lids



Rolled Rim
Gives rigidity to the container and ensures secure leak-resistant lid fit



Versatile Applications
Serves hot or cold foods



Moisture Barrier
Container lined with polyethylene on the inside to prevent leaking



Sustainable Alternative
Made with at least 90% plant-based renewable resources; we source fibers certified under the SFI® chain of custody



Wide Mouth and Squat Profile
Easy to serve, easy to eat



Variety
Containers available in multiple sizes with multiple lid styles made with different materials

| Items | Description | Packing Bag/Case | Case Wt. (lbs) | Case Cube (ft³) | Use With |
|---|---|----------------------|-----------------------|-----------------|---|
| VS SINGLE-SIDED POLY PAPER FOOD CONTAINERS | | | | | |
| White | Symphony® | Jazz® | | | |
| VS535-02050* | VS535-J8000 | VS535-00055* | 3.5 oz Food Container | 60/2400 | 25.5 4.5 DF35-0090, LVS535-00007 |
| VS506X-02050 | VS506X-J8000 | VS506X-00055* | 6 oz Food Container | 50/1000 | 17.6 3.9 |
| VS508-2050 | VS508-J8000 | VS508-00055* | 8 oz Food Container | 50/1000 | 19.9 3.8 DF8-0090, LS8-00090, 8TFLV-18701, LVS508-0007, LVP508-0100 |
| VN510-02050 | VN510-J8000 | VN510-00055* | 10 oz Food Container | 50/1000 | 22.5 3.2 |
| VS512-02050 | VS512-J8000 | VS512-00055* | 12 oz Food Container | 60/1200 | 32.5 6.1 DF12-0090, LVS512-0007, LVP512-0100 |
| VS516-02050 | VS516-J8000 | VS516-00055* | 16 oz Food Container | 25/500 | 19.4 3.9 DF16-0090, LVS516-00007, LVP516-0100 |
| FLAT TOP DOME PETE LIDS NO HOLE - CLEAR | | | | | |
| DF35-0090 | Dome No Hole PET Lid - Fits 3.5 oz | 100/1000 | 6.3 | 1.1 | VS535-J8000 |
| DF8-0090 | Dome No Hole PET Lid - Fits 6, 8, 10 oz | 100/1000 | 11.3 | 2.0 | VS506X, VS508 & VN510 series |
| DF12-0090 | Dome No Hole PET Lid - Fits 12 oz | 100/1000 | 13.8 | 2.6 | VS512 series |
| DF16-0090 | Dome No Hole PET Lid - Fits 16 oz | 100/500 | 8.1 | 1.6 | VS516 series |
| FLAT NON-VENTED PS LID - TRANSLUCENT | | | | | |
| 8TFLNV | Flat Non-Vented Lid - Fits 6, 8, 10 oz | 100/2000 | 19.7 | 3.9 | VS506X, VS508 & VN510 series |
| FLAT VENTED PS LID - TRANSLUCENT | | | | | |
| 8TFLV-18701 | Flat Vented Lid - Fits 6, 8, 10 oz | 100/2000 | 20.6 | 3.9 | VS506X, VS508 & VN510 series |
| RECESSED HIGH HEAT VENTED PS LIDS - WHITE | | | | | |
| LVS535-00007 | Vented PS Lid - Fits 3.5 oz | 100/2400 | 14.7 | 3.2 | VS535-J8000 |
| LVS508-0007 | Vented PS Lid - Fits 6, 8, 10 oz | 100/2000 | 19.8 | 4.9 | VS506X, VS508 & VN510 series |
| LVS512-0007 | Vented PS Lid - Fits 12 oz | 100/1200 | 14.0 | 3.6 | VS512 series |
| LVS516-00007 | Vented PS Lid - Fits 16 oz | 50/1000 | 15.2 | 2.7 | VS516 series |
| RECESSED HIGH HEAT PLUG FIT VENTED PP LIDS - CLEAR | | | | | |
| LVP508-0100 | Vented PP Lid - Fits 6, 8, 10 oz | 100/1000 | 10.2 | 2.8 | VS506X, VS508 & VN510 series |
| LVP512-0100 | Vented PP Lid - Fits 12 oz | 100/1000 | 13.2 | 3.1 | VS512 series |
| LVP516-0100 | Vented PP Lid - Fits 16 oz | 100/1000 | 15.5 | 3.8 | VS516 series |

* Available as Made To Order only



For additional information, contact your Dart representative or call 1-800-248-5960

www.dart.biz



DART CONTAINER CORPORATION
The Industry Standard of Excellence

Mason, Michigan 48854 U.S.A.
Ph: (800) 248-5960 • Fax: (517) 676-3883
Email: sales@dart.biz • www.dartcontainer.com

Buyer's Guide

*foam and impact plastic
dinnerware with dome covers*



DART CONTAINER CORPORATION

THE INDUSTRY STANDARD OF EXCELLENCE

Foam Plastic Dinnerware

The attractive design of Dart foam dinnerware is lightweight yet strong enough to hold a full portion of food without bending. Superior insulation makes it perfect for serving both hot and cold foods. Quiet Classic dinnerware lines are laminated for extra strength and gloss. Our Concorde dinnerware line offers the same Dart quality in a non-laminated version.



Laminated

| Stock Number | | | Stock Number | | | Description | Packing Bag | Case | Case Cube | Case Wt. | Case Cube | Case Wt. |
|--------------|---------------------|--------|--------------|--------------------|----------|-----------------------------|-------------|------|-----------|-----------|-----------|-----------|
| White | Standard Cube Honey | Black | White | Reduced Cube Honey | Black | | | | | | | |
| 35BWWQ | 35BWHQ | 35BWBQ | — | — | — | 3 1/2-4 oz. Bowl | 125 | 1000 | 2.0/— | 4.7/— | 2.0/— | 4.6/— |
| 5BWWQ | 5BWHQ | 5BWBQ | — | — | — | 5-6 oz. Bowl | 125 | 1000 | 2.3/— | 4.8/— | 2.3/— | 5.0/— |
| 12BWWQ | — | 12BWBQ | 12BWWQR | 12BWHQR | 12BWBQR | 10-12 oz. Bowl | 125 | 1000 | 4.0/3.7 | 9.0/8.9 | 4.0/3.7 | 9.6/8.9 |
| 6PWQ | — | 6PBQ | 6PWQR | 6PHQR | 6PBQR | 6" Plate | 125 | 1000 | 2.9/2.6 | 7.7/7.6 | 2.9/2.6 | 7.7/7.6 |
| — | — | — | 7PWQR | 7PHQR | 7PBQR | 7" Plate | 125 | 1000 | —/3.5 | —/9.4 | —/3.5 | —/9.4 |
| 9PWQ | — | 9PBQ | 9PWQR | 9PHQR | 9PBQR | 9" Plate | 125 | 500 | 3.5/3.2 | 9.4/9.4 | 3.5/3.2 | 9.7/9.4 |
| 9CPWQ | — | 9CPBQ | 9CPWQR | 9CPHQR | 9CPBQR | 9" Compartmented Plate | 125 | 500 | 3.5/3.2 | 9.7/9.6 | 3.5/3.2 | 9.7/9.6 |
| 10PWQ | — | 10PBQ | 10PWQR | 10PHQR | 10PBQR | 10 1/4" Plate | 125 | 500 | 4.6/4.3 | 12.3/12.2 | 4.6/4.3 | 12.6/12.2 |
| 10CPWQ | — | 10CPBQ | 10CPWQR | 10CPHQR | 10CPBQR | 10 1/4" Compartmented Plate | 125 | 500 | 5.0/4.7 | 12.7/12.6 | 5.0/4.7 | 12.7/12.6 |
| — | — | — | 9PRWQR | 9PRHQR | 9PRBQR | 9" Platter | 125 | 500 | —/2.6 | —/7.6 | —/2.6 | —/7.6 |
| — | — | — | 11PRWQRS | 11PRHQRS | 11PRBQRS | 11" Platter | 125 | 500 | —/3.2 | —/10.2 | —/3.2 | —/10.2 |
| — | — | — | — | 8CDHQR | 8CDBQR | 8 oz. Casserole Dish | 125 | 1000 | —/3.9 | —/11.1 | —/3.9 | —/11.1 |

SC = Item is available in standard cube version.

RC = Item is available in reduced cube version (with R stock number) in certain Dart plant-served areas.

Non-Laminated

CONCORDE®



| Stock Number | | Description | Packing Bag | Case | Case Cube | Case Wt. |
|---------------------|--------------------|-----------------------------|-------------|------|-----------|-----------|
| Standard Cube White | Reduced Cube White | | | | | |
| 35BWWC | — | 3 1/2-4 oz. Bowl | 125 | 1000 | 2.0/— | 3.6/— |
| 5BWWC | — | 5-6 oz. Bowl | 125 | 1000 | 2.3/— | 4.4/— |
| 12BWWC | 12BWWCR | 10-12 oz. Bowl | 125 | 1000 | 4.0/3.5 | 7.7/7.3 |
| 6PWC | 6PWCR | 6" Plate | 125 | 1000 | 2.9/2.2 | 6.2/5.5 |
| — | 7PWCR | 7" Plate | 125 | 1000 | —/3.0 | —/8.3 |
| 9PWC | 9PWCR | 9" Plate | 125 | 500 | 3.5/3.2 | 7.7/6.8 |
| 9CPWC | 9CPWCR | 9" Compartmented Plate | 125 | 500 | 3.5/3.2 | 7.7/7.4 |
| 10PWC | 10PWCR | 10 1/4" Plate | 125 | 500 | 4.6/3.8 | 11.8/10.7 |
| 10CPWC | 10CPWCR | 10 1/4" Compartmented Plate | 125 | 500 | 5.0/4.2 | 11.9/10.8 |
| — | 9PRWCR | 9" Platter | 125 | 500 | —/2.6 | —/7.0 |
| — | 11PRWCRS | 11" Platter | 125 | 500 | —/3.0 | —/9.1 |

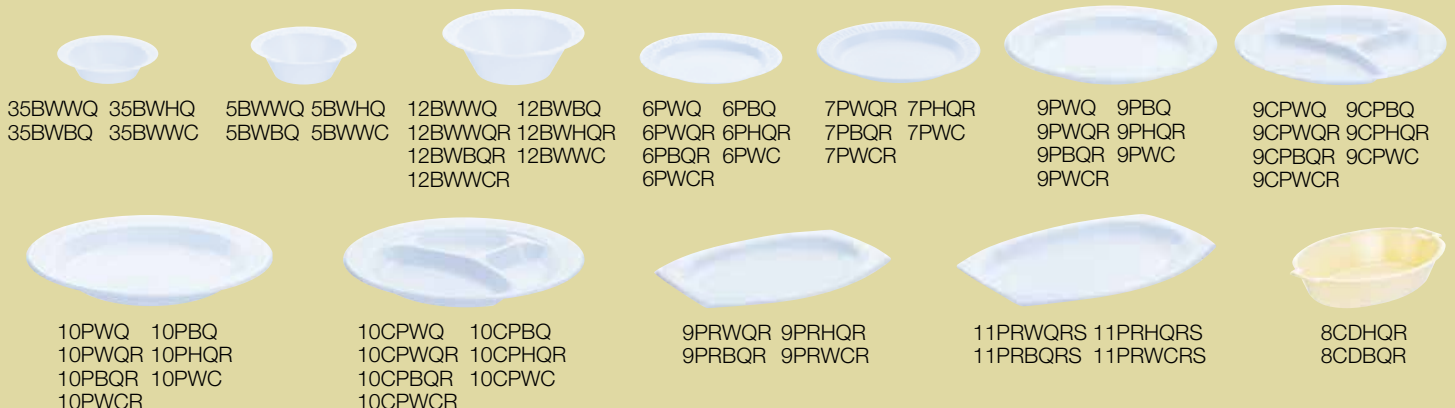

Impact Plastic Dinnerware

Add elegance to any meal with Dart Famous Service impact plastic dinnerware. The glossy, china-like finish and rigid construction enhance food presentation. The non-absorbent, cut-resistant surface keeps sauces from soaking through. Decorative, yet functional, the rim design offers a sophisticated accent while providing for easy product separation. Famous Service also nests more closely than foam or conventional dinnerware, saving you money by reducing storage requirements.

FAMOUS SERVICE

| Stock Number | Description | Packing Bag | Case | Case Cube | Case Wt. |
|--------------|-----------------------------|-------------|------|-----------|----------|
| White | | | | | |
| 4BWWF | 3 1/2-4 oz. Bowl | 125 | 1000 | 0.6 | 9.6 |
| 5BWWF | 5-6 oz. Bowl | 125 | 1000 | 0.7 | 10.7 |
| 12BWWF | 10-12 oz. Bowl | 125 | 1000 | 1.2 | 16.6 |
| 6PWF | 6" Plate | 125 | 1000 | 1.0 | 14.9 |
| 7PWF | 7" Plate | 125 | 1000 | 1.2 | 18.1 |
| 9PWF | 9" Plate | 125 | 500 | 1.0 | 17.1 |
| 9CPWF | 9" Compartmented Plate | 125 | 500 | 1.0 | 17.6 |
| 10PWF | 10 1/4" Plate | 125 | 500 | 1.3 | 23.8 |
| 10CPWF | 10 1/4" Compartmented Plate | 125 | 500 | 1.3 | 23.9 |
| 11PRWF | 11" Platter | 125 | 500 | 1.3 | 23.1 |



Stock Number Legend:

Numbers denote size.

Letters denote a specific style.

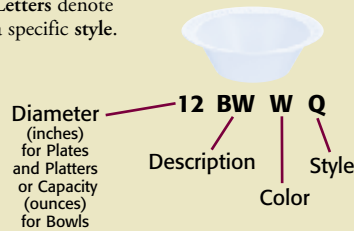

Description:

- P** Plate
- CP** Compartmented Plate
- BW** Bowl
- PR** Platter
- CD** Casserole Dish
- CR** Cover

Color:

- W** White
- H** Honey
- B** Black
- CL** Clear
- T** Translucent

Style:

- Q** Quiet Classic
- C** Concorde
- F** Famous Service



Dome Covers for Dinnerware

Dart dome covers are the ideal complement to our dinnerware lines. A secure seal protects and preserves the freshness of your food while allowing for maximum visual appeal. They're perfect for merchandising pre-packaged salads, sandwiches, and desserts or keeping an entire meal under cover for carryout applications.



| Stock Number | Description | Packing Bag | Case | Case Cube | Case Wt. | For Use With: |
|--------------|-------------|-------------|------|-----------|----------|---|
| CL5BW | Clear | 125 | 1000 | 2.4 | 7.0 | 35BWWQ, 35BWHQ, 35BWBQ, 35BWWC, 5BWWQ, 5BWHQ, 5BWBQ, 5BWWC, 4BWWF |
| CL6P | Clear | 125 | 500 | 2.8 | 9.0 | 6PWQ, 6PWQR, 6PHQR, 6PBQ, 6PBQR, 6PWC, 6PWCR, 12BWWQ, 12BWWQR, 12BWHQR, 12BWBQ, 12BWBQR, 12BWWC, 12BWWCR, 6PWF, 12BWWF |
| CL12BW | Clear | 125 | 1000 | 4.3 | 11.8 | 6PWQ, 6PWQR, 6PHQR, 6PBQ, 6PBQR, 6PWC, 6PWCR, 12BWWQ, 12BWWQR, 12BWHQR, 12BWBQ, 12BWBQR, 12BWWC, 12BWWCR, 6PWF, 12BWWF |
| CL8CD | Clear | 125 | 1000 | 4.9 | 14.9 | 8CDHQR, 8CDBQR |
| CL9P | Clear | 125 | 500 | 5.7 | 16.2 | 9PWQ, 9PWQR, 9PHQR, 9PBQ, 9PBQR, 9PWC, 9PWCR, 9CPWQ, 9CPWQR, 9CPHQR, 9CPBQ, 9CPBQR, 9CPWC, 9CPWCR, 9PWF, 9CPWF |
| 9CRTF | Translucent | 125 | 500 | 5.7 | 16.2 | 9PWQ, 9PWQR, 9PHQR, 9PBQ, 9PBQR, 9PWC, 9PWCR, 9CPWQ, 9CPWQR, 9CPHQR, 9CPBQ, 9CPBQR, 9CPWC, 9CPWCR, 9PWF, 9CPWF |
| CL9PR | Clear | 125 | 500 | 6.3 | 15.5 | 9PRWQR, 9PRHQR, 9PRBQR, 9PRWCR |
| CL10P | Clear | 125 | 500 | 7.4 | 25.5 | 10PWQ, 10PWQR, 10PHQR, 10PBQ, 10PBQR, 10PWC, 10PWCR, 10CPWQ, 10CPWQR, 10CPHQR, 10CBQ, 10CPBQR, 10CPWC, 10CPWCR, 10PWF, 10CPWF |
| CL11PR | Clear | 125 | 500 | 4.5 | 22.3 | 11PWQRS, 11PRHQRS, 11PRBQRS, 11PRWCRS |



FOR ENVIRONMENTAL
INFORMATION, VISIT
WWW.DART.BIZ

©2016 Dart Container Corporation. All rights reserved.
Dart®, the Dart logo, Concorde®, Quiet Classic®, Honey®, and
Famous Service® are trademarks of Dart Container Corporation.
M932USED_050916

DART CONTAINER CORPORATION
The Industry Standard of Excellence

Mason, Michigan 48854 U.S.A.
Ph: 800-248-5960 • Fax: 517-676-3883
Email: sales@dart.biz • www.dart.biz



Heavy Laminated Foam Dinnerware

Heavy laminated foam provides excellent insulation and is the perfect alternative to permanentware. Its thick, yet elegant, high-gloss top laminate creates a strong cutting surface which supports more substantial food applications. Silent Service® is ideal for the most upscale of foodservice environments.





Features

Black color

Provides contrast for food improving overall presentation

Deep shoulders on plate

Helps keep food and sauces on the plate

Skid-resistant surface on base

Helps prevent sliding on tray or tables

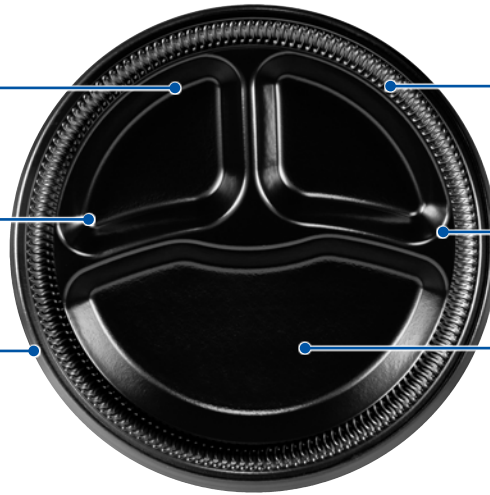

Glossy finish

Provides upscale, high-quality look

Strong and sturdy design

Helps support heavy foods

Cut-resistant heavy-laminated surface

Makes it difficult to cut through



| Stock Number | Product Description | Packing Bag | Packing Case | Case Cube (ft ³) | Case Weight (lbs) | Use With |
|---|-----------------------------|-------------|--------------|------------------------------|-------------------|-----------------------|
| Black Silent Service® Heavy Laminated Foam Dinnerware | | | | | | |
| 35WBSS | 3.5-4 oz Bowl | 125 | 1000 | 1.7 | 5.7 | L35DB1-0090 |
| 12WBSS | 10-12 oz Bowl | 125 | 1000 | 3.1 | 13.0 | LF12B-0090, LF6P-0090 |
| 30WBSS | 30 oz Bowl | 125 | 500 | 3.7 | 12.5 | LF30B-0090 |
| 6PBSS | 6" Plate | 125 | 1000 | 2.6 | 8.7 | LF12B-0090, LF6P-0090 |
| 9PBSS | 9" Plate | 125 | 500 | 2.9 | 12.8 | LC9TKN-0090 |
| 9CPBSS | 9" Compartmented Plate | 125 | 500 | 3.4 | 13.9 | LC9TKN-0090 |
| 10CPBSS | 10 3/4" Compartmented Plate | 125 | 500 | 4.6 | 20.4 | LF10P-0090 |
| 11PRBSS | 11" Platter | 125 | 500 | 3.2 | 15.5 | CL11PR |
| Honey® Silent Service® Heavy Laminated Foam Dinnerware | | | | | | |
| 30BWHSS | 30 oz (887 ml) Bowl | 125 | 500 | 3.7 | 12.5 | LF30B-0090 |



| Stock Number | Product Description | Packing Bag | Packing Case | Case Cube (ft ³) | Case Weight (lbs) | Use With |
|--|---------------------|-------------|--------------|------------------------------|-------------------|-----------------|
| Clear Dome Lids for Silent Service® Heavy Laminated Foam Dinnerware | | | | | | |
| L35DB1-0090 | Dome Lid | 100 | 1000 | 3.6 | 10.5 | 35WBSS, 5WBSS |
| LF12B-0090 | Dome Lid | 125 | 1000 | 4.5 | 13.8 | 12WBSS, 6PBSS |
| LF30B-0090 | Dome Lid | 125 | 500 | 3.8 | 15.9 | 30WBSS, 30BWHSS |
| LF6P-0090 | High Dome Lid | 62/63* | 250 | 1.9 | 7.4 | 12WBSS, 6PBSS |
| LC9TKN-0090 | Dome Lid | 62/63* | 250 | 4.2 | 14.0 | 9PBSS, 9CPBSS |
| CL11PR | Dome Lid | 125 | 500 | 4.5 | 22.3 | 11PRBSS |
| CL8CD | Fluted, Dome Lid | 125 | 1000 | 5.0 | 14.6 | 8CDBSS |

*Two inner packages of 62 lids and two inner packages of 63 lids.



For additional information,
contact your Dart representative
or call (800) 248-5960
www.dartcontainer.com

DART CONTAINER CORPORATION

The Industry Standard of Excellence

Mason, Michigan 48854 U.S.A.

Ph: (800) 248-5960 • Fax: (517) 676-3883

Email: sales@dart.biz • www.dartcontainer.com





Glossy and Strong

Our laminated foam dinnerware has extra strength and gloss—giving a more upscale look. Available in white, Honey®, or black it's sure to match any theme or table setting.



Features

Skid-Resistant Surface on Base

Helps prevent sliding on tray or tables

Glossy Finish

Provides upscale, high-quality look

Durable Laminated Surface

Resists cut through

Strong and Sturdy Design

Helps support heavy foods

Deep Shoulders on Plate

Helps keep food and sauces on the plate

Available in Black, Honey®, or White

Provides contrast for food improving overall presentation

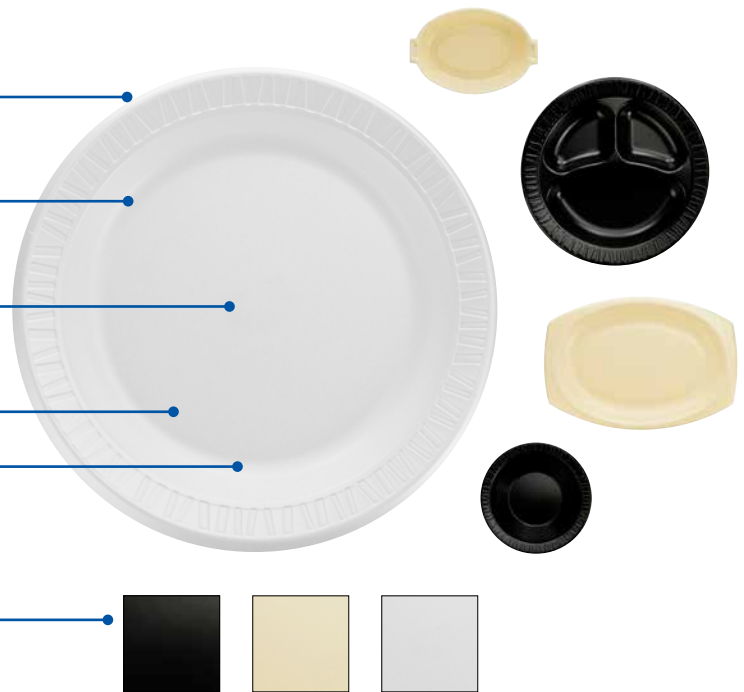

35BWWQ



5BWWQ



12BWWQ
12BWWQR



6PWQ
6PWQR



7PWQR



9PWQ
9PWQR



9CPWQ
9CPWQR



10PWQ
10PWQR



10CPWQ
10CPWQR



9PRWQR



11PRWQRS

| Item | Description | Sleeve | Case Pack | Case Cube (ft ³) | Case Weight (lbs) | Use with |
|---|---------------------------|--------|-----------|------------------------------|-------------------|--------------|
| White Quiet Classic® Laminated Foam Dinnerware | | | | | | |
| 35BWWQ | 3.5-4 oz Bowl | 125 | 1000 | 2.0 | 4.6 | CL5BW |
| 5BWWQ | 5-6 oz Bowl | 125 | 1000 | 2.3 | 5.0 | CL5BW |
| 12BWWQ | 10-12 oz Bowl | 125 | 1000 | 4.1 | 9.0 | CL12BW, CL6P |
| 12BWWQR | 10-12 oz Bowl | 125 | 1000 | 3.8 | 8.9 | CL12BW, CL6P |
| 6PWQ | 6" Plate | 125 | 1000 | 2.9 | 7.6 | CL12BW, CL6P |
| 6PWQR | 6" Plate | 125 | 1000 | 2.6 | 7.6 | CL12BW, CL6P |
| 7PWQR | 7" Plate | 125 | 1000 | 3.6 | 9.4 | — |
| 9PWQ | 9" Plate | 125 | 500 | 3.5 | 9.3 | CL9P, 9CRTF |
| 9PWQR | 9" Plate | 125 | 500 | 3.3 | 9.4 | CL9P, 9CRTF |
| 9CPWQ | 9" Compartmented Plate | 125 | 500 | 3.5 | 9.7 | CL9P, 9CRTF |
| 9CPWQR | 9" Compartmented Plate | 125 | 500 | 3.3 | 9.6 | CL9P, 9CRTF |
| 10PWQ | 10 ¼" Plate | 125 | 500 | 4.7 | 12.2 | CL10P |
| 10PWQR | 10 ¼" Plate | 125 | 500 | 4.3 | 12.2 | CL10P |
| 10CPWQ | 10 ¼" Compartmented Plate | 125 | 500 | 5.0 | 12.7 | CL10P |
| 10CPWQR | 10 ¼" Compartmented Plate | 125 | 500 | 4.7 | 12.6 | CL10P |
| 9PRWQR | 9" Platter | 125 | 500 | 2.6 | 7.6 | CL9PR |
| 11PRWQRS | 11" Platter | 125 | 500 | 3.2 | 10.0 | CL11PR |



| Item | Description | Sleeve | Case Pack | Case Cube (ft ³) | Case Weight (lbs) | Use with |
|--|---------------------------|--------|-----------|------------------------------|-------------------|--------------|
| Honey® Quiet Classic® Laminated Foam Dinnerware | | | | | | |
| 35BWHQ | 3.5-4 oz Bowl | 125 | 1000 | 2.0 | 4.9 | CL5BW |
| 5BWHQ | 5-6 oz Bowl | 125 | 1000 | 2.3 | 5.0 | CL5BW |
| 12BWHQR | 10-12 oz Bowl | 125 | 1000 | 3.8 | 8.9 | CL12BW, CL6P |
| 6PHQR | 6" Plate | 125 | 1000 | 2.6 | 7.6 | CL12BW, CL6P |
| 7PHQR | 7" Plate | 125 | 1000 | 3.6 | 9.4 | — |
| 9PHQR | 9" Plate | 125 | 500 | 3.3 | 9.4 | CL9P, 9CRTF |
| 9CPHQR | 9" Compartmented Plate | 125 | 500 | 3.3 | 9.5 | CL9P, 9CRTF |
| 10PHQR | 10 ¼" Plate | 125 | 500 | 4.3 | 12.2 | CL10P |
| 10CPHQR | 10 ¼" Compartmented Plate | 125 | 500 | 4.7 | 12.6 | CL10P |
| 8CDHQR | 8 oz Casserole Dish | 125 | 1000 | 4.0 | 11.0 | CL8CD |
| 9PRHQR | 9" Platter | 125 | 500 | 2.6 | 7.6 | CL9PR |
| 11PRHQRS | 11" Platter | 125 | 500 | 3.2 | 10.2 | CL11PR |



| Item | Description | Sleeve | Case Pack | Case Cube (ft ³) | Case Weight (lbs) | Use with |
|---|---------------------------|--------|-----------|------------------------------|-------------------|--------------|
| Black Quiet Classic® Laminated Foam Dinnerware | | | | | | |
| 35BWBQ | 3.5-4 oz Bowl | 125 | 1000 | 2.0 | 4.6 | CL5BW |
| 5BWBQ | 5-6 oz Bowl | 125 | 1000 | 2.3 | 5.0 | CL5BW |
| 12BWBQ | 10-12 oz Bowl | 125 | 1000 | 4.1 | 8.9 | CL12BW, CL6P |
| 12BWBQR | 10-12 oz Bowl | 125 | 1000 | 3.8 | 8.9 | CL12BW, CL6P |
| 6PBQ | 6" Plate | 125 | 1000 | 2.9 | 7.7 | CL12BW, CL6P |
| 6PBQR | 6" Plate | 125 | 1000 | 2.6 | 7.6 | CL12BW, CL6P |
| 7PBQR | 7" Plate | 125 | 1000 | 3.6 | 9.3 | — |
| 9PBQ | 9" Plate | 125 | 500 | 3.5 | 9.7 | CL9P, 9CRTF |
| 9PBQR | 9" Plate | 125 | 500 | 3.3 | 9.4 | CL9P, 9CRTF |
| 9CPBQ | 9" Compartmented Plate | 125 | 500 | 3.5 | 9.5 | CL9P, 9CRTF |
| 9CPBQR | 9" Compartmented Plate | 125 | 500 | 3.3 | 9.5 | CL9P, 9CRTF |
| 10PBQ | 10 ¼" Plate | 125 | 500 | 4.7 | 12.2 | CL10P |
| 10PBQR | 10 ¼" Plate | 125 | 500 | 4.3 | 12.2 | CL10P |
| 10CPBQ | 10 ¼" Compartmented Plate | 125 | 500 | 5.0 | 12.7 | CL10P |
| 10CPBQR | 10 ¼" Compartmented Plate | 125 | 500 | 4.7 | 12.6 | CL10P |
| 8CDBQR | 8 oz Casserole Dish | 125 | 1000 | 4.0 | 11.0 | CL8CD |
| 9PRBQR | 9" Platter | 125 | 500 | 2.6 | 7.6 | CL9PR |
| 11PRBQRS | 11" Platter | 125 | 500 | 3.2 | 10.2 | CL11PR |

Features

Clear or Translucent Lids and Covers

Minimizes food contamination while increasing visual appeal

Side Ribbing

Provides strength to prevent crushing

Secure Seal

Helps protect and preserve food freshness

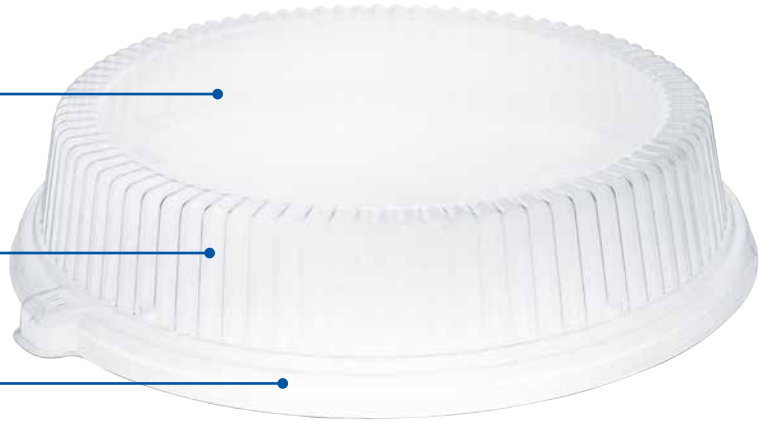

| Item | Description | Sleeve | Case Pack | Case Cube (ft ³) | Case Weight (lbs) | Use with |
|---|---------------|--------|-----------|------------------------------|-------------------|---|
| Clear Dome Lids for Quiet Classic® Laminated Foam Dinnerware | | | | | | |
| CL5BW | Dome Lid | 125 | 1000 | 2.5 | 6.9 | 35BWWQ, 35BWHQ, 35BWBQ, 5BWWQ, 5BWHQ, 5BWBQ |
| CL12BW | Dome Lid | 125 | 1000 | 4.4 | 11.6 | 12BWWQ, 12BWWQR, 12BWHQR, 12BWBQ, 12BWBQR, 6PWQ, 6PWQR, 6PHQR, 6PBQ, 6PBQR |
| CL6P | High Dome Lid | 125 | 500 | 2.9 | 9.8 | 12BWWQ, 12BWWQR, 12BWHQR, 12BWBQ, 12BWBQR, 6PWQ, 6PWQR, 6PHQR, 6PBQ, 6PBQR |
| CL9P | Dome Lid | 125 | 500 | 5.8 | 15.8 | 9PWQ, 9PWQR, 9PHQR, 9PBQ, 9PBQR, 9CPWQ, 9CPWQR, 9CPHQR, 9CPBQ, 9CPBQR |
| CL10P | Dome Lid | 125 | 500 | 7.4 | 25.6 | 10PWQ, 10PWQR, 10PHQR, 10PBQ, 10PBQR, 10CPWQ, 10CPWQR, 10CPHQR, 10CPBQ, 10CPBQR |
| CL9PR | Dome Lid | 125 | 500 | 6.4 | 15.2 | 9PRWQR, 9PRHQR, 9PRBQR |
| CL11PR | Dome Lid | 125 | 500 | 4.5 | 22.3 | 11PRWQRS, 11PRHQRS, 11PRBQRS |
| CL8CD | Dome Lid | 125 | 1000 | 5.0 | 14.6 | 8CDHQR, 8CDBQR |
| Translucent Dome Covers for Quiet Classic® Laminated Foam Dinnerware | | | | | | |
| 9CRTF | Dome Cover | 125 | 500 | 2.4 | 25.8 | 9PWQ, 9PWQR, 9PHQR, 9PBQ, 9PBQR, 9CPWQ, 9CPWQR, 9CPHQR, 9CPBQ, 9CPBQR |



For additional information,
contact your Dart representative
or call (800) 248-5960

www.dartcontainer.com

DART CONTAINER CORPORATION

The Industry Standard of Excellence

Mason, Michigan 48854 U.S.A.

Ph: (800) 248-5960 • Fax: (517) 676-3883

Email: sales@dart.biz • www.dartcontainer.com



PRINTED ON RECYCLED PAPER



CONCORDE

Non-Laminated Foam Dinnerware



Lightweight and Sturdy

Our economical, non-laminated foam dinnerware is strong enough to handle a variety of applications. The superior insulation suits both hot and cold foods making this is a perfect choice for casual dining environments.





Features

White Color

Provides contrast for food improving overall presentation.

Deep Shoulders on Plate

Helps keep food and sauces on the plate.

Skid-Resistant Surface on Base

Helps prevent sliding on tray or tables.

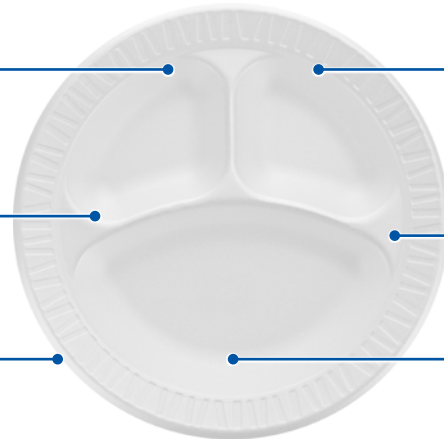

Matte Finish

Provides upscale, high-quality look.

Compartment Anchor

Provides additional plate strength.

Non-Laminated Surface

Economical and sturdy alternative.



| Stock Number | Product Description | Packing Bag | Packing Case | Case Cube (ft ³) | Case Weight (lb) | Use with |
|--|-----------------------------|-------------|--------------|------------------------------|------------------|--------------|
| Concorde® Non-Laminated Foam Dinnerware | | | | | | |
| 35BWWC | 3.5-4 oz Bowl | 125 | 1000 | 2.0 | 3.6 | CL5BW |
| 5BWWC | 5-6 oz Bowl | 125 | 1000 | 2.3 | 4.4 | CL5BW |
| 12BWWC | 10-12 oz Bowl | 125 | 1000 | 4.1 | 7.7 | CL12BW, CL6P |
| 12BWWCR | 10-12 oz Bowl | 125 | 1000 | 3.6 | 7.3 | CL12BW, CL6P |
| 6PWC | 6" Plate | 125 | 1000 | 2.9 | 6.2 | CL12BW, CL6P |
| 6PWCR | 6" Plate | 125 | 1000 | 2.2 | 5.5 | CL12BW, CL6P |
| 7PWCR | 7" Plate | 125 | 1000 | 3.0 | 8.2 | — |
| 9PWC | 9" Plate | 125 | 500 | 3.5 | 7.6 | CL9P, 9CRTF |
| 9PWCR | 9" Plate | 125 | 500 | 3.2 | 6.8 | CL9P, 9CRTF |
| 9CPWC | 9" Compartmented Plate | 125 | 500 | 3.5 | 7.7 | CL9P, 9CRTF |
| 9CPWCR | 9" Compartmented Plate | 125 | 500 | 3.2 | 7.4 | CL9P, 9CRTF |
| 10PWC | 10 1/4" Plate | 125 | 500 | 4.7 | 11.8 | CL10P |
| 10PWCR | 10 1/4" Plate | 125 | 500 | 3.9 | 10.6 | CL10P |
| 10CPWC | 10 1/4" Compartmented Plate | 125 | 500 | 5.0 | 11.0 | CL10P |
| 10CPWCR | 10 1/4" Compartmented Plate | 125 | 500 | 4.3 | 10.7 | CL10P |
| 9PRWCR | 9" Platter | 125 | 500 | 2.6 | 7.0 | CL9PR |
| 11PRWCRS | 11" Platter | 125 | 500 | 3.0 | 9.2 | CL11PR |



| Stock Number | Product Description | Packing Bag | Packing Case | Case Cube (ft ³) | Case Weight (lb) | Use with |
|--|------------------------|-------------|--------------|------------------------------|------------------|--------------------------------|
| Clear Dome Lids for Concorde® Non-Laminated Foam Dinnerware | | | | | | |
| CL5BW | Dome Lid - Clear | 125 | 1000 | 2.5 | 6.9 | 35BWWC, 5BWWC |
| CL12BW | Dome Lid - Clear | 125 | 1000 | 4.4 | 11.6 | 12BWWC, 12BWWCR, 6PWC, 6PWCR |
| CL6P | Dome Lid - Clear | 125 | 500 | 2.9 | 9.8 | 12BWWC, 12BWWCR, 6PWC, 6PWCR |
| CL9P | Dome Lid - Clear | 125 | 500 | 5.8 | 15.8 | 9PWC, 9PWCR, 9CPWC, 9CPWCR |
| 9CRTF | Dome Lid - Translucent | 125 | 500 | 2.5 | 25.8 | 9PWC, 9PWCR, 9CPWC, 9CPWCR |
| CL10P | Dome Lid - Clear | 125 | 500 | 7.4 | 25.6 | 10PWC, 10PWCR, 10CPWC, 10CPWCR |
| CL9PR | Dome Lid - Clear | 125 | 500 | 6.4 | 15.2 | 9PRWCR |
| CL11PR | Dome Lid - Clear | 125 | 500 | 4.5 | 22.3 | 11PRWCRS |



For additional information, contact your Dart representative or call (800) 248-5960

www.dartcontainer.com

DART CONTAINER CORPORATION

The Industry Standard of Excellence

Mason, Michigan 48854 U.S.A.

Ph: (800) 248-5960 • Fax: (517) 676-3883

Email: sales@dart.biz • www.dartcontainer.com





For today. For tomorrow. For good.™

Bare® by Solo® Eco-Forward® Bagasse (Surgarcane) Hinged Lid Containers & Dinnerware

Compostable in a commercial composting facility which may not exist in your community (not suitable for backyard composting)

ASTM-D6868 Certified for commercial compostability

Biodegradable Products Institute (BPI) Certified for commercial compostability

Made from 99% Plant-Based Material that can replenish itself and meets sustainability goals

Application Versatility - Ideal for hot and cold food applications - breakfast, lunch, dinner and desserts





Features

Recessed/Raised Stacking Platform

Increases operational efficiency and reduces spills

Locking Tabs

Provide a secure closure

Raised Compartment Walls

Keep food and sauces in their proper compartment

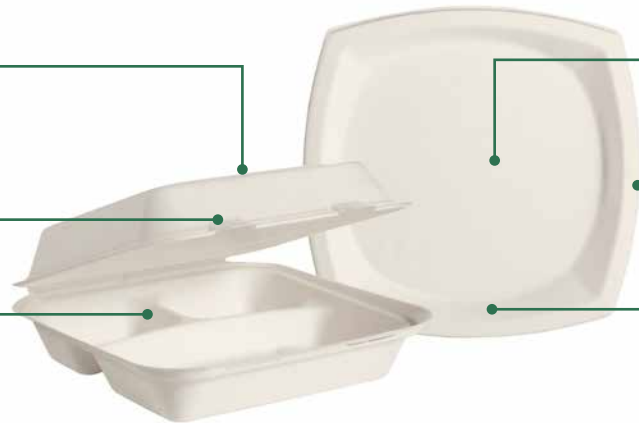

Sturdy Construction

Able to hold full portions without bending or buckling

Unique Square Design

Provides an upscale and on-trend appearance

Deep Shoulders

Keeps food & sauces on the plate



HC6SC-2050



HC8SC-2050



HC8CSC-2050



6PSC-2050



8PSC-2050



HC9SC-2050



HC9CSC-2050



HC206SC-2050



10PSC-2050



12BSC-2050

| Stock Number | Description | Outside Dimensions | Packaging Bag/Case | Case Cube | Case Weight |
|--|---------------------------|--------------------|--------------------|-----------|-------------|
| Bagasse (Sugarcane) Hinged Containers — Ivory | | | | | |
| HC6SC-2050 | 6" Hinged Container | 6.1" × 5.8" × 3.2" | 100/400 | 1.5 | 19.6 |
| HC8SC-2050 | 8" Hinged Container | 7.9" × 8.7" × 2.6" | 50/300 | 2.2 | 26.9 |
| HC8CSC-2050 | 8" Hinged - 3 Compartment | 8.1" × 8.7" × 2.6" | 50/300 | 2.2 | 26.9 |
| HC9SC-2050 | 9" Hinged Container | 9.4" × 9.5" × 3.2" | 100/200 | 2.1 | 23.6 |
| HC9CSC-2050 | 9" Hinged - 3 Compartment | 9.4" × 9.5" × 3.2" | 100/200 | 2.1 | 23.6 |
| HC206SC-2050 | 9" × 6" Hinged Container | 9.1" × 6.1" × 3.0" | 50/200 | 1.2 | 14.3 |
| Bagasse (Sugarcane) Dinnerware — Ivory | | | | | |
| 6PSC-2050 | 6.7" Square Plate | — | 125/1000 | 1.7 | 26.5 |
| 8PSC-2050 | 8.25" Square Plate | — | 125/500 | 1.4 | 21.5 |
| 10PSC-2050 | 10" Square Plate | — | 125/500 | 2.0 | 24.0 |
| 12BSC-2050 | 12 oz Square Bowl | — | 125/1000 | 1.8 | 26.4 |



For additional information,
contact your Dart representative
or call (800) 248-5960

www.dartcontainer.com

DART CONTAINER CORPORATION

The Industry Standard of Excellence

Mason, Michigan 48854 U.S.A.

Ph: (800) 248-5960 • Fax: (517) 676-3883

Email: sales@dart.biz • www.dartcontainer.com



Impact Plastic Dinnerware



Elegant and Functional

Our impact plastic dinnerware has a glossy, "china-like" finish, and rigid construction. The non-absorbent, cut-resistant surface keeps sauces from soaking through. These features enhance food presentation and keep customers coming back for more.



Impact Plastic Dinnerware

FAMOUS SERVICE

Crystal cap layer

Provides a glossy, "china-like" finish

Non-absorbent

Prevents liquids from soaking through

Separation lugs

Allows for easy plate separation

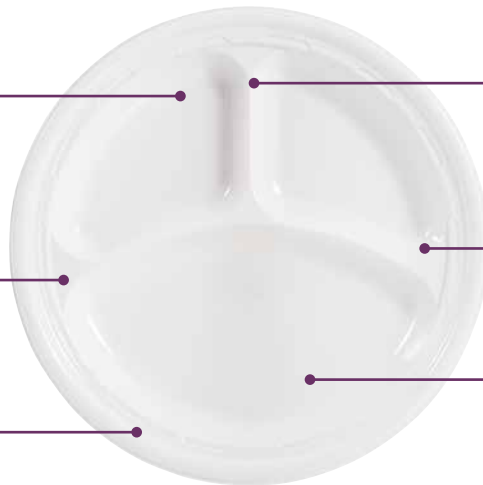

Compartment anchors

Flared divider at the end of the compartments provides additional plate strength

Deep shoulders on plate

Helps keep food and sauces on the plate

Cut-Resistant surface

Makes it difficult to cut through

Party Plastic

Premium plastic

Delivers strength and elegance in a superior plate

Crystal cap layer

Provides a glossy, "china-like" finish

Non-absorbent

Prevents liquids from soaking through



Decorative rim pattern

Allows for easy plate separation

Deep shoulders on plate

Help keep food and sauces on the plate

Cut-resistant surface

Makes it difficult to cut through

Solo® Ultra Clear™

Crystal cap layer

Provides a glossy, "china-like" finish

Non-absorbent

Prevents liquids from soaking through

Clarity

Provides an upscale, premium look

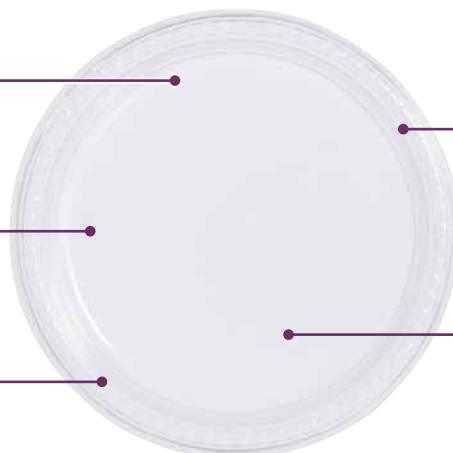

Deep shoulders on plate

Help keep food and sauces on the plate

Cut-resistant surface

Makes it difficult to cut through

Impact Plastic Dinnerware

Famous Service® Impact Plastic Dinnerware



| Item | Description | Sleeve | Case Pack | Case Cube (ft ³) | Case Weight (lbs) | TI/HI | Use With |
|--|-----------------------------|--------|-----------|------------------------------|-------------------|-------|--------------------|
| Famous Service® Impact Plastic Dinnerware - White | | | | | | | |
| 4BWWF | 3.5-4 oz Bowl | 125 | 1000 | 0.6 | 9.6 | 8/9 | CL5BW |
| 5BWWF | 5-6 oz Bowl | 125 | 1000 | 0.7 | 10.7 | 7/9 | — |
| 12BWWF | 10-12 oz Bowl | 125 | 1000 | 1.2 | 16.6 | 6/7 | CL12BW, CL6P |
| 6PWF | 6" Plate | 125 | 1000 | 1.0 | 14.9 | 12/4 | CL12BW, CL6P |
| 7PWF | 7" Plate | 125 | 1000 | 1.2 | 18.1 | 12/3 | — |
| 9PWF | 9" Plate | 125 | 500 | 1.0 | 17.1 | 10/4 | CL9P, 9CRTF, LPF95 |
| 9CPWF | 9" Compartmented Plate | 125 | 500 | 1.0 | 17.6 | 10/4 | CL9P, 9CRTF, LPF95 |
| 10PWF | 10 1/4" Plate | 125 | 500 | 1.3 | 23.8 | 10/4 | CL10P |
| 10CPWF | 10 1/4" Compartmented Plate | 125 | 500 | 1.3 | 23.9 | 10/4 | CL10P |
| 11PRWF | 11" Platter | 125 | 500 | 1.3 | 23.1 | 6/5 | — |

Party Plastic Premium Dinnerware



| Item | Description | Sleeve | Case Pack | Case Cube (ft ³) | Case Weight (lbs) | TI/HI | Use With |
|---|-----------------------------|--------|-----------|------------------------------|-------------------|-------|----------|
| Party Plastic Premium Dinnerware - Black | | | | | | | |
| PB12E-0099 | 12 oz Bowl | 25 | 1000 | 1.7 | 17.9 | 6/5 | — |
| P65E-0099 | 6" Plate | 50 | 1000 | 1.2 | 16.8 | 12/5 | — |
| P75E-0099 | 7" Plate | 25 | 1000 | 2.3 | 22.9 | 6/6 | — |
| PS95E-0099 | 9" Plate | 25 | 500 | 1.6 | 19.8 | 6/5 | LPF95 |
| PS15E-0099 | 10 1/4" Plate | 25 | 500 | 2.3 | 28.5 | 6/5 | CL10P |
| PS1CE-0099 | 10 1/4" Compartmented Plate | 25 | 500 | 2.3 | 28.5 | 6/5 | CL10P |
| Party Plastic Premium Dinnerware - White | | | | | | | |
| PB12W-0099 | 12 oz Bowl | 25 | 1000 | 1.7 | 17.9 | 6/5 | — |
| P65-0099 | 6" Plate | 50 | 1000 | 1.2 | 16.8 | 12/5 | — |
| P75W-0099 | 7" Plate | 25 | 1000 | 2.3 | 22.9 | 6/6 | — |
| PS95W-0099 | 9" Plate | 25 | 500 | 1.6 | 19.8 | 6/5 | LPF95 |
| PS15W-0099 | 10 1/4" Plate | 25 | 500 | 2.3 | 28.5 | 6/5 | CL10P |

Solo® Ultra Clear™ Plastic Dinnerware



| Item | Description | Sleeve | Case Pack | Case Cube (ft ³) | Case Weight (lbs) | TI/HI | Use With |
|--|-------------|--------|-----------|------------------------------|-------------------|-------|----------|
| Solo® Ultra Clear™ Plastic Dinnerware - Clear | | | | | | | |
| PT65-0099 | 6" Plate | 50 | 1000 | 1.3 | 23.0 | 12/4 | — |
| PST75-0099 | 7" Plate | 25 | 500 | 1.2 | 14.8 | 6/6 | — |
| PST95-0099 | 9" Plate | 25 | 500 | 1.6 | 32.0 | 6/5 | LPF95 |



Impact Plastic Dinnerware

Features

Clear lids and translucent cover
Minimize food contamination while increasing visual appeal

Side ribbing
Provides strength to prevent crushing

Secure seal
Helps protect and preserve food freshness

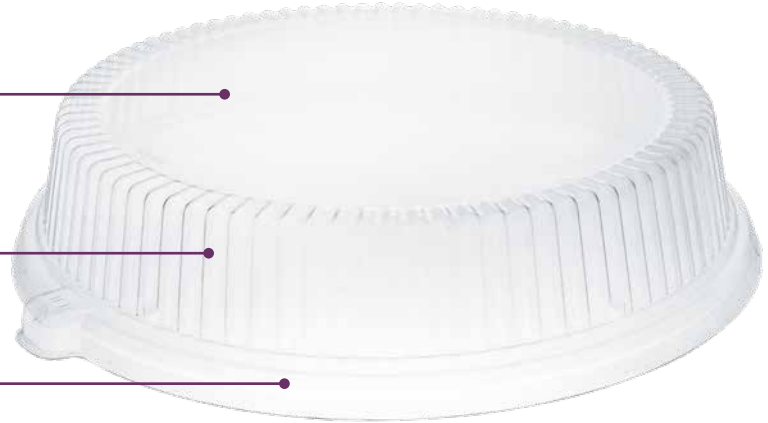

Cover and Lids



CL5BW



CL12BW



CL6P



CL9P



LPF95



9CRTF



CL10P

| Item | Description | Sleeve | Case Pack | Case Cube (ft ³) | Case Weight (lbs) | TI/Hi | Use With |
|---|---------------|--------|-----------|------------------------------|-------------------|-------|---|
| Clear Dome Lids for Plastic Dinnerware | | | | | | | |
| CL5BW | Dome Lid | 125 | 1000 | 2.5 | 6.9 | 8/5 | 4BWWF |
| CL12BW | Dome Lid | 125 | 1000 | 4.4 | 11.6 | 6/3 | 12BWWF, 6PWF |
| CL6P | High Dome Lid | 125 | 500 | 2.8 | 9.8 | 4/7 | 12BWWF, 6PWF |
| CL9P | Dome Lid | 125 | 500 | 5.8 | 15.8 | 3/5 | 9PWF, 9CPWF |
| LPF95 | Dome Lid | 75 | 300 | 5.0 | 15.0 | 4/4 | PS95E-0099, PS95W-0099, PST95-0099, 9PWF, 9CPWF |
| CL10P | Dome Lid | 125 | 500 | 7.4 | 25.6 | 4/4 | PS15E-0099, PS15W-0099, PS1CE-0099, 10PWF, 10CPWF |
| Translucent Dome Covers for Plastic Dinnerware | | | | | | | |
| 9CRTF | Dome Cover | 125 | 500 | 2.4 | 25.8 | 4/4 | 9PWF, 9CPWF |



For additional information,
contact your Dart representative
or call (800) 248-5960

www.dartcontainer.com

DART CONTAINER CORPORATION

The Industry Standard of Excellence

Mason, Michigan 48854 U.S.A.

Ph: (800) 248-5960 • Fax: (517) 676-3883

Email: sales@dart.biz • www.dartcontainer.com



Solo's strongest paper dinnerware yet!

Solo® Paper Dinnerware

Using paper dinnerware shouldn't limit what types of food are served. Durable and reliable, Dart® provides a variety of offerings and three unique geometries that target specific applications. Serving meals with the appropriate geometry helps reduce spills and waste from product doubling.





Features

Available in 3 unique geometries for a variety of applications



Shallow
Ideal for light foods like sandwiches

Good Value



Standard
Perfect for oversized meals like pizza and salads

Better Value



Deep well
Great for heavy or saucy foods like steak and pasta

Best Value



Deep well geometry

At least 50% stronger than a standard 9" plate and provides added security against spills

Nonabsorbent coating

Helps keep sauces and liquids from soaking into products, reducing customer complaints

Renewable resources

Made with 99% plant-based renewable resources and made with either SFI or FSC certified paperboard

Compostability

Meets ASTM D5338 standard for compostability*

Third-party certified

On the Cedar Grove list of accepted products

Paper Dinnerware

| | Stock Number | Description | Color or Design | Weight | Packing Bag | Packing Case | Case Cube (ft ³) | Case Weight (lbs) |
|---------------------------|--------------|-----------------|-----------------|--------|-------------|--------------|------------------------------|-------------------|
| Deep Well Geometry | | | | | | | | |
| 🌿 | MP6B-2054 | 6" Plate | White | Medium | 125 | 1000 | 0.7 | 14.0 |
| 🌿 | MP7B-2054 | 7" Plate | White | Medium | 125 | 1000 | 1.2 | 18.5 |
| 🌿 | MP9B-2054 | 8.5" Plate | White | Medium | 125 | 500 | 1.0 | 16.5 |
| 🌿 | HP10BR-2054 | 10" Plate | White | Heavy | 125 | 500 | 1.6 | 25.0 |
| 🌿 | HB12B-2054 | 12 oz Bowl | White | Heavy | 125 | 1000 | 1.5 | 24.2 |
| | MP6-J8001 | 6" Plate | Symphony® | Medium | 125 | 1000 | 0.7 | 14.0 |
| | MP7-J8001 | 7" Plate | Symphony® | Medium | 125 | 1000 | 1.2 | 18.5 |
| | MP9-J8001 | 8.5" Plate | Symphony® | Medium | 125 | 500 | 1.0 | 16.5 |
| | HB12-J8001 | 12 oz Bowl | Symphony® | Heavy | 125 | 1000 | 1.5 | 24.2 |
| 🌿 | MP6B-J7234 | 6" Plate | Bare® | Medium | 125 | 1000 | 0.7 | 14.0 |
| 🌿 | MP9B-J7234 | 8.5" Plate | Bare® | Medium | 125 | 500 | 1.0 | 16.5 |
| 🌿 | HB12B-J7234 | 12 oz Bowl | Bare® | Heavy | 125 | 1000 | 1.5 | 24.2 |
| Standard Geometry | | | | | | | | |
| 🌿 | MWP9B-2054 | 9" Plate | White | Medium | 125 | 500 | 0.8 | 14.5 |
| 🌿 | HWP6-02050 | 6" Plate | White | Heavy | 250 | 1000 | 0.8 | 13.4 |
| 🌿 | HP9S-2050 | 9" Plate | White | Heavy | 125 | 500 | 1.0 | 17.4 |
| | PL86-J8001 | 8" x 6" Platter | Symphony® | Medium | 125 | 1000 | 2.1 | 36.0 |
| | HWP6-J8001 | 6" Plate | Symphony® | Heavy | 250 | 1000 | 0.8 | 13.4 |
| | HP9S-J8001 | 9" Plate | Symphony® | Heavy | 125 | 500 | 1.0 | 17.4 |
| Shallow Geometry | | | | | | | | |
| 🌿 | LP6B-2054 | 6" Plate | White | Light | 100 | 1000 | 0.5 | 10.8 |
| 🌿 | LP9B-2054 | 9" Plate | White | Light | 100 | 1000 | 1.2 | 22.5 |

* Appropriate commercial composting facilities may not exist in your community. Please check with your local municipality. Not suitable for backyard composting.

🌿 = Bare® by Solo® Eco-Forward® product.



For additional information,
contact your Dart representative
or call (800) 248-5960

www.dartcontainer.com

DART CONTAINER CORPORATION

The Industry Standard of Excellence

Mason, Michigan 48854 U.S.A.

Ph: (800) 248-5960 • Fax: (517) 676-3883

Email: sales@dart.biz • www.dartcontainer.com





Solo® Paper Portion Containers



Economical solution for front or back-of-the-house applications

Serving sauces or sides is easy with Solo® Paper Soufflés. A multitude of shapes and sizes can be leveraged to control customer portions or act as a measuring tool for back-of-the-house applications.





Solo® Paper Portion Containers

Features

Commercially Compostable

Compostable in a commercial composting facility. Appropriate commercial composting facilities may not exist in your community

Superior Leak Resistance

Select sizes available with a poly-lining, which prevents leaks and liquid absorption



Squat Sizes Available

Shallow, wide mouth profile provides perfect container for dipping sauces

Multitude of Sizes

Ranging from 0.5 oz to 5.5 oz to fit any application

| Item | Description | Color or Design | Packing Bag | Packing Case | Case Cube (ft ³) | Case Weight (lbs) |
|---|---|-----------------|-------------|--------------|------------------------------|-------------------|
| Solo® Treated Paper Portion Cups | | | | | | |
| 050-2050 | 0.5 oz Treated Paper Soufflé Portion Cup | White | 250 | 5000 | 0.8 | 8.8 |
| 050S-X2050 | 0.5 oz Squat Treated Paper Soufflé Portion Cup | White | 250 | 5000 | 1.1 | 8.0 |
| 075-2050 | 0.75 oz Treated Paper Soufflé Portion Cup | White | 250 | 5000 | 1.0 | 8.7 |
| 075S-2050 | 0.75 oz Squat Treated Paper Soufflé Portion Cup | White | 250 | 5000 | 1.4 | 7.5 |
| 100-2050 | 1 oz Treated Paper Soufflé Portion Cup | White | 250 | 5000 | 1.2 | 9.9 |
| 100S-X2050 | 1 oz Squat Treated Paper Soufflé Portion Cup | White | 250 | 5000 | 1.8 | 10.4 |
| 125-2050 | 1.25 oz Treated Paper Soufflé Portion Cup | White | 250 | 5000 | 1.6 | 13.4 |
| 200-2050 | 2 oz Treated Paper Soufflé Portion Cup | White | 250 | 5000 | 1.8 | 15.9 |
| 325-2050 | 3.25 oz Treated Paper Soufflé Portion Cup | White | 250 | 5000 | 2.7 | 19.4 |
| 450-2050 | 3.5 oz Treated Paper Soufflé Portion Cup | White | 100 | 5000 | 2.6 | 33.0 |
| 400-2050 | 4 oz Treated Paper Soufflé Portion Cup | White | 250 | 5000 | 3.1 | 25.0 |
| 550-2050 | 5.5 oz Treated Paper Soufflé Portion Cup | White | 250 | 5000 | 4.0 | 28.0 |
| Solo® Paper Portion Containers (Single-Sided Poly) | | | | | | |
| 400P-2050 | 4 oz Single-Sided Poly Paper Soufflé Cup | White | 250 | 5000 | 3.1 | 24 |
| 550P-2050 | 5.5 oz Single-Sided Poly Paper Soufflé Cup | White | 250 | 5000 | 4.0 | 30.1 |



For additional information,
contact your Dart representative
or call (800) 248-5960

www.dartcontainer.com

DART CONTAINER CORPORATION

The Industry Standard of Excellence

Mason, Michigan 48854 U.S.A.

Ph: (800) 248-5960 • Fax: (517) 676-3883

Email: sales@dart.biz • www.dartcontainer.com



Use with other Dart® products for creative packaging



Conex Complements® Polypropylene Portion Containers

Made of durable, crack-resistant polypropylene, Conex Complements® are ideal for the many diverse dining and carryout applications in today's foodservice market. For dining, Conex Complements can serve anything from small side dishes to salad dressing and whipped butter. For carryout, when coupled with one of our three clear lids, they safely transport side sauces such as ranch dressing, marinara, salsa, and more.





Features

Audible snap closure ensures secure lid seal

Microwaveable made of durable, microwaveable polypropylene

Available in a variety of sizes from 0.5 oz through 5.5 oz capacity

Superior clarity increases impulse sales



Clear Portion Containers



Black Portion Containers



| Item | Description | Packing Bag | Packing Case | Case Cube (ft ³) | Case Weight (lbs) | Use With |
|--|-----------------------------|-------------|--------------|------------------------------|-------------------|--------------|
| Conex Complements® Portion Containers - Contact Clear | | | | | | |
| 050PC | 0.5 oz Container | 125 | 2500 | 0.7 | 6.0 | PL100N |
| 075PC | 0.75 oz Container | 125 | 2500 | 0.7 | 6.9 | |
| 100PC | 1 oz Container | 125 | 2500 | 0.7 | 7.9 | |
| 125PCG | 1.25 oz Graduated Container | 125 | 2500 | 0.9 | 8.9 | |
| 150PC | 1.5 oz Container | 125 | 2500 | 1.4 | 11.6 | PL200N |
| 200PC | 2 oz Container | 125 | 2500 | 1.4 | 12.4 | |
| 250PC | 2.5 oz Container | 125 | 2500 | 1.5 | 14.7 | |
| 325PC | 3.25 oz Container | 125 | 2500 | 2.0 | 19.3 | PL4N, PL4TSN |
| 400PC | 4 oz Container | 125 | 2500 | 2.0 | 21.6 | |
| 550PC | 5.5 oz Container | 125 | 2500 | 2.6 | 27.1 | |
| Conex Complements® Portion Containers - Black | | | | | | |
| 200PCBLK | 2 oz Container | 125 | 2500 | 1.4 | 12.4 | PL200N |
| 325PCBLK | 3.25 oz Container | 125 | 2500 | 2.0 | 19.3 | PL4N, PL4TSN |
| 400PCBLK | 4 oz Container | 125 | 2500 | 2.0 | 21.6 | |
| 550PCBLK | 5.5 oz Container | 125 | 2500 | 2.8 | 27.1 | |

Portion Container Lids



| Item | Description | Packing Bag | Packing Case | Case Cube (ft ³) | Case Weight (lbs) | Use With |
|--|-----------------------------|-------------|--------------|------------------------------|-------------------|---|
| Clear PET Lids for Dart® Plastic Portion Containers | | | | | | |
| PL100N | Small PET Lid | 125 | 2500 | 1.0 | 4.6 | 050PC, 075PC, 100PC, 125PCG |
| PL200N | Medium PET Lid | 125 | 2500 | 1.7 | 8.0 | 150PC, 200PC, 250PC, 200PCBLK |
| PL4N | Large PET Lid | 125 | 2500 | 2.5 | 11.9 | 325PC, 400PC, 550PC, 325PCBLK, 400PCBLK, 550PCBLK |
| PL4TSN | Large Straw-Slotted PET Lid | 125 | 2500 | 2.5 | 11.9 | |



For additional information,
contact your Dart representative
or call (800) 248-5960
www.dartcontainer.com

DART CONTAINER CORPORATION

The Industry Standard of Excellence

Mason, Michigan 48854 U.S.A.

Ph: (800) 248-5960 • Fax: (517) 676-3883

Email: sales@dart.biz • www.dartcontainer.com



Show off your sweet and saucy side!

Sauces, Sides & Sweets™ Plastic Containers and Lids

Sauces, Sides & Sweets™ portion containers are great for use with everything from chips and wings, to fruits and desserts. Featuring a wide-mouth opening that is perfect for dipping and scooping, the low-profile design of these containers presents a more upscale look to showcase signature menu items. Pair with one of the five leak-resistant lid options to keep dipping sauces, side dishes, and tasty treats safe when on-the-go.





Sauces, Sides & Sweets™

Features

Flat and dome lids available in heat-resistant polypropylene or clear PET

Shallow design and wide mouth perfect for sauce, sides, dipping, and dessert presentation



Mix-and-match a wide assortment of containers and lids with limitless applications

Strong lid closure to resist spilling

Spoonable base allows all food or sauce in the container to be captured



| Item | Description | Color/Design | Packing Bag | Packing Case | Case Cube (ft ³) | Case Wt (lb) | Use with |
|---|----------------------------------|--------------|-------------|--------------|------------------------------|--------------|--|
| Sauces, Sides & Sweets™ Plastic Containers | | | | | | | |
| DSS2-0001 | 2.5 oz. Container | Black | 250 | 2500 | 2.1 | 12.8 | LDSS23-0090, DL620 |
| DSS3-0001 | 3.5 oz. Container | Black | 250 | 2500 | 2.2 | 14.9 | LDSS23-0090, DL620 |
| DSS5-0001 | 5.5 oz. Container | Black | 250 | 2500 | 3.1 | 21.2 | LDSS5-0090, 626TP, DNR626, SDL12, DLR626, DLW626 |
| Snap-Tight Plastic Lids | | | | | | | |
| LDSS23-0090 | Flat Raised Center - PP | Clear | 100 | 2500 | 3.2 | 12.1 | DSS2-0001, DSS3-0001 |
| DL620 | Dome With No Hole - PET | Clear | 100 | 2500 | 3.2 | 19.0 | |
| LDSS5-0090 | Flat Raised Center - PP | Clear | 100 | 1000 | 1.9 | 8.3 | DSS5-0001 |
| 626TP | Flat Raised Center - PET | Clear | 100 | 1000 | 1.9 | 7.6 | |
| SDL12 | Flat Top Dome With No Hole - PET | Clear | 50 | 1000 | 2.3 | 14.0 | |
| DNR626 | Dome With No Hole - PET | Clear | 100 | 1000 | 1.9 | 10.5 | |
| DLR626 | Dome With Hole - PET | Clear | 100 | 1000 | 1.9 | 10.1 | |
| DLW626 | Dome With Wide Hole - PET | Clear | 100 | 1000 | 1.9 | 8.7 | |



For additional information,
contact your Dart representative
or call (800) 248-5960
www.dartcontainer.com

DART CONTAINER CORPORATION

The Industry Standard of Excellence

Mason, Michigan 48854 U.S.A.

Ph: (800) 248-5960 • Fax: (517) 676-3883

Email: sales@dart.biz • www.dartcontainer.com



Solo® Soufflés Portion Containers

Quality performance for a wide variety of dine-in and carryout applications. Solo® Soufflés portion containers and lids offer choices in an assortment of sizes to meet your diverse application needs.





Features

Strong lid closure
Audible “snap” lid closure prevents leaks

Full range of sizes
From 0.75 oz to 5.5 oz



Lid interchangeability
Uses the same lids as the PET and PP portion containers

Black color option
Popular sizes available in black for a more upscale presentation



| Item | Description | Packaging Bag | Packaging Case | Case Cube (ft') | Case Weight (lbs) | Use With |
|--|----------------------------------|---------------|----------------|-----------------|-------------------|--|
| Solo® Soufflés Plastic Portion Containers (Translucent) | | | | | | |
| P075SN | 0.75 oz Squat Container | 250 | 2500 | 0.7 | 5.9 | PL100N |
| P100N | 1 oz Container | 250 | 2500 | 0.8 | 7.7 | |
| P101M | 1 oz Graduated Container - Clear | 200 | 5000 | 2.0 | 20.0 | |
| P125N | 1.25 oz Container | 250 | 2500 | 0.8 | 8.5 | |
| P150N | 1.5 oz Container | 250 | 2500 | 1.3 | 10.0 | PL200N |
| P200N | 2 oz Container | 250 | 2500 | 1.3 | 9.8 | |
| P250N | 2.5 oz Container | 250 | 2500 | 1.3 | 12.2 | |
| P325N | 3.25 oz Container | 250 | 2500 | 1.9 | 17.2 | PL4N |
| P400N | 4 oz Container | 250 | 2500 | 1.9 | 18.0 | |
| P550N | 5.5 oz Container | 250 | 2500 | 2.2 | 25.5 | |
| Solo® Soufflés Plastic Portion Containers (Black) | | | | | | |
| P100BLK | 1 oz Container | 250 | 2500 | 0.8 | 7.6 | PL100N |
| P150BLK | 1.5 oz Container | 250 | 2500 | 1.3 | 10.0 | PL200N |
| P200BLK | 2 oz Container | 250 | 2500 | 1.3 | 9.8 | |
| P325BLK | 3.25 oz Container | 250 | 2500 | 1.9 | 17.2 | PL4N |
| P400BLK | 4 oz Container | 250 | 2500 | 1.9 | 18.0 | |
| P550BLK | 5.5 oz Container | 250 | 2500 | 2.2 | 25.4 | |
| Solo® PET Portion Container Lids | | | | | | |
| PL100N | Non-vented Lid | 125 | 2500 | 0.9 | 4.3 | P075SN, P100N, P101M, P125N, P100BLK |
| PL200N | Non-vented Lid | 125 | 2500 | 1.7 | 8.0 | P150N, P200N, P250N, P150BLK, P200BLK |
| PL4N | Non-vented Lid | 125 | 2500 | 2.5 | 12.0 | P325N, P400N, P550N, P325BLK, P400BLK, P550BLK |



For additional information,
contact your Dart representative
or call (800) 248-5960
www.dartcontainer.com

DART CONTAINER CORPORATION

The Industry Standard of Excellence

Mason, Michigan 48854 U.S.A.

Ph: (800) 248-5960 • Fax: (517) 676-3883

Email: sales@dart.biz • www.dartcontainer.com

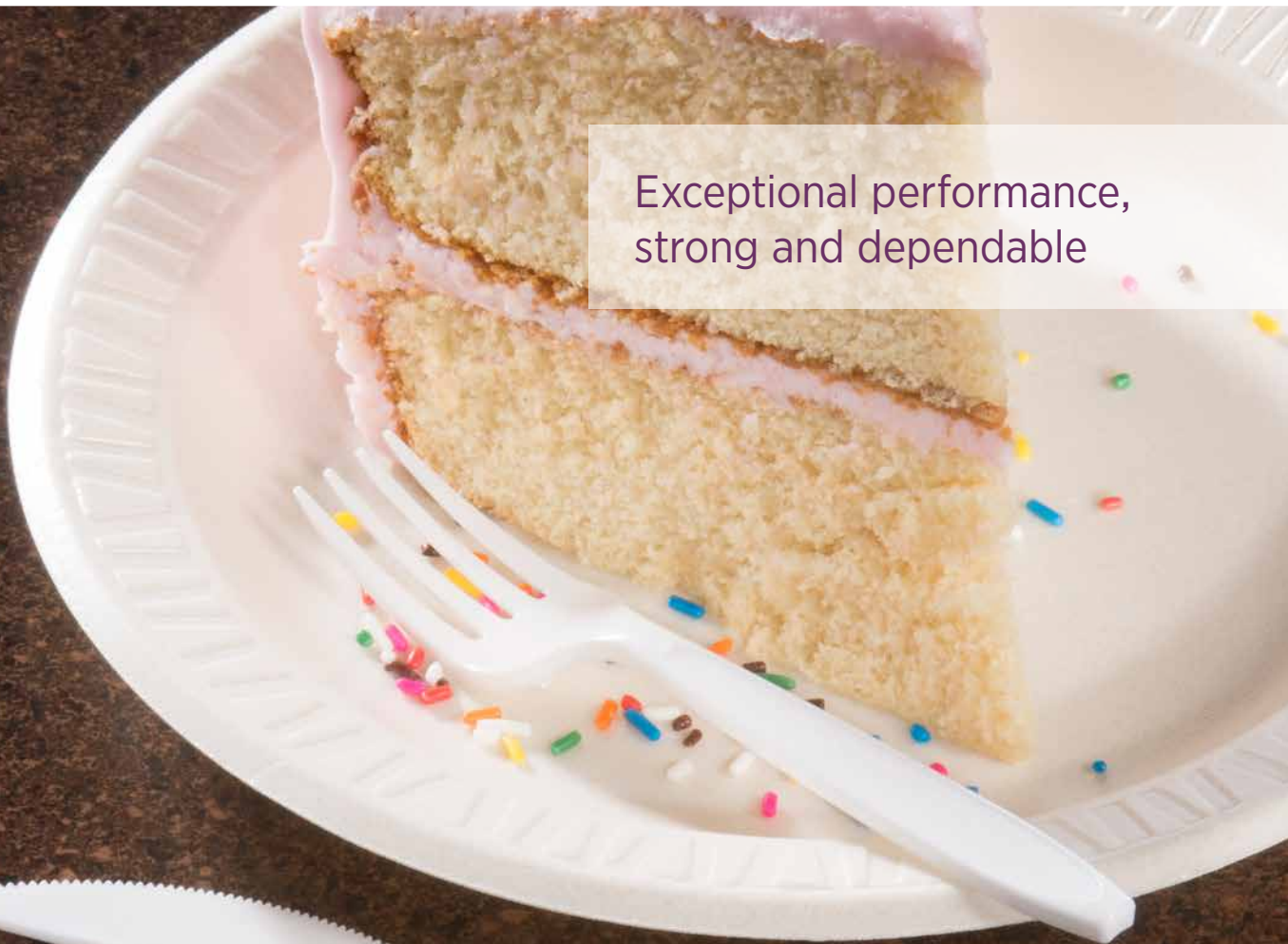

Exceptional performance,
strong and dependable



Reliance® Medium-Heavy-Weight Polystyrene Cutlery

- Product design and optimized strength-to-weight ratio provides superior performance
- Standard length and size — perfect fit for takeout or casual on-premise dining
- Streamlined handle and improved grip
- Interchangeable styling with Impress®
- Three colors that tie in with any color scheme





Features

Rigid and Sturdy
Made from polystyrene

Serrated Edge
Makes cutting easy

Standard Length
Perfect for takeout or casual on-premise dining

Sanitary Presentation
Individually wrapped, kits



| Item | Description | Case Pack | Case Dimensions (in) | Case Cube (ft ³) | Case Weight (lb) |
|---|--|-----------|----------------------|------------------------------|------------------|
| Reliance® Medium-Heavy-Weight Polystyrene Cutlery — Oriented — Bulk | | | | | |
| RSKF-0004 | Fork - Black | 1000 | 16.3 × 6.7 × 9.3 | 0.6 | 8.6 |
| RSKK-0004 | Knife - Black | 1000 | 15.8 × 7.2 × 5.7 | 0.4 | 10.3 |
| RSKT-0004 | Teaspoon - Black | 1000 | 17.1 × 8.3 × 7.1 | 0.6 | 8.5 |
| RSKS-0004 | Soup Spoon - Black | 1000 | 17.1 × 8.1 × 8.1 | 0.6 | 8.3 |
| RSWF-0007 | Fork - White | 1000 | 16.3 × 6.7 × 9.3 | 0.6 | 8.6 |
| RSWK-0007 | Knife - White | 1000 | 15.8 × 7.2 × 5.7 | 0.4 | 10.3 |
| RSWT-0007 | Teaspoon - White | 1000 | 17.1 × 8.3 × 7.1 | 0.6 | 8.5 |
| RSWS-0007 | Soup Spoon - White | 1000 | 17.1 × 8.1 × 8.1 | 0.6 | 8.3 |
| RSAF-0019 | Fork - Champagne | 1000 | 16.3 × 6.7 × 9.3 | 0.6 | 8.6 |
| RSKA-0019 | Knife - Champagne | 1000 | 15.8 × 7.2 × 5.7 | 0.4 | 10.3 |
| RSAT-0019 | Teaspoon - Champagne | 1000 | 17.1 × 8.3 × 7.1 | 0.6 | 8.5 |
| RSAS-0019 | Soup Spoon - Champagne | 1000 | 17.1 × 8.1 × 8.1 | 0.6 | 8.3 |
| Reliance® Medium-Heavy-Weight Polystyrene Cutlery — Oriented — Boxed | | | | | |
| RSWFX-0007 | Fork - White | 1000 | 15.4 × 11.1 × 6.5 | 0.6 | 9.7 |
| RSWKX-0007 | Knife - White | 1000 | 11.4 × 8.7 × 7.3 | 0.4 | 11.3 |
| RSWTX-0007 | Teaspoon - White | 1000 | 16.4 × 12.3 × 6.1 | 0.7 | 9.7 |
| Reliance® Medium-Heavy-Weight Polystyrene Cutlery — Individually-Wrapped | | | | | |
| RSK1-0004 | Fork - Black | 1000 | 17.7 × 13.8 × 8.3 | 1.2 | 10.7 |
| RSK2-0004 | Knife - Black | 1000 | 15.8 × 7.9 × 9.1 | 0.7 | 12.0 |
| RSK3-0004 | Teaspoon - Black | 1000 | 15.3 × 12.9 × 9.0 | 1.0 | 10.0 |
| RSW1-0007 | Fork - White | 1000 | 17.7 × 13.8 × 8.3 | 1.2 | 10.7 |
| RSW2-0007 | Knife - White | 1000 | 15.8 × 7.9 × 9.1 | 0.7 | 12.0 |
| RSW3-0007 | Teaspoon - White | 1000 | 15.3 × 12.9 × 9.0 | 1.0 | 10.0 |
| RSW4-0007 | Soup Spoon - White | 1000 | 17.7 × 12.6 × 8.6 | 1.1 | 10.3 |
| Reliance® Medium-Heavy-Weight Polystyrene Cutlery — Wrapped Kits | | | | | |
| RSW7Z-0007 | Fork, Knife, Teaspoon - White | 500 | 15.8 × 14.4 × 10.3 | 1.3 | 14.9 |
| RSK8Y-0004 | Fork, Knife, Teaspoon, Napkin, Salt & Pepper - Black | 250 | 17.8 × 7.6 × 12.0 | 0.9 | 10.0 |
| RSW8Y-0007 | Fork, Knife, Teaspoon, Napkin, Salt & Pepper - White | 250 | 17.8 × 7.6 × 12.0 | 0.9 | 10.0 |



For additional information,
contact your Dart representative
or call (800) 248-5960

www.dartcontainer.com

DART CONTAINER CORPORATION

The Industry Standard of Excellence

Mason, Michigan 48854 U.S.A.

Ph: (800) 248-5960 • Fax: (517) 676-3883

Email: sales@dart.biz • www.dartcontainer.com

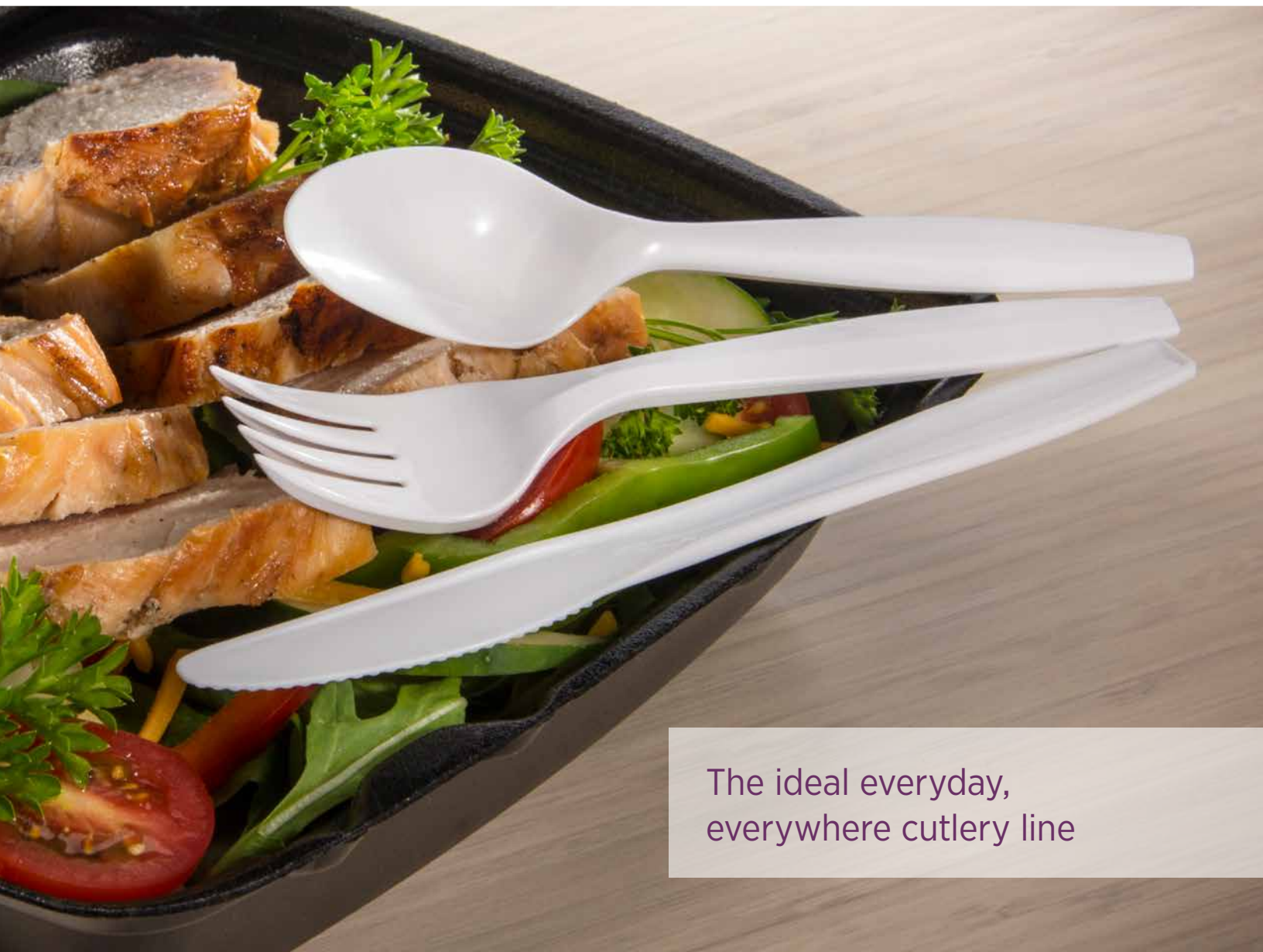

The ideal everyday,
everywhere cutlery line

Regal™ Medium-Weight Polypropylene Cutlery

- **Dependable performance** — made of polypropylene for strength, rigidity, and weight in a semi-pliant utensil
- **Standard length and size** — perfect fit for takeout or casual on-premise dining
- **Especially ideal for younger hands** — larger, wider handle gives user better grip
- **Economical** — engineered for high performance at a cost effective price point



Features

Break-Resistant for Safety

Made from medium-weight polypropylene

Standard Length

Perfect for takeout or casual on-premise dining

Sanitary Presentation

Individually-wrapped kits



| Item | Description | Case Pack | Case Dimensions (in) | Case Cube (ft ³) | Case Weight (lb) |
|--|---|-----------|----------------------|------------------------------|------------------|
| Regal® Medium-Weight Polypropylene Cutlery Kits — Individually-Wrapped Pieces | | | | | |
| MOW1-0007 | Fork | 1000 | 18.3 × 7.5 × 15.3 | 1.2 | 8.8 |
| MOW2-0007 | Knife | 1000 | 13.3 × 8.0 × 10.9 | 0.7 | 9.3 |
| MOW3-0007 | Teaspoon | 1000 | 15.9 × 7.4 × 15.3 | 1.0 | 9.0 |
| MOW4-0007 | Soup Spoon | 1000 | 18.6 × 7.3 × 15.7 | 1.2 | 8.6 |
| MOW6-0007 | Spork | 1000 | 15.9 × 7.4 × 15.3 | 1.0 | 8.3 |
| Regal® Medium-Weight Polypropylene Cutlery Kits — Wrapped Kits | | | | | |
| MOW7Z-0007 | Fork, Knife, Teaspoon | 500 | 20.1 × 12.1 × 9.8 | 1.4 | 12.5 |
| MOW8Y-0007 | Fork, Knife, Teaspoon, Napkin*, Salt & Pepper | 250 | 20.1 × 12.1 × 7.0 | 1.0 | 8.3 |
| MOW8Z-0007 | Fork, Knife, Teaspoon, Napkin*, Salt & Pepper | 500 | 20.1 × 12.1 × 12.3 | 1.7 | 15.0 |
| MOW9Y-0007 | Fork, Knife, Teaspoon, Napkin* | 250 | 13.4 × 12.0 × 9.6 | 0.9 | 7.5 |
| MOW9Z-0007 | Fork, Knife, Teaspoon, Napkin* | 500 | 20.1 × 12.1 × 12.3 | 1.7 | 14.7 |
| MOW12-0007 | Spork, Napkin*, Straw** | 1000 | 16.1 × 13.5 × 15.3 | 1.9 | 13.8 |
| MOW13-0007 | Spork, Napkin* | 1000 | 20.1 × 12.1 × 12.3 | 1.7 | 13.1 |
| MOW14Y-0007 | Fork, Knife, Napkin*, Salt & Pepper | 250 | 13.3 × 12.0 × 8.0 | 0.7 | 6.5 |
| MOW16Z-0007 | Fork, Teaspoon, Napkin*, Salt & Pepper | 500 | 20.0 × 11.9 × 10.6 | 1.5 | 8.7 |
| MOW18Z-0007 | Fork, Knife, Napkin* | 500 | 16.1 × 12.1 × 10.9 | 1.2 | 10.6 |

*Napkin measures 9" × 13" (22.9cm × 33.0cm) **Straw measures 6" (15.2cm) long



For additional information,
contact your Dart representative
or call (800) 248-5960

www.dartcontainer.com

DART CONTAINER CORPORATION

The Industry Standard of Excellence

Mason, Michigan 48854 U.S.A.

Ph: (800) 248-5960 • Fax: (517) 676-3883

Email: sales@dart.biz • www.dartcontainer.com

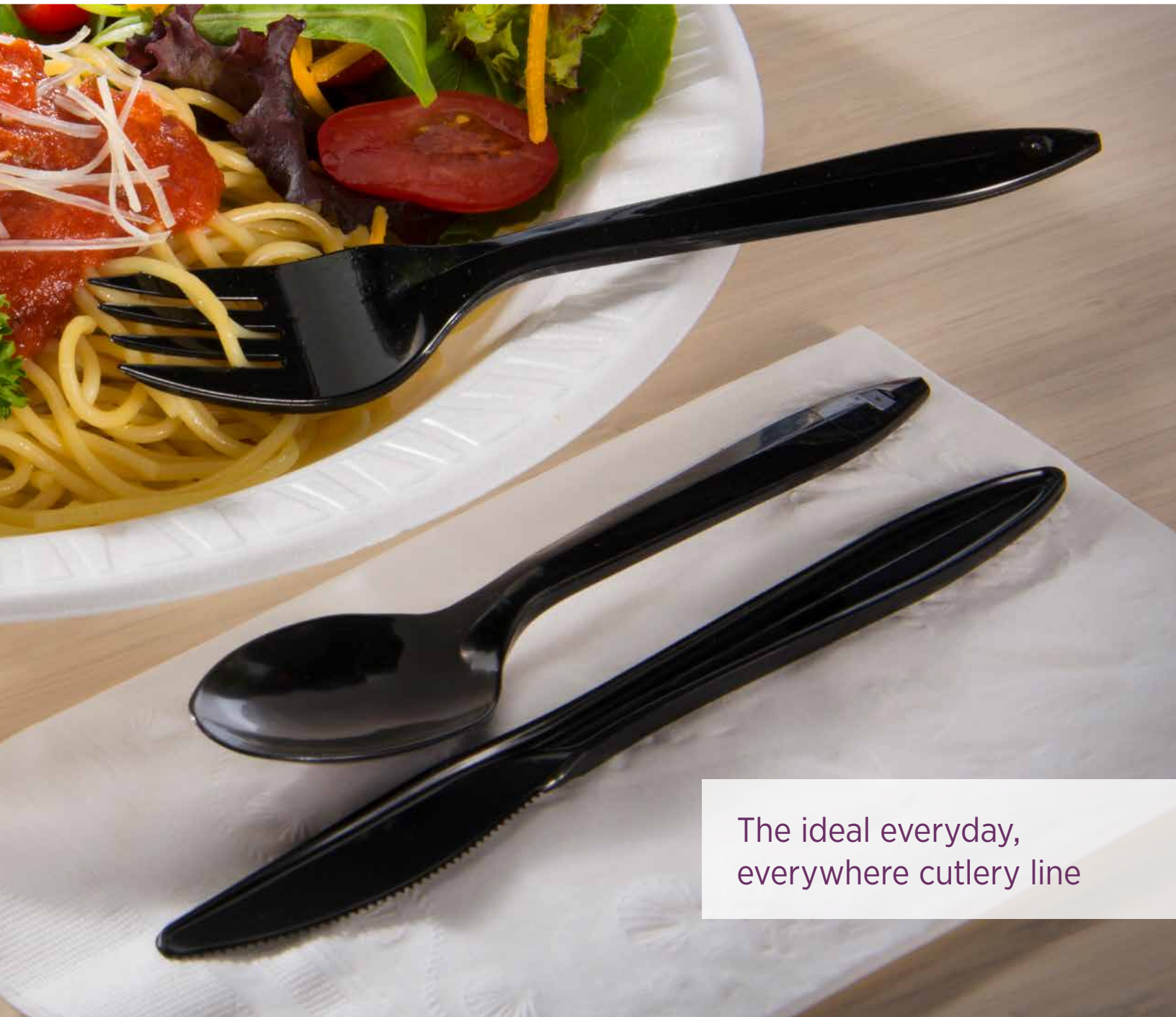

The ideal everyday,
everywhere cutlery line

StyleSelect® Medium-Weight Polystyrene Cutlery

- **Standard length and size** — perfect fit for takeout or casual on-premise dining
- **Recycled polystyrene** — made from 70% re-processed material
- **American made** — Style Select® cutlery is made in the USA
- **Black color** — gives an upscale appearance



Features

Serrated Edge

Makes cutting easy

Ribbed Lines

Provides added strength

Strong and Sturdy Bowl

Helps prevent bending and breakage with hot and cold applications

Reinforced Neck

Provides extra strength and rigidity

Ergonomically-Designed Handle

Provides comfortable grip and control



| Item | Description | Case Pack | Case Dimensions (in) | Case Cube (ft ³) | Case Weight (lb) |
|--|--------------------|-----------|----------------------|------------------------------|------------------|
| Style Select® Medium-Weight Polystyrene Cutlery – Non-Oriented Bulk | | | | | |
| F6BBPS | Fork - Black | 1000 | 18.1 × 11.8 × 10.9 | 1.3 | 7.7 |
| K6BBPS | Knife - Black | 1000 | 11.8 × 9.6 × 9.4 | 0.6 | 8.1 |
| S6BBPS | Teaspoon - Black | 1000 | 17.8 × 11.8 × 10.9 | 1.3 | 7.9 |
| SU6BBPS | Soup Spoon - Black | 1000 | 17.8 × 11.8 × 10.9 | 1.3 | 8.1 |



For additional information,
contact your Dart representative
or call (800) 248-5960

www.dartcontainer.com

DART CONTAINER CORPORATION

The Industry Standard of Excellence

Mason, Michigan 48854 U.S.A.

Ph: (800) 248-5960 • Fax: (517) 676-3883

Email: sales@dart.biz • www.dartcontainer.com





Style Setter®

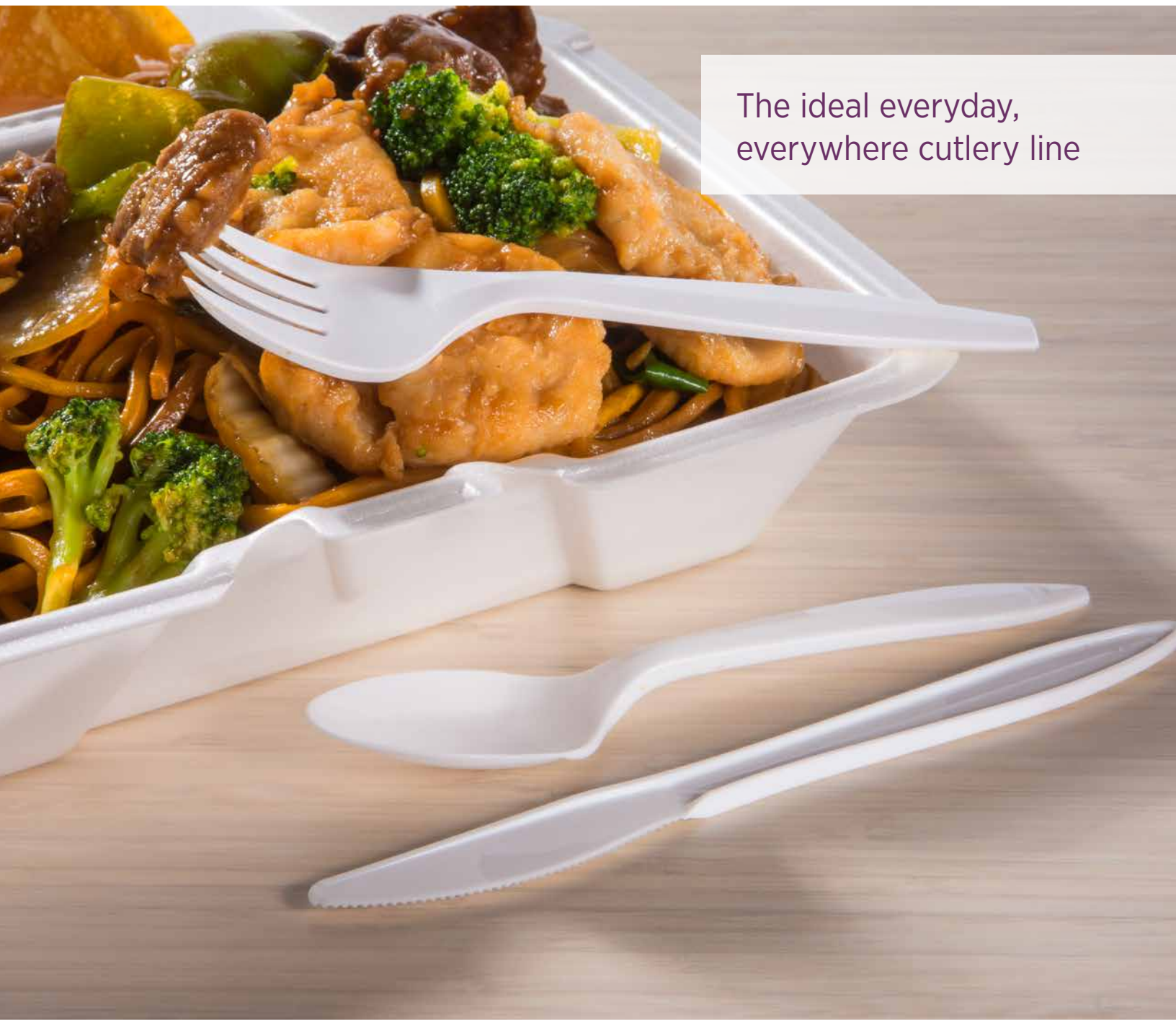

The ideal everyday,
everywhere cutlery line

Style Setter® Medium-Weight Polypropylene Cutlery

- **Standard length and size** — perfect fit for takeout or casual on-premise dining
- **Made from durable polypropylene** - virtually unbreakable and heat resistant
- **Economical**





Features

Ribbed tines
adds strength and functionality

Reinforced neck
adds strength and performance

Serrated edge
makes cutting easy

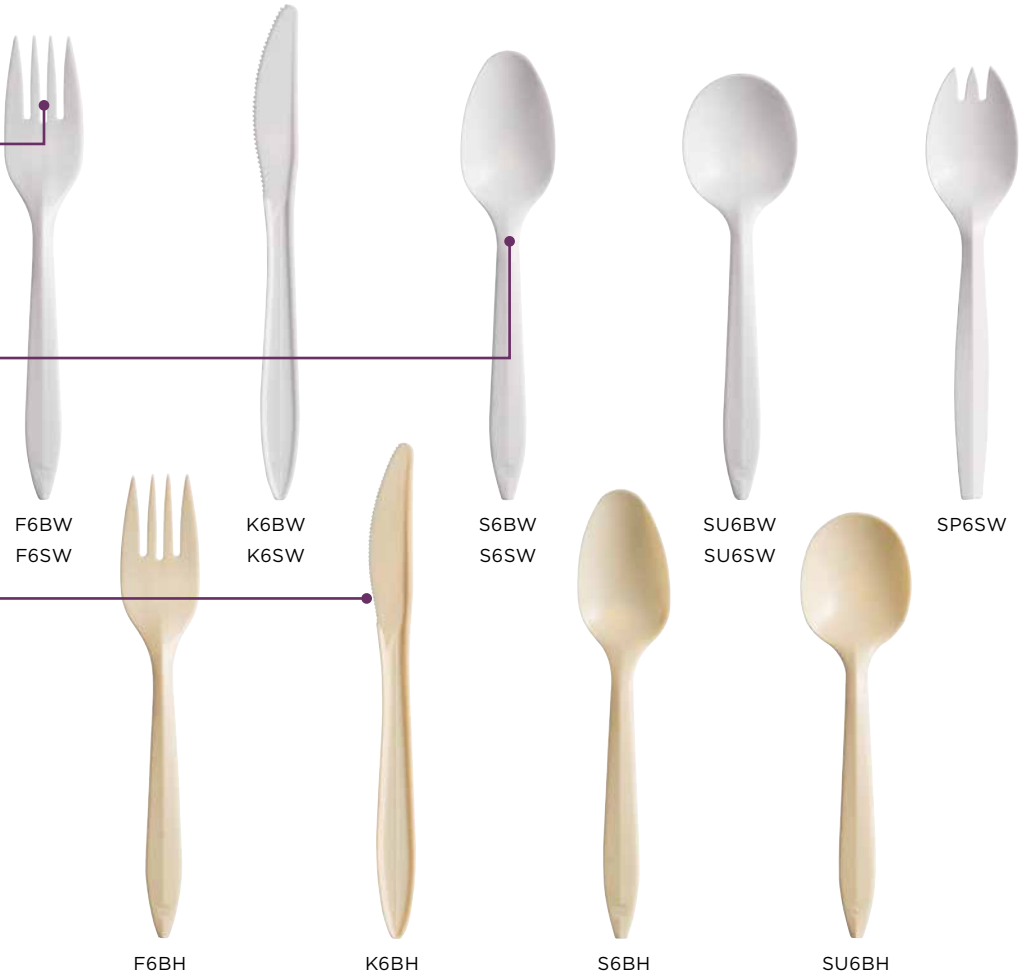

| Stock Number | Description | Color | Utensil Length (in) | Packing Case | Case Cube (ft ³) | Case Weight (lb) |
|---|-------------|--------|---------------------|--------------|------------------------------|------------------|
| Style Setter® Medium-Weight Polypropylene Cutlery — Non-Oriented Bulk | | | | | | |
| F6BW | Fork | White | 6.1 | 1000 | 1.3 | 6.3 |
| K6BW | Knife | White | 6.5 | 1000 | 0.6 | 6.6 |
| S6BW | Teaspoon | White | 5.9 | 1000 | 1.3 | 6.3 |
| SU6BW | Soup Spoon | White | 5.6 | 1000 | 1.3 | 6.6 |
| F6BH | Fork | Honey® | 6.1 | 1000 | 1.3 | 6.3 |
| K6BH | Knife | Honey® | 6.5 | 1000 | 0.6 | 6.6 |
| S6BH | Teaspoon | Honey® | 5.9 | 1000 | 1.3 | 6.3 |
| SU6BH | Soup Spoon | Honey® | 5.6 | 1000 | 1.3 | 6.6 |
| Style Setter® Medium-Weight Polypropylene Cutlery — Semi-Oriented Bulk | | | | | | |
| F6SW | Fork | White | 6.1 | 1000 | 0.8 | 5.7 |
| K6SW | Knife | White | 6.5 | 1000 | 0.4 | 6.4 |
| S6SW | Teaspoon | White | 5.9 | 1000 | 0.8 | 5.9 |
| SU6SW | Soup Spoon | White | 5.6 | 1000 | 0.8 | 6.2 |
| SP6SW* | Spork | White | 5.7 | 1000 | 0.5 | 7.0 |

* Item not made in the USA.



For additional information,
contact your Dart representative
or call (800) 248-5960

www.dartcontainer.com

DART CONTAINER CORPORATION

The Industry Standard of Excellence

Mason, Michigan 48854 U.S.A.

Ph: (800) 248-5960 • Fax: (517) 676-3883

Email: sales@dart.biz • www.dartcontainer.com



PRINTED ON RECYCLED PAPER



The practical choice
cutlery line

Bonus[®] Light Weight Polypropylene Cutlery

- **Reduced length and size** – perfect fit for small containers or petite desserts or tastings
- **Long-handled soda spoon** – ideal for ice cream, smoothies and other frozen drinks
- **Made of durable polypropylene** – virtually unbreakable and heat-resistant
- **Economical**





BONUS[®]

Features

Reinforced neck
adds strength and performance

Serrated edge
makes cutting easy

Stylized handle
provides added strength and easy use

Long-handled spoon
ideal for use with frozen desserts

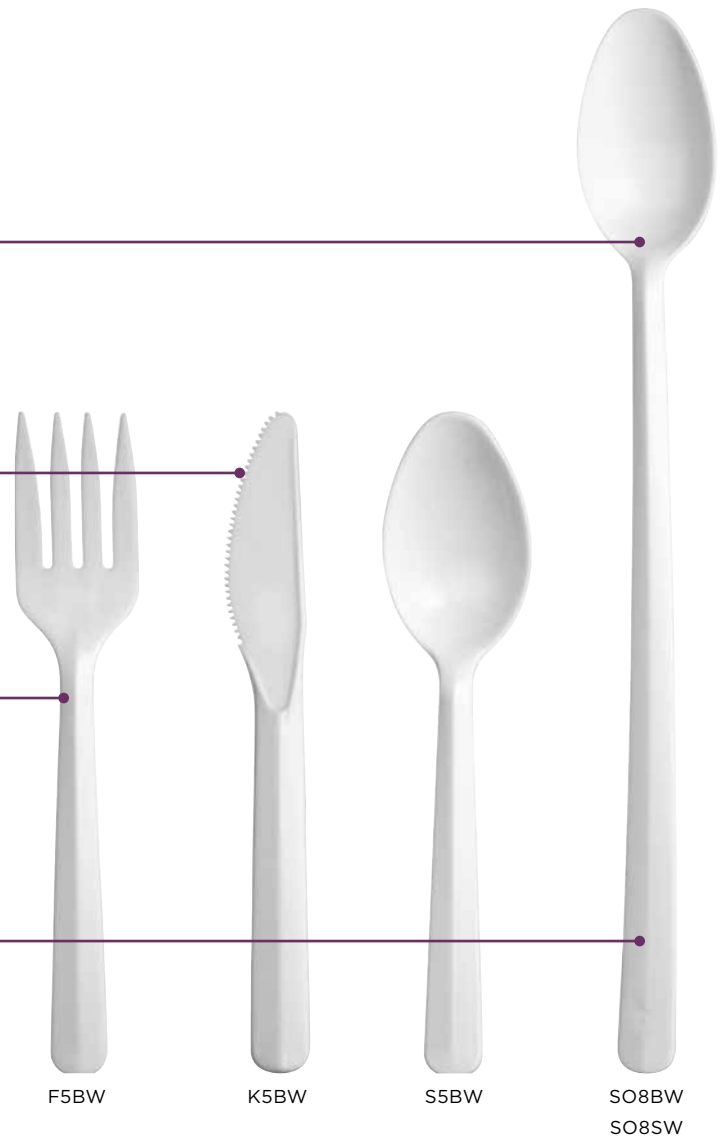

| Stock Number | Description | Color | Utensil Length (in) | Packing Case | Case Cube (ft ³) | Case Weight (lb) |
|--|-------------|-------|---------------------|--------------|------------------------------|------------------|
| Bonus[®] Light Weight Polypropylene Cutlery — Non-Oriented Bulk | | | | | | |
| F5BW | Fork | White | 5.0 | 1000 | 0.9 | 4.4 |
| K5BW | Knife | White | 5.0 | 1000 | 0.4 | 3.3 |
| S5BW | Teaspoon | White | 5.0 | 1000 | 0.9 | 4.8 |
| SO8BW | Soda Spoon | White | 8.0 | 1000 | 1.6 | 7.0 |
| Bonus[®] Light Weight Polypropylene Cutlery — Semi-Oriented Bulk | | | | | | |
| SO8SW | Soda Spoon | White | 8.0 | 1000 | 0.8 | 6.7 |



For additional information,
contact your Dart representative
or call (800) 248-5960

www.dartcontainer.com

DART CONTAINER CORPORATION

The Industry Standard of Excellence

Mason, Michigan 48854 U.S.A.

Ph: (800) 248-5960 • Fax: (517) 676-3883

Email: sales@dart.biz • www.dartcontainer.com





PERMANENT FLATWARE'S NEW RIVAL.

Premium look and performance

- Look and performance of permanent flatware, designer styling with textured handles
- Full length and size—perfect for steakhouse takeout, catering and other high-end meal service occasions
- Classic design retains legacy Sweetheart[®] features and quality





WHEN ONLY THE
BEST WILL DO

Guildware® Cutlery

EXTRA HEAVY WEIGHT POLYSTYRENE



BULK



BOXED

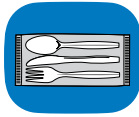

KITS

MATERIAL

Extra heavy weight polystyrene

SIZE

Full length

PIECES

Fork, knife, teaspoon, soup spoon

COLORS

Black, white, clear, champagne

PACKAGING

Bulk, boxed, kits

KEY FEATURES

Full length, textured handles with classic superior strength

Product Specifications

BULK

| Item | Description | Pack Case | Case Wt (lbs.) | Case Dimensions (in.) | Case Cube (cu. ft.) | Pallet TiHi |
|-------------|-------------------|-----------|----------------|-----------------------|---------------------|-------------|
| GDR5FK-0004 | Black Fork | 1M | 18.0 | 15.7 x 10.3 x 8.4 | 0.8 | 10/5 |
| GDR6KN-0004 | Black Knife | 1M | 17.0 | 13.3 x 8.3 x 10.4 | 0.7 | 15/4 |
| GDR7TS-0004 | Black Teaspoon | 1M | 11.5 | 12.8 x 8.8 x 8.6 | 0.6 | 16/5 |
| GDR8SS-0004 | Black Soup Spoon | 1M | 13.0 | 12.9 x 8.3 x 10.1 | 0.6 | 16/4 |
| GD5FW-0007 | White Fork | 1M | 18.0 | 15.7 x 10.3 x 8.4 | 0.8 | 10/5 |
| GD6KW-0007 | White Knife | 1M | 17.5 | 13.3 x 8.3 x 10.4 | 0.7 | 15/4 |
| GD7TW-0007 | White Teaspoon | 1M | 11.5 | 12.8 x 8.8 x 8.6 | 0.6 | 16/5 |
| GD8SW-0007 | White Soup Spoon | 1M | 13.0 | 12.9 x 8.3 x 10.1 | 0.6 | 16/4 |
| GDC5FK-0090 | Clear Fork | 1M | 18.0 | 15.7 x 10.3 x 8.4 | 0.8 | 10/5 |
| GDC6KN-0090 | Clear Knife | 1M | 17.5 | 13.3 x 8.3 x 10.4 | 0.7 | 15/4 |
| GDC7TS-0090 | Clear Teaspoon | 1M | 11.5 | 12.8 x 8.8 x 8.6 | 0.6 | 16/5 |
| GDC8SS-0090 | Clear Soup Spoon | 1M | 13.0 | 12.9 x 8.3 x 10.1 | 0.6 | 16/4 |
| GD5FK-0019 | Champagne Fork | 1M | 18.0 | 15.7 x 10.3 x 8.4 | 0.8 | 10/5 |
| GD6KN-0019 | Champagne Knife | 1M | 17.0 | 13.3 x 8.3 x 10.4 | 0.7 | 15/4 |
| GD7TS-0019 | Champ. Teaspoon | 1M | 11.5 | 12.8 x 8.8 x 8.6 | 0.6 | 16/5 |
| GD8SS-0019 | Champ. Soup Spoon | 1M | 13.0 | 12.9 x 8.3 x 10.1 | 0.6 | 16/4 |

BOXED

| Item | Description | Pack Case | Case Wt (lbs.) | Case Dimensions (in.) | Case Cube (cu. ft.) | Pallet TiHi |
|-------------|-------------------|-----------|----------------|-----------------------|---------------------|-------------|
| GBX5FW-0007 | White Fork | 1M | 20.0 | 15.1 x 10.4 x 9.3 | 0.8 | 10/5 |
| GBX6KW-0007 | White Knife | 1M | 20.0 | 14.1 x 8.2 x 11.0 | 0.7 | 15/4 |
| GBX7TW-0007 | White Teaspoon | 1M | 12.5 | 13.1 x 8.2 x 9.8 | 0.6 | 16/4 |
| GBX8SW-0007 | White Soup Spoon | 1M | 14.5 | 12.2 x 8.2 x 11.2 | 0.6 | 16/4 |
| GBX5FK-0019 | Champagne Fork | 1M | 20.0 | 15.1 x 10.4 x 9.3 | 0.8 | 10/5 |
| GBX6KN-0019 | Champagne Knife | 1M | 20.0 | 14.1 x 8.2 x 11.0 | 0.7 | 15/4 |
| GBX7TS-0019 | Champ. Teaspoon | 1M | 12.5 | 13.1 x 8.2 x 9.8 | 0.6 | 16/4 |
| GBX8SS-0019 | Champ. Soup Spoon | 1M | 14.5 | 12.2 x 8.2 x 11.2 | 0.6 | 16/4 |

KITS

| Item | Description | Pack Case | Case Wt (lbs.) | Case Dimensions (in.) | Case Cube (cu. ft.) | Pallet TiHi |
|------------|-------------------|-----------|----------------|-----------------------|---------------------|-------------|
| GDKFS-0019 | Champagne F-K-Tsp | 500 | 27.0 | 23.4 x 12.4 x 12.9 | 2.2 | 6/3 |

SPICE IT UP!

Guildware® adds a finishing touch to every meal occasion.



For additional information, contact your Solo representative or call 1-800-367-2877

www.solocup.com



Impress™
Heavy Weight Polystyrene Cutlery



STRONGER, BETTER, AFFORDABLY PRICED.

Upscale cutlery—for less

- Designed and optimized strength-to-weight ratio for superior performance, preferred 60:40 over industry leader per in-house operator survey
- Full length and size—optimal proportions for high-end takeout and upscale meal service
- Interchangeable styling with Reliance™
- Four colors that tie in with any color scheme





SUPERIOR STRENGTH THAT
BEATS THE COMPETITION

Impress™ Cutlery
HEAVY WEIGHT POLYSTYRENE



ORIENTED BULK

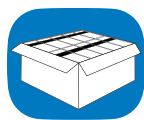

BOXED

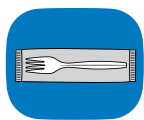

INDIVIDUALLY
WRAPPED

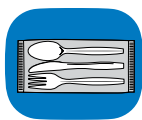

KITS

| | |
|--------------|---|
| MATERIAL | Heavy weight polystyrene |
| SIZE | Full length |
| PIECES | Fork, knife, teaspoon, soup spoon |
| COLORS | Black, white, clear, champagne |
| PACKAGING | Oriented bulk, boxed, individually wrapped, kits |
| KEY FEATURES | Superior strength, new shape and textured handles |

Product Specifications

| Item | Description | Pack Case | Case Wt (lbs.) | Case Dimensions (in.) | Case Cube (ft³) | Pallet TiHi |
|-----------------------------|--|-----------|----------------|-----------------------|-----------------|-------------|
| ORIENTED BULK | | | | | | |
| HSKF-0004 | Black Fork | 1M | 14.2 | 16.7 × 8.2 × 11.8 | 0.9 | 15/4 |
| HSKK-0004 | Black Knife | 1M | 14.0 | 15.7 × 8.4 × 7.3 | 0.6 | 15/6 |
| HSKT-0004 | Black Teaspoon | 1M | 10.4 | 17.2 × 7.2 × 11.5 | 0.8 | 15/4 |
| HSKS-0004 | Black Soup Spoon | 1M | 10.5 | 19.8 × 9.2 × 8.0 | 0.8 | 10/5 |
| HSWF-0007 | White Fork | 1M | 14.2 | 16.7 × 8.2 × 11.8 | 0.9 | 15/4 |
| HSWK-0007 | White Knife | 1M | 14.0 | 15.7 × 8.4 × 7.3 | 0.6 | 15/6 |
| HSWT-0007 | White Teaspoon | 1M | 10.4 | 17.2 × 7.2 × 11.5 | 0.8 | 15/4 |
| HSWS-0007 | White Soup Spoon | 1M | 10.5 | 19.8 × 9.2 × 8.0 | 0.8 | 10/5 |
| HSCF-0090 | Clear Fork | 1M | 14.2 | 16.7 × 8.2 × 11.8 | 0.9 | 15/4 |
| HSCK-0090 | Clear Knife | 1M | 14.0 | 15.7 × 8.4 × 7.3 | 0.6 | 15/6 |
| HSCT-0090 | Clear Teaspoon | 1M | 10.4 | 17.2 × 7.2 × 11.5 | 0.8 | 15/4 |
| HSCS-0090 | Clear Soup Spoon | 1M | 10.5 | 19.8 × 9.2 × 8.0 | 0.8 | 10/5 |
| HSAF-0019 | Champagne Fork | 1M | 14.2 | 16.7 × 8.2 × 11.8 | 0.9 | 15/4 |
| HS AK-0019 | Champagne Knife | 1M | 14.0 | 15.7 × 8.4 × 7.3 | 0.6 | 15/6 |
| HSAT-0019 | Champ. Teaspoon | 1M | 10.4 | 17.2 × 7.2 × 11.5 | 0.8 | 15/4 |
| HSAS-0019 | Champ. Soup Spoon | 1M | 10.5 | 19.8 × 9.2 × 8.0 | 0.8 | 10/5 |
| BOXED | | | | | | |
| HSKFX-0004 | Black Fork | 1M | 14.2 | 16.7 × 8.2 × 11.8 | 0.9 | 15/4 |
| HSKKX-0004 | Black Knife | 1M | 14.0 | 15.7 × 8.4 × 7.3 | 0.6 | 15/6 |
| HSKTX-0004 | Black Teaspoon | 1M | 10.4 | 17.2 × 7.2 × 11.5 | 0.8 | 15/4 |
| HSWFX-0007 | White Fork | 1M | 14.2 | 16.7 × 8.2 × 11.8 | 0.9 | 15/4 |
| HSWKX-0007 | White Knife | 1M | 14.0 | 15.7 × 8.4 × 7.3 | 0.6 | 15/6 |
| HSWTX-0007 | White Teaspoon | 1M | 10.4 | 17.2 × 7.2 × 11.5 | 0.8 | 15/4 |
| HSWSX-0007 | White Soup Spoon | 1M | 10.5 | 19.8 × 9.2 × 8.0 | 0.8 | 10/5 |
| HSCFX-0090 | Clear Fork | 1M | 14.2 | 16.7 × 8.2 × 11.8 | 0.9 | 15/4 |
| HSCKX-0090 | Clear Knife | 1M | 14.0 | 15.7 × 8.4 × 7.3 | 0.6 | 15/6 |
| HSCTX-0090 | Clear Teaspoon | 1M | 10.4 | 17.2 × 7.2 × 11.5 | 0.8 | 15/4 |
| HSAFX-0019 | Champagne Fork | 1M | 14.2 | 16.7 × 8.2 × 11.8 | 0.9 | 15/4 |
| HS AKX-0019 | Champagne Knife | 1M | 14.0 | 15.7 × 8.4 × 7.3 | 0.6 | 15/6 |
| HSATX-0019 | Champ. Teaspoon | 1M | 10.4 | 17.2 × 7.2 × 11.5 | 0.8 | 15/4 |
| INDIVIDUALLY WRAPPED | | | | | | |
| HSK1-0004 | Black Fork | 1M | 17.3 | 16.7 × 9.2 × 20.8 | 1.8 | 12/4 |
| HSK2-0004 | Black Knife | 1M | 16.7 | 15.7 × 8.4 × 11.8 | 0.9 | 15/4 |
| HSK3-0004 | Black Teaspoon | 1M | 13.2 | 16.9 × 8.2 × 17.5 | 1.4 | 15/5 |
| HSK4-0004 | Black Soup Spoon | 1M | 13.2 | 16.9 × 9.7 × 15.5 | 1.5 | 12/3 |
| HSW1-0007 | White Fork | 1M | 17.3 | 16.7 × 9.2 × 20.8 | 1.8 | 12/4 |
| HSW2-0007 | White Knife | 1M | 16.7 | 15.7 × 8.4 × 11.8 | 0.9 | 15/4 |
| HSW3-0007 | White Teaspoon | 1M | 13.2 | 16.9 × 8.2 × 17.5 | 1.4 | 15/5 |
| HSW4-0007 | White Soup Spoon | 1M | 13.2 | 16.9 × 9.7 × 15.5 | 1.5 | 12/3 |
| HSA1-0019 | Champagne Fork | 1M | 17.3 | 16.7 × 9.2 × 20.8 | 1.8 | 12/4 |
| HSA2-0019 | Champagne Knife | 1M | 16.7 | 15.7 × 8.4 × 11.8 | 0.9 | 15/4 |
| HSA3-0019 | Champ. Teaspoon | 1M | 13.2 | 16.9 × 8.2 × 17.5 | 1.4 | 15/5 |
| HSA4-0019 | Champ. Soup Spoon | 1M | 13.2 | 16.9 × 9.7 × 15.5 | 1.5 | 12/3 |
| KITS | | | | | | |
| HSK18Y-0004 | Black Fork, Knife, Napkin | 250 | 9.9 | 15.9 × 8.4 × 11.4 | 0.9 | 12/4 |
| HSK8Y-0004 | Black Fork, Knife, Teaspoon, Napkin, Salt & Pepper | 250 | 13.6 | 15.9 × 8.4 × 15.3 | 1.2 | 12/3 |



For additional information,
contact your Dart representative
or call 1-800-367-2877

www.dart.biz