

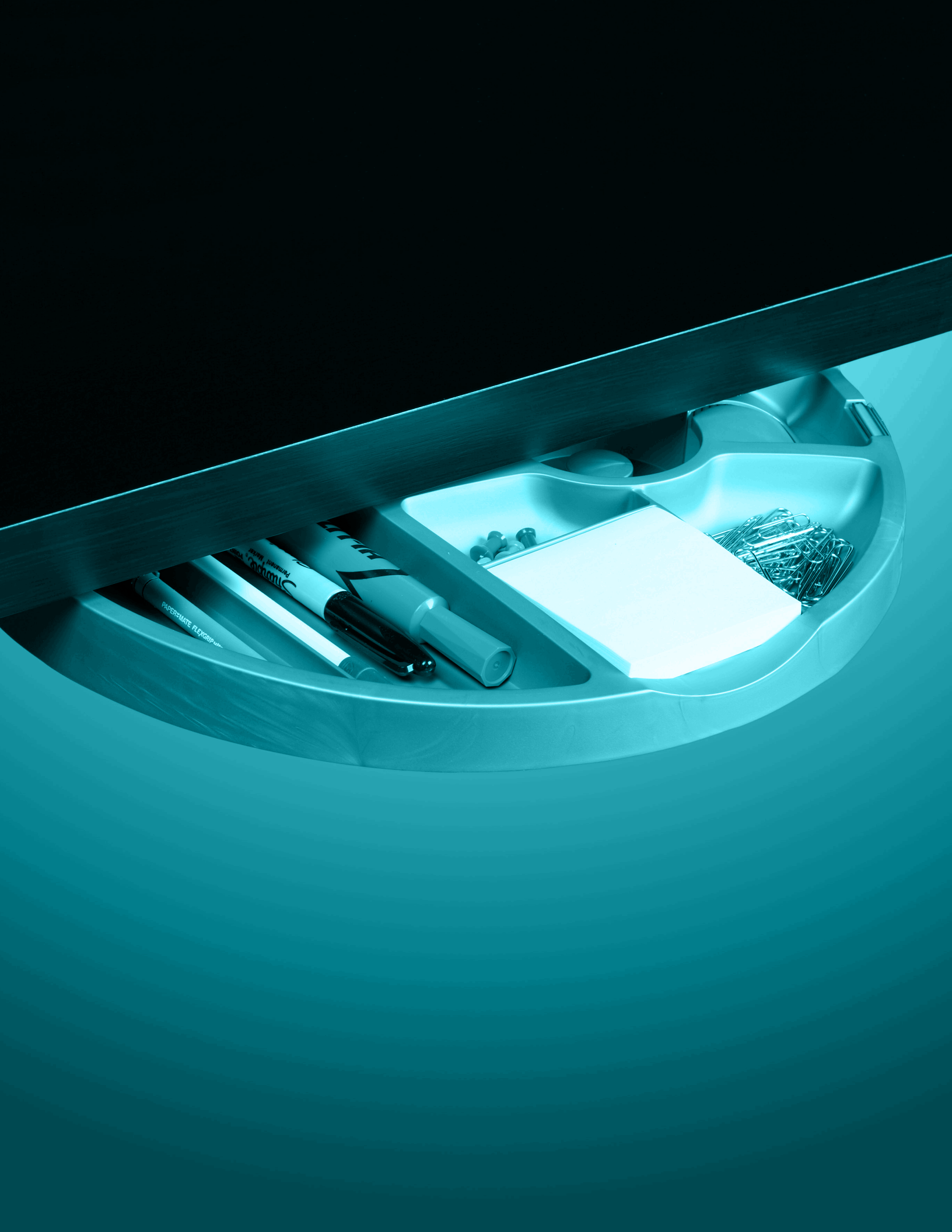





2015 Product Catalog





Contents

-  **GROMMETS.....04**
-  **VERSALOGIC POWER PRODUCTS12**
-  **WIRE MANAGEMENT.....20**
-  **TABLE CONNECTORS & ACCESSORIES32**
-  **BELOW THE DESK STORAGE.....46**
-  **ABOVE THE DESK STORAGE.....56**
-  **GLOSSARY OF PRODUCTS.....70**
-  **ORDERING INFORMATION71**



Innovation

The Custom Accents® grommet collection is designed to help facilitate the flow of wires and cords around the desktop and work areas. Streamline the desk or work station with this extensive selection of grommets. Telephone wires, computer and keyboard cables, desk lighting cords, laptop wires, cell phone / tablet cables, and video component cables are easily managed and controlled. By eliminating wire clutter, office and home environments become neater, safer, and more efficient.

Shown Here

Gland Ring Grommet



GROMMETS

Neatly coordinate wires at the desktop and working surfaces



GROMMETS

Neatly coordinate wires at the desktop and working surfaces



WIRE GROMMET



This unique three-piece wire grommet allows for adjustable hole openings. The wire grommet is offered in three different sizes and several different color options. Ideal for workspaces with computers and various electronics, this grommet can easily handle multiple data, power, and peripheral cables, as well as phone, fax, and coaxial lines. The 50mm Wire Grommet is ideal for smaller spaces with a single computer, whereas the 60mm and 80mm Wire Grommet is ideal for multiple computers and electronics. The adjustable top allows cables to be fed through from any direction while the size of the opening can be adjusted to free up more space or tighten to secure the cables.

Custom colors are available upon request.

50MM WIRE GROMMET

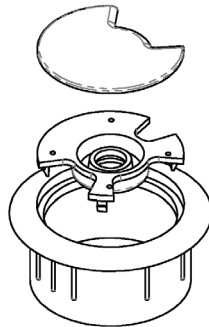
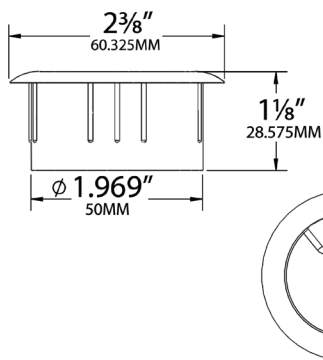

PARTS / CARTON	PART NO.	COLOR
100	CPF-2500	BLACK
100	CPF-2501	WHITE
100	CPF-2502	BROWN
100	CPF-2503	GRAY
100	CPF-2504	ALMOND
100	CPF-2506	BEIGE
100	CPF-2507	BATTLESHIP GRAY
100	CPF-2512	STUDIO GRAY
100	CPF-2517	LIGHT SLATE

60MM WIRE GROMMET

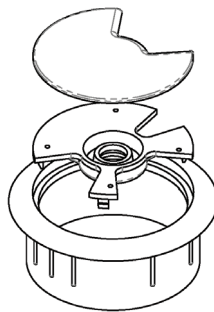
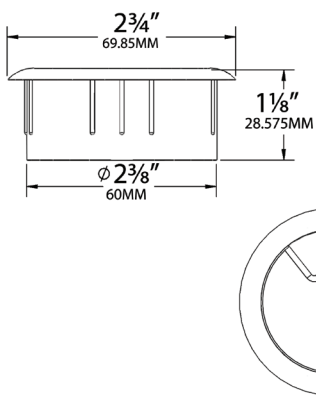

PARTS / CARTON	PART NO.	COLOR
100	CPF-2600	BLACK
100	CPF-2601	WHITE
100	CPF-2602	BROWN
100	CPF-2603	GRAY
100	CPF-2604	ALMOND
100	CPF-2606	BEIGE
100	CPF-2607	BATTLESHIP GRAY
100	CPF-2610	SLATE GRAY
100	CPF-2612	STUDIO GRAY
100	CPF-2617	LIGHT SLATE
100	CPF-2623	SILVER

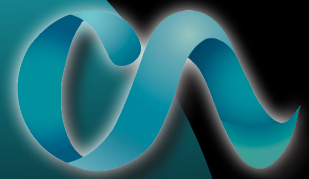

PARTS / CARTON	PART NO.	COLOR
100	CPF-2800	BLACK
100	CPF-2801	WHITE
100	CPF-2802	BROWN
100	CPF-2803	GRAY
100	CPF-2804	ALMOND
100	CPF-2806	BEIGE
100	CPF-2807	BATTLESHIP GRAY
100	CPF-2810	SLATE GRAY
100	CPF-2812	STUDIO GRAY
100	CPF-2817	LIGHT SLATE
100	CPF-2823	SILVER

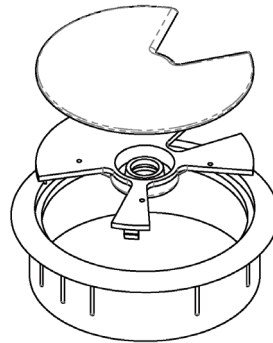

80MM WIRE GROMMET

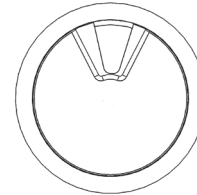
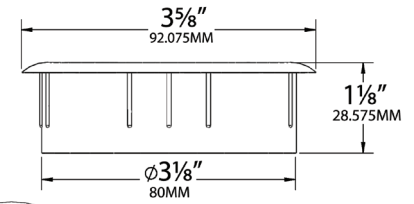

FLEXIGROM® WIRE GROMMET



The Flexigrom® Wire Grommet features a flexible top that allows multiple wires to be fed from any direction. This grommet also features a one-piece construction that eliminates lost covers or pieces. The soft top is safe for all wires and cables that are fed through the grommet, and will easily allow movement through the grommet without causing damage, while providing a firm grip that will prevent the wires and cables from falling down when not in use.



Custom colors are available upon request.

Patent Number: D443, 811

PARTS / CARTON	PART NO.	COLOR
100	CPF-2670	BLACK
100	CPF-2671	WHITE
100	CPF-2672	BROWN
100	CPF-2673	GRAY
100	CPF-2674	ALMOND
100	CPF-2676	BEIGE
100	CPF-2677	SILVER METALLIC

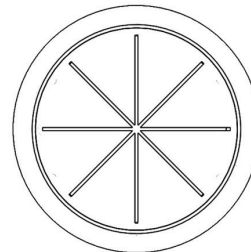

60MM FLEXIGROM®

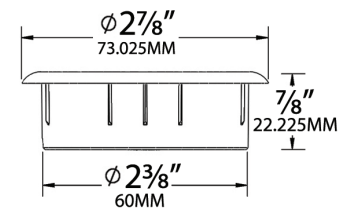

PARTS / CARTON	PART NO.	COLOR
100	CPF-2870	BLACK
100	CPF-2871	WHITE
100	CPF-2872	BROWN
100	CPF-2873	GRAY
100	CPF-2874	ALMOND
100	CPF-2876	BEIGE
100	CPF-2877	SILVER METALLIC

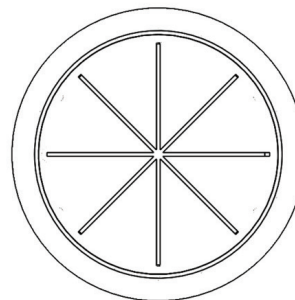

80MM FLEXIGROM®

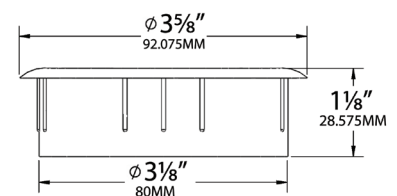



GROMMETS

Neatly coordinate wires at the desktop and working surfaces

OVAL GROMMET



Excellent for multiple work centers, the Oval Grommet is designed with the same unique three-piece top as the wire grommet and allows for adjustable openings.

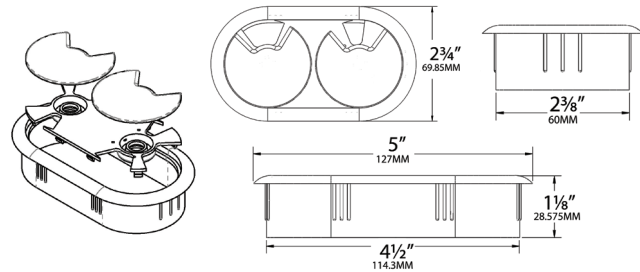

DESCRIPTION	PARTS / CARTON	PART NO.	COLOR
OVAL GROMMET	100	CPF-2900	BLACK

STORAGE GROMMET



Designed with wire management in mind, the Storage Grommet helps organize wires as well as commonly used office supplies. This Storage Grommet has one opening for wires and four compartments to store pens, scissors, paper clips, and business cards.

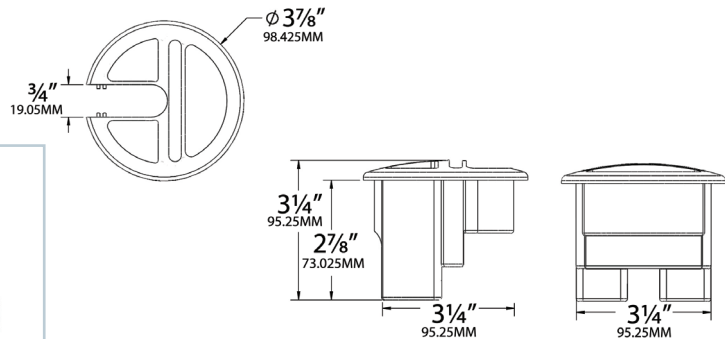

DESCRIPTION	PARTS / CARTON	PART NO.	COLOR
83.8MM STORAGE GROMMET	100	CPF-KF8865	BLACK

PAPER SLOT GROMMET

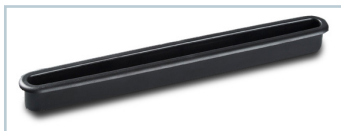

Paper Slot Grommets are designed to be used in either commercial or consumer sized tractor-feed computer printer stands. These grommets have a slightly outward bow, which assists in keeping grommets in place after installation.

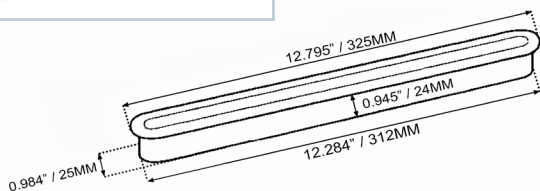

DESCRIPTION	PARTS / CARTON	PART NO.	COLOR
PAPER SLOT GROMMET	100	CPF-21500	BLACK

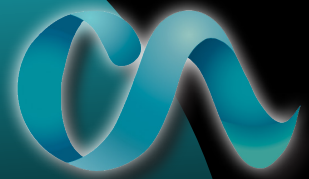

GLAND RING GROMMET

The Gland Ring Grommet fits standard 60mm (2.362") holes and knockouts. This grommet is designed to cover both sides of a vertical panel in order to cover any visual raw wood surfaces. The front section is a two-piece design with a hole cover, and the rear section is an open ring.



DESCRIPTION	PARTS / CARTON	PART NO.	COLOR
60MM GLAND RING GROMMET	100	CPF-2678	BLACK

EXECUTIVE GROMMET COLLECTION

The Executive Grommet Collection offered by Custom Accents® is a compilation of sleek metal and plastic cable grommets that give any workstation the functionality of cable management as well as an elegant and beautiful design. This collection is offered in both 60mm and 80mm sizes. Accent executive desks and conference tables with this smart and sophisticated grommet collection to bring a sense of refined style to any workstation.



80MM EXECUTIVE METAL DONUT GROMMET

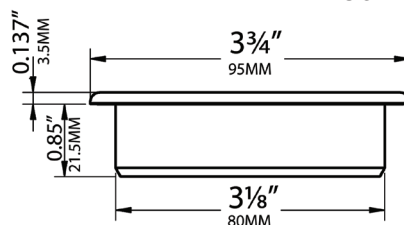
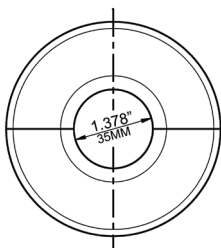

DESCRIPTION	PARTS / CARTON	PART NO.	COLOR
80MM EXECUTIVE METAL DONUT GROMMET	1	CPF-04-80-30-CV	MATTE CHROME





GROMMETS

Neatly coordinate wires at the desktop and working surfaces

60MM EXECUTIVE METAL ROUND GROMMET

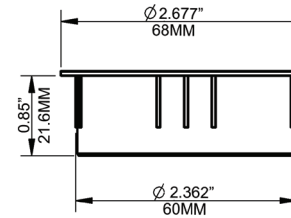
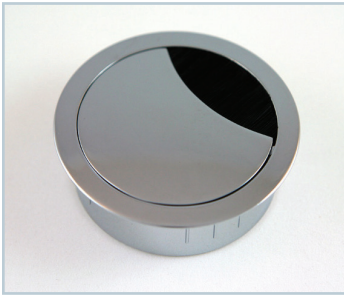

DESCRIPTION	PARTS / CARTON	PART NO.	COLOR
60MM EXECUTIVE METAL ROUND GROMMET	1	CPF-04-60-22-CL	POLISHED CHROME
	1	CPF-04-60-22-NS	SATIN NICKEL
	1	CPF-04-60-22-IN	STAINLESS STEEL

80MM EXECUTIVE METAL ROUND GROMMET

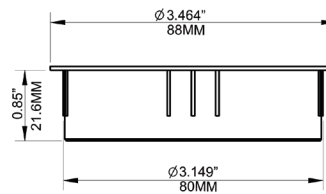
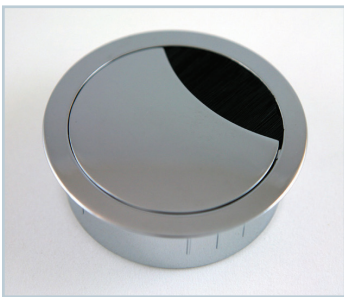

DESCRIPTION	PARTS / CARTON	PART NO.	COLOR
80MM EXECUTIVE METAL ROUND GROMMET	1	CPF-04-80-22-CL	POLISHED CHROME
	1	CPF-04-80-22-NS	SATIN NICKEL
	1	CPF-04-80-22-IN	STAINLESS STEEL

80MM CARRÉ PLASTIC GROMMET

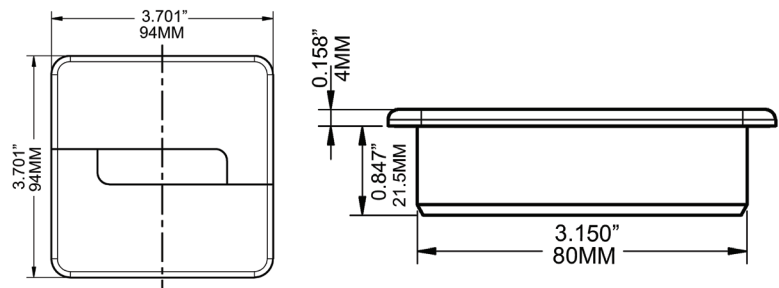

DESCRIPTION	PARTS / CARTON	PART NO.	COLOR
80MM CARRÉ PLASTIC GROMMET	50	CPF-03-80-30-ALV	VARNISHED ALUMINUM
	50	CPF-03-80-30-CL	POLISHED CHROME

80MM DONUT PLASTIC GROMMET

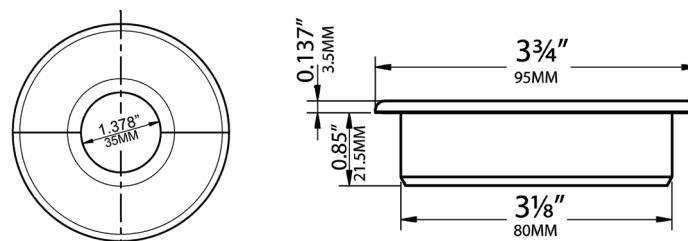

DESCRIPTION	PARTS / CARTON	PART NO.	COLOR
80MM DONUT PLASTIC GROMMET	50	CPF-03-80-31-ALV	VARNISHED ALUMINUM
	50	CPF-03-80-31-CL	POLISHED CHROME

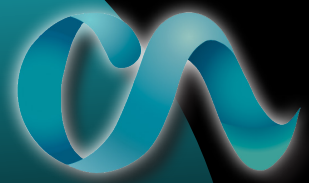

80MM GV PLASTIC GROMMET

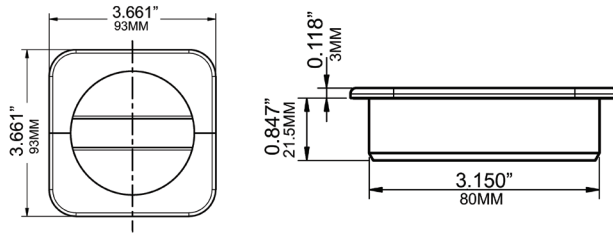

DESCRIPTION	PARTS / CARTON	PART NO.	COLOR
80MM GV PLASTIC GROMMET	50	CPF-03-80-32-ALV	VARNISHED ALUMINUM
80MM GV PLASTIC GROMMET W/ BRUSH	50	CPF-03-80-33-ALV	VARNISHED ALUMINUM
	50	CPF-03-80-33-BK	BLACK

EXIT EDGE GROMMET SERIES



These modern over-sized grommets are constructed out of polished aluminum, enhanced with a soft close feature, and finished with a chemical zero coating. This wire management accessory offers architects and designers elegance without compromising functionality and durability, setting a new standard for modern office environments.

The Exit Edge grommets include a neutral-colored brush for covering and managing the cables when installed.

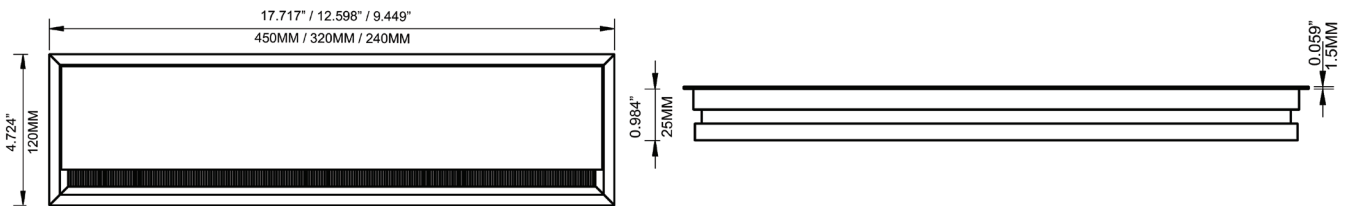
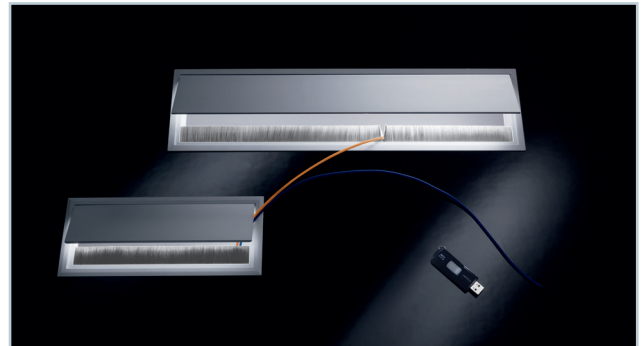

DESCRIPTION	PARTS / CARTON	PART NO.	COLOR
25MM X 120MM X 240MM (.984" X 4.724" X 9.449")	1	CPF-03-EX251224-AL	POLISHED ALUMINUM
25MM X 120MM X 320MM (.984" X 4.724" X 12.598")	1	CPF-03-EX251232-AL	POLISHED ALUMINUM
25MM X 120MM X 450MM (.984" X 4.724" X 17.717")	1	CPF-03-EX251245-AL	POLISHED ALUMINUM



Powerful

The VersaLOGIC line offers a collection of high-capacity electrical systems designed for the most demanding client where aesthetics are paramount. These power systems are ideal for multiple applications with a range of configurations and socket systems. The benefit of these systems is they provide power to the work surface conveniently and beautifully.

Shown Here
VersaPAD

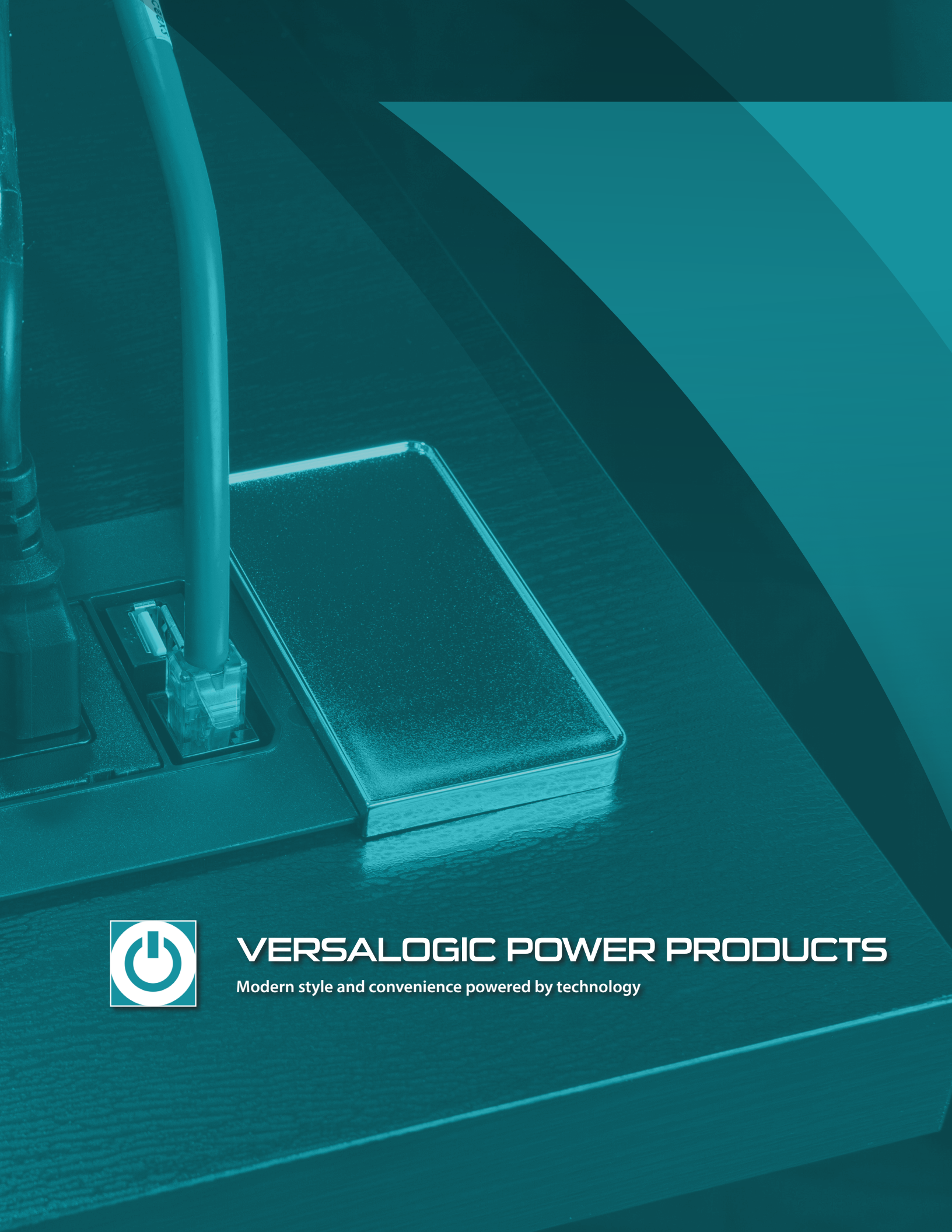

VERSALOGIC POWER PRODUCTS

Modern style and convenience powered by technology



VERSALOGIC POWER PRODUCTS

Modern style and convenience powered by technology

VERSAPAD



The VersaPAD is a compact and fully customizable grommet power system. Designed to fit in a standard 80mm diameter hole, the VersaPAD allows a selective use of the power socket or data connection, thanks to the sliding covers.

The highly customizable design of the cover makes the VersaPAD suitable for many environments such as lounge areas, kitchens, offices, hotel rooms, and many more.

Choose your cover color, as well as an additional coupler if desired.

The power cord comes attached to the power module.

PICTURE	DESCRIPTION	PARTS / CARTON	PART NO.	COLOR
	POWER MODULE, 1 POWER PLUG, 1 5V POWERED USB	1	CPF-03VI8-3-DNR-1	BLACK
1.A	VERSAPAD COVER	1	CPF-03VI8-9-UNR	BLACK
1.B	VERSAPAD COVER	1	CPF-03VI8-9-UBN	WHITE
1.C	VERSAPAD COVER	1	CPF-03VI8-9-UIIN	BRUSHED ALUMINUM
1.D	VERSAPAD COVER	1	CPF-03VI8-9-UICL	POLISHED CHROME
1.E	USB DATA COUPLER (NO POWER)	1	CPF-10VI99-21-NR	BLACK
1.F	HDMI COUPLER	1	CPF-10VI99-39-NR	BLACK
1.G	CAT 6 RJ45 COUPLER	1	CPF-10VI99-46-NR	

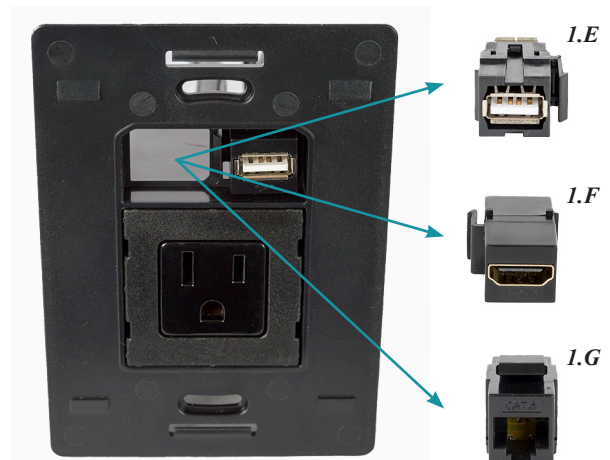
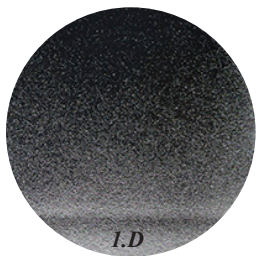
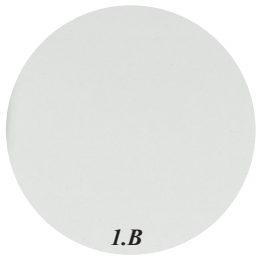

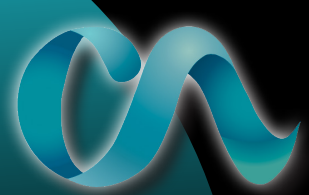

The VersaPULL is a unique power system that installs into an 80mm hole and simply pulls up to extend access to power plugs and data ports. When not in use, the VersaPULL can retract down into the desktop or surface to reduce clutter and provide as much usable space as possible.

The VersaPULL is offered with RJ45 Cat 6 ethernet connections and optional 5V USB connections for charging portable devices. Perfect for the home office, executive office, conference rooms, schools, libraries, and much more.

*A two meter long power cord is available for this product.
Part number: PF-03-VI9-3-02-NR02.*



DESCRIPTION	PARTS / CARTON	PART NO.	COLOR
VERSAPULL, 2 SOCKETS, 2 RJ45 CAT 6	1	CPF-03-VI6-3-02-AL	ALUMINUM COVER
VERSAPULL, 2 SOCKETS, 2 RJ45 CAT 6	1	CPF-03-VI6-3-02-NNR	BLACK COVER
VERSAPULL, 2 SOCKETS, 1 RJ45 CAT 6, 1 5V USB	1	CPF-03-VI6-3-78-NR	ALUMINUM COVER
VERSAPULL, 2 SOCKETS, 1 RJ45 CAT 6, 1 5V USB	1	CPF-03-VI6-3-78-NNR	BLACK COVER

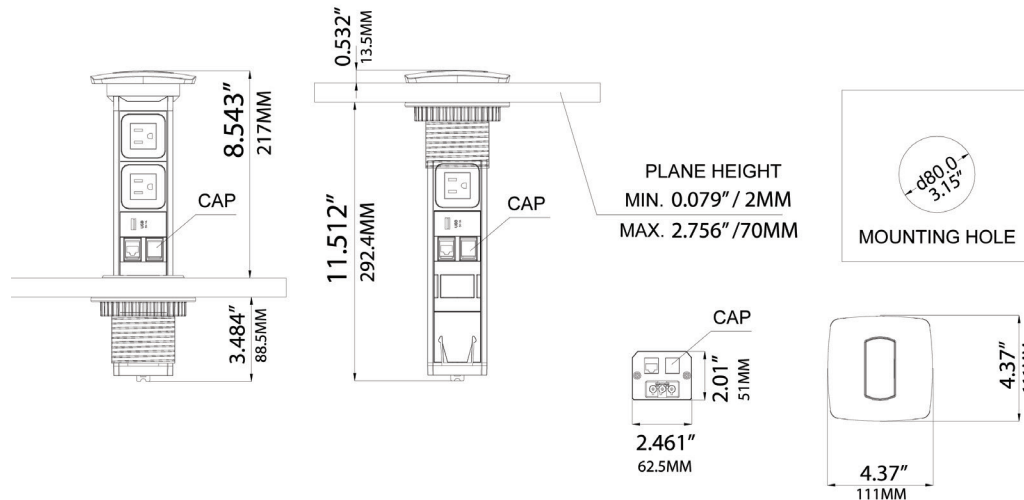

Office



Home



Great for the office and home!



VERSALOGIC POWER PRODUCTS

Modern style and convenience powered by technology



VERSATEK



The VersaTEK power module is the perfect power system that can be easily installed under the work surface or in a cabinet, keeping the wires and module out of sight. This allows the desktop to stay clear providing as much work area as possible.

In addition to the three standard power outlets, the VersaTEK comes with a RJ45 Cat 6 ethernet connection as well as a 5V USB connection for charging portable devices. Ideal for any workstation in offices, schools, libraries, as well as in the home office.

A two meter long POWER CORD is available for this product. Part number: CPF-03-VI9-3-02-NR02.

DESCRIPTION	PARTS / CARTON	PART NO.	COLOR
VERSATEK, 3 SOCKETS, 1 RJ45 CAT 6, 1 5V USB	1	CPF-03VI0-3-79-NR	ALUMINUM / BLACK

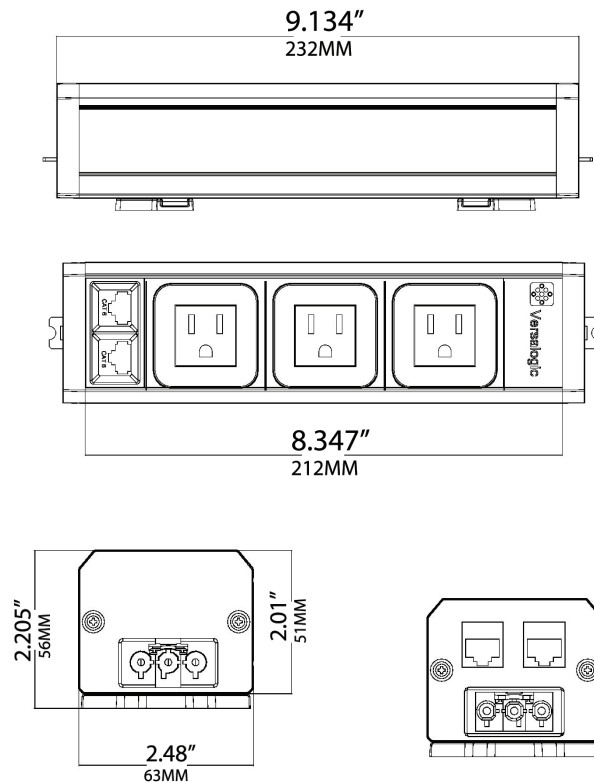

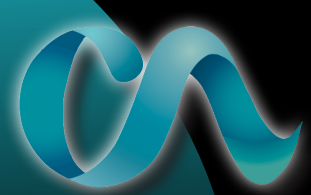

The VersaFLAP offers a beautifully styled exit edge complete with a below-surface power module mounted at a 45-degree angle to avoid damage from spilled liquids. Wires and plugs can easily be connected to the module while the cover of the VersaFLAP can be closed or left open, reducing clutter and increasing usable work space.

The VersaFLAP comes with two RJ45 Cat 6 ethernet connections as well as one 5V USB connection. Ideal for desktops and community tables at schools and libraries, as well as conference and hotel rooms.

A two meter long power cord is available for this product. Part number: CPF-03-VI9-3-02-NR02.

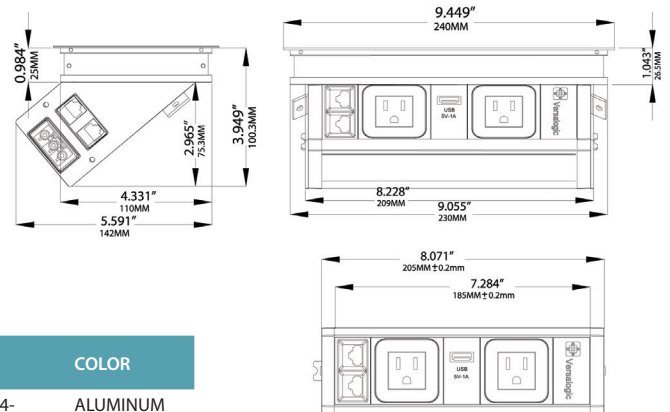
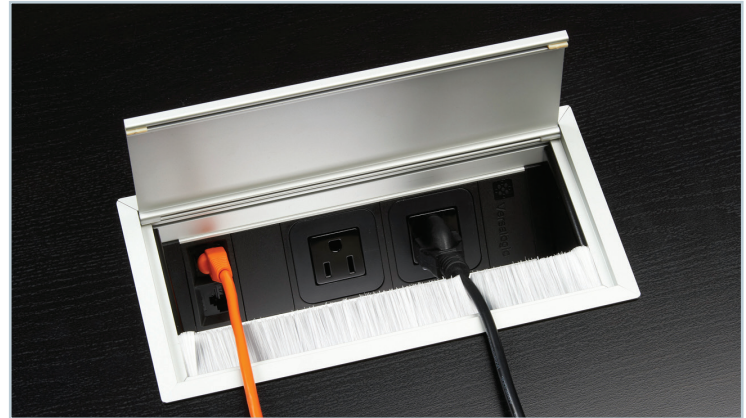

DESCRIPTION	PARTS / CARTON	PART NO.	COLOR
VERSAFLAP, 2 SOCKETS, 2 RJ45 CAT 6, 1 5V USB	1	CPF-03-EX251224-AL381NR	ALUMINUM / BLACK





VERSALOGIC POWER PRODUCTS

Modern style and convenience powered by technology

PULL UP POWER GROMMET



The Pull Up Power Grommet features an easy to use hide-away design allowing users to quickly and easily access both AC and USB charging ports. To access the power outlets, simply pull the unit up and it will lay flat allowing access to multiple power options. When not in use the unit sits flush with the work station. Ideal for conference rooms, workstations, hotel rooms, countertops, or anywhere else power access is needed.

Overall measures 2.86" in diameter and requires a 2.36" (60mm) hole.

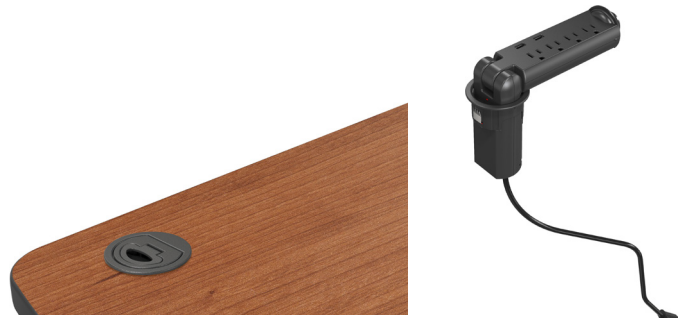

DESCRIPTION	PARTS / CARTON	PART NO.	COLOR
60MM PULL UP POWER GROMMET	1	CPF-66666	BLACK

ROUND POWER STATION



The Round Power Station is a heavy-duty metal unit with a flip-up cover. This Power Station comes complete with two grounded power outlets, one reset switch, two RJ45 Cat 5 jacks, two USB data ports, and a six foot power cord.

Installation is simple and only requires a 129mm mounting hole. Designed with a satin black finish, the Round Power Station is the perfect combination of style and functionality for desktops, furniture, and workstations.

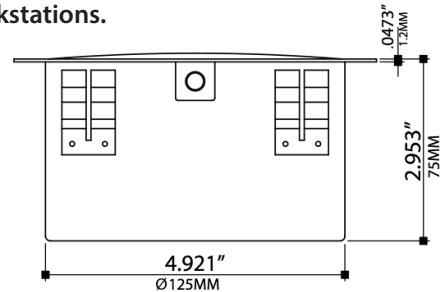

DESCRIPTION	PARTS / CARTON	PART NO.	COLOR
ROUND POWER STATION	16	CPF-88600	BLACK



*Beauty Where You Want It
Power Where You Need It*

The VersaPULL by Custom Accents®

Design

Managing wires is a necessity. Yet, it does not have to be at the cost of design. The Custom Accents® offerings of wire management products are attractive and functional. The epitome of form following function, these hip, sleek wire managers provide different ways to contain wires in unique styles.

Shown Here
Helix Cable Manager



WIRE MANAGEMENT

Organize and control wires from the floor to the work surface



WIRE MANAGEMENT

Organize and control wires from the floor to the work surface

CABLE SNAKE



The Cable Snake is a unique wire manager for controlling wires from the work surface to the floor. All wires are completely hidden and protected inside the Cable Snake; the wires are then fed out through the bottom at the foot enabling the user to plug them into a socket. It is highly flexible and can be used on stationary or height-adjustable desks and comes with the top mounting plate and foot.

The Cable Snake can also be purchased a la carte, enabling you to configure it how you would like.

It can be used with or without the Cable Trough (sold separately).

DESCRIPTION	PARTS / CARTON	PART NO.	COLOR
CABLE SNAKE, 720MM, 28.346"	16	CPF-46055A10	BLACK
CABLE SNAKE, 720MM, 28.346"	16	CPF-46055AB1	SILVER
CABLE SNAKE, 1300MM, 51.181"	12	CPF-46055B10	BLACK
CABLE SNAKE, 1300MM, 51.181"	12	CPF-46055BB1	SILVER
CABLE SNAKE TOP MOUNTING PLATE	12	CPF-46056A10	BLACK
CABLE SNAKE TOP MOUNTING PLATE	12	CPF-46056AB1	SILVER
CABLE SNAKE SINGLE ELEMENT	100	CPF-46056B10	BLACK
CABLE SNAKE SINGLE ELEMENT	100	CPF-46056BB1	SILVER
CABLE SNAKE FOOT	12	CPF-46056C10	BLACK
CABLE SNAKE FOOT	12	CPF-46056CB1	SILVER



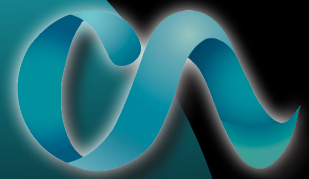

CABLE TROUGH 

The Cable Trough is an injection molded wiring duct made from high-impact glass-filled nylon and designed to be snapped together to create any length channel you need in 8" increments. It is also designed to be easily installed underneath a work surface by means of the Fold Fastening Set or to a vertical panel with the Wall Mounting Bracket. The Fold Fastening system allows the Cable Trough to be tilted in either direction so that you can easily access the cabling when necessary. Enclose the channel with the Cable Trough End Cap and guide the wires down to the floor using the snap-in Cable Snake (sold separately). The Cable Clamp can snap into the hole in the Trough for help in managing and securing the cables.



Special kit packaging available upon request.

PICTURE	DESCRIPTION	PARTS / CARTON	PART NO.	COLOR
1.A	CABLE TROUGH, 6" WIDE X 8" LENGTH	60	CPF-46052C10	BLACK
1.A	CABLE TROUGH, 6" WIDE X 8" LENGTH	60	CPF-46052CB1	SILVER
1.B	CABLE TROUGH WALL MOUNT BRACKET	50	CPF-46052D10	BLACK
1.B	CABLE TROUGH WALL MOUNT BRACKET	50	CPF-46052DB1	SILVER
1.C	CABLE TROUGH FOLD FASTENING SET	50	CPF-46053A10	BLACK
1.C	CABLE TROUGH FOLD FASTENING SET	50	CPF-46053AB1	SILVER
1.D	CABLE TROUGH END CAP	25	CPF-46056D10	BLACK
1.D	CABLE TROUGH END CAP	25	CPF-46056DB1	SILVER
1.E	CABLE TROUGH CABLE CLAMP	25	CPF-46053D10	BLACK

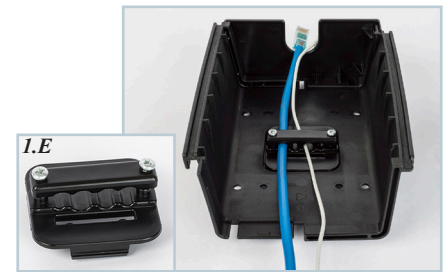



WIRE MANAGEMENT

Organize and control wires from the floor to the work surface

LATCH DUCT AND WIREMASTER CHANNELS

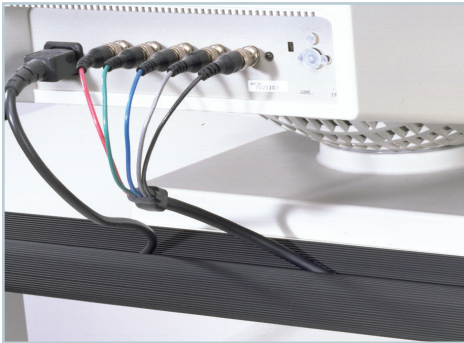

Easily organize wires and cables with these expertly designed cable channels. Extruded from the highest quality plastics, the Custom Accents® cable channels feature a simple design that provides wire management functionality to any work station. Each channel is available with double-sided 3M™ tape for easy installation and can be cut to size on-site to fit any desk length.

LATCH DUCT CHANNEL

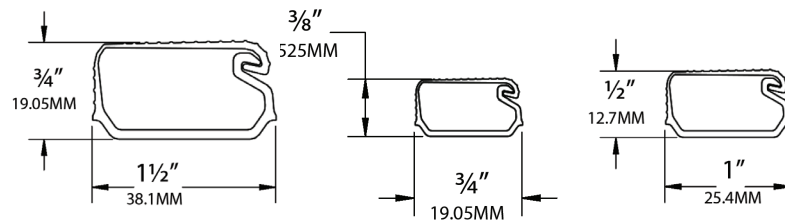
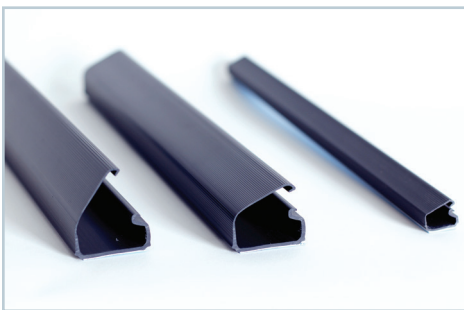

Features a living hinge that encloses the wires and snaps shut. Users can easily add and remove cables as their wire management needs change over time.

DESCRIPTION	PARTS / CARTON	PART NO.	COLOR
1 1/2" LATCH DUCT CHANNEL, 2.5 METERS	40	CPF-3100	BLACK
3/4" LATCH DUCT CHANNEL, 2.5 METERS	100	CPF-3300	BLACK
1" LATCH DUCT CHANNEL, 2.5 METERS	84	CPF-3500	BLACK

LATCH DUCT CLIP

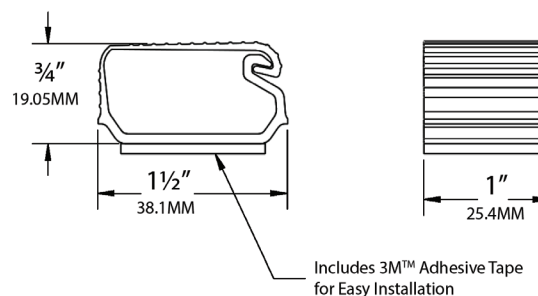

Allows use of smaller lengths in different configurations to keep wires hidden.

DESCRIPTION	PARTS / CARTON	PART NO.	COLOR
1 1/2" X 1" LATCH DUCT CLIP	1000	CPF-3110	BLACK

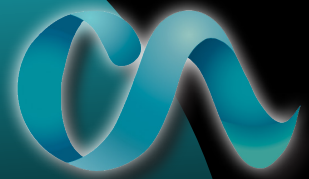

WIREMASTER J CHANNEL

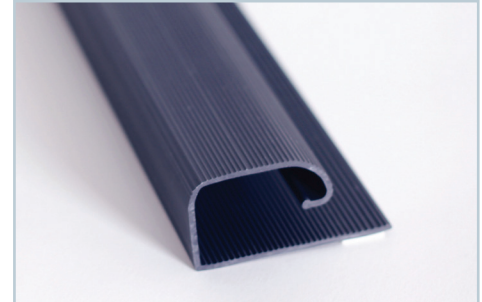
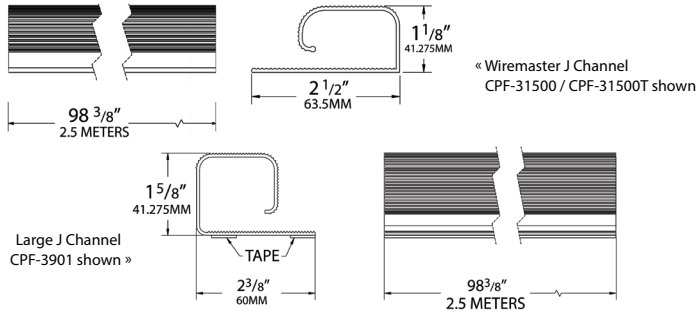

DESCRIPTION	PARTS / CARTON	PART NO.	COLOR
WIREMASTER J CHANNEL, 2.5M, W/TAPE	36	CPF-31500T	BLACK
WIREMASTER J CHANNEL, 2.5M, NO TAPE	36	CPF-31500	BLACK
LARGE J CHANNEL, 2.5M, W/TAPE	24	CPF-3901	BLACK

The Wiremaster channel sets the industry standard for simple, yet highly effective wire management hardware. Wires can easily be added and removed by the user. Upgrade to the Large size for additional wire capacity.

WIREWAY CHANNEL

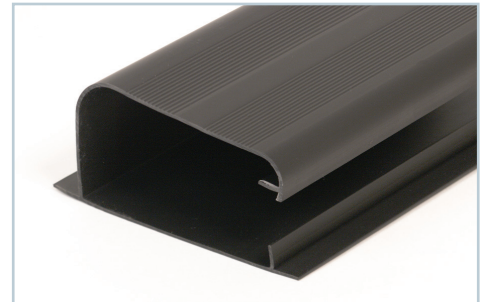
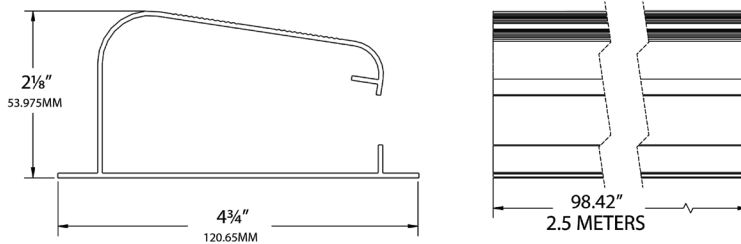

DESCRIPTION	PARTS / CARTON	PART NO.	COLOR
WIREWAY CHANNEL, 2.5M, NO TAPE	16	CPF-3990	BLACK

A modified version of the Wiremaster Channel, the Wireway Channel features an angled hinge to create additional storage space without increasing the product's footprint.





WIRE MANAGEMENT

Organize and control wires from the floor to the work surface



VERTEBRA WIRE MANAGER



The Vertebra is a beautifully designed oval spine wire management system that brings a sense of elegance to any work environment. It features a double-channel cable system enabling the separation of cords when required by code. Expands from the work surface to the floor and can be connected to a grommet or simply use the included clip to hang the product off the side of a workspace. A weighted base unit is attached to the vertebra system enhancing the product's stability. The modular design allows users to add or subtract individual vertebra as their wire management needs change over time. Each set includes fifteen (15) rings (ideal for 39" high work stations), one head clip, one edge clip, one clamp and two screws. Kits are individually packaged for easy resale.

DESCRIPTION	PARTS / CARTON	PART NO.	COLOR
VERTEBRA WIRE MANAGER KIT	15	CPF-03-77-01-AL	ALUMINUM
	15	CPF-03-77-01-CL	CHROME
	15	CPF-03-77-01-GF	GRAPHITE
	15	CPF-03-77-01-TR	TRANSLUCENT

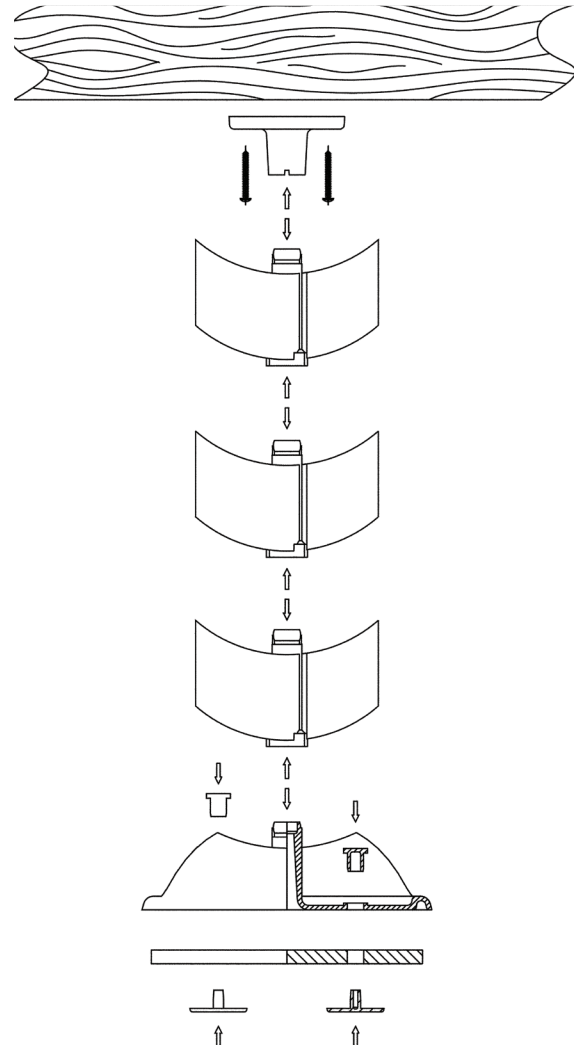

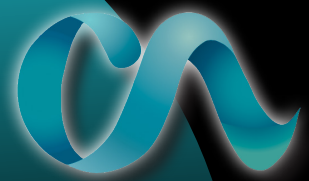

BRICK VERTEBRA 

The Brick Vertebra provides a casual and conventional looking wire management solution. Installing this unit throughout the work environment provides a modern and unified aesthetic. This product features two separate wire management channels so cables can be separated when required by code. Users can easily add and remove vertebra pieces to accommodate various work surface heights. Packaged as a kit containing fourteen (14) vertebra pieces (ideal for 39" high work stations), a foot piece, top mounting bracket, and installation hardware and instructions. Height adjustment range per kit is approximately 3.5". Kits are individually packaged for easy resale.



DESCRIPTION	PARTS / CARTON	PART NO.	COLOR
BRICK VERTEBRA WIRE MANAGER KIT	8	CPF-03-77-Q1-AL	ALUMINUM
	8	CPF-03-77-Q1-GF	GRAPHITE
	8	CPF-03-77-Q1-TR	TRANSLUCENT

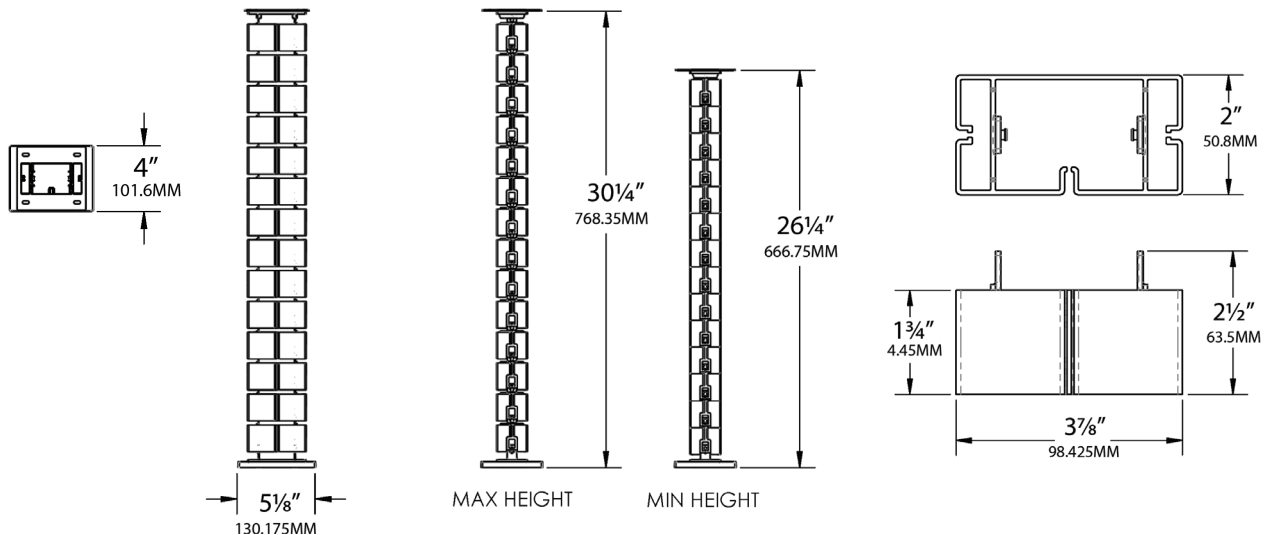



WIRE MANAGEMENT

Organize and control wires from the floor to the work surface



THE HELIX CABLE MANAGER

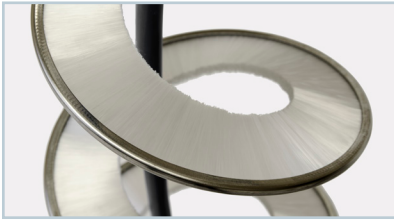

Impress your clients with one of the most stylish cable managers on the market. Ideal for both standard and sit-stand desks, this modern coil system has stainless steel rings impregnated with different color brushes to keep wires under control while adding an element of modern design to the home or work environment. The Helix is weighted by a smooth, shiny metal base and comes with mounting hardware.

DESCRIPTION	PICTURE	PARTS / CARTON	PART NO.	COLOR
HELIX CABLE MANAGER	1.A	1	CPF-03-77-H1-NN15-NT	BLACK CHROME / NEUTRAL BRUSH
	1.B	1	CPF-03-77-H1-B15-NT	WHITE / NEUTRAL BRUSH
	1.C	1	CPF-03-77-H1-CL15-NR	POLISHED CHROME / BLACK BRUSH
	1.D	1	CPF-03-77-H1-CL15-NT	POLISHED CHROME / NEUTRAL BRUSH

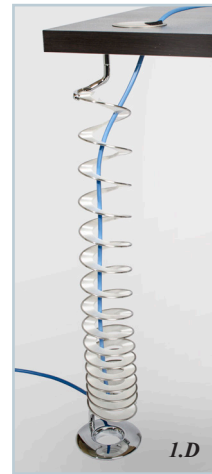
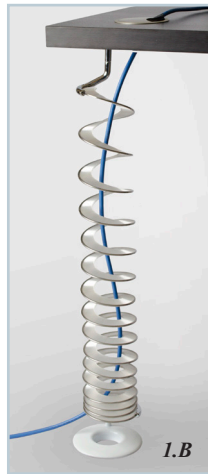
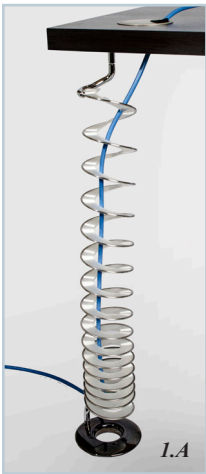

THE PASSACAVI CABLE MANAGER



The Passacavi Cable Manager is the definition of versatility. The flexible coil design allows for seamless wire management functionality for sit-stand desks as well as fixed height work surfaces. The simple yet elegant design allows for anyone to add wire management functionality to their work environment at an economical price. This unit is easy to install and can be detached quickly for routing cables. Manufactured from high-impact ABS material, the Passacavi Cable Manager is constructed to withstand the everyday abuses of home or commercial office spaces. Stylish, versatile, and economically priced, the Passacavi Cable manager is sure to excite your clients for years to come.

DESCRIPTION	PARTS / CARTON	PART NO.	COLOR
PASSACAVI CABLE MANAGER	1	CPF-663-00-02-00-00	BLACK
	1	CPF-663-00-71-00-00	SILVER



Organization Never Looked So Good

The Helix Cable Manager by Custom Accents®



WIRE MANAGEMENT

Organize and control wires from the floor to the work surface



CABLE GRIPS



The most unique cable manager on the market, the Custom Accents® Cable Grips feature an intelligent design that allows wires to slip into the unit and stay in place without the use of any accessories or adhesives. Place these grips anywhere you need to get wires under control, such as the bottom of the desktop, sides of work stations, walls, or even on top of a desk. Simple to install with only four screws, users can easily move the Cable Grips to different positions as their work environment changes.

CABLE GRIP 90MM X 65MM (3.543" X 2.559")

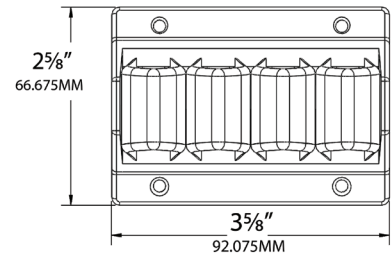
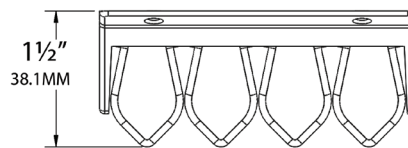
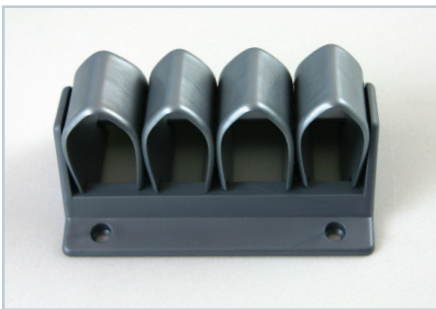

DESCRIPTION	PARTS / CARTON	PART NO.	COLOR
CABLE GRIP 90MM X 65MM (3.543" X 2.559")	150	CPF-03-30-02-NR	BLACK
	150	CPF-03-30-02-AL	ALUMINUM

CABLE GRIP 135MM X 65MM (5.315" X 2.559")

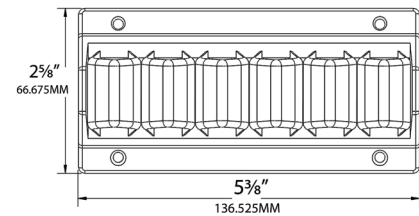
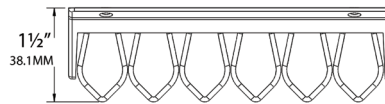

DESCRIPTION	PARTS / CARTON	PART NO.	COLOR
CABLE GRIP 135MM X 65MM (5.315" X 2.559")	100	CPF-03-30-01-NR	BLACK
	100	CPF-03-30-01-AL	ALUMINUM

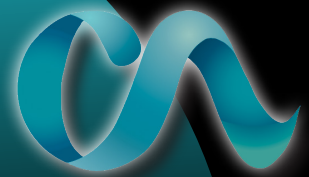

ROUND LEG CABLE CLIPS

The Round Leg Cable Clips are one of our most popular cable management solutions. These Round Leg Clips are available in three different sizes and come in three elegant finishes for enhanced aesthetic appeal. Simple to use and no installation hardware required, simply snap onto a table leg and start organizing wires. Your customers will love these as their position can always be adjusted and re-adjusted to fit the changing needs of the user.



CABLE CLIP FOR 50MM TO 60MM ROUND LEG

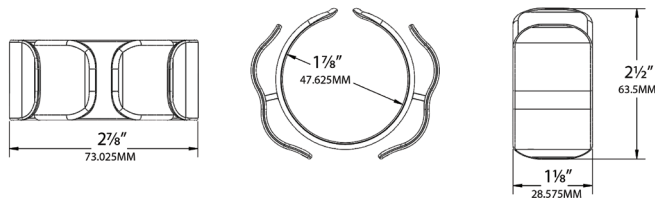

DESCRIPTION	PARTS / CARTON	PART NO.	COLOR
CABLE CLIP FOR 50MM TO 60MM ROUND LEG	100	CPF-03-CL-01-GF	GRAPHITE
	100	CPF-03-CL-01-AL	ALUMINUM
	100	CPF-03-CL-01-TR	TRANSLUCENT

CABLE CLIP FOR 35MM TO 40MM ROUND LEG

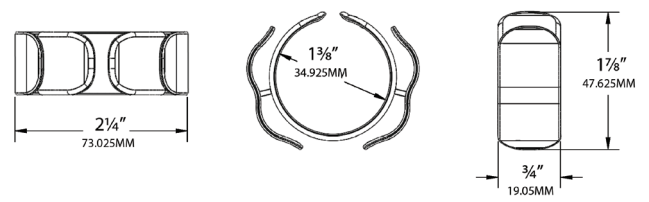

DESCRIPTION	PARTS / CARTON	PART NO.	COLOR
CABLE CLIP FOR 35MM TO 40MM ROUND LEG	100	CPF-03-CL-02-GF	GRAPHITE
	100	CPF-03-CL-02-AL	ALUMINUM
	100	CPF-03-CL-02-TR	TRANSLUCENT

CABLE CLIP FOR 70MM TO 80MM ROUND LEG

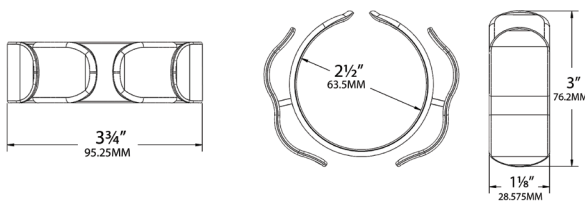

DESCRIPTION	PARTS / CARTON	PART NO.	COLOR
CABLE CLIP FOR 70MM TO 80MM ROUND LEG	100	CPF-03-CL-05-GF	GRAPHITE
	100	CPF-03-CL-05-AL	ALUMINUM
	100	CPF-03-CL-05-TL	TRANSLUCENT





Setting New Standards

Custom Accents® introduces a brand new product line from Plako®, a premier European furniture accessory manufacturer. Now providing an innovative table connector and accessory line, Custom Accents® continues to be at the forefront of the furniture design industry. All of the products being offered are manufactured using the highest quality materials and designed with functionality and style in mind.

Shown Here

Table Connectors Type “Lock”



TABLE CONNECTORS & ACCESSORIES

Intelligent and space-saving innovations for modern desk systems



TABLE CONNECTORS & ACCESSORIES

Intelligent and space-saving innovations for modern desk systems

TABLE CONNECTORS



Easily connect and disconnect tables and desks for simple room configurations.

Quick to install and built to last, these Table Connectors will provide clients with durability and functionality for years to come.

- Easily connect multiple desks or tables of any shape
- Seamless assembly and handling
- Ability to support a top without the use of legs
- Steel and plastic construction
- Low profile design
- High-load capacity
- No "male" or "female" parts

TABLE CONNECTOR TYPE "LOCK"

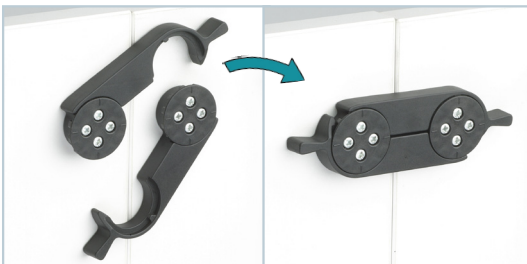

DESCRIPTION	PARTS / CARTON	PART NO.	COLOR
TABLE CONNECTOR TYPE "LOCK" 1 HALF-PART, RAL 9005	100	CPF-47900A10	BLACK
SCREW SPAX-S, PANHEAD 4X30MM (0.16" X 0.18")		CPF-Z4790101	

TABLE CONNECTOR TYPE "DIVIDE"

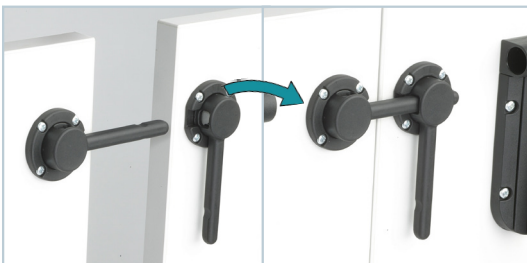

DESCRIPTION	PARTS / CARTON	PART NO.	COLOR
TABLE CONNECTOR TYPE "DIVIDE" 1 HALF-PART, RAL 9005	100	CPF-47905A10	BLACK
SCREW SPAX-S, PANHEAD 4X20MM (0.16" X 0.79")		CPF-Z4790501	

TABLE CONNECTOR TYPE "STEEL"

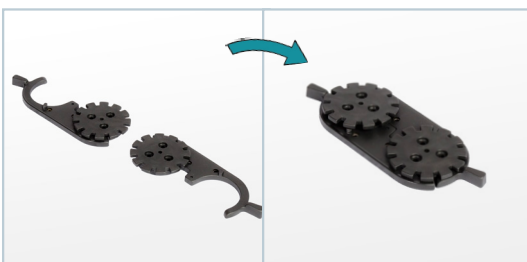

DESCRIPTION	PARTS / CARTON	PART NO.	COLOR
TABLE CONNECTOR TYPE "STEEL" 1 HALF-PART, RAL 9005	100	CPF-47901A10	BLACK
SCREW SPAX-S, PANHEAD 4.5X25MM (0.18" X 0.99")		CPF-Z4820101	

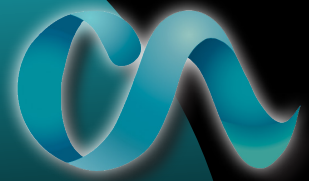

MODULE CONNECTORS 

With just a twist or a “click”, simply connect modular furniture in any configuration to form rows, groups, or unique seating formations.

Ideal for any communal seating area in residential, commercial, or educational settings.

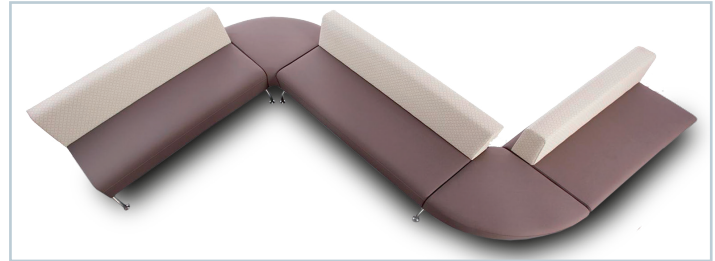

Universal connectors for upholstery, modules, and more

- Manufactured using high-quality nylon with no metallic or sharp edges
- Greatly reduces damage to upholstery and base unit
- Single component items - no separate male or female parts

Easily connected or disconnected by using integral handle.

360 degrees of connectivity.

DESCRIPTION	PARTS / CARTON	PART NO.	COLOR
MODULE CONNECTOR TYPE “LOCK” 120MM (4.73”) (1 FIXING PLATE + 1 HOOK), RAL 9005	80	CPF-47920A10	BLACK

SV-LOCK

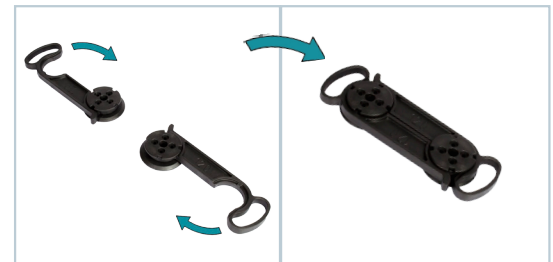

Ratcheted at 5mm (0.2”) increments.

Easily connected or disconnected by pushing or pulling components together or apart.

360 degrees of connectivity.

DESCRIPTION	PARTS / CARTON	PART NO.	COLOR
MODULE CONNECTOR TYPE “DIVIDE” 120MM (4.73”) (1 FIXING PLATE + 1 HOOK), RAL 9005	80	CPF-47921A10	BLACK

SV-DIVIDE

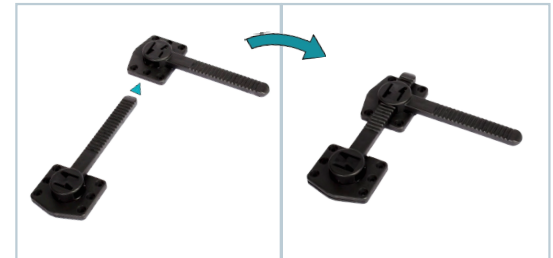



TABLE CONNECTORS & ACCESSORIES

Intelligent and space-saving innovations for modern desk systems

HAL-IR WHEEL



The most functional table wheel on the market.

The inner wheel fits firmly on the end of the table leg allowing the user to move the table or desk by tilting and rolling the unit with ease. Adding the glide cap (sold separately) allows the table to rest on a secure surface when stationary. With the wheel and the glide cap installed correctly, clients will never have to sacrifice mobility for style and functionality again.



PICTURE	DESCRIPTION	PARTS / CARTON	PART NO.	COLOR
1.A	HAL-IR ROLLE/WHEEL 40 X 40 X 2MM (1.58" X 1.58" X 0.08")	200	CPF-46026A10	BLACK
1.B	HAL-IR ROLLE/WHEEL 50 X 2MM (1.97" X 0.08")	200	CPF-46026F10	BLACK
1.C	HAL-IR GLIDE CAP, 40 X 40MM (1.58" X 1.58")	200	CPF-46027A10	BLACK
1.D	HAL-IR GLIDE CAP, 50 X 2MM (1.97" X 0.08")	200	CPF-46027D10	BLACK

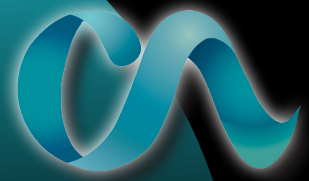

HAL-AR WHEEL / FOOT 

Make your furniture mobile.

The HAL-AR Wheel / Foot offers an easy way to make tables mobile by use of the wheel on one end of the furniture and the foot on the other. The foot end of the table is picked up and then moved on the wheels.

The product is designed to fit 50mm, 2" round or square legs.



PICTURE	DESCRIPTION	PARTS / CARTON	PART NO.	COLOR
	HAL-AR WHEEL, 50 X 50 X 2MM (1.97" X 1.97" X 0.08")	100	CPF-46028B10	BLACK
1.A	HAL-AR WHEEL, 50 X 2MM (1.97" X 0.08")	100	CPF-46028F10	BLACK
	HAL-AR FOOT, 50 X 50 X 2MM (1.97" X 1.97" X 0.08")	100	CPF-46029B10	BLACK
1.C	HAL-AR FOOT, 50 X 2MM (1.97" X 0.08")	100	CPF-46029F10	BLACK



TABLE CONNECTORS & ACCESSORIES

Intelligent and space-saving innovations for modern desk systems

MOS SYSTEM



Protect your customers' modular cabinet and chest units with the state-of-the-art MOS System.

Utilizing a combination of soft foam and high-impact plastic, this system adds a new element of protection for high-end storage furniture.

UFSLK Swivel Castor



UFPR Swivel Castor



Soft Frame

Offering optional soft-edge protection



2.B

Base Plate

Designed to fasten directly under the corpus

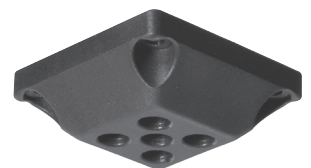

2.C

JIB 45 Degree Bumper

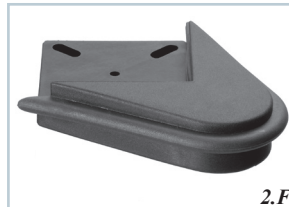

2.F

Metal Pin

For installation of the castor



2.A

PICTURE	DESCRIPTION	PARTS / CARTON	PART NO.	COLOR
2.A	METAL PIN BS21 10 X 51MM (0.39" X 2")	50	CPF-26201A99	BLACK
2.B	SOFT FRAME 84 X 84MM (3.31" X 3.31")	200	CPF-47002A06	BLACK / GRAY
2.C	BASE PLATE 70 X 70MM (2.76" X 2.76"), MOS SYSTEM RAL 9005	200	CPF-47001A10	BLACK
2.D	UFSLK 75 DOUBLE SWIVEL CASTOR W/ BRAKE, DIA. 10MM (0.39"), SOFT TREAD	200	CPF-09803A10	BLACK
2.E	UFPR 75 DOUBLE SWIVEL CASTOR W/ BRAKE, DIA. 10MM (0.39"), SOFT TREAD	200	CPF-10300A10	BLACK
2.F	MOS JIB 45 DEGREE SOFT BUMPER	100	CPF-47004B2C	BLACK

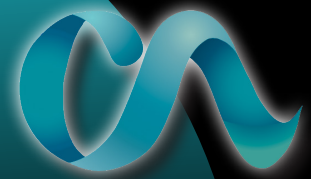

The MOS FIX product is designed for mobile carts for the protection of the furniture by use of the MOS bumper system. The foot-activated bar allows the end user to lock and unlock the cart by pushing or lifting the bar.

The aluminum bar can be cut to custom sizes to fit your cabinet size.

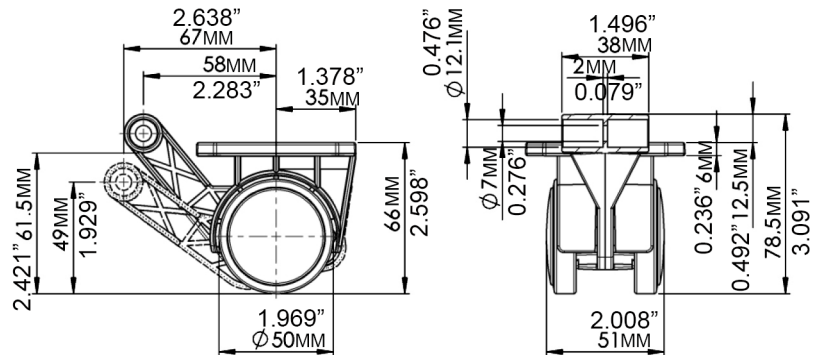
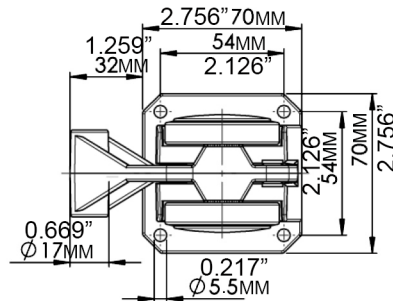
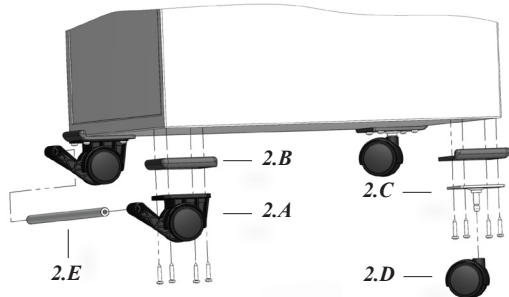
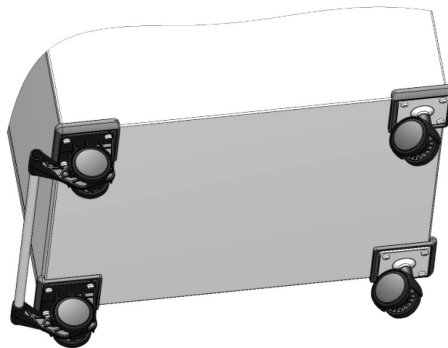
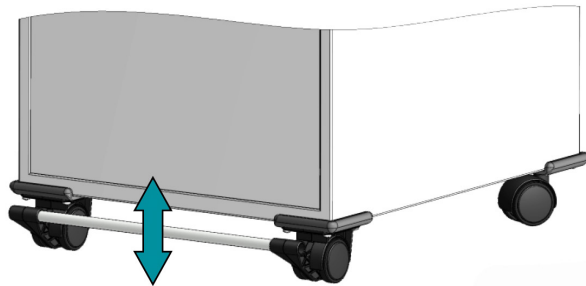

PICTURE	DESCRIPTION	PARTS / CARTON	PART NO.	COLOR
2.A	MOS FIX 50MM CASTOR W/ LOCK DEVICE	100	CPF-47006A10	BLACK
2.B	MOS SYSTEM SOFT FRAME 84 X 84MM (3.3\"/>			
2.C	MOS FIX METAL PLATE TYPE B 65 X 65 X 10MM (2.56\"/>			
2.D	MOS FIX UPR 50 DOUBLE SWIVEL CASTOR D10 SOFT TREAD	100	CPF-16100A10	BLACK
2.E	MOS FIX ALUMINUM TUBE 2920MM (115\"/>			



TABLE CONNECTORS & ACCESSORIES

Intelligent and space-saving innovations for modern desk systems

SYSTEM PANEL

The perfect removable modesty panel holder that also works with folding tables.

Neutral design.

Makes transport and service easier.

Easy assembly and disassembly with only one "click".

For wood, perforated plate, glass, and fabric.

SYSTEM PANEL FIX



SYSTEM PANEL FLEX



PICTURE	DESCRIPTION	PARTS / CARTON	PART NO.	COLOR
3.A	SYSTEM PANEL FIX, RAL 9005	80	CPF-48200A10	BLACK
3.B	SYSTEM PANEL FLEX, RAL 9005	80	CPF-48200B10	BLACK
3.C	SYSTEM PANEL SPACER, RAL 9005, H = 40MM (1.58")	80	CPF-48201A10	BLACK
	SCREW SPAX-S, PANHEAD 4.5 X 25MM (0.17" X 0.99")	80	CPF-Z4820101	

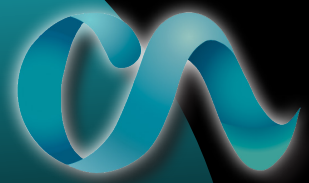

SYSTEM TOP 

Multiple connectors for over-the-desk screens, under-the-desk modesty panels, or between two desks. This multi-screen system has a neutral design ideal for any desk or table top system.

Simply Clamp and Go.

All System Top products are pre-assembled saving you installation time and providing your customers with a product that is easy to use with no small parts to misplace.

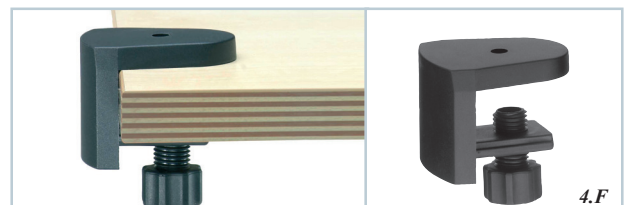
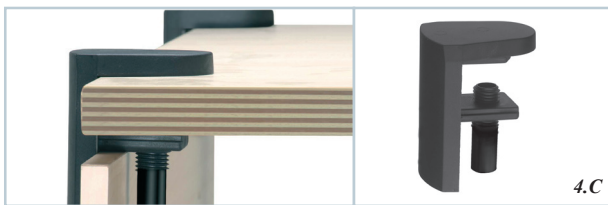
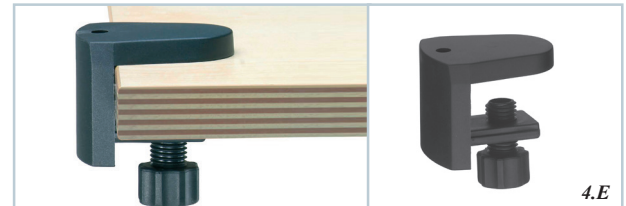
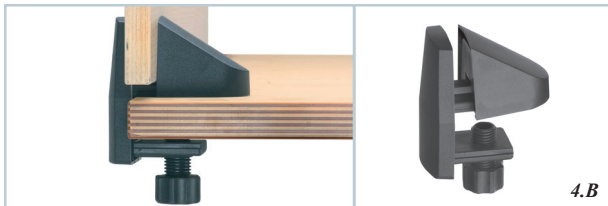
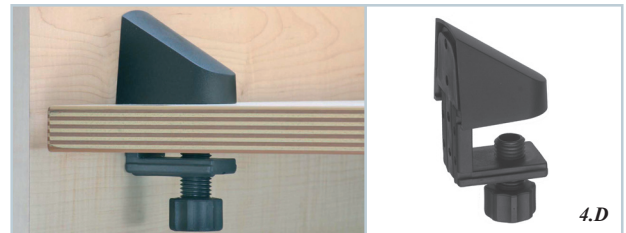
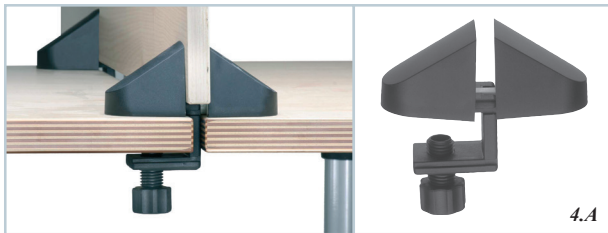

PICTURE	DESCRIPTION	PARTS / CARTON	PART NO.	COLOR
4.A	TOP-SYSTEM, SCREENHOLDER "CALL CENTER" CPLT. RAL 9005	10	CPF-47701A10	BLACK
4.B	TOP-SYSTEM, SCREENHOLDER "OVERDESK" CPLT. RAL 9005	10	CPF-47702A10	BLACK
4.C	TOP-SYSTEM, SCREENHOLDER "MODESTY" CPLT. RAL 9005	10	CPF-47703A10	BLACK
4.D	TOP-SYSTEM, SCREENHOLDER "MIDISCREEN" CPLT. RAL 9005	10	CPF-47704A10	BLACK
4.E	TOP-SYSTEM, SCREENHOLDER "PLUG-IN SCREEN" CPLT. RAL 9005	10	CPF-47705A10	BLACK
4.F	TOP-SYSTEM, SCREENHOLDER "TUBE HOLDER" CPLT. RAL 9005	10	CPF-47706A10	BLACK



TABLE CONNECTORS & ACCESSORIES

Intelligent and space-saving innovations for modern desk systems

TIP TOP FOLDING TABLE SYSTEM FULL KIT PACKAGES

The Tip Top System is an intelligent, space-saving folding desk and table system with an elegant design.

Ideal for conference areas, training areas, and desks.

The full kit includes all necessary components except for the table top.



5.A



5.A



5.A



5.B

PICTURE	DESCRIPTION	PARTS / CARTON	PART NO.	COLOR
5.A	TIP TOP STANDARD KIT, 1400MM (55.12")	1	CPF-47631A99	SILVER LEGS
5.A	TIP TOP STANDARD KIT, 1600MM (63")	1	CPF-47632A99	SILVER LEGS
5.A	TIP TOP STANDARD KIT, 1800MM (70.87")	1	CPF-47633A99	SILVER LEGS
5.B	TIP TOP 710 KIT, 1400MM (55.12")	1	CPF-48703A99B	BLACK LEGS
5.B	TIP TOP 710 KIT, 1600MM (63")	1	CPF-48704A99B	BLACK LEGS
5.B	TIP TOP 710 KIT, 1800MM (70.87")	1	CPF-48705A99B	BLACK LEGS

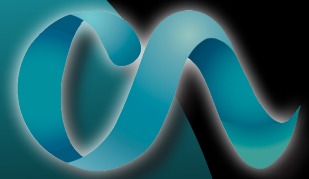

TIP TOP FOLDING TABLE SYSTEM ADAPTER PIECES



FOLDING LEG MECHANISMS



These heavy duty adapters allow you to take a standard round or square table leg and make it a folding leg.

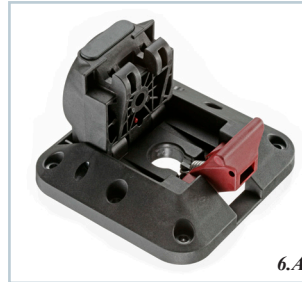

FIS 409 Table Adapter

Adapter for linking table leg and table top. The simple and robust release mechanism enables easy handling and a secure connection.

FIS Function Adapter

Suitable for foldable tables with a single column. Adjustable tilt from 0°-25°, foldable to 90°.

RELEASE KIT FOR TIP TOP TABLES



Designed to quickly and effortlessly release the table top when used with the Tip Top Table System.

Legs, castors, and release bar not included.

PICTURE	DESCRIPTION	PARTS / CARTON	PART NO.	COLOR
6.A	TABLE ADAPTER FIS 409 DIA 50MM (1.97") - USED WITH 50MM (2.00") ROUND	12	CPF-47530A10	BLACK, RED LEVEL
6.A	TABLE ADAPTER FIS 409 DIA 70MM (2.75") - USED WITH 70MM (2.75") TO 76MM (3.00") ROUND OR 2.00" SQUARE LEGS	12	CPF-47530C10	BLACK, RED LEVEL
6.B	FIS FUNCTION ADAPTER RAL 9005 - USED WITH 50MM (2.00") ROUND TABLE LEGS - ALLOWS UP TO A 25-DEGREE TILT	12	CPF-47540A10	BLACK
6.B	RING FOR 76MM (3.00") LEGS ON CPF-47530C10	12	CPF-47533A10	BLACK
6.C	TIP TOP RELEASE 710 - 1 PAIR COMPLETE, 2 X RELEASE MECHANISM COMPLETE, 4 X SPAX-S PANHEAD 4.5X35 (0.18"X1.38"). FOR USE WITH FIS 409	12	CPF-48792A99	BLACK
	FIS 409 WEDGE (ANTI-TWIST DEVICE) FOR 2.00" SQUARE LEGS	12	CPF-47532A99	BLACK
	FOOT CLAMP - NECESSARY FOR UPRIGHT SECURED POSITION		CPF-47531A99	BLACK



TABLE CONNECTORS & ACCESSORIES

Intelligent and space-saving innovations for modern desk systems

SYSTEM TAKE OFF

SYSTEM TAKE OFF ADAPTER



Suitable for all tabletop shapes.

Freely positional.

Low staking height with integrated protection buffer.

Will accept table legs up to 60mm (2.362").



SYSTEM SL FOLDING LEG ADAPTER

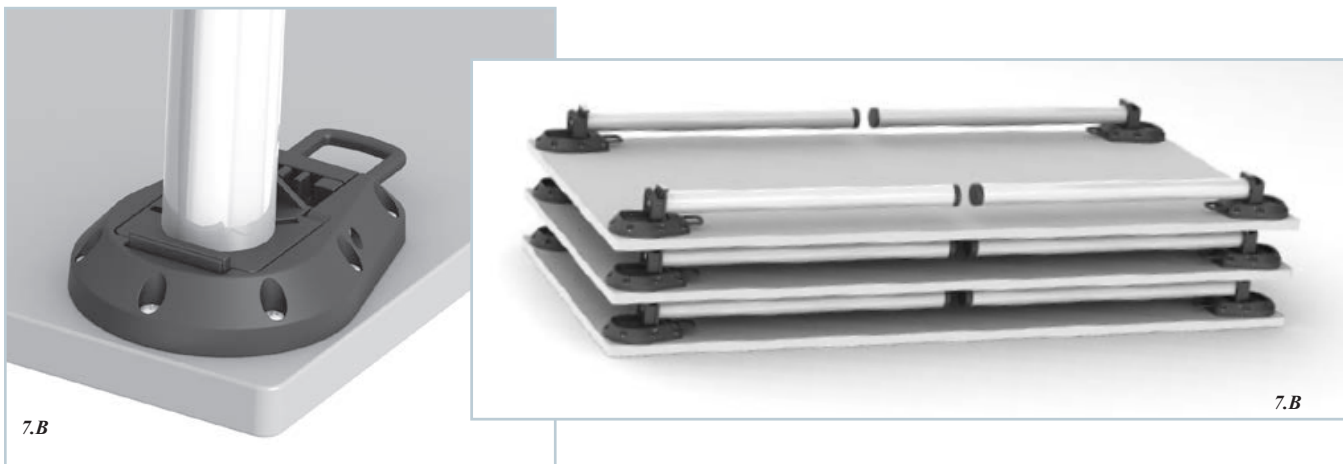

The System SL Folding Leg Adapter is designed to quickly and effortlessly allow users to fold table legs for easy storage. Adding this accessory to tables also allows for added functionality when moving multiple tables from one area to another.

Will accept table legs up to 60mm (2.362").

PICTURE	DESCRIPTION	PARTS / CARTON	PART NO.	COLOR
7.A	SYSTEM TAKE OFF ADAPTER	1	CPF-46250A10	BLACK
7.B	SYSTEM SL FOLDING LEG ADAPTER	1	CPF-47541A10	BLACK

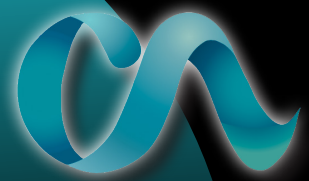

SINGLE DESK HEIGHT ADJUSTABLE MECHANISM

The Single Desk Height Adjustable Mechanism provides a flat tabletop workspace that can be transformed and stacked together to free up space.

There is a height adjustment from 29" to 44" (740-1120mm) to allow for an ergonomic position for any person.

Suitable for table tops up to a maximum width of 31.5" (800mm).

Allows table tops to be tilted up to a 25-degree angle.

Table tops are not included.



DESCRIPTION	PARTS / CARTON	PART NO.	COLOR
SINGLE DESK HEIGHT ADJUSTABLE MECHANISM	12	CPF-48095B99	SILVER

ADJUSTABLE HEIGHT TABLE BASE

The Adjustable Height Table Base allows you to raise and lower your work surface and monitor throughout the day, enabling you to sit or stand while working.

LED Programmable Handset



Heavy duty lifting capacity of 330 lbs (150kg).

3-stage legs offer added strength and large height adjustment range of 24.5" to 50" (62.23cm to 127cm).

Quick and quiet adjustment speed of 1.5" (3.8cm) per second.

Four programmable height presets.

LED readout for height position.

Work surface support frame width adjusts from 42.25" to 74" wide (107.315cm to 187.96cm).

Sturdy steel constructed with powder-coated finish.

Plugs into standard 110 outlet.

Control box and motors are UL and CE certified.



Only the table base and control box is included.

DESCRIPTION	PARTS / CARTON	PART NO.	COLOR
ADJUSTABLE HEIGHT TABLE BASE	1	CPF-HR2000S	SILVER



Convenient

Keeping keyboards, office supplies, and files within reach is a requirement for an efficient, comfortable work space. Reducing ergonomic stressors is important to office workers sitting or standing for long periods of time. The Custom Accents® storage options for below the desk include keyboard trays, pencil drawers, a laptop storage holder, and a panel for added seated privacy.

Shown Here
Narrow Pencil Drawer



BELOW THE DESK STORAGE

Organization products designed to create smarter work environments



BELOW THE DESK STORAGE

Organization products designed to create smarter work environments



KEYBOARD AND PENCIL TRAYS

Every ergonomically designed workstation starts with a well-designed keyboard system. The line of Custom Accents® Keyboard and Pencil Trays supports a healthy work environment by allowing users to have correct typing posture, which helps to reduce back pain and carpal tunnel syndrome. Made of the highest quality materials, we are confident that our line of keyboard trays will enable your clients to have a healthy work environment for years to come.

KEYBOARD TRAY WITH PENCIL COMPARTMENT



The keyboard tray includes reversible mouse tray, flip-up pencil compartment, ball bearing slides, and all mounting hardware.

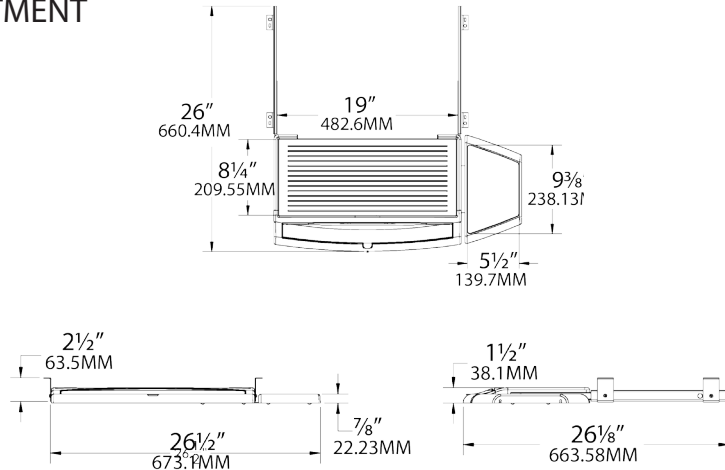

DESCRIPTION	PARTS / CARTON	PART NO.	COLOR
KEYBOARD TRAY W/ PENCIL COMPARTMENT	5	CPF-89260	BLACK

CONTOURED KEYBOARD TRAY



This keyboard tray has a built-in contoured wrist rest and includes ball bearing slides and mounting hardware.

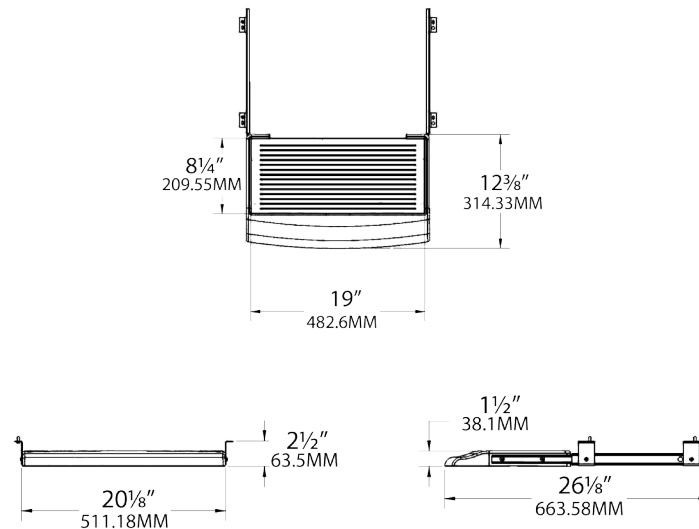

DESCRIPTION	PARTS / CARTON	PART NO.	COLOR
CONTOURED KEYBOARD TRAY	10	CPF-89270	BLACK

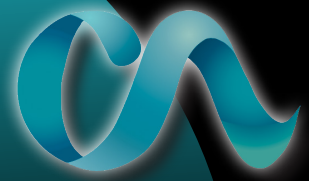

KEYBOARD TRAY WITH MOUSE TRAY

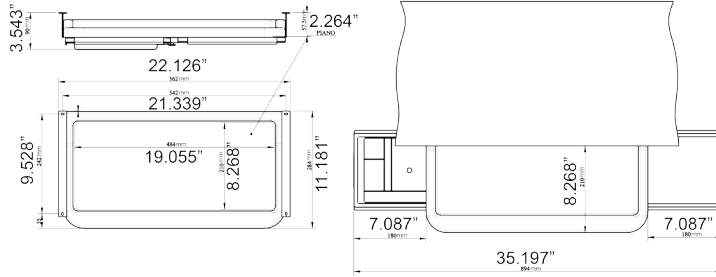

The Keyboard Tray with Mouse Tray includes mouse tray, ball bearing slides, and all mounting hardware.

The mouse tray allows you to reduce desktop clutter by moving the mouse next to the keyboard

DESCRIPTION	PARTS / CARTON	PART NO.	COLOR
KEYBOARD TRAY W/ MOUSE TRAY	5	CPF-90350TMNR	BLACK

PENCIL TRAY WITH FLAT FRONT

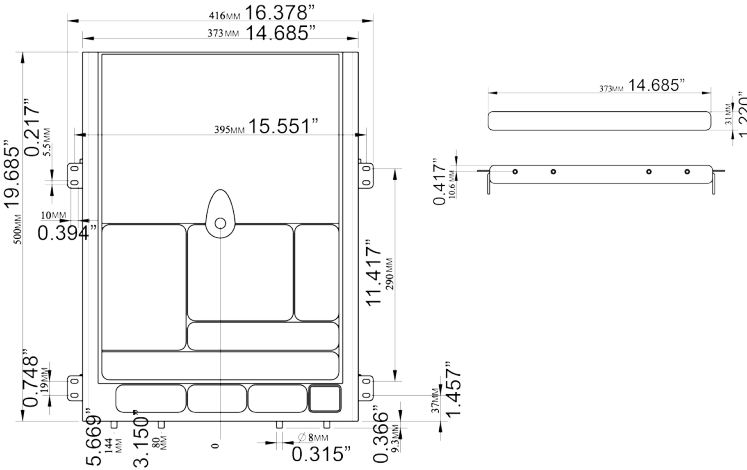

This pencil tray features a flat front and includes ball bearing slides and all mounting hardware.

The flat front enables the tray to sit flush underneath the desktop while not in use.

DESCRIPTION	PARTS / CARTON	PART NO.	COLOR
PENCIL TRAY W/ FLAT FRONT	10	CPF-90620MNR	BLACK

PENCIL TRAY

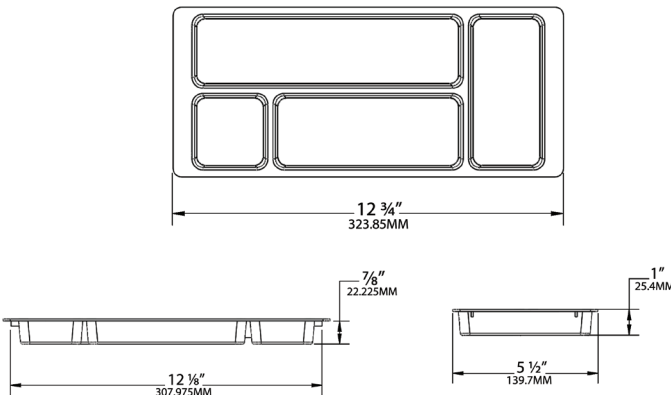

A perfect little organization accessory for the home or office environment, the Pencil Tray is designed to sit on top of most desk drawers and provides additional storage for items such as paper clips, pens, pencils, etc.

DESCRIPTION	PARTS / CARTON	PART NO.	COLOR
PENCIL TRAY	100	CPF-F815P	BLACK



BELOW THE DESK STORAGE

Organization products designed to create smarter work environments

PENCIL AND NOTEBOOK DRAWERS

The Custom Accents® pencil drawers feature a generous amount of storage space packed into a low profile of only 2". Each Pencil Drawer is designed with deep storage compartments for larger items, such as cell phones, note pads, and even Custom Accents® catalogs, as well as smaller compartments for pens, clips, and other office products. The compartments of the Pencil Drawers are ribbed to prevent items from sliding around and help to keep the drawers organized. The included ball bearing slide rails allow the units to smoothly open and shut with very little effort. The units are easy to install with the included hardware and are available in two convenient sizes.

WIDE PENCIL DRAWER

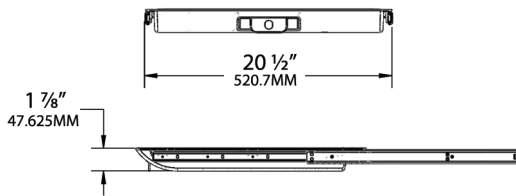
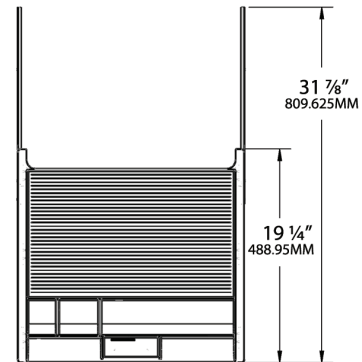

DESCRIPTION	PARTS / CARTON	PART NO.	COLOR
WIDE PENCIL DRAWER	10	CPF-89777	BLACK

NARROW PENCIL DRAWER

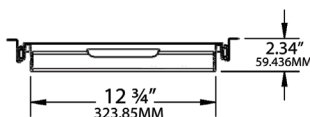
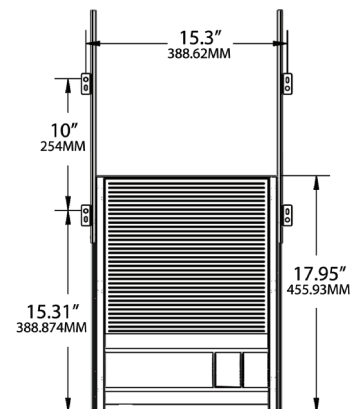

DESCRIPTION	PARTS / CARTON	PART NO.	COLOR
NARROW PENCIL DRAWER	10	CPF-89310	BLACK

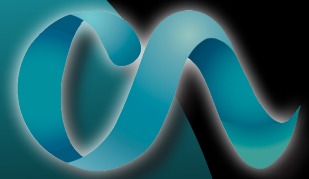

WORKSTATION LAPTOP STORAGE 

LOCKING NOTEBOOK DRAWER

The Locking Notebook Drawer is designed for the modern employee who is working just as hard outside of the office as they are in the office. Users are able to quickly turn their mobile laptop into their work desktop. In the open position, the drawer can be used as a working platform complete with soft wrist rest, wire management channels, and ventilation holes.

The Locking Notebook Drawer is made of heavy-duty steel and features a key-lock to ensure the device stays secure. The perfect addition to any modern workstation, this product is ideal for employees who regularly use laptop computers and tablets.



DESCRIPTION	PARTS / CARTON	PART NO.	COLOR
LOCKING NOTEBOOK DRAWER	4	CPF-89401	BLACK

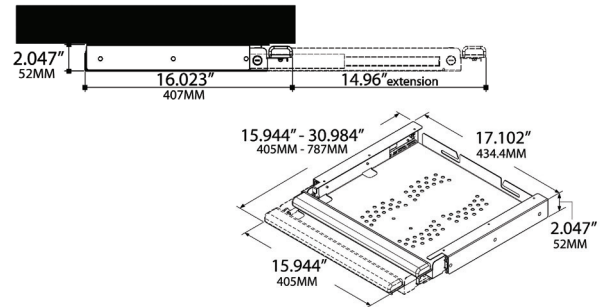

In today's workplace, employees often bring their laptop to work with them only to have their mobile computer take up valuable work space. The Laptop Glider solves this problem by providing a secure way to store a laptop off the side of a desktop. The Glider's functionality is further enhanced as it allows for full access to a laptop's media ports and charging stations.

LAPTOP GLIDER

DESCRIPTION	PARTS / CARTON	PART NO.	COLOR
LAPTOP GLIDER	1	CPF-6500	BLACK

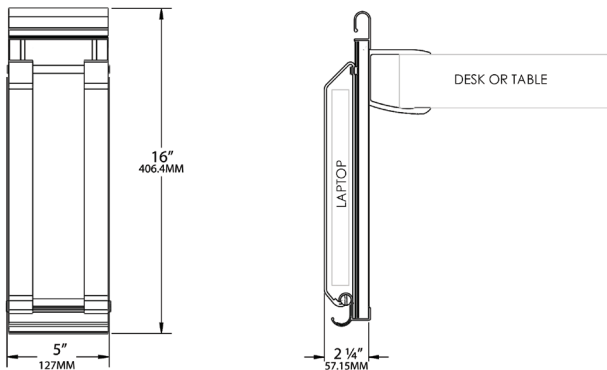



BELOW THE DESK STORAGE

Organization products designed to create smarter work environments

RADIUS ORGANIZER



This uniquely designed drawer can be installed almost anywhere. Simply push one end and the drawer rotates 180 degrees to allow access to commonly used items including pens, pencils, paper clips, and tape.

Includes one assembled organizer and installation hardware with instructions.

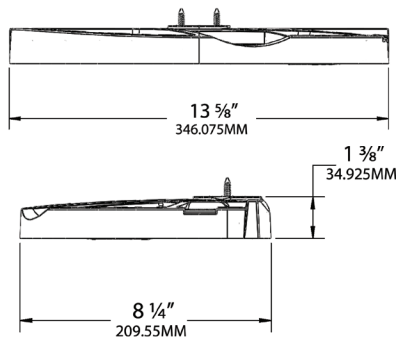

DESCRIPTION	PARTS / CARTON	PART NO.	COLOR
	16	CPF-SCI-WK451B	BLACK
RADIUS ORGANIZER TRAY	16	CPF-SCI-WK451C	CLEAR
	16	CPF-SCI-WK451S	SILVER

RADIUS ORGANIZER JR.



The compact Radius Organizer Jr. is best used for smaller spaces keeping supplies organized. The sleek design rotates and stops in open and closed positions concealing contents from view. Simply push one end and the drawer rotates 180 degrees to allow access to commonly used items.

Includes one assembled organizer, screws, and installation instructions.

DESCRIPTION	PARTS / CARTON	PART NO.	COLOR
	20	CPF-SCI-WK455B	BLACK
RADIUS ORGANIZER JR. TRAY	20	CPF-SCI-WK455S	SILVER

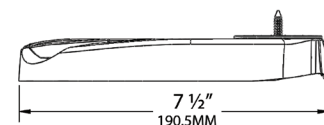
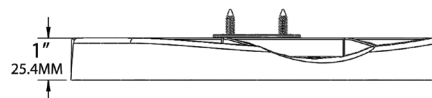

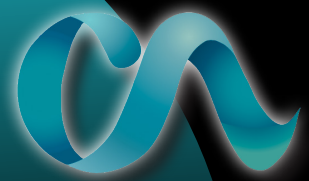

MODESTY PANEL



Our Modesty Panel provides employees with an extra sense of privacy without taking away from the design of modern open-plan work environments. An affordable accessory, this product shields co-workers from seeing under the desk giving employees the privacy they deserve. The Modesty Panel is easy to install and includes a mesh pocket for convenient wire management.

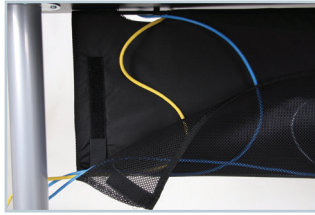

DESCRIPTION	SIZE	PARTS / CARTON	PART NO.	COLOR
MODESTY PANEL	48"	10	CPF-MP48	BLACK
WITH WIRE MANAGEMENT	60"	10	CPF-MP60	BLACK
	72"	10	CPF-MP72	BLACK

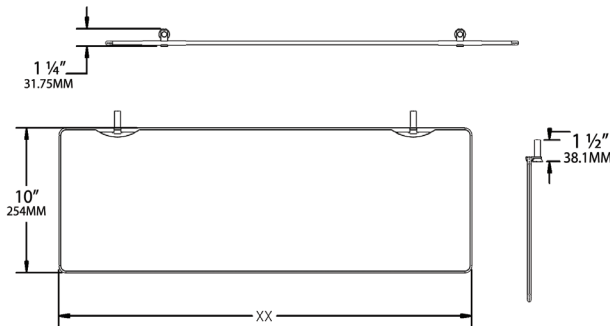



BELOW THE DESK STORAGE

Organization products designed to create smarter work environments

HANGING FILE RAIL

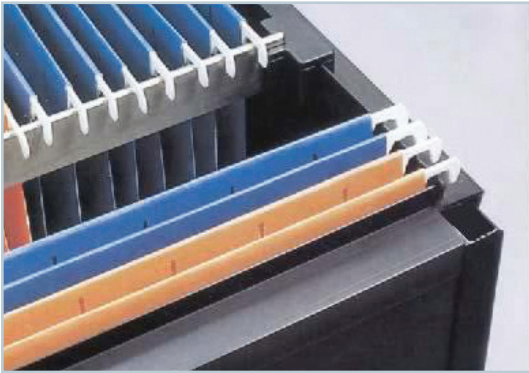

The Hanging File Rail is a simple H extrusion that fits securely on wood drawers and is easy to cut to desired lengths. Pendeflex files hang over the top to create a simple, yet highly effective drawer organization system.

The Hanging File Rail is available in three sizes and two color options.



DESCRIPTION	SIZE	PARTS / CARTON	PART NO.	COLOR
FILE RAIL, 2.5M	1/2"	100	CPF-32500	BLACK
		100	CPF-312501	WHITE
	5/8"	100	CPF-580FR	BLACK
		100	CPF-581FR	WHITE
	3/4"	100	CPF-32750	BLACK
		100	CPF-32750W	WHITE

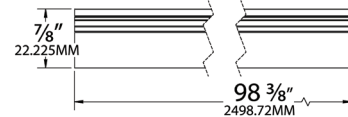
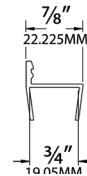
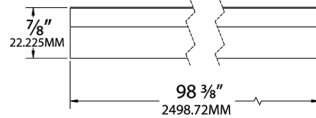
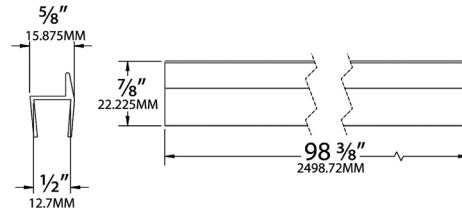

FILE RAIL CLIP

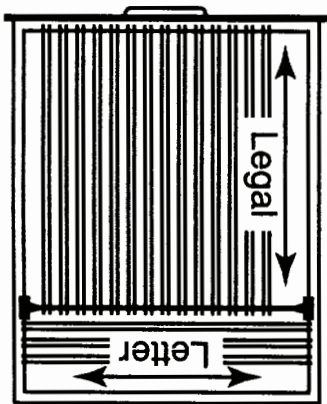

The File Rail Clip converts file drawers to accommodate letter size and legal size folders and is compatible with standard aluminum and steel bar stock. The File Rail Clip always stays in place and is easy to install.

Custom colors are available upon request.

DESCRIPTION	PARTS / CARTON	PART NO.	COLOR
FILE RAIL CLIP	3000	CPF-9000	BLACK
	1000	CPF-900K	BLACK

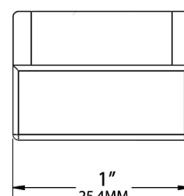
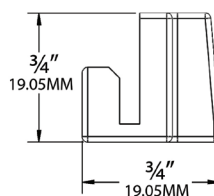



Maximize Organization

Desktop real estate is always at a premium. An open desk surface is ideal for impromptu meetings, reviewing blueprints, or just opening up the imagination for new product ideas. Custom Accents® offers flexible, easy to install work space paneling that houses a variety of compartments for office accessories. These hard-working products help keep office clutter under control.

Shown Here
HandiWALL® and HandiWALL® Accessories



ABOVE THE DESK STORAGE

Maximize desktop space with innovative hardware



ABOVE THE DESK STORAGE

Maximize desktop space with innovative hardware

SLATWALL II

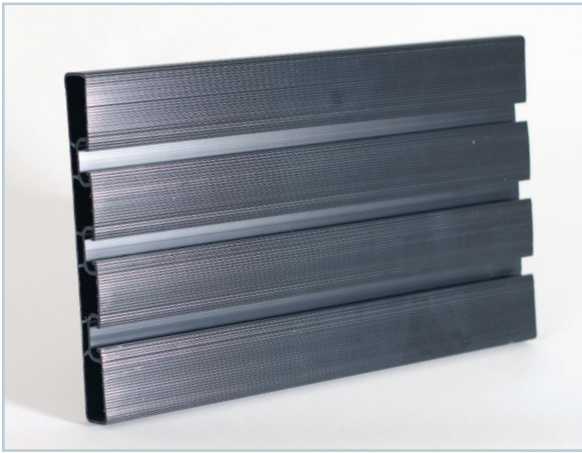

Slatwall II is designed to create additional work space by storing items and accessories above the desk surface. This tubular plastic toolbar can be mounted with fasteners to walls or furniture to support our full line of accessories.

Custom lengths available upon request.

Made from high-impact PVC.

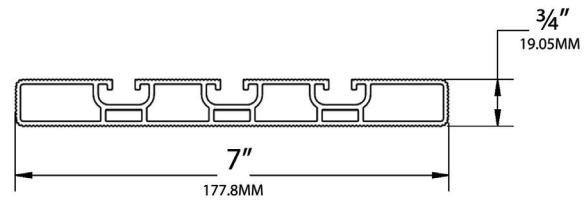

DESCRIPTION	SIZE	PARTS / CARTON	PART NO.	COLOR
SLATWALL II PANEL	24"	17	CPF-2024	BLACK
	36"	17	CPF-2036	BLACK
	48"	17	CPF-2048	BLACK
	72"	17	CPF-2072	BLACK

SLATWALL III



The Slatwall III is a stackable plastic toolbar designed to create added workspace for the office environment.

It can be wall or hutch mounted.

Made from high-impact PVC; panels are stackable and snap into place with tongue-and-groove connection.

Desk items are stored above the desk surface, leaving more surface area for work activities.

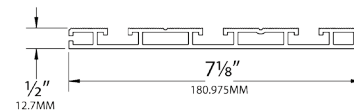

DESCRIPTION	SIZE	PARTS / CARTON	PART NO.	COLOR
SLATWALL III PANEL	24"	25	CPF-2224	BLACK
	36"	25	CPF-2236	BLACK
	48"	25	CPF-2248	BLACK
	72"	25	CPF-2272	BLACK
	72"	25	CPF-22725	SILVER

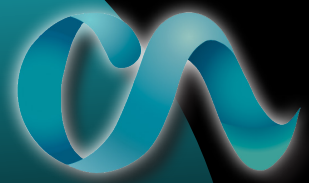

ALUMINUM SLATWALL TOOLBAR 

The Aluminum Slatwall Toolbar is designed for system-based furniture by eliminating work surface clutter while easily storing items vertically and out of the way. By using our extensive slatwall accessory line, you can easily create your own efficient office area.

The Aluminum Slatwall Toolbar is available in both black and silver powder coated finishes. This product is also available in a mill finish* which is ready to be painted or anodized.

The mounting brackets for the Aluminum Slatwall Toolbar fit most panel systems. End caps and custom lengths are available. See page 60 for additional information.

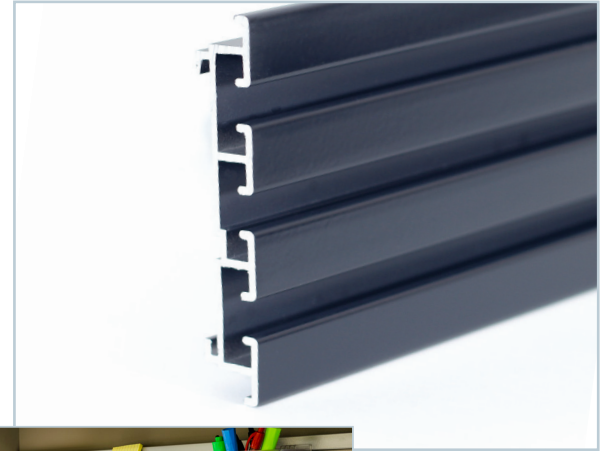

DESCRIPTION	SIZE	PARTS / CARTON	PART NO.	COLOR
ALUMINUM SLATWALL TOOLBAR	24"	5	CPF-A2400B	BLACK
	24"	5	CPF-A2400S	SILVER
	24"	5	CPF-A2400M	MILL FINISH*
	30"	5	CPF-A3000B	BLACK
	30"	5	CPF-A3000S	SILVER
	30"	5	CPF-A3000M	MILL FINISH*
	36"	5	CPF-A3600B	BLACK
	36"	5	CPF-A3600S	SILVER
	36"	5	CPF-A3600M	MILL FINISH*
	42"	5	CPF-A4200B	BLACK
	42"	5	CPF-A4200S	SILVER
	42"	5	CPF-A4200M	MILL FINISH*
	48"	5	CPF-A4800B	BLACK
	48"	5	CPF-A4800S	SILVER
	48"	5	CPF-A4800M	MILL FINISH*
	54"	5	CPF-A5400B	BLACK
	54"	5	CPF-A5400S	SILVER
	54"	5	CPF-A5400M	MILL FINISH*
	60"	5	CPF-A6000B	BLACK
	60"	5	CPF-A6000S	SILVER
60"	5	CPF-A6000M	MILL FINISH*	
144"	5	CPF-A1440B	BLACK	
144"	5	CPF-A1440S	SILVER	
144"	5	CPF-A1440M	MILL FINISH*	

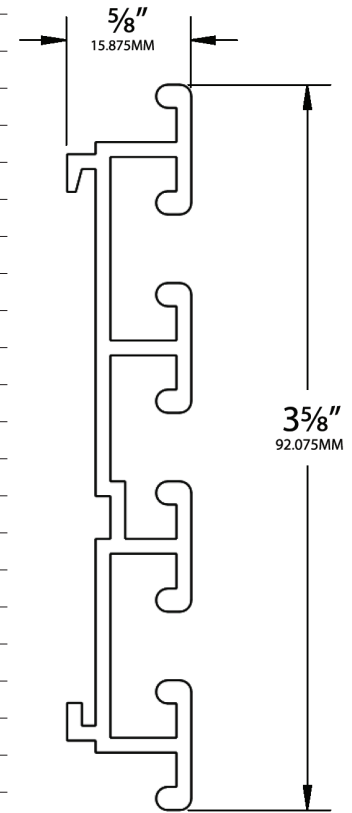

**Must be painted*



ABOVE THE DESK STORAGE

Maximize desktop space with innovative hardware

ALUMINUM TOOLBAR BRACKET KIT

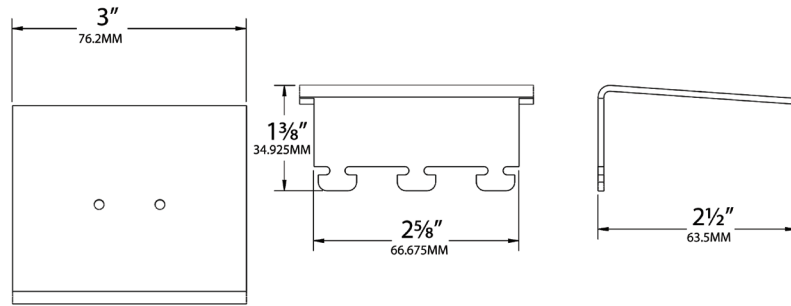

DESCRIPTION	PARTS / CARTON	PART NO.	COLOR
ALUMINUM TOOLBAR BRACKET KIT	5	CPF-A7000	BLACK

END CAPS FOR SLATWALL PANELS



End Caps compliment the Slatwall panels by neatly finishing off the edges and protecting them from everyday use.

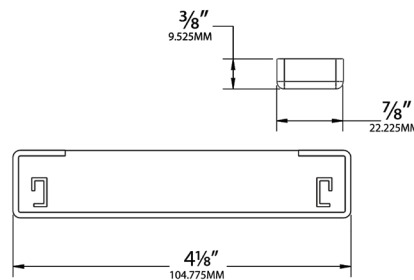
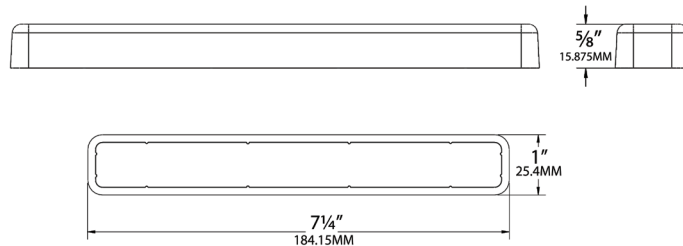

PICTURE	DESCRIPTION	PARTS / CARTON	PART NO.	COLOR
8.A	END CAPS FOR ALUMINUM TOOLBAR (1 PAIR)	10	CPF-A7050	BLACK
		10	CPF-A7051	SILVER
8.B	END CAPS FOR SLATWALL II PANEL	10	CPF-EC101P	BLACK

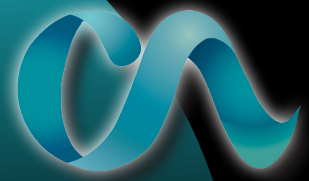

DESK MOUNT POSTS



This is a free-standing above the desk system. It utilizes the end post, connector post, and the 90-degree corner post to support the Slatwall II in various configurations.

This product can provide a toolbar to any desk system. End posts clamp on or can be installed with the bolt-through design. It can be configured for any length and installed around a 90 degree corner.



DESK MOUNT POST

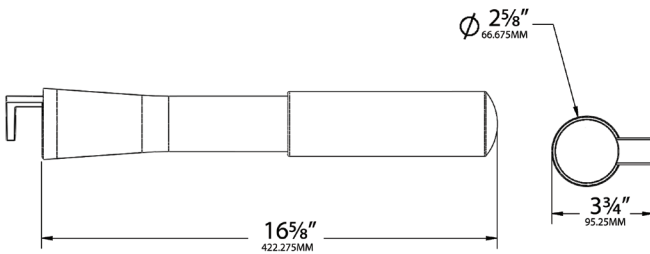

DESCRIPTION	PARTS / CARTON	PART NO.	COLOR
DESK MOUNT POST FOR SLATWALL II	10	CPFS-5000P	BLACK

DESK MOUNT POST, 90 DEGREE FOR SLATWALL II

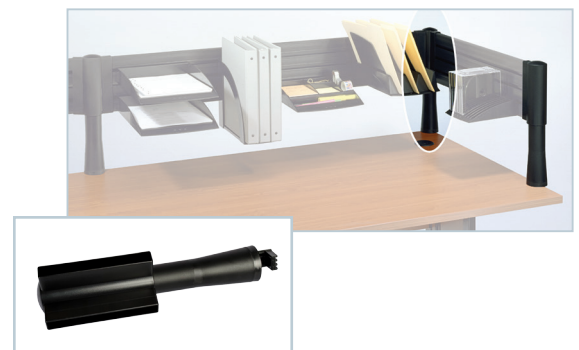
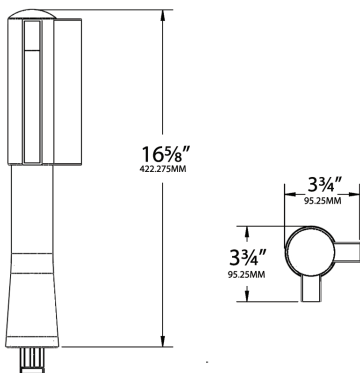

DESCRIPTION	PARTS / CARTON	PART NO.	COLOR
DESK MOUNT POST 90 DEGREE FOR SLATWALL II	10	CPFS-5090P	BLACK



ABOVE THE DESK STORAGE

Maximize desktop space with innovative hardware

DESK MOUNT POST, 180 DEGREE FOR SLATWALL II

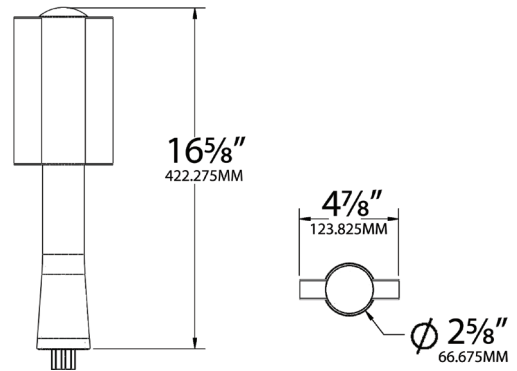
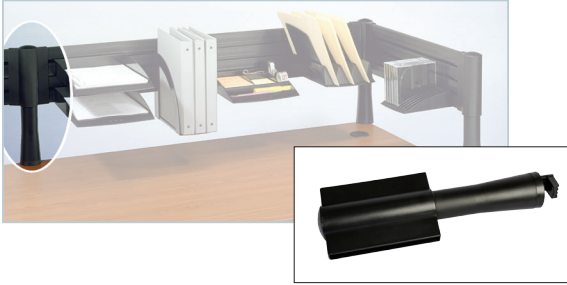

DESCRIPTION	PARTS / CARTON	PART NO.	COLOR
DESK MOUNT POST 180 DEGREE FOR SLATWALL II	10	CPFS-50180P	BLACK

DESK MOUNT POST FOR SLATWALL II, BOLT-THROUGH DESIGN



DESCRIPTION	PARTS / CARTON	PART NO.	COLOR
DESK MOUNT POST, BOLT-THROUGH DESIGN	10	CPFS-550K	BLACK
DESK MOUNT POST, 90 DEGREE, BOLT-THROUGH DESIGN	10	CPFS-559K	BLACK
DESK MOUNT POST, 180 DEGREE, BOLT-THROUGH DESIGN	10	CPFS-55180K	BLACK

SLATWALL ACCESSORIES

These slatwall accessories fit into all Slatwall II, Slatwall III, and Aluminum Toolbar panels. Organize the accessories to reduce clutter and create an efficient work area.

PENCIL CUP

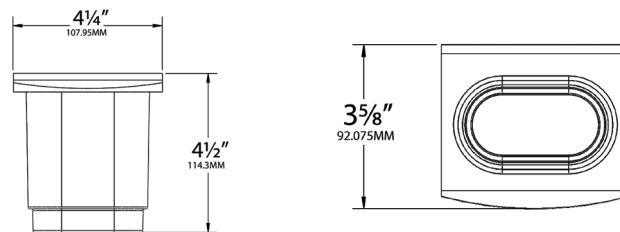

DESCRIPTION	PACKAGING MATERIALS	PARTS / CARTON	PART NO.	COLOR
PENCIL CUP	BULK PACKED	125	CPF-1000	BLACK
	INDV. PACKED	10	CPF-1000P	BLACK
	BULK PACKED	125	CPF-1200	CLEAR
	INDV. PACKED	10	CPF-1200P	CLEAR
	BULK PACKED	125	CPF-1260	SILVER
	INDV. PACKED	10	CPF-1260P	SILVER

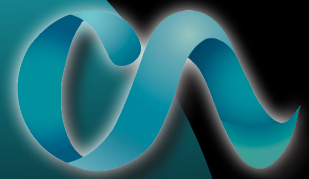

CD HOLDER



DESCRIPTION	PACKAGING MATERIALS	PARTS / CARTON	PART NO.	COLOR
CD HOLDER	BULK PACKED	50	CPF-1001	BLACK
	INDV. PACKED	10	CPF-1001P	BLACK
	BULK PACKED	50	CPF-1201	CLEAR
	INDV. PACKED	10	CPF-1201P	CLEAR
	BULK PACKED	50	CPF-1261	SILVER
	INDV. PACKED	10	CPF-1261P	SILVER

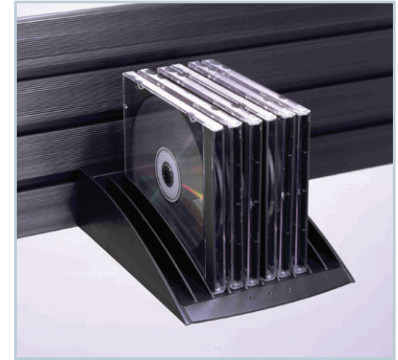

PAPER TRAY

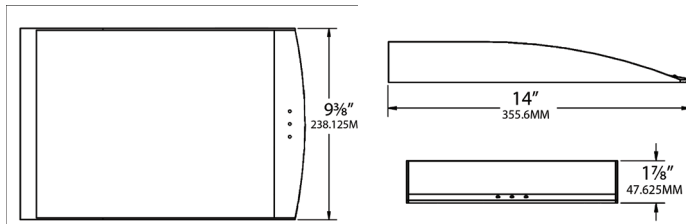

DESCRIPTION	PACKAGING MATERIALS	PARTS / CARTON	PART NO.	COLOR
PAPER TRAY	BULK PACKED	40	CPF-1003	BLACK
	INDV. PACKED	10	CPF-1003P	BLACK
	BULK PACKED	40	CPF-1203	CLEAR
	INDV. PACKED	10	CPF-1203P	CLEAR
	BULK PACKED	40	CPF-1263	SILVER
	INDV. PACKED	10	CPF-1263P	SILVER



ACCESSORY TRAY

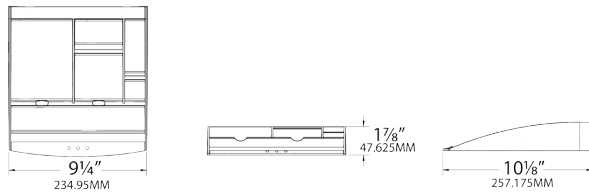

DESCRIPTION	PACKAGING MATERIALS	PARTS / CARTON	PART NO.	COLOR
ACCESSORY TRAY	BULK PACKED	19	CPF-1004	BLACK
	INDV. PACKED	10	CPF-1004P	BLACK
	BULK PACKED	19	CPF-1204	CLEAR
	INDV. PACKED	10	CPF-1204P	CLEAR
	BULK PACKED	19	CPF-1264	SILVER
	INDV. PACKED	10	CPF-1264P	SILVER





ABOVE THE DESK STORAGE

Maximize desktop space with innovative hardware

PHONE SUPPORT

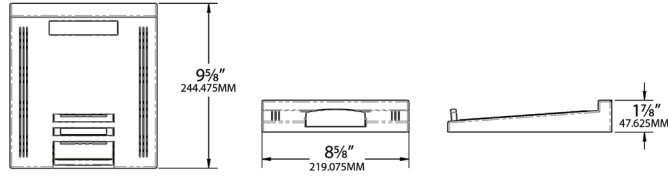

DESCRIPTION	PACKAGING MATERIALS	PARTS / CARTON	PART NO.	COLOR
PHONE SUPPORT	BULK PACKED	60	CPF-1005	BLACK
	INDV. PACKED	10	CPF-1005P	BLACK
	BULK PACKED	60	CPF-1205	CLEAR
	INDV. PACKED	10	CPF-1205P	CLEAR
	BULK PACKED	60	CPF-1265	SILVER
	INDV. PACKED	10	CPF-1265P	SILVER

LEGAL / A4 PAPER TRAY

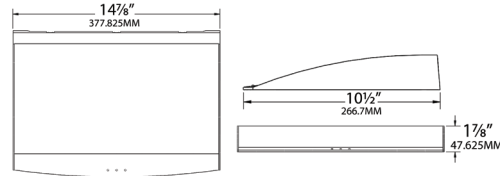
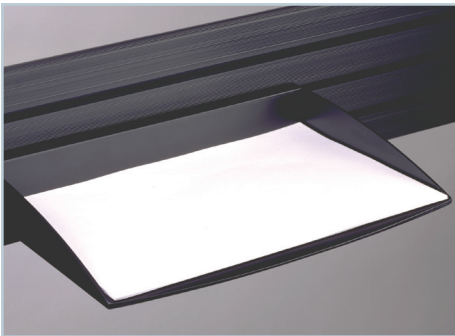

DESCRIPTION	PACKAGING MATERIALS	PARTS / CARTON	PART NO.	COLOR
LEGAL / A4 PAPER TRAY	BULK PACKED	22	CPF-1007	BLACK
	INDV. PACKED	10	CPF-1007P	BLACK
	BULK PACKED	22	CPF-1207	CLEAR
	INDV. PACKED	10	CPF-1207P	CLEAR
	BULK PACKED	22	CPF-1267	SILVER
	INDV. PACKED	10	CPF-1267P	SILVER

FOLDER SORTER TRAY

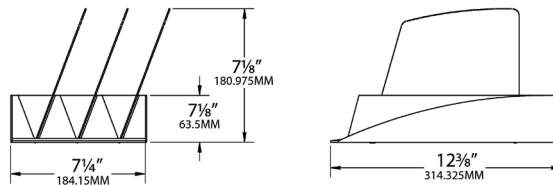
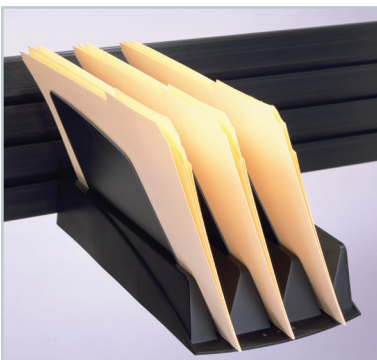

DESCRIPTION	PACKAGING MATERIALS	PARTS / CARTON	PART NO.	COLOR
FOLDER SORTER TRAY	BULK PACKED	25	CPF-1008	BLACK
	INDV. PACKED	10	CPF-1008P	BLACK
	BULK PACKED	25	CPF-1208	CLEAR
	INDV. PACKED	10	CPF-1208P	CLEAR
	BULK PACKED	25	CPF-1268	SILVER
	INDV. PACKED	10	CPF-1268P	SILVER

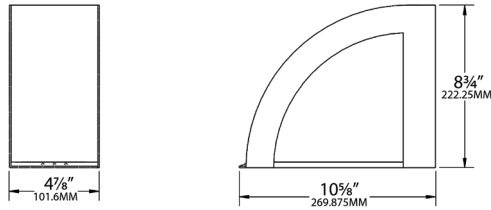
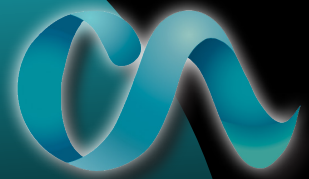

BINDER HOLDER

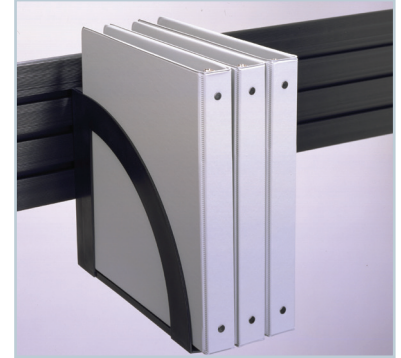

DESCRIPTION	PACKAGING MATERIALS	PARTS / CARTON	PART NO.	COLOR
BINDER HOLDER	BULK PACKED	16	CPF-1009	BLACK
	INDV. PACKED	10	CPF-1009P	BLACK
	BULK PACKED	16	CPF-1209	CLEAR
	INDV. PACKED	10	CPF-1209P	CLEAR
	BULK PACKED	16	CPF-1269	SILVER
	INDV. PACKED	10	CPF-1269P	SILVER

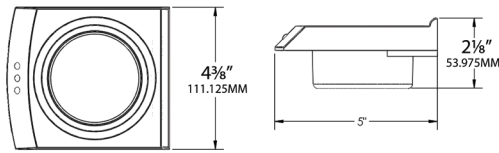

CUP HOLDER

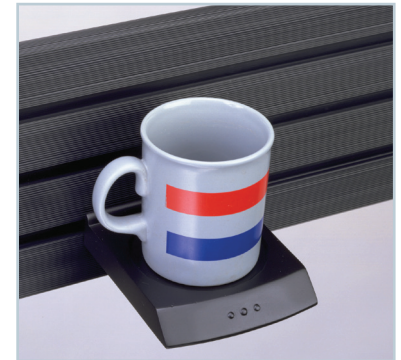

DESCRIPTION	PACKAGING MATERIALS	PARTS / CARTON	PART NO.	COLOR
CUP HOLDER	BULK PACKED	36	CPF-1014	BLACK
	INDV. PACKED	10	CPF-1014P	BLACK
	BULK PACKED	36	CPF-12014	CLEAR
	INDV. PACKED	10	CPF-12014P	CLEAR
	BULK PACKED	36	CPF-12614	SILVER
	INDV. PACKED	10	CPF-12614P	SILVER

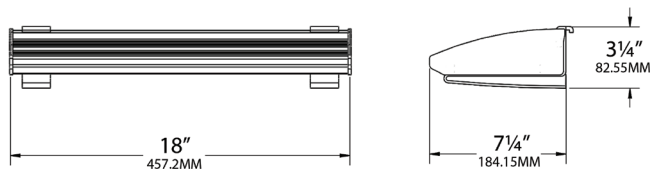

SHELF ASSEMBLY



DESCRIPTION	SHELF SIZE	PARTS / CARTON	PART NO.	COLOR
SHELF ASSEMBLY	18"	5	CPF-1018P	BLACK
	24"	5	CPF-1024P	BLACK
	30"	5	CPF-1030P	BLACK
	36"	5	CPF-1036P	BLACK
	24"	5	CPF-10246P	SILVER
	30"	5	CPF-10306P	SILVER
	36"	5	CPF-10366P	SILVER



ABOVE THE DESK STORAGE

Maximize desktop space with innovative hardware

HANDIWALL® PVC SLATWALL PANELS



HandiWALL® is a cellular PVC slatwall which can be directly installed onto drywall, concrete, or any other flat surface. This slatwall system and accompanying accessories are a perfect addition to any office, storage room, or product gallery.

Made of our own proprietary blend of foam PVC, the durability of this product is unmatched and will last for decades. The panels will retain their new look for the life of the product and cleaning is easy with a damp rag or mild chemical cleaning agents.

The HandiWALL® panels are stackable with tongue and groove fit and are available in solid colors and beautiful warm wood grains. Request your sample of HandiWALL® today to see for yourself the amazing durability and unmatched beauty of our HandiWALL® PVC slatwall panels.



DESCRIPTION	PANEL LENGTH	PARTS / CARTON	PART NO.	COLOR
HANDIWALL PVC SLATWALL PANEL	48"	8	CPF-HSW1004	WHITE
	96"	4	CPF-HSW1008	WHITE
	48"	8	CPF-HSW2004	TAUPE
	96"	4	CPF-HSW2008	TAUPE
	48"	8	CPF-HSW3004	GRAY
	96"	4	CPF-HSW3008	GRAY
	48"	8	CPF-HSW4004	BLACK
	96"	4	CPF-HSW4008	BLACK
	48"	8	CPF-HSW5004	MAPLE WOODGRAIN
	96"	4	CPF-HSW5008	MAPLE WOODGRAIN
	48"	8	CPF-HSW6004	OAK WOODGRAIN
	96"	4	CPF-HSW6008	OAK WOODGRAIN
	48"	8	CPF-HSW7004	CHERRY WOODGRAIN
	96"	4	CPF-HSW7008	CHERRY WOODGRAIN
	48"	8	CPF-HSW8004	ANTIQUÉ WHITE
	96"	4	CPF-HSW8008	ANTIQUÉ WHITE

HANDISCREWS™



Color-coordinated wood screws to be used to install the HandiWALL® panels.



DESCRIPTION	SCREW LENGTH	PARTS / CARTON	PART NO.	COLOR
WOODSCREW	1 5/8"	100	CPF-HSWS100TBK	WHITE
		100	CPF-HSWS200TBK	TAUPE
		100	CPF-HSWS300TBK	GRAY
		100	CPF-HSWS400TBK	BLACK
		100	CPF-HSWS500TBK	MAPLE
		100	CPF-HSWS600TBK	OAK
		100	CPF-HSWS700TBK	CHERRY
		100	CPF-HSWS800TBK	ANTIQUÉ WHITE

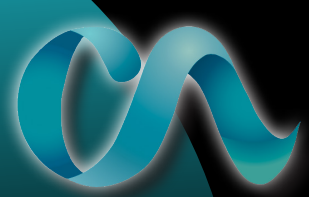

HANDIWALL® PVC SLATWALL ACCESSORIES



These slatwall accessories can be arranged in a variety of ways to help paper flow management. The clear accessories are translucent and add a modern edge to the work environment. For dimensions of the accessories seen below, see SLATWALL ACCESSORIES on page 62.

PENCIL CUP



DESCRIPTION	PARTS / CARTON	PART NO.	COLOR
	10	CPF-HSW4000P	BLACK
PENCIL CUP	10	CPF-HSW1200P	CLEAR
	10	CPF-HSW3000P	GRAY

PAPER TRAY



DESCRIPTION	PARTS / CARTON	PART NO.	COLOR
	10	CPF-HSW4003P	BLACK
PAPER TRAY	10	CPF-HSW1203P	CLEAR
	10	CPF-HSW3003P	GRAY

ACCESSORY TRAY



DESCRIPTION	PARTS / CARTON	PART NO.	COLOR
	10	CPF-HSW4004P	BLACK
ACCESSORY TRAY	10	CPF-HSW1204P	CLEAR
	10	CPF-HSW3004P	GRAY

PHONE HOLDER



DESCRIPTION	PARTS / CARTON	PART NO.	COLOR
	10	CPF-HSW4005P	BLACK
PHONE HOLDER	10	CPF-HSW1205P	CLEAR
	10	CPF-HSW3005P	GRAY

LEGAL / A4 PAPER TRAY



DESCRIPTION	PARTS / CARTON	PART NO.	COLOR
	10	CPF-HSW4007P	BLACK
LEGAL / A4 PAPER TRAY	10	CPF-HSW1207P	CLEAR
	10	CPF-HSW3007P	GRAY

FOLDER SORTER TRAY



DESCRIPTION	PARTS / CARTON	PART NO.	COLOR
	10	CPF-HSW4008P	BLACK
FOLDER SORTER TRAY	10	CPF-HSW1208P	CLEAR
	10	CPF-HSW3008P	GRAY

BINDER HOLDER



DESCRIPTION	PARTS / CARTON	PART NO.	COLOR
	10	CPF-HSW4009P	BLACK
BINDER HOLDER	10	CPF-HSW1209P	CLEAR
	10	CPF-HSW3009P	GRAY

RESIN SHELF



DESCRIPTION	SHELF LENGTH	PARTS / CARTON	PART NO.	COLOR
RESIN SHELF	24"	1	CPF-HSRK24B	BLACK
		1	CPF-HSRK24G	GRAY

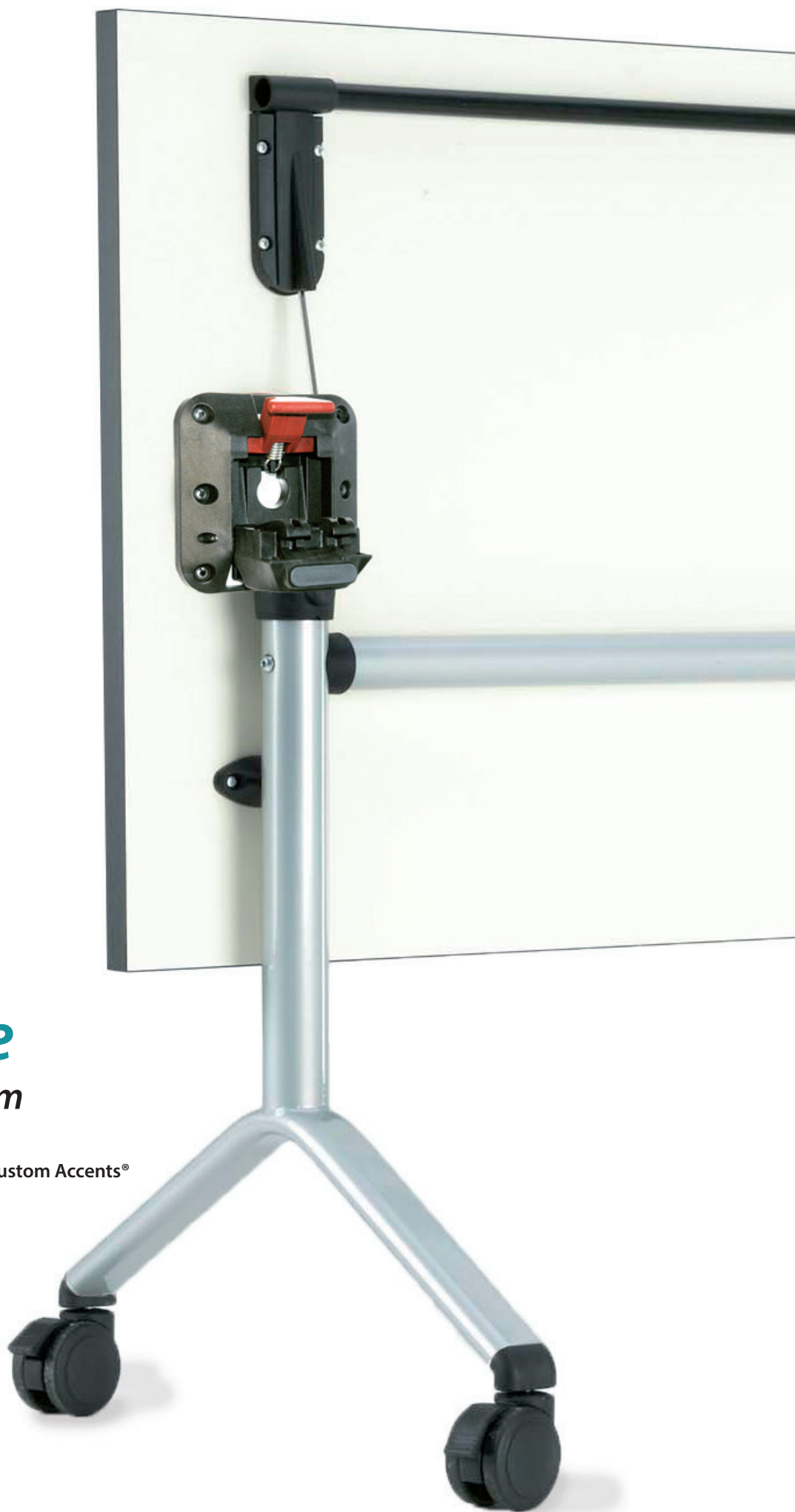

Elegance
in Style and Form

The Tip-Top Standard Kit by Custom Accents®



Visit our website to stay up to date on products and information.

www.customaccents.com



GLOSSARY OF PRODUCTS

50MM Wire Grommet	6	Legal / A4 Paper Tray (HandiWALL® Accessory)	67
60MM Executive Metal Round Grommet	10	Legal / A4 Paper Tray (Slatwall Accessory)	64
60MM Flexigrom	7	Locking Notebook Drawer	51
60MM Wire Grommet	6	Modesty Panel	53
80MM Carré Plastic Grommet	10	Module Connector Type "Divide"	35
80MM Donut Plastic Grommet	10	Module Connector Type "Lock"	35
80MM Executive Metal Round Grommet	10	MOS FIX	39
80MM Executive Metal Donut Grommet	9	MOS System	38
80MM Flexigrom	7	Narrow Pencil Drawer	50
80MM Wire Grommet	7	Oval Grommet	8
80MM GV Plastic Grommet	11	Paper Slot Grommet	8
Accessory Tray (HandiWALL® Accessory)	67	Paper Tray (HandiWALL® Accessory)	67
Accessory Tray (Slatwall Accessory)	63	Paper Tray (Slatwall Accessory)	63
Adjustable Height Table Base	45	Passacavi Cable Manager	28
Aluminum Slatwall Toolbar	59	Pencil Cup (HandiWALL® Accessory)	67
Aluminum Toolbar Bracket Kit	60	Pencil Cup (Slatwall Accessory)	62
Aluminum Toolbar End Caps	60	Pencil Tray	49
Binder Holder (HandiWALL® Accessory)	67	Pencil Tray with Flat Front	49
Binder Holder (Slatwall Accessory)	65	Phone Holder (HandiWALL® Accessory)	67
Brick Vertebra	27	Phone Support (Slatwall Accessory)	64
Cable Clip	31	Pull Up Power Grommet	18
Cable Grip 135MM x 65MM	30	Radius Organizer	52
Cable Grip 90MM x 65MM	30	Radius Organizer Jr.	52
Cable Snake	22	Release Kit for Tip Top Tables	43
Cable Trough	23	Resin Shelf (HandiWALL® Accessory)	67
CD Holder (Slatwall Accessory)	63	Round Power Station	18
Contoured Keyboard Tray	48	Shelf Assembly (Slatwall Accessory)	65
Cup Holder (Slatwall Accessory)	65	Single Desk Height Adjustable Mechanism	45
Desk Mount Post	61	Slatwall II	58
Desk Mount Post 180 Degree	62	Slatwall II Panel End Caps	60
Desk Mount Post 90 Degree	61	Slatwall III	58
Desk Mount Post Bolt-Through Design	62	Storage Grommet	8
Exit Edge Grommet	11	System Panel "Fix"	40
File Rail Clip	54	System Panel "Flex"	40
Folder Sorter Tray (HandiWALL® Accessory)	67	System SL Folding Leg Adapter	44
Folder Sorter Tray (Slatwall Accessory)	64	System Take Off Adapter	44
Folding Leg Mechanisms	43	System Top	41
Gland Ring Grommet	9	Table Connector Type "Divide"	34
HAL-AR Wheel / Foot	37	Table Connector Type "Lock"	34
HAL-IR Wheel	36	Table Connector Type "Steel"	34
HandiScrews™	66	Tip Top Folding Table Full Kit	42
HandiWALL® PVC Slatwall Panels	66	VersaFLAP	17
Hanging File Rail	54	VersaPAD	14
Helix Cable Manager	28	VersaPULL	15
Keyboard Tray with Pencil Compartment	48	VersaTEK	16
Keyboard Tray with Mouse Tray	49	Vertebra Wire Manager	26
Laptop Glider	51	Wide Pencil Drawer	50
Latch Duct Channel	24	Wiremaster J Channel	25
Latch Duct Clip	24	Wireway Channel	25

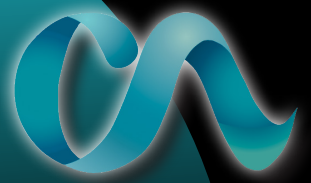

ORDERING INFORMATION

**MINIMUM ORDER**

As per OEM and Distributor Price Schedules.

FREIGHT

As per OEM and Distributor Price Schedules.

PAYMENT

Net 30 days with an approved account or by credit card.

ORDERS

All orders should include the Custom Accents part number, quantity, price, and have a purchase order. Full cartons sold only.

LEAD TIME

Product normally ships within 3 to 5 business days upon receipt of approved purchase order.

CONTACT US BY PHONE

Phone: 888.553.6789

Phone: 847.640.4725

CONTACT US BY EMAIL

info@customaccents.com

OUR LOCATION

Custom Accents*

1940 Lunt Avenue

Elk Grove Village, IL 60007

FIND US ONLINE AT

www.customaccents.com

