



**Corbin  
Russwin**  
**ASSA ABLOY**

## Price List

Price Book #28

Effective November 1, 2015

SECTION	PAGES
Order Forms	1
Key System Information Request Form	5
Keyed Order Lead Sheet	6
Tools and Rules	9
Terms and Conditions	13
Warranty	17
Finishes, Samples, Templates	19
<b>MUSEO®</b>	
TL3700 Series: Museo Levers & Inspire Trim	21
TL3700 Series: Museo Levers & Roses	22
TL3700 Series: Options	26
ML2000 Series: Museo Levers & Inspire Trim	27
ML2000 Series: Museo Levers, Roses & Thumbturns	28
ML2000 Series: Museo Levers & Escutcheons	33
ML20900 Series: Museo Levers, Escutcheons, Roses and Thumbturns	38
ML20800 AC2 Series: Museo Levers	50
ED5000 AC2 Series: Museo Levers	53
ED5000 Series: Museo Levers with 900 Series Escutcheon	56
<b>KEY SYSTEMS</b>	
General Information	59
Policy	62
Construction Core	63
Keying, Stamping, Cut Keys	64
Bitting List	65
Key Wizard	66
Key Blanks	67
Access 3 AP Security Cylinders	69
Pyramid Cylinders	75
Conventional Cylinders	81
Interchangeable Core Cylinders	89
Security Cylinders	93
Master Ring Cylinders	99
Service Equipment	102
<b>ACCESS CONTROL</b>	
Access 800® AC2	103
ML20800 Series	104
CL33800 Series	108
ED5000 x 9800 AC2 Series	112
WM800 Reader/Controller	118
Wiring Diagram Services and Accessories	119
<b>MORTISE LOCKSETS AND TRIM</b>	
ML2000 Series	121
Vineyard™ Collection	131
Vandal Resistant Trim	133
ML20900 Series	134
Cylinder and Keying Options	146
Miscellaneous Options	149
ML2000HS Series	150
<b>SPECIALTY HARDWARE</b>	
MicroShield® How to Order	155
BHSS Trim	156
BLSS Trim	157
HSS Trim	158
HPSK Trim	159
HP3000 Series Tubular Lock with Push/Pull Trim	160

**CYLINDRICAL LOCKS**
**PAGES**

MicroShield® How to Order	162
Grade 1 Vandal Resistant Cylindrical Lever Locksets – CL3100 Series	163
Grade 1 Extra Heavy-Duty Cylindrical Lever Locksets – CL3300 Series	169
Grade 1 Heavy-Duty Cylindrical Lever Locksets – CL3500 Series	175
Grade 2 Standard-Duty Lever Locksets – CL3800 Series	181
Grade 1 Heavy-Duty Cylindrical Knob Locksets – CK4300 Series	185
Grade 2 Standard-Duty Cylindrical Knob Locksets – CK4400 Series	188

**PRE-ASSEMBLED UNIT LOCKSETS**

UT5200 Series	191
---------------	-----

**AUXILIARY HARDWARE**

PL5000 Series Padlocks	197
DL2200 Series Cylindrical Deadlocks	199
DL3000 Series Cylindrical Deadlocks	202
DL3200 Series Cylindrical Deadlocks	205
DL4100 Series Mortise Deadlocks	208

**MULTI-POINT LOCKS**

FE5400S	211
FE6700	227
FE6800	231

**EXIT DEVICES**

MicroShield® Technology	237
ED3000 Crossbar Series	239
ED4000 Narrow Stile Pushpad Series	251
ED5000 Pushpad Series	263
ED7000 Narrow Stile Crossbar Series	286
ED8000 Pushpad Series	297

**DOOR CLOSERS**

DC3000 Series	307
DC5000 Series (Cam Action Door Closer)	309
DC6000 Series	311
DC8000 Series	315
DC46900 Series (Safeguard™)	320
DC62900 Series	321

**ASSA ABLOY**

**Service Center Business Hours**

**ASSA ABLOY Door Security Solutions®**

**Customer Service – Monroe** .....8:00 a.m. – 4:30 p.m. (Eastern)

1902 Airport Road  
Monroe, NC 28110

Telephone Number: .....(800) 543-3658

Fax Number: .....(800) 447-6714

**Technical Product Support** .....8:00 a.m. - 4:30 p.m. (Eastern)

225 Episcopal Road  
Berlin, CT 06037

Telephone Number: .....(888) 607-5703

Fax Number: .....(800) 659-7293

**Electrified Technical Product Support** .....8:00 a.m. - 4:30 p.m. (Eastern)

Telephone Number: .....(800) 810-WIRE (9473)

Fax Number: .....(203) 603-5981

**Holiday Schedule\***

**The ASSA ABLOY Door Security Solutions Service Center and Electrified Technical Product Support, Monroe, NC will be CLOSED on the following dates:**

- November 26, 2015
- November 27, 2015
- December 24, 2015
- December 25, 2015
- December 28, 2015
- December 29, 2015
- January 1, 2016
- March 25, 2016
- May 30, 2016
- July 4, 2016
- September 5, 2016
- November 24, 2016
- November 25, 2016
- December 23, 2016
- December 26, 2016
- December 27, 2016
- December 28, 2016
- December 29, 2016
- December 30, 2016

**Technical Product Support, Berlin, CT will be CLOSED on the following dates:**

- November 26, 2015
- November 27, 2015
- December 24, 2015
- December 25, 2015
- December 28, 2015
- December 29, 2015
- December 30, 2015
- December 31, 2015
- January 1, 2016
- March 25, 2016
- May 30, 2016
- July 4, 2016
- September 5, 2016
- November 24, 2016
- November 25, 2016
- December 23, 2016
- December 26, 2016
- December 27, 2016
- December 28, 2016
- December 29, 2016
- December 30, 2016

**\* Dates subject to change.**





ASSA ABLOY



ASSA ABLOY

CUSTOMER ACCOUNT #			PLEASE CHECK				DATE REQUESTED		SOLD TO ADDRESS	
			<input type="checkbox"/> PART SHIP <input type="checkbox"/> SHIP COMPLETE							
CUSTOMER P.O. #			P.O. DATE		CONTACT PERSON			SHIP TO ADDRESS		
					PHONE #					
					FAX #					
SHIP VIA			<b>MARKS</b> If markings are required, purchase order will be entered to the factory. See <i>Stock Condensed Order Form</i> to include appropriate information.				BUYING PROGRAM <input type="checkbox"/> <b>OR</b> <input type="checkbox"/>		<b>CPQ NUMBER</b> _____	
QTY <i>Required</i>	PART # <i>Required</i>	CYLINDER <i>(2000X033)</i>	KEY BLANKS <i>(6 pin-10)</i>	SERIES & FUNCTION <i>Required</i>	TRIM, DR WIDTH & HEIGHT	HAND <i>R, L, RR, LR</i>	FINISH <i>Required</i>	KEYWAY/ SECTION	QUICK CODE <i>M52, M54, M55, M94, KR Electrified Locks (Requires Voltage)</i>	

Sheet \_\_\_\_\_ of \_\_\_\_\_  
 This Sheet Only

<b>Customer Name</b>				<b>Purchase Order No.</b>	
----------------------	--	--	--	---------------------------	--

Qty.	Series and Function	Trim	Keyway	Finish	Quick Code Options

**Special Notes:**

Item	Qty.	Key Symbol	Hand				Door Number (Up to 10 characters)	Heading (Up to 10 characters)
			RH	LH	RHR	LHR		

Copyright © 2002 - 2015 Corbin Russwin, Inc.

# Keyed Order - Condensed Form (Cylinders Ordered Separately)

Sheet \_\_\_\_\_ of \_\_\_\_\_  
 This Sheet Only

<b>Customer Name</b>				<b>Purchase Order No.</b>		
Qty.	Cylinder	Length	Pins	Keyway	Cam/Tailpiece	Finish

**Special Notes:**

Item	Qty.	Key Symbol	Door Number (Up to 10 characters)	Heading (Up to 10 characters)	Keyed Function Used

Copyright © 2002 - 2015 Corbin Russwin, Inc.

Keyed Order - Condensed Form  
(Cylinders Ordered With Lockset/Device)

Sheet \_\_\_\_\_ of \_\_\_\_\_  
 This Sheet Only

Customer Name				Purchase Order No.	
---------------	--	--	--	--------------------	--

Qty.	Series and Function	Trim	Keyway	Finish	Quick Code Options

Special Notes:

Item	Qty.	Key Symbol	Hand				Door Number (Up to 10 characters)	Heading (Up to 10 characters)
			RH	LH	RHR	LHR		



**ASSA ABLOY**

Date: \_\_\_\_\_

**KEY SYSTEMS INFORMATION**

\*Registry Number: \_\_\_\_\_

\*Job Name and Location: \_\_\_\_\_

\*Keyway: \_\_\_\_\_ Top Master Key Bitting: \_\_\_\_\_

Any Other Known System Information:

Information Requested:

Requested By: \_\_\_\_\_

Phone: \_\_\_\_\_ Fax: \_\_\_\_\_ Email: \_\_\_\_\_

Agency/Distributor Name: \_\_\_\_\_

Key System Administration Response:

**Please attach a Letter of Authorization from the end user if requesting bitting information.**

**\*Required Information**

Sheet 1 of \_\_\_\_\_

Date:

Purchase Order No.:

Date Required:

**SOLD TO:**

**SHIP TO:**

**1. JOB NAME AND ADDRESS**

**2. SYSTEM STATUS**

New  Existing ..... Registry No. \_\_\_\_\_

Customer Bittings (Please attach and indicate How to Read)  Bow to Tip  Tip to Bow

Corbin Russwin Factory Order No. \_\_\_\_\_ Authorized Security Code\* \_\_\_\_\_

\* Not required if opt-out has been recorded on SID

**3. HIGHEST LEVEL OF SYSTEM**

1 - SKD  2 - MK  3 - GM  4 - GGM  5 - GGGM

**4. SYSTEM TYPE**

Security  IC  Master Ring  Conventional  Pyramid\*\*  Access 3 - AP\*\*  Access 3 - AS\*\*  Access 3 - AHS\*\*  
 Other \_\_\_\_\_

\*\*Required documentation must accompany each initial Pyramid or Access 3 order to avoid delay.

**5. KEYS**

**Keyway Selection:**  Stock-L4  Standard  Restricted\*  Patented\* Protected

Specific Keyway \_\_\_\_\_

**Number of Pins:**  5  6 (Default)  7

\* Requires PRIOR Key Systems Approval

**Depth System:**  System 70 (Default)  Pre-System 70  Access 3-AP  Access 3-AS/AHS

**Key Bow Style:** \_\_\_\_\_

**Pyramid & Access 3 have dedicated Bows:** \_\_\_\_\_

**Key Stamping:**

VKC0 - No Bitting or Key Set Stamping on Keys

VKC1 - Visual Key Control Keys Only

VKC2 - Visual Key Control Keys and Cylinders

VKC3 - Visual Key Control Cylinders Only

CKC2 - Concealed Key Control Cylinders and VKC Keys

CKC3 - Concealed Key Control Cylinders Only

Bittings (Standard for Conventional Change Keys)

DO NOT DUPLICATE

US PROPERTY DO NOT DUPLICATE

Special Stamping: \_\_\_\_\_

**6. KEY QUANTITY**

Master Level	Qty.	Special Function	Qty.
<input type="checkbox"/> GGGM _____	_____	<input type="checkbox"/> Control .....	_____
<input type="checkbox"/> GGM _____	_____	<input type="checkbox"/> CMK .....	_____
<input type="checkbox"/> GM _____	_____	<input type="checkbox"/> CMK Control .....	_____
<input type="checkbox"/> _____	_____	<input type="checkbox"/> Emergency .....	_____
<input type="checkbox"/> _____	_____	<input type="checkbox"/> SKD Control .....	_____
<input type="checkbox"/> MK / Group _____	_____	<input type="checkbox"/> SKD CMK .....	_____
<input type="checkbox"/> _____	_____	<input type="checkbox"/> SKD CMK Control .....	_____
<input type="checkbox"/> _____	_____	<input type="checkbox"/> Blockout .....	_____
<input type="checkbox"/> Other _____	_____	<input type="checkbox"/> Maintenance .....	_____
<input type="checkbox"/> _____	_____	<input type="checkbox"/> Housekeeping .....	_____
<input type="checkbox"/> _____	_____	<input type="checkbox"/> Mechanical .....	_____
<input type="checkbox"/> _____	_____	<input type="checkbox"/> Engineering .....	_____
<input type="checkbox"/> _____	_____	<input type="checkbox"/> Janitorial .....	_____
<input type="checkbox"/> _____	_____	<input type="checkbox"/> Other .....	_____

<b>Change Keys*</b>	<b>Qty.</b>
Per cylinder _____	
Per keyed alike group _____	
Per keyed different cylinder _____	

\*Two cut change keys are standard per lockset/cylinder, keyblanks cannot be substituted for cut keys.

**7. CROSS KEYING**

Key Symbol:	To Be Operated By (OBY):

Sheet 2 of \_\_\_\_\_

Date: \_\_\_\_\_

Purchase Order No.: \_\_\_\_\_

Date Required: \_\_\_\_\_

**SOLD TO:**

\_\_\_\_\_

\_\_\_\_\_

\_\_\_\_\_

\_\_\_\_\_

**8. CONSTRUCTION MASTER KEYING\***

\*This section Does NOT Refer To Temporary Construction Cores  
 This Order: Yes  No  Establish for future use only

Ship Construction Keys To: \_\_\_\_\_

\_\_\_\_\_

Attention: \_\_\_\_\_

\_\_\_\_\_

**9. PRICING**

Order subject to follow pricing:

- Price List Dated \_\_\_\_\_
- Special Job Quote \_\_\_\_\_
- Date Quoted \_\_\_\_\_
- Quote No. \_\_\_\_\_

- Discounts Quoted**
- Cylindrical Locks \_\_\_\_\_
  - Mortise Locks \_\_\_\_\_
  - Deadlocks \_\_\_\_\_
  - Cylinders Only \_\_\_\_\_

- Exit Devices \_\_\_\_\_
- Door Closers \_\_\_\_\_
- Electrical Options \_\_\_\_\_
- Other \_\_\_\_\_
- Other \_\_\_\_\_

**10. PACKAGING AND MARKING**

- Pack change keys with locks (Standard)
- Pack change keys separately (Security, Pyramid and CMK jobs always)

- Label Boxes:
- Key symbol
  - Door No.
  - Heading

Ship Change Keys To: \_\_\_\_\_

\_\_\_\_\_

\_\_\_\_\_

Attention: \_\_\_\_\_

\_\_\_\_\_

\_\_\_\_\_

**11. SHIPPING INSTRUCTIONS FOR MASTER KEYS**

Ship Master Keys To: \_\_\_\_\_

\_\_\_\_\_

\_\_\_\_\_

Attention: \_\_\_\_\_

\_\_\_\_\_

\_\_\_\_\_

**12. BITTING LIST**

Provide Bitting List for This Order:  Yes  No

Letter of Authorization:  Attached

Mail Bitting List To: \_\_\_\_\_

\_\_\_\_\_

\_\_\_\_\_

\_\_\_\_\_

Attention: \_\_\_\_\_

**13. CONTACT**

Name of individual in your organization who is knowledgeable about this project, should any clarification be necessary. (Please print or type.)

Name: \_\_\_\_\_

Phone \_\_\_\_\_ Fax \_\_\_\_\_

This form has been completed by: (please print)

Name: \_\_\_\_\_

**ADDITIONAL INFORMATION (attach)**

System Expansion Requirements, Special Remarks, etc.



## Ordering Tips

- Please submit **Quick Ship Program Orders** and **Plant Product Orders** on separate order forms.
- Please use **Quick Ship Program Forms** for all **Quick Ship Product Orders** and include **Quick Ship Part Numbers**.
- **Order Forms** are included in the Price Book and at [www.corbinrusswin.com](http://www.corbinrusswin.com).
- We recommend using the **Order Form** included with this Price Book when placing purchase orders for Corbin Russwin products. The **Order Form** is available for copying prior to placing your order.
- Please include **Job Name and Registry Number** for all contract orders.
- Be sure to include **Voltage** on all Electrified Hardware orders.
- A **Letter of Authorization** is required for all Protected and Pyramid Keyways.
- **Keyed Lead Sheets A and B** are *recommended* for contract orders that are keyed to existing Master Key systems.
- Remember to include **Keysets** on all contract orders.
- Be sure to include **Handing** for all unit locks, mortise locks and exit devices.
- If you have a **Quote**, please include it with the purchase order. Orders without this information may be delayed.

## Ordering Tip — Administrative Documentation

When submitting purchase orders to ASSA ABLOY Door Security Solutions® Consultants for processing, please remember that certain cylinder types and/or keyways require additional administrative documentation before the order can be entered.

Purchase orders will be held and questioned if the following keyway/cylinder types do not have the proper administrative documentation submitted with each purchase order:

- Protected and Pyramid keyway products
- Security cylinders and keys
- High security cylinders and keys

All of the above product types must be accompanied by additional administrative documents unless they are shipping direct to the end user facility. These administrative documents include, but may not be limited to, the following:

- Letter of Authorization – must be submitted on the end user facility letterhead, dated and signed by an authorized individual from the facility. Letter must be quantity specific for certain product types. ASSA ABLOY Door Security Solutions Consultants does not keep letters of authorization on file.
- Registration Certificate – only required for Pyramid systems.

## Ordering Checklist

Before placing your order, check for the following:

- ✓ Purchase Order on company letterhead
- ✓ Purchase Order is legible
- ✓ Purchase Order Number
- ✓ Account Number
- ✓ Ship To Address
- ✓ Contact Person for additional information requirements
- ✓ Pricing Requirements – Buying Program or CPQ (please attach)
- ✓ Quick Ship Order (Quick Ship Order Form or Quick Ship part numbers included)
- ✓ Contract Order (Keyed Lead Sheets attached)
- ✓ Handing (if applicable)
- ✓ Design (if applicable)
- ✓ Backset & Strike (if applicable)
- ✓ Finish (if applicable)

## Website

Corbin Russwin's website at [www.corbinrusswin.com](http://www.corbinrusswin.com) is the place to go for all your Corbin Russwin product information needs. Easy-to-navigate menus and intuitive icons allow simple and fast access to the latest on new products, as well as the most up-to-date catalogs, templates and installation instructions.

Another great benefit of the Corbin Russwin website is the ability to become an eBusiness member. Access gives additional information for Corbin Russwin account customers only.

## eBusiness

Visit [www.corbinrusswin.com](http://www.corbinrusswin.com) to sign up for ASSA ABLOY Door Security Solutions eBusiness access.

ASSA ABLOY Door Security Solutions Consultants provides sales, marketing and support for Corbin Russwin.

To sign up for eBusiness, follow the simple instructions listed below. Register today and start enjoying the many benefits!

eBusiness offers anytime access to:

- Order Status
- Stock Status Check
- Key Systems
- Newsletters
- Contact Webmaster
- Fax Order Acknowledgement
- Extended Literature (Price Books, Order Forms, Keyed Lead Sheets)
- Order Check by P.O.
- Cross Reference Guide
- Key Wizard® Order Forms
- ASSA ABLOY Door Security Solutions Online Store
- Fax Program Sign Up
- Fax Invoice

## How to sign up for eBusiness access:

Step 1: Visit our website at [www.corbinrusswin.com](http://www.corbinrusswin.com)

Step 2: Double-click eBusiness icon (top right corner)

Step 3: Complete ASSA ABLOY Door Security Solutions eBusiness sign up form



## ONLINE ORDER ENTRY

Would you like to reduce the time to get your orders entered to the factory and eliminate errors associated with manual order entry?

Then try our on-line order entry system. Our convenient web-based order forms can help you submit your orders directly to the factory in minutes.

Contact your customer service representative who will be able to issue your user name and password as well as set up appropriate training sessions for you and your staff.

The screenshot shows the ASSA ABLOY website's 'PLACE AN ORDER' section. At the top, there is a navigation menu with links: START | TEMPLATES | PARTS | HISTORY | CART | QUICK ORDER | QUICK SEARCH | ORDER EXPORT | CONTACT. A search bar is present with the text 'Search customer name, etc.' and buttons for 'SEARCH' and 'CLEAR'. Below the search bar, there are sections for 'NEWS' and 'BRANDS'. The 'NEWS' section contains information about ordering for CURRIES and GRAHAM. The 'BRANDS' section lists 'ADAMS RITE'. The main 'PLACE AN ORDER' section has a breadcrumb trail: 'FIND A CUSTOMER / SELECT A CUSTOMER / FIND PARTS / ADD PARTS / REVIEW & SUBMIT'. Below this is a table with columns: Brand, Customer Number, Customer Name, Territory, and Ship To Address. The table contains two entries for CORBIN RUSSWIN.

Brand	Customer Number	Customer Name	Territory	Ship To Address
CORBIN RUSSWIN	404051	84 LUMBER COMPANY #1975	A28	22770 N. WESTLAKE HOUSTON TX 77095
CORBIN RUSSWIN	403670	A G MAURO COMPANY	A08	1221 BERNARD DRIVE BALTIMORE MD

## FAX PROGRAM

Would you like to receive your acknowledgements and invoices, invoices and Return good Authorizations quickly and efficiently?

If so, ASSA ABLOY Door Security Solutions offers the Order Acknowledgement and Invoice, invoices and Return good Authorizations Fax Program. Please see the simple steps below to get signed up today!

Requirement: Valid eBusiness User ID and Password. (If you do not have an eBusiness User ID and Password, please refer to eBusiness Sign Up Section included in this Price Book.)

Step 1: Log into eBusiness.

Step 2: Double-click on "Sign Up for ASSA ABLOY Door Security Solutions's Fax Program Now!"

Step 3: Fill in appropriate information and send.

### Fax Program Signup

If your distributor would like to receive their CORBIN RUSSWIN, NORTON, RIXSON and YALE order acknowledgements, invoices, and return goods authorizations by fax, please complete the form below to sign them up today!

Yes - Fax Invoices to Fax #:

Yes - Fax Order Acknowledgements to Fax #:

Yes - Fax Return Goods Authorizations to Fax #:

Enter the distributor's Account Number in the input box below and click [Add] to add it to your Account Number list. Repeat for each distributor Account Number that you have.

Enter Account Number:

Account Number List:

## Terms and Conditions

### ACCEPTANCE

Corbin Russwin reserves the right to decline an order, in whole or in part, when the type or quantity of goods or credit worthiness of the Purchaser is not satisfactory to us in our sole and absolute discretion.

Purchase Orders, Quote Requests, Acknowledgements or the like issued by the Purchaser that have contrary standard terms and conditions are not binding on Corbin Russwin, unless such terms and conditions are approved in a separate written agreement by Corbin Russwin's authorized representatives. In the event of an acceptance of Purchaser's Purchase Order by Corbin Russwin, the Purchaser agrees that such acceptance is solely conditioned on Purchaser's acceptance of the terms and conditions set forth in this instrument, regardless of the terms and conditions specified in Purchaser's Purchase Order. The terms and conditions in Purchaser's Purchase Order which conflict with the terms and conditions of this instrument shall be disregarded and are hereby rejected, and this instrument shall constitute the entire agreement between Corbin Russwin and the Purchaser.

In the event that Corbin Russwin does not enforce or require strict performance of any term or condition hereof, or of any other document, instrument or other agreement relating to goods sold, such lack of enforcement or requirement of strict performance will not waive, affect or diminish any right of Corbin Russwin to enforce or require strict performance of such term or condition in the future.

### PRICES

All prices are subject to change without notice and are not guaranteed. All shipments will be made at prices in effect at the time of shipment.

Possession of this price list does not constitute an agreement to sell.

We reserve the right to correct clerical, stenographic and other obvious errors at any time.

### TERMS

Invoices dated the 1st through the 15th will be due for 2% discount on the \*10th of the following month. Invoices dated the 16th through the 31st will be due for 2% discount on the \*25th of the following month. \*Net immediately thereafter. (Corbin Russwin retains the right to sell or to decline to sell to any Customer for any reason whatsoever when in its judgment is deemed sufficient.)

It is understood that Corbin Russwin may impose and charge a finance charge which is the lesser of one and one-half percent (1-1/2%) per month or the highest rate allowed by law on any amount which becomes past due and delinquent. Additionally the Customer shall be responsible for all collection costs, court costs and reasonable attorney's fees (where allowed by law) in connection with the recovery of any delinquent amount.

### FREIGHT

All orders are shipped FOB factory/warehouse, except as expressly provided below. When delivered to the Transportation Company, the Purchaser assumes the risk of loss or damage in transit.

Customer orders with net product value in excess of \$12,000.00 will be shipped prepaid by Corbin Russwin's carrier of choice to a single destination point in the United States.

Customer orders with net product value less than \$12,000.00 will be shipped prepaid by Corbin Russwin's carrier of choice and freight and handling charges will be added to the customer's invoice.

A minimum freight and handling charge of \$15.00 will be charged on orders with net product value of \$400.00 or less. The minimum freight and handling charge will not apply to orders for only Cut (bitted) keys of any type, Master Keys, Master keyed cylinders or padlocks and factory generated bitting lists that do not have any other product types included on the order. Freight on these orders will be charged as the percentage of invoice value.

For orders with net product value greater than \$400.00 and less than \$12,000.00, freight charges will be calculated as a percentage of the net invoice value and will be added to Customer's invoice. The percentage is based on the National U.S. Average On Highway Diesel Fuel Prices as reported by the US Department of Energy in effect at the beginning of each quarter. On the first Monday of each quarter, the new rate will be published on the Corbin Russwin and Door Security Solutions extranet and will go into effect on the 2nd Monday of the quarter. Please refer to the extranet for the rate chart and information on the current freight charge percentage. The percentage in effect at the time of shipment of the order will be charged.

Great Grand Master keys, Grand Master keys, Master keys, Construction Master keys, Control Keys, Lot Day Keys which are shipped separate from customer order for security reasons, on orders with total net product value in excess of \$12,000.00 will be shipped prepaid by Corbin Russwin's carrier of choice. If the total order value is less than \$12,000.00, the shipping charges will be added to Customer's invoice.

If a customer provides their own freight account # for the freight charges, Corbin Russwin will apply a handling fee of \$25.00 to the invoice.

Quick Ship Orders – All 1-Week Quick Ship orders are guaranteed to ship from Corbin Russwin 5 working days after receipt of all information necessary to process order or Corbin Russwin will pay freight costs. If Quick Ship is held for credit reasons Corbin Russwin will not be responsible for freight costs.

Expedited shipping options – If the customer requests an expedited method of shipment such as "Next Day Air" the charges will be prepaid by Corbin Russwin and the full rate for the service, as published by the carrier, will be added to the customer's invoice.

### **Terms and Conditions continued**

Packing – Corbin Russwin will pack, mark and ship the products according to its standard procedures for shipment, unless the parties agree, in writing, that Corbin Russwin will comply with any special instructions provided by the customer. Special instructions must be submitted, in writing, at time of order placement. Compliance with special instructions may result in an increased price.

#### **MINIMUM ORDER**

Minimum order value for complete product is \$250.00 net product value. The minimum order value for parts orders is \$100.00 net product value. In the event that the net product value does not meet the required net minimum, Corbin Russwin may, at its sole discretion (a) apply a minimum order charge, (b) reject the order or (c) waive the minimum requirement provided that the waiver of the requirement for one order shall not constitute a waiver of the requirement for any future orders.

The following products are exempt from this policy: Cut (bitted) Keys of any type, Master Keyed Cylinders, Master Keyed Padlocks and Factory Generated Biting Lists.

#### **QUOTATIONS**

If Corbin Russwin elects to offer a quote, such quote will be valid until the expiration date on that quote. Complete shipment of the order must be accepted by Purchaser within standard manufacturing lead times. The quote number must be referenced on the order. Any invoiced order that has the incorrect discount applied to it and did not have the quote number written on the order will have a service fee of \$100.00 net DEDUCTED from any sales credit issued for the difference in discount. The quote is null and void if the Purchase Order does not include ALL product lines listed on the quote or if the quantities for any item covered by the quote deviate by 10% or more. With the issuance and acceptance of a quote for the purchase of products, the Purchaser agrees that products so purchased will not be resold or transferred to any Distributor not authorized by Corbin Russwin to sell its products. This would be inclusive of branches of the quoted Distributor. Failure to abide by this restriction may result in the Distributor's ineligibility for Quotations, or other actions in Corbin Russwin's discretion. Corbin Russwin and its sales representatives reserve the right, in their sole discretion and for any reason, to refuse a Distributor's request to quote a price other than Corbin Russwin's standard list price and regardless of whether Corbin Russwin or its sales representatives have previously quoted discounted prices to the Distributor on some or all of its orders.

#### **NON-CATALOGED PRODUCTS**

Products not cataloged or listed in this price book will be considered as special products, and will not be manufactured without prior written approval from Corbin Russwin. A minimum special handling charge of \$50.00 will be added for non-cataloged product. Any additional labor or material required will be charged accordingly. Special products require special handling, and therefore standard lead times may not apply. Please consult with your Sales Representative for further details.

#### **CHANGES/CANCELLATION OF ORDERS**

Changes or cancellations to an order will result in a charge of costs for material and labor expenses that have been incurred prior to notification from Customer. If products have already been made and/or are located in the shipping room, the 45% restocking fee will apply. Handling charges are billed on Customer's original order. All Non-Cataloged Goods and Corbin Russwin Quick Ship Orders may not be changed or cancelled.

#### **ADD-ON ORDERS TO QUOTE**

Any new order requesting special pricing to match an existing quote number, which has already been ordered, will be accepted up to sixty (60) days after the acknowledgement of the original order. All add-on orders must reference the original factory order number, and the corresponding quote number to receive the quoted pricing discount. Add-on orders for stock will not be accepted.

#### **PACKAGING**

Many items are defined as to Case Lot Packaging or Minimum Order. The Case Lot policy does not apply to hardware to be used on a specific hardware project.

#### **DELIVERY**

Orders will be acknowledged and given a scheduled delivery date based on estimated manufacturing lead times. Complete information is required to process all orders. Orders with insufficient information for processing (i.e. keying information, door sizes, handing, etc.) may be subject to extended lead times which are relative to the time required in obtaining the necessary information for order processing. Manufacturing lead time will begin once all information is received to process an order. Corbin Russwin will use reasonable efforts to deliver products as estimated, but makes no guarantees as to delivery dates. Corbin Russwin will not be liable for back charges incurred based on availability of product or as a result of delays in delivery caused by insufficient information required to process an order. Corbin Russwin will not be held responsible for delays in delivery caused by strikes, fires, floods or any other causes beyond our control, including the delivery of material to us. Under no circumstances shall Corbin Russwin be liable or accountable for consequential damages due to failure of delivery.

#### **CLAIMS**

In the event of Company or Customer error, claims for shortages, pricing errors and/or incorrectly filled orders must be submitted in writing to Customer Service within thirty (30) days from receipt of material. Any claims for shortages or damage by the Carrier must be made by the Customer directly to the Carrier.

**Terms and Conditions continued****INVOICE DEDUCTION**

A Corbin Russwin Sales Representative or Customer Service Representative must be notified of any disputed invoices within sixty (60) days from the date of invoice. Deductions should only be taken for the disputed amount and the balance of the invoice is due and payable within standard payment terms.

**RETURNED GOODS**

It is the policy of Corbin Russwin to not accept returns of any materials that are correctly furnished as per the Distributor's Purchase Order. Return of product due to customer order error or accommodation must be pre-arranged with Corbin Russwin and approved in writing by Sales Management.

All products returned as "Goodwill" must meet the following criteria to be considered a return:

- Be in original, unmarked and undamaged cartons.
- Be valued in excess of \$250.00 net.
- Shipped and invoiced within the previous one hundred twenty (120) days.
- Custom, non-cataloged goods, master-keyed or Corbin Russwin Quick Ship product is not returnable.

A MINIMUM restocking fee of 45% will be charged. Upon receipt and verification by Corbin Russwin that the returned merchandise meets the foregoing conditions, a credit will be issued for the original invoice amount less the MINIMUM 45% restocking fee.

Defective goods and "Goodwill" products that meet the foregoing criteria may be returned by fulfilling the following conditions:

- Send an RGA request in writing to the Corbin Russwin Sales Representative serving the Purchaser's area.
- Ensure the RGA labels that are sent to Purchaser by Corbin Russwin are visible on return goods shipment.
- Ensure that the RGA number appears on the return shipment label and is legible.
- Return the authorized merchandise within sixty (60) days from the date of RGA issuance date.
- Return shipments must be freight prepaid to the location specified on the RGA.
- Corbin Russwin is not liable for damages to product during shipping.

No credit may be taken or issued prior to RGA approval and receipt of product.

All defective goods within the terms of our limited warranty may be returned for credit or replacement.

**RETURNED GOODS – ELECTROMECHANICAL**

All defective replacement requests for electromechanical products/components must be authorized by contacting the Electromechanical Applications Team at 1-800-810-WIRE to obtain a case number. In order to receive credit for the replacement of an electromechanical product the following criteria needs to be met:

- Defective product return must be under warranty
- Defective product/component return must arrive at factory within 60 days of the Returned Goods Authorization issuance
- Returned product must be found defective or nonfunctional upon test at factory
- Returned product must not have been damaged during installation process

**TAXES**

Prices do not include any present or future Federal, State, or Local property, license, privilege, sales, use, excise, gross receipts or other like taxes or assessments, which may result from transactions or any services performed in connection herewith.

**GOVERNING LAW**

The rights and obligations of the parties shall be governed by the laws of the State of North Carolina, excluding any conflicts of law provisions. The United Nations Convention on Contracts for the International Sale of Goods shall not apply to this Agreement.

**LIMITED WARRANTY**

The Terms and Conditions outlined above are subject to Corbin Russwin's Limited Warranty, which is included in this Price List and incorporated herein by reference.

**PRODUCT MODIFICATIONS**

Corbin Russwin products are not designed or intended for aftermarket modification. The warranty on Corbin Russwin products becomes void if the product is modified in any way, regardless of whether the modification causes or contributes to any alleged defect. Warranty voiding modifications include, but are not limited to, third-party electrification of non-electric products and/or the installation of non-approved or non-Corbin Russwin components.

If a Corbin Russwin product is modified it no longer meets industry certification and quality control standards applicable to the original product and is no longer a genuine Corbin Russwin product. A modified product may not be sold as a Corbin Russwin product and the Corbin Russwin and Design® trademark or certification marks based on the original Corbin Russwin product, such as U.L. or ANSI/BHMA marks, may not appear anywhere on the modified product or on any packaging, literature, or instructions sold with the modified product.

All original Corbin Russwin packaging and literature carries the Corbin Russwin and Design® trademark and must be destroyed if the original Corbin Russwin product is modified. Portions of the product that carry the Corbin Russwin and Design® trademark or certification mark must be discarded and/or replaced by the party making the modification. U.L. and other certification testing and marking are also the responsibility of the party making modification. The use of the Corbin Russwin and Design® trademark on modified products constitutes trademark infringement.



**Terms and Conditions continued****FIRE RATED OPENINGS**

Any retrofit or other field modification to a fire rated opening can potentially impact the fire rating of the opening, and Corbin Russwin, Inc. makes no representations or warranties concerning what such impact may be in any specific situation. When retrofitting any portion of an existing fire-rated opening, or specifying and installing a new fire-rated opening, please consult with a code specialist or local code official (Authority Having Jurisdiction) to ensure compliance with all applicable codes and ratings.

The following policy ("Policy") of ASSA ABLOY Americas ("ASSA ABLOY"), and all of its affiliated group companies (collectively, the "Group Companies"), applies to the use of certain intellectual property of all such Group Companies, including all trademarks, names, logos, product images, and related information (the "ASSA ABLOY Marks"). ASSA ABLOY Marks are proprietary and critical to the success of ASSA ABLOY and the Group Companies, and may only be used in strict compliance with this Policy.

This Policy covers any person or entity reselling any product of any Group Company with the consent of such Group Company (each, an "Approved Reseller"). Each Approved Reseller has a non-exclusive right to use certain of the ASSA ABLOY Marks relating to any of the Group Companies for which it is an Approved Reseller, subject to the following conditions:

- (1) Approved Reseller's use of ASSA ABLOY Marks must be truthful, fair, and not misleading;
- (2) Approved Reseller's advertising must clearly indicate that it is advertising of the Approved Reseller, and is not advertising of ASSA ABLOY;
- (3) Approved Reseller may not use any ASSA ABLOY Marks as part of or in connection with a domain name;
- (4) Approved Reseller's advertising must not imply or suggest an association between the Approved Reseller and ASSA ABLOY other than that of buyer and seller;
- (5) Approved Reseller's use of ASSA ABLOY Marks must be a positive representation of ASSA ABLOY, the Group Companies, and their products;
- (6) Approved Reseller's trade name must be more predominant on Approved Reseller's advertising than the ASSA ABLOY Marks;
- (7) Approved Reseller's use of ASSA ABLOY Marks must include the trademark symbol ® or ™, as appropriate, along with the following trademark legend printed in legible text on the Web page or document containing ASSA ABLOY Marks: "[describe ASSA ABLOY Marks] are trademarks or registered trademarks of ASSA ABLOY, Inc. or one of its affiliates in the United States and other countries.";
- (8) Approved Reseller must not make modifications of any ASSA ABLOY Marks; and
- (9) Approved Reseller may use only ASSA ABLOY Marks associated with the Group Companies for which it is an Approved Reseller (e.g., an Approved Reseller that sells Group Company X products but not Group Company Y products may use Group Company X trademarks in connection with its sale of Group Company X products, but may not use Group Company Y trademarks).

ASSA ABLOY reserves the right to review Approved Reseller's usage of ASSA ABLOY Marks at any time and may:

- (a) require changes to the use of ASSA ABLOY Marks at any time in its sole discretion, which changes must be implemented within 30 days of written notice to Approved Reseller;
- (b) condition the use of ASSA ABLOY Marks on ASSA ABLOY's prior approval of such use, which approval may be withheld in its sole discretion;
- (c) revoke permission to use ASSA ABLOY Marks at any time for any or no reason upon 30 days prior written notice to Approved Reseller; and
- (d) revoke permission to use ASSA ABLOY Marks immediately upon notice to Approved Reseller in the event Approved Reseller is in violation of this Policy, or of any other agreement with ASSA ABLOY or any Group Company.

Approved Reseller's right to use ASSA ABLOY Marks in no way conveys to Approved Reseller any proprietary or economic interest in any ASSA ABLOY Marks.

Use of ASSA ABLOY Marks in violation of this Policy may result in severe civil and criminal liabilities. ASSA ABLOY will vigorously enforce this Policy by seeking all appropriate legal remedies, including, but not limited to, pecuniary damages and injunctive relief.

If there are any questions on this policy, please contact Linda Dean at [ldean@assaabloyusa.com](mailto:ldean@assaabloyusa.com) or 203-498-5596.

**TECHNICAL INFORMATION AND ADVICE**

(a) All designs, data, and specifications provided by Company are proprietary and will not be disclosed or reused by Customer without the prior written consent of Company; (b) Company assumes no obligation or liability for any advice given by Company, the results obtained, or damages incurred, and all such advice is given and accepted at Customer's risk.



**Limited Warranty**

Corbin Russwin, Inc. (Company) warrants that its products sold under the Corbin Russwin and Design® trade name in the United States of America are free from defects in workmanship and materials under normal use and service. This warranty does not cover defects or damage arising from improper installation, lack of or improper maintenance, improper storage, shipping and handling, corrosion, erosion, ordinary wear and tear, misuse, abuse, accident, unauthorized service, or use with unauthorized non-Corbin Russwin products or parts. This warranty is void if any modification is made to the warranty product, regardless of whether the modification causes or contributes to the alleged defect. All modifications are made at the risk of the party making the modification.

The only liability of the Company in tort or contract whether under this warranty or otherwise shall be limited to the repair or replacement of any product or component part which shall prove defective as covered by this warranty, within the stated time frame listed below, after delivery to the original purchaser.

Access 3 Cylinders	.1 year
Pyramid Cylinders	.5 years
CL3100 Series Cylindrical Locksets	.10 years
CL3300 Series Cylindrical Locksets	.7 years
CL3500 Series Cylindrical Locksets	.7 years
CL3800 Series Cylindrical Locksets	.7 years
ML2000 Series Mortise Locksets	.10 years
Electrified Locksets	.2 years
ED3000, ED7000, ED8000 Series Exit Devices & Trim	.1 year
ED4000, ED5000 Series Exit Devices & 900 Series Trim	.5 years
All Other Exit Device Trim	.1 year
Electrified Exit Devices	.2 years
FE5400S	.7 years
FE6700	.7 years
FE6800	.7 years
Access 800® CL33800 x TCAC2 Cylindrical	.7 years (mechanical), 2 years (electrical)
Access 800® ML20800 x TCAC2 Mortise Locks	.10 years (mechanical), 2 years (electrical)
Access 800® ED5000 x 9800 x TCAC2 Exit Devices	.5 years (mechanical), 2 years (electrical)
DC3000 Series Closers	.15 years
DC5000 Series Closers	.10 years
DC6000 Series Closers	.25 years
DC8000 Series Closers	.25 years
All Other Corbin Russwin Products	.1 year
MicroShield® Finish	.1 year

**Finishes:**

Corbin Russwin finishes are covered by a limited warranty period of one year after invoice date.

**Warranty Requirements for Cylinders Factory or Field Combined:**

Cylinders are lubricated at the factory with a petroleum based lubricant (Medeco KeyLube). Cylinders should be lubricated periodically depending upon environmental conditions. Petroleum based lubricant is recommended. Never mix petroleum based lubricants with dry lubricants. Corbin Russwin cylinder and/or core warranty will be voided if used in non-Corbin Russwin locking devices.

**Warranty Requirements for Cylinders Field Combined:**

1. Keys shall be cut to the Corbin Russwin key biting specifications required for the particular keyway and depth system.
2. All pin lengths shall be selected according to prevailing factory standards.
3. Original Corbin Russwin cylinders and cylinder components, including pin tumblers and key blanks, shall be used. We reserve the right to void the warranty if we deem that a malfunction is a result of non-original components which do not conform to Corbin Russwin standards.

**Keying Systems:**

All bittings shall be originated or authorized by the Corbin Russwin Key Systems Department to be compatible with one another in a specific type of cylinder (Pyramid, conventional, security, master ring, interchangeable core) and within a particular keying system.

All components of electromagnetic products are covered by a limited warranty period of one year after invoice date thereof of the original purchaser from us. Product repair or replacement, or associated charges, will not be accepted under this warranty unless prior authorization from Corbin Russwin has been given. Upon receipt of products returned for repair or replacement, we will determine whether products qualify for repair or replacement under this warranty. If they do not, we will obtain authorization prior to proceeding.

We have no liability to pay any costs of repair performed by anyone other than qualified personnel authorized by Corbin Russwin prior to the work being done.

**Terms and Conditions continued**

The Company will not pay for the cost of repair performed other than in accordance with this warranty. Written notice of a product or component part believed to be defective as covered by this warranty should be sent to Corbin Russwin, Inc. 225 Episcopal Road, Berlin, CT 06037, and should include your name and address, an identification of the product or component part and a brief description of the defect. Upon receipt of such notice, the Company will inform you where to ship such product or component part, shipping charges prepaid, for examination and, in the event such examination reveals defect covered by this warranty, the product will be repaired or replaced. The Company reserves the right to replace discontinued product with an equivalent product as deemed by the Company.

THIS WARRANTY IS IN LIEU OF ALL OTHER EXPRESS WARRANTIES. TO THE EXTENT PERMITTED BY LAW, ALL IMPLIED WARRANTIES ARE LIMITED TO THE DURATION OF THIS WARRANTY. CORBIN RUSSWIN, INC. SHALL NOT BE LIABLE FOR ANY INCIDENTAL OR CONSEQUENTIAL DAMAGES. NO AGENT, SALES REPRESENTATIVE OR DEALER HAS THE AUTHORITY TO INCREASE OR ALTER THE OBLIGATIONS OF THIS WARRANTY. SOME STATES DO NOT ALLOW LIMITATIONS ON HOW LONG AN IMPLIED WARRANTY LASTS OR THE EXCLUSION OR LIMITATION OF INCIDENTAL OR CONSEQUENTIAL DAMAGES, SO THE ABOVE LIMITATION OR EXCLUSIONS MAY NOT APPLY TO YOU. THIS WARRANTY GIVES YOU SPECIFIC LEGAL RIGHTS, AND YOU MAY ALSO HAVE OTHER RIGHTS WHICH VARY FROM STATE TO STATE.

## Finishes

ANSI/BHMA 600	Primed for Painting (USP)
ANSI/BHMA 605	Bright Brass (US3)
ANSI/BHMA 606	Satin Brass (US4)
ANSI/BHMA 611	Bright Bronze (US9)
ANSI/BHMA 612	Satin Bronze (US10)
ANSI/BHMA 613	Dark Oxidized Satin Bronze, Oil Rubbed (US10B)
613E	Dark Oxidized Satin Bronze - Equivalent
ANSI/BHMA 613L	Dark Oxidized Satin Bronze, Clear Coated
ANSI/BHMA 618	Bright Nickel Plated (US14)
ANSI/BHMA 619	Satin Nickel Plated (US15)
ANSI/BHMA 622	Flat Black Coated (US19)
ANSI/BHMA 625	Bright Chromium Plated (US26)
ANSI/BHMA 626	Satin Chromium Plated (US26D)
ANSI/BHMA 628	Satin Aluminum, Clear Anodized (808 Mullion)
ANSI/BHMA 629	Bright Stainless Steel (US32)
ANSI/BHMA 630	Satin Stainless Steel (US32D)
ANSI/BHMA 689	Silver Aluminum Painted (SBL)
ANSI/BHMA 690	Dark Bronze Painted (LBL)
ANSI/BHMA 691	Light Bronze Painted (DBL)
ANSI/BHMA 693	Black Painted (FBL)
ANSI/BHMA 695	Dark Bronze Painted or Anodized (808 Mullion)
ANSI/BHMA 696	Satin Brass Painted (GBL)
ANSI/BHMA 722	Black oxidized bronze, oil rubbed

## Samples

Display Mounts (Base Hardware not included). Price covers mount only.

For Product Series	Specify	Price
CL3100, CK4400	SM-CL-NTB	\$155.00
CL3300, CL3500, CL3800	SM-CL-TB	\$155.00
ML2000 x Sectional Trim (Lever, Knob, BLSS, HSS, HPSK)	SM-ML-L	\$166.00
ML2000 x BHSS trim	SM-ML-WAVE-CYL x TP	\$166.00
ML2000 x Roseless	SM-ML-RL	\$166.00
UT5200	SM-UT	\$155.00
HP3000	SM-CL-HP3000	\$148.00
Access 800® CL33800	SM-CL-A800	\$155.00
Access 800® ML20800	SM-ML-A800	\$165.00
Access 800® ED5000 x 9800	SM-ED-A800	\$198.00
Inspire - 5 Levers	SM-ML-RL-5LEV	\$398.00

Pyramid Sample Display Case

Specify	Price
PS-20-DC	\$310.00

Finish folder with cylinder scalps.

Specify	Price
FP	\$160.00

## Corbin Russwin Templates

Templates of Corbin Russwin products that are most commonly used are available through our website <http://www.corbinrusswin.com/en/site/corbin-russwin/Library/Product-Templates/>

--

# Tubular Locksets

TL3700 Series: Muséo Levers and Inspire™ Roseless Trim

# MUSÉO®

contemporary trim to complement the interior design of your next project

## GEORGIA



## PABLO



## JACKSON¹



## SALVADOR



## MARC¹



J Collar

¹Handed: specify hand when ordering  
²Contact factory for current lead time

613E Dark Oxidized Satin Bronze - Equivalent  
626 Satin Chromium Plated

605 Bright Brass, Clear Coated  
606 Satin Brass, Clear Coated  
611 Bright Bronze, Clear Coated  
612 Satin Bronze, Clear Coated  
613 Dark Oxidized Satin Bronze, Oil Rubbed  
613L Dark Oxidized Satin Bronze, Clear Coated  
618 Bright Nickel Plated  
619 Satin Nickel Plated  
625 Bright Chromium Plated  
629 Bright Stainless Steel  
630 Satin Stainless Steel  
722 Black Oxidized Bronze, Oil Rubbed

### Function

TL3710	Passage Set	\$220.00	\$230.00
TL3710A	Passage Set-3 Hour	\$226.00	\$236.00
TL3720	Privacy Set	\$232.00	\$242.00
TL3720A	Privacy Set-3 Hour	\$238.00	\$248.00
TL3750	Single Lever Pull-Through Bolted	\$97.00	\$102.00
TL3770	Double Lever Pull	\$182.00	\$192.00
TL3780	Communicating Set	\$220.00	\$230.00
TL3780A	Communicating Set-3 Hour	\$226.00	\$236.00

Ordering Example Details →

TL3710 Passage: Non-Keyed tubular lock  
102J Georgia Family Lever, J Collar  
626 Satin Chrome Finish  
LH Left Handed

Trim Only				
Quantity	Series/Function	Trim	Finish	Hand
24	TL3710	102J	626	LH

contemporary trim to complement the interior design of your next project

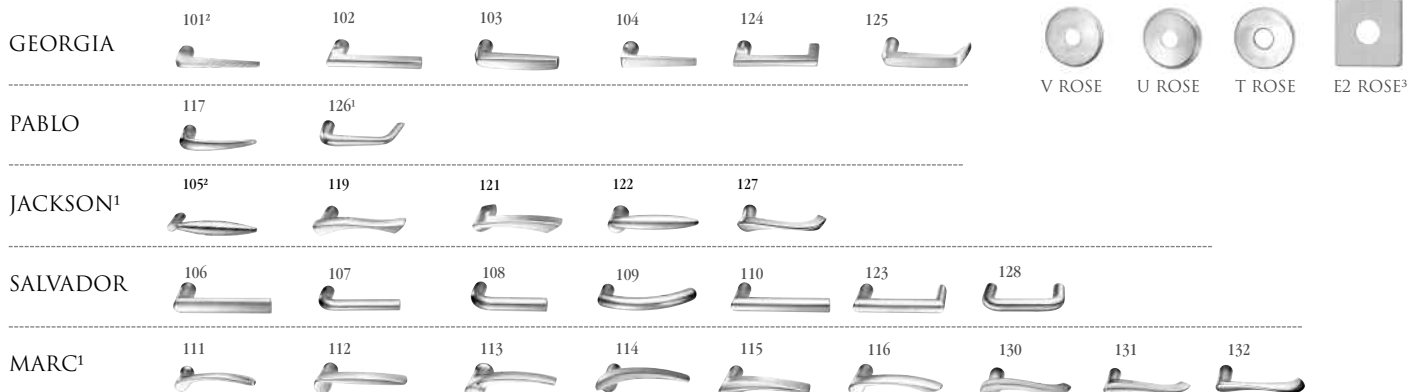

<sup>1</sup>Handed: specify hand when ordering

<sup>2</sup>Contact factory for current lead time

<sup>3</sup>CAUTION: Cannot retrofit on existing cylindrical lock door preps with through-bolt holes outside the 2-1/8" bored hole (Ex. CL3300 & CL3500).

613E	Dark Oxidized Satin Bronze - Equivalent
626	Satin Chromium Plated

605	Bright Brass, Clear Coated
606	Satin Brass, Clear Coated
611	Bright Bronze, Clear Coated
612	Satin Bronze, Clear Coated
613	Dark Oxidized Satin Bronze, Oil Rubbed
613L	Dark Oxidized Satin Bronze, Clear Coated
618	Bright Nickel Plated
619	Satin Nickel Plated
625	Bright Chromium Plated
629	Bright Stainless Steel
630	Satin Stainless Steel
722	Black Oxidized Bronze, Oil Rubbed

**Function**

TL3710	Passage Set	\$205.00	\$215.00
TL3710A	Passage Set-3 Hour	\$211.00	\$221.00
TL3720	Privacy Set	\$217.00	\$227.00
TL3720A	Privacy Set-3 Hour	\$223.00	\$233.00
TL3750	Single Lever Pull-Through Bolted	\$120.00	\$125.00
TL3750S	Single Lever Pull-Surface Mounted	\$90.00	\$95.00
TL3770	Double Lever Pull	\$171.00	\$181.00
TL3780	Communicating Set	\$205.00	\$215.00
TL3780A	Communicating Set-3 Hour	\$211.00	\$221.00

Ordering Example Details →

TL3710 Passage: Non-Keyed tubular lock  
 111T Marc Lever, T-Rose  
 626 Satin Chrome Finish  
 LH Left Handed

Trim Only				
Quantity	Series/Function	Trim	Finish	Hand
24	TL3710	111T	626	LH

# Tubular Locksets

TL3700 Series: Muséo Levers and Roses



contemporary levers to complement the interior design of your next project

JOSEF

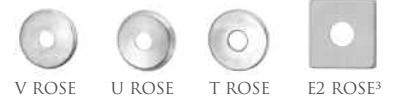

<sup>1</sup>Handed: specify hand when ordering

<sup>2</sup>Contact factory for current lead time

<sup>3</sup>**CAUTION:** Cannot retrofit on existing cylindrical lock door preps with through-bolt holes outside the 2-1/8" bored hole (Ex. CL3300 & CL3500).

613E Dark Oxidized Satin Bronze - Equivalent  
626 Satin Chromium Plated

605 Bright Brass, Clear Coated  
606 Satin Brass, Clear Coated  
611 Bright Bronze, Clear Coated  
612 Satin Bronze, Clear Coated  
613 Dark Oxidized Satin Bronze, Oil Rubbed  
613L Dark Oxidized Satin Bronze, Clear Coated  
618 Bright Nickel Plated  
619 Satin Nickel Plated  
625 Bright Chromium Plated  
629 Bright Stainless Steel  
630 Satin Stainless Steel  
722 Black Oxidized Bronze, Oil Rubbed

## Function

TL3710	Passage Set	\$214.00	\$224.00
TL3710A	Passage Set-3 Hour	\$220.00	\$230.00
TL3720	Privacy Set	\$226.00	\$236.00
TL3720A	Privacy Set-3 Hour	\$232.00	\$242.00
TL3750	Single Lever Pull-Through Bolted	\$122.00	\$132.00
TL3750S	Single Lever Pull-Surface Mounted	\$92.00	\$102.00
TL3770	Double Lever Pull	\$180.00	\$190.00
TL3780	Communicating Set	\$214.00	\$224.00
TL3780A	Communicating Set-3 Hour	\$220.00	\$230.00

Ordering Example Details →

TL3710 Passage: Non-Keyed tubular lock  
133E2 Josef Lever, E2 Rose  
626 Satin Chrome Finish  
LH Left Handed

Trim Only				
Quantity	Series/Function	Trim	Finish	Hand
24	TL3710	133E2	626	LH



Corbin Russwin Architectural Hardware | 225 Episcopal Road | Berlin, CT 06037  
Phone 800-543-3658 | Fax 800-447-6714 | corbinrusswinMUSEO.com

ASSA ABLOY, the global leader in door opening solutions

Price List. 23

November 1, 2015

contemporary levers to complement the interior design of your next project

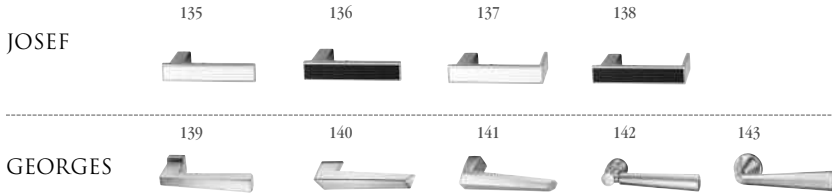

<sup>1</sup>Handed: specify hand when ordering  
<sup>2</sup>Contact factory for current lead time  
<sup>3</sup>**CAUTION:** Cannot retrofit on existing cylindrical lock door preps with through-bolt holes outside the 2-1/8" bored hole (Ex. CL3300 & CL3500).

613E	Dark Oxidized Satin Bronze - Equivalent	605	Bright Brass, Clear Coated
626	Satin Chromium Plated	606	Satin Brass, Clear Coated
		611	Bright Bronze, Clear Coated
		612	Satin Bronze, Clear Coated
		613	Dark Oxidized Satin Bronze, Oil Rubbed
		613L	Dark Oxidized Satin Bronze, Clear Coated
		618	Bright Nickel Plated
		619	Satin Nickel Plated
		625	Bright Chromium Plated
		629	Bright Stainless Steel
		630	Satin Stainless Steel
		722	Black Oxidized Bronze, Oil Rubbed

**Function**

TL3710	Passage Set	\$284.00	\$294.00
TL3710A	Passage Set-3 Hour	\$290.00	\$300.00
TL3720	Privacy Set	\$294.00	\$304.00
TL3720A	Privacy Set-3 Hour	\$300.00	\$310.00
TL3750	Single Lever Pull-Through Bolted	\$192.00	\$202.00
TL3750S	Single Lever Pull-Surface Mounted	\$162.00	\$172.00
TL3770	Double Lever Pull	\$249.00	\$259.00
TL3780	Communicating Set	\$284.00	\$294.00
TL3780A	Communicating Set-3 Hour	\$290.00	\$300.00

Ordering Example Details →

TL3710 Passage: Non-Keyed tubular lock  
 135E2 Josef Lever, E2 Rose  
 626 Satin Chrome Finish  
 LH Left Handed

Trim Only				
Quantity	Series/Function	Trim	Finish	Hand
24	TL3710	135E2	626	LH



# Tubular Locksets

TL3700 Series: Muséo Levers and Roses



contemporary trim to complement the interior design of your next project

PIET



629	Bright Stainless Steel
630	Satin Stainless Steel

### Function

TL3710	Passage Set	224.00
TL3710A	Passage Set - 3 Hour	230.00
TL3720	Privacy Set	236.00
TL3720A	Privacy Set - 3 Hour	242.00
TL3750	Single Lever Pull - Through Bolted	132.00
TL3750S	Single Lever Pull - Surface Mounted	102.00
TL3770	Double Lever Pull	190.00
TL3780	Communicating Set	224.00
TL3780A	Communicating Set - 3 Hour	230.00

PIET



629	Bright Stainless Steel
630	Satin Stainless Steel

### Function

TL3710	Passage Set	277.00
TL3710A	Passage Set - 3 Hour	283.00
TL3720	Privacy Set	287.00
TL3720A	Privacy Set - 3 Hour	293.00
TL3750	Single Lever Pull - Through Bolted	184.00
TL3750S	Single Lever Pull - Surface Mounted	154.00
TL3770	Double Lever Pull	242.00
TL3780	Communicating Set	277.00
TL3780A	Communicating Set - 3 Hour	283.00

PIET



629	Bright Stainless Steel
630	Satin Stainless Steel

### Function

TL3710	Passage Set	294.00
TL3710A	Passage Set - 3 Hour	300.00
TL3720	Privacy Set	304.00
TL3720A	Privacy Set - 3 Hour	310.00
TL3750	Single Lever Pull - Through Bolted	202.00
TL3750S	Single Lever Pull - Surface Mounted	172.00
TL3770	Double Lever Pull	259.00
TL3780	Communicating Set	294.00
TL3780A	Communicating Set - 3 Hour	300.00

### Ordering Example Details

TL3710 Passage: Non-Keyed tubular lock  
 21WU Piet Family Lever - Wood Insert, U-Rose  
 29BH29 Lever Finish  
 Wood insert with polished  
 stainless steel (629) shank and  
 polished stainless steel (629) grip  
 629 Lock Finish  
 LH Left Handed

### Stock Order

Quantity	Series/ Function	Trim	Lever Finish	Lock Finish	Hand
2	TL3710	21WU	29BH29	629	LH

**CAUTION:** Cannot retrofit on existing cylindrical lock door preps with through-bolt holes outside the 2-1/8" bored hole (Ex. CL3300 & CL3500).



Corbin Russwin Architectural Hardware | 225 Episcopal Road | Berlin, CT 06037  
 Phone 800-543-3658 | Fax 800-447-6714 | corbinrusswinMUSEO.com

ASSA ABLOY, the global leader in door opening solutions

Price List. 25

November 1, 2015

contemporary trim to complement the interior design of your next project

**Door Thickness Options**

Description	Specify Quick Code	Add or Deduct
1-3/8" (35mm) up to 1-3/4" (44mm)	D138	No Charge
1-3/4" (44mm) up to 2-1/4" (57mm)	(standard)	
2-1/4" (57mm) up to 2-1/2" (64mm)	D214	
(Consult factory if over 2-1/2" (64mm))		

**Backset Options**

Description	Specify Quick Code	Add or Deduct
2-3/4"	(standard)	No Charge
2-3/8" <sup>1</sup>	B238	

**Strike Options**

Lip Length	ANSI Curved Lip - Specify Quick Code	Curved Lip Box - Specify Quick Code	Add or Deduct
1"	SA100	SC100	No Charge
1-1/8"	SA118	SC118	
1-1/4"	SA114	(standard)	
1-3/8"	SA138	SC138	
1-1/2"	SA112	SC112 <sup>2</sup>	
1-3/4"	SA134	SC134	Add \$16.00 per lockset
2"	SA200	SC200	
2-1/4"	SA214	SC214	
2-1/2"	SA212	SC212	
2-3/4"	SA234	SC234	
3"	SA300	SC300	

**Miscellaneous Options**

Description	Specify Quick Code	Add or Deduct
Latch front, rounded corners	M13	Add \$2.50 per latch
1" (25mm) latch front, square corners <sup>2</sup>	M14	No Charge
1" (25mm) latch front, rounded corners	M15	Add \$2.50 per latch
ANSI wrought strike box	M17	No Charge

Notes:

- 1" front supplied standard
- Standard for D214
- Standard for 2-3/8" backset

# Mortise Locksets

ML2000 Series: Muséo Levers and Inspire™ Roseless Trim



contemporary trim to complement the interior design of your next project

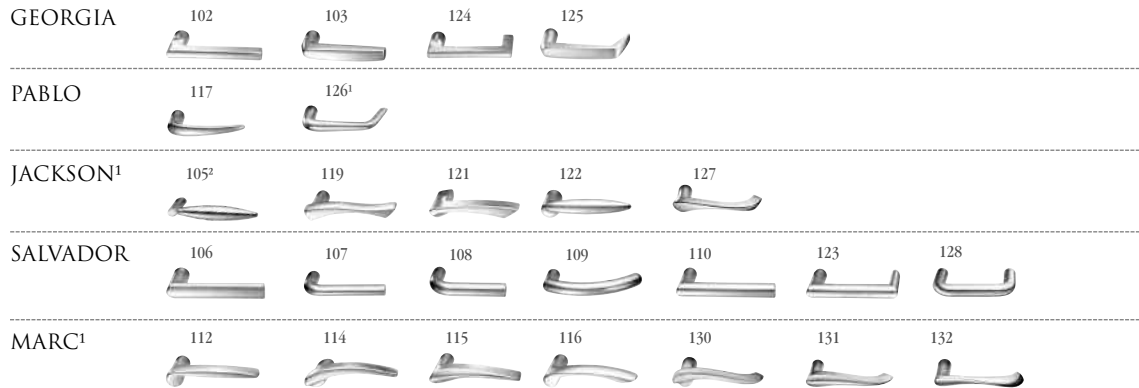

J Collar

<sup>1</sup>Handed: specify hand when ordering  
<sup>2</sup>Contact factory for current lead time

613E	Dark Oxidized Satin Bronze - Equivalent	605	Bright Brass, Clear Coated	618	Bright Nickel Plated
626	Satin Chromium Plated	606	Satin Brass, Clear Coated	619	Satin Nickel Plated
		611	Bright Bronze, Clear Coated	625	Bright Chromium Plated
		612	Satin Bronze, Clear Coated	629	Bright Stainless Steel
		613	Dark Oxidized Satin Bronze, Oil Rubbed	630	Satin Stainless Steel
		613L	Dark Oxidized Satin Bronze, Clear Coated	722	Black Oxidized Bronze, Oil Rubbed

## Function

Function	Model	Description	Price	Price
Non-Keyed	ML2010	Passage	\$721.00	\$745.00
	ML2020	Privacy		
	ML2030	Privacy	\$837.00	\$861.00
	ML2060	Privacy	\$791.00	\$815.00
	ML2050	Half Dummy	\$289.00	\$301.00
	ML2070	Full Dummy	\$578.00	\$602.00
	ML2080	Half Active Dummy Trim	\$465.00	\$477.00
	ML2090	Full Active Dummy Trim	\$754.00	\$778.00
Single Cylinder	ML2003	Classroom		
	ML2051	Office		
	ML2055	Classroom		
	ML2056	Classroom Holdback	\$877.00	\$901.00
	ML2057	Storeroom		
	ML2069	Institution Privacy		
	ML2053	Entrance		
	ML2054	Entrance	\$890.00	\$914.00
Single Cylinder with Deadbolt	ML2024	Entrance		
	ML2048	Entrance		
	ML2059	Security Storeroom		
	ML2065	Dormitory	\$913.00	\$937.00
	ML2067	Apartment		
	ML2068	Privacy or Classroom		
	ML2073	Classroom Security		
	ML2075	Entrance/Office		
Double Cylinder	ML2029	Hotel	\$968.00	\$992.00
	ML2002	Classroom Intruder		
	ML2032	Institution	\$953.00	\$977.00
	ML2042	Entrance		
	ML2052	Classroom Intruder		
	ML2022	Store Door		
	ML2062	Intruder Deadbolt		
	ML2072	Classroom Security Intruder	\$989.00	\$1,013.00
ML2082	Dormitory			
ML2092	Security Institution			
Full Working Trim (Quick Code M31) No cylinder; includes thumbturn lever			\$608.00	\$632.00



### Ordering Example Details

<b>ML2000</b>	ML2051	Office Function
Sectional Trim	102	Georgia Family Lever
(rose)	J	Collar
	625	Finish
	RHR	Handing

### Stock Order

Quantity	Series/Function	Trim	Finish	Hand
24	ML2051	102J	625	RHR



Corbin Russwin Architectural Hardware | 225 Episcopal Road | Berlin, CT 06037  
 Phone 800-543-3658 | Fax 800-447-6714 | corbinrusswinMUSEO.com

ASSA ABLOY, the global leader in door opening solutions

Price List. 27

November 1, 2015

# Mortise Locksets

ML2000 Series: Muséo Levers, Roses and Thumbturns



contemporary levers to complement the interior design of your next project

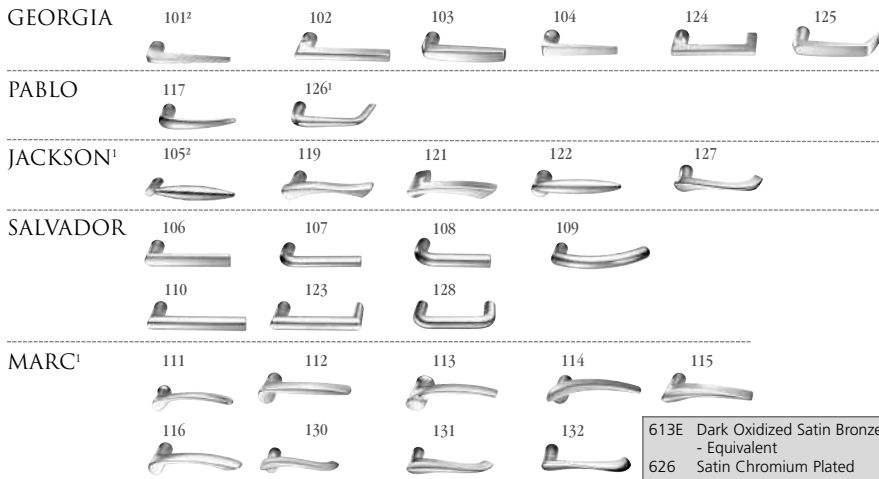

## ROSES

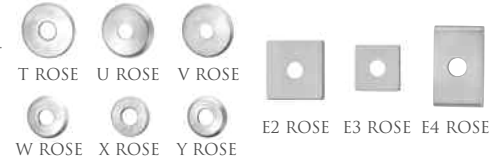

## THUMBTURNS<sup>3</sup>



1. Handed: specify hand when ordering
2. Contact factory for current lead time
3. Specify thumbturn as quick code. Thumbturn backplate will match shape of rose chosen (i.e. round or square)

## Function

613E	Dark Oxidized Satin Bronze - Equivalent	605	Bright Brass, Clear Coated	618	Bright Nickel Plated
626	Satin Chromium Plated	606	Satin Brass, Clear Coated	619	Satin Nickel Plated
		611	Bright Bronze, Clear Coated	625	Bright Chromium Plated
		612	Satin Bronze, Clear Coated	629	Bright Stainless Steel
		613	Dark Oxidized Satin Bronze, Oil Rubbed	630	Satin Stainless Steel
		613L	Dark Oxidized Satin Bronze, Clear Coated	722	Black Oxidized Bronze, Oil Rubbed

Function	Model	Description	Price	Price
Non-Keyed	ML2010	Passage	\$680.00	\$704.00
	ML2020	Privacy		
	ML2030	Privacy	\$796.00	\$820.00
	ML2060	Privacy	\$755.00	\$779.00
	ML2050	Half Dummy	\$331.00	\$355.00
	ML2070	Full Dummy	\$662.00	\$686.00
	ML2080	Half Active Dummy Trim	\$388.00	\$412.00
	ML2090	Full Active Dummy Trim	\$719.00	\$743.00
Single Cylinder	ML2003	Classroom		
	ML2051	Office		
	ML2055	Classroom	\$836.00	\$860.00
	ML2056	Classroom Holdback		
	ML2057	Storeroom		
	ML2069	Institution Privacy		
Single Cylinder with Deadbolt	ML2053	Entrance		
	ML2054	Entrance	\$849.00	\$873.00
	ML2058	Entrance Holdback		
	ML2024	Entrance		
	ML2048	Entrance		
	ML2059	Security Storeroom		
	ML2065	Dormitory	\$872.00	\$896.00
	ML2067	Apartment		
Double Cylinder	ML2068	Privacy or Classroom		
	ML2073	Classroom Security		
	ML2075	Entrance/Office		
	ML2029	Hotel	\$927.00	\$951.00
	ML2002	Classroom Intruder		
	ML2032	Institution	\$912.00	\$936.00
	ML2042	Classroom Intruder		
	ML2052	Store Door		
Full Working Trim (Quick Code M31) No cylinder; includes thumbturn lever	ML2022	Intruder Deadbolt		
	ML2062	Intruder Deadbolt		
	ML2072	Classroom Security Intruder	\$948.00	\$972.00
	ML2082	Dormitory		
	ML2092	Security Institution		
				\$644.00



Ordering Example Details

**ML2000** Sectional Trim (rose)

ML2051 Office Function  
111 Marc Family Lever  
W Rose  
625 Finish  
RHR Handing

Stock Order				
Quantity	Series/Function	Trim	Finish	Hand
24	ML2051	111W	625	RHR

Copyright © 2002 - 2015 Corbin Russwin, Inc.



Corbin Russwin Architectural Hardware | 225 Episcopal Road | Berlin, CT 06037  
Phone 800-543-3658 | Fax 800-447-6714 | corbinrusswinMUSEO.com

ASSA ABLOY, the global leader in door opening solutions

Price List. 28

November 1, 2015

# Mortise Locksets

ML2000 Series: Muséo Levers, Roses and Thumbturns



contemporary levers to complement the interior design of your next project

## JOSEF



## ROSES

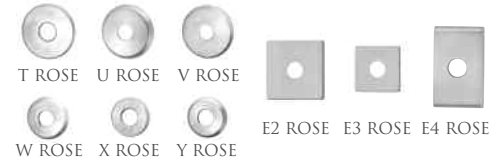

## THUMBTURN<sup>3</sup>



1. Handed: specify hand when ordering
2. Contact factory for current lead time
3. Specify thumbturn as quick code. Thumbturn backplate will match shape of rose chosen (i.e. round or square)

613E	Dark Oxidized Satin Bronze - Equivalent	605	Bright Brass, Clear Coated	618	Bright Nickel Plated
626	Satin Chromium Plated	606	Satin Brass, Clear Coated	619	Satin Nickel Plated
		611	Bright Bronze, Clear Coated	625	Bright Chromium Plated
		612	Satin Bronze, Clear Coated	629	Bright Stainless Steel
		613	Dark Oxidized Satin Bronze, Oil Rubbed	630	Satin Stainless Steel
		613L	Dark Oxidized Satin Bronze, Clear Coated	722	Black Oxidized Bronze, Oil Rubbed

## Function

Function	Model	Description	Price	Price
Non-Keyed	ML2010	Passage	\$789.00	\$813.00
	ML2020	Privacy		
	ML2030	Privacy	\$961.00	\$885.00
	ML2060	Privacy	\$820.00	\$844.00
	ML2050	Half Dummy	\$306.00	\$330.00
	ML2070	Full Dummy	\$636.00	\$660.00
	ML2080	Half Active Dummy Trim	\$459.00	\$483.00
	ML2090	Full Active Dummy Trim	\$789.00	\$813.00
Single Cylinder	ML2003	Classroom		
	ML2051	Office		
	ML2055	Classroom		
	ML2056	Classroom Holdback	\$901.00	\$925.00
	ML2057	Storeroom		
	ML2069	Institution Privacy		
	ML2053	Entrance		
ML2054	Entrance	\$914.00	\$938.00	
	ML2058	Entrance Holdback		
Single Cylinder with Deadbolt	ML2024	Entrance		
	ML2048	Entrance		
	ML2059	Security Storeroom		
	ML2065	Dormitory	\$937.00	\$961.00
	ML2067	Apartment		
	ML2068	Privacy or Classroom		
	ML2073	Classroom Security		
ML2075	Entrance/Office			
	ML2029	Hotel	\$992.00	\$1,016.00
Double Cylinder	ML2002	Classroom Intruder		
	ML2032	Institution		
	ML2042	Entrance	\$977.00	\$1,001.00
	ML2052	Classroom Intruder		
	ML2022	Store Door		
	ML2062	Intruder Deadbolt		
	ML2072	Classroom Security Intruder	\$1,013.00	\$1,037.00
	ML2082	Dormitory		
	ML2092	Security Institution		
Full Working Trim (Quick Code M31) No cylinder; includes thumbturn lever			\$629.00	\$653.00



### Ordering Example Details

<b>ML2000</b>	ML2051	Office Function
Sectional Trim (rose)	133	Josef Family Lever
	E4	Rose
	625	Finish
	RHR	Handing

### Stock Order

Quantity	Series/Function	Trim	Finish	Hand
24	ML2051	133E4	625	RHR



Corbin Russwin Architectural Hardware | 225 Episcopal Road | Berlin, CT 06037  
Phone 800-543-3658 | Fax 800-447-6714 | corbinrusswinMUSEO.com

ASSA ABLOY, the global leader in door opening solutions

Price List. 29

November 1, 2015

# Mortise Locksets

ML2000 Series: Muséo Levers, Roses and Thumbturns



contemporary levers to complement the interior design of your next project

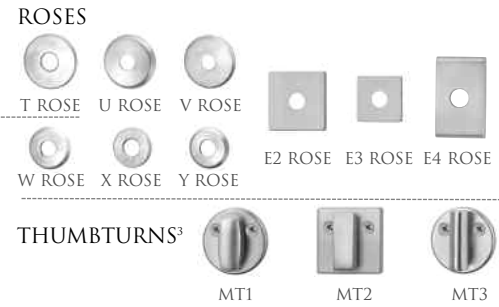
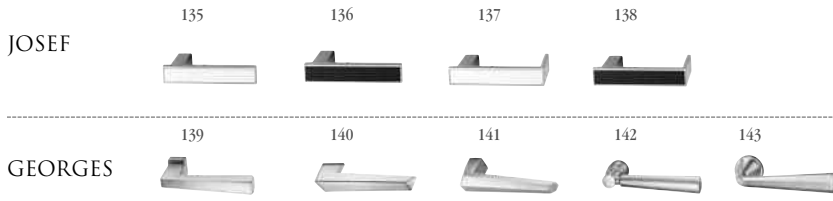

1. Handed: specify hand when ordering
2. Contact factory for current lead time
3. Specify thumbturn as quick code. Thumbturn backplate will match shape of rose chosen (i.e. round or square)

613E	Dark Oxidized Satin Bronze - Equivalent	605	Bright Brass, Clear Coated	618	Bright Nickel Plated
626	Satin Chromium Plated	606	Satin Brass, Clear Coated	619	Satin Nickel Plated
		611	Bright Bronze, Clear Coated	625	Bright Chromium Plated
		612	Satin Bronze, Clear Coated	629	Bright Stainless Steel
		613	Dark Oxidized Satin Bronze, Oil Rubbed	630	Satin Stainless Steel
		613L	Dark Oxidized Satin Bronze, Clear Coated	722	Black Oxidized Bronze, Oil Rubbed

## Function

Function	Model	Description	Price	Price
Non-Keyed	ML2010	Passage	\$856.00	\$880.00
	ML2020	Privacy	\$928.00	\$952.00
	ML2030	Privacy		
	ML2060	Privacy	\$882.00	\$906.00
	ML2050	Half Dummy	\$334.00	\$358.00
	ML2070	Full Dummy	\$692.00	\$716.00
	ML2080	Half Active Dummy Trim	\$493.00	\$517.00
	ML2090	Full Active Dummy Trim	\$851.00	\$875.00
Single Cylinder	ML2003	Classroom	\$968.00	\$992.00
	ML2051	Office		
	ML2055	Classroom		
	ML2056	Classroom Holdback		
	ML2057	Storeroom	\$981.00	\$1,005.00
	ML2069	Institution Privacy		
Single Cylinder with Deadbolt	ML2024	Entrance	\$1,004.00	\$1,028.00
	ML2048	Entrance		
	ML2059	Security Storeroom		
	ML2065	Dormitory		
	ML2067	Apartment		
	ML2068	Privacy or Classroom		
	ML2073	Classroom Security		
	ML2075	Entrance/Office		
	ML2029	Hotel		
Double Cylinder	ML2002	Classroom Intruder	\$1,044.00	\$1,066.00
	ML2032	Institution		
	ML2042	Entrance		
	ML2052	Classroom Intruder		
	ML2022	Store Door	\$1,080.00	\$1,104.00
	ML2062	Intruder Deadbolt		
	ML2072	Classroom Security Intruder		
	ML2082	Dormitory		
ML2092	Security Institution			
Full Working Trim (Quick Code M31) No cylinder; includes thumbturn lever			\$693.00	\$717.00



### Ordering Example Details

<b>ML2000</b>	ML2051	Office Function
Sectional Trim	135	Josef Family Lever
(rose)	E4	Rose
	625	Finish
	RHR	Handing

### Stock Order

Quantity	Series/Function	Trim	Finish	Hand
24	ML2051	135E4	625	RHR

Copyright © 2002 - 2015 Corbin Russwin, Inc.



ASSA ABLOY

Corbin Russwin Architectural Hardware | 225 Episcopal Road | Berlin, CT 06037  
Phone 800-543-3658 | Fax 800-447-6714 | corbinrusswinMUSEO.com

ASSA ABLOY, the global leader in door opening solutions

Price List. 30

November 1, 2015

# Mortise Locksets

ML2000 Series: Muséo Levers, Roses and Thumbturns



contemporary trim to complement the interior design of your next project

## PIET



## ROSES

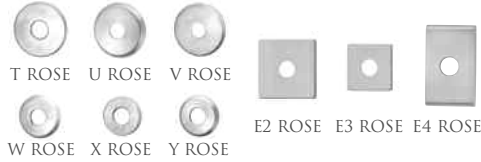

## THUMBTURNS



629	Bright Stainless Steel
630	Satin Stainless Steel

Specify thumbturn as quick code. Thumbturn backplate will match shape of rose chosen (i.e. round or square)

## Function

Function	Model	Description	Price
Non-Keyed	ML2010	Passage	\$813.00
	ML2020	Privacy	\$885.00
	ML2030	Privacy	
	ML2060	Privacy	\$844.00
	ML2050	Half Dummy	\$330.00
	ML2070	Full Dummy	\$660.00
	ML2080	Half Active Dummy Trim	\$483.00
	ML2090	Full Active Dummy Trim	\$813.00
Single Cylinder	ML2003	Classroom	\$925.00
	ML2051	Office	
	ML2055	Classroom	
	ML2056	Classroom Holdback	
	ML2057	Storeroom	\$938.00
	ML2069	Institution Privacy	
	ML2053	Entrance	
	ML2054	Entrance	\$938.00
	ML2058	Entrance Holdback	
Single Cylinder with Deadbolt	ML2024	Entrance	\$961.00
	ML2048	Entrance	
	ML2059	Security Storeroom	
	ML2065	Dormitory	
	ML2067	Apartment	
	ML2068	Privacy or Classroom	
	ML2073	Classroom Security	
ML2075	Entrance/Office	\$1,016.00	
ML2029	Hotel		
Double Cylinder	ML2002	Classroom Intruder	\$1,001.00
	ML2032	Institution	
	ML2042	Entrance	
	ML2052	Classroom Intruder	\$1,037.00
	ML2022	Store Door	
	ML2062	Intruder Deadbolt	
	ML2072	Classroom Security Intruder	
ML2082	Dormitory	\$1,037.00	
ML2092	Security Institution		
Full Working Trim (Quick Code M31) No cylinder; includes thumbturn lever			\$653.00



### Ordering Example Details

**ML2000**  
Sectional Trim  
(rose)

ML2051 Office Function  
21M Piet Family Lever - Polished with Satin Insert  
V Rose  
293029 Lever Finish  
Polished with satin stainless steel insert (630),  
polished stainless steel (629) shank and  
polished stainless steel (629) grip  
629 Lock Finish  
RHR Handing

### Stock Order

Quantity	Series/Function	Trim	Lever Finish	Lock Finish	Hand
2	ML2051	21MV	293029	629	RHR



Corbin Russwin Architectural Hardware | 225 Episcopal Road | Berlin, CT 06037  
Phone 800-543-3658 | Fax 800-447-6714 | corbinrusswinMUSEO.com

ASSA ABLOY, the global leader in door opening solutions

Price List. 31

November 1, 2015



# Mortise Locksets

ML2000 Series: Muséo Levers, Roses and Thumbturns

# MUSÉO®

contemporary levers to complement the interior design of your next project

## PIET



## ROSES

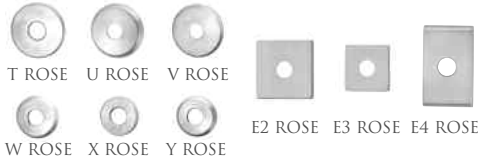

## THUMBTURNS



629 Bright Stainless Steel  
630 Satin Stainless Steel

Specify thumbturn as quick code. Thumbturn backplate will match shape of rose chosen (i.e. round or square)

### Function

Non-Keypad	ML2010	Passage	\$880.00
	ML2020	Privacy	\$952.00
	ML2030	Privacy	\$906.00
	ML2060	Privacy	\$358.00
	ML2050	Half Dummy	\$716.00
	ML2070	Full Dummy	\$517.00
	ML2080	Half Active Dummy Trim	\$875.00
	ML2090	Full Active Dummy Trim	
Single Cylinder	ML2003	Classroom	\$992.00
	ML2051	Office	
	ML2055	Classroom	
	ML2056	Classroom Holdback	
	ML2057	Storeroom	\$1,005.00
	ML2069	Institution Privacy	
	ML2053	Entrance	
	ML2054	Entrance	
Single Cylinder with Deadbolt	ML2024	Entrance	\$1,028.00
	ML2048	Entrance	
	ML2059	Security Storeroom	
	ML2065	Dormitory	
	ML2067	Apartment	
	ML2068	Privacy or Classroom	
	ML2073	Classroom Security	
	ML2075	Entrance/Office	
ML2029	Hotel	\$1,083.00	
Double Cylinder	ML2002	Classroom Intruder	\$1,068.00
	ML2032	Institution	
	ML2042	Entrance	
	ML2052	Classroom Intruder	\$1,104.00
	ML2022	Store Door	
	ML2062	Intruder Deadbolt	
	ML2072	Classroom Security Intruder	
	ML2082	Dormitory	
ML2092	Security Institution		
Full Working Trim (Quick Code M31) No cylinder; includes thumbturn lever			\$717.00



### Ordering Example Details

ML2000 Sectional Trim (rose)	ML2051	Office Function
	21W	Piet Family Lever - Wood Insert
	U	Rose
	29BH29	Lever Finish
	629	Wood insert with polished stainless steel (629) shank and polished stainless steel (629) grip
RHR	Lock Finish	
		Handing

### Stock Order

Quantity	Series/Function	Trim	Lever Finish	Lock Finish	Hand
2	ML2051	21WU	29BH29	629	RHR



# Mortise Locksets

ML2000 Series: Muséo Levers and Escutcheons



contemporary levers to complement the interior design of your next project

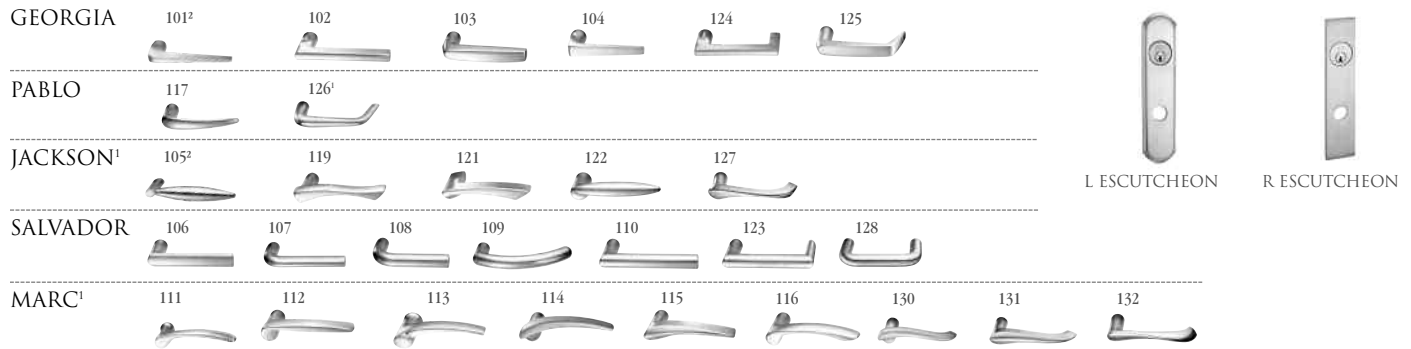

- 1. Handed: specify hand when ordering
- 2. Contact factory for current lead time

613E	Dark Oxidized Satin Bronze - Equivalent	605	Bright Brass, Clear Coated	618	Bright Nickel Plated
626	Satin Chromium Plated	606	Satin Brass, Clear Coated	619	Satin Nickel Plated
		611	Bright Bronze, Clear Coated	625	Bright Chromium Plated
		612	Satin Bronze, Clear Coated	629	Bright Stainless Steel
		613	Dark Oxidized Satin Bronze, Oil Rubbed	630	Satin Stainless Steel
		613L	Dark Oxidized Satin Bronze, Clear Coated	722	Black Oxidized Bronze, Oil Rubbed

### Function

Function	Model	Description	Price	Price
Non-Keyed	ML2010	Passage	\$734.00	\$758.00
	ML2020	Privacy	\$850.00	\$874.00
	ML2030	Privacy		
	ML2060	Privacy	\$809.00	\$833.00
	ML2050	Half Dummy	\$358.00	\$382.00
	ML2070	Full Dummy	\$716.00	\$740.00
	ML2080	Half Active Dummy Trim	\$415.00	\$439.00
	ML2090	Full Active Dummy Trim	\$773.00	\$797.00
Single Cylinder	ML2003	Classroom	\$890.00	\$914.00
	ML2051	Office		
	ML2055	Classroom		
	ML2056	Classroom Holdback		
	ML2057	Storeroom	\$903.00	\$927.00
	ML2069	Institution Privacy		
	ML2053	Entrance		
ML2054	Entrance	\$903.00	\$927.00	
ML2058	Entrance Holdback			
Single Cylinder with Deadbolt	ML2024	Entrance	\$926.00	\$950.00
	ML2048	Entrance		
	ML2059	Security Storeroom		
	ML2065	Dormitory		
	ML2067	Apartment	\$981.00	\$1,005.00
	ML2068	Privacy or Classroom		
	ML2073	Classroom Security		
	ML2075	Entrance/Office	\$981.00	\$1,005.00
ML2029	Hotel			
Double Cylinder	ML2002	Classroom Intruder	\$966.00	\$990.00
	ML2032	Institution		
	ML2042	Entrance		
	ML2052	Classroom Intruder	\$1,002.00	\$1,026.00
	ML2022	Store Door		
	ML2062	Intruder Deadbolt		
	ML2072	Classroom Security Intruder		
ML2082	Dormitory	\$1,002.00	\$1,026.00	
ML2092	Security Institution			
Full Working Trim (Quick Code M31) No cylinder; includes thumbturn lever			\$698.00	\$722.00



### Ordering Example Details

<b>ML2000</b>	ML2051	Office Function
Escutcheon Trim	111	Marc Family Lever
	L	Escutcheon
	619	Finish
	RHR	Handing

### Stock Order

Quantity	Series/Function	Trim	Finish	Hand
24	ML2051	111L	619	RHR



Corbin Russwin Architectural Hardware | 225 Episcopal Road | Berlin, CT 06037  
 Phone 800-543-3658 | Fax 800-447-6714 | corbinrusswinMUSEO.com

ASSA ABLOY, the global leader in door opening solutions

Price List. 33

November 1, 2015

# Mortise Locksets

ML2000 Series: Muséo Levers and Escutcheons



contemporary levers to complement the interior design of your next project

JOSEF



L ESCUTCHEON R ESCUTCHEON

1. Handed: specify hand when ordering
2. Contact factory for current lead time

613E	Dark Oxidized Satin Bronze - Equivalent	605	Bright Brass, Clear Coated	618	Bright Nickel Plated
626	Satin Chromium Plated	606	Satin Brass, Clear Coated	619	Satin Nickel Plated
		611	Bright Bronze, Clear Coated	625	Bright Chromium Plated
		612	Satin Bronze, Clear Coated	629	Bright Stainless Steel
		613	Dark Oxidized Satin Bronze, Oil Rubbed	630	Satin Stainless Steel
		613L	Dark Oxidized Satin Bronze, Clear Coated	722	Black Oxidized Bronze, Oil Rubbed

### Function

Function	Model	Description	Price	Price
Non-Keypad	ML2010	Passage	\$862.00	\$886.00
	ML2020	Privacy		
	ML2030	Privacy	\$934.00	\$958.00
	ML2060	Privacy	\$893.00	\$917.00
	ML2050	Half Dummy	\$342.50	\$366.50
	ML2070	Full Dummy	\$709.00	\$733.00
	ML2080	Half Active Dummy Trim	\$495.50	\$519.50
	ML2090	Full Active Dummy Trim	\$862.00	\$886.00
Single Cylinder	ML2003	Classroom		
	ML2051	Office		
	ML2055	Classroom	\$974.00	\$998.00
	ML2056	Classroom Holdback		
	ML2057	Storeroom		
	ML2069	Institution Privacy		
	ML2053	Entrance		
ML2054	Entrance	\$987.00	\$1,011.00	
ML2058	Entrance Holdback			
Single Cylinder with Deadbolt	ML2024	Entrance		
	ML2048	Entrance		
	ML2059	Security Storeroom		
	ML2065	Dormitory	\$1,010.00	\$1,034.00
	ML2067	Apartment		
	ML2068	Privacy or Classroom		
	ML2073	Classroom Security		
	ML2075	Entrance/Office		
ML2029	Hotel	\$1,065.00	\$1,089.00	
Double Cylinder	ML2002	Classroom Intruder		
	ML2032	Institution	\$1,050.00	\$1,074.00
	ML2042	Entrance		
	ML2052	Classroom Intruder		
	ML2022	Store Door		
	ML2062	Intruder Deadbolt		
	ML2072	Classroom Security Intruder	\$1,084.00	\$1,108.00
	ML2082	Dormitory		
ML2092	Security Institution			
Full Working Trim (Quick Code M31) No cylinder; includes thumbturn lever			\$702.00	\$726.00



### Ordering Example Details

<b>ML2000</b>	ML2051	Office Function
Escutcheon Trim	133	Josef Family Lever
	L	Escutcheon
	619	Finish
	RHR	Handing

### Stock Order

Quantity	Series/Function	Trim	Finish	Hand
24	ML2051	133L	619	RHR

Copyright © 2002 - 2015 Corbin Russwin, Inc.



ASSA ABLOY

Corbin Russwin Architectural Hardware | 225 Episcopal Road | Berlin, CT 06037  
Phone 800-543-3658 | Fax 800-447-6714 | corbinrusswinMUSEO.com

ASSA ABLOY, the global leader in door opening solutions

Price List. 34

November 1, 2015

# Mortise Locksets

ML2000 Series: Muséo Levers and Escutcheons



contemporary levers to complement the interior design of your next project

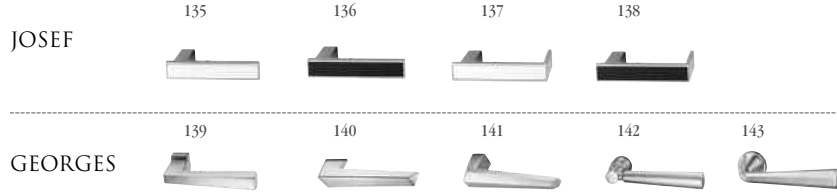

1. Handed: specify hand when ordering
2. Contact factory for current lead time

613E	Dark Oxidized Satin Bronze - Equivalent	605	Bright Brass, Clear Coated	618	Bright Nickel Plated
626	Satin Chromium Plated	606	Satin Brass, Clear Coated	619	Satin Nickel Plated
		611	Bright Bronze, Clear Coated	625	Bright Chromium Plated
		612	Satin Bronze, Clear Coated	629	Bright Stainless Steel
		613	Dark Oxidized Satin Bronze, Oil Rubbed	630	Satin Stainless Steel
		613L	Dark Oxidized Satin Bronze, Clear Coated	722	Black Oxidized Bronze, Oil Rubbed

### Function

Function	Model	Description	Price 1	Price 2
Non-Keyed	ML2010	Passage	\$929.00	\$953.00
	ML2020	Privacy		
	ML2030	Privacy	\$1,001.00	\$1,025.00
	ML2060	Privacy	\$955.00	\$979.00
	ML2050	Half Dummy	\$371.00	\$395.00
	ML2070	Full Dummy	\$765.00	\$789.00
	ML2080	Half Active Dummy Trim	\$529.50	\$553.50
	ML2090	Full Active Dummy Trim	\$924.00	\$948.00
Single Cylinder	ML2003	Classroom		
	ML2051	Office		
	ML2055	Classroom	\$1,041.00	\$1,065.00
	ML2056	Classroom Holdback		
	ML2057	Storeroom		
	ML2069	Institution Privacy		
	ML2053	Entrance		
ML2054	Entrance	\$1,054.00	\$1,078.00	
ML2058	Entrance Holdback			
Single Cylinder with Deadbolt	ML2024	Entrance		
	ML2048	Entrance		
	ML2059	Security Storeroom		
	ML2065	Dormitory	\$1,077.00	\$1,101.00
	ML2067	Apartment		
	ML2068	Privacy or Classroom		
	ML2073	Classroom Security		
	ML2075	Entrance/Office		
ML2029	Hotel	\$1,132.00	\$1,156.00	
Double Cylinder	ML2002	Classroom Intruder		
	ML2032	Institution	\$1,117.00	\$1,141.00
	ML2042	Entrance		
	ML2052	Classroom Intruder		
	ML2022	Store Door		
	ML2062	Intruder Deadbolt		
	ML2072	Classroom Security Intruder	\$1,153.00	\$1,177.00
	ML2082	Dormitory		
ML2092	Security Institution			
Full Working Trim (Quick Code M31) No cylinder; includes thumbturn lever			\$766.00	\$790.00



### Ordering Example Details

<b>ML2000</b>	ML2051	Office Function
Escutcheon Trim	135	Josef Family Lever
	L	Escutcheon
	619	Finish
	RHR	Handing

### Stock Order

Quantity	Series/Function	Trim	Finish	Hand
24	ML2051	135L	619	RHR



Corbin Russwin Architectural Hardware | 225 Episcopal Road | Berlin, CT 06037  
 Phone 800-543-3658 | Fax 800-447-6714 | corbinrusswinMUSEO.com

ASSA ABLOY, the global leader in door opening solutions

Price List. 35

November 1, 2015

# Mortise Locksets

ML2000 Series: Muséo Levers and Escutcheons

# MUSÉO®

contemporary levers to complement the interior design of your next project

PIET



L ESCUTCHEON R ESCUTCHEON

629 Bright Stainless Steel  
630 Satin Stainless Steel

## Function

Non-Keypad	ML2010	Passage	\$886.00
	ML2020	Privacy	\$958.00
	ML2030	Privacy	\$917.00
	ML2060	Privacy	\$367.00
	ML2050	Half Dummy	\$733.00
	ML2070	Full Dummy	\$519.00
	ML2080	Half Active Dummy Trim	\$886.00
	ML2090	Full Active Dummy Trim	
Single Cylinder	ML2003	Classroom	\$998.00
	ML2051	Office	
	ML2055	Classroom	
	ML2056	Classroom Holdback	
	ML2057	Storeroom	
	ML2069	Institution Privacy	
	ML2053	Entrance	
ML2054	Entrance		
ML2058	Entrance Holdback		
Single Cylinder with Deadbolt	ML2024	Entrance	\$1,034.00
	ML2048	Entrance	
	ML2059	Security Storeroom	
	ML2065	Dormitory	
	ML2067	Apartment	
	ML2068	Privacy or Classroom	
	ML2073	Classroom Security	
	ML2075	Entrance/Office	
ML2029	Hotel	\$1,089.00	
Double Cylinder	ML2002	Classroom Intruder	\$1,074.00
	ML2032	Institution	
	ML2042	Entrance	
	ML2052	Classroom Intruder	\$1,110.00
	ML2022	Store Door	
	ML2062	Intruder Deadbolt	
	ML2072	Classroom Security Intruder	
	ML2082	Dormitory	
ML2092	Security Institution		
Full Working Trim (Quick Code M31) No cylinder; includes thumbturn lever			\$726.00



### Ordering Example Details

**ML2000**  
Escutcheon  
Trim

ML2051 Office Function  
21M Piet Family Lever - Polished with Satin Insert  
L Escutcheon  
293029 Lever Finish  
Polished with satin stainless steel insert (630),  
polished stainless steel (629) shank and  
polished stainless steel (629) grip

629 Lock Finish  
RHR Handing

### Stock Order

Quantity	Series/Function	Trim	Lever Finish	Lock Finish	Hand
2	ML2051	21ML	293029	629	RHR



ASSA ABLOY

Corbin Russwin Architectural Hardware | 225 Episcopal Road | Berlin, CT 06037  
Phone 800-543-3658 | Fax 800-447-6714 | corbinrusswinMUSEO.com

ASSA ABLOY, the global leader in door opening solutions

Price List. 36

November 1, 2015

# Mortise Locksets

ML2000 Series: Muséo Levers and Escutcheons



contemporary levers to complement the interior design of your next project

PIET



L ESCUTCHEON

R ESCUTCHEON

629 Bright Stainless Steel  
630 Satin Stainless Steel

## Function

<b>Non-Keypad</b>	ML2010	Passage	\$953.00
	ML2020	Privacy	\$1,025.00
	ML2030	Privacy	
	ML2060	Privacy	\$979.00
	ML2050	Half Dummy	\$395.00
	ML2070	Full Dummy	\$789.00
	ML2080	Half Active Dummy Trim	\$553.00
	ML2090	Full Active Dummy Trim	\$948.00
<b>Single Cylinder</b>	ML2003	Classroom	\$1,065.00
	ML2051	Office	
	ML2055	Classroom	
	ML2056	Classroom Holdback	
	ML2057	Storeroom	
	ML2069	Institution Privacy	
	ML2053	Entrance	\$1,078.00
ML2054	Entrance		
ML2058	Entrance Holdback		
<b>Single Cylinder with Deadbolt</b>	ML2024	Entrance	\$1,101.00
	ML2048	Entrance	
	ML2059	Security Storeroom	
	ML2065	Dormitory	
	ML2067	Apartment	
	ML2068	Privacy or Classroom	
	ML2073	Classroom Security	
	ML2075	Entrance/Office	
ML2029	Hotel	\$1,156.00	
<b>Double Cylinder</b>	ML2002	Classroom Intruder	\$1,141.00
	ML2032	Institution	
	ML2042	Entrance	
	ML2052	Classroom Intruder	\$1,177.00
	ML2022	Store Door	
	ML2062	Intruder Deadbolt	
	ML2072	Classroom Security Intruder	
	ML2082	Dormitory	
ML2092	Security Institution		
Full Working Trim (Quick Code M31) No cylinder; includes thumbturn lever			\$790.00



### Ordering Example Details

**ML2000**  
Escutcheon  
Trim

ML2051 Office Function  
21W Piet Family Lever - Wood Insert  
L Escutcheon  
29BH29 Lever Finish  
Wood insert with polished stainless steel (629)  
shank and polished stainless steel (629) grip  
629 Lock Finish  
RHR Handing

### Stock Order

Quantity	Series/Function	Trim	Lever Finish	Lock Finish	Hand
2	ML2051	21WL	29BH29	629	RHR



ASSA ABLOY

Corbin Russwin Architectural Hardware | 225 Episcopal Road | Berlin, CT 06037  
Phone 800-543-3658 | Fax 800-447-6714 | corbinrusswinMUSEO.com

ASSA ABLOY, the global leader in door opening solutions

Price List. 37

November 1, 2015

# Mortise Locksets

ML20900 Series Museo Levers and Inspire Roseless Trim

# MUSÉO®

contemporary levers to complement the interior design of your next project

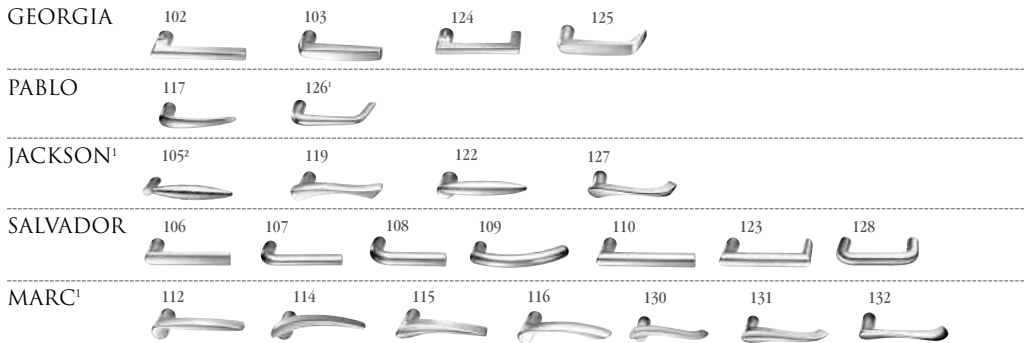

J Collar

1. Handed: specify hand when ordering
2. Contact factory for current lead time

613E	Dark Oxidized Satin Bronze - Equivalent	605	Bright Brass, Clear Coated	618	Bright Nickel Plated
626	Satin Chromium Plated	606	Satin Brass, Clear Coated	619	Satin Nickel Plated
		611	Bright Bronze, Clear Coated	625	Bright Chromium Plated
		612	Satin Bronze, Clear Coated	629	Bright Stainless Steel
		613	Dark Oxidized Satin Bronze, Oil Rubbed	630	Satin Stainless Steel
		613L	Dark Oxidized Satin Bronze, Clear Coated	722	Black Oxidized Bronze, Oil Rubbed

## Function

Lever with Roses					
Single Cylinder	ML20914	Fail Safe	\$1,095.00	\$1,119.00	
	ML20906	Fail Safe Fail Secure Fail Secure			
No Cylinder Override	ML20907	Fail Safe	\$1,019.00	\$1,043.00	
	ML20915	Fail Safe Fail Secure Fail Secure			
Double Cylinder	ML20932	Fail Safe Fail Secure	\$1,171.00	\$1,195.00	



### Ordering Example Details

**ML2000**  
Sectional Trim  
(rose)

ML2051 Office Function  
102 Georgia Family Lever  
J Collar  
625 Finish  
RHR Handing

### Stock Order

Quantity	Series/Function	Trim	Finish	Hand
24	ML2051	102J	625	RHR

contemporary levers to complement the interior design of your next project

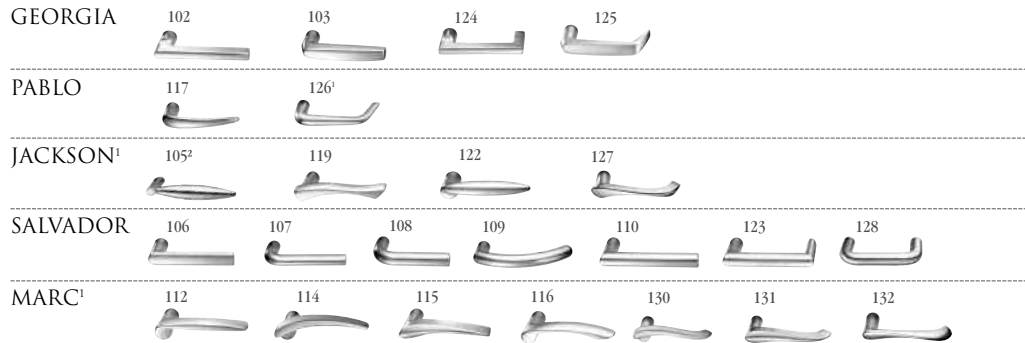

1. Handed: specify hand when ordering
2. Contact factory for current lead time

613E	Dark Oxidized Satin Bronze - Equivalent	605	Bright Brass, Clear Coated	618	Bright Nickel Plated
626	Satin Chromium Plated	606	Satin Brass, Clear Coated	619	Satin Nickel Plated
		611	Bright Bronze, Clear Coated	625	Bright Chromium Plated
		612	Satin Bronze, Clear Coated	629	Bright Stainless Steel
		613	Dark Oxidized Satin Bronze, Oil Rubbed	630	Satin Stainless Steel
		613L	Dark Oxidized Satin Bronze, Clear Coated	722	Black Oxidized Bronze, Oil Rubbed

**Function**

Lever with Roses					
Single Cylinder	ML20606 x NAC	Fail Safe/Fail Secure	\$1,270.00		\$1,294.00
	ML20608 x NAC	Fail Safe/Fail Secure	\$1,345.00		\$1,369.00
No Cylinder Override	ML20607 x NAC	Fail Safe/Fail Secure	\$1,196.00		\$1,220.00
	ML20609 x NAC	Fail Safe/Fail Secure	\$1,271.00		\$1,295.00

**ML20600 High Security Monitoring Options**

Description	Specify	Add or Deduct
Mercury and Lenel compatible 1KΩ/2KΩ resistance supervision	R01	Add \$100.00 per lockset
Software House compatible 1KΩ/2KΩ resistance supervision	R03	Add \$100.00 per lockset
AMAG compatible 4-state supervision	R04	Add \$100.00 per lockset
Deadbolt Privacy Function	PHR	Add \$100.00 per lockset
Deadbolt Privacy and Mercury / Lenel 1KΩ/2KΩ	PHRR01	Add \$200.00 per lockset
Deadbolt Privacy and Software House 1KΩ/2KΩ	PHRR03	Add \$200.00 per lockset
Deadbolt Privacy and AMAG 4-State	PHRR04	Add \$200.00 per lockset



Ordering Example Details →

ML2000 Mortise Lock x NAC x No Cylinder x Deadbolt x Fail-Secure

- Muséo® lever 102 with J Collar
- Polished chrome finish
- Right hand reverse
- Deadbolt privacy function, Mercury and Lenel compatible 1KΩ/2KΩ resistance supervision

Stock Order							
Quantity	Series/Function	Technology Code	Trim	Finish	Hand	Fail Safe/Fail Secure	High Security Monitoring Options
24	ML20608	NAC	102J	625	RHR	SEC	PHRR01

# Electrically Controlled Mortise Locksets

ML20900 Series: Muséo Levers, Escutcheons, Roses and Thumbturns



contemporary levers to complement the interior design of your next project

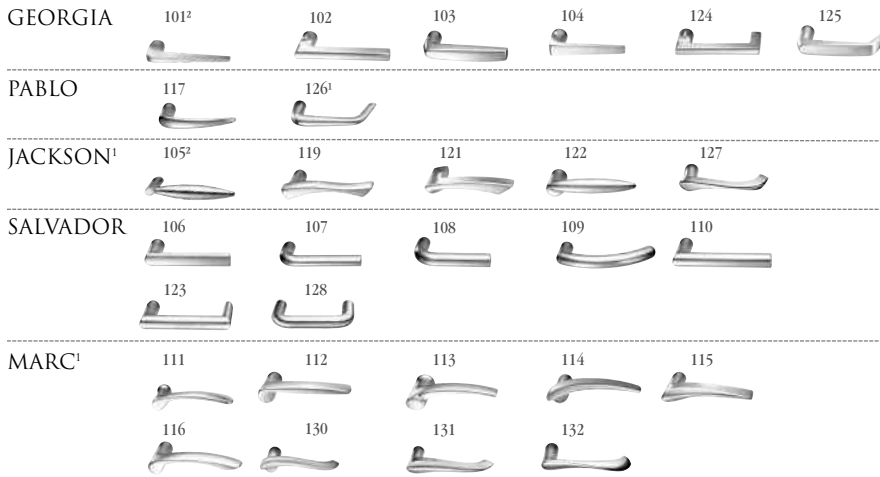

## ROSES

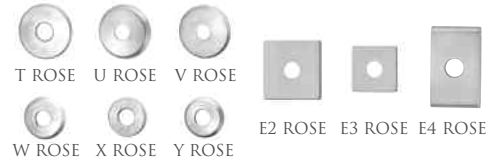

## ESCUTCHEONS



## THUMBTURNS<sup>3</sup>



1. Handed: specify hand when ordering
2. Contact factory for current lead time
3. Specify thumbturn as quick code. Thumbturn backplate will match shape of rose chosen (i.e. round or square). Not available with escutcheons.

613E	Dark Oxidized Satin Bronze - Equivalent	605	Bright Brass, Clear Coated	618	Bright Nickel Plated
626	Satin Chromium Plated	606	Satin Brass, Clear Coated	619	Satin Nickel Plated
		611	Bright Bronze, Clear Coated	625	Bright Chromium Plated
		612	Satin Bronze, Clear Coated	629	Bright Stainless Steel
		613	Dark Oxidized Satin Bronze, Oil Rubbed	630	Satin Stainless Steel
		613L	Dark Oxidized Satin Bronze, Clear Coated	722	Black Oxidized Bronze, Oil Rubbed

## Function

Lever with Escutcheons: L,R					
Single Cylinder	ML20914	Fail Safe/Fail Secure*	\$1,108.00		\$1,132.00
	ML20906				
No Cylinder Override	ML20907	Fail Safe/Fail Secure*	\$1,032.00		\$1,056.00
	ML20915				
Double Cylinder	ML20932	Fail Safe/Fail Secure*	\$1,184.00		\$1,208.00
Lever with Roses: V,U,T,Y,X,W,E2,E3,E4					
Single Cylinder	ML20914	Fail Safe/Fail Secure*	\$1,054.00		\$1,078.00
	ML20906				
No Cylinder Override	ML20907	Fail Safe/Fail Secure*	\$978.00		\$1,002.00
	ML20915				
Double Cylinder	ML20932	Fail Safe/Fail Secure*	\$1,130.00		\$1,154.00

\*Must specify: SAF for Fail Safe or SEC for Fail Secure.



### Ordering Example Details

<b>ML20900 ECL</b>	ML20914	Single Cylinder
Escutcheon Trim	SEC	Fail Secure
	104	Salvador Family Lever
	L	Escutcheon
	613	Finish
	RHR	Handing
	24 AD	24 Volt AC/DC

### Stock Order

Quantity	Series/Function	Fail Safe/Fail Secure	Trim	Finish	Hand	Voltage
24	ML20914	SEC	104L	613	RHR	24 AD





contemporary levers to complement the interior design of your next project

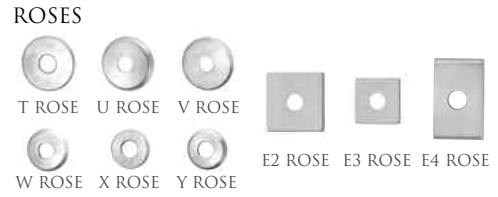
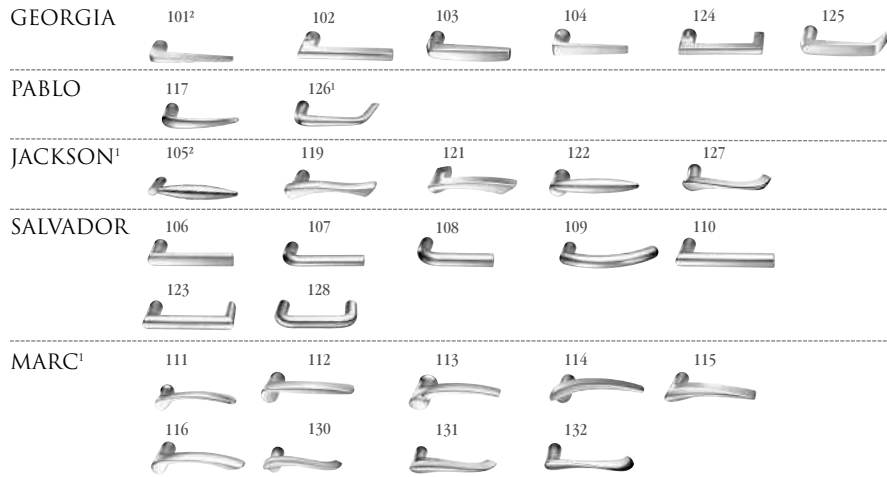

1. Handed: specify hand when ordering
2. Contact factory for current lead time
3. Specify thumbturn as quick code. Thumbturn backplate will match shape of rose chosen (i.e. round or square). Not available with escutcheons.

613E	Dark Oxidized Satin Bronze - Equivalent	605	Bright Brass, Clear Coated	618	Bright Nickel Plated
626	Satin Chromium Plated	606	Satin Brass, Clear Coated	619	Satin Nickel Plated
		611	Bright Bronze, Clear Coated	625	Bright Chromium Plated
		612	Satin Bronze, Clear Coated	629	Bright Stainless Steel
		613	Dark Oxidized Satin Bronze, Oil Rubbed	630	Satin Stainless Steel
		613L	Dark Oxidized Satin Bronze, Clear Coated	722	Black Oxidized Bronze, Oil Rubbed

**Function**

Lever with Escutcheons: L,R					
Single Cylinder	ML20606 x NAC	Fail Safe/Fail Secure	\$1,283.00		\$1,307.00
	ML20608 x NAC	Fail Safe/Fail Secure	\$1,358.00		\$1,382.00
No Cylinder Override	ML20607 x NAC	Fail Safe/Fail Secure	\$1,209.00		\$1,233.00
	ML20609 x NAC	Fail Safe/Fail Secure	\$1,284.00		\$1,308.00

Lever with Roses: V,U,T,Y,X,W,E2,E3,E4					
Single Cylinder	ML20606 x NAC	Fail Safe/Fail Secure	\$1,229.00		\$1,253.00
	ML20608 x NAC	Fail Safe/Fail Secure	\$1,304.00		\$1,328.00
No Cylinder Override	ML20607 x NAC	Fail Safe/Fail Secure	\$1,155.00		\$1,179.00
	ML20609 x NAC	Fail Safe/Fail Secure	\$1,230.00		\$1,254.00

\*Must specify: SAF for Fail Safe or SEC for Fail Secure.

**ML20600 High Security Monitoring Options**

Description	Specify	Add or Deduct
Mercury and Lenel compatible 1KΩ/2KΩ resistance supervision	R01	Add \$100.00 per lockset
Software House compatible 1KΩ/2KΩ resistance supervision	R03	Add \$100.00 per lockset
AMAG compatible 4-state supervision	R04	Add \$100.00 per lockset
Deadbolt Privacy Function	PHR	Add \$100.00 per lockset
Deadbolt Privacy and Mercury / Lenel 1KΩ/2KΩ	PHRR01	Add \$200.00 per lockset
Deadbolt Privacy and Software House 1KΩ/2KΩ	PHRR03	Add \$200.00 per lockset
Deadbolt Privacy and AMAG 4-State	PHRR04	Add \$200.00 per lockset



Ordering Example Details

<b>ML20600 NAC</b> Escutcheon Trim	ML20608	Single Cylinder
	SEC	Fail Secure
	104	Salvador Family Lever
	L	Escutcheon
	613	Finish
	RHR	Handing
	24 AD	24 Volt AC/DC

**Stock Order**

Quantity	Series/Function	Technology Code	Trim	Finish	Hand	Fail Safe/Fail Secure	High Security Monitoring Options
24	ML20608	NAC	104L	613	RHR	SEC	PHRR01



Corbin Russwin Architectural Hardware | 225 Episcopal Road | Berlin, CT 06037  
Phone 800-543-3658 | Fax 800-447-6714 | corbinrusswinMUSEO.com



ASSA ABLOY, the global leader in door opening solutions

Price List. 41

November 1, 2015

contemporary levers to complement the interior design of your next project

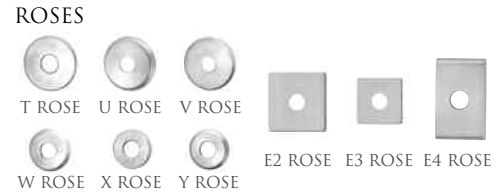

1. Handed: specify hand when ordering
2. Contact factory for current lead time
3. Specify thumbturn as quick code. Thumbturn backplate will match shape of rose chosen (i.e. round or square). Not available with escutcheons.

613E	Dark Oxidized Satin Bronze - Equivalent	605	Bright Brass, Clear Coated	618	Bright Nickel Plated
626	Satin Chromium Plated	606	Satin Brass, Clear Coated	619	Satin Nickel Plated
		611	Bright Bronze, Clear Coated	625	Bright Chromium Plated
		612	Satin Bronze, Clear Coated	629	Bright Stainless Steel
		613	Dark Oxidized Satin Bronze, Oil Rubbed	630	Satin Stainless Steel
		613L	Dark Oxidized Satin Bronze, Clear Coated	722	Black Oxidized Bronze, Oil Rubbed

**Function**

Lever with Escutcheons: L,R					
Single Cylinder	ML20914	Fail Safe/Fail Secure*	\$1,192.00		\$1,216.00
	ML20906				
No Cylinder Override	ML20907	Fail Safe/Fail Secure*	\$1,118.00		\$1,142.00
	ML20915				
Double Cylinder	ML20932	Fail Safe/Fail Secure*	\$1,266.00		\$1,290.00
Lever with Roses: V,U,T,Y,X,W,E2,E3,E4					
Single Cylinder	ML20914	Fail Safe/Fail Secure*	\$1,119.00		\$1,143.00
	ML20906				
No Cylinder Override	ML20907	Fail Safe/Fail Secure*	\$1,045.00		\$1,069.00
	ML20915				
Double Cylinder	ML20932	Fail Safe/Fail Secure*	\$1,193.00		\$1,217.00

\*Must specify: SAF for Fail Safe or SEC for Fail Secure.



Ordering Example Details

**ML20900 ECL**  
Escutcheon Trim

ML20914	Single Cylinder
SEC	Fail Secure
133	Josef Family Lever
L	Escutcheon
613	Finish
RHR	Handing
24 AD	24 Volt AC/DC

**Stock Order**

Quantity	Series/Function	Fail Safe/Fail Secure	Trim	Finish	Hand	Voltage
24	ML20914	SEC	133L	613	RHR	24 AD

contemporary levers to complement the interior design of your next project

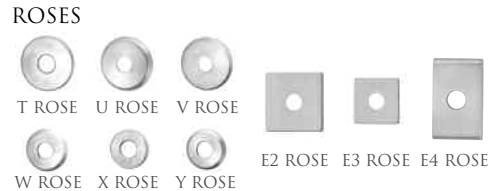

1. Handed: specify hand when ordering
2. Contact factory for current lead time
3. Specify thumbturn as quick code. Thumbturn backplate will match shape of rose chosen (i.e. round or square). Not available with escutcheons.

613E	Dark Oxidized Satin Bronze - Equivalent
626	Satin Chromium Plated

605	Bright Brass, Clear Coated	618	Bright Nickel Plated
606	Satin Brass, Clear Coated	619	Satin Nickel Plated
611	Bright Bronze, Clear Coated	625	Bright Chromium Plated
612	Satin Bronze, Clear Coated	629	Bright Stainless Steel
613	Dark Oxidized Satin Bronze, Oil Rubbed	630	Satin Stainless Steel
613L	Dark Oxidized Satin Bronze, Clear Coated	722	Black Oxidized Bronze, Oil Rubbed

**Function**

Lever with Escutcheons: L,R				
Single Cylinder	ML20606 x NAC	Fail Safe/Fail Secure	\$1,367.00	\$1,391.00
	ML20608 x NAC	Fail Safe/Fail Secure	\$1,442.00	\$1,466.00
No Cylinder Override	ML20607 x NAC	Fail Safe/Fail Secure	\$1,293.00	\$1,317.00
	ML20609 x NAC	Fail Safe/Fail Secure	\$1,368.00	\$1,392.00

Lever with Roses: V,U,T,Y,X,W,E2,E3,E4				
Single Cylinder	ML20606 x NAC	Fail Safe/Fail Secure	\$1,294.00	\$1,318.00
	ML20608 x NAC	Fail Safe/Fail Secure	\$1,369.00	\$1,393.00
No Cylinder Override	ML20607 x NAC	Fail Safe/Fail Secure	\$1,220.00	\$1,244.00
	ML20609 x NAC	Fail Safe/Fail Secure	\$1,295.00	\$1,319.00

\*Must specify: SAF for Fail Safe or SEC for Fail Secure.

**ML20600 High Security Monitoring Options**

Description	Specify	Add or Deduct
Mercury and Lenel compatible 1KΩ/2KΩ resistance supervision	R01	Add \$100.00 per lockset
Software House compatible 1KΩ/2KΩ resistance supervision	R03	Add \$100.00 per lockset
AMAG compatible 4-state supervision	R04	Add \$100.00 per lockset
Deadbolt Privacy Function	PHR	Add \$100.00 per lockset
Deadbolt Privacy and Mercury / Lenel 1KΩ/2KΩ	PHRR01	Add \$200.00 per lockset
Deadbolt Privacy and Software House 1KΩ/2KΩ	PHRR03	Add \$200.00 per lockset
Deadbolt Privacy and AMAG 4-State	PHRR04	Add \$200.00 per lockset

**BHMA CERTIFIED** Ordering Example Details →

<b>ML20600 NAC</b>	ML20608	Single Cylinder
Escutcheon Trim	SEC	Fail Secure
	104	Salvador Family Lever
	L	Escutcheon
	613	Finish
	RHR	Handing
	24 AD	24 Volt AC/DC

**Stock Order**

Quantity	Series/Function	Technology Code	Trim	Finish	Hand	Fail Safe/Fail Secure	High Security Monitoring Options
24	ML20608	NAC	133L	613	RHR	SEC	PHRR01



Corbin Russwin Architectural Hardware | 225 Episcopal Road | Berlin, CT 06037  
Phone 800-543-3658 | Fax 800-447-6714 | corbinrusswinMUSEO.com

ASSA ABLOY, the global leader in door opening solutions

Price List. 43

November 1, 2015

# Electrically Controlled Mortise Locksets

ML20900 Series: Muséo Levers, Escutcheons, Roses and Thumbturns



contemporary levers to complement the interior design of your next project

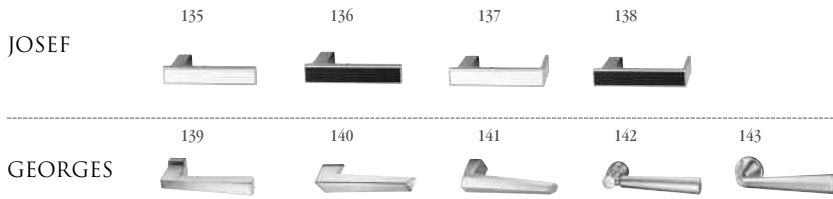

## ROSES

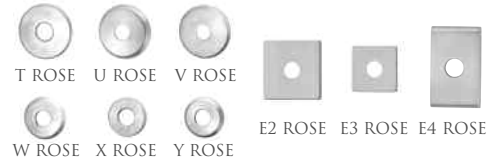

## ESCUTCHEONS



## THUMBTURNS<sup>3</sup>



1. Handed: specify hand when ordering
2. Contact factory for current lead time
3. Specify thumbturn as quick code. Thumbturn backplate will match shape of rose chosen (i.e. round or square). Not available with escutcheons.

613E	Dark Oxidized Satin Bronze - Equivalent	605	Bright Brass, Clear Coated	618	Bright Nickel Plated
626	Satin Chromium Plated	606	Satin Brass, Clear Coated	619	Satin Nickel Plated
		611	Bright Bronze, Clear Coated	625	Bright Chromium Plated
		612	Satin Bronze, Clear Coated	629	Bright Stainless Steel
		613	Dark Oxidized Satin Bronze, Oil Rubbed	630	Satin Stainless Steel
		613L	Dark Oxidized Satin Bronze, Clear Coated	722	Black Oxidized Bronze, Oil Rubbed

## Function

Lever with Escutcheons: L,R					
Single Cylinder	ML20914	Fail Safe/Fail Secure*	\$1,259.00		\$1,283.00
	ML20906				
No Cylinder Override	ML20907	Fail Safe/Fail Secure*	\$1,185.00		\$1,209.00
	ML20915				
Double Cylinder	ML20932	Fail Safe/Fail Secure*	\$1,333.00		\$1,357.00
Lever with Roses: V,U,T,Y,X,W,E2,E3,E4					
Single Cylinder	ML20914	Fail Safe/Fail Secure*	\$1,186.00		\$1,210.00
	ML20906				
No Cylinder Override	ML20907	Fail Safe/Fail Secure*	\$1,112.00		\$1,136.00
	ML20915				
Double Cylinder	ML20932	Fail Safe/Fail Secure*	\$1,260.00		\$1,284.00

\*Must specify: SAF for Fail Safe or SEC for Fail Secure.

## Ordering Example Details

<b>ML20900 ECL</b>	ML20914	Single Cylinder
Escutcheon Trim	SEC	Fail Secure
	135	Josef Family Lever
	L	Escutcheon
	613	Finish
	RHR	Handing
	24 AD	24 Volt AC/DC



Stock Order								
Quantity	Series/Function	Technology Code	Trim	Finish	Hand	Voltage	Fail Safe/Fail Secure	High Security Monitoring Options
24	ML20914	NAC	135L	613	RHR	24 AD	SEC	PHRR01

Copyright © 2002 - 2015 Corbin Russwin, Inc.



Corbin Russwin Architectural Hardware | 225 Episcopal Road | Berlin, CT 06037  
Phone 800-543-3658 | Fax 800-447-6714 | corbinrusswinMUSEO.com

ASSA ABLOY, the global leader in door opening solutions

Price List. 44

November 1, 2015

contemporary levers to complement the interior design of your next project

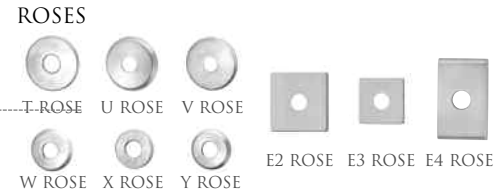
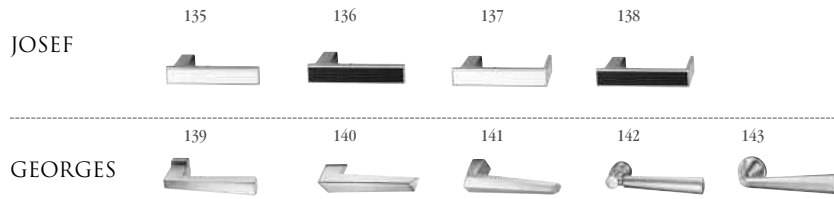

1. Handed: specify hand when ordering
2. Contact factory for current lead time
3. Specify thumbturn as quick code. Thumbturn backplate will match shape of rose chosen (i.e. round or square). Not available with escutcheons.

613E	Dark Oxidized Satin Bronze - Equivalent	605	Bright Brass, Clear Coated	618	Bright Nickel Plated
626	Satin Chromium Plated	606	Satin Brass, Clear Coated	619	Satin Nickel Plated
		611	Bright Bronze, Clear Coated	625	Bright Chromium Plated
		612	Satin Bronze, Clear Coated	629	Bright Stainless Steel
		613	Dark Oxidized Satin Bronze, Oil Rubbed	630	Satin Stainless Steel
		613L	Dark Oxidized Satin Bronze, Clear Coated	722	Black Oxidized Bronze, Oil Rubbed

**Function**

Lever with Escutcheons: L,R					
Single Cylinder	ML20606 x NAC	Fail Safe/Fail Secure	\$1,434.00		\$1,458.00
	ML20608 x NAC	Fail Safe/Fail Secure	\$1,509.00		\$1,533.00
No Cylinder Override	ML20607 x NAC	Fail Safe/Fail Secure	\$1,360.00		\$1,384.00
	ML20609 x NAC	Fail Safe/Fail Secure	\$1,435.00		\$1,459.00

Lever with Roses: V,U,T,Y,X,W,E2,E3,E4					
Single Cylinder	ML20606 x NAC	Fail Safe/Fail Secure	\$1,361.00		\$1,385.00
	ML20608 x NAC	Fail Safe/Fail Secure	\$1,436.00		\$1,460.00
No Cylinder Override	ML20607 x NAC	Fail Safe/Fail Secure	\$1,395.00		\$1,419.00
	ML20609 x NAC	Fail Safe/Fail Secure	\$1,470.00		\$1,494.00

\*Must specify: SAF for Fail Safe or SEC for Fail Secure.

**ML20600 High Security Monitoring Options**

Description	Specify	Add or Deduct
Mercury and Lenel compatible 1KΩ/2KΩ resistance supervision	R01	Add \$100.00 per lockset
Software House compatible 1KΩ/2KΩ resistance supervision	R03	Add \$100.00 per lockset
AMAG compatible 4-state supervision	R04	Add \$100.00 per lockset
Deadbolt Privacy Function	PHR	Add \$100.00 per lockset
Deadbolt Privacy and Mercury / Lenel 1KΩ/2KΩ	PHRR01	Add \$200.00 per lockset
Deadbolt Privacy and Software House 1KΩ/2KΩ	PHRR03	Add \$200.00 per lockset
Deadbolt Privacy and AMAG 4-State	PHRR04	Add \$200.00 per lockset



Ordering Example Details

<b>ML20600 NAC</b>	ML20608	Single Cylinder
Escutcheon Trim	SEC	Fail Secure
	104	Salvador Family Lever
	L	Escutcheon
	613	Finish
	RHR	Handing
	24 AD	24 Volt AC/DC

**Stock Order**

Quantity	Series/Function	Technology Code	Trim	Finish	Hand	Fail Safe/Fail Secure	High Security Monitoring Options
24	ML20608	NAC	135L	613	RHR	SEC	PHRR01



Corbin Russwin Architectural Hardware | 225 Episcopal Road | Berlin, CT 06037  
Phone 800-543-3658 | Fax 800-447-6714 | corbinrusswinMUSEO.com

ASSA ABLOY, the global leader in door opening solutions

Price List. 45

November 1, 2015

*Electrically Controlled Mortise Locksets*  
 ML20900 Series: Muséo Levers, Escutcheons, Roses and Thumbturns



contemporary levers to complement the interior design of your next project



Specify thumbturn as quick code. Thumbturn backplate will match shape of rose chosen (i.e. round or square)

629	Bright Stainless Steel
630	Satin Stainless Steel

**Function**

Lever with Escutcheons: L,R			
Single Cylinder	ML20914	Fail Safe/Fail Secure*	\$1,216.00
	ML20906		
No Cylinder Override	ML20907	Fail Safe/Fail Secure*	\$1,140.00
	ML20915		
Double Cylinder	ML20932	Fail Safe/Fail Secure*	\$1,292.00
Lever with Roses: V,U,T,Y,X,W,E2,E3,E4			
Single Cylinder	ML20914	Fail Safe/Fail Secure*	\$1,143.00
	ML20906		
No Cylinder Override	ML20907	Fail Safe/Fail Secure*	\$1,067.00
	ML20915		
Double Cylinder	ML20932	Fail Safe/Fail Secure*	\$1,219.00

\*Must specify: SAF for Fail Safe or SEC for Fail Secure.



Ordering Example Details

**ML20900 ECL** ML20914 Single Cylinder  
 Escutcheon SAF Fail Safe  
 Trim 21M Piet Family Lever - Polished with Satin Insert  
 L Escutcheon  
 293029 Lever Finish  
 Polished with satin stainless steel insert  
 (630), polished stainless steel (629) shank  
 and polished stainless steel (629) grip  
 629 Lock Finish  
 RHR Handing  
 24 AD 24 Volt AC/DC

**Stock Order**

Quantity	Series/ Function	Fail Safe/ Fail Secure	Trim	Lever Finish	Lock Finish	Hand	Voltage
2	ML20914	SAF	21ML	293029	629	RHR	24 AD

Copyright © 2002 - 2015 Corbin Russwin, Inc.



Corbin Russwin Architectural Hardware | 225 Episcopal Road | Berlin, CT 06037  
 Phone 800-543-3658 | Fax 800-447-6714 | corbinrusswinMUSEO.com

ASSA ABLOY, the global leader in door opening solutions

Price List. 46

November 1, 2015

*Electrically Controlled Mortise Locksets*  
ML20600 NAC Series Electrified Mortise Lock with High Security Monitoring



contemporary levers to complement the interior design of your next project

PIET



ROSES



ESCUTCHEONS



THUMBTURNS



Specify thumbturn as quick code. Thumbturn backplate will match shape of rose chosen (i.e. round or square)

629	Bright Stainless Steel
630	Satin Stainless Steel

Function

Lever with Escutcheons: L,R			
Single Cylinder	ML20606 x NAC	Fail Safe/Fail Secure*	\$1,391.00
	ML20608 x NAC		\$1,466.00
No Cylinder Override	ML20607 x NAC	Fail Safe/Fail Secure*	\$1,317.00
	ML20609 x NAC		\$1,392.00
Lever with Roses: V,U,T,Y,X,W,E2,E3,E4			
Single Cylinder	ML20606 x NAC	Fail Safe/Fail Secure*	\$1,318.00
	ML20608 x NAC		\$1,393.00
No Cylinder Override	ML20607 x NAC	Fail Safe/Fail Secure*	\$1,244.00
	ML20609 x NAC		\$1,319.00

ML20600 High Security Monitoring Options

Description	Specify	Add or Deduct
Mercury and Lenel compatible 1KΩ/2KΩ resistance supervision	R01	Add \$100.00 per lockset
Software House compatible 1KΩ/2KΩ resistance supervision	R03	Add \$100.00 per lockset
AMAG compatible 4-state supervision	R04	Add \$100.00 per lockset
Deadbolt Privacy Function	PHR	Add \$100.00 per lockset
Deadbolt Privacy and Mercury / Lenel 1KΩ/2KΩ	PHRR01	Add \$200.00 per lockset
Deadbolt Privacy and Software House 1KΩ/2KΩ	PHRR03	Add \$200.00 per lockset
Deadbolt Privacy and AMAG 4-State	PHRR04	Add \$200.00 per lockset

\*Must specify: SAF for Fail Safe or SEC for Fail Secure.

Ordering Example Details

<b>ML20600 NAC</b>	ML20914	Single Cylinder
Escutcheon	SEC	Fail Secure
Trim	21W	Piet Family Lever - Wood Insert
	L	Escutcheon
	29BH29	Lever Finish Wood insert with polished stainless steel (629) shank and polished stainless steel (629) grip
	629	Lock Finish
	RHR	Handing
	24 AD	24 Volt AC/DC

Stock Order										
Qty	Series/Function	Tech. Code	Trim	Lever Finish	Finish	Hand	Voltage	Fail Safe/Fail Secure	High Security Monitoring Options	
2	ML20608	NAC	21ML	29BH29	629	RHR	24 AD	SEC	PHRR01	



Corbin Russwin Architectural Hardware | 225 Episcopal Road | Berlin, CT 06037  
Phone 800-543-3658 | Fax 800-447-6714 | corbinrusswinMUSEO.com

ASSA ABLOY, the global leader in door opening solutions

Price List. 47

November 1, 2015



*Electrically Controlled Mortise Locksets*  
 ML20900 Series: Muséo Levers, Escutcheons, Roses and Thumbturns



contemporary levers to complement the interior design of your next project



Specify thumbturn as quick code. Thumbturn backplate will match shape of rose chosen (i.e. round or square)

629	Bright Stainless Steel
630	Satin Stainless Steel

**Function**

Lever with Escutcheons: L,R			
Single Cylinder	ML20914	Fail Safe/Fail Secure*	\$1,283.00
	ML20906		
No Cylinder Override	ML20907	Fail Safe/Fail Secure*	\$1,207.00
	ML20915		
Double Cylinder	ML20932	Fail Safe/Fail Secure*	\$1,359.00
Lever with Roses: V,U,T,Y,X,W,E2,E3,E4			
Single Cylinder	ML20914	Fail Safe/Fail Secure*	\$1,210.00
	ML20906		
No Cylinder Override	ML20907	Fail Safe/Fail Secure*	\$1,134.00
	ML20915		
Double Cylinder	ML20932	Fail Safe/Fail Secure*	\$1,286.00

\*Must specify: SAF for Fail Safe or SEC for Fail Secure.

**BHMA CERTIFIED** Ordering Example Details →

<b>ML20900 ECL</b>	ML20914 Single Cylinder
Escutcheon	SEC Fail Secure
Trim	21W Piet Family Lever - Wood Insert
	L Escutcheon
	29BH29 Lever Finish
	Wood insert with polished stainless steel (629) shank and polished stainless steel (629) grip
	629 Lock Finish
	RHR Handing
	24 AD 24 Volt AC/DC

Stock Order							
Quantity	Series/Function	Fail Safe/Fail Secure	Trim	Lever Finish	Lock Finish	Hand	Voltage
2	ML20914	SEC	21ML	29BH29	629	RHR	24 AD

Copyright © 2002 - 2015 Corbin Russwin, Inc.



Corbin Russwin Architectural Hardware | 225 Episcopal Road | Berlin, CT 06037  
 Phone 800-543-3658 | Fax 800-447-6714 | corbinrusswinMUSEO.com

ASSA ABLOY, the global leader in door opening solutions

Price List. 48

November 1, 2015



*Electrically Controlled Mortise Locksets*  
ML20600 NAC Series Electrified Mortise Lock with High Security Monitoring



contemporary levers to complement the interior design of your next project

PIET



ROSES



ESCUTCHEONS



THUMBTURNS



Specify thumbturn as quick code. Thumbturn backplate will match shape of rose chosen (i.e. round or square)

629	Bright Stainless Steel
630	Satin Stainless Steel

Function

Lever with Escutcheons: L,R			
Single Cylinder	ML20606 x NAC	Fail Safe/Fail Secure*	\$1,458.00
	ML20608 x NAC		\$1,533.00
No Cylinder Override	ML20607 x NAC	Fail Safe/Fail Secure*	\$1,384.00
	ML20609 x NAC		\$1,459.00
Lever with Roses: V,U,T,Y,X,W,E2,E3,E4			
Single Cylinder	ML20606 x NAC	Fail Safe/Fail Secure*	\$1,385.00
	ML20608 x NAC		\$1,460.00
No Cylinder Override	ML20607 x NAC	Fail Safe/Fail Secure*	\$1,311.00
	ML20609 x NAC		\$1,386.00

ML20600 High Security Monitoring Options

Description	Specify	Add or Deduct
Mercury and Lenel compatible 1KΩ/2KΩ resistance supervision	R01	Add \$100.00 per lockset
Software House compatible 1KΩ/2KΩ resistance supervision	R03	Add \$100.00 per lockset
AMAG compatible 4-state supervision	R04	Add \$100.00 per lockset
Deadbolt Privacy Function	PHR	Add \$100.00 per lockset
Deadbolt Privacy and Mercury / Lenel 1KΩ/2KΩ	PHRR01	Add \$200.00 per lockset
Deadbolt Privacy and Software House 1KΩ/2KΩ	PHRR03	Add \$200.00 per lockset
Deadbolt Privacy and AMAG 4-State	PHRR04	Add \$200.00 per lockset

\*Must specify: SAF for Fail Safe or SEC for Fail Secure.

BHMA CERTIFIED Ordering Example Details →

<b>ML20600 NAC</b>	ML20608 Single Cylinder
Escutcheon Trim	SEC Fail Secure
	21W Piet Family Lever - Wood Insert
	L Escutcheon
	29BH29 Lever Finish
	Wood insert with polished stainless steel (629) shank and polished stainless steel (629) grip
	629 Lock Finish
	RHR Handing
	24 AD 24 Volt AC/DC

Stock Order									
Qty	Series/Function	Tech. Code	Trim	Lever Finish	Finish	Hand	Voltage	Fail Safe/Fail Secure	High Security Monitoring Options
2	ML20608	NAC	21ML	29BH29	629	RHR	24 AD	SEC	PHRR01



Corbin Russwin Architectural Hardware | 225 Episcopal Road | Berlin, CT 06037  
Phone 800-543-3658 | Fax 800-447-6714 | corbinrusswinMUSEO.com

ASSA ABLOY, the global leader in door opening solutions

Price List. 49

November 1, 2015

# Access 800® AC2 Mortise Locksets

ML20800 Series: Muséo Levers

# MUSÉO®

contemporary levers to complement the interior design of your next project

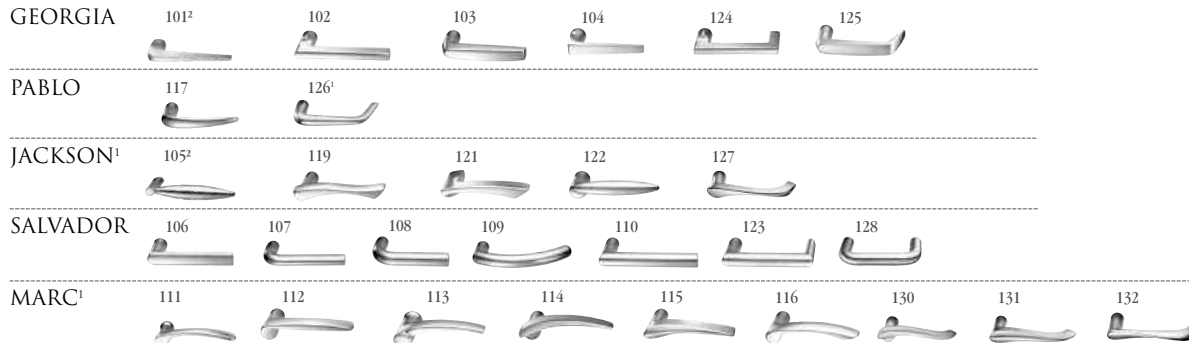

1. Handed: specify hand when ordering
2. Contact factory for current lead time

613E Dark Oxidized Satin Bronze - Equivalent  
626 Satin Chromium Plated

605 Bright Brass, Clear Coated  
606 Satin Brass, Clear Coated  
611 Bright Bronze, Clear Coated  
612 Satin Bronze, Clear Coated  
613 Dark Oxidized Satin Bronze, Oil Rubbed  
613L Dark Oxidized Satin Bronze, Clear Coated

618 Bright Nickel Plated  
619 Satin Nickel Plated  
625 Bright Chromium Plated  
629 Bright Stainless Steel  
630 Satin Stainless Steel  
722 Black Oxidized Bronze, Oil Rubbed

Function Description

### Levers: Georgia, Pablo, Jackson, Salvador, Marc

ML20833	Without key override x M800	\$987.00	\$1,089.00
ML20834	With key override x M800	\$1,063.00	\$1,165.00
ML20835	Deadbolt without key override x M800	\$1,001.00	\$1,103.00
ML20836	Deadbolt with key override x M800	\$1,077.00	\$1,179.00
ML20837*	Dormitory Entry with Deadbolt and inside lever switch x M802	\$1,610.00	\$1,712.00
	Dormitory Entry with Deadbolt and inside lever switch x M803	\$1,669.00	\$1,771.00

\*ML20837 only compatible with proximity readers, M802 and M803

### Access 800® Options

Description	Specify Quick Code	Add
100 User, keypad only	M800	No Charge
2000 User, keypad only	M801	\$141.00
2000 User, proximity only	M802	\$533.00
2000 User, keypad and proximity	M803	\$592.00
2000 User, keypad and RF actuation	M804	\$335.00
2000 User, proximity and RF actuation	M805	\$727.00
2000 User, keypad, proximity and RF actuation	M806	\$786.00
Gasket	M99	No Charge



Ordering Example Details

**ML20800**  
ML20834 Key Override  
114 Marc Family Lever  
619 Finish  
RHR Handing

### Stock Order

Quantity	Series/Function	Technology Code	Trim	Finish	Hand	Option
24	ML20834	TCAC2	114Z	619	RHR	M801

Copyright © 2002 - 2015 Corbin Russwin, Inc.



**ASSA ABLOY**

Corbin Russwin Architectural Hardware | 225 Episcopal Road | Berlin, CT 06037  
Phone 800-543-3658 | Fax 800-447-6714 | corbinrusswinMUSEO.com

ASSA ABLOY, the global leader in door opening solutions

Price List. 50

November 1, 2015

# Access 800® AC2 Mortise Locksets

ML20800 Series: Muséo Levers

# MUSÉO®

contemporary levers to complement the interior design of your next project

JOSEF



GEORGES



1. Handed: specify hand when ordering
2. Contact factory for current lead time

613E Dark Oxidized Satin Bronze - Equivalent  
626 Satin Chromium Plated

605 Bright Brass, Clear Coated  
606 Satin Brass, Clear Coated  
611 Bright Bronze, Clear Coated  
612 Satin Bronze, Clear Coated  
613 Dark Oxidized Satin Bronze, Oil Rubbed  
613L Dark Oxidized Satin Bronze, Clear Coated

618 Bright Nickel Plated  
619 Satin Nickel Plated  
625 Bright Chromium Plated  
629 Bright Stainless Steel  
630 Satin Stainless Steel  
722 Black Oxidized Bronze, Oil Rubbed

Function	Description		
<b>Levers: Georgia, Pablo, Jackson, Salvador, Marc</b>			
ML20833	Without key override x M800	\$1,065.00	\$1,089.00
ML20834	With key override x M800	\$1,141.00	\$1,165.00
ML20835	Deadbolt without key override x M800	\$1,079.00	\$1,103.00
ML20836	Deadbolt with key override x M800	\$1,155.00	\$1,179.00
ML20837*	Dormitory Entry with Deadbolt and inside lever switch x M802	\$1,688.00	\$1,712.00
	Dormitory Entry with Deadbolt and inside lever switch x M803	\$1,747.00	\$1,771.00

\*ML20837 only compatible with proximity readers, M802 and M803

## Access 800® Options

Description	Specify Quick Code	Add
100 User, keypad only	M800	No Charge
2000 User, keypad only	M801	\$141.00
2000 User, proximity only	M802	\$533.00
2000 User, keypad and proximity	M803	\$592.00
2000 User, keypad and RF actuation	M804	\$335.00
2000 User, proximity and RF actuation	M805	\$727.00
2000 User, keypad, proximity and RF actuation	M806	\$786.00
Gasket	M99	No Charge



Ordering Example Details

**ML20800**  
ML20834 Key Override  
133 Josef Family Lever  
619 Finish  
RHR Handing

### Stock Order

Quantity	Series/Function	Technology Code	Trim	Finish	Hand	Option
24	ML20834	TCAC2	133Z	619	RHR	M801



**ASSA ABLOY**

Corbin Russwin Architectural Hardware | 225 Episcopal Road | Berlin, CT 06037  
Phone 800-543-3658 | Fax 800-447-6714 | corbinrusswinMUSEO.com

ASSA ABLOY, the global leader in door opening solutions

Price List. 51

November 1, 2015

# Access 800® AC2 Mortise Locksets

ML20800 Series: Muséo Levers

# MUSÉO®

contemporary levers to complement the interior design of your next project

PIET



629	Bright Stainless Steel
630	Satin Stainless Steel

Function

Description

**Levers: Piet**

ML20833	Without key override x M800	\$1,089.00
ML20834	With key override x M800	\$1,165.00
ML20835	Deadbolt without key override x M800	\$1,103.00
ML20836	Deadbolt with key override x M800	\$1,179.00
ML20837 <sup>1</sup>	Dormitory Entry with Deadbolt and inside lever switch x M802	\$1,712.00
	Dormitory Entry with Deadbolt and inside lever switch x M803	\$1,771.00

### Access 800® Options

Description	Specify Quick Code	Add
100 User, keypad only	M800	No Charge
2000 User, keypad only	M801	\$141.00
2000 User, proximity only	M802	\$533.00
2000 User, keypad and proximity	M803	\$592.00
2000 User, keypad and RF actuation	M804	\$335.00
2000 User, proximity and RF actuation	M805	\$727.00
2000 User, keypad, proximity and RF actuation	M806	\$786.00



Ordering Example Details

**ML20800**

ML20834	Key Override
21MZ	Piet Family Lever - Polished with Satin Insert
293029	Lever Finish
	Polished with satin stainless steel insert (630), polished stainless steel (629) shank and polished stainless steel (629) grip
625	Lock Finish
RHR	Handing

### Stock Order

Quantity	Series/Function	Technology Code	Trim	Lever Finish	Lock <sup>2</sup> Finish	Hand	Option
2	ML20834	TCAC2	21MZ	293029	625	RHR	M801

<sup>1</sup>ML20837 only compatible with proximity readers, M802 and M803

<sup>2</sup>Escutcheons (lock finish) are plated to match satin stainless steel (630) and polished stainless steel (629) finishes.

Copyright © 2002 - 2015 Corbin Russwin, Inc.



**ASSA ABLOY**

Corbin Russwin Architectural Hardware | 225 Episcopal Road | Berlin, CT 06037  
Phone 800-543-3658 | Fax 800-447-6714 | corbinrusswinMUSEO.com

ASSA ABLOY, the global leader in door opening solutions

Price List. 52

November 1, 2015

contemporary levers to complement the interior design of your next project

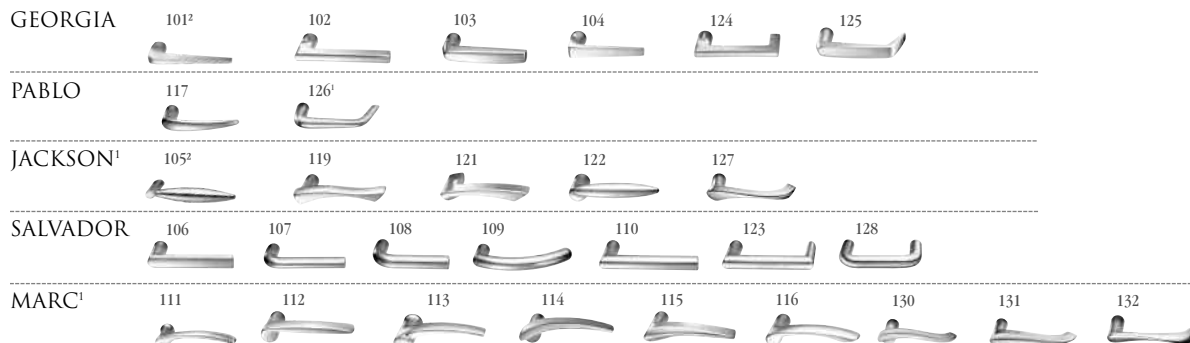

1. Handed: specify hand when ordering
2. Contact factory for current lead time

**Levers: Georgia, Pablo, Jackson, Salvador, Marc**

613E Dark Oxidized Satin Bronze - Equivalent	605 Bright Brass, Clear Coated	618 Bright Nickel Plated
630 Satin Stainless Steel	606 Satin Brass, Clear Coated	619 Satin Nickel Plated
	611 Bright Bronze, Clear Coated	625 Bright Chromium Plated
	612 Satin Bronze, Clear Coated	629 Bright Stainless Steel
	613 Dark Oxidized Satin Bronze, Oil Rubbed	722 Black Oxidized Bronze, Oil Rubbed
	613L Dark Oxidized Satin Bronze, Clear Coated	

Function	Description				
<b>Use with ED5200(S)(A) Rim/SecureBolt® Device</b>					
9833	Without key override x M800	\$1,078.00	\$1,098.00	Note: For key override, add Cylinder Quick Code Option and price. *When specifying function, prefix with lever design. Refer to page 230 for mechanical push bar pricing.	
9834	With key override x M800				
<b>Use with ED5633(A)L &amp; ED5634(A)L Mortise Device</b>					
9M833	Without key override x M800	\$1,041.00	\$1,061.00		
9M834	With key override x M800				

Note: 9M833 and 9M834 cannot be retrofitted to an existing ED5000 Series mortise device. When ordered as "Trim Only" 9M833 and 9M834 will be furnished with the appropriate mortise lock (refer to Parts Price List for mortise lock body pricing). If a "Trim Only" order is intended for retrofitting and exit device with an M91 Bolt Monitor or an M93 Trim Monitor function, that function must be specified with the trim order to ensure the correct lock is furnished.

**Access 800® Options**

Description	Specify Quick Code	Add
100 User, keypad only	M800	No Charge
2000 User, keypad only	M801	\$141.00
2000 User, proximity only	M802	\$533.00
2000 User, keypad and proximity	M803	\$592.00
2000 User, keypad and RF actuation	M804	\$335.00
2000 User, proximity and RF actuation	M805	\$727.00
2000 User, keypad, proximity and RF actuation	M806	\$786.00
Gasket	M99	No Charge

- Notes:
1. Available 0-bitted and Key Random (KR) only.
  2. Available 0-bitted only.



Ordering Example Details  
ED5000 Series

112 9M833 Marc Family Lever Mortise without key override function

Trim Only					
Quantity	Trim/Function	Technology Code	Finish	Hand	Options
24	1129M833	TCAC2	625	RHR	M800



Corbin Russwin Architectural Hardware | 225 Episcopal Road | Berlin, CT 06037  
Phone 800-543-3658 | Fax 800-447-6714 | corbinrusswinMUSEO.com



ASSA ABLOY, the global leader in door opening solutions

Price List. 53

November 1, 2015

contemporary levers to complement the interior design of your next project

JOSEF



GEORGES



1. Handed: specify hand when ordering
2. Contact factory for current lead time

Levers: Georgia, Pablo, Jackson, Salvador, Marc

613E Dark Oxidized Satin Bronze - Equivalent	605 Bright Brass, Clear Coated	618 Bright Nickel Plated
630 Satin Stainless Steel	606 Satin Brass, Clear Coated	619 Satin Nickel Plated
	611 Bright Bronze, Clear Coated	625 Bright Chromium Plated
	612 Satin Bronze, Clear Coated	629 Bright Stainless Steel
	613 Dark Oxidized Satin Bronze, Oil Rubbed	722 Black Oxidized Bronze, Oil Rubbed
	613L Dark Oxidized Satin Bronze, Clear Coated	

Function	Description			
<b>Use with ED5200(S)(A) Rim/SecureBolt® Device</b>				
9833	Without key override x M800		\$1,088.00	\$1,108.00
9834	With key override x M800			
<b>Use with ED5633(A)L &amp; ED5634(A)L Mortise Device</b>				
9M833	Without key override x M800		\$1,051.00	\$1,071.00
9M834	With key override x M800			

Note: For key override, add Cylinder Quick Code Option and price.  
\*When specifying function, prefix with lever design.  
Refer to page 230 for mechanical push bar pricing.

Note: For key override, add Cylinder Quick Code Option and price. See page 93.  
\*When specifying function, prefix with lever design.  
Refer to page 230 for mechanical push bar pricing.

Note: 9M833 and 9M834 cannot be retrofitted to an existing ED5000 Series mortise device. When ordered as "Trim Only" 9M833 and 9M834 will be furnished with the appropriate mortise lock (refer to Parts Price List for mortise lock body pricing). If a "Trim Only" order is intended for retrofitting and exit device with an M91 Bolt Monitor or an M93 Trim Monitor function, that function must be specified with the trim order to ensure the correct lock is furnished.

Access 800® Options

Description	Specify Quick Code	Add
100 User, keypad only	M800	No Charge
2000 User, keypad only	M801	\$141.00
2000 User, proximity only	M802	\$533.00
2000 User, keypad and proximity	M803	\$592.00
2000 User, keypad and RF actuation	M804	\$335.00
2000 User, proximity and RF actuation	M805	\$727.00
2000 User, keypad, proximity and RF actuation	M806	\$786.00
Gasket	M99	No Charge

- Notes:
1. Available 0-bitted and Key Random (KR) only.
  2. Available 0-bitted only.

Ordering Example Details



ED5000 Series

133 Josef Family Lever  
9M833 Mortise without key override function

Trim Only					
Quantity	Trim/Function	Technology Code	Finish	Hand	Options
24	1339M833	TCAC2	625	RHR	M800



Corbin Russwin Architectural Hardware | 225 Episcopal Road | Berlin, CT 06037  
Phone 800-543-3658 | Fax 800-447-6714 | corbinrusswinMUSEO.com

ASSA ABLOY, the global leader in door opening solutions

Price List. 54

November 1, 2015

# Access 800® AC2 Exit Devices

ED5000 Series: Muséo Levers

# MUSÉO®

contemporary levers to complement the interior design of your next project

PIET



Function Description

629 Bright Stainless Steel  
630 Satin Stainless Steel

Use with ED5200(S)(A) Rim/SecureBolt® Device		
9833	Without key override x M800	\$1,108.00
9834	With key override x M800	
Use with ED5633(A)L & ED5634(A)L Mortise Device		
9M833	Without key override x M800	\$1,071.00
9M834	With key override x M800	

Note: 9M833 and 9M834 cannot be retrofitted to an existing ED5000 Series mortise device. When ordered as "Trim Only" 9M833 and 9M834 will be furnished with the appropriate mortise lock (refer to Parts Price List for mortise lock body pricing). If a "Trim Only" order is intended for retrofitting and exit device with an M91 Bolt Monitor or an M93 Trim Monitor function, that function must be specified with the trim order to ensure the correct lock is furnished.

## Access 800® Options

Description	Specify Quick Code	Add
100 User, keypad only	M800	No Charge
2000 User, keypad only	M801	\$141.00
2000 User, proximity only	M802	\$533.00
2000 User, keypad and proximity	M803	\$592.00
2000 User, keypad and RF actuation	M804	\$335.00
2000 User, proximity and RF actuation	M805	\$727.00
2000 User, keypad, proximity and RF actuation	M806	\$786.00
Gasket	M99	No Charge

Notes:

1. Available 0-bitted and Key Random (KR) only.
2. Available 0-bitted only.

### Ordering Example Details

<b>ED5000 Series</b>	21W	Piet Family Lever - Wood Insert
	9M833	Mortise without key override function
	29BH29	Lever Finish Wood insert with polished stainless steel (629) shank and polished stainless steel (629) grip
	625 RHR	Lock Finish Handing

Trim Only						
Quantity	Trim/Function	Technology Code	Lever Finish	Lock <sup>2</sup> Finish	Hand	Option
2	21W9M833	TCAC2	29BH29	625	RHR	M800

<sup>2</sup>Escutcheons (lock finish) are plated to match satin stainless steel (630) and polished stainless steel (629) finishes.



Corbin Russwin Architectural Hardware | 225 Episcopal Road | Berlin, CT 06037  
Phone 800-543-3658 | Fax 800-447-6714 | corbinrusswinMUSEO.com

ASSA ABLOY, the global leader in door opening solutions

Price List. 55

November 1, 2015



contemporary levers to complement the interior design of your next project

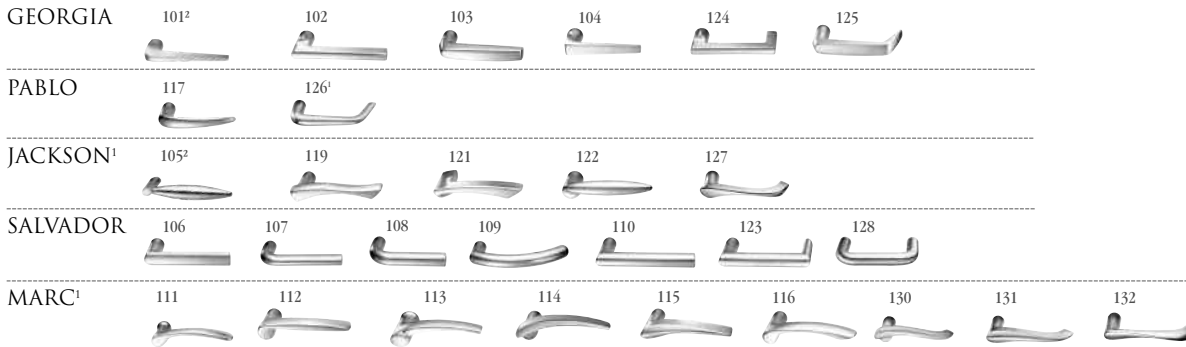

Parabolic Trim  
Specify: M60



Standard Trim

1. Handed: specify hand when ordering
2. Contact factory for current lead time

613E	Dark Oxidized Satin Bronze - Equivalent	605	Bright Brass, Clear Coated
630	Satin Stainless Steel	606	Satin Brass, Clear Coated
		611	Bright Bronze, Clear Coated
		612	Satin Bronze, Clear Coated
		613	Dark Oxidized Satin Bronze, Oil Rubbed
		613L	Dark Oxidized Satin Bronze, Clear Coated
		618	Bright Nickel Plated
		619	Satin Nickel Plated
		625	Bright Chromium Plated
		629	Bright Stainless Steel
		722	Black Oxidized Bronze, Oil Rubbed

**Function**

<b>Rim/SVR/CVR</b>	910	Passage		
	950	Dummy		
	955	Classroom	\$572.00	\$598.00
	957	Nightlatch		
	959	Storeroom		
<b>Mortise</b>	9M10	Passage		
	9M50	Dummy	\$572.00	\$598.00
	9M55	Classroom		
	9M57	Nightlatch		
<b>Electrified</b>	9903	Fail Safe	\$960.00	\$986.00
	9905	Fail Secure		
<b>Options</b>	M60	Parabolic Escutcheon	Add \$78.00 per device	Add \$78.00 per device

Ordering Example Details

- 111 Marc family lever
- 9M50 Dummy Trim; Mortise
- 625 Bright Chrome finish
- RHR Right Hand Reverse
- D214 2-1/4" Door Thickness
- M60 Parabolic Escutcheon Design (mechanical)



Trim Only						
Quantity	Trim/Function	Finish	Hand	Door Thickness	Option	
24	1119M50	625	RHR	D214	M60	

Copyright © 2002 - 2015 Corbin Russwin, Inc.



Corbin Russwin Architectural Hardware | 225 Episcopal Road | Berlin, CT 06037  
Phone 800-543-3658 | Fax 800-447-6714 | corbinrusswinMUSEO.com

ASSA ABLOY, the global leader in door opening solutions

Price List. 56

November 1, 2015



# Pushpad Exit Devices

ED5000 Series: Muséo Levers with 900 Series Escutcheon

# MUSÉO

contemporary levers to complement the interior design of your next project

## JOSEF



## GEORGES



Parabolic Trim  
Specify: M60



Standard Trim

1. Handed: specify hand when ordering
2. Contact factory for current lead time

613E	Dark Oxidized Satin Bronze - Equivalent	605	Bright Brass, Clear Coated
630	Satin Stainless Steel	606	Satin Brass, Clear Coated
		611	Bright Bronze, Clear Coated
		612	Satin Bronze, Clear Coated
		613	Dark Oxidized Satin Bronze, Oil Rubbed
		613L	Dark Oxidized Satin Bronze, Clear Coated
		618	Bright Nickel Plated
		619	Satin Nickel Plated
		625	Bright Chromium Plated
		629	Bright Stainless Steel
		722	Black Oxidized Bronze, Oil Rubbed

### Function

Function	Model	Description	Price	Option Price
Rim/SVR/CVR	910	Passage		
	950	Dummy		
	955	Classroom	\$572.00	\$598.00
	957	Nightlatch		
	959	Storeroom		
Mortise	9M10	Passage		
	9M50	Dummy	\$572.00	\$598.00
	9M55	Classroom		
	9M57	Nightlatch		
Electrified	9903	Fail Safe	\$960.00	\$986.00
	9905	Fail Secure		
Options	M60	Parabolic Escutcheon	Add \$78.00 per device	Add \$78.00 per device

### Ordering Example Details

- 133 Josef family lever
- 9M50 Dummy Trim; Mortise
- 625 Bright Chrome finish
- RHR Right Hand Reverse
- D214 2-1/4" Door Thickness
- M60 Parabolic Escutcheon Design (mechanical)



Trim Only					
Quantity	Trim/Function	Finish	Hand	Door Thickness	Option
24	1339M50	625	RHR	D214	M60



Corbin Russwin Architectural Hardware | 225 Episcopal Road | Berlin, CT 06037  
Phone 800-543-3658 | Fax 800-447-6714 | corbinrusswinMUSEO.com

ASSA ABLOY, the global leader in door opening solutions

Price List 57

November 1, 2015

# Pushpad Exit Devices

ED5000 Series: Muséo Levers with 900 Series Escutcheon



contemporary levers to complement the interior design of your next project

PIET



Parabolic Trim  
Specify: M60

Standard Trim

629	Bright Stainless Steel
630	Satin Stainless Steel

## Function

<b>Rim/SVR/CVR</b>	910	Passage	\$598.00
	950	Dummy	
	955	Classroom	
	957	Nightlatch	
	959	Storeroom	
<b>Mortise</b>	9M10	Passage	\$598.00
	9M50	Dummy	
	9M55	Classroom	
	9M57	Nightlatch	
<b>Electrified</b>	9903	Fail Safe	\$986.00
	9905	Fail Secure	
<b>Options</b>	M60	Parabolic Escutcheon	Add \$78.00 per device



## Ordering Example Details

21M Piet Family Lever - Polished with Satin Insert  
 9M50 Dummy Trim; Mortise  
 293029 Lever Finish  
 Polished with satin stainless steel insert (630), polished stainless steel (629) shank and polished stainless steel (629) grip  
 629 Lock Finish  
 D214 2-1/4" Door Thickness  
 M60 Parabolic Escutcheon Design (mechanical)

## Trim Only

Quantity	Trim/Function	Lever Finish	Lock Finish	Hand	Door Thickness	Option
2	21M9M50	293029	629	RHR	D214	M60

**Standard Features**

**Keying**

0-bitted except high security; random keying option offered at no charge

**Keys**

Two nickel silver keys

**Pins**

5-pin for 252, 752, 852 and A Class; all others furnished 6-pin

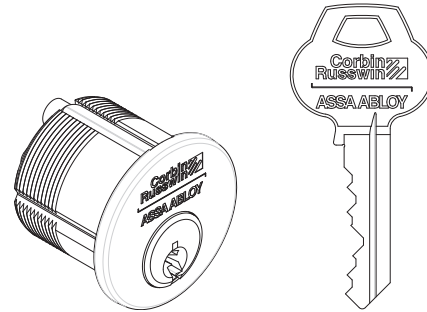

**Ordering Examples**

**Stock Order - Conventional Cylinder**

Quantity	Cylinder	Finish
25	1000	626

**Contract/Detailed Order - Conventional Cylinder**

Quantity	Keyset	Cylinder	Finish	Option
25	AA1	1000-138-A02-7	626	CKC2

**Stock Order - IC Cylinder**

Quantity	Cylinder	Finish
20	1080	626

**Contract/Detailed Order - IC Cylinder**

Quantity	Keyset	Cylinder	Finish	Misc.Option
4	AF3	1080-112-A04-7	606	CKC2

## Keyway Availability

Corbin Russwin keyways are separated into categories known as **Key Classes**, based on blade width and bitting dimensions. **Certain key blanks and cylinders are not available for certain key classes**, and notes to that effect appear in the catalog and price book. If you find a keyway exclusion notice and do not know the class of the keyway you need, refer to the list below.

Some keyways listed here are *inactive*. They remain available to support existing systems, but no *new systems* are generated on them.

Keyway	Remarks
26	Discontinued
27 Series	X Class (28 and 29 are inactive)
57 Series	X Class
59 Series	Z Class
60	Z Class
67 Series	X Class (68 and 69 are inactive)
70	Z Class
77 Series	X Class (77 and 78 are inactive)
97 and 99	X Class
252	852 Class (inactive)
752	752 Class (inactive)
852	852 Class (inactive)
981, 982, 983	981 Class (inactive)
A1 thru A24	A Class (inactive)
Access 3	Access 3
AR, BR, BL	X Class
D1 thru D4	DH Class
G	852 Class (inactive)
H1 thru H8	DH Class
L1 thru L4	Z Class (L2 formerly CCL)
N1 thru N28	N Class (inactive)
Pyramid	Pyramid
Protected	DH or Z Class
Restricted	DH or Z Class

## Keyway Name Changes

All Multiplex Keyways using letters with numbers are now standardized to have the letter first and number last. Also, keyway designation will no longer include the number of pins. K and Z designations are being replaced by the more common N and A Series, respectively. 960 and 970 Series are replaced by the more common 980 Series. Only the following Russwin® older keyways are affected:

Old Designation	Pins	New Designation
1N thru 28N	6	N1 thru N28
1K thru 28K	5 or 7	N1 thru N28
1A thru 24A	5	A1 thru A24
1Z thru 24Z	6	A1 thru A24
961, 962, 963	6	981, 982, 983
971, 972, 973	7	981, 982, 983

<b>Category</b>	<b>Description</b>	<b>Price</b>
Stock L4	Keyway used for stock orders and limited keying systems.	No Charge
Standard (see list at left)	Keyways in general use for keying systems.	No Charge
Restricted (not published)	Selective keyways for use in new and existing keying systems.	No Charge
Protected	Notice of Acceptance showing facilities name, address and contact information must be submitted to key records before orders can be processed. Key system administration approval required prior to processing of order.	No Charge
Pyramid	One of Corbin Russwin's line of high security cylinders	See Pyramid pages 59-64
Security	Old Emhart®/Security cylinders.	For existing systems only
Access 3	Corbin Russwin's highest level of key control.	See pages 53-58

## Key Systems Security Policy

The purpose of this security policy is to enforce our policies Access 3, Pyramid, Security, Protected & Restricted keyway product, including key system information.

No master key system information or security related product is to be given or sold to anyone other than the facility owner through written correspondence. Verification must be submitted (fax copy will be acceptable) to Key Systems Administration. The verification must be on the facility's letterhead and signed by a facility authorized systems administrator. Key Systems Administration does not maintain "Letters of Authorization" on file. Each order must be accompanied by proper authorization. Only after the authorization has been verified will the order be processed for production.

Also includes:

- Bitting information (even one bitting, absolutely no top-level master keys)
- Bitting lists (all formats; i.e., hard copy, disc)
- Key blanks and systems components for Access 3, Pyramid, protected and security cylinder systems.

Please note:

- No orders are to be processed through Key Systems Administration without proper authorization.
- Only orders with appropriate authorization attached will be given priority.
- Requests for systems information without proper authorization from the owner will be denied.
- Requests for information regarding the purchase of any systems support products as listed above will be referred to the local authorized sales agency.
- Refer to the current price lists for additional policies and procedures as they relate to this security policy.

Remember:

The purpose for the establishment of any security system is to provide an increased level of protection for the Facility owner.

## Construction Core Program

### How To Order

Use Quick Code CT6 for 6-PIN, CT7 for 7-PIN, and CTP for Access 3, Pyramid IC products. Use a separate purchase order or line item to order the permanent systems' core.

### Cut Keys

Specify the required number of change keys and control keys on the order. Two control keys are provided at no charge. Two change keys are provided at no charge for the first 20 units ordered. One additional change key is provided for every 10 additional units at no charge.

Examples: 25 units provide 2 operating keys; 30 units provide 3; 100 units provide 10. Additional keys will be invoiced at the prevailing cut key price.

### How To Return Cores

Contact your Customer Service Representative for a Returned Goods Authorization.

Provide the factory order number and year of the original order. Credit is issued for all cores returned in good operating condition, based on the price of a standard 6- or 7-pin core at the time of the original order.

Applicable discounts to the original unit are applied to the returned core.

Current pricing is as follows:	Price
6-PIN CONSTRUCTION CORE: (e.g. 8000-CT6) returned for credit	\$64.00
7-PIN CONSTRUCTION CORE: (e.g. 8000-CT7) returned for credit	\$66.00

## How To Price

Use Quick Code charts in lockset and exit device price sections.

1 ea. Lockset	ML2051 NSA 626	\$745.00	List Price
x Construction Core	CTP	\$59.00	List Price
		\$804.00	Subtotal
	Less 50/25% discount	\$301.50	Subtotal Net Price
1 ea. Pyramid Permanent Core	8027 x 626	\$99.00	List Price
	Less 50% discount	\$49.50	Net Price
		\$351.00	Subtotal Net Price
Return Construction Core	8000 Construction Core	\$59.00	List Price
	Less 50/25% discount	\$22.12	(Credit - RGA from factory)
		\$328.88	Your Total Cost

**Masterkey Service Fee:**

The value-added service of a customized masterkey security solution is provided when requested for a nominal charge with the purchase of complete Corbin Russwin keyed locking devices. In addition to the standard masterkeying charge, a masterkey service charge will be assessed, based on quantity, cylinder type, key system type, for an order that includes only Corbin Russwin cylinders or cores for use in non- Corbin Russwin manufactured locking devices for which Corbin Russwin has an equivalent.

### Keying

Description	Specify Quick Code	Add or Deduct
Keyed random <sup>3</sup>	KR	No Charge
Masterkey Service Fee. Applies to cylinders not being installed in Assa Abloy products		Consult Factory
Master keyed (all cylinders except 8000, 8020, 8027 IC, 8500, 8600, 8700core)	specify keyset	Add \$16.00 per cylinder
Master keyed Pyramid (except 8020, 8027 IC core)	specify keyset	Add \$16.00 per cylinder
Master keyed Access 3 (except 8500, 8600, 8700 IC core)	specify keyset	Add \$16.00 per cylinder
Master keyed Security (including IC cylinder and core)	specify keyset	Add \$16.00 per cylinder
Master keyed (8000, 8020, 8027 IC core 8500, 8600, 8700)	specify keyset	No Charge
Master keyed to customer bittings or sample key	specify keyset	Add \$16.00 per cylinder
Construction master keyed <sup>1,2</sup>	CMK	Add \$16.00 per cylinder
Temporary Construction core, 6-pin (Red, Blue or Green)	CT6R, CT6B, CT6G	No Charge
Temporary Construction core, 7-pin (Red, Blue or Green) Including Access 3 AP & AS	CT7R, CT7B, CT7G	No Charge
Temporary Construction core, 6-pin (Red, Blue or Green) Access 3 AHS	CT6AHR, CT6AHB, CT6AHG	No Charge
Temporary Construction core, Access 3 Pyramid	CTP	No Charge
Temporary Disposable core <sup>7</sup>	CT6D, CT7D, CTPD	No Charge
Small Format Temporary Disposable Cores <sup>7</sup>	CTSD	No Charge
Uncombined (Access 3, Pyramid, Security fixed and IC core) <sup>8</sup>	UC	Deduct \$8.00
Uncombined (conventional 8000 IC core) <sup>8</sup>	UC	Deduct \$2.00
Bump-Resistant Cylinder; Standard on Access 3 except LFIC	BRP	Add \$22.00 per cylinder
More than 2 keys per lock	KY# (e.g., KY6)	See Cut Keys Section Below

### Stamping

Visual key control (VKC)		
- No stamping	VKC0	\$4.30
- Keys only	VKC1	No Charge
- Cylinders and Keys <sup>4</sup>	VKC2	\$8.00
- Cylinders only <sup>4</sup>	VKC3	\$8.00
Concealed key control (CKC)		
- CKC cylinders with VKC keys	CKC2	\$8.00
- CKC cylinders only <sup>4</sup>	CKC3	\$8.00
DO NOT DUPLICATE	Order by number	see pages 51-52
End user custom die stamps* for key bows <sup>6</sup>		\$4.00
Other stamping on keys or cylinders <sup>6</sup> (Up to 7 characters on cylinders)		\$2.50 per character

\* For development of custom key stamp add one-time charge of \$840.00<sup>6</sup>. Dies property of Corbin Russwin.

### Cut Keys

	Conventional Keyway <sup>5</sup> Restricted Keyway		Protected Keyway		Security Keys	Pyramid Keys	Access 3		
	10 Series Bow	50 Series Bow	10 Series Bow	50 Series Bow	KB90 or KB92	KB28	AP	AS	AHS
Extra cut change keys with lockset/cylinder	\$4.50	\$5.00	\$5.50	\$5.90	\$17.70	\$9.40	\$4.70	\$9.40	\$9.40
Cut change keys without lockset/cylinder	\$9.40	\$9.90	\$10.40	\$10.80	\$17.70	\$13.10	\$9.40	\$14.60	\$14.60
Cut master keys (all levels) and control keys with or without lockset/cylinder	\$9.40	\$9.90	\$10.40	\$10.80	\$17.70	\$13.10	\$9.40	\$14.60	\$14.60
Cut construction master keys with or without lockset/cylinder	\$9.40	\$9.90	\$10.40	\$10.80	N/A	N/A	\$9.40	\$14.60	NA

Note: Two (2) cut change keys are provided per lockset or cylinder at no charge. Keyblanks cannot be substituted for cut keys. For keys with bows other than 10 and 90, specify "KB" + number as Quick Code, e.g. KB12. KB92 cannot be furnished with VKC or other markings. Cylinders pinned directly to GMK or MK level keys do not include cut keys. Please order GMK and MK keys separately.

**Notes:**

1. CMK Construction master keying charge is in addition to master keying charge.
2. CMK Construction master keying is not available in Pyramid or Security series.
3. Access 3 and Pyramid series is not available keyed random or 0-bitted.
4. VKC2, VKC3 is not available in Access 3, Pyramid or Security series.
5. Conventional cut change keys are furnished standard with key section, system type and bitting number.
6. Discount 50% only.
7. Disposable cores ordered separately - \$3.70 per set. Sold in multiples of 10 sets.
8. Keys, springs, and spring covers not included.



<b>Presentation Keys</b>		<b>Discount 50% Only</b>
Specify:	Key Symbol; Plating (nickel is standard); Stamping; Bow, if available for key class	
Standard Bow:	51 for all except below	
	90 for Security series	Nickel Plated \$101.00
	10 for 6PIN 852 & A Class keys	Gold Plated \$195.00

**Bitting Lists**

A letter of authorization from the end user is required to release a copy of the bitting lists for a factory established system. To protect the security of keying systems, bitting lists will only be sent to the end user or his designated agent, via Certified Mail Return Receipt Requested or UPS AOD. Copies will not be transmitted via fax. The complete name and address where the bitting list is to be sent must be indicated on the letter of authorization and on the purchase order.

Master key system bitting lists will not be created by Corbin Russwin Key Systems Administration unless the request is accompanied by an order for factory keyed product. Corbin Russwin releases all liabilities for cylinders not pinned to factory master key systems.

<b>Number of Bittings</b>	<b>Discount 50% Only</b>
1-50	\$173.00
51-200	\$265.00
201-1000	\$354.00
1001-3000	\$446.00
3001-6000*	\$531.00
6001-9000*	\$774.00
Over 9000*	Consult Key Systems Administration

\*Lead times may vary; consult Key Systems Administration

**NOTE:** Bitting Lists requested for keysets ordered with factory keyed product for either a new or existing system will be provided at no charge, except when KeyWizard® disc requested. For existing system pricing above will apply. For new system see page 50.

- Additional Bittings or P.O.'s for Bitting Lists Only – **EXISTING MASTER KEY GROUPS**  
Up to 10 **total** for keysets tied to **existing** master key groups will be provided at no charge  
11 or more bittings will be charged per above chart
- Additional Bittings or P.O.'s for Bitting Lists Only – **NEW MASTER KEY GROUPS**  
Regardless of the quantity being requested, will be charged per above chart

**Bitting lists will be billed at 50% off of list price – No additional discounts will apply.**

These prices are for a hierarchial Master Key system with no cross-keying of selected keys.  
For special requirements or for systems prior to 1999, consult Key Systems Administration for a quote.

Corbin Russwin releases all liabilities for cylinders not pinned to factory master key systems.

**Masterkey Service Fee:**

The value-added service of a customized masterkey security solution is provided when requested for a nominal charge with the purchase of complete Corbin Russwin keyed locking devices. In addition to the standard masterkeying charge, a masterkey service charge will be assessed, based on quantity, cylinder type, key system type, for an order that includes only Corbin Russwin cylinders or cores for use in non- Corbin Russwin manufactured locking devices for which Corbin Russwin has an equivalent.

<b>Key Management Software</b>		<b>Discount 50% Only</b>
Key Wizard® - Special online ordering procedures - contact customer service for more information		
Single Version - Order part number 68092		\$1,066.00
Network Version - Order part number 68093		\$1,283.00
Upgrade from Single Version to Network Version - Order part number 68095		\$645.00
Corbin Russwin factory key system formatted for importing to KeyWizard®. For existing systems, see Bitting Lists pricing on page 49. Note: Not available for key systems established prior to 1999. May not be available for systems since 1999. Consult Key Systems Administration for eligibility of system.		\$505.00
<b>Key Systems Administration</b>		
Customer bittings and sample keys 1,2,3,4,5		Add \$16.00 per cylinder <b>(Discount of 50% only)</b>
<p>Notes:</p> <ol style="list-style-type: none"> <li>1. This charge is for keying to customer supplied bittings only.</li> <li>2. All cylinders requested to be keyed to combinations not supplied by Corbin Russwin will be subject to this charge.</li> <li>3. Corbin Russwin releases all liabilities, including key interchange, to systems generated by customer-supplied bittings and/or sample keys that are supplied by others.</li> <li>4. Purchase orders with customer-supplied bittings or sample keys not meeting Corbin Russwin's specifications will be processed 0-bitted in the specified keyway and exempt from upcharge.</li> <li>5. Master keying or CMK charges not included.</li> </ol> <p><b>Disclaimer</b> Corbin Russwin reserves the right to release total liability of any factory generated master key system which incorporates cross keying, both controlled and uncontrolled. A master key system incorporating cross keying yields less security and jeopardizes system expansion.</p>		
Cross Keying		No Charge
<p><b>Controlled Cross Keying:</b> A condition in which two or more different keys of the same level of keying and under the same higher level key(s) operate one cylinder by design; e.g., XAA1 operated by AA2.</p> <p><b>Uncontrolled Cross Keying:</b> A condition in which two or more different keys under different higher-level keys operate one cylinder by design; e.g., XAA1 operated by AB, AB1.</p>		

**Stamping Key Section on Key Blanks**

Key blanks are furnished standard with no key section ID. When so specified, key blanks can be stamped with the key section at no charge. The minimum quantity for this service is a box of 50 key blanks

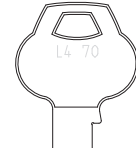

**Standard Bow, Nickel Silver (Order in multiples of 50)**



Coined Logo	Plain Both Sides	DO NOT DUPLICATE	US PROPERTY DO NOT DUPLICATE	RESTRICTED DO NOT DUPLICATE	Price Each		
					Standard Single Section	Restricted Single Section	Standard and Restricted Multi-Section**
(X1, Z1, R)*	(X4, Z4, P)*	(X5, Z5, P5)*	(X6, Z6, P6)*				
xx-5PIN-10	xx-5PIN-11	xx-5PIN-12	xx-5PIN-13	xx-5PIN-19	\$2.00	\$2.15	\$2.30
xx-6PIN-10	xx-6PIN-11	xx-6PIN-12	xx-6PIN-13	xx-6PIN-19			
xx-7PIN-10	xx-7PIN-11	xx-7PIN-12	xx-7PIN-13	xx-7PIN-19	\$2.07	\$2.22	\$2.29

\*(Old Reference)  
 \*\*Multi-section keys enter more than one keyway; eg. D12, H41, 2852, 9812, 59A, 57AD, 067, etc.  
 † Protected keyway keys will be stamped "Restricted"

**Pyramid (Available in quantities of 10, 25, 50 and multiples of 50)**

Standard bow furnished for all Pyramid Keys.



Key Blank Number	Description	Price Each
XX-7PIN-28	Single section	\$6.70
	Multi-section	\$12.00

**Access 3**



Key Blank Number	Description	Price Each
6PIN-38-AP	Standard key blanks for AP cylinders	\$3.50
6PIN-38-AS	Standard key blanks for AS & AHS cylinders	\$6.30

**Security Bow No other shape for security keys. (Order in multiples of 50)**

Not Available for 252, 752, 852, A, N, or X Class keys.  
Inactive, for existing systems only.



Coined Logo	Plain Both Sides	DO NOT DUPLICATE	US PROPERTY DO NOT DUPLICATE	RESTRICTED DO NOT DUPLICATE	Price Each
xx-6PIN-90	xx-6PIN-91	xx-6PIN-92	xx-6PIN-93	xx-6PIN-99	\$6.30
xx-7PIN-90 for hotel EMK					\$8.60

**Large Bows (Order in multiples of 50)**

Large Not Available for 252, 752, 852 or A Class keys.



Plain Both Sides	DO NOT DUPLICATE	US PROPERTY DO NOT DUPLICATE	RESTRICTED DO NOT DUPLICATE	Price Each	PROTECTED DO NOT DUPLICATE	Price Each
(Y4 and S)	(Y5 and S5)	(Y6 and S6)				
xx-5PIN-51	xx-5PIN-52	xx-5PIN-53	xx-5PIN-59	\$3.15	xx-5PIN-59	\$4.80
xx-6PIN-51	xx-6PIN-52	xx-6PIN-53	xx-6PIN-59		xx-6PIN-59	
xx-7PIN-51	xx-7PIN-52	xx-7PIN-53	xx-7PIN-59		xx-7PIN-59	

**Emergency Key Blanks for Hotel Function Access 3 Cylinder**

Description	Key Number	Price Each
Emergency key for mortise AP cylinders	6PIN-38-E2-AP	\$4.90
Emergency key for mortise AS & AHS cylinders	6PIN-38-E2-AS	\$7.20
Emergency key for key-in lever AP cylinders	6PIN-38-E6-AP	\$4.90
Emergency key for key-in lever AS & AHS cylinders	6PIN-38-E2-AS	\$7.20

**Emergency Master Key Blanks for Hotel Function Cylinder (Order in multiples of 10)**

Non-IC mortise cylinder use 7PIN blanks, as already listed: xx-7PIN-51 & xx-7PIN-90. (Order in multiples of 50)

Not Available for 252, 752, 852 or A Class keys.



Lockset	EMK Blank	Price Each
IC Mortise	xx-6PIN-51-E1	\$4.90
IC Mortise, Security	xx-6PIN-90-E1	\$7.20
CK4229, including IC; CK4429	xx-6PIN-51-E4	\$4.90
CK4229 Security, Including IC	xx-6PIN-90-E4	\$7.20
CL3329, CL3429, CL3629 6PIN, Including IC	xx-6PIN-51-E8	\$4.90
CL3329, CL3429, CL3629 7PIN, Including IC	xx-7PIN-51-E8	\$4.90
1400/4300 and 5600/3300 Series	xx-6PIN-51-E5	\$5.90

**AP Fixed Core - Mortise Cylinder**

Cylinder Number	Description	Finish: 605, 606, 611, 612, 613, 613E, 618, 619, 622, 625, 626, 629, 630, 722
1500-114	ML2000 Series mortise locks (including electrified and EAC devices) DL3000 and DL4100 deadlocks ED5600, ED6600 and ED7600 exit devices All ED5000 cylinder dogging, alarm units, delayed egress cylinders	\$76.00
1500-114		
1500-112		
1500-134		\$86.00

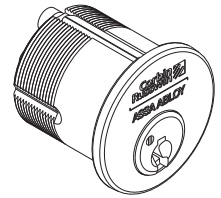

**AP Fixed Core - Rim Cylinder**

Cylinder Number	Description	Finish: 605, 606, 611, 612, 613, 613E, 618, 619, 622, 625, 626, 629, 630, 722
3500-058	5/8" tailpiece	\$76.00
3500-138	1-3/8" M61 & M62 option for ED8200 and obsolete ED9200 exit device alarms; ED5202(A) inside cylinder	
3500-200	2" tailpiece	
3500-200N	2" ED4000/ED5000 night latch function	
3500-200V	2" vertical tailpiece	
3500-312	3-1/2" tailpiece	\$78.00
3500-312V	3-1/2" vertical tailpiece	

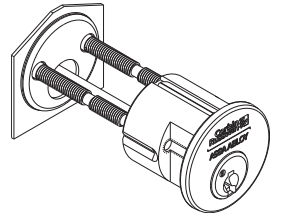

**AP LFIC - Mortise Cylinder**

Cylinder Number	Description	Finish: 605, 606, 611, 612, 613, 613E, 618, 619, 622, 625, 626, 629, 630, 722
1580-114	ML2000 Series mortise locks (including electrified and EAC devices) DL3000 and DL4100 deadlocks ED5600, ED6600 and ED7600 exit devices All ED5000 cylinder dogging, alarm units, delayed egress cylinders	\$140.00
1580-138		\$143.00
1580-112		\$151.00
1580-134		\$151.00

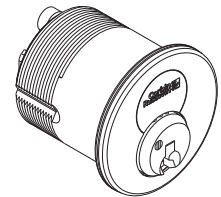

**AP LFIC - Rim Cylinder**

Cylinder Number	Description	Finish: 605, 606, 611, 612, 613, 613E, 618, 619, 622, 625, 626, 629, 630, 722
3580-058	5/8" tailpiece	\$140.00
3580-114	1-1/4" M61 & M62 option for ED8200 and ED9200 exit device alarms	
3580-178	1-7/8" tailpiece	
3580-178V	1-7/8" vertical tailpiece	
3580-318	3-1/8" tailpiece	\$142.00

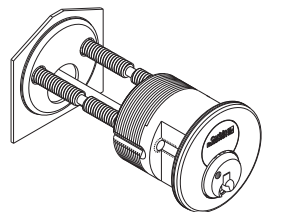

**AP LFIC Core**

Cylinder Number	Description	Finish: 605, 606, 611, 612, 613, 613E, 618, 619, 622, 625, 626, 629, 630, 722
8500	All Corbin Russwin LFIC cylinders	\$64.00

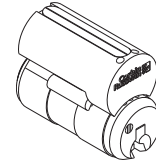

**AP Fixed Core Component Cylinder**

Cylinder Number	Description	Finish: 606, 626
2500-031	CL3100 Series Vandal Resistant	\$69.00
2500-033	CL3300, CL3500, CL3600 (June 2000 and after), CL3800, Lever Trim - A6/N6/PR6	
2500-033H	G10 Exit Device Knob Trim	
2500-037	CL3700 Lever, CK4700 Knob	
2500-039	CL3900	
2500-039L	CL3900 Lever (2" and 2-1/4" Thick Door)	
2500-044	CK4400	
2500-052	CK4200/UT5200	

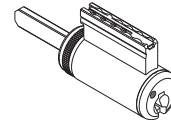

**AP Fixed Core Deadlock Cylinder**

Cylinder Number	Description	Finish: 606, 626
4500-134-A51	DL2200/DL3200 Series	\$69.00
4500-134-A52		
4500-214-A52		

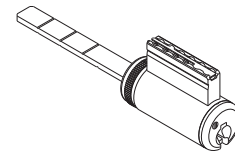

**AS Fixed Core - Mortise Cylinder**

Cylinder Number	Description	Finish: 605, 606, 611, 612, 613, 613E, 618, 619, 622, 625, 626, 629, 630, 722
1600-114	ML2000 Series mortise locks (including electrified and EAC devices)	\$121.00
1600-138	DL3000 and DL4100 deadlocks	
1600-112	ED5600, ED6600 and ED7600 exit devices	\$131.00
1600-134	All ED5000 cylinder dogging, alarm units, delayed egress cylinders	

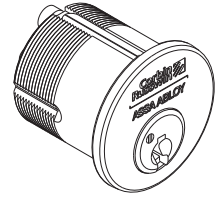

**AS Fixed Core - Rim Cylinder**

Cylinder Number	Description	Finish: 605, 606, 611, 612, 613, 613E, 618, 619, 622, 625, 626, 629, 630, 722
3600-058	5/8" tailpiece	\$121.00
3600-138	1-3/8" M61 & M62 option for ED8200 and obsolete ED9200 exit device alarms; ED5202(A) inside cylinder	
3600-200	2" tailpiece	
3600-200N	2" night latch function	
3600-200V	2" vertical tailpiece	
3600-312	3-1/2" tailpiece	\$123.00
3600-312V	3-1/2" vertical tailpiece	

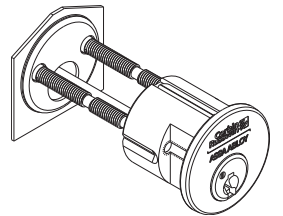

**AS LFIC - Mortise Cylinder**

Cylinder Number	Description	Finish: 605, 606, 611, 612, 613, 613E, 618, 619, 622, 625, 626, 629, 630, 722
1680-114	ML2000 Series mortise locks (including electrified and EAC devices)	\$185.00
1680-138	DL3000 and DL4100 deadlocks	\$188.00
1680-112	ED5600, ED6600 and ED7600 exit devices	
1680-134	All ED5000 cylinder dogging, alarm units, delayed egress cylinders	\$196.00

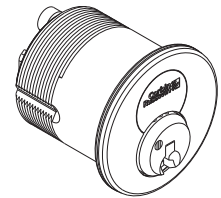

**AS LFIC - Rim Cylinder**

Cylinder Number	Description	Finish: 605, 606, 611, 612, 613, 613E, 618, 619, 622, 625, 626, 629, 630, 722
3680-058	5/8" tailpiece	\$185.00
3680-114	1-1/4" M61 & M62 option for ED8200 and ED9200 exit device alarms	
3680-178	1-7/8" tailpiece	
3680-178V	1-7/8" vertical tailpiece	
3680-318	3-1/8" tailpiece	
		\$187.00

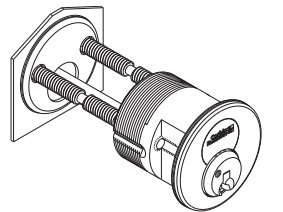

**AS LFIC Core**

Cylinder Number	Description	Finish: 605, 606, 611, 612, 613, 613E, 618, 619, 622, 625, 626, 629, 630, 722
8600	All Corbin Russwin LFIC Cylinders	\$109.00

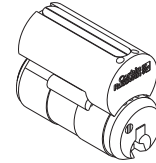

**AS Fixed Core Component Cylinder**

Cylinder Number	Description	Finish: 606, 626
2600-031	CL3100 Series Vandal Resistant	\$114.00
2600-033	CL3300, CL3500, CL3600 (June 2000 and after), CL3800, Lever Trim - A6/N6/PR6	
2600-033H	G10 Exit Device Knob Trim	
2600-037	CL3700 Lever, CK4700 Knob	
2600-039	CL3900	
2600-039L	CL3900 Lever (2" and 2-1/4" Thick Door)	
2600-044	CK4400	
2600-052	CK4200/UT5200	

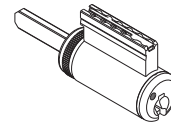

**AS Fixed Core Deadlock Cylinder**

Cylinder Number	Description	Finish: 606, 626
4600-134-A51	DL2200/DL3200 Series	\$114.00
4600-134-A52		
4600-214-A52		

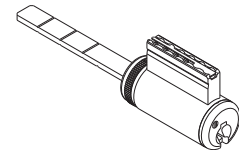



**AHS Fixed Core - Mortise Cylinder**

Cylinder Number	Description	Finish: 605, 606, 611, 612, 613, 613E, 618, 619, 622, 625, 626, 629, 630, 722
1700-114	ML2000 Series mortise locks (including electrified and EAC devices)	\$140.00
1700-138	DL3000 and DL4100 deadlocks	
1700-112	ED5600, ED6600 and ED7600 exit devices	\$150.00
1700-134	All ED5000 cylinder dogging, alarm units, delayed egress cylinders	

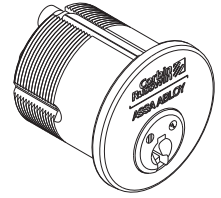

**AHS Fixed Core - Rim Cylinder**

Cylinder Number	Description	Finish: 605, 606, 611, 612, 613, 613E, 618, 619, 622, 625, 626, 629, 630, 722
3700-058	5/8" tailpiece	\$140.00
3700-138	1-3/8" M61 & M62 option for ED8200 and obsolete ED9200 exit device alarms; ED5202(A) inside cylinder	
3700-200	2" tailpiece	
3700-200N	2" night latch function	
3700-200V	2" vertical tailpiece	
3700-312	3-1/2" tailpiece	\$142.00
3700-312V	3-1/2" vertical tailpiece	

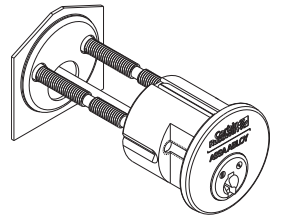

**AHS LFIC - Mortise Cylinder**

Cylinder Number	Description	Finish: 605, 606, 611, 612, 613, 613E, 618, 619, 622, 625, 626, 629, 630, 722
1788-114	ML2000 Series mortise locks (including electrified and EAC devices)	\$204.00
1788-138	DL3000 and DL4100 deadlocks	\$207.00
1788-112	ED5600, ED6600 and ED7600 exit devices	
1788-134	All ED5000 cylinder dogging, alarm units, delayed egress cylinders	\$215.00

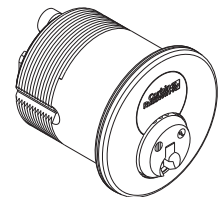

**AHS LFIC - Rim Cylinder**

Cylinder Number	Description	Finish: 605, 606, 611, 612, 613, 613E, 618, 619, 622, 625, 626, 629, 630, 722
3788-058	5/8" tailpiece	\$204.00
3788-114	1-1/4" M61 & M62 option for ED8200 and ED9200 exit device alarms	
3788-178	1-7/8" tailpiece	
3788-178V	1-7/8" vertical tailpiece	
3788-318	3-1/8" tailpiece	\$206.00

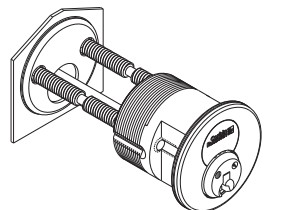

### AHS LFIC Core

Cylinder Number	Description	Finish: 605, 606, 611, 612, 613, 613E, 618, 619, 622, 625, 626, 629, 630, 722
8700	All Corbin Russwin LFIC cylinders	\$128.00

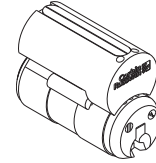

### AHS Fixed Core Component Cylinder

Cylinder Number	Description	Finish: 606, 626
2700-031	CL3100 Series Vandal Resistant	\$133.00
2700-033	CL3300, CL3500, CL3600 (June 2000 and after), CL3800, Lever Trim - A6/N6/PR6	
2700-033H	G10 Exit Device Knob Trim	
2700-037	CL3700 Lever, CK4700 Knob	
2700-039	CL3900	
2700-039L	CL3900 Lever (2" and 2-1/4" Thick Door)	
2700-044	CK4400	
2700-052	CK4200/UT5200	

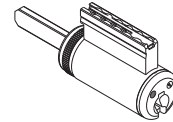

### AHS Fixed Core Deadlock Cylinder

Cylinder Number	Description	Finish: 606, 626
4700-134-A51	DL2200/3200 Series	\$133.00
4700-134-A52		
4700-214-A52		

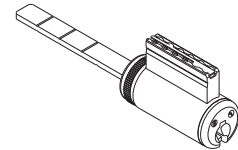

### UL LFIC 6-Pin Mortise Housing

Cylinder Number	Description	Finish: 605, 606, 611, 612, 613, 613E, 618, 619, 622, 625, 626, 629, 630, 722
1078-114	ML2000 Series mortise locks (including electrified and EAC devices)	\$76.00
1078-138	DL3000 and DL4100 deadlocks	\$79.00
1078-112	ED5600, ED6600 and ED7600 exit devices	
1078-134	All ED5000 cylinder dogging, alarm units, delayed egress cylinders	\$87.00

### UL LFIC 6-Pin Rim Housing

Cylinder Number	Description	Finish: 605, 606, 611, 612, 613, 613E, 618, 619, 622, 625, 626, 629, 630, 722
3078-058	5/8" tailpiece	\$76.00
3078-114	1-1/4" M61 & M62 option for ED8200 and ED9200 exit device alarms	
3078-178	1-7/8" tailpiece	
3078-178V	1-7/8" vertical tailpiece	
3078-318	3-1/8" tailpiece	\$78.00

**Fixed Core Mortise**

7-Pin - No Cross Keying - Furnished standard with 610502 solid recessed collar unless otherwise indicated.  
High Security UL437 Listed.

**Cylinder Number Example**

To simplify ordering, options designated "standard" may be omitted from the ordering sequence.



Length		Cam		Finish	
114	(1-1/4")	A01	Cloverleaf (standard)	605	619
		A02	Straight	606	622
112	(1-1/2")	A03	Adams Rite® MS	611	625
		A04	DL4000 Deadlock	612	626
		A05	Adams Rite® 4070	613	629
		A06 <sup>2</sup>	Schlage® L9000	613E	630
				618	722
		A07	DL4100 Series Deadlock		
		A92	Exit Grip O1, O2		
		A93 <sup>1</sup>	For Obsolete Corbin® 610 Series and Russwin®1403 Series Deadlock		
Cylinder No.				Price	
1020-114				\$151.00	

Notes: 1. Add \$2.00 per cylinder for A93 cam  
2. Add \$5.00 per cylinder for A06 cam

**Fixed Core Rim**

7-Pin - No Cross Keying - Furnished standard with 422F88 surface mount collar unless otherwise indicated.  
High Security UL437 Listed.

**Cylinder Number Example**

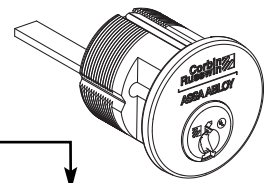
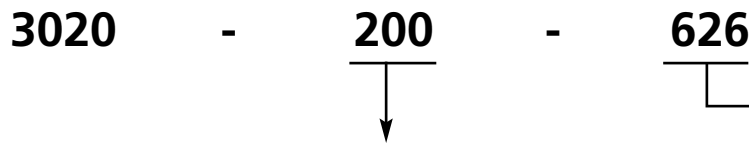

Tailpiece Length	Finish	
058 - 5/8"	605	619
138 - 1-3/8" M61 & M62 option for ED8200 and obsolete ED9200 exit device alarms	606	622
200 - 2"	611	625
200N - 2" ED4000/ED5000 Night Latch Function	612	626
200V - 2" vertical	613	629
312 - 3-1/2"	613E	630
312V - 3-1/2" vertical	618	722
Cylinder Number	Price	
3020 - _____	\$151.00	

**Key-In-Lever/Knob**

7-Pin - No Cross Keying

**High Security UL437 Listed**

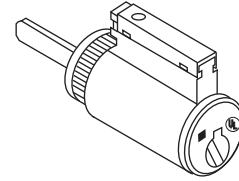

Cylinder Number	Used for	Finish: 606, 626
2020-031	CL3100 Lever	\$142.00
2020-033	CL3300, CL3500, CL3800 [CL3600 (June 2000 and after)], A6, N6, PR6 Exit device trim	
2020-033H	G10 Exit device trim	
2020-034	CL3400, [CL3600 (prior to June 2000)], A5, N5 obsolete ED8000 trims	
2020-037	CL3700 Lever, CK4700 Knob	
2020-038	CL3800 Lever	
2020-039	CL3900 Lever	
2020-039L	CL3900 Lever (2" - 2-1/4" door)	
2020-051	G3 Exit device knob trim	
2020-052	CK4200 knob, UT5200 knob and lever	
4420-134-A51	DL2200, DL3200 Cylindrical Deadlock	
4420-134-A52	DL2200, DL3200 Cylindrical Deadlock	
4420-214-A52	DL2200, DL3200 Cylindrical Deadlock	

**Key-In-Lever/Knob**

For Other Manufacturers' Products

**High Security UL437 Listed**

Cylinder Number	Used for	Finish: 606, 626
2220-001-P21	Alarm Lock DL2500 Series	\$144.00
	Arrow® H Series Knobs and Levers	
	Arrow Q Series Levers	
	Sargent® 10 line (Enlarge Lever Hole)	
	Schlage® D Series Levers	
2220-002-P21	Schlage D Series Knobs	
2220-001-P22	Schlage AL and ND Series Levers	
2220-002-P22	Schlage A Series Knobs (PLY, etc.)	
2220-002-P23	Schlage A Series Knob (ORB only)	

**IC Mortise**

7-Pin - No Cross Keying - Furnished standard with 610F02 solid recessed collar unless otherwise indicated.

**Cylinder Number Example**

To simplify ordering, options designated "standard" may be omitted from the ordering sequence.

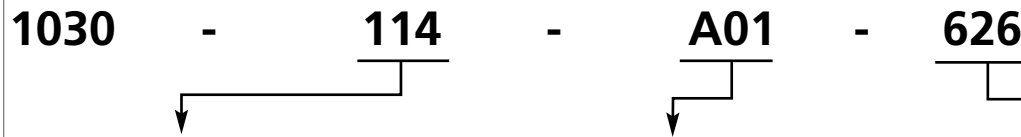
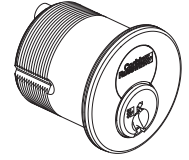

Length		Cam		Finish	
114	1-1/4"	A01	Cloverleaf (standard)	605	619
138	1-3/8"	A02	Straight	606	622
112	1-1/2"	A03	Adams Rite® MS & DL3000	611	625
134	1-3/4"	A04	DL4000 Deadlock	612	626
		A05	Adams Rite® 4070	613	629
		A06 <sup>2</sup>	Schlage® L9000	613E	630
		A07	DL4100 Series Deadlock	618	722
		A93 <sup>1</sup>	For Obsolete Corbin® 610 Series and Russwin® 1403 Series Deadlock		
Cylinder Number				Price	
1030-114				\$214.00	

Notes:

1. Add \$2.00 per cylinder for A93 cam.
2. Add \$5.00 per cylinder for A06 cam.

**IC Rim**

7-Pin - No Cross Keying - Furnished standard with 422F88 surface mount collar unless indicated.

**Cylinder Number Example**

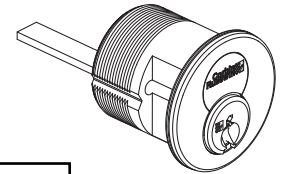
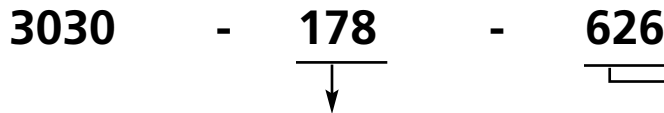

Tailpiece Length	Finish	
058 - 5/8"	605	619
114 - 1-1/4" M61 & M62 option for ED8200 and ED9200 exit device alarms	606	622
178 - 1-7/8"	611	625
178V - 1-7/8" vertical	612	626
318 - 3-1/8"	613	629
	613E	630
	618	722
Cylinder Number	Price	
3030-_____	\$214.00	

**Pyramid Core Only**

Cylinder Number	Price
8020	\$138.00

Note: For mortise and rim housing only, see page 75.

**Fixed Core Mortise**

7-Pin - No Cross Keying - Furnished standard with 605F43 spring collar unless otherwise indicated.

**Cylinder Number Example**

To simplify ordering, options designated "standard" may be omitted from the ordering sequence.

**1027 - 114 - A01 - 626**



Length		Cam	Finish	
114	(1-1/4")	A01	605	619
		A02	606	622
112	(1-1/2")	A03	611	625
		A04	612	626
		A05	613	629
		A06 <sup>2</sup>	613E	630
		A07	618	722
		A92		
		A93 <sup>1</sup>		
<b>Cylinder Number</b> 1027-114			<b>Price</b> \$125.00	

Notes:

1. Add \$2.00 per cylinder for A93 cam.
2. Add \$5.00 per cylinder for A06 cam.

**Fixed Core Rim**

7-Pin - No Cross Keying - Furnished standard with 422F88 surface mount collar unless otherwise indicated.

**Cylinder Number Example**

**3027 - 200 - 626**

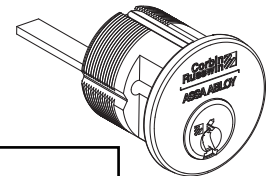

Tailpiece Length	Finish	
058 - 5/8"	605	619
138 - 1-3/8" M61 & M62 option for ED8200 and obsolete ED9200 exit device alarms	606	622
200 - 2"	611	625
200N - 2" ED4000/ED5000 Night Latch Function	612	626
200V - 2" (vertical)	613	629
312 - 3-1/2"	613E	630
312V - 3-1/2" (vertical)	618	722
<b>Cylinder Number</b> 3027-____		<b>Price</b> \$125.00

**Key-In-Lever/Knob**

7-Pin - No Cross Keying.

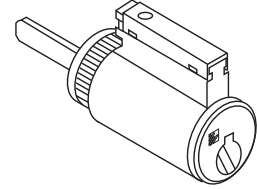

Cylinder Number	Used for	Finish: 606, 626
2027-031	CL3100 lever	\$118.00
2027-033	CL3300, CL3500, CL3800 [CL3600 (June 2000 and after)], A6, N6, PR6 Exit device trim	
2027-033H	G10 Exit device trim	
2027-034	CL3400, [CL3600 (before June 2000)], A5, N5 obsolete ED8000 trims	
2027-037	CL3700 lever, CK4700 knob	
2027-038	CL3800 lever	
2027-039	CL3900 lever	
2027-039L	CL3900 lever (2" - 2-1/4" door)	
2027-051	G3 Exit device knob trim	
2027-052	CK4200 knob, UT5200 knob and lever	
4427-134-A51	DL2200, DL3200 Cylindrical Deadlock	
4427-134-A52	DL2200, DL3200 Cylindrical Deadlock	
4427-214-A52	DL2200, DL3200 Cylindrical Deadlock	

**Key-In-Lever/Knob**

**For Other Manufacturer's Products**

Cylinder Number	Used for	Finish: 606, 626
2227-001-P21	Alarm Lock DL2500 Series	\$120.00
	Arrow® H Series Knobs and Levers	
	Arrow Q Series Levers	
	Sargent® 10 line (Enlarge Lever Hole)	
	Schlage® D Series Levers	
2227-002-P21	Schlage D Series Knobs	
2227-001-P22	Schlage AL and ND Series Levers	
2227-002-P22	Schlage A Series Knobs (PLY, etc.)	
2227-002-P23	Schlage A Series Knob (ORB only)	

**IC Mortise**

7-Pin - No Cross Keying - Furnished standard with 605F43 spring collar unless otherwise indicated.

**Cylinder Number Example**

To simplify ordering, options designated "standard" may be omitted from the ordering sequence.

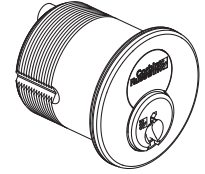

**1037 - 114 - A01 - 626**

Length	Cam		Finish	
114 1-1/4"	A01	Cloverleaf (standard)	605	619
138 1-3/8"	A02	Straight	606	622
112 1-1/2"	A03	Adams Rite® MS & DL3000	611	625
134 1-3/4"	A04	DL4000 Deadlock	612	626
	A05	Adams Rite® 4070	613	629
	A06 <sup>2</sup>	Schlage® L9000	613E	630
	A07	DL4100 Series Deadlock	618	722
	A93 <sup>1</sup>	For Obsolete Corbin® 610 Series and Russwin® 1403 Series Deadlock		
Cylinder Number			Price	
1037-114			\$189.00	

Notes:

- 1. Add \$2.00 per cylinder for A93 cam.
- 2. Add \$5.00 per cylinder for A06 cam.

**IC Rim**

7-Pin - No Cross Keying - Furnished standard with 422F88 surface mount collar unless otherwise indicated.

**Cylinder Number Example**

**3037 - 178 - 626**

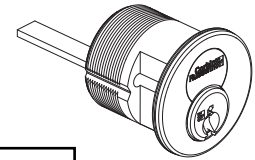

Tailpiece Length	Finish	
058 - 5/8"	605	619
114 - 1-1/4" M61 & M62 option for ED8200 and ED9200 exit device alarms	606	622
	611	625
178 - 1-7/8"	612	626
178V - 1-7/8" vertical	613	629
	613E	630
318 - 3-1/8"	618	722
Cylinder Number		Price
3037-_____		\$189.00

**Pyramid Core Only**

Cylinder Number	Price
8027	\$113.00

Note: For mortise and rim housing only, see page 75.



**Standard Mortise**

**Cylinder Number Example**

To simplify ordering, options designated "standard" may be omitted from the ordering sequence.

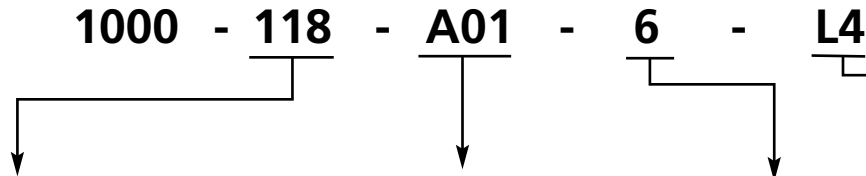

Length	Cam	Pins	Keyway
100 1" (5-pin only)	A01 Cloverleaf (standard)	5	L4
118 1-1/8" (standard)	A02 Straight	6 (standard)	(standard)
114 1-1/4"	A03 Adams Rite® MS	7	
138 1-3/8"	A04 DL4000 Deadlock		
112 1-1/2"	A05 Adams Rite 4070		
134 1-3/4"	A06 <sup>2</sup> Schlage® L9000		
200 2"	A07 DL4100 Series Deadlock		
214 2-1/4"	A92 Exit Grip O1, O2		
212 2-1/2"	A93 <sup>1</sup> For Obsolete		
234 2-3/4"	Corbin® 610 Series and Russwin®		
300 3"	1403 Series Deadlock		
314 3-1/4"			
312 3-1/2"			
334 3-3/4"			

Cylinder Number	Finish: 605, 606, 611, 612, 613, 613E, 618, 619, 622, 625, 626, 629, 630, 722	
	5- OR 6-PIN	7-PIN
1000-100-__-5-Keyway	\$76.00	Not Available
1000-118-__-__-Keyway		
1000-114-__-__-Keyway		
1000-138-__-__-Keyway	\$76.00	\$78.00
1000-112-__-__-Keyway	\$86.00	\$88.00
1000-134-__-__-Keyway		
1000-200-__-__-Keyway		
1000-214-__-__-Keyway		
1000-212-__-__-Keyway		
1000-234-__-__-Keyway	\$96.00	\$98.00
1000-300-__-__-Keyway	\$106.00	Not Available
1000-314-__-__-Keyway		
1000-312-__-__-Keyway		
1000-334-__-__-Keyway		

- Notes:  
 1. Add \$2.00 per cylinder for A93 cam.  
 2. Add \$5.00 per cylinder for A06 cam.

**Flexible Head Mortise**

**Cylinder Number Example**

To simplify ordering, options designated "standard" may be omitted from the ordering sequence.

**1100 - 118 - A01 - 6 - L4**



Length	Cam	Pins	Keyway
100 1" (6-pin standard)	A01 Cloverleaf (standard)	5	L4
118 1-1/8"	A02 Straight	6 (standard)	(standard)
114 1-1/4"		7	

Cylinder Number	Finish: 605, 606, 611, 612, 613, 613E, 618, 619, 622, 625, 626, 722	
	5- OR 6-PIN	7-PIN
1100-100-__ - __ - Keyway	\$142.00	Not Available
1100-118-__ - __ - Keyway		\$144.00
1100-114-__ - __ - Keyway	\$144.00	\$146.00

**Concealed Shell Mortise**

**Cylinder Number Example**

To simplify ordering, options designated "standard" may be omitted from the ordering sequence.

**1200 - 118 - A01 - 6 - L4**



Length	Cam	Pins	Keyways
100 1" (5-pin standard)	A01 Cloverleaf (standard)	5	L4
118 1-1/8" (6-pin standard)	A02 Straight	6 (standard)	(standard)
114 1-1/4"		7	
138 1-3/8"			
112 1-1/2"			

Cylinder Number	Finish: 606, 626	
	5- OR 6-PIN	7-PIN
1200-100-__ - 5 - Keyway	\$113.00	Not Available
1200-118-__ - __ - Keyway		
1200-114-__ - __ - Keyway		\$115.00
1200-138-__ - __ - Keyway		
1200-112-__ - __ - Keyway		

**Special Function Mortise**
**Hotel Function\* Cylinders**

To simplify ordering, you may specify only the first 4 digits (1001, 1101, 1201).

Cylinder Number	Description	Finish: 605, 606, 611, 612, 613, 613E, 618, 619, 625, 626, 629, 630, 722
1001-114-A01	Standard	\$109.00
1101-118-A01	Flex Head	\$133.00
1201-114-A01	Concealed Shell	\$123.00

Note: When ordering cylinders to accommodate the old Russwin® extra long EMK's in current ML2029 locks, specify A91 cam.  
\* Not available with D1, D2, L1, L2, 752, 852 or A class keyways.

**Brink Function Cylinders**

Cylinder Number	Description	Finish: 605, 606, 611, 612, 613, 613E, 618, 619, 625, 626, 629, 630, 722
1004-118-A02	Standard Clockwise	\$99.00
1005-118-A02	Standard Counter-Clockwise	
1004-118-A05	For Brink "CKS" Clockwise	
1005-118-A05	For Brink "CKS" Counter - Clockwise	

Note: For Security series, see page 71.

**Cylinder for Discontinued Exit Device**

Inside of Corbin® 3726-1/2, 3727-1/2 and Russwin® 736-1/2, 737-1/2

Cylinder Number	Finish: 605, 606, 611, 612, 613, 613E, 618, 619, 625, 626, 629, 630, 722
1006-118-A02	\$92.00

**Non-Keyed Mortise**

**Thumbturn Cylinders**

Cylinder Number	Description	Finish: 605, 606, 611, 612, 613, 613E, 618, 619, 625, 626, 629, 630, 722
1300-100-A02	Standard	\$76.00
1300-118-A02		
1300-114-A02	Standard	\$80.00
1300-138-A02		
1300-100-A03	Standard	\$76.00
1300-118-A03		
1300-114-A03	Standard	\$80.00
1300-138-A03		
1300-118-A93	Standard	\$78.00
1303-100-A03	Classroom	
1303-118-A03		
1303-114-A03	Classroom	\$82.00
1303-138-A03		

**Dummy Cylinders**

Cylinder Number	Finish: 605, 606, 611, 612, 613, 613E, 618, 619, 625, 626, 629, 630, 722
1400-118	\$63.00
1400-114	\$67.00
1400-138	\$71.00

**Rim Thumbturn Cylinders**

Cylinder Number	Finish: 605, 606, 611, 612, 613, 613E, 618, 619, 625, 626, 629, 630, 722
3300 -138	\$71.00
3300-138-M34	\$86.00
3300-200	\$71.00
3300-200-M34	\$86.00

**Rim (.552 dia. Plug)**

**Cylinder Number Example**

To simplify ordering, options designated "standard" may be omitted from the ordering sequence.

**3000 - 200 - 6 - L4**

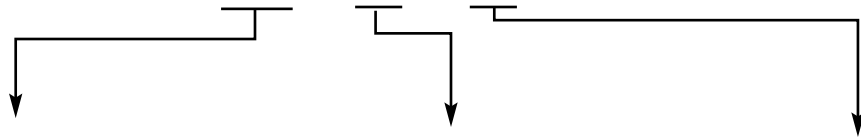
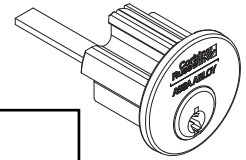

Tailpiece Length		Pins	Keyway
058	5/8"	5	L4 (Standard)
138	1-3/8" M61 & M62 option for ED8200 and obsolete ED9200 Exit Device Alarms	6 (Standard)	See page 45 for pricing of options.
200	2" (Standard)	7	
200N	2" ED4000/ED5000 Night Latch Function		
200V	2" Vertical		
312	3-1/2" (Thick door)		
312	3-1/2" (Thick door) Vertical		

Cylinder No.	Finish: 605, 606, 611, 612, 613, 613E, 618, 619, 622, 625, 626, 629, 630, 722	
	5- OR 6-PIN	7-PIN
3000-058      __- Keyway		
3000-138      __- Keyway		
3000-200-      __- Keyway	\$76.00	\$78.00
3000-200N-    __- Keyway		
3000-200V-    __- Keyway		
3000-312-      __- Keyway	\$78.00	\$80.00
3000-312V-    __- Keyway		

### Key-In-Lever/Knob (.509" plug)

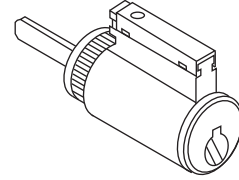

Cylinder Number		Finish: 606, 626		
		Series	6-PIN	7-PIN <sup>4</sup>
2000-031	Standard	CL3100	\$69.00	\$71.00
2001-031	Hotel	CL3100	\$83.00	\$85.00
2400-031-C	Schlage® C Keyway	CL3100	\$69.00	Not Available
2400-031-LA	Sargent® LA Keyway	CL3100		
2000-033	Standard	CL3300, CL3500, CL3600, CL3800		\$71.00
2000-038	Standard	CL3800 <sup>A</sup>		
2001-034 <sup>1</sup>	Hotel	CL3300	\$83.00	\$85.00
2400-033-C <sup>2</sup>	Schlage® C keyway	CL3300, CL3500, CL3600, CL3800 <sup>B</sup>	\$69.00	Not Available
2400-033-LA <sup>3</sup>	Sargent® LA keyway			
2000-037	Standard			
2400-037-C <sup>2</sup>	Schlage® C keyway	CL3700, CK4700		
2400-037-LA	Sargent® LA keyway			
2000-039	Standard	CL3900		
2000-039L	2" to 2-1/4" Door			
2400-039-C <sup>2</sup>	Schlage® C keyway			
2400-039-LA <sup>3</sup>	Sargent® LA keyway			
2000-034	Standard	CL3400, CL3600 (Prior to June 2000)	\$69.00	\$71.00
2001-034	Hotel		\$83.00	\$85.00
2400-034-C <sup>2</sup>	Schlage® C keyway		\$69.00	Not Available
2400-034-LA <sup>3</sup>	Sargent® LA keyway			

**Notes:**

1. Not available in 752, 852 or A Class keyways.
  2. Available 0-bitted & keyed random only.
  3. Available 0-bitted only.
  4. For 7-pin version suffix "-7" to number. Not available in 752, 852 or A Class keyways.
- A. CL3800 manf. 1993-1997  
 B. CL3800 manf. 2006 -

### Cylindrical Deadlocks DL2200, DL3200 Series

Cylinder Number		Door Thickness	Function	Finish: 606, 626 Price
4400-134-A51	6-Pin Conventional	All	11, 13, 17	\$69.00
4400-134-A52	6-Pin Conventional	1-3/8" to 1-3/4"	12	
4400-214-A52	6-Pin Conventional	2" to 2-1/4"	12	
4400-134-A51-7	7-Pin Conventional	All	11, 13, 17	\$71.00
4400-134-A52-7	7-Pin Conventional	1-3/8" to 1-3/4"	12	
4400-214-A52-7	7-Pin Conventional	2" to 2-1/4"	12	

**Key-In-Lever/Knob**
**For UT5200 & CK4200 Series Locksets (.552" dia plug)**

Cylinder Number	Description	Finish: 606, 626
2000-052	Standard	\$69.00
2001-052*	Hotel with Indicator	\$83.00
2100-052**	Discontinued Ronde & Continental Knob	\$83.00

**For CK4400 Series Locksets (.509" dia plug)**

Cylinder Number	Description	Finish: 606, 626
2000-044	All except below	\$69.00
2003-044	CK4455 & CK4482 before 8/93	
2001-044*	CK4429 with Indicator Pin New Style Straight Tailpiece	\$83.00
2001-066*	CK4429 with Indicator Pin Old Style Twisted Tailpiece	

**For G10 Exit Device Knob Trim**

Cylinder Number	Description	Finish: 606, 626
2000-033H	Standard	\$69.00

\* Not available with 752, 852 or A Class keyways.

\*\* Also available in 605, 611, 612, 613, 625 finishes. Not available with X Class keyways.

**For PL5000 Series Rekeyable Fixed Core Padlocks**

Cylinder Number	Description	Finish: 606, 626
2300	Standard 6-pin	\$69.00
2310	Security	\$165.00
2320	Pyramid High Security	\$142.00
2327	Pyramid Security	\$118.00

**For B2, G2, G3 Exit Device Trim**

Cylinder Number	Description	Finish: 606, 626
2000-051	Standard 6-pin	\$69.00

**Key-In-Lever/Knob (.552 dia Plug)**

For Other Manufacturers' Products

Cylinder Number	Description	Finish: 606, 626
2200-001-A21	Alarm Lock DL2500 Series	\$73.00
	Arrow® H Series Knobs and Levers	
	Arrow Q Series Levers	
	Sargent® 10 line (Enlarge Lever Hole)	
	Schlage® D Series Levers	
2200-001-A22	Schlage AL and ND Series Levers	
2200-002-A21	Schlage D Series Knobs	
2200-002-A23	Schlage A Series Knobs (ORB only)	
2200-002-A22	Schlage A Series Knobs (PLY, etc.)	
2200-003-A24	Lockwood® H Series Knobs (Enlarge Knob Hole)	
2200-008	Sargent 7, 8, 9 Line (Enlarge Knob Hole)	
2200-054	Yale® 5400, 6200 Knobs Only (Enlarge Knob Hole)	
2200-076	Sargent 7600 Integralock	\$79.00

**For Adams Rite® 4025 Pull (.552" dia. Plug)**

Cylinder Number	Description	Finish: 606, 626
4200-003-A47	Cylinder & Housing	\$118.00
4200-002-A47	Cylinder Only	\$69.00



**IC Mortise**

For Construction Core Program, see page 47.  
For housing only, see page 75.

**Cylinder Number Example**

To simplify ordering, options designated "standard" may be omitted from the ordering sequence.

**1080 - 114 - A01 - 6 - L4**

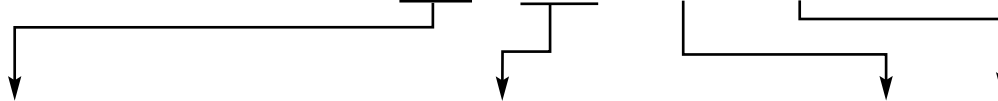
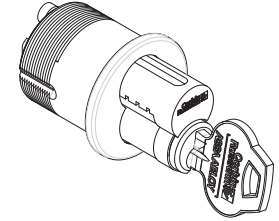

Length	Cam	Pins	Keyway
114 1-1/4" (6-pin standard)	A01 Cloverleaf (standard)	6 (standard)	L4 (standard)
138 1-3/8"	A02 Straight	7**	See page 45 for pricing of options.
112 1-1/2"	A03 Adams Rite® MS & DL300		
134 1-3/4"	A04 DL4000 Deadlock		
	A05 Adams Rite 4070		
	A06 <sup>2</sup> Schlage® L9000		
	A07 DL4100 Series Deadlock		
	A93 <sup>1</sup> For obsolete Corbin® 610 Series and Russwin® 1403 Series Deadlocks		

Cylinder Number	Finish: 605, 606, 611, 612, 613, 613E, 618, 619, 622, 625, 626, 629, 630, 722	
	6- PIN	7-PIN
1080-114-	\$140.00	Not Available
1080-138-	\$143.00	Not Available
1080-112-__-	\$143.00	\$147.00
1080-134-__-	\$151.00	\$155.00

Notes:

1. Add \$2.00 per cylinder for A93 Cam.
2. Add \$5.00 per cylinder for A06 Cam.

**Hotel Function IC Mortise**

To simplify ordering, options designated "standard" may be omitted from the ordering sequence.

Cylinder Number	Finish: 605, 606, 611, 612, 613, 613E, 618, 619, 622, 625, 626, 629, 630, 722	
	6-PIN	7-PIN
1081-138-A01-6** (Hotel function uses E1-suffix EMK blank)	\$154.00	Not Available

- \*\* Not available with 752, 852 or A Class keyways.
- \*\* Only available in 1-1/2" and 1-3/4" length.

**IC Rim**

For Construction Core Program, see page 47.  
For housing only, see page 75.

**Cylinder Number Example**

To simplify ordering, options designated "standard" may be omitted from the ordering sequence.

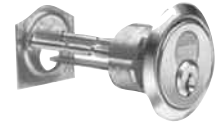

**3080 - 178 - 6 - L4**

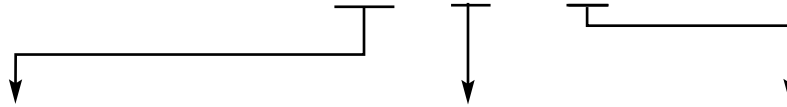

Tailpiece Length		Pins	Keyway
058	5/8" Tailpiece	6 Pin (standard)	L4 (standard)
178	1-7/8" (standard)	7 Pin	See page 45 for pricing of options
178V	1-7/8" Vertical		
318	3-1/8" (Thick door)		
114	1-1/4" M61 & M62 option for ED8200 and obsolete ED9200 exit device alarms		

Cylinder Number	Finish: 605, 606, 611, 612, 613, 613E, 618, 619, 622, 625, 626, 629, 630, 722	
	6 PIN	7 PIN
3080-058-	\$140.00	\$144.00
3080-178-__		
3080-178V-__		
3080-318-__	\$142.00	\$146.00
3080-114-__ (no back plate or screw)	\$142.00	\$146.00

**Core Only**



Cylinder Number (specify keyway)		Finish: 605, 606, 611, 612, 613, 613E, 618, 619, 622, 625, 626, 722
8000	6-Pin Standard	\$64.00
8000EMK*	6-Pin Standard set to hotel mortise EMK	
8000-7	7-Pin	\$66.00
8001-034*	6-Pin for CL3329, hotel indicator pin	\$80.00
8001-034-7*	7-Pin for CL3329, hotel indicator pin	\$82.00
8001-042*	6-Pin for CK4229, hotel indicator pin	\$80.00

\* Not available with 752, 852 or A Class keyways.  
Note: For uncombined cores suffix "UC". See page 48 for deduct.

**LFIC Mortise Housing Only**

**Housing Number Example**

To simplify ordering, options designated "standard" may be omitted from the ordering sequence.

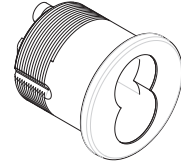

**1070 - 114 - A01 - 6**



Length	Cam		Pins
114 1-1/4" (6-pin standard)	A01	Cloverleaf (standard)	6 (standard)
138 1-3/8"	A02	Straight	7
112 1-1/2"	A03	Adams Rite® MS	
134 1-3/4"	A04	DL4000 Deadlock	
214 2-1/4"	A05	Adams Rite® 4070	
	A06 <sup>2</sup>	Schlage® L9000	
	A07	DL4100 Series Deadlock	
	A93 <sup>1</sup>	For obsolete Corbin® 610 Series and Russwin® 1403 Series Deadlocks	

Cylinder Number	Finish: 605, 606, 611, 612, 613, 613E, 618, 619, 622, 625, 626, 629, 630, 722	
	6 PIN	7 PIN
1070-114-	\$76.00	Not Available
1070-138-	\$79.00	Not Available
1070-112-__-	\$79.00	\$81.00
1070-134-__-	\$87.00	\$89.00
1070-214-	\$93.00	Not Available
1071-138-A01 (Hotel function uses -E1 suffix EMK blank)	\$90.00	Not Available

Notes:

To simplify ordering, you may specify only "1071" since no length or cam variations exists.

1. Add \$2.00 per cylinder for A93 Cam.
2. Add \$5.00 per cylinder for A06 Cam.

**LFIC Rim Housing Only**

**3070 - 058 - 626**

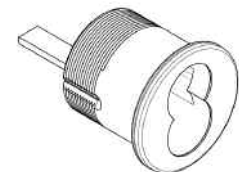
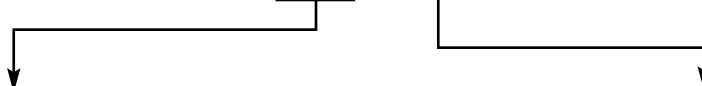

Cylinder Number		Finish : 605, 606, 611, 612, 613, 613E, 618, 619, 622, 625, 626, 629, 630, 722	
		6 PIN	7 PIN
3070-058-	5/8" tailpiece	\$76.00	\$78.00
3070-178-__	1-7/8" tailpiece (standard)		
3070-178V-__	1-7/8" vertical		
3070-318-__	3-1/8" tailpiece (thick door)	\$78.00	\$80.00
3070-114-__	1-1/4" tailpiece for M61, M62 exit alarm options. No back plate or screws.		

**SFIC Mortise Housing Only**

**Cylinder Number Example**

**1040 - 114 - A01 - 6**

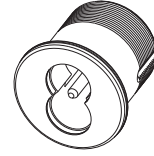

Length	Cam	Pins
114 1-1/4" (6-pin standard)	A01 Cloverleaf (standard)	6 (standard)
138 1-3/8" (7-pin standard)	A02 Straight	7
112 1-1/2" (7-pin standard)	A03 Adams Rite® MS	
134 1-3/4" (7-pin standard)	A04 DL4000 Series Deadlock	
	A05 Adams Rite 4070	
	A06 Schlage® L9000	

Cylinder Number	Finish: 605, 606, 611, 612, 613, 613E, 618, 619, 622, 625, 626, 629, 630, 722	
	6 PIN	7 PIN
1040-114-__	\$76.00	Not Available
1040-138-__	\$79.00	\$81.00
1040-112-__	\$79.00	\$81.00
1040-134-__	\$87.00	\$89.00

**SFIC Rim Housing Only**

**3040 - 058 - 626**

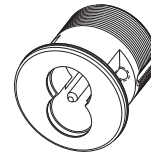

Cylinder Number	Finish : 605, 606, 611, 612, 613, 613E, 618, 619, 622, 625, 626, 629, 630, 722	6 PIN		7 PIN	
3040-058- 5/8" tailpiece		\$76.00		\$78.00	
3040-178-__ 1-7/8" tailpiece		\$76.00		\$78.00	
3040-318-__ 3-1/8" tailpiece		\$78.00		\$80.00	

**Standard Security Mortise**

For Existing Systems Only.\*  
For uncombined cylinders, suffix "UC".  
See page 48 for deduct.

6-Pin Only - No Cross Keying - Available in Z and DH Class Keyways only.  
Available UC or master keyed only.  
Not available KR or 0-bitted.

\* L4, D1 and 60 keyway sections may be ordered Keyed Random only, without prior Key Systems Administration approval

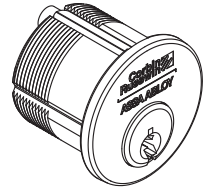

**Cylinder Number Example**

To simplify ordering, options designated "standard" may be omitted from the ordering sequence.

**1010 - 118 - A01 - L4**

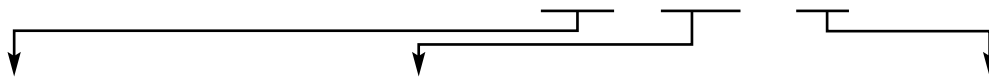

Length		Cam		Keyway
118	1-1/8" (standard)	A01	Cloverleaf (standard)	L4 (standard)
114	1-1/4"	A02	Straight	Available only with Z and DH Class keyways. See page 45 for pricing of options.
138	1-3/8"	A03	Adams Rite® MS & DL3000	
112	1-1/2"	A04	DL4000 Deadlock	
134	1-3/4"	A05	Adams Rite 4070	
200	2"	A06 <sup>2</sup>	Schlage® L9000	
214	2-1/4"	A07	DL4100 Series Deadlock	
212	2-1/2"	A93 <sup>1</sup>	For obsolete Corbin® 610 Series and Russwin® 1403 Series Deadlocks	
234	2-3/4"			

Cylinder Number	Finish: 605, 606, 611, 612, 613, 613E, 618, 619, 622, 625, 626, 629, 630, 722
1010-118-__	\$171.00
1010-114-__	
1010-138-__	\$179.00
1010-112-__	\$201.00
1010-134-__	\$211.00
1010-200-__	\$217.00
1010-214-__	\$223.00
1010-212-__	\$231.00
1010-234-__	\$235.00

Notes:

1. Add \$2.00 per cylinder for A93 Cam.
2. Add \$5.00 per cylinder for A06 Cam.

### Special Function Security Mortise

For Existing Systems Only.\*  
 6-Pin Only - No Cross Keying - Available in Z and DH Class Keyways only.  
 Available UC or master keyed only.  
 Not available KR or 0-bitted.  
 \* L4, D1 and 60 keyway sections may be ordered Keyed Random only, without prior Key Systems Administration approval

### Hotel Function Cylinders

Cylinder Number	Description	Finish: 605, 606, 611, 612, 613, 613E, 618, 619, 622, 625, 626, 629, 630, 722
1011-114-A01	1-1/4" Cloverleaf cam only	\$189.00

To simplify ordering, you may specify only "1011" since no length or cam variations exist.  
 For uncombined cylinders, suffix "UC". See page 48 for deduct.  
 Not available in D1, D2, L1 or L2 keyways.

### Blockout Function Cylinders

Cylinder Number	Description	Finish: 605, 606, 611, 612, 613, 613E, 618, 619, 622, 625, 626, 629, 630, 722
1012-114-A01	Cloverleaf	\$182.00
1012-114-A02	Straight	
1012-114-A03	DL3000 Series, Adams Rite® MS	
1012-114-A04	DL4000 Series Deadlock	
1012-114-A07	DL4100 Series Deadlock	
1012-114-A05	Adams Rite 4070	\$184.00
1012-114-A93	Obsolete Corbin® 610 Series and Russwin® 1403 Series Deadlock	

### Brink Function Cylinders

Cylinder Number	Description	Finish: 605, 606, 611, 612, 613, 613E, 618, 619, 622, 625, 626, 629, 630, 722
1014-118-A02	Standard Clockwise	\$175.00
1015-118-A02	Standard Counterclockwise	
1014-118-A05	For Brink "CKS" Clockwise	
1015-118-A05	For Brink "CKS" Counterclockwise	

**Security Rim**

For Existing Systems Only.\*

6-Pin Only - No Cross Keying - Available in Z and DH Class Keyways Only.  
Available UC or master keyed only. Not available KR or 0-bitted.

\* L4, D1 and 60 keyway sections may be ordered Keyed Random only, without prior Key Systems Administration approval

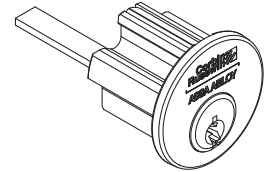

**Cylinder Number Example**

To simplify ordering, options designated "standard" may be omitted from the ordering sequence.

**3010 - 200 - L4**

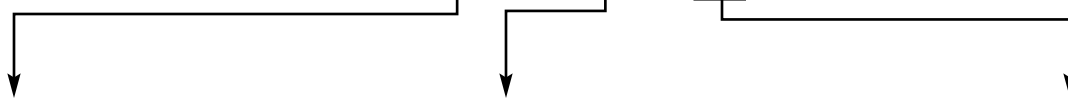

Function	Tailpiece Length	Keyway
<b>For 3010 Only:</b>	<b>For 3010 Only:</b>	L4 (standard) Available only with Z and DH Class keyways. See page 45 for pricing of options.
0 (standard)	200 2" (standard)	
2 Blockout	200V 2" vertical	
	312 3-1/2" (thick door)	
	312V 3-1/2" (thick door) vertical	
	058 5/8" Tailpiece	
	138 1-3/8" M61 and M62 option for ED8200 . . . . and obsolete ED9200 exit device alarms	
	<b>For 3012 Only:</b>	
	178 1-7/8" (standard)	
	178V 1-7/8" vertical	
	318 3-1/8" (thick door)	
	318V 3-1/8" (thick door) vertical	

Cylinder Number	Finish: 605, 606, 611, 612, 613, 613E, 618, 619, 622, 625, 626, 629, 630, 722
3010-058-__	\$171.00
3010-200-__	
3010-200V-__	
3010-312-__	\$173.00
3010-312V-__	
3010-138-__ No back plate or screws	\$171.00
3012-178-__	\$179.00
3012-178V-__	
3012-318-__	\$181.00
3012-318V-__	

**Security Key-In-Lever/Knob**

For Existing Systems Only.\*  
6-Pin Only - No Cross Keying - Available in Z and DH Class Keyways Only.  
Available UC or master keyed only. Not available KR or 0-bitted.

\* L4, D1 and 60 keyway sections may be ordered Keyed Random only, without prior Key Systems Administration approval

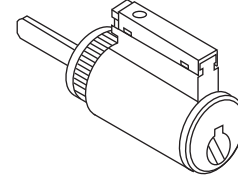

**For Key-In-Lever/Knob Trim (.552" plug)**

Cylinder Number	Series	Finish: 606, 626
2010-031	CL3100	\$165.00
2010-033	CL3300, CL3500, CL3800B, [CL3600 (June 2000 and after)]	
2010-034	CL3400, [CL3600 (prior to June 2000)]	
2010-038	CL3800A	
2010-039	CL3900	
2010-039L	CL3900 ( 2 - 2-1/4" door)	
2010-052	CK4200, UT5200	
2011-042	CK4229 Hotel Function*	\$179.00
2010-051	B2, G2 Exit Device Knob Trim	\$165.00
4410-134-A51	DL2200, DL3200 Cylindrical Deadlock	\$165.00
4410-134-A52	DL2200, DL3200 Cylindrical Deadlock	\$165.00
4410-214-A52	DL2200, DL3200 Cylindrical Deadlock	\$165.00

For uncombined cylinders suffix "UC" - See page 48 for deduct.  
\*Not available with 752, 852, or A Class Keyways.

**For Other Manufacturers' Products (.552" plug)**

Cylinder Number	Series	Finish: 606, 626
2210-001-A21	Alarm Lock DL2500 Series	\$169.00
	Arrow® H Series Knobs and Levers	
	Arrow Q Series Levers	
	Sargent® 10 line (Enlarge Lever Hole)	
	Schlage® D Series Levers	
2210-001-A22	Schlage AL and ND Series Levers	
2210-002-A21	Schlage D Series Knobs	
2210-002-A23	Schlage A Series Knobs (ORB, only)	
2210-002-A22	Schlage A Series Knobs (PLY, ect)	
2210-003-A24	Lockwood® H Series Knobs (enlarge knob hole)	
2210-008	Sargent 7, 8, 9 Line (enlarge knob hole)	
2210-054	Yale® 5400, 6200 Knobs only (enlarge knob hole)	

Notes: A CL3800 manf. 1993-1997  
B CL3800 manf. 2006 -



**IC Mortise**

For Existing Systems Only.\*  
For Construction Core Program, see page 47. For housing only, see page 75.

6-Pin Only - No Cross Keying - Available in Z and DH Class Keyways Only.  
Available UC or master keyed only. Not available KR or 0-bitted.

\* L4, D1 and 60 keyway sections may be ordered Keyed Random only, without prior Key Systems Administration approval

**Cylinder Number Example**

To simplify ordering, options designated "standard" may be omitted from the ordering sequence.

**1090 - 114 - A01- L4**

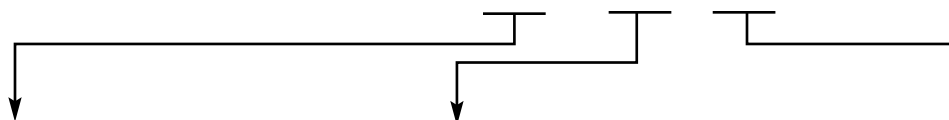
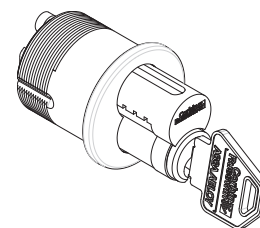

Length	Cam	Keyway
114 1-1/4" (standard)	A01 Cloverleaf (standard)	L4 (standard) Available only with Z and DH Class keyways. See page 45 for pricing of options.
138 1-3/8"	A02 Straight	
112 1-3/8"	A03 Adams Rite® MS & DL3000	
134 1-3/4"	A04 DL4000 Deadlock	
	A05 Adams Rite 4070	
	A06 <sup>2</sup> Schlage® L9000	
	A07 DL4100 Series Deadlock	
	A93 <sup>1</sup> For obsolete Corbin® 610 Series and Russwin® 1403 Series Deadlocks	

Cylinder Number	Finish: 605, 606, 611, 612, 613, 613E, 618, 619, 622, 625, 626, 629, 630, 722
1090-114-	\$236.00
1090-138-	\$239.00
1090-112-	
1090-134-	\$247.00

Notes:

1. Add \$2.00 per cylinder for A93 Cam.
2. Add \$5.00 per cylinder for A06 Cam.

**Hotel Function IC Mortise**

Cylinder Number	Finish: 605, 606, 611, 612, 613, 613E, 618, 619, 622, 625, 626, 629, 630, 722
1091-138-A01 Hotel function uses - E1 suffix EMK blank	\$250.00

To simplify ordering, you may specify only "1091" since no length or cam variations exist.

**IC Rim**

For Existing Systems Only.\*  
 For Construction Core Program, see page 47.  
 For housing only, see page 75.  
 6-Pin Only - No Cross Keying - Available in Z and DH Class Keyways Only. Available UC or master keyed only. Not available 0-bitted.  
 \* L4, D1 and 60 keyway sections may be ordered Keyed Random only, without prior Key Systems Administration approval

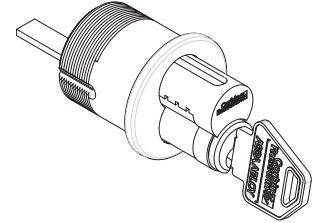

**Cylinder Number Example**

To simplify ordering, options designated "standard" may be omitted from the ordering sequence.

**3090 - 178 - L4**

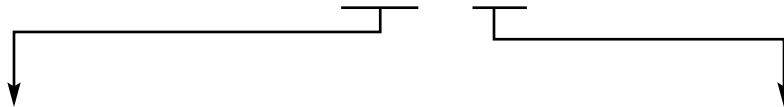

Tailpiece Length		Keyway
058	5/8" Tailpiece	L4 (standard). Available only with Z and DH Class keyways. See page 45 for pricing of options.
178	1-7/8" (standard)	
178V	1-7/8" (standard) vertical	
318	3-1/8" (thick door)	
114	1-1/4" for M61 and M62 option alarmed exit devices	

Cylinder Number	Finish: 605, 606, 611, 612, 613, 613E, 618, 619, 622, 625, 626, 629, 630, 722
3090-058	\$236.00
3090-178	
3090-178V	
3090-318	\$238.00
3090-114 No back plate or screws	\$238.00

**Security Core Only**

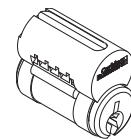

Cylinder Number	Finish: 605, 606, 611, 612, 613, 613E, 618, 619, 622, 625, 626, 722
8010 6-pin standard	\$160.00
8010EMK 6-pin standard set to hotel mortise EMK	
8011-042 6-pin for CK4229, hotel indicator pin	\$174.00

For uncombined cores, suffix "UC," see page 48 for deduct.

**Standard Master Ring Mortise**

**Cylinder Number Example**

To simplify ordering, options designated "standard" may be omitted from the ordering sequence.

**1060 - 118 - A61 - 6 - L4**

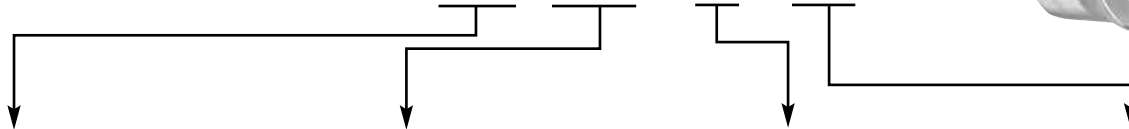

Length	Cam	Pins	Keyway
100 1" (5-pin only)	A61 New Cloverleaf (standard) (for locks made after 5/93; requires thumbturn hub 562F41-2)	5	L4 (standard) See page 45 for pricing of options.
118 1-1/8" (std)	A62 Straight	6 (standard)	
114 1-1/4"	A63* Large Short	7 (optional for 1-3/8" only)	
138 1-3/8"	A64* Large Long		
134 1-3/4"	A65* Old Cloverleaf (formerly 11A)		
112 1-1/2"			
200 2"			
214 2-1/4"			
212 2-1/2"			
234 2-3/4"			
300 3"			

Cylinder Number	Finish: 605, 606, 611, 612, 613, 613E, 618, 619, 622, 625, 626, 722
1060-100-__-5	\$116.00
1060-118-__-__	
1060-114-__-__	
1060-138-__-__	\$126.00
1060-112-__-__	
1060-134-__-__	
1060-200-__-__	\$136.00
1060-214-__-__	
1060-212-__-__	
1060-234-__-__	
1060-300-__-__	

\*Add \$2.00 per cylinder for A63, A64 and A65 Cam.

**Flexible Head Master Ring Mortise**

**Cylinder Number Example**

To simplify ordering, options designated "standard" may be omitted from the ordering sequence.

**1160 - 118 - A61 - 6 - L4**

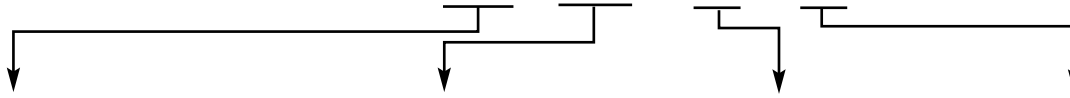

Length	Cam	Pins	Keyway
100 1" (6-pin std)	A61 New Cloverleaf (standard) (for locks made after 5/93; requires thumbturn hub 562F41-2)	5	L4 (standard) See page 45 for pricing of options.
118 1-1/8"		6 (standard)	
114 1-1/4"			
	A62 Straight		
	A63* Large Short		
	A64* Large Long		
	A65* Old Cloverleaf (formerly 11A)		

Cylinder Number	Finish: 605, 606, 611, 612, 613, 613E, 618, 619, 622, 625, 626, 722
1160-100-__-__	\$154.00
1160-118-__-__	
1160-114-__-__	

\* Add \$2.00 per cylinder for A63, A64 or A65 Cam.

**Dummy Master Ring Mortise Cylinders**

Cylinder Number	Finish: 605, 606, 611, 612, 613, 613E, 618, 619, 622, 625, 626, 722
1460-118	\$108.00
1460-114	
1460-138	
1460-112	

**Master Ring Rim**

Cylinder Number (Specify Keyway)		Finish: 605, 606, 611, 612, 613, 613E, 618, 619, 622, 625, 626, 722
3060-200	Standard horizontal tailpiece	\$116.00
3060-312	Thick door, horizontal tailpiece	
3060-200V	Vertical tailpiece	
3060-312V	Thick door, vertical tailpiece	

**For CK4200 & UT5200 Series Locksets (.552" dia. plug)**

Cylinder Number		Finish: 606, 626
2060-052	Standard	\$98.00
2061-042*	CK4229 Hotel with indicator pin	\$124.00
2160-052**	Discontinued Ronde and Continental Knob	\$108.00

\* Not Available with 752, 852 or A Class keyways.  
 \*\* Also Available in 605, 611, 612, 613, 625 finishes.  
 Not Available with X Class and certain restricted keyways.

**Master Ring Special Applications For Exit Device Operators (.552" plug)**

Cylinder Number		Finish: 606, 626
4266-001-A02	ED6800 x B5 or B6 trim	\$112.00
	ED7400 x 03 or 04 trim	
4266-001-A92	ED6800 x 01 or 02 trim	

**Pin Kits**

Description	Catalog Number	Part Number	Price
Corbin Russwin System 70 and Pre-System 70, 752, 852 and A Class keyways Not for System 70 Security	PK-1070	610F53-8	\$788.00
Corbin® Z Class and Russwin® DH Class keyways System 70, all cylinders except Security	PK-70-ZDH	602F12-9	\$524.00
Russwin N Class System, all cylinders	PK-70-N	602F11-9	\$410.00
Corbin X Class, all cylinders	PK-70-X	602F10-9	\$400.00
Pyramid High Security cylinders	PK-20-HS	694F96-8	\$1,079.00
Pyramid Security cylinders	PK-20-PS	715F96-8	\$797.00
Security cylinders, including interchangeable core, blockout and Brink	PK-70-HS	610F52-9	\$1,487.00
Access 3 Key System AP only	PK-30-AP	763F088	\$767.00
Access 3 Key System - AP, AS, AHS	PK-30-MASTER	763F098	\$1,118.00

**Tools**

Description	Catalog Number	Part Number	Price
Tool kit - contains 1 each: CT-4, CT-11, CT-19, CT-21, CT-22, CT-23, CT-26, CT-54	CT-93	612F58-8	\$264.00
Plug follower, .509" brass	CT-4	073F99-2	\$26.00
Pin chamber reamer	CT-5	239F75-8	\$71.00
Pin chamber burring tool	CT-7	382F18-8	\$187.00
Loading tool for .509" shell	CT-10	577F49-9	\$71.00
Key gauge, all Corbin® key classes	CT-11	239F37-7	\$26.00
Tweezers (was CT-6)	CT-19	239F36-8	\$30.00
Plug follower, .496	CT-20	694F97-2	\$14 (order in mult.of 10)
Key gauge, Pyramid	CT-20K	698F36-7	\$26.00
Key gauge, Access 3	CT-30K	????	
Key gauge, Russwin® N	CT-21	603F27-7	
Key gauge, Russwin® D & H	CT-22	604F19-7	
Key gauge, Russwin® 981/852	CT-23	604F18-7	
Pliers for CK4200/UT5200 knob shank retainer (was 101F78)	CT-25	101F78-8	\$91.00
Pliers for plug retainers (was 239F35 -8)	CT-26	239F35-8	\$72.00
Pliers for UT5200 lever designs (was 103F92)	CT-27	103F92-8	\$91.00
Plug follower, .552" brass	CT-54	073F98-2	\$32.00
IC mortise cylinder installation wrench	CT-80	363F61-2	\$44.00
Follower, disposable, .509" plug		484F72-9	\$0.80 (order in mult. Of 50)
Follower, disposable, .552" plug		484F73-9	\$0.40 (order in mult. Of 100)



Look for the   
MicroShield icon.

**MicroShield®**

As part of their promise to provide innovative solutions to their customers, certain ASSA ABLOY Group brands offer the MicroShield® technology, a silver-based antimicrobial coating designed to inhibit the growth of bacteria.

MicroShield® is a registered trademark of Yale Security Inc., an ASSA ABLOY Group company.

Product	Series	MicroShield® Coated Components
Access 800®	All	Levers* and escutcheons

**AVAILABLE FINISHES**

- MicroShield® is available on 626 and 630. Other finishes available by Special Product Application Request Form only.
- Specify 626C (satin chrome plated) or 630C (satin stainless steel) when ordering.
- MicroShield® coating will be applied over 626 and 630 finishes. All components will match 626.

*Note: MicroShield® coating will only be applied to "high touch" components.*

**PRICING - Discount is 50% off list only**

Description	Add
Mortise Locks	Add \$40.00
Cylindrical Locks	Add \$40.00
Exit Devices & Outside Trims (ordered together)	Add \$60.00 (when ordered together)
Exit Devices & Trims (ordered separately)	Add \$40.00

**ML20800 Mortise  
Standard Features**

**Handing**

Handed; quick reversible

**Door Thickness**

1-3/4"

**Backset**

2-3/4" Standard

**Strike**

ANSI straight lip  
4-7/8" x 1-1/4" x 1-1/8"

**Cylinder**

1000-138-A01, 6-pin, L4, keyed random,  
finished standard for 1-3/4" door

**Keys**

Two nickel silver standard

**Weight**

11 lbs

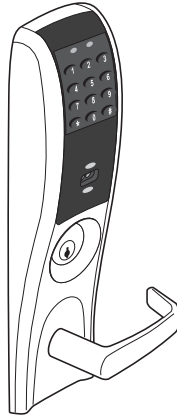

**ML20800 Mortise Lock Ordering Examples**

**Stock Order**

Quantity	Series/Function	Technology Code	Trim	Finish	Hand	Credential Quick Code
24	ML20834	TCAC2	LSZ	626	RHR	M803

**Split Trim/Finish Order**

Quantity	Series/Function	Technology Code	Trim		Finish		Hand	Credential Quick Code
			Outside	Inside	Outside	Inside		
24	ML20834	TCAC2	LSZ	CSZ	626	606	RHR	M803

**Contract/Detailed Order**

Quantity	Keypad	Series/Function	Technology Code	Trim	Finish	Hand	Door Thickness	Optional Strike	Credential Quick Code	Optional Cylinder	Keying
24	AA1	ML20834	TCAC2	LSZ	626	RHR	D214	SA200	M803	C7	VKC3



**Lever Design: ASZ, CSZ, DSZ, ESZ, LSZ, NSZ, PSZ, RSZ**

**Lever:** Cast    **Escutcheon:** Zinc Die Cast

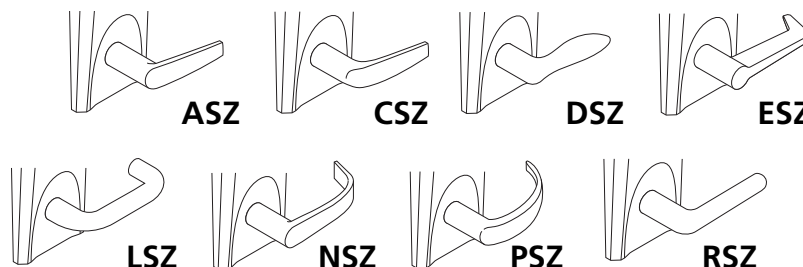

**Lever Design: FSZ, MSZ, TSZ, ZSZ**

**Lever:** Cast    **Escutcheon:** Zinc Die Cast



Function	Description	ASZ, CSZ, DSZ, ESZ, LSZ, NSZ, PSZ, RSZ		FSZ, MSZ, TSZ, ZSZ	
		Finish: 613E, 626	Finish: 605, 606, 611, 612, 613, 613L, 618, 619, 625, 630, 722	Finish: 613E, 626	Finish: 605, 606, 611, 612, 613, 613L, 618, 619, 625, 722
ML20833	Without key override x M800	\$987.00	\$1,089.00	\$987.00	\$1,089.00
ML20834	With key override x M800	\$1,063.00	\$1,165.00	\$1,063.00	\$1,165.00
ML20835	Deadbolt without key override x M800	\$1,001.00	\$1,103.00	\$1,001.00	\$1,103.00
ML20836	Deadbolt with key override x M800	\$1,077.00	\$1,179.00	\$1,077.00	\$1,179.00
ML20837*	Dormitory Entry with Deadbolt and inside leverswitch x M802	\$1,610.00	\$1,712.00	\$1,610.00	\$1,712.00
	Dormitory Entry with Deadbolt and inside leverswitch x M803	\$1,669.00	\$1,771.00	\$1,669.00	\$1,771.00

**Access 800® Options**

Description	Specify	Add
100 User, keypad only	M800	No Charge
2000 User, keypad only	M801	\$141.00
2000 User, proximity only	M802	\$533.00
2000 User, keypad and proximity	M803	\$592.00
2000 User, keypad and RF actuation**	M804	\$335.00
2000 User, proximity and RF actuation**	M805	\$727.00
2000 User, keypad, proximity and RF actuation**	M806	\$786.00

\* ML20837 only compatible with proximity readers, M802 and M803

\*\* Note: RF Fob must be ordered separately. See page 104.

**Mortise Lockset ML20800 Series Cylinder Options**

For Key Override function only

Description	Specify	Add or Deduct
Conventional 6-pin	(standard)	No Charge
Conventional 7-pin	7P	Add \$2.00 per cylinder
Less Standard Cylinder	LC	Deduct \$76.00 per cylinder
Access 3 Patented	AP	No Charge
Access 3 Security	AS	Add \$49.00 per cylinder
Access 3 High Security, UL 437	AHS	Add \$69.00 per cylinder
Access 3 IC Patented	ACP	Add \$64.00 per cylinder
Access 3 IC Security	ACS	Add \$113.00 per cylinder
Access 3 IC High Security, UL 437	ACHS	Add \$133.00 per cylinder
Pyramid Security Fixed Core	PS	Add \$49.00 per cylinder
Pyramid Security IC	PCS	Add \$113.00 per cylinder
Pyramid High Security Fixed Core	PHS	Add \$75.00 per cylinder
Pyramid High Security IC	PCHS	Add \$138.00 per cylinder
Pyramid IC with Temporary Construction Core	CTP	Add \$64.00 per cylinder
Pyramid IC with Temporary Disposable Core	CTPD	No Charge
Pyramid IC Less Core	CLP	No Charge
Security	HS	Add \$95.00 per cylinder
Security IC	CHS	Add \$161.00 per cylinder
IC 6-pin	C6	Add \$64.00 per cylinder
IC 6-pin with Temporary Construction Core (Red)	CT6R	Add \$64.00 per cylinder
IC 6-pin with Temporary Construction Core (Blue)	CT6B	Add \$64.00 per cylinder
IC 6-pin with Temporary Construction Core (Green)	CT6G	Add \$64.00 per cylinder
IC 6-pin with Temporary Disposable Core	CT6D	No Charge
IC 6-pin Less Core	CL6	No Charge
SFIC 6-pin with Less Core	CLS6	No Charge
IC 6-pin with SFIC disposable temporary core	CT6SD	No Charge
IC 7-pin	C7	Add \$66.00 per cylinder
IC 7-pin with Temporary Construction Core (Red)	CT7R	Add \$66.00 per cylinder
IC 7-pin with Temporary Construction Core (Blue)	CT7B	Add \$66.00 per cylinder
IC 7-pin with Temporary Construction Core (Green)	CT7G	Add \$66.00 per cylinder
IC 7-pin with Temporary Disposable Core	CT7D	Add \$2.00 per cylinder
IC 7-pin Less Core	CL7	Add \$2.00 per cylinder
SFIC 7-pin with Less Core	CLS7	Add \$2.00 per cylinder
IC 7-pin with SFIC disposable temporary core	CT7SD	Add \$2.00 per cylinder

**Keying Options\***

Description	Specify	Add or Deduct
0-Bitted with 2 blank keys	(standard)	No Charge
Keyed random	KR	No Charge
Construction master keyed <sup>1,2</sup>	CMK	Add \$16.00 per cylinder
Visual key control (VKC)		
- No Stamping	VKC0	\$4.30
- Keys only	VKC1	No Charge
- Cylinders and Keys <sup>3</sup>	VKC2	\$8.00
- Cylinders only <sup>3</sup>	VKC3	\$8.00
Concealed key control (CKC)		
- CKC cylinders with VKC keys	CKC2	\$8.00
- CKC cylinders only <sup>3</sup>	CKC3	\$8.00
More than 2 keys per lock	KY# (e.g., KY6)	See page 48 - Cut Keys Section

\*For key bows other than 10 and 90, specify "KB" + bow number as Quick Code, e.g. KB12.

Notes:

1. CMK Construction master keying charge is in addition to master keying charge.
2. CMK Construction master keying is not available in Pyramid or Security series.
3. VKC2, VKC3, CKC3 are not available in Pyramid or Security series.

**Door Thickness**

Description	Specify	Add or Deduct
1-3/4"	(standard)	No Charge
2"	D200	
2-1/4"	D214	

**Strike Options\***

(To purchase strike separately, see catalog or parts manual for part no.)

Lip Length	ANSI Straight Lip - Specify	ANSI Curved Lip - Specify	Add or Deduct
7/8"	SS078	N/A	No Charge
1-1/8"	(standard)	N/A	
1-1/4"	SS114	SA114	
1-3/8"	SS138	SA138	
1-1/2"	SS112	SA112	
1-3/4"	SS134	SA134	Add \$16.00 per lockset
2"	SS200	SA200	
2-1/4"	SS214	SA214	
2-1/2"	SS212	SA212	
2-3/4"	SS234	SS234	
3"	SS300	SA300	

Description	Door Thickness	Specify	Add or Deduct
Open Back Strike	1-3/4"	SB134	Add \$82.00 per lockset
Open Back Strike	2"	SB200	Add \$124.00 per lockset
Open Back Strike	2-1/4"	SB214	
Rabbeted front and strike		SR118	Add \$86.00 per lockset

\* If door thickness is standard or has been specified and no special door or frame condition exists, then only the first two characters of the optional strike Quick Code must be specified (e.g. "SA").

The correct lip length will be determined by our order entry system based on the standard or specified door thickness.

**Miscellaneous Options**

Description	Specify	Add or Deduct
Torx® head screws	M04	Add \$22.00 per lockset
ANSI wrought strike box	M17	No Charge
Knurling outside and inside <sup>1</sup>	M20	Add \$132.00 per lockset
Knurling outside only <sup>1</sup>	M21	Add \$66.00 per lockset
Knurling inside only	M22	Add \$66.00 per lockset
Abrasive coat outside and inside <sup>1</sup>	M23	Add \$82.00 per lockset
Abrasive coat inside only <sup>1</sup>	M24	Add \$41.00 per lockset
Abrasive coat outside only	M25	Add \$41.00 per lockset
Power/Remote Unlocking Harness	M35	Add \$42.00 per lockset
Forced/Propped Door <sup>2</sup>	M861	Add \$11.00 per lockset

Notes:

1. Not available with Vineyard™ or Muséo® levers.
2. Not compatible with M800

**CL33800 Cylindrical  
Standard Features**

**Handing**

Non-handed

**Door Thickness**

1-3/4" - 2"

**Backset**

2-3/4" Standard

**Strike**

ANSI curved lip

4-7/8" x 1-1/4" x 1-1/4"

**Cylinder**

6-pin, L4, keyed random,  
0-bitted standard

**Keys**

Two nickel silver standard

**Weight**

9.5 lbs

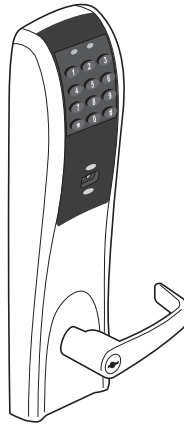

**CL33800 Cylindrical Lock Ordering Examples**

**Stock Order**

Quantity	Series/ Function	Technology Code	Trim	Finish	Hand	Credential Quick Code
100	CL33834	TCAC2	NZZ	626	RHR	M803

**Split Trim/Finish Order**

Quantity	Series/ Function	Technology Code	Trim		Finish		Hand	Credential Quick Code
			Outside	Inside	Outside	Inside		
12	CL33834	TCAC2	NZZ	AZZ	626	625	LH	M803

**Contract/Detailed Order**

Quantity	Keypad	Series/ Function	Technology Code	Trim	Finish	Hand	Door Thickness	Backset	Optional Strike	Credential Quick Code	Optional Cylinder	Keying
24	AA1	CL33834	TCAC2	NZZ	626	RHR	D214	B334	SC114	M802	C6	VKC3

**Lever Design: AZZ, NZZ, PZZ**

**Lever:** Zinc Die Cast

**Escutcheon:** Zinc Die Cast

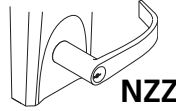
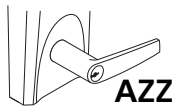

Function	Description	AZZ, NZZ, PZZ, FZZ	
		Finish: 613E, 626	Finish: 611, 605, 606, 612, 613, 613L, 618, 619, 625, 722
CL33834	With key override x M800	\$993.00	\$1,088.00

**Access 800® Options**

Description	Specify	Add
100 User, keypad only	M800	No Charge
2000 User, keypad only	M801	\$141.00
2000 User, proximity only	M802	\$533.00
2000 User, keypad and proximity	M803	\$592.00
2000 User, keypad and RF actuation*	M804	\$335.00
2000 User, proximity and RF actuation*	M805	\$727.00
2000 User, keypad, proximity and RF actuation*	M806	\$786.00

\* Note: RF Fob must be ordered separately. See page 104.

**Cylindrical Lockset CL33800 Series Cylinder Options**

Description	Specify	Add or Deduct
Conventional 6-pin	(standard)	No Charge
Conventional 7-pin	7P	Add \$2.00 per cylinder
Less Standard Cylinder	LC	Deduct \$69.00 per cylinder
Access 3 Patented	AP	No Charge
Access 3 Security	AS	Add \$49.00 per cylinder
Access 3 High Security, UL 437	AHS	Add \$69.00 per cylinder
Access 3 IC Patented	ACP	Add \$64.00 per cylinder
Access 3 IC Security	ACS	Add \$113.00 per cylinder
Access 3 IC High Security, UL 437	ACHS	Add \$133.00 per cylinder
Pyramid Security Fixed Core	PS	Add \$49.00 per cylinder
Pyramid Security IC	PCS	Add \$110.00 per cylinder
Pyramid High Security Fixed Core	PHS	Add \$73.00 per cylinder
Pyramid High Security IC	PCHS	Add \$138.00 per cylinder
Pyramid IC Less Core	CLP	No Charge
Security	HS	Add \$95.00 per cylinder
Security IC	CHS	Add \$160.00 per cylinder
IC 6-pin	C6	Add \$64.00 per cylinder
IC 6-pin with Temporary Construction Core (Red)	CT6R	Add \$64.00 per cylinder
IC 6-pin with Temporary Construction Core (Blue)	CT6B	Add \$64.00 per cylinder
IC 6-pin with Temporary Construction Core (Green)	CT6G	Add \$64.00 per cylinder
IC 6-pin with Temporary Disposable Core	CT6D	No Charge
IC 6-pin Small Format Disposable Core	CTSD	No Charge
IC 6-pin Less Core	CL6	No Charge
IC 7-pin	C7	Add \$66.00 per cylinder
IC 7-pin with Temporary Construction Core (Red)	CT7R	Add \$66.00 per cylinder
IC 7-pin with Temporary Construction Core (Blue)	CT7B	Add \$66.00 per cylinder
IC 7-pin with Temporary Construction Core (Green)	CT7G	Add \$66.00 per cylinder
IC 7-pin with Temporary Disposable Core	CT7D	No Charge
IC 7-pin Less Core	CL7	No Charge
Lockset furnished in Schlage® C Keyway <sup>1</sup>	C	No Charge
Lockset furnished in SARGENT® LA Keyway <sup>2</sup>	LA	No Charge

**Keying Options\***

Description	Specify	Add or Deduct
0-Bitted with 2 blank keys	(standard)	No Charge
Keyed random	KR	No Charge
Construction master keyed <sup>1, 2</sup>	CMK	Add \$16.00 per cylinder
Visual key control (VKC)		
- No Stamping	VKC0	\$4.30
- Keys only	VKC1	No Charge
- Cylinders and Keys <sup>3</sup>	VKC2	\$8.00
- Cylinders only <sup>3</sup>	VKC3	\$8.00
Concealed key control (CKC)		
- CKC cylinders with VKC keys	CKC2	\$8.00
- CKC cylinders only <sup>3</sup>	CKC3	\$8.00
More than 2 keys per lock	KY# (e.g., KY6)	See page 48 - Cut Keys Section

\*For key bows other than 10 and 90, specify "KB" + bow number as Quick Code, e.g. KB12.

Notes:

1. CMK Construction master keying charge is in addition to master keying charge.
2. CMK Construction master keying is not available in Pyramid or Security series.
3. VKC2, VKC3, CKC3 are not available in Pyramid or Security series.

**Door Thickness Options**

Description	Specify	Add or Deduct
1-3/4"	(standard)	
2"	D214	Add \$5.50 per lockset

**Backset Options**

Description	Specify	Add or Deduct
2-3/4"	(standard)	No Charge
3-3/4"	B334	Add \$15.00 to lockset
5"	B500	Add \$24.00 to lockset

**Strike Options\***

(To purchase strike separately, see catalog or parts manual for part no.)

Lip Length	ANSI Straight Lip - Specify	ANSI Curved Lip - Specify	Add or Deduct
1"	SA100	SC100	No Charge
1-1/8"	SA118	SC118	
1-1/4"	(standard)	SC114	
1-3/8"	SA138	SC138	
1-1/2"	SA112	SC112	
1-3/4"	SA134	SC134	Add \$16.00 per lockset
2"	SA200	SC200	
2-1/4"	SA214	SC214	
2-1/2"	SA212	SC212	
2-3/4"	SA234	SC234	
3"	SA300	SC300	
Rabbeted front and strike		SR118	Add \$86.00 per lockset

\*If door thickness is standard or has been specified and no special door or frame condition exists, then only the first two characters of the optional strike Quick Code must be specified (e.g. "SC").  
 The correct lip length will be determined by our order entry system based on the standard or specified door thickness.

**Miscellaneous Options**

Description	Specify	Add or Deduct
Torx® head screws	M04	Add \$22.00 per lockset
Less cylinder, with tailpiece for Schlage® cylinder	M06	No Charge
Lever to accept Best® type core (NZD & PZD designs only)	M08	No Charge
Lever to accept Sargent® cylinder (NZD & PZD design only)	M09	No Charge
Rounded corners on latch front	M13	Add \$2.50 per latch
3/4" (19mm) throw fire latch	M16	Add \$94.00 per lockset
ANSI wrought strike box	M17	No Charge
Knurling outside and inside	M20	Add \$132.00 per lockset
Knurling outside only	M21	Add \$66.00 per lockset
Knurling inside only	M22	Add \$66.00 per lockset
Abrasive coat outside and inside	M23	Add \$82.00 per lockset
Abrasive coat inside only	M24	Add \$41.00 per lockset
Abrasive coat outside only	M25	Add \$41.00 per lockset
Power/Remote Unlocking Harness	M35	Add \$45.00
Lever to accept Schlage® interchangeable core (NZD & PZD design only)	M69	No Charge
Forced door/propped door <sup>2</sup>	M861	Add \$12

Notes: 2. Not compatible with M800

**ED5000 Exit Devices**

**Standard Features**

**Handing**

Device non-handed; lever trim is handed

**Door Thickness**

1-3/4" Standard

**Stile**

4-1/2" Minimum width

**Strike**

Rim Device: Surface mounted 3/8" diameter roller strike

Mortise Device: ANSI curved lip strike

**Projection**

3-1/4" active, 2-3/4" dogged

**Trim**

Cylinder is not included. See page 99 for Cylinder options.

**Weight**

8.5 lbs



**ED5000 Series Exit Devices Ordering Examples**

**Exit Device Only**

Quantity	Series/Function	Finish	Hand	Misc. Options
24	ED5200S	626	RHR	M51-M54

**Trim Only**

Quantity	Trim/Function	Technology Code	Finish	Hand	Credential Quick Code
24	N9M833	TCAC2	625	RHR	M800

**Exit Device with Trim**

Quantity	Exit Device	Trim/Function	Technology Code	Finish	Hand	Cylinder Option	Door Thickness	Optional Strike	Door Width	Misc. Options	Credential Quick Code
65	ED5634L	N9M834	TCAC2	605	LHR	6P	D200	SB134	W048	M51-M54 & M800	M800

**Contract/Detailed Order - Rim Exit Device with Trim**

Quantity	Keyset	Exit Device	Trim/Function	Technology Code	Finish	Hand	Door Width	Credential Quick Code	Cylinder Option
36	AA1	ED5200	C9834	TCAC2	626	LHR	W048	M804	79

**Removable Mullion**

Quantity	Mullion	Misc. Options
24	908A	M57

**Mortise Exit Only**

Trim Type	Function	Panic	Fire
Lever	Entry without key override	ED5600L	ED5600AL
Lever	Entry with key override	ED5634L	ED5634AL



**ED5200(S)(A) Rim/SecureBolt® Device**  
**Lever Design: A, C, D, E, L, N, PR, R**

**Lever:** Cast      **Keypad/Controller Escutcheon:** Zinc Die Cast  
**Trim Escutcheon:** Forged

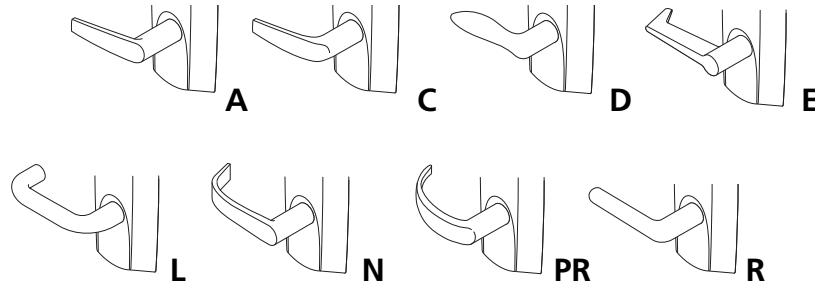

**Lever Design: FR, M, TS, Z**

**Lever:** Cast      **Keypad/Controller Escutcheon:** Zinc Die Cast  
**Trim Escutcheon:** Forged

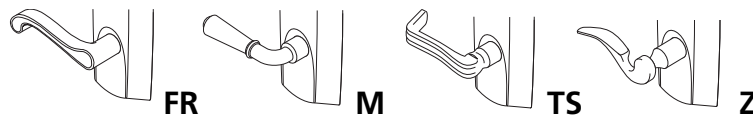

**Use with ED5200(S)(A) Rim/SecureBolt® Device**

Note: Exit Device ordered separately, starting on page 207.

Function*	Description	A, C, D, E, L, N, R, PR		FR, M, TS, Z	
		Finish: 613E, 630	Finish: 605, 606, 611, 612, 613, 618, 619, 625, 626, 629, 722	Finish: 613E, 626	Finish: 605, 606, 611, 612, 613, 618, 619, 625, 722
9833	Without key override x M800	\$1,078.00	\$1,098.00	\$1,078.00	\$1,098.00
9834	With key override x M800				

Note: For key override add Cylinder Quick Code Option and price.  
\*When specifying function, prefix with lever design.  
Refer to ED7000 sections for mechanical push bar pricing.  
Refer to the ED5000 section push pad exit device for order info.

**Access 800® Options**

Description	Specify	Add
100 User, keypad only	M800	No Charge
2000 User, keypad only	M801	\$141.00
2000 User, proximity only	M802	\$533.00
2000 User, keypad and proximity	M803	\$592.00
2000 User, keypad and RF actuation*	M804	\$335.00
2000 User, proximity and RF actuation*	M805	\$727.00
2000 User, keypad, proximity and RF actuation*	M806	\$786.00

\* Note: RF Fob must be ordered separately. See page 104.

**ED5633(A)L & ED5634(A)L Mortise Device**

**Lever Design: A, C, D, E, L, N, PR, R**

**Lever:** Cast

**Keypad/Controller Escutcheon:** Zinc Die Cast

**Trim Escutcheon:** Forged

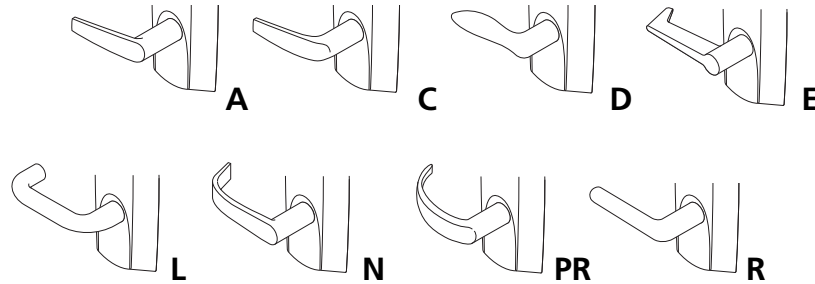

**Lever Design: FR, M, TS, Z**

**Lever:** Cast

**Keypad/Controller Escutcheon:** Zinc Die Cast

**Trim Escutcheon:** Forged

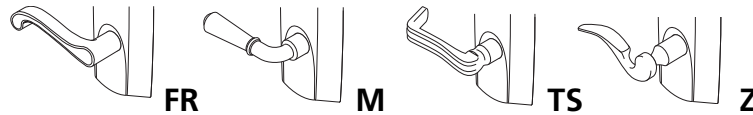

**Use with ED5633(A)L & ED5634(A)L Mortise Device**

Note: Exit Device ordered separately, starting on page 207.

Function*	Description	A, C, D, E, L, N, R, PR		FR, M, TS, Z	
		Finish: 613E, 630	Finish: 605, 606, 611, 612, 613, 618, 619, 625, 626, 629, 722	Finish: 613E, 626	Finish: 605, 606, 611, 612, 613, 618, 619, 625, 722
9M833	Without key override x M800	\$1,041.00	\$1,061.00	\$1,041.00	\$1,061.00
9M834	With key override x M800				

Note: 9M833 and 9M834 cannot be retrofitted to an existing ED5600 Series mortise device. When ordered as "Trim Only", 9M833 and 9M834 will be furnished with the appropriate mortise lock (refer to Parts Price List for mortise lock body pricing). If a "Trim Only" order is intended for retrofitting and exit device with an M91 Bolt Monitor or an M93 Trim Monitor function, that function must be specified with the trim order to ensure the correct lock is furnished.

Note: For key override, add Cylinder Quick Code Option and price. See page 99.

\*When specifying function, prefix with lever design.

Refer to ED7000 sections for mechanical push bar pricing.

Refer to the ED5000 section push pad exit device for order info.

**Access 800® Options**

Description	Specify	Add
100 User, keypad only	M800	No Charge
2000 User, keypad only	M801	\$141.00
2000 User, proximity only	M802	\$533.00
2000 User, keypad and proximity	M803	\$592.00
2000 User, keypad and RF actuation*	M804	\$335.00
2000 User, proximity and RF actuation*	M805	\$727.00
2000 User, keypad, proximity and RF actuation*	M806	\$786.00
Gasket	M99	No Charge

Notes: 1. Available 0-bitted and Key Random (KR) only.

2. Available 0-bitted only.

\* Note: RF Fob must be ordered separately. See page 104.

<b>Exit Device ED5000 Series Cylinder Options*</b>		
<b>Description</b>	<b>Specify</b>	<b>Add or Deduct</b>
Conventional 6-pin	6P**	Add \$76.00 per cylinder
Conventional 7-pin	7P	Add \$78.00 per cylinder
Access 3 Patented	AP	Add \$76.00 per cylinder
Access 3 Security	AS	Add \$125.00 per cylinder
Access 3 High Security, UL 437	AHS	Add \$145.00 per cylinder
Access 3 IC Patented	ACP	Add \$143.00 per cylinder
Access 3 IC Security	ACS	Add \$189.00 per cylinder
Access 3 IC High Security, UL 437	ACHS	Add \$209.00 per cylinder
Pyramid Security Fixed Core	PS	Add \$125.00 per cylinder
Pyramid Security IC	PCS	Add \$189.00 per cylinder
Pyramid High Security Fixed Core	PHS	Add \$151.00 per cylinder
Pyramid High Security IC	PCHS	Add \$214.00 per cylinder
Pyramid IC with Temporary Construction Core	CTP	Add \$143.00 per cylinder
Pyramid IC with Temporary Disposable Core	CTPD	Add \$76.00 per cylinder
Pyramid IC Less Core	CLP	Add \$76.00 per cylinder
Security	HS	Add \$171.00 per cylinder
Security IC	CHS	Add \$236.00 per cylinder
IC 6-pin	C6	Add \$143.00 per cylinder
IC 6-pin with Temporary Construction Core (Red)	CT6R	Add \$143.00 per cylinder
IC 6-pin with Temporary Construction Core (Blue)	CT6B	Add \$143.00 per cylinder
IC 6-pin with Temporary Construction Core (Green)	CT6G	Add \$143.00 per cylinder
IC 6-pin with Temporary Disposable Core	CT6D	Add \$76.00 per cylinder
IC 6-pin less core	CL6	Add \$76.00 per cylinder
SFIC 6-pin with Less Core	CLS6	Add \$76.00 per cylinder
IC 6-pin with SFIC disposable temporary core	CT6SD	Add \$76.00 per cylinder
IC 7-pin	C7	Add \$144.00 per cylinder
IC 7-pin with Temporary Construction Core (Red)	CT7R	Add \$144.00 per cylinder
IC 7-pin with Temporary Construction Core (Blue)	CT7B	Add \$144.00 per cylinder
IC 7-pin with Temporary Construction Core (Green)	CT7G	Add \$144.00 per cylinder
IC 7-pin with Temporary Disposable Core	CT7D	Add \$78.00 per cylinder
IC 7-pin less core	CL7	Add \$78.00 per cylinder
SFIC 7-pin with Less Core	CLS7	Add \$78.00 per cylinder
IC 7-pin with SFIC disposable temporary core	CT7SD	Add \$78.00 per cylinder

\*Optional dogging cylinder will be furnished with the same mechanism and keyed alike with the trim cylinder, unless otherwise specified. If different keying or cylinder type is required, specify outside (trim) first, then inside (dogging) cylinder.

\*\*6P cylinder option is supplied in 6-pin, L4 keyway, 0-bitted with two nickel silver keys.

<b>Keying Options*</b>		
<b>Description</b>	<b>Specify</b>	<b>Add or Deduct</b>
0-Bitted with 2 blank keys	(standard)	No Charge
Keyed random	KR	No Charge
Construction master keyed <sup>1,2</sup>	CMK	Add \$16.00 per cylinder
Visual key control (VKC)		
- No stamping	VKC0	\$4.30
- Keys only	VKC1	No Charge
- Cylinders and keys <sup>3</sup>	VKC2	\$8.00
- Cylinders only <sup>3</sup>	VKC3	\$8.00
Concealed key control (CKC)		
- CKC cylinders with VKC keys	CKC2	\$8.00
- CKC cylinders only <sup>3</sup>	CKC3	\$8.00
More than 2 keys per lock	KY# (e.g., KY6)	See page 48 - Cut Keys Section

\*For key bows other than 10 and 90, specify "KB" + bow number as Quick Code, e.g. KB12.

Notes:

1. CMK Construction master keying charge is in addition to master keying charge.
2. CMK Construction master keying is not available in Pyramid or Security series.
3. VKC2, VKC3, CKC3 are not available in Pyramid or Security series.

**Strike Options\***

Description	Specify	Add or Deduct
Mortise Device		
-ANSI strike for pair of doors w/astragal (7/8" L to C)	SS078	No Charge
-Open back strike for 1-3/4" door	SB134	Add \$72.00 per lockset
-Open back strike for 2-1/4" door	SB214	\$120.00

\*(To purchase strike separately, see catalog or parts manual for part no.)

**Door Thickness Options**

Description	Specify	Add or Deduct
1-3/4"	(standard)	No Charge
2"	D200	No Charge
2-1/4"	D214	No Charge

**Door Width Options**

Description	Specify	Add or Deduct
24"	W024	Add \$292.00 per device
36"	(standard)	No Charge
48"	W048	Add \$35.00 per device

**Miscellaneous Options**

Description	Specify	Add or Deduct
Torx® Head Screws	M04	Add \$42.00 per device
ANSI wrought strike box (mortise)	M17	No Charge
Knurling outside & inside (embossed touchbar - device side) <sup>1</sup>	M20	Add \$139.00 per device
Knurling outside only (trim side) <sup>1</sup>	M21	Add \$65.00 per device
Knurling inside only (embossed touchbar - device side)	M22	Add \$74.00 per device
Abrasive coat outside and inside (trim and device) <sup>1</sup>	M23	Add \$88.00 per device
Abrasive coat inside only (device side)	M24	Add \$46.00 per device
Abrasive coat outside only (trim side) <sup>1</sup>	M25	Add \$42.00 per device
Power/Remote Unlocking Harness	M35	Add \$45.00
Less dogging	M51	No Charge
Cylinder dogging	M52	Add \$78.00 per device
Sex nuts and bolts (SNBs)	M54	No Charge
Shim kit (for vision light)	M58	Add \$96.00 per device
Wood screws for use on fire-rated solid wood or wood core doors	M64	No Charge
Forced/Propped Door <sup>2</sup>	M861	Add \$12

Notes: 1. Not available with Vineyard™ or Muséo® levers.  
 2. Not compatible with M800

**Electrified Options**

Description	Specify	Add or Deduct
Exit Alarm Device (cylinder not included)	M61	\$647.00
Bolt Position Monitoring	M91	Add \$217.00
Touchbar Monitoring or Signaling	M92*	Add \$204.00
Outside Monitoring or Signaling	M93	Add \$204.00
Electric Latch Pullback	M94	Add \$870.00
Electric Dogging	M97	Add \$416.00

\*M92 is included with M861 option.

**Delayed Egress Options**

Description	Specify	Add or Deduct
Delayed Egress (15-second delay)	D	Add \$1533.00
30-second delay (may be accepted by local jurisdiction)	M88	\$98.00
BOCA 15-second delay	M89	\$98.00
BOCA 30-second delay	M90	\$98.00

**Electrified Accessories**

Description	Specify	Add or Deduct
Controller (Required for Electric Latch Retraction)	782	\$683.00
Power Supply 9VDC Output	784	\$396.00
Power Supply 1.0 Amp @ 24 VDC Output	BPS-24-1	\$295.00
Power Supply 2 Amp @ 24 VDC Output	BPS-24-2	\$600.00
SPDT Maintained Switch (includes LED)	MKA, MKAN	\$170.00
SPDT Momentary Switch (includes LED)	MK	\$170.00
SPDT Momentary Switch (illuminated)	PB3	\$127.00
SPDT Maintained (Alt. Action) Switch	PB3EA	\$100.00
Sonalert 90lbs. @ 2ft. 12-24VDC mounted on one gang stainless steel plate	PZ1	\$84.00
Alarm Kit (cylinder is not included)**	ED50AK	\$699.00
Concealed transfer for over 120° swing doors	EPTL	\$112.00

\*\*Alarm Kit cannot be installed in the field to surface vertical rod device.  
 Any attempt to do so voids all warranties

**WM800**

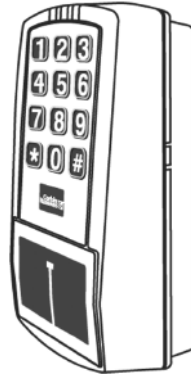

<b>Function</b>	<b>Description</b>	<b>Finish: Dark Gray</b>
WM800	Reader/Controller	\$965.00

Includes weather gasket and glass mounting kit

**Custom Wiring Diagram Services:**

Part Number	Description	Price
WD-BASIC	Basic riser / elevation diagrams	Contact 800-810-WIRE (9473) for pricing
WD-SPEC	Specification package	
WD-P2P	Point to Point package	
WD-SYSPK	System Package	
WD-SWP	Special Wiring Package	

**Keypad Versions (w/Ribbon Cable)**

Part Number	Description	Price
708F809	M800 (100 user, keypad only)	\$175.00
708F089	M801, M803, M804, M806 (2000 user keypad and keypad + prox)	\$413.00
708F099	M802, M805 (2000 user prox only)	\$346.00

**100 User Controllers – Contact 800-810-WIRE (9473) for pricing**

Part Number	Description	Price
708F819	M800 (100 user, keypad only) - Cylindrical	\$363.00
708F829	M800 (100 user, keypad only) - Mortise/Exits	

**2000 User Cylindrical Controllers**

Part Number	Description	Price
712F009	M801 (2000 user, keypad)	\$604.00
712F019	M802 or M803 (2000 user prox only or keypad + prox)	\$938.00
712F029	M804 (2000 user keypad + RF*)	\$804.00
712F039	M805 or M806 (prox + RF* or keypad + prox + RF*)	\$1,140.00

**2000 User Mortise & Exit Controllers**

Part Number	Description	Price
712F049	M801 (2000 user, keypad)	\$604.00
712F059	M802 or M803 (2000 user prox only or keypad + prox)	\$938.00
712F069	M804 (2000 user keypad + RF*)	\$804.00
712F079	M805 or M806 (prox + RF* or keypad + prox + RF*)	\$1,140.00

**Software**

Part Number	Description	Price
790F139	SoloPlus™ Software	\$294.00

\* Note: RF Fob must be ordered separately. See page 104.

**Credentials**

Part Number	Description	Order Multiples*	Order Minimums	Price (Each)
794F319	C/R 26 bit ISO Prox® II with logo	Order 25-	25	\$15.00
794F329	C/R 26 bit ISO Prox II blank	Order 25-	100	
794F359	HID® 26 bit ISO Prox II with logo	Order 25-	100	
794F369	HID 26 bit ISO Prox II without logo	Order 25-	100	
794F339	C/R 26 bit ProxCard® II with logo	Order 25-	25	\$8.00
794F349	C/R 26 bit ProxCard II blank	Order 25-	100	
794F379	HID 26 bit ProxCard II with logo	Order 25-	100	
794F389	HID 26 bit ProxCard II without logo	Order 25-	100	
794F399	C/R DuoProx® II - Prox and mag stripe with logo	Order 100-	100	\$15.00
794F409	C/R DuoProx II - Prox and mag stripe without logo	Order 100-	100	
794F419	HID 26 bit DuoProx II - Prox and mag stripe	Order 100-	100	
794F429	C/R MicroProx® tag	Order 10-	100	\$9.00
794F449	HID MicroProx tag with customer site code	Order 10-	100	
708F999	RF FOB	Order 1	1	\$88.00

\*Sold only in multiples of the number indicated.

Note: For HID credentials, site/facility code and card sequence numbers must be specified.

**Hardware**

Part Number	Description	Price
708F979	Conduit	\$12.00
793F039	784 Remote power supply (includes Plug-in Wall Transformer, 12 feet of shielded wire)	\$409.00
793F049	Plug in wall transformer	\$53.00
793F059	Cable assembly - power supply	\$50.00
793F069	Power/remote unlocking harness	\$55.00
793F089	12 V 1.2 A/Hr. Gel Cell Battery	\$59.00
793F199	Battery, Alkaline (AA) (single battery)	\$3.00
793F029	Ribbon Cable	\$31.00
712F089	New Enrollment Station	\$648.00
712F119	Forced/Propped Door Harness; when ordered separately	\$22.00
M861	Forced/Propped Door Function ordered with device	Add \$12
M35	Power/Remote Unlocking Harness; ordered with device	Add \$45.00
711F989	Power/Remote Unlocking Harness; when ordered separately	\$55.00

**Gaskets**

Part Number	Description	Price
794F509	Exit device - Keypad	\$10.00
794F519	Exit device trim	\$10.00
794F529	Cylindrical lock	\$12.00
794F539	Mortise lock	\$12.00

**Accessories**

Part Number	Description	Price
790F109	Data Transfer Device (DTD)	\$714.00

Notes: 1. Data Transfer Device (DTD) package includes: Handheld DTD, SoloPlus software CD, USB cable, four (4) AA batteries, instructions and a lanyard.





Look for the  *MicroShield* icon.

**MicroShield®**

As part of their promise to provide innovative solutions to their customers, certain ASSA ABLOY Group brands offer the MicroShield® technology, a silver-based antimicrobial coating designed to inhibit the growth of bacteria.

MicroShield® is a registered trademark of Yale Security Inc., an ASSA ABLOY Group company.

Product	Series	MicroShield® Coated Components
Mortise Locks	ML2000 Series	Knobs/Levers, roses and/or escutcheons

**AVAILABLE FINISHES**

- MicroShield® is available on 626 and 630. Other finishes available by Special Product Application Request Form only.
- Specify 626C (satin chrome plated) or 630C (satin stainless steel) when ordering.
- MicroShield® coating will be applied over 626 and 630 finishes. All components will match 626.

*Note: MicroShield® coating will only be applied to "high touch" components.*

**HOW TO ORDER**

Product	How to Order
Mortise Locks	ML2055 x LWA x 626C x RHR

**PRICING - Discount is 50% off list only**

Description	Add
Mortise Locks	Add \$40.00

**Standard Features**

**Handing**

Field reversible

**Door Thickness**

1-3/4"

**Backset**

2-3/4"

**Warranty**

10 Years

**Strike**

ANSI straight lip  
4-7/8" x 1-1/4" x 1-1/8" lip to center

**Cylinder**

Brass, 6-pin, L4 keyway, 0-bitted

**Keys**

Two nickel silver keys

**Case Quantity**

6

**Case Weight**

Variable

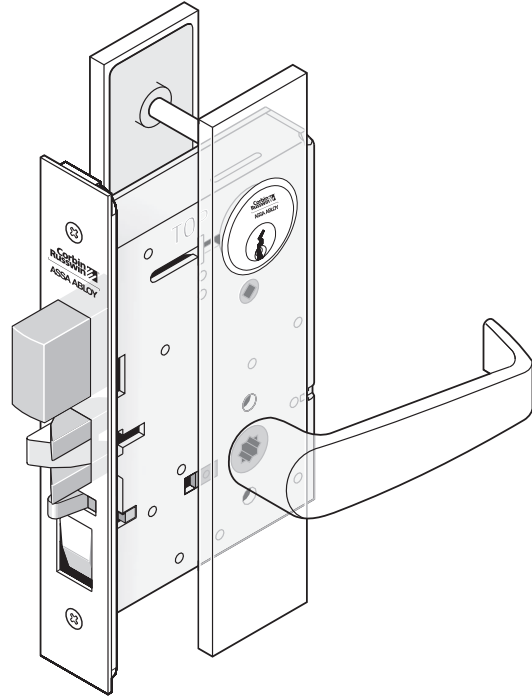

**Ordering Example**

**Stock Order**

Quantity	Series/Function	Trim	Finish	Hand
100	ML2055	LSB	626	RHR

**Split Trim/Split Finish**

Quantity	Series/Function	Trim		Finish		Hand
		Outside	Inside	Outside	Inside	
12	ML2055	LSB	GRC	626	625	RHR

Split trim is not available mixing escutcheon with sectional trim or with a different escutcheon

**Contract/Detailed Order**

Quantity	Keyset	Series/Function	Trim	Finish	Hand	Strike	Misc. Options	Cylinder and Keying
24	AA1	ML2055	LSB	626	RHR	SA200	M17-M26	C7-VKC3

**Working Trim Only**

Quantity	Function only	Trim	Finish	Hand	Door Thickness	Misc. Options
6	ML2055	LWA	626	RHR	D214	M31

(includes grip and spindle, rose or escutcheon, thumbturn, adapters and screws)

**High Security Monitoring Option Order**

Quantity	Series/Function	Technology Code	Trim	Finish	Hand	Fail Safe/ Fail Secure	High Security Monitoring Options
24	ML20608	NAC	ASA	626	RHR	SEC	PHRR01



**LWA RWA**  
Lever: Wrought  
Rose: Wrought

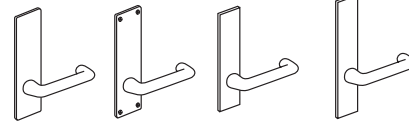

**LWM LWN LWP LWR**  
Lever: Wrought  
Escutcheon: Wrought

Lever: Wrought  
Escutcheon: Solid Stainless Steel  
or Forged Brass

<b>Levers: LW, RW</b>	
<b>Roses: A</b>	
Roses: B, F (see note 1)	
<b>613E, 630</b>	<b>605, 606, 611, 612, 613, 618, 619, 625, 626, 629, 722</b>

<b>Levers: LW, RW</b>	
<b>Escutcheons: M, N, P</b>	
<b>613E, 626</b>	<b>605, 606, 611, 612, 613, 618, 619, 625, 629, 630, 722</b>

<b>Levers: LW, RW</b>	
<b>Escutcheons: R (see note 2)</b>	
<b>613E, 626</b>	<b>605, 606, 611, 612, 613, 618, 619, 625, 629, 630, 722</b>

Function	Model	Description	Price 1	Price 2	Price 3	Price 4	Price 5	Price 6
Non-Keyed	ML2010	Passage	\$535.00	\$559.00	\$555.00	\$579.00	\$609.00	\$633.00
	ML2020	Privacy	\$654.00	\$678.00	\$674.00	\$698.00	\$728.00	\$752.00
	ML2030	Privacy						
	ML2060	Privacy	\$591.00	\$615.00	\$611.00	\$635.00	\$665.00	\$689.00
	ML2050	Half Dummy	\$255.00	\$267.00	\$265.00	\$289.00	\$292.00	\$316.00
	ML2070	Full Dummy	\$510.00	\$534.00	\$530.00	\$554.00	\$584.00	\$608.00
	ML2080	Half Active Dummy Trim	\$293.00	\$305.00	\$313.00	\$337.00	\$367.00	\$391.00
	ML2090	Full Active Dummy Trim	\$548.00	\$572.00	\$568.00	\$592.00	\$622.00	\$646.00
Single Cylinder	ML2003	Classroom	\$665.00	\$689.00	\$685.00	\$709.00	\$739.00	\$763.00
	ML2051	Office						
	ML2055	Classroom						
	ML2056	Classroom						
	ML2057	Storeroom						
	ML2069	Institution Privacy						
ML2053	Entrance	\$678.00	\$702.00	\$698.00	\$722.00	\$752.00	\$776.00	
ML2054	Entrance							
ML2058	Entrance Holdback							
ML2068	Privacy or Apartment							
Single Cylinder with Deadbolt	ML2024	Entrance	\$701.00	\$725.00	\$721.00	\$745.00	\$775.00	\$799.00
	ML2048	Entrance						
	ML2065	Dormitory						
	ML2059	Security Storeroom						
	ML2067	Apartment						
	ML2073	Classroom Security						
	ML2075	Entrance/Office						
	ML2029	Hotel	\$756.00	\$780.00	\$776.00	\$800.00	\$830.00	\$854.00
Double Cylinder	ML2002	Classroom Intruder	\$741.00	\$765.00	\$761.00	\$785.00	\$815.00	\$839.00
	ML2032	Institution						
	ML2042	Entrance						
	ML2052	Classroom Intruder						
Double Cylinder with Deadbolt	ML2022	Store Door	\$777.00	\$801.00	\$797.00	\$821.00	\$851.00	\$875.00
	ML2062	Intruder Deadbolt						
	ML2072	Classroom Security						
	ML2082	Intruder						
	ML2092	Dormitory Security Institution						
Full Working Trim (Quick Code M31) No cylinder; includes thumbturn lever			\$438.00	\$462.00	\$458.00	\$482.00	\$512.00	\$536.00

NOTE:  
 1 - Rose substitutions for LWA, RWA: 2-1/4" cast rose in place of 2-1/4" wrought rose, substitute letter "B" in place of "A" (e.g. LWB). **Add \$38.00 per lockset.** 2-7/8" cast rose in place of 2-1/4" wrought rose, substitute letter "F" in place of "A" (e.g. RWF). **Add \$52.00 per lockset.**  
 2 - "R" Escutcheon trims are available for 1 3/8", 1 3/4", 2", or 2 1/4" door thickness only.

**LSA**

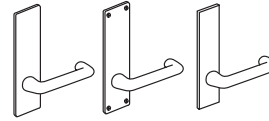
 Lever: Cast  
Rose: Wrought

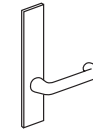
**LSM LSN LSP**

 Lever: Cast  
Escutcheon: Wrought

**LSR**

 Lever: Cast  
Escutcheon: Solid Stainless Steel  
or Forged Brass

<b>Levers: LS</b>	
<b>Roses: A</b>	
Roses: B, F (see note 1)	
<b>613E, 626</b>	<b>605, 606, 611, 612, 613, 618, 619, 625, 629, 630, 722</b>

<b>Levers: LS</b>	
<b>Escutcheons: M, N, P</b>	
<b>613E, 626</b>	<b>605, 606, 611, 612, 613, 618, 619, 625, 629, 630, 722</b>

<b>Levers: LS</b>	
<b>Escutcheons: R (see note 2)</b>	
<b>613E, 626</b>	<b>605, 606, 611, 612, 613, 618, 619, 625, 629, 630, 722</b>

**Function**

Non-Keyed	ML2010	Passage	\$551.00	\$664.00	\$677.00	\$701.00	\$711.00	\$735.00
	ML2020	Privacy	\$667.00	\$780.00	\$793.00	\$817.00	\$827.00	\$851.00
	ML2030	Privacy						
	ML2060	Privacy	\$626.00	\$739.00	\$752.00	\$776.00	\$786.00	\$810.00
	ML2050	Half Dummy	\$217.00	\$274.00	\$318.00	\$342.00	\$335.00	\$359.00
	ML2070	Full Dummy	\$434.00	\$547.00	\$636.00	\$660.00	\$670.00	\$694.00
	ML2080	Half Active Dummy Trim	\$373.00	\$430.00	\$398.00	\$422.00	\$442.00	\$466.00
	ML2090	Full Active Dummy Trim	\$590.00	\$703.00	\$716.00	\$740.00	\$750.00	\$774.00
Single Cylinder	ML2003	Classroom	\$707.00	\$820.00	\$833.00	\$857.00	\$867.00	\$891.00
	ML2051	Office						
	ML2055	Classroom						
	ML2056	Classroom						
	ML2057	Storeroom						
	ML2069	Institution Privacy						
ML2053	Entrance	\$720.00	\$833.00	\$846.00	\$870.00	\$880.00	\$904.00	
ML2054	Entrance							
ML2058	Entrance Holdback							
ML2068	Privacy or Apartment							
Single Cylinder with Deadbolt	ML2024	Entrance	\$743.00	\$856.00	\$869.00	\$893.00	\$903.00	\$927.00
	ML2048	Entrance						
	ML2065	Dormitory						
	ML2059	Security Storeroom						
	ML2067	Apartment						
	ML2073	Classroom Security						
	ML2075	Entrance/Office						
ML2029	Hotel	\$798.00	\$911.00	\$924.00	\$948.00	\$958.00	\$982.00	
Double Cylinder	ML2002	Classroom Intruder	\$783.00	\$896.00	\$909.00	\$933.00	\$943.00	\$967.00
	ML2032	Institution						
	ML2042	Entrance						
Double Cylinder with Deadbolt	ML2022	Store Door	\$819.00	\$932.00	\$945.00	\$969.00	\$979.00	\$1,003.00
	ML2062	Intruder Deadbolt						
	ML2072	Classroom Security Intruder						
	ML2082	Dormitory						
	ML2092	Security Institution						
Full Working Trim (Quick Code M31) No cylinder; includes thumbturn lever			\$450.00	\$563.00	\$654.00	\$678.00	\$688.00	\$712.00

**NOTE:**

 1 - Rose substitutions for LSA: 2-1/4" cast rose in place of 2-1/4" wrought rose, substitute letter "B" in place of "A" (e.g. LSB). **Add \$38.00 per lockset.**  
 2-7/8" cast rose in place of 2-1/4" wrought rose, substitute letter "F" in place of "A" (e.g. LSF). **Add \$52.00 per lockset.**

2 - "R" Escutcheon trims are available for 1 3/8", 1 3/4", or 2 1/4" door thickness only

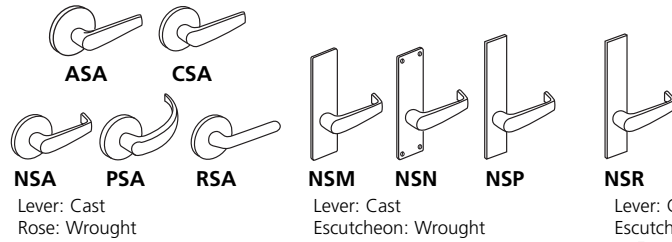

<b>Lever: AS, CS, NS PS, RS</b> <b>Roses: A</b> <b>Roses: B, F (see note 1)</b>		<b>Lever: AS, CS, NS, PS, RS</b> <b>Escutcheons: M, N, P</b>		<b>Lever: AS, CS, NS, PS, RS</b> <b>Escutcheons: R (see note 2)</b>	
<b>613E, 626</b>	<b>605, 606, 611, 612, 613, 618, 619, 625, 629, 630, 722</b>	<b>613E, 626</b>	<b>605, 606, 611, 612, 613, 618, 619, 625, 629, 630, 722</b>	<b>613E, 626</b>	<b>605, 606, 611, 612, 613, 618, 619, 625, 629, 630, 722</b>

Function	Model	Description	Price 1	Price 2	Price 3	Price 4	Price 5	Price 6
Non-Keyed	ML2010	Passage	\$657.00	\$681.00	\$677.00	\$701.00	\$711.00	\$735.00
	ML2020	Privacy						
	ML2030	Privacy	\$773.00	\$797.00	\$793.00	\$817.00	\$827.00	\$851.00
	ML2060	Privacy	\$732.00	\$756.00	\$752.00	\$776.00	\$786.00	\$810.00
	ML2050	Half Dummy	\$308.00	\$320.00	\$318.00	\$342.00	\$335.00	\$359.00
	ML2070	Full Dummy	\$616.00	\$640.00	\$636.00	\$660.00	\$670.00	\$694.00
	ML2080	Half Active Dummy Trim	\$388.00	\$400.00	\$398.00	\$422.00	\$442.00	\$466.00
	ML2090	Full Active Dummy Trim	\$696.00	\$720.00	\$716.00	\$740.00	\$750.00	\$774.00
Single Cylinder	ML2003	Classroom						
	ML2051	Office						
	ML2055	Classroom	\$813.00	\$837.00	\$833.00	\$857.00	\$867.00	\$891.00
	ML2056	Classroom						
	ML2057	Storeroom						
	ML2069	Institution Privacy						
	ML2053	Entrance						
	ML2054	Entrance	\$826.00	\$850.00	\$846.00	\$870.00	\$880.00	\$904.00
	ML2058	Entrance Holdback						
	ML2068	Privacy or Apartment						
Single Cylinder with Deadbolt	ML2024	Entrance						
	ML2048	Entrance						
	ML2065	Dormitory						
	ML2059	Security Storeroom	\$849.00	\$873.00	\$869.00	\$893.00	\$903.00	\$927.00
	ML2067	Apartment						
	ML2073	Classroom Security						
	ML2075	Entrance/Office						
	ML2029	Hotel	\$904.00	\$928.00	\$924.00	\$948.00	\$958.00	\$982.00
Double Cylinder	ML2002	Classroom Intruder						
	ML2032	Institution	\$889.00	\$913.00	\$909.00	\$933.00	\$943.00	\$967.00
	ML2042	Entrance						
	ML2052	Classroom Intruder						
Double Cylinder with Deadbolt	ML2022	Store Door						
	ML2062	Intruder Deadbolt						
	ML2072	Classroom Security	\$925.00	\$949.00	\$945.00	\$969.00	\$979.00	\$1,003.00
	ML2082	Intruder						
	ML2092	Dormitory Security Institution						
Full Working Trim (Quick Code M31) No cylinder; includes thumbturn lever			\$634.00	\$658.00	\$654.00	\$678.00	\$688.00	\$712.00

**NOTE:**

1 - Rose substitutions for ASA, CSA, etc.: 2-1/4" cast rose in place of 2-1/4" wrought rose, substitute letter "B" in place of "A" (e.g. NSB). **Add \$38.00 per lockset.** 2-7/8" cast rose in place of 2-1/4" wrought rose, substitute letter "F" in place of "A" (e.g. NSF). **Add \$52.00 per lockset.**

2 - "R" Escutcheon trims are available for 1 3/8", 1 3/4", or 2 1/4" door thickness only



**DSA ESA**  
Lever: Cast  
Rose: Wrought

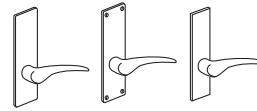

**DSM DSN DSP**  
Lever: Cast  
Escutcheon: Wrought

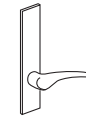

**DSR**  
Lever: Cast  
Escutcheon: Solid Stainless Steel  
or Forged Brass

<b>Levers: DS, ES</b>	
<b>Roses: A</b>	
<b>Roses: B, F (see note 1)</b>	
<b>613E, 626</b>	<b>605, 606, 611, 612, 613, 618, 619, 625, 629, 630, 722</b>

<b>Levers: DS, ES</b>	
<b>Escutcheons: M, N, P</b>	
<b>613E, 626</b>	<b>605, 606, 611, 612, 613, 618, 619, 625, 629, 630, 722</b>

<b>Levers: DS, ES</b>	
<b>Escutcheons: R (see note 2)</b>	
<b>613E, 626</b>	<b>605, 606, 611, 612, 613, 618, 619, 625, 629, 630, 722</b>

Function			613E, 626		605, 606, 611, 612, 613, 618, 619, 625, 629, 630, 722		613E, 626		605, 606, 611, 612, 613, 618, 619, 625, 629, 630, 722	
Non-Keyed	ML2010	Passage	\$680.00	\$704.00	\$700.00	\$724.00	\$734.00	\$758.00		
	ML2020	Privacy	\$796.00	\$820.00	\$816.00	\$840.00	\$850.00	\$874.00		
	ML2030	Privacy								
	ML2060	Privacy	\$755.00	\$779.00	\$775.00	\$799.00	\$809.00	\$833.00		
	ML2050	Half Dummy	\$331.00	\$355.00	\$341.00	\$365.00	\$358.00	\$382.00		
	ML2070	Full Dummy	\$662.00	\$686.00	\$682.00	\$706.00	\$716.00	\$740.00		
	ML2080	Half Active Dummy Trim	\$388.00	\$412.00	\$398.00	\$422.00	\$415.00	\$439.00		
	ML2090	Full Active Dummy Trim	\$719.00	\$743.00	\$739.00	\$763.00	\$773.00	\$797.00		
Single Cylinder	ML2003	Classroom								
	ML2051	Office								
	ML2055	Classroom	\$836.00	\$860.00	\$856.00	\$880.00	\$890.00	\$914.00		
	ML2056	Classroom								
	ML2057	Storeroom								
	ML2069	Institution Privacy								
	ML2053	Entrance								
	ML2054	Entrance	\$849.00	\$873.00	\$869.00	\$893.00	\$903.00	\$927.00		
ML2058	Entrance Holdback									
ML2068	Privacy or Apartment									
Single Cylinder with Deadbolt	ML2024	Entrance								
	ML2048	Entrance								
	ML2065	Dormitory	\$872.00	\$896.00	\$892.00	\$916.00	\$926.00	\$950.00		
	ML2059	Security Storeroom								
	ML2067	Apartment								
	ML2073	Classroom Security								
	ML2075	Entrance/Office								
ML2029	Hotel	\$927.00	\$951.00	\$947.00	\$971.00	\$981.00	\$1,005.00			
Double Cylinder	ML2002	Classroom Intruder								
	ML2032	Institution	\$912.00	\$936.00	\$932.00	\$956.00	\$966.00	\$990.00		
	ML2042	Entrance								
	ML2052	Classroom Intruder								
Double Cylinder with Deadbolt	ML2022	Store Door								
	ML2062	Intruder Deadbolt								
	ML2072	Classroom Security Intruder	\$948.00	\$972.00	\$968.00	\$992.00	\$1,002.00	\$1,026.00		
	ML2082	Dormitory								
ML2092	Security Institution									
Full Working Trim (Quick Code M31) No cylinder; includes thumbturn lever			\$644.00	\$668.00	\$664.00	\$688.00	\$698.00	\$722.00		

**NOTE:**

1 - Rose substitutions for DSA, ESA: 2-1/4" cast rose in place of 2-1/4" wrought rose, substitute letter "B" in place of "A" (e.g. DSB). **Add \$38.00 per lockset.**  
 2-7/8" cast rose in place of 2-1/4" wrought rose, substitute letter "F" in place of "A" (e.g. ESF). **Add \$52.00 per lockset.**

2 - "R" Escutcheon trims are available for 1 3/8", 1 3/4", or 2 1/4" door thickness only



**GRC**

**GRD**

**GRE**



**BRC**

**BRD**

**BRE**

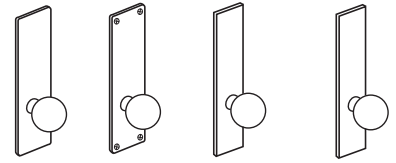

**GRM**

**GRN**

**GRP**

**GRR**

Knob: Wrought Reinforced  
Rose: Wrought

Knob: Wrought Reinforced  
Escutcheon: Wrought

Knob: Wrought Reinforced  
Escutcheon: Solid Stainless  
Steel or Forged Brass

Knobs: GR, BR Roses: C, D, E	
613E, 626	605, 606, 611, 612, 613, 618, 619, 625, 629, 630, 722

Knobs: GR, BR Escutcheons: M, N, P	
613E, 626	605, 606, 611, 612, 613, 618, 619, 625, 629, 630, 722

Knobs: GR, BR Escutcheons: R (see note 1)	
613E, 626	605, 606, 611, 612, 613, 618, 619, 625, 629, 630, 722

Function	Model	Description	613E, 626	605, 606, 611, 612, 613, 618, 619, 625, 629, 630, 722	613E, 626	605, 606, 611, 612, 613, 618, 619, 625, 629, 630, 722	613E, 626	605, 606, 611, 612, 613, 618, 619, 625, 629, 630, 722
Non-Keyed	ML2010	Passage	\$722.00	\$746.00	\$742.00	\$766.00	\$776.00	\$800.00
	ML2020	Privacy	\$802.00	\$826.00	\$822.00	\$846.00	\$856.00	\$880.00
	ML2030	Privacy						
	ML2060	Privacy	\$778.00	\$802.00	\$798.00	\$822.00	\$832.00	\$856.00
	ML2050	Half Dummy	\$337.00	\$361.00	\$347.00	\$359.00	\$364.00	\$376.00
	ML2070	Full Dummy	\$674.00	\$698.00	\$694.00	\$718.00	\$728.00	\$752.00
	ML2080	Half Active Dummy Trim	\$388.00	\$412.00	\$398.00	\$422.00	\$415.00	\$427.00
	ML2090	Full Active Dummy Trim	\$725.00	\$749.00	\$745.00	\$769.00	\$779.00	\$803.00
Single Cylinder	ML2003	Classroom	\$842.00	\$866.00	\$862.00	\$886.00	\$896.00	\$920.00
	ML2051	Office						
	ML2055	Classroom						
	ML2056	Classroom						
	ML2057	Storeroom						
	ML2069	Institution Privacy						
	ML2053	Entrance	\$855.00	\$879.00	\$875.00	\$899.00	\$909.00	\$933.00
	ML2054	Entrance						
	ML2058	Entrance Holdback						
ML2068	Privacy or Apartment							
Single Cylinder with Deadbolt	ML2024	Entrance	\$878.00	\$902.00	\$898.00	\$922.00	\$932.00	\$956.00
	ML2048	Entrance						
	ML2065	Dormitory						
	ML2059	Security Storeroom						
	ML2067	Apartment						
	ML2073	Classroom Security						
	ML2075	Entrance/Office						
	ML2029	Hotel	\$933.00	\$957.00	\$953.00	\$977.00	\$987.00	\$1,011.00
Double Cylinder	ML2002	Classroom Intruder	\$918.00	\$942.00	\$938.00	\$962.00	\$972.00	\$996.00
	ML2032	Institution						
	ML2042	Entrance						
	ML2052	Classroom Intruder						
Double Cylinder with Deadbolt	ML2022	Store Door	\$918.00	\$942.00	\$938.00	\$962.00	\$972.00	\$996.00
	ML2062	Intruder Deadbolt						
	ML2072	Classroom Security Intruder						
	ML2082	Dormitory						
	ML2092	Security Institution						
Full Working Trim (Quick Code M31) No cylinder; includes thumb-turn lever			\$692.00	\$716.00	\$712.00	\$736.00	\$746.00	\$770.00

NOTE 1:

"R" Escutcheon trims are available for 1 3/8", 1 3/4", or 2 1/4" door thickness only

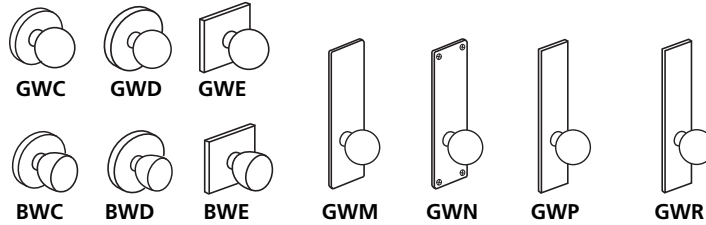

Knob: Wrought  
Rose: Wrought

Knob: Wrought  
Escutcheon: Wrought

Knob: Wrought  
Escutcheon: Solid Stainless Steel or Forged Brass

Knobs: GW, BW Roses: C, D, E		Knobs: GW, BW Escutcheons: M, N, P		Knobs: GW, BW Escutcheons: R (see note 1)	
613E, 626	605, 606, 611, 612, 613, 618, 619, 625, 722	613E, 626	605, 606, 611, 612, 613, 618, 619, 625, 722	613E, 626	605, 606, 611, 612, 613, 618, 619, 625, 722

Function			Knobs: GW, BW Roses: C, D, E		Knobs: GW, BW Escutcheons: M, N, P		Knobs: GW, BW Escutcheons: R (see note 1)	
Non-Keyed	ML2010	Passage	\$669.00	\$693.00	\$689.00	\$713.00	\$732.00	\$756.00
	ML2020	Privacy	\$749.00	\$773.00	\$769.00	\$793.00	\$803.00	\$827.00
	ML2030	Privacy						
	ML2060	Privacy	\$725.00	\$749.00	\$745.00	\$769.00	\$758.00	\$782.00
	ML2050	Half Dummy	\$284.00	\$296.00	\$294.00	\$306.00	\$311.00	\$323.00
	ML2070	Full Dummy	\$568.00	\$592.00	\$588.00	\$612.00	\$622.00	\$646.00
	ML2080	Half Active Dummy Trim	\$388.00	\$400.00	\$398.00	\$410.00	\$415.00	\$427.00
	ML2090	Full Active Dummy Trim	\$672.00	\$696.00	\$692.00	\$716.00	\$726.00	\$750.00
Single Cylinder	ML2003	Classroom	\$789.00	\$813.00	\$809.00	\$833.00	\$843.00	\$867.00
	ML2051	Office						
	ML2055	Classroom						
	ML2056	Classroom						
	ML2057	Storeroom	\$802.00	\$826.00	\$822.00	\$846.00	\$856.00	\$880.00
	ML2069	Institution Privacy						
	ML2053	Entrance						
	ML2054	Entrance						
ML2058	Entrance Holdback	\$825.00	\$849.00	\$845.00	\$869.00	\$879.00	\$903.00	
ML2068	Privacy or Apartment							
Single Cylinder with Deadbolt	ML2024	Entrance	\$880.00	\$904.00	\$900.00	\$924.00	\$939.00	\$963.00
	ML2048	Entrance						
	ML2065	Dormitory						
	ML2059	Security Storeroom						
	ML2067	Apartment						
	ML2073	Classroom Security						
	ML2075	Entrance/Office						
ML2029	Hotel	\$901.00	\$925.00	\$921.00	\$945.00	\$955.00	\$979.00	
Double Cylinder	ML2002							Classroom Intruder
	ML2032							Institution
	ML2042							Entrance
ML2052	Classroom Intruder	\$550.00	\$574.00	\$570.00	\$594.00	\$604.00	\$628.00	
Double Cylinder with Deadbolt	ML2022							Store Door
	ML2062							Intruder Deadbolt
	ML2072							Classroom Security Intruder
	ML2082							Dormitory
ML2092	Security Institution							
Full Working Trim (Quick Code M31) No cylinder; includes thumb-turn lever			\$550.00	\$574.00	\$570.00	\$594.00	\$604.00	\$628.00

Note: 1  
"R" Escutcheon trims are available for 1 3/8", 1 3/4", or 2 1/4" door thickness only.





**YWA**

Knob: Wrought  
Rose: Wrought



**YWM**

Knob: Wrought  
Escutcheon: Wrought



**YWN**



**YWP**

Knob: Wrought  
Escutcheon: Solid Stainless  
Steel or Forged Brass



**YWR**

<b>Knobs: YW</b>	
<b>Roses: A</b>	
Roses: B, F (see note 1)	
613E, 626	605, 606, 611, 612, 613, 618, 619, 625, 629, 630, 722

<b>Knobs: YW</b>	
<b>Escutcheons: M, N, P</b>	
613E, 626	605, 606, 611, 612, 613, 618, 619, 625, 629, 630, 722

<b>Knobs: YW</b>	
<b>Escutcheons: R</b>	
(see note 2)	
613E, 626	605, 606, 611, 612, 613, 618, 619, 625, 629, 630, 722

Function									
Non-Keyed	ML2010	Passage	\$722.00	\$746.00	\$742.00	\$766.00	\$776.00	\$800.00	
	ML2020	Privacy							
	ML2030	Privacy	\$802.00	\$826.00	\$822.00	\$846.00	\$856.00	\$880.00	
	ML2060	Privacy	\$778.00	\$802.00	\$798.00	\$822.00	\$832.00	\$856.00	
	ML2050	Half Dummy	\$337.00	\$361.00	\$347.00	\$359.00	\$364.00	\$376.00	
	ML2070	Full Dummy	\$674.00	\$698.00	\$694.00	\$718.00	\$728.00	\$752.00	
	ML2080	Half Active Dummy Trim	\$388.00	\$412.00	\$398.00	\$422.00	\$415.00	\$427.00	
	ML2090	Full Active Dummy Trim	\$725.00	\$749.00	\$745.00	\$769.00	\$779.00	\$803.00	
Single Cylinder	ML2003	Classroom							
	ML2051	Office							
	ML2055	Classroom	\$842.00	\$866.00	\$862.00	\$886.00	\$896.00	\$920.00	
	ML2056	Classroom							
	ML2057	Storeroom							
	ML2069	Institution Privacy							
	ML2053	Entrance							
	ML2054	Entrance	\$855.00	\$879.00	\$875.00	\$899.00	\$909.00	\$933.00	
ML2058	Entrance Holdback								
ML2068	Privacy or Apartment								
Single Cylinder with Deadbolt	ML2024	Entrance							
	ML2048	Entrance							
	ML2065	Dormitory	\$878.00	\$902.00	\$898.00	\$922.00	\$932.00	\$956.00	
	ML2059	Security Storeroom							
	ML2067	Apartment							
	ML2073	Classroom Security							
	ML2075	Entrance/Office							
ML2029	Hotel	\$933.00	\$957.00	\$953.00	\$977.00	\$987.00	\$1,011.00		
Double Cylinder	ML2002	Classroom Intruder							
	ML2032	Institution	\$918.00	\$942.00	\$938.00	\$962.00	\$972.00	\$996.00	
	ML2042	Entrance							
	ML2052	Classroom Intruder							
ML2022	Store Door								
Double Cylinder with Deadbolt	ML2062	Intruder Deadbolt	\$918.00	\$942.00	\$938.00	\$962.00	\$972.00	\$996.00	
	ML2072	Classroom Security Intruder							
	ML2082	Dormitory							
	ML2092	Security Institution							
Full Working Trim (Quick Code M31) No cylinder; includes thumb-turn lever			\$692.00	\$716.00	\$712.00	\$736.00	\$746.00	\$770.00	

NOTES:

1 - Rose substitutions for YWA: 2-1/4" cast rose in place of 2-1/4" wrought rose, substitute letter "B" in place of "A" (e.g. YWB). **Add \$38.00 per lockset.**  
2-7/8" cast rose in place of 2-1/4" wrought rose, substitute letter "F" in place of "A" (e.g. YWF). **Add \$52.00 per lockset.**

2 - "R" Escutcheon trims are available for 1 3/8", 1 3/4", or 2 1/4" door thickness only



**GSA**

Knob: Cast  
Rose: Wrought



**GSM**

Knob: Cast  
Escutcheon: Wrought



**GSN**



**GSP**



**GSR**

Knob: Cast  
Escutcheon: Solid Stainless Steel or Forged Brass

<b>Knobs: GS</b>	
<b>Roses: A</b>	
Roses: B, F (see note 1)	
<b>613E, 626</b>	<b>605, 606, 611, 612, 613, 618, 619, 625, 629, 630, 722</b>

<b>Knobs: GS</b>	
<b>Escutcheons: M, N, P</b>	
<b>613E, 626</b>	<b>605, 606, 611, 612, 613, 618, 619, 625, 629, 630, 722</b>

<b>Knobs: GS</b>	
<b>Escutcheons: R</b>	
(see note 2)	
<b>613E, 626</b>	<b>605, 606, 611, 612, 613, 618, 619, 625, 629, 630, 722</b>

**Function**

Function	Model	Description	613E, 626	605, 606, 611, 612, 613, 618, 619, 625, 629, 630, 722	613E, 626	605, 606, 611, 612, 613, 618, 619, 625, 629, 630, 722	613E, 626	605, 606, 611, 612, 613, 618, 619, 625, 629, 630, 722
Non-Keyed	ML2010	Passage	\$835.00	\$859.00	\$855.00	\$879.00	\$889.00	\$913.00
	ML2020	Privacy	\$915.00	\$939.00	\$935.00	\$959.00	\$969.00	\$993.00
	ML2030	Privacy						
	ML2060	Privacy	\$891.00	\$915.00	\$911.00	\$935.00	\$945.00	\$969.00
	ML2050	Half Dummy	\$340.00	\$352.00	\$350.00	\$362.00	\$367.00	\$379.00
	ML2070	Full Dummy	\$680.00	\$704.00	\$700.00	\$724.00	\$734.00	\$758.00
	ML2080	Half Active Dummy Trim	\$498.00	\$510.00	\$508.00	\$532.00	\$525.00	\$537.00
	ML2090	Full Active Dummy Trim	\$838.00	\$862.00	\$858.00	\$882.00	\$892.00	\$916.00
Single Cylinder	ML2003	Classroom						
	ML2051	Office						
	ML2055	Classroom	\$955.00	\$979.00	\$975.00	\$999.00	\$1,009.00	\$1,033.00
	ML2056	Classroom						
	ML2057	Storeroom						
	ML2069	Institution Privacy						
	ML2053	Entrance						
	ML2054	Entrance	\$968.00	\$992.00	\$988.00	\$1,012.00	\$1,022.00	\$1,046.00
ML2058	Entrance Holdback							
ML2068	Privacy or Apartment							
Single Cylinder with Deadbolt	ML2024	Entrance						
	ML2048	Entrance						
	ML2065	Dormitory						
	ML2059	Security Storeroom	\$991.00	\$1,015.00	\$1,011.00	\$1,035.00	\$1,045.00	\$1,069.00
	ML2067	Apartment						
	ML2073	Classroom Security						
	ML2075	Entrance/Office						
ML2029	Hotel	\$1,046.00	\$1,070.00	\$1,066.00	\$1,090.00	\$1,100.00	\$1,124.00	
Double Cylinder	ML2002	Classroom Intruder						
	ML2032	Institution						
	ML2042	Entrance	\$1,031.00	\$1,055.00	\$1,051.00	\$1,075.00	\$1,085.00	\$1,109.00
	ML2052	Classroom Intruder						
Double Cylinder with Deadbolt	ML2022	Store Door						
	ML2062	Intruder Deadbolt						
	ML2072	Classroom Security Intruder	\$1,067.00	\$1,091.00	\$1,087.00	\$1,111.00	\$1,121.00	\$1,145.00
	ML2082	Dormitory						
	ML2092	Security Institution						
Full Working Trim (Quick Code M31) No cylinder; includes thumb-turn lever			\$712.00	\$736.00	\$732.00	\$756.00	\$766.00	\$790.00

**NOTES:**

1 - Rose substitutions for GSA: 2-1/4" cast rose in place of 2-1/4" wrought rose, substitute letter "B" in place of "A" (e.g.GSB). **Add \$38.00 per lockset.**

2-7/8" cast rose in place of 2-1/4" wrought rose, substitute letter "F" in place of "A" (e.g. GSF). **Add \$52.00 per lockset.**

2 - "R" Escutcheon trims are available for 1 3/8", 1 3/4", or 2 1/4" door thickness only

**Lever Designs: FSG, MSG, ZSG**



**Lever: Rose:**  
Cast Cast



FSG



MSG



ZSG

**Frascati**

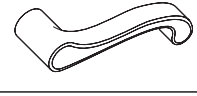

**Lever Designs: FSL, MSL<sup>1</sup>, ZSL**



**Lever: Escutcheon:**  
Cast Cast



FSL

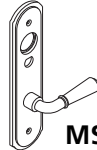

MSL



ZSL

**Zinfandel**



**Merlot**

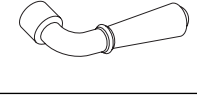

**Tuscany**



Function	Description		FSG, MSG, ZSG		FSL, MSL, ZSL	
			613E, 626	605, 606, 611, 612, 613 <sup>2</sup> , 613L <sup>2</sup> , 618, 619, 625, 722	613E, 626	605, 606, 611, 612, 613 <sup>2</sup> , 613L <sup>2</sup> , 618, 619, 625, 722
Non-Keyed	ML2010	Passage	\$680.00	\$704.00	\$734.00	\$758.00
	ML2020	Privacy	\$796.00	\$820.00	\$850.00	\$874.00
	ML2030	Privacy				
	ML2060	Privacy	\$755.00	\$779.00	\$809.00	\$833.00
	ML2050	Half Dummy	\$331.00	\$355.00	\$358.00	\$382.00
	ML2070	Full Dummy	\$662.00	\$686.00	\$716.00	\$740.00
	ML2080	Half Active Dummy Trim	\$388.00	\$412.00	\$415.00	\$439.00
	ML2090	Full Active Dummy Trim	\$719.00	\$743.00	\$773.00	\$797.00
Single Cylinder	ML2003	Classroom	\$836.00	\$860.00	\$890.00	\$914.00
	ML2051	Office				
	ML2055	Classroom				
	ML2056	Classroom Holdback				
	ML2057	Storeroom	\$849.00	\$873.00	\$903.00	\$927.00
	ML2069	Institution Privacy				
	ML2053	Entrance				
	ML2054	Entrance				
ML2058	Entrance Holdback	\$927.00	\$950.00			
ML2068	Privacy or Apartment					
Single Cylinder with Deadbolt	ML2024	Entrance	\$872.00	\$896.00	\$926.00	\$950.00
	ML2048	Entrance				
	ML2059	Security Storeroom				
	ML2065	Dormitory				
	ML2067	Apartment				
	ML2073	Classroom Security				
	ML2075	Entrance/Office				
ML2029	Hotel	\$927.00	\$951.00	\$981.00	\$1,005.00	
Double Cylinder	ML2002	Classroom Intruder	\$912.00	\$936.00	\$966.00	\$990.00
	ML2032	Institution				
	ML2042	Entrance				
	ML2052	Classroom Intruder				
Double Cylinder with Deadbolt	ML2022	Store Door	\$948.00	\$972.00	\$1,002.00	\$1,026.00
	ML2062	Intruder Deadbolt				
	ML2072	Classroom Security Intrude				
	ML2082	Dormitory				
	ML2092	Security Institution				
Full Working Trim (Quick Code M31) No cylinder; includes thumbturn lever			\$644.00	\$668.00	\$698.00	\$722.00



Notes:

- Escutcheon trims are available for 1-3/8", 1-3/4" or 2-1/4" door thicknesses only. \*Infini-T® is a technologically advanced finish produced by a coating process called Physical Vapor Deposition (PVD). Infini-T provides the ultimate surface protection against the elements and everyday wear and tear.
- 613 finish is brass base lever & rose/escutcheon

**Deadbolt Only**

Include lockcase, armored front, strike, screw pack, cylinder(s) and thumbturn lever.

**Ordering Example**

Quantity	Series/Function	Trim Design (Escutcheon Type Only)	Finish	Door Thickness
12	ML2013	N	626	D138

**Function**

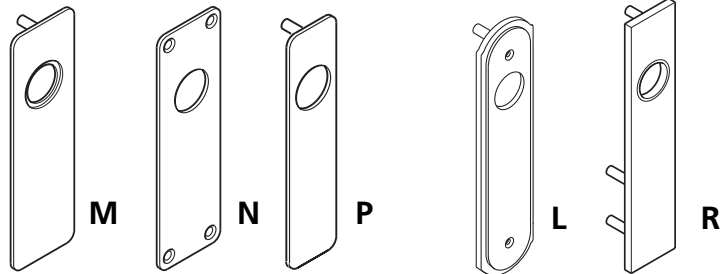

Deadlock No Trim

613E, 626	605, 606, 611, 612, 613, 618, 619, 625, 629, 630, 722
-----------	---

Wrought

M, N, P	
613E, 626	605, 606, 611, 612, 613, 618, 619, 625, 629, 630, 722

Solid Stainless Steel or Forged Brass

L, R	
613E, 626	605, 606, 611, 612, 613, 618, 619, 625, 629, 630, 722

**Function**

Single Cylinder	ML2011	\$330.00	\$336.00	\$386.00	\$392.00	\$458.00	\$464.00
Double Cylinder	ML2012	\$406.00	\$412.00	\$490.00	\$496.00	\$579.00	\$585.00
Cylinder x Thumbturn	ML2013	\$347.00	\$353.00	\$431.00	\$437.00	\$520.00	\$526.00
Classroom Function Cylinder x Thumbturn	ML2017	\$347.00	\$353.00	\$431.00	\$437.00	\$520.00	\$526.00

NOTE:  
Escutcheon trims are available for 1 3/8", 1 3/4", or 2 1/4" door thickness only

**Vandal Resistant Trim**

**Lever Designs: CSV, NSV**



**Citation**



**Newport**

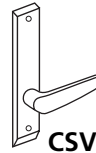
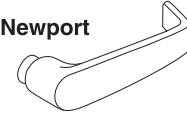

**CSV**

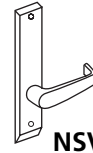

**NSV**

Lever: Cast  
Escutcheon: Cast

**CSV, NSV**

**630**

Function			
Non-Keyed	ML2010VR	Passage	\$1,124.00
	ML2020VR	Privacy	\$1,240.00
	ML2030VR	Privacy	\$1,199.00
	ML2060VR	Privacy	\$1,199.00
Single Cylinder	ML2051VR	Office	\$1,280.00
	ML2055VR	Classroom	
	ML2056VR	Classroom Holdback	
	ML2057VR	Storeroom	
	ML2069VR	Institution Privacy	\$1,293.00
	ML2053VR	Entrance	
	ML2054VR	Entrance	
ML2058VR	Entrance Holdback		
Single Cylinder with Deadbolt	ML2024VR	Entrance	\$1,316.00
	ML2048VR	Entrance	
	ML2059VR	Security Storeroom	
	ML2065VR	Dormitory	
	ML2067VR	Apartment	
	ML2073VR	Classroom Security	
	ML2075VR	Entrance/Office	
ML2029VR	Hotel	\$1,371.00	
Double Cylinder	ML2032VR	Institution	\$1,392.00
	ML2042VR	Entrance	
	ML2052VR	Classroom Intruder	
	ML2022VR	Store Door	
	ML2062VR	Intruder Deadbolt	
	ML2072VR	Classroom Security Intruder	
	ML2082VR	Dormitory	
ML2092VR	Security Institution		
Deadlock	ML2011VR	Single Cylinder	\$1,042.00
	ML2013VR	Cylinder x Thumbturn	
	ML2017VR	Double Cylinder	\$1,118.00
	ML2012VR	Double Cylinder	
Full Working Trim (Quick Code M31) No cylinder; includes thumbturn lever			\$980.00

NOTE:  
Escutcheon trims are available for 1 3/4", 2", or 2 1/4" door thickness only

**Electrically Controlled Mortise Locksets**

**ML20900 Series**



**LWA RWA**

Lever: Wrought  
Rose: Wrought

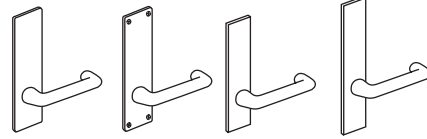

**LWM LWN LWP LWR**

Lever: Wrought  
Escutcheon: Wrought

Lever: Wrought  
Escutcheon: Solid Stainless Steel  
or Forged Brass

**Levers: LW, RW  
Roses: A  
Roses: B, F (see note 1)**

**Levers: LW, RW  
Escutcheons: M, N, P**

**Levers: LW, RW  
Escutcheons: R  
(see note 2)**

Description	Function	Option (See Note)	613E, 626		605, 606, 611, 612, 613, 618, 619, 625, 629, 630, 722		613E, 626		605, 606, 611, 612, 613, 618, 619, 625, 629, 630, 722		613E, 626		605, 606, 611, 612, 613, 618, 619, 625, 629, 630, 722	
			Single Cylinder	ML20914	Fail Safe/Fail Secure	\$883.00	\$907.00	\$903.00	\$927.00	\$957.00	\$981.00			
	ML20906													
No Cylinder Override	ML20907	Fail Safe/Fail Secure	\$807.00	\$831.00	\$827.00	\$851.00	\$881.00	\$905.00						
	ML20915													
Double Cylinder	ML20932	Fail Safe/Fail Secure	\$959.00	\$983.00	\$979.00	\$1,003.00	\$1,033.00	\$1,057.00						



**ASA CSA LSA**



**NSA PSA RSA**

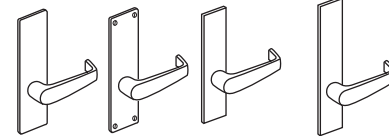

**NSM NSN NSP NSR**

Lever: Cast  
Rose: Wrought

Lever: Cast  
Escutcheon: Wrought

Lever: Cast  
Escutcheon: Solid Stainless Steel  
or Forged Brass

**Levers: AS, CS, LS, NS, PS, RS  
Roses: A  
Roses: B, F (see note 1)**

**Levers: AS, CS, LS, NS, PS, RS  
Escutcheons: M, N, P**

**Levers: AS, CS, LS, NS, PS, RS  
Escutcheons: R (see note 2)**

Description	Function	Option (See Note)	613E, 626		605, 606, 611, 612, 613, 618, 619, 625, 629, 630, 722		613E, 626		605, 606, 611, 612, 613, 618, 619, 625, 629, 630, 722		613E, 626		605, 606, 611, 612, 613, 618, 619, 625, 629, 630, 722	
			Single Cylinder	ML20914	Fail Safe/Fail Secure	\$1,031.00	\$1,055.00	\$1,051.00	\$1,075.00	\$1,085.00	\$1,109.00			
	ML20906													
No Cylinder Override	ML20907	Fail Safe/Fail Secure	\$955.00	\$979.00	\$975.00	\$999.00	\$1,009.00	\$1,033.00						
	ML20915													
Double Cylinder	ML20932	Fail Safe/Fail Secure	\$1,107.00	\$1,131.00	\$1,127.00	\$1,151.00	\$1,161.00	\$1,185.00						

**NOTES:**

1 - Rose substitutions for LWA, LSA, etc.: 2-1/4" cast rose in place of 2-1/4" wrought rose, substitute letter "B" in place of "A" (e.g. LSB). Add \$38.00 per lockset.

2-7/8" cast rose in place of 2-1/4" wrought rose, substitute letter "F" in place of "A" (e.g. LWF). Add \$52.00 per lockset.

2 - "R" Escutcheon trims are available for 1 3/8", 1 3/4" or 2 1/4" door thickness only.

Must Specify: SAF for Fail Safe or SEC for Fail Secure.



**ElectroLynx®**

As part of their promise to provide innovative, fast and effective high security solutions to their customers, certain ASSA ABLOY Group brands offer *ElectroLynx®*, a universal quick-connect system that simplifies the electrification of the door opening.

# Electrified Mortise Lock with High Security Monitoring ML20600 Series NAC



**LWA RWA**

Lever: Wrought  
Rose: Wrought

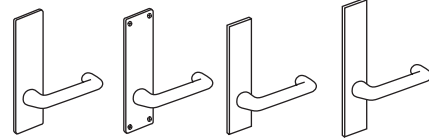

**LWM LWN LWP LWR**

Lever: Wrought  
Escutcheon: Wrought

Lever: Wrought  
Escutcheon: Solid Stainless Steel  
or Forged Brass

**Levers: LW, RW  
Roses: A  
Roses: B, F (see note 1)**

**Levers: LW, RW  
Escutcheons: M, N, P**

**Levers: LW, RW  
Escutcheons: R  
(see note 2)**

Description	Function	Option (See Note)	Levers: LW, RW Roses: A Roses: B, F (see note 1)		Levers: LW, RW Escutcheons: M, N, P		Levers: LW, RW Escutcheons: R (see note 2)	
			613E, 626	605, 606, 611, 612, 613, 618, 619, 625, 629, 630, 722	613E, 626	605, 606, 611, 612, 613, 618, 619, 625, 629, 630, 722	613E, 626	605, 606, 611, 612, 613, 618, 619, 625, 629, 630, 722
Single Cylinder	ML20606 x NAC	Fail Safe/Fail Secure	\$1,058.00	\$1,082.00	\$1,078.00	\$1,102.00	\$1,132.00	\$1,156.00
	ML20608 x NAC		\$1,133.00	\$1,157.00	\$1,153.00	\$1,177.00	\$1,207.00	\$1,231.00
No Cylinder Override	ML20607 x NAC	Fail Safe/Fail Secure	\$982.00	\$1,006.00	\$1,002.00	\$1,026.00	\$1,056.00	\$1,080.00
	ML20609 x NAC		\$1,057.00	\$1,081.00	\$1,077.00	\$1,101.00	\$1,131.00	\$1,155.00



**ASA CSA LSA**

Lever: Cast  
Rose: Wrought

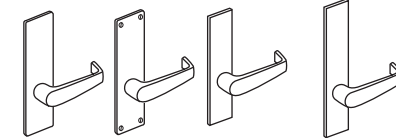

**NSM NSN NSP NSR**

Lever: Cast  
Escutcheon: Wrought

Lever: Cast  
Escutcheon: Solid Stainless Steel  
or Forged Brass

**Levers: AS, CS, LS, NS, PS, RS  
Roses: A  
Roses: B, F (see note 1)**

**Levers: AS, CS, LS, NS, PS, RS  
Escutcheons: M, N, P**

**Levers: AS, CS, LS, NS, PS, RS  
Escutcheons: R (see note 2)**

Description	Function	Option (See Note)	Levers: AS, CS, LS, NS, PS, RS Roses: A Roses: B, F (see note 1)		Levers: AS, CS, LS, NS, PS, RS Escutcheons: M, N, P		Levers: AS, CS, LS, NS, PS, RS Escutcheons: R (see note 2)	
			613E, 626	605, 606, 611, 612, 613, 618, 619, 625, 629, 630, 722	613E, 626	605, 606, 611, 612, 613, 618, 619, 625, 629, 630, 722	613E, 626	605, 606, 611, 612, 613, 618, 619, 625, 629, 630, 722
Single Cylinder	ML20606 x NAC	Fail Safe/Fail Secure	\$1,206.00	\$1,230.00	\$1,226.00	\$1,250.00	\$1,260.00	\$1,284.00
	ML20608 x NAC		\$1,281.00	\$1,305.00	\$1,301.00	\$1,325.00	\$1,335.00	\$1,359.00
No Cylinder Override	ML20607 x NAC	Fail Safe/Fail Secure	\$955.00	\$979.00	\$1,150.00	\$1,174.00	\$1,184.00	\$1,208.00
	ML20609 x NAC		\$1,030.00	\$1,054.00	\$1,225.00	\$1,249.00	\$1,259.00	\$1,283.00

**NOTES:**

1 - Rose substitutions for LWA, LSA, etc.: 2-1/4" cast rose in place of 2-1/4" wrought rose, substitute letter "B" in place of "A" (e.g. LSB). Add \$38.00 per lockset.

2-7/8" cast rose in place of 2-1/4" wrought rose, substitute letter "F" in place of "A" (e.g. LWF). Add \$52.00 per lockset.

2 - "R" Escutcheon trims are available for 1 3/8", 1 3/4" or 2 1/4" door thickness only.

Must Specify: SAF for Fail Safe or SEC for Fail Secure.



**ElectroLynx®**

As part of their promise to provide innovative, fast and effective high security solutions to their customers, certain ASSA ABLOY Group brands offer *ElectroLynx®*, a universal quick-connect system that simplifies the electrification of the door opening.



Lever: Cast  
Rose: Wrought

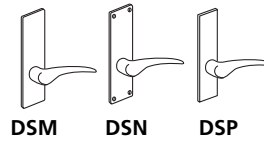

Lever: Cast  
Escutcheon: Wrought

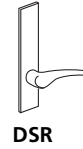

Lever: Cast  
Escutcheon: Solid Stainless Steel  
or Forged Brass

Lever: DS, ES  
Roses: A  
Roses: B, F (see note 1)

Lever: DS, ES  
Escutcheons: M, N, P

Lever: DS, ES  
Escutcheons: R (see note 2)

Description	Function	Option (See Note)	Lever: DS, ES Roses: A Roses: B, F (see note 1)		Lever: DS, ES Escutcheons: M, N, P		Lever: DS, ES Escutcheons: R (see note 2)	
			613E, 626	605, 606, 611, 612, 613, 618, 619, 625, 629, 630, 722	613E, 626	605, 606, 611, 612, 613, 618, 619, 625, 629, 630, 722	613E, 626	605, 606, 611, 612, 613, 618, 619, 625, 629, 630, 722
Single Cylinder	ML20914	Fail Safe/Fail Secure	\$1,054.00	\$1,078.00	\$1,074.00	\$1,098.00	\$1,108.00	\$1,132.00
	ML20906							
No Cylinder Override	ML20907	Fail Safe/Fail Secure	\$978.00	\$1,002.00	\$998.00	\$1,022.00	\$1,032.00	\$1,056.00
	ML20915							
Double Cylinder	ML20932	Fail Safe/Fail Secure	\$1,130.00	\$1,154.00	\$1,150.00	\$1,174.00	\$1,184.00	\$1,208.00

**NOTES:**

1 - Rose substitutions for DSA, ESA: 2-1/4" cast rose in place of 2-1/4" wrought rose, substitute letter "B" in place of "A" (e.g.DSB). **Add \$38.00 per lockset.**  
2-7/8" cast rose in place of 2-1/4" wrought rose, substitute letter "F" in place of "A" (e.g. ESF). **Add \$52.00 per lockset.**

2 - "R" Escutcheon trims are available for 1 3/8", 1 3/4", or 2 1/4" door thickness only.

Must Specify: SAF for Fail Safe or SEC for Fail Secure.

**Lever Designs: CSV, NSV**

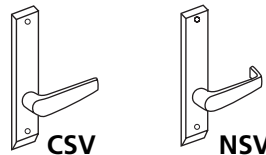

Lever: Cast  
Escutcheon: Cast

Description	Function	Option (See Note)	CSV, NSV	
			Finish: 630	
Single Cylinder	ML20914	Fail Safe/Fail Secure		
	ML20906		\$1,417.00	
No Cylinder Override	ML20907	Fail Safe/Fail Secure		
	ML20915		\$1,341.00	
Double Cylinder	ML20932	Fail Safe/Fail Secure	\$1,493.00	

**Note:**

Escutcheon trims are available for 1 3/8", 1 3/4", or 2 1/4" door thickness only.

Must Specify: SAF for Fail Safe or SEC for Fail Secure.



**ElectroLynx®**

As part of their promise to provide innovative, fast and effective high security solutions to their customers, certain ASSA ABLOY Group brands offer ElectroLynx®, a universal quick-connect system that simplifies the electrification of the door opening.



# Electrified Mortise Lock with High Security Monitoring ML20600 Series NAC



Lever: Cast  
Rose: Wrought

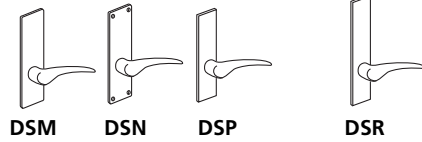

Lever: Cast  
Escutcheon: Wrought

Lever: Cast  
Escutcheon: Solid Stainless Steel  
or Forged Brass

Description	Function	Option (See Note)	Lever: DS, ES Roses: A Roses: B, F (see note 1)		Lever: DS, ES Escutcheons: M, N, P		Lever: DS, ES Escutcheons: R (see note 2)	
			613E, 626	605, 606, 611, 612, 613, 618, 619, 625, 629, 630, 722	613E, 626	605, 606, 611, 612, 613, 618, 619, 625, 629, 630, 722	613E, 626	605, 606, 611, 612, 613, 618, 619, 625, 629, 630, 722
Single Cylinder	ML20606 x NAC	Fail Safe/Fail Secure	\$1,229.00	\$1,253.00	\$1,249.00	\$1,273.00	\$1,283.00	\$1,307.00
	ML20608 x NAC		\$1,304.00	\$1,328.00	\$1,324.00	\$1,348.00	\$1,358.00	\$1,382.00
No Cylinder Override	ML20607 x NAC	Fail Safe/Fail Secure	\$1,153.00	\$1,177.00	\$1,173.00	\$1,197.00	\$1,207.00	\$1,231.00
	ML20609 x NAC		\$1,228.00	\$1,252.00	\$1,248.00	\$1,272.00	\$1,282.00	\$1,306.00

**NOTES:**

1 - Rose substitutions for DSA, ESA: 2-1/4" cast rose in place of 2-1/4" wrought rose, substitute letter "B" in place of "A" (e.g.DSB). **Add \$38.00 per lockset.**  
2-7/8" cast rose in place of 2-1/4" wrought rose, substitute letter "F" in place of "A" (e.g. ESF). **Add \$52.00 per lockset.**

2 - "R" Escutcheon trims are available for 1 3/8", 1 3/4", or 2 1/4" door thickness only.

Must Specify: SAF for Fail Safe or SEC for Fail Secure.

## Lever Designs: CSV, NSV

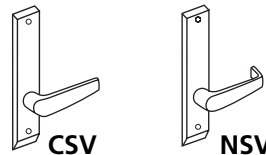

Lever: Cast  
Escutcheon: Cast

Description	Function	Option (See Note)	CSV, NSV	
			Finish: 630	
Single Cylinder	ML20606 x NAC	Fail Safe/Fail Secure	\$1,592.00	
	ML20608 x NAC		\$1,667.00	
No Cylinder Override	ML20607 x NAC	Fail Safe/Fail Secure	\$1,516.00	
	ML20609 x NAC		\$1,591.00	

**Note:**

Escutcheon trims are available for 1 3/8", 1 3/4", or 2 1/4" door thickness only.

Must Specify: SAF for Fail Safe or SEC for Fail Secure.



**ElectroLynx®**

As part of their promise to provide innovative, fast and effective high security solutions to their customers, certain ASSA ABLOY Group brands offer ElectroLynx®, a universal quick-connect system that simplifies the electrification of the door opening.

**Lever Designs: FSG, MSG, ZSG**



**Frascati**



**Lever: Rose:**  
Cast Cast



**FSG**



**MSG**



**ZSG**

Vineyard™  
collection

**Merlot**



**Lever Designs: FSL, MSL<sup>1</sup>, TSL, ZSL**



**Lever: Escutcheon:**  
Cast Cast



**FSL**

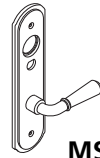

**MSL**

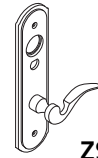

**ZSL**

Vineyard™  
collection

**Zinfandel**



**Tuscany**



Description	Function	Option (See Note)	FSG, MSG, ZSG		FSL, MSL, ZSL	
			Finish: 613E, 626	Finish: 605, 606, 611, 612, 613 <sup>2</sup> , 613L <sup>2</sup> , 618, 619, 625, 722	Finish: 613E, 626	Finish: 605, 606, 611, 612, 613 <sup>2</sup> , 613L <sup>2</sup> , 618, 619, 625, 722
Single Cylinder	ML20914	Fail Safe/Fail Secure	\$1,054.00	\$1,078.00	\$1,108.00	\$1,132.00
	ML20906					
No Cylinder Override	ML20907	Fail Safe/Fail Secure	\$978.00	\$1,002.00	\$1,032.00	\$1,056.00
	ML20915					
Double Cylinder	ML20932	Fail Safe/Fail Secure	\$1,130.00	\$1,154.00	\$1,184.00	\$1,208.00



Notes:

1. Escutcheon trims are available for 1-3/8", 1-3/4" or 2-1/4" door thicknesses only.

2. 613 finish is brass base lever & rose/escutcheon.

3. Infini-T® is a technologically advanced finish produced by a coating process called Physical Vapor Deposition (PVD). Infini-T provides the ultimate surface protection against the elements and everyday wear and tear.

Must Specify: SAF for Fail Safe or SEC for Fail Secure



**ElectroLynx®**

As part of their promise to provide innovative, fast and effective high security solutions to their customers, certain ASSA ABLOY Group brands offer *ElectroLynx®*, a universal quick-connect system that simplifies the electrification of the door opening.

**Lever Designs: FSG, MSG, ZSG** 

**Lever: Rose:**  
Cast Cast

Vineyard™ collection 

 **FSG**  **MSG**  **ZSG**

 **Frascati**

 **Merlot**

**Lever Designs: FSL, MSL<sup>1</sup>, TSL, ZSL** 

**Lever: Escutcheon:**  
Cast Cast

Vineyard™ collection 

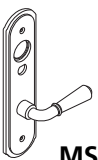
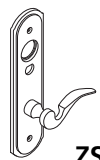
 **FSL**  **MSL**  **ZSL**

 **Zinfandel**

 **Tuscany**

Description	Function	Option (See Note)	FSG, MSG, ZSG		FSL, MSL, ZSL	
			Finish: 613E, 626	Finish: 605, 606, 611, 612, 613 <sup>2</sup> , 613L <sup>2</sup> , 618, 619, 625, 722	Finish: 613E, 626	Finish: 605, 606, 611, 612, 613 <sup>2</sup> , 613L <sup>2</sup> , 618, 619, 625, 722
Single Cylinder	ML20606 x NAC	Fail Safe/Fail Secure	\$1,229.00	\$1,253.00	\$1,249.00	\$1,273.00
	ML20608 x NAC		\$1,304.00	\$1,328.00	\$1,324.00	\$1,348.00
No Cylinder Override	ML20607 x NAC	Fail Safe/Fail Secure	\$1,153.00	\$1,177.00	\$1,173.00	\$1,197.00
	ML20609 x NAC		\$1,228.00	\$1,252.00	\$1,248.00	\$1,272.00



**Notes:**

1. Escutcheon trims are available for 1-3/8", 1-3/4" or 2-1/4" door thicknesses only.
  2. 613 finish is brass base lever & rose/escutcheon.
  3. Infini-T® is a technologically advanced finish produced by a coating process called Physical Vapor Deposition (PVD). Infini-T provides the ultimate surface protection against the elements and everyday wear and tear.
- Must Specify: SAF for Fail Safe or SEC for Fail Secure



**ElectroLynx®**

As part of their promise to provide innovative, fast and effective high security solutions to their customers, certain ASSA ABLOY Group brands offer *ElectroLynx®*, a universal quick-connect system that simplifies the electrification of the door opening.

**GRC GRD GRE**

**BRC BRD BRE**

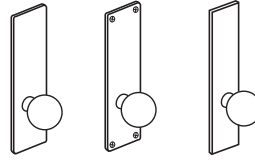
 Knob: Wrought Reinforced  
Rose: Wrought

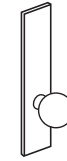
**GRM GRN GRP**

 Knob: Wrought Reinforced  
Escutcheon: Wrought

**GRR**

 Knob: Wrought Reinforced  
Escutcheon: Solid Stainless  
Steel or Forged Brass

Description	Function	Option (See Note)	Knobs: GR, BR Roses: C, D, E		Knobs: GR, BR Escutcheons: M, N, P		Knobs: GR, BR Escutcheons: R (see note)	
			613E, 626	605, 606, 611, 612, 613, 618, 619, 625, 629, 630, 722	613E, 626	605, 606, 611, 612, 613, 618, 619, 625, 629, 630, 722	613E, 626	605, 606, 611, 612, 613, 618, 619, 625, 629, 630, 722
Single Cylinder	ML20914	Fail Safe/ Fail Secure	\$1,060.00	\$1,084.00	\$1,080.00	\$1,104.00	\$1,114.00	\$1,138.00
	ML20906							
No Cylinder Override	ML20907	Fail Safe/ Fail Secure	\$984.00	\$1,008.00	\$1,004.00	\$1,028.00	\$1,038.00	\$1,062.00
	ML20915							
Double Cylinder	ML20932	Fail Safe/ Fail Secure	\$1,136.00	\$1,160.00	\$1,156.00	\$1,180.00	\$1,190.00	\$1,214.00

**GWC GWD GWE**

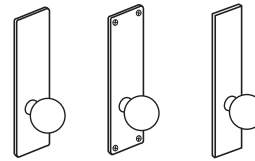
**BWC BWD BRE**

 Knob: Wrought  
Rose: Wrought

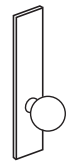
**GWM GWN GWP**

 Knob: Wrought  
Escutcheon: Wrought

**GWR**

 Knob: Wrought  
Escutcheon: Solid Stainless  
Steel or Forged Brass

Description	Function	Option (See Note)	Knobs: GW, BW Roses: C, D, E		Knobs: GW, BW Escutcheons: M, N, P		Knobs: GW, BW Escutcheons: R (see note)	
			613E, 626	605, 606, 611, 612, 613, 618, 619, 625, 722	613E, 626	605, 606, 611, 612, 613, 618, 619, 625, 722	613E, 626	605, 606, 611, 612, 613, 618, 619, 625, 722
Single Cylinder	ML20914	Fail Safe/ Fail Secure	\$1,007.00	\$1,031.00	\$1,027.00	\$1,051.00	\$1,061.00	\$1,085.00
	ML20906							
No Cylinder Override	ML20907	Fail Safe/ Fail Secure	\$931.00	\$955.00	\$951.00	\$975.00	\$985.00	\$1,009.00
	ML20915							
Double Cylinder	ML20932	Fail Safe/ Fail Secure	\$1,083.00	\$1,107.00	\$1,103.00	\$1,127.00	\$1,137.00	\$1,161.00

Note: "R" Escutcheon trims are available for 1 3/8", 1 3/4", or 2 1/4" door thickness only.  
Must Specify: SAF for Fail Safe or SEC for Fail Secure.



**ElectroLynx®**

 As part of their promise to provide innovative, fast and effective high security solutions to their customers, certain ASSA ABLOY Group brands offer *ElectroLynx®*, a universal quick-connect system that simplifies the electrification of the door opening.

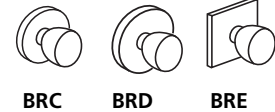
# Electrified Mortise Lock with High Security Monitoring ML20600 Series NAC

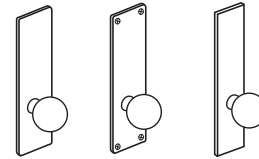

Knob: Wrought Reinforced  
Rose: Wrought



Knob: Wrought Reinforced  
Escutcheon: Wrought



Knob: Wrought Reinforced  
Escutcheon: Solid Stainless  
Steel or Forged Brass

**Knobs: GR, BR  
Roses: C, D, E**

**Knobs: GR, BR  
Escutcheons: M, N, P**

**Knobs: GR, BR  
Escutcheons: R (see note)**

Description	Function	Option (See Note)	613E, 626		605, 606, 611, 612, 613, 618, 619, 625, 629, 630, 722		613E, 626		605, 606, 611, 612, 613, 618, 619, 625, 629, 630, 722		613E, 626		605, 606, 611, 612, 613, 618, 619, 625, 629, 630, 722			
			Single Cylinder	ML20606 x NAC	Fail Safe/ Fail Secure	\$1,235.00	\$1,259.00	\$1,255.00	\$1,279.00	\$1,289.00	\$1,313.00	ML20608 x NAC	Fail Safe/ Fail Secure	\$1,310.00	\$1,334.00	\$1,330.00
No Cylinder Override	ML20607 x NAC	Fail Safe/ Fail Secure	\$1,159.00	\$1,183.00	\$1,179.00	\$1,203.00	\$1,213.00	\$1,237.00	ML20609 x NAC	Fail Safe/ Fail Secure	\$1,234.00	\$1,258.00	\$1,254.00	\$1,278.00	\$1,288.00	\$1,312.00

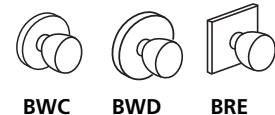

Knob: Wrought  
Rose: Wrought

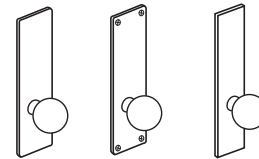

Knob: Wrought  
Escutcheon: Wrought



Knob: Wrought  
Escutcheon: Solid Stainless  
Steel or Forged Brass

**Knobs: GW, BW  
Roses: C, D, E**

**Knobs: GW, BW  
Escutcheons: M, N, P**

**Knobs: GW, BW  
Escutcheons: R (see note)**

Description	Function	Option (See Note)	613E, 626		605, 606, 611, 612, 613, 618, 619, 625, 722		613E, 626		605, 606, 611, 612, 613, 618, 619, 625, 722		613E, 626		605, 606, 611, 612, 613, 618, 619, 625, 722			
			Single Cylinder	ML20606 x NAC	Fail Safe/ Fail Secure	\$1,182.00	\$1,206.00	\$1,202.00	\$1,226.00	\$1,236.00	\$1,260.00	ML20608 x NAC	Fail Safe/ Fail Secure	\$1,257.00	\$1,281.00	\$1,277.00
No Cylinder Override	ML20607 x NAC	Fail Safe/ Fail Secure	\$1,106.00	\$1,130.00	\$1,126.00	\$1,150.00	\$1,160.00	\$1,184.00	ML20609 x NAC	Fail Safe/ Fail Secure	\$1,181.00	\$1,205.00	\$1,201.00	\$1,225.00	\$1,235.00	\$1,259.00

Note: "R" Escutcheon trims are available for 1 3/8", 1 3/4", or 2 1/4" door thickness only.  
Must Specify: SAF for Fail Safe or SEC for Fail Secure.



**ElectroLynx®**

As part of their promise to provide innovative, fast and effective high security solutions to their customers, certain ASSA ABLOY Group brands offer *ElectroLynx®*, a universal quick-connect system that simplifies the electrification of the door opening.

# Electrically Controlled Mortise Locksets

## ML20900 Series

**YWA**

 Knob: Wrought  
Rose: Wrought

**YMM**

**YWN**

**YWP**

**YWR**

 Knob: Wrought  
Escutcheon: Solid Stainless Steel or Forged Brass

<b>Knobs: YW</b>	
<b>Roses: A</b>	
Roses: B, F (see note 1)	
<b>613E, 626</b>	<b>605, 606, 611, 612, 613, 618, 619, 625, 629, 630, 722</b>

<b>Knobs: YW</b>	
<b>Escutcheons: M, N, P</b>	
<b>613E, 626</b>	<b>605, 606, 611, 612, 613, 618, 619, 625, 629, 630, 722</b>

<b>Knobs: YW</b>	
<b>Escutcheons: R</b>	
<b>613E, 626</b>	<b>605, 606, 611, 612, 613, 618, 619, 625, 629, 630, 722</b>

Description	Function	Option (See Note)	613E, 626	605, 606, 611, 612, 613, 618, 619, 625, 629, 630, 722	613E, 626	605, 606, 611, 612, 613, 618, 619, 625, 629, 630, 722	613E, 626	605, 606, 611, 612, 613, 618, 619, 625, 629, 630, 722
Single Cylinder	ML20914	Fail Safe/	\$1,060.00	\$1,084.00	\$1,080.00	\$1,104.00	\$1,114.00	\$1,138.00
	ML20906	Fail Secure						
No Cylinder Override	ML20907	Fail Safe/	\$984.00	\$1,008.00	\$1,004.00	\$1,028.00	\$1,038.00	\$1,062.00
	ML20915	Fail Secure						
Double Cylinder	ML20932	Fail Safe/ Fail Secure	\$1,136.00	\$1,160.00	\$1,156.00	\$1,180.00	\$1,190.00	\$1,214.00

**GSA**

 Knob: Cast  
Rose: Wrought

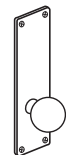
**GSM**

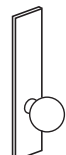
**GSN**

**GSP**

**GSR**

 Knob: Cast  
Escutcheon: Solid Stainless Steel or Forged Brass

<b>Knobs: GS</b>	
<b>Roses: A</b>	
Roses: B, F (see note 1)	
<b>613E, 626</b>	<b>605, 606, 611, 612, 613, 618, 619, 625, 629, 630, 722</b>

<b>Knobs: GS</b>	
<b>Escutcheons: M, N, P</b>	
<b>613E, 626</b>	<b>605, 606, 611, 612, 613, 618, 619, 625, 629, 630, 722</b>

<b>Knobs: GS</b>	
<b>Escutcheons: R</b>	
<b>613E, 626</b>	<b>605, 606, 611, 612, 613, 618, 619, 625, 629, 630, 722</b>

Description	Function	Option (See Note)	613E, 626	605, 606, 611, 612, 613, 618, 619, 625, 629, 630, 722	613E, 626	605, 606, 611, 612, 613, 618, 619, 625, 629, 630, 722	613E, 626	605, 606, 611, 612, 613, 618, 619, 625, 629, 630, 722
Single Cylinder	ML20914	Fail Safe/	\$1,173.00	\$1,197.00	\$1,193.00	\$1,217.00	\$1,227.00	\$1,251.00
	ML20906	Fail Secure						
No Cylinder Override	ML20907	Fail Safe/	\$1,097.00	\$1,121.00	\$1,117.00	\$1,141.00	\$1,038.00	\$1,175.00
	ML20915	Fail Secure						
Double Cylinder	ML20932	Fail Safe/ Fail Secure	\$1,249.00	\$1,273.00	\$1,269.00	\$1,293.00	\$1,303.00	\$1,327.00

**NOTE:**

Must Specify: SAF for Fail Safe or SEC for Fail Secure.

 1 - Rose substitutions for GSA, YWA: 2-1/4" cast rose in place of 2-1/4" wrought rose, substitute letter "B" in place of "A" (e.g. GSB). **Add \$38.00 per lockset.**  
 2-7/8" cast rose in place of 2-1/4" wrought rose, substitute letter "F" in place of "A" (e.g. YWF). **Add \$52.00 per lockset.**

2 -Escutcheon trims are available for 1 3/8", 1 3/4", or 2 1/4" door thickness only

**ElectroLynx®**

 As part of their promise to provide innovative, fast and effective high security solutions to their customers, certain ASSA ABLOY Group brands offer *ElectroLynx®*, a universal quick-connect system that simplifies the electrification of the door opening.

# Electrified Mortise Lock with High Security Monitoring ML20600 Series NAC



**YWA**

Knob: Wrought  
Rose: Wrought



**YMM**

Knob: Wrought  
Escutcheon: Wrought



**YWN**



**YWP**



**YWR**

Knob: Wrought  
Escutcheon: Solid Stainless Steel  
or Forged Brass

Description	Function	Option (See Note)	Knobs: YW Roses: A Roses: B, F (see note 1)		Knobs: YW Escutcheons: M, N, P		Knobs: YW Escutcheons: R	
			613E, 626	605, 606, 611, 612, 613, 618, 619, 625, 629, 630, 722	613E, 626	605, 606, 611, 612, 613, 618, 619, 625, 629, 630, 722	613E, 626	605, 606, 611, 612, 613, 618, 619, 625, 629, 630, 722
Single Cylinder	ML20606 x NAC	Fail Safe/	\$1,235.00	\$1,259.00	\$1,255.00	\$1,279.00	\$1,289.00	\$1,313.00
	ML20608 x NAC	Fail Secure	\$1,310.00	\$1,334.00	\$1,330.00	\$1,354.00	\$1,364.00	\$1,388.00
No Cylinder Override	ML20607 x NAC	Fail Safe/	\$1,159.00	\$1,183.00	\$1,179.00	\$1,203.00	\$1,213.00	\$1,237.00
	ML20609 x NAC	Fail Secure	\$1,234.00	\$1,258.00	\$1,254.00	\$1,278.00	\$1,288.00	\$1,312.00



**GSA**

Knob: Cast  
Rose: Wrought



**GSM**

Knob: Cast  
Escutcheon: Wrought



**GSN**



**GSP**



**GSR**

Knob: Cast  
Escutcheon: Solid Stainless Steel  
or Forged Brass

Description	Function	Option (See Note)	Knobs: GS Roses: A Roses: B, F (see note 1)		Knobs: GS Escutcheons: M, N, P		Knobs: GS Escutcheons: R	
			613E, 626	605, 606, 611, 612, 613, 618, 619, 625, 629, 630, 722	613E, 626	605, 606, 611, 612, 613, 618, 619, 625, 629, 630, 722	613E, 626	605, 606, 611, 612, 613, 618, 619, 625, 629, 630, 722
Single Cylinder	ML20606 x NAC	Fail Safe/	\$1,348.00	\$1,372.00	\$1,368.00	\$1,392.00	\$1,402.00	\$1,426.00
	ML20608 x NAC	Fail Secure	\$1,423.00	\$1,447.00	\$1,443.00	\$1,467.00	\$1,477.00	\$1,501.00
No Cylinder Override	ML20607 x NAC	Fail Safe/	\$1,272.00	\$1,296.00	\$1,292.00	\$1,316.00	\$1,326.00	\$1,350.00
	ML20609 x NAC	Fail Secure	\$1,347.00	\$1,371.00	\$1,367.00	\$1,391.00	\$1,401.00	\$1,425.00

**NOTE:**

Must Specify: SAF for Fail Safe or SEC for Fail Secure.

1 - Rose substitutions for GSA, YWA: 2-1/4" cast rose in place of 2-1/4" wrought rose, substitute letter "B" in place of "A" (e.g. GSB). **Add \$38.00 per lockset.**

2-7/8" cast rose in place of 2-1/4" wrought rose, substitute letter "F" in place of "A" (e.g. YWF). **Add \$52.00 per lockset.**

2 -Escutcheon trims are available for 1 3/8", 1 3/4", or 2 1/4" door thickness only



**ElectroLynx®**

As part of their promise to provide innovative, fast and effective high security solutions to their customers, certain ASSA ABLOY Group brands offer *ElectroLynx®*, a universal quick-connect system that simplifies the electrification of the door opening.

Fail Safe/Fail Secure	
Description	Specify Quick Code
Fail Safe	SAF
Fail Secure	SEC

Electrified Options for ML20900		
Description	Specify Quick Code	Add or Deduct
Latchbolt Monitor	M91	\$178.00
Request to Exit (REX)	M92	\$176.00
Security monitor	M105	\$310.00
Latchbolt monitor x request to exit	M91 x M92	\$354.00
Request to Exit x security monitor	M92 x M105	\$486.00

Accessories		
Part No.	Description	Add or Deduct
BPS-24-1	Power Supply 24V 1 AMP	\$295.00
BPS-12-1	Power Supply 12V 1 AMP	
BPS-24-2	Power Supply 24V 2 AMP	\$600.00
BPS-12-3	Power Supply 12V 3 AMP	

### ML20600 High Security Monitoring Options

EcoFlex™ Mortise Lock End-of-Line Resistors and Deadbolt Privacy Options		
Description	Specify Quick Code	Add or Deduct
Mercury and Lenel compatible 1KΩ/2KΩ resistance supervision	R01	Add \$100.00 per lockset
Software House compatible 1KΩ/2KΩ resistance supervision	R03	Add \$100.00 per lockset
AMAG compatible 4-state supervision	R04	Add \$100.00 per lockset
Deadbolt Privacy Function	PHR	Add \$100.00 per lockset
Deadbolt Privacy and Mercury / Lenel 1KΩ/2KΩ	PHRR01	Add \$200.00 per lockset
Deadbolt Privacy and Software House 1KΩ/2KΩ	PHRR03	Add \$200.00 per lockset
Deadbolt Privacy and AMAG 4-State	PHRR04	Add \$200.00 per lockset

**ElectroLynx®**

As part of their promise to provide innovative, fast and effective high security solutions to their customers, certain ASSA ABLOY Group brands offer *ElectroLynx®*, a universal quick-connect system that simplifies the electrification of the door opening.



**Lock Only**

Includes lockcase, armored front, strike and screw pack. Cylinder(s) and thumbturn lever are not included.

**Ordering Example**

Quantity	Series/Function	Trim See Key Below	Finish	Door Thickness	Optional Strike
12	ML2055	LL	626	D138	SS078

**Trim Key**

KK	Knob x Knob	LK	Lever x Knob	HL	Lever Inside only
LL	Lever x Lever	KL	Knob x Lever	HK	Knob inside Only

Function	Description	LL, LK, KL, HL, HK <sup>2</sup> , KK <sup>2</sup>	
		Available in all listed mortise trim finishes	
Non-Keyed	ML2010	Passage	\$309.00
	ML2020	Privacy	\$383.00
	ML2030	Privacy	
	ML2060	Privacy	
Single Cylinder	ML2051	Office	\$347.00
	ML2003	Classroom	\$360.00
	ML2053	Entrance	
	ML2054	Entrance	\$347.00
	ML2055	Classroom	
	ML2056	Classroom Holdback	
	ML2057	Storeroom	
	ML2058	Entrance Holdback	\$360.00
	ML2068	Privacy and Apartment	\$347.00
ML2069	Institution Privacy		
Single Cylinder with Deadbolt	ML2024	Entrance	\$383.00
	ML2048	Entrance	
	ML2059	Security Storeroom	
	ML2065	Dormitory	
	ML2067	Apartment	
	ML2073	Classroom Security	
	ML2075	Entrance/Office	\$392.00
Double Cylinder	ML2002	Classroom Intruder	\$347.00
	ML2022	Store Door	
	ML2032	Institution	
	ML2042	Entrance	
	ML2052	Classroom Intruder	
	ML2062	Intruder Deadbolt	
	ML2072	Classroom Security Intruder	
	ML2082	Dormitory	
ML2092	Security Institution		
Single Cylinder	ML20914	Fail Safe/Fail Secure	\$565.00
	ML20906		
No Cylinder Override	ML20907	Fail Safe/Fail Secure	
	ML20915		
Double Cylinder	ML20932	Fail Safe/Fail Secure	

**Conversion Kits**

Part Number	Description	Price
683F34	Knob operation to lever operation <sup>1</sup>	\$38.00

Notes: 1. Kits contain internal lock parts only. Order knobs, spindles, escutcheons, cylinders and collars separately.  
 2. For master ring, specify quick code MR-LC. Add \$20.00. Not available for ML20900 series.

### Cylinder & Keying Options

Description	Specify Quick Code	Add or Deduct
Conventional 6-pin	(standard)	No Charge
Conventional 7-pin	7P	Add \$2.00 per cylinder
Less Standard Cylinder	LC	Deduct \$76.00 per cylinder
Less Hotel Cylinder	LC	Deduct \$109.00 per cylinder
Less Master Ring Cylinder <sup>3</sup>	MR-LC	Deduct \$38.00 per cylinder
Less Concealed Shell Cylinder	PO-LC	Add \$5.00 per lockset
Access 3 Patented	AP	No Charge
Access 3 Security	AS	Add \$49.00 per cylinder
Access 3 High Security, UL 437	AHS	Add \$69.00 per cylinder
Access 3 IC Patented	ACP	Add \$64.00 per cylinder
Access 3 IC Security	ACS	Add \$113.00 per cylinder
Access 3 IC High Security, UL 437	ACHS	Add \$133.00 per cylinder
Pyramid Security Fixed Core <sup>2</sup>	PS	Add \$49.00 per cylinder
Pyramid Security IC <sup>2</sup>	PCS	Add \$113.00 per cylinder
Pyramid High Security Fixed Core <sup>2</sup>	PHS	Add \$75.00 per cylinder
Pyramid High Security IC <sup>2</sup>	PCHS	Add \$138.00 per cylinder
Pyramid IC with Temporary Construction Core <sup>2,4</sup>	CTP	Add \$64.00 per cylinder
Pyramid IC with Temporary Disposable Core <sup>2,4</sup>	CTPD	No Charge
Pyramid IC Less Core <sup>2</sup>	CLP	No Charge
Security <sup>5</sup>	HS	Add \$95.00 per cylinder
Security IC <sup>1,5</sup>	CHS	Add \$161.00 per cylinder
Blockout Function Cylinder	BO	Add \$101.00 per cylinder
IC 6-pin	C6	Add \$64.00 per cylinder
IC 6-pin with Temporary Construction Core (Red)	CT6R	Add \$64.00 per cylinder
IC 6-pin with Temporary Construction Core (Blue)	CT6B	Add \$64.00 per cylinder
IC 6-pin with Temporary Construction Core (Green)	CT6G	Add \$64.00 per cylinder
IC 6-pin with Temporary Disposable Core	CT6D	No Charge
IC 6-pin Less Core	CL6	No Charge
SFIC 6-pin with Less Core <sup>2</sup>	CLS6	No Charge
IC 6-pin with SFIC disposable temporary core <sup>2</sup>	CT6SD	No Charge
IC 7-pin <sup>2</sup>	C7	Add \$66.00 per cylinder
IC 7-pin with Temporary Construction Core (Red) <sup>2</sup>	CT7R	Add \$66.00 per cylinder
IC 7-pin with Temporary Construction Core (Blue) <sup>2</sup>	CT7B	Add \$66.00 per cylinder
IC 7-pin with Temporary Construction Core (Green) <sup>2</sup>	CT7G	Add \$66.00 per cylinder
IC 7-pin with Temporary Disposable Core <sup>2</sup>	CT7D	Add \$2.00 per cylinder
IC 7-pin Less Core <sup>2</sup>	CL7	Add \$2.00 per cylinder
SFIC 7-pin with Less Core <sup>2</sup>	CLS7	Add \$2.00 per cylinder
IC 7-pin with SFIC disposable temporary core <sup>2</sup>	CT7SD	Add \$2.00 per cylinder
Master Ring <sup>3</sup>	MR	Add \$63.00 per cylinder
Flex Head Cylinder, 6-pin (sectional trim)	FX6	Add \$66.00 per cylinder
Flex Head Cylinder, 7-pin (sectional trim)	FX7	Add \$69.00 per cylinder
Flex Head Master Ring (sectional trim)	FXM	Add \$112.00 per cylinder
Plug only to show, 6-pin (concealed shell) (available for M and R escutcheons and single cylinder functions only)	P06	Add \$81.00 per lockset
Plug only to show, 7-pin (concealed shell) (available for M and R escutcheons and single cylinder functions only)	P07	Add \$83.00 per lockset

**Notes:**

1. CHS ordered with CT6 option no charge.
2. Pyramid series and IC-7 pin are not available in ML2029 function.
3. Available for "M" escutcheon and sectional trim only. Not available for 17, 29 or 32 functions, and ECL functions. Not available for ML20900 series.
4. Refer to Key construction core program, pg. 47 for example of CTP option pricing.
5. For existing systems only.

**Cylinder & Keying Options\* (con't)**

Description	Specify Quick Code	Add or Deduct
0-Bitted with two blank keys <sup>5</sup>	(standard)	No Charge
Keyed Random <sup>4</sup>	KR	No Charge
Master keyed (all cylinders except 8000, 8020, 8027 IC core)	specify keyset	Add \$16.00 per cylinder
Master keyed Pyramid	specify keyset	Add \$16.00 per cylinder
Master keyed Security (including IC cylinder and core)	specify keyset	Add \$16.00 per cylinder
Master keyed (8000, 8020, 8027 IC core)	specify keyset	No Charge
Master keyed to customer bittings or sample key	specify keyset	Add \$16.00 per cylinder
Construction master keyed <sup>1,2</sup>	CMK	Add \$16.00 per cylinder
Visual key control (VKC)		
- No Stamping	VKC0	\$4.30
- Keys only	VKC1	No Charge
- Cylinders and Keys <sup>3</sup>	VKC2	\$8.00
- Cylinders only <sup>3</sup>	VKC3	\$8.00
Concealed key control (CKC)		
- CKC cylinders with VKC keys	CKC2	\$8.00
- CKC cylinders only <sup>3</sup>	CKC3	\$8.00
More than 2 keys per lock	KY# (e.g., KY6)	See page 48 - Cut Keys Section

\*Double Cylinder Keying: Unless otherwise specified, both cylinders of ML2012, 2022, 2032, 2052, 2062, 2072, 2082, 2092 function locks will be keyed alike. The inside cylinder of 42 function locks will be keyed to the master key(s) only, while the outside cylinder will include the change key. If different is required, specify outside cylinder first, then inside cylinder. For key bows other than 10 and 90, specify "KB" + bow number as Quick Code, e.g. KB12. No extra charge.

**Notes:**

1. CMK Construction master keying charge is in addition to master keying charge.
2. CMK Construction master keying is not available in Pyramid series cylinders.
3. VKC2, VKC3, CKC3 are not available in Pyramid or Security series.
4. Pyramid series is not available keyed random.
5. Security series is not available 0-bitted.

**Strike Options\***

(To purchase strike separately, see catalog or parts manual for part no.)

Lip Length	ANSI Straight Lip - Specify Quick Code	ANSI Curved Lip - Specify Quick Code	Add or Deduct
7/8"	SS078	N/A	No Charge
1-1/8"	(standard)	N/A	
1-1/4"	SS114	SA114	
1-3/8"	SS138	SA138	
1-1/2"	SS112	SA112	
1-3/4"	SS134	SA134	Add \$16.00 per lockset
2"	SS200	SA200	
2-1/4"	SS214	SA214	
2-1/2"	SS212	SA212	
2-3/4"	SS234	SS234	
3"	SS300	SA300	

Description	Door Thickness	Specify Quick Code	Add or Deduct
Open Back Strike	1-3/4"	SB134	Add \$82.00 per lockset
Open Back Strike	2"	SB200	Add \$124.00 per lockset
Open Back Strike	2-1/4"	SB214	
Rabbeted front and strike		SR118	Add \$86.00 per lockset

\* If door thickness is standard or has been specified and no special door or frame condition exist, then only the first two characters of the optional strike Quick Code must be specified (e.g. "SA").

The correct lip length will be determined by our order entry system based on the standard or specified door thickness.

**Door Thickness with Locksets Mortised on Center**

(Note: Door thickness with panel not to exceed 2" from centerline of lock.)

Door Thickness	Sectional Rose Trim Specify Quick Code	Escutcheon <sup>1,2</sup> Trim Specify Quick Code	Add or Deduct
1-3/4" (standard)	—	—	No Charge
1-3/8"	D138	D138	Add \$56
1-7/8"	D178	N/A	No Charge
2"	D200	D200	
2-1/8"	D218	N/A	
2-1/4"	D214	D214	
2-3/8"	D238	D238	Add \$92.00 per lockset
2-1/2"	D212	D212	
2-5/8"	D258	D258	
2-3/4"	D234	D234	
2-7/8"	D278	D278	
3"	D300	D300	
3-1/8"	D318	D318	
3-1/4"	D314	D314	
3-3/8"	D338	D338	
3-1/2"	D312	D312	
3-5/8"	D358	D358	
3-3/4"	D334	D334	
3-7/8"	D378	D378	
4"	D400	D400	

**Notes:**

- For 2-3/8" to 4" door thickness: throughbolts and thumbturn lever spindle for 4" door will be provided. Throughbolts and spindles may be field cut.
- "VR" and "T" escutcheons are only available for 1-3/8", 1-3/4" and 2-1/4" door thicknesses.

**Panel Applications**

Specify Quick Code	Description	Add or Deduct
PNL1	Centerline of lockcase to edge of panel not to exceed 2"	Add \$92.00 per lockset

**Note:**

- When ordering, specify door thickness (less panel), panel thickness, and side of door panel will be applied (outside or inside).

**Miscellaneous Options**

Description	Specify Quick Code	Add or Deduct
Split designs and split finishes	Outside Trim x Inside Trim	Higher set price prevails
Spanner head screws	M02	Add \$16.00 per lockset
Torx® head screws (n/a with N escutcheon)	M04	Add \$22.00 per lockset
ANSI wrought strike box	M17	No Charge
Occupancy indicator (hotel function only)	M19	No Charge
Single Occupancy Indicator - Secure/Unsecure (Outside)	M19S*	Add \$81.00 per lockset
Single Occupancy Indicator - Vacant/Occupied (Outside)	M19V*	Add \$81.00 per lockset
Single Occupancy Indicator - Secure/Unsecure (Inside)	M19N*	Add \$81.00 per lockset
Double Occupancy Indicator - Secure/Unsecure (Outside)	M19SN*	Add \$162.00 per lockset
Double Indicator Vacant/Occupied (Outside)	M19VN*	Add \$162.00 per lockset
Knurling outside and inside	M20 <sup>1</sup>	Add \$132.00 per lockset
Knurling outside only	M21 <sup>1</sup>	Add \$66.00 per lockset
Knurling inside only	M22 <sup>1</sup>	Add \$66.00 per lockset
Abrasive coat outside and inside	M23 <sup>1</sup>	Add \$82.00 per lockset
Abrasive coat inside only	M24 <sup>1</sup>	Add \$41.00 per lockset
Abrasive coat outside only	M25 <sup>1</sup>	Add \$41.00 per lockset
Non-ferrous lockcase	M26	Add \$208.00 per lockset
Lead wrapped case	M29	Add \$252.00 per lockset
Half trim (for ML2010, ML2020, ML2022, ML2024, ML2029, ML2030, ML2032, ML2052, ML2053, ML2055, ML2056, ML2057, ML2058, ML2059, ML2062, ML2065 only) supplied with inside trim only	M30**	Deduct \$40.00 per lockset
Working trim only	M31	See pages 101 thru 111
Latch Hold Back 42, 51, 52, 55, 57 functions	LHB	Add \$40.00 per lockset
HPSK Positive Pull Stop Kit (813F068)		Add \$16.00
HPSK "PUSH" & "PULL" Identification (non-handed)	M38	Add \$20.00

\*Refer to ML2000 catalog for available indicators by locking function. Not available w/ BHSS or BLSS trim.

\*\*Not available with BHSS trim. Requires special application for BLSS, HSS, and HPSK trim.

**Thumbturn Options**

Specify door thickness	Specify Quick Code	Add or Deduct
Ergonomic	M34 <sup>2</sup>	Add \$14.00 per TT
Decorative	MT1	No Charge
Decorative square	MT2	No Charge
Decorative cylinder	MT3	No Charge

**MT1**

**MT2**

**MT3**

Notes:

1. Not available on Vineyard™ Collection.
2. M34 is not available with M19N, M19VN or M19SN.

Note: Thumbturn backplate will match shape of rose chosen (i.e. round or square)

**Standard Features**

**Handing**

Field reversible

**Door Thickness**

1-3/4"

**Backset**

2-3/4"

**Strike**

ANSI straight lip  
4-7/8" x 1-1/4" x 1-1/8" lip to center

**Cylinder**

Brass, 6-pin, L4 keyway

**Keys**

Two nickel silver keys

**Screws**

Torx® head

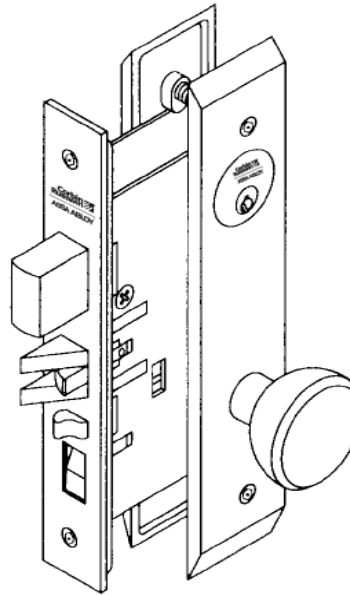

**Ordering Examples**

**Stock Order**

Quantity	Series/Function	Trim	Finish	Hand
100	ML2055HS	SST	626	RHR

**Split Finish Order**

Quantity	Series/Function	Trim	Finish		Hand
			Outside	Inside	
12	ML2055HS	SST	626	625	RHR

Split trim is not available mixing escutcheon with sectional trim or with a different escutcheon.

**Contract/Detailed Order**

Quantity	Keyset	Series/Function	Trim	Finish	Hand	Strike	Misc. Options	Cylinder and Keying
24	AA1	ML2055HS	SST	626	RHR	SA200	M17	C7-VKC3

**Working Trim Only**

Quantity	Function only	Trim	Finish	Hand	Door Thickness	Misc. Options
6	ML2055HS	SST	626	RHR	D214	M31

Includes grip and spindle, rose or escutcheon, thumbturn, adapters and screws.

**Knob Designs: SST**

Surety

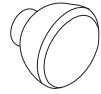

**KK\* (Lock Only)**

\*Includes lockcase, armored front, strike and screw pack.  
Cylinder and thumbturn are not included.



**SST**

Knob: Cast  
Rose: Cast

**KK\* (Lock only)**

**SST**

**605, 606, 611, 612, 613,  
613E, 625, 626, 722**

**KK**

**605, 606, 611, 612, 613,  
613E, 625, 626, 722**

**Function**

Function	Model	Description	SST Price	KK Price
Non-Keyed	ML2010HS	Passage	\$1,160.00	\$361.00
	ML2020HS	Privacy	\$1,255.00	\$447.00
	ML2030HS	Privacy		
Single Cylinder	ML2051HS	Office	\$1,295.00	\$411.00
	ML2055HS	Classroom		
	ML2056HS	Classroom Holdback		
	ML2057HS	Storeroom		
	ML2069HS	Institution Privacy	\$1,308.00	\$393.00
	ML2053HS	Entrance		
	ML2054HS	Entrance		
Single Cylinder with Deadbolt	ML2058HS	Entrance Holdback	\$1,331.00	\$447.00
	ML2024HS	Entrance		
	ML2048HS	Entrance		
	ML2065HS	Dormitory		
	ML2067HS	Apartment		
	ML2073HS	Classroom Security		
	ML2075HS	Entrance/Office		
ML2029HS	Hotel	\$1,386.00	\$456.00	
Double Cylinder	ML2022HS	Store Door	\$1,407.00	\$411.00
	ML2032HS	Institution		
	ML2042HS	Entrance		
	ML2052HS	Classroom Intruder		
	ML2062HS	Intruder Deadbolt		
	ML2072HS	Classroom Security Intruder		
	ML2082HS	Dormitory		
ML2092HS	Security Institution			
Deadlock	ML2012HS	Double Cylinder	\$1,046.00	\$297.00
	ML2013HS	Cylinder x Thumbturn		
Full Working Trim (Quick Code M31) No cylinder; includes thumbturn lever			\$994.00	
			No. of screws: 8	

### Cylinder & Keying Options\*

Description	Specify Quick Code	Add or Deduct
Conventional 6-pin	(standard)	No Charge
Conventional 7-pin	7P	Add \$2.00 per cylinder
Less Standard Cylinder	LC	Deduct \$76.00 per cylinder
Less Hotel Cylinder	LC	Deduct \$109.00 per cylinder
Less Master Ring Cylinder <sup>3</sup>	MR-LC	Deduct \$38.00 per cylinder
Less Concealed Shell Cylinder	PO-LC	Add \$5.00 per lockset
Access 3 Patented	AP	No Charge
Access 3 Security	AS	Add \$49.00 per cylinder
Access 3 High Security, UL 437	AHS	Add \$69.00 per cylinder
Access 3 IC Patented	ACP	Add \$64.00 per cylinder
Access 3 IC Security	ACS	Add \$113.00 per cylinder
Access 3 IC High Security, UL 437	ACHS	Add \$133.00 per cylinder
Pyramid Security Fixed Core <sup>2</sup>	PS	Add \$49.00 per cylinder
Pyramid Security IC <sup>2</sup>	PCS	Add \$113.00 per cylinder
Pyramid High Security Fixed Core <sup>2</sup>	PHS	Add \$75.00 per cylinder
Pyramid High Security IC <sup>2</sup>	PCHS	Add \$138.00 per cylinder
Pyramid IC with Temporary Construction Core <sup>2,4</sup>	CTP	Add \$64.00 per cylinder
Pyramid IC with Temporary Disposable Core <sup>2,4</sup>	CTPD	No Charge
Pyramid IC Less Core <sup>2</sup>	CLP	No Charge
Security <sup>5</sup>	HS	Add \$95.00 per cylinder
Security IC <sup>1,5</sup>	CHS	Add \$161.00 per cylinder
Blockout Function Cylinder	BO	Add \$101.00 per cylinder
IC 6-pin	C6	Add \$64.00 per cylinder
IC 6-pin with Temporary Construction Core (Red)	CT6R	Add \$64.00 per cylinder
IC 6-pin with Temporary Construction Core (Blue)	CT6B	Add \$64.00 per cylinder
IC 6-pin with Temporary Construction Core (Green)	CT6G	Add \$64.00 per cylinder
IC 6-pin with Temporary Disposable Core	CT6D	No Charge
IC 6-pin Less Core	CL6	No Charge
SFIC 6-pin with Less Core <sup>2</sup>	CLS6	No Charge
IC 6-pin with SFIC disposable temporary core <sup>2</sup>	CT6SD	No Charge
IC 7-pin <sup>2</sup>	C7	Add \$66.00 per cylinder
IC 7-pin with Temporary Construction Core (Red) <sup>2</sup>	CT7R	Add \$66.00 per cylinder
IC 7-pin with Temporary Construction Core (Blue) <sup>2</sup>	CT7B	Add \$66.00 per cylinder
IC 7-pin with Temporary Construction Core (Green) <sup>2</sup>	CT7G	Add \$66.00 per cylinder
IC 7-pin with Temporary Disposable Core <sup>2</sup>	CT7D	Add \$2.00 per cylinder
IC 7-pin Less Core <sup>2</sup>	CL7	Add \$2.00 per cylinder
SFIC 7-pin with Less Core <sup>2</sup>	CLS7	Add \$2.00 per cylinder
IC 7-pin with SFIC disposable temporary core <sup>2</sup>	CT7SD	Add \$2.00 per cylinder
Master Ring <sup>3</sup>	MR	Add \$63.00 per cylinder
Flex Head Cylinder, 6-pin (sectional trim)	FX6	Add \$66.00 per cylinder
Flex Head Cylinder, 7-pin (sectional trim)	FX7	Add \$69.00 per cylinder
Flex Head Master Ring (sectional trim)	FXM	Add \$112.00 per cylinder
Plug only to show, 6-pin (concealed shell) (available for M and R escutcheons and single cylinder functions only)	P06	Add \$81.00 per lockset
Plug only to show, 7-pin (concealed shell) (available for M and R escutcheons and single cylinder functions only)	P07	Add \$83.00 per lockset

\* Double Cylinder Functions: Unless otherwise specified, both cylinders of 22 function locks will be keyed alike. The inside cylinder of 42 function locks will be keyed to the master key(s) only, while the outside cylinder will include the change key. If different is required, specify outside cylinder first, then inside cylinder.  
For key bows other than 10 and 90, specify "KB" + bow number as Quick Code, e.g. KB12. No extra charge.

Notes:

1. Pyramid series is not available in ML2029 function.
2. Pyramid series is not available keyed random.
3. Refer to Key construction core program, pg. 47 for example of CTP option pricing.
4. For existing systems only.



**Cylinder & Keying Options\***

Description	Specify Quick Code	Add or Deduct
Keyed Random <sup>2</sup>	KR	No Charge
Master keyed (all cylinders except 8000, 8020, 8027 IC core)	Specify keyset	Add \$16.00 per cylinder
Master keyed Security (Including IC cylinder and core)	Specify keyset	
Master keyed Pyramid	Specify keyset	
Master keyed (8000, 8020, 8027 IC core)	Specify keyset	No Charge
Master keyed to customer bittings or sample key		Add \$16.00 per cylinder
Construction master keyed <sup>1,2</sup>	CMK	Add \$16.00 per cylinder
Visual key control (VKC)		
-No stamping	VKC0	\$4.30
-Keys only	VKC1	No Charge
-Cylinders and Keys <sup>3</sup>	VKC2	\$8.00
-Cylinders only <sup>3</sup>	VKC3	\$8.00
Concealed key control (CKC)		
-CKC cylinders with VKC keys	CKC2	\$8.00
-CKC cylinders only <sup>3</sup>	CKC3	\$8.00
More than 2 keys per lock	KY# (e.g., KY6)	See page 48 - Cut Keys Section

\* Double Cylinder Functions: Unless otherwise specified, both cylinders of ML2012, ML2022, ML2032, ML2052, ML2062, ML2072, ML2082, and ML2092 function locks will be keyed alike.  
The inside cylinder of 42 function locks will be keyed to the master key(s) only, while the outside cylinder will include the change key. If different is required, specify outside cylinder first, then inside cylinder.  
For key bows other than 10 and 90, specify "KB" + bow number as Quick Code, e.g. KB12. No extra charge.

**Notes:**

1. CMK Construction master keying charge is in addition to master keying charge.
2. CMK Construction master keying is not available in Pyramid or Security series.
3. VKC2, VKC3 are not available in Pyramid or Security series.

**Door Thickness Options**

Description	Specify Quick Code	Add or Deduct
1-3/4"	(standard)	No Charge
2"	D200	
2-1/4"	D214	

**Strike Options\***

Lip Length	ANSI Straight Lip - Specify Quick Code	ANSI Curved Lip - Specify Quick Code	Add or Deduct
7/8"	SS078	N/A	No Charge
1-1/8"	(standard)	N/A	
1-1/4"	SS114	SA114	
1-3/8"	SS138	SA138	
1-1/2"	SS112	SA112	
1-3/4"	SS134	SA134	Add \$16.00 per lockset
2"	SS200	SA200	
2-1/4"	SS214	SA214	
2-1/2"	SS212	SA212	
2-3/4"	SS234	SA234	
3"	SS300	SA300	

\*To purchase strike separately, see catalog or parts manual for part no.

**Strike Options\***

Description	Door Thickness	Specify Quick Code	Add or Deduct
Open Back Strike	1-3/4"	SB134	Add \$82.00 per lockset
Open Back Strike	2"	SB200	Add \$124.00 per lockset
Open Back Strike	2-1/4"	SB214	
Rabbeted front and strike		SR118	Add \$86.00 per lockset

**Miscellaneous Options**

Description	Specify Quick Code	Specify Quick Code
Split finishes	Outside Trim x Inside Trim	Higher set price prevails
Torx® screws	(standard)	No Charge
Spanner head screws	M02	
Lead wrapped case	M29	Add \$252.00 per lockset
Blank escutcheon inside	M07	No Charge
ANSI wrought strike box	M17	
Working trim only	M31	See functions pages



Look for the  *MicroShield* icon.

**MicroShield®**

As part of their promise to provide innovative solutions to their customers, certain ASSA ABLOY Group brands offer the MicroShield® technology, a silver-based antimicrobial coating designed to inhibit the growth of bacteria.

MicroShield® is a registered trademark of Yale Security Inc., an ASSA ABLOY Group company.

Product	Trim	MicroShield® Coated Components
Specialty Hardware	BHSS, BLSS, BHD, HPSK	Knobs/Levers, roses and/or escutcheons

**AVAILABLE FINISHES**

- MicroShield® is available on 626 and 630. Other finishes available by Special Product Application Request Form only.
- Specify 626C (satin chrome plated) or 630C (satin stainless steel) when ordering.
- MicroShield® coating will be applied over 626 and 630 finishes. All components will match 626.

*Note: MicroShield® coating will only be applied to "high touch" components.*

**HOW TO ORDER**

Product	How to Order
Mortise Locks	ML2055 x BHSS x 626C x RHR

**PRICING - Discount is 50% off list only**

Description	Add
Cylindrical Locks & Mortise Locks	Add \$40.00

**Behavioral Health Series™**

**Lever Design: BHSS**

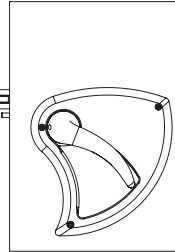

**BHSS**

Lever: Cast  
Escutcheon: Cast

			630	629
Non-Keyed	ML2010	Passage	\$1,375.00	\$1,399.00
	ML2020	Privacy	\$1,494.00	\$1,518.00
	ML2030	Privacy		
	ML2060	Privacy	\$1,432.00	\$1,456.00
Single Cylinder	ML2003	Classroom	\$1,510.00	\$1,534.00
	ML2051	Office		
	ML2055	Classroom		
	ML2056	Classroom HB		
	ML2057	Storeroom	\$1,527.00	\$1,551.00
	ML2069	Institution Privacy		
	ML2053	Entrance		
	ML2054	Entrance		
Single Cylinder with Deadbolt	ML2058	Entrance Holdback	\$1,546.00	\$1,570.00
	ML2068	Privacy or Apartment		
	ML2024	Entrance		
	ML2048	Entrance		
	ML2065	Dormitory	\$1,601.00	\$1,625.00
	ML2059	Security Storeroom		
	ML2067	Apartment		
	ML2073	Classroom Security		
Double Cylinder	ML2075	Entrance/Office	\$1,586.00	\$1,610.00
	ML2029	Hotel		
	ML2002	Classroom Intruder		
	ML2032	Institution		
Double Cylinder with Deadbolt	ML2042	Entrance	\$1,622.00	\$1,646.00
	ML2052	Classroom Intruder		
	ML2022	Store Door		
	ML2062	Intruder Deadbolt		
	ML2072	Classroom Security Intruder		
Single Cylinder	ML2082	Dormitory	1,728.00	\$1,752.00
	ML2092	Security Institution		
No Cylinder Override	ML20906	Fail Safe/Fail Secure	\$1,532.00	\$1,556.00
	ML20914			
Double Cylinder	ML20907	Fail Safe/Fail Secure	\$1,804.00	\$1,828.00
	ML20915			
Full Working Trim	ML20932	Fail Safe/Fail Secure	\$1,804.00	\$1,828.00
	M31	No cylinder; includes thumbturn lever	\$1,066.00	\$1,090.00

**Behavioral Health Series™**

**Lever Design: BLSS**

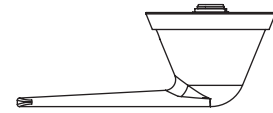
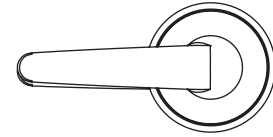

**BLSS**

Lever: Cast  
Rose: Wrought

			630	629
Non-Keyed	ML2010	Passage	\$1,313.00	\$1,337.00
	ML2030	Privacy	\$1,432.00	\$1,456.00
	ML2060	Privacy	\$1,370.00	\$1,394.00
Single Cylinder	ML2055	Classroom	\$1,448.00	\$1,472.00
	ML2057	Storeroom		
	ML2069	Institution Privacy	\$1,465.00	\$1,489.00
	ML2054	Entrance		
Single Cylinder with Deadbolt	ML2024	Entrance	\$1,484.00	\$1,508.00
	ML2065	Dormitory		
	ML2067	Apartment		
Double Cylinder	ML2032	Institution	\$1,524.00	\$1,548.00
	ML2042	Entrance		
	ML2052	Classroom Intruder		
Double Cylinder with Deadbolt	ML2022	Store Door	\$1,560.00	\$1,584.00
	ML2062	Intruder Deadbolt		
Single Cylinder	ML20906	Fail Safe/Fail Secure	\$1,666.00	\$1,690.00
	ML20914			
No Cylinder Override	ML20907	Fail Safe/Fail Secure	\$1,470.00	\$1,494.00
	ML20915			
Double Cylinder	ML20932	Fail Safe/Fail Secure	\$1,742.00	\$1,766.00
Full Working Trim	M31	No cylinder; includes thumbturn lever	\$1,004.00	\$1,028.00

**Anti-Harm Knob Trim**

**Knob Design: HSS**



**HSS** Knob: Brass

**HSS<sup>1</sup>**

**606, 626**

Function			
Non-Keyed	ML2010	Passage	\$1,105.00
	ML2020	Privacy	\$1,526.00
	ML2060	Privacy	\$1,485.00
	ML2090	Full Active Dummy Trim	\$1,134.00
Single Cylinder	ML2003	Classroom	\$1,566.00
	ML2051	Office	
	ML2055	Classroom	
	ML2056	Classroom Holdback	
	ML2057	Storeroom	\$1,581.00
	ML2069	Institution Privacy	
	ML2053	Entrance	
	ML2054	Entrance	
Single Cylinder with Deadbolt	ML2058	Entrance Holdback	\$1,602.00
	ML2068	Privacy or Apartment	
Double Cylinder	ML2024	Entrance	\$1,642.00
	ML2002	Classroom Intruder	
	ML2032	Institution	
	ML2042	Entrance	
Double Cylinder with Deadbolt	ML2052	Classroom Intruder	\$1,678.00
	ML2022	Store Door	
Deadlock	ML2092	Security Institution	\$516.00
	ML2011	Single Cylinder	
	ML2012	Double Cylinder	
	ML2013	Cylinder x Thumbturn	
Single Cylinder	ML2017	Cylinder x Thumbturn	\$1,784.00
	ML20906	Fail Safe/Fail Secure	
ML20914			
No Cylinder Override	ML20907	Fail Safe/Fail Secure	\$1,708.00
	ML20915		
Double Cylinder	ML20932	Fail Safe/Fail Secure	\$1,860.00

Notes:  
1. Sectional lever trim x HSS available.

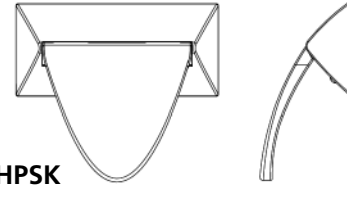

**HPSK**

Lever: Cast  
Rose: Wrought

Function			613E, 630	605, 606, 611, 612, 613, 618, 619, 629, 722
Non-Keyed	ML2010	Passage	\$848.00	\$872.00
	ML2020	Privacy	\$880.00	\$904.00
	ML2030	Privacy		
	ML2060	Privacy	\$876.00	\$900.00
Single Cylinder	ML2003	Classroom	\$959.00	\$983.00
	ML2051	Office		
	ML2055	Classroom		
	ML2056	Classroom		
	ML2057	Storeroom		
	ML2069	Institution Privacy	\$972.00	\$996.00
	ML2053	Entrance		
	ML2054	Entrance		
	ML2058	Entrance Holdback		
ML2068	Privacy or Apartment			
Single Cylinder with Deadbolt	ML2024	Entrance	\$995.00	\$1,019.00
	ML2048	Entrance		
	ML2065	Dormitory		
	ML2059	Security Storeroom		
	ML2067	Apartment		
	ML2073	Classroom Security		
	ML2075	Entrance/Office		
ML2029	Hotel	\$1,050.00	\$1,074.00	
Double Cylinder	ML2002	Classroom Intruder	\$1,035.00	\$1,059.00
	ML2032	Institution		
	ML2042	Entrance		
	ML2052	Classroom Intruder		
Double Cylinder with Deadbolt	ML2022	Store Door	\$1,111.00	\$1,135.00
	ML2062	Intruder Deadbolt		
	ML2072	Classroom Security Intruder		
	ML2082	Dormitory		
	ML2092	Security Institution		
Single Cylinder	ML20906	Fail Safe/Fail Secure	\$1,177.00	\$1,201.00
	ML20914			
No Cylinder Override	ML20907	Fail Safe/Fail Secure	\$1,101.00	\$1,125.00
	ML20915			
Double Cylinder	ML20932	Fail Safe/Fail Secure	No Match!	\$1,277.00
Full Working Trim	M31	No cylinder, includes thumbturn lever	\$505.00	\$529.00

**Standard Features**

**Handing**

Passage (HP3010) function is non-handed  
Privacy (HP3020) function is handed

**Door Thickness**

1-3/4" (44mm) standard.  
Optional door thicknesses available

**Backset (5" - Standard)**

5" (127mm) standard.  
Optional: 2-3/4" (70mm) and 7" (177mm)

**Strike**

ANSI curved lip strike standard, 4-7/8" x 1-1/4" x 1-1/4" lip to center.

Optional strikes, lip lengths and ANSI wrought strike box available

**Latchbolt**

Brass, 1/2" (13mm) throw

**Covers**

Cast stainless steel or brass

**Paddles**

Cast stainless steel or brass



**Ordering Example**

**Stock Order**

Series/Function	Trim	Finish	Hand*
HP3010	HPSK	630	RH

Note: Passage (HP3010) function is non-handed and privacy (HP3020) function is handed.

Function	Description	Finish	Finish
		613E, 630	605, 606, 611, 612, 613, 613L, 618, 619, 629, 722
HP3010	Passage	\$380.00	\$392.00
HP3020	Privacy	\$492.00	\$504.00



## Strike Options

Lip to Center	ANSI Curved Lip. Specify	Curved Lip Box. Specify	Full Lip. Specify	Add or Deduct
1" (25mm)	SA100	SC100		No Charge
1-1/8" (29mm)	SA118	SC118		
1-1/4" (32mm)	(standard)	SC114	SF114*	
1-3/8" (35mm)	SA138	SC138		
1-1/2" (38mm)	SA112	SC112		
1-3/4" (44mm)	SA134	SC134		Add \$16.00 per lockset
2" (51mm)	SA200	SC200		
2-1/4" (57mm)	SA214	SC214		
2-1/2" (63mm)	SA212	SC212		
2-3/4" (70mm)	SA234	SC234		
3" (76mm)	SA300	SC300		

\* Specify SFR114 for rounded corner.

## Door Thickness Options

Description	Specify Quick Code	Add or Deduct
1-3/4" (44mm)	(standard)	No Charge
2" (51mm)	D200	
2-1/4" (57mm)	D214	

## Backset Options

Description	Specify Quick Code	Add or Deduct
2-3/4" (70mm)	B234	No Charge
5" (127mm)	(standard)	
7" (177mm)	B700	Add \$6.00 per lockset

## Miscellaneous Options

Description	Specify Quick Code	Add or Deduct
Spanner head screws	M02	Add \$16.00 per lockset
Torx® head screws	M04	Add \$22.00 per lockset
Latch front, rounded corners	M13	Add \$2.50 per latch
ANSI wrought strike box	M17	No Charge
Lead lining. Specify Push or Pull side.	M28	Add \$237.00 per lockset
"PUSH & PULL" Identification*	M38	Add \$20.00
Retrofit Kit (part no. 791F39)		Add \$52.00
HP3000 Positive Pull Stop Kit (813F068)		Add \$16.00



CL3100  
CL3300  
CL3500  
CL3800  
CK4300

**MicroShield®**

As part of their promise to provide innovative solutions to their customers, certain ASSA ABLOY Group brands offer the MicroShield® technology, a silver-based antimicrobial coating designed to inhibit the growth of bacteria.

MicroShield® is a registered trademark of Yale Security Inc., an ASSA ABLOY Group company.

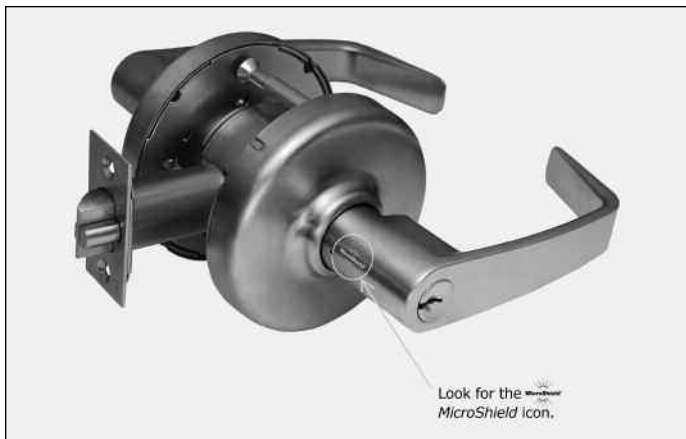

Product	Series	MicroShield® Coated Components
Cylindrical Locks	CL3100, CL3300, CL3500, and CL3800 Series	Levers*, roses

**AVAILABLE FINISHES**

- MicroShield® is available on 626. Other finishes available by Special Product Application Request Form only.
- Specify 626C (satin chrome plated) when ordering.
- MicroShield® coating will be applied over 626 finish. All components will match 626.

*Note: MicroShield® coating will only be applied to "high touch" components.*

**HOW TO ORDER**

Product	How to Order
Cylindrical Locks	CL3355 x NZD x 626C

**PRICING - Discount is 50% off list only**

Description	Add
Cylindrical Locks	Add \$40.00

**Standard Features**

**Handing**

Non-handed

**Door Thickness**

1-3/4" - 2 standard

**Backset**

2-3/4" standard

**Strike**

ANSI curved lip  
4-7/8" x 1-1/4" x 1-1/4" lip to center

**Cylinder**

Brass, 6-pin, L4 keyway, 0-bitted

**Keys**

Two nickel silver keys

**Case Quantity**

6

**Case Weight**

32 lbs

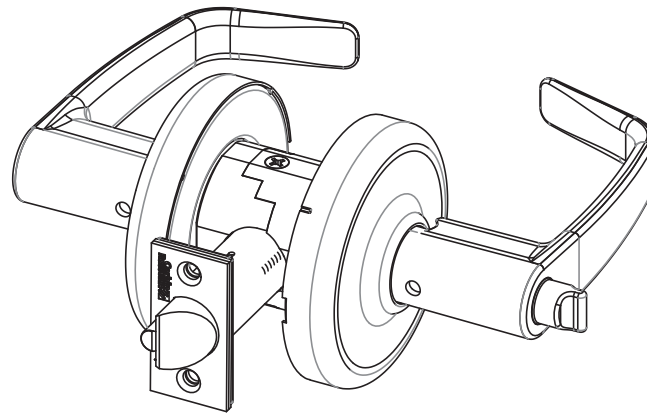

**Ordering Examples**

**Stock Order**

Quantity	Series/Function	Trim	Finish	Hand
100	CL3155	NZD	626	RHR

**Split Finish Order**

Quantity	Series/Function	Finish		Hand
		Outside	Inside	
12	CL3155	626	625	RHR

**Note:** Higher set price prevails

**Contract/Detailed Order**

Quantity	Keyset	Series/Function	Trim	Finish	Hand	Strike	Misc. Options	Cylinder and Keying
24	AA1	CL3155	NZD	626	RHR	SA112	M17	C6-VKC3

**Lever Designs:**



**Levers**

**Roses**

**Lever:**

Die cast zinc

**Rose:**

Brass

**Newport**



**Armstrong**

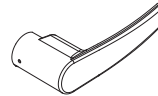

**Princeton**



C ROSE



D ROSE

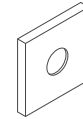

E ROSE



K ROSE

Function	Description		AZC, AZD, AZE, AZK, NZC, NZD, NZE, NZK, PZC, PZD, PZE, PZK	
			Finish: 613E, 626	Finish: 605, 606, 611, 612, 613, 618, 619, 625, 722
CL3110	Non-Keyed	Passage	\$427.00	\$443.00
CL3120		Privacy	\$486.00	\$502.00
CL3120H		Hospital Privacy		
CL3140NT		Exit Latch		
CL3150		Half Dummy	\$191.00	\$199.00
CL3170		Full Dummy	\$377.00	\$393.00
CL3180		Passage x blank plate	\$486.00	\$502.00
CL3151	Single Cylinder	Entrance	\$573.00	\$589.00
CL3155		Classroom		
CL3157		Storeroom		
CL3161		Entrance	\$586.00	\$602.00
CL3175		Corridor/dormitory	\$643.00	\$659.00
CL3193		Service Station		
CL3129	Hotel			
CL3132	Double Cylinder	Institution	\$654.00	\$670.00
CL3152		Classroom Intruder		
CL3162		Communicating		
CL3172		Public Toilet		

Cylinder Options		
Description	Specify Quick Code	Add or Deduct
Conventional 6-pin	(standard)	No Charge
Conventional 7-pin	7P	Add \$2.00 per cylinder
Less Cylinder <sup>4</sup>	LC	Deduct \$69.00 per cylinder
Access 3 Patented	AP	No Charge
Access 3 Security	AS	Add \$49.00 per cylinder
Access 3 High Security, UL 437	AHS	Add \$69.00 per cylinder
Access 3 IC Patented	ACP	Add \$64.00 per cylinder
Access 3 IC Security	ACS	Add \$113.00 per cylinder
Access 3 IC High Security, UL 437	ACHS	Add \$133.00 per cylinder
Pyramid Security Fixed Core <sup>3</sup>	PS	Add \$49.00 per cylinder
Pyramid Security IC <sup>3</sup>	PCS	Add \$110.00 per cylinder
Pyramid High Security Fixed Core <sup>3</sup>	PHS	Add \$73.00 per cylinder
Pyramid High Security IC <sup>3</sup>	PCHS	Add \$138.00 per cylinder
Pyramid IC with Temporary Construction Core	CTP	Add \$64.00 per cylinder
Pyramid IC with Temporary Disposable Core	CTPD	No Charge
Pyramid IC Less Core	CLP	No Charge
Security <sup>3</sup>	HS	Add \$95.00 per cylinder
Security IC <sup>3</sup>	CHS	Add \$160.00 per cylinder
IC 6-pin	C6	Add \$64.00 per cylinder
IC 6-pin with Temporary Construction Core (Red)	CT6R	Add \$64.00 per cylinder
IC 6-pin with Temporary Construction Core (Blue)	CT6B	Add \$64.00 per cylinder
IC 6-pin with Temporary Construction Core (Green)	CT6G	Add \$64.00 per cylinder
IC 6-pin with Temporary Disposable Core	CT6D	No Charge
Small Format Temporary Disposable Core	CTSD	No Charge
IC 6-pin Less Core <sup>3</sup>	CL6	No Charge
IC 7-pin	C7	Add \$66.00 per cylinder
IC 7-pin with Temporary Construction Core (Red)	CT7R	Add \$66.00 per cylinder
IC 7-pin with Temporary Construction Core (Blue)	CT7B	Add \$66.00 per cylinder
IC 7-pin with Temporary Construction Core (Green)	CT7G	Add \$66.00 per cylinder
IC 7-pin with Temporary Disposable Core	CT7D	No Charge
IC 7-pin Less Core <sup>3</sup>	CL7	
Lockset furnished in Schlage® C Keyway <sup>1, 3</sup>	C	
Lockset furnished in Sargent® LA Keyway <sup>2, 3</sup>	LA	

**Notes:**

1. Available 0-bitted & key random (KR) only.
2. Available 0-bitted only.
3. Not available in CL3129 function.
4. CL3129 function is not available less cylinder.

### Keying Options\*

Description	Specify Quick Code	Add or Deduct
0-Bitted with 2 blank keys	(standard)	No Charge
Keyed random	KR	
Master keyed (all cylinders except 8000, 8020, 8027 IC core)	Specify keyset	Add \$16.00 per cylinder
Master keyed Pyramid	Specify keyset	
Master keyed Security (including IC cylinder and core)	Specify keyset	
Master keyed (8000, 8020, 8027 IC core)	Specify keyset	No Charge
Master keyed to customer bittings or sample key	Specify keyset	Add \$16.00 per cylinder
Construction master keyed <sup>1,2</sup>	CMK	Add \$16.00 per cylinder
Visual key control (VKC)		
-No stamping	VKC0	\$4.30
-Keys only	VKC1	No Charge
-Cylinder and Keys <sup>3</sup>	VKC2	\$8.00
-Cylinders only <sup>3</sup>	VKC3	\$8.00
Concealed key control (CKC)		
-CKC cylinders with VKC keys	CKC2	\$8.00
-CKC cylinders only <sup>3</sup>	CKC3	\$8.00
More than 2 keys per lock	KY# (e.g., KY6)	See page 48 - Cut Keys Section

**Notes:**

1. CMK Construction master keying charge is in addition to master keying charge.
2. CMK Construction master keying is not available in Pyramid or Security series.
3. VKC2, VKC3, CKC3 are not available in Access 3, Pyramid or Security series.

\*Double cylinder keying: unless otherwise specified, both cylinders of 32, 52 and 62 functions will be keyed alike. The inside cylinder of 72 function will be keyed to the master key(s) only, while the outside cylinder will include the change key.

If different keying is required, specify outside cylinder first, then inside cylinder.

For key bows other than 10 and 90, specify 'KB' + bow number as Quick Code, e.g. KB12.

**Door Thickness Options**

Description	Specify Quick Code	Add or Deduct
1-3/4" - 2"	(standard)	No Charge
Over 2" up to 2-1/4"	D214	

**Backset Options**

Description	Specify Quick Code	Add or Deduct
2-3/4"	(standard)	No Charge
3-3/4"	B334	Add \$15.00 to lockset
5"	B500	Add \$24.00 to lockset

**Strike Options<sup>2</sup>** (to purchase strike separately, see catalog or parts manual for part no.)

Lip Length	ANSI Curved Lip - Specify Quick Code	Curved Lip Box - Specify Quick Code	Add or Deduct
1"	SA100	SC100	No Charge
1-1/8"	SA118	SC118	
1-1/4"	(standard)	SC114	
1-3/8"	SA138	SC138	
1-1/2"	SA112	SC112	
1-3/4"	SA134	SC134	Add \$16.00 per lockset
2"	SA200	SC200	
2-1/4"	SA214	SC214	
2-1/2"	SA212	SC212	
2-3/4"	SA234	SC234	
3"	SA300	SC300	

<sup>12</sup> If door thickness is standard or has been specified and no special door or frame condition exist, then only the first two characters of the optional strike Quick Code must be specified (e.g. "SC"). The correct lip length will be determined by our order entry system based on the standard or specified door thickness.

**Miscellaneous Options**

Description	Specify Quick Code	Add or Deduct
Spanner head screws	M02	Add \$16.00 per lockset
Torx® head screws	M04	Add \$22.00 per lockset
Less cylinder and with tailpiece for Schlage® cylinder <sup>2</sup>	M06	No Charge
Lever to accept SFIC core <sup>2</sup>	M08	No Charge
Lever to accept Sargent® cylinder <sup>2</sup>	M09	No Charge
Security Lever (not available on non-keyed functions)	M111	No Charge
3/4" throw fire latch x 2-3/4" backset (not available for CL3120, 29, 40, and 93 functions) <div style="display: flex; justify-content: space-between; margin-left: 20px;"> <div>                     Finishes Available                      605                      606                      626                 </div> <div>                     Matching Lock Finish                      605                      606, 611, 612, 613                      625, 626                 </div> </div>	M16	Add \$94.00 per lockset
ANSI wrought strike box	M17	No Charge
Knurling outside and inside	M20	Add \$132.00 per lockset
Knurling outside only	M21	Add \$66.00 per lockset
Knurling inside only	M22	Add \$66.00 per lockset
Abrasive coat outside and inside	M23	Add \$82.00 per lockset
Abrasive coat inside only	M24	Add \$41.00 per lockset
Abrasive coat outside only	M25	Add \$41.00 per lockset
Lead lining (roses)	M28	Add \$164.00 per lockset
Lever to accept Schlage® IC core <sup>2</sup>	M69	No Charge

## Notes:

2. Not available in CL3129 function.



**Standard Features**

**Handing**

Non-handed except FZD

**Door Thickness**

1-3/4" - 2"

**Backset**

2-3/4"

**Strike**

ANSI curved lip  
4-7/8" x 1-1/4" x 1-1/4" lip to center

**Cylinder**

Brass, 6-pin, L4 keyway, 0-bitted

**Keys**

Two nickel silver keys

**Case Quantity**

6

**Case Weight**

32 lbs

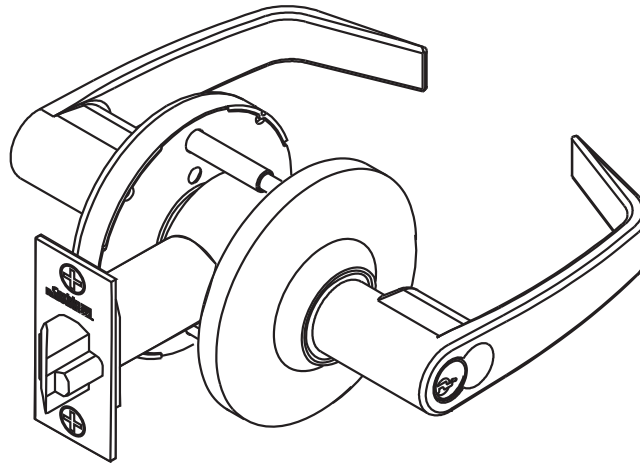

**Ordering Examples**

**Stock Order**

Quantity	Series/Function	Trim	Finish	Hand
100	CL3355	NZD	626	RHR

**Split Trim/Split Finish Order**

Quantity	Series/Function	Trim		Finish		Hand
		Outside	Inside	Outside	Inside	
12	CL3355	NZD	AZD	626	625	RHR

**Contract/Detailed Order**

Quantity	Keypad	Series/Function	Trim	Finish	Hand	Strike	Misc. Options	Cylinder and Keying
24	AA1	CL3355	NZD	626	RHR	SA112	M17	C6-VKC3

**Lever Designs: AZD, NZD, PZD, FZD**



**Lever:**  
Die cast zinc

**Rose:**  
Brass

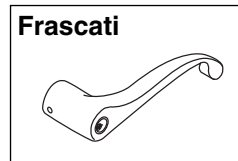
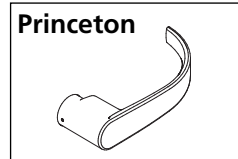
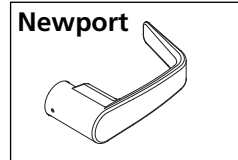

Function	Description	AZD, NZD, PZD, FZD	
		Finish: 613E, 626	Finish: 605, 606, 611, 612, 613, 613L, 618, 619, 625, 722
CL3310	Passage	\$413.00	\$429.00
CL3380	Passage x Blank Plate		
CL3390	Passage x Turnpiece		
CL3320	Privacy	\$466.00	\$482.00
CL3320H	Hospital Privacy	\$561.00	\$577.00
CL3320TO	Time Out Lock	\$466.00	\$482.00
CL3340	Patio		
CL3340NT	Exit Latch		
CL3350	Half Dummy	\$174.00	\$182.00
CL3370	Full Dummy	\$349.00	\$365.00
CL3351	Entrance	\$561.00	\$577.00
CL3355	Classroom		
CL3357	Storeroom		
CL3359	Storeroom or Public Restroom	\$574.00	\$590.00
CL3361	Entrance		
CL3375	Corridor/Dormitory		
CL3393	Service Station	\$628.00	\$644.00
CL3329	Hotel	\$561.00	\$577.00
CL3381	Keyed x Blank Plate		
CL3391	Keyed x Blank Plate		
CL3332	Institution	\$652.00	\$668.00
CL3352	Classroom Intruder		
CL3362	Communicating		
CL3372	Public Toilet	\$786.00	\$802.00
CL33903*	Fail Safe		
CL33905*	Fail Secure		



\*ElectroLynx®

As part of their promise to provide innovative, fast and effective, and higher security solutions to their customers, ASSA ABLOY Group companies offer ElectroLynx, a universal quick-connect system that simplifies the electrification of the door opening. ElectroLynx® is a registered trademark of ASSA ABLOY, Inc.

Cylinder Options		
Description	Specify Quick Code	Add or Deduct
Conventional 6-pin	(standard)	No Charge
Conventional 7-pin	7P	Add \$2.00 per cylinder
Less Cylinder <sup>4</sup>	LC	Deduct \$69.00 per cylinder
Access 3 Patented	AP	No Charge
Access 3 Security	AS	Add \$49.00 per cylinder
Access 3 High Security, UL 437	AHS	Add \$69.00 per cylinder
Access 3 IC Patented	ACP	Add \$64.00 per cylinder
Access 3 IC Security	ACS	Add \$113.00 per cylinder
Access 3 IC High Security, UL 437	ACHS	Add \$133.00 per cylinder
Pyramid Security Fixed Core <sup>3</sup>	PS	Add \$49.00 per cylinder
Pyramid Security IC <sup>3</sup>	PCS	Add \$110.00 per cylinder
Pyramid High Security Fixed Core <sup>3</sup>	PHS	Add \$73.00 per cylinder
Pyramid High Security IC <sup>3</sup>	PCHS	Add \$138.00 per cylinder
Pyramid IC with Temporary Construction Core	CTP	Add \$64.00 per cylinder
Pyramid IC with Temporary Disposable Core	CTPD	No Charge
Pyramid IC Less Core	CLP	No Charge
Security <sup>3</sup>	HS	Add \$95.00 per cylinder
Security IC <sup>3</sup>	CHS	Add \$160.00 per cylinder
IC 6-pin	C6	Add \$64.00 per cylinder
IC 6-pin with Temporary Construction Core (Red)	CT6R	Add \$64.00 per cylinder
IC 6-pin with Temporary Construction Core (Blue)	CT6B	Add \$64.00 per cylinder
IC 6-pin with Temporary Construction Core (Green)	CT6G	Add \$64.00 per cylinder
IC 6-pin with Temporary Disposable Core	CT6D	No Charge
Small Format Temporary Disposable Core	CTSD	No Charge
IC 6-pin Less Core <sup>3</sup>	CL6	No Charge
IC 7-pin	C7	Add \$66.00 per cylinder
IC 7-pin with Temporary Construction Core (Red)	CT7R	Add \$66.00 per cylinder
IC 7-pin with Temporary Construction Core (Blue)	CT7B	Add \$66.00 per cylinder
IC 7-pin with Temporary Construction Core (Green)	CT7G	Add \$66.00 per cylinder
IC 7-pin with Temporary Disposable Core	CT7D	No Charge
IC 7-pin Less Core <sup>3</sup>	CL7	
Lockset furnished in Schlage® C Keyway <sup>1, 3</sup>	C	
Lockset furnished in Sargent® LA Keyway <sup>2, 3</sup>	LA	

**Notes:**

1. Available 0-bitted & key random (KR) only.
2. Available 0-bitted only.
3. Not available in CL3329 function.
4. CL3329 function is not available less cylinder.

**Keying Options\***

Description	Specify Quick Code	Add or Deduct
0-Bitted with 2 blank keys	(standard)	No Charge
Keyed random	KR	
Master keyed (all cylinders except 8000, 8020, 8027 IC core)	Specify keyset	Add \$16.00 per cylinder
Master keyed Pyramid	Specify keyset	
Master keyed Security (including IC cylinder and core)	Specify keyset	
Master keyed (8000, 8020, 8027 IC core)	Specify keyset	No Charge
Master keyed to customer bittings or sample key	Specify keyset	Add \$16.00 per cylinder
Construction master keyed <sup>1,2</sup>	CMK	Add \$16.00 per cylinder
Visual key control (VKC)		
-No stamping	VKC0	\$4.30
-Keys only	VKC1	No Charge
-Cylinder and Keys <sup>3</sup>	VKC2	\$8.00
-Cylinders only <sup>3</sup>	VKC3	\$8.00
Concealed key control (CKC)		
-CKC cylinders with VKC keys	CKC2	\$8.00
-CKC cylinders only <sup>3</sup>	CKC3	\$8.00
More than 2 keys per lock	KY# (e.g., KY6)	See page 48 - Cut Keys Section

**Notes:**

1. CMK Construction master keying charge is in addition to master keying charge.
2. CMK Construction master keying is not available in Access 3, Pyramid or Security series.
3. VKC2, VKC3, CKC3 are not available in Access 3, Pyramid or Security series.

\*Double cylinder keying: unless otherwise specified, both cylinders of 32 and 82 functions will be keyed alike. The inside cylinder of 72 function will be keyed to the master key(s) only, while the outside cylinder will include the change key.

If different keying is required, specify outside cylinder first, then inside cylinder.

For key bows other than 10 and 90, specify 'KB' + bow number as Quick Code, e.g. KB12.

**Door Thickness Options**

Description	Specify Quick Code	Add or Deduct
1-3/4" - 2"	(standard)	No Charge
Over 2" up to 2-1/4"	D214	

**Backset Options**

Description	Specify Quick Code	Add or Deduct
2-3/4"	(standard)	No Charge
3-3/4"	B334	Add \$15.00 to lockset
5"	B500	Add \$24.00 to lockset

**Strike Options\*** (to purchase strike separately, see catalog or parts manual for part no.)

Lip Length	ANSI Curved Lip - Specify Quick Code	Curved Lip Box - Specify Quick Code	Add or Deduct
1"	SA100	SC100	No Charge
1-1/8"	SA118	SC118	
1-1/4"	(standard)	SC114	
1-3/8"	SA138	SC138	
1-1/2"	SA112	SC112	
1-3/4"	SA134	SC134	Add \$16.00 per lockset
2"	SA200	SC200	
2-1/4"	SA214	SC214	
2-1/2"	SA212	SC212	
2-3/4"	SA234	SC234	
3"	SA300	SC300	

Description	Specify Quick Code	Add or Deduct
Rabbeted front and strike	SR118	Add \$86.00 per lockset

\*If door thickness is standard or has been specified and no special door or frame condition exist, then only the first two characters of the optional strike Quick Code must be specified (e.g. "SC").  
The correct lip length will be determined by our order entry system based on the standard or specified door thickness.

**Miscellaneous Options**

Description	Specify Quick Code	Add or Deduct
Split designs and split finishes	Outside Trim x Inside Trim	Higher set price prevails
Spanner head screws	M02	Add \$16.00 per lockset
Torx® head screws	M04	Add \$22.00 per lockset
Less cylinder and with tailpiece for Schlage® cylinder <sup>2</sup>	M06	No Charge
Lever to accept SFIC core <sup>2</sup> (NZD and PZD designs only)	M08	No Charge
Lever to accept Sargent® cylinder <sup>2</sup>	M09	No Charge
1-1/8" latch front, rounded corners	M13	Add \$2.50 per latch
3/4" throw fire latch x 2-3/4" backset (not available for CL3320, 29, 40, and 93 functions)	M16	Add \$94.00 per lockset
Finishes                      Matching		
Available                    Lock Finish		
605                              605		
606                              606, 611, 612, 613		
626                              625, 626		
ANSI wrought strike box	M17	No Charge
Knurling outside and inside	M20	Add \$132.00 per lockset
Knurling outside only	M21	Add \$66.00 per lockset
Knurling inside only	M22	Add \$66.00 per lockset
Abrasive coat outside and inside	M23	Add \$82.00 per lockset
Abrasive coat inside only	M24	Add \$41.00 per lockset
Abrasive coat outside only	M25	Add \$41.00 per lockset
Lead lining (roses)	M28	Add \$164.00 per lockset
Lever to accept Schlage® IC core <sup>2</sup> (NZD and PZD designs only)	M69	No Charge
Request to Exit (REX) Switch (CL33900 only)	M92	\$176.00
CL33900 Series electrified options	12 AD	No Charge
12VAC/DC <sup>1</sup>	24 AD	
24VAC/DC		

**Notes:**

1. Voltage is universal for AC or DC current.
2. Not available in CL3329 function.

**Standard Features**

**Handing**

Non-handed

**Door Thickness**

1-3/4"

**Backset**

2-3/4"

**Strike**

ANSI curved lip  
4-7/8" x 1-1/4" x 1-1/4" lip to center

**Cylinder**

Brass, 6-pin, L4 keyway  
0-bitted

**Keys**

Two nickel silver keys

**Case Quantity**

6

**Case Weight**

26 lbs

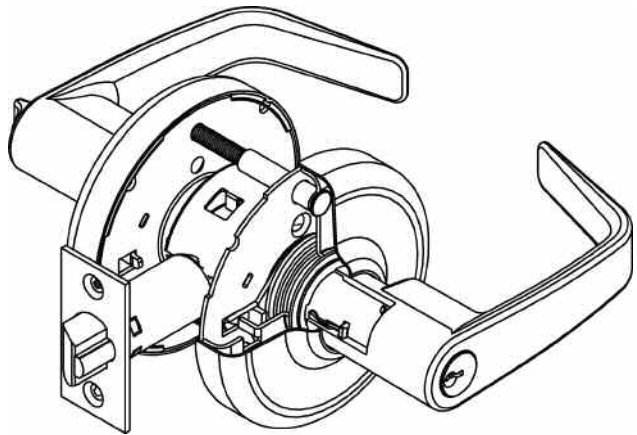

**Ordering Examples**

**Stock Order**

Quantity	Series/Function	Trim	Finish	Hand
100	CL3555	NZD	626	RH

**Split Trim/Split Finish Order**

Quantity	Series/Function	Trim		Finish		Hand
		Outside	Inside	Outside	Inside	
12	CL3555	NZD	AZD	626	625	RH

**Contract/Detailed Order**

Quantity	Keypad	Series/Function	Trim	Finish	Hand	Strike	Misc. Options	Cylinder and Keying
24	AA1	CL3555	NZD	626	RH	SA112	M17	C6-VKC3

**Lever Designs: AZD**



**Lever:**  
Die cast zinc

**Rose:**  
Brass



**AZD**

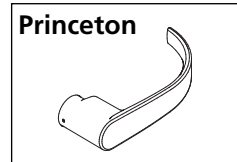
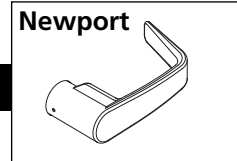

**Lever Designs: NZD**



**Lever:**  
Die cast zinc

**Rose:**  
Wrought Brass or Bronze



**NZD**

**Lever Designs: PZD**



**Lever:**  
Die cast zinc

**Rose:**  
Wrought Brass or Bronze



**PZD**

Function	Description		AZD, NZD, PZD	
			Finish: 613E, 626	Finish: 605, 606, 611, 612, 613, 613L, 618, 619, 625, 722
CL3510	Non-Keyed	Passage	\$385.00	\$401.00
CL3580		Passage x Blank Plate		
CL3520		Privacy		
CL3550		Half Dummy		
CL3570		Full Dummy		
CL3551	Single Cylinder	Entrance	\$493.00	\$509.00
CL3555		Classroom		
CL3557		Storeroom		
CL3561		Office or Privacy		
CL3581	Double Cylinder	Keyed x Blank Plate	\$561.00	\$577.00
CL3582		Store Door		



<b>Cylinder Options</b>		
<b>Description</b>	<b>Specify Quick Code</b>	<b>Add or Deduct</b>
Conventional 6-pin	(standard)	No Charge
Conventional 7-pin	7P	Add \$2.00 per cylinder
Less Cylinder	LC	Deduct \$69.00 per cylinder
Access 3 Patented	AP	No Charge
Access 3 Security	AS	Add \$49.00 per cylinder
Access 3 High Security, UL 437	AHS	Add \$69.00 per cylinder
Access 3 IC Patented	ACP	Add \$64.00 per cylinder
Access 3 IC Security	ACS	Add \$113.00 per cylinder
Access 3 IC High Security, UL 437	ACHS	Add \$133.00 per cylinder
Pyramid Security Fixed Core	PS	Add \$49.00 per cylinder
Pyramid Security IC	PCS	Add \$110.00 per cylinder
Pyramid High Security Fixed Core	PHS	Add \$73.00 per cylinder
Pyramid High Security IC	PCHS	Add \$138.00 per cylinder
Pyramid IC with Temporary Construction Core	CTP	Add \$64.00 per cylinder
Pyramid IC with Temporary Disposable Core	CTPD	No Charge
Pyramid IC Less Core	CLP	No Charge
Security	HS	Add \$95.00 per cylinder
Security IC	CHS	Add \$160.00 per cylinder
IC 6-pin	C6	Add \$64.00 per cylinder
IC 6-pin with Temporary Construction Core (Red)	CT6R	Add \$64.00 per cylinder
IC 6-pin with Temporary Construction Core (Blue)	CT6B	Add \$64.00 per cylinder
IC 6-pin with Temporary Construction Core (Green)	CT6G	Add \$64.00 per cylinder
IC 6-pin with Temporary Disposable Core	CT6D	No Charge
Small Format Temporary Disposable Core	CTSD	No Charge
IC 6-pin less core	CL6	No Charge
IC 7-pin	C7	Add \$66.00 per cylinder
IC 7-pin with Temporary Construction Core (Red)	CT7R	Add \$66.00 per cylinder
IC 7-pin with Temporary Construction Core (Blue)	CT7B	Add \$66.00 per cylinder
IC 7-pin with Temporary Construction Core (Green)	CT7G	Add \$66.00 per cylinder
IC 7-pin with Temporary Disposable Core	CT7D	No Charge
IC 7-pin Less Core	CL7	No Charge
Lockset furnished in Schlage® C Keyway <sup>1</sup>	C	
Lockset furnished in Sargent® LA Keyway <sup>2</sup>	LA	

**Notes:**

1. Available 0-bitted & key random (KR) only.
2. Available 0-bitted only.

**Keying Options\***

Description	Specify Quick Code	Add or Deduct
0-Bitted with 2 blank keys	(standard)	No Charge
Keyed random	KR	
Master keyed (all cylinders except 8000, 8020, 8027 IC core)	Specify keyset	Add \$16.00 per cylinder
Master keyed Pyramid	Specify keyset	
Master keyed Security (including IC cylinder and core)	Specify keyset	
Master keyed (8000, 8020, 8027 IC core)	Specify keyset	No Charge
Master keyed to customer bittings or sample key	Specify keyset	Add \$16.00 per cylinder
Construction master keyed <sup>1,2</sup>	CMK	Add \$16.00 per cylinder
Visual key control (VKC)		
-No stamping	VKC0	\$4.30
-Keys only	VKC1	No Charge
-Cylinder and Keys <sup>3</sup>	VKC2	\$8.00
-Cylinders only <sup>3</sup>	VKC3	\$8.00
Concealed key control (CKC)		
-CKC cylinders with VKC keys	CKC2	\$8.00
-CKC cylinders only <sup>3</sup>	CKC3	\$8.00
More than 2 keys per lock	KY# (e.g., KY6)	See page 48 - Cut Keys Section

## Notes:

1. CMK Construction master keying charge is in addition to master keying charge.
2. CMK Construction master keying is not available in Access 3, Pyramid or Security series.
3. VKC2, VKC3, CKC3 are not available in Access 3, Pyramid or Security series.

\*Double cylinder keying: unless otherwise specified, both cylinders of 82 functions will be keyed alike.

If different keying is required, specify outside cylinder first, then inside cylinder.

For key bows other than 10 and 90, specify "KB" + bow number as Quick Code, e.g. KB12.

**Door Thickness Options**

Description	Specify Quick Code	Add or Deduct
1-3/4"	(standard)	No Charge
1-3/8"	D138**1	

**Backset Options**

Description	Specify Quick Code	Add or Deduct
2-3/8"	B238 <sup>1</sup>	No Charge
2-3/4"	B234 (standard)	
3-3/4"	B334	Add \$15.00 to lockset
5"	B500	Add \$24.00 to lockset

**Strike Options\*** (to purchase strike separately, see catalog or parts manual for part no.)

Lip Length	ANSI Curved Lip Specify Quick Code	Curved Lip Box Specify Quick Code	Full Lip Specify Quick Code	Add or Deduct
1"	SA100	SC100		No Charge
1-1/8"	SA118	SC118	SF118	
1-1/4"	(standard)	SC114		
1-3/8"	SA138	SC138		
1-1/2"	SA112	SC112		Add \$16.00 per lockset
1-3/4"	SA134	SC134		
2"	SA200	SC200		
2-1/4"	SA214	SC214		
2-1/2"	SA212	SC212		
2-3/4"	SA234	SC234		
3"	SA300	SC300		

Description	Specify Quick Code	Add or Deduct
Rabbeted front and strike	SR118	Add \$86.00 per lockset

\*If door thickness is standard or has been specified and no special door or frame condition exist, then only the first two characters of the optional strike Quick Code must be specified (e.g. "SC").

The correct lip length will be determined by our order entry system based on the standard or specified door thickness.

\*\*If D138 is specified, 2-3/8" backset latch will be supplied unless B234 option is also specified.

1. M14 and B238 (2-3/8" backset) standard with D138 (1-3/8" door thickness) option.

**Miscellaneous Options**

Description	Specify Quick Code	Add or Deduct
Split designs and split finishes	Outside Trim x Inside Trim	Higher set price prevails
Spanner head screws	M02	Add \$16.00 per lockset
Torx® head screws	M04	Add \$22.00 per lockset
Less cylinder and with tailpiece for Schlage® cylinder	M06	No Charge
Lever to accept SFIC core (NZD & PZD design only)	M08	No Charge
Lever to accept Sargent® cylinder (NZD design only)	M09	No Charge
Lever to accept Schlage® Interchangeable core (NZD & PZD design only)	M69	No Charge
1-1/8" latch front, rounded corners	M13	Add \$2.50 per latch
1" latch front, square corners <sup>1</sup>	M14	No Charge
1" latch front, rounded corners	M15	Add \$2.50 per latch
ANSI wrought strike box	M17	No Charge
Knurling outside and inside	M20	Add \$132.00 per lockset
Knurling outside only	M21	Add \$66.00 per lockset
Knurling inside only	M22	Add \$66.00 per lockset
Abrasive coat outside and inside only	M23	Add \$82.00 per lockset
Abrasive coat inside only	M24	Add \$41.00 per lockset
Abrasive coat outside only	M25	Add \$41.00 per lockset
1-1/8" latch front, square corners (standard for 2-3/4" and 5" backsets)	M32	No Charge

## Note:

1. M14 and B238 (2-3/8" backset) standard with D138 (1-3/8" door thickness) option.

**Standard Features**

**Handing**

Non-handed

**Door Thickness**

1-3/8" - 1-7/8"

Available in 1-7/8" - 2-1/4" upon request

**Backset**

2-3/4" standard

**Strike**

ANSI curved lip  
4-7/8" x 1-1/4" x 1-1/4" lip to center

**Cylinder**

Brass, 6-pin, L4 keyway  
0-bitted

**Keys**

Two nickel silver keys

**Case Quantity**

6

**Case Weight**

32 lbs

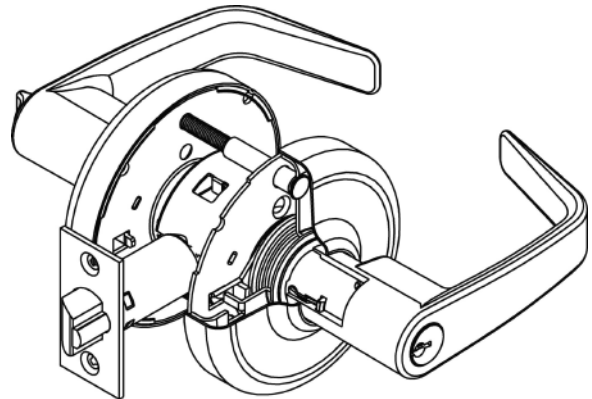

**Ordering Examples**

**Stock Order**

Quantity	Series/Function	Trim	Finish	Hand
100	CL3855	NZD	626	RHR

**Split Trim/Split Finish Order**

Quantity	Series/Function	Trim		Finish		Hand
		Outside	Inside	Outside	Inside	
12	CL3855	NZD	AZD	626	625	RHR

**Contract/Detailed Order**

Quantity	Keyset	Series/Function	Trim	Finish	Hand	Strike	Misc. Options	Cylinder and Keying
24	AA1	CL3855	NZD	626	RHR	SA112	M02	C6-VKC3

**Lever Designs: AZD, NZD, PZD**



**Lever:**

Die cast zinc

**Rose:**

Wrought Brass or Bronze



**Armstrong**

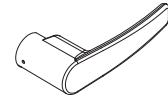

**Newport**



**Princeton**

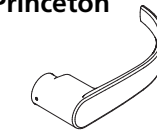

Function	Description	AZD, NZD, PZD	
		Finish: 613E, 626	Finish: 606, 605, 611, 612, 613, 613L, 618, 619, 625, 722
CL3810	Passage	\$200.00	\$216.00
CL3880	Passage x Blank Plate		
CL3820	Privacy	\$220.00	\$236.00
CL3840	Patio		
CL3840NT	Exit Latch		
CL3890	Passage x Turn Piece		
CL3850	Half Dummy		
CL3870	Full Dummy	\$212.00	\$228.00
CL3851	Entrance	\$276.00	\$292.00
CL3855	Classroom		
CL3857	Storeroom		
CL3861	Office		
CL3893	Service Station		
CL3891	Keyed x Turn Piece		
CL3881	Keyed x Blank Plate	\$253.00	\$269.00
CL3862	Communicating	\$344.00	\$360.00
CL3832	Institute		
CL3872	Apartment		

**Cylinder & Keying Options**

Description	Specify Quick Code	Add or Deduct
Conventional 6-pin	(standard)	No Charge
Conventional 7-Pin	7P	Add \$2.00 per cylinder
Less Cylinder	LC	Deduct \$69.00 per cylinder
Access 3 Patented	AP	No Charge
Access 3 Security	AS	Add \$49.00 per cylinder
Access 3 High Security, UL 437	AHS	Add \$69.00 per cylinder
Access 3 IC Patented	ACP	Add \$64.00 per cylinder
Access 3 IC Security	ACS	Add \$113.00 per cylinder
Access 3 IC High Security, UL 437	ACHS	Add \$133.00 per cylinder
Pyramid Security Fixed Core <sup>3</sup>	PS	Add \$49.00 per cylinder
Pyramid Security IC <sup>3</sup>	PCS	Add \$110.00 per cylinder
Pyramid High Security Fixed Core <sup>3</sup>	PHS	Add \$73.00 per cylinder
Pyramid High Security IC <sup>3</sup>	PCHS	Add \$138.00 per cylinder
Pyramid IC with Temporary Construction Core	CTP	Add \$64.00 per cylinder
Pyramid IC with Temporary Disposable Core	CTPD	No Charge
Pyramid IC Less Core	CLP	No Charge
Security	HS	Add \$95.00 per cylinder
Security IC	CHS	Add \$160.00 per cylinder
IC 6-pin	C6	Add \$64.00 per cylinder
IC 6-pin with Temporary Construction Core (Red)	CT6R	Add \$64.00 per cylinder
IC 6-pin with Temporary Construction Core (Blue)	CT6B	Add \$64.00 per cylinder
IC 6-pin with Temporary Construction Core (Green)	CT6G	Add \$64.00 per cylinder
IC 6-pin with Temporary Disposable Core	CT6D	No Charge
Small Format Temporary Disposable Core	CTSD	No Charge
IC 6-pin Less Core	CL6	No Charge
IC 7-Pin	C7	Add \$66.00 per cylinder
IC 7-Pin with Temporary Construction Core (Red)	CT7R	Add \$66.00 per cylinder
IC 7-Pin with Temporary Construction Core (Blue)	CT7B	Add \$66.00 per cylinder
IC 7-Pin with Temporary Construction Core (Green)	CT7G	Add \$66.00 per cylinder
IC 7-Pin with Temporary Disposable Core	CT7D	No Charge
IC 7-Pin Less Core	CL7	No Charge
Lockset furnished in Schlage® C Keyway <sup>1</sup>	C	No Charge
Lockset furnished in SARGENT® LA Keyway <sup>2</sup>	LA	No Charge
0-Bitted with 2 blank keys	(standard)	No Charge
Keyed random	KR	
Master keyed (all cylinders except 8000, 8020, 8027 IC core)	Specify keyset	Add \$16.00 per cylinder
Master keyed Pyramid	Specify keyset	
Master keyed Security (including IC cylinder and core)	Specify keyset	
Master keyed (8000, 8020, 8027 IC core)	Specify keyset	No Charge
Master keyed to customer bittings or sample key	Specify keyset	Add \$16.00 per cylinder
Construction master keyed <sup>3,4</sup>	CMK	Add \$16.00 per cylinder
Visual key control (VKC)		
-No stamping	VKC0	\$4.30
-Keys only	VKC1	No Charge
-Cylinder and Keys <sup>5</sup>	VKC2	\$8.00
-Cylinders only <sup>5</sup>	VKC3	\$8.00
Concealed key control (CKC)		
-CKC cylinders with VKC keys	CKC2	\$8.00
-CKC cylinders only <sup>3</sup>	CKC3	\$8.00
More than 2 keys per lock	KY# (e.g., KY6)	See page 48 - Cut Keys Section

**Notes:**

1. Available 0-bitted & key random (KR) only.
  2. Available 0-bitted only.
  3. CMK Construction master keying charge is in addition to master keying charge.
  4. CMK Construction master keying is not available in Pyramid or Security series.
  5. VKC2, VKC3, CKC3 are not available in Access 3, Pyramid or Security series.
- For key bows other than 10 and 90, specify "KB" + bow number as Quick Code, e.g. KB12. No extra charge.

**Door Thickness Options**

Description	Specify Quick Code	Add or Deduct
1-3/8" — 1-7/8"	(standard)	No Charge
1-7/8"	D214	Add \$5.00 per lockset

**Backset Options**

Description	Specify Quick Code	Add or Deduct
2-3/8"	B238 <sup>1</sup>	No Charge
2-3/4"	(standard)	
3-3/4"	B334	Add \$12.00 to lockset
5"	B500	Add \$14.00 to lockset

**Strike Options\*** (to purchase strike separately, see catalog or parts manual for part no.)

Lip Length	ANSI Curved Lip Specify Quick Code	Curved Lip Box Specify Quick Code	Full Lip Specify Quick Code	Full Lip Radius Corner Specify Quick Code	Add or Deduct
1"	SA100	SC100			No Charge
1-1/8"	SA118	SC118	SF114		
1-1/4"	(standard)	SC114		SFR114	
1-3/8"	SA138	SC138			
1-1/2"	SA112	SC112			
1-3/4"	SA134	SC134			Add \$16.00 per lockset
2"	SA200	SC200			
2-1/4"	SA214	SC214			
2-1/2"	SA212	SC212			
2-3/4"	SA234	SC234			
3"	SA300	SC300			

Description	Specify Quick Code	Add or Deduct
Rabbeted front and strike	SR118	Add \$86.00 per lockset

\*If door thickness is standard or has been specified and no special door or frame condition exist, then only the first two characters of the optional strike Quick Code must be specified (e.g. "SC"). The correct lip length will be determined by our order entry system based on the standard or specified door thickness.

**Miscellaneous Options**

Description	Specify Quick Code	Add or Deduct
Split designs and split finishes	Outside Trim x Inside Trim	Higher set price prevails
Spanner head screws	M02	Add \$16.00 per lockset
Torx® head screws	M04	Add \$22.00 per lockset
Less cylinder and with tailpiece for Schlage® cylinder	M06	No Charge
Lever to accept SFIC core (NZD & PZD design only)	M08	No Charge
Lever to accept Sargent® cylinder (NZD & PZD design only)	M09	No Charge
1-1/8" latch front, rounded corners	M13	Add \$2.50 per latch
1" latch front, square corners <sup>1</sup>	M14	No Charge
1" latch front, rounded corners	M15	Add \$2.50 per latch
ANSI wrought strike box	M17	No Charge
Knurling outside and inside	M20	Add \$132.00 per lockset
Knurling outside only	M21	Add \$66.00 per lockset
Knurling inside only	M22	Add \$66.00 per lockset
Abrasive coat outside and inside only	M23	Add \$82.00 per lockset
Abrasive coat inside only	M24	Add \$41.00 per lockset
Abrasive coat outside only	M25	Add \$41.00 per lockset
1-1/8" latch front, square corners (standard for 2-3/4" and 5" backsets)	M32	No Charge
Lever to accept Schlage® IC core (NZD & PZD designs only)	M69	No Charge

Note:  
1. M14 and B238 (2-3/8" backset) standard with D138 (1-3/8" door thickness) option.



**Standard Features**

**Handing**

Field reversible

**Door Thickness**

1-3/4" - 2"

**Backset**

2-3/4"

**Strike**

ANSI curved lip 4-7/8" - 1-1/4" x  
1-1/4" lip to center

**Cylinder**

Brass, 6-pin, L4 keyway  
0-bitted

**Keys**

Two nickel silver keys

**Case Quantity**

10

**Case Weight**

32 lbs

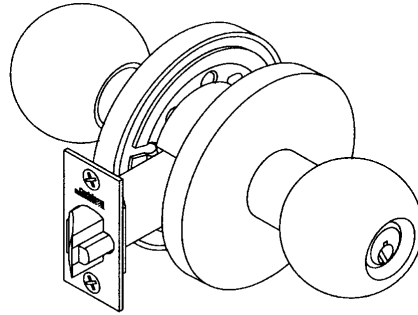

**Ordering Example**

**Stock Order**

Quantity	Series/Function	Trim	Finish	Hand
100	CK4355	GRD	630	RHR

**Contract/Detailed Order**

Quantity	Keyset	Series/Function	Trim	Finish	Hand	Strike	Misc. Options	Cylinder and Keying
24	AA1	CK4355	GRD	630	RHR	SA112	M02	VKC3

**Knob Designs: GRD**
**Knob:**

 Wrought  
Reinforced

**Rose:**

 Wrought  
Reinforced

Function	Description		GRD
			Finish: 605, 613E, 630
CK4310	Non-Keyed	Passage	\$499.00
CK4320		Privacy	\$226.00
CK4350		Half Dummy	\$214.00
CK4351	Single Cylinder	Entrance	\$618.00
CK4355		Classroom	
CK4357		Storeroom	
CK4332	Double Cylinder	Institution	\$674.00

**Cylinder Options**

Description	Specify Quick Code	Add or Deduct
Conventional 6-pin	(standard)	No Charge
Less (1) Cylinder	LC	Deduct \$69.00 per cylinder
Access 3 Patented	AP	No Charge
Access 3 Security	AS	Add \$49.00 per cylinder
Access 3 High Security, UL 437	AHS	Add \$69.00 per cylinder
Pyramid Security Fixed Core	PS	Add \$49.00 per cylinder
Pyramid High Security Fixed Core Security	PHS	Add \$73.00 per cylinder
	HS	Add \$95.00 per cylinder

**Keying Options\***

Description	Specify Quick Code	Add or Deduct
0-Bitted with 2 blank keys	(standard)	No Charge
Keyed random	KR	
Master keyed	Specify keyset	Add \$16.00 per cylinder
Master keyed Pyramid	Specify keyset	Add \$16.00 per cylinder
Master keyed Security	Specify keyset	Add \$16.00 per cylinder
Master keyed	Specify keyset	No Charge
Master keyed to customer bittings or sample key	Specify keyset	Add \$16.00 per cylinder
Construction master keyed <sup>1,2</sup>	CMK	Add \$16.00 per cylinder
Visual key control (VKC)		
-No stamping	VKC0	\$4.30
-Keys only	VKC1	No Charge
-Cylinder and Keys <sup>3</sup>	VKC2	\$8.00
-Cylinders only <sup>3</sup>	VKC3	\$8.00
Concealed key control (CKC)		
-CKC cylinders with VKC keys	CKC2	\$8.00
-CKC cylinders only <sup>3</sup>	CKC3	\$8.00
More than 2 keys per lock	KY# (e.g., KY6)	See page 48 - Cut Keys Section

**Notes:**

1. CMK Construction master keying charge is in addition to master keying charge.
2. CMK Construction master keying is not available in Pyramid or Security series.
3. VKC2, VKC3, CKC3 are not available in Access 3, Pyramid or Security series.

\*Double cylinder keying: unless otherwise specified, both cylinders of 32 functions will be keyed alike. If different keying is required, specify outside cylinder first, then inside cylinder. For key bows other than 10 and 90, specify "KB" + bow number as Quick Code, e.g. KB12. No extra charge.

**Strike Options\***

To purchase strike separately, see catalog or parts manual for part number.

Lip Length	ANSI Curved Lip - Specify Quick Code	Curved Lip Box - Specify Quick Code	Add or Deduct
1"	SA100	SC100	No Charge
1-1/8"	SA118	SC118	
1-1/4"	(standard)	SC114	
1-3/8"	SA138	SC138	
1-1/2"	SA112	SC112	
1-3/4"	SA134	SC134	Add \$16.00 per lockset
2"	SA200	SC200	
2-1/4"	SA214	SC214	
2-1/2"	SA212	SC212	
2-3/4"	SA234	SC234	
3"	SA300	SC300	

\*If door thickness is standard or has been specified and no special door or frame condition exist, then only the first two characters of the optional strike Quick code must be specified(e.g. "SC").

The correct lip length will be determined by our order entry system based on the standard or specified door thickness.

**Backset Options**

Description	Specify Quick Code	Add or Deduct
2-3/4"	(standard)	No Charge

**Door Thickness Options**

Description	Specify Quick Code	Add or Deduct
1-3/4" - 2"	(standard)	No Charge

**Miscellaneous Options**

Description	Specify Quick Code	Add or Deduct
Spanner head screws	M02	Add \$16.00 per lockset
Torx® head screws	M04	Add \$22.00 per lockset
ANSI wrought strike box	M17	No Charge

**Standard Features**

**Handing**

Field reversible

**Door Thickness**

1-3/8" - 1-3/4"

**Backset**

2-3/4"

**Strike**

ANSI curved Lip 4-7/8" x 1-1/4"  
x 1-1/4" lip to center

**Cylinder**

Brass, 6-pin, L4 keyway,  
0-bitted

**Keys**

Two nickel silver keys

**Case Quantity**

20

**Case Weight**

40 lbs

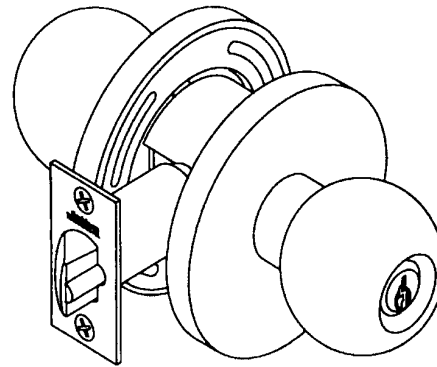

**Ordering Example**

**Stock Order**

Quantity	Series/Function	Trim	Finish	Hand
100	CK4451	GWC	630	RHR

**Split Trim/Split Finish Order** (Privacy function CK4430 only: inside finish 629 only)

Quantity	Series/Function	Finish	Finish		Hand
			Outside	Inside	
12	CK4430	GWC	605	629	RHR

**Contract/Detailed Order**

Quantity	Keyset	Series/Function	Trim	Finish	Hand	Strike	Misc. Options	Cylinder and Keying
24	AA1	CK4451	GWC	630	RHR	SA200	M17	VK1

**Knob Designs: GWC**
**Knob:**  
Wrought

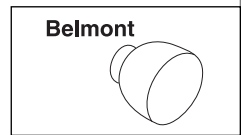
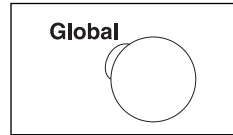
**Rose:**  
Wrought  
Reinforced

**Knob Designs: BWC**
**Knob:**  
Wrought

**Rose:**  
Wrought  
Reinforced

Function	Description	GWC, BWC		
		Finish: 630	Finish: 605, 612, 613, 629	
CK4410	Non-Keyed	Passage	\$161.00	\$177.00
CK4480		Communicating		
CK4430		Privacy	\$180.00	\$196.00
CK4440		Patio		
CK4450	Half Dummy	\$132.00	\$140.00	
CK4451	Single Cylinder	Entrance	\$238.00	\$254.00
CK4455		Classroom		
CK4457		Storeroom		
CK4429		Hotel		
CK4482	Double Cylinder	Storeroom	\$306.00	\$322.00

**Cylinder & Keying Options\***

Description	Specify Quick Code	Add or Deduct
Conventional 6-pin	(standard)	No Charge
Less (1) cylinder	LC	Deduct \$69.00 per cylinder
Less hotel cylinder	LC	Deduct \$80.00
0-Bitted with 2 blank keys	(standard)	No Charge
Keyed random	KR	No Charge
Master keyed*	specify keyset	Add \$16.00 per cylinder
Master keyed to customer bittings or sample key	specify keyset	Add \$16.00 per cylinder
Construction master keyed <sup>1</sup>	CMK	Add \$16.00 per cylinder
Visual key control (VKC)		
-No stamping	VKC0	\$4.30
-Keys only	VKC1	No Charge
Concealed key control (CKC)		
-CKC cylinders with VKC keys	CKC2	\$8.00
-CKC cylinders only	CKC3	\$8.00
More than 2 keys per lock	KY# (e.g., KY6)	See page 48 - Cut Keys Section

Notes:

1. CMK Construction master keying charge is in addition to master keying charge.

\*Both cylinders of double cylinder function locksets will be keyed alike, unless otherwise specified.

If different keying is required, specify outside cylinder first, then inside cylinder.

For key bows other than 10 and 90, specify "KB" + bow number as Quick Code, e.g. KB12. No extra charge.

**Backset Options**

Description	Specify Quick Code	Add or Deduct
2-3/8"	B238	No Charge
2-3/4"	(standard)	
3-3/4"	B334	Add \$12.00 to lockset
5"	B500	Add \$14.00 to lockset

**Strike Options\***

To purchase strike separately, see catalog or parts manual for part no.

**Strike Options\*** (to purchase strike separately, see catalog or parts manual for part no.)

Lip Length	ANSI Curved Lip Specify Quick Code	Curved Lip Box Specify Quick Code	Full Lip Specify Quick Code	Full Lip Radius Corner Specify Quick Code	Add or Deduct
1"	SA100	SC100			No Charge
1-1/8"	SA118	SC118	SF114		
1-1/4"	(standard)	SC114		SFR114	
1-3/8"	SA138	SC138			
1-1/2"	SA112	SC112			
1-3/4"	SA134	SC134			Add \$16.00 per lockset
2"	SA200	SC200			
2-1/4"	SA214	SC214			
2-1/2"	SA212	SC212			
2-3/4"	SA234	SC234			
3"	SA300	SC300			

\*If door thickness is standard or has been specified and no special door or frame condition exist, then only the first two characters of the optional strike Quick Code must be specified (e.g. "SC").

**Miscellaneous Options**

Description	Specify Quick Code	Add or Deduct
Split designs and split finishes	Outside Trim x Inside Trim	Higher set price prevails
NOTE: Split finish on inside must be 629 for CK4430 only.		
1" latch front, square corners (for 2-3/8" backset only)	M14	Add \$4.00 per lockset
ANSI wrought strike box	M17	No Charge
Abrasive coat outside and inside	M23	Add \$82.00 per lockset
Abrasive coat inside only	M24	Add \$41.00 per lockset
Abrasive coat outside only	M25	Add \$41.00 per lockset

**Standard Features**

**Handing**

Specify hand

**Door Thickness**

1-3/4" only

**Backset**

2-3/4" only

**Strike**

ANSI curved lip 4-7/8" x 1-1/4" x 1-1/4" lip to center

**Cylinder**

Brass, 6-pin, L4 keyway, 0-bitted

**Keys**

Two nickel silver keys

**Case Quantity**

6 leversets  
9 knobsets

**Case Quantity**

36

**Case Weight**

45 lbs

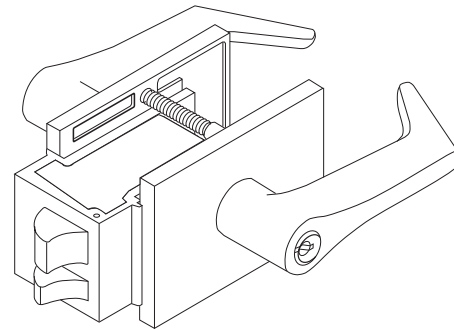

Now available with MicroShield® antimicrobial finish. Specify 626C finish (\$35.00 upcharge per lockset)

**Ordering Example**

**Stock Order**

Quantity	Series/Function	Trim	Finish	Hand
100	UT5251	ESE	626	RH

**Split Trim/Split Finish Order**

Quantity	Series/Function	Trim	Finish		Hand
			Outside	Inside	
12	UT5251	ESE	626	625	RHR

**Contract/Detailed Order**

Quantity	Keyset	Series/Function	Trim	Finish	Hand	Strike	Misc. Options	Cylinder and Keying
24	AA1	UT5251	ESE	626	RHR	SC200	M21	MR-VKC3

**Lever Designs: ESE**

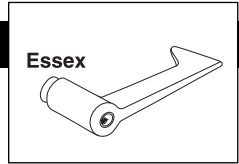

**Lever:**  
Forged

**Escutcheon:**  
Forged

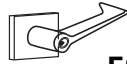

**ESE**

Function	Description		ESE
			Finish: 612, 613, 613E, 625, 626
UT5210	Non-keyed	Passage or Closet	\$996.00
UT5220		Privacy	\$1,078.00
UT5251	Single Cylinder	Entrance	\$1,164.00
UT5255		Classroom	
UT5257		Storeroom	
UT5282	Double Cylinder	Store Door	\$1,232.00



**Cylinder Options**

Description	Specify Quick Code	Add or Deduct
Conventional 6-pin	(standard)	No Charge
Less (1) Cylinder	LC	Deduct \$69.00 per cylinder
Access 3 Patented	AP	No Charge
Access 3 Security	AS	Add \$49.00 per cylinder
Access 3 High Security, UL 437	AHS	Add \$69.00 per cylinder
Access 3 IC Patented	ACP	Add \$64.00 per cylinder
Access 3 IC Security	ACS	Add \$113.00 per cylinder
Access 3 IC High Security, UL 437	ACHS	Add \$133.00 per cylinder
Pyramid Security Fixed Core	PS	Add \$49.00 per cylinder
Pyramid Security IC	PCS	Add \$110.00 per cylinder
Pyramid High Security Fixed Core	PHS	Add \$73.00 per cylinder
Pyramid High Security IC	PCHS	Add \$138.00 per cylinder
Pyramid IC with Temporary Construction Core	CTP	Add \$64.00 per cylinder
Pyramid IC with Temporary Disposable Core	CTPD	No Charge
Pyramid IC Less Core	CLP	No Charge
Security	HS	Add \$95.00 per cylinder
Security IC	CHS	Add \$160.00 per cylinder
IC 6-pin	C6	Add \$64.00 per cylinder
IC 6-pin with Temporary Construction Core (Red)	CT6R	Add \$64.00 per cylinder
IC 6-pin with Temporary Construction Core (Blue)	CT6B	Add \$64.00 per cylinder
IC 6-pin with Temporary Construction Core (Green)	CT6G	Add \$64.00 per cylinder
IC 6-pin with Temporary Disposable Core	CT6D	No Charge
IC 6-pin with Small Format Temporary Disposable Core	CTSD	No Charge
IC 6-pin Less Core	CL6	No Charge
IC 7-pin	C7	Add \$66.00 per cylinder
IC 7-pin with Temporary Construction Core (Red)	CT7R	Add \$66.00 per cylinder
IC 7-pin with Temporary Construction Core (Blue)	CT7B	Add \$66.00 per cylinder
IC 7-pin with Temporary Construction Core (Green)	CT7G	Add \$66.00 per cylinder
IC 7-pin with temporary Disposable Core	CT7D	No Charge
IC 7-pin Less Core	CL7	No Charge
Master Ring	MR	\$0.00

**Keying Options\***

Description	Specify Quick Code	Add or Deduct
0-Bitted with 2 blank keys	(standard)	No Charge
Keyed Random	KR	
Master keyed (all cylinders except 8000, 8020, 8027 IC core)	Specify keyset	Add \$16.00 per cylinder
Master keyed Pyramid	Specify keyset	
Master keyed Security (including IC cylinder and core)	Specify keyset	
Master keyed (8000, 8020, 8027 IC core)	Specify keyset	No Charge
Master keyed to customer bittings or sample key	Specify keyset	Add \$16.00 per cylinder
Construction master keyed <sup>1,2</sup>	CMK	Add \$16.00 per cylinder
Visual key control (VKC)		
-No stamping	VKC0	\$4.30
-Keys only	VKC1	No Charge
-Cylinder and Keys <sup>3</sup>	VKC2	\$8.00
-Cylinders only <sup>3</sup>	VKC3	
Concealed key control (CKC)		
-CKC cylinders with VKC keys	CKC2	\$8.00
-CKC cylinders only <sup>3</sup>	CKC3	
More than 2 keys per lock	KY# (e.g., KY6)	See page 48 - Cut Keys Section

**Notes:**

1. CMK Construction master keying charge is in addition to master keying charge.
2. CMK Construction master keying is not available in Pyramid or Security series.
3. VKC2, VKC3, CKC3 are not available in Access 3, Pyramid or Security series.

\*Double cylinder keying: unless otherwise specified, both cylinders of 32 and 82 functions will be keyed alike. The inside cylinder of 72 function will be keyed to the master key(s) only, while the outside cylinder will include the change key.

If different keying is required, specify outside cylinder first, then inside cylinder.

For key bows other than 10 and 90, specify "KB" + bow number as Quick Code, e.g. KB12. No extra charge.

**Strike Options\***

To purchase strike separately, see catalog for part no.

Lip Length	ANSI Curved Lip Specify Quick Code	T-Strike Curved Lip Box Specify Quick Code	Add or Deduct
1-1/4"	Standard	NA	No Charge
2"	N/A	SC200	Add \$16.00 per lockset
2-1/8"	N/A	SC218	
2-1/4"	N/A	SC214	
2-1/2"	N/A	SC212	
2-3/4"	N/A	SC234	
3"	N/A	SC300	

Lip Length	ANSI Straight Lip For Door Pair** Quick Code	For Door Pair** Quick Code	Add or Deduct
1-13/16"	SA136	SP136	No Charge

Lip length	ANSI Straight Lip For Extended Lip Escutcheon Quick Code	For Extended Lip Escutcheon Quick Code	Add or Deduct
15/16"	Standard when Extended Lip Option is Specified	SX156	No Charge

\*If door thickness is standard or has been specified and no special door or frame condition exist, then only the first two characters of the optional strike Quick code must be specified (e.g. "SC").

The correct lip length will be determined by our order entry system based on the standard or specified door thickness.

\*\* Lip is measured from back of strike.

**Miscellaneous Options**

Description	Specify Quick Code	Add or Deduct
Split designs and split finishes	Outside Trim x Inside Trim	Higher set price prevails
Delrin insert (knob filler cover)	M01	Add \$2.00 per lockset
Spanner head screws	M02	Add \$16.00 per lockset
Torx® head screws (on strike)	M04	Add \$22.00 per lockset
Lever to accept SFIC core (ESE only)	M08	Deduct \$20.00 per lockset
Knob to accept SFIC core, less core	M10	Add 10.00 per knob; less core no cylinder deduct allowed
Extended lip escutcheon (for single door reverse bevel; 630 finish to match 626 only)	M11	Add \$52.00 per lockset
Knurling outside and inside	M20	Add \$132.00 per lockset
Knurling outside only	M21	Add \$66.00 per lockset
Knurling Inside only	M22	
Abrasive coat outside and inside	M23	
Abrasive coat inside only	M24	Add \$41.00 per lockset
Abrasive coat outside only	M25	
Lead lining escutcheon	M28	
Unstaked lever retainer	M33	No Charge

A large empty rectangular box intended for handwritten notes.

**Standard Features**
**Case**

Extruded Brass

**Shackle**

1 1/32" (8.7mm) diameter hardened steel (PL5000 Series), brass (PL5100 Series) or stainless steel (PL5200 Series)

**Locking**

Ball-bearing locking heel and toe

**Cylinder**

 RFC model: 6-pin Fixed Core (2300)  
 IC model: 6-pin & Pyramid IC (8000 series)  
 L4 keyway standard

**Case Quantity**

36

**Case Weight**

27 lbs

**Ordering Example**
**Stock Order**

Quantity	Series/Function
10	PL5000R

**Access 3 Order**

Quantity	Series/Function	Misc. Options
8	PL5070	ACP M44

**Contract Order**

Quantity	Keyset	Series/Function	Shackle Length	Misc. Options
10	AA1	PL5080	258	M45

**Padlocks**

Hardened Steel Shackle	Brass Shackle	Description	List Price
PL5000R	PL5100R	Rekeyable Fixed Core (RFC)	\$88.00
PL5070*	PL5170*	Interchangeable core (IC), less core	\$94.00
PL5080	PL5180	IC 6-pin	\$158.00
PL5090	PL5190	IC security	\$254.00
PL5030	PL5130	Pyramid High Security (IC)	\$232.00
PL5037	PL5137	Pyramid Security (IC)	\$207.00

Stainless Steel Shackle	Description	List Price
PL5200R	Rekeyable Fixed Core (RFC)	\$93.00
PL5270*	Interchangeable core (IC), less core	\$99.00
PL5280	IC 6-pin	\$163.00
PL5290	IC security	\$259.00
PL5230	Pyramid High Security (IC)	\$237.00
PL5237	Pyramid Security (IC)	\$212.00

**Shackle Length Options with Padlocks**

Description	Specify Quick Code	Add or Deduct
7/8"	(standard)	No Charge
2-5/8"	258	Add \$4.60 to padlock

\* Access 3 is only available with Less Core.

**Cylinder & Keying Options\***

Description	Specify Quick Code	Add or Deduct
Access 3 IC Patented	ACP	Add \$64.00 per cylinder
Access 3 IC Security	ACS	Add \$113.00 per cylinder
Access 3 IC High Security, UL 437	ACHS	Add \$133.00 per cylinder
Keyed random (standard for Pyramid & IC security padlocks)	KR	No Charge
0-Bitted (not available for Pyramid & IC security padlocks)	(standard)	
Master Keyed RFC	specify keyset	Add \$16.00 per cylinder
Master Keyed IC security	specify keyset	
Master Keyed IC 6-pin & Pyramid IC	specify keyset	No Charge
Master Keyed to customer bittings or sample key	specify keyset	Add \$16.00 per cylinder
Construction Master Keyed (RFC & IC 6-pin padlocks only) <sup>1, 2</sup>	CMK	Add \$16.00 per cylinder
Temporary construction core (IC 6-pin padlocks only) (Red)	CT6R	No Charge
Temporary Construction Core (IC 6-pin padlocks only) (Blue)	CT6B	No Charge
Temporary Construction Core (IC 6-pin padlocks only) (Green)	CT6G	No Charge
Visual key control (VKC)		
- No Stamping	VKC0	\$4.30
- Keys only	VKC1	No Charge
- Locks and Keys <sup>3</sup> (RFC & IC 6-pin padlocks only)	VKC2	\$8.00
- Locks only <sup>3</sup> (RFC & IC 6-pin padlocks only)	VKC3	
Concealed key control (CKC) (IC 6-pin & IC security padlocks only)		
- CKC cores with VKC keys <sup>4</sup>	CKC2	\$8.00
- CKC cores only <sup>3, 4</sup>	CKC3	
More than 2 keys per lock	KY# (e.g., KY6)	See page 48 - Cut Keys Section
Rekeybale FC (RFC) Less Cylinder	LC	Deduct \$20.00

**Notes:**

1. CMK Construction master keying charge is in addition to master keying charge.
  2. CMK is not available in Pyramid or Security series.
  3. VKC2, VKC3, CKC3 are not available in Access 3, Pyramid or Security series.
  4. CKC2, CKC3 is not available in PL5000, PL5100, PL5070 or PL5170 padlock.
- \*For key bows other than 10 and 90, specify "KB" + bow number as Quick Code, e.g. KB12. No extra charge.

**Miscellaneous Options**

Description	Specify Quick Code	Add or Deduct
Chain and clevis attached	M44	Add \$3.60 per padlock
Custom die stamped case* (specify existing die number or lettering specifications for artwork)	M45**	Add \$5.2 per padlock

\*To create new die stamp, contact factory. Provide artwork with request for quotation.  
Die stamps remain the property of Corbin Russwin.

\*\*Only available on PL5200 Series stainless steel shackle padlocks.

**ANSI/BHMA 156.5  
Grade 2**

**Standard Features**

**Handing**

Non-handed

**Door Thickness**

1-3/8" - 2-1/4"

**Backset**

2-3/4" (standard)  
2-3/8" available

**Strike**

2-3/4" x 1-1/8"

**Cylinder**

Brass 6-pin,  
0-bitted, L4 keyway

**Keys**

Two nickel silver keys

**Case Quantity**

14

**Case Weight**

30 lbs

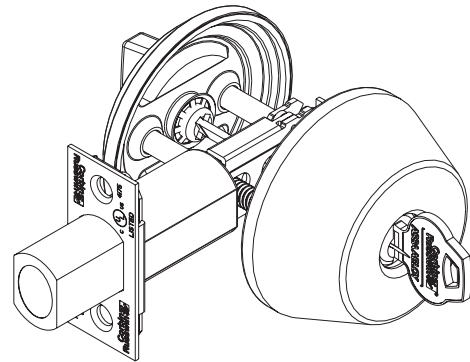

**Ordering Example**

**Stock Order**

Quantity	Series/Function	Finish
30	DL2213	626

**Contract Order**

Quantity	Keyset	Finish	Keyset	Optional Strike
30	DL2213	626	AA1	SS134

Function	Description	Finish: 613E, 626	Finish: 605, 606, 612, 613, 625
DL2213	Single Cylinder	\$94.00	\$98.00
DL2212	Double Cylinder	\$122.00	\$128.00
DL2217	Classroom	\$94.00	\$98.00
DL2211	Cylinder x Blank		
DL2260	Thumbturn x Blank	\$68.00	\$72.00

**Cylinder & Keying Options\***

Description	Specify Quick Code	Add or Deduct
Conventional 6-pin	(standard)	No Charge
Conventional 7-pin	7P	Add \$2.00 per cylinder
Less cylinder	LC	No Deduct
Interchangeable core (IC) 6-pin	C6	Add \$64.00 per cylinder
IC 6-pin less core	CL6	No Charge
SFIC 6-pin with Less Core	CLS6	No Charge
IC 6-pin with temporary construction core	CT6	Add \$64.00 per cylinder
IC 7-pin	C7	Add \$66.00 per cylinder
IC 7-pin less core	CL7	No Charge
SFIC 7-pin with Less Core	CLS7	No Charge
IC 7-pin with temporary construction core	CT7	Add \$66.00 per cylinder
Security	HS	Add \$95.00 per cylinder
Security IC	CHS	Add \$160.00 per cylinder
Access 3 Patented	AP	No Charge
Access 3 Security	AS	Add \$49.00 per cylinder
Access 3 High Security, UL 437	AHS	Add \$69.00 per cylinder
Access 3 IC Patented	ACP	Add \$64.00 per cylinder
Access 3 IC Security	ACS	Add \$113.00 per cylinder
Access 3 IC High Security, UL 437	ACHS	Add \$133.00 per cylinder
Pyramid High Security Fixed Core	PHS	Add \$73.00 per cylinder
Pyramid High Security IC	PCHS	Add \$138.00 per cylinder
Pyramid Security Fixed Core	PS	Add \$49.00 per cylinder
Pyramid Security IC	PCS	Add \$110.00 per cylinder
0-Bitted with two blank keys	(standard)	No Charge
Keyed Random	KR	No Charge
Construction Master Keyed (not available for Pyramid & Security cylinders) <sup>1</sup>	CMK	Add \$16.00 per cylinder
Visual key control (VKC)		
- Keys only	VKC1	No Charge
- Cylinders and Keys (not for Access 3, Pyramid, HS or CHS)	VKC2	\$8.00
- Cylinders only (not for Access 3, Pyramid, HS or CHS)	VKC3	
Concealed key control (CKC)		
- CKC cylinders with VKC keys	CKC2	\$8.00
- CKC cylinders only	CKC3	
More than 2 keys per lock	KY# (e.g., KY6)	See page 48 - Cut Keys Section

**Notes:**

1. CMK Construction master keying charge is in addition to master keying charge.

\*Both cylinders of double cylinder deadlocks are keyed alike, unless otherwise specified. If different keying is required, specify outside cylinder first, then inside cylinder.

For key bows other than 10 and 90, specify 'KB' + bow number as Quick Code, e.g. KB12.

Note: KB92 cannot be furnished with VKC or other markings.



**Strike Options**

To purchase strike separately, see catalog or parts manual for part no.

Lip Length	ANSI Straight Lip - Specify Quick Code	Add or Deduct
7/8"	SS078	No Charge
1-1/8"	SS118	
1-1/4"	SS114	
1-3/8"	SS138	
1-1/2"	SS112	
1-3/4"	SS134	
2"	SS200	Add \$16.00 per lockset
2-1/4"	SS214	
2-1/2"	SS212	
2-3/4"	SS234	
3"	SS300	

**Door Thickness Options**

Description	Specify Quick Code	Add or Deduct
1-3/8"	D138	No Charge
1-3/4"	(standard)	No Charge
2"	D200	No Charge
2-1/4"	D214	No Charge

**Miscellaneous Options**

Description	Specify Quick Code	Add or Deduct
1" (25mm) bolt front, square corners	M14	No Charge
ANSI wrought strike box	M17	
Plastic box for standard strike	(standard)	
2-3/8" (60mm) backset bolt	B238	

**Standard Features**

**Handing**

Non-handed, except DL3017 function

**Door Thickness**

1-3/4" - 2-1/4"

**Backset**

2-3/4" (standard)

**Strike**

Wrought brass or bronze  
2-3/4" x 1-1/8" with  
wrought box

**Cylinder**

Brass 6-pin,  
0-bitted, L4 keyway

**Keys**

Two nickel silver keys

**Weight**

2.5 lbs each



**Ordering Example**

**Stock Order**

Quantity	Series/Function	Finish
30	DL3013	626

**Contract Order**

Quantity	Keyset	Finish	Keyset	Optional Strike
30	DL3013	626	AA1	SD002

Function	Description	Finish: 605, 606, 612 613 613E, 618, 619, 625, 626, 722
DL3013	Single Cylinder	\$218.00
DL3012	Double Cylinder	\$294.00
DL3017	Classroom*	\$224.00
DL3011	Cylinder x Blank	\$218.00
DL3060	Thumbturn x Blank	

\*Thumbturn will not project deadbolt. Specify hand.

**Cylinder & Keying Options\***

Description	Specify Quick Code	Add or Deduct
Conventional 6-pin	(standard)	No Charge
Conventional 7-pin	7P	Add \$2.00 per cylinder
Less cylinder	LC	Deduct \$76.00 per cylinder
Access 3 Patented	AP	No Charge
Access 3 Security	AS	Add \$49.00 per cylinder
Access 3 High Security, UL 437	AHS	Add \$69.00 per cylinder
Access 3 IC Patented	ACP	Add \$64.00 per cylinder
Access 3 IC Security	ACS	Add \$113.00 per cylinder
Access 3 IC High Security, UL 437	ACHS	Add \$133.00 per cylinder
Pyramid Security fixed core	PS	Add \$49.00 per cylinder
Pyramid Security IC	PCS	Add \$113.00 per cylinder
Pyramid High Security fixed core	PHS	Add \$64.00 per cylinder
Pyramid High Security IC	PCHS	Add \$138.00 per cylinder
Pyramid IC with Temporary Construction Core	CTP	Add \$64.00 per cylinder
Security	HS	Add \$95.00 per cylinder
Security IC	CHS	Add \$161.00 per cylinder
IC 6-pin	C6	Add \$64.00 per cylinder
IC 6-pin with temporary construction core	CT6	
UL IC 6-Pin Housing Less Core	CL6AH	\$61.00
UL IC 6-Pin Housing with Disposable Core	CTAHD	
UL IC 6-Pin Housing with (Red/Blue/ Green) Temporary Construction Core	CT6AH(R/B/G)	\$133.00
IC 6-pin less core	CL6	
SFIC 6-pin with Less Core	CLS6	
SFIC 7-pin less core	CLS7	No Charge
0-Bitted with 2 blank keys	(standard)	
Keyed random	KR	
Construction master keyed <sup>1,2</sup>	CMK	Add \$16.00 per cylinder
Visual key control (VKC)		
- Keys only	VKC1	No Charge
- Cylinders and Keys <sup>3</sup>	VKC2	
- Cylinders only <sup>3</sup>	VKC3	\$8.00
Concealed key control (CKC)		
- CKC cylinders with VKC keys	CKC2	
- CKC cylinders only <sup>3</sup>	CKC3	\$8.00
More than 2 keys per lock	KY# (e.g., KY6)	See page 48 - Cut Keys Section

**Notes:**

1. CMK Construction master keying charge is in addition to master keying charge.

2. CMK is not available in Pyramid or Security series.

3. VKC2, VKC3, CKC3 are not available in Access 3, Pyramid or Security series.

\*Both cylinders of double cylinder deadlocks are keyed alike, unless otherwise specified. If different keying is required, specify outside cylinder first, then inside cylinder.

For key bows other than 10 and 90, specify "KB" + bow number as Quick Code, e.g. KB12. No extra charge.

4. Refer to page 47 for example of CTP option pricing.

**Strike Options\***

To purchase strike separately, see catalog or parts manual for part no.

Lip Length	ANSI Straight Lip - Specify Quick Code	Add or Deduct
7/8"	SS078	No Charge
1-1/8"	SS118	
1-1/4"	SS114	
1-3/8"	SS138	
1-1/2"	SS112	
1-3/4"	SS134	
2"	SS200	Add \$16.00 per lockset
2-1/4"	SS214	
2-1/2"	SS212	
2-3/4"	SS234	
3"	SS300	

**Strike Options (No lip)**

	Specify Quick Code	Add or Deduct
2-3/4" x 1-1/8"	(standard)	No Charge
3-1/2" x 1-1/8"	SD001	

**Door Thickness Options**

Description	Specify Quick Code	Add or Deduct
1-3/8" (Not available in IC option)	D138	No Charge
1-3/4" - 2"	(standard)	
2-1/4"	D214	Add \$7.00 per deadlock

**Miscellaneous Options**

Description	Specify Quick Code	Add or Deduct
ANSI wrought box	M17	No Charge
Wrought box for standard strike	(standard)	
2-3/8" backset	B238	

**Standard Features**

**Handing**

Non-handed

**Door Thickness**

1-3/8" - 2-1/4"

**Backset**

2-3/4" (standard)  
2-3/8" available

**Strike**

2-3/4" x 1-1/8"

**Cylinder**

Brass 6-pin,  
0-bitted, L4 keyway

**Keys**

Two nickel silver keys

**Case Quantity**

14

**Case Weight**

30 lbs

**ANSI/BHMA 156.5**

**Grade 1**

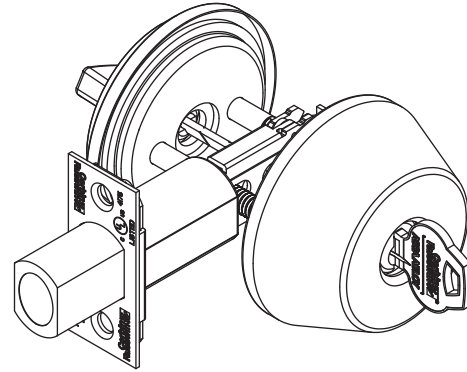

**Ordering Example**

**Stock Order**

Quantity	Series/Function	Finish
30	DL3213	626

**Contract Order**

Quantity	Keypad	Finish	Keypad	Optional Strike
30	DL3213	626	AA1	SS134

Function	Description	Finish: 613E, 626	Finish: 605, 606, 612, 613, 625
DL3213	Single Cylinder	\$170.00	\$177.00
DL3212	Double Cylinder	\$238.00	\$245.00
DL3217	Classroom	\$170.00	\$177.00
DL3211	Cylinder x Blank		
DL3260	Thumbturn x Blank	\$145.00	\$149.00

**Cylinder & Keying Options\***

Description	Specify Quick Code	Add or Deduct
Conventional 6-pin	(standard)	No Charge
Conventional 7-pin (except ML2229)	7P	Add \$2.00 per cylinder
Less (1) cylinder	LC	Deduct \$69.00 per cylinder
IC 6-pin	C6	Add \$64.00 per cylinder
SFIC 6-pin with Less Core	CLS6	No Charge
IC 6-pin less core	CL6	No Charge
IC 6-pin with temporary construction core	CT6	Add \$64.00 per cylinder
IC 7-pin	C7	Add \$66.00 per cylinder
IC 7-pin with temporary construction core	CT7	Add \$66.00 per cylinder
SFIC 7-pin with Less Core	CLS7	No Charge
IC 7-pin less core	CL7	No Charge
Security	HS	Add \$95.00 per cylinder
Security IC	CHS	Add \$160.00 per cylinder
Access 3 Patented	AP	No Charge
Access 3 Security	AS	Add \$49.00 per cylinder
Access 3 High Security, UL 437	AHS	Add \$69.00 per cylinder
Access 3 IC Patented	ACP	Add \$64.00 per cylinder
Access 3 IC Security	ACS	Add \$113.00 per cylinder
Access 3 IC High Security, UL 437	ACHS	Add \$133.00 per cylinder
Pyramid High Security Fixed Core	PHS	Add \$73.00 per cylinder
Pyramid High Security IC	PCHS	Add \$138.00 per cylinder
Pyramid Security Fixed Core	PS	Add \$49.00 per cylinder
Pyramid Security IC	PCS	Add \$113.00 per cylinder
0-Bitted with 2 blank keys	(standard)	No Charge
Keyed Random	KR	No Charge
Construction Master Keyed (not available for Pyramid & Security cylinders) <sup>1</sup>	CMK	Add \$16.00 per cylinder
Visual key control (VKC)		
- Keys only	VKC1	No Charge
- Cylinders and Keys (not for Access 3, Pyramid, CHS)	VKC2	\$8.00
- Cylinders only (not for Access 3, Pyramid, CHS)	VKC3	
Concealed key control (CKC)		
- CKC cylinders with VKC keys	CKC2	\$8.00
- CKC cylinders only	CKC3	
More than 2 keys per lock	KY# (e.g., KY6)	See page 48 - Cut Keys Section

**Notes:**

1. CMK Construction master keying charge is in addition to master keying charge.

\*Both cylinders of double cylinder deadlocks are keyed alike, unless otherwise specified. If different keying is required, specify outside cylinder first, then inside cylinder.

For key bows other than 10 and 90, specify 'KB' + bow number as Quick Code, e.g. KB12.

NOTE: KB92 cannot be furnished with VKC or other markings.

**Strike Options**

To purchase strike separately, see catalog or parts manual for part no.

Lip Length	ANSI Straight Lip - Specify Quick Code	Add or Deduct
7/8 "	SS078	No Charge
1-1/8 "	SS118	
1-1/4 "	SS114	
1-3/8 "	SS138	
1-1/2 "	SS112	
1-3/4 "	SS134	Add \$16.00 per lockset
2 "	SS200	
2-1/4 "	SS214	
2-1/2 "	SS212	
2-3/4 "	SS234	
3 "	SS300	

**Door Thickness Options**

Description	Specify Quick Code	Add or Deduct
1-3/8 "	D138	No Charge
1-3/4 "	(standard)	
2 "	D200	
2-1/4 "	D214	

**Miscellaneous Options**

Description	Specify Quick Code	Add or Deduct
1 " (25mm) bolt front, square corners	M14	No Charge
ANSI wrought strike box	M17	
Plastic box for standard strike	(standard)	
2-3/8 " (60mm) backset bolt	B238	

**Standard Features**

**Handing**

Non-handed

**Door Thickness**

1-3/4"

**Backset**

2-3/4"

**Strike**

Wrought brass or bronze  
3-1/2" x 1-1/8"

**Cylinder**

6-pin, L4 keyway, 0-bitted

**Keys**

Two nickel silver keys

**Weight**

2.25 lbs each

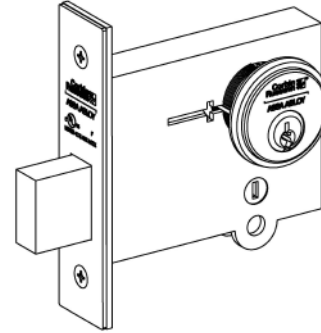

**Ordering Example**

**Stock Order**

Quantity	Series/Function	Finish
30	DL4113	626

**Contract Order**

Quantity	Keypad	Finish	Keypad	Optional Strike
30	DL4113	626	AA1	SS118

Function	Description	Finish: 613E, 626	Finish: 605, 606, 611, 612, 613, 618, 619, 625
DL4113	Single Cylinder	\$297.00	\$302.00
DL4112	Double Cylinder	\$325.00	\$330.00
DL4117	Classroom*	\$297.00	\$302.00
DL4111	Cylinder x Blank	\$249.00	\$254.00
DL4122	Double Cylinder x Thumbturn*	\$373.00	\$378.00
DL4160	Thumbturn x Blank	\$221.00	\$226.00

\*Thumbturn will not project deadbolt.



**Cylinder & Keying Options\***

Description	Specify Quick Code	Add or Deduct
Conventional 6-pin	(standard)	No Charge
Conventional 7-pin	7P	Add \$2.00 per cylinder
Less cylinder	LC	Deduct \$76.00 per cylinder
Access 3 Patented	AP	No Charge
Access 3 Security	AS	Add \$49.00 per cylinder
Access 3 High Security, UL 437	AHS	Add \$69.00 per cylinder
Access 3 IC Patented	ACP	Add \$64.00 per cylinder
Access 3 IC Security	ACS	Add \$113.00 per cylinder
Access 3 IC High Security, UL 437	ACHS	Add \$133.00 per cylinder
Pyramid High Security fixed core	PS	Add \$75.00 per cylinder
Pyramid High Security IC	PCS	Add \$138.00 per cylinder
Pyramid High Security fixed core	PHS	Add \$75.00 per cylinder
Pyramid High Security IC	PCHS	Add \$138.00 per cylinder
Security	HS	Add \$95.00 per cylinder
Security IC	CHS	Add \$161.00 per cylinder
IC 6-pin	C6	Add \$64.00 per cylinder
IC 6-pin less core	CL6	No Charge
IC 6-pin with temporary construction core	CT6	\$61.00
UL IC 6-Pin Housing Less Core	CL6AH	
UL IC 6-Pin Housing with Disposable Core	CTAHD	
UL IC 6-Pin Housing with (Red/Blue/Green) Temporary Construction Core	CT6AH(R/B/G)	\$133.00
IC 7-pin	C7	Add \$66.00 per cylinder
IC 7-pin less core	CL7	Add \$2.00 per cylinder
IC 7-pin with temporary construction core	CT7	
0-Bitted with 2 blank keys	(standard)	No Charge
Keyed random	KR	
Construction master keyed <sup>1,2</sup>	CMK	Add \$16.00 per cylinder
Visual key control (VKC)		
- Keys only	VKC1	No Charge
- Cylinders and Keys <sup>3</sup>	VKC2	\$8.00
- Cylinders only <sup>3</sup>	VKC3	
Concealed key control (CKC)		
- CKC cylinders with VKC keys	CKC2	\$8.00
- CKC cylinders only <sup>3</sup>	CKC3	
More than 2 keys per lock	KY# (e.g., KY6)	See page 48 - Cut Keys Section

**Notes:**

1. CMK Construction master keying charge is in addition to master keying charge.
2. CMK is not available in Pyramid or Security series.
3. VKC2, VKC3, CKC3 are not available in Access 3, Pyramid or Security series.  
\*Both cylinders of double cylinder deadlocks are keyed alike, unless otherwise specified. If different keying is required, specify outside cylinder first, then inside cylinder.  
For key bows other than 10 and 90, specify "KB" + bow number as Quick Code, e.g. KB12.
4. Refer to page 47 for example of CTP option pricing.

**Strike Options**

To purchase strike separately, see catalog for part no.

Lip length	ANSI Straight Lip Specify Quick Code	Add or Deduct
7/8"	SS078	Add \$16.00 per lockset
1-1/8"	SS118	
1-1/4"	SS114	
1-3/8"	SS138	
1-1/2"	SS112	
1-3/4"	SS134	
2"	SS200	
2-1/4"	SS214	
2-1/2"	SS212	
2-3/4"	SS234	
3"	SS300	

**Door Thickness Options**

Description	Specify Quick Code	Add or Deduct
1-3/4" - 2"	(standard)	No Charge
2-1/4"	D214	
2-1/2"	D212	Add \$20.00 per dead lock
2-3/4"	D234	
3"	D300	
3-1/4"	D314	Add \$32.00 per deadlock
3-1/2"	D312	
3-5/8"	D358	
3-3/4"	D334	
3-7/8"	D378	
4"	D400	

**Miscellaneous Options**

Description	Specify Quick Code	Add or Deduct
Spanner head screws	M02	Add \$16.00 per lockset
Torx head screws	M04	Add \$22.00 per lockset
ANSI wrought box	M17	No Charge
Lead wrapped case	M29	Add \$252.00 per lockset
Ergonomic Thumbturn (specify door thickness)	M34	Add \$15.00 per TT
Box for standard strike	M40	No Charge

## FE5400S

### Multi-Point Exit Device Latching System

#### Standard Features

##### Handing

Device is non-handed  
Lever trim is handed

##### Bar Length

Standard: 36" (914mm) bar fits 30" - 36"  
(762mm-914mm) door

##### Door Height

7'0" (2134mm) standard

##### Door Thickness

1-3/4" (44mm) standard

##### Stile

Minimum width 4-1/2" (114mm).

##### Projection

3-1/4" (83mm) active, 2-3/4" (70mm) dogged.

##### Cylinders

Cylinder not included unless specified.

##### Warranty

Seven-year limited

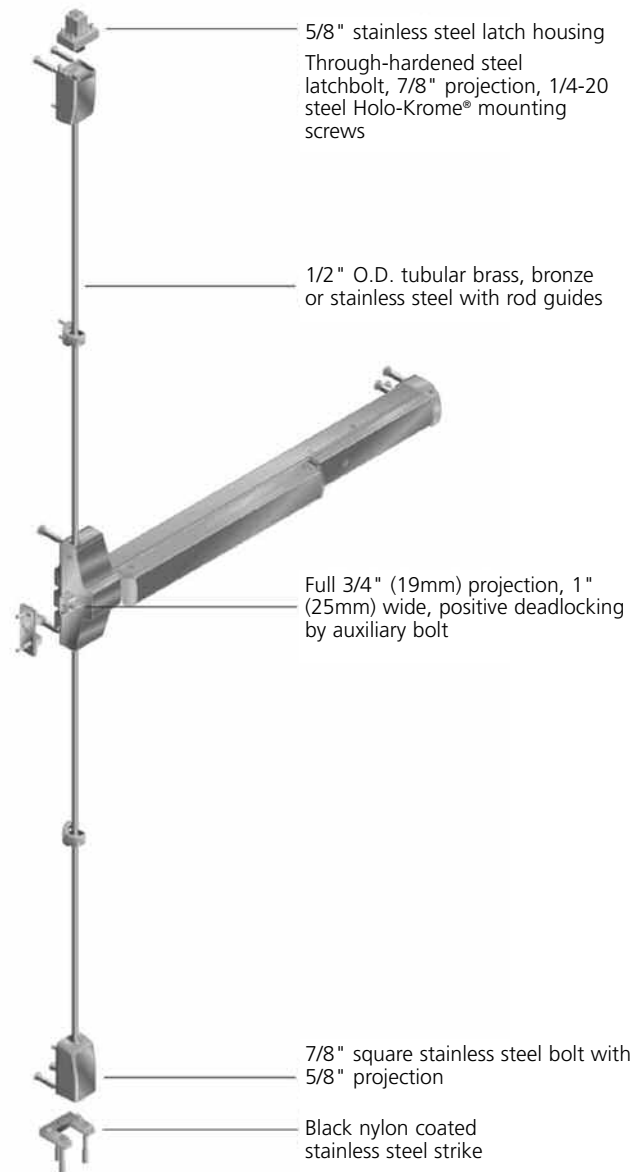

# FE5400S

## Multi-Point Exit Device Latching System



### Ordering Examples

#### Exit Device Only

Quantity	Series/ Function	Finish	Hand	Misc. Options
65	FE5400S	626	RHR	M51

#### Trim Only

Quantity	Trim/ Function	Finish	Hand	Door Thickness
24	N955	625	RHR	D214

#### Exit Device with Trim

Quantity	Exit Device	Trim/ Function	Finish	Hand	Door Thickness	Door Width	Misc. Options
65	FE5400S	N955	605	LHR	D214	W048	M51

#### Contract/Detailed Order — Exit Device with Trim

Quantity	Keypad	Exit Device	Trim/ Function	Finish	Hand	Door Height	Door Width	Misc. Options	Cylinder Option
36	AA1	FE5400S	C955	626	LHR	HO800	W048	M52	7P

### Pricing

#### 36" Device Only

Includes device, strike(s) and screw pack. No cylinder or trim.

FE5400S Series			
Function	Description	Finish: 613E, 630'	Finish: 605, 606, 611, 612, 613, 618, 619, 625, 626, 629, 722
FE5400S	Panic	\$3,102.00	\$3,182.00
FE5400SA	3 Hour Fire Rated	\$3,265.00	\$3,345.00

Caution: Be sure of your measurements. Exit devices are NOT returnable.

# FE5400S

## Multi-Point Exit Device Latching System



### FE5400S Series Heavy-Duty Trim

Cylinder is not included.

#### Escutcheon Trim Design: A9 Armstrong

**Lever:** Cast

**Escutcheon:** Forged

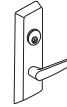

Function	Description	Finish: 613E, 630 <sup>1</sup>	Finish: 605, 606, 611, 612, 613, 618, 619, 625, 626, 629 <sup>2</sup> , 722
A910	Passage	\$572.00	\$598.00
A950	Dummy		
A955	Classroom <sup>3</sup>		
A959	Storeroom		

#### Escutcheon Trim Design: C9 Citation

**Lever:** Cast

**Escutcheon:** Forged

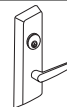

Function	Description	Finish: 613E, 630 <sup>1</sup>	Finish: 605, 606, 611, 612, 613, 618, 619, 625, 626, 629 <sup>2</sup> , 722
C910	Passage	\$572.00	\$598.00
C950	Dummy		
C955	Classroom <sup>3</sup>		
C959	Storeroom		

#### Escutcheon Trim Design: D9 Dirke

**Lever:** Cast

**Escutcheon:** Forged

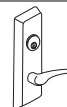

Function	Description	Finish: 613E, 630 <sup>1</sup>	Finish: 605, 606, 611, 612, 613, 618, 619, 625, 626, 629 <sup>2</sup> , 722
D910	Passage	\$572.00	\$598.00
D950	Dummy		
D955	Classroom <sup>3</sup>		
D959	Storeroom		

#### Escutcheon Trim Design: E9 Essex

**Lever:** Cast

**Escutcheon:** Forged

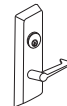

Function	Description	Finish: 613E, 630 <sup>1</sup>	Finish: 605, 606, 611, 612, 613, 618, 619, 625, 626, 629 <sup>2</sup> , 722
E910	Passage	\$572.00	\$598.00
E950	Dummy		
E955	Classroom <sup>3</sup>		
E959	Storeroom		

**Notes:**

1. 619 finish provided to match 630 finish
2. 618 finish provided to match 629 finish.
3. Classroom function trim may be converted to storeroom function by a simple field adjustment. No additional parts required.

# FE5400S

## Multi-Point Exit Device Latching System



### FE5400S Series Heavy-Duty Trim

Cylinder is not included.

#### Escutcheon Trim Design: L9 Lustra



**Lever:** Cast

**Escutcheon:** Forged

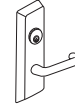

Function	Description	Finish: 613E, 630 <sup>1</sup>	Finish: 605, 606, 611, 612, 613, 618, 619, 625, 626, 629 <sup>2</sup> , 722
L910	Passage	\$572.00	\$598.00
L950	Dummy		
L955	Classroom <sup>3</sup>		
L959	Storeroom		

#### Escutcheon Trim Design: N9 Newport



**Lever:** Cast

**Escutcheon:** Forged

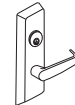

Function	Description	Finish: 613E, 630 <sup>1</sup>	Finish: 605, 606, 611, 612, 613, 618, 619, 625, 626, 629 <sup>2</sup> , 722
N910	Passage	\$572.00	\$598.00
N950	Dummy		
N955	Classroom <sup>3</sup>		
N959	Storeroom		

#### Escutcheon Trim Design: R9 Regis



**Lever:** Cast

**Escutcheon:** Forged

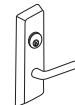

Function	Description	Finish: 613E, 630 <sup>1</sup>	Finish: 605, 606, 611, 612, 613, 618, 619, 625, 626, 629 <sup>2</sup> , 722
R910	Passage	\$572.00	\$598.00
R950	Dummy		
R955	Classroom <sup>3</sup>		
R959	Storeroom		

#### Escutcheon Trim Design: PR9 Princeton



**Lever:** Cast

**Escutcheon:** Forged



Function	Description	Finish: 613E, 630 <sup>1</sup>	Finish: 605, 606, 611, 612, 613, 618, 619, 625, 626, 629 <sup>2</sup> , 722
PR910	Passage	\$572.00	\$598.00
PR950	Dummy		
PR955	Classroom <sup>3</sup>		
PR959	Storeroom		

**Notes:**

1. 619 finish provided to match 630 finish. - Escutcheons only
2. 618 finish provided to match 629 finish. - Escutcheons only
3. Classroom function trim may be converted to storeroom function by a simple field adjustment. No additional parts required.

# FE5400S

## Multi-Point Exit Device Latching System



### FE5400S Series Heavy-Duty Trim

Cylinder is not included.

#### Escutcheon Trim Design: G9

**Lever:** Cast

**Escutcheon:** Forged



Function	Description	Finish: 613E, 630 <sup>1</sup>	Finish: 605, 606, 612, 613, 618, 619, 625, 626, 629 <sup>2</sup> , 722
G910	Passage	\$572.00	\$598.00
G950	Dummy		
G955	Classroom <sup>3</sup>		
G959	Storeroom		

Notes:

1. 619 finish provided to match 630 finish. - Escutcheons only
2. 618 finish provided to match 629 finish. - Escutcheons only
3. Classroom function trim may be converted to storeroom function by a simple field adjustment. No additional parts required.

#### Escutcheon Trim Design: TH900 Pull/Thumbpiece

**Grip:** Extruded

**Escutcheon:** Forged



Function	Description	Finish: 613E, 630 <sup>1</sup>	Finish: 605, 606, 611, 612, 613, 618, 619, 625, 626, 629 <sup>2</sup> , 722
TH910	Passage	\$413.00	\$439.00
TH950	Dummy (No thumbpiece)	\$383.00	\$409.00
TH955	Classroom <sup>3</sup>	\$413.00	\$439.00
TH959	Storeroom	\$383.00	\$409.00

#### Escutcheon Trim Design: P9 Pull

**Pull:** Extruded

**Escutcheon:** Forged

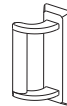

Function	Description	Finish: 613E, 630 <sup>1</sup>	Finish: 605, 606, 611, 612, 613, 618, 619, 625, 626, 629 <sup>2</sup> , 722
P950*	Dummy	\$354.00	\$380.00

\* Specify Hand. Field Reversible.

**FE5400S**  
Multi-Point Exit Device Latching System

**FE5400S Series Heavy-Duty Trim**

Cylinder is not included.

**Escutcheon Trim Design: FR9 Frascati\***



**Escutcheon:** Forged

\* Handed Lever. Handing cannot be changed in the field.

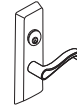

Function	Description	Finish: 613E, 626	Finish: 605, 606, 611, 612, 613, 618, 619, 625, 629, 722
FR910	Passage	\$572.00	\$598.00
FR950	Dummy		
FR955	Classroom <sup>3</sup>		
FR959	Storeroom		

**Escutcheon Trim Design: M9 Merlot**



**Escutcheon:** Forged

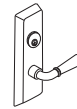

Function	Description	Finish: 613E, 626	Finish: 605, 606, 611, 612, 613, 618, 619, 625, 629, 722
M910	Passage	\$572.00	\$598.00
M950	Dummy		
M955	Classroom <sup>3</sup>		
M959	Storeroom		

**Escutcheon Trim Design: TS9 Tuscany**



**Escutcheon:** Forged



Function	Description	Finish: 613E, 626	Finish: 605, 606, 611, 612, 613, 618, 619, 625, 629, 722
TS910	Passage	\$572.00	\$598.00
TS950	Dummy		
TS955	Classroom <sup>3</sup>		
TS959	Storeroom		

**Escutcheon Trim Design: Z9 Zinfandel\***



**Escutcheon:** Forged

\* Handed Lever. Handing cannot be changed in the field.

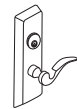

Function	Description	Finish: 613E, 626	Finish: 605, 606, 611, 612, 613, 618, 619, 625, 629, 722
Z910	Passage	\$572.00	\$598.00
Z950	Dummy		
Z955	Classroom <sup>3</sup>		
Z959	Storeroom		

Notes:  
3. Classroom function trim may be converted to storeroom function by a simple field adjustment. No additional parts required.



**FE5400S**  
Multi-Point Exit Device Latching System

**FE5400S Series Heavy-Duty Trim**

Cylinder is not included.

**Escutcheon Trim Design: Muséo®** 

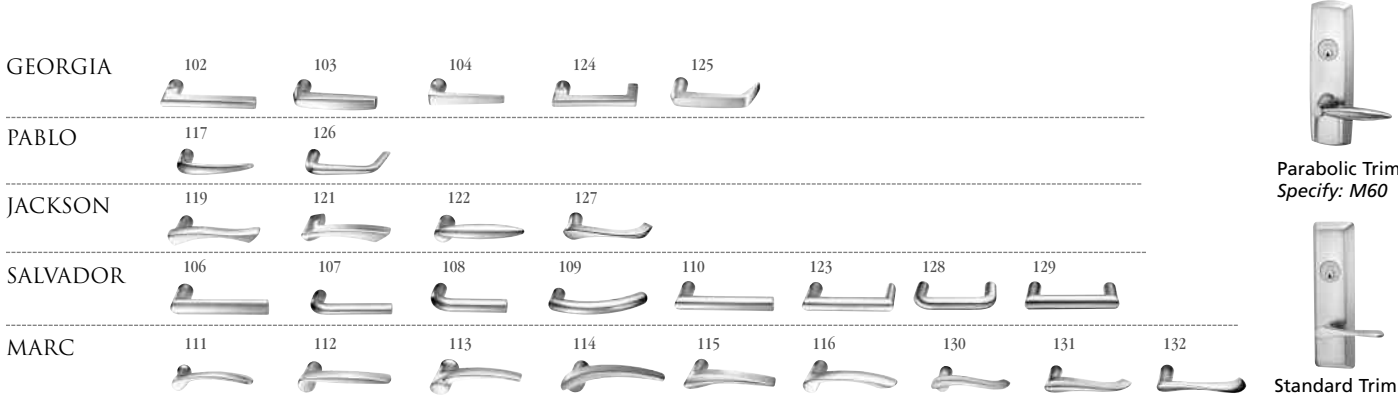

Function	Description	Finish: 613E, 630	Finish: 605, 606, 611, 612, 613, 613L, 618, 619, 625, 626, 629, 722
910	Passage	\$572.00	\$598.00
950	Dummy		
955	Classroom		
959	Storeroom		

**Escutcheon Trim Design: Muséo®** 

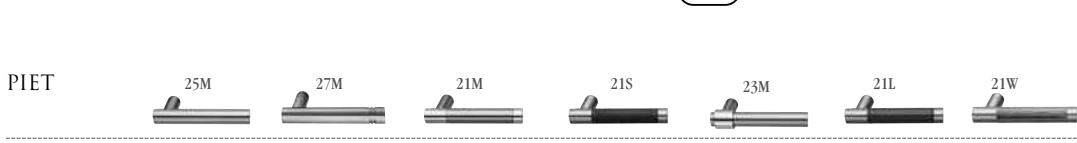

Function	Description	Finish: 629, 630
910	Passage	\$598.00
950	Dummy	
955	Classroom	
959	Storeroom	

**FE5400S**  
Multi-Point Exit Device Latching System

**FE5400S Series Electrically Controlled Trim**

Cylinder is not included.

**Escutcheon Trim Design: A9 Armstrong**



**Lever:** Cast    **Escutcheon:** Forged

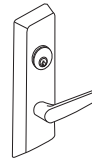

Function	Description	Finish: 613E, 630 <sup>1</sup>	Finish: 605, 606, 611, 612, 613, 618, 619, 625, 626, 629 <sup>2</sup> , 722
A9903*	Fail Safe	\$960.00	\$986.00
A9905*	Fail Secure		

**Escutcheon Trim Design: C9 Citation**



**Lever:** Cast    **Escutcheon:** Forged

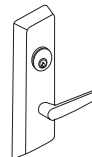

Function	Description	Finish: 613E, 630 <sup>1</sup>	Finish: 605, 606, 611, 612, 613, 618, 619, 625, 626, 629 <sup>2</sup> , 722
C9903*	Fail Safe	\$960.00	\$986.00
C9905*	Fail Secure		

**Escutcheon Trim Design: D9 Dirke\***



**Lever:** Cast    **Escutcheon:** Forged

\* Handed Lever. Handing cannot be changed in the field.

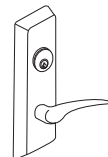

Function	Description	Finish: 613E, 630 <sup>1</sup>	Finish: 605, 606, 611, 612, 613, 618, 619, 625, 626, 629 <sup>2</sup> , 722
D9903*	Fail Safe	\$960.00	\$986.00
D9905*	Fail Secure		

**Escutcheon Trim Design: E9 Essex**



**Lever:** Cast    **Escutcheon:** Forged

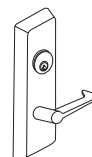

Function	Description	Finish: 613E, 630 <sup>1</sup>	Finish: 605, 606, 611, 612, 613, 618, 619, 625, 626, 629 <sup>2</sup> , 722
E9903*	Fail Safe	\$960.00	\$986.00
E9905*	Fail Secure		

Notes:  
1. 619 finish provided to match 630 finish. - Escutcheons only  
2. 618 finish provided to match 629 finish. - Escutcheons only



\*ElectroLynx®  
As part of their promise to provide innovative, fast and effective high security solutions to their customers, certain ASSA ABLOY Group brands offer **ElectroLynx®**, a universal quick-connect system that simplifies the electrification of the door opening.

**FE5400S Series Electrically Controlled Trim**

Cylinder is not included.

**Escutcheon Trim Design: L9 Lustra** 

**Lever:** Cast    **Escutcheon:** Forged

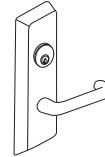

Function	Description	Finish: 613E, 630 <sup>1</sup>	Finish: 605, 606, 611, 612, 613, 618, 619, 625, 626, 629 <sup>2</sup> , 722
L9903*	Fail Safe	\$960.00	\$986.00
L9905*	Fail Secure		

**Escutcheon Trim Design: N9 Newport** 

**Lever:** Cast    **Escutcheon:** Forged

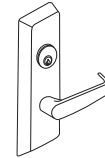

Function	Description	Finish: 613E, 630 <sup>1</sup>	Finish: 605, 606, 611, 612, 613, 618, 619, 625, 626, 629 <sup>2</sup> , 722
N9903*	Fail Safe	\$960.00	\$986.00
N9905*	Fail Secure		

**Escutcheon Trim Design: R9 Regis** 

**Lever:** Cast    **Escutcheon:** Forged

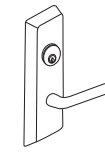

Function	Description	Finish: 613E, 630 <sup>1</sup>	Finish: 605, 606, 611, 612, 613, 618, 619, 625, 626, 629 <sup>2</sup> , 722
R9903*	Fail Safe	\$960.00	\$986.00
R9905*	Fail Secure		

**Escutcheon Trim Design: PR9 Princeton** 

**Lever:** Cast    **Escutcheon:** Forged

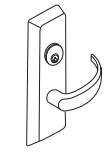

Function	Description	Finish: 613E, 630 <sup>1</sup>	Finish: 605, 606, 611, 612, 613, 618, 619, 625, 626, 629 <sup>2</sup> , 722
PR9903*	Fail Safe	\$960.00	\$986.00
PR9905*	Fail Secure		

Notes:  
 1. 619 finish provided to match 630 finish. - Escutcheons only  
 2. 618 finish provided to match 629 finish. - Escutcheons only



**\*ElectroLynx®**  
 As part of their promise to provide innovative, fast and effective high security solutions to their customers, certain ASSA ABLOY Group brands offer *ElectroLynx®*, a universal quick-connect system that simplifies the electrification of the door opening.

**FE5400S**  
Multi-Point Exit Device Latching System

**FE5400S Series Electrically Controlled Trim**

Cylinder is not included.

**Escutcheon Trim Design: FR9 Frascati** 

**Lever:** Cast **Escutcheon:** Forged

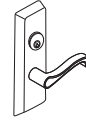

Function	Description	Finish: 613E, 626	Finish: 605, 606, 611, 612, 613, 618, 619, 625, 629, 722
FR9903*	Fail Safe	\$960.00	\$986.00
FR9905*	Fail Secure		

**Escutcheon Trim Design: M9 Merlot** 

**Lever:** Cast **Escutcheon:** Forged

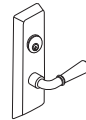

Function	Description	Finish: 613E, 626	Finish: 605, 606, 611, 612, 613, 618, 619, 625, 629, 722
M9903*	Fail Safe	\$960.00	\$986.00
M9905*	Fail Secure		

**Escutcheon Trim Design: TS9 Tuscany** 

**Lever:** Cast **Escutcheon:** Forged

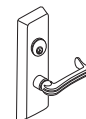

Function	Description	Finish: 613E, 626	Finish: 605, 606, 611, 612, 613, 618, 619, 625, 629, 722
TS9903*	Fail Safe	\$960.00	\$986.00
TS9905*	Fail Secure		

**Escutcheon Trim Design: Z9 Zinfandel** 

**Lever:** Cast **Escutcheon:** Forged

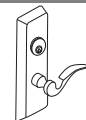

Function	Description	Finish: 613E, 626	Finish: 605, 606, 611, 612, 613, 618, 619, 625, 629, 722
Z9903*	Fail Safe	\$960.00	\$986.00
Z9905*	Fail Secure		



**\*ElectroLynx®**

As part of their promise to provide innovative, fast and effective high security solutions to their customers, certain ASSA ABLOY Group brands offer **ElectroLynx®**, a universal quick-connect system that simplifies the electrification of the door opening.

**FE5400S**  
Multi-Point Exit Device Latching System

**FE5400S Series Electrically Controlled Trim**

Cylinder is not included.

**Escutcheon Trim Design: Muséo®**



GEORGIA



PABLO



JACKSON



SALVADOR



MARC



Parabolic Trim  
Specify: M60



Standard Trim

Function	Description	Finish: 613E, 630	Finish: 605, 606, 611, 612, 613, 613L, 618, 619, 625, 626, 629, 722
9903*	Fail Safe	\$960.00	\$986.00
9905*	Fail Secure		

**Escutcheon Trim Design: Muséo®**



PIET



Function	Description	Finish: 629, 630
9903*	Fail Safe	\$986.00
9905*	Fail Secure	



**\*ElectroLynx®**

As part of their promise to provide innovative, fast and effective high security solutions to their customers, certain ASSA ABLOY Group brands offer **ElectroLynx®**, a universal quick-connect system that simplifies the electrification of the door opening.

# FE5400S Electrically Controlled Trim

## Multi-Point Exit Device Latching System



### Electrified Options

Description	Specify Quick Code	Add or Deduct
Touchbar Monitoring or Signaling/Request to Exit (REX)	M92*	Add \$204.00
Outside Trim Monitoring or Signaling	M93*	Add \$204.00
SPDT Lock and Unlock security monitor switch (Electric Trim Only)	M98*	Add \$196.00
Trim gasket for exterior applications (Electric Trim Only)	M99	Add \$22.00

### Electrified Accessories

Part Number	Description	Specify	Price
709F649	Power Supply 1 Amp @ 12VDC Output	BPS-12-1	\$295.00
709F659	Power Supply 3 Amp @ 12VDC Output	BPS-12-3	\$600.00
709F609	Power Supply 2 Amp @ 24VDC Output	BPS-24-1	\$295.00
709F619	Power Supply 2 Amp @ 24VDC Output	BPS-24-2	\$600.00
709F629	Power Supply 4 Amp @ 24VDC Output	BPS-24-4	\$975.00
704F288	Concealed transfer (for over 120-degree swing door)	EPTL	\$112.00
709F689	(1) SPDT Maintained Switch (Includes LED)	MKA	\$162.00
709F709	(1) SPDT Momentary Switch (Includes LED)	MK	\$170.00
709F759	(1) SPDT Maintained (Alternating Action) Switch	PB3EA	\$100.00
709F729	DPDT Momentary Key Switch	2' MK2	\$196.00
704F719	Narrow Stile Momentary Key Switch	MKN	\$170.00
709F789	Sonalert 90db @ 2 ft. 12-24VDC Mounted on one gang stainless steel plate.	PZ1	\$84.00



#### \*ElectroLynx®

As part of their promise to provide innovative, fast and effective high security solutions to their customers, certain ASSA ABLOY Group brands offer *ElectroLynx*®, a universal quick-connect system that simplifies the electrification of the door opening.

# FE5400S Electrically Controlled Trim

## Multi-Point Exit Device Latching System



### Cylinder Options\*

Description	Specify Quick Code	Add or Deduct
Conventional 6-pin	6P**	Add \$76.00 per cylinder
Conventional 7-pin	7P	Add \$78.00 per cylinder
Access 3 Patented	AP	No Charge
Access 3 Security	AS	Add \$49.00 per cylinder
Access 3 High Security, UL 437	AHS	Add \$69.00 per cylinder
Access 3 IC Patented	ACP	Add \$64.00 per cylinder
Access 3 IC Security	ACS	Add \$113.00 per cylinder
Access 3 IC High Security, UL 437	ACHS	Add \$133.00 per cylinder
Pyramid Security fixed core	PS	Add \$125.00 per cylinder
Pyramid Security IC	PCS	Add \$189.00 per cylinder
Pyramid High Security fixed core	PHS	Add \$151.00 per cylinder
Pyramid High Security IC	PCHS	Add \$214.00 per cylinder
Pyramid IC with temporary construction core	CTP	Add \$143.00 per cylinder
Pyramid IC with temporary disposable core	CTPD	Add \$76.00 per cylinder
Pyramid IC less core	CLP	Add \$76.00 per cylinder
Security	HS	Add \$171.00 per cylinder
Security IC	CHS	Add \$236.00 per cylinder
Blockout function	BO	Add \$214.00 per cylinder
IC 6-pin	C6	Add \$143.00 per cylinder
IC 6-pin with temporary construction core (Red)	CT6R	Add \$143.00 per cylinder
IC 6-pin with temporary construction core (Blue)	CT6B	Add \$143.00 per cylinder
IC 6-pin with temporary construction core (Green)	CT6G	Add \$143.00 per cylinder
IC 6-pin with temporary disposable core	CT6D	Add \$76.00 per cylinder
IC 6-pin less core	CL6	Add \$76.00 per cylinder
SFIC 6-pin with Less Core	CLS6	Add \$76.00 per cylinder
IC 6-pin with SFIC disposable temporary core	CT6SD	Add \$76.00 per cylinder
IC 7-pin	C7	Add \$144.00 per cylinder
IC 7-pin with temporary construction core (Red)	CT7R	Add \$144.00 per cylinder
IC 7-pin with temporary construction core (Blue)	CT7B	Add \$144.00 per cylinder
IC 7-pin with temporary construction core (Green)	CT7G	Add \$144.00 per cylinder
IC 7-pin with temporary disposable core	CT7D	Add \$78.00 per cylinder
IC 7-pin less core	CL7	Add \$78.00 per cylinder
SFIC 7-pin with Less Core	CLS7	Add \$78.00 per cylinder
IC 7-pin with SFIC disposable temporary core	CT7SD	Add \$78.00 per cylinder

\*Optional dogging cylinder will be furnished with the same mechanism and keyed alike with the trim cylinder, unless otherwise specified. If different keying or cylinder type is required, specify outside (trim) first, then inside (dogging) cylinder.

\*\*6P cylinder option is supplied in 6-pin, L4 keyway, 0-bitted with two nickel silver keys.

### Keying Accessories\*

Description	Specify Quick Code	Add or Deduct
0-Bitted with 2 blank keys	(standard)	No Charge
Keyed random	KR	No Charge
Master keyed (all cylinders except 8000, 8020, 8027 IC)	specify keyset	Add \$16.00 per cylinder
Master keyed Pyramid	specify keyset	Add \$16.00 per cylinder
Master keyed Security (including IC cylinder and core)	specify keyset	Add \$16.00 per cylinder
Master keyed (8000, 8020, 8027 IC core)	specify keyset	No Charge
Master keyed to customer bittings or sample key	specify keyset	Add \$16.00 per cylinder
Construction master keyed <sup>1,2</sup>	CMK	Add \$16.00 per cylinder
Visual key control (VKC)		
- No Stamping	VKC0	\$4.30
- Keys only	VKC1	No Charge
- Cylinders and Keys <sup>3</sup>	VKC2	\$8.00
- Cylinders only <sup>3</sup>	VKC3	\$8.00
Concealed key control (CKC)		
- CKC cylinders with VKC keys	CKC2	\$8.00
- CKC cylinders only <sup>3</sup>	CKC3	\$8.00
More than 2 keys per lock	KY# (e.g., KY6)	See page 48 - Cut Keys Section

\*For key bows other than 10 and 90, specify "KB" + bow number as Quick Code, e.g. KB12.

Notes:

1. CMK Construction master keying charge is in addition to master keying charge.

2. CMK Construction master keying is not available in Pyramid or Security series.

3. VKC2, VKC3, CKC3 are not available in Pyramid or Security series.

# FE5400S Electrically Controlled Trim

## Multi-Point Exit Device Latching System



### Door Height Options

Door Height	Specify Quick Code	Add or Deduct
7'0"	(standard)	No Charge
7'2"	H0702	No Charge
7'6"	H0706	No Charge
8'0"	H0800	No Charge

### Door Width Options

Door Width	Specify Quick Code	Add or Deduct
32"	W032	No Charge
36"	(standard)	No Charge
42"	W042	No Charge
48"	W048	Add \$35.00 per device

### Door Thickness Options

Door Thickness	Specify Quick Code	Add or Deduct
1-3/4"	(standard)	No Charge
2"	D200	No Charge
2-1/4"	D214	No Charge

### Miscellaneous Options

Description	Specify	Add or Deduct
Knurling outside and inside (Embossed Touchbar - device side)	M20	Add \$139.00 per device
Knurling outside only (trim side)	M21	Add \$65.00 per device
Knurling inside only (Embossed Touchbar - device side)	M22	Add \$74.00 per device
Abrasive coat outside and inside (trim and device)	M23	Add \$88.00 per device
Abrasive coat inside only (device side)	M24	Add \$46.00 per device
Abrasive coat outside only (trim side)	M25	Add \$42.00 per device
PathLite™ Photoluminescent Touchbar cover	M49	Add \$335.00 per device
Less dogging	M51	No Charge
Cylinder dogging (less cylinder)	M52	Add \$78.00 per device
Mullion stabilizer	M57	Add \$62.00 per mullion
Parabolic Design Exit Trim	M60	Add \$78.00 per device
MicroShield® Antimicrobial finish coating	626C	Add \$40.00 (Exit Devices & Trims (ordered separately))
		Add \$60.00 (Exit Devices & Outside Trims (ordered together))
MicroShield® Antimicrobial finish coating	630C	Add \$40.00 (Exit Devices & Trims (ordered separately))
		Add \$60.00 (Exit Devices & Outside Trims (ordered together))



# FE5400S

## Multi-Point Exit Device Latching System



### Removable Mullions

Door Height	Description	Specify	Price
Up to 7'0"	Steel Mullion - 3 Hour Fire Rated, Windstorm Certified	FE707A <sup>4</sup>	\$995.00
Up to 8'0"	Steel Mullion - 3 Hour Fire Rated, Windstorm Certified	FE708A <sup>4</sup>	\$1,005.00

Note:

- 4. For use with UL listed door assemblies that comply to FEMA 361 and ICC 500.  
For the latest listings on compliant door assemblies visit our website at [corbinrusswin.com](http://corbinrusswin.com)

### Options

Description	Specify Quick Code	Add or Deduct
Door frame filler block for double rabbeted frames	M95	Add \$42.00 per mullion
Door frame angle bracket for aluminum frames	M96	Add \$42.00 per mullion

FE5400S

Notes



# FE6700

## Storm Shutter Multi-Point Latching System

### Standard Features

#### Handing

Device is handed

#### Shutter Thickness

FE6700 is for use with standard 1-3/4" thick shutters

#### Optional Cylinders for FE6755

##### Classroom Function

Brass, 6-pin, L4 keyway, 0-bitted, 1-1/8" standard. Optional cylinders available; see Quick Codes

#### Warranty

Seven-year limited

#### UL Approved

Meets FEMA 361 and ICC 500 for inswing shutters 1'8" w x 3'0" h min to 4'0" w x 6'8" h max.

*Solid brass lever and heavy duty escutcheon*

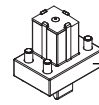
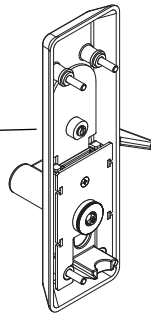

*5/8" stainless steel latch housing  
Through-hardened steel latchbolt 7/8" projection  
1/4-20 steel Holo-Krome® mounting screws*

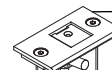

*1/8" thick, through-hardened steel front*

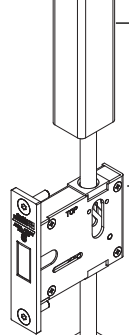

*11 gage steel 12" top bolt reinforcement*

*Mortised centerbolt utilizes a one-piece stainless steel, 19/32" x 1-1/4" x 1" throw bolt, 3/16" thick stainless steel front, 13 gage steel case & cap*

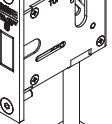
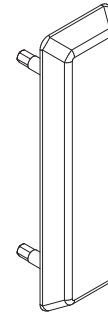

*11 gage steel 12" bottom bolt reinforcement*

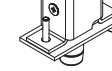

*1/8" steel reinforcement plate 3/4" steel nylon coated lower bolt, 3/4" projection*

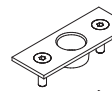

*Brass bottom strike 1/4-20 steel Holo-Krome fasteners*

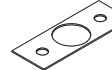

### Ordering Example

#### Stock Order

Quantity	Series/ Function	Trim	Finish	Hand	Shutter Height
100	FE6780	FSH	626	RH	H0400

# FE6700

## Storm Shutter Multi-Point Latching System

**Lever: Solid cast  
Escutcheon: Forged**

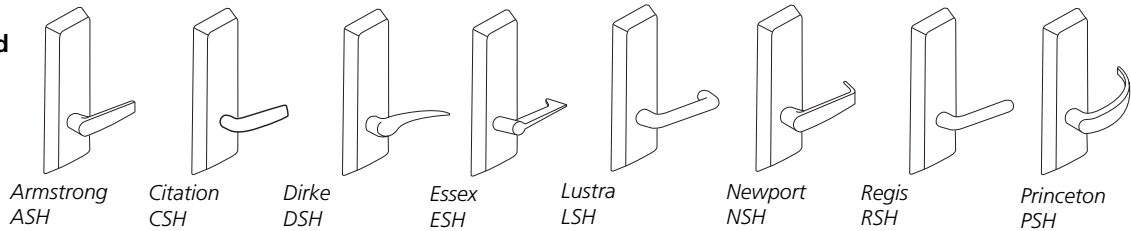

### FE6700 Series

Function	Description	ASH, CSH, DSH, ESH, LSH, NSH, PSH, RSH			
		Finish Group 1		Finish Group 2	
		613E Dark Oxidized Satin Bronze	605 Polished Brass	619 Satin Nickel	
		630 Satin Stainless Steel(1)	606 Satin Brass	625 Polished Chrome	
			611 Polished Bronze	629 Polished Stainless Steel(1)	
			612 Satin Bronze	626 Satin Chrome	
			613 Oil Rubbed Bronze	722 Black Oil Rubbed Bronze	
			618 Polished Nickel		
<b>For Typical Shutter Applications</b>					
FE6780	Passage Lever x Blank Plate				
<b>Optional Functions</b>					
FE6710	Passage or Closet				
FE6755	Classroom <sup>3</sup>				
			\$3,347.00		\$3,357.00

1. H escutcheon is a brass forging finished to match 629 and 630 finishes  
3. Collar is required depending on length and type of cylinder. See Miscellaneous Options section on page 205

**Lever: Solid Cast  
Escutcheon: Forged**

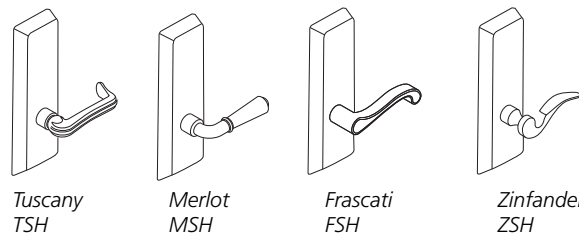

**Vineyard™**  
collection

### FE6700 Series

Function	Description	FSH, MSH, TSH, ZSH			
		Finish Group 1		Finish Group 2	
		613E Dark Oxidized Satin Bronze	605 Polished Brass	619 Satin Nickel	
		626 Satin Chrome	606 Satin Brass	625 Polished Chrome	
			611 Polished Bronze	722 Black Oil Rubbed Bronze	
			612 Satin Bronze		
			613 Oil Rubbed Bronze		
			618 Polished Nickel		
<b>For Typical Shutter Applications</b>					
FE6780	Passage Lever x Blank Plate				
<b>Optional Functions</b>					
FE6710	Passage or Closet				
FE6755	Classroom <sup>3</sup>				
			\$3,347.00		\$3,357.00

3. Collar is required depending on length and type of cylinder. See Miscellaneous Options section on page 205

# FE6700

## Storm Shutter Multi-Point Latching System



### Optional Cylinder & Keying Options

Description	Specify	Add or Deduct
Conventional 6-pin	(standard)	No Charge
Conventional 7-pin	7P	Add \$2.00 per cylinder
Less Standard Cylinder	LC	Deduct \$76.00 per cylinder
Access 3 Patented	AP	No Charge
Access 3 Security	AS	Add \$49.00 per cylinder
Access 3 High Security, UL 437	AHS	Add \$69.00 per cylinder
Access 3 IC Patented	ACP	Add \$64.00 per cylinder
Access 3 IC Security	ACS	Add \$113.00 per cylinder
Access 3 IC High Security, UL 437	ACHS	Add \$133.00 per cylinder
Pyramid Security Fixed Core	PS	Add \$49.00 per cylinder
Pyramid Security IC	PCS	Add \$113.00 per cylinder
Pyramid High Security fixed core	PHS	Add \$75.00 per cylinder
Pyramid High Security IC	PCHS	Add \$138.00 per cylinder
Pyramid IC with Temporary Construction Core <sup>3</sup>	CTP	Add \$64.00 per cylinder
Pyramid IC with Temporary Disposable Core <sup>3</sup>	CTPD	No Charge
Pyramid IC Less Core <sup>2</sup>	CLP	No Charge
Security	HS	Add \$95.00 per cylinder
Security IC <sup>1,4</sup>	CHS	Add \$161.00 per cylinder
Blockout Function Cylinder	BO	Add \$101.00 per cylinder
IC 6-pin	C6	Add \$64.00 per cylinder
IC 6-pin with Temporary Construction Core (Red)	CT6R	Add \$64.00 per cylinder
IC 6-pin with Temporary Construction Core (Blue)	CT6B	Add \$64.00 per cylinder
IC 6-pin with Temporary Construction Core (Green)	CT6G	Add \$64.00 per cylinder
IC 6-pin with Temporary Disposable Core	CT6D	No Charge
IC 6-pin Less Core	CL6	No Charge
SFIC 6-pin with Less Core	CLS6	No Charge
SFIC 6-pin with SFIC disposable temporary core	CT6SD	No Charge
IC 7-pin	C7	Add \$66.00 per cylinder
IC 7-pin with Temporary Construction Core (Red)	CT7R	Add \$66.00 per cylinder
IC 7-pin with Temporary Construction Core (Blue)	CT7B	Add \$66.00 per cylinder
IC 7-pin with Temporary Construction Core (Green)	CT7G	Add \$66.00 per cylinder
IC 7-pin with Temporary Disposable Core	CT7D	Add \$2.00 per cylinder
IC 7-pin Less Core	CL7	Add \$2.00 per cylinder
SFIC 7-pin with Less Core	CLS7	Add \$2.00 per cylinder
SFIC 7-pin with SFIC disposable temporary core	CT7SD	Add \$2.00 per cylinder

Notes:

1. CHS ordered with CT6 option no charge.
3. Refer to page 47 for example of CTP option pricing.
4. For existing systems only.

# FE6700

## Storm Shutter Multi-Point Latching System



### Optional Cylinder & Keying Options (con't)

Description	Specify	Add or Deduct
0-Bitted with two blank keys <sup>5</sup>	(standard)	No Charge
Keyed Random <sup>4</sup>	KR	No Charge
Master keyed (all cylinders except 8000, 8020, 8027 IC core)	specify keyset	Add \$16.00 per cylinder
Master keyed Pyramid	specify keyset	Add \$16.00 per cylinder
Master keyed Security (including IC cylinder and core)	specify keyset	Add \$16.00 per cylinder
Master keyed (8000, 8020, 8027 IC core)	specify keyset	No Charge
Master keyed to customer bittings or sample key	specify keyset	Add \$16.00 per cylinder
Construction master keyed <sup>1,2</sup>	CMK	Add \$16.00 per cylinder
Visual key control (VKC)		
- No Stamping	VKC0	\$4.30
- Keys only	VKC1	No Charge
- Cylinders and Keys <sup>3</sup>	VKC2	\$8.00
- Cylinders only <sup>3</sup>	VKC3	\$8.00
Concealed key control (CKC)		
- CKC cylinders with VKC keys	CKC2	\$8.00
- CKC cylinders only <sup>3</sup>	CKC3	\$8.00
More than 2 keys per lock	KY# (e.g., KY6)	See page 48 - Cut Keys Section

Notes:

1. CMK Construction master keying charge is in addition to master keying charge.
2. CMK Construction master keying is not available in Pyramid series cylinders.

3. VKC2, VKC3, CKC3 are not available in Pyramid or Security series.
4. Pyramid series is not available keyed random.
5. Security series is not available 0-bitted.

### Shutter Thickness

Description	Specify
1-3/4"	(standard)

### Shutter Height Options

Description	Specify
3'0" - 4'6"	H0400
4'6" - 6'8"	H0500

### Miscellaneous Options

Description	Specify	Add or Deduct
Torx Screws	M04	Add \$16.00 per lockset
1-1/8" cylinder collar (for 6-pin mortise cylinder) <sup>12</sup>	721F36	No Charge
1-1/4" cylinder collar (for 7-pin mortise cylinder) <sup>12</sup>	721F37	No Charge
1-1/2" cylinder collar (for 7-pin IC mortise cylinder) <sup>12</sup>	721F38	No Charge
MicroShield® Antimicrobial finish coating	630C	Add \$60.00 per lockset
<i>MicroShield</i> Antimicrobial finish coating	626C	Add \$60.00 per lockset

Notes:

1. For optional FE6755 classroom function, collar is required depending on length and type of cylinder.
2. Specify as optional collar when ordering cylinders only.

# FE6800

## Fortified Multi-Point Latching System

### Standard Features

#### Handing

Device is handed

#### Door Thickness

FE6800 is for use with standard 1-3/4" thick doors and frames

#### Cylinder

Brass, 6-pin, L4 keyway, 0-bitted, 1-1/8" standard. Optional cylinders available; see Quick Codes

#### Warranty

Seven-year limited

#### UL /ULc:

Meets FEMA 320 and FEMA 361 Guidelines for both inswing and outswing doors; single door 2'6" x 5'6" min and 4'0" x 8'0" max.

All locks listed for 3 hour single doors. UL compliant with fire and windstorm markings

#### FE6800 Series:

FE6855 Classroom

FE6810 Passage or Closet

FE6880 Passage Lever x Blank Plate

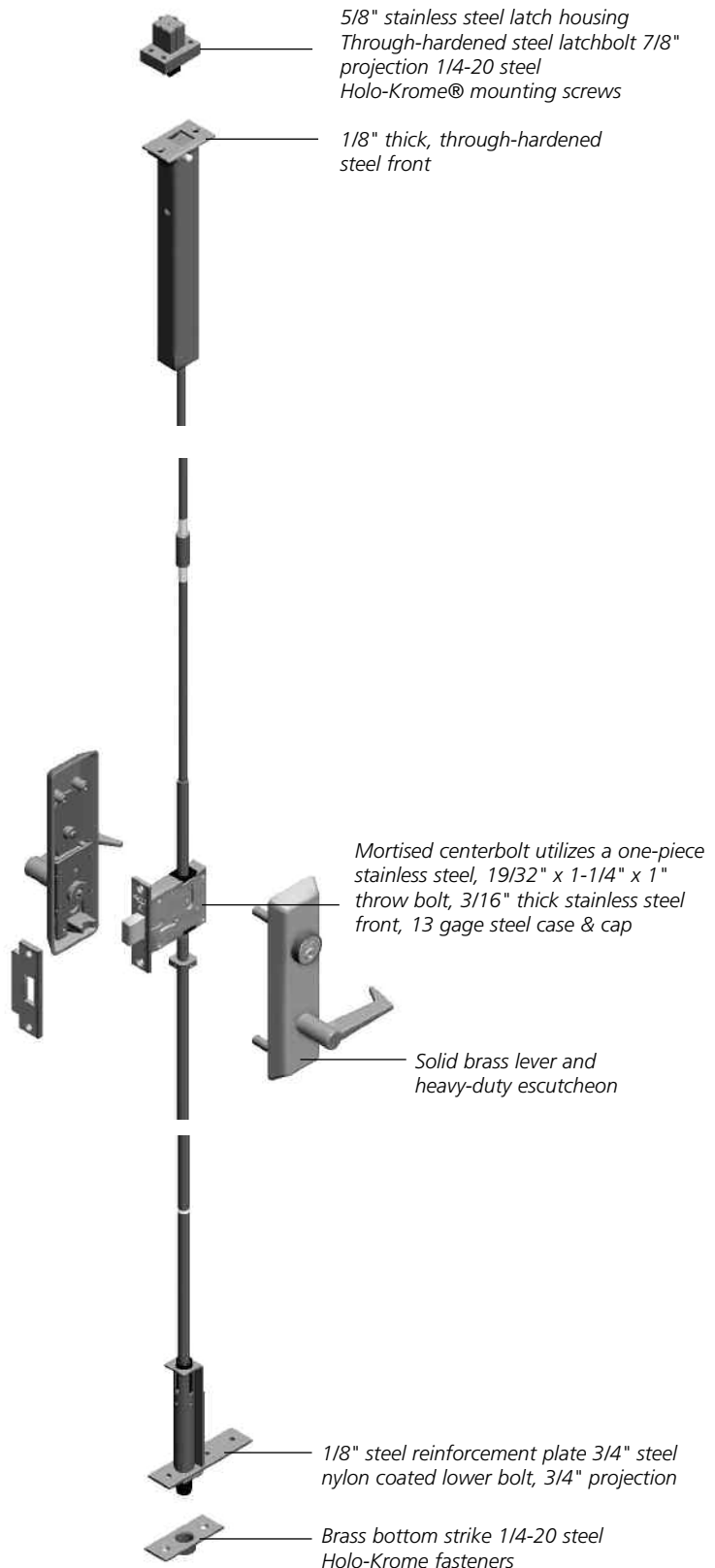

# FE6800

Fortified Multi-Point Latching System



## How to Order FE6800 Multi-Point Auto Deadlock

### Ordering Examples

---

#### Stock Order

---

Quantity	Series/ Function	Trim	Finish	Hand
100	FE6855	FSH	626	RHR

#### Split Trim/Split Finish Order

Quantity	Series/ Function	Trim		Finish		Hand
		Outside	Inside	Outside	Inside	
12	FE6855	FSH	NSH	626	625	RHR

#### Contract/Detailed Order

---

Quantity	Keyset	Series/ Function	Trim	Finish	Hand	Optional Cylinder	Keying
24	AA1	FE6855	NSH	626	RHR	PHS	CKC2



**FE6800**  
Fortified Multi-Point Latching System

**Lever:** Solid cast  
**Escutcheon:** Forged

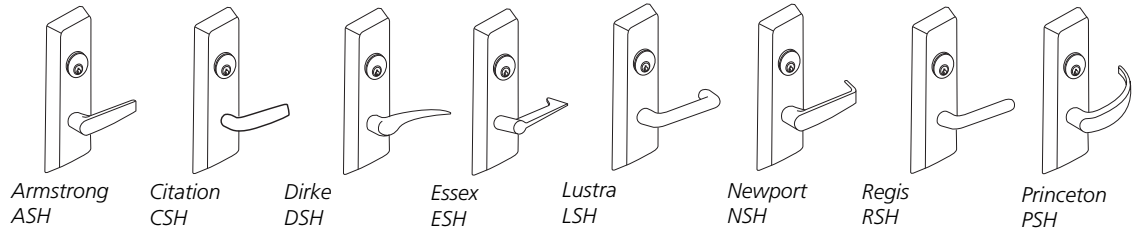

**FE6800 Series**

Function	Description	ASH, CSH, DSH, ESH, LSH, NSH, PSH, RSH			
		Finish Group 1		Finish Group 2	
		613E Dark Oxidized Satin Bronze	605 Polished Brass	619 Satin Nickel	
		630 Satin Stainless Steel(1)	606 Satin Brass	625 Polished Chrome	
			611 Polished Bronze	629 Polished Stainless Steel(1)	
			612 Satin Bronze	626 Satin Chrome	
			613 Oil Rubbed Bronze	722 Black Oil Rubbed Bronze	
			618 Polished Nickel		
FE6810	Passage or Closet				
FE6855	Classroom		\$3,347.00		\$3,357.00
FE6880	Passage Lever x Blank Plate				

1. H escutcheon is a brass forging finished to match 629 and 630 finishes

**Lever:** Solid cast  
**Escutcheon:** Forged

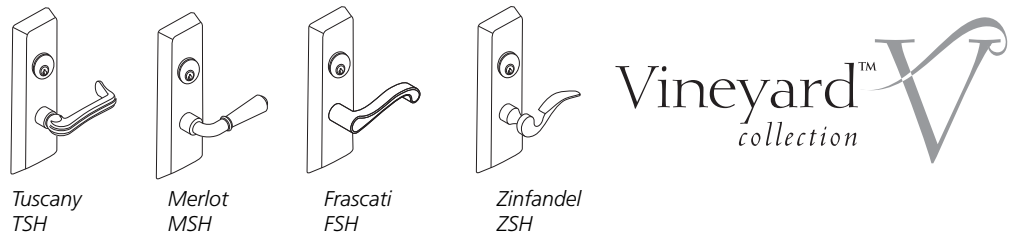

**FE6800 Series**

Function	Description	FSH, MSH, TSH, ZSH			
		Finish Group 1		Finish Group 2	
		613E Dark Oxidized Satin Bronze	605 Polished Brass	619 Satin Nickel	
		626 Satin Chrome	606 Satin Brass	625 Polished Chrome	
			611 Polished Bronze	722 Black Oil Rubbed Bronze	
			612 Satin Bronze		
			613 Oil Rubbed Bronze		
			618 Polished Nickel		
FE6810	Passage or Closet				
FE6855	Classroom		\$3,347.00		\$3,357.00
FE6880	Passage Lever x Blank Plate				

# FE6800

## Fortified Multi-Point Latching System



### Cylinder & Keying Options

Description	Specify	Add or Deduct
Conventional 6-pin	(standard)	No Charge
Conventional 7-pin	7P	Add \$2.00 per cylinder
Less Standard Cylinder	LC	Deduct \$76.00 per cylinder
Access 3 Patented	AP	No Charge
Access 3 Security	AS	Add \$49.00 per cylinder
Access 3 High Security, UL 437	AHS	Add \$69.00 per cylinder
Access 3 IC Patented	ACP	Add \$64.00 per cylinder
Access 3 IC Security	ACS	Add \$113.00 per cylinder
Access 3 IC High Security, UL 437	ACHS	Add \$133.00 per cylinder
Pyramid Security Fixed Core	PS	Add \$49.00 per cylinder
Pyramid Security IC	PCS	Add \$113.00 per cylinder
Pyramid High Security fixed core	PHS	Add \$75.00 per cylinder
Pyramid High Security IC	PCHS	Add \$138.00 per cylinder
Pyramid IC with Temporary Construction Core <sup>3</sup>	CTP	Add \$64.00 per cylinder
Pyramid IC with Temporary Disposable Core <sup>3</sup>	CTPD	No Charge
Pyramid IC Less Core <sup>2</sup>	CLP	No Charge
Security4	HS	Add \$95.00 per cylinder
Security IC <sup>1,4</sup>	CHS	Add \$161.00 per cylinder
Blockout Function Cylinder	BO	Add \$101.00 per cylinder
IC 6-pin	C6	Add \$64.00 per cylinder
IC 6-pin with Temporary Construction Core (Red)	CT6R	Add \$64.00 per cylinder
IC 6-pin with Temporary Construction Core (Blue)	CT6B	Add \$64.00 per cylinder
IC 6-pin with Temporary Construction Core (Green)	CT6G	Add \$64.00 per cylinder
IC 6-pin with Temporary Disposable Core	CT6D	No Charge
IC 6-pin Less Core	CL6	No Charge
IC 7-pin	C7	Add \$66.00 per cylinder
IC 7-pin with Temporary Construction Core (Red)	CT7R	Add \$66.00 per cylinder
IC 7-pin with Temporary Construction Core (Blue)	CT7B	Add \$66.00 per cylinder
IC 7-pin with Temporary Construction Core (Green)	CT7G	Add \$66.00 per cylinder
IC 7-pin with Temporary Disposable Core	CT7D	Add \$2.00 per cylinder
IC 7-pin Less Core	CL7	Add \$2.00 per cylinder

#### Notes:

1. CHS ordered with CT6 option no charge.
3. Refer to page 47 for example of CTP option pricing.
4. For existing systems only.

# FE6800

## Fortified Multi-Point Latching System



### Cylinder & Keying Options (con't)

Description	Specify	Add or Deduct
0-Bitted with two blank keys <sup>5</sup>	(standard)	No Charge
Keyed Random <sup>4</sup>	KR	No Charge
Master keyed (all cylinders except 8000, 8020, 8027 IC core)	specify keyset	Add \$16.00 per cylinder
Master keyed Pyramid	specify keyset	Add \$16.00 per cylinder
Master keyed Security (including IC cylinder and core)	specify keyset	Add \$16.00 per cylinder
Master keyed (8000, 8020, 8027 IC core)	specify keyset	No Charge
Master keyed to customer bittings or sample key	specify keyset	Add \$16.00 per cylinder
Construction master keyed <sup>1,2</sup>	CMK	Add \$16.00 per cylinder
Visual key control (VKC)		
- No Stamping	VKC0	\$4.30
- Keys only	VKC1	No Charge
- Cylinders and Keys <sup>3</sup>	VKC2	\$8.00
- Cylinders only <sup>3</sup>	VKC3	\$8.00
Concealed key control (CKC)		
- CKC cylinders with VKC keys	CKC2	\$8.00
- CKC cylinders only <sup>3</sup>	CKC3	\$8.00
More than 2 keys per lock	KY# (e.g., KY6)	See page 48 - Cut Keys Section

#### Notes:

1. CMK Construction master keying charge is in addition to master keying charge.
2. CMK Construction master keying is not available in Pyramid series cylinders.
3. VKC2, VKC3, CKC3 are not available in Pyramid or Security series.
4. Pyramid series is not available keyed random.
5. Security series is not available 0-bitted.

### Door Height

Description	Specify	Add or Deduct
6'8" - 8'0"	(Standard)	No Charge

### Miscellaneous Options

Description	Specify	Add or Deduct
Torx Screws	M04	Add \$16.00 per lockset
1-1/8" cylinder collar (for 6-pin mortise cylinder)	721F36	No Charge
1-1/4" cylinder collar (for 7-pin mortise cylinder)	721F37	No Charge
1-1/2" cylinder collar (for 7-pin IC mortise cylinder)	721F38	No Charge
MicroShield® Antimicrobial finish coating	630C	Add \$60.00 per lockset
MicroShield Antimicrobial finish coating	626C	Add \$60.00 per lockset

**FE6800**  
Notes





Look for the  *MicroShield* icon.

ED3000  
ED4000  
ED5000  
ED7000

**MicroShield®**

As part of their promise to provide innovative solutions to their customers, certain ASSA ABLOY Group brands offer the MicroShield® technology, a silver-based antimicrobial coating designed to inhibit the growth of bacteria.

MicroShield® is a registered trademark of Yale Security Inc., an ASSA ABLOY Group company.

Product	Series	MicroShield® Coated Components
Exit Devices	ED4000 and ED5000 Series	Inside rail, push rail, head cover, end cap* Outside trim: levers/pull* and escutcheons
	ED3000 and ED7000 Series	Active/Inactive case covers, cross bar, arms Outside trim: levers/pull* and escutcheons

**AVAILABLE FINISHES**

- MicroShield® is available on 626 and 630. Other finishes available by Special Product Application Request Form only.
- Specify 626C (satin chrome plated) or 630C (satin stainless steel) when ordering.
- MicroShield® coating will be applied over 626 and 630 finishes. All components will match 626.

*Note: MicroShield® coating will only be applied to “high touch” components.*

**HOW TO ORDER**

Product	How to Order
Exit Devices & Outside Trims (ordered together)	ED5200 x C955 x 630C x LHR
Exit Devices & Trims (ordered separately)	N955 x 630C x RHR

**PRICING - Discount is 50% off list only**

Description	Add
Exit Devices & Outside Trims (ordered together)	Add \$60.00 (when ordered together)
Exit Devices & Trims (ordered separately)	Add \$40.00

[Empty rectangular box for notes]

**Standard Features**

**Handing**

Handed, specify hand

**Door Thickness**

1-3/4"

**Backset**

2-3/4"

**Projection**

5-3/4"; 4-1/2" depressed

**Trim**

Cylinder is not included.  
See page 246 for  
cylinder options.

**Rim**

ED3200  
ED3200A

Panic  
3 Hour Fire Rated

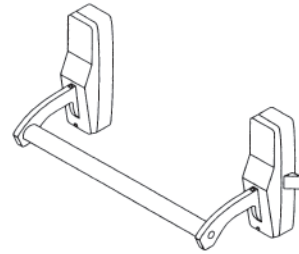

**Surface Vertical Rod**

ED3400    Panic  
ED3400A    3 Hour Fire Rated

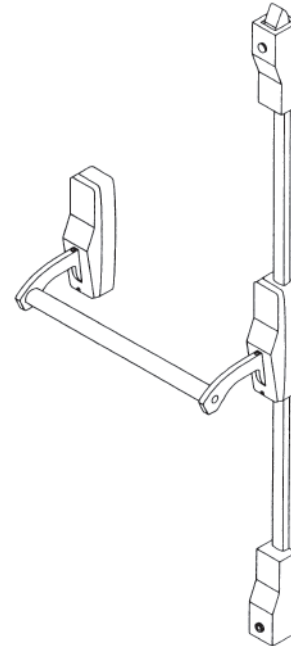

**Mortise**

ED3600    Panic  
ED3600A    3 Hour Fire Rated

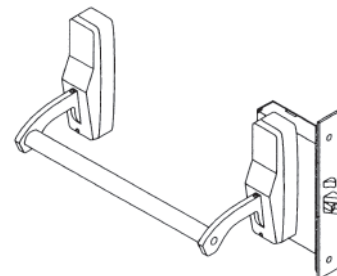

**Ordering Examples**
**Rim Exit Device**

Quantity	Exit Device	Finish	Hand	Misc. Options
20	ED3250	630	RHR	M51-M54

**Rim Exit Device with Trim**

Quantity	Exit Device	Trim	Finish	Hand	Door Thickness	Door Width	Misc. Options
50	ED3255A	A3355	630	RHR	D200	W048	M53

**Trim Only (Rim Exit Device or Vertical Rod)**

Quantity	Exit Device	Finish	Hand
10	L3310	606	RHR

**Surface Vertical Rod Exit Device with Trim**

Quantity	Exit Device	Trim	Finish	Hand	Door Thickness	Door Width	Misc. Options
50	ED3410	R3310	606	RHR	D214	W048	H1000

**Mortise Exit Device with Trim**

Quantity	Exit Device	Trim	Finish	Hand	Door Thickness	Strike	Door Width
50	ED3657	L3357	630	LHR	D200	SB200	W048

**Contract/Detailed Order - Rim Exit Device with Trim**

Quantity	Keyset	Exit Device	Trim	Finish	Hand	Door Thickness	Door Width	Optional Cylinders	Keying
50	AA1	ED3255	N3355	630	LHR	D200	W048	C6	VKC3



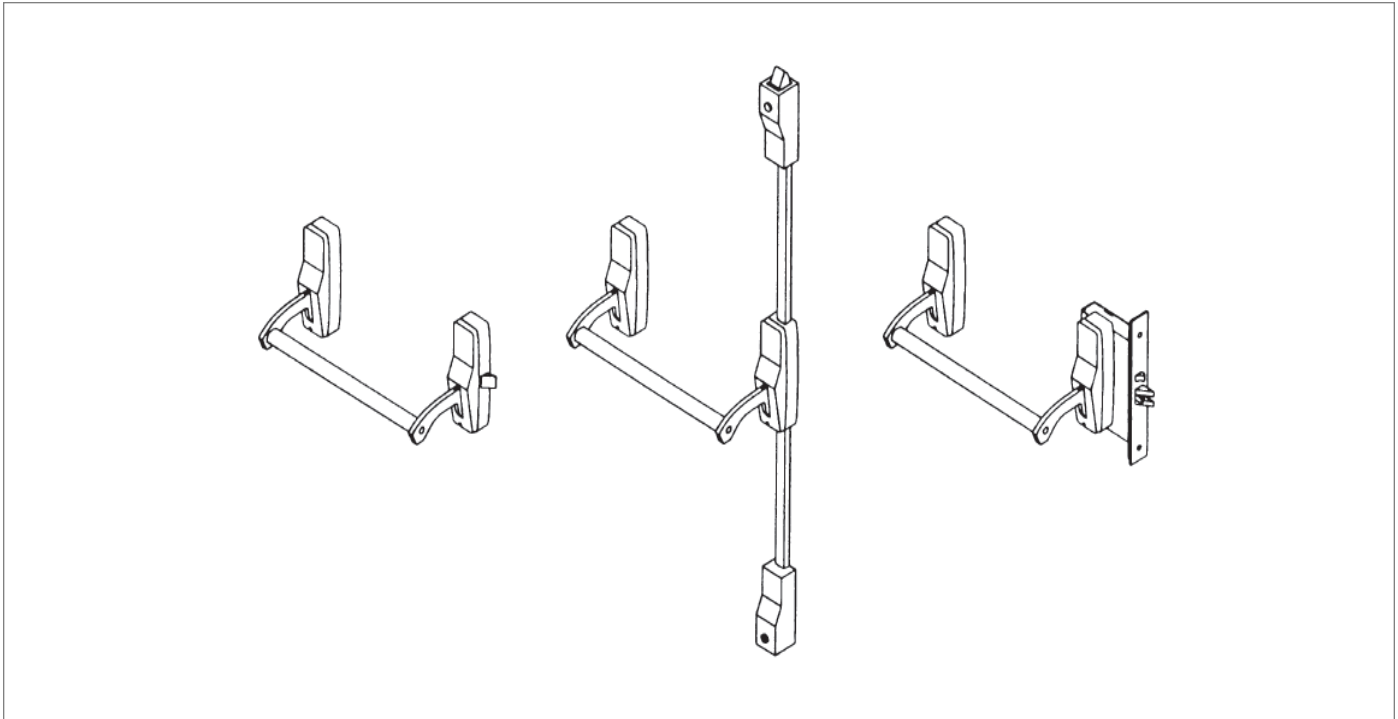

**36" Device Only**

Includes device, strike(s) and screw pack. No cylinder or trim.

**Rim ED3200 Series**

Function	Description	Finish: 613E	Finish: 605, 606, 611, 612, 613, 629, 630
ED3210	Panic device only (Passage)	\$1,560.00	\$1,730.00
ED3250	Panic device only (Dummy)		
ED3255	Panic (Classroom)		
ED3257	Panic (Nightlatch)		
ED3210T	Thumb Piece (Passage)		
ED3255T	Thumb Piece (Classroom)		
ED3210A	3 Hour Fire Rated (Passage)	\$1,723.00	\$1,893.00
ED3250A	3 Hour Fire Rated (Dummy)		
ED3255A	3 Hour Fire Rated (Classroom)		
ED3257A	3 Hour Fire Rated (Nightlatch)		
ED3210AT	Thumb Piece – 3 Hour Fire Rated (Passage)		
ED3255AT	Thumb Piece – 3 Hour Fire Rated (Classroom)		

For rim and surface vertical rod exit trim prices, see pages 269-272.

For fire rated rim exit trim prices, see pages 273-276.

For mortise exit device trim prices see pages 277-280.

**Caution:** Be sure of your measurements. Exit devices are NOT returnable.

Notes:

For doors over 1-3/4" thick, a Special Application Request must be submitted to the factory prior to approval and pricing.

**Surface Vertical Rod ED3400 Series**

Function	Description	Finish: 613E	Finish: 605, 606, 611, 612, 613, 629, 630
ED3410	Panic (Passage)	\$2,065.00	\$2,235.00
ED3450	Panic (Dummy)		
ED3455	Panic (Classroom)		
ED3457	Panic (Nightlatch)		
ED3410T	Thumb Piece (Passage)		
ED3455T	Thumb Piece (Classroom)		
ED3410A	3 Hour fire rated (Passage)	\$2,228.00	\$2,398.00
ED3450A	3 Hour fire rated (Dummy)		
ED3455A	3 Hour Fire Rated (Classroom)		
ED3457A	3 Hour Fire Rated (Nightlatch)		
ED3410AT	Thumb Piece – 3 Hour Fire Rated (Passage)		
ED3455AT	Thumb Piece – 3 Hour Fire Rated (Classroom)		

**Mortise ED3600 Series**

Function	Description	Finish: 613E	Finish: 605, 606, 611, 612, 613, 629, 630
ED3610	Panic (Passage)	\$1,840.00	\$2,010.00
ED3650	Panic (Dummy)		
ED3655	Panic (Classroom)		
ED3657	Panic (Nightlatch)		
ED3610T	Thumb Piece (Passage)		
ED3655T	Thumb Piece (Classroom)		
ED3610A	3 Hour fire rated (Passage)		
ED3650A	3 Hour fire rated (Dummy)		
ED3655A	3 Hour Fire Rated (Classroom)		
ED3657A	3 Hour Fire Rated (Nightlatch)		
ED3610AT	Thumb Piece – 3 Hour Fire Rated (Passage)		
ED3655AT	Thumb Piece – 3 Hour Fire Rated (Classroom)		

For rim and surface vertical rod exit trim prices, see pages 269-272.

For fire rated rim exit trim prices, see pages 273-276.

For mortise exit device trim prices see pages 277-280.

**Caution:** Be sure of your measurements. Exit devices are NOT returnable.

Notes:

For doors over 1-3/4" thick, a Special Application Request must be submitted to the factory prior to approval and pricing.

**ED3200/ED3200A/ED3400/ED3400A/ED3600/ED3600A Rim, Surface Vertical Rod, and Mortise Trim**

Cylinder is not included.

**Escutcheon Trim Design: A33 Armstrong**



**Lever:** Cast    **Escutcheon:** Cast

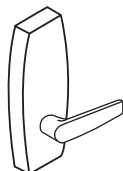

Function	Description	Finish: 613E, 626	Finish: 605, 606, 611, 612, 613, 618, 619, 625
A3310	Passage	\$445.00	\$481.00
A3350	Dummy		
A3355	Classroom		
A3357	Nightlatch – Rim		
A33V57	Nightlatch – SVR		
A33M57	Nightlatch – Mortise		

**Escutcheon Trim Design: C33 Citation**



**Lever:** Cast    **Escutcheon:** Cast



Function	Description	Finish: 613E, 626	Finish: 605, 606, 611, 612, 613, 618, 619, 625
C3310	Passage	\$445.00	\$481.00
C3350	Dummy		
C3355	Classroom		
C3357	Nightlatch – Rim		
C33V57	Nightlatch – SVR		
C33M57	Nightlatch – Mortise		

**Escutcheon Trim Design: D33 Dirke**



**Lever:** Cast    **Escutcheon:** Cast

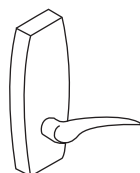

Function	Description	Finish: 613E, 626	Finish: 605, 606, 611, 612, 613, 618, 619, 625
D3310	Passage	\$445.00	\$481.00
D3350	Dummy		
D3355	Classroom		
D3357	Nightlatch – Rim		
D33V57	Nightlatch – SVR		
D33M57	Nightlatch – Mortise		

**Escutcheon Trim Design: L33 Lustra**



**Lever:** Cast    **Escutcheon:** Cast

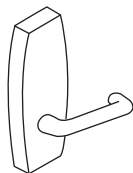

Function	Description	Finish: 613E, 626	Finish: 605, 606, 611, 612, 613, 618, 619, 625
L3310	Passage	\$445.00	\$481.00
L3350	Dummy		
L3355	Classroom		
L3357	Nightlatch – Rim		
L33V57	Nightlatch – SVR		
L33M57	Nightlatch – Mortise		

**ED3200/ED3200A/ED3400/ED3400A/ED3600/ED3600A Rim, Surface Vertical Rod, and Mortise Trim**

Cylinder is not included.

**Escutcheon Trim Design: N33 Newport**



**Lever:** Cast    **Escutcheon:** Cast

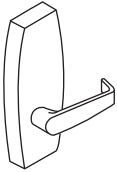

Function	Description	Finish: 613E, 626	Finish: 605, 606, 611, 612, 613, 618, 619, 625
N3310	Passage	\$445.00	\$481.00
N3350	Dummy		
N3355	Classroom		
N3357	Nightlatch – Rim		
N33V57	Nightlatch – SVR		
N33M57	Nightlatch – Mortise		

**Escutcheon Trim Design: PR33 Princeton**



**Lever:** Cast    **Escutcheon:** Cast



Function	Description	Finish: 613E, 626	Finish: 605, 606, 611, 612, 613, 618, 619, 625
PR3310	Passage	\$445.00	\$481.00
PR3350	Dummy		
PR3355	Classroom		
PR3357	Nightlatch – Rim		
PR33V57	Nightlatch – SVR		
PR33M57	Nightlatch – Mortise		

**Escutcheon Trim Design: R33 Regis**



**Lever:** Cast    **Escutcheon:** Cast

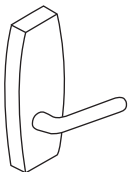

Function	Description	Finish: 613E, 626	Finish: 605, 606, 611, 612, 613, 618, 619, 625
R3310	Passage	\$445.00	\$481.00
R3350	Dummy		
R3355	Classroom		
R3357	Nightlatch – Rim		
R33V57	Nightlatch – SVR		
R33M57	Nightlatch – Mortise		

**ED3200/ED3200A/ED3400/ED3400A/ED3600/ED3600A Rim, Surface Vertical Rod, and Mortise Trim**

Cylinder is not included.

**Escutcheon Trim Design: T33 D Grip**

**Grip:** Extruded **Escutcheon:** Wrought



Function	Description	Finish: 613E, 626	Finish: 605, 606, 611, 612, 613, 618, 619, 625, 629, 630
T3310	Passage	\$290.00	\$318.00
T3350	Dummy		
T3355	Classroom		
T3357	Nightlatch – Rim		
T33M55	Classroom – Mortise		
T33M57	Nightlatch – Mortise		

**Escutcheon Trim Design: T34 Round Grip**

**Grip:** Extruded **Escutcheon:** Wrought



Function	Description	Finish: 613E, 626	Finish: 605, 606, 611, 612, 613, 618, 619, 625
T3410	Passage	\$290.00	\$318.00
T3450	Dummy		
T3455	Classroom		
T3457	Nightlatch – Rim		
T34M55	Classroom – Mortise		
T34M57	Nightlatch – Mortise		

**Escutcheon Trim Design: T35 Sectional Grip**

**Grip:** Extruded



Function	Description	Finish: 613E, 626	Finish: 605, 606, 611, 612, 613, 618, 619, 625, 629, 630
T3510	Passage	\$320.00	\$350.00
T3550	Dummy		
T3555	Classroom		
T3557	Nightlatch – Rim		
T35M55	Classroom – Mortise		
T35M57	Nightlatch – Mortise		

**Auxiliary Control/Inside Lever Assembly: 3357T Nightlatch**

Auxiliary Control



Function	Description	Finish: 613E, 626	Finish: 605, 606, 611, 612, 613, 618, 619, 625, 629, 630
3357T	Auxiliary Control/Inside Lever Assembly	\$582.00	\$618.00

Inside Lever Assembly



**Offset Pull Trim: P12, P13, P14**

Offset Pull Trim	Part Number	Finish: 613E, 630	Finishes: 605, 606, 612, 613, 626, 629
P12	716F50M X Finish	\$233.00	\$247.00
P13	716F51M X Finish	\$286.00	\$300.00
P14	716F52M X Finish	\$202.00	\$216.00

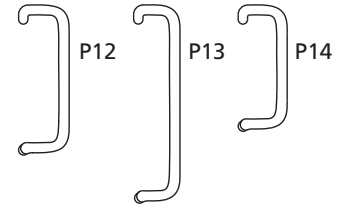
**Cylinder Options**

Description	Specify	Add or Deduct
Conventional 6-pin	6P*	Add \$76.00 per cylinder
Conventional 7-pin	7P	Add \$78.00 per cylinder
Access 3 Patented	AP	Add \$76.00 per cylinder
Access 3 Security	AS	Add \$125.00 per cylinder
Access 3 High Security, UL 437	AHS	Add \$145.00 per cylinder
Access 3 IC Patented	ACP	Add \$143.00 per cylinder
Access 3 IC Security	ACS	Add \$189.00 per cylinder
Access 3 IC High Security, UL 437	ACHS	Add \$209.00 per cylinder
Pyramid Security fixed core	PS	Add \$125.00 per cylinder
Pyramid Security IC	PCS	Add \$189.00 per cylinder
Pyramid High Security fixed core	PHS	Add \$151.00 per cylinder
Pyramid High Security IC	PCHS	Add \$214.00 per cylinder
Pyramid IC with temporary construction core	CTP	Add \$143.00 per cylinder
Pyramid IC with temporary disposable core	CTPD	Add \$76.00 per cylinder
Pyramid IC less core	CLP	Add \$76.00 per cylinder
Security	HS	Add \$171.00 per cylinder
Security IC	CHS	Add \$236.00 per cylinder
Blockout function cylinder	BO	Add \$214.00 per cylinder
IC 6-pin	C6	Add \$143.00 per cylinder
IC 6-pin with temporary construction core (Red)	CT6R	Add \$143.00 per cylinder
IC 6-pin with temporary construction core (Blue)	CT6B	Add \$143.00 per cylinder
IC 6-pin with temporary construction core (Green)	CT6G	Add \$143.00 per cylinder
IC 6-pin with temporary disposable core	CT6D	Add \$76.00 per cylinder
IC 6-pin less core	CL6	Add \$76.00 per cylinder
SFIC 6-pin with Less Core	CLS6	Add \$76.00 per cylinder
IC 6-pin with SFIC disposable temporary core	CT6SD	Add \$76.00 per cylinder
IC 7-pin	C7	Add \$144.00 per cylinder
IC 7-pin with temporary construction core (Red)	CT7R	Add \$144.00 per cylinder
IC 7-pin with temporary construction core (Blue)	CT7B	Add \$144.00 per cylinder
IC 7-pin with temporary construction core (Green)	CT7G	Add \$144.00 per cylinder
IC 7-pin with temporary disposable core	CT7D	Add \$78.00 per cylinder
IC 7-pin less core	CL7	Add \$78.00 per cylinder
SFIC 7-pin with Less Core	CLS7	Add \$78.00 per cylinder
IC 7-pin with SFIC disposable temporary core	CT7SD	Add \$78.00 per cylinder
IC 7-pin with disposable temporary core	CT7D	Add \$78.00 per cylinder

\*6P cylinder option is supplied in 6-pin, L4 keyway 0-bitted with two nickel silver keys.  
 IC 6-pin with temporary construction core CT6  
 IC 7-pin with temporary construction core CT7

**Keying Options**

Description	Specify	Add or Deduct
0-Bitted with 2 blank keys	(standard)	No Charge
Keyed random	KR	No Charge
Construction master keyed <sup>1, 2</sup>	CMK	Add \$16.00 per cylinder
Visual key control (VKC)		
- No Stamping	VKC0	\$4.30
- Keys only	VKC1	No Charge
- Cylinders and Keys <sup>3</sup>	VKC2	\$8.00
- Cylinders only <sup>3</sup>	VKC3	\$8.00
Concealed key control (CKC)		
- CKC cylinders with VKC keys	CKC2	\$8.00
- CKC cylinders only <sup>3</sup>	CKC3	\$8.00
More than 2 keys per lock	KY# (e.g., KY6)	See page 48 - Cut Keys Section

Notes:

1. CMK Construction master keying charge is in addition to master keying charge.
2. CMK Construction master keying is not available in Pyramid or Security series.
3. VKC2, VKC3, CKC3 are not available in Pyramid or Security series.

**Strike Options**

To purchase strike separately see catalog for part no.

Description	Specify Quick Code	Add or Deduct
Fire rated rim strike on ED3200	(standard)	No Charge
Mortised adjustable rim strike	S04	
Rim x vertical rod strike for pairs of doors	S02	Add \$26.00 to device
Vertical rod flush bottom strike (ED3400 only)	S03	No Charge
Vertical rod surface projecting bottom strike on ED3400 device	(standard)	
Fire rated vertical rod bottom strike on ED3400A device	(standard)	
Fire rated vertical rod bottom strike for threshold	S06	

Description	Door Thickness	Specify	Add or Deduct
Curved lip ANSI strike	1-3/4"	SA114 (standard)	No Charge
	2"	SA138	
	2-1/4"	SA158	

Description	Door Thickness	Specify	Add or Deduct
Mortise straight lip ANSI strike on ED3600, ED3600A	1-3/4"	SS118	No Charge
	2"	SS138	
	2-1/4"	SS158	

Description	Door Thickness	Specify	Add or Deduct
Mortise open back strike	1-3/4"	SB134	Add \$80.00 per device
	2"	SB200	Add \$120.00 per device
	2-1/4"	SB214	Add \$120.00 per device



**Miscellaneous Options**

Description	Specify	Add or Deduct
Spanner head screws	M02	Add \$32.00 per device
Torx® screws for rim, mortise	M04	Add \$42.00 per device
Torx® screws for surface vertical rod		Add \$80 per device
Abrasive coat outside and inside (trim and device)	M23	Add \$88.00 per device
Abrasive coat inside only (device side)	M24	Add \$46.00 per device
Abrasive coat outside only (trim side)	M25	Add \$42.00 per device
Steel reinforced crossbar	M53	Add \$68.00 per device
Sex nuts and bolts (SNBs)	M54	No Charge
Mullion stabilizer	M57	Add \$62.00 per mullion
Shim for 2-3/4" backset on doors with 1/2" stop (rim devices only)	M59	No Charge
Flush transom bracket	M67	Add \$30.00 per device

**Door Width Options**

Description	Specify	Add or Deduct
36"	(standard)	No Charge
48"	W048	Add \$35.00 per device

**Door Thickness Options**

Description	Specify	Add or Deduct
1-3/4"	(standard)	No Charge
2"	D200	
2-1/4"	D214	

**Door Height Options**

Description	Specify	Add or Deduct
7'0" H0700	H0700	No Charge
7'2" H0702	H0702	
7'6" H0706	H0706	
8' (Standard)	(standard)	
8'6" H0806 (ED3400 device only)	H0806	Add \$62.00 per device
9' H0900 (ED3400 device only)	H0900	
10' H01000 (ED3400 device only)	H01000	

**Mullions**

Cylinder not included

**Ordering Example**

Quantity	Mullion Number
10	507

**Removable Mullion**

Description	Specify	Price
Up to 7'0" Steel Mullion - Panic Rated	907	\$574.00
Up to 8'0" Steel Mullion - Panic Rated	908	\$584.00
Up to 10'0" (ED3200 only), Steel Mullion - Panic Rated	910	\$692.00
Up to 7'0", Steel Mullion - 3 Hour Fire Rated	907A	\$798.00
Up to 8'0", Steel Mullion - 3 Hour Fire Rated	908A	\$808.00

**Key Removable Mullion**

Description	Specify	Price
Up to 7'0", key removable mullion, 1-1/2 Hour Fire Rated	907BKM <sup>1</sup>	\$1,229.00
Up to 8'0", key removable mullion, 1-1/2 Hour Fire Rated	908BKM <sup>1</sup>	\$1,239.00
Up to 10'0" (ED3200 only), key removable mullion, Panic Rated	910KM <sup>1</sup>	\$1,086.00
Door frame filler block for double rabbetted frames	M95	Add \$42.00 per mullion
Door frame angle bracket for aluminum frames	M96	Add \$42.00 per mullion

Note 1: Cylinder and collars not included, specify separately

**Mullions Cylinder Options**

Description	Specify	Add or Deduct
Conventional 6-pin	6P	Add \$76.00 per cylinder
Conventional 7-pin	7P	Add \$78.00 per cylinder
IC 6-pin	C6	Add \$143.00 per cylinder
IC 7-pin	C7	Add \$144.00 per cylinder
Pyramid High Security Fixed Core	PHS	Add \$151.00 per cylinder
Pyramid Security Fixed Core	PS	Add \$125.00 per cylinder
Pyramid High Security IC	PCHS	Add \$214.00 per cylinder
Pyramid Security IC	PCS	Add \$189.00 per cylinder
Security	HS	Add \$171.00 per cylinder
Security IC	CHS	Add \$236.00 per cylinder
IC 6-pin less core	CL6	Add \$76.00 per cylinder
IC 7-pin less core	CL7	Add \$78.00 per cylinder

**Mortise Lock Only**

Lock Number	Description	Finish: 605, 606, 611, 612, 613, 613E, 625, 626
MLE012	Lockbody for Nightlatch/Dummy function	\$527.00
MLE013	Lockbody for Classroom function	
MLE014	Lockbody for Passage function	
MLE015	Lockbody for Passage Thumbpiece function	
MLE016	Lockbody for Classroom Thumbpiece function	

**Ordering Example**
**Mortise Lock Only**

Quantity	Lock Number	Finish	Hand
2	MLE013	630	LHR



The PathLite™ patent pending technology offers a number of benefits:

- Requires no wiring or maintenance
- Recharges with exposure to ambient light
- Unaffected by heat or cold
- Non-toxic, will not rub or fade
- Vandal resistant
- Fire resistant and non-radioactive
- Green contrasting word "EXIT" centered on touchbar in 1-1/4" high lettering
- Cost effective; especially suited for existing buildings

PathLite™ photoluminescent exit devices meet New York City's newly adopted standards for requirement of photoluminescent signage and stairwell markings in all office buildings in excess of 75 feet in height.

**How To Order Complete Device**

Exit Device	Trim/Function	Finish	Hand	Misc. Options
ED4200	A810	630	RHR	M49

ED4200 x A810 x 630 x RHR x M49

Options	Specify	Price
24" , 36" , and 48" PathLite™ Photoluminescent Touchbar Cover	M49	Add: \$335.00

**How to Order Touchbar Cover Only**

Options	Part Number	Price
24" PathLite™ Photoluminescent Touchbar cover	710F797	\$374.00
36" PathLite™ Photoluminescent Touchbar cover	710F737	
48" PathLite™ Photoluminescent Touchbar cover	710F747	

**Standard Features**

**Handing**

Devices are field reversible; specify hand. Lever trims are handed; specify hand

**Door Thickness**

1-3/4"

Product	Minimum Stile
ED4200S	2"
ED4200SM	3 1/2"
ED4200SMA	3 1/2"
ED4200	2"
ED4200M	3 1/2"
ED4200MA	3 1/2"
ED4400	2"
ED4400M	3 1/2"
ED4400MA	3 1/2"
ED4800	2"
ED4800M	3 1/2"
ED4800MA	3 1/2"

**Projection**

3-1/4"; 2-3/4" dogged

**Trim**

Cylinder is not included. See page 236 for cylinder options

**Door Width**

36"

**SecureBolt®**

ED4200S      Panic  
 ED4200SM    Panic  
 ED4200SMA   3 Hour Fire Rated

**Rim**

ED4200      Panic  
 ED4200M    Panic  
 ED4200MA   3 Hour Fire Rated

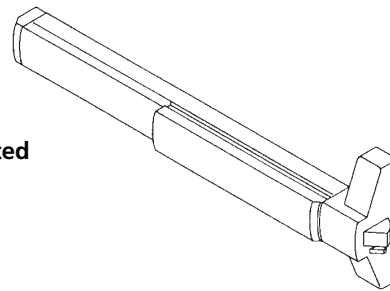

**Surface Vertical Rod**

ED4400      Panic  
 ED4400M    Panic  
 ED4400MA   3 Hour Fire Rated

**Concealed Vertical Rod**

ED4800      Panic  
 ED4800M    Panic  
 ED4800MA   3 Hour Fire Rated

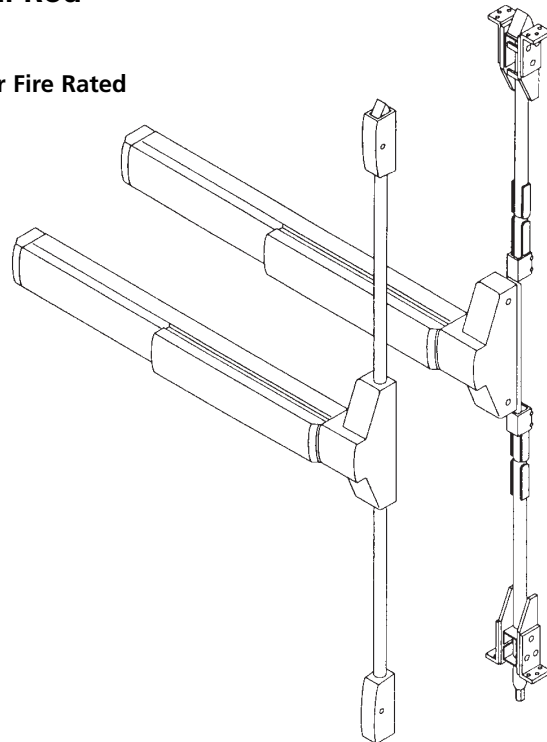

**Ordering Example**
**Exit Device Only**

Quantity	Exit Device	Finish	Hand	Misc. Options
20	ED4200	606	RHR	M51-M54

**Removable Mullions**

Quantity	Mullion	Finish	Misc. Options
12	808	695	M57

**Exit Device with Trim**

Quantity	Exit Device	Trim/Function	Finish	Hand	Door Thickness	Door Width	Door Height	Misc. Options
10	ED4400	N855	605	LHR	D200	W048	H0706	M51-M54

**Trim Only**

Quantity	Trim/Function	Finish	Hand	Door Thickness
24	N855	625	RHR	D214

**Contract/Detailed Order - Rim Exit Device with Trim**

Quantity	Keypad	Exit Device	Trim/Function	Finish	Hand	Door Height	Optional Strike	Door Width	Misc. Options	Optional Cylinder
36	AA1	ED4400	C855	626	LHR	H0800	S09	W048	M52-M54	7P

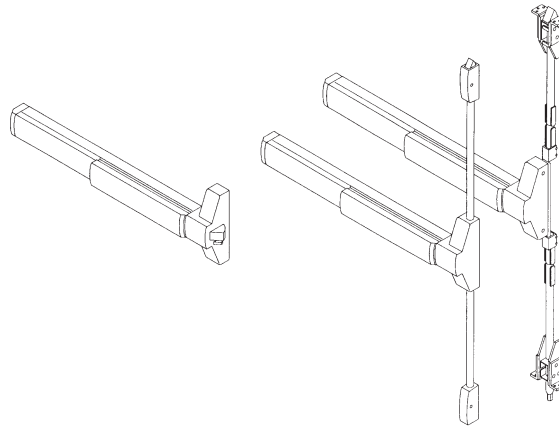

**36" Device Only, See Quick Code section for 24" and 48" door width options**

Includes device, strike(s) and screw pack. No cylinder or trim.

**SecureBolt® ED4200S Series**

Function	Description	Finish: 613E, 630*	Finish: 605, 606, 611, 612, 613, 618, 619, 625, 629, 722
ED4200S	Panic	\$1,773.00	\$1,853.00
ED4200SM	Panic	\$1,773.00	\$1,853.00
ED4200SMA	3 Hour Fire Rated	\$1,936.00	\$2,016.00

**Rim ED4200 Series**

Function	Description	Finish: 613E, 630*	Finish: 605, 606, 611, 612, 613, 618, 619, 625, 629, 722
ED4200	Panic	\$1,705.00	\$1,785.00
ED4200M	Panic	\$1,705.00	\$1,785.00
ED4200MA	3 Hour Fire Rated	\$1,868.00	\$1,948.00

**Vertical Rod ED4400 Series**

Function	Description	Finish: 613E, 630*	Finish: 605, 606, 611, 612, 613, 618, 619, 625, 629, 722
ED4400	Panic	\$2,015.00	\$2,095.00
ED4400M	Panic	\$2,015.00	\$2,095.00
ED4400MA	3 Hour Fire Rated	\$2,178.00	\$2,258.00

**Concealed V.R. ED4800 Series**

Function	Description	Finish: 613E, 630*	Finish: 605, 606, 611, 612, 613, 618, 619, 625, 629, 722
ED4800	Panic	\$2,276.00	\$2,356.00
ED4800M	Panic	\$2,276.00	\$2,356.00
ED4800MA	3 Hour Fire Rated	\$2,439.00	\$2,519.00

For rim, surface and concealed vertical rod exit trim prices, see pages 235-238.

Caution: Be sure of your measurements. Exit devices are NOT returnable.

\* Contact factory for 626 finish availability.

**ED4200S/ED4200/ED4400/ED4800 SecureBolt®, Rim, Surface and Concealed V.R. Trim**

Cylinder is not included.

**Escutcheon Trim Design: A8 Armstrong**



**Lever:** Cast

**Escutcheon:** Wrought

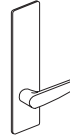

Function	Description	Finish: 613E, 630	Finish: 605, 606, 611, 612, 613, 618, 619, 625, 626, 629, 722
A810	Passage	\$531.00	\$557.00
A850	Dummy		
A855	Classroom <sup>1</sup>		
A859	Storeroom		

**Escutcheon Trim Design: C8 Citation**



**Lever:** Cast

**Escutcheon:** Wrought

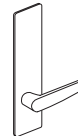

Function	Description	Finish: 613E, 630	Finish: 605, 606, 611, 612, 613, 618, 619, 625, 626, 629, 722
C810	Passage	\$531.00	\$557.00
C850	Dummy		
C855	Classroom <sup>1</sup>		
C859	Storeroom		

**Escutcheon Trim Design: D8 Dirke**



**Lever:** Cast

**Escutcheon:** Wrought

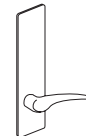

Function	Description	Finish: 613E, 630	Finish: 605, 606, 611, 612, 613, 618, 619, 625, 626, 629, 722
D810	Passage	\$531.00	\$557.00
D850	Dummy		
D855	Classroom <sup>1</sup>		
D859	Storeroom		

Note:

1. Classroom function trim may be converted to storeroom function by a simple field adjustment. No additional parts required.

**ED4200S/ED4200/ED4400/ED4800 SecureBolt®, Rim, Surface and Concealed V.R. Trim**

Cylinder is not included.

**Escutcheon Trim Design: E8 Essex**



**Lever:** Cast

**Escutcheon:** Wrought

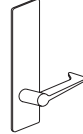

Function	Description	Finish: 613E, 630	Finish: 605, 606, 611, 612, 613, 618, 619, 625, 626, 629, 722
E810	Passage	\$531.00	\$557.00
E850	Dummy		
E855	Classroom <sup>1</sup>		
E859	Storeroom		

**Escutcheon Trim Design: L8 Lustra**



**Lever:** Cast

**Escutcheon:** Wrought

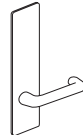

Function	Description	Finish: 613E, 630	Finish: 605, 606, 611, 612, 613, 618, 619, 625, 626, 629, 722
L810	Passage	\$531.00	\$557.00
L850	Dummy		
L855	Classroom <sup>1</sup>		
L859	Storeroom		

**Escutcheon Trim Design: N8 Newport**



**Lever:** Cast

**Escutcheon:** Wrought

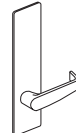

Function	Description	Finish: 613E, 630	Finish: 605, 606, 611, 612, 613, 618, 619, 625, 626, 629, 722
N810	Passage	\$531.00	\$557.00
N850	Dummy		
N855	Classroom <sup>1</sup>		
N859	Storeroom		

**Escutcheon Trim Design: R8 Regis**



**Lever:** Cast

**Escutcheon:** Wrought

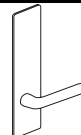

Function	Description	Finish: 613E, 630	Finish: 605, 606, 611, 612, 613, 618, 619, 625, 626, 629, 722
R810	Passage	\$531.00	\$557.00
R850	Dummy		
R855	Classroom <sup>1</sup>		
R859	Storeroom		

Note:

1. Classroom function trim may be converted to storeroom function by a simple field adjustment. No additional parts required.



**ED4200S/ED4200/ED4400/ED4800 SecureBolt®, Rim, Surface and Concealed V.R. Trim**

Cylinder is not included.

**Escutcheon Trim Design: PR8 Princeton**



**Lever:** Cast

**Escutcheon:** Wrought



Function	Description	Finish: 613E, 630	Finish: 605, 606, 611, 612, 613, 618, 619, 625, 626, 629, 722
PR810	Passage	\$531.00	\$557.00
PR850	Dummy		
PR855	Classroom <sup>1</sup>		
PR859	Storeroom		

**Escutcheon Trim Design: G8 Global**

**Knob:** Wrought

**Escutcheon:** Wrought



Function	Description	Finish: 613E, 630	Finish: 605, 606, 611, 612, 613, 618, 619, 625, 626, 629, 722
G810	Passage	\$490.00	\$516.00
G850	Dummy		
G855	Classroom <sup>1</sup>		
G859	Storeroom		

**Escutcheon Trim Design: F4 Plate**

**Plate:** Wrought



Function	Description	Finish: 613E, 630	Finish: 605, 606, 611, 612, 613, 618, 619, 625, 626, 629, 722
F450	Dummy	\$201.00	\$227.00
F457	Nightlatch		

**Escutcheon Trim Design: O8 Plate x Thumbturn**

**Plate:** Wrought

**Thumbturn:** Cast



Function	Description	Finish: 613E, 630	Finish: 605, 606, 612, 613, 722
O810	Passage	\$426.00	\$452.00
O855 <sup>1</sup>	Classroom		
O859	Storeroom		

Note:

1. Classroom function trim may be converted to storeroom function by a simple field adjustment. No additional parts required.

**ED4200S/ED4200/ED4400/ED4800 SecureBolt®, Rim, Surface and Concealed V.R. Trim**

Cylinder is not included.

**Escutcheon Trim Design: O14 Plate x Thumbturn**

**Pull:** Cast      **Escutcheon:** Wrought      **Thumbturn:** Cast



Function	Description	Finish: 613E, 630	Finish: 605, 606, 611, 612, 613, 618, 619, 625, 626, 629, 722
O1410	Passage	\$521.00	\$547.00
O1455 <sup>1</sup>	Classroom		
O1459	Storeroom		

**Escutcheon Trim Design: T14 Pull/Thumbpiece**

**Grip:** Cast      **Escutcheon:** Wrought



Function	Description	Finish: 613E, 630	Finish: 605, 606, 611, 612, 613, 618, 619, 625, 626, 629, 722
T1410	Passage	\$503.00	\$529.00
T1450	Dummy	\$433.00	\$459.00
T1455 <sup>1</sup>	Classroom	\$503.00	\$529.00
T1457	Nightlatch (see note 2)	\$433.00	\$459.00

**Escutcheon Trim Design: P10 Pull**



**Pull:** Extruded      **Escutcheon:** Wrought



Function	Description	Finish: 613E, 630	Finish: 605, 606, 611, 612, 613, 618, 619, 625, 626, 629, 722
P1050	Dummy	\$508.00	\$534.00
P1057	Nightlatch (see note 2)		

**Escutcheon Trim Design: K1 Key Only**

Note: Available with cylinder option only. Example: K157 x 6P



Function	Description	Finish: 605, 606, 611, 612, 613, 618, 619, 622, 625, 626, 722
K157	Nightlatch <sup>2</sup>	See cylinder option price pg. 234

Notes:

1. Classroom function trim may be converted to storeroom function by a simple field adjustment. No additional parts required.
2. Not recommended for use on surface or concealed vertical rod exit devices.

**Offset Pull Trim: P12, P13, P14**

Offset Pull Trim	Part Number	Finishes: 613E, 630	Finishes: 605, 606, 612, 613, 626, 629
P12	716F50M X Finish	\$233.00	\$247.00
P13	716F51M X Finish	\$286.00	\$300.00
P14	716F52M X Finish	\$202.00	\$216.00

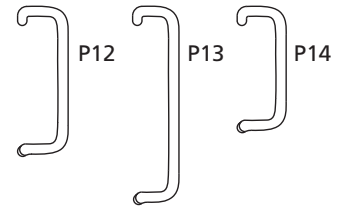
**Electrified Options for Exit Devices**

Description	Specify	Add or Deduct
Exit Alarm Device (cylinder is not included)	M61	\$647.00
Bolt Position Monitoring	M91*	Add \$217.00
Touchbar Monitoring or Signaling/Request to Exit (REX)	M92*	Add \$204.00
Outside Trim Monitoring or Signaling	M93*	
Latch Pullback	M94	Add \$870.00
Electric Dogging	M97	Add \$416.00

**Delayed Egress Device**

Description	Specify	Add or Deduct
Delayed Egress (Suffix the letter D to device. Ex: ED4200)	D	Add \$1533.00
30-Second Delay	M88*	\$98.00
BOCA 15-Second Delay	M89*	
BOCA 30-Second Delay	M90*	

**Electrified Accessories**

Part Number	Description	Specify	Price
741F899	Controller (Required for Electric Latch. Retraction)	782	\$683.00
709F609	Power Supply 1 Amp (controls 1 'D' device)	BPS-24-1	\$295.00
709F619	Power Supply 2 Amp (controls 2 'D' devices or 1 "D" with SAF or SEC)	BPS-24-2	\$600.00
709F269	Power Supply 4 amp 24VDC	BPS-24-4	\$975.00
704F288	Concealed transfer (for over 120-degree swing door)	EPTL	\$112.00
709F689	(1) SPDT Maintained Switch (Includes LED)	MKA	\$112.00
709F709	(1) SPDT Momentary Switch (Includes LED)	MK	\$170.00
709F749	(1) SPDT Momentary Switch (Illuminated)	PB2	\$131.00
709F759	(1) SPDT Maintained (Alternating Action) Switch	PB3EA	\$100.00
709F769	(1) SPDT Momentary Switch (Illuminated)	PB3	\$127.00
709F779	(1) SPDT Momentary Switch	PB3ER	\$84.00
709F729	DPDT Momentary Key Switch	MK2	\$196.00
709F699	Narrow Stile Key Switch (Alt. action)	MKAN	\$170.00
709F719	Narrow Stile Momentary Key Switch	MKN	\$170.00
709F789	Sonalert 90db @ 2 ft. 12-24VDC. Mounted on one gang stainless steel plate.	PZ1	\$84.00
	Alarm Kit (cylinder is not included) <sup>1</sup>	ED40AK	\$699.00
709F679	Door Cord	TSK-C	\$26.00
741F739	Digital Entry System (4 users)	DK-12	\$222.00
709F809	Digital Entry System (59 users) ST finish	DK-26ST	\$502.00
709F819	Digital Entry System (59 users) Black finish	DK-26BK	\$502.00
709F669	Power Transfer	EPT	\$84.00

**Notes:**

- Alarm kit cannot be installed in the field to surface vertical rod exit device. Any attempt to do so voids all warranties.

**\*ElectroLynx®**

As part of their promise to provide innovative, fast and effective high security solutions to their customers, certain ASSA ABLOY Group brands offer *ElectroLynx®*, a universal quick-connect system that simplifies the electrification of the door opening.

Cylinder Options*		
Description	Specify	Add or Deduct
Conventional 6-pin	6P**	Add \$76.00 per cylinder
Conventional 7-pin	7P	Add \$78.00 per cylinder
Access 3 Patented	AP	Add \$76.00 per cylinder
Access 3 Security	AS	Add \$125.00 per cylinder
Access 3 High Security, UL 437	AHS	Add \$145.00 per cylinder
Access 3 IC Patented	ACP	Add \$143.00 per cylinder
Access 3 IC Security	ACS	Add \$189.00 per cylinder
Access 3 IC High Security, UL 437	ACHS	Add \$209.00 per cylinder
Pyramid Security fixed core	PS	Add \$125.00 per cylinder
Pyramid Security IC	PCS	Add \$189.00 per cylinder
Pyramid High Security fixed core	PHS	Add \$151.00 per cylinder
Pyramid High Security IC	PCHS	Add \$214.00 per cylinder
Pyramid IC with temporary construction core	CTP	Add \$143.00 per cylinder
Pyramid IC with temporary disposable core	CTPD	Add \$76.00 per cylinder
Pyramid IC less core	CLP	Add \$76.00 per cylinder
Security	HS	Add \$171.00 per cylinder
Security IC	CHS	Add \$236.00 per cylinder
Blockout function	BO	Add \$214.00 per cylinder
IC 6-pin	C6	Add \$143.00 per cylinder
IC 6-pin with temporary construction core (Red)	CT6R	Add \$143.00 per cylinder
IC 6-pin with temporary construction core (Blue)	CT6B	Add \$143.00 per cylinder
IC 6-pin with temporary construction core (Green)	CT6G	Add \$143.00 per cylinder
IC 6-pin with temporary disposable core	CT6D	Add \$76.00 per cylinder
IC 6-pin less core	CL6	Add \$76.00 per cylinder
SFIC 6-pin with Less Core	CLS6	Add \$76.00 per cylinder
IC 6-pin with SFIC disposable temporary core	CT6SD	Add \$76.00 per cylinder
IC 7-pin	C7	Add \$144.00 per cylinder
IC 7-pin with temporary construction core ( Red)	CT7R	Add \$144.00 per cylinder
IC 7-pin with temporary construction core ( Blue)	CT7B	Add \$144.00 per cylinder
IC 7-pin with temporary construction core ( Green)	CT7G	Add \$144.00 per cylinder
IC 7-pin with temporary disposable core	CT7D	Add \$78.00 per cylinder
IC 7-pin less core	CL7	Add \$78.00 per cylinder
SFIC 7-pin with Less Core	CLS7	Add \$78.00 per cylinder
IC 7-pin with SFIC disposable temporary core	CT7SD	Add \$78.00 per cylinder

\*Optional dogging cylinder will be furnished with the same mechanism and keyed alike with the trim cylinder, unless otherwise specified. If different keying or cylinder type is required, specify outside (trim) first, then inside (dogging) cylinder.  
 \*\*6P cylinder option is supplied in 6-pin, L4 keyway, 0-bitted with two nickel silver keys.

Keying Options*		
Description	Specify	Add or Deduct
0-Bitted with 2 blank keys	(standard)	No Charge
Keyed random	KR	No Charge
Master keyed (all cylinders except 8000, 8020, 8027 IC)	specify keyset	Add \$16.00 per cylinder
Master keyed Pyramid	specify keyset	Add \$16.00 per cylinder
Master keyed Security (including IC cylinder and core)	specify keyset	Add \$16.00 per cylinder
Master keyed (8000, 8020, 8027 IC core)	specify keyset	No Charge
Master keyed to customer bittings or sample key	specify keyset	Add \$16.00 per cylinder
Construction master keyed <sup>1,2</sup>	CMK	Add \$16.00 per cylinder
Visual key control (VKC)		
- No Stamping	VKC0	\$4.30
- Keys only	VKC1	No Charge
- Cylinders and Keys <sup>3</sup>	VKC2	\$8.00
- Cylinders only <sup>3</sup>	VKC3	\$8.00
Concealed key control (CKC)		
- CKC cylinders with VKC keys	CKC2	\$8.00
- CKC cylinders only <sup>3</sup>	CKC3	\$8.00
More than 2 keys per lock	KY# (e.g., KY6)	See page 48 - Cut Keys Section

\*For key bows other than 10 and 90, specify "KB" + bow number as Quick Code, e.g. KB12.

- Notes:  
 1. CMK Construction master keying charge is in addition to master keying charge.  
 2. CMK Construction master keying is not available in Pyramid or Security series.  
 3. VKC2, VKC3, CKC3 are not available in Pyramid or Security series.

**Door Height Options**
**ED4400 Device**

Door Height	Specify	Add or Deduct
7'0"	(standard)	No Charge
7'2"	H0702	
7'6"	H0706	
8'0"	H0800	
9'0"	H0900	
10'0"	H1000	Add \$82.00 per device

**ED4800 Device**

Door Height	Specify	Add or Deduct
8'0"	(standard)	No Charge
8'2"	H0802	
8'6"	H0806	
9'0"	H0900	Add \$82.00 per device
10'0"	H1000	

**Door Width Options**

Door Width	Specify	Add or Deduct
24"	W024	Add \$292.00 per device
36"	(standard)	No Charge
48"	W048	Add \$35.00 per device

**Door Thickness Options**

Door Thickness	Specify	Add or Deduct
1-3/4"	(standard)	No Charge
2"	D200	
2-1/4"	D214	

**Strike Options**

Description	Specify	Add or Deduct
Surface or concealed vertical rod	S09	No Charge
Bottom strike for 1/2" threshold		
Flush transom top strike bracket	M67	Add \$29.00 per device

**Miscellaneous Options**

Description	Specify	Add or Deduct
Torx® screws for rim, concealed vertical rod, mortise	M04	Add \$42.00 per device
Torx® screws for surface vertical rod	M04	Add \$80.00 per device
Knurling outside and inside (Embossed Touchbar - device side)	M20	Add \$139.00 per device
Knurling outside only (trim side)	M21	Add \$65.00 per device
Knurling inside only (Embossed Touchbar - device side)	M22	Add \$74.00 per device
Abrasive coat outside and inside (trim and device)	M23	Add \$88.00 per device
Abrasive coat inside only (device side)	M24	Add \$46.00 per device
Abrasive coat outside only (trim side)	M25	Add \$42.00 per device
Pathlite™ Photoluminescent Touchbar cover	M49	Add \$335.00 per device
Less dogging	M51	No Charge
Cylinder dogging (less cylinder)	M52	Add \$78.00 per device
Sex nuts and bolts (SNBs)	M54	No Charge
Mullion stabilizer*	M57	Add \$62.00 per mullion
Shim kit (for vision light)		
- All rim and concealed vertical rod	M58	Add \$96.00 per device
- All surface vertical rod	M58	Add \$96.00 per device
End Cap Reinforcement (used with standard end cap only)	M109	Add \$78.00 per device
Flush End Cap	M110	No Charge

**Removable Mullion**
**Ordering Example**

Quantity	Mullion Number	Finish
10	808	628

Door Height	Specify	Finish	Price
Up to 8'0"	808	628	\$1,244.00
Up to 8'0"	808	695	\$1,429.00

\*Standard with all 808 mullions.



The PathLite™ patent pending technology offers a number of benefits:

- Requires no wiring or maintenance
- Recharges with exposure to ambient light
- Unaffected by heat or cold
- Non-toxic, will not rub off or fade
- Vandal resistant
- Fire resistant and non-radioactive
- Green contrasting word "EXIT" centered on touchbar in 1-1/4" high lettering
- Cost effective; especially suited for existing buildings

PathLite™ photoluminescent exit devices meet New York City's newly adopted standards for requirement of photoluminescent signage and stairwell markings in all office buildings in excess of 75 feet in height.

**How To Order Complete Device**

Exit Device	Trim/Function	Finish	Hand	Misc. Options
ED5200	N910	630	RHR	M49

ED5200 x N910 x 630 x RHR x M49

Options	Specify	Price
24", 36", and 48" PathLite™ Photoluminescent Touchbar Cover	M49	Add \$335.00 per device

**How to Order Touchbar Cover Only**

Options	Part Number	Price
24" PathLite™ Photoluminescent Touchbar cover	710F797	\$374.00
36" PathLite™ Photoluminescent Touchbar cover	710F737	
48" PathLite™ Photoluminescent Touchbar cover	710F747	

**Standard Features**

**Handing**

Devices are field reversible; specify hand. Lever trims are handed; specify hand.

Note:  
Specify hand for all double cylinder exit devices

**Door Thickness**

1-3/4"

**Door Width**

36"

**Projection**

3-1/4"; 2-3/4" dogged

**Trim**

Cylinder is not included.  
See page 258 for cylinder options.

**SecureBolt®**

- ED5200S Panic
- ED5200SA 3 Hour Fire Rated
- ED5202S Double Cylinder Panic, SecureBolt®
- ED5202SA Double Cylinder, Secure Bolt, 3 Hour Fire Rated

**RIM**

- ED5200 Panic
- ED5200A 3 Hour Fire Rated
- ED5202 Double Cylinder Panic
- ED5202A Double Cylinder; 3 Hour fire rated

**Vertical Rod**

- ED5400 Panic
- ED5470 Panic
- ED5400A 3 Hour Fire Rated
- ED5470B 1-1/2 Hour Fire Rated

**Concealed Vertical Rod**

- ED5800 Panic
- ED5860 Panic
- ED5800A 3 Hour Fire Rated
- ED5860B 1-1/2 Hour Fire Rated

**Mortise**

- ED5600 Panic
- ED5600A 3 Hour Fire Rated
- ED5602L Double Cylinder Panic (Classroom Function)
- ED5602AL Double Cylinder (Classroom Function); 3 Hour Fire Rated

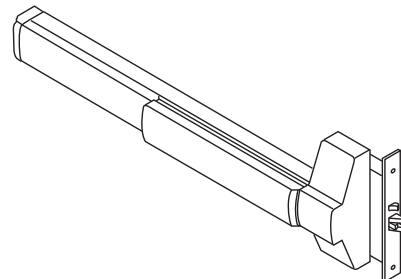
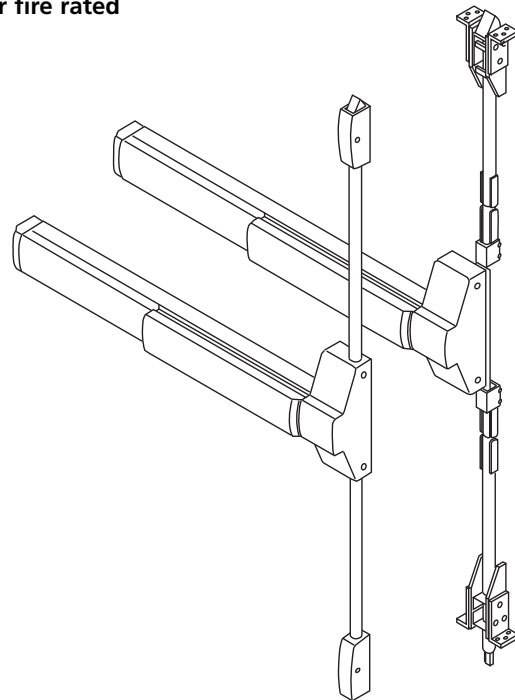
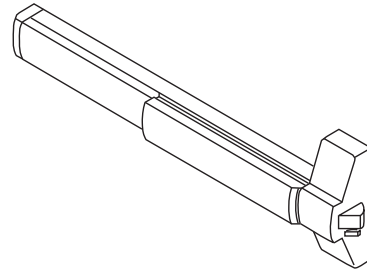



**Ordering Examples**
**Exit Device with Trim**

Quantity	Exit Device	Trim/Function	Finish	Hand	Door Thickness	Optional Strike	Door Width	Misc. Options
36	ED5600L	N9M55	605	LHR	D200	SB134	W048	M51-M54

**Trim Only**

Quantity	Trim/Function	Finish	Hand	Door Thickness
24	N955	625	RHR	D214

**Contract/Detailed Order - Rim Exit Device with Trim**

Quantity	Keypad	Exit Device	Trim/Function	Finish	Hand	Door Thickness	Door Width	Misc. Options	Optional Cylinder
36	AA1	ED5200	C955	626	LHR	D200	W048	M52-M54	6P

**Notes:**

M55 less bottom rod option is available on ED5470(B) and ED5860(B) devices only.  
 H0900 and H1000 options are available on ED5470(B) and ED5860(B) devices only.  
 Non fire rated devices do not have a door size limitation set by UL.

**36" Device Only**

Includes device, strike(s) and screw pack. No cylinder or trim.

**SecureBolt® ED5200S Series**

Function	Description	Finish: 613E, 630*	Finish: 605, 606, 611, 612, 613, 618, 619, 625, 629, 722
ED5200S	Panic	\$1,383.00	\$1,479.00
ED5202S <sup>1</sup>	Double Cylinder Panic <i>Classroom function Trim only</i>	\$1,605.00	\$1,701.00
ED5200SA	3 Hour Fire Rated	\$1,546.00	\$1,642.00
ED5202SA <sup>1</sup>	Double Cylinder 3 Hour Fire Rated <i>Classroom function Trim only</i>	\$1,768.00	\$1,864.00

**Rim ED5200 Series**

Function	Description	Finish: 613E, 630*	Finish: 605, 606, 611, 612, 613, 618, 619, 625, 629, 722
ED5200	Panic	\$1,315.00	\$1,411.00
ED5202 <sup>1</sup>	Double Cylinder Panic <i>Classroom function Trim only</i>	\$1,537.00	\$1,633.00
ED5200A	3 Hour Fire Rated	\$1,478.00	\$1,574.00
ED5202A <sup>1</sup>	Double Cylinder 3 Hour Fire Rated <i>Classroom function Trim only</i>	\$1,700.00	\$1,796.00

**Vertical Rod ED5400 Series**

Function	Description	Finish: 613E, 630*	Finish: 605, 606, 611, 612, 613, 618, 619, 625, 629, 722
ED5400	Panic	\$1,861.00	\$1,957.00
ED5470	Panic	\$1,927.00	\$2,023.00
ED5400A	3 Hour Fire Rated	\$2,024.00	\$2,120.00
ED5470B	1-1/2 Hour Fire Rated	\$2,090.00	\$2,186.00

**Mortise ED5600 Series**

Function	Description	Finish: 613E, 630*	Finish: 605, 606, 611, 612, 613, 618, 619, 625, 629, 722
ED5600K	Panic	\$1,829.00	\$1,925.00
ED5657K			
ED5600L			
ED5657L			
ED5600T			
ED5657T	Double Cylinder Panic <i>Classroom function Trim only</i>	\$2,051.00	Empty Field!
ED5602L <sup>1</sup>			
ED5600AK			
ED5657AK			
ED5600AL			
ED5657AL	3 Hour Fire Rated	\$1,992.00	\$2,147.00
ED5600AT			
ED5657AT			
ED5602AL <sup>1</sup>			
ED5633L			
ED5634L	Access 800® Only - Panic – Without Cylinder	\$1,829.00	\$1,925.00
ED5634L	Access 800® Only - Panic – With Cylinder	\$1,829.00	\$1,925.00
ED5633AL	Access 800® Only - 3 Hour Fire Rated – Without Cylinder	\$1,992.00	\$2,147.00
ED5634AL	Access 800® Only - 3 Hour Fire Rated – With Cylinder	\$1,992.00	\$2,147.00

**Concealed V.R. ED5800 Series**

Function	Description	Finish: 613E, 630*	Finish: 605, 606, 611, 612, 613, 619, 625, 629, 722
ED5800	Panic	\$2,118.00	Empty Field!
ED5860	Panic	\$2,250.00	\$2,214.00
ED5800A	3 Hour Fire Rated	\$2,281.00	\$2,346.00
ED5860B	1-1/2 Hour Fire Rated	\$2,413.00	\$2,377.00

**Inactive Bar ED5000DB Series**

Function	Description	Finish: 613E, 630*	Finish: 605, 606, 611, 612, 613, 619, 625, 629, 722
ED5000DB	Inactive Bar	\$649.00	\$745.00

For rim, surface and concealed vertical rod exit trim prices, see pages 247-251.  
 For mortise exit device trim prices see pages 252-256.  
 1. Specify handing for double cylinder devices

Only classroom function trim can be used with double cylinder devices.  
 Caution: Be sure of your measurements. Exit devices are NOT returnable.  
 \* Contact factory for 626 finish availability.

**ED5200S/ED5200/ED5400/ED5800 SecureBolt®, Rim, Surface and CVR Heavy-Duty Trim**

Cylinder is not included.

**Escutcheon Trim Design: A9 Armstrong**



**Lever:** Cast

**Escutcheon:** Forged

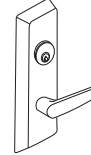

Function	Description	Finish: 613E, 630 <sup>1</sup>	Finish: 605, 606, 611, 612, 613, 618, 619, 625, 626, 629 <sup>2</sup> , 722
A910	Passage	\$572.00	\$598.00
A950	Dummy		
A955	Classroom <sup>3, 4</sup>		
A957	Nightlatch <sup>5</sup>		
A959	Storeroom		

**Escutcheon Trim Design: C9 Citation**



**Lever:** Cast

**Escutcheon:** Forged

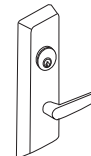

Function	Description	Finish: 613E, 630 <sup>1</sup>	Finish: 605, 606, 611, 612, 613, 618, 619, 625, 626, 629 <sup>2</sup> , 722
C910	Passage	\$572.00	\$598.00
C950	Dummy		
C955	Classroom <sup>3, 4</sup>		
C957	Nightlatch <sup>5</sup>		
C959	Storeroom		

**Escutcheon Trim Design: D9 Dirke**



**Lever:** Cast

**Escutcheon:** Forged

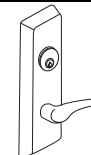

Function	Description	Finish: 613E, 630 <sup>1</sup>	Finish: 605, 606, 611, 612, 613, 618, 619, 625, 626, 629 <sup>2</sup> , 722
D910	Passage	\$572.00	\$598.00
D950	Dummy		
D955	Classroom <sup>3, 4</sup>		
D957	Nightlatch <sup>5</sup>		
D959	Storeroom		

Notes:

1. 619 finish provided to match 630 finish
2. 618 finish provided to match 629 finish.
3. Classroom function trim may be converted to storeroom function by a simple field adjustment. No additional parts required.
4. Only Classroom function may be used with Double Cylinder exit devices.
5. Not recommended for use with surface or concealed vertical rod exit devices (ED5400, ED5800)

**ED5200S/ED5200/ED5400/ED5800 SecureBolt®, Rim, Surface and CVR Heavy-Duty Trim**

Cylinder is not included.

**Escutcheon Trim Design: E9 Essex**



**Lever:** Cast      **Escutcheon:** Forged



Function	Description	Finish: 613E, 630 <sup>1</sup>	Finish: 605, 606, 611, 612, 613, 618, 619, 625, 626, 629 <sup>2</sup> , 722
E910	Passage	\$572.00	\$598.00
E950	Dummy		
E955	Classroom <sup>3,4</sup>		
E957	Nightlatch <sup>5</sup>		
E959	Storeroom		

**Escutcheon Trim Design: L9 Lustra**



**Lever:** Cast      **Escutcheon:** Forged

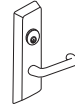

Function	Description	Finish: 613E, 630 <sup>1</sup>	Finish: 605, 606, 611, 612, 613, 618, 619, 625, 626, 629 <sup>2</sup> , 722
L910	Passage	\$572.00	\$598.00
L950	Dummy		
L955	Classroom <sup>3,4</sup>		
L957	Nightlatch <sup>5</sup>		
L959	Storeroom		

**Escutcheon Trim Design: N9 Newport**



**Lever:** Cast      **Escutcheon:** Forged

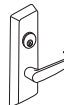

Function	Description	Finish: 613E, 630 <sup>1</sup>	Finish: 605, 606, 611, 612, 613, 618, 619, 625, 626, 629 <sup>2</sup> , 722
N910	Passage	\$572.00	\$598.00
N950	Dummy		
N955	Classroom <sup>3,4</sup>		
N957	Nightlatch <sup>5</sup>		
N959	Storeroom		

**Escutcheon Trim Design: R9 Regis**



**Lever:** Cast      **Escutcheon:** Forged

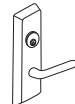

Function	Description	Finish: 613E, 630 <sup>1</sup>	Finish: 605, 606, 611, 612, 613, 618, 619, 625, 626, 629 <sup>2</sup> , 722
R910	Passage	\$572.00	\$598.00
R950	Dummy		
R955	Classroom <sup>3,4</sup>		
R957	Nightlatch <sup>5</sup>		
R959	Storeroom		

Notes:  
 1. 619 finish provided to match 630 finish. - Escutcheons only  
 2. 618 finish provided to match 629 finish. - Escutcheons only  
 3. Classroom function trim may be converted to storeroom function by a simple field adjustment. No additional parts required.

4. Only Classroom function trim may be used with Double Cylinder exit devices.  
 5. Not recommended for use with surface or concealed vertical rod exit devices (ED5400, ED5800)

**ED5200S/ED5200/ED5400/ED5800 SecureBolt®, Rim, Surface and CVR Heavy-Duty Trim**

Cylinder is not included.

**Escutcheon Trim Design: PR9 Princeton**



**Lever:** Cast

**Escutcheon:** Forged



Function	Description	Finish: 613E, 630 <sup>1</sup>	Finish: 605, 606, 611, 612, 613, 618, 619, 625, 626, 629 <sup>2</sup> , 722
PR910	Passage	\$572.00	\$598.00
PR950	Dummy		
PR955	Classroom <sup>3,4</sup>		
PR957	Nightlatch <sup>5</sup>		
PR959	Storeroom		

**Escutcheon Trim Design: F9**

**Lever:** Cast

**Escutcheon:** Forged



Function	Description	Finish: 613E, 630 <sup>1</sup>	Finish: 605, 606, 611, 612, 613, 618, 619, 625, 626, 629 <sup>2</sup> , 722
F950	Dummy	\$245.00	\$271.00
F957	Nightlatch <sup>5</sup>		

**Escutcheon Trim Design: G9**

**Lever:** Cast

**Escutcheon:** Forged



Function	Description	Finish: 613E, 630 <sup>1</sup>	Finish: 605, 606, 611, 612, 613, 618, 619, 625, 626, 629 <sup>2</sup> , 722
G910	Passage	\$572.00	\$598.00
G950	Dummy		
G955	Classroom <sup>3,4</sup>		
G957	Nightlatch <sup>5</sup>		
G959	Storeroom		

**Escutcheon Trim Design: VT9**

**Plate:** Stamped or Formed Stainless Steel



Function	Description	Finish: 613E, 630 <sup>1</sup>
VT957	Nightlatch <sup>6</sup>	\$515.00
VTL957	Nightlatch with Lip <sup>6</sup>	
VT950	Pull	
VTL950	Pull with Lip	

Notes:

1. 619 finish provided to match 630 finish. - Escutcheons only
2. 618 finish provided to match 629 finish. - Escutcheons only
3. Classroom function trim may be converted to storeroom function by a simple field adjustment. No additional parts required.

4. Only Classroom function trim may be used with Double Cylinder exit devices.
5. Not recommended for use with surface or concealed vertical rod exit devices (ED5400, ED5800)
6. VT957 and VTL957 trims are handed and not reversible

**ED5200S/ED5200/ED5400/ED5800 SecureBolt®, Rim, Surface and CVR Heavy-Duty Trim**

Cylinder is not included.

**Escutcheon Trim Design: FR9 Frascati\***



**Escutcheon:** Forged

\* Handed Lever. Handing cannot be changed in the field.



Function	Description	Finish: 613E, 626	Finish: 605, 606, 611, 612, 613, 618, 619, 625, 722
FR910	Passage	\$572.00	\$598.00
FR950	Dummy		
FR955	Classroom <sup>3,4</sup>		
FR957	Nightlatch <sup>5</sup>		
FR959	Storeroom		

**Escutcheon Trim Design: M9 Merlot**



**Escutcheon:** Forged

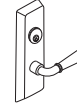

Function	Description	Finish: 613E, 626	Finish: 605, 606, 611, 612, 613, 618, 619, 625, 722
M910	Passage	\$572.00	\$598.00
M950	Dummy		
M955	Classroom <sup>3,4</sup>		
M957	Nightlatch <sup>5</sup>		
M959	Storeroom		

**Escutcheon Trim Design: TS9 Tuscany**



**Escutcheon:** Forged

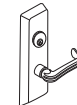

Function	Description	Finish: 613E, 626	Finish: 605, 606, 611, 612, 613, 618, 619, 625, 722
TS910	Passage	\$572.00	\$598.00
TS950	Dummy		
TS955	Classroom <sup>3,4</sup>		
TS957	Nightlatch <sup>5</sup>		
TS959	Storeroom		

**Escutcheon Trim Design: Z9 Zinfandel\***



**Escutcheon:** Forged

\* Handed Lever. Handing cannot be changed in the field.

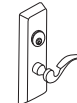

Function	Description	Finish: 613E, 626	Finish: 605, 606, 611, 612, 613, 618, 619, 625, 722
Z910	Passage	\$572.00	\$598.00
Z950	Dummy		
Z955	Classroom <sup>3,4</sup>		
Z957	Nightlatch <sup>5</sup>		
Z959	Storeroom		

Notes:

3. Classroom function trim may be converted to storeroom function by a simple field adjustment. No additional parts required.

4. Only Classroom function trim may be used with Double Cylinder exit devices.  
5. Not recommended for use with surface or concealed vertical rod exit devices.

**ED5200S/ED5200/ED5400/ED5800 SecureBolt®, Rim, Surface and CVR Trim**

Cylinder is not included.

**Escutcheon Trim Design: TH900 Pull/Thumbpiece**

**Grip:** Extruded

**Escutcheon:** Forged



Function	Description	Finish: 613E, 630 <sup>1</sup>	Finish: 605, 606, 611, 612, 613, 618, 619, 625, 626, 629 <sup>2</sup> , 722
TH910	Passage	\$413.00	\$439.00
TH950	Dummy (No thumbpiece)	\$383.00	\$409.00
TH955	Classroom <sup>3,4</sup>	\$413.00	\$439.00
TH957	Nightlatch <sup>5</sup> (No thumbpiece)	\$383.00	\$409.00
TH959	Storeroom	\$383.00	\$409.00

**Escutcheon Trim Design: P9 Pull**



**Pull:** Extruded

**Escutcheon:** Forged

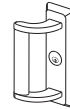

Function	Description	Finish: 613E, 630 <sup>1</sup>	Finish: 605, 606, 611, 612, 613, 618, 619, 625, 626, 629 <sup>2</sup> , 722
P950*	Dummy	\$354.00	\$380.00
P957*	Nightlatch <sup>5</sup>		

\* Specify Hand. Field Reversible.

**Escutcheon Trim Design: K1 Key Only**

**Note:** Only available with cylinder option. Example K157 x 6P



Function	Description	Finish: 605, 606, 611, 612, 613, 618, 619, 622, 625, 626, 722
K157	Nightlatch <sup>5</sup>	See cylinder option price pg. 262

Note:

1. 619 finish provided to match 630 finish. - Escutcheons only
2. 618 finish provided to match 629 finish. - Escutcheons only
3. Classroom function trim may be converted to storeroom function by a simple field adjustment. No additional parts required.
4. Only Classroom function trim may be used with Double Cylinder exit devices.
5. Not recommended for use on surface or concealed vertical rod exit devices.

**ED5600 Mortise Heavy-Duty Trim**

Cylinder is not included.

**Escutcheon Trim Design: A4M Armstrong**



**Lever:** Cast

**Escutcheon:** Forged

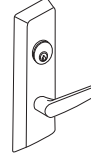

Function	Description	Finish: 613E, 630 <sup>1</sup>	Finish: 605, 606, 611, 612, 613, 618, 619, 625, 626, 629 <sup>2</sup> , 722
A9M10	Passage <sup>3</sup>	\$572.00	\$598.00
A9M50	Dummy <sup>3</sup>		
A9M55	Classroom <sup>4, 5</sup>		
A9M57	Nightlatch <sup>4</sup>		

**Escutcheon Trim Design: C9M Citation**



**Lever:** Cast

**Escutcheon:** Forged

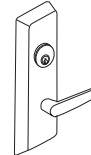

Function	Description	Finish: 613E, 630 <sup>1</sup>	Finish: 605, 606, 611, 612, 613, 618, 619, 625, 626, 629 <sup>2</sup> , 722
C9M10	Passage <sup>3</sup>	\$572.00	\$598.00
C9M50	Dummy <sup>3</sup>		
C9M55	Classroom <sup>4, 5</sup>		
C9M57	Nightlatch <sup>4</sup>		

**Escutcheon Trim Design: D9M Dirke\***



**Lever:** Cast

**Escutcheon:** Forged

\* Handed Lever. Handing cannot be changed in the field.

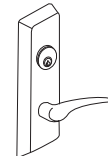

Function	Description	Finish: 613E, 630 <sup>1</sup>	Finish: 605, 606, 611, 612, 613, 618, 619, 625, 626, 629 <sup>2</sup> , 722
D9M10	Passage <sup>3</sup>	\$572.00	\$598.00
D9M50	Dummy <sup>3</sup>		
D9M55	Classroom <sup>4, 5</sup>		
D9M57	Nightlatch <sup>4</sup>		

- Notes:
1. 619 finish provided to match 630 finish. - Escutcheons only
  2. 618 finish provided to match 629 finish. - Escutcheons only
  3. Dummy and passage functions are the same. For dummy function, mortise lock body must be installed in the locked mode. No additional parts required.
  4. Classroom and nightlatch function trims are the same. Trim function must be specified when ordered with an exit device to ensure that the correct lock body is supplied.
  5. Only Classroom function trim may be used with Double Cylinder exit devices.



**ED5600 Mortise Heavy-Duty Trim**

Cylinder is not included.

**Escutcheon Trim Design: E9M Essex**



**Lever:** Cast

**Escutcheon:** Forged

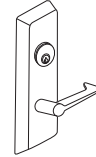

Function	Description	Finish: 613E, 630 <sup>1</sup>	Finish: 605, 606, 611, 612, 613, 618, 619, 625, 626, 629 <sup>2</sup> , 722
E9M10	Passage <sup>3</sup>	\$572.00	\$598.00
E9M50	Dummy <sup>3</sup>		
E9M55	Classroom <sup>4, 5</sup>		
E9M57	Nightlatch <sup>4</sup>		

**Escutcheon Trim Design: L9M Lustra**



**Lever:** Cast

**Escutcheon:** Forged

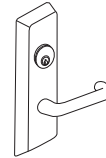

Function	Description	Finish: 613E, 630 <sup>1</sup>	Finish: 605, 606, 611, 612, 613, 618, 619, 625, 626, 629 <sup>2</sup> , 722
L9M10	Passage <sup>3</sup>	\$572.00	\$598.00
L9M50	Dummy <sup>3</sup>		
L9M55	Classroom <sup>4, 5</sup>		
L9M57	Nightlatch <sup>4</sup>		

**Escutcheon Trim Design: N9M Newport**



**Lever:** Cast

**Escutcheon:** Forged

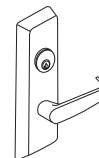

Function	Description	Finish: 613E, 630 <sup>1</sup>	Finish: 605, 606, 611, 612, 613, 618, 619, 625, 626, 629 <sup>2</sup> , 722
N9M10	Passage <sup>3</sup>	\$572.00	\$598.00
N9M50	Dummy <sup>3</sup>		
N9M55	Classroom <sup>4, 5</sup>		
N9M57	Nightlatch <sup>4</sup>		

Notes:

1. 619 finish provided to match 630 finish. - Escutcheons only
2. 618 finish provided to match 629 finish. - Escutcheons only
3. Dummy and passage functions are the same. For dummy function, mortise lock body must be installed in the locked mode. No additional parts required.
4. Classroom and nightlatch function trims are the same. Trim function must be specified when ordered with an exit device to ensure that the correct lock body is supplied.
5. Only Classroom function trim may be used with Double Cylinder exit devices.

**ED5600 Mortise Heavy-Duty Trim**

Cylinder is not included.

**Escutcheon Trim Design: R9M Regis**



**Lever:** Cast

**Escutcheon:** Forged

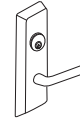

Function	Description	Finish: 613E, 630 <sup>1</sup>	Finish: 605, 606, 611, 612, 613, 618, 619, 625, 626, 629 <sup>2</sup> , 722
R9M10	Passage <sup>3</sup>	\$572.00	\$598.00
R9M50	Dummy <sup>3</sup>		
R9M55	Classroom <sup>4, 5</sup>		
R9M57	Nightlatch <sup>4</sup>		

**Escutcheon Trim Design: PR9M Princeton**



**Lever:** Cast

**Escutcheon:** Forged



Function	Description	Finish: 613E, 630 <sup>1</sup>	Finish: 605, 606, 611, 612, 613, 618, 619, 625, 626, 629 <sup>2</sup> , 722
PR9M10	Passage <sup>3</sup>	\$572.00	\$598.00
PR9M50	Dummy <sup>3</sup>		
PR9M55	Classroom <sup>4, 5</sup>		
PR9M57	Nightlatch <sup>4</sup>		

**Escutcheon Trim Design: F9**

**Escutcheon:** Forged



Function	Description	Finish: 613E, 630 <sup>1</sup>	Finish: 605, 606, 611, 612, 613, 618, 619, 625, 626, 629 <sup>2</sup> , 722
F950	Dummy	\$245.00	\$271.00
F9M57	Nightlatch <sup>4</sup>		

**Escutcheon Trim Design: G9M**

**Escutcheon:** Forged



Function	Description	Finish: 613E, 630 <sup>1</sup>	Finish: 605, 606, 611, 612, 613, 618, 619, 625, 626, 629 <sup>2</sup> , 722
G9M10	Passage <sup>3</sup>	\$572.00	\$598.00
G9M50	Dummy <sup>3</sup>		
G9M55	Classroom <sup>4, 5</sup>		
G9M57	Nightlatch <sup>4</sup>		

Notes:

- 619 finish provided to match 630 finish. - Escutcheons only
- 618 finish provided to match 629 finish. - Escutcheons only
- Dummy and passage functions are the same. For dummy function, mortise lock body must be installed in the locked mode. No additional parts required.

- Classroom and nightlatch function trims are the same. Trim function must be specified when ordered with an exit device to ensure that the correct lock body is supplied.
- Only Classroom function trim may be used with Double Cylinder exit devices.

**ED5600 Mortise Heavy-Duty Trim**

Cylinder is not included.

**Escutcheon Trim Design: FR9M Frascati\***



**Lever:** Cast

**Escutcheon:** Forged



\* Handed Lever. Handing cannot be changed in the field.

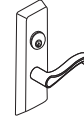

Function	Description	Finish: 613E, 626	Finish: 605, 606, 611, 612, 613, 618, 619, 625, 722
FR9M10	Passage <sup>1</sup>	\$572.00	\$598.00
FR9M50	Dummy <sup>1</sup>		
FR9M55	Classroom <sup>2, 3</sup>		
FR9M57	Nightlatch <sup>2</sup>		

**Escutcheon Trim Design: M9M Merlot**



**Lever:** Cast

**Escutcheon:** Forged

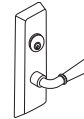

Function	Description	Finish: 613E, 626	Finish: 605, 606, 611, 612, 613, 618, 619, 625, 722
M9M10	Passage <sup>1</sup>	\$572.00	\$598.00
M9M50	Dummy <sup>1</sup>		
M9M55	Classroom <sup>2, 3</sup>		
M9M57	Nightlatch <sup>2</sup>		

**Escutcheon Trim Design: TS9M Tuscany**



**Lever:** Cast

**Escutcheon:** Forged

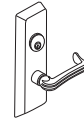

Function	Description	Finish: 613E, 626	Finish: 605, 606, 611, 612, 613, 618, 619, 625, 722
TS9M10	Passage <sup>1</sup>	\$572.00	\$598.00
TS9M50	Dummy <sup>1</sup>		
TS9M55	Classroom <sup>2, 3</sup>		
TS9M57	Nightlatch <sup>2</sup>		

**Escutcheon Trim Design: Z9M Zinfandel\***



**Lever:** Cast

**Escutcheon:** Forged



\* Handed Lever. Handing cannot be changed in the field.

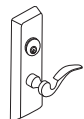

Function	Description	Finish: 613E, 626	Finish: 605, 606, 611, 612, 613, 618, 619, 625, 722
Z9M10	Passage <sup>1</sup>	\$572.00	\$598.00
Z9M50	Dummy <sup>1</sup>		
Z9M55	Classroom <sup>2, 3</sup>		
Z9M57	Nightlatch <sup>2</sup>		

Notes:

- Dummy and passage functions are the same. For dummy function, mortise lock body must be installed in the locked mode. No additional parts required.
- Classroom and nightlatch function trims are the same. Trim function must be specified when ordered with an exit device to ensure that the correct lock body is supplied.
- Only Classroom function trim may be used with Double Cylinder exit devices.

**Mortise Trim Design: ED5600**

Cylinder is not included.

**Escutcheon Trim Design: TH900, TH9M00 Pull/Thumbpiece**

**Grip:** Extruded      **Escutcheon:** Forged



Function	Description	Finish: 613E, 630 <sup>1</sup>	Finish: 605, 606, 611, 612, 613, 618, 619, 625, 626, 629 <sup>2</sup> , 722
TH9M10	Passage	\$413.00	\$439.00
TH950	Dummy (No Thumbpiece)	\$383.00	\$409.00
TH9M55	Classroom <sup>3</sup>	\$413.00	\$439.00
TH9M57	Nightlatch (No Thumbpiece)	\$383.00	\$409.00

**Escutcheon Trim Design: P9M Pull**



**Pull:** Extruded      **Escutcheon:** Forged

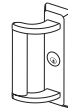

Function	Description	Finish: 613E, 630 <sup>1</sup>	Finish: 605, 606, 611, 612, 613, 618, 619, 625, 626, 629 <sup>2</sup> , 722
P950*	Dummy	\$354.00	\$380.00
P9M57*	Nightlatch		

\*Specify Hand. Field Reversible.

**Escutcheon Trim Design: VT9M**

**Plate:** Stamped or Formed Stainless Steel



Function	Description	Finish: 613E, 630
VT9M57	Nightlatch	\$515.00
VTL9M57	Nightlatch with Lip	

Note: For mortise exit dummy functions, specify VT950 and VTL950

**Escutcheon Trim Design: K1M Key Only**

Note: Available with cylinder option only. Example: K1M57 x 6P



Function	Description	Finish: 605, 606, 611, 612, 613, 618, 619, 622, 625, 626, 722
K1M57	Nightlatch	See cylinder option price pg. 256

Note:  
 1. 619 finish provided to match 630 finish. - Escutcheons only  
 2. 618 finish provided to match 629 finish. - Escutcheons only  
 3. Only Classroom function trim may be used with Double Cylinder exit devices.

**ED5200S/ED5200/ED5400/ED5800 SecureBolt®, Rim, Surface & CVR Heavy-Duty Trim**

Cylinder is not included.

**Escutcheon Trim Design: A9 Armstrong**



**Lever:** Cast    **Escutcheon:** Forged

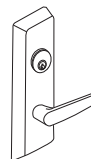

Function	Description	Finish: 613E, 630 <sup>1</sup>	Finish: 605, 606, 611, 612, 613, 618, 619, 625, 626, 629 <sup>2</sup> , 722
A9903*	Fail Safe	\$960.00	\$986.00
A9905*	Fail Secure		

**Escutcheon Trim Design: C9 Citation**



**Lever:** Cast    **Escutcheon:** Forged

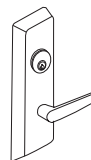

Function	Description	Finish: 613E, 630 <sup>1</sup>	Finish: 605, 606, 611, 612, 613, 618, 619, 625, 626, 629 <sup>2</sup> , 722
C9903*	Fail Safe	\$960.00	\$986.00
C9905*	Fail Secure		

**Escutcheon Trim Design: D9 Dirke\***



**Lever:** Cast    **Escutcheon:** Forged

\* Handed Lever. Handing cannot be changed in the field.

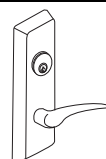

Function	Description	Finish: 613E, 630 <sup>1</sup>	Finish: 605, 606, 611, 612, 613, 618, 619, 625, 626, 629 <sup>2</sup> , 722
D9903*	Fail Safe	\$960.00	\$986.00
D9905*	Fail Secure		

**Escutcheon Trim Design: E9 Essex**



**Lever:** Cast    **Escutcheon:** Forged

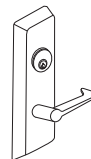

Function	Description	Finish: 613E, 630 <sup>1</sup>	Finish: 605, 606, 611, 612, 613, 618, 619, 625, 626, 629 <sup>2</sup> , 722
E9903*	Fail Safe	\$960.00	\$986.00
E9905*	Fail Secure		

Notes:

1. 619 finish provided to match 630 finish. - Escutcheons only
2. 618 finish provided to match 629 finish. - Escutcheons only



\*ElectroLynx®

As part of their promise to provide innovative, fast and effective high security solutions to their customers, certain ASSA ABLOY Group brands offer *ElectroLynx*®, a universal quick-connect system that simplifies the electrification of the door opening.

**ED5200S/ED5200/ED5400/ED5800 SecureBolt®, Rim, Surface & CVR Heavy-Duty Trim**

Cylinder is not included.

**Escutcheon Trim Design: L9 Lustra**



**Lever:** Cast    **Escutcheon:** Forged

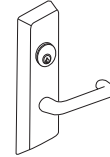

Function	Description	Finish: 613E, 630 <sup>1</sup>	Finish: 605, 606, 611, 612, 613, 618, 619, 625, 626, 629 <sup>2</sup> , 722
L9903*	Fail Safe	\$960.00	\$986.00
L9905*	Fail Secure		

**Escutcheon Trim Design: N9 Newport**



**Lever:** Cast    **Escutcheon:** Forged

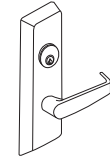

Function	Description	Finish: 613E, 630 <sup>1</sup>	Finish: 605, 606, 611, 612, 613, 618, 619, 625, 626, 629 <sup>2</sup> , 722
N9903*	Fail Safe	\$960.00	\$986.00
N9905*	Fail Secure		

**Escutcheon Trim Design: R9 Regis**



**Lever:** Cast    **Escutcheon:** Forged

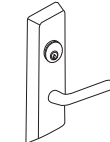

Function	Description	Finish: 613E, 630 <sup>1</sup>	Finish: 605, 606, 611, 612, 613, 618, 619, 625, 626, 629 <sup>2</sup> , 722
R9903*	Fail Safe	\$960.00	\$986.00
R9905*	Fail Secure		

**Escutcheon Trim Design: PR9 Princeton**



**Lever:** Cast    **Escutcheon:** Forged

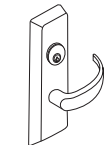

Function	Description	Finish: 613E, 630 <sup>1</sup>	Finish: 605, 606, 611, 612, 613, 618, 619, 625, 626, 629 <sup>2</sup> , 722
PR9903*	Fail Safe	\$960.00	\$986.00
PR9905*	Fail Secure		

Notes:  
 1. 619 finish provided to match 630 finish. - Escutcheons only  
 2. 618 finish provided to match 629 finish. - Escutcheons only



\*ElectroLynx®  
 As part of their promise to provide innovative, fast and effective high security solutions to their customers, certain ASSA ABLOY Group brands offer *ElectroLynx*®, a universal quick-connect system that simplifies the electrification of the door opening.

**ED5200S/ED5200/ED5400/ED5800 SecureBolt®, Rim, Surface & CVR Heavy-Duty Trim**

Cylinder is not included.

**Escutcheon Trim Design: FR9 Frascati**



**Lever:** Cast **Escutcheon:** Forged

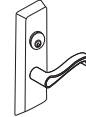

Function	Description	Finish: 613E, 626	Finish: 605, 606, 611, 612, 613, 618, 619, 625, 722
FR9903*	Fail Safe	\$960.00	\$986.00
FR9905*	Fail Secure		

**Escutcheon Trim Design: M9 Merlot**



**Lever:** Cast **Escutcheon:** Forged

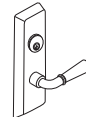

Function	Description	Finish: 613E, 626	Finish: 605, 606, 611, 612, 613, 618, 619, 625, 722
M9903*	Fail Safe	\$960.00	\$986.00
M9905*	Fail Secure		

**Escutcheon Trim Design: TS9 Tuscany**



**Lever:** Cast **Escutcheon:** Forged

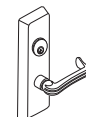

Function	Description	Finish: 613E, 626	Finish: 605, 606, 611, 612, 613, 618, 619, 625, 722
TS9903*	Fail Safe	\$960.00	\$986.00
TS9905*	Fail Secure		

**Escutcheon Trim Design: Z9 Zinfandel**



**Lever:** Cast **Escutcheon:** Forged

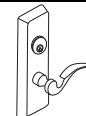

Function	Description	Finish: 613E, 626	Finish: 605, 606, 611, 612, 613, 618, 619, 625, 722
Z9903*	Fail Safe	\$960.00	\$986.00
Z9905*	Fail Secure		



\*ElectroLynx®

As part of their promise to provide innovative, fast and effective high security solutions to their customers, certain ASSA ABLOY Group brands offer *ElectroLynx*®, a universal quick-connect system that simplifies the electrification of the door opening.

**Offset Pull Trim: P12, P13, P14**

Offset Pull Trim	Part Number	Finish: 613E, 630	Finishes: 605, 606, 612, 613, 626, 629
P12	716F50M X Finish	\$233.00	\$247.00
P13	716F51M X Finish	\$286.00	\$300.00
P14	716F52M X Finish	\$202.00	\$216.00

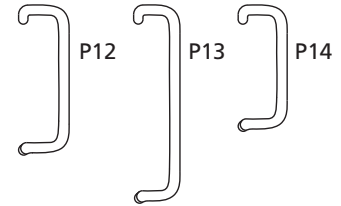
**Electrified Options for Exit Devices**

Description	Specify	Add or Deduct
Exit Alarm Device (cylinder is not included)	M61	\$647.00
Bolt Position Monitoring	M91*	Add \$217.00
Touchbar Monitoring or Signaling/Request to Exit (REX)	M92*	Add \$204.00
Outside Trim Monitoring or Signaling	M93*	
Latch Pullback	M94*	Add \$870.00
Electric Dogging	M97*	Add \$416.00
SPDT Lock and Unlock security monitor switch (Electric Trim Only)	M98*	Add \$196.00
Trim gasket for exterior applications (Electric Trim Only)	M99	Add \$22.00
Mortise device lock with Outside Trim Control (Fail Safe)	SAF <sup>2</sup> *	\$651.00
Mortise device lock with Outside Trim Control (Fail Secure)	SEC <sup>2</sup> *	

**Delayed Egress Device**

Description	Suffix	Add or Deduct
Delayed Egress (Suffix the letter D to device. Ex: ED4200)	D	Add \$1533.00
30-Second Delay	M88*	\$98.00
BOCA 15-Second Delay	M89*	
BOCA 30-Second Delay	M90*	

**Notes:**

- Alarm kit cannot be installed in the field to surface vertical rod exit device. Any attempt to do so voids all warranties.
- Only available with ED5600(A) (Except knob trim)
- M88, M89 and M90 are available only as options for suffix "D" Delayed Egress Exit Devices.
- The following options cannot be ordered together on the same device: a) M94 or M97 & D; b) M94 x M97; c) M52 x M97; d) M97 x M107; e) M61 or M92 & D; f) M61 x M92; g) M61x M52; h) M52 & D; i) ED5600 x M91 & M93; j) ED5600 SAF or SEC x M91 or M93; k) Surface vertical rod exit devices with M61 x M91, M92 or M93.

**\*ElectroLynx®**

As part of their promise to provide innovative, fast and effective high security solutions to their customers, certain ASSA ABLOY Group brands offer **ElectroLynx®**, a universal quick-connect system that simplifies the electrification of the door opening.



**Electrified Accessories**

Part Number	Description	Specify	Price
741F899	Controller (Required for Electric Latch Retraction	782	\$683.00
709F609	Power Supply 1 Amp (controls 1 "D" device)	BPS-24-1	\$295.00
709F619	Power Supply 2 Amp (controls 2 "D" devices or 1 "D" with SAF or SEC)	BPS-24-2	\$600.00
709F629	Power Supply 4 amp 24VDC	BPS-24-4	\$975.00
704F288	Concealed transfer (for over 120-degree swing door)	EPTL	\$112.00
709F689	(1) SPDT Maintained Switch (Includes LED)	MKA	\$112.00
709F709	(1) SPDT Momentary Switch (Includes LED)	MK	\$170.00
709F749	(1) SPDT Momentary Switch (Illuminated)	PB2	\$131.00
709F759	(1) SPDT Maintained (Alternating Action) Switch	PB3EA	\$100.00
709F769	(1) SPDT Momentary Switch (Illuminated)	PB3	\$127.00
709F779	(1) SPDT Momentary Switch	2' PB3ER	\$84.00
709F729	DPDT Momentary Key Switch	2' MK2	\$196.00
709F699	Narrow Stile Key Switch (Alt. action)	MKAN	\$170.00
704F719	Narrow Stile Momentary Key Switch	MKN	\$170.00
709F789	Sonalert 90db @ 2 ft. 12-24VDC Mounted on one gang stainless steel plate.	PZ1	\$84.00
	Alarm Kit (cylinder is not included) <sup>1</sup>	ED50AK	\$699.00
709F679	Door Cord	TSB-C	\$26.00
741F739	Digital Entry System (4 users)	DK-12	\$222.00
709F809	Digital Entry System (59 users) SS finish	FADK-26SS	\$502.00
709F819	Digital Entry System (59 users) Black finish	DK-26BK	\$502.00
709F669	Power Transfer	EPT	\$84.00

**Cylinder Options\***

Description	Specify	Add or Deduct
Conventional 6-pin	6P**	Add \$76.00 per cylinder
Conventional 7-pin	7P	Add \$78.00 per cylinder
Access 3 Patented	AP	Add \$76.00 per cylinder
Access 3 Security	AS	Add \$125.00 per cylinder
Access 3 High Security, UL 437	AHS	Add \$145.00 per cylinder
Access 3 IC Patented	ACP	Add \$143.00 per cylinder
Access 3 IC Security	ACS	Add \$189.00 per cylinder
Access 3 IC High Security, UL 437	ACHS	Add \$209.00 per cylinder
Pyramid Security fixed core	PS	Add \$125.00 per cylinder
Pyramid Security IC	PCS	Add \$189.00 per cylinder
Pyramid High Security fixed core	PHS	Add \$151.00 per cylinder
Pyramid High Security IC	PCHS	Add \$214.00 per cylinder
Pyramid IC with temporary construction core	CTP	Add \$143.00 per cylinder
Pyramid IC with temporary disposable core	CTPD	Add \$76.00 per cylinder
Pyramid IC less core	CLP	Add \$76.00 per cylinder
Security	HS	Add \$171.00 per cylinder
Security IC	CHS	Add \$236.00 per cylinder
Blockout function	BO	Add \$214.00 per cylinder
IC 6-pin	C6	Add \$143.00 per cylinder
IC 6-pin with temporary construction core (Red)	CT6R	Add \$143.00 per cylinder
IC 6-pin with temporary construction core (Blue)	CT6B	Add \$143.00 per cylinder
IC 6-pin with temporary construction core (Green)	CT6G	Add \$143.00 per cylinder
IC 6-pin with temporary disposable core	CT6D	Add \$76.00 per cylinder
IC 6-pin less core	CL6	Add \$76.00 per cylinder
SFIC 6-pin with Less Core	CLS6	Add \$76.00 per cylinder
IC 6-pin with SFIC disposable temporary core	CT6SD	Add \$76.00 per cylinder
IC 7-pin	C7	Add \$144.00 per cylinder
IC 7-pin with temporary construction core (Red)	CT7R	Add \$144.00 per cylinder
IC 7-pin with temporary construction core (Blue)	CT7B	Add \$144.00 per cylinder
IC 7-pin with temporary construction core (Green)	CT7G	Add \$144.00 per cylinder
IC 7-pin with temporary disposable core	CT7D	Add \$78.00 per cylinder
IC 7-pin less core	CL7	Add \$78.00 per cylinder
SFIC 7-pin with Less Core	CLS7	Add \$78.00 per cylinder
IC 7-pin with SFIC disposable temporary core	CT7SD	Add \$78.00 per cylinder

\*Optional dogging cylinder will be furnished with the same mechanism and keyed alike with the trim cylinder, unless otherwise specified. If different keying or cylinder type is required, specify outside (trim) first, then inside (dogging) cylinder.

\*\*6P cylinder option is supplied in 6-pin, L4 keyway, 0-bitted with two nickel silver keys.

**Keying Options\***

Description	Specify	Add or Deduct
0-Bitted with 2 blank keys	(standard)	No Charge
Keyed random	KR	No Charge
Master keyed (all cylinders except 8000, 8020, 8027 IC)	specify keyset	Add \$16.00 per cylinder
Master keyed Pyramid	specify keyset	Add \$16.00 per cylinder
Master keyed Security (including IC cylinder and core)	specify keyset	Add \$16.00 per cylinder
Master keyed (8000, 8020, 8027 IC core)	specify keyset	No Charge
Master keyed to customer bittings or sample key	specify keyset	Add \$16.00 per cylinder
Construction master keyed <sup>1,2</sup>	CMK	Add \$16.00 per cylinder
Visual key control (VKC)		
- No Stamping	VKC0	\$4.30
- Keys only	VKC1	No Charge
- Cylinders and Keys <sup>3</sup>	VKC2	\$8.00
- Cylinders only <sup>3</sup>	VKC3	\$8.00
Concealed key control (CKC)		
- CKC cylinders with VKC keys	CKC2	\$8.00
- CKC cylinders only <sup>3</sup>	CKC3	\$8.00
More than 2 keys per lock	KY# (e.g., KY6)	See page 48 - Cut Keys Section

\*For key bows other than 10 and 90, specify "KB" + bow number as Quick Code, e.g. KB12.

Notes:

1. CMK Construction master keying charge is in addition to master keying charge.

2. CMK Construction master keying is not available in Pyramid or Security series.

3. VKC2, VKC3, CKC3 are not available in Pyramid or Security series.

**Door Height Options**
**ED5400, ED5400A, ED5470(B) Devices**

Door Height	Specify	Add or Deduct
7'0"	(standard)	No Charge
7'2"	H0702	
7'6"	H0706	
8'0"	H0800	

**ED5800, ED5800A, ED5860(B) Devices**

Door Height	Specify	Add or Deduct
8'0"	(standard)	No Charge

**ED5470(B), ED5860(B) Devices**

Door Height	Specify	Add or Deduct
9'0" <sup>1</sup>	H0900	Add \$82.00 per device
10'0" <sup>1</sup>	H1000	

**Door Width Options**

Door Width	Specify	Add or Deduct
24"	W024	Add \$292.00 per device
36"	(standard)	No Charge
48"	W048	Add \$35.00 per device

**Door Thickness Options**

Door Thickness	Specify	Add or Deduct
1-3/4"	(standard)	No Charge
2"	D200	
2-1/4"	D214	

**Strike Options**

Description	Specify	Add or Deduct
Rim x Vertical Rod on pairs of doors	S02	Add \$36.00 per device
Surface or Concealed Vertical Rod device bottom strike for 1/2" threshold	S09	No Charge
Flush transom top strike bracket	M67	Add \$29.00 per device
<b>Mortise Device</b>		
-ANSI wrought strike box	M17	No Charge
-ANSI strike for pair of doors w/astragal (7/8" L to C)	SS078	
-Open back strike for 1-3/4" door	SB134	Add \$80.00 per device
-Open back strike for 2-1/4" door	SB214	\$120.00

Note:  
 1. H0900 and H1000 options for ED5470(B), ED5860(B) devices only

**Miscellaneous Options**

Description	Specify	Add or Deduct
Torx® screws for rim, concealed vertical rod, mortise	M04	Add \$42.00 per device
Torx® screws for surface vertical rod	M04	Add \$80.00 per device
Knurling outside and inside (Embossed Touchbar - device side) <sup>1</sup>	M20	Add \$139.00 per device
Knurling outside only (trim side) <sup>1</sup>	M21	Add \$65.00 per device
Knurling inside only (Embossed Touchbar - device side)	M22	Add \$74.00 per device
Abrasive coat outside and inside (trim and device)	M23	Add \$88.00 per device
Abrasive coat inside only (device side)	M24	Add \$46.00 per device
Abrasive coat outside only (trim side)	M25	Add \$42.00 per device
Pathlite™ Photoluminescent Touchbar cover	M49	Add \$335.00 per device
Less dogging	M51	No Charge
Cylinder dogging (less cylinder)	M52	Add \$78.00 per device
Sex nuts and bolts (SNBs)	M54	No Charge
Less bottom vertical rod <sup>2</sup>	M55	
Narrow stile cover	M56	No Charge
Shim kit (for vision light)		
- All rim and concealed vertical rod	M58	Add \$72.00 per device
- All surface vertical rod	M58	Add \$96.00 per device
Parabolic Design Exit Trim	M60	Add \$78.00 per device
Wood screws For use on fire rated solid wood or wood core doors	M64	No Charge
Windstorm Certified products for ED5200S(A) and ED5470(B) Only <sup>3, 4, 5</sup>	M107	Add \$85.00 per device
End Cap Reinforcement (used with standard end cap only)	M109	Add \$78.00 per device
Flush End Cap	M110	No Charge

## Notes:

1. Not available with VT9, VTL9, VT9M and VTL9M trim.
2. Available with ED5470 and ED5860 series only.
3. ED5200S(A) x M107 requires through bolts.
4. ED5470(B) maximum opening height is 8'0".
5. Contact Ceco, Curries® or Fleming for detailed frame/door requirements and limitations.

**Surface Bolt™**

Description	Specify	Price
Surface Bolt Kit For Approved Windstorm Code Applications - bright zinc plated finish	988CR	\$122.00

**Mullions**
**Ordering Example**

Quantity	Mullion Number
10	907A

**Removable Mullions**

Door Height	Description	Specify	Price
Up to 7'0"	Steel Mullion - Panic Rated	907	\$574.00
Up to 8'0"	Steel Mullion - Panic Rated	908	\$584.00
Up to 10'0" (ED5200, ED5200S only)	Steel Mullion - Panic Rated	910	\$692.00
Up to 7'0"	Steel Mullion - 3 Hour Fire Rated	907A	\$798.00
Up to 8'0"	Steel Mullion - 3 Hour Fire Rated	908A	\$808.00
Up to 7'0"	Steel Mullion - 3 Hour Fire Rated, Windstorm Certified	FE707A <sup>1</sup>	\$995.00
Up to 8'0"	Steel Mullion - 3 Hour Fire Rated, Windstorm Certified	FE708A <sup>1</sup>	\$1,005.00

**Key Removable Mullions**

Door Height	Description	Specify	Price
Up to 7'0"	Steel Mullion - 1-1/2 Hour Fire Rated	907BKM <sup>2</sup>	\$1,229.00
Up to 8'0"	Steel Mullion - 1-1/2 Hour Fire Rated	908BKM <sup>2</sup>	\$1,239.00
Up to 10'0" (ED5200, ED5200S only)	Steel Mullion - Panic Rated	910KM <sup>2</sup>	\$1,086.00
Up to 7'0"	Steel Mullion - 3 Hour Fire Rated, Windstorm Certified	WS707AKM <sup>2</sup>	\$1,396.00
Up to 8'0"	Steel Mullion - 3 Hour Fire Rated, Windstorm Certified	WS708AKM <sup>2</sup>	\$1,406.00

**Notes:**

1 For use with UL approved door assemblies that comply to FEMA 361 and FEMA 320 guidelines.

For the latest listings on compliant door assemblies visit our website at [corbinrusswin.com](http://corbinrusswin.com)

2 Cylinder and collars not included, specify separately

**Mullions Cylinder Options**

Description	Specify	Add or Deduct
Conventional 6-pin	6P	Add \$76.00 per cylinder
Conventional 7-pin	7P	Add \$78.00 per cylinder
IC 6-pin	C6	Add \$143.00 per cylinder
IC 7-pin	C7	Add \$144.00 per cylinder
Pyramid High Security Fixed Core	PHS	Add \$151.00 per cylinder
Pyramid Security Fixed Core	PS	Add \$125.00 per cylinder
Pyramid High Security IC	PCHS	Add \$214.00 per cylinder
Pyramid Security IC	PCS	Add \$189.00 per cylinder
Security	HS	Add \$171.00 per cylinder
Security IC	CHS	Add \$236.00 per cylinder
IC 6-pin less core	CL6	Add \$76.00 per cylinder
IC 7-pin less core	CL7	Add \$78.00 per cylinder

**Options**

Description	Specify	Add or Deduct
Door frame filler block for double rabbetted frames	M95	Add \$42.00 per mullion
Door frame angle bracket for aluminum frames	M96	Add \$42.00 per mullion
Mullion stabilizer	M57	Add \$62.00 per mullion

**Standard Features**

**Handing**

Handed, specify hand

**Door Thickness**

1-3/4"

**Backset**

2-3/4"

**Projection**

4-7/8"; 3-1/8" depressed

**Trim**

Cylinder is not included.  
See page 292 for  
cylinder options.

**Rim**

ED7200

Panic

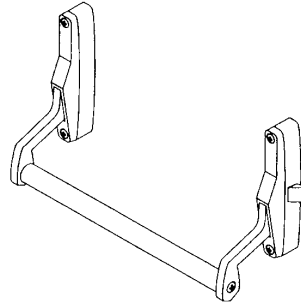

**Vertical Rod**

ED7400

Panic

**Concealed Vertical Rod**

ED7800

Panic

ED7800A 3 Hour Fire Rated

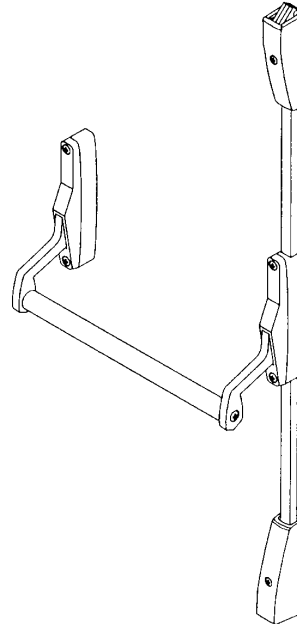

**Mortise**

ED7600

Panic

ED7600A 3 Hour Fire Rated

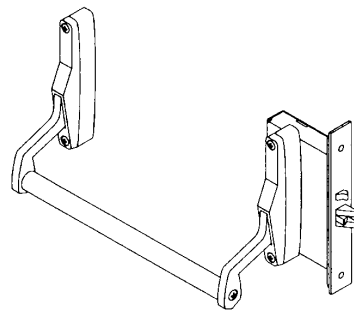

**Ordering Example**
**Rim Exit Device**

Quantity	Exit Device	Finish	Hand	Misc. Options
20	ED7200	606	RHR	M51-M54

**Rim Exit Device with Trim**

Quantity	Exit Device	Trim/Function	Finish	Hand	Door Thickness	Door Width	Misc. Options
50	ED7200	P557	630	LHR	D214	W048	M53

**Trim Only (Rim Device)**

Quantity	Exit Device	Finish
10	P457	630

**Vertical Rod Exit Device with Trim**

Quantity	Exit Device	Trim/Function	Finish	Hand	Door Thickness	Door Width	Misc. Options
50	ED7401	C455	613	RHR	D214	W048	H1000

**Mortise Exit Device with Trim**

Quantity	Exit Device	Trim/Function	Finish	Hand	Door Thickness	Strike	Door Width
50	ED7600A	T11M55	626	LHR	D200	SB200	W048

**Contract/Detailed Order - Rim Exit Device with Trim**

Quantity	Keyset	Exit Device	Trim/Function	Finish	Hand	Door Thickness	Door Width	Optional Cylinders	Keying
50	AA1	ED7200	P457	626	LHR	D200	W048	C6	VKC3

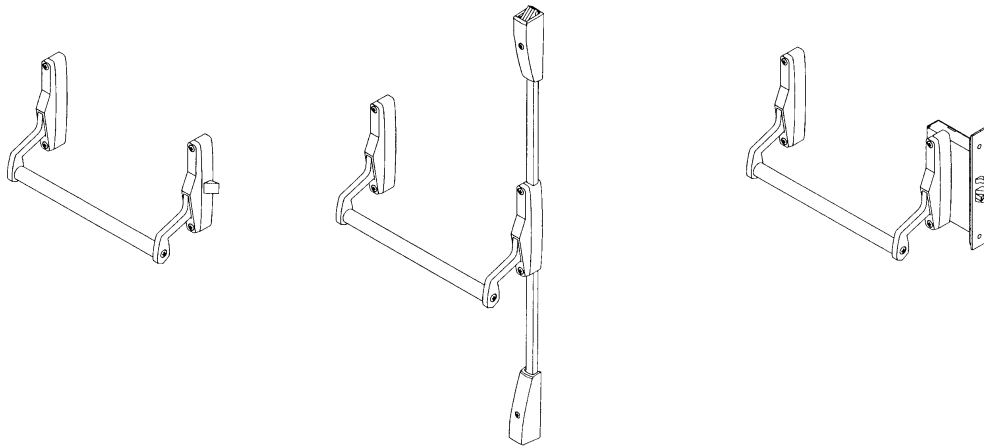

**36" Device Only**

Includes device, strike(s) and screw pack. No cylinder or trim.

**Rim ED7200 Series**

Function	Description	Finish: 613E, 626	Finish: 605, 606, 611, 612, 613, 618, 619, 625, 629, 630, 722
ED7200	Panic	\$2,341.00	\$2,418.00

**Vertical Rod ED7400 Series**

Function	Description	Finish: 613E, 626	Finish: 605, 606, 611, 612, 613, 618, 619, 625, 629, 630, 722
ED7400	Panic Exit Trim Only (accepts operator trim)	\$2,787.00	\$2,864.00
ED7401	Panic Exit Trim Only (accepts lever trim)		

**Mortise ED7600 Series**

Function	Description	Finish: 613E, 626	Finish: 605, 606, 611, 612, 613, 618, 619, 625, 629, 630, 722
ED7600	Panic	\$2,499.00	\$2,576.00
ED7600A	3 Hour Fire Rated		

**Concealed V.R. ED7800 Series**

Function	Description	Finish: 613E, 626	Finish: 605, 606, 611, 612, 613, 618, 619, 625, 629, 630, 722
ED7800	Panic	\$2,677.00	\$2,754.00
ED7800A	3 Hour Fire Rated	\$2,840.00	\$2,917.00

For rim exit trim prices, see page 292.  
 For vertical rod exit trim prices, see page 293.  
 For mortise exit device trim prices see pages 294-295.  
 For concealed vertical rod exit trim prices, see page 295.

Caution: Be sure of your measurements. Exit devices are NOT returnable.



**ED7200 Rim Trim**

Cylinder is not included.

**Pull Trim Design: P4 D Grip Pull**



**Grip:** Extruded

**Escutcheon:** Wrought



Function	Description	Finish: 613E, 626	Finish: 605, 606, 611, 612, 613, 618, 619, 625, 629, 630, 722
P450	Dummy	\$315.00	\$343.00
P457	Nightlatch		

**Pull Trim Design: P5 Round Grip Pull**



**Grip:** Extruded

**Escutcheon:** Wrought



Function	Description	Finish: 613E, 626	Finish: 605, 606, 611, 612, 613, 618, 619, 625, 629, 630, 722
P550	Dummy	\$315.00	\$343.00
P557	Nightlatch		

**Pull Trim Design: P6 Pull**



**Grip:** Wrought  
MR option available

**Escutcheon:** Wrought



Function	Description	Finish: 613E, 626	Finish: 605, 606, 611, 612, 613, 618, 619, 625, 629, 630, 722
P650	Dummy	\$315.00	\$343.00
P657	Nightlatch		

**Pull Trim Design: P7 Plate**

**Escutcheon:** Wrought  
MR option available



Function	Description	Finish: 613E, 626	Finish: 605, 606, 611, 612, 613, 618, 619, 625, 629, 630, 722
P757	Nightlatch	\$307.00	\$335.00

**ED7400 Surface Vertical Rod Trim**

Cylinder is not included.

**Escutcheon Trim Design: C4 Citation**



**Lever:** Cast  
MR option available

**Escutcheon:** Wrought  
Available with ED7401 device only.

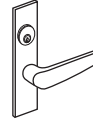

Function	Description	Finish: 613E, 626	Finish: 605, 606, 611, 612, 613, 618, 619, 625, 629, 630, 722
C455*	Classroom	\$659.00	\$687.00
C457*	Nightlatch		

\*1-3/4 doors only

**Escutcheon Trim Design: D4 Dirke**



**Lever:** Cast  
MR option available

**Escutcheon:** Wrought  
Available with ED7401 device only.



Function	Description	Finish: 613E, 626	Finish: 605, 606, 611, 612, 613, 618, 619, 625, 629, 630, 722
D455*	Classroom	\$659.00	\$687.00
D457*	Nightlatch		

\*1-3/4 doors only

**Escutcheon Trim Design: O3 D Grip Operator**



**Pull:** Extruded  
MR option available

**Escutcheon:** Cast  
Available with ED7400 only.



Function	Description	Finish: 613E, 626	Finish: 605, 606, 611, 612, 613, 618, 619, 625, 629, 630, 722
O355	Classroom	\$659.00	\$687.00
O356**	Nightlatch		
O357	Nightlatch		

**Escutcheon Trim Design: O4 Round Grip Operator**



**Pull:** Extruded  
MR option available

**Escutcheon:** Cast  
Available with ED7400 only.



Function	Description	Finish: 613E, 626	Finish: 605, 606, 611, 612, 613, 618, 619, 625, 629, 630, 722
O455	Classroom	\$659.00	\$687.00
O456**	Nightlatch		
O457	Nightlatch		

\*\*Key also used to hold top and bottom latchbolts in retracted position.

**ED7600 Mortise Trim**

Cylinder is not included.

**Escutcheon Trim Design: C4M Citation**



**Lever:** Cast

**Escutcheon:** Cast

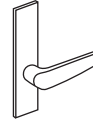

Function	Description	Finish: 613E, 626	Finish: 605, 606, 611, 612, 613, 618, 619, 625, 629, 630, 722
C4M10	Passage	\$659.00	\$687.00
C4M55	Classroom		

**Escutcheon Trim Design: D4M Dirke**



**Lever:** Cast

**Escutcheon:** Cast

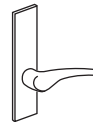

Function	Description	Finish: 613E, 626	Finish: 605, 606, 611, 612, 613, 618, 619, 625, 629, 630, 722
D4M10	Passage	\$659.00	\$687.00
D4M55	Classroom		

**Escutcheon Trim Design: B5M Belmont**

**Knob:** Wrought Reinforced

**Escutcheon:** Cast



Function	Description	Finish: 613E, 626	Finish: 605, 606, 611, 612, 613, 618, 619, 625, 629, 630, 722
B5M10	Passage	\$659.00	\$687.00
B5M50	Dummy		
B5M55	Classroom		

**Escutcheon Trim Design: G6M Global**

**Knob:** Wrought Reinforced

**Escutcheon:** Cast

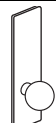

Function	Description	Finish: 613E, 626	Finish: 605, 606, 611, 612, 613, 618, 619, 625, 629, 630, 722
G6M10	Passage	\$659.00	\$687.00
G6M50	Dummy		
G6M55	Classroom		

**ED7600 Mortise Trim**

Cylinder is not included.

**Thumbpiece Trim Design: T11M D Grip**

**Grip:** Extruded      **Escutcheon:** Cast



Function	Description	Finish: 613E, 626	Finish: 605, 606, 611, 612, 613, 618, 619, 625, 629, 630, 722
T11M10	Passage	\$486.00	\$514.00
T11M50	Dummy		
T11M55	Classroom		
T11M57	Nightlatch		

**Thumbpiece Trim Design: T12M Round Grip**

**Grip:** Extruded      **Escutcheon:** Cast



Function	Description	Finish: 613E, 626	Finish: 605, 606, 611, 612, 613, 618, 619, 625, 629, 630, 722
T12M10	Passage	\$486.00	\$514.00
T12M50	Dummy		
T12M55	Classroom		
T12M57	Nightlatch		

**ED7800 Concealed Vertical Rod Trim**

Cylinder is not included.

**Trim Design: O5 Operator**

**Escutcheon:** Cast



Function	Description	Finish: 613E, 626	Finish: 605, 606, 611, 612, 613, 618, 619, 625, 629, 630, 722
O557	Nightlatch	\$234.00	\$270.00

**Offset Pull Trim: P12, P13, P14**

Offset Pull Trim	Part Number	Finish: 613E, 630	Finishes: 605, 606, 612, 613, 626, 629
P12	716F50M X Finish	\$233.00	\$247.00
P13	716F51M X Finish	\$286.00	\$300.00
P14	716F52M X Finish	\$202.00	\$216.00

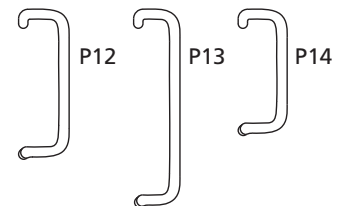

**Cylinder Options**

Description	Specify	Add or Deduct
Conventional 6-pin <sup>7</sup>	6P*	Add \$76.00 per cylinder
Conventional 7-pin <sup>7</sup>	7P	Add \$78.00 per cylinder
Access 3 Patented	AP	Add \$76.00 per cylinder
Access 3 Security	AS	Add \$125.00 per cylinder
Access 3 High Security, UL 437	AHS	Add \$145.00 per cylinder
Access 3 IC Patented	ACP	Add \$143.00 per cylinder
Access 3 IC Security	ACS	Add \$189.00 per cylinder
Access 3 IC High Security, UL 437	ACHS	Add \$209.00 per cylinder
Pyramid Security fixed core <sup>1, 5, 6</sup>	PS	Add \$125.00 per cylinder
Pyramid Security IC <sup>2, 6</sup>	PCS	Add \$189.00 per cylinder
Pyramid High Security fixed core <sup>1, 5, 6</sup>	PHS	Add \$151.00 per cylinder
Pyramid High Security IC <sup>2, 6</sup>	PCHS	Add \$214.00 per cylinder
Pyramid IC with temporary construction core <sup>2, 6</sup>	CTP	Add \$143.00 per cylinder
Pyramid IC with temporary disposable core <sup>1, 3, 6</sup>	CTPD	Add \$76.00 per cylinder
Pyramid IC less core <sup>2, 6</sup>	CLP	Add \$76.00 per cylinder
Security <sup>1</sup>	HS	Add \$171.00 per cylinder
Security IC <sup>2</sup>	CHS	Add \$236.00 per cylinder
Blockout function	BO	Add \$214.00 per cylinder
IC 6-pin <sup>2</sup>	C6	Add \$143.00 per cylinder
IC 6-pin with temporary construction core <sup>2</sup> (Red)	CT6R	Add \$143.00 per cylinder
IC 6-pin with temporary construction core <sup>2</sup> (Blue)	CT6B	Add \$143.00 per cylinder
IC 6-pin with temporary construction core <sup>2</sup> (Green)	CT6G	Add \$143.00 per cylinder
IC 6-pin with temporary disposable core <sup>2</sup>	CT6D	Add \$76.00 per cylinder
IC 6-pin less core <sup>2</sup>	CL6	Add \$76.00 per cylinder
SFIC 6-pin with Less Core	CLS6	Add \$76.00 per cylinder
IC 6-pin with SFIC disposable temporary core	CT6SD	Add \$76.00 per cylinder
IC 7-pin <sup>3</sup>	C7	Add \$144.00 per cylinder
IC 7-pin with temporary construction core <sup>3</sup> (Red)	CT7R	Add \$144.00 per cylinder
IC 7-pin with temporary construction core <sup>3</sup> (Blue)	CT7B	Add \$144.00 per cylinder
IC 7-pin with temporary construction core <sup>3</sup> (Green)	CT7G	Add \$144.00 per cylinder
IC 7-pin with temporary disposable core <sup>3</sup>	CT7D	Add \$78.00 per cylinder
IC 7-pin less core <sup>3</sup>	CL7	Add \$78.00 per cylinder
SFIC 7-pin with Less Core	CLS7	Add \$78.00 per cylinder
IC 7-pin with SFIC disposable temporary core	CT7SD	Add \$78.00 per cylinder
Less master ring cylinder <sup>4</sup>	MR-LC	No Charge
Master Ring <sup>4</sup>	MR	Add \$116.00 per cylinder

\*6P cylinder option is supplied in 6-pin, L4 keyway, 0-bitted with two nickel silver keys.

**Notes:**

- |                                    |  |  |
|------------------------------------|--|--|
| 1. Available on outside trim only. | 4. Available on C4, D4, OBS, O3, O4 trims only.          | 6. Pyramid is not available on ED7600 with door thicknesses over 2-1/4". |
| 2. Not available on O5 trim.       | 5. Not available on ED7600 C4M, D4M, E4M B5M, G6M trims. | 7. Not available on P4, P5, P5, P7 trims.                                |
| 3. Rim only.                       |  |  |

**Keying Options**

Description	Specify	Add or Deduct
0-Bitted with 2 blank keys	(standard)	No Charge
Keyed Random	KR	No Charge
Master Keyed (all cylinders except 8000, 8020, 8027 IC core)	specify keyset	Add \$16.00 per cylinder
Master Keyed Pyramid	specify keyset	Add \$16.00 per cylinder
Master Keyed Security (including IC cylinder and core)	specify keyset	Add \$16.00 per cylinder
Master Keyed (8000, 8020, 8027 IC core)	specify keyset	No Charge
Master Keyed to customer bittings or sample key	specify keyset	Add \$16.00 per cylinder
Construction master keyed <sup>1, 2</sup>	CMK	Add \$16.00 per cylinder
Visual key control (VKC)		
- No Stamping	VKC0	\$4.30
- Keys only	VKC1	No Charge
- Cylinders and Keys <sup>3</sup>	VKC2	\$8.00
- Cylinders only <sup>3</sup>	VKC3	\$8.00
Concealed key control (CKC)		
- CKC cylinders with VKC keys	CKC2	\$8.00
- CKC cylinders only <sup>3</sup>	CKC3	\$8.00
More than 2 keys per lock	KY# (e.g., KY6)	See page 48 - Cut Keys Section

**Notes:**

1. CMK Construction master keying charge is in addition to master keying charge.
2. CMK Construction master keying is not available in Pyramid or Security series.
3. VKC2, VKC3, CKC3 are not available in Pyramid or Security series.

**Strike Options**

To purchase strike separately, see catalog for part no.

Description	Specify	Add or Deduct
Open rim strike on ED7200	(standard)	No Charge
Rim strike	S07	
Rim strike for aluminum frames with blade stops	S08	
Mortised adjustable rim strike	S04	
Vertical rod top strike on ED7400 device	(standard)	
Vertical rod bottom strike on ED7400	(standard)	
Vertical rod flush bottom strike on ED7400 device	S03	
Concealed vertical rod top strike on ED7800 device	(standard)	
Fire rated concealed vertical rod top strike on ED7800A device	(standard)	
Fire rated concealed vertical rod bottom strike on ED7800 and ED7800A devices	(standard)	

Description	Lip Length	Specify	Add or Deduct
Mortise straight lip ANSI strike on ED7600, ED7600A	1-1/8"	(standard)	No Charge
	1-1/4"	SS114	
	1-3/8"	SS138	
Mortise open back strike	1-3/4"	SB134	Add \$80.00 per device
	2"	SB200	\$120.00
	2-1/4"	SB214	

<b>Door Width Options</b>		
<b>Description</b>	<b>Specify</b>	<b>Add or Deduct</b>
36"	(standard)	No Charge
48"	W048	Add \$35.00 per device
<b>Door Thickness Options</b>		
<b>Description</b>	<b>Specify</b>	<b>Add or Deduct</b>
1-3/4"	(standard)	No Charge
2" (Not available for ED7800 Series)	D200	
2-1/4" (Not available for ED7800 Series)	D214	
<b>Door Height Options</b>		
<b>Description</b>	<b>Specify</b>	<b>Add or Deduct</b>
7'6" (ED7400 devices)	(standard)	No Charge
7'2" (ED7400A & 7800A devices)	(standard)	
8'6" (ED7800 devices)	(standard)	
10'0" (ED7400 devices only)	H1000	Add \$62.00 per device
10'8" (ED7800 devices only)	H1008	
<b>Miscellaneous Options</b>		
<b>Description</b>	<b>Specify</b>	<b>Add or Deduct</b>
Spanner head screws	M02	Add \$32.00 per device
ANSI wrought strike box (for mortise only)	M17	No Charge
Knurling outside and inside (trim and device)	M20	Add \$139.00 per device
Knurling outside only (trim side)	M21	Add \$65.00 per device
Knurling inside only (device side)	M22	Add \$74.00 per device
Abrasive coat outside and inside (trim and device)	M23	Add \$88.00 per device
Abrasive coat inside only (device side)	M24	Add \$46.00 per device
Abrasive coat outside only (trim side)	M25	Add \$42.00 per device
Stainless steel crossbar <sup>1</sup>		
- When ordered with 626 or 630 finish	M50	No Charge
- All other finishes	M50	Add \$74.00 per device
Less dogging	M51	No Charge
Steel reinforced crossbar	M53	Add \$68.00 per device
Sex nuts and bolts (SNBs)	M54	No Charge
Shim for 2-3/4" backset on doors with 1/2" stop (for ED7200 only)	M59	Add \$22.00 per device
Less latch hold-back (for ED7200 and ED7600 devices only)	M66	No Charge
Note: 1. Not available with M22 or M20 option.		

**Mortise Lock Only**

Includes lockcase, armored front, strike and screw pack. No cylinder.

**Ordering Example**

Qty	Lock Number	Hand	Finish
10	MLE09	RHR	626

Lock Number	Description	Finish: 605, 606, 611, 612, 613, 622, 625, 626, 629, 630
MLE08	ED7600	\$517.00
MLE09	ED7600A	\$527.00

**Removable Mullion**

**Ordering Example**

Quantity	Mullion Number
10	507

Mullion Number	Description	Price
507	For doors up to 7'2"	\$577.00
508	For doors up to 8'0"	\$808.00
510	For doors up to 10'	\$692.00



**Standard Features**

**Handing**

ED8200 Non-handed  
ED8400 Handed; specify hand

**Door Thickness**

1-3/4"

**Backset**

2-3/4"

**Bar Length**

36 standard; 30", 42" and 48"  
available. Easily field cut to size.

**Projection**

2-1/2"

**Trim**

Cylinder is not included.  
See page 303 for  
cylinder options.

**RIM**

ED8200  
ED8200B  
ED8200A

Panic  
1-1/2 Hour Fire Rated  
3 Hour Fire Rated

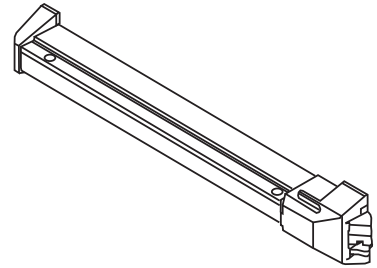

**VERTICAL ROD**

ED8400  
ED8400A

Panic  
3 Hour Fire Rated

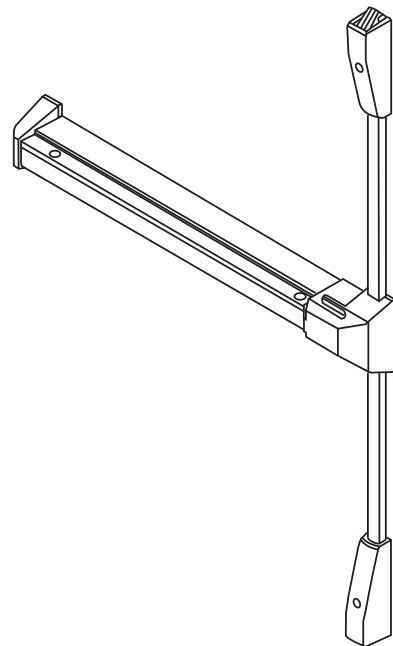

**Ordering Example**
**Rim Exit Device**

Quantity	Exit Device	Finish
20	ED8200	689

**Rim Exit Device with Trim**

Quantity	Exit Device	Trim/Function	Finish		Hand	Door Thickness	Door Width	Misc. Options
			Trim	Device				
50	ED8200A	A657	613	690	RHR	D200	W048	M58

**Trim Only (Rim or Vertical Rod)**

Quantity	Trim/Function	Finish	Hand
10	N655	606	RHR

**Vertical Rod Exit Device with Trim**

Quantity	Exit Device	Trim/Function	Finish		Hand	Optional Strike	Door Width	Height
			Trim	Device				
50	ED8400	PR610	626	689	RHR	S03	W048	H1000

**Contract/Detailed Order - Rim Exit Device with Trim**

Quantity	Keypad	Exit Device	Trim/Function	Finish		Hand	Door Thickness	Door Width	Optional Cylinder	Keying
				Trim	Device					
50	AA1	ED8200	N655	626	689	LHR	D200	W048	C6	VKC3

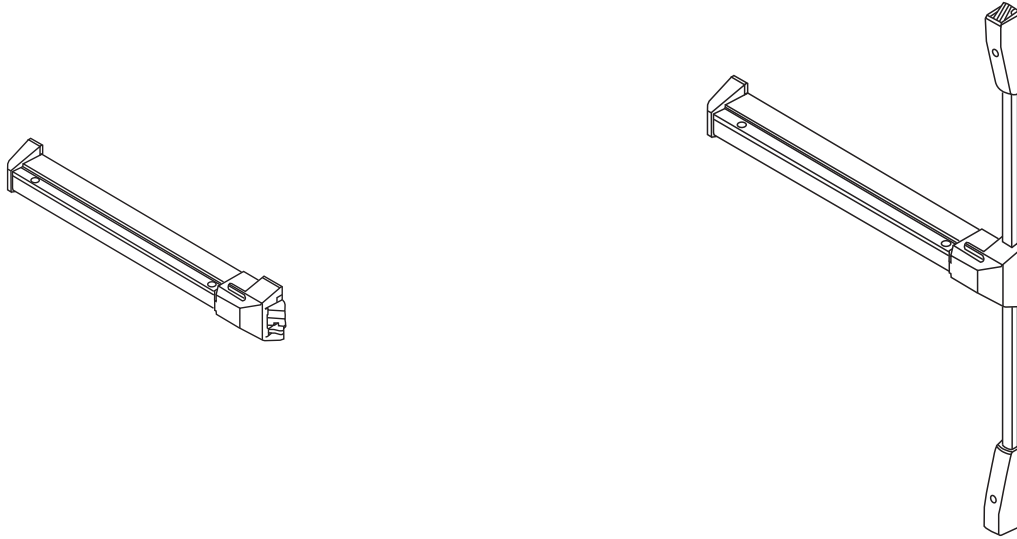

**30", 36" and 42" Exit Devices**

Includes device, strike(s) and screw pack. No cylinder or trim.

**Rim ED8200 Series**

Function	Description	Finish: 689, 690, 691
ED8200	Panic	\$474.00
ED8200B	1-1/2 Hour Fire Rated	\$546.00
ED8200A	3 Hour Fire Rated	\$627.00

**Vertical Rod ED8400 Series**

Function	Description	Finish: 689, 690, 691
ED8400	Panic	\$832.00
ED8400A	3 Hour Fire Rated	\$985.00

For exit trim prices see pages 304-306.

Caution: Be sure of your measurements. Exit devices are NOT returnable.

**ED8200/ED8400 Rim and Vertical Rod Trim**

Cylinder is not included, except where noted.

**Rose Trim Design: A6 Armstrong**



**Lever:** Die cast zinc  
Cylinder included

**Rose:** Wrought brass or bronze

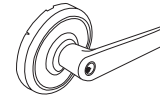

Function	Description	Finish: 613E, 626	Finish: 605, 606, 611, 612, 613, 619, 625, 722
A610	Passage	\$274.00	\$284.00
A650	Dummy	\$274.00	\$284.00
A655	Classroom	\$300.00	\$310.00
A657	Nightlatch <sup>1</sup>		
A659	Storeroom		

**Rose Trim Design: N6 Newport**



**Lever:** Die cast zinc  
Cylinder included

**Rose:** Wrought brass or bronze

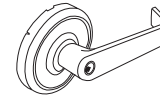

Function	Description	Finish: 613E, 626	Finish: 605, 606, 611, 612, 613, 619, 625, 722
N610	Passage	\$274.00	\$284.00
N650	Dummy	\$274.00	\$284.00
N655	Classroom	\$300.00	\$310.00
N657	Nightlatch <sup>1</sup>		
N659	Storeroom		

**Rose Trim Design: PR6 Princeton**



**Lever:** Die cast zinc  
Cylinder included

**Rose:** Wrought brass or bronze

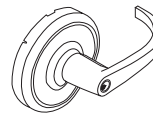

Function	Description	Finish: 613E, 626	Finish: 605, 606, 611, 612, 613, 619, 625, 722
PR610	Passage	\$274.00	\$284.00
PR650	Dummy	\$274.00	\$284.00
PR655	Classroom	\$300.00	\$310.00
PR657	Nightlatch <sup>1</sup>		
PR659	Storeroom		

Note:  
1. Not recommended for use with ED8400 and ED8400A surface vertical rod exit devices.

**ED8200/ED8400 Rim and Vertical Rod Trim**

Cylinder is not included, except where noted.

**Rose Trim Design: G10 Global**

**Knob:** Wrought  
Cylinder included

**Rose:** Wrought brass or bronze



Function	Description	Finish: 613E, 626	Finish: 605, 606, 611, 612, 613, 619, 625, 722
G1010	Passage	\$258.00	\$268.00
G1055	Classroom	\$284.00	\$294.00
G1050	Dummy	\$258.00	\$268.00
G1057	Nightlatch <sup>1</sup>	\$284.00	\$294.00
G1059	Storeroom	\$284.00	\$294.00

**Flat Plate Trim Design: F1 Flat Plate**

**Plate:** Steel

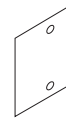

Function	Description	Finish: 613E, 626	Finish: 605, 606, 611, 612, 613, 619, 625, 722
F150	Dummy	\$73.00	\$83.00
F157	Nightlatch <sup>1</sup>		

**Pull Trim Design: P1 Z-Pull**



**Pull:** Extruded Aluminum

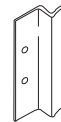

Function	Description	Finish: 613E, 626	Finish: 605, 606, 611, 612, 613, 619, 625, 722
P150	Dummy	\$222.00	\$232.00
P157	Nightlatch <sup>1</sup>		

Note:  
1. Not recommended for use with ED8400 and ED8400A surface vertical rod exit devices.

**ED8200/ED8400 Rim and Vertical Rod Trim**

Cylinder is not included, except where noted.

**Pull Trim Design: P2 Offset Pull**



**Pull:** Extruded Aluminum



Function	Description	Finish: 613E, 626	Finish: 605, 606, 611, 612, 613, 619, 625, 722
P250	Dummy	\$262.00	\$272.00
P257	Nightlatch <sup>1</sup>		

**Pull Trim Design: P8 Wing Pull**



**Pull:** Extruded Aluminum

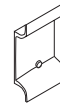

Function	Description	Finish: 689, 690, 691
P850	Dummy	\$75.00
P857	Nightlatch <sup>1</sup>	

**Trim Design: KO Key Only**

Note: Available with cylinder option only.  
Example: KO57 x 6P



Function	Description	Finish: 605, 606, 611, 612, 613, 619, 622, 625, 626, 722
KO57	Nightlatch <sup>1</sup>	See cylinder option Price, pg. 285

**Offset Pull Trim: P12, P13, P14**

Offset Pull Trim	Part Number	Finishes: 613E, 630	Finishes: 605, 606, 612, 613, 626, 629
P12	716F50M X Finish	\$233.00	\$247.00
P13	716F51M X Finish	\$286.00	\$300.00
P14	716F52M X Finish	\$202.00	\$216.00

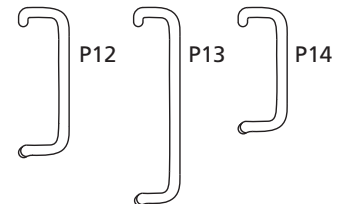

Note:  
1. Not recommended for use with ED8400 and ED8400A surface vertical rod exit devices.

**Cylinder Options\***
**Rim Cylinder Trim**

Description	Specify	Add or Deduct
Conventional 6-pin	6P**	Add \$76.00 per cylinder
Conventional 7-pin	7P	Add \$78.00 per cylinder
Access 3 Patented	AP	Add \$76.00 per cylinder
Access 3 Security	AS	Add \$125.00 per cylinder
Access 3 High Security, UL 437	AHS	Add \$145.00 per cylinder
Access 3 IC Patented	ACP	Add \$143.00 per cylinder
Access 3 IC Security	ACS	Add \$189.00 per cylinder
Access 3 IC High Security, UL 437	ACHS	Add \$209.00 per cylinder
Pyramid Security fixed core	PS	Add \$125.00 per cylinder
Pyramid Security IC	PCS	Add \$189.00 per cylinder
Pyramid High Security fixed core	PHS	Add \$151.00 per cylinder
Pyramid High Security IC	PCHS	Add \$214.00 per cylinder
Pyramid IC with temporary construction core	CTP	Add \$143.00 per cylinder
Pyramid IC with temporary disposable core	CTPD	Add \$76.00 per cylinder
Pyramid IC less core	CLP	Add \$76.00 per cylinder
Security	HS	Add \$171.00 per cylinder
Security IC	CHS	Add \$236.00 per cylinder
IC 6-pin	C6	Add \$143.00 per cylinder
IC 6-pin with temporary construction core (Red)	CT6R	Add \$143.00 per cylinder
IC 6-pin with temporary construction core (Blue)	CT6B	Add \$143.00 per cylinder
IC 6-pin with temporary construction core (Green)	CT6G	Add \$143.00 per cylinder
IC 6-Pin with temporary disposable core	CT6D	Add \$76.00 per cylinder
IC 6-pin less core	CL6***	Add \$76.00 per cylinder
SFIC 6-pin with Less Core	CLS6	Add \$76.00 per cylinder
IC 6-pin with SFIC disposable temporary core	CT6SD	Add \$76.00 per cylinder
IC 7-pin	C7	Add \$144.00 per cylinder
IC 7-pin with temporary construction core (Red)	CT7R	Add \$144.00 per cylinder
IC 7-pin with temporary construction core (Blue)	CT7B	Add \$144.00 per cylinder
IC 7-pin with temporary construction core (Green)	CT7G	Add \$144.00 per cylinder
IC 7-Pin with temporary disposable core	CT7D	Add \$78.00 per cylinder
IC 7-pin less core	CL7	Add \$78.00 per cylinder
SFIC 7-pin with Less Core	CLS7	Add \$78.00 per cylinder
IC 7-pin with SFIC disposable temporary core	CT7SD	Add \$78.00 per cylinder
Blockout function	BO	Add \$214.00 per cylinder

**Knob and Lever Trim**

Description	Specify	Add or Deduct
Conventional 6-pin	6P**	No Charge
Conventional 7-pin	7P	Add \$2.00 per cylinder
Access 3 Patented	AP	No Charge
Access 3 Security	AS	Add \$49.00 per cylinder
Access 3 High Security, UL 437	AHS	Add \$69.00 per cylinder
Access 3 IC Patented	ACP	Add \$64.00 per cylinder
Access 3 IC Security	ACS	Add \$113.00 per cylinder
Access 3 IC High Security, UL 437	ACHS	Add \$133.00 per cylinder
Pyramid Security fixed core	PS	Add \$49.00 per cylinder
Pyramid Security IC	PCS	Add \$110.00 per cylinder
Pyramid High Security fixed core	PHS	Add \$73.00 per cylinder
Pyramid High Security IC	PCHS	Add \$138.00 per cylinder
Security	HS	Add \$95.00 per cylinder
Security IC	CHS	Add \$160.00 per cylinder
IC 6-pin	C6	Add \$64.00 per cylinder
IC 6-pin with temporary construction core (Red)	CT6R	Add \$64.00 per cylinder
IC 6-pin with temporary construction core (Blue)	CT6B	Add \$64.00 per cylinder
IC 6-pin with temporary construction core (Green)	CT6G	Add \$64.00 per cylinder
IC 6-pin with temporary disposable core	CT6D	No Charge
IC 6-pin less core	CL6	No Charge
IC 7-pin	C7	Add \$66.00 per cylinder
IC 7-pin with temporary construction core (Red)	CT7R	Add \$66.00 per cylinder
IC 7-pin with temporary construction core (Blue)	CT7B	Add \$66.00 per cylinder
IC 7-pin with temporary construction core (Green)	CT7G	Add \$66.00 per cylinder
IC 7-pin with temporary disposable core	CT7D	No Charge
IC 7-pin less core	CL7	No Charge
Less (1) cylinder	LC	Deduct \$69.00 per cylinder

\*Optional alarm unit cylinder and trim are keyed alike unless otherwise specified.

If different keying is required, specify outside cylinder, then inside cylinder.

\*\*6P cylinder option is supplied in 6-pin, L4 keyway, 0-bitted with two nickel silver keys.

\*\*\* Not available for G10 trim

**Keying Options\***

Description	Specify	Add or Deduct
0-Bitted with 2 blank keys	(standard)	No Charge
Keyed random	KR	No Charge
Master Keyed (all cylinders except (8000, 8020, 8027 IC core)	specify keyset	Add \$16.00 per cylinder
Master Keyed Pyramid	specify keyset	Add \$16.00 per cylinder
Master Keyed Security (including IC cylinder and core)	specify keyset	Add \$16.00 per cylinder
Master Keyed 8000, 8020, 8027 IC core	specify keyset	No Charge
Master Keyed to customer bittings or sample key	specify keyset	Add \$16.00 per cylinder
Construction master keyed <sup>1,2</sup>	CMK	Add \$16.00 per cylinder
Visual key control (VKC)		
- No Stamping	VKC0	\$4.30
- Keys only	VKC1	No Charge
- Cylinders and Keys <sup>3</sup>	VKC2	\$8.00
- Cylinders only <sup>3</sup>	VKC3	\$8.00
Concealed key control (CKC)		
- CKC cylinders with VKC keys	CKC2	\$8.00
- CKC cylinders only <sup>3</sup>	CKC3	\$8.00
More than 2 keys per lock	KY# (e.g., KY6)	See page 48 - Cut Keys Section

**Notes:**

1. CMK Construction master keying charge is in addition to master keying charge.
  2. CMK construction master keying is not available in Pyramid or Security Series.
  3. VKC2, VKC3, CKC3 are not available in Pyramid or Security series.
- \*For key bows other than 10 and 90, specify 'KB' + bow number as Quick Code, e.g. KB12. No extra charge.

**Door Width Options**

Door Width	Specify	Add or Deduct
36"	(standard)	No Charge
30"	W030	
42"	W042	
48"	W048	Add \$35.00 per device

**Door Thickness Options**

Door Thickness	Specify	Add or Deduct
1-3/8" (G10, A6, N6, PR6 Trim only)	D138	No Charge
1-3/4"	(standard)	
2"	D200	
2-1/4"	D214	

**Door Height Options**

Door Height	Specify	Add or Deduct
7'6" (ED8400 devices)	(standard)	No Charge
8'0" (ED8400A devices)	(standard)	
10'0" (ED8400 devices only)	H1000	



**Miscellaneous Options**

Description	Specify	Add or Deduct
Less cylinder with tailpiece for Schlage® cylinder (A6, N6, PR6 designs only)	M06	No Charge
Lever to accept 6- or 7-pin Best-type IC core (SFIC) (N6, PR6 design only)	M08	No Charge
Lever to accept Sargent® cylinder (N6, PR6 design only)	M09	
Lever to accept <i>Schlage</i> IC core (N6, PR6 design only)	M69	
Knurling outside only (trim side)	M21	Add \$66.00 per lockset
Abrasive coat outside and inside (trim and device)	M23	Add \$82.00 per lockset
Abrasive coat inside only (device side)	M24	Add \$41.00 per lockset
Abrasive coat outside only (trim side)	M25	Add \$41.00 per lockset
Less dogging	M51	No Charge
Sex nuts and bolts (SNBs) <sup>1</sup>	M54	No Charge
Mullion Stabilizer	M57	Add \$62.00 per mullion
Shim kit (for vision light)		
- Rim device	M58	Add \$62.00 to device
- Vertical Rod device	M58	Add \$110.00 to device
Shim for 2-3/4" backset on doors with 1/2" stop	M59	Add \$30.00 to device
Exit alarm (for rim devices only)		
- Rim	M61	Add \$572.00 to device
- 1-1/2" hour fire rated rim	M61	Add \$578.00 to device
Exit alarm with delay (for rim devices only)		
- Rim	M62	Add \$601.00 to device
- 1-1/2" hour fire rated rim	M62	Add \$597.00 to device

Note:

1. Not available with D138 option.

**Strike Options\***

Description	Specify	Add or Deduct
Rim strike on ED8200, ED8200B devices	(standard)	No Charge
Fire rated Rim strike on ED8200A devices		
Rim x Vertical Rod strike for pairs of doors	S02	Add \$36.00 to device
Vertical Rod top strike on ED8400 device	(standard)	No Charge
Vertical Rod surface projecting bottom strike on ED8400 device		
Vertical Rod flush bottom strike on ED8400 device	S03	No Charge
Fire rated Vertical Rod top strike on ED8400A device	(standard)	No Charge
Fire rated Vertical Rod bottom strike on ED8400A device	(standard)	No Charge

\*To purchase strike separately, see catalog or parts manual for part no.

**Alarm Kit**

**Ordering Example**

Quantity	Kit Number	Finish	Options
4	ED82AK	689	M62

Function	Description	Finish: 689, 690, 691
ED82AK	Cylinder is not included, M61 option	\$662.00
ED82AK	Cylinder is not included, M62 option	\$686.00

**Removable Mullion (Cylinder not included)**

Cylinder not included

**Ordering Example**

Quantity	Mullion Number
10	508

**Door Height Options**

Door Height	Specify	Price
Up to 8'0" 3 hour fire rated	508	\$808.00
Up to 7'2"	507	\$577.00
(SFIC) Up to 10'0" (ED8200 only)	510	\$692.00
Up to 7'0" Steel Mullion - Panic Rated	907	\$574.00
Up to 8'0" Steel Mullion - Panic Rated	908	\$584.00
Up to 10'0" (ED8200 only), Steel Mullion - Panic Rated	910	\$692.00
Up to 7'0", Steel Mullion - 3 Hour Fire Rated	907A	\$798.00
Up to 8'0", Steel Mullion - 3 Hour Fire Rated	908A	\$808.00

**Options**

Description	Specify	Price
Up to 7'0", key removable mullion, 1-1/2 Hour Fire Rated	907BKM <sup>1</sup>	\$1,229.00
Up to 8'0", key removable mullion, 1-1/2 Hour Fire Rated	908BKM <sup>1</sup>	\$1,239.00
Up to 10'0" (ED8200 only), key removable mullion, Panic Rated	910KM <sup>1</sup>	\$1,086.00
Door frame filler block for double rabbeted frames	M95	Add \$42.00 per mullion
Door frame angle bracket for aluminum frames	M96	Add \$42.00 per mullion

Note 1: Cylinder and collars not included, specify separately

**Mullions Cylinder Options**

Description	Specify	Add or Deduct
Conventional 6-pin	6P	Add \$76.00 per cylinder
Conventional 7-pin	7P	Add \$78.00 per cylinder
IC 6-pin	C6	Add \$143.00 per cylinder
IC 7-pin	C7	Add \$144.00 per cylinder
Pyramid High Security Fixed Core	PHS	Add \$151.00 per cylinder
Pyramid Security Fixed Core	PS	Add \$125.00 per cylinder
Pyramid High Security IC	PCHS	Add \$214.00 per cylinder
Pyramid Security IC	PCS	Add \$189.00 per cylinder
Security	HS	Add \$171.00 per cylinder
Security IC	CHS	Add \$236.00 per cylinder
IC 6-pin less core	CL6	Add \$76.00 per cylinder
IC 7-pin less core	CL7	Add \$78.00 per cylinder

**Standard Features**

**Handing**

Non-handed

**Spring Power**

DC3200 Series: Non-sized  
fully adjustable 1 thru 6.

**Degree of Opening**

Up to 180° opening standard for  
regular, top jamb and  
parallel arm mounting.

**Case Quantity**

4

**Case Weight**

42 lbs

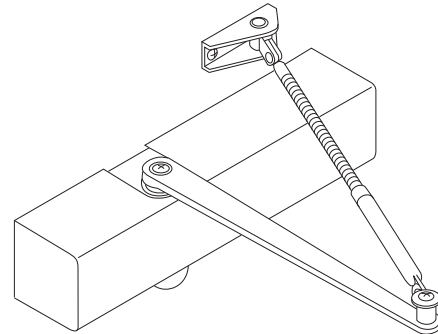

**Ordering Examples**

**Stock Order**

Quantity	Series/Mounting	Finish
48	DC3210	689

**Contract Order**

Quantity	Series/Mounting	Arm	Finish	Option
100	DC3210	A4	689	M54

**DC3200 Series**

Non-sized: full adjustability from sizes 1-6

Function	Description	Finish: 600, 689, 690, 691, 693, 696
DC3200	Regular arm	\$323.00
DC3210	Parallel arm	
DC3220	Top jamb	

DC3210 closers are tri-packed standard (for regular arm, top jamb or parallel arm mounting) unless specialty arm is requested.

**Arm Options**

Description	Specify Quick Code	Add or Deduct
Hold open arm	A1	Add \$57.00 per closer
Heavy-duty parallel arm with hold open	A2	Add \$73.00 per closer
Heavy-duty parallel arm	A3	Add \$37.00 per closer
Heavy-duty parallel arm with backstop	A4	Add \$68.00 per closer
Heavy-duty parallel arm with backstop & hold open	A5	Add \$128.00 per closer
Heavy-duty regular arm	A10	Add \$37.00 per closer

**Miscellaneous Options**

Description	Specify Quick Code	Add or Deduct
Sex nuts and bolts (SNB)	M54	No Charge
Backcheck intensity	(standard)	No Charge
Delayed Action	M71	Add \$36.00 per closer
Full ABS Cover	(standard)	No Charge
Corrosion protection	M75	Add \$37.00 per closer
Heavy-duty parallel arm flush transom bracket (499F30). Used with A2, A3, A4 & A5 arms)	M79	Add \$16.50 per closer

**Miscellaneous Brackets**

Description	Specify Quick Code	Add or Deduct
Parallel arm flush transom bracket	M82	Add \$25.00 per closer
Parallel arm offset bracket	M83	Add \$27.00 per closer
Mortise arm bracket for regular arm mounting	M84	Add \$27.00 per closer
Angle Support bracket	M85	Add \$27.00 per closer

**Door Thickness**

Description	Specify
1-3/4"	(standard)

**Drop Plates**

Closer Plates	Old Quick Ship #	Full Cover	List price
DC3210	M80	597F58	\$56.00
DC3220	M80	188F65	\$48.00

**Finish Options**

Description	Add or Deduct
600, 613E, 689, 690, 691, 693, 696	(standard)

**Standard Features**

**Handing**

Non-handed

**Spring Power**

DC5000 Series: sizes 1 thru 6 fully adjustable.

**Degree of Opening**

110° opening range for Push Side and Pull Side installations.

**Slide Track**

Standard

**Case Weight**

DC5230 8 lbs.

DC5240 8 lbs.



**Ordering Example**

**Stock Order**

Quantity	Series/Mounting	Finish
100	DC5230	689

**Contract Order**

Quantity	Series/Mounting	Arm	Finish
100	DC5240	A1	689

**DC5000 Series**

Non-sized: full adjustability from sizes 1-6

Function	Description	Finish: 600, 689, 690, 691, 693, 696
DC5230	Pull Side Track	\$479.00
DC5240	Push Side Track	

**Arm Options**

Description	Specify Quick Code	Add or Deduct
Hold open arm	A1	\$30.00

**Door Thickness**

Description	Specify
1-3/4"	(standard)

**Handing**

Description	Specify
Left Hand	LH
Right Hand	RH
Left Hand Reverse	RH
Right Hand Reverse	LH

**Finish Options**

Description	Add or Deduct
Painted finishes: 600, 689, 690, 691, 693, 696	(standard)

**Miscellaneous Options**

Description	Specify Quick Code	Add or Deduct
Sex nuts and bolts (SNB)	M54	No Charge

**Drop Plate**

Description	Part Number	Add or Deduct
Drop Plate (Push side)	754F80	\$39.00

**Standard Features**

**Handing**

Non-handed

**Spring Power**

DC6200 Series: sizes 1 thru 6 non-sized fully adjustable.

DC6400 Series: sizes 1 thru 6 half-size adjustability.

**Degree of Opening**

Up to full 180° opening standard for regular, top jamb and parallel arm applications.

**Case Quantity**

4

**Case Weight**

DC6200 42 lbs

DC6400 42 lbs



**Ordering Example**

**Stock Order**

Quantity	Series/Mounting	Finish
100	DC6210	689

**Contract Order**

Quantity	Series/Mounting	Arm	Finish	Door Thickness
100	DC6406	A6	689	D138

**DC6200 Series**

Non-sized: full adjustability from sizes 1-6

Function	Description	Finish: 600, 689, 690, 691, 693, 696
DC6200	Regular arm	\$365.00
DC6210	Parallel arm	
DC6220	Top jamb	
DC6230	Pull side track**	\$420.00
DC6240	Push side track	

DC6210 closers are tri-packed standard (for regular arm, top jamb or parallel arm mounting) unless specialty arm is requested.  
 \*\*Minimum 3" top jamb required.

**DC6400 Series**

Sized: 1/2-size adjustability

Function	Description	Finish: 600, 689, 690, 691, 693, 696	
DC6401	Regular arm	\$365.00	
DC6402			Size 1
DC6403			Size 2
DC6404			Size 3
DC6405			Size 4
DC6406			Size 5
DC6411	Parallel arm	\$365.00	
DC6412			Size 1
DC6413			Size 2
DC6414			Size 3
DC6415			Size 4
DC6416			Size 5
DC6421	Top jamb	\$365.00	
DC6422			Size 1
DC6423			Size 2
DC6424			Size 3
DC6425			Size 4
DC6426			Size 5
DC6433	Pull side track	\$420.00	
DC6434			Size 3
DC6435			Size 4
DC6436			Size 5
DC6443	Push side track	\$420.00	
DC6444			Size 3
DC6445			Size 4
DC6446			Size 5

Note: See page 317 for plated finishes.  
 DC641X closers are tri-packed standard (for regular arm, top jamb or parallel arm mounting) unless specialty arm is requested.



**Arm Options**

Description	Specify Quick Code	Add or Deduct
Hold open arm	A1	Add \$57.00 per closer
Heavy-duty parallel arm with hold open	A2	Add \$73.00 per closer
Heavy-duty parallel arm	A3	Add \$37.00 per closer
Heavy-duty parallel arm with backstop	A4	Add \$68.00 per closer
Heavy-duty parallel arm with backstop & hold open	A5	Add \$128.00 per closer
Deep reveal (3-1/4" - 7-1/4")	A6	No Charge
Deep reveal with hold open	A8	Add \$57.00 per closer
Heavy-duty regular arm	A10	Add \$37.00 per closer
Heavy-duty Unitrol®	A11*	Add \$186.00 per closer
Heavy-duty Unitrol® with hold open	A12*	Add \$245.00 per closer
Heavy-duty parallel arm with extra clearance	A13	Add \$29.00 per closer
Heavy-duty friction hold open arm	A14	Add \$72.00 per closer
Push side track with hold open	A1	Add \$57.00 per closer

\* Specify door width

**Door Width Options**

Description	Specify Quick Code	Add or Deduct
A11, A12 door width 28" - 32"	W28	No Charge
A11, A12 door width 33" - 41"	W33	
A11, A12 door width 42" - 48"	W42	

**Finish Options\***

Description	Add or Deduct
	<b>605, 606, 611, 612, 625, 626</b>
Painted finishes: 600, 613E, 689, 690, 691, 693, 696	(standard)
Plated finishes: specify 605, 606, 611, 612, 625, 626	
Regular, parallel, hold open:	
- Plated arm & cover*	Add \$490.00 per closer
- Plated cover (metal)	Add \$200.00 per closer
- Plated arm*	Add \$290.00 per closer
Heavy-Duty arms (A2, A3, A4, A5, A10, A11, A12, A13, A14) are not available plated. Track & arm for track-type closers are not available plated.	

\*For split finish of closer cover and arm, specify cover first, then arm finish; e.g. DC6200 x 625 x 689.

**Door Thickness**

Description	Specify
1- 3/4"	(standard)
2"	D200

**Handing**

Description	Specify
Left Hand	LH
Right Hand	RH
Left Hand Reverse	RH
Right Hand Reverse	LH

**Miscellaneous Options**

Description	Specify Quick Code	Add or Deduct
Torx® Screws	M04	Add \$23.00 per closer
Sex nuts and bolts (SNB)	M54	No Charge
Backcheck intensity and location valves	(standard)	No Charge
Delayed Action	M71	Add \$36.00 per closer
Full ABS Cover	(standard)	No Charge
Full Metal Cover	M73	Add \$16.00 per closer
Extreme temperature fluid	(standard)	No Charge
Corrosion protection	M75	Add \$37.00 per closer
Security package*	M87	A2-Arm - Add \$106.00 per closer
		A3 Arm - Add \$73.00 per closer
		A4 Arm - Add \$104.00 per closer
		A5 Arm - Add \$164.00 per closer
		A10 Arm - Add \$73.00 per closer

\*M87 includes full metal cover, Torx® fasteners and A2, A3, A4, A5, or A10 arm. Specify arm when ordering.

**Blade Stop Spacer**

Description	Specify Quick Code	Add or Deduct
1/2" spacer (597F92)	M77	Add \$20.00 per closer
5/8" spacer (597F93)	M78	Add \$32.00 per closer

**Miscellaneous Brackets**

Description	Specify Quick Code	Add or Deduct
HD PA flush transom bracket (used with all parallel arms except the Unicontrol®)	M79	Add \$33.00 per closer
Parallel arm flush transom bracket	M82	Add \$25.00 per closer
Parallel arm offset bracket	M83	Add \$27.00 per closer
Mortise arm bracket for regular arm mounting	M84	Add \$27.00 per closer
Angle support bracket	M85	Add \$27.00 per closer
Deep Reveal Reinforcement Kit	M103	Add \$27.00 per closer
Flush partition bracket	M104	Add \$22.00 per closer
Lead lined cover (metal cover only)	M108	Add \$18.00 per closer

**Drop Plates**

Closer Plates	Old Quick Ship #	Full Cover	List Price
DC6210, DC6410 (Parallel)	M80	597F58	\$56.00
DC6220, DC6420 (Top Jamb)	M80	188F65	\$48.00
DC6230, DC6430 (Pull Side)	M81	597F59	\$48.00
DC6240, DC6440 (Push Side)	M102	597F59	\$48.00

**Standard Features**

**Handing**

Non-handed

**Spring Power**

DC8200 Series: sizes 1 thru 6 non-sized fully adjustable.

DC8200 Series: sizes 1 thru 6 half-size adjustability.

**Degree of Opening**

Up to full 180° opening standard for regular, top jamb and parallel arm applications.

**Case Quantity**

4

**Case Weight**

DC8200 54 lbs

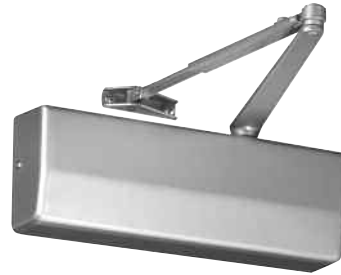

**Ordering Example**

**Stock Order**

Quantity	Series/Mounting	Finish
100	DC8210	689

**Contract Order**

Quantity	Series/Mounting	Arm	Finish	Door Thickness
100	DC8206	A6	689	D138

**DC8200 Series**

Non-sized full adjustability from sizes 1-6

Function	Description	Finish: 600, 689, 690, 691, 693, 696
DC8200	Regular arm	\$472.00
DC8210	Parallel arm	
DC8220	Top Jamb	
DC8230	Pull side track**	\$526.00
DC8240	Push side track	

DC8210 closers are tri-packed standard (for regular arm, top jamb or parallel arm mounting) unless specialty arm is requested.  
 \*Minimum 3" top jamb required.

**Factory Pre-Sized (available upon request)**

Function	Description		Finish: 600, 689, 690, 691, 693, 696
DC8201	Regular arm	Size 1	\$472.00
DC8202		Size 2	
DC8203		Size 3	
DC8204		Size 4	
DC8205		Size 5	
DC8206		Size 6	
DC8211	Parallel arm	Size 1	
DC8212		Size 2	
DC8213		Size 3	
DC8214		Size 4	
DC8215		Size 5	
DC8216		Size 6	
DC8221	Top Jamb	Size 1	
DC8222		Size 2	
DC8223		Size 3	
DC8224		Size 4	
DC8225		Size 5	
DC8226		Size 6	
DC8233	Pull side track	Size 3	\$526.00
DC8234		Size 4	
DC8235		Size 5	
DC8236		Size 6	
DC8243	Push side track	Size 3	
DC8244		Size 4	
DC8245		Size 5	
DC8246		Size 6	

DC821X closers are tri-packed standard (for regular arm, top jamb or parallel arm mounting) unless specialty arm is requested.

### Arm Options

Description	Specify Quick Code	Add or Deduct
Hold open arm	A1	Add \$57.00 per closer
Heavy-duty parallel arm with hold open	A2	Add \$73.00 per closer
Heavy-duty parallel arm	A3	Add \$37.00 per closer
Heavy-duty parallel arm with backstop	A4	Add \$68.00 per closer
Heavy-duty parallel arm with backstop & hold open	A5	Add \$128.00 per closer
Deep reveal (3-1/4" - 7-1/4")	A6	No Charge
Deep reveal with hold open	A8	Add \$57.00 per closer
Heavy-duty regular arm	A10	Add \$37.00 per closer
Unitrol® arm	A11*	Add \$186.00 per closer
Unitrol arm x hold open	A12*	Add \$245.00 per closer
Heavy-duty parallel arm with extra clearance	A13	Add \$29.00 per closer
Heavy-duty friction hold open	A14	Add \$72.00 per closer
Push side track with hold open	A1	Add \$57.00 per closer

\*Specify door width

### Door Width Options

Description	Specify Quick Code	Add or Deduct
A11, A12 - door width 28" - 32"	W28	No Charge
A11, A12 - door width 33" - 41"	W33	
A11, A12 - door width 42" - 48"	W42	

### Finish Options\*

Description	Add or Deduct
	<b>605, 606, 611, 612, 625, 626</b>
Painted finishes: 600, 613E, 689, 690, 691, 693, 696	(standard)
Plated finishes: specify 605, 606, 611, 612, 625, 626	
Regular, parallel, hold open:	
- Plated arm & cover*	Add \$490.00 per closer
- Plated cover (metal)**	Add \$200.00 per closer
- Plated arm*	Add \$290.00 per closer

Heavy-Duty arms (A2, A3, A4, A5, A10, A11, A12, A13, A14) are not available plated.  
 Track & arm for track-type closers are not available plated.

\*For split finish of closer cover and arm, specify cover first, then arm finish; e.g. DC6200 x 625 x 689.

\*\*Price of M73 option is not included.

**Miscellaneous Options**

Description	Specify Quick Code	Add or Deduct
Torx® Screws	M04	Add \$23.00 per closer
Sex nuts and bolts (SNB)	M54	No Charge
Backcheck valve	(standard)	No Charge
Delayed Action	M71	Add \$36.00 per closer
Full PVC Cover	M115	Deduct \$4.00 per closer
Full ABS Cover	(standard)	No Charge
Full Metal Cover	M73	Add \$16.00 per closer
Extreme Temperature Fluid	(standard)	No Charge
Corrosion Protection	M75	Add \$37.00 per closer
Security Package*	M87	A2-Arm - Add \$106.00 per closer
		A3 Arm - Add \$73.00 per closer
		A4 Arm - Add \$104.00 per closer
		A5 Arm - Add \$164.00 per closer
		A10 Arm - Add \$73.00 per closer

\*M87 includes full metal cover, Torx® fasteners and A2, A3, A4, A5, A10 or A13. Specify arm when ordering

**Blade Stop Spacer**

Description	Specify Quick Code	Add or Deduct
1/2" spacer (597F92)	M77	Add \$20.00 per closer
5/8" spacer (597F93)	M78	Add \$32.00 per closer

**Miscellaneous Brackets**

Description	Specify Quick Code	Add or Deduct
HD PA flush transom bracket (used with all parallel arms except the Unitrol®)	M79	Add \$33.00 per closer
Parallel arm flush transom bracket	M82	Add \$25.00 per closer
Parallel arm offset bracket	M83	Add \$27.00 per closer
Mortise arm bracket for regular arm mounting	M84	Add \$27.00 per closer
Angle support bracket	M85	Add \$27.00 per closer
Deep reveal reinforcement kit	M103	Add \$27.00 per closer
Flush partition bracket (used with Unitrol® arm)	M104	Add \$22.00 per closer
Lead lined cover	M108	Add \$18.00 per closer

**Drop Plates**

Closer Series	Part Number	List Price
DC8200 (regular)	754F20	\$59.00
DC8200 (with concealed holder)	754F24	\$59.00
DC8210 (parallel)	754F25	\$59.00
DC8220 (top jamb)	754F24	\$59.00
DC8230 (pull side track)	754F20	\$59.00
DC8240 (push side track)	754F25	\$59.00

**Safeguard™ Door Controls**

Non-sized closer.  
689 and 690 Finishes.

**Ordering Example**

Quantity	Series/Mounting	Finish	Voltage
10	DC46920	689	24A

**DC46900 Series**

Model	Description	Price
DC46920	Pull side for RH and LH single doors and pair of doors	\$1,063.00
DC46925	Push side for LHR double egress doors	
DC46928	Pull side holder body with push side closer for reverse bevel doors	

**Voltage**

Description	Specify Quick Code
24VAC	24A
24VDC	24D
120VAC	120A



**Electromechanical Door Controls**

Sex nuts and bolts are furnished standard.  
 689 Finish.

**Ordering Example**

Quantity	Series/Mounting	Finish	Voltage	Options
24	DC62930	689	24A	M54

**DC62900 Series**

Model	Quick Code	Description	Finish: 600, 689, 690, 691, 693, 696
DC62930	ETD	Pull Side	Master Unit
DC62930	ETS		Slave Unit
DC62930	ET		Support Unit
DC62940	ETD	Push Side	Master Unit
DC62940	ETS		Slave Unit
DC62940	ET		Support Unit

**Miscellaneous Options**

Description	Specify Quick Code	Add or Deduct
Torx® machine screws	M04	Add \$28.00 per closer
Sex nuts and bolts		
- DC62930	(standard)	(standard)
- DC62940	(standard)	(standard)
Backcheck intensity valve	M70	Add \$23.00 per closer

**Voltage\***

Description	Specify Quick Code
24VAC	24A
24VDC	24D
120VAC	120A

A large empty rectangular box with a thin black border, intended for handwritten notes.

# Parts Price List

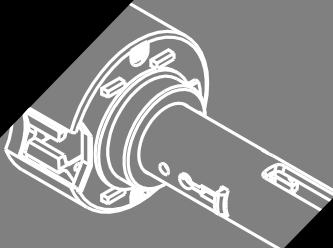
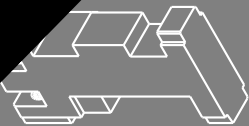
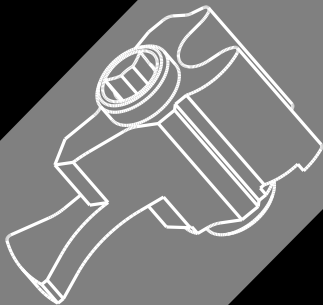
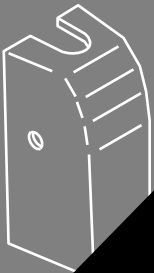
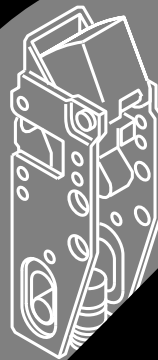
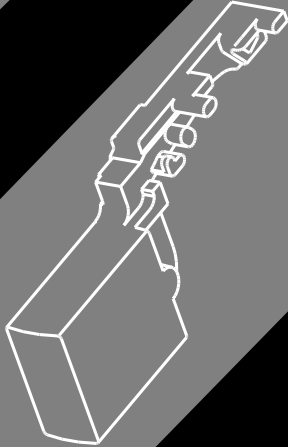
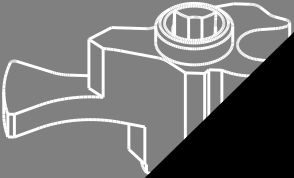

SECTION	PAGES
PART NUMBER INDEX .....	A-L
KEY SYSTEMS	
Plugs and Shells .....	1
Cylinder Parts .....	2 - 3
Standard Diameter Cylinder Collars .....	4
Master Ring Cylinder Collars .....	5
Tools .....	5
MORTISE LOCKSETS AND TRIM	
ML2000 and ML2000HS Series	
Mortise Locks .....	6 - 8
Mortise Trim .....	9 - 17
EXTRA HEAVY-DUTY CYLINDRICAL LEVER LOCKSETS	
CL3300 Series .....	18 - 20
HEAVY-DUTY CYLINDRICAL LEVER LOCKSETS	
CL3500 Series .....	21 - 22
GRADE 2 KEY-IN-LEVER	
CL3700 Series .....	22
CL3800 Series .....	23 - 24
HEAVY-DUTY CYLINDRICAL KNOB LOCKSETS	
CK4200 Series .....	25
CK4300 Series .....	25
STANDARD-DUTY CYLINDRICAL KNOB LOCKSETS	
CK4400 Series .....	26
CK4700 Series .....	26
PRE-ASSEMBLED UNIT LOCKSETS	
UT5200 Series .....	27 - 28
PADLOCKS, DEADLOCKS AND PUSH-PULL LATCHES	
Padlocks .....	28
DL3000 Series Deadlocks .....	28
ED4000 AND ED5000 SERIES	
Device Parts .....	29 - 31
Trim Parts .....	31 - 33
CROSSBAR EXIT DEVICES AND TRIMS	
ED7000 Series .....	34 - 39
PUSHPAD EXIT DEVICES AND TRIMS	
ED8000 Series .....	40 - 41
DOOR CLOSERS	
DC3000 Series .....	42
DC5000 Series .....	42
DC6000 Series .....	43
DC8000 Series .....	44
ELECTRONIC HARDWARE PARTS	
DC46900 Series .....	45
DC62900 Series .....	45
Access 800® AC2 Series .....	45

Part Number	Page	Part Number	Page	Part Number	Page	Part Number	Page	Part Number	Page
019F11-7	28	120F768	20	143F26-5	35	173F72-8	35	198F71	27
019F13-7	27	120F768	20	143F42*	35	173F79-8	3	200F16-8	36
021F68-8	3	120F768	22	143F43*	35	173F79-8	3	201F18-8	28
021F71-8	3	120F768	24	143F52*	35	174F79-7	35	206F53	15
022F72-3	28	120F76-8	7	143F83-3	35	174F80-7	35	207F55-8	35
022F80	27	120F76-8	22	144F29-8	28	175F51-8	35	207F64*	35
025F72-2	2	120F76-8	26	144F30-8	28	176F65-3	34	207F68*	35
025F858	22	120F76-8	26	144F33	27	183F74	35	207F69*	35
025F858	24	121F01-2	2	144F34	27	183F75	35	209F55*	35
026F75-7	2	121K10	1	144F88-8	28	183F85-7	34	213F10-7	35
041F47-8	3	121K11	1	145F32-8	28	184F57	35	213F11-7	36
060F05-3	28	122F18-8	35	145F54-3*	35	184F82-5	35	217F42-2	2
060F33-8	27	122F24-8	35	146K80	1	184F94-8	35	217F43	3
060F42-8	27	122F41-3	35	147F07-8	27	184F97*	35	217F43	4
065F36-2	2	122F50-8	35	147F77-2	2	185F55-8	35	217F43-2	2
067F42-8	27	122F51-8	35	147F77-8	2	186F23	35	217F44	3
070F42-8	27	122F56-8	35	147F83-8	35	186K75	1	217F44	4
070F43-8	27	122F57-8	35	147F84-9	35	187F21-3	35	217F44-2	2
071F62-8	27	122F59-3	35	147F87-8	35	187F88-7	35	217L13	24
071F63-8	27	122F60-8	35	147F88-8	35	187F89-7	35	217L13	22
071F67-3	28	122F61-8	35	148F15-7	35	188F03	43	217L13	26
077F19-8	39	122F63-9	35	148F17	35	188F03	42	217L13M016	20
756567	2	122F64-3*	35	148F22-8	35	188F03	42	217L13M016	22
078F07-8	27	123F22	34	148F36-7	35	188F03	45	217L13M016	25
078F08-8	27	123F53-8	40	148F44-8	35	188F41	44	217L13M016 Fin*	20
079F00	6	123F53-8	35	154F96-6	35	188F41	43	217L13M018	20
079F02	6	129F49-9	35	156F43	27	188F41	42	217L13M018	22
081F77-8	27	129F84-8	3	156F64-8	28	188F41	42	217L13M018	25
082L67	28	129F84-8	35	156F65-8	28	188F62	44	217L13M018 Fin*	20
083L96M032	28	131F27-8	27	156F83-7	27	188F62	43	217L13M020	20
083L96M034	28	134F05	4	157F11	27	188F62	42	217L13M020	22
083L96M036	28	134F05	35	158F06-2	3	188F62	42	217L13M020	25
083L96M040	28	135F10-8	3	158F52-8	35	188F63	44	217L13M020 Fin*	20
083L96M048	28	135F19-2	2	158F53-8	35	188F63	43	217L13M022	20
092F78-9	28	138F88-8	27	158F54-8	35	188F63	42	217L13M022	22
095F35-1	35	140F52-8	35	158F55-8	35	188F63	42	217L13M022	25
102F19-8	28	140F97-8	27	159F36-7	2	188F65	43	217L13M022 Fin*	20
102F27-8	28	141F41-8	35	164F32-9	35	188F73-8	28	217L13M024	20
102F37-8	28	141F84*	35	166F34-7	35	188F75-8	28	217L13M024	22
103F44-8	28	141F86*	35	168F81-8	28	193K09	1	217L13M024	25
103F45-8	28	141F87*	35	171F46-8	2	193K10	1	217L13M024 Fin*	20
105F70-2	2	141L54-8	35	171F79-8	27	193K11	1	217L13M028	20
111F55-8	2	141L59	35	171F89-6	35	194F22-8	27	217L13M028	22
114F67-8	28	142F16*	35	171F90-9	35	195K68	1	217L13M028	25
118F29-9	15	142F43	34	172F21-7	2	197F34-7	3	217L13M028 Fin*	20
118F29-9	33	142F44*	35	173F44-6	35	197F35-7	3	217L13M032	20
118F48-8	9	143F24-8	35	173F45-6	35	197F52-7	2	217L13M032	22
120F55-8	35	143F25	35	173F69-8	35	197K51*	1	217L13M032	25

Part Number	Page	Part Number	Page	Part Number	Page	Part Number	Page	Part Number	Page
217L13M032 Fin*	20	236L72014	7	242F50-8	28	269F31	36	287F60-8	28
217L13M036	20	236L72018	7	243F76-9	36	269F32	36	287F96-8	37
217L13M036	22	236L72020	7	243F79-8	36	269F33	36	291F49-8	37
217L13M036	25	236L72022	7	243F80-8	36	269F34	36	291F57-8	37
217L13M036 Fin*	20	236L72024	7	243F85	36	269F35	36	292F41-3*	37
217L13M040	20	236L72028	7	244F17	44	269F36	36	292K95	1
217L13M040	22	236L72032	7	244F17	43	269F37-8	36	292K96	1
217L13M040	25	236L72036	7	244F17	42	269F39-3	36	292K97	1
217L13M040 Fin*	20	236L72040	7	244F17	42	269F40-3	36	292K98	1
217L13M044	20	236L72044	7	244F64-7	28	269F41-3	36	292K99	1
217L13M044	22	236L72048	7	245K37	1	269F42	36	293F18-3	37
217L13M044	25	236L73014	8	249F33*	36	269F46-8	36	293K00	1
217L13M044 Fin*	20	236L73018	8	249F76-8	28	269F47-9	36	293K01	1
217L13M048	20	236L73020	8	249F77-3	28	269F48-8	36	293K02	1
217L13M048	22	236L73022	8	250F08-8	3	269F49-9	36	293K03	1
217L13M048	25	236L73024	8	250F08-8	3	269F52-8	36	293L14	28
217L13M048 Fin*	20	236L73028	8	251F19-8	28	269F53-8	36	294F05-2	2
219F80-8	28	236L73032	8	252F82	4	269F54-9	36	300F68-8	16
219F88-8	3	236L73036	8	253F11-8	36	269F55-9	36	300F71	34
219F88-8	3	236L73040	8	253F75-8	3	269F56-9	36	301F56-7	27
220F49-8	36	236L73044	8	253K66	1	269F57-8	36	301F59-8	5
220F72-2	36	236L73048	8	253K67	1	269F58-7	36	301F61-8	5
220F75	36	236L74014	8	254F73	36	269F60-8	36	301F62-8	5
220F77-8	36	236L74018	8	255F41*	36	269F73	34	301F65-8	5
220F82-7	36	236L74020	8	255F53	4	269F74	34	303F18	16
220F84-8	36	236L74022	8	255F54	5	269F75	34	303F19	16
220F85*	36	236L74024	8	261F11-8	28	269F76	34	303F20	16
221F94-8*	36	236L74028	8	261F28-8	36	269F91*	36	303F24-2	28
222F71*	36	236L74032	8	261F29-8	28	269F92*	36	303F25	4
222F85	28	236L74036	8	261F29-8	36	270F01*	36	304F33-7	34
223F29	28	236L74040	8	261F30-8	40	270F02*	36	304F34-7	34
224F00-8*	25	236L74044	8	261F31-8	36	270F11*	36	304F65-7	37
224F34-8	36	236L74048	8	261F54	36	270F13	40	304F66-7	37
224F39-2	36	236L75M020	28	261F65-8	36	270F15	4	305F07	37
224F44-8	36	240L50	34	261F95	43	281F27-2	2	305F72-8	37
224F50-8	36	240L51	34	262F90-1	36	282F32-5	36	305F73-8	37
225F99-8	36	240L53M016	26	264F69-8	12	282F35-7	36	306F06-8	37
228F18-8	36	240L53M018	26	264F95-8	36	283F81	28	306F07-8	37
228F34-8	28	240L53M020	26	266F34-2	2	284F67*	36	306F15-8	37
228F49-7	36	240L53M022	26	267F34-8*	36	284F68*	37	306F20-8	37
228F51-7	36	240L53M024	26	267F97	4	284F69*	37	306F22-8	37
228F52-8	36	240L53M028	26	268F64-7	36	284F70*	37	308F78-2	2
228F54-8	15	240L53M032	26	268F84-8	36	284F78	37	310F48-8	3
228F55-8	36	240L53M036	26	268F87-8	36	284F79	37	314F52-8	37
228F68-7	36	240L53M040	26	269F04-8	36	284F97-7	37	314F71-8	37
228F80-8	36	240L53M044	26	269F05-8	36	286F50-7	27	314F88-7	2
228F81-7	36	240L53M048	26	269F08	36	286F91	37	314F98-7	2
228F84-7	36	242F48-2	28	269F09-8	36	286F92	37	314F99-7	3

Part Number	Page	Part Number	Page	Part Number	Page	Part Number	Page	Part Number	Page
315F93 Fin	20	340L61040	8	352F05	34	382F63-6	37	392F27-9	38
315F93 Fin*	20	340L61044	8	352F06-8	37	382F68-6	37	392F28	34
315F94 Fin	20	340L61048	8	352F07*	37	382F69-8	38	392F29	34
315F94 Fin*	20	340L62020	8	353F86-8	3	382F72-9	38	392L19*	38
318F64	8	340L62022	8	354F19-8	3	382F78/8	38	392L20 x 547	38
318F65	8	340L62024	8	361F30-8	37	382F79-8	38	392L20 x 568	38
318F66	8	340L62028	8	361F91-3	34	382F80-8	38	393L13-M672*	38
318F67	8	340L62032	8	362F15-3	3	382F81-8	38	393L13-M672*	39
318F68	8	340L62036	8	362F15-3	28	382F82-8	38	393L14 x 672	38
318F69	8	340L62040	8	362F42-8	2	382F85-8	38	394F19-8	28
320F44-2	3	340L62044	8	362F43-2	2	382F86-5	38	397F91-8	38
320F44-2	28	340L62048	8	362F49-8	37	382F87-8	38	398F43-8	27
321F23	40	340L63020	8	362F50-2	2	382F88-8	38	398F69-8	38
321F24	40	340L63022	8	362F91-8	37	382F95-6	38	398F89	38
321F24*	39	340L63024	8	364F22-8	37	382F98-6	38	398F91-9	38
321F90-7	37	340L63028	8	364F27-2	37	383F82	11	398F94-8	38
328F80	40	340L63032	8	364F28-8	37	384F03	15	398F95-7	38
329F75	37	340L63036	8	364F30-8	37	384F11	11	398F99-7	38
329F76	37	340L63040	8	364F36*	37	385F54-5	40	399F00*	38
330F10	42	340L63044	8	364F37*	37	386F15-8	38	399F02-7	38
333F51-9	37	340L63048	8	364F38*	37	386F45-3	41	399F05-7	38
333F99-8	3	341F31-8	37	364F39*	37	387F21-8	40	399F06-7	38
333F99-8	3	342F03-2	28	365F00-3	37	387F24-8	40	399F07-7	38
334F12-8	3	342F05-2	27	365F01-3	37	387F27-8	40	399F10-8	38
334F13-8	2	349F06-8	37	365F03-3	37	387F30-8	40	399F12*	38
334F23-8	3	351F50*	37	365F95-8	3	387F63-8	40	399F13*	38
334F23-8	3	351F51*	37	365F95-8	3	387F66-8	40	399F17-8	39
334F99	39	351F52-8	37	365F98*	37	387F69-8	40	399F18-8	38
334F998	6	351F55-3	37	366F70	5	387F72-8	40	399F21*	38
334K00	1	351F56*	37	368F91-8	3	389F54*	38	399F22*	38
334K01	1	351F57*	37	368F91-8	3	389F62	38	399F23*	38
335F98-8	28	351F72	37	370F29	4	391F57-5	41	399F25*	38
340F27-9	15	351F73	37	370F31	4	391F65-8	5	399L11 x 563	38
340L60020	8	351F79-7	37	370F33	5	391F65-8	13	402F29	6
340L60022	8	351F80-7	37	370F35	5	391F88-2*	38	402F30	6
340L60024	8	351F82-3	37	370F55-8	37	391F94-8	38	402F31	6
340L60028	8	351F83-3	37	370F56-8	37	391F96-8*	38	402F33	6
340L60032	8	351F84-9	37	370F63-8	37	391F99*	38	402F34	6
340L60036	8	351F85*	37	376F37*	35	392F02	38	402F35	6
340L60040	8	351F86-7	37	376F42	37	392F05*	38	402F617	7
340L60044	8	351F87-3	37	377F30-8	13	392F08-8	38	402F73-8	6
340L60048	8	351F88-3	37	377F80	11	392F10	38	402F98-3	39
340L61020	8	351F89-7	37	378F74-5	37	392F11	38	402F99*	38
340L61022	8	351F90-7*	37	378K18	1	392F14-8	38	402F99*	39
340L61024	8	351F98-8	37	379F25	37	392F22	34	403F03-5	38
340L61028	8	352F02-1	37	379F26	37	392F23*	38	403F30*	38
340L61032	8	352F03-8	37	379F805	3	392F23-7*	38	403F56-8	7
340L61036	8	352F04-2	34	381F30	27	392F24	34	403F66-8	7

Part Number	Page	Part Number	Page	Part Number	Page	Part Number	Page	Part Number	Page
403F67-7	6	411L62M020	8	427F06	9	438F38	9	449F82-8	40
404F85-8	7	411L63	34	427F07-8	9	438F41-8	3	463F91-8	34
404F86-8	6	411L63M016	8	427F36	10	438F42-8	3	463F92-8	41
405F42-8	38	411L63M018	8	427F37	10	438F90	12	464F02-8	39
405F45-8	38	411L63M020	8	427F39	10	439F25	9	464F91-5	39
405F47-6	38	412F03-7	38	427F43	10	439F26	9	464K97	1
405F49-6	38	412F06-7	38	427F45	10	439F27	9	465F57	7
405F77-2	28	412F07-8	38	427F47	10	439F33	16	466F22-9	7
405L138018	8	412F08-7	38	428F32	9	439F34	16	466F40	9
405L138020	8	412F09-1	38	428F33	9	439F35	16	466F41	9
405L138022	8	412F11-7	38	428F34	9	442F95-2	27	466F42	9
405L148018	8	412F13-3*	38	429F08	7	444K87	1	466F45	9
405L148020	8	412F15-7	39	429F31-7	15	444K88	1	466F46	9
405L148022	8	412F16-7	39	429F41	7	444K89	1	466F47	9
406F43-8	2	412F45-1	39	429F41	30	444K94	1	466F50	9
407K63	1	413F22-8	2	430F47	12	444K96	1	466F51	9
407K64	1	415F16	27	432F86	16	444K97	1	466F52	9
407K65	1	415K73	1	433F48	11	444K98	1	466F73	9
407T31-4097 2L	2	415K74	1	433F49	11	444K99	1	466F74	9
407T31-4125 3L	2	416F35-5	34	433F76	16	445F31-8	16	466F75	9
407T31-4153 4L	2	416F38	28	433F77	16	445F38	13	467F01*	16
407T32-4097 2R	2	416F39	4	433F78	16	445F41	16	467F33-8	28
407T32-4125 3R	2	416F49	7	433F97-8	39	445F43	13	467F34-5	28
407T32-4153 4R	2	416F81-8	39	433F98-8	39	445F82	15	467F35-8	28
407T33-4097 2S	2	416F84	7	434F00-8	39	445F83	15	467F36	28
407T33-4125 3S	2	416K07	1	434F02-8	39	445F84	15	467F37-8	28
407T33-4153 4S	2	416K08	1	435F00	12	445F85	16	467F73-3	34
407T41-4242 2L	2	418F28-8	39	436F03-8	34	445F86-9	15	467F94-2	39
407T41-4270 3L	2	418F30-8	39	436F17-7	7	446F20-8	40	467F95-2*	39
407T41-4298 4L	2	418F35-2	39	436F25-8	40	446F21M	41	468F02-2*	39
407T41-4326 5L	2	418F36-8	39	436F29-8	40	446F22-8	41	468F03-2*	39
407T41-4354 6L	2	418F37-8	39	436F41-8	40	446F23-1	40	468F12-2	39
407T42-4242 2R	2	420F12-8*	39	436F42-8	40	446F57-2	3	468F13-2	39
407T42-4270 3R	2	422F88	4	436F43-8	40	446F58-2	3	468F14-7	39
407T42-4298 4R	2	422L84-2144	28	436F44-8	40	446K68	1	468F15-7	39
407T42-4326 5R	2	422L84-8144	28	436F80-1	40	447F14	44	468F16-2	39
407T42-4354 6R	2	423F49-8	2	436F81-1	40	447F14	43	468F17-2	39
408F25-8	39	423F54	6	436F82-8	40	447F14	42	468F20-2*	39
408K45	1	423F55	6	436F83-8	40	447F14	42	468F21-2*	39
409K12*	1	423F57	6	436F858	40	447F24	15	468F24-6	39
410F13*	38	423F58	6	436L32-8557	40	447F25	15	468F25-6	39
410F14*	38	423L71	28	437F16	9	447F41	4	468F26-6	39
410F20*	38	424F42-8	34	437F26	9	447F42	4	468F27-6	39
411F96-4	38	424F43-8	34	437F28	9	447F43	4	468F30-5	41
411F98-7	38	424F52-8	34	437F40	9	447F43	30	468F34	43
411L62	34	424F83-8	28	437F41	9	447F44	5	468F35-5	39
411L62M016	8	425F86-8	6	437F42	9	447F45	5	468K87	1
411L62M018	8	426F52	10	438F37	9	447F46	5	469F67	40



Part Number	Page	Part Number	Page	Part Number	Page	Part Number	Page	Part Number	Page
469F68	40	487K13	1	494F75	45	509F49	42	544F88	10
480F06-2	2	487K15	1	494F76	45	509F49	42	544F89	10
480F12-8	39	487K17	1	494F77	45	511F51	9	544F91	10
480F13*	39	487K19	1	494F86	45	511F52	9	544F92	10
480F18-8	39	487K21	1	494F92	45	511F73	13	544F93	10
480F19-8	39	487K38	1	494F93	45	518F06-7	41	544F94	11
480F20-8	39	487L048-697	41	494F94	45	518K73	1	544F95	11
480F28*	39	487M048-589	41	496F32	27	518K74	1	544F96	11
480F30*	39	487M048-589	34	496F33	27	518K75	1	544F97	11
480F33*	39	488F00	12	496F34	27	518K76	1	544F98	11
480F37-5	39	488F01	12	496F68	40	518K77	1	544F99	11
480F68	25	488F03	11	496F69	40	519F09	16	545F00	11
480F688 Fin	20	488F04	11	496F71-8	28	519F10	16	545F42	11
480F69	28	488F05	11	497F52-8	15	519F11	16	545F43	11
480F70	28	488F07	11	498F84	16	519F12	16	545F44	11
480F70-8	28	488F08-8	3	498F85	16	522F93-2	3	545F45	11
481K19	1	488F08-8	9	498F86	13	523F03-8	40	545F79	10
481K28	1	488F09	7	498F87	13	523K21	1	545F80	10
482F37	9	488F10-8	3	498F92-8	16	525F99-8	40	545F81	10
482F44-2	39	488F10-8	9	499F30	44	526F16-8	40	545F82	10
482F49*	39	488F27	9	499F30	43	526F32-1	40	545F83	10
482F73*	39	488F30	9	499F59-8	34	526F52-7	41	545F84	10
482F79-8	40	488F31	9	499F60-8*	39	526F53-3	41	545F85	10
483F11-8	13	488F32	9	499F82-8	15	526F66-2	2	545F86	10
483F30	9	488F92-8	3	499F83-8	15	526L51-8540	40	545F87	10
483F34	9	488F92-8	3	499F84-8	15	526L928759	41	545F88	10
483F35	9	488K84	1	499F86-8	15	534F008	40	546F97-8	2
483F36	9	488K85	1	499F87-8	15	534K25	1	549F35-2	27
483F79	15	488K98	1	499F88-8	15	540F27	42	549F36-2	27
483F80	15	488K99	1	499F90-8	15	544F13	12	552F36-8	40
483F81	15	489F88-2	27	499F91-8	15	544F14	12	552F41-6	40
483F82	15	489F89-2	27	499F92-8	15	544F38	12	552F468	40
483F83	15	489K49	1	502F10	13	544F40	12	552F478	40
483F84	15	492F19-5	39	502F27	13	544F41	12	552F59-8	40
483K01	1	492F20	40	502F29	13	544F42	12	552F60-8	40
484F20-8	40	492F21	40	502F62	13	544F43	11	553F48-4	2
484F21-8	40	492F59	40	502F75	34	544F44	12	553F49-2	2
484F41-8	39	492K90	1	502F96	34	544F45	12	553F50-2	2
484F74	7	492K91	1	503F15	13	544F46	11	556F55-8	25
484F76	12	492K92	1	503F52	34	544F76	10	557F29	11
484F89-8	39	493F29-7	2	503F53-3	34	544F77	10	557F92-8	40
484F90	11	493F31	15	503F53-3	39	544F79	10	557F93-8	40
485F74	10	493F34	15	503F55-7	39	544F80	10	557F94-8	40
486F83*	25	493F76	1	503F56-7	39	544F82	10	557F95-8	40
486F89*	25	493F77	1	506F57	5	544F83	10	558F52-8	40
487F08	15	493F78	1	507F01	13	544F84	10	559K94	1
487K10	1	494F72	45	509F49	44	544F85	10	559K95	1
487K11	1	494F74	45	509F49	43	544F87	10	561F29	39

Part Number	Page	Part Number	Page	Part Number	Page	Part Number	Page	Part Number	Page
562F40-2	2	578F435	18	586F82	19	586L19M048 Fin*	20	598F809	22
562F42-2	3	578F435	41	586F86	19	596F548	19	598F809	24
563F885	18	579F11	26	586F87	19	596F548	20	598F815	22
563F885	41	579K14	1	586F88	19	596F61-8	25	598F815	24
563F895	18	580F38	26	586L19	24	596F618 Fin	20	598F825	22
563F895	41	580F38-7	26	586L19M016	20	596F62-8	25	598F825	24
563F905	18	580K99	1	586L19M016	25	596F628 Fin	20	598F835	22
563F905	41	581F96	16	586L19M016	26	596F63-8	25	598F835	24
563F945	18	582F11-2	27	586L19M016 Fin*	20	596F66	19	598F905	22
563F945	41	582F12-2	27	586L19M018	20	596F67	19	598F905	24
563F955	18	582F13-2	27	586L19M018	25	596F68	19	599F275	22
563F955	41	582F14-2	27	586L19M018	26	596F825	18	599F275	24
563F965	18	584F46	15	586L19M018 Fin*	20	596F825	41	599F91	21
563F965	41	585F31-2	3	586L19M020	20	596F87-9	3	599F91	23
564F115	40	585F31-2	3	586L19M020	25	596K29	1	599F92	21
564F128	40	585F32-7	2	586L19M020	26	596K30	1	599F92	23
564F345	40	585F36-7	3	586L19M020 Fin*	20	596K31	1	599F93	21
564F378	40	585F37-7	3	586L19M022	20	596K32	1	599F93	23
564F408	40	585F38-7	3	586L19M022	25	597F24	44	599F94	21
564F438	40	585F39-7	2	586L19M022	26	597F24	43	599F94	23
564F688	40	585F40-7	3	586L19M022 Fin*	20	597F24	42	599F95	21
564F888	40	585F705	18	586L19M024	20	597F35	42	599F95	23
564F898	40	585F705	41	586L19M024	25	597F52	44	599F96	21
564F908	40	585F715	18	586L19M024	26	597F52	43	599F96	23
564F918	40	585F715	41	586L19M024 Fin*	20	597F52	42	599F97	21
564K52	1	585F72	41	586L19M028	20	597F58	43	599F97	23
564K53	1	585F729	19	586L19M028	25	597F59	43	599F98	21
564K59	1	585F76 Fin	20	586L19M028	26	597F78	43	599F98	23
564K60	1	585F762	21	586L19M028 Fin*	20	597F78	42	599F99	21
565F04-8	7	585F762	23	586L19M032	20	597F78	45	599F99	23
566F50	33	585F77 Fin	20	586L19M032	25	597F92	44	600F00	21
566F51	33	585F772	21	586L19M032	26	597F92	43	600F00	23
568F11	13	585F772	23	586L19M032 Fin*	20	597F93	44	600F01	21
568F12	13	585F78 Fin	20	586L19M036	20	597F93	43	600F01	23
569F45	15	585F79 Fin	20	586L19M036	25	597F94	43	600F02	21
574F15-8	5	585F792	23	586L19M036	26	597F94	42	600F02	23
574F25-8	26	585K24	1	586L19M036 Fin*	20	597F95	43	600F03	21
574F26-8	26	585K25	1	586L19M040	20	597F95	42	600F03	23
574F29	26	585K26	1	586L19M040	25	597F96	43	600F04	21
574F29 x574F25	26	585K27	1	586L19M040	26	597F96	42	600F04	23
574F29 x574F26	26	585K46	1	586L19M040 Fin*	20	597F97	43	600F05	21
574F30	26	586F16	19	586L19M044	20	597F97	42	600F05	23
574F30 x574F25	26	586F17	19	586L19M044	25	598F20	19	600F06	21
574F30 x574F26	26	586F18	19	586L19M044	26	598F21	19	600F06	23
574F55	26	586F51 Fin	20	586L19M044 Fin*	20	598F22	19	600F07	21
574F56	26	586F512	24	586L19M048	20	598F59 Fin	20	600F07	23
574K05	1	586F80	19	586L19M048	25	598F592	22	600F08	21
574K07	1	586F81	19	586L19M048	26	598F592	24	600F08	23

Part Number	Page	Part Number	Page	Part Number	Page	Part Number	Page	Part Number	Page
600F09	21	602F15-1	40	610F01	4	616F08-8	15	650F03	29
600F09	23	602F17-1	40	610F01	30	616F12	7	650F04	29
600F10	21	602F18-1	40	610F02	4	622F308	18	650F05	29
600F10	23	602F19-8	6	610F49	1	622F308	21	650F06	29
600F11	21	603F20-7	2	610K46	1	622F308	23	650F07	29
600F11	23	603F55	43	610K48	1	622F68	39	650F08	29
600F12	21	603F55	45	610L43	28	622F69-8	3	650F09-5	31
600F12	23	603F57	43	610L44	28	622F728	3	650F10-5	31
600F13	21	603F57	45	612K88	1	624F42-7	7	650F11	29
600F13	23	603F64	40	612K90	1	624F43-9	7	650F12	29
600F14	21	604F228	22	612K91	1	624F44-9	7	650F13	29
600F14	23	604F228	24	612K93	1	624F45-5	7	650F14	29
600F415	18	604F22-8	25	612K94	1	624F47-8	7	650F15	29
600F415	41	604F228 Fin	20	613F02-9	27	624F48-8	6	650F16	29
600F425	18	604F23-8	25	613F10-2	27	624F49	6	650F18-9	29
600F425	41	604F238 Fin	20	613F11-2	27	624F53	6	650F21	29
600F62	21	604F24-8	25	613F12-2	27	626F077	2	650F22-8	29
600F62	23	604F248 Fin	20	613F13-2	27	626F077	2	650F23-8	29
600F63	21	604F25-8	25	613F14-2	27	628F10-7-142	2	650F24-8	29
600F63	23	604F268	22	613F15-2	27	628F10-7-171	2	650F27-9	40
600F64	21	604F268	24	613F16-2	27	628F10-7-236	2	650F27-9	30
600F64	23	604F26-8	25	613F17-2	27	628F825	3	650F28-8	30
600F65	21	604F268 Fin	20	613F22-2	27	628F835	3	650F29-8	30
600F65	23	604F27-8	25	613F23-2	27	628F892	2	650F30-8	30
600F66	21	604F278 Fin	20	613F24-2	27	628F912	2	650F31-8	30
600F66	23	604F28-8	25	613F25-2	27	628F922 x Fin	2	650F35-8	29
600F67	21	604F288 Fin	20	613F35-2	27	628F932	3	650F36-8	29
600F67	23	604F29-8	25	613F42-2	27	628F932	4	650F37-8	29
600F68	21	605F42	9	613F43-2	27	628F962	2	650F38-8	29
600F68	23	605F76-8	28	615F51	44	628K852 x Fin	1	650F39-8	29
600F69	21	605F77-8	28	615F51	43	628K872 x Fin	1	650F40-8	29
600F69	23	605F90	27	615F52	44	628K882 x Fin	1	650F41-8	29
600F70	21	606F01-8	28	615F52	43	628K902 x Fin	1	650F42-8	29
600F70	23	606F02-8	28	615F53	44	628K952 x Fin	1	650F43-8	29
600F71	21	606F03-8	27	615F53	43	628K972 x Fin	1	650F44-8	29
600F71	23	606K73	1	615F54	44	628K992 x Fin	1	650F45-8	29
600F72	21	606K74	1	615F54	43	629F062 x Fin	2	650F46-8	29
600F72	23	606K75	1	615F55	44	629F072 x Fin	2	650F48-9	31
600F73	21	606K76	1	615F55	43	629K002 x Fin	1	650F49-8	31
600F73	23	606K77	1	615F56	44	629K012 x Fin	1	650F50-8	30
601F24	19	606K78	1	615F56	43	629K022 x Fin	1	650F51-8	30
601F25	19	606K79	1	615F58	44	629K032 x Fin	1	650F52-8	29
601F26	19	607F91-9	3	615F58	43	629K042 x Fin	1	650F53-8	30
601F283 Fin	20	609F36	4	615F59	44	630F482 x Fin	2	650F54-8	31
601F283 Fin*	20	609F36	30	615F59	43	630F494	2	650F55-8	31
601F69	19	609F37	4	615F60	44	630K472 x Fin	1	650F56-8	31
601F829	19	609F37	30	615F60	43	631F248	18	650F57-8	30
601F829	20	609F38	4	616F07-8	15	649F99 fin	29	650F58-8	29

Part Number	Page	Part Number	Page	Part Number	Page	Part Number	Page	Part Number	Page
650F59-8	29	651F57-8	33	652F62	32	653F02	31	653F74	31
650F60 fin	31	651F58-7	33	652F63	31	653F03	31	653F74	32
650F62	30	651F60-8	33	652F64	31	653F04	31	653F75	31
650F63	30	651F61-8	33	652F64	32	653F05	31	653F75	32
650F64	29	651F62-8	33	652F65	31	653F08	31	653F76	31
650F67-8LR	30	651F63-8	33	652F65	32	653F09	31	653F76	32
650F67-8RR	30	651F64-8	33	652F66	31	653F10	31	653L15-7014	30
650F69-8LR	30	651F65-5	33	652F67	31	653F12	29	653L16-3016	30
650F69-8RR	30	651F67-5	33	652F67	32	653F13	29	653L16-3020	30
650F71-8	31	651F70-8	33	652F68	31	653F14	29	653L18-3016	30
650F72-8	31	651F73-8	33	652F68	32	653F50	31	653L18-3020	30
650F73-8	31	651F75-8	33	652F69	31	653F50	32	654F07	4
650F77-8	29	651F82-8	33	652F70	31	653F53	31	654F08	4
650F79-8	29	651F83-8	33	652F70	32	653F53	32	654F20-8	30
650F80-8	31	651F84-8	33	652F71	31	653F54	31	654F21-8	30
650F81-8	31	651F85-8	33	652F71	32	653F54	32	655F02-8	33
650F82-8	30	651F86-8	33	652F72	31	653F55	31	655F15	30
650F87-8	30	651F87-8	33	652F73	31	653F55	32	655F16	30
650F88-8	30	651F88-8	33	652F73	32	653F56	31	655F17	30
650F93	29	651F89-8	33	652F74	31	653F56	32	655F48-8LR	30
650F959	30	651F92-8	33	652F74	32	653F57	31	655F48-8RR	30
650F96-8	29	651F93-8	33	652F75	31	653F57	32	655F54-8	33
650F97-8	30	651F94-8	33	652F76	31	653F59	31	655F69-8	33
650F99-8	29	651F96-5	33	652F76	32	653F59	32	655F70-8	33
650L65	30	651F98-8	33	652F77	31	653F60	31	655F71-8	30
650L65-7020	30	652F04-8	33	652F77	32	653F60	32	656F40-8	30
651F00	32	652F05-8	33	652F78	31	653F61	31	656F41	30
651F01	32	652F06-8	33	652F79	31	653F61	32	656F44	31
651F04	32	652F09-8	33	652F79	32	653F62	31	656F45	31
651F06	32	652F10-8	33	652F80	31	653F62	32	656F46	31
651F08	32	652F11-8	33	652F80	32	653F63	31	656F47	31
651F09	32	652F12-8	33	652F81	31	653F63	32	656F48	31
651F10	32	652F13-8	33	652F82	31	653F65	31	656F49	31
651F36-2	33	652F14-8	33	652F82	32	653F65	32	656F50	31
651F37-2	33	652F15-8	33	652F83	31	653F66	31	656F51	31
651F38-9	33	652F21-8	33	652F83	32	653F66	32	656F52	31
651F39-8	33	652F22-8	33	652F84	31	653F68	31	656F53	31
651F40-8	33	652F23-9	33	652F85	31	653F68	32	656F58	32
651F41-8	33	652F29-8	30	652F86	31	653F69	31	656F59	32
651F42-5	33	652F57	31	652F87	31	653F69	32	656F60	32
651F43-8	33	652F58	31	652F88	31	653F70	31	656F61	32
651F44-8	33	652F58	32	652F89	31	653F70	32	656F62	32
651F47-8	33	652F59	31	652F90	31	653F71	31	656F63	32
651F49-8	33	652F59	32	652F92	31	653F71	32	656F64	33
651F50-8	33	652F60	31	652F93	31	653F72	31	656F65-8	33
651F53-8	33	652F61	31	652F95	31	653F72	32	656F66-8	30
651F54-5	33	652F61	32	652F96	31	653F73	31	670F31	14
651F56-8	33	652F62	31	652F99	31	653F73	32	670F32	14

Part Number	Page	Part Number	Page	Part Number	Page	Part Number	Page	Part Number	Page
670F33	14	677F42	1	682F398	18	684F785	24	687F64	22
670F34	14	677F768LR 626	33	682F398	21	684F795	19	687F64	26
670F35	14	677F768RR 626	33	682F608	20	684F795	24	687F65	22
670F36	14	677F778LR 626	33	682F618	20	684F805	19	687F65	26
670F37	14	677F778RR 626	33	682F628	20	684F805	24	687F66	22
670F38	14	678F00-8LR	30	682F638	20	684F815	19	687F66	26
670F57	14	678F00-8RR	30	682F64 Fin	20	684F815	24	687F71	22
670F58	14	678F02-8	33	682F65 Fin	20	684F825	19	687F71	26
670F59	14	678F248	20	682F67 Fin	20	684F825	24	687F94	22
670F60	14	678F248	22	682F68 Fin	20	684F835	19	687F94	26
670F61	14	678F248	24	682F788	20	684F835	24	687F95	22
670F62	14	678F25	41	682F788	22	684F845	19	687F95	26
670F63	14	678F25 Fin	20	682F788	24	684F845	24	687F96	22
670F64	14	678F252	22	682F86 Fin	20	684F855	19	687F96	26
670F65	14	678F252	24	682F87 Fin	20	684F855	24	688F01-7	7
670F66	14	678F498	20	682F91	41	684F865	19	688F03-8	7
670F67	14	678F498	24	682F918	21	684F865	24	688F14-8	6
670F68	14	678F54-8	6	682F918	23	684F875	24	688F17-7	7
670F69	14	678F67-7	6	682F91-8	3	684F885	19	688F77	44
670F70	14	679F818	22	682F958	18	684F885	24	688F77	43
670F71	14	680F34-8	16	682F958	21	685F38-7	7	688F77	42
670F72	14	680F35-8	16	682F958	23	685F505	41	688F77	42
670F73	14	680F36-8	16	682F969	18	685F515	41	688F95	44
670F74	14	680F64-5	3	682F969	21	685F525	41	688F95	43
671F02	14	680F64-5	3	682F969	23	685F535	41	688F95	42
671F03	14	680L50	24	682F969	23	685F545	41	688F95	42
671F04	14	680L51	24	684F05-5	7	685F555	41	689F01	44
671F05	14	680L52	24	684F06-8	7	685F875	19	689F01	43
671F06	14	681F30	6	684F09-8	7	686F858	18	689F01	42
671F07	14	681F31	6	684F10-8	7	686F858	21	689F02	44
671F08	14	681F36-8	6	684F11-9	7	686F858	23	689F02	43
671F09	14	681F37-8	6	684F12-9	7	686F868	18	689F02	42
671F10	14	681F40	6	684F14-7	7	686F868	21	689F03	44
676F03	32	681F41	6	684F42	30	686F868	23	689F03	43
676F04	32	681F44-8	7	684F427	30	686F88 Fin	20	689F03	42
677F00	32	681F48-9	6	684F44 Fin	20	686F882	24	689F04	44
677F01	32	681F60-8	29	684F448	22	687F53-8	6	689F04	43
677F04	32	681F61-8	29	684F448	24	687F54-8	6	689F04	42
677F05	32	681F63	29	684F45 Fin	20	687F55-8	6	689F12	43
677F06-8	33	681F70-8	31	684F46 Fin	20	687F56-8	6	689F12	45
677F09-8	33	681F71-8	31	684F528	20	687F60	22	689F13	43
677F13	32	681F758	30	684F528	22	687F60	26	689F14	43
677F14	32	681F76-8	31	684F528	24	687F61	22	689F15	43
677F15	32	681F77-8	31	684F539	24	687F61	26	689F16	43
677F16	32	682F01-8	7	684F55-9	6	687F62	22	689F17	43
677F26	32	682F298	18	684F775	19	687F62	26	689F18	43
677F27	32	682F298	21	684F775	24	687F63	22	689F19	43
677F28	32	682F298	23	684F785	19	687F63	26	689F28	13

Part Number	Page	Part Number	Page	Part Number	Page	Part Number	Page	Part Number	Page
689F30	13	692F05	43	695F244139 - .139"	2	695F257189 - .189"	2	698F52	41
689F31	13	692F14	42	695F244155 - .155"	2	695F257204 - .204"	2	698F53	41
689F33	13	692F14	45	695F244171 - .171"	2	695F257220 - .220"	2	698F64	32
689F37	13	692F15	42	695F244187 - .187"	2	695F257236 - .236"	2	698F65	32
689F39	13	692F15	45	695F244202 - .202"	2	695F257252 - .252"	2	698F66	32
689F50	13	692F16	42	695F244218 - .218"	2	695F257267 - .267"	2	698F67	32
689F51	13	692F16	45	695F244234 - .234"	2	695F257283 - .283"	2	698F68	32
689F52	13	692F17	45	695F244250 - .250"	2	695F257299 - .299"	2	698F69	32
689F53	13	692F19	45	695F244265 - .265"	2	696F05	41	698F70	32
689F54	13	692F20	45	695F244281 - .281"	2	696F318	40	698F71	32
689F55	13	692F21	45	695F247139 - .139"	2	696F39	16	700F16-8	16
689F58	13	692F23	45	695F247155 - .155"	2	696F42	3	700F21-8	6
689F60	13	692F24	45	695F247171 - .171"	2	696F42	4	700F22-8	6
689F62	13	692F25	45	695F247187 - .187"	2	696F472	2	700F25-8	7
690F44	41	692F632	17	695F247202 - .202"	2	696F499	2	700F278	6
690F82-7	7	692F642	17	695F247218 - .218"	2	696F502 x Fin	2	700F36-7	16
690F975	18	692F652	17	695F247234 - .234"	2	696F51	3	700F37-8	16
690F985	19	692F662	17	695F247250 - .250"	2	696F51	4	700F42	12
690F985	24	692F672	17	695F247265 - .265"	2	696F57-8	16	700F43	12
691F292	21	692F682	17	695F247281 - .281"	2	696F58-8	16	700F44	12
691F52	43	692F752	17	695F252031 - .031"	2	696F59-8	16	700F45	12
691F53	43	692F762	17	695F252047 - .047"	2	696K43	1	700F46	12
691F54	43	692F862	17	695F252063 - .063"	2	696K45	1	700F47	12
691F55	43	692F932	17	695F252078 - .078"	2	696K46	1	700F575	3
691F56	43	692F942	17	695F252094 - .094"	2	696K48	1	700F65	16
691F57	43	692F952	17	695F252110 - .110"	2	696K52	1	700F66	16
691F72	44	692F962	17	695F252126 - .126"	2	697F33-8	30	700F67	16
691F72	43	693F20-8	28	695F252141 - .141"	2	697F34-8	30	700F70-8	7
691F74	44	694F312	17	695F252157 - .157"	2	697F35-8	30	700F74-8	7
691F74	43	694F322	17	695F252173 - .173"	2	697F36-8	30	700F80	12
691F78	43	694F332	17	695F252189 - .189"	2	697F50	3	700F81	12
691F89	43	694F352	17	695F252204 - .204"	2	697F50	4	700F82	12
691F90	43	694F392	17	695F252220 - .220"	2	697F507	2	700F83	12
691F93	43	694F442	17	695F252236 - .236"	2	697F862	29	700F84	12
691F94	43	694F482	17	695F252252 - .252"	2	697F942	18	700F86	12
691F96	44	694F522	17	695F252267 - .267"	2	697F942	23	700F87	12
691F96	43	694F562	17	695F252283 - .283"	2	697F98-8	40	700F90-7	6
691F98	42	694F602	17	695F252299 - .299"	2	697F995	19	700F95-7	7
691F99	42	694F682	17	695F257031 - .031"	2	698F03-8	29	701F22-8	6
692F00	43	694F722	17	695F257047 - .047"	2	698F31	32	701F237	2
692F01	43	694F76	32	695F257063 - .063"	2	698F32	32	701F237	2
692F02	43	694F802	17	695F257078 - .078"	2	698F33	32	701F60	30
692F02	42	695F042 x Fin	2	695F257094 - .094"	2	698F34	32	701F61	30
692F03	43	695F052 x Fin	2	695F257110 - .110"	2	698F43	41	701F62	30
692F03	42	695F075	18	695F257126 - .126"	2	698F44	41	701F63	30
692F04	44	695F18	32	695F257141 - .141"	2	698F45	41	701F70-5	7
692F04	43	695F22	40	695F257157 - .157"	2	698F46	41	702F98-7	6
692F05	44	695F23	40	695F257173 - .173"	2	698F51	41	703F997	7

Part Number	Page	Part Number	Page	Part Number	Page	Part Number	Page	Part Number	Page
704F269	29	712F265	18	712F785	19	754F03	45	754F57	45
704F279	29	712F275	18	712F795	19	754F04	45	754F58	45
704F479	29	712F305	19	713F518	30	754F05	45	754F59	45
704F489	29	712F315	19	713F528	30	754F09	44	754F61	45
704F569	29	712F325	19	713F908	30	754F09	43	754F62	45
704F579	29	712F335	19	713F938	30	754F09	42	754F63	45
704F589	29	712F345	19	713F948	30	754F10	44	754F64	45
704F599	29	712F355	19	713F958	30	754F10	43	754F65	42
704F62	30	712F365	19	713F988	30	754F10	42	754F66	45
704F63	30	712F375	19	713F998	30	754F12	44	754F68	42
704F64-8	30	712F385	18	714F005	18	754F12	43	754F69	42
704F658	30	712F395	18	714F035	18	754F13	44	754F70	42
704F66	30	712F405	18	714F065	18	754F13	43	754F71	45
706F00-5	33	712F415	18	714F125	18	754F14	44	754F72	45
706F01-5	33	712F425	18	714F155	19	754F14	43	754F73	45
706F03-8	29	712F435	18	714F185	19	754F14	42	754F78	42
706F04-8	29	712F445	19	714F215	19	754F15	44	754F79	42
706F05-8	29	712F455	19	714F255	18	754F15	43	754F80	42
706F06-8	29	712F465	19	714F275	19	754F15	42	754F81	42
706F07-8	29	712F475	19	714F305	18	754F16	44	754F84	44
706F08-8	29	712F485	19	714F315	18	754F16	43	756F567	2
706F09-8	29	712F495	19	714F365	18	754F16	43	783F208	18
706F10-8	29	712F505	18	714F375	18	754F17	44	783F308	18
706F15	29	712F515	18	714F425	18	754F18	44	783F408	18
706F16	29	712F525	18	714F455	18	754F19	44	785F008	18
706F46-2	30	712F535	18	714F485	19	754F20	44	785F018 Fin	18
706F70	16	712F545	18	714F495	19	754F21	44	785F028 Fin	18
707F57	16	712F555	18	714F545	19	754F22	44	785F038	18
707F58	16	712F565	18	714F555	19	754F23	44	785F048	18
707F59	16	712F575	18	714F605	19	754F24	44	785F058	18
707F60	16	712F605	19	714F635	19	754F25	44	785F068	18
710F00M	30	712F615	19	715F152	2	754F26	44	785F078 Fin	18
710F31-8LR	30	712F625	19	715F245	18	754F29	44	785F088	18
710F31-8RR	30	712F635	19	715F892	3	754F30	44	785F088	18
710F32-8LR	30	712F645	19	715K14	1	754F34	44	785F108	18
710F32-8RR	30	712F655	19	716K16	1	754F35	44	785F118 Fin	18
710F33-8LR	30	712F665	19	716K43	1	754F36	44	785F128 Fin	18
710F33-8RR	30	712F675	19	716K45	1	754F37	44	785F138 Fin	18
710F618	20	712F685	18	716K46	1	754F38	44	785F148	18
710F628	20	712F695	18	716K48	1	754F43	43	785F158 Fin	18
710F658	20	712F705	18	720F43	6	754F44	43	785F168	18
710F668	20	712F715	18	720F46	6	754F45	43	785F178	18
711F002	16	712F725	18	744F208	30	754F46	44	785F188	18
711F395	7	712F735	18	744F258	30	754F52	45	785F198	18
712F205	18	712F745	19	744F662	2	754F53	45	785F218 Fin	18
712F215	18	712F755	19	751F16	11	754F54	45	785F228	18
712F225	18	712F765	19	751F17	11	754F55	45	785F238	18
712F235	18	712F775	19	754F02	45	754F56	45	785F248	18



Part Number	Page	Part Number	Page	Part Number	Page	Part Number	Page	Part Number	Page
785F258	18	797F708	23	798F235	24				
785F268 Fin	18	797F718	23	798F245	24				
785F278	18	797F728	23	798F255	24				
785F288	18	797F738	23	798F265	24				
785F298	18	797F748	23	798F275	24				
785F308	18	797F758	23	798F285	24				
785F318 Fin	18	797F768	23	798K912 x Fin	1				
785F328	18	797F778	23	798K922 x Fin	1				
785F338	18	797F788	23	799F505	18				
785F348	18	797F808	23	799F515	18				
785F358	18	797F818	24	799F525	18				
785F378 Fin	18	797F828	22	799F535	18				
785F388 Fin	18	797F828	24	799F545	18				
794F509	45	797F838	24	799F555	18				
794F519	45	797F845	22	799F565	18				
794F529	45	797F845	24	799F575	18				
794F539	45	797F855	22	799F585	18				
796F118	22	797F855	24	799F595	18				
796F118	24	797F865	22	799F605	19				
796F208	21	797F865	24	799F615	19				
796F218	21	797F875	22	799F625	19				
796F228	21	797F875	24	799F635	19				
796F238	21	797F915	22	799F645	19				
796F248	21	797F915	24	799F655	19				
796F258	21	797F925	22	799F665	19				
796F268	21	797F925	24	799F675	19				
796F318	21	797F935	22	799F685	19				
796F328	21	797F935	24	799F695	19				
796F338	21	797F945	22	799F805	18				
796F358	21	797F945	24	799F815	18				
796F368	21	798F115	22	799F825	18				
796F378	21	798F115	24	799F835	18				
796F378	23	798F125	22	799F845	19				
796F388	21	798F125	24	799F855	19				
796F398	21	798F135	22	799F865	19				
796F398	21	798F135	24	799F875	19				
796F398	23	798F145	22	∅ 195F67	35				
796F408	21	798F145	24	∅ 236L718018	39				
796F408	23	798F155	22	∅ 326F73-7	37				
797F618	23	798F155	24	∅ 391F90-9	38				
797F628	23	798F165	22	∅ 399F16-8	39				
797F638	23	798F165	24	∅ 399F58-8	38				
797F648	23	798F175	22	∅ 405F46-6	38				
797F658	23	798F175	24	∅ 409F83-6	38				
797F668	23	798F185	22						
797F678	23	798F185	24						
797F688	23	798F215	24						
797F698	23	798F225	24						



**PLUGS AND SHELLS**

6-PIN PLUGS, BULK PACKS		606, 626
PART NO.	DESCRIPTION	LIST PRICE

These packages are priced at a savings over individual plug prices. Keyway availability is limited to L4, D1, HI, 60, 59A1 and 981.

492K90	25 Pack for 1-1/8" Mortise	\$627.00
492K91	25 Pack for 3000 Rim	
492K92	50 Pack for CK4200, UT5200	\$1,254.00
610K48	50 Pack for CL3300	

**5- AND 6-PIN INDIVIDUAL PLUGS**

X CLASS	STANDARD	USED IN	LIST PRICE
487K10	121K10	1" Mortise (5-pin)	\$31.00
487K11	121K11	1-1/8" Mortise	
606K73	193K09	3-1/4" Mortise	\$56.00
606K74	193K10	3-1/2" Mortise	\$58.00
606K75	193K11	3-3/4" Mortise	\$60.00
487K38	197K51*	1001 Hotel Mortise	\$33.00
559K94	464K97	1004 Brink Mortise	\$35.00
559K95	468K87	1005 Brink Mortise	
488K99	488K98	CK4200, UT5200 (.552") and 2000-051	\$31.00
564K53	574K05	CK4400, except below	\$40.00
564K60	564K52	CK4429 Hotel, old tailpiece	
564K59	579K14	CK4429, new tailpiece	
580K99	574K07	CK4455, CK4482, before 8/93	
596K29	585K24	CL3300, CL3500, CL3600, CL3700, CL3800	\$31.00
596K31	585K26	CL3329, CL3629 Hotel	\$42.00
489K49	186K75	2001-051 (1429/3433EM)	\$42.00
534K25	245K37	2100/2160 (large head)	\$40.00
612K90	444K87	2200-001 and -009	
612K91	444K89	2200-002	
612K88	444K94	2200-008	
612K93	444K88	2200-054	
612K94	523K21	2200-076	
488K84	253K66	3000 Rim Cylinder	\$31.00
610K46	146K80	4200-002 for AR Pull	\$40.00
	195K68	4266 for MR Exit Operators	\$48.00
334K01	334K00	8000-6 Interchangeable Core	\$31.00
n/a	378K18	Fox Police Rim Cyl. (5-pin)	\$48.00

**7-PIN PLUGS 606, 626**

X CLASS	STANDARD	USED IN	LIST PRICE
487K13	292K95	1-1/4" Mortise	\$33.00
487K15	292K96	1-3/8" Mortise	
487K17	292K97	1-1/2" Mortise	
487K19	292K98	1-3/4" Mortise	\$45.00
487K21	292K99	2" Mortise	\$47.00
606K76	293K00	2-1/4" Mortise	
606K77	293K01	2-1/2" Mortise	
606K78	293K02	2-3/4" Mortise	
606K79	293K03	3" Mortise	\$49.00
596K30	585K25	CL3300 Non-Hotel	\$41.00
596K32	585K27	CL3329 Hotel	\$45.00
488K85	253K67	3000-7 Rim Cylinder	\$33.00
416K08	416K07	8000-7 Core	\$41.00

**SECURITY PLUGS (USE IN SECURITY SHELLS ONLY)**

PART NO.	DESCRIPTION	LIST PRICE
407K63	1-1/8" Mortise	\$49.00
407K64	1-1/4" and 1012 (Blockout)	
415K73	1-3/8" Mortise	\$55.00
415K74	1-1/2" Mortise	
518K73	1-3/4" Mortise	\$65.00
518K74	2" Mortise	\$67.00
518K75	2-1/4" Mortise	
518K76	2-1/2" Mortise	\$69.00
518K77	2-3/4" Mortise	
409K12*	1011 Mortise Hotel	\$49.00
481K19	1014 Brink Mortise	\$51.00
481K28	1015 Brink Mortise	
408K45	CK4200, UT5200	\$45.00
585K46	CL3300 Non-Hotel	\$55.00
444K97	2210-001 and -009	\$55.00
444K98	2210-002	\$49.00
444K96	2210-008	\$55.00
444K99	2210-054	\$49.00
407K65	3010 Rim Cylinder	\$45.00
483K01	3012 Rim (Blockout)	\$53.00
446K68	8010 Interchangeable Core	\$41.00

**PYRAMID STANDARD PLUGS**

696K43	Used with 1020	†Order 10-	\$41.00
798K912 x Fin	Used with 1020 -112	†Order 10-	
696K45	Used with 3020	†Order 10-	
696K46	Used with 2020	†Order 10-	
696K48	Used with 2020	†Order 10-	
696K52	Used with 8020, 8027	†Order 10-	
715K14	Used with 2220	†Order 10-	\$43.00

**PYRAMID SECURITY PLUGS**

716K43	Used with 1027	†Order 10-	\$41.00
798K922 x Fin	Used with 1027 -112	†Order 10-	
716K45	Used with 3027	†Order 10-	
716K46	Used with 2027 KIL	†Order 10-	
716K48	Used with 2027 KIK	†Order 10-	
716K16	Used with 2227	†Order 10-	\$43.00

**PYRAMID SIDE PIN PLUGS**

628K852 x Fin	Used with 1020-114	†Order 10-	\$43.00
628K972 x Fin	Used with 1020-112	†Order 10-	
628K872 x Fin	Used with 3020	†Order 10-	
628K902 x Fin	Used with 2020-052	†Order 10-	
628K882 x Fin	Used with 2020-03x	†Order 10-	\$45.00
628K952 x Fin	Used with 2220	†Order 10-	
629K032 x Fin	Used with 8020, 8027	†Order 10-	\$43.00
628K992 x Fin	Used with 1027-114	†Order 10-	
630K472 x Fin	Used with 1027-112	†Order 10-	
629K002 x Fin	Used with 3027	†Order 10-	
629K022 x Fin	Used with 2027-052	†Order 10-	
629K012 x Fin	Used with 2027-03x	†Order 10-	
629K042 x Fin	Used with 2227	†Order 10-	\$45.00

**6-PIN LOADED SHELLS, BULK PACKS**

Finishes available for rim and mortise shells: 605, 606, 612, 613, 625, 626		
493F76	25 Pack for 1000-118 Mortise	\$1,170.00
677F42	25 Pack for 1000-114 Mortise	
493F77	25 Pack for 3000 Rim	
493F78	50 Pack for CK4200, UT5200	\$1,170.00
610F49	50 Pack for CL3300, CL3700	

\*Not available in D1, D2, L1, L2, 752, 852 or A class keyways.  
†Sold only in multiples of the number indicated. Price is each.

**CYLINDER PARTS**

PART NO.	DESCRIPTION	LIST PRICE	SOLD IN MULT. OF	PART NO.	DESCRIPTION	LIST PRICE	SOLD IN MULT. OF	
<b>PYRAMID SHELLS</b>				<b>SECURITY MASTER PINS</b>				
695F042 x Fin	Used with 1020-114, 1027-114, 3020-058, 3027-058	\$57.00	10+	407T31-4097	2L	\$4.10	20+	
695F052 x Fin	Used with 3020, 3027 (Slotted)							
696F502 x Fin	Used with 8020, 8027							
696F472	Used with 2020, 2027 (KIL))	\$48.00						
696F499	Used with 2020, 2027 (KIK)							
715F152	Used with 2220, 2227	\$49.00						
<b>PYRAMID SHELLS - SIDE PINS</b>				<b>SECURITY TOP PINS</b>				
628F922 x Fin	Used with 8020, 8027	\$48.00		1	407T43-4193	Size 1 Long	\$3.80	20+
629F062 x Fin	Used with 1020-114, 1027-114, 3020-058, 3027-058							
630F482 x Fin	Used with 1020-112, 1027-112							
628F912	Used with 2020-052, 2027-052	\$49.00						
628F892	Used with 2020, 2027 (Levers)							
628F962	Used with 2220, 2227 (Competitors)	\$49.00						
629F072 x Fin	Used with 3020, 3027 (Slotted)	\$48.00						
<b>PYRAMID SIDE PINS (VIAL OF 20 PINS)</b>					<b>BUMP-RESISTANT TOP SPOOL PINS (VIAL OF 100 PINS)</b>			
630F494	Pyramid Side Pins - Vial Of 20 Pins	\$16.00			628F10-7-171	Conventional	\$42.00	1
<b>PYRAMID HIGH SECURITY PINS (VIAL OF 100 PINS)</b>					628F10-7-142	Pyramid A	\$92.00	1
<b>TOP PINS</b>				628F10-7-236	Pyramid C	\$100.00	1	
695F257031 - .031"	695F257173 - .173"	\$39.00	1	<b>SPRINGS AND SPRING COVERS</b>				
695F257047 - .047"	695F257189 - .189"			172F21-7	Spring, interchangeable core	\$0.10	100+	
695F257063 - .063"	695F257204 - .204"			493F29-7	Replaced by 603F20-7			
695F257078 - .078"	695F257220 - .220"			603F20-7	Spring, security and convent	\$0.10	100+	
695F257094 - .094"	695F257236 - .236"			026F75-7	Spring, hotel mortise blocking pin			
695F257110 - .110"	695F257252 - .252"			585F32-7	Spring, cylinder cap pin for 2000-034 type	\$0.20	100+	
695F257126 - .126"	695F257267 - .267"			314F98-7	Spring for 2001-034 indicator	\$0.10	100+	
695F257141 - .141"	695F257283 - .283"			217F42-2	Spring Cover, 5-pin brass	\$0.30	100+	
695F257157 - .157"	695F257299 - .299"			217F44-2	Spring Cover, 6-pin brass	\$0.30	100+	
<b>BOTTOM PINS</b>				314F88-7	Spring Cover, 6-pin stainless for most 2000 Series	\$0.50	50+	
695F247139 - .139"	695F247218 - .218"			217F43-2	Spring Cover, 7-pin brass	\$0.25	100+	
695F247155 - .155"	695F247234 - .234"			585F39-7	Spring Cover for 2000-034-7	\$1.10	10+	
695F247171 - .171"	695F247250 - .250"			171F46-8	Spring for 1100 Series Cyl. Head	\$0.10	100+	
695F247187 - .187"	695F247265 - .265"			697F507	Spring for all Pyramid Cyls	\$0.10	100+	
695F247202 - .202"	695F247281 - .281"			<b>CONVENTIONAL AND SECURITY</b>				
<b>PYRAMID SECURITY PINS (VIAL OF 100 PINS)</b>				701F237	A01 Cloverleaf (was #11)	\$2.50	20+	
<b>TOP PINS</b>				147F77-2	A02 Straight, brass (was #1)	\$3.70	10+	
695F252031 - .031"	695F252173 - .173"	\$32.00	1	147F77-8	A02 Straight, steel (was #1)	\$2.40	20+	
695F252047 - .047"	695F252189 - .189"			111F55-8	A03 (was A)	\$3.00	10+	
695F252063 - .063"	695F252204 - .204"			413F22-8	A04 (was J)	\$3.10	10+	
695F252078 - .078"	695F252220 - .220"			105F70-2	A05 AR4070 (was B)	\$3.70	10+	
695F252094 - .094"	695F252236 - .236"			626F077	A06	\$5.00	1	
695F252110 - .110"	695F252252 - .252"			756567	A07			
695F252126 - .126"	695F252267 - .267"			065F362	A62			
695F252141 - .141"	695F252283 - .283"			480F06-2	A91	\$4.90	5+	
695F252157 - .157"	695F252299 - .299"			266F34-2	A92	\$3.90	10+	
<b>BOTTOM PINS</b>				281F27-2	A93 (was C)	\$6.50	5+	
695F244139 - .139"	695F244218 - .218"			406F43-8	Cam for O5 Exit trim	\$10.20	1	
695F244155 - .155"	695F244234 - .234"			<b>CAMS - LFIC VERSION</b>				
695F244171 - .171"	695F244250 - .250"			701F237	A01 Cloverleaf (was #11)	\$2.50	10+	
695F244187 - .187"	695F244265 - .265"			334F13-8	A02 Straight (was #1)	\$4.10		
695F244202 - .202"	695F244281 - .281"			362F42-8	A03 (was A)			
<b>PINS (SPECIFY SIZE WHERE APPROPRIATE)</b>				423F49-8	A04 (was J)			
553F48-4	Vial of 100 bottom pins (L Pins)	\$18.00	1	362F50-2	A05 AR4070 (was B)	\$4.90	5+	
553F50-2	Vial of 100 spool top pins (J Pins)			626F077	A06	5.00	1	
553F49-2	Vial of 100 top pins (= master & Bu) (M Pins)			756F567	A07			
546F97-8	Vial of 1500 construction balls	\$17.00	1	756F582	A62 Straight	\$15.00	1	
197F52-7	Pin, blocking of 1001, 1011 (hotel)	\$1.00	50+	294F05-2	A63 MR adaptation	\$4.90	5+	
159F36-7	Ball bearing for wear resistance	\$0.20	100+	308F78-2	A64 MR adaptation	\$7.20	5+	
<b>SECURITY BOTTOM PINS</b>				526F66-2	A61 MR adaptation	\$8.20	5+	
407T41-4242	2L	\$3.90	20+	362F43-2	A93 (was C)	\$8.20	5+	
407T42-4242	2R			<b>MASTER RING</b>				
407T41-4270	3L			562F40-2	A61 New Cloverleaf (locks after 5/93)	\$4.10	10+	
407T42-4270	3R			065F36-2	A62 Straight (was 1A)	\$15.00	10+	
407T41-4298	4L			121F01-2	A63 (was 1MR)	\$4.20	5+	
407T42-4298	4R			135F19-2	A64 (was 2MR)	\$7.20	5+	
407T41-4326	5L			025F72-2	A65 Old Cloverleaf (was 11A)	\$5.10	5+	
407T42-4326	5R							
407T41-4354	6L							
407T42-4354	6R							

tSold only in multiples of the number indicated. Price is each.

**CYLINDER PARTS (CONT'D)**

PART NO.	DESCRIPTION	LIST PRICE	SOLD IN MULT. OF	PART NO.	DESCRIPTION	LIST PRICE	SOLD IN MULT. OF
<b>RETAINERS</b>				<b>LFIC THROW MEMBERS</b>			
173F79-8	.020" Plug Retainer-3300/5600,1400/4300	\$1.00	50†	715F892	CK4200, UT5200	\$3.80	1
368F91-8	.030" Plug Retainer-3000 and 3010 rim cylinders	\$1.60	20†	320F44-2	CK4200, UT5200 Best® knob	\$5.40	1
488F92-8	.032" Plug Retainer-2000-052, -044 and -051	\$1.30	20†	622F728	CL3400, CL3600 Series packet (before 6/2000) straight	\$3.40	10†
333F99-8	Plug Retainer, LFIC, CK4400, 2200-008, 2020 KIK	\$0.20	100†	682F91-8	CL3300, CL3600 series packet (after 6/2000) twisted	\$5.00	10†
334F23-8	Retainer, LFIC rim tailpiece	\$3.20	10†	379F805	Used with 1030-134, 1037-134	\$37.00	1
365F95-8	Retainer, Fox Police rim cylinder	\$4.20	10†	628F825	Used with 1030-114, 1037-114, 1030-138, 1037-138, 3030, 3037	\$9.00	1
250F08-8	Retainer for flex head cylinder	\$0.10	100†	628F835	Used with 1030-112, 1037-112	\$13.00	1
680F64-5	Cap for 2000-033, 034	\$4.00	10†	362F15-3	Padlock	\$7.10	10†
585F31-2	Cap Pin for 2000-034	\$0.10	100†	<b>OTHER LFIC PARTS</b>			
219F88-8	Plug Retainer for 2060-052	\$0.20	100†	353F86-8	Inner cam for 1071 (hotel)	\$7.30	5†
<b>TAILPIECES</b>				446F57-2	Control Sleeve for 8000 core	\$12.00	5†
444F74-8	A21	\$1.70	20†	446F58-2	Control Sleeve for 8010 core	\$14.80	5†
461F10-8	A22	\$2.20	10†	438F42-8	Mortise Cylinder Cam Screw	\$0.27	100†
520F35-8	A23	\$4.10	10†	334F12-8	Mortise Cylinder Cam Plate	\$1.90	20†
444F75-8	A24	\$2.20	10†	622F69-8	Security disk for CL3400, CL3600		
365F96-8	A38 (Fox square)	\$3.20	5†	607F91-9	Spacer for 6-pin Best type core		
329F99-8	A39 (Fox round)	\$5.40	5†	<b>OTHER MASTER RING CYLINDER PARTS</b>			
484F95-8	A41	\$1.90	10†	522F93-2	Adapter Bushing for MR	\$65.00	1
484F92-8	A42			135F10-8	Backplate, MR rim	\$3.50	10†
484F91-8	A43	\$1.40	20†	158F06-2	Cam Spacer for A61, A62, A65	\$1.30	20†
484F96-8	A44	\$3.70	10†	700F575	Thumbturn Hub for A61 MR cam	\$28.00	1
484F93-8	A45	\$2.40	10†	562F42-2	Kit, A61 cam / hub conversion		
484F94-8	A46	\$3.50	10†	488F10-8	Mortise Cylinder Set Screw Pkt	\$1.80	20†
146F78-8	A47	\$13.70	1	354F19-8	Thumbturn disk, A64 cam	\$78.00	1
585F33-7	For 2001-034-6	\$1.70	20†	197F35-7	Wave Washer for collar	\$3.50	10†
585F35-8	For 2001-034-7	\$2.40	10†	<b>OTHER MORTISE/RIM CYLINDER PARTS</b>			
622F29-8	For 2000-034-6	\$3.10	10†	253F75-8	Backplate, rim cylinder	\$1.40	20†
596F89-8	For 2000-038			438F41-8	Cam Screw	\$0.25	100†
622F30-8	For 2000-033-6, 2000-034-7	\$1.80	20†	488F08-8	Mortise Cylinder Set Screw Pkt	\$0.55	20†
489F02-8	For 2000-051			021F68-8	Screw, rim cyl. mounting, 2-9/32"	\$0.55	20†
682F298	For 2000-033-7	\$1.70	20†	021F71-8	Screw, rim cyl. mounting, 3-1/8"	\$3.90	10†
186F74-8	For 2001-051	\$1.60	20†	197F34-7	Wave Washer for collar	\$2.70	20†
622F328	For 2400-033	\$6.10	1	129F84-8	Cylinder Nut	\$6.70	1
682F398	For 2400-034			310F48-8	Thumbturn Disk, A02 cam	\$32.00	1
685F098	For 2400-037			<b>OTHER KNOB/LEVER CYLINDER PARTS</b>			
616F208	For 2400-039	\$6.90	1	596F87-9	Obsolete by new design		
616F218	For 2400-039L			585F38-7	2001-034 Indicator fork	\$1.20	20†
490F55-8	For 3000-138	\$2.90	10†	585F37-7	2001-034 Stabilizer Pin	\$2.30	20†
253F76-8	For 3000-200	\$1.80	20†	314F99-7	2001-034-6 Indicator Pin	\$4.10	20†
413F48-8	For 3000-200-V	\$2.80	10†	585F40-7	2001-034-7 Indicator Pin	\$7.20	1
253F77-8	For 3000-312	\$1.80	20†	585F36-7	Tailpiece Anchor, 2001-034	\$1.60	20†
413F49-8	For 3000-312-V	\$3.10	10†	041F47-8	Key, hotel shut-out		50†
582F29-8	For 3080-114 for exit alarm options M61 & M62	\$3.50	10†	<b>PYRAMID CYLINDER PARTS</b>			
253F85-8	For 3080-178	\$3.40	10†	696F42	Blocking plate	\$3.80	20†
284F13-8	For 3080-318	\$2.70	10†	697F50	Tumbler spring	\$0.10	100†
599F38-9	Kit for Sargent® in CL3600	\$9.20	1	217F43	Spring cover	\$0.25	100†
601F22-9	Kit for Sargent in CL3400	\$9.70	1	217F44	LFIC Spring cover	\$0.25	100†
622F32-8	For Schlage® cyl. in CL3400/CL3600	\$6.70	5†	696F51	Control sleeve	\$24.00	10†
715F108	P21	\$4.30	10†	628F932	Control sleeve - Used with 8020, 8027	\$26.00	10
715F118	P22						
715F128	P23						

†Sold only in multiples of the number indicated. Price is each.

**STANDARD DIAMETER CYLINDER COLLARS**

PART NO.	DESCRIPTION	LIST PRICE	SOLD IN MULT. OF
<b>STAMPED COLLARS</b>			
253F97	<b>Spring collar</b>		10†
	618, 619, 626	\$5.00	
	605, 606, 612, 613, 622, 625	\$6.30	
428F66	<b>2-Piece (was 574 1/2, H)</b>		5† 1
	618, 619, 626	\$5.80	
	605, 606, 612, 613, 622, 625	\$10.40	
549F52	<b>.219" Straight (was 154 1/2, H1)</b>		10†
	618, 619, 626	\$3.90	
	605, 606, 612, 613, 622, 625	\$5.90	
605F43	<b>.350 Tapered spring collar</b>		
	618, 619, 626	\$4.00	
	605, 606, 612, 613, 622, 625	\$6.20	
<b>SPACER FOR FLEXIBLE HEAD CYLINDER</b>			
370F29	.125" (1/8")	\$31.00	1
370F31	.250" (1/4")	\$32.00	1
252F82	.312" (5/16")	\$33.00	1
<b>SOLID, RECESSED FOR CYLINDER HEAD</b>			
447F41	<b>.031" (was 575 1/4, 910)</b>		1
	618, 619, 626	\$13.00	
	605, 606, 612, 613, 622, 625	\$15.00	
270F15	<b>.156"</b>		1
	622, 626, 630	\$16.50	
	605, 606, 612, 613, 622, 625	\$19.50	
447F42	<b>.172" (was 575 3/8, 910-6)</b>		1
	618, 619, 626	\$11.50	
	605, 606, 611, 612, 613, 625	\$13.30	
610F01	<b>.221" (was 5574 3/4, C)</b>		1
	611, 612, 613, 625, 626	\$22.50	
	605, 606, 618, 619	\$26.50	
610F02	<b>.289" (was 5574 1/4, L)</b>		1
	611, 612, 613, 625, 626	\$22.50	
	605, 606, 618, 619	\$26.50	
654F07	<b>.356" for ED4000/ED5000</b>		1
	606, 626, 630	\$14.00	
	612, 622, 629	\$17.50	
	605, 611, 613, 625	\$18.50	
447F43	<b>.375" (was 575 9/16, 910-9)</b>		1
	612, 619, 626	\$12.80	
	605, 606, 611, 613, 618, 625	\$15.80	
609F36	<b>.500"</b>		1
	605, 606, 611, 612, 613	\$28.50	
	618, 619, 625, 626		

PART NO.	DESCRIPTION	LIST PRICE	SOLD IN MULT. OF
<b>SOLID, RECESSED FOR CYLINDER HEAD (Cont'd)</b>			
654F08	<b>.556" for ED4000/ED5000</b>		1
	606, 622, 626	\$14.40	
	605, 625, 630	\$16.50	
	611, 612, 613, 629	\$20.50	
609F37	<b>.650"</b>		1
	605, 606, 611, 612, 613	\$30.50	
	618, 619, 625, 626		
609F38	<b>.850"</b>		1
	605, 606, 611, 612, 613	\$30.50	
	618, 619, 625, 626		
134F05	<b>With lip, .510" ED7400, ED7800</b>		1
	606, 619, 622, 626	\$28.50	
	605, 611, 612, 613, 618, 625	\$30.50	
267F97	<b>With lip, .635"</b>		1
	606, 619, 622, 626	\$29.50	
	605, 611, 612, 613, 618, 625	\$31.50	
<b>OTHER CYLINDER COLLARS</b>			
416F39	<b>Security .172" (was 95)</b>		1
	605, 606, 625, 626	\$18.50	
	611, 612, 613, 618, 619	\$23.50	
303F25	<b>Solid .312" (was 571/J)</b>		1
	605, 606, 625, 626	\$25.50	
	611, 612, 618, 619	\$25.50	
	613	\$29.50	
<b>RIM CYLINDER COLLARS</b>			
255F53	<b>Flush Mount (was 151/ R1290)</b>		10†
	606, 612, 619, 626	\$8.80	
	605, 611, 622, 625	\$10.70	
	613, 618	\$11.90	
422F88	<b>Surface Mount</b>		5†
	605, 606, 611, 612, 619, 622, 626	\$10.80	
	613, 618, 625	\$13.20	

†Sold only in multiples of the number indicated. Price is each.

## ASSA ABLOY

### MASTER RING CYLINDER COLLARS

PART NO.	DESCRIPTION	LIST PRICE	SOLD IN MULT. OF
<b>SOLID, RECESSED FOR CYLINDER HEAD</b>			
447F44	<b>.031" (was 576 1/4, MR910)</b>	\$18.40	1
	606, 626		
	605, 611, 612		
	613, 618, 619, 625		
447F45	<b>.172" (was 576 3/8, MR910-6)</b>	\$24.40	1
	605, 611, 612, 613, 625		
	606, 618, 619, 626		
447F46	<b>.375" (was 576 9/16, MR910-9)</b>	\$28.40	1
	606, 618, 619, 626		
	605, 611, 612, 613, 625		
<b>SPACERS FOR FLEXIBLE HEAD CYLINDERS</b>			
366F70	.090" tapered	\$8.20	5
370F33	.094"		
370F35	.281"	\$10.20	1
<b>RIM CYLINDER COLLARS</b>			
255F54	<b>(was 151 3/4, T)</b>	\$14.00	1
	605, 619, 625		
	606, 612, 613, 626	\$12.00	

PART NO.	DESCRIPTION	LIST PRICE
<b>CYLINDER SERVICE TOOLS</b>		
See main price book		
<b>LOCKSET INSTALLATION TOOLS</b>		
574F15-8	CK4400 Series Knob Removal Tool	\$2.00
506F57	CK4400 Series Knob Cover Removal Tool	\$6.00
391F65-8	Knob Release Tool, CK4200, ML2200 †Order 100-	\$0.50
<b>OTHER LOCKSET SERVICE TOOLS</b>		
301F65-8	Waldes Pliers CR28 for UT5200 Series	\$78.00
301F59-8	Waldes Ring Applicator E15 for UT5251	\$92.00
301F62-8	Waldes Ring Applicator E18 for UT5255	\$72.00
301F61-8	Waldes Ring Applicator E25 for UT5200	\$88.00

# ML2000/ML2000HS Mortise Lock Series

PART NO.	DESCRIPTION	LIST PRICE
<b>ARMORED FRONT</b>		
Finish: 605, 606, 611, 612, 612, 613, 619, 625, 626, 629**, 630**		
<b>Deadbolt</b>		
079F00	Armored front, 1-1/4" standard	\$30.00
079F02	Armored front, 1-1/8"	
<b>Deadbolt, latchbolt, aux. latch, toggle</b>		
402F29	Armored front, 1-1/4" standard	\$30.00
402F33	Armored front, 1-1/8"	
<b>Deadbolt, latchbolt, auxiliary latch</b>		
402F30	Armored front, 1-1/4" standard	\$30.00
402F34	Armored front, 1-1/8"	
<b>Deadbolt, latchbolt, toggle</b>		
402F31	Armored front, 1-1/4" standard	\$30.00
402F35	Armored front, 1-1/8"	
<b>Latchbolt, auxiliary latch, toggle</b>		
681F31	Armored front, 1-1/4" standard	\$30.00
681F30	Armored front, 1-1/8"	
681F41	LHB, 1-1/4"	
681F40	LHB, 1-1/16"	
<b>Blank Front</b>		
720F43	Armored front, 1-1/4"	\$30.00
720F46	Armored front, 1-1/16"	
<b>Filler Plate</b>		
334F998	USP Filler, 8" x 1-1/4"	
<b>Deadbolt, latchbolt</b>		
423F54	Armored front, 1-1/4" standard	\$30.00
423F57	Armored front, 1-1/8"	
<b>Latchbolt only</b>		
423F55	Armored front, 1-1/4" standard	\$30.00
423F58	Armored front, 1-1/8"	
<b>Latchbolt, auxiliary latch</b>		
624F49	Armored front, 1-1/4" standard	\$30.00
624F53	Armored front, 1-1/8"	

PART NO.	DESCRIPTION	LIST PRICE
<b>AUXILIARY LATCH</b>		
403F67-7	Auxiliary latch	\$13.50
<b>AUXILIARY LATCH LEVER</b>		
678F54-8	Auxiliary latch lever	\$4.40
<b>Auxiliary Latch Lever Spring</b>		
678F67-7	Auxiliary latch lever spring. †Order 100-	\$0.22
<b>CAP</b>		
700F278	Cap	\$20.00
<b>CASE &amp; FRONT SA</b>		
687F53-8	1-1/4" wide front - all functions except 60, 69	\$66.00
687F55-8	1-1/4" wide front - functions 60, 69	
687F54-8	1-1/8" wide front - all functions except 60, 69	
687F56-8	1-1/8" wide front - functions 60, 69	
<b>CYLINDER LATCH LEVER SA</b>		
688F14-8	Cylinder latch lever	\$1.00
700F22-8	Cylinder latch lever (functions 72, 75 )	
<b>CYLINDER LATCH LEVER STOP</b>		
681F48-9	Cylinder latch lever stop	\$1.80
<b>CYLINDER SET SCREW BRACKET</b>		
402F73-8	Cylinder set screw bracket	\$4.80
<b>DEADBOLT</b>		
702F98-7	Deadbolt	\$36.00
<b>DEADBOLT SPRING</b>		
701F22-8	Deadbolt spring †Order 50-	\$1.00
<b>DEADLOCKING LEVER</b>		
602F19-8	Functions 29, 51, 67	\$3.30
624F48-8	Functions 42, 55, 57, 69	
700F21-8	Functions 72, 75	
<b>DEADLOCKING LEVER SPRING</b>		
700F90-7	Deadlocking lever spring	\$0.29
<b>FIXED STOP</b>		
684F55-9	Fixed stop	\$3.90
<b>HUB ALIGNMENT BRACKET</b>		
404F86-8	Hub alignment bracket	\$5.00
<b>HUB ALIGNMENT BRACKET SCREW</b>		
425F86-8	FHUM-PH #8-32 X 3/8" Screw †Order 20-	\$0.12
<b>HUB LEVER</b>		
681F36-8	Functions 67, 30, 65, 29	\$4.40
681F37-8	All functions except 29, 30, 65, 67	

†Sold only in multiples of the number indicated. Price is each.

\*\*618, 619 finish provided to match 629, 630.



PART NO.	DESCRIPTION	LIST PRICE
<b>HUB LEVER SPRING</b>		
565F04-8	Hub lever spring †Order 10-	\$1.70
<b>HUB SPACER</b>		
684F11-9	Hub spacer	\$1.70
<b>KNOB HUB</b>		
684F14-7	Knob hub	\$18.00
<b>LATCHBOLT</b>		
688F17-7	Latchbolt	\$42.00
<b>LATCH LEVER SPRING</b>		
700F95-7	Latch lever spring	\$0.66
<b>LEVER HUB</b>		
684F09-8	Cap side	\$10.30
684F10-8	Case side	
<b>LEVER RETURN SPRING</b>		
404F85-8	Lever return spring †Order 20-	\$1.30
<b>LOCKING LEVER</b>		
403F66-8	Locking lever	\$19.00
<b>OCCUPANCY INDICATOR, ML2029</b>		
<b>605, 606, 611, 612, 613, 618, 619, 625, 626</b>		
416F84	1-3/4" door, sectional	\$70.00
429F08	1-3/8" door, sectional	\$72.00
484F74	2-1/4" door, sectional	\$74.00
416F49	Escutcheon trim - 1-3/4" door	\$54.00
<b>RETAINING RING</b>		
436F17-7	Retaining ring †Order 100-	\$0.70
<b>RETRACTOR</b>		
688F03-8	Retractor †Order 100-	\$1.60
<b>RETRACTOR SPRING</b>		
690F82-7	Retractor spring †Order 100-	\$0.20
<b>SCREW PACKETS</b>		
<b>Finish: 606, 612, 613, 619</b>		
429F41	Mounting screw pack, standard	\$3.50
488F09	Mounting screw pack, MR option	\$7.00
465F57	Mounting screw pack, M04 (VR, HS)	\$21.00
616F12	Mounting screw pack, MR x M04	
<b>SEAT SPRING</b>		
402F617	Seat spring †Order 20-	\$1.10
<b>SPACER</b>		
466F22-9	Spacer	\$0.28
624F43-9	Spacer	
624F44-9	Spacer	
<b>SPACER SPRING</b>		
684F12-9	Spacer spring	0.20
<b>SPRINGS</b>		
403F56-8	Spring	\$7.30
688F01-7	Spring, kickoff	\$1.20
624F42-7	Spring	\$2.30

PART NO.	DESCRIPTION	LIST PRICE
<b>STOP</b>		
684F05-5	Stop	\$3.70
<b>STOP CYLINDER LEVER</b>		
701F70-5	Stop cylinder lever	\$5.00
<b>STOP LEVERS</b>		
700F70-8	Stop lever	\$1.60
624F47-8	Stop lever	\$5.00
681F44-8	Stop lever	\$0.80
682F01-8	Stop lever	\$5.00
700F74-8	Stop lever	\$1.60
700F25-8	Stop lever	
<b>STOP SCREW</b>		
684F06-8	Stop screw	\$0.50
<b>STOP SPRING</b>		
685F38-7	Stop spring	\$0.40
703F997	Stop spring	\$1.20
<b>THUMBTURN LEVER HUB</b>		
624F45-5	Thumbturn lever hub	\$6.00
<b>TURNPIECE HUB</b>		
711F395	Turnpiece hub	\$2.30
<b>WROUGHT STRIKE BOX</b>		
120F76-8	ANSI wrought strike box	\$3.60
<b>STRIKES</b>		
<b>605, 606, 611, 612, 613, 619, 625, 626, 629**, 630**</b>		
<b>Latchbolt &amp; Deadbolt - Straight Lip</b>		
236L72014	7/8" Lip Length	\$29.00
236L72018	1-1/8" Lip Length	
236L72020	1-1/4" Lip Length	
236L72022	1-3/8" Lip Length	
236L72024	1-1/2" Lip Length	
236L72028	1-3/4" Lip Length	
236L72032	2" Lip Length	
236L72036	2-1/4" Lip Length	
236L72040	2-1/2" Lip Length	
236L72044	2-3/4" Lip Length	
236L72048	3" Lip Length	

†Sold only in multiples of the number indicated. Price is each.

\*\*618, 619 finish provided to match 629, 630

# ML2000/ML2000HS Mortise Lock Series

PART NO.	DESCRIPTION	LIST PRICE	PART NO.	DESCRIPTION	LIST PRICE
<b>STRIKES (Cont'd)</b>			<b>STRIKES (Cont'd)</b>		
<b>605, 606, 611, 612, 619, 613, 625, 626, 629**, 630**</b>			<b>605, 606, 611, 612, 613, 619, 625, 626, 629**, 630**</b>		
<b>Latchbolt - Straight Lip</b>			<b>Latchbolt - Curved Lip (RH)</b>		
236L73014	7/8" Lip Length	\$29.00	340L62020	1-1/4" Lip Length RH	\$33.00
236L73018	1-1/8" Lip Length		340L62022	1-3/8" Lip Length RH	
236L73020	1-1/4" Lip Length		340L62024	1-1/2" Lip Length RH	
236L73022	1-3/8" Lip Length		340L62028	1-3/4" Lip Length RH	
236L73024	1-1/2" Lip Length		340L62032	2" Lip Length RH	
236L73028	1-3/4" Lip Length		340L62036	2-1/4" Lip Length RH	
236L73032	2" Lip Length		340L62040	2-1/2" Lip Length RH	
236L73036	2-1/4" Lip Length		340L62044	2-3/4" Lip Length RH	
236L73040	2-1/2" Lip Length		340L62048	3" Lip Length RH	
236L73044	2-3/4" Lip Length				
236L73048	3" Lip Length				
<b>Deadbolt - Straight Lip</b>			<b>Latchbolt - Curved Lip (LH)</b>		
236L74014	7/8" Lip Length	\$29.00	340L63020	1-1/4" Lip Length LH	\$33.00
236L74018	1-1/8" Lip Length		340L63022	1-3/8" Lip Length LH	
236L74020	1-1/4" Lip Length		340L63024	1-1/2" Lip Length LH	
236L74022	1-3/8" Lip Length		340L63028	1-3/4" Lip Length LH	
236L74024	1-1/2" Lip Length		340L63032	2" Lip Length LH	
236L74028	1-3/4" Lip Length		340L63036	2-1/4" Lip Length LH	
236L74032	2" Lip Length		340L63040	2-1/2" Lip Length LH	
236L74036	2-1/4" Lip Length		340L63044	2-3/4" Lip Length LH	
236L74040	2-1/2" Lip Length		340L63048	3" Lip Length LH	
236L74044	2-3/4" Lip Length				
236L74048	3" Lip Length				
<b>Latchbolt &amp; Deadbolt - Curved Lip (RH)</b>			<b>STRIKE - MORTISE EXIT DEVICE - ED7600</b>		
340L60020	1-1/4" Lip Length RH	\$33.00	<b>689, 690, 691</b>		
340L60022	1-3/8" Lip Length RH		405L138018	1-1/8" Lip Length LHR	\$27.00
340L60024	1-1/2" Lip Length RH		405L138020	1-1/4" Lip Length LHR	
340L60028	1-3/4" Lip Length RH		405L138022	1-3/8" Lip Length LHR	
340L60032	2" Lip Length RH		405L148018	1-1/8" Lip Length RHR	
340L60036	2-1/4" Lip Length RH		405L148020	1 1/4" Lip Length RHR	
340L60040	2-1/2" Lip Length RH		405L148022	1 3/8" Lip Length RHR	
340L60044	2-3/4" Lip Length RH				
340L60048	3" Lip Length RH				
<b>Latchbolt &amp; Deadbolt - Curved Lip (LH)</b>			<b>STRIKE - OPEN BACK</b>		
340L61020	1-1/4" Lip Length LH	\$33.00	<b>605, 606, 611, 612, 613, 619, 625, 626, 629**, 630**</b>		
340L61022	1-3/8" Lip Length LH		411L63M016	1-3/4" Door RHR	\$97.00
340L61024	1-1/2" Lip Length LH		411L62M016	1-3/4" Door LHR	
340L61028	1-3/4" Lip Length LH		411L63M018	2" Door RHR	\$144.00
340L61032	2" Lip Length LH		411L62M018	2" Door LHR	
340L61036	2-1/4" Lip Length LH		411L63M020	2 1/4" Door RHR	
340L61040	2-1/2" Lip Length LH		411L62M020	2-1/4" Door LHR	
340L61044	2-3/4" Lip Length LH				
340L61048	3" Lip Length LH				
<b>Latchbolt &amp; Deadbolt - Curved Lip (RH)</b>			<b>STRIKE - RABBETED FRONT</b>		
<b>605, 606, 611, 612, 613, 619, 625, 626, 629**, 630**</b>			<b>605, 606, 611, 612, 613, 619, 625, 626, 629**, 630**</b>		
318F64	Latch RH/LHR	\$166.00	318F64	Latch RH/LHR	
318F65	Deadbolt RH/LHR		318F65	Deadbolt RH/LHR	
318F66	Latch and Deadbolt RH/LHR		318F66	Latch and Deadbolt RH/LHR	
318F67	Latch LH/RHR		318F67	Latch LH/RHR	
318F68	Deadbolt LH/RHR		318F68	Deadbolt LH/RHR	
318F69	Latch and Deadbolt LH/RHR		318F69	Latch and Deadbolt LH/RHR	

†Sold only in multiples of the number indicated. Price is each.

\*\*618, 619 finish provided to match 629, 630, except on 1-1/4" length curved lip strike



PART NO.	DESCRIPTION	LIST PRICE	PART NO.	DESCRIPTION	LIST PRICE
<b>TRIM ALIGNMENT (ADAPTER) PACKETS</b>			<b>TRIM ALIGNMENT (ADAPTER) PACKETS (Cont'd)</b>		
<b>Finish: 605, 606, 611, 612, 613, 619, 625, 626, 629**, 630**</b>			<b>Knob or Lever Trim Outside &amp; Blank Escutcheon Inside</b>		
<b>"P" Escutcheon</b>			466F45	1-3/8" door	\$34.00
			466F46	1-3/4" door	
			466F47	2-1/4" door	\$36.00
<b>Knob or Lever Trim</b>			<b>Full Escutcheon Knob Trim &amp; Sectional Lever or Knob Trim</b>		
			<b>Regularly Furnished with Working Trim</b>		
466F73	1-3/8" door	\$49.00	<b>No Finish</b>		
466F74	1-3/4" door		466F40	1-3/8" door	\$22.00
466F75	2-1/4" door	\$57.00	466F41	1-3/4" door	\$20.00
			466F42	2-1/4" door	\$22.00
<b>Half Working Trim</b>			<b>Half Working Trim</b>		
439F25	1-3/8" door	\$30.00	437F40	1-3/8" door	\$24.00
439F26	1-3/4" door		437F41	1-3/4" door	
439F27	2-1/4" door		437F42	2-1/4" door	
<b>Lever Half Dummy Trim</b>			<b>Half Dummy Trim</b>		
488F31	"P" Escutcheon	\$63.00	438F38	Cast Knob	\$62.00
<b>Knob Half Dummy Trim</b>			488F30	Lever	\$38.00
437F28	"P" Escutcheon	\$63.00	511F51	Wrought Knob	\$44.00
<b>Wrought Knob Half Dummy Trim</b>			<b>Full Dummy Trim</b>		
511F52	"P" Escutcheon	\$55.00	437F16	Lever	\$11.00
<b>Cast Knob Half Dummy Trim</b>			<b>Inside Adapter Only - Lockbody</b>		
<b>"M" and "N" Escutcheons</b>			427F06	Knob Half Working Trim	\$24.00
<b>Regularly Furnished with Working Trim</b>			488F27	Lever Half Working Trim	\$45.00
466F50	1-3/8" door	\$42.00	<b>Adjustable Locknut Assembly</b>		
466F51	1-3/4" door	\$46.00	482F37	Adjustable Locknut Assembly	\$6.70
466F52	2-1/4" door	\$48.00	<b>Adjusting Bolt for Half Lever Trim</b>		
			483F34	1-3/8" door	\$6.70
			483F35	1-3/4" door	\$7.70
			483F36	2-1/4" door	\$8.70
			<b>Adjusting Nut</b>		
			118F48-8	Adjusting Nut for Cast Knob	\$3.80
			<b>Cylinder Set Screw Packet</b>		
			488F08-8	Standard †Order 20	\$0.55
			488F10-8	Master Ring	\$1.80
			<b>Cylinder Collar</b>		
			See page 4 & 5		
			<b>Dowel Screw</b>		
			483F30	for Inside Lever	\$2.50
			<b>Emergency Key</b>		
			605F42	for ML2020, ML2030, ML2060	\$4.50
			<b>E-Ring</b>		
			427F07-8	for working half trim adapter. †Order 100-	\$0.15

†Sold only in multiples of the number indicated. Price is each.

\*\*618, 619 finish provided to match 629, 630.

PART NO.	DESCRIPTION	613E, 626	605, 606, 611, 612, 613, 618, 619, 625, 629, 630, 722
<b>"R" ESCUTCHEON - CAST</b>			
<b>Blank</b>			
426F52	Outside	\$188.00	\$196.00
545F79	Inside	---	\$196.00
<b>For Cylinder only</b>			
427F45	Outside	---	\$196.00
545F88	Inside	---	\$196.00
<b>For Grip only</b>			
427F43	Outside	---	\$196.00
545F87	Inside	---	\$196.00
<b>For Cylinder &amp; Grip</b>			
427F39	Outside	---	\$196.00
545F80	Inside	---	\$196.00
<b>For Thumbturn Lever only</b>			
545F84	Inside-1-3/8" door	\$188.00	\$196.00
545F86	Inside-2-1/4" door	\$188.00	\$196.00
545F85	Inside-1-3/4" door	---	\$196.00
<b>For Thumbturn Lever &amp; Grip</b>			
545F81	Inside-1-3/8" door	\$188.00	\$196.00
545F83	Inside-2-1/4" door	\$188.00	\$196.00
545F82	Inside-1-3/4" door	---	\$196.00
<b>For Grip &amp; Emergency Key</b>			
427F47	Outside	---	\$196.00
<b>For Cylinder, Grip &amp; Indicator</b>			
427F37	Outside-1-3/4" door	---	\$196.00
427F36	Outside-1-3/8" door	\$188.00	\$196.00
485F74	Outside-2-1/4" door	\$188.00	\$196.00
PART NO.	DESCRIPTION	613E, 626	605, 606, 611, 612, 613, 618, 619, 625, 629, 630, 722
<b>"N" ESCUTCHEON - WROUGHT</b>			
<b>Blank</b>			
544F93	Inside or Outside	\$107.00	\$109.00
<b>For Cylinder only</b>			
544F80	Inside or Outside	\$107.00	\$109.00
<b>For Grip only</b>			
544F76	Inside or Outside	\$107.00	\$109.00
<b>For Cylinder &amp; Grip</b>			
544F77	Inside or Outside	\$107.00	\$109.00
<b>For Thumbturn Lever only</b>			
544F89	Inside-1-3/4" door	\$107.00	\$109.00
544F92	Inside-1-3/8" door		
544F91	Inside-2-1/4" door		
<b>For Thumbturn Lever &amp; Grip</b>			
544F85	Inside-1-3/4" door	\$107.00	\$109.00
544F87	Inside-2-1/4" door		
544F88	Inside-1-3/8" door		
<b>For Grip &amp; Emergency Key</b>			
544F79	Outside	\$107.00	\$109.00
<b>For Cylinder, Grip &amp; Indicator</b>			
544F82	Outside-1-3/8" door	\$107.00	\$109.00
544F83	Outside-1-3/4" door		
544F84	Outside-2-1/4" door		

PART NO.	DESCRIPTION	613E, 626	605, 606, 611, 612, 613, 618, 619, 625, 629, 630, 722
<b>"M" ESCUTCHEON - WROUGHT</b>			
<b>Blank</b>			
383F82	Outside	\$107.00	\$109.00
545F45	Inside		
<b>For Cylinder only</b>			
488F07	Outside	\$107.00	\$109.00
751F16	Outside - Master Ring		
545F00	Inside		
751F17	Inside - Master Ring		
<b>For Grip only</b>			
488F04	Outside	\$107.00	\$109.00
544F95	Inside		
<b>For Cylinder &amp; Grip</b>			
488F05	Outside - Conventional	\$107.00	\$109.00
557F29	Outside - Master Ring		
544F96	Inside - Conventional		
377F80	Inside - Master Ring		
<b>For Thumbturn Lever only</b>			
545F42	Inside-1-3/8" door	\$107.00	\$109.00
545F43	Inside-1-3/4" door		
545F44	Inside-2-1/4" door		
<b>For Thumbturn Lever &amp; Grip</b>			
544F97	Inside-1-3/8" door	\$107.00	\$109.00
544F98	Inside-1-3/4" door		
544F99	Inside-2-1/4" door		
<b>For Grip &amp; Emergency Key</b>			
544F94	Outside	\$107.00	\$109.00
<b>For Cylinder, Grip &amp; Indicator</b>			
433F48	Outside-1-3/8" door	\$107.00	\$109.00
433F49	Outside-1-3/4" door		
484F90	Outside-2-1/4" door		
<b>"P" ESCUTCHEON - WROUGHT</b>			
<b>Blank</b>			
544F46	Inside	\$107.00	\$109.00
384F11	Outside		
<b>For Cylinder only</b>			
488F03	Outside	\$107.00	\$109.00
544F43	Inside		

PART NO.	DESCRIPTION	613E, 626	605, 606, 611, 612, 613, 618, 619, 625, 629, 630, 722
<b>"P" ESCUTCHEON - WROUGHT</b>			
<b>For Grip only</b>			
488F00	Outside	\$107.00	\$109.00
544F39	Inside		
<b>For Cylinder &amp; Grip</b>			
488F01	Outside	\$107.00	\$109.00
544F40	Inside		
<b>For Thumbturn Lever only</b>			
544F14	Inside-1-3/8" door	\$107.00	\$109.00
544F44	Inside-2-1/4" door		
544F45	Inside-1-3/4" door		
<b>For Thumbturn Lever &amp; Grp</b>			
544F13	Inside-1-3/8" door	\$107.00	\$109.00
544F41	Inside-2-1/4" door		
544F42	Inside-1-3/4" door		
<b>For Grp &amp; Emergency Key</b>			
544F38	Outside	\$107.00	\$109.00
<b>For Cylinder, Grip &amp; Indicator</b>			
430F47	Outside-1-3/8" door	\$107.00	\$109.00
435F00	Outside-1-3/4" door		
484F76	Outside-2-1/4" door		

PART NO.	DESCRIPTION	613E, 630
<b>"V" ESCUTCHEON - CAST</b>		
<b>Blank</b>		
700F80	Outside	\$220.00
700F40	Inside	
<b>For Cylinder only</b>		
700F83	Outside	\$220.00
700F43	Inside	
<b>For Grip only</b>		
700F81	Outside	\$220.00
700F41	Inside	
<b>For Cylinder &amp; Grip</b>		
700F82	Outside	\$220.00
700F87	Outside - 7P & C6 (Use when collar is required)	
700F42	Inside	
700F47	Inside - 7P & C6 (Use when collar is required)	
<b>For Thumbturn Lever only</b>		
700F45	Inside	\$220.00
<b>For Thumbturn Lever &amp; Grip</b>		
700F44	Inside	\$220.00
<b>For Grp &amp; Emergency Key</b>		
700F84	Outside	\$220.00
<b>For Cylinder, Grip &amp; Indicator</b>		
700F86	Outside	\$220.00
700F46	Inside	

PART NO.	DESCRIPTION	LIST PRICE
<b>Hex Wrench</b>		
		<b>No Finish</b>
264F69-8	Hex Wrench	\$0.70
<b>Key Plate Packet</b>		
438F90	Key Plate Packet 612, 619, 625, 626	\$21.00
	605, 606, 611, 613, 619, 629**, 630**	\$22.00

\*\*618, 619 finish provided to match 629, 630.

PART NO.	DESCRIPTION	613E, 626	605, 606, 611, 612, 613, 618, 619, 625, 629, 630, 722
<b>KNOB - WROUGHT AND CAST</b>			
<b>"YW" KNOB - WROUGHT</b>			
<b>Inside Knob</b>			
502F62		\$144.00	\$150.00
<b>Outside Knob &amp; Spindle Assembly</b>			
689F33	for 1-3/4" door	\$144.00	\$150.00
689F30	for 1-3/8" door		
689F39	for 2-1/4" door		
<b>"GS" KNOB - CAST</b>			
<b>Inside Knob</b>			
503F15		\$238.00	\$244.00
<b>Outside Knob &amp; Spindle Assembly</b>			
689F37	for 2-1/4" door	\$238.00	\$244.00
689F31	for 1-3/4" door		
689F28	for 1-3/8" door		
PART NO.	DESCRIPTION	613E, 626	605, 606, 611, 612, 613, 625
<b>"SS" KNOB - CAST</b>			
<b>Inside Knob</b>			
445F38		\$238.00	\$244.00
<b>Outside Knob &amp; Spindle Assembly</b>			
445F43	for 1-3/4" door	\$238.00	\$244.00
498F86	for 2" door		
498F87	for 2-1/4" door		
<b>"GW" KNOB - WROUGHT</b>			
<b>Inside Knob</b>			
568F11		\$144.00	\$150.00
<b>Outside Knob &amp; Spindle Assembly</b>			
689F60	for 1-3/4" door	\$144.00	\$150.00
689F58	for 1-3/8" door		
689F62	for 2-1/4" door		
<b>"BW" KNOB - WROUGHT</b>			
<b>Inside Knob</b>			
568F12		\$144.00	\$150.00
<b>Outside Knob &amp; Spindle Assembly</b>			
502F10	for 1-3/4" door	\$144.00	\$150.00
507F01	for 1-3/8" door		
511F73	for 2-1/4" door		
PART NO.	DESCRIPTION	613E, 626	605, 606, 611, 612, 613, 625, 629, 630
<b>"GR" KNOB - WROUGHT REINFORCED</b>			
<b>Inside Knob</b>			
502F27		\$154.00	\$160.00
<b>Outside Knob &amp; Spindle Assembly</b>			
689F52	for 1-3/4" door	\$154.00	\$160.00
689F50	for 1-3/8" door		
689F54	for 2-1/4" door		
<b>"BR" KNOB - WROUGHT REINFORCED</b>			
<b>Inside Knob</b>			
502F29		\$154.00	\$160.00
<b>Outside Knob &amp; Spindle Assembly</b>			
689F53	for 1-3/4" door	\$154.00	\$160.00
689F51	for 1-3/8" door		
689F55	for 2-1/4" door		
PART NO.	DESCRIPTION	LIST PRICE	
<b>Knob Release Tool</b>			
391F65-8	Knob Release Tool	No Finish See page 5	
<b>Knob Shank Adapter</b>			
483F11-8	Knob Shank Adapter	No Finish \$6.00	
<b>Spring Clip</b>			
377F30-8	Spring Clip	\$1.50	

PART NO.	DESCRIPTION	613E, 626	605, 606, 611, 612, 613, 618, 619, 625, 629, 630, 722
<b>"AS" LEVER - CAST</b>			
<b>Inside Lever</b>			
670F37		\$166.00	\$172.00
<b>Outside Lever &amp; Spindle Assembly</b>			
670F64	for 1-3/8" door	\$166.00	\$172.00
670F73	for 1-3/4" door		
671F09	for 2-1/4" door		
<b>"CS" LEVER - CAST</b>			
<b>Inside Lever</b>			
670F30		\$166.00	\$172.00
<b>Outside Lever &amp; Spindle Assembly</b>			
670F57	for 1-3/8" door	\$166.00	\$172.00
670F66	for 1-3/4" door		
671F02	for 2-1/4" door		
<b>"DS" LEVER - CAST</b>			
<b>Inside Lever</b>			
670F32	LH/LHR	\$166.00	\$172.00
670F31	RH/RHR		
<b>Outside Lever &amp; Spindle Assembly</b>			
670F59	for 1-3/8" door RH/RHR	\$166.00	\$172.00
670F68	for 1-3/4" door RH/RHR		
671F04	for 2-1/4" door RH/RHR		
670F58	for 1-3/8" door LH/LHR		
670F67	for 1-3/4" door LH/LHR		
671F03	for 2-1/4" door LH/LHR		
<b>"ES" LEVER - CAST</b>			
<b>Inside Lever</b>			
670F33		\$166.00	\$172.00
<b>Outside Lever &amp; Spindle Assembly</b>			
670F60	for 1-3/8" door	\$166.00	\$172.00
670F69	for 1-3/4" door		
671F05	for 2-1/4" door		
<b>"LS" LEVER - CAST</b>			
<b>Inside Lever</b>			
670F34		\$166.00	\$172.00
<b>Outside Lever &amp; Spindle Assembly</b>			
670F61	for 1-3/8" door	\$166.00	\$172.00
670F70	for 1-3/4" door		
671F06	for 2-1/4" door		
<b>"NS" LEVER - CAST</b>			
<b>Inside Lever</b>			
670F36		\$166.00	\$172.00
<b>Outside Lever &amp; Spindle Assembly</b>			
670F63	for 1-3/8" door	\$166.00	\$172.00
670F72	for 1-3/4" door		
671F08	for 2-1/4" door		
<b>"PS" LEVER - CAST</b>			
<b>Inside Lever</b>			
670F38		\$166.00	\$172.00
<b>Outside Lever &amp; Spindle Assembly</b>			
670F65	for 1-3/8" door	\$166.00	\$172.00
670F74	for 1-3/4" door		
671F10	for 2-1/4" door		
<b>"RS" LEVER - CAST</b>			
<b>Inside Lever</b>			
670F35		\$166.00	\$172.00
<b>Outside Lever &amp; Spindle Assembly</b>			
670F62	for 1-3/8" door	\$166.00	\$172.00
670F71	for 1-3/4" door		
671F07	for 2-1/4" door		

PART NO.	DESCRIPTION	613E, 630	605, 606, 611, 612, 613, 618, 619, 625, 626, 629, 722
<b>"LW" LEVER - WROUGHT</b>			
<b>Inside Lever</b>			
493F31		\$138.00	\$144.00
<b>Outside Lever &amp; Spindle Assembly</b>			
483F79	for 1-3/8" door	\$138.00	\$144.00
483F80	for 1-3/4" door		
483F81	for 2-1/4" door		
<b>"RW" LEVER - WROUGHT</b>			
<b>Inside Lever</b>			
493F34		\$138.00	\$144.00
<b>Outside Lever &amp; Spindle Assembly</b>			
483F82	for 1-3/8" door	\$138.00	\$144.00
483F83	for 1-3/4" door		
483F84	for 2-1/4" door		

PART NO.	DESCRIPTION	LIST PRICE
<b>LOCK CONVERSION KIT</b>		
See Main Price book, See ML2000 Section - Lock Body Only		
<b>NYLON BUSHING NO FINISH</b>		
118F29-9	Nylon Brushing †Order 100-	\$0.20
<b>O-RING NO FINISH</b>		
340F27-9	for YW, GS inside knob †Order 100-	\$0.34
<b>ROLL PIN NO FINISH</b>		
228F54-8	Roll Pin for knob	\$0.34
<b>ROSE PACKET</b>		
445F82	<b>Wrought Rose Packet- (Qty 2) 2-7/8" dia. (C)</b>	
	606, 612, 619, 626, 630	\$48.00
	605, 611, 613, 625, 629	\$64.00
445F83	<b>Wrought Rose Packet- (Qty 2) 3-1/2" dia. (D)</b>	
	606, 612, 619, 626, 630	\$48.00
	605, 611, 613, 625, 629	\$64.00
445F84	<b>Wrought Rose Packet- (Qty 2) 3" square (E)</b>	
	606, 612, 619, 626, 630	\$48.00
	605, 611, 613, 625, 629	\$64.00
447F24	<b>Cast Rose Packet - (Qty 2) 2-7/8" dia. (F)</b>	
	612, 619, 625, 626	\$138.00
	605, 606, 613	\$144.00
	611, 629, 630	\$154.00
447F25	<b>Cast Rose Packet- (Qty 2) 2-1/4" dia. (B)</b>	
	612, 619, 625, 626	\$66.00
	605, 606, 613	\$72.00
	611, 629, 630	\$82.00
487F08	<b>Wrought Rose Packet- (Qty 2) 2-1/4" dia. (A)</b>	
	612, 619, 625, 626	\$42.00
	605, 606, 613	\$50.00
	611, 629, 630	\$56.00

PART NO.	DESCRIPTION	LIST PRICE
<b>ROSE REINFORCEMENT PACKET NO FINISH</b>		
445F86-9	Rose Reinforcement Packet	\$5.50
<b>SCREW PACKET</b>		
<b>605, 606, 611, 612, 613, 619, 625, 626, 629, 630</b>		
569F45	For M & P half dummy trim	\$5.00
429F31-7	Screw Packet for "N" Surface Mounted Escutcheon	\$6.80
616F08-8	Lock mounting, spanner	\$7.20
584F46	Escutcheon for 1-3/4" door, spanner	\$4.30
384F03	Escutcheon for 2" - 2-1/4" door, spanner	
616F07-8	T20 Torx® bit	\$10.20
<b>SLEEVE</b>		
<b>605, 606, 611, 612, 613, 619, 625, 626, 629, 630</b>		
206F53	Sleeve for Cast Knob	\$12.00
<b>SPACER NO FINISH</b>		
497F52-8	Spacer for Cast Knob	\$2.70
<b>SPINDLES NO FINISH</b>		
<b>33L (Lever x Lever) Spindle</b>		
499F82-8	1-3/8" door	\$28.00
499F83-8	1-3/4" door	
499F84-8	2-1/4" door	
<b>33LK (Lever x Knob) Spindle</b>		
499F86-8	1-3/8" door	\$28.00
499F87-8	1-3/4" door	
499F88-8	2-1/4" door	
<b>33KL (Knob x Lever) Spindle</b>		
499F90-8	1-3/8" door	\$28.00
499F91-8	1-3/4" door	
499F92-8	2-1/4" door	

†Sold only in multiples of the number indicated. Price is each.

# ML2000/ML2000HS Mortise Lock Series

PART NO.	DESCRIPTION	LIST PRICE
<b>SPINDLE (Cont'd)</b>		
<b>32 (Knob x Knob) Spindle</b>		
696F59-8	2-1/4" door	\$28.00
696F57-8	1-3/8" door	\$27.00
696F58-8	1-3/4" door	
<b>SPINDLE FOR KNOB HALF TRIM</b>		
303F18	1-3/8" door	\$27.00
303F19	1-3/4" door	
303F20	2-1/4" door	\$28.00
<b>INSIDE SPINDLE FOR HALF LEVER TRIM</b>		
680F34-8	1-3/8" door	\$15.00
680F35-8	1-3/4" door	\$4.60
680F36-8	2-1/4" door	\$9.20
<b>HIGH SECURITY SPINDLE</b>		
445F41	1-3/4" door	\$25.20
498F84	2" door	\$26.20
498F85	2-1/4" door	\$27.20
<b>VANDAL RESISTANT SPINDLE &amp; SCREW PACK</b>		
700F65	1-3/4" door	\$13.00
700F66	2" door	
700F67	2 -1/4" door	
<b>THIMBLE PACKET</b>		
432F86	<b>(Qty 2) for wrought escutcheon knob trim designs</b>	
	605, 606, 611, 612, 613, 619, 625, 626, 629, 630	\$25.00
	629, 630	\$30.00
445F85	<b>(Qty 2) for sectional knob trim designs</b>	
	605, 606, 611, 612, 619, 625, 626, 613	\$33.00
	613	\$38.00
467F01*	<b>(Qty 2) for levers x large rose</b>	
	605, 606, 611, 612, 619, 625, 626, 613	\$19.00
<b>THIMBLE WRENCH NO FINISH</b>		
300F68-8	Thimble Wrench	See page 5

\*Note: Recommend Rose Reinforcement packet (445F86-9) with this item.

PART NO.	DESCRIPTION	LIST PRICE
<b>THROUGHBOLT PACKET</b>		
<b>605, 606, 611, 612, 613, 619, 625, 626, 629, 630</b>		
<b>"M" and "P" Escutcheons</b>		
433F76	1-3/8" door	\$6.80
433F77	1-3/4" door	
433F78	2-1/4" door	
<b>"R" Escutcheon</b>		
439F33	1-3/8" door	\$6.80
439F34	1-3/4" door	
439F35	2-1/4" door	
<b>"T" Escutcheon (spanner head)</b>		
445F31-8	1-3/4" door	\$12.00
498F92-8	2" to 2-1/4" door	
<b>THUMBTURN LEVER PACKET</b>		
<b>605, 606, 611, 612, 613, 625, 626, 629, 630</b>		
519F09	for 1-3/8" door	\$42.00
519F10	for 1-3/4" door	
519F11	for 2-1/4" door	
519F12	for up to 3" door	\$54.00
581F96	for up to 3-1/2" door	
696F39	Blank Plate	\$54.00
<b>ERGONOMIC THUMBTURN LEVER PACKET FOR SECTIONAL TRIM</b>		
<b>605, 606, 611, 612, 613, 619, 625, 626, 629, 630</b>		
707F57	for 1-3/8" door	\$60.00
707F58	for 1-3/4" to 2" doors	
707F59	for 2-1/4" door	
707F60	for up to 3" door	
706F70	for up to 4" door	\$60.00
<b>ERGONOMIC THUMBTURN KIT FOR ESCUTCHEON TRIM</b>		
<b>605, 606, 611, 612, 613, 619, 625, 626, 629, 630</b>		
711F002	for up to 4" door (must be field cut to size)	\$60.00
<b>WASHER FOR VANDAL RESISTANT TRIM</b>		
700F37-8	Washer	\$2.20
<b>RETAINING RING FOR VANDAL RESISTANT TRIM</b>		
700F16-8	Retaining ring	\$0.66
<b>LEVER SPINDLE SPRING FOR VANDAL RESISTANT TRIM</b>		
700F36-7	Lever spindle spring	\$0.90



<b>VINEYARD™ COLLECTION TRIM</b>					
PART NO.	DESCRIPTION	613E, 626	*605, *606, 619, 625		
<b>INSIDE LEVERS</b>					
692F632	Frascati LH/LHR	\$216.00	\$226.00		
692F642	Frascati RH/RHR				
692F682	Tuscany				
692F662	Zinfandel LH/LHR				
692F672	Zinfandel RH/RHR				
692F652	Merlot				
		\$200.00	\$210.00		
<b>OUTSIDE LEVERS</b>					
692F762	Frascati for 1 3/4" door LH/LHR	\$216.00	\$226.00		
692F752	Frascati for 1 3/4" door RH/RHR				
692F962	Tuscany for 1 3/4" door				
692F952	Zinfandel for 1 3/4" door LH/LHR				
692F942	Zinfandel for 1 3/4" door RH/RHR				
692F932	Merlot for 1 3/4" door				
		\$200.00	\$210.00		
<b>L ESCUTCHEON - CAST</b>					
<b>Blank</b>					
692F862	Inside	\$176.00	\$186.00		
<b>For Cylinder Only</b>					
694F322	Inside				
694F522	Outside				
<b>For Grip Only</b>					
694F312	Inside				
694F442	Outside				
<b>For Cylinder &amp; Grip</b>					
694F332	Inside				
694F562	Outside				
<b>For Thumbturn Lever Only</b>					
694F352	Inside				
<b>For Thumbturn Lever &amp; Grip</b>					
694F392	Inside				
<b>For Grip &amp; Emergency Key</b>					
694F482	Outside				
<b>For Cylinder, Grip &amp; Indicator</b>					
694F602	Outside				
<b>For Grip x Plug Only</b>					
694F682	Outside				
<b>For Grip x Plug Only x Indicator</b>					
694F722	Outside				
<b>ROSES (PAIR)</b>					
694F802	G-Rose (All functions)			\$200.00	\$210.00

†Sold only in multiples of the number indicated. Price is each.

Notes: 1. Kit contains lock parts only. Order knobs, spindles, escutcheons, cylinders and collars separately.  
2. Kit contains armored front, specify finish.

# CL3300 Cylindrical Lock Series

## Extra Heavy-Duty Lever Lockset

### LOCKSET PARTS

PART NO.	DESCRIPTION	LIST PRICE	PART NO.	DESCRIPTION	LIST PRICE
<b>CHASSIS ASSEMBLY STANDARD</b>			<b>LEVERS 1-3/4" TO 2" DOORS (Cont'd)</b>		
785F008	for CL3310	\$142.00	596F825	NZD - SFIC (Best®) cylinder	\$95.00
785F118 Fin	for CL3320, CL3361	\$150.00	714F425	NZD - SFIC (Best®) cylinder CL3352 inside	
785F138 Fin	CL3320TO	\$156.00	690F975	NZD - Schlage® LFIC cylinder	
785F078 Fin	for CL3329	\$178.00	714F455	NZD - Schlage® LFIC cylinder CL3352 inside	\$91.00
785F068	for CL3332	\$172.00	563F885	AZD - Plain	
785F028 Fin	for CL3340	\$168.00	563F895	AZD - Cylinder or button	
785F038	for CL3340NT	\$152.00	714F005	AZD - CL3352 inside	\$93.00
785F018 Fin	CL3351, CL3357	\$152.00	563F905	AZD - Emergency key hole	
785F048	for CL3352, CL3355	\$178.00	585F705	AZD - LFIC cylinder - 6 pin	
785F148	for CL3359	\$152.00	714F305	AZD - LFIC cylinder - 6 pin CL3352 inside	\$93.00
785F058	for CL3362	\$172.00	600F425	AZD - LFIC cylinder - 7 pin	
785F088	for CL3372	\$172.00	714F315	AZD - LFIC cylinder - 7 pin CL3352 inside	
785F158 Fin	CL3375	\$172.00	695F075	AZD - Sargent® cylinder	\$93.00
785F088	for CL3380, CL3390	\$140.00	714F035	AZD - Sargent® cylinder CL3352 inside	
785F108	for CL3381, CL3391	\$162.00	578F435	NZD - Sargent cylinder	
785F378 Fin	CL3393	\$172.00	714F125	NZD - Sargent cylinder CL3352 inside	\$91.00
785F188	CL33903-12AD	\$428.36	799F505	PZD - plain	
785F168	CL33903-24AD	\$428.36	799F515	PZD - Cylinder or button	
785F198	CL33905-12AD	\$428.36	799F535	PZD - CL3352 inside	\$93.00
785F178	CL33905-24AD	\$428.36	799F525	PZD - Emergency key hole	
<b>CHASSIS ASSEMBLY, LFIC</b>			799F565	PZD - LFIC Cylinder - 6 pin	
785F298	for CL3361	\$170.00	799F575	PZD - LFIC Cylinder - 6 pin CL3352 inside	\$93.00
785F268 Fin	for CL3329	\$188.00	799F585	PZD - LFIC Cylinder - 7 pin	
785F258	for CL3332	\$182.00	799F595	PZD - LFIC Cylinder - 7 pin CL3352 inside	
785F218 Fin	for CL3351, CL3357, CL3393	\$166.00	799F805	PZD - SFIC (Best®) cylinder	\$95.00
785F238	for CL3352	\$182.00	799F815	PZD - SFIC (Best®) cylinder CL3352 inside	
785F228	for CL3355	\$166.00	799F825	PZD - Schlage® LFIC cylinder	
785F308	for CL3359	\$166.00	799F835	PZD - Schlage® LFIC cylinder CL3352 inside	\$93.00
785F248	for CL3362	\$182.00	799F545	PZD - Sargent® cylinder	
785F278	for CL3372	\$175.00	799F555	PZD - Sargent® cylinder CL3352 inside	
785F318 Fin	CL3375	\$175.00	712F205	FZD - LH plain	\$93.00
785F288	for CL3381, CL3391	\$174.00	712F215	FZD - LH cylinder or button	
785F388 Fin	CL3393	\$175.00	712F385	FZD - LH CL3352 inside	
785F348	CL33903-12AD	\$438.36	712F225	FZD - LH emergency key hole	\$95.00
785F328	CL33903-24AD	\$438.36	715F245	FZD - LH LFIC cylinder - 6 pin	
785F358	CL33905-12AD	\$438.36	712F405	FZD - LH LFIC cylinder - 6 pin CL3352 inside	
785F338	CL33905-24AD	\$438.36	714F255	FZD - LH LFIC cylinder - 7 pin	\$97.00
<b>CYLINDER PARTS</b>			712F415	FZD - LH LFIC cylinder - 7 pin CL3352 inside	
622F308	Tailpiece 6-pin	\$1.80	712F265	FZD - LH SFIC (Best®) cylinder	
682F298	Tailpiece 7-pin	\$1.70	712F425	FZD - LH SFIC (Best®) cylinder CL3352 inside	\$95.00
631F248	Corbin Russwin LFIC core kit	\$5.00	712F275	FZD - LH Schlage® LFIC cylinder	
682F958	SFIC (Best®) tailpiece kit	\$5.00	712F435	FZD - LH Schlage® LFIC cylinder CL3352 inside	
682F969	Sargent® tailpiece kit	\$16.00	712F235	FZD - LH Sargent® cylinder	\$93.00
697F942	Schlage® LFIC tailpiece kit	\$21.00	712F395	FZD - LH Sargent® cylinder CL3352 inside	
682F398	Schlage® tailpiece kit	\$6.10	712F505	FZD - RH plain	
<b>HOUSING ASSEMBLIES</b>			712F515	FZD - RH cylinder or button	\$97.00
783F208	Spring housing O/S	\$30.00	712F685	FZD - RH CL3352 inside	
783F308	Spring housing I/S 1 3/4" -2"	\$26.50	712F525	FZD - RH emergency key hole	
783F408	Spring housing I/S 2 1/4"	\$26.50	712F545	FZD - RH LFIC cylinder - 6 pin	\$95.00
686F858	Dummy housing I/S	\$99.00	712F705	FZD - RH LFIC cylinder - 6 pin CL3352 inside	
686F868	Dummy housing O/S	\$87.00	712F555	FZD - RH LFIC cylinder - 7 pin	
<b>LEVERS 1-3/4" TO 2" DOORS</b>			712F715	FZD - RH LFIC cylinder - 7 pin CL3352 inside	\$97.00
563F945	NZD - Plain	\$91.00	712F565	FZD - RH SFIC (Best®) cylinder	
563F955	NZD - Cylinder button		712F725	FZD - RH SFIC (Best®) cylinder CL3352 inside	
714F065	NZD - CL3352 inside		712F575	FZD Schlage® LFIC cylinder	
563F965	NZD - Emergency key hole	\$93.00	712F735	FZD Schlage® LFIC cylinder CL3352 inside	
585F715	NZD - LFIC cylinder - 6 pin		712F535	FDZ - RH Sargent® cylinder	
714F365	NZD - LFIC cylinder - 6 pin CL3352 inside		712F695	FDZ - RH Sargent® cylinder CL3352 inside	
600F415	NZD - LFIC cylinder - 7 pin	\$95.00			
714F375	NZD - LFIC cylinder - 7 pin CL3352 inside				

### LOCKSET PARTS

PART NO.	DESCRIPTION	LIST PRICE	PART NO.	DESCRIPTION	LIST PRICE
<b>LEVERS 2 1/4" DOORS</b>			<b>LEVERS 2 1/4" DOORS (Cont'd)</b>		
684F825	NZD - Plain	\$91.00	712F335	FZD - LH Sargent® cylinder	\$95.00
684F835	NZD - Cylinder or button		712F455	FZD - LH Sargent® cylinder CL3352 inside	
714F215	NZD - CL3352 inside		712F605	FZD - RH plain	\$93.00
684F845	NZD - Emergency key hole		712F615	FZD - RH cylinder or button	
684F865	NZD - LFIC cylinder - 6 pin	712F745	FZD - RH CL3352 inside		
714F545	NZD - LFIC cylinder - 6 pin CL3352 inside	712F625	FZD - RH emergency key hole	\$95.00	
685F875	NZD - LFIC cylinder - 7 pin	712F645	FZD - RH LFIC cylinder - 6 pin		
714F555	NZD - LFIC cylinder - 7 pin CL3352 inside	712F765	FZD - RH LFIC cylinder - 6 pin CL3352 inside		
684F885	NZD - SFIC (Best®) cylinder	712F655	FZD - RH LFIC cylinder - 7 pin		\$97.00
714F605	NZD - SFIC (Best®) cylinder CL3352 inside	712F775	FZD - RH LFIC cylinder - 7 pin CL3352 inside		
690F985	NZD - Schlage® LFIC cylinder	712F665	FZD - RH SFIC (Best®) cylinder		
714F635	NZD - Schlage® LFIC cylinder CL3352 inside	712F785	FZD - RH SFIC (Best®) cylinder CL3352 inside	\$95.00	
684F855	NZD - Sargent® cylinder	712F675	FZD - RH Schlage® LFIC cylinder		
714F275	NZD - Sargent® cylinder CL3352 inside	712F795	FZD - RH Schlage® LFIC cylinder CL3352 inside		
684F775	AZD - Plain	712F635	FZD - RH Sargent® cylinder		\$97.00
684F785	AZD - Cylinder or button	712F755	FZD - RH Sargent® cylinder CL3352 inside		
714F155	AZD - CL3352 inside	<b>EMERGENCY RELEASE TOOL</b>			
684F795	AZD - Emergency key hole	596F548	Emergency Release Tool (CL3320)	\$1.00	
684F805	AZD - LFIC cylinder - 6 pin	601F829	Emergency Release Label (CL3320)		
714F485	AZD - LFIC cylinder - 6 pin CL3352 inside	<b>LEVER INSERT</b>			
684F815	AZD - LFIC cylinder - 7 pin	585F729	Lever insert (black)	\$0.24	
714F495	AZD - LFIC cylinder - 7 pin CL3352 inside	<b>LATCH ASSEMBLY</b>			
697F995	AZD - Sargent® cylinder	<b>2 3/4" Backsets</b>			
714F185	AZD - Sargent® cylinder CL3352 inside	586F16	Plain, square corner	\$65.00	
799F605	PZD - Plain	596F66	Plain, round corner		
799F615	PZD - Cylinder or button	586F17	Deadlocking square corner	\$73.00	
799F635	PZD - CL3352 inside	596F67	Deadlocking round corner		
799F625	PZD - Emergency key hole	586F18	Throw-Off square corner		
799F665	PZD - LFIC cylinder - 6 pin	596F68	Throw-Off round corner		
799F675	PZD - LFIC cylinder - 6 pin CL3352 inside	601F69	3/4" Through deadlocking fire latch square corner	\$96.00	
799F685	PZD - LFIC cylinder - 7 pin	<b>3 3/4" Backsets</b>			
799F695	PZD - LFIC cylinder - 7 pin CL3352 inside	586F80	Plain, square corner	\$124.00	
799F845	PZD - SFIC (Best®) cylinder	586F86	Plain, round corner		
799F855	PZD - SFIC (Best®) cylinder CL3352 inside	586F81	Deadlocking square corner	\$132.00	
799F865	PZD - Schlage® LFIC cylinder	586F87	Deadlocking round corner		
799F875	PZD - Schlage LFIC cylinder CL3352 inside	586F82	Throw-Off square corner		
799F645	PZD - Sargent® cylinder	586F88	Throw-Off round corner		
799F655	PZD - Sargent® cylinder CL3352 inside	<b>5" Backsets</b>			
712F305	FZD - LH plain	598F20	Plain, square corner	\$91.00	
712F315	FZD - LH cylinder or botton	601F24	Plain, round corner		
712F445	FZD - LH CL3352 inside	598F21	Deadlocking square corner	\$99.00	
712F325	FZD - LH emergency key hole	601F25	Deadlocking round corner		
712F345	FZD - LH LFIC cylinder - 6 pin	598F22	Throw-Off square corner		
712F465	FZD - LH LFIC cylinder - 6 pin CL3352 inside	601F26	Throw-Off round corner		
712F355	FZD - LH LFIC cylinder - 7 pin				
712F475	FZD - LH LFIC cylinder - 7 pin CL3352 inside				
712F365	FZD - LH SFIC (Best®) cylinder				
712F485	FZD - LH SFIC (Best®) cylinder CL3352 inside				
712F375	FZD - LH Schlage® LFIC cylinder				
712F495	FZD - LH Schlage® LFIC cylinder CL3352 inside				

# CL3300 Cylindrical Lock Series Extra Heavy-Duty Lever Lockset

## LOCKSET PARTS

PART NO.	DESCRIPTION	LIST PRICE
<b>LATCH &amp; STRIKE SCREW PACKS</b>		
604F228 Fin	Latch & ANSI (4 7/8") strike - phillips head	\$4.30
604F238 Fin	Latch & ANSI (4 7/8") strike - spanner head	\$12.00
604F248 Fin	Latch & ANSI (4 7/8") strike - Torx head	\$12.00
604F268 Fin	Latch & T (2 3/4") strike - phillips head	\$4.20
604F278 Fin	Latch & T (2 3/4") strike - spanner head	\$12.00
604F288 Fin	Latch & T (2 3/4") strike - Torx head	\$12.00
480F688 Fin	Rabbetted Strike - phillips head	\$4.30
596F618 Fin	Rabbetted Strike - spanner head	\$12.00
596F628 Fin	Rabbetted Strike - Torx head	\$12.00
<b>MOUNTING SCREW PACKS</b>		
682F608	1 3/4" - 2" doors (pre June 2004)	\$4.90
710F658	1 3/4" - 2" doors (after June 2004)	
682F618	Over 2" (pre June 2004)	\$9.00
710F668	Over 2" (after June 2004)	
682F628	CL3380, CL3381 1 3/4" - 2" doors	\$4.90
682F638	CL3380, CL3381 over 2" doors	\$9.00
682F64 Fin	CL3390, CL3391 1 3/4" - 2" phillips head	\$6.90
682F67 Fin	CL3390, CL3391 1 3/4" - 2" spanner head	\$12.00
682F68 Fin	CL3390, CL3391 1 3/4" - 2" Torx head	\$12.00
682F65 Fin	CL3390, CL3391 over 2" phillips head	\$38.00
682F86 Fin	CL3390, CL3391 over 2" spanner head	\$41.00
682F87 Fin	CL3390, CL3391 over 2" Torx head	\$43.00
684F44 Fin	CL3350 Half Dummy Trim - phillips head	\$9.00
684F45 Fin	CL3350 Half Dummy Trim - spanner head	\$41.00
684F46 Fin	CL3350 Half Dummy Trim - Torx head	\$43.00
684F528	CL3370 Half Dummy Trim	\$4.90
<b>BUTTONS</b>		
585F76 Fin	Turnbutton CL3351	\$18.00
585F77 Fin	Pushbutton CL3320, CL3320H, CL3320TO, CL3340, CL3361, CL3375	\$16.00
585F78 Fin	Hotel button CL3329	
585F79 Fin	Slotted button CL3393	

PART NO.	DESCRIPTION	LIST PRICE
<b>STRIKE BOX</b>		
120F768	4-7/8" ANSI strike box	\$3.30
<b>FRONT PLATE RABBETTED STRIKE</b>		
315F93 Fin*	606, 612, 619, 626, 605, 611, 613, 625	\$51.00
<b>RABBETTED STRIKE</b>		
315F94 Fin*	606, 612, 619, 626, 605, 611, 613, 625	\$51.00
601F283 Fin*	Rabbetted Strike & Front	\$82.00
<b>ROSES</b>		
678F25 Fin	Rose	\$24.00
598F59 Fin	Blank Rose	\$26.00
710F618	Rose liner I/S 1 3/4" - 2" after June 2004	\$4.00
710F628	Rose liner I/S over 2" after June 2004	\$4.70
678F248	Rose liner O/S 1 3/4" - 2"	
678F498	Rose liner O/S over 2"	\$5.40
586F51 Fin	Thumbturn ass'y 1 3/4" - 2"	\$79.00
686F88 Fin	Thumbturn ass'y over 2"	
682F788	Rose liner CL3380, CL3381	\$22.00
<b>STRIKES - 4 7/8" ANSI CURVED LIP</b>		
217L13M016	1" Lip Length	\$17.80
217L13M018	1 1/8" Lip Length	
217L13M020	1 1/4" Lip Length	
217L13M022	1 3/8" Lip Length	
217L13M024	1 1/2" Lip Length	
217L13M028	1 3/4" Lip Length	\$18.80
217L13M032	2" Lip Length	
217L13M036	2 1/4" Lip Length	
217L13M040	2 1/2" Lip Length	
217L13M044	2 3/4" Lip Length	
217L13M048	3" Lip Length	
<b>STRIKES - 2 3/4" T- CURVED LIP</b>		
586L19M016	1" Lip Length	\$18.80
586L19M018	1 1/8" Lip Length	
586L19M020	1 1/4" Lip Length	
586L19M022	1 3/8" Lip Length	
586L19M024	1 1/2" Lip Length	
586L19M028	1 3/4" Lip Length	\$20.80
586L19M032	2" Lip Length	
586L19M036	2 1/4" Lip Length	
586L19M040	2 1/2" Lip Length	
586L19M044	2 3/4" Lip Length	
586L19M048	3" Lip Length	
<b>STRIKE BOX</b>		
120F768	4 7/8" ANSI strike box	\$3.30
<b>RABBETTED STRIKE</b>		
<b>Front Plate Rabbetted Strike</b>		
315F93 Fin	606, 612, 619, 626	\$51.00
	605, 611, 613, 625	\$53.00
<b>Rabbetted Strike</b>		
315F94 Fin	606, 612, 619, 626	\$51.00
	605, 611, 613, 625	\$53.00
601F283 Fin	Rabbetted Strike & Front	\$82.00
<b>EMERGENCY RELEASE TOOL</b>		
596F548	Emergency Release Tool (CL3320)	\$1.00
601F829	Emergency Release Label (CL3320)	

## ASSA ABLOY

PART NO.	DESCRIPTION	LIST PRICE
<b>BUTTONS</b>		<b>ALL FINISH</b>
585F762	CL3551 (Turn Button)	\$18.00
585F772	CL3520, 61 (Push Button)	\$16.00
<b>CASSETTE HOUSING O/S</b>		<b>NO FINISH</b>
796F378	Standard	\$26.50
686F858	CL3550, 70	\$99.00
<b>CASSETTE HOUSING I/S</b>		<b>NO FINISH</b>
796F408	CL3580, 81	\$19.00
686F868	CL3570	\$87.00
796F398	Standard I/S Spring Housing	\$11.00
<b>CHASSIS ASSEMBLY, STANDARD</b>		<b>NO FINISH</b>
796F208	CL3510	\$74.00
796F218	CL3520, 61	\$100.00
796F248	CL3580	\$102.00
796F228	CL3551, 57	\$102.00
796F238	CL3555	\$106.00
796F258	CL3581	\$121.00
796F268	CL3582	\$145.00
<b>CHASSIS ASSEMBLY, LFIC</b>		<b>NO FINISH</b>
796F318	CL3561	\$106.00
796F328	CL3551, 57	\$108.00
796F338	CL3855	\$112.00
796F358	CL3581	\$127.00
796F368	CL3582	\$151.00
<b>CYLINDER PARTS</b>		<b>NO FINISH</b>
622F308	Tailpiece 6-Pin	\$1.80
682F298	Tailpiece 7-pin	\$1.70
682F398	M06 - Schlage® tailpiece kit	\$6.10
682F969	M09 - Sargent® tailpiece kit	\$16.00
682F918	C6/C7 - LFIC tailpiece kit	\$5.00
682F958	M08 - small format IC kit	\$5.00
691F292	M69 - Schlage® IC tailpiece kit	\$21.00
<b>HOUSING ASSEMBLIES</b>		
796F388	Housing Assembly, I/S, D134	\$19.00
796F398	Housing Assembly, I/S, D138	\$14.30

## CL3500 Cylindrical Lock Series Heavy-Duty Lever Lockset

PART NO.	DESCRIPTION	LIST PRICE
<b>LATCHES</b>		<b>ALL FINISH</b>
<b>Deadlatches</b>		
599F92	2-3/8" backset x 1" front	\$57.00
599F95	2-3/8" backset x 1" round corner	
599F98	2-3/8" backset x 1-1/8" front	
600F01	2-3/8" backset x 1-1/8" round corner	
600F04	2-3/4" backset x 1" front	
600F07	2-3/4" backset x 1" round corner	
600F10	2-3/4" backset x 1-1/8" front	\$81.00
600F13	2-3/4" backset x 1-1/8" round corner	
600F63	3-3/4" backset x 1-1/8" front	
600F66	3-3/4" backset x 1-1/8" round corner	\$83.00
600F69	5" backset x 1-1/8" front	
600F72	5" backset x 1-1/8" round corner	
<b>Deadlatches with release (CL3620 &amp; 29)</b>		
599F93	2-3/8" backset x 1" front	\$57.00
599F96	2-3/8" backset x 1" round corner	
599F99	2-3/8" backset x 1-1/8" front	
600F02	2-3/8" backset x 1-1/8" round corner	
600F05	2-3/4" backset x 1" front	
600F08	2-3/4" backset x 1" round corner	
600F11	2-3/4" backset x 1-1/8" front	\$81.00
600F14	2-3/4" backset x 1-1/8" round corner	
600F64	3 3/4" backset x 1 1/8" front	
600F67	3-3/4" backset x 1-1/8" round corner	\$83.00
600F70	5" backset x 1 1/8" front	
600F73	5" backset x 1-1/8" round corner	
<b>Spring Latches (CL3610)</b>		
599F91	2-3/8" backset x 1" front	\$51.00
599F94	2-3/8" backset x 1" round corner	
599F97	2-3/8" backset x 1-1/8" front	
600F00	2-3/8" backset x 1-1/8" round corner	
600F03	2-3/4" backset x 1" front	
600F06	2-3/4" backset x 1" round corner	
600F09	2-3/4" backset x 1-1/8" front	\$71.00
600F12	2-3/4" backset x 1-1/8" round corner	
600F62	3-3/4" backset x 1-1/8" front	
600F65	3-3/4" backset x 1-1/8" round corner	\$73.00
600F68	5" backset x 1-1/8" front	
600F71	5" backset x 1-1/8" round corner	

## CL3500 Cylindrical Lock Series Heavy-Duty Lever Lockset

PART NO.	DESCRIPTION	LIST PRICE
<b>LEVERS</b>		<b>ALL FINISH</b>
598F815	AZD x plain	\$76.00
598F825	AZD x cylinder or button	\$76.00
598F835	AZD x emergency hole	\$76.00
598F905	AZD x C6 LFIC 6-pin	\$78.00
599F275	AZD x C7 LFIC 7-pin	\$78.00
797F845	NZD x plain	\$76.00
797F855	NZD x cylinder or button	\$76.00
797F865	NZD x emergency hole	\$76.00
797F875	NZD x M09 Sargent® cylinder	\$78.00
797F915	NZD x C6 LFIC 6-pin	\$78.00
797F925	NZD x C7 LFIC 7-pin	\$78.00
797F935	NZD x M69 Schlage LFIC	\$80.00
797F945	NZD x M08 small format LFIC	\$80.00
798F115	PZD x plain	\$76.00
798F125	PZD x cylinder or button	
798F135	PZD x emergency hole	
798F145	PZD x M09 Sargent® cylinder	\$78.00
798F155	PZD x C6 LFIC 6-pin	
798F165	PZD x C7 LFIC 7-pin	
798F175	PZD x M69 Schlage® LFIC	\$80.00
798F185	PZD x M08 small format LFIC	
<b>LEVER INSERT</b>		<b>ALL FINISH</b>
598F809	Standard	\$0.20
<b>MOUNTING SCREW PACK</b>		
796F118	Standard	\$3.50
797F828	Standard - CL3580, 81	\$11.00
684F448	CL3550 (ALL FINISH)	\$9.00
684F528	CL3570	\$4.90

PART NO.	DESCRIPTION	LIST PRICE
<b>ROSES</b>		<b>ALL FINISH</b>
678F252	Standard	\$24.00
598F592	Blank - CL3580, 81	\$26.00
<b>ROSE LINER O/S</b>		<b>NO FINISH</b>
678F248	Standard	\$4.70
682F788	CL3580, 81	\$22.00
<b>SCREW PACKS FOR LATCH &amp; STRIKE</b>		
604F228	For Latch & ANSI Strike	\$4.30
604F268	For Latch & (T strike)	\$4.20
<b>STRIKES</b>		<b>NO FINISH</b>
<b>ANSI Curved Lip Strike</b>		
217L13M016	1" Lip Length	\$17.80
217L13M018	1-1/8" Lip Length	
217L13M020	1-1/4" Lip Length	
217L13M022	1-3/8" Lip Length	
217L13M024	1-1/2" Lip Length	
217L13M028	1-3/4" Lip Length	\$18.80
217L13M032	2" Lip Length	
217L13M036	2-1/4" Lip Length	
217L13M040	2-1/2" Lip Length	
217L13M044	2-3/4" Lip Length	
217L13M048	3" Lip Length	
<b>STRIKE BOX</b>		<b>NO FINISH</b>
120F768	M17 - ANSI wrought	\$3.30
025F858	Curved lip (T strike)	\$2.60

## CL3700 Cylindrical Lock Series Grade 2 Key-In-Lever Locksets

<b>CL3700 SERIES</b>			<b>CL3700 SERIES</b>		
PART NO.	DESCRIPTION	LIST PRICE	PART NO.	DESCRIPTION	LIST PRICE
<b>UL LATCH ASSEMBLY</b>		<b>605, 612, 613, 626</b>	<b>STRIKES</b>		
<b>2-3/4" BACKSET</b>			687F60	Curved lip "T"	\$6.00
687F63	2-1/4" x 1-1/8" square corner front	\$19.00	687F61	Full lip square corner	\$6.40
<b>2-3/8" BACKSET</b>			687F62	Full lip radius corner	
687F64	2-1/4" x 1" square corner front	\$19.00	687F94	Dust box for 687F60 strike	\$3.90
687F65	2-1/4" x 1" x 1/4" rounded corner front				
Note: All CL3700 latches are deadlocking			687F95	Dust box for 687F61, 687F62 strikes	\$17.80
<b>LATCH SLEEVE</b>			217L13	ANSI curved lip	
687F71	1" Latch sleeve	\$0.70	120F76-8	Dust box for 679L25 strike	\$3.60
			<b>MISCELLANEOUS</b>		
			687F96	Screw pack	\$5.00
			687F66	UL Fire cup	\$7.60
			679F818	Emergency key	\$2.10



## CL3800 PARTS

PART NO.	DESCRIPTION	LIST PRICE
<b>BUTTONS</b>		<b>ALL FINISH</b>
585F762	CL3851 (Turn Button)	\$18.00
585F772	CL3820, 40, 61 (Push Button)	\$16.00
585F792	CL3893 (Slotted Turn Button)	\$16.00
<b>CASSETTE HOUSING O/S</b>		<b>NO FINISH</b>
796F378	Standard	\$26.50
686F858	CL3850, 70	\$99.00
<b>CASSETTE HOUSING I/S</b>		<b>NO FINISH</b>
796F398	Standard - 1-3/8" to 1-7/8" door	\$14.30
797F808	D214 - 2" to 2-1/4" door	\$19.00
796F408	CL3880, 81	\$19.00
686F868	CL3870	\$87.00
<b>CHASSIS ASSEMBLY, STANDARD</b>		<b>NO FINISH</b>
797F618	CL3810	\$45.00
797F628	CL3820, 61	\$51.00
797F648	CL3840	\$51.00
797F788	CL3840NT	\$51.00
797F658	CL3880, 90	\$45.00
797F668	CL3851, 57, 93	\$55.00
797F688	CL3855	\$55.00
797F708	CL3881, 91	\$55.00
797F728	CL3832	\$59.00
797F748	CL3862	\$59.00
797F768	CL3872	\$59.00
<b>CHASSIS ASSEMBLY, IC</b>		<b>NO FINISH</b>
797F638	CL3861	\$53.00
797F678	CL3851, 57, 93	\$57.00
797F698	CL3855	\$57.00
797F718	CL3881, 91	\$57.00
797F738	CL3832	\$61.00
797F758	CL3862	\$61.00
797F778	CL3872	\$61.00

PART NO.	DESCRIPTION	LIST PRICE
<b>CYLINDER PARTS</b>		<b>NO FINISH</b>
622F308	Tailpiece 6-Pin	\$1.80
682F298	Tailpiece 7-pin	\$1.70
682F969	M06 - Schlage® tailpiece kit	\$16.00
682F969	M09 - SARGENT® tailpiece kit	\$16.00
682F918	C6/C7 - LFIC tailpiece kit	\$5.00
682F958	M08 - small format LFIC kit	\$5.00
697F942	M69 - Schlage® LFIC tailpiece kit	\$21.00
<b>LATCHES</b>		<b>ALL FINISH</b>
<b>Deadlatches</b>		
599F92	2-3/8" backset x 1" front	\$57.00
599F95	2-3/8" backset x 1" round corner	
599F98	2-3/8" backset x 1-1/8" front	
600F01	2-3/8" backset x 1-1/8" round corner	
600F04	2-3/4" backset x 1" front	
600F07	2-3/4" backset x 1" round corner	
600F10	2-3/4" backset x 1-1/8" front	
600F13	2-3/4" backset x 1-1/8" round corner	\$81.00
600F63	3-3/4" backset x 1-1/8" front	
600F66	3-3/4" backset x 1-1/8" round corner	\$81.00
600F69	5" backset x 1-1/8" front	\$83.00
600F72	5" backset x 1-1/8" round corner	\$83.00
<b>Deadlatches with release (CL3620 &amp; 29)</b>		
599F93	2-3/8" backset x 1" front	\$57.00
599F96	2-3/8" backset x 1" round corner	
599F99	2-3/8" backset x 1-1/8" front	
600F02	2-3/8" backset x 1-1/8" round corner	
600F05	2-3/4" backset x 1" front	
600F08	2-3/4" backset x 1" round corner	
600F11	2-3/4" backset x 1-1/8" front	
600F14	2-3/4" backset x 1-1/8" round corner	\$81.00
600F64	3 3/4" backset x 1 1/8" front	
600F67	3-3/4" backset x 1-1/8" round corner	\$81.00
600F70	5" backset x 1 1/8" front	\$83.00
600F73	5" backset x 1-1/8" round corner	\$83.00
<b>Spring Latches (CL3610)</b>		
599F91	2-3/8" backset x 1" front	\$51.00
599F94	2-3/8" backset x 1" round corner	
599F97	2-3/8" backset x 1-1/8" front	
600F00	2-3/8" backset x 1-1/8" round corner	
600F03	2-3/4" backset x 1" front	
600F06	2-3/4" backset x 1" round corner	
600F09	2-3/4" backset x 1-1/8" front	
600F12	2-3/4" backset x 1-1/8" round corner	\$71.00
600F62	3-3/4" backset x 1-1/8" front	
600F65	3-3/4" backset x 1-1/8" round corner	\$71.00
600F68	5" backset x 1-1/8" front	\$73.00
600F71	5" backset x 1-1/8" round corner	\$73.00

# CL3800 Cylindrical Lock Series Grade 2 Key-In-Lever Lockset

## CL3800 PARTS

PART NO.	DESCRIPTION	LIST PRICE
<b>LEVERS 1-3/8" to 1-7/8" Doors</b>		<b>ALL FINISH</b>
598F815	AZD x plain	\$76.00
598F825	AZD x cylinder or button	\$76.00
598F835	AZD x emergency hole	\$76.00
598F905	AZD x C6 LFIC 6-pin	\$78.00
599F275	AZD x C7 LFIC 7-pin	\$78.00
797F845	NZD x plain	\$76.00
797F855	NZD x cylinder or button	\$76.00
797F865	NZD x emergency hole	\$76.00
797F875	NZD x M09 Sargent® cylinder	\$78.00
797F915	NZD x C6 LFIC 6-pin	\$78.00
797F925	NZD x C7 LFIC 7-pin	\$78.00
797F935	NZD x M69 Schlage LFIC	\$80.00
797F945	NZD x M08 small format LFIC	\$80.00
798F115	PZD x plain	\$76.00
798F125	PZD x cylinder or button	\$76.00
798F135	PZD x emergency hole	\$76.00
798F145	PZD x M09 Sargent® cylinder	\$78.00
798F155	PZD x C6 LFIC 6-pin	\$78.00
798F165	PZD x C7 LFIC 7-pin	\$78.00
798F175	PZD x M69 Schlage® LFIC	\$80.00
798F185	PZD x M08 small format LFIC	\$80.00
<b>LEVERS 2" to 2-1/4" Doors - D214</b>		<b>ALL FINISH</b>
684F775	AZD x plain	\$91.00
684F785	AZD x cylinder or button	\$91.00
684F795	AZD x emergency hole	\$91.00
684F805	AZD x C6 LFIC 6-pin	\$93.00
684F815	AZD x C7 LFIC 7-pin	\$93.00
684F825	NZD x plain	\$91.00
684F835	NZD x cylinder or button	\$91.00
684F845	NZD x emergency hole	\$91.00
684F855	NZD x M09 Sargent® cylinder	\$93.00
684F865	NZD x C6 LFIC 6-pin	\$93.00
684F875	NZD x C7 LFIC 7-pin	\$93.00
690F985	NZD x M69 Schlage® LFIC	\$95.00
684F885	NZD x M08 small format LFIC	\$95.00
798F215	PZD x plain	\$91.00
798F225	PZD x cylinder or button	\$91.00
798F235	PZD x emergency hole	\$91.00
798F245	PZD x M09 Sargent® cylinder	\$93.00
798F255	PZD x C6 LFIC 6-pin	\$93.00
798F265	PZD x C7 LFIC 7-pin	\$93.00
798F275	PZD x M69 Schlage® LFIC	\$95.00
798F285	PZD x M08 small format LFIC	\$95.00

PART NO.	DESCRIPTION	LIST PRICE
<b>LEVER INSERT</b>		<b>ALL FINISH</b>
598F809	Standard - 1-3/8" to 1-7/8" door	\$0.20
684F539	D214 - 2" to 2-1/4" door	\$37.00
<b>MOUNTING SCREW PACK</b>		
796F118	Standard - 1-3/8" to 1-7/8" door	\$3.50
797F818	D214 - 2" to 2-1/4" door	\$14.00
797F828	Standard - CL3880, 81, 90, 91	\$11.00
797F838	D214 - CL3880, 81, 90, 91	\$14.00
684F448	CL3850 (ALL FINISH)	\$9.00
684F528	CL3870	\$4.90
<b>ROSES</b>		<b>ALL FINISH</b>
678F252	Standard	\$24.00
598F592	Blank - CL3880, 81	\$26.00
<b>ROSE LINER O/S</b>		<b>NO FINISH</b>
678F248	Standard - 1-3/8" to 1-7/8" door	\$4.70
678F498	D214 - 2" to 2-1/4" door	\$5.40
682F788	CL3880, 81	\$22.00
<b>SCREW PACK FOR LATCH &amp; STRIKE</b>		<b>ALL FINISH</b>
604F228	For Latch & ANSI Strike	\$4.30
604F268	For Latch & 'T' or Full Lip Strike	\$4.20
<b>STRIKES</b>		<b>ALL FINISH</b>
217L13	ANSI Curved Lip Strike	\$17.80
680L52	ANSI Curved Lip Blank Strike	
586L19	T-Strike	\$18.80
680L50	Full Lip Strike	\$12.80
680L51	Full Lip Strike 1/4" Radius (Available Only 1-1/4" Lip)	
<b>STRIKE BOX</b>		<b>NO FINISH</b>
120F768	M17 - ANSI wrought	\$3.30
025F858	Curved lip (T strike)	\$2.60
<b>THUMBTURNS</b>		<b>ALL FINISH</b>
586F512	Standard - CL3890, 91	\$79.00
686F882	D214 - CL3890, 91	\$79.00

\*Specify length and finish



## CK4200 Series Heavy-Duty Cylindrical Locksets

LATCHES		
PART NO.	DESCRIPTION	LIST PRICE
(2-1/4" X 1-1/8" SQUARE CORNER FRONT) 605, 613E, 630		
<b>- 2-3/4" Backset</b>		
486F83*	Plain, beveled	\$52.00
486F89*	Deadlocking, beveled	\$62.00

\*For M26 non-ferrous option, change "-8" to "-7". Contact factory for prices

## CK4300 Series Heavy-Duty Cylindrical Locksets

LOCKSET PARTS					
PART NO.	DESCRIPTION	LIST PRICE	PART NO.	DESCRIPTION	LIST PRICE
<b>SCREW PACKET</b> 605, 613E, 630			<b>STRIKE (Cont'd)</b>		
556F55-8	for CK4250 †Order 50-	\$1.30	<b>Curved Lip Box Strike</b>		
604F26-8	for curved lip strike	\$4.20	586L19M016	1" Lip Length	\$18.80
604F29-8	for curved lip strike x hex head (M04)	\$10.00	586L19M018	1-1/8" Lip Length	
604F27-8	for curved lip strike x spanner head (M02)	\$13.30	586L19M020	1-1/4" Lip Length	
604F28-8	for curved lip strike x Torx® head (M04)	\$12.00	586L19M022	1-3/8" Lip Length	
604F25-8	for hex head (M04)	\$3.90	586L19M024	1-1/2" Lip Length	
604F23-8	for spanner head (M02)	\$12.00	586L19M028	1-3/4" Lip Length	
480F68	for SR118	\$4.30	586L19M032	2" Lip Length	\$20.80
596F63-8	for SR118 & hex head (M04)	\$6.00	586L19M036	2-1/4" Lip Length	
596F61-8	for SR118 & spanner head (M02)	\$7.00	586L19M040	2-1/2" Lip Length	
596F62-8	for SR118 & Torx head (M04)		586L19M044	2-3/4" Lip Length	
604F22-8	standard	\$4.30	586L19M048	3" Lip Length	<b>No Finish</b>
604F24-8	for Torx head (M04)	\$12.00	<b>ANSI Wrought Strike Box</b>		
224F00-8*	Screw, Sems Assembly #8 -32 X 1-1/4" †Order 100-	\$0.40	120F76-8	ANSI Wrought Strike Box (M17)	\$3.60
<b>STRIKE</b> 605, 613E, 630					
<b>ANSI Curved Lip Strike</b>					
217L13M016	1" Lip Length	\$17.80			
217L13M018	1-1/8" Lip Length				
217L13M020	1-1/4" Lip Length				
217L13M022	1-3/8" Lip Length				
217L13M024	1-1/2" Lip Length				
217L13M028	1-3/4" Lip Length				
217L13M032	2" Lip Length	\$18.80			
217L13M036	2-1/4" Lip Length				
217L13M040	2-1/2" Lip Length				
217L13M044	2-3/4" Lip Length				
217L13M048	3" Lip Length				

†Sold only in multiples of the number indicated. Price is each.

# CK4400/CK4700 Series Standard Cylindrical Locksets

CK4400 SERIES		
PART NO.	DESCRIPTION	LIST PRICE
<b>STRIKES AND WROUGHT BOX</b>		
ANSI TYPE      605, 606, 611, 612, 613, 619, 625, 626		
240L53M016	1" Lip to Center	\$17.80
240L53M018	1-1/8" Lip to Center	
240L53M020	1-1/4" Lip to Center (standard)	
240L53M022	1-3/8" Lip to Center	
240L53M024	1-1/2" Lip to Center	
240L53M028	1-3/4" Lip to Center	\$18.80
240L53M032	2" Lip to Center	
240L53M036	2-1/4" Lip to Center	
240L53M040	2-1/2" Lip to center	
240L53M044	2-3/4" Lip to Center	
240L53M048	3" Lip to Center	
<b>ANSI WROUGHT STRIKE BOX      NO FINISH</b>		
120F76-8	Box only	\$3.60
<b>CURVED LIP BOX TYPE STRIKE      605, 606, 611, 612, 613, 619, 625, 626</b>		
586L19M016	1" Lip Length	\$18.80
586L19M018	1-1/8" Lip Length	
586L19M020	1-1/4" Lip Length	
586L19M022	1-3/8" Lip Length	
586L19M024	1-1/2" Lip Length	
586L19M028	1-3/4" Lip Length	\$20.80
586L19M032	2" Lip Length	
586L19M036	2-1/4" Lip Length	
586L19M040	2-1/2" Lip Length	
586L19M044	2-3/4" Lip Length	
586L19M048	3" Lip Length	
<b>ROSE      NO FINISH</b>		
579F11	Screw Packet & Strike Box	\$4.80
580F38-7	Rose Sub Assembly, stainless I/S	\$14.00
580F38	Rose Sub Assembly I/S	\$12.50
<b>LATCHES</b>		
574F29	2-3/8" deadlatch	\$33.00
574F30	2-3/8" deadlatch with throw-off	
574F55	2-3/4" deadlatch	
574F56	2-3/4" deadlatch with throw-off	
574F29 x574F25	3-3/4" deadlatch	\$59.00
574F30 x574F25	3-3/4" deadlatch with throw-off	
574F29 x574F26	5" deadlatch	
574F30 x574F26	5" deadlatch with throw-off	
<b>BACKSET EXTENDER KIT</b>		
574F25-8	Extender ONLY (No Latch Unit) - Must be added to 2-3/8" Latch Unit	\$26.00
574F26-8	Extender ONLY (No Latch Unit) - Must be added to 2-3/8" Latch Unit	

CK4700 SERIES		
PART NO.	DESCRIPTION	LIST PRICE
<b>UL LATCH ASSEMBLY      605, 612, 613, 626</b>		
<b>2-3/4" Backset</b>		
687F63	2-1/4" x 1-1/8" square corner front	\$19.00
<b>2-3/8" Backset</b>		
687F64	2-1/4" x 1" square corner front	\$19.00
687F65	2-1/4" x 1" x 1/4" rounded corner front	
Note: All CK4700 latches are deadlocking		
<b>LATCH SLEEVE</b>		
687F71	1" Latch sleeve	\$0.70
<b>STRIKES</b>		
687F60	Curved lip 'T'	\$6.00
687F61	Full lip square corner	\$6.40
687F62	Full lip radius corner	
687F94	Dust box for 687F60 strike	\$3.90
687F95	Dust box for 687F61, 687F62 strikes	
217L13	ANSI curved lip	\$17.80
120F76-8	Dust box for 679L25 strike	\$3.60
<b>MISCELLANEOUS</b>		
687F96	Screw pack	\$5.00
687F66	UL Fire cup	\$7.60

**LOCKSET PARTS**

PART NO.	DESCRIPTION	LIST PRICE	PART NO.	DESCRIPTION	LIST PRICE
<b>BUSHING</b>			<b>HUB SPACER</b>		
194F22-8	Bushing	NO FINISH	060F33-8	for UT5210, 61 †Order 50-	\$1.60
<b>BUTTON ASSEMBLY</b> 612,619,626 613,625			070F42-8	for UT5220 †Order 50-	\$1.60
022F80	for UT5220	\$23.00	070F43-8	for UT5220 †Order 50-	\$3.40
157F11	for UT5251	\$27.00	606F03-8	for UT5255	\$1.00
156F43	for UT5261	\$45.00	067F42-8	for UT5257	\$2.70
<b>CHASSIS COVER</b>			<b>LEVER</b> 612, 619, 626 613, 625		
138F88-8	Chassis Cover	NO FINISH	582F12-2	cyl/button LH	\$159.00
<b>CHASSIS</b> 612,619,626 613, 625			582F11-2	cyl/button RH	\$167.00
496F33	for UT5210	\$249.00	582F14-2	cyl/button LH tactile	\$167.00
496F34	for UT5220	\$257.00	582F13-2	cyl/button RH tactile	\$175.00
496F32	for UT5251, 55, 57, 72	\$263.00	489F89-2	LFIC 6-pin LH	\$165.00
198F71	for UT5261	\$263.00	489F88-2	LFIC 6-pin RH	\$173.00
381F30	for UT5282	\$263.00	549F36-2	LFIC 6-pin LH tactile	\$171.00
<b>CORE HOUSING</b>			549F35-2	LFIC 6-pin RH tactile	\$179.00
342F05-2	for 6-pin LFIC	\$10.00	613F23-2	LFIC 7-pin LH	\$165.00
442F95-2	for 7-pin LFIC		613F22-2	LFIC 7-pin RH	
613F35-2	for 6/7 pin Best-type LFIC	\$7.70	613F25-2	LFIC 7-pin LH tactile	\$173.00
<b>COUPLING</b>			613F24-2	LFIC 7-pin RH tactile	\$181.00
131F27-8	Coupling	NO FINISH	613F11-2	plain LH	\$159.00
<b>EMERGENCY KEY</b>			613F10-2	plain RH	
398F43-8	for UT5220	NO FINISH	613F15-2	plain LH tactile	\$167.00
<b>ESCUTCHEON</b> 612,619,626			613F14-2	plain RH tactile	\$175.00
144F33	for inside lever	\$94.00	613F13-2	priv. key hole LH	\$159.00
415F16	for outside knob		\$100.00	613F12-2	priv. key hole RH
144F34	for outside lever	\$104.00	613F17-2	priv. key hole LH tactile	\$175.00
605F90	for inside lever, lead lined	\$104.00	613F16-2	priv. key hole RH tactile	\$185.00
301F56-7	for outside lever, ext. lip 630 only	\$138.00	613F43-2	Best - type core prep LH	
<b>GRIP RETAINER</b>			613F42-2	Best - type core prep RH	
078F07-8	Grip Retainer †Order 50-	NO FINISH	<b>LEVER INSERT</b> NO FINISH		
<b>GRIP RETAINER RING</b>			613F02-9	Lever Insert †Order 50-	\$0.70
078F08-8	Grip Retainer Ring †Order 100-	NO FINISH	<b>LEVER SPRING ANCHOR</b> NO FINISH		
<b>HUB</b>			171F79-8	Lever Spring Anchor	\$14.00
060F42-8	for all but UT5255	NO FINISH	<b>PIN</b> NO FINISH		
071F62-8	for UT5210	\$2.70	019F13-7	Pin, Spindle Drive †Order 50-	\$1.20
081F77-8	for UT5220	\$4.00	156F83-7	Pin, UT5261 shank †Order 50-	\$0.50
147F07-8	for UT5251, 55, 72	\$4.30	286F50-7	Pin, UT5282 spindle †Order 50-	\$0.68
140F97-8	for UT5251, 57, 72	\$2.40			
071F63-8	for UT5257	\$2.20			
		\$2.30			

†Sold only in multiples of the number indicated. Price is each.

# UT5200 Series Pre-Assembled Unit Locksets

PART NO.	DESCRIPTION	LIST PRICE
<b>PLUG DRIVER NO FINISH</b>		
144F88-8	Plug Driver & Spindle Assembly UT5282	\$34.00
168F81-8	Plug Driver Assembly	\$23.00
144F29-8	Plug Driver UT5251, 57, 72	\$13.00
606F01-8	Plug Driver UT5255	\$12.00
145F32-8	Plug Driver UT5282	\$34.00
<b>RETAINING RING NO FINISH</b>		
251F19-8	Retaining Ring for UT5282 Spindle †Order 100-	\$0.15
<b>SCREW 612, 619, 626, 613, 625</b>		
480F70	Screw Pkt. (strike mount'g) †Order 20-	\$1.80
<b>No Finish</b>		
249F76-8	Screw, Fixed Escutcheon †Order 50-	\$0.40
092F78-9	Screw, Strike Adjustment (nylon) †Order 50-	\$0.68
<b>SHANK, LEVER NO FINISH</b>		
102F19-8	for UT5210, 57 outside	\$41.00
102F37-8	for UT5220 inside	
114F67-8	for UT5220 outside	
188F75-8	for UT5251, 57, 72 outside	
188F73-8	for UT5251, 72 inside	\$47.00
605F76-8	for UT5255 inside	\$43.00
605F77-8	for UT5255 outside	\$43.00
156F65-8	for UT5261 inside	\$77.00
156F64-8	for UT5261 outside	\$51.00
102F27-8	for UT5282 inside	\$43.00
287F60-8	for UT5282 outside	\$65.00
<b>SHANK RETAINER NO FINISH</b>		
219F80-8	for knob †Order 20-	\$1.10
242F50-8	for lever †Order 50-	\$0.70

† Sold only in multiples of the number indicated. Price is each.

PART NO.	DESCRIPTION	LIST PRICE	
<b>SPINDLE NO FINISH</b>			
201F18-8	for UT5220	\$6.80	
144F30-8	for UT5251, 72	\$6.30	
606F02-8	for UT5255	\$6.40	
335F98-8	for UT5257	\$9.80	
<b>SPRING NO FINISH</b>			
022F72-3	Spring, Button UT5220, 61 †Order 50-	\$0.25	
103F45-8	Spring, Lever Return LH	\$8.00	
103F44-8	Spring, Lever Return RH	\$8.00	
060F05-3	Spring, Shoe UT5220, 61 †Order 100-	\$0.32	
071F67-3	Spring, Spindle for UT5220 †Order 100-	\$0.26	
249F77-3	Spring, Spindle for UT5251, 55, 57, 72 †Order 100-	\$0.26	
261F11-8	Spring, Spindle for UT5282 †Order 100-	\$0.18	
<b>SPRING SEAT NO FINISH</b>			
019F11-7	Spring Seat	1.60	
<b>STRIKE 612, 626 613, 625</b>			
236L75M020	ANSI curved lip	\$17.80	\$19.80
610L44	ANSI straight lip		
610L43	ANSI straight lip for ext. esc.		
083L96M032	curved lip box, 2"		
083L96M036	curved lip box, 2-1/4"		
083L96M034	curved lip box, 2-1/8" (std)		
083L96M040	curved lip box, 2-1/2"		
083L96M048	curved lip box, 3"		
293L14	curved lip box for ext. lip esc.		
082L67	pairs of doors		
<b>THROUGHBOLT</b>			
222F85	Regular	\$4.60	\$4.30
223F29	Spanner head	\$4.30	\$3.70
<b>THROW MEMBER NO FINISH</b>			
320F44-2	for Best® style core	\$5.40	
342F03-2	for Corbin Russwin core	\$5.00	

## Padlocks and Deadlocks

<b>PADLOCKS</b>			
PART NO.	DESCRIPTION	LIST PRICE	SOLD IN MULT. OF
422L84-2144	Chain & clevis, 9" brass	\$18.00	1
422L84-8144	Chain & clevis, 9" steel	\$16.00	1
303F24-2	Pin chamber cap	\$0.50	100
242F48-2	Plug and shackle retainer screw	\$0.60	100
228F34-8	Plug retainer, oversize Spirol pin	\$0.40	100
244F64-7	Plug retainer, standard solid pin	\$1.28	20
405F77-2	Security disc	\$0.70	50
362F15-3	Throw member, LFIC models	\$7.10	10

<b>DL3000 SERIES DEADLOCKS</b>			
PART NO.	DESCRIPTION	LIST PRICE	SOLD IN MULT. OF
261F29-8	Allen wrench 5/64"	\$2.30	10
467F36	Bolt front	\$14.00	1
467F34-5	Cylinder housing	\$44.00	1
467F33-8	Cylinder housing screw	\$1.10	20
480F70-8	Screw pack for ANSI strike	\$1.80	20
480F69	Screw pack for strikes 424F83 and 394F19	\$2.70	20
283F81	Collar Base / Rose	\$40.00	1
<b>Strike, 2-3/4" x 1-1/8</b>			
424F83-8	611, 613	\$25.00	1
	619, 625, 626	\$14.00	1
	605, 606, 612, 618	\$18.00	1
394F19-8	Strike, 3-1/2" x 1-1/8"	\$17.00	1
<b>Strike, ANSI</b>			
423L71	611,613	\$24.00	1
	All other finishes	\$17.00	1
416F38	Security collar	\$36.00	1
467F35-8	Bolt, less front -2-3/4" B.S.	\$37.00	1
693F20-8	Bolt, less front -2-3/8" B.S.	\$37.00	1
467F37-8	Strike box	\$5.00	1
496F71-8	Strike box	\$4.20	1

# ED4000/ED5000 Series Pushpad Exit Devices

## DEVICE PARTS

PART NO.	DESCRIPTION	LIST PRICE
<b>ACTIVE HEAD (FIELD REVERSIBLE, WHERE HANDED)</b>		
650F37-8	ED4200	\$212.00
681F61-8	ED4200S	\$228.00
650F41-8	ED4400 LHR	\$224.00
650F40-8	ED4400 RHR	
650F46-8	ED4800 LHR	\$234.00
650F45-8	ED4800 RHR	
650F35-8	ED5200	\$212.00
650F36-8	ED5200A	\$224.00
706F03-8	ED5202 RHR	\$252.00
706F04-8	ED5202 LHR	
706F05-8	ED5202A RHR	\$264.00
706F06-8	ED5202A LHR	
681F60-8	ED5200S(A)	\$228.00
706F07-8	ED5202S(A) RHR	\$268.00
706F08-8	ED5202S(A) LHR	
650F39-8	ED5400(A) LHR	\$224.00
650F38-8	ED5400(A) RHR	
650F42-8	ED5600(A)	\$212.00
706F09-8	ED5602(A) RHR	\$252.00
706F10-8	ED5602(A) LHR	
650F44-8	ED5800(A) LHR	\$234.00
650F43-8	ED5800(A) RHR	
<b>ARMORED FRONT 605, 606, 611, 612, 613, 619, 625, 626, 629, 630</b>		
650F06	ED5600	\$15.00
<b>BAR &amp; CARRIER ASSEMBLY</b>		
<b>NO FINISH</b>		
650F24-8	All 48"	\$246.00
650F23-8	ED4000 36"	\$232.00
650F22-8	ED5000 36"	
<b>BAR CAP</b>		
<b>NO FINISH</b>		
650F18-9	Black nylon	†Order 10- \$4.00
<b>BOTTOM BOLT CASE</b>		
<b>NO FINISH</b>		
650F58-8	ED4400, ED5400	\$38.00
650F59-8	ED5400A	\$42.00
<b>BOTTOM BOLT PACKET</b>		
<b>NO FINISH</b>		
650F77-8	ED4800	\$114.00
698F03-8	ED5800(A)	\$100.00
<b>BOTTOM RAIL</b>		
650F21	48"	
	606, 612, 630	\$121.00
	605, 613	\$149.00
	611, 625, 626, 629	\$159.00
<b>BOTTOM ROD &amp; COUPLER ASSEMBLY</b>		
<b>NO FINISH</b>		
650F79-8	ED4800, ED5800(A)	\$84.00
<b>BOTTOM ROD &amp; END PIN ASSEMBLY 605, 606, 611, 612, 613, 618, 619, 625, 626, 629, 630, 722</b>		
649F99 fin	Surface devices	\$136.00
<b>CARRIER BAR NO FINISH</b>		
650F99-8	Internal	\$13.00
<b>COVER, ACTIVE HEAD 605, 606, 611, 612, 613, 619, 625, 626, 629, 630</b>		
650F03	ED4200	\$172.20
681F63	ED4200S	
650F04	ED4400	
650F05	ED4800	
706F15	ED5602 RHR	\$182.20
706F16	ED5602 LHR	

PART NO.	DESCRIPTION	LIST PRICE	
<b>DELAYED EGRESS PC BOARDS</b>			
704F269	DEED PC BD SA 36" NFPA-15	\$1,190.00	
704F279	DEED PC BD SA 36" NFPA-30		
704F479	DEED PC BD SA 36" BOCA-15		
704F489	DEED PC BD SA 36" BOCA-30		
704F569	DEED PC BD SA 48" NFPA-15		
704F579	DEED PC BD SA 48" NFPA-30		
704F589	DEED PC BD SA 48" BOCA-15		
704F599	DEED PC BD SA 48" BOCA-30		
<b>COVER, BAR 605, 606, 611, 612, 613, 619, 625, 626, 629, 630</b>			
650F07	36"	\$43.00	
650F08	48"	\$47.00	
<b>COVER, END</b>			
650F93	<b>ED5000DB</b>		
	606, 612, 630	\$260.00	
	605, 613	\$280.00	
650F14	611, 619, 625, 626, 629	\$310.00	
	<b>ED4000 36" cyl. dogging</b>		
	606, 612, 630	\$99.00	
650F14	605, 613	\$119.00	
	611, 619, 625, 626, 629	\$133.00	
	<b>ED4000 36" standard</b>		
650F13	606, 612, 630	\$97.00	
	605, 613	\$117.00	
	611, 619, 625, 626, 629	\$131.00	
650F12	<b>ED5000 36" cyl. dogging</b>		
	606, 612, 630	\$99.00	
	605, 613	\$119.00	
650F12	611, 619, 625, 626, 629	\$133.00	
	<b>ED5000(A) 36" standard</b>		
	606, 612, 630	\$97.00	
650F11	605, 613	\$117.00	
	611, 619, 625, 626, 629	\$131.00	
	<b>All 48" standard</b>		
650F15	606, 612, 630	\$109.00	
	605, 613	\$129.00	
	611, 619, 625, 626, 629	\$143.00	
650F16	<b>All 48" cyl. dogging</b>		
	606, 612, 630	\$111.00	
	605, 613	\$131.00	
650F16	611, 619, 625, 626, 629	\$145.00	
	<b>COVER, TOP &amp; BOTTOM LATCH</b>		
	650F64	<b>ED4400, ED5400(A)</b>	
606, 612, 630		\$63.00	
605, 613		\$71.00	
611, 619, 625, 626, 629			
<b>CYLINDER DOGGING KIT</b>			
653F13	<b>ED4000 36" bar</b>		
	606, 612, 630	\$92.00	
	605, 613	\$118.00	
653F12	611, 619, 625, 626, 629	\$130.00	
	<b>ED5000 36" bar</b>		
	606, 612, 630	\$92.00	
653F12	605, 613	\$118.00	
	611, 619, 625, 626, 629	\$130.00	
	<b>All 48" bar</b>		
653F14	606, 612, 630	\$100.00	
	605, 613	\$126.00	
	611, 619, 625, 626, 629	\$138.00	
<b>DOGGING ASSEMBLY</b>			
<b>NO FINISH</b>			
650F96-8	Cylinder type	\$37.00	
650F52-8	Hex Key type	\$33.00	
<b>DOGGING CYLINDER NUT</b>			
<b>NO FINISH</b>			
697F862	Dogging Cylinder Nut	\$13.00	

†Sold only in multiples of the number indicated. Price is each.

# ED4000/ED5000 Series Pushpad Exit Devices

## DEVICE PARTS (Cont'd)

PART NO.	DESCRIPTION	LIST PRICE
<b>DOGGING CYLINDER SLEEVE</b>		
650F959	Dogging Cylinder Sleeve	\$7.50
<b>DOGGING HOLE PLUG</b>		
650F27-9	Dogging Hole Plug †Order 50-	\$0.70
<b>DOGGING KEY, HEX</b>		
656F40-8	5/32"	\$2.90
<b>END CAP RETROFIT KIT</b>		
704F66	End Cap Retrofit Kit	\$71.00
<b>END CAP</b>		
704F62	End Cap	\$52.00
710F00M	Flush End Cap Retrofit Kit (M110)	
<b>END CLAMP PACKET</b>		
704F658	ED4200(S), ED5200S(A)	\$10.50
704F64-8	ED4000, ED5000(A)	
<b>FLUSH STRIKE TRANSOM BRACKET</b>		
650F87-8	Flush strike transom brkt., ED5400(A)	\$46.00
<b>LATCH PACKET</b>		
654F21-8	Latch pkt, ED4400, ED5400 †Order 10-	\$3.40
<b>MORTISE LOCK BODY</b>		
655F48-8RR	ED5610 knob - RHR	\$281.00
655F48-8LR	ED5610 knob - LHR	
650F69-8RR	ED5602, ED5610, ED5655 lever - RHR	\$287.00
650F69-8LR	ED5602, ED5610, ED5655 lever - LHR	
678F00-8RR	ED5610, ED5655 thumbpiece - RHR	\$291.00
678F00-8LR	ED5610, ED5655 thumbpiece - LHR	
650F67-8RR	ED5650,57 knob, lever/thumbpiece - RHR	\$287.00
650F67-8LR	ED5650,57 knob, lever/thumbpiece - LHR	
710F31-8LR	ED5634L - LHR	\$508.00
710F31-8RR	ED5634L - RHR	
710F32-8LR	ED5634L - LHR - M91	\$494.00
710F32-8RR	ED5634L - RHR - M91	
710F33-8LR	ED5634L - LHR - M93	\$494.00
710F33-8RR	ED5634L - RHR - M93	
<b>ADAPTER ASSEMBLY, MORTISE</b>		
706F46-2	ED5602(A)	\$30.00
<b>MOUNTING PACKET</b>		
650F57-8	ED4400, ED5400(A)	\$77.00
654F20-8	Non-rated, wood door †Order 20-	\$2.50
<b>900, WS700 &amp; FE700 SERIES MULLION PACKETS</b>		
<b>TOP RETAINER AND SCREW PACKET</b>		
713F518	907, 908, 910, 907A, 908A	\$180.00
713F938	FE707A, FE708A	\$187.00
713F948	907BKM, 908BKM, 910KM	\$180.00
713F958	WS707AKM, WS708AKM	\$187.00
<b>BOTTOM RETAINER AND SCREW PACKET</b>		
713F528	907, 908, 910, 907A, 908A	\$118.00
713F998	FE707A, FE708A	\$187.00
713F988	907BKM, 908BKM, 910KM	\$118.00
713F908	WS707AKM, WS708AKM	\$187.00
<b>LOCKING MECHANISM PACKET</b>		
744F258	907BKM, 908BKM, 910KM	\$388.00
744F208	WS707AKM, WS708AKM	\$404.00
<b>1-1/4" CYLINDER COLLAR PACKET†</b>		
447F43	907BKM <sup>2</sup> , 908BKM <sup>2</sup> , 910KM <sup>2</sup>	See page 4
610F01	WS707AKM <sup>2</sup> , WS708AKM <sup>2</sup>	See page 4
<b>1-1/2" LFIC CYLINDER COLLAR PACKET†</b>		
609F37	907BKM <sup>2</sup> , 908BKM <sup>2</sup> , 910KM <sup>2</sup>	See page 4
609F36	WS707AKM <sup>2</sup> , WS708AKM <sup>2</sup>	See page 4

Notes: 1. Cylinder collar packets contain a collar & spring washer.  
2. Specify finish when ordering packets.

PART NO.	DESCRIPTION	LIST PRICE
<b>ROD EXTENSION KIT (CONCEALED VERTICAL)</b>		
684F427	Rod Extension Kit, 24"	\$75.00
<b>ROD EXTENSION KIT (SURFACE VERTICAL)</b>		
<b>Rod Extension Kit, 2"</b>		
655F15	606, 612, 630	\$64.00
	605, 613	\$68.00
	611, 619, 625, 626, 629	\$74.00
<b>Rod Extension Kit, 6"</b>		
655F16	606, 612, 630	\$76.00
	605, 613	\$80.00
	611, 619, 625, 626, 629	\$86.00
<b>Rod Extension Kit, 12"</b>		
655F17	606, 612, 630	\$80.00
	605, 613	\$84.00
	611, 619, 625, 626, 629	\$90.00
<b>Rod Extension Kit, 24"</b>		
684F42	606, 612, 630	\$82.00
	605, 613	\$86.00
	611, 619, 625, 626, 629	\$92.00
<b>ROD GUIDE COVER</b>		
<b>Rod Guide Cover</b>		
650F63	606, 612, 630	\$24.00
	605, 613	\$28.00
	611, 619, 625, 626, 629	\$29.00
<b>ROD GUIDE PACKET</b>		
<b>Rod Guide Packet</b>		
650F62	626	\$12.00
	606, 612	\$15.00
	613	\$18.00
<b>SCREWS</b>		
605, 606, 611, 612, 613, 619, 625, 626, 629, 630		
429F41	Pack, Armored Front †Order 20-606, 612, 613, 619	\$3.50
704F63	Packet, Cover 606,612,613,630 finish	\$3.10
656F66-8	#10-24 x 1/4" PH †Order 100-	\$0.40
650F53-8	Dogging Assembly †Order 50-	\$0.52
650F51-8	Latch head to carrier †Order 50-	\$0.52
650F28-8	Touch bar caps (622 only) †Order 50-	\$0.62
650F50-8	Trim slide †Order 100-	\$0.20
<b>SCREW PACK, TORX® PIN</b>		
701F60	ED4200(S), ED4800, ED5200(S), ED5800	\$15.00
701F61	ED4400, ED5400, ED5470	\$15.00
701F62	ED5600	\$16.00
701F63	ED5860	\$15.00
<b>SEX NUT PACKET</b>		
652F29-8	Sex Nut Packet (4 sex nuts)	\$17.00
<b>SHIM KIT</b>		
697F33-8	ED5200(S)(A), ED5600(A), ED5800(A)	\$97.00
697F34-8	ED5400(A)	\$117.00
697F35-8	ED4200(S), ED4800	\$97.00
697F36-8	ED4400	\$117.00
<b>SPRING, TOUCH PAD</b>		
656F41	Spring, Touch Pad	\$2.40
<b>STRIKE PACKET 622 FINISH ONLY</b>		
650F88-8	bottom for 1/2" threshold (S09)	\$53.00
650F31-8	ED4200(S), ED4800	\$51.00
650F29-8	ED5200, ED5202	\$51.00
650F30-8	ED5200(S)(A), ED5202(S)(A)	\$75.00
650L65	ED5600	\$32.00
650L65-7020	Mortise strike for ED5602(A)	\$32.00
653L15-7014	Mortise strike for doors with astragal	\$29.00
655F71-8	ED5200 x S02	\$53.00
653L16-3016	open back straight lip for 1-3/4" door	\$83.00
653L16-3020	open back straight lip for 2-1/4" door	\$113.00
653L18-3016	open back curved lip for 1-3/4" door	\$83.00
653L18-3020	open back curved lip for 2-1/4" door	\$113.00

†Sold only in multiples of the number indicated. Price is each.



**DEVICE PARTS (Cont'd)**

PART NO.	DESCRIPTION	LIST PRICE	PART NO.	DESCRIPTION	LIST PRICE
<b>TOP LATCH</b>			<b>TOP STRIKE PACKET</b>		
650F73-8	Top Latch & Bracket Assembly, ED4800	\$165.00	650F54-8	Top strike packet	\$69.00
650F71-8	Top Latch & Bracket Assembly, ED5800	\$167.00	681F70-8	Top strike packet for ED5470B	\$26.00
650F72-8	Top Latch & Bracket Assembly, ED5800A	\$179.00	681F77-8	Top strike for ED5860B	\$30.00
650F55-8	Top Latch, ED4400, ED5400, ED5470	\$153.00	<b>TOUCH PAD CAP 622 ONLY</b>		
650F56-8	Top Latch, ED5400A, ED5470B	\$163.00	650F10-5	Touch Pad Cap, front	\$30.00
681F76-8	Top Latch, ED5860B	\$189.00	650F09-5	Touch Pad Cap, rear	\$24.00
681F71-8	Top Mtg. Plate for ED5470B	\$46.00	<b>TRIM SLIDE NO FINISH</b>		
<b>TOP ROD NO FINISH</b>			650F49-8	Trim Slide Retainer †Order 10-	\$3.30
650F81-8	Top Rod Tube, concealed	\$84.00	650F48-9	Trim Slide, ED4000	\$5.30
650F80-8	Top Rod, concealed	\$70.00			
650F60 fin	<b>Top Rod, surface</b>				
	606, 612, 630	\$94.00			
	605, 613	\$114.00			
	611, 619, 625, 626, 629	\$114.00			

**TRIM PARTS, GRIPS**

DESIGN	STANDARD PART NO.	STANDARD PRICE 606, 612, 630	STANDARD PRICE 605, 611, 613, 619 625, 626, 629	KNURLED PART NO. ADD \$65.00 TO STD. PRICE	ABRASIVE PART NO. ADD \$42.00 TO STD. PRICE		
A7	652F78	\$147.00	\$151.00	652F79	652F80		
C7	652F66			652F67	652F68		
D7 RHR	652F69			652F70	652F71		
D7 LHR	652F72			652F73	652F74		
E7	652F57			652F58	652F59		
G7	656F45			656F48	656F51		
L7	652F60			652F61	652F62		
N7	652F75			652F76	652F77		
PR7	652F81			652F82	652F83		
R7	652F63			652F64	652F65		
A7M	653F71			653F72	653F73		
C7M	653F59			653F60	653F61		
D7M RHR	653F62			653F63			
D7M LHR	653F65			653F66			
E7M	653F50						
G7M	656F44			656F47	656F50		
L7M	653F53			653F54	653F55		
N7M	653F68			653F69	653F70		
PR7M	653F74			653F75	653F76		
R7M	653F56			653F57			
A8	653F05						
C8	652F93				652F95		
D8 RHR	652F96						
D8 LHR	652F99						
E8	652F84				652F85		
G8	656F46				656F49		
L8	652F87				652F88		
N8	653F02				653F03		
PR8	653F08				653F09		
R8	652F90						
08, 014	656F53				n/a		
							n/a

†Sold only in multiples of the number indicated. Price is each.

**TRIM PARTS, GRIPS, ESCUTCHEONS (Cont'd)**

DESIGN	STANDARD PART NO.	STANDARD PRICE 606, 612, 630	STANDARD PRICE 605, 611, 613, 619, 625, 626, 629	KNURLED PART NO. ADD \$65.00 TO STD. PRICE	ABRASIVE PART NO. ADD \$42.00 TO STD. PRICE
A9	677F16	\$147.00	\$151.00	652F79	652F80
C9	677F15			652F67	652F68
D9 RHR	677F26			652F70	652F71
D9 LHR	677F27			652F73	652F74
E9	677F13			652F58	652F59
L9	677F04			652F61	652F62
N9	677F05			652F76	652F77
PR9	677F28			652F82	652F83
R9	677F14			652F64	652F65
A9M	653F71			653F72	653F73
C9M	653F59			653F60	653F61
D9M RHR	653F62			653F63	
D9M LHR	653F65			653F66	
E9M	653F50				
L9M	653F53			653F54	653F55
N9M	653F68			653F69	653F70
PR9M	653F74			653F75	653F76
R9M	653F56			653F57	

DESIGN	PART NO.	LIST PRICE 606	LIST PRICE 605, 613, 625, 626
FR9 RHR	698F64	\$167.00	\$163.00
FR9 LHR	698F66		
TS9	698F31		
Z9 RHR	698F68		
Z9 LHR	698F70		
M9	698F33	\$151.00	\$143.00
FR9M RHR	698F65	\$167.00	\$163.00
FR9M LHR	698F67		
TS9M	698F32		
Z9M RHR	698F69		
Z9M LHR	698F71		
M9M	698F34	\$151.00	\$143.00

PART NO.	DESCRIPTION	630, 606, 612	605, 613	611, 619, 625, 626, 629
656F58	x8 cyl. x knob	\$109.00	\$115.00	\$121.00
656F59	x8 cyl. x lever	\$117.00	\$123.00	\$129.00
656F60	x8 plain x knob or thumbturn	\$109.00	\$115.00	\$121.00
656F61	x8 plain x lever	\$117.00	\$123.00	\$129.00
677F00	x9 blank x lever	\$151.00	\$157.00	\$163.00
677F01	x9 cylinder x lever			
695F18	x957 cylinder x lever			
651F00	F450	\$103.00	\$109.00	\$115.00
651F01	F457			
676F04	F950	\$151.00	\$157.00	\$163.00
676F03	F957			
694F76	F9M57			
651F10	O14, T14 bottom	\$42.00	\$48.00	\$54.00
656F62	O1410 top	\$103.00	\$109.00	\$115.00
656F63	O1455/59 top			
651F09	T1410 top	\$92.00	\$98.00	\$104.00
651F06	T1450 top	\$88.00	\$94.00	\$100.00
651F08	T1455, T1459 top	\$92.00	\$98.00	\$104.00
651F04	T1457 top	\$88.00	\$94.00	\$100.00

†Sold only in multiples of the number indicated. Price is each.



**TRIM PARTS (Cont'd)**

PART NO.	DESCRIPTION	LIST PRICE
<b>BUSHING, NYLON</b> NO FINISH		
652F23-9	Bushing, Nylon †Order 20-	\$3.50
<b>CLUTCH LEVER</b> NO FINISH		
651F53-8	Clutch Lever †Order 20-	\$3.00
<b>COTTER PIN</b> NO FINISH		
677F09-8	Cotter Pin †Order 100-	\$0.40
<b>COVER PLATE</b> NO FINISH		
651F85-8	Cover Plate, x8, O14, T14	\$12.00
<b>CYLINDER COLLAR</b>		
	various	see page 4
<b>GEAR &amp; BLACK HOUSING ASSEMBLY</b> NO FINISH		
651F63-8	Gear & Black Housing Assembly (all but x750)	\$14.00
651F64-8	Gear, levers	\$5.70
655F54-8	Gear, dummy lever	
<b>HEX NUT/BUSHING</b> NO FINISH		
651F39-8	Hex Nut/Bushing for spring	\$4.10
<b>HOUSING</b> NO FINISH		
651F67-5	Housing & Cam Assembly, x755, T1355	\$38.60
651F96-5	Housing & Cam Assembly, x855, x859, O/T1455/59	\$31.00
651F42-5	Housing, Cylinder, F2, F3, T1357, O/T1457	\$6.90
651F54-5	Housing, Tailpiece Assembly	\$25.60
706F01-5	Housing, Cylinder ED5202(S)(A), ED5602(A)	\$8.00
706F00-5	Housing, Cylinder, Trim, ED5202(S)(A), ED5602(A)	\$38.00
<b>HUB</b> NO FINISH		
652F22-8	Hub	\$22.00
651F65-5	Hub, lever	\$6.80
656F64	Hub, G knob	\$7.20
<b>LOCK WASHER</b> NO FINISH		
651F44-8	for screw post †Order 50-	\$0.40
<b>NUT</b> NO FINISH		
651F88-8	Nut, Cover Plate †Order 50-	\$0.48
651F92-8	Nut, Spring Post	\$4.40
<b>PIN</b> NO FINISH		
651F83-8	Pin, Clutch Lever †Order 50-	\$1.10
651F98-8	Pin, Groove, 5/32" x 1-1/8" for T1410, T1455, T145 †Order 50-	\$0.70
651F58-7	Pin, Thumbpiece, T13M †Order 20-	\$1.08
<b>PULL</b>		
651F37-2	Pull, Offset - 606, 612, 619, 626, 630	\$114.00
	605, 611, 613, 625, 629	\$124.00
651F36-2	Pull, Straight - 606, 612, 619, 626, 630	\$92.00
	605, 611, 613, 625, 629	\$100.00
<b>RACK &amp; TAILPIECE ASSEMBLY</b> NO FINISH		
651F82-8	x810, x855, x859, O14, T14	\$79.00
652F21-8	x850	\$67.00
<b>RETAINER, CLUTCH LEVER PIN</b> NO FINISH		
651F89-8	Retainer, Clutch Lever Pin †Order 100-	\$0.20
<b>RETAINING RING</b> NO FINISH		
651F60-8	Retaining Ring, T13M †Order 50-	\$0.40
<b>ELECTRIFIED LOCKBODY USED WITH "SAF" &amp; "SEC" ED5600L DEVICES:</b>		
677F768LR 626	LOCK SA-L5 MORT.SAFE LHR	\$670.00
677F768RR 626	LOCK SA-L5 MORT.SAFE RHR	\$670.00
677F778LR 626	LOCK SA-L5 MORT.SEC. LHR	\$670.00
677F778RR 626	LOCK SA-L5 MORT.SEC. RHR	\$670.00
<b>SCREW</b> NO FINISH		
655F02-8	Screw, Cylinder Mounting †Order 100-	\$0.34
651F87-8	Screw, FHM-PH #8-32 x 7/16" †Order 50-	\$0.36

PART NO.	DESCRIPTION	LIST PRICE
<b>SCREW (CONT'D)</b> NO FINISH		
656F65-8	Screw, Function	\$0.46
651F41-8	Screw, RHM-PH #1/4-20 x 5/8" †Order 50-	\$0.38
651F50-8	Screw, Tailpiece Plate, PHT-T-PH #6 x 3/8 †Order 50-	\$0.46
<b>SCREW PACKET, MOUNTING</b>		
652F12-8	1-3/4" - 2" door - 606, 612, 613, 619, 626	\$7.20
652F10-8	1-3/4" - 2" door - 606, 612, 613, 619, 626	\$5.10
652F11-8	2-1/4" door - 606, 612, 613, 619, 626	\$5.10
652F13-8	2-1/4" door - 606, 612, 613, 619, 626	\$7.20
652F14-8	F3, T13 for 1-3/4" - 2" door - 606, 612, 613, 619, 626	\$9.80
652F15-8	F3, T13 for 2-1/4" door - 606, 612, 613, 619, 626	\$9.80
<b>SCREW POST</b> NO FINISH		
651F43-8	Screw Post	\$5.40
<b>SLIDER, THUMBPIECE</b> NO FINISH		
651F49-8	Slider, Thumbpiece	\$5.00
<b>SPINDLE BRACKET</b> NO FINISH		
652F04-8	Spindle Bracket, lever	\$5.10
<b>SPINDLE NUT</b> NO FINISH		
651F73-8	Spindle Nut, x7 †Order 20-	\$1.70
652F09-8	Spindle Nut, x7M lever †Order 50-	\$0.54
<b>SPINDLE WASHER</b> NO FINISH		
652F06-8	Spindle washer, G Knob	\$3.40
652F05-8	Spindle Washer, Levers	\$3.80
<b>SPRING</b> NO FINISH		
651F94-8	Spring, Extension	\$1.70
651F75-8	Spring, Grip Return, knob †Order 10-	\$3.40
651F61-8	Spring, Grip Return, lever, LHR (red)	\$3.50
651F62-8	Spring, Grip Return, lever, RHR (blue)	
651F93-8	Spring, Rack, lever †Order 50-	\$1.60
651F47-8	Spring, Thumbpiece, T13	\$3.90
678F02-8	Spring, Thumbpiece T13M	\$5.90
651F40-8	Spring, various trim †Order 20-	\$1.70
651F86-8	Spring, various trim †Order 50-	\$1.60
<b>TAILPIECE ASSEMBLY</b> NO FINISH		
677F06-8	1-3/4" door without shim kit	\$34.00
655F69-8	2" - 2-1/4" door or 1 3/4" door with shim kit - TH9 series trims	\$34.00
655F70-8	2" - 2-1/4" door or std. door with shim kit - All trims except TH9 series	\$34.00
<b>THIMBLE INSERT</b>		
651F38-9	Knob & thumbturn †Order 50-	\$0.50
118F29-9	Lever †Order 100-	\$0.20
<b>THUMBPIECE BRACKET</b>		
651F57-8	Thumbpiece Bracket, T13M	\$17.60
<b>THUMBPIECE TAB</b> NO FINISH		
651F56-8	Thumbpiece Tab, T13M	\$2.20
<b>THUMBPIECE</b> 605, 606, 611, 612, 613, 619, 625, 626, 629, 630		
566F50	Thumbpiece, T13, T14	\$42.00
566F51	Thumbpiece, T13M	\$48.00
<b>WASHER</b> NO FINISH		
651F70-8	Washer under tailpiece †Order 50-	\$0.56
651F84-8	Washer, Grip †Order 20-	\$2.10

**ACTIVE & INACTIVE CASES**

PART NO.	DESCRIPTION	LIST PRICE
<b>ACTIVE CASE ASSEMBLIES, COMPLETE</b>		
<b>LOCK BODY ASSEMBLY - CROSSBAR SPECIFY HAND</b>		
<b>No Finish</b>		
424F42-8	MLE08 (ED 7600)	\$506.00
424F43-8	MLE09 (ED7600A)	
424F52-8	MLE05	\$506.00

**STRIKES FOR CROSSBAR EXIT DEVICES**

PART NO.	DESCRIPTION	LIST PRICE
269F73	ED7000 LHR with dogging	\$753.00
269F74	ED7000 RHR with dogging	
269F75	ED7000 LHR less dogging	\$707.00
269F76	ED7000 RHR less dogging	
<b>VERTICAL ROD STRIKES 605, 606, 612, 613, 622, 626, 629</b>		
392F24	Top	\$82.00
392F22	Top	\$64.00
392F28	Bottom flush	\$51.00
392F29	Bottom surface	\$43.00
176F65-3	Top bracket	\$43.00
304F33-7	Bottom 630 only	\$28.00
304F34-7	Bottom 630 only	\$43.00
352F04-2	Bottom	\$28.00
352F05	Top	\$51.00
361F91-3	Bottom flush	\$51.00
123F22	Bottom	
183F85-7	Top 630 only	
502F75	Bottom mortised	\$30.00
502F96	Surface	\$40.00

**ED7000 Series Crossbar Exit Devices**
**STRIKES FOR CROSSBAR EXIT DEVICES (Cont'd)**

PART NO.	DESCRIPTION	LIST PRICE
<b>CONCEALED VERTICAL ROD STRIKES 605, 606, 612, 613, 622, 626</b>		
503F52	Bottom Strike	\$52.00
503F53-3	Fire Rated Bottom Strike	\$52.00
<b>RIM EXIT DEVICE STRIKES 605, 606, 612, 613, 622, 626</b>		
142F43	Adj. Packet	\$120.00
467F73-3	Pack, rim vert. rod	\$78.00
300F71	Packet	\$101.00
499F59-8	Adj.	\$72.00
<b>MORTISE STRIKES 605, 606, 612, 613, 619, 622, 625, 626</b>		
240L50	Stainless Mortise - LHR 629, 630 only	\$44.00
240L51	Stainless Mortise - RHR 629, 630 only	
411L63	Open Back - RHR	See page 10
411L62	Open Back - LHR	See page 10
<b>LOW PROFILE EXIT DEVICE STRIKES</b>		
416F35-5	Strike 622 689, 690, 691	\$40.00
436F03-8	Strike, bottom	\$16.00
487M048-589	Top Rod (for 10' Doors)	\$116.00
463F91-8	Flush Bottom Strike	\$19.00

**DEVICE PARTS**

PART NO.	DESCRIPTION	LIST PRICE	PART NO.	DESCRIPTION	LIST PRICE
095F35-1	Strap/Stabilizer for Mullion	\$26.00	154F96-6	Clamp	\$20.00
120F55-8	Screw	\$2.40	158F52-8	Cylinder Retainer, MR	\$11.00
122F18-8	Mounting Bracket	\$26.00	158F53-8	Cylinder Retainer, regular	\$4.50
122F24-8	Washer †Order 100-	\$0.10	158F54-8	Washer	\$2.30
122F41-3	Lower Rod Guide	\$9.80	158F55-8	Stud	\$6.30
122F50-8	Lower Bolt Tube Sub Assembly	\$74.00	164F32-9	Nylon Washer †Order 50-	\$0.35
122F51-8	Bottom Guide Sub Assembly	\$70.00	166F34-7	Latch Pin	\$4.60
122F56-8	Locking Lever	\$19.00	171F89-6	Top Plate Sub Assembly	\$69.00
122F57-8	Locking Lever	\$14.00	171F90-9	Insert	\$17.00
122F59-3	Locking Lever Spring	\$22.00	173F44-6	Bottom Plate	\$31.00
122F60-8	Locking Hub	\$11.00	173F45-6	Bottom Filler Plate	\$27.00
122F61-8	Locking Hub	\$5.50	173F69-8	Stud	\$1.70
122F63-9	Spacer Washer (Nylon)	\$1.70	173F72-8	Nut	\$4.40
122F64-3*	Handle Lever	\$103.00	174F79-7	Top Plate & Stud Sub Assembly	\$182.00
123F53-8	Dogging Key, 3/16" hex	\$3.00	174F80-7	Top Plate & Stud Sub Assembly	
129F49-9	Sound Deadener	\$7.00	175F51-8	Rod Insert	\$17.00
129F84-8	Cylinder Nut	\$6.70	183F74	Top Latch Sub Assembly (with top rod doors 6'4" to 8'6")	\$330.00
134F05	Cylinder Collar	See page 4	183F75	Top Latch Sub Assembly (with top rod door 8'6" to 10'8")	\$330.00
140F52-8	Stud †Order 20-	\$0.90	184F57	Thumbpiece	\$37.00
141F41-8	Springwasher †Order 20-		184F82-5	Shim	\$17.00
141F84*	Case housing, active & inactive	\$130.00	184F94-8	Jam Nut	\$6.00
141F86*	Case (Active - No Bot. Rod)		184F97*	Thumbpiece	\$41.00
141F87*	Active Case		185F55-8	Lifting Lever	\$13.00
141L54-8	Reinforcing Tube	\$126.00	186F23	Cyl. Collar	\$33.00
141L59	<b>Crossbar</b>		187F21-3	<b>Latch</b>	
	605, 606, 611, 612, 613, 619, 622, 625, 626	\$234.00		605, 606, 611, 613, 619, 622, 625, 626	\$79.00
	629, 630	\$290.00		629, 630	\$136.00
142F16*	Case Sub Assembly	\$176.00	187F88-7	Latch Spring RH	\$1.60
142F44*	Adj. Strike	\$66.00	187F89-7	Latch Spring LH	
143F24-8	Spring †Order 50-	\$0.70	Ø 195F67	<b>Cylinder Housing</b> (for master ring) 605, 606, 611, 612, 613, 619, 622, 625, 626	\$81.00
143F25	Rollback	\$13.00	207F55-8	Screw Packet	\$34.00
143F26-5	Slide	\$46.00	207F64*	Screw Packet	
143F42*	Thumbpiece	\$44.00	207F68*	Screw Packet	\$41.00
143F43*	Thumbpiece		207F69*	Screw Packet	\$51.00
143F52*	Thumbpiece		376F37*	Sex Nut (For 1-3/4 & 2" doors)	\$6.00
143F83-3	Stud	\$6.00	209F55*	Screw Packet	\$45.00
145F54-3*	Strike Plate	\$72.00	213F10-7	<b>Top Strike Ass'y</b> (reveal 5-1/2" - 8")	
147F83-8	Lazy Cam	\$2.40		629, 630	\$64.00
147F84-9	Washer (White Nylon)	\$2.80			
147F87-8	Cam	\$3.10			
147F88-8	Slide Spring †Order 50-	\$0.80			
148F15-7	Release Pkg. 613, 630	\$13.00			
148F17	<b>Cover Retaining Screw</b>				
	606, 612, 613, 619, 622, 626	\$5.80			
	611, 625, 629, 630	\$10.00			
148F22-8	Pin	\$2.40			
148F36-7	Release Plunger Sub Assembly	\$20.00			
148F44-8	Mounting Wrench	\$4.50			

**DEVICE PARTS (Cont'd)**

PART NO.	DESCRIPTION	LIST PRICE
213F11-7	Top Strike S/A (reveal less 5-1/2")	\$81.00
	629, 630	
200F16-8	Screw 12-24 x 1/2" FHMS	\$2.20
220F49-8	Screw 1/4-20 x 2" FHMS	\$1.90
220F72-2	Screw 12-24 x 1/2" FHMS-PH †Order 20-	\$1.80
220F75	<b>Screw 1/4-20 x 5/8" FHMS-PH</b>	
	606, 619, 622, 625, 626, 630	\$1.80
	605, 611, 512, 613, 629	\$2.80
220F77-8	<b>Screw</b> 622, CDC, MTD, 613	\$1.90
220F82-7	Screw 1/4-20 x 1" FHMS-PH	\$2.90
220F84-8	Screw 12-24 x 1-1/4" FHMS-PH	\$0.50
220F85*	Screw 1/4-20 x 1-1/4" FHMS-PH x Anchor	\$2.70
221F94-8*	Mounting Screw	\$2.80
222F71*	Throughbolt	
224F34-8	Screw 12 x 1" FHWS †Order 20-	\$0.72
224F39-2	Screw 14 x 1-1/4" FHWS †Order 20-	
224F44-8	Screw 14 x 1-1/2" FHWS	\$2.70
224F50-8	Screw 14 x 2" FHWS †Order 20-	\$0.72
225F99-8	Screw 12 x 1-1/2" OHWS-PH	\$2.10
228F18-8	Roll Pin †Order 100-	\$0.20
228F49-7	Roll Pin (79-028-125-0343)	\$0.96
228F51-7	Roll Pin (79-028-125-0500 St'd) †Order 100-	\$0.26
228F52-8	Roll Pin †Order 100-	\$0.24
228F55-8	Roll Pin 1/8 x 3/4" †Order 100-	\$0.26
228F68-7	Roll Pin 156 x 9/16" †Order 50-	\$0.48
228F80-8	Roll Pin 187 x 3/4" †Order 100-	\$0.30
228F81-7	Roll Pin 187 x 1-15/16" †Order 20-	\$0.74
228F84-7	Roll Pin 187 x 1-3/8" †Order 20-	\$0.70
243F76-9	Stop Nut †Order 20-	\$0.80
243F79-8	Spring Lock Washer †Order 100-	\$0.24
243F80-8	1/4-20 x 5/8" FRMS-PH	\$2.70
243F85	Top Cover Sub Assembly	
	606, 612, 619, 626, 630	\$97.00
	605, 611, 613, 625, 629	\$135.00
249F33*	1/4-20 NC-2A x 1-1/4" Lg. Phillips OHMS	\$3.30
253F11-8	Drive Screw †Order 100-	\$0.20
254F73	<b>Screw 8-32 x 3/8" OHMS-PH</b>	
	605, 606, 611, 612, 613, 619, 625, 626, 630	\$2.10
255F41*	Screw 12-24 x 2" FHMS-PH	\$4.20
261F28-8	Screw 8-32 x 3/8" HSS Cone-SOC	\$2.60
261F29-8	Hex Key 5/64" †Order 10-	\$2.30
261F31-8	<b>Screw 5/16-24 x 1-1/2" FHMS-SOC</b>	
	605, 611, 612, 613, 619, 625, 626, 630	\$3.10
261F54	Cylinder Collar See page 4	
261F65-8	Screw 1/4-20 x 1/2" PHMS	\$2.30
262F90-1	River 3/32" x 5/32" †Order 100-	\$0.24

PART NO.	DESCRIPTION	LIST PRICE
264F95-8	Screw 12-24 x 7/8" RHMS-PH	\$0.70
	(Metal Doors) †Order 20-	
267F34-8*	Mounting Screw †Order 20-	
268F64-7	Washer †Order 50-	\$0.60
268F84-8	Screw 6-32 x 5/8" RHMS †Order 20-	\$0.70
268F87-8	Retainer Ring †Order 20-	
269F04-8	Cotter Pin †Order 50-	\$0.60
269F05-8	Lockwasher †Order 100-	\$0.24
269F08	<b>Screw 8-32 x 3/8" FHMS-PH</b>	
	605, 606, 611, 613, 619, 625, 626, 630	\$0.70
269F09-8	Screw 1-32 x 1/4" OHMS-PH †Order 100-	\$0.36
<b>Lever</b>		
269F31	605, 606, 611, 612, 619, 613, 619, 625, 626	\$269.00
269F32	605, 606, 611, 612, 619, 613, 619, 625, 626	
<b>COVER</b>		
269F33	606, 612, 619, 626, 630	\$255.00
	605, 611, 613, 625, 629	\$281.00
269F34	606, 612, 619, 626, 630	\$255.00
	605, 611, 613, 625, 629	\$281.00
269F35	606, 612, 619, 626, 630	\$255.00
	605, 611, 613, 625, 629	\$281.00
<b>Active Case Less Cover, ED7200 RHR &amp; LHR</b>		
269F36	606, 612, 619, 626, 630	\$273.00
	605, 611, 613, 625, 629	\$305.00
269F37-8	Hub	\$37.00
269F39-3	Latch Retractor	\$33.00
269F40-3	Latch Retractor	\$37.00
269F41-3	Slide	\$45.00
<b>Inactive Case S/A, all ED7000</b>		
269F42	606, 612, 619, 626, 630	\$271.00
	605, 611, 613, 625, 629	\$303.00
269F46-8	Hold Back Sleeve	\$37.00
269F47-9	Nyliner	\$2.80
269F48-8	Lever Pivot	\$2.40
269F49-9	Bushing	\$3.60
269F52-8	Hub Shank	\$4.80
269F53-8	Latch Spring	\$2.80
269F54-9	Button	\$0.80
269F55-9	Washer †Order 50-	\$0.48
269F56-9	Washer †Order 50-	
269F57-8	Spring Washer	\$5.70
269F58-7	Latch Pin	\$2.50
269F60-8	Inner Spring	\$5.70
269F91*	Screw Packet	\$82.00
269F92*	Screw Packet	\$59.00
270F01*	Screw Packet	\$82.00
270F02*	Screw Packet	\$61.00
270F11*	Through Bolt	\$3.20
282F32-5	Caulking Anchor	\$3.90
282F35-7	Caulking Anchor	\$2.80
284F67*	Lever RH	\$108.00

\*Specify Finish. Ø Subject to availability.

† Sold only in multiples of the number indicated. Price is each.

**DEVICE PARTS (Cont'd)**

PART NO.	DESCRIPTION	LIST PRICE	PART NO.	DESCRIPTION	LIST PRICE
284F68*	Lever LH	\$108.00	351F72	<b>Bottom Latch Cover</b>	
284F69*	Lever RH			606, 612, 619, 626, 630	\$154.00
284F70*	Lever LH			605, 611, 613, 625, 629	\$206.00
284F78	Lifting Finger RH	\$8.80	351F73	<b>Top Latch Cover</b>	
284F79	Lifting Finger LH			606, 612, 619, 626, 630	\$166.00
284F97-7	Roll Pin †Order 50-	\$0.48		605, 611, 613, 625, 629	\$218.00
286F91	<b>Lever S/A LH (Inactive)</b>		351F79-7	Top Latch Sub Assembly	\$48.00
	605, 606, 611, 612, 613, 619, 625, 626	\$180.00	351F80-7	Roll Pin †Order 50-	\$0.60
286F92	<b>Lever S/A RH (Inactive)</b>		351F82-3	Top Latch Backplate	\$88.00
	605, 606, 611, 612, 613, 619, 625, 626	\$180.00	351F83-3	Top Latch Slide	
287F96-8	1/4-20 x 13/16" FRMH-PH	\$3.50	351F84-9	Spacer	\$8.90
291F49-8	Stop Plate	\$22.00	351F85*	Top Latch Sub Assembly No Cover	\$340.00
291F57-8	Screw 10-31 x 1" FHM-PH †Order 50-	\$0.60	351F86-7	Bottom Latch	\$88.00
292F41-3*	Strike	\$105.00	351F87-3	Latch Link	\$86.00
293F18-3	Slide Assembly	\$97.00	351F88-3	Bottom Latch Backplate	\$88.00
304F65-7	<b>Screw 12-24 x 7/8" OHU-MS-PH (1-3/4", 2" Doors)</b>		351F89-7	Spring †Order 20-	\$0.70
	622, 629, 630	\$1.50	351F90-7*	Bottom Latch Sub Assembly	\$306.00
304F66-7	Screw 12-24 x 1-1/8" OHU-MS-PH (2-1/4" Doors)	\$4.20	351F98-8	Rod Connector Sub Assembly	\$4.40
305F07	Screw 12-24 x 3/4" FRHMS-PH †Order 20-	\$0.80	352F02-1	Drive Rivet †Order 20-	\$0.80
305F72-8	Lower Bolt Sub Assembly - includes Bottom Rod	\$396.00	352F03-8	Pin	\$4.10
305F73-8	Guard Plate	\$28.00	352F06-8	1/4-20 x 3/4" BHUMS-PH Screw †Order 20-	\$0.70
306F06-8	Screw 10-24 x 5/16" RHMS-PH †Order 20-	\$0.90	352F07*	2-1/2" x 14 OHWS-PH Screw	\$0.94
306F07-8	Spring Lockwasher †Order 100-	\$0.20	361F30-8	Anchor	\$5.10
306F15-8	Plate	\$1.90	362F49-8	Nut	\$20.00
306F20-8	Backplate Sub Assembly	\$149.00	362F91-8	Plate	\$6.60
306F22-8	Center Rod	\$7.50	364F22-8	Washer	\$5.60
314F52-8	Screw HS-O-SK 3/8" - 16 x 1/2" †Order 50-	\$0.90	364F27-2	Locking Slide	\$24.00
314F71-8	Screw 1/4-20 x 2-3/8" FHMS	\$2.20	364F28-8	Locking Lever Sub Assembly	\$32.00
321F90-7	Dogging Device Sub Assembly	\$39.00	364F30-8	Lifting Lever	\$26.00
Ø 326F73-7	Set Screw	\$4.50	364F36*	Escutcheon Assembly RHR, C4, D4, E4 - std.	\$259.00
329F75	Screw Packet	\$81.00	364F37*	Escutcheon Assembly LHR, C4, D4, E4 - std.	
329F76	Screw Packet	\$64.00	364F38*	Escutcheon Assembly RHR, C4, D4, E4 - MR	\$271.00
333F51-9	Screw	\$1.80	364F39*	Escutcheon Assembly LHR, C4, D4, E4 - MR	
341F31-8	Shim	\$18.00	365F00-3	Slide Extension S/A Door 1-3/4"	\$41.00
349F06-8	Lifting Finger (Inactive Case)	\$24.00	365F01-3	Slide Extension S/A Door 2-1/4"	
351F50*	<b>Active Case - less cover, ED7400 standard</b>		365F03-3	Slide Extension S/A Door 1-3/4" or Lever Trim	
	606, 612, 619, 622, 626	\$152.00	365F98*	1/4-20 x 2" OHTS-F-PH Metal Door	\$5.20
	605, 611, 613, 625, 629, 630	\$190.00	370F55-8	Spindle 1-3/4" door	
351F51*	<b>Active Case - less cover, ED74000, ED7401, no bottom rod</b>		370F56-8	Spindle 2" door	\$19.00
	606, 612, 619, 622, 626	\$152.00	370F63-8	Spindle Sub Assembly	\$6.40
	605, 611, 613, 625, 629, 630	\$190.00	376F42	<b>Latch Sub Assembly</b>	
351F52-8	10-32 x 7/16" FHUMS-PH Screw †Order 100-	\$0.50		611, 612, 613, 619, 625, 626	\$46.00
351F55-3	Slide Sub Assembly	\$138.00		605, 606, 629, 630	\$56.00
351F56*	Active Case Sub Ass'y, ED7400 with dogging -RHR	\$770.00	378F74-5	Tenon Sub Assembly	\$37.00
351F57*	Active Case Sub Ass'y, ED7400 with dogging -LHR		379F25	<b>Lever Sub Assembly RH</b>	
				605, 606, 619, 625, 626	\$132.00
				611, 612, 613	\$231.00
			379F26	<b>Lever Sub Assembly LH</b>	
				605, 606, 619, 625, 626	\$132.00
				611, 612, 613	\$231.00
			382F63-6	Backplate Sub Assembly Active	\$128.00
			382F68-6	Slide	\$43.00

\*Specify Finish. Ø Subject to availability.

† Sold only in multiples of the number indicated. Price is each.



**DEVICE PARTS (Cont'd)**

PART NO.	DESCRIPTION	LIST PRICE	PART NO.	DESCRIPTION	LIST PRICE
382F69-8	Compensator	\$17.00	398F69-8	Rose Liner	\$3.20
382F72-9	Flanged Nyliner	\$4.50		<b>Case Cover</b>	
382F78/8	Cam	\$21.00	398F89	606, 612, 619, 626, 630	\$55.00
382F79-8	Clip †Order 50-	\$0.50		605, 611, 613, 625, 629	\$80.00
382F80-8	Bushing	\$3.10	398F91-9	Bumper	\$4.80
382F81-8	Cam Driver	\$5.40	398F94-8	Connecting Pin	\$3.60
382F82-8	Cam Driver	\$5.40	398F95-7	Trip	\$4.80
382F85-8	Pivot	\$2.80	398F99-7	Top Pusher Assembly	\$92.00
382F86-5	Half Case	\$17.00	399F00*	Case Cover	\$66.00
382F87-8	Lever Assembly	\$21.00	399F02-7	Bridge	\$41.00
382F88-8	Lever Assembly	\$23.00	399F05-7	Case	\$65.00
382F95-6	Backplate Assembly	\$310.00	399F06-7	Top Latch Sub Assembly	\$195.00
382F98-6	Backplate Assembly (Active)	\$263.00	399F07-7	Bottom Bolt	\$80.00
386F15-8	Cover Screw 8-31 x 1/2" FHMS-PH	\$0.50	399F10-8	Frame and Bridge Assembly	\$94.00
389F54*	Grip	\$108.00	399F12*	Top Pusher Assembly	\$366.00
389F62	Grip	\$104.00	399F13*	Bottom Bolt Assembly	\$336.00
391F88-2*	Top Latch Assembly	\$90.00	399F18-8	Lower Bolt Assembly	\$304.00
Ø 391F90-9	Pad †Order 20-	\$2.04	399F21*	Grip	\$92.00
391F94-8	Frame	\$25.00	399F22*	Grip	\$196.00
391F96-8*	Frame & Yoke Assembly	\$88.00	399F23*	Escutcheon	\$102.00
391F99*	Bushing Retainer Assembly	\$17.00	Ø 399F58-8	Washer	\$4.20
392F02	<b>Top Latch S/A</b>			<b>Bottom Rod</b>	
	605, 606, 611, 612, 613, 619, 625, 626, 629, 630	\$265.00	399L11 x 563	606, 612, 619, 626	\$141.00
392F05*	Latchbolt Assembly	\$88.00		605, 611, 613, 625, 629, 630	\$205.00
392F08-8	Bottom Slide Assembly	\$24.00	402F99*	Thumbpiece	\$41.00
392F10	Bottom Latch Assembly	\$210.00	403F03-5	Slide x4M Trim	\$81.00
392F11	<b>Bottom Latch S/A</b>		403F30*	Washer	\$3.00
	605, 606, 611, 612, 613, 619, 625, 626, 629, 630	\$300.00	405F42-8	Anchor	\$6.20
392F14-8	Adjusting Bolt	\$22.00	405F45-8	Mullion (507) 7'2" door	\$210.00
392F23*	Adjusting Top Strike	\$84.00	Ø 405F46-6	Bottom Plate	\$95.00
392F23-7*	Adjusting Top Strike, stainless	\$118.00	405F47-6	Top Plate	\$83.00
392F27-9	Rod Guide Sub Assembly	\$5.40	405F49-6	Bottom Plate Assembly	
392L19*	Adj. Bottom Rod Assembly	\$210.00	Ø 409F83-6	Top Plate Assembly	
	<b>Adjusting Bottom Rod S/A Flush Strike</b>		410F13*	Escutcheon	
392L20 x 547	605, 606, 619, 626	\$196.00	410F14*	Escutcheon x cyl.	
	611, 612, 613, 625, 630	\$234.00	410F20*	Escutcheon	
392L20 x 568	<b>Adjusting Bottom Rod S/A</b>		411F96-4	Spring	\$10.00
	Regular Strikes 605, 606, 619, 626	\$196.00	411F98-7	Plunger Spring †Order 100-	\$3.00
	611, 612, 613, 625, 630	\$234.00	412F03-7	Retractor Spring †Order 20-	\$1.80
393L13-M672*	Top Rod	\$154.00	412F06-7	Latch Bushing	\$6.90
393L14 x 672	<b>Top Rod S/A (Standard)</b>		412F07-8	Latch Pivot Screw	\$3.20
	605, 606, 611, 612, 619, 625, 626	\$196.00	412F08-7	Latch Spring	\$3.00
	613, 629, 630	\$234.00	412F09-1	Spacer	\$3.70
397F91-8	Backplate Sub Assembly	\$102.00	412F11-7	Spring	\$3.00
			412F13-3*	Screw, 8-32 x 5/16"	

\*Specify Finish. Ø Subject to availability.

† Sold only in multiples of the number indicated. Price is each.

**DEVICE PARTS (Cont'd)**

PART NO.	DESCRIPTION	LIST PRICE	PART NO.	DESCRIPTION	LIST PRICE
412F15-7	Lever Pivot	\$9.30	<b>BLANK FRONTS AND STRIKES FOR STOCK HOLLOW METAL DOORS AND FRAMES Steel, USP</b>		
412F16-7	Deadlocking Plunger	\$18.00			
412F45-1	Inactive Backplate Assembly	\$92.00	077F19-8	Front, 2-1/4" x 1-1/8"	\$8.00
416F81-8	Stud	\$7.30	334F99	Front, 8" x 1-1/4"	\$18.00
418F28-8	Dogging Screw	\$6.00	Ø 236L718018	Strike, 4-7/8" x 1-1/4"	\$8.00
418F30-8	Rivet	\$3.20	321F24*	RHR Bracket for P3 trim	\$95.00
418F35-2	Hub	\$44.00	393L13-M672*	Top Rod	\$154.00
418F36-8	Lever, RH	\$4.50	Ø 399F16-8	Spindle Adapter	\$45.00
418F37-8	Lever, LH		399F17-8	Lower Rod Assembly	\$154.00
420F12-8*	Screw Packet	\$40.00	402F98-3	Extension Slide	\$30.00
433F97-8	Lever Pivot	\$38.00	402F99*	Thumbpiece	\$41.00
433F98-8	Lever Pivot		408F25-8	Guide Spring	\$0.70
434F00-8	Lever Pivot	\$22.00	503F53-3	Bottom Strike	\$52.00
434F02-8	Screw 1/4-20 x 3/4" BUHC-SK	\$0.60	503F55-7	Top Strike	\$48.00
464F02-8	Mullion (508) 8' door	\$205.00	503F56-7	Top Strike - Fire Rated	
464F91-5	Active Case Casting only	\$40.00			
467F94-2	Thumbpiece Lever RH	\$72.00			
467F95-2*	Thumbpiece Lever LH				
468F02-2*	Lever, inactive RH	\$112.00			
468F03-2*	Lever, inactive LH				
468F12-2	Thumbpiece Lever Assembly RH	\$187.00			
468F13-2	Thumbpiece Lever Assembly LH				
468F14-7	Latch Pin Assembly RH	\$72.00			
468F15-7	Latch Pin Assembly LH				
468F16-2	Lever Assembly RH	\$68.00			
468F17-2	Lever Assembly LH				
468F20-2*	Lever Assembly RH	\$172.00			
468F21-2*	Lever Assembly LH				
468F24-6	Active Backplate Assembly, RH	\$710.00			
468F25-6	Active Backplate Assembly, LH				
468F26-6	Active Backplate Assembly, RH				
468F27-6	Active Backplate Assembly, LH				
468F35-5	Cylinder housing	\$9.00			
480F12-8	Inactive Backplate Assembly	\$95.00			
480F13*	Lever	\$240.00			
480F18-8	Spindle	\$39.00			
480F19-8	Nut	\$9.00			
480F20-8	Rollback	\$9.50			
480F28*	Lever & Spindle Assembly	\$222.00			
480F30*	Lever & Spindle Assembly	\$222.00			
480F33*	Lever & Spindle Assembly	\$226.00			
480F37-5	Slide	\$45.00			
482F44-2	*Bushing	\$49.00			
482F49*	Escutcheon	\$220.00			
482F73*	Escutcheon & Bushing	\$226.00			
484F41-8	Rollback	\$15.00			
484F89-8	Knob Shank Sub Assembly	\$28.00			
492F19-5	Slide	\$79.00			
499F60-8*	Tenon Packet	\$51.00			
622F68	Screw Pack for 2"-2-1/4" door 613, 626	\$47.00			
<b>BLANK PLATE FOR STOCK HOLLOW METAL DOORS</b>					
561F29	<b>Bank Plate 14" x 3-1/2"</b> Used on the outside of stock cut-out hollow metal doors where no trim is desired				
	605, 606, 612, 619, 625, 626, 630	\$112.00			
	613	\$118.00			

\*Specify Finish.      Ø Subject to availability.

**DEVICE PARTS (Cont'd)**

PART NO.	DESCRIPTION	LIST PRICE
<b>ALARM DELAY SWITCH</b>		
696F318	for M62 option	\$47.00
<b>BAR</b> 689, 690, 691		
436F41-8	for ED8400, 30" door width, with dogging	\$300.00
436F42-8	for ED8400, 36" door width, with dogging	
436F43-8	for ED8400, 42" door width, with dogging	\$324.00
436F44-8	for ED8400, 48" door width, with dogging	
387F21-8	for ED8200, 30" door width, with dogging	\$280.00
387F24-8	for ED8200, 36" door width, with dogging	
387F27-8	for ED8200, 42" door width, with dogging	\$302.00
387F30-8	for ED8200, 48" door width, with dogging	
387F63-8	for ED8200, 30" door width, less dogging	\$274.00
387F66-8	for ED8200, 36" door width, less dogging	
387F69-8	for ED8200, 42" door width, less dogging	\$296.00
387F72-8	for ED8200, 48" door width, less dogging	
564F888	for ED8400, 30" door width, less dogging	\$294.00
564F898	for ED8400, 36" door width, less dogging	
564F908	for ED8400, 42" door width, less dogging	\$318.00
564F918	for ED8400, 48" door width, less dogging	
564F378	for ED8400A, 30" door width, less dogging	\$294.00
564F408	for ED8400A, 36" door width, less dogging	
564F438	for ED8400A, 42" door width, less dogging	\$318.00
564F688	for ED8400A, 48" door width, less dogging	
<b>BOTTOM ROD</b>		
436L32-8557	for ED8400, 40-5/16" Pushbar Height, for Door 7'6" high	\$158.00
526L51-8540	for ED8400A	
<b>BRACKET</b> 605, 606, 611, 612, 613, 619, 622, 625, 626		
321F23	LHR Bracket for P3 trim	\$110.00
321F24	RHR Bracket for P3 trim	
<b>FRAME PLATES</b>		
552F59-8	for ED8400 - RHR	\$143.00
552F60-8	for ED8400 - LHR	
552F468	for ED8400A - RHR	\$207.00
552F478	for ED8400A - LHR	
<b>FRONT COVER</b>		
564F345	for ED8400 (A) (not handed)	\$41.00
385F54-5	for ED8200(B) (not handed)	\$49.00
564F115	for ED8200A (not handed)	\$61.00
<b>KNOB</b> 605, 606, 611, 612, 613, 619, 625, 626		
695F22	for G10 Trim, plain	\$101.00
695F23	for G10 Trim, with cylinder hole	\$99.00
<b>LATCH</b>		
436F25-8	for ED8400, Top No Finish	\$165.00
436F29-8	for ED8400, Bottom No Finish	\$88.00
552F36-8	for ED8200(B) 626	\$104.00
552F41-6	for ED8200A	\$242.00
525F99-8	for ED8400A, top	\$176.00
526F16-8	for ED8400A, bottom	\$203.00
<b>LATCH COVER</b> 689, 690, 691		
526F32-1	for ED8400A, Top or Bottom Latches	\$79.00
446F23-1	for ED8400, Top or Bottom Latches	\$67.00

PART NO.	DESCRIPTION	LIST PRICE
<b>MISCELLANEOUS</b>		
650F27-9	Dogging Hole Plug	\$0.70
697F98-8	Sex Nut Pack (M54)	\$15.00
436F858	Latch Assembly Screw	\$0.60
558F52-8	Mounting packet for F1 and P8 Trim 689, 690, 691	\$20.00
482F79-8	ANSI fastening plate packet for G3 Trim No Finish	\$8.19
123F53-8	Dogging Key, 3/16" hex No Finish	\$3.00
<b>MOUNTING PACKET</b> 605, 606, 611, 612, 613, 619, 622, 625, 626		
469F67	for F157, P157, P857 trim	\$23.00
469F68	for F150, P150, P850 trim (dummy)	\$13.00
496F68	for P257 trim	\$25.00
496F69	for P250 trim (dummy)	\$23.00
<b>PLATES AND PULLS</b> 689, 690, 691		
436F82-8	for F1 Trim, plate - no cylinder hole	\$35.00
436F83-8	for F1 Trim, plate - with cylinder hole	
436F80-1	for P8 Trim, pull - no cylinder hole	\$41.00
436F81-1	for P8 Trim, pull - with cylinder hole	
602F15-1	Pull Grip (Black) for P2 622 Only	\$48.00
<b>605, 606, 611, 612, 613, 619, 622, 625, 626</b>		
270F13	Escutcheon for P3 trim without cylinder hole	\$93.00
492F20	Offset Pull for P1 trim without cylinder hole	\$115.00
492F21	Offset Pull for P1 trim with cylinder hole	\$134.00
602F18-1	Pull Base for P2 trim plate without cylinder hole	\$175.00
602F17-1	Pull Base for P2 trim plate with cylinder hole	\$193.00
328F80	Pull Tube for P3 trim	\$93.00
<b>REAR COVER</b> 689, 690, 691		
603F64	for ED8000 devices purchased AFTER Nov. 1, 1993	\$24.00
<b>ROD GUIDE PACKET SCREW PACKET</b>		
446F20-8	Rod guide packet	\$31.00
523F03-8	for ED8200(B) and ED8400(A), Packet for mounting bar & active case with SNB	\$31.00
484F20-8	for ED8400, Packet for mounting top latch	\$50.00
484F21-8	for ED8400, Packet for mounting bottom latch	\$21.00
261F30-8	for ED8200, Latch & Frame Plate Attachment Screw †Order 20-	\$2.30
<b>ROD GUIDE PACKET SCREW PACKET (Cont'd)</b>		
449F82-8	for ED8200(B) and ED8400 for bar & active case	\$21.00
492F59	Rear Side Screw Packet for P1 trim	\$4.50
564F128	for ED8200A, Packet for mtg. bar & active case with SNB	\$37.00
534F008	for ED8400A, Packet for mtg. Top & bottom latch	\$45.00
<b>SHIM KITS</b>		
557F92-8	for ED8200 (B)	\$74.00
557F93-8	for ED8200A	\$74.00
557F94-8	for ED8400	\$123.00
557F95-8	for ED8400A	\$123.00

†Sold only in multiples of the number indicated. Price is each.



PART NO.	DESCRIPTION	LIST PRICE	PART NO.	DESCRIPTION	LIST PRICE
<b>STRIKE PACKET</b>			<b>LEVERS ALL FINISHES</b>		
391F57-5	for ED8200, Shim used with 1/2" Stop	\$25.00	<b>LFIC, 1-3/8" TO 2-1/4" DOORS</b>		
446F21M	for ED8400, Packet for Top Latch.Strike 605, 606, 611, 612, 613, 622, 625, 626	\$41.00	585F715	N6 x cylinder (LFIC core 6-pin)	\$93.00
446F22-8	for ED8400, Packet for Bottom Latch (Surface Mounting) 625 only	\$31.00	600F415	N6 x cylinder (LFIC core 7-pin)	
463F92-8	for ED8400, Packet for Bottom Latch (Flush Mounting) 625 only	\$27.00	596F825	N6 x Best® cylinder cutout	\$95.00
386F45-3	for ED8200(B) Strike Packet 612, 613, 626	\$37.00	585F705	A6 x cylinder (LFIC core 6-pin)	\$93.00
468F30-5	Packet for Rim by Vertical Rod 605, 606, 612, 613, 622, 625, 626, 689, 690, 691	\$31.00	600F425	A6 x cylinder (LFIC core 7-pin)	
518F06-7	for ED8200A	\$61.00	685F535	P6 x cylinder (LFIC core 6-pin)	
526F52-7	for ED8400A, Packet for Top Strike	\$42.00	685F545	P6 x cylinder (LFIC core 7-pin)	\$95.00
526F53-3	for ED8400A, Packet for Bottom Strike	\$38.00	685F555	P6 x Best cylinder cutout	
<b>TOP ROD</b>					
487L048-697	for ED8400, 40-5/16" Pushbar Height, for Door 7'6" high	\$88.00			
487M048-589	for ED8400, 40-5/16" Pushbar Height, for Door 7'6" high to 10' high	\$116.00			
526L928759	for ED8400A	\$74.00			
<b>CHASSIS, 1-3/4" TO 2-1/4" DOORS NO FINISH</b>					
690F44	Dummy (50)	\$84.00			
698F43	Passage (10)				
698F44	Classroom (55)	\$92.00			
698F45	Nightlatch (57)				
698F46	Storeroom (59)				
698F51	Classroom - LFIC	\$98.00			
698F52	Nightlatch - LFIC				
698F53	Storeroom - LFIC				
<b>MISCELLANEOUS 605, 606, 611, 612, 613, 619, 625, 626</b>					
678F25	Rose for X6 trim	\$24.00			
585F72	Lever Insert for X6 trim	\$1.30			
682F91	Recore Driver Packet	\$5.00			
696F05	Mounting Packet	\$3.40			
<b>LEVERS ALL FINISHES</b>					
<b>STANDARD 1-3/8" TO 2-1/4" DOORS</b>					
563F955	N6 design x cylinder or button	\$91.00			
563F965	N6 design x emergency key hole				
563F945	N6 design x plain				
578F435	N6 x Sargent® cylinder cutout	\$93.00			
563F895	A6 design x cylinder or button	\$91.00			
563F905	A6 design x emergency key hole				
563F885	A6 design x plain				
685F515	P6 design x cylinder or button				
685F525	P6 design x emergency key hole				
685F505	P6 design x plain				

†Sold only in multiples of the number indicated. Price is each.

## ASSA ABLOY

## DC3000/DC5000 Series Door Closers

### DC3000 CLOSER PARTS

PART NO.	DESCRIPTION	LIST PRICE
<b>TOOLS</b>		
330F10	Hex wrench for closer valve, 3/32"	\$2.80
597F24	Torx tool kit	\$155.00
<b>CLOSER BODIES 600, 689, 690, 691, 693, 696</b>		
540F27	Closer body for DC3200	\$283.00
597F35	Closer body for DC3200 x M71	\$283.00
M71 = Delayed action		
<b>ARMS 600, 689, 690, 691, 693, 696</b>		
688F95	Regular arm	\$57.80
688F77	Regular arm with hold-open	\$87.00
688F95	Top jamb	\$57.80
688F77	Top jamb with hold-open	\$87.00
689F02	Heavy-duty parallel arm	\$91.00
689F01	Heavy-duty parallel arm with hold-open	\$111.00
597F52	Heavy-duty regular arm	\$91.00
689F03	Heavy-duty parallel arm with backstop	\$99.00
689F04	Heavy-duty parallel arm with backstop & hold-open	\$143.00
691F98	Reg. secondary arm assy.	\$23.00
691F99	Deep reveal secondary arm assembly	\$24.00
692F02	Reg. H.D. secondary arm assembly	\$131.00
692F03	Deep reveal H.D. secondary arm assembly	\$225.00
<b>BRACKETS 600, 689, 690, 691, 693, 696</b>		
188F03	Quik-Install™	\$15.00
188F41	Parallel arm	\$4.80
509F49	Parallel arm with hold-open	\$33.00
188F62	Parallel arm offset	\$22.00
188F63	Parallel arm for flush transom	\$33.00
244F17	Regular arm mortise	\$41.00
447F14	Angle Support Bracket and Spacer	\$33.00
<b>DROP PLATES 600, 689, 690, 691, 693, 696</b>		
188F65	For DC3220 x full cover	\$50.00
597F58	For DC3210 x full cover	\$56.00
<b>COVERS 600, 689, 690, 691, 693, 696</b>		
597F78	Full cover and insert packet (standard)	\$32.00
<b>PAINT (PER CAN)</b>		
597F94	Silver Aluminum - 689	\$42.00
597F95	Dark Bronze - 690	
597F96	Light Bronze - 691	
597F97	Satin Brass - 696	

### DC5000 CLOSER PARTS

PART NO.	DESCRIPTION	LIST PRICE
<b>CLOSER BODY 600, 689, 690, 691, 693, 696</b>		
754F68	Closer Body Only	\$361.00
<b>ARMS 600, 689, 690, 691, 693, 696</b>		
754F95	Pull Side Slide Track & Arm Assy., Non-Hold Open	\$148.00
754F96	Pull Side Slide Track & Arm Assy., Hold Open	\$224.00
795F97	Push Side Slide Track & Arm Assy., Non-Hold Open	\$148.00
754F98	Push Side Slide Track & Arm Assy., Hold Open	\$224.00
754F92	Hold Open Assembly	\$36.00
<b>COVER</b>		
754F79	Plastic Cover	\$33.00
<b>DROP PLATE</b>		
754F80	Push side, drop plate	\$39.00
<b>ANGLE BRACKET</b>		
754F93	Stop Mount Track Angle Bracket	\$76.00
<b>SCREW PACKETS</b>		
754F69	Closer Screw Pack	\$8.50
754F70	Spline Screw Pack	\$22.00
754F94	Track Screw Pack	\$11.00

**CLOSER PARTS**

PART NO.	DESCRIPTION	LIST PRICE
<b>CLOSER BODIES 600, 689, 690, 691, 693, 696</b>		
689F12	Closer body for DC6200	\$333.00
689F13	Closer body for DC6200 x M71	\$331.00
689F14	Closer body for DC6401	\$333.00
689F15	Closer body for DC6402	
689F16	Closer body for DC6403	
689F17	Closer body for DC6404	
689F18	Closer body for DC6405	
689F19	Closer body for DC6406	
691F52	Closer body for DC6401 x M71	
691F53	Closer body for DC6402 x M71	
691F54	Closer body for DC6403 x M71	
691F55	Closer body for DC6404 x M71	
691F56	Closer body for DC6405 x M71	
691F57	Closer body for DC6406 x M71	
M71 = Delayed action		
<b>ARMS 600, 689, 690, 691, 693, 696</b>		
688F95	Regular arm, consists of:	\$57.80
	688F99 main arm & tube assembly	\$37.00
	688F98 rod & shoe assembly	\$15.30
	688F92 hex screw pkg.	\$5.50
688F77	Regular arm with hold-open (A1), consists of:	\$87.00
	691F92 main arm & rod assy	\$35.00
	540F40 hold-open bracket assembly	\$52.00
689F02	Heavy duty parallel arm (A3)	\$91.00
689F01	Heavy duty parallel arm with hold-open (A2)	\$111.00
597F52	Heavy duty regular arm (A10)	\$91.00
689F03	Heavy duty parallel arm with backstop (A4)	\$99.00
689F04	Heavy duty parallel arm with backstop & hold-open (A5)	\$143.00
615F52	HD Spring stop for Dr. wdth. 28"-32" (A11)	\$147.00
615F54	Unitrol® for Dr. wdth. 33"-41"	
615F56	Unitrol® for Dr. wdth. 42"-48"	
615F51	Unitrol®/HO for Dr. wdth. 28"-32" (A12)	\$167.00
615F53	Unitrol®/HO for Dr. wdth. 33"-41"	
615F55	Unitrol®/HO for Dr. wdth. 42"-48"	
691F96	Heavy-duty offset arm (A13)	\$98.00
754F16	DC6230, DC6430 pull side - arm only	\$76.00
754F10	DC6230, DC6430 - track only (hold-open)	\$224.00
754F09	DC6230, DC6430 - track only (non hold-open)	\$148.00
754F44	DC6230, DC6430 pull side track assembly, non-hold open	\$318.00
754F45	DC6230, DC6430 pull side track assembly, hold open	\$397.00
754F12	DC6240, DC6440 push side track & arm (non hold open)	\$221.00
754F14	DC6240, DC6440 - track only (non hold-open)	\$148.00
754F13	DC6240, DC6440 track & arm (hold-open)	\$300.00
754F15	DC6240, DC6440 - track only (hold-open)	\$224.00
754F16	DC6240, DC6440 - arm only (hold-open)	\$76.00
691F72	Deep reveal arm (7-1/4" max), consists of:	\$52.30
	688F99 main arm and arm tube assy	\$37.00
	691F75 rod & shoe assembly	\$11.00

PART NO.	DESCRIPTION	LIST PRICE
<b>ARMS 600, 689, 690, 691, 693, 696</b>		
691F74	Deep reveal arm w/hold-open (7-1/4" max), consists of:	\$84.00
	691F95 main arm & rod assy- deep reveal	\$84.00
	540F40 hold-open bracket assy.	\$26.00
		\$52.00
615F58	Reinforcing bracket	\$28.00
615F59	Deep reveal reinforcing kit	\$38.50
615F60	Flush partition bracket	\$27.00
692F04	Friction, Hold Open Arm RH	\$90.00
692F05	Friction, Hold Open Arm LH	\$90.00
692F00	Reg. Secondary Arm Assy.	\$34.00
692F01	Top Jamb Secondary Arm Assy.	\$35.00
692F02	Reg. H.D. Secondary Arm Assy.	\$131.00
692F03	Deep Reveal HD. Secondary Arm Assy.	\$225.00
<b>BRACKETS 600, 689, 690, 691, 693, 696</b>		
188F03	Quik-Install™	\$15.00
188F41	Parallel arm	\$4.80
509F49	Parallel arm with hold-open	\$33.00
188F63	Parallel arm for flush transom	\$33.00
188F62	Parallel arm offset	\$22.00
244F17	Regular arm mortise	\$41.00
447F14	Angle support	\$33.00
499F30	Flush transom	\$21.00
691F78	Spacer	\$3.50
<b>COVERS 600, 689, 690, 691, 693, 696</b>		
597F78	Full cover and insert pkt. (standard)	\$32.00
603F55	Full metal cover RH/LHR	\$37.00
603F57	Full metal cover LH/RHR	
261F95	Cover screw pack	\$3.20
<b>DROP PLATES 600, 689, 690, 691, 693, 696</b>		
188F65	For DC6220 x full cover	\$50.00
	For DC6420 x full cover	
597F58	For DC6210, DC6410, DC6240, DC6440 x full cover	\$56.00
597F59	For DC6230, DC6240, x full cover	\$50.00
	For DC6430, DC6440 x full cover	
<b>BLADE STOP SPACER</b>		
597F92	1/2" Spacer block	\$20.00
597F93	5/8" Spacer block	\$33.00
<b>SCREW PACKETS 600, 689, 690, 691, 693, 696</b>		
691F93	Standard Screw Pack	\$9.40
691F94	Standard Screw Pack w/ Sex Nuts	\$16.00
468F34	SNB for 1-3/4" door	\$8.80
691F89	Torx® Screw Pack	\$22.00
691F90	Torx Screw Pack with Sex Nuts	\$26.00
597F24	Torx® tool kit	\$155.00
754F43	Screw pack (push or pull track)	\$14.00
<b>PAINT (PER CAN)</b>		
597F94	Silver Aluminum - 689	\$42.00
597F95	Dark Bronze - 690	
597F96	Light Bronze - 691	
597F97	Satin Brass - 696	

**CLOSER PARTS**

PART NO.	DESCRIPTION	LIST PRICE
<b>CLOSER BODIES</b>		
754F21	Closer body for DC8200	\$410.00
754F26	Closer body for DC8200 x M71	\$410.00
<b>ARMS</b>		
688F95	Regular arm, consists of:	\$57.80
	688F99 main arm & tube assembly	\$37.00
	688F98 rod & shoe assembly	\$15.30
	688F92 hex screw pkg.	\$5.50
688F77	Regular arm with hold-open (A1), consists of:	\$87.00
	691F92 main arm & rod assy	\$35.00
	540F40 hold open bracket assembly	\$52.00
689F02	Heavy-duty parallel arm (A3)	\$91.00
689F01	Heavy-duty parallel arm with hold-open (A2)	\$111.00
597F52	Heavy-duty regular arm (A10)	\$91.00
689F03	Heavy-duty parallel arm with backstop (A4)	\$99.00
689F04	Heavy-duty parallel arm with backstop & hold-open (A5)	\$143.00
615F52	Unitrol® - Dr. width 28"-32" (A11)	\$147.00
615F54	Unitrol® - Dr. width 33"-41" (A11)	
615F56	Unitrol® - Dr. width 42"-48" (A11)	
615F51	Unitrol® w/ Hold Open - Dr. width 28"-32" (A12)	\$167.00
615F53	Unitrol® w/ Hold Open - Dr. width 33"-41" (A12)	
615F55	Unitrol® w/ Hold Open - Dr. width 42"-48" (A12)	
691F96	Heavy-duty offset arm (A13)	\$98.00
692F04	Heavy duty friction hold open, RH (A14)	\$90.00
692F05	Heavy duty friction hold open, LH (A14)	\$90.00
754F09	Pull side track only, non-hold open	\$148.00
754F10	Pull side track only, hold open	\$224.00
754F12	Push side track & arm, non-hold open	\$221.00
754F13	Push side track & arm, hold open	\$300.00
754F14	Push side track only, non-hold open	\$148.00
754F15	Push side track only, hold open	\$224.00
754F16	Slide track assembly (non-hold open or hold open)	\$76.00
691F72	Deep reveal arm (7 1/4" max) consists of:	\$52.30
	688F99 main arm and arm tube assy	\$37.00
	691F75 rod & shoe assembly	\$11.00
691F74	Deep reveal arm with hold-open (7 1/4" max), consists of:	\$84.00
	691F95 main arm & rod assy- deep reveal	\$26.00
	540F40 hold open bracket assy.	\$52.00
615F58	Reinforcing bracket	\$28.00
615F59	Deep reveal reinforcing kit	\$38.50
615F60	Flush partition bracket	\$27.00

PART NO.	DESCRIPTION	LIST PRICE
<b>BRACKET</b>		
754F18	Quik-Install™	\$16.00
188F41	Parallel arm	\$4.80
509F49	Parallel arm with hold-open	\$33.00
188F63	Parallel arm for flush transom	\$33.00
188F62	Parallel arm offset	\$22.00
244F17	Regular arm mortise	\$41.00
447F14	Angle support	\$33.00
499F30	Heavy duty parallel arm flush transom bracket	\$21.00
<b>COVERS</b>		
754F19	Full PVC cover	\$35.00
754F84	Full ABS cover	
754F22	Full metal cover RH/LHR	\$50.00
754F23	Full metal cover LH/RHR	
754F17	Cover screw pack	\$3.80
<b>DROP PLATES</b>		
754F20	For DC8200 (regular)	\$70.00
754F24	For DC8200 (with concealed holder)	\$70.00
	For DC8220 (top jamb)	
754F25	For DC8210 (parallel)	\$70.00
	For DC8230 (pull side track)	
	For DC8240 (push side track)	
<b>BLADE STOP SPACER</b>		
597F92	1/2" Spacer block	\$20.00
597F93	5/8" Spacer block	\$33.00
<b>SCREW PACKETS</b>		
754F37	Standard screw pack	\$10.00
754F29	Standard screw pack (includes sex nuts)	
754F30	SNB for 1-3/4" door	\$13.00
754F38	Torx® screw pack	\$32.00
754F34	Torx screw pack (includes sex nuts)	
597F24	Torx® tool kit	\$4.40
754F35	Main arm screw & washer	
<b>RETROFIT PLATES</b>		
754F36	To Replace DC6000 (Reg. Arm)	\$74.00
754F46	To Replace DC6000 (Par. Arm or Top Jamb)	\$74.00

PART NO.	DESCRIPTION	LIST PRICE
<b>DC62900 SERIES ELECTROMECHANICAL CLOSERS</b>		
689F12	DC6000 Closer Body	\$333.00
188F03	Quik-Install Bracket	\$15.00
597F78	Full Cover	\$32.00
603F55	Full Metal Cover RH	\$37.00
603F57	Full Metal Cover LH	\$37.00
692F24	Standard Arm Assembly	\$73.00
692F25	Adjusting Head and Tube Assembly	\$91.00
692F14	Slide Assembly	\$78.00
692F15	Arm Stud Clip	\$6.90
692F16	Track Assembly End Cap	\$5.70
692F17	Solenoid Block Assembly, 24V	\$233.00
692F19	Adjusting Rod Assembly	\$38.00
692F20	Arm Stud	\$4.60
692F21	Retaining Ring	\$2.20
692F23	Arm Length Adjusting Screw	\$1.50
754F02	Double Egress Arm, RH	\$133.00
754F03	Double Egress Arm, LH	\$133.00
754F04	Adjusting Head and Tube Assembly, RH	\$89.00
754F05	Adjusting Head and Tube Assembly, LH	\$89.00
754F52	Track Assy. (Hinge Side) Master or support units	\$290.00
754F53	Track Assy. (Stop Side) Master or support units	
754F54	Hook-Up Board, Master or Support, 24V	\$95.00
754F55	Hook-Up Board, Master or Support, 120V	\$142.00
754F56	Hook-Up Box, Master unit, 24V, push side	\$252.00
754F57	Hook-Up Box, Master unit, 120V, push side	
754F58	Hook-Up Box, Support unit, 24V, push side	\$242.00
754F59	Hook-Up Box, Support unit, 120V, push side	
754F61	Hook-Up Box, Master unit, 24V, pull side	\$252.00
754F62	Hook-Up Box, Master unit, 120V, pull side	
754F63	Hook-Up Box, Support unit, 24V, pull side	\$252.00
754F64	Hook-Up Box, Support unit, 120V, pull side	
754F66	Fuse	\$14.00
754F71	Hook-Up Box Cover Kit (included cover & screws), Master	\$252.00
754F72	Hook-Up Box Cover Kit (included cover & screws), Support	\$43.00
754F73	Smoke Detector Board	\$375.00

PART NO.	DESCRIPTION	LIST PRICE
<b>DC46920 SERIES ELECTROMECHANICAL DOOR HOLDER AND CLOSER</b>		
494F77	Arm Assembly "Pull side"	\$153.00
494F76	Arm Assembly "Push side"	
494F74	Holder - 120VAC	\$325.00
494F75	Holder - 24VAC/DC	\$325.00
494F72	Holder cover - Non Detector	\$124.00
494F86	System plug - 120VAC/24VAC	\$75.00
494F92	System plug - 24VDC	
494F93	Wire harness - 120VAC/24VAC	\$60.00
494F94	Wire harness - 24VDC	

PART NO.	DESCRIPTION	LIST PRICE
<b>Access 800° AC2 Series</b>		
794F509	Gaskets Exit device - Reader	\$13.40
794F519	Gaskets Exit device trim	\$13.40
794F529	Gaskets Cylindrical lock	\$6.60
794F539	Gaskets Mortise lock	\$6.60



ASSA ABLOY

Notes



For more information regarding Corbin Russwin Locksets, Exit Devices, Door Controls and Key Systems, contact your authorized Corbin Russwin Distributor or Sales Representative.



**Corbin Russwin Architectural Hardware**

225 Episcopal Road  
Berlin, CT 06037  
Phone 800-543-3658  
Fax 800-447-6714  
[www.corbinrusswin.com](http://www.corbinrusswin.com)

**Notice:** This price book takes precedence over the catalog as to the correctness and availability of items in our entire line.

Corbin Russwin and Design®, Corbin®, Russwin®, and Design® Access 800®, Muséo®, and SecureBolt® are registered trademarks of Corbin Russwin, Inc., an ASSA ABLOY Group company. Safeguard™, PathLite™ and Vineyard™ are trademarks of Corbin Russwin, Inc. an ASSA ABLOY Group company. Unitrol® is a registered trademark of Yale Security Inc., an ASSA ABLOY Group company. These materials are protected under US copyright laws. All contents current at time of publication. Corbin Russwin Inc., an ASSA ABLOY Group company reserves the right to change availability of any item in this catalog, its design, construction, and/or its materials. Other products' brand names may be trademarks or registered trademarks of their respective owners and are mentioned for reference purposes only.

Copyright © 2002 - 2015 Corbin Russwin, Inc., an ASSA ABLOY Group company. All rights reserved. Reproduction in whole or in part without the express written permission of Corbin Russwin, Inc. is prohibited.