



DOOR CLOSERS



Ver. 2.0, Rev. 11/12
© 2012  CAL ROYAL

900 Series List Price

GRADE 1 ADA / Barrier Free Adjustable Door Closer With Full Cover



ILLUSTRATION	ITEM #	DESCRIPTION	1 CASE	5 CASES	10 CASES	PCS /MC	UNIT
	N900-PBF	Barrier free, (Interior & Exterior) Adjustable size 1-6, door weights 30-260 lbs (Full Cover)	\$110.88	\$105.89	\$100.89	6	Ea.
	N900-PBFDA	Barrier free, Adjustable size 1-6, door weights 30-260 lbs with Delay Action (Interior & Exterior) (Full Cover)	118.37	113.38	108.39		

◆◆◆ Prices above are for Aluminum, Duro and Gold finish only ◆◆◆

Specify "MADE IN KOREA" when ordering "THE BUY AMERICAN ACT" compliant models

PLATED AND PAINTED FINISHES

PLATED FINISHES	US3, US26, US26D, US10B, US5, US4, US15, US10 In stock (Includes: Metal cover, full arm, screws and parallel bracket.)	Add 74.91 List Each
PLATED FINISHES	Other finishes (Allow 6-8 weeks delivery)	
PAINTED	Special colors (Allow 6-8 weeks delivery)	Add 49.95 List Each

► PACKAGING INCLUDES

- Parallel bracket
- Wood screws and **self-tapping machine screws**
- Full cover
- Sex bolts







► STOCK FINISHES

- Aluminum
- Duranodic
- Gold
- US3, US26, US26D, US10B, US5, US4, US15, US10
- US32D – Cover Only

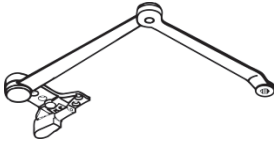
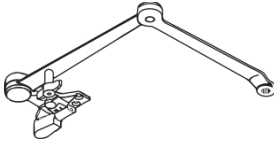
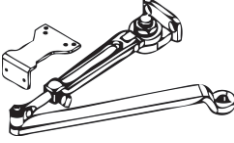
► PARTS & ACCESSORIES

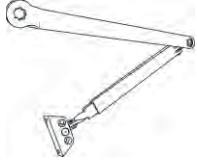
◆◆◆ STANDARD DISCOUNT ONLY ◆◆◆

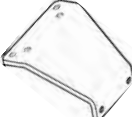
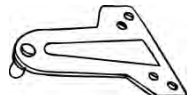
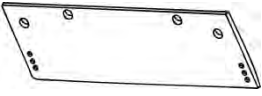
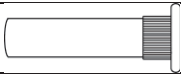
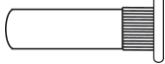
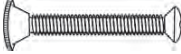
ILLUSTRATION	ITEM #	DESCRIPTION	LIST PRICE	UNIT
ARMS				
	SPAS/900	Super rigid parallel arm stopper, non-handed with stop in soffit shoe. (Equivalent to LCN CUSH-N-STOP ARM)	44.94	Ea.
	SPAS/900 PLATED FINISH	Super rigid parallel arm stopper, non-handed US3, US26	89.89	
	HOSRPS/900	Super rigid parallel arm stopper hold open, non-handed with stop in soffit shoe. Handle controls hold open function. (Equivalent to LCN H-CUSH ARM)	49.95	
	HOSRPS/900 PLATED FINISH	Super rigid parallel arm stopper hold open non-handed US3, US26	104.11	

◆◆◆ STANDARD DISCOUNT ONLY ◆◆◆					
ILLUSTRATION	ITEM #	DESCRIPTION	LIST PRICE	UNIT	
ARMS					
	900SPRING	Super rigid non handed parallel arm with spring loaded stop in the soffit shoe. Equivalent to LCN SPRING CUSH ARM	\$134.00	Ea.	
	900HOSPRING	Super rigid parallel arm stopper hold open, non-handed with spring loaded stop in soffit shoe. Handle controls hold open function. Equivalent to LCN SPRING H-CUSH ARM	145.00		
	901/902	Hold open arm with parallel bracket, non-handed with stop in soffit shoe.	34.97		
	901/902 PLATED FINISH	Hold open arm with parallel bracket US3, US26	79.91		
	TRACK/900	Slide track arm with hold open	49.95		
	TRACK/900 PLATED FINISH	Slide track arm with hold open US3, US26	99.88		
	945AR	Door closer arm (Main and regular forearm)	12.50		
	900EXT	Extended long arm (3" extension) for top jamb with deep reveals	24.97		
OTHER ACCESSORIES					
	904 NEW ITEM	Parallel arm drop bracket for non-hold open parallel arm applications to clear a surface-applied stop/holder	13.50		Ea.
	905	Parallel arm bracket	4.00		
	950	Flat drop bracket	14.99		
	950 PLATED FINISH	Flat drop bracket US3, US26	47.45		
	970	Sex bolts, female part only 1/4" - 20 (set of 4)	3.51		
	970138	Sex bolts for 1 3/8" doors, female part only 1/4" - 20 (set of 4)			
	706	Thru bolts and grommet nuts (set of 4)	2.25		
	900COV	Full Cover only	9.99		
	900COV PLATED FINISH	Full Cover only US3, US26	62.42		
	900SMET NEW ITEM	US32D Stainless Steel (Slim Cover)	45.00		
	900MET	Optional full metal cover, stock finish (Alum)	14.13		

CR441 Series List Price



UL approved for Fire Doors Up to 3 Hours

GRADE 1 ADA / Barrier Free Adjustable Door Closer With Full Cover

Same Hole Pattern as LCN 4040 / 4041

ILLUSTRATION	ITEM #	DESCRIPTION	1 CASE	5 CASES	10 CASES	PCS /MC	UNIT
	CR441	Barrier free, Adjustable size 1-6 door weights 30-260 lbs (Full Cover)	\$163.31	\$150.84	\$140.84	4 NEW PACKAGING	Ea.
	CR441DA	Barrier free, Adjustable size 1-6 door weights 30-260 lbs with Delay Action (Full Cover)	170.81	158.33	148.34		

◆◆◆ Prices above are for Aluminum, Duro and Gold finish only ◆◆◆

Specify "MADE IN KOREA" when ordering "THE BUY AMERICAN ACT" compliant models

PLATED AND PAINTED FINISHES

PLATED FINISHES	Metal base, square corners. US3, US26, US10B, US26D NOW IN STOCK other finishes (Allow 6-8 weeks delivery)	Add 74.91 List Each
PAINTED	Special colors (allow 6-8 weeks delivery)	Add 49.95 List Each



► PACKAGING INCLUDES

- Parallel bracket
- Wood screws and **self-tapping machine screws**
- Full cover
- Sex bolts

► STOCK FINISHES







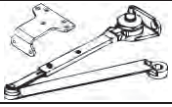

- Aluminum
- Duranodic
- Gold
- US3, US26, US10B, US26D
- US32D – Cover Only

► PARTS & ACCESSORIES

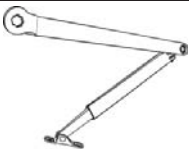
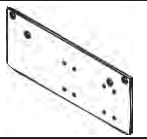
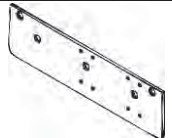
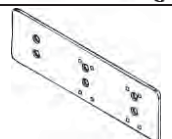
◆◆◆ STANDARD DISCOUNT ONLY ◆◆◆

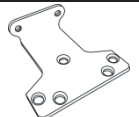
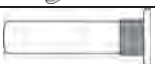
ILLUSTRATION	ITEM #	DESCRIPTION	LIST PRICE	UNIT
ARMS				
	CR3077SPAS	Super rigid parallel arm stopper, non-handed with stop in soffit shoe. Equivalent to LCN CUSH-N-STOP (CUSH) ARM	44.94	Ea.
	CR3049HOSRPS	Super rigid parallel arm stopper hold open, non-handed with stop in soffit shoe. Handle controls hold open function. Equivalent to LCN HOLD-OPEN (H-CUSH) ARM	49.95	
	CR3077SPRING	Super rigid non handed parallel arm with spring loaded stop in the soffit shoe. Equivalent to LCN SPRING CUSH ARM	134.00	
	3049HOSPRING	Super rigid parallel arm stopper hold open, non-handed with spring loaded stop in soffit shoe. Handle controls hold open function. Equivalent to LCN SPRING H-CUSH ARM	145.00	

◆◆◆ CONTINUED NEXT PAGE ◆◆◆

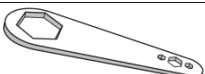
◆◆◆ STANDARD DISCOUNT ONLY ◆◆◆				
ILLUSTRATION	ITEM #	DESCRIPTION	LIST PRICE	UNIT
ARMS				
	CR3049HO	Non-handed Hold open arm with parallel bracket Equivalent to LCN 3049	\$65.17	Ea.
	CR3077HDAR	Non handed parallel arm features forged, solid steel main and forearm for potentially abusive installations Equivalent to LCN 3077 EDA	47.19	
	CR441EXT	Extended long arm (3" extension) for top jamb with reveals	24.97	
	CR441ARM	Door closer arm (Main and regular forearm)	20.00	
OTHER ACCESSORIES				
	CR18PA	Drop plate for parallel arm mounting top rail is less than 5 1/2" measured from stop. Plate requires 2" minimum top rail	25.84	Ea.
	CR18	Drop plate used where top rail is less than 3 3/4"		
	CR18TJ	Drop plate for top jamb where face is less than 3 1/2"		
	CR18G	Drop plate for top jamb mounted closer flush with top of head frame face in flush ceiling condition. Plate requires 1 3/4" minimum head frame		
	CR441PA	Parallel Arm Bracket	4.67	
	970	Sex bolts, female part only 1/4" - 20 (set of 4)	3.51	
	970138	Sex bolts for 1 3/8" doors, female part only 1/4" - 20 (set of 4)		
	CR441COV	Plastic Cover Only	9.99	
	CR441COV (US32D) NEW ITEM	Stainless Steel Cover Only	67.00	
	CRWRENCH NEW ITEM	Variable-sized hexagonal wrench for CR3049HO Arm	8.89	

CR801S/ CR801 Series List Price

GRADE 1 ADA / Barrier Free Adjustable Door Closer With Full Cover



Same Hole Pattern as Norton 8301/8501

ILLUSTRATION	ITEM #	DESCRIPTION	1 CASE	5 CASES	10 CASES	PCS /MC	UNIT
	CR801S	Barrier free, Adjustable size 1-6 (Exterior/ Interior) door weights 30-260 lbs (Slim Cover)	\$113.38	\$108.39	\$103.38	6	Ea.
	CR801SDA	Barrier free, Adjustable size 1-6 (Exterior/ Interior) door weights 30-260 lbs with Delay Action. (Slim Cover)	120.87	115.87	110.88		
	CR801	Barrier free, Adjustable size 1-6 (Exterior/ Interior) door weights 30-260 lbs (Full Cover)	113.38	108.39	103.38		
	CR801DA	Barrier free, Adjustable size 1-6 (Exterior/ Interior) door weights 30-260 lbs with Delay Action. (Full Cover)	120.87	115.87	110.88		

◆◆ Prices above are for Aluminum, Duro and Gold finish only ◆◆

Specify "MADE IN KOREA" when ordering "THE BUY AMERICAN ACT" compliant models

NON- STOCK PAINTED FINISHES (Factory Lead-time)

PAINTED	Special colors	Add 49.95 List Each
---------	----------------	----------------------------

► PACKAGING INCLUDES

- Parallel bracket
- Wood screws and **self-tapping machine screws**
- Slim Cover (CR801S)
- Full Cover (CR801)
- Sex bolts

► STOCK FINISHES

- Aluminum
- Duranodic
- Gold

► PARTS & ACCESSORIES

◆◆◆ STANDARD DISCOUNT ONLY ◆◆◆

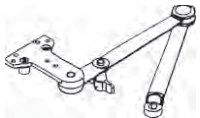
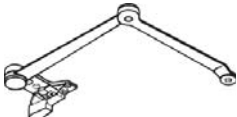
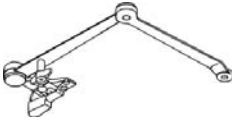
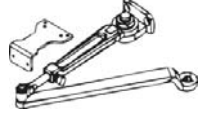



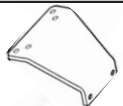

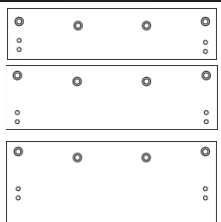

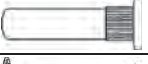



ILLUSTRATION	ITEM #	DESCRIPTION	LIST PRICE	UNIT
ARMS				
	SPAS/900	Super rigid parallel arm stopper, non-handed with stop in soffit shoe. (Equivalent to LCN CUSH-N-STOP ARM)	44.94	Ea.

◆◆◆ CONTINUED NEXT PAGE ◆◆◆

CAL-ROYAL PRODUCTS, INC.

Ver. 2.0, Rev. 11/12
©2012 CAL-ROYAL

DC5

◆◆◆ STANDARD DISCOUNT ONLY ◆◆◆				
ILLUSTRATION	ITEM #	DESCRIPTION	LIST PRICE	UNIT
ARMS				
	HOSRPS/900	Super rigid parallel arm stopper hold open, non-handed with stop in soffit shoe. Handle controls hold open function. (Equivalent to LCN H-CUSH ARM)	\$49.95	Ea.
	900SPRING	Super rigid non handed parallel arm with spring loaded stop in the soffit shoe. (Equivalent to LCN SPRING CUSH ARM)	134.00	
	900HOSPRING	Super rigid parallel arm stopper hold open, non-handed with spring loaded stop in soffit shoe. Handle controls hold open function. (Equivalent to LCN SPRING H-CUSH ARM)	145.00	
	901/902	Hold open arm with parallel bracket, non-handed with stop in soffit shoe.	34.97	
	TRACK/900	Slide track arm with hold open	49.95	
	945AR	Door closer arm (Main and regular forearm)	12.50	
	900EXT	Extended long arm (3" extension) for top jamb with deep reveals	24.97	
OTHER ACCESSORIES				
	904 NEW ITEM	Parallel arm drop bracket for non-hold open parallel arm applications to clear a surface-applied stop/holder	13.50	Ea.
	905	Parallel arm bracket	4.00	
	850S	Slim Flat drop bracket	14.99	
	850W NEW ITEM	Wide Flat drop bracket		
	850F	Full Flat drop bracket		
	970	Sex bolts, female part only 1/4" - 20 (set of 4)	3.51	
	970138	Sex bolts for 1 3/8" doors, female part only 1/4" - 20 (set of 4)		
	706	Thru bolts and grommet nuts (set of 4)	2.25	
	801S COV	Slim Cover only	9.99	
	801COV	Full Cover only		

300 Series List Price

ADA / Barrier Free Adjustable Door Closer With Full Cover
ANSI - A156.2, SERIES 4000, **GRADE 1**



Template Universal hole pattern as: Norton, Yale and Dorma Size 4

ILLUSTRATION	ITEM #	DESCRIPTION	1 CASE	5 CASES	10 CASES	PCS /MC	UNIT
	300-PCOV	Adjustable size 3-6 door weights 85-260 lbs (Exterior) (Full Cover)				6 NEW PACKAGING	Ea.
	300-PBFCOV	Adjustable size 1-4 door weights 30-185 lbs Barrier free (Interior) (Full Cover)	\$82.40	\$77.40	\$69.92		
	300-PBFDACOV	Adjustable size 1-4 door weights 30-185 lbs Barrier free (Interior) with Delay Action (Full Cover)	89.90	84.90	77.41		

► **PLATED FINISHES**

PLATED FINISHES	US3 In stock (Includes: Plastic cover, full arm, screws and parallel bracket)	Add 24.97 List Each
-----------------	--	----------------------------

► **PACKAGING INCLUDES**

- Parallel bracket
- Wood screws and **self-tapping machine screws**
- Full cover

► **STOCK FINISHES**

- Aluminum
- Duranodic
- Gold
- US3 (Polished Brass)



► **PARTS & ACCESSORIES**

◆◆◆ **STANDARD DISCOUNT ONLY** ◆◆◆

ILLUSTRATION	ITEM #	DESCRIPTION	LIST PRICE	UNIT
	301/302	Hold open arm & parallel bracket	21.73	Ea.
	905	Parallel arm bracket	4.00	
	706	Thru bolts with grommet nuts (set of 4)	2.25	
	970	Sex bolts, female part only 1/4" - 20 (set of 4)	3.51	
	970138	Sex bolts for 1 3/8" doors, female part only 1/4" - 20 (set of 4)		
	704	Flat drop bracket	12.50	
	904 NEW ITEM	Parallel arm drop bracket for non-hold open parallel arm applications to clear a surface-applied stop/holder	13.50	
COVER				
	COV/400	Additional plastic full cover	7.49	Ea.

700 Series List Price

Dual Valve Sized Door Closers **GRADE 1** (Optional Back Check and Cover)



Template Universal hole pattern as: Norton, Yale and Dorma Size 4						
ILLUSTRATION	ITEM #	DESCRIPTION	LIST PRICE	PCS /MC	DOOR WEIGHT	UNIT
	720	Regular / Parallel arm size 2 door weights 55-100 lbs	\$47.78	10	55-100 Lbs.	Ea.
	730	Regular / Parallel arm size 3 door weights 88-143 lbs	51.33		80-140 Lbs.	
	730 BC	Regular / Parallel arm size 3 /BC door weights 88-143 lbs	54.56			
	740	Regular / Parallel arm size 4 door weights 120-187 lbs	56.53		120-160 Lbs.	
	740 BC	Regular / Parallel arm size 4 /BC door weights 120-187 lbs	58.78			
	750	Regular / Parallel arm size 5 door weights 176-265 lbs	61.00		170-260 Lbs.	
	750 BC	Regular / Parallel arm size 5 /BC door weights 176-265 lbs	63.00			

Specify "MADE IN KOREA" when ordering "THE BUY AMERICAN ACT" compliant models

► **PACKAGING INCLUDES**

- Wood screws and self-tapping machine screws
- Parallel Bracket

► **STOCK FINISHES**



- Aluminum
- Duranodic
- Gold
- White (740BC only)

QUANTITY DISCOUNT
50 UNITS MIXED --- LESS 5%
100 UNITS MIXED --- LESS 10%

► **PARTS & ACCESSORIES**

◆◆◆ STANDARD DISCOUNT ONLY ◆◆◆					
ILLUSTRATION	ITEM #	DESCRIPTION	LIST PRICE	UNIT	
COVER					
	COV/700	COV/700 slim plastic cover, fits all sizes (Shipped separately)	9.01	Ea.	
ARMS					
	901/902	Hold open arm with parallel bracket	34.97		
	745AR	Door closer arm (Main and regular forearm)	12.50		

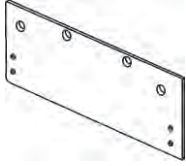
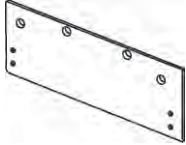
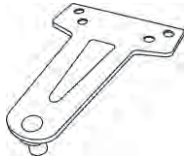
► PARTS & ACCESSORIES

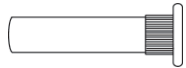
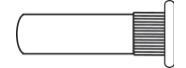
◆◆◆ STANDARD DISCOUNT ONLY ◆◆◆				
ILLUSTRATION	ITEM #	DESCRIPTION	LIST PRICE	UNIT
OTHER ACCESSORIES				
	703	Flat drop bracket / 720,730 (size 2,3)	\$11.24	Ea.
	704	Flat drop bracket / 740,750 (size 4,5)	12.50	
	905	Parallel arm bracket	4.00	
	706	Thru bolts and grommet nuts (set of 4)	2.25	
	970	Sex bolts, female part only 1/4" – 20 (set of 4)	3.51	
	970138	Sex bolts for 1 3/8" doors, female part only 1/4" – 20 (set of 4)		

400 Series List Price

Contender Dual Valve Sized Door Closer **Grade 2**



UL approved for
Fire Doors
Up to 3 Hours

(Optional Back Check and Cover)

ILLUSTRATION	ITEM #	DESCRIPTION	LIST PRICE	PCS /MC	DOOR WEIGHT	UNIT
	420-P	Regular arm / parallel arm size 2 door weights 55 – 100 lbs	\$38.36	10	55-100 Lbs.	Ea.
	SM430-P	Regular arm / Smaller body size 3 door weights 88 - 143 lbs (ALUM finish only) ACCESSORIES BELOW NOT APPLICABLE TO SM430-P	41.50		80-140 Lbs.	
	430-P	Regular arm / parallel arm size 3 door weights 88 - 143 lbs	46.27		120-160 Lbs.	
	430-PBC	Regular arm / parallel arm size 3 with back check door weights 88 - 143 lbs	49.00			
	440-P	Regular arm / parallel arm size 4 door weights 120 - 187 lbs	53.00			

► **PACKAGING INCLUDES**

- Parallel bracket
- Machine and wood screws

► **STOCK FINISHES**

- Aluminum
- Duranodic
- Gold
- White (430-P only)

QUANTITY DISCOUNT

50 UNITS MIXED -- LESS 5%





100 UNITS MIXED -- LESS 10%

5-YEAR

WARRANTY

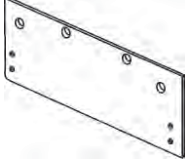
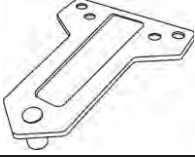
► **PARTS & ACCESSORIES**

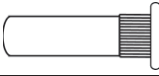
◆◆◆ STANDARD DISCOUNT ONLY ◆◆◆				
ILLUSTRATION	ITEM #	DESCRIPTION	LIST PRICE	UNIT
	301/302	Hold open arm & parallel bracket	21.73	Ea.
	402	Flat drop bracket / 420-P (size 2)	12.50	

◆◆◆ STANDARD DISCOUNT ONLY ◆◆◆				
ILLUSTRATION	ITEM #	DESCRIPTION	LIST PRICE	UNIT
	703	Flat drop bracket / 430-P (size 3) and 440-P (size 4)	\$11.24	Ea.
	905	Parallel arm bracket	4.00	
	970	Sex bolts, female part only 1/4" - 20 (set of 4)	3.51	
	970138	Sex bolts for 1 3/8" doors, female part only 1/4" - 20 (set of 4)		
	706	Thru bolts and grommet nuts (set of 4)	2.25	
COVER				
	COV/400	Plastic full cover, fits all sizes (shipped separately)	7.49	Ea.



LOCKSETS



Ver. 2.0, Rev. 11/12
© 2012  CAL ROYAL

CR3000 Series List Price

HEAVY DUTY, GRADE 1 DIGITAL KEYPAD DOOR LOCK

 Optional Interchangeable Core for Best, Falcon and Arrow



3 HOUR FIRE RATED
UL10C, UBC7-2-1997

- Finger Keypad Programmable
- 90 Different User Codes
- 10 Manager Codes
- 5 Service Codes
- Easy To Program
- Weatherproof
- Fastest and Easiest Installation in the Industry

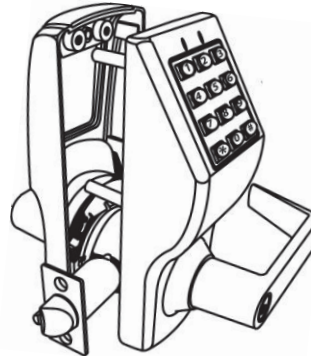

FUNCTIONS	ITEM #	US26D	US10B	MC QTY
Entrance	CR3000	\$534.00	\$561.00	6
	 ICCR3000	561.00	590.00	
Passage	CR3030	520.00	546.00	

 (IC) Indicates function available with **Best, Falcon and Arrow Interchangeable Core**. Prices do not include cores. For IC Core pricing and Cylinder PART# see pages L73 – L75.

ADDITIONAL KEYWAYS: 6-pin solid brass "C" keyway standard. Optional: Schlage E, Schlage C-K, Russwin D1-2-3-4, Corbin 59/60, Corbin-Russwin L4, Sargent LA-LB-LC, Falcon/Weiser E, Arrow A, Yale 8, Yale GA and Kwikset. Can also accept Medeco, Assa, Kaba and **Cal-Royal HSK** High Security Cylinders. See pages L75-L76 for keying charges and Cylinder PART#.

► ADDITIONAL PARTS & CHARGES

Backsets: UL listed 2 3/8", 2 1/4" x 1 1/8" faceplate, **NO EXTRA CHARGE** if ordered with lock only. If ordered separately **\$12.72 List Each**.

◆◆ STANDARD DISCOUNT ONLY ◆◆				
ILLUSTRATION	ITEM #	DESCRIPTION	FINISH	LIST PRICE
EXTRA UL LISTED BACKSETS				
	CALSLD238	CAL Series Dead latch 2 3/8" 2 1/4" x 1 1/8" Faceplate	US26D	\$12.72
	CALSLS238	CAL Series Spring Latch 2 3/8" 2 1/4" x 1 1/8" Faceplate	US26D	
	CALSLP238	CAL Series Privacy Latch 2 3/8" 2 1/4" x 1 1/8" Faceplate	US26D	
	CAL334 EXT	CAL Series 3 3/4" Extension Link To be used with CALSLD238	----	16.96
	CAL5 EXT	CAL Series 5" Extension Link	----	
	CAL750	2 3/4" Backset, 2 1/4" x 1 1/8" faceplate, 3/4" throw, anti-friction Dead latch for pairs of fire doors	US26D	62.54
STRIKES				
	TS	T-Strike	US3,26D, 10B, 26,10,4	2.12
	FLS	Full Lip Strike		

ELDB-89 Series List Price

HEAVY DUTY, GRADE 2 DIGITAL KEYPAD DEADBOLT



- 4-6 digit codes with over 1 million possible combinations
- 10 User Codes
- Non-handed design
- Stand -alone unit, no wiring needed
- Illuminated keypad
- Weather Resistant
- 1 min lockout after 4 invalid input
- Easy installation and programming
- Remote control Locking/Unlocking (50 ft)
- Long-life battery operation
- Auto locking function (option)
- Back-up key cylinder override
- User friendly

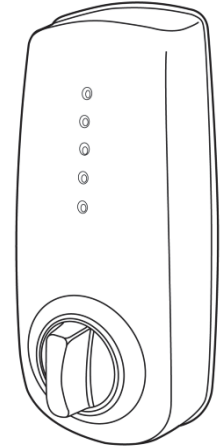

FUNCTIONS	ITEM #	FINISHES		MC QTY
		US26D, US3, US15	US10B, US11P	
Single Cylinder	ELDB-89	236.00 ea.	242.00 ea.	4

ADDITIONAL KEYWAYS: 6-pin solid brass "C" keyway standard. Optional: Schlage E, Schlage C-K, Russwin D1-2-3-4, Corbin 59/60, Corbin-Russwin L4, Sargent LA-LB-LC, Falcon/Weiser E, Arrow A, Yale 8, Yale GA and Kwikset. Can also accept Medeco, Assa, Kaba and *Cal-Royal HSK* High Security Cylinders. See pages L75-L76 for keying charges and Cylinder PART#.

► ADDITIONAL PARTS & CHARGES

◆◆ STANDARD DISCOUNT ONLY ◆◆				
ILLUSTRATION	ITEM #	DESCRIPTION	FINISH	LIST PRICE
STRIKE and REMOTE CONTROLS				
	T2STRK	Deadbolt Strike 1 1/8" X 2 3/4"	US3, 10B, 26D	2.00
	SS114358	Deadbolt Security Strike 1 1/4" x 3 5/8", 1/4" Rad.	US3, US5, US15, US26D, US10B	2.67
	ELDB-RC	Additional Remote Control (Maximum of 10 remote controls per lockset)	BLACK	18.60

NM Series List Price



HEAVY DUTY, GRADE 1 MORTISE LOCKSET

Optional Interchangeable Core Small Format (Best, Falcon and Arrow) or Large Format (Schlage)

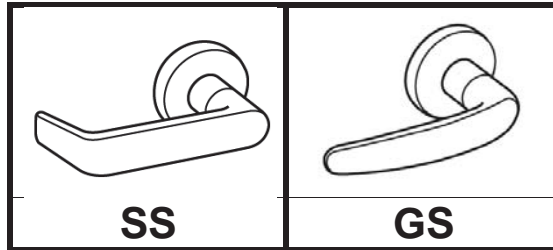

STOCK ITEM PRICES IN BOLD. (FOR OTHER DESIGNS, SEE NEXT PAGE)
NON-STOCK FINISHES AVAILABLE WITH FACTORY LEAD TIME AND SUBJECT TO MINIMUM ORDER

SS and GS SECTIONAL TRIM ONLY								
FUNCTIONS	ANSI	FINISHES						
		US26D	US32D	US32	US10B	US3	US26	US4
◀Single cylinder without deadbolt								
NM8050 - Office / Entrance	F04							
NM8070 - Classroom	F05	\$226.29	\$267.12	\$267.12	\$237.02	\$237.02	\$237.02	\$237.02
NM8080 - Storeroom	F07							
◀Single cylinder with deadbolt								
NM8453 - Entrance	F20	233.44	287.04	287.04	244.16	244.16	244.16	244.16
NM8456 - Corridor	F13							
NM8495 - Keyed Privacy w/ Indicator	NEW ITEM	308.44	362.04	362.04	319.16	319.16	319.16	319.16
NM8465 - Closet / Storeroom	----							
NM8473 - Dormitory/Bedroom	F21	233.44	287.04	287.04	244.16	244.16	244.16	244.16
◀Double cylinder without deadbolt								
NM8060 - Apartment Entrance	F09	252.49						
NM8082 - Institution	F30	252.49						
			306.10	306.10	263.22	263.22	263.22	263.22
◀ Double cylinder with deadbolt								
NM8466 - Storeroom	F14	252.49						
◀Other Functions								
NM8040 - Privacy with Deadbolt	F02,F19,F22	202.47	256.06	213.19	213.19	213.19	213.19	213.19
NM8445 - Privacy with Indicator	NEW ITEM	277.47	331.06	288.19	288.19	288.19	288.19	288.19
NM8010 - Passage	F01	178.65	232.25	232.25	189.37	189.37	189.37	189.37
NM8170 - Single Fixed Dummy	----	59.55	113.14	113.14	70.27	70.27	70.27	70.27
NM8172 - Double Fixed Dummy	----	125.00	156.00	156.00	148.75	148.75	148.75	148.75

⊗ All keyed lock functions are available with Best, Falcon and Arrow and Schlage Large Format Interchangeable Cores (See page L20 for additional charges). Prices do not include cores. For IC Core pricing see pages L73 – L75.



QUANTITY DISCOUNT
 UP TO 30 UNITS MIXED →→ **STANDARD DISCOUNT ONLY**
 31 – 60 UNITS MIXED →→→ **LESS 5%**
 61 AND MORE UNITS MIXED →→→→ **LESS 10%**

↻ Continued Next Page ↻

HEAVY DUTY, GRADE 1 MORTISE LOCKSET *List P*

Optional Interchangeable Core Small Format (Best, Falcon and Arrow) or Large Format (Schlage)



3 HOUR FIRE RATED
UL10C, UBC7-2-1997

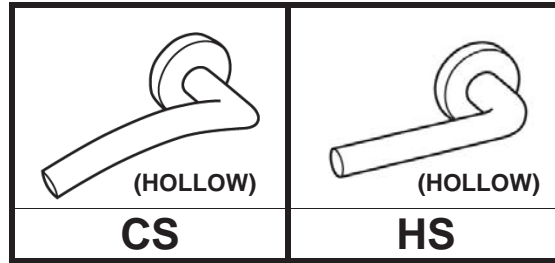

ALL ITEMS BELOW AVAILABLE WITH FACTORY LEAD TIME AND SUBJECT TO MINIMUM ORDER

CS and HS SECTIONAL TRIM ONLY		
FUNCTIONS	ANSI	FINISH
		US32D
◀Single cylinder without deadbolt		
NM8050 - Office / Entrance	F04	\$267.12
NM8070 - Classroom	F05	
NM8080 - Storeroom	F07	
◀Single cylinder with deadbolt		
NM8453 - Entrance	F20	287.04
NM8456 - Corridor	F13	
NM8495 - Keyed Privacy w/ Indicator	----	362.04
NM8465 - Closet / Storeroom	----	287.04
NM8473 - Dormitory/Bedroom	F21	
◀Double cylinder without deadbolt		
NM8060 - Apartment Entrance	F09	306.10
NM8082 - Institution	F30	
◀ Double cylinder with deadbolt		
NM8466 - Storeroom	F14	
◀Other Functions		
NM8040 - Privacy with Deadbolt	F02,F19,F22	256.06
NM8445 - Privacy with Indicator	----	331.06
NM8010 - Passage	F01	232.25
NM8170 - Single Fixed Dummy	----	113.14
NM8172 - Double Fixed Dummy	----	156.00

All keyed lock functions are available with Best, Falcon and Arrow and Schlage Large Format Interchangeable Cores (See page L20 for additional charges). Prices do not include cores. For IC Core pricing see pages L73 – L75.



QUANTITY DISCOUNT	
UP TO 30 UNITS MIXED →→	<u>STANDARD DISCOUNT ONLY</u>
31 – 60 UNITS MIXED →→→	<u>LESS 5%</u>
61 AND MORE UNITS MIXED →→→	<u>LESS 10%</u>

HEAVY DUTY, GRADE 1 MORTISE LOCKSET

Optional Interchangeable Core Small Format (Best, Falcon and Arrow) or Large Format (Schlage)



3 HOUR FIRE RATED
UL10C, UBC7-2-1997

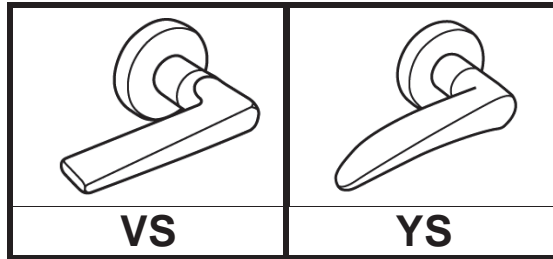

ALL ITEMS BELOW AVAILABLE WITH FACTORY LEAD TIME AND SUBJECT TO MINIMUM ORDER QUANTITY

VS and YS SECTIONAL TRIM ONLY							
FUNCTIONS	ANSI	FINISHES					
		US26D	US32	US10B	US3	US26	US4
◀Single cylinder without deadbolt							
NM8050 - Office / Entrance	F04	\$226.29	\$267.12	\$237.02	\$237.02	\$237.02	\$237.02
NM8070 - Classroom	F05						
NM8080 - Storeroom	F07						
◀Single cylinder with deadbolt							
NM8453 - Entrance	F20	233.44	287.04	244.16	244.16	244.16	244.16
NM8456 - Corridor	F13						
NM8495 - Keyed Privacy w/ Indicator	----	308.44	362.04	319.16	319.16	319.16	319.16
NM8465 - Closet / Storeroom	----	233.44	287.04	244.16	244.16	244.16	244.16
NM8473 - Dormitory/Bedroom	F21						
◀Double cylinder without deadbolt							
NM8060 - Apartment Entrance	F09	252.49	306.10	263.22	263.22	263.22	263.22
NM8082 - Institution	F30	252.49					
◀ Double cylinder with deadbolt							
NM8466 - Storeroom	F14	252.49					
◀Other Functions							
NM8040 - Privacy with Deadbolt	F02,F19,F22	202.47	256.06	213.19	213.19	213.19	213.19
NM8445 - Privacy with Indicator	----	277.47	331.06	288.19	288.19	288.19	288.19
NM8010 - Passage	F01	178.65	232.25	189.37	189.37	189.37	189.37
NM8170 - Single Fixed Dummy	----	59.55	113.14	70.27	70.27	70.27	70.27
NM8172 - Double Fixed Dummy	----	125.00	156.00	148.75	148.75	148.75	148.75

All keyed lock functions are available with Best, Falcon and Arrow and Schlage Large Format Interchangeable Cores (See page L20 for additional charges). Prices do not include cores. For IC Core pricing see pages L73 – L75.



QUANTITY DISCOUNT
 UP TO 30 UNITS MIXED →→ STANDARD DISCOUNT ONLY
 31 – 60 UNITS MIXED →→→ LESS 5%
 61 AND MORE UNITS MIXED →→→→ LESS 10%

Continued Next Page

HEAVY DUTY, GRADE 1 MORTISE LOCKSET *List Price*

Optional Interchangeable Core Small Format (Best, Falcon and Arrow) or Large Format (Schlage)



3 HOUR FIRE RATED
UL10C, UBC7-2-1997

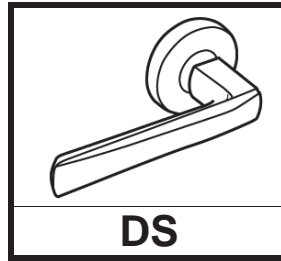

ALL ITEMS BELOW AVAILABLE WITH FACTORY LEAD TIME AND SUBJECT TO MINIMUM ORDER QUANTITY

DS SECTIONAL TRIM ONLY

FUNCTIONS	ANSI	FINISHES						
		US26D	US32D	US32	US10B	US3	US26	US4
◀Single cylinder without deadbolt								
NM8050 - Office / Entrance	F04							
NM8070 - Classroom	F05	\$226.29	\$267.12	\$267.12	\$237.02	\$237.02	\$237.02	\$237.02
NM8080 - Storeroom	F07							
◀Single cylinder with deadbolt								
NM8453 - Entrance	F20	233.44	287.04	287.04	244.16	244.16	244.16	244.16
NM8456 - Corridor	F13							
NM8495 - Keyed Privacy w/ Indicator	----	308.44	362.04	362.04	319.16	319.16	319.16	319.16
NM8465 - Closet / Storeroom	----							
NM8473 - Dormitory/Bedroom	F21	233.44	287.04	287.04	244.16	244.16	244.16	244.16
◀Double cylinder without deadbolt								
NM8060 - Apartment Entrance	F09							
NM8082 - Institution	F30	252.49	306.10	306.10	263.22	263.22	263.22	263.22
◀Double cylinder with deadbolt								
NM8466 - Storeroom	F14							
◀Other Functions								
NM8040 - Privacy with Deadbolt	F02,F19,F22	202.47	256.06	213.19	213.19	213.19	213.19	213.19
NM8445 - Privacy with Indicator	----	277.47	331.06	288.19	288.19	288.19	288.19	288.19
NM8010 - Passage	F01	178.65	232.25	232.25	189.37	189.37	189.37	189.37
NM8170 - Single Fixed Dummy	----	59.55	113.14	113.14	70.27	70.27	70.27	70.27
NM8172 - Double Fixed Dummy	----	125.00	156.00	156.00	148.75	148.75	148.75	148.75

All keyed lock functions are available with Best, Falcon and Arrow and Schlage Large Format Interchangeable Cores (See page L20 for additional charges). Prices do not include cores. For IC Core pricing see pages L73 – L75.



QUANTITY DISCOUNT UP TO 30 UNITS MIXED →→ <u>STANDARD DISCOUNT ONLY</u> 31 – 60 UNITS MIXED →→→ <u>LESS 5%</u> 61 AND MORE UNITS MIXED →→→→ <u>LESS 10%</u>

HEAVY DUTY, GRADE 1 MORTISE LOCKSET *List Price*

Optional Interchangeable Core Small Format (Best, Falcon and Arrow) or Large Format (Schlage)



3 HOUR FIRE RATED
UL10C, UBC7-2-1997

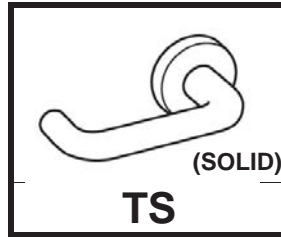

STOCK ITEM PRICES IN BOLD.
NON-STOCK FINISHES AVAILABLE WITH FACTORY LEAD TIME AND SUBJECT TO MINIMUM ORDER

TS SECTIONAL TRIM ONLY								
FUNCTIONS	ANSI	FINISHES						
		US26D	US32D	US32	US10B	US3	US26	US4
◀Single cylinder without deadbolt								
NM8050 - Office / Entrance	F04	\$226.29	\$267.12					
NM8070 - Classroom	F05	226.29	267.12	\$267.12	\$237.02	\$237.02	\$237.02	\$237.02
NM8080 - Storeroom	F07	226.29	267.12					
◀Single cylinder with deadbolt								
NM8453 - Entrance	F20	233.44	287.04	287.04	244.16	244.16	244.16	244.16
NM8456 - Corridor	F13	233.44	287.04					
NM8495 - Keyed Privacy w/ Indicator	NEW ITEM	308.44	362.04	362.04	319.16	319.16	319.16	319.16
NM8465 - Closet / Storeroom	----	233.44	287.04					
NM8473 - Dormitory/Bedroom	F21	233.44	287.04	287.04	244.16	244.16	244.16	244.16
◀Double cylinder without deadbolt								
NM8060 - Apartment Entrance	F09							
NM8082 - Institution	F30							
		252.49	306.10	306.10	263.22	263.22	263.22	263.22
◀Double cylinder with deadbolt								
NM8466 - Storeroom	F14							
◀Other Functions								
NM8040 - Privacy with Deadbolt	F02,F19,F22	202.47	256.06	256.06	213.19	213.19	213.19	213.19
NM8445 - Privacy with Indicator	NEW ITEM	277.47	331.06	331.06	288.19	288.19	288.19	288.19
NM8010 - Passage	F01	178.65	232.25	232.25	189.37	189.37	189.37	189.37
NM8170 - Single Fixed Dummy	----	59.55	113.14	113.14	70.27	70.27	70.27	70.27
NM8172 - Double Fixed Dummy	----	125.00	156.00	156.00	148.75	148.75	148.75	148.75

All keyed lock functions are available with Best, Falcon and Arrow and Schlage Large Format Interchangeable Cores (See page L20 for additional charges). Prices do not include cores. For IC Core pricing see pages L73 – L75.



QUANTITY DISCOUNT
UP TO 30 UNITS MIXED →→ **STANDARD DISCOUNT ONLY**
31 – 60 UNITS MIXED →→→ **LESS 5%**
61 AND MORE UNITS MIXED →→→ **LESS 10%**

HEAVY DUTY, GRADE 1 MORTISE LOCKSET *List Price*

Optional Interchangeable Core Small Format (Best, Falcon and Arrow) or Large Format (Schlage)

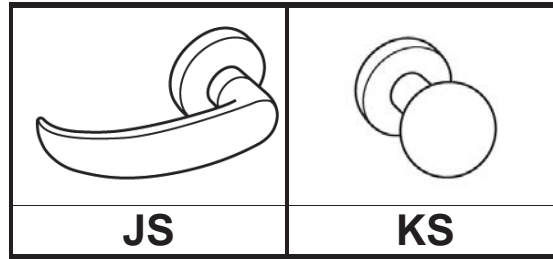

ALL ITEMS BELOW AVAILABLE WITH FACTORY LEAD TIME AND SUBJECT TO MINIMUM ORDER QUANTITY

JS AND KS SECTIONAL TRIM ONLY

FUNCTIONS	ANSI	FINISHES						
		US26D	US32D	US32	US10B	US3	US26	US4
◀Single cylinder without deadbolt								
NM8050 - Office / Entrance	F04							
NM8070 - Classroom	F05	\$226.29	\$267.12	\$267.12	\$237.02	\$237.02	\$237.02	\$237.02
NM8080 - Storeroom	F07							
◀Single cylinder with deadbolt								
NM8453 - Entrance	F20							
NM8456 - Corridor	F13	233.44	287.04	287.04	244.16	244.16	244.16	244.16
NM8495 - Keyed Privacy w/ Indicator	NEW ITEM	308.44	362.04	362.04	319.16	319.16	319.16	319.16
NM8465 - Closet / Storeroom	----							
NM8473 - Dormitory/Bedroom	F21	233.44	287.04	287.04	244.16	244.16	244.16	244.16
◀Double cylinder without deadbolt								
NM8060 - Apartment Entrance	F09							
NM8082 - Institution	F30	252.49	306.10	306.10	263.22	263.22	263.22	263.22
◀Double cylinder with deadbolt								
NM8466 - Storeroom	F14							
◀Other Functions								
NM8040 - Privacy with Deadbolt	F02,F19,F22	202.47	256.06	256.06	213.19	213.19	213.19	213.19
NM8010 - Passage	F01	178.65	232.25	232.25	189.37	189.37	189.37	189.37
NM8445 - Privacy with Indicator	NEW ITEM	277.47	331.06	331.06	288.19	288.19	288.19	288.19
NM8170 - Single Fixed Dummy	----	59.55	113.14	113.14	70.27	70.27	70.27	70.27
NM8172 - Double Fixed Dummy	----	125.00	156.00	156.00	148.75	148.75	148.75	148.75

88 All keyed lock functions are available with **Best, Falcon and Arrow** and **Schlage Large Format Interchangeable Cores**. (See page L13 for additional charges). Prices do not include cores. For IC Core pricing see pages L73 – L75.



QUANTITY DISCOUNT
 UP TO 30 UNITS MIXED →→ **STANDARD DISCOUNT ONLY**
 31 – 60 UNITS MIXED →→→ **LESS 5%**
 61 AND MORE UNITS MIXED →→→ **LESS 10%**

NM Series List Price



3 HOUR FIRE RATED
UL10C, UBC7-2-1997

HEAVY DUTY, GRADE 1 MORTISE LOCKSET

Optional Interchangeable Core Small Format (Best, Falcon and Arrow) or Large Format (Schlage)

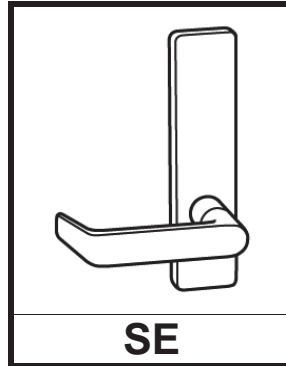

STOCK ITEM PRICES IN BOLD. (FOR OTHER DESIGNS, SEE NEXT PAGE)
NON-STOCK FINISHES AVAILABLE WITH FACTORY LEAD TIME AND SUBJECT TO MINIMUM ORDER

SE ESCUTCHEON TRIM ONLY								
FUNCTIONS	ANSI	FINISHES						
		US26D	US32D	US32	US10B	US3	US26	US4
◀Single cylinder without deadbolt								
NM8050 - Office / Entrance	F04							
NM8070 - Classroom	F05	\$246.55	\$300.14	\$300.14	\$257.26	\$257.26	\$257.26	\$257.26
NM8080 - Storeroom	F07							
◀Single cylinder with deadbolt								
NM8453 - Entrance	F20	252.49	306.10	306.10	263.22	263.22	263.22	263.22
NM8456 - Corridor	F13				263.22	263.22	263.22	
NM8495 - Keyed Privacy w/ Indicator	NEW ITEM	327.49	381.10	381.10	338.22	338.22	338.22	338.22
NM8465 - Closet / Storeroom	----	252.49	306.10	306.10	263.22	263.22	263.22	263.22
NM8473 - Dormitory / Bedroom	F21							
◀Double cylinder without deadbolt								
NM8060 - Apartment Entrance	F09	265.59						
NM8082 - Institution	F30	265.59	319.19	319.19	276.32	276.32	276.32	276.32
◀ Double cylinder with deadbolt								
NM8466 - Storeroom	F14	265.59						
◀Other Functions								
NM8040 - Privacy with Deadbolt	F02,F19,F22	235.82	289.41	289.41	246.55	246.55	246.55	246.55
NM8445 - Privacy with Indicator	NEW ITEM	310.82	364.41	364.41	321.55	321.55	321.55	321.55
NM8010 - Passage	F01	204.86	258.45	258.45	215.57	215.57	215.57	215.57
NM8170 - Single Fixed Dummy	----	66.70	120.29	120.29	77.41	77.41	77.41	77.41
NM8172 - Double Fixed Dummy	----	147.00	178.00	178.00	175.00	175.00	175.00	175.00

88 All keyed lock functions are available with Best, Falcon and Arrow and Schlage Large Format Interchangeable Cores. (See page L20 for additional charges). Prices do not include cores. For IC Core pricing see pages L73 – L75.



QUANTITY DISCOUNT
UP TO 30 UNITS MIXED →→ **STANDARD DISCOUNT ONLY**
31 – 60 UNITS MIXED →→→ **LESS 5%**
61 AND MORE UNITS MIXED →→→ **LESS 10%**

Continued Next Page

HEAVY DUTY, GRADE 1 MORTISE LOCKSET *List Price* ••

•• Optional Interchangeable Core Small Format (Best, Falcon and Arrow) or Large Format (Schlage)



3 HOUR FIRE RATED
UL10C, UBC7-2-1997

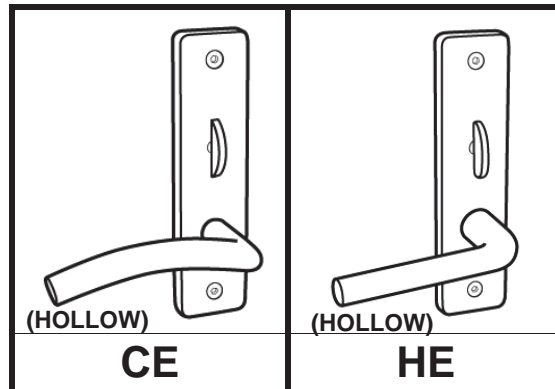

ALL ITEMS BELOW AVAILABLE WITH FACTORY LEAD TIME AND SUBJECT TO MINIMUM ORDER QUANTITY

CE and HE ESCUTCHEON TRIM ONLY

FUNCTIONS	ANSI	FINISH
		US32D
◀Single cylinder without deadbolt		
NM8050 - Office / Entrance	F04	\$300.14
NM8070 - Classroom	F05	
NM8080 - Storeroom	F07	
◀Single cylinder with deadbolt		
NM8453 - Entrance	F20	306.10
NM8456 - Corridor	F13	
NM8495 - Keyed Privacy w/ Indicator	----	381.10
NM8465 - Closet / Storeroom	----	306.10
NM8473 - Dormitory/Bedroom	F21	
◀Double cylinder without deadbolt		
NM8060 - Apartment Entrance	F09	319.19
NM8082 - Institution	F30	
◀Double cylinder with deadbolt		
NM8466 - Storeroom	F14	319.19
◀Other Functions		
NM8040 - Privacy with Deadbolt	F02,F19,F22	289.41
NM8445 - Privacy with Indicator	----	364.41
NM8010 - Passage	F01	258.45
NM8170 - Single Fixed Dummy	----	120.29
NM8172 - Double Fixed Dummy	----	178.00

•• All keyed lock functions are available with Best, Falcon and Arrow and Schlage Large Format Interchangeable Cores (See page L20 for additional charges). Prices do not include cores. For IC Core pricing see pages L73 – L75.



QUANTITY DISCOUNT UP TO 30 UNITS MIXED →→ <u>STANDARD DISCOUNT ONLY</u> 31 – 60 UNITS MIXED →→→ <u>LESS 5%</u> 61 AND MORE UNITS MIXED →→→ <u>LESS 10%</u>
--

HEAVY DUTY, GRADE 1 MORTISE LOCKSET *List Price*

Optional Interchangeable Core Small Format (Best, Falcon and Arrow) or Large Format (Schlage)

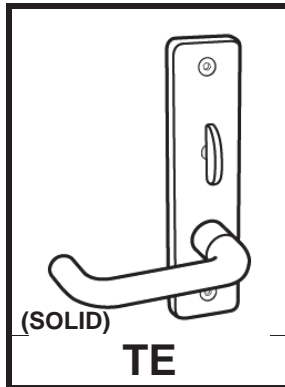

STOCK ITEM PRICES IN BOLD. (FOR OTHER DESIGNS, SEE NEXT PAGE)
NON-STOCK FINISHES AVAILABLE WITH FACTORY LEAD TIME AND SUBJECT TO MINIMUM ORDER

TE ESCUTCHEON TRIM ONLY

FUNCTIONS	ANSI	FINISHES						
		US26D	US32D	US32	US10B	US3	US26	US4
◀Single cylinder without deadbolt								
NM8050 - Office / Entrance	F04							
NM8070 - Classroom	F05	\$246.55	\$300.14	\$300.14	\$257.26	\$257.26	\$257.26	\$257.26
NM8080 - Storeroom	F07							
◀Single cylinder with deadbolt								
NM8453 - Entrance	F20	252.49	306.10	306.10	263.22	263.22	263.22	263.22
NM8456 - Corridor	F13							
NM8495 - Keyed Privacy w/ Indicator	NEW ITEM	327.49	381.10	381.10	338.22	338.22	338.22	338.22
NM8465 - Closet / Storeroom	----	252.49	306.10	306.10	263.22	263.22	263.22	263.22
NM8473 - Dormitory / Bedroom	F21							
◀Double cylinder without deadbolt								
NM8060 - Apartment Entrance	F09							
NM8082 - Institution	F30							
◀ Double cylinder with deadbolt		265.59	319.19	319.19	276.32	276.32	276.32	276.32
NM8466 - Storeroom	F14							
◀Other Functions								
NM8040 - Privacy with Deadbolt	F02,F19,F22	235.82	289.41	289.41	246.55	246.55	246.55	246.55
NM8445 - Privacy with Indicator	NEW ITEM	310.82	364.41	364.41	321.55	321.55	321.55	321.55
NM8010 - Passage	F01	204.86	258.45	258.45	215.57	215.57	215.57	215.57
NM8170 - Single Fixed Dummy	----	66.70	120.29	120.29	77.41	77.41	77.41	77.41
NM8172 - Double Fixed Dummy	----	147.00	178.00	178.00	175.00	175.00	175.00	175.00

88 All keyed lock functions are available with Best, Falcon and Arrow and Schlage Large Format Interchangeable Cores. (See page L20 for additional charges). Prices do not include cores. For IC Core pricing see pages L73 – L75.



QUANTITY DISCOUNT
 UP TO 30 UNITS MIXED →→ **STANDARD DISCOUNT ONLY**
 31 – 60 UNITS MIXED →→→ **LESS 5%**
 61 AND MORE UNITS MIXED →→→ **LESS 10%**

HEAVY DUTY, GRADE 1 MORTISE LOCKSET *List Price*

Optional Interchangeable Core Small Format (Best, Falcon and Arrow) or Large Format (Schlage)



3 HOUR FIRE RATED
UL10C, UBC7-2-1997

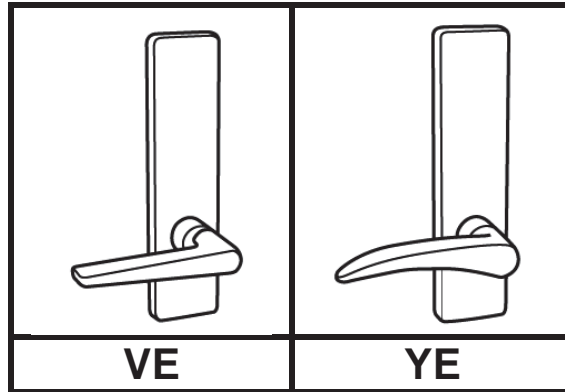

ALL ITEMS BELOW AVAILABLE WITH FACTORY LEAD TIME AND SUBJECT TO MINIMUM ORDER QUANTITY

VE AND YE ESCUTCHEON TRIM ONLY

FUNCTIONS	ANSI	FINISHES					
		US26D	US32	US10B	US3	US26	US4
◀Single cylinder without deadbolt							
NM8050 - Office / Entrance	F04						
NM8070 - Classroom	F05	\$246.55	\$300.14	\$257.26	\$257.26	\$257.26	\$257.26
NM8080 - Storeroom	F07						
◀Single cylinder with deadbolt							
NM8453 - Entrance	F20	252.49	306.10	263.22	263.22	263.22	263.22
NM8456 - Corridor	F13						
NM8495 - Keyed Privacy w/ Indicator	NEW ITEM	327.49	381.10	270.22	270.22	270.22	270.22
NM8465 - Closet / Storeroom	----						
NM8473 - Dormitory / Bedroom	F21	252.49	306.10	263.22	263.22	263.22	263.22
◀Double cylinder without deadbolt							
NM8060 - Apartment Entrance	F09						
NM8082 - Institution	F30	265.59	319.19	276.32	276.32	276.32	276.32
◀ Double cylinder with deadbolt							
NM8466 - Storeroom	F14						
◀Other Functions							
NM8040 - Privacy with Deadbolt	F02,F19,F22	235.82	289.41	246.55	246.55	246.55	246.55
NM8445 - Privacy with Indicator	NEW ITEM	310.82	364.41	321.55	321.55	321.55	321.55
NM8010 - Passage	F01	204.86	258.45	215.57	215.57	215.57	215.57
NM8170 - Single Fixed Dummy	----	66.70	120.29	77.41	77.41	77.41	77.41
NM8172 - Double Fixed Dummy	----	147.00	178.00	175.00	175.00	175.00	175.00

All keyed lock functions are available with Best, Falcon and Arrow and Schlage Large Format Interchangeable Cores. (See page L20 for additional charges). Prices do not include cores. For IC Core pricing see pages L73 – L75.



QUANTITY DISCOUNT
 UP TO 30 UNITS MIXED →→ STANDARD DISCOUNT ONLY
 31 – 60 UNITS MIXED →→→ LESS 5%
 61 AND MORE UNITS MIXED →→→ LESS 10%

HEAVY DUTY, GRADE 1 MORTISE LOCKSET *List Price*

Optional Interchangeable Core Small Format (Best, Falcon and Arrow) or Large Format (Schlage)



3 HOUR FIRE RATED
UL10C, UBC7-2-1997



ALL ITEMS BELOW AVAILABLE WITH FACTORY LEAD TIME AND SUBJECT TO MINIMUM ORDER QUANTITY

DE ESCUTCHEON TRIM ONLY

FUNCTIONS	ANSI	FINISHES						
		US26D	US32D	US32	US10B	US3	US26	US4
◀Single cylinder without deadbolt								
NM8050 - Office / Entrance	F04	\$246.55	\$300.14	\$300.14	\$257.26	\$257.26	\$257.26	\$257.26
NM8070 - Classroom	F05							
NM8080 - Storeroom	F07							
◀Single cylinder with deadbolt								
NM8453 - Entrance	F20	252.49	306.10	306.10	263.22	263.22	263.22	263.22
NM8456 - Corridor	F13							
NM8495 - Keyed Privacy w/ Indicator	NEW ITEM	327.49	381.10	381.10	338.22	338.22	338.22	338.22
NM8465 - Closet / Storeroom	----	252.49	306.10	306.10	263.22	263.22	263.22	263.22
NM8473 - Dormitory / Bedroom	F21							
◀Double cylinder without deadbolt								
NM8060 - Apartment Entrance	F09	265.59	319.19	319.19	276.32	276.32	276.32	276.32
NM8082 - Institution	F30							
◀ Double cylinder with deadbolt								
NM8466 - Storeroom	F14							
◀Other Functions								
NM8040 - Privacy with Deadbolt	F02,F19,F22	235.82	289.41	289.41	246.55	246.55	246.55	246.55
NM8445 - Privacy with Indicator	NEW ITEM	310.82	364.41	364.41	321.55	321.55	321.55	321.55
NM8010 - Passage	F01	204.86	258.45	258.45	215.57	215.57	215.57	215.57
NM8170 - Single Fixed Dummy	----	66.70	120.29	120.29	77.41	77.41	77.41	77.41
NM8172 - Double Fixed Dummy	----	147.00	178.00	178.00	175.00	175.00	175.00	175.00

All keyed lock functions are available with Best, Falcon and Arrow and Schlage Large Format Interchangeable Cores. (See page L20 for additional charges). Prices do not include cores. For IC Core pricing see pages L73 – L75.



QUANTITY DISCOUNT
 UP TO 30 UNITS MIXED →→ **STANDARD DISCOUNT ONLY**
 31 – 60 UNITS MIXED →→→ **LESS 5%**
 61 AND MORE UNITS MIXED →→→ **LESS 10%**

HEAVY DUTY, GRADE 1 MORTISE LOCKSET *List Price*

Optional Interchangeable Core Small Format (Best, Falcon and Arrow) or Large Format (Schlage)

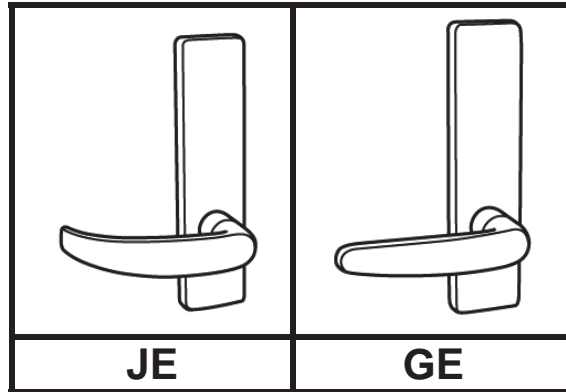

STOCK ITEM PRICES IN BOLD. (FOR OTHER DESIGNS, SEE PREVIOUS PAGES)
NON-STOCK FINISHES AVAILABLE WITH FACTORY LEAD TIME AND SUBJECT TO MINIMUM ORDER

JE AND GE ESCUTCHEON TRIM								
FUNCTIONS	ANSI	FINISHES						
		US26D	US32D	US32	US10B	US3	US26	US4
◀Single cylinder without deadbolt								
NM8050 - Office / Entrance	F04	\$246.55	\$300.14	\$300.14	\$257.26	\$257.26	\$257.26	\$257.26
NM8070 - Classroom	F05							
NM8080 - Storeroom	F07							
◀Single cylinder with deadbolt								
NM8453 - Entrance	F20	252.49	306.10	306.10	263.22	263.22	263.22	263.22
NM8456 - Corridor	F13							
NM8495 - Keyed Privacy w/ Indicator	NEW ITEM	327.49	381.10	381.10	338.22	338.22	338.22	338.22
NM8465 - Closet / Storeroom	----	252.49	306.10	306.10	263.22	263.22	263.22	263.22
NM8473 - Dormitory / Bedroom	F21							
◀Double cylinder without deadbolt								
NM8060 - Apartment Entrance	F09	265.59	319.19	319.19	276.32	276.32	276.32	276.32
NM8082 - Institution	F30	265.59						
◀Double cylinder with deadbolt								
NM8466 - Storeroom	F14	265.59						
◀Other Functions								
NM8040 - Privacy with Deadbolt	F02,F19,F22	235.82	289.41	289.41	246.55	246.55	246.55	246.55
NM8445 - Privacy with Indicator	NEW ITEM	310.82	364.41	364.41	321.55	321.55	321.55	321.55
NM8010 - Passage	F01	204.86	258.45	258.45	215.57	215.57	215.57	215.57
NM8170 - Single Fixed Dummy	----	66.70	120.29	120.29	77.41	77.41	77.41	77.41
NM8172 - Double Fixed Dummy	----	147.00	178.00	178.00	175.00	175.00	175.00	175.00

All keyed lock functions are available with Best, Falcon and Arrow and Schlage Large Format Interchangeable Cores. (See page L20 for additional charges). Prices do not include cores. For IC Core pricing see pages L73 – L75.



QUANTITY DISCOUNT
 UP TO 30 UNITS MIXED →→ **STANDARD DISCOUNT ONLY**
 31 – 60 UNITS MIXED →→→ **LESS 5%**
 61 AND MORE UNITS MIXED →→→ **LESS 10%**

HEAVY DUTY, GRADE 1 MORTISE LOCKSET *List Price* •

Optional Interchangeable Core Small Format (Best, Falcon and Arrow) or Large Format (Schlage)

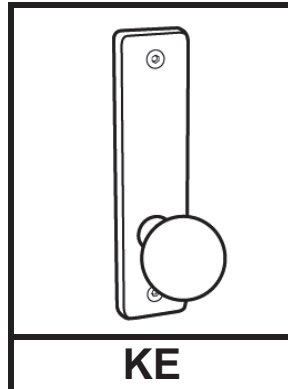

STOCK ITEM PRICES IN BOLD. (FOR OTHER DESIGNS, SEE PREVIOUS PAGES)
NON-STOCK FINISHES AVAILABLE WITH FACTORY LEAD TIME AND SUBJECT TO MINIMUM ORDER

KE ESCUTCHEON TRIM ONLY								
FUNCTIONS	ANSI	FINISHES						
		US26D	US32D	US32	US10B	US3	US26	US4
◀Single cylinder without deadbolt								
NM8050 - Office / Entrance	F04							
NM8070 - Classroom	F05	\$246.55	\$300.14	\$300.14	\$257.26	\$257.26	\$257.26	\$257.26
NM8080 - Storeroom	F07							
◀Single cylinder with deadbolt								
NM8453 - Entrance	F20	252.49	306.10	306.10	263.22	263.22	263.22	263.22
NM8456 - Corridor	F13							
NM8495 - Keyed Privacy w/ Indicator	NEW ITEM	327.49	381.10	381.10	338.22	338.22	338.22	338.22
NM8465 - Closet / Storeroom	----	252.49	306.10	306.10	263.22	263.22	263.22	263.22
NM8473 - Dormitory / Bedroom	F21							
◀Double cylinder without deadbolt								
NM8060 - Apartment Entrance	F09							
NM8082 - Institution	F30	265.59	319.19	319.19	276.32	276.32	276.32	276.32
◀Double cylinder with deadbolt								
NM8466 - Storeroom	F14							
◀Other Functions								
NM8040 - Privacy with Deadbolt	F02,F19,F22	235.82	289.41	289.41	246.55	246.55	246.55	246.55
NM8445 - Privacy with Indicator	NEW ITEM	310.82	364.41	364.41	321.55	321.55	321.55	321.55
NM8010 - Passage	F01	204.86	258.45	258.45	215.57	215.57	215.57	215.57
NM8170 - Single Fixed Dummy	----	66.70	120.29	120.29	77.41	77.41	77.41	77.41
NM8172 - Double Fixed Dummy	----	147.00	178.00	178.00	175.00	175.00	175.00	175.00

Optional Interchangeable Cores. All keyed lock functions are available with Best, Falcon and Arrow and Schlage Large Format Interchangeable Cores. (See page L20 for additional charges). Prices do not include cores. For IC Core pricing see pages L73 – L75.



QUANTITY DISCOUNT
 UP TO 30 UNITS MIXED →→ **STANDARD DISCOUNT ONLY**
 31 – 60 UNITS MIXED →→→ **LESS 5%**
 61 AND MORE UNITS MIXED →→→ **LESS 10%**

WI Series List Price

HEAVY DUTY, GRADE 1 WIDE ESCUTCHEON MORTISE LOCKSET

Optional Interchangeable Core Small Format (Best, Falcon and Arrow) or Large Format (Schlage)



3 HOUR FIRE RATED
UL10C, UBC7-2-1997

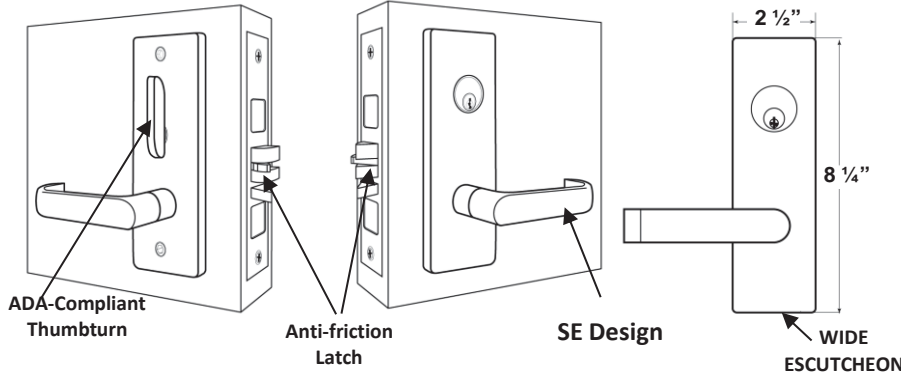

STOCK ITEM PRICES IN BOLD. (FOR OTHER DESIGNS, SEE NEXT PAGE)
NON-STOCK FINISHES AVAILABLE WITH FACTORY LEAD TIME AND SUBJECT TO MINIMUM ORDER

WIDE ESCUTCHEON SE TRIM ONLY						
FUNCTIONS	ANSI	FINISHES				
		US26D	US10B	US3	US26	US4
◀Single cylinder without deadbolt						
WI8050 - Office / Entrance	F04					
WI8070 - Classroom	F05	\$312.70	\$313.00	\$313.00	\$313.00	\$313.00
WI8080 - Storeroom	F07					
◀Single cylinder with deadbolt						
WI8453 - Entrance	F20	318.00	318.00	318.00	318.00	318.00
WI8456 - Corridor	F13					
WI8495 - Keyed Privacy w/ Indicator	NEW ITEM	393.00	393.00	393.00	393.00	393.00
WI8465 - Closet / Storeroom	----	318.00	318.00	318.00	318.00	318.00
WI8473 - Dormitory / Bedroom	F21					
◀Double cylinder without deadbolt						
WI8060 - Apartment Entrance	F09	332.84				
WI8082 - Institution	F30	332.84	333.00	333.00	333.00	333.00
◀ Double cylinder with deadbolt						
WI8466 - Storeroom	F14	332.84				
◀Other Functions						
WI8040 - Privacy	F02,F19,F22	301.04	301.00	301.00	301.00	301.00
WI8445 - Privacy with Indicator	NEW ITEM	376.04	376.00	376.00	376.00	376.00
WI8010 - Passage	F01	267.12	267.00	267.00	267.00	267.00
WI8170 - Single Fixed Dummy	----	117.66	118.00	118.00	118.00	118.00

All keyed lock functions are available with Best, Falcon and Arrow and Schlage Large Format Interchangeable Cores. (See page L20 for additional charges). Prices do not include cores. For IC Core pricing see pages L73 – L75.



QUANTITY DISCOUNT	
UP TO 30 UNITS MIXED	→→ STANDARD DISCOUNT ONLY
31 – 60 UNITS MIXED	→→→ LESS 5%
61 AND MORE UNITS MIXED	→→→→ LESS 10%

WI Series List Price

HEAVY DUTY, GRADE 1 WIDE ESCUTCHEON MORTISE LOCKSET

Optional Interchangeable Core Small Format (Best, Falcon and Arrow) or Large Format (Schlage)



3 HOUR FIRE RATED
UL10C, UBC7-2-1997

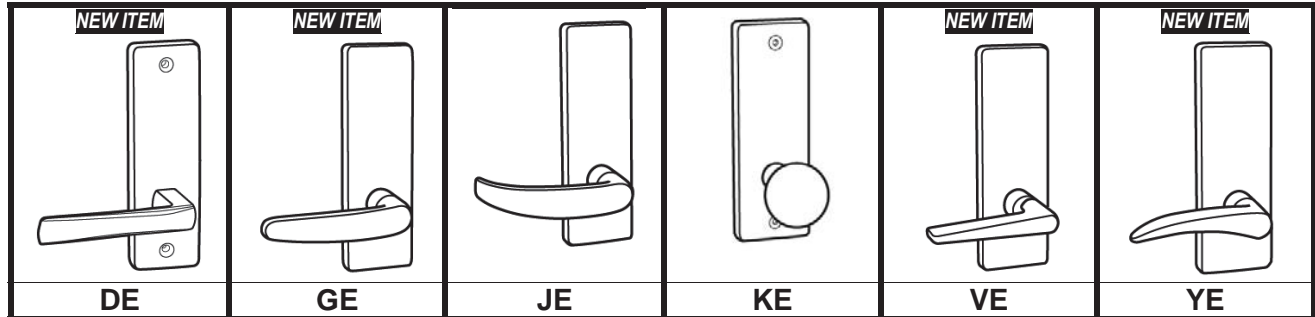

ALL ITEMS BELOW AVAILABLE WITH FACTORY LEAD TIME AND SUBJECT TO MINIMUM ORDER QUANTITY

WIDE ESCUTCHEON CE, DE, GE, HE, JE, KE, TE, VE, YE TRIM ONLY						
FUNCTIONS	ANSI	FINISHES				
		US26D	US10B	US3	US26	US4
◀Single cylinder without deadbolt						
WI8050 - Office / Entrance	F04					
WI8070 - Classroom	F05	\$312.70	\$313.00	\$313.00	\$313.00	\$313.00
WI8080 - Storeroom	F07					
◀Single cylinder with deadbolt						
WI8453 - Entrance	F20					
WI8456 - Corridor	F13	318.00	318.00	318.00	318.00	318.00
WI8495 - Keyed Privacy w/ Indicator	----	393.00	393.00	393.00	393.00	393.00
WI8465 - Closet / Storeroom	----					
WI8473 - Dormitory / Bedroom	F21	318.00	318.00	318.00	318.00	318.00
◀Double cylinder thout deadbolt						
WI8060 - Apartment Entrance	F09					
WI8082 - Institution	F30	332.84	333.00	333.00	333.00	333.00
◀ Double cylinder th deadbolt						
WI8466 - Storeroom	F14					
◀Other Functions						
WI8040 - Privacy	F02,F19,F22	301.04	301.00	301.00	301.00	301.00
WI8445 - Privacy with Indicator	----	376.01	376.00	376.00	376.00	376.00
WI8010 - Passage	F01	267.12	267.00	267.00	267.00	267.00
WI8170 - Single Fixed Dummy	----	117.66	118.00	118.00	118.00	118.00

All keyed lock functions are available with Best, Falcon and Arrow and Schlage Large Format Interchangeable Cores. (See page L20 for additional charges). Prices do not include cores. For IC Core pricing see pages L73 – L75.

QUANTITY DISCOUNT
UP TO 30 UNITS MIXED →→ **STANDARD DISCOUNT ONLY**
31 – 60 UNITS MIXED →→→ **LESS 5%**
61 AND MORE UNITS MIXED →→→ **LESS 10%**

Lifetime Warranty **BHMA** CERTIFIED **MEETS** The Buy American Act

HURRICANE APPROVED HARDWARE
FLORIDA BUILDING CODE:
FL13922-R1
ASTM E1886/E1996
ASTM E330
TAS 201, 202, 203
UL10B
UL10C

WI Series List Price



HEAVY DUTY, GRADE 1 WIDE ESCUTCHEON MORTISE LOCKSET

Optional Interchangeable Core Small Format (Best, Falcon and Arrow) or Large Format (Schlage)

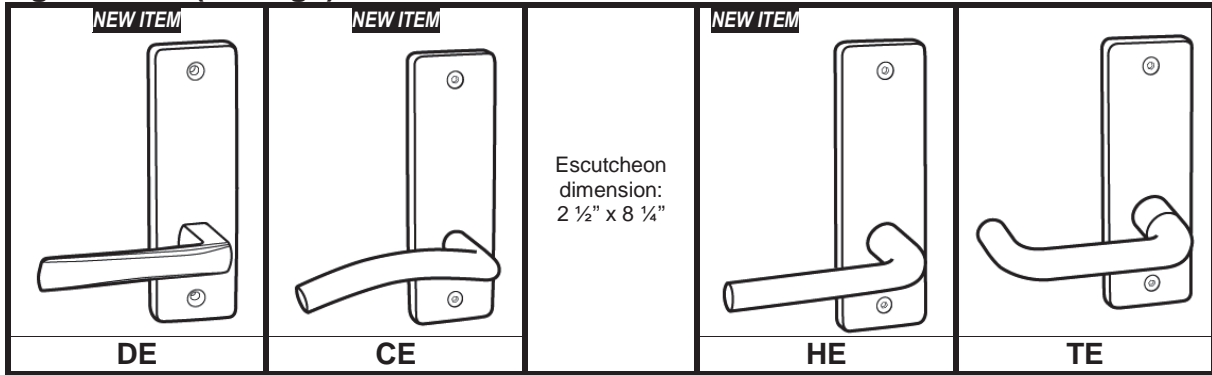

ALL ITEMS BELOW AVAILABLE WITH FACTORY LEAD TIME AND SUBJECT TO MINIMUM ORDER QUANTITY

WIDE ESCUTCHEON WDE, WCE, WHE, WTE TRIM ONLY		
FUNCTIONS	ANSI	FINISH US32D
◀Single cylinder without deadbolt		
WI8050 - Office / Entrance	F04	\$381.00
WI8070 - Classroom	F05	
WI8080 - Storeroom	F07	
◀Single cylinder th deadbolt		
WI8453 - Entrance	F20	389.00
WI8456 - Corridor	F13	
WI8495 - Keyed Privacy w/ Indicator	----	464.00
WI8465 - Closet / Storeroom	----	389.00
WI8473 - Dormitory / Bedroom	F21	
◀Double cylinder thout deadbolt		
WI8060 - Apartment Entrance	F09	405.00
WI8082 - Institution	F30	
◀ Double cylinder th deadbolt		
WI8466 - Storeroom	F14	
◀Other Functions		
WI8040 - Privacy	F02,F19,F22	367.55
WI8445 - Privacy with Indicator	----	442.55
WI8010 - Passage	F01	328.00
WI8170 - Single Fixed Dummy	----	153.00



All keyed lock functions are available with Best, Falcon and Arrow and Schlage Large Format Interchangeable Cores. (See page L20 for additional charges). Prices do not include cores. For IC Core pricing see pages L73 – L75.



<p>QUANTITY DISCOUNT UP TO 30 UNITS MIXED →→ <u>STANDARD DISCOUNT ONLY</u> 31 – 60 UNITS MIXED →→→ <u>LESS 5%</u> 61 AND MORE UNITS MIXED →→→ <u>LESS 10%</u></p>

NM Series List Price

HEAVY DUTY, GRADE 1 MORTISE DEADBOLTS

Optional Interchangeable Core Small Format (Best, Falcon and Arrow) or Large Format (Schlage)

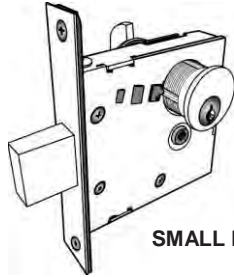

SMALL LOCKCASE

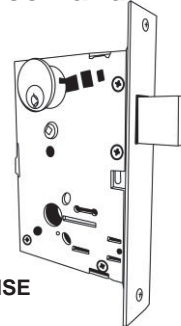

FULL MORTISE



STOCK ITEM PRICES IN BOLD
NON-STOCK FINISHES AVAILABLE WITH FACTORY LEAD TIME AND SUBJECT TO MINIMUM ORDER

MODEL #	ANSI	LIST PRICE EACH		FUNCTIONS	MODEL #	ANSI	LIST PRICE EACH	
		US26D, 32D	US10B, 3,26,4				US26D, 32D	US10B, 3,26,4
SM4608	E06071	\$86.92	95.40	Cylinder and Thumbturn Deadbolt thrown or retracted by key outside or thumbturn inside	M8460	F17	\$114.48	\$126.14
SM4628	E06061	96.46	106.00	Double Cylinder Deadbolt operated by key on either side	M8462	F16	121.90	134.62
SM4638	E06091	96.46	106.00	Classroom Lock Deadbolt thrown or retracted by key from outside. Inside cylinder turn retracts deadbolt but cannot project it	M8463	F29	121.90	134.62
SM4648	E06081	81.62	90.10	Cylinder Lock Deadbolt thrown or retracted by key from one side. No trim on opposite side	M8464	F18	111.30	122.96
SM4808	---	76.00	84.92	Door Bolt Deadbolt thrown or retracted by thumbturn from one side. No trim on opposite side NEW ITEM	M8480	---	196.90	215.57
SM4968	---	160.00	179.20	Deadbolt with "OCCUPIED" indicator Deadbolt thrown or retracted by key outside or thumbturn inside. "OCC" plate is displayed when deadbolt is thrown. NEW ITEM	M8496	---	196.90	215.57

All keyed lock functions are available with Best, Falcon and Arrow and Schlage Large Format Interchangeable Cores. (See page L20 for additional charges). Prices do not include cores. For IC Core pricing see pages L73 – L75.



QUANTITY DISCOUNT
UP TO 30 UNITS MIXED →→ **STANDARD DISCOUNT ONLY**
31 – 60 UNITS MIXED →→→ **LESS 5%**
61 AND MORE UNITS MIXED →→→ **LESS 10%**

NM Series List Price

HEAVY DUTY, GRADE 1 MORTISE LOCKSET

► PACKAGING INCLUDES

- 6 locks per case
- UL listed single point latch
- Standard "C", 6-pin cylinder
- Non-handed strike

► KEYWAYS

6-pin solid brass "C" keyway standard. Optional: Schlage E, Schlage C-K, Russwin D1-2-3-4, Corbin 59/60, Arrow A, Corbin-Russwin L4, Sargent LA-LB-LC, Falcon/Weiser E, Yale 8, Yale GA and Kwikset. Can also accept Medeco, Assa, Kaba and **Cal-Royal HSK** High Security Cylinders. See pages L75-L76 for keying charges and Cylinder PART#.

ADD \$24.00 List Each

When using 1 1/8" length Mortise cylinder for sectional trim and 1 1/4" length Mortise cylinder for Escutcheon **MUST USE CLOVER CAM** supplied by Cal-Royal.

Part # MCAM List \$1.60

► KEYING CHARGES

Refer to page L73 – L75

► IC CORE

For **Best, Falcon and Arrow Interchangeable**

Core prefix "**IC**" before Part#.
(Mortise housing Part# ICH961387)
Add \$31.11 List

For **Schlage Large Format Interchangeable Core** prefix "**ICSC**" before Part#.

(Mortise housing Part# 7000ICMC)
Add \$31.80 List

Price does not include Core.
Refer to pages L73 – L75 for Core prices.

Due to easy reversibility of NM Series, if handing is not available at time of shipment opposite hand will be shipped

► QUICKMARK TEMPLATE

Available heavy duty steel template for fast and easy installation. Reduces installation time. Eliminates using paper templates.

Part # MTCAL List \$52.95

► OPTIONAL ADA THUMBTURN

Add \$13.50 List
Prefix "**ADA**" before Mortise lock ITEM#
Use Part# "**ADATHUMBTURN**"
when ordering separately.

STANDARD DISCOUNT ONLY

► FOR 2" up to 2 1/4" Thick door

Order kit:
SSMKIT214 - for sectional trim
SEMKIT214 - for escutcheon trim
LIST \$38.16

ADA THUMBTURN

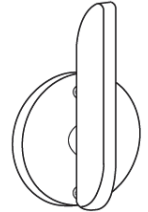

► TACTILE

Tactile: Part #TAC Add \$26.97 List

► ELECTRIFIED

Available on Storeroom Only

➤ Electrified Part #ELEC Add \$167.00 List
(Specify Options)

FEATURES:

- UL and CSFM Listings
- Continuous duty solenoids for cooler operation during "continuously on" applications
- Standard plug-in rectifier allows for an AC or DC power source
- Low current draw
- Numerous switch options
- 3 year "No Hassle" warranty

OPTIONS:

- Voltage requirement -12 VAC/DC or 24 VAC/DC
- Amperage - 700mA @ 12V or 350mA @ 24V
- Function - available "Fail Safe" (FS) or "Fail Secure" (FSE)

➤ **REX - Request to Exit Add \$68.00 List**
Available on M8080 and M8453 Functions

► LEAD LINING

➤ Available on request.

► ANTI MICROBIAL COATING

Available on US26D and US32D finishes. Add \$34.00 List.
Prefix "**ANTB**" before PART#.

► HOW TO ORDER

NM8050 – SS – US26D RH

1. Office Function
2. SS Trim Sectional
3. Satin Chrome
4. Right Handed

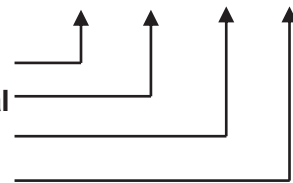



Heavy Duty Mortise Lock COMPARISON CHART

FUNCTION	ILLUSTRATION	ANSI NO	CAL-ROYAL MODEL NO	NT FALCON M SERIES	ARROW B Series	CORBIN/RUSSWIN	SARGENT 7800 / 8200	SCHLAGE L SERIES	PDQ MR SERIES	YALE	HAGER
ENTRANCE or OFFICE		Single Cylinder Without Deadbolt									
		F04	NM8050	M521	BM22	ML2051	5	L9050	MR116	8807	3850
CLASSROOM		F05	NM8070	M561	BM17	ML2055	37	L9070	MR148	8808	3870
STOREROOM or CLOSET		F07	NM8080	M371	BM12	ML2057	4	L9080	MR115	8805	3880
APARTMENT/ DORMITORY		Single Cylinder With Deadbolt									
		F20	NM8453	M531	BM11	ML2067	45	L9453	MR162	8847	3853
DORMITORY/ BEDROOM		F21	NM8473	M541	BM20	ML2024	24	L9473	MR135	8860	----
CORRIDOR/ EXIT		F13	NM8456	M571	BM19	ML2065	25	L9456	MR136	8822	
KEYED PRIVACY INDICATOR		----	NM8495	M451	----	ML2024 M19	----	L9495 L9496	---	8864	----
CLOSET / STOREROOM		----	NM8465	----	----	----	27	L9465	MR139	----	----
APARTMENT ENTRANCE/ VESTIBULE		Double Cylinder Without Deadbolt									
		F09	NM8060	M381	BM32	ML2042	16	L9060	MR186	8817	----
INSTITUTION		F30	NM8082	M411	BM33	ML2032	17	L9082	---	8830-2	3882
STOREROOM UTILITY		Double Cylinder With Deadbolt									
		F14	NM8466	M371	BM31	ML2022	26	L9466	MR137	8860	----
PRIVACY or BATHROOM		Other Functions									
		F02 F19 F22	NM8040	M311	BM02	ML2020	65	L9040	MR178 MR179	8802	3840
		----	NM8445	----	----	ML2020 M19	49	----	----	8862	3896
PASSAGE or CLOSET		F01	NM8010	M101	BM01	ML2010	13	L9010	MR126	8801	3810
SINGLE FIXED DUMMY		----	NM8170	M12	BM08	ML2050	93	L0170	MR211	8855	3817
DOUBLE FIXED DUMMY		---	NM8172	M18	BM09	ML2070	96	L0172	MR205	8838	3827

GENESYS Series List Price



HEAVY DUTY CYLINDRICAL LEVERSETS WITH CLUTCH ANSI - A156.2, SERIES 4000, GRADE 1

Optional Interchangeable Core for Best, Falcon and Arrow

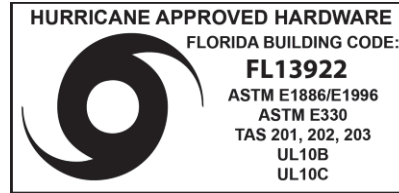
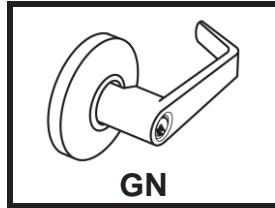

STOCK ITEM PRICES IN BOLD.
NON-STOCK FINISHES AVAILABLE WITH FACTORY LEAD TIME AND SUBJECT TO MINIMUM ORDER

FUNCTIONS	ANSI	ITEM #	US26D	US10B	US3	US10	US26	US4	PCS /MC
Entrance	F109	CGN00	\$156.16	\$164.10	\$164.10	\$164.10	\$164.10	\$164.10	10
		ICCGN00	156.16	164.10	164.10	164.10	164.10	164.10	
Entrance Push Button Lock	F82	CGN01	156.16	164.10	164.10	164.10	164.10	164.10	
		ICCGN01	156.16	164.10	164.10	164.10	164.10	164.10	
Store lock Non Clutch (keyed Dbl. cyl.)	F91	GN02	185.27	193.22	193.22	193.22	193.22	193.22	
		ICGN02	185.27	193.22	193.22	193.22	193.22	193.22	
Classroom	F84	CGN03	161.45	169.40	169.40	169.40	169.40	169.40	
		ICCGN03	161.45	169.40	169.40	169.40	169.40	169.40	
Communicating (keyed Dbl. cyl.)	F80	CGN04	185.27	193.22	193.22	193.22	193.22	193.22	
		ICCGN04	185.27	193.22	193.22	193.22	193.22	193.22	
Storeroom	F86	CGN05	156.16	164.10	164.10	164.10	164.10	164.10	
		ICCGN05	156.16	164.10	164.10	164.10	164.10	164.10	
Vestibule	F88	CGN06	185.27	193.22	193.22	193.22	193.22	193.22	
		ICCGN06	185.27	193.22	193.22	193.22	193.22	193.22	
Classroom/ Intruder	F110	CGN07	185.27	193.22	193.22	193.22	193.22	193.22	
		ICCGN07	185.27	193.22	193.22	193.22	193.22	193.22	
Dormitory (Non-Clutch)	F90	NEW ITEM GN101	161.45	169.40	169.40	169.40	169.40	169.40	
Institution (keyed Dbl. cyl.)	F87	CGN09	185.27	193.22	193.22	193.22	193.22	193.22	
		ICCGN09	185.27	193.22	193.22	193.22	193.22	193.22	
Privacy	F76	CGN20	145.57	150.87	150.87	150.87	150.87	150.87	
Passage	F75	GN30	119.10	127.04	127.04	127.04	127.04	127.04	
Exit	F89	NEW ITEM GN50	119.10	127.04	127.04	127.04	127.04	127.04	
Single Dummy	----	GN40	39.71	42.35	42.35	42.35	42.35	42.35	20

(IC) Indicates function available with Best, Falcon and Arrow Interchangeable Core. Prices do not include cores. For IC Core pricing see pages L73 – L75.



QUANTITY DISCOUNT
UP TO 30 UNITS MIXED →→ **STANDARD DISCOUNT ONLY**
31 – 60 UNITS MIXED →→→ **LESS 5%**
61 AND MORE UNITS MIXED →→→ **LESS 10%**

HEAVY DUTY CYLINDRICAL LEVERSETS WITH CLUTCH ANSI - A156.2, SERIES 4000, GRADE 1

Optional Interchangeable Core for Best, Falcon and Arrow



3 HOUR FIRE RATED
UL10C, UBC7-2-1997

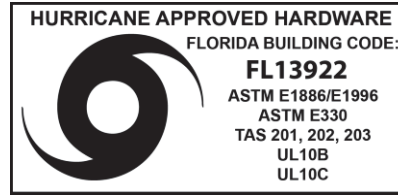
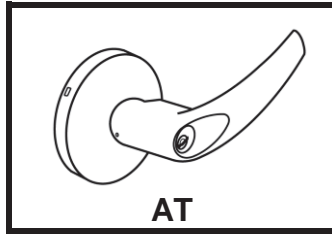

STOCK ITEM PRICES IN BOLD
NON-STOCK FINISHES AND DESIGNS AVAILABLE WITH FACTORY LEAD TIME AND SUBJECT TO MINIMUM ORDER

FUNCTIONS	ANSI	ITEM #	US26D	US10B	US3	US10	US26	US4	PCS /MC
Entrance	F109	CAT00	\$156.16	\$164.10	\$164.10	\$164.10	\$164.10	\$164.10	10
		⊗ ICCAT00	156.16	164.10	164.10	164.10	164.10	164.10	
Entrance Push Button Lock	F82	CAT01	156.16	164.10	164.10	164.10	164.10	164.10	
		⊗ ICCAT01	156.16	164.10	164.10	164.10	164.10	164.10	
Store lock Non Clutch (keyed Dbl. cyl.)	F91	AT02	185.27	193.22	193.22	193.22	193.22	193.22	
		⊗ ICAT02	185.27	193.22	193.22	193.22	193.22	193.22	
Classroom	F84	CAT03	161.45	169.40	169.40	169.40	169.40	169.40	
		⊗ ICCAT03	161.45	169.40	169.40	169.40	169.40	169.40	
Communicating (keyed Dbl. cyl.)	F80	CAT04	185.27	193.22	193.22	193.22	193.22	193.22	
		⊗ ICCAT04	185.27	193.22	193.22	193.22	193.22	193.22	
Storeroom	F86	CAT05	156.16	164.10	164.10	164.10	164.10	164.10	
		⊗ ICCAT05	156.16	164.10	164.10	164.10	164.10	164.10	
Vestibule	F88	CAT06	185.27	193.22	193.22	193.22	193.22	193.22	
		⊗ ICCAT06	185.27	193.22	193.22	193.22	193.22	193.22	
Classroom/ Intruder	F110	CAT07	185.27	193.22	193.22	193.22	193.22	193.22	
		⊗ ICCAT07	185.27	193.22	193.22	193.22	193.22	193.22	
Institution (keyed Dbl. cyl.)	F87	CAT09	185.27	193.22	193.22	193.22	193.22	193.22	
		⊗ ICCAT09	185.27	193.22	193.22	193.22	193.22	193.22	
Privacy	F76	CAT20	145.57	150.87	150.87	150.87	150.87		
Passage	F75	AT30	119.10	127.04	127.04	127.04	127.04		
Exit	F89	AT50	119.10	127.04	127.04	127.04	127.04		
Single Dummy	----	AT40	39.71	42.35	42.35	42.35	42.35	20	

⊗ (IC) Indicates function available with Best, Falcon and Arrow Interchangeable Core. Prices do not include cores. For IC Core pricing see pages L73 – L75.



QUANTITY DISCOUNT
UP TO 30 UNITS MIXED →→ **STANDARD DISCOUNT ONLY**
31 – 60 UNITS MIXED →→→ **LESS 5%**
61 AND MORE UNITS MIXED →→→ **LESS 10%**

HEAVY DUTY CYLINDRICAL LEVERSETS WITH CLUTCH ANSI - A156.2, SERIES 4000, GRADE 1



Optional Interchangeable Core for **Best, Falcon and Arrow**

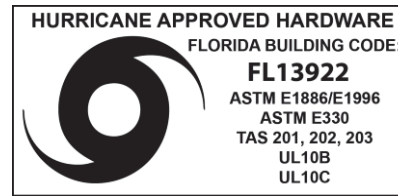

STOCK ITEM PRICES IN BOLD
NON-STOCK FINISHES AND DESIGNS AVAILABLE WITH FACTORY LEAD TIME AND SUBJECT TO MINIMUM ORDER

FUNCTIONS	ANSI	ITEM #	US26D	US10B	US3	US10	US26	US4	PCS /MC
Entrance	F109	CSPA00	\$156.16	\$164.10	\$164.10	\$164.10	\$164.10	\$164.10	10
		ICCSPA00	156.16	164.10	164.10	164.10	164.10	164.10	
Entrance Push Button Lock	F82	CSPA01	156.16	164.10	164.10	164.10	164.10	164.10	
		ICCSPA01	156.16	164.10	164.10	164.10	164.10	164.10	
Store lock Non Clutch (keyed Dbl. cyl.)	F91	SPA02	185.27	193.22	193.22	193.22	193.22	193.22	
		ICSPA02	185.27	193.22	193.22	193.22	193.22	193.22	
Classroom	F84	CSPA03	161.45	169.40	169.40	169.40	169.40	169.40	
		ICCSPA03	161.45	169.40	169.40	169.40	169.40	169.40	
Communicating (keyed Dbl. cyl.)	F80	CSPA04	185.27	193.22	193.22	193.22	193.22	193.22	
		ICCSPA04	185.27	193.22	193.22	193.22	193.22	193.22	
Storeroom	F86	CSPA05	156.16	164.10	164.10	164.10	164.10	164.10	
		ICCSPA05	156.16	164.10	164.10	164.10	164.10	164.10	
Vestibule	F88	CSPA06	185.27	193.22	193.22	193.22	193.22	193.22	
		ICCSPA06	185.27	193.22	193.22	193.22	193.22	193.22	
Classroom/ Intruder	F110	CSPA07	185.27	193.22	193.22	193.22	193.22	193.22	
		ICCSPA07	185.27	193.22	193.22	193.22	193.22	193.22	
Institution (keyed Dbl. cyl.)	F87	CSPA09	185.27	193.22	193.22	193.22	193.22	193.22	
		ICCSPA09	185.27	193.22	193.22	193.22	193.22	193.22	
Privacy	F76	CSPA20	145.57	150.87	150.87	150.87	150.87	150.87	
Passage	F75	SPA30	119.10	127.04	127.04	127.04	127.04	127.04	
Exit	F89	SPA50	119.10	127.04	127.04	127.04	127.04	127.04	
Single Dummy	----	SPA40	39.71	42.35	42.35	42.35	42.35	42.35	20



QUANTITY DISCOUNT
UP TO 30 UNITS MIXED →→ **STANDARD DISCOUNT ONLY**
31 – 60 UNITS MIXED →→→ **LESS 5%**
61 AND MORE UNITS MIXED →→→ **LESS 10%**

HEAVY DUTY CYLINDRICAL LEVERSETS WITH CLUTCH ANSI - A156.2, SERIES 4000, GRADE 1



Optional Interchangeable Core for Best, Falcon and Arrow

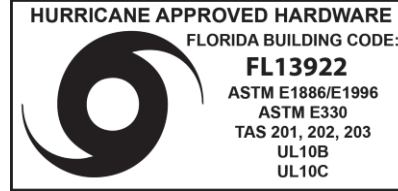
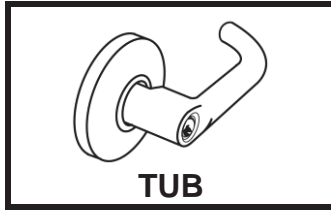

STOCK ITEM PRICES IN BOLD
NON-STOCK FINISHES AND DESIGNS AVAILABLE WITH FACTORY LEAD TIME AND SUBJECT TO MINIMUM ORDER

FUNCTIONS	ANSI	ITEM #	US26D	US10B	US3	US10	US26	US4	PCS /MC
Entrance	F109	CTUB00	\$156.16	\$164.10	\$164.10	\$164.10	\$164.10	\$164.10	10
		ICCTUB00	156.16	164.10	164.10	164.10	164.10	164.10	
Entrance Push Button Lock	F82	CTUB01	156.16	164.10	164.10	164.10	164.10	164.10	
		ICCTUB01	156.16	164.10	164.10	164.10	164.10	164.10	
Store lock Non Clutch (keyed Dbl. cyl.)	F91	TUB02	185.27	193.22	193.22	193.22	193.22	193.22	
		ICTUB02	185.27	193.22	193.22	193.22	193.22	193.22	
Classroom	F84	CTUB03	161.45	169.40	169.40	169.40	169.40	169.40	
		ICCTUB03	161.45	169.40	169.40	169.40	169.40	169.40	
Communicating (keyed Dbl. cyl.)	F80	CTUB04	185.27	193.22	193.22	193.22	193.22	193.22	
		ICCTUB04	185.27	193.22	193.22	193.22	193.22	193.22	
Storeroom	F86	CTUB05	156.16	164.10	164.10	164.10	164.10	164.10	
		ICCTUB05	156.16	164.10	164.10	164.10	164.10	164.10	
Vestibule	F88	CTUB06	185.27	193.22	193.22	193.22	193.22	193.22	
		ICCTUB06	185.27	193.22	193.22	193.22	193.22	193.22	
Classroom/ Intruder	F110	CTUB07	185.27	193.22	193.22	193.22	193.22	193.22	
		ICCTUB07	185.27	193.22	193.22	193.22	193.22	193.22	
Institution (keyed Dbl. cyl.)	F87	CTUB09	185.27	193.22	193.22	193.22	193.22	193.22	
		ICCTUB09	185.27	193.22	193.22	193.22	193.22	193.22	
Privacy	F76	CTUB20	145.57	150.87	150.87	150.87	150.87	150.87	
Passage	F75	TUB30	119.10	127.04	127.04	127.04	127.04	127.04	
Exit	F89	TUB50	119.10	127.04	127.04	127.04	127.04	127.04	
Single Dummy	----	TUB40	39.71	42.35	42.35	42.35	42.35	42.35	20



QUANTITY DISCOUNT
UP TO 30 UNITS MIXED →→ STANDARD DISCOUNT ONLY
31 – 60 UNITS MIXED →→→ LESS 5%
61 AND MORE UNITS MIXED →→→ LESS 10%

HEAVY DUTY CYLINDRICAL LEVERSETS WITH CLUTCH ANSI - A156.2, SERIES 4000, GRADE 1

Optional Full Size Interchangeable Core for
Corbin/Ruswin, Sargent and Yale



QUANTITY DISCOUNT
UP TO 30 UNITS MIXED
STANDARD DISCOUNT
31 - 60 UNITS MIXED LESS 5%
61 AND MORE UNITS MIXED LESS 10%

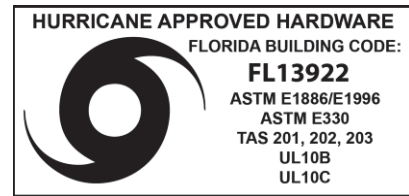
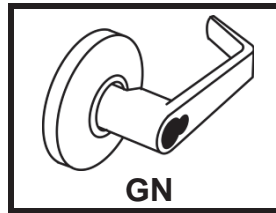

STOCK ITEM PRICES IN BOLD.
NON-STOCK FINISHES AVAILABLE WITH FACTORY LEAD TIME AND SUBJECT TO MINIMUM ORDER

CORBIN/RUSSWIN (Large Format Interchangeable Core) 7 OR 6 PIN ONLY

FUNCTIONS	ANSI	ITEM #	US26D	US10B	US3	US10	US26	US4	PCS /MC
Entrance	F109	RUSICGN00	189.00	199.00	199.00	199.00	199.00	199.00	10
Classroom	F84	RUSICGN03	195.00	205.00	205.00	205.00	205.00	205.00	
Communicating (keyed Dbl. cyl.)	F80	RUSICGN04	224.00	234.00	234.00	234.00	234.00	234.00	
Storeroom	F86	RUSICGN05	189.00	199.00	199.00	199.00	199.00	199.00	
Vestibule	F88	RUSICGN06	224.00	234.00	234.00	234.00	234.00	234.00	
Classroom/ Intruder	F110	RUSICGN07	224.00	234.00	234.00	234.00	234.00	234.00	
Institution (keyed Dbl. cyl.)	F87	RUSICGN09	224.00	234.00	234.00	234.00	234.00	234.00	
Dormitory (Non-Clutch)	F90	RUSICGN101	224.00	234.00	234.00	234.00	234.00	234.00	

SARGENT (Large Format Interchangeable Core) 6 PIN ONLY

FUNCTIONS	ANSI	ITEM #	US26D	US10B	US3	US10	US26	US4	PCS /MC
Entrance	F109	SARICGN00	189.00	199.00	199.00	199.00	199.00	199.00	10
Classroom	F84	SARICGN03	195.00	205.00	205.00	205.00	205.00	205.00	
Communicating (keyed Dbl. cyl.)	F80	SARICGN04	224.00	234.00	234.00	234.00	234.00	234.00	
Storeroom	F86	SARICGN05	189.00	199.00	199.00	199.00	199.00	199.00	
Vestibule	F88	SARICGN06	224.00	234.00	234.00	234.00	234.00	234.00	
Classroom/ Intruder	F110	SARICGN07	224.00	234.00	234.00	234.00	234.00	234.00	
Institution (keyed Dbl. cyl.)	F87	SARICGN09	224.00	234.00	234.00	234.00	234.00	234.00	
Dormitory (Non-Clutch)	F90	SARICGN101	224.00	234.00	234.00	234.00	234.00	234.00	

YALE (Large Format Interchangeable Core) 6 PIN ONLY

FUNCTIONS	ANSI	ITEM #	US26D	US10B	US3	US10	US26	US4	PCS /MC
Entrance	F109	YALICGN00	189.00	199.00	199.00	199.00	199.00	199.00	10
Classroom	F84	YALICGN03	195.00	205.00	205.00	205.00	205.00	205.00	
Communicating (keyed Dbl. cyl.)	F80	YALICGN04	224.00	234.00	234.00	234.00	234.00	234.00	
Storeroom	F86	YALICGN05	189.00	199.00	199.00	199.00	199.00	199.00	
Vestibule	F88	YALICGN06	224.00	234.00	234.00	234.00	234.00	234.00	
Classroom/ Intruder	F110	YALICGN07	224.00	234.00	234.00	234.00	234.00	234.00	
Institution (keyed Dbl. cyl.)	F87	YALICGN09	224.00	234.00	234.00	234.00	234.00	234.00	
Dormitory (Non-Clutch)	F90	YALICGN101	224.00	234.00	234.00	234.00	234.00	234.00	

Prices do not include cores.

Continued Next Page

HEAVY DUTY CYLINDRICAL LEVERSETS WITH CLUTCH ANSI - A156.2, SERIES 4000, GRADE 1



Optional Full Size Interchangeable Core for **SCHLAGE**

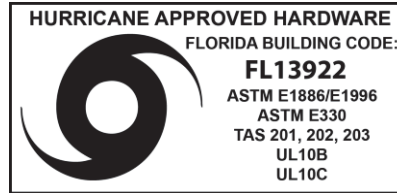
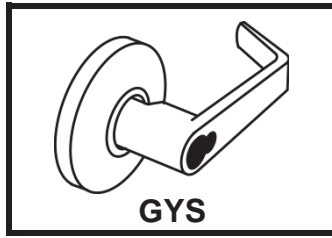

STOCK ITEM PRICES IN BOLD
NON-STOCK FINISHES AND DESIGNS AVAILABLE WITH FACTORY LEAD TIME AND SUBJECT TO MINIMUM ORDER

SCHLAGE (Large Format Interchangeable Core) 6 PIN ONLY

FUNCTIONS	ANSI	ITEM #	US26D	US10B	US3	US10	US26	US4	PCS /MC
Entrance	F109	ICGYS00	156.16	164.10	164.10	164.10	164.10	164.10	10
Storeroom	F86	ICGYS05	156.16	164.10	164.10	164.10	164.10	164.10	
Classroom	F84	ICGYS03	185.27	193.22	193.22	193.22	193.22	193.22	
Communicating (keyed Dbl. cyl.)	F80	ICGYS04	161.45	169.40	169.40	169.40	169.40	169.40	
Vestibule	F88	ICGYS06	185.27	193.22	193.22	193.22	193.22	193.22	
Classroom/ Intruder	F110	ICGYS07	156.16	164.10	164.10	164.10	164.10	164.10	
Institution (keyed Dbl. cyl.)	F87	ICGYS09	185.27	193.22	193.22	193.22	193.22	193.22	
Dormitory (Non-Clutch)	F90	ICGYS101	185.27	193.22	193.22	193.22	193.22	193.22	

(IC) Indicates function available with SCHLAGE Full Size format Interchangeable Core. Prices do not include cores.



QUANTITY DISCOUNT
UP TO 30 UNITS MIXED
STANDARD DISCOUNT
31 – 60 UNITS MIXED
LESS 5%
61 AND MORE UNITS MIXED
LESS 10%

► **PACKAGING INCLUDES**

- UL Listed 2 3/4" Backset, 2 1/4" x 1 1/8" faceplate
- Standard "C", 6-pin cylinder
- ASA strike

► **For 2" up to 2 1/4" Thick Door Use PART# below and Add \$139.33 List**

CGN214T00 - Entrance, CGN00	CGN214T05 - Storeroom, CGN05
GN214T02 - Store Lock, GN02	CGN214T09 - Institution, CGN09
CGN214T03 - Classroom, CGN03	CGN214T20 - Privacy, CGN20
CGN214T04 - Communicating, CGN04	GN214T30 - Passage, GN30
● ICCGN214T00 - Entrance, ICCGN00	Available on AT, SPA & TUB Design. Use same Part No.
● ICCGN214T03 - Classroom, ICCGN03	
● ICCGN214T05 - Storeroom, ICCGN05	

► **KEYWAYS**

6-pin solid brass "C" keyway standard. Optional: Schlage E, Schlage C-K, Russwin D1-2-3-4, Corbin 59/60, Corbin-Russwin L4, Sargent LA-LB-LC, Falcon/Weiser E, Arrow A, Yale 8, Yale GA and Kwikset. Can also accept Medeco, Assa, Kaba and *Cal-Royal HSK* High Security Cylinders. See **pages L75-L76** for additional charges.

► **MOUNT**

1 hole wooden mount
Part# CGNMOUNT List: \$52.95 Each

●●► **IC CORES, KEYING CHARGES**

Refer to pages **L73 - L75**

► **ANTI MICROBIAL COATING**

Available on **US26D** finish only.
Add \$34.00 List.
Prefix "**ANTB**" before **PART#**.

► **TACTILE, LEAD LINING**

- Lead Lining Part # **LEAD**, Add **\$132.35**
- Tactile Part # **TAC**, Add **\$26.97 List.**

STOCK ITEM PRICES IN BOLD

NON-STOCK FINISHES AND DESIGNS AVAILABLE WITH FACTORY LEAD TIME AND SUBJECT TO MINIMUM ORDER

► **ELECTRIFIED**





Available on Storeroom Only

- Electrified Part # **ELEC**, Add **\$172.70 List.**
Specify 12V or 24V, fail safe (SAF) or fail secure (SEC)

ELECTRIFIED				
DESCRIPTION	ITEM #	US26D	US10B	US4
FAIL SAFE	ECGN0512SAF	\$328.85	\$336.80	\$336.80
OPTION 12V	EICCGN0512SAF	328.85	336.80	336.80
AC/DC	EICGYS0512SAF	328.85	336.80	336.80
FAIL SECURE	ECGN0512SEC	328.85	336.80	336.80
OPTION 12V	EICCGN0512SEC	328.85	336.80	336.80
AC/DC	EICGYS0512SEC	328.85	336.80	336.80
FAIL SAFE	ECGN0524SAF	328.85	336.80	336.80
OPTION 24V	EICCGN0524SAF	328.85	336.80	336.80
AC/DC	EICGYS0524SAF	328.85	336.80	336.80
FAIL SECURE	ECGN0524SEC	328.85	336.80	336.80
OPTION 24V	EICCGN0524SEC	328.85	336.80	336.80
AC/DC	EICGYS0524SEC	328.85	336.80	336.80

► **ADDITIONAL PARTS & CHARGES**

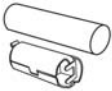
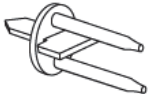
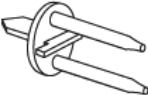
Backsets: UL listed 2 3/8", 2 1/4" x 1" Faceplate, **NO EXTRA CHARGE** if ordered with lock only.
If ordered separately **\$11.91 List Each.**

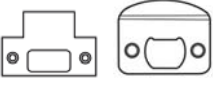
◆◆ STANDARD DISCOUNT ONLY ◆◆				
ILLUSTRATION	ITEM #	DESCRIPTION	FINISH	LIST PRICE
	GND-238	CGN Series Dead Latch 2 3/8", 2 1/4" x 1" Faceplate	US3, 26D, 10B	\$11.91
	GND750	3/4" throw, anti-friction Dead latch for pairs of fire doors, 2 1/4" x 1 1/8" Faceplate	US3, 26D, 10B, 10	62.92
	GEN5EXT	5" Backset Extension Link	-----	16.96
	GEN334EXT	3 3/4" Backset Extension Link		
TAIL PIECE				
	ICTP-01	6-pin Tail Piece for IC Genesys Series		1.67
	ICTP-02	7 Pin Tail Piece for IC Genesys Series		1.67
	ICTP-07	Tail Piece for Schalge Large Format IC Core		1.67
EXTRA UL LISTED BACKSET				
	GND-234	CGN Series 2 3/4" Dead latch, 2 1/4" x 1 1/8" Faceplate	US3,26D,10B	11.91
STRIKES				
	TS	T-Strike	US3,26D,10B, 26,10,4	2.12
	FLS	Full Lip Strike, Round Corner	US3,26D,10B,26,10	

CALYPSO CAL Series List Price ..



EXTRA HEAVY DUTY CYLINDRICAL LEVERSETS ANSI - A156.2, SERIES 4000, GRADE 1

Optional Interchangeable Core for Best, Falcon and Arrow



When ordering: "SAN" or "MHM" design **Example:** CAL00 Entrance in "SAN" design is SAN00 or in "MHM" design is MHM00

STOCK ITEM PRICES IN BOLD
 NON-STOCK FINISHES AND DESIGNS AVAILABLE WITH FACTORY LEAD TIME AND
 SUBJECT TO MINIMUM ORDER.
 FOR SAN AND MHM DESIGN USE SAME PRICE AS CAL FOR REFERENCE



FUNCTION	ANSI	ITEM #	US26D	US10B, 3, 10, 26, 4	PCS /MC
Entrance	F109	● CAL00 ● ICCAL00	\$139.92	\$147.34	6
Storelock	F91	● CAL02 ● ICCAL02	165.36	173.84	
Classroom	F84	● CAL03 ● ICCAL03	144.16	151.58	
Communicating	F80	● CAL04 ● ICCAL04	165.36	173.84	
Storeroom	F86	● CAL05 ● ICCAL05	139.92	147.34	
Vestibule	F88	● CAL06 ● ICCAL06	165.36	173.84	
Classroom Intruder	F110	● CAL07 ● ICCAL07			
Institution	F87	● CAL09 ● ICCAL09			
Dormitory	F90	● CAL101 ● ICCAL101			
Privacy	F76	CAL20	130.38	136.74	
Passage	F75	CAL30	106.00	111.30	
Dummy	----	CAL40	36.04	38.16	12

**QUANTITY
DISCOUNT**

UP TO 30
UNITS MIXED
**STANDARD
DISCOUNT**

31 – 60 UNITS
MIXED
LESS 5%

61 AND MORE
UNITS MIXED
LESS 10%

**LIFETIME
WARRANTY**

● (IC) Indicates function available with Best, Falcon and Arrow Interchangeable Core. Prices do not include cores. For IC Core pricing see pages L73 – L75.

Continued Next Page

► **PACKAGING INCLUDES**

UL Listed 2 3/4" Backset, 2 1/4" x 1 1/8" faceplate, Standard "C", 6-pin cylinder, ASA Strike

► **KEYWAYS**

6-pin solid brass "C" keyway standard. Optional: Schlage E, Schlage C-K, Russwin D1-2-3-4, Corbin 59/60, Corbin-Russwin L4, Sargent LA-LB-LC, Falcon/Weiser E, Arrow A, Yale 8, Yale GA and Kwikset.

Can also accept Medeco, Assa, Kaba and **Cal-Royal HSK** High Security Cylinders. See **pages L75-L76** for additional charges.

8 ► **IC CORE, KEYING CHARGES**

Refer to pages **L73 - L75**

► **ANTI MICROBIAL COATING**

Available on US26D finish only.

Add \$34.00 List. Prefix "ANTB" before PART#.

► **TACTILE, LEAD LINING**

- Lead Lining Part # LEAD, Add \$132.35
- Tactile Part # TAC, Add \$26.97 List

► **ADDITIONAL PARTS & CHARGES**

Backsets: UL listed 2 3/8", 2 1/4" x 1 1/8" faceplate, **NO EXTRA CHARGE** if ordered with lock only. If ordered separately **\$12.72 List Each.**

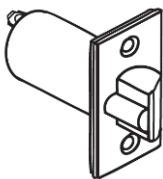
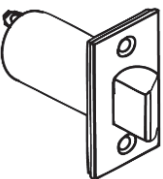
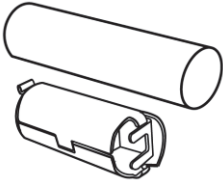
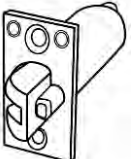
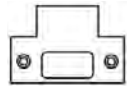
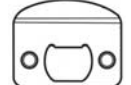
◆◆◆ STANDARD DISCOUNT ONLY ◆◆◆				
ILLUSTRATION	ITEM #	DESCRIPTION	FINISH	LIST PRICE
EXTRA UL LISTED BACKSET				
	CALSLD238	CAL Series Dead latch 2 3/8" 2 1/4" x 1 1/8" Faceplate	US26D	\$12.72
	CALDOR238	CAL101 Dormitory Dead latch 2 3/8" 2 1/4" x 1 1/8" Faceplate	US26D	12.72
	CALSLS238	CAL Series Spring Latch 2 3/8" 2 1/4" x 1 1/8" Faceplate	US26D	12.72
	CALSPL238	CAL Series Privacy Latch 2 3/8" 2 1/4" x 1 1/8" Faceplate	US26D	12.72
	CAL334 EXT	CAL Series 3 3/4" Extension Link To be used with CALSLD238	----	16.96
	CAL5 EXT	CAL Series 5" Extension Link	----	
	CAL750	2 3/4" Backset, 2 1/4" x 1 1/8" faceplate, 3/4" throw, anti-friction Dead latch for pairs of fire doors	US26D	62.54
STRIKES				
	TS	T-Strike	US3,26D,10B, 26,10,4	2.12
	FLS	Full Lip Strike Round Corner	US3,26D,10B, 26,10	

OMEGA GRB Series List Price

HEAVY DUTY CYLINDRICAL LOCKSETS ANSI A156.2 SERIES 4000 GRADE 1



⌘ Optional Interchangeable Core for Best, Falcon and Arrow

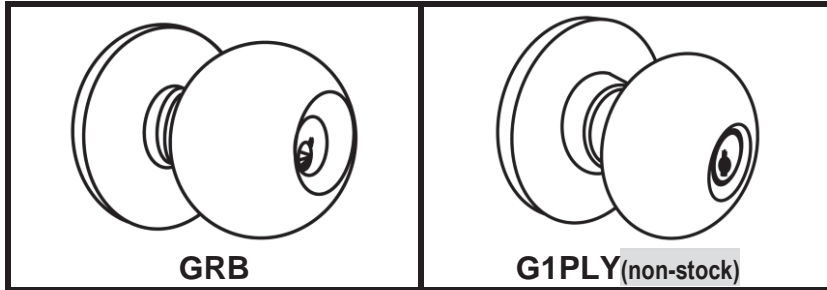

MEETS
The Buy American Act

When ordering: "G1PLY" design **Example:** GRB00 Entrance in G1PLY design is G1PLY00

STOCK ITEM PRICES IN BOLD
NON-STOCK FINISHES AND DESIGNS AVAILABLE WITH FACTORY LEAD TIME
AND SUBJECT TO MINIMUM ORDER.
FOR G1PLY USE SAME PRICE AS GRB FOR REFERENCE

FUNCTION	ANSI	ITEM #	US32D	US3	US10B, 10, 4, 26	PCS /MC
Entrance	F109	⌘ GRB00 or ICGRB00	\$119.10	\$119.10	\$127.44	10
Storelock (keyed Dbl. cyl.)	F91	GRB02	159.59	159.59	167.94	
Classroom	F84	⌘ GRB03 or ICGRB03	132.20	132.20	140.53	
Communicating (keyed Dbl. cyl.)	F80	GRB04	159.59	159.59	167.94	
Storeroom	F86	⌘ GRB05 or ICGRB05	119.10	119.10	127.44	
Institution (keyed Dbl. cyl.)	F87	GRB09	159.59	159.59	167.94	
Privacy	F76	GRB20	106.00	106.00	111.96	
Passage	F75	GRB30	92.90	92.90	98.86	
Single Dummy	----	GRB40	47.64	47.64	52.41	



QUANTITY DISCOUNT
50 UNITS MIXED
LESS 5%

100 UNITS MIXED
LESS 10%



⌘ (IC) Indicates function available with **Best, Falcon and Arrow Interchangeable Core**. Prices do not include cores. For IC Core pricing see pages L73 – L75.

► **PACKAGING INCLUDES**

UL Listed 2 3/4" Backset, 2 1/4" x 1 1/8" faceplate, Standard "C", 6-pin cylinder, ASA Strike

► **KEYWAYS**

6-pin solid brass "C" keyway standard. Optional: Schlage E, Schlage C-K, Russwin D1-2-3-4, Corbin 59/60, Corbin-Russwin L4, Sargent LA-LB-LC, Falcon/Weiser E, Arrow A, Yale 8, Yale GA and Kwikset. Can also accept Medeco, Assa, Kaba and **Cal-Royal HSK** High Security Cylinders. See **pages L75-L76** for additional charges.

8 ► **IC CORES, KEYING CHARGES**

Refer to pages L73 - L75

► **ANTI MICROBIAL COATING**

Available on US32D finish only.
Add **\$34.00 List**. Prefix "ANTB" before PART#.

► **TACTILE, LEAD LINING**





- Lead Lining Part # LEAD, Add \$137.25
- Tactile Part # TAC, Add \$26.97 List

► **ELECTRIFIED**

- Electrified Part # ELEC, Add \$172.70 List
- (Specify 12V or 24V, fail safe (EL) or fail secure (EU)

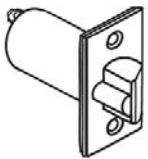
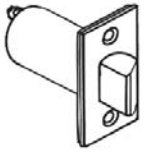
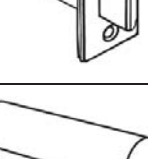
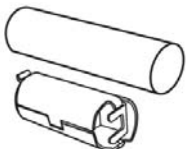
► **ADDITIONAL PARTS & CHARGES**

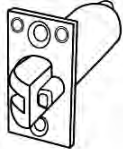
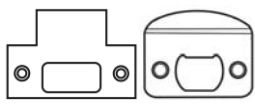
Backsets: UL listed 2 3/8", 2 1/4" x 1 1/8" faceplate, **NO EXTRA CHARGE** if ordered with lock only. If ordered separately **\$12.72 List Each**.

◆◆◆ STANDARD DISCOUNT ONLY ◆◆◆				
ILLUSTRATION	ITEM #	DESCRIPTION	FINISH	LIST PRICE
EXTRA UL LISTED BACKSET				
	CALSLD238	CAL Series Dead latch 2 3/8" 2 1/4" x 1 1/8" Faceplate	US26D	\$12.72
	CALSLS238	CAL Series Spring Latch 2 3/8" 2 1/4" x 1 1/8" Faceplate	US26D	
	CALSLP238	CAL Series Privacy Latch 2 3/8" 2 1/4" x 1 1/8" Faceplate	US26D	
	CAL334 EXT	CAL Series 3 3/4" Extension Link To be used with CALSLD238	----	16.96
	CAL5 EXT	CAL Series 5" Extension Link	----	
	CAL750	2 3/4" Backset, 2 1/4" x 1 1/8" faceplate, 3/4" throw, anti-friction Dead latch for pairs of fire doors	US26D	62.54
STRIKES				
	TS	T-Strike	US3,26D, 10B, 26,10,4	2.12
	FLS	Full Lip Strike		
TAIL PIECE				
	ICTP-09	Tail Piece for ICGRB	----	1.67



**CAL-ROYAL PRODUCTS, INC.
COMPARISON CHART**

Effective February 2013

GENESYS "CGN" AND CALYPSO "CAL" SERIES (GRADE 1 CLUTCH LEVER)

FUNCTION	ANSI #	CAL-ROYAL GENESYS & CALYPSO	SCHLAGE VANDLGDARD	SARGENT CLUTCH	RUSSWIN CORBIN	PDQ	FALCON CLUTCH	YALE CLUTCH	HAGER
Entrance	F82/F109	CGN00, CAL00	ND53/ND92PD	10G05	CL3351	GT 116/182	T501	5407L	3450/3453
Storeroom	F86	CGN05, CAL05	ND80/ND96PD	10G04	CL3357	GT 115	T581	5405L	3480
Classroom	F84	CGN03, CAL03	ND70S/ND94PD	10G37	CL3355	GT 148	T561	5408L	3470
Privacy	F76	CGN20, CAL20	ND40S	10U65	CL3320	GT 176	T301	5402L	3440
Passage	F75	GN30, CAL30	ND10S	10U15	CL3310	GT 126	T101	5401L	3410
Dummy	---	GN40, CAL40	ND170	U94	CL3350	GT 211/205	T12	455L	3417
Storelock / Double Cylinder	F91	GN02, CAL02	ND66PD	10G26	CL3382	GT 137	T371	5419L	---
Communication / Double Cylinder	F80	CGN04, CAL04	ND72PD	10G30	CL3362	GT 150	T391	5421L	---
Vestibule	F88	CGN06, CAL06	ND60PD	10G16	CL3372	GT 135	T381	5417L	---
Classroom Intruder	F110	CGN07, CAL07	ND75PD	10G38	CL3352	GT 148	T561	5418L	3495
Institution / Double Cylinder	F87	CGN09, CAL09	ND82PD	10G17	CL3332	GT 128	T411	5430L	---
Exit/Communicating	F89	GN50	ND25D	10G15-3	CL3380	GT 125	---	5428L	---
Dormitory	F90	CAL101	ND73PD	10G54	CL3375	GT 165	T571	5422L	3473

PIONEER "SL" SERIES, EXPLORER "XP" SERIES (GRADE 2 NON-CLUTCH LEVER)

PIONEER "CSL" SERIES(GRADE 2 CLUTCH LEVER), APOLLO "ALC" SERIES (GRADE 2 NON-CLUTCH)

FUNCTION	ANSI #	CAL-ROYAL PIONEER & APOLLO SERIES	SCHLAGE NON-CLUTCH	SARGENT NON-CLUTCH	RUSSWIN CORBIN	PDQ	FALCON TUBULAR NON-CLUTCH	YALE	HAGER
Entrance	F82/F109	ALC00/CSL00/SL00	AL53	65G05	CL3851	SP/SK	W511	5307LN	3553
	F109	SL01	AL50	---	CL3861	116	W501	---	3550
Storeroom	F86	ALC05/CSL05/SL05	AL80	65G04	CL3857	115	W581	5305LN	3580
Classroom	F84	ALC03/CSL03/SL03	AL70	65G37	CL3855	148	W561	5308LN	3570
Privacy	F76	ALC20/CSL20/SL20	AL40S	65U65	CL3820	176	W301	5302LN	3540
Passage	F75	ALC30/SL30	AL10S	65U15	CL3810	126	W101	5301LN	3510
Dummy	---	ALC/40SL40	AL170	65U93	CL3850	211/205	W12	5355LN	3517
Exit / Communicating	F89/F111	SL50	AL25	N/A	CL3880	125	W161	5328LN	3525
Exit Communicating	F112	SL80	---	---	---	---	---	---	---
Keyed									
Patio	F77	SL10	---	---	CL3840	GP182	---	---	---

HIL AND JHIL SERIES (INTERCONNECTED GRADE 2 LEVER)

FUNCTION	ANSI NO	CAL-ROYAL HIL SERIES	SCHLAGE	FALCON	HAGER
Entrance Double Locking	F97	HIL00, JHIL00	S251PD	H101DG	3753
Entrance Single Locking	F95	HIL30, JHIL30	S210PD	H511DG	3710

Other functions available upon request and subject to minimum quantity. Storeroom, single/double dummy trim.



CAL-ROYAL PRODUCTS, INC.

Effective February 2013

COMPARISON CHART

GRADE 2 CYLINDRICAL LEVER (SG DESIGN)

FUNCTION	ANSI #	CAL-ROYAL SG SERIES	SCHLAGE S	FALCON "Y" Dane	YALE 4300LN	PDQ SE	CORBIN RUSSWIN	HAGER 3600
Entrance	F82/F109	SG00	S51PD	Y521	4307LN	SE-116	CL3751	3653
Storeroom	F86	SG05	S80PD	Y581	4305LN	SE-115	CL3759	3680
Classroom	F84	SG03	S70PD	Y561	4308LN	SE-148	CL3755	3670
Patio	F77	SG10	----	----	----	----	----	----
Privacy	F76	SG20	S40D	Y301	4302LN	SE-176	CL3720	3640
Passage	F75	SG30	S10D	Y101	4301LN	SE-126	CL3710	3610
Dummy	----	SG40	S170	Y12	4355LN	SE-211	CL3750	3617
Exit	F89	SG50	----	Y161	----	SE-125	CL3780	----

GRADE 2 CYLINDRICAL LOCKSET, ORBIT STYLE (BA & PLG DESIGNS)

FUNCTION	ANSI #	CAL-ROYAL BA SERIES	SCHLAGE A SERIES	CORBIN 5600	RUSSWIN 3300	SARGENT 6 LINE	YALE 5300	ARROW 151	PDQ SV	FED. NO.
Entrance	F82/F109	BA00	A53PD	5651	CK4251	6G05	5307	151	SV116	160A
Privacy	F76-2	BA20	A40S	5620	CK4220	6U65	----	157	SV176	160L
Passage	F75-2	BA30	A10S	5610	CK4210	6U15	5301	156	SV126	160N
Storeroom	F86-2	BA05	A80PD	5657	CK4257	6G04	5305	151F	SV115	160D
Classroom	F84-2	BA03	A70PD	5655	CK4255	6G37	5308	151S	SV148	160R
Double Cyl	----	BA04	A66D	----	CK4262	----	5316	----	SV137	----
Sgl Dummy	F79-2	BA40	A170	½ DT	CK4250	6U93	355	125	SV211	----
Storage	F91	BA02	----	----	CK4282	----	----	----	----	----
Institution	F87	BA09	----	----	CK4232	----	----	----	----	----
Exit	F89	BA50	A25D	----	----	6G15-3	5328	156CB	SV125	----

PIONEER SL Series List Price

HEAVY DUTY CYLINDRICAL LEVERSETS

ANSI - A156.2, Series 4000, Grade 2

Optional Interchangeable Core, Best, Falcon and Arrow



3 HOUR FIRE RATED
UL10C, UBC7-2-1997

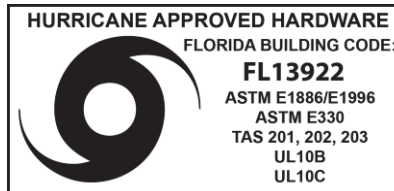
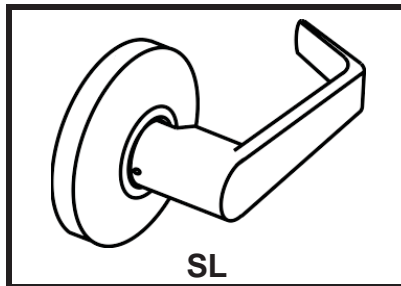

STOCK ITEM PRICES IN BOLD
NON-STOCK FINISHES AND DESIGNS AVAILABLE WITH FACTORY LEAD TIME
AND SUBJECT TO MINIMUM ORDER

FUNCTIONS	ANSI	ITEM #	US26D	US3	US10B, 10, 26, 4, 15, 5	PCS /MC
Entrance	F109	SL00 ICSL00				10
Storeroom	F91	SL05 ICSL05	\$86.02	\$86.02	\$89.19	
Classroom	F84	SL03 ICSL03				
Entrance Push Button Lock	F82	SL01	86.02	86.02	89.19	
		ICSL01	86.02	86.02	89.19	
Exit Lock / Connecting Room with key	----	SL80	86.02	86.02	89.19	
		ICSL80	86.02	86.02	89.19	
Dormitory / Assited Living	F90	SL101	92.22	92.22	95.40	
		ICSL101	92.22			
Privacy (see below for split finishes)	F76	SL20	71.47	71.47	75.44	
Patio	F77	SL10	70.76	70.76	75.44	
Passage	F75	SL30	68.83	68.83	72.79	
Exit	F89	SL50	69.70	69.70	75.77	
Single Dummy	----	SL40	23.82	23.82	26.47	20



(IC) Indicates function available with Best, Falcon and Arrow Interchangeable Core. Prices do not include cores. For IC Core pricing see pages L73 – L75.

► SPLIT FINISHES FOR PRIVACY FUNCTION

ILLUSTRATION	ITEM #	FUNCTIONS	ANSI	LISTPRICE	PCS/MC	UNIT
	SL20 US3/26(Inside)	Privacy	F76	82.58	10	Ea.
	SL20 US10B/26(Inside)					
	SL20 US4/26D(Inside)					
	SL20 US4/26(Inside)					
	SL20 US4/3 (Inside)					
	SL20 US3/26D(Inside)					
	SL20 US10B/26D(Inside)					

PIONEER RL & AG Series List Price

HEAVY DUTY CYLINDRICAL LEVERSETS

ANSI - A156.2, Series 4000, Grade 2

Optional Interchangeable Core, Best, Falcon and Arrow

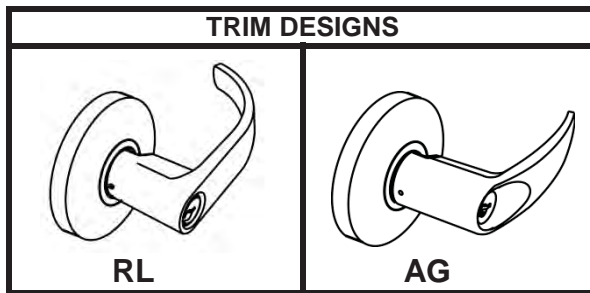

MEETS
The Buy American Act

HURRICANE APPROVED HARDWARE
FLORIDA BUILDING CODE:
FL13922
ASTM E1886/E1996
ASTM E330
TAS 201, 202, 203
UL10B
UL10C

STOCK ITEM PRICES IN BOLD
NON-STOCK FINISHES AND DESIGNS AVAILABLE WITH FACTORY LEAD TIME
AND SUBJECT TO MINIMUM ORDER

FUNCTIONS	ANSI	ITEM #		US26D	US3	US10B, 10,26,4,15	PCS /MC	
Entrance	F109	RL00	AG00	\$91.32	\$91.32	\$94.49	10	
		ICRL00	ICAG00		91.32	94.49		
Storeroom	F91	RL05	AG05		91.32	94.49		
		ICRL05	ICAG05		91.32	94.49		
Classroom	F84	RL03	AG03		91.32	94.49		
		ICRL03	ICAG03		91.32	94.49		
Entrance Push Button Lock	F82	RL01	AG01		91.32	91.32		94.49
		ICRL01	ICAG01		91.32	91.32		94.49
Exit Lock / Connecting Room with key	----	RL80	AG80	91.32	91.32	94.49		
		ICRL80	ICAG80	91.32	91.32	94.49		
Dormitory / Assisted Living	F90	RL101	AG101	97.52	97.52	100.70		
		ICRL101	ICAG101	97.52	97.52			
Privacy(see below for split finishes)	F76	RL20	AG20	76.77	76.77	80.74		
Patio	F77	RL10	AG10	75.00	75.00	80.74		
Passage	F75	RL30	AG30	74.13	74.13	78.09		
Exit	F89	RL50	AG50	75.00	75.00	81.07		
Single Dummy	----	RL40	AG40	29.12	29.12	31.77	20	



QUANTITY DISCOUNT

50 UNITS
MIXED
LESS 5%
.....
100 UNITS
MIXED
LESS 10%

IC Indicates function available with Best, Falcon and Arrow Interchangeable Core.
Prices do not include cores. For IC Core pricing see pages L73 – L75.

► SPLIT FINISHES FOR PRIVACY FUNCTION

ILLUSTRATION	ITEM #	FUNCTIONS	ANSI	LIST PRICE	PCS /MC	UNIT
<p>RL20</p>	RL20 or AG20 US3/26(Inside)	Privacy	F76	82.58	10	Ea.
	RL20 or AG20 US10B/26(Inside)					
	RL20 or AG20 US4/26D(Inside)					
	RL20 or AG20 US4/26(Inside)					
	RL20 or AG20US4/3(Inside)					
	RL20 or AG20 US3/26D(Inside)					
	RL20 or AG20 US10B/26D(Inside)					

PIONEER CSL, CRL & CAG CLUTCH ...

HEAVY DUTY CYLINDRICAL LEVERSETS WITH CLUTCH
ANSI - A156.2, Series 4000, Grade 2



Optional Interchangeable Core, Best, Falcon and Arrow



MEETS
The Buy American Act

HURRICANE APPROVED HARDWARE
FLORIDA BUILDING CODE:
FL13922
ASTM E1886/E1996
ASTM E330
TAS 201, 202, 203
UL10B
UL10C

STOCK ITEM PRICES IN BOLD
NON-STOCK FINISHES AND DESIGNS AVAILABLE WITH FACTORY LEAD TIME
AND SUBJECT TO MINIMUM ORDER

FUNCTIONS	ANSI	ITEM #	US26D	US3	US10B	US 10, 26, 4, 15, 5	PCS /MC
Entrance	F109	CSL00	\$96.62	\$96.62	\$99.79	\$99.79	10
		ICCSL00		96.62	99.79		
Storeroom	F91	CSL05	96.62	96.62	99.79		
		ICCSL05	96.62	96.62	99.79		
Classroom	F84	CSL03	96.62	96.62	99.79		
		ICCSL03	96.62	96.62	99.79		
Privacy	F76	CSL20	82.04	82.04	86.02	86.02	

FUNCTIONS	ANSI	ITEM #		US26D, 3	US10B, 10, 26, 4, 15, 5	PCS /MC
Entrance	F109	CRL00	CAG00	96.62	99.79	10
		ICCRL00	ICCAG00	96.62	99.79	
Storeroom	F91	CRL05	CAG05	96.62	99.79	
		ICCRL05	ICCAG05	96.62	99.79	
Classroom	F84	CRL03	CAG03	96.62	99.79	
		ICCRL03	ICCAG03	96.62	99.79	
Privacy	F76	CRL20	CAG20	82.04	86.02	

(IC) Indicates function available with **Best, Falcon and Arrow Interchangeable Core**.
Prices do not include cores. For IC Core pricing see pages L73 – L75.

► PACKAGING INCLUDES

UL Listed 2 3/4" Backset, 2 1/4" x 1 1/8" faceplate ASA Strike

► KEYWAYS

6-pin solid brass "C" keyway standard. Optional: Schlage E, Schlage C-K, Russwin D1-2-3-4, Corbin 59/60, Arrow A, Corbin-Russwin L4, Sargent LA-LB-LC, Falcon/Weiser E, Yale 8, Yale GA and Kwikset. Can also accept Medeco, Assa, Kaba and **Cal-Royal HSK** High Security Cylinders. See pages L75-L76 for additional charges.



► IC CORES, KEYING CHARGES

Refer to pages L73 - L75

► TACTILE AND LEAD LINING







Lead Lining Part # LEAD Add \$132.35 List
Tactile Part# TAC Add \$26.97 List

QUANTITY DISCOUNT

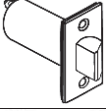
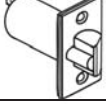
50 UNITS MIXED - LESS 5%
100 UNITS MIXED - LESS 10%

► ADDITIONAL PARTS & CHARGES

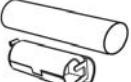
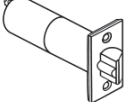
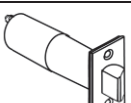
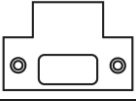
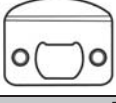
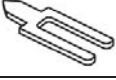
Backsets: UL listed 2 3/8", (2 1/4" x 1") faceplate, **NO EXTRA CHARGE** if ordered with lock only. Otherwise \$11.91 **List Each**.

◆◆◆ STANDARD DISCOUNT ONLY ◆◆◆				
ILLUSTRATION	ITEM #	DESCRIPTION	FINISH	LIST PRICE
	ULSLD238	SL Series UL-listed Dead Latch 2 3/8" 2 1/4" x 1" Faceplate	US3,26D,10B,10,26	\$11.91
	ULSLS238	SL Series UL-listed Spring Latch 2 3/8" 2 1/4" x 1" Faceplate	US26D,10B,10,26	
	ULSGPA238	2 3/8" UL-listed Dead Latch, 2 1/4" x 1" Faceplate (for SG10, SL10 Patio Function and SL101 Dormitory/Assisted Living Function)	US26D	
	SLDRI-1	2 3/4" Entrance, Drive-in Latch bolt for G2 Lockset	ZINC	
	SLDRI-2	2 3/4" Privacy/Passage, Drive-in Latch bolt for G2 Lockset		
	SLDRI-4	2 3/8" Entrance, Drive-in Latch bolt for G2 Lockset		
	SLDRI-5	2 3/8" Privacy/Passage, Drive-in Latch bolt for G2 Lockset		
EXTRA UL LISTED BACKSET				
	ULSLD234	SL Series Dead Latch 2 3/4" 2 1/4" x 1 1/8" Faceplate	US3,26D,10B,10,26	11.91
	ULSLS234	SL Series Spring Latch 2 3/4" 2 1/4" x 1 1/8" Faceplate	US3,26D,10B,10,26	
3 3/4", 5" UL LISTED BACKSET				
	SL5	5" UL listed Extension Link	----	17.21
	SLD334	3 3/4" Dead latch, 2 1/4" x 1 1/8" Faceplate	US3,26D,10B	
	SLS334	3 3/4" Spring Latch, 2 1/4" x 1 1/8" Faceplate	US3,26D,10B	
STRIKES				
	TS	T-Strike	US3,26D,10B, 10,26,15,4	2.12
	FLS	Full lip strike	US3,26D,10B, 10,26,15,4	
TAIL PIECE				
	ICTP-03	6-pin Tail Piece for IC Pioneer Series	----	1.67
	ICTP-04	7 Pin Tail Piece for IC Pioneer Series		1.67

COMMANDER COM (CLUTCH) Series

HEAVY DUTY CYLINDRICAL LEVERSETS WITH CLUTCH
ANSI - A156.2, SERIES 4000, GRADE 2



3 HOUR FIRE RATED
UL10C, UBC7-2-1997

With Interchangeable Core to accept **Schlage Full Size** format
OEM Interchangeable Core cylinder

MEETS
The Buy American Act

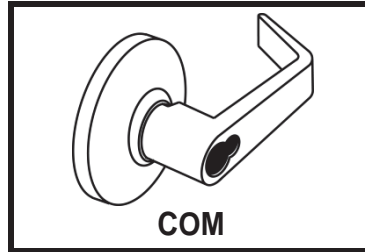

**LIFETIME
WARRANTY**

STOCK ITEM PRICES IN BOLD

NON-STOCK FINISHES AND DESIGNS AVAILABLE WITH FACTORY LEAD TIME AND SUBJECT TO MINIMUM ORDER

FUNCTIONS	ANSI	ITEM #	US26D, 3	US10B	US10, 26, 4, 5	PCS /MC
Entrance	F109	ICCOM00	\$105.62	\$108.99	\$108.99	10
Storeroom	F86	ICCOM05				
Classroom	F84	ICCOM03	107.87	111.24	111.24	

**QUANTITY
DISCOUNT**
50 UNITS MIXED
LESS 5%
100 UNITS MIXED
LESS 10%

***Use SL Pioneer series lockset for interior locks. Prices do not include cores. See page L61.

► PACKAGING INCLUDES

- UL Listed 2 3/4" Backset, 2 1/4" x 1 1/8" faceplate
- Less cylinder
- ASA Strike

► TACTILE AND LEAD LINING

- Lead Lining part # LEAD Add \$132.35 List
- Tactile part # TAC Add \$26.97 List

► ADDITIONAL PARTS & CHARGES

Backsets: UL listed 2 3/8", 2 1/4" x 1 1/8" Faceplate, **NO EXTRA CHARGE** if ordered with lock only. If ordered separately \$11.91 List Each.

◆◆◆ STANDARD DISCOUNT ONLY ◆◆◆

ILLUSTRATION	ITEM #	DESCRIPTION	FINISH	LIST PRICE
	GND238	CGN Series UL-listed Dead Latch 2 3/8"	US3,26D,10B,26	11.91
	GND750	2 3/4" x 1 1/8" x 3/4" throw, anti-friction Dead latch for pairs of fire doors	US3,26D,10B,10	62.92
	SLDRI-1	2 3/4" Entrance, Drive-in Latch bolt for G2 Lockset	ZINC	11.91
	SLDRI-4	2 3/8" Entrance, Drive-in Latch bolt for G2 Lockset	ZINC	
◆ EXTRA UL LISTED BACKSET				
	GND-234	CGN Series Dead Latch 2 3/4"	US3,26D,10B,26	11.91
	GEN5EXT	5" Backset Extension Link	-----	16.96
GEN334EXT	3 3/4" Backset Extension Link			
STRIKES				
	TS	T-Strike	US3,26D,10B,26,10	2.12
	FLS	Full lip strike		
TAIL PIECE				
	ICTP07	Tail piece for Schlage Large format IC Core	-----	1.67

EXPLORER XP Series List Price ..



3 HOUR FIRE RATED
UL10C, UBC7-2-1997

HEAVY DUTY CYLINDRICAL LEVERSETS ANSI - A156.2, SERIES 4000, GRADE 2

Optional Interchangeable Core, Best, Falcon and Arrow

QUANTITY DISCOUNT

50 UNITS MIXED
LESS 5%
.....
100 UNITS MIXED
LESS 10%

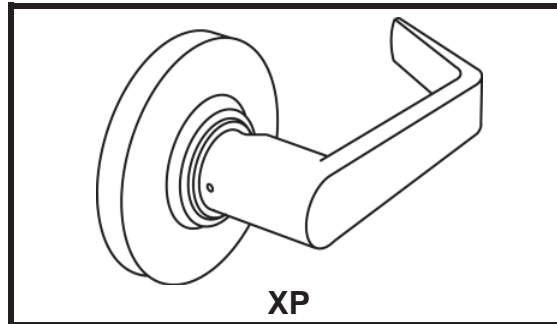

MEETS
The Buy American Act

Lifetime
Warranty
BHMA
CERTIFIED

STOCK ITEM PRICES IN BOLD
NON-STOCK FINISHES AND DESIGNS AVAILABLE WITH FACTORY LEAD TIME
AND SUBJECT TO MINIMUM ORDER

ANSI	FUNCTIONS	ITEM #	US26D	US3	US10B, 10 ,26, 4	US5,15	PCS /MC		
F109	Entrance	XP00	\$86.02	\$86.02	\$89.19	\$89.19	10		
		ICXP00		86.02	89.19				
F91	Storeroom	XP05		86.02	89.19				
		ICXP05		86.02	89.19				
F84	Classroom	XP03		86.02	89.19				
		ICXP03		86.02	89.19				
F76	Privacy (See below for split finishes)	XP20		71.47	71.47			75.44	75.44
F75	Passage	XP30		68.83	68.83			72.79	72.79
F89	Exit	XP50	69.70	69.70	75.77	75.77			
----	Single Dummy	XP40	23.82	23.82	26.47	26.47	20		

(IC) Indicates function available with Best, Falcon and Arrow Interchangeable Core. Prices do not include cores. For IC Core pricing see pages L73 – L75.

◆ SPLIT FINISHES FOR PRIVACY FUNCTION

ILLUSTRATION	ITEM #	FUNCTIONS	ANSI	FINISH	LIST PRICE	PCS /MC
	XP20	Privacy	F76	US3/26D (Inside)	82.58	10
				US4/26 (Inside)		
				US10B/26 (Inside)		
				US4/26D (Inside)		

EXPLORER XPRL Series List Price •

HEAVY DUTY CYLINDRICAL LEVERSETS ANSI - A156.2, SERIES 4000, GRADE 2

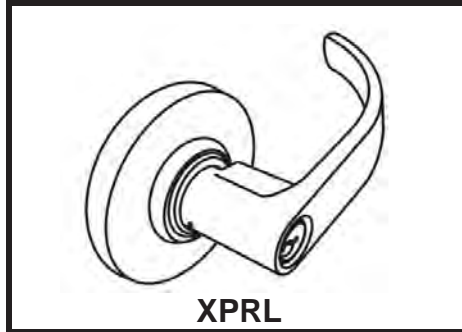

3 HOUR FIRE RATED
UL10C, UBC7-2-1997

 Optional Interchangeable Core, Best, Falcon and Arrow



MEETS
The Buy American Act

STOCK ITEM PRICES IN BOLD
NON-STOCK FINISHES AND DESIGNS AVAILABLE WITH FACTORY LEAD TIME
AND SUBJECT TO MINIMUM ORDER

FUNCTIONS	ANSI	ITEM #	US26D	US10B	US3	US10,4 26,15	PCS /MC
Entrance	F109	XPRL00	\$89.19	\$91.32			
		 ICXPRL00	89.19	91.32			
Storeroom	F91	XPRL05	89.19	91.32	\$91.32	\$89.19	
		 ICXPRL05	89.19	91.32			
Classroom	F84	XPRL03	89.19	91.32			
		 ICXPRL03	89.19	91.32			
Privacy (See below for split finishes)	F76	XPRL20	76.77	80.74	76.77	80.74	10
Passage	F75	XPRL30	74.13	78.09	74.13	78.09	
Exit	F89	XPRL50	75.00	81.07	75.00	81.07	
Single Dummy	----	XPRL40	29.12	31.77	29.12	31.77	20

Lifetime
Warranty
BHMA
CERTIFIED

**QUANTITY
DISCOUNT**
50 UNITS MIXED
LESS 5%
100 UNITS MIXED
LESS 10%

 (IC) Indicates function available with Best, Falcon and Arrow Interchangeable Core.
Prices do not include cores. For IC Core pricing see pages L73 – L75.

◆ SPLIT FINISHES FOR PRIVACY FUNCTION

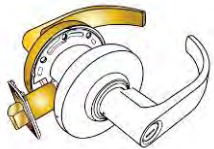
ILLUSTRATION	ITEM #	FUNCTIONS	ANSI	FINISH	LIST PRICE	PCS /MC
	XPRL20	Privacy	F76	US3/26D (Inside)	87.88	10
				US4/26 (Inside)		
				US10B/26 (Inside)		
				US4/26D (Inside)		

EXPLORER CXP, CXPRL CLUTCH



3 HOUR FIRE RATED
UL10C, UBC7-2-1997

HEAVY DUTY CYLINDRICAL LEVERSETS WITH CLUTCH ANSI - A156.2, Series 4000, Grade 2

8 Optional Interchangeable Core, Best, Falcon and Arrow

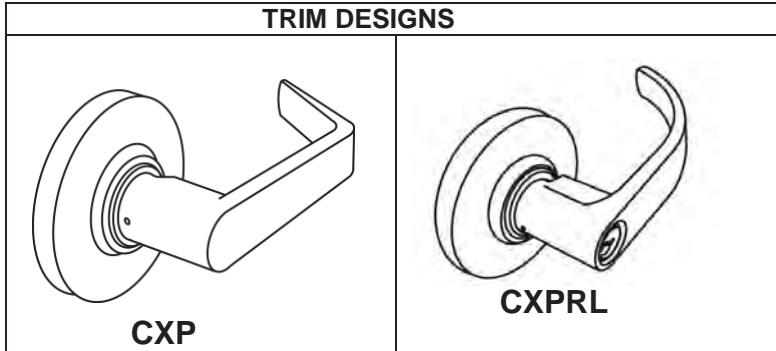

MEETS
The Buy American Act



STOCK ITEM PRICES IN BOLD
NON-STOCK FINISHES AND DESIGNS AVAILABLE WITH FACTORY LEAD TIME
AND SUBJECT TO MINIMUM ORDER

FUNCTIONS	ANSI	ITEM #	US26D	US10B	US3	US 10, 26, 4, 15, 5	PCS /MC
Entrance	F109	CXP00	\$96.62	\$99.79	\$96.62	\$99.79	10
		8 ICCXP00	96.62	99.79	96.62		
Storeroom	F91	CXP05	96.62	99.79	96.62		
		8 ICCXP05	96.62	99.79	96.62		
Classroom	F84	CXP03	96.62	99.79	96.62		
		8 ICCXP03	96.62	99.79	96.62		
Privacy	F76	CXP20	82.04	86.02	82.04	86.02	

FUNCTIONS	ANSI	ITEM #	US26D,	US10B	US3	US10, 26, 4, 15, 5	PCS /MC
Entrance	F109	CXPRL00	96.62	99.79	96.62	\$99.79	10
		8 ICCXPRL00	96.62	99.79	96.62		
Storeroom	F91	CXPRL05	96.62	99.79	96.62		
		8 ICCXPRL05	96.62	99.79	96.62		
Classroom	F84	CXPRL03	96.62	99.79	96.62		
		8 ICCXPRL03	96.62	99.79	96.62		
Privacy	F76	CXPRL20	82.04	86.02	82.04	86.02	

8 (IC) Indicates function available with **Best, Falcon and Arrow Interchangeable Core**.
Prices do not include cores. For IC Core pricing see pages L73 – L75.

QUANTITY DISCOUNT
50 UNITS MIXED
LESS 5%
.....
100 UNITS MIXED
LESS 10%

► **PACKAGING INCLUDES**

- UL Listed 2 ¾" Backset with 2 ¼" x 1" Faceplate, Square corner, packed with ⅛" Filler for 1 ⅛" width
- Standard "C", 6-pin cylinder
- ASA Strike

► **TACTILE AND LEAD LINING**

Lead Lining **part # LEAD Add \$132.35 List**
 Tactile **part # TAC Add \$26.97 List**

► **MOUNT**

2 hole wooden mount
Part# SLMOUNT
List: \$66.17 Each

► **IC CORES, KEYING CHARGES**







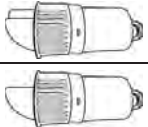

Refer to pages **L73 – L75**

► **KEYWAYS**

6-pin solid brass "C" keyway standard. Optional: Schlage E, Schlage C-K, Russwin D1-2-3-4, Corbin 59/60, Corbin-Russwin L4, Sargent LA-LB-LC, Falcon/Weiser E, Arrow A, Yale 8, Yale GA and Kwikset. Can also accept Medeco, Assa, Kaba and **Cal-Royal HSK** High Security Cylinders. See **pages L75-L76** for additional charges.

► **ADDITIONAL PARTS & CHARGES**

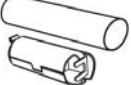
Backsets: UL listed 2 ⅜", (2 ¼" x 1") faceplate, **NO EXTRA CHARGE** if ordered with lock only. Otherwise **\$11.91 List Each**.

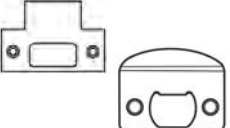
◆◆ STANDARD DISCOUNT ONLY ◆◆				
ILLUSTRATION	ITEM #	DESCRIPTION	FINISH	LIST PRICE
 ULSLD238 ULSLS238	ULSLD238	XP Series UL-listed Dead Latch 2 ¾" 2 ¼" x 1" Faceplate	US3, 26D, 10B, 10, 26	\$11.91
	ULSLS238	XP Series UL-listed Spring Latch 2 ¾" 2 ¼" x 1" Faceplate	US3, 26D, 10B, 10, 26	
	SLDRI-1	2 ¾" Entrance, Drive-in Latch bolt for G2 Lockset	ZINC	
	SLDRI-2	2 ¾" Privacy/Passage, Drive-in Latch bolt for G2 Lockset		
	SLDRI-4	2 ¾" Entrance, Drive-in Latch bolt for G2 Lockset		
	SLDRI-5	2 ¾" Privacy/Passage, Drive-in Latch bolt for G2 Lockset		
TAIL PIECE				
	ICTP-03	6-pin Tail Piece for IC Explorer Series	----	1.67
	ICTP-04	7 Pin Tail Piece for IC Explorer Series		1.67
	ICTP-05	6-pin Tail Piece for ICXP03 Explorer Series Classroom Function Only		1.67
	ICTP-06	7 Pin Tail Piece for ICXP03 Explorer Series Classroom Function Only		1.67
EXTRA UL LISTED BACKSET				
 ULHIL234 ULSHIL234	ULHIL234	XP Series Dead Latch 2 ¾" 2 ¼" x 1" Faceplate	US3, 26D, 10B, 10, 26	11.91
	ULSHIL234	XP Series Spring Latch 2 ¾" 2 ¼" x 1" Faceplate	US3, 26D, 10B, 10, 26	
3 ¾", 5" UL LISTED BACKSET				
	SL5	5" UL listed Extension Link	----	17.21
 SLD334 SLS334	SLD334	3 ¾" Dead latch, 2 ¼" x 1 ⅛" Faceplate	US3, 26D,10B	
	SLS334	3 ¾" Spring Latch, 2 ¼" x 1 ⅛" Faceplate	US3, 26D,10B	
STRIKES				
	TS	T-Strike	US3, 4, 26D, 26 10B, 10, 15	2.12
	FLS	Full lip strike	US3, 26D, 10B, 10, 15, 26, 5	

APOLLO ALC Series List Price ...

HEAVY DUTY CYLINDRICAL LEVERSETS

ANSI - A156.2, SERIES 4000, GRADE 2

ALC Series (Non-Clutch Mechanism), CLALC Series (Clutch Mechanism)

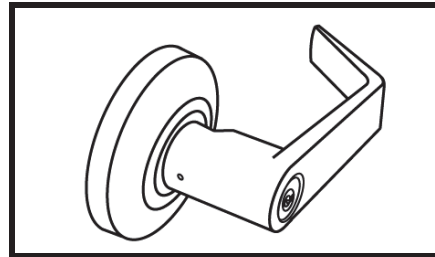

STOCK ITEM PRICES IN BOLD

NON-STOCK FINISHES AND DESIGNS AVAILABLE WITH FACTORY LEAD TIME AND SUBJECT TO MINIMUM ORDER

FUNCTION	ANSI	ITEM #	US26D	US10B	US3	PCS/MC
Entrance	F109	ALC00				10
Storeroom	F91	ALC05	\$80.56	83.74	80.56	
Classroom	F84	ALC03				
Privacy	F76	ALC20	66.78	71.02	66.78	
Passage	F75	ALC30	64.66	67.84	64.66	
Dummy	----	ALC40	23.32	25.44	23.32	
Exit	F89	ALC50	65.66	68.84	65.66	
Entrance (Clutch)	F109	CLALC00				
Storeroom (Clutch)	F91	CLALC05	84.27	87.45	84.27	
Classroom (Clutch)	F84	CLALC03				

QUANTITY DISCOUNT

50 UNITS MIXED
LESS 5%
.....
100 UNITS MIXED
LESS 10%

► **PACKAGING INCLUDES**

- UL Listed 2 3/4", 2 1/4" faceplate
- Standard "C", 6-pin cylinder
- ASA Strike

► **MOUNT**

2 hole wooden mount
Part# SLMOUNT
List: \$66.17

► **TACTILE LEAD LINING**

Lead lining **Part#** LEAD Add \$124.86 list
Tactile **Part#** TAC Add \$25.44 list

► **ADDITIONAL PARTS & CHARGES**

Backsets: UL listed 2 3/8", (2 1/4" x 1") faceplate, **NO EXTRA CHARGE** if ordered with lock only. Otherwise \$11.66 **List Each**.

◆◆◆ STANDARD DISCOUNT ONLY ◆◆◆

ILLUSTRATION	ITEM #	DESCRIPTION	FINISH	LIST PRICE
EXTRA UL LISTED BACKSET				
	ALC-ULSLD-238	ALC Series Dead Latch 2 3/8"	US3, 26D, 10B	11.66
	ALC-ULSLS-238	ALC Series Spring Latch 2 3/8"		
	ALC-ULSLD-234	ALC Series Dead Latch 2 3/4"		
	ALC-ULSLS-234	ALC Series Spring Latch 2 3/4"		
STRIKES				
	FLS	Full lip strike	US3, 26D, 10B	2.12
	TS	T-strike		

CHALLENGER Series List Price ...

STANDARD DUTY CYLINDRICAL LEVERSETS ANSI STANDARD A156.2, GRADE 2



Optional Interchangeable Core, Best, Falcon and Arrow

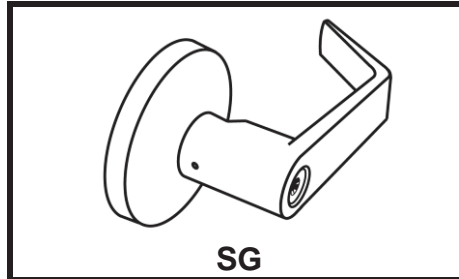

QUANTITY DISCOUNT
50 UNITS MIXED LESS 5%
100 UNITS MIXED LESS 10%

STOCK ITEM PRICES IN BOLD
NON-STOCK FINISHES AND DESIGNS AVAILABLE WITH FACTORY LEAD TIME AND SUBJECT TO MINIMUM ORDER

FUNCTIONS	ANSI	ITEM #	US26D	US3	US10B, 26	US15	US10, 4, 15A	PCS /MC
Entrance	F109	SG00	\$65.51	\$65.51	\$71.47	\$71.47	\$71.47	10
		IC SG00	65.51	65.51	71.47	71.47		
Storeroom	F91	SG05	65.51	65.51	71.47	71.47		
		IC SG05	65.51	65.51	71.47	71.47		
Classroom	F84	SG03	65.51	65.51	71.47	71.47		
		IC SG03	65.51	65.51	71.47	71.47		
Patio	F77	SG10	58.30	58.30	64.26	64.26	64.26	
Privacy	F76	SG20	53.59	53.59	59.55	59.55	59.55	
Passage	F75	SG30	52.41	52.41	58.36	58.36	58.36	
Exit	F89	SG50					58.36	
Single Dummy	----	SG40	26.20	26.20	32.16	32.16	32.16	

(IC) Indicates function available with **Best, Falcon and Arrow Interchangeable Core**.
Prices do not include cores. For IC Core pricing see pages L73 – L75.

STANDARD DUTY CYLINDRICAL LEVERSETS ANSI STANDARD A156.2, GRADE 2



3 HOUR FIRE RATED
UL10C, UBC7-2-1997

Optional Interchangeable Core, Best, Falcon and Arrow

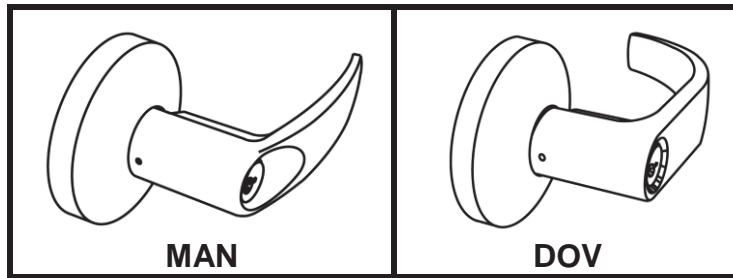

MEETS
The Buy American Act

Lifetime
Warranty
BHMA
CERTIFIED

STOCK ITEM PRICES IN BOLD
NON-STOCK FINISHES AND DESIGNS AVAILABLE WITH FACTORY LEAD TIME
AND SUBJECT TO MINIMUM ORDER

FUNCTIONS	ANSI	ITEM #	US26D	US3	US10B, 26, 15, 15A	PCS /MC		
Entrance	F109	MAN00	\$65.51	\$65.51	\$71.47	10		
		IC MAN00	65.51					
Storeroom	F91	MAN05	65.51					
		IC MAN05	65.51					
Classroom	F84	MAN03	65.51					
		IC MAN03	65.51					
Patio	F77	MAN10	58.30				58.30	64.26
Privacy	F76	MAN20	53.59				53.59	59.55
Passage	F75	MAN30	52.41				52.41	58.36
Exit	F89	MAN50	52.41					
Single Dummy	----	MAN40	26.20	26.20	32.16			
Entrance	F109	DOV00	\$65.51	\$65.51	\$71.47	10		
		IC DOV00	65.51					
Storeroom	F91	DOV05	65.51					
		IC DOV05	65.51					
Classroom	F84	DOV03	65.51					
		IC DOV03	65.51					
Patio	F77	DOV10	58.30				58.30	64.26
Privacy	F76	DOV20	53.59				53.59	59.55
Passage	F75	DOV30	52.41				52.41	58.36
Exit	F89	DOV50	52.41					
Single Dummy	----	DOV40	26.20	26.20	32.16			

**QUANTITY
DISCOUNT**
50 UNITS MIXED
LESS 5%
.....
100 UNITS MIXED
LESS 10%

IC (IC) Indicates function available with **Best, Falcon and Arrow Interchangeable Core**. Prices do not include cores. For IC Core pricing see pages L73 – L75.

STANDARD DUTY CYLINDRICAL LEVERSETS ANSI STANDARD A156.2, GRADE 2

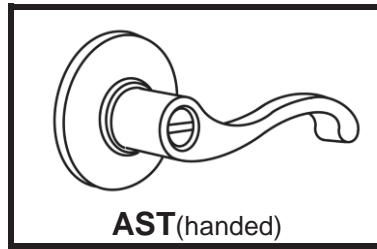

STOCK ITEM PRICES IN BOLD
NON-STOCK FINISHES AND DESIGNS AVAILABLE WITH FACTORY LEAD TIME
AND SUBJECT TO MINIMUM ORDER

FUNCTIONS	ANSI	ITEM #	US3	US15,15A	US26D	US10B, 26	PCS /MC
Entrance	F109	AST00	\$65.51	\$71.47			10
Storeroom	F91	AST 05	65.51	71.47	\$65.51	\$71.47	
Classroom	F84	AST 03	65.51	71.47			
Privacy	F76	AST 20	53.59	59.55	53.59	59.55	
Passage	F75	AST 30	52.41	58.36	52.41	58.36	
Exit	F89	AST 50	52.41	58.36			
Single Dummy	----	AST 40	26.20	32.16	26.20	32.16	

*SH SPECIFY HANDING FOR "AST" Design.

*HANDING: Entrance, Privacy and Passage functions are reversible non handed on AST designs. Specify handing for convenience. If handing is not available at time of shipment, opposite hand will be shipped. Other functions are handed.

► **PACKAGING INCLUDES**

- UL Listed 2 3/4" backset (2 1/4" x 1", square corner packed with 1/8" filler for 1 1/8" width). 2 3/8" available on request.
- Standard "C" rekeyable 6-pin cylinder
- All locksets are packed with ASA Strike

► **KEYWAYS**

6-pin solid brass "C" keyway standard. Optional: Schlage E, Schlage C-K, Russwin D1-2-3-4, Corbin 59/60, Arrow A, Corbin-Russwin L4, Sargent LA-LB-LC, Falcon/Weiser E, Yale 8, Yale GA and Kwikset. Can also accept Medeco, Assa, Kaba and Cal-Royal HSK High Security Cylinders. See pages L75-L76 for additional charges.

► **IC CORES, KEYING CHARGES**

Refer to pages L73 - L75

► **MOUNT**

2 hole wooden mount
List: \$66.17 Each







**QUANTITY
DISCOUNT**

50 UNITS MIXED LESS 5%

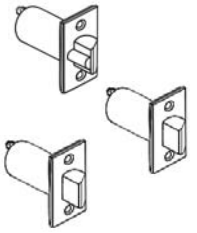
100 UNITS MIXED LESS 10%

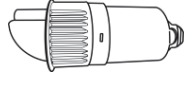
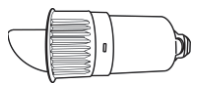
► **ADDITIONAL PARTS & CHARGES**

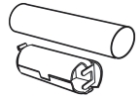
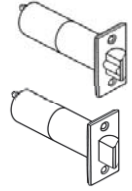
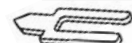
Backsets: UL listed 2 3/8", (2 1/4" x 1") faceplate, **NO EXTRA CHARGE** if ordered with lock only. Otherwise \$11.66 **List Each**.

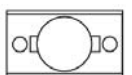
◆◆ STANDARD DISCOUNT ONLY ◆◆				
ILLUSTRATION	ITEM #	DESCRIPTION	FINISH	LIST PRICES
	ULHIL238	2 3/8" UL-listed Dead latch, 2 1/4" x 1" Faceplate (key functions only)	US3,26D, 10B,10,26	\$11.91
	ULSLS238	2 3/8" UL-listed Spring Latch, 2 1/4" x 1" Faceplate (for privacy only)	US3,26D, 10B,10,26	
	ULSHIL238	2 3/8" UL-listed Spring Latch, 2 1/4" x 1" Faceplate (for passage only)	US3,26D, 10B,10,26	
	ULSGPA238	2 3/8" UL-listed Dead Latch, 2 1/4" x 1" Faceplate (for SG10, SL10 Patio Function and SL101 Dormitory/Assisted Living Function)	US26D	
	SLDRI-1	2 3/4" Entrance, Drive-in Latch bolt for G2 Lockset	ZINC	
	SLDRI-4	2 3/8" Entrance, Drive-in Latch bolt for G2 Lockset	ZINC	
	SLDRI-2	2 3/4" Privacy/Passage, Drive-in Latch bolt for G2 Lockset	ZINC	
	SLDRI-5	2 3/8" Privacy/Passage, Drive-in Latch bolt for G2 Lockset	ZINC	
EXTRA UL LISTED BACKSET				
 <small>ULHIL234 ULSHIL234</small>	ULHIL234	Dead Latch 2 3/4" 2 1/4" x 1" Faceplate	US3, 26D, 10B, 10, 26	11.91
	ULSHIL234	Spring Latch 2 3/4" 2 1/4" x 1" Faceplate	US3, 26D, 10B, 10, 26	
3 3/4", 5" UL LISTED BACKSET				
	SL5	5" UL listed Extension Link	----	17.21
	SLD334	3 3/4" Dead latch, 2 1/4" x 1 1/8" Faceplate	US3,26D, 10B	
	SLS334	3 3/4" Spring Latch, 2 1/4" x 1 1/8" Faceplate	US3,26D, 10B	
TAIL PIECE				
	ICTP-03	6-pin Tail Piece for IC Challenger Series	----	1.67
	ICTP-04	7 Pin Tail Piece for IC Challenger Series		1.67
STRIKES				
	TS	Full lip strike	US3,26D, 10B,10,15, 26,4	2.12
	FLS	T strike		
	LFA18	Latch front adapter to convert 1" faceplate to 1 1/8" wide door preparation	CLEAR	0.25

BARRINGTON BA Series List Price



STANDARD DUTY CYLINDRICAL LOCKSETS ANSI A156.2 Series 4000 Grade 2

Optional Interchangeable Core. Best, Falcon and Arrow



QUANTITY DISCOUNT

50 UNITS MIXED
LESS 5%

100 UNITS MIXED
LESS 10%

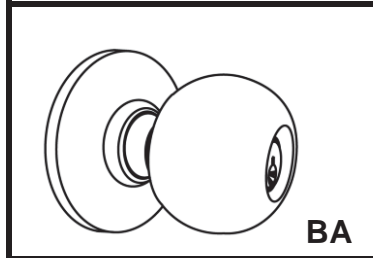

STOCK ITEM PRICES IN BOLD
NON-STOCK FINISHES AND DESIGNS AVAILABLE WITH FACTORY LEAD TIME
AND SUBJECT TO MINIMUM ORDER

Made in Korea								
FUNCTION	ANSI	ITEM #	US32D	US10B	US3	US10	US4, 26	PCS /MC
Entrance ****KA/4	F109	BA00	\$41.82	\$49.31	\$49.31	\$49.31	\$49.31	20
		ICBA00	47.70	54.06	47.70	54.06	54.06	
Classroom	F84	BA03	49.31	51.81	51.81	51.81	51.81	
		ICBA03	51.94	58.30	51.94	58.30	58.30	
Storeroom	F86	BA05	41.82	49.31	49.31	49.31	49.31	
		ICBA05	47.70	54.06	47.70	54.06	54.06	
Communicating	F80	BA04	71.78	81.78	81.78	81.78	81.78	
Institution	F87	BA09	71.78	81.78	81.78	81.78	81.78	
Privacy	F76	BA20	34.33	36.84	36.84	36.84	36.84	
Passage	F75	BA30	29.34	34.33	34.33	34.33	34.33	
Exit	F89	BA50	29.34	34.33	34.33	34.33	34.33	
Single Dummy	----	BA40	12.50	16.24	16.24	16.24	16.24	50
Made in Taiwan								
Entrance ****KA/4	F109	TBA00	36.67	43.27	43.27		43.27	20
		ICTBA00	36.67	43.27	43.27		43.27	
Classroom	F84	TBA03	42.23	49.83	49.83		49.83	
		ICTBA03	42.23	49.83	49.83		49.83	
Storeroom	F86	TBA05	36.67	43.28	43.28		43.28	
		ICTBA05	36.67	43.28	43.28		43.28	
Storelock	F91	TBA02		84.00	84.00			
Communicating	F80	TBA04	71.78	84.00	84.00		84.00	
Institution	F87	TBA09		84.00	84.00			
Privacy	F76	TBA20	26.67	31.47	31.47		31.47	
Passage	F75	TBA30	24.45	28.85	28.85		28.85	
Exit	F89	TBA50	24.45	28.85	28.85		28.85	
Single Dummy	----	TBA40	12.00	14.16	14.16		14.16	50

(IC) Indicates function available with **Best, Falcon and Arrow Interchangeable Core**.
Prices do not include cores. For IC Core pricing see pages L73 – L75.

POLYGON PLG Series List Price ..



STANDARD DUTY CYLINDRICAL LOCKSETS ANSI A156.2 Series 4000 Grade 2

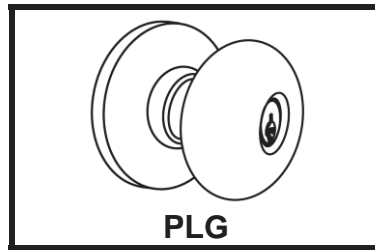

MEETS
The Buy American Act

STOCK ITEM PRICES IN BOLD
NON-STOCK FINISHES AND DESIGNS AVAILABLE WITH FACTORY LEAD TIME
AND SUBJECT TO MINIMUM ORDER

QUANTITY DISCOUNT
50 UNITS MIXED LESS 5%

100 UNITS MIXED LESS 10%

FUNCTION	ANSI	ITEM #	US32D	US3, 10B	US4, 10	PCS /MC
Entrance *****KA/4	F109	PLG00	\$41.82	\$49.31	\$52.27	20
Classroom	F91	PLG03	49.31	51.81	54.92	
Storeroom	F84	PLG05	41.82	49.31	52.27	
Storelock	F91	PLG02	76.09	86.69	86.69	
Communicating	F80	PLG04				
Institution	F87	PLG09				
Privacy	F76	PLG20	36.39	39.05	39.05	
Passage	F75	PLG30	31.10	36.39	36.39	
Exit	F89	PLG50	31.10	36.39	36.39	
Single Dummy	----	PLG40	13.25	17.21	17.21	50

LIFETIME WARRANTY

*****All entrance locks are packaged keyed alike/4 (KA/4) at no extra charge

► **PACKAGING INCLUDES**

- UL Listed 2 3/4" Backset (2 1/4"x 1 1/8" faceplate)
- Standard "C", 6-pin cylinder
- ASA strike

8 ► **IC CORES, KEYING CHARGES**

- Refer to pages L73 - L75

► **TACTILE, LEAD LINING**









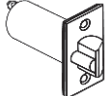
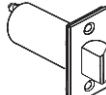
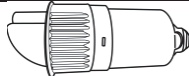
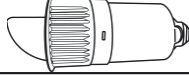

- Lead Lining part# LEAD, Add \$132.35 List
- Tactile part # TAC, Add \$26.97 List

► **KEYWAYS**

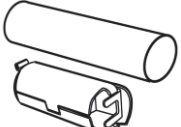
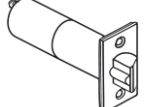
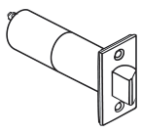
6-pin solid brass "C" keyway standard. Optional: Schlage E, Schlage C-K, Russwin D1-2-3-4, Corbin 59/60, Corbin-Russwin L4, Sargent LA-LB-LC, Falcon/Weiser E, Arrow A, Yale 8, Yale GA and Kwikset. Can also accept Medeco, Assa, Kaba and **Cal-Royal HSK** High Security Cylinders. See pages L75-L76 for additional charges.

► **ADDITIONAL PARTS & CHARGES**

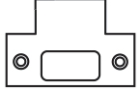
Backsets: UL listed 2 3/8", (2 1/4" x 1") faceplate, **NO EXTRA CHARGE** if ordered with lock only. Otherwise \$11.91 **List Each.**

◆◆◆ STANDARD DISCOUNT ONLY ◆◆◆				
ILLUSTRATION	ITEM #	DESCRIPTION	FINISH	LIST PRICE
	ULSLD238	BA Series UL-listed Dead Latch 2 3/8" PLG Series UL-listed Dead Latch 2 3/8" 2 1/4" x 1" Faceplate	US3,32D,10B	\$11.91
	ULSLS238	BA Series UL-listed Spring Latch 2 3/8" PLG Series UL-listed Spring Latch 2 3/8" 2 1/4" x 1" Faceplate	US3,32D,10B	
	SLDRI-1	2 3/4" Entrance, Drive-in Latch bolt for G2 Lockset	ZINC	
	SLDRI-4	2 3/8" Entrance, Drive-in Latch bolt for G2 Lockset	ZINC	
	SLDRI-2	2 3/4" Privacy/Passage, Drive-in Latch bolt for G2 Lockset	ZINC	
	SLDRI-5	2 3/8" Privacy/Passage, Drive-in Latch bolt for G2 Lockset	ZINC	
EXTRA UL LISTED BACKSET				
	ULSLD234	Dead Latch 2 3/4" 2 1/4" x 1 1/8" Faceplate	US3,26D, 10B,10,26	11.91
	ULSLS234	Spring Latch 2 3/4" 2 1/4" x 1 1/8" Faceplate	US3,26D, 10B,10,26	
3 3/4", 5" UL LISTED BACKSET				
	SL5	5" UL Listed Extension Link	----	17.21
	SLD334	BA Series 3 3/4" Dead latch PLG Series 3 3/4" Dead latch 2 1/4" x 1 1/8" Faceplate	US3,26D,10B	
	SLS334	BA Series 3 3/4" Spring Latch PLG Series 3 3/4" Spring Latch 2 1/4" x 1 1/8" Faceplate	US3,26D,10B	
TAIL PIECE				
	ICTP-03	6-pin Tail Piece for ICBA Series	----	1.67
	ICTP-04	7 Pin Tail Piece for ICBA Series		1.67
	ICTP-08	Tail Piece for ICTBA Only		1.67
STRIKES				
	TS	T-Strike	US3,26D,10B,10,15,26,4	2.12
	FLS	Full Lip Strike	US3,26D,10B,10,15,26	

COLUMBUS Series List Price

ANSI A156.2 GRADE 3 CYLINDRICAL LOCKSET, ORBIT STYLE

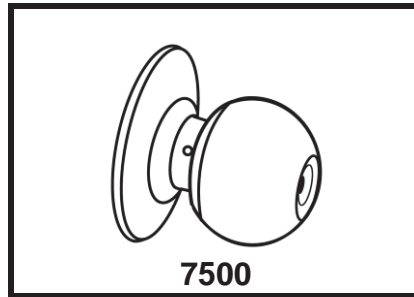

STOCK ITEM PRICES IN BOLD
 NON-STOCK FINISHES AND DESIGNS AVAILABLE WITH FACTORY LEAD TIME
 AND SUBJECT TO MINIMUM ORDER

QUANTITY DISCOUNT
 50 UNITS MIXED
 LESS 5%

 100 UNITS MIXED
 LESS 10%

FUNCTION	ANSI	ITEM #	US32D	US3,5	US10B	US4,10,15,15A	PCS /MC
Entrance KA / 4	F109	7500	\$23.82	\$25.15	\$25.15	\$25.15	20
Classroom	F84	7503	25.42	26.74	26.74	26.74	
Storeroom	F86	7505	23.82	25.15	25.15	25.15	
Privacy	F76	7520	18.01	19.32	19.32	19.32	
Passage	F75	7530	17.21	18.53	18.53	18.53	
Single Dummy	----	7540	9.28	10.59	10.59	10.59	40

LIFETIME WARRANTY

► **PACKAGING INCLUDES**

- **Adjustable** 2 3/8" to 2 3/4" backset square corner. Preset 2 3/8"
- Standard "C", 5 pin cylinder
- T-strike

► **KEYWAYS**

6-pin solid brass "C" keyway standard. Optional: Schlage E, Schlage C-K, Russwin D1-2-3-4, Corbin 59/60, Corbin-Russwin L4, Sargent LA-LB-LC, Falcon/Weiser E, Arrow A, Yale 8, Yale GA and Kwikset.
 Can also accept Medeco, Assa, Kaba and **Cal-Royal HSK** High Security Cylinders. See **pages L75-L76** for additional charges.

► **ADDITIONAL PARTS & CHARGES**

◆◆◆ STANDARD DISCOUNT ONLY ◆◆◆				
ILLUSTRATION	ITEM #	DESCRIPTION	FINISH	LIST PRICE
<p style="text-align: center;">FLS ASAST</p>	FLS	Full Lip Strike	US3, 26D, 10B, 10, 15, 26	2.12
	ASAST	ASA ANSI Strike	US3, 26D, 26 US10, 10B, 4, 5	2.00 3.00
<p style="text-align: center;">7500ADJ 7520ADJ</p>	7500ADJ	7500 Series Entrance Dead latch Adjustable 2 3/8" or 2 3/4" Backset 2 1/4" x 1" Faceplate	US3, 26D, 10B	11.24
	7520ADJ	7500 Series Privacy Spring latch Adjustable 2 3/8" or 2 3/4" Backset 2 1/4" x 1" Faceplate		

HIL Series List Price

INTERCONNECTED ENTRANCE LEVER SERIES ANSI - A156.12 SERIES 5000, GRADE 2, UL LISTED



Optional Interchangeable Core, Best, Falcon and Arrow
With Interconnecting Mechanism, Can be used with 4" CTC

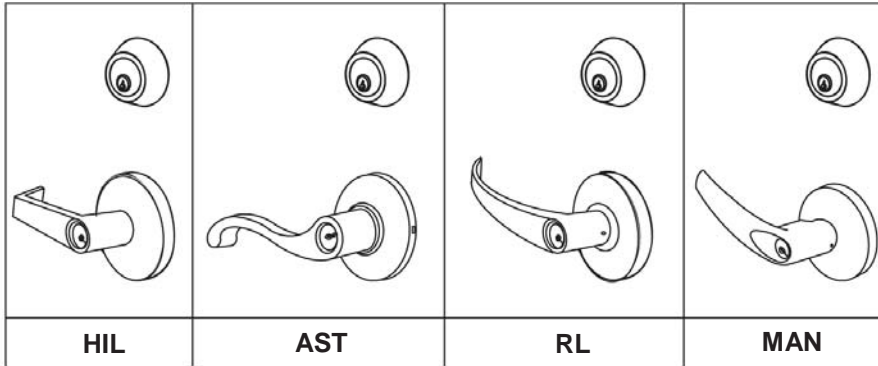

QUANTITY DISCOUNT
50 UNITS MIXED LESS 5%

100 UNITS MIXED LESS 10%

STOCK ITEM PRICES IN BOLD
NON-STOCK FINISHES AND DESIGNS AVAILABLE WITH FACTORY LEAD TIME AND SUBJECT TO MINIMUM ORDER

FUNCTIONS	ANSI	ITEM #	US26D	US3, 15	US10B	US4, 5, 26	PCS /MC
Entrance, Double Locking	F109	HIL00	\$145.57	\$145.57	\$154.83	\$154.83	10
		ICHIL00		145.57	154.83	154.83	
Entrance, Single Locking	F75	HIL30	132.34	132.34	141.73	141.73	
		ICHIL30					
Entrance, Double Locking	F109	HILAST00	145.57	145.57	154.83	154.83	
		ICHILAST00		145.57	154.83	154.83	
Entrance, Single Locking	F75	HILAST30	132.34	132.34	141.73	141.73	
		ICHILAST30					
Entrance, Double Locking	F109	HILRL00	145.57	145.57	154.83	154.83	
		ICHILRL00		145.57	154.83	154.83	
Entrance, Single Locking	F75	HILRL30	132.34	132.34	141.73	141.73	
		ICHILRL30					
Entrance, Double Locking	F109	HILMAN00	145.57	145.57	154.83	154.83	
		ICHILMAN00					
Entrance, Single Locking	F75	HILMAN30	132.34	132.34	141.73	141.73	
		ICHILMAN30		132.34	141.73	141.73	

* Specify handing when ordering AST design

- 8 Indicates deadbolt available with Interchangeable Core. Cores are compatible 6 or 7 pin with **Best, Falcon and Arrow**. Prices do not include cores. For IC Core pricing see pages L73 – L75.
- 88 Indicates deadbolt and entrance lever available with Interchangeable Core. Cores are compatible 6 or 7 pin with **Best, Falcon and Arrow**. Prices do not include cores. For IC Core pricing see pages L73 – L75.



JHIL Series List Price

INTERCONNECTED ENTRANCE LEVER SERIES ANSI - A156.12 SERIES 5000, GRADE 2, UL LISTED



8 Optional Interchangeable Core, Best, Falcon and Arrow
With Interconnecting Mechanism, Can be used with 4" or 5 1/2" CTC

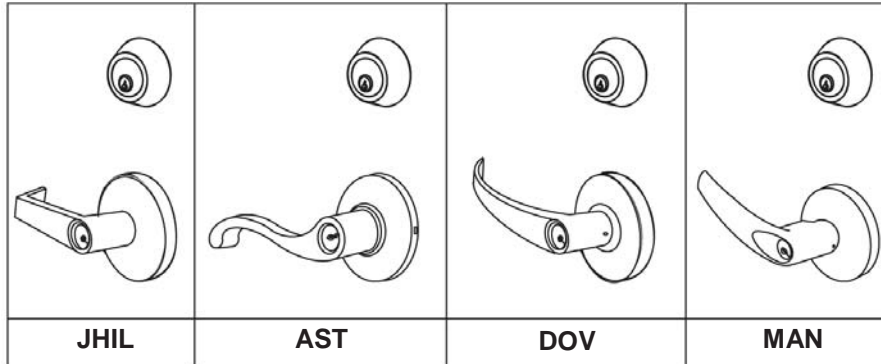

QUANTITY DISCOUNT
50 UNITS MIXED LESS 5%

100 UNITS MIXED LESS 10%

STOCK ITEM PRICES IN BOLD
NON-STOCK FINISHES AND DESIGNS AVAILABLE WITH FACTORY LEAD TIME AND SUBJECT TO MINIMUM ORDER

FUNCTIONS	ANSI	ITEM #	US26D	US3, 15	US10B	PCS /MC
Entrance, Double Locking	F109	JHIL00	\$145.57	\$145.57	\$154.83	10
		8 ICJHIL00				
Entrance, Single Locking	F75	JHIL30	132.34	132.34	141.73	
		8 ICJHIL30				
Entrance, Double Locking	F109	JHILAST00	145.57	145.57	154.83	
		8 ICJHILAST00	145.57	145.57	154.83	
Entrance, Single Locking	F75	JHILAST30	132.34	132.34	141.73	
		8 ICJHILAST30		132.34	141.73	
Entrance, Double Locking	F109	JHILDOV00	145.57	145.57	154.83	
		8 ICJHILDOV00	145.57	145.57	154.83	
Entrance, Single Locking	F75	JHILDOV30	132.34	132.34	141.73	
		8 ICJHILDOV30		132.34	141.73	
Entrance, Double Locking	F109	JHILMAN00	145.57	145.57	154.83	
		8 ICJHILMAN00	145.57	145.57	154.83	
Entrance, Single Locking	F75	JHILMAN30	132.34	132.34	141.73	
		8 ICJHILMAN30	132.34	132.34	141.73	

8 (IC) Indicates deadbolt available with Interchangeable Core. Cores are compatible 6 or 7 pin with Best, Falcon and Arrow. Prices do not include cores. For IC Core pricing see pages L73 – L75.

► **PACKAGING INCLUDES**

- UL Listed 2 3/4" backset, 2 1/4" x 1 1/8" faceplate for **HIL Series**
- UL Listed 2 3/4" backset, 2 1/4" x 1" faceplate with 1/8" plastic filler for **JHIL Series**
- Standard "C", 6-pin cylinder
- T Strike, square strike 2 3/4" X 1 1/8" for deadbolt

► **KEYWAYS**





6-pin solid brass "C" keyway standard. Optional: Schlage E, Schlage C-K, Russwin D1-2-3-4, Corbin 59/60, Corbin-Russwin L4, Corbin-Russwin L4, Sargent LA-LB-LC, Falcon/Weiser E, Arrow A, Yale 8, Yale GA and Kwikset. Can also accept Medeco, Assa, Kaba and **Cal-Royal HSK** High Security Cylinders. See **pages L75-L76** for additional charges.

► **IC CORES, KEYING CHARGES**

Refer to pages **L73 - L75**.

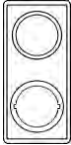
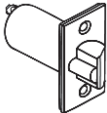
► **ADDITIONAL PARTS & CHARGES**

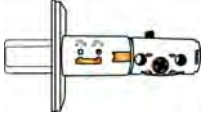
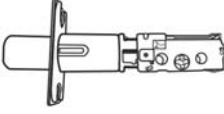
Backset: UL Listed 2 3/8" with 2 1/4" x 1 1/8" Faceplate, **NO EXTRA CHARGE** if ordered with lock only. If ordered separately **ADD \$12.72 List Each**.

◆◆ STANDARD DISCOUNT ONLY ◆◆				
ILLUSTRATION	ITEM#	FINISH	DESCRIPTION	LIST PRICE
	HILESC1	US3, 26D, 15, 10B	Escutcheon Plate for Exterior Trim for HIL and JHIL Series (JHIL used with 4" CTC Only)	\$11.79
	ULHIL238	US3, 26D, 10B	For HIL & JHIL: Dead Latch 2 3/8" for lever lock, 2 1/4" x 1" faceplate (for entry only)	11.91
	ULHIL234		For HIL: Dead Latch 2 3/4" for lever lock 2 1/4" x 1 1/8" faceplate (for entry only)	
	ULJHIL234		For JHIL: Dead Latch 2 3/4" for lever lock 2 1/4" x 1" faceplate (for entry only)	
	ULSHIL238		FOR HIL & JHIL: 2 3/8" UL-listed Spring Latch, 2 1/4" x 1" faceplate (for passage only)	
	ULSHIL234		For HIL: 2 3/4" UL-listed Spring Latch 2 1/4" x 1 1/8" faceplate (for passage only)	
	ULSJHIL234		For JHIL: 2 3/4" UL-listed Spring Latch 2 1/4" x 1" faceplate (for passage only)	
	ULJHILADJ		Adjustable Deadbolt Latch 2 3/8" or 2 3/4" for JHIL	12.72
	T220ADJ		Adjustable Deadbolt Latch 2 3/8" or 2 3/4" for HIL	
STRIKES				
	FLS	US3, 26D, 10B	Full Lip Strike	2.12
	ASAST	US3, 26D	ASA Strike	2.00
		US10B		3.00

EPIC Series List Price

LIGHT DUTY CYLINDRICAL LEVERSETS MEETS ANSI STANDARD A156.2, GRADE 3

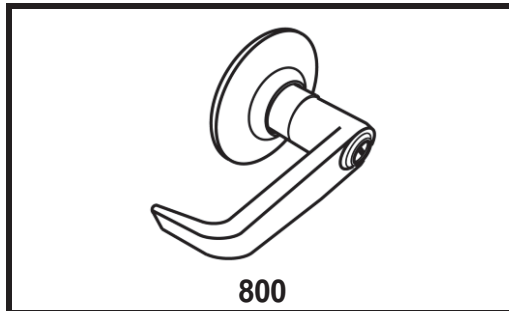

STOCK ITEM PRICES IN BOLD
NON-STOCK FINISHES AND DESIGNS AVAILABLE WITH FACTORY LEAD TIME AND SUBJECT TO MINIMUM ORDER

COMMERCIAL PACKAGING

ENTRANCE leversets, Schlage "C" 5 pin keyway, KD packed with ASA Strike, 2 3/4" backset (1 1/8" x 2 1/4" square corner).

ITEM #	FINISH	FUNCTION	ANSI	LIST PRICE	PCS /MC
800	US26D, 3	Entrance Cylindrical Lock with 4 7/8" ASA Commercial Strike, 5 pin Schlage "C" cylinder, KD	F109	\$32.86	24
800	US4			36.04	
800	US10B			40.28	

PRIVACY AND PASSAGE leversets packed with T Strike, 2 3/4" backset (1 1/8" x 2 1/4" square corner).

*802	US26D	Privacy	F76	29.68	24
803	US26D	Passage	F75	28.62	
*802	US10B	Privacy	F76	37.10	
803	US10B	Passage	F75	36.04	
*802	US4	Privacy	F76	32.86	
*802	US4 X US26D	Bathroom (split finish)	F76	32.86	
803	US4	Passage	F75	31.80	
805	US26D, 3, 5, 26, 10B, 4	Dummy	----	13.78	36

RESIDENTIAL PACKAGING

PRIVACY AND PASSAGE leversets packed with Full Lip Strike round corner, 2 3/8" backset (1" x 2 1/4" round corner).

*RES802	US26D	Privacy	F76	29.68	24
RES803	US26D	Passage	F75	28.62	
*802	US3, 26	Privacy	F76	29.68	
803	US3, 26	Passage	F75	28.62	
*802	US5	Privacy	F76	32.86	
803	US5	Passage	F75	31.80	
805	US26D, 3, 5, 26, 10B, 4	Dummy	----	13.78	

*Turning inside lever or closing door releases button



**Other strikes and backsets available upon request subject to minimum quantity and lead time.

► **KEYWAY**

6-pin solid brass "C" keyway standard.

► **ADDITIONAL PARTS & CHARGES**

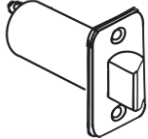
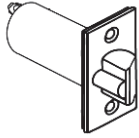
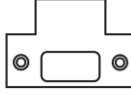
Backset: 2 5/8" with 2 1/4" x 1 1/8" Faceplate, **NO EXTRA CHARGE** if ordered with lock only.
If ordered separately **ADD \$12.72 List Each.**

◆◆ STANDARD DISCOUNT ONLY ◆◆				
ILLUSTRATION	ITEM #	DESCRIPTION	FINISH	LIST PRICE
	8PAS238	Round Corner 2 3/8" Passage Spring Latch	US3, 26D, 10B	\$11.91
	8PRI238	Round Corner 2 3/8" Privacy Spring Latch	US3, 26D, 10B	
	ULSLS234	Round Corner 2 3/4" Spring Latch	US3, 26D, 10B	
	ULSLD234	Square Corner 2 3/4" x 1 1/8" Dead latch	US3, 26D, 10B	
	EPD238 / ULSLD238	Square Corner 2 3/8" x 1" Dead latch	US3, 26D, 10B	
STRIKES				
	TS	T-Strike	US3, 26D, 10B, 26	2.12
	FLS	Full Lip Strike		
	ASAST	ASA Strike	US3, 26D, 26	2.00
			US10B, 4	3.00

CRB Series List Price

HEAVY DUTY DEADBOLTS, ANSI STANDARD- A156.5, GRADE 1

 Optional Interchangeable Core, Best, Falcon and Arrow



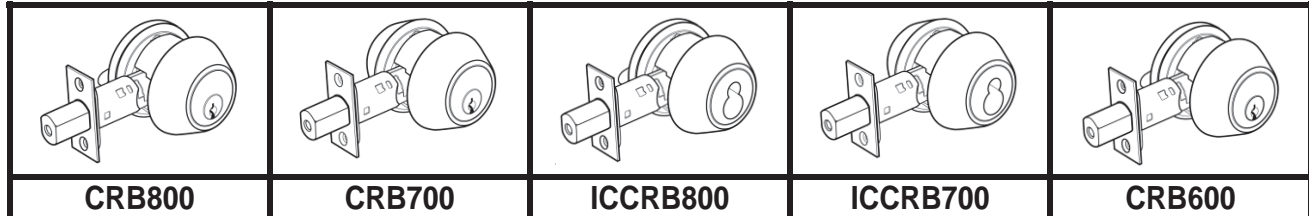

MEETS
The Buy American Act

Lifetime
Warranty **BHMA**
CERTIFIED

3 HOUR FIRE RATED
UL10C, UBC7-2-1997



STOCK ITEM PRICES IN BOLD
NON-STOCK FINISHES AND DESIGNS AVAILABLE WITH FACTORY LEAD TIME AND SUBJECT TO MINIMUM ORDER

DESCRIPTION	ANSI	ITEM #	US26D	US3	US10B, 26	US4, 10	PCS /MC
Grade 1, UL Listed Single Cylinder Deadbolt, "C" Keyway	E0152	 CRB800  ICCRB800	\$71.02	\$71.02	\$73.14	\$73.14	20
Grade 1, UL Listed Double Cylinder Deadbolt, "C" Keyway	E0142	CRB700	89.04	89.04	91.16	91.16	
		 ICCRB700	89.04	89.04	91.16	91.16	
Classroom Deadbolt lock, Deadbolt thrown or retracted by key outside. Inside turn unit will retract bolt only. Bolt automatically deadlocks when fully thrown		 CRB600  ICCRB600	73.14	73.14	75.26	75.26	

 (IC) Indicates functions available with Interchangeable Core. Cores are compatible 6 or 7 pin with **Best, Falcon and Arrow**.
Prices do not include cores. For IC Core pricing see pages L73 – L75.

► **PACKAGING INCLUDES**

- Standard "C" 6-pin cylinder
- Standard UL Listed 2 3/4" backset, optional 2 3/8" backset available. Please specify.
- Latch: Backset latch size 1 1/8" x 2 1/4" faceplate.
- Strike: 1 1/8" x 2 3/4", packed with 3" screws with wood frame reinforcer.

► **KEYWAYS**

6-pin solid brass "C" keyway standard. Optional: Schlage E, Schlage C-K, Russwin D1-2-3-4, Corbin 59/60, Corbin-Russwin L4, Corbin-Russwin L4, Sargent LA-LB-LC, Falcon/Weiser E, Arrow A, Yale 8, Yale GA and Kwikset. Can also accept Medeco, Assa, Kaba and **Cal-Royal HSK** High Security Cylinders. See **pages L75-L76** for additional charges.

► **ANTI MICROBIAL COATING**

Available on US26D and US32D finishes. **Add \$34.00 List.** Prefix "**ANTB**" before **PART#**.

8 ► **IC CORES, KEYING CHARGES**

Refer to pages **L73 - L75**.

► **ADDITIONAL PARTS & CHARGES**

Backsets: 2 3/8", NO EXTRA CHARGE if ordered with lock only. Otherwise **\$12.72 List Each**.

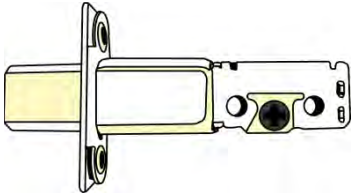
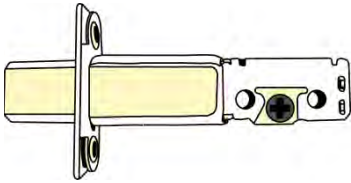
◆◆ STANDARD DISCOUNT ONLY ◆◆			
ILLUSTRATION	ITEM #	DESCRIPTION	LIST PRICE
	B800-238 US3, 26D, 10B	2 3/8" backset (2 1/4" x 1") faceplate	\$12.72
	B800-234 US3, 26D, 10B	2 3/4" backset (2 1/4" x 1 1/8") faceplate	

T300 Series List Price

COMMERCIAL / RESIDENTIAL HEAVY DUTY DEADBOLTS ANSI STANDARD A 156.5, GRADE 2



3 HOUR FIRE RATED
UL10C, UBC7-2-1997

Optional Interchangeable Core, Best, Falcon and Arrow

Optional Conversion Kit for up to 2 1/4" Thick Doors



ULT360 / CL600	ULT362	ULT700	ULID363	ULID365

STOCK ITEM PRICES IN BOLD
NON-STOCK FINISHES AND DESIGNS AVAILABLE WITH FACTORY LEAD TIME AND SUBJECT TO MINIMUM ORDER

DESCRIPTION	ANSI	ITEM #	US3	US26D	US10B	US4	US15	US26	US10	US5	PCS /MC
Heavy Duty Single Cylinder Deadbolt, UL Listed	E0152	ULT360	\$41.03	\$41.03	\$43.42	\$41.03	\$41.03	\$41.03	\$41.03	\$41.03	20
Heavy Duty Single Cylinder Deadbolt, UL Listed	E0152	ICULT360	38.99	38.99	40.00	38.99	38.99	38.99	38.99	38.99	
Heavy Duty Double Cylinder Deadbolt, UL Listed	E0142	ULT362	52.95	52.95	56.52	52.95	52.95	52.95	52.95	52.95	
Heavy Duty Double Cylinder Deadbolt, UL Listed	E0142	ICULT362	54.49	54.49	55.73	54.49	54.49	54.49	54.49	54.49	
Classroom deadbolt lock. UL Listed. Deadbolt thrown or retracted by key outside. Inside turn unit will retract bolt only. Bolt automatically deadlocks when fully thrown.	E0172	CL600	59.89	59.89	62.32	59.89	59.89	59.89	59.89	59.89	
		ICCL600	63.07	63.07	66.74	63.07	63.07	63.07	63.07	63.07	
UL Listed One Sided Latch Bolt retracted by thumb turn, no outside trim . Visible from one side of door only.	---	ULID363 NEW ITEM	25.50	25.50	28.00	28.00	28.00	28.00	28.00	28.00	
UL Listed One Sided Latch Bolt retracted by thumb turn unit. Blank plate on external trim to be used on bore holes 1 5/8" and 2 1/8" diameter.	---	ULID365 NEW ITEM	28.50	28.50	31.50	31.50	31.50	31.50	31.50	31.50	
One-Way Deadbolt Lock UL Listed Deadbolt thrown or retracted by key outside. Blank plate on internal trim to be used on bore holes 1 5/8" and 2 1/8" dia. Bolt automatically deadlocks when fully thrown. (Exposed Screws)	E1161	ULT700 NEW ITEM	43.50	43.50	47.85	47.85	47.85	47.85	47.85	47.85	
		ICULT700 NEW ITEM									

(IC) Indicates functions available with Interchangeable Core. Cores are compatible 6 or 7 pin with **Best, Falcon and Arrow**. Prices do not include cores. For IC Core pricing see pages L73 – L75.

► **PACKAGING INCLUDES**

- Standard "C" 6-pin cylinder
- Standard : Adjustable UL Listed 3 Hour Fire Rating 2 3/8" or 2 3/4" latchbolt.
- Latch: Backset latch size 1" x 2 1/4" faceplate, packed with latch front adapter to convert 1" face plate for 1 1/8" wide door preparations
- Strike: 1 1/8" x 2 3/4", packed with 3" screws with wood frame reinforcer.

► **KEYWAYS**



6-pin solid brass "C" keyway standard. Optional: Schlage E, Schlage C-K, Russwin D1-2-3-4, Arrow A, Corbin 59/60, Corbin-Russwin L4, Sargent LA-LB-LC, Falcon/Weiser E, Yale 8, Yale GA and Kwikset. Can also accept Medeco, Assa, Kaba and *Cal-Royal HSK* High Security Cylinders. See pages L75-L76 for additional charges.

8 ► **IC CORES, KEYING CHARGES**

Refer to pages L73 - L75.

► **ADDITIONAL PARTS**

Backsets: 2 3/8", NO EXTRA CHARGE if ordered with lock only. Otherwise **\$12.72 List Each**.

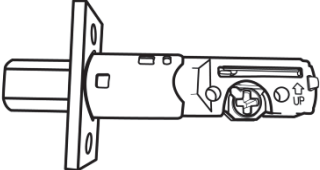
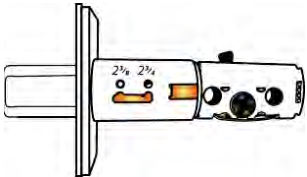
◆◆ STANDARD DISCOUNT ONLY ◆◆				
ILLUSTRATION	ITEM #	DESCRIPTION	FINISH	LIST PRICE
	T2STRK	Deadbolt strike 1 1/8" X 2 3/4"	US3, 10B, 26D	\$2.00
	CONV T360	Conversion Kit for 2 1/4" thick doors with tail piece and screws for ULT360 single cylinder deadbolt		5.94
	CONV T362	Conversion Kit for 2 1/4" thick doors with tail piece and screws for ULT362 double cylinder deadbolt		12.72
	ULT360ADJ	2 3/8"- 2 3/4" Adjustable Latch bolt for ULT360 and ULT362		12.72
	ULJHILADJ	Adjustable Deadbolt Latch 2 3/8" or 2 3/4" for CL600 Classroom Deadbolt		12.72

T400 Series List Price

**COMMERCIAL / RESIDENTIAL HEAVY DUTY DEADBOLTS
ANSI STANDARD- A156.5, GRADE 2
OPTIONAL 6-PIN "C" OR 5-PIN KWIKSET KW1 KEYWAY**

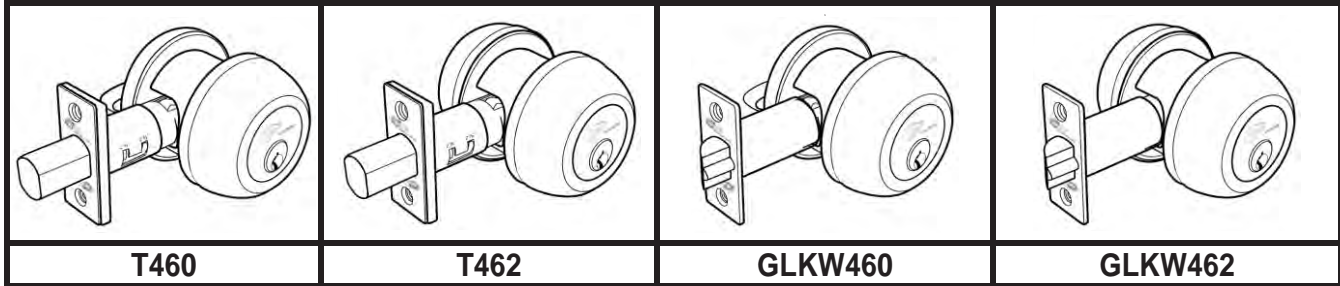

STOCK ITEM PRICES IN BOLD
NON-STOCK FINISHES AND DESIGNS AVAILABLE WITH FACTORY LEAD TIME AND
SUBJECT TO MINIMUM ORDER

DESCRIPTION	ANSI	ITEM #	US26D, US15, US3	US10B, VB (Venetian Bronze)	US5	PCS /MC
Single Cylinder Deadbolt, 6-pin "C" Keyway	E0152	T460	33.50	39.00	39.00	20
Double Cylinder Deadbolt, 6-pin "C" Keyway	E0142	T462	44.50	49.00	49.00	
Single Cylinder Deadbolt, 5-pin Kwikset KW1 Keyway	E0152	KWT460	33.50	39.00	39.00	
Double Cylinder Deadbolt, 5-pin Kwikset KW1 Keyway	E0142	KWT462	44.50	49.00	49.00	

Single Cylinder Gate Latch, 6-pin "C" Keyway	E0152	GL460 2 3/8" Backset	70.42	75.92	75.92	20
Single Cylinder Gate Latch, 6-pin "C" Keyway	E0152	GL460/234 2 3/4" Backset	70.42	75.92	75.92	
Double Cylinder Gate Latch, 6-pin "C" Keyway	E0142	GL462 2 3/8" Backset	81.42	85.92	85.92	
Double Cylinder Gate Latch, 6-pin "C" Keyway	E0142	GL462/234 2 3/4" Backset	81.42	85.92	85.92	
Single Cylinder Gate Latch, 5-pin Kwikset KW1 Keyway	E0152	GLKW460 2 3/8" Backset	70.42	75.92	75.92	
Single Cylinder Gate Latch, 5-pin Kwikset KW1 Keyway	E0152	GLKW460/234 2 3/4" Backset	70.42	75.92	75.92	
Double Cylinder Gate Latch, 5-pin Kwikset KW1 Keyway	E0142	GLKW462 2 3/8" Backset	81.42	85.92	85.92	
Double Cylinder Gate Latch, 5-pin Kwikset KW1 Keyway	E0142	GLKW462/234 2 3/4" Backset	81.42	85.92	85.92	

► **PACKAGING INCLUDES**

- Optional Standard "C" 6-pin cylinder or 5-pin Kwikset KW1
- Adjustable 2 3/4" and 2 3/8" backset.
- Latch: Standard 2 1/4" x 1" packed with 1 1/8" plastic filler to convert face plate to 1 1/8" wide door preparations
- Strike: 1 1/8" x 2 3/4", packed with 1 1/2" screws with wood frame reinforcer.



► **KEYWAYS**

Optional 6-pin solid brass "C" or 5 pin Kwikset KW1 keyway standard. Optional: Schlage E, Schlage C-K, Arrow A, Russwin D1-2-3-4, Corbin 59/60, Corbin-Russwin L4, Corbin-Russwin L4, Sargent LA-LB-LC, Falcon/Weiser E, Yale 8 and Yale GA. Can also accept Medeco, Assa, Kaba and **Cal-Royal HSK** High Security Cylinders. See **pages L75-L76** for additional charges.

► **KEYING CHARGES**

Refer to **pages L75-L76**

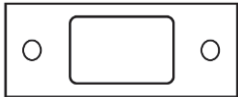
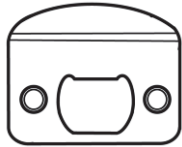
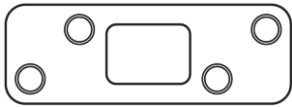
► **ADDITIONAL PARTS**

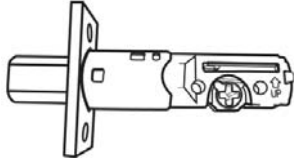

◆◆ STANDARD DISCOUNT ONLY ◆◆				
ILLUSTRATION	ITEM #	DESCRIPTION	FINISH	LIST PRICE
	T2STRK	Deadbolt strike 1 1/8" X 2 3/4"	US3, US10B, US26D	\$2.00
	DBFLS	Deadbolt Full Lip Strike, Round Corner	US3, 5, 10B, 15, 15A, 26	1.53
	SS114358	Deadbolt Security Strike 1 1/4" x 3 5/8", 1/4" Rad.		2.67
	DBS1214RC	Deadbolt Strike Round Corner 1" X 2 1/4", 1/4" Rad.	US3, US5, US26D	0.59
	DBS1214SC	Deadbolt Strike Square Corner 1" X 2 1/4"		0.59
	T460ADJ	Adjustable 2 3/4" and 2 3/8" Latch Bolt	US3, US26D, US10B	11.12

CB160 Series List Price

HEAVY DUTY DEADBOLTS, ANSI STANDARD - A156.5, GRADE 2

COMMERCIAL / RESIDENTIAL GR 2 DEADBOLTS / DEAD LATCHES

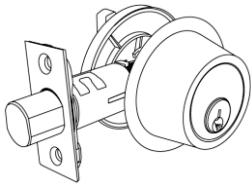
Grade 2 Specifications, Equivalent to Schlage B160 - Series Deadbolts

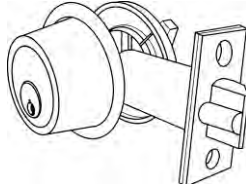
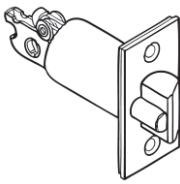
			
CB160	ADP160	GL160	GL238 (2 3/8") GL234 (2 3/4")



STOCK ITEM PRICES IN BOLD
NON-STOCK FINISHES AND DESIGNS AVAILABLE WITH FACTORY LEAD TIME
AND SUBJECT TO MINIMUM ORDER

DESCRIPTION	ANSI	ITEM #	US3, 26D	US10, 10B, 26, 4, 5, 15	PCS /MC
Heavy Duty Single Cylinder Deadbolt	E0152	CB160	\$36.04	\$38.16	36
Heavy Duty Double Cylinder Deadbolt	E0142	CB162	46.64	48.76	
Single Cylinder Gate Latch	E0152	GL160 (2 3/8" backset)	72.08	74.20	
Double Cylinder Gate Latch	E0142	GL162 (2 3/8" backset)	82.68	84.80	
Single Cylinder GateLatch	E0152	GL160/234 (2 3/4" backset)	72.08	74.20	
Double Cylinder Gate Latch	E0142	GL162/234 (2 3/4" backset)	82.68	84.80	

► **PACKAGING INCLUDES**

- 2 1/2" Diameter Adapter Ring for 2 1/8" Door Preparations
- Standard "C" 6-pin cylinder
- Adjustable 2 3/4" and 2 3/8" backset
- For gate latches Fixed 2 3/4" and 2 3/8" latch bolt
- Latch: Backset latch size 1" x 2 1/4" faceplate, packed with latch front adapter to convert 1" face plate for 1 1/8" wide door preparations
- Strike: 1 1/8" x 2 3/4"

► **KEYWAYS**

6-pin solid brass "C" keyway standard. Optional: Schlage E, Schlage C-K, Russwin D1-2-3-4, Corbin 59/60, Corbin-Russwin L4, Sargent LA-LB-LC, Falcon/Weiser E, Arrow A, Yale 8, Yale GA and Kwikset.





Can also accept Medeco, Assa, Kaba and **Cal-Royal HSK** High Security Cylinders. See **pages L75-L76** for additional charges.

► **KEYING CHARGES**

Refer to **pages L75-L76**

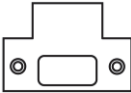
► **ADDITIONAL PARTS & CHARGES**

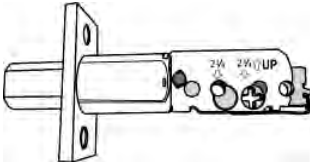
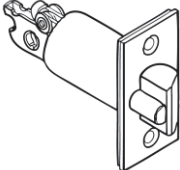
Backsets: 2 3/8", NO EXTRA CHARGE if ordered with lock only. Otherwise **\$12.72 List Each**.

◆◆ STANDARD DISCOUNT ONLY ◆◆				
ILLUSTRATION	ITEM #	DESCRIPTION	FINISH	LIST PRICE
	TS	T-Strike	US3, 26D, 10B, 26	\$2.12
	T2STRK	Deadbolt Strike 1 1/8" X 2 3/4"	US3, 10B, 26D	2.00
	CB160ADJ	2 3/8" - 2 3/4" Adjustable Latch bolt for CB160		12.72
	GL238	2 3/8" Dead latch (1 1/8" x 2 1/4")		36.92
	GL234	2 3/4" Dead latch (1 1/8" x 2 1/4")		
	ADP160	Adapter Ring	US10B, 15, 26, 26D, 3, 4, 5	3.82

STANDARD DUTY DEADBOLTS Series ...

ANSI STANDARD- A156.5, GRADE 3 COMMERCIAL / RESIDENTIAL DEADBOLTS / DEAD LATCHES

- ⚙ Optional Interchangeable Core for Best, Falcon and Arrow
- ⚙ Optional Interchangeable Core for Schlage full size format

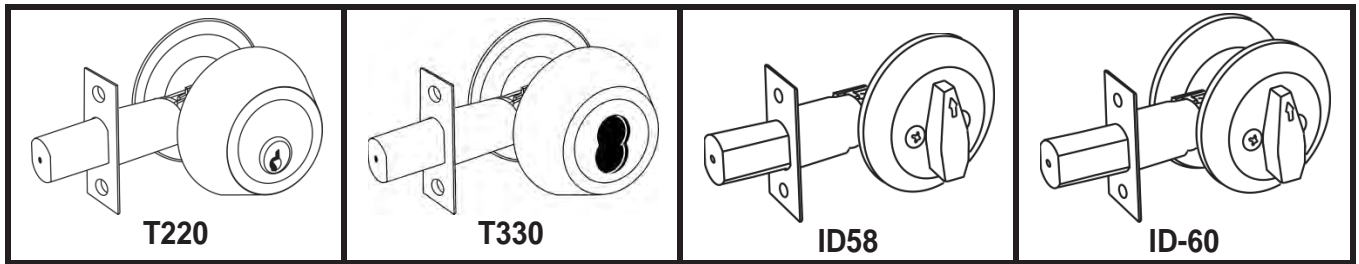

STOCK ITEM PRICES IN BOLD

NON-STOCK FINISHES AND DESIGNS AVAILABLE WITH FACTORY LEAD TIME AND SUBJECT TO MINIMUM ORDER

DESCRIPTION	ANSI	ITEM #	US3, 26D	US10B	US10	US15	US26	NEW FINISH US32D	US5	US4	PCS / MC
Standard Duty Single Cylinder Deadbolt	E0153	T220	\$28.84	\$30.87	\$30.87	\$30.87	\$30.87	\$28.84	\$30.87	\$30.87	20
		⚙ ICT220						28.84			
Standard Duty Double Cylinder Deadbolt	E0143	T330	38.44	40.47	40.47	40.47	40.47	38.44	40.47	40.47	
		⚙ ICT330						38.44			

⚙ (IC) Indicates functions available with Interchangeable Core. Cores are compatible 6 or 7 pin with **Best, Falcon and Arrow**.
Prices do not include cores. For IC Core pricing see pages L73 – L75.



Standard Duty Single Cylinder Deadbolt With Schlage Big Format IC	E0153	⚙ SCICT220	38.20	40.87	40.87	40.87	40.87	38.20	40.87	40.87	20
Standard Duty Double Cylinder Deadbolt With Schlage Big Format IC	E0143	⚙ SCICT330	58.43	62.52	62.52	62.52	62.52	58.43	62.52	62.52	

⚙ (SCIC) Indicates function available with **Schlage full size format** Interchangeable Core.

Deadbolt thrown or retracted by turn unit only no outside trim. Bore halfway through door for installation visible from one side of door only	----	ID58	14.96	21.70	21.70	21.70	21.70	14.96	21.70	21.70	50
Deadbolt thrown or retracted by turn unit only. Blank plate is on external trim to be used on bore holes 1 5/8" and 2 1/8" wide	----	ID60	17.21	23.03	23.03	23.03	23.03	17.21	23.03	23.03	

► **ADDITIONAL PARTS**

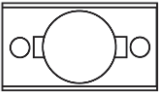
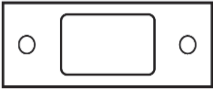
Backsets: 2 3/8", **NO EXTRA CHARGE** if ordered with lock only. Otherwise **\$12.72 List Each**.

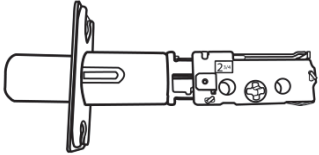
◆◆ STANDARD DISCOUNT ONLY ◆◆				
ILLUSTRATION	ITEM #	DESCRIPTION	FINISH	LIST PRICE
	LFA18	Latch front adapter to convert 1" Plate to 1 1/8" wide door preparations	CLEAR	\$0.25
	T2STRK	Deadbolt strike 1 1/8" x 2 3/4"	US3, 10B, 26D	2.00
	T22DRI-6	2 3/8" Drive-in Latch bolt for T220/T330 Deadbolt	ZINC	11.91
	T22DRI-3	2 3/4" Drive-in Latch bolt for T220/T330 Deadbolt		
	T220ADJ	2 3/8"- 2 3/4" Adjustable Latch bolt for T220/T330 Deadbolt	US3, 10B, 26D	12.72

► **PACKAGING INCLUDES**

- Standard "C" 6-pin cylinder.
- Adjustable 2 3/4" and 2 3/8" backset.
- Latch bolt size: 1" x 2 1/4".
Latch front adapter is supplied in packaging to convert 1" faceplate for 1 1/8" wide door preparations.

► **KEYWAYS**

6-pin solid brass "C" keyway standard.

► **IC CORES, KEYING CHARGES**

Refer to pages L73 - L75



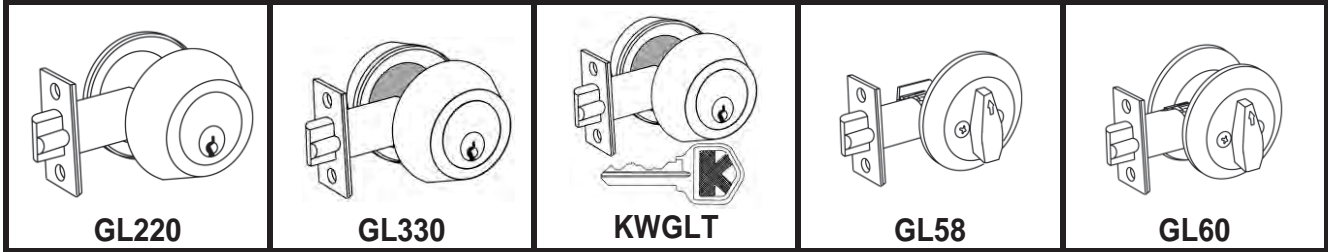

GATE LATCH DEAD LATCHES

Series List Price

 Optional Interchangeable Core for Best, Falcon and Arrow



STOCK ITEM PRICES IN BOLD
NON-STOCK FINISHES AND DESIGNS AVAILABLE WITH FACTORY LEAD TIME AND SUBJECT TO MINIMUM ORDER

DESCRIPTION	ANSI	ITEM #	US3	US26D	US4	US10B	US10	US15	US26	US5	PCS /MC
Single Cylinder Gate Latch, "C" Keyway	E0153	 GL220 ICGL220 (2 3/8" backset)	\$66.70	\$66.70	\$67.89	\$67.89	\$67.89	\$67.89	\$67.89	\$67.89	20
Single Cylinder Gate Latch, "C" Keyway	E0153	 GL220234 ICGL220234 (2 3/4" backset)	66.70	66.70	67.89	67.89	67.89	67.89	67.89	67.89	
Single Cylinder Gate Latch, Kwikset Keyway	E0153	KWGLT220 (2 3/8" backset)	66.70	66.70	67.89	67.89	67.89	67.89	67.89	67.89	
Single Cylinder Gate Latch, Kwikset Keyway	E0153	KWGLT220234 (2 3/4" backset)	66.70	66.70	67.89	67.89	67.89	67.89	67.89	67.89	
Double Cylinder Gate Latch, "C" Keyway	E0143	 GL330 ICGL330 (2 3/8" backset)	76.22	76.22	77.41	77.41	77.41	77.41	77.41	77.41	
Double Cylinder Gate Latch, "C" Keyway	E0143	 GL330234 ICGL330234 (2 3/4" backset)	76.22	76.22	77.41	77.41	77.41	77.41	77.41	77.41	
Double Cylinder Gate Latch, Kwikset Keyway	E0143	KWGLT330 (2 3/8" backset)	76.22	76.22	77.41	77.41	77.41	77.41	77.41	77.41	
Double Cylinder Gate Latch, Kwikset Keyway	E0143	KWGLT330234 (2 3/4" backset)	76.22	76.22	77.41	77.41	77.41	77.41	77.41	77.41	

 (IC) Indicates functions available with Interchangeable Core. Cores are compatible 6 or 7 pin with **Best, Falcon and Arrow**. **Prices do not include cores.** For IC Core pricing see pages L73 – L75.

STOCK ITEM PRICES IN BOLD
NON-STOCK FINISHES AND DESIGNS AVAILABLE WITH FACTORY LEAD TIME AND SUBJECT TO MINIMUM ORDER

DESCRIPTION	ITEM #	US3	US26D	US4	US10B	US10	US15	US26	US5	PCS /MC
Dead latch retracted by turn unit only no outside trim. Bore halfway through door for installation visible from one side of door only.	GL58 (2 3/8" backset)	\$52.41	\$52.41	\$58.36	\$58.36	\$58.36	\$58.36	\$58.36	\$58.36	50
Dead latch retracted by turn unit only. Blank plate is on external trim to be used on bore holes 1 5/8" x and 2 1/8" wide.	GL60 (2 3/8" backset)	54.79	54.79	60.74	60.74	60.74	60.74	60.74	60.74	
Dead latch retracted by turn unit only no outside trim. Bore halfway through door for installation visible from one side of door only.	GL58234 (2 3/4" backset)	52.41	52.41	58.36	58.36	58.36	58.36	58.36	58.36	
Dead latch retracted by turn unit only. Blank plate is on external trim to be used on bore holes 1 5/8" x and 2 1/8" wide.	GL60234 (2 3/4" backset)	54.79	54.79	60.74	60.74	60.74	60.74	60.74	60.74	

► PACKAGING INCLUDES

- Standard "C" 6-pin cylinder or Kwikset KW
- Standard 2 3/8" backset or 2 3/4". Specify backset.
- Latch bolt size: 1 1/8" x 2 1/4"
- Strike size: 1 1/8" x 2 3/4"

► IC CORES, KEYING CHARGES

Refer to pages L73 - L75.

► KEYWAYS

6-pin solid brass "C" keyway standard.

► ADDITIONAL PARTS

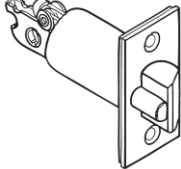
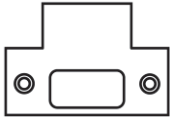
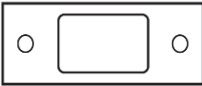
◆◆ STANDARD DISCOUNT ONLY ◆◆				
ILLUSTRATION	ITEM #	DESCRIPTION	FINISH	LIST PRICE
	GL238	2 3/8" Dead latch (1 1/8" X 2 1/4")	US3, 10B, 26D	\$36.92
	GL234	2 3/4" Dead latch (1 1/8" X 2 1/4")		
	TS	T-Strike	US3, 26D, 10B, 26	2.12
	T2STRK	Deadbolt Strike 1 1/8" X 2 3/4"	US3, 10B, 26D	2.00

LSD Series List Price

LIGHT COMMERCIAL/RESIDENTIAL STANDARD DUTY DEADBOLTS, ANSI Grade 3

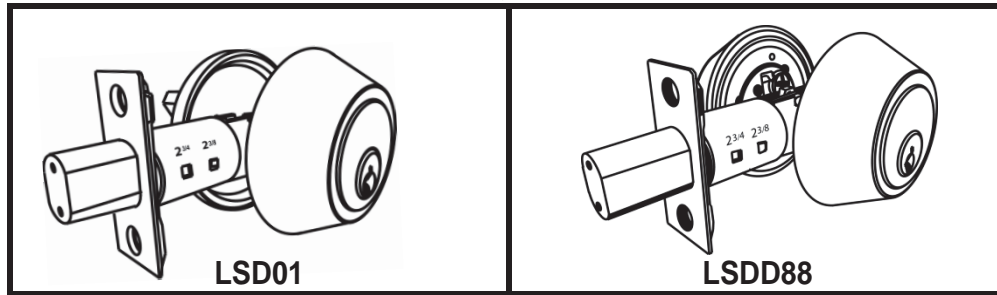

STOCK ITEM PRICES IN BOLD
 NON-STOCK FINISHES AND DESIGNS AVAILABLE WITH FACTORY LEAD TIME
 AND SUBJECT TO MINIMUM ORDER

DESCRIPTION	ANSI	ITEM #	US3, 26D, 32D	US5, 15, 10B	US32	PCS /MC
Standard Duty Single Cylinder Deadbolt	E0153	LSD01	\$19.08	\$21.73	\$21.73	36
Standard Duty Double Cylinder Deadbolt	E0143	LSDD88	21.20	24.91	24.91	36

► **PACKAGING INCLUDES**

- Standard "C" 6-pin cylinder
- Adjustable 2 3/4" and 2 3/8" backset
- Latch: Backset latch size 1" x 2 1/4" faceplate. Latch front adapter is available to convert 1" face plate for 1 1/8" wide door preparations. See below.
- Strike: 1 1/8" x 2 3/4"



► **KEYWAYS**

6-pin solid brass "C" keyway standard. Optional: Schlage E, Schlage C-K, Russwin D1-2-3-4, Corbin 59/60, Corbin-Russwin L4, Sargent LA-LB-LC, Falcon/Weiser E, Arrow A, Yale 8, Yale GA and Kwikset.
 Can also accept Medeco, Assa, Kaba and **Cal-Royal HSK** High Security Cylinders. See **pages L75-L76** for additional charges.

► **KEYING CHARGES**

Refer to **pages L75-L76**

► **ADDITIONAL PARTS**

◆◆◆ STANDARD DISCOUNT ONLY ◆◆◆				
ILLUSTRATION	ITEM #	DESCRIPTION	FINISH	LIST PRICE
	LFA18	Latch front adapter to convert 1" face plate to 1 1/8" wide door preparations	CLEAR	0.25
	T2STRK	Deadbolt strike 1 1/8" X 2 3/4"	US3, 10B, 26D	2.00
	ED500ADJ	ED500 Adjustable Latch bolt, round corner 1" X 2 1/4"	US3, 10B, 26D	6.04

IND84 Indicator Deadbolts

Series List Price

COMMERCIAL / RESIDENTIAL INDICATOR DEADBOLTS

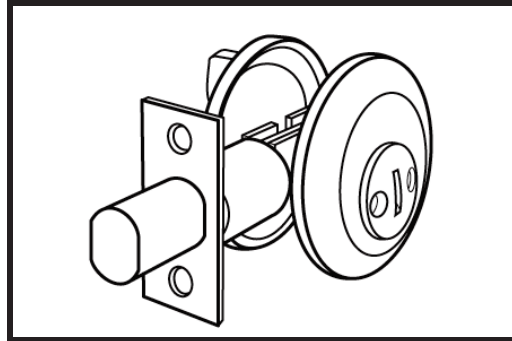

STOCK ITEM PRICES IN BOLD
 NON-STOCK FINISHES AND DESIGNS AVAILABLE WITH FACTORY LEAD TIME
 AND SUBJECT TO MINIMUM ORDER

ITEM #	DESCRIPTION	US3, 4, 26D	US10B	PCS /MC
IND84	Indicator Deadbolt	\$32.86	\$35.51	36

► **PACKAGING INCLUDES**









- Adjustable 2 3/4" and 2 3/8" backset
- Latch: Backset latch size 1" x 2 1/4" faceplate. Latch front adapter is provided to convert 1" face plate for 1 1/8" wide door preparations. See below.
- Strike: 1 1/8" x 2 3/4"

► **ADDITIONAL PARTS**

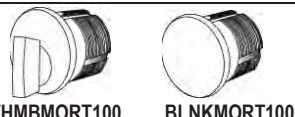
◆◆◆ STANDARD DISCOUNT ONLY ◆◆◆				
ILLUSTRATION	ITEM #	DESCRIPTION	FINISH	LIST PRICE
	LFA18	Latch front adapter to convert 1" face plate to 1 1/8" wide door preparations	CLEAR	0.25
	T2STRK	Deadbolt strike 1 1/8" X 2 3/4"	US3, 10B, 26D	2.00
	ED500ADJ	ED500 Adjustable Latch bolt, round corner 1" X 2 1/4"	US3, 10B, 26D	6.04

RIM AND MORTISE CYLINDERS

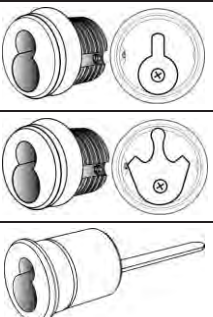
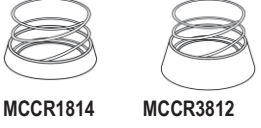
NET PRICES

6-pin SCHLAGE "C" KEYWAY MORTISE AND RIM CYLINDERS				
ILLUSTRATION	ITEM #	DESCRIPTION	FINISH	NET PRICE (EA.)
	CX96RIM	6-pin SCHLAGE "C" keyway 1 1/8" Rim Cylinder with mounting plate & screws	US26D	\$5.50
			US10B,3	6.00
	AMORTCYL118	6-pin SCHLAGE "C" Keyway Mortise Cylinder 1 1/8" length, with ADAMS RITE cam	US26D	5.50
	AMORTCYL114	6-pin SCHLAGE "C" Keyway Mortise Cylinder 1 1/4" length, with ADAMS RITE cam	US10B,3	6.00
	CMORTCYL118	6-pin SCHLAGE "C" Keyway Mortise Cylinder 1 1/8" length, with CLOVER LEAF cam	US26D	5.50
	CMORTCYL114	6-pin SCHLAGE "C" Keyway Mortise Cylinder 1 1/4" length, with CLOVER LEAF cam	US10B,3	6.00
	THMBMORT100	1" Mortise Cylinder with Thumbturn	US26D	5.50
	BLNKMORT100		US10B,3	6.00
			US26D	5.50
			US10B,3	6.00
BEST/FALCON 6/7 PIN SMALL FORMAT INTERCHANGEABLE CORE MORTISE AND RIM CYLINDERS				
	308-602	Best/Falcon and Arrow 6 / 7 Pin Small Format Interchangeable Core Rim Cylinder with mounting plate & screws	US26D	10.49
			US10B,3	10.97
	307-601	Best/Falcon and Arrow 6 / 7 Pin Small Format Interchangeable Core Mortise Cylinder, with ADAMS RITE cam, 1 1/4"	US26D	10.49
			US10B,3	10.97
	ICH961387	Best/Falcon and Arrow 6 / 7 Pin Small Format Interchangeable Core Mortise Cylinder, CLOVER LEAF cam 1 1/4" length. To be used with Cal-Royal NM Series mortise locks	US26D	14.00
			US10B,3	14.50
SCHLAGE LARGE FORMAT 6-pin INTERCHANGEABLE CORE MORTISE AND RIM CYLINDERS				
	6000ICMA	SCHLAGE Large Format Interchangeable Core Mortise Cylinder with Adams Rite Cam 1 1/2" long	US3, US10B, US26D	14.31
	7000ICMC	SCHLAGE Large Format Interchangeable Core Mortise Cylinder with Cloverleaf Cam 1 1/2" long. To be used with Cal-Royal NM Series Mortise locks		
	8000ICRIM	SCHLAGE Large Format Interchangeable Core rim Cylinder with mounting plate and screws		
MORTISE CYLINDER ACCESSORIES				
	MCCR1814	Mortise Cylinder Compression Ring 1/8" to 1/4"	US3, US10B, US26D	3.85
	MCCR3812			
	CGR175 NEW ITEM	Cylinder Guard Ring 1 3/4" with Wave Washer and Spacing Collar	US26D, 10B, 3, 4	2.45

INTERCHANGEABLE CORE CYLINDERS

NET PRICES
NO DISCOUNT ALLOWED

Schlage "C" Large Format 6 Pin

Features:

- Operates on all **Schlage Large Format Interchangeable Cores** locksets, deadbolts, rim and Mortise cylinders.
- Operates on Cal-Royal's Commander Grade 2 leversets with large format, Genesys Grade 1 leversets with Large Format IC Core, T220 Series deadbolts with Large Format IC Core.

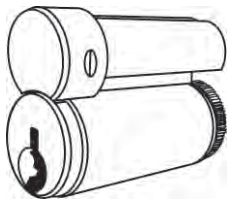
ILLUSTRATION	ITEM #	DESCRIPTION	FINISH	NET PRICE EA
LARGE FORMAT 6-pin INTERCHANGEABLE CORE CYLINDERS				
	3000ICC	6-pin "C" keyway combined SCHLAGE large format IC core cylinder KA# 111111 with "C" keys	US3, US26D	\$17.49
	4000ICCK	6-pin "C-K" keyway combined SCHLAGE large format IC core cylinder KA# 111111 with "E" keys		
	5000ICE	6-pin "E" keyway combined SCHLAGE large format IC core cylinder KA# 111111 with "E" keys		
	1000ICC	6-pin "C" keyway combined SCHLAGE large format IC core cylinder KD and MK		
	2000ICC	Temporary 6-PIN Construction Cores (Keyed Alike) will be charged on a separate memo billing for 6 months. On return to the factory credit will be issued.		

Best, Falcon and Arrow Small Format 6 / 7 Pin

Features:

- Operates on **Best, Falcon and Arrow Small Format Interchangeable Cores** locksets, deadbolts, rim and Mortise cylinders.
- Operates on all of Cal-Royal's keyed lock functions that specify availability with **Best, Falcon and Arrow Small Format Interchangeable Cores**.

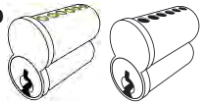
ILLUSTRATION	ITEM #	DESCRIPTION	FINISH	NET PRICE EA
SMALL FORMAT 6 / 7 PIN INTERCHANGEABLE CORE CYLINDERS				
	6PCC-KD	Best, Arrow Small Format. 6-pin "A" keyway Combinated KD Interchangeable Core	US3, US26D	12.72**
	6PUC	6-pin "A" keyway Uncombinated		9.00
	7PCC-KD	Best, Arrow Small Format. 7-pin "A" keyway Combinated KD Interchangeable Core		12.72**
	7PUC	7-pin "A" keyway Uncombinated		9.00
**Prices include all keying charges (Including MK). 2nd / 3rd Level keying systems will require additional charges				

► BEST, FALCON AND ARROW IC CORE KEYWAYS

A,B,C,D,E,F,G,H,J,K,L,M. "A" is stock keyway. Allow 2 to 3 weeks for other keyways.

◆ CONSTRUCTION CORES

PART#	DESCRIPTION
ICCC	Temporary 6-PIN construction cores are available. Construction cores will be charged on a separate memo billing for 6 months. \$12.72 Net Each . On return to the factory credit will be issued.
ICCC7	Temporary 7-PIN construction cores are available. Construction cores will be charged on a separate memo billing for 6 months. \$12.72 Net Each . On return to the factory credit will be issued.
ICPTT	Plastic thumb turns available for non-secured areas. \$2.65 Net Each .

► IC CORE KEY CHARGES

- ✓ Interchangeable Core cylinders can be returned to the factory for rekeying (Includes 2 keys) **\$9.00 Net Each**.
- ✓ Extra cut keys regular and control **\$1.58 Net Each**. Two control keys are supplied with each Masterkey System at no charge.
- ✓ Additional Control Key Part# **CONKEY \$1.58 Net Each** for Best, Falcon and Arrow.
- ✓ Additional Control Key Part# **SCCONKEY-8 \$1.58 Net Each** for Schlage "C".

KEYS & KEYING *NET Price...*

NET PRICES
NO DISCOUNT
ALLOWED

For Commercial Grade Locksets

COMMERCIAL LOCKSETS (NOT INCLUDING ASHLEY AND CHELSIE SERIES RESIDENTIAL LOCKSETS)

ITEM #	DESCRIPTION	NET PRICE
KA	Key Alike / 0-bitted	\$1.06/cylinder
MK	Master Keying (Including KA charges)	3.18/cylinder
GMK	Grand Master Keying (Including KA & MK charges)	4.00/cylinder
CMK	Construction Master Keying (Including KA & MK charges)	5.00/cylinder
KM	Key Marking letters or numbers (AA1,AA2, ...) on key bow or cylinder core	1.33/key
DND	Do Not Duplicate	0.85/key
ECK	Extra Cut Key (2 keys standard per lock)	0.80/key
CRSC15	Schalge "C" Key Blanks (5 pins)	0.67/key
CRSC16	Schalge "C" Key Blanks (6-pins)	0.67/key
CRKW1	Kwikset Key Blanks (5 pins)	0.67/key
♦ KEYING KITS		
KKC100	Keying Kit - "C" Keyway	53.55/ea.
KKWI200	Keying Kit - KWI Keyway	

Available on
"C" keyway.
Other keyways
keying available
with factory
lead-time.

2nd / 3rd Level
keying systems
will require
additional
charges

ADDITIONAL KEYWAYS (Not available for T220 & T330 Series Deadbolts and ASHLEY Series Residential Locks)

ITEM #	CYLINDER DESCRIPTION	FINISH	NET PRICE EACH	ITEM #	1 1/4" MORTISE CYLINDER with CLOVER LEAF CAM for use with "NM" Series Mortise Locks	FINISH	NET PRICE EACH
CX98-100	Yale 8	US26D, 3	\$6.00	CX96-100	Yale 8	US26D	10.80
CX98-1000	Russwin D1-2-3-4			CX96-1000	Russwin D1-2-3-4		
CX98-1100	Yale "GA"			CX96-1100	Yale "GA"		
CX98-200	Kwikset			CX96-200	Kwikset		
CX98-3000	Schlage "C-K" (Specify CR Lock Series)			CX96-3000	Schlage "C-K"		
CX98-3100	Schlage "E"			CX96-3100	Schlage "E"		
CX98-400	Corbin 59/60			CX96-400	Corbin 59/60		
CX98-4300	Corbin-Russwin "L4"			CX96-4300	Corbin-Russwin "L4"		
CX98-800	Weiser "E"			CX96-700	Sargent LA-LB-LC		
CX98-700	Sargent LA-LB-LC			CX96-800	Falcon/Weiser "E"		
CX98-800A	Falcon/Weiser "E"			CX96-900	Arrow A		
CX98-900	Arrow A						

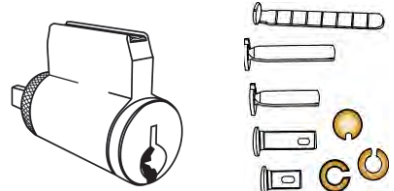

Packed with Assorted tail pieces Including single and double cylinder tailpieces

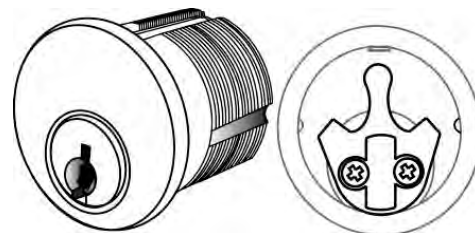

CYLINDERS CAN BE ORDERED SEPARATELY

▶ OTHER ACCESSORIES

ITEM #	DESCRIPTION	NET PRICE
PDBFLS	Plastic Dust box for Full Lip Strike	\$0.59
PDB1214	Plastic Dust box for Residential Deadbolt Strike 1" x 2 1/4"	
PDB118234	Plastic Dust box for T-Strike 1 1/8" x 2 3/4"	
PDBTS	Plastic Dust box for Deadbolt T2STRK Strike	1.19
PDB478	Plastic Dust box for ASA Strike	
LFA18	Latch front adapter to convert 1" plate to 1 1/8" wide door preparations (Clear)	0.11

CRP HSK HIGH SECURITY LIST Price

EXCLUSIVE PATENTED SIDE BAR KEYWAY

MEETS
The Buy American Act

ILLUSTRATION	ITEM#	DESCRIPTION	LIST PRICE EA.	FINISH
	KIKL5 (Includes 2 Keys and all Tailpieces & Caps shown)	Universal 5-pin Grade 3 0-bitted 0B Key-In-Knob/Lever & Deadbolt Cylinder	\$42.00	US26D, US3
		Universal 5-pin Keyed Different KD Grade 3 Key-In-Knob/Lever & Deadbolt Cylinder	46.50	
	KIKL6 (Includes 2 Keys and all Tailpieces & Caps shown)	Universal 6-pin Keyed 0-bitted 0B Key-In-Knob/Lever & Deadbolt Cylinder	42.00	
		Universal 6-pin Keyed Different KD Key-In-Knob/Lever & Deadbolt Cylinder	46.50	
	ULKIKL6 (Includes 2 Keys and all Tailpieces & Caps shown)	UL-Listed Universal 6-pin 0-bitted 0B Key-In-Knob/Lever & Deadbolt Cylinder	57.00	
		UL-Listed Universal 6-pin Keyed Different KD Key-In-Knob/Lever & Deadbolt Cylinder	60.00	
	LFIC6 (Includes 2 Keys)	6-pin 0-bitted 0B Schlage Large Format Interchangeable Core	59.50	
		6-pin Keyed Different KD Schlage Large Format Interchangeable Core	66.50	
	ULLFIC6 (Includes 2 Keys)	UL-Listed 6-pin "A" 0-bitted 0B Schlage Large Format Interchangeable Core	74.00	
		UL-Listed 6-pin "A" Keyed Different KD Schlage Large Format Interchangeable Core	78.50	
	SFIC7 (Includes 2 Keys)	7-pin 0-bitted 0B Small Format Interchangeable Core Cylinder	49.00	
		7-pin Keyed Different KD Small Format Interchangeable Core Cylinder	54.50	
	ANSFIC7 (Includes 2 Keys)	ANSI/BHMA A156.30 certified 7-pin 0-bitted 0B "A" Small Format Interchangeable Core Cylinder	62.00	
		ANSI/BHMA A156.30 certified 7-pin Keyed Different KD "A" Small Format Interchangeable Core Cylinder	65.50	
<p>Adams Rite Cam Standard</p>	MRC114 (Includes 2 Keys)	6-pin 1 1/4" 0-bitted 0B Mortise-Rim Combination Cylinder Rim Pack Included	49.00	US26D
		6-pin 1 1/4" Keyed Different KD Mortise-Rim Combination Cylinder Rim Pack Included	54.00	
	ULMRC114 (Includes 2 Keys)	UL-Listed 6-pin 1 1/4" "A" 0-bitted 0B Mortise-Rim Combination Cylinder Rim Pack Included	62.00	
		UL-Listed 6-pin 1 1/4" "A" Keyed Different KD Mortise-Rim Combination Cylinder Rim Pack Included	66.00	
	MRC118 (Includes 2 Keys)	6-pin 1 1/8" 0-bitted 0B Mortise-Rim Combination Cylinder Rim Pack Included	49.00	
		6-pin 1 1/8" Keyed Different KD Mortise-Rim Combination Cylinder Rim Pack Included	54.00	
	ULMRC118 (Includes 2 Keys)	UL-Listed 6-pin 1 1/8" "A" 0-bitted 0B Mortise-Rim Combination Cylinder Rim Pack Included	62.00	
		UL-Listed 6-pin 1 1/8" "A" Keyed Different KD Mortise-Rim Combination Cylinder Rim Pack Included	66.00	
	MRCLFIC-2-H	Mortise-Rim Combination Large Format IC Housing Adams Rite Cam Standard (Rim Pack Included)	34.50	
	MRCSFIC-1-H	Mortise-Rim Combination Small Format IC Housing Adams Rite Cam Standard (Rim Pack Included)	34.50	
	KBL5	5-pin sidebar keyway Key Blank For Key-In-Knob/Lever, Schlage LFIC and Mortise/Rim Cylinders	4.70	
	KBL6	6-pin sidebar keyway Key Blank For Key-In-Knob/Lever, Schlage LFIC and Mortise/Rim Cylinders	4.70	
	KBLSF7	7-pin sidebar keyway Key Blank For Small Format Interchangeable Core	4.70	
	KCK6	Schlage LFIC, 6-pin Key-In-Knob/Lever and Mortise /Rim Cylinder sidebar keyway Control Key	4.70	

Standard Schlage Pinning kits are used for all cylinders except for Small Format, which uses Best pinning kits

CRP HSK HIGH SECURITY LIST Price

ACCESSORIES

ILLUSTRATION	ITEM#	DESCRIPTION	PACK QUANTITY	LIST PRICE /PACK
MORTISE-RIM CYLINDER COMBO and Small Format IC Housing COMPONENTS (NON-UL)				
	CAMADAM-1	Adams Rite Cam	5	\$2.15
	CAMYALE-2	Yale Wide Cam	5	2.15
	CAMYALE-2A	Yale Standard Cam	5	2.15
	CAMRUSS-3	Corbin Russwin Cam	5	2.15
	CAMFLCN-4	Falcon Cam	5	2.15
	CAMSCHL-7	Schlage Cam	5	2.15
	CAMSGNT-8	Sargent Offset Cam	5	2.15
	CAMSCREW	Cam Screw	25	2.25
MORTISE AND KIKL CYLINDER COMPONENTS (NON-UL)				
	SIDEBAR-1	Side Bar	10	6.50
	SPIN1	Side Pin #1	10	6.70
	SPIN2	Side Pin #2	10	6.70
	SPIN3	Side Pin #3	10	6.70
	SPIN4	Side Pin #4	10	6.70
	SIDEBARSPRING	Spring for Side Bar	20	0.80
	KIKSPRING	Spring for Screw Cap	25	1.50
	MRTPINSPRING	Mortise Pin Spring	50	2.00
	KIKPINSPRING	Top Pin Spring	50	2.00
	LZTPSD-01	Lazy Tailpiece Long for Single Cylinder	10	9.60
	LZTPDD-01	Lazy Tailpiece Short for Double Cylinder Black	10	2.00
	LZTPDD-02	Lazy Tailpiece Short for Double Cylinder Gold	10	2.00
	TPWASHER	Black Washer to retain Long Tailpiece LZTPSD-01	10	3.91
	KIKLZTP-01	Lazy Tailpiece for Knob/Lever 5/8"	5	4.89
	KIKLZTP-02	Lazy Tailpiece for Knob/Lever 5/8"	5	4.89
	KIKLZTP-03	Lazy Tailpiece for Knob/Lever 7/8"	5	4.89
	KIKLZTP-04	Lazy Tailpiece for Knob/Lever 15/16"	5	4.89
	KIKLZTP-05	Lazy Tailpiece for Knob/Lever 1 5/32"	5	4.89
	KIKLZTP-06	Lazy Tailpiece for Knob/Lever 1 5/32" Narrow Tip	5	7.09
		ALLNSCRW-BLK	Allen Screw Black	25
KIKPIN		Pin for Screw Cap	25	29.75
KIKLCAP-01		KIKL Cap Long	10	21.40
KIKLCAP-02		KIKL Cap Short	10	18.10
MSHRMTPIN		Mushroom Top Pin	50	6.50
RIM PACK		Mortise-Rim Combo component parts pack	1	2.31
SMALL FORMAT INTERCHANGEABLE CORE (SFIC) CYLINDER HOUSING COMPONENTS				
	SFICSPIN1	SFIC Side Pin #1	10	6.70
	SFICSPIN2	SFIC Side Pin #2	10	6.70
	SFICSPIN3	SFIC Side Pin #3	10	6.70
	SFICSIDEBAR	SFIC Side Bar	10	6.50
	SFICCLIP	SFIC "C" Clip	25	5.75
	SFICSBSPR	SFIC Side Bar Spring	25	1.00
	SFICALLNSCRW	SFIC Allen Screw	25	16.00
	SFICPSPR	SFIC Pin Spring	50	2.00



CRP HSK HIGH SECURITY LIST Price

ACCESSORIES

ILLUSTRATION	ITEM#	DESCRIPTION	PACK QUANTITY	LIST PRICE /PACK
LARGE FORMAT INTERCHANGEABLE CORE (LFIC) CYLINDER HOUSING COMPONENTS				
	LFCAMADAM-1	LFIC Adams Rite Cam	5	\$2.10
	LFCAMYALE-2	LFIC Yale Wide Cam	5	2.10
	LFCAMYALE-2A	LFIC Yale Standard Cam	5	2.10
	LFCAMRUSS-3	LFIC Corbin Russwin Cam	5	2.10
	LFCAMFLCN-4	LFIC Falcon Cam	5	2.10
	LFCAMSCHL-7	LFIC Schlage Cam	5	2.10
	LFCAMSCRW	LFIC Cam Screw	15	2.20

MORTISE-RIM CYLINDER COMBO and Small Format IC Housing COMPONENTS (UL-LISTED)				
	ULCAMADAM-1	UL-Listed Adams Rite Cam	5	7.95
	ULCAMYALE-2	UL-Listed Yale Wide Cam	5	7.95
	ULCAMYALE-2A	UL-Listed Yale Standard Cam	5	7.95
	ULCAMRUSS-3	UL-Listed Corbin Russwin Cam	5	7.95
	ULCAMFLCN-4	UL-Listed Falcon Cam	5	7.95
	ULCAMSCHL-7	UL-Listed Schlage Cam	5	7.95
	ULCAMSGNT-8	UL-Listed Sargent Offset Cam	5	7.95
	CAMSCREW	Cam Screw	25	2.25

MORTISE AND KIKL CYLINDER COMPONENTS (UL-LISTED)				
	ALLNSCRW-SS	Allen Screw Stainless Steel	25	11.25
	ULMSHRMTPN	UL-Listed Mushroom Top Pin	50	18.50
	SSBPIN1	Stainless Steel Bottom Pin#1	12	1.85
	SSBPIN2	Stainless Steel Bottom Pin#2	12	1.85
	SSBPIN3	Stainless Steel Bottom Pin#3	12	1.85
	SSBPIN4	Stainless Steel Bottom Pin#4	12	1.85
	SSBPIN5	Stainless Steel Bottom Pin#5	12	1.85
	SSBPIN6	Stainless Steel Bottom Pin#6	12	1.85
	SSBPIN7	Stainless Steel Bottom Pin#7	12	1.85
	SSBPIN8	Stainless Steel Bottom Pin#8	12	1.85
SSBPIN9	Stainless Steel Bottom Pin#9	12	1.85	

OTHER ACCESSORIES				
SEE PAGE L79	REGCARD	High Security Plastic Registration Card	10	23.00
	KITPARTS-1	Parts Kit for CRP High Security	1	145.35
	KITSTDPIN-2	Standard Pin Kit for CRP High Security	1	112.51
	KITULPIN-3	UL-Pinning Kit for CRP High Security	1	80.05
	KITULPIN-4	UL-Parts Kit for CRP High Security	1	165.22
	KITSFICPARTS-5	SFIC Parts	1	88.45
	KITCAM-6	Small & Large Format Cams UL & Non-UL	1	116.71

COMMERCIAL LOCKSETS KEYING CHARGES		NET PRICE
ITEM #	DESCRIPTION	
KA	Key Alike KA / 0-bitted 0B	\$1.06/cylinder
MK	Master Keying (Including KA charges)	3.18/cylinder
GMK	Grand Master Keying (Including KA & MK charges)	4.00/cylinder
CMK	Construction Master Keying (Including KA & MK charges)	5.00/cylinder
KM	Key Marking letters or numbers (AA1,AA2, ...) on key bow or cylinder core	1.33/key
DND	Do Not Duplicate	0.85/key
HECK	Extra Cut High Security Keys (2 keys standard per lock)	3.00/key



Standard Schlage Pinning kits are used for all cylinders except for Small Format, which uses Best pinning kits

CRP HSK HIGH SECURITY LIST Price

ACCESSORY KITS

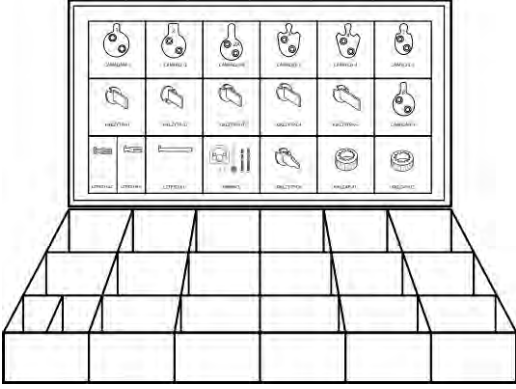
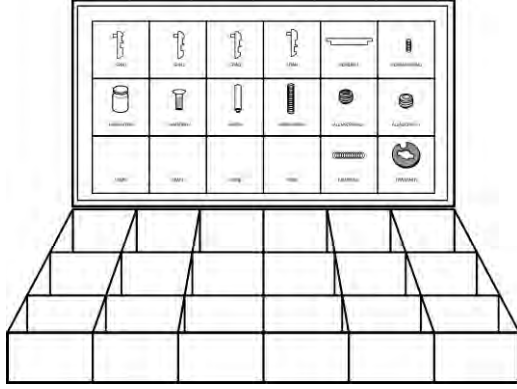
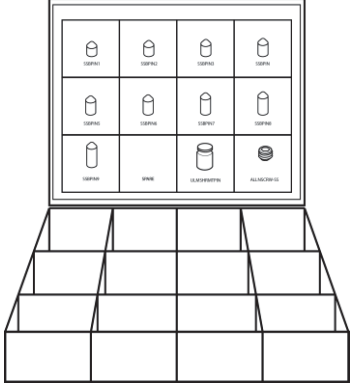
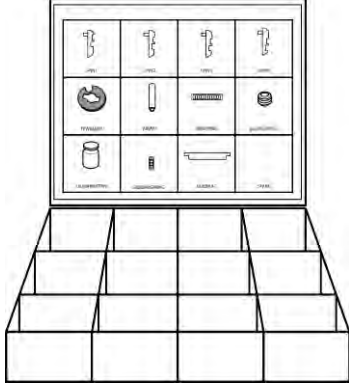
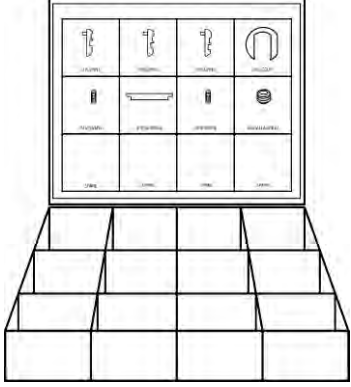
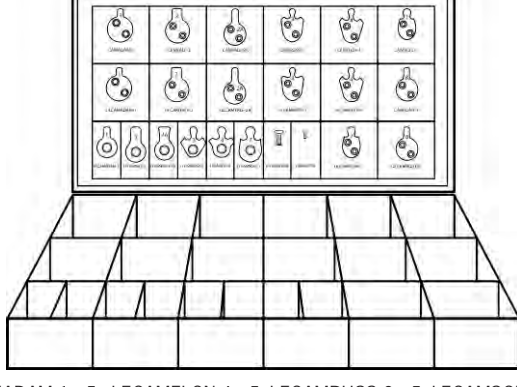
KITPARTS-1	\$145.35	KITSTDPIN-2	\$112.51
 <p>CAMADAM-1 x 10, CAMYALE-2 x 10, CAMYALE-2A x 10, CAMRUSS-3 x 10, CAMFLCN-4 x 10, CAMSCHL-7 x 10, CAMSGNT-8 x 10, KIKLCAP-01 x 10, KIKLCAP-02 x 10, RIMPACK x 2, KIKLZTP-01 x 5, KIKLZTP-02 x 5, KIKLZTP-03 x 5, KIKLZTP-04 x 5, KIKLZTP-05 x 5, KIKLZTP-06 x 5, LZTPDD-BLK x 20, LZTPDD-GLD x 20, LZTPSD-01 x 10</p>	 <p>ALLNSCRW-SS x 25, ALLNSCRW-BLK x 25, KIKPINSRING x 100, KIKSPRING x 25, CAMSCREW x 25, SIDEBAR-1 x 10, MSHRMTPIN x 50, KIKPIN x 25, SPIN1 x 10, SPIN2 x 10, SPIN3 x 10, SPIN4 x 10, TPWASHER x 10, SIDEBARSPRING x 20</p>		
KITULPIN-3	80.05	KITULPIN-4	165.22
 <p>SSBPIN1 x 24, SSBPIN2 x 24, SSBPIN3 x 24, SSBPIN4 x 24, SSBPIN5 x 24, SSBPIN6 x 24, SSBPIN7 x 24, SSBPIN8 x 24, SSBPIN9 x 24, ULMHRMTPIN x 50, ALLNSCRW-SS x 25</p>	 <p>SPIN1 x 20, SPIN2 x 20, SPIN3 x 20, SPIN4 x 20, TPWASHER x 20, KIKPIN x 25, KIKSPRING x 25, ALLNSCRW-SS x 25, ULMHRMTPIN x 100, SIDEBARSPRING x 20, SIDEBAR-1 x 10</p>		
KITSFICPARTS-5	88.45	KITCAM-6	116.71
 <p>SFICSPIN1 x 20, SFICSPIN2 x 20, SFICSPIN3 x 20, SFICCCLIP x 25, SFICSPR x 50, SFICSIDEBAR x 10, SFICBSPR x 25, SFICALLNSCRW x 25</p>	 <p>LFCAMADAM-1 x 5, LFCAMFLCN-4 x 5, LFCAMRUSS-3 x 5, LFCAMSCHL-7 x 5, LFCAMSCRW x 30, LFCAMYALE-2 x 5, LFCAMYALE-2A x 5, MRTPINSPRING x 50, ULCAMADAM-1 x 5, ULCAMFLCN-4 x 5, ULCAMRUSS-3 x 5, ULCAMSCHL-7 x 5, CAMSCREW x 25, ULCAMSGNT-8 x 5, ULCAMYALE-2 x 5, ULCAMYALE-2A x 5, CAMADAM-1 x 5, CAMYALE-2 x 5, CAMYALE-2A x 5, CAMRUSS-3 x 5, CAMFLCN-4 x 5, CAMSCHL-7 x 5, CAMSGNT-8 x 5</p>		

ASHLEY Series List Price

RESIDENTIAL TUBULAR LOCKSETS AND LEVERSETS ANSI STANDARD A156.2, GRADE 3

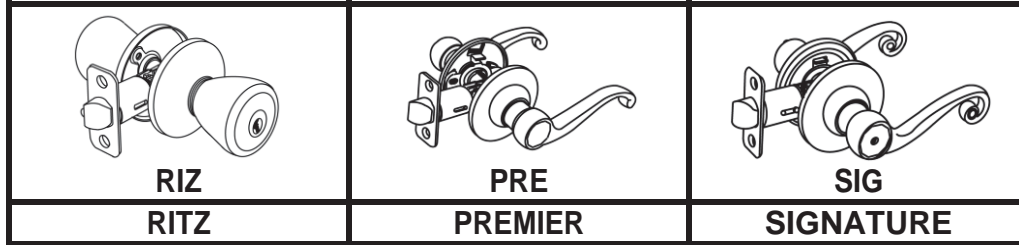

QUANTITY DISCOUNT

300 UNITS
MIXED
LESS 5%

600 UNITS
MIXED
LESS 10%

► KEYWAYS KW 5-PIN KWIKSET

STOCK ITEM PRICES IN BOLD

NON-STOCK FINISHES AND DESIGNS AVAILABLE WITH FACTORY LEAD TIME
AND SUBJECT TO MINIMUM ORDER

► KNOB DESIGNS

RITZ ----- RIZ SERIES

FUNCTIONS	ANSI	ITEM #	US3	US26D	US5	US15	US4,15A, 10B	US26	PCS /MC
Entry KA/3	F109	RIZ-00	\$18.39	\$18.39	\$20.15	\$20.15	\$20.15	\$20.15	36
Storeroom KD	F86	RIZ-05		18.39	20.15	20.15	\$20.15	\$20.15	
Privacy	F76	RIZ-20	15.03	15.03	16.78	16.78	\$16.78	16.78	
Bathroom split	F76	RIZ-20/26	15.03	15.03	16.78	----	\$15.03	-----	
Passage	F75	RIZ-30	14.45	14.45	16.18	16.18	\$16.18	16.18	
Dummy	----	RIZ-40	5.69	5.69	6.42	6.42	\$6.42	6.42	

► LEVERSET DESIGNS

PREMIER ----- PRE SERIES

FUNCTIONS	ANSI	ITEM #	US3, 26D	US15	US10B	US26, 15A	US5	US4	PCS /MC
Entry KD Lever/Lever *SH	F109	LEPRE-00	24.23	24.23	25.20	25.61	\$25.61	\$25.61	24
Privacy *SH	F76	PRE-20	22.75	24.80	24.08	24.52	24.52	\$24.52	
Bathroom split *SH	F76	PRE-20/26		----	----	24.52	24.52	\$24.52	
Passage *SH	F75	PRE-30	21.89	21.89	22.71	23.63	23.63	\$23.63	
Dummy *SH	----	PRE-40	10.78	10.78	12.95	11.68	\$11.68	\$11.68	36

*SH is for specify handing

SIGNATURE ----- SIG SERIES

FUNCTIONS	ANSI	ITEM #	US3	US26D	US5	US4,15A, 15,10B	US26	PCS /MC
Entry KD Lever/Lever *SH	F109	LESIG-00	24.23	24.23	27.13	\$27.13	\$27.13	24
Privacy *SH	F76	SIG-20	22.75	22.75	24.52	\$24.52	24.52	
Bathroom split *SH	F76	SIG-20/26		24.52	24.52	----	----	
Passage *SH	F75	SIG-30	21.89	21.89	23.63	\$23.63	23.63	
Dummy *SH	----	SIG-40	10.78	10.78	11.68	\$11.68	\$11.68	36

*SH is for specify handing

Premier and Signature Series are reversible non-handed except **LESIG-00**. Specify handing for convenience. If handing is not available at time of shipment opposite hand will be supplied.

➤ Continued Next Page ➤

► **PACKAGING INCLUDES**

- **Adjustable steel** 2 3/8" and 2 3/4" backset (2 1/4" x 1", 1/4" radius). Drive in latch bolt also available on request. Square corner available on request on special factory order with lead time and subject to minimum quantity.
- All locksets are packed with full lip strike round corner 1/4" radius.
- Square corner available on request.
- Kwikset rekeyable 5-pin cylinder.

QUANTITY DISCOUNT
300 UNITS MIXED – LESS 5%
600 UNITS MIXED – LESS 10%

► **ADDITIONAL PARTS & CHARGES** (STANDARD DISCOUNT ONLY)

ITEM #	DESCRIPTION	LIST PRICE
DRESADJ	Entrance four way adjustable drive-in latch bolt, square corner	\$4.49
SRESADJ	Privacy, passage four way adjustable drive-in latch bolt, square corner	
ASHADJ	Entrance standard adjustable latch bolt, round corner 1" x 2 1/4"	
TS	T-Strike	2.12
FLS	Full lip strike	
ASAST US3, 26D, 26	ANSI ASA strike	2.00
ASASTUS10B, 10		3.00
K1-KEY	Blank keys K1	0.67
KEYS	Extra cut keys	1.56
CRT800	Cylinder removal tool	0.80
LFA18	Latch front adapter to convert 1" faceplate to 1 1/8" wide door preparation	0.25
PDBFLS	Plastic Dust box for Full Lip Strike	1.31
PDB1214	Plastic Dust box for Residential Deadbolt Strike 1" x 2 1/4"	
PDB118234	Plastic Dust box for T-Strike 1 1/8" x 2 3/4"	
PDBTS	Plastic Dust box for Deadbolt T2STRK Strike	
PDB478	Plastic Dust box for ASA Strike	2.64
KEYING KITS		
KKW1200	Keying Kit - KWI Keyway	119.10
MOUNT		
RESMOUNT	3 hole mount for residential locks	70.18

NET PRICES
ON KEYING
NO DISCOUNT ALLOWED

► **KEYING CHARGES** (NO DISCOUNTS ALLOWED)

ITEM #	DESCRIPTION	NET PRICES
KARES	Key Alike	1.06
MKRES	Master Key (Including KA Charges)	1.33
CMKRES	Builder Construction Master Key (Including KA & MK Charges)	1.86
GMKRES	Grand Master Key (Including KA, MK & CMK Charges)	2.38

CHELSIE Series List Price

RESIDENTIAL TUBULAR LOCKSETS, DEADBOLTS, LEVERS AND HANDLESETS, ANSI STANDARD A156.2, GRADE 3

- ▶ **KEYWAYS (STD, "KW" 5-PIN KWIKSET) OPTIONAL 5-PIN SCHLAGE "C" & WEISER**
- All locksets, handle sets and deadbolts are available with **Schlage "C"** and **Weiser** keyway on special factory order only, with no additional charge. Consult factory.
- **SCHLAGE "C" KEYWAY OPTION:** For immediate stock shipment **add \$3.54 List** for keyed entrance lock and single cylinder deadbolts. Prefix C before part# (Ex: REN00 with C keyway is CREN000)
- **WEISER KEYWAY OPTION:** For keyed knob and leversets **add \$2.23 List**. For Single Cylinder Deadbolts, **add \$3.34 List** and for Double Cylinder Deadbolts **add \$6.67 List**. Prefix "W" before Part# (Ex: REN00 with Weiser keyway is WREN00)

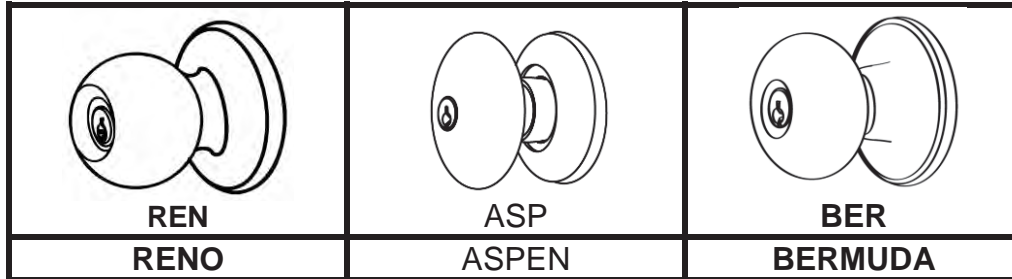

STOCK ITEM PRICES IN BOLD

NON-STOCK FINISHES AND DESIGNS AVAILABLE WITH FACTORY LEAD TIME AND SUBJECT TO MINIMUM ORDER

RENO ----- REN SERIES

FUNCTIONS	ANSI	ITEM #	US15	US10B	US3, 26D, 32D	US5, US26	US15A	PCS/MC
Entry - KA/3	F109	REN-00	\$17.63	\$20.60	\$17.63	\$19.41	\$19.41	36
Storeroom - KA/3	F86	REN-05 ^{***}						
Privacy	F76	REN-20	14.67	17.63	14.67	16.16	16.16	
Passage	F75	REN-30	13.78	16.74	13.78	15.11	15.11	
Dummy	----	REN-40	6.08	9.04	6.08	6.67	6.67	

 Prefix "UL" before PART# when ordering UL Listed, available on Entrance and Passage functions. **Add \$3.00 List.**
 ***REN05 US26 Non-Stock

ASPEN ----- ASP SERIES

FUNCTIONS	ANSI	ITEM #	US3	US15	US10B	US5, 15A, 26, 26D	PCS /MC
Entry - KA/3	F109	ASP-00	20.60	23.55	26.51	23.55	36
Storeroom - KA/3	F86	ASP-05					
Privacy	F76	ASP-20	17.63	20.60	23.55	20.60	
Passage	F75	ASP-30	16.74	19.71	22.66	19.71	
Dummy	----	ASP-40	9.04	10.52	13.49	10.52	

 Prefix "UL" before PART# when ordering UL Listed, available on Entrance and Passage functions. **Add \$3.00 List.**

BERMUDA ----- BER SERIES

FUNCTIONS	ANSI	ITEM #	US3	US15	US10B	US5,15A, 26,26D	PCS /MC
Entry - KA/3	F109	BER-00	19.12	20.60	24.74	20.60	36
Storeroom - KA/3	F86	BER-05					
Privacy	F76	BER-20	15.56	17.04	20.60	17.04	
Passage	F75	BER-30	14.67	16.16	19.41	16.16	
Dummy	----	BER-40	6.67	7.27	8.74	7.27	

 Prefix "UL" before PART# when ordering UL Listed, available on Entrance and Passage functions. **Add \$3.00 List.**

QUANTITY DISCOUNT

300 UNITS MIXED - LESS 5%

600 UNITS MIXED - LESS 10%

► LEVERSET DESIGNS

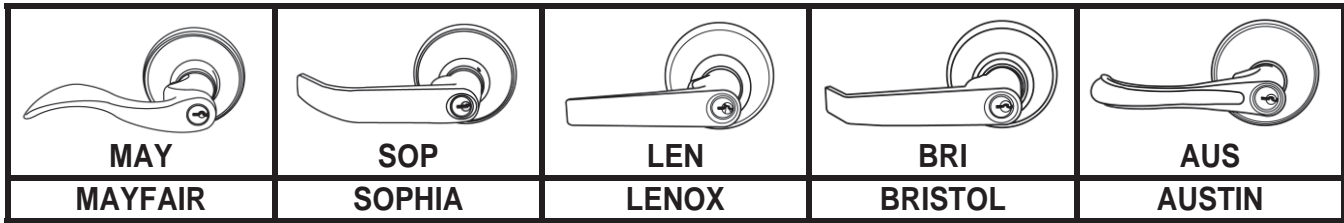

MAYFAIR ----- MAY SERIES

FUNCTIONS	ANSI	ITEM #	US3, 15	US10B	US26D	US5	US15A, 26	PCS/MC
Entry - KA/3 *SH	F109	MAY-00	\$22.07	\$25.04	\$22.07	\$24.30	\$24.30	24
Storeroom - KA/3 *SH	F86	MAY-05						
Privacy *SH	F76	MAY-20	20.00	22.96	20.00	22.07	22.07	
Passage *SH	F75	MAY-30	19.12	22.07	19.12	21.03	21.03	
Active Dummy *SH	----	MAY-40	9.64	12.60	9.64	10.66	10.66	

UL Prefix "UL" before PART# when ordering UL Listed, available on Entrance and Passage functions. Add \$3.00 List.
 * SH is for Specify Handing

SOPHIA ----- SOP SERIES

FUNCTIONS	ANSI	ITEM #	US3, 15	US 10B	US26D	US5, 15A, 26	PCS/MC
Entry - KA/3	F109	SOP-00	22.07	25.04	22.07	24.30	24
Storeroom - KA/3	F86	SOP-05					
Privacy	F76	SOP-20	20.00	22.96	20.00	22.07	
Passage	F75	SOP-30	19.12	22.07	19.12	21.03	
Active Dummy	----	SOP-40	9.64	12.60	9.64	10.66	

UL Prefix "UL" before PART# when ordering UL Listed, available on Entrance and Passage functions. Add \$3.00 List.

LENOX ----- LEN SERIES

FUNCTIONS	ANSI	ITEM #	US15	US10B	US3, 26D	US5, 26	US15A	PCS/MC
Entry - KA/3	F109	LEN-00	22.07	25.04	22.07	24.30	24.30	24
Storeroom - KA/3	F86	LEN-05						
Privacy	F76	LEN-20	20.00	22.96	20.00	22.07	22.07	
Passage	F75	LEN-30	19.12	22.07	19.12	21.03	21.03	
Active Dummy	----	LEN-40	9.64	12.60	9.64	10.66	10.66	

UL Prefix "UL" before PART# when ordering UL Listed, available on Entrance and Passage functions. Add \$3.00 List.

BRISTOL ----- BRI SERIES

FUNCTIONS	ANSI	ITEM #	US15	US10B	US3, 26D	US5, 15A, 26	PCS /MC
Entry - KA/3	F109	BRI-00	22.07	25.04	22.07	26.51	24
Storeroom - KA/3	F86	BRI-05					
Privacy	F76	BRI-20	20.00	22.96	20.00	22.07	
Passage	F75	BRI-30	19.12	22.07	19.12	21.03	
Active Dummy	----	BRI-40	9.64	12.60	9.64	10.66	

UL Prefix "UL" before PART# when ordering UL Listed, available on Entrance and Passage functions. Add \$3.00 List.

QUANTITY DISCOUNT

300 UNITS MIXED - LESS 5%

600 UNITS MIXED - LESS 10%

AUSTIN ----- AUS SERIES

FUNCTIONS	ANSI	ITEM #	US3, 15	US10B	US5	US26D	US15A, 26	PCS/MC
Entry - KA/3	F109	AUS-00	22.07	25.04	24.30	24.30	24.30	24
Storeroom - KA/3	F86	AUS-05						
Privacy	F76	AUS-20	20.00	22.96	22.07	22.07	22.07	
Passage	F75	AUS-30	19.12	22.07	21.03	21.03	21.03	
Active Dummy	----	AUS-40	9.64	12.60	10.66	10.66	10.66	

UL Prefix "UL" before PART# when ordering UL Listed, available on Entrance and Passage functions. Add \$3.00 List.

► CONTEMPORARY SERIES LEVERSET DESIGNS

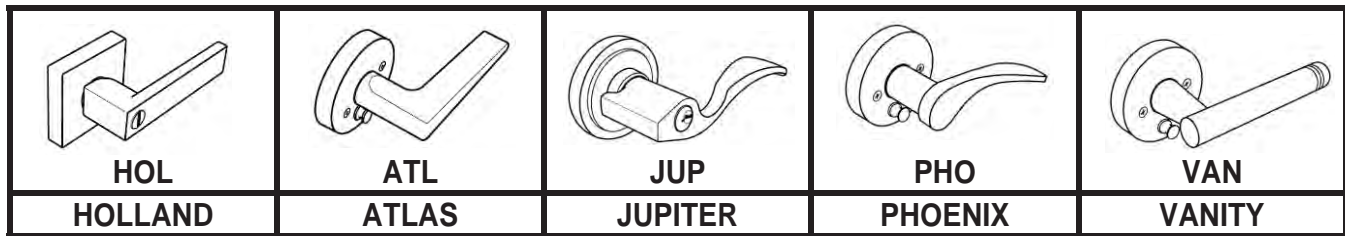

STOCK ITEM PRICES IN **BOLD**

NON-STOCK FINISHES AND DESIGNS AVAILABLE WITH FACTORY LEAD TIME AND SUBJECT TO MINIMUM ORDER

HOLLAND ----- HOL SERIES **NEW PRODUCT**

FUNCTIONS	ANSI	ITEM #	US15	US10B	US3, 26D	US5, 15A, 26	PCS/MC
Entry - KA/3	*NH	F109	HOL-00	45.00	48.00	45.00	48.00
Privacy	*NH	F76	HOL-20	43.00	46.00	43.00	46.00
Passage	*NH	F75	HOL-30	41.00	44.00	41.00	44.00
Dummy	*NH	----	HOL-40	20.00	22.00	20.00	22.00

* NH is for Non Handed

ATLAS ----- ATL SERIES **NEW PRODUCT**

FUNCTIONS	ANSI	ITEM #	US15	US10B	US3, 26D	US5, 15A, 26	PCS/MC
Privacy	*R	F76	ATL-20	41.00	44.00	41.00	44.00
Passage	*NH	F75	ATL-30	39.00	42.00	39.00	42.00
Dummy	*NH	----	ATL-40	19.00	21.00	19.00	21.00

* NH is for Non Handed

* R is for Reversible (Order Handling for Convenience)

JUPITER ----- JUP SERIES **NEW PRODUCT**

FUNCTIONS	ANSI	ITEM #	US15	US10B	US3, 26D	US5, 15A, 26	PCS/MC
Entry - KA/3	*H	F109	JUP-00	36.00	38.00	36.00	38.00
Privacy	*R	F76	JUP-20	34.00	36.00	34.00	36.00
Passage	*R	F75	JUP-30	31.00	33.00	31.00	33.00
Dummy	*H	----	JUP-40	18.00	20.00	18.00	20.00

* H is for Handed (Order Handling, **Not** Reversible)

* R is for Reversible (Order Handling for Convenience)

PHOENIX ----- PHO SERIES **NEW PRODUCT**

FUNCTIONS	ANSI	ITEM #	US15	US10B	US3, 26D	US5, 15A, 26	PCS/MC
Entry - KA/3	*R	F109	PHO-00	45.00	48.00	45.00	48.00
Privacy	*R	F76	PHO-20	43.00	46.00	43.00	46.00
Passage	*R	F75	PHO-30	41.00	44.00	41.00	44.00
Dummy	*H	----	PHO-40	20.00	22.00	20.00	22.00

* R is for Reversible (Order Handling for Convenience)

* H is for Handed (Order Handling, **Not** Reversible)

**QUANTITY
DISCOUNT**

**300 UNITS
MIXED -
LESS 5%**

**600 UNITS
MIXED -
LESS 10%**

VANITY ----- VAN SERIES **NEW PRODUCT**

FUNCTIONS	ANSI	ITEM #	US15	US10B	US3, 26D	US5, 15A, 26	PCS/MC
Privacy	*R	F76	VAN-20	41.00	44.00	41.00	44.00
Passage	*NH	F75	VAN-30	39.00	42.00	39.00	42.00
Dummy	*NH	----	VAN-40	19.00	21.00	19.00	21.00

* NH is for Non Handed

* R is for Reversible (Order Handling for Convenience)

► **LEVERSET PACKAGING INCLUDES**

- **Adjustable steel 2 3/8" and 2 3/4" backset** (2 1/4" x 1", 1/4" radius). Drive in latch bolt also available on request. Square corner available on request on special factory order with lead time and subject to minimum quantity.
- All locksets are packed with full lip strike round corner 1/4" radius. Square corner available on request.
- Kwikset rekeyable 5 pin cylinder.

QUANTITY DISCOUNT
300 UNITS MIXED – LESS 5% ♦
600 UNITS MIXED – LESS 10%

STOCK ITEM PRICES IN BOLD
NON-STOCK FINISHES AND DESIGNS AVAILABLE
WITH FACTORY LEAD TIME AND SUBJECT TO
MINIMUM ORDER

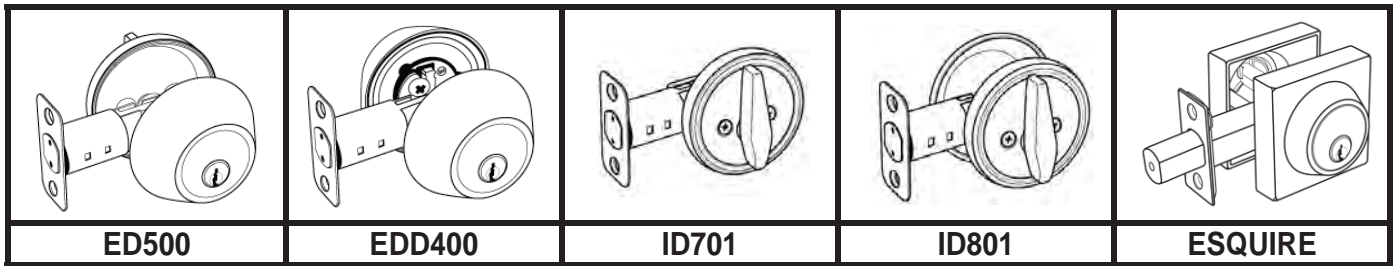

► **DEADBOLTS**

FUNCTIONS	ITEM #	US3	US15	US26D	US10B	US15A	US32D	US5	US26	PCS /MC
Single cylinder deadbolt	ED-500	\$15.94	\$15.94	\$15.94	\$18.77	\$17.35	\$15.94	\$17.35	\$17.35	36
Single cylinder deadbolt UL	ULED-500	21.58	21.58	21.58	24.41	23.01	21.98	23.01	23.00	
Square single cylinder deadbolt	ESQ-101 NEW ITEM	24.00	24.00	24.00	26.00	26.00	N/A	26.00	26.00	
Square double cylinder deadbolt	ESQ-102 NEW ITEM	31.00	31.00	31.00	33.00	33.00	N/A	33.00	33.00	
Double cylinder deadbolt	EDD-400	18.21	18.21	18.21	21.02	20.03	18.21	20.03	20.03	
One sided deadbolt	ID-701	8.93	10.44	10.44	12.55	10.44	10.44	10.44	10.44	
One sided deadbolt with exterior cover plate	ID-801	11.59	13.27	13.27	15.39	13.27	11.59	13.27	13.27	



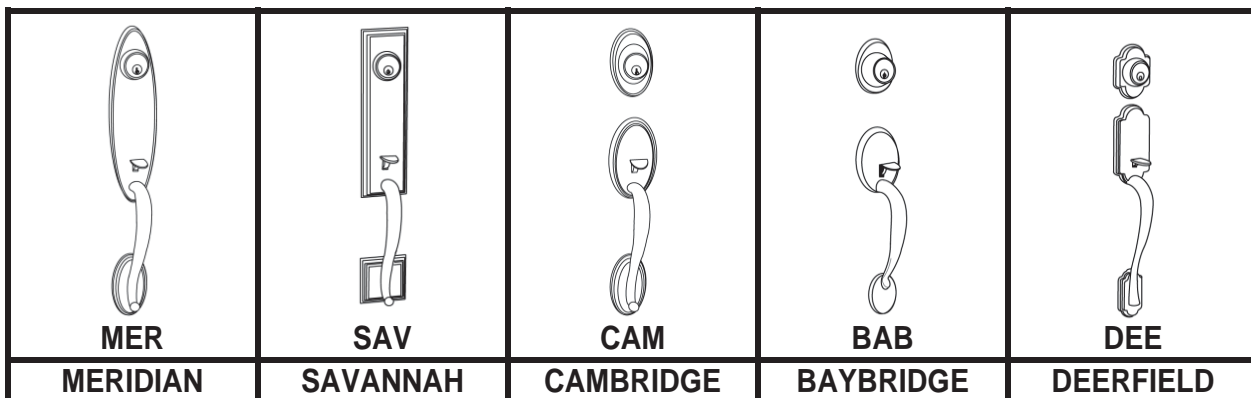

► **HANDLESETS**



MERIDIAN ----- MER SERIES

FUNCTIONS	ITEM #	PVD, US3	US10B	US5,15, 15A, 26	PCS /MC
Solid Brass Handle w/ single cylinder deadbolt KD	MER-00	150.29	150.29	137.64	10
Dummy handle set w/ dummy deadbolt and matching trim	MER-40	143.26	143.26	130.62	

*** All prices above on the **MER Series** are for any design on knobs and lever sets for interior handle. **PRE Premier Series** is not available for interior handle set. All other trims designs are available. On **Chelsie Series** specify at time of order (Ex: MER00/REN)

				
MER	SAV	CAM	BAB	DEE
MERIDIAN	SAVANNAH	CAMBRIDGE	BAYBRIDGE	DEERFIELD

STOCK ITEM PRICES IN BOLD
 NON-STOCK FINISHES AND DESIGNS AVAILABLE WITH FACTORY LEAD TIME AND SUBJECT TO MINIMUM ORDER

SAVANNAH ----- SAV SERIES

FUNCTIONS	ITEM #	PVD, US3	US10B	US5, 15, 15A, 26	PCS /MC
Solid Brass Handle w/ single cylinder deadbolt KD	SAV-00	150.29	150.29	137.64	10
Dummy handle set w/ dummy deadbolt and matching trim	SAV-40	143.26	143.26	130.62	

*** All prices above on the **SAV Series** are for any design on knobs and lever sets for interior handle. **SIG Signature / PRE Premier** Series are not available for interior handle set. All other trims designs are available. On **Chelsie Series** specify at time of order (Ex: SAV00/REN)

CAMBRIDGE -----CAM SERIES

FUNCTIONS	ITEM #	PVD US3	US10B	US5, 15 15A, 26	PCS /MC
Solid Brass Handle w/ single cylinder deadbolt KD	CAM-00	\$144.52	\$144.52	\$123.88	10
Dummy handle set w/ dummy deadbolt and matching trim	CAM-40	137.15	137.15	117.98	

*** All prices above on the **CAM Series** are for any design on knobs and lever sets for interior handle. **PRE Premier** Series is not available for interior handle set. All other trims designs are available. On **Chelsie Series** specify at time of order (Ex: CAM00/REN)

QUANTITY DISCOUNT

300 UNITS MIXED - LESS 5%

600 UNITS MIXED - LESS 10%

BAY BRIDGE ----- BAB SERIES

FUNCTIONS	ITEM #	US15,15A, 26	US10B	US3, 26D	US5	PCS/MC
Handle w/ single cylinder deadbolt	BAB-00	104.88	124.54	95.05	104.88	10
Dummy handle set w/ dummy deadbolt and matching trim	BAB-40	98.32	117.98	88.48	98.32	

*** All prices above on the **BAB Series** are for design knob for interior handle. **PRE Premier and SIG Signature** Series are not available for interior handle set. All other trims designs are available. Specify at time of order (Ex BAB00/LENTRIM is BAB00 with LEN lever design on interior.)

DEERFIELD ----- DEE SERIES

FUNCTIONS	ITEM #	US3	US15	US10B	US5,15A, 26	US26D	PCS/MC
Handle w/ single cylinder deadbolt	DEE-00	104.88	114.70	134.38	114.70	114.70	10
Dummy handle set w/ dummy deadbolt and matching trim	DEE-40	98.32	108.16	127.82	108.16	108.16	



*** All prices above on the **DEE Series** are for design knob for interior handle. **PRE Premier and SIG Signature** Series are not available for interior handle set. All other trims designs are available. Specify at time of order (Ex BAB00/LENTRIM is BAB00 with LEN lever design on interior.)

► **DEADBOLT AND HANDLESET PACKAGING INCLUDES:**

- **Adjustable steel** 2 3/8" and 2 3/4" backset (2 1/4" x 1", 1/4" radius). Drive in latch bolt also available on request. Square corner available upon request on special factory order with lead time.
- Deadbolts packed with 1" x 2 1/4" strike round corner 1/4" radius and full lip strike 1/4" radius. Square corner available upon request. On special factory order with lead time.
- **Security strike** (1 1/4" x 3 5/8", 1/4" radius) with 3" screws available with an additional charge.
- Kwikset rekeyable 5 pin cylinder.

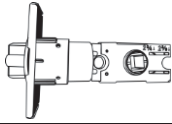
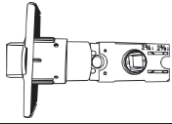
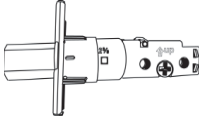
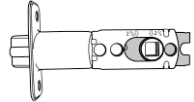
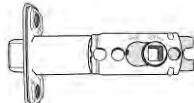
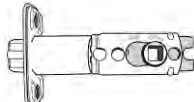
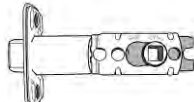
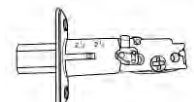
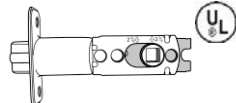
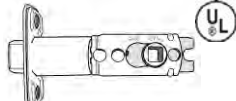
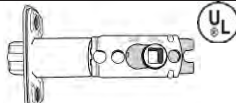
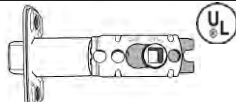
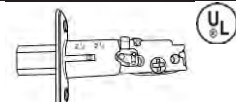
ADDITIONAL PARTS & CHARGES

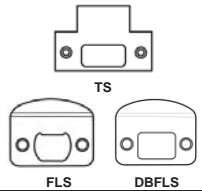
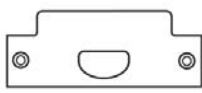
◆◆◆ STANDARD DISCOUNT ONLY ◆◆◆			
ILLUSTRATION	ITEM #	DESCRIPTION	LIST PRICE
	4DRIVE2-1	Entrance Four Way Adjustable Drive In Latch bolt, with removable Square Corner faceplate for knobsets	\$4.49
	4DRIVE2-2	Entrance Four Way Adjustable Drive In Latch bolt, with removable Square Corner faceplate for leversets	
	4DRIVP2-1	Privacy, Passage Four Way Adjustable Drive In Latch bolt, with removable Square Corner faceplate for knobsets	
	4DRIVP2-2	Privacy, Passage Four Way Adjustable Drive In Latch bolt, with removable Square Corner faceplate for leversets	
	4DRIV31	Deadbolt Four Way Adjustable Drive-In Latch bolt, with removable Square Corner faceplate	6.04
	ENTK-4 NEW ITEM	Adjustable Dead Latch 2 3/8" or 2 3/4" with round corner faceplate for Entrance Knobsets	4.49
	PASK-6 NEW ITEM	Adjustable Spring Latch 2 3/8" or 2 3/4" with round corner faceplate for Passage Knobsets	4.49
	ENTL-5 NEW ITEM	Adjustable Dead Latch 2 3/8" or 2 3/4" with round corner faceplate for Entrance Leversets	4.49
	PASL-7 NEW ITEM	Adjustable Spring Latch 2 3/8" or 2 3/4" with round corner faceplate for Passage Leversets	4.49
	DB-8 NEW ITEM	Adjustable Deadbolt Latch 2 3/8" or 2 3/4" for Deadbolts	6.04
	ULENTK-4 NEW ITEM	UL-Listed Adjustable Dead Latch 2 3/8" or 2 3/4" with round corner faceplate for Entrance Knobsets	7.12
	ULPASK-6 NEW ITEM	UL-Listed Adjustable Spring Latch 2 3/8" or 2 3/4" with round corner faceplate for Passage Knobsets	7.12
	ULENTL-5 NEW ITEM	UL-Listed Adjustable Dead Latch 2 3/8" or 2 3/4" with round corner faceplate for Entrance Leversets	7.12
	ULPASL-7 NEW ITEM	UL-Listed Adjustable Spring Latch 2 3/8" or 2 3/4" with round corner faceplate for Passage Leversets	7.12
	ULDB-8 NEW ITEM	UL-Listed Adjustable Deadbolt Latch 2 3/8" or 2 3/4" for Deadbolts	9.34

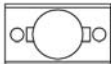
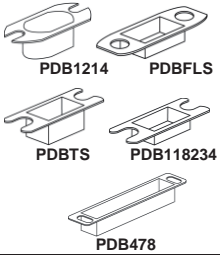
◆◆◆ STANDARD DISCOUNT ONLY ◆◆◆			
	TS	T-Strike	2.12
	FLS	Full Lip Strike	
	DBFLS	Deadbolt Full Lip Strike, Round Corner	1.53
	ASAST US3, 26D, 26	ANSI ASA Strike	2.00
	ASAST US10B, 10	ANSI ASA Strike	3.00
	SS114358	Security Strike 1 1/4" X 3 5/8", 1/4" Rad With 2pcs each of 3" and 1 1/4" Screws US3,5,25,26D,10B	2.67
	K1-KEY	Blank Keys K1	0.67
	KEYS	Extra Cut Keys	1.56
	LFA18	Latch Front Adapter To Convert 1" Faceplate To 1 1/8" Wide Door Preparation	0.25
	PDBFLS	Plastic Dust box for Full Lip Strike	0.59
	PDB1214	Plastic Dust box for Residential Deadbolt Strike 1" x 2 1/4"	
	PDB118234	Plastic Dust box for T-Strike 1 1/8" x 2 3/4"	
	PDBTS	Plastic Dust box for Deadbolt T2STRK Strike	
	PDB478	Plastic Dust box for ASA Strike	2.64
◆ KEYING KITS			
	KKW1200	Keying Kit - KWI Keyway	119.10
◆ MOUNT			
	RESMOUNT	3 Hole Mount For Residential Locks	70.18

KEYING CHARGES (NO DISCOUNTS ALLOWED)		
ITEM #	DESCRIPTION	NET PRICE
KARES	Key alike	1.06
MKRES	Master key (Including KA charges)	1.33
CMKRES	Builder construction master key (Including KA & MK Charges)	1.86
GMKRES	Grand master key (Including KA, MK)	2.38

**NET PRICES
ON KEYING
NO DISCOUNT
ALLOWED**



HINGES



Ver. 2.0, Rev. 11/12
© 2012  CAL ROYAL

ALL HINGES ARE STAMPED WITH CRP LOGO. FINISHES IN **REVERSE BOLD** *ITALICS* ARE ALSO AVAILABLE W/O LOGO. PREFIX "UN" WHEN ORDERING.

HINGES

Effective February 2013

ITEM #	SIZE	FINISH	LIST PRICE	BOX QTY	CASE QTY
All hinges shown below are stock items for immediate shipment. Designs, sizes and finishes not shown in price list are available subject to quantity and minimum order and lead time.					
HEAVY WEIGHT, BALL BEARING HINGES					
Full Mortise, Heavy Weight, Four Ball Bearings					
UNIT / EACH					
BB-5500	5" x 5"	US26DNRP	\$23.56	3	48
		US32D	51.41		
		US10E	24.74		
BB-5210	5" x 4 1/2"	USP	20.62		
		US26D	22.39		
		US26DNRP	23.56		
		US10	24.74		
		US10A	24.74	3	48
		US10E	24.74		
		US10BNRP	25.92		
		US3	24.74		
		US4	22.39		
		US26	24.74		
		US32D	45.35		
		US32DNRP	47.70		
BB-5254	5" x 4"	USP	20.62		
		US26D	22.29	3	48
		US10A	24.74		
		US10B	24.74		
		US32D	45.35		
BB-5200	4 1/2" x 4 1/2"	USP	15.90		
		US26DNRP	18.14		
		US10A	19.08		
		US10E	19.08		
		US10BNRP	20.26	3	48
		US10	15.90		
		US4	15.90		
		US3	19.08		
		US3NRP	20.26		
		US26	19.08		
		US32DNRP	35.21		
BB-52454	4 1/2" x 4"	USP	15.90		
		US26D	16.96		
		US10A	19.08	3	48
		US4	15.90		
		US3	19.08		
		US26	19.08		
		US32D	32.86		
		US32DNRP	35.21		
**Other sizes and finishes available up to 8" x 8" upon request. All hinges above are steel base material with the exception of US32D. (STAINLESS STEEL) For solid brass base, prefix "SB" before part # Price and availability on application. (SUBJECT TO LEAD TIME AND QUANTITY)					
STANDARD WEIGHT, BALL BEARING HINGES					
Full Mortise, Standard Weight, Two Ball Bearings					
UNIT / EACH					
BB-55	5" x 5"	US26D	14.14		
		US3	20.02		
		US4	18.38	3	48
		US26	20.02		
		US10	18.38		
		US10E	18.38		
		US32D	44.75		
BB-545	5" x 4 1/2"	USP	10.60		
		US26D	12.72		
		US26	17.67		
		US4	15.07		
		US10	15.07	3	48
		US10A	15.07		
		US10E	15.07		
		US3	17.67		
		US32D	31.80		

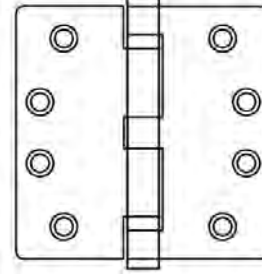
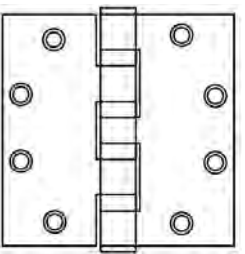
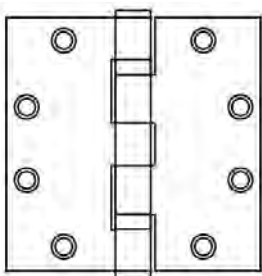

ITEM #	SIZE	FINISH	LIST PRICE	BOX QTY	CASE QTY
STANDARD WEIGHT, BALL BEARING HINGES					
UNIT / EACH					
BB-54	5" x 4"	USP	\$10.60		
		US26D	12.72		
		US10A	15.07	3	48
		US3	17.67		
		US32D	31.80		
BB-31	4 1/2" x 4 1/2"	USP	5.18		
		USPNRP	5.89		
		US26D	7.48		
		US26DNRP	8.19		
		US10A	8.13		
		US10ANRP	9.31		
		US10E	8.84		
		US10BNRP	10.02		
		US10	7.30		
		US10NRP	8.48		
		US15A	8.13	3	48
		US15	8.13		
		US4	6.72		
		US4NRP	7.90		
		US3	9.90		
		US3NRP	11.08		
		US5	8.13		
		US26	9.90		
		DURO	6.24		
		US1D	6.24		
		US32D	21.20		
		US32DNRP	23.55		
BB-454	4 1/2" x 4"	USP	5.18		
		US26D	7.48		
		US26DNRP	8.66		
		US10A	8.13		
		US10B	8.13	3	48
		US4	6.72		
		US3	9.90		
		US26	9.90		
		US1DNRP	6.24		
		US32DNRP	23.55		
BB SC-56	4" x 4"	USP	5.43		
		US1D	8.25		
		US26D	6.13		
		US10	7.66		
		US10A	7.66		
		US15A	7.66		
		US10E	7.66	3	48
		US15	7.66		
		US4	6.13		
		US3	8.84		
		US5	7.66		
		US26	8.84		
		US32D	18.26		
RCBB454	4 1/2" x 4"	US1NRP	8.19		
	1/8" Radius	US26DNRP	8.19	3	48
BB RC-45	4" x 4"	USP	5.43		
	1/4" Radius Template	US1D	8.84		
		US26D	6.13		
		US10	7.66		
		US10A	7.66		
		US10ANRP	8.84		
		US15A	7.66		
		US10B	7.66	3	48
		US15	7.66		
		US4	6.13		
		US3	8.84		
		US5	7.66		
		US26	8.84		
		US32D	15.50		
		DURO	7.07		



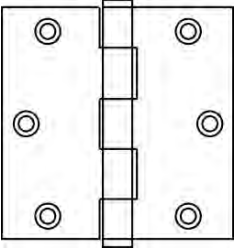
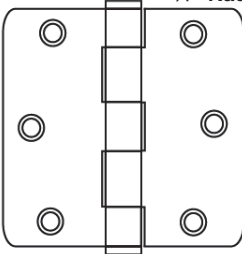

ALL HINGES ARE STAMPED WITH CRP LOGO. FINISHES IN **REVERSE BOLD ITALICS** ARE ALSO AVAILABLE W/O LOGO. PREFIX "UN" WHEN ORDERING.

HINGES

Effective February 2013

ITEM #	SIZE	FINISH	LIST PRICE	BOX QTY	CASE QTY
STANDARD WEIGHT, PLAIN BEARING HINGES					
UNIT / EACH					
TBH RC-5844	4" x 4" 5/8" Radius	US3	\$6.49	3	48
TBH SC-77	3 1/2" x 3 1/2"	USP US1D US26D US10A US15A US10B US15 US4 US3 US5 US26 US10 US32D US32DNRP	2.60 4.24 3.77 4.37 4.37 4.37 4.37 3.77 5.30 4.37 5.30 4.24 14.14 16.49	2	100
					
TBH RC-66	3 1/2" x 3 1/2" 1/4" Radius	USP US1D US26D US10A US10B US15 US15A US4 US3 US5 US26	3.54 4.24 4.72 5.30 5.30 5.30 5.30 4.72 5.30 5.30 5.30	2	100
					
TBH SC-33	3" x 3"	US26D US10A US10B US15 US15A US26 US3 US32D	3.06 4.35 4.35 4.35 4.35 4.35 6.60	2	100
** Other sizes AND FINISHES available up to 6" X 6" upon request. ALL hinges above are steel base material with the exception of US32D. (STAINLESS STEEL) For solid brass base, prefix "SB" before part #. Price and availability on application. (SUBJECT TO LEAD TIME AND QUANTITY)					
DECORATIVE TIPS FOR STEEL PLATED COMMERCIAL HINGES					
BALL TIP					
UNIT / EACH Price Includes: 1 Pin & 2 Tips					
BALL33KIT	Ball Tip Commercial 3" x 3" TBHSC-33 & BBSC-33	US3 US5 US10B US15 US15A US26 US26D	\$2.83	2	100
					
BALL35KIT	Ball Tip Commercial 3 1/2" x 3 1/2" TBHSC77, TBHRC-66 & BBSC-77	US3 US5 US10B US15 US15A US26 US26D	2.83	2	100

ITEM #	SIZE	FINISH	LIST PRICE	BOX QTY	CASE QTY
DECORATIVE TIPS FOR STEEL PLATED COMMERCIAL HINGES					
BALL TIP					
UNIT / EACH Price Includes: 1 Pin & 2 Tips					
BALL44KIT	Ball Tip Commercial 4" x 4" TBHRC-44, TBHSC-55, BBSC-56, BBRC-45, BBRC-5844	US3 US5 US10B US15 US15A US26 US26D	\$2.83	2	100
					
BALL45KIT	Ball Tip Commercial 4 1/2" x 4 1/2" TBH-30, TBH-454, BB-31, BB-454	US3 US5 US10B US15 US15A US26 US26D	2.83	2	100
BALL55KIT	Ball Tip Commercial 5" x 5" BB-55	US3 US5 US10B US15 US15A US26 US26D	2.83	2	100
STEEPLE TIP					
STP33KIT	Steeple Tip Commercial 3" x 3" TBHSC-33 & BBSC-33	US3 US5 US10B US15 US15A US26 US26D	2.83	2	100
					
STP35KIT	Steeple Tip Commercial 3 1/2" x 3 1/2" TBHSC77, TBHRC-66, BBSC-77	US3 US5 US10B US15 US15A US26 US26D	2.83	2	100
STP44KIT	Steeple Tip Commercial 4" x 4" TBHRC-44, TBHSC-55, BBSC-56, BBRC-45, BBRC-5844	US3 US5 US10B US15 US15A US26 US26D	2.83	2	100
STPK45KIT	Steeple Tip Commercial 4 1/2" x 4 1/2" THB-30, TBH-454, BB-31, BB-454	US3 US5 US10B US15 US15A US26 US26D	2.83	2	100
STP55KIT	Steeple Tip Commercial 5" x 5" BB-55	US3 US5 US10B US15 US15A US26 US26D	2.83	2	100
Price Includes: 1 Pin & 2 Tips					

ALL HINGES ARE STAMPED WITH CRP LOGO. FINISHES IN **REVERSE BOLD ITALICS** ARE ALSO AVAILABLE W/O LOGO. PREFIX "UN" WHEN ORDERING.

HINGES

Effective February 2013

ITEM #	SIZE	FINISH	LIST PRICE	BOX QTY	CASE QTY
SOLID BRASS HINGES					
Full Mortise, Standard Weight, Plain Bearing					
UNIT / EACH					
SB TBH-30	4 1/2" x 4 1/2"	US3	\$24.75	3	48
		US26D	18.25		
Two Ball Bearings. Full Mortise, Standard Weight					
SB BB-31	4 1/2" x 4 1/2"	US26D	25.97		
		US10A	27.14		
		US10ANRP	28.32		
		US10B	27.14	3	48
		US3	27.14		
		US26	27.14		
		US4	27.14		

Full Mortise, Heavy Weight, Four Ball Bearing					
SB BB5200	4 1/2" x 4 1/2"	US10A	44.10		
		US10B	44.10	3	48
		US10BNRP	45.28		
		US26DNRP	45.28		
** Other sizes and finishes available upon request. (Subject to lead time and quantity)					

SPECIALTY HINGES

CONCEALED BALL BEARING

Full Mortise, Standard Weight, Concealed Ball Bearings					
UNIT / EACH					
BB-2255	5" x 5"	US26D	18.55		
		US10A	24.86	3	48
		US10B	24.86		
		US32D	49.82		

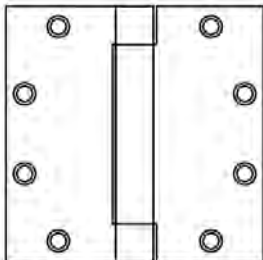

BB-2200	4 1/2" x 4 1/2"	US26D	8.25		
		US4	10.60		
		US10	8.96		
		US10A	8.96		
		US10B	8.96	3	48
		US15	8.96		
		US3	10.60		
		US26	10.60		
		US32D	29.45		

Full Mortise, Heavy Weight, Concealed Ball Bearings

BB-7755	5" x 5"	US26D	\$32.49		
		US10A	43.99	3	48
		US10B	43.99		
		US32D	64.66		

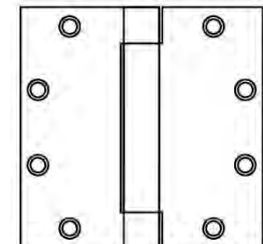

ITEM #	SIZE	FINISH	LIST PRICE	BOX QTY	CASE QTY
--------	------	--------	------------	---------	----------

CONCEALED BALL BEARING

Full Mortise, Heavy Weight, Concealed Ball Bearings					
UNIT / EACH					
BB-3300	4 1/2" x 4 1/2"	US26DNRP	\$26.08		
		US10ANRP	31.80		
		US10B	31.80	3	48
		US3NRP	31.80		
		US26NRP	31.80		
		US32D	52.79		
		US32DNRP	55.14		

** Other sizes and finishes available up to 5" X 5" upon request. All hinges above are steel base material with the exception of US32D. (STAINLESS STEEL) For solid brass base, prefix "SB" before part #. Price and availability on application. (SUBJECT TO LEAD TIME AND QUANTITY)

HALF MORTISE

Half Mortise, Standard Weight, Two Ball Bearings					
UNIT / EACH					
HM-BB4100	4 1/2"	USPNRP	14.14		
		US26DNRP	16.96	3	36
		US10A	21.20		

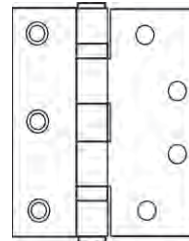

** Half Mortise, Heavy Weight Ball Bearing 4 1/2", 5" available upon request. (Subject to lead time and quantity)

HALF SURFACE

Half Surface, Standard Weight Two Ball Bearings					
UNIT / EACH					
HSBB-4900	4 1/2"	USPNRP	14.14		
		US26DNRP	16.96	3	36
		US10ANRP	21.20		

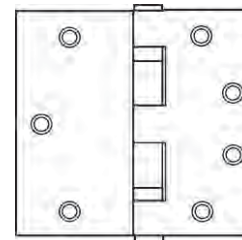

**5" and Half Surface, Heavy Weight Ball Bearing 4 1/2", 5" available upon request. (Subject to lead time and quantity)

FULL SURFACE

Full Surface Standard Weight, Five Knuckle Ball Bearing Hinge With Non Removable Pin

UNIT / EACH					
FSHBB45	4 1/2"	USPNRP	14.14	2	24

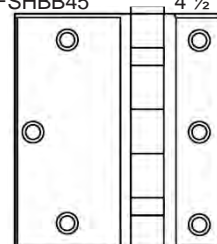

N.R.P. (Non-Removable Pin) where not shown ADD \$1.18/Each List.
N.R.P. for **US32D** ADD \$2.35/Each List.

ALL HINGES ARE STAMPED WITH CRP LOGO. FINISHES IN **REVERSE BOLD ITALICS** ARE ALSO AVAILABLE W/O LOGO. PREFIX "UN" WHEN ORDERING.

HINGES

Effective February 2013

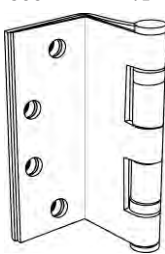
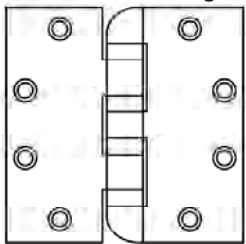
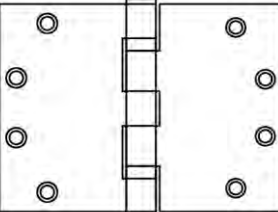
ITEM #	SIZE	FINISH	LIST PRICE	BOX QTY	CASE QTY
SPECIALTY HINGES					
SWING CLEAR					
Full Mortise, Standard Weight, Two Ball Bearings, Swing clear					
			UNIT / EACH		
BB-600	4 1/2"	USP	\$28.62		
		US26D	28.62	3	48
		US10A	33.92		
		US32DNRP	67.84		
					
Full Mortise, Heavy Weight, Four Ball Bearings, Swing clear					
BB-800	4 1/2"	US26D	43.88	3	24
		US32D	83.66		
<p>** 5" Swing Clear, Heavy Weight Ball Bearing 4 1/2", 5".</p> <p>** 5" Half Mortise, Heavy Weight Ball Bearing Swing Clear.</p> <p>** 5" Full Surface, Heavy Weight Ball Bearing Swing Clear.</p> <p>** 5" Half Surface, Heavy Weight Ball Bearing Swing Clear.</p> <p>***** All of above available for Beveled door upon request. *****</p> <p>(Subject to lead time and quantity)</p>					
HOSPITAL TIP HINGES					
With ball bearing, with Hospital Tip					
			UNIT / EACH		
HOSBB31	4 1/2" x 4 1/2"	US26DNRP	15.90	3	48
	0.134" Gauge	US32DNRP	27.56		
HOSBB5200	4 1/2" x 4 1/2"	US26DNRP	25.44	3	48
	0.180" Gauge	US32DNRP	44.52		
					
Other sizes available. (Subject to lead time and quantity)					
WIDE THROW HINGES					
Full Mortise, Standard Weight, Two Ball Bearings					
			UNIT / EACH		
WTHBB-456	4 1/2" x 6"	US26D	28.27		
		US10A	30.62		
		US3	30.62	3	24
		US26	30.62		
		US4	30.62		
		US10	30.62		
					
<p>**Full Mortise, Standard Weight, Plain Bearing from 3 1/2" x 5" to 5" x 8", available upon request.</p> <p>**Full Mortise, Standard Weight, Two Ball Bearings from 3 1/2" x 5" to 5" x 8", available upon request.</p> <p>**Full Mortise, Heavy Weight, Two Ball Bearings from 4 1/2" x 5" to 5" x 8", available upon request.</p> <p>(Subject to lead time and quantity)</p>					

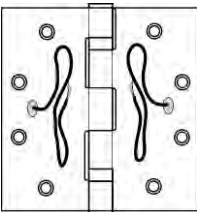
ITEM #	SIZE	FINISH	LIST PRICE	BOX QTY	CASE QTY
ELECTRIFIED HINGES (ENERGY TRANSFER HINGES)					
STANDARD WEIGHT					
Full Mortise, Two Ball Bearings					
			UNIT / EACH		
ELE4BB31	4 1/2" x 4 1/2"	4 wires	US26D		\$151.50
			US3		151.50
			US10A		151.50
			US10B		151.50
			US26		151.50
			US32D	1	202.00
			US10		151.50
			US15		151.50
			US4		151.50
			US5		151.50
					
ELE6BB31	4 1/2" x 4 1/2"	6 wires	US10B		172.50
			US26D	1	172.50
			US32D		222.50
ELE8BB31	4 1/2" x 4 1/2"	8 wires	US10B		198.00
			US26D	1	198.00
			US32D		242.00
HEAVY WEIGHT					
Full Mortise, Four Ball Bearings					
			UNIT / EACH		
ELE4BB5200	4 1/2" x 4 1/2"	4 wires	US10B		192.50
			US26D	1	192.50
			US32D		232.00
ELE4BB5210	5" x 4 1/2"	4 wires	US10B		192.50
			US26D	1	192.50
			US32D		232.00
CONCEALED					
Standard Weight Concealed Ball Bearing					
			UNIT / EACH		
ELE4BB2200	4 1/2" x 4 1/2"	4 wires	US26D	1	160.00
ELE8BB2200		8 wires	US26D	1	202.00
ENERGY TRANSFER HINGES FOR ELECTRIFIED PANIC BAR (ELR)					
STANDARD WEIGHT					
Full Mortise, Two Ball Bearings					
ELELR4BB31	4 1/2" x 4 1/2"	4 wires	US26D	1	212.00
ELELR6BB31	4 1/2" x 4 1/2"	6 wires	US26D	1	212.00
ELELR8BB31	4 1/2" x 4 1/2"	8 wires	US26D	1	222.00
HEAVY WEIGHT					
Full Mortise, Four Ball Bearings					
ELELR4BB5200	4 1/2" x 4 1/2"	4 wires	US26D	1	251.00
ELELR6BB5200	4 1/2" x 4 1/2"	6 wires	US26D	1	251.00
ELELR8BB5200	4 1/2" x 4 1/2"	8 wires	US26D	1	262.00
Extra Charge On Other Hinges and wires CONSULT FACTORY FOR ELECTRIFICATION ON HINGES, FINISHES AND 2, 4, 6, 8, 10 or 12 WIRES NOT LISTED ABOVE					

CAL-ROYAL PRODUCTS, INC.

N.R.P. (Non-Removable Pin) where not shown ADD \$1.18/Each List.
N.R.P. for US32D ADD \$2.35/Each List.

STANDARD DISCOUNT ONLY

Ver. 2.0, Rev. 11/12
©2012 CAL-ROYAL

H5

ALL HINGES ARE STAMPED WITH CRP LOGO. FINISHES IN **REVERSE BOLD ITALICS** ARE ALSO AVAILABLE W/O LOGO. PREFIX "UN" WHEN ORDERING.

HINGES

Effective February 2013

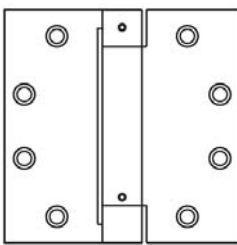
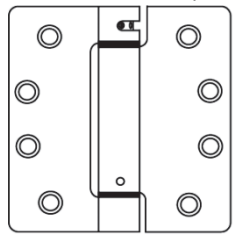
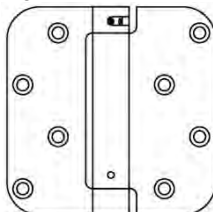
ITEM #	SIZE	FINISH	LIST PRICE	BOX QTY	CASE QTY	
SPRING HINGES						
Full Mortise, Standard Weight, Spring Hinge						
UNIT / EACH						
	NEWSH-140	4 1/2" x 4 1/2"	USP			
			\$9.37			
			US26D	12.85		
			US15	13.55		
			US10A	13.55		
			US10E	13.55		
			US10	11.54	2	48
			US4	11.54		
			US5	13.55		
			US3	15.32		
		US26	15.32			
		US32D	23.56			
NEWSH-454 4 1/2" x 4"						
		USP	9.37			
		US26D	12.85			
		US10A	13.55			
		US15A	13.55	2	48	
		US4	11.54			
		US3	15.32			
		US26	15.32			
BB14031						
		US26D	33.18	2 pcs	32 pcs	
		US10B	35.93	SH140	SH140	
		US4	29.81	and	and	
		US15	35.22	1 pc	16 pcs	
		US26	40.53	BB31	BB31	
		USP	23.92			
2 PCS 4 1/2" X 4 1/2" SH140 SPRING HINGES 1 PC 4 1/2" X 4 1/2" BB31 2-BALL BEARING HINGE PACKAGED IN ONE INNER BOX						
Full mortise, Round Corner, .110" Gauge, Spring Hinge						
	NEWSH-44R	4" x 4"	USP			
			8.25			
			1/4" Radius	US26D	10.60	
			Template	US10A	11.19	
				US10B	11.19	
				US15A	11.19	
				US15	11.19	
				US4	7.95	2
				US3/4	7.95	
				US5	11.19	
			US2D	7.95		
			US3	11.19		
			US26	11.19		
			DURO	8.25		
BENCHMARK, ROUND CORNER, .110" GAUGE, SPRING HINGE						
NBENSH4458R 4" x 4"						
		US4	7.19			
		5/8" Radius	US26D	8.75	2	
					48	
Benchmark Spring hinge screws specification:						
4 pcs wood screws #10 x 1"						
4 pcs machine screws						
1/2 x 12-24 per hinge.						
						
CASTLEGATE COMBINATION CORNER SPRING HINGE						
CASSH4458SQLH		US26D	10.60			
CASSH4458SQRH		US2D	4.89	2	48	
Handed, combination square and round corner 5/8" spring hinge						
LH (Left Hand)						
RH (Right Hand) NEW ITEM						
8 pcs wood screws 1"x10						
4 pcs machine screws #10 head						
1/2" x 10-24 per hinge						

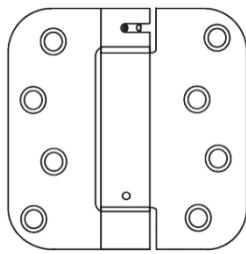
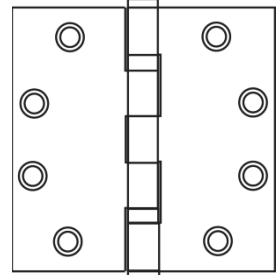



ITEM #	SIZE	FINISH	LIST PRICE	BOX QTY	CASE QTY	
SPRING HINGES						
UNIT / EACH						
	NEWSH-4458R	4" x 4"	USP			
			\$7.95			
			5/8" Radius	US26D	10.60	
			Non-template	US4	7.95	
				US3/4	7.95	
				US2D	7.95	
				US3	11.19	2
				US5	11.19	48
				US26	11.19	
				US10B	11.19	
			US15A	11.19		
			US15	11.19		
NEWSH-35R 3 1/2" x 3 1/2"						
		USP	7.30			
		1/4" Radius	US26D	10.02		
		Template	US10A	10.60		
			US10B	10.60		
			US15	10.60		
			US15A	10.60	2	
			US2D	7.30	48	
			US4	7.30		
			US3	10.60		
			US26	10.60		
NEWSH-3558R 3 1/2" x 3 1/2"						
		US4	7.30			
		5/8" Radius	US2D	7.30		
		Template	US3	10.60		
			US26	10.60		
			US26D	7.30	2	
			US10B	10.60	48	
			US15	10.60		
			US15A	10.60		
NEWSCSH-35 3 1/2" x 3 1/2"						
		US4	7.30			
		Square corner	US26D	10.02	2	
		Template			48	
** Other finishes available upon request						
EXTRUDED SOLID BRASS HINGES						
Full Mortise, Two Ball Bearings						
LIFE TIME FINISH						
UNIT / EACH						
LIFSBBH45	4 1/2" x 4 1/2"	US3	23.23	2	60	
	.134" Gauge					
LIFSBBH44	4" x 4"	US3	20.00	2	60	
	.130" Gauge					
LIFSBBH35	3 1/2" x 3 1/2"	US3	17.23	2	60	
	.123" Gauge					
STANDARD FINISH						
SBBH-45	4 1/2" x 4 1/2"	US3	22.23			
	.134" Gauge	US5	22.23			
		US26	22.23			
		US10B	22.23	2	60	
		US15	22.23			
		US15A	22.23			
		US26D	22.23			
						

N.R.P. (Non-Removable Pin) where not shown ADD \$1.18/Each List.
N.R.P. for **US32D** ADD \$2.35/Each List.

HINGES

Effective February 2013

ALL HINGES ARE STAMPED WITH CRP LOGO. FINISHES IN **REVERSE BOLD** **ITALICS** ARE ALSO AVAILABLE W/O LOGO. PREFIX "UN" WHEN ORDERING.

ITEM #	SIZE	FINISH	LIST PRICE	BOX QTY	CASE QTY
EXTRUDED SOLID BRASS HINGES					
UNIT / EACH					
SBBH-44	4" x 4" .130" Gauge	US3	\$20.00		
		US5	20.00		
		US26	20.00		
		US10B	20.00	2	60
		US15	20.00		
		US15A	20.00		
		US26D	20.00		
SBBH-35	3 1/2" x 3 1/2" .123" Gauge	US3	17.23		
		US5	17.23		
		US26	17.23		
		US10B	17.23	2	60
		US15	17.23		
		US15A	17.23		
		US26D	17.23		
Full Mortise, Plain Bearing					
SBH-45	4 1/2" x 4 1/2" .134" Gauge	US3	21.23	2	60
SBH-44	4" x 4" .130" Gauge	US3	19.00	2	60
SBH-35	3 1/2" x 3 1/2" .123" Gauge	US3	18.00	2	60
DECORATIVE TIPS FOR EXTRUDED SOLID BRASS HINGES					
LIFE TIME FINISH					
			UNIT EACH PER HINGE		
LIFST	Steeple Tip	US3			
LIFAC	Acorne Tip	US3	2.35	1	---
LIFBL	Ball Tip	US3			
LIFUR	Urne Tip	US3			
STANDARD FINISH					
			UNIT EACH PER HINGE		
BL	Ball Tip	US3			
		US5			
		US26			
		US10B	1.89	1	---
		US15			
		US15A			
		US26D			
ST	Steeple Tip	US3			
		US5			
		US26			
		US10B	1.89	1	---
		US15			
		US15A			
		US26D			
AC	Acorne Tip	US3			
		US5			
		US26			
		US10B	1.89	1	---
		US15			
		US15A			
		US26D			
UR	Urne Tip	US3			
		US5			
		US26			
		US10B	1.89	1	---
		US15			
		US15A			
		US26D			
Tips fit all sizes. Prefix tip design to item number.					

ITEM #	SIZE	FINISH	LIST PRICE	BOX QTY	CASE QTY
TIMELY, REDDI FRAME HINGES					
Round Corner, Full Mortise, Plain Bearing-Template Residential Weight, 1/2 MS - 1/2 WS					
UNIT / EACH					
TBH RC-33	4" x 4" 1/4" Radius	US26D	\$3.56		
		US26DNRP	4.00		
		US10A	3.56		
		US10B	3.56		
		US4	3.56		
		US3	4.00	3	48
		US26	4.00		
		US28	2.56		
		DURO	2.56		
		US1D	2.56		
TBH RC-45	3 1/2" x 3 1/2" 1/4" Radius	US26D	3.11		
		US10A	3.11		
		US10B	3.11		
		US4	2.36		
		US3	4.01	2	100
		US26	4.01		
		US28	1.91		
		DURO	1.91		
		US1D	1.91		
		RESIDENTIAL HINGES			
Full Mortise, Residential Weight, 2-Ball Bearings, 2 each / Inner Box w/ flycut wood screws, Round Corner, 5 Knuckles					
UNIT / EACH					
BBRH60	4" x 4" 1/4" Radius	US3	3.23		
		US4	2.46		
		US10B	3.12		
		US15	2.90	2	100
		US26	3.23		
		US26D	2.90		
		US26DNRP	3.11		
BBRH61	3 1/2" x 3 1/2" 1/4" Radius	US3	2.92		
		US4	1.96		
		US10B	2.79		
		US15	2.54	2	100
		US26	2.92		
		US26D	2.54		
		US26DNRP	3.72		
BBRH40	4" X 4" 5/8" Radius	US3	3.23		
		US4	2.46		
		US10B	3.12		
		US15	2.90	2	100
		US26	3.23		
		US26D	2.90		
		US26DNRP	3.11		
BBRH35	3 1/2" x 3 1/2" 5/8" Radius	US3	2.92		
		US4	1.96		
		US10B	2.79		
		US15	2.54	2	100
		US26	2.92		
		US26D	2.54		
		US26D	2.54		

HINGES

Effective February 2013

ALL HINGES ARE STAMPED WITH CRP LOGO. FINISHES IN **REVERSE BOLD ITALICS** ARE ALSO AVAILABLE W/O LOGO. PREFIX "UN" WHEN ORDERING.

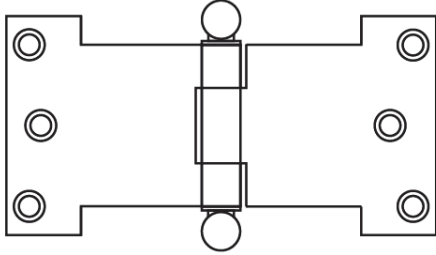
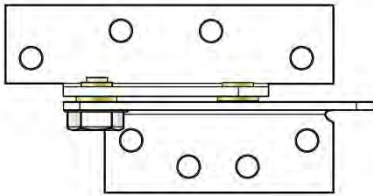

ITEM #	SIZE	FINISH	LIST PRICE	BOX QTY	CASE QTY
RESIDENTIAL HINGES					
Full Mortise, Residential Weight, Plain Bearing, Bulk Unassembled w/ flycut wood screws, Round Corner, 6 Knuckles					
UARH-35-6	3 1/2" x 3 1/2" 5/8" Radius	US4	UNIT / EACH \$1.22	---	100
**All hinges above are steel base material with the exception of US32D. (STAINLESS STEEL) For solid brass base, prefix "SB" before part #. Price and availability on application. Other sizes and finishes, radiuses available upon request (subject to lead-time and minimum quantity)					
Benchmark, Hole Pattern, Residential Weight, Bulk Assembled, with screws					
BENRH40B	4" x 4" 5/8" Radius	US26DNRP US4 USP USPNRP	UNIT / EACH 3.54 1.40 1.40 1.98	---	100
Benchmark residential weight screw specification 3 pcs wood screws #10 x 3/4", 1 pcs wood screw #10 x 2", 4 pcs machine screws 1/2" x 10-24 per hinge. ▶ Benchmark spring hinges available. See spring hinge section.					
RESIDENTIAL SQUARE CORNER STAINLESS STEEL HINGES					
Full Mortise, Residential Weight, Template hole pattern, Plain Bearing, 2 Each/Inner Box with wood screws, Square Corner, 0.080" Gauge					
LTBHSC-55	4" x 4" Square Corner	US32D	UNIT / EACH 6.45	2	100
LTBHSC-77	3 1/2" x 3 1/2" Square Corner	US32D	5.60	2	100
LTBHSC-33	3" x 3" Square Corner	US32D	4.70	2	100
DECORATIVE TIPS FOR STEEL PLATED RESIDENTIAL HINGES					
Ball Tip					
RESBLTP35KIT	Ball Tip Residential 3 1/2" x 3 1/2" hinge	US3 US5 US10B US15 RH-35, RH35B, RH61, RH61B	UNIT / EACH 2.83	2	100
RESBLTP44KIT	Ball Tip Residential 4" x 4" hinge	US3 US5 US10B US15 RH60, RH-40, RH-60B, RH-40B	UNIT / EACH 2.83	2	100
Steeple Tip					
RESSTP35KIT	Steeple Tip Residential 3 1/2" x 3 1/2" Hinge for	US3 US5 US10B US15 RH-35, RH-61, RH-35B, RH-61B	UNIT / EACH 2.83	2	100

ITEM #	SIZE	FINISH	LIST PRICE	BOX QTY	CASE QTY
DECORATIVE TIPS FOR STEEL PLATED RESIDENTIAL HINGES					
Steeple Tip					
RESSTP44KIT	Steeple Tip Residential 4" x 4" hinge	US3 US5 US10B US15 RH60, RH40 RH60B, RH40B	UNIT / EACH \$2.83	2	100
Price Includes: 1 Pin & 2 Tips					
SOLID BRASS PARLIAMENT HINGES					
					
▶ PACKAGING INCLUDES ♦ One pair per inner box, individually poly bagged. ♦ 100 Pcs / Master carton Packed with #9 x 3/4" wood screws. Ball tip attached					
UNIT / EACH					
PARH-3A	3" x 2 1/4" x 0.093"	US3 US15 US10B US15A US26 US5	11.66	2	100
PARH-4B	4" x 2 1/2" x 0.093"	US3 US15 US10B US15A US26 US5	12.72	2	100
PARH-458C	4 5/8" x 2 1/2" x 0.093"	US3 US15 US10B US15A US26 US5	13.78	2	100
REINFORCING PIVOT HINGES					
Full Surface Reinforcing Pivot Hinge for 4 1/2" Wide Hinges					
RPH45	4 1/2" wide	US26D	UNIT / EACH 70.00	1	10
					
ADDITIONAL SCREWS SEE PAGE H10					
RPH45SHIM	1/8" Shim plate for RPH45	USP	6.67	1	1
NEW ITEM					

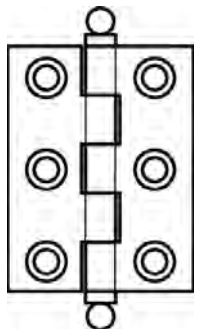

HINGES

Effective February 2013

ITEM #	SIZE	FINISH	LIST PRICE	BOX QTY	CASE QTY
CABINET HINGES					
CABH-2015	2" x 1 1/2"	US10B	\$7.80	10	100
		US15	7.40	10	100

ITEM #	SIZE	FINISH	LIST PRICE	BOX QTY	CASE QTY
CABINET HINGES					
CABH-2517	2 1/2" x 1 11/16"	US10B	\$9.00	10	100
		US15	8.45	10	100

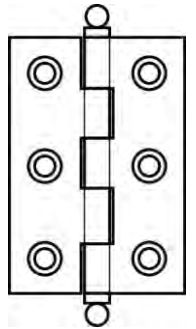
HINGE SCREWS *List Price* . . .

STANDARD DISCOUNT ONLY

STEEL SCREWS FOR CONTRACT GRADE SIZE 4", 4.5" and 5"

ITEM #	FINISH	LIST PRICE	BOX QTY
MACHINE 1/2" x 12 - 24 FPHM			
MSC1224	USP, US26D, US10A, US10B, US10, US4, US3, US26, DURO US32D	\$14.14	100
		28.27	100
WOOD 1 1/4" x 12 FPHW			
WSC11412	USP, US26D, US10A, US10B, US10, US4, US3, US26, DURO US32D	14.14	100
		28.27	100
WOOD 1" x 12 FPHW			
WSC11299	USP, US26D, US10A, US10B, US10, US4, US3, US26, US15, DURO	14.14	100

STEEL SCREWS FOR RESIDENTIAL HINGES (4" x 4" and 3 1/2" x 3 1/2")

ITEM #	FINISH	LIST PRICE	BOX QTY
Wood 1" x 9 With flycut (4" x 4" size hinge)			
TWSC19	US26D, US10A, US4, US3, US26	\$14.14	100
Wood 3/4" x 9 With flycut (3 1/2" x 3 1/2" size hinge)			
RESWC349	US26D, US10A, US4, US3, US26	14.14	100

STEEL SCREWS FOR TBHRC33 AND TBHRC45, 4" X 4" AND 3 1/2" X 3 1/2" TIMELY HINGES 4" x 4" and 3 1/2" x 3 1/2" Spring Hinges 3 1/2" x 3 1/2" Contract Grade Hinges

ITEM #	FINISH	LIST PRICE	BOX QTY
Machine 1/2" x 12 - 24 with #10 head FPHM (4" x 4" size hinge, 1/4" radius)			
TMC1224	USP, US26D, US10A, US4, US3, US26, US28, US15, US10B, DURO	\$14.14	100
Machine 1/2" x 10 - 24 with #10 head FPHM (4" x 4" size hinge, 5/8" radius) for SH4458R Spring Hinges			
TMC10244458R	USP, US26D, US10A, US4, US3, US26, US10B, DURO	14.14	100
Wood 1" x 10 FPHW (4" x 4" size hinge)			
TWSC110	USP, US26D, US10A, US4, US3, US26, US15, US10B, US15A, USP, DURO	14.14	100
Machine 1/2" x 10 - 24 No. 9 Head FPHM (3 1/2" x 3 1/2" size hinge)			
TMC121024	USP, US26D, US10A, US4, US3, US26, US10B, US32D, DURO	14.14	100
Wood 1" x 9 FPHW (3 1/2" x 3 1/2" size hinge)			
TWSC19	USP, US26D, US10A, US4, US3, US26, US28, US10B, US15, US15A, DURO	14.14	100

GEARED ALUMINIUM CONTINUOUS HINGES

Series List Price



3 HOUR FIRE RATED
UL10C, UBC7-2-1997

► Heavy Duty Hinges

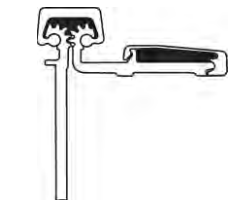
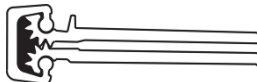
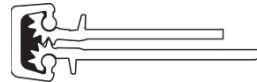
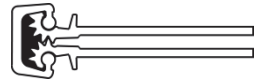

ITEM #	DESCRIPTION	SIZE	FINISH	LIST PRICE	CASE QTY	UNIT			
CONCEALED LEAF									
CRHD78 1120	Leaves are concealed between the rabbet of the frame and the hinge edge of the door.	83"	Clear	\$137.00	1	Ea.			
			DB	142.00					
		95"	Clear	157.00					
			DB	164.00					
CRHD78 1110		83"	Clear	142.00					
			DB	148.00					
		95"	Clear	163.00					
			DB	169.00					
CRHD78 2240 1 3/4" doors	83"	Clear	148.00						
		DB	153.00						
	95"	Clear	170.00						
		DB	176.00						
FULL SURFACE									
CRHD78 1570	Frame leaf mounted to the face of the frame and the face of the door. The door leaf is mounted to the door with through bolts.	83"	Clear	158.00	1	Ea.			
			DB	164.00					
		95"	Clear	183.00					
			DB	188.00					
CRHD78 2100		83"	Clear	164.00					
			DB	170.00					
		95"	Clear	188.00					
			DB	195.00					
CRHD78 0570	Frame face dimension limitation.	83"	Clear	180.00	1	Ea.			
			DB	186.00					
		95"	Clear	207.00					
			DB	213.00					
HALF SURFACE									
CRHD78 0530		Frame leaf concealed between the rabbet of the frame and the edge of the door. The door leaf is mounted to the face of the door with sex bolts or screws.	83"	Clear			175.00	1	Ea.
				DB			181.00		
			95"	Clear			200.00		
	DB			207.00					

◆◆◆◆ Specify size and finish after ITEM #

For additional fire rating Prefix "UL" before part #. Add \$38.00 List. Refer to fire rating chart for standard fire rating.

◆◆◆◆ Continued Next Page ◆◆◆◆

► **Additional Heavy Duty Channel Cover**

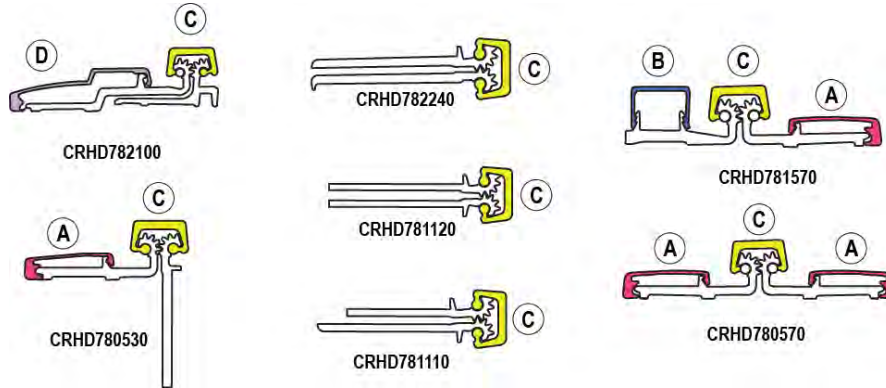

ITEM #	DESCRIPTION	SIZE	FINISH	LIST PRICE	CASE QTY	UNIT
CC83A	Channel Cover (A). Can be used for CRHD781570, CRHD780570 and CRHD780530.	83"	Clear	21.00	1	Ea.
CC95A			Dark bronze	21.00		
CC83B	Channel Cover (B) Can be used for CRHD781570	83"	Clear	18.00		
			Dark bronze	19.00		
CC95B		95"	Clear	20.00		
			Dark bronze	21.00		
CC83C	Common Channel Gear Cover (C) Can be used for all models of continuous geared hinges.	83"	Clear	29.00		
			Dark bronze	30.00		
CC95C		95"	Clear	32.00		
			Dark bronze	34.00		
CC83D	Channel Cover (D) Can be used for CRHD782100.	83"	Clear	31.00		
			Dark bronze	32.00		
CC95D		95"	Clear	35.00		
			Dark bronze	36.00		

CONTINUOUS HINGE MODEL CROSS REFERENCE

CAL-ROYAL	ROTON	PEMKO	MARKAR	MCKINNEY	ZERO	STANLEY	ABH	SELECT
CRHD781120	780-112HD	FMSLFHD	FM2000	MCK12HD	910DB	661HD	A110HD	SL11HD
CRHD782240	780-224HD	FMHD	FM2011	MCK25HD	914DB	662HD	A240HD	SL24HD
CRHD781570	780-157HD	FSCPHD		MCK58HD	935DB	664HD	A570HD	SL57HD
CRHD782100	780-210HD	FSHD	FM2009	MCK22HD	930DB		A210HD	SL18HD
CRHD781110	780-111HD	FMSLIHD		MCK-14HD			A111HD	SL18HD
CRHD780530	780-053HD				925DB		A530HD	SL53HD
CRHD780570	780-057HD		FS 2002				A571HD	SL60HD



EXIT DEVICES



Ver. 2.0, Rev. 11/12
© 2012  CAL ROYAL

7700 & 7760 (Non-Fire Rated)

F7700 & F7760 (Fire Rated)

Series List Price

Push Bar Exit Device / ANSI 156.3 Grade 1, 3 Hour Rated, UL Listed

Optional with Alarm / Electrified ♦ Fits same hole pattern as Von Duprin 99 & 98

Series using 7700 Escutcheon Trims ♦ Optional Delayed Egress



ILLUSTRATION	ITEM #	DESCRIPTION	US32D	US3, 10B	NON STOCK	
<div style="border: 1px solid black; padding: 5px; margin: 10px;"> <p>Lifetime Warranty BHMA CERTIFIED</p> </div> <div style="border: 1px solid black; padding: 5px; margin: 10px;"> <p>DELAYED EGRESS OPTION AVAILABLE See PAGE E32</p> </div> <div style="border: 1px solid black; padding: 5px; margin: 10px;"> <p>ELR, RX, LX, RXLX and POWER SUPPLIES AVAILABLE See PAGE E33</p> </div> <div style="background-color: yellow; padding: 5px; margin: 10px;"> <p>MEETS The Buy American Act</p> </div>	PANIC EXIT HARDWARE		LIST PRICE EA.			
	7700EO36	Rim exit, 36"	\$447.00	\$480.00	\$528.00	
	7720EO48	Rim exit, 48"	474.00	507.00	558.00	
	NALRM7700EO36	Alarm Panic Rim Device 36" <small>NEW ITEM</small>	667.00	676.00	855.00	
	NALRM7720EO48	Alarm Panic Rim Device 48" <small>NEW ITEM</small>	680.00	692.00	897.00	
	7760V3684	Surface vertical rod 36" X 84" *SH	585.00	626.00	689.00	
	7790V3696	Surface vertical rod 36" X 96" *SH	622.00	667.00	734.00	
	7750V36120	Surface vertical rod 36" X 120" *SH	659.00	705.00	776.00	
	7780V4896	Surface vertical rod 48" X 96" *SH	628.00	672.00	739.00	
	7740V48120	Surface vertical rod 48" X 120" *SH	665.00	712.00	783.00	
	FIRE EXIT HARDWARE RATED 3 HOURS (Includes thru bolts)					
	F7700EO36	Rim exit, 36"	525.00	562.00	618.00	
	F7720EO48	Rim exit, 48"	551.00	590.00	649.00	
	FNALRM770036	Alarm Panic Rim Device 36" <small>NEW ITEM</small>	731.00	743.00	856.00	
	FNALRM772048	Alarm Panic Rim Device 48" <small>NEW ITEM</small>	761.00	814.00	895.00	
	F7760V3684	Surface vertical rod 36" X 84" *SH	678.00	726.00	799.00	
	F7790V3696	Surface vertical rod 36" X 96" *SH	715.00	765.00	842.00	
	F7780V4896	Surface vertical rod 48" X 96" *SH				
	NOTE:		US32D is US26D with US32D (Stainless Steel) Push Pad.			

*SH Specify Left Hand Reverse (LHR) or Right Hand Reverse (RHR) for convenience on VERTICAL ROD ONLY.
RIM DEVICES are non-handed and are Easily field reversible.

◆ **MUST ORDER TRIM SEPARATELY** ◆

▶ **PACKAGING INCLUDES**

- Thru bolts for fire rated Devices only.
- 4 Pcs per master carton
- Strike Filler, Lock Front Filler packed with Rim Devices at no extra charge.

▶ **NON-STOCK FINISHES**

- Availability subject to quantity and lead-time. Consult factory

▶ **ALARM AVAILABLE**

Alarm available on vertical rod exit devices. Prefix **NALRM** before part#. Add \$218.00 List.

QUANTITY DISCOUNT

16 UNITS MIXED - LESS 5%

32 UNITS MIXED - LESS 10%

LBR7760 (Non-fire Rated)

LBRF7760 (Fire Rated) Series List Price ...

Vertical Rod Type Exit Device **Less Bottom Rod – LBR**
 Push Bar Exit Device / ANSI 156.3 Grade 1, 3 Hour Rated, UL Listed
 Optional with Alarm / Electrified
 Optional Delayed Egress



ILLUSTRATION	ITEM #	DESCRIPTION	US32D	US3, 10B	NON STOCK	
	PANIC EXIT HARDWARE		LIST PRICE EACH			
	***7760V3684	Surface vertical rod 36" X 84" *SH	\$585.00	\$626.00	\$689.00	
	***7790V3696	Surface vertical rod 36" X 96" *SH	622.00	667.00	734.00	
	***7750V36120	Surface vertical rod 36" X 120" *SH	659.00	705.00	776.00	
	***7780V4896	Surface vertical rod 48" X 96" *SH	628.00	672.00	739.00	
	***7740V48120	Surface vertical rod 48" X 120" *SH	665.00	712.00	783.00	
	*** Standard surface vertical rod is used for less bottom rod in installation					
	FIRE EXIT HARDWARE RATED 3 HOURS					
	LBRF7760V3684	Surface vertical rod LBR 36" X 84" Includes thru bolts & AUX Latch *SH	678.00	726.00	799.00	
	LBRF7790V3696	Surface vertical rod LBR 36" X 96" Includes thru bolts & AUX Latch *SH	715.00	765.00	842.00	
LBRF7780V4896	Surface vertical rod LBR 48" X 96" Includes thru bolts & AUX Latch *SH					

*SH Specify Left Hand Reverse (LHR) or Right Hand Reverse (RHR) for convenience. Easily field reversible.

DELAYED EGRESS OPTION
 AVAILABLE See PAGE E32

**QUANTITY DISCOUNT
 ON STANDARD DISCOUNT ONLY**
16 UNITS MIXED - LESS 5%
32 UNITS MIXED - LESS 10%

◆ ACCESSORIES

AUXFL	Additional auxiliary latch (Raw Finish)	49.95
-------	---	-------

◆ MUST ORDER TRIM SEPARATELY ◆

▶ LBR FIRE RATED DEVICES PACKAGING

- Packed with auxiliary spring latch to be installed in the lower edge of door.
- Thru bolts for fire Vertical rod Devices only.
- 4 pcs per master carton.

▶ NON-STOCK FINISHES

- Availability subject to quantity and lead-time. Consult factory

▶ ALARM AVAILABLE

- Alarm available. Prefix NALRM before part#. Add \$218.00 List.

► **TRIMS & ACCESSORIES LIST PRICE**

➤ All trims are 6-pin "C" keyway. Other major manufacturers' keyways available. (See page E5)

STANDARD DISCOUNT ONLY ON TRIMS AND ACCESSORIES

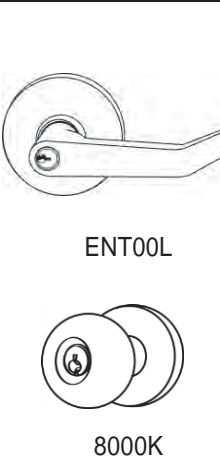
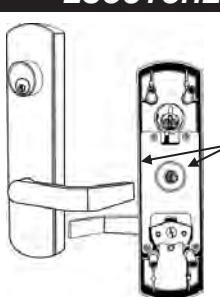
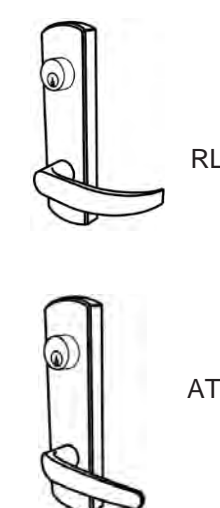
ILLUSTRATION	ITEM #	DESCRIPTION	LIST PRICE EACH			
			US26D, 3, 10B	OTHER		
ROSE TRIMS (Non-handed)						
	ENT00L	●●●●●● ICENT00L (Best, Falcon SFIC) ICSCENT00L4 (Schlage LFIC)	Clutch entrance, key locks / unlocks lever trim ANSI FUNCTION (08) - operates as classroom function	\$115.73		
		●●●●●● SARICENT00L (Sargent) RUSICENT00L (Corbin/Ruswin) YALICENT00L (Yale)		NEW ITEM US26D 140.00		
		●●●●●● STR05L ICSTR05L (Best, Falcon SFIC) ICSCSTR05L4 (Schlage LFIC)		Clutch storeroom, key operates lever ANSI FUNCTION (04)		\$115.73
		●●●●●● SARICSTR05L (Sargent) RUSICSTR05L (Corbin/Ruswin) YALICSTR05L (Yale)				NEW ITEM US26D 140.00
		PAS30L	Passage, lever always operable ANSI FUNCTION (15)		\$115.73	
		DUM40L	Dummy, lever trim. ANSI FUNCTION (10)			
		8000K	Ball knob keylock, "C" keyway		US10B 89.00	US32D,3 \$75.50
	For 2 1/4" thick door order part # TAIL1				----	12.36
	ESCUTCHEON TRIMS (Non-handed)					
		ESC7700	●●●●●● ICESC7700 ICSCESC7700	Rigid Entrance, key locks or unlocks escutcheon trim - operates as classroom ANSI FUNCTION (63)	145.00	----
		ESC7705	●●●●●● ICESC7705 ICSCESC7705			
		ESC7730		Passage, trim always operable and free ANSI FUNCTION (62)		
		ESC7740		Dummy Escutcheon trim ANSI FUNCTION (10)		
		ELR, RX, LX & RXLX		See PAGE E33		
For 2 1/4" thick door order part # TAIL3				----		
ESCUTCHEON TRIMS RL & AT Design (Non-handed)						
	ATESC7700	●●●●●● ICATEESC7700 ICSCATEESC7700	Rigid Entrance, key locks or unlocks escutcheon trim. Operates as classroom ANSI FUNCTION (63)	164.00	----	
		ATESC7705				●●●●●● ICATEESC7705 ICSCATEESC7705
		ATESC7730				Passage, trim always operable and free. ANSI FUNCTION (62)
		ATESC7740				Dummy Escutcheon trim ANSI FUNCTION (10)
		RLESC7700	●●●●●● ICRLESC7700 ICSCRLESC7700			Rigid Entrance, key locks or unlocks escutcheon trim. Operates as classroom ANSI FUNCTION (63)
		RLESC7705	●●●●●● ICRLESC7705 ICSCRLESC7705			
		RLESC7730				Passage, trim always operable and free. ANSI FUNCTION (62)
		RLESC7740				Dummy Escutcheon trim. ANSI FUNCTION (10)
		Electrification				Available see PAGE E33
	For 2 1/4" thick door order part # TAIL3					

● (IC) Indicates function available with **Best, Falcon & Arrow Interchangeable Core.**

● (ICSC) Indicates function available with **Schlage Full Size Format Interchangeable Core.**

Prices do not include cores. For IC Core pricing see pages L73 - L76.

► **TRIMS & ACCESSORIES LIST PRICE**

► All trims are 6-pin "C" keyway. Other major manufacturers' keyways available. (See page E5)

STANDARD DISCOUNT ONLY ON TRIMS AND ACCESSORIES

ILLUSTRATION	ITEM #	DESCRIPTION	US32D, 10B,3	
ELECTRIFIED LEVER TRIMS				
	FS12ESC77 ICFS12ESC77 ICSCFS12ESC77	FAIL-SAFE (FS) OPTION 12V AC/DC US26D in stock	389.02	
	FS24ESC77 ICFS24ESC77 ICSCFS24ESC77	FAIL-SAFE (FS) OPTION 24V AC/DC US26D in stock		
	FSE12ESC77 ICSE12ESC77 ICSCFSE12ESC77	FAIL-SECURE (FSE) OPTION 12V AC/DC US26D in stock		To order other lever design, insert "AT" or "RL" before "ESC"
	FSE24ESC77 ICSE24ESC77 ICSCFSE24ESC77	FAIL-SECURE (FSE) OPTION 24V AC/DC US26D in stock		
	THUMB PIECE TRIMS (Non-handed)			
		77TP00 IC77TP00 ICSC77TP00	Entrance, key locks or unlocks thumb piece ANSI FUNCTION (63) operates as classroom function	\$120.00
		77TP05 IC77TP05 ICSC77TP05	Storeroom, always locked ANSI FUNCTION (04)	
		77TP30	Passage trim, always operable and free ANSI FUNCTION (62)	
77TP40		Dummy trim, ANSI FUNCTION (10)		
For 2 1/4" thick door order part # TAIL7			12.36	
PULL TRIMS				
	7700NL IC7700NL ICSC7700NL	To be used with rim panic exit device Pull & rim cylinder, key retracts latch bolt ANSI FUNCTION (03).	80.00	
	7700DTP	Dummy trim (Pull) ANSI FUNCTION (02)	63.00	
	7700EOP	Cover plate (blank plate) ANSI FUNCTION (10)	35.00	
HEAVY DUTY KEYLESS LOCK				
	CRCODE007LH CRCODE007RH	Heavy Duty Clutch Keyless Digital Lock to be used for 9800/7700 Series Exit Device. (Specify handing when ordering) Available with other major manufacturer's keyway see page E5.	US26D 542.72 Must order exit device from stock. Prefix DL before PART# of exit device	
	CRCODE101	Heavy Duty Rigid Keyless Mechanical Lock to be used for 9800/7700 Series Exit Device. NonHanded. Available with other major manufacturer's keyway see page E5.	US26D 542.72	
	CR5000 ICCR5000	Trilogy © Exit Device Trims for 7700 Series Exit Devices (**note - IC includes CYLINDER ADAPTER KIT for Best, Falcon & Arrow Interchangeable Core)	US26D 1187.00 US10B 1220.00 IC CORE ADD \$78.00 List Excludes Rim Cylinder Housing and Core.	

(IC) Indicates function available with **Best, Falcon & Arrow Interchangeable Core.**
 (ICSC) Indicates function available with **Schlage Full Size Format Interchangeable Core.**
 Prices do not include cores. For IC Core pricing see pages L73 - L76.

► **TRIMS & ACCESSORIES LIST PRICE**

➤ All trims are 6-pin "C" keyway. Other major manufacturers' keyways available. (See below)

▣ STANDARD DISCOUNT ONLY ON TRIMS AND ACCESSORIES ▣

ITEM #	DESCRIPTION	US3, 10B	NYLON BLACK COATED	OTHER	PCS /MC	
36CD7700 ●●● IC 36CD7700 ●●● ICSC 36CD7700	Cylinder dogging kit for non-fire rated 36" exit Devices	\$63.60		US32D \$63.60		
48CD7700 ●●● IC 48CD7700 ●●● ICSC 48CD7700	Cylinder dogging kit for non-fire rated 48" exit Devices					
N36ALARM77 ●●● ICN 36ALARM77 ●●● ICSCN 36ALARM77	Alarm kit for 36" 7700 Series Rim and vertical rod Exit Device	US10B, US3 218.00	----	US32D 218.00		
N48ALARM77 ●●● ICN 48ALARM77 ●●● ICSCN 48ALARM77	Alarm kit for 48" 7700 Series Rim and vertical rod Exit Device					
221	Bottom strike, non-fire vertical rod Device	----	\$10.11	----	1	
227	Top strike, non-fire vertical rod Device					
233	Alternate flush mounting bottom strike. Standard for fire rated vertical rod					
938	Surface applied strike, rim					
245	Surface applied strike, rim fire and top strike fire rated vertical rod Device					
357	Thrubolts for rim fire and Panic grade 1 ¾" door (6 PCs)					
363	Thrubolts for rim fire and Panic grade 2 ¼" door (6 PCs)					
369	Thrubolts for vertical rod fire and Panic grade to be used with trim 1 ¾" door (14 pcs)					
901	Rim shim kit ⅛" thick					
906	Panic vertical rod shim kit ⅛" thick					
912	Fire rated vertical rod shim kit ⅛" thick					
951	Overlapping Strike, surface applied. Used on inactive leaf for Device on active leaf of pair of doors without mullion	US26D 13.48				
375	Thrubolts for vertical rod fire and Panic grade to be used with trim 2 ¼" door (14 pcs)	----		39.95		
418	96" T-shaped removable mullion non-fire rated application (Prime coat).			250.56		
424	96" Square steel mullion fire rated application (Prime coat)			300.00		
418 BRACKETS	Top and Bottom retaining brackets for 418 mullion			58.89		
424 BRACKETS	Top and Bottom retaining brackets for 424 mullion			58.89		
LCK418 ●●● ICLCK 418 ●●● ICSC LCK418	Lockable 96" T-shaped removable mullion (Aluminum Prime coat), Non-fire Rated				826.80	
Additional keyway if ordered with LCK418 Lockable Mullion (US26D)					24.00	
VRRD10	Vertical rod for 10 feet doors, for non-fire rated Devices only			34.83		
LFF	Lock front filler (Zinc plated)			----	1.14	
SF	Strike filler (Zinc plated)				1.73	
CUT CHARGE	Labor for cutting exit devices to size (applicable to all Series)			NET 50.00		

●●● (IC) Indicates function available with **Best, Falcon & Arrow Interchangeable Core.**

●●● (ICSC) Indicates function available with **Schlage Full Size Format Interchangeable Core.**

Prices do not include cores. **For IC Core pricing see pages L73 - L76.**

◆ **OTHER KEYWAYS**

Available for ENT00L, STR05L, CRCODE007, CRCODE101	Schlage C-K, Russwin D1,D2,D3, Corbin 60, Sargent LA-LB-LC, Falcon/Weiser E, Corbin-Russwin L4, Arrow A, Yale 8, Yale GA, Kwikset	ADD 13.33
ESC7700, ESC7705, 77TP00, 77TP05, 7700NL, 36CD7700, 48CD7700, N36ALARM77, N48ALARM77, LCK418, CR5000		ADD 24.00

▶▶▶ CONSULT FACTORY FOR TEMPLATES ON ALL EXIT DEVICES AND TRIMS

WCVR7700 & MCVR7700 (Non-Fire) FWCVR7700 & FMCVR7700 (Fire-Rated) Wood & Metal Concealed Vertical Rod Exit Device Series List Price



Push Bar Exit Device / ANSI 156.3 Grade 1, 3 Hour Rated, UL Listed
Optional with Alarm / Electrified
Optional Delayed Egress

ILLUSTRATION	ITEM #	DESCRIPTION	LIST PRICE EA		NON-STK FINISHES
			US32D	US10B	
	PANIC EXIT HARDWARE				
	M77CVR3684	Concealed vertical rod 36" X 84" Metal Door *SH	\$673.00	\$720.00	\$792.00
	W77CVR3684	Concealed vertical rod 36" X 84" Wood Door *SH			
	M77CVR3696	Concealed vertical rod 36" X 96" Metal Door *SH	714.00	763.00	840.00
	W77CVR3696	Concealed vertical rod 36" X 96" Wood Door *SH			
	FIRE EXIT HARDWARE RATED 3 HOURS				
	FM77CVR3684	Concealed vertical rod 36" X 84" Metal Door *SH	780.00	835.00	918.00
	FW77CVR3684	Concealed vertical rod 36" X 84" Wood Door *SH			
	FM77CVR3696	Concealed vertical rod 36" X 96" Metal Door *SH	827.00	885.00	973.00
	FW77CVR3696	Concealed vertical rod 36" X 96" Wood Door *SH			

*SH Specify Left Hand Reverse (LHR) or Right Hand Reverse (RHR) for convenience.

- Easily field reversible.
- 4 pcs per master carton

ELR, RX, LX, RXLX and
POWER SUPPLIES AVAILABLE
See PAGE E33

QUANTITY DISCOUNT
16 UNITS MIXED - LESS 5%
32 UNITS MIXED - LESS 10%

◆◆ MUST ORDER TRIM SEPARATELY ◆◆

► **NON STOCK FINISHES**
Availability subject to quantity & lead-time.
Consult factory.

► **TRIMS & ACCESSORIES LIST PRICE**
All trims are 6-pin "C" keyway. Other major manufacturers' keyways available.
(See page E8)

DELAYED EGRESS OPTION
AVAILABLE See PAGE E32

▣ STANDARD DISCOUNT ONLY ON TRIMS AND ACCESSORIES ▣

ILLUSTRATION	ITEM #	DESCRIPTION	US26D, 10B	PCS /MC	UNIT
ESCUTCHEON TRIMS (Non-handed)					
<p>CVRESC7700</p>	CVRESC7700 or ICCVRESC7700 ICSCCVRESC7700	Clutch Entrance, key locks or unlocks escutcheon trim ANSI FUNCTION (63)	156.00	12	Ea.
	CVRESC7705 or ICCVRESC7705 ICSCCVRESC7705	Clutch Storeroom, key unlocks the lever, lever retracts latch bolt, otherwise always locked ANSI FUNCTION (04)			
	CVRESC7730**	Passage, trim always operable and free ANSI FUNCTION (62)			
	CVRESC7740	Dummy Escutcheon trim ANSI FUNCTION (10)			

LBRWCVR7700 & LBRMCVR7700 (Non-Fire)

LBRFWCVR7700 & LBRFMCVR7700 (Fire-Rated)

Wood & Metal Less Bottom Concealed Vertical Rod Exit Device

Series List Price



Push Bar Exit Device / ANSI 156.3 Grade 1, 3 Hour Rated, UL Listed
 Optional with Alarm / Electrified
 Optional Delayed Egress

ILLUSTRATION	ITEM #	DESCRIPTION	LIST PRICE EA		NON-STK FINISHES
			US32D	US10B	
	PANIC EXIT HARDWARE				
	***M77CVR3684	Concealed vertical rod 36" X 84" Metal Door	\$673.00	\$720.00	\$792.00
	***W77CVR3684	Concealed vertical rod 36" X 84" Wood Door			
	***M77CVR3696	Concealed vertical rod 36" X 96" Metal Door	714.00	763.00	840.00
	***W77CVR3696	Concealed vertical rod 36" X 96" Wood Door			
	*** Standard surface vertical rod is used for less bottom rod in installation				
	FIRE EXIT HARDWARE RATED 3 HOURS				
	LBRFM77CVR3684	Concealed vertical rod 36" X 84" Metal Door Includes AUX Latch *SH	780.00	835.00	918.00
	LBRFW77CVR3684	Concealed vertical rod 36" X 84" Wood Door Includes AUX Latch *SH			
	LBRFM77CVR3696	Concealed vertical rod 36" X 96" Metal Door Includes AUX Latch *SH	827.00	885.00	973.00
LBRFW77CVR3696	Concealed vertical rod 36" X 96" Wood Door Includes AUX Latch *SH				

*SH Specify Left Hand Reverse (LHR) or Right Hand Reverse (RHR) for convenience.

- Easily field reversible.
- 4 pcs per master carton

ELR, RX, LX, RXLX and
 POWER SUPPLIES AVAILABLE
 See PAGE E33

QUANTITY DISCOUNT
 16 UNITS MIXED - LESS 5%
 32 UNITS MIXED - LESS 10%

DELAYED EGRESS OPTION
 AVAILABLE See PAGE E32

STANDARD DISCOUNT ONLY ON TRIMS AND ACCESSORIES					
ITEM #	DESCRIPTION	US10B	OTHERS	PCS /MC	UNIT
STRIKES & ACCESSORIES					
36CD7700 IC 36CD7700 ICSC 36CD7700	Cylinder dogging kit for non-fire rated 36" applications	63.60	US32D 63.60	1	Ea.
48CD7700 IC 48CD7700 ICSC 48CD7700	Cylinder dogging kit for non-fire rated 48" applications				
N36ALARM77 IC 36ALARM77 ICSC 36ALARM77	Alarm kit w/ micro switch for 36"	US10B, US3 218.00	US32D 218.00		
N48ALARM77 IC N48ALARM77 ICSC N48ALARM77	Alarm kit w/ micro switch for 48"				
265	Bottom strike, concealed vertical rod device	----	12.72		
260	Top strike, concealed vertical rod device				
418	96" T-shaped removable mullion non-fire rated application (Prime coat)		250.56		
424	96" Square steel mullion fire rated application (Prime coat)		300.00		
418 BRACKETS	Top and Bottom retaining brackets for 418 mullion		58.89		
424 BRACKETS	Top and Bottom retaining brackets for 424 mullion		58.89		
LCK418 IC LCK418 ICSC LCK418	Lockable 96" T-shaped removable mullion (Aluminum Prime coat), Non-fire Rated		826.80		
Additional keyway if ordered with LCK418 Lockable Mullion (US26D)			24.00		
LFF	Lock front filler (Zinc plated)		1.14		
SF	Strike filler (Zinc plated)		1.73		
MCVROD96	Vertical Top Rod for 96" metal door	53.00			
WCVROD96	Vertical Top Rod for 96" wood door				
CUT CHARGE	Labor for cutting exit devices to size (applicable to all Series)	NET 50.00			

OTHER KEYWAYS		
CVRESC7700, CVRESC7705, 36CD7700, 48CD7700, N36ALARM77, N48ALARM77, LCK418	Schlage C-K, Russwin D1,D2, D3, Corbin 60, Sargent LA-LB-LC, Falcon/Weiser E, Corbin-Russwin L4, Arrow A, Yale8, Yale GA, Kwikset.	ADD 24.00

- (IC)** Indicates function available with **Best, Falcon & Arrow Interchangeable Core.**
- (ICSC)** Indicates function available with **Schlage Full Size Format Interchangeable Core.**

Prices do not include cores. **For IC Core pricing see pages L73 - L76.**

▶▶▶ **CONSULT FACTORY FOR TEMPLATES ON ALL EXIT DEVICES AND TRIMS**



GLS7700 (Non-Fire Rated)

Narrow Stile Rim, Concealed Vertical Rod Exit Device, Optional Less Bottom Rod (**LBR) *Series List Price*



Push Bar Exit Device / ANSI 156.3 Grade 1, UL Listed for Panic & Safety
Optional with Alarm / Electrified

ILLUSTRATION	ITEM #	DESCRIPTION	LIST PRICE EA		NON-STK FINISHES
			US32D	US10B	
PANIC EXIT HARDWARE					
	GLS7700EO36	Rim Exit Device for 36"	\$559.00	\$600.00	\$660.00
	GLS7700EO48	Rim Exit Device for 48"	593.00	636.00	700.00
	GLSCVR773684 **Handed (Specify Handing)	Concealed vertical rod 36" X 84"	841.00	900.00	990.00
	GLSCVR774884 **Handed (Specify Handing)	Concealed vertical rod 48" X 84"	892.00	954.00	1,050.00

**LBR Optional upon installation

**ELR, RX, LX, RXLX and
POWER SUPPLIES AVAILABLE**
See PAGE E33

- Field reversible.
- 4 pcs per master carton

◆◆ **MUST ORDER TRIM SEPARATELY** ◆◆

► **NON STOCK FINISHES**

Availability subject to quantity & lead-time. Consult factory.

► **TRIMS & ACCESSORIES LIST PRICE**

All trims are 6-pin "C" keyway. Other major manufacturers' keyways available. (See page E10)

IMPORTANT: GLS7700 and GLSCVR7700 Trims are interchangeable with GLS9800 and GLSCVR9800 Trims

▣ STANDARD DISCOUNT ONLY ON TRIMS AND ACCESSORIES ▣					
ILLUSTRATION	ITEM #	DESCRIPTION	10B, US26D	PCS /MC	UNIT
ESCUTCHEON TRIMS (Non-handed)					
	GLSRIM9800 ICGLSRIM9800 ICSCGLSRIM9800	Clutch Entrance, key locks or unlocks escutcheon trim ANSI FUNCTION (63)	180.00	12	Ea.
	GLSRIM9805 ICGLSRIM9805 ICSCGLSRIM9805	Clutch Storeroom, key unlocks the lever, lever retracts latch bolt, otherwise always locked ANSI FUNCTION (04)			
	GLSRIM9830	Passage, trim always operable and free ANSI (62)			
	GLSRIM9840	Dummy Escutcheon trim ANSI FUNCTION (10)			
	CVR ESCUTCHEON TRIMS (Non-handed)				
	GLSCVR9800 ICGLSCVR9800, ICSCGLSCVR9800	Clutch Entrance, key locks or unlocks escutcheon trim ANSI FUNCTION (63)	180.00	12	Ea.
	GLSCVR9805 ICSCGLSCVR9805, ICSCGLSCVR9805	Clutch Storeroom, key unlocks the lever, lever retracts latch bolt, otherwise always locked ANSI FUNCTION (04)			
	GLSCVR9830	Passage, trim always operable and free ANSI (62)			
	GLSCVR9840	Dummy Escutcheon trim ANSI FUNCTION (10)			

STANDARD DISCOUNT ONLY ON TRIMS AND ACCESSORIES

ITEM #	DESCRIPTION	US26D, 10B	OTHERS	PCS /MC	UNIT	
PULL TRIMS						
	OFSTPUL-10	Offset Pull Trim for Narrow Stile device	10B 122.00	US32D 111.00 ALUM 45.00	1	Ea.
	 98GLSNL IC98GLSNL ICSC98GLSNL	C-Pull Trim with Cylinder for Narrow Stile device (Specify Handing)	10B 117.00	US32D 107.00 ALUM, DB 89.00		
	98GLSUP	C-Pull Trim without Cylinder for Narrow Stile device	10B 110.00	US32D 100.00 ALUM, DB 82.00		
	GLSRIMEOP	Outside cover plate for rim devices only	38.00	38.00		
 98GLSCYL-1 IC98GLSCYL-1 ICSC98GLSCYL-1	Cylinder Trim for Narrow stile device	22.00	----			

STRIKES & ACCESSORIES

 36CD7700 IC36CD7700 ICSC36CD7700	Cylinder dogging kit for non-fire rated 36" applications	\$63.60	US32D \$63.60	1	Ea.	
 48CD7700 IC48CD7700 ICSC48CD7700	Cylinder dogging kit for non-fire rated 48" applications					
 N36ALARM77 ICN36ALARM77 ICSCN36ALARM77	Alarm kit w/ <i>micro switch</i> for 36"	US10B, US3 218.00	US32D 218.00	1	Ea.	
 N48ALARM77 ICN48ALARM77 ICSCN48ALARM77	Alarm kit w/ <i>micro switch</i> for 48"					
265	Bottom strike, concealed vertical rod device	----	12.72	1	Ea.	
260	Top strike, concealed vertical rod device					
246	Standard strike for GLS9800. Used on frames with integral blade stop.					
247	Applied to surface of stop. No mortise required. 1" x 3 1/2"					
418	96" T-shaped removable mullion non-fire rated application					250.56
424	96" Square steel mullion fire rated application (Prime coat)					300.00
418 BRACKETS	Top and Bottom retaining brackets for 418 mullion					58.89
424 BRACKETS	Top and Bottom retaining brackets for 424 mullion					58.89
 LCK418 ICLCK418 ICSC LCK418	Lockable 96" T-shaped removable mullion (Aluminum Prime coat), Non-fire Rated					826.80
Additional keyway if ordered with LCK418 Lockable Mullion (US26D)						24.00
LFF	Lock front filler (Zinc plated)					1.14
SF	Strike filler (Zinc plated)					1.73
MCVROD96	Vertical Top Rod for 96" for narrow stile					53.00
CUT CHARGE	Labor for cutting exit devices to size (applicable to all Series)					NET 50.00

◆ OTHER KEYWAYS		
GLSRIM7700, GLSRIM7705, GLSCVR7700, GLSCVR7705, 36CD7700, 48CD7700, N36ALARM77, N48ALARM77, LCK418	Schlage C-K, Russwin D1,D2, D3, Corbin 60, Sargent LA-LB-LC, Falcon/Weiser E, Arrow A, Corbin-Russwin L4, Yale8, Yale GA, Kwikset.	ADD 24.00

- (IC) Indicates function available with **Best, Falcon & Arrow Interchangeable Core.**
 - (ICSC) Indicates function available with **Schlage Full Size Format Interchangeable Core.**
- Prices do not include cores. **For IC Core pricing see pages L73 - L76.**
- ▶▶▶ **CONSULT FACTORY FOR TEMPLATES ON ALL EXIT DEVICES AND TRIMS**

MR7700 (Non-Fire) & FMR7700 (Fire-Rated) Series

Mortise Lock Rim Exit Device *List Price*

Push Bar Exit Device / ANSI 156.3 Grade 1, 3 Hour Rated, UL Listed
Optional with Alarm / Optional Delayed Egress



ILLUSTRATION	ITEM #	DESCRIPTION	LIST PRICE EA.		NON-STK FINISHES
			US32D	US10B	
 <p>MEETS The Buy American Act</p> <p>Lifetime Warranty BHMA CERTIFIED</p>	PANIC EXIT HARDWARE				
	MR7700EO36 **Handed (Specify Handing)	Entrance Mortise Rim exit for doors 36" wide	\$626.00	\$672.00	\$739.00
	MR7700EO48 **Handed (Specify Handing)	Entrance Mortise Rim exit for doors 48" wide	664.00	712.00	783.00
	MR7705EO36 **Handed (Specify Handing)	Storeroom Mortise Rim exit for doors 36" wide	626.00	672.00	739.00
	MR7705EO48 **Handed (Specify Handing)	Storeroom Mortise Rim exit for doors 48" wide	664.00	712.00	783.00
	FIRE EXIT HARDWARE RATED 3 HOURS				
	FMR7700EO36 **Handed (Specify Handing)	Entrance Mortise Rim exit for doors 36" wide	735.00	787.00	866.00
	FMR7700EO48 **Handed (Specify Handing)	Entrance Mortise Rim exit for doors 48" wide	779.00	834.00	918.00
	FMR7705EO36 **Handed (Specify Handing)	Storeroom Mortise Rim exit for doors 36" wide	735.00	787.00	860.00
	FMR7705EO48 **Handed (Specify Handing)	Storeroom Mortise Rim exit for doors 48" wide	779.00	834.00	918.00

DELAYED EGRESS OPTION
AVAILABLE See PAGE E32

ELR, RX, LX, RXLX and
POWER SUPPLIES AVAILABLE
See PAGE E33

QUANTITY DISCOUNT
16 UNITS MIXED - LESS 5%
32 UNITS MIXED - LESS 10%

◆◆ **MUST ORDER TRIM SEPARATELY** ◆◆

▶ **NON STOCK FINISHES & SIZES**

Availability subject to quantity & lead-time. Consult factory

▶ **TRIMS & ACCESSORIES LIST PRICE**

➢ All trims are 6-pin "C" keyway. Other major manufacturers' keyways available. (See page E12)

▣ **STANDARD DISCOUNT ONLY ON TRIMS AND ACCESSORIES** ▣

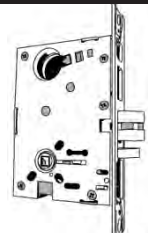
ILLUSTRATION	ITEM #	DESCRIPTION	US26D 10B	OTHER FINISHES	PCS /MC	UNIT
ESCUTCHEON TRIMS (Non-handed)						
	MRESC7700 ICMRESC7700 ICSCMRESC7700	Entrance, key locks or unlocks escutcheon trim ANSI FUNCTION (63)	152.00		12	Ea.
	MRESC7705 ICMRESC7705 ICSCMRESC7705	Storeroom, always locked ANSI FUNCTION (04) * MUST USE MR7705EO36/48 Mortise Rim Exit Device *				
	MRESC7730	Passage, trim always operable and free ANSI FUNCTION (62) * MUST USE MR7705EO36/48 Mortise Rim Exit Device *				
ELECTRIFICATION FOR THE MORTISE LOCK BODY ABOVE						
	FS12MR77	FAIL-SAFE (FS) OPTION 12V AC/DC	<p style="text-align: center;">\$167.00</p> <p style="text-align: center;">Non-Stock subject to factory lead time</p> <p style="text-align: center;">Electrification price only. PRICES DO NOT INCLUDE Mortise Body</p>			
	FS24MR77	FAIL-SAFE (FS) OPTION 24V AC/DC				
	FSE12MR77	FAIL-SECURE (FSE) OPTION 12V AC/DC				
	FSE24MR77	FAIL-SECURE (FSE) OPTION 24V AC/DC				

▶▶▶ **CONSULT FACTORY FOR TEMPLATES ON ALL EXIT DEVICES AND TRIMS**

◆ STANDARD DISCOUNT ONLY ON TRIMS AND ACCESSORIES ▢				
ITEM #	DESCRIPTION	OTHER	PCS /MC	UNIT
STRIKES & ACCESSORIES				
36CD7700 IC 36CD7700 ICSC 36CD7700	Cylinder dogging kit for non-fire rated 36" applications	US32D,10B \$63.60	1	Ea.
48CD7700 IC 48CD7700 ICSC 48CD7700	Cylinder dogging kit for non-fire rated 48" applications			
N36ALARM77 ICN 36ALARM77 ICSCN 36ALARM77	Alarm kit w/ micro switch for 36"	US32D, 10B,3 218.00		
N48ALARM77 ICN 48ALARM77 ICSCN 48ALARM77	Alarm kit w/ micro switch for 48"			
418	96" T-shaped removable mullion non-fire rated application (Prime coat)	250.56		
424	96" Square steel mullion fire rated application (Prime coat)	300.00		
418 BRACKETS	Top and Bottom retaining brackets for 418 mullion	58.89		
424 BRACKETS	Top and Bottom retaining brackets for 424 mullion	58.89		
LCK418 ICLCK 418 ICSC LCK418	Lockable 96" T-shaped removable mullion (Aluminum Prime coat), Non-fire Rated	826.80		
Additional keyway if ordered with LCK418 Lockable Mullion (US26D)		24.00		
LFF	Lock front filler (Zinc plated)	1.14		
SF	Strike filler (Zinc plated)	1.73		
OBSTRKRHR OBSTRKLHR	Open Back Strike FOR MR7700 SERIES MORTISE LOCK EXIT DEVICE ANSI A-115.14 (specify handing)	58.89		
MR9800LCK	MR9800 Mortise Lock Case (Entrance Function)	115.00		
MR9805LCK	MR9800 Mortise Lock Case (Storeroom and Passage Functions)			
CUT CHARGE	Labor for cutting exit devices to size (applicable to all Series)	NET 50.00		

Ⓜ (IC) Indicates function available with **Best, Falcon & Arrow Interchangeable Core.**

Ⓜ (ICSC) Indicates function available with **Schlage Full Size Format Interchangeable Core.**

Prices do not include cores. **For IC Core pricing see pages L73 - L76.**

◆ OTHER KEYWAYS		
MRESC7700, MRESC7705, 36CD7700, 48CD7700, N36ALARM77, N48ALARM77, LCK418	Schlage C-K, Russwin D1,D2, D3, Corbin 60, Sargent LA-LB-LC, Falcon/Weiser E, Arrow A, Corbin-Russwin L4, Yale 8, Yale GA, Kwikset	ADD 24.00

9800 & 9860 (Non-fire Rated)

F9800 & F9860 (Fire Rated) Series List Price



Push Bar Exit Device / ANSI 156.3 Grade 1, 3 Hour Rated, UL Listed
 Optional with Alarm/ Electrified ♦ Fits same hole pattern as Sargent 8800 Series using 9800 Escutcheon Trims

ILLUSTRATION	ITEM #	DESCRIPTION	US32D	US3, 4, 10, 10B	NONSTK FINISHES	
<p>Lifetime Warranty BHMA CERTIFIED</p> <p>ELR, RX, LX, RXLX and POWER SUPPLIES AVAILABLE See PAGE E33</p> <p>MEETS <i>The Buy American Act</i></p>	PANIC EXIT HARDWARE		LIST PRICE EACH			
	9800EO24	Rim exit, 24", 32D only	\$409.92	----	\$439.09	
	9800EO32	Rim exit, 32", 32D only				
	9800EO36	Rim exit, 36"	350.56	\$379.78	417.98	
	9820EO48	Rim exit, 48"	373.04	402.25	442.70	
	NALRM9800EO36	Alarm rim exit, 36" NEW ITEM	542.00	580.00	682.72	
	NALRM9820EO48	Alarm rim exit, 48" NEW ITEM	567.00	605.00	713.00	
	9810V2484	Surface vertical rod 24" X 84" 32D only *SH	522.28	----	553.74	
	9870V3284	Surface vertical rod 32" X 84" 32D only *SH				
	9860V3684	Surface vertical rod 36" X 84" *SH	462.92	494.38	543.82	
	9890V3696	Surface vertical rod 36" X 96" *SH	494.38	524.70	577.53	
	9850V36120	Surface vertical rod 36" X 120" *SH	524.72	576.41	634.83	
	9880V4896	Surface vertical rod 48" X 96" *SH	494.38	524.72	577.53	
	9840V48120	Surface vertical rod 48" X 120" *SH	524.72	576.41	634.83	
	NALRM	Prefix "NALRM" for vertical devices	ADD 218.00	ADD 218.00	ADD 218.00	
	FIRE EXIT HARDWARE RATED 3 HOURS (Includes thru bolts)					
	F9800EO24	Rim exit, 24", 32D only	471.70	----	502.06	
	F9800EO32	Rim exit, 32", 32D only				
	F9800EO36	Rim exit, 36"	412.34	442.70	487.64	
	F9820EO48	Rim exit, 48"	434.83	465.17	512.36	
FNALRM980036	Alarm rim exit, 36" NEW ITEM	616.00	651.00	768.54		
FNALRM982048	Alarm rim exit, 48" NEW ITEM	642.00	673.00	796.00		
F9810V2484	Surface vertical rod 24" X 84" 32D only *SH	589.36	----	621.16		
F9870V3284	Surface vertical rod 32" X 84" 32D only *SH					
F9860V3684	Surface vertical rod 36" X 84" *SH	530.34	561.80	617.98		
F9890V3696	Surface vertical rod 36" X 96" *SH	561.80	592.14	651.69		
F9880V4896	Surface vertical rod 48" X 96" *SH					
NALRM	Prefix "NALRM" for vertical devices	ADD 218.00	ADD 218.00	ADD 218.00		

*SH Specify Left Hand Reverse (LHR) or Right Hand Reverse (RHR) for convenience. Easily field reversible.

♦♦ **MUST ORDER TRIM SEPARATELY** ♦♦

▶ **NON STOCK FINISHES**

- Availability subject to quantity & lead-time. Consult factory

▶ **PACKAGING INCLUDES**



- Thru bolts for fire rated devices only.
- 4 Pcs per master carton
- Strike Filler, Lock Front Filler packed with Rim Devices at no extra charge.

<p>QUANTITY DISCOUNT 16 UNITS MIXED - LESS 5% 32 UNITS MIXED - LESS 10%</p>
--

LBR9800 & 9860 (Non-fire Rated) LBRF9800 & F9860 (Fire Rated) Series List Price

Vertical Rod Type Exit Device **Less Bottom Rod - LBR**
Push Bar Exit Device / ANSI 156.3 Grade 1, 3 Hour Rated, UL Listed
Optional with Alarm / Electrified

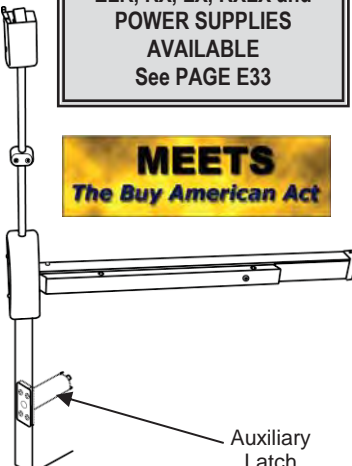

ILLUSTRATION	ITEM #	DESCRIPTION	US32D	US3, 10B, 4, US10	NON STOCK FINISHES	
 <p>ELR, RX, LX, RXLX and POWER SUPPLIES AVAILABLE See PAGE E33</p>   <p>Auxiliary Latch</p>	PANIC EXIT HARDWARE		LIST PRICE EACH			
	***9810V2484	Surface vertical rod 24" X 84"	\$522.28	---	\$533.74	
	***9870V3284	Surface vertical rod 32" X 84"				
	***9860V3684	Surface vertical rod 36" X 84"	462.92	\$494.38	543.82	
	***9890V3696	Surface vertical rod 36" X 96"	494.38	524.72	577.53	
	***9850V36120	Surface vertical rod 36" X 120"	524.72	576.41	634.83	
	***9880V4896	Surface vertical rod 48" X 96"	494.38	524.72	577.53	
	***9840V48120	Surface vertical rod 48" X 120"	524.72	576.41	634.83	
	*** Standard surface vertical rod is used less bottom rod in installation					
	FIRE EXIT HARDWARE RATED 3 HOURS					
LBRF9810V2484	Surface vertical rod LBR 24" X 84" Includes thru bolts & AUX Latch *SH	589.36	---	621.16		
LBRF9870V3284	Surface vertical rod LBR 32" X 84" Includes thru bolts & AUX Latch *SH					
LBRF9860V3684	Surface vertical rod LBR 36" X 84" Includes thru bolts & AUX Latch *SH	530.34	561.80	617.98		
LBRF9890V3696	Surface vertical rod LBR 36" X 96" Includes thru bolts & AUX Latch *SH	561.80	592.14	651.69		
LBRF9880V4896	Surface vertical rod LBR 48" X 96" Includes thru bolts & AUX Latch *SH	561.80	592.14	651.69		

*SH Specify Left Hand Reverse (LHR) or Right Hand Reverse (RHR) for convenience. Easily field reversible.

◆ ACCESSORIES

AUXFL	Additional auxiliary latch (Raw finish)	49.95
-------	---	-------

◆◆ MUST ORDER TRIMS SEPARATELY ◆◆

▶ LBR FIRERATED DEVICES PACKAGING

- Packed with auxiliary spring latch to be installed in the lower edge of door.
- Thru bolts for fire vertical rod devices only.

▶ LBR NON-FIRE RATED PACKAGING

- 4 pcs per master carton.

▶ NON-STOCK FINISHES

- Availability subject to quantity and lead-time. Consult factory.

▶ ALARM AVAILABLE

- Alarm available. Prefix NALRM before part#. Add \$218.00 List.



**QUANTITY DISCOUNT
ON STANDARD DISCOUNT ONLY**
16 UNITS MIXED - LESS 5%
32 UNITS MIXED - LESS 10%

► **TRIMS & ACCESSORIES LIST PRICE**

➤ All trims are 6-pin "C" keyway. Other major manufacturers' keyways available. (See page E17)

STANDARD DISCOUNT ONLY ON TRIMS				
ILLUSTRATION	ITEM #	DESCRIPTION	US26D,3, 10B,4,10	OTHER

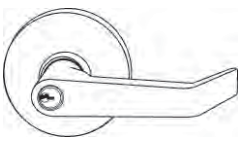
◆ **TRIMS**

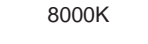
ROSE TRIMS (Non-handed)			LIST PRICE EACH		
 ENT00L	●●●●●● ENT00L or ●●●●●● IC ENT00L (Best, Falcon SFIC) ●●●●●● ICSC ENT00L4 (Schlage LFIC)	Clutch Entrance, key locks / unlocks lever trim ANSI FUNCTION (08) Operates as classroom function	\$115.73		
	●●●●●● SARICENT00L (Sargent) ●●●●●● RUSICENT00L (Corbin/Ruswin) ●●●●●● YALICENT00L (Yale)	Operates as classroom function	NEW ITEM US26D 140.00		
	 STR05L or ●●●●●● IC STR05L (Best, Falcon SFIC) ●●●●●● ICSC STR05L4 (Schlage LFIC)	Clutch Storeroom, key operates lever ANSI FUNCTION (04)	\$115.73		
		●●●●●● SARICSTR05L (Sargent) ●●●●●● RUSICSTR05L (Corbin/Ruswin) ●●●●●● YALICSTR05L (Yale)	Operates as classroom function		NEW ITEM US26D 140.00
		●●●●●● PAS30L ●●●●●● DUM40L	Passage, lever always operable. ANSI FUNCTION (15) Dummy, lever trim. ANSI FUNCTION(10)		\$115.73
 8000K	●●●●●● 8000K	Ball knob keylock, "C" keyway	US10B 89.00	US32D,3 \$75.50	

For 2 1/4" thick door order part # TAIL1

ESCUTCHEON TRIMS (Non-handed)				
 NESC9800 or ●●●●●● IC NESC9800 ●●●●●● ICSC NESC9800	Rigid Entrance, key locks or unlocks escutcheon trim. Operates as classroom ANSI FUNCTION (63)	145.00		
	●●●●●● NESC9805 or ●●●●●● IC NESC9805 ●●●●●● ICSC NESC9805	Rigid Storeroom, always locked ANSI FUNCTION (04)		145.00
	●●●●●● NESC9830	Passage, trim always operable and free ANSI FUNCTION (62)		145.00
	●●●●●● NESC9840	Dummy Escutcheon trim. ANSI FUNCTION (10)		145.00
	●●●●●● ELR, RX, LX & RXLX	See PAGE E33		145.00

For 2 1/4" thick door order part # TAIL3

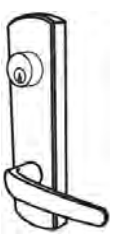
ESCUTCHEON TRIMS RL & AT Design (Non-handed)				
 RL	●●●●●● ATEESC9800 ●●●●●● IC ATEESC9800 ●●●●●● ICSC ATEESC9800	Rigid Entrance, key locks or unlocks escutcheon trim. Operates as classroom ANSI FUNCTION (63)	164.00	
	●●●●●● ATEESC9805 ●●●●●● IC ATEESC9805 ●●●●●● ICSC ATEESC9805	Rigid Storeroom, always locked ANSI FUNCTION (04)	164.00	
	●●●●●● ATEESC9830 ●●●●●● ATEESC9840	Passage, trim always operable and free. ANSI FUNCTION (62) Dummy Escutcheon trim ANSI FUNCTION (10)	164.00	
	●●●●●● RLESC9800 ●●●●●● IC RLESC9800 ●●●●●● ICSC RLESC9800	Rigid Entrance, key locks or unlocks escutcheon trim. Operates as classroom ANSI FUNCTION (63)	164.00	
 AT	●●●●●● RLESC9805 ●●●●●● IC RLESC9805 ●●●●●● ICSC RLESC9805	Rigid Storeroom, always locked ANSI FUNCTION (04)	164.00	
	●●●●●● RLESC9830 ●●●●●● RLESC9840	Passage, trim always operable and free. ANSI FUNCTION (62) Dummy Escutcheon trim. ANSI FUNCTION (10)	164.00	
	●●●●●● Electrification	Available see PAGE E33	164.00	
	●●●●●●	Available see PAGE E33	164.00	

For 2 1/4" thick door order part # TAIL3

- (IC) Indicates function available with **Best, Falcon & Arrow Interchangeable Core.**
 - (ICSC) Indicates function available with **Schlage Full Size Format Interchangeable Core.**
- Prices do not include cores. For IC Core pricing see pages L73 - L76.

► **TRIMS & ACCESSORIES LIST PRICE**

➤ All trims are 6-pin "C" keyway. Other major manufacturers' keyways available. (See Page E17)

STANDARD DISCOUNT ONLY ON TRIMS AND ACCESSORIES

ILLUSTRATION	ITEM #	DESCRIPTION	US26D, 3 10B, 4, 10	OTHER
ELECTRIFIED LEVER TRIM				
	FS12NESEC98 ICFSE12NESEC98 ICSCFSE12NESEC98	FAIL-SAFE (FS) OPTION 12V AC/DC US26D in stock	\$389.02	
	FS24NESEC98 ICFSE24NESEC98 ICSCFSE24NESEC98	FAIL-SAFE (FS) OPTION 24V AC/DC US26D in stock		
	FSE12NESEC98 ICFSE24NESEC98 ICSCFSE24NESEC98	FAIL-SECURE (FSE) OPTION 12V AC/DC US26D in stock		
	FSE24NESEC98 ICFSE24NESEC98 ICSCFSE24NESEC98	FAIL-SECURE (FSE) OPTION 24V AC/DC US26D, 10B, 4 in stock		
THUMB PIECE TRIMS (Non-handed)				
	98TP00 IC98TP00 ICSC98TP00	Entrance, key locks or unlocks thumb piece ANSI FUNCTION (63) operates as classroom function	120.00	US32D 120.00
	98TP05or IC98TP05 ICSC98TP05	Storeroom, always locked ANSI FUNCTION (04)		
	98TP30	Passage trim, always operable and free ANSI FUNCTION (62)		
	98TP40	Dummy trim, ANSI FUNCTION (10)		
For 2 1/4" thick door order part # TAIL7			----	12.36
PULL TRIMS				
	9800NL IC9800NL ICSC9800NL	To be used with rim panic exit device Pull & rim cylinder, key retracts latch bolt ANSI FUNCTION (03).	80.00	US32D 80.00
	9800DTP	Dummy trim (Pull) ANSI FUNCTION (02)	63.00	US32D 63.00
	9800EOP	Cover plate (blank plate) ANSI FUNCTION (10)	35.00	US32D 35.00
HEAVY DUTY KEYLESS LOCK				
	CRCODE007LH CRCODE007RH	Heavy Duty Clutch Keyless Digital Lock to be used for 9800/7700 Series Exit Device. (Specify handing when ordering) Available with other major manufacturer's keyway see page E10	US26D 542.72 Must order exit device from stock. Prefix DL before PART# of exit device	
	CRCODE101	Heavy Duty Rigid Keyless Mechanical Lock to be used for 9800/7700 Series Exit Device. Non-Handed. Available with other major manufacturer's keyway see page E10	US26D 542.72	
	CR4000	Trilogy© Exit Device Trims for 9800 Series Exit Devices	US26D 1187.00 US10B 1220.00	
	ICCR4000	(**note - IC includes CYLINDER ADAPTER KIT for Best, Falcon & Arrow Interchangeable Core)	IC CORE ADD \$78.00 List. Excludes Rim Cylinder Housing and Core.	

● (IC) Indicates function available with **Best, Falcon & Arrow Interchangeable Core.**
 ● (ICSC) Indicates function available with **Schlage Full Size Format Interchangeable Core.**
 Prices do not include cores. For IC Core pricing see pages L73 - L76.

► **TRIMS & ACCESSORIES LIST PRICE**

► All trims are 6-pin "C" keyway. Other major manufacturers' keyways available. (See below)

STANDARD DISCOUNT ONLY ON TRIMS AND ACCESSORIES					
ITEM #	DESCRIPTION	US10B, 3, 4	NYLON BLACK COATED	OTHER	UNIT
STRIKES & ACCESSORIES					
●●● 36CD9800 ●●● IC36CD9800 ●●● ICSC36CD9800	Cylinder dogging kit for non-fire rated 36" applications	\$63.60		US32D \$63.60	Ea.
●●● 48CD9800 ●●● IC48CD9800 ●●● ICSC48CD9800	Cylinder dogging kit for non-fire rated 48" applications				
●●● 36ALARM98 ●●● IC36ALARM98 ●●● ICSC36ALARM98	Replacement alarm kit for 36" 9800 Series Alarm-ready Rim Exit	111.30	----	US32D 111.30	
●●● 48ALARM98 ●●● IC48ALARM98 ●●● ICSC48ALARM98	Replacement alarm kit for 48" 9800 Series Alarm-ready Rim Exit	111.30		US32D 111.30	
●●● NVALARM36 ●●● ICNVALARM36 ●●● ICSCNVALARM36	Alarm kit w/ <i>micro switch</i> for 36" Vertical Rod Exit Device	191.00		US32D 191.00	
●●● NVALARM48 ●●● ICNVALARM48 ●●● ICSCNVALARM48	Alarm kit w/ <i>micro switch</i> for 48" Vertical Rod Exit Device	195.00		US32D 195.00	
DOGGINGKIT	Standard Dogging Assembly Kit with allen wrench			16.67	
RIM238	Rim strike for 2 3/8" backset		\$11.24		
221	Bottom strike, non-fire vertical rod device	----	10.11	----	
227	Top strike, non-fire vertical rod device				
233	Alternate flush mounting bottom strike. Standard for fire rated vertical rod				
239	Surface applied strike, rim non-fire				
245	Surface applied strike, rim fire and top strike fire rated vertical rod device				
N251	Overlapping strike				
357	Thrubolts for rim fire and panic grade 1 3/4" door (6 PCs)			US32D 19.98	
363	Thrubolts for rim fire and panic grade 2 1/4" door (6 PCs)				
369	Thrubolts for vertical rod fire and panic grade to be used with trim 1 3/4" door (14 pcs)	----	----	US32D 39.95	
375	Thrubolts for vertical rod fire and panic grade to be used with trim 2 1/4" door (14 pcs)				
801	Rim shim kit 1/8" (Thick)			22.47	
806	Panic vertical rod shim kit 1/8" (Thick)			40.45	
812	Fire rated vertical rod shim kit 1/8" (Thick)				
CUT CHARGE	Labor for cutting exit devices to size (applicable to all Series)			NET 50.00	

- (IC) Indicates function available with **Best, Falcon & Arrow Interchangeable Core.**
 - (ICSC) Indicates function available with **Schlage Full Size Format Interchangeable Core.**
- Prices do not include cores. For IC Core pricing see pages L73 - L76.

OTHER KEYWAYS			
Available for ENT00L, STR05L, CRCODE007, CRCODE 101	Schlage C-K, Russwin D1,D2, D3, Corbin 60, Sargent LA-LB-LC, Falcon/Weiser E, Corbin-Russwin L4, Arrow A, Yale 8, Yale GA, Kwikset	ADD 13.33	E A C H
NESC9800, NESC9805, 98TP00, 98TP05, 9800NL, 36CD9800, 48CD9800, 36ALARM98, CR4000, 48ALARM98, VALARM36, VALARM48	Schlage C-K, Russwin D1,D2, D3, Corbin 60, Sargent LA-LB-LC, Falcon/Weiser E, Corbin-Russwin L4, Arrow A, Yale 8, Yale GA, Kwikset	ADD 24.00	

► TRIMS & ACCESSORIES LIST PRICE

➤ All trims are 6-pin "C" keyway. Other major manufacturers' keyways available. (See below)

▣ STANDARD DISCOUNT ONLY ON TRIMS AND ACCESSORIES ▣

ITEM #	DESCRIPTION	US26D,3 , 10B, 4, 10	ALUM, GOLD, DURO	OTHER	UNIT
STRIKES & ACCESSORIES					
418	96" T-shaped removable mullion non-fire rated application (Aluminum Prime coat)			\$250.56	Ea.
424	96" Square steel mullion fire rated application (Prime coat)			300.00	
418 BRACKETS	Top and Bottom retaining brackets for 418 mullion			58.89	
424 BRACKETS	Top and Bottom retaining brackets for 424 mullion	----	----	58.89	
LCK418 ICLCK418 ICSC LCK418	Lockable (Aluminum Prime coat), Non-fire Rated			826.80	
Additional keyway if ordered with LCK418 Lockable Mullion				24.00	
VRRD10	Vertical rod for 10' doors, for non-fire rated devices only	\$34.83	\$24.97	----	
LFF	Lock front filler (Zinc plated)			1.14	
SF	Strike filler (Zinc plated)	----	----	1.73	
CUT CHARGE	Labor for cutting exit devices to size (applicable to all Series)	NET 50.00			

◆ OTHER KEYWAYS

LCK418	Schlage C-K, Russwin D1, D2, D3, Corbin 60, Sargent LA-LB-LC, Falcon/Weiser E, Corbin-Russwin L4, Arrow A, Yale 8, Yale GA, Kwikset	ADD 24.00	Ea.
--------	---	---------------------	-----

● (IC) Indicates function available with **Best, Falcon & Arrow Interchangeable Core.**

● (ICSC) Indicates function available with **Schlage Full Size Format Interchangeable Core.**

Prices do not include cores. For IC Core pricing see pages L73 - L76.

▶▶▶ **CONSULT FACTORY FOR TEMPLATES ON ALL EXIT DEVICES AND TRIMS**

WCVR9800 & MCVR9800 (Non-Fire) FWCVR9800 & FMCVR9800 (Fire-Rated)



Wood & Metal Concealed Vertical Rod Exit Device Series List Price

Push Bar Exit Device / ANSI 156.3 Grade 1, 3 Hour Rated, UL Listed
Optional with Alarm / Electrified

ILLUSTRATION	ITEM #	DESCRIPTION	LIST PRICE EA		NON-STK FINISHES
			US32D	US10B	
	PANIC EXIT HARDWARE				
	M98CVR3684	Concealed vertical rod 36" X 84" Metal Door *SH	\$524.00	\$559.00	\$615.00
	W98CVR3684	Concealed vertical rod 36" X 84" Wood Door *SH			
	M98CVR3696	Concealed vertical rod 36" X 96" Metal Door *SH	571.00	609.00	670.00
	W98CVR3696	Concealed vertical rod 36" X 96" Wood Door *SH			
	FIRE EXIT HARDWARE RATED 3 HOURS				
	FM98CVR3684	Concealed vertical rod 36" X 84" Metal Door *SH	601.02	634.94	689.00
	FW98CVR3684	Concealed vertical rod 36" X 84" Wood Door *SH			
	FM98CVR3696	Concealed vertical rod 36" X 96" Metal Door *SH	654.02	687.94	742.00
	FW98CVR3696	Concealed vertical rod 36" X 96" Wood Door *SH			

*SH Specify Left Hand Reverse (LHR) or Right Hand Reverse (RHR) for convenience.

- Easily field reversible
- 4 pcs per master carton

ELR, RX, LX, RXLX and
POWER SUPPLIES AVAILABLE
See PAGE E33

QUANTITY DISCOUNT
16 UNITS MIXED - LESS 5%
32 UNITS MIXED - LESS 10%

◆◆ MUST ORDER TRIM SEPARATELY ◆◆

► **NON STOCK FINISHES**

Availability subject to quantity & lead-time.
Consult factory.

► **TRIMS & ACCESSORIES LIST PRICE**

- All trims are 6-pin "C" keyway. Other major manufacturers' keyways available. (See page E21)

▣ STANDARD DISCOUNT ONLY ON TRIMS AND ACCESSORIES ▣					
ILLUSTRATION	ITEM #	DESCRIPTION	US26D, 10B	PCS /MC	UNIT
ESCUTCHEON TRIMS (Non-handed)					
<p>CVRESC9800</p>	CVRESC9800 or ICCVRESC9800 ICSCCVRESC9800	Clutch Entrance, key locks or unlocks escutcheon trim ANSI FUNCTION (63)	156.00	12	Ea.
	CVRESC9805 or ICCVRESC9805 ICSCCVRESC9805	Clutch Storeroom, key unlocks the lever, lever retracts latch bolt, otherwise always locked ANSI FUNCTION (04)			
	CVRESC9830	Passage, trim always operable and free ANSI FUNCTION (62)			
	CVRESC9840	Dummy Escutcheon trim ANSI FUNCTION (10)			

LBRWCVR9800 & LBRMCVR9800 (Non-Fire)

LBRFWCVR9800 & LBRFMCVR9800 (Fire-Rated)

Wood & Metal Less Bottom Concealed Vertical Rod Exit Device

Series List Price



Push Bar Exit Device / ANSI 156.3 Grade 1, 3 Hour Rated, UL Listed
Optional with Alarm / Electrified

ILLUSTRATION	ITEM #	DESCRIPTION	LIST PRICE EA		NON-STK FINISHES	
			US32D	US10B		
	PANIC EXIT HARDWARE					
	***M98CVR3684	Concealed vertical rod 36" X 84" Metal Door *SH	\$524.00	\$559.00	\$615.00	
	***W98CVR3684	Concealed vertical rod 36" X 84" Wood Door *SH				
	***M98CVR3696	Concealed vertical rod 36" X 96" Metal Door *SH	571.00	609.00	670.00	
	***W98CVR3696	Concealed vertical rod 36" X 96" Wood Door *SH				
	*** Standard surface vertical rod is used for less bottom rod in installation					
	FIRE EXIT HARDWARE RATED 3 HOURS					
	LBRFM98CVR3684	Concealed vertical rod 36" X 84" Metal Door Includes AUX Latch *SH	601.02	634.94	689.00	
	LBRFW98CVR3684	Concealed vertical rod 36" X 84" Wood Door Includes AUX Latch *SH				
	LBRFM98CVR3696	Concealed vertical rod 36" X 96" Metal Door Includes AUX Latch *SH	654.02	687.94	742.00	
LBRFW98CVR3696	Concealed vertical rod 36" X 96" Wood Door Includes AUX Latch *SH					

*SH Specify Left Hand Reverse (LHR) or Right Hand Reverse (RHR) for convenience.

- Easily field reversible.
- 4 pcs per master carton

ELR, RX, LX, RXLX and
POWER SUPPLIES AVAILABLE
See PAGE E33

QUANTITY DISCOUNT
16 UNITS MIXED - LESS 5%
32 UNITS MIXED - LESS 10%

STANDARD DISCOUNT ONLY ON TRIMS AND ACCESSORIES

All trims are 6-pin "C" keyway. Other major manufacturers' keyways available. (See below)

ITEM #	DESCRIPTION	US10B, US3	OTHERS	PCS /MC	UNIT
STRIKES & ACCESSORIES					
36CD9800 IC 36CD9800 ICSC 36CD9800	Cylinder dogging kit for <i>non-fire rated</i> 36" applications	\$63.60	US32D \$63.60	1	Ea.
48CD9800 IC 48CD9800 ICSC 48CD9800	Cylinder dogging kit for <i>non-fire rated</i> 48" applications				
NVALARM36 IC NVALARM36 ICSC NVALARM36	Alarm kit w/ <i>micro switch</i> for 36"	191.00	US32D 191.00		
NVALARM48 IC NVALARM48 ICSC NVALARM48	Alarm kit w/ <i>micro switch</i> for 48"	195.00	US32D 195.00		
265	Bottom strike, concealed vertical rod device	----	12.72		
260	Top strike, concealed vertical rod device		250.56		
418	96" T-shaped removable mullion <i>non-fire rated</i> application (Prime coat)		300.00		
424	96" Square steel mullion fire rated application (Prime coat)		58.89		
418 BRACKETS	Top and Bottom retaining brackets for 418 mullion		58.89		
424 BRACKETS	Top and Bottom retaining brackets for 424 mullion		826.80		
LCK418 IC LCK418 ICSC LCK418	Lockable 96" T-shaped removable mullion (Aluminum Prime coat), Non-fire Rated		24.00		
Additional keyway if ordered with LCK418 Lockable Mullion (US26D)			1.14		
LFF	Lock front filler (Zinc plated)		1.73		
SF	Strike filler (Zinc plated)		53.00		
MCVROD96	Vertical Top Rod for 96" metal door		NET 50.00		
WCVROD96	Vertical Top Rod for 96" wood door				
CUT CHARGE	Labor for cutting exit devices to size (applicable to all Series)				

OTHER KEYWAYS

CVRESC9800, CVRESC9805, 36CD9800, 48CD9800, 36ALARM98, 48ALARM98, VALARM36, VALARM48, LCK418	Schlage C-K, Russwin D1,D2, D3, Corbin 60, Sargent LA-LB-LC, Falcon/Weiser E, Corbin-Russwin L4, Arrow A, Yale8, Yale GA, Kwikset.	ADD 24.00
--	--	---------------------

- (IC)** Indicates function available with **Best, Falcon & Arrow Interchangeable Core.**
- (ICSC)** Indicates function available with **Schlage Full Size Format Interchangeable Core.**

Prices do not include cores. **For IC Core pricing see pages L73 - L76.**

▶▶▶ CONSULT FACTORY FOR TEMPLATES ON ALL EXIT DEVICES AND TRIMS

GLS9800 & GLSCVR9800 (Non-Fire Rated)

Narrow Stile Rim, Concealed Vertical Rod Exit Device,
Optional Less Bottom Rod (**LBR) *Series List Price*



Push Bar Exit Device / ANSI 156.3 Grade 1, UL Listed for Panic & Safety
Optional with Alarm / Electrified

3 HOUR FIRE RATED
Panic & Safety

ILLUSTRATION	ITEM #	DESCRIPTION	LIST PRICE EA		NON-STK FINISHES
			US32D	US10B	
	PANIC EXIT HARDWARE				
	GLS9800EO36	Rim Exit Device, 36"	438.00	475.00	523.00
	GLS9800EO48	Rim Exit Device, 48"	466.00	503.00	553.00
	GLSCVR983684 **Handed (Specify Handing)	Concealed vertical rod 36" X 84" High	661.00	699.00	758.00
	GLSCVR984884 **Handed (Specify Handing)	Concealed vertical rod 48" X 84" High	719.00	757.00	816.00

***LBR Optional upon installation

► NON STOCK FINISHES

Availability subject to quantity & lead-time. Consult factory.

- Non-handed on rim only.
- Concealed Vertical rod is handed. Specify LHR or RHR at time of order.
- 4 pcs per master carton

**ELR, RX, LX, RXLX and
POWER SUPPLIES AVAILABLE
See PAGE E33**

◆◆ **MUST ORDER TRIM SEPARATELY** ◆◆

TRIMS & ACCESSORIES LIST PRICE

▣ **STANDARD DISCOUNT ONLY ON TRIMS AND ACCESSORIES** ▣

ILLUSTRATION	ITEM #	DESCRIPTION	10B, US26D	PCS /MC	UNIT
RIM ESCUTCHEON TRIMS (NON-HANDED)					
	GLSRIM9800, ICGLSRIM9800, ICSCGLSRIM9800	Clutch Entrance, key locks or unlocks escutcheon trim ANSI FUNCTION (63)	180.00	12	Ea.
	GLSRIM9805, ICGLSRIM9805, ICSCGLSRIM9805	Clutch Storeroom, key unlocks the lever, lever retracts latch bolt, otherwise always locked ANSI FUNCTION (04)			
	GLSRIM9830	Passage, trim always operable and free ANSI (62)			
	GLSRIM9840	Dummy Escutcheon trim ANSI FUNCTION (10)			
CVR ESCUTCHEON TRIMS (NON-HANDED)					
	GLSCVR9800, ICGLSCVR9800, ICSCGLSCVR9800	Clutch Entrance, key locks or unlocks escutcheon trim ANSI FUNCTION (63)	180.00	12	Ea.
	GLSCVR9805, ICSCGLSCVR9805, ICSCGLSCVR9805	Clutch Storeroom, key unlocks the lever, lever retracts latch bolt, otherwise always locked ANSI FUNCTION (04)			
	GLSCVR9830	Passage, trim always operable and free ANSI (62)			
	GLSCVR9840	Dummy Escutcheon trim ANSI FUNCTION (10)			

All trims are 6-pin "C" keyway. Other major manufacturers' keyways available. (See Page E23)

STANDARD DISCOUNT ONLY ON TRIMS AND ACCESSORIES

All trims are 6-pin "C" keyway. Other major manufacturers' keyways available. (See below)

ITEM #	DESCRIPTION	US26D, 10B	OTHERS	PCS /MC	UNIT	
PULL TRIMS						
	OFSTPUL-10	Offset Pull Trim for Narrow Stile device	10B 122.00	US32D 111.00 ALUM 45.00	1 Ea.	
	98GLSNL IC98GLSNL ICSC98GLSNL	C-Pull Trim with Cylinder for Narrow Stile device (Specify Handing)	10B 117.00	US32D 107.00 ALUM, DB 89.00		
	98GLSUP	C-Pull Trim without Cylinder for Narrow Stile device	10B 110.00	US32D 100.00 ALUM, DB 82.00		
	GLSRIMEOP	Outside cover plate for rim devices only	38.00	38.00		
	98GLSCYL-1 IC98GLSCYL-1 ICSC98GLSCYL-1	Cylinder Trim for Narrow stile device	22.00	----		
STRIKES & ACCESSORIES						
36CD9800 IC36CD9800 ICSC36CD9800	Cylinder dogging kit for non-fire rated 36" applications	\$63.60	US32D \$63.60	1	Ea.	
NVALARM36 ICNVALARM36 ICSCNVALARM36	Alarm kit w/ micro switch for 36"	191.00	US32D 191.00			
48CD9800 IC48CD9800 ICSC48CD9800	Cylinder dogging kit for non-fire rated 48" applications	\$63.60	US32D \$63.60	1	Ea.	
NVALARM48 ICNVALARM48 ICSCNVALARM48	Alarm kit w/ micro switch for 48"	195.00	US32D 195.00			
265	Bottom strike, concealed vertical rod device	----	12.72			
260	Top strike, concealed vertical rod device					
246	Standard strike for GLS9800. Used on frames with integral blade stop.					
247	Applied to surface of stop. No mortise required. 1" x 3 1/2"					
418	96" T-shaped removable mullion non-fire rated application					250.56
424	96" Square steel mullion fire rated application (Prime coat)					300.00
418 BRACKETS	Top and Bottom retaining brackets for 418 mullion					58.89
424 BRACKETS	Top and Bottom retaining brackets for 424 mullion					58.89
LCK418 ICLCK418 ICSC LCK418	Lockable 96" T-shaped removable mullion (Aluminum Prime coat), Non-fire Rated					826.80
Additional keyway if ordered with LCK418 Lockable Mullion (US26D)				24.00		
LFF	Lock front filler (Zinc plated)			1.14		
SF	Strike filler (Zinc plated)	1.73				
MCVROD96	Vertical Top Rod for 96" for narrow stile	53.00				
CUT CHARGE	Labor for cutting exit devices to size (applicable to all Series)	NET 50.00				

OTHER KEYWAYS

GLSRIM9800, GLSRIM9805, GLSCVR9800, GLSCVR9805, 36CD9800, NVALARM36, NVALARM48, LCK418

Schlage C-K, Russwin D1,D2, D3, Corbin 60, Arrow A, Sargent LA-LB-LC, Falcon/Weiser E, Corbin-Russwin L4, Yale8, Yale GA, Kwikset. **See page L62 for ITEM#.**

ADD
24.00

● (IC) Indicates function available with **Best, Falcon & Arrow Interchangeable Core.**
 ● (ICSC) Indicates function available with **Schlage Full Size Format Interchangeable Core.**
 Prices do not include cores. **For IC Core pricing see pages L73 - L76.**

▶▶▶ **CONSULT FACTORY FOR TEMPLATES ON ALL EXIT DEVICES AND TRIMS**

MR9800 (Non-Fire) & FMR9800 (Fire-Rated) Series

Mortise Lock Rim Exit Device *List Price*

Push Bar Exit Device / ANSI 156.3 Grade 1, 3 Hour Rated, UL Listed
Optional with Alarm

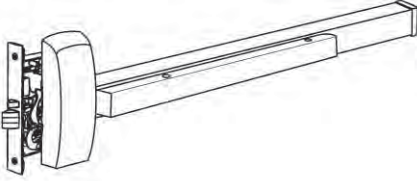

ILLUSTRATION	ITEM #	DESCRIPTION	LIST PRICE EA.		NON-STK FINISHES
			US32D	US10B	
 <p>MEETS <i>The Buy American Act</i></p> <p>Lifetime Warranty BHMA CERTIFIED</p>	PANIC EXIT HARDWARE				
	MR9800EO36 **Handed (Specify Handing)	Entrance Mortise Rim exit for doors 36" wide	\$491.00	\$532.00	\$584.00
	MR9800EO48 **Handed (Specify Handing)	Entrance Mortise Rim exit for doors 48" wide	521.00	564.00	619.00
	MR9805EO36 **Handed (Specify Handing)	Storeroom Mortise Rim exit for doors 36" wide	491.00	532.00	584.00
	MR9805EO48 **Handed (Specify Handing)	Storeroom Mortise Rim exit for doors 48" wide	521.00	564.00	619.00
	FIRE EXIT HARDWARE RATED 3 HOURS				
	FMR9800EO36 **Handed (Specify Handing)	Entrance Mortise Rim exit for doors 36" wide	\$540.60	\$594.66	\$683.70
	FMR9800EO48 **Handed (Specify Handing)	Entrance Mortise Rim exit for doors 48" wide	572.40	629.64	723.98
	FMR9805EO36 **Handed (Specify Handing)	Storeroom Mortise Rim exit for doors 36" wide	540.60	594.66	683.70
	FMR9805EO48 **Handed (Specify Handing)	Storeroom Mortise Rim exit for doors 48" wide	572.40	629.64	723.98

ELR, RX, LX, RXLX and POWER SUPPLIES AVAILABLE
See PAGE E33

QUANTITY DISCOUNT
16 UNITS MIXED - LESS 5%
32 UNITS MIXED - LESS 10%

◆◆ **MUST ORDER TRIM SEPARATELY** ◆◆



▶ **NON STOCK FINISHES & SIZES**

➤ Availability subject to quantity & lead-time. Consult factory

▶ **TRIMS & ACCESSORIES LIST PRICE**

➤ All trims are 6-pin "C" keyway. Other major manufacturers' keyways available. (See page E25)

▣ **STANDARD DISCOUNT ONLY ON TRIMS AND ACCESSORIES** ▣

ILLUSTRATION	ITEM #	DESCRIPTION	US26D 10B	OTHER FINISHES	PCS /MC	UNIT
ESCUTCHEON TRIMS (Non-handed)						
	MRESC9800 ●●● ICMRESC9800 ●●● ICSCMRESC9800	Entrance, key locks or unlocks escutcheon trim ANSI FUNCTION (63)	152.00		12	Ea.
	MRESC9805 ●●● ICMRESC9805 ●●● ICSCMRESC9805	Storeroom, always locked ANSI FUNCTION (04) * MUST USE MR9805EO36/48 Mortise Rim Exit Device *				
	MRESC9830	Passage, trim always operable and free ANSI FUNCTION (62) * MUST USE MR9805EO36/48 Mortise Rim Exit Device *				
ELECTRIFICATION FOR THE MORTISE LOCK BODY ABOVE						
	FS12MR98	FAIL-SAFE (FS) OPTION 12V AC/DC	\$167.00 Non-Stock subject to factory lead time Electrification price only. PRICES DO NOT INCLUDE Mortise Body			
	FS24MR98	FAIL-SAFE (FS) OPTION 24V AC/DC				
	FSE12MR98	FAIL-SECURE (FSE) OPTION 12V AC/DC				
	FSE24MR98	FAIL-SECURE (FSE) OPTION 24V AC/DC				

▶▶▶ CONSULT FACTORY FOR TEMPLATES ON ALL EXIT DEVICES AND TRIMS

◆ **STANDARD DISCOUNT ONLY ON TRIMS AND ACCESSORIES** ▢

ITEM #	DESCRIPTION	OTHER	PCS /MC	UNIT
STRIKES & ACCESSORIES				
36CD9800 ● IC 36CD9800 ● ICSC 36CD9800	Cylinder dogging kit for non-fire rated 36" applications	US32D,10B \$63.60	1	Ea.
48CD9800 ● IC 48CD9800 ● ICSC 48CD9800	Cylinder dogging kit for non-fire rated 48" applications			
NV36ALARM98 ● ICNV 36ALARM98 ● ICSCNV 36ALARM98	Alarm kit w/ <i>micro switch</i> for 36"	US32D,10B 191.00		
NV48ALARM98 ● ICNVV 48ALARM98 ● ICSCNV 48ALARM98	Alarm kit w/ <i>micro switch</i> for 48"	US32D,10B 195.00		
418	96" T-shaped removable mullion non-fire rated application (Prime coat)	250.56		
424	96" Square steel mullion fire rated application (Prime coat)	300.00		
418 BRACKETS	Top and Bottom retaining brackets for 418 mullion	58.89		
424 BRACKETS	Top and Bottom retaining brackets for 424 mullion	58.89		
LCK418 ● ICLCK 418 ● ICSLCK 418	Lockable 96" T-shaped removable mullion (Aluminum Prime coat), Non-fire Rated	826.80		
Additional keyway if ordered with LCK418 Lockable Mullion (US26D)		24.00		
LFF	Lock front filler (Zinc plated)	1.14		
SF	Strike filler (Zinc plated)	1.73		
OBSTRKRH OBSTRKLH	Open Back Strike FOR MR9800 SERIES MORTISE LOCK EXIT DEVICE ANSI A-115.14 (specify handing)	58.89		
MR9800LCK MR9805LCK	MR9800 Mortise Lock Case (Entrance Function) MR9800 Mortise Lock Case (Storeroom and Passage Functions)	115.00		
CUT CHARGE	Labor for cutting exit devices to size (applicable to all Series)	NET 50.00		

- **(IC)** Indicates function available with **Best, Falcon & Arrow Interchangeable Core.**
 - **(ICSC)** Indicates function available with **Schlage Full Size Format Interchangeable Core.**
- Prices do not include cores. **For IC Core pricing see pages L73 - L76.**

◆ OTHER KEYWAYS		
MRESC9800, MRESC9805, 36CD9800, 48CD9800, NV36ALARM98, NV48ALARM98, LCK418	Schlage C-K, Russwin D1,D2, D3, Corbin 60, Sargent LA-LB-LC, Falcon/Weiser E, Arrow A, Corbin-Russwin L4, Yale 8, Yale GA, Kwikset	ADD 24.00

2200 & 2260 (Non-fire Rated) F2200 & F2260 (Fire Rated)



Series List Price

Push Bar Exit Device / ANSI 156.3 Grade1, 3 Hour Rated, UL Listed, Retrofits
Sargent 12-2823 and 12-2838 Series, Optional with Alarm / Electrified

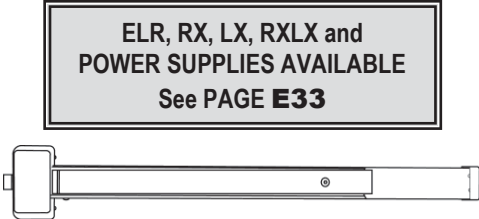
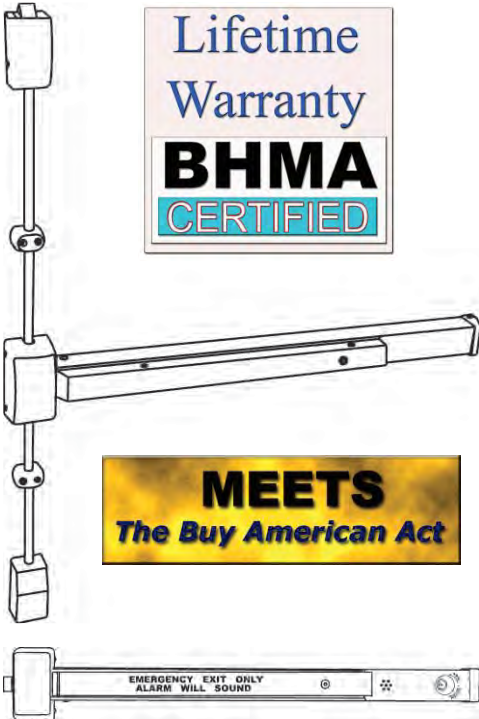
ILLUSTRATION	ITEM #	DESCRIPTION	LIST PRICE EA.
PANIC EXIT HARDWARE			
 <p>ELR, RX, LX, RXLX and POWER SUPPLIES AVAILABLE See PAGE E33</p> <p>Lifetime Warranty BHMA CERTIFIED</p> <p>MEETS <i>The Buy American Act</i></p> 	2200EO24	Rim exit, 24", ALUM ONLY	\$222.28
	2200EO32	Rim exit, 32", ALUM ONLY	
	2200EO36	Rim exit, 36", AL, DURO, GO	162.92
	2220EO48	Rim exit, 48", AL, DURO, GO	170.79
	NALRM2200EO36	Alarm rim exit, 36", AL, DURO, GO NEW ITEM	333.00
	NALRM2220EO48	Alarm rim exit, 48", AL, DURO, GO NEW ITEM	352.00
	2210V2484	Surface vertical rod 24" X 84", ALUM ONLY *SH	322.24
	2270V3284	Surface vertical rod 32" X 84", ALUM ONLY *SH	
	2260V3684	Surface vertical rod 36" X 84", AL,DURO,GO *SH	262.92
	2290V3696	Surface vertical rod 36" X 96" AL,DURO,GO *SH	270.79
	2250V36120	Surface vertical rod 36" X 120", AL,DURO,GO *SH	287.64
	2280V4896	Surface vertical rod 48" X 96", AL,DURO,GO *SH	275.28
	2240V48120	Surface vertical rod 48" X 120", AL,DURO,GO *SH	287.64
	NALRM	Prefix "NALRM" for vertical devices	ADD 218.00
	FIRE EXIT HARDWARE RATED 3 HOURS (Includes thru bolts)		
	F2200EO24	Rim exit, 24", ALUM ONLY	284.08
	F2200EO32	Rim exit, 32", ALUM ONLY	
	F2200EO36	Rim exit, 36", AL, DURO, GO	224.72
	F2220EO48	Rim exit, 48", AL, DURO,GO	238.20
	FNALRM2200EO36	Alarm rim exit, 36", AL, DURO, GO NEW ITEM	394.00
	FNALRM2220EO48	Alarm rim exit, 48", AL, DURO, GO NEW ITEM	409.00
	F2210V2484	Surface vertical rod 24" X 84", ALUM ONLY *SH	409.16
	F2270V3284	Surface vertical rod 32" X 84", ALUM ONLY *SH	
	F2260V3684	Surface vertical rod 36" X 84", AL, DURO, GO *SH	350.56
	F2290V3696	Surface vertical rod 36" X 96", AL, DURO, GO *SH	358.43
	F2280V4896	Surface vertical rod 48" X 96", AL, DURO, GO *SH	362.92
	NALRM	Prefix "NALRM" for vertical devices	ADD 218.00

*SH Specify Left Hand Reverse (LHR) or Right Hand Reverse (RHR) for convenience. Easily field reversible.

◆◆ **MUST ORDER TRIMS SEPARATELY** ◆◆

▶ **PAINTED FINISHES**

- ALUM (AL)
- Dark Duranodic (DURO)
- Gold (GO)

▶ **PACKAGING INCLUDES**

- 4 pcs per master carton
- Thru bolts for fire rated devices only
- Strike Filler, Lock Front Filler packed with Rim Devices at no extra charge.

QUANTITY DISCOUNT

16 UNITS MIXED - LESS 5%

32 UNITS MIXED - LESS 10%

LBR2200 & 2260 (Non-fire Rated)

LBRF2200 & F2260 (Fire Rated)

Series List Price



Vertical Rod Type Exit Device **Less Bottom Rod – LBR**

Push Bar Exit Device / ANSI 156.3 Grade 1, 3 Hour Rated, UL Listed

Optional with Alarm / Electrified

ILLUSTRATION	ITEM #	DESCRIPTION	LIST PRICE EACH	
	PANIC EXIT HARDWARE			
	***2210V2484	Surface vertical rod 24" X 84", ALUM ONLY *SH	\$322.24	
	***2270V3284	Surface vertical rod 32" X 84", ALUM ONLY *SH		
	***2260V3684	Surface vertical rod 36" X 84", AL, DURO, GO *SH	262.92	
	***2290V3696	Surface vertical rod 36" X 96", AL, DURO, GO *SH	270.79	
	***2250V36120	Surface vertical rod 36" X 120", AL, DURO, GO *SH	287.64	
	***2280V4896	Surface vertical rod 48" X 96", AL, DURO, GO *SH	275.28	
	***2240V48120	Surface vertical rod 48" X 120", AL, DURO, GO *SH	287.64	
	*** Standard surface vertical rod is used for less bottom rod in installation			
	FIRE EXIT HARDWARE RATED 3 HOURS			
LBRF2210V2484	Surface vertical rod LBR 24" X 84", ALUM ONLY *SH Includes thru bolts & AUX latch	409.16		
LBRF2270V3284	Surface vertical rod LBR 32" X 84", ALUM ONLY *SH Includes thru bolts & AUX latch			
LBRF2260V3684	Surface vertical rod LBR 36" X 84", AL, DURO, GO *SH Includes thru bolts & AUX latch	350.56		
LBRF2290V3696	Surface vertical rod LBR 36" X 96", AL, DURO, GO *SH Includes thru bolts & AUX latch	358.43		
LBRF2280V4896	Surface vertical rod LBR 48" X 96", AL, DURO, GO *SH Includes thru bolts & AUX latch	362.92		

*SH Specify Left Hand Reverse (LHR) or Right Hand Reverse (RHR) for convenience. Easily field reversible.

ACCESSORIES

AUXFL	Additional auxiliary latch (Raw finish)	49.95
-------	---	-------

◆◆ MUST ORDER TRIM SEPARATELY ◆◆

▶ LBR FIRE RATED DEVICES PACKAGING

- Packed with auxiliary spring latch to be installed in the lower edge of door.
- Thru bolts for fire vertical rod devices only.
- 4 Pcs per Master Carton

▶ PAINTED FINISHES

- ALUM (AL)
- Dark Durotonic (DURO)
- Gold (GO)

▶ ALARM AVAILABLE



- Alarm available. Prefix **NALRM** before part#
Add \$218.00 List.

QUANTITY DISCOUNT
16 UNITS MIXED - LESS 5%
32 UNITS MIXED - LESS 10%

► **TRIMS & ACCESSORIES LIST PRICE**

► All trims are 6-pin "C" keyway. Other major manufacturers' keyways available. (See below)

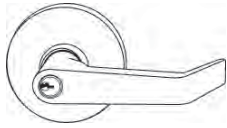
STANDARD DISCOUNT ONLY ON TRIMS AND ACCESSORIES

ILLUSTRATION	ITEM #	DESCRIPTION	US26D, 10B,3,4	ALUM, DURO, GOLD	OTHER
◆ TRIMS		LIST PRICE EACH			
 <p>ENT00L</p>  <p>8000K</p>	ENT00L ICENT00L (Best, Falcon SFIC) ICSCENT00L4 (Schlage LFIC)	Clutch Entrance, key locks / unlocks lever trim ANSI FUNCTION (08), operates as classroom function	\$115.73	----	----
	SARICENT00L (Sargent) RUSICENT00L (Corbin/Russwin) YALICENT00L (Yale)		NEW ITEM US26D 140.00		
	STR05L ICSTR05L (Best, Falcon SFIC) ICSCSTR05L4 (Schlage LFIC)	Clutch Storeroom, key operates lever. ANSI FUNCTION (04)	\$115.73		
	SARICSTR05L (Sargent) RUSICSTR05L (Corbin/Russwin) YALICSTR05L (Yale)		NEW ITEM US26D 140.00		
	PAS30L	Passage, lever always operable. ANSI FUNCTION (15)	\$115.73		
	DUM40L	Dummy, lever trim. ANSI FUNCTION (10) 2 3/4"			
8000K	Ball knob keylock, "C" keyway	US10B 89.00	US32D,3 \$75.50		
For 2 1/4" thick door order part # TAIL1					12.36

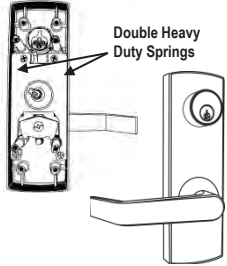
◆ ESCUTCHEON TRIMS (Non-handed)					
 <p>Double Heavy Duty Springs</p>	NESC2200 ICNESC2200 ICSCNESC2200	Rigid Entrance, key locks or unlocks escutcheon trim, operates as classroom function ANSI FUNCTION (63)			
	NESC2205 ICNESC2205 ICSCNESC2205	Rigid Storeroom, always locked ANSI FUNCTION (04)	----	\$122.00	----
	NESC2230	Passage, trim always operable and free ANSI FUNCTION (62)			
	NESC2240	Dummy Escutcheon trim ANSI FUNCTION (10)			
For 2 1/4" thick door order part # TAIL3					12.36

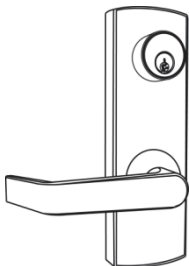
◆ ELECTRIFIED LEVER TRIM					
	FS12ESC22 ICFS12ESC22 ICSCFS12ESC22	FAIL-SAFE (FS) OPTION 12V AC/DC		389.02	SPECIAL ORDER ONLY. Requires additional door prep
	FS24ESC22 ICFS24ESC22 ICSCFS24ESC22	FAIL-SAFE (FS) OPTION 24V AC/DC			
	FSE12ESC22 ICFSE12ESC22 ICSCFSE12ESC22	FAIL-SECURE (FSE) OPTION 12V AC/DC			
	FSE24ESC22 ICFSE24ESC22 ICSCFSE24ESC22	FAIL-SECURE (FSE) OPTION 24V AC/DC			

● (IC) Indicates function available with **Best, Falcon & Interchangeable Core.**
 ● (ICSC) Indicates function available with **Schlage Full Size Format Interchangeable Core.**
 Prices do not include cores. For IC Core pricing see pages L73 - L76.

◆ OTHER KEYWAYS		
Available for ENT00L, STR05L, 8000K	Schlage C-K, Russwin D1,D2,D3, Corbin 60, Sargent LA-LB-LC, Falcon/Weiser E, Corbin-Russwin L4, Arrow A, Yale 8, Yale GA, Kwikset	ADD 13.33
NESC2200, NESC2205	Schlage C-K, Russwin D1,D2, D3, Corbin 60, Sargent LA-LB-LC, Falcon/Weiser E, Corbin-Russwin L4, Arrow A, Yale 8, Yale GA, Kwikset	ADD 24.00

► **TRIMS & ACCESSORIES LIST PRICE**

► All trims are 6-pin "C" keyway. Other major manufacturers' keyways available. (See below)

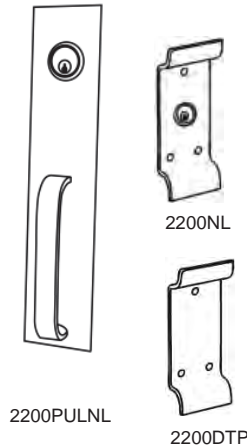
▣ STANDARD DISCOUNT ONLY ON TRIMS AND ACCESSORIES ▣						
ILLUSTRATION	ITEM #	DESCRIPTION	US26D, 10B,3,4	ALUM, DURO, GOLD	OTHER	
◆ THUMB PIECE TRIMS (Non-handed)						
	THP00 ●●● IC THP00 ●●● ICSC THP00	Entrance, key locks or unlocks thumb piece, operates as classroom function ANSI FUNCTION (63)	----	\$103.00	----	
	THP05 ●●● IC THP05 ●●● ICSC THP05	Storeroom, always locked ANSI FUNCTION (04)				
	THP30	Passage trim, always operable and free ANSI FUNCTION (62)				
	THP40	Dummy trim, ANSI FUNCTION (10)				
	For 2 1/4" thick door order part # TAIL7					----
◆ PULL TRIMS						
	2200PULNL ●●● IC 2200PULNL ●●● ICSC 2200PULNL	To be used with rim only Pull & rim cylinder, key retracts latch bolt 2 5/8" W X 14 3/4" L. ANSI FUNCTION (03)	----	62.00	----	
	2200NL ●●● IC 2200NL ●●● ICSC 2200NL	To be used with rim only Pull & rim cylinder, key retracts latch bolt 3" W X 7 3/4" L. ANSI FUNCTION (03).				50.00
	2200DTP	Dummy trim (Pull) ANSI FUNCTION (02)				26.00
	2200EOP	Cover plate (blank plate) ANSI FUNCTION (10)				23.00
						23.00

- **(IC)** Indicates function available with **Best, Falcon & Arrow Interchangeable Core.**
 - **(ICSC)** Indicates function available with **Schlage Full Size Format Interchangeable Core.**
- Prices do not include cores. For IC Core pricing see pages L73 - L76.

◆ OTHER KEYWAYS		
THP00, THP05, 2200PUL, 2200NL	Schlage C-K, Russwin D1,D2, D3, Corbin 60, Falcon/Weiser E, Sargent LA-LB-LC, Corbin-Russwin L4, Arrow A, Yale 8, Yale GA, Kwikset	ADD 24.00

►►► **CONSULT FACTORY FOR TEMPLATES ON ALL EXIT DEVICES AND TRIMS**

► **TRIMS & ACCESSORIES LIST PRICE**

► All trims are 6-pin "C" keyway. Other major manufacturers' keyways available. (See Below)

STANDARD DISCOUNT ONLY ON TRIMS AND ACCESSORIES

ITEM #	DESCRIPTION	US26D, 10B, 3, 4	ALUM, DURO, GOLD	NYLON BLACK COATED	OTHER
◆ STRIKES & ACCESSORIES					
36CD2200 IC36CD2200 ICSC36CD2200	Cylinder dogging kit for <i>non-fire rated</i> 36" applications		\$47.19		
48CD2200 IC48CD2200 ICSC48CD2200	Cylinder dogging kit for <i>non-fire rated</i> 48" applications				
36ALARM22 IC36ALARM22 ICSC36ALARM22	Replacement alarm kit for 36" 2200 Series <i>Alarm-ready</i> Rim Exit	----	111.30	----	----
48ALARM22 IC48ALARM22 ICSC48ALARM22	Replacement alarm kit for 48" 2200 Series <i>Alarm-ready</i> Rim Exit	----	111.30	----	----
NV36ALARM ICNV36ALARM ICSCNV36ALARM	Alarm kit w/ <i>micro switch</i> for 36" Vertical Rod Exit Device		191.00		
NV48ALARM ICNV48ALARM ICSCNV48ALARM	Alarm kit w/ <i>micro switch</i> for 48" Vertical Rod Exit Device		195.00		
DOGGINGKIT	Standard Dogging Assembly Kit with allen wrench			----	\$16.67
221	Bottom strike, non-fire vertical rod device				
227	Top strike, non-fire vertical rod device				
233	Alternate flush mounting bottom strike. Standard for fire rated vertical rod			\$10.11	----
239	Surface applied strike, rim non-fire				
245	Surface applied strike, rim fire and top strike fire rated vertical rod device				
RIM238	Rim strike for 2 3/8" backset			11.24	
N251	Overlapping strike	----	----		US32D \$13.48
357	Thrubolts for rim fire and panic grade 1 3/4" door (6 PCs)				US32D 19.98
363	Thrubolts for rim fire and panic grade 2 1/4" door (6 PCs)				
369	Thrubolts for vertical rod fire and panic grade to be used with trim 1 3/4" door (14 pcs)			----	US32D 39.95
375	Thrubolts for vertical rod fire and panic grade to be used with trim 2 1/4" door (14 pcs)				
401	Rim shim kit 1/8" (Thick)				22.47
406	Panic vertical rod shim kit 1/8" (Thick)				40.45
412	Fire rated vertical rod shim kit 1/8" (Thick)				
CUT CHARGE	Labor for cutting exit devices to size (applicable to all Series)				NET 50.00

Ⓜ (IC) Indicates function available with **Best, Falcon & Arrow Interchangeable Core**.
 Ⓜ (ICSC) Indicates function available with **Schlage Full Size Format Interchangeable Core**.
 Prices do not include cores. For IC Core pricing see pages L73 - L76.

◆ OTHER KEYWAYS

36CD2200, 48CD2200, 36ALARM22, 48ALARM22, V36ALARM22, V48ALARM22	Schlage C-K, Russwin D1,D2,D3, Corbin 60, Sargent LA-LB-LC, Falcon/Weiser E, Corbin-Russwin L4, Arrow A, Yale 8, Yale GA, Kwikset	ADD 24.00
--	---	--------------

► **TRIMS & ACCESSORIES LIST PRICE**

➤ All trims are 6-pin "C" keyway. Other major manufacturers' keyways available. (See below)

▣ STANDARD DISCOUNT ONLY ON TRIMS AND ACCESSORIES ▣

ITEM #	DESCRIPTION	US26D, US10B, US3,4,10	ALUM, DURO, GOLD	OTHER
STRIKES & ACCESSORIES				
418	96" T-shaped removable mullion non-fire rated application (Prime coat)			\$250.56
424	96" Square steel mullion fire rated application (USP)			300.00
418 BRACKETS	Top and Bottom retaining brackets for 418 mullion			58.89
424 BRACKETS	Top and Bottom retaining brackets for 424 mullion	---	---	58.89
LCK418 ICLCK418 ICSC LCK418	Lockable 96" T-shaped removable mullion (Aluminum Prime coat), Non-fire Rated			826.80
<i>Additional keyway if ordered with LCK418 Lockable Mullion (US26D)</i>				24.00
VRRD10	Vertical rod for 10' doors, for non-fire rated devices only	\$34.83	\$24.97	----
LFF	Lock front filler (Zinc plated)			1.14
SF	Strike filler (Zinc plated)	---	----	1.73
CUT CHARGE	Labor for cutting exit devices to size (applicable to all Series)			NET 50.00

- (IC) Indicates function available with **Best, Falcon & Arrow Interchangeable Core.**
 - (ICSC) Indicates function available with **Schlage Full Size Format Interchangeable Core.**
- Prices do not include cores. For IC Core pricing see pages L73 - L76.

◆ **OTHER KEYWAYS**

LCK418	Schlage C-K, Russwin D1,D2, D3, Corbin 60, Sargent LA-LB-LC, Falcon/Weiser E, Corbin-Russwin L4, Arrow A, Corbin-Russwin L4, Yale 8, Yale GA, Kwikset.	ADD 24.00
--------	--	------------------

►►► **CONSULT FACTORY FOR TEMPLATES ON ALL EXIT DEVICES AND TRIMS**

Delayed Egress Option for 7700 Series Exit Devices...

ITEM #	DESCRIPTION	LIST PRICE (ADD ON)	UNIT
DE	Delayed Egress Master Option	\$1,890.00	Ea.
DS	Delayed Egress Slave Option	1,711.00	
CR602RF	Power Supply 12V or 24V DC 1.0 Amp, regulated and filtered	367.00	
CR631RF	Power Supply 12V or 24V DC 1.5 Amp, regulated and filtered	379.00	

MUST ORDER CR602RF or CR631RF POWER SUPPLY TO HONOR WARRANTY AND UL MARKING

Specify: 7700 Series model after **ITEM#** when ordering, for example: **DE7700EO36** to order Delayed Egress option for 7700 series rim exit devices (Exit Device priced separately)

STOCK ITEMS IN US32D FINISH ONLY					
ITEM#	DESCRIPTION	LIST PRICE	ITEM#	DESCRIPTION	LIST PRICE
DE7700EO36	36" non-fire Rim Exit Device	\$2,337.00	DEMR77EO36R	36" Right Hand non-fire Mortise Rim Exit Device	\$2,516.00
DEF7700EO36	36" fire-rated Rim Exit Device	2,415.00	DEMR77EO36L	36" Left Hand non-fire Mortise Rim Exit Device	2,516.00
DE7720EO42	42" non-fire Rim Exit Device	2,364.00	DEMR77EO48R	48" Right Hand non-fire Mortise Rim Exit Device	2,554.00
DE7720EO48	48" non-fire Rim Exit Device	2,364.00	DEMR77EO48L	48" Left Hand non-fire Mortise Rim Exit Device	2,554.00
DEF7720EO48	48" fire-rated Rim Exit Device	2,441.00	DEM77CV3684L	36" Left Hand Concealed Vertical Rod	2,563.00
			DEM77CV3684R	36" Right Hand Concealed Vertical Rod	2,563.00

NON-STOCK ITEMS AND FINISHES AVAILABLE ON ORDER WITH FACTORY LEAD TIME



**DE7700EO36, DE7700EO42, DE7700EO48
DEF7700EO36, DEF7700EO42, DEF7700EO48**



**DEMR77EO36, DEMR77EO48
DEFMR77EO36, DEFMR77EO48**

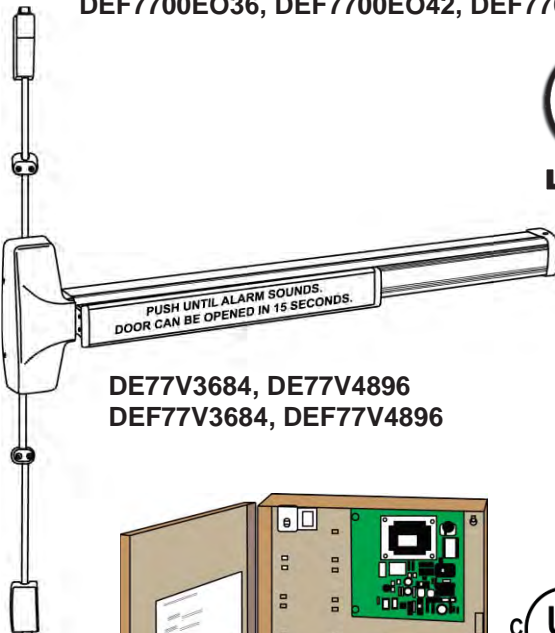

**DE77V3684, DE77V4896
DEF77V3684, DEF77V4896**

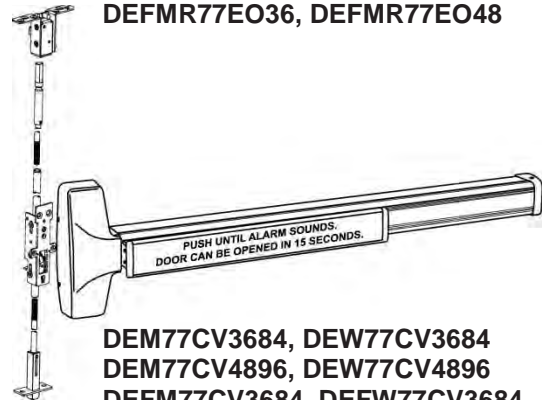

**DEM77CV3684, DEW77CV3684
DEM77CV4896, DEW77CV4896
DEFM77CV3684, DEFW77CV3684
DEFM77CV4896, DEFW77CV4896**

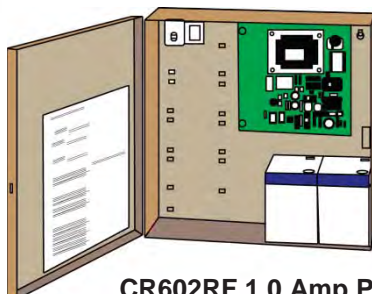

**CR602RF 1.0 Amp POWER SUPPLY
CR631RF 1.5 Amp POWER SUPPLY**

- EGRESS DELAY FEATURES**
- All in One Device
 - 15 or 30 second exit delay (Factory set to 15 secs)
 - 1 or 2 second nuisance delay
 - Alarm and Lock reset
 - 1 to 30 second momentary bypass
 - Sustained bypass

⚡ MUST ORDER CR602RF or CR631RF POWER SUPPLY TO HONOR WARRANTY AND UL MARKING ⚡

(ELR)Electrical Latch Retraction ..

Our electrified latch pullback exit device allows for remote keyless access control in high occupancy/high traffic conditions where exit devices are required. Common applications include conditions such as hospitals, airports, schools, churches and where they are commonly specified in applications that require automatic door openers. The device may be continuously energized allowing for a push/pull condition if desired.

Features:

- Available on 9800, 7700 & 2200 Series, including rim, vertical rod, concealed vertical rod, mortise exit device, fire and non fire-rated devices.
- High-performance quality solenoids designed for demanding applications
- The PM200* interface power module (included) is programmed to meet the requirements of the specific exit device modification. It maximizes the efficiency and life of the solenoid, allows for a much longer wire run and may be used with 24VDC power supplies rated at 1.5A or greater
- Dual coil solenoids, or PWM programming, allow for either momentary or extended time latch retraction
- No hassle 3-Year Warranty

Specifications

- Voltage – 24VDC
- Amperage – Surge current – 12A for 200ms@24V / Holding – 250mA@24V
- Coil resistance – 3.7Ω

To Order, Specify:

- Prefix **ELR** before PART#



ITEM #	DESCRIPTION	LIST PRICE (ADD ON)	UNIT
ELR	Electrified Latch Retractor	\$545.90	Ea.

Signal Switch RX and LX.....

RX (request to exit) signal switch is used to signal the use of an opening from the push side. When the push pad is depressed, the switch is activated. These devices are equipped with an internal SPDT (single pole double throw) switch that monitors the touch bar.

LX (latch bolt monitoring) signal switch monitors both egress and access of an opening. When the latch bolt is retracted, the switch is activated. These devices are equipped with an internal SPDT (single pole double throw) switch that monitors the latch bolt position.

LX and **RX** switches can be combined with **EL** (electric latch retraction) option.

Specifications

RX or **LX**..... Switch rated 0.5 amperes @ 24VAC/DC resistive

Low current **RX** or **LX**..... Switch rated 0.5 amperes @ 24VAC/DC resistive

For Factory Installed:

To Order, Specify:

Prefix:

RX..... Request to Exit

LX..... Latch bolt Monitoring

LXRX..... Latch bolt Monitoring/Request to Exit Combination



ITEM #	DESCRIPTION	LIST PRICE (ADD ON)	UNIT
RX	Request to Exit switch for field installation.	132.50	Ea.
LX	Latch bolt Monitoring switch for field installation.		
LXRX	Latch bolt Monitoring/Request to Exit Combination	265.00	

Specify : 7700, 9800 or 2200 after **ITEM#** when ordering, for example: **RX7700** to order RX switch for 7700 series exit devices



POWER SUPPLIES FOR ELECTRIFIED EXIT DEVICES....

The CRPS1N is a heavy duty, high quality, low cost solution for powering a single latch retracting exit device. The solid state design insures years of trouble-free operation. The power supply delivers raw, unregulated DC current which is ideal for the extreme in-rush requirement of most solenoid driven electric latch retracting exit devices. The power supply comes housed in a sturdy, yet compact metal enclosure.

CRPS1N

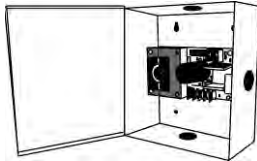

LIST PRICE: \$259.70

STANDARD DISCOUNT ONLY

Features:

- Power supply delivers the necessary high current in-rush for a single exit device
- Solid-state design eliminates problems associated with mechanical relays
- Single input/output

Specifications:

- Input voltage – 120 VAC
- Output voltage – 24 VDC unregulated @ 1A
- Temperature range – 0 to 120F
- 1 Solid-State input/output (input triggered by dry contact)
- LEDs – RED = Power indicator
GREEN = Channel on
- Enclosure dimensions: 10" x 10" x 4"



The CRPS2 Series power supplies are high quality, cost effective solution for powering two electric latch-retracting exit devices. These power supplies provide the necessary surge current that most latch-retracting exit devices require. The CRPS2 Series offers features found on power supplies costing much more; and the solid-state design and careful attention to detail make the CRPS2 Series ideal choice for the discerning user who requires a power supply that can offer years of trouble-free operation.

CRPS2 CRPS2BB

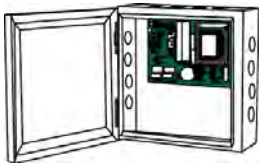

LIST PRICE:
CRPS2 \$376.30
CRPS2BB 431.42

STANDARD DISCOUNT ONLY

Features:

- Delivers the necessary in-rush current to power two latch pullback exit devices.
- Two independent inputs/outputs
- Solid-state design eliminates mechanical problems associated with relays
- Thermal overload sensing reduces risk of failure due to overheating
- Fire alarm disconnect link
- Inputs triggered by dry contact
- Intelligent short circuit detection, detects shorts much faster than fuses and isolates the short to the individual output
- Removable Euro-style terminal blocks allow for easy installation
- UL Pending at time of print
- No hassle 3-Year Warranty

Additional Features (CRPS2BB Only):

- Efficient battery backup/charging circuitry with zero voltage drop at power loss
- Solid state reverse polarity protection for battery connections
- Audible alert when sensing AC power failure & low battery (batteries not included)
- Output Voltage – 24 VDC unregulated @ 2.3A
- Enclosure dimensions: 12.5" x 15" x 4"

Specifications:

- Input Voltage – 120 VAC
 - Output Voltage – 24 VDC unregulated @ 2A**
 - Temperature Range – 0 to 120 F
 - 1 Solid-State input/output (input triggered by dry contact)
 - LEDs – Red = Power indicator
GREEN = Channel on
 - Enclosure dimensions: 10" x 10" x 4" **
- **CRPS2 only**



The CRSW3 power supply is a low cost, regulated switching power supply. It is designed specifically to supply power to low current DC devices such as mortise locks, cylindrical locks and electric strikes. The CRSW3 supplies 2.4A @ 27VDC and provides (3) non-fused outputs. The CRSW3 comes housed in a 10" x 10" x 4" sturdy metal enclosure.

CRSW3

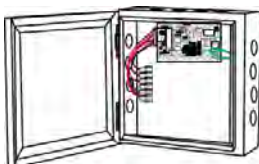

LIST PRICE: \$146.67

STANDARD DISCOUNT ONLY

Features:

- Adjustable output voltage (22-27V under load)
- No hassle 3-Year Warranty

Specifications:

- Input voltage – 110 or 240VAC
- Output voltage – 2.4A @ 27VDC
- (3) Non-fused outputs
- Enclosure dimensions : 10" x 10" x 4"

4400 SERIES RIM TYPE EXIT DEVICE

Series List Price

Push Bar Exit Device / ANSI 156.3 Grade 2

UL Listed for Panic and Safety



Panic & Safety

Lifetime Warranty

ILLUSTRATION	ITEM #	DESCRIPTION	LIST PRICE
	PANIC EXIT HARDWARE		
	4400EO36	Rim exit, 36" wide, 26D, DURO	\$165.36
	4420EO48	Rim exit, 48" wide, 26D, DURO	169.60

QUANTITY DISCOUNT
36 UNITS MIXED - LESS 5%
72 UNITS MIXED - LESS 10%

▶ PAINTED FINISHES

➤ US26D (Satin Chrome), Dark Duranodic (DURO)

▶ TRIMS & ACCESSORIES LIST PRICE

➤ All trims are 6-pin "C" keyway. Other major keyways available. (See below)

▣ STANDARD DISCOUNT ONLY ON TRIMS AND ACCESSORIES ▣

ILLUSTRATION	ITEM #	DESCRIPTION	26D, DURO
ESCUTCHEON TRIMS (Non-handed)			
	ESC4400	Rigid entrance, key locks or unlocks escutcheon trim ANSI FUNCTION (63) 2 3/4" Width X 8 1/2" Length. Lever length: 4 3/4". Fits and covers 2 1/8" 161 cutout. Operates as classroom function.	125.00
	ICESC4400		
	ESC4430	Passage, trim always operable and free ANSI FUNCTION (62)	
	ESC4440	Dummy Escutcheon trim ANSI FUNCTION (10)	
THUMB PIECE TRIMS (Non-handed)			
	THP4400	Entrance, key locks or unlocks thumb piece. Operates as classroom function. 3 1/2" Width X 16" Length ANSI FUNCTION (63)	67.00
	ICTHP4400		
	ICCTHP4400		
	THP4430	Passage trim, always operable and free. ANSI FUNCTION (62)	
STRIKES & ACCESSORIES			
357	Thrubolts for rim panic grade, 1 3/4" door (6 PCs)		19.98
418	96" T-shaped removable mullion non-fire rated application (Prime coat)		250.56
424	96" Square steel mullion fire rated application (USP)		300.00
440	Roller Strike		11.24
418 BRACKETS	Top and Bottom retaining brackets for 418 mullion		58.89
424 BRACKETS	Top and Bottom retaining brackets for 424 mullion		58.89
LCK418	Lockable 96" T-shaped removable mullion (Aluminum Prime coat), Non-fire Rated		826.80
ICLCK418			
ICSLCK418			
Additional keyway if ordered with LCK418 Lockable Mullion (US26D)			24.00
LFF	Lock front filler (Zinc plated)		1.14
SF	Strike filler (Zinc plated)		1.73

● (IC) Indicates function available with **Best, Falcon & Arrow Interchangeable Core.**

● (ICSC) Indicates function available with **Schlage Full Size Format Interchangeable Core.**

Prices do not include cores. For IC Core pricing see pages L73 - L76.

▶▶▶ CONSULT FACTORY FOR TEMPLATES ON ALL EXIT DEVICES AND TRIMS

◆ OTHER KEYWAYS		
ESC4400, THP4400, LCK418	Schlage C-K, Russwin D1, D2, D3, Corbin 60, Sargent LA-LB-LC, Falcon/Weiser E, Corbin-Russwin L4, Arrow A, Corbin-Russwin L4, Yale 8, Yale GA, Kwikset.	ADD 24.00

5000 & 5000V (Non-fire Rated)

F5000 & F5000V (Fire Rated) Series List Price

Push Bar Exit Device / ANSI 156.3 Grade 2,
3 Hour Rated, UL Listed



ILLUSTRATION	ITEM #	DESCRIPTION	LIST PRICE EACH
	PANIC EXIT HARDWARE		
	5000EO36	Rim exit, 36" wide, ALUM	\$130.34
	5000EO36	Rim exit, 36" wide, US32D	189.89
	5500EO48	Rim exit, 48" wide, ALUM	136.86
	5500EO48	Rim exit, 48" wide, US32D	199.39
	5000V3684	Surface vert rod 36" X 84", ALUM	221.35
	5000V3684	Surface vert rod 36" X 84", US32D	275.28
	F5000EO36	Rim exit, 36" wide, ALUM Includes thru bolts	175.28
	F5000EO36	Rim exit, 36" wide, US32D Includes thru bolts	257.30
	F5500EO48	Rim exit, 48" wide, ALUM Includes thru bolts	184.05
	F5500EO48	Rim exit, 48" wide, US32D Includes thru bolts	270.17
	F5000V3684	Surface vert rod 36" X 84", ALUM Includes thru bolts	285.39
	F5000V3684	Surface vert rod 36" X 84", US32D Includes thru bolts	387.64

NON-HANDED on both Rim and Vertical Rod Exit Devices

QUANTITY DISCOUNT

20 UNITS MIXED - LESS 5%

40 UNITS MIXED - LESS 10%

◆◆ MUST ORDER TRIMS SEPARATELY ◆◆

▶ PAINTED FINISHES

- Aluminum (AL)
- US32D (Stainless Steel)

▶ PACKAGING INCLUDES

- 4 pcs per master carton
- Strike filler, lock front filler. Packed with rim device at no extra charge.
- Thru bolts for fire rated devices only.



AUTO FLUSHBOLTS
MAGNETIC DOOR HOLDERS
DOOR HOLDERS/STOPS





Ver. 2.0, Rev. 11/12
© 2012  CAL ROYAL

DOOR COORDINATORS, AUTO FLUSHBOLTS, MAGNETIC DOOR HOLDERS SURFACE OVERHEAD DOOR HOLDERS / STOPS

ILLUSTRATION	ITEM/DESCRIPTION	SIZE	ITEM#	FINISH	LIST PRICE	BOX QTY	CASE QTY
DOOR COORDINATORS							
	UL-GRAVITY COORDINATOR	Projection: 7" BHMA: 4.1.1 Type 25	FRGCO65	US26D,	\$46.07	1	20
		Projection: 8" BHMA: 4.1.1 Type 25	FRGCO85	10B, 3, 4, 10	50.56		
				26	73.03		
	COORDINATORS	Frame openings: 60" and 72" BHMA 4.1.1 Type 21	DORCO1	Black Prime Coat, Alum	62.42	1	10
	FILLER BAR	18 5/8" for up to 72" door	FB1858		12.51	1	50
		32 3/8" for up to 96" door	FB3258		19.98		
	CARRY BAR Material: Steel	Plate: 1 3/4" x 2 1/4" Fasteners: 1/4" x 20 Sex Bolts	CBO-1		19.98	1	100
	MOUNTING BRACKETS	Jamb Depth: 4 1/4" Stop Height: 5/8" Stop Width: 2 1/4" and over	MB4250		26.96 per pair <i>sold per pair only</i>	1 pair	20 pairs
		Jamb Depth: 4 1/4" Stop Height: 5/8" Stop Width: 3/8" to 2 1/4" and over	MB4750				
AUTO FLUSHBOLTS							
	METAL DOOR AUTOMATIC FLUSH BOLTS, Includes Automatic (Top) & Self Latching (Bottom) Bolt Combination	Auto Flushbolt: Face Plate: 1" x 6 3/4" BoltHead: 1/2" Square Bolt Throw: 3/4" Fastener: #8 x 1" Material: Steel BHMA 4.4 Type 25	AUTOFLM1	US3, 4, 10B, 15, 26, 26D	97.38 per pair <i>sold per pair only</i>	1 pair	12 pairs
	WOOD DOOR AUTOMATIC FLUSH BOLTS, Includes Automatic (Top) & Self Latching (Bottom) Bolt Combination	Auto Flushbolt: Face Plate: 1" x 8 1/2" BoltHead: 1/2" Square Bolt Throw: 1" Fastener: #8 x 3/4" Material: Steel BHMA 4.4 Type 25	AUTOFLW22		107.37 per pair <i>sold per pair only</i>	1 pair	12 pairs
	METAL DOOR AUTOMATIC FLUSH BOLT, 1 set includes, 1 Auto Flush Bolt (Top) and 1 Auxiliary Fire Latch (Bottom)	Auto Flushbolt: Face Plate: 1" x 6 3/4" BoltHead: 1/2" Square Bolt Throw: 3/4" Fastener: #8 x 1" Material: Steel Auxiliary Latch: Face Plate: 1" x 1 3/4" Body: 7/8" bore x 3 1/4" Deep	AUXAUTOFLM1		92.00 per set	1 set	12 sets
	WOOD DOOR AUTOMATIC FLUSH BOLT, 1 set includes, 1 Auto Flush Bolt (Top) and 1 Auxiliary Fire Latch (Bottom)	Auto Flushbolt: Face Plate: 1" x 8 1/2" BoltHead: 1/2" Square Bolt Throw: 1" Fastener: #8 x 3/4" Material: Steel Auxiliary Latch: Face Plate: 1" x 1 3/4" Body: 7/8" bore x 3 1/4" Deep	AUXAUTOFLW22		92.00 per set	1 set	12 sets

DOOR COORDINATORS, AUTO FLUSHBOLTS, MAGNETIC DOOR HOLDERS
SURFACE OVERHEAD DOOR HOLDERS / STOPS

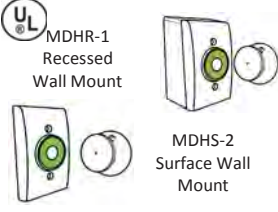
MAGNETIC DOOR HOLDERS

ILLUSTRATION	ITEM/DESCRIPTION	SIZE	ITEM#	FINISH	LIST PRICE	BOX QTY	CASE QTY
 <p>MDHR-1 Recessed Wall Mount</p> <p>MDHS-2 Surface Wall Mount</p>	<p>MAGNETIC DOOR HOLDER Recessed/Surface Wall Mount</p> <ul style="list-style-type: none"> Tri-Voltage (12, 24VDC or 120V AC) 30-45 pound holding power Thru-Bolted Armature for Security 	2 3/4" x 4 5/8"	MDHR-1 (Recessed)	US28, DURO, GOLD	122.96	1	20
			MDHS-2 (Surface)		131.44		
	ADDITIONAL EXTENSION BOLT	1"	MDHEXT-3	ZINC	6.89	1	1

SURFACE OVERHEAD DOOR HOLDERS / STOPS

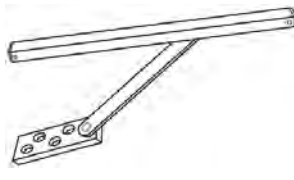
	Surface Overhead Door Stop Only UL-Listed	SIZE 2, 23 1/16" - 27"	CR552S	US26D, 32D	US26D 74.00	1	10
		SIZE 3, 27 1/16" - 33"	CR553S				
		SIZE 4, 33 1/16" - 39"	CR554S				
		SIZE 5, 39 1/16" - 45"	CR555S				
	Surface Overhead Door Holder With Hold Open	SIZE 2, 23 1/16" - 27"	CR552H		NON-STK 100.00		
		SIZE 3, 27 1/16" - 33"	CR553H				
		SIZE 4, 33 1/16" - 39"	CR554H				
		SIZE 5, 39 1/16" - 45"	CR555H				



SIGNS



Ver. 2.0, Rev. 11/12
© 2012  CAL ROYAL

HANDICAP SIGNS (ADA) WITH BRAILLE Series List Price

ITEM#	DESCRIPTION	FINISH	LIST PRICE	UNIT
M-68	Men, with Braille, pictogram, text, 6" x 8"	Blue or Black	\$9.37	Ea.
MH-68	Men handicap, with Braille, pictogram, text, 6" x 8"			
BOYH68	Boys handicap, with Braille, pictogram, text, 6" x 8"			
W-68	Women, with Braille, pictogram, text, 6" x 8"			
WH-68	Women handicap, with Braille, pictogram, text, 6" x 8"			
GIRH68	Girls handicap, with Braille, pictogram, text, 6" x 8"			
RS-68	Unisex restroom, with Braille, pictogram, text, 6" x 8"			
RSH-68	Unisex handicap restroom, with Braille, pictogram, text 6" x 8"		11.00	
NS-68	No smoking, with Braille, pictogram, text, 6" x 8"			
CAEXT69	Exit, with Braille, pictogram, text 6" x 9" NEW ITEM		5.49	
CAEXRT4534	Exit Route, with Braille, text 4" x 5 3/4" NEW ITEM			
M-1346	Men, with Braille, text 1 3/4" x 6"			
W-1346	Women, with Braille, text 1 3/4" x 6"			
RS-1346	Restroom, with Braille, text 1 3/4" x 6"			

► **PACKAGING:** 10 Pcs/Inner box, 100 Pcs/Master carton
Prefix "BL" for black when ordering.

*** 20% Charge on broken boxes ***

**QUANTITY DISCOUNT
100 UNITS MIXED – LESS 10%**

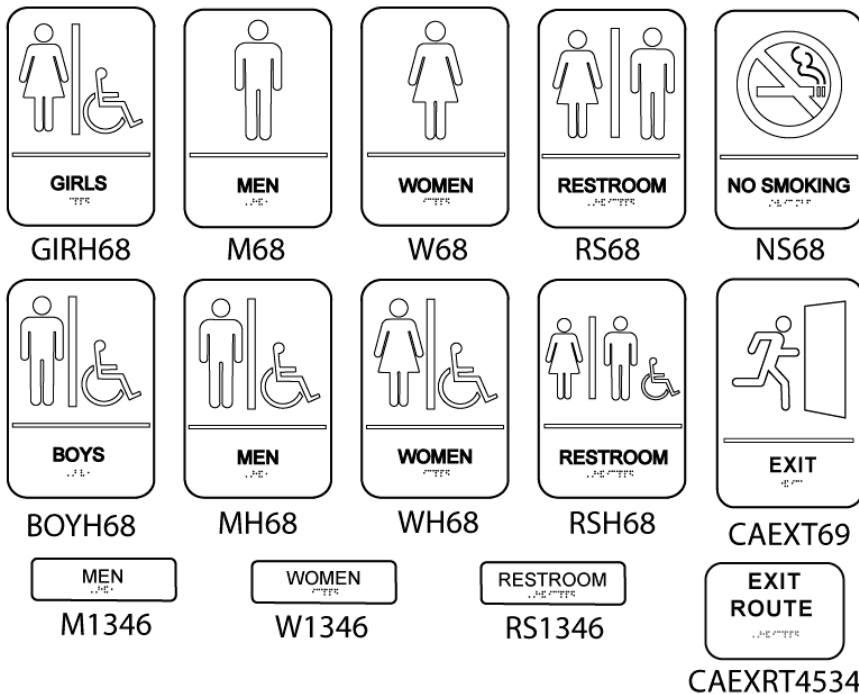

ITEM#	DESCRIPTION	FINISH	LIST PRICE	UNIT
WHS-5	Women sign raised & Braille, 12" circle	Blue or Black	\$16.85	Ea.
GHS4	Girls sign raised & Braille, 12" circle			
MHS-6	Men sign raised & Braille, 10 1/2" high triangle			
BHS1	Boys sign raised & Braille, 10 1/2" high triangle			
WHS-5A	Women sign raised & Braille & handicap logo, 12" circle			
MHS-6A	Men sign raised & Braille & handicap logo, 10 1/2" high triangle		20.60	
UHS-7	Unisex raised & Braille, 12" circle			
UCHS-10	Unisex raised & Braille & handicap logo, 12" circle			
NEWUCHS7	Unisex raised & Braille, 12" circle NEW ITEM			
NEWUCHS10	Unisex raised & Braille & handicap logo, 12" circle NEW ITEM			

► **PACKAGING:** 10 Pcs/Inner box, 50Pcs/Master carton
 Prefix "BL" for black when ordering

ITEM#	DESCRIPTION	LIST PRICE	UNIT
CHS-9	Blue square plastic sign & handicap logo (8" X 8")	\$10.29	Ea.
HI-11	Blue insignia handicap logo (4" x 4")	2.08	
WDC-13	This door to remain unlocked during business hours, white on black		
BDC-12	This door to remain unlocked during business hours, black on clear		
TDUW-8	These doors to remain unlocked during business hours, white on black		
TDUB-1	These doors to remain unlocked during business hours, black on white		
BDO-5	This door to remain unlocked when building is occupied, black on white		
WDO-11	This door to remain unlocked when building is occupied, white on black		
TWOC-14	These doors to remain unlocked when building is occupied, white on black		
TBOC-19	These doors to remain unlocked when building is occupied, black on white		

► **PACKAGING:** 10 Pcs Poly Bagged.

**QUANTITY DISCOUNT
100 UNITS MIXED -- LESS 10%**

*** 20% Charge on broken boxes ***

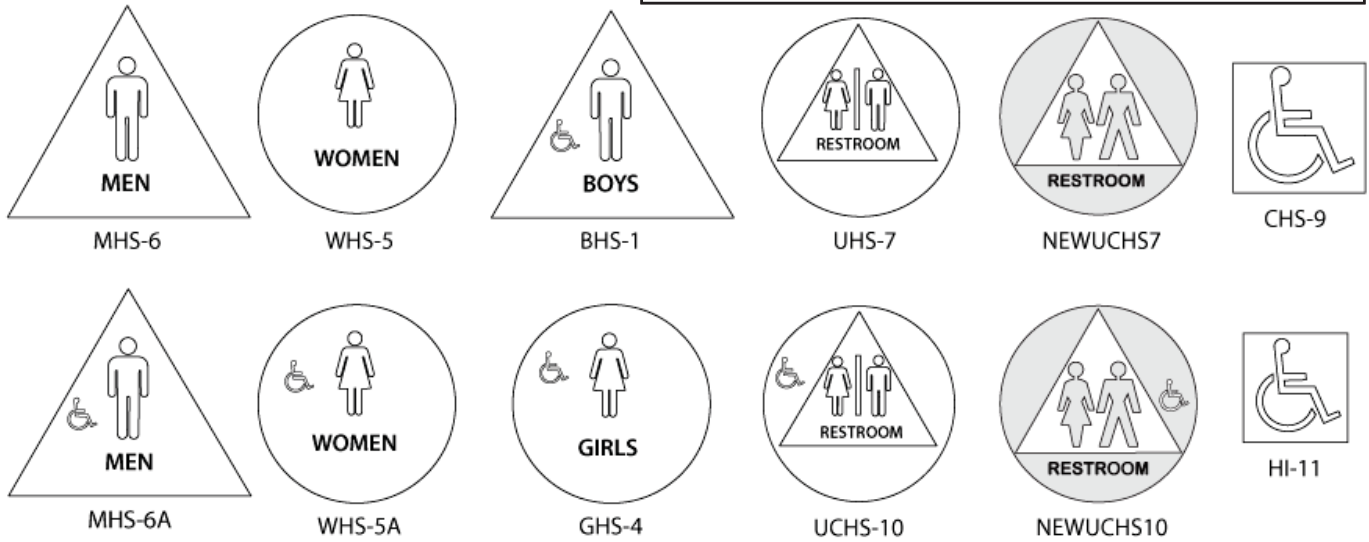

THIS DOOR TO REMAIN UNLOCKED DURING BUSINESS HOURS

WDC-13

THIS DOOR TO REMAIN UNLOCKED WHEN BUILDING IS OCCUPIED

WDO-11

THIS DOOR TO REMAIN UNLOCKED DURING BUSINESS HOURS

BDC-12

THIS DOOR TO REMAIN UNLOCKED WHEN BUILDING IS OCCUPIED

BDO-5

THESE DOORS TO REMAIN UNLOCKED DURING BUSINESS HOURS

TDUW-8

THESE DOORS TO REMAIN UNLOCKED WHEN BUILDING IS OCCUPIED

TWOC-14

THESE DOORS TO REMAIN UNLOCKED DURING BUSINESS HOURS

TDUB-1

THESE DOORS TO REMAIN UNLOCKED WHEN BUILDING IS OCCUPIED

TBOC-19

CALIFORNIA-APPROVED RESTROOM SIGNS WITH BRAILLE *Series List Price*

ITEM#	DESCRIPTION	FINISH	LIST PRICE	UNIT
CAMH69	Men handicap, with Braille, pictogram, text, 6" x 9"	Blue	\$11.00	Ea.
CAWH69	Women handicap, with Braille, pictogram, text, 6" x 9"			
CARSH69	Unisex Restroom handicap, with Braille, pictogram, text, 6" x 9"			
CACCS68	Handicap Accessible, with Braille, pictogram, text, 6" x 9"			
CAEXT69	Exit, with Braille, text 6" x 9"			
CAM1348	Men, with Braille, text 1 3/4" x 8"	Blue, Black		
CAW1348	Women, with Braille, text 1 3/4" x 8"	Blue	6.50	
CARS1348	Restroom, with Braille, text 1 3/4" x 8"			

► **PACKAGING:** 10 Pcs/Inner box, 100 Pcs/Master carton

**QUANTITY DISCOUNT
100 UNITS MIXED -- LESS 10%**

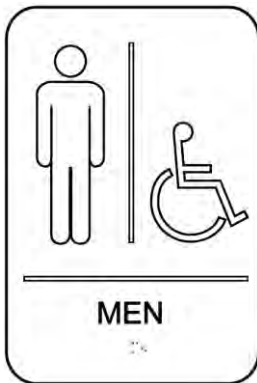

CAMH69

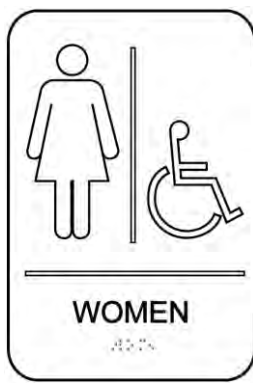

CAWH69



CARSH69



CAEXT69



CACCS68



CAM1348



CAW1348



CARS1348



THRESHOLDS



Ver. 2.0, Rev. 11/12
© 2012  CAL ROYAL

COMMERCIAL SADDLE THRESHOLD

CR 2000 SERIES

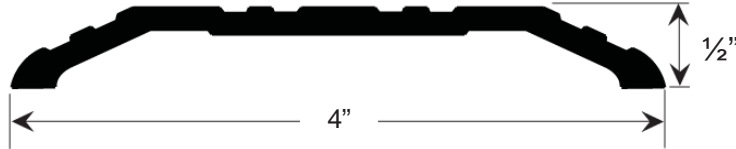

ITEM #	SIZE	FINISH	LIST PRICE PER EA. / LENGTH				PCS /MC	UNIT
			36"	48"	72"	96"		
CR2704	1/2" H x 4" W	ALUM	\$18.87	\$25.18	\$37.74	\$50.35	20	Ea.
		DB	31.59	42.14	63.18	84.27		

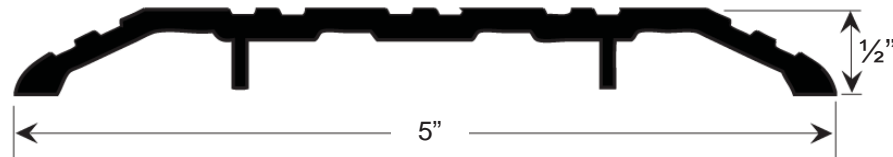

ITEM #	SIZE	FINISH	LIST PRICE PER EA. / LENGTH				PCS /MC	UNIT
			36"	48"	72"	96"		
CR2715	1/2" H x 5" W	ALUM	27.88	37.21	55.76	74.41	20	Ea.
		DB	40.60	54.17	81.20	108.33		

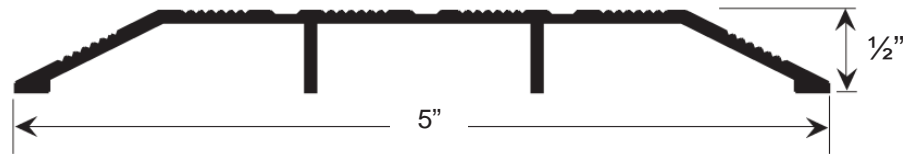

ITEM #	SIZE	FINISH	LIST PRICE PER EA. / LENGTH				PCS /MC	UNIT
			36"	48"	72"	96"		
CR27105	1/2" H x 5" W	ALUM	21.41	28.51	42.82	56.60	20	Ea.
		DB	34.13	42.40	68.26	91.00		

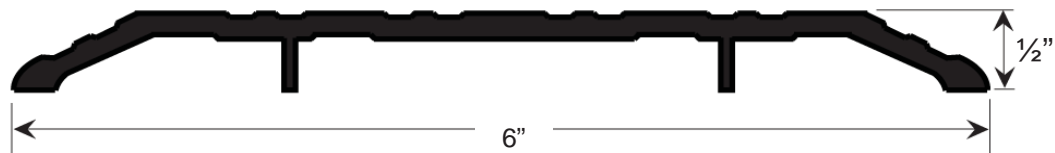

ITEM #	SIZE	FINISH	LIST PRICE PER EA. / LENGTH				PCS /MC	UNIT
			36"	48"	72"	96"		
CR2726	1/2" H x 6" W	ALUM	34.77	46.38	69.54	92.75	20	Ea.
		DB	47.49	63.34	94.98	126.67		

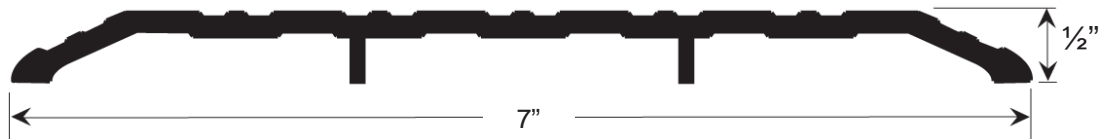

ITEM #	SIZE	FINISH	LIST PRICE PER EA. / LENGTH				PCS /MC	UNIT
			36"	48"	72"	96"		
CR2767	1/2" H x 7" W	ALUM	47.17	62.86	94.34	125.72	20	Ea.
		DB	59.89	79.82	119.78	160.06		



Ver. 2.0, Rev. 11/12
© 2012 CAL-ROYAL



COMMERCIAL SADDLE THRESHOLD

CR 3700 SERIES



ITEM #	SIZE	FINISH	LIST PRICE PER EA. / LENGTH				PCS /MC	UNIT
			36"	48"	72"	96"		
CR3704	1/4" H x 4" W	ALUM	\$17.81	\$23.74	\$35.62	\$47.49	20	Ea.
		DB	30.53	40.70	61.06	81.41		



ITEM #	SIZE	FINISH	LIST PRICE PER EA. / LENGTH				PCS /MC	UNIT
			36"	48"	72"	96"		
CR3715	1/4" H x 5" W	ALUM	27.93	37.21	55.86	74.52	20	Ea.
		DB	40.65	54.22	81.30	108.44		



ITEM #	SIZE	FINISH	LIST PRICE PER EA. / LENGTH				PCS /MC	UNIT
			36"	48"	72"	96"		
CR3726	1/4" H x 6" W	ALUM	34.82	46.43	69.64	92.86	20	Ea.
		DB	47.54	63.39	95.08	126.28		



ITEM #	SIZE	FINISH	LIST PRICE PER EA. / LENGTH				PCS /MC	UNIT
			36"	48"	72"	96"		
CR3767	1/4" H x 7" W	ALUM	47.17	62.91	94.34	125.52	20	Ea.
		DB	59.89	79.87	119.78	159.74		



TH2

Ver. 2.0, Rev. 11/12
© 2012 CAL-ROYAL

<p>CLASSIFIED cUL US</p>	<p>Barrier-free over carpet</p>	<p>3 HR POSITIVE PRESSURE</p>
<p>Meets UL10B, UL10C and UBC 7-2 (1997) Category J</p>		

CARPET/SPECIAL PURPOSE THRESHOLD

CR 3300 & CR 4000 SERIES

CR3361 CARPET/SPECIAL PURPOSE THRESHOLD

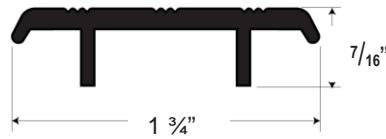

ITEM #	SIZE	FINISH	LIST PRICE PER EA. / LENGTH				PCS /MC	UNIT
			36"	48"	72"	96"		
CR3361	7/16" x 1 3/4"	ALUM	\$13.78	\$18.39	\$27.56	\$36.78	50	Ea.
		DB	18.55	24.75	37.10	49.50		

CR33641 CARPET/SPECIAL PURPOSE THRESHOLD

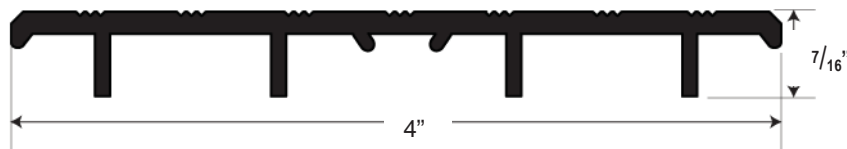

ITEM #	SIZE	FINISH	LIST PRICE PER EA. / LENGTH				PCS /MC	UNIT
			36"	48"	72"	96"		
CR33641	7/16" x 4"	ALUM	24.65	32.86	49.29	65.72	50	Ea.
		DB	34.19	45.58	68.37	91.16		

CR4462 DOOR TOP WEATHERSTRIP

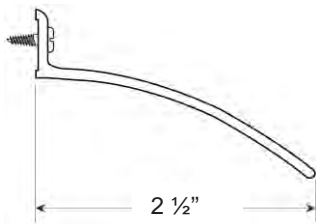

- ▶ Packaging includes:
 - Fasteners:
 - #10 x 3/4" wood screws

Note: Suggested length should be 4" longer than width of door. Allow 2" distance on each end for maximum cover.

ITEM #	SIZE	FINISH	LIST PRICE PER EA. / LENGTH				PCS /MC	UNIT
			36"	40"	52"	76"		
CR4462	2 1/2"	ALUM	13.46	13.46	18.02	26.92	50	Ea.
		DB	16.96	18.87	22.68	33.92		

CR4243 SILL NOSING

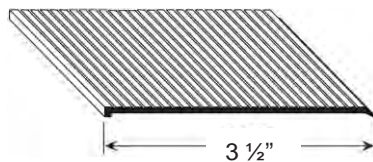

- Designed for use in extending the nose of the threshold.
- Serves as cover, protection and aesthetics for step or slab in front of threshold.
- Furnished undrilled and without screws.

ITEM #	SIZE	FINISH	LIST PRICE PER EA. / LENGTH				PCS /MC	UNIT
			36"	48"	72"	96"		
CR4243	3 1/2"	ALUM	12.35	16.43	24.70	32.86	50	Ea.
		DB	15.85	21.09	31.69	41.45		



TH3

Ver. 2.0, Rev. 11/12
© 2012 CAL-ROYAL





BUILDERS HARDWARE

LIST PRICES

July 2014







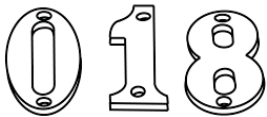

CAL-ROYAL PRODUCTS, INC.
6605 Flotilla St., Commerce,
California 90040 USA

TEL: (323) 888-6601 FAX: (323) 888-6699
Website: www.cal-royal.com
Email: sales@cal-royal.com



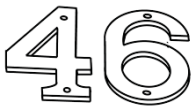

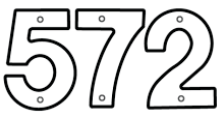
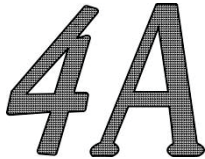

Ver.3.0 Rev.07/14
©2014 CRP, Inc.

CAL-ROYAL PRODUCTS, INC. PRICE LIST JULY 2014

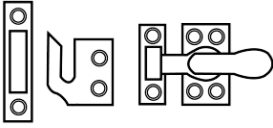
	ITEM #	FINISH	DESCRIPTION	INNER QTY	MSTR QTY	LIST PRICE EA.
SOLID BRASS NUMBERS AND LETTERS						
	SBN2	US3	2" Solid Brass Numbers 0-9. Thickness: 3/16"	10	200	\$3.13
	SBN3 SBN4	US3 US3	3" Solid Brass Numbers 0-9. 4" Solid Brass Numbers 0-9. Thickness: 3/16"	10 10	100 100	4.05 5.57
	SBL2 SBL3 SBL4	US3 US3 US3	2" Solid Brass Letters A-Z. 3" Solid Brass Letters A-Z. 4" Solid Brass Letters A-Z. Thickness: 7/32"	10 10 10	200 100 100	4.13 4.98 6.89
	SBN3 SBL3 SBN4 SBL4	US15,10B US15,10B US15,10B,26 US15,10B,26	3" Solid Brass Numbers 0-9. Thickness: 3/16" 3" Solid Brass Letters A-F. Thickness: 7/32" 4" Solid Brass Numbers 0-9. Thickness: 3/16" 4" Solid Brass Letters A-F. Thickness: 7/32"	20 20 20 10	200 200 200 100	6.63 6.63 8.85 8.85
<i>*26D Finishes available subject to quantity and factory lead time</i>						
	SBN6	US3	6" Solid Brass Numbers 0-9. Thickness: 3/16"	10	100	11.24
	SBN8	US3	8" Solid Brass Numbers 0-9. Thickness: 9/32"	5	50	26.98
AVAILABLE WHILE SUPPLIES LAST						
DIE CAST NUMBERS AND LETTERS						
	ZN5	US3,15,10B	5" Diecast Numbers 0-9. Thickness: 7/32"	50	100	6.52
	PN20BK PN20US3	BLACK US3	4" Die Cast House Number (0-9) and Letters (A-F) Packed With Nails. Affix number or letter to be ordered with Item code. E.g. "PN20BK 4" to order (4) in black finish. Thickness: 3/32" 4" Die Cast House Number (0-9) and Letters (A-E) Packed With Nails. Affix number or letter to be ordered with Item code. E.g. "PN20US3 4" to order (4) in US3 finish. Thickness: 3/32"	100 100	1000 1000	0.78 0.93

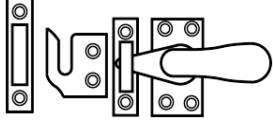
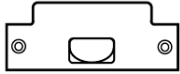
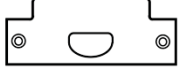

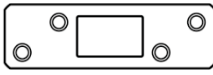
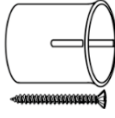
CAL-ROYAL PRODUCTS, INC. PRICE LIST JULY 2014

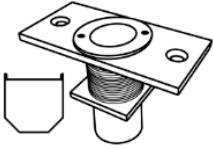
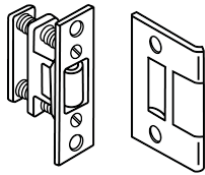
	ITEM #	FINISH	DESCRIPTION	INNER QTY	MSTR QTY	LIST PRICE EA.
MISCELLANEOUS DOOR AND WINDOW HARDWARE						
	SBCF222	US3,5, US10B,19, US15,15A, US26, 26D	Window Casement Fasteners, Solid Brass (1 3/8" x 7/8", Projection 1 3/8")	20	100	\$11.80
						
	SBCF333	US3,5, US10B,19, US15,15A, US26, 26D	Window Casement Fasteners, Solid Brass (2 1/16" x 1 1/16", Projection 1 7/8")	10	100	17.33
	ASA478	US32D US3,26, US10, 10B	Template ASA Strike (4 7/8" x 3 3/8" x 1 1/4"), Stainless Steel Template ASA Strike (4 7/8" x 3 3/8" x 1 1/4"), Solid Brass	100	100	3.34 5.78
	ASAST	US3, 26,26D US10,10B	Template ASA Strike (4 7/8" x 3 3/8" x 1 1/4"), Steel Base	100	100	2.00 3.00
	SDTP3625	US3,10B,15, US15A,26	Heavy Duty Security Strike Size: 3 5/8" x 1 7/8" Individually Poly-bagged with 2 pcs #10 x 3/4" Wood Screws	1	200	1.29
	SS114358	US3, 5,15, US26D, 10B	Deadbolt Security Strike 1 1/4" x 3 5/8", 1/4" Rad. Packed with 2 pcs #12 x 3" and 2 pcs #12 x 1 1/4" wood screws	50	300	2.67
	DTS80	ZINC	Drive In Thimble Strike (Length: 1 1/8", Diameter 1")	100	200	0.90
						
	DPSTRK1	US3, 10B, US26, 26D	Brass Dustproof Strike. Face Plate: 1 3/8" x 2 7/8" ANSI/BHMA LO4021	10	100	13.87**
	ARL1338	US3, 5, 10B, US15, 15A, US26, 26D, US19	Heavy Duty Roller Catch. Adjustable Nylon Roller With Square Heavy Duty Cast 2 1/4" Full Lip Strike: Size: 1 1/8" x 1" x 3 3/8", Depth: 1 13/16" ANSI/BHMA:E09091	10	100	18.70**

**Effective July 1, 2014

**20% CHARGE
FOR BROKEN
QUANTITY**

CAL-ROYAL PRODUCTS, INC. PRICE LIST JULY 2014

ITEM #	FINISH	DESCRIPTION	INNER QTY	MSTR QTY	LIST PRICE EA.
MISCELLANEOUS DOOR AND WINDOW HARDWARE					

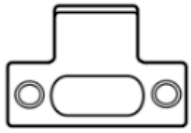

ARLTSTRK62	US3, 5, 10B, US26, 26D, US15, 15A, 19	Optional T Strike for Heavy Duty Roller Catch ARL1338	1	1	3.69**
------------	---	---	---	---	--------



DSM21	Rubber	Door Silencer. 1/2" Dia. 1 1/16" Length For Metal Frames ANSI/BHMA LO3011	200/Bag	10,000	17.80/200
-------	--------	---	---------	--------	-----------



DSW85	Rubber	Door Silencer. 3/8" x 3/4" Base, 3/4" Length For Wood Frames. ANSI/BHMA LO3021	200/Bag	10,000	26.68/200
-------	--------	--	---------	--------	-----------

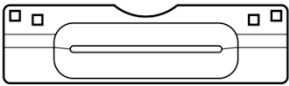

LPG2	USP, ALUM, DURO, GOLD	Latch Guard Protector Size: 2 7/8" x 11"	10	60	\$7.00
------	--------------------------	--	----	----	--------

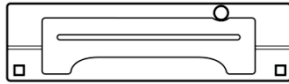

GJLPG2	US32D	Latch Guard Protector Size: 3" x 11" Similar to Glynn Johnson #LP1	10	60	22.23
--------	-------	---	----	----	-------

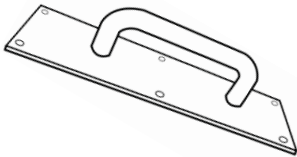

	SIZES		FINISHES		
			US32D**	US3**	US10B**
1000	3.5" x 15"	Solid Bar Round Pull Plates 3/4" diameter 6" CTC (Pcs/Inner Box: 1; Pcs/Master Carton: 10)	29.10	49.11	58.21
1001	4' x 16"		30.32	52.15	61.85
1001 ADA			35.78	--	--
1002	3.5" x 15"	Solid Bar Round Pull Plates 3/4" diameter 8" CTC (Pcs/Inner Box: 1; Pcs/Master Carton: 10)	32.14	53.35	63.06
1003	4' x 16"		32.74	55.79	66.70
1003 ADA			38.20	--	--
1004	3.5" x 15"	Solid Bar Round Pull Plates 1" diameter 8" CTC (Pcs/Inner Box: 1; Pcs/Master Carton: 10)	51.54	81.24	95.79
1005	4' x 16"		52.75	84.88	99.43
1005 ADA			58.21	--	--
1006	3.5" x 15"	Solid Bar Round Pull Plates 1" diameter 10" CTC (Pcs/Inner Box: 1; Pcs/Master Carton: 10)	55.79	88.52	104.90
1007	4' x 16"		56.99	90.95	108.53
1007 ADA			63.06	--	--

**Effective July 1, 2014



CAL-ROYAL PRODUCTS, INC. PRICE LIST JULY 2014

ITEM #	FINISH	DESCRIPTION	INNER QTY	MSTR QTY	LIST PRICE EA.
--------	--------	-------------	-----------	----------	----------------

MISCELLANEOUS DOOR AND WINDOW HARDWARE

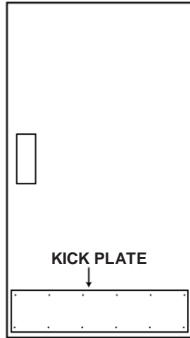

BKICK834	US32D	Metal Kick Plates With Screws	1	10	30.74
KICK834	US10B	Size: .050" x 8" x 34"			76.60
AKICK834	US32D	Metal Kick Plates With Screws	1	10	26.67
		Size: .040" x 8" x 34"			
BKICK1034	US32D	Metal Kick Plates With Screws	1	10	38.69
KICK1034	US10B	Size: .050" x 10" x 34"			95.75
AKICK1034	US32D	Metal Kick Plates With Screws	1	10	33.34
		Size: .040" x 10" x 34"			
BKICK1046	US32D	Metal Kick Plates With Screws	1	8	52.35
NEW ITEM		Size: .050" x 10" x 46"			\$25.00 NET PALLET CHARGE FOR ORDERS WITH 5 PIECES OR LESS

PRICES ON STAINLESS STEEL KICK PLATES ARE SUBJECT TO CHANGE WITHOUT NOTICE. PLEASE INQUIRE CURRENT PRICE BEFORE ORDERING

ANSI/BHMA J102

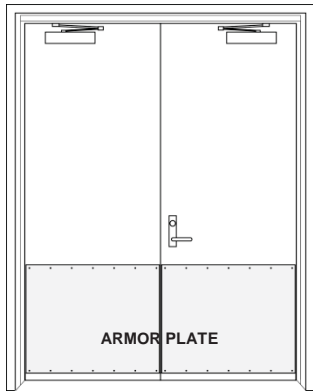

ANO634	US3, US4 US10B, 15	Aluminum Kick Plate With Screws	1	10	14.00
		Size: 0.32" x 6" x 34"			14.00
ANO834	US3, US4 US10B, 15	Aluminum Kick Plate With Screws	1	10	16.00
		Size: 0.32" x 8" x 34"			16.00
ANO1034	US3, US4 US10B, 15	Aluminum Kick Plate With Screws	1	10	21.10
		Size: 0.32" x 10" x 34"			21.10
BARM3434	US32D	Stainless Steel Armor Plates	1	3	98.90
NEW ITEM		Size: .050" x 34" x 34"			\$25.00 NET PALLET CHARGE FOR ORDERS WITH 5 PIECES OR LESS
BARM3436	US32D	Stainless Steel Armor Plates	1	3	104.72
NEW ITEM		Size: .050" x 34" x 36"			\$25.00 NET PALLET CHARGE FOR ORDERS WITH 5 PIECES OR LESS



PSPL3515	US32D US3 US10, 10B, US26, 4, 5	Push Plate Size 0.050" x 3 1/2" x 15"	1	60	7.40**
		Packed with Protective Film and Screws.			16.97**
					19.06**
PSPL4016	US32D US3 US10, 10B, US26, 4, 5	Push Plate Size 0.050" x 4" x 16"	1	60	8.18**
		Packed with Protective Film and Screws.			19.66**
		ANSI/BHMA J301			21.93**

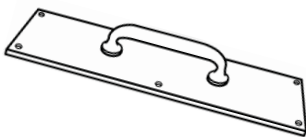

PULPL3515	US32D,3 US10, 10B, US4, 5, 26	Pull Plate Size: 0.050" x 3 1/2" x 15"	1	6	34.68**
		Packed with Solid Brass 6" Handle, Fasteners and Washers.			43.37**
		One piece mounted, easy installation.			
PULPL4016	US32D, 3 US10, 10B, US4, 5, 26	Pull Plate Size: 0.050" x 4" x 16"	1	6	36.09**
		Packed with Solid Brass 6" Handle, Fasteners and Washers.			45.14**
		One piece mounted, easy installation.			

ANSI/BHMA J102

**Effective July 1, 2014



CAL-ROYAL PRODUCTS, INC.

DH5



Ver. 3.0, Rev. 07/14
© 2014 CAL-ROYAL

CAL-ROYAL PRODUCTS, INC. PRICE LIST JULY 2014

ITEM #	FINISH	DESCRIPTION	INNER QTY	MSTR QTY	LIST PRICE EA.
MISCELLANEOUS DOOR AND WINDOW HARDWARE					

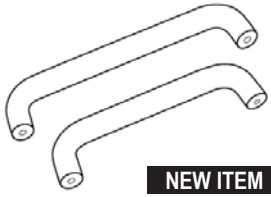

NEW ITEM

PUL200	US3	Solid Bar Round Pull, 1" diameter, 10" CTC Projection: 2 1/2"	1	10	63.00**
	US32D				43.91**

PUL201	US3	Solid Bar Round Pull, 1" diameter, 8" CTC Projection: 2 1/2"	1	10	53.15**
	US32D				42.47**

PUL202	US3	Solid Bar Round Pull, 3/4" diameter, 10" CTC Projection: 2 1/4"	1	10	35.50**
	US32D				26.30**

PUL203	US3	Solid Bar Round Pull, 3/4" diameter, 8" CTC Projection: 2 1/4"	1	10	32.35**
	US10B				41.60**
	US32D				21.95**
	ALUM				13.29**

PUL204	US3	Solid Bar Round Pull, 3/4" diameter, 6" CTC Projection: 2 1/4"	1	10	28.89**
	US10B				36.98**
	US32D				20.80**
	ALUM				12.71**

PUL205	US3	Solid Bar Round Pull 3/4" diameter, 5 1/2" CTC Projection: 2 1/4"	1	10	25.42**
	US15				25.66**
	US10B				34.66**
	US32D				20.57**
	ALUM				14.33**

PUL206	US3	Solid Bar Round Pull, 5/8" diameter, 5 1/2" CTC Projection: 2"	1	10	25.42**
	US10B				34.66**
	US32D				18.49**
	ALUM				12.48**

NEW ITEM

PUL207	US3	Solid Bar Pull Handle, 3/8" x 1 1/4", 10" CTC Projection: 2"	1	10	45.53**
	US10B				55.70**
	US15				43.45**
	US28				18.95**

PUL208	US3	Solid Bar Pull Handle, 3/8" x 1 1/4", 8" CTC Projection: 2"	1	10	43.22**
	US10B				47.38**
	US15				37.21**
	US28				17.10**

PUL209	US3	Solid Bar Pull Handle, 3/8" x 1 1/4", 6" CTC Projection: 2"	1	10	33.05**
	US10B				38.14**
	US15				27.97**
	US26				33.05**
	US28				16.64**

NEW ITEM

PUL210	US3	Solid Bar Pull Handle, 7/8" x 1/2" Ellipse, 5 1/8" CTC Projection: 1 3/4"	1	10	20.57**
	US28				11.33**

PUL211	US3	Solid Bar Pull Handle, 3/4" x 1/2" Ellipse, 5 1/2" CTC Projection: 1 3/4"	1	10	25.19**
	US10B				26.34**
	US15				13.86**
	US26				29.82**
	US32D				36.51**

NEW ITEM

**Effective July 1, 2014









CAL-ROYAL PRODUCTS, INC.

DH6

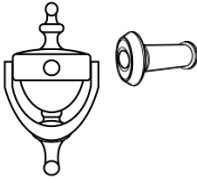

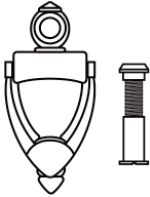
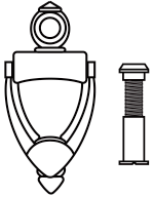

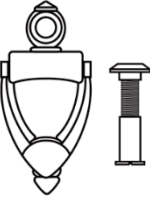

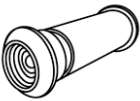
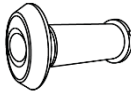
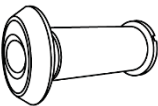
Ver. 3.0, Rev. 07/14
© 2014 CAL-ROYAL

CAL-ROYAL PRODUCTS, INC. PRICE LIST JULY 2014

	ITEM #	FINISH	DESCRIPTION	INNER QTY	MSTR QTY	LIST PRICE EA.
DOOR KNOCKERS, DOOR VIEWERS						
	SBDK356	US3, 5, 10B, US15, 15A, US26, 26D	Solid Brass Door Knocker Size: 3 1/2" x 6 7/8" Similar to IVES#312	10	50	\$18.90
	SBDK/DV180	US3	Solid Brass Door Knocker With 180° Door Viewer, 9/16" Bore. Size: 3 1/2" x 6" For Doors 1 3/8" to 1 3/4" Thick	10	50	23.50
	SSBDK234	US3 US15, 10B	Solid Brass Door Knocker Size: 2 1/8" x 3 3/4" Similar to IVES#3102	20	200	15.60 18.00
	DK93	US3,5,26D, US15, 15A, US10B	Door Knocker With 160° Viewer, 1/2" Bore. Size 1 3/4" x 4" For Doors 1 3/8" to 1 3/4" Thick. Non UL.	24	240	6.00
	ULDK93	US3,5,26D, US15	Door Knocker With 160° Viewer, 1/2" Bore. Size 1 3/4" x 4" For Doors 1 3/8" to 1 3/4" Thick. UL Listed.	24	240	7.48
						
	DK94	US3,5,26D, US15, 15A, US10B	Door Knocker With 180° Viewer, 9/16" Bore. Size 2 3/8" x 5 1/4" For Doors 1 3/8" to 1 3/4" Thick. Non UL.	12	120	7.70
	DKN95	US3,5	Door Knocker With 160° Viewer Name Card. Size 2" x 4 3/4", For Doors 1" to 1 3/4" Thick.	12	120	6.67
(US5) AVAILABLE WHILE SUPPLIES LAST						
	DV90	US3,5, US15,10B, US26D, 26	Brass Door Viewer, 160°, 1/2" Bore, Plastic Lens For Doors 1 3/8" to 2" Thick. ANSI/BHMA LO3172	24	600	1.80
	DV91	US3,5, US15,10B, US26D, 26	Brass Door Viewer, 180°, 1/2" Bore, Plastic Lens For Doors 1 3/8" to 2" Thick.	12	600	2.45
	DV180	US3,5, US15,15A, US26D, 26, US10B	Brass Door Viewer, 180°, 9/16" Bore, Plastic Lens For Doors 1 3/8" to 2" Thick. ANSI/BHMA LO3171	12	600	2.45

CAL-ROYAL PRODUCTS, INC. PRICE LIST JULY 2014

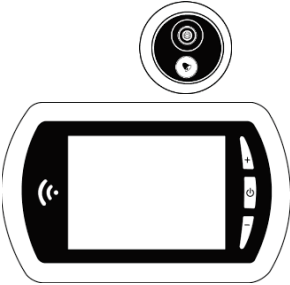
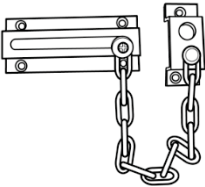
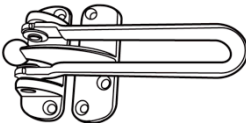
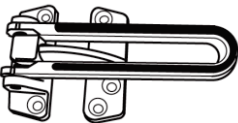
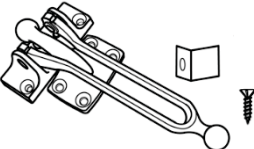
	ITEM #	FINISH	DESCRIPTION	INNER QTY	MSTR QTY	LIST PRICE EA.
DOOR VIEWERS						
	ULDV160	US3,26,26D, US10B,10A,U S15	UL Listed Door Viewer, 160°, ½" Bore Glass Lens For Doors 1 ¾" to 2" Thick. BHMA LO3172	25	1000	\$4.25
	ULDV200	US3,26,26D, US10B,10A,U S15	UL Listed Door Viewer, 200°, ⅜" Bore Glass Lens For Doors 1 ¾" to 2" Thick.	25	500	6.70
	10ULDV201	US3,10B,26D, US15	UL Listed Door Viewer, 200°, ⅜" Bore Glass Lens For Doors 1" to 1 ¾" Thick.	25	500	6.70
	COV160	US3,10B, US15,26D	½" Door Viewer Cover. To be used with DV90, DV91, ULDV160 Door Viewers	10	100	1.91
	COV200	US3,10B, US15,26D	⅜" Door Viewer Cover. To be used with DV180, ULDV200, ULDV201 Door Viewers	10	100	1.91
ELECTRONIC DIGITAL DOOR VIEWER						
NEW ITEM						
	ELDVBEL150	Silver, Duro, Gold	<ul style="list-style-type: none"> • Dia. 1/2" ~ 1-1/8" (13mm ~ 29mm) Supported Existing Door Bores • 3.5" TFT, (90mm) 320x240 resolution LCD Viewer Screen size • Fully Integrated Digital Camera and LCD display • Quick and Easy Installation • Clear Large Image 0.3 Mega Pixels CMOS Resolution • Easy Operation • Convenient for children and elderly • Provides additional privacy • 3 X AA Batteries included • 8.5oz (240g) Net Weight 	1	20	155.00
DOOR GUARDS						
	DG22	US3 US5,26	Solid Brass Chain Door Guard, 6 ¾" Chain. BHMA LO3041	20	200	4.90 5.40
	BBDHG88	US3,4, US5, 10B, US26, 26D	Zinc Diecast Swing Bar Door Guard With Ball Bearing	10	100	6.45
	PDG88	US3,4, US26, 26D, US10B	Diecast Swing Bar Door Guard With Ball Bearing and Protective Rubber Insert On Both Sides Of Arms	10	100	9.01
	SBDG00	US26D US3,26, US4, 10B	Solid Brass Door Guard Packed With Angle Protector. Comparable to IVES 482B, arm length 4¾". With Ball Bearing ANSI/BHMA LO3041	10	100	16.90** 18.60**

**Effective July 1, 2014







DH8



CAL-ROYAL PRODUCTS, INC.

Ver. 3.0, Rev. 07/14
©2014 CAL-ROYAL

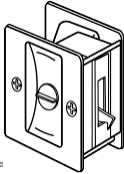

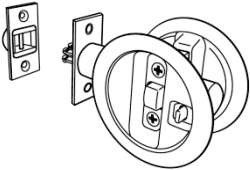
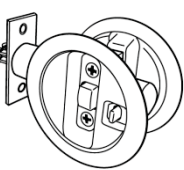
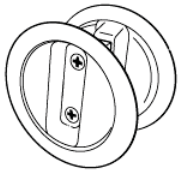
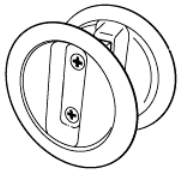
CAL-ROYAL PRODUCTS, INC. PRICE LIST JULY 2014

	ITEM #	FINISH	DESCRIPTION	INNER QTY	MSTR QTY	LIST PRICE EA.
DOOR GUARDS						
	DAP77	US3,4, 5, US26, 26D, US10B	Door Angle Protector with Adhesive and Individual Screw for secure mounting. To be used with BDHG88 and PDG88 Door Guards.	100	500	\$1.57**
	DGS39	Black	Door Guard Shim to be used when face of door is recessed from face of jamb. Fits under door guardsector which attaches to door. To be used with BBDHG88 and PDG88 . 1/8" Thick.	100	500	1.57**
	DGS100	Black	Door Guard Shim to be used when face of door is recessed from face of jamb. Fits under door guardsector which attaches to door. To be used with SBDG00 . 1/8" Thick.	100	500	1.57**
SLIDING DOOR LOCKS						
	PRIPDL21	US3, 5, 10B, US15, 15A, US26, 26D	Heavy Duty Privacy Sliding Door Lock Function, Standard Door Prep 2 7/8"(L) x 1 3/4"(W) Can be used on 1 3/8" and 1 3/4" door thickness.	10	50	14.61
	PASPDL34	US3, 5, 10B, US15, 15A, US26, 26D	Heavy Duty Passage Sliding Door Lock Function, Standard. Door Prep 2 7/8"(L) x 1 3/4"(W) Can be used on 1 3/8" and 1 3/4" door thickness.	10	50	13.48
	SDL16	US3 US3/26,5/26 US5,26,26D US10B,10B/26, US15, 15A, 19	Privacy Sliding Door Lock Comparable to Quality No. 101	10	50	9.33 11.31 11.31 11.31
	SDLPIN	Zinc	1 1/8" Long Extension Pin for SDL16 Privacy Function. To be used for 1 3/4" door thickness.	1	1	0.27
SDLPIN not shown to size						
	SDL17	US3 US5,26,26D US10B, 19 US15A,15 US3/26	Passage Sliding Door Lock Comparable to Quality No. 100	10	50	7.15 8.90 8.90 8.90 8.90
	RSDL20	US10B US3 US5 US15, 15A, 19, 26, 26D	Privacy Sliding Door Lock 1-3/8" Door Thickness			21.30 19.54 20.88 20.88
	134RSDL20	US10B US3 US5 US15, 15A, 19, 26, 26D	Privacy Sliding Door Lock 1-3/4" Door Thickness			21.49 19.68 21.06 21.06
NEW ITEM						
	RSDL40	US10B US3 US5 US15, 15A, 19, 26, 26D	Dummy Sliding Door Lock 1-3/8" Door Thickness			12.41 11.32 12.17 12.17
	134RSDL40	US10B US3 US5 US15, 15A, 19, 26, 26D	Dummy Sliding Door Lock 1-3/4" Door Thickness			12.50 11.39 12.24 12.24
NEW ITEM						

**Effective July 1, 2014

**20% CHARGE
FOR BROKEN
QUANTITY**

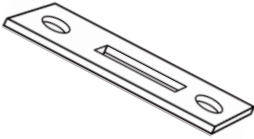
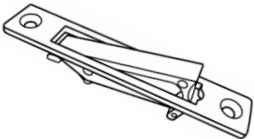
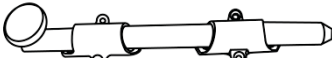
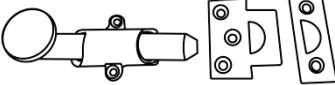

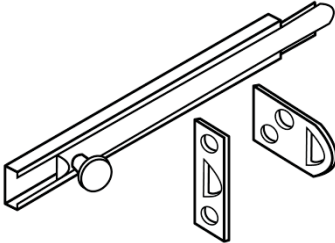
CAL-ROYAL PRODUCTS, INC. PRICE LIST JULY 2014

	ITEM #	FINISH	DESCRIPTION	INNER QTY	MSTR QTY	LIST PRICE EA.
SLIDING DOOR LOCKS						
	STRKSDL	US3,5,10B, US26, 26D, US15, 15A	Strike for Privacy SDL16 Packed with 2 Screws	10	50	1.26
	EP23	US3,5	Edge Pull, Flush Mount Size 3"	150	600	1.95
SECURITY BOLTS						
	DDSB4	US3 US26,10B US15A,15,5	Solid Brass 4" Decorative Dutch Door Bolt Packed With Mortise and Universal Strikes.	10	60	21.04** 23.04** 23.04**
	DDSB8	US3 US26,10B US15A,15,5	Solid Brass 8" Decorative Dutch Door Bolt Packed With Mortise and Universal Strikes.	10	60	25.89** 28.44** 28.44**
	DDSB12	US3 US26,10B US15A,15,5	Solid Brass 12" Decorative Dutch Door Bolt Packed With Mortise and Universal Strikes.	10	60	35.59** 39.17** 39.17**
	DDSB18	US3 US26,10B US15A,15,5	Solid Brass 18" Decorative Dutch Door Bolt Packed With Mortise and Universal Strikes.	10	60	44.31** 48.74** 48.74**
	DDSB24	US3 US26,10B US15A,15,5	Solid Brass 24" Decorative Dutch Door Bolt Packed With Mortise and Universal Strikes.	10	60	55.00** 60.51** 60.51**
	ANGSTRK	US3,5, US26,10B, US15,15A	Angle Strike for Decorative Heavy Duty Surface Bolt	1	1	3.83**
	SB873	US3,15,26 US15A,10B,5	3" Brass Surface Bolt, Poly Packed With Screws.	20	400	4.61 5.53
	SB874	US3,15,26 US15A,10B,5	4" Brass Surface Bolt, Poly Packed With Screws.	20	200	4.88 5.85
	SB876	US3,15,26 US15A,10B,5	6" Brass Surface Bolt, Poly Packed With Screws.	20	200	7.38 8.05
	SB8712	US3,15,26 US15A,10B,5	12" Brass Surface Bolt, Poly Packed With Screws.	10	100	15.10 16.60
ANSI/BHMA L04151						

**Effective July 1, 2014

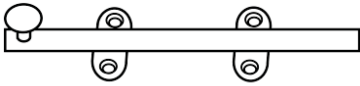

CAL-ROYAL PRODUCTS, INC. PRICE LIST JULY 2014

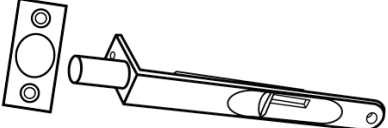
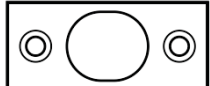
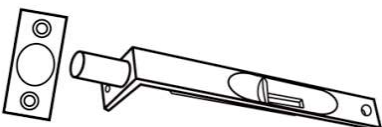
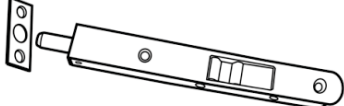
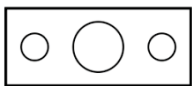
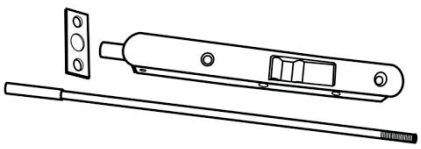
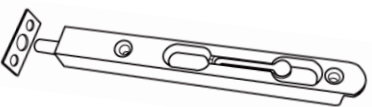
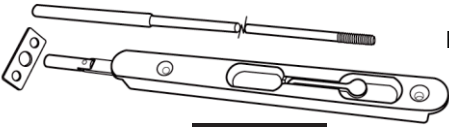
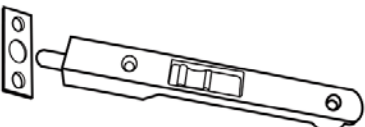
	ITEM #	FINISH	DESCRIPTION	INNER QTY	MSTR QTY	LIST PRICE EA.
SECURITY BOLTS						
	DCSB4	US3,5,10B, US15,15A, US26,26D	Decorative 4" Surface Bolt Included: Packed in individual Poly Bag with 2 strikes and Screws. Comparable to IVES No. 043 surface bolt.	50	300	\$5.41
	DCSB6	US3,5,10B, US15,15A, US26,26D	Decorative 6" Surface Bolt Included: Packed in individual Poly Bag with 2 strikes and Screws. Comparable to IVES No. 043 surface bolt.	50	200	5.98
	MB85R	US3 US5,10B, US26, 26D, US15, 15A	6" Brass Flush Bolt Round End. 1" Throw ANSI/BHMA LO4201	10 10	100 100	6.97** 7.38**
	STRKMB85R	US3,5, US15,15A, US26, 26D	Strike for MB85R and MB86S. Packed with 2 screws.	10	50	1.42
	MB86S	US3 US5,10B, US26, 26D, US15, 15A	6" Brass Flush Bolt Square End. 1" Throw ANSI/BHMA LO4201	10 10	100 100	6.97** 7.38**
	FBG6	US3,5, US26, 26D, US15, 15A US4, 10B	Solid Brass Single Route Flush Bolt Round End, Similar to (IVES #260) Size 7"	10 10	100 100	5.00 6.30
	STRKFBG6	US3, 5, 10B, US26, 26D, US15, 15A	Strike for FBG6 and FBGEX12 Packed with 2 screws	10	100	1.26
	FBGEX12	US3, 5, US26, 26D, US15, 15A US4, 10B	Solid Brass Single Route Extension Flush Bolt, 18" Rod, Size 7 3/8" Round Both Ends.	2 2	100 100	7.49 each 8.77 each
SOLD PER PAIR ONLY PRICED EACH						
	FLPFB400	US3, US15, US26D	Flip Style Mortise Flush Bolt 7" L x 3/4" W; Throw: 1 1/16"; Strike 1 1/2" L x 5/8" W	10	100	8.12
NEW ITEM		US5, US10B, US15A, US26				9.34
	EXT FB-1	US3, US15, US26D	Flip Style Mortise Flush Bolt with 18" Extension Rod 7 7/16" L x 3/4" W; Throw: 1 1/16"; Strike 1 1/2" L x 5/8" W	2	100	9.34 each
NEW ITEM		US5, US10B, US15A, US26				10.27 each
	ZDFB800	US3 US5, 15, 10B, US26, 26D	Solid One Piece Heavy Construction , Diecast Base, Single Route Flushbolt, Round End. Size 6 3/4"	10 10	100 100	5.49 5.76

**Effective July 1, 2014



CAL-ROYAL PRODUCTS, INC.

DH11



Ver. 3.0, Rev. 07/14
© 2014 CAL-ROYAL

CAL-ROYAL PRODUCTS, INC. PRICE LIST JULY 2014

ITEM #	FINISH	DESCRIPTION	INNER QTY	MSTR QTY	LIST PRICE EA.
--------	--------	-------------	-----------	----------	----------------

SECURITY BOLTS

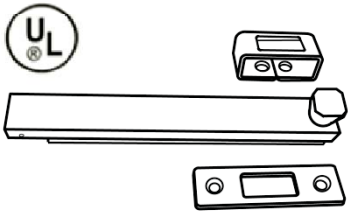

SBUL8	US26D	UL Listed 8" Surface Bolt. Features Tamper-Resistant Mounting. Concealed Screw, Steel Construction. Bolt Throw - 1", Width 1", Projection 1 5/8", Length 8" Comparable to IVES #361	1	36	16.85
-------	-------	---	---	----	-------

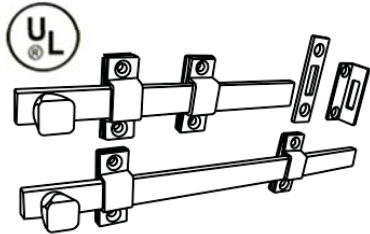

ESBUL50	US26D	UL-Listed 8" Surface Mounted Heavy Duty Surface Bolt. Steel Construction. Bolt Throw 1 3/16", Width 1", Length 8" Projection 1 5/8". Packed with Mortise and Universal Strikes. Comparable to IVES #453 ANSI/BHMALO4161	1	50	13.48
ESBUL12	US26D	12" Length, same specs as above	1	50	17.24

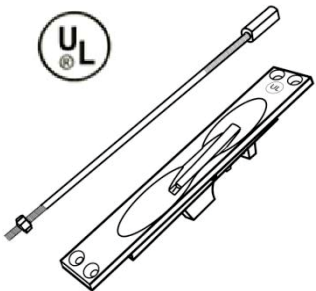

ULFB634	US26D,3 US10, 10B, US4, 5,26, US15, 15A, Almond/White	UL-Listed Solid Brass Lever Extension Flush Bolt. Commercial Type, 1" x 6 3/4", 12" Extension, 3/4" Throw. New Extruded Brass Design. ANSI/BHMALO4081	2	50	17.37 each** 18.10 each**
FBROD18		18" Extended Rod for ULFB634	1	1	2.76
FBROD24		24" Extended Rod for ULFB634	1	1	2.76
FBROD36		36" Extended Rod for ULFB634	1	1	2.76
FBROD48		48" Extended Rod for ULFB634	1	1	5.51

**SOLD PER PAIR ONLY
PRICED EACH**

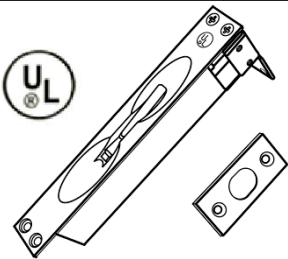

WFUL634	US3, 10B, US15, 15A, US26, 26D	UL-Listed Solid Brass Lever Extension Flush Bolt. Commercial Type, 1" x 6 3/4", 3/4" Throw. For Wood or Composite Doors.	1	50	22.07**
---------	--------------------------------------	---	---	----	---------

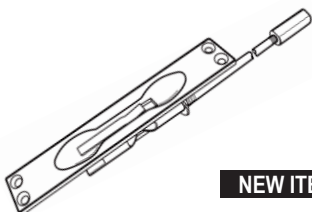

SBFB825	US3 US10B, 15, 26D	Stamped Brass Lever Extension Flush Bolt. Commercial Type, 1" x 6 3/4", 12" Extension, 3/4" Throw. Non-handed Extended Rods Available. See ULFB634 (above).	2	50	12.30 each 13.25 each
---------	--------------------------	---	---	----	--------------------------

**SOLD PER PAIR ONLY
PRICED EACH**

DOUBLE-ACTING FLOOR SPRING HINGE

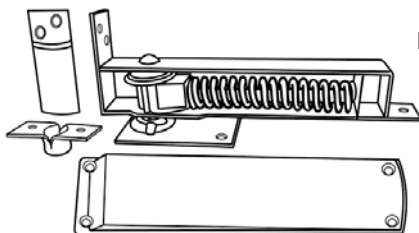

DAFH8	US3, 5, 15, US26D, 10B	ANSI/BHMALO4081 Heavy Duty Ball Bearing Type with 90° Hold Open. Door Range 1 1/8" - 1 3/4". Can Hold Doors up to 90 lbs.	1	10	34.45
-------	---------------------------	---	---	----	-------

**Effective July 1, 2014







CAL-ROYAL PRODUCTS, INC.

DH12



Ver. 3.0, Rev. 07/14
©2014 CAL-ROYAL

CAL-ROYAL PRODUCTS, INC. PRICE LIST JULY 2014

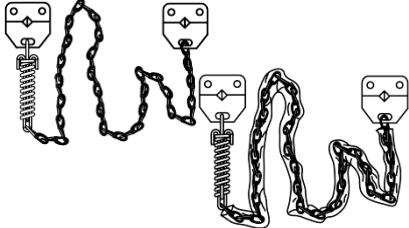
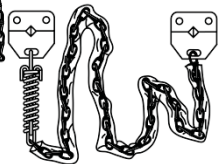
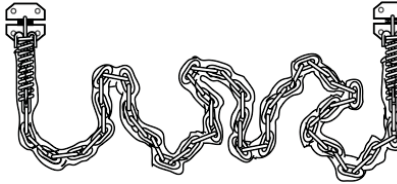
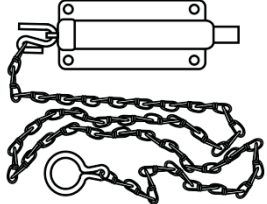





	ITEM #	FINISH	DESCRIPTION	INNER QTY	MSTR QTY	LIST PRICE EA.
HANDRAIL BRACKETS						
	JUHB28	US3,5,26, US15, 15A US10B	Jumbo Heavy Duty Handrail Bracket Packed With Mounting Screws Height: 2 7/8", Width: 2 1/8" Projection: 2 7/8"	50	100	\$4.40 4.77
	HB96	US3, 5, 26 US15, 15A, US26D, 10B	Hand Rail Bracket, Poly Bagged With Screws. Height: 2 7/8", Width: 1 3/16" Projection: 2 7/8"	50	200	2.00 2.27
	HDHB40	US3, 5, 26 US15, 15A, 26D US10B	Heavy Duty Cast Aluminum Handrail Bracket Comparable to IVES #059 Height: 3 1/4", Width: 1 7/16" Projection: 3 1/4"	50	200	2.65 2.94 3.45
	DMHB83	US3, 26D, US15, 15A US10B	Heavy Duty Handrail Bracket. Poly Bagged with Screws. Height: 2 3/4", Width: 1 3/8" Projection: 3 1/4"	50	100	4.43 4.90
	ADAHB-4	US3, 5, 15, 15A, US26, US26D, 10B	Heavy Duty Cast Handrail Bracket Height: 3 1/2", Width: 1 5/16" Projection: 4" American with Disabilities Act (ADA) compliant	50	250	3.12
NEW ITEM						
CRASH CHAINS AND BOLTS						
	CCD30	Zinc	Single Spring Crash Chain Door Guard, No Vinyl , 21 3/4" Chain	10	120	2.05
	CDV24	Zinc	Single Spring Crash Chain Door Guard, With Vinyl , 21 3/4" Chain	10	120	2.22
	HDCDV-48	US26D	Super Heavy Duty Adjustable Chain Door Stop with Vinyl Cover, comparable to IVES #115. For Heavy Commercial Doors. Adjustable 20" to 30 1/2". ANSI/BHMA LO2222	1	50	15.49
	CB6	Zinc Chromium	24" Chain Bolt Hardened Steel, Supplement to a regular doorLock for added security. Included: Packed in individual poly bag with strikes andscrews.	10	50	6.22

NEW LOWER PRICE

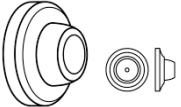
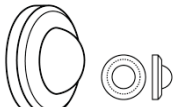
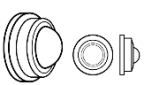
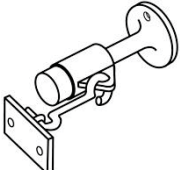
20% CHARGE FOR BROKEN QUANTITY



CAL-ROYAL PRODUCTS, INC. PRICE LIST JULY 2014

	ITEM #	FINISH	DESCRIPTION	INNER QTY	MSTR QTY	LIST PRICE EA.
DOOR STOPS						
	WB26	US32D	Stainless Steel Concave Wall Stop, Size 2 1/2" Diameter Projection: 1 3/16", Toggler& RP.	50	300	\$ 2.08**
		US3,26, US4,5,15A, US10, 10B	Solid Brass Concave Wall Stop, Size 2 1/2" Diameter Projection: 1 3/16", Toggler& RP. ANSI/BHMA 156.16 L12251	50	300	2.86**
	CONWB42	US32D	Stainless Steel Convex Wall Stop, Size 2 1/2" Diameter Projection: 1 3/16", Toggler& RP.	50	300	2.08**
		US3,10B,26, US10,4,5	Solid Brass Convex Wall Stop, Size 2 1/2" Diameter Projection: 1 3/16", Toggler& RP. ANSI/BHMA 156.16 L12101	50	300	2.86**
	SWB	US26, 26D, US10B,4,3, US15, 15A	Solid Brass Convex Wall Stop, 1" Diameter, 1/2" Projection, Concealed Mounting. Comparable to IVES #404 ANSI/BHMA L02101	50	500	2.91**
	HDWDS99	US3,26D,10B	Heavy Duty Commercial Grade Wall Door Stop for high traffic conditions. Solid cast brass or bronze heavy duty construction. Includes mounting hardware for all wall construction applications. Overall projection of unit is 3 5/8", Base Diameter is 2 1/4". ANSI: A156.16, BHMA, L11351, FED SPEC: 1321E	10	50	21.84**
	HDFDSH66	US3,10B, US26D	Heavy Duty Commercial Grade Floor Door Stop for high Traffic Conditions. Solid cast brass or bronze heavy duty Construction. Includes mounting hardware for all floor construction applications. Overall projection of unit is 3 3/8", Base Diameter is 2 1/4". ANSI: A156.16, BHMA, L11371, FED SPEC: 1329E	10	50	21.84**
	CWS18	US3,26D	Commercial Grade Wall Door Stop For High Traffic Conditions. Solid cast brass or bronze heavy duty Construction. Includes mounting hardware for all wall construction applications. Overall projection of unit is 3 3/8", Base Diameter is 2 1/4". ANSI: A156.16, BHMA, L12021, FED SPEC: 1320E	10	50	16.89**
		US10B				18.70**
	CFS20	US3,26D US10B	Commercial Grade Floor Door Stop For High Traffic Conditions. Solid cast brass or bronze heavy duty Construction. Includes mounting hardware for all floor construction applications. Overall projection of unit is 3", Base Diameter is 2 1/2". ANSI: A156.16, BHMA, L12131, FED SPEC: 1328E	10	50	16.89** 18.70**
	GS118	US26D, 3	Cast Floor Stop, 2 1/8" High, Base: 2 5/8" x 1 5/8". Combo Packed with (1) 5/16" Hanger Bolt and (1) #14 x 1" Woodscrew, 5/16" x 2 1/2" Stud with expansion shield and (1) 1/4- 20 x 1" Machine Screw and Anchor. ANSI/BHMA 156.16	10	50	14.06**
		US4, 26, US10, 10B, US15, 15A				15.43**
	GS119	US26D, 3	Cast Floor Stop, 2 7/8" High, Base: 2 3/4" x 1 1/2". Combo Packed with (1) 5/16" Hanger Bolt and (1) #14 x 1" Woodscrew, 5/16" x 2 1/2" Stud with expansion shield and (1) 1/4- 20 x 1" Machine Screw and Anchor. ANSI/BHMA 156.16	10	50	15.77**
		US4, 26, US10, 10B, US15, 15A				17.31**
	SMGNS-1	US3, US15, US26, US26D US5, US10B, US15A	Small Gooseneck Door Stopper Door Stopper for light to medium duty doors Height: 1 1/4"; Base: 1 1/8"; Projection: 1 1/4" Woodscrew, #10 x 1 3/16" Individually Poly Bagged	10	200	7.35

NEW ITEM

**Effective July 1, 2014









CAL-ROYAL PRODUCTS, INC.

DH14

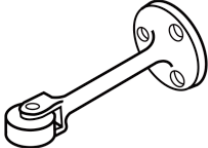

Ver. 3.0, Rev. 07/14
© 2014 CAL-ROYAL

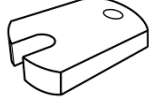
CAL-ROYAL PRODUCTS, INC. PRICE LIST JULY 2014

	ITEM #	FINISH	DESCRIPTION	INNER QTY	MSTR QTY	LIST PRICE EA.
SOLID BRASS DOOR STOPS						
	CURB19	US3,4,10B, US26D	Solid Brass Curved Roller Stop ANSI/BHMA 156.16, LO2211 Height (Base): 1 3/4", Width (Base): 2 1/4" Projection: 2 3/4"	10	100	\$19.08
	SRB82	US3,4,10B, US26D	Solid Brass Straight Roller Stop ANSI/BHMA 156.16, LO2191 Base: 2" Diameter Projection: 4 1/4"	10	100	18.02
	DSHP18	US3, 4, 5, US26, 26D, US15,15A, US10, 10B	Solid Brass Dome Stop High Profile. (1 3/4" Diameter, 3/8" Thick Base) Projection: 1 3/8" ANSI/BHMA 156.6, LO2141	10	200	5.32**
	DSP4	US3, 4, 5, US26, 26D, US15, 15A, US10, 10B	Solid Brass Dome Stop Low Profile. (1 3/4" Diameter, 1/8" Thick Base) Projection: 1 1/8" ANSI/BHMA 156.6, LO2141	10	200	4.63**
	UNDS14	US3, 4, 5, US10, 10B, US26, 26D, US15	Heavy Duty cast brass riser designed for both low and high profiles. Meets ANSI/BHMA 156.1, L12161 when used as DSP4. Fastener : #14 x 1 1/2" wood screw w/ plastic shield and 1/4" - 20 x 3/4" machine screw with lead anchor Dimensions: Base Diameter : 1 3/4", Base : 1/4",Height: 1 5/8"	10	100	7.39**
RISERS						
	RIS375	Alum	Riser For Dome Stops With 1 3/4" Screws, 3/8" Thick.	50	400	2.87**
	RIS625	Alum	Riser For Dome Stops With 1 3/4" Screws, 5/8" Thick.	50	250	2.87**
	NEWRIS3750	US3, 4, 5, US26,26D, US10, 10B, US15, 15A	Riser For Dome Stops With 2" Screws, 3/8" Thick. ANSI/BHMA 156.1	10	100	2.90

**Effective July 1, 2014









CAL-ROYAL PRODUCTS, INC.

DH15

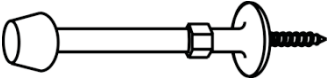
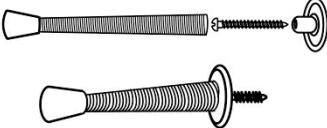

Ver. 3.0, Rev. 07/14
©2014 CAL-ROYAL

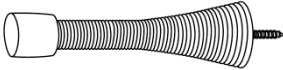
CAL-ROYAL PRODUCTS, INC. PRICE LIST JULY 2014

	ITEM #	FINISH	DESCRIPTION	INNER QTY	MSTR QTY	LIST PRICE EA.
DOOR STOPS						
	SBRS3	US3, 26, US15, 15A US10B	3" Solid Brass Rigid Door Stop, Packed With Both White and Black Rubber Tips Comparable to IVES #64.	50	200	\$5.10** 5.62**
	SBRS4	US3, 26, US15, 15A US10B	4" Solid Brass Rigid Door Stop, Packed With Both White and Black Rubber Tips Comparable to IVES #64.	50	200	6.18** 6.83**
	FS89	US3, 5, 26, US15, 15A US10B	3" Flexible Door Stop With Fixed Screw. Diecast Base, One Piece Style.	100	1000	0.38 0.50
	RS92	US3, 5, 26 US26D, 10B, US15, 15A	3" Cast Rigid Door Stop With Molded Screw.	100	1000	0.94 1.03
	SOF3	US3, 5, 26 US15, 15A, US10B	3" Heavy Duty Flexible Snap On Door Stop 3 Pieces, Steel Base. Comparable to IVES #060.	100	1000	0.61 0.72
	HDFS3	US3, 5, 26 US15A, 15, US10B	3 1/8" Heavy Duty Flexible Door Stop with Screw and Metal Base.	100	600	0.46 0.56
	JFS13	US3, 5, 26 US15, 15A, US10B	3 3/4" Heavy Duty Jumbo Spring Door Stop with Screw and Metal Base.	100	600	0.49 0.58
	JRS34	US3, 5, 26, US15, 15A US10B	4" Diecast Jumbo Rigid Door Stop with Molded Screw.	100	500	1.96 2.27

**Effective July 1, 2014





CAL-ROYAL PRODUCTS, INC.

DH16

Ver. 3.0, Rev. 07/14
©2014 CAL-ROYAL

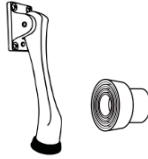
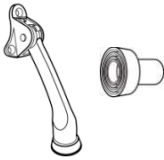
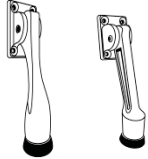
CAL-ROYAL PRODUCTS, INC. PRICE LIST JULY 2014

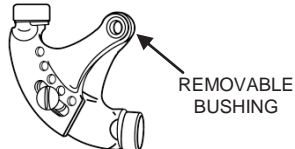
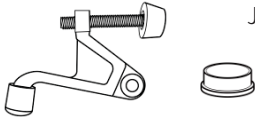
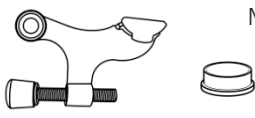
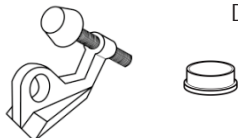
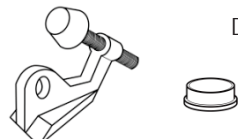
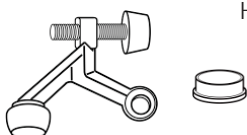
	ITEM #	FINISH	DESCRIPTION	INNER QTY	MSTR QTY	LIST PRICE EA.
DOOR STOPS						
	SBDH41300	US26D US3,4, 26, US10,10B	5" Solid Brass Kick Down Holder, Base: 1 1/4" x 2". ANSI/BHMA 156.16 L11391	10	60	\$18.51** 20.38**
	RUBSBDH	Grey	Vinyl Rubber Stop With Concentric Circular Groove Design For use with SBDH5 or SBDH41300 door stops.	1	1	0.55**
	DH25	US3,26,26D, DURO	4" Zinc Diecast Drop Down Door Holder. ANSI/BHMA 156.16 L11382	50	200	4.81
	RUBDH25	Grey	Vinyl Rubber Stop With Concentric Circular Groove Design For use with DH25	1	1	0.60**
	IRODH-4	ALUM, DURO	4" Cast Iron Drop Down Door Holder	10	100	7.95
	IRODH-5	ALUM, DURO	5" Cast Iron Drop Down Door Holder	10	100	8.27
	SBDH5	US3, US26,26D, US10, 10B	5" Solid Brass Kick Down Door Holder, Base: 7/8" x 1 3/4". Comparable to IVES #455. ANSI/BHMA 156.16 L11382	10	100	12.74**
	IVHP23	US3,5, 10B, US26, 26D, US15, 15A	Jumbo Heavy Duty Hinge Pin Stop With Removable Bushing, Adjustable Angle Setting. For Commercial Grade Hinges, 1/4" or 5/16" Diameter Hinge Pins. For hinge sizes: 3 1/2" x 3 1/2", 4" x 4" and 4 1/2" x 4 1/2" Individually Poly Packed. Comparable to IVES #69, 69F.	50	500	1.63
	JHP11	US3, 5, 26 US15, 15A, US10B	Jumbo Hinge Pin Door Stop. Poly Bagged With Nylon Bushing Recommended for commercial and residential applications For hinge sizes: 3 1/2" x 3 1/2", 4" x 4" and 4 1/2" x 4 1/2"	50	500	1.16 1.22
	NHP78	US3, 5, 26 US15, 15A, US10B, 26D	Deluxe Hinge Pin Door Stop. Poly Bagged W/ Nylon Bushing Recommended for residential use. For hinge sizes: 3 1/2" x 3 1/2" and 4" x 4"	50	500	1.23 1.33
	DSL81	US3, 5, 10B, US15, 15A, US26, 26D	Light Duty Door Protector Hinge Pin Stop with Nylon Bushing. Recommended for Residential Hinges. For hinge sizes: 3 1/2" x 3 1/2" and 4" x 4"	50	500	1.17
	DSDH105	US3, 5, 10B, US15, 15A, US26, 26D	Heavy Duty Door Protector Hinge Pin Stop with Nylon Bushing. Recommended for Commercial Applications. For hinge sizes: 3 1/2" x 3 1/2", 4" x 4" and 4 1/2" x 4 1/2"	25	250	2.65
	HP95	US3, 5, 26, US15A, 15, US10B	Hinge Pin Door Stop. Poly Bagged W/ Nylon Bushing Recommended for residential use. For hinge sizes: 3 1/2" x 3 1/2" and 4" x 4"	100	1000	0.80

**Effective July 1, 2014



CAL-ROYAL PRODUCTS, INC.

DH17





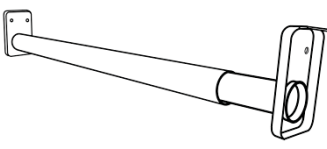
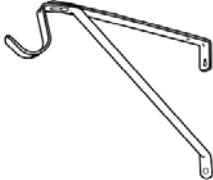
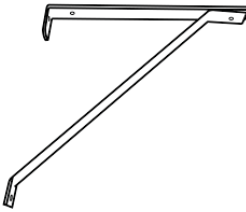
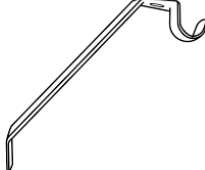
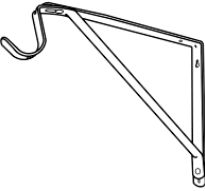
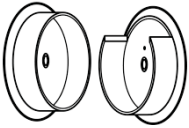
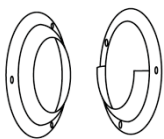
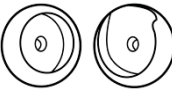

Ver. 3.0, Rev. 07/14
©2014 CAL-ROYAL

CAL-ROYAL PRODUCTS, INC. PRICE LIST JULY 2014

	ITEM #	FINISH	DESCRIPTION	INNER QTY	MSTR QTY	LIST PRICE EA.
CLOSET HARDWARE						
	ACR1830	Bright Zinc	18" to 30" Adjustable Closet Rod	1	10	\$3.67
	ACR3048	Bright Zinc	30" to 48" Adjustable Closet Rod			4.90
	ACR4872	Bright Zinc	48" to 72" Adjustable Closet Rod			6.64
	ACR7296	Bright Zinc	72" to 96" Adjustable Closet Rod			8.75
	ACR72120	Bright Zinc	72" to 120" Adjustable Closet Rod			11.31
	ACR96150	Bright Zinc	96" to 150" Adjustable Closet Rod			13.35
	ASR41	White	Adjustable Shelf and Rod Support. Supports Shelves Up to 14" Wide and Rods up to 1 1/2" Dia. Screws Packed Individually with Bracket.	40	40	2.73
				CASE QUANTITY ONLY		
	ADJ42	White	Adjustable Shelf Support Only. Supports Shelves up to 14" wide. Screws Packed Individually with Bracket.	20	20	2.56
				CASE QUANTITY ONLY		
	SR27	White	Single Shelf & Rod Support. Supports Shelves Up to 14" Wide and Rods up to 1 1/2" Dia. Screws Packed Individually with Bracket.	80	80	1.76
				CASE QUANTITY ONLY		
	FSR123	White	Heavy Duty Shelf & Rod Support. Supports Shelves Up to 14" Wide and Rods up to 1 1/2" Dia. Screws Packed Individually with Bracket.	40	40	2.89
				CASE QUANTITY ONLY		
	PS99	White	Closet Pole Socket for 1 3/8" Pole, Nylon. Poly Bagged with Screws.	50	500	0.38
	MPS3	US3,26	Steel Closet Pole Socket for 1 3/8" Pole. Poly Bagged with Screws.	100	500	0.81
		US15, 10B				1.12
		NEW ITEM				
	WDPS82	Wood	Wood Closet Pole Socket 1 3/8"	50	400	0.89
				NEW PRICE		

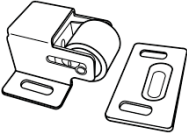
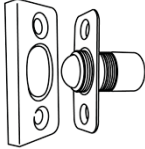
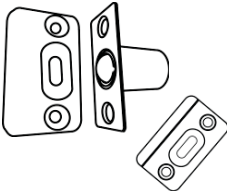

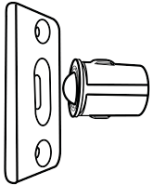
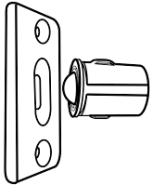
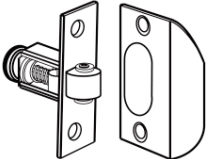
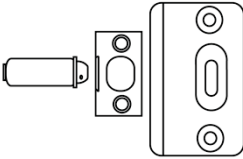
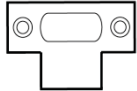
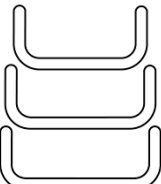
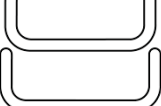
CAL-ROYAL PRODUCTS, INC. PRICE LIST JULY 2014

	ITEM #	FINISH	DESCRIPTION	INNER QTY	MSTR QTY	LIST PRICE EA.
CLOSET HARDWARE						
	RC88	US3, Zinc US10B	Jumbo Roller Catch, Size 2" Poly Bagged with Screws. Strike Size: 1 1/4" x 7/8", Square Corner	50	500	\$0.90 1.08
	SBBC58	US3 US5, 10B, US15,15A, US26, 26D	Solid Brass Adjustable Ball Catch 1" x 2 1/8", 1/4" Radius Latch Face & Strike Strike Size: 1 3/8" x 2 1/8", Round Corner	20	200	4.63 5.25
	BC97	US3,5 US15, 15A, 10B, US26,26D	Adjustable Ball Catch (2 1/4" x 1") with Full Lip Strike Plate RC Strike Size: 1 3/8" x 2 1/4", Round Corner	100	200	1.98 1.98
	STRKBC97	US3,5,10B, US15, 15A, US26, 26D	Full Lip Strike Plate Round Corner For BC97 and DIB1 Strike Size: 1 3/8" x 2 1/4", Round Corner	10	100	0.48
	DIB1	US3,5,26 US26D,15, US15A,10B	Adjustable Drive-In Ball Catch, Packed With Full Lip Strike, Round Corner, Poly-Bagged with Screws. Strike Size: 1 3/8" x 2 1/4", Round Corner	100	200	1.84 1.84
	BLKDIB777	US3	Adjustable Drive-In Ball Catch, Packed With Full Lip Strike, Round Corner, Poly-Bagged with Screws. Strike Size: 1 3/8" x 2 1/4", Round Corner Bulk Packed	100	200	1.84
	ARCT3350	US3, 10B, 15, US26D	Soft latching action. Special nylon roller for silent performance. Adjustable tension 4 - 17 lbs of holding power. Installs easily on thin doors. Includes brass full lip strike. Conforms to ANSI/BHMA A156.16 L27081 for brass and L87081 for steel. Dimensions: Face Plate: 2 1/4" x 7/8", Bore: 13/16" x 1 3/4" Strike : 2 1/4" x 1 3/4" Lip 1 13/16" to center	10	200	7.65
	BULLCAT11	US3,15 US10B,26,5	Bullet Catch 1/2" Diameter x 1 1/8" Packaging: Individually poly-bagged with standard full lip round corner and square corner strikes. Square Corner Strike Size: 5/8" x 1 1/4" Optional T-strike: Part# TCAT-108	50	500	1.67 1.84
	TCAT108	US3,15, US10B,26,5	T-Strike For Bullet Catch Size: 7/8" x 2 1/4"	50	500	0.37
	WP300	US3,26,26D US10B	3" Solid Brass Drawer Pull, 5/16" Dia. Of Rod. Screws for 3/4" - 1 3/8" thick drawers or doors.	50	200	3.07** 3.68**
	WP350	US3,26,26D US10B	3 1/2" Solid Brass Drawer Pull, 5/16" Dia. Of Rod. Screws for 3/4" - 1 3/8" thick drawers or doors.	50	200	4.27** 4.70**
	WP400	US3,26,26D US10B	4" Solid Brass Drawer Pull, 5/16" Dia. Of Rod. Screws for 3/4" - 1 3/8" thick drawers or doors.	50	200	4.63** 5.10**

**Effective July 1, 2014







CAL-ROYAL PRODUCTS, INC.

DH19

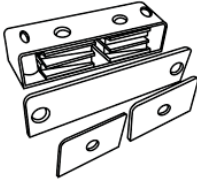
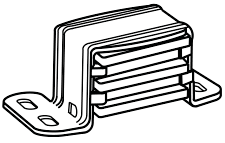
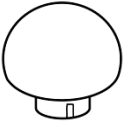

Ver. 3.0, Rev. 07/14
©2014 CAL-ROYAL

CAL-ROYAL PRODUCTS, INC. PRICE LIST JULY 2014

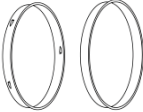
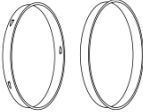
ITEM #	FINISH	DESCRIPTION	INNER QTY	MSTR QTY	LIST PRICE EA.	
CLOSET HARDWARE						
	HDMC3270	US2G (ZINC PLATED)	Dual triple pole. Self-aligning magnets for maximum pull. Surface or mortise mounted. Steel case. Individually packed with sheet metal screws and 3 strikes. Conforms to ANSI/BHMA A156.9 B43161 Dimensions: 3 1/8" Long x 1" Deep x 7/8" Thick Load Capacity: 14 lbs.	50	200	\$6.67
	TPMC3230	US2G (ZINC PLATED)	Triple pole. Self-aligning magnets for maximum pull. Adjustable. Steel case. Individually packed with sheet metal screws, 1 strike size. Conforms to ANSI/BHMA A156.9 Dimensions: 2 1/16" Long x 1 5/32" Deep x 7/8" Thick Load Capacity: 6 lbs.	50	500	2.78
	BK14	US3,5,26D,26 US15A,15,10B	Bi-Fold Ball Knob (Width: 1 1/4", Height: 1 3/8") Poly-Bagged Individually with 1 5/8", 1 1/8" and 2" screws.	20	200	1.96 1.96
	PLA2	US3,5,26D,26, US15A,15,10B	Back Plates For BK14, Diameter 1 3/4".	20	200	1.00
	CH28	US3,26	Coat and Hat Hook, Diecast Material	50	1000	1.60
	CK130	US3,5,26D	Bi-Fold Concave Knob Beveled Edge (1") Screw, 1 3/8" Dia.	20	200	0.98
	DIFP218	US3,5,26 US15, 15A, US26D, 10B	Drive In Finger Pull (2 1/8" Diameter) Without Nails	150	600	0.67 0.70
	FP98	US3, 5,26	Drive In Finger Pull (2 1/8" Diameter) With Nails	150	600	0.67

SURFACE OVERHEAD DOOR HOLDER / STOPS

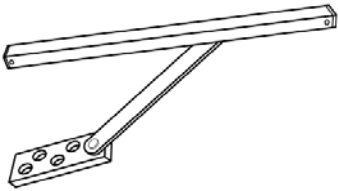
	CR552S	SIZE 2, 23 1/16" - 27"	Surface overhead Door stop only UL-listed	1	10	US26D 74.00
	CR553S	SIZE 3, 27 1/16" - 33"				
	CR554S	SIZE 4, 33 1/16" - 39"				
	CR555S	SIZE 5, 39 1/16" - 45"				
	CR552H	SIZE 2, 23 1/16" - 27"				
CR553H	SIZE 3, 27 1/16" - 33"					
CR554H	SIZE 4, 33 1/16" - 39"					
CR555H	SIZE 5, 39 1/16" - 45"					

