

CRL GLASS WALL AND POOL FENCING SYSTEMS

Glass Fencing Systems,
Pool Enclosures,
and Much More...

MANUFACTURED BY C.R. LAURENCE COMPANY

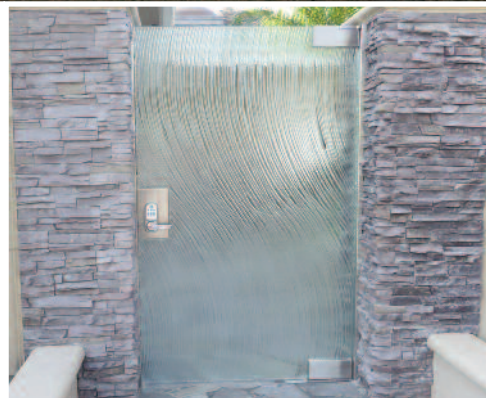

New Products Engineered and Designed
for Residential and Commercial Needs

Component and Accessory Items
Complement Each Product Line



ISO 9001:2008 Certified
C.R. LAURENCE COMPANY
crlaurence.com | Worldwide Supplier

CRL GLASS WALL AND POOL FENCING SYSTEMS

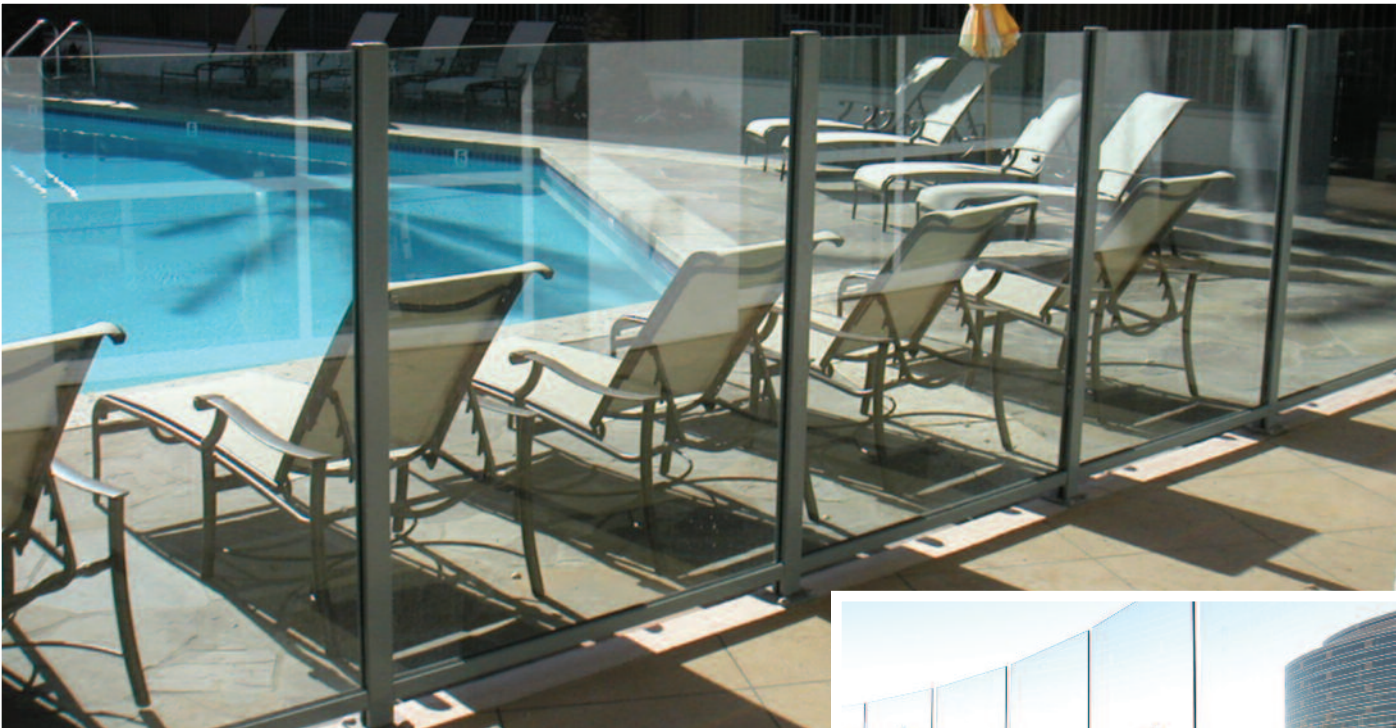

C.R. LAURENCE COMPANY

crlaurence.ca

crlaurence.com.au

crlaurence.co.uk

crlaurence.de

crlaurence.eu

crlaurence.com

CRL GLASS WALL AND POOL FENCING SYSTEMS

CRL Frameless Windscreen Clamp System

Pages 2-3



CRL's Frameless Glass Windscreen Clamp System is typically used for windscreens or pool deck surrounds. They were developed in Australia to create a windscreen that minimizes distractions from vertical or horizontal frame members. CRL has multiple designs to choose from that are manufactured for surface, core, and fascia mounted applications. Two architectural stainless steel finishes are available from stock. They are designed to support 1/2" (12 mm) glass.



CRL Frameless Windscreen Base Shoe System

Pages 4-5

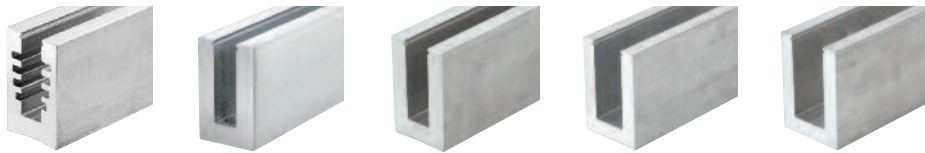

B5A Series
1/2" (12 mm)
Monolithic Glass

B5S Series
1/2" (12 mm)
Monolithic Glass

B6S Series
5/8" (15.9 mm)
Monolithic Glass

L56S Series
9/16" (14.3 mm)
Laminated Glass

L21S Series
27/32" (21 mm)
Laminated Glass

CRL's Frameless Windscreen Glass Base Shoe System is typically used for windbreaks, pool decks, and glass fencing surrounds. This system minimizes visual distractions for virtually unobstructed views it provides. CRL has multiple profiles to select from for monolithic tempered and laminated tempered glass, and cladding in six architectural finishes.



CRL AWS Aluminum Windscreen System

Pages 6-7

Round or Rectangular Post Kits

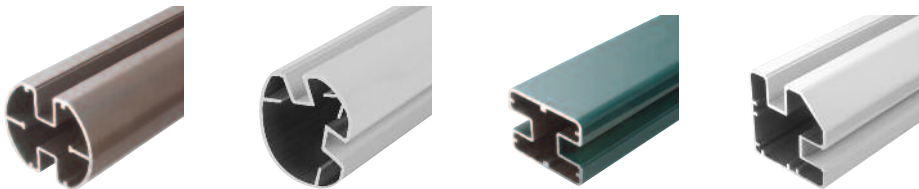

CRL's Aluminum Windscreen System was developed to provide a sturdy low maintenance transparent glass fence. This system is offered in seven standard powder coated finishes, and can be mounted to a wide range of substrates.



CRL Gate Systems and Hardware

Pages 8-9



Gates are an integral part of most glass fencing projects. CRL offers a range of gate components for residential or commercial applications. Offered in multiple architectural finishes, these components will complement the total installation.

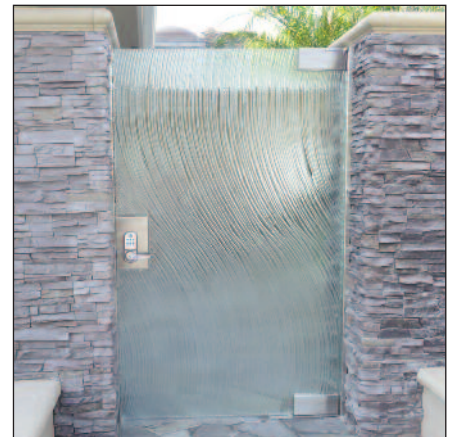

CRL GLASS WALL AND POOL FENCING SYSTEMS

CRL Frameless Windscreen Clamp System

- Also Known as Spiggots
- Gives a Frameless 'All-Glass' Look
- Great for Pool Fencing, Balcony and Deck Applications
- Available in Two Standard Architectural Finishes
- 316 Alloy and Duplex 2205 Marine Grade Finishes
- Designed for Tempered or Laminated Glazing



Glass Fabricator, JE Berkowitz, LP



Our Frameless Windscreen Clamps, which are also known as Spiggots, provide a break from the wind using an almost invisible "frameless" look. No vertical posts are used between the panels of glass; they are solely supported from the bottom by these high strength stainless steel clamps.

They are intended for use with tempered or laminated glass panels, which requires drilled holes on which to fasten the Clamps. Their quality 316 alloy stainless steel construction provides superior weather resistance, and there are two models made of Duplex 2205 Marine Grade Stainless for installations within one mile of saltwater environments.

Core, side, and new surface mount models give you a choice of installation options. All models are available in a brushed stainless finish, and some are also available in a polished finish. Optional Garnish Rings and U-Channel Cap can be added to finish the installation.

Please contact CRL Technical Sales about this safe and attractive solution to your windscreen needs for balconies, decks, and pool surrounds.



CRL GLASS WALL AND POOL FENCING SYSTEMS

CRL Windscreen Clamps (Spigots)

- Quality Stainless Steel in Seven Distinct Designs



One-Piece Core Mount Clamp

- 1-3/16" (30 mm) Rod Easily Inserts Into Core-Drilled Hole

CAT. NO.	HEIGHT	FINISH
AFWC1	9-11/16" (246 mm)	Brushed Stainless Steel
AFWC6	9-11/16" (246 mm)	Polished Stainless Steel



Three-Piece Core Mount Clamp

- 5/8" (16 mm) Rod Easily Inserts Into Core-Drilled Hole

CAT. NO.	HEIGHT	FINISH
AFWC3	8-1/8" (206 mm)	Brushed Stainless Steel
AFWC8	8-1/8" (206 mm)	Polished Stainless Steel



Three-Piece Core Mount Clamp

- Duplex 2205 Grade Stainless has Higher Corrosive Resistance

CAT. NO.	HEIGHT	FINISH
DFWC3	8-5/8" (220 mm)	Brushed Stainless Steel



One-Piece Beveled Surface Mount Clamp

- New, Easy to Install Surface Mount Design

CAT. NO.	HEIGHT	FINISH
AFWC1SBS	9-11/16" (246 mm)	Brushed Stainless Steel
AFWC1SPS	9-11/16" (246 mm)	Polished Stainless Steel



Two-Piece Side Mount Clamp

- Mounts on Face of Wall or Planter Box

CAT. NO.	HEIGHT	FINISH
AFWC2	5-5/8" (143 mm)	Brushed Stainless Steel



Two-Piece Core Mount Round Clamp

- Duplex 2205 Grade Stainless has Higher Corrosive Resistance

CAT. NO.	HEIGHT	FINISH
AFWC4	9-1/16" (230 mm)	Brushed Stainless Steel



One-Piece Low Profile Surface Mount Clamp

- New, Easy to Install Surface Mount Design

CAT. NO.	HEIGHT	FINISH
AFWC4SBS	7-1/16" (179 mm)	Brushed Stainless Steel
AFWC4SPS	7-1/16" (179 mm)	Polished Stainless Steel

CRL Garnish Rings for Windscreen Clamps



CAT. NO. AFWC1G



CAT. NO. AFWC3G

Garnish Rings easily slip over the Frameless Windscreen Clamp

CRL U-Channel Cap



CAT. NO. GRUC5BS10

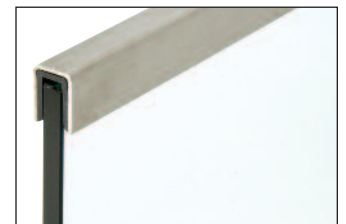

CAT. NO. GRL10BS

Optional stainless steel 'cap' for top edge of glass

CRL GLASS WALL AND POOL FENCING SYSTEMS

CRL Frameless Base Shoe System

- Great for Glass Windbreaks, Pool Enclosures, Perimeter Fencing, Sound Barriers, Balconies, and Any Applications That are View-Oriented
- Unique Designs That Allow Completely Unobstructed Views
- Designed and Engineered to Meet the Strictest Codes
- Custom Fabrication is Also Available to Meet Your Specifications



CRL Base Shoe Profiles

- Drilled and Counter Bored Base Shoes for Monolithic and Laminated Tempered Glazing
- Typically Used as the Base Channel for Glass Windscreen or Railing Systems
- Six Architectural Finishes Available

CRL Aluminum Base Shoes

- Choices Available for Various Glass Thicknesses

CRL Aluminum Base Shoe is used as the base channel for glass railing systems and frameless glass windscreen systems. There are ten distinct series to accommodate monolithic tempered and laminated glass in various thicknesses from 3/8" to 25.52 millimeters.

In typical glass pool surrounds or frameless windscreen systems monolithic is the glass of choice. But in situations where the glass panels are elevated above pedestrian areas, such as in shopping plazas or on balconies, the use of laminated glass is recommended to prevent broken pieces from falling to lower levels.

CRL Aluminum Base Shoe is available for both choices. With our variety of Base Shoe Series there is really no reason not to select this tried and true method of anchoring glass panels. CRL supports the method with both dry glazed and wet glazed installation methods, along with all of the tools and supplies required to make a safe and successful installation.

Stock Base Shoe is available pre-drilled and counter bored, or in un-drilled lengths that can be custom fabricated to your exact job requirements. Accessory cladding is available in six beautiful architectural finishes, or you can even specify custom powder-coated paint in hundreds of quick-turn colors.

For complete details on delivery and pricing of Aluminum Base Shoe, contact CRL Railing Technical Sales.

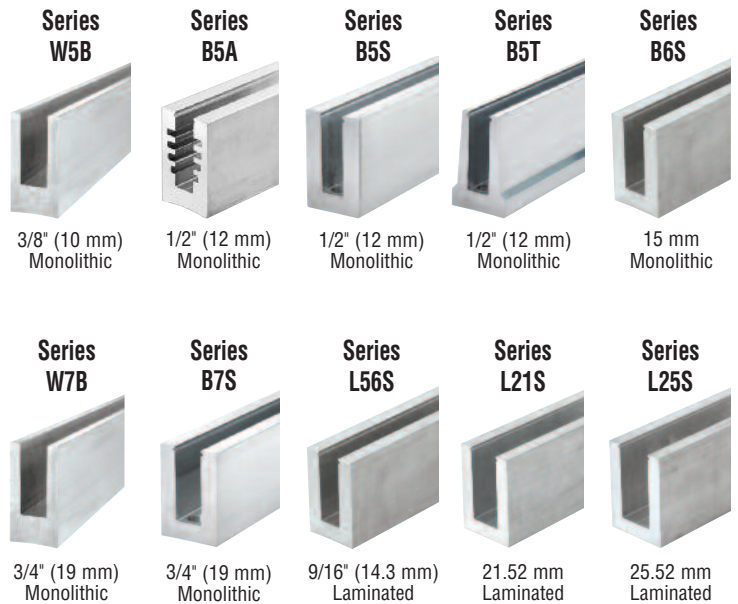

Available Base Shoe Accessories

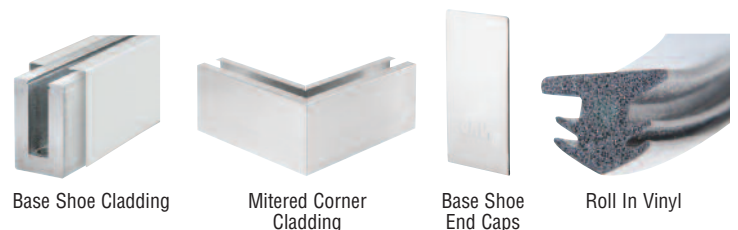

CRL GLASS WALL AND POOL FENCING SYSTEMS

CRL Dry Glazed TAPER-LOC™ Glass Railing System



- Now in Three Taper Designs to Meet All Residential and Commercial Applications Using Monolithic Tempered Glass and Laminated Tempered Glass
- Dry Glazing Means Installation Time is Reduced By 50 Percent Because There's No Mixing or Clean-Up of Messy Cement
- TAPER-LOC™ Meets and Exceeds Code Standards
- Engineering and Testing Reports Available at crlaurence.com



Installation Labor Time Reduced By 50%



- STEP 1** - Place the TAPER-LOC™ Tapers into base shoe finger tight
STEP 2 - Place the TAPER-LOC™ Installation/Removal Tool into position
STEP 3 - Tighten the TAPER-LOC™ components using our Integrated Torque Wrench

The innovative Dry Glazed TAPER-LOC™ Glass Railing System has advantages other Railing systems cannot duplicate. Designed for residential and commercial applications, this system works with laminated and monolithic tempered glass railing and windscreen applications.

TAPER-LOC™ Tapers are simply installed with CRL's exclusive TLK9 Installation/Removal Tool. This tool mechanically slides the Tapers horizontally and compresses them together to secure the glass in the aluminum base shoe without the use of messy wet cement. When compressed, they expand in thickness and lock in place.

The CRL TAPER-LOC™ System reduces installation time by up to 50 percent, supports all mounting methods, and is designed to meet and exceed code standards.

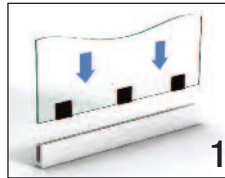

Adhere TAPER-LOC™ L-Setting Block to the Bottom Edge of Glass.



Install TAPER-LOC™ Tapers to Lock the Glass Securely in Place.



Roll in the Glazing Vinyl and You Are Done.

• TAPER-LOC™ Taper Sets for Monolithic Tempered and Laminated Tempered Glass



CAT. NO. TL5X10
for 1/2" (12 mm) and 3/4" (19 mm)
Monolithic Tempered Glass

CAT. NO. LTL96X
for 9/16" (14.3 mm)
Laminated Glass

CAT. NO. LTL10X
for 21.52 mm or 25.52 mm
Laminated Glass

CAT. NO. TL3W10
for 3/8" (10 mm) Monolithic
Tempered Glass

• Special Tools Reduce Installation Labor Time By 50 Percent



CAT. NO. TLK9

CRL TAPER-LOC™ Installation/Removal Tool Kit



CAT. NO. PAL1K

CRL PAL Plumb/Angle/Level Locator Kit

CRL GLASS WALL AND POOL FENCING SYSTEMS

CRL AWS Aluminum Windscreen System

- Accepts 1/4" to 1/2" (6 to 12 mm) Thick Glass for the Creation of Attractive and Functional Glass Barriers



The AWS Aluminum Windscreen System was developed to provide an attractive, maintenance-free glass wall that will enhance any residential or commercial application. All AWS Systems can be used in conjunction with a concrete slab, block wall or individual footings. If our stock components do not fit your application, allow us to design a system that can. CRL has the ability to design, engineer, and fabricate a custom system that will satisfy not only your need for safety and security, but also your artistic tastes.

Visual Appeal - The property owner will love the clean look of this wall and the virtually unobstructed view it provides.

Noise Reduction - The AWS System is superbly suited as a sound wall along busy streets and highways. Our system provides a much higher sound transmission rating than conventional fencing.

Maintenance - The AWS System is low maintenance. All components are specially coated to prevent corrosion and ensure that the property owner will be satisfied for many years.

Flexibility - The AWS System adapts to a wide variety of terrain and wall designs. It can easily handle slopes, steps, and curves. In addition, the system is ideal for pool areas, decks, and balcony applications. This system can be installed during almost any phase of construction, allowing the builder or contractor important scheduling flexibility.

Integrity - The AWS System has been designed to provide a safe, transparent fence during high wind conditions. All glass installed must be fully tempered to meet all safety requirements and building codes.

Price - Because of this efficient design, our system is priced very competitively to other less attractive alternatives, such as wrought iron or wood fencing.



- Seven Standard Colors Available in Stock. Custom Colors Also Available



CRL GLASS WALL AND POOL FENCING SYSTEMS

CRL AWS Aluminum Windscreen System

2" x 2-5/8" (50.8 x 66.7 mm) Rectangular Aluminum Windscreen Post Profiles

3" (76.2 mm) Round Aluminum Windscreen Post Profiles

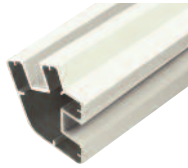
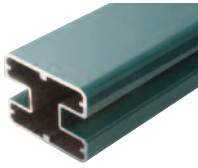

180 Degree Center/
End Post Kits

90 Degree
Post Kits

135 Degree
Post Kits

180 Degree Center/
End Post Kits

90 Degree
Post Kits

135 Degree
Post Kits

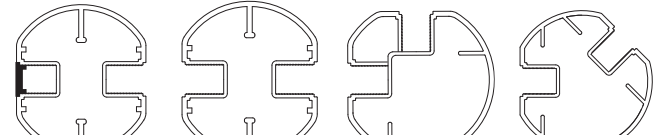
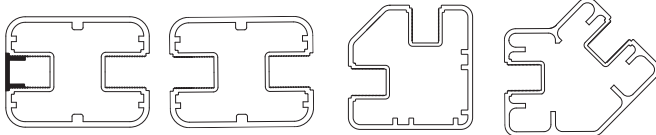

End Posts

Center Posts

90 Degree
Corner Post

135 Degree
Post

End Posts

Center Posts

90 Degree
Corner Post

135 Degree
Post

Unlike other glass wind wall systems, the AWS Aluminum Windscreen System keeps all aluminum out of contact with concrete. The lime in concrete is very corrosive to aluminum, and over time will degrade the physical properties of the components. The AWS System utilizes a painted steel embedment that supports the vertical post and eliminates the possibility of damaging corrosion. An added benefit of the steel embed is that the contractor can install the steel components early in the construction process, then install the painted aluminum post later when the chances of damage by the other tradesmen are greatly reduced. These are strong attributes of the AWS System, and have a real value to the builder and property owner.

The AWS System was designed to be a wind wall that is very aesthetically pleasing. Because of the great design and the interaction with the steel insert, AWS has enhanced structural properties, allowing for increased height and span capabilities.



Custom Fascia Mounted Aluminum Windscreen

Typical Mounting Options

Core Mounted Installation
for a Concrete Slab

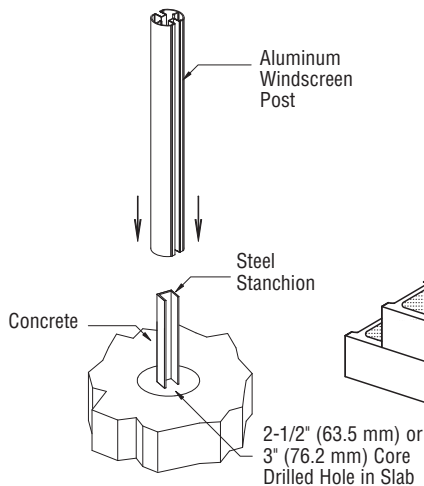

Core Mounted Installation
for CMU Block Walls

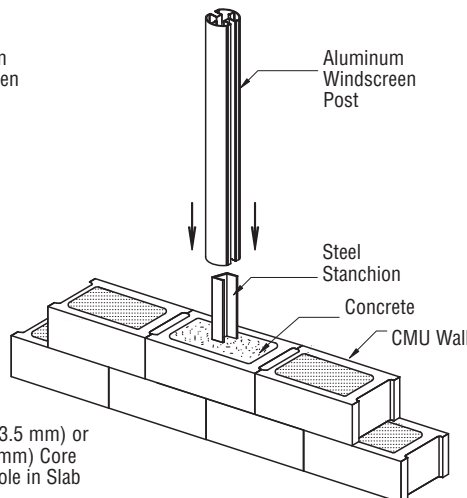

Surface Mounted Installation
for a Concrete Slab

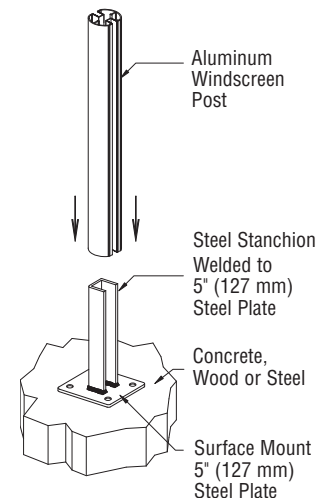

CRL GLASS WALL AND POOL FENCING SYSTEMS

CRL Gate Systems

- Cap Railing and Aluminum Gate Systems Custom Fabricated to Your Exact Needs
- Designs for Pool Surrounds, Patios, and Outdoor Dining Areas

We have the experience and the resources to create gate systems to your exact requirements that are both attractive in appearance and precise in function. These sturdy systems lend security to pool surrounds, patios, and outdoor dining areas. CRL Technical Sales will help you design the perfect gate for just about any application.



CRL AWS Glass Gate System

- Many Styles of Glass Gates in Seven Standard Colors, Plus Custom Colors for Passageways, Driveways, and Doors

Gates and Gate Systems are an integral part of most commercial, multi-family, and residential projects. Your choice of gate designs range from the basic swing gate to the most customized automatic or manual gate you can create. CRL Gates can accommodate standard, electronic or remotely operated locksets, as well as a variety of opening mechanisms.



STANDARD COLORS (ALSO AVAILABLE UNFINISHED)



Colors shown are representative only, and may vary slightly from actual gloss, color, and texture. If color match is critical, please contact Technical Sales for additional information.

Additional Color Options - CRL has over 250 quick turn custom color options with the ability to color match as well.

CRL Cap Rail Swinging Gate Systems

- Heavy-Duty Glass Gate With Optional Cap Rail
- Beautiful in Design and Functional in Operation
- Ask About Our New Free-Standing Post Model
- Gate Can Be Adjusted In and Out at Both the Top and the Bottom
- Several Attractive Architectural Finishes

We have developed a Swinging Gate for residential or commercial use with our GRS Glass Rail System. The bottom rail is widened so it matches the width of the adjacent fixed railing Base Shoe. The upper patch fitting is modified to allow for mounting to the stainless steel wall bracket and the modified Cap Rail. The top of the Gate pivots on a heavy-duty ball bearing, while the bottom pivots on a floor mounted commercial door closer. The floor closer always returns the Gate to the closed position, and the closing speed is adjustable.

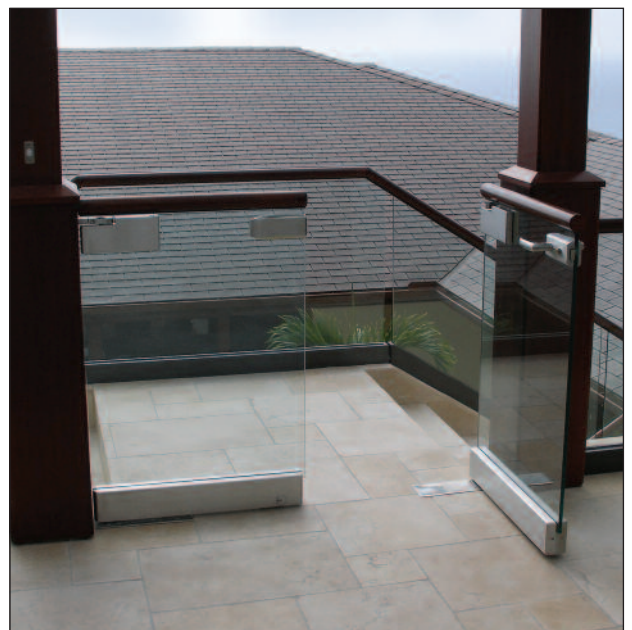

CRL GLASS WALL AND POOL FENCING SYSTEMS

CRL Gate Hardware

- Pivot Patches and Gate Fittings
- Gate Locks and Latches
- Hinge Mechanisms



We provide a large selection of hardware for the fabrication and mounting of attractive and secure gate systems. All of this hardware is designed to provide smooth operation and look good while doing it. Here are just some of your options. For the complete selection of Gate Hardware contact CRL Technical Sales.

Pivots and Patch Fittings



Self-Closing Hinges



Locks, Bolts, and Latches



CRL ARS Picket Fence and Gate Systems for Pools

- Extremely Sturdy and Maintenance Free
- Seven Standard Powder Painted Colors
- Meets or Exceeds Code Requirements

Our Aluminum Railing System also makes for a safe and sturdy fence for swimming pools and spas in both residential and commercial applications. Each can be custom built to your exact requirements for safety while being an attractive addition to the swimming environment. Please contact us for details.



CRL GLASS WALL AND POOL FENCING SYSTEMS

CRL GRS Structural Glass Railing System

CRL's GRS Glass Railing Systems for interior and exterior applications are designed to provide an attractive 'all-glass' frameless look to view-oriented residential or commercial projects. Designed for monolithic or laminated tempered glazing, this high quality system also serves as an effective wind barrier, further enhancing the outdoor environment. CRL offers a variety of Base Shoes, Cap Rails, Cladding, and Accessories. Custom fabricated railings for project specific requirements are also available.

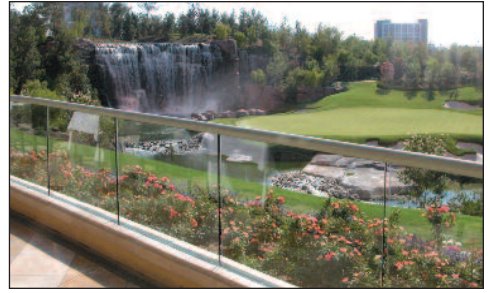
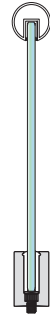

GRS Glass Rail System With Stainless Steel Cap Rail

CRL P-Series Post Railing System

CRL manufactures a comprehensive selection of Post Railing Kits that combine the durability of stainless steel components with innovative designs and engineering. Designed for interior or exterior Hand Rail and Guard Rail applications, these low maintenance stainless steel posts come ready to install.

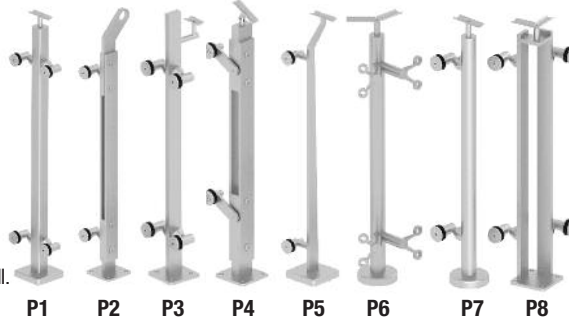

P-Series Stainless Steel Post System With Stainless Top Rail

CRL SRS Standoff Glass Railing System

C.R. Laurence Company is now manufacturing Standoff Railing Systems. By specializing in the design and manufacturing of this innovative system, we offer you the ability to create custom railings that will address project-specific criteria. Product development is an ongoing process at CRL. Rest assured that the products we offer will represent the current evolution of the railing industry.



SRS Standoff Glass Rail System With Hand Rail

CRL ARS Aluminum Railing System

CRL's high quality, versatile residential or commercial Aluminum Railing Systems are manufactured from extruded aluminum framing members, all of which utilize tempered glass, aluminum pickets, cast infills, and stainless steel cable that is engineered to meet applicable building codes.

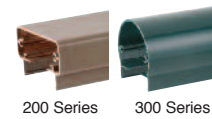

Seven standard powder coated finishes from stock, and custom colors available



ARS Surface Mount With Square Pickets



ARS Surface Mount With Glass Infills



C.R. Laurence Co., Inc.

Corporate Headquarters
Post Office Box 58923,
Los Angeles, CA 90058-0923

Phone: (800) 421-6144
Direct Fax: (800) 587-7501

International Phone: (323) 588-1281
International Fax: (323) 581-6522



C.R. LAURENCE COMPANY

crlaurence.com

10

crlaurence.ca

crlaurence.com.au

crlaurence.co.uk

crlaurence.de

crlaurence.eu

AVD84019_03/10