

# 73R TME

## Tools, Machinery, and Equipment

■ Glazing Tools and  
Glass Shop Equipment

---

■ Glass Processing  
Machinery

■ General Tools, Shop  
Supplies, and Safety Gear

---

■ Glass Handling and  
Storage Equipment

Page  
Intentionally  
Left  
Blank



CRL Corporate Headquarters in Los Angeles, California. CRL operates from 40 worldwide locations.

## To Our Valued Customers

We would like to say "Thank You" to all of our customers and employees. Your help and encouragement has made it possible for C.R. Laurence Company to grow into the industry leader, and we plan to continue growing. Our goal is to listen, and challenge ourselves to better serve our customers.

Because of you we set our standards for innovation, service, and selection of quality products at the highest level. We consider it our responsibility to bring new technology to our industry so that we can all prosper.

Access to all CRL products and services is available to you through our "self-service" web site, [crlaurence.com](http://crlaurence.com), the most comprehensive and convenient information source we can offer our customers. The CRL web site is a powerful communications device between your business and the CRL people who serve you. It also allows us to empower you to have more flexibility and control of your orders, making it possible for you to contribute in the process of our providing you with excellent service.

C.R. Laurence Company is making a major commitment to the improvement of our web site. It's your source for information and technical support, and to make it even more convenient, we have included in this catalog our [crlaurence.com](http://crlaurence.com) User's Guide, step-by-step instructions to a more satisfying visit to our "self-service" web site. In the next pages we will demonstrate just how simple it is for you to do business with us online. We hope you will find it easy to understand, and easy to use.

This catalog is the latest evidence of our commitment to bringing the glass and aluminum industries the most complete line of tools, machinery, and equipment. CRL has searched the world to gather the tools that glaziers and tradesmen can use to make their jobs easier and more efficient. CRL73R has over 5,000 items that will help you do a better job for your clients. Many of these are made in our own manufacturing plants, and as we move more into the area of manufacturing we will continue to bring you high quality tools made to the exacting standards that have earned us ISO9000:2008 Certification.

CRL's success has been made possible through our transition into manufacturing. We are producing a growing number of products to fill all of your requirements, and we will continue to listen to your ideas for products to manufacture for our industry. As always, we plan to expand our product line to be a continuing source for the glass industry. We have expanded the total number of distribution and manufacturing facilities throughout all of North America, Australia, and Europe to bring our products and services closer to you.

Again, we thank you for your continued support. Without your ideas for better service, new products, and generally high expectations, we would not have enjoyed our growth and success. Let's continue our success together.

**Donald E. Friese**  
Chairman and C.E.O.



**Lloyd W. Talbert**  
President and C.O.O.

## C.R. Laurence Co., Inc.

C.R. Laurence Company has over 20 distribution locations in or near major metropolitan areas to serve our customers in the United States. Los Angeles, California is home to Corporate Headquarters and to CRL Manufacturing. It is from here that over 60,000 quality products are distributed to the regional CRL service center that serves your business. For contact information and locations of all CRL facilities go to our web site at [crlaurence.com](http://crlaurence.com).

## C.R. Laurence Worldwide

C.R. Laurence Canada has five locations to serve all of Canada from coast-to-coast. We invite our customers in Canada to turn to page 745K for more information.

C.R. Laurence also has locations in Europe and Australia. Please see page 745K for information on CRL Worldwide Service.



## CRL Serves the World From Three Continents With Ever-Improving Service Capabilities

- North America • Europe • Australia

C.R. Laurence has been a supplier to customers worldwide for decades, and can now offer our unmatched range of products and services from CRL locations on three continents: North America, Europe, and Australia.

### Communicating

In our history we have prospered as a company because we've followed a path of innovation and growth, always seeking new ways to use the latest technology to expand our service capabilities. Major advancements in the world of communications have made much of this possible. We've always been among the first to introduce new ways of reaching our customers, and in return, have made it easier for them to do business with us.

C.R. Laurence was the first in our industry to offer toll free telephone ordering. For over 40 years our customers have been able to call our 800 number to place orders, ask questions about products, get prices, and communicate with us without it costing them a cent. Our recent expansion into Europe lets us offer the same free phone and free fax service to our customers on that continent.

In the early '80's we added toll free fax ordering, making it possible for our customers to fax their purchase orders, parts lists, shop drawings and other documents directly to our Customer Service Department at CRL Corporate Headquarters. It was during this time that we also introduced CRL FastFax, providing customers instant notification that their orders had been shipped.

One of our most important advances was the installation of the CRL Computer System in 1978. The power of our abilities multiplied many times when we went 'online' because we were better able to track inventory levels throughout our distribution network, and better able to process your orders quickly and more accurately. The ongoing evolution of the CRL Computer System now includes our Internet and fax servers, which empowers us to offer our customers in every corner of the world ever-improving service at every step in the process, from order entry through shipping and billing.

Some say our most important communications advancement was our entry into the business of Electronic Commerce with the introduction of the CRL web site in 1997. What was once a fledgling effort has blossomed into a self service web site featuring information regarding all of the products and services CRL has to offer. Customers who use [crlaurence.com](http://crlaurence.com) find an enlightening and comprehensive web site that is constantly improving with the addition of new features that make it quicker and easier to use. And now we have web sites especially tailored to the countries with which we do business.

C.R. Laurence makes a serious effort to promote ever-improving service by making the investments required to improve communications at every level. We want your business dealings with CRL to be simple, clear, and



convenient. If you feel that we can improve communications at any level, we would like to hear from you. To submit comments, go to [crlaurence.com](http://crlaurence.com) and click on Contact Us, then click on Web Comments.

### Building A Network

Providing the ever-improving service level we strive for means bringing CRL to our customers. From a single Los Angeles, California location we have grown to a network of Service Centers in six countries on three continents.

Each of our Service Centers is connected to Corporate Headquarters through our computer system, which monitors and updates inventory levels with the arrival of each new delivery truck and the shipment of each customer order. Every Service Center receives fresh inventory each week through our Inter-Branch Transfer System so stock levels can remain high. This improves the percentage of your orders we can ship complete, and usually on the same day we receive them.

Another advantage of having regionally located Service Centers in or near major metropolitan areas is the opportunity to serve our customers in person. Each CRL location has a Will Call Trade Counter open six days a week. For directions to CRL locations go to [crlaurence.com](http://crlaurence.com) and click on About CRL under the General Information menu to the left of your screen. The pop-up menu will give you a selection for Service Centers.

And in order to provide ever-improving service, the CRL network of Service Centers will continue to grow. In recent years CRL service has come to Australia and Europe with the opening of locations to serve customers on these continents. New or enlarged Service Centers are planned for metropolitan areas throughout the U.S. With the opening of each new facility, we make getting what you want from CRL faster and easier.

### Investing In People To Serve You

The best way we can serve you is to have capable people available to answer your questions, take and expedite your orders, suggest solutions to problems you may be having with a job, or to assist you in any manner we can. We maintain ongoing training programs so that the CRL people who serve you will have at their command the resources to make your business transactions with us a pleasant experience.





## CRL Serves the World With Local and International Brands of Your Favorite Products

• North America

• Europe

• Australia



CRL's Global Headquarters in the Los Angeles, California area

### Brand Names

Product branding is the identification of a product by a specific name, and it is present in just about everything you buy. Whether it's groceries, garments, appliances, electronics or vehicles, we all have our favorite brands. We get to know and trust certain brands for their reputation of quality, good or bad, and we make buying decisions in part based on our familiarity and trust in a brand name.

The same is true for the products we use. Every professional has favorite brands that they trust for quality, service life, and value. Some of these names are familiar worldwide, and can be found in shops in virtually every country. Others are more local in scope, marketed only in certain countries or on certain continents.

As for quality, in many cases the "local" brands are just as good as the "international" brands, and provide equal value. They have their particular markets, and have excelled in them by producing top quality products at affordable prices.



CRL's Canadian Headquarters in the Toronto, Ontario area

### CRL Brings The Best To You

Operating on three continents allows us to bring brands to you that you may not otherwise have local access to. Our purchasing agents select quality products from vendors across the globe, and because we have a global distribution network these products can be made available through any of our Service Centers.

When you review our catalogs, both in print and online, you'll see many familiar brand names and some that will be new to you. Be assured that these new brands, including those products bearing the CRL brand name, are tested products that will deliver both quality and value.

As both a manufacturer and a distributor CRL can bring you the best products at value prices. We're a brand name that you can trust.



CRL's European Headquarters in the Manchester, England area

### Need It But Don't See It? Just Ask CRL

Our access to suppliers worldwide gives us the ability to deliver products from any of the brand names we advertise. If you need a certain product from a specific brand name, don't hesitate to ask us for a price and delivery time. We're experts at getting you what you want when you need it. Just ask us and we'll do our best to serve you.



CRL's Australian Headquarters in the Sydney, New South Wales area



## CRL Provides Global Service With Regionally Oriented Web Sites

- Access to All CRL Products and Services is Available 24 Hours a Day, Seven Days a Week When You Visit Us Online
- Our Sites are Updated Continually to Bring You Our Newest Products and Special Offers
- The Entry Port for 'All-Glass' Storefronts Online®, Showers Online, Hand Rails Online, and Our Other Web-Based Services

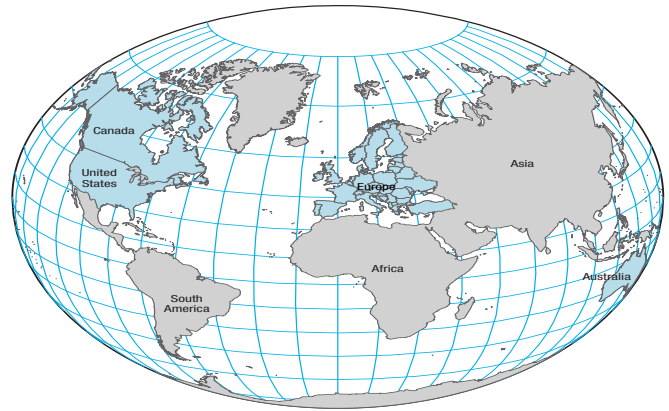

As a global supplier to the industries we serve, CRL recognizes that the power of electronic commerce strengthens our ability to serve you locally, as well as our other customers worldwide. And while the Internet has created a virtual "global village", it's important to also have the capability to tailor our web sites to the specific needs and business conditions of the continents on which we are based. That said, it became apparent that our web site, **crlaurence.com**, had to at the same time be global in appeal, but still local enough to be relevant.

Thus the creation of our Global Web Site Directory. When you visit our web site you are directed to the home page of the individual site designated to host your home country.

You can also move from one site to another simply by clicking on the directory icon at the top of the home page. From here you have access to all of our sites, giving you the opportunity to explore the entire scope of CRL's online world.

As we progress in this global strategy, look for us to include new translations of our Online Catalog into many more of the major languages. We are committed to spreading the virtual world of C.R. Laurence around the globe, and making your online shopping experience at **crlaurence.com** pleasant and easy to understand. We want you to be comfortable with CRL, and will work hard to make that possible.

### Welcome to the C.R. Laurence Global Web Site Directory

Please select from one of these web sites to begin your visit

 UNITED STATES and INTERNATIONAL English Language <a href="http://crlaurence.com">crlaurence.com</a>	 CANADA English Language <a href="http://crlaurence.ca">crlaurence.ca</a>	 EUROPE - UK English Language <a href="http://crlaurence.co.uk">crlaurence.co.uk</a>	 EUROPE - DE Deutsche Sprache <a href="http://crlaurence.de">crlaurence.de</a>
 UNITED STATES and INTERNATIONAL MX idioma español <a href="http://crlaurence.com.mx">crlaurence.com.mx</a>	 CANADA FR en français <a href="http://crlaurence.qc.ca">crlaurence.qc.ca</a>	 EUROPE FR en français <a href="http://crlaurence.fr">crlaurence.fr</a>	 EUROPE English Language <a href="http://crlaurence.eu">crlaurence.eu</a>
 EUROPE - IT Lingua Italiana <a href="http://crlaurence.it">crlaurence.it</a>	 AUSTRALIA <a href="http://crlaurence.com.au">crlaurence.com.au</a>	 EUROPE Spanish Language <a href="http://crlaurence.es">crlaurence.es</a>	 SCANDINAVIA ApS <a href="http://crlaurence.dk">crlaurence.dk</a>
 USALUMINUM <a href="http://usalum.com">usalum.com</a>	 USALUMINUM Architectural Products & Services <a href="http://crl-arch.com">crl-arch.com</a>	 SOMACA A Division of C.R. Laurence Co., Inc. <a href="http://somaca.com">somaca.com</a>	 CRL STONE A Division C.R. Laurence of Europe LTD <a href="http://crlaurence.co.uk">crlaurence.co.uk</a>
 GUARDA COLUMBIA SECURITY AND SCREEN PRODUCTS <a href="http://crlaurence.com">crlaurence.com</a>		 mobile web site	



## CRL Methods of Ordering Online at [crlaurence.com](http://crlaurence.com)

- [crlaurence.com](http://crlaurence.com) Never Closes!
- It's the Home of Our Online Catalog

Many of our customers have found the most convenient method of ordering from CRL is through our "self-service" web site. When you use [crlaurence.com](http://crlaurence.com) to place your orders you have many options that other methods don't provide. You set the schedule and the pace because you can sign on 24 hours a day, seven days a week. You can build a personal catalog and even make changes or additions to your orders online. There's no easier way! See pages VI through XX for more information about the benefits of ordering at [crlaurence.com](http://crlaurence.com).



## Toll Free Fax Service

- This Convenient Way of Ordering is Used Over 1,000 Times Every Day

When we introduced toll free fax service in the '80's we had no idea how popular it would become, but now our customers send us over 1,000 orders or quote requests every business day! Fax ordering is very convenient because you can fill out your own purchase orders and then just fax them to us. You can be specific about shipping instructions or other details that will help us serve you. To send your orders or quote requests by toll free fax from anywhere in the U.S. or Canada, just dial **(800) 262-3299**. In Australia the number is **1800 813 013**. In Europe the freefax number is **00 800 0262 3299**.



## Toll Free Customer Service Order Desk

- Our Friendly, Trained Staff is Always Happy to Hear From You

For over 40 years CRL has provided toll free ordering at **(800) 421-6144**. When you call our Customer Service Order Desk you'll find CRL staff who are trained to provide assistance with CRL products and services. They have instant access to pricing, stock availability, and the status of your account, plus they can connect you to CRL Technical Sales personnel if you need specialized product assistance. Order Desk hours are 6 am to 5 pm (Pacific Time) Monday through Friday, and 7 am to 12 pm Saturdays. In Australia our number is **1800 424 275**. In Europe our freephone number is **00 800 0421 6144**.



## Will Call Trade Counter

- When You Need It Today, Our Will Call Trade Counter is Your Fastest Option
- Come In and Visit Us at All CRL Service Center Locations

Every CRL Service Center location has a Will Call Trade Counter where you can place and pick up your orders in person. And when you place your order in advance by phone, fax, or over the Internet, we can have it ready and waiting for you, which can save you a lot of time. Will Call Trade Counter hours are 8 am to 5 pm Monday through Friday, and 8 am to 12 pm Saturdays. Some of our most experienced people staff our Will Call Trade Counter, and they are always happy to see you. Remember, to save time just place your order in advance.

## Who May Buy

C.R. Laurence is a manufacturer and wholesale distributor. Possession of this catalog, or any other CRL sales literature, does not constitute an offer to sell. Orders from individuals (except professional tradesmen) may not be accepted.

# WELCOME TO THE CRL ONLINE CATALOG

## Welcome to the C.R. Laurence Online Catalog

- Thousands of Pages of Quality Products and Helpful Information are Just Clicks Away, Anytime, and at Your Convenience
- It's the Best Way to Shop at CRL

What's the best way to shop at C.R. Laurence? Visit the Online Catalog at [crlaurence.com](http://crlaurence.com). Our Online Catalog brings you thousands of pages from our many printed catalogs, all of them in full color, and linked to our ordering module so you can browse and shop at any time it's convenient. You can check prices, review stock levels, and get the most complete and up-to-date details on the products we offer. And you can do it all from any PC.

Our "self-service" web site and Online Catalog are the most comprehensive and convenient up-to-date information sources we can offer. Explore some of our most popular product lines or review individual products. CRL has over 60,000 of them organized by specific product categories.

The convenience of having all CRL catalogs combined into one Online Catalog is the quick and easy way to find just what you need, available at your convenience, whenever you're ready.

Please review the following pages for easy to follow instructions on how to do business at [crlaurence.com](http://crlaurence.com). And if you ever need assistance, just contact us over the Internet or by toll free phone. We'll be glad to help.



C.R. LAURENCE COMPANY

[crlaurence.com](http://crlaurence.com) | [usalum.com](http://usalum.com)

VI | [crlaurence.ca](http://crlaurence.ca) [crlaurence.com.au](http://crlaurence.com.au) [crlaurence.co.uk](http://crlaurence.co.uk) [crlaurence.de](http://crlaurence.de) [crlaurence.eu](http://crlaurence.eu)



## Introduction

Of all the products we bring you, our Online Catalog may be the most important. We know that the most efficient way for our customers to shop at CRL is by using this carefully planned and thoroughly prepared Online Catalog to make it easy for them to find exactly what they need. C.R. Laurence Company is committed to making our Online Catalog your best source for information and technical support.

What you will find at **crlaurence.com** is a link to who we are, what we do, and what we have to offer our customers. The CRL "self-service" web site allows us to use the powers of Electronic Commerce to bring you closer to all of the products and services that we offer.

The screenshot shows the CRL website homepage. At the top left is the CRL logo and "C.R. Laurence Co., Inc.". To the right is a navigation bar with links for "Sign Off", "Your Account", "View Cart", "Help", and "Home". Below this is a search bar with the text "Enter Your Search Word(s) Here" and a "Search" button. A horizontal menu contains categories: "Frameless Shower Door", "Storefronts & Entrances", "Architectural Railings", "Architectural Metals", "Transaction Hardware", "Hospitality & Display", "Automotive Products", "Guarda Protective Screens", "Contact Us/ CRL Locations", and "Quote Request". On the left is a "Customer Menu Bar" with links for "Express Ordering", "Quick Pricing", "Your eStatements", "Your Quotes", "Your Orders", "Your Invoices", "Personal Catalog", "Your Products", "Your Credit Reference", "Searching on CRL", "CRL Total Search", "New Product Area", "Popular Product Lines", "Products by Industry", "Products & Services", "Architectural Metal Systems", "Architectural Railing Systems", "Architectural Customers", "Automotive Products", "Display Systems", "Entrance Systems", "Glass and Glazing", "Glass Machinery", "Hand Held and Power Tools", "Hospitality and Service Hardware", "Key Control Specialists", "Machinery and Large Equipment", "Post Systems", and "Product Finishes/Collections". The main content area features a large banner for "CRL Mobile is here!" with the text "Save Time While On the Job, or On the Go" and "Visit **crlaurence.com** from any smart device". The banner lists features: "Search for Products", "Personal Catalog", "View Product Details", "Find CRL Locations", "Contact Us", and "Place an Order". It also mentions a "FREE App Now Available at: Google play" and shows images of a smartphone and a tablet displaying the CRL mobile app. Below the banner are several buttons: "New Promotion", "Screen Special", "Designer Handles", "CRL Mobile", "Online Programs", "Serenity Series", "Machinery Brochure", and "Stay in Touch". On the right side, there is a "Follow CRL" section with social media icons for Facebook, Twitter, YouTube, LinkedIn, and Bebo. Below that is a "Customer Help" section with links for "Customers", "News / Events", "Online Programs", "Products", "Web Sites", and "Upcoming Shows". At the bottom right is a box for "THE NEW HOME FOR ARCHITECTS, DESIGNERS, & SPECIFIERS" with the URL "CRL-ARCH.com".

We take a Business-to-Business approach of conducting business over the Internet because it gives us so many ways to connect with you. Methods of searching for and ordering products that just a few years ago would have been impossible were it not for the versatility of this powerful tool.

Empowerment is what a good web site is all about. We let you make the decisions that will best serve you. You can build your orders and submit them 24 hours a day, seven days a

week, at your convenience. You can review over 60,000 products we make available, including pricing and current stock availability.

All of this and more is available to CRL customers who have signed in to our web site and become part of the World of **crlaurence.com**. The next few pages will provide the "How To" answers to the features you can access, making it more convenient to shop by using the CRL Online Catalog.

## User's Guide Menu to CRL Online

- [How to Create a User Name and Password](#)
- [How to Sign On and Recover Your Log In Information](#)
- [How to Search for Products](#)
- [How to Check Prices](#)
- [How to Check Stock](#)
- [How to View/Print Invoices](#)
- [How to Place or Change Orders](#)
- [How to Request, Process or Change a Quote](#)
- [How to Request Product Data Sheets](#)
- [How to Pay Your Statement](#)
- [How to Contact Us](#)
- [How to View the Online Catalog Library](#)
- [New Mobile Site!](#)

The following User's Guide Menu is easy to learn and a quick way to locate necessary information. We've written step-by-step instructions to help you navigate through our Online Catalog (see pages IX - XX). Take some time to explore all it has to offer!

## Navigation Menu

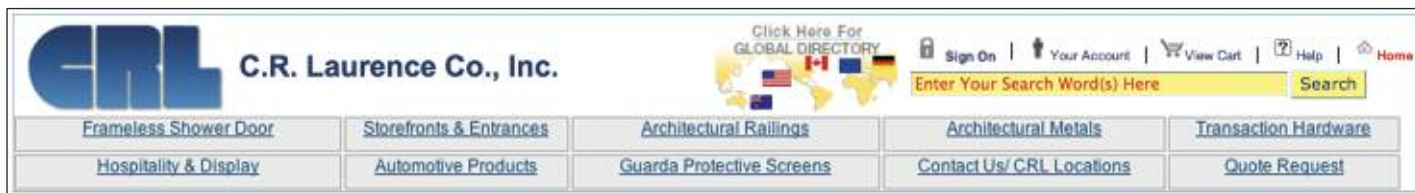

The Home Page is topped by a Navigation Menu that has buttons you can click on to link directly to the most popular areas of [crlaurence.com](http://crlaurence.com). You can easily get to our Global Directory and choose the appropriate web site; eight popular Product Groups; Phone and fax numbers for CRL Departments; Directions to all CRL Service Centers; Access to our Customer Support Center; Product Quotes in a timely fashion. All of this is just a click away.

The Navigation Menu is also where you'll find our all-important 'Enter Your Search Word(s) Here' box. This powerful tool lets you

locate CRL Products by entering their Catalog Number, or even a portion of the number. You can also use it to find products by entering key words or the names of products.

Navigating a web site with so many products doesn't need to be difficult. The 'Enter Your Search Word(s) Here' box is the surest way to find exactly what you are looking for. For more information about finding products at [crlaurence.com](http://crlaurence.com), turn to page XI.

## Customer Menu Bar

The Customer Menu Bar is a good starting point for navigating around [crlaurence.com](http://crlaurence.com). It provides a direct link to virtually all areas that can be accessed after you sign on, or after you have reviewed and selected products and now wish to order them.

Near the top our **Customer Menu** is your link to **Express Ordering**, an easy to learn and quick to complete method of placing orders online whenever it's convenient for you. You set the schedule and the pace because you are in control. You can also build your **Personal Catalog** by matching your part numbers to our Catalog Numbers.



Next in the menu is **Searching on CRL**. We've gone into a lot of detail on this subject, and ask you to turn to page XI to review the different search methods we offer. There's also a link to our Document Library of Comparison, Cross-Referenciation Charts, Application Guides, New Product Submittal Forms, and more by clicking on **CRL Total Search**. **Products and Services** has direct links to our "Information Centers" for many of our major product lines. They act like "hubs" where you can reference the various categories of information pertaining to these product lines, including Product Offer Pages, Product Specs, Technical Drawings, Measurement Templates, and a variety of helpful information sources.



When you click into **General Information** you are presented with a selection that includes information about CRL's Business Policies, Videos, ways to contact us, our service center locations, and package tracking.

**Online Applications Login** allows customers who subscribe to any of CRL's Online Programs to login fast and easy.

**News and Events** lets you review CRL e-News, Press Releases, Technical Articles, upcoming Trade Show dates and locations, and useful Internet links. When you click on the link called "What's New" you'll see categories showing our recently added products.

As stated above, the "Customer Menu Bar" offers you so many directions you can use to navigate around [crlaurence.com](http://crlaurence.com). Take some time to explore it all.

# WELCOME TO THE CRL ONLINE CATALOG

## How to Create a User Name and Password

You will need your Customer Number from your CRL Monthly Statement or from a previous CRL Invoice.

1 Have Your CRL Customer Number Ready



2 Click **Sign On**

3 Click on **Create New User Name and Password**

A screenshot of the 'Create New User Name and Password' form. It includes a language selection dropdown, a note about the 10-character CRL Customer Number, and several required fields: 'CRL Customer Number', 'Zip Code', 'User Name You Prefer' (4-12 letters or numbers, no spaces), 'Password' (4-12 letters or numbers, no spaces), 'Confirm the Password', 'Your Name', 'Your e-mail Address', and 'Confirm your e-mail Address'. There is also a checkbox for 'Do you wish to receive our Monthly e-mail Newsletter?' with 'Yes' and 'No' radio buttons. At the bottom, there is a 'Need Help with this page?' link and a 'Submit' button. A red arrow points from the 'Submit' button to the 'Account Sign On Confirmation Page'.

4 Fill out the page to create a user name and password, then click on **Submit**

5 Correct any errors if they appear after clicking **Submit**

6 Once the information is accepted, you will see this "Account Sign On Confirmation Page."

7 Click **Home** to begin using full web site services.

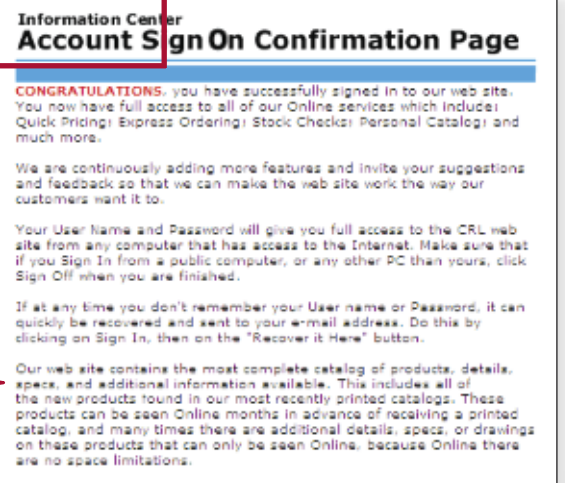

# WELCOME TO THE CRL ONLINE CATALOG

## How to Sign On

- 1 Click **Sign On** or enter **"LOGIN"** in the yellow search box



- 2 Enter your user name and password, **Click Here to Sign On**

A screenshot of the sign-on form. It has two input fields: "User Name" and "Password". Below the "Password" field is a "Click Here to Sign On" button. Below the button are links: "Forgot Your User Name or Password? Create New User Name & Password Now To CRL?".

- 3 If this screen appears, you have either mistyped the user name and/or password or one needs to be created



- 4 To confirm your user name and password, or to check if you have one set up, click on **Forgot Your User Name or Password? Recover It Here**

## How to Recover Your Sign On Information

- 1 Click **Sign On**  
(see step 1 above)

- 2 Click **Forgot Your User Name or Password? Recover It Here**  
(see step 4 above)

- 3 Enter your Email Address, then click **Submit**

A screenshot of the email recovery form. At the top, it says "Instructions: Enter your email and then press Submit. Your password will be sent to the Email that matches the one you entered." Below that, it says "\* Required Fields". There is an input field labeled "Enter your Email Address:" with a red asterisk. Below the input field is a "Submit" button.

# WELCOME TO THE CRL ONLINE CATALOG

## Best Ways to Search

### Search methods to find products in order of importance

- 1 **Search Box** Search by Cat. No. and by Keyword(s). (Only good for products, not other pages on our site at this time).
- 2 **Sitemap** Used to be the same or a little more descriptive than mall pages.
- 3 **Products By Industry** Broader than mall pages, catering more to our core industries.
- 4 **Mall Pages** Overview of product lines to start drilling down to products.

### Search methods to find other information

- 7 Click on **CRL Total Search**. On this page you have a search box to locate products, the same as the yellow search box on the top right of every page.
- 8 To find, Technical Details, Drawings, MSDS, Spec Data, Instructions, User Guides, Catalog Pages, or anything else, you can click on one of the tabs located on this same page. Product specific information and details can also be found on each product's offer page.

The screenshot shows the CRL website homepage. Red arrows and circles with numbers 1 through 8 point to specific features:

- 1** Points to the 'Search Box' in the top right corner.
- 2** Points to the 'Sitemap' link in the footer area.
- 3** Points to the 'Products By Industry' menu in the left sidebar.
- 4** Points to the 'Mall Pages' section in the left sidebar.
- 5** Points to the 'Catalog Page Search' feature in the 'CRL Total Search' section.
- 6** Points to the 'Online Catalogs' section in the 'CRL Total Search' area.
- 7** Points to the 'CRL Total Search' button in the top right.
- 8** Points to the navigation tabs (e.g., 'Technical Details', 'Drawings') located below the search box.

# WELCOME TO THE CRL ONLINE CATALOG

## How to View/Print Product Information

- 1 Enter the **CRL Catalog Number** or **product description** in the Search Box, then click **Search**

**CRL C.R. Laurence Co., Inc.**

Click Here For GLOBAL DIRECTORY | Sign Off | Your Account | View Cart | Help | Home

Enter Your Search Word(s) Here **Search**

Frameless Shower Door | Storefronts & Entrances | Architectural Railings | Architectural Metals | Transaction & Hospitality

U.S. Aluminum | Automotive Products | Guarda Protective Screens | Contact Us/ CRL Locations | Quote Request

**Customer Menu Bar**

- Express Ordering
- Quick Pricing
- Your eStatements
- Your Quotes
- Your Orders
- Your Invoices
- Personal Catalog
- Your Products
- Your Credit Reference

Searching on CRL

- CRL Total Search
- New Product Area
- Popular Product Lines
- Products by Industry

Products & Services

- Architectural Metal Systems
- Architectural Railing Systems
- Architectural Customers
- Automotive Products
- Display Systems
- Entrance Systems

**CRL 95C Silicone Building Sealant** [Back To CRL 95C Silicone Building Sealant Models](#)

MSDS | SPEC. Data | Product Specification

Can Ship UPS

**CRL Gray 95C Silicone Building Sealant**

Service Center Location	Quantity Available	Intransit
Los Angeles, California	4352	0
San Diego, California	42	0

Order Quantity

[Add To Cart](#)

Item(s) in Cart: 8

[View Cart](#)

Click here to check stock at alternate CRL locations.

Quantity	U.S. Dollars Per Each
1	XX.XX
30	XX.XX
90	XX.XX
180	XX.XX

View Larger Image

- 2 Available link tabs will appear near the top of the product page

- 3 Click on the desired data link

- 4 You have the option to view links through **HTML** or **PDF** Format

- 5 If you only want to view this information, click on **HTML** Format

- 6 If you want to print this information, click on **PDF** Format

### Instructions on How to Use This Page

To open a file if you already have that type of application installed on your computer: Click on the word for the file type associated with the type of file you wish to view.

To save a MSDS or Product Spec Sheet, open the type of file you want to view, then click on File, then Save.

To save a Spec Data Sheet or Technical Drawing

1. Right Click on the word View located under the heading for the type of file you want to save
2. Next, left (normal) click on words Save Target As Or Save File As
3. A dialog box should now appear you where the file is going to be saved on your computer
4. Click on the word Save.

[Click Here to view this product's Warning](#) Don't see what you are looking for? [Search Again...](#)

**MSDS**

Products 1 found

33SAL	HTML	PDF
-------	------	-----

**MATERIAL SAFETY DATA SHEET**

**Company Name:** C.R. LAURENCE CO., INC.  
**Address:** 2503 E. VERNON AVE.  
**City / State / Zip:** LOS ANGELES / CA / 90058  
**US-CHEMTREC Phone(I):** (800)424-9300  
**US-CHEMTREC Phone(II):** (703)527-3887  
**CAN-CANUTEC Phone:** (613)996-6666  
**Vendor Update:** 4/7/2008  
**Date Prepared:** 4/7/2008  
**MSDS Number:** 33SAL ; 33SAL52GL ; 33SAL5GL ; 33SBL ; 33SBL52GL ; 33SBL5GL ; 33SBRZ ; 33SBRZ52GL ; 33SBRZ5GL ; 33SC ; 33SC52GL ; 33SC5GL ; 33SMRC ; 33SMRC52GL ; 33SMRC5GL ; 33ST ; 33ST48GL ; 33ST52GL ; 33ST5GL ; 33STW ; 33STW52GL ; 33STW5GL ; 33SW ; 33SW52GL ; 33SW5GL ; 33SXX ;

**I. CHEMICAL PRODUCT IDENTIFICATION**

# WELCOME TO THE CRL ONLINE CATALOG

## How to Check Prices

- On the **Product Page:**

  - Enter a CRL Catalog Number in the search box located at the top right of page, then click **Search**
  - If you are signed on, pricing will automatically appear on the right hand side

**CRL 95C Silicone Building Sealant**

Service Center Location	Quantity Available	Intransit
Los Angeles, California	4352	0
San Diego, California	42	0

Quantity	U.S. Dollars Per Each
1	XX.XX
30	XX.XX

- On the **Quick Pricing Page:**

  - Click on **Quick Pricing** under "Customer Menu Bar" located on the top left (see above image)
  - Enter the CRL Catalog Number then click **Look Up**

**Customer Menu Bar**

- Express Ordering
- Quick Pricing**
- Your eStatements
- Your Quotes
- Your Orders
- Personal Catalog

To use this page, type in the CRL Catalog Number and click 'Look Up'

Catalog Number: 95CGRY

Branch Location	Quantity Available	Intransit
Los Angeles, California	2825	0
San Diego, California	42	0

Quantity	U.S. Dollars Per Each
1	XX.XX
30	XX.XX
90	XX.XX
180	XX.XX
Your Price	XX.XX

- On the **Shopping Cart Page:**

  - Click on **View Cart** located at the top right of the page

Your Account | **View Cart** | Help | Home

- If you decide not to order this item, click **Remove Item**

- Enter the quantity and CRL Catalog Number then click **Add to Cart**

Quantity	Catalog Number	Update Order	Product Description	Check Stock	Product Warning	UM	UM Price	Ext Price
30	95CGRY	Add To Cart						
1	1973	Remove Item	CRL 1973 Glass Cleaner	Check	Read	CS	22.85	22.85
100	818	Remove Item	CRL Single Edge Razor Blades	Check	Read	EA	0.0390	3.88
5	95CBL	Remove Item	CRL Black 95C Silicone Building Sealant	Check	Read	EA	6.80	34.45

# WELCOME TO THE CRL ONLINE CATALOG

## How to Check Stock

- On the **Product Page:**

  - Enter a CRL Catalog Number in the search box located at the top right of page, then click **Search**
  - If you are signed on, the page will show the quantity available at your local CRL Service Center, other Service Centers in your region, and CRL's Corporate Headquarters.

- On the **Quick Pricing Page**

  - Click on **Quick Pricing** under "Customer Menu Bar" located on the top left (see image above)
  - Enter the CRL Catalog Number then click **Look Up**

- On the **Shopping Cart Page:**

  - Enter the quantity and CRL Catalog Number, then click **Add to Cart**
  - If you decide not to order this item, click **Remove Item**
  - Click on the word **Check** next to the product description to see available stock at each CRL Service Center





# WELCOME TO THE CRL ONLINE CATALOG

## How to Request a Quote

1 Click on **Quote Request**

The screenshot shows the C.R. Laurence Co., Inc. website. At the top, there is a navigation bar with links for 'Sign Off', 'Your Account', 'View Cart', 'Help', and 'Home'. Below this is a search bar with the text 'Enter Your Search Word(s) Here' and a 'Search' button. A horizontal menu contains various product categories: 'Frameless Shower Door', 'Storefronts & Entrances', 'Architectural Railings', 'Architectural Metals', 'Transaction & Hospitality', 'U.S. Aluminum', 'Automotive Products', 'Guarda Protective Screens', 'Contact Us/ CRL Locations', and 'Quote Request'. The 'Quote Request' link is highlighted. Below the navigation bar is a 'Customer Menu Bar' with links for 'Express Ordering', 'Quick Pricing', 'Your eStatements', 'Your Quotes', 'Your Orders', 'Your Invoices', 'Personal Catalog', 'Your Products', and 'Your Credit Reference'. There is also a 'Searching on CRL' section with 'CRL Total Search' and 'New Product Area'. A central section titled 'Request a Quote' provides instructions on how to use the online quote request system. Below this are two sub-sections: 'Request a Quote for Stock, Non-Stock or Special Item' and 'Request a Balanced Door Quote', each with a small image and descriptive text.

2 Select one of the categories for a summary of the product line then click **Continue to Request Quote**

3 Enter the quantity, CRL Catalog Number, Color or Size (if applicable) and detailed Description, then click **Add To My Quote**

4 Continue to add or click on **Continue to Process Quote**

5 Review the information entered, add a project name and any instructions, then click **Submit**

6 You will receive a quote number for your reference and an email response within one business day

The screenshot shows the 'e-Quotes' form. At the top, there is a navigation bar with links for 'View Your Unprocessed Orders', 'View and Pay Your Invoices', 'View Your History of Shipped Orders', and 'Quote Quotes'. Below this is a section titled 'Looking for something you could not find in our catalog? C.R. Laurence carries over 50,000 products. Simply fill in the details into each of the relevant fields below, then press the "Add to My Quote" button. Once you have entered all of the items you are looking for, press the "Process Quote" button to proceed. You should receive a reply via e-mail/fax within one business day.' Below this is a table with the following columns: 'Quantity', 'Similar CRL Catalog Number', 'Color', 'Size', and 'Description'. The first row contains the values: '1', '1336', 'GREEN', and 'GREEN SLICONE'. Below the table are three buttons: 'Add To My Quote', 'Update All Quantities', and 'Continue To Process Quote >>'. The 'Add To My Quote' button is highlighted with a red arrow.

The screenshot shows the 'e-Quotes' form review section. At the top, there is a navigation bar with links for 'View Your Unprocessed Orders', 'View and Pay Your Invoices', 'View Your History of Shipped Orders', and 'Quote Quotes'. Below this is a section titled 'Please review the information you entered below, and click submit to request a quote.' Below this are four fields: 'Name', 'Fax', 'Email', and 'Project Name'. The 'Name' field contains 'louie', the 'Fax' field contains '0185541246', and the 'Email' field contains 'mike\_schwenck@crlaurence.com'. Below these fields is a 'Special Instructions or Details (Limited to 60 characters)' field. At the bottom are two buttons: '<< Make Additional Changes' and 'Submit'. The 'Submit' button is highlighted with a red arrow.

# WELCOME TO THE CRL ONLINE CATALOG

## How to Place an Order

- 1 Click on **Express Ordering** under "Customer Menu Bar"
- 2 Enter the quantity and CRL Catalog Number then click **Add to Cart**
- 3 Continue adding items to the order or click **Secure Checkout**

CRL C.R. Laurence Co., Inc.

Click Here For GLOBAL DIRECTORY

Sign Off | Your Account | View Cart | Help | Home

Enter Your Search Word(s) Here Search

Frameless Shower Door Storefronts & Entrances Architectural Railings Architectural Metals Transaction & Hospitality

U.S. Aluminum Automotive Products Guarda Protective Screens Contact Us/ CRL Locations Quote Request

Customer Menu Bar

- Express Ordering
- Quick Pricing
- Your eStatements
- Your Quotes
- Your Orders
- Your Invoices
- Personal Catalog
- Your Products
- Your Credit Reference

Searching on CRL

- CRL Total Search
- New Product Area
- Popular Product Lines

Quantity	Catalog Number	Update Order	Product Description	Check Stock	Product Warning	UM	UM Price	Ext Price
<input type="text"/>	<input type="text"/>	Add To Cart						
1	M12396	Remove Item	CRL Black Beaded Flexible Belt Molding for 1953 to 1964 Chrysler	Check		EA	13.00	13.00
							Subtotal	\$ 13.00

Update All Quantities Secure Checkout

Shipping costs not included. Click [here](#) to view our shipping policies.

**NOTE:** To change a quantity, simply enter the new quantity next to the product you want to change and click **Update All Quantities**

- 4 For Ship Via selection, click on the drop down arrow

Ship via  [Order in Progress](#)

Special instructions regarding shipping, packaging, if any

Freight Allowance Policy

[Return to Shopping Cart](#) [Continue To Checkout](#)

- 5 Enter special instructions about your order (if any), then click **Continue to Checkout**

Ship to different address  yes  no [Order in Progress](#)

Bill to Address	Ship to Address <i>*Required</i>
Company: TEST GLASS CO	<input type="text"/>
Contact: mike	<input type="text"/>
Phone: 8004216144	<input type="text"/>
Email: cr@crl.com	<input type="text"/>
Street 1: 2503 E VERNON AVE	<input type="text"/>
Street 2:	<input type="text"/>
City: LOS ANGELES	<input type="text"/>
State: CA	<input type="text"/>
Zip: 90058	<input type="text"/>

[Make Additional Changes](#) [Continue To Checkout](#)

- 6 Shipping to a different address? If no, click **Continue to Checkout**. If yes, enter the drop ship address, then click **Continue to Checkout** or **Make Additional Changes**

# WELCOME TO THE CRL ONLINE CATALOG

## How to Place an Order (Continued)

7 Enter PO Number or Name

**\*Required**

PO number or name \*

Current terms for this account: Open Account

Alternate payments methods: Open Account

[Order in Progress](#)

[Make Additional Changes](#) [Continue To Checkout](#)

8 For alternate payment method selection, click on the drop down arrow, then click **Make Additional Changes** or **Continue to Checkout**

9 Review the order confirmation page, then click **Make Additional Changes** or **Continue to Checkout**

Ship To: TEST GLASS CO, 5563 E VERNON AVE, LOS ANGELES, CA 90056

Bill To: TEST GLASS CO, 5563 E VERNON AVE, LOS ANGELES, CA 90056

Quantity	Catalog Number	Product Description	UOM	UM Price	Est Price	
7	082	CRL 8 Bleach Cleaner and Surface Prep	EA	10.85	73.85	
1	1303	CRL Offcut Glass Film	EA	37.80	37.80	
10	330C	CRL Clear 330 Bleach Solution	EA	2.39	23.80	
3	3413	CRL 8" Straight Jaw General Glass Pliers (Pliers)	EA	6.70	20.10	
4	4802	CRL 16" Hex Multi Point Undercut Phillips Insert Bit	EA	0.50	2.00	
1	31310	CRL Metal Handle Straight Head D4 Cutter	EA	13.80	13.80	
1	38160K	CRL Swivel Key - 1.35" Lg. 10" Width - Package of 25	PK	4.50	4.50	
1308	VTPH1	CRL Panic Handle Instructional Video Tape	EA	0.80	0.80	
					<b>Total</b>	<b>\$165.95</b>

[Make Additional Changes](#) [Continue To Checkout](#)

10 If your order does not yet qualify to receive one of our Internet Bonuses, you can click **Return to Shopping Cart** to increase your order, or click **Finalize Without Bonus**

We thank you for your order. It is valued at **\$165.05** and does not yet qualify for one of our Free Internet Order Bonuses. If you wish to increase your order to qualify for one of the Bonus Items shown below just click on the Return to Shopping Cart button or on View Cart. If you want to process your order as-is click on the Finalize This Order As-is button below. Thank you once again.

[Order in Progress](#)

[Return to Shopping Cart](#)

[Finalize Without Bonus](#)

Orders over \$500.00 qualify to receive one item from this category.

HCT20SPG CRL 4.5 Pound Can Hand Cleaner	LEVRSPG CRL 9" Magnetic Level	MUGSPG CRL Coffee Mug	SS403SPG CRL Glass Cutter and Pencil Pouch	SP1015PG CRL Sparkle Cleaner and Stain Remover

11 If your order does qualify for an Internet Bonus, click on the **bonus item of your choice** or click **Finalize Without Bonus**

Thank you for your order. Please print this page for your records. [Order Complaints](#)

You will be able to check on, change, or view information about this or any other order by clicking on My CRL located on the top of every page. This order will be posted and viewable within minutes during regular business hours. Reference #: 58810

Customer Information		Shipping Information	
Contact:	mlca	This order will ship from:	LOS ANGELES, CALIFORNIA
Account number:	00017000	Ship via:	UPS Ground
Phone:	800216146	OK to call items:	No
PO number:	12345		
Payment method:	Open Account		
Order confirmation:	Email		
Email:	mlca@crl.com		

Ship To: TEST GLASS CO, 5563 E VERNON AVE, LOS ANGELES, CA 90056

Bill To: TEST GLASS CO, 5563 E VERNON AVE, LOS ANGELES, CA 90056

Quantity	Catalog Number	Product Description	UOM	UM Price	Est Price	
7	082	CRL 8 Bleach Cleaner and Surface Prep	EA	10.85	73.85	
1	1303	CRL Offcut Glass Film	EA	37.80	37.80	
10	330C	CRL Clear 330 Bleach Solution	EA	2.39	23.80	
3	3413	CRL 8" Straight Jaw General Glass Pliers (Pliers)	EA	6.70	20.10	
4	4802	CRL 16" Hex Multi Point Undercut Phillips Insert Bit	EA	0.50	2.00	
1	31310	CRL Metal Handle Straight Head D4 Cutter	EA	13.80	13.80	
1	38160K	CRL Swivel Key - 1.35" Lg. 10" Width - Package of 25	PK	4.50	4.50	
1308	VTPH1	CRL Panic Handle Instructional Video Tape	EA	0.80	0.80	
					<b>Total</b>	<b>\$165.95</b>

[Print](#) [Place Another Order](#)

12 Print the confirmation screen for your records or click **Place Another Order**

# WELCOME TO THE CRL ONLINE CATALOG

## How to Pay Your Statement

1 Click on **Your Account**

C.R. Laurence Co., Inc. [Click Here For Primary Information](#) [Your Account](#) [View Cart](#) [Help](#) [Home](#)

Enter Your Search Word(s) Here

Frameless Shower Door | Stonefronts & Entrances | Architectural Railings | Architectural Metals | Transaction & Hospitality  
U.S. Aluminum | Automotive Products | Guardia Protective Screens | Contact Us/CRL Locations | Quote Request

Customer Menu Bar  
Express Ordering  
Quick Pricing  
Your Statements  
Your Quotes  
Your Orders  
Your Invoices

My CRL Orders | My CRL Products & Orderings | My CRL Locations & Contacts | Other Information

**My CRL Orders - Shipped and Unshipped**

- CRL Express Checkout** - CRL Express Checkout can be enabled on your account when you edit your settings for each section listed in your CRL Express Checkout. Once complete simply click on the Turn Express Checkout On button. Now when you go to your shopping cart you will see the Express Checkout button visible. Your order will be automatically charged to the payment method on your Express Checkout account and shipped to the address indicated on your Express Checkout account--you skip the shopping cart checkout process! For more information on this new value-added application, click [here](#).
- View and Pay My Invoices** - This page will display your most recently shipped orders, while also displaying a list of all unpaid invoices. You can view tracking information and details for each invoice, as well as print and e-mail multiple invoices.

2 Click on **View and Pay My Invoices**

3 Click on the box next to each Invoice you want to pay, then click **Pay with Check** or **Pay with Credit Card**

<input type="checkbox"/>	Invoice #	Order #	Product #	Quantity	Ship Date	Unit Price	Subtotal	Tax	Shipping	Total
<input checked="" type="checkbox"/>	L48103	3196428	1758	24	2/4/2013	0.00	188.20	0.00	0.00	188.20
<input type="checkbox"/>	L80179	3196992	1757	24	2/4/2013	0.00	185.20	0.00	0.00	185.20
<input type="checkbox"/>	L61376	3196901	206664	24	2/4/2013	0.00	99.20	0.00	0.00	99.20
<input type="checkbox"/>	L61145	3196928	1758	24	2/4/2013	0.00	13.68	0.00	0.00	13.68
<input checked="" type="checkbox"/>	L67976	3200994	1757	24	2/2/2013	0.00	443.88	0.00	0.00	443.88
<input type="checkbox"/>	L39928	3200734	1754	24	2/2/2013	0.00	1,368.15	0.00	0.00	1,368.15
<input checked="" type="checkbox"/>	L41588	3204089	206428	24	2/6/2013	0.00	377.73	0.00	0.00	377.73

To print multiple invoices, click the box in front of each invoice that you want to print, and then click on Email Checked Invoices button to process. You will then be emailed each invoice individually for your records.

Month	Amount
FEB	28826.78
JAN	36830.53
DEC	35230.90
NOV	0.00
OCT	0.00
SEP	0.00

4 Enter comments about your payment (if any) then click **Process Online**

**Comments:**  
Enter any comments about this payment here

**Total Being Paid: 977.91**      **Date 2/6/2013**

**Details:**

Order Number	Reference Number	PO Number	Reference Date	Adjustment Amount	Charges	Payments	Credit Memo	Balance	Pay Amount?
L41588	3204089	206428	2/6/2013	0.00	377.73	0.00	0.00	377.73	377.73

5 You will be given a Confirmation Number for your payment

**Confirmation #: 11042009-72**  
Thank you for the payment.



C.R. LAURENCE COMPANY

crlaurence.com | usalum.com

XVIII | crlaurence.ca crlaurence.com.au crlaurence.co.uk crlaurence.de crlaurence.eu

# WELCOME TO THE CRL ONLINE CATALOG

## How to Contact CRL

- 1 Click on **Contact Us/CRL Locations**
- 2 Click on the **department** you want to contact via email or fax

**C.R. Laurence Co., Inc.**

Frameless Shower Door | Specifications & Enquiries | Architectural Railings | Architectural Metals | Transaction & Hospitality

U.S. Aluminum | Automotive Products | Guests Protective Screens | **Contact Us/CRL Locations** | Quote Request

**CRL US LOCATIONS**

**USALUMINUM LOCATIONS**

**C.R. Laurence Co., Inc.**  
 Corporate Headquarters  
 2503 E. Vernon Ave. Los Angeles, CA 90058-1826  
 Toll Free Phone (800) 421-6144  
 Toll Free Fax (800) 262-3299  
 International Phone (323) 588-1281  
 International Fax (323) 581-8522

DEPARTMENT	FAX	DEPARTMENT	FAX
<b>Architectural Business Development</b> Contact Architectural Services Division About Specifications, CAD Details, LEED® Statement and Receiving Architectural Orders	(866) 921-9533	<b>Tajima Metals Division</b> Contact Our Tajima Metals Division About any Tajima Metals Specific Question	(866) 321-0932
<b>Blowcraft or Blastcraft</b> Click on the link to view the Contact Us page for Blastcraft	(412) 681-8840	<b>Technical Sales for Automotive Products</b> Contact Automotive Technical Sales About any Detailing Product Specific Question	(800) 845-4522
<b>Credit</b> Contact the Credit Department About Your Statement or an Invoice	(800) 845-4529	<b>Technical Sales for Architectural Metals Products</b> Contact Architectural Metals Technical Sales About any Detailed Product Specific Question	(866) 321-0932
<b>Customer Service</b> Contact Customer Service About any Order or Customer Service Issue	(800) 262-3299	<b>Technical Sales for Door and Window Products</b> Contact Door and Window Technical Sales About any Detailed Product Specific Question	(866) 321-0931
		<b>Technical Sales for Commercial Products</b>	(866) 587-7601

## How to Find Addresses for CRL Service Centers

- 1 Click on **Contact Us/CRL Locations** (see above image)

**C.R. Laurence Co., Inc.**

Corporate Headquarters  
 2503 E. Vernon Ave. Los Angeles, CA 90058-1826  
 Toll Free Phone (800) 421-6144  
 Toll Free Fax (800) 262-3299  
 International Phone (323) 588-1281  
 International Fax (323) 581-8522

**Remittance Address**  
 P.O. Box 58923 Los Angeles, CA 90056-0923

I'm online [Get Skype and call CRL for free](#)

1. Los Angeles, California (323) 588-1281	16. Miami Area (954) 846-8233
2. Dallas, Texas (214) 634-7305	17. Chicago, Illinois (800) 323-8480
3. Chicago Area (847) 426-3900	18. San Diego, California (658) 678-8684
4. San Francisco / Oakland Area (510) 475-1000	20. Waco/Fachia, Texas (800) 827-8440

- 2 Click on the **CRL Service Center** nearest you
- 3 View and/or print map directions



**CRL of Southern California**

Map showing service center locations in Southern California.

**Key Personnel:**

- Mr. [Name]
- Mr. [Name]
- Mr. [Name]

# WELCOME TO THE CRL ONLINE CATALOG

## Some Other Features of [crlaurence.com](http://crlaurence.com)

The screenshot shows the CRL website header with the logo and 'C.R. Laurence Co., Inc.' name. It includes a 'Click Here For GLOBAL DIRECTORY' link with a world map, and navigation links for 'Sign Off', 'Your Account', 'View Cart', 'Help', and 'Home'. A search bar is present with the text 'Enter Your Search Word(s) Here' and a 'Search' button. Below the header is a navigation menu with categories: 'Frameless Shower Door', 'Storefronts & Entrances', 'Architectural Railings', 'Architectural Metals', and 'Transaction & Hospitality'. A secondary row of links includes 'U.S. Aluminum', 'Automotive Products', 'Guarda Protective Screens', 'Contact Us/ CRL Locations', and 'Quote Request'.

### CRL Express Checkout

If you want to be able to complete your online orders in one click, and if you use the same billing and shipping methods on most orders, this is for you. To turn this valuable time-saving feature on:



Express Checkout

- 1 Click on **Your Account**
- 2 Click on **CRL Express Checkout**
- 3 Click on **Turn Express Checkout On**

### CRL e-News



Subscribers to this free service get once a month updates on new products, our monthly promotion, industry events, technical bulletins, and more.



- 1 Sign up and view past issues by clicking on **News/Events**, then on the **CRL e-Newsletter** link.



### CRL Online Software

Shows Online  
Details and LOG-IN

All Glass Storefronts Online  
Details and LOG-IN

Hand Rails Online  
Details and LOG-IN

Subscribers to our Showers Online, Storefronts Online, and Hand Rails Online Optimization Programs access them by clicking on Online Programs. These web-based programs save subscribers countless man-hours, helping reduce labor costs.



### CRL Webinars (Web Seminars)

The screenshot shows a list of webinar tutorials. Each entry includes a title, description, time, and a 'Space is Limited, Click Here to Register' link. The tutorials listed are: 'CRL Showers Online Free Trial Tutorial', 'CRL All-Glass Storefronts Online Free Trial Tutorial', 'CRL Hand Rails Online Free Trial Tutorial', and 'CRL UV Glass Bonding System'.

Register to join us online by clicking on News/Events, then clicking on Webinars for live training by industry professionals, or view previous Webinars. New topics are added regularly, so check in frequently.

### Connect With CRL While You Are Online

If you wish to contact or connect with CRL while you are online, you can reach us on Facebook, Twitter, YouTube, LinkedIn, Behance, Google Plus, Flickr, and you can even use Skype to call us for free from anywhere in the world.

Be the first to know about new content, videos, press releases, and more by connecting with CRL from these pages.

You can connect with CRL using any of these methods right from our home page.



C.R. LAURENCE COMPANY

[crlaurence.com](http://crlaurence.com) | [usalum.com](http://usalum.com)

XX | [crlaurence.ca](http://crlaurence.ca) [crlaurence.com.au](http://crlaurence.com.au) [crlaurence.co.uk](http://crlaurence.co.uk) [crlaurence.de](http://crlaurence.de) [crlaurence.eu](http://crlaurence.eu)

## C.R. Laurence is a Catalog Company

- Master and Specialty Catalogs in Print and Online
- Thousands of Products Presented in an Organized Manner
- Color Photos and Detailed Illustrations
- Easy to Understand Ordering Information



Of all the products we bring you, our catalogs may be the most important. C.R. Laurence is in the business of making catalogs because we know that our customers find it convenient and informative to use these carefully planned and thoroughly prepared catalogs that make it easy for them to find exactly what they need.

Part of our catalog philosophy is to provide more of the information you need, and not overburden you with excess catalog literature. That is why we make our Master Catalogs that usually contain all of the products we offer to certain industries, as well as our Specialty Catalogs that focus on particular product groups. You can select CRL Catalogs for only the areas that pertain to your business, or choose to shop from our Master Catalogs because you like the convenience of finding such a wide variety of products all under one cover.

Our Catalog Library continues to grow with the publication of new Specialty Catalogs on a regular basis. Visit our Catalog Library online at [crlaurence.com](http://crlaurence.com) to see our latest editions.

## Master Catalog Selection

- 03 SEALANTS, ADHESIVES, AND FASTENERS
- 23R FRAMELESS SHOWER DOOR HARDWARE
- 43 AUTO GLASS TOOLS AND WINDOWS
- 53R GLASS AND GLAZING HARDWARE
- 63A ARCHITECTURAL HARDWARE
- 63R ARCHITECTURAL RAILING
- 73R TOOLS, MACHINERY, AND EQUIPMENT
- 83R DOOR AND WINDOW REPLACEMENT HARDWARE

## Free CRL Catalogs Online

You can also view or download CRL Catalogs free of charge any time at [crlaurence.com](http://crlaurence.com). Go to the Home Page and click on the link for the CRL Catalog Library.



Once you open the page you'll be able to view full PDF versions of each catalog simply by clicking on the image of that catalog's cover. Browse through them page by page at your convenience. When you find a product that you want more information about, or would like to order, just click on its Catalog Number and you'll go directly to that product's Offer Page. It's another convenient way for you to shop at [crlaurence.com](http://crlaurence.com).

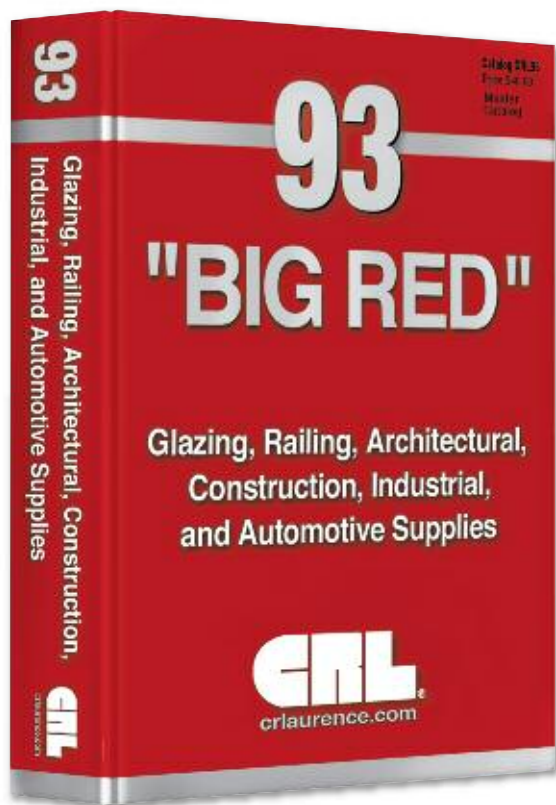

## "BIG RED" CAT. NO. CRL93

This massive full-color volume will feature an extensive A to Z Product Index for quick look-up of products

## The CRL93 Master Catalog

- The Return of "Big Red", Our Original Master Catalog
- Our Most Popular Catalog Ever Features Our Best Selling Product Lines in One Comprehensive Volume
- The Most Asked for Everyday Glazing Tools and Supplies for the Successful Glass Business
- A Full Selection of Our Most Popular General Tools, Plus Safety and Maintenance Supplies That Can Be Used By Most Any Business

For many years we offered all of our products in just one catalog. CRL93, or "Big Red" as it was called, was the single resource for our entire selection of tools and supplies for the glazing industry. It was so popular that we eventually made four reprints, and over the years distributed over 200,000 copies.

As CRL expanded to serve many more industries it became apparent that we just couldn't get everything under one cover any longer. And so was born our volume of Master Catalogs, with individualized catalogs that focus on core product lines for the industries we serve. We've printed and distributed many thousands of these volumes as well, and they have spawned our popular Specialty Catalogs for individual product lines.

But for many years our customers have commented that they would still like to have one resource catalog for the everyday supplies they use the most, one catalog of the most popular every day items. At CRL we strive to oblige the customers we value so dearly, and because so many have asked, "Big Red" is about to make its return.

The new CRL93 "Big Red" will bring our customers just what they asked for; the best of CRL's product line under one cover. It will feature the top quality items that most any business can use for their day-to-day needs. Products will be organized for easy selection and ordering, and we'll list the details you need to know in order to make an informed selection.

Look for "Big Red" in early 2014. In the meantime, all other CRL Master and Specialty Catalogs are available for order, download, or viewing online at [crlaurence.com](http://crlaurence.com). Click into our Catalog Library to see our full selection of informative and colorful product catalogs for your successful business.

- Hardware for Glass and Mirrors, Doors and Windows and Screens, Frameless Showers, Retail Displays
- Glazing Tools and Machinery
- Glass Handling Equipment
- Auto Glass Shop Tools and Supplies
- Sealants, Adhesives, Mastics

## View Any Page of the CRL93 Online at [crlaurence.com](http://crlaurence.com)

Viewing the CRL93 Catalogs online is as easy as 1-2-3. Simply start from our home page, [crlaurence.com](http://crlaurence.com), and click on CRL Catalog Library.



1



2

Then choose a viewing option. It's that easy!



3



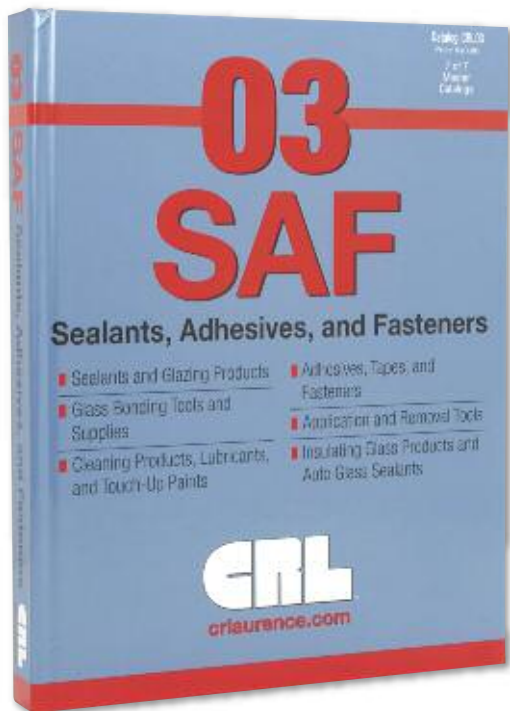

**CAT. NO. CRL03**

Over 400 full-color pages, including an extensive A to Z Product Index for quick look-up of products

## Sealants, Adhesives, and Fasteners Master Catalog CRL03

- Silicones, Polyurethanes, Butyls, Acrylics, and Other High Performance Sealants
- Application and Finishing Tools
- Shims, Setting Blocks, and Backer Rod
- Fast Curing and Durable Adhesives
- Paper, Plastic, Metal, and Foam-Based Tapes
- Screws, Nails, Rivets, Nuts and Bolts, Washers, Anchors, and Other Mechanical Fasteners
- Setting and Fastening Tools
- Cleaning and Maintenance Products

CRL03 is where you will find our extensive line of sealants, adhesives, cleaners, lubricants, and other chemical construction, fabrication, and maintenance products. We also feature CRL's line of mechanical fasteners and tape products in a variety unmatched in the glass industry. The CRL03 Master Catalog is organized into sections for fast and easy product reference. It's the seventh in CRL's series of eight Master Catalogs that serve the glass industry and related businesses, each focusing on one of our core business groups.



### View Any Page of the CRL03 Online at [crlaurence.com](http://crlaurence.com)

Viewing the CRL03 Catalog online is as easy as 1-2-3. Simply start from our home page, [crlaurence.com](http://crlaurence.com), and click on CRL Catalog Library.

1



2



Then choose a viewing option. It's that easy!

3



### Technical Assistance for Glass and Glazing

Live consultation by phone is available from 6:00 am to 5:00 pm (Pacific Time) Monday through Friday, and 7:00 am to 12:00 pm on Saturday.

Ask for Extension  
**5275**

Direct Fax  
**(800) 262-3299**

Direct E-Mail  
[crl@crlaurence.com](mailto:crl@crlaurence.com)



# WELCOME TO THE CRL ONLINE CATALOG

## How to Check Stock

- 1** On the **Product Page:**

  - Enter a CRL Catalog Number in the search box located at the top right of page, then click **Search**
  - If you are signed on, the page will show the quantity available at your local CRL Service Center, other Service Centers in your region, and CRL's Corporate Headquarters.

**CRL C.R. Laurence Co., Inc.**

Click Here For GLOBAL DIRECTORY | Sign Off | Your Account | View Cart | Help | Home

Enter Your Search Word(s) Here **Search**

Frameless Shower Door | Storefronts & Entrances | Architectural Railings | Architectural Metals | Transaction & Hospitality

U.S. Aluminum | Automotive Products | Guarda Protective Screens | Contact Us/ CRL Locations | Quote Request

**Customer Menu Bar**

- Express Ordering
- Quick Pricing
- Your eStatements
- Your Quotes
- Your Orders
- Your Invoices
- Personal Catalog
- Your Products
- Your Credit Reference

Searching on CRL

CRL Total Search

New Product Area

Popular Product Lines

Products by Industry

Products & Services

Architectural Metal Systems

**CRL 95C Silicone Building Sealant** | Back To CRL 95C Silicone Building Sealant Models

MSDS | SPEC. Data | Product Specification

UPS Can Ship UPS

**CRL Gray 95C Silicone Building Sealant**

Service Center Location	Quantity Available	Intransit
Los Angeles, California	4352	0
San Diego, California	42	0

Order Quantity:

**Add To Cart**

Item(s) in Cart: 8

**View Cart**

Click here to check stock at alternate CRL locations.

Quantity	U.S. Dollars Per Each
1	XX.XX

- 2** On the **Quick Pricing Page**

  - Click on **Quick Pricing** under "Customer Menu Bar" located on the top left (see image above)

**Customer Menu Bar**

- Express Ordering
- Quick Pricing**
- Your eStatements
- Your Quotes
- Your Orders
- Personal Catalog

- Enter the CRL Catalog Number then click **Look Up**

To use this page, type in the CRL Catalog Number and click 'Look Up'

Catalog Number:  **Look Up**

Catalog Number: **95CGRAY**

Description: **CRL Gray 95C Silicone Building Sealant**

Service Center Location	Quantity Available	Intransit
Los Angeles, California	4352	0
San Diego, California	42	0

Check box to view alternate CRL locations

The highested location and quantity available shows your normal shipping branch.

The quantity available shown above is deemed to be accurate as of last night. If you need a certain quantity shipped out immediately, add the item to your cart, process your order, and in the comments section of your order ask for stock to be verified. You can also contact Customer Service by calling (800) 421-6144 for immediate verification.

Availability is shown by each of our stocking locations listed. If your shipping location shows zero click here to read our stocking policy.

**View Larger Image**

More Choices | Product Details

**View Cart** | **Add To Catalog** | **Add To Cart**

Item(s) in Cart: 8

- 3** On the **Shopping Cart Page:**

- Enter the quantity and CRL Catalog Number, then click **Add to Cart**
- If you decide not to order this item, click **Remove Item**
- Click on the word **Check** next to the product description to see available stock at each CRL Service Center

If the order below is complete, click **Secure Checkout**.

Quantity	Catalog Number	Product Description	Check Stock	Product Warning	IME	UM Price	Est Price
0	633	CRL Silicone Cleaner and Surface Prep	<b>Check</b>	Bad	CA	13.95	13.95
1	128	CRL Other Glass Piler	<b>Check</b>		CA	37.90	37.90

**Add To Cart** | **Remove Item** | **Remove Item**



**C.R. LAURENCE COMPANY**

**crlaurence.com | usalum.com**

XIV | [crlaurence.ca](http://crlaurence.ca) [crlaurence.com.au](http://crlaurence.com.au) [crlaurence.co.uk](http://crlaurence.co.uk) [crlaurence.de](http://crlaurence.de) [crlaurence.eu](http://crlaurence.eu)

# DOOR AND WINDOW CATALOG

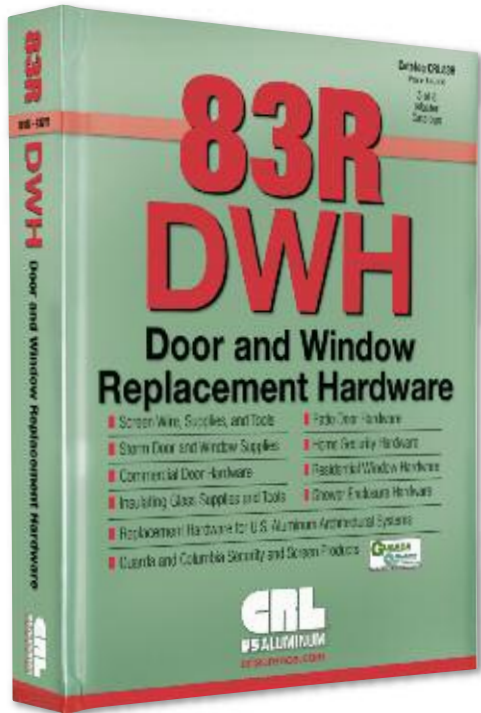

**CAT. NO. CRL83R**

864 full-color pages, including an extensive A to Z Product Index for quick look-up of products

## Door and Window Replacement Hardware Master Catalog CRL83R

- Replacement Hardware for U.S. Aluminum Architectural Systems
- Screen Wire, Supplies, and Tools
- Patio Door Hardware
- Storm Door and Window Supplies
- Home Security Hardware
- Commercial Door Hardware
- Residential Window Hardware
- Insulating Glass Supplies and Tools
- Shower Enclosure Hardware

CRL83R features our comprehensive selection of door and window replacement parts for residential, commercial, and institutional use. There is also a full selection of hardware for use in shower enclosures, and our full program for the fabrication and installation of energy saving insulating glass units. The CRL83R Master Catalog is separated into six sections for fast and easy product reference. It's the fifth in CRL's series of eight Master Catalogs that serve the glass industry and related businesses, each focusing on one of our core business groups.

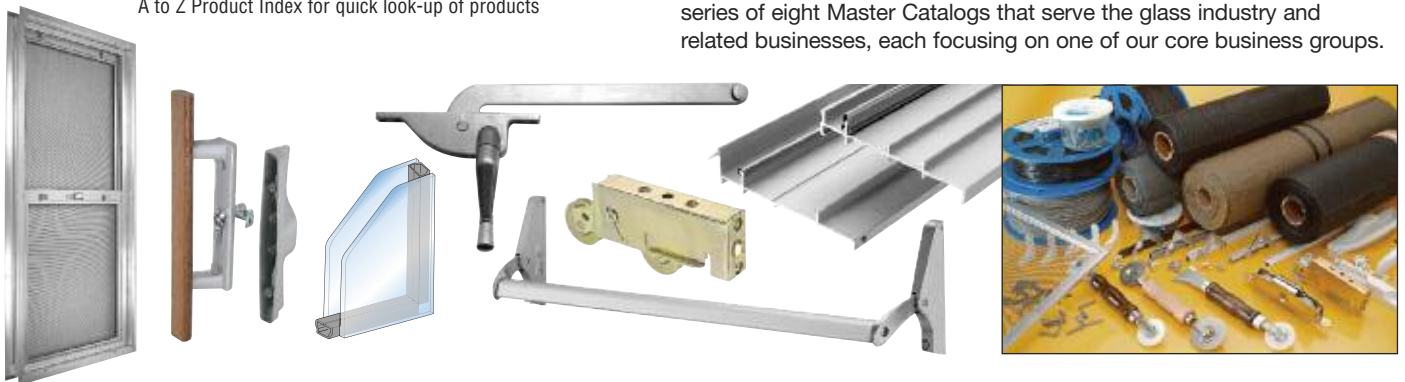

### View Any Page of the CRL83R Online at [crlaurence.com](http://crlaurence.com)

Viewing the CRL83R Catalog online is as easy as 1-2-3. Simply start from our home page, [crlaurence.com](http://crlaurence.com), and click on CRL Catalog Library.

**1**



**2**



Then choose a viewing option. It's that easy!

**3**



### Technical Assistance for Door and Window Hardware, Including Our Blumcraft and Jackson Brands

Live consultation by phone is available from 6:00 am to 5:00 pm (Pacific Time) Monday through Friday, and 7:00 am to 12:00 pm on Saturday.

Ask for Extension  
**7520**

Direct Fax  
**(866) 921-0531**

Direct E-Mail  
[glazing@crlaurence.com](mailto:glazing@crlaurence.com)



# ARCHITECTURAL HARDWARE CATALOG

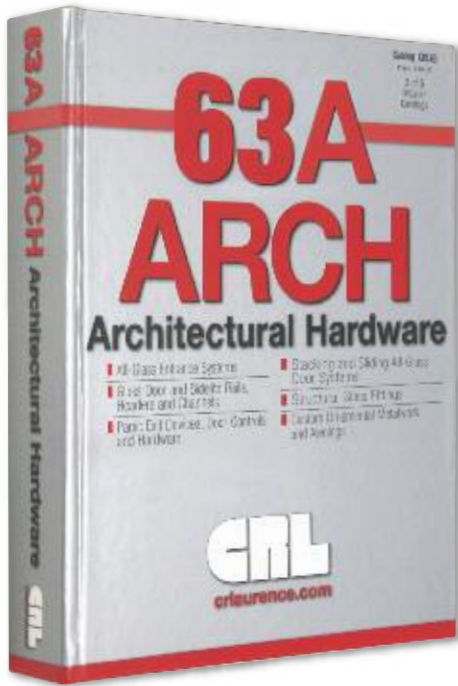

**CAT. NO. CRL63A**

Over 500 full-color pages, including an extensive A to Z Product Index for quick look-up of products

## CRL Architectural Hardware Master Catalog CRL63A

- All-Glass Entrance Systems
- Glass Door and Sidelite Rails, Headers and Channels
- Panic Exit Devices, Door Controls and Hardware
- Stacking and Sliding All-Glass Door Systems
- Structural Glass Fittings
- Custom Ornamental Metalwork and Awnings



Ask about a FREE 30-Day Trial of 'All-Glass' Storefronts Online® our Web-based glass sizing and estimating program

The CRL63A Architectural Hardware Master Catalog features the most comprehensive line of heavy glass and architectural hardware. CRL63A is organized and indexed for fast and easy product reference. CRL63A is the third in CRL's series of eight Master Catalogs that serve the glass industry and related businesses, each focusing on one of our core business groups.

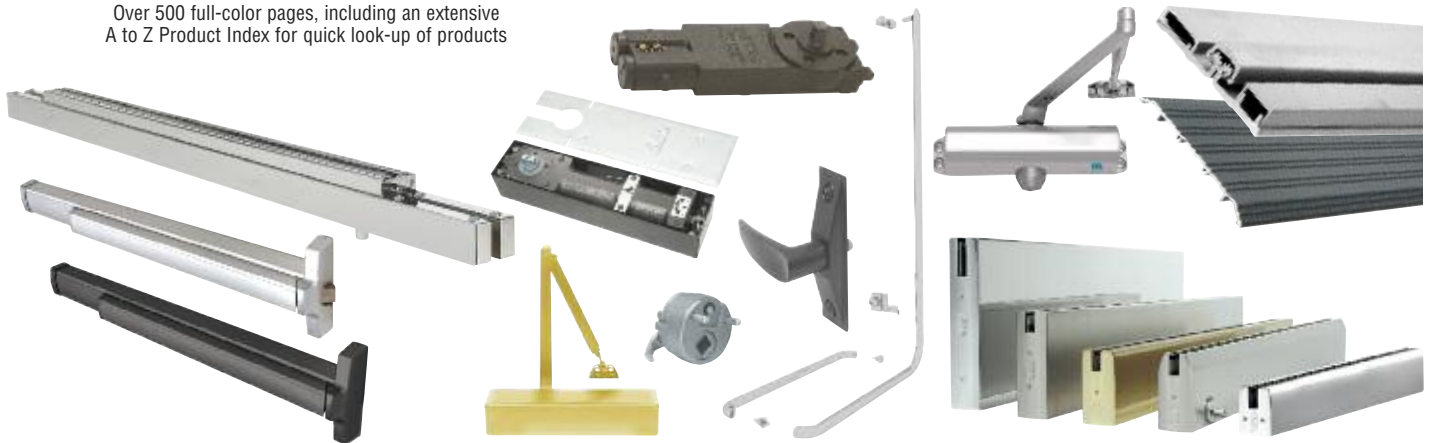

### View Any Page of the CRL63A Online at [crlaurence.com](http://crlaurence.com)

Viewing the CRL63A Catalog online is as easy as 1-2-3. Simply start from our home page, [crlaurence.com](http://crlaurence.com), and click on CRL Catalog Library.

1



2



Then choose a viewing option. It's that easy!

3



### Technical Assistance for Architectural Hardware

Live consultation by phone is available from 6:00 am to 5:00 pm (Pacific Time) Monday through Friday, and 7:00 am to 12:00 pm on Saturday.

Ask for Extension

# 7700

Direct Fax  
(800) 587-7501

Direct E-Mail  
[architectural@crlaurence.com](mailto:architectural@crlaurence.com)



**C.R. LAURENCE COMPANY**

[crlaurence.com](http://crlaurence.com) | [usalum.com](http://usalum.com)

XXVI | [crlaurence.ca](http://crlaurence.ca) [crlaurence.com.au](http://crlaurence.com.au) [crlaurence.co.uk](http://crlaurence.co.uk) [crlaurence.de](http://crlaurence.de) [crlaurence.eu](http://crlaurence.eu)

# ARCHITECTURAL RAILING CATALOG

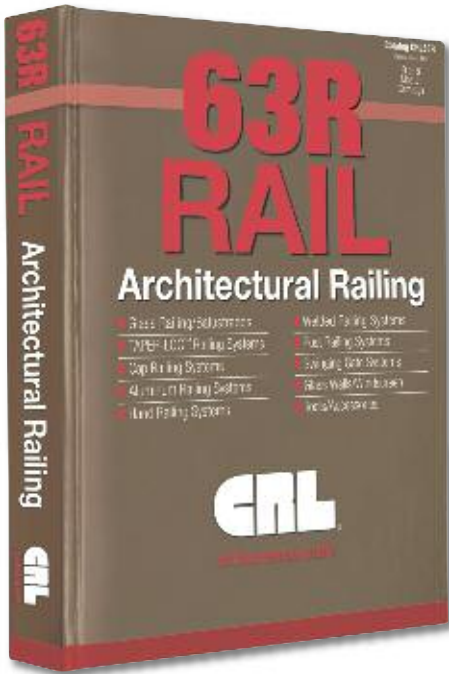

**CAT. NO. CRL63R**

Over 500 full-color pages, including an extensive A to Z Product Index for quick look-up of products

## CRL Architectural Railing Master Catalog CRL63R

- Glass Railings/Balustrades
- TAPER-LOC® Railing Systems
- Cap Railing Systems
- Aluminum Railing Systems
- Hand Railing Systems
- Welded Railing Systems
- Post Railing Systems
- Swinging Gate Systems
- Glass Walls/Windscreens
- Tools/Accessories



Ask about a FREE 30-Day Trial of Hand Rails Online, our Web-based glass sizing and estimating program

The CRL63R Architectural Railing Master Catalog features our extensive line of hand rails, guard rails, aluminum railing and windscreen hardware. CRL63R is organized into sections for fast and easy product reference. It's part of CRL's series of Master Catalogs that serve the glass industry and related businesses, each focusing on one of our core business groups.



### View Any Page of the CRL63R Online at [crlaurence.com](http://crlaurence.com)

Viewing the CRL63R Catalog online is as easy as 1-2-3. Simply start from our home page, [crlaurence.com](http://crlaurence.com), and click on CRL Catalog Library.

1



2



Then choose a viewing option. It's that easy!

3



### Technical Assistance for Architectural Railings

Live consultation by phone is available from 6:00 am to 5:00 pm (Pacific Time) Monday through Friday, and 7:00 am to 12:00 pm on Saturday.

Ask for Extension  
**7730**

Direct Fax  
**(800) 587-7501**

Direct E-Mail  
[railings@crlaurence.com](mailto:railings@crlaurence.com)



# FRAMELESS SHOWER HARDWARE CATALOG

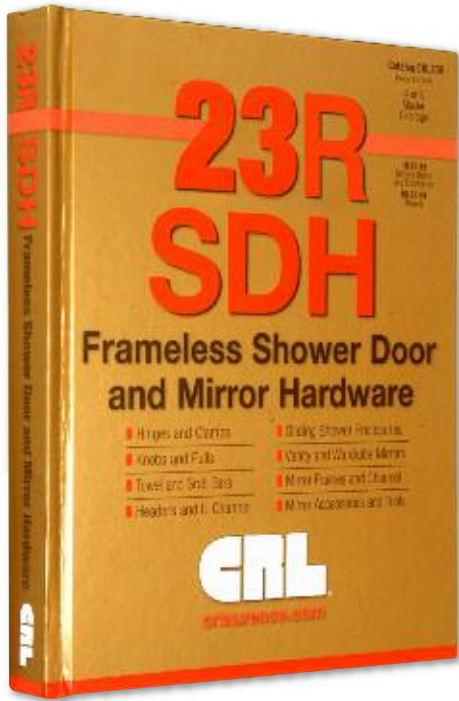

**CAT. NO. CRL23R**

Over 400 full-color pages, including an extensive A to Z Product Index for quick look-up of products

## CRL Frameless Shower Door and Mirror Hardware Master Catalog CRL23R

- Hinges and Clamps
- Knobs and Pulls
- Towel and Grab Bars
- Headers and U-Channel
- Sliding Shower Enclosures
- Vanity and Wardrobe Mirrors
- Mirror Frames and Channels
- Mirror Accessories and Tools

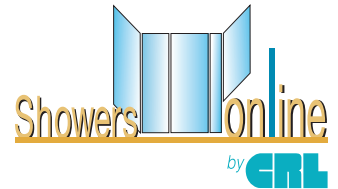

Ask about a FREE 30-Day Trial of Showers Online, our Web-based glass sizing and estimating program

CRL23R is the catalog you need when you are looking specifically for frameless shower and mirror hardware. CRL23R features thousands of products, including hundreds of new products selected for their appeal to your customers. The CRL23R Frameless Shower Door and Mirror Hardware Master Catalog is separated into four sections for fast and easy product reference. It's the fourth in CRL's series of eight Master Catalogs that serve the glass industry and related businesses, each focusing on one of our core business groups.



### View Any Page of the CRL23R Online at [crlaurence.com](http://crlaurence.com)

Viewing the CRL23R Catalog online is as easy as 1-2-3. Simply start from our home page, [crlaurence.com](http://crlaurence.com), and click on CRL Catalog Library.

1



2



Then choose a viewing option. It's that easy!

3



### Technical Assistance for Frameless Shower Hardware

Live consultation by phone is available from 6:00 am to 5:00 pm (Pacific Time) Monday through Friday, and 7:00 am to 12:00 pm on Saturday.

Ask for Extension  
**7740**

Direct Fax  
**(800) 458-7496**

Direct E-Mail  
[showers@crlaurence.com](mailto:showers@crlaurence.com)



# AUTOMOTIVE CATALOG

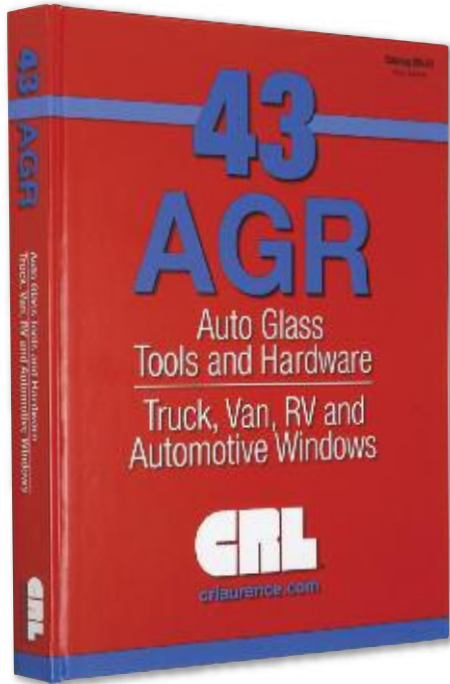

**CAT. NO. CRL43**

Over 400 full-color pages, including an extensive A to Z Product Index for quick look-up of products

## CRL Auto Glass Tools and Hardware Master Catalog CRL43

- Truck, Van, RV, and Automotive Windows
- Auto Glass Adhesives and Sealants
- Auto Glass Shop Tools and Equipment
- Cleaning Supplies and Lubricants
- Automotive Weatherstrips, Moldings, and Replacement Gaskets
- Auto Glass Clips and Fasteners
- Safety Gear and First Aid Kits

The CRL43 Auto Glass Catalog focuses on tools, equipment, supplies, safety gear, and accessories used by the auto glass industry. The CRL43 Auto Glass Master Catalog is separated into five sections for fast and easy product reference. It's the first in CRL's series of eight Master Catalogs that serve the glass industry and related businesses, each focusing on one of our core business groups.



### View Any Page of the CRL43 Online at [crlaurence.com](http://crlaurence.com)

Viewing the CRL43 Catalog online is as easy as 1-2-3. Simply start from our home page, [crlaurence.com](http://crlaurence.com), and click on CRL Catalog Library.



**1**



**2**

Then choose a viewing option. It's that easy!



**3**

### Technical Assistance for Automotive Accessories

Live consultation by phone is available from 6:00 am to 5:00 pm (Pacific Time) Monday through Friday, and 7:00 am to 12:00 pm on Saturday.

Ask for Extension

**7780**

Direct Fax  
(800) 587-7501

Direct E-Mail

[automotive@crlaurence.com](mailto:automotive@crlaurence.com)



# U.S. ALUMINUM STOREFRONT CATALOG

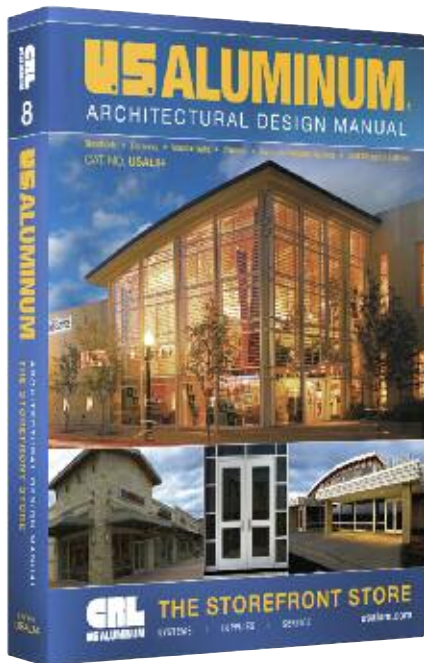

CAT. NO. USAL14

Over 500 pages of extensive information on Entrances, Storefronts, Window Walls, Windows, Hurricane Resistant, and Blast Mitigation Systems.

## U.S. Aluminum The Storefront Store Architectural Design Manual USAL14

- Storefronts
- Entrance Doors
- Window Walls
- Windows
- Hurricane Resistant Systems
- Blast Resistant Systems

Our USAL14 Architectural Design Manual will show you how simple it can be to get into the storefront installation and repair business. U.S. Aluminum has designed and engineered a number of proven and attractive storefront systems with long-lasting quality, reliability, and durability. Whatever the climate and environment, our storefront systems are known performers that deliver value on a daily basis.

The USAL14 Architectural Design Manual has over 500 pages of extensive information on Aluminum Entrance Doors, Storefronts, Window Walls, Windows, Hurricane (Impact) Resistant Systems, Blast Mitigation Systems, 'All-Glass' Entrances, and Interior Office Front Systems, including an A to Z Index for quick look-up of products. Organized into sections for fast and easy product reference, the USAL14 Architectural Design Manual is your premier source for all things storefront.



### View Any Page of the USAL14 Online at [crlaurence.com](http://crlaurence.com)

Viewing the USAL14 Catalog online is as easy as 1-2-3. Simply start from our home page, [crlaurence.com](http://crlaurence.com), and click on CRL Catalog Library.

1



2



Then choose a viewing option. It's that easy!

3



### Technical Assistance for U.S. Aluminum Storefront Systems

Live consultation by phone is available from 6:00 am to 5:00 pm (Pacific Time) Monday through Friday, and 7:00 am to 12:00 pm on Saturday.

Ask for Extension

# 5305

Direct Fax  
(866) 262-3299

Direct E-Mail  
[usalum@crlaurence.com](mailto:usalum@crlaurence.com)



C.R. LAURENCE COMPANY

[crlaurence.com](http://crlaurence.com) | [usalum.com](http://usalum.com)

XXX | [crlaurence.ca](http://crlaurence.ca) [crlaurence.com.au](http://crlaurence.com.au) [crlaurence.co.uk](http://crlaurence.co.uk) [crlaurence.de](http://crlaurence.de) [crlaurence.eu](http://crlaurence.eu)



# U.S. ALUMINUM CURTAIN WALL CATALOG

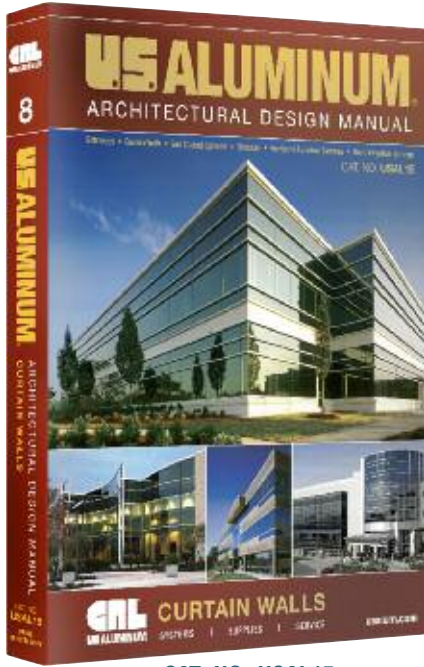

## U.S. Aluminum Curtain Wall Architectural Design Manual USAL15

- Entrance Doors
- Windows
- Curtain Walls
- Hurricane Resistant Systems
- Sun Control Systems
- Blast Resistant Systems

Our USAL15 Architectural Design Manual offers you a full range of curtain wall systems with superior thermal performance. The quality, performance, and aesthetic beauty of our products permit architects and designers to fully utilize the unique structural properties of aluminum for both interior and exterior design. Finishes range from custom matched painted coatings to a wide selection of clear, bronze or black anodic finishes.

Our engineering staff constantly updates product design to satisfy the performance requirements and economic concerns of today's most demanding projects. After design, certified independent testing labs test our systems to the highest industry standards.

The USAL15 Architectural Design Manual has over 500 pages of extensive information on Aluminum Entrance Doors, Curtain Walls, Sun Control Systems, Windows, Hurricane (Impact) Resistant Systems, Blast Mitigation Systems, 'All-Glass' Entrances, and Interior Office Front Systems, including an A to Z Index for quick look-up of products. Organized into sections for fast and easy product reference, the USAL15 Architectural Design Manual is your guide for the selection of efficient and attractive curtain wall systems.

### CAT. NO. USAL15

Over 500 pages of extensive information on Entrances, Curtain Walls, Sun Control Systems, Windows, Hurricane Resistant, and Blast Mitigation Systems.



### View Any Page of the USAL15 Online at [crlaurence.com](http://crlaurence.com)

Viewing the USAL15 Catalog online is as easy as 1-2-3. Simply start from our home page, [crlaurence.com](http://crlaurence.com), and click on CRL Catalog Library.

1



2



Then choose a viewing option. It's that easy!

3



### Technical Assistance for U.S. Aluminum Curtain Wall Systems

Live consultation by phone is available from 6:00 am to 5:00 pm (Pacific Time) Monday through Friday, and 7:00 am to 12:00 pm on Saturday.

Ask for Extension

# 5305

Direct Fax  
(866) 262-3299

Direct E-Mail

[usalum@crlaurence.com](mailto:usalum@crlaurence.com)



# SPECIALTY HARDWARE CATALOGS

## CRL Specialty Catalogs

- Full Color Catalogs Showcasing Specific Product Lines
- Great for Customer Presentations
- The Latest Product Updates

CRL Specialty Catalogs are available for some of our major product lines. Each catalog is presented in full color, and contains descriptive and informative specifications that will assist your field sales and estimating staff in the selection of the right product to satisfy your customer's needs. We invite you to contact CRL Customer Service by phone, fax, mail or e-mail. You can order them separately, or add them to your regular product orders. You can also view them over the Internet, or download them when you visit our Catalog Library at [crlaurence.com](http://crlaurence.com).



CRL is your source for the largest selection of Frameless Shower Door Hardware and Supplies. See it all, plus a gallery of finished installations, in this informative catalog.

ASK FOR CATALOG SD12

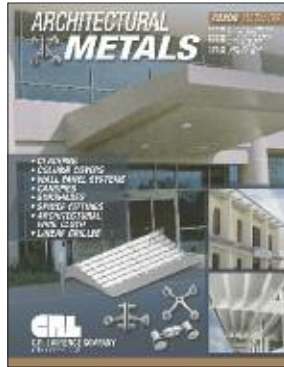

We fabricate an extensive selection of architectural metal systems and related hardware for the construction of beautiful and code-compliant building facades.

ASK FOR CATALOG AM09

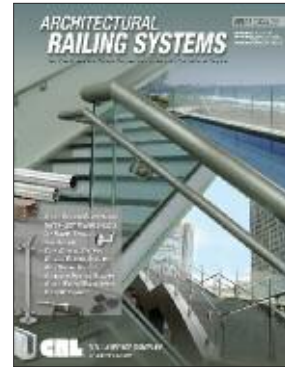

CRL offers the largest selection of Architectural Railing Systems. See them all, plus beautiful photographs of finished installations, in our Railing Systems Catalog.

ASK FOR CATALOG HR11



Our Architectural Hardware Catalog features our expanded selection of architectural metal and glass hardware for construction of the 'all-glass' entrances in commercial office buildings and storefronts. There are photos of finished projects, as well as helpful technical data to help you create your designs.

ASK FOR CATALOG AH11



We've expanded our selection of architectural metal and glass hardware for the construction of entrances in commercial, retail, and residential buildings. Over 400 pages of color photos of finished projects, as well as helpful technical data.

ASK FOR CATALOG CRL14D



Our line of Door Closers and related Door Control Hardware can be found in this full color catalog. Specifications and ordering information make it easy for you to select the right product every time.

ASK FOR CATALOG DC14



See the latest in top quality Transaction Hardware and bullet resistant exchange products, beautifully illustrated with specifications and installation photographs.

ASK FOR CATALOG TH10

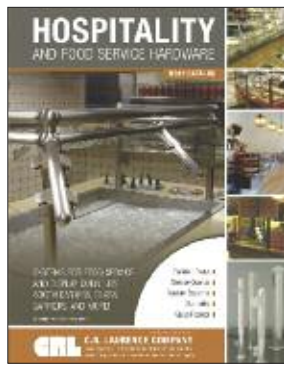

Your source for the largest supply of stock and custom products for the Hospitality and Food Service Markets. See it all with beautiful photographs in this informative catalog.

ASK FOR CATALOG HS12

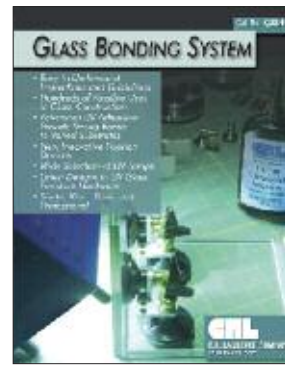

See the latest in UV Glass Bonding tools and accessories including UV Adhesives, Fixation Devices, Curing Lamps, and Unique Hardware. Loaded with full color photos and technical data.

ASK FOR CATALOG GB10

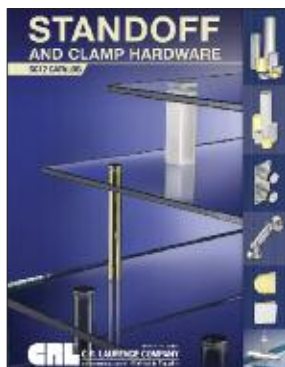

A complete family of Standoff related products. From our standard line of Round and Square Standoffs, Cap Assemblies, Tube Style Standoffs, Edge Grips, Slot Mount Standoffs, Accent Rings, Swivel Fittings, Framepegs, and Mounting Hardware, CRL has everything you will need to create innovative designs.

ASK FOR CATALOG SC12



SCR14 offers you a full range of Screen Doors with superior security performance. Included is the full line of Columbia Manufacturing Corp., and the new Guarda Protective Security Screens.

ASK FOR CATALOG SCR14



Our Truck and Van Accents Catalog details the CRL automotive product line of quality truck sliders, sunroofs, van windows, and other automotive accessories.

ASK FOR CATALOG TV12A

# 1

## Glazier's Tools

- ABRASIVE BELTS
- BELT SANDERS
- CIRCLE CUTTERS
- DRILLING MACHINES
- GLASS CUTTERS
- GLASS DRILLS
- GLASS MARKERS
- GLASS SAWS
- GLAZING PLIERS
- PLASTIC CUTTERS
- RULES AND SQUARES

See other side for Section Index.

**CRL**  
**US ALUMINUM**  
crlaurence.com • usalum.com

# SECTION 1 INDEX

For a complete index to this catalog, turn to Section 7. To search for all CRL products, go to CRL Total Search at [crlaurence.com](http://crlaurence.com).

3M® Abrasives .....185K, 192K, 196K

## A

Abrasives .....177K, 179K-193K, 195K-196K  
 Aerosol Plastic Cleaner.....149K  
 Amazing Glazing Diamond Products .....161K, 165K, 176K  
 Angle Protractor.....132K

## B

Ball End Glass Cutters.....109K-110K, 112K, 117K  
 Base Rings .....171K  
 Belt Lubricants .....180K  
 Belt Sanders .....179K-192K  
 Bench Model Wet Belt Sander.....186K  
 Blades, Diamond Saw .....176K

## C

Carbide Point Scriber and Marker .....137K  
 Carbide Wheel Gold-Tip Glass Cutters .....112K  
 Center Coolant Chucks .....157K  
 Chipping Tool .....130K  
 Circle and Oval Cutters .....127K-129K  
 Cleaning and Polishing Products.....104K-105K  
 Comfort-Grip Supercutter.....116K  
 Concentrate Glass Cleaner .....105K  
 Coolant, Diamond Tool .....167K  
 Cordless Glass Saws .....174K-176K  
 Core Drill Coolant Feeder .....165K  
 Corner Nipper Glass Pliers .....141K  
 Corner Radius Cutter.....126K  
 Crystolon Rubbing Brick .....196K  
 Custom-Grip Supercutter® .....115K  
 Cutter Oiling Stand .....122K  
 Cutters, Glass .....108K-120K, 123K-129K  
 Cutters, Plastic.....146K-148K  
 Cutting Frame.....132K  
 Cutting Guide .....126K

## D

Deluxe Brass Oil Cutter .....114K  
 Deluxe Spring Clamps .....135K  
 Diamantor Wooden Handle Glass Cutters .....108K  
 Diamond Router Bits .....172K-173K  
 Diamond Tip Glass Cutters.....126K  
 Diamond Tool Coolant.....167K  
 Dixon Markers .....136K-137K  
 Double Edge Plastic Cutters .....147K  
 Double Edge Razor Blades .....147K  
 Drilling Machines.....152K-156K, 158K  
 Drills for Glass and Accessories .....160K-171K  
 Drills for Plastic Materials .....148K  
 Drop Jaw Glass Pliers .....138K

## E

Electro-Formed Diamond Drills .....162K  
 Engraver .....137K  
 European Abrasive Belts (Metric).....192K  
 European Style L-Square .....132K  
 European Upright Wet Belt Sanders.....188K  
 Evaporating Glass Cutting Oil.....121K

## F

FastCUT Glass and Metal Optimizing Software .....144K  
 Flare Jaw Glass Pliers .....138K  
 Flexible Diamond Hand Pads.....196K  
 Freeze-It Spray Propellant.....143K

## G

Gauge Glass Cutter.....126K

Glass Cleaner .....104K-105K  
 Glass Cutting Turrets and Wheels .....111K-113K, 124K-125K, 127K  
 Glass Running Pliers .....139K-140K  
 Glass Sling Shot Kit .....143K  
 Glazier's Rule Holder.....135K  
 Glazing Pliers.....138K-142K  
 Grip Strip.....135K

## H

Habit Fit Diamond Drills .....164K  
 Hand Glass Seamer.....196K  
 Hand Pads, Abrasive .....196K  
 Heavy-Duty 6 Wheel Glass Cutters.....110K  
 Heavy-Duty Oil-Type Glass Cutters.....119K  
 Hi-SHEEN Glass Cleaner.....104K

## I

Industrial Cutting Wheels .....113K

## L

Lens Cutter Circle Machine .....129K  
 Lightweight Glass Running Pliers .....139K  
 Lint-Free Wipes .....105K  
 Listo Marking Pencils.....137K

## M

Measuring and Marking Tools .....131K-137K  
 Metal Handle Glass Cutters .....109K-110K, 112K  
 Mini Diamond Drills .....167K  
 Mini L-Square.....132K  
 Mini Water/Coolant Adapter .....157K  
 Mirror Drilling Machines.....152K-154K  
 Mirror Drills .....160K-165K, 167K-170K  
 Mirror Notching Saw .....175K  
 Multi-Function Tool .....179K

## O

Offset Glass Breakers .....140K  
 Offset Pliers.....140K  
 Oil Type Glass Cutters.....114K-120K  
 Oil T-Cutters .....123K  
 Oiling Stand.....122K  
 Original Supercutter .....115K

## P

Paint Markers .....137K  
 Phenolic L-Squares.....131K-133K  
 Phenolic Straight Edges .....134K  
 Phenolic T-Squares .....132K  
 Plate Glass Lifter .....141K  
 Plated Diamond Saw Blades.....176K  
 Pliers.....138K-142K  
 Polishing Oil .....180K  
 Portable Belt Sanders .....179K-185K  
 Power Breaker Set for Thick Glass .....142K  
 PPG Glass Running Pliers.....139K  
 Precision Circle Cutters .....127K  
 Precision Cut Opener .....142K  
 Prismatic Glass Drills .....169K  
 Production Diamond Glass Drilling Machine.....153K  
 Production Oil T-Cutters.....123K  
 Production Speed Cutters .....124K  
 Professional Glass Cutter Oil.....121K

## R

Ready Mix Glass Cleaner.....105K  
 Replacement Blades, Plastic Cutter .....146K  
 Replacement Cutting Heads .....110K, 114K-120K, 123K-124K

Replacement Head, Speed Cutter .....124K  
 Replacement Rollers, Speed Cutter .....124K  
 Resin Bond Diamond Saw Blades .....176K  
 Round Edge Template Guide .....130K  
 Router Bits.....172K-173K  
 Rubber Base Rings.....171K  
 Rubbing Bricks.....196K

## S

Sanders .....179K-189K, 192K  
 Sanding Belts.....179K-193K  
 Saw Blades, Diamond .....175K-176K  
 Saws for Glass.....174K-176K  
 Scalloping Tool and Positioners .....130K  
 Scribing Tool, Carbide Point.....137K  
 Segment Radius Cutter .....126K  
 Self-Oiling Circle Supercutter®.....127K  
 Self-Oiling Glass Cutters.....114K-120K  
 Sharpie Blue Fine Point Pen.....137K  
 Silicon Carbide Grain .....168K  
 Small Diameter Glass Drills .....160K-164K  
 Soft Nose Glass Pliers.....138K  
 Spearpoint Glass Drills.....169K  
 Speed Cutters .....124K  
 Sprayway Glass Cleaner .....104K  
 Squeeze and Pop Glass Cutter .....126K  
 Stabilo Glass Marking Pencils and Pens .....136K  
 Stalter Wheel Assemblies.....112K  
 Standard Plated Diamond Drills .....160K  
 Standard Wheels and Straight Axles .....112K  
 Stick-On Sanding Discs .....195K  
 Straight Edges.....134K  
 Straight Jaw Glass Pliers .....138K  
 Suction Base Drilling Rings.....171K  
 Suction Cup Straight Edges .....134K  
 Supercutter Circle Cutter .....127K  
 Supercutter Glass Cutters.....110K, 115K-116K, 119K-120K  
 Swivel Drill Machine.....154K

## T

Template Guide, Round Edge .....130K  
 Thick Glass Cut Opening Tapper .....141K  
 Thick Glass Supercutter .....120K  
 Thomas-Grip Supercutter .....116K  
 Three-in-One Glass Drill .....170K  
 Touch-Up Markers.....137K  
 TOYO® Glass Cutters .....110K, 115K-116K, 119K-120K, 127K  
 TP2800 Deluxe Brass Oil Cutter .....114K  
 Tripod Glass Drilling Machine .....152K  
 Tube Drills .....168K  
 Tube Wax Lubricant.....180K  
 T-Squares .....132K

## U

Upright Wet Belt Sanders .....186K-189K

## V

Vacuum Base Portable Drilling Machine .....156K  
 Variable Speed Drilling Machine.....152K-154K  
 Vertical Glass Drilling Machine .....158K-159K

## W

Wet Abrasive Belts.....186K-192K  
 Wet Belt Sanders .....186K-189K  
 Wheels, Glass Cutter .....111K-113K, 120K, 125K  
 White Marking Pens .....136K  
 Wood Handle Glass Cutters.....108K



**C.R. LAURENCE COMPANY**

[crlaurence.com](http://crlaurence.com) | [usalum.com](http://usalum.com)

**US ALUMINUM**

[crlaurence.ca](http://crlaurence.ca)

[crlaurence.com.au](http://crlaurence.com.au)

[crlaurence.co.uk](http://crlaurence.co.uk)

[crlaurence.de](http://crlaurence.de)

[crlaurence.eu](http://crlaurence.eu)

# SECTION 1

## Glazier's Tools

### QUICK INDEX

For a complete index to this catalog, turn to Section 7. To search for all CRL Products, go to CRL Total Search at [crlaurence.com](http://crlaurence.com).

#### Glass Cutting Tools – Pages 106K to 130K



#### Glass Measuring and Marking Tools – Pages 131K to 137K



#### Glass Breaking and Running Tools – Pages 138K to 143K



#### Plastic Cutting Tools – Pages 146K to 149K



#### Glass Drilling Tools – Pages 150K to 171K



#### Glass Sawing and Routing Tools – Pages 172K to 176K



#### Glass Sanding Tools – Pages 177K to 196K



## C.R. Laurence: Supplier to the Glazing Industry

The C.R. Laurence brand is well known as the world's leading supplier to the glazing industry. CRL has continued to grow from its original 5,000 square foot Los Angeles, California facility in 1966 into a global distributor featuring a product line of 60,000+ products with over 30 service centers located on three continents.

For more than 50 years C.R. Laurence has been outdistancing the competition because of our ability to adapt and incorporate new technologies and methods to the way we do business. We were the first to provide customers with toll free telephone ordering, and then later toll free fax service. Our web site contains our complete product selection and provides our customers with the ability to order whatever supplies they need at any time of the day. One of our goals at C.R. Laurence is to ensure the shopping experience of our customers is as quick and easy as possible. We want you to know that CRL has what you need and the ability to get it to you when you need it.

It is no coincidence that CRL finds itself the preeminent distributor to the glazing industry. The hard work of the more than 1,000 employees around the world and the knowledge of our experts in the glazing field make us a welcome choice for our customers.



## CRL Product Managers Work With Customers to Improve Glazing Technology

The products we produce and distribute are often the ideas of experienced glazing professionals. C.R. Laurence recognizes that no one knows better what is needed in a tool than the individuals who use those tools each and every day. One of the reasons CRL stays at the top of the glazing industry is because of the feedback from our customers.

CRL will work with customers who have ideas of how to improve on an existing design or have completely new ideas for glazing tools. Combining the extensive knowledge of our customers with that of our own Product Managers creates an unbeatable team with the ability to stay on the cutting edge in the field of glazing innovation.

To submit an idea for a new tool please fill out the "New Product Submittal Form" found on our web site, [crlaurence.com](http://crlaurence.com). Start at "CRL Total Search" menu then click on the "Charts, Guides, and Forms" section, then click on "New Product Submittal" and follow the instructions. You can also contact CRL's Product Managers direct at (800) 421-6144 in the U.S., (877) 421-6144 from Canada, or (323) 588-1281 International.

Online "New Product Submittal Form"



Tools Designed by CRL Customers



## Some Good Advice on Customer Satisfaction

### • Delivering the Finishing Touch

Nothing shows you care about quality as much as leaving a thoroughly clean end product when you leave the job site. A job left unclean can quickly turn off customers who have trusted your experience and craftsmanship.

CRL has a complete line of glass cleaning products ranging from ammoniated and non-ammoniated aerosols to bulk concentrate glass cleaners, glass stain removers, and glass surface protectants. We offer detergents for production glass washing machines and masking materials to protect glass during transit and installation. Also available are the tools to apply our cleaners, and a host of wipes for making sure the end result is sparkling clean. We have what you need to make sure the product you present to your customers is as clean as it can possibly be. Advertise your company by leaving a can of Logo or Private Label Glass Cleaner. Contact CRL Customer Service for details and pricing for this unique service.

## Clean Before You Cut

### • Achieving Optimal Cutting Results

With our experienced staff and our years in the glazing industry, CRL is a trusted name when looking for glazing tools and products, or for information and advice related to their use.

One of the most important, yet under-emphasized aspects of working with glass is cleanliness. To get quality cutting results it is imperative that glass be thoroughly cleaned before any cutwork is done. Very often lites of glass arrive at the job site or workshop with residue from packaging or transportation. In order to achieve maximum clarity from the glass and a precise score line all residue must be removed before work can begin.

CRL's glass cleaning products range from aerosols to bulk liquid concentrates to granulated detergents used in production line glass washing machines. All have been tested through years of use by the glass industry. And all can be relied upon to assure consistently clean glass, thus aiding in the efficiency of your glass cutting operations.



## Working Smart, Not Hard

### • Doing It the Right Way Using Quality Tools and Supplies

CRL's complete selection of cleaning tools and supplies will help to ensure efficiency in your cleaning efforts and the satisfaction of your clients. The cleaning tools on display in our catalogs and on our web site are intended to make tough cleaning jobs easy and quick. Why work hard when you can work smart?

Every cleaning product we offer is of the highest quality because we know that our customers depend on what they purchase from CRL to provide them with quality results. We make every effort to offer only the best tools and cleaning agents available at reasonable prices. And we strive to seek out new tools that will lessen your workload whenever they become available so you can do it right and get results that are even better than you expect.



## CRL's Selection of Glass Cleaners

CRL's selection of Glass Cleaners has long been considered the most complete and comprehensive in the glazing industry. The vast assortment of choices allows you and your customers to always select your favorite Cleaner plus the option to have your company logo or private label on each can. CRL's entire line of Glass Cleaners can be viewed online at [crlaurence.com](http://crlaurence.com) by simply entering "Glass Cleaners" into the search box on the home page.

### CRL 1973 Glass Cleaner

- A Long Time Favorite of the Glass Industry
- Low-Ammoniated Formula
- Pleasant Aroma



CRL 1973 Glass Cleaner, a long time favorite of CRL customers, is a low ammoniated glass cleaner that is packaged in original 19 ounce (539 g) cans and new 4 ounce (113 g) Mini cans. CRL 1973 features effective cleaning agents and a pleasant aroma, with the added feature of Sprayway's logo, so your customers will be able to identify the quality of this product. Minimum order is one case of 12 cans (1973) or 24 cans (1973M).

**NOTE:** Also available with your **Logo** or **Private Label** right on the can. Contact CRL Customer Service for details and pricing for this unique service.



Comfort-Use Finger Pad Nozzle on 1973, Hi-SHEEN® and S50 Glass Cleaners



CAT. NO. 1973  
19 oz. (539 g)

SIZE **new**



CAT. NO. 1973M  
4 oz. (113 g)



### CRL/Somaca Hi-SHEEN® Glass Cleaner

- Industrial Strength Cleaner
- Low-Ammoniated Formula
- Won't Leave Streaks, Blurs or Rainbows

Somaca/CRL Hi-SHEEN® Glass Cleaner has been faithfully cleaning commercial and residential glass since 1970. It's dependable, no-nonsense aerosol formula is the reason, year after year, Somaca/CRL Hi-SHEEN® is always a popular product! Having an effective, reliable glass cleaner is just as important today as it was 40 years ago. This is a great resale item for glass shops. Minimum order is one case of 12 cans.

**NOTE:** Also available with your **Logo** or **Private Label** right on the can. Contact CRL Customer Service for details and pricing for this unique service.



Resale Display Carton



CAT. NO. 3371100  
19 oz. (538 g)

### CRL S50 Sprayway® Glass Cleaner

- Ammonia Free Formula
- Fast Evaporation Rate, Just Spray and Wipe Clean

CRL S50 is Sprayway's® leading glass cleaner. The formula includes perfume-grade alcohols, which are the best cleaning agents you can use. It also has a fast evaporation rate, which keeps it from leaving a film and adversely interacting with other materials. Large 19 ounce (539 g) cans are packed 12 per case. Minimum order is one case.

**NOTE:** Also available with your **Logo** or **Private Label** right on the can. Contact CRL Customer Service for details and pricing for this unique service.

Sprayway is a registered trademark of Claire-Sprayway, Inc.



CAT. NO. S50  
19 oz. (539 g)



## CRL Lint Free Glass Wipes

- Strong, Four-Ply White Paper Wipes are Virtually Lint Free
- Reinforced Nylon Scrim in Both Directions So They Work Great Wet or Dry
- Convenient Pop-Up Dispenser Box

Extra-tough CRL Lint Free Glass Wipes bring the absorbing power you need in a lighter weight material that's reinforced with a nylon scrim for extra strength. The ripple texture makes them easy to hold during use, and provides just the right amount of surface area for cleaning solutions to do their work.

CRL Lint Free Glass Wipes have no adhesives or binders so they leave nothing behind except clean, lint free surfaces. Besides glass, they are ideal for your most demanding shop clean up tasks.

CRL Lint Free Glass Wipes measure a big 16-1/2" x 9-3/4" (419 x 248 mm). Each case has six pop-up boxes containing 150 Wipes each for a total of 900 Wipes per case. **NOTE:** Order Cat. No. K73900 Wall Mount Bracket to Mount BX15 to a wall.



**CAT. NO. 1550**  
900 Wipes Per Case

- Six Pop-Up Boxes in Each Case

**CAT. NO. BX15**  
150 Wipes Per Box



CAT. NO.	DESCRIPTION
1550	Case of 900 Wipes
BX15	Box of 150 Wipes

Minimum order: 1 case of 1550 or 1 box of BX15.

## CRL Micro Fiber Wipes

- Streak Free Cleaning on Windows and Mirrors
- Washable Up to 500 Times



CRL Micro Fiber Wipes have thousands of microscopic fibers that trap dirt and grime to increase cleaning effectiveness and reduce cleaning and drying times. Our large 16" x 16" (406 x 406 mm) size takes on big polishing, waxing, cleaning, and dusting jobs, and when you're done you can simply machine wash them (without fabric softener). Packed two per poly bag with a hanger hole so you can also offer them for resale to your customers.

CAT. NO.	DESCRIPTION	QTY/PACK
MFW2	Micro Fiber Wipes	2

Minimum order: 1 pack.

## CRL Mirror and Glass Cleaner

- Non-Streaking, Environmentally Safe Formula
- Contains No Ammonia or Vinegar



5 Gallons (18.9 l)

CRL Mirror and Glass Cleaner is an all-purpose cleaner that contains no ammonia or vinegar to harm mirror backing. Non-streaking, environmentally safe formula. Sold in a five gallon boxed container with an easy-pour spout included. Spray on glass with Cat. No. DB21 or Cat. No. 3371032 Dispensers (see page 170K). Minimum order is one each.

**CAT. NO. 3377000**

## CRL Concentrate Glass Cleaner

- One Gallon of Concentrate Makes 10 Gallons of Strong Cleaning Fluid

The most popular Glass Cleaner for in-shop and on-the-job use. It's easy to use and leaves no film or smears on glass. It's easy to mix-one gallon makes ten gallons of strong, safe cleaning fluid. Use it with less water for those extra tough cleaning jobs. 695 is also available in 55 gallon drums for industrial users.



CAT. NO.	CONTENTS	QTY/CASE
695	1 Gallon (3.785 l) Bottle	4
69555GL	55 Gallon (208 l) Drum	1

Minimum order: 1 gallon of 695 or 1 each of 69555GL.

## CRL Ready Mix Glass Cleaner

- Ready Mix Bulk Liquid
- Available in Private Label for Your Resale

Our professional strength Ready Mix Glass Cleaner is also available for bulk filling of your spray dispensers. It's precisely formulated to give great glass cleaning results without the effort of mixing it yourself. It is also available for resale in containers with your private label.



CAT. NO.	CONTENTS	QTY/CASE
895GL	1 Gallon (3.785 l) Bottle	4

Minimum order: 1 case.

## CRL Glass Cutting Introduction

The art and science of glass cutting, like every other craft known to man, has evolved and advanced as new technologies and new discoveries in material science have been developed. One of the earliest methods of glass "cutting" involved scratching, or scoring the glass surface with a fixed diamond point. Although still available from CRL, these diamond tip cutters are now relegated to those in the industry who were trained early on in their use.

The most common and efficient method of manually cutting glass today incorporates very precise oil delivery systems with finely machined, honed Tungsten Carbide alloy cutting wheels. All this in the palm of your hand, packaged in anything from clear high impact plastic resin handles to ergonomically designed, perfectly balanced brass handles.

The following pages represent the finest collection of cutting devices and accessories from around the world. Here you will find everything and anything needed by the glass cutting professional: from cutters to cutter pouches, marking pencils to hydraulic tilt cutting tables. However, if you are searching for something specific and you do not find it here, please call the industry professionals at CRL for help. Many products and services offered by CRL started out as the needs and ideas of people like you, working with the sharp end of the cutter.



### Manual Glass Cutting

Years of research and sales history have guided CRL in our efforts to provide the glass industry with the most current technology in hand glass cutting.

From wood handle, steel wheel economy glass cutters, to state-of-the-art brass handle self oiling carbide wheel cutters, CRL has the solutions your business requires. Hone angles ranging from 114 degrees for brittle stained glass, to 158 degrees for 3/4" (19 mm) and 1" (25 mm) thick glass, our selection will answer your needs.

Replacement steel or carbide wheels, replacement head assemblies, individual cutters or complete systems, you will find the best technology from around the world within these pages.

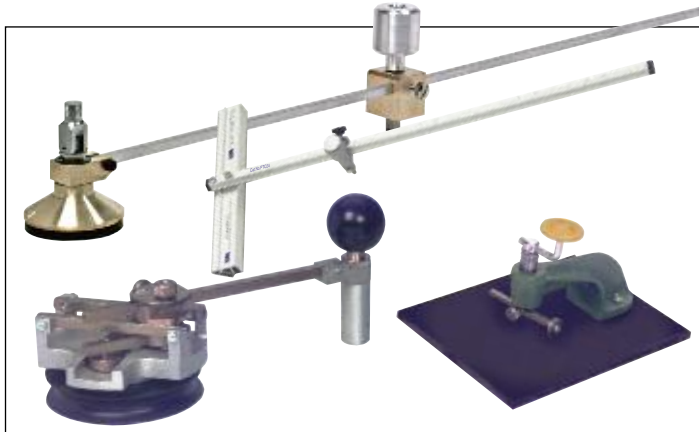

### Mechanically Assisted Glass Cutting

Although it is possible to cut a circle or oval freehand with no aids, perfect, repetitive patterns require some mechanical assistance. CRL offers the full range of tried and true circle cutters and oval cutters, as well as the most recent innovations in the industry.

This range of tools will be admired by the professional and appreciated by the novice. CRL can supply the tools you need for custom fabrication or repetitive production.

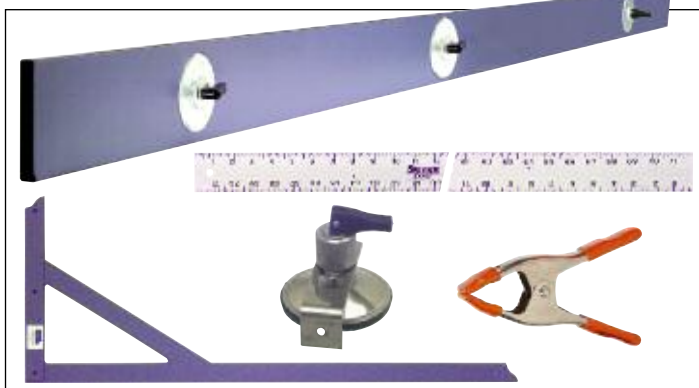

### Straight Edges and L-Squares

Whatever material you are cutting, regardless of thickness, the basic requirements are that cuts have to be exactly straight and the corners exactly square. CRL Phenolic Resin Straight Edge and L-Squares are fabricated in our own facilities under strict ISO-9001 guidelines. These products are certified accurate to within 1/16" (1.6 mm).

Further cutting accuracy is guaranteed by our assortment of clamps and vacuum devices designed to hold your edge guide exactly where you need it to be.

## CRL Glass Cutting Introduction



### Markers, Pens, Pencils, Engravers

"Measure twice, cut once" is an old adage, but it applies to glass cutting as well as any other craft. Even better is "measure twice, mark and cut once". CRL offers a full range of pencils, pens, felt markers, and engraving tools that can be used to mark cutting dimensions, label products and tools, and even touch up storefront metals.

From high tech paint dispensing pens to low tech carpenters crayons, CRL has the products that help you get the job done – and done right.



### Pliers and Break Out Tools

Every glazier will acknowledge that quality cutting tools are only half of the equation. Without the highest-quality running and break-out tools, the end result can only be mediocre.

The CRL selection of pliers and break out tools are manufactured to the highest standards of engineering, forging, milling, and assembly from sources all over the world. This focus on quality and engineering translates into quality craftsmanship for the end user, whether cutting and running single strength window glass or producing flare free heavy glass table tops.

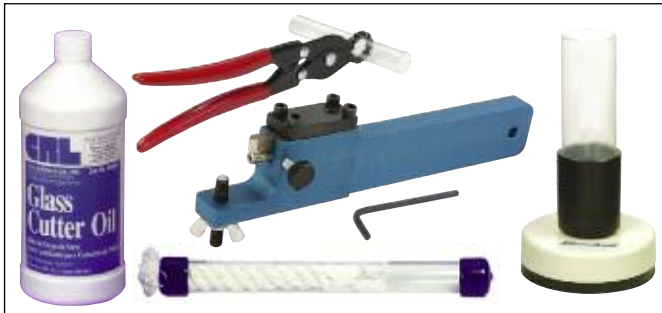

### Accessories and Specialty Tools

Just as important as the basic tools are the accessories that are necessary to produce quality finished products. Cutting oils formulated for specific applications, convenience products for applying oil and holding cutters, cutters for neon tube and other round products, patterns and templates, edge scalloping and chipping tools; all can be found here.



### Plastic Cutters and Accessories

Whether cutting plastic or acrylic products is a regular offering for your business or a once-in-a-while or as-needed occurrence, you will find the appropriate tools here.

From light-duty disposable cutters to heavy-duty tools designed to last a lifetime, you can choose the tool to fit your requirements. You can even choose blades to convert your common utility knives into heavy-duty plastic cutters. Everything you need can be found here.



### Cutting Tables and Accessories

Floor space, production volume and cost are important considerations when it comes to choosing a business asset such as a glass cutting table. Counterbalance, torsion spring, hydraulic, with or without air flotation, with or without breaker bars – whatever your requirements, and whatever volume you need to achieve, CRL has the cutting table options to satisfy your current and future needs.

## CRL Wood Handle Glass Cutters

- For General Purpose and Pattern Cutting
- Precision Steel Wheel
- Comfortable Wood Handle
- Nickel Plated Head
- Individually Sleeved
- Manufactured in the U.S.A.

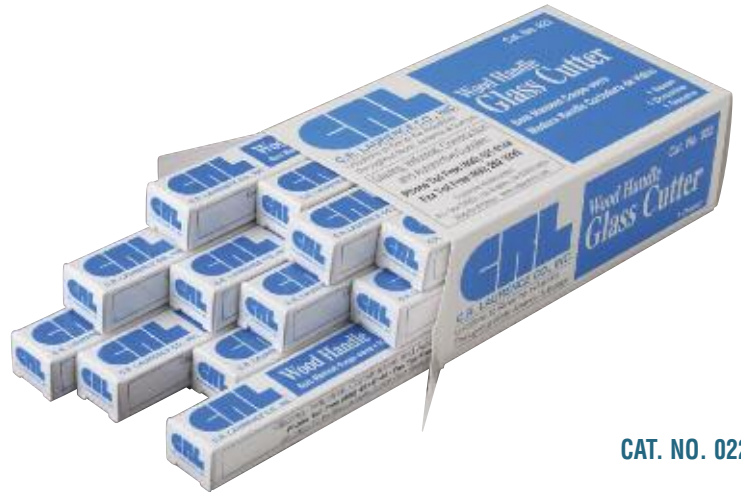

This is one of the most popular cutters in the industry. We combined a precision ground 122 degree steel cutting wheel with a solid, one-piece contoured handle to come up with the most practical and useful cutter on the market. The CRL 022 Cutter is ideal for general purpose and pattern glass cutting. This tool is first class all the way, from its nickel plated head through its smooth, comfortable grip. Its affordable price makes it even more attractive. Minimum order is one dozen.

**NOTE:** Not available in Australia.

CAT. NO. 022

## CRL Diamantor® Wood Handle Glass Cutters

- A Long Time Favorite of Professional Glaziers
- For General Purpose Cutting
- Comfortably Contoured Wood Handle
- Nickel Plated Head
- Individually Sleeved



These CRL Diamantor® Wood Handle Glass Cutters feature a precision ground steel cutting wheel set into a nickel plated steel head. This is attached to a contoured wood handle, balanced for cutting comfort stroke after stroke. Three breakout notches in the cutting head round out the fine features of the CRL Diamantor® 2001 Glass Cutter. Minimum order is one dozen.

**NOTE:** Not available in Australia.

Diamantor is a registered trademark of Bohle AG

CAT. NO. 2001

## CRL Metal Handle Ball End Glass Cutter

- For General Purpose Cutting
- High-Quality Glass Cutter With Preferred Ball End Handle
- Precision Machined Steel Wheel
- Individually Sleeved

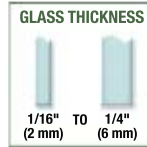

CAT. NO. 202

Our CRL Professional Glass Cutter incorporates the industry-preferred all-metal handle with ball end style. The outstanding features of CRL 202 Cutters include: precision machined 7/32" (5.5 mm) diameter steel cutting wheel, expertly honed for the highest cutting results; three different sizes of breaking grooves; and a comfortably contoured, streamlined metal handle with ball tip. This is a Cutter designed to be efficient and dependable. The most attractive feature is the surprisingly low price. Compared against other metal handle cutters, the CRL 202 Glass Cutter is undoubtedly your best buy. Minimum order is one dozen.

## CRL Fletcher® Gold Tip® Metal Handle Ball End Glass Cutter

- For General Purpose Cutting
- 120 Degree Hone Angle
- Classic Ball End Design
- Individually Sleeved

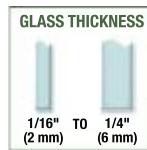

CAT. NO.	PACK
02	Dozen
2101006	Each

The CRL Fletcher® Gold Tip® General Purpose Glass Cutter has a ball end handle and features a 120 degree hone angle wheel with a phosphor bronze axle. This Cutter is very popular with professional glaziers, and is widely used throughout the glass industry. Sold by the dozen, each Cutter is individually boxed for protection. Minimum order is one dozen.

**NOTE:** 2101006 Cutter is sold individually.

## CRL Fletcher® Gold Tip® Metal Handle Straight End Glass Cutter

- For General Purpose Cutting
- 120 Degree Hone Angle
- Classic Straight End Design
- Individually Sleeved

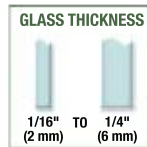

CAT. NO. 01

The CRL Fletcher® Gold Tip® General Purpose Glass Cutter has a straight end handle and features a 120 degree hone angle wheel with a phosphor bronze axle. This Cutter is very popular with professional glaziers, and is widely used throughout the glass industry. Sold by the dozen, each cutter is individually boxed for protection.

Fletcher and Gold Tip are registered trademarks of The Fletcher-Terry Company, LLC

## CRL Fletcher® Hard, Foreign, and Cathedral Glass Cutter

- Blue Band on Handle



A sharper angle on the cutting wheel gives the required deeper penetration, causing easier breaks, cleaner edges, and reduced waste. It requires less pressure so you do not tire as easily. Hone angle is 114 degrees. Individually carded and packed 10 per pack. Minimum order is one pack.

CAT. NO. 07

## CRL Fletcher® 1/4" and Thicker Float Glass Cutter

- Classic Ball End Handle



The wider angle cutting wheel on these Cutters reduces flaking and slivering. Hone angle is 130 degrees. Designed especially for cutting float glass. Individually boxed and packed in dozens. Handle is stamped 02A. Minimum order is one dozen.

CAT. NO. 02F

## CRL Heavy-Duty 6 Wheel Glass Cutter

- Best Selling Glass Cutter in Europe

This CRL Glass Cutter has six high grade carbide alloy wheels mounted in a Cat. No. T101 Turret on the nickel-plated cutting head. The contoured wood handle makes it comfortable for you to hold. Each Cutter is individually boxed and packed in dozens. Hone angle is 126 degrees. For replacement Cutter Turrets see Cat. No. T101 on opposite page. **NOTE:** Not available in Australia. Minimum order is one dozen.

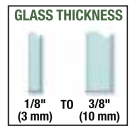

CAT. NO. G100

## CRL Glass Cutter and Pencil Pouch

- Made From Top Quality Leather
- Includes a Strap for Your Tape Measure or Pliers



This CRL Glass Cutter and Pencil Pouch is one of our most popular items. The leather pouch has three pockets to hold your pens, pencils, or glass cutter. In addition, a leather strap has been added to hold a measuring tape or pliers. The large top belt loop will fit belts up to 1-1/2" (38 mm) wide. Minimum order is one each.

CAT. NO. S5403

## CRL TOYO "Dry Wheel" Supercutters

- Interchangeable Heads
- Long-Lasting TOYO Carbide Wheels



CAT. NO. TC22



CAT. NO. TC20



CAT. NO. TC22H



CAT. NO. TC20H

CRL TOYO "Dry Wheel" Supercutters feature interchangeable heads mounted on a heavy brass collar. The molded handles are black wood grain resin for a positive grip. Hone angle is 140 degrees. Minimum order is one each for Cutters and Heads. **NOTE:** "Dry Wheel" refers to no self-oiling features. CRL strongly suggests the use of cutting oil.

Fletcher is a registered trademark of The Fletcher-Terry Company, LLC.

## CRL Replacement Cutter Turrets

- Fit a Wide Range of CRL Cutting Tools
- Six 134 Degree Tungsten Carbide Wheels
- High Quality and Long Life

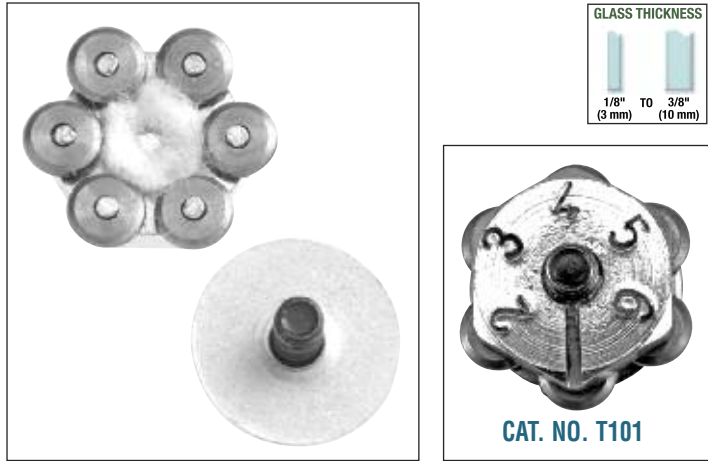

The CRL Replacement Turret will fit all the tools listed to the right. Each six position Cutting Turret is equipped with precision ground tungsten carbide cutting wheels with a hone angle of 134 degrees, making this the ideal cutter head for 1/8" through 3/8" (3 to 10 mm) glass. Minimum order is one each.

## CRL Replacement Cutting Wheels

- Tungsten Carbide
- Precision Machined
- Three Available Hone Angles

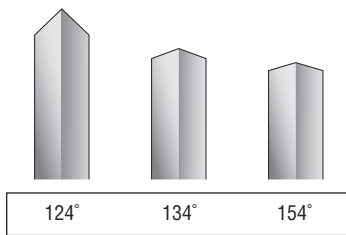

These CRL Replacement Cutting Wheels are precision milled tungsten carbide, and are designed as replacement wheels for the CRL Cutter Turrets shown above. However, the universal 5/32" (4 mm) wheel diameter will fit many modern cutter handles or housings. These Cutting Wheels are available in three different hone angles, covering the majority of glass cutting requirements. Wheels are sold by the dozen.

CAT. NO.	HONE ANGLE	PACKAGE
LW20	124 Degree	1 Dozen
LW21	134 Degree	1 Dozen
LW22	154 Degree	1 Dozen

Minimum order: 1 dozen.

## CRL Replacement Turrets and Wheels Fit The Following:



CAT. NO. G100



CAT. NOS. PSC200, PSC400, PSC600



CAT. NOS.  
530 and 532



CAT. NOS. 511CC, 512CC,  
514CC, and 516CC

## CRL Fletcher® Carbide Wheel Gold Tip® Glass Cutters

- The Gold Standard of Dry Cutters
- Quality Since 1868
- Ball or Straight Handle Styles



Your eyes can discern no difference between a Carbide Wheel Glass Cutter and a Steel Wheel Glass Cutter, but the difference is great. This is primarily reflected in the life and price. Since there is also a broad range of difference between carbides, we have selected the tungsten carbide that incorporates the best qualities for glass cutting. It is designed to deliver extremely long life and fine edge quality. CRL Fletcher® Gold Tip® Carbide Wheel Cutters are ideal for industrial use, and continuous high production cutting, because they're long lasting.

CAT. NO.	HONE ANGLE	WHEEL DIAM.	CUTTING USE	END STYLE
<b>CA2124</b>	124 Degree	7/32" (5.6 mm)	General Purpose	Ball
<b>CA1134</b>	134 Degree	7/32" (5.6 mm)	Thick, Float Glass	Ball

Minimum order: 1 each. Can be combined for quantity pricing.

CAT. NO.	HONE ANGLE	WHEEL DIAM.	CUTTING USE	END STYLE
<b>CA9122</b>	122 Degree	5/32" (3.9 mm)	Patterns	Ball
<b>CA8114</b>	114 Degree	5/32" (3.9 mm)	Hard Glass	Straight
<b>CA8134</b>	134 Degree	5/32" (3.9 mm)	Soft 1/2" (12 mm) Float Glass	Straight

Minimum order: 1 each. Can be combined for quantity pricing.

## CRL Standard Wheels and Straight Axles

- Choose From Steel or Carbide

Precision honed and machined to exact specifications, each and every Steel and Carbide Wheel is hand tested for uniformity of grade, temper and performance. Steel Wheels with axles are sold 10 per package; carbide wheels without axles are sold individually.

STEEL WHEEL CAT. NO.	CARBIDE WHEEL CAT. NO.	WHEEL DIAM.	HONE ANGLE	RECOMMENDED FOR
<b>F02312</b>	<b>F03314</b>	7/32" (5.6 mm)	114 Degree	Hard and Cathedral Glass
<b>F02313</b>	--	7/32" (5.6 mm)	120 Degree	General Purpose Use
--	<b>F03315</b>	7/32" (5.6 mm)	124 Degree	General Purpose Use
<b>F02314</b>	<b>F03316</b>	7/32" (5.6 mm)	134 Degree	Thicker Float and 1/4" (6 mm) Glass
--	<b>F03325</b>	5/32" (3.9 mm)	134 Degree	Prod. Cutting Soft Glass

Minimum order for Steel Wheels: 1 package of 10. Minimum order for Carbide Wheels: 1 each.



## CRL Wheel Unit Assemblies

- Steel or Carbide Wheels in Steel Shields

These quality wheel assemblies have a steel or carbide wheel revolving on a hardened steel axle within a hardened steel shield. Wheels are designed to fit Cat. No. HDG15 Heavy-Duty Hand Glass Cutters, 3000 and 8400 Series Machines, and CircleMate™ Cutters. Steel Wheel Units are sold in packages of 10, Carbide Wheel Units are sold individually.

STEEL WHEEL CAT. NO.	CARBIDE WHEEL CAT. NO.	WHEEL DIAM.	HONE ANGLE	RECOMMENDED FOR
<b>F02118</b>	<b>F03125</b>	7/32" (5.6 mm)	114 Degree	Hard Glass
<b>F02120</b>	--	7/32" (5.6 mm)	120 Degree	General Purpose Use
--	<b>F03126</b>	7/32" (5.6 mm)	124 Degree	General Purpose Use
--	<b>F03111</b>	7/32" (5.6 mm)	134 Degree	Thicker Float and 1/4" (6 mm) Glass
--	<b>F03129</b>	7/32" (5.6 mm)	154 Degree	Thick Glass

Minimum order for Steel Wheels: 1 package of 10. Minimum order for Carbide Wheels: 1 each.

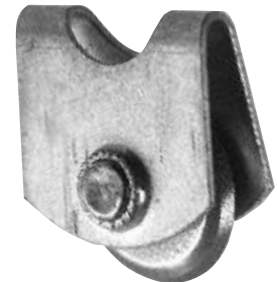

## CRL Wheel Assemblies for CRL Stalter Strip Cutters

- Steel and Carbide Wheels
- Mounted in Metal 'T' Housing

CAT. NO.	MATERIAL	HOUSING	HONE ANGLE
<b>35660022</b>	Carbide	Red	114°
<b>2103224</b>	Carbide	Yellow	124°
<b>35660026</b>	Carbide	Green	134°
<b>35660027</b>	Carbide	Blue	144°
<b>35660025</b>	Steel	Gold	126°



Minimum order: 1 each.

Fletcher and Gold Tip are registered trademarks of The Fletcher-Terry Company, LLC.



Cutting Heads on a CRL/Somaca Stalter Machine in action, cutting mirror strips.



## CRL Industrial Cutting Wheels and Accessories – European Market

CRL is proud to offer these quality Fletcher® Industrial Glass Scoring Wheels and Accessories. Since 1868 Fletcher-Terry has been the world leader in product innovation for all aspects of the glass cutting industry worldwide. The products listed on this page are the most popular items available to suit your specific needs. These tungsten carbide wheels are precision machined and honed for consistent results.



Available Only in Europe

Choose from "Quick Change" units complete with Carbide Wheels and Axles (colour coded for easy hone angle selection), or individual wheels and axles designed to fit ATF and M1 Wheel Holders (see below).

### CRL "Quick Change" Carbide Wheel Units

#### • Colour Coded

White 135° 4 mm Glass	Gray 140° 5 mm Glass	Gray 145° 6-8 mm Glass	Green 150° 8-10 mm Glass	Red 155° 10+ mm Glass
<b>CAT. NO.</b> PC215055135RG	<b>CAT. NO.</b> PC215055140RG	<b>CAT. NO.</b> PC215055145RG	<b>CAT. NO.</b> PC215055150RG	<b>CAT. NO.</b> PC215055155RG

### CRL Wheels Only

4.4 MM: USE HOLDER H, AXLE F

CAT. NO.	FINISH	HONE ANGLE
<b>C175055154RG</b>	Regular Grind	154°
<b>C175055160RG</b>	Regular Grind	160°

Minimum order: 1 each.

5 MM: USE AXLE D-E

CAT. NO.	FINISH	HONE ANGLE
<b>C196051135CR</b>	Coarse Grind	135°
<b>C196051140CR</b>	Coarse Grind	140°
<b>C196051145CR</b>	Coarse Grind	145°
<b>C196051150CR</b>	Coarse Grind	150°
<b>C196051155CR</b>	Coarse Grind	155°

Minimum order: 1 each. Note: No Wheel Holder Available.

5.6 MM: USE HOLDER G, AXLE F

CAT. NO.	FINISH	HONE ANGLE
<b>C221055135RG</b>	Regular Grind	135°
<b>C221055140RG</b>	Regular Grind	140°
<b>C221055145RG</b>	Regular Grind	145°
<b>C221055150RG</b>	Regular Grind	150°
<b>C221055155RG</b>	Regular Grind	155°
<b>C221055158RG</b>	Regular Grind	158°

Minimum order: 1 each.

5.79 MM: USE HOLDER I, AXLE F

CAT. NO.	FINISH	HONE ANGLE
<b>C228055140R</b>	Regular Grind	140°
<b>C228055144R</b>	Regular Grind	144°
<b>C228055155RG</b>	Regular Grind	155°

Minimum order: 1 each.

6.22 MM: USE HOLDER I, AXLE C

CAT. NO.	FINISH	HONE ANGLE
<b>W245062114P</b>	Polished Grind	114°
<b>W245062128R</b>	Regular Grind	128°
<b>W245062132D</b>	Regular Grind	132°
<b>W245062135D</b>	Regular Grind	135°
<b>W245062142D</b>	Regular Grind	142°
<b>W245062152D</b>	Regular Grind	152°
<b>W245062154D</b>	Regular Grind	154°

Minimum order: 1 each.

12.7 MM: USE AXLE A

CAT. NO.	FINISH	HONE ANGLE
<b>V500118114P</b>	Polished Grind	114°

Minimum order: 1 each. Note: No Wheel Holder Available.

### CRL Wheel Holders Only

ATF Style

M1 Style



Code "I"  
**CAT. NO.**  
125002800

Code "G"  
**CAT. NO.**  
125004001

Code "H"  
**CAT. NO.**  
125004002

### CRL Carbide Axles Only



CARBIDE AXLES

CAT. NO.	O.D.	LENGTH "L"	CODE
<b>AC1116375</b>	2.9 mm	9.5 mm	A
<b>AC1062250</b>	1.6 mm	6.4 mm	B
<b>AC1062370</b>	1.6 mm	9.4 mm	C
<b>AC1049165</b>	1.2 mm	4.2 mm	D
<b>AC1049315</b>	1.2 mm	8 mm	E
<b>AC1054180</b>	1.4 mm	4.6 mm	F

Minimum order: 1 each.

## CRL Industrial Cutting Wheels and Accessories – Australian Market

### CRL TOYO Wheel Holders

#### • Carbide Wheels Offer Superior Cutting Quality

#### • Colour Coded Holders for Quick Selection

Grey 120° .7-2 mm Glass	White 125° 2 mm Glass	Brown 130° 3 mm Glass	Yellow 135° 4 mm Glass
<b>CAT. NO. G8901</b>	<b>CAT. NO. G8902</b>	<b>CAT. NO. G8903</b>	<b>CAT. NO. G8904</b>
Green 140° 5 mm Glass	Blue 145° 6-8 mm Glass	Red 150° 8-10 mm Glass	Black 155° 10+ mm Glass
<b>CAT. NO. G8905</b>	<b>CAT. NO. G8906</b>	<b>CAT. NO. G8907</b>	<b>CAT. NO. G8908</b>

Wheel holders are sold individually. Minimum order is one each.

Fletcher is a registered trademark of The Fletcher-Terry Company, LLC.

### CRL TOYO Replacement Cutting Wheels



Available Only in Australia



#### • Four Most Popular Sizes

CAT. NO.	O.D.	I.D.	THICKNESS	HONE ANGLE
<b>G9003</b>	6 mm	1.5 mm	1.1 mm	135°
<b>G9004</b>	6 mm	1.5 mm	1.1 mm	145°
<b>G9005</b>	6 mm	1.4 mm	1.1 mm	140°
<b>G9006</b>	4 mm	1.5 mm	0.7 mm	135°

Minimum order: 1 each.

# CRL SELF-OILING GLASS CUTTERS

For Pricing Visit [crlaurence.com](http://crlaurence.com) or Call Us Toll Free at the Phone Numbers Shown on the Back Cover

## CRL TP2800 Deluxe Brass Oil Cutter

- 360 Degree Swivel Wheel Holders
- Tungsten Carbide Cutting Wheels
- Use For Pattern or Straight Cuts



360 Degree Swivel Housing

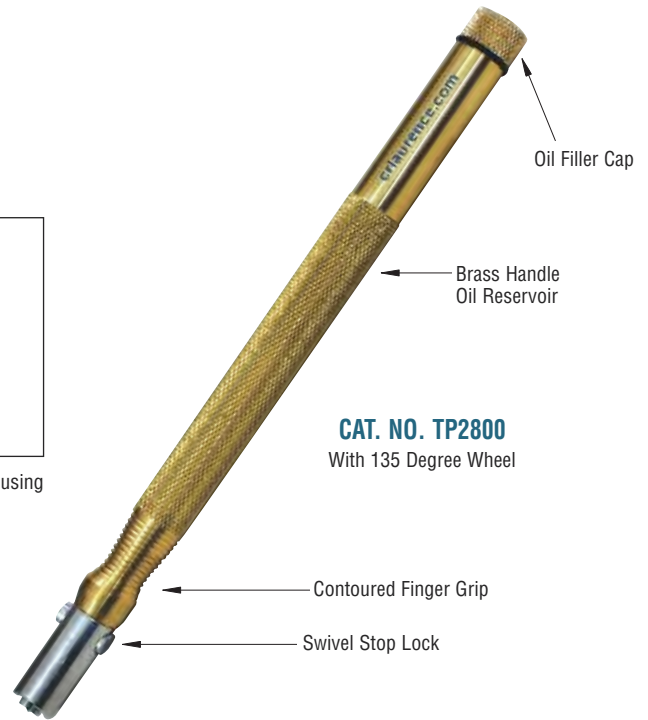

**CAT. NO. TP2800**  
With 135 Degree Wheel

The CRL TP2800 is designed with professional features that will appeal to any glazier who spends 8 hours per day on a cutting table, or to the occasional craftsman cutting a few sheets per week. The balanced solid brass handle and contoured finger grip provide just the right amount of scoring pressure every time. The reservoir filling cap controls oil flow. Tightening the cap seats a valve against the cutter head, cutting off the oil flow. Loosening the cap opens the valve, allowing oil to flow to the cutting wheel.

TP2800 Cutting Heads are mounted in a precision, ball bearing 360 degree swivel housing allowing the head to move when following patterns or performing freehand cuts. For straight edge cutting, housing can be locked in place to eliminate swivel function. Rounded housing reduces drag against straight edges and squares.

Interchangeable Carbide Wheel Holders are available with four different hone angles to accommodate glass from 3/32" to 1" (2 to 25 mm) thick.

### TP2800 DELUXE OIL CUTTER ACCESSORIES

CAT. NO.	HONE ANGLE	COLOR CODE	GLASS
<b>TP2825</b>	125 Degree	Green	3/32" to 1/4" (2 to 6 mm)
<b>TP2835</b>	135 Degree	Yellow	1/4" to 3/8" (6 to 10 mm)
<b>TP2845</b>	145 Degree	Red	1/4" to 5/8" (6 to 15 mm)
<b>TP2855</b>	155 Degree	Black	1/2" to 1" (12 to 25 mm)
<b>TP28SET</b>	Set of All Four Cutter Heads		3/32" to 1" (2 to 25 mm)
<b>TP039</b>	Transverse Handle		

Minimum order: 1 each.



**CAT. NO. TP039**  
Transverse Handle



Free Hand Pattern Cutting



**CAT. NO. TP28SET**  
Set of All Four Cutter Heads

### Cutter Head Color Codes

	<b>CAT. NO. TP2825</b>	125 Degree Wheel
	<b>CAT. NO. TP2835</b>	135 Degree Wheel
	<b>CAT. NO. TP2845</b>	145 Degree Wheel
	<b>CAT. NO. TP2855</b>	155 Degree Wheel

# CRL SELF-OILING GLASS CUTTERS

For Pricing Visit [crlaurence.com](http://crlaurence.com) or Call Us Toll Free at the Phone Numbers Shown on the Back Cover

## CRL TOYO Original Supercutters

- Straight End Handles
- Brass or Plastic Handle
- Carbide Wheels
- Premium Quality
- Now Available With Tap Wheel™



Tap Wheel™ on TC17BV and TC17BBV

CAT. NO. TC17B

Straight Cutting Head



CAT. NO. TC10P

Pattern Cutting Head



The TOYO Supercutter is the standard of the stained glass and glazing industry. It features a precision-ground carbide cutting wheel in a replaceable Cutting Head. The wheel is automatically lubricated by an ingenious, constant oil feed system.

The narrow head is prized by art glass craftsmen to make intricate scores while doing pattern work. The wide head is designed for straight line production cutting.

Cat. Nos. TC17BV and TC17BBV feature the Tap Wheel™ with seven microscopic cams that create seven "taps" per revolution of the wheel for a cleaner and more consistent score.

CAT. NO.	HEAD TYPE	CUT TYPE	HONE ANGLE	HANDLE
TC10B	Narrow	Pattern	140 Degree	Brass
TC17B	Wide	Straight	140 Degree	Brass
TC10P	Narrow	Pattern	140 Degree	Plastic
TC17P	Wide	Straight	140 Degree	Plastic
TC17BV	Wide	Straight	140 Degree Tap Wheel™	Brass
TC17BBV	Wide	Straight	153 Degree Tap Wheel™	Brass

Minimum order: 1 each. Oil Type Glass Cutters can be combined for quantity pricing.

## CRL TOYO Custom-Grip Supercutters

- Adjustable Grip
- Improved Oil Control
- Tap Wheel™ Technology



Tap Wheel™



CAT. NO. TC21SVR

The CRL TOYO Custom-Grip Supercutter saddle fits between the thumb and forefinger, allowing the fingers to remain straight, relieving them of strain while scoring. To fit all hand sizes, the saddle is adjustable to four different heights by reversing it and a bushing from the top and bottom.

The Custom-Grip Supercutter has a new spring-controlled oil flow system. Pressing down on the cutting head opens a valve and allows oil to flow, stopping completely when pressure is released.

The TAP Wheel™ has an axle bore with seven microscopic cams creating seven "taps" per revolution of the wheel. The result is longer wheel life and a clean, consistent score.

Saddle and spacer positioned for a small size hand

Saddle and spacer positioned for a medium size hand

Saddle and spacer positioned for a large hand

Saddle and spacer positioned for an extra large hand



CAT. NO. TC21HSV



CAT. NO. TC21HPV



CAT. NO. TC21HSVR

CAT. NO.	HONE ANGLE	DESCRIPTION
TC21SVR	140 Degree	Custom-Grip Supercutter with Straight Head
TC21PVR	140 Degree	Custom-Grip Supercutter with Pattern Head
TC21HSV	140 Degree	Replacement Straight Cutting Head
TC21HPV	140 Degree	Replacement Pattern Cutting Head
TC21HSVR	153 Degree	Thick Glass Cutting Head 3/8" to 1" (10 to 25 mm) Glass

Minimum order: 1 each. TC21 Heads fit TC21 Cutters only. Oil Type Glass Cutters can be combined for quantity pricing.

# CRL SELF-OILING GLASS CUTTERS

For Pricing Visit [crlaurence.com](http://crlaurence.com) or Call Us Toll Free at the Phone Numbers Shown on the Back Cover

## CRL TOYO Comfort-Grip Supercutters

- Straight End Handle
- Self-Oiling
- Premium Quality



The Comfort-Grip Supercutter has a lightweight, tapered acrylic barrel with contoured finger channels designed to fit all hand sizes. Cutter has a precision ground cutting head and an automatic oil-feed system with a 140 degree carbide wheel.

CAT. NO.	DESCRIPTION
TC1S	Supercutter with Straight Head
TC1SR	Rainbow Color Supercutter with Straight Head
TC1P	Supercutter with Pattern Head
TC1PR	Rainbow Color Supercutter with Pattern Head

Minimum order: 1 each. Oil-Type Glass Cutters can be combined for quantity pricing.



## CRL TOYO Thomas-Grip Supercutters

- Self-Oiling
- Unique Grip



The Thomas-Grip Supercutter is an automatic oil-feed cutter that features a unique, ergonomically designed handle. The barrel is topped with a saddle that fits between the thumb and forefinger, creating a three point grip that ensures precise control and reduced strain. They are available in six fluorescent colors which will be shipped in random order and use standard Supercutter Heads.

CAT. NO.	DESCRIPTION
TC9SR	Supercutter with Straight Head
TC9PR	Supercutter with Pattern Head

Minimum order: 1 each. Oil-Type Glass Cutters can be combined for quantity pricing.



## CRL TOYO Supercutter Replacement Cutting Heads



- Quality Cutting Head Engineered for Long Service Life
- Fits CRL TOYO Oil Glass Cutters
- Tap Wheels™ and Standard Wheels



Tap Wheel™ Technology

These precision crafted CRL TOYO Replacement Cutting Heads have a quality wheel honed to a 140 or 153 degree angle, perfect for all of your general cutting needs.

CAT. NO.	HONE ANGLE	STYLE	HEAD TYPE
TC10H	140 Degree	Standard	Pattern
TC600HV	140 Degree	Tap Wheel™	Pattern
TC17H	140 Degree	Standard	Straight
TC17HV	140 Degree	Tap Wheel™	Straight

Minimum order: 1 each. These Cutting Heads do not fit TC21 Series Glass Cutters.



CAT. NO.	HONE ANGLE	STYLE	HEAD TYPE
TC600HPV	153 Degree	Tap Wheel™	Pattern
TC600HS	153 Degree	Standard	Straight
TC600HSV	153 Degree	Tap Wheel™	Straight

Minimum order: 1 each. These Cutting Heads do not fit TC21 Series Glass Cutters.



C.R. LAURENCE COMPANY

[crlaurence.com](http://crlaurence.com) | [usalum.com](http://usalum.com)

116K | [crlaurence.ca](http://crlaurence.ca) [crlaurence.com.au](http://crlaurence.com.au) [crlaurence.co.uk](http://crlaurence.co.uk) [crlaurence.de](http://crlaurence.de) [crlaurence.eu](http://crlaurence.eu)

## CRL Self-Oiling Glass Cutters

- Automatic Oil Dispensing System
- Choice of Four Interchangeable Cutting Heads

The CRL Self-Oiling Glass Cutter is a performance tool for the professional glazier. Consistent glass cutting results are attributed to the interchangeable Cutting Heads which are available for pattern, straight, and thick glass cutting applications. The self-contained oil metering system allows a small amount of fluid to be delivered to the cutting wheel, adding service life to the tool. To add oil, simply remove the Cutter Head with attached self-sealing o-ring and fill with CRL W410 Glass Cutter Oil (see page 121K). Cutter and Heads are sold individually.

### REPLACEMENT CUTTING HEADS

CAT. NO.	HONE ANGLE	DESCRIPTION
<b>0GC3P</b>	140 Degree	Pattern Cutting Head
<b>0GC4S</b>	140 Degree	Straight Cutting Head
<b>0GC5H</b>	154 Degree	Head for Thick Glass
<b>03703</b>	114 Degree	Head for Thin Glass

Minimum order: 1 each.



**CAT. NO. 0GC1S**  
Self-Oiling Glass Cutter with 140 Degree Straight Cutting Head



**CAT. NO. 0GC3P**  
140 Degree Pattern Cutting Head



**CAT. NO. 0GC5H**  
154 Degree Head for Thick Glass



**CAT. NO. 0GC4S**  
140 Degree Straight Cutting Head



**CAT. NO. 03703**  
114 Degree Head for Thin Glass

## CRL Fletcher® Gold Tip® Designer II™ Glass Cutters

- The Premium Line From Fletcher-Terry, Makers of Glass Cutting Tools Since 1868



**CAT. NO. 01711**  
Clear Plastic Contour Grip Handle, Pattern Cutting, 140 Degree Wheel, Narrow Head



**CAT. NO. 01712**  
Solid Brass Contour Grip Handle, Straight Edge Cutting, 140 Degree Wheel, Wide Head



**CAT. NO. 01713**  
Solid Brass Contour Grip Handle, Pattern Cutting, 140 Degree Wheel, Narrow Head



**CAT. NO. 03711**  
Replacement Tungsten Carbide Cutting Heads, Straight Edge Cutting, 140 Degree Wheel



**CAT. NO. 03713**  
Replacement Tungsten Carbide Cutting Heads, Thick Glass Cutting, 154 Degree Wheel



**Fiberlock™ Anti-Leak Fluid Dispensing System**



**CAT. NO. 03712**  
Replacement Tungsten Carbide Cutting Heads, Pattern Cutting, 140 Degree Wheel

Fletcher® Gold Tip® Designer II™ Series are high quality, fluid dispensing cutters that meet the standards of the professional glazier. The entire series features a Fiberlock™ Anti-Leak Fluid Dispensing System that lays down a perfect bead of cutting fluid for smooth, precise scores. Interchangeable heads that simply snap in and out are available for straight or pattern cutting.

**NOTE:** CRL W410 Cutting Oil is approved by the manufacturer for use with all Fletcher Self-Oiling Glass Cutters.

Tungsten carbide cutting wheels provide smooth, flake-free scores on flat glass and textured stained glass. Choose from a solid brass contoured handle or the lightweight ease of a clear plastic handle. Whichever you choose, you will find the Designer II™ Series an unbeatable system for the glass professional. All Glass Cutters can be combined for quantity pricing. Minimum order is one each for Cutters and Cutting Heads.

Fletcher and Gold Tip are registered trademarks of The Fletcher-Terry Company, LLC

## CRL Oil-Type Glass Cutters

- Self-Lubricating Wheel for Long Life
- Interchangeable Cutting Heads
- Available in Brass or Plastic Handles

Our Oil-Type Glass Cutters combine classic shape and quality construction into a long lasting, reliable tool used by every glazier. These self-oiling Cutters allow continuous cutting of large quantities of glass without loss of sharpness to the 134 degree hone angle of the cutting wheels. Every time the spring-loaded cutting head is depressed to make a score in the glass, the cutting wheel comes into contact with an oil soaked wick, which extends down from the oil reservoir in the handle. As long as the pressure is maintained during the score, the wick continuously coats the cutting wheel with lubricant. This self-oiling function ensures a cool, non-flaking score line and helps to lower friction on the cutting wheel, thus extending the life of the wheel. Choose from the classic brass handle or the lightweight plastic handle (which allows visual check on oil level), mounted with either a Standard Straight Cutting Head or the smaller Pattern Cutting Head. For heavier plate glass in the 1/2" to 1" (12 to 25 mm) range we offer a 154 degree Straight Cutting Head.



Each Cutter comes with Plastic Oil Dropper for convenient filling of handle oil reservoir



**CAT. NO. S1050**  
Brass Handle  
Oil Glass Cutter

**CAT. NO. P1050D**  
Plastic Handle  
Oil Glass Cutter

### OIL-TYPE GLASS CUTTERS

CAT. NO.	HANDLE	HONE ANGLE	HEAD TYPE
<b>P1050</b>	Plastic	134 Degree	Straight Head
<b>P1050D</b>	Plastic	134 Degree	Pattern Head
<b>S1050</b>	Brass	134 Degree	Straight Head
<b>S1050D</b>	Brass	134 Degree	Pattern Head

Minimum order: 1 each. Oil Type Glass Cutters can be combined for quantity pricing.



**CAT. NO. 41050**  
Straight Cutting Head

**CAT. NO. 41050D**  
Pattern Cutting Head

**CAT. NO. 41050R**  
Cutting Head for  
1/2" to 1" Thick Glass

### REPLACEMENT CUTTING HEADS

CAT. NO.	HONE ANGLE	HEAD TYPE
<b>41050</b>	134 Degree	Straight Cutting
<b>41050D</b>	134 Degree	Pattern Cutting
<b>41050R</b>	154 Degree	For 1/2" to 1" (12 to 25 mm)

Minimum order: 1 each. These Cutting Heads are for CRL Glass Cutters only. Replacement Heads can be combined for quantity pricing.



Spring-Loaded Cutting Head and wick extending into the handle oil reservoir to provide continuous lubrication



# CRL SELF-OILING GLASS CUTTERS

For Pricing Visit [crlaurence.com](http://crlaurence.com) or Call Us Toll Free at the Phone Numbers Shown on the Back Cover

## CRL TOYO Pistol-Grip Supercutters

- Clear Polycarbonate Handle With Straight Head
- Rainbow Colored Handles With Pattern Head
- 140 Degree Hone Angle

TOYO's Pistol-Grip Heavy-Duty Supercutter is designed for hours of fatigue-free cutting, and features a self-lubricating head fed by an oil reservoir in the handle. See page 116K for a complete selection of TOYO Replacement Cutting Heads.



Tap Wheel™ Technology

**TOYO** Supercutter® Series



CAT. NO. TC600S

CAT. NO. TC600PR

CAT. NO. TC600PRV

### TOYO PISTOL-GRIP SUPERCUTTERS

CAT. NO.	DESCRIPTION
TC600S	Clear Handle With 140 Degree Straight Head
TC600PR	Rainbow Colored Handle With 140 Degree Pattern Head
TC600PRV	Rainbow Colored Handle With 140 Degree Pattern Tap Wheel™ Head

Minimum order: 1 each. All Oil Glass Cutters can be combined for quantity pricing.

## CRL Heavy-Duty Oil-Type Glass Cutters

- Molded Plastic Grip for Superior Control and Comfort
- Accepts Straight, Pattern, or Thick Glass Cutting Heads

The pistol grip handle of these CRL Heavy-Duty Oil-Type Glass Cutters is ergonomically designed for low-stress glass cutting. The clear polycarbonate handle also acts as an oil reservoir and allows the user to keep track of the oil level at all times. Cutting oil is dispensed automatically every time the precision honed 134 degree steel wheel makes a cut. Choose from pattern or straight 134 degree Cutting Heads, or the 154 degree thick glass Cutting Head.

### REPLACEMENT CUTTING HEADS

CAT. NO.	HONE ANGLE	HEAD TYPE
41050	134 Degree	Straight Cutting
41050D	134 Degree	Pattern Cutting
41050R	154 Degree	For 1/2" to 1" (12 to 25 mm) Glass

Minimum order: 1 each. Cutter Heads can be combined for quantity pricing.

**CAT. NO. 41050**  
134 Degree Straight Cutting Head

**CAT. NO. 41050D**  
134 Degree Pattern Cutting Head

**CAT. NO. 41050R**  
154 Degree Cutting Head for 1/2" to 1" (12 to 25 mm) Glass

**CAT. NO. 600P**  
Oil Glass Cutter With Pattern Cutting Head, Plastic Handle

**CAT. NO. 600S**  
Oil Glass Cutter With Straight Cutting Head, Plastic Handle

### HEAVY-DUTY OIL-TYPE GLASS CUTTERS

CAT. NO.	DESCRIPTION
600P	Pattern Head
600S	Straight Head

Minimum order: 1 each. All Oil Glass Cutters can be combined for quantity pricing.

## CRL Self-Oiling Glass Cutters

- Automatic Oil Dispensing System
- Choice of Four Interchangeable Cutting Heads

The CRL Self-Oiling Glass Cutter is a performance tool for the professional glazier. Consistent glass cutting results are attributed to the interchangeable Cutting Heads which are available for pattern, straight, and thick glass cutting applications. The self-contained oil metering system allows a small amount of fluid to be delivered to the cutting wheel, adding service life to the tool. The transparent handle shows the level of cutting oil in the reservoir. To add oil, simply remove Cutter Head with attached self-sealing o-ring and fill with CRL W410 Glass Cutter Oil.

### REPLACEMENT CUTTING HEADS

CAT. NO.	HONE ANGLE	HEAD TYPE
0GC4S	140 Degree	Straight Cutting
0GC3P	140 Degree	Pattern Cutting
0GC5H	154 Degree	For 1/2" to 1" (12 to 25 mm) Glass
03703	114 Degree	For Thin Glass

Minimum order: 1 each. Cutter Heads can be combined for quantity pricing.

**CAT. NO. 0GC4S**  
140 Degree Straight Cutting Head

**CAT. NO. 0GC3P**  
140 Degree Pattern Cutting Head

**CAT. NO. 0GC5H**  
154 Degree Cutting Head for 1/2" to 1" (12 to 25 mm) Glass

**CAT. NO. 03703**  
114 Degree Cutting Head for Thin Glass

**CAT. NO. 0GC2G**  
Heavy-Duty Self-Oiling Glass Cutter With 140 Degree Head

## CRL TOYO Tap Wheel™ Thick Glass Supercutter

**TOYO** Supercutter Series



Tap Wheel™ Technology

- Standard Wide Head or Optional Pattern Head
- Smooth Cutting Action for Glass Up to 1" (25 mm) Thick
- Automatic Self-Oiling Action



**CAT. NO. TC600SVB**

Thick Glass Pistol Grip Oil Cutter with TC600HSV 153 Degree Cutter Head



**CAT. NO. TC600HPV**

Pattern Head 153 Degree Replacement Thick Glass Cutter



**CAT. NO. TC600HSV**

Wide Head 153 Degree Replacement Thick Glass Cutter

The CRL TOYO Tap Wheel™ Supercutter is an automatic oil-feed Glass Cutter designed for 1/2" to 1" (12 to 25 mm) thick glass. The Tap Wheel™ Technology employs seven cams inside the axle bore of a 153 degree cutting wheel. These cams produce a slight vibration or "tap" during the score. The result is longer wheel life, deeper, cleaner, more consistent scoring, improved breakout and edge quality. While scoring, the reservoir oil-fill cap should be opened a 1/2 turn to improve oil flow. As with all self-oiling cutters, the first use requires priming the oil system by depressing the cutting head several times until oil reaches the wheel. See page 116K for a complete selection of TOYO Replacement Cutter Heads. Minimum order is one each.

## CRL Fletcher® Gold Tip® Designer II Glass Cutters

- The Premium Line From Fletcher-Terry, Makers of Glass Cutting Tools Since 1868
- Interchangeable Cutting Heads

These CRL Fletcher® Gold Tip® Designer II Series Glass Cutters are made from the highest quality materials for flawless performance time after time. The FiberLock Anti-Leak Fluid Dispensing System lays down a perfect bead of fluid for smooth, precise scores. Machined from hardened steel, the head, ball bearing axle, and wheel slot are designed to resist wear and tear and guide the polished tungsten carbide cutting wheel. The lightweight plastic handle is perfectly balanced for effortless cutting and features a viewing window to monitor the cutting fluid level. Manufacturer has approved W410 CRL Cutting Oil for all Gold Tip® Glass Cutters and Cutting Heads.



**CAT. NO. 01715**

Clear Handle Glass Cutter with 03711 Straight 140 Degree Cutting Head



**CAT. NO. 01714**

Clear Handle Glass Cutter with 03712 Pattern 140 Degree Cutting Head



**CAT. NO. 03711**



**CAT. NO. 03712**



**CAT. NO. 03713**

### REPLACEMENT CUTTING HEADS FOR DESIGNER II CUTTERS

CAT. NO.	TYPE
<b>03711</b>	140 Degree Tungsten Carbide Straight
<b>03712</b>	140 Degree Tungsten Carbide Pattern
<b>03713</b>	154 Degree Tungsten Carbide Thick Glass

Minimum order: 1 each.

## CRL Fletcher® Heavy-Duty Glass Cutter With Replaceable Wheel Units

- Bio-Engineered Handle
- Extra Pressure Production Cutting
- Uses Steel or Carbide Wheels

The exclusive shape of this Glass Cutter makes production cutting of heavy plate and hard glass easier by giving you 40 percent more pressure-power than regular models. It comes with complete instructions. Steel Wheels come 10 per package. Carbide Wheels come one per package.



See Chart for Replacement Wheels



**CAT. NO. HDG15**

Heavy-Duty Glass Cutter with F03129 154 Degree Carbide Wheel

### REPLACEMENT WHEELS FOR HDG15 CUTTER

CAT. NO.	WHEEL TYPE	HONE ANGLE	RECOMMENDED FOR
<b>F02118</b>	Steel	114 Degree	Hard Glass
<b>F02120</b>	Steel	120 Degree	General Purpose
<b>F03125</b>	Carbide	114 Degree	Hard Glass
<b>F03126</b>	Carbide	124 Degree	General Purpose
<b>F03111</b>	Carbide	134 Degree	1/4" (6 mm) and Thicker Float
<b>F03129</b>	Carbide	154 Degree	Thick Glass

Steel Wheels minimum order: 1 pack of 10. Carbide Wheel minimum order: 1 each.

Fletcher and Gold Tip are registered trademarks of The Fletcher-Terry Company, LLC



## CRL Professional Glass Cutter Oil

- For Automatic or Hand-Held Glass Cutters
- Saves You Money by Increasing the Life of the Cutter Wheel
- No Mixing - Ready to Use
- Easy Clean-Up



**CAT. NO. W410QT**  
1 Quart Glass Cutter Oil  
Quantity Per Case is 12



**CAT. NO. W410GL**  
1 Gallon Glass Cutter Oil  
Quantity Per Case is 4



**CAT. NO. W4105GL**  
5 Gallon Glass Cutter Oil

CRL Professional Glass Cutter Oil was originally developed for use in production type glass cutting bridges and X-Y glass cutting machines. Because it worked so well and cleaned up easily, it is now being used in all phases of glass cutting from hand glass cutters to computer controlled glass cutting machines. CRL Professional Glass Cutter Oil produces cleaner cuts and increases the life of the cutter wheel dramatically. It has been approved by Fletcher-Terry for use in all Gold Tip® Oil Cutters. Minimum order is one each.

## CRL Evaporating Glass Cutting Oil

- 100% Evaporation Within One Hour When Exposed to Air
- Lubricant for Cutting Heads
- Leaves No Residue

CRL Evaporating Glass Cutting Oil is an excellent glass cutting lubricant that is widely used throughout the glazing industry. The viscosity is perfect for precision feed-automated oiling systems, and today's modern oil-feed hand cutters. Fast evaporation makes it ideal for the insulating glass industry. It lowers the chance of contamination in washing machines, and no residue is left to interfere with edge adhesion. Minimum order is one each.



**CAT. NO. V020**  
20 Liter (5.3 gal.) Pail Evaporating  
Glass Cutting Oil



**CAT. NO. V024**  
4 kg (1.1 gal.) Bottle Evaporating  
Glass Cutting Oil

## CRL Thick Glass Cutting Oil

- Recommended for Thick Glass
- Splintered Glass is Bound

CRL Thick Glass Cutting Oil is the only fluid recommended for lubricating your cutter when cutting glass that is 1/2" (12 mm) or thicker. This professional cutting fluid lubricates the cutting wheel and binds the glass dust created by scoring. Due to its low viscosity, it creeps into the cut to delay the "healing process" of the glass. Packed in a convenient 4 kg (1.1 gal) bottle. Minimum order is one each.



**CAT. NO. TGC04**  
Thick Glass Cutting Oil

## CRL Glass Cutter and Pencil Pouch

- Made From Top Quality Leather
- Includes a Strap for Your Tape Measure or Pliers

This CRL Glass Cutter and Pencil Pouch is one of our most popular items. The leather pouch has three pockets to hold your pens, pencils or glass cutter. In addition, a leather strap has been added to hold a measuring tape or pliers. The large top belt loop will fit belts up to 1-1/2" (38 mm) wide. Minimum order is one each.



**CAT. NO. S5403**  
Glass Cutter Pencil Pouch  
(Accessories Sold Separately)

Gold Tip is a registered trademark of The Fletcher-Terry Company, LLC

## CRL Glass Slicker

- Deposits Thin Film of Lubricant on Glass



Our Glass Slicker is an innovative and inexpensive way to increase productivity and prolong cutter life. By drawing the Glass Slicker along the straight edge, the glass is wiped clean. At the same time, a thin film of oil is deposited on the glass. This helps to prevent "hot cuts" and skips resulting in a cleaner, smoother cut and break. The Glass Slicker can be filled with CRL W410 Cutting Oil (see page 121K). Minimum order is one each.

CAT. NO. GLS1

## CRL Cutter Oiling Stand

- Vacuum Cup Base Holds Firm to Glass
- Keeps Cutter Wheel Oiled Between Cuts



The handy CRL Cutter Oiling Stand holds your cutter until you need it. Just place a few drops of cutting oil in the base and your cutter is always lubricated and ready to cut. A vacuum base holds the stand in place. Use with CRL W410 Glass Cutting Oil (see page 121K) for best results. Minimum order is one each.

CAT. NO. OCS671

## CRL Glass Chip Brush

- Safe and Effective Way to Clean Up Glass Chips and Splinters



The glass splinters on cutting tables can not only cause scratches on the next glass pane you want to cut, but you also risk getting them stuck in your hands. The solution is the CRL Glass Chip Brush. You brush over the cutting table's surface and the little mechanical roller-brush collects splinters inside the plastic body. The body can then be opened and the glass chips thrown into the waste bin. This is an indispensable little helper for ensuring a proper work area. Minimum order is one each.

CAT. NO. TG070

## CRL Glass Tapper

- Soft, Solid Brass Ball End
- High-Grade Hickory Handle



This is a perfectly balanced tool for starting a "run" of scored glass. The CRL Glass Tapper is a 3/4" (19 mm) solid brass ball attached to a long brass ferrule. This ferrule is then bonded onto a high-grade hickory handle resulting in a 9" (229 mm) tapper. **NOTE:** Not available in Australia. Minimum order is one each.

CAT. NO. GT366

## CRL Quick Draw Mirror Outlet Cut-Out Templates

- Reduces Layout Time and Increases Accuracy

These clear, high-impact acrylic templates were designed to simplify drilling cut-outs in glass and mirror. The non-skid bumpers adhered on the underside prevent slippage and scratches. The hole in the corner lets you hang the templates in a convenient location near the cutting table. Select one of the three templates in the set when drilling for switch, decora, duplex, T.V. cable, telephone cable, thermostat, and more. Minimum order is one set.

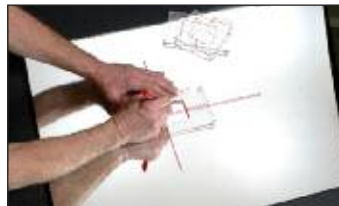

## Three Templates for Drawing Six Cut-Outs

- 2" Hole
- Double Cut-Outs
- Single Cut-Outs
- 3" Hole
- Triple Cut-Outs
- Quad Cut-Outs

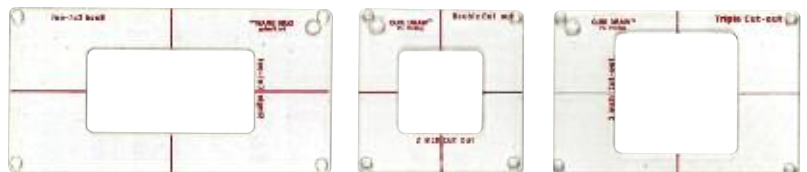

CAT. NO. QD1

## CRL Production Oil T-Cutters

- The Fastest Way to Manually Make Repeat Cuts
- The Smoothest-Running, Fastest-Cutting, Easiest-to-Use Production Glass Cutters on the Market
- Available in 12", 24", 48", and 72" (305, 610, 1219, and 1829 mm) Models
- Features Large Capacity Oil-Feed Cutting Head



CRL Production Oil T-Cutter is the ideal strip cutting tool for any size glass, window or framing shop. Whether splitting sheets for more economical storage, or making repetitive cuts of the same dimension, CRL Production Oil T-Cutters are state-of-the-art in manual strip cutting technology. A large capacity oil reservoir automatically delivers exact amounts of cutting oil to the precision ground carbide cutting wheel ensuring low maintenance and long service life. The easy to read scale makes changing dimensions fast, easy, and accurate. These CRL T-Cutters ride along the edge of the glass guided by adjustable and replaceable Edge Guide Rollers to provide a perfect cut parallel to the edge guide.



**CAT. NO. PTC12**  
Min. Width: 1-1/2" (38 mm)  
Max. Width: 12" (305 mm)

**CAT. NO. PTC24**  
Min. Width: 2-1/2" (63 mm)  
Max. Width: 24" (610 mm)

**CAT. NO. PTC48**  
Min. Width: 7" (178 mm)  
Max. Width: 48" (1219 mm)

**CAT. NO. PTC72**  
Min. Width: 16" (406 mm)  
Max. Width: 72" (1829 mm)



**CAT. NO. G0059**  
Replacement Oil Holder and Cutting Head for Models With 4-Sided or 6-Sided Bars



**CAT. NO. EC1901**  
Replacement Oil Holder and Cutting Head for Newer Models With the 8-Sided Bar

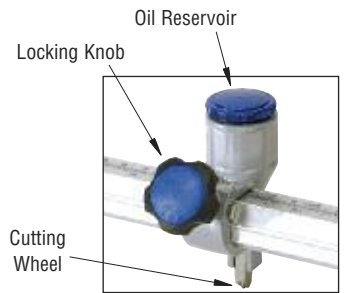

**CAT. NO. PTC1903**  
Roller and Housing for all PTC Cutters shown on this page



**CAT. NO. EC1902**  
Replacement Cutting Head

CAT. NO.	SIZE
PTC12	1-1/2" to 12" (38 to 305 mm)
PTC24	2-1/2" to 24" (63 to 610 mm)
PTC48	7" to 48" (178 to 1219 mm)
PTC72	16" to 72" (406 to 1829 mm)

Minimum order: 1 each.

## CRL Production Speed Cutters

- Truly Makes Cutting Glass a One Man Operation
- Saves Manpower – and That Saves You Money



**CAT. NO. PSC200**  
Min. Width 3" (76 mm)  
Max. Width 27" (686 mm)

**CAT. NO. PSC400**  
Min. Width 11.5" (292 mm)  
Max. Width 50.5" (1282 mm)

**CAT. NO. PSC600**  
Min. Width 43" (1092 mm)  
Max. Width 74" (1880 mm)

This CRL Production Speed Cutter is a precision tool for simplifying repeat production cuts. It is constructed of lightweight anodized extruded aluminum, which rides on adjustable rollers. Easy to operate, the Production Speed Cutter is placed on any straight edge of your glass, and then simply run across your glass, making the score. The Cutting Head features a six wheel replaceable Cutting Turret. The best part about this tool is that it's now possible for one person to do all of the work! Minimum order for Speed Cutters and replacement parts is one each.

## CRL Production Speed Cutter Parts

- Replaceable Parts to Keep Your Speed Cutter in Top Condition

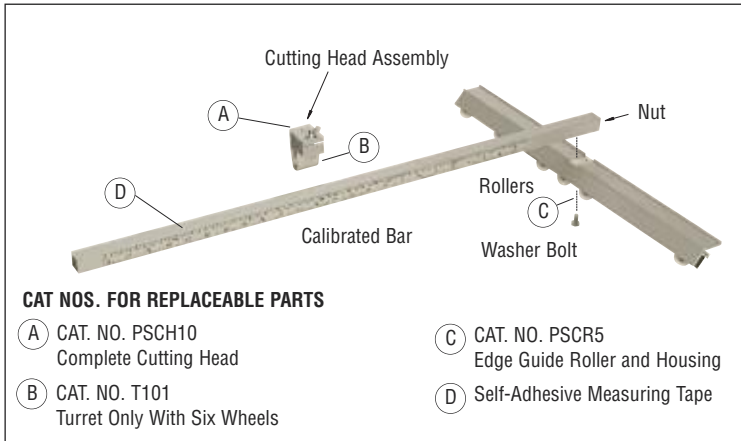

**CAT. NO. PSCH10**  
Complete Cutting Head  
With Turret



**CAT. NO. T101**  
Turret Only With  
Six Wheels



**CAT. NO. PSCR5**  
Edge Guide Roller  
and Housing

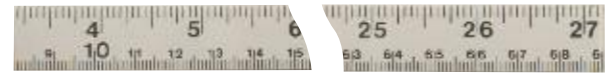

### REPLACEMENT SELF-ADHESIVE MEASURING TAPES

CAT. NO.	DESCRIPTION
<b>PSCT20</b>	Replacement Tape For PSC200
<b>PSCT40</b>	Replacement Tape For PSC400
<b>PSCT60</b>	Replacement Tape For PSC600

Minimum order: 1 each.

## CRL Self-Oiling Cutting Head

- Convert Your Production Speed Cutter to Self-Oiling
- Replaceable Cutting Heads
- Supplied With 140 Degree Cutting Wheel

CAT. NO.	DESCRIPTION
<b>G0059</b>	Self-Oiling Cutting Head Complete
<b>TC17H</b>	Replacement 140 Degree Head
<b>TC600HS</b>	Replacement 153 Degree Head

Minimum order: 1 each.



The CRL Self-Oiling Cutting Head replaces the standard PSCH10 Head on your Production Speed Cutter to provide a steady source of oil to the cutting wheel. The durable glass reinforced nylon body is designed to withstand years of wear and tear.

**NOTE:** There may be slight difference in measuring tape location of cutting wheel between turret model head and self-oiling head.

## CRL Fletcher® Glass, Plastic, and Matboard Cutting Machine

- Unique Triple-Turret Cutting Assembly
- Cuts Glass, Plastic, Plexiglass, and Matboard Up to 1/4" (6 mm) Thick

A real timesaver for glass shops, hardware stores, retail building supply centers, etc. This CRL Fletcher® Glass and Plastic Cutting Machine is built from sturdy anodized aluminum and offers unsurpassed quality when cutting glass, plastic or matboard. The unique three-position cutting turret allows switching from matboard to plastic to glass with only one quick turn. The incredibly keen cutting blade will cut through matboard, cardboard or foamboard up to 1/4" (6 mm) thick. A steel wheel cutting unit is enclosed for scoring single and double strength glass - and thicker glass up to 1/4" (6 mm). In addition, a special scoring tip is included for scoring plastics and acrylics up to 1/4" (6 mm) thick. A simple press of the breakout lever will project twin rollers to apply pressure to each side of the score, producing a clean break.



Measuring Stop



Cutting Head



CAT. NO. F04711  
Shown

### EACH MACHINE INCLUDES:

- Ten Glass Cutting Wheel Units
- Ten Plastic Cutting Blades
- Ten Mat Cutting Blades
- Cleaning Brush
- Mounting Hardware
- Instructions



CAT. NO. F24106  
Handle Bushing



CAT. NO. F04112  
Measuring Stop



CAT. NO. F02120  
120 Degree Steel Wheel Assembly



CAT. NO. F03126  
124 Degree Carbide Wheel Assembly

CAT. NO.	DESCRIPTION
F04711	48" (1219 mm) Cutting Machine
F04712	60" (1524 mm) Cutting Machine
F24106	Handle Bushing
F04112	Measuring Stop
F02120	120 Degree Steel Wheels (10/pkg)
F03126	124 Degree Carbide Wheel (1/pkg)
APB121	Plastic Cutting Blades (10/pkg)
F05001	Mat Cutting Blades (10/pkg)

Minimum order: 1 each on the Cutting Machines, Measuring Stop, and Carbide Wheels, and 1 pack on the Steel Wheels and Blades. All Steel Cutter Wheels and Blades can be combined in pack quantities for quantity pricing. All Carbide Wheels can be combined for quantity pricing. Additional parts available on request.



CAT. NO. APB121  
Plastic Cutting Blades

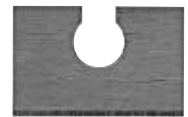

CAT. NO. F05001  
Mat Cutting Blades

Fletcher is a registered trademark of The Fletcher-Terry Company, LLC

## CRL Corner Radius Cutter

- Makes Cutting Rounded Corners Simple
- Saves Grinding Time

This Radius Cutter is designed to fit over a 90 degree corner. It automatically centers itself every time you use it so there is no room for error. Adjustable from two separate points: the fulcrum of the cut and the actual radius. Depending on the application, a radius of 25/32" to 3-17/32" (20 to 90 mm) can be made by simply adjusting the cutting turret. Cutting head has six steel wheels with a 134 degree hone angle. Minimum order is one each.

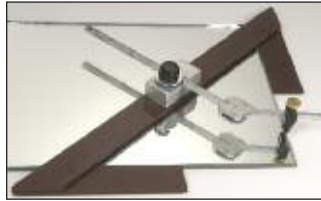

CAT. NO. CR09  
Corner Radius Cutter



CAT. NO. T101  
Replacement Cutting Head

## CRL Segment Radius Cutter

- Cuts a Radius From 4" to 118" (102 to 2997 mm)
- Also Cuts Circles



CRL TP2522 Segment Radius Cutter is capable of scoring circles over 19-1/2' (6 m) in diameter! Two precision rollers guide and stabilize its cutting path to assure a smooth, consistent cut. Included is the CRL TP2000 Oil Glass Cutter for glass up to 1/4" (6 mm) thick, TP20450 Transverse Handle, protective storage case, and a complete instruction booklet. Minimum order is one each.

CAT. NO. TP2522

## CRL Diamond Tip Glass Cutter

- Made From the Finest Industrial Diamonds
- Recommended for the Experienced Glass Worker



Diamond Tip

The CRL Diamond Glass Cutter is recommended for the glass professional. This is a great alternative to the standard glass cutter. Made from the highest quality industrial diamonds available, this Cutter makes an excellent score every time. Minimum order is one each.

CAT. NO. 545DGC

## CRL Squeeze and Pop Glass Cutter

- For Cutting Glass Tubing Up to 3/4" (19 mm) in Diameter



CRL Squeeze and Pop Glass Cutter is the perfect tool for cutting glass tubing such as gauge glass, neon sign glass, oil burner electrodes, porcelain insulators, thermocouple protection tubes and more. This tool employs the same unique cutting action used in cutting cast iron and cement pipe. Minimum order is one each.

CAT. NO. 69012

## CRL Glass Cutting Guide

- Equal Measure Every Cut
- Ideal for Cutting Small Strips of Glass



You can uniformly cut small strips of glass with the CRL Glass Cutting Guide. You save time because you can cut each strip up to 3-1/4" (82 mm) wide without stopping to measure each time. Just set the cutter on the guide arm, set width adjustment, and start cutting! Glass Cutter not included. Minimum order is one each.

CAT. NO. 101CG

## CRL Gauge Glass Cutter

- For Repetitive Cutting of Glass Tubing

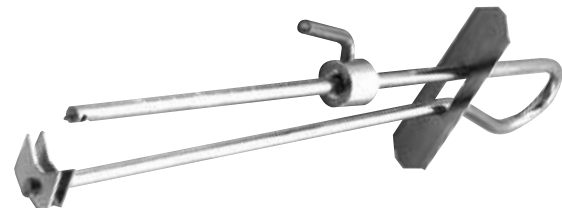

CRL Gauge Glass Cutter is designed to cut glass tubes quickly and efficiently. Just pull the trigger close to the glass and turn. The Cutter stays still while you rotate the glass! A hairline score is made, then you just tap, and your glass is cut. Graduated markings in 1/4" (6.4 mm) increments are inscribed for accuracy. Use CRL W410 Cutting Oil for best results. Minimum order is one each.

CAT. NO. 996GC

## CRL TOYO Self-Oiling Circle Supercutters

- Cuts Circles Up to 72" (1829 mm)
- Dispenses Oil With Every Cut
- Vacuum Cup Base
- Replaceable Cutting Wheels are Easily Installed

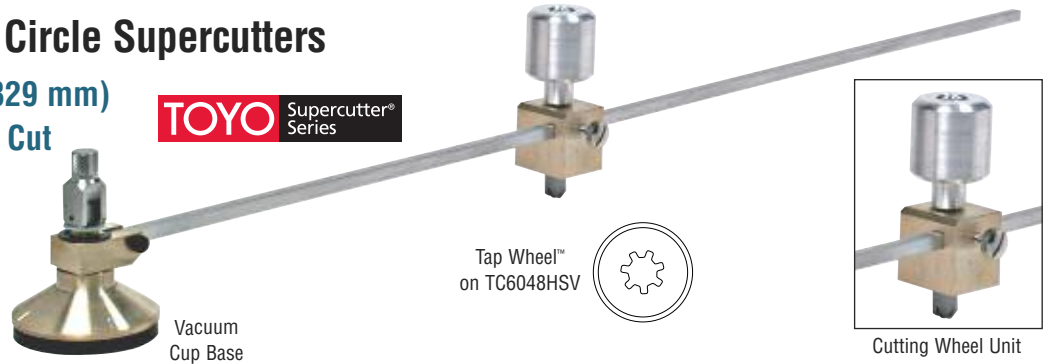

CRL TOYO Self-Oiling Circle Supercutters are professional quality tools with a built-in oil reservoir, vacuum cup base, and graduated pivoting radius bar. The Wheel Unit is self-oiling and swivels 360 degrees in a thrust bearing for accurate and consistent scoring. Replacement Wheel and Axle Units for general purpose or thick glass cutting are available. The Cat. No. TC6048HSV features the Tap Wheel™ with seven microscopic cams that create "taps" upon revolution of the wheel for a cleaner and more consistent score.

CAT. NO.	DESCRIPTION	MAXIMUM CIRCLE DIAMETER
<b>TC6025</b>	Self-Oiling Circle SuperCutter	25" (635 mm)
<b>TC6048</b>	Self-Oiling Circle SuperCutter	48" (1219 mm)
<b>TC6048HSV</b>	Self-Oiling Circle SuperCutter with Tap Wheel™	48" (1219 mm)
<b>TC6072</b>	Self-Oiling Circle SuperCutter	72" (1829 mm)
<b>TC60H</b>	Replacement Cutting Wheel	---
<b>TC60HS</b>	Replacement Thick Glass Wheel	---
<b>TC60HSV</b>	Replacement Thick Glass Tap Wheel™	---
<b>TC6072B</b>	36" Extension Bar for TC6048	---

Minimum order: 1 each.

## CRL Precision Circle Cutters

- Our Most Popular Circle Cutters
- Precision Action Cutting Wheels
- Vacuum Cup Base
- Models for Diameters Up to 78" (1981 mm)

This popular Circle Cutter is made from the highest quality materials. The CRL Precision Circle Cutter features a 2-3/8" (60 mm) suction cup that holds steady while you are scoring. There are cross lines so you can accurately position the tool on a predetermined center. A ball handle allows for a smooth cutting motion for the duration on your cut. The machined brass extension bar is scaled in inches and millimeters. This unit is supplied with a Six Wheel Cutting Turret that is replaceable.



### CIRCLE CUTTERS

CAT. NO.	DESCRIPTION
<b>511CC</b>	2-1/2" to 24" (64 to 610 mm)
<b>512CC</b>	2-1/2" to 32" (64 to 813 mm)
<b>514CC</b>	2-1/2" to 48" (64 to 1219 mm)
<b>516CC</b>	2-1/2" to 78" (64 to 1981 mm)
<b>5181</b>	Cutting Head Assembly

Minimum order: 1 each.

### ACCESSORIES

CAT. NO.	DESCRIPTION
<b>T101</b>	Turret with Six 134 Degree Steel Wheels
<b>LW21</b>	134 Degree Steel Wheel (12 Per Pack)
<b>519</b>	Replacement Cup with 2-21/64" (59 mm) Stem
<b>5195</b>	Replacement Cup with 1-53/64" (46 mm) Stem
<b>5195X</b>	Replacement Cup with 1-5/8" (41 mm) Stem

Minimum order: 1 each.

## CRL Fletcher® CircleMate™ II Circle Cutters

- Professional Quality Circle Cutters
- Cuts Circles Up to 28" (711 mm)
- Cuts Strips Up to 12" (305 mm)
- Optional Scale Beams Allow You to Extend Cutting Radius

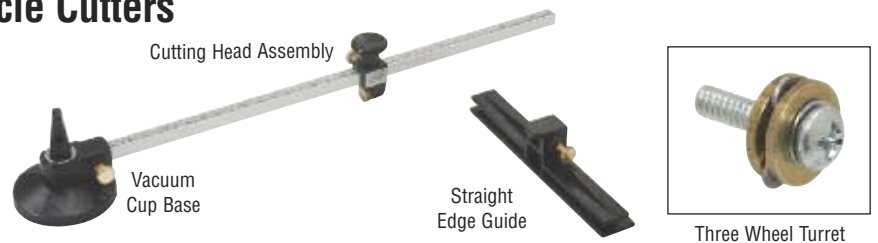

The CRL Fletcher® CircleMate™ II is a high quality Circle Cutter that has a vacuum cup base which locks it to the glass surface for accurate cuts every time. Its 14" (356 mm) scale beam will let you cut circles up to 28" (711 mm) in diameter. Optional Scale Beams allow you to extend the cutting radius. Included is a 6" (152 mm) straight edge guide which allows you to cut glass strips up to 12" (305 mm). This unit is supplied with a Three Wheel Cutting Turret for extended cutting life.

CAT. NO.	DESCRIPTION
<b>F05214</b>	CircleMate™ II Circle Cutter
<b>F12273</b>	Handle/Head Assembly
<b>F02613</b>	132 Degree Three Wheel Turret (10 Per Pack)
<b>F05348</b>	Optional 48" (1219 mm) Scale Beam
<b>F05372</b>	Optional 72" (1829 mm) Scale Beam

Circle Cutter and Scale Beams minimum order: 1 each. Wheel Turret minimum order: 1 pack of 10.

Fletcher is a registered trademark of The Fletcher-Terry Company, LLC

## CRL Circle and Oval Cutter

- Our Best Circle and Oval Cutter
- Cut Circles and Ovals From 6-3/8" to 55" (160 to 1400 mm)
- Optional Extension Kit Expands Cutting Range to 90-1/2" (2300 mm)

This is the largest capacity manual Oval and Circle Cutter available today. The standard Cat. No. 1550CC comes with a short bar with oval cutting capacity from 6-3/8" to 27-1/2" (160 to 700 mm), and a long bar with a range from 6-3/8" to 55" (160 to 1400 mm). Add the optional Cat. No. 1550EXT Extension Bar and extend your oval capacity to 90-1/2" (2300 mm).

The cutting mechanism is fixed to the glass surface by either two or six suction cups depending on the size of job. The unique, precisely machined cutting grip and head contains a built-in oil reservoir which delivers oil via wick to the cutting wheel and axle, extending the life of the tungsten carbide cutting wheels. The replaceable wheel holder is mounted into a ball bearing swivel allowing the holder to rotate 360 degrees to accurately follow the track of the preset machine. Each Cutter is packed in a hardwood storage box.



CAT. NO.	DESCRIPTION
1550CC	Circle and Oval Cutter
1550EXT	90-1/2" (2300 mm) Extension Kit
155035	135 Degree Wheel Holder
155055	155 Degree Wheel Holder

Minimum order: 1 each.

### Breakout Procedure:

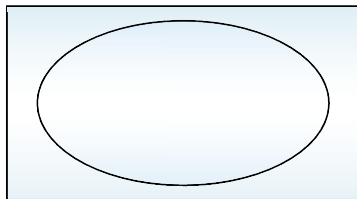

① Oval or circle score the glass

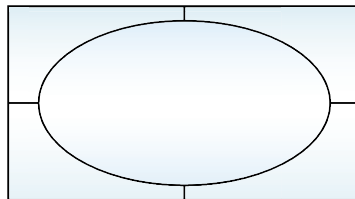

② Make quarter point relief score lines

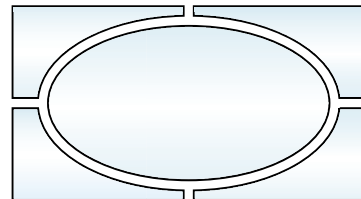

③ Breakout and remove scrap, leaving finished oval or circle

## CRL TP2800 Deluxe Circle Cutters

- Lever Actuated Suction Cup Base
- Graduated Scale Bar Adjusts at Base Cup
- Includes TP2800 Deluxe Oil Cutter

This CRL Deluxe Circle Cutter System comes complete with a TP2800 Deluxe Brass Oil Cutter. The graduated scale bar adjusts and locks into place at the suction cup base. The ball bearing head on the TP2800 freely rotates 360 degrees, and the trailing cutting wheel yields superior results. Wheel Holders are interchangeable for different applications including thick glass cutting. See page 114K for Wheel Holder selection.

CAT. NO.	DESCRIPTION	MAXIMUM CIRCLE DIAMETER
TP2824CC	Deluxe Circle Cutter	23.5" (600 mm)
TP2848CC	Deluxe Circle Cutter	47.2" (1200 mm)
TP2878CC	Deluxe Circle Cutter	78.8" (2000 mm)
TP2800	Deluxe Oil Cutter With 135 Degree Wheel (Included)	--
TP039	Transverse Handle (Sold Separately)	--

Minimum order: 1 each





## CRL Circle and Oval Cutting Machine

- Precision Action Gives Perfect Cuts Time and Time Again
- Vacuum Cup Base



CAT. NO. 540

CAT. NO. 54010

CAT. NO. JB427

CRL's Circle and Oval Cutting Machine meets almost all your circle and oval cutting needs. A product of superb ingenuity and craftsmanship, it is quick and easy to use because a vacuum cup holds it in place. Its cutting range is 4" to 16-3/4" (102 to 426 mm), with a maximum difference of 3-1/8" (79 mm) between the long and short dimensions. Replacement Cutter Head is available for older machine (Cat. No. JB427), as well as the current model (Cat. No. 54010). Minimum order is one each.

## CRL Fletcher® Circle and Oval Cutter

- Cuts Small Circles and Ovals
- Suction Cup Base



CAT. NO. F03131



CAT. NO. F05221

CRL's Fletcher® Circle and Oval Cutter is perfect for the glass shop that needs a Circle and Oval Cutter combination. Ovals can be cut from a minimum of 4-1/2" (114 mm) to a maximum of 24" (610 mm). A 3" (76 mm) maximum offset between the two measurements is allowed. The largest circle that can be cut is 21" (533 mm). Unit is secured to the glass by a small suction cup.

CAT. NO.	DESCRIPTION
F05221	Circle and Oval Cutter
F03131	Single Replacement Carbide Wheel

Minimum order: 1 each.

## CRL Lens Cutter Circle Machine

- Makes Small Diameter Cut Circles From 1/2" to 5" (12 to 127 mm)

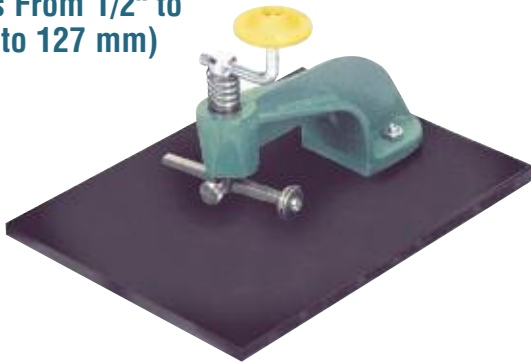

A graduated rod makes it easy for you to cut any sized circle within a 1/2" to 5" (12 to 127 mm) diameter size range. Its Turret has three wheels and is easily replaced. The entire unit can be replaced quickly if necessary. Overall size is 8" (203 mm) long, 6" (152 mm) wide, and 5" (127 mm) high.

CAT. NO.	DESCRIPTION	CIRCLE DIAMETERS
32	Lens Cutter Circle Machine	1/2" to 5" (12 to 127 mm)
GRS32	Replacement Arm and 3-Wheel Turret	--
3T	Replacement 3-Wheel Turret	--

Minimum order: 1 each.

Fletcher is a registered trademark of The Fletcher-Terry Company, LLC

## CRL Circle Cutting Machine

- Great for Repetitive Circle Cutting
- Comes Complete With a Six Wheel Turret



With the CRL Circle Cutting Machine you can cut circles on a production basis with a minimal investment. This steel frame cutter has a precision calibrated brass scale rod for accurate circles time after time. The markings are in fractions and metric for universal use. A knurled thumbscrew allows for easy adjustments without tools. There is also a spring which keeps the cutting head off of the glass until you are ready to cut, reducing the risk of mistakes.

CAT. NO.	DESCRIPTION	CIRCLE DIAMETERS
530	Circle Cutting Machine	1" to 12" (25 to 305 mm)
532	Circle Cutting Machine	1" to 24" (25 to 610 mm)
T101	Replacement 6-Wheel Turret	--

Minimum order: 1 each.

## CRL Glass Chipping Tool

- Used to "Scalloped" Glass Edges
- Adjustable for Chip Size and Glass Thickness
- Great for Tabletops!



**CAT. NO. CT007CP**

Replacement Carbide Steel Chipping Point



**CAT. NO. CT007**  
Glass Chipping Tool



CRL Glass Chipping Tool is used by glaziers and craftsmen in the furniture industry to make "scallop" chips in plate glass from 1/8" to 3/4" (3 to 19 mm) thick. Use on tabletops or any place where a decorative "chipped" look is desired. This is a very popular tool for this type of work throughout the industry. The CRL Glass Chipping Tool adjusts to any glass thickness and "chip" size that is desired. Angle of chip is also adjustable. Minimum order is one each.

## CRL Glass Scalloping Tool and Positioner

- Make Beautiful Scalloped Edges Without Machinery
- Simple and Easy to Use



**CAT. NO. ST719RB**

Replacement Carbide Steel Scalloping Point

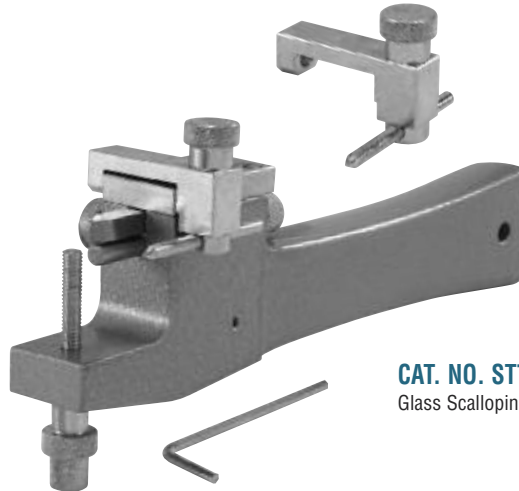

**CAT. NO. ST719**  
Glass Scalloping Tool

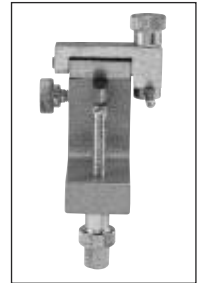

CRL Glass Scalloping Tool and Positioner will produce a uniform scalloped edge on glass from 1/8" to 1" (3 to 25 mm) thick. The tool was designed to provide the user with the best possible edge while keeping the chips spaced evenly from each other. Depth and width of the scallops are fully adjustable, regardless of glass thickness. The unique positioning aid (included) keeps the tool in the correct position so the chip uniformity is remarkably consistent. The easiest to use of all scalloping tools available! A detailed instruction manual is included. Minimum order is one each.

## CRL Round Edge Template Guide

- Make Consistent Radius Corners Easier Than Ever
- Choose From 12 Radii (10 to 70 mm)



The CRL Round Edge Template Guide gives you 12 radii (10 to 70 mm) to pick from, allowing you to score precise, repetitive cuts for tabletops, shelves, automotive glass, mirrors, and more. Manufactured in a tough, durable material, the RET12 features four slip-resistant pads that not only keep the Template in place during use, but also reduce the risk of scratching the glass. Minimum order is one each.

**CAT. NO. RET12**

## CRL Phenolic L-Squares

- Made of Durable, Non-Warping, 1/4" (6 mm) High-Impact Phenolic

- Available in Four Sizes
- Factory Calibrated for Accuracy

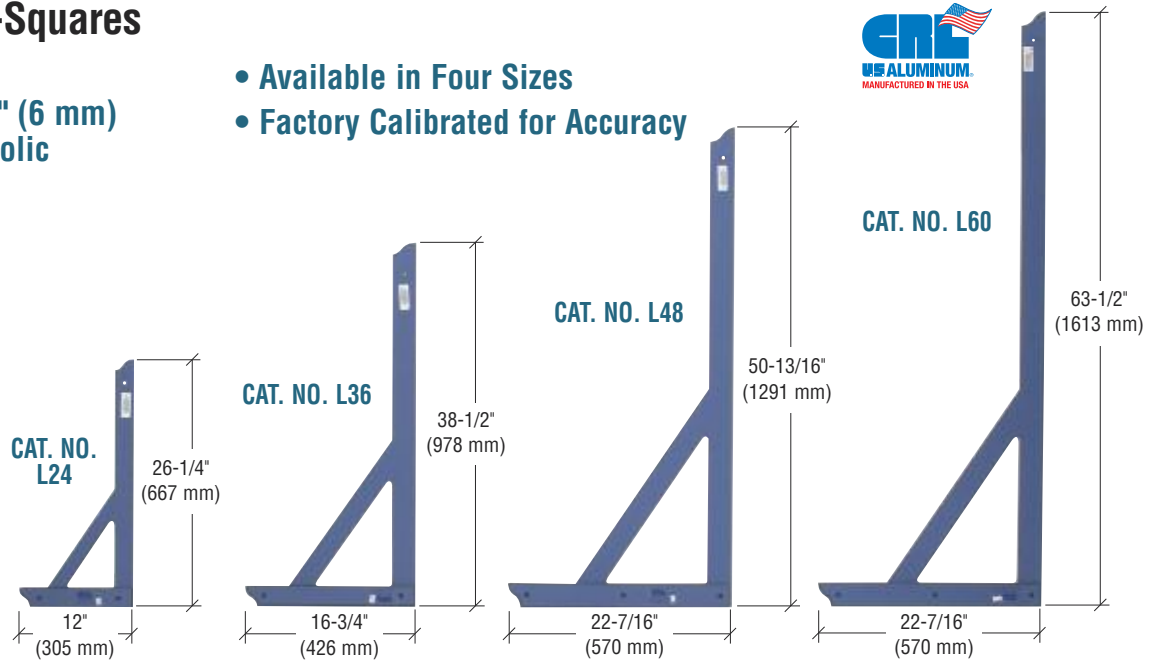
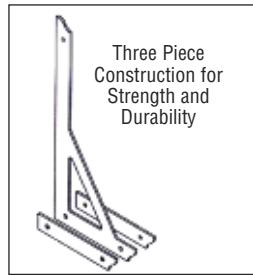
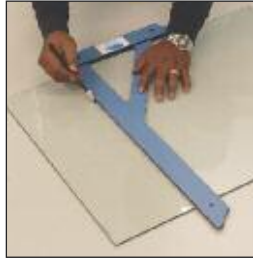

These inexpensive, durable L-Squares really do the job. Because they are made of high-impact phenolic, they take a lot of on-the-job punishment without warping, and last a long time. L-Square Combo Sets are also available (see below).

**HELPFUL HINT:** Take good care of your L-Square by always storing it flat or hanging against a flat surface to prevent warping.

CAT. NO.	LENGTH
L24	26-1/4" (667 mm)
L36	38-1/2" (978 mm)
L48	50-13/16" (1291 mm)
L60	63-1/2" (1613 mm)
LSQBRNUT	Replacement Nut and Screw

Minimum order: 1 each. Sizes can be combined for quantity pricing.

## CRL 60" Phenolic L-Square With Suction Cup

- Now Available With a Suction Cup for Added Stability When Cutting

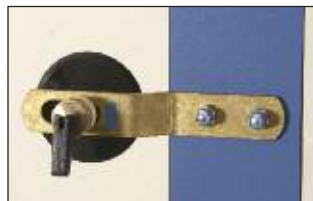

The L60V L-Square has a Suction Cup (Cat. No. L60RVC) affixed to the inside of the vertical leg. With a quick snap of the suction cup lever, the top of the square is firmly held to the glass, preventing the square from slipping during scoring. Retro-Fit Suction Cup Kits with mounting hardware and instructions for all CRL L-Squares are also available.

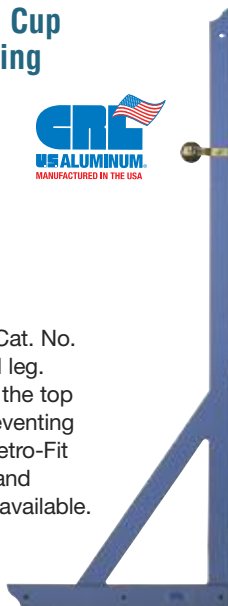

CAT. NO.	DESCRIPTION
L60V	60" (1524 mm) L-Square with Suction Cup
L60RVC	Retro-Fit Suction Cup Kit

Minimum order: 1 each.

## CRL Phenolic L-Square Combo Sets

- Includes Two L-Squares
- Choose From 48" and 24" (1219 and 610 mm) or 60" and 24" (1524 and 610 mm) Sets



Keep one L-Square in the shop and take one with you to the job site, and save money too!

CAT. NO.	SET CONTAINS
L4824C	48" and 24" (1219 and 610 mm) L-Squares
L6024C	60" and 24" (1524 and 610 mm) L-Squares

Minimum order: 1 each.

## CRL Euro Style L-Squares

- Durable Phenolic Construction
- Speeds Square Placement and Repositioning

The CRL Euro Style L-Square makes square placement and repositioning of the square faster, by eliminating the brace. The Euro L-Square does not need to be completely lifted from the table or glass to get it out of the way. Simply pull the Square back from the table a few inches and let the "L" fall vertical. The Square will take up only a fraction of it's original space on the table.

CAT. NO.	SIZE
L24EURO	24" (610 mm)
L48EURO	48" (1219 mm)

Minimum order: 1 each. Sizes can be combined for quantity pricing.



## CRL T-Squares

- Durable Phenolic Construction
- Ideal for Cutting Narrow Pieces of Glass

The CRL T-Square has several advantages over conventional L-Squares. One advantage is when you are cutting tall, narrow pieces of glass where there is not enough glass on either side of the cut to give a stable true square of the cutting arm. The "T" is not limited to squaring up on just one side of the cut.

CAT. NO.	SIZE
TSQ24	24" (610 mm)
TSQ48	48" (1219 mm)

Minimum order: 1 each. Sizes can be combined for quantity pricing.



## CRL Mini L-Square

- Ideal for Mirror Squares, Floor Tiles, or Picture Frame Glass
- Made From High-Impact Plastic So it Won't Scratch the Glass

The CRL Mini L-Square is ideal for cutting small pieces of glass, mirror, or floor tiles. It is made from a tough non-abrasive material, which will not scratch the glass. Vertical leg of square is 12" (305 mm) long. Minimum order is one each.



CAT. NO. L12

## CRL Angle Protractors

- Precision Calibrated Protractor
- Made From Durable Phenolic

The CRL Angle Protractor lays out angled corners for cutting, using a very precise calibrated angle gauge which measures angles from 0 to 180 degrees in 1 degree intervals. Once the Angle Protractor has been positioned, simply tighten the brass thumb screw to keep the arm locked into position.

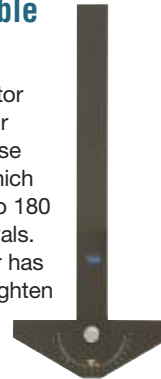

CAT. NO.	ARM LENGTH
355A	24" (610 mm)
356A	40" (1016 mm)

Minimum order: 1 each.

## CRL Cutting Frames

- Durable Phenolic Construction
- Precision Graduated Metric Scales on Both Legs
- Ideal for Copying Angles and Transferring Those Angles to Glass

This CRL Cutting Frame is the most practical tool for laying out odd shaped or angular shaped patterns, such as trapezoids or parallelograms. The movable cross bar can be slid up the legs, either equally or at an angle. Once the cross bar is in place simply tighten the thumb screws to secure the cross bar into position. Both of the legs have scale graduations to give an accurate position of the cross bar relative to the base. The Cutting Frame also has a pull handle for sliding the frame along the side or edge of a very long piece of glass. When cutting long strips from a sheet of glass, simply set the cross bar to the desired distance from the edge. Hold the cross bar handle in one hand, position your cutter with the other hand, and then slide the entire frame and cutter simultaneously along the length of the cut. Other frame sizes are available by special order.



CAT. NO.	SIZE
171F	24" x 24" (610 x 610 mm)
173F	40" x 40" (1016 x 1016 mm)

Minimum order: 1 each.

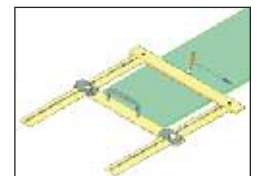
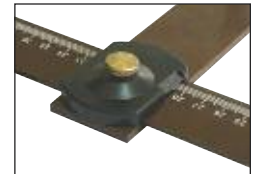

## CRL European Phenolic L-Squares

- Single Unbraced Leg
- Five Convenient Sizes
- Sturdy and Durable

This CRL European L-Square is sturdy, durable, and accurate. Made to exacting specifications to ensure the right angle time after time. Visit [crlaurence.eu](http://crlaurence.eu) for additional information.

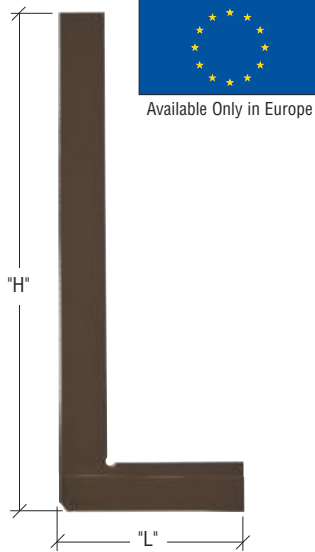

CAT. NO.	LENGTH "L"	HEIGHT "H"
M00553	22 cm	64 cm
M00554	29 cm	84.5 cm
M00555	38 cm	110 cm
M00556	44.5 cm	131 cm
M00557	50.5 cm	156 cm

Minimum order: 1 each.

## CRL European Sole Piece Squares

- Solid Phenolic Block Squares
- Super Rigid to Prevent Flex
- 4 mm Thickness, 12 mm 3-Ply Guide Base
- Available in Europe Only

CRL European Sole Piece Squares are made of sturdy and durable solid phenolic design. Available in five sizes. Visit [crlaurence.eu](http://crlaurence.eu) for additional information.

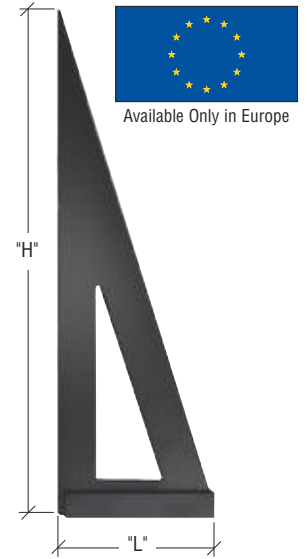

CAT. NO.	LENGTH "L"	HEIGHT "H"
M00566	22 cm	62 cm
M00567	26 cm	75 cm
M00568	32 cm	94 cm
M00569	38 cm	116 cm
M00570	44 cm	129 cm

Minimum order: 1 each.

## CRL Notching Cut-Out Template

- Perfect for Teller Window Openings
- Makes Cutting Hinge or Hardware Notches an Easy Task
- No Need to Drill Holes

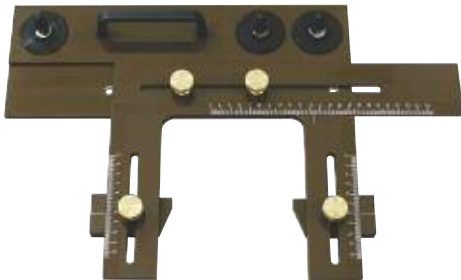

The CRL Notching Cut-Out Template is a labor saving device used for fabricating those "impossible" notches in glass up to 3/8" (10 mm) thick. Any size three-sided notch between 3/4" x 7/8" (19 x 22 mm) minimum and 13-1/8" x 6" (333 x 152 mm) maximum can be made easily using this template. A 9/32" (7 mm) corner radius is produced while using our TP2800 Glass Cutter. The template is constructed from a synthetic resin and the finest hardware. It is secured to the glass by three built-in suction cups. There are also two adjustable depth stops that double as "runoff strips" for your cutting wheel. Ideal for fabrication of window pass-thrus, shower door hinge notches, and just about any place a cut-out is needed. Minimum order is one each.

CAT. NO. TP181

## CRL Corner Notching Template

- Allows You to Make Consistent Quality Notches
- Corner Radius is 9/32" (7 mm)



The CRL Corner Notching Template allows right angle notches to be cut out of glass up to 5/8" (16 mm) thick when used with the TP2800 Glass Cutter's 360 degree wheel rotation (see page 114K). Two trigger-actuated vacuum cups secure the template to the glass, while the adjustable glass edge guides hold the 90 degree angle. Notch depth can be varied from 1-3/4" to 6-7/8" (44 to 175 mm); corner radius is 9/32" (7 mm). Made from 3/8" (9.5 mm) thick phenolic resin. Minimum order is one each.

CAT. NO. TP078

## CRL Phenolic Straight Edges

- Phenolic Straight Edges Won't Warp Like Wood, and Are Built to Last
- Available in Five Lengths

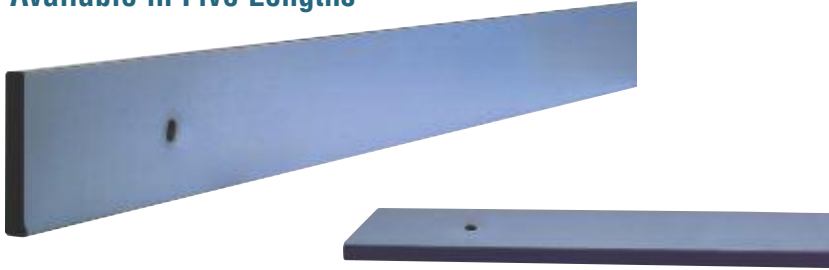

These tough CRL Phenolic Straight Edges are built to last. They have no markings, but are accurate and easy to use. Used by leading glass companies, these high quality straight edges are valuable tools whenever glass is cut. All Straight Edges measure 3" (76.2 mm) wide by 1/2" (12.7 mm) thick.

**NOTE:** To prevent distortion always store your Straight Edges in a flat position, not leaning against a vertical surface.

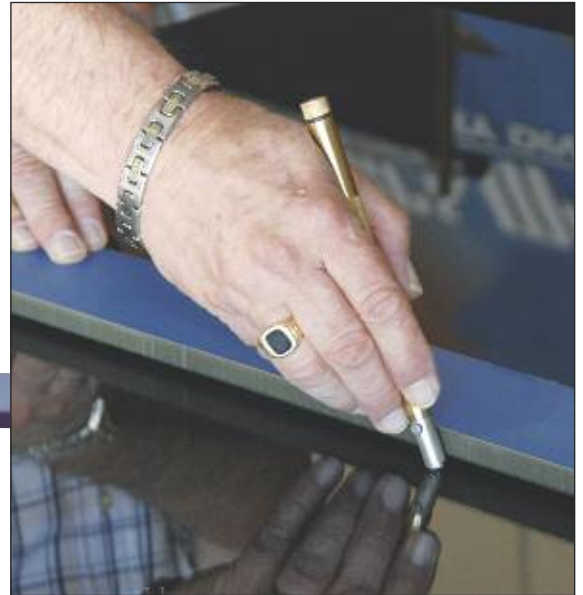
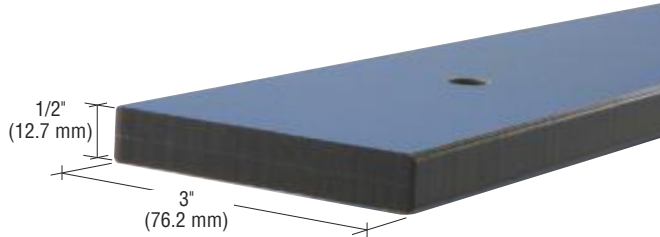

CAT. NO.	LENGTH
SEP48	48" (1219 mm)
SEP72	72" (1829 mm)
SEP96	96" (2438 mm)
SEP120*	120" (3048 mm)
SEP144*	144" (3658 mm)

Minimum order: 1 each. Can be combined with all other rulers and squares for quantity pricing, except L-Square Combo Sets. \*Over UPS size limits. Must ship common carrier.

## CRL Suction Cup Straight Edges

- Holds Securely to Glass Better Than Ever
- Available in Five Lengths



CAT. NO. VCRCUP  
Replacement Cup

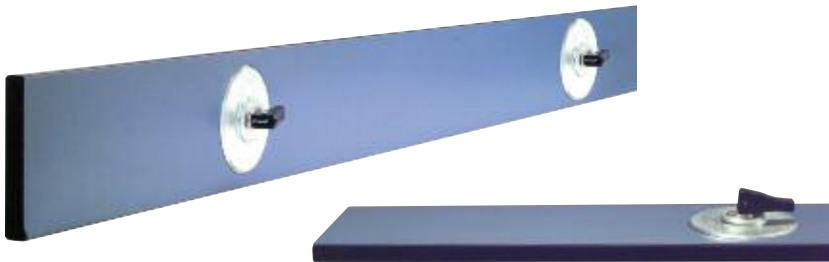

CRL Suction Cup Straight Edges have been re-designed to hold to glass better than ever. Made from the same material as our popular CRL Phenolic Straight Edges, this glazier's tool is built to last. All new steel body suction cups have the best quality rubber pads available. Using these Straight Edges eliminates the need for clamps, tape or a second person. Suction cups are placed approximately 8" (203 mm) from each end. Each CRL Suction Cup Straight Edge is hand made in our factory to exacting specifications. All Straight Edges measure 3" (76.2 mm) wide by 1/2" (12.7 mm) thick.

**NOTE:** To prevent distortion always store your Straight Edges in a flat position, not leaning against a vertical surface.



CAT. NO.	NO. OF CUPS	LENGTH
VCR48	2	48" (1219 mm)
VCR72	3	72" (1829 mm)
VCR96	3	96" (2438 mm)
VCR120*	4	120" (3048 mm)
VCR144*	5	144" (3658 mm)
VCRCUP	-	Replacement Cup

Minimum order: 1 each. Can be combined with all other rulers and squares for quantity pricing, except L-Square Combo Sets. \*Over UPS size limits. Must ship common carrier.

## CRL Glazier's Rule Holder

- Reduces Straight Edge Slip
- Replacement Suction Cups Available

This handy CRL Glazier's Rule Holder holds the straight edge on your glass for an accurate cut every time. The large 2" (51 mm) rubber suction cup on the bottom of the holder holds the straight edge securely to the glass or any smooth flat surface when cutting or marking. It's like having an extra pair of hands. The brass nut can be loosened to adjust the clamp height to accommodate thin metal or thicker phenolic straight edges.



CAT. NO.	DESCRIPTION
RH670	Glazier's Rule Holder
5195	Replacement Suction Cup

Minimum order: 1 each.

## CRL Solo One-Handed G-Clamp

- Strong Die Cast Zinc Frame

The patented design, CRL Solo G-Clamp is an excellent clamp for one handed use. The large grip range up to 4" (102 mm) makes this a good general-purpose clamp, however the large nylon grip pad makes it ideally suited for holding straight edges to glass or for clamping Insulated Glass units. Minimum order is one each.



CAT. NO. 71004P

## CRL Deluxe Spring Clamps

- Vinyl Coated Grips and Tips



CAT. NO.	MAX. JAW OPENING	SIZE
JC3201HT	1" (25 mm)	4" (102 mm)
JC3202HT	2" (51 mm)	6" (152 mm)
JC3203HT	3" (76 mm)	9" (228 mm)

Minimum order: 1 each. Sizes can be combined for quantity pricing.

## CRL Straight Edge Rule



- Two Sizes Available

The smooth, square and straight edges of this extremely accurate rule make measuring jobs easier and more exact. The 2" (51 mm) wide flexible aluminum rule is bend resistant and lies flat. The markings are in 8ths on one side and 16ths on the other; they are large and easy to read.

CAT. NO.	LENGTH
SE48	48" (1219 mm)
SE72	72" (1829 mm)

Minimum order: 1 each. Sizes can be combined for quantity pricing.

## CRL Grip Strip

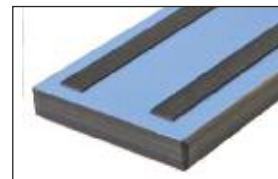

- Self Adhesive Black Tape Grips Glass But Does Not Stick to It

CRL Grip Strip is a unique, self-adhesive tape you apply to your straight edges and L-Squares to keep them from slipping on glass while cutting. It grips the glass but will not stick to it or leave a messy residue. This good quality tape is quick and easy to apply, and comes on release paper rolls. Tape measures 1/2" x 25" (12.7 mm x 7.6 m). Minimum order is one roll.

CAT. NO. GG1225

## CRL Yellow Glass Marking Pencil

- Our Most Popular Marking Pencil
- Bright, Stand-Out Yellow Color



CRL Yellow Glass Marking Pencils are great for marking on glass, acrylics, marble, tile, etc. They sharpen to a precise point, and their bright yellow color makes them ideal for all marking purposes. Great for labeling stock and making measured cuts. Marks rub off easily with a dry cloth. **NOTE:** Not available in Australia.

CAT. NO.	COLOR	QTY/BOX
GM44	Yellow	12

Minimum order: 1 each.

## CRL Stabilo® Glass Marking Pencils

- For Writing on Smooth Surfaces
- Holds a Point for Drawing Thin Lines



CRL Stabilo® Marking Pencils not only write on glass and paper, but also on metal, plastics, ceramics, porcelain, stone, film, painted or lacquered surfaces, and just about any other glossy surface. They are erasable from paper, and marks will wipe off of glossy surfaces with a damp cloth. **NOTE:** Not available in Australia.

CAT. NO.	COLOR	QTY/BOX
8040	Red	12
8044	Yellow	12
8046	Black	12

Minimum order: 1 each. Colors can be combined for quantity pricing.

## CRL Stabilo® Marking Pens

- Designed for Marking on Glass
- Quick-Drying Permanent Ink



CRL Stabilo® Marking Pens are designed expressly for marking on glass. They are quick-drying and easy to read because of the broader soft tip. Marks will not rub off under normal contact, but can be removed if necessary. Also great for marking cut lines or patterns on stained glass.

CAT. NO.	COLOR	QTY/BOX
76P40	Red	10
76P46	Black	10

Minimum order: 1 each. Colors can be combined for quantity pricing.

## CRL Dixon® Felt Tip Markers

- Instant Drying, Long Lasting
- Perfect for Cartons, Shelves, Signs and More



CRL Dixon® Redimark® Felt-Tipped Markers are made to be long-lasting in all of your industrial marking uses. They are leak proof, and the permanent instant drying ink lets you write on any surface. These markers are designed for heavy-duty use so they won't dry out prematurely.

CAT. NO.	COLOR	QTY/BOX
DX8711	Red	12
DX8717	Black	12

Minimum order: 1 each. Colors can be combined for quantity pricing.

## CRL White Felt Marker

- Quick Drying
- Thick Point-Great for Marking Glass



Available Only in Australia



CRL White Felt Markers are quick drying and suitable for use on non-absorbent materials like rubber, metal, glass, or plastic. Wipes off with a moist cloth.

CAT. NO.	COLOR	QTY/BOX
G2135	White	12

Minimum order: 1 each.

Stabilo is a registered trademark of Schwan-STABILO Schwanhaeusser GmbH & Co. KG LLC. Dixon and Redimark are registered trademarks of Dixon Ticonderoga Company. Pentel is a registered trademark of Pentel Co., Ltd.

## CRL Pentel® Marking Pens

- Quick Drying White Color
- Three Tip Sizes Available



Available Only in Australia



CRL Pentel® White Marking Pens are quick drying and suitable for use on nonporous surfaces like metal, glass, plastic and rubber.

CAT. NO.	COLOR	TIP	QTY/BOX
100WS	White	Fine	6
100WM	White	Medium	6
100W	White	Broad	6

Minimum order: 1 each.



## CRL Dixon® China Markers



The Dixon® China Marker's true, opaque pigment makes it one of the most versatile marking instruments available. Since it will mark on all glazed and polished surfaces, it is ideal for marking glass, plastic or lacquered wood surfaces. Its round shape makes writing comfortable for long periods, and to sharpen it, you merely pull the string. Packaged 12 per box.

CAT. NO.	COLOR
<b>DX71</b>	Red
<b>DX73</b>	Yellow
<b>DX81</b>	Black

Minimum order: 1 dozen. Colors can be combined for quantity pricing.

## CRL Listo® Marking Pencils



To write on glossy surfaces, the Listo® Mechanical Pencil is a great choice. Used to mark glass, metal or plastic, its smooth plastic point won't scratch. A heavy-duty pocket clip holds it securely in your pocket, tool belt, cutter pouch, etc. Packed 12 per box; refill leads come 72 per box.

CAT. NO.	COLOR	DESCRIPTION	QTY/BOX
<b>MP1</b>	Black	Pencil	12
<b>MP2</b>	Red	Pencil	12
<b>MPL11</b>	Black	Refill Leads	72
<b>MPL12</b>	Red	Refill Leads	72

Minimum order for pencils: 1 each. Minimum order for leads: 1 box. Can be combined for quantity pricing.

## CRL Sharpie® Blue Fine Point Pen



CRL Sharpie® Fine Point Pens are American-made markers that write on anything - plastic, glass, ceramic, metal, enamel, wax paper, cellophane, rubber, leather, film, wood and much more. Quantity per box is 12. Minimum order is one each.

**CAT. NO. 2113338**

## CRL Paint Markers **new**

CRL Paint Markers are great for marking on glass, stone, or any other surface. They are available in both fine and medium tip styles. There are six pens per box.



CAT. NO.	COLOR	DESCRIPTION	QTY/BOX
<b>2113459</b>	White	Metal Fine Tip	6
<b>2113460</b>	Black	Metal Fine Tip	6
<b>2113461</b>	Neon Yellow	Metal Fine Tip	6
<b>2113462</b>	White	Plastic Medium Tip	6
<b>2113463</b>	Black	Plastic Medium Tip	6
<b>2113464</b>	Neon Yellow	Plastic Medium Tip	6

Minimum order: 1 box.

## CRL Touch-Up Markers



**CAT. NO. TUM8**  
Medium Bronze



**CAT. NO. TUM9**  
Black

CRL Touch-Up Markers will cover scratches on metal beautifully, and can be a real time saver to the glazier. Use them for thin scratches, to touch up cut ends of extrusions, or for covering screw heads. Vary the hand pressure of the point and you can adjust the width of the stroke. Positive-seal cap prevents the marker from drying out. 12 per box. Minimum order is one each.

## CRL 120V Industrial Engraver **new**

The CRL 120 Volt Industrial Engraver is a powerful, durable tool for all your marking or engraving needs. Delivering 7200 strokes per minute, the 29005 has an adjustable 5 position stroke depth selector dial, and a cushioned soft grip body. Each tool is packed with four carbide tips, tip and wrench storage box, and heavy gauge plastic alpha-numeric template. This is the perfect tool for engraving identification on tools, electronics, cameras, and car parts.



CAT. NO.	DESCRIPTION
<b>29005</b>	Industrial Engraver
<b>DR9924</b>	Carbide Tipped Point
<b>DR9929</b>	Diamond Tipped Point

Minimum order: 1 each.

## CRL Diamond Scribing Tool



This handy Diamond Scribing Tool has a diamond point that lets you scribe glass as if you were writing with a pencil. Ideal for making intricate designs on glass objects. Pocket clip keeps it handy. Minimum order is one each.

**CAT. NO. DS67**

Dixon is a registered trademark of Dixon Ticonderoga Company.  
Listo is a registered trademark of Listo Pencil Corporation.  
Sharpie is a registered trademark of Sanford, L.P.

## CRL Carbide Point Scriber and Marker



**CAT. NO. G88**  
Carbide Scriber

**CAT. NO. G88P**  
Replacement Scriber Point

The CRL Carbide Point Scriber and Marker, with its tungsten carbide tip, will mark steel, aluminum, stainless steel, copper, ceramics, and glass. It has a screw chuck for reversing the point when not in use or when changing points. The tool measures 6" (152 mm) overall, and comes with a handy pocket clip. Minimum order is one each.

## CRL Drop Jaw Glass Pliers



- Excellent Forged Steel Pliers for Glass Up to 1/2" (12 mm) in Thickness

Machined to our exact specifications, this Plier's precision ground jaws support the glass, and at the same time, develop powerful leverage under slight pressure to cleanly sever glass at the cut line. The long 8-1/2" (216 mm) length will feel balanced and comfortable in your hand, even when breaking out 1/2" (12 mm) thick glass. Minimum order is one each.

CAT. NO. RD1932

## CRL Drop Jaw Glass Pliers



- Our Most Popular Glazier's Pliers
- Heavy-Duty All Steel Construction

This popular CRL Drop Jaw Glass Plier has a flat upper jaw that supports the top surface of the glass, while the humped lower jaw develops powerful leverage under slight pressure, and cleanly severs the glass at the cut line. Maximum glass thickness is 1/2" (12 mm), and the overall plier length is 8" (203 mm). Minimum order is one each.

CAT. NO. 3210

## CRL Straight Jaw Glass Pliers (Flare)



- High-Quality, General Glazing Pliers Widely Used in the Industry

CRL offers one of the best imported general Glass Pliers available. A precision machined tool featuring great strength, balance, and the flaring wide jaw preferred by many glaziers. 8" (203 mm) overall length. Minimum order is one each.

CAT. NO. 3410

## CRL Flare Jaw Glass Pliers



- Excellent Forged Steel Pliers With Machined Jaws for Consistent Breaks

The 1" (25.4 mm) wide flared jaws of our Flare Jaw Pliers are preferred by many professional glaziers. The RD1935's jaws are machined with great attention to the tips to be sure that there is no gap between them when closed, ensuring that they are perfectly parallel. That means cleaner, more consistent breaks for you. 8-1/4" (210 mm) overall length. Minimum order is one each.

CAT. NO. RD1935

## CRL Straight Jaw Glass Pliers



- Compact Design is Easy to Carry
- Ideal for Stained Glass Work

This tool is a smaller version of Cat. No. 3410 Straight Jaw Glass Pliers. They are large enough to do the work, yet small enough to fit in your pocket; an ideal Plier for stained glass and regular work. 6" (152 mm) overall length. Minimum order is one each.

CAT. NO. 3416

## CRL Soft Nose Glass Pliers



- Designed for Working With Art Glass

Soft Nose Glass Pliers are specially made for working with art glass. They have an angled top and a curved, serrated lower jaw for nibbling glass. Polished head with vinyl coated handles. 6" (152 mm) overall length. Minimum order is one each.

CAT. NO. GC6

## CRL PPG® Glass Running Pliers

- Self-Aligning "Floating Block" Jaws Stay Parallel to Glass
- For Use With Up to 1/2" (12 mm) Thick Glass or Mirror
- Made in U.S.A.

CRL PPG® Glass Running Pliers have unique "floating block" jaws that are self-aligning to keep them perpendicular to the glass at all times. This eliminates any "flares" caused by conventional pliers. Excellent for long cuts, as well as specialty cuts for mail slots, corner notches, and speak tube holes. The PPG1 can be used on all thicknesses of glass from double strength to 1/2" (12 mm). These quality Pliers for the professional glazier are made in the U.S.A. Overall length is 9-1/2" (241 mm). Minimum order is one each.

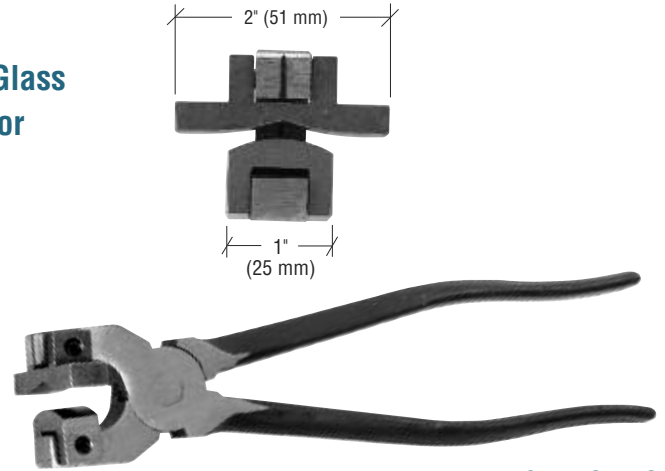

CAT. NO. PPG1

## CRL Glass Running Pliers

- Lightweight Aluminum
- Plastic Jaws Won't Chip Glass

Finally, a set of Glass Running Pliers that is both lightweight and durable. The high-density plastic jaws will not chip or mar your glass like steel jaw pliers. Runs score lines in glass and mirror from 1/8" to 3/8" (3 to 10 mm) thick. They fit easily in a cutter pouch or in your pocket, and are light enough to carry around all day. Built to last, they will never rust. Overall length is 8-1/2" (216 mm). Minimum order is one each.



CAT. NO. GRP512

## CRL Lightweight Glass Running and Nipping Pliers

- Made From Strong, Lightweight Plastic
- Provides Excellent Leverage for Clean Breaks

These CRL Lightweight Glass Running and Nipping Pliers are engineered from a very strong, very durable plastic, and are sure to give you years of service. Choose from the compact, easy to carry 6" (152 mm) size, or the added leverage of the 8" (203 mm) version. Both feature snap in replaceable jaws, one set for running and one for nipping. Maximum glass thickness for these Pliers is 1/4" (6 mm) which makes them ideal for a glazier's workshop. Minimum order on the Pliers is one each; the Replacement Jaw Inserts are sold per set.



CAT. NO. 189

8" (203 mm) Glass Running and Nipping Pliers



CAT. NO. 169

6" (152 mm) Glass Running and Nipping Pliers

- Replaceable Jaws



Plastic Jaw Set for Glass Running  
Two Per Set



Metal Jaw Set for Glass Nipping  
Two Per Set

### REPLACEMENT JAW SETS

CAT. NO.	DESCRIPTION
189NJ	Nipping Jaw Set for 189 Pliers
189RJ	Running Jaw Set for 189 Pliers
169NJ	Nipping Jaw Set for 169 Pliers
169RJ	Running Jaw Set for 169 Pliers

Minimum order: 1 set.

PPG is a registered trademark of PPG Industries Ohio, Inc.

## CRL 6-1/2" Glass Running Pliers

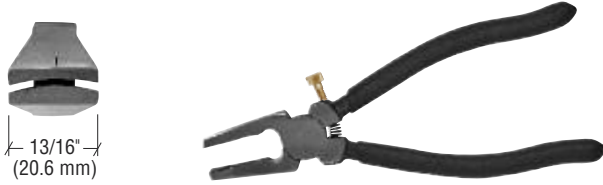

- Adjustment Screw Allows for Fine Adjustment According to Various Glass Thicknesses
- Perfect Glass Run Every Time

CRL 6-1/2" (165 mm) Glass Running Pliers have curved jaws designed to give you a perfect run every time. Just place the alignment mark over the score line, adjust the screw, and squeeze. The adjustment screw allows fine adjustment for various glass thicknesses, and helps to minimize glass breakage. The rubber coated handles give you a positive grip. Minimum order is one each.

CAT. NO. RP612

## CRL 8" Glass Running Pliers



- Adjustment Screw to Set for Correct Glass Thickness
- Minimize Glass Breakage

CRL 8" (203 mm) Glass Running Pliers are designed to be placed over the score line with the Pliers facing the same direction as the cut line, and the alignment mark placed directly above the line. Then simply set the thickness adjustment screw and squeeze. Perfect for running those thin strips of glass. Minimum order is one each.

CAT. NO. 3610

## CRL Offset Glass Pliers

- Used to Trim Plate Glass in Hard to Reach Places
- Very Useful in Storefront Glazing
- All Steel Construction

CRL Offset Glass Pliers reach places that ordinary pliers cannot, a real time saver when working close to ceilings and awnings. CRL Offset Glass Pliers are a 'must have' tool for every glazier's tool box. The tough, medium-grade steel construction allows these Pliers to withstand the daily abuse associated with storefront glazing and mirror installation. Tough, but compact, these Pliers will fit easily in your pocket. Designed for 3/32" to 7/16" (2 to 11 mm) thick plate glass. Minimum order is one each.



CAT. NO. 1050

## CRL Offset Glass Pliers

- A Must for the Storefront Glazier
- Hardened Steel Jaws
- Cushion-Grip Handles

Our 8-1/2" (216 mm) Offset Glass Pliers are a must for the storefront glazier. Perfect for custom fits on the job site, they make trimming glass easy, even when the lite is already in a vertical position close to the ceiling. A real time and labor saver, they have hardened steel jaws and cushion-grip handles. Minimum order is one each.



CAT. NO. 4000510

## CRL Offset Glass Breaker Bar

- Very Handy for Storefront Glazing
- Sturdy Steel Tool has Openings for 1/4" (6 mm) and 5/16" (8 mm) Glass

This CRL Offset Glass Breaker Bar was developed for the glass industry. With this 6-3/4" x 1" (171 x 25 mm) tool you can chip or break plate glass in an upright position. Especially handy for storefront work. Glass openings are 1/4" and 5/16" (6 and 8 mm). Minimum order is one each.



CAT. NO. 3614

## CRL Heavy-Duty Glass Nipper

- For Heavy Glass Up to 1" (25 mm) Thick
- Cushion-Grip Handles

CRL's Heavy-Duty Glass Nippers are designed for working with heavy plate glass, Carrara, Vitrolite, etc., in thicknesses up to 1" (25 mm). Comfortable handles and an overall length of 14-1/2" (368 mm) make these strong, perfectly balanced tools easy to use. Minimum order is one each.



CAT. NO. SM555

## CRL Corner Nipper Glass Pliers

- Makes Ready-to-Finish Radius on 90 Degree Corners
- Available in Three Different Radiuses

CRL Corner Nipper Glass Pliers cut a round corner into the square cut corner of 1/8" to 1/4" (3 to 6 mm) glass or mirror in one single "bite". When properly positioned, the hardened carbide steel jaws easily remove glass and leave a rounded edge. Light grinding with a belt machine is all that is needed to finish the corner. Automatic internal stops prevent the jaws from ever touching. A removable spring holds the jaws in the open position on these 10" (254 mm) tools so they are always ready to use.

CNP10 Jaw

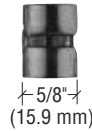

CNP20 Jaw



CNP30 Jaw



CAT. NO. CNP30

CAT. NO.	RADIUS
CNP10	3/8" (10 mm)
CNP20	25/32" (20 mm)
CNP30	1-3/16" (30 mm)

Minimum order: 1 each.

## CRL Plate Glass Lifter

- Simple Plier Type Tool Lifts Heavy Plate Glass for Inserting Blocks or Shims

The popular CRL Plate Glass Lifter is used to lift or position large plates of glass for inserting setting blocks or shims. The Glass Lifter has an overall length of 10" (254 mm). The 7/8" (22 mm) lifting plate has a rubber pad to protect the edge of the glass. Every glazier should have this time saving tool. Minimum order is one each.



CAT. NO. 104

## CRL Mirror Hole Nibbler



- Removes Small, Uneven Pieces of Mirror or Glass From Holes or Cut-Outs

The CRL Mirror Hole Nibbler is the perfect tool for removing pieces of mirror or glass to properly align your mirror cover plate installation. This 5-3/4" (146 mm) tool is a must if you have custom mirror plate projects. Minimum order is one each.

CAT. NO. MN1750

## CRL Thick Glass Cut Opening Tapper



- For Glass Up to 3/4" Thick



The CRL Thick Glass Cut Opening Tapper operates on a spring driven bolt principle. This unique glass working tool opens and runs score lines in glass from 3/8" to 3/4" (10 to 19 mm) thick. The CRL TP710 features an industrial steel body that has a chemically applied nickel coating. The internal spring mechanism adjusts to regulate the tapping force from very light for thinner glass to a powerful punch for thick plate glass up to 3/4" (19 mm). Minimum order is one each.

CAT. NO. TP710

## CRL TOYO Power Breaker Set for Thick Glass

- For Running Score Lines in Glass Up to 3/4" (19 mm) Thick
- Pistol Grip Cutter has Special Tap Wheel™

The CRL TOYO Power Breaker Tool easily runs scores in glass ranging from 1/2" to 3/4" (12 to 19 mm) thick. This tool features replaceable, adjustable nylon pressure pads along the top bar and a replaceable nylon pressure cap on the bottom. Simply spread the pressure pads as far apart as the glass score allows, align the pressure cap directly under the score and squeeze. The 19:1 power ratio gently snaps and runs the score. Vinyl dipped handles assure a positive, comfortable grip.

The Power Breaker Set includes a heavy-duty, pistol-grip oil cutter mounted with a 153 degree cutting head. This cutter employs the latest Tap Wheel™ cutting technology, which helps to drive the score deeper into the glass. The deeper score allows the Power Breaker Tool to deliver a nearly flare free break even in 3/4" (19 mm) glass. Minimum order for the CRL Power Breaker Set, including Breaker Tool and Cutter is one each. Replacement Cutter Heads and Nylon Pressure Cap also sold one each. Replacement Nylon Pressure Tips are sold per set of two. Breaker and Cutter are also available individually.



Tap Wheel™



**TOYO** Supercutter Series

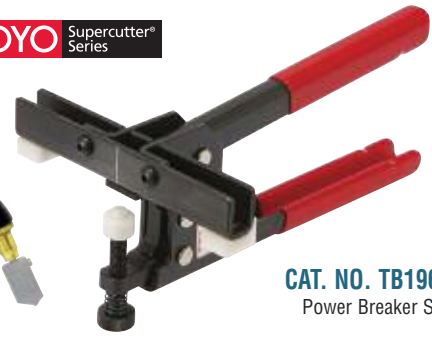

**CAT. NO. TB19600**  
Power Breaker Set

### Power Breaker Accessories



**CAT. NO. TB1912**  
Replacement Square Pressure Tips



**CAT. NO. TB1911**  
Replacement Bottom Pressure Cap



**CAT. NO. TC600SVB**  
Cutter Only



**CAT. NO. TC600HSV**  
153 Degree Cutter Head Straight



**CAT. NO. TC600HPV**  
153 Degree Cutter Head Pattern



**CAT. NO. TB19**  
Breaker Only

## CRL Fletcher® Glass Breaker Tool

- Breaks Glass Up to 1" (25 mm) Thick
- Includes 148 Degree Carbide Cutter



**CAT. NO. CAB**

Replacement Carbide Wheel Glass Cutter



**CAT. NO. BR1**  
Glass Breaker Tool with Carbide Wheel Glass Cutter



This portable breaking tool "runs" your score line with precise control, unlike any other tool on the market. After scoring the glass, mount the Breaker on the glass with the screw knob facing down. Spread the two silver round anvils as far apart as possible, locating the pointed silver fulcrum directly under the score line. Turn the black knob so that the fulcrum presses upward on the glass from below. There is no crushing of the glass edge or breaking of your glass sheet, and uncontrolled runs are a thing of the past. The BR1 is guaranteed to produce a clean edge every time. It comes complete with a carbide glass cutter which has a 148 degree angle wheel for cutting glass up to 1" (25 mm) thick. Minimum order for BR1 Tool and CAB Carbide Cutter is one each.

## CRL Heavy Glass Breaking Pliers

- For Glass Up to 1" (25 mm) Thick
- Simple to Operate

These Heavy Glass Breaking Pliers are indispensable for running score lines in all heavy plate glass. The compound action handle allows for precise application of pressure. Minimum order is one each.



**CAT. NO. TP7020**  
For Glass to 1" (25 mm)

## CRL Precision Cut Opener

- Runs Difficult Cuts Easily
- Precise Control

The CRL Precision Cut Opener makes difficult cuts in glass up to 1/2" (12 mm) thick an easy task. Now 90 degree corners and three-sided notches can be opened effortlessly. A run can be controlled to ensure a precise break every time. Throat depth is 5" (127 mm). Minimum order is one each.



**CAT. NO. TP046**  
For Glass to 1/2" (12 mm)

Fletcher is a registered trademark of The Fletcher-Terry Company, LLC.

## CRL Glass Break-Out Tools

- Easy to Use – Fits in Your Cutter and Pencil Pouch
- Speeds Common Break-Outs of Glass and Mirror



These CRL Break-Out Tools come with or without a cutting head, depending on the style you prefer using. The B0T10 appears to be a standard oil cutter, but further examination reveals a spring loaded "plunger". After placing the back end of the tool on the glass, you simply pull and release the plunger which causes a snapping action, breaking out your cut-out holes and circles. This method is faster and more accurate than others because you can see what you are doing from the top of your work, instead of "guessing" your position when tapping from the bottom. These tools fit right in your cutter pouch until needed for outlet holes, circles, shapes and just about anywhere you would normally use a "ball tapper" or similar tool. With the CRL B0T10, your cutter and breaker

are built into one tool. Designed by a glazier, this high-quality aluminum cutter is lightweight and built to last. The CRL B0T20 is the same tool as the B0T10, but without a cutting head. A "must have" tool for anyone who does break-out work. Minimum order is one each.

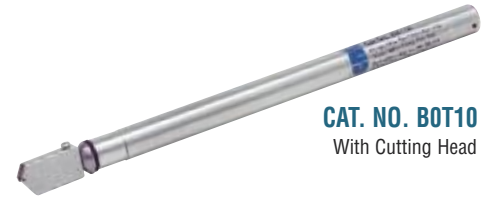

CAT. NO. B0T10  
With Cutting Head



CAT. NO. B0T20  
Without Cutting Head



CAT. NO. 41050  
Replacement Cutting Head

## CRL Freeze-It Spray Propellant



- Freeze Glass to Run Scored Circles in Glass
- Environmentally Safe Propellant



Getting the center out of a circle scored in glass has never been easy, but this Freeze-It Spray makes this tough job easier. CRL Freeze-It Spray Propellant is used to run a scored circle without any tapping required. Doing it this way, the run will have no flares. It works on basic scientific principles that cold objects contract. When the center contracts it creates a true run around the circle. Small circles can be sprayed in the middle, larger circles should be sprayed 1" (25 mm) inside score line. As it runs, follow it with the Freeze-It Spray propellant until the run is complete.

CAT. NO.	DESCRIPTION	SIZE	QTY/CASE
FNB8	Freeze-It Spray Propellant	7 oz. (198 g)	12

Minimum order: 1 each.

## CRL Glass Sling Shot

- For Breaking Out Glass Circle Centers
- Easy to Use

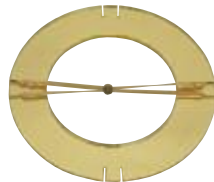

The CRL Glass Sling Shot was designed to break out the center of glass circles that have been scored and run. After extensive testing, a special size and weight steel ball was selected for its outstanding performance. The Glass Sling Shot Kit consists of a flat ring, steel ball, twenty rubber bands and a threading wire. The Replacement Kit consists of two steel balls and 20 rubber bands. You will be amazed at how efficiently and quickly the Glass Sling Shot works to break out the center of glass circles.

CAT. NO.	DESCRIPTION
20GSS	Glass Sling Shot Kit
20SRK	Replacement Rubber Band and Ball Kit

Minimum order: 1 each.

## HOW IT WORKS:



1 Cut a circle using a standard circle cutter. Make sure your cut is well-oiled and does not overlap.

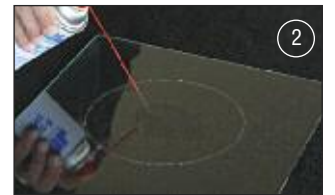

2 Freeze the center of the circle with Freeze-It Spray Propellant until the scored line has run completely around. This feature is very important as any of the radiating breaks caused by the contact of the Glass Sling Shot ball will not run past this run.



3 Score a couple of lines in the center. It will help start the break for the Sling Shot. We've all heard that more score lines are better for weakening the glass. NOT TRUE HERE! Only two are needed.



4 Line up the Sling Shot with the cross-hairs set up in the glass. Pull up on the ball approximately 3" (36 mm) and let go. This amount of pressure is safe for the first cut because radiating cracks won't go past the run in the outer line.



5 Continue to pull on the ball and release, but gradually decrease pressure as you approach the outer edge. Continue until you have a full break across the center of the hole.

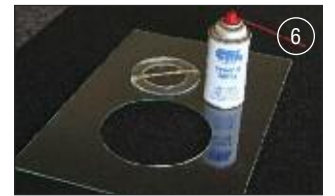

6 The rest is easy!

**NOTE:** Always wear safety glasses or goggles when using the Glass Sling Shot to protect your eyes.

## CRL FastCUT® Glass and Metal Optimizing Software for Square, Rectangular, and Stock Length Material

- Now Exports DXF Formatted Data
- Calculates in Inches or Millimeters for Maximum Usage from Stock Sheets, and in Many Different Languages
- Works on any Computer Using Windows 98/2000/ME/NT, XP (SP1 and SP2), Vista, and 7
- Fast (Printed) Cutting Lists
- Quote Customers Immediately
- Saves on Materials
- Optimizes Panes and Window Frame Components
- Optimizes Remnant Stock Before Using New
- Compatible With the Optional Label Program Cat. No. 2000FLM Shown Below

**CRL FastCUT® Glass Optimizer** will help you eliminate the time consumed quoting and calculating materials. Both plate glass and linear materials are handled with ease. Simply enter the quantity and sizes you wish to cut, then list your stock. You can also do this by using a macro that runs seamlessly within Excel. **NOTE:** May be downloaded once to one computer only. Minimum order is one each.



1. List the Cut Sizes



2. List the Stock



3. Press GO!

Do you spend too much time on estimating and preparing factory work orders? Do you over-estimate material usage to get quotes out quickly?

**CRL FastCUT® Glass Optimizer** is an easy and affordable PC software package that produces fast and accurate estimates and work orders for panes and linear product.

**CRL FastCUT® Glass Optimizer** is ideal for all materials including window production stock components. A simple switch will swap the software into linear mode for optimizing length-based items such as aluminum sections for windows or shower enclosures. Printed cutting lists, nest images and costing reports offer benefits for office and factory. All reports are printable, including material utilization and dimensioned patterns.

### **CRL FastCUT® Powerful™ Optimization Engine**

Optimization is about getting the greatest possible yield from material by trying millions of computer generated layouts. Sometimes it is about working out what stock to order in the first place. Even small improvements can result in large savings of material and considerably reduce production costs, maximizing the material utilization and therefore minimizing the [wasted] area. The optimization/nesting technology used today is vastly improved on what it was even several years ago because of the fantastic increase in micro-speeds.

### **Import/Export Microsoft Excel™ Data**

You can simply cut and paste information from FastCUT® to and from Excel™. Alternatively you can tailor your own quoting system. All your data can be entered into a Microsoft Excel™ spreadsheet. This data can be linked to FastCUT® via a VBA MACRO. Run the FastCUT® optimization program from Excel™, returning the results accurately and quickly to your spreadsheet. A sample macro is provided free with FastCUT® Glass Optimizer.

**CAT. NO. 2000FCS**

## CRL FastCUT® Labels Add On Module

- Easily Integrated With FastCUT®
- Prints Labels for Easy Cut Selection and Part Identification
- Works on Any Computer Using Windows 98/2000/ME/NT/XP (SP1 and SP2), Vista, and 7

You can select almost any label size because you are able to change the label sheet size and position in FastCUT®. This feature makes no drop down listing of labels by brand or style required. On the second screen in the Labels program, you can put in the number of rows, number of columns and then the distance from the edges of the page. Go to the next page and review the template to ensure that you have the correct settings. There are so many labels available on the market, this gives you the ability to choose the style, size, and brand of labels you want to purchase.



**CAT. NO. 2000FLM**

FastCUT is a registered trademark of Fagan Microprocessor Systems PTY LTD.



## CRL Showers Online

- New 3-D View Brings Dynamic Color Images to Your Quote Page
- Now Supports Hydroslide and Cottage Series Sliding Enclosures, and Bi-Fold Doors
- Hardware Packages Can Be Assembled to Use Your Most Popular Items as Default Lists - One Button and Your Hardware is Complete!
- New Branding Feature Lets You Add Your Logo and Company Information to Reports

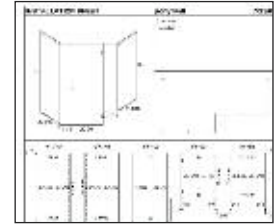
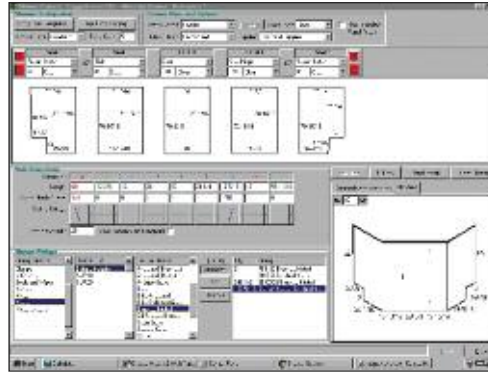

CRL Showers Online is a glass size program that lets you enter a list of products used for a particular shower enclosure, and the rough opening dimensions. Showers Online then calculates final glass sizes and displays detailed information, including hinge and handle locations, miters and much more. Showers Online is tailored to work with most any shower enclosure configuration. This program eliminates the weakest link in your ability to compete and increase your shower door business. Showers Online issues warnings about possible problems with the shower design. It also builds a library of your most common showers, which you can use to start a new job by copying from the most similar design in the library. Online access means availability to the program anytime, anywhere... from the office, shop or field. The sophisticated CAD processing takes place on our web servers. Any Windows-based PC running Windows 2000 or newer with a minimum of 56K modem can be used. **Go to [crlaurence.com](http://crlaurence.com) and sign up for our Webinar and a 30-day FREE trial.**

## CRL Hand Rails Online

- Produces a Complete Quote Package Instantly From Your Desk Top
- Produces a Full Color 3-D Rendering and Dimensional Plan View for Field Installation
- Allows You to Order Material Directly From Your Computer
- Determines All Material Quantities Needed for Each Project

CRL Hand Rails Online is a software package designed to work for you. You now have the power to become a professional estimator and installer of glass railing and windscreen systems. This innovative program will automatically generate material lists, glass sizes, and fabrication details for your project. You can create a quote and order from your own computer. You will easily save up to half the time in estimating and ordering hand rails and windscreens systems. **Go to [crlaurence.com](http://crlaurence.com) and sign up for our Webinar and a 30-day FREE trial.**

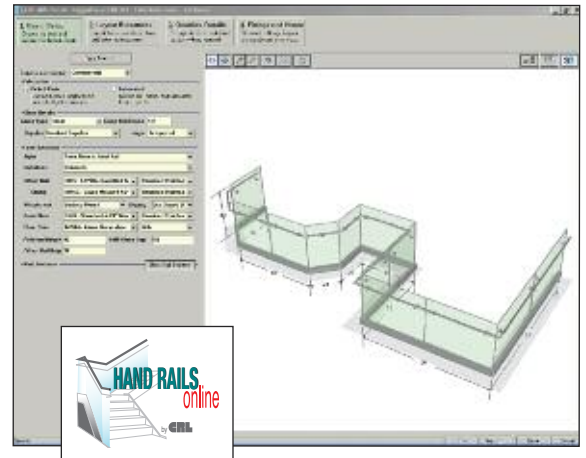

## CRL 'All-Glass' Storefronts Online®

- Request Quotes and Order Directly From Program
- You Can Create a Job Template Library or Clone Any Saved Project
- New Branding Features Add Your Company Logo to Documents
- Direct Link to CRL Web Site From Program



Designers of 'all-glass' storefronts will find our web based 'All-Glass' Storefronts Online® program to be a real time and money saver. It is tailored for use in most any 'all-glass' storefront application using 3/8", 1/2", or 3/4" (10, 12, or 19 mm) glass, including doors, sidelites, transoms, and fin supports with full top and bottom rails or patch fittings. Our program will create a hardware list, print glass sizes, and create a quote sheet in minutes. This includes warnings regarding any issues that may conflict with a complete and sound entrance. You can simply log on from any computer that is connected to the internet. All the processing takes place on our computers so you do not need any special hardware to run it. Any Windows-based PC running Windows 2000 or newer with a minimum of 56K modem can be used.

**Go to [crlaurence.com](http://crlaurence.com) and sign up for our Webinar and a 30-day FREE trial.**

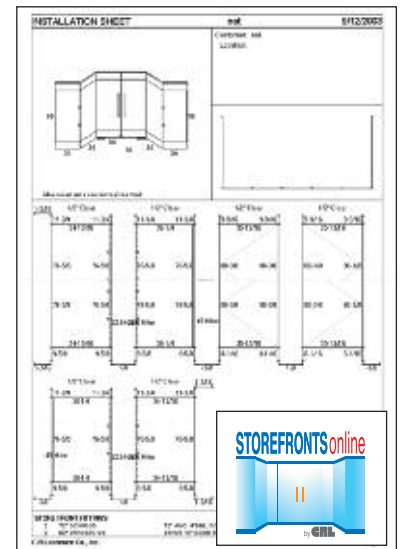

## CRL Fletcher® Heavy-Duty Plastic Cutter

- Exclusive Replaceable Blades
- Design Delivers 55% More Pressure Power
- Bio-Engineered for Production Cutting Comfort

The special grip on the CRL Fletcher® Plastic Cutter was designed to give you fatigue-free, easy-production cutting of plastic and related products. The solid 13 oz. (363 g) metal body provides unique stability required for deep, even scoring. Special blade design reduces any possibility of flexing or blade breakage during use. Comes with one long blade and complete instructions. Minimum order is one each. Replacement Blades and a Blade Retaining Clip are available separately.



**CAT. NO. HDP11**



**CAT. NO. APB12**

Short Replacement Plastic Cutting Blade 10 Per Pack. Minimum order is one pack.



**CAT. NO. APB121**

Long Replacement Plastic Cutting Blade 10 Per Pack. Minimum order is one pack.



**CAT. NO. BC11**

Blade Retaining Clip for the HDP11. Minimum order is one each.

## CRL Plastic-Plus Cutting Tool

- Safe and Easy to Use
- Available Carded or in Bulk
- Also Used to Cut Vinyl Floor Tile, Thin Copper, Brass, and Aluminum



**CAT. NO. KS20**

Plastic-Plus Cutting Tool, Carded. Minimum order is one each.

The CRL Plastic-Plus Cutting Tool makes easy and accurate cutting of acrylic sheets, plastic lighting panels, vinyl floor tile, and laminated plastics used for countertops, etc. The hardened steel cutting blade can be resharpened to keep scribing lines deep and chipping to a minimum. The blade also folds into the compact plastic handle for safety while carrying. This heavy-duty tool is built to be lightweight, sturdy, and to perform with a high level of quality.



Blade Folds Into Handle



**CAT. NO. KS20B**

Plastic-Plus Cutting Tool, Bulk Box of 50. Minimum order is 50 each.

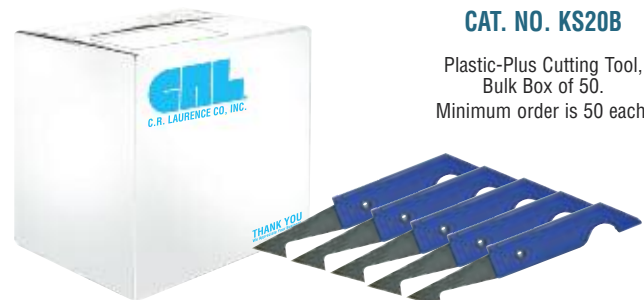

Fletcher is a registered trademark of The Fletcher-Terry Company, LLC.

## CRL Fletcher® Double Edge Plastic Cutter

- Made From the Highest Quality Steel Available
- Precision Ground Cutting Edge



This professional quality 6" (152 mm) CRL Fletcher® Plastic Cutter works for both normal and extra-pressure scoring. It has precision ground edges, and a non-slip vinyl grip handle for easy use. This tool is used throughout the industry and known for its reliability. Cutter is individually carded. Minimum order is one each.



CAT. NO. HPC22

## CRL Red Devil® Plastic Cutter

- Lightweight and Tough
- Ergonomic Handle
- Cuts Acrylic, Styrene, Plexiglass, and More



The CRL Red Devil® Plastic Cutter gives clean, accurate cuts to acrylic sheets, styrene, tile board, and some thin metal. Can also be used to cut shingles. The rugged ergonomic plastic handle features a securely mounted sharp steel blade. This 7" (178 mm) cutter will last long enough to provide many cuts in the toughest of materials. Cutter is individually carded. Minimum order is one each.



CAT. NO. 1170

## CRL Heavy-Duty Hook-End Blades

- Package of 10 or 100 Double-End Blades
- Fits All Standard Utility Knives

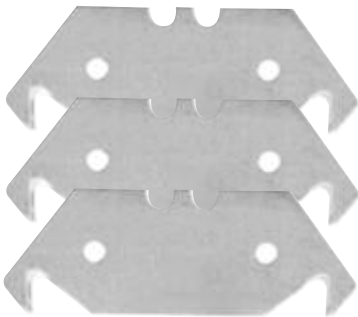

CRL Heavy-Duty Hook-End Blades are designed to fit all standard and retractable utility knife handles. Blades are double end configuration, and the short length of exposed blade works to minimize twisting of the blade when heavier pressure is applied for cutting thicker plastic. Available in the popular 10 blade pack or the shop size 100 blade, bulk dispenser box.

CAT. NO.	DESCRIPTION
1996X10	10 Blade Package
1996C	100 Blade Package

Minimum order: 1 pack.

Fletcher is a registered trademark of The Fletcher-Terry Company, LLC.  
Red Devil is a registered trademark of Red Devil, Inc.

## CRL Plastic Cutter Knife

- Cuts .100" (2.5 mm) and .125" (3.2 mm) Thick Plastic



CAT. NO. PB800  
3 Plastic Cutter Blades



Replacement Blades  
Store in Handle

Cutting plastic is simple with our 6-1/2" (165 mm) P800 Plastic Cutter Knife. For those temporary repairs using plastic, every installer should have our cutter in their tool box. Each knife comes with two replacement blades which can be stored in the handle. A simple to remove thumb screw makes blade changes easy. Please use this knife with Olfa PB800 blades. Minimum order for carded plastic Cutting Knife is one each. Blades are sold three per package with minimum order of one package. May be combined with other utility knives for quantity pricing.

CAT. NO. P800

## CRL Fletcher® Plastic, Glass, and Matboard Cutting Machine

- **Unique Triple-Turret Cutting Assembly**
- **Cuts Plastic, Glass, Plexiglass, and Matboard Up to 1/4" (6 mm) Thick**

A real timesaver for glass shops, hardware stores, retail building supply centers, etc. This CRL Fletcher® Plastic and Glass Cutting Machine is built from sturdy anodized aluminum and offers unsurpassed quality when cutting plastic, glass, or matboard. The unique three-position cutting turret allows switching from matboard to plastic to glass with only one quick turn. The incredibly keen cutting blade will cut through matboard, cardboard or foamboard up to 1/4" (6 mm) thick. A special scoring tip is included for scoring plastics and acrylics up to 1/4" (6 mm) thick. In addition, a steel wheel cutting unit is enclosed for scoring single and double strength glass - and thicker glass up to 1/4" (6 mm). A simple press of the breakout lever will project twin rollers to apply pressure to each side of the score, producing a clean break.



Measuring Stop



Cutting Head



CAT. NO. F04711  
Shown

CAT. NO. APB121  
Plastic Cutting Blades



CAT. NO.	DESCRIPTION
F04711	48" Cutting Machine
F04712	60" Cutting Machine
APB121	Plastic Cutting Blades (10/pkg)
F04112	Measuring Stop

Minimum Order: 1 each. 1 pack on the Cutting Blades.

### EACH MACHINE INCLUDES:

- Ten Glass Cutting Wheel Units
- Ten Plastic Cutting Blades
- Ten Mat Cutting Blades
- Cleaning Brush
- Mounting Hardware
- Instructions

## CRL Drills for Plastic Materials



- **Special Tip Angle Prevents "Grab" in Plastic**
- **Special Sharp Grind Helps Prevent Chipping**

These CRL Drill Bits are made especially for drilling plastic. The special, sharp taper point makes drilling fast and neat, while reducing the tendency of the plastic to crack and chip during drilling. **NOTE:** Not to be used on wood or metal.

CAT. NO.	DESCRIPTION
61408	1/8" (3.2 mm) Plexiglass Drill Bit
61412	3/16" (4.8 mm) Plexiglass Drill Bit
61416	1/4" (6.3 mm) Plexiglass Drill Bit
71124*	3/8" (9.5 mm) Plexiglass Drill Bit

Minimum order: 1 each. \*1/4" shank. Drills can be combined for quantity pricing.

Fletcher is a registered trademark of The Fletcher-Terry Company, LLC.

## CRL Nordic Carbide Tipped Saw Blades for Plastic



- **Uni-Chip Design Tooth Pattern**
- **10" and 12" (254 and 305 mm) Sizes Available**

The CRL Nordic Plastic Cutting Blades are designed to give clean, chip-free cutting on formica, acrylics, Plexiglas, heavy wall PVC pipe, and other plastics. Uni-chip design tooth pattern makes cutting smooth and fast. Arbor size is 5/8" (15.9 mm). Visit [crlaurence.com](http://crlaurence.com) for all.

CAT. NO.	DIAMETER	TEETH
CSB10X80P	10" (254 mm)	80
CSB10X100P	10" (254 mm)	100
CSB12X100P	12" (305 mm)	100

Minimum order: 1 each. Not for Lexan or Polycarbonate.

## CRL Running Pliers

- Starts Break Along Score Line in Plastic

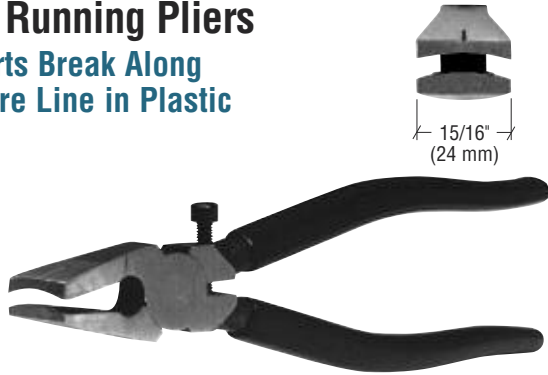

CRL Running Pliers work on plastic in the same manner that they work to run the score line in glass. Place the jaws over the score line with the pliers facing in the same direction as the cut line and the alignment mark placed directly above the line. Then set the thickness adjustment screw, squeeze, and you get a perfect start every time. 8" (203 mm) overall length. Minimum order is one each.

CAT. NO. 3610

## CRL Stabilo® Marking Pencils

- For Marking Cut Lines on Smooth Surfaces, Such as Plastics and Glass
- Holds a Point for Drawing Thin Lines

CRL Stabilo® Marking Pencils not only write on glass and paper, but also on metal, plastics, ceramics, porcelain, stone, film, painted or lacquered surfaces, and just about any other glossy surface. They are erasable from paper, and marks will wipe off of glossy surfaces with a damp cloth.

**NOTE:** Not available in Australia.

CAT. NO.	COLOR	QTY/BOX
8040	Red	12
8044	Yellow	12
8046	Black	12



Minimum order: 1 each. Colors can be combined for quantity pricing.

## CRL Aerosol Plastic Cleaner

- Anti-Static, Anti-Fog, Non-Streaking Formula

CRL Aerosol Plastic Cleaner is an anti-static, anti-fog, non-streaking formula that is fast-drying and economical to use. Apply it to a variety of plastic materials including: acrylic, plexiglass, polycarbonates, and safety glazing panels. CRL848 wipes away without streaking, and leaves a sparkling, clean surface. This large 19 ounce (539 g) aerosol will clean a large area. 12 cans per case. Minimum order is one can.



CAT. NO. CRL848

## CRL Plastic Cleaner and Polish

- Contains No Abrasives
- Non-Static/Non-Glare
- Great for Removing Tiny Scratches

Developed especially for the glass industry, CRL Plastic Cleaner and Polish cleans and polishes virtually everything made of plastic. It's great for removing tiny scratches from acrylic windows in boats, campers, RV's, airplanes, or any other vehicle. It can polish the plastic on boat surfaces, seat covers, shower doors, Formica tops, etc. Handy squeeze bottles make it easy to carry, easy to apply, and a fast mover in over-the-counter sales. Eight fluid ounce (236 ml) bottles are packed 12 per case. Minimum order is one each.



CAT. NO. CRL10

## CRL Novus® Plastic Polishes

- No. 2 for Fine Scratches
- No. 3 for Heavy Scratches

CRL offers two Novus® Plastic Polishes in convenient eight fluid ounce bottles. CRL Novus® No. 2 removes fine scratches, haziness, and abrasion from most plastic surfaces. It is not just a surface cover up, but will restore and protect. CRL Novus® No. 3 removes heavy scratches and abrasions from most acrylic surfaces. Both polishes contain a light abrasive and are not for use on eyeglasses, polycarbonates, or coated plastics. Novus® No. 2 should be used as a follow-up to Novus® No. 3 for best results.

CAT. NO.	DESCRIPTION	CONTENTS
PN7030	Novus® Polish No. 2 (Fine)	8 Fl. Oz. (237 ml)
PN7080	Novus® Polish No. 3 (Heavy)	8 Fl. Oz. (237 ml)

Minimum order: 1 each.

Stabilo is a registered trademark of Schwan-STABILO Schwanhaeusser GmbH & Co. KG LLC  
Novus is a registered trademark of TCG International Inc.



## CRL is Your Source for Glass Drilling Tools and Accessories

Making a hole in glass is a delicate process, and only by using the right tools can the outcome be successful. C.R. Laurence has spent years perfecting this process by gathering machines and drill bits from makers worldwide, thoroughly testing them, and refining the methods. This experience allows us to offer the modern glazier the best of these tools available, and to bring you choices dependant on the types of holes to be produced, the number of holes required, and price points. As always, we offer selection assistance through our web site and our Customer Service Department.

### CRL Drilling Machines

- **The Largest Selection With the Widest Range of Features**
- **Designed With the Modern Glazier in Mind**

C.R. Laurence offers one of the largest selections of fixed and portable glass drilling machines on the market. Many are equipped with features such as variable speed motors and vacuum cup bases, and are compatible with several different types of drills such as diamond core or small diameter carbide. These machines have been designed with the modern glazier in mind, and like all CRL products, they are built to be durable to give you the best product for your money. If you need assistance in choosing the right machine for your drilling needs contact CRL's Customer Service Department.



See page 152K



See page 153K



See page 154K



See page 156K



See page 154K



See page 158K

## CRL's Centralized Stocking Program for Glass Drills

- Our Centralized Stocking Program for Glass Drills Puts Hundreds of Drills at Your Disposal
- Production Type to Drills for Only a Single Hole, We Have the Largest Selection
- Quick Air Shipment From Three CRL Locations to Anywhere in the World



★ Sydney, Serving Australia, Asia, and the Pacific

★ Los Angeles, Serving the Americas

★ Manchester, Serving Europe, Africa, and the Middle East

CRL offers Glass Drills in diameters from 1/32" (.8 mm) to 6" (152 mm), and in various mounting types. And while we keep good inventories of the most popular sizes in our warehouses around the world, it's not possible to stock all of them in all locations.

That's why we established our Centralized Stocking Program for Glass Drills from our headquarters in North America, Australia, and Europe. If your nearest CRL warehouse does not have the size drill you need we can ship it from our stocking warehouses to you overnight to almost anywhere in the world. There's no extra charge for this service, you just pay the regular price for the drill plus the overnight shipping charges from the carrier you select.

So don't put a hold on a job because you don't have the right glass drill. CRL's Centralized Stocking Program can help you get the drill you need right away. Not sure of which glass drill is right for your project? Then contact CRL Customer Service Department for selection and ordering assistance. From our web site click on Contact Us, and then click on Customer Service.

## CRL Drills for Glass

- Drills for a Single Job or Production Runs
- Drills for Portable Drills and Factory Machinery

Any type of drill bit or accessory you may need to make holes in glass can be found at C.R. Laurence. Our decades of serving the glazing industry has allowed us to explore and refine this delicate process, thanks to feedback from our customers and the efforts of our knowledgeable staff. Whether you're looking to make just one hole or interested in the production drilling of holes, CRL has what you need to do it quickly, efficiently, and remain cost-effective. For assistance in selecting the proper drill to meet your requirements, contact CRL's Customer Service Department.



Straight Shank Drill Bit



Belgian Thread Drill Bit



Straight Shank Countersink

Belgian Thread Countersink



Prismatic Drill Bit

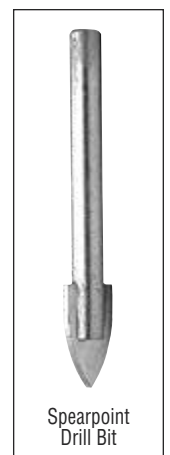

Spearpoint Drill Bit

## CRL Tripod Glass Drilling Machine



CAT. NO. CRL2

Years of experience in the sales and service of glass machinery, combined with extensive market research, has enabled C.R. Laurence to develop a superior piece of equipment to fill the glass drilling needs of the glass business. The CRL Tripod Glass Drilling Machine is the most widely used machine in the industry.

It is completely portable so it can be used at the shop or on the job site. It plugs into any 110V AC circuit. The drill can easily be positioned directly over any area to be drilled. The non-skid rubber leg caps hold the machine firmly to the drilling surface. It has a heavy-duty motor with a 3/8" (9.5 mm) ball bearing supported chuck to eliminate wobble.

- Our Best Selling Drill Machine
- For Use With Diamond, Steel or Brass Tube Drills, as Well as Spearpoint and Prismatic Drills
- Heavy-Duty, 4 AMP Variable Speed Motor With Ball-Type Thrust Bearings
- Variable Speed Adjustment Up to 1,300 RPM
- Dual Adjustment System for Quick and Micro-Depth Adjustments to Reduce Chipping of the Glass
- Self-Drilling Design Eliminates the Need for Operator Applied Pressure
- Lubricated Sealed Bearings to Reduce Maintenance Costs
- Non-Skid Rubber Leg Caps Add Stability and Minimize Vibration
- Compound Action Handle for Easy Lifting

Quick adjustment pre-sets the desired drilling depth slightly less than the thickness of the glass, stopping within a fraction of an inch of the bottom surface so that the last little bit may be drilled slowly to reduce chipping of the glass. This is extremely important when drilling mirrors.

Variable speed adjustment allows for use with most Tube Drills (Brass, Steel or Diamond Types) along with Spearpoint Drills. Our Prismatic Carbide Tipped Drills can only be used at a reduced speed. The CRL2 comes complete with a chuck key and eight foot (2.4 m) power cord.



Heavy-Duty 3/8" (9.5 mm) Chuck



Accepts Drills Up to 6" (152 mm) in Diameter



Works with Diamond, Brass, Steel, Spearpoint, and Prismatic Glass Drills



Fast and Easy Micro-Depth Adjustment System Ensures Minimal Breakouts



Cat. No. CRL2DK Starter Kit. See page 155K.

### TRIPOD GLASS DRILLING MACHINE

CAT. NO.	DESCRIPTION
CRL2	110 Volt Tripod Glass Drilling Machine
EU3	230 Volt Tripod Glass Drilling Machine-European Plug
AU3	230 Volt Tripod Glass Drilling Machine-Australian Plug

### REPLACEMENT PARTS

CAT. NO.	DESCRIPTION
CRL2MB*	1/4" x 5/16" (6 x 7 mm) Replacement Motor Brushes
869734#	1/4" x 1/4" (6 x 6 mm) Replacement Motor Brushes
DMP103	Replacement Motor for CRL2
DMP110	Replacement Chuck Key
DMP112	Replacement Guide Roller Bearings
DMP115	Replacement Non-Skid Rubber Leg Cap
DMP141	Replacement Switch

Minimum order: 1 each. \*CAT. NO. CRL2MB fits motors with black plastic holder surrounding a brass tube on three sides. # CAT. NO. 869734 fits motors with all brass holders. Brushes sold two per pack.



## CRL Production Diamond Glass Drilling Machine



**CAT. NO. AMZ1**  
110V AC Model

**CAT. NO. AMZ1AU**  
230V AC Model

- Variable Speed, High Torque DC Motor
- Drills Holes Faster and More Precisely Than Any Other Portable Glass Drilling Machine
- Built-In Water Coolant Chuck
- Locking Vacuum Cup Base
- Accepts Belgian Thread Diamond Drills 1/8" to 4" (3 to 102 mm) in Diameter

### AMZ1 Features:

- Advanced electronic circuitry
- A powerful DC motor with an electronic variable speed control that provides full torque at all speeds ranging from 0 to 2900 RPM
- Twin vertical guide posts for precise drilling
- A dual locking vacuum cup base keeps the machine steady while drilling

### Standard Accessories:

- 12' (3.6 m) Heavy-Duty Power Cord
- Coolant Retaining Ring
- Coolant Chuck With Supply Hose
- Externally Serviceable Motor, Brushes, and Fuse
- Built-in Handle for Easy Carrying
- Service Wrenches
- Complete Operation Manual

The CRL AMZ1 Production Diamond Drilling Machine drills 1/8" to 4" (3 to 102 mm) holes faster and more precisely than any other portable glass drilling machine. In comparison to other machines on the market, drilling a 2" (50.8 mm) hole in 1/4" (6 mm) mirror can be done in less than ten seconds while using a properly dressed drill bit (tests done under controlled conditions).

The CRL AMZ1 ships ready for use with a grounded plug for use with a Ground Fault Circuit Interrupt Device, such as our Cat. No. GF1. It is also loaded with popular features, and durable enough to give you years of dependable service. Make the move up from steel and brass tube drills, and their messy silicon carbide slurry, to our technically advanced Belgian Mount Multi-Layer Metal Bond Drills. Most commonly used with the AMZ1 are the Belgian Mount PDT Series (Metal Bond) and HBT Series (Electro-Formed) Diamond Drills (see pages 162K – 163K).

**NOTE:** When purchasing the AMZ1 Drill Machine you should also purchase a Sharpening Stone to dress your Metal Bond Diamond Drills. The stone should be wider than the diameter of the drill being sharpened. Sharpening Stones are located on page 167K.



Electronic Variable Speed Control



Center Fed Coolant Chuck

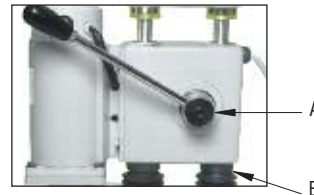

Depth Indicator (A) and Twin Vertical Guide Posts (B)



Locking Rubber Vacuum Cup Base

## Optional Accessories



Optional Straight Shank Conversion Collet  
**CAT. NO. AMZ229**



Optional Base Ring With Drain Tube  
**CAT. NO. AMZ228**



Optional Coolant Supply Pressure Tank  
**CAT. NO. AMZ200**



Accepts Threaded Belgian Mount Drills, Countersinks, and Spot Facers

### PRODUCTION DRILLING MACHINE AND ACCESSORIES

CAT. NO.	DESCRIPTION
<b>AMZ1</b>	Drilling Machine 110V AC
<b>AMZ1AU</b>	Drilling Machine 230V AC
<b>AMZ200</b>	Optional Coolant Pressure Tank
<b>AMZ228</b>	Base Ring With Drain Tube
<b>AMZ229</b>	Conversion Collet for Straight Shank Drills

Minimum order: 1 each.

### REPLACEMENT PARTS FOR AMZ1 DRILLING MACHINE

CAT. NO.	DESCRIPTION
<b>AMZ205</b>	Spindle With Drill Chuck
<b>AMZ213</b>	Replacement 10 x 6 mm Brush
<b>AMZ214</b>	Two Motor Brushes 8 x 7 mm
<b>AMZ215</b>	Replacement 250-Volt 7amp Fuse
<b>AMZ226</b>	Replacement Circuit Board
<b>AMZ227</b>	Replacement Motor

Minimum order: 1 each.

## CRL Swivel Drill Machine

- Drills Outlet Cut-Outs Without Repositioning
- Built-in Retaining Ring

This unique Drilling Machine was designed primarily to make cut-outs for plug and switch receptacles. The CRL Swivel Drill Machine has a suction cup base that also acts as a coolant retainer when drilling with Diamond Tube Drills. Drill the first hole, insert the rubber plug, swivel drill head, and then drill the second hole.

It can also be used for drilling larger holes with tube drills up to 6" (152 mm) in diameter. The drill head has the unique ability to swing a full 360 degrees so drilling up close to the glass edge is made easy. This also lets you use larger diameter drills than will fit in the built-in retaining ring. The machine is powered by a 1000 RPM, 110V AC motor. **NOTE:** Always wear the proper safety gear when using any type of power tool. A Cat. No. GF1 Ground Fault Circuit Interrupt Device should be used with any type of wet-working electric tool (see page 550K).

CAT. NO.	DESCRIPTION
SDM4	Swivel Drill Machine
SDM03G	Replacement Coolant Ring

Minimum order: 1 each.



Drill first hole, swivel head, and then drill the second hole



Swivel the head to one side for drilling larger holes up to 6" (152 mm)

## CRL Two-Speed Pro Vertical Drilling Machine

- Powerful Two-Speed 110V or 220V AC Motor
- Precise Depth Control Feature
- Built-In Coolant Chuck
- Accepts 1/8" Through 4" (3 through 102 mm) Belgian Thread Diamond Drills
- Twin Vertical Guide Posts

With this CRL Two-Speed Pro Vertical Drilling Machine you get the finest in European glass drilling technology. This precision drill machine offers a tough two-speed, 110 volt, 60 hertz motor capable of running at 1650 or 3280 RPM. The twin guide posts permit smooth travel of the drill head and precise alignment of drill bits to the glass surface. The spring-loaded front post provides just enough resistance for effortless control of the drilling depth.

The built-in Water Chuck has its own water control valve and feeds water through the core of Belgian Threaded Diamond Drill Bits. This Two-Speed Pro Vertical Drilling Machine is capable of drilling holes up to 4" (102 mm) in diameter. The drill platform base is covered with a layer of textured rubber to protect the glass surface and to provide a firm hold on any smooth glass surface. Minimum order is one each. **NOTE:** Always wear the proper safety gear when using any type of power tool. A Cat. No. GF1 Ground Fault Circuit Interrupt Device should be used with any type of wet-working electric tool (see page 550K). 220 Volt, 50 hertz European model also available.



Speed Control



Coolant Control Valve

CAT. NO.	DESCRIPTION
PDM108	110V AC Two-Speed Drill Machine
1524	220V AC Two-Speed Drill Machine (European)

Minimum order: 1 each.

## CRL Port-O-Holer Glass Drilling Tool

- The Most Portable Drilling Tool Available
- Uses Your Own Cordless or Power Drill With GFI Device
- Drills Up to a 2" (51 mm) Hole Using Your Own 3/8" (9.5 mm) Shank Plated Diamond Drills



**NOTE:** We recommend you only use CRL EDD Series Diamond Drills with the Port-O-Holer.



The Port-O-Holer Glass Drilling Tool drills holes up to 2" (51 mm) in diameter in glass and mirror, regardless of the location. All you need is your own cordless or Power Drill, and you are ready to drill. Never has there been a tool that is so simple and economical, yet so accurate and easy to use.

Just place the Port-O-Holer where you want to drill your hole and pump the vacuum cup to hold it in place. There are center reference marks inscribed on the outside of the drill housing for easy lineup of your holes. Then just fill the drill housing with coolant using the included squeeze bottle, and you are ready to drill. The PH1 Port-O-Holer comes complete with a Wood's W4000 8" (203 mm) Lexan Handle Vacuum Cup, or use your own 8" (203 mm) or 9" (229 mm) Vacuum Cup with the PH2 Port-O-Holer. Combined with the all-aluminum frame, this tool weighs in at just over 3-1/2 lbs. (7.7 kg).

CAT. NO.	DESCRIPTION
PH1	Port-O-Holer Glass Drilling Tool With Cat. No. W4000 8" Vacuum Cup
PH2	Port-O-Holer Glass Drilling Tool Only
PH3	Port-O-Holer Replacement Gaskets 3/pk.

Minimum order: 1 each.

## CRL Glass Drilling Starter Kit

- Drill Your Own Holes and Save Fabrication Costs
- Starter Set Includes Our Reliable Tripod Glass Drilling Machine and Five of the Most Popular Diameters of Diamond Drills
- It's a Truly Affordable Start-Up System for Glass Fabrication

Our Glass Drilling Starter Set has everything you need to begin drilling holes in glass up to 3/4" (19 mm) thick. The CRL2 Glass Drilling Machine features a powerful variable speed motor, a heavy-duty 3/8" (9.5 mm) chuck, a micro-depth adjustment feature, and non-skid rubber feet. It accepts drills up to 6" (152 mm) in diameter.

CRL stocks a complete range of EDD Series Diamond Drills in diameters from 1/8" to 6" (3.2 to 152 mm). Their sturdy solid steel construction allows quick hole drilling with clean break-outs. This set contains five of our most called for diameters: 1/4", 1/2", 3/4", 1", and 2".

To start drilling simply prepare a 50:1 ratio mix of water and our DTC80QT Diamond Tool Coolant and pour the solution into the RR65 Suction Drilling Ring over the position of the intended hole. Turn on the machine and lower the drill onto the glass, occasionally lifting the drill to allow coolant back into the cut until the drill completes the hole. It's a very simple and safe method for drilling glass and mirror. Minimum order is one each.

**NOTE:** For our customers in Australia and Europe we offer a Starter Kit with EDD Series Diamond Drills in these Metric sizes: 6, 8, 10, 16, and 60 millimeters. The Drilling Machine is the same as our CRL2, only in a 240 Volt model. Specify Cat. No. AU3DK for Australia or EU3DK for Europe.



Starter Set includes 1 each CRL2 Glass Drilling Machine, 1 quart DTC80QT Diamond Tool Coolant Concentrate, 1 each RR65 Suction Drilling Ring, and 1 each of our EDD Series Diamond Drills in diameters of 1/4", 1/2", 3/4", 1", and 2".

**CAT. NO. CRL2DK**

## CRL Vacuum Base Portable Drilling Machine



- Available in Three Configurations
- Vacuum Base Holds it Securely to Glass
- Convenient, Portable, and Easy to Use

The Vacuum Base Portable Drilling Machine uses a reliable CRL 8" (203 mm) Vacuum Lifter Pad as a base that will hold it securely to the glass to be drilled. Mounted to the base is a Drill Stand that holds your electric or cordless drill.

Mount the drill to the Drill Stand, and then insert into the chuck your Glass Drill Bit of choice up to 6" (152 mm) in diameter. You can also use it with a choice of Water Chucks that accept either Habit Style or Belgian Thread Diamond Glass Drills.

The flexibility afforded by this unit is unmatched by other drill machines with built-in motors that must be disassembled if service is ever needed. Should your electric or cordless drill ever break down, just replace it with another. No need for costly downtime while your drill machine is being repaired.

And CRL has a host of drilling accessories to fit this unit, from Electric Drills and Water Chucks to Diamond Coolant. All of these can be found in this catalog, along with a full selection of Glass Drills in diameters from 1/16" to 6" (1.6 to 152 mm). Minimum order is one each.

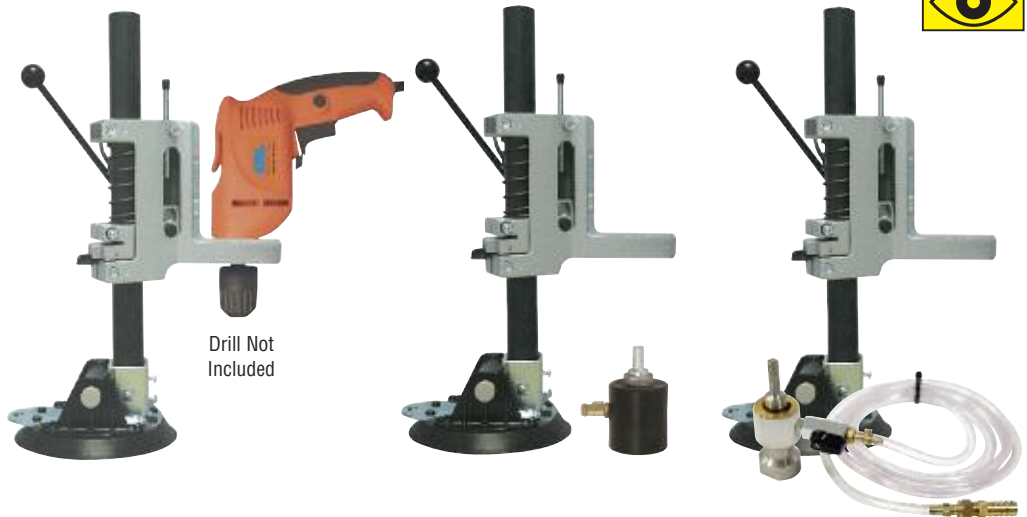

Vacuum Cup Base and Drill Stand Only  
**CAT. NO. G0650**

Vacuum Cup Base, Drill Stand, and Habit Drill Water Chuck  
**CAT. NO. G0655**

Vacuum Cup Base, Drill Stand, and Belgian Drill Water/Coolant Adapter  
**CAT. NO. G0656**

**NOTE:** Always wear the proper safety gear including gloves and eye protection when drilling glass. Work should be performed on a flat, horizontal surface. A Ground Fault Circuit Interrupt Device (Cat. No. GF1) must be used when using any type of electric tool in conjunction with water or coolant. Failure to follow any of these precautions can result in operator injury.

## Accessories for Use With the CRL Vacuum Base Portable Drilling Machine



Habit Drill Water Chuck  
See page 157K



Belgian Drill Water/Coolant Adapter  
See page 167K



Ground Fault Interrupt Device  
See page 550K



Glass Drills  
See pages 160K-170K



3/8" Electric Drill  
See page 477K



Diamond Tool Coolant  
See page 167K



Safety Glasses  
See pages 278K-279K

## CRL Center Coolant Chucks

- Provide Center Coolant Delivery
- Accept CRL Belgian Threaded Drills
- Fit Popular Large Drill Presses

Build your own glass drilling machine using CRL Center Coolant Chucks and your industrial drill press. They are perfect for high volume drilling of small pieces, vases, lamps, etc. They also accept our Belgian Threaded Drills, and provide optimum performance by supplying coolant continuously through the center of the drill. Coolant pressure ejects the core out of the diamond drill after drilling cycle is completed.

Our Taper Type Center Coolant Chucks replace your machine's adjustable jaw chuck. Select CRL Cat. No. WCCJ3, WCCJT33 or WCCJ6 Taper Type to match your drill press. Hollow spindle machines will require a transition arbor of our supply. The CRL WC10A Habit Taper Type is for hand drills with 3/8" (9.5 mm) or larger chucks. The WC10B Habit Taper Type fits pedestal drill presses outfitted with a #2 morse taper shank arbor and a #6 Jacobs taper. The barbed water inlets fit 3/8" (9.5 mm) I.D. supply hose. After extensive use, CRL Center Coolant Chucks can be rebuilt with the WCCRK Kit which includes: two Bronze Bushings, two Rubber Seals, and two Circlips.

**NOTE:** Always use a Ground Fault Interrupt Circuit Device (See Cat. No. GF1 on page 550K) when using electrical tools in wet areas.



Taper Type  
WCCJ3, WCCJT33, or WCCJ6



Habit Type  
WC10A  
(WC10B plus G0645)

CAT. NO.	DESCRIPTION	TAPER	DRILL TYPE
WCCJ3	Taper Type	J-3	Belgian
WCCJT33	Taper Type	JT-33	Belgian
WCCJ6	Taper Type	J-6	Belgian
WC10A	Habit Type	Straight 3/8" (9.5 mm)	Habit
WC10B	Habit Type	J-6	Habit
WCCRK	Rebuild Kit for Coolant Chucks	---	---

Minimum order: 1 each.

## CRL Amazing Glazing Drill Adapter

- Allows Use of Belgian Threaded Drills in a Standard Drill Chuck

This Drill Adapter allows you to use typical Belgian Threaded Drills in a shank-type glass drilling machine. The adapter threads to the drill, and leaves you a 3/8" (9.5 mm) diameter straight shank to fit into the jaws of your drill machine's chuck. Minimum order is one each.

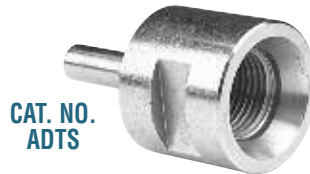

CAT. NO. ADTS



Typical Belgian Threaded Drill (Sold Separately. See page 162K.)

## CRL Mini Water/Coolant Adapter

- Uses High Yield Metal Bond Belgian Threaded Drills

Add efficiency to your tripod or vacuum cup-type glass drilling machines with this CRL Mini Water/Coolant Adapter. The 3/8" (9.5 mm) straight shaft fits most drill machines. Always use with a Ground Fault Interrupt Circuit Device (Cat. No. GF1 on page 550K). Minimum order is one each.



**NOTE:** 6-1/4" (159 mm) minimum clearance from end of chuck to drilling surface is required. Drill Machine sold separately.

CAT. NO. WCCM1N1

## CRL Habit Shank Drill Adapters



CAT. NO. G0645



CAT. NO. SSA

CAT. NO.	DESCRIPTION
G0645	Converts WC10B into WC10A for Tools with Straight Chucks such as G0650
SSA	Adapts Habit Fit Drill for Use with Straight Chuck Tools such as G0650 - Australia Only

Minimum order: 1 each.

## CRL Portable Coolant Pressure Tank

- 3 Liter Capacity
- Continuous Coolant Flow
- Ideal for Any Portable Diamond Tool

The CRL Portable Coolant Pressure Tank is an easy and efficient means of providing tool-saving coolant to any portable diamond drill, router, or saw. It provides three liters of pressurized, continuous coolant flow for all your manual fabrication needs. Minimum order is one each.



CAT. NO. LD172PT

## CRL TD25 Vertical Two-Sided Glass Drill

- Horizontally Opposed Drill Motors Move Smoothly and Independently
- Adjustable Stops Make Repeat Hole Placement Easy
- No Need to Pre-Mark Hole Position - Uses X-Y Coordinates
- Digital Vertical Scale for Y Axis
- Motorized Lower Glass Support Rail Sets X-Coordinate
- 110V AC - Works Anywhere



**new**



- Available for Purchase or Lease



CAT. NO. TD25



Two Belgian Thread Drill Bits are Required for Each Size Hole. See Pages 162K-163K for Drill Bits



Pneumatic Pressure Controls and Joy Stick for Drill Motors



Digital Position System for Accuracy of Y Axis Coordinates

### • Processes Glass Vertically – Automatically Drills Holes Up to 5-1/2" (140 mm) in Diameter

Our Automatic Feed TD25 Vertical Two-Sided Glass Drill is a compact, accurate, and affordable system. Designed to save valuable floor space, the machine measures only 120" (3048 mm) long x 48" (1219 mm) wide. The TD25 accommodates glass up to 1-1/4" (32 mm) thick and produces holes up to 5-1/2" (140 mm) in diameter. Maximum glass sheet size is 60" x 100" (1524 x 2540 mm), and maximum drill depth from edge is 32-1/2" (826 mm).

The motors are horizontally mounted on adjustable pneumatic tracks and drilling is done with a simple joystick lever control. All work is processed vertically, which is the normal transport and storage position for glass. This allows the system to use X-Y coordinates for precise location of the hole center, and also minimizes the chances of scratching or glass breaking during handling. Bottom edge rollers easily guide the vertical glass edge to the Y-coordinate. A hand operated glass clamp secures the glass in position during fabrication. Drills are kept cool and lubricated with a recirculating coolant tank and pump system.

CAT. NO.	GLASS SIZE	MACHINE WEIGHT
TD25	Up to 60" x 100" (1524 x 2540 mm); Up to 1-1/4" (32 mm) Glass Thickness	1200 Lbs. (544 kg)

Minimum order: 1 each.

#### Controls

All controls are built to OSHA requirements, utilizing CE, CSA and UL Certified components. Wiring for single phase, 60 cycle, 110V AC power.

#### Utilities

Electrical ..... 4 motors total 1.5HP (1.2kw)  
Voltage ..... Single Phase, 60 Cycle, 110V AC  
Power ..... 15 AMP service @ 110V AC  
Air ..... 60 - 90 PSI (4 - 6 atm) @ 1 CFM

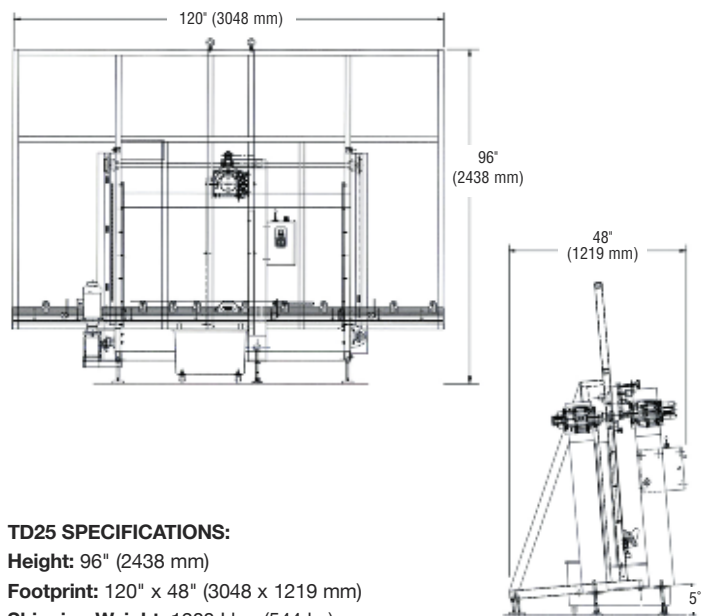

#### TD25 SPECIFICATIONS:

- Height: 96" (2438 mm)
- Footprint: 120" x 48" (3048 x 1219 mm)
- Shipping Weight: 1200 Lbs. (544 kg)



**CRL TD25 Drill**  
**Three Phase, 50/60 Hz Export Model**



Export versions of the TD25 Vertical Drill can be built to operate on Single Phase, 50/60 Hz power. Contact the Machinery Division with your power requirements.

## CRL TD25 Vertical Two-Sided Glass Drill Features

### X and Y Calibrations on TD25 Drill



A full vertical and horizontal scale is provided. This can eliminate the time and labor involved with measuring and marking glass for drilling. Just measure from two edges to the hole center and drill.

### Two Drill Bits Create a Smooth Hole



Drilling part of the way through from the back then drilling the rest of the way through from the front creates a clean hole with none of the "Blow-Out" that happens with one-sided drilling.

### Stops and Guides Help to Position Glass



Rollers and stops on the glass rail make repeat drilling tasks easy and accurate. A Small Parts Stop is provided for precise set up of holes in smaller glass pieces.

### Convenient Motor and Pump Controls



All controls are found on the front mounted control box. The Air Pressure Regulator and Drill Motor Joystick control are on top. Motor Speed, On-Off, Coolant Pump, and Glass Rack Switches are front-mounted.

### Stop Assembly with Rack Extension

Attach to glass rail for repeat drilling of holes in the same position, close to the drill bit.

CAT. NO.	DESCRIPTION
39811700	Stop Assembly With Rack Extension

Minimum order: 1 each.



### Stop Assembly

Attach to glass rail for repeat drilling of holes in the same position, close to the drill bit.

CAT. NO.	DESCRIPTION
39784000	Stop Assembly

Minimum order: 1 each.



### Adjustable Roller Assembly

Attach to glass rail for repeat drilling of holes in the same position, close to the drill bit.

CAT. NO.	DESCRIPTION
39784100	Adjustable Roller Assembly

Minimum order: 1 each.



### Adjustable Stops for Precise Drilling



Front and rear drill depth adjustments are easy to change.



The rear drill stop has a sensor that will light an indicator on the control panel when the stop is contacted.

## CRL Standard Plated Diamond Drills

- Our Most Popular Diamond Drill
- Durable and Cost Efficient
- Available in Sizes from 1/8" to 6" (3.2 mm to 152.4 mm)
- Smooth Continuous Rim
- For Tripod and Cup Style Drilling Machines

These Standard Plated Diamond Drills are designed as a cost effective method of general glass drilling. The sturdy, solid steel construction of these drills allows quick hole drilling with clean break-outs. All sizes of CRL Standard Plated Diamond Drills have 3/8" (9.5 mm) diameter shanks.

Cut your cost per drill when you order one of the Sets listed below which includes the most popular sizes. Also available is a Drill Starter Kit that includes the popular CRL2 Drilling Machine, Coolant, Drilling Ring, and five EDD Glass Drills.

**NOTE:** Always wear the proper safety gear, including eye protection, when drilling glass. Work should be performed on a flat, horizontal surface. A Cat. No. GF1 Ground Fault Circuit Interrupt Device (see page 550K) is recommended when using any type of electric tool in conjunction with water or coolant. Failure to follow any of these precautions can result in operator injury.

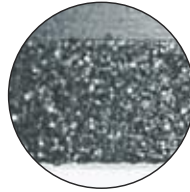

Magnified View of Diamond Crystals



### INDIVIDUAL DRILLS

CAT. NO.	DRILL DIAMETER	CAT. NO.	DRILL DIAMETER
EDD3MM	3 mm	EDD32MM	32 mm
EDD18	1/8" (3.2 mm)	EDD38MM	38 mm
EDD316	3/16" (4.8 mm)	EDD112	1-1/2" (38.1 mm)
EDD6MM	6 mm	EDD45MM	45 mm
EDD14	1/4" (6.4 mm)	EDD134	1-3/4" (44.5 mm)
EDD516	5/16" (7.9 mm)	EDD50MM	50 mm
EDD8MM	8 mm	EDD2	2" (50.8 mm)
EDD38	3/8" (9.5 mm)	EDD218	2-1/8" (54 mm)
EDD10MM	10 mm	EDD214	2-1/4" (57.2 mm)
EDD11MM	11 mm	EDD60MM	60 mm
EDD716	7/16" (11.1 mm)	EDD212	2-1/2" (63.5 mm)
EDD12	1/2" (12.7 mm)	EDD234	2-3/4" (69.9 mm)
EDD13MM	13 mm	EDD70MM	70 mm
EDD58	5/8" (15.9 mm)	EDD75MM	75 mm
EDD16MM	16 mm	EDD3	3" (76.2 mm)
EDD34	3/4" (19 mm)	EDD314	3-1/4" (82.6 mm)
EDD19MM	19 mm	EDD312	3-1/2" (88.9 mm)
EDD22MM	22 mm	EDD334	3-3/4" (95.3 mm)
EDD78	7/8" (22.2 mm)	EDD100MM	100 mm
EDD25MM	25 mm	EDD4	4" (101.6 mm)
EDD1	1" (25.4 mm)	EDD412	4-1/2" (114.3 mm)
EDD26MM	26 mm	EDD125MM	125 mm
EDD28MM	28 mm	EDD5	5" (127 mm)
EDD118	1-1/8" (28.6 mm)	EDD150MM	150 mm
EDD30MM	30 mm	EDD6	6" (152.4 mm)
EDD114	1-1/4" (31.8 mm)		



### DIAMOND DRILL SETS

CAT. NO.	DRILL QTY	DRILL DIAMETERS
DDK5	5	1/4", 1/2", 3/4", 1", 2" (6.4, 12.7, 19, 25.4, 50.8 mm)
DDK8	8	DDK5 Set plus 3/8", 5/8", 2-1/4" (9.5, 15.9, 57.2 mm)
DDK12	12	DDK8 Set plus 1/8", 1-1/4", 1-1/2", 4" (3.2, 31.8, 38.1, 101.6 mm)

Minimum order: 1 set.

Minimum order: 1 each. All CRL Diamond Drills can be combined for quantity pricing.

## CRL Glass Drill Starter Kit

- Includes Everything Required to Drill Holes in Glass

See Page 155K for Details



CAT. NO. CRL2DK

## Recommended Operating Speeds for All Plated Diamond Drills

DRILL DIAMETER	RPM RANGE
1/8" - 1/2" (3.2 - 12.7 mm)	1600 - 2000
9/16" - 1" (14.3 - 25.4 mm)	1400 - 1600
1-1/8" - 2" (28.6 - 50.8 mm)	1100 - 1400
2-1/8" - 3" (54 - 76.2 mm)	900 - 1100
3-1/4" - 4" (82.6 - 101.6 mm)	700 - 900
4-1/2" (114.3 mm) +	500 - 700

These are the ideal speeds for drilling various diameters with CRL Plated Diamond Drills. Acceptable results may also be achieved by varying your drilling speeds. CRL Standard Plated Diamond Drills may also be used in standard 1,300 RPM drill machines.



## CRL Amazing Glazing Plated Diamond Drills

- Unique, Aggressive Sawtooth Profile
- Our Most Durable Plated Drill
- Diameters From 1/8" to 4-1/2" (3.2 mm to 114.3 mm)

The special sawtooth design of CRL Amazing Glazing Plated Diamond Drills reduces the contact area, allowing better grinding action and increased coolant penetration. They are perfect for use in portable tripod and cup style machines. Our most durable drill has been machined from solid steel. Use with DTC80 Diamond Tool Coolant (see page 167K) and submerge in a retaining ring for best results.

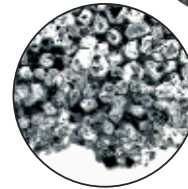

Magnified View of Diamond Crystals



**NOTE:** Always wear the proper safety gear, including eye protection, when drilling glass. Work should be performed on a flat, horizontal surface. A Cat. No. GF1 Ground Fault Circuit Interrupt Device (see page 550K) is recommended when using any type of electric tool in conjunction with water or coolant. Failure to follow any of these precautions can result in operator injury.



Cut your cost per drill when you order one of these Sets, which include the most popular sizes.

### PLATED DIAMOND DRILL SETS

CAT. NO.	DRILL QTY	DRILL DIAMETERS
<b>AGSET1</b>	5	1/4", 1/2", 3/4", 1", 2" (6.4, 12.7, 19, 25.4, 50.8 mm)
<b>AGSET2</b>	8	AGSET1 plus 3/8", 5/8", 2-1/4" (9.5, 15.9, 57.2 mm)
<b>AGSET3</b>	12	AGSET2 plus 1/8", 1-1/4", 1-1/2", 4" (3.2, 31.8, 38.1, 101.6 mm)

Minimum order: 1 each.

### INDIVIDUAL DRILLS

CAT. NO.	DRILL DIAMETER	CAT. NO.	DRILL DIAMETER
<b>AG18</b>	1/8" (3.2 mm)	<b>AG11316</b>	1-3/16" (30.2 mm)
<b>AG316</b>	3/16" (4.8 mm)	<b>AG114</b>	1-1/4" (31.8 mm)
<b>AG14</b>	1/4" (6.4 mm)	<b>AG138</b>	1-3/8" (34.9 mm)
<b>AG516</b>	5/16" (7.9 mm)	<b>AG112</b>	1-1/2" (38.1 mm)
<b>AG38</b>	3/8" (9.5 mm)	<b>AG134</b>	1-3/4" (44.5 mm)
<b>AG716</b>	7/16" (11.1 mm)	<b>AG2</b>	2" (50.8 mm)
<b>AG12</b>	1/2" (12.7 mm)	<b>AG218</b>	2-1/8" (54 mm)
<b>AG916</b>	9/16" (14.3 mm)	<b>AG214</b>	2-1/4" (57.2 mm)
<b>AG58</b>	5/8" (15.9 mm)	<b>AG212</b>	2-1/2" (63.5 mm)
<b>AG1116</b>	11/16" (17.5 mm)	<b>AG234</b>	2-3/4" (69.9 mm)
<b>AG34</b>	3/4" (19 mm)	<b>AG3</b>	3" (76.2 mm)
<b>AG1316</b>	13/16" (20.6 mm)	<b>AG312</b>	3-1/2" (88.9 mm)
<b>AG78</b>	7/8" (22.2 mm)	<b>AG4</b>	4" (101.6 mm)
<b>AG1</b>	1" (25.4 mm)	<b>AG412</b>	4-1/2" (114.3 mm)
<b>AG118</b>	1-1/8" (28.6 mm)		

Minimum order: 1 each. All CRL Diamond Drills can be combined for quantity pricing.

## Recommended Operating Speeds for All Plated Diamond Drills

DRILL DIAMETER	RPM RANGE
1/8" – 1/2" (3.2 – 12.7 mm)	1600 – 2000
9/16" – 1" (14.3 – 25.4 mm)	1400 – 1600
1-1/8" – 2" (28.6 – 50.8 mm)	1100 – 1400
2-1/8" – 3" (54 – 76.2 mm)	900 – 1100
3-1/4" – 4" (82.6 – 101.6 mm)	700 – 900
4-1/2" (114.3 mm) +	500 – 700

These are the ideal speeds for drilling various diameters with CRL Plated Diamond Drills. Acceptable results may also be achieved by varying your drilling speeds. CRL Amazing Glazing Plated Diamond Drills may also be used in standard 1,300 RPM drill machines.

## CRL Electro-Formed Diamond Drills

- For Fast Cutting, High Production Runs
- Extended Work Life
- 1/2" Diamond Matrix Depth
- Two Mounting Styles to Choose From: Straight Shank or Belgian Type

These CRL Electro-Formed Diamond Drills are thin-walled, with a 1/2" (12.7 mm) deep multi-layer of diamonds and bonding matrix designed for high speed, high production drilling. These drills give outstanding results when exacting conditions are met. The CRL DCD Series features an extra long 1-3/8" (35 mm) by 3/8" (9.5 mm) diameter shank for a positive grip on the drill. The CRL HBT Series features Belgian style mounts, also known as 1/2-gas or continental threads, which is a popular choice for U.S. and European glass drilling machines.

**IMPORTANT NOTE:** CRL DCD and HBT Series Diamond Drills have a very thin wall which makes them EXTREMELY FRAGILE. They are intended for the drilling of flat (plate) glass ONLY, in a true running production type drilling press. NEVER use in any type of hand drill. The use of these drills in any manner other than as specified above may damage them and will void any warranty. Always wear the proper safety gear including gloves and eye protection when drilling glass. Work should be performed on a flat, horizontal surface. A Ground Fault Circuit Interrupt Device Cat. No. GF1 must be used when using any type of electric tool in conjunction with water or coolant. Failure to follow any of these precautions can result in operator injury.

**NOTE:** Sharpening or "dressing" of this drill before each use will substantially increase its cutting capabilities and minimize "glazing" or dulling of the bit. A Dressing Stone is a necessity when working with an Electro-Formed Diamond Drill (see page 167K).

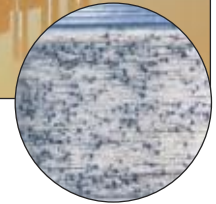
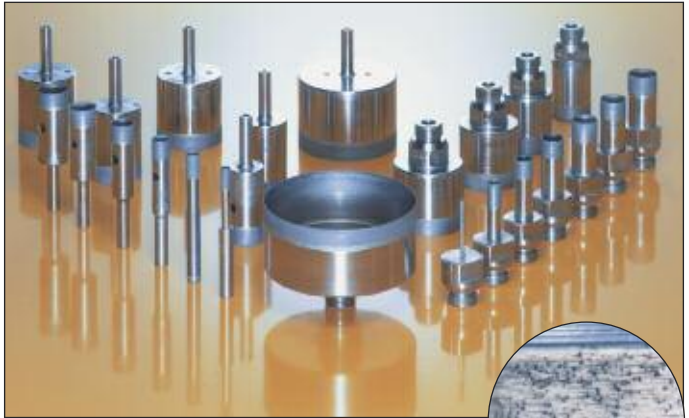

Magnified View of Diamond Crystals



Straight Shank

Belgian Thread



### DCD SERIES STRAIGHT SHANK

CAT. NO.	DRILL DIAMETER
DCD14	1/4" (6.4 mm)
DCD516	5/16" (7.9 mm)
DCD38	3/8" (9.5 mm)
DCD716	7/16" (11.1 mm)
DCD12	1/2" (12.7 mm)
DCD58	5/8" (15.9 mm)
DCD34	3/4" (19.1 mm)
DCD78	7/8" (22.2 mm)
DCD1	1" (25.4 mm)
DCD114	1-1/4" (31.8 mm)
DCD112	1-1/2" (38.1 mm)
DCD134	1-3/4" (44.5 mm)
DCD2	2" (50.8 mm)
DCD214	2-1/4" (57.2 mm)
DCD212	2-1/2" (63.5 mm)
DCD234	2-3/4" (69.9 mm)
DCD3	3" (76.2 mm)
DCD312	3-1/2" (88.9 mm)
DCD4	4" (101.6 mm)

Minimum order: 1 each. All CRL Diamond Drills may be combined for quantity pricing.

### HBT SERIES BELGIAN THREAD

CAT. NO.	DRILL DIAMETER
HBT332	3/32" (2.4 mm)
HBT18	1/8" (3.2 mm)
HBT316	3/16" (4.8 mm)
HBT14	1/4" (6.4 mm)
HBT516	5/16" (7.9 mm)
HBT38	3/8" (9.5 mm)
HBT716	7/16" (11.1 mm)
HBT12	1/2" (12.7 mm)
HBT916	9/16" (14.3 mm)
HBT58	5/8" (15.9 mm)
HBT34	3/4" (19.1 mm)
HBT1316	13/16" (20.6 mm)
HBT78	7/8" (22.2 mm)
HBT1	1" (25.4 mm)
HBT114	1-1/4" (31.8 mm)
HBT138	1-3/8" (34.9 mm)
HBT716	1-7/16" (36.5 mm)
HBT112	1-1/2" (38.1 mm)
HBT134	1-3/4" (44.5 mm)
HBT2	2" (50.8 mm)
HBT214	2-1/4" (57.2 mm)
HBT212	2-1/2" (63.5 mm)
HBT234	2-3/4" (69.9 mm)
HBT3	3" (76.2 mm)
HBT312	3-1/2" (88.9 mm)
HBT4	4" (101.6 mm)

Minimum order: 1 each. All CRL Diamond Drills may be combined for quantity pricing.

## Recommended Operating Speeds for DCD and HBT Diamond Drills

DRILL DIAMETER	RPM RANGE
3/32" - 1/8" (2.4 - 3.2 mm)	6000
3/16" - 5/16" (4.8 - 7.9 mm)	4500
3/8" - 7/16" (9.5 - 11.1 mm)	3000
1/2" - 5/8" (12.7 - 15.9 mm)	2500
3/4" - 1" (19.1 - 25.4 mm)	2000
1-1/4" - 1-3/4" (31.8 - 44.5 mm)	1500
2" - 2-1/2" (50.8 - 63.5 mm)	1200
2-3/4" - 3-1/2" (69.9 - 88.9 mm)	900
4" (101.6 mm)	800

These are the ideal speeds for drilling various diameters. You may vary somewhat with acceptable results. Drills can also be used with standard 1300 RPM machines, but drilling time is increased on small diameter holes.

## CRL Metal Bond Diamond Drills

- **Designed for High-Volume Glass Fabrication**
- **3/8" Diamond Matrix Depth**
- **Two Mounting Styles to Choose From: Straight Shank or Belgian Thread**

CRL PD and PDT Series Metal Bond Diamond Drills use a special diamond and brass bond for maximum performance in glass. Metal Bond Drills offer the longest life of any type of diamond drill: 1,000 to 2,000 holes in 1/4" (6.4 mm) glass with proper maintenance and the use of a wet Sharpening Stone to expose fresh diamonds. These Italian made multi-layer drills cut faster and run cooler than any other drill on the market. They have a full 3/8" (9.5 mm) deep cutting surface filled with diamonds and bronze bond, which allows for extended drill life, but also makes this style of drill more fragile. They should always be used in true running machines on flat glass surfaces. The CRL PD Series features an extra long 1-3/8" (35 mm) by 3/8" (10 mm) diameter shank for a positive grip on the drill. The CRL PDT Series features Belgian style mounts also known as 1/2-gas or continental threads, which are popular among all U.S. and European glass drilling machines. They can be used in portable drill machines such as the CRL AMZ1 (page 153K), but they are especially suited for production equipment.

**NOTE:** Sharpening or "dressing" of this drill before each use will substantially increase its cutting capabilities and minimize "glazing" or dulling of the bit. A Dressing Stone is a necessity when working with a Metal Bond Diamond Drill (see page 167K).

**NOTE:** Always wear the proper safety gear including gloves and eye protection when drilling glass. Work should be performed on a flat, horizontal surface. A Ground Fault Circuit Interrupt Device (Cat. No. GF1) must be used when using any type of electric tool in conjunction with water or coolant. Failure to follow any of these precautions can result in operator injury.



Magnified View of Diamond Crystals

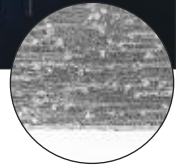

Straight Shank



Belgian Thread

### Recommended Operating Speeds for PD and PDT Diamond Drills

DIAMETER RANGE	RPM
3 – 4 mm	6000
5 – 8 mm	4500
9 – 12 mm	3000
13 – 16 mm	2500
17 – 25 mm	2000
26 – 28 mm	1800
29 – 44 mm	1500
45 – 64 mm	1200
65 – 89 mm	900
90 – 102 mm	800

These are the ideal speeds for drilling various diameters. You may vary somewhat with acceptable results. Drills can also be used with standard 1,300 RPM machines, but drilling time is increased on small diameter holes.

STRAIGHT SHANK CAT. NO.	BELGIAN THREAD CAT. NO.	DRILL DIAMETER	STRAIGHT SHANK CAT. NO.	BELGIAN THREAD CAT. NO.	DRILL DIAMETER
PD3MM	PDT3MM	3 mm	PD1	PDT1	1" (25.4 mm)
PD18	PDT18	1/8" (3.2 mm)	PD27MM	PDT27MM	27 mm
PD316	PDT316	3/16" (4.8 mm)	PD118	PDT118	1-1/8" (28.6 mm)
PD6MM	PDT6MM	6 mm	PD11316	PDT11316	1-3/16" (30.2 mm)
PD14	PDT14	1/4" (6.4 mm)	PD114	PDT114	1-1/4" (31.8 mm)
PD516	PDT516	5/16" (3.2 mm)	PD32MM	PDT32MM	32 mm
PD9MM	PDT9MM	9 mm	PD138	PDT138	1-3/8" (34.9 mm)
PD38	PDT38	3/8" (9.5 mm)	PD112	PDT112	1-1/2" (38.1 mm)
PD716	PDT716	7/16" (11.1 mm)	PD134	PDT134	1-3/4" (44.5 mm)
PD12MM	PDT12MM	12 mm	PD2	PDT2	2" (50.8 mm)
PD12	PDT12	1/2" (12.7 mm)	PD218	PDT218	2-1/8" (54 mm)
PD13MM	PDT13MM	13 mm	PD214	PDT214	2-1/4" (57.2 mm)
PD916	PDT916	9/16" (14.3 mm)	PD212	PDT212	2-1/2" (63.5 mm)
PD58	PDT58	5/8" (15.9 mm)	PD234	PDT234	2-3/4" (69.9 mm)
PD1116	PDT1116	11/16" (17.5 mm)	PD3	PDT3	3" (76.2 mm)
PD34	PDT34	3/4" (19 mm)	PD314	PDT314	3-1/4" (82.6 mm)
PD20MM	PDT20MM	20 mm	PD312	PDT312	3-1/2" (88.9 mm)
PD1316	PDT1316	13/16" (20.6 mm)	PD334	PDT334	3-3/4" (95.3 mm)
PD78	PDT78	7/8" (22.2 mm)	PD100MM	PDT100MM	100 mm
PD24MM	---	24 mm	PD4	PDT4	4" (101.6 mm)
PD25MM	PDT25MM	25 mm			

Minimum order: 1 each. All CRL Diamond Drills may be combined for quantity pricing.

## CRL Habit Fit Diamond Drills

- For Fast Cutting, High Production Runs
- Long Lasting Reliability
- Available in Australia and Europe Only

CRL Habit Fit A40 and 100 Series Diamond Drills are commonly used for glass drilling throughout Australia and Europe. They are especially suited for high production equipment and have an extended work life.

CRL A40 Series Metal Bond Diamond Drills use a special 3/8" (9.5 mm) diamond and brass bond for maximum performance in glass. Metal Bond Drills offer the greatest life, with an expectancy of 1000 to 2000 holes in 1/4" (6 mm) glass with proper maintenance. These multi-layer drills run cooler than any other drill on the market.

CRL 100 Series Electro-Formed Diamond Drills are thin-walled, with a 1/2" (12.7 mm) deep layer of diamonds and bonding matrix designed for high speed, high production drilling. These drills are fragile, and are intended for the drilling of flat (plate) glass ONLY, in a true running production-type drilling machine. These drills offer superior results when exacting conditions are met.

Sharpening or "dressing" of these drills periodically will substantially increase their cutting capabilities and minimize "glazing" or dulling of the bit. A Dressing Stone is a recommended necessity when working with an Electro-Formed or Metal Bond Diamond Drill. See page 167K for our selection of Dressing Stones.

**IMPORTANT NOTES:** These Drills are designed for use in a true running production-type drilling machine. NEVER use in any type of hand drill. The use of these Drills in any manner other than as specified above may damage them and will void any warranty.

**WARNING:** Always wear the proper safety gear, including gloves and eye protection, when drilling glass. Work should be performed on a flat, horizontal surface. A Ground Fault Circuit Interrupt Device (Cat. No. GF1) must be used when using any type of electric tool in conjunction with water or coolant. Failure to follow any of these precautions can result in operator injury.

### Recommended Operating Speeds for A40 and 100 Series Diamond Drills

DIAMETER RANGE	RPM
3 – 4 mm	6000
5 – 8 mm	4500
9 – 12 mm	3000
13 – 16 mm	2500
17 – 25 mm	2000
26 – 28 mm	1800
29 – 44 mm	1500
45 – 64 mm	1200
65 – 89 mm	900
90 – 102 mm	800

These are the ideal speeds for drilling various diameters. You may vary somewhat with acceptable results. Drills can also be used with standard 1,300 RPM drilling machines, but drilling time is increased on small diameter holes.



Available Only in Australia and Europe

**A40 Series Drills**

These Drills have thicker walls to withstand higher pressure. They offer a longer service life, but don't cut as fast as the thin-walled 100 Series Electro-Formed Drills.



**100 Series Drills**

These Drills have thin walls with a 1/2" (12.7 mm) layer of diamonds and bonding matrix. They drill faster than the A40 Series Metal Bond Drills, but may not offer the same service life.

A40 SERIES CAT. NO.	100 SERIES CAT. NO.	DRILL DIAMETER	A40 SERIES CAT. NO.	100 SERIES CAT. NO.	DRILL DIAMETER
A40103	---	3 mm	---	100337H	37 mm
A40104	100304H	4 mm	A40138	100338H	38 mm
A40105	100305H	5 mm	---	100339H	39 mm
A40106	100306H	6 mm	A40140	100340H	40 mm
---	1003065H	6.5 mm	---	100341H	41 mm
A40107	100307H	7 mm	A40142	100342H	42 mm
A40108	100308H	8 mm	A40143	100343H	43 mm
---	1026085H	8.5 mm (70 mm Length)	A40144	100344H	44 mm
---	1003085H	8.5 mm (85 mm Length)	A40145	100345H	45 mm
A40109	100309H	9 mm	---	100346H	46 mm
A40110	100310H	10 mm	---	100347H	47 mm
A40111	100311H	11 mm	---	100348H	48 mm
A40112	100312H	12 mm	---	100349H	49 mm
---	1003125H	12.5 mm	A40150	100350H	50 mm
A40113	100313H	13 mm	A40151	100351H	51 mm
A40114	100314H	14 mm	A40152	100352H	52 mm
A40115	100315H	15 mm	---	100353H	53 mm
A40116	100316H	16 mm	A40154	100354H	54 mm
A40117	100317H	17 mm	A40155	100355H	55 mm
A40118	100318H	18 mm	---	100356H	56 mm
A40119	100319H	19 mm	A40157	100357H	57 mm
A40120	100320H	20 mm	---	100358H	58 mm
A40121	100321H	21 mm	---	100359H	59 mm
A40122	100322H	22 mm	A40160	100360H	60 mm
A40123	100323H	23 mm	---	100361H	61 mm
A40124	100324H	24 mm	---	100362H	62 mm
A40125	100325H	25 mm	---	100363H	63 mm
A40126	100326H	26 mm	---	100364H	64 mm
A40127	100327H	27 mm	A40165	100365H	65 mm
A40128	100328H	28 mm	A40166	---	66 mm
A40129	100329H	29 mm	A40170	100370H	70 mm
A40130	100330H	30 mm	A40175	100375H	75 mm
A40131	100331H	31 mm	---	100378H	78 mm
A40132	100332H	32 mm	A40180	100380H	80 mm
A40133	100333H	33 mm	A40185	100385H	85 mm
A40134	100334H	34 mm	A40190	100390H	90 mm
A40135	100335H	35 mm	A40195	100395H	95 mm
A40136	100336H	36 mm	A401100	1003100H	100 mm

Minimum order: 1 each. All CRL Diamond Drills may be combined for quantity pricing.

Minimum order: 1 each. All CRL Diamond Drills may be combined for quantity pricing.

## CRL Starlite® Diamond Core Drills

- Mounted on a Brass Collet
- Metal Matrix Bond
- Super Thin Wall

CRL Starlite® Diamond Core Drills are mounted on a brass collet. They have a metal matrix bond with a 150 diamond concentration with a super thin wall. It is 3/8" (9.5 mm) diamond impregnated. Use with CRL DTC80 Diamond Tool Coolant, see page 167K.

5/8"-18 Thread



CAT. NO.	SIZE	SUGGESTED DRILL RPM
2202197	3/16" (4.8 mm)	1800-2400
2202198	1/4" (6.4 mm)	1800-2400
2202202	1/2" (12.7 mm)	1800-2400
2202208	5/8" (15.9 mm)	1800-2400
2202209	3/4" (19.1 mm)	1800-2400
2202210	1" (25.4 mm)	1250-1800

Minimum order: 1 each.

## CRL Amazing Glazing Diamond Countersinks

- Straight Shank or Belgian Type Mounts
- Metal Bond Diamonds

CRL Diamond Countersinks feature a medium grit diamond for grinding precise, chip-free, 90 degree tapers into existing holes in glass. They are available in three sizes that can be used on any hole size up to the maximum countersink diameter.



STRAIGHT SHANK CAT. NO.	BELGIAN THREADED CAT. NO.	DIAMETER
SDC12	BDC12	1/2" (12.7 mm)
SDC1	BDC1	1" (25.4 mm)
SDC112	BDC112	1-1/2" (38.1 mm)

Minimum order: 1 each.

## CRL Core Drill Coolant Feeder

- Provides Center Coolant Delivery
- Accepts 5/8"-18 Threaded Drills Only
- Fits Popular Large Drill Presses

Build your own glass drilling machine by using the CRL Core Drill Coolant Feeder and your industrial drill press. Perfect for high volume drilling of small pieces such as vases, lamps, and other small parts. Provides optimum drill performance by supplying coolant continuously through the center of the drill. Coolant pressure ejects the core out of the diamond drill after the drilling cycle is completed.

Straight Shank



CAT. NO.	DESCRIPTION
2202010	5/8"-18 Thread Core Drill Coolant Feeder

Minimum order: 1 each. Always use a ground fault interrupt circuit device (Cat. No. GF1) when using electrical tools in wet areas.

## CRL Habit Mount Diamond Countersinks

- Habit Shank Threaded Mount For Sure Fit
- Metal Bond Diamonds For Maximum Life

These CRL Diamond Countersinks feature a Habit Shank Mount offering you the best and most accurate way to achieve a fine finish and minimize chipping. The center water feed assures proper cooling when making a deep cut in thick plate glass. The 90 degree angle provides an even 360 degree chamfer into existing holes in glass.



Available Only in Australia



CAT. NO.	DIAMETER
A40030	0-30 mm
A40040	0-40 mm
A40050	0-50 mm

Minimum order: 1 each.

## CRL Diamond Countersink/Drill for Spider Fittings

**new**

- Designed Especially for Our Heavy-Duty Spider Fitting Hardware
- 1-13/16" (46 mm) Countersink and 1-7/16" (36 mm) Drill

Most CRL Spider Fitting Hardware require one countersunk hole per glass fastening. This CRL Countersink/Drill is designed specifically for our heavy-duty fittings which require a 36 millimeter hole with a 46 millimeter countersink. It is a Belgian mount diamond drill, which assures fast, clean countersunk holes every time. Minimum order is one each.



CAT. NO. CSD36SF

Starlite is a registered trademark of Starlite Industries, Inc.

## CRL Amazing Glazing Diamond Spot Facers

- Three Popular Sizes
- Custom Sizes Available

These 100 grit Belgian Mount Diamond Spot Facers are designed for drilling flat bottom holes in glass to a partial depth. A center coolant feed is required.



CAT. NO.	GRIT	DIAMETER
SF14	100X	1/4" (6.4 mm)
SF38	100X	3/8" (9.5 mm)
SF12	100X	1/2" (12.7 mm)

Minimum order: 1 each.

## How to Use CRL Diamond Tool Coolant

CRL Diamond Tool Coolant increases cutting speed and reduces tool wear. It is designed for use when drilling and sawing glass. A chemical emulsion concentrate, it contains no chemicals that will harm or affect glass, mirrors or mirror backings.



Add 1 Part Coolant to 50 Parts of Water



Pour the Mixed Solution into Your Wet Saw or Drill's Holding Tank

**NOTE:** DO NOT mix CRL Diamond Tool Coolant with any other lubricating fluids or additives. Always add the required amount of Coolant Concentrate to the required amount of water - **NEVER THE REVERSE.**

### SPECIFICATIONS:

**Mix ratio:** 1 part coolant to 50 parts water. To achieve optimum emulsion stability, pre-mix the coolant solution as follows:

#### Mixture for One Pint Coolant Bottle:

2 teaspoons (10 ml) to 16 oz (.5 liter) of water.

#### Mixture for One Gallon Coolant Tank:

2.5 oz. or 5 tablespoons (75 ml) to 128 oz. (3.8 liters) of water.

## How to Properly Sharpen a Diamond Drill

CRL Sharpening Stones are intended for use with multi-layer diamond drills, such as our DCD, HBT, PD, and PDT Series Drills. The purpose of the Stone is to remove bond matrix and expose a fresh layer of diamond crystal. Use the Stone when your diamond drill becomes slow in drilling.

When using a CRL Sharpening Stone, make sure the drill diameter is smaller than the sharpening surface. This is for your safety. A smaller stone can catch and spin in the drill, causing potential injury to the operator. The entire diamond section of the drill should be in contact with the Stone. Do not over-use the Stone. Only light dressing is needed to expose fresh diamond. Do not dress sides of diamond drills.

**TO SHARPEN:** Submerge Stone in water or suitable coolant solution before use to fully saturate Stone. Position Stone securely under drill mounted in the machine. Block or hold Stone securely to prevent spinning. Set drill speed to slowest setting and lower the drill onto the Stone several times with just enough pressure to insure 360 degree contact with the Stone. Raise and remove the diamond tube drill from machine. By hand, lightly turn the diamond drill counter-clockwise three or four turns in the groove just created in the Stone. Now try drilling your glass again. Your drilling performance should be greatly improved.

**NOTE:** For sharpening diamond wheels, use our finer EMSS Type Stones (page 669K).

**IMPORTANT NOTES:** Always wear the proper safety gear including eye protection when using a sharpening stone. A Cat. No. GF1 Ground Fault Circuit Interrupt Device (see page 550K) should be used with any type of wet-working electric tool. Do not wear loose clothing that could be caught in the machine. Failure to follow any of these precautions can result in operator injury.

For more information, contact CRL Customer Service Department at (800) 421-6144 in the U.S., (877) 421-6144 from Canada, or (323) 588-1281 International. Ask for Ext. 5275. You can also send e-mail from the home page of [crlaurence.com](http://crlaurence.com). Click on Contact Us, and then click on Customer Service.



## CRL Diamond Tool Coolant Concentrate

- An Excellent Coolant for Glass Drilling, Cutting or Routing
- Extends the Life of the Tool

CRL Diamond Tool Coolant Concentrate is mixed with water to create an excellent coolant solution for drilling, sawing, and routing glass. It is economical to use, because a ratio of 50 parts water to one part Concentrate is all it takes for optimum cooling and lubricating performance. CRL Diamond Tool Coolant Concentrate is biodegradable, which means it can be safely disposed of in your shop's drain without causing harm to the environment.



CAT. NO. DTC80Z  
8 Fl. Oz. (236 ml)



CAT. NO. DTC80QT  
1 Quart (945 ml)



CAT. NO. DTC80GL  
1 Gallon (3.785 l)

CAT. NO.	CONTENTS
DTC80Z	8 Ounces (236 ml)
DTC80QT	1 Quart (945 ml)
DTC80GL	1 Gallon (3.785 l)

Minimum order: 1 each.

## CRL Sharpening Stones

- Brings Life Back to Your Production Diamond Drills
- Use to Expose Fresh Diamonds

Achieve maximum life from your diamond drills by using the correct Sharpening Stone. Highly abrasive CRL Sharpening Stones remove worn diamond and bond contact, exposing fresh cutting crystals. They are designed for use with CRL Production Style Metal Bond and Electro-Formed Diamond Drills. **NOTE:** When using a CRL Sharpening Stone, make sure the drill diameter is smaller than the sharpening surface. Always thoroughly saturate CRL Sharpening Stones in coolant before use. This will avoid any unnecessary heating of the drill bit.



- Four Sizes to Work With Drills Up to 6" (152 mm) in Diameter



CAT. NO.	SIZE
PDSS	2" x 7" x 1/2" (51 x 178 x 12 mm)
PDSS3	4" x 6" x 1" (102 x 152 x 25 mm)
PDSS4	6" x 8-1/2" x 1/2" (152 x 216 x 12 mm)
G0513	3" x 1-1/2" x 1/4" (75 x 35 x 6 mm) - Australia Only

Minimum order: 1 each.

## CRL Miniature Flat Tip and Tripple-Ripple™ Diamond Drills

- Music Wire Diamond Drills for Use in Hand Held Rotary Tools

CRL Plated Diamond Flat-Tip Drills are to be used in hand held Dremel, Foredom or small precision drill presses. Diamond is plated on flexible music wire. Tripple-Ripple™ Drills have twice the life and cutting rate of our Flat-Tip Drills. The Tripple-Ripple™ Diamond Drill has three flutes to allow cuttings to flush away, and decrease frontal contact and drag. As the edges wear, fresh diamond in the flutes maintain the cutting action. **NOTE:** Always submerge in CRL Diamond Tool Coolant solution.

### MINIATURE PLATED DIAMOND FLAT-TIP DRILLS

CAT. NO.	SIZE-U.S.	DESCRIPTION
MD346	.0295"	.75 mm Flat-Tip Drill
MD16	.0394"	1 mm Flat-Tip Drill
MD1146	.0492"	1.25 mm Flat-Tip Drill
MD1126	.0590"	1.50 mm Flat-Tip Drill
MD26	.0787"	2 mm Flat-Tip Drill
MD2146	.0886"	2.25 mm Flat-Tip Drill
MD2126	.0985"	2.5 mm Flat-Tip Drill
MD36	.1182"	3 mm Flat-Tip Drill
MD3126	.1379"	3.5 mm Flat-Tip Drill
MD46	.1576"	4 mm Flat-Tip Drill

Minimum order: Six Drills of one size. Sizes can be combined for quantity pricing.



Flat-Tip Drill

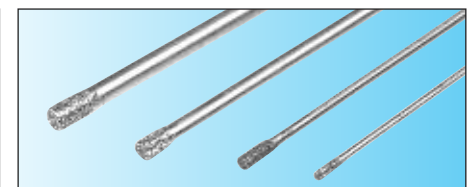

Tripple-Ripple™ Drill



Shown in Dremel Tool

### TRIPPLE-RIPPLE™ PLATED DIAMOND DRILLS

CAT. NO.	SIZE-U.S.	DESCRIPTION
TRD346	.0295"	.75 mm Tripple-Ripple™ Drill
TRD116	.0433"	1.1 mm Tripple-Ripple™ Drill
TRD146	.0551"	1.4 mm Tripple-Ripple™ Drill
TRD186	.0709"	1.8 mm Tripple-Ripple™ Drill
TRD216	.0827"	2.1 mm Tripple-Ripple™ Drill

Minimum order: Six Drills of one size. Sizes can be combined for quantity pricing.

## CRL Steel Tube Drills

### • The "Old Reliable" Way to Drill Glass

CRL Steel Tube Drills are designed for use in our CRL Tripod Drill or similar type drill machine. They work with an abrasive grain such as CRL Silicon Carbide Grain to "drill" holes in glass through rotational abrasion. A coolant (or water) is mixed with the abrasive to form a slurry which is retained by a CRL Rubber Base Drilling Ring (see page 171K). The even and steady rotation of the Tube Drill against the glass will produce a clean hole with minimal breakage or chipping. CRL Steel Tube Drills are the economical fulfillment of your glass drilling needs. They have a 1/4" (6.4 mm) diameter shank to fit most drilling machines.



CRL2 Variable Speed Drilling Machine is sold separately (see page 152K).

CAT. NO.	DRILL DIAMETER	CAT. NO.	DRILL DIAMETER
STD12	1/2" (12.7 mm)	STD212	2-1/2" (63.5 mm)
STD58	5/8" (15.9 mm)	STD234	2-3/4" (69.9 mm)
STD34	3/4" (19 mm)	STD3	3" (76.2 mm)
STD1316	13/16" (20.6 mm)	STD314	3-1/4" (82.6 mm)
STD78	7/8" (22.2 mm)	STD312	3-1/2" (88.9 mm)
STD1	1" (25.4 mm)	STD334	3-3/4" (95.3 mm)
STD114	1-1/4" (31.8 mm)	STD4	4" (101.6 mm)
STD112	1-1/2" (38.1 mm)	STD412	4-1/2" (114.3 mm)
STD134	1-3/4" (44.5 mm)	STD5	5" (127 mm)
STD2	2" (50.8 mm)	STD512	5-1/2" (139.7 mm)
STD214	2-1/4" (57.2 mm)	STD6	6" (152.4 mm)

Minimum order: 1 each

**NOTE:** Always wear the proper safety gear including eye protection when drilling glass. Work should be performed on a flat, horizontal surface. A Cat. No. GF1 Ground Fault Circuit Interrupt Device (see page 550K) must be used when using any type of electric tool in conjunction with water or coolant. Failure to follow any of these precautions can result in operator injury.

## CRL Silicon Carbide Grain

- For Use With Brass and Steel Tube Drills
- Easy to Use

Use CRL Silicon Carbide Grain for almost any glass drilling need. Most commonly used with CRL Steel and Brass Tube Drills, the abrasive action of the silicon carbide is applied by the rotation of the tube drill. The slots in the drill pick up the grain, which causes the glass to wear. Can be used to drill holes for speak tube applications or outlets. You can also use it on roughing plates for grinding and polishing.

**NOTE:** Always wear the proper safety gear, including gloves and eye protection, when drilling glass. Work should be performed on a flat, horizontal surface. A Cat. No. GF1 Ground Fault Circuit Interrupt Device (see page 550K) must be used when using any type of electric tool in conjunction with water or coolant. Failure to follow any of these precautions can result in operator injury.

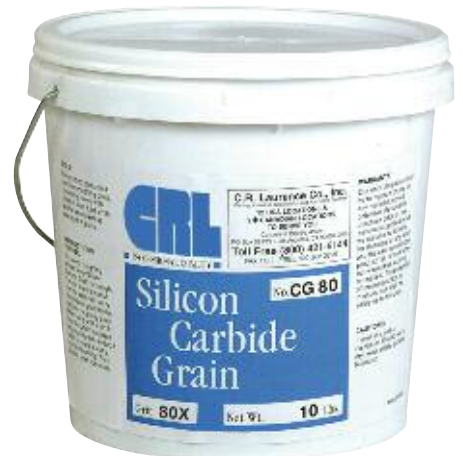

AVAILABLE IN 10, 25, 50, AND 100 POUND BULK CONTAINERS

CAT. NO.	GRIT	DESCRIPTION
CG60X	60X	Extra Rough
CG80X	80X	Rough
CG100X	100X	Medium
CG120X	120X	Smooth
CG220X	220X	Fine

Minimum order: 10 pounds of one grit.



## CRL Prismatic Glass Drills

- Our Best Carbide Drill
- Precision Ground on Three Sides
- Available Sizes From 1/8" to 1/2"

The CRL Prismatic Glass Drill is the standard of quality for glass drilling throughout the flat glass industry. The tungsten carbide tips mean you can produce hundreds of high quality holes without needing to resharpen the drill. The extra long tip assures long lasting, precision drilling.

**NOTE:** Prismatic Drills should only be used in glass drilling machines such as the CRL2, SDM4, and 41, or in a securely held electric drill. We do not recommend you use them with hand brace drills. Be sure to keep the drill cool using CRL Cat. No. DTC80 Coolant during drilling.

**WARNING:** These drills should be run at 400-600 RPM to achieve maximum drilling performance (see chart at right). The tip of the CRL Prismatic Drill is not ground to a sharp point. There is a slight angle at the tip to allow the drill to first scratch the glass and begin the drilling of the hole.

**NOTE:** Always wear the proper safety gear, including gloves and eye protection, when drilling glass. Work should be performed on a flat, horizontal surface. A Ground Fault Circuit Interrupter, such as CRL Cat. No. GF1, must be used when using any type of electric tool in conjunction with water or coolant. Failure to follow any of these precautions can result in operator injury.



CAT. NO.	DRILL DIAMETER	SHANK DIAMETER	RECOMMENDED RPM
2600*	1/8" (3.2 mm)	1/4" (6.4 mm)	500 – 600
2601	5/32" (4 mm)	1/4" (6.4 mm)	500 – 600
2602	3/16" (4.8 mm)	1/4" (6.4 mm)	500 – 600
2603	7/32" (5.6 mm)	1/4" (6.4 mm)	500 – 600
2604	1/4" (6.4 mm)	1/4" (6.4 mm)	500 – 600
2605	5/16" (7.9 mm)	1/4" (6.4 mm)	500 – 600
2606	3/8" (9.5 mm)	1/4" (6.4 mm)	400 – 500
2607	7/16" (11 mm)	1/4" (6.4 mm)	400 – 500
2608	1/2" (12.7 mm)	1/4" (6.4 mm)	400 – 500

\* NOTE: The 1/8" Drill is extremely fragile and used at the purchaser's risk. Minimum order: 1 each. All Prismatic Drills can be combined for quantity pricing.

## CRL Spearpoint Glass Drills

- For Use With Low RPM Drilling Machines
- Available Sizes From 1/8" to 1/2"

The CRL Spearpoint Glass Drill meets your demand for a low priced, reliable glass drill. The diamond-lapped, spade-shaped tip will drill many smooth holes in glass, vitrolite, china, ceramic, tile, etc. You can use this drill with hand held, low RPM drilling machines.

Capable of drilling holes very fast, this drill is easy to use, and will give you extended service life. You can conveniently use the CRL Spearpoint Drill in models such as CRL2, SDM4, and 41 Glass Drilling Machines, but it works best in a regular power drill. When working with these drills, be sure to keep the drill cool by using a lubricant, such as our Cat. No. DTC80 Coolant (see page 167K).

**NOTE:** Always wear the proper safety gear, including gloves and eye protection, when drilling glass. Work should be performed on a flat, horizontal surface. A Ground Fault Circuit Interrupter, such as CRL Cat. No. GF1, must be used when using any type of electric tool in conjunction with water or coolant. Failure to follow any of these precautions can result in operator injury.



CAT. NO.	DRILL DIAMETER	SHANK DIAMETER	RECOMMENDED RPM
216	1/8" (3.2 mm)	3/32" (2.4 mm)	400 – 800
316	3/16" (4.8 mm)	7/64" (2.8 mm)	400 – 800
416	1/4" (6.4 mm)	11/64" (4.4 mm)	400 – 800
516	5/16" (7.9 mm)	13/64" (5.2 mm)	400 – 800
616	3/8" (9.5 mm)	15/64" (6 mm)	400 – 800
816	1/2" (12.7 mm)	19/64" (7.5 mm)	200 – 400

Minimum order: 1 each. All Spearpoint Drills can be combined for quantity pricing.

## CRL "Three-In-One" Glass Drill



- Drills Three Hole Sizes From 3/16" to 5/16" (4.8 to 7.9 mm)



The long taper on the CRL "Three-In-One" Drill makes it useful for drilling 3/16", 1/4" or 5/16" (4.8, 6.4 or 7.9 mm) holes. The convenient "step-down" feature makes a gradual opening in the glass, resulting in a cleaner cut. Proven to last longer, it drills cleaner holes faster than other drills. The 1" (25.4 mm) long tungsten carbide steel blade is great for drilling tile, ceramic, and glass. Use with CRL Diamond Coolant Cat. No. DTC80GL to cool the bit while drilling. Minimum order is one each.

**NOTE:** Always wear the proper safety gear including gloves and eye protection when drilling glass. Work should be performed on a flat, horizontal surface. A Ground Fault Circuit Interrupter (Cat. No. GF1) must be used when using any type of electric tool in conjunction with water or coolant. Failure to follow any of these precautions can result in operator injury.

CAT. NO. 301

## CRL Small Diameter Glass Drills



- Three Sizes From 1/16" to 3/32" (1.6 to 2.4 mm)
- Ideal for Intricate Work



This CRL Small Diameter Glass Drill is especially suited for detailed work such as restoration and art glass applications. The small diameter makes it handy to use on glass, vitrolite, tile, ceramic, and china. It can be used in a securely held hand drill, but like most glass drilling applications, a standard drill press is best suited for this application. The CRL2 or SDM4 Drill Machines are good choices when using these Small Diameter Drills.

CAT. NO.	DRILL DIAMETER	RECOMMENDED RPM
SD116	1/16" (1.6 mm)	400
SD564	5/64" (2 mm)	400
SD332	3/32" (2.4 mm)	400

Minimum order: 1 each. All CRL Diamond Drills may be combined for quantity pricing.

## CRL Plastic Spray Dispenser Bottle

- Ideal for Applying CRL Diamond Tool Coolant to Drills to Keep Them Cool



This 16 fl. oz. (473 ml) CRL Plastic Spray Dispenser Bottle has an adjustable spray nozzle that can be fine tuned to apply a stream of coolant directly to the drill point on CRL Prismatic and Spearpoint Drills. Minimum order is one each.

CAT. NO. DB21

## CRL 32 Oz. Plastic Spray Dispenser Bottle

- Oversized Trigger for Powerful Pumping Action
- High-Volume Output
- Lasts Longer Than Regular Sprayers



This 32 fl.oz. (946 ml) CRL Plastic Dispenser Bottle provides the easiest and most economical way to use Diamond Tool Coolant or Concentrate Glass Cleaner. The easy trigger operation sprays a large, fine mist pattern for best coverage. Easily cleaned valve and intake strainer. This Dispenser will replace and outlast expensive, high pressure aerosol containers. Minimum order is one each.

CAT. NO. 3371032

## CRL Suction Base Drilling Rings

- Instantly Creates a Coolant Dam
- Slanted Walls Helps Stop Splashing



Round Rings  
in Four Sizes



Oval Ring With  
2" Tapered Plug

Use these handy CRL Suction Base Rings for drilling glass whenever you use coolant or carbide grain. Made of a special dual durometer rubber compound which is harder up top to retain their shape, and very soft on the bottom for the suction lip to create a vacuum. A nice feature of these drill rings is they won't break the glass if dropped on it accidentally because of the material they are made from.

CAT. NO.	DESCRIPTION
RR15	1-1/2" (38.1 mm) Round Ring
RR30	3" (76.2 mm) Round Ring
RR45	4-1/2" (114.3 mm) Round Ring
RR65	6-1/2" (165.1 mm) Round Ring
RR24	2" x 4" (50.8 x 101.6 mm) Oval Ring with Plug
RP20	2" (50.8 mm) Tapered Plug Only

Minimum order: 1 each.

## CRL Rubber Base Drilling Rings

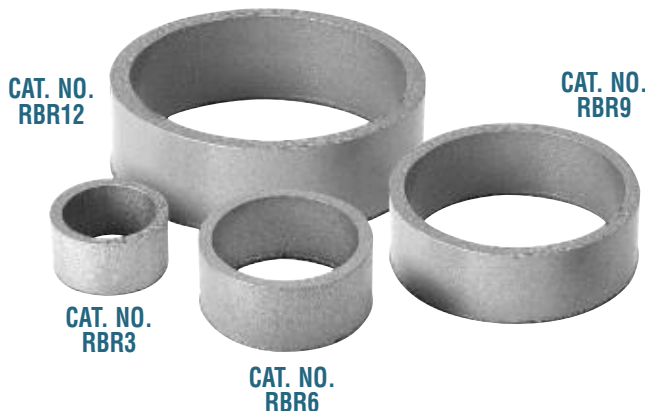

- Cast Iron Rings With Rubber Bases
- Retains Abrasive Grain Slurry

Use these CRL Rubber Base Drilling Rings to retain the abrasive grain slurry while the drill is rotating and cutting into the glass. These cast iron rings have rubber bases to hold them securely to the glass, providing a proper seal, and allowing the coolant to mix with the grain for quick efficient drilling. They are available in four diameters, individually or as a set of the three most popular.

CAT. NO.	FITS DRILL DIAMETERS
RBR3	1/2" (12.7 mm) to 1-1/4" (31.8 mm)
RBR6	1/2" (12.7 mm) to 2-1/2" (63.5 mm)
RBR9	1/2" (12.7 mm) to 4" (101.6 mm)
RBR369	Set of Three (RBR3, RBR6, RBR9)
RBR12	1/2" (12.7 mm) to 6" (152.4 mm)

Minimum order: 1 each.

## CRL Glass Protection Film Roll

- Used to Prevent Scratching
- Low-Tack Adhesive
- 25' and 50' Rolls



CRL Glass Protection Film is a clear sheet of flexible plastic that prevents scratching and marring of your glass while routing or sawing. The film is backed by a low-tack adhesive that won't "gum" up the glass after it is removed. Also works well with CRL Steel or Brass Tube Drills because the abrasive grain can easily scratch your glass. Convenient 25' (7.6 m) or 50' (15.2 m) rolls give you an ample supply to carry to a job site. CRL Glass Protection Film is one of the best products anybody who fabricates glass with surface mount machines can invest in.

CAT. NO.	ROLL WIDTH	ROLL LENGTH
GPF25	12" (305 mm)	25' (7.6 m)
GPF50	12" (305 mm)	50' (15.2 m)
99118	18" (457 mm)	50' (15.2 m)

Minimum order: 1 roll.

## CRL Base Ring With Coolant Drain



- Allows for the Constant Flow of Coolant During Drilling Process
- Conserves Coolant, Avoids Overspilling
- Unique Seal Holds Ring to the Glass

The CRL AMZ228 Coolant Retaining Ring is unlike others available. It features a drain tube that allows your coolant to be recycled to a collection container, minimizing waste. This prevents an overflow of water onto your work surface and shop floor. It also provides a consistent flow of coolant through your water chuck at all times, providing proper cooling and core ejection while drilling. Minimum order is one each.

CAT. NO. AMZ228

## CRL Portable Glass Router

- New Improved Version of Our Most Popular Router is Lightweight and Maneuverable
- Comes With Everything You Need to Cut Any Shape in Glass Up to 1/2" (12 mm) Thick

Our popular ADR2 Portable Glass Router has a new feature that incorporates more power and better performance. The ADR2 Router is a glass working marvel. You will be amazed at the intricate shapes that can be cut with this tool. With very little practice you can cut almost any curve or radius, while leaving a structurally sound piece of glass. Mirror outlets, switch plates, circles, speak holes, and desk tops with computer/phone wire cut-outs are easily fabricated with the ADR2.

The biggest advantage of the CRL ADR2 is that it can plunge cut its own starter holes! No need to stop and drill a pilot hole before routing. This means less down time and more production. This corded, 110V AC, variable speed (10,000-30,000 RPM) machine is rated at 850 Watts. There is no changing, charging, and purchasing of multiple batteries.

The ADR2 comes complete with: the Router and Base, Ground Fault Circuit Interrupter, 5-pack of 1/8" (3.2 mm) High Speed 80 Grit Router Bits, one 1/4" (6.3 mm) Seaming Bit, one 1/8" (3.2 mm) High Speed 40 Grit Router Bit, Custom Cooling System Manifold, Pressure Tank, one bottle of CRL Diamond Tool Coolant, Special Valve Assembly, one roll of Glass Protective Film, and a complete Instruction Manual.

Our Cat. No. ADR2T Deluxe Portable Glass Router comes with all of the above, as well as the Cat. No. TPS Router Template Option and a Steel Template Guide.



CAT. NO. ADR2

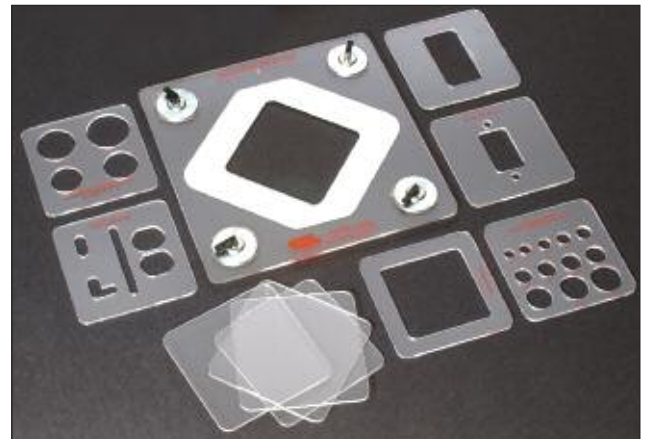

CAT. NO. TPS  
Router Template Option



Notch Example



Freeform Example



Notch Example



CAT. NO. GPF25  
12" Wide Glass Protecting  
Film - 25' Roll



CAT. NO. ADRB40  
40 Grit 1/8" High Speed Diamond Router Bit



CAT. NO. ADRB120  
120 Grit 1/8" High Speed Diamond Router Bit



CAT. NO. SFRB14220  
220 Grit 1/4" Flat with Seam Diamond Router Bit



CAT. NO. GF1  
Ground Fault Circuit Interrupter



CAT. NO. AMZ200  
Optional Coolant Pressure Tank

CAT. NO.	DESCRIPTION
ADR2	110 Volt Portable Glass Router System
ADR2240V	240 Volt Portable Glass Router System
ADR2T	Deluxe 110 Volt Portable Router System With Template
ADR2T240V	Deluxe 240 Volt Portable Router System With Template
TPS	Router Template Option
ADRB40	40 Grit 1/8" (3.2 mm) High Speed Router Bit
ADRB120	120 Grit 1/8" (3.2 mm) High Speed Router Bit
SFRB14220	220 Grit Seaming Bit for 1/4" (6 mm) Glass
DTC80Z	8 Oz. (236 ml) Diamond Tool Coolant
GPF25	12" (305 mm) Wide x 25 Ft. (7.62 m) Roll Glass Protective Film
GPF50	12" (305 mm) Wide x 50 Ft. (15.2 m) Roll Glass Protective Film
GF1	Ground Fault Circuit Interrupter
AMZ200	Pressure Tank

Minimum order: 1 each.

## CRL Diamond Router Bits

- CRL Diamond Router Bits are Available in Four Distinct Styles
- For Use in CRL ADR2 Diamond Glass Router
- 1/4" (6 mm) Shank

### Round Tip

Round Tip Bits are the first choice for plunge cutting and are available in a variety of grits. The more coarse the grit, the faster the cut, but the rougher the edge will be.

**CAT. NO. ADRB40**  
40 Grit 1/8" High Speed 

**CAT. NO. ADRB120**  
120 Grit 1/8" High Speed 

**CAT. NO. BRTRB40**  
40 Grit Brazed 

**CAT. NO. BRTRB100**  
100 Grit Brazed 

**CAT. NO. RTRB60**  
60 Grit Plated 

**CAT. NO. RTRB100**  
100 Grit Plated 

**CAT. NO. RTRB220**  
220 Grit Plated 

**CAT. NO. SBRB60**  
60 Grit Plated; High Speed 

**CAT. NO. SBRB100**  
100 Grit Plated; High Speed 

**CAT. NO. SBRB220**  
220 Grit Plated; High Speed 

### Flat Tip

Flat Tip Bits are primarily used for routing or actually cutting through the glass, whether from the glass edge or from a plunge cut starting hole. Flat Tip Bits are also offered in a wide range of grits.

**CAT. NO. BFTRB40**  
40 Grit Brazed 

**CAT. NO. BFTRB100**  
100 Grit Brazed 

**CAT. NO. FTRB60**  
60 Grit Plated 

**CAT. NO. FTRB100**  
100 Grit Plated 

**CAT. NO. FTRB220**  
220 Grit Plated 

### 2-Step

2-Step Bits offer a small diameter tip to plunge cut, then go to an increased diameter which is faster for routing. These Bits also give you double the diamond surface for extended routing life.

**CAT. NO. BTRB40**  
40 Grit Brazed 

**CAT. NO. BTRB100**  
100 Grit Brazed 

**CAT. NO. TTRB60**  
60 Grit Plated 

**CAT. NO. TTRB100**  
100 Grit Plated 

**CAT. NO. DTRB100**  
100 Grit Plated Detail 

**CAT. NO. DTRB220**  
220 Grit Plated 

### Profile Detail - Flat/Seam, Pencil Edge

Profile Bits come in both flat/seam and pencil edge profiles. These Bits allow the user to finish the edges of the cuts for a smooth, machined look.

**CAT. NO. SFRB18100**  
100 Grit 1/8" Plated 

**CAT. NO. SFRB18220**  
220 Grit 1/8" Plated 

**CAT. NO. SFRB14100**  
100 Grit 1/4" Plated 

**CAT. NO. SFRB14220**  
220 Grit 1/4" Plated 

**CAT. NO. SFRB38100**  
100 Grit 3/8" Plated 

**CAT. NO. SFRB38220**  
220 Grit 3/8" Plated 

**CAT. NO. SFRB12100**  
100 Grit 1/2" Plated 

**CAT. NO. SFRB12220**  
220 Grit 1/2" Plated 

**CAT. NO. PERB100**  
100 Grit 1/4" Plated; Pencil Edge 

**CAT. NO. PERB220**  
220 Grit 1/4" Plated; Pencil Edge 

Minimum order: 1 each.

## CRL Diamond Notch and Saw Machine

- Produces Notches and Free-Style Pattern Edge Cuts
- Fast-Cutting Ring Blade With 360 Degree Diamond Coating Cuts in All Directions
- Optional Radius and Glass Clamp Templates Available

CRL's Diamond Notch and Saw Machine is the latest advancement in glass fabrication machinery. This amazing saw utilizes a high-quality 5-3/4" (146 mm) Steel Ring Blade with specially coated diamonds to provide smooth, fast cutting in all directions of glass up to 1/2" (12 mm) thick.

Use it freehand and reduce labor time 75% on patterns such as crown molding with smooth, chip-free results, or use the adjustable jig tool to eliminate drilling and cut your labor by more than 50%. No more double layouts. Simply cut forward and sideways, back out and you are done. Minimal or no sanding is required. This is the only saw capable of producing strong, square corners. An Internal Sponge Cover provides cutting coolant with no pump required.

Optional Radius Templates for 9/32" (7.1 mm), 5/16" (7.9 mm), 3/8" (9.5 mm), and 7/16" (11.1 mm) radii create "mouse ear" and U- shape sized cut-outs for popular CRL Shower Door Hinges. Templates for CRL BGCU1, SGCU1, GCB188, and SGC188 Glass Clamps also eliminate the need for drilling, scoring, break-out, and costly CNC machine set-up.

Kit includes: Diamond Notch and Saw Machine, Standard Blade, Blade Stabilizer with Template Disc, Adjustable Jig Tool with 1/4" (6.3 mm) Radius Templates, Two Adjustable Clamps, a Set of six Replacement Grommets, and Instructions. Additional replacement parts are also available. We recommend that all electrical glass tools be used with a Cat. No. GF1 Ground Fault Circuit Interrupt Device (see page 550K). Minimum order is one each.



CAT. NO. DNS1



**NOTE:** Always Wear Eye Protection When Using Glass Fabrication Power Tools.

## Easy to Set Up and Use



Measure



Position



Saw

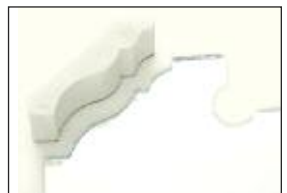
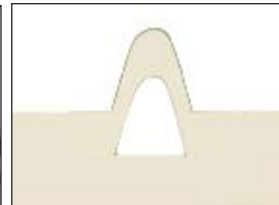

## Optional Templates and Replacement Parts

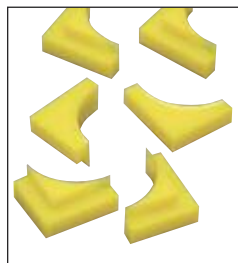

Radii Template Set



Glass Clamp Template Set



Shower Door Template Set

### CAT. NO.

### DESCRIPTION

<b>DNS1</b>	Diamond Notch and Saw Kit 110V 60Hz
<b>DNS1AU</b>	Diamond Notch and Saw Kit 240V 50Hz Australian Plug
<b>DNS1TS</b>	Four Radii Template Set – 9/32", 5/16", 3/8" & 7/16"
<b>DNS1TA</b>	Template for CRL BGCU1 and SGCU1 Glass Clamps
<b>DNS1TB</b>	Template for CRL GCB188 Glass Clamps
<b>DNS1TC</b>	Template for CRL SGC188 Glass Clamps
<b>DNS1X</b>	Template for CRL Geneva and Pinnacle Shower Door Hinges
<b>DNS1Y</b>	Template for CRL Vienna Shower Door Hinges
<b>DNS1Z</b>	Template for CRL Concord Shower Door Hinges
<b>DNS1BL</b>	Diamond Ring Blade with Two Orange Groove Grommets
<b>DNS10G</b>	Orange Groove Grommets – Two Per Pack
<b>DNS1RG</b>	Red Gear Grommets with Bearings – Two Per Pack
<b>DNS1DB</b>	Drive Belt
<b>DNS1SC</b>	Sponge Cover

Minimum order: 1 each.

## CRL 12 Volt Mirror and Glass Notching Saw

- 12V Lithium-Ion Battery Powered – Completely Self-Contained
- Makes Plunge Cuts and Edge Cuts
- Refillable Coolant Dispenser

The CRL NS4000 12V Cordless Notching Saw Kit is an example of innovative CRL design and engineering. The NS4000 combines the latest technology from the Makita® Lithium-Ion power system, and a coolant delivery system featuring a unique body mount designed and assembled by CRL. Using this 1400 RPM Notching Saw to cut notches and cut outs in glass and mirror is simple and fast. The thin 3-3/8" (85 mm) diamond blade provides very narrow stock removal so measurements remain accurate. Makes edge cuts or plunge cuts in glass up to 1/2" (12 mm) thick. Lithium-Ion battery pods do not retain charging memory so each charge brings battery back to 100%. These batteries also retain charge with little or no power loss during storage.

**new**



**CAT. NO. NS4000**

**Standard Equipment Includes:** Two Rechargeable Lithium-Ion Battery Cartridges, 110V Battery Charger, Blade Wrench, 3-3/8" (85 mm) Carbide Tip Blade, 3-3/8" (85 mm) Diamond Smooth Cut Blade, Coolant Dispenser, Full instructions for use.

CAT. NO.	DESCRIPTION
<b>NS4000</b>	12V Mirror and Glass Notching Saw - 110 Volt
<b>NS3B</b>	3-3/8" (85 mm) Diamond Smooth Cut Glass and Mirror Blade
<b>7249508C</b>	3-3/8" (85 mm) Diamond Tile Cutting Blade
<b>BL1014</b>	12V DC Lithium-Ion Battery Cartridge
<b>DC10WB</b>	12V Lithium-Ion Battery Charger - 110 Volt
<b>DTC80Z</b>	8 Oz. (236 ml) Diamond Tool Coolant
<b>NS3PB</b>	Coolant Dispenser Bottle

Minimum order: 1 each.



3-3/8" (85 mm) Optional Diamond Tile Cutting Blade



3-3/8" (85 mm) Included Diamond Smooth Cut Glass and Mirror Blade

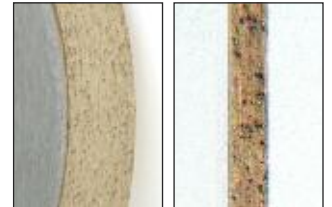

Diamond Metal Bond Edge of NS3B Blade

## CRL 18 Volt Cordless Diamond Glass Saw Kit

- Powerful 18 Volt Cordless Saw Cuts 1/4" to 3/4" (6 to 19 mm) Thick Glass
- Polycarbonate Base Won't Scratch Mirror

The CRL 18 Volt Cordless Diamond Glass Saw utilizes a powerful 18V DC battery to cut glass quickly, leaving a beautiful chip-free finish. This powerful saw will plunge, straight, and angle cut thin and thick glass from 1/4" (6 mm) up to 3/4" (19 mm) thick with power to spare.

The LD172 utilizes a thin kerf, 5-3/8" (136.5 mm) Diamond Blade and a Pressurized Coolant System with an easy disconnect feature. Use the single nozzle coolant line for glass up to 1/4" (6 mm) thick, or the double nozzle coolant line for thicker glass. It has a polycarbonate base to provide a smooth cutting surface with less chance for scratching the glass. A molded plastic case keeps your saw and accessories safe and organized. The Medium 100 Grit Diamond Blade (Cat. No. DBM) offers fast cutting speeds where edge quality is not critical. You can also use the optional Fine 220 Grit Diamond Blade (Cat. No. DBF). Although slower cutting than the DBM Diamond Blade, it produces an extremely smooth edge. Blades are adjustable from 90 degrees to 45 degrees for miter cuts.



**CAT. NO. LD172**

**Standard Equipment Includes:** 18 Volt Cordless Saw, 5-3/8" (136.5 mm) Medium 100 Grit Diamond Blade, 18V DC Battery Cartridge, One Hour 18V DC Battery Charger, Pressurized Coolant System, Quart of Diamond Tool Coolant, and a Carrying Case.

CAT. NO.	DESCRIPTION
<b>LD172</b>	18V Cordless Diamond Glass Saw Kit - 110 Volt
<b>DBF</b>	5-3/8" (136.5 mm) Fine 220 Grit Diamond Blade
<b>DBM</b>	5-3/8" (136.5 mm) Medium 100 Grit Diamond Blade
<b>LD172B</b>	18V DC Battery Cartridge
<b>LD172C</b>	One Hour 18V DC Battery Charger - 110 Volt
<b>LD172C240V</b>	One Hour 18V DC Battery Charger - 240 Volt
<b>LD172PT</b>	1 Gallon (3.8 l) Pressure Tank

Minimum order: 1 each.



DBM and DBF Diamond Blades

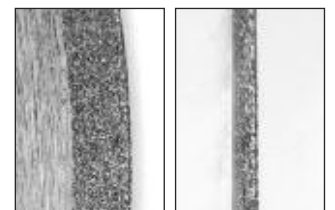

Diamond Plated Edge

Makita is a registered trademark of Makita Corporation.

## CRL Amazing Glazing Diamond Glass Saw

- Power 18 Volt Cordless Saw
- Cuts Glass Up to 3/4" (19 mm) Thick

This modified DEWALT® Saw quickly cuts glass and laminated glass, leaving a beautiful, chip-free finish. This amazing Saw will plunge, straight, and angle cut thin and thick glass with power to spare. The ADGS utilizes our proven pressurized coolant system with an easy disconnect feature. It has a polycarbonate base to provide a smooth cutting surface. Special Fine Diamond Glass Blades (Cat. No. DBF included with kit) are 5-3/8" (136.5 mm) diameter, and provide a beautiful finish cut.

Use optional Medium Grit Blades (Cat. No. DBM) to increase travel speed where edge quality is less important. The CRL Diamond Glass Saw System includes our modified Diamond Saw, 18 Volt Battery, Charger, Diamond Fire Glass Blade, Diamond Tool Coolant, and Pressurized Coolant System.



CAT. NO.	DESCRIPTION
<b>ADGS</b>	18 Volt Cordless Diamond Glass Saw System
<b>DBF</b>	5-3/8" (136.5 mm) Fine 220 Grit Diamond Blade
<b>DBM</b>	5-3/8" (136.5 mm) Medium 100 Grit Diamond Blade
<b>DW9096</b>	18V DC Battery Cartridge

Minimum order: 1 each.

## CRL Plated Diamond Saw Blades



CRL Plated Diamond Saw Blades are very durable and especially useful for hand-held saws. They are quite thin, resulting in minimal removal and fast cutting speeds. Plated Blades work well on glass, mirror, and laminated glass. Use CRL Diamond Tool Coolant to prolong blade life. Plated Blades offer low cost, superior finish, and moderate life span. DBF and DBM are used on the CRL ADGS 18 Volt Cordless Saws.

CAT. NO.	SIZE	ARBOR	GRIT	THICKNESS CORE/RIM
<b>DBF</b>	5-3/8" (137 mm)	10 mm	220	.020"/.030"
<b>DBM</b>	5-3/8" (137 mm)	10 mm	100	.020"/.030"
<b>DB6P58</b>	6" (153 mm)	5/8" (16 mm)	100	.025"/.033"
<b>DB8P58</b>	8" (204 mm)	5/8" (16 mm)	100	.025"/.035"
<b>DB10P58</b>	10" (254 mm)	5/8" (16 mm)	100	.032"/.042"

Minimum order: 1 each.

## CRL Metal Bond Diamond Saw Blades



CRL Metal Bond Diamond Saw Blades are multi-layer products which continue to expose fresh diamond as the blades wear. They are ideal for production use where edge finish is not critical, or where a second finishing operation is performed. Metal Bond Blades offer the best life and produce a medium finish. Re-sharpen as necessary with a sharpening stone. They also cut ceramic, marble, and similar materials. NS3B is used on our NS3000 and NS4000 Notching Saws.

CAT. NO.	SIZE	ARBOR	GRIT	THICKNESS CORE/RIM
<b>NS3B</b>	3-3/8" (86 mm)	9/16" (14.3 mm)	100	.033"/.033"
<b>DB6MB58</b>	6" (153 mm)	5/8" (16 mm)	100	.045"/.063"
<b>DB8MB58</b>	8" (204 mm)	5/8" (16 mm)	100	.045"/.063"
<b>DB10MB58</b>	10" (254 mm)	5/8" (16 mm)	100	.045"/.063"

Minimum order: 1 each.

## CRL Resin Bond Diamond Saw Blades



CRL Resin Bond Diamond Saw Blades use a softer bond to allow for the fine grit sizes recommended for use in chop saws and precision equipment. Resin Bond Diamond Blades offer the best finish, less chipping, and can eliminate secondary grinding applications. Full 9/32" diamond depth Resin Bond Blades are more "forgiving" than other blades. Use with straight water to cool. These blades are the most popular, and are also available in different diameters, grits, concentrations, and arbor sizes. 50 concentration provides best finish at a slower cutting rate and with shorter blade life compared to 75 concentration, which cuts faster.

CAT. NO.	SIZE	ARBOR	GRIT	CONCENTRATION	THICKNESS CORE/RIM
<b>DBR1022050</b>	10" (254 mm)	3/4" (19 mm)	220-250	50	.036"/.050"
<b>DBR1022075</b>	10" (254 mm)	3/4" (19 mm)	220-275	75	.036"/.050"
<b>DBR1222050</b>	12" (305 mm)	3/4" (19 mm)	220-250	50	.045"/.070"
<b>DBR1222075</b>	12" (305 mm)	3/4" (19 mm)	220-275	75	.045"/.070"

Minimum order: 1 each.

DEWALT is a registered trademark of The Black and Decker Corporation.



## CRL Abrasive Tools for Glass Working

- Machines for Local Glass Shops and High Output Fabricators
- Abrasives by Recognized and Trusted Manufacturers

- The Full Support of CRL's Global Distribution Network and Technical Sales Experts

Whether you are a local glass shop and your sanding, seaming, grinding, and polishing can be accomplished with hand held portable equipment, or you are a high production or larger volume glazing contractor that requires maximum output and workhorse reliability, CRL has the machines you need to satisfy your cost objectives and quality requirements.

For years CRL has supplied the glass industry with sanders, edgers, grinders, and polishers – a full range of portable to production size machines for glass edgework. We offer tools from prominent manufacturers as well as our own CRL brand power tools and CRL Heavy Glass Machinery. All are supported by CRL's distribution network on three continents, including trained machinery experts that can assist your selection of the right tool for every job.

We also use only the most recognized and trusted suppliers of abrasive belts, bands, discs, and wheels, making every effort to ensure you will get only the best of these products when you choose CRL as your abrasive supplier.



### Portable Belt Sanders



### Upright Belt Sanders



### Disc Sanders, Polishers and Grinders



### Abrasive Belts, Bands, Discs, and Hand Pads; Polishing Pads; Grinding Wheels and Bits; Seaming Tools



## CRL Abrasives in Sizes and Grits You Need, When You Need Them



### • Stock Sizes and Grits

C.R. Laurence Company carries an extensive line of high quality, long lasting Abrasive Belts and Discs, in a large selection of available grits that enables professional glaziers to complete projects quickly and cost efficiently. Our polyester backed, wet or dry Belts and Discs from 36X to 600X grit are in stock and ready to ship from all CRL warehouses.

### • Large User Abrasive Program

If you use a large number of abrasive belts or discs, CRL has a bulk quantity program that can really cut your costs. For additional information on this program, reference catalog page 191K or contact our Customer Service Department by e-mail at [glazing@crlaurence.com](mailto:glazing@crlaurence.com) for pricing and program details.

### • Custom Sizes and Grits

If you do not find the belt size or grit that you use in our extensive inventory of stock products, let us give you a competitive quote on the special sized abrasives your company uses. Contact our Customer Service Department by e-mail at [glazing@crlaurence.com](mailto:glazing@crlaurence.com) regarding your requirements for custom sizes and grits.

### • Some of the Machines Used in the Fabrication of Abrasive Belts



The Roll Slitting Machine accommodates a 55' wide x 600' long (1397 mm wide x 182 m long) roll of belt material and performs multiple precision cuts into 12" (305 mm) wide lengths.



The Cut-to-Length Machine then cuts the abrasive cloth material into various overall lengths to make abrasive belts.



The 1-1/8", 3" or 4" (3, 76, 102 mm) wide belts are then fed into the Scuffer/Gluer Machine which:

- (1) Prepares the back of the belt material to receive adhesive by scuffing the back filler from the cloth. This improves bonding, durability, and belt longevity.
- (2) Applies and cures the adhesive to the seam to assure strength.

# CRL SANDERS AND POLISHERS

For Pricing Visit [crlaurence.com](http://crlaurence.com) or Call Us Toll Free at the Phone Numbers Shown on the Back Cover

## CRL 1/2" x 18" Detail Belt Sander

- Ideal for Intricate Finishing Work
- Includes Three Separate Belt Guide Arms

The CRL Detail Belt Sander is the ideal sander for getting into small or intricate areas for finishing detail work. Using 1/2" x 18" (13 x 457 mm) silicon carbide abrasive belts (sold separately), finishing the inside edges of circles or notches becomes simple and easy. The added bonus of this unique tool is the inclusion of two additional belt guide arms: One angled tip arm for the 1/2" x 18" belts that runs belts with a 45 degree sanding surface, and a mini belt guide arm that uses 5/16" x 18" (8 x 457 mm) abrasive belts for really intricate sanding jobs. All three arms are included with the sander in a black plastic storage and carry case. Go to [crlaurence.com](http://crlaurence.com) for specifications.



• Variable Speed



**new**



CAT. NO. LD1218

CAT. NO.	DESCRIPTION
LD1218	110V Detail Belt Sander
LD1218AU	240V Detail Belt Sander w/AU Plug
LD1218EU	220V Detail Belt Sander w/EU Plug

Minimum order: 1 each.

## CRL 18" (457 mm) Glass Grinding Belts

- Available in Two Widths 5/16" and 1/2" (8 and 13 mm)
- For Use With CRL Cat. No. LD1218 Detail Sander



### MOST POPULAR GRITS FOR GLASS, AND EXAMPLES OF THEIR USE:

- 80X - Rough, Quick-Contouring
- 120X - Smooth, Seaming and Polishing
- 220X - Extra-Smooth, Fine Frosted Finish
- 400X - Fine, Satin Finish

### 5/16" X 18" (8 X 457 MM) BELTS

CAT. NO.	GRIT	QTY/BOX
CRL516X1880X	80X	10
CRL516X18120X	120X	10
CRL516X18220X	220X	10
CRL516X18400X	400X	10

### 1/2" X 18" (13 X 457 MM) BELTS

CAT. NO.	GRIT	QTY/BOX
CRL12X1880X	80X	10
CRL12X18120X	120X	10
CRL12X18220X	220X	10
CRL12X18400X	400X	10

Minimum order: 1 box. All Glass Grinding Belts can be combined for quantity pricing.

## CRL Multi Function Tool

- Multiple Use Tool With Variable Speed Oscillating Head
- Perfect for Glass Sanding, Edging, Sealant Cut-Outs and More
- Double Insulated and UL Approved

The CRL MFT1 Multi Function Tool is perfect for glass edge seaming. The variable speed head oscillates at 11,000 to 22,000 oscillations per minute. The Kit comes complete with the double insulated Multi Function Tool, plastic storage case, five assorted blades, triangle backer pad, and a blade wrench. For additional information on blades see page 582K.



CAT. NO.	DESCRIPTION
MFT1	110V Multi Function Tool
MFT1AU	240V Multi Function Tool w/AU Plug
MFT1EU	220V Multi Function Tool w/EU Plug
MFTTSD	Triangle Backer Pad
MFT180X	80X Glass Grinding Triangles 50/BX
MFT1120X	120X Glass Grinding Triangles 50/BX
MFT1220X	220X Glass Grinding Triangles 50/BX

Minimum order: 1 each for tool and accessories; 50 each for grinding triangles.



Grinding Triangles

MFTTSD Triangle Backer Pad

## CRL Makita® 3/8" x 21" Belt Sander

- Great for Small, Confined Areas
- Adjustable Sanding Arm
- Electronic Speed Control

The CRL Makita® 3/8" x 21" (9.5 x 533 mm) Belt Sander makes polishing notches and corners a breeze. Tight spaces no longer limit your ability to produce a quality edge. The sanding arm pivots a full 100 degrees for easy operation, while providing balance and high performance at any position. The electronically controlled motor provides sanding speeds from 980' to 5600' (298 to 1707 m) per minute for precision sanding and polishing in any position, and on any material thickness. There is also an easy quick-release lever for changing the abrasive belts. A belt tracking knob is conveniently located for fine adjustment of the belt, and no tools are needed for any of the adjustments. Minimum order is one each. Go to [crlaurence.com](http://crlaurence.com) for specifications.



- Lightweight, Only 3.3 Lbs (1.5 kg)

CAT. NO. 9032

## CRL 3/8" x 21" (9.5 x 533 mm) Glass Grinding Belts

**MOST POPULAR GRITS FOR GLASS, AND EXAMPLES OF THEIR USE:**

- 60X** - Extra-Rough, Fast Glass Removal (Mitered Edge)
- 80X** - Rough, Quick-Contouring (Auto Glass Edge)
- 120X** - Smooth, Seaming and Polishing (Desk Top Edge)
- 220X** - Extra-Smooth, Fine Frosted Finish (Glass Shelf Edge)
- 400X** - Fine, Satin Finish (Opaque Edge)
- CORK** - Polish, Smooth Luster Finish



- Use With CRL Cat. No. 9032 Portable Belt Sander to Make Grinding and Polishing Notches and Cut-Outs Easier Than Ever

CAT. NO.	GRIT	QTY/BOX
CRL38X2160X	60X	20
CRL38X2180X	80X	20
CRL38X21120X	120X	20
CRL38X21220X	220X	20
CRL38X21400X	400X	20
CRL38X21CORK	CORK	5

Minimum order: 1 box. All Grits sold 20 per box except Cork, which are sold 5 per box. All Glass Grinding Belts can be combined for quantity pricing.

## CRL Polishing Oil

- Spray on Belts and Discs for Faster, Brighter Polishing
- Promotes Longer Belt Life



CAT. NO. CRL920

Spray CRL Polishing Oil on your abrasive belts and discs to keep them soft and free cutting. CRL920 helps to reduce "loading" while at the same time improving finish edges on metal and glass. Net weight is 11 oz. (312 g). 12 per case. Minimum order is one each.

Makita is a registered trademark of Makita Corporation.

## CRL Tube Wax Lubricant

- Improves Finish and Performance While Sanding and Grinding



CRL Tube Wax Lubricant is a special formulation of solid waxes that comes in a convenient, soft stick. Use it for all sanding, grinding, drilling, tapping, sawing, and fastening operations to increase production quality and improve tool life. It is neat, easy to use, and requires no special storage or handling. Net weight is 15 oz. (425 g). 24 per case. Minimum order is one each.

CAT. NO. WS140

## CRL 1-1/8" x 21" Belt Sander

- Professional Quality Power Tool for Sanding Notches and Cut-Outs
- Side Handle for Easy Maneuverability
- Available in 110V and 240V Models

The CRL 1-1/8" x 21" (29 x 533 mm) Belt Sander's design is compact and lightweight for close quarter work with excellent maneuverability, making it ideal for sanding irregular openings or shapes. 4.2 AMP motor provides excellent results at variable speeds.



CAT. NO.	DESCRIPTION
LD118	Belt Sander 110V
LD118AU	Belt Sander 240V Australian Plug
LD118EU	Belt Sander 220V U.K. Plug
LD118BRSH	Replacement Brushes
LD118FR	Replacement Front Roller
LD118SW	Replacement Switch

Minimum order: 1 each.

### SPECIFICATIONS:

Belt Speed is 656' to 3,280' (200 to 1,000 m) Per Minute  
Belt Size to Use 1-1/8" x 21" (29 x 533 mm)

## CRL Makita® 1-1/8" x 21" Belt Sander

- Extremely Popular Portable Sander for Sanding Notches and Cut-Outs
- Available in 110V and 240V Models

The CRL Makita® 1-1/8" x 21" (29 x 533 mm) Belt Sander is compact and lightweight for close quarter work, with excellent maneuverability for sanding irregular openings or shapes. The 5 AMP motor drives the belt from 656' to 3,280' (199 to 1,000 m) per minute for maximum performance. A multi-position side handle lets you maneuver it with less operator fatigue. Comes with 10 Abrasive Belts (two each of five different grits).



CAT. NO.	DESCRIPTION
9031M	Belt Sander 110V
9031	Belt Sander 240V Australian Plug
EU9031M	Belt Sander 240V U.K. Plug

Minimum order: 1 each.

### SPECIFICATIONS:

Belt Speed is 656' to 3,280' (200 to 1,000 m) Per Minute  
Belt Size to Use 1-1/8" x 21" (29 x 533 mm)

## CRL 1-1/8" x 21" (29 x 533 mm) Glass Grinding Belts

- Fast-Grinding 100% Polyester Backed Belts in 12 Grits From 40X to CORK
- Ask About Our Large User Program

CRL Portable Grinding Belts for portable belt sanders have 100 percent polyester backing, allowing them to be used wet or dry. They are available in grits from 40X (Super Coarse) to CORK (Polishing) to fit most portable belt sanders.



### MOST POPULAR GRITS FOR GLASS, AND EXAMPLES OF THEIR USE:

- 60X** - Extra-Rough, Fast Glass Removal (Mitered Edge)
- 80X** - Rough, Quick-Contouring (Auto Glass Edge)
- 120X** - Smooth, Seaming and Polishing (Desk Top Edge)
- 220X** - Extra-Smooth, Fine Frosted Finish (Glass Shelf Edge)
- 400X** - Fine, Satin Finish (Opaque Edge)
- CORK** - Polish, Smooth Luster Finish

CAT. NO.	GRIT	QTY/BOX	CAT. NO.	GRIT	QTY/BOX
CRL118X2140X	40X	10	CRL118X21180X	180X	10
CRL118X2160X	60X	10	CRL118X21220X	220X	10
CRL118X2180X	80X	10	CRL118X21320X	320X	10
CRL118X21100X	100X	10	CRL118X21400X	400X	10
CRL118X21120X	120X	10	CRL118X21600X	600X	10
CRL118X21150X	150X	10	CRL118X21CORK	CORK	5

Minimum order: 1 box (except CORK). All Glass Grinding Belts can be combined for quantity pricing. Minimum order for Cork Belts is five each. All Cork Belts can be combined for quantity pricing.

Makita is a registered trademark of Makita Corporation.

## CRL 3" x 18" Belt Sander With Dust Bag

- Compact, Ergonomic Design
- 110V, 240V, and 220V Models
- Uses 3" x 18" (76 x 457 mm) Belts

CRL's 3" x 18" (76 x 457 mm) Belt Sander is powered by a strong 7.0 AMP motor which drives the belt at 1,240' (380 m) per minute. Features include an efficient dust collection system, a belt tracking system, lock-on switch for continuous use, and external brush caps for easy brush changes.



CAT. NO.	DESCRIPTION
<b>LD318</b>	120V Belt Sander With Dust Bag
<b>LD318AU</b>	240V Belt Sander With Dust Bag/AU Plug
<b>LD318EU</b>	220V Belt Sander With Dust Bag/EU Plug
<b>LD318BRSH</b>	Replacement Brushes for LD318 Belt Sander
<b>LD318SW</b>	Replacement Switch for LD318 Belt Sander

Minimum order: 1 each.

## CRL Makita® 3" x 18" Belt Sander With Dust Bag

- Popular 240 Volt European Model
- Uses 3" x 18" (76 x 457 mm) Belts
- Electronic Speed Control

The CRL Makita® Cat. No. 15635 is our most popular 3" x 18" (76 x 457 mm) 240 Volt Sander. The lever control allows belts to be changed easily and quickly. The 650W input wattage AC motor drives the belt between 75 and 270 meters per minute. It is light enough to be easily maneuvered, and still sturdy enough for production or job site use. Our features include an adjustable tracking mechanism to ensure proper belt tension, and externally accessible motor brushes for easy maintenance. It is double-insulated and CE compliant for safety.



Available Only in Europe



CAT. NO.	DESCRIPTION
<b>15635</b>	240V Belt Sander With Dust Bag/EU Plug

Minimum order: 1 each.

## CRL 3" x 18" (76 x 457 mm) Glass Grinding Belts

- Fast-Grinding 100% Polyester Backed Belts in Six Grits From 60X to CORK
- Ask About Our Large User Program

CRL 3" x 18" (76 x 457 mm) Glass Grinding Belts for portable belt sanders have 100 percent polyester backing, so you can use them wet or dry. They are available in grits from 60X (Extra-Rough) to CORK (Polishing) to fit most portable belt sanders.

### MOST POPULAR GRITS FOR GLASS, AND EXAMPLES OF THEIR USE:

- 60X** - Extra-Rough, Fast Glass Removal (Mitered Edge)
- 80X** - Rough, Quick-Contouring (Auto Glass Edge)
- 120X** - Smooth, Seaming and Polishing (Desk Top Edge)
- 220X** - Extra-Smooth, Fine Frosted Finish (Glass Shelf Edge)
- 400X** - Fine, Satin Finish (Opaque Edge)
- CORK** - Polish, Smooth Luster Finish

Makita is a registered trademark of Makita Corporation.



CAT. NO.	GRIT	QTY/BOX
<b>CRL3X1860X</b>	60X	10
<b>CRL3X1880X</b>	80X	10
<b>CRL3X18120X</b>	120X	10
<b>CRL3X18220X</b>	220X	10
<b>CRL3X18400X</b>	400X	10
<b>CRL3X18CORK</b>	CORK	5

Minimum order: 1 box. All Glass Grinding Belts can be combined for quantity pricing. All Cork Belts can be combined for quantity pricing.

## CRL 3" x 21" Belt Sander With Dust Bag



- Double-Insulated and Sands Cleanly With Dust Collector
- Available in 110V, 240V, and 220V Models
- Professional Quality Power Tool

This highly portable, 3" x 21" (76 x 533 mm) CRL Belt Sander with Dust Bag is lightweight and easy to maneuver. It features a powerful 7.8 AMP motor for fast and even belt tracking, an efficient dust collector bag, a lock-on switch, and an extra long power cord.

CAT. NO.	DESCRIPTION
LD321	110V Belt Sander with Dust Bag
LD321AU	240V Belt Sander with Dust Bag/AU Plug
LD321EU	220V Belt Sander With Dust Bag/EU Plug
LD321BRSH	Replacement Brushes for LD321 Belt Sander
LD321SW	Replacement Switch for LD321 Belt Sander

Minimum order: 1 each.

## CRL Makita® 3" x 21" Belt Sander With Dust Bag

- Double-Insulated
- Sands Cleanly With Dust Collector
- Lever Control for Belt Replacement



This highly portable CRL Makita® 3" x 21" (76 x 533 mm) Belt Sander is lightweight and easy to maneuver. A powerful 7.8 AMP motor drives the belt at 1,180' (360 m) per minute for fast and even belt tracking. Features include an efficient dust collector, a lock-on switch, an extra long power cord, and flush-to-wall standard design. Comes with one abrasive belt (100 grit). Go to [crlaurence.com](http://crlaurence.com) for specifications.

CAT. NO. 9903

## CRL 3" x 21" (76 x 533 mm) Glass Grinding Belts

- Fast-Grinding 100% Polyester Backed Belts in 12 Grits From 36X to CORK
- Ask About Our Large User Program

CRL 3" x 21" (76 x 533 mm) Glass Grinding Belts for portable belt sanders have 100 percent polyester backing, so you can use them wet or dry. They are available in grits from 36X (Super Coarse) to CORK (Polishing) to fit most portable belt sanders.



### MOST POPULAR GRITS FOR GLASS, AND EXAMPLES OF THEIR USE:

- 60X** - Extra-Rough, Fast Glass Removal (Mitered Edge)
- 80X** - Rough, Quick-Contouring (Auto Glass Edge)
- 120X** - Smooth, Seaming and Polishing (Desk Top Edge)
- 220X** - Extra-Smooth, Fine Frosted Finish (Glass Shelf Edge)
- 400X** - Fine, Satin Finish (Opaque Edge)
- CORK** - Polish, Smooth Luster Finish

CAT. NO.	GRIT	QTY/BOX	CAT. NO.	GRIT	QTY/BOX
CRL3X2136X	36X	10	CRL3X21120X	120X	10
CRL3X2140X	40X	10	CRL3X21180X	180X	10
CRL3X2150X	50X	10	CRL3X21220X	220X	10
CRL3X2160X	60X	10	CRL3X21400X	400X	10
CRL3X2180X	80X	10	CRL3X21600X	600X	10
CRL3X21100X	100X	10	CRL3X21CORK	CORK	5

Minimum order: 1 box. All Glass Grinding Belts can be combined for quantity pricing. All Cork Belts can be combined for quantity pricing.

Makita is a registered trademark of Makita Corporation.

## CRL 3" x 24" Portable Belt Sander With Dust Bag

- Powerful 10 Amp Motor
- Professional Quality Power Tool
- Double Insulated

The CRL LD324 Belt Sander powers our most common abrasive belt: 3" x 24" (76 x 610 mm). This heavy-duty 10 amp power sander comes with a dust bag and is ruggedly built to provide years of service. Belt tensioning lever and belt centering adjustment screw are simple to use and easily accessible. Minimum order is one each.



CAT. NO. LD324

## CRL Makita® 3" x 24" Portable Belt Sander With Dust Bag

- Fast-Sanding Belt Speed With Lever Control for Quick Belt Change
- Powerful 7.8 AMP Motor

One of our most popular sanders, the CRL Makita® 9924DB uses any 3" x 24" (76 x 610 mm) abrasive or polishing belt. Lever control allows belts to be changed easily and quickly. A unique design allows flush-to-wall sanding, and an adjustable tracking mechanism ensures proper belt tension. It's externally accessible motor brushes allow for easy maintenance, and it comes with one abrasive belt (100 grit) and dust bag. Go to [crlaurence.com](http://crlaurence.com) for specifications. Minimum order is one each.



CAT. NO. 9924DB

## CRL Porter-Cable® 3" x 24" Portable Belt Sander With Dust Bag

- Famous Porter-Cable® Quality Construction
- Extra-Powerful, Rugged, and Dependable Power Tool

Use CRL Porter-Cable® Belt Sander with any 3" x 24" (76 x 610 mm) abrasive belt. The extra-powerful 1.48 HP motor gets those big jobs done fast, yet the tool's compact size makes it easy to maneuver. Quality construction makes it rugged, durable, and dependable for years of good service. Minimum order is one each.



CAT. NO. 360

## CRL 3" x 24" (76 x 610 mm) Glass Grinding Belts

- Fast-Grinding 100% Polyester Backed Belts in 14 Grits From 36X to CORK
- Ask About Our Large User Program

CRL 3" x 24" (76 x 610 mm) Glass Grinding Belts for portable belt sanders have 100 percent polyester backing, so you can use them wet or dry. They are available in grits from 36X (Super Coarse) to CORK (Polishing) to fit most portable belt sanders.



### MOST POPULAR GRITS FOR GLASS, AND EXAMPLES OF THEIR USE:

- 60X** - Extra-Rough, Fast Glass Removal (Mitered Edge)
- 80X** - Rough, Quick-Contouring (Auto Glass Edge)
- 120X** - Smooth, Seaming and Polishing (Desk Top Edge)
- 220X** - Extra-Smooth, Fine Frosted Finish (Glass Shelf Edge)
- 400X** - Fine, Satin Finish (Opaque Edge)
- CORK** - Polish, Smooth Luster Finish

Makita is a registered trademark of Makita Corporation.  
Porter-Cable is a registered trademark of The Black & Decker Corporation.

CAT. NO.	GRIT	QTY/BOX	CAT. NO.	GRIT	QTY/BOX
<a href="#">CRL3X2436X</a>	36X	10	<a href="#">CRL3X24150X</a>	150X	10
<a href="#">CRL3X2440X</a>	40X	10	<a href="#">CRL3X24180X</a>	180X	10
<a href="#">CRL3X2450X</a>	50X	10	<a href="#">CRL3X24220X</a>	220X	10
<a href="#">CRL3X2460X</a>	60X	10	<a href="#">CRL3X24320X</a>	320X	10
<a href="#">CRL3X2480X</a>	80X	10	<a href="#">CRL3X24400X</a>	400X	10
<a href="#">CRL3X24100X</a>	100X	10	<a href="#">CRL3X24600X</a>	600X	10
<a href="#">CRL3X24120X</a>	120X	10	<a href="#">CRL3X24CORK</a>	CORK	5

Minimum order: 1 box. All Glass Grinding Belts can be combined for quantity pricing.  
All Cork Belts can be combined for quantity pricing.



## CRL Makita® 4" x 24" Portable Belt Sander With Dust Bag

- 33 Percent More Sanding Surface Than 3" (76 mm) Models
- Extra Powerful 8.5 AMP Motor

This extra-wide 4" x 24" (102 x 610 mm) CRL Makita® Belt Sander has 33 percent more sanding surface than 3" x 24" (76 to 610 mm) models, so it removes stock quicker. The powerful 8.5 AMP motor drives the belt at 1,148' (350 m) per minute. The multi-groove V-belt gives the improved power you need for heavy production use. It's designed for flush sanding, and is well balanced with a low center of gravity for better control. It features a built-in dust bag for clean convenience, and comes with one abrasive belt (100 grit). Minimum order is one each.



CAT. NO. 9403

## CRL 4" x 24" (102 x 610 mm) Glass Grinding Belts

- Fast-Grinding 100% Polyester Backed Belts in 7 Grits From 40X to CORK
- Ask About Our Large User Program

CRL 4" x 24" (102 x 610 mm) Glass Grinding Belts for portable belt sanders have 100 percent polyester backing, so you can use them wet or dry. They are available in grits from 40X (Super Coarse) to CORK (Polishing) to fit most portable belt sanders.



### MOST POPULAR GRITS FOR GLASS, AND EXAMPLES OF THEIR USE:

- 60X** - Extra-Rough, Fast Glass Removal (Mitered Edge)
- 80X** - Rough, Quick-Contouring (Auto Glass Edge)
- 120X** - Smooth, Seaming and Polishing (Desk Top Edge)
- 220X** - Extra-Smooth, Fine Frosted Finish (Glass Shelf Edge)
- 400X** - Fine, Satin Finish (Opaque Edge)
- CORK** - Polish, Smooth Luster Finish

CAT. NO.	GRIT	QTY/BOX
<b>CRL4X2440X</b>	40X	10
<b>CRL4X2460X</b>	60X	10
<b>CRL4X2480X</b>	80X	10
<b>CRL4X24120X</b>	120X	10
<b>CRL4X24220X</b>	220X	10
<b>CRL4X24400X</b>	400X	10
<b>CRL4X24CORK</b>	CORK	5

Minimum order: 1 box. All Glass Grinding Belts can be combined for quantity pricing. All Cork Belts can be combined for quantity pricing.

## CRL 3M® Duo-Glass Grinding Belts

- Silicon Carbide Grit
- Even-Run Seam for Smooth Flowing Action

CRL 3M® Duo-Glass high quality belts feature silicon carbide grit bonded to a strong, waterproof, cloth-backed belt. An even-run seam produces a smooth flowing action for a great finish on glass. A belt trusted throughout the industry and known for its quality and reliability. Five belts per box. All sizes and grits can be combined for quantity pricing.



### 3" X 21" (76 X 533 mm) SIZE

CAT. NO.	GRIT
<b>3M3X2180X</b>	80X
<b>3M3X21120X</b>	120X
<b>3M3X21220X</b>	220X

Minimum order is 1 box.

### 3" X 24" (76 X 610 mm) SIZE

CAT. NO.	GRIT
<b>3M3X2480X</b>	80X
<b>3M3X24220X</b>	220X

Minimum order is 1 box.

### 4" X 24" (102 X 610 mm) SIZE

CAT. NO.	GRIT
<b>3M4X24120X</b>	120X

Minimum order is 1 box.

Makita is a registered trademark of Makita Corporation.  
3M is a registered trademark of 3M Company Corporation.

# CRL BELT SANDERS

For Pricing Visit [crlaurence.com](http://crlaurence.com) or Call Us Toll Free at the Phone Numbers Shown on the Back Cover

## CRL 4" x 64" (102 x 1626 mm) Bench Model Wet Abrasive Belt Sander



- **Extremely Mobile Unit is Ideal for Work Bench or Truck Bed**
- **Heavy-Duty, 1 HP, Single-Phase, 110V, 220V, and 240V Models**
- **Self-Contained Water Tank – No Water Hook-Up Needed**

This CRL Bench Model Belt Sander uses all standard 4" x 64" (102 x 1626 mm) Wet or Dry Abrasive Belts, and is specially designed for use in the shop or on the job site. It's perfect for bench work where there is only a limited need for edge-work capacity. This Sander can also be mounted right onto a glass truck for rough grinding, smoothing, and polishing the edges of glass on a job site. Water for wet grinding sprays on the back of the belt from a built-in spray nozzle connected to a built-in water tank. Just pour water in the reservoir and you can wet grind anywhere.

### SPECIFICATIONS:

- Height:** 37-1/2" (952 mm)
- Width (including motor):** 24" (610 mm)
- Footprint:** 19" x 16" (483 x 406 mm)
- Shipping Weight:** 150 Lbs. (68 kg)



Water Reservoir



BM64B Model



EUBM64B Model



### IMPORTANT NOTES:

Always wear the proper safety gear when using any type of power tool. A Cat. No. GF1 Ground Fault Circuit Interrupt Device (see page 550K) should be used with any type of wet-working electric tool. Replacement parts can be found on page 643K or at [crlaurence.com](http://crlaurence.com).

### Controls

All controls are built to OSHA requirements, utilizing CE, CSA and UL Certified components.

### Belts

Wet or Dry ..... 4" x 64" (102 x 1626 mm) belt, various grits

### Utilities – Standard

Electrical ..... One Motor, Total 1 HP  
 Voltage ..... Single Phase, 60 Cycle  
 Power ..... 15 AMP Service @ 110V AC, 240V AC, or 220V AC

CAT. NO.	DESCRIPTION
BM64B	Bench Model Belt Sander – 110V AC/60 Hz
AUBM64B	Bench Model Belt Sander – 240V AC/50 Hz – Australia
EUBM64B	Bench Model Belt Sander – 220V AC/50 Hz – Europe

Minimum order: 1 each.

## CRL 4" x 64" (102 x 1626 mm) Wet Abrasive Glass Grinding Belts

- **Fast-Grinding 100% Polyester Backed Belts in Seven Grits From 40X to CORK**
- **Ask About Our Large User Program**

CRL Wet Abrasive Glass Grinding Belts have 100 percent polyester backing, so you can use them wet or dry. They are available in grits from 40X (Super Coarse) to CORK (Polishing) to fit most upright belt sanders.



### MOST POPULAR GRITS FOR GLASS, AND EXAMPLES OF THEIR USE:

- 60X** – Extra-Rough, Fast Glass Removal (Mitered Edge)
- 80X** – Rough, Quick-Contouring (Auto Glass Edge)
- 120X** – Smooth, Seaming and Polishing (Desk Top Edge)
- 220X** – Extra-Smooth, Fine Frosted Finish (Glass Shelf Edge)
- 400X** – Fine, Satin Finish (Opaque Edge)
- CORK** – Polish, Smooth Luster Finish

CAT. NO.	GRIT	QTY/BOX
CRL4X6440X	40X	5
CRL4X6460X	60X	5
CRL4X6480X	80X	5
CRL4X64120X	120X	5
CRL4X64220X	220X	5
CRL4X64400X	400X	5
CRL4X64CORK	CORK	2

Minimum order: 1 Box. All Glass Grinding Belts can be combined for quantity pricing. All Cork Belts can be combined for quantity pricing.



C.R. LAURENCE COMPANY

[crlaurence.com](http://crlaurence.com) | [usalum.com](http://usalum.com)

186K | [crlaurence.ca](http://crlaurence.ca) [crlaurence.com.au](http://crlaurence.com.au) [crlaurence.co.uk](http://crlaurence.co.uk) [crlaurence.de](http://crlaurence.de) [crlaurence.eu](http://crlaurence.eu)



## CRL 2200RP 4" x 106" (102 x 2690 mm) Wet Abrasive Belt Sander

- Uses Industry Standard 4" x 106" (102 x 2690 mm) Abrasive Belts
- Rugged Construction and Powerful 1 H.P. Direct Drive Motor
- Thick-Walled, Rust-Proof, High-Density Polyethylene Tank Extends Machine Life

Combine the rugged construction and innovative design of the Somaca 106" (2690 mm) Belt Machine and the streamlined CRL 2200 Belt Sander and you have the CRL 2200RP 4" x 106" (102 x 2690 mm) Wet Abrasive Belt Sander. More affordable and packed with solid engineering, the 2200RP Wet Belt Sander is ideal for use by glass fabricators and processors, and it's still designed to use industry standard 4" x 106" (102 x 2690 mm) belts.

North American models include a direct drive, one H.P., 60 cycle, 1725 RPM, 110 Volt AC Motor and a 5" (127 mm) diameter Drive Pulley. Sander can be wired for 220 volts at an additional cost. An Electric Water Valve keeps the belts wet during sanding, and the Water Delivery System is designed for use with a standard city water supply. This machine now features a rustproof HDPE (High Density Polyethylene) Water Tank that won't chip or dent, and comes with a urethane covered Roller Platen and a Front Rest Guide Bar as standard equipment.

### IMPORTANT NOTES:

Always wear the proper safety gear when using any type of power tool. Cat. No. GF1 Ground Fault Circuit Interrupt Device (see page 550K) should be used with any type of wet-working electric tool. Replacement parts can be found on page 636K or at [crlaurence.com](http://crlaurence.com).

- Durable Urethane Roller Platen and Front Rest Guide Bar
- Fast Abrasive Belt Changing Mechanism



### 2200RP SPECIFICATIONS:

**Height:**  
72" (1829 mm)  
**Footprint:**  
30" x 24" (762 x 609 mm)  
**Shipping Weight:**  
265 lbs. (120 kg)

See next page for CE Compliant European Model

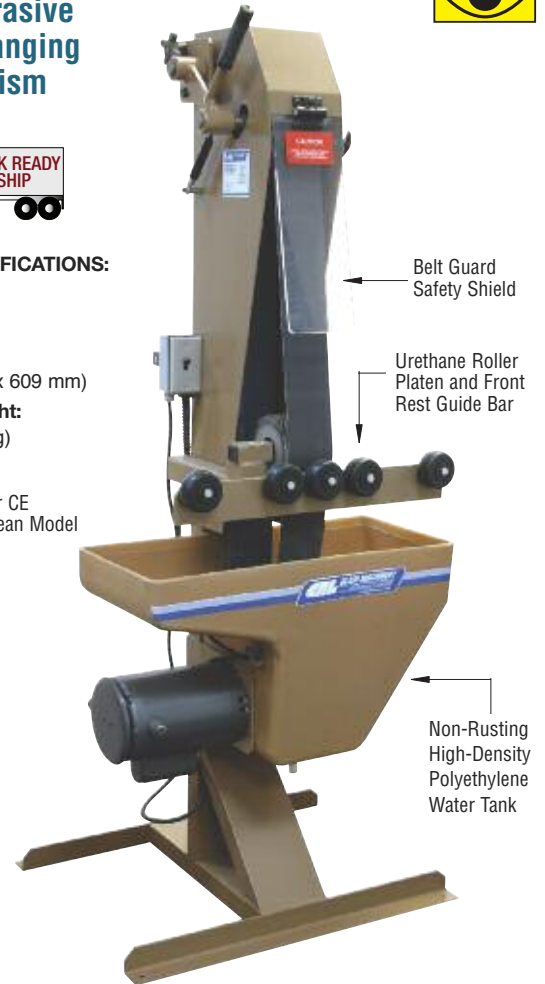

CAT. NO.	DESCRIPTION
2200RP	Belt Sander With Roller Platen and Guide Bar - 110V AC
AU22	Belt Sander With Roller Platen and Guide Bar - 220V AC/50 Hz - Australia

Minimum order: 1 each. All Abrasive Belt Machines for export can be built to operate on Three Phase, 50/60 Hz power. Contact the Machinery Division with your power requirements.

## CRL 4" x 106" (102 x 2690 mm) Wet Abrasive Glass Grinding Belts

- Fast-Grinding 100% Polyester Backed Belts in 14 Grits From 36X to CORK
- Ask About Our Large User Program

CRL Wet Abrasive Glass Grinding Belts have 100 percent polyester backing, so you can use them wet or dry. They are available in grits from 36X (Super Coarse) to CORK (Polishing) to fit most upright belt sanders.

### MOST POPULAR GRITS FOR GLASS, AND EXAMPLES OF THEIR USE:

- 60X – Extra-Rough, Fast Glass Removal (Mitered Edge)
- 80X – Rough, Quick-Contouring (Auto Glass Edge)
- 120X – Smooth, Seaming and Polishing (Desk Top Edge)
- 220X – Extra-Smooth, Fine Frosted Finish (Glass Shelf Edge)
- 400X – Fine, Satin Finish (Opaque Edge)
- CORK – Polish, Smooth Luster Finish



CAT. NO.	GRIT	QTY/BOX	CAT. NO.	GRIT	QTY/BOX
CRL4X10636X	36X	5	CRL4X106150X	150X	5
CRL4X10640X	40X	5	CRL4X106180X	180X	5
CRL4X10650X	50X	5	CRL4X106220X	220X	5
CRL4X10660X	60X	5	CRL4X106320X	320X	5
CRL4X10680X	80X	5	CRL4X106400X	400X	5
CRL4X106100X	100X	5	CRL4X106600X	600X	5
CRL4X106120X	120X	5	CRL4X106CORK	CORK	2

Minimum order: 1 Box. All Glass Grinding Belts can be combined for quantity pricing. All Cork Belts can be combined for quantity pricing.

## CRL 3300RP Wet Abrasive Belt Sander/CE Compliant



Available Only in Europe

- Uses Industry Standard 4" x 106" (102 x 2690 mm) Abrasive Belts
- Rugged Construction and Powerful 1 H.P. Direct Drive Motor
- Durable Urethane Roller Platen and Front Rest Guide Bar
- Thick-Walled, Rust-Proof High Density Polyethylene Tank Extends Machine Life
- Fast Abrasive Belt Changing Mechanism

Increased production needed during the early 40's drove the evolution of our Wet Abrasive Belt Sander. This innovation, which ran the 4" (102 mm) wide belt through a water tray, greatly reduced glass dust and heat generated by grinding, resulting in a faster and safer machine. There can be little doubt that the Sommer and Maca wet belt design made a good machine better and made the work environment around it safer.

Combine the rugged construction and innovative design of the Somaca 106 inch (2690 mm) belt machine and the streamlined CRL 2200 Belt Sander, add the correct specifications to meet European Community CE standards, and you have the New 3300RP Wet Abrasive Belt Sander. More affordable and packed with solid engineering, the 3300RP Wet Abrasive Belt Sander is ideal for use by glass fabricators and processors, and it's still designed to use industry standard 4" x 106" (102 x 2690 mm) belts.

These export models include a direct drive, one H.P., 50 cycle, 1600 RPM, 240V AC Motor and a 5" (127 mm) diameter Drive Pulley. A manual Water Valve keeps the belts wet during sanding, and the Water Delivery System is designed for use with a standard city water supply. Additional safety features include E-Stop On/Off Control, Metal Belt Guards, and a Limit Switch on the Belt Door to shut off power when door is opened. This machine now features a rustproof HDPE (High Density Polyethylene) Water Tank that won't rust, chip or dent. The Model 3300RP also includes a urethane covered Roller Platen and a Front Rest Guide Bar as standard equipment.

### IMPORTANT NOTES:

Always wear the proper safety gear when using any type of power tool. Replacement parts are available at [crlaurence.eu](http://crlaurence.eu).



### 3300RP SPECIFICATIONS:

**Height:**  
72" (1829 mm)

**Footprint:**  
30" x 24"  
(762 x 609 mm)

**Shipping Weight:**  
265 lbs. (120 kg)



CAT. NO.	DESCRIPTION
3300RP	Belt Sander With Roller Platen and Guide Bar - 240V AC/50 Hz - Europe

Minimum order: 1 each.

## CRL 4" x 106" (102 x 2690 mm) Wet Abrasive Glass Grinding Belts

- Fast-Grinding 100% Polyester Backed Belts in 14 Grits From 36X to CORK
- Ask About Our Large User Program

CRL Wet Abrasive Glass Grinding Belts have 100 percent polyester backing, so you can use them wet or dry. They are available in grits from 36X (Super Coarse) to CORK (Polishing) to fit most belt sanders.

### MOST POPULAR GRITS FOR GLASS, AND EXAMPLES OF THEIR USE:

- 60X** - Extra-Rough, Fast Glass Removal (Mitered Edge)
- 80X** - Rough, Quick-Contouring (Auto Glass Edge)
- 120X** - Smooth, Seaming and Polishing (Desk Top Edge)
- 220X** - Extra-Smooth, Fine Frosted Finish (Glass Shelf Edge)
- 400X** - Fine, Satin Finish (Opaque Edge)
- CORK** - Polish, Smooth Luster Finish



CAT. NO.	GRIT	QTY/BOX	CAT. NO.	GRIT	QTY/BOX
CRL4X10636X	36X	5	CRL4X106150X	150X	5
CRL4X10640X	40X	5	CRL4X106180X	180X	5
CRL4X10650X	50X	5	CRL4X106220X	220X	5
CRL4X10660X	60X	5	CRL4X106320X	320X	5
CRL4X10680X	80X	5	CRL4X106400X	400X	5
CRL4X106100X	100X	5	CRL4X106600X	600X	5
CRL4X106120X	120X	5	CRL4X106CORK	CORK	2

Minimum order: 1 Box. All Glass Grinding Belts can be combined for quantity pricing. All Cork Belts can be combined for quantity pricing.



C.R. LAURENCE COMPANY

[crlaurence.com](http://crlaurence.com) | [usalum.com](http://usalum.com)

188K | [crlaurence.ca](http://crlaurence.ca) [crlaurence.com.au](http://crlaurence.com.au) [crlaurence.co.uk](http://crlaurence.co.uk) [crlaurence.de](http://crlaurence.de) [crlaurence.eu](http://crlaurence.eu)

## CRL BM132RP 4" x 132" Upright Wet Abrasive Belt Sander

- Built-In 24" (610 mm) Roller Platen
- Heavy-Gauge Steel Welded Frame

Our heavy-duty 4" x 132" (102 x 3353 mm) Upright Wet Abrasive Belt Sander is designed for continuous grinding, smoothing, and polishing of glass edges. It is similar in design to the 106" Model, but has larger diameter pulleys, and is twice the weight because of its heavy, reinforced construction.

You will be pleased with the superior performance of our 4" x 132" (102 x 3353 mm) Upright Wet Belt Sander, and the years of dependable service it will give you.

**CAUTION:** When grinding, always wear protective safety glasses and an approved glass dust respirator. One of each is provided with the machine.

### ABRASIVE BELTS

These machines use standard 4" x 132" (102 x 3353 mm) abrasive belts. One 120 grit belt, one pair of safety glasses, and one approved respirator are furnished with each machine. A safety shield is mounted to the hood.

### MOTOR AND STARTER

A 1 HP, 3450 RPM motor, with V-Belt drive, provides all the power for normal usage. The motor is three phase, 60 Hz, 220 or 440 Volts. It is wired to a manual push button starter. Please specify power requirements.

### PULLEYS

Both pulleys are 8" (203 mm) diameter, and made of machined and balanced cast iron.

### BELT TENSION DEVICE

Eccentric type with locking handle and control knob for tracking the belt.

### BEARINGS

Standard ball bearings are used throughout the drive system.

### COOLANT SYSTEM

A water supply line with an electrical solenoid control valve and a low water consumption spray nozzle (3.5 gph @ 30 psi) are included for wet grinding.

- Conveniently Converted From 220 to 440 Volts
- Available for Purchase or Lease

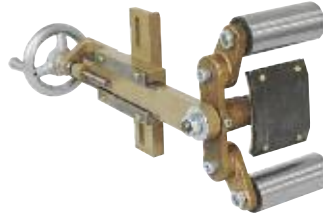

**CAT. NO. 2621320**  
Optional Double Roller Platen



24" (610 mm) Glass Rest and Roller Platen

**CAT. NO. BM132RP**  
4" x 132" (102 x 3353 mm) Upright Wet Abrasive Belt Sander



**CAT. NO. 3LTRT**  
Optional Universal Rolling Table for consistent edging of large or heavy glass lites. Height adjusts to any belt machine. Four swivel castors built into the table top raise the glass for ease of turning the working edge. See page 635K.

## CRL 4" x 132" (102 x 3352 mm) Wet Abrasive Glass Grinding Belts

- Fast-Grinding 100% Polyester Backed Belts in Six Grits From 60X to CORK
- Ask About Our Large User Program

CRL Wet Abrasive Glass Grinding Belts have 100 percent polyester backing, so you can use them wet or dry. They are available in grits from 60X (Extra-Rough) to CORK (Polishing) to fit most belt sanders.

### MOST POPULAR GRITS FOR GLASS, AND EXAMPLES OF THEIR USE:

- 60X** – Extra-Rough, Fast Glass Removal (Mitered Edge)
- 80X** – Rough, Quick-Contouring (Auto Glass Edge)
- 120X** – Smooth, Seaming and Polishing (Desk Top Edge)
- 220X** – Extra-Smooth, Fine Frosted Finish (Glass Shelf Edge)
- 400X** – Fine, Satin Finish (Opaque Edge)
- CORK** – Polish, Smooth Luster Finish



CAT. NO.	GRIT	QTY/BOX
CRL4X13260X	60X	5
CRL4X13280X	80X	5
CRL4X132120X	120X	5
CRL4X132220X	220X	5
CRL4X132400X	400X	5
CRL4X132CORK	CORK	2

Minimum order: 1 Box. All Glass Grinding Belts can be combined for quantity pricing. All Cork Belts can be combined for quantity pricing.

## CRL Glass Grinding Belts for Portable Sanders

- Tough, Fast Grinding, 100% Polyester Backed Belts are Long Lasting
- A Variety of Grits in Six Popular Sizes are Available, From 36X to 600X, Plus Cork Polishing
- Stock Sizes to Fit Virtually All Portable Belt Sanders (Other Sizes on Special Order)

CRL Glass Grinding Belts have been an industry favorite for years, and our alliance with a major abrasive manufacturer allows us to bring you high quality belts at low prices. Cost-efficient packaging techniques let us give you better value in all sizes and grits from 36X (Super Coarse) to CORK (Polishing) on a 100 percent polyester backing that works either wet or dry. We even offer custom sizes to meet your needs. Call CRL Customer Service Department at (800) 421-6144 in the U.S., (877) 421-6144 from Canada, or (323) 588-1281 International, and ask for Ext. 5275 for details and pricing on custom size and grit abrasives.



### MOST POPULAR GRITS FOR GLASS, AND EXAMPLES OF THEIR USE:

- 60X:** Extra-Rough, Fast Glass Removal (Mitered Edge)
- 80X:** Rough, Quick-Contouring (Auto Glass Edge)
- 120X:** Smooth, Seaming and Polishing (Desk Top Edge)
- 220X:** Extra-Smooth, Fine Frosted Finish (Glass Shelf Edge)
- 400X:** Fine, Satin Finish (Opaque Edge)
- CORK:** Polish, Smooth Luster Finish



For Portable Sanders see pages 179K-185K

### 5/16" X 18" (8 X 457 MM) BELTS

CAT. NO.	GRIT	QTY/BOX
CRL516X1880X	80X	10
CRL516X18120X	120X	10
CRL516X18220X	220X	10
CRL516X18400X	400X	10

### 1/2" X 18" (13 X 457 MM) BELTS

CAT. NO.	GRIT	QTY/BOX
CRL12X1880X	80X	10
CRL12X18120X	120X	10
CRL12X18220X	220X	10
CRL12X18400X	400X	10

### 3/8" X 21" (9.5 X 533 MM)

CAT. NO.	GRIT	QTY/BOX
CRL38X2160X	60X	20
CRL38X2180X	80X	20
CRL38X21120X	120X	20
CRL38X21220X	220X	20
CRL38X21400X	400X	20
CRL38X21CORK	CORK	5

### 1-1/8" X 21" (29 X 533 MM)

CAT. NO.	GRIT	QTY/BOX
CRL118X2140X	40X	10
CRL118X2160X	60X	10
CRL118X2180X	80X	10
CRL118X21100X	100X	10
CRL118X21120X	120X	10
CRL118X21150X	150X	10
CRL118X21180X	180X	10
CRL118X21220X	220X	10
CRL118X21320X	320X	10
CRL118X21400X	400X	10
CRL118X21600X	600X	10
CRL118X21CORK	CORK	5

### 3" X 21" (76 X 533 MM)

CAT. NO.	GRIT	QTY/BOX
CRL3X2136X	36X	10
CRL3X2140X	40X	10
CRL3X2150X	50X	10
CRL3X2160X	60X	10
CRL3X2180X	80X	10
CRL3X21100X	100X	10
CRL3X21120X	120X	10
CRL3X21180X	180X	10
CRL3X21220X	220X	10
CRL3X21400X	400X	10
CRL3X21600X	600X	10
CRL3X21CORK	CORK	5

### 3" X 24" (76 X 610 MM)

CAT. NO.	GRIT	QTY/BOX
CRL3X2436X	36X	10
CRL3X2440X	40X	10
CRL3X2450X	50X	10
CRL3X2460X	60X	10
CRL3X2480X	80X	10
CRL3X24100X	100X	10
CRL3X24120X	120X	10
CRL3X24150X	150X	10
CRL3X24180X	180X	10
CRL3X24220X	220X	10
CRL3X24320X	320X	10
CRL3X24400X	400X	10
CRL3X24600X	600X	10
CRL3X24CORK	CORK	5

### 4" X 24" (102 X 610 MM)

CAT. NO.	GRIT	QTY/BOX
CRL4X2440X	40X	10
CRL4X2460X	60X	10
CRL4X2480X	80X	10
CRL4X24120X	120X	10
CRL4X24220X	220X	10
CRL4X24400X	400X	10
CRL4X24CORK	CORK	5

3M is a registered trademark of 3M Company Corporation.

Minimum order: 1 box. All Glass Grinding Belts can be combined for quantity pricing. All Cork Belts can be combined for quantity pricing.



C.R. LAURENCE COMPANY

[crlaurence.com](http://crlaurence.com) | [usalum.com](http://usalum.com)

190K | [crlaurence.ca](http://crlaurence.ca) [crlaurence.com.au](http://crlaurence.com.au) [crlaurence.co.uk](http://crlaurence.co.uk) [crlaurence.de](http://crlaurence.de) [crlaurence.eu](http://crlaurence.eu)

## CRL Wet Abrasive Belts for Upright Belt Sanders

- Tough, Fast Grinding, 100% Polyester Backed Belts are Long Lasting
- Grits Available From 36X to 600X, Plus Cork Polishing
- Stock Sizes to Fit Virtually All Upright Belt Sanders (Other Sizes on Special Order)
- Selected 3M® Brand Belts Also Available

CRL Wet Abrasive Belts have a 100 percent polyester backing, so you can use them wet or dry. Available in six standard sizes in grits from 36X (Extra Coarse) to 600X (Super Fine) to fit most any upright belt sanding machine. All Upright Sander Belts come five belts per box, unless otherwise marked. Cork Polishing Belts are also available. If you don't see your belt size or grit here, contact CRL Customer Service Department (800) 421-6144 in the U.S., (877) 421-6144 from Canada, or (323) 588-1281 International, and ask for Ext. 5275 for details and pricing on custom size and grit abrasives.



### MOST POPULAR GRITS FOR GLASS, AND EXAMPLES OF THEIR USE:

- 60X:** Extra-Rough, Fast Glass Removal (Mitered Edge)
- 80X:** Rough, Quick-Contouring (Auto Glass Edge)
- 120X:** Smooth, Seaming and Polishing (Desk Top Edge)
- 220X:** Extra-Smooth, Fine Frosted Finish (Glass Shelf Edge)
- 400X:** Fine, Satin Finish (Opaque Edge)
- CORK:** Polish, Smooth Luster Finish

### LARGE USER PROGRAM

If you use lots of sanding belts and discs, CRL has a bulk quantity program that can really cut your costs. All sizes and grits can be quoted, including any we don't normally stock. If you need them, CRL can supply them quickly at prices you'll find hard to beat. Please call CRL Customer Service Department at (800) 421-6144 in the U.S., (877) 421-6144 from Canada, or (323) 588-1281 International, and ask for Ext. 5275 for details.



For Upright Belt Sanders see pages 186K-189K

### CRL 4" X 64" (102 X 1626 MM)

CAT. NO.	GRIT	QTY/BOX
CRL4X6440X	40X	5
CRL4X6460X	60X	5
CRL4X6480X	80X	5
CRL4X64120X	120X	5
CRL4X64220X	220X	5
CRL4X64400X	400X	5
CRL4X64CORK	CORK	2

### CRL 4" X 82" (102 X 2083 MM)

CAT. NO.	GRIT	QTY/BOX
CRL4X8260X	60X	5
CRL4X8280X	80X	5
CRL4X82120X	120X	5
CRL4X82220X	220X	5
CRL4X82400X	400X	5

### CRL 4" X 84" (102 X 2134 MM)

CAT. NO.	GRIT	QTY/BOX
CRL4X8460X	60X	5
CRL4X8480X	80X	5
CRL4X84100X	100X	5
CRL4X84120X	120X	5
CRL4X84220X	220X	5
CRL4X84400X	400X	5

### CRL 4" X 106" (102 X 2692 MM)

CAT. NO.	GRIT	QTY/BOX
CRL4X10636X	36X	5
CRL4X10640X	40X	5
CRL4X10650X	50X	5
CRL4X10660X	60X	5
CRL4X10680X	80X	5
CRL4X106100X	100X	5
CRL4X106120X	120X	5
CRL4X106150X	150X	5
CRL4X106180X	180X	5
CRL4X106220X	220X	5
CRL4X106320X	320X	5
CRL4X106400X	400X	5
CRL4X106600X	600X	5
CRL4X106CORK	CORK	2

### 3M® DUO-GLASS 4" X 106" (102 X 2692 MM)

CAT. NO.	GRIT	QTY/BOX
3M4X106120X	120X	5
3M4X106180X	180X	5
3M4X106220X	220X	5

### CRL 4" X 118" (102 X 2997 MM)

CAT. NO.	GRIT	QTY/BOX
CRL4X11860X	60X	5
CRL4X11880X	80X	5
CRL4X118120X	120X	5
CRL4X118220X	220X	5
CRL4X118400X	400X	5
CRL4X118CORK	CORK	2

### CRL 4" X 132" (102 X 3353 MM)

CAT. NO.	GRIT	QTY/BOX
CRL4X13260X	60X	5
CRL4X13280X	80X	5
CRL4X132120X	120X	5
CRL4X132220X	220X	5
CRL4X132400X	400X	5
CRL4X132CORK	CORK	2

### 3M® DUO-GLASS 4" X 132" (102 X 3353 MM)

CAT. NO.	GRIT	QTY/BOX
3M4X13280X	80X	5

Minimum order: 1 box. All Abrasive Belts can be combined for quantity pricing. All Cork Belts can be combined for quantity pricing.

3M is a registered trademark of 3M Company Corporation.

## CRL Metric Size Silicon Carbide Abrasive and Cork Polishing Belts

- Most Popular Metric Sizes and Grits
- Non-Directional
- Polyester Wet-Dry Backing
- Available in Europe Only



Available Only in Europe



Top quality, long lasting Silicon Carbide Abrasives provide the best in glass finishing. These Belts feature polyester wet-dry, non-directional backing material, and most abrasive belt sizes are available in grits ranging from 60X to CORK. Cork Belts yield best results when used wet. Avoid letting belts dry out and overheat while running. These Belts are sold 10 per box unless otherwise noted. For additional sizes and grits visit [crlaurence.eu](http://crlaurence.eu).

6 X 535 MM			12 X 535 MM			13 X 460 MM			19 X 535 MM			20 X 480 MM		
CAT. NO.	GRIT	QTY/BOX	CAT. NO.	GRIT	QTY/BOX	CAT. NO.	GRIT	QTY/BOX	CAT. NO.	GRIT	QTY/BOX	CAT. NO.	GRIT	QTY/BOX
1337K	80X	10	1340K	80X	10	1350K	80X	10	1343AK	60X	10	13271K	80X	10
1338K	180X	10	1341K	180X	10	1351K	180X	10	1343K	80X	10	13272K	180X	10
1339K	400X	10	1342K	400X	10	1352K	400X	10	1344K	180X	10	13273K	400X	10
13392K	CORK	1	1342AK	CORK	10				1345K	400X	10	1353K	CORK	1
									1344AK	CORK	1			

20 X 520 MM			25 X 480 MM			25 X 610 MM			100 X 2400 MM			100 X 2690 MM		
CAT. NO.	GRIT	QTY/BOX	CAT. NO.	GRIT	QTY/BOX	CAT. NO.	GRIT	QTY/BOX	CAT. NO.	GRIT	QTY/BOX	CAT. NO.	GRIT	QTY/BOX
1374K	CORK	1	13280K	80X	10	1358K	80X	1	13038K	60X	1	1301K	80X	1
			13292CK	100X	10	1359K	180X	1	1304K	80X	1	1301AK	120X	1
			1329K	180X	10	1360K	400X	1	1304AK	120X	1	1302K	180X	1
			13293CK	400X	10	1361K	CORK	1	1305K	180X	1	1302AK	220X	1
									1305AK	220X	1	1303K	400X	1
									1306K	400X	1	1310K	CORK	1
									1311K	CORK	1			

  

80 X 850 MM			100 X 550 MM			70 X 800 MM		
CAT. NO.	GRIT	QTY/BOX	CAT. NO.	GRIT	QTY/BOX	CAT. NO.	GRIT	QTY/BOX
139450K	80X	1	13121K	80X	1	1364K	80X	1
139450AK	180X	1				1365K	180X	1
139450BK	400X	1				1366K	400X	1

Minimum order: 1 box. All Grits sold 10 per box except where noted. All Glass Grinding Belts can be combined for quantity pricing.

## CRL 3M® 1-1/8" x 21" Diamond Belts

- Longer Life Than Silicon Carbide Belts
- Fits Portable Sanders Using 1-1/8" x 21" (29 x 533 mm) Belts
- Consistent Edge Quality

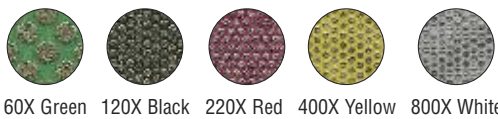

60X Green 120X Black 220X Red 400X Yellow 800X White



1-1/8" x 21" Portable Sanders Sold Separately (see page 181K)



CAT. NO.	GRIT	COLOR
ZB1182160	60X	Green
ZB11821120	120X	Black
ZB11821220	220X	Red
ZB11821400	400X	Yellow
ZB11821800	800X	White

Minimum order: 1 each. Diamond Belts sold individually.

CRL 3M® 1-1/8" x 21" (29 x 533 mm) Diamond Belts offer tremendous longevity compared to silicon carbide belts. In addition, the edge quality is consistent throughout the belt life. Since diamonds cut, rather than scratch like sandpaper, less pressure is required to accomplish the same material removal. **NOTE:** Always use Diamond Belts on machines in good condition with true running rollers, and be sure to wear appropriate dust protection gear.

**BELT SELECTION:** Diamond grits required are based upon required finish and amount of material to be removed. Use 60 grit (green) only for high material removal situations. If a high polish is required, progress to 800 grit (white).

3M is a registered trademark of 3M Company Corporation. Makita is a registered trademark of Makita Corporation.

## CRL Makita® Finishing Sander

- Dust Bag for Clean Sanding
- Powerful 2AMP Motor



This CRL Makita® Finishing Sander, at 2.5 pounds (1.1 kg) is lightweight, and can handle any heavy-duty sanding job in the shop or on the jobsite. The powerful 2 AMP motor operates at 14,000 RPM for super smooth sanding. It comes complete with a dust bag and punch plate. Minimum order is one each.

CAT. NO. B04552



## CRL Glass Devil Sanding Tool and Kit

- Let's You Do Quick Edge Work Without an Electric Sander
- Holds Standard 3" x 21" (76 x 533 mm) Size Belts
- Belts Change Quickly and Easily



CAT. NO. GD321  
Glass Devil Sanding Tool



CAT. NO. GDK1T  
Glass Devil Sanding Tool Kit  
Kit Comes With 10 Each 80X, 120X, and 220X Belts

Just slip a 3" x 21" (76 x 533 mm) Sanding Belt on the CRL Glass Devil Sanding Tool and you're ready to do quick edge work without having to bring out a portable sander. The patented design of the Glass Devil makes it easy to change belts quickly, and belts are held in place securely so they will not slip or slide. The comfortable grip gives you control at any angle, and its shape provides more sanding surfaces: flat, angled, curved, and edged. Minimum order is one each.

## CRL Sanding Sticks

- Available in Two Widths - 1/4" and 1/2" (6.3 and 12.7 mm)
- Ideal for Cut-Outs and Other Hard-to-Reach Areas

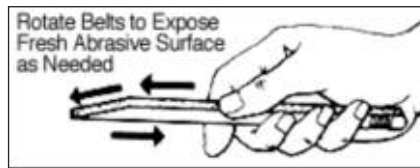

This CRL Sanding Stick was developed for detailed finish work or hard-to-reach surfaces. Its unique design allows the user to rotate the abrasive belt 360 degrees for its complete use. The spring-loaded tensioning device keeps the belt firmly in place and allows for quick belt change. You can use it wet or dry. The leading edge is tapered for work in tiny openings. Abrasive Belts for Sanding Sticks come 20 per package, all of one grit, in three popular grits: 80X, 120X, and 240X.



8" (203 MM) SANDING STICKS

CAT. NO.	HOLDS BELT WIDTH
SS128H	1/2" (12.7 mm)
SS146H	1/4" (6.4 mm)

Minimum order: 1 each. Can be combined for quantity pricing.



SANDING STICK ABRASIVE BELTS

CAT. NO.	BELT WIDTH	GRIT
SSA1480X	1/4" (6.4 mm)	80X
SSA14120X	1/4" (6.4 mm)	120X
SSA14240X	1/4" (6.4 mm)	240X
SSA1280X	1/2" (12.7 mm)	80X
SSA12120X	1/2" (12.7 mm)	120X
SSA12240X	1/2" (12.7 mm)	240X

Minimum order: 1 package (20 Belts).

## CRL Sanding Bands

- Fits Standard 1" and 2" (25 and 51 mm) Sanding Drums

Use these CRL Sanding Bands with portable drills to polish rounded edges, inside circles, notches, and more. The abrasive bands have aluminum oxide grit for use on wood, steel, metal and glass, and they easily slip over the rubber cushioned drums (shown below).

1" (25 mm) Diameter x 2" (51 mm) Long Sanding Bands for 12SD Sanding Drum (see below)



2" (51 mm) Diameter x 2" (51 mm) Long Sanding Bands for 22SD Sanding Drum (see below)



CAT. NO.	GRIT	BANDS PER BOX
1X260X	60X	10
1X280X	80X	10
1X2120X	120X	10
1X2220X	220X	10

Minimum order: 1 box. Sizes and grits can be combined for quantity pricing.

CAT. NO.	GRIT	BANDS PER BOX
2X260X	60X	10
2X280X	80X	10
2X2120X	120X	10
2X2220X	220X	10

## CRL Sanding Drums

Use these CRL Sanding Drums with our Sanding Bands (above) in your portable drill to sand rounded edges, inside circles, notches, etc. Simply slip the Sanding Band over the rubber-cushioned drum and you are ready to go.

- For Sanding Cut-Outs and Incurves, Speak Hole, and Mail Slot Openings



CAT. NO. 12SD



CAT. NO. 22SD



CAT. NO.	DIAMETER	LENGTH	SHANK
12SD	1" (25 mm)	2" (51 mm)	1/4" (6.4 mm)
22SD	2" (51 mm)	2" (51 mm)	1/4" (6.4 mm)

Minimum order: 1 each. Sizes can be combined for quantity pricing.

# CRL DISC SANDERS AND POLISHERS

For Pricing Visit [crlaurence.com](http://crlaurence.com) or Call Us Toll Free at the Phone Numbers Shown on the Back Cover

## CRL 5" Disc Sander

- Lightweight for Easy Operation
- Powerful Motor Provides 5,000 RPM

The CRL 5" (127 mm) Disc Sander is a compact, lightweight tool for sanding and polishing. It has a powerful, double-insulated 3.5 AMP motor that delivers 5,000 RPM for fast and efficient sanding. Lightweight for easy handling, it features a motor-over-the-pad design for better balance and control. The ball-and-needle bearing is sealed against dust, as is the switch, to help extend the life of the tool. Includes: Abrasive Disc, Plastic Pad, and Side Handle.



See page 195K for Discs to fit this Sander



- 120V/60Hz or 240V/50Hz
- Professional Quality Power Tool

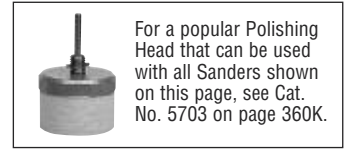

For a popular Polishing Head that can be used with all Sanders shown on this page, see Cat. No. 5703 on page 360K.

CAT. NO.	DESCRIPTION
LD903	5" (127 mm) Disc Sander – 120 Volts
LD903AU	5" (127 mm) Disc Sander – 240 Volts

Minimum order: 1 each.

## CRL Makita® 5" Disc Sander/Polisher

- Powerful 3.6 AMP Motor
- 4,500 RPM for Fast and Efficient Sanding
- Lightweight, Weighs Only 2.6 Lbs. (1.2 kg)

This CRL Makita® 5" (127 mm) Disc Sander/Polisher is a compact, lightweight tool for sanding and polishing. It has a powerful, double-insulated 3.6 AMP motor that delivers 4,500 RPM for fast and efficient sanding. Weighing only 2.6 lbs (1.2 kg) for easy handling, it also features a motor-over-the-pad design for better balance and control. The ball-and-needle bearing and switch are sealed against dust to help extend the life of the tool. Includes lock-on button for continuous operation. Minimum order is one each.



See page 195K for Discs to fit this Sander

CAT. NO. GV5000

## CRL Makita® 7" Disc Sander/Polisher

- Highest Power-to-Weight Ratio
- Quick-Flip Speed Change
- Two Speed Selections: Low (600 RPM) and Variable (600-2,000 RPM)

This CRL Makita® 7" (178 mm) Disc Sander/Polisher is a compact, lightweight tool for sanding and polishing. It has a powerful, double-insulated 7.9 AMP burnout protected motor with a maximum speed of 2,000 RPM. A Quick-Flip™ Speed Change Button lets you choose two speed settings: Low (600 RPM) and Variable (600 to 2,000 RPM). The ball-and-needle bearings and the switch are sealed to protect against dust. Minimum order is one each.



See page 195K for Discs to fit this Sander

CAT. NO. PV7001C

## CRL Pads for Stick-On Sanding Discs

- Holds "PSA" Stick-On Sanding Discs

CRL PAD5 and PAD6 Backup Pads can be used with GV5000 Sander/Polisher or units accepting a 3/8" (9.5 mm) long, 5/16"-18 male stud. The PAD7 is compatible with our PV7001C Sander. It can also be used with the CRL Cat. No. 5704 Shank Adapter in any 1/4" or 3/8" electric drill.



CAT. NO. PAD5 5" (127 mm) CAT. NO. PAD6 6" (152 mm) CAT. NO. PAD7 7" (178 mm)

CAT. NO.	SIZE	MOUNTING TYPE
PAD5	5" (127 mm)	3/8" (9.5 mm) Long, 5/16"-18 Male Stud
PAD6	6" (152 mm)	3/8" (9.5 mm) Long, 5/16"-18 Male Stud
PAD7	7" (178 mm)	5/8"-11 Thread Adapter
5704	-	5/8"-11 to 1/4" Diameter Shank Adapter

Minimum order: 1 each.

## CRL Rubber Pads for Sanding Discs

- Replacement Pad for Sanders

This CRL Rubber Pad works with any sander that has a 5/8"-11 UNC spindle.

Makita is a registered trademark of Makita Corporation.



CAT. NO.	DESCRIPTION
7430169	6" (152 mm) Rubber Pad for Makita® Sanders
1929782	7" (178 mm) Rubber Pad for Makita® Sanders
2245171	Locking Nut for 6" and 7" Rubber Pad for 9227C and PV7001C Sanders

Minimum order: 1 each.



C.R. LAURENCE COMPANY

[crlaurence.com](http://crlaurence.com) | [usalum.com](http://usalum.com)

194K | [crlaurence.ca](http://crlaurence.ca) [crlaurence.com.au](http://crlaurence.com.au) [crlaurence.co.uk](http://crlaurence.co.uk) [crlaurence.de](http://crlaurence.de) [crlaurence.eu](http://crlaurence.eu)

# CRL DISC SANDERS AND POLISHERS

For Pricing Visit [crlaurence.com](http://crlaurence.com) or Call Us Toll Free at the Phone Numbers Shown on the Back Cover

## CRL Stick-On Sanding Discs

- 100% Polyester Backing With Pressure Sensitive Adhesive
- Peel and Stick Application Saves Time
- Three Popular Sizes 5", 6", and 7" (127, 152, and 178 mm)

CRL Stick-On Sanding Discs with pressure sensitive adhesive are 100% polyester waterproof material. Made with high quality silicon carbide grain, these Discs provide savings where it counts most, time and labor. Simply peel off the lining and stick the Disc on your backup pad. Five popular grits are stocked. Other grits ranging between 60X to 400X are available on special order.

### MOST POPULAR GRITS FOR GLASS, AND EXAMPLES OF THEIR USE:

- 60X** - Extra-Rough, Quick General Roughing (Mitered Edge)
- 80X** - Rough, Quick Contouring (Auto Glass Edge)
- 120X** - Smooth, Seaming and Polishing (Desk Top Edge)
- 220X** - Extra Smooth, Fine Frosted Finish (Glass Shelf Edge)
- 400X** - Extra Fine, Extra Fine Frosted Finish (Opaque Edge)



5" (127 MM) SIZE		6" (152 MM) SIZE		7" (178 MM) SIZE	
CAT. NO.	GRIT	CAT. NO.	GRIT	CAT. NO.	GRIT
PSA560	60X	PSA660	60X	PSA760	60X
PSA580	80X	PSA680	80X	PSA780	80X
PSA5120	120X	PSA6120	120X	PSA7120	120X
PSA5220	220X	PSA6220	220X	PSA7220	220X
PSA5400	400X	PSA6400	400X	PSA7400	400X

Minimum order: 50 each (1 box). All sizes and grits can be combined for quantity pricing.

## CRL Sanding Discs

- Fast Grinding 100% Polyester Backed Discs
- Bolt-On Type With Hole in Center Fits Most Disc Sanders
- Three Popular Sizes: 5", 6", and 7" (127, 152, and 178 mm)

Our Silicon Carbide Sanding Discs come in 5", 6" and 7" diameters to fit most popular brands of disc sanders. They have 100% polyester backing that lets you use them wet or dry. Available in five grits: 60X (Extra Rough); 80X (Rough); 120X (Smooth); 220X (Extra Smooth); 400X (Fine), they come 50 discs per box. Minimum order is 50 Discs of one grit and size.

### MOST POPULAR GRITS FOR GLASS, AND EXAMPLES OF THEIR USE:

- 60X** - Extra-Rough, Fast Glass Removal (Mitered Edge)
- 80X** - Rough, Quick-Contouring (Auto Glass Edge)
- 120X** - Smooth, Seaming and Polishing (Desk Top Edge)
- 220X** - Extra-Smooth, Fine Frosted Finish (Glass Shelf Edge)
- 400X** - Extra-Fine, Satin Finish (Opaque Edge)



5" (127 MM) SIZE		6" (152 MM) SIZE		7" (178 MM) SIZE	
CAT. NO.	GRIT	CAT. NO.	GRIT	CAT. NO.	GRIT
5X7860CB	60X	6X7860CB	60X	7X7860CB	60X
5X7880CB	80X	6X7880CB	80X	7X7880CB	80X
5X78120CB	120X	6X78120CB	120X	7X78120CB	120X
5X78220CB	220X	6X78220CB	220X	7X78220CB	220X
5X78400CB	400X	6X78400CB	400X	7X78400CB	400X

Minimum order: 50 each (1 box). All sizes and grits can be combined for quantity pricing.

## CRL Electric Polisher

- Portable Polisher With Center Water Feed
- Uses 3M® QRS Diamond Discs

The CRL AEP Electric Polisher is designed for portable polishing, shaping, and light grinding. This unit includes our pressurized coolant delivery system, and a faucet/garden hose connector kit. It is powered by 115 volts and is double-insulated, with a Ground Fault Interrupt Circuit Device (CRL Cat. No. GF1) included. The AEP runs at 2000 RPM, accepts 4" 3M® Disc Pads in 5/8"-11 thread, and uses 3M® QRS Diamond Discs for superior results. One QRS 4" (102 mm) Backing Pad included. 3M is a registered trademark of 3M Company Corporation.



CAT. NO. AEP

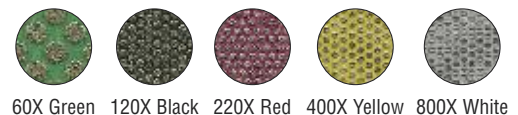

60X Green 120X Black 220X Red 400X Yellow 800X White

CAT. NO.	DESCRIPTION	GRIT
ZDP4Q58	5/8"-11 QRS Disc Pad	---
ZD4Q60	3M® QRS Diamond Disc	60X
ZD4Q120	3M® QRS Diamond Disc	120X
ZD4Q220	3M® QRS Diamond Disc	220X
ZD4Q400	3M® QRS Diamond Disc	400X
ZD4Q800	3M® QRS Diamond Disc	800X

Minimum order: 1 each.

## CRL Diamond Hand Pads

- Long-Lasting Diamond Abrasive
- Works Great on Smooth or Uneven Surfaces
- Use Wet or Dry

CRL Diamond Hand Pads are plated diamond abrasive surfaces permanently glued to rigid foam support pads. Use wet or dry for fine finish work on glass, marble, ceramics, granite, and other composites. Their convenient size requires minimal effort and allows a more consistent finish. Diamond grade or grades required are based upon the finish and amount of material to be removed: Use 60 grit only for high material removal situations. Use a 400 grit pad if a high polish is required. Pads measure 2-1/4" by 3-3/4" (57 by 95 mm).

**GRADE RANGE FOR GLASS**

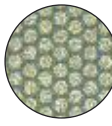
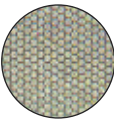
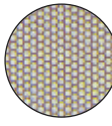
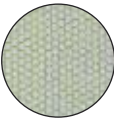
<b>GREEN</b> 250 micron	<b>BLACK</b> 125 micron
	
60 Grit	120 Grit
<b>RED</b> 74 micron	<b>YELLOW</b> 40 micron
	
220 Grit	400 Grit



CAT. NO.	COLOR	GRIT
DHP60	Green	60X
DHP120	Black	120X
DHP220	Red	220X
DHP400	Yellow	400X
DHPSET	All	Set of All Four

Minimum order: 1 each.

## CRL 3M® Flexible Diamond Hand Pads



3M® Flexible Diamond Hand Pads have a diamond surface bonded to comfortable foam backing with finger holds. Slight flexibility allows pad to conform to the surface being worked. Choice of grits based upon the finish and amount of material to be removed: Use 60 grit only for high-material removal. Use 800 grit if a high polish is required. Pads measure 2-1/4" by 3-3/4" (57 by 95 mm).

- Available in Grits From 60X to 800X
- Use Wet or Dry

CAT. NO.	COLOR	GRIT
Z2G6021	Green	60X
Z2B12018	Black	120X
Z2R22018	Red	220X
Z2Y40018	Yellow	400X
Z2W80018	White	800X
Z2SET	All	Set of All Five

Minimum order: 1 each.

## CRL Diamond Grinding Bits



- Bonded 220X Diamond

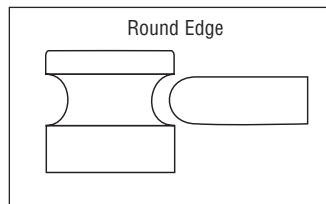

The Round Edge Bit produces a round edge on 3/16" (5 mm) and 1/4" (6 mm) glass. Minimum order is one each.

CAT. NO. DRB14

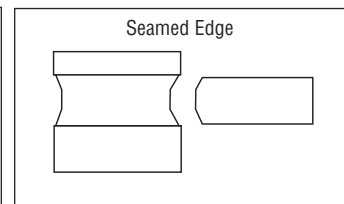

The Seamed Edge Bit produces an edge with flat arrises on 1/4" (6 mm) glass. Minimum order is one each.

CAT. NO. DSB14

## CRL Crystolon Rubbing Brick

- Use for Hand Grinding or Truing Wheels

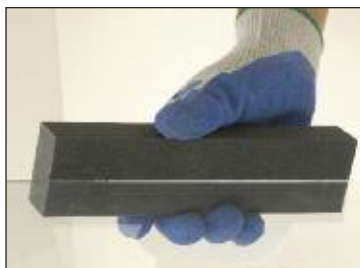

CRL Crystolon Rubbing Bricks are used for hand grinding and smoothing glass edges. They are also useful for truing up flat faces on smoothing wheels. Choice of three grits.

CAT. NO.	GRIT
CRS80	80X
CRS120	120X
CRS220	220X

Minimum order: 1 each. Can be combined for quantity pricing.

3M is a registered trademark of 3M Company Corporation.

## CRL Hand Glass Seamer

- Seams Both Edges of Glass at Once



With the CRL Hand Glass Seamer you can seam both edges of freshly cut glass at once, saving yourself time. Built-in safety hand guards prevent your hands from slipping. This light, hand-held tool smooths glass from 1/8" to 1/2" (3 to 12 mm) thick.

CAT. NO.	DESCRIPTION
2612251	Seamer Tool
2612252	Replacement Stone

Minimum order: 1 each.



# 2

## Glass Handling and Safety Gear

- CUT PROTECTION GARMENTS
- GLASS HANDLING AND STORAGE
- GLAZIER'S GLOVES
- PUMP-UP VACUUM CUPS
- SAFETY EQUIPMENT
- SAFETY EYEWEAR
- SHOP CARTS
- TRUCK RACKS
- VACUUM LIFTERS

See other side for Section Index.

# SECTION 2 INDEX

For a complete index to this catalog, turn to Section 7. To search for all CRL products, go to CRL Total Search at [crlaurence.com](http://crlaurence.com).

## A

Adjustable Lanyard.....	284K
All Terrain Dolly.....	225K
Aluminum Glass Racks.....	248K-249K
Aluminum Side Slats.....	255K-256K
Aluminum Vacuum Lifters.....	210K
Aprons.....	277K, 286K-288K
Atlas Gloves.....	266K-267K, 271K

## B

Back Support Belts.....	283K
Band Mount Hearing Protectors.....	280K
Bandanas.....	291K
Barkleats.....	254K
Barpads.....	257K
Baseplate Pads.....	257K
Black Nitrile Gloves.....	270K
Blue Denim Protection Sleeves.....	274K
Bungee Cord Assortment.....	261K

## C

Camber Glass Dolly.....	226K
Cane Mesh Sleeves.....	273K
Cargo Handler Aprons and Chaps.....	286K-287K
Carrymate Door Lifter.....	241K
Carts and Dollies.....	224K-235K
Chain Cable Sling.....	237K
Clamp Bars With Gear Boxes.....	259K
Configurator.....	200K-201K
Cork Glass Protectors.....	243K-246K
Corner Protectors.....	247K
Cushion Grommets.....	259K
Cut Protection Garments.....	272K-277K

## D

Dollies.....	224K-228K
Door Jack and Lifter.....	241K
Double Loop Case Slings.....	237K
Double Swivel Vacuum Cups.....	211K
Dust Masks and Respirators.....	281K

## E

Ear Plugs.....	280K
Eye Protection.....	278K-279K
Eyewash.....	291K

## F

Fabricators Aprons and Sleeves.....	288K
Face Shield.....	282K
Fall Protection Harness.....	284K
Felt Glass Protectors.....	244K-245K
Fingerless Gloves.....	271K
Fire Extinguishers.....	292K
First Aid Kits.....	289K-290K
Flashlights.....	292K
Fuzzy Duck PVC Gloves.....	267K

## G

Gauntlet Gloves.....	264K
Glass.....	
Case Bracket.....	239K
Dollies.....	224K-228K
Dust Respirator.....	281K
Gloves.....	264K-269K
Handler Kit.....	221K
Jacks.....	241K
Lifting Sling and Hand Pad.....	240K
Protectors and Shipping Pads.....	242K-247K
Racks for Pickups.....	248K, 250K-251K
Racks for Vans.....	249K, 252K-253K
Slings.....	236K-237K
Tie Straps.....	228K, 261K
Tongs.....	239K
Transport Racks.....	258K
Truck Racks.....	248K-253K

Glasses, Safety.....	278K-279K
Glassworker Cut Protection Gear.....	264K-269K, 271K-277K
Gloves.....	264K-271K

## H

Hand Held Vacuum Lifters.....	202K-218K
Hard Hats.....	282K
Hardwood Slot Rack Flooring.....	239K
Harness.....	284K
Harp Racks.....	234K-235K
Hearing Protection.....	280K
Heavy-Duty.....	
Glass Dolly.....	225K
Knee Pads.....	285K
Shop Carts.....	229K-231K
Truck Mount A-Frame.....	258K
Vacuum Cups.....	209K

## I

Igloo Water Cooler.....	261K
Insulating Glass Storage Rack.....	235K
Interior Glass Rack for Vans.....	258K

## J

Jackets, Cut Protection.....	274K-275K
------------------------------	-----------

## K

Kevlar Garments.....	267K, 275K-277K
Knee Pads.....	285K
Knit Wrist Gloves.....	265K-267K, 269K
Knuckle and Fingertip Bandages.....	291K
Knuckle Saver Lifter.....	223K
Kraft Paper and Dispensers.....	262K

## L

LED Flashlight.....	292K
Leg Chaps.....	277K
Lexan Vacuum Cup.....	211K
Lifters, Vacuum.....	198K-223K
Lint-Free Nylon Gloves.....	271K
Little Grabber Lifter.....	223K
Load Stopper.....	257K
Long Glass Dolly.....	226K
Low Dollies.....	227K

## M

Mechanix Gloves.....	268K
Mini Stretch Film and Dispensers.....	262K
Mobile Harp Racks.....	235K
Multi-Purpose Glass Storage System.....	238K

## N

Neck Protector.....	275K
Nitrile Gloves.....	269K-271K
No-Adhesive Shipping Pads.....	243K
Nylon Gloves.....	271K
Nylon Wrist Protectors.....	276K-277K

## O

Octopus Suction Lifters.....	208K
Online Configurator.....	200K-201K

## P

Particulate Respirator.....	281K
Pebbled No-Adhesive Shipping Pads.....	244K
Pickup Truck Glass Racks.....	248K, 250K-251K
Plastic Vacuum Lifters.....	211K
Plunger Assembly with Low Vacuum Audio Alarm.....	214K
Poly Truck Rope.....	260K
Power Puller.....	260K
Protective.....	
Aprons.....	277K, 286K-288K
Earwear.....	280K
Eyewash.....	278K-279K
Gloves.....	264K-271K
Head Gear.....	282K

Jackets.....	274K-275K
Kneewear.....	285K
Masks and Respirators.....	281K
Neckwear.....	275K
Shirts.....	275K
Sleeves.....	272K-276K
Wristwear.....	276K-277K
Pump-Up Vacuum Cups.....	202K-208K, 212K-219K
PVC Slot Rack Flooring.....	239K

## R

Radians Safety Glasses.....	278K-279K
Rain Suits and Boots.....	288K
Ratchet Suspension Hard Hat.....	282K
Replacement Rubber Pads for Lifters.....	209K-210K
Respirators.....	281K
RoI-A-Lift Glass Crate Truck.....	228K
Roller Blocks.....	240K
Rolling Glass Racks.....	234K-235K
Rubber Aprons.....	288K
Rubber Coated Gloves.....	264K-267K, 269K

## S

Safety.....	
Cones.....	292K
Harness.....	284K
Tapes.....	292K
Vests.....	292K
Shipping Pads and Glass Protectors.....	242K-247K
Single Cup Vacuum Lifters.....	209K-211K, 222K
Single Sided Shop Carts and Racks.....	229K-231K
Slit-Rak Glass Rack Expander.....	257K
Slings.....	236K
Special Application Vacuum Cups.....	219K-223K
Split Case Dolly.....	228K
Spreader Bar and Sling System.....	236K
Stakes, Truck Rack.....	254K
Sure-Grip Glass Gloves.....	269K
Sure-Grip Vacuum Lifters.....	202K
Swivel Vacuum Cups.....	211K

## T

Top Hat Glass Rack Channels.....	259K
Transport Pads.....	246K
Transport Racks.....	231K
Truck Bed Racks.....	258K
Truck Racks and Accessories.....	248K-259K
Truck Rope.....	260K

## U

UV Goggles.....	279K
-----------------	------

## V

Vacuum.....	
Cup Exchange Program.....	207K, 217K
Cups, Automotive.....	219K, 221K
Cups, Wood's.....	212K-220K, 222K
Lifters, Hand Held.....	202K-211K
Lifting Configurator.....	200K-201K
Ratchet Tensioning Kit.....	204K
Visitor Spectacles.....	279K

## W

Water Cooler.....	261K
Water Resistant Flashlight.....	292K
Web Strap and Clamp.....	261K
Wheel Step.....	261K
Wheeled Carts and Dollies.....	224K-233K
Wheeled Storage Racks.....	234K-235K
Wood's™ Low Vacuum Audio Alarm.....	214K
Wood's™ Powr-Grip® Vacuum Cups.....	212K-220K, 222K
Woven Bandage Assortment.....	291K
Wrist and Thumb Protectors.....	276K-277K
Wrist Supports.....	283K



C.R. LAURENCE COMPANY

ALUMINUM

[crlaurence.ca](http://crlaurence.ca)

[crlaurence.com.au](http://crlaurence.com.au)

[crlaurence.co.uk](http://crlaurence.co.uk)

[crlaurence.de](http://crlaurence.de)

[crlaurence.eu](http://crlaurence.eu)

[crlaurence.com](http://crlaurence.com) | [usalum.com](http://usalum.com)

# SECTION 2 Glass Handling and Safety Gear

## QUICK INDEX

For a complete index to this catalog, turn to Section 7. To search for all CRL Products, go to CRL Total Search at [crlaurence.com](http://crlaurence.com).

### CRL Hand Held Vacuum Lifters – Pages 198K to 211K



### Wood's™ Hand Held Vacuum Cups – Pages 212K to 220K



### Glass Handling and Storage Equipment – Pages 221K to 247K



### Glass Transporting Equipment – Pages 248K to 262K



### Safety Apparel and Equipment – Pages 263K to 292K



## CRL Offers Solutions to Fit All Your Vacuum Lifting Requirements

- Hand-Held Vacuum Cups
- Below-the-Hook Vacuum Lifting Frames
- Custom Fabricated Lifting Frames

CRL has worked through the decades to provide the industries with safe and practical methods of handling glass and other materials. The following pages represent the latest advancements in vacuum lifting technology with products made by safety conscious and demanding manufacturers. The versatility of the lifting equipment shown here can fulfill most every requirement for today's demands, but should you have unique applications that necessitate special parts fabrication, CRL has the capability of providing customized equipment engineered to meet your needs. For additional information, contact the CRL Customer Service Department at (800) 421-6144 in the U.S., (877) 421-6144 from Canada, or (323) 588-1281 International, and ask for Ext. 5275. You can also e-mail us through our web site, [crlaurence.com](http://crlaurence.com). From the home page click on Contact Us, and then click on Customer Service.



### Hand Held Lifters

(See Pages 202K to 223K)

Frequently called hand cups, vacuum cups or suction cups, Hand Held Lifters use manually operated pumps, levers or simple press-on application to create a vacuum. Different models are available for handling loads with flat, curved or textured surfaces.

Several factors determine the most appropriate style of hand cup to use, including the weight and type of material, the duration of the lift, and the attachment speed required. For carrying larger loads over longer distances, pump-style cups offer the greatest advantage. These cups are attached by pumping a plunger that removes air from between the load surface and the rubber pad. A red line on the plunger warns the user of any vacuum loss. Should the line reappear during the lift, a check valve allows the user to repump the cup without losing the remaining vacuum. In contrast, handling speed may be a primary concern with lighter, smaller loads. In this case, lever-style or press-on cups could be an appropriate choice.

When using any type of manually operated vacuum cup, it is important that the surfaces of the load and of the cup itself be relatively free of contaminants that could cause the load to slip. This is particularly true for press-on and lever-style cups, because vacuum indicators are usually not present, and the vacuum level attained may be less than that of pump-style cups.



CAT. NO. S338



CAT. NO. W4950



CAT. NO. 05062

### Below-The-Hook Lifters

(See Pages 714K to 740K)

Below-the-Hook Vacuum Lifters are used to handle large sheet materials with the aid of floor hoists, cranes or forklifts, which provide vertical and horizontal movement of the load. These Lifters normally come with a powered vacuum system, and are available in models for handling materials strictly in the upright or flat position, or in versions that provide powered or manually operated rotation and tilt movements.

To select an appropriate Lifter, first assess the kind(s) of work it is expected to do. List the features and functions needed in terms of material size and weight, load manipulation, speed requirements, and available power. If versatility is the primary consideration, the ideal Lifter is one that does many jobs reasonably well. For medium to high volume production, speed and ease of handling are critically important. Keep in mind that a single Lifter may not always be the most effective solution. Specialized Lifters, dedicated to one aspect of an operation, sometimes lead to greater efficiency and may be just as cost-effective.







## Capacity and Support

Load capacity ratings for CRL Wood's Below-the-Hook Lifters include a safety factor calculated to cover variations in slip resistance, due to contamination on the load or vacuum pads, and weight magnification, which may occur when cranes, hoists or forklifts vary between countries, so make sure the rated capacity meets or exceeds the standards for your location. After selecting a Lifter with the correct load capacity, you must also confirm that the crane, hoist or any other equipment used is rated to carry the combined weight of the Lifter and load.

Capacity is often defined strictly in terms of load weight. However, the support that a Vacuum Lifter supplies across the load surface is equally important. Support requirements depend on the type and thickness of material being lifted, and the angle of the material during the lift. Materials such as glass, stone or sheet metal each have different properties that affect how they can be securely lifted and manipulated. The Lifter's pad spread must limit load overhang and provide adequate support to prevent bending or breaking of the material. Consult the CRL Customer Service Department for more specific information about support requirements.

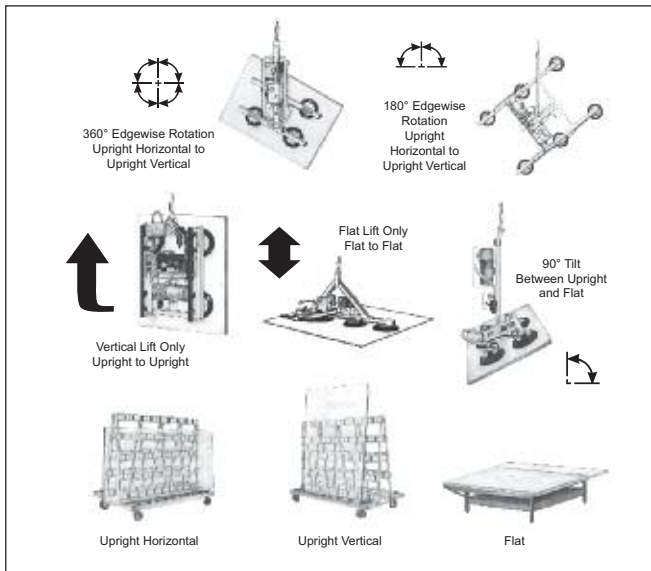

## Load Manipulation

One of the most significant contributions that Below-the-Hook Lifters offer is their ability to lift and manipulate loads without excessive strain to the user. A wide variety of models are available to handle most installation or manufacturing requirements, including Vertical Lifters, Flat Lifters, Rotators, Tilters, and Rotator/Tilter Combinations, with manual or powered load movements. Whatever the job requirements, we can design Below-the-Hook Lifters with the manipulation capabilities to move loads quickly and ergonomically. The diagrams to the left provide a common language for specifying load movements.

## Speed

Lifter speed is the time required to move a load from where it is to where you want it. A number of important factors must be considered to determine speed requirements, such as the time to apply the Lifter to or release it from a load, the time for a powered tilt or rotation cycle, the number of times per hour a movement is performed, and the distance the load must travel. Another factor that may influence the rate of movement is the type of hoisting equipment used to support the Lifter. For example, the speed of chain-operated hoists varies dramatically from that of a block and tackle hoist or an electrically powered hoist. Once speed and frequency requirements have been identified, the CRL Customer Service Department and Wood's Powr-Grip® can determine what kind of Vacuum Lifter is needed for the application.



## Power

Below-the-Hook Lifters are available with AC, DC or compressed air vacuum systems. AC electric or air-powered systems are normally chosen for high-speed production operations. Air-powered systems use compressed air to generate vacuum and, in some cases, to manipulate the load. The capacity of the compressed air source must be specified in terms of pressure and flow in order to select an appropriate air-powered system. Since DC Lifters provide cord-free, self-contained operation, they are recommended when a Lifter must be used in various locations, or when AC power is inconvenient or unreliable. In order to conserve battery energy, DC-powered vacuum systems are designed to turn the pump on and off as needed to maintain an adequate vacuum level. AC power systems and DC battery chargers are both available in most standard voltages used around the world.

Wood's Powr-Grip is a registered trademark of Wood's Powr-Grip Co., Inc.

## CRL Online Vacuum Lifter Configurator Programs

- This Program Helps Determine Which Vacuum Lifting Equipment is Best Suited for Your Needs
- Access the Configurator Online at [crlaurence.com](http://crlaurence.com) for Below-The-Hook or Hand Held Vacuum Lifting Products



CRL has developed a web site "Vacuum Lifter Configurator" or product selection program for our line of Hand Held and Below-The-Hook Vacuum Lifting Devices. CRL offers so many Vacuum Lifting Devices that the selection process can become overwhelming. However, with our new Vacuum Lifter Configurator program there is now a way to quickly identify which Vacuum Cup or Lifting Frame is right for you!

By selecting a few basic qualifiers, the appropriate Vacuum Lifting Device is quickly narrowed down from our large selection. Find the right Vacuum Cup for use on glass, stone or metal; for use in glass fabrication, field installation or auto glass installation; for flat or curved pieces; smooth or textured surfaces; and based on the maximum weight (load) that needs to be lifted. Also choose how the load needs to be manipulated and/or tilted, tilt assisted, rotated, rotated and tilted, flat lifted or vertically lifted. To access the CRL Vacuum Lifter Configurator, simply go to [crlaurence.com](http://crlaurence.com) and click on Glass and Glazing, then Vacuum Lifter Configurator. See the next page for images and illustrations that demonstrate the easy selection process.



CAT. NO. P11104DC



CAT. NO. PFHL69AC



CAT. NO. MRT411LDC



CAT. NO. 550



CAT. NO. 05063



CAT. NO. S338



CAT. NO. W4950



CAT. NO. S106VHP



CAT. NO. MRTA611LDC



## CRL Online Vacuum Lifter Configurator Programs

- Choose From Either Below-the-Hook Vacuum Frames for Heavy Lifting or Hand Held Vacuum Lifters for Manual Lifting

### CRL Below-The-Hook Vacuum Lifting Frame Configurator (Example)

See the complete selection of Below-The-Hook Vacuum Lifting Frames on pages 714K-740K.

**CRL Configurator**

This online tool will help you select the most appropriate below-the-hook vacuum lifter to suit your particular requirement.

At any time you can place an order, click [here](#) to view your cart. You can also request an online quote, click [here](#) to request a quote. To speak with Customer Service simply call Toll Free at (800) 421-6144 ask for extension 5275, or to contact us via email, click [here](#).

• What type of material will you be handling?  
 ← Glass, Stone

• How will you be using the lifter?  
 ← Glass Fabrication, Installation, Auto Glass

• How does the load need to be manipulated?  
 ← Tilt Only, Rotate Only, Rotate and Tilt, Flat to Flat, Upright to Upright

• Do you prefer Manual or Power?

• What is the Maximum Load Weight in LBS/KGS?

23 Item(s) found!

PRODUCT	DESCRIPTION
• <a href="#">CFMR411LACS</a>	CRL Wood's™ Powr-Grip® AC Powered C-Frame Manual Rotator 4-Cup Vacuum Lifter 700 Series
• <a href="#">CFMR49ACS</a>	CRL Wood's™ Powr-Grip® AC Powered C-Frame Manual Rotator 4-Cup Vacuum Lifter 500 Series
• <a href="#">CFMT49ACS</a>	CRL Wood's™ Powr-Grip® AC Powered C-Frame Manual Tilting 4-Cup Vacuum Lifter 500 Series
• <a href="#">CFMT69ACS</a>	CRL Wood's™ Powr-Grip® AC Powered C-Frame Manual Tilting 6-Cup Vacuum Lifter 750 Series
• <a href="#">CFPT49AC</a>	CRL Wood's™ Powr-Grip® AC Powered C-Frame Power Tilter 4-Cup Vacuum Lifter 500 Series

### CRL Hand Held Vacuum Cup Configurator (Example)

See the complete selection of Hand Held Vacuum Cups on pages 202K-223K.

**CRL Configurator**

This online tool will help you select the most appropriate Hand Cup to suit your particular requirement.

At any time you can place an order, click [here](#) to view your cart. You can also request an online quote, click [here](#) to request a quote. To speak with Customer Service simply call Toll Free at (800) 421-6144 ask for extension 5275, or to contact us via email, click [here](#).

• What will the Hand Cup be used for?  
 ← Lifter, Mounting

• For Smooth or Textured Surfaces?  
 ← Smooth, Textured

• Flat, Curved Glass or Both?  
 ← Flat, Curved, Both

• What is the Maximum Load Weight in LBS/KGS?

• Lever or Pump Type Activation or Pressure Applied?

8 Item(s) found!

PRODUCT	DESCRIPTION
• <a href="#">250</a>	CRL 5" Heavy-Duty Double Vacuum Cup
• <a href="#">H4500</a>	CRL Wood's Power-Grip® Hybrid Handle 8" Vacuum Cup
• <a href="#">S338</a>	CRL Sure-Grip® 8" Vacuum Lifter
• <a href="#">W4000</a>	CRL Wood's Power-Grip® 8" ABS Handle Vacuum Cup
• <a href="#">W4000WBP</a>	CRL Wood's Power-Grip® 8" Vacuum Cups With Low Vacuum Audio Alarm - ABS Handle

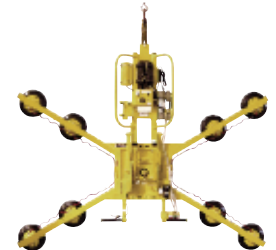
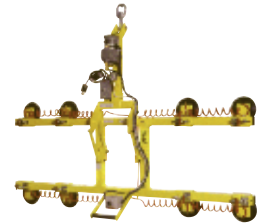
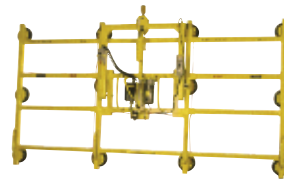

# CRL HAND HELD VACUUM LIFTERS

For Pricing Visit [crlaurence.com](http://crlaurence.com) or Call Us Toll Free at the Phone Numbers Shown on the Back Cover



## CRL Sure-Grip 8" Vacuum Lifter

- Greatest Lifting Capacity of Any 8" (203 mm) Pump Activated Vacuum Lifter
- Meets CE and GS Conformance
- Eligible for Exchange Program

This Sure-Grip Vacuum Lifter is manufactured by C.R. Laurence Co. in Australia. The state-of-the-art design of the S338 offers unique features, setting it apart from other 8" (203 mm) pump-activated vacuum lifters. Minimum order is one each.

### • Superior Comfort and Grip

The ergonomically designed shape of the S338's soft contoured Sure-Grip provides a comfortable hold during lifting compared to straight, hard handles. Thousands of micro-pads are aligned in the handle material to provide greater slip resistance during lifts for yet another measure of safety.



### • Superior Release

Extremely fast release from the work surface is attributed to a combination of the S338's uniquely designed rubber pad and new, specially designed relief valve placed safely inside the valve's guard.



### • Convenient Vacuum Indicator

The pump's plunger has a red indicator line to show the vacuum level when the lifter is in use. When the lifter is properly attached to the load's surface, the red line will be hidden inside the pump. Should the red line become visible during a lift, set down the load and re-pump until red line is again hidden.



### • Excellent Attachment

The S338 has a wide 1/2" (12 mm) lip for fast attachment to glass and other non-porous, flat surfaces. This is also a major factor in the S338's 150 pound (68 kg) lifting capacity with a 3.3 safety factor. Protective carrying case included.

CAT. NO. S338

Lifting Capacity  
150 Lbs. (68 kg)



### • Superior "Press and Pump" Attachment Feature

The special rubber pad lip design enables one hand attachment of the vacuum lifter with only light pressure, allowing you to pump with the fingers of the same hand holding the lifter. Your other hand is free to secure your position for greater safety, especially important when you have the need to reposition your lifter on large vertical glass lites.



### • Superior Lifting Capacity Performance

Third party independent lab tests rate the S338 at 150 pounds (68 kg) with a big 3.3 safety factor.



C.R. LAURENCE COMPANY

[crlaurence.com](http://crlaurence.com) | [usalum.com](http://usalum.com)

202K | [crlaurence.ca](http://crlaurence.ca) [crlaurence.com.au](http://crlaurence.com.au) [crlaurence.co.uk](http://crlaurence.co.uk) [crlaurence.de](http://crlaurence.de) [crlaurence.eu](http://crlaurence.eu)

## CRL S7950 8" Pump-Action Vacuum Lifter

Lifting Capacity  
125 lb. (57 kg)



- Heavy-Duty Steel Handle
- Fast Attachment on Smooth, Nonporous Flat Surfaces
- Tough ABS Plunger With Red-Line Indicator
- Full Pad Face Contact When Pumped Reduces Distortion
- Can Be Re-Pumped Without Losing Remaining Vacuum
- Wide Release Valve Lever With Safety Guard Permits Quick and Complete Release
- Special Distributor Pricing Available

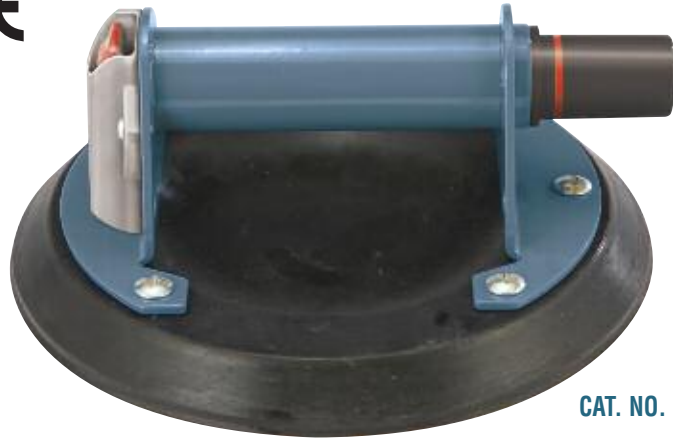

CAT. NO. S7950

CRL has developed the Cat. No. S7950 8" (203 mm) Pump-Action Vacuum Lifter with the strength of a heavy-duty steel handle and a tough ABS 3-stroke Plunger Pump for extra-fast attachment to glass and other nonporous surfaces. The Plunger uses a red-line indicator to let you know that you have sufficient vacuum to lift your load. Should the red-line appear after pumping, a built-in check valve allows you to re-pump without vacuum loss.

The large rubber pad area of over 50 square inches (323 square centimeters) makes full face contact when the Lifter is pumped, and allows attachment to glass of varying thickness with very little risk of damage.

To release the S7950 Lifter from the surface, simply press the vacuum release lever (which is protected by a guard during use) and the pad detaches from the surface without any residual sticking.

Four 5/16" (7.9 mm) diameter holes in the handle are convenient locations to attach guide ropes when using these Vacuum Lifters mounted on one of CRL's Manual Lifting Frames (shown on pages 712K to 715K), as well as for other utility attachments. Minimum order is one each.

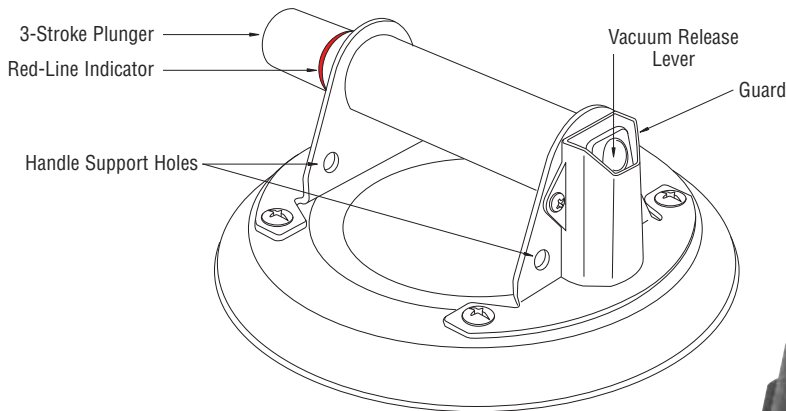

Holes in Handle for Optional Guide Ropes



Protective Carrying Case Included

## CRL S108 8" Pump-Action Vacuum Lifter

- Proven Reliability Throughout the World
- Fast, Safe Attachment to Smooth, Nonporous Flat Surfaces
- Four Extra Mounting Points Make it Easy to Attach to Metal Lifting Frames, Jigs, and Our Vacuum Ratchet Tensioning Kit
- Heavy-Duty 5 mm Thick ABS Handle Resists Bending, Especially During Heavy Lifts
- Eligible for Exchange Program



The CRL Cat. No. S108 8" (203 mm) Pump-Action Vacuum Lifter is designed to make the carrying of large flat glass lites safe and easy. The basic components are a tough ABS handle, with zinc plated parts designed not to rust, attached to a precision molded rubber suction pad.

Vacuum attachment is achieved to nonporous surfaces by depressing the pump plunger 8 to 12 times until it stays well within the handle, beyond the red safety band that is easily seen against the plunger color. The heavy 3/16" (5 mm) walls of the handle resist bending, and will not dent like metal handles.

Once the attachment has been achieved the glass lite can easily be lifted by hand. The rubber pad has the capability of handling almost any manual lift without damaging delicate surfaces, and can be released instantly by pressing the thumb release.

The four extra mounting points set the S108 apart from other pump style Vacuum Lifters. Here you can easily mount multi-use brackets of your own design or use. Examples of this can be seen on our CRL Vacuum Ratchet Tensioning Kit (see below), and Vacuum Base Portable Drilling Machine shown on page 156K.

All Cat. No. S108 Vacuum Lifters include a sturdy, protective Carrying Case. Minimum order is one each.

### A Proud History of Proven Performance

CRL "S" Series Pump-Action Vacuum Lifters have developed into the high performance products they are today through many years of successful refinement.

- 1989 to 1992  
Australian company AGT identified a local need for replacement pads. The success of the spare parts program stimulated the desire to develop the S108 Vacuum Lifter.
- April 1992  
AGT designed and commissioned tooling for the production of the initial version of the S108 Vacuum Lifter. Australia wide distribution was rapidly achieved during the second half of 1992 via a network of wholesalers situated in all major capital cities.
- November 1992  
First export order ships overseas.
- March 1993  
Exports to the UK and Europe were established with Ebor Equipment Ltd. Ebor was subsequently appointed as the "exclusive agent" for the UK.

From this point, word spread of the reliability and performance of these Lifters. In 1999 suitable molding equipment was purchased for in-house manufacture and quality control testing.

During the past 18 years over 300,000 units have been manufactured and sold worldwide. Parts refinement of the 11 major components continues today to ensure that the highest level of quality is achieved.

## CRL S108 Independent Testing Results

- All CRL "S" Series Vacuum Lifters Are Tested to Ensure Your Safety
- Multiple Tests Were Made for Each Style Vacuum Lifter

Based on the independent laboratory testing at Advanced Technology Testing and Research in Springvale, Victoria, Australia, quality assurance at the highest level is maintained during all phases of CRL Manufactured Vacuum Lifters.

Under stringent conditions, our Vacuum Lifters were set up in an Instron Tensile Test Machine using a specially designed rig to secure the Vacuum Lifter and a glass plate. Load was then applied at a constant rate until a failure took place well above our noted lifting capacities.



## CRL Vacuum Ratchet Tensioning Kit

- Uses S108 Vacuum Lifter Mounting Points
- Pulls With Tremendous Force

The CRL Vacuum Ratchet Tensioning Kit is designed to pull two flat surfaces or seams together. They are perfect for Formica countertops, marble and granite, flooring, cladding, mirrors, glass, plastic, or any situation in which flat, nonporous surfaces need to be pulled together.

While one set is handy, large mirrors and counters usually need two sets, one on each corner, for an even pull. The ratchet can be removed in order to use the Lifters alone as manual lift aids. Minimum order is one each.

**NOTE:** Minimum order is one each. Cat. No. S108 Vacuum Lifters are sold separately.



CAT. NO. G0284

## CRL 8" ABS Handle Vacuum Lifter for Curved Surfaces

- Designed Primarily for Lifting Curved Architectural Glass
- Red-Line Indicator Warns User of Any Vacuum Loss
- Providing Safe Lifting to the Industries Since 1992
- Eligible for Exchange Program



Lifting Capacity  
125 Lbs. (57 kg)



CRL Pump-Up Vacuum Lifters for Curved Glass are designed to make the carrying and lifting of large architectural curved glass sheets, windscreens (windshields), and thin flexible materials such as 1/16" (2 mm) sheet metals safe and easy. The handle is composed of tough ABS plastic, and the rubber suction cup has a diameter of 8" (203 mm). Vacuum attachment to flat, non-porous surfaces is achieved in a few seconds by depressing the pump's plunger until it stays well within the handle, beyond the red-line safety indicator. Once attachment has been achieved the glass sheet can be lifted easily by hand. The rubber cup has the capability of handling almost any manual lift without damaging the delicate surface, and is released instantly from the material by pressing the thumb release. It comes with a protective Carrying Case. Minimum order is one each.

CAT. NO. S109

## CRL 10" ABS Handle Vacuum Lifter for Flat Surfaces

- Designed to Carry Large Sheets of Glass, Marble or Stone Safely
- Supplied With Protective Carrying Case
- Providing Safe Lifting to the Industries Since 1992
- Eligible for Exchange Program

Lifting Capacity  
175 Lbs. (80 kg)

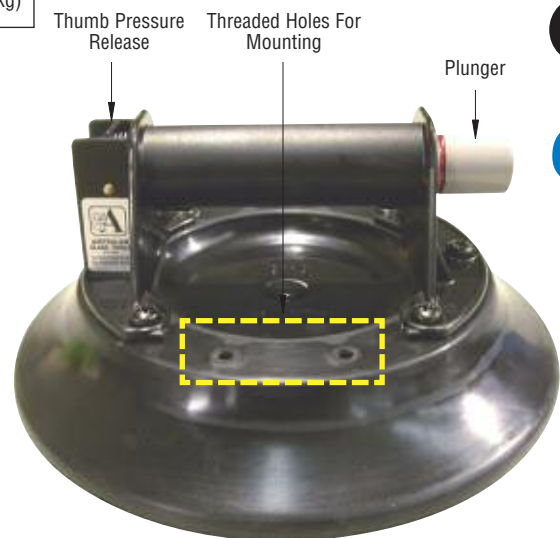

CRL Pump-Up Vacuum Lifters are designed to make the carrying and lifting of large glass sheets, marble or stone safe and easy. The handle is composed of tough ABS plastic, and the rubber suction cup has a diameter of 10" (254 mm). Vacuum attachment to flat, non-porous surfaces is achieved in a few seconds by depressing the pump's plunger until it stays well within the handle, beyond the red-line safety indicator. Once attachment has been achieved the glass sheet can be lifted easily by hand. The rubber cup has the capability of handling almost any manual lift without damaging the delicate surface, and is released instantly from the material by pressing the thumb release. It comes with a protective Carrying Case. Minimum order is one each.

CAT. NO. S110

# CRL HAND HELD VACUUM LIFTERS

For Pricing Visit [crlaurence.com](http://crlaurence.com) or Call Us Toll Free at the Phone Numbers Shown on the Back Cover

## CRL Vertical Handle Vacuum Lifter

- **Lightweight ABS Handle, Designed for Convenient Hand Placement**
- **Large-Volume Pump for Quick Attachment on Curved or Flat Surfaces**
- **Red-Line Indicator Warns User of Any Vacuum Loss**

The ideal tool for removing or installing windshields or custom bent glass. The S106VHP Vertical Handle Vacuum Lifter provides comfortable hand placement when ordinary handles cannot. Its large volume pump permits quick attachment on both curved and flat glass surfaces. A rigid handle provides support for easy glass positioning, while non-slip grip holds the glass securely at any angle. The flexible pad conforms to the surface, and then flattens out, providing maximum gripping power. It is supplied with a vacuum pad protector. Pad measures 6" (152 mm) in diameter. Minimum order is one each.



Lifting Capacity  
55 lbs. (25 kg)



CAT. NO. S106VHP

## CRL Vacuum Lifter With Bail Handle

- **Red-Line Indicator Warns User of Any Vacuum Loss**

The narrow profile of the S106BH Vacuum Lifter makes them an excellent tool for pulling glass sheets from narrow storage locations, as well as for general purpose handling. Designed to work with flat or curved glass, the rubber pad has a dual seal system to protect against vacuum loss. It is also handy for pulling sheet materials from storage racks. It is supplied with a vacuum pad protector. Pad is 5-7/8" (150 mm) in diameter. Minimum order is one each.



Lifting Capacity  
66 lbs. (30 kg)



CAT. NO. S106BH

## CRL Vacuum Lifters With Threaded Mounts

- **Accessory Mount With Threaded Stud for Attaching Equipment**
- **Two Thread Sizes to Choose From 1/4"-20 and 3/8"-16**



CRL Thread Mounting Vacuum Lifters are ideal for temporary mounting of equipment such as telescopes, cameras, and survey equipment. Choose from either a 1/4"-20 or 3/8"-16 threaded mount. The rubber suction pad diameter is 6" (152 mm). Each Lifter is supplied with a vacuum pad protector.

CAT. NO.	THREAD SIZE	LIFTING CAPACITY
S114MC	1/4"-20	55 lbs. (30 kg)
S138MC	3/8"-16	55 lbs. (30 kg)

Minimum order: 1 each.



CAT. NO. S114MC



CAT. NO. S138MC



# CRL HAND HELD VACUUM LIFTERS

For Pricing Visit [crlaurence.com](http://crlaurence.com) or Call Us Toll Free at the Phone Numbers Shown on the Back Cover

## CRL Vacuum Lifter Exchange Program

- Your Safety Is Our Concern - Never Use Unsafe Vacuum Lifters
- Conserve Resources - Exchange Your CRL Vacuum Lifter Instead of Replacing It
- Available From All C.R. Laurence Shipping Locations

C.R. Laurence offers an exchange service to keep your Vacuum Lifters in safe operating condition. Exchanges may be made for 6" (152 mm) Cat. No. S106VHP Vertical Handle Vacuum Lifters, 8" (203 mm) Cat. No. S108 ABS Handle Vacuum Lifters, 8" (203 mm) Cat. No. S338 Sure-Grip Vacuum Lifters, 8" (203 mm) Cat. No. S109 ABS Handle Vacuum Lifters for curved glass, and 10" (254 mm) diameter Cat. No. S110 ABS Handle Vacuum Lifters.

Because this service relies on a continued source of parts to recondition, a remanufactured Vacuum Lifter is only available in exchange for another lifter. Minimum order is one each.



Exchange This (Worn)



For This (Reconditioned)



CAT. NO. XCS106VHP



CAT. NO. XCS338



CAT. NO. XCS108



CAT. NO. XCS109



CAT. NO. XCS110

Your CRL Vacuum Lifter is a valuable tool, but like any other frequently used item it can wear out or become damaged. Your options at this point are to replace it (costly), or repair it (time-consuming). CRL now offers an alternative that saves both time and money – the CRL Exchange Program. Bring your worn Vacuum Lifters to any C.R. Laurence warehouse or send it there by UPS or mail. We replace it with a factory reconditioned lifter, normally within 24 hours, at a price that beats buying a new one, and is comparable (and quicker) than having it repaired. We can perform this service at each of our conveniently located warehouses, reducing turnaround and shipping times. Remanufactured (exchanged) Vacuum Lifters meet exacting factory specifications and pass the same tests as new ones.

## CRL Web Site Forms and Address Labels

If you are unable to bring your CRL Vacuum Lifters to a CRL warehouse location, please visit our web site, [crlaurence.com](http://crlaurence.com) and enter "EXCHANGE FORMS" in the search box. There you will be guided to our page where you can download and print our exchange form as well as a shipping label for your nearest CRL warehouse.

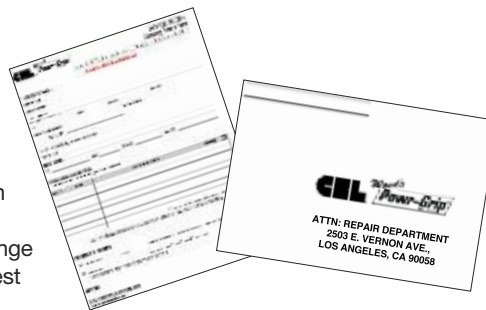

## CRL Vacuum Handling Equipment Repair Service

- Keep Your Vacuum Lifting Equipment Safe

C.R. Laurence Co. also offers a repair service to keep all your vacuum handling equipment in safe operating condition. We are the only authorized service center for Wood's Powr-Grip® products. To arrange repairs, please contact CRL Customer Service Department by e-mail at [glazing@crlaurence.com](mailto:glazing@crlaurence.com) or call us in the U.S. at (800) 421-6144, from Canada at (877) 421-6144, or (323) 588-1281 International, and ask for extension 5275.

Wood's Powr-Grip is a registered trademark of Wood's Powr-Grip Co., Inc.



# CRL HAND HELD VACUUM LIFTERS

For Pricing Visit [crlaurence.com](http://crlaurence.com) or Call Us Toll Free at the Phone Numbers Shown on the Back Cover

## CRL Octopus 70 Single Pad Suction Lifter

- Pump Action Type
- Includes Plastic Carrying Case
- 152 mm Diameter



Available Only in Europe

Lifting Capacity  
70 kg (154 Lbs.)



The CRL Octopus 70 Single Pad Suction Lifter is a pump action type for applying suction to glass or other smooth, nonporous flat surfaces. Pump incorporates a suction loss warning device. Supplied in a heavy-duty plastic carrying case. 152 mm (6") diameter pad. Lifting capacity is approximately 70 kilograms (154 lbs.). Minimum order is one each.

CAT. NO. 0504

## CRL Octopus 150 Single Pad Suction Lifter

- Pump Action Type
- Includes Plastic Carrying Case
- 203 mm Diameter



Available Only in Europe

Lifting Capacity  
150 kg (330 Lbs.)



The CRL Octopus 150 Single Pad Suction Lifter is a pump action type for applying suction to glass or other smooth, nonporous flat surfaces. Pump incorporates a suction loss warning device. Supplied in a heavy-duty plastic carrying case. 203 mm (8") diameter pad. Lifting capacity is approximately 150 kilograms (330 lbs.). Minimum order is one each.

CAT. NO. 0505

## CRL Octopus 150W Single Pad Suction Lifter With Gauge

- Built-in Pressure Gauge
- Pump Action Type
- Includes Plastic Carrying Case
- 203 mm Diameter



Available Only in Europe

Lifting Capacity  
150 kg (330 Lbs.)



The CRL Octopus 150W Single Pad Suction Lifter is a pump action type with a Built-in Pressure Gauge to monitor vacuum while lifting glass or other smooth, nonporous flat surfaces. Supplied in a heavy-duty plastic carrying case. 203 mm (8") diameter pad. Lifting capacity is 150 kilograms (330 lbs.). Minimum order is one each.

CAT. NO. 0510

## CRL Octopus Accessories and Replacement Parts



Available Only in Europe



Carrying Case  
CAT. NO. 0510B



Replacement Piston  
CAT. NO. 0530  
For 70 Series  
CAT. NO. 0531  
For 150 Series



Replacement Miniskirt  
CAT. NO. 0534  
For 70 Series  
CAT. NO. 0535  
For 150 Series

Minimum order for all Replacement Parts is one each.

## An Industry Standard for Over 45 Years

When a tool maintains its presence as a professional quality necessity to the glazing industry year after year, you know it's reliable. Every aspect of these CRL Vacuum Cups is heavy-duty for long-term performance. Strong aluminum castings, thick cut-resistant rubber and rugged trigger components add up to one tough tool. Whether your lifting glass, polished stone or any other smooth non-porous material, you can depend on CRL 5" (127 mm) Heavy-Duty Vacuum Cups to do the job safely.

### CRL 5" Heavy-Duty Double Vacuum Cup

- Classic Style Cup
- Industry Proven

Lifting Capacity  
125 Lbs. (56 kg)



Two 5" (127 mm) rubber gripping pads make this Double Vacuum Cup Lifter the most practical way to put a handle on glass, marble, granite or any smooth-surface material. It has many uses including for setting mirrors, removing salvage, handling structural glass, and weighs only 3-1/2 lbs. (1.6 kg). Minimum order is one each.

CAT. NO. 550

### CRL 5" Heavy-Duty Triple Vacuum Cup

- The Professional Glazier's Choice
- Heavy-Duty

Lifting Capacity  
150 Lbs. (68 kg)



For a more positive grip on glass, try the CRL 5" (127 mm) Heavy-Duty Triple Vacuum Cup. The third 5" (127 mm) cup gives added grip, which enables the glass setter to maneuver the glass without changing the position of the cups. They are made of the same sturdy material and same size rubber as the double cup models. Minimum order is one each.

CAT. NO. 555

### CRL 5" Heavy-Duty Cross-Handle Double Vacuum Cup

- An Industry Proven Cup
- Solid Construction



Lifting Capacity  
100 Lbs. (45 kg)

Made with the same solid construction as the CRL Double Cup (above), the cross-handle design features the handle across the width rather than the length. This is the ideal lifter for those who prefer the handle in this position. It weighs 4 lbs. (1.8 kg). Minimum order is one each.

CAT. NO. 550A

### CRL 5" Heavy-Duty Single Vacuum Cup

- All-Metal Construction
- Convenient Handle Position
- Great for Smaller Size Plates



Lifting Capacity  
40 Lbs. (19 kg)

This heavy-duty, single 5" (127 mm) Vacuum Cup is ideally suited for small plates and mirrors. Minimum order is one each.

CAT. NO. 505

### CRL 5" Heavy-Duty Vacuum Cup Replacement Parts

CRL 5" (127 mm) Vacuum Cups were engineered to make the ordering of replacement parts as easy as possible. All of the above cups use the same replacement parts listed here.

CAT. NO.	DESCRIPTION
RR150	5" (127 mm) Replacement Rubber
RT152	Replacement Trigger and Pin
RP151	Replacement Pin Only
RW153	Replacement Washer (Under Trigger)

Minimum order: 1 each.

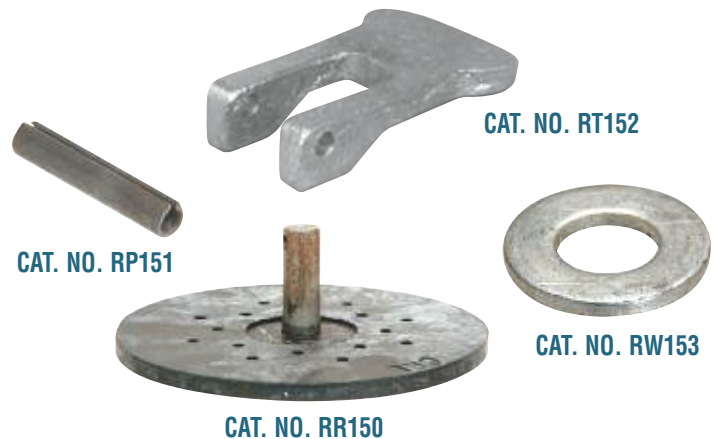

CAT. NO. RT152

CAT. NO. RP151

CAT. NO. RW153

CAT. NO. RR150

**How to Use CRL Vacuum Cups** Use only on clean, dry surfaces. Place securely on flat substrate and push down vacuum lever. Do not relieve pressure until lever is completely down. When not in use, keep lever in released (upright) position. Oil lever frequently. Keep rubber disc clean; wipe occasionally with water and mild soap solution. If vacuum cup pad is cut or severely worn, replace immediately.

## CRL Aluminum Single Pad Vacuum Lifter



Lifting Capacity  
66 Lbs. (30 kg)



- Compact Design
- One-Handed Operation

The split-handle design of the CRL Aluminum Single Pad Vacuum Lifter allows you to securely attach the pad to surfaces by simply pressing against the glass, then squeezing the two handle sections together. Also suitable for slightly curved or textured surfaces. The pad diameter is 4-1/2" (114 mm). Minimum order is one each.

CAT. NO. 05061

## CRL Aluminum Double Pad Vacuum Lifter



Lifting Capacity  
132 Lbs. (60 kg)



- Handle Design Allows Easy Maneuvering
- Strong, Lightweight Aluminum

The CRL Aluminum Double Pad Vacuum Lifter is suitable for all types of loads. Made with a combination of synthetic material and the high strength of lightweight aluminum, it has a powerful lifting capacity of 132 lbs. (60 kg). It's suitable for slightly curved or textured surfaces. The pad diameter is 4-1/2" (114 mm). Minimum order is one each.

CAT. NO. 05062

## CRL Aluminum Movable Double Pad Vacuum Lifter



Lifting Capacity  
132 Lbs. (60 kg)



- Movable Pads Self-Adjust to Curved Glass
- Suitable for Glass, Plastic, Metal, Coated Wood, Marble, and Any Other Smooth, Airtight Surface

Tested to high standards, the lightweight CRL Aluminum Double Vacuum Lifter with movable pad design attaches quickly to curved glass during use. Tilting over the levers creates a vacuum suction to the substrate. Always check for resistance caused by the vacuum build-up while doing this to ensure proper attachment is made. The lifting capacity is 132 lbs. (60 kg). The pad diameter is 4-1/2" (114 mm). Minimum order is one each.

CAT. NO. 05064

## CRL Aluminum Triple Pad Vacuum Lifter



Lifting Capacity  
220 Lbs. (100 kg)



- Three Suction Pads Individually Operated
- Strong, Lightweight Aluminum

Tilting over the three levers of the CRL Aluminum Triple Pad Vacuum Lifter produces a huge 220 lb. (100 kg) lifting capacity. As with all CRL Aluminum Vacuum Lifters, the ergonomically designed handle remains comfortable even through long use. The durable metal construction and hard coating make it tough enough for everyday use and years of reliable service. The pad diameter is 4-1/2" (114 mm). Minimum order is one each.

CAT. NO. 05063

## CRL Replacement Rubber Pad for Vacuum Lifters

- 4-1/2" (114 mm) Diameter Pad Fits Both Our Plastic and Aluminum Vacuum Lifters
- Lever Included

This CRL Replacement Pad is compatible with both our Plastic and Aluminum Vacuum Lifters. It is 4-1/2" (114 mm) in diameter and the lever is included. To order just the Lever and Pin only use Cat. No. RR0506LVR. Minimum order is one each.



CAT. NO. RR0506

## CRL Plastic Single Pad Vacuum Lifter

Lifting Capacity  
66 Lbs. (30 kg)



- Lightweight Plastic Design
- One-Handed Operation

Our lightweight CRL Plastic Single Pad Vacuum Lifter is easy to attach with its split-handle design for one-hand operation. For its weight and size, it is one of the highest capacity Lifters we sell, developing over 66 lbs. (30 kg) of lift. The pad will adhere to any smooth, non-porous surface. This is a simple, reliable, easy-to-use Vacuum Lifter. Minimum order is one each.

CAT. NO. 05061P

## CRL Plastic Double Pad Vacuum Lifter

Lifting Capacity  
132 Lbs. (60 kg)



- Two Individually Operated Pads
- Lightweight Plastic Body

The lightweight plastic body makes this easy to use on almost any surface. Individual lift tabs create suction when pulled down. To release you merely lift the tab upright. The Plastic Double Pad Vacuum Lifter has a load capacity of 132 lbs. (60 kg). The pad diameter is 4-1/2" (114 mm). Minimum order is one each.

CAT. NO. 05062P

## CRL Plastic Double Swivel Vacuum Lifter

Lifting Capacity  
132 Lbs. (60 kg)



- Plastic Handle and Double 4-1/2" (114 mm) Vacuum Pads
- Movable Pads Self-Adjust to Curved Glass

The CRL Double Swivel Vacuum Lifter is specially designed for lifting flat glass as well as the positioning and fitting of windshields or truck and bus glass. The strong, plastic body has double-swivel points to allow fast attachment to a wide variety of curved and flat surfaces. Replacement rubber pads for this cup are Cat. No. RR911. Lifting capacity is approximately 132 lbs. (60 kg). Minimum order is one each.

CAT. NO. 911VC

## CRL Plastic Triple Pad Vacuum Lifter

Lifting Capacity  
220 Lbs. (100 kg)



- Three Suction Pads Individually Operated
- Lightweight Plastic Design

This plastic-body lifter has three pads that operate individually. Pulling the individual tabs on the pads down creates the suction on the substrate. To release, the tabs are pulled to the upright position. The Vacuum Lifter can be used on almost any substrate. It has the load capacity of approximately 220 lbs. (100 kg). The pad diameter is 4-1/2" (114 mm). Minimum order is one each.

CAT. NO. 05063P

## CRL Safety Gloves

From Glass Handling Gloves to Work Gloves to Nitrile and Latex Gloves, CRL provides you with the most up-to-date products in the industry. From the very popular CRL Gauntlet Cuff Natural Rubber Gloves to the latest cut protection Atlas® Kevlar® and Nitrile Textured Gloves, CRL offers the various glove styles you need for all glass fabrication and general work requirements. See pages 264K-271K.

Atlas is a registered trademark of Showa Glove Company.  
Kevlar is a registered trademark of E.I. du Pont de Nemours and Company.



# CRL WOOD'S™ HAND HELD VACUUM CUPS

For Pricing Visit [crlaurence.com](http://crlaurence.com) or Call Us Toll Free at the Phone Numbers Shown on the Back Cover

## CRL Wood's Powr-Grip® 8" Vacuum Cup

- Durable Metal Handle
- Fast Attachment on Smooth, Nonporous Flat Surfaces
- Red-Line Indicator Warns User of Any Vacuum Loss
- Check Valve Allows Re-Pumping Without Loss of Remaining Vacuum
- Release Valve Lever Permits Quick, Complete Release
- Eligible for Exchange Program

CRL proudly offers you our Cat. No. W4950, the most popular and safest model of CRL Wood's hand held Vacuum Cups available on the market today. These specially designed, hand actuated cups operate on a pump system, and create a vacuum under the rubber pad. The pump's plunger has a red-line to indicate vacuum level at all times. When it shows less than 100% vacuum, simply pump the plunger until you reach the original vacuum pressure without removing the cup from the glass. To release, just depress the release lever on the opposite end of the handle from the plunger. These cups come with a release valve guard to prevent accidental loss of vacuum. Cat. No. W4950 has an 8" (203 mm) diameter vacuum pad, and comes with a molded Carrying Case to protect the cup when not in use. Minimum order is one each.



Lifting Capacity  
125 lbs. (57 kg)



CAT. NO. W4950



Vacuum Cups employ the force of atmospheric pressure to grip a surface: When a vacuum exists between the cup and the surface on which it is attached, the weight of Earth's atmosphere holds the cup in place with incredible force. Unlike suction cups that produce a vacuum as they pull away from the surface, Powr-Grip® Vacuum Cups use a hand-actuated pump to efficiently remove air from between the rubber pad and the attaching surface – thus creating a much more reliable hold. Because the full face of the pad is brought into contact with the surface, distortion is reduced, allowing the cup to be used on materials of almost any thickness with little risk of damage.



## CRL Wood's Air-Powered 8" Vacuum Cup

- For Use in Many Manufacturing Applications
- No Pumping Required, Uses Compressed Air to Supply Continuous Vacuum
- Release Mechanism Permits Quick and Complete Release
- Durable Metal Handle

When you combine a Wood's Powr-Grip® Cup with a compressed air supply, the result is a tool that provides a better way to manually handle glass on production lines. The W4950A1R Vacuum Cup attaches quickly without any pumping, and it never needs to be re-pumped during operation. The red-line vacuum indicator and continuous vacuum source also make this vacuum cup much safer than the slap-on suction cups sometimes used in such settings. The 8" (203 mm) diameter vacuum pad is supplied with a protective Carrying Case. Compressed air required at 3 SCFM (85 liters/minute) at 80 psi (550 kPa). Minimum order is one each.

All Wood's™ Vacuum Cups can be combined for quantity pricing.

Wood's Powr-Grip is a registered trademark of Wood's Powr-Grip Co., Inc.

Lifting Capacity  
125 lbs. (57 kg)



CAT. NO. W4950A1R



C.R. LAURENCE COMPANY

[crlaurence.com](http://crlaurence.com) | [usalum.com](http://usalum.com)

212K | [crlaurence.ca](http://crlaurence.ca) [crlaurence.com.au](http://crlaurence.com.au) [crlaurence.co.uk](http://crlaurence.co.uk) [crlaurence.de](http://crlaurence.de) [crlaurence.eu](http://crlaurence.eu)

# CRL WOOD'S™ HAND HELD VACUUM CUPS

For Pricing Visit [crlaurence.com](http://crlaurence.com) or Call Us Toll Free at the Phone Numbers Shown on the Back Cover

## CRL Wood's Powr-Grip® 9" Vacuum Cups

Lifting Capacity  
150 lbs. (68 kg)

- Durable Metal Handle
- Red-Line Indicator Warns User of Any Vacuum Loss
- Check Valve Allows Re-Pumping Without Loss of Remaining Vacuum
- Release Valve Lever Permits Quick and Complete Release
- Eligible for Exchange Program

In addition to all of the advantages of our Cat. No. W4950 8" (203 mm) diameter Vacuum Cup, the Cat. No. W5450 and W5450CS 9" (229 mm) diameter Vacuum Cups feature a higher lifting capacity for glass, and a pad with flexible edges to handle Plexiglass and other materials that may bend when lifted. The W5450CS has a more concave rubber pad designed to lift both curved and flat loads including flat glass, bent glass, and auto glass.

As with all CRL Wood's Powr-Grip® Vacuum Cups, the red-line indicator warns users of any vacuum loss, and the built-in release valve lever with guard permits quick and complete release from surfaces. Supplied with a protective Carrying Case. All Wood's Vacuum Cups can be combined for quantity pricing. Minimum order is one each.



CAT. NO. W5450



Concave Rubber Pad

CAT. NO. W5450CS

## CRL Wood's Powr-Grip® 10" Vacuum Cup

Lifting Capacity  
175 lbs. (79 kg)

- Durable Metal Handle
- Deep, Concave Pad for Easy Attachment on Curved or Irregular Non-Porous Surfaces (Not for Use on Thin, Fragile Materials)
- Red-Line Indicator Warns User of Any Vacuum Loss
- Check Valve Allows Re-Pumping Without Loss of Remaining Vacuum
- Release Valve Lever Permits Quick and Complete Release
- Eligible for Exchange Program

Designed for use with curved or bent glass, the concave vacuum pad of our Cat. No. W6450 10" (254 mm) diameter Powr-Grip® Vacuum Cup is indispensable for heavy lifting all kinds of rounded loads, with radii as small as 13" (330 mm). In addition, this Vacuum Cup has even greater lifting capacity than other CRL Wood's Powr-Grip® models. Although distorting forces are minor, it is not recommended for use on thin, fragile materials. Supplied with a protective Carrying Case. All Wood's Vacuum Cups can be combined for quantity pricing. Minimum order is one each.



CAT. NO. W6450

## CRL Wood's Powr-Grip® Protective Carrying Cases

- Protects and Preserves Cups for Optimum Performance

Made of high-impact plastic, these CRL Wood's Powr-Grip® Vacuum Cup Carrying Cases will protect and preserve your Cups to keep them safe and clean. Each Case is made to fit a specific diameter Wood's Powr-Grip® Vacuum Cup.

CAT. NO.	MAXIMUM CUP DIAMETER
4950BOX	8" (203 mm)
5450BOX	9" (229 mm)
6450BOX	10" (254 mm)

Minimum order: 1 each.

Wood's Powr-Grip is a registered trademark of Wood's Powr-Grip Co., Inc.



# CRL WOOD'S™ HAND HELD VACUUM CUPS

For Pricing Visit [crlaurence.com](http://crlaurence.com) or Call Us Toll Free at the Phone Numbers Shown on the Back Cover

## CRL Wood's Powr-Grip® Plunger Assembly With Low Vacuum Audio Alarm

- **Durable, Metal-Clad Plunger Emits an Audible Warning in the Case of a Vacuum Loss**

The Low Vacuum Audio Alarm adds another dimension of safety to handling materials with Powr-Grip's® world-famous Vacuum Cups. In addition to the visible red-line indicator, the plunger incorporates an audible indicator to signal any vacuum loss. In applications where it is difficult to maintain visual confirmation of the vacuum level, the Audio Alarm provides the security of knowing that vacuum is sufficient for lifting. With automatic on/off function, the Audio Alarm is as simple to operate as any standard Powr-Grip® cup. Minimum order is one each.

### FEATURES:

- Ideal for use with Hand Cup Frames, the Ace Dolly, and other products that incorporate hand cups not held by the user.
- Available with any new W-Series Vacuum Cup (including Cat. No. W4000, W4950, W5450, and W6450), or separately for Powr-Grip® hand cups currently in the field.
- Advanced design automatically turns alarm on or off as necessary, eliminating power switch, increasing battery life, and simplifying operation.
- Comes complete with long-lasting, easy-to-replace AAA battery.



CAT. NO. WBP1

### SPECIFICATIONS:

- Volume: 70 dBA at 36" (914 mm)
- Power Source: one AAA, 1.2-1.5 volt battery; automatic on/off function
- Battery Life: provides 30 hours of continuous tone

## CRL Wood's Powr-Grip® 8" Vacuum Cups With Low Vacuum Audio Alarm

- **8" (203 mm) Vacuum Cups With Two Handle Type Options**

CRL Wood's 8" (203 mm) diameter Vacuum Cups are available in a lightweight, heavy-duty ABS handle or durable metal handle. The Cups are easily attached to smooth, nonporous flat surfaces. The red-line indicator provides user with visual warning of any vacuum loss. Low Vacuum Audio Alarm supplements visual red-line indicator with an audible indicator, increasing peace of mind in circumstances that make it difficult to monitor the visual indicator. Advanced design automatically turns Audio Alarm on or off as necessary, eliminating power switch, increasing battery life, and simplifying operation. Release valve lever permits quick and complete release. Supplied with protective Carrying Case. Minimum order is one each.



CAT. NO. W4000WBP  
8" (203 mm) Cup with ABS Handle

Lifting Capacity  
125 lbs. (57 kg)

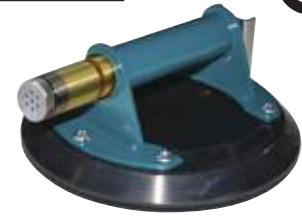

CAT. NO. W4950WBP  
8" (203 mm) Cup with Metal Handle



## CRL Wood's Powr-Grip® 9" Vacuum Cup With Low Vacuum Audio Alarm

- **Flexible Vacuum Pad Edge for Materials That May Bend or Flex When Lifted**
- **9" (229 mm) Diameter**

CRL Wood's 9" (229 mm) diameter Vacuum Cups are available with a durable metal handle. Low Vacuum Audio Alarm supplements visible red-line indicator with an audible indicator, adding a measure of safety in circumstances that make it difficult to monitor the visual indicator. Plunger emits an audible warning to the user and others, in the case of a vacuum loss. Advanced design automatically turns Audio Alarm on or off as necessary, eliminating power switch, increasing battery life, and simplifying operation. Check valve allows re-pumping without loss of vacuum. Release valve lever permits quick and complete release. Supplied with protective Carrying Case. Minimum order is one each.

Lifting Capacity  
150 lbs. (68 kg)



CAT. NO. W5450WBP  
9" (229 mm) Cup with Metal Handle



## CRL Wood's Powr-Grip® 10" Vacuum Cup With Low Vacuum Audio Alarm

- **Deep Concave Pad for Curved or Irregular Surfaces**
- **10" (254 mm) Diameter**

This CRL Wood's 10" (254 mm) diameter Vacuum Cup is available with a heavy-duty metal handle. They have deep, concave pads for easy attachment on curved or irregular nonporous surfaces. Not for use on thin, fragile materials. The minimum radius for curved loads is 13" (330 mm). Low Vacuum Audio Alarm supplements visible red-line indicator with an audible indicator, increasing peace of mind in circumstances that make it difficult to monitor the visual indicator. Advanced design automatically turns Audio Alarm on or off as necessary, eliminating power switch, increasing battery life, and simplifying operation. Release valve lever permits quick and complete release. Supplied with protective Carrying Case. Minimum order is one each.

Lifting Capacity  
175 lbs. (79 kg)



CAT. NO. W6450WBP  
10" (254 mm) Cup with Metal Handle



All Wood's™ Vacuum Cups can be combined for quantity pricing.  
Wood's Powr-Grip is a registered trademark of Wood's Powr-Grip Co., Inc.



C.R. LAURENCE COMPANY

[crlaurence.com](http://crlaurence.com) | [usalum.com](http://usalum.com)

214K | [crlaurence.ca](http://crlaurence.ca) [crlaurence.com.au](http://crlaurence.com.au) [crlaurence.co.uk](http://crlaurence.co.uk) [crlaurence.de](http://crlaurence.de) [crlaurence.eu](http://crlaurence.eu)



## CRL Wood's Powr-Grip® 8" ABS Handle Vacuum Cup

- Lightweight, Heavy-Duty ABS Handle
- Check Valve Allows Re-Pumping Without Loss of Remaining Vacuum
- Release Valve Lever Permits Quick and Complete Release
- Fast Attachment on Smooth, Nonporous Flat Surfaces
- Red-Line Indicator Warns User of Any Vacuum Loss
- Supplied With Protective Carrying Case
- Eligible for Exchange Program

The W4000 is a value priced Vacuum Cup for use with flat glass. The ABS polymer used in the pump and handle makes the Cup lightweight, strong, and rust-resistant. A red-line on the pump's plunger indicates the vacuum level of the W4000. When the 8" (203 mm) diameter Cup is attached completely, the plunger is partially hidden inside the pump and the red-line is not visible. A visible red-line indicates vacuum is not sufficient for lifting. If the red-line starts to show during a lift, a check valve allows the user to re-pump the Vacuum Cup without losing the remaining vacuum. When the lift is completed, a release mechanism allows air to refill the evacuated space under the Vacuum Pad, so that release is complete.



CAT. NO.	DESCRIPTION	LIFTING CAPACITY
W4000	8" (203 mm) ABS Handle Vacuum Cup	125 lbs. (57 kg)

Minimum order: 1 each.

## CRL Wood's Powr-Grip® Hybrid Handle Vacuum Cups

- Easy Attachment on Smooth, Nonporous Surfaces
- Durable Metal Handle With ABS Plunger
- Red-Line Indicator Warns User of Any Vacuum Loss
- Rust-Resistant Components

CRL Wood's Vacuum Cups with Hybrid Plunger/Handles combine Powr-Grip's® lightweight ABS plunger, durable metal handle, and rubber vacuum pad to create a heavy-duty, rust resistant cup for use in humid or wet environments. Reliable and economical, these vacuum cups work for handling windows and other flat glass products, as well as for handling stone slabs in fabrication settings. A built-in check valve allows re-pumping without loss of vacuum, and a release lever permits quick and complete release. Supplied with protective Carrying Case.



CAT. NO.	DESCRIPTION	LIFTING CAPACITY
H4300	8" (203 mm) Hybrid Handle Vacuum Cup	125 lbs. (57 kg)
H5300	9" (229 mm) Hybrid Handle Vacuum Cup	150 lbs. (68 kg)
H6300	10" (254 mm) Hybrid Handle Vacuum Cup*	175 lbs. (79 kg)

Minimum order: 1 each. \* Designed for use with curved surfaces. Do not use for thin, fragile materials.

## CRL Wood's Powr-Grip® Textured Surface Vacuum Cups

- 8" (203 mm) Diameter Cup Specifically Designed for Patterned or Irregular Glass
- Available in Two Models (Metal or ABS Handle)

The CRL Wood's Powr-Grip® Textured Surface Cup features a softer vacuum pad with a larger sealing edge specifically designed for irregular surfaces such as textured glass. The 8" (203 mm) diameter pad is made of a low durometer rubber, so the cup will attach to most textured surfaces, and carries a 75 lb. (34 kg) lifting capacity. Available in two styles: Cat. No. TS8M Metal Handle; Cat. No. TS8P ABS Handle. Both Cups are supplied with a protective Carrying Case.

**NOTE:** Although made specifically for patterned or irregular glass, the Cup can not be guaranteed to work on materials having extreme surface variations.

All Wood's™ Vacuum Cups can be combined for quantity pricing. Wood's Powr-Grip is a registered trademark of Wood's Powr-Grip Co., Inc.



CAT. NO. TS8M  
Metal Handle Cup



CAT. NO. TS8P  
ABS Handle Cup

CAT. NO.	DESCRIPTION	LIFTING CAPACITY
TS8M	8" (203 mm) Metal Handle Textured Surface Vacuum Cup	75 lbs. (34 kg)
TS8P	8" (203 mm) ABS Handle Textured Surface Vacuum Cup	75 lbs. (34 kg)

Minimum order: 1 each.

## CRL Wood's Powr-Grip® 6" Vertical Handle Vacuum Cup

- Durable Metal Handle, Designed for Convenient Hand Placement
- Handle Position is Ideal for Use With Windshields
- Large-Volume Pump for Quick Attachment on Curved or Flat Surfaces
- Red-Line Indicator Warns User of Any Vacuum Loss
- Lift Tabs on Pad Edges Permit Instant Release
- Eligible for Exchange Program
- Available With Standard or Low Vacuum Audio Alarm Plunger



Lifting Capacity  
70 lbs. (32 kg)

The ideal tool for removing or installing windshields or custom bent glass, the W6100 Wood's Powr-Grip® 6" (152 mm) Vertical Handle Vacuum Cup provides comfortable hand placement when ordinary handles can't. Its large volume pump permits quick attachment on both curved and flat glass surfaces. A rigid handle provides support for easy glass positioning, while non-slip grip holds the glass securely at any angle. The flexible cup conforms to the surface, then flattens out, providing maximum gripping power. Supplied with vacuum pad protector.

CAT. NO.	DESCRIPTION
W6100	Cup With Standard Plunger
W6100WBP	Cup With Low Vacuum Audio Alarm Plunger

Minimum order: 1 each. All Wood's Cups can be combined for quantity pricing.

## CRL Wood's Powr-Grip® 6" Rigid Handle Vacuum Cups

- Offset, Fixed Handle Helps Prevent Load From Swinging or Changing Orientation When Lifted
- Strong Enough for Most Jobs, Yet Small Enough to Fit in a Tool Box
- Red-Line Indicator Warns User of Any Vacuum Loss
- Lift Tabs on Pad Edges Permit Instant Release



CAT. NO. W6250  
For Flat Materials

Lifting Capacity  
70 lbs. (32 kg)



CAT. NO. W6200  
For Curved Materials

Compact and portable, these CRL Wood's Powr-Grip® 6" (152 mm) Rigid Handle Vacuum Cups put a handle where you want it on awkward, bulky items such as storm windows or shower doors. Cat. No. W6250 uses a flat pad for quick attaching on flat surfaces; the W6200 is for curved or flat surfaces. The rigid handle style is conveniently sized for use in the glass shop or at the installation site. Supplied with vacuum pad protector. Minimum order is one each.

Wood's Powr-Grip is a registered trademark of Wood's Powr-Grip Co., Inc.

## CRL Wood's Powr-Grip® 6" Flip Handle Vacuum Cups

- Flip-Over Bail Handle Permits Load to Swing or Change Orientation as Needed
- Red-Line Indicator Warns User of Any Vacuum Loss
- Lift Tabs on Pad Edges Permit Instant Release



Lifting Capacity  
70 lbs. (32 kg)



CAT. NO. W6300  
For Flat Materials

CAT. NO. W6350  
For Curved Materials

CAT. NO. TL6TD  
Flat or Curved Materials

The narrow profile of the CRL Wood's Powr-Grip® 6" (152 mm) Flip Handle Vacuum Cups makes them an excellent tool for pulling glass sheets from narrow storage locations, as well as for general purpose handling. Cat. No. W6300 uses a flat pad for quick attachment on flat surfaces; the W6350 and the TL6TD are for curved or flat surfaces. They are large enough for most manual lifts, yet small enough to fit in a toolbox. This makes them convenient to use in the glass shop or at the installation site. Supplied with vacuum pad protector. Minimum order is one each.

## CRL Wood's Powr-Grip® Vacuum Cup Exchange Program

- Your Safety is Our Concern-Never Use Unsafe Vacuum Cups
- Conserve Resources-Exchange Your Powr-Grip® Vacuum Cup Instead of Replacing It
- Exchanges Available for Catalog Numbers W4950, W4000, W5450, W6450, and W6100
- Available From All C.R. Laurence Shipping Locations

C.R. Laurence offers an exchange service to keep your vacuum cups in safe operating condition. Exchanges may be made for 8" (203 mm) Cat. No. W4950 Metal Handle Vacuum Cups, 8" (203 mm) Cat. No. W4000 ABS Handle Vacuum Cups, 9" (229 mm) Cat. No. W5450 Metal Handle Vacuum Cups, 10" (254 mm) Cat. No. W6450 Metal Handle Vacuum Cups, and 6" (152 mm) Cat. No. W6100 Vertical Handle Vacuum Cups.



Exchange This (Worn)



For This (Reconditioned)



CAT. NO. XC4950



CAT. NO. XC4000



CAT. NO. XC5450



CAT. NO. XC6450



CAT. NO. XC6100

Your Wood's Powr-Grip® might be one of your most valuable tools, but like any other frequently used item it can wear out or become damaged. Your options at this point are to replace it (costly), or repair it (time-consuming). CRL now offers an alternative that saves both time and money—the CRL Wood's Powr-Grip® Exchange Program. Bring your worn Powr-Grip® Vacuum Cups to any C.R. Laurence warehouse or send it there by UPS or mail. We replace it with a factory reconditioned cup, normally within 24 hours, at a price that beats buying a new one, and is comparable (and quicker) than having it repaired. We can perform this service at each of our conveniently located warehouses, reducing turnaround and shipping times. Remanufactured (exchanged) vacuum cups meet the exact factory specifications and pass the same tests as new ones.

EXCHANGE CAT. NO.	DESCRIPTION
XC4950	8" Metal Handle Vacuum Cup
XC4000	8" ABS Handle Vacuum Cup
XC5450	9" Metal Handle Vacuum Cup
XC6450	10" Metal Handle Vacuum Cup
XC6100	6" Vertical Handle Vacuum Cup

## CRL Web Site Forms and Address Labels

If you are unable to bring your Powr-Grip® Vacuum Cups to a CRL warehouse location, please visit our web site, [crlaurence.com](http://crlaurence.com) and enter "exchange forms" in the search box. There you will be guided to our page where you can download and print our exchange form, as well as a shipping label for your nearest CRL warehouse.

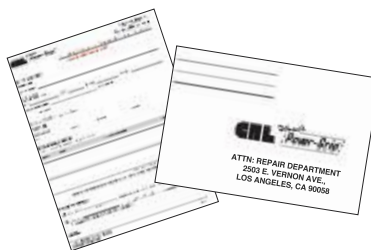

## CRL Vacuum Handling Equipment Repair Service

- Keep Your Vacuum Lifting Equipment Safe

C.R. Laurence also offers a repair service to keep all your vacuum handling equipment in safe operating condition. We work with Wood's Powr-Grip® (the only authorized service center for Wood's Powr-Grip® products) to service your equipment, big or small. To arrange repairs, please contact CRL Customer Service Department by e-mail at [glazing@crlaurence.com](mailto:glazing@crlaurence.com) or call us in the U.S. at (800) 421-6144, from Canada at (877) 421-6144, or (323) 588-1281 International, ask for extension 5275.

Wood's Powr-Grip is a registered trademark of Wood's Powr-Grip Co., Inc.



# CRL WOOD'S™ HAND HELD VACUUM CUPS

For Pricing Visit [crlaurence.com](http://crlaurence.com) or Call Us Toll Free at the Phone Numbers Shown on the Back Cover

## CRL Wood's Powr-Grip® Handi-Grip™ Vacuum Cups

### • Rugged and Convenient Aluminum Handles

CRL Wood's Powr-Grip® Vacuum Cups with Handi-Grip™ handles are designed to easily lift and position a wide variety of items including windshields, stone tiles, and sheet materials. They are available in styles for gripping smooth, curved, or flat nonporous surfaces. The red-line indicator warns the user of any vacuum loss, and a check valve allows re-pumping without loss of the remaining vacuum. Lift tabs on the pad edges permit instant release. Each Cup comes with a vacuum pad protector.



CAT. NO. LJ45HG



CAT. NO. TL6HG



CAT. NO. LP6HG

CAT. NO.	DIAMETER	FOR SURFACES	LIFTING CAPACITY
LJ45HG	4-1/2" (114 mm)	Smooth, Flat or Curved	40 Lbs. (18 kg)
TL6HG	6" (152 mm)	Smooth, Flat or Curved	70 Lbs. (32 kg)
LP6HG	6" (152 mm)	Smooth or Flat	70 Lbs. (32 kg)

Minimum order: 1 each.

## CRL Wood's Powr-Grip® Vacuum Cups With Threaded Holes and Studs

### • Durable Polycarbonate Accessory Mount Vacuum Cups for Attaching Equipment

These versatile CRL Wood's Powr-Grip® 4-1/2" (114 mm) and 6" (153 mm) Mounting Cups provide a reliable, temporary fastener on almost any smooth, curved, or flat nonporous surface such as metal or glass. Choose from either Cat. Nos. LJ45AMP or TL6AM with a 1/4"-20 x 3/8" (9.5 mm) stud or Cat. No. LJ45AMC with 1/4"-20 threaded insert. All feature a red-line indicator to warn users of any vacuum loss, and check valves that allow re-pumping without the loss of the remaining vacuum. Cups come with a vacuum pad protector. Minimum order is one each.



CAT. NO. LJ45AMP



CAT. NO. LJ45AMC



CAT. NO. TL6AM

CAT. NO.	DIAMETER	FOR SURFACES	LIFTING CAPACITY
LJ45AMP	4-1/2" (114 mm)	Smooth or Flat	40 Lbs. (18 kg)
LJ45AMC	4-1/2" (114 mm)	Smooth or Flat	40 Lbs. (18 kg)
TL6AM	6" (152 mm)	Smooth, Flat or Curved	70 Lbs. (32 kg)

Minimum order: 1 each.

## CRL Wood's Powr-Grip® 10" Vacuum Cup With Mounting Plate

### • Big 10" Concave Vacuum Cup for Attaching Equipment

This CRL Wood's Powr-Grip® 10" (254 mm) Concave Vacuum Cup attaches to flat and curved surfaces with a minimum radius of 13" (330 mm). The aluminum accessory mount has both 1/4"-20 and 3/8"-16 thread tapped holes for attaching equipment. The red-line indicator warns of vacuum loss. Supplied with a vacuum pad protector. Minimum order is one each.



Lifting Capacity  
175 lbs. (79 kg)

CAT. NO. N6000BP

All Wood's™ Vacuum Cups can be combined for quantity pricing.  
Wood's Powr-Grip is a registered trademark of Wood's Powr-Grip Co., Inc.



C.R. LAURENCE COMPANY

[crlaurence.com](http://crlaurence.com) | [usalum.com](http://usalum.com)

218K | [crlaurence.ca](http://crlaurence.ca) [crlaurence.com.au](http://crlaurence.com.au) [crlaurence.co.uk](http://crlaurence.co.uk) [crlaurence.de](http://crlaurence.de) [crlaurence.eu](http://crlaurence.eu)

## CRL Wood's Powr-Grip® Low Marking Vacuum Cup

**new**

- Low-Marking Rubber Compound Will Not Mark or Stain Most Surfaces
- Lipped Vacuum Pad Attaches Faster and Easier to Nonporous Flat Surfaces
- Red-Line Indicator Warns User of a Significant Vacuum Loss
- Cast Metal Handle

Lifting Capacity  
125 lbs. (57 kg)



CRL Wood's Powr-Grip® Low Marking Vacuum Cup features all the advantages of the original W Series metal cups plus additional benefits: a cast metal handle provides improved comfort and corrosion-resistance, a lipped vacuum pad attaches faster and easier to all kinds of flat glass products, including pattern glass, and low-marking rubber compound makes glass clean-up simple. Supplied with a protective carrying case. 8" (203 mm) diameter. Minimum order is one each.

CAT. NO. W4800LM

## CRL Wood's Powr-Grip® High-Elevation Vacuum Cup

**new**

- Designed for Use at Elevations Up to 12,000 Feet (3658 m)
- Blue Plunger Enables User to Distinguish This Vacuum Cup From Standard Cups

Lifting Capacity  
100 lbs. (45 kg)



For years, there has been a void in the vacuum lifting market when it comes to performance at higher elevations. CRL Wood's Powr-Grip's® W4100 is a new breed of vacuum cup that is specifically designed to fill this void and function at elevations up to 12,000 feet (3658 m).

The W4100 features a lightweight, rugged ABS handle that helps prevent user fatigue. It attaches rapidly to smooth, flat nonporous surfaces ranging from glass to metal. While in use, the CRL Wood's Powr-Grip® red-line indicator warns the user of any loss of vacuum. The W4100 is supplied with a protective carrying case. 8" (203 mm) diameter. Minimum order is one each.

CAT. NO. W4100

## CRL 7" Curved Glass Vacuum Cup

**new**

- Ideal for Use on Windshields
- Red-Line Indicator Warns User of Any Vacuum Loss
- Durable Metal Handle and Brass Plunger
- Concave Pad for Curved Surface

Lifting Capacity  
70 lbs. (32 kg)



The ideal tool for removing or installing windshields or custom bent glass, the CRL 7" Curved Glass Vacuum Cup provides comfortable and secure handling of glass with its unique style metal handle. Concave pad allows attachment to curved glass found on automobile windshields and can also be used on flat surfaces. Red-Line indicator on brass plunger warns user of any vacuum loss. Lift tab on the edge of the pad permits instant release. Minimum order is one each.

CAT. NO. WH9601HP7B

## CRL Rectangular Single Suction Cup

**new**

- Unique Rectangular Shape Pad
- Swivel Handle
- 6-1/4" x 3-1/2" Pad

Lifting Capacity  
40 lbs. (18 kg)



The powerful suction created by this CRL Rectangular Single Suction Cup can lift small to moderate loads of glass, sheet metal, plastic, or just about any material that has a flat, non porous surface. The rectangular 6-1/4" x 3-1/2" (159 x 89 mm) surface of this cup permits attachment to shapes that are otherwise not permitted by standard round profile vacuum cups. Its large swivel handle assures a positive grip, and the large distance from handle to cup allows users to wear gloves. Strong aluminum body casting, thick cut-resistant rubber pad, and rugged trigger add up to one tough tool. Minimum order is one each.

CAT. NO. WH9601S

Wood's Powr-Grip is a registered trademark of Wood's Powr-Grip Co., Inc.

## CRL Wood's Powr-Grip® Vacuum Cups With Nukklehead Mount

CRL Wood's Powr-Grip® Vacuum Cups with the Nukklehead Mount allow attachment of cameras, scopes, and camcorders with standard 1/4"-20 threads using a Bogen Manfrotto® Model 155 Camera Mount. It mounts photographic umbrellas in screw-down side receptacles as it provides a reliable, temporary vacuum mount without drilling holes. It attaches to most flat or curved smooth, nonporous surfaces. The red-line indicator warns the user of any vacuum loss, and the check valve allows you to re-pump without losing any of the remaining vacuum. Lift tabs on the vacuum pad edges allow instant release from the surface. Supplied with a vacuum pad protector.



- Accessory Mount With Double Ball-Joint Head for Panning, Tilting, and Rotating
- Standard 1/4"-20 Thread

CAT. NO.	CUP DIAMETER	LOAD CAPACITY
TL6PH155	6" (152 mm)	8.9 Lbs. (4 kg)
LJ45PH155	4-1/2" (114 mm)	8.9 Lbs. (4 kg)

Minimum order: 1 each. All Wood's Vacuum Cups can be combined for quantity pricing.

## CRL Wood's Powr-Grip® Vacuum Cups With Gripper Head

The CRL Cat. No. TL6PH3025 comes with a black aluminum accessory mount, while the Cat. No. LJ45PH3025 comes with ABS accessory mount. Both have fully adjustable pan-and-tilt heads. Features a Bogen™ Model 3025 camera head mount to mount cameras, scopes, and camcorders with standard 1/4"-20 threads to provide a reliable, temporary vacuum mount without drilling holes. This mounting device attaches to flat or curved smooth, nonporous surfaces. The rubber vacuum pad will not mark or damage most surfaces. The red-line indicator warns the user of any vacuum loss, and the check valve allows re-pumping without loss of remaining vacuum. Supplied with a vacuum pad protector.



- Bogen™ Camera Mount With 1/4"-20 Thread
- Lift Tabs Permit Instant Release

CAT. NO.	CUP DIAMETER	LOAD CAPACITY
TL6PH3025	6" (152 mm)	6.7 Lbs. (3 kg)
LJ45PH3025	4-1/2" (114 mm)	6.7 Lbs. (3 kg)

Minimum order: 1 each. All Wood's Vacuum Cups can be combined for quantity pricing.

## CRL Wood's Powr-Grip® Vacuum Cup With Cleat Head

Use this CRL Wood's Powr-Grip® Vacuum Cup With Cleat Head to mount cameras, scopes, and camcorders with standard 1/4"-20 threads to provide a reliable, temporary vacuum mount without drilling holes. The 4-1/2" (114 mm) rubber vacuum pad will not mark or damage flat or curved smooth nonporous surfaces. The red-line indicator warns the user of any vacuum loss, and the check valve allows re-pumping without loss of the remaining vacuum. Lift tabs on the vacuum pad edges permit instant release. Supplied with a vacuum pad protector. Minimum order is one each.



- Durable Black Polycarbonate Accessory Mount
- Fully Adjustable Pan-and-Tilt Head
- Load Capacity: 10 Lbs. (5 kg)

CAT. NO. LJ45PHC

## CRL Wood's Studs

- Adapter to Mount Photographic Lights
- Two Sizes Available



Use with Cleat, Gripper, Nukklehead or other mounting cups to mount photographic lights on almost any smooth nonporous surface. Choose from Cat. No. AS375 3/8" (9.5 mm) diameter by 2" (51 mm) length, or Cat. No. AS625 5/8" (16 mm) diameter by 3" (76 mm) length to fit on 1/4"-20 studs.

CAT. NO.	DIAMETER	LENGTH
AS375	3/8" (9.5 mm)	2" (51 mm)
AS625	5/8" (16 mm)	3" (76 mm)

Minimum order: 1 each.

Wood's Powr-Grip is a registered trademark of Wood's Powr-Grip Co., Inc. Manfrotto is a registered trademark of Lino Manfrotto + Co. S.P.A.

## CRL Thread Converter

- U.S. to European Thread Conversion



Mounting cup accessory converts 1/4"-20 U.S. thread to 3/8"-16 European thread. Minimum order is one each.

CAT. NO. W60102

## CRL Wood's T-Handle

- Fits 1/4"-20 Studs



Use these CRL Wood's T-Handles with most mounting cups to aid in the placement and positioning of small loads. 2-3/8" (60 mm) width by 1-1/4" (32 mm) height handle. Minimum order is one each.

CAT. NO. 1TLT

## CRL Glass Handler Kit

- Allows One Man to Set Large Windshields
- Reduces Back Strain

The CRL Glass Handler Kit is the ultimate tool for setting auto glass. Ergonomic handle design allows for easier sets without strain on arms and back. Foam elbow pad rests on hood/cowl area for pivot point, which reduces strain. Replacement pumps are available order Cat. No. 90111.



The Glass Handler Kit contains: Two 6" (152 mm) diameter Pump-Actuated Vacuum Cups, Foam Block Elbow Pad, Suction Cup Lubrication, and an Instruction Video, all packed in a sturdy plastic Carrying Case. Minimum order is one each.

CAT. NO. K1T1710

## CRL Lil Buddy® Junior Suction Cups

- Unique Locking Handle
- Red Line Safety Indicator
- 6-1/2" (165 mm) Diameter

The CRL Lil Buddy® Junior Suction Cups are designed for use with the Lil Buddy® Pro Windshield Setting System (see page 395K), but the special properties of these cups make them useful for any automotive or light flat glass application. The cushioned, ergonomic 'D' handle mechanically lifts and locks into place activating the vacuum as it locks. The locking action automatically pulls in the safety plunger to verify vacuum. Special release triggers in the base of the mechanism allow the handle to fold down and release the vacuum.



CRL Lil Buddy® Junior suction cups are sold in pairs only and come packaged in a padded carrying case. These 6-1/2" (165 mm) cups are rated at 50 lbs. (22.7 kg) each. Minimum order is one pair.

CAT. NO. LBJ2

## CRL All Rubber 6" Auto Vacuum Cup

- The Perfect Tool for Handling Curved Windshields and Backlites

The CRL All Rubber Auto Vacuum Cup provides the installer with the easiest way to handle windshields and backlites. They fit the contour of bent windshields and backlites to allow you to maneuver the glass into place, reducing the possibility of breakage by hitting the glass. Diameter of cup is 6" (152 mm). Minimum order is one each.



CAT. NO. CRL69

## CRL Automotive Suction Cups

- Ideal for Dent Removal or Sheet Metal and Flat Panel Handling

CRL Automotive Suction Cups are ideal for auto glass shops. You can use them for many jobs, such as pulling out panel dents and lifting sheet metal, glass or plastic. The steel bar handle swivels and flexes, and will permit pulls with a chain, jack or other similar methods. The thick rubber pad is long-lasting and possesses great grip strength.

**NOTE:** Not recommended for use on curved auto glass.

Lil Buddy is a registered trademark of Lilbuddy, LLC.



CAT. NO. VC81810

6" (152 mm) Automotive Suction Cup



CAT. NO. 77131

8" (203 mm) Automotive Suction Cup

## CRL Wood's™ Handi-Grip Vacuum Cup



- Lightweight and Compact
- Unique Oval Shape for Lifting Long or Narrow Objects
- Lifting Capacity 40 Lbs. (18 kg)

The CRL Wood's™ Handi-Grip 3" x 6" (76 x 152 mm) Vacuum Cup can lift small to moderate loads of glass, sheet metal, plastic, or just about any material that has a flat, non-porous surface. The oval shape of this cup permits attachment to shapes that are otherwise not permitted by standard profile vacuum cups. Its aluminum T-Handle assures a positive grip for added safety. The offset height of the handle lets users who prefer to wear gloves feel comfortable with this cup. Attachment of the RF36HG is accomplished by pumping the plunger several times to achieve its full vacuum. Releasing the cup is done by simply lifting the tabs on the side of the rubber pad. Minimum order is one each.

CAT. NO. RF36HG

## CRL Double Cup Vacuum Lifters With Release Bar



- For One or Two-Handed Grips
- Great for Large Lites

The convenient CRL Double Cup Vacuum Lifter comes in 3", 4" and 5" (76, 102 and 127 mm) models. They are ideal for use when you are limited in space. The vacuum created by the dual cups allows easy lifting of heavy weights. The suction is broken only when the fingertip-operated bar is lifted.

CAT. NO.	CUP DIAMETER	MAXIMUM LIFT CAPACITY
VC6520	3" (76 mm)	30 Lbs. (13 kg)
VC6540	4" (102 mm)	50 Lbs. (22 kg)
VC6541	5" (127 mm)	75 Lbs. (34 kg)

Minimum order: 1 each. Sizes can be combined for quantity pricing.

## CRL 4" Vacuum Cup With Handle



- 12" (305 mm) Long Handle
- Push Button Release
- Lifting Capacity 6 Lbs. (2.7 kg)

The CRL 4" (102 mm) Vacuum Cup With Handle has the strength to grip and hold dry or oiled sheet metal, glass, plastic and other smooth-surface materials that weigh up to 6 lbs. (2.7 kg). The featured pistol grip design permits easy and positive holding, even with bulky work gloves, and it releases quickly. Not only is this tool versatile and responsive, but the precision-fabricated metal components also make it extremely durable.

CAT. NO.	CUP DIAMETER	MAXIMUM LIFT CAPACITY
VC6470	4" (102 mm)	6 Lbs. (2.7 kg)

Minimum order: 1 each.

## CRL Single Cup Vacuum Lifters With Release Trigger



- Convenient Handle Design
- Single-Finger Release

Generally used for the loading, unloading, stacking, and shifting of sheet products, CRL Single-Cup Vacuum Lifters can protect you from cuts on your hands and gloves. Production time is increased by the easy application and removal of this cup. The release valve is triggered by a single finger so you can keep a good grip on the handle at all times.

CAT. NO.	CUP DIAMETER	MAXIMUM LIFT CAPACITY
VC1859	4" (102 mm)	25 Lbs. (11 kg)
VC1912	5" (127 mm)	35 Lbs. (16 kg)

Minimum order: 1 each. Sizes can be combined for quantity pricing.



## CRL Pick-Up Stick and Valve Grinder Lifter

- Finger-Operated Plunger in Handle
- Ideal for Lifting and Positioning Small Materials
- 3 Lb. (1.3 kg) Lifting Capacity



CAT. NO. PU0950  
1-1/4" (32 mm) Pad



CAT. NO. V1275  
1-1/4" (32 mm) Pad

These Vacuum Lifters are ideal for lifting and positioning small materials. They provide easy-grip handles for critical placement during assembly operations, such as framing pictures, assembling printed circuit boards or lapping valves. Minimum order is one each.

## CRL 2-1/8" Little Grabber Lifter

- Single Finger Handle Provides Precise Control
- 4 Lb. (1.8 kg) Lifting Capacity



This CRL Little Grabber Lifter is ideal for light objects or raising corners for a better grip. It is always handy and ready for use while leaving one hand free for other work. It is made from tough rubber compound. 2-1/8" (54 mm) diameter pad with release tabs. Minimum order is one each.

CAT. NO. VC1230

## CRL 3" Compact T-Handle and Threaded Insert Vacuum Lifters

- Fast Application and Removal Time
- 15 Lb. (7 kg) Lifting Capacity



CAT. NO. TL3TH



CAT. NO. TL3AM

The CRL T-Handle Lifter is compact and quick-attaching for accurate positioning of small items. Cat. No. TL3AM has a 1/4"-20 threaded insert for a multitude of applications. Both are designed for gripping flat or curved smooth, non-porous surfaces. The concave pad diameter is 3" (76 mm). Includes pad protector. Minimum order is one each.

## CRL 3-1/4" Knuckle Saver Lifter

- Comfortable Finger Handle Reduces Fatigue
- 10 Lb. (4.5 kg) Lifting Capacity



The CRL Knuckle Saver Lifter features a two-finger grip for extra lifting capacity and a 3-1/4" (83 mm) diameter pad with release tabs. Minimum order is one each.

CAT. NO. VC3825

## CRL 3-1/4" Grifter Vacuum Lifter

- Solid Rubber Design
- 15 Lb. (7 kg) Lifting Capacity



The CRL Grifter is an all-rubber cup designed for quick and easy lifting and positioning of lightweight, smooth, non-porous objects. It features a concave 3-1/4" (83 mm) pad. Minimum order is one each.

CAT. NO. G609

## CRL 3-1/4" Push-Button Vacuum Lifter

- Push-Button Release Speeds Production
- 10 Lb. (4.5 kg) Lifting Capacity



The CRL Push-Button Vacuum Lifter features sturdy construction and a fast-action, metal push-button release valve for the safe and speedy handling of smooth-surface materials. The full handgrip improves the operator's gripping ability, while also allowing greater freedom of movement. The pad has a diameter of 3-1/4" (83 mm). Minimum order is one each.

CAT. NO. VC2260

## CRL Glass Dolly



- 350 Pound (159 kg) Weight Capacity
- Wood Frame Construction
- Felt Pads to Protect the Glass
- Tough Phenolic Wheels

Use the CRL Plate Glass Dolly to move glass easier, and faster from upright storage. The hardwood stock has a 1-1/2" (38 mm) wide groove to handle single or multiple lites. The balanced arrangement of casters allows you to turn-on-a-dime so you can use it in restricted spaces. Two thick felt pads are located near each end to cushion the load. All wheels and casters are made of tough phenolic plastic and roll on ball bearings. An ideal dolly for moving insulating glass units, safety glass, mirrors, plastics, or marble. The Dolly has a 350 lb. (159 kg) capacity.

**NOTE:** Not available in Australia.



### • Three Sizes Available



72" (1829 mm)



60" (1524 mm)



36" (914 mm)



CAT. NO. PGD260



CAT. NO. PGD270



CAT. NO. PGD280



CAT. NO. PGD290



CAT. NO. PGD300

### DOLLY REPLACEMENT PARTS

CAT. NO.	DESCRIPTION
PGD260	Swivel End Caster
PGD270	5/8" (16 mm) Axle 6" (152 mm) Dia. Center Wheel (Older Style Dollies)
PGD280	1/2" (13 mm) Axle 5" (127 mm) Dia. Center Wheel (Current Models)
PGD290*	Replacement Felt Pads (Pair)
PGD300	Complete Two Wheel Center Caster

Minimum order: 1 each. \*Minimum order: 1 pair.

### COMPLETE DOLLIES

CAT. NO.	LENGTH	WIDTH	HEIGHT
13063	36" (914 mm)	5" (127 mm)	6-3/4" (171 mm)
13065	60" (1524 mm)	5" (127 mm)	6-3/4" (171 mm)
13066	72" (1829 mm)	5" (127 mm)	6-3/4" (171 mm)

Minimum order: 1 each. Sizes can be combined for quantity pricing.

## CRL All Terrain Dolly

- Goes Where Other Glass Dollies Won't
- Heavy Welded Aluminum Construction
- 16" Diameter (406 mm) Two-Ply Pneumatic Tire
- Built-in 8" (203 mm) Wood's™ Powr-Grip® Vacuum Cup
- Includes Set of CRL RB200 Rolling Blocks

CRL's All Terrain Dolly is like having an extra person on the job site. Moving large glass lites, insulating units, patio door panels, and even stone slabs across any terrain is now a snap. Curbs, door sills, and scrap lumber are no longer obstacles when your crew is using the CRL All Terrain Dolly. Its large 16" (406 mm) diameter pneumatic tire won't bog down in the grass or dirt, common to residential and commercial job sites. This handy device also eliminates back and arm strain associated with carrying heavy loads suspended over long distances.

Included is a Wood's 8" (203 mm) diameter Powr-Grip® Vacuum Cup and a set of Cat. No. RB200 Roller Blocks to protect the cargo's edges once unloaded. The Roller Blocks are stored conveniently inside the frame of the All Terrain Dolly so you always know where to find them. Maximum capacity: 400 lbs. (181 kg). Minimum order is one each.



**CAT. NO. ATD1**  
All Terrain Dolly



Patent Pending



**CAT. NO. RB200**  
Roller Blocks (Included)

## CRL Heavy-Duty Steel Frame Glass Dolly

- 600 Pounds (272 kg) Weight Capacity
- Sturdy Steel Construction
- Two Sizes Available
- Large Pneumatic Tires

CRL Heavy-Duty Steel Frame Glass Dollies can be used indoors or outside for transporting heavy plate glass or insulated units. The large 8-1/2" (216 mm) diameter pneumatic tires will roll smoothly, even over rough surfaces. Constructed from a rubber lined, 3" wide x 1/4" thick (76 x 6 mm), heavy steel channel which supports the glass 5-1/2" (140 mm) off of the floor. Wheels are set 12" (305 mm) apart to provide stability.



**CAT. NO. 2401280**



**CAT. NO. 2401281**

CAT. NO.	OVERALL LENGTH	CAPACITY
<b>2401280</b>	48" (1219 mm)	600 lbs. (272 kg)
<b>2401281</b>	72" (1829 mm)	600 lbs. (272 kg)

Minimum order: 1 each.

Wood's Powr-Grip is a registered trademark of Wood's Powr-Grip Co., Inc.

## CRL Framed Glass Handling Dolly

- 300 Lb. (136 kg) Capacity
- Perfect for Framed Glass, Storefront Doors or Almost Any Flat Surfaced Item



With the CRL Framed Glass Handling Dolly, heavy items such as storefront doors, framed windows, storm windows, I.G. units, or just about any other flat surfaced item can be easily moved in an upright position. The dolly is adjustable to widths from 2-1/2" to 4-1/2" (63 to 114 mm), and the steel carriage is carpeted to prevent marring. Minimum order is one each.

CAT. NO. LD450

## CRL Glasstrax Dolly

- 600 Lb. (275 kg) Capacity
- Self Clamping Action Locks Loads Up to 2" (50.8 mm) Thick
- One Person Can Load and Maneuver



The CRL Glasstrax Glass Dolly makes it easier than ever to move heavy glass lites smoothly and safely. Load your glass centered on the Glasstrax and the weight of the glass will automatically pull the rubber lined side walls together, clamping it in place. The more weight loaded, the tighter the grip. Self-adjusting for glass or doors up to 2" (50.8 mm) thick. Minimum order is one each.



CAT. NO. GT02

## CRL Camber Glass Dolly

- 600 Lb. (275 kg) Capacity
- Great for Shops of All Sizes



The CRL Camber Glass Dolly is designed for transporting smaller lites of glass within the shop environment, or from your truck to the delivery site. This Dolly has two 8" (203 mm) diameter, solid rubber wheels and a vulcanized rubber frame channel, which protects the glass against chipping or damage while in the process of being moved. The inside width of the channel measures 3-1/8" (79 mm); overall length of the channel is 20" (508 mm). Minimum order is one each.

CAT. NO. GSD1

## CRL Four Wheel Glass Dolly

- 700 Lb. (320 kg) Capacity
- Four Wheels for Extra Stability



This CRL Four Wheel Glass Dolly is designed to provide additional stability while transporting lites of glass within the shop environment or from your truck to the delivery site. The Dolly has two 8" (203 mm) diameter solid rubber wheels and two caster wheels attached to a vulcanized rubber frame channel, which protects the glass against chipping or damage while in the process of being moved. The inside width of the channel measures 3-1/8" (79 mm); overall length of the channel is 20" (508 mm). Minimum order is one each.

CAT. NO. GSD3

## CRL Self-Locking Dolly

- 880 Lb. (399 kg) Capacity

This CRL Self-Locking Dolly is designed with "self-locking jaws" for transporting lites of glass within the shop environment or from your truck to the delivery site. The "all-terrain" Self-Locking Dolly has 11" (279 mm) diameter solid rubber wheels and a vulcanized rubber frame channel, which protects the glass or stone against chipping or damage while in the process of being moved. The inside width of the channel is 4" (102 mm); overall length of the vulcanized rubber "V" channel is 20" (508 mm). Minimum order is one each.

- Self-Locking Jaws Grip Tightly



CAT. NO. GSD2

## CRL Long Glass Dolly

- 750 Lb. (340 kg) Capacity for Larger Loads

This CRL Long Glass Dolly is designed with an extra-long trolley channel and bottom-mounted third wheel to provide improved stability. This Dolly can transport longer lites of glass within the shop environment or from your truck to the delivery site. The Long Dolly has two 9-1/2" (240 mm) diameter solid rubber wheels and a vulcanized rubber frame channel, which protects the glass against chipping or damage. The inside width of the channel measures 3-1/8" (79 mm); overall length of the channel is 36" (914 mm). Minimum order is one each.



CAT. NO. GSD4

## CRL Pry Dollies

- Strong, Hardwood Handle
- Large 5" (127 mm) Diameter Steel Wheels

These CRL Pry Dollies are designed to move extra heavy or cumbersome crates, cases of glass, or heavy machinery. The 5" diameter x 2" wide (127 x 51 mm) steel wheels provide a smooth roll, while the 5" wide x 3/8" thick (127 x 9.5 mm) bevelled nose lifting plate offers plenty of prying strength. What makes this Pry Dolly truly amazing is the extremely strong, straight-grained hardwood handle. **NOTE:** Not available in Australia.



CAT. NO.	LIFTING CAPACITY	LENGTH
16001001	3,500 lbs. (1588 kg)	60" (1524 mm)
16001003	5,000 lbs. (2268 kg)	84" (2134 mm)

Minimum order: 1 each.

## CRL Mule Pry Truck

- 5,000 Pound (2268 kg) Capacity
- 7' (2.1 m) Steel Handle

This CRL Mule Pry Truck is designed to move extra heavy or cumbersome crates, cases of glass, or heavy machinery. The Mule Pry Truck has two 4" diameter x 2" wide (102 x 51 mm) phenolic wheels and a 4" wide x 1/2" thick (102 x 12.7 mm) bevelled nose lifting plate. Minimum order is one each.



CAT. NO. 585

## CRL Low Floor Dolly

- 2,000 Pound (907 kg) Capacity
- Raised Textured Top Resists Slipping



The CRL Low Floor Dolly is only 4-1/2" (114 mm) tall, yet this strong roller dolly can handle the heaviest loads. The top is 12" long x 10" wide (305 x 254 mm). Minimum order is one each.

CAT. NO. 5286

## CRL Low Profile Case Dolly

- 4,000 Pound (1814 kg) Capacity
- Six Solid Steel Ball Bearing Wheels

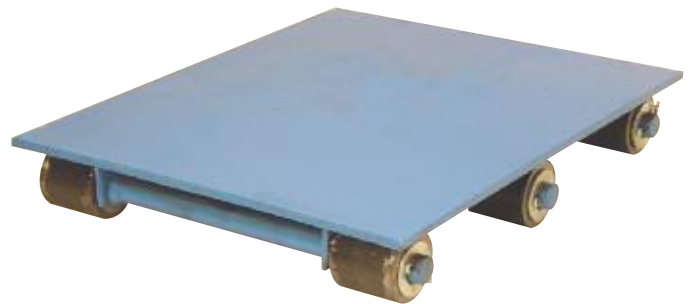

The CRL Low Profile Case Dolly is only 3-1/2" (89 mm) tall. This dolly has a unique six-wheel design, in that the two center wheels are set slightly lower, allowing the Dolly to turn or pivot within it's own length. The top is 22-1/2" long x 17-1/4" wide (572 x 438 mm). Minimum order is one each.

CAT. NO. 253CD

## CRL Split Case Dolly

- Designed for Transporting Large Cases of Plate Glass
- 4,400 Pound (1996 kg) Capacity

The CRL Split Case Dolly is designed as two separate carrying frames, each with a 12" diameter x 3" wide (305 x 76 mm) steel ball bearing wheel. The upper portion of the frame is made from 2" (51 mm) steel angle. It stands 47" tall and is 34" in length (1194 x 864 mm). The lower angle provides a 3" (76 mm) lip to support each side of the bottom edge of the glass crate. Once the glass crate is lifted, move the two halves of the dolly to the sides of the crate, close to the middle, and lower the crate onto the lower supporting angle. Once loaded into the Split Case Dolly even glass crates weighing as much as 4,400 pounds (1996 kg) can be moved about your shop with relative ease. Minimum order is one pair. Must ship common carrier.

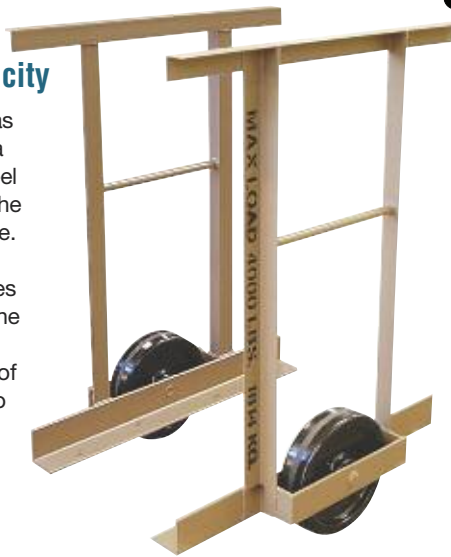

CAT. NO. 050

## CRL Rol-A-Lift Hydraulic Glass Crate Truck

- Makes Open-End Case Storage and Handling Easy
- Lifts Crates Up to 12" (305 mm) Off the Floor
- Swivel Casters Allow for Maneuvering in Tight Places



Front View



Back View



Sold Individually

The CRL Rol-A-Lift Hydraulic Jack is ideal for moving large crates of glass or other heavy objects. A pair of Rol-A-Lifts will lift large crates up to 4,000 pounds (1814 kg), up to 12" (305 mm) off the floor. Rol-A-Lifts can be used in tandem, and optional nylon straps are available as shown below. The overall height is 44" (1118 mm); the width is 23" (584 mm); the weight is 163 pounds (74 kg). Sold individually. Minimum order is one each. Must ship common carrier.

CAT. NO. M4R0L

## CRL Rol-A-Lift Nylon Tie Straps

- For Use With M4R0L Rol-A-Lift

These heavy-duty Nylon Straps for use with Cat. No. M4R0L (shown above) have steel "D" Ring Brackets on each end, and come with a ratchet clamp to tighten and lock the strap securely. All Straps have a 3,000 pound (1360 kg) working load limit. When moving large crates with two dollies, two Straps are required. Straps can be joined for extra large crates.

CAT. NO.	LENGTH
97501	12' (3.6 m)
97520	20' (6.1 m)

Minimum order: 1 each.



## CRL Six Wheel Fabrication Carts

- **3,200 Pound (1451 kg) Capacity**
- **Easy Mobility and Zero Turning Radius**
- **Welded, Galvanized Steel**

CRL Six Wheel Fabrication Carts are designed for easy movement and storage in tight confines. A load capacity rated at 3,200 pounds (1451 kg) makes these CRL Fabrication Carts ideal for fabricated parts, stock sheets, or cases. Each Cart features two large wheels in the center of the frame and two locking swivel casters on each end, allowing for tight 90 degree turns. With load deck heights of 13-1/4" (337 mm) on the FC48 and 14-3/4" (375 mm) on the FC82, chances of back strain and stress are reduced during loading and unloading. All contact surfaces on these Carts are lined with heavy rubber strips to prevent slipping and damage to materials. Ratchet straps are provided to secure material during movement or transport. Forklift slots are incorporated into the welded base.



CAT. NO.	SIZE (LENGTH X WIDTH X HEIGHT)	LOAD HEIGHT
<b>FC48</b>	48" x 25" x 53" (1219 x 635 x 1346 mm)	42" (1067 mm)
<b>FC82</b>	82" x 25" x 73" (2083 x 635 x 1854 mm)	60" (1524 mm)

Minimum order: 1 each. F.O.B. Woodstock, Illinois. Must ship common carrier.

## CRL One Stop A-Frames

- **2,200 Pound (1000 kg) Capacity**
- **Two Eyelets Allows for Pick Up by an Overhead Crane**



Available Only in Australia

CRL One Stop A-Frame is a sturdy structure, designed to eliminate any risk of tipping over. Glass is placed on a special rubber profile and secured with four ratchet securing bars. Contains an extra storage section in the center, which is ideal for storing tools, etc. Rack has built-in slots on all sides for forklift transport. Four 6" (152 mm) heavy-duty removable casters are included.



CAT. NO.	SIZE (LENGTH X WIDTH X HEIGHT)
<b>CRL83100</b>	60-5/8" x 38-3/8" x 50-9/16" (1540 x 975 x 1285 mm)
<b>CRL81100</b>	71-1/4" x 43-5/16" x 62-3/8" (1810 x 1100 x 1585 mm)
<b>CRL84100</b>	71-1/4" x 43-5/16" x 78-1/8" (1810 x 1100 x 1985 mm)
<b>CRL87100</b>	86-1/4" x 43-5/16" x 78-1/8" (2190 x 1100 x 1985 mm)

Minimum order: 1 each. Must ship common carrier.

## CRL Glass Slab Buggy

- **Sturdy Steel Frame is Stable and Compact - Fits Through Doors**
- **Supports Up to 800 Pounds (363 kg)**



Available Only in Australia

The CRL Glass Slab Buggy is ideal for transporting and storing glass in a warehouse or shop environment, as well as on the job site. It has pneumatic tires that allow it to roll on uneven surfaces, and swivel casters for easy turning in tight spaces. Rubber lined contact surfaces protect finished pieces and prevents slipping during movement.



CAT. NO.	SIZE (LENGTH X WIDTH X HEIGHT)
<b>7265</b>	48-13/16" x 25" x 45-11/16" (1240 x 635 x 1160 mm)

Minimum order: 1 each. Must ship common carrier.

## CRL Double-Sided Block Glass Barrow

- **Safe Working Load: 3,600 Pounds (1633 kg)**



Available Only in Australia

CRL Double-Sided Block Glass Barrow is designed for handling cut-to-size and loose sheets of glass up to 55" (1400 mm) high, and block glass. The Barrow is compatible with block glass loading grabs, and can be supplied with clamping systems for on-site work. Optional Cat. No. G4100SC Retaining Bars are available to secure loads.



Shown with Optional Clamp System

CAT. NO.	SIZE (LENGTH X WIDTH X HEIGHT)
<b>G4100</b>	60-1/4" x 35-13/16" x 63" (1530 x 910 x 1600 mm)

Minimum order: 1 each. Must ship common carrier.

## CRL Single-Sided Block Glass Barrow

- **Safe Working Load: 3,600 Pounds (1633 kg)**



Available Only in Australia

CRL Single-Sided Block Glass Barrow is designed for handling cut-to-size and loose sheets of glass up to 55" (1400 mm) high, and block glass. The Barrow is compatible with block glass loading grabs, and can be supplied with clamping systems for on-site work. Heavier load bearing wheels available upon request.



CAT. NO.	SIZE (LENGTH X WIDTH X HEIGHT)
<b>G4102</b>	60-1/4" x 24-7/16" x 63" (1530 x 620 x 1600 mm)

Minimum order: 1 each. Must ship common carrier.

## CRL Heavy-Duty Shop Carts

- Rugged 4,000 Pound (1814 kg) Capacity
- 8" (203 mm) Casters: Two Rigid, Two Swivel With Brake
- Heavy Rubber Lining on All Contact Surfaces
- 2" (51 mm) Wide Polyester Ratchet Straps

CRL Heavy-Duty Shop Carts are the answer to all your in-shop fabrication, storage, shipping, and receiving needs. Sturdy steel construction, and an open frame design allow easy visual check of the product. These Carts are perfect for moving product from one production stage to another, receiving vendor products prior to storage, the staging of product prior to shipping, or loading for job sites.

All three sizes feature a hot-dipped galvanized finish, heavy rubber lining on all contact points, and pull handles mounted on one end for easy maneuverability. The HDSC5448 has 11-1/2" (292 mm) ledge depth while the two larger carts both offer 10-1/4" (260 mm) ledge depth.



CAT. NO. HDSC5448



CAT. NO. HDSC8448



CAT. NO. HDSC8472

CAT. NO.	LENGTH	WIDTH	LOAD HEIGHT	OVERALL HEIGHT	STRAPS PER SIDE	WEIGHT
HDSC5448	54" (1372 mm)	38" (965 mm)	48" (1219 mm)	62" (1575 mm)	2	215 lbs. (97 kg)
HDSC8448	84" (2134 mm)	40" (1016 mm)	48" (1219 mm)	63" (1600 mm)	3	360 lbs. (163 kg)
HDSC8472	84" (2134 mm)	40" (1016 mm)	72" (1829 mm)	87" (2210 mm)	3	460 lbs. (209 kg)

Minimum order: 1 each. F.O.B. Woodstock, Illinois. Must ship common carrier.

## CRL Single-Sided Shop Cart

- 2,000 Pound (907 kg) Capacity
- Maneuverable in Tight Areas
- Two 10" (254 mm) Pneumatic Tires and Two 5" (127 mm) Solid, Locking Casters

The CRL Single-Sided Shop Cart is designed for shop and job site use. The combination of 5" (127 mm) locking swivel casters and 10" (254 mm) pneumatic tires, mounted outside of the welded steel frame for stability, make this Cart highly maneuverable in tight areas. Measuring 24" (610 mm) wide, 40" (1016 mm) long and 36" (914 mm) working load height, this Cart is perfect for job site elevators and the tight aisles in busy fabrication shops. All upright contact points are lined with neoprene rubber and the ledge depth is 6" (152 mm). Minimum order is one each. Ships F.O.B. Woodstock, Illinois. Must ship common carrier.



CAT. NO. 2401282



## CRL Glass Transport Racks

- 4,000 Pound (1814 kg) Capacity
- Rubber Padding on All Contact Surfaces
- 16-3/4" (425 mm) Ledge Depth and Durable Hot-Dipped Galvanized Finish
- Removable Casters (Sold Separately)



End Pick Up



CAT. NO. 2404482

Shown With Optional 2404479 Casters



Side Pick Up

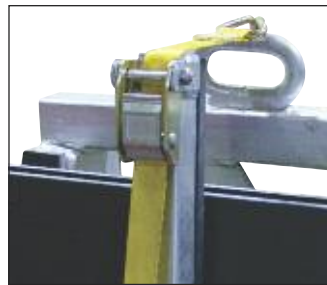

Stake Locks



8" (203 mm)  
Caster Kit

These CRL Glass Transport Racks are the strongest, safest racks in the industry. Available in 82" and 96" lengths, both Racks feature thick rubber padding on all contact surfaces, hot-dipped galvanized finish, multiple rubber lined stakes with ratchet tightened web strapping, and heavy cable eyes on each corner for crane lifting. Stakes are fitted into slots on the bottom of the ledge deck at 1/2" (12.7 mm) increments from front to back, ensuring secure pressure no matter the size of the load. Four-way forklift access permits a variety of loading and unloading options. Optional 8" (203 mm) Caster Kit converts stationary rack into mobile cart in less than a minute. Caster Kit includes two fixed casters, two swivel casters with locks, and four mounting posts with quick release pins.

CAT. NO.	LENGTH	WIDTH	LOAD HEIGHT	OVERALL HEIGHT	HEIGHT W/CASTERS	LEDGE DEPTH	STAKES PER SIDE	WEIGHT
2404482	82" (2083 mm)	44" (1118 mm)	48" (1219 mm)	58" (1473 mm)	69" (1753 mm)	16" (406 mm)	4	540 lbs. (245 kg)
2404481	96" (2438 mm)	44" (1118 mm)	60" (1524 mm)	70" (1778 mm)	81" (2057 mm)	16-3/4" (426 mm)	5	740 lbs. (336 kg)
2404479	8" Diameter Caster Kit With Mounting Posts and Quick Release Pins							

Minimum order: 1 each. F.O.B. Woodstock, Illinois. Must ship common carrier.

## CRL Single-Sided Transport Racks

- Full Rubber Lining on All Contact Surfaces
- Durable Hot-Dipped Galvanized Finish

CRL Single-Sided Transport Racks are designed for use as internal racks for delivery and cube vans. The 16" (406 mm) ledge depth provides adequate space for glass, windows, doors, and anything else your project requires. These Racks feature full rubber lining on all contact surfaces, durable hot-dipped galvanized finish, and mounting pads for bolting directly to truck or van beds.

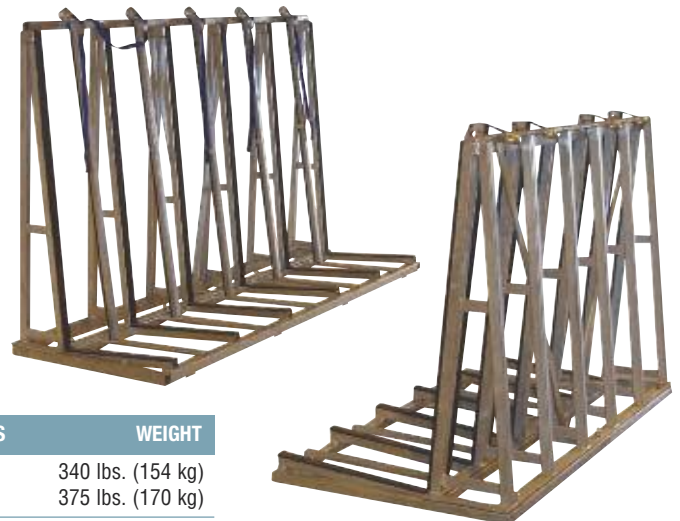

CAT. NO.	LENGTH	WIDTH	HEIGHT	STAKES	WEIGHT
TRSS2482	82" (2083 mm)	24" (610 mm)	50-1/2" (1283 mm)	4	340 lbs. (154 kg)
TRSS2496	96" (2438 mm)	24" (610 mm)	63" (1600 mm)	5	375 lbs. (170 kg)

Minimum order: 1 each. F.O.B. Woodstock, Illinois. Must ship common carrier.

## CRL Tilting Crate Handler

- 4,000 Pound (1814 kg) Capacity
- Designed to Move Full Crates
- Solid Steel Construction

The CRL Solid Steel Tilting Crate Handler can lean forward to lift crates like a common dolly then lean back on to its rollers for moving the crates throughout the shop. This Handler has extending support arms which extend 24" (610 mm) on either end, increasing the load capacity to 120" (3048 mm) wide. The back support braces are adjustable for changing the tilt angle of the handler to increase the load capacity. Designed to carry loads up to 60" (1524 mm) high and 4,000 lbs. (1814 kg) in weight. This Handler measures 40" (1016 mm) wide, 72" (1829 mm) long (with extensions retracted), and 52" (1321 mm) high. Approximate shipping weight is 180 lbs. (82 kg). Ships disassembled F.O.B. the nearest CRL service center. Minimum order is one each.



CAT. NO. AB

## CRL Tilt Back Table Truck

- 4,000 Pound (1814 kg) Capacity
- Tilts Back to Become a Table



Tilt it Back, It's a Table!

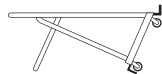

With the CRL Tilt Back Table Truck you can move crates around the shop, or it can be tilted back 90 degrees (with ample manpower) to act as a 26" (660 mm) high table supported by strong steel rear legs and front tip-up shoes. With the truck in this position, it becomes a stable surface for marking, cutting or unloading of glass. Maximum truck capacity is 4000 lbs. (1814 kg). Truck measures 50" (1270 mm) wide, 72" (1829 mm) long, and 56" (1422 mm) high. Approximate shipping weight is 200 lbs. (90.7 kg). Ships disassembled F.O.B. the nearest CRL service center. Minimum order is one each.

CAT. NO. AWL

## CRL "Jumbo" Flat Crate Truck

- 4,000 Pound (1814 kg) Capacity
- Handles Jumbo Size Crates



This CRL Jumbo Crate Truck has the capability to move large crates with a maximum thickness up to 10" (254 mm) and a maximum height up to 72" (1829 mm). The heavy-duty tubular steel frame and the 6" (152 mm) diameter swivel casters (two locking) provide a maximum working capacity of 4,000 lbs. (1814 kg). This truck measures 48" (1270 mm) wide, 72" (1829 mm) long, and 73" (1854 mm) high. Shipping weight is 160 lbs. (72.6 kg). Ships disassembled F.O.B. the nearest CRL service center. Minimum order is one each.

CAT. NO. J

## CRL Hydraulic Boom Manipulator

- Can Be Knocked Down for Transporting and Re-Assembled in Minutes
- Reversible Boom With Minute Hydraulic Control
- 1,000 Pound (453 kg) Rating
- Large Wheels for Easy Rolling
- Manual Winch With 25' (7.6 m) Cable

### OPTIONS AVAILABLE:

12 Volt DC Electric Winch with 25' (7.6 m) Winch Cable (Cat. No. ROWEWD)

110 Volt AC Electric Winch with 25' (7.6 m) Winch Cable (Cat. No. ROWEW)

Ballast Containers - One pair (Cat. No. ROWBLST)

This innovative tool has a hydraulic controlled boom so you can set glass in place for glazing in difficult to reach positions. Used in conjunction with a vacuum lifting frame (not included, see pages 714K-715K), the CRL Hydraulic Boom Manipulator simplifies glass handling anywhere you use it. The boom can also be reversed, which extends the unit's reach. It is easily assembled without tools in only five minutes. You can knock down the unit and move it from floor to floor to glaze high-rise buildings from the inside. Simply lower the glass into position from one floor above using the standard manual winch. Put it in a pickup or van and move it from job to job. Electric Winch options are also available. The optional pair of movable ballast boxes keep it steady even under the maximum load of 1,000 lbs. (453 kg). Minimum order is one each. Shipping weight is 360 lbs. (163 kg). F.O.B. Cicero, Illinois. Must ship common carrier.



CAT. NO. ROW1

## CRL Optional Extension Boom and Outrigger

This optional Extension Boom extends the vertical reach of your ROW1 Manipulator by 36" (914 mm). It bolts on in minutes. CRL can also make a vertical Boom Extension to your specifications which will extend the Boom's reach up to 133-1/2" (3.4 m). The Outrigger Support gives stability to the ROW1 when used with vertical Boom Extensions exceeding 36" (914 mm).

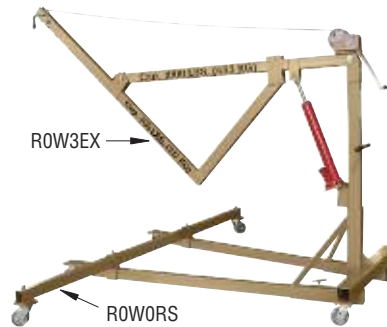

Vacuum Lifters and Frame sold separately

CAT. NO.	DESCRIPTION	WEIGHT
ROW3EX	36" (914 mm) Boom Extension	60 lbs. (27 kg)
ROWORS	Outrigger Support	90 lbs. (41 kg)

Minimum order: 1 each.

## CRL Rolling Glass Manipulator

- Perfect for One Person Glass Transport and Installation
- Rotates Lites Up to 96" (2.4 m) Long
- Assembles in Minutes
- Unloads Glass Truck Racks and "A" Frames
- Extra Large 12" (305 mm) Vacuum Pads

Handling insulating glass and windows can be a back breaker due to the weight and size of the plates, as well as the uneven grounds at construction sites. CRL now offers the Rolling Glass Manipulator, an innovative small portable lifter that allows one person to move lites weighing up to 220 lbs. (100 kg) or two people up to 330 lbs. (150 kg). The RGM1 is lightweight and can easily be assembled in under a minute. Once assembled, the RGM1 can unload glass lites off your truck and then transport the lites on site. The wheelbase can be adjusted from 31-1/2" to 21-1/4", allowing for narrow on site walkways. The RGM1 allows the lite to be rotated 360 degrees, and then the operator can also index the lite allowing movement through standard 36" wide doorways. Minimum order is one each.

**new**



CAT. NO. RGM1

## CRL Harp Rack



This 60RACK is normally stocked and ready to transfer to your closest CRL warehouse once your order is placed. We provide this service to offer you the convenience and benefit of a shorter lead time and lower shipping expense.

- Stores Full Size Plates or Cutoffs
- Glass Can Be Easily and Safely Retrieved
- Lightweight and Easy to Set Up
- Now With High-Density PVC Flooring

This CRL Harp Rack consists of a steel frame (A), attached at one end to grooved PVC Flooring (B), and supported at the other end by two channel columns (C). Steel rods are strung within the frame, each covered with a plastic sheath. The plate is slipped into the grooved PVC flooring and between the rods, which support the plate at all times. Free standing, it can be disassembled and moved. Additional units can be bolted to the frame, forming an integral storage unit. **NOTE:** Racks are heavy and require a forklift and/or loading dock for delivery. Must ship common carrier.

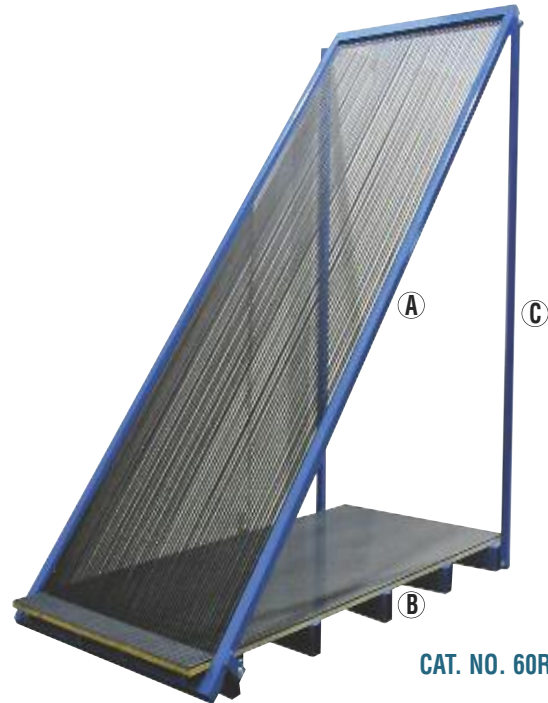

CAT. NO. 60RACK

### 40RACK SPECIFICATIONS:

**Number of Slots:** 40  
**Slot Width:** 7/16" (11.1 mm)  
**Maximum Glass Size:** 120" x 96" (3048 x 2438 mm)  
**Width:** 39" (991 mm)  
**Depth:** 101-3/4" (2584 mm)  
**Inside Height:** 97" (2464 mm)  
**Weight:** 500 lbs. (227 kg)  
 Ships KD F.O.B. Red Oak, Texas.

### 60RACK SPECIFICATIONS:

**Number of Slots:** 60  
**Slot Width:** 7/16" (11.1 mm)  
**Maximum Glass Size:** 120" x 96" (3048 x 2438 mm)  
**Width:** 54" (1372 mm)  
**Depth:** 101-3/4" (2584 mm)  
**Inside Height:** 97" (2464 mm)  
**Weight:** 600 lbs. (272 kg)  
 Ships KD from nearest CRL location.

CAT. NO.	NUMBER OF SLOTS
40RACK	40
60RACK	60

Minimum order: 1 each. Must ship common carrier.

## CRL Rolling Glass Rack

- Store Up to 60 Pieces of Plate Glass as Large as 60" x 60" (1524 x 1524 mm)
- All-Steel Rack is Free Rolling

The CRL Rolling Glass Rack is a free rolling, 60 plate harp style rack with heavy-duty casters. It holds glass up to 60" x 60" (1524 x 1524 mm) with plastic covered steel divider rods and grooved PVC Flooring. The all-steel tube construction makes it sturdy, yet the heavy-duty casters allow for easy movement. Foot actuated step-locks on the frame keep the Rack from rolling when set. The Rack is excellent for storage, or for moving lites between work areas. **NOTE:** Racks are heavy and require a forklift and/or a loading dock for delivery. Ships F.O.B. Cicero, Illinois. Must ship common carrier.

### SPECIFICATIONS:

**Number of Slots:** 60  
**Slot Width:** 7/16" (11.1 mm)  
**Maximum Glass Size:** 60" x 60" (1524 x 1524 mm)  
**Width:** 60-1/2" (1537 mm) (Front of Rack)  
**Depth:** 65" (1651 mm)  
**Height:** 60-3/8" (1533 mm)  
**Weight:** 600 lbs. (272 kg)  
**Load Capacity:** 3600 lbs. (1633 kg)



CAT. NO.	NUMBER OF SLOTS
RR60	60

Minimum order: 1 each. Must ship common carrier.

## CRL 55 Unit Insulating Glass Storage Rack

- Holds Units Up to 38" x 72" (965 x 1829 mm)
- 3000 Pound (1360 kg) Load Capacity
- Welded Tubular Steel Construction

This CRL IG Storage Rack will hold up to 55 Insulating Glass units. It is a free rolling Harp Rack mounted on four (two swivel and two fixed) heavy-duty casters with one floor lock. The divider rods are 5/16" (7.9 mm) diameter steel rods covered with PVC tubing. The floor is OBS backer board with four glass contact HDPE strips. The rods can be removed so that the PVC tubing can be easily replaced when worn. The welded steel tube construction makes it sturdy, yet the heavy-duty casters allow for easy movement. A slot numbering system is an available option. The Rack is shipped knocked down and assembly is quick and easy. Racks are heavy and require a forklift and/or a loading dock for delivery. Ships common carrier from the nearest CRL branch location. Minimum order is one each.



CAT. NO. R55RACK

**SPECIFICATIONS:**

<b>Number of Slots:</b> 55	<b>Height:</b> 41-1/2" (1054 mm)
<b>Slot Width:</b> 1-1/16" (27 mm)	<b>Depth:</b> 40" (1016 mm)
<b>Minimum Glass Size:</b> 18" (457 mm) Square	<b>Length:</b> 89" (2261 mm)
<b>Maximum Glass Size:</b> 38" x 72" (965 x 1829 mm)	<b>Weight:</b> 380 lbs. (172 kg)
	<b>Load Capacity:</b> 3000 lbs. (1360 kg)

## CRL 100 Piece Window Fabricator's Mobile Harp Rack

- Organizes Glass for Manufacturing Process
- 3000 Pound (1360 kg) Load Capacity
- Numbering System for Sorting

The CRL 100 Piece Window Fabricator's Mobile Harp Rack combines milled ultra-high density PVC Flooring with a welded heavy-duty tubular steel frame and base to provide an exceptionally durable piece of equipment for any window manufacturing environment. The 1/4" (6.4 mm) steel separators are sleeved in PVC tubing, and the 3000 pound (1360 kg) capacity is supported by five heavy-duty casters, two of which feature floor locks.

A slot numbering system is included that can be used with all cutting systems and software packages for easy sorting at break-out. Rack ships mostly assembled, the user need only unfold the Rack and mount the casters. Minimum order is one each, F.O.B. Red Oak, Texas. Must ship common carrier.

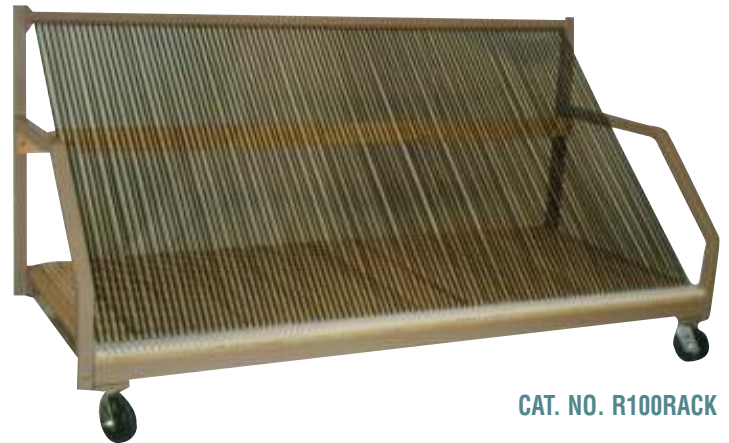

CAT. NO. R100RACK

**SPECIFICATIONS:**

<b>Number of Slots:</b> 100	<b>Depth:</b> 47" (1194 mm)
<b>Slot Width:</b> 7/16" (11 mm)	<b>Width:</b> 100" (2540 mm)
<b>Maximum Glass Size:</b> 46" x 60" (1168 x 1524 mm)	<b>Weight:</b> 600 lbs. (272 kg)
<b>Height:</b> 46-1/2" (1181 mm)	<b>Capacity:</b> 3000 lbs. (1360 kg)

## CRL 100 Piece Small Lite Mobile Harp Rack

- Organizes Small Glass Lites for Manufacturing
- Heavy-Duty Casters and Floor Lock

The CRL 100 Piece Small Lite Mobile Harp Rack is ideal for window manufacturing where volumes of smaller lites are needed. Using many of the same construction techniques as our other harp racks, this 'L' frame style incorporates handles on each end of the frame to aid in positioning. The high density polyethylene base is fabricated with 7/16" (11 mm) grooves spaced 7/16" (11 mm) apart. Minimum order is one each. Shipped F.O.B. Red Oak, Texas. Must ship common carrier.



CAT. NO. SL100RACK

**SPECIFICATIONS:**

<b>Number of Slots:</b> 100	<b>Depth:</b> 44" (1118 mm)
<b>Slot Width:</b> 7/16" (11 mm)	<b>Width:</b> 93-5/16" (2370 mm)
<b>Maximum Glass Size:</b> 44" x 48" (1118 x 1219 mm)	<b>Weight:</b> 350 lbs. (158 kg)
<b>Height:</b> 38-1/2" (978 mm) Deck to Sleeve Top	<b>Capacity:</b> 2400 lbs. (1088 kg)

## CRL Spreader Bars

- Two Sizes With Adjustable Sling Positions
- Glass Slings Sold Separately (See Below)

CRL Steel Spreader Bars are equipped with multiple lift points to allow for differing sizes of glass packs. These lift points are designed to secure the high-density polyester Slings at the proper width. Cat. No. 2403471 measures 4" wide x 8" high x 108" long (102 x 203 x 2743 mm) and Cat. No. 2403469 measures 4" wide x 8" high x 168" long (102 x 203 x 4267 mm). The Spreader Bars and Glass Slings are sold separately; choose a matching 3" Glass Sling from the assortment shown below.

When ordering a Spreader Bar, please be ready to provide the maximum glass size to be lifted and the width of the packs. For assistance contact the CRL Customer Service Department.

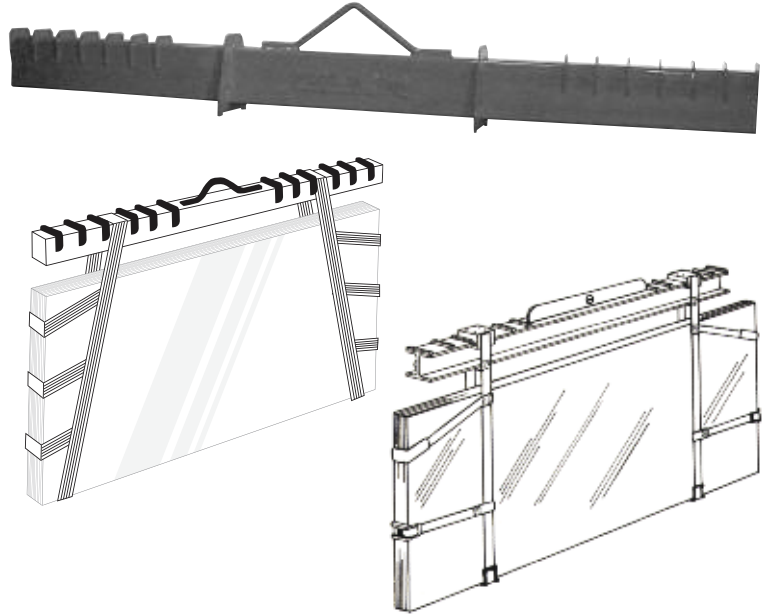

CAT. NO.	LIFTING CAPACITY	WEIGHT
2403471	4,000 lbs. (1,814 kg)	145 lbs. (66 kg)
2403469	10,000 lbs. (4,536 kg)	600 lbs. (272 kg)

Minimum order: 1 each. F.O.B. Woodstock, Illinois. Must ship common carrier.

## CRL Glass Slings

- Workloads Rated at 9,600 Pounds (4354 kg) Per Pair in Vertical Lift
- Available in Four Different Sizes
- 3" (76.2 mm) Wide Polyester Web Construction

The polyester webbing in these CRL Glass Slings minimizes elongation to three percent or less. The inside of the Slings and Cross-Straps are covered with a reinforced PVC coating to help prevent cutting of the webbing. Hook-and-loop straps prevent the Slings from shifting on the spreader beam when not under load. CRL Glass Slings are sold two per set, and are available in four different sizes.



CAT. NO.	SLING LENGTH	GLASS CAPACITY
2403487	78" (1.98 m)	36" to 54" High (914 to 1371 mm)
2403488	108" (2.74 m)	60" to 84" High (1524 to 2134 mm)
2403489	124" (3.15 m)	72" to 100" High (1829 to 2540 mm)
2403490	160" (4.06 m)	130" to 204" High (3302 to 5182 mm)

Minimum order: 1 set.

## CRL Glass Sling Shoe Blocks

- Neoprene Rubber Lined Steel Shoes to Fit Our Glass Slings
- Quick-Release Pins for Easy Mounting

These CRL Glass Sling Shoe Blocks feature covered vertical ledges to prevent glass contact with Slings. Shoe Blocks are held in place with quick-release pins for easy mounting and removal. The pin also holds the shoe in place during use. There are three sizes to choose from. They are sold two Shoe Blocks per set, and are available for CRL Glass Slings only.

CAT. NO.	WIDTH
2403459	4-3/4" (121 mm)
2403460	6-3/4" (171 mm)
2403462	10-1/4" (260 mm)

Minimum order: 1 set.



## CRL Chain Cable Sling

- Adjusts to All Sizes of Glass Cases
- 4,000 Pound (1814 kg) Capacity

The CRL Chain Cable Sling is an adjustable, braided wire rope and chain combination. The wire rope is lightweight and flexible, but strong. It will cut into the corners of the wooden frame for a positive grip on cases. The Chain is adjustable for large cases up to 12' (3.6 m) long, or small boxes by a patented chain lock head. Minimum order is one each.

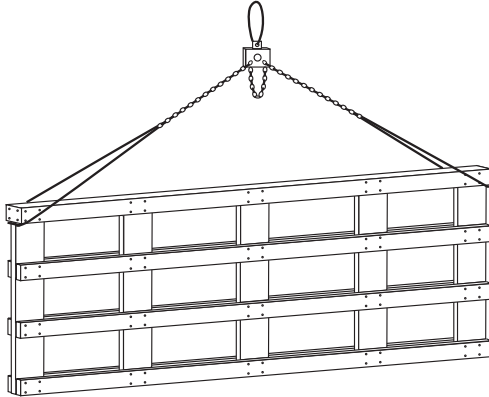

CAT. NO. 599

## CRL Double Loop Case Slings

- Wire Rope Slings Hold Wood Cases Securely
- 4000 Pound (1814 kg) Capacity

Slip the 1/2" (12 mm) thick wire rope Double Loop Case Sling around the first or second horizontal crate boards and the lifting process allows the cable to bite into the vertical end boards to prevent slippage. Heavy-duty construction allows lifting of the heaviest cases.

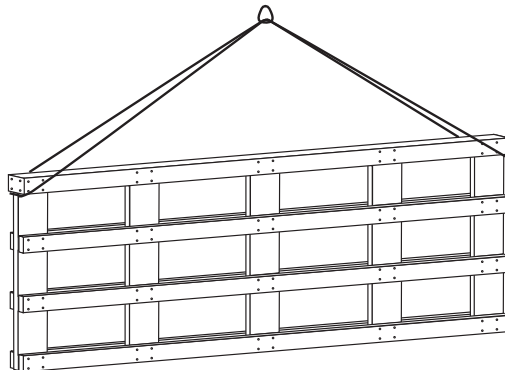

CAT. NO.	GLASS CASE LENGTH	CABLE LENGTH
<b>DLS60</b>	60"-90" (1524-2286 mm)	60" (1524 mm)
<b>DLS90</b>	90"-120" (2286-3048 mm)	72" (1829 mm)
<b>DLS120</b>	120"-150" (3048-3810 mm)	90" (2286 mm)

Minimum order: 1 each.

## CRL Multi-Purpose Glass Storage System

- Fixed Post System for Storage of Wood Cases, Glass Packs, and Loose Lites
- Rated Up to 4000 Pounds (1814 kg) Between Posts
- Customize for Your Space Using Individual Components or Choose From Selection of Storage Packages

CRL Multi-Purpose Glass Storage Systems are designed for the upright storage of glass cases, glass (stoce) packs and loose lites. All components are protected with a hot dip galvanized finish.

Posts are available in three stock lengths: 60" (1524 mm), 80" (2032 mm), and 102" (2591 mm). 2" (51 mm) square steel posts are matched to precision cut holes in the base rails spaced 4" (102 mm) apart for maximum adjustability. A heavy steel plate is fabricated with the same hole pattern and is welded inside the rail 1" (25 mm) up from the bottom to provide rigid, plumb alignment of all posts.

Base Rails can be butted together in 60" (1524 mm) increments to form any length system required, and are predrilled with 1/2" (12.7 mm) holes for anchoring to shop floor. Base Rails are kept in alignment when butted together with a unique 1" (25 mm) square slip-joint tube that ensures a straight line is maintained.

Low friction EZ Slide option with Center Rail provides for easy handling and edge protection for loose lites and glass (stoce) packs. Standard Case Storage Packages are intended for wooden case storage only, and do not include Center Rail or EZ Slide materials. EZ Slide Glass Pack Packages can be used for wooden cases, glass packs or loose lites. All products ship F.O.B. Woodstock, Illinois.



### STANDARD WOOD CASE STORAGE PACKAGES

CAT. NO.	DESCRIPTION	COMPONENTS	WEIGHT
2005431	4 Case Package	2 Outside Rails, 6 60" Posts, 4 80" Posts	250 lbs./113 kg
2005432	9 Case Package	4 Outside Rails, 10 60" Posts, 10 80" Posts	508 lbs./230 kg
2005433	19 Case Package	8 Outside Rails, 16 60" Posts, 16 80" Posts, 8 102" Posts	1104 lbs./501 kg

No substitutions. Minimum order: one package. Must ship via common carrier.

### EZ SLIDE GLASS PACK (STOCE) PACKAGES

CAT. NO.	DESCRIPTION	COMPONENTS	WEIGHT
2005434	4 Stoce Package	2 Outside Rails, 1 Center Rail, 6 60" Posts, 4 80" Posts	324 lbs./147 kg
2005435	9 Stoce Package	4 Outside Rails, 2 Center Rails, 10 60" Posts, 10 80" Posts	596 lbs./270 kg
2005436	19 Stoce Package	8 Outside Rails, 4 Center Rails, 16 60" Posts, 16 80" Posts, 8 102" Posts	1272 lbs./577 kg

No substitutions. Minimum order: one package. Must ship via common carrier.

### STANDARD COMPONENTS

CAT. NO.	DESCRIPTION	WEIGHT
2005423	60" (1524 mm) Long Outside Rail	55 lbs./25 kg
2005425	60" (1524 mm) Post	15 lbs./7 kg
2005427	80" (2032 mm) Post	19 lbs./9 kg
2005429	102" (2591 mm) Post	28 lbs./13 kg

Minimum order: 1 each.

### EZ SLIDE COMPONENTS

CAT. NO.	DESCRIPTION	WEIGHT
2005424	60" (1524 mm) Long Outside Rail	60 lbs./27 kg
2005545	60" (1524 mm) Long Center Rail	30 lbs./14 kg
2005426	60" (1524 mm) Post	16 lbs./7 kg
2005428	80" (2032 mm) Post	20 lbs./9 kg
2005430	102" (2591 mm) Post	28 lbs./13 kg

Minimum order: 1 each.

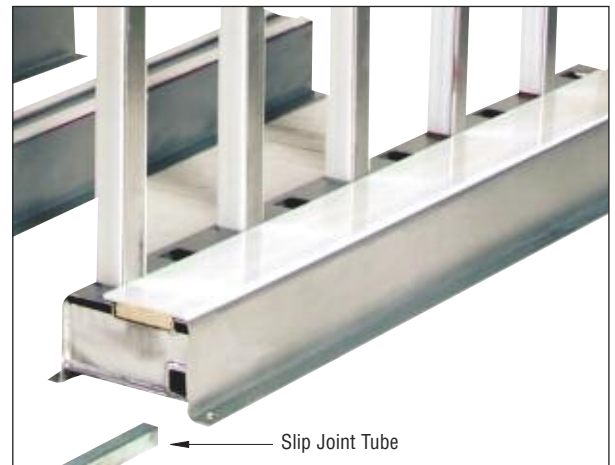



## CRL PVC Slot Rack Flooring

- Made From High Density PVC
- Milled With 3/8" Grooves
- Create Your Own Storage System

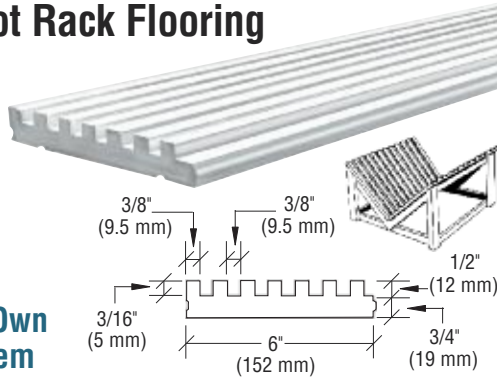

CRL High Density PVC Slot Rack Flooring is precision milled with 3/8" (9.5 mm) wide by 3/16" (5 mm) deep grooves to provide quality replacement rack flooring or to provide a base for racking of your own design. This 1/2" (12.7 mm) PVC material, bonded onto 3/4" (19 mm) OSB board, provides the ultimate in low friction slide storage systems. Minimum order is one 96" (2.44 m) length. Must ship common carrier.

CAT. NO. SFPVC

## CRL Hardwood Slot Rack Flooring

- Made of the Finest Grade Hardwood
- Use to Make Your Own Harp or V-Rack

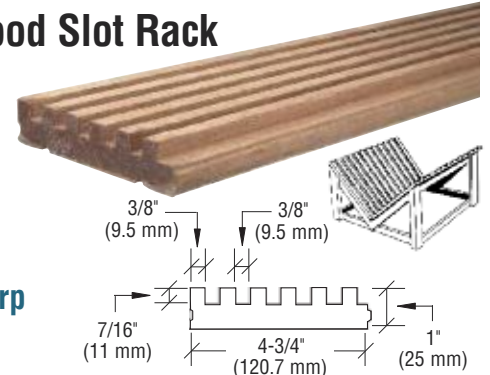

The finest grade of clear grain hardwood is accurately milled and used for this flooring as it provides long wear and easy glass handling. You can make your own harp rack with Slot Rack Flooring or use it to make a "V" shaped rack for cut off pieces. Simply lay lengths on the floor – they are grooved to join together snugly without nails or other fasteners. Minimum order is one 12' (3.66 m) length. Must ship common carrier. **NOTE:** Not Available in Australia.

CAT. NO. 25012

## CRL Glass Case Bracket

- Economical Method of Case Storage
- Allows Easy Adjustments

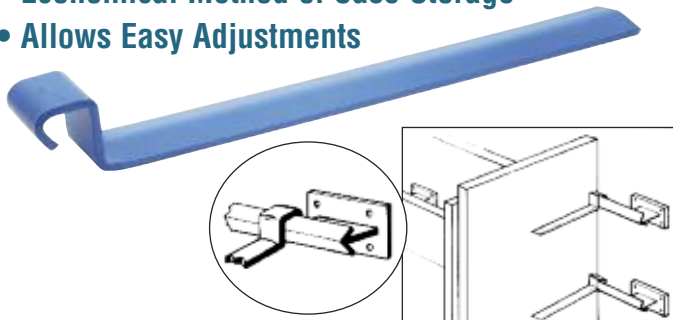

CRL Glass Case Brackets are an economical and simple way to keep cases of glass organized. Just mount a stand-off 1-1/2" x 1-1/2" (38 x 38 mm) angle-iron on a blank wall and hang the Case Bracket wherever you need them to hold cases upright. They are made of steel, and are 18" (457 mm) long. We suggest cases be supported near the top and bottom. Minimum order is one each.

CAT. NO. 662CB

## CRL Glass Tongs

- For Working With Heavy Glass in Slot Racks
- Made From High Quality Steel



CRL Glass Tongs have rubber lined jaws so they do not scratch or mar your glass while in use. The extra-long handles give you a firm grip on the glass, and provide an extra safety margin in the event of sheet breakage. One end of the Tongs is hooked to give you a better grip when pulling sheets of glass out of your rack. Their overall length is 18" (457 mm), and they are made from drop-forged steel. Minimum order is one each.

CAT. NO. 404

## CRL Shipping Pads and Glass Protectors

- Foam, Cork, Felt, Plastic, or Vinyl
- Adhesive or Static Cling
- 1/16" to 1/2" (1.6 to 12.7 mm) Thickness
- 1/2" to 2" (12.7 to 51 mm) Square
- Convenient Small Rolls or Efficient Bulk Packs

CRL provides a total selection of glass protection methods for every transport and storage situation, from shower doors to mirrors, windows to patio doors, or heavy tables to insulating units. Adhesive back or static cling choices and other packaging options cater to your production demands.

CRL vinyl or plastic corner protectors slip onto your fabricated glass corners to combine with shipping pad separators to provide the ultimate in product protection for you and your customers. See pages 242K-247K for the complete selection.



# CRL GLASS HANDLING EQUIPMENT

For Pricing Visit [crlaurence.com](http://crlaurence.com) or Call Us Toll Free at the Phone Numbers Shown on the Back Cover

## CRL Roller Blocks

- Rotate and Support Heavy Sheet or Insulated Glass With Ease
- Turn Over to Use as a Set of Resting Blocks
- Rubber Base Ensures Traction



CAT. NO. RB200

CRL Roller Blocks are made from extremely strong, high-density polyethylene so they won't chip or scratch the glass. They are especially useful for tipping large, heavy sheets of glass 90 degrees vertically. Rubber pads placed inside and outside prevent slippage and provide traction for tipping. Maximum weight per Block is 400 lbs. (181 kg). Minimum order is one pair.

## CRL Glass Grippers



GG1 Single Grip



GG2 Double Grip

With the CRL Glass Grippers two people can easily lift and position large sheets of glass each using only one hand, leaving the other hand free to guide and position the glass into place. The steel frame has serrated vulcanized rubber pads, which tightly hold the glass without slipping, or damaging the glass surface.

CAT. NO.	DESCRIPTION	CAPACITY	QTY/PKG
GG1	Single Grip	220 lbs. (100 kg)	2/Pack
GG2	Double Grip	440 lbs. (200 kg)	1/Pack

Minimum order: 1 pair of GG1, and 1 each of GG2.

## CRL Plate Glass Lifter

- For Lifting and Setting Glass



The popular CRL Plate Glass Lifter is used to lift or position large plates of glass for inserting setting blocks or shims. These work like a reverse pair of pliers to ease in lifting while reducing strain on your back. There is also a rubber pad that protects the glass from the metal pliers. Minimum order is one each.

CAT. NO. 104

## CRL Glass Lifting Sling and Hand Pad



CAT. NO. LGS50  
Glass Lifting Sling



CAT. NO. HG245  
Hand Pad

The CRL Glass Lifting Sling is made from high-strength nylon webbing and has a thick rubber bottom pad. Each side of the sling has a 10-1/2" (267 mm) aluminum handle with rubber grips.

The CRL Hand Pad is a molded, textured rubber pad measuring 4-7/8" x 6-3/4" (124 x 172 mm). This flexible pad is molded with a 1" (25 mm) thumb hole for extra gripping dexterity. Minimum order is one each.

## CRL Plate Glass Lifting Tool

- For Lifting and Setting Glass

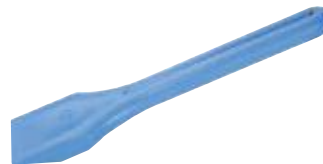

The CRL Plate Glass Lifting Tool is used to lift or position large plates of glass for inserting setting blocks or shims. Its uniquely shaped 2-3/4" (70 mm) tip is narrow enough to fit under the glass. Lightweight yet extremely durable, it is made of tough glass filled resin. Overall length is 10-3/4" (273 mm). Minimum order is one each.

CAT. NO. PGL11



C.R. LAURENCE COMPANY

[crlaurence.com](http://crlaurence.com) | [usalum.com](http://usalum.com)

240K | [crlaurence.ca](http://crlaurence.ca) [crlaurence.com.au](http://crlaurence.com.au) [crlaurence.co.uk](http://crlaurence.co.uk) [crlaurence.de](http://crlaurence.de) [crlaurence.eu](http://crlaurence.eu)

## CRL Glass Jack

- Use With Vacuum Lifters
- A Simple and Affordable Tool That Makes Adjusting Large Glass Panels Easy
- Great for Smaller Glass Shops

The CRL Glass Jack makes adjusting (or lifting) large glass and mirror panels a simple, one-person job. Used in conjunction with your vacuum lifter (not included), this precision machined tool lets you adjust and set your glass, while getting a better view of what you are doing without any interference. At the same time, you reduce your risk of back injury.

The CRL Glass Jack is set on a solid surface while you position it's cradle under your vacuum lifter. Then by simply attaching your vacuum lifter to the glass and turning the center adjustment bar, the glass will raise or lower accordingly. The turnbuckle mechanism lets you move glass panels in the smallest of increments, without sudden movements.

Made from the highest quality aluminum, the CRL Glass Jack is built for years of service. **NOTE:** Never exceed the recommended weight limit of your vacuum lifter. Minimum order is one each.



Vacuum Lifter Sold Separately  
See Page 212K.

CAT. NO. J1

## CRL Carrymate® Door Lifter

- For the Installation of Doors Including Fire Doors, Windows, Furniture, Dry Walls, Partitions, Etc.
- Easy Foot Operation; Lifts, Swivels, and Lowers
- For Doors Weighing Up To 264 Pounds (120 kg)



CRL Carrymate® Door Lifter is a panel and board swivel lifter which makes installation of doors a breeze. Includes an integrated tilt compensating lever to prevent the door from falling towards you. Lifts, swivels, and lowers up to 264 lbs. (120 kg). Also ideal for partitions and to align furniture. A rubber pad is included so no glass-to-metal contact is made when working with glass panels. A must-have tool for joiners, glaziers, painters, and locksmith's. Minimum order is one each.

CAT. NO. 0553

## CRL Door Jack

- A Combination Jack, Dolly, and Vise That Eases Transport and Installation of Doors

The CRL Door Jack is an "extra hand" that makes removing, moving, installing, or repairing doors a one person operation. Door Jack clamps to the strike side of most standard commercial and residential doors. Adjustable height casters make aligning the door and frame easy. For transport, just tilt the door back on the Door Jack's dolly wheels and move out. A support caster allows easy movement without lifting the door back to an upright position. Another accessory support holds the door in an upright position for hinge work. Door Jack handles doors and other materials in thickness from 1/2" to 2" (12 to 51 mm), and weighing up to 300 lbs. (136 kg). Minimum order is one each.



Carrymate is a registered trademark of Dr. Gold & Co. KG

CAT. NO. DJ1

# CRL GLASS PROTECTORS AND SHIPPING PADS

For Pricing Visit [crlaurence.com](http://crlaurence.com) or Call Us Toll Free at the Phone Numbers Shown on the Back Cover

## CRL Sponge Rubber Shipping Pads

- Economical and Easy to Use
- Leave No Residue When Removed
- For Storing and Transporting Glass
- Now in 1/8" (3.2 mm) and 1/4" (6.3 mm) Thickness

Developed for the tempering industry for use on hot glass during processing, and made of heavy-duty composition rubber, these CRL Shipping Pads have a special adhesive that leaves no residue when removed from the glass. They are excellent to use when transporting or storing glass to prevent surface scratches and breakage. Application is simple - just peel from the release paper roll and stick them to the glass. No special equipment, tools or solvents are needed to remove them. Pre-cut pads are available in two ways: on rolls of 1,000; in bulk quantities of 5,000 each of the 3/4" (19 mm) size, and 10,000 each of the 1/2" (12.7 mm) size.



CAT. NO.	PAD SIZE	THICKNESS	PADS/ROLL
SP1412	1/2" (12.7 mm) Square	1/4" (6.3 mm)	1,000
SP1412B	1/2" (12.7 mm) Square	1/4" (6.3 mm)	10,000
SP1834	3/4" (19 mm) Square	1/8" (3.2 mm)	1,000
SP1834B	3/4" (19 mm) Square	1/8" (3.2 mm)	25,000
SP1434	3/4" (19 mm) Square	1/4" (6.3 mm)	1,000
SP1434B	3/4" (19 mm) Square	1/4" (6.3 mm)	5,000

Minimum order: 1 roll. Sizes can be combined for quantity pricing.



## CRL Super-Duty Shipping Pads

- Used by Aluminum Window and Door Fabricators
- Handles Heavy Loads and Shock
- Easy-to-See Light Yellow Color

These CRL Super-Duty Shipping Pads are used by aluminum window and door fabricators to support and separate finished units during transport and storage. The highly condensed white troc ellen foam compresses slightly under load, and has great capacity to handle shock and heavy loads. The adhesive coating sticks tight in all climates, yet leaves no residue or discoloration on metal surfaces when removed, even after months of storage. CRL Super-Duty Shipping Pads are die-cut on sheets of release paper, and peel off easily for application, even in high-production situations. Standard thicknesses are 1/4" and 1/2" (6.3 and 12.7 mm), and all sizes are packed in boxes that will ship U.P.S.



CAT. NO.	PAD SIZE	THICKNESS	PADS/ROLL
NSP1411	1" x 1" (25.4 x 25.4 mm)	1/4" (6.3 mm)	12,096
NSP141515	1-1/2" x 1-1/2" (38.1 x 38.1 mm)	1/4" (6.3 mm)	5,376
NSP14152	1-1/2" x 2" (38.1 x 50.8 mm)	1/4" (6.3 mm)	4,032
NSP1422	2" x 2" (50.8 x 50.8 mm)	1/4" (6.3 mm)	3,024
NSP1211	1" x 1" (25.4 x 25.4 mm)	1/2" (12.7 mm)	6,048
NSP121515	1-1/2" x 1-1/2" (38.1 x 38.1 mm)	1/2" (12.7 mm)	2,668

Minimum order: 1 box. Sizes can be combined for quantity pricing.

## CRL Cork No-Adhesive Shipping Pads

- Extra Firm for Minimal Compression Under Heavy Loads
- Peel Off Without Leaving Residue

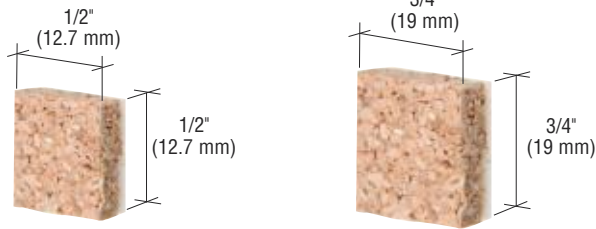

These CRL Cork No-Adhesive Shipping Pads are laminated with cork instead of sponge, therefore they are firmer and will not compress like sponge. This makes them excellent for use with heavy or large stacks of glass. Adhesive cleanup is eliminated since CRL Cork No-Adhesive Shipping Pads peel off without leaving any residue. They are even reusable if kept clean! Available in two ways: on rolls of 1,000 pre-cut pads, or on bulk rolls for volume users.

CAT. NO.	PAD SIZE	THICKNESS	PADS/ROLL
<b>CNA12</b>	1/2" (12.7 mm) Square	1/4" (6.3 mm)	1,000
<b>CNA12B</b>	1/2" (12.7 mm) Square	1/4" (6.3 mm)	10,000
<b>CNA34</b>	3/4" (19 mm) Square	1/4" (6.3 mm)	1,000
<b>CNA34B</b>	3/4" (19 mm) Square	1/4" (6.3 mm)	5,000

Minimum order: 1 roll. Sizes can be combined for quantity pricing.



## CRL Foam No-Adhesive Shipping Pads

- Adhesion by Static Electricity
- No Adhesive to Clean Up

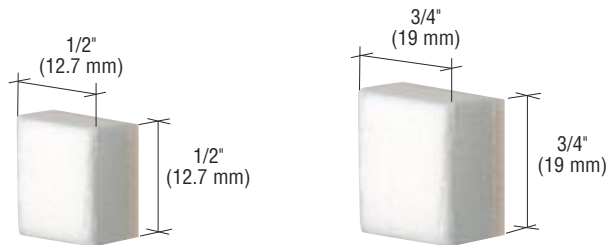

CRL Foam No-Adhesive Shipping Pads attach themselves to glass by static electricity. This eliminates many problems caused by the adhesives on normal shipping pads, such as adhesive residue cleanup, adhesive staining, and the limited shelf life of some adhesives. They are even reusable if kept clean! Foam Pads come 1,000 per roll. Economical bulk rolls for volume users contain either 5,000 pads in the 3/4" (19 mm) square size, or 10,000 pads in the 1/2" (12.7 mm) size on release paper rolls.

CAT. NO.	PAD SIZE	THICKNESS	PADS/ROLL
<b>NAP12</b>	1/2" (12.7 mm) Square	1/4" (6.3 mm)	1,000
<b>NAP12B</b>	1/2" (12.7 mm) Square	1/4" (6.3 mm)	10,000
<b>NAP34</b>	3/4" (19 mm) Square	1/4" (6.3 mm)	1,000
<b>NAP34B</b>	3/4" (19 mm) Square	1/4" (6.3 mm)	5,000

Minimum order: 1 roll. Sizes can be combined for quantity pricing.



# CRL GLASS PROTECTORS AND SHIPPING PADS

For Pricing Visit [crlaurence.com](http://crlaurence.com) or Call Us Toll Free at the Phone Numbers Shown on the Back Cover

## CRL Felt Glass Protectors

- Easy to Apply
- Helps Prevent Breakage
- Protects Glass From Scratches

Used to separate glass during shipping or storage, these high density CRL Felt Glass Protectors have an adhesive backing that holds them to the glass. This prevents scratches or breakage that sometimes occurs when two glass surfaces come in contact with each other. They are easy to apply and remove.

CRL Felt Glass Protectors can also be used on the base of objects such as vases, statuettes or ashtrays to keep them from scratching glass table tops. Green in color, they come on rolls of release paper for easy application. They are also available in other colors such as, black, white, brown, gray, blue, red, or yellow in quantities of 100,000 or more.



CAT. NO.	DIAMETER	THICKNESS	PADS/ROLL
FGP126	1/2" (12.7 mm)	1/16" (1.6 mm)	1,000
FGP128	1/2" (12.7 mm)	1/8" (3.2 mm)	1,000
FGP346	3/4" (19 mm)	1/16" (1.6 mm)	1,000
FGP348	3/4" (19 mm)	1/8" (3.2 mm)	1,000

Minimum order: 1 roll. Sizes can be combined for quantity pricing.

## CRL Pebbled No-Adhesive Shipping Pads

- Heavy Density 25 Pound Pebbled PVC on a Cling Foam Backing
- No Sticky Residue Left After Removal Means No Clean Up

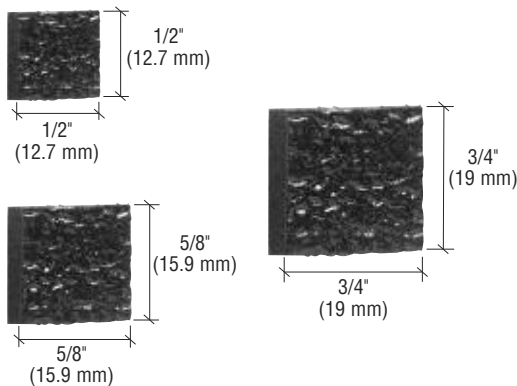
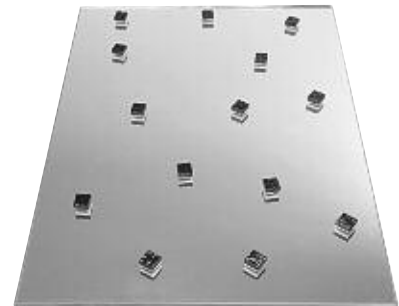

CRL Pebbled No-Adhesive Shipping Pads are a heavy density, 25 pound pebbled PVC laminated to a special cling foam. Since there's no adhesive, there's no residue, making clean up unnecessary. They are non-marking on glass, and can be reused in extremely clean conditions.

CAT. NO.	PAD SIZE	THICKNESS	PADS/ROLL
PNA12B	1/2" (12.7 mm) Square	1/4" (6.3 mm)	10,000
PNA58B	5/8" (15.9 mm) Square	1/4" (6.3 mm)	5,000
PNA34B	3/4" (19 mm) Square	1/4" (6.3 mm)	5,000

Minimum order: 1 roll. Sizes can be combined for quantity pricing.

## CRL Cork Tabs on a Roll

- Cork Pads With a Low Tack Adhesive
- Ideal for Mirror or Tempering Lines

These CRL Cork Tabs on a Roll are great for fabricators, distributors, glass shops or for any of your production needs. With thorough testing and industry feedback, we have found that these low-tack adhesive pads are a popular and reliable size. There are 3,000 pads per roll. Other sizes and types are available on special order.

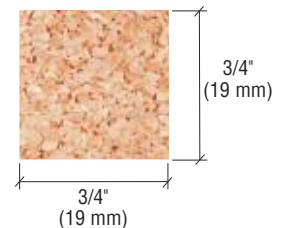

CAT. NO.	PAD SIZE	THICKNESS	PADS/ROLL
CSP34X132	3/4" (19 mm) Square	1/32" (0.8 mm)	3,000

Minimum order: 1 roll.

## CRL Felt Glass Protectors

- Easy to Use and Remove
- Available in Brown and Green



3/4" (19 mm) Diameter



1/16" (1.6 mm) Thick



3/4" (19 mm) Diameter

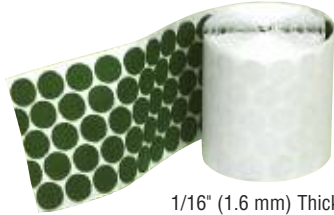

1/16" (1.6 mm) Thick

CRL Felt Glass Protectors have an adhesive on one side that adheres to any clean, dry surface. Buttons are 3/4" diameter x 1/16" (19 x 1.6 mm) thick, and available in green or brown color felt. Sold 1,000 buttons per roll on release paper.

CAT. NO.	COLOR	SIZE	QTY/ROLL
FA5BRW	Brown	3/4" (19 mm) Diameter	1,000
FA5GRN	Green	3/4" (19 mm) Diameter	1,000

Minimum order: 1 roll. All Glass Protectors can be combined for quantity pricing.

## CRL Cork Glass Protectors

- Easy to Use and Remove
- Made of 100% Cork



3/4" (19 mm) Diameter



1/16" (1.6 mm) Thick

CRL Cork Glass Protectors have adhesive on one side and are 3/4" diameter x 1/16" (19 x 1.6 mm) thick. They keep the glass from slipping or scratching the surface, and help protect the surface of the desk or table top. Sold 1,000 buttons per roll on release paper.

CAT. NO.	COLOR	SIZE	QTY/ROLL
CB2	Tan	3/4" (19 mm) Diameter	1,000

Minimum order: 1 roll. All Glass Protectors can be combined for quantity pricing.

## CRL Cork and Neoprene Composition Glass Protectors

- Easy to Use and Remove
- Slightly Softer Than Cork
- Excellent as a Glass Separator



3/4" (19 mm) Diameter



1/16" (1.6 mm) Thick

CRL Cork and Neoprene Composition Glass Protectors have adhesive on one side and are 3/4" diameter x 1/16" (19 x 1.6 mm) thick. They cushion glass on furniture tops, and are slightly more resilient than all-cork buttons. Sold 1,000 buttons per roll on release paper.

CAT. NO.	COLOR	SIZE	QTY/ROLL
CN1B	Tan/Black	3/4" (19 mm) Diameter	1,000

Minimum order: 1 roll. All Glass Protectors can be combined for quantity pricing.

## CRL Sponge Rubber Glass Protectors

- Easy to Use and Remove
- Cushion Glass in Stacks
- Protects Against Scratches and Abrasions



3/4" (19 mm) Diameter



1/8" (3.2 mm) Thick

CRL Sponge Rubber Glass Protectors have adhesive on one side of the black color sponge. They measure 3/4" diameter x 1/8" (19 x 3.2 mm) thick. Sold 1,000 buttons per roll on release paper.

CAT. NO.	COLOR	SIZE	QTY/ROLL
SR3	Black	3/4" (19 mm) Diameter	1,000

Minimum order: 1 roll. All Glass Protectors can be combined for quantity pricing.

## CRL Blue Transport Pads

- Medium Density
- Low Tack
- Available in Europe Only



These medium density PVC foam Transport Pads feature a low-tack, pressure sensitive, peelable adhesive that allows clean removal from glass, metal, and PVC-u surfaces leaving no adhesive residue or ghosting marks. They are designed for separating and protecting sheets of flat glass, sealed units, and automotive glass in transit or storage.

CAT. NO.	COLOR	DENSITY	SIZE	QTY/ROLL
1407LOG10	Blue	Medium	24 x 19 x 4 mm	10,000
1407LOG20	Blue	Medium	23 x 18 x 4 mm	20,000
1407E	Blue	Medium	23 x 18 x 4 mm	1,000

Minimum order: 1 roll.

## CRL Green Transport Pads

- Highest Density
- Adhesive-Free
- Available in Europe Only



These high and extra-high density PVC foam Transport Pads are used for protecting and transporting thicker, heavier, and/or coated glass. Available in low tack (Cat. No. 1407G4MM) and adhesive-free, these pads feature the highest density PVC in our range.

CAT. NO.	COLOR	DENSITY	SIZE	QTY/ROLL
1407G4MM	Green	High	25 x 19 x 4 mm	20,000
1416S	Green	Extra High	19 x 19 x 4 mm	16,000
1416R	Green	Extra High	23 x 18 x 4 mm	16,000

Minimum order: 1 roll.

## CRL Red Transport Pads

- High Density
- Low Tack
- Available in Europe Only



These high-density PVC foam Transport Pads are used for protecting and transporting thicker, heavier, and/or coated glass. The adhesive is U.V. and temperature resistant, and will offer consistent bonding strengths and clean peel, even after prolonged periods in contact with the surface.

CAT. NO.	COLOR	DENSITY	SIZE	QTY/ROLL
1407R4MM	Red	High	25 x 19 x 4 mm	10,000
1407R4MM50S	Red	High	50 x 50 x 4 mm	500
1407R2MM	Red	High	25 x 19 x 2 mm	10,000

Minimum order: 1 roll.

## CRL Cork Transport Pads

- Very Popular in Mainland Europe
- Cost Effective Option to PVC
- Available in Europe Only



Cork Transport Pads provide a cost effective option to higher priced PVC foam pads. They are specially developed with a thin foam underside using the same single sided adhesive coating technology as the PVC foam pads. They offer excellent high-compression resistance.

CAT. NO.	COLOR	DENSITY	SIZE	QTY/PACK
1407B	Cork/Black	Medium	19 x 19 x 4.5 mm	1,000
1407BA1	Cork/PVC	Medium	24 x 24 x 9.5 mm	4,000
1407W25	Cork/White	Medium	19 x 19 x 2.5 mm	1,000

Minimum order: 1 pack.



# CRL GLASS CORNER PROTECTORS

For Pricing Visit [crlaurence.com](http://crlaurence.com) or Call Us Toll Free at the Phone Numbers Shown on the Back Cover

## CRL Corner Protectors

- Protect Corners of Glass and Mirror
- Six Different Sizes for 1/8", 1/4", 5/16", 3/8", 1/2", and 3/4" (3, 6, 8, 10, 12, and 19 mm) Thicknesses

These CRL Corner Protectors are designed to protect glass and mirror edges during shipping, handling or storing. Black plastic Corner Protectors will not scratch or damage glass or mirror surfaces, and they help protect large cut-offs from breakage or becoming scrap. Protectors are re-usable, they simply slide on and off the corners of glass and mirror. Ensure your customers are getting a quality piece of glass; protect the corners with CRL Corner Protectors. Available in economical bulk packs or handy boxes of 100 each.

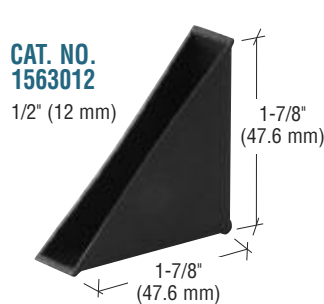
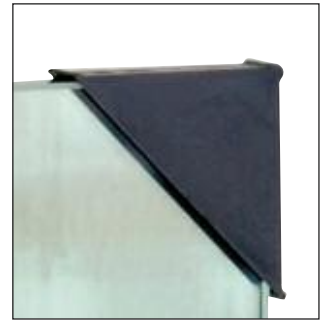

CAT. NO.	GLASS THICKNESS
1563004	1/8" (D.S.) - 3/16" (5 mm)
1563006	1/4" (6 mm)
1563008	5/16" (8 mm)
1563010	3/8" (10 mm)
1563012	1/2" (12 mm)
1563020	3/4" (19 mm)

Minimum order: 100 each. Must be ordered in increments of 100. Sizes can be combined for quantity pricing.

## CRL Armored Corner Protectors

- Economical, Reusable Corners Absorb Impact When Glass is Bumped or Dropped
- A Small Investment Can Save Expensive Glass and Help Prevent Costly Accidents



Glass fabricators, shower door installers, glazing contractors, and anyone handling glass panels can worry less about glass breakage using our new Armored Corner Protectors. These uniquely designed corners can absorb impacts during transport. The Corner's heel offers the maximum impact protection while the interior surfaces channel away impact energy from the surface of the glass. Cut-outs formed on the Corner's edge allow belt fastening.

CRL Armored Corners can be used for all types of flat and beveled glass. Packed in bags of 12 or bulk boxes of 100 each, they are color-coded by size for easy selection. See our online video at [crlaurence.com](http://crlaurence.com) for a demonstration of how effective these corners are against the worst type of dropped glass impacts.

**new**

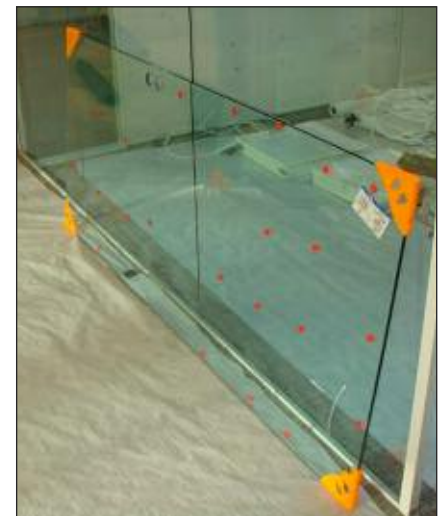

CAT. NO.	GLASS THICKNESS
ACP14	1/4" (6 mm)
ACP38	3/8" (10 mm)
ACP12	1/2" (12 mm)
ACP58	5/8" (15 mm)

Minimum order: 12 each. All Armored Corner Protectors can be combined for quantity pricing.

## CRL Aluminum Glass Racks for Pickup Trucks

- Double-Sided Racks for All Full Size Pickup Trucks
- Free Installation at Manufacturer's Plant, or Fully Assembled in Solid Wood Crates for Guaranteed Safe Shipping Anywhere, Including Overseas
- Available With or Without Removable Wheel Skirts

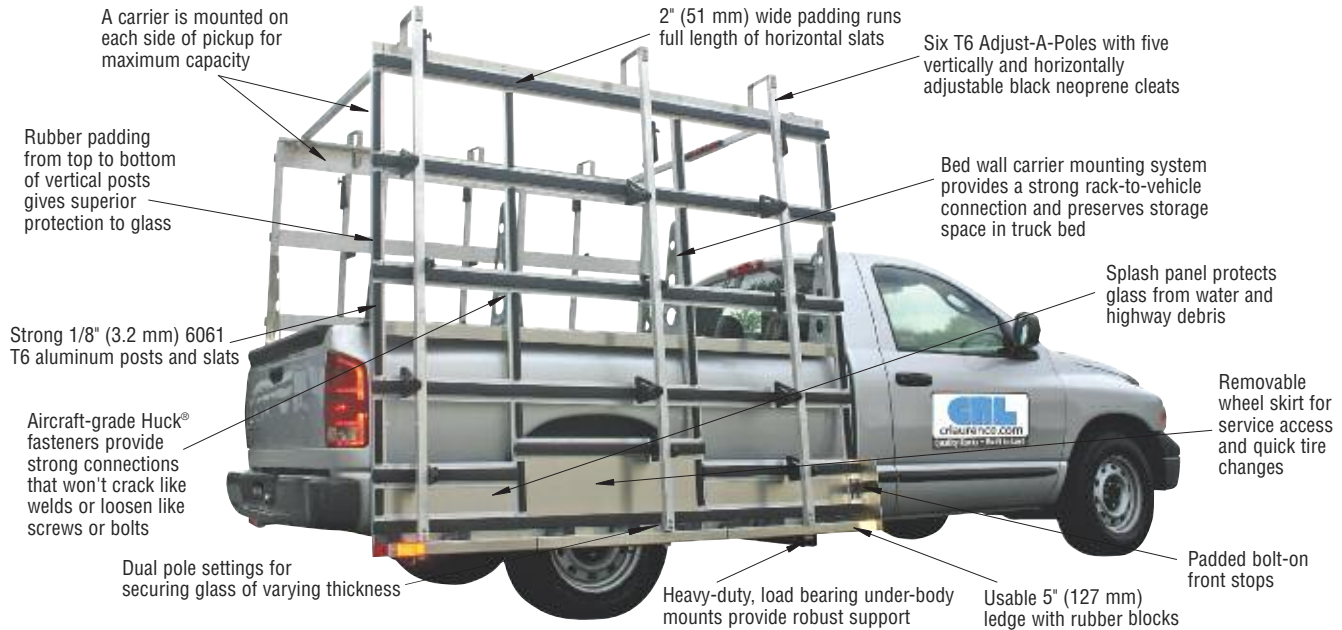

Three models to choose from, all two-sided (driver and passenger) 8' (2.4 m) long by 7' (2.1 m) high with or without Removable Wheel Skirt and either installed at no extra charge in Glassboro, New Jersey, or shipped crated and fully assembled (just bolt to your truck, best choice for domestic), or Knocked Down (KD for customer assembly for shipments outside the 48 contiguous states). Crates are solid wood boxes for guaranteed safe shipping anywhere, F.O.B. Glassboro, New Jersey. The Removable Wheel Skirt allows easy service access to wheels and also lowers the rack height for easier loading and unloading of glass. The Rack comes with a 5" (127 mm) wide usable ledge with 2" (51 mm) wide rubber ledge blocks and double pole settings for top and bottom; one row of splash panel; computer designed load bearing with fully adjustable Under-Body Mounts; horizontal and full length vertical rubber; and six Adjust-A-Poles with five sliding triangular black neoprene cleats. Optional equipment includes: Sign Panel (customer applies own logo, phone number, etc., does not come with lettering), or lettering can be done at factory for an additional charge; extra T6 Adjust-A-Pole 7' (2.1 m) long with five sliding cleats. Racks are designed for all full size pickup trucks with 8' (2.4 m) beds. Please specify make, model, and year when ordering.

### Optional Equipment



Sign Panel for Pickups  
CAT. NO. GR113P

T6 Adjust-A-Pole  
CAT. NO. GR102



Removable Wheel Skirt Included With  
CAT. NO. GRAL2000WS

#### 8' LONG X 7' HIGH (2.4 X 2.1 M) PICKUP TRUCK RACKS

CAT. NO.	DESCRIPTION
GRAL2000WS	Aluminum Pickup Truck Rack With Wheel Skirt
GRAL2000	Aluminum Pickup Truck Rack Without Wheel Skirt
GRAL2000KD	Aluminum Pickup Truck Rack Knocked Down Without Wheel Skirt

Minimum order: 1 each. F.O.B. Manufacturer.

## CRL Aluminum Glass Racks for Vans

- For All Full Size and Sprinter-Type Vans
- Free Installation at Manufacturer's Plant, or Fully Assembled in Solid Wood Crates for Guaranteed Safe Shipping Anywhere, Including Overseas
- Available With or Without Removable Wheel Skirts

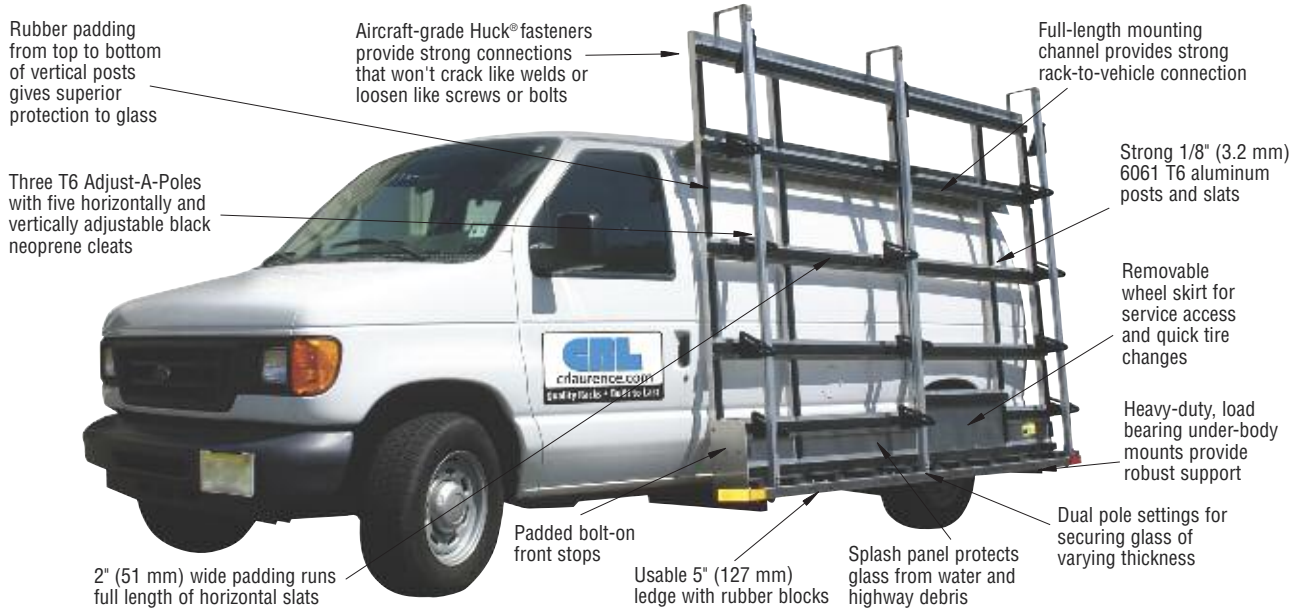

Three models to choose from, all one side (driver) 10' (3.05 m) long by 7' (2.1 m) high with or without Removable Wheel Skirt and either installed at no extra charge in Glassboro, New Jersey, or shipped crated and fully assembled (just bolt to your van, best choice for domestic), or Knocked Down (KD for customer assembly for shipments outside the 48 contiguous states). Crates are solid wood boxes for guaranteed safe shipping anywhere, F.O.B. Glassboro, New Jersey. Removable Wheel Skirt allows easy service access to wheels and also lowers the rack height for easier loading and unloading of glass. The Rack comes with a 5" (127 mm) wide usable ledge with 2" (51 mm) wide rubber ledge blocks and double pole settings for top and bottom; one row of splash panel; computer designed load bearing with fully adjustable Under-Body Mounts; horizontal and full length vertical rubber; and three T6 Adjust-A-Poles with five sliding triangular black neoprene cleats. Optional equipment includes: Sign panel (customer applies own logo, phone number etc., does not come with lettering), or lettering can be done at factory for an additional charge; extra T6 Adjust-A-Pole 7' (2.1 m) long with five sliding cleats; 3-Piece Roof Rack mounts to rack (no drilling in side of van required). For all full size and Sprinter type Vans. Please specify make, model, and year when ordering.

### Optional Equipment



Demountable Van Rack (Call for Details)



CAT. NO. GR113V Sign Panel for Vans



CAT. NO. GR102 T6 Adjust-A-Pole



Removable Wheel Skirt Included With  
CAT. NO. GRAL1000WS



Optional 3-Piece Roof Rack  
CAT. NO. GVRR112

#### 10' LONG X 7' HIGH (3.05 X 2.1 M) VAN RACKS

CAT. NO.	DESCRIPTION
GRAL1000WS	Aluminum Van Rack With Wheel Skirt
GRAL1000	Aluminum Van Rack Without Wheel Skirt
GRAL1000KD	Aluminum Van Rack Knocked Down Without Wheel Skirt

Minimum order: 1 each. F.O.B. Manufacturer.

Huck is a registered trademark of Huck International Inc.

## CRL Glass Racks for Pickup Trucks

- Right and Left Side Racks Included
- Racks Available in 72" (1829 mm), 86" (2184), and 96" (2438 mm) Heights
- Six Outside Stakes With Barkleats™ and Hardware
- 1-1/2" (38 mm) Square Tube Uprights and Stakes
- Double Row of Stake Slots
- Barpad® Glass Cushions on 8" (203 mm) Centers
- Neoprene Baseplate on 12" (305 mm) Centers With 5" (127 mm) Usable Ledgeboard
- Front Load Stops
- Full Bottom Panel to Protect Glass From Debris
- Includes All Necessary Lights and Reflectors
- Front Corner Braces and Rear Stabilizer Assemblies
- Solid Upper Sign Panels Standard on Steel and Stainless Steel Racks



### Available in Three Materials

**\* STEEL CONSTRUCTION**

Rated **GOOD** - Uses high-tensile steel; primed, finished, and painted white

**\*\* ALUMINUM CONSTRUCTION**

Rated **BETTER** - Lighter than steel with polished finish.

**\*\*\* STAINLESS STEEL CONSTRUCTION**

Rated **BEST** - lighter and stronger than steel, three times stronger than aluminum with minimum maintenance, brushed finish.

**Available Options:**

- Cantilevered or Goal Post Metal Carriers
- 30" (762 mm) Vertical Rack Extension

CAT. NO.	LENGTH x HEIGHT	CONSTRUCTION	MFG.#
BR706M	72" x 72" (1829 x 1829 mm)	Steel	706-MINI <sup>△</sup>
BR706MA	72" x 72" (1829 x 1829 mm)	Aluminum	706-A MINI <sup>△</sup>
BR706	72" x 86" (1829 x 2184 mm)	Steel	706
BR707M	84" x 72" (2134 x 1829 mm)	Steel	707-MINI <sup>△</sup>
BR707MA	84" x 72" (2134 x 1829 mm)	Aluminum	707-A MINI <sup>△</sup>
BR707	84" x 86" (2134 x 2184 mm)	Steel	707
BR708	96" x 86" (2438 x 2184 mm)	Steel	708
BR708A	96" x 86" (2438 x 2184 mm)	Aluminum	708-A
BR708S	96" x 86" (2438 x 2184 mm)	Stainless Steel	708-S
BR709	108" x 86" (2743 x 2184 mm)	Steel	709
BR709A	108" x 86" (2743 x 2184 mm)	Aluminum	709-A
BR709S	108" x 86" (2743 x 2184 mm)	Stainless Steel	709-S
BR709EH	108" x 96" (2743 x 2438 mm)	Steel	709-EH
BR709EHA	108" x 96" (2743 x 2438 mm)	Aluminum	709-EH-A
BR709EHS	108" x 96" (2743 x 2438 mm)	Stainless Steel	709-EH-S
BR710	120" x 86" (3048 x 2184 mm)	Steel	710
BR710S	120" x 86" (3048 x 2184 mm)	Stainless Steel	710-S
BR710EH	120" x 96" (3048 x 2438 mm)	Steel	710-EH

Minimum order: 1 each. F.O.B. Milwaukee, Wisconsin. Must ship common carrier. <sup>△</sup> Mini designates racks for compact pickups.

Barpad is a registered trademark of F. Barkow, Inc.

## CRL Glass Racks for Pickup Trucks

- Complete With Barkleats™, Stakes, Barpads®, and Base Pads
- Made to be Field Installed With a Minimum Amount of Labor
- Step-by-Step Instructions Included

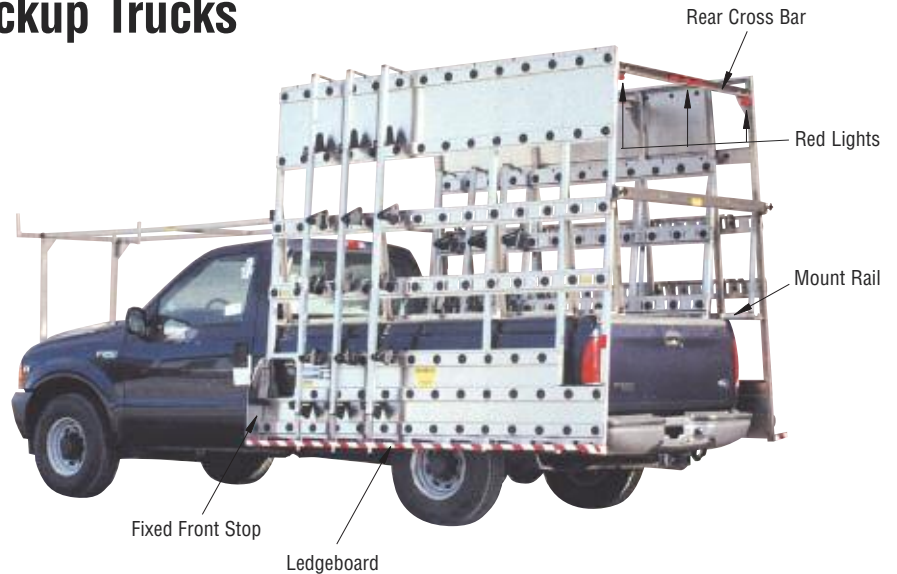

CRL Glass Racks for Pickup Trucks are available in painted steel, polished aluminum, or brushed stainless steel finish. Most Racks are also available in several height and width options. Among the many options are: 30" (762 mm) Gear and Rack Extensions that make it possible to haul larger lites of glass, Cantilever or Goal Post Metal Carriers. Glass Racks for Pickup Trucks are ordered and shipped with both a driver's side rack and a passenger side rack.

When placing your order the CRL Technical Support Staff will need to know: the CRL Glass Rack Catalog Number; the Make, Model, Year and Wheel Base of the vehicle; Cab Style (Standard or Extended); and the Bed Length (Short or Long). Many options can only be installed at time of manufacturing and should also be discussed: custom paint, signboards, or racks extension. CRL Glass Racks for Pickup Trucks are custom built and non-returnable. Racks are shipped common carrier F.O.B. Milwaukee, Wisconsin.

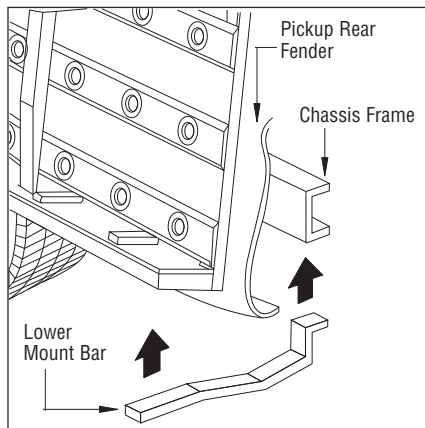

**CHASSIS TO RACK MOUNT BARS**

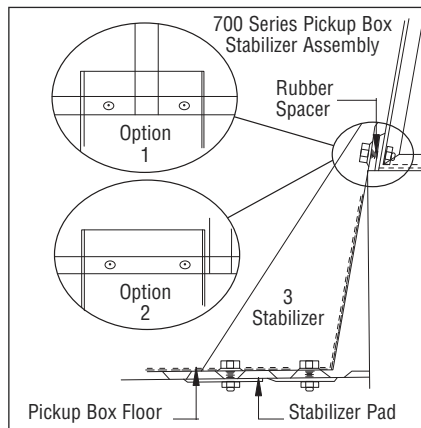

**NEW REAR BOX STABILIZERS**

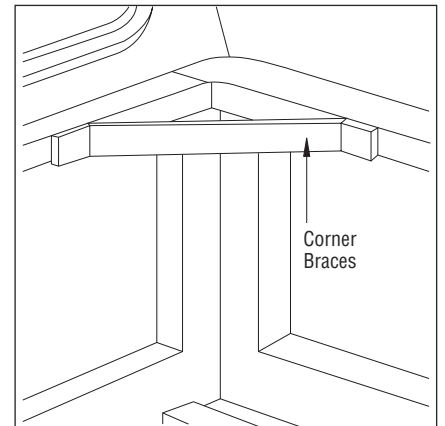

**BOX FRONT CORNER BRACES**

### TYPICAL INSTALLATION STEPS:

- (1) Identify and position driver and passenger sides by location of Fixed Front Stops.
- (2) Set A-frames on top of bed walls, align front post flush with bulkhead to clear gas flap door.
- (3) Bolt Cross Bars across top with amber lights facing forward and red lights facing rear. Adjust angle of Rack to preferred six degree tilt. Do not exceed 102" (2591 mm) side to side legal width limit. Tighten top bolts.
- (4) Check carrier for straightness. Drill and bolt A-frame Mount Rail to top lip of truck box.
- (5) Re-check carrier for straightness. Drill and bolt four Bottom Chassis Mount Bars between truck frame and underside of Ledgeboards – two front and two rear.
- (6) Drill and mount Front Box Corner Braces and Rear Box Stabilizer Assembly so closing of gate is not impaired.
- (7) Run and connect wires for clearance lights. Cut and finish opening for gas flap door using hole saw and reciprocating saw.

Barpad is a registered trademark of F. Barkow, Inc.

## CRL Glass Racks for Vans

- Right or Left Side Racks Sold Individually
- Racks Available in 72" (1829 mm), 86" (2184 mm), and 96" (2438 mm) Heights
- Four Outside Stakes With Barkleats™ and Hardware
- All Welded Construction
- 1-1/2" (38 mm) Square Tube Uprights and Stakes
- Double Row of Stake Slots
- Barpad® Glass Cushions on 8" (203 mm) Centers
- Neoprene Baseplate Pads on 12" (305 mm) Centers With 5" (127 mm) Usable Ledgeboard
- Front Load Stops Left and Right
- Includes All Necessary Lights and Reflectors



### Available Options:

- Cantilevered or Goal Post Metal Carriers
- Solid Sign Panels
- Stainless Steel Roof Rack
- 30" (762 mm) Vertical Rack Extension With Extendable Stakes

## Available in Three Materials

### \* STEEL CONSTRUCTION

Rated **GOOD** - Uses high-tensile steel; primed, finished, and painted white

### \*\* ALUMINUM CONSTRUCTION

Rated **BETTER** - Lighter than steel with polished finish.

### \*\*\* STAINLESS STEEL CONSTRUCTION

Rated **BEST** - lighter and stronger than steel, three times stronger than aluminum with minimum maintenance, brushed finish.

CAT. NO.	LENGTH x HEIGHT	CONSTRUCTION	MFG.#
BR606M	72" x 72" (1829 x 1829 mm)	Steel	606-MINI <sup>1</sup> △
BR606MA	72" x 72" (1829 x 1829 mm)	Aluminum	606-A MINI <sup>1</sup> △
BR608L	96" x 72" (2438 x 1829 mm)	Steel	608-L
BR608LA	96" x 72" (2438 x 1829 mm)	Aluminum	608-LA
BR608LS	96" x 72" (2438 x 1829 mm)	Stainless Steel	608-LS
BR608H	96" x 86" (2438 x 2184 mm)	Steel	608-H
BR608HA	96" x 86" (2438 x 2184 mm)	Aluminum	608-HA
BR608HS	96" x 86" (2438 x 2184 mm)	Stainless Steel	608-HS
BR609H	108" x 86" (2743 x 2184 mm)	Steel	609-H <sup>2</sup>
BR609HA	108" x 86" (2743 x 2184 mm)	Aluminum	609-HA <sup>2</sup>
BR609HS	108" x 86" (2743 x 2184 mm)	Stainless Steel	609-HS <sup>2</sup>
BR610H	120" x 86" (3048 x 2184 mm)	Steel	610-H
BR610HA	120" x 86" (3048 x 2184 mm)	Aluminum	610-HA
BR610HS	120" x 86" (3048 x 2184 mm)	Stainless Steel	610-HS
BR610EH	120" x 96" (3048 x 2438 mm)	Steel	610-EH
BR610EHA	120" x 96" (3048 x 2438 mm)	Aluminum	610-EHA
BR610EHS	120" x 96" (3048 x 2438 mm)	Stainless Steel	610-EHS
BR612H	144" x 86" (3658 x 2184 mm)	Steel	612-H
BR612HA	144" x 86" (3658 x 2184 mm)	Aluminum	612-HA
BR612EH	144" x 96" (3658 x 2438 mm)	Steel	612-EH

Minimum order: 1 each. F.O.B. Milwaukee, Wisconsin. Must ship common carrier. △ Mini designates Racks for compact vans. NOTE: Right and left sided Racks are sold individually.

<sup>1</sup> Window or Passenger Vans Require Roof Rack.

<sup>2</sup> For GMC Savanna/Chevy Express

Barpad is a registered trademark of F. Barkow, Inc.

## CRL Glass Racks for Vans

- Complete With Barkleats™, Stakes, Barpads® and Base Pads
- Made to be Field Installed With a Minimum Amount of Labor
- Available for Driver and/or Passenger Side (Sold Individually)
- Complete Instructions and Mounting Hardware

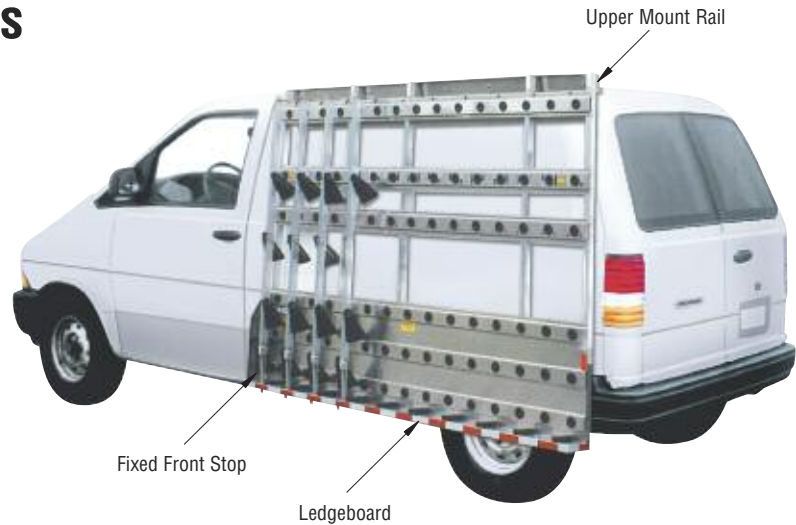

CRL Glass Racks for Vans are available in painted steel, polished aluminum, or brushed stainless steel finish. Each Glass Rack comes with complete instructions and all necessary mounting hardware. Since Van Racks are ordered individually per side, you are able to customize your van with a full driver's side rack and a short passenger side rack to clear side doors.

Popular options for CRL Van Racks are: Upper Sign Boards, 30" (762 mm) Gear and Rack Extensions, and Cantilever or Goal Post Carriers, and a Stainless Steel Roof Rack. **NOTE:** Be sure not to exceed the maximum allowable vehicle width of 102" (2591 mm).

When placing your order the CRL Technical Support Staff will need to know: the CRL Van Rack Catalog Number; the Make, Model, Year and Wheel Base of your van. If ordering for the passenger side, our staff will also need to know the type and location of doors on that side. CRL Van Racks are custom built and not returnable. Racks are shipped common carrier F.O.B. Milwaukee, Wisconsin.

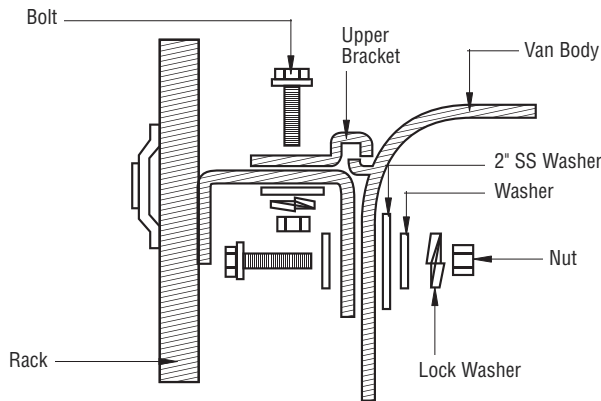

TOP MOUNT

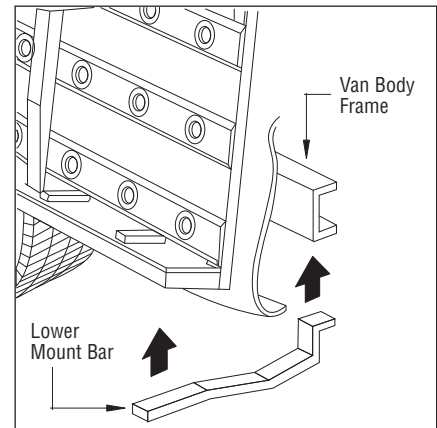

BOTTOM MOUNT

### TYPICAL INSTALLATION STEPS:

- (1) Identify and position Rack according to location of Fixed Front Stop.
- (2) Place Rack against side of van with Upper Mount Rail about 1/2" (12 mm) below drip rail, or as indicated by instructions and block underneath to support Rack. Side Rails should clear side of van by about 1/2" (12 mm). Make sure door is not blocked and that vertical Rack Rail does not cover fuel door.
- (3) Adjust bottom of Rack out to set angle of six degrees. Do not exceed 102" (2591 mm) maximum allowable overall width.
- (4) Per instructions drill holes from inside van through wall and through inside of Mounting Rail.
- (5) Use supplied Rubber Shims to compensate for body curve, check Rack for straightness, and then bolt Rack in place.
- (6) Recheck for straightness and mount two Lower Mount Bars between vehicle frame and underside of Ledgeboard.
- (7) Place Upper Mount Brackets over rain gutter and drill and bolt to top of upper mounting rail.
- (8) Drill and cut opening in Rack side to provide access to fuel door. Vinyl Grommet is provided to finish edge of cut.

Barpad is a registered trademark of F. Barkow, Inc.

## CRL Barkleats™

- For All CRL Glass Racks
- Triangular Shape Gives a Gripping Range From 1" to 6" (25 mm or 152 mm)



The CRL Barkleat™ Set includes the unique Barkleat™, a stainless steel bolt, stainless steel washer, and acetal wingnut. The Barkleat™ is a simple yet highly effective glass holding clamp for all CRL Racks and most other racks available today. They are molded out of fiber-impregnated rubber, which makes them weather-resistant and able to withstand years of use. The triangular design allows the CRL Barkleat™ to be used in two different orientations, giving each Barkleat™ a clamping range from 1" to 6" (25 to 152 mm).

### COMPLETE BARKLEAT™ SETS

CAT. NO.	DESCRIPTION
BK36	Complete Kit with Stainless Steel Bolt
BK36A	Complete Kit with Aluminum Bolt

Minimum order: 1 each

### REPLACEMENT PARTS

CAT. NO.	DESCRIPTION
BKB3BOLTA	Aluminum Bolt Only
BKB3NUT	Acetal Wing Nut Only
BKB3WASHER	Stainless Steel Washer Only
BK36KO	Kleat Only/No Hardware

Minimum order: 1 each

## CRL Truck Rack Kleats

- Available in Right or Left Handed
- Replacement Bolt Kits Available



The CRL Truck Rack Kleat is made from high strength phenolic with a rubber pad to secure the glass. It's gripping range is 1-1/4" to 5-3/4" (32 to 146 mm). Kleats are available in either right or left hand to resist loosening during vibration. The Kleat includes a steel and a nylon washer, as well as an oversized wing nut. The bolt and nut replacement set also includes both washers.

CAT. NO.	DESCRIPTION	QTY/PKG
687L	Complete Kleat Left Hand	1 Set
687R	Complete Kleat Right Hand	1 Set
2405686	Bolt and Nut Only L.H.	1 Set
2405699	Bolt and Nut Only R.H.	1 Set
W1NGNUT	Wing Nut Only	1 Each

Minimum order: 1 each. Complete Kleat Sets can be combined for quantity pricing.

## CRL Truck Rack Stakes

- Two Sizes Available to Increase the Capacity of Your Truck Rack



CRL offers additional Truck Rack Stakes to increase your existing rack capacity. Due to the large number of sizes, styles, and options available, please visit [crlaurence.com](http://crlaurence.com) and enter the catalog number in the search box, then open the detailed CRL Truck Stake Worksheet. Fill this form out and fax back to our Quotations Department. Qualified CRL Technical Sales Personnel will complete the quote and fax it back to you.



CAT. NO.	LENGTH
BRS86	86" (2184 mm)
BRS105	105" (2667 mm)

Minimum order: 1 each. F.O.B. Milwaukee, Wisconsin.



## CRL Aluminum Side Slats

- Heavy-Duty Aluminum With Vinyl Cushions
- Make a New Rack or Fix Up Your Old One
- 12' (3.6 m) Stock Lengths

Make your own glass truck rack, or repair an old one with this CRL Aluminum Truck Side Slat. This heavy-duty Slat is made of anodized aluminum so it won't rust or split, and has 7/16" (11 mm) wide vinyl insert strips to cushion the glass. Installation with rivets or screws is easy, and the vinyl cushion is easily replaced when worn. These CRL Aluminum Side Slats are also virtually maintenance free.



### ALUMINUM SIDE SLATS

CAT. NO.	LENGTH
TSS12	12' (3.6 m)

Minimum order: 1 each.

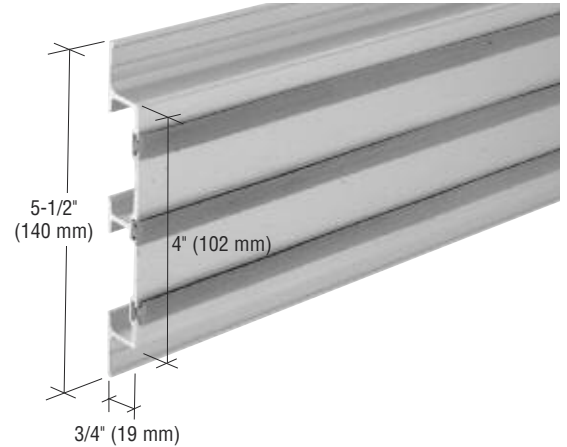
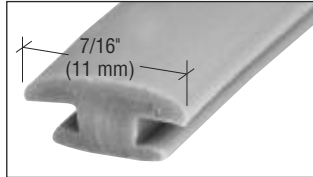

### REPLACEMENT VINYL

CAT. NO.	ROLL LENGTH
TSV1203C	100' (30.5 m)
TSV1203B	750' (228 m)

Minimum order: 1 roll.



## CRL Truck Rack Cushion

- Made From Non-Marring Neoprene Rubber
- Make Your Old Rack Look Like New
- Great for Refurbishing Old Wooden Racks or Shop Dollies

This CRL Truck Rack Cushion can be mounted on pre-existing glass rack horizontal slats. Made from weather-resistant neoprene rubber, this cushion is non-marring and provides a non-slip surface for supporting the glass. It can also be mounted to just about any surface where glass is to be stored. Just glue or tack this cushion in place for years of use. Minimum order is 12' (3.6 m). Must be ordered in 12' (3.6 m) increments.

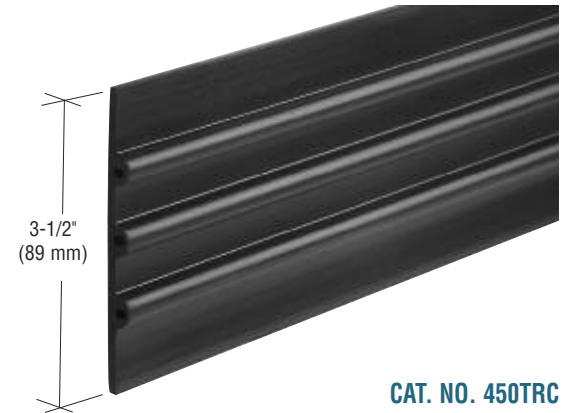

CAT. NO. 450TRC

## CRL Tube Container System

- Excellent Storage System for Moldings or Straight Edges
- Works With Common 6" (152 mm) PVC Pipe

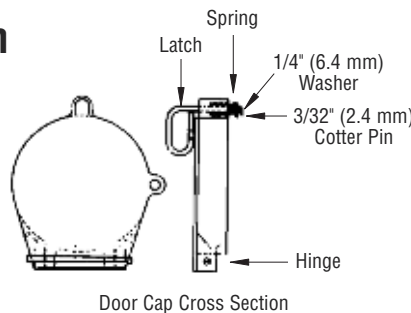

Door Cap Cross Section



Pipe Shown Not Included

The CRL Tube Container System works with common 6" (152 mm) Schedule 40 PVC pipe to create an efficient and protective storage system for any long stock lengths of product or tools, such as straight edges and levels. Cat. No. 658TE includes one weather-tight Door Cap which you can close and lock as well as a Permanent End Cap. The Cat. No. 658SU includes two U-Bolts with Saddle Brackets to firmly mount your storage tube on your vehicle. There is no limit as to the length since you provide and cut your pipe to any size you want.

CAT. NO.	DESCRIPTION
658TE	One Door Cap and End Cap
658SU	Two Saddle Brackets and U-Bolts

Minimum order: 1 pack.

## CRL Glass Rack Type "B" Side Slat

- Available in Steel or Aluminum
- Perforated for BP2 Barpads®, BP3 Barpads®, Load Stoppers, and Glass Ties
- 10' (3 m) Stock Lengths

These CRL Glass Rack Type "B" Side Slats have a combination of holes and slots. With these you can mount Cat. No. BP2 Barpads®, Cat. No. BP3 Barpads®, Cat. No. BRLS1 Load Stoppers or use our Cat. No. BRGT4 Glass Tie Straps to secure your glass loads. You can mount these Slats on existing racks or use them to make your own truck racks. Slots are 4" (102 mm) on center, and the 1" (25 mm) diameter holes are 8" (203 mm) on center.

CAT. NO.	MATERIAL	THICKNESS	LENGTH
BRBS10	Steel	12 ga.	10' (3 m)
BRBA10B	Aluminum	1/8" (3.2 mm)	10' (3 m)

Minimum order: 1 each. Must ship common carrier.

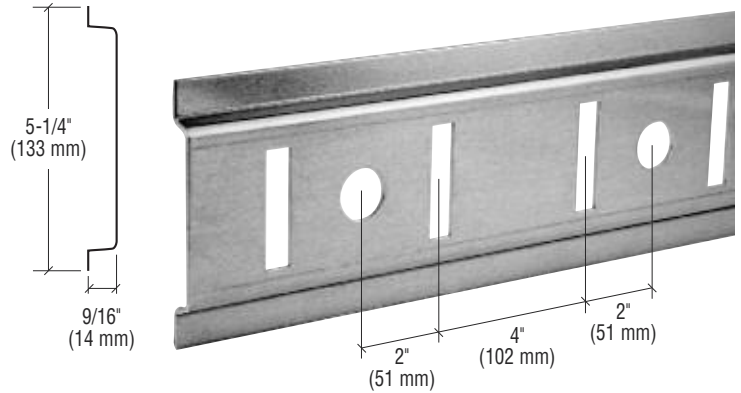

## CRL Glass Rack Type "E" Side Slat

- Made From Heavy-Duty 1/8" (3.2 mm) Aluminum
- Accepts Cat. No. BP3 Barpads®
- 10' (3 m) Stock Lengths

This CRL Glass Rack Type "E" Side Slat has only slots for mounting Cat. No. BRGT4 Glass Tie Straps (see page 257K). Also accepts Cat. No. BP3 Barpads® which snap into any of the slots. You can mount these Slats to an existing rack or you can use them to make a new rack. The slots are 4" (102 mm) on center.

CAT. NO.	MATERIAL	THICKNESS	LENGTH
BRBA10E	Aluminum	1/8" (3.2 mm)	10' (3 m)

Minimum order: 1 each. Must ship common carrier.

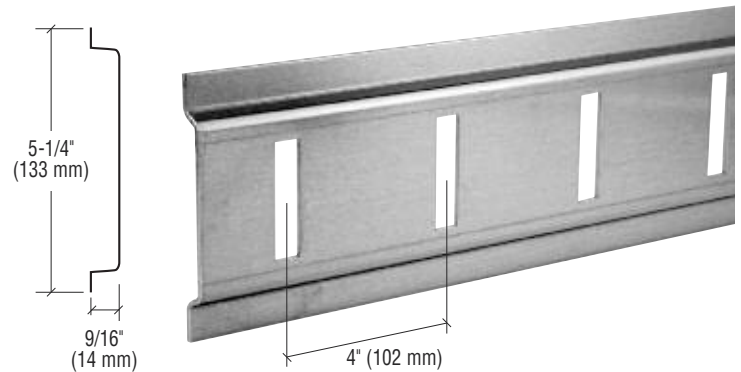

## CRL Glass Rack Type "A" Side Slat

- Made From Heavy-Duty 1/8" (3.2 mm) Aluminum
- Accepts Cat. No. BP2 Barpads®
- 10' (3 m) Stock Lengths

This CRL Glass Rack Type "A" Side Slat has only 1" (25 mm) diameter holes for mounting Cat. No. BP2 Barpads®. These Slats can be mounted on existing racks as replacements, or you can use them to make new racks. Holes are located on 8" (203 mm) centers, and there are a total of 15 holes per 10' (3 m) stock length.

CAT. NO.	MATERIAL	THICKNESS	LENGTH
BRBA10A	Aluminum	1/8" (3.2 mm)	10' (3 m)

Minimum order: 1 each. Must ship common carrier.

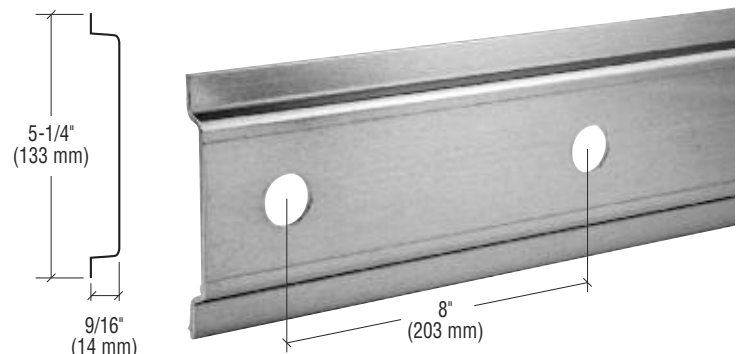

Barpad is a registered trademark of F. Barkow, Inc.

## CRL Barpads®

### • Self-Adhesive or Snap-In

These CRL Barpads® are made of tough neoprene rubber and are available with either self-adhesive backing or a snap-in type. Both Barpads® are 2-3/8" (60 mm) in diameter and 1/4" (6 mm) thick. Cat. No. BP1 has the adhesive back, while Cat. No. BP2 has a round button on the back that will snap into the 1" (25 mm) diameter holes found on our aluminum or steel Side Slats. Minimum order is one each. Barpads® can be combined for quantity pricing.



**CAT. NO. BP1**  
Self-Adhesive



**CAT. NO. BP2**  
Snap-In

## CRL Baseplate Pads

### • Made From Tough, Durable Neoprene

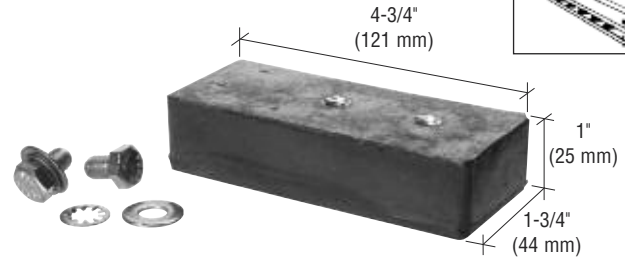

Our CRL Baseplate Pads are molded from tough neoprene rubber, and come with threaded inserts and bolts for attaching to the ledgeboard. They can be mounted on CRL Truck Racks or any other truck's glass rack with a minimum 3-1/2" (89 mm) of ledgeboard width. Minimum order is one each.

**CAT. NO. BPP414**

## CRL Slotted Barpad®

### • Fits Aluminum or Steel Slats With Slots

This CRL Slotted Barpad® is made of tough neoprene rubber, and designed for use on either aluminum or steel Barkow Side Slats. Choose the desired slot and this Barpad® will just snap into place. Minimum order is one each. Barpads® can be combined for quantity pricing.

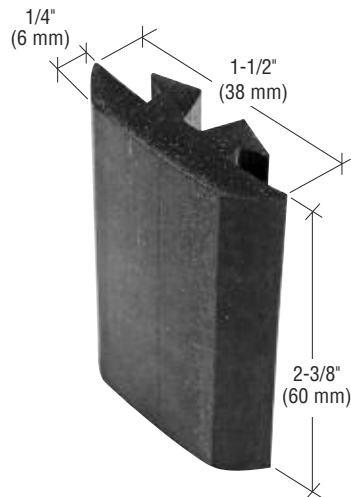

**CAT. NO. BP3**

## CRL Load Stopper

This CRL Load Stopper is designed to keep your glass loads from shifting along the truck's glass rack and ledgeboard. Designed for use with aluminum and steel Side Slats, each Load Stopper has a locking cleat, which snaps into the slat slots, holding it tight while the heavy neoprene pad cushions and protects the glass. Load Stoppers will work with either 3-1/2" or 5-3/4" (89 or 146 mm) ledgeboards. Minimum order is one each.

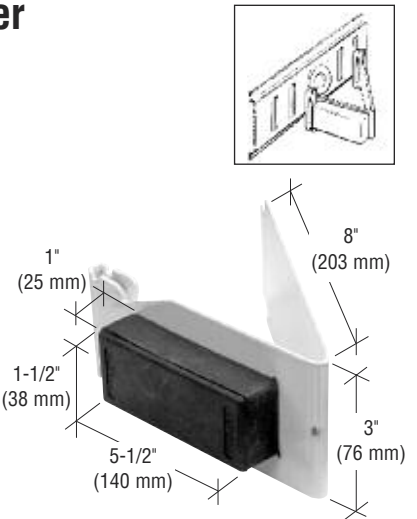

**CAT. NO. BRLS1**

## CRL Slic-Rak® Glass Rack Expanders

The CRL Slic-Rak® was actually invented by a glass shop owner to maximize the rack capacity for both his truck and shop racks. The Slic-Rak® is especially handy when moving many smaller lites of glass. Just slip the mounting plate on the back of the angle over an existing slat and tighten the wingnut. The Slic-Rak® will work on slats up to 2-1/4" (57 mm) thick. Made from 1/4" (6 mm) thick aluminum angle, each has a thick neoprene pad to protect the edge of the glass and to prevent slippage. Minimum order is one pair.

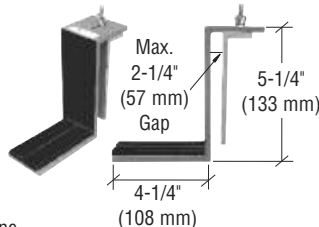

**CAT. NO. SLR2**

Barpad is a registered trademark of F. Barkow, Inc.  
Slic-Rak is a registered trademark of Thomas E. Cole.

## CRL Glass Ties



The CRL Glass Tie is a very heavy 2" (51 mm) wide polyester strap with a plated steel attachment bracket on each end for use on steel or aluminum Side Slats. A spring-loaded brake locks the strap tight until depressed. This strap has a working strength of 835 pounds (380 kg).

CAT. NO.	QTY/PKG
<b>BRGT4</b>	4' (1219 mm)
<b>BRGT8</b>	8' (2438 mm)

Minimum order: 1 each. Can be combined for quantity pricing.

## CRL Truck Bed Racks

- Polished Aluminum or Primed White Painted Steel
- 94" (2388 mm) Long, 62" (1575 mm) High With a 5" (127 mm) Useable Ledgeboard

CRL Truck Bed Racks are offered in interior Side Mount or A-Frame configurations to fit your individual needs. Both styles come with neoprene Base Plate Pads on 5" (127 mm) useable ledgeboards, longitudinal slats welded to uprights with snap-in Barpads on 8" (203 mm) centers, and 1-1/2" (38 mm) uprights and stakes. Offered in two finishes: polished aluminum or primed painted (white) steel.

The interior Side Mount Rack comes with three stakes, each equipped with three Barkleats™, and has convenient ladder hooks welded on the backside. Specify left or right side when ordering.

The A-Frame Rack comes with four stakes, each equipped with 3 Barkleats™. Racks are easy to install in truck bed, and just as easily removed when not needed.

Side Mount



A-Frame



CAT. NO.	STYLE	FINISH
<b>BR808</b>	Side Mount	Steel
<b>BR808A</b>	Side Mount	Aluminum
<b>BR1012</b>	A-Frame	Steel
<b>BR1012A</b>	A-Frame	Aluminum

Minimum order: 1 each. F.O.B. Milwaukee, Wisconsin.

## CRL Heavy-Duty Truck Mount A-Frame

- 24,000 Lbs. (10,886 kg) Total Capacity
- Galvanized Finish
- Ships KD for Freight Savings

The CRL Heavy-Duty Truck Mounted A-Frame turns any flatbed truck or trailer into a case or stock sheet transporter. Six mounting plates are provided for bolting down to truck or trailer bed. Removable "X" and cross brace bars reduce shipping costs and offer a knocked down alternative for storage when not in use. Rubber lined uprights provide protection for uncrated products. Frame measures 60" (1524 mm) long, 48" (1219 mm) wide, and 78" (1981 mm) tall with 13" (330 mm) ledge depth. Minimum order is one each. F.O.B. Woodstock, Illinois.



CAT. NO. TMA6078

## CRL Interior Glass Rack for Standard Cargo Van

- Three Stakes With Three Barkleats™ Each
- 1-1/2" (38 mm) Square, Tubular Uprights
- Longitudinal Slats With Snap-in Barpads® on 8" (203 mm) Centers
- 5" (127 mm) Usable Ledgeboards

This CRL Glass Rack for Standard Van Interiors is made with the same materials and quality construction as our exterior steel or aluminum pickup truck and van racks. They include three 1-1/2" (38 mm) square stakes with three Barkleats™ on each. All of the steel components are primed, and then painted with a white finish. Left and right side models are available, so please specify your preference when ordering. They are easily installed and will remain sturdy and reliable for years.

CAT. NO. STEEL	CAT. NO. ALUMINUM	LENGTH	HEIGHT
<b>BR500</b>	<b>BR500A</b>	96" (2438 mm)	46" (1168 mm)
<b>BR525</b>	<b>BR525A</b>	120" (3048 mm)	46" (1168 mm)
<b>BR550</b>	<b>BR550A</b>	120" (3048 mm)	60" (1524 mm)
<b>BR575</b>	<b>BR575A</b>	120" (3048 mm)	72" (1829 mm)

Minimum order: 1 each. F.O.B. Milwaukee, Wisconsin.

Barpad is a registered trademark of F. Barkow, Inc.



## CRL Clamp Bars With Gearboxes

- The Quick and Easy Way to Secure Glass to Mobile Racks
- Three Sizes Available With Your Choice of Aluminium or Nylon Gear Boxes
- Custom Sizes Also Available

CRL 2200 mm Clamp Bars with Two Gearboxes

Our Clamp Bars are perfect for securing glass to your mobile racks. They are available in three heights with your choice of either aluminium or nylon gearboxes. Sturdy yet lightweight aluminium construction makes Clamp Bars easy to position in just seconds. All gearboxes can be adjusted up or down the Clamp Bars to the optimum height to properly secure large or small glass lites. Nylon gearboxes are especially weather-resistant. Clamp Bars are handy and affordable, and if our standard size Clamp Bars won't fit your rack, we make custom Clamp Bars too.

CAT. NO.	SIZE	GEARBOXES
G4000	1905 mm (75")	Two Aluminium
G4002	2200 mm (86")	Two Aluminium
G4005	2665 mm (105")	Three Aluminium
G4040	1905 mm (75")	Two Nylon
G4041	2200 mm (86")	Two Nylon
G4042	2665 mm (105")	Three Nylon

Minimum order: 1 each.



**NOTE:** Always be sure to check that Clamp Bars are secure and Gearboxes have been tightened before moving vehicle.

## CRL Top Hat Glass Rack Channel

- Strong Steel Side Channel for Mobile Glass Racks

Our sturdy steel Top Hat Glass Rack Channels are perfect for fabricating mobile glass racks. They are drilled with twelve 25 mm holes to accept our CG25 Cushion Grommets. Unfinished steel channels can be painted to match existing vehicle rack.

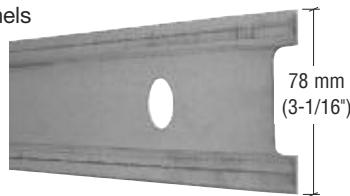

CAT. NO.	LENGTH
TH24S	2.4 m (94")

Minimum order: 1 each. Must ship common carrier or road freight.

## CRL Ribbed Rubber Strip

- Replacement for Glass Truck Racks, Storage Racks, and "A" Frames

CRL Ribbed Rubber Strip forms a cushion between the glass and metal, protecting the glass from getting damaged. Measures 45 mm (1-3/4") wide x 3 mm (1/8") thick x 10 m (393") long.



CAT. NO.	LENGTH
ATG0695	10 m (393")

Minimum order: 1 each. Must ship common carrier or road freight.

## CRL Truck Strip Cushion

- Heavy-Duty Strips Protect Glass

Heavy-Duty EPDM Truck Strip Cushion is ideal as a base protector on glass truck racks, shop storage racks, and barrows. They measure 65 mm (2-1/2") wide, 30 mm (1-3/16") tall, 1 m (39-3/8") long.



CAT. NO.	LENGTH
SB10	1 m (39")

Minimum order: 1 each.

## CRL Cushion Grommets

- Ideal for Use With Top Hat Glass Rack Channel

Our Cushion Grommets fit into the pre-drilled holes in the TH24S Top Hat Glass Rack Channel. Suction cup design helps keep glass from slipping. Easily installed in just seconds, they remain pliable through many seasons.

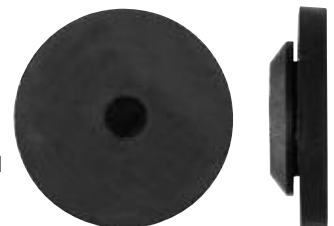

CAT. NO.	DIAMETER
CG25	50 mm (2")

Minimum order: 1 each.

## CRL Ty Webbing

- Shrink Resistant Cotton



Made of shrink resistant cotton, CRL Ty Webbing has high tensile strength. It can be used to secure glass, aluminum tubes, screen doors, or other materials to your glass truck rack. It is also good for bundling lengths of track, metal or wood.

CAT. NO.	WIDTH	TENSILE STRENGTH	ROLL LENGTH
TW200	1-1/2" (38 mm)	540 lbs. (245 kg)	200' (61 m)

Minimum order: 1 Roll.

## CRL Heavy-Duty Ty Webbing

- 100% Nylon



This CRL Heavy-Duty Ty Webbing is made of 100% nylon, chemically treated to be mildew and water repellent. Ty Webbing is used mostly outdoors, where it is subjected to harsh climatic conditions. It has a tensile strength of over 10,000 pounds (4536 kg), so it will hold almost anything you tie down.

CAT. NO.	WIDTH	TENSILE STRENGTH	ROLL LENGTH
TW201	1-3/4" (44.5 mm)	10,000 lbs. (4536 kg)	300' (91.4 m)

Minimum order: 1 Roll.

## CRL Cotton Sash Cord

- Solid-Braided Cotton
- Great Utility Cord



This superior-quality, solid-braided CRL Cotton Sash Cord has a break strength of over 200 pounds (91 kg). It is ideal for tying, bundling, or for securing almost anything.

CAT. NO.	SIZE	BREAK STRENGTH	ROLL LENGTH
CSC316	3/16" (4.7 mm)	205 lbs. (92 kg)	100' (30.5 m)
CSC14	1/4" (6.4 mm)	220 lbs. (100 kg)	100' (30.5 m)

Minimum order: 1 Roll.

## CRL Sisal Rope

- Made From Tough, Natural Sisal Fibers



Use CRL Heavy-Duty Sisal Rope for tying glass or other items to your truck or shop racks. It's made from tough, natural sisal fibers.

CAT. NO.	SIZE	ROLL LENGTH
SR14	1/4" (6.4 mm)	100' (30.5 m)
SR38	3/8" (9.5 mm)	100' (30.5 m)

Minimum order: 1 Roll.

## CRL Poly Rope

- Black-Orange Truck Rope Meets C.H.P. Specifications
- Made of Polypropylene Synthetic Fibers



Black and orange CRL Poly Rope is made of intertwined polypropylene synthetic fibers that will not stretch like ordinary nylon rope. Both the 3/8" and 1/2" (9.5 and 12.7 mm) diameters meet specifications of all states requiring that non-stretch tie-downs be used on all side or top load racks.

CAT. NO.	SIZE	WORK LOAD	ROLL LENGTH
CTR3850	3/8" (9.5 mm)	405 lbs. (183 kg)	50' (15.2 m)
CTR1250	1/2" (12.7 mm)	630 lbs. (285 kg)	50' (15.2 m)

Minimum order: 1 Roll.

## CRL 2-Ton Power Puller

- 4,000 Pound (1814 kg) Maximum Load Pulling Capacity
- Convenient Thumb Control Reversing Ratchet
- 21" to 72" (533 to 1829 mm) Pulling Range



This manually operated CRL 2-Ton Power Puller is ideal for lifting crates, machinery, motors, small cases of glass and more up to two tons (1814 kg). All steel plates are plated, and cast parts are made of special heat-treated steel. Large, full capacity take-up drum and 6' (1,829 mm) long, 3/16" (4.8 mm) diameter galvanized aircraft cable with self-aligning steel spool. Minimum order is one each.

CAT NO. 30329

## CRL Igloo® 5 Gallon Water Cooler

- Meets OSHA Requirements
- Keeps Water Cold and Clean

This CRL Igloo® 5 Gallon Water Cooler has the best cold water retention in the water cooler industry. Rugged and durable, it keeps water cold and clean longer, and is ideal for hydrating the entire crew on the job site or in the shop. Built for the real world, the cooler takes the abuse of the toughest job site and the most punishing work crews. All plastic, rustproof construction. Sanitary white liner, foamed-in-place Ultratherm® insulation. Drinking Water imprint meets OSHA requirements. Safety yellow with red lid. Truck Mount Rack, Cup Dispenser, and Cups are all sold separately.

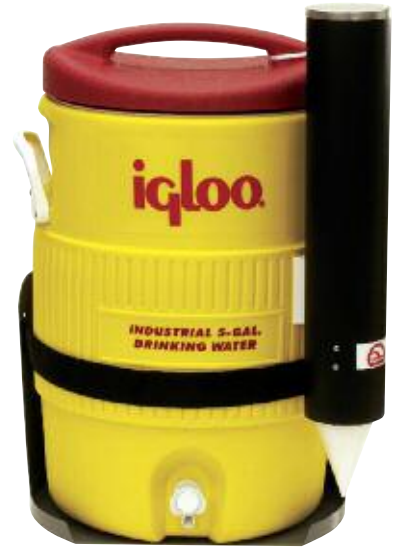

CAT. NO.	DESCRIPTION
000451	5 Gallon (18.9 l) Cooler
025042	Truck Mount Rack
008242	Cup Dispenser
025010	4.25 Oz. (1.25 l) Cone Cups 200/Box

Minimum order: 1 each; For Cups: 1 box.

## CRL Wheel Step

- Gives Easy Access to Windshields on Large Vehicles
- Perfect for Trucks and SUV's
- Rated to 500 Pounds (227 kg)



The CRL Wheel Step makes it easier for you to reach windshields on large vehicles, such as pickups and SUV's. Simply unfold Wheel Step, hook it over the tire, and step up to work on the windshield. Wheel Step gives you a 12" to 20" (305 to 508 mm) boost, depending on tire size. It has a non-slip surface, and folds flat for storage. Minimum order is one each.

CAT. NO. SL493

## CRL Universal Tie-Downs

- Easy-Release Ratchet and 6' (1.83 m) Straps Are Fully Adjustable
- Greater Holding Tension
- Vinyl Coated Hooks



These CRL Universal Tie-Downs provide unlimited ways to securely tie down cargo. The cam buckles will not slip, yet will release instantly with thumb pressure. The high tensile steel hooks are extra strong and vinyl coated to protect painted or chrome finishes. Each Tie-Down features 1" (25 mm) wide nylon webbing that is long lasting and provides maximum strength. Each 6 foot (1.83 m) Tie-Down has an average rated capacity of 2,000 pounds (907 kg). Four per pack. Minimum order is one pack.

CAT. NO. 6381

## CRL Web Strap and Clamp

- Positive, Even Pressure
- Ratchet Action Clamp
- 12' (3.6 m) Long, Tough Nylon Webbing

The ratchet-action clamp keeps the nylon webbing on this CRL Web Strap and Clamp tight. Made of tough nylon, the webbing is 12' (3.6 m) long and 1" (25 mm) wide. This Strap has a capacity rating of 1500 pounds (680 kg). Minimum order is one each.



CAT. NO. ST83159

Igloo and Ultratherm are registered trademarks of Igloo Products Corp.

## CRL 10-Piece Bungee Cord Assortment

- Vinyl Coated Hooks

This CRL Bungee Cord Assortment is made of high quality rubber which is encased in long-lasting stretch braid. The hooks are vinyl coated to prevent scratches. This is the perfect Bungee Cord Assortment to have stored in your truck. Minimum order is one pack.



Contents: 2 ea. 16" (406 mm);  
4 ea. 24" (610 mm);  
4 ea. 36" (914 mm).

CAT. NO. 6102

## CRL Mini Stretch Film and Dispensers

- Wraps and Unwraps Without Damaging Surfaces or Leaving Residue
- Costs Less Than Strapping Tape, Twine or Wire
- Perfect for Bundling Lengths of Aluminum Channels or Screen Frame

CRL Mini Stretch Film is an economical alternative to strapping tape, twine or wire. It comes in two convenient sizes, 3" (76 mm) and 5" (127 mm). It provides visibility while eliminating surface damage or adhesive residue on boxes, metals, etc. It clings to itself without adhesives. The 80 gauge thickness makes this film highly puncture resistant.

CRL Stretch Film Dispensers hold 3" and 5" (76 and 127 mm) rolls. The Deluxe Dispenser features a soft E-Z grip handle, and has an adjustable brake.



**CAT. NO. HW380**  
Stretch Film



**CAT. NO. SL256**  
Standard Dispenser



**CAT. NO. SL257**  
Deluxe Dispenser

CAT. NO.	DESCRIPTION	QTY/CASE
<b>HW380</b>	3" x 1500' (76 mm x 457 m) Stretch Film	16
<b>HW580</b>	5" x 1500' (127 mm x 457 m) Stretch Film	12
<b>SL256</b>	Standard Dispenser	1
<b>SL257</b>	Deluxe Dispenser	1

Minimum order: 1 each for Dispenser; 1 roll for Stretch Film. Sizes can be combined for quantity pricing.

## CRL 18" Stretch Wrap and Dispenser

- Economical Way to Secure Loads
- Easy-to-Use Heavy-Duty Dispenser

This CRL 18" (457 mm) Stretch Wrap is an easy way to secure pallet loads without strapping or expensive tie-downs. The roll fits on the economical, Heavy-Duty Dispenser to facilitate wrapping and stretching of the film to secure the load. The adjustable Heavy-Duty Dispenser can accommodate rolls with a standard 3" (76 mm) core and a range of 12" to 20" (305 to 508 mm) wide. The adjustable tension allows full control of the Stretch Wrap.



**CAT. NO. SW181500**  
18" (457 mm) Stretch Wrap



**CAT. NO. SL277**  
Dispenser

CAT. NO.	DESCRIPTION	QTY/CASE
<b>SW181500</b>	18" x 1500' (457 mm x 457 m) Stretch Wrap	4
<b>SL277</b>	Heavy-Duty Dispenser	1

Minimum order: 1 each for Dispenser; 1 roll for Stretch Wrap.

## CRL Kraft Paper and Dispensers

- Heavy 60 Pound Weight in Two Widths
- Rugged All Steel Dispensers

Heavy 60 pound weight Kraft Paper is ideal for wrapping and packing breakable items (glass and mirrors, etc.) for shipping. Large 825' (251 m) roll costs pennies per square foot. Rugged all steel Dispenser with spring-loaded blade can be mounted on walls, table tops or under counters. Both can be shipped U.P.S. Paper and Dispensers are sold separately.

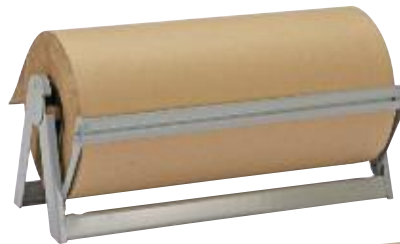

- 18" Width is Convenient for Packaging

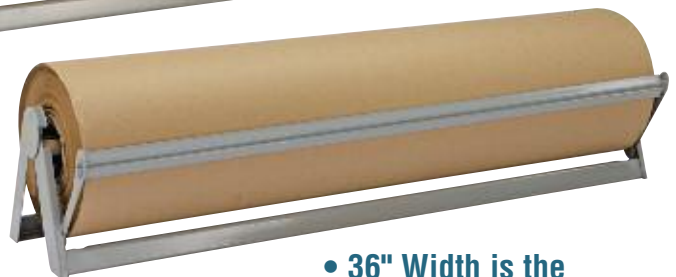

- 36" Width is the Best Seller

CAT. NO.	WIDTH	DESCRIPTION
<b>K60W18</b>	18" (457 mm)	825' (251 m) Kraft Paper
<b>K60W36</b>	36" (914 mm)	825' (251 m) Kraft Paper
<b>A50018</b>	18" (457 mm)	Dispenser
<b>A50036</b>	36" (914 mm)	Dispenser

Minimum order: 1 each.



## CRL Safety Apparel and Equipment

### Gloves

From Glass Handling Gloves to Work Gloves to Nitrile and Latex Gloves, CRL provides you with the most up-to-date products in the industry. From the very popular CRL Gauntlet Cuff Natural Rubber Gloves to the latest cut protection Atlas® Kevlar® and Nitrile Textured Gloves, CRL offers the various glove styles you need for all glass fabrication and general work requirements.



**new**

Look for the "NEW" icon. It accompanies tools being introduced in this catalog. It also alerts you to improved designs or new options for existing tools.



### Glassworker Cut Protection Gear

CRL knows how important it is to be wearing the right equipment when cutting and fabricating glass. CRL has several types and styles of Sleeves, Jackets, and Wrist Protectors that are both comfortable and provide maximum protection. CRL's new "Oversize" Sleeves are perfect for those winter months when you need to wear the Sleeves over a sweater or jacket. We also provide all the information you need to order Custom Sleeves or Jackets.



### Safety Glasses

CRL has the latest selections of lens colors and frame styles in Safety Eye Wear. Choose from new wrap around clear, smoke and indoor/outdoor lenses as well as new frame designs with great standard features. CRL has the latest in Safety Eye Wear products.



### Hearing Protection

If you need Band Mounted or Cap Mounted Hearing Protectors, CRL has the latest designs and features. There are also selections of Reusable and Disposable Ear Plugs for both small and large shop environments.



### Respiration Protection

CRL offers a range of products for respiration safety. From simple dust masks, up to HEPA filtered masks, CRL carries the latest in respiration protection.



### First Aid Kits

CRL has a selection of the most up-to-date First Aid Kits available for the glass fabrication industry. From Small Shop Kits to Wall Mounted Metal Supply Cabinets and our new Kut Kits, CRL offers the latest technology in First Aid.

Atlas is a registered trademark of Showa Glove Company.  
Kevlar is a registered trademark of E.I. du Pont de Nemours and Company.

## CRL Gauntlet Cuff Smooth Natural Rubber Palm Gloves

- For Handling Glass and Sheet Metal
- Allows Freedom of Hand Movement
- A Favorite With Glass Fabricators

CRL Gauntlet Cuff Glass Handling Gloves have a special smooth, natural rubber coating on the palm side, and their flexible back allows freedom of hand movement. The interior is lined for comfort with soft, fleece-like material. Available in full Gauntlet Cuff or loose Knit Wrist Glove styles. Reference Cat. No. 10 on page 265K for Knit Wrist style. Minimum order is one pair.



CAT. NO. 12

## CRL "New Style" Gauntlet Cuff Smooth Palm Gloves

- For Handling Glass and Sheet Metal
- Quality Glove at a Cost Savings
- Smooth Rubber Coating for Glass Use

New Style CRL Glass Handling Work Gloves have a special smooth, natural rubber coating on the palm side. Their flexible back allows freedom of hand movement. The interior is lined for comfort with soft, fleece-like material. Minimum order is one pair.



CAT. NO. SG12

## CRL Gauntlet Cuff Wrinkle Finish Natural Rubber Palm Gloves



4141

- Wrinkled to Prevent Slippage
- For Handling Glass or Sheet Metal
- Flexible Natural Rubber Coating

CRL Gauntlet Cuff Wrinkle Finish Rubber Gloves offer improved wet or dry gripping. Natural rubber gives you higher cut and snag resistance, with more flexibility and increased wear. We have added a soft interlining for your comfort. Available in Gauntlet Cuff or Knit Wrist styles. Reference Cat. No. 63PNFW on page 265K for Knit Wrist style. Minimum order is one pair.



CAT. NO. 66NFW

## CRL Insulated Gauntlet Cuff Wrinkle Finish Natural Rubber Palm Gloves

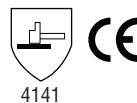

4141

- Foam Insulated for Working in Colder Climates
- Cushioned Warmth and Comfort

Fully insulated with a cushioned foam liner, these wrinkled finish CRL Insulated Gauntlet Cuff Glass Handling Gloves are ideal for working outside in cold climates, snow, sleet or wet weather. You can also wear them and work in comfort inside cold storage or refrigerated compartments. Their highly flexible latex coating gives them high cut and snag resistance and durability. Minimum order is one pair.



CAT. NO. 96NFW

All CRL Gloves can be combined for quantity pricing.

## CRL Knit Wrist Smooth Natural Rubber Palm Gloves

- A Favorite With Glass Fabricators for Handling Glass and Sheet Metal
- Smooth Rubber Coating for Glass Use

CRL Knit Wrist Glass Handling Gloves have a special smooth natural rubber coating on the palm side. Their flexible back allows freedom of hand movement. The interior is lined for comfort with soft, fleece-like material. Available in full Gauntlet Cuff or loose Knit Wrist Glove styles. Reference Cat. No. 12 on page 264K for Gauntlet Cuff style. Minimum order is one pair.



CAT. NO. 10

## CRL Knit Wrist Wrinkle Finish Natural Rubber Palm Gloves

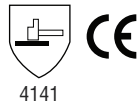

- Wrinkle Finish Helps Prevent Slippage
- Wet or Dry Gripping of Glass or Sheet Metal
- Flexible Natural Rubber Coating

CRL Wrinkle Finish Rubber Gloves with Knit Wrist Cuff offer improved wet or dry gripping. Natural rubber gives you higher cut and snag resistance, with more flexibility and increased wear. We have added a soft inner lining for your comfort. Available in Knit Wrist or Gauntlet Cuff styles. Reference Cat. No. 66NFW on page 264K for Gauntlet Cuff style. Minimum order is one pair.



CAT. NO. 63PNFW  
Regular

CAT. NO. L63PNFW  
Small

## CRL Glove Sizing

All glove sizes vary depending upon their style. Nitrile gloves for instance, require a skin tight fit. On the other hand, general purpose work gloves or glass handling gloves need not fit too tight or too loose. Measure around the palm of your hand, and use the chart to the right to get the correct fit.

- What Size Glove Should You Order?
- Use the Chart Below to Determine the Correct Size

SIZE	PALM MEASUREMENT
Small	7" to 8" (178 to 203 mm)
Medium	8" to 9" (203 to 229 mm)
Large	9" to 10" (229 to 254 mm)
X-Large	10" to 11" (254 to 279 mm)



Measure around your palm

All CRL Gloves can be combined for quantity pricing.

## Technical Information for CRL Gloves

**LAUNDERING AND CLEANING INSTRUCTIONS:** Gloves manufactured using materials such as Kevlar® or other various fabrics will require different laundering or cleaning instructions. This information may be located on the C.R. Laurence web site, [crlaurence.com](http://crlaurence.com), by clicking on Additional Product Information under each specific product.

**CUT AND PUNCTURE RESISTANCE LEVELS:** If information concerning Cut and Puncture Resistance is available, it will be noted along with the glove description and specifications in the catalog.

**EUROPEAN SPECIFICATIONS:** European specifications tested in accordance with EN388/EC type examination may show the insignia  followed by a series of four numbers, i.e., 4142. These numbers indicate the Resistance Level from 1 to 5 (5 being highest) and always in the following category order: Abrasion, Cut, Tear, and Puncture. If complete testing has not been completed, individual ratings may be noted.

**U.S. SPECIFICATIONS:** U.S. Specifications are tested using ANSI Standards and are rated on the same 1 to 5 scale, however, the testing procedures may differ from European testing procedures.

Kevlar is a registered trademark of E.I. du Pont de Nemours and Company.

# CRL GLASS HANDLING GLOVES

For Pricing Visit [crlaurence.com](http://crlaurence.com) or Call Us Toll Free at the Phone Numbers Shown on the Back Cover

## CRL Brand Knit Fit Gloves

- Quick and Easy On and Off
- Machine Washable and Dryable

CRL Brand Knit Fit Gloves have wrinkled finish latex coated palms that are ideal for handling all smooth surfaces, even wet glass. The seamless knit liner makes them form-fitting for increased comfort, and the uncoated back section allows your hand to breathe. Machine washable CRL Brand Knit Fit Gloves will provide you with the gripping power, dexterity, durability, and protection you need on the job.

Knit Fit Gloves are available in small, medium, large, and extra-large sizes to fit any size hand comfortably. They feature comfortable poly-cotton knit with durable wrinkle finish palms and fingers for a secure grip on all surfaces.



CAT. NO.	SIZE
KF1TS	Small
KF1TM	Medium
KF1TL	Large
KF1TXL	X-Large

Minimum order: 1 pair. All CRL Gloves can be combined for quantity pricing.

- Available in Four Sizes

## CRL Atlas® Fit Gloves

- Excellent Choice for Glass Handling
- Flexible, Form-Fitting, and Ventilated
- A Great Glove for Shop or Job Site Work

The CRL Atlas® Fit Glove is perfect for light lifting situations where hand protection is needed. The poly-cotton knit glove is latex covered for maximum durability, and protects your hands while providing ventilation through the back and wrists. The specially formulated latex palm provides maximum wet gripping power while it guards against punctures and abrasions. Both versatile and economical, the CRL Atlas® Fit Glove is a sure winner in hand protection. They are available in small, medium, large, and extra-large.



CAT. NO.	SIZE
300AFS	Small
300AFM	Medium
300AFL	Large
300AFXL	X-Large

Minimum order: 1 pair. All CRL Gloves can be combined for quantity pricing.

- Available in Four Sizes

## CRL Brand Knit Nitrile Gloves

- Our Most Affordable Nitrile Coated Knit Gloves
- Machine Washable and Dryable

These affordable Knit Gloves have a nitrile coating on the palms and fingers which makes them ideal for handling glass. A seamless polyester knit liner makes them form fitting, while the well ventilated back allows your hand to breathe. These lightweight gloves provide a high level of dexterity and sensitivity, and can be used around oils, greases, and paints. Machine washable.

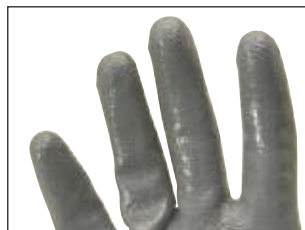

CAT. NO.	SIZE
NF1TS	Small
NF1TM	Medium
NF1TL	Large
NF1TXL	X-Large

Minimum order: 1 dozen pair. Sold only by the dozen. All CRL Gloves can be combined for quantity pricing.

- Available in Four Sizes

Atlas is a registered trademark of Showa Glove Company.

# CRL GLASS HANDLING GLOVES

For Pricing Visit [crlaurence.com](http://crlaurence.com) or Call Us Toll Free at the Phone Numbers Shown on the Back Cover

## CRL Fuzzy Duck® PVC Gloves

- Breathable PVC Coating Keeps Hands Cool
- Two-Piece Jersey Liner for Comfort
- Excellent Gripping Properties on Glass
- Four Sizes to Assure a Perfect Fit
- ANSI Cut Resistance: 1

CRL Fuzzy Duck® PVC Gloves have a breathable PVC coating on a soft, cool, comfortable, two-piece jersey liner. Their textured coating provides an excellent grip on glass, and minimizes absorption of water, oil, and grease. Although not a true anti-vibration glove, they are able to absorb and minimize shock. Fuzzy Duck® Gloves outwear and replace cotton, light-to-medium weight leather, and goatskin gloves in a wide variety of applications. Sold only by the pair.



CAT. NO.	SIZE
962FDS	Small
962FDM	Medium
962FDL	Large
962FDXL	X-Large

Minimum order: 1 pair. All CRL Gloves can be combined for quantity pricing.

## CRL Atlas® Kevlar® Cut Resistant Gloves

- The Perfect Glove for Glass Fabricators
- ANSI Cut Resistance: 3

CRL's new Atlas® Kevlar® Cut Resistant Gloves are used by glass fabricators to protect against cuts, punctures, and slashes. The 10-gauge 100% Kevlar® fiber seamless knit liner provides an ergonomic fit as well as an outstanding grip.



CAT. NO.	SIZE
300KVS	Small
300KVM	Medium
300KVL	Large
300KVXL	X-Large

Minimum order: 1 pair. All CRL Gloves can be combined for quantity pricing. Kevlar® is a registered trademark of DuPont or one of its affiliates.

## CRL D-Flex® Cut Resistant Glass Handling Gloves

- ANSI Cut Resistance: 4

We offer D-Flex® Cut Resistant Glass Handling Gloves in two popular sizes and material weights. All D-Flex® products are sold only by the pair.



CAT. NO.	TYPE	SIZE
910CM	Light Weight	Medium
910CL	Light Weight	Large
917CM	Medium Weight	Medium
917CL	Medium Weight	Large

Minimum order: 1 pair. All CRL Gloves can be combined for quantity pricing.

## CRL Atlas® Textured Nitrile Coated Gloves

- Exceptional Grip
- ANSI Cut Resistance: 2

This durable flat-dipped dark green colored Nitrile Coated Glove features exceptional grip, dexterity, and durability with oil resistant Nitrile coating. The cotton/polyester lining provides an extremely comfortable fit. An elastic knit wrist secures the glove above the wrist for comfort and prevents debris from entering the glove.



CAT. NO.	SIZE
350S	Small
350M	Medium
350L	Large
350XL	X-Large

Minimum order: 1 pair. All CRL Gloves can be combined for quantity pricing.

## CRL Atlas® Therma-Fit Insulated Gloves

- Available in Four Sizes
- Wrinkle Finish
- ANSI Cut Resistance: 3

This cold weather glove combines a mixture of acrylic loop-in terry cotton liner for warmth, lightweight feel and suppleness. The natural rubber coating on the palm and fingertips protects the hand from abrasion, cutting, puncturing, and tearing. The rough textured grip allows slippery objects to be gripped firmly. This durable glove is ideal for all work in cold rooms or outside in cold weather conditions.



CAT. NO.	SIZE
451S	Small
451M	Medium
451L	Large
451XL	X-Large

Minimum order: 1 pair. All CRL Gloves can be combined for quantity pricing.

Fuzzy Duck, Atlas, and D-Flex are all registered trademarks of Showa Glove Company. Kevlar is a registered trademark of E.I. du Pont de Nemours and Company.

# CRL GENERAL PURPOSE WORK GLOVES

For Pricing Visit [crlaurence.com](http://crlaurence.com) or Call Us Toll Free at the Phone Numbers Shown on the Back Cover

## CRL Brand GripPro Impact Performance Gloves

- Shock Absorbing Impact-X Padding
- Heavy-Duty Elastic Velcro Closure
- Lightweight and Durable RhinoTex Synthetic Leather Palm

CRL Brand GripPro Impact Performance Gloves provide superior protection against injury-causing shock and impact. Made with the finest materials available, they are designed to endure demanding environments while providing comfort. They are also machine washable.



• Five Sizes



CAT. NO.	SIZE
GR1PS	Small
GR1PM	Medium
GR1PL	Large
GR1PXL	X-Large
GR1P2X	XX-Large

Minimum order: 1 pair. Sold only by the pair. Sizes can be combined for quantity pricing.

## CRL Mechanix Wear® M-Pact® Gloves

- No Other Glove Compares for Superior Comfort and Feel
- CRL is the Exclusive Distributor to the Glass Industry

CRL Mechanix Wear® M-Pact® Gloves offer the same quality construction and materials as the Original® Mechanix Gloves, but have additional padding and foam-filled patches on the palm area to absorb the vibrations from power tools and impact tools like hammers or air tools. This helps to eliminate the potential for injuries. Easy on-off fit with hook-and-loop wrist closures.



CAT. NO.	DESCRIPTION	SIZE
MPT010	Black M-Pact® Gloves	Large
MPT011	Black M-Pact® Gloves	X-Large
MPT012	Black M-Pact® Gloves	XX-Large

Minimum order: 1 pair. Sold only by the pair.

## CRL Mechanix Wear® FastFit® Gloves

- Easy-Entry, Wide Opening, Elastic Cuff
- Soft, Durable Clarino® Synthetic Leather Palm
- Reinforced Thumb and Fingertips
- Available in Blue and Black

CRL's Mechanix Wear® FastFit® Gloves give you great comfort, flexibility, and protection. You'll work with more confidence when wearing these gloves. You get uncompromising comfort and protection from abrasion without losing dexterity when performing even the most difficult task.



CAT. NO.	DESCRIPTION	SIZE
MFF03010	Blue FastFit® Gloves	Large
MFF05010	Black FastFit® Gloves	Large
MFF03011	Blue FastFit® Gloves	X-Large
MFF05011	Black FastFit® Gloves	X-Large

Minimum order: 1 pair. Sold only by the pair.

## CRL Mechanix Wear® The Original® Gloves

- The Tool That Fits Like a Glove
- Ergonomically and Anatomically Designed
- Machine Washable
- Available in Blue and Black

CRL Mechanix Wear® The Original® Glove, the glove that started it all, has been a mainstay in just about every industrial work setting.

Mechanix Wear, M-Pact, FastFit, and The Original are all registered trademarks of Mechanix Wear, Inc. Clarino is a registered trademark of Kuraray Co., Ltd.



CAT. NO.	DESCRIPTION	SIZE
MG03010	Blue Mechanix Wear® Gloves	Large
MG05010	Black Mechanix Wear® Gloves	Large
MG03011	Blue Mechanix Wear® Gloves	X-Large
MG05011	Black Mechanix Wear® Gloves	X-Large

Minimum order: 1 pair. Sold only by the pair.



C.R. LAURENCE COMPANY

[crlaurence.com](http://crlaurence.com) | [usalum.com](http://usalum.com)

268K | [crlaurence.ca](http://crlaurence.ca) [crlaurence.com.au](http://crlaurence.com.au) [crlaurence.co.uk](http://crlaurence.co.uk) [crlaurence.de](http://crlaurence.de) [crlaurence.eu](http://crlaurence.eu)

# CRL GENERAL PURPOSE WORK GLOVES

For Pricing Visit [crlaurence.com](http://crlaurence.com) or Call Us Toll Free at the Phone Numbers Shown on the Back Cover

## CRL Nitri-Flex® Lite Gloves



- Popular With Auto Glass Professionals
- Smooth Finish
- ANSI Cut Resistance: 1



CRL's Nitri-Flex® Lite Gloves are the choice of auto glass professionals. This very comfortable glove has a nitrile coated palm with smooth finish. The seamless nylon knit liner provides moisture absorption and all weather comfort.

CAT. NO.	SIZE
2404130	Medium
2404264	Large
2404131	X-Large

Minimum order: 1 pair.

## CRL Nitri-Flex® Plus Gloves



- The Auto Glass Professionals Glove
- Textured Finish
- ANSI Cut Resistance: 2



Used extensively by auto glass professionals, the Nitri-Flex® Plus provides all day comfort as well as excellent gripping power. This nitrile coated glove with textured finish provides an alternative to cotton and lightweight leather gloves. The seamless cotton poly-knit liner allows your hands to breathe in all weather conditions.

CAT. NO.	SIZE
2404132	Medium
2404133	Large
2404265	X-Large

Minimum order: 1 pair.

## CRL Sure Grip Glass Gloves

- Knit Wrist
- Coated Palm
- Thread-Rubber Finish



These Sure Grip Glass Gloves are comfortable, pliable gloves that provide the user with an extremely aggressive grip. Vulcanized rubber coated fingers and palm on a cotton knit base makes this glove safe, durable, and flexible. Minimum order is one pair.

CAT. NO. 2404065

## CRL Leather Gloves

- All-Leather Palm, Thumb, Forefinger, and Fingertips
- Gauntlet Cuff With Elastic Wrist Band



These heavy-duty CRL Leather Gloves feature an all-leather palm, thumb, forefinger, and fingertips. The rubberized, waterproof safety cuff, leather knuckle strap, and elastic wrist band make them comfortable to wear. They offer strong, rugged protection. Minimum order is one pair.

CAT. NO. LG5231

## CRL Knit Wrist Cotton Gloves

- White 100% Cotton for Light Duty Work
- Washable



These CRL 100% Cotton Gloves are excellent for light-duty shop work or clean up. Knitted wrist bands allow for easy removal. Also ideal for home and garden use. They offer only minimal protection against cuts or abrasions. Minimum order is one pair.

CAT. NO. 8K

## CRL Vinyl Coated Cotton Work Gloves

- Flexible and Durable
- Washable



CRL's Vinyl Coated Cotton Work Gloves have a grainy, vinyl finish that is both flexible and durable. These gloves provide a firm grip on metal, wood, or glass surfaces. The cotton material breathes so that hands feel more comfortable. They remain pliable after washing and drying. Minimum order is one pair.

CAT. NO. 2404105

All CRL Gloves can be combined for quantity pricing. Nitri-Flex is a registered trademark of Showa Glove Company.

## CRL Disposable Nitrile Gloves

100% Nitrile Gloves provide better protection against solvents, and resist a broad range of chemicals where more splash protection is required than you can get with latex gloves. Nitrile compound gives greater puncture resistance than comparable natural rubber and vinyl disposable gloves. They also provide greater comfort by reducing hand pressure and fatigue caused by elastomeric stress.



- Medical Grade
- Provide Resistance Against Solvents and Other Chemicals
- Powder Free
- Available in Four Sizes

CAT. NO.	SIZE	QTY/BOX
7005SM	Small	100
7005MD	Medium	100
700512	Large	12 Pair
7005NG	Large	100
7005XL	X-Large	90

Minimum order: 1 box. All gloves on this page can be combined for quantity pricing.

## CRL Powder Free Disposable Latex Gloves

These CRL Powder Free Disposable Latex Gloves minimize the risk of allergic reaction to protein or chemical residue. They are made of natural rubber and molded to be worn on either hand. The fully-textured surface provides superior grip in wet or dry applications.



- Fully-Textured Surface
- Can Be Worn on Either Hand
- Powder Free
- Available in Four Sizes

CAT. NO.	SIZE	QTY/BOX
262SM	Small	100
265MD	Medium	100
266LG	Large	100
268XL	X-Large	90

Minimum order: 1 box. All gloves on this page can be combined for quantity pricing.

## CRL Tear Resistant Black Latex Gloves

CRL's Tear Resistant Black Latex Gloves are designed to provide extra protection and stronger resistance to wear and tear on the job. The thickness of the fingers is almost double that of regular latex gloves. The added thickness provides confidence for manufacturing professionals during glass fabrication.



- 10 Mil Thickness for Extra Protection
- Textured Surface for Superior Grip
- Powder Free
- Available in Four Sizes

CAT. NO.	SIZE	QTY/BOX
2005SM	Small	100
2005MD	Medium	100
2005LG	Large	100
2005XL	X-Large	90

Minimum order: 1 box. All gloves on this page can be combined for quantity pricing.

## CRL Black Nitrile Gloves

CRL's Black Nitrile Gloves are the alternative for those who are allergic to natural rubber latex. The textured surface makes them an excellent choice for the glass fabrication industry in both wet and dry applications. These gloves provide puncture, tear, and chemical resistance while allowing excellent dexterity.



- 100% Latex Free With No Powder
- Textured Surface for Superior Grip
- Excellent Puncture and Tear Resistance
- Resistant to Solvents

CAT. NO.	SIZE	QTY/BOX
5005SM	Small	100
5005MD	Medium	100
5005LG	Large	100
5005XL	X-Large	90

Minimum order: 1 box. All gloves on this page can be combined for quantity pricing.



## CRL Lint Free Nylon Gloves

- A Must for Insulating Glass Fabrication
- Keeps Fingerprints Off Glass



CRL Lint Free Nylon Gloves are perfect for handling glass or mirrors without oily fingerprints or other contaminants. An absolute must for handling glass during insulated glass fabrication. Gloves are available in two sizes to fit most hands.

CAT. NO.	SIZE
NG170	Small
NG171	Large

Minimum order: 1 dozen pairs. Sizes can be combined for quantity pricing.

## CRL Fingerless Gloves

- Made of Top Grain Cowhide
- Stitched With Kevlar® Thread
- Hook-and-Loop Closure Around Wrist



These CRL Fingerless Gloves will help protect your palms and lower finger areas while handling glass or other sharp objects. Your finger tips remain exposed enough to allow dexterity and handling. Sold only by the pair.

CAT. NO.	SIZE
FGS	Small
FGL	Large

Minimum order: 1 pair. Sizes can be combined for quantity pricing.

## CRL Atlas® Nitrile Gloves

- Tough Nitrile Coating
- Resists Many Chemicals
- ANSI Cut Resistance: 2



These CRL Atlas® Nitrile Gloves have a coating that make them extra resistant to punctures and abrasions. That's good news for glaziers with heavy jobs to do! The patented Atlas dipping process and seamless knit liner give hands comfortable protection. Machine washable. Sold only by the pair.

CAT. NO.	SIZE
PR0720	X-Large

Minimum order: 1 pair.

## CRL Flexx-Rap® Protective Wrap for Hands and Fingers

- Waterproof, Flexible, and Porous
- Self-Adhesive Without Leaving Residue



CRL Flexx-Rap® is an innovative tape that protects fingers from cuts and blisters. It also improves your grip when wrapped around fingers, tools, or sporting equipment. Flexx-Rap® is waterproof, flexible, porous, hypoallergenic, and self-adhesive. Flexx-Rap® goes on easily and won't come loose with movement, even when wet. If you work with your hands, protect them with Flexx-Rap®. Roll size is 1" x 15' (25 mm x 4.6 m). Minimum order is one roll.

CAT. NO. FR51

## Technical Information for CRL Gloves

**LAUNDERING AND CLEANING INSTRUCTIONS:** Gloves manufactured using materials such as Kevlar® or other various fabrics will require different laundering or cleaning instructions. This information may be located on the C.R. Laurence web site, [crlaurence.com](http://crlaurence.com), by clicking on Additional Product Information under each specific product.

**CUT AND PUNCTURE RESISTANCE LEVELS:** If information concerning Cut and Puncture Resistance is available, it will be noted along with the glove description and specifications in the catalog.

**EUROPEAN SPECIFICATIONS:** European specifications tested in accordance with EN388/EC type examination may show the insignia  followed by a series of four numbers, i.e., 4142. These numbers indicate the Resistance Level from 1 to 5 (5 being highest) and always in the following category order: Abrasion, Cut, Tear, and Puncture. If complete testing has not been completed, individual ratings may be noted.

**U.S. SPECIFICATIONS:** U.S. Specifications are tested using ANSI Standards and are rated on the same 1 to 5 scale, however, the testing procedures may differ from European testing procedures.

Atlas is a registered trademark of Showa Glove Company.

Flexx-Rap is a registered trademark of Henry, D.F.

Kevlar is a registered trademark of E.I. du Pont de Nemours and Company.

## CRL Glassworkers Protective Sleeves

- Staggered Grommets Protect Against Puncture
- Custom Sleeves and Options Available
- ANSI Cut Resistance: 1



Strap Close Up



Sleeve Close Up



CRL Glassworkers Sleeves provide vital protection for your arms and shoulders. Made of strong, reinforced, white cotton denim with staggered grommets to protect against glass puncture and provide ventilation. Elastic shoulder straps make them easy and comfortable to wear. Sold only in pairs.

**NOTE:** For replacement elastic straps, order Cat. No. GWSSTRAP.

CAT. NO.	LENGTH	SIZE
GWS8353	25" (635 mm)	Small
GWS8354	27" (686 mm)	Medium
GWS8355	29" (737 mm)	Large

Minimum order: 1 pair. Can be combined with all other glassworker's sleeves for quantity pricing.

## CRL Glassworkers Oversize Protective Sleeves

- Extra Width From Top to Bottom
- Fit Easily Over Jackets
- Two Sizes Available
- ANSI Cut Resistance: 1

CRL's Oversize Protective Sleeves are wider than our standard sleeves, and are perfect for those cold, winter weather months because they can be comfortably worn over heavy sweaters or jackets with complete range of motion. The extra-wide Sleeves are made to the same rigid specifications and provide the same level of protection as our standard sleeves. Sold only in pairs.

**NOTE:** For replacement elastic straps, order Cat. No. GWSSTRAP.



Sleeve Close Up



Strap Close Up



CAT. NO.	LENGTH	SIZE
GWS8374	27" (686 mm)	Medium
GWS8375	29" (737 mm)	Large

Minimum order: 1 pair. Can be combined with all other glassworker's sleeves for quantity pricing.

## How to Order Custom CRL Glassworkers Protective Sleeves

### What are Your Ordering Options for Custom Protective Sleeves?

- Custom Sleeve Length
- Extra-Wide Sleeves
- Sleeves Without Grommets
- Reinforced Webbing on Nylon Sleeves
- Extra-Long Alligator Clips
- Hook-and-Loop Closures to Replace Snaps

#### Measurement Guidelines for Shoulder Cap Sleeves

Measure from wrist bone to shoulder.

**NOTE:** Carefully measure for custom sleeve length.

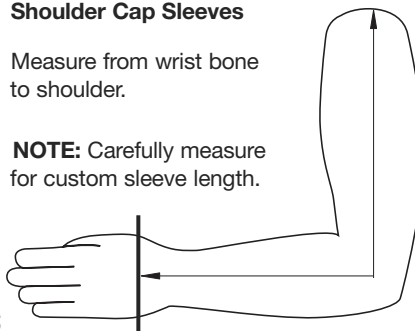

Custom Sleeves Without Grommets

## CRL Cane Mesh Sleeves

- Cane Nylon for Comfort
- Leather Straps Add Protection



Sleeve Close Up



These Sleeves are made of a single layer of cane mesh, with canvas elbows for toughness. Leather strips running the length of the Sleeve provide further protection. Open weave stitching allows air through the Sleeves keeping you comfortable in warm weather. Sold only in pairs.

**NOTE:** For replacement elastic straps, order Cat. No. GWSSTRAP

CAT. NO.	LENGTH
CN85029	29" (737 mm)
CN85031	31" (787 mm)

Minimum order: 1 pair. Can be combined with all other Glassworker's Sleeves for quantity pricing.

## CRL Oversize Cane Mesh Sleeves

- Extra Width From Top to Bottom
- Fit Easily Over Jackets
- Two Sizes Available

CRL's Oversize Cane Mesh Sleeves are perfect for those cold days because these Sleeves can be easily worn over your sweater or jacket. These Oversize Sleeves have the same features, benefits, and durability of the standard Cane Mesh Sleeve. Custom lengths can also be ordered by following measuring instructions below. Sold only in pairs.

**NOTE:** For replacement elastic straps, order Cat. No. GWSSTRAP.



Sleeve Close Up



Strap Close Up



CAT. NO.	LENGTH
CN86029	29" (737 mm)
CN86031	31" (787 mm)

Minimum order: 1 pair. Can be combined with all other Glassworker's Sleeves for quantity pricing.

## How to Order Custom CRL Cane Mesh Sleeves

### What are Your Ordering Options for Custom Cane Mesh Sleeves?

- Custom Sleeve Length
- Extra-Wide Sleeves in Custom Lengths
- 14" (356 mm) Alligator Clips
- Hook-and-Loop Closures to Replace Snaps

Custom Sleeves can be ordered through our Customer Service Department.

#### Measurement Guidelines for Shoulder Cap Sleeves

Measure from wrist bone to shoulder.

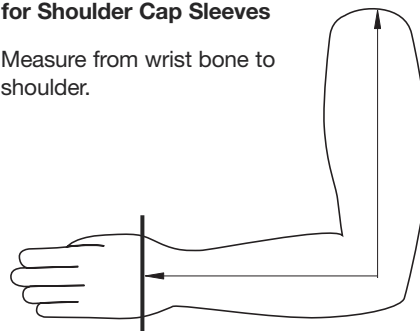

**IMPORTANT NOTE:**  
After measuring from wrist to shoulder, add 7" (178 mm) to sleeve measurement to order your custom sleeve.

## CRL Kevbest™ Protective Sleeves



CRL Kevbest™ Sleeves offer excellent protection from glass cuts and have the added reinforcement of lightweight Kevlar®. The metal eyelets are evenly spaced to help guard against deep cuts and punctures while offering superior ventilation through the grommets. ANSI Cut Level Rating 2. EN388 Puncture Level 2. Sold only in pairs.



- Top Notch Fabric With Metal Grommets for Safety

CAT. NO.	SIZE
<b>S30KV25</b>	25" (635 mm)
<b>S30KV27</b>	27" (686 mm)
<b>S30KV29</b>	29" (737 mm)

Minimum order: 1 pair. Sizes can be combined for quantity pricing.

## CRL Blue Denim Protective Sleeves

- 2-Ply Blue Denim Cotton
- Protects Shoulders, Elbows, and Arms



CRL Blue Denim Protective Sleeves provide important protection for your arms and shoulders. Lightweight and flexible, the 24" (609 mm) long Blue Denim Sleeves come with plated, staggered grommets to protect against punctures and provide air circulation. Adjustable shoulder straps are included. For replacement shoulder straps order Cat. No. 2404442. Sold only in pairs. Minimum order is one pair.

**CAT. NO. 2404446**

## CRL Cut Protection Jackets

- Provides Excellent Cut Protection
- Available With or Without Grommets in Body and Sleeves

CRL Cut Protection Jackets were designed for the safety of the glass worker. Wearing the proper safety gear is required in order to safely carry and install glass. These Jackets are made from 8 oz. Kevbest™ Kevlar®, which is many times more cut-resistant than comparable materials of the same weight. The metal eyelets allow increased air circulation, and the jacket has a zipper in front for easy removal. ANSI Cut Level Rating 2. EN388 Puncture Level 2.



CAT. NO.	GROMMETS	SIZE
<b>C35GKVSM</b>	Yes	Small
<b>C35GKVMD</b>	Yes	Medium
<b>C35GKVLG</b>	Yes	Large
<b>C35GKVXL</b>	Yes	X-Large

Minimum order: 1 each. All Jackets can be combined for quantity pricing.

CAT. NO.	GROMMETS	SIZE
<b>C35KVSM</b>	No	Small
<b>C35KVMD</b>	No	Medium
<b>C35KVLG</b>	No	Large
<b>C35KVXL</b>	No	X-Large

Minimum order: 1 each. All Jackets can be combined for quantity pricing.

## How to Order Custom CRL Cut Protection Jackets



Half-Jacket



Eisenhower Style Jacket

Kevlar is a registered trademark of E.I. du Pont de Nemours and Company.

## What Are My Ordering Options?

- Reversed Grommets
- No Grommets
- Half or Eisenhower Style Jackets
- Custom-Sized Jacket

HALF-JACKET			EISENHOWER JACKET	
CHEST MEASUREMENTS	SLEEVE LENGTH	ORDER SIZE	CHEST MEASUREMENT	SLEEVE LENGTH
40" (1016 mm)	27" (686 mm)	Small	48" (1219 mm)	29" (737 mm)
44" (1118 mm)	31" (787 mm)	Medium	50" (1270 mm)	31" (787 mm)
46" (1168 mm)	35" (889 mm)	Large	52" (1321 mm)	33" (838 mm)
50" (1270 mm)	39" (991 mm)	X-Large	54" (1372 mm)	35" (889 mm)

Minimum order: 1 each. \*NOTE: Jackets are designed to be worn over clothing. We suggest you take chest measurements while wearing a light jacket or sweatshirt to make sure you will have freedom of movement while wearing the Kevlar® Jacket.

## CRL Cut Protection T-Shirt

- Very Comfortable and Lightweight
- Offers Maximum Cut Protection

CRL's Cut Protection T-Shirt is a very functional and comfortable shirt that your glass handlers and fabricators will look forward to wearing. This well styled shirt is made of COOLMAX® fabric which transports body heat to the outside, while at the same time has a cooling effect. The sleeves have Kevlar® knit wrist material, which offers a maximum cut resistance rating of 5 on the forearms.



CAT. NO.	CHEST SIZE
993096MD	Medium 40"-42" (102-106 cm)
993096LG	Large 44"-46" (112-116 cm)
993096XL	X-Large 48"-50" (122-128 cm)

Minimum order: 1 each.

## CRL Cut Protection Poloshirt

- Maximum Cut and Puncture Resistance
- Offers Both Style and Comfort

CRL's Cut Protection Poloshirt provides all-day comfort and maximum cut resistance for shoulders and arms which are the highest risk areas when cutting and handling glass. Cordura® material reinforcement in the belly area, and the front and back of the Poloshirt are made from COOLMAX® fabric, which cools the wearer. This shirt has a puncture rating of 4 in the belly area and a cut resistance rating of 5 for the arms and shoulders.



CAT. NO.	CHEST SIZE
993898MD	Medium 40"-42" (102-106 cm)
993898LG	Large 44"-46" (112-116 cm)
993898XL	X-Large 48"-50" (122-128 cm)

Minimum order: 1 each.

## CRL Cut Protection Jacket

- Provides Maximum Protection
- Well Styled and Comfortable

CRL's Cut Protection Jacket is ideal for cold weather projects. This great looking Jacket is durable, can be laundered, and provides cut resistance to level 5 for the arms and shoulders and a puncture rating of 3. The exterior design features a snap front and two front flap pockets, while the inside has a comfortable poly-cotton liner.



CAT. NO.	CHEST SIZE
PKJ153MD	Medium 40"-42" (102-106 cm)
PKJ153LG	Large 44"-46" (112-116 cm)
PKJ153XL	X-Large 48"-50" (122-128 cm)

Minimum order: 1 each.

## CRL Cut Protection Kevlar® Neck Protector

- Comfortable
- Easy-On, Easy-Off



CRL's Neck Protector is constructed from knitted Kevlar®, and is designed for glass fabricators who regularly carry and handle annealed or tempered glass. The Neck Protector provides a cut resistance rating of 4. Comfortable in all climates, it is designed to be worn all day. The hook-and-loop closure makes the Neck Protector fully adjustable to any neck size. Minimum order is one each.

CAT. NO. 99995

## CRL Shin and Foot Protectors

- A Must Have Item for Anybody in the Glass Industry

Give your feet and lower legs added protection with CRL Shin and Foot Protectors. They are made of high quality leather and reinforced with a steel frame. The foot guard is a 1/8" (3 mm) piece of rubber attached to the leggings and cut to follow the foot contour. Great for people in a shop or window factory where the constant carrying of plate glass poses a hazard. Minimum order is one pair.



CAT. NO. SFP1234

Cordura® and Kevlar® are registered trademarks of E.I. du Pont de Nemours and Company. COOLMAX is a registered trademark of INVISTA North America S.A.R.L.

## CRL Nylon Wrist Protectors

- Lightweight and Flexible
- Available in Two Lengths
- Stitched With Kevlar®
- ANSI Level 2 Cut Protection



CRL Nylon Wrist Protectors with improved cut resistance help protect you from cuts and abrasions. The nylon mesh provides ventilation, and two hook-and-loop strips make them easy to put on or take off. These are great for general glaziers, window factory workers, or anybody who handles glass. Stitched with Kevlar®, they are comfortable to wear. Sold only by the pair.



CAT. NO.	WRIST CIRCUMFERENCE	FOREARM CIRCUMFERENCE	LENGTH
4X2257M	9-1/2" (241 mm)	13-1/2" (343 mm)	7" (178 mm)
4X2257XL	11-1/2" (292 mm)	15-1/2" (394 mm)	7" (178 mm)
4X2259M	9-1/2" (241 mm)	14-1/2" (368 mm)	9" (229 mm)
4X2259XL	11-1/2" (292 mm)	16-1/2" (419 mm)	9" (229 mm)

Minimum order: 1 pair. All Wrist Protectors can be combined for quantity pricing.

## CRL Leather Wrist Protectors

- Made of Heavy-Duty Leather
- Zipper On and Off



If you carry glass, these Leather Wrist Protectors are a must! Made of heavy-duty leather-bound pigskin, they are also grommeted for protection and ventilation. A strong, steel zipper stitched to the leather makes them easy to remove. Minimum order is one pair.

CAT. NO. 5135

## CRL Kevlar® Armor Wristlets

- ANSI Level 4 Cut Protection
- Lightweight and Flexible

- EN388 Puncture Rating: 1



CRL's Kevlar® Armored Wristlets provide superior cut protection for the wrist and forearm. They have single layer construction which means they are lightweight and flexible, and do not restrict arm or hand motion while providing twice the cut protection of similar products. They are made from a single layer of Kevlar®, and secured with durable hook-and-loop closers. Sold by the pair.

CAT. NO.	LENGTH
S01KZ7	7" (178 mm)
S01KZ9	9" (229 mm)

Minimum order: 1 pair. All Wrist Protectors can be combined for quantity pricing.

## CRL D-Flex® Cut Resistant Sleeves

- D-Flex® Has Three Times the Cut Resistance of Kevlar®
- ANSI Level 5 Cut Protection

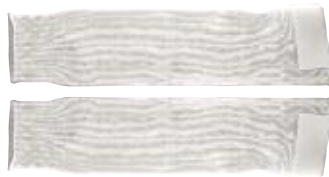

CRL D-Flex® Cut Resistant Sleeves are 21" (533 mm) long, with a hook-and-loop fastener on top to adjust to any arm size. These heavy-weight D-Flex® Cut Resistant Sleeves can be laundered and bleached without losing their protective qualities. Sold only by the pair. Minimum order is one pair.

CAT. NO. 927S

## CRL Black Nylon Wrist Guards

- Lightweight and Flexible



Available Only in Australia

CRL Black Nylon Wrist Guards help protect you from cuts and abrasions. These lightweight nylon mesh sleeves provide ventilation, and have two hook-and-loop strips making them easy to put on or take off. Sold only by the pair.



CAT. NO.	SIZE
WGV	Large
WGVXXL	XX Large

Minimum order: 1 pair.

Kevlar is a registered trademark of E.I. duPont de Nemours and Company. D-Flex is a registered trademark of Showa Glove Company.

## CRL Wristlets With Thumbhole

- One Size Fits All



Nylon Mesh Wristlet

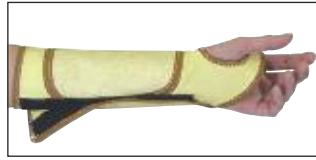

Kevlar® Wristlet

CRL's Nylon Mesh and Kevlar® Wristlets are designed with a thumbhole which keeps the Wristlet in place and allows for a comfortable fit. The Wristlets are 9-1/2" (241 mm) in length, and provide added protection for your wrist and palm. They can also be adjusted to fit any arm. They offer excellent protection against cuts and abrasions from sharp edges.

CAT. NO.	CUT PROTECTION	MATERIAL
S04MP08	Cut Level 2	Nylon Mesh
S04KX018	Cut Level 4	Kevlar®

Minimum order: 1 pair.

## CRL Wrist and Thumb Joint Protector

- Comfortable and Lightweight
- Easy to Put On and Take Off
- Provides Protection Against Possible Injury



CRL's 9" (228 mm) long leather Wrist and Thumb Joint Protector is perfect for glaziers or anyone who handles or fabricates glass. A full length hook-and-loop closer provides a secure and snug fit around the forearm. It does not restrict wrist or arm movement. Sold only by the pair. Minimum order is one pair.

CAT. NO.	SIZE
2404420	Small
2404421	Large

Minimum order: 1 pair. Sizes can be combined for quantity pricing.

## CRL Kevlar® Waist Apron

- ANSI Cut Level 2
- Protects From Waist to Knee

CRL's Kevlar® Waist Apron is made from lightweight Kevlar® twill, and provides excellent cut protection from waist to knee area. Leather tie straps permit easy adjustment and long-wearing comfort. Kevlar® Apron measures 20" (508 mm) wide and 24" (610 mm) in length. Minimum order is one each.



CAT. NO. A01KV2024

## CRL Protective Leg Chaps

- Fits Waist Sizes Up to 46" (1168 mm)

These Protective Leg Chaps guard against cuts and abrasions from glass and sheet metal. Made from 22 oz. Thermobest Kevlar® material at the waist, and 8 oz. Kevbest™ Kevlar® over the legs for maximum protection and flexibility while working. Hook-and-loop closures hold the chaps to your ankles for a sure fit. Kevlar® material is lighter than leather while offering the same level of protection. Sold only in pairs.



CAT. NO.	LENGTH
L49TC34	34" (864 mm)
L49TC36	36" (914 mm)
L49TC38	38" (965 mm)

Minimum order: 1 pair. Sizes can be combined for quantity pricing.

## CRL Leather Wrist Guards With Cane Inserts

- Made of Heavy-Duty Leather
- Velcro® Adjustment Fits All



Available Only in Australia

These CRL Leather Wrist Guards have reinforced cane inserts to help protect tendons in the wrist. Convenient Velcro® adjustment fits all. Sold by the pair. Minimum order is one pair.

CAT. NO. S00754

Kevlar is a registered trademark of E.I. du Pont de Nemours and Company. Velcro is a registered trademark of Velcro Industries B.V. LLC.

## CRL Leather Aprons

- Heavy-Duty Leather
- Maximum Protection



ACL1



ACL2



Available Only in Australia

CAT. NO.	DESCRIPTION
ACL1	24" x 24" (610 x 610 mm) Waist Apron
ACL2	36" x 24" (914 x 610 mm) Bib Style Apron

Minimum order: 1 each.

## CRL Radians® Vector™ Safety Glasses

- Great Protection
- Classic Style



**CAT. NO. CL0210**  
Clear Lens

CRL Radians® Vector™ Safety Glasses feature a 100% polycarbonate lens that meets the ANSI Z87.1-1989 Standard, and is distortion-free with fog and scratch resistance built in. The adjustable temple and full 155 degree width provide increased protection. Minimum order is one pair.

## CRL Radians® AV™ Safety Glasses

- 99 Percent UV Protection
- Anti-Scratch Coating



**CAT. NO. JP2000**



**CAT. NO. AV1110**

CRL Radians® AV™ Safety Glasses employ the best in eye and ear protection that meets or exceeds ANSI Standards. The lens has a hard anti-scratch coating and is 99% UV protected. They also resist fogging in all types of weather and working conditions. Each pair comes with a neck cord to hold them while not in use. JP2000 Ear Protectors are reusable, washable, and conveniently replaceable. Made in the U.S.A. Minimum order is one pair.

## CRL Radians® Rad-Apocalypse™ Safety Glasses

- Available in Three Lens Colors
- Great Style



CRL's Radians® Rad-Apocalypse™ Safety Glasses not only provide excellent eye protection, but have great style. Features include soft rubber temples and a nosepiece which allows all-day comfort, coated scratch-resistant lenses, and a convenient neck cord. The polycarbonate lenses meet the ANSI Z87.1 rating and have 99.9 percent UV protection.

CAT. NO.	LENS COLOR
<b>RAP1C</b>	Clear
<b>RAP1S</b>	Smoke
<b>RAP1O</b>	Indoor/Outdoor

Minimum order: 1 pair.

## CRL Radians® Rad-Infinity™ Safety Glasses

- Excellent Features
- Superior Protection



CRL's Radians® Rad-Infinity™ Safety Glasses are uniquely styled and offer superior eye protection. They are available in clear, smoke, and indoor/outdoor lenses. Rad-Infinity™ Glasses have cushioned rubber temple pads which provide outstanding comfort, a gel non-slip nosepiece, coated scratch-resistant lenses, and a neck cord for convenient on/off situations. The lenses conform to ANSI Z87.1 standards and provide 99.9 percent UV protection.

CAT. NO.	LENS COLOR
<b>R1N1C</b>	Clear
<b>R1N1S</b>	Smoke
<b>R1N1O</b>	Indoor/Outdoor

Minimum order: 1 pair.

## CRL Radians® Rad-Sequel™ Safety Glasses

- Meets ANSI Z87.1 Standards
- Comfortable Fit



CRL's Radians® Rad-Sequel™ Series Safety Glasses provide wrap-around eye protection in a lightweight design. Choose either clear, smoke or indoor/outdoor polycarbonate, impact-resistant lenses. The rubber tipped temples offer a secure, comfortable fit. The hard coated lenses are also 99.9 percent UV effective.

CAT. NO.	LENS COLOR
<b>RDS1C</b>	Clear
<b>RDS1S</b>	Smoke
<b>RDS1O</b>	Indoor/Outdoor

Minimum order: 1 pair.

## CRL Radians® Mirage™ Safety Glasses

- Made in USA
- Sleek, Lightweight Design



CRL's Radians® Mirage™ Series Safety Glasses offer a comfortable fit for both men and women. The snap-fit temples provide a secure fit and the optically correct lenses give distortion-free viewing. The wrap-around lens design provides impact resistance and a nearly perfect orbital seal. They are ANSI approved, 99.9 percent UV effective, and available in clear, smoke and indoor/outdoor lenses.

CAT. NO.	LENS COLOR
<b>MR01C</b>	Clear
<b>MR01S</b>	Smoke
<b>MR01O</b>	Indoor/Outdoor

Minimum order: 1 pair.

All Safety Glasses on this page can be combined for quantity pricing. Radians is a registered trademark of Radians, Inc.



## CRL Patriot® Safety Eyewear

- Red, White, and Blue Frame
- Integrated Side Guards



CRL Patriot® Safety Eyewear provides wrap-around protection in an attractive, lightweight, colorful frame with adjustable temples. The single-lens style with nosepiece and brow guard provides a comfortable fit and also meets ANSI Z87.1 Spec. The clear, hard coated lenses are scratch resistant. Minimum order is one pair.

CAT. NO. 2404443

## CRL Deluxe Safety Spectacles

**new**

- Wrap-Around Eye Protection
- Can Be Worn Over Eyeglasses



CRL's New Clear Deluxe Safety Glasses are perfect for both visitors to your facility or employees. The wrap-around polycarbonate lenses are impact resistant and provide ultimate protection. These stylish glasses have telescoping temples for a customized and comfortable fit. Certified to ANSI Z87.1 Standards and provides 99.9% UVA/UVB protection. Minimum order is one Pair.

CAT. NO. SH610

## CRL Radians® Coveralls™ Safety Glasses

- Safety and Comfort
- Can Be Worn Over Eyeglasses



Traditionally styled Radians® Coveralls™ give you protection at an economic price. They can be worn over prescription glasses. They're an excellent choice for use as "visitor" glasses. Minimum order is one pair.

CAT. NO. VS0010

## CRL Lightweight Visitor Spectacles

- Wrap-Around Shields
- Distortion-Free Lens



Extremely comfortable CRL Lightweight Spectacles can be worn with or without prescription glasses. They feature wrap-around side shields, and an anti-glare brow guard. The distortion-free clear lenses are .080" (2 mm) thick for added protection. Minimum order is one pair.

CAT. NO. ES461

## CRL Protective Goggles

- Soft Vinyl Frame
- Distortion Free Lens



CRL Protective Goggles offer comfort as well as protection against flying particles, dust and splash. Injection molded from soft, pliable, non-irritating vinyl, these Goggles fit all sizes and shapes. They even fit comfortably over large prescription glasses. They have a soft vinyl frame with perforations for maximum ventilation. They also feature a high-optical quality, distortion-free, replaceable polycarbonate lens. Minimum order is one pair.

CAT. NO. ES432

## CRL UV Goggles

- Provides Maximum Protection From Exposure to Extended or High-Intensity Ultraviolet Sources



CRL UV Goggles protect the user against most ultraviolet light sources. These Goggles specifically provide maximum protection from exposure to extended or high-intensity UV sources. Meet ANSI specification Z87.1 for safety eye-wear and OSHA standard 1910.133 for eye and face protection. They fit easily over regular eyeglasses. Minimum order is one each.

CAT. NO. UVG50

## CRL UV-Absorbing Spectacles

- Protects Against UV Exposure
- Fits Easily Over Regular Eyeglasses



These CRL UV-Absorbing Spectacles are specially designed to protect the user against limited exposure to low intensity UV sources. Attractive and durable, these well proportioned frames fit easily over conventional eyeglasses. Minimum order is one each.

CAT. NO. UVS30

Patriot is a registered trademark of Sperian Eye & Face Protection, Inc.  
Radians is a registered trademark of Radians, Inc.

## CRL Disposable Foam Ear Plugs

- Economical Ear Protection
- One Size Fits All



These popular low density CRL Foam Ear Plugs are easy to use. Simply roll them in your hand to reduce their diameter, insert them in your ears and they will expand to stay secure and provide ear protection. Permits conversational noise levels while providing comfortable and economical ear protection. 200 wrapped pairs per box. Minimum order is one box.

CAT. NO. ES986

## CRL Hard Hat Hearing Protectors

- Fits All Slotted Hard Hats
- NRR Rated at 26



CRL's Hard Hat Mounted Ear Protectors have adjustable head bands with side wire guides which adjust for the best fit. The soft, foam padded ear cups fit securely and comfortably over the ear. These Ear Protectors will fit virtually all slotted hard hats, and are rated at NRR 26. Minimum order is one pair.

CAT. NO. CMT26

## CRL Eliminator 29 Hearing Protectors

- Designed to Equalize Pressure
- Lightweight Earcups



CRL's Eliminator 29 Hearing Protectors have a flexible headband which allows for the earcups to automatically adjust to the shape of your head. The headband is also designed to equalize pressure, which provides an even seal for better protection. The earcups are lightweight for all day comfort, and will flip outward for an easy comfortable fit when hanging around your neck. Minimum order is one each.

CAT. NO. EL29

## CRL Band Mount Hearing Protectors

- Swivel Ear Cup Construction
- For Low-Noise Environments



This CRL Band Mount Hearing Protector is rugged, comfortable, and lightweight. It gives excellent protection against noise pollution. It effectively seals the ear with minimum pressure, permitting conversational speech and warning signals to be heard. The ear cushions are ultra-soft for comfort and extended wear. Minimum order is one each.

CAT. NO. ES515

## CRL Ear Plugs

- Soft, Pliable, and Reusable
- Includes Neck Cord



CRL Ear Plugs are soft and pliable for a comfortable, non-irritating fit. They permit hearing at a normal conversational level, yet provide effective protection against noise pollution, and are resistant to ear wax and soil. They are easily washed with mild soap and warm water, will not deteriorate or harden, and are attached to a plastic neck cord. 10 sets per pack. Minimum order is one pack.

CAT. NO. 67221

## CRL Radband Ear Protectors

- Lightweight and Comfortable
- Reusable

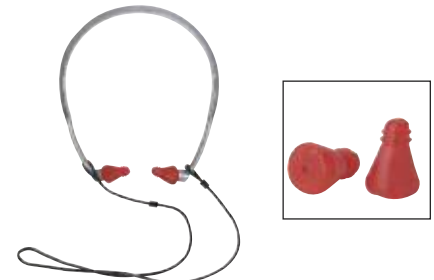

CRL's Radband Ear Protectors provide effective hearing protection when needed, and can easily be worn around the neck when not in use. Rated at NRR 23, these Ear Protectors are super soft and made from FDA approved non-toxic material. The Radband is designed to align the ear protectors with the ear canal for maximum comfort and sound protection. The Radband is reusable since the ear plugs are washable. The head band is lightweight and durable. Minimum order is one each.

CAT. NO. RB1100

## CRL Dual Cartridge Organic Vapor Respirator

- Protects Against Dust, Tiny Particles, and Fumes



Requires Two Cartridges

This CRL Dual Cartridge Respirator comes with NIOSH approved Cartridges for organic vapors. Common applications include degreasing, adhesive use, working with other airborne contaminants. The elastomeric face piece is soft on the face. Low breathing resistance lessens fatigue, resulting in higher productivity. Protection is also offered against highly toxic dusts, including asbestos, mists, and fumes.

CAT. NO.	DESCRIPTION
ES285X	Respirator and Cartridges
MD8100	Replacement Cartridges (Pair)

Minimum order: Respirator is 1 each. Cartridges are 1 pair. Respirators can be combined for quantity pricing.

## CRL Glass Dust Respirator

- Soft, Durable Face Piece Designed for Safety and Comfort



Requires Two Filters

The CRL Glass Dust Respirator comes complete with Filter Disks certified under NIOSH 42 CFR 84 to have a filter efficiency of 99.97% or greater against oil, non-oil aerosols, and silica (glass) dust. It also conforms to requirements for contaminants falling under OSHA substance specific standards of High Efficiency Particulate Air (HEPA) Filters.

CAT. NO.	DESCRIPTION
ES287X	Respirator and Filter Disks
MD8940	Replacement Filter Disks (Pair)

Minimum order: Respirator is 1 each. Filter Disks are 1 pair. Respirators can be combined for quantity pricing.

## CRL Disposable Dust Mask

- Ideal Protection Against Dust When Sanding, Grinding and Cutting



**NOTE:** This mask is not suitable for use against toxic or hazardous air contaminants.

These CRL Disposable Dust Masks protect against nuisance and non-toxic dusts, powders, pollen, and other common airborne irritants. Comfortable and lightweight, they are designed to be worn with or without eyeglasses or goggles without interfering with your maximum field of vision.

CAT. NO.	QTY/BOX
G1001	50

Minimum order: 1 box. All Dust Masks can be combined for quantity pricing.

## CRL Dust and Mist Respirator

- NIOSH/MSHA Approved for Dust and Mists With PEL
- Meets OSHA Up to 10X PEL



For excellent balance of performance and cost, choose the CRL Dust/Mist Respirator, the first maintenance-free respirator to be approved. The ES8710 is used throughout general industry in a wide variety of applications. Protects against coal, cadmium, chromium, lead, cotton, dust, silica, and other substances. NIOSH/OSHA approved for dusts and mists with PEL not less than 0.05 mg/m<sup>3</sup>. Meets OSHA Standards for use up to 10X PEL.

CAT. NO.	QTY/BOX
ES8710	20

Minimum order: 1 box. All Dust Masks can be combined for quantity pricing.

## CRL Particulate Respirator

- Perfect for Glass Fabricators

CRL's Particulate Respirator is ideal for anyone in the glass industry who cuts, seams, drills or edges glass. This is the perfect Respirator to filter out glass dust particles in the air caused by any glass fabrication process. The Particulate Respirator is designed with inner foam which provides a custom seal, and a dual head strap for optimum fit. NIOSH approved.



CAT. NO.	QTY/BOX
G1002	20

Minimum order: 1 box. All Dust Masks can be combined for quantity pricing.

## CRL Valved Particulate Respirator

- Valve Permits Easy Respiration

CRL's Valved Particulate Respirator has the same features and benefits as our Cat. No. G1002 Particulate Respirator, except it permits the person wearing the mask to exhale comfortably through a valve which automatically closes after exhalation. NIOSH approved.



CAT. NO.	QTY/BOX
G1003	10

Minimum order: 1 box. All Dust Masks can be combined for quantity pricing.

## CRL Face Shields

- Adjustable for All Head Sizes
- Available Models- Standard or UV Absorbing

Our all plastic CRL Face Shields have extra-wide windows which offer protection and comfort. Designed for protection from flying particles during woodworking, metal finishing, and exposure to ultraviolet light. Adjustable for all head sizes.



CAT. NO.	DESCRIPTION
ES484	Standard Shield
UVF80	UV-Absorbing Shield

Minimum order: 1 each.

## CRL Safety Hard Hat

- Complies With OSHA Requirements ANSI Z89.1-1986 Class A and B

These CRL Safety Hard Hats are made from an improved, injection-molded, high-density polyethylene that offers superior protection against impact, penetration, and shock. It has good resistance to chemicals and voltage, yet it weighs less than 12 ounces (340 gm), making it comfortable to wear. The four point integral suspension has a head gripping, extra-contoured nape strap for a better fit.



CAT. NO.	COLOR
ES3412	Red
ES3442	White
ES3452	Yellow
ES3492	Blue

Minimum order: 1 each.

## CRL Ratchet Suspension Hard Hat

CRL's Ratchet Suspension Hard Hat is made of lightweight polyethylene with impact absorbing ridges. These very comfortable Hats meet ANSI Z89.12003 Standard, Type 1, Class G & E. The innovative ratchet nylon suspension allows the wearer to easily adjust the fit of the Hat while it is being worn by simply turning the rear knob. The soft brow band is washable and reusable, and the universal slots will accommodate most cap mounted ear muffs.



- Fit Can Be Adjusted While Wearing Hat

CAT. NO.	COLOR
HH300W	White
HH300Y	Yellow
HH300B	Blue

Minimum order: 1 each.

## CRL Hard Hat Head Lamp

- Waterproof for Use in Inclement Weather
- Lightweight, With Swivel Lens

This CRL Hard Hat Head Lamp is a multi-purpose battery-powered lamp for use on Hard Hats or worn on the forehead. This hands-free lamp gives you an extended viewing range with a swivel lens that focuses light up to 90 degrees to either side. Easy on/off button. Uses AA batteries, which are included. Minimum order is one each.



Shown with Hard Hat (Sold Separately)

CAT. NO. ES015

## CRL Hard Hat Chin Strap

- Adjustable - One Size Fits All



Shown with Hard Hat (Sold Separately)

This CRL Chin Strap has an adjustable elastic web which clips onto your hard hat, wrapping under your chin and keeping the hat snug on your head. One size fits all. Minimum order is one each.

CAT. NO. ES003

## CRL Hard Hat Winter Liner

- Add Warmth to Your Safety Cap
- Soft Non-Irritating Fabric

This CRL Winter Liner makes hard hats warm and comfortable to wear during the coldest weather. They are made of pre-shrunk and washable cotton, and help keep head, neck, and ears warm in frigid temperatures. Minimum order is one each.



CAT. NO. ES524

## CRL Elastic Back Support Belt

- Hook-and-Loop Quick Fit
- Adjusts for Comfort
- Breathable Material
- Four Sizes



Our Elastic Back Support Belt was professionally designed to reduce the possibility of back stress and injury, while encouraging proper body mechanics. Adjustable suspenders, plus hook-and-loop waist closure make it flexible and comfortable for extended wear. Breathable material keeps you cool.

CAT. NO.	WAIST SIZE
5900SB	Small 28" to 32" (711 to 813 mm)
5900MB	Medium 32" to 38" (813 to 965 mm)
5900LB	Large 38" to 46" (965 to 1168 mm)
5900XLB	X-Large 46" to 56" (1168 to 1422 mm)

Minimum order: 1 each.

## CRL Mesh Back Support Belt

- Available in Four Sizes
- Fabricated to Provide Maximum Support and Comfort



CRL's new Mesh Back Support Belt is 8" (203 mm) wide and fabricated from breathable Lycra. The black back support has a spandex power net back panel and four internal stays to keep the belt from rolling. The double 4" (102 mm) wide elastic side panels are adjustable for a custom fit. The adjustable suspenders are made from 1-1/2" (38 mm) comfortable woven elastic. Tapered front panels provide comfort while bending.

CAT. NO.	WAIST SIZE
5300SB	Small 26" to 33" (660 to 838 mm)
5300MB	Medium 32" to 38" (813 to 965 mm)
5300LB	Large 37" to 43" (940 to 1092 mm)
5300XLB	X-Large 41" to 49" (1041 to 1245 mm)

Minimum order: 1 each.

## CRL Weight Belt Back Support

- Lightweight Yet Strong
- Sturdy Metal Buckle
- Four Sizes



Our 5" (127 mm) wide Weight Belt offers back support when doing heavy lifting. This lightweight black fiber-filled belt has a neoprene back support to provide additional comfort. More colors and sizes are available on special order.

CAT. NO.	WAIST SIZE
WBS2834	Small 28" to 34" (711 to 864 mm)
WBM3438	Medium 34" to 38" (864 to 965 mm)
WBL3842	Large 38" to 42" (965 to 1067 mm)
WBXL4246	X-Large 42" to 46" (1067 to 1168 mm)

Minimum order: 1 each.

## CRL Dual-Flex Wrist Support

- Can Be Worn on Either Hand
- Four Sizes



CRL Dual-Flex Wrist Supports have a high-grade ribbed support. These Wrist Supports have a lightweight design with strategically placed stays that restrict harmful flexing and extension. Available in four different sizes, the black Dual-Flex Wrist Supports may be worn on either hand, and are machine washable.



CAT. NO.	SIZE
EHD1S	Small
EHD1M	Medium
EHD1L	Large
EHD1XL	X-Large

Minimum order: 1 each.

## CRL Full-Body Modular Safety Harness

- Certified and Compliant With ANSI, CSA, and OSHA Requirements
- For Fall Arrest, Positioning, and Retrieval

This CRL Full-Body Modular Safety Harness is designed to arrest free falls and distribute impact forces as required by OSHA. The straps provide extra comfort during normal use as well as support before, during and after a fall. It is equipped with one adjustable, forged, circle D-ring with roller at the back for attaching a fall-arrest connecting device. Made of tough 1-3/4" (44 mm) nylon webbing. Shoulder straps have friction slide adjusters for optimum fit. It is also equipped with adjustable parachute-type D-rings for quick retrieval purposes. Minimum order is one each.



CAT. NO. 5481

## CRL Adjustable Lanyard

- Quick Action Snap Hooks at Both Ends
- Adjustable Length From 78" to 120"
- Resin-Impregnated Nylon Webbing for Great Durability



This CRL Adjustable Lanyard is made of 1" (25 mm) wide orange nylon webbing that has been resin-impregnated for greater durability. The Lanyard has drop-forged snap hooks at each end for quick action and strength. It can be adjusted in length from 78" to 120" (2 to 3 m). Ideal for linemen, iron workers, and high-rise construction workers. Minimum order is one each.

CAT. NO. 5492W10

## CRL Fall Protection Harness Kit

- One Size Fits All 5-Point Harness
- Designed for Fall Arrest and Retrieval



CRL's Fall Protection Harness Kit contains all the essential elements needed for fall protection: one 5-point harness, one D-ring, one 72" (1829 mm) energy absorbing web lanyard with snaphooks installed at each end, and one convenient carry bag. These affordable Kits are ideal for the contract glazier to keep packed away until needed for those special projects where fall protection is required. Minimum order is one each.

CAT. NO. E05501

## CRL Fall Protection Harness

- One Size Fits All 5-Point Harness
- Installed Sliding D-Ring
- Made of Polyester

CRL's 5-point Fall Protection Harness conforms to OSHA requirements for fall arresting equipment. Made of polyester, the Harness has a sliding steel D-ring installed in the center of the back and parachute buckles mating chest and leg straps. The one size fits all Harness adjusts from small thru x-large. If you have glazing projects for multi-level buildings, your crew is required to wear fall protection equipment. Minimum order is one each.



CAT. NO. E48103

## CRL Gel Knee Pads

- Gel Provides Maximum Cushioning for All-Day Wear
- One Size Fits All

CRL's Gel Knee Pads have a gel center which provides maximum cushioning for all-day wear. The soft, flexible rubber outer shell protects and grips most surfaces without scratching, scuffing or skidding. The durable rubber straps offer added stability, and the ultra-flex construction is designed for increased comfort and protection. Minimum order is one pair.



CAT. NO. G361

## CRL Pro Pads™ Knee Pads

- Provide Protection and Comfort While Kneeling
- One Size Fits All

These CRL Pro Pads™ give support while kneeling, and protection against bumps and scrapes. Stitched-on caps are stronger than rivet-on style, and will not collect debris under the caps. Medical grade, tight weave elastic straps hold comfortably without binding, and give excellent service longevity. Minimum order is one pair.



CAT. NO. PP91012

## CRL Heavy-Duty Knee Pads

- Slip-Buckle Fastening System With Adjustable Straps



CRL's Heavy-Duty Knee Pads have a dual layer of ballistic poly fabric and a textured PVC outer shell which provides extra durability. The high density, closed-cell foam padding helps reduce pressure on the kneecap for added comfort, and the neoprene inner fabric keeps the knees comfortable throughout the day. Minimum order is one pair.

CAT. NO. DG5224

## CRL Professional Knee Pads With Layered Gel

- Provides All-Day Comfort
- One Size Fits All



CRL's Professional Knee Pads are designed with a special layered gel technology over thick, closed-cell foam padding which surrounds the knee for ultimate comfort. The heavy-duty cap provides added stability, and the convenient upper tab allows for easy repositioning. These Knee Pads have a durable, ballistic poly-outer fabric for wear and a neoprene inner fabric for all day comfort. Minimum order is one pair.

CAT. NO. DG5204

## CRL Armadillo Knee Pads

- Flexible Air Cushion for Added Protection
- One Size Fits All



CRL's Armadillo Knee Pads have a full-size cap design engineered with air cushion chambers that provide stability and protection over the roughest surfaces. The tough poly-nylon shell has a cushioned neoprene liner for comfort and durability. The nylon web and elastic straps allow for easy adjustment and a secure fit for all-day wear. Minimum order is one pair.

CAT. NO. 347

## CRL Leather Knee Pads

- Top-Grain Leather Exterior
- Rivet Reinforced



These CRL Leather Knee Pads are made from top-grain leather. The inner liner is water resistant felt. This Knee Pad is rivet-reinforced, and has a single 3/4" (19 mm) wide leather strap with plated metal buckles. Minimum order is one pair.

CAT. NO. MN309

## CRL Cargo Handler's Chaps

- Split Leg Heavy-Duty Sueded Leather



These CRL Cargo Handler's Chaps are popular with material and glass handlers because of the heavy-duty leather front straps on each leg that keep them in place, affording protection from waist to mid-shin. The Chaps feature an adjustable all-leather belt with buckle, reinforced crotch area, and leg straps with snap rings. Minimum order is one each.

CAT. NO. MN431

## CRL Two-Pocket Split Leg Apron

- Reinforced Thigh and Lap Area



This CRL Two-Pocket Split Leg Apron offers a rugged leather front and below-the-knee protection for tough loading and material handling jobs. It is made of 10 oz. green, 100% cotton canvas with reinforced split leather legs and belly area. Exclusive interlocking crotch construction prevents "gapping". Other features include double stitched pockets, criss-cross shoulder straps, and leather leg straps. Minimum order is one each.

CAT. NO. MND93

## CRL Protective Leather Apron

- Heavy Leather Apron With a Hook/Clasp Buckle and Web Belt



This CRL Protective Leather Apron is a heavy 22" x 24" (559 x 610 mm) tan waist apron with a hook/clasp-style buckle webbed belt. Minimum order is one each.

CAT. NO. TG340

## CRL Baler Style Protective Leather Apron

- Measures 24" Wide x 18" Long (609 x 457 mm)
- Protects Below Waist and Above Knees



CRL's full cut Baler Style Protective Leather Apron is widely used by the glazing, construction, and packaging industries. It gives surface protection to the areas below the waist and above the knees. Not only does it protect the body, but it also protects work clothes from tears and stains. Minimum order is one each.

CAT. NO. 2404432



## CRL 5-Pocket Machinist Apron

- Double Stitched Blue
- 100% Cotton Canvas

This CRL 5-Pocket Machinist Apron was designed with the machinist's needs in mind, but we found it perfect for the shop glazier. Made of heavy weight, eight ounce blue 100% cotton canvas with double stitching on all pockets and stress points. The Apron has two large waist pockets, two bib pencil pockets, and swing pockets for your glass cutter or running pliers. Minimum order is one each.



CAT. NO. MNT27

## CRL Plastic Apron

- Full Splash Protection



This tough 44" (1117 mm) long CRL Vinyl Apron provides splash protection at an affordable price. Cotton shoulder straps tie to reinforced grommets to prevent rip-out. Comfortable, lightweight, and washable in cold water. Minimum order is one each.



CAT. NO. 2235

## CRL Cargo Handlers Apron

- Heavy-Duty Suede Leather
- No Split Leg Design

This tough, full coverage CRL Cargo Handlers Apron is designed for maximum protection and comfort. Made of heavy-duty light gray suede leather, with bib styling, and steel staple reinforcement for long life. Minimum order is one each.



CAT. NO. MN433

## CRL Truckers 4-Pocket Apron

- Green Heavy-Duty
- 100% Cotton Canvas
- Lightweight and Comfortable

This heavy-duty 10 oz. (283 g) green 100% cotton CRL Truckers 4-Pocket Apron has two large waist pockets plus pencil and pad bib pockets. It features extra reinforcement at stress points. It has two harness and leg straps. Interlocking crotch construction prevents apron legs from "gapping" open in center. Minimum order is one each.



CAT. NO. MNM71

## CRL 14-Pocket Bib Apron

- Room for Small Tools and Fasteners
- Functional Design
- Tough Construction

This professional quality CRL 14-Pocket Bib Apron with highly functional design features a 14-pocket, double tier design; left and right hammer loop; rivet reinforcement; and strong 8 oz. (227 g) cotton canvas construction. Minimum order is one each.



CAT. NO. MNC7

## CRL 5-Pocket Waist Apron

- Strong Eight Ounce Cotton Canvas Construction
- Machine Washable



This CRL 5-Pocket Waist Apron is a basic waist apron for nails and small tools. Rivet reinforced at stress points for strength and long wear. The 8 oz. (227 g) cotton canvas material is machine washable. Has a polypropylene hammer loop on right side. Minimum order is one each.



CAT. NO. MNC12

## CRL Rubber Apron

- Full Splash Protection
- 44" (1118 mm) Long



This full-length, rubberized nylon, CRL Rubber Apron with welded seams and grommets for cotton shoulder straps offers full splash protection, while being comfortable to wear. It is even washable in cold water. Minimum order is one each.

CAT. NO. 114

## CRL Neoprene Apron

- Lightweight Protection
- 45" (1143 mm) Long



CRL's bright Yellow Neoprene Apron has a nylon base fabric. This lightweight Apron is comfortable to wear with a convenient neck strap and ties in back. It is ideal for protecting clothing during wet fabrication operations. Minimum order is one each.

CAT. NO. 2404290

## CRL Fabricators Apron

- Extra Long and Wide
- Stretchable Waist Belt



CRL's Fabricators Apron is both light and durable. It is 48" (1291 mm) long and 33" (838 mm) wide. Made of extra-tough Cordura, the blue and black Apron has a stretchable waist belt with buckle. Wear the apron with CRL's Cat. No. 2404287 Fabricators Sleeves for maximum protection. Minimum order is one each.

CAT. NO. 2404289

## CRL Fabricators Sleeves

- Soft Wrist Seal
- Wear Over Sweatshirt or Jacket



CRL's Fabricators Sleeves are the solution for splash protection when wet polishing or working with water fed tools. The 18" (457 mm) long black sleeves can be comfortably worn over a sweater or jacket during cool weather since they provide extra warmth and are waterproof. Minimum order is one pair.

CAT. NO. 2404287

## CRL Nylon Rain Suit

- Cut to Fit Over Clothing
- Reflective Material on Arms and Legs

CRL's Nylon Rain Suit includes a storm jacket with zippered closure, pants with an elastic waist, and a detachable hood. The black suit with yellow reflective stripes is made from lightweight, durable .18 mm thick 190T nylon with a PVC backing. The suit has an internal back mesh for breathability, and the pants come with a convenient, durable drawstring.



CAT. NO.	SIZE
R103M	Medium
R103L	Large
R103XL	X-Large

Minimum order: 1 each. Other sizes available on special order.

## CRL Rain Boots

- Keep Feet Dry in Wet Weather Projects
- Fabric Lined for Comfort

Wear CRL's Rain Boots along with our Rain Suit for total protection in wet, stormy weather. The black rubber knee high Rain Boots are designed to be worn over-the-sock and are fabric lined for all day wear. The bar tread outsole provides maximum traction in wet weather conditions.



CAT. NO.	SIZE
R23009	9
R23010	10
R23012	12

Minimum order: 1 pair. Other sizes available on special order.

## CRL 10 Person First Aid Kit

### • Meets ANSI Standard Z308.1.2009

Carry this Compact First Aid Kit to the job site, in your truck or keep one in your shop. It will come in handy anywhere you need First Aid in a hurry. The Kit can also be attached to any wall for convenient access. The 10 Person Kit contains all the basic supplies, and meets and exceeds ANSI Standard Z308.1.2009.

#### KIT CONTAINS:

##### Bandage Assortment

Certi-Strip Plastic, 1" x 3"  
 Certi-Gauze Pad, 3" x 3"  
 Gauze Non-Stick Pad, 2" x 3"  
 Triangular Bandage, 40"  
 Certi-Strip, Fingertip  
 Certi-Strip, Knuckle

##### First Aid Assortment

BZK Towelettes, 5" x 7"  
 Certi-Burn Cream, 1 gm.  
 Certi-Antibiotic Cream, 1 gm.  
 Ammonia Inhalant  
 PVP Iodine Wipe-Ups, 1" x 2"  
 Absorbent Compress, 32 sq. in.  
 Nitrile Gloves, 1 pr.  
 Adhesive Certi-Tape, 1/2" x 2-1/2 yd.  
 First Aid Facts Sheet



CAT. NO. K61027

## CRL 25 Person First Aid Kit

### • Meets ANSI Standard Z308.1.2009

This is an ideal First Aid Kit for a small shop environment. The 25 Person Kit should be kept where it is quickly and easily accessible to all shop employees. The Kit can also be attached to any wall for convenient access. This Kit services up to 25 people, and meets and exceeds ANSI Standard Z308.1.2009.

#### KIT CONTAINS:

##### Bandage Assortment

Certi-Strip Plastic, 1" x 3"  
 Certi-Gauze Pad, 3" x 3"  
 Gauze Non-Stick Pad, 2" x 3"  
 Triangular Bandage, 40"  
 Certi-Strip, Fingertip  
 Certi-Strip, Knuckle

##### First Aid Assortment

BZK Towelettes, 5" x 7"  
 Certi-Burn Cream, 1 gm.  
 Certi-Antibiotic Cream, 1 gm.  
 Ammonia Inhalant  
 PVP Iodine Wipe-Ups, 1" x 2"  
 Absorbent Compress, 32 sq. in.  
 Alcohol Gel, 1 gm.  
 Eye Wash, 4 oz.  
 Certi-Cool Pack  
 Nitrile Gloves, 1 pr.  
 Adhesive Certi-Tape, 1/2" x 2-1/2 yd.  
 First Aid Facts Sheet



CAT. NO. K61029

## CRL 50 Person First Aid Kit

### • Meets ANSI Standard Z308.1.2009

The CRL Large Shop First Aid Kit is designed for a business that has 25 to 50 employees. This Kit, along with the 10 Person and 25 Person Kits, are neatly organized with all products easily identified. The Kit can also be attached to any wall for convenient access. This Kit meets and exceeds ANSI Standard Z308.1.2009.

#### KIT CONTAINS:

##### Bandage Assortment

Certi-Strip Plastic, 75 pc Assort.  
 Certi-Gauze Pad, 3" x 3"  
 Gauze Non-Stick Pad, 2" x 3"  
 Certi-Gauze Roll, 2" x 6 yd.  
 Elastic Bandage, Ace Style 2"  
 Triangular Bandage, 40"  
 Trauma Pad, 5" x 9"  
 Eye Pads

##### First Aid Assortment

BZK Antiseptic Towelettes, 5" x 7"  
 Alcohol Gel, 1 gm.  
 Certi-Burn Cream, 1 gm.  
 Certi-Antibiotic Cream, 1 gm.  
 PVP Iodine Wipe-Ups, 1" x 2"  
 Absorbent Compress, 32 sq. in.  
 Ammonia Inhalant  
 Eye Wash, 4 oz.  
 Certi-Cool Pack  
 Nitrile Gloves, 1 pr.



Bandage Scissors, 4"  
 Forceps, Plastic, 4"  
 Adhesive Certi-Tape – 1/2" x 5 yd.  
 First Aid Facts Sheet

CAT. NO. K61033

## CRL Wall Mounted Metal First Aid Supply Cabinet

### • A Must for Every Shop

CRL's Metal First Aid Supply Cabinet contains a large assortment of high quality first aid products. The heavy-duty, wall mountable cabinet is dust resistant, has three shelves, and easily accessible door pockets. The Metal First Aid Supply Cabinet meets and exceeds ANSI Standard Z308.1 2009. Minimum order is one each.

#### KIT CONTAINS:

Certi-Strip Adhesive Bandage, Plastic  
 Certi-Strip Adhesive Bandage, Woven  
 Certi-Strip Adhesive Bandage, Fingertip  
 Certi-Strip Adhesive Bandage, Knuckle  
 Certi-Adhesive Tape Spool  
 Certi-Skin Closures M/L  
 Alcohol Wipe-Ups  
 Ammonia Inhalant  
 Antiseptic BZK Spray  
 Antiseptic BZK Towelettes  
 Bandage Compress  
 Biohazard Bag with Tie  
 Tri-Buffered Aspirin Tablets  
 Certi-Burn Gel  
 Certi-Burn Spray  
 Certi-Ache Tablets, Analgesic

Certi-Cet Plus Tablets, Non-Aspirin  
 Cold Pack, Certi-Cool Large  
 Absorbent Compress  
 Cotton Swabs, Package 100  
 CPRotector, "Mouth-to-Mouth" Barrier  
 Certi-Rip Elastic Cohesive Bandage  
 Oval Eye Pads with Tape  
 Certi-Lizer Eye and Skin Wash

Eye Wash with Eye Cup  
 First Aid Cream  
 Forceps, Plastic  
 Certi-Non Stick Pads  
 Certi-Gauze Pads  
 Certi-Gauze Roll  
 Nitrile Gloves, 2 Pair  
 Hydrocortisone Cream

Insect Sting Wipe-Ups  
 PVP Iodine Wipe-Ups  
 Bandage Scissors  
 Trauma Dressing XL  
 Triangular Bandage with Pins  
 Antibiotic Cream, Certi-Sporyn  
 First Aid Facts Sheet  
 12 Pocket Door Pouch



CAT. NO. K206

## CRL Kut Kit™

### • First Aid for Lacerations



Anyone in the glass fabrication industry, no matter how careful they may be while handling or cutting glass, will eventually require first aid from a cut or laceration. CRL's new Kut Kit™ is perfect for glass shops of any size. The Kit contains everything required for first aid and cuts, including the innovative QR WoundSeal™ Powder, which stops bleeding instantly. Keep a Kut Kit™ close to every work center. Minimum order is one each.

CAT. NO. K607

## CRL QR WoundSeal™ Powder

### • Stops Bleeding Instantly



CRL's new QR WoundSeal™ Powder literally stops bleeding instantly. Two powder dispensers are included along with instructions. QR WoundSeal™ Powder should be in multiple locations, such as tool boxes and medicine cabinets in every glass shop. Minimum order is one each.

CAT. NO. K506

## CRL Adhesive Bandage Strips

### • Industrial Bulk Pack

CRL's Adhesive Bandage Strips are individually wrapped, ultra-comfortable, and have non-stick center pads. Keep a box in your shop, truck, tool box or office. Each box contains 100 each 1" x 3" (25 x 76 mm) bandages. Minimum order is one box.



CAT. NO. K220

## CRL Eye and Skin Wash

### • Wall Mounted

This convenient Eye and Skin Wash Kit contains two bottles of wash, and is designed to be attached to wall locations around your shop. These bottles of wash are perfect for flushing out particles and dust from eyes and washing skin after contact with contaminants. Each Kit contains simple instructions. Minimum order is one each.



CAT. NO. K250507

## CRL Adhesive Bandage Assortment

- Perfect for Glass Fabricators and Installers
- 45 Total Bandages



CRL's Adhesive Bandage Assortment contains a combination of five different size bandages, including finger tip and knuckle. Minimum order is one box.

The box contains the following products:

- 30 Adhesive Bandages, 1" x 3" (25 x 76 mm)
- 5 Adhesive Bandages, 2" x 3" (51 x 76 mm)
- 5 Fingertip Bandages
- 5 Knuckle Bandages

CAT. NO. R220113

## CRL Antiseptic Assortment

- A Selection of Important Glazing Shop Antiseptics



CRL's Antiseptic Assortment pack contains the most important antiseptic products for glaziers in the shop and on installation projects. The pack contains: 10 Antiseptic 5" x 7" (127 x 178 mm) Towelettes, 6 Burn Cream Packets, and 10 Antibiotic Cream Packets. Minimum order is one each.

CAT. NO. K220111

## CRL Knuckle and Fingertip Bandages

- Ideal for Any Glass Shop
- Designed to Fit Flexing Joints

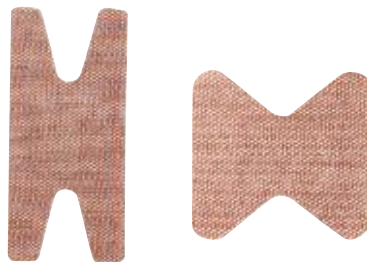

CAT. NO. 2404232  
Knuckle Bandage

CAT. NO. 2404230  
Fingertip

CRL's Knuckle and Fingertip Bandages are mandatory for any glass shop or tool box. These anatomically designed bandages help protect wounds without "crimping" or the need for multiple bandages or tape. A unique adhesive keeps the bandages in place over the wound or flexing joints until removed. The soft, thick, unitized pad provides protection and cushion, and the non-adherent surface is designed for easy removal.

CAT. NO.	DESCRIPTION	QTY/BOX
2404232	Knuckle Bandage	100
2404230	Fingertip	100

Minimum order: 1 box. Can be combined for quantity pricing.

## CRL Evaporative Cooling Bandana

- Reusable and Non-Toxic
- Keeps You Cool All Day



This Bandana can be worn around the head and neck, or used as a hard hat insert to provide cool comfort all day. Activate in water for 15 minutes and the Cooling Bandana is ready to wear for work, sports or gardening activities. Royal blue color, the Bandana can be worn comfortably by all ages.

CAT. NO.	COLOR
2404000	Royal Blue

Minimum order: 1 each.

## CRL Dry Pressurized Fire Extinguishers

- Three Easy-to-Use Sizes
- For Class A,B or C Fires

Smother fires quickly and safely with our CRL Dry Pressurized Fire Extinguishers. Several easy-to-use sizes are available for your shop, office, home or vehicle. All have sturdy steel cylinders with pressure gauges, and are rated to fight Class A, B or C fires.

CAT. NO.	SIZE
2025AV	2.5 Lb.
FB500	5.0 Lb.
2100AH	10 Lb.

Minimum order: 1 each.



## CRL Safety Vests

- Available in Two Highly Visible Colors



CRL's Safety Vests are lightweight with highly visible green or orange polyester mesh and feature an adjustable front closure with hook-and-loop material. Each Vest includes a 2" (51 mm) reflective stripe on both front and back for increased visibility or night work. Maintains brightness even after 25 washings.

CAT. NO.	COLOR	SIZE
SV2GMLG	Green	Large
SV20MLG	Orange	Large
SV2GM2X	Green	2X
SV20M2X	Orange	2X

Minimum order: 1 each.

## CRL Safety Cones

- Fluorescent Orange Color
- Available in Two Sizes

Our CRL Safety Cones are used to channel or barricade vehicle or pedestrian traffic around job sites or your parked truck. Fluorescent orange color Safety Cones are 100% soft and flexible PVC with UV Stabilizers to minimize color fading. Color cannot chip or peel. Performance tested from 10°F to 150°F. Will return to and retain original shape after repeated impact; practically indestructible.



CAT. NO.	HEIGHT
ES17618	18" (457 mm)
ES17628	28" (711 mm)

Minimum order: 1 each.

## CRL Safety Tapes

- Weather Resistant, High-Visibility Tape



Caution Tape



Flagging Tape

CRL's high visibility Caution Tape or Flagging Tape are perfect for keeping spectators at a distance or marking off work sites. Both Tapes are made of weather resistant vinyl and the bright fluorescent colors provide easy-to-see barriers, even from a distance.

CAT. NO.	DESCRIPTION	WIDTH	ROLL LENGTH
BT300	Caution Tape	3" (76 mm)	300' (91.4 m)
FT150G0	Flagging Tape	1-3/16" (30 mm)	150' (45.7 m)

Minimum order: 1 roll.

## CRL Water Resistant Flashlight

- Water Resistant
- High Intensity Bulb



Our Water Resistant Flashlight has a powerful and very bright high intensity bulb. This flashlight comes with a shatterproof lens and a special parabolic reflector which focuses the beam into a very bright intensified point. Works with four "D" batteries, which are included. The impact resistant casing measures 7-1/8" long by 4" wide (181 by 102 mm). Minimum order is one each.

CAT. NO. F7

## CRL Heavy-Duty LED Flashlight

- High Performance and Durability



Everyone needs a super-bright dependable flashlight to keep in your tool box, truck, or clipped to your belt when on the job. CRL's Heavy-Duty Aluminum Flashlight has a premium LED bulb that produces a combination flood and spot beam through a tempered glass lens which resists impact and scratches. The hex head design keeps the light stationary and the anodized aluminum grip pattern resists corrosion and crushing. The O-ring seals provide moisture protection. Requires one AA battery (not included). Dimensions are 4-5/16" x 3/4" (110 x 19 mm). Minimum order is one each.

CAT. NO. DPGA



# 3

## Specialty Tools

- AUTO GLASS TOOLS
- CUT-OUT KNIVES AND BLADES
- MIRROR INSTALLATION TOOLS
- RAILING INSTALLATION TOOLS AND EQUIPMENT
- SCREEN FABRICATION TOOLS AND EQUIPMENT
- SHOWER INSTALLATION TOOLS
- UV BONDING TOOLS AND LAMPS

See other side for Section Index.

**CRL**  
**U.S. ALUMINUM**  
crlaurence.com • usalum.com

# SECTION 3 INDEX

For a complete index to this catalog, turn to Section 7. To search for all CRL products, go to CRL Total Search at [crlaurence.com](http://crlaurence.com).

## Specialty Tools

Bonding Fixation Devices.....	322K-330K
Cable Tools.....	302K-303K
Curing Lamps.....	331K-334K
Deluxe Laser Tool.....	299K, 337K
Disposable Brush.....	392K
Double Tube UV Curing Lamp.....	334K
Dremel Rotary Tools.....	391K
E.Z.D. Glazer De-Glazing Tool.....	354K
Electronic Levels and Angle Locaters.....	297K, 336K
Expansion Cement Dispensing Bottle.....	300K
E-Z Slide Cut-Off Gauge.....	351K
Fixation Devices.....	322K-330K
Folding Post Level.....	309K
Fractional Size Taps.....	306K
Frameless Blocks.....	340K
Glass Railing Setting Tool.....	296K
Heat Guns.....	314K
Hilti Tools.....	307K-308K
Hot Air Gun Kit.....	314K
Impact Driver/Drill and Accessories.....	306K-307K

J-Channel Punch and Countersink Tool.....	344K
Lamps, UV Curing.....	331K-334K
Laser Tools.....	297K, 299K
Levels.....	298K, 336K-337K
Loctite ODC-Free Cleaner and Degreaser.....	314K
Makita Saws.....	304K-305K
Measuring and Marking Tools.....	298K
Mirror Installation Tools.....	343K-344K
Miter Saw Table Kits.....	351K-352K
Notching Jig and Tool.....	350K
PAL Plumb/Angle/Level Laser Tool.....	297K
Palmer Mastic Applicator.....	344K
Plate Glass Dollies.....	301K
Plumb/Level Finder Gauges.....	336K
Plunger Latch Tools.....	350K
Portable Band Saw.....	305K
Post Leveling Stand.....	309K
Pouring Ramp for Base Shoe.....	300K
Prexiso Distance Measurer.....	299K
P-Post Top Rail Installation Tool Kit.....	307K
Quik-Draw Mirror Outlet Cut-Out Template Set.....	343K
Replacement Bulbs for UV Lamps.....	332K-334K

S.D.S. Masonry Drills.....	308K
Screen Fabrication Tools.....	349K-353K
Screen Shears.....	349K
Screen Spline Tools.....	345K-349K
Sharpening Stone.....	364K
Shower Door Tools.....	336K-341K
Single Cut Miter Tool.....	344K
Suction Holders.....	323K-327K
TAPER-LOC™ Tools.....	294K-295K
Template Set for Outlets.....	343K
Tensioning Gauge.....	302K
T-Handle Wrenches.....	306K
Universal Pressure Drill.....	307K
Utility Knives and Blades.....	369K-370K
UV Bonding Fixation Devices.....	322K-330K
UV Bonding Starter Kits.....	311K-313K
UV Curing Lamps and Accessories.....	331K-334K
UV Glass Bonding Catalog.....	322K
Window Balance Tools.....	355K
Window De-Glazing Tool.....	354K
Window Frame Extractor.....	354K

## Auto Glass Tools

Auto Electrical Supplies and Tools.....	418K-420K
Booster Cables.....	418K
Bristle Discs.....	391K
BTB Tools.....	386K-387K
Burco Glass Racks.....	399K
Car Protectors.....	417K
Channel and Vent Tool.....	409K
Channel Chisel.....	409K
Clip-Zip Trim Fastener Tool.....	403K
Combination Rivet Tool.....	409K
Cordless Auto Glass Cut-Out Tools.....	375K-377K
Cut-Out Tools.....	361K-388K
Door Glass Window Holders.....	414K
Door Handle and Window Crank Spring Tool.....	405K
Door Panel Removal Tools.....	403K-404K
Door Upholstery Remover.....	406K
Electric Cut-Out Knives.....	373K, 376K-377K
Equalizer Cut-Out Tools.....	376K-378K, 385K, 388K
Extra Long Cut-Out Blades.....	369K, 388K
Extractor Pro Tool.....	388K
Fein Cut-Out Knives and Blades.....	373K-375K, 383K-384K
Fiber Driving Wedge.....	407K
Flexible Shaft Pick-Up Tools.....	404K
Flexible Windshield Knife.....	368K
Folding Glass Racks.....	398K
Folding Windshield Stands.....	397K
Folding Work Seat.....	404K
Freestanding Windshield Racks.....	400K
Gasket Installation Tool.....	413K
General Purpose Adhesive Cleaner.....	378K
Glass Polishers and Scratch Removers.....	359K
GM and Chrysler Roller Nut Wrench.....	406K
Grip-Tite Handles.....	372K
Headliner Tools.....	405K
Hex End Mirror Wrench.....	410K

Hook Tool.....	413K
Hydraulic Rivet Gun.....	408K
Impact Performance Gloves.....	417K
Import Car Clip Tool.....	402K
Knives, Cut-Out.....	361K-388K
Latch Pin Removal Pliers.....	407K
Locking Strip Tools.....	411K-414K
Long Reach Retractable Knife.....	369K
Mirror Bracket Iron.....	410K
Mirror Bracket Release Tools.....	410K
Mobile Auto Glass Racks.....	398K
Molding Release Tools.....	402K, 405K
Multi-Knife.....	366K
MultiSpanner Door Glass Retainer Tool.....	406K
Oscillating Cut-Out Knives and Blades.....	373K, 375K, 379K-384K, 388K
Pinchheld Prep Tools.....	389K-392K
Pipe Handle Knives.....	367K
Plastic Trim Fastener.....	403K
Plastic Window Washer Holder/Separator.....	407K
Power Inverter.....	420K
POWR Cat Oscillating Pneumatic Knife.....	379K
Radial and Roloc Bristle Discs.....	391K
Razor Blade Holders and Scrapers.....	390K
Rear Slider Installation Kit.....	415K
Rear View Mirror Installer.....	410K
Reciprocating Cut-Out Tools.....	376K-378K, 385K-387K
Rivet Eater.....	409K
Rivet Head Removal Tool.....	409K
Rivet Stem Removal Tool.....	407K
Rivet Tools.....	407K-409K
Rolling Windshield Cart.....	401K
Rope Insert Tool for Rubber Gaskets.....	415K
Rotary Tools.....	391K
Rubber Donuts.....	398K
Rubber Gasket Cleaning Tool.....	409K

Saturn Roller Nut Wrench.....	406K
Scraper Chisel.....	389K
Scratch Polishers.....	358K-359K
Self Sealing Weatherstrip Locking Tool.....	413K
Slider Helper Installation Tool.....	415K
Slip-N-Grip Mats and Covers.....	416K
Sticks, Windshield.....	405K
Suck-N-Clamp.....	414K
Suction Cups.....	393K-396K
Super Hot Knife Cut-Out Blades.....	365K
Swivel Tip Locking Strip Tool.....	411K
Technician's Kit.....	357K
Tightwire Grips.....	372K
Time Saver Blades.....	381K
Torx® End Mirror Wrench.....	410K
Tree Molding Removal Tool.....	402K
Truck Bed Racks.....	398K-399K
UltraWiz Blades and Knives.....	363K-364K
Underside Molding Installation Tool.....	405K
Universal Molding Release Tool.....	402K
Universal Trim Tool.....	403K
Upholstery Nail Remover.....	406K
Utility Knives and Blades.....	368K-370K
U-Blade Knives.....	366K
Vacuum Cups.....	393K-396K
Wildcat Pneumatic Knives.....	380K
Window Guide Pliers.....	407K
Window Molding Clip Tool.....	402K
Window Roller Nut Tool.....	406K
Windshield Cut-Out Tools.....	361K-388K
Windshield Hold-Down Vacuum Cup Set.....	396K
Windshield Molding and Door Clip Release Tool.....	405K
Windshield Stands.....	397K
Windshield Stick Setting Tools.....	405K
Windshield Wiper Arm Removal Tool.....	414K
Windshield Wire and Tools.....	371K-372K



C.R. LAURENCE COMPANY

[crlaurence.com](http://crlaurence.com) | [usalum.com](http://usalum.com)

US ALUMINUM

[crlaurence.ca](http://crlaurence.ca)

[crlaurence.com.au](http://crlaurence.com.au)

[crlaurence.co.uk](http://crlaurence.co.uk)

[crlaurence.de](http://crlaurence.de)

[crlaurence.eu](http://crlaurence.eu)



# SECTION 3 Specialty Tools

## QUICK INDEX

For a complete index to this catalog, turn to Section 7. To search for all CRL Products, go to CRL Total Search at [crlaurence.com](http://crlaurence.com).

### Railing Tools and Accessories – Pages 294K to 310K



### UV Glass Bonding Tools – Pages 311K to 335K



### Shower Installation Tools – Pages 336K to 341K



### Mirror Installation Tools – Pages 342K to 344K



### Screen and Window Tools – Pages 345K to 355K



### Auto Glass Tools – Pages 356K to 420K



## CRL TAPER-LOC® Installation/Removal Tool Kit for Glass Railing and Windscreen Systems

**new**



U.S. Patents 8,122,654 and 8,201,366.  
Commonwealth of Australia  
Patent No. 2008207524



- Works With All of CRL's TAPER-LOC® Systems and Components, Including Our New TAPER-LOC® "X"
- Features Integrated Torque Wrench Designed for Precise Lock-Up Force
- Supports All Mounting Methods
- Reduces Installation Time by 50%
- Easily Allows You to Remove, Adjust or Replace Glass Panels
- Can Be Used With Monolithic Tempered and Laminated Tempered Glass



**CAT. NO. TLK12**  
Installation/Removal  
Tool Kit

The Installation/Removal Tool is used for tightening TAPER-LOC® Tapers in the channel of the base shoe. It has an Integrated Torque Wrench that applies the precise lock-up force necessary to set the glass panels. Simply set in place and turn the wrench until a clicking sound is heard. This assures the Tapers have been locked together. It can also remove all models of TAPER-LOC® Tapers when glass panels need to be reset or replaced. You can also use the Tool for

base shoe that has been recessed into the floor by switching the standard Compression Blades (blue) with the longer Recessed Blades (red), both included. The Tool Kit comes with the Integrated Torque Wrench, a Glass Railing Setting Tool for Monolithic Glass, a Laminated Glass Setting Tool, a pair of Glass Setting Roller Blocks, three sets of color-coded Blades (yellow, red, and blue), matching Pusher Plates, and Instructions, all in a Molded Carrying Case.

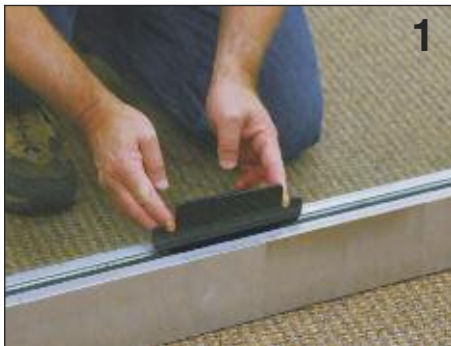

1 Place the TAPER-LOC® Tapers into base shoe finger tight at designated spacing.



2 Place the TAPER-LOC® Installation/Removal Tool into position directly over the Taper Set.



3 Tighten the TAPER-LOC® components using our measured Torque Wrench and you are done.

## How to Remove TAPER-LOC® Tapers

To adjust or remove a glass panel that is already installed with TAPER-LOC® Tapers, use the standard TLK12 Installation/Removal Tool Kit and follow these steps.



**Step 1**  
For adjustment or removal of the glass panel, the Cat. No. TLK12 Installation/Removal Tool and Cat. No. BL992 2" (51 mm) Blue Masking Tape will be required.



**Step 2**  
Apply the 2" (51 mm) masking tape to the finished cladded surface to protect it during this removal/adjustment process.



**Step 3**  
Insert the TLK12 Installation/Removal Tool into position, reverse the torque setting, and apply force to open the Tapers.



**Step 4**  
Complete the process by removing the Tapers from the Base Shoe, then adjust or replace the panel using normal installation procedures.

## CRL TAPER-LOC® Installation/Removal Tool Replacement Blades

- For Use With TLK5, TLK9, and TLK12 TAPER-LOC® Tools for Surface Mount and Recessed Installs

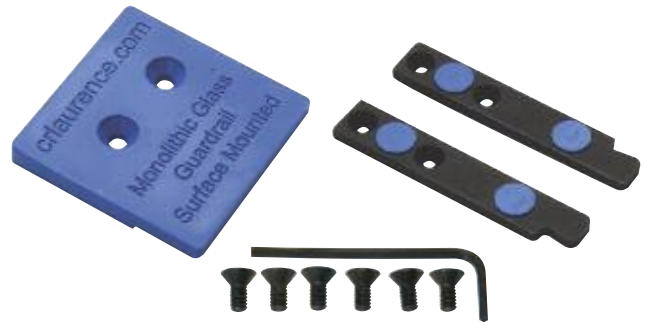

These CRL Standard Base Shoe Blades are designed for surface mounting of Guard Rails and Railings when using either of the TLK5, TLK9 or TLK12 TAPER-LOC® Installation/Removal Tools. Blades install easily using the supplied screws. Includes two Blades, one Pusher Plate, six Screws, and one Allen Wrench per pack. Minimum order is one pack.

CAT. NO. TLB5



These CRL Extended Blades work with both the TLK5, TLK9 and TLK12 TAPER-LOC® Installation/Removal Tools for fascia mount or recessed base shoe conditions. They install easily using the supplied screws. Includes two Blades, one Pusher Plate, six Screws, and one Allen Wrench per pack. Minimum order is one pack.

CAT. NO. TLB6R

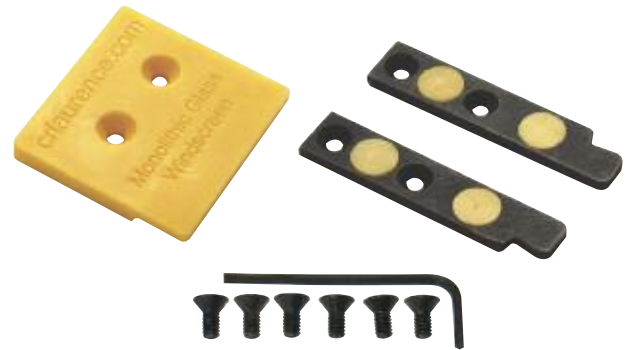

These CRL Windscreen Base Shoe Blades are designed to work with the TLK5, TLK9, and TLK12 TAPER-LOC® Installation/Removal Tools. They install easily using the supplied screws. Includes two Blades, one Pusher Plate, six Screws, and one Allen Wrench per pack. Minimum order is one pack.

CAT. NO. TLB3

## CRL TAPER-LOC® Extraction Tool

- For Extraction of Stuck TAPER-LOC® Tapers
- Designed for Either Right or Left Hand Use

**new**



- Works With All TAPER-LOC® Taper Sets

Use this Extraction Tool to remove TAPER-LOC® Tapers that have become stuck in the aluminum base shoe and cannot be removed by normal methods with the TLK5, TLK9 or TLK12 Installation/Removal Tools. Minimum order is one each.

CAT. NO. TLEX1

## CRL TAPER-LOC® Angle Adjustment Tool

- Safely Adjusts XA Series Tapers on Drop-Side

**new**

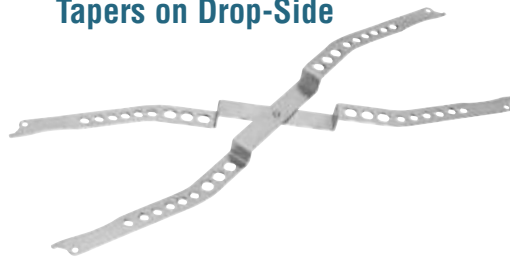

The new TAPER-LOC® XA System provides angular adjustment of the glass panel to correct for misalignment and glass curvature. This specialized tool will adjust the outside (drop-side) Tapers without the need for scaffolding or inconvenient leaning over the railing. Simply engage the tool with pre-installed Tapers and squeeze together with light pressure. Both ends of the tool are functional, and holes are provided for attachment of a safety lanyard (not included). Minimum order is one each.

CAT. NO. TLXAAT

## CRL Upgrade Kit for TLK5 Installation/Removal Tools

- Allows Original Model TLK5 Tools to Work With All Monolithic Tempered and Laminated Tempered Glass Installs
- Color Coded Blades and Pusher Plates for Easy Identification and Matching

The TLK5 Upgrade Kit is available to bring your original model TLK5 TAPER-LOC® Installation/Removal Tool Kit current and enables one tool to work with all different profiles of base shoe and glass thicknesses. The Kit consists of: one pair of Yellow Blades and Pusher Plate for monolithic windscreen installs; one pair of Blue Blades and Pusher Plate for monolithic surface-mount guard rail and railing installs; one pair of Red Blades and Pusher Plate for monolithic recessed-mount guard rail and railing mounts; one black Pusher Plate for all laminated glass installs, and a Laminated Glass Setting Tool. **NOTE:** This Upgrade Kit intended for TLK5 Tools sold after December, 2008. Minimum order is one each.



- Blades Work With Original Tapers and Our New TAPER-LOC® 'X'

CAT. NO. TLK7

## CRL Monolithic Glass Railing Setting Tool

- For Use With CRL's Dry Glazed TAPER-LOC® System for Monolithic Glass
- Stabilizes and Centers the Glass Panel in the Base Shoe Pocket During Installation of Tapers

The CRL Monolithic Glass Railing Setting Tool was designed to stabilize and center the monolithic glass panel in the aluminum base shoe during installation of CRL's Dry Glazed TAPER-LOC® Tapers. The temporary setting tool also secures the monolithic glass panel in place, giving the installer time to adjust or align as required. Minimum order is one each.



CAT. NO. GWST2

## CRL Laminated Glass Railing Setting Tool

- For Use With CRL's Dry Glazed TAPER-LOC® System for Laminated Glass

The CRL Laminated Glass Railing Setting Tool was designed to stabilize and center the laminated glass panel in the aluminum base shoe during installation of CRL's Dry Glazed TAPER-LOC® Tapers. The temporary setting tool also secures the laminated glass panel in place, giving the installer time to adjust or align as required. Minimum order is one each.



CAT. NO. LTLST3

## CRL Rubber Spacing Block Installation Tool

- Makes Positioning of Spacing Blocks Fast and Easy

Simply push the CRL Rubber Spacing Block, with the adhesive side out, into the notch at the end of the Installation Tool, and then remove the release paper. Slip the Tool into Base Shoe pocket and slide it towards the edge of the glass panel. When contact is made push firmly, and then slide the Tool back. The Rubber Spacing Block is now in the proper location. Minimum order is one each.

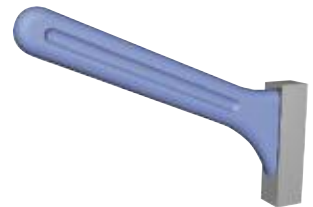

CAT. NO. RSB1T

## CRL PAL Plumb/Angle/Level Locator Kit



- Plumb and Level All Your TAPER-LOC® Dry Glaze Railing Installs
- Works With All CRL Guard Rail and Windscreen Base Shoe
- Electronic Angle Finder for Custom Corners and Stairway Applications

This CRL PAL Plumb/Angle/Level Locator Kit was designed to assist you with level and plumb installations of all CRL railing base shoes. This innovative tool levels the shoe in both vertical and horizontal orientations. Each Kit includes: Laser Tool with Case, Base Shoe Alignment Adapter, Laser Target, Chalk Line, an 8 oz. (237 ml) bottle of Blue Chalk Refill, Black Listo Marking Pencil, Blue Sharpie Pen, and instructions, all packaged in a molded Carrying Case. Minimum order is one each.

CAT. NO. PAL1K

## CRL PAL Plumb/Angle/Level Locator Laser Tool



- Use for Setting Glass in Base Shoe Prior to Installing TAPER-LOC® Dry Glaze System
- Angle Measurements in Degrees
- Displays Angle and Inclination Simultaneously

This CRL PAL Plumb/Angle/Level Locator Laser Tool displays angle measurements in degrees. Both the angle and inclination measurements are displayed simultaneously. Includes: Laser Tool and Carrying Case. Minimum order is one each.

CAT. NO. 406065

## CRL Base Shoe Alignment Adapter

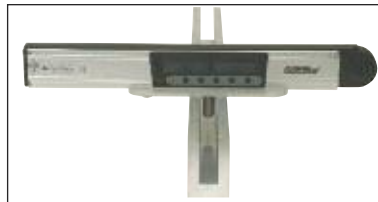

Laser Tool Sold Separately (See Above)

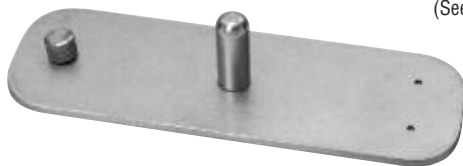

- Use With 406065 Laser to Adapt to Railing Base Shoe
- Plumb and Level All Your TAPER-LOC® Dry Glaze Railing Installs

The CRL Base Shoe Alignment Adapter was designed to attach to the Cat. No. 406065 Laser to assist you with level and plumb installations of Railing Base Shoe. Minimum order is one each.

CAT. NO. AMA1

## CRL Laser Target



Laser Tool Sold Separately (See Above)

- Use With 406065 Laser to Level Railing Base Shoe During Install

The CRL Laser Target was designed to work with the Cat. No. 406065 Laser to assist you with level and plumb installations of Railing Base Shoe. Minimum order is one each.

CAT. NO. LT1

## CRL "Angletronic" Measuring Tool

- Measures Angles Between 0 and 180 Degrees
- Stores Up to 56 Measurement Values
- Battery-Saving Automatic Shut-Off Feature

With the CRL "Angletronic", angles between 0 and 180 degrees can be measured quickly, precisely and reliably, and read off the digital display. You can even take measurements in difficult positions, store the measurements, and access them at a later time.

Optoelectronics provides accuracy and maintenance free service for years. Operates on four AA batteries (included). Minimum order is one each.



CAT. NO. TT505

## CRL POLYCAST® Protractor/Angle Finder

- High-Impact POLYCAST® Plastic Construction
- Adjustable Angle Pointer for Marking Angles
- Magnetic Base



The CRL Magnetic POLYCAST® Protractor/Angle Finder measures any angle from 0 to 90 degrees in any quadrant. It comes with a dampened pendulum for quicker readings and an adjustable angle pointer for marking and transferring angles. The magnetic back and base provides "hands-free" use when working with ferrous surfaces. Minimum order is one each.

CAT. NO. 36MPP

## CRL "Anglefix" Measuring Tool

- Measures Angles Quickly and Precisely
- Built-in-Spirit Levels Help Keep it in Position
- Easy-to-Read Analog Display

The "Anglefix" Measuring Tool is a precision measuring device that works quickly and easily. Built-in horizontal and vertical spirit levels assist in keeping it in position, so you can reliably set and read any angle. The angle measurement is displayed on an easy to read analog display. A clamping screw locks the "Anglefix" in any position. Two types of "Anglefix" are offered. The Mini "Anglefix" is a handy tool for glaziers, interior finishers, and metal workers. The Maxi "Anglefix" is intended for glaziers, carpenters, builders, and metal workers. The Maxi Model is additionally fitted with points, one of which can be removed and fitted with a pencil for compass use.



CAT. NO.	MODEL	LEG LENGTH	MEASURING POINT
TT450	Mini	14-9/16" (370 mm)	No
TT500	Maxi	23-5/8" (600 mm)	Yes

Minimum order: 1 each. Sizes can be combined for quantity pricing.

## CRL Stanley® 9" Torpedo Level

- Heavy-Duty Cast Aluminum Frame
- Easy Top and Side Reading
- Powerful Magnetic Base for "Hands-Free" Use



The CRL Stanley® 9" (228.6 mm) Torpedo Level is a durable, heavy-duty cast aluminum frame with large, top-read vial window. It's three tinted 360 degree vials (one for plumb, level, and 45 degree miter) are easy to read and replaceable in seconds. Ideal for commercial work, a powerful magnetic strip on the base allows for "hands-free" operation, and holds the level securely to all iron and steel surfaces. Individually carded in a vinyl pouch.

CAT. NO. ST42465

## CRL Stanley® 48" FatMax® Level

- Superior Aluminum Structure for Increased Durability
- Shock Absorbing End Caps

The CRL Stanley® 48" (1219 mm) FatMax® Level is constructed with a seamless one-piece aluminum extrusion, and has a level accuracy of 0.0005" (.01 mm). Block vials and shock absorbing end caps assure maximum accuracy and durability. The FatMax® Level also features non-marring side bumpers to prevent damage when working against finished surfaces. Minimum order is one each.



CAT. NO. ST43548

Polycast is a registered trademark of Empire Level Mfg. Corp. Stanley and FatMax are registered trademarks of Stanley Logistics, LLC.

## CRL Prexiso® X2 Laser Distance Measurer

- Measures to 100' (30.5 m) With Accuracy of 1/8" (3.2 mm) or Better
- Measures Distances, Areas, and Volumes for Material Estimates

This CRL Prexiso® X2 Laser Distance Measurer will measure distances in feet-inches, inches or meters from 4" to 100' (0.1 m to 30.5 m). It is accurate to 1/8" (3.2 mm) or better over the entire range. This unit is designed for indoor and limited outdoor applications while being able to measure and calculate areas and volumes. Minimum order is one each.



CAT. NO. 3350

## CRL Construction Master® Pro Calculator

- Feet-Inch-Fraction Calculator
- Includes Problem Solving for Stairs, Studs, Drywall, Siding, Panels, and More

The Construction Master® Pro quickly finds solutions to challenging building and dimensional problems, and eliminates the need to remember complicated formulas. Enter the numbers just as you would say them and the solutions appear in an instant. Battery included. Minimum order is one each.



CAT. NO. CM6

## CRL Deluxe Spot Laser Tool

- Establishes Plumb, Level, and Square
- Projects Laser Beams Five Ways



The CRL Deluxe Spot Laser Tool provides simultaneous plumb, level, and square references in a compact, accurate, and affordable package. True point-to-point alignment information speeds layout and installation of railings. Accuracy is guaranteed to be within 1/8" (3.2 mm) at 100' (30.5 m), even if the mounting surface is out of level. Five bright reference points are easily seen indoors or out, and are powered by three AA batteries. Comes complete with Floor Mount, Magnetic Wall Mount, Layout Targets, Carrying Case, Operating Manual, and full one year warranty. Batteries not included. Minimum order is one each.

CAT. NO. PLS5

## CRL Standard Spot Laser Tool

- Establishes Plumb and Level
- Projects Laser Beams Three Ways



The CRL Standard Spot Laser Tool gives you the convenience of a torpedo level with the quality of information available only from a professional point-to-point laser. Three bright laser points allow the PLS3 to be used anywhere on the job site for level reference and point-to-point plumb from floor to ceiling. Operates on three AA batteries up to 30 hours. Comes with a Leather Carrying Pouch, Operating Manual, and full one year warranty. Batteries not included. Minimum order is one each.

CAT. NO. PLS3

## CRL 5-Point Laser Level

- Increases Productivity - Projects Plumb, Level, and Square Laser Points
- Electronically Motorized Leveling
- Range Up to 100' (30.5 m)



The CRL 5-Point Laser Level eliminates set-up time and ensures accuracy. It transfers and aligns level, plumb, 90 degrees, and grade points. The robust housing is water and dust proof to ensure years of dependable operation. Includes: Laser Tool, Multi-Purpose Attachment, Recalibration Wrench, Laser Enhancement Glasses, Mounting Strap, and Carrying Case. Requires four AA batteries (not included). Minimum order is one each.

CAT. NO. GPL5

Prexiso is a registered trademark of Prexiso AG Corporation Switzerland. Construction Master is a registered trademark of Calculated Industries, Inc.

## CRL Clamp and Alignment Fixture

- Secures and Aligns the Glass Plumb Within 1/32" (.8 mm) When Used With Laser
- Retains Position Until the Expansion Cement Sets

The CRL Clamp and Alignment Fixture is a dual-purpose tool. It not only aligns the glass, but can also be used to secure the cladding and hold it in place. A simple turn of the knob moves the glass in or out to achieve a plumb position. Minimum order is one each.



CAT. NO. GRAT1

## CRL Wet Glaze Pump and Accessories

- Portable, Lightweight, Compact Delivery System for Expansion Cement
- Dramatically Increases Speed of Application
- On/Off Control at Point of Delivery
- Quick and Easy Hose Replacement

When CRL decided to enter the Glass Rail market, we went at it in typical CRL fashion and asked the question "How can we improve on the antiquated processes and equipment currently being used to benefit our customers?" So when it came time to look at the way that the expansion cement was being delivered to the Base Shoe, we knew we had to find a better way. We did just that by developing our Wet Glaze Pump and Accessories.

The Wet Glaze Pump has been designed to reduce the labor associated with the application of expansion cement to Hand Rail Base Shoe, and to improve the quality, efficiency, and effectiveness of the final assembly of the Base Shoe and glass. The Wet Glaze Pump not only increases speed of application dramatically, it also offers superior control over the flow rate and delivery location than that of manual applicators.

This unique delivery system utilizes a pair of rollers fixed to a rotating disk that squeezes the cement through flexible tubing. Since the tubing is the only thing to come in contact with the cement, there are no seals to leak, giving you a virtually maintenance free pump.

Simply mix your cement in the mixing bucket, insert the end of the Inlet Hose into the mixture, and depress the handy ON/OFF Switch located on the Delivery Nozzle. The Pump will immediately start to move the cement through the hose. Purge any excess water from the hose and release the ON/OFF Switch. You are now ready to start pumping cement into the Base Shoe at a rate of 11' (3.3 m) per minute.



### CAT. NO. GRP1

Pump Kit Includes: One Pump with Hoses, One Nozzle, One Momentary ON/OFF Switch, Two 5 Gallon Buckets, Two Measuring Pitchers, One Plastic Scoop, One Mixing Spoon, One GFC1 15A Ground Fault Interrupt Device, and One GRP2 Replacement Hose Kit.

**NOTE:** Clamp and Alignment Fixture not included. See page 299K for information. Minimum order is one each.

### CAT. NO. GRP2

Replacement Hose Kit Includes: Hoses, One Nozzle, and Clamps (No ON/OFF Switch). Minimum order is one each.

Details on Kit components are available from CRL Technical Sales or the CRL web site at [crlaurence.com](http://crlaurence.com).



## CRL Pouring Ramp for Base Shoe Applications Using Expansion Cement

- Neat and Effective Manual Delivery of Expansion Cement
- Shields Gasket Retention Groove in Base Shoe
- Wide Delivery Area

The CRL Pouring Ramp provides a wide delivery area for mess-free pouring of cement into Base Shoe. It shields the gasket retention groove area in the Base Shoe, thereby eliminating further clean up. You will find the Pouring Ramp to be a neat and effective method to manually deliver the expansion cement used in our Wet Glaze System.



CAT. NO.	DESCRIPTION
GRP35	Cement Pouring Ramp

Minimum order: 1 each.



## CRL Cement Mixing Accessories

- Ideal for Small, Hard-to-Pour Areas

These durable plastic accessories ideally mix and apply expansion cement to small, hard-to-pour areas. The clean and neat Dispensing Bottle saves you clean up time on the job, and makes spot-pours easy. Bottle capacity is 32 fl. oz. (946 ml).



Dispensing Bottle



Plastic Scoop



Mixing Spoon

CAT. NO.	DESCRIPTION
GRP36	Cement Dispensing Bottle
GRP33	Plastic Scoop
GRP34	Mixing Spoon

Minimum order: 1 each.



## CRL Plate Glass Dollies

- Caster Design Allows Turn-on-a-Dime Maneuvering
- Felt Pads Cushion Loads
- Three Available Lengths



CRL Plate Glass Dollies are ideal for moving large glass infills for railings and windscreens. Their hardwood construction features ball bearing casters and wheels. The 1-1/2" (38 mm) center groove is wide enough for even thick laminated panels. Felt pads on either end cushion loads during movement. Dollies have a capacity of 350 pounds (159 kg). **NOTE:** Not available in Australia.

CAT. NO.	LENGTH
13063	36" (914 mm)
13065	60" (1524 mm)
13066	72" (1829 mm)

Minimum order: 1 each. Sizes can be combined for quantity pricing.

## CRL All Terrain Dolly



- Terrific for Moving Heavy Glass Panels Around the Job Site
- Goes Where Other Glass Dollies Won't
- Built-In 8" Wood's Powr-Grip® Vacuum Cup
- Includes a Set of Our RB200 Roller Blocks
- 400 Pound (181 kg) Capacity



CRL's All Terrain Dolly is like having an extra person on the job site. Moving large glass lites, insulating units, patio door panels, or even stone slabs across any terrain is now a snap. Curbs, door sills, and scrap lumber are no longer obstacles when your crew is using the All Terrain Dolly. Its large 16" (406 mm) diameter pneumatic tire won't bog down in grass or dirt, common to residential or commercial job sites. This handy device also eliminates back and arm strain associated with carrying heavy loads suspended over long distances. Included is a Wood's 8" (203 mm) Powr-Grip® Vacuum Cup and set of Cat. No. RB200 Roller Blocks to protect the panel's edges once unloaded. The Roller Blocks are stored conveniently inside the frame of the All Terrain Dolly so you always know where to find them. Maximum capacity is 400 pounds (181 kg). Minimum order is one each.

CAT. NO. ATD1

## CRL Roller Blocks

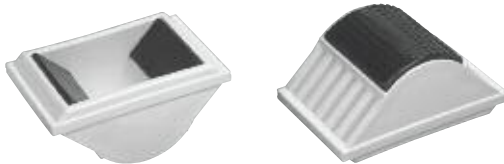

- Roller Design Lets You Rotate Heavy Glass Panels With Ease
- Turn Them Over to Use as Resting Blocks
- Rubber Base Ensures Traction

CRL Roller Blocks were developed to aid in the safe handling of large and/or heavy glass panels. Each of these blocks has a cushioned 90 degree inside corner on which to rest the glass while rotating or maneuvering it into position. Maximum capacity is 400 pounds (181 kg) per block. Minimum order is one pair.

CAT. NO. RB200

Wood's Powr-Grip is a registered trademark of Wood's Powr-Grip Co., Inc.

## CRL Two-Wheel Adjustable Glass Dolly

- Perfect for Large and Heavy Glass Panels
- 300 Pound (136 kg) Capacity



With the CRL Two-Wheel Adjustable Glass Dolly, heavy items such as railing panels, storefront doors, framed windows, storm windows, I.G. units or just about any other flat surfaced item can be easily moved in an upright position. The Dolly is adjustable to widths from 2-1/2" to 4-1/2" (63 to 114 mm). The steel carriage is carpeted to prevent marring of the surfaces. Minimum order is one each.

CAT. NO. LD450

## CRL Cable Installation Tools

- Everything for Installing Stainless Steel Cable Railing Systems
- Ensure Safety and an Attractive Installation by Employing the Proper Tools

Cable Railing Systems are increasingly popular, and CRL supports installers with a number of quality tools that will facilitate the safe and proper installation of the stainless steel cable used in these systems.

To be code compliant all cables must be taut and properly fastened, and to do this you must have tools specifically intended for these purposes. The railing experts in our Architectural Railing Division have selected these tools because of their quality and sufficiency to perform their specific tasks. They always promote the use of the proper tools for these functions, as short-cutting the process by improvising with the improper tools can jeopardize the safety factor of a cable railing system.

For more information about the selection of the right tools for your cable railing projects, please contact our Architectural Railing Division. From our home page [crlaurence.com](http://crlaurence.com) click on Contact Us, and then click on Technical Sales for Railing Products.

## CRL Cable Cutter

- Top Quality, Pocket-Size Cutter



Shear-Cut Blades



These CRL Cable Cutters will cut thin stranded stainless steel wire cable up to 3/16" (5 mm) in diameter. Overall length is 7-1/2" (191 mm). Minimum order is one each.

CAT. NO. 0690TN

## CRL Ultra-tec® Cable Cutter

- Ensures Burr-Free Cutting of Cable



Use this CRL Ultra-tec® Cable Cutter for burr-free cutting of cable up to 1/4" (6.3 mm) in diameter. Overall length is 13-1/4" (337 mm). Minimum order is one each.

CAT. NO. CBLCTR1

Ultra-tec is a registered trademark of Ultra-tec Corporation.

## CRL Ultra-tec® Cable Grip Locking Pliers

- Powerful Grip Without Damaging Cable



CRL Ultra-tec® Cable Grip Locking Pliers have machined jaws to grip the cable as you are tensioning it. It prevents damage to the cable while being tensioned. Minimum order is one each.

CAT. NO. CBLGP1

## CRL Ultra-tec® Pre-Tensioner Locking Pliers

- Greater Ease When Working With Long Runs of Cable



The CRL Ultra-tec® Pre-Tensioner can be used when installing longer runs of cable. The tool allows you to tension the cable through the last intermediate post, making it easy to connect to the last end post. Minimum order is one each.

CAT. NO. CBLPT1

## CRL Ultra-tec® Tensioning Gauge

- Check Tension on Standard Railing System Cable



Use this CRL Ultra-tec® Cable Tensioning Gauge to accurately check the tension on 1/8" and 3/16" (3.2 and 4.8 mm) diameter cables typically installed in cable railing systems. Minimum order is one each.

CAT. NO. CBLTG1

## CRL Cable Swager Installation Tool Kit

### • A Complete Kit for Working With Stainless Steel Cable

**Kit Includes:**

- Air Over Hydraulic Pump
- Air Hoses and Fittings
- Cable Grip Locking Pliers
- Cable Cutter
- Hand Held Swager
- Grommet Tool Set
- Allen Wrenches
- Safety Glasses
- Radius Ferrule/Clip On Stop Gauge
- Tool Box

**NOTE:** Air Over Hydraulic Pump requires an air compressor capable of delivering at least 20 CFM and 120 P.S.I. at the air inlet on the box. Minimum 1/4" (6.3 mm) I.D. air hose with a 1/4" male pipe thread required (not included).



Air Over Hydraulic Pump



Cable Grip Locking Pliers



Cable Cutter



Hand Held Swager



Radius Ferrule/Clip On Stop Gauge



Tool Box with Lock and Key

**CAT. NO. CBL51K**

## CRL Ultra-tec® Cable Release Tool



### • For Use With 1/8" (3.2 mm) Cable

It is an innovative tool that allows the release of cable from Push Lock and Pull Lock type fittings before cables are tensioned. It fits 1/8" (3.2 mm) diameter cable. Minimum order is one each.



**CAT. NO. PLKEY**

## CRL Ultra-tec® Grommet Installation Tool Kit



If Cable Grommets are required, CRL's Ultra-tec® Grommet Installation Tool Kit is needed for proper alignment and installation. Simply place grommet over hole, and tap lightly with a hammer.

**NOTE:** Fits Cable Grommets CBLG4 and CBLG5.

**CAT. NO. CBLGK1**

## CRL Scratch-B-Gone Professional Brushed Stainless Steel Restoration Kits

- Easy, Fast, and Simple to Use
- Removes Scuffs, Fine Scratches, Light and Deep Scratches
- Removes Chemical Discoloration Caused by Cleaning Products, Bleach, and Acids
- Removes Oxidation and Black, Blue, Gold Colors From Heat Scorching / Welding

CRL's Scratch-B-Gone provides a complete solution to common problems associated with brushed stainless steel surfaces, including scratches and gouges, rust, heat scorching, and chemical stains. If you are working with architectural surfaces such as these, you now have a time and money saving alternative to replacing damaged metal components.

Choose our Cat. No. SBG1 Basic Professional Kit or the larger Cat. No. SBG2 Master Professional Kit to get started. Kits contain burgundy coarse pads for deep scratches, brown pads for reconditioning, and gray pads for removing light scratches, rust, and chemical stains. The Ultra Shine™ Cutting Lubricant and Surface Oxidant used with the pads lifts particulates created during the re-graining process. Its proprietary formula speeds the return of the "warm look" by chemically oxidizing the "new" restored surface to quickly blend and match surrounding areas.

To ensure successful results, each kit includes both written instructions and a DVD demonstration video that will take you through the easy restoration process. The complete list of components for the Basic Professional Kit and the Master Professional Kit can be found online at [crlaurence.com](http://crlaurence.com).

For new stainless steel installations and for surfaces restored with the CRL Scratch-B-Gone kits, we recommend Cat. No. ARM32 CRL EZ Armor Acrylic Surface Protector. It offers protection for aluminum, stainless steel, brass, and copper against harsh chemicals and acids, rust stains, salt spray, pitting, weathering, and corrosion.

Ultra-tec is a registered trademark of Ultra-tec Corporation.



**CAT. NO. SBG2**  
Master Professional Kit



**CAT. NO. SBG1**  
Basic Professional Kit



**CAT. NO. US8**



**CAT. NO. ARM32**

CAT. NO.	DESCRIPTION
<b>SBG1</b>	CRL Scratch-B-Gone Basic Professional Kit
<b>SBG2</b>	CRL Scratch-B-Gone Master Professional Kit
<b>US2</b>	CRL Ultra Shine™ 2 oz. (59 ml) Bottle
<b>US8</b>	CRL Ultra Shine™ 8 oz. (237 ml) Bottle
<b>ARM32</b>	CRL EZ Armor Acrylic Surface Protector

Minimum order: 1 each. Other consumables available. Contact us for pricing.

## CRL Makita® 12" Cold Cut Metal Chop Saw

**new**

- 12" (305 mm) Blade With 1" (25.4 mm) Arbor
- Cuts Mild Steel and Stainless Steel
- Cuts Cool and Dry
- 4-1/2" (114.3 mm) Maximum Cut Depth at 90 Degrees

The CRL Makita® 12" (305 mm) Cold Cut Metal Chop Saw is designed to use special dry cutting carbide saw blades to cut mild steel and stainless steel with virtually no sparking, no burring, and no heat discoloring. Saw comes with a fixed angle head and adjustable fence/clamp stop to allow 0 - 45 degree cutting. Powered by a 15 Amp, 1300 RPM motor that will cut through mild steel with ease, yet cuts thin wall stainless cladding without distortion or flaring. This saw and blade combination requires no lubrication or coolant. Saw comes with one 60 tooth carbide blade, which should be used to cut mild steel and stainless steel only. **NOTE:** The low RPM and closed tooth design of the blade will not work on aluminum.



CAT. NO.	DESCRIPTION
<b>LC1230</b>	110 Volt 12" Cold Metal Chop Saw With Blade
<b>A91039</b>	Replacement 12" x 1" Arbor 60 Tooth Carbide Saw Blade

Minimum order: 1 each.

## CRL Makita® 18 Volt Cordless Metal Cutting Saw

**new**

- Uses 5-3/8" (136.5 mm) Carbide Saw Blades
- 2" (51 mm) Maximum Cutting Depth
- 30 Tooth Carbide Blade for Mild Steel and Aluminum Cutting Included
- 3600 RPM No Load Speed
- 18 Volt Lithium-Ion Batteries
- 110 Volt Charger Included

The CRL Makita® 18 Volt Cordless Metal Cutting Saw is both powerful and portable. Using the latest in lithium-ion battery technology, the BCS550 represents the best of rapid charge and slow discharge cordless power tools from Makita®. The dry cutting BCS550 comes equipped with a 30 tooth 5-3/8" (136.5 mm) diameter carbide tipped saw blade engineered for mild steel or aluminum fabricating. Also included are two 18 volt 3.0Ah lithium-ion batteries and a 110 volt charger to make sure you are never out of power. Everything is packed in a sturdy plastic case.

The 56 tooth 5-3/8" (136.5 mm) A95794 Carbide Saw Blade is the first in its class designed to cut stainless steel material with a cordless saw. The ultra thin kerf (.043") provides smoother cuts with less drag on the motor and minimal material loss. Using this blade mounted on the new BCS550 Cordless Saw will mean more cuts per charge. **NOTE:** The A95794 is engineered for stainless steel cutting only and should not be used on aluminum.



CAT. NO.	DESCRIPTION
<b>BCS550</b>	18 Volt Cordless Metal Saw Kit
<b>BCS550SS</b>	18 Volt Cordless Metal Saw Kit with A95794 Blade for S.S.
<b>BL1830</b>	18V DC Lithium-Ion Battery Cartridge
<b>DC18RA</b>	18V Lithium-Ion Battery Charger - 110 Volt
<b>A95794</b>	5-3/8" (136.5 mm) 56 Tooth Carbide Blade for S.S.

Minimum order: 1 each.

Makita is a registered trademark of Makita Corporation.

## CRL Makita® 4-1/2" Angle Grinder

- Durable and Ergonomic 110V AC Tool
- Powerful 6.0 AMP Motor Delivers 11,000 RPM
- Small Circumference 2-1/4" (57 mm) Barrel Grip for Comfort
- Refined Design Weighing Only 3.1 Lbs. (1.4 kg) for Better Control
- Great for Cutting and Notching Metal Cladding and 1 x 19 Type Stainless Steel Cables

This CRL Makita® Angle Grinder is the perfect tool for cutting, notching, and edge finishing of metal cladding, as well as for cutting 1 x 19 type stainless steel cables in railing applications. The 6 AMP, 11,000 RPM motor delivers smooth continuous power for even the most demanding applications. The small-circumference barrel grip and light weight assure increased control and added comfort. Motor brushes are externally accessible, and the all-ball bearing design with a metal gear housing combine to make the GA4530 the ultimate in serviceability and durability.



### Standard Equipment:

- 4-1/2" (114 mm) Grinding Wheel
- Wheel Guard
- Lock Nut
- Lock Nut Wrench
- Side Handle
- Inner Flange

The accessory control handle can be mounted on the left or right for added operator comfort, while the entire gear housing rotates to 90 degree stop-points to aid with cutting operations. Special 'Labyrinth' construction featuring protective, zig-zag varnish seals help protect the motor from dust and debris, and extend tool life. Minimum order is one each.

CAT. NO. GA4530

## CRL Makita® Super-Thin Cut-Off Wheel

- Used for Cutting and Notching Stainless Steel Cladding and Cables
- 4-1/2" (114.3 mm) Diameter
- Just 3/64" (1.2 mm) Thick



CRL Super-Thin Cut-Off Wheels are just 3/64" (1.2 mm) thick for minimal stock removal and quick cutting when notching or cutting metal cladding. The fine grit edge also cuts with minimum edge distortion. These stainless wheels are sold by the package of 25.

CAT. NO.	DESCRIPTION
7241112A25	25-Pack 4-1/2" (114.3 mm) Super Thin Wheel
1351032*	Wheel Guard
2243789*	Inner Flange

Minimum order: 1 pack or 1 each. \*Wheel Flange and Wheel Guard are required to use Super Thin Wheels on the GA4530 Grinder.

## CRL Makita® Resin Fiber Finishing Discs

- Used to Remove Sharp Edges or Burrs From Cladding or Hand Rails
- 4-1/2" (114.3 mm) Diameter
- Superior Stock Removal



These 4-1/2" (114 mm) Finishing Discs are great for wood or metal. Quickly finish freshly cut cable or cladding edges to remove burrs or rough edges. 7/8" (22 mm) center hole. Choice of three grits.

CAT. NO.	DESCRIPTION
794106A5	5-Pack 50 Grit Discs
794107A5	5-Pack 80 Grit Discs
794108A5	5-Pack 120 Grit Discs
7430363*	4-1/2" (114.3 mm) Rubber Backer Pad
1930480*	Lock Nut for Backer Pad

Minimum order: 1 pack or 1 each. \*Backer Pad and Lock Nut are required to use Finishing Discs on GA4530 Grinder

## CRL Makita® Portable Band Saw

- Variable Speed Dial for Optimum Cutting Speed
- Powerful 6.5 AMP Motor for the Toughest Jobs
- Belt Lever for Fast and Easy Blade Replacement

This Portable Band Saw cuts up to 4-3/4" (120 mm) round or rectangular material to handle most requirements, and uses standard 44-7/8" x 1/2" (1140 x 12.7 mm) metal cutting blades. The CRL Cat. No. 792556A Bi-Metal Blade lasts up to three times longer than carbon steel blades. Cutting speeds range from 200' to 350' (61 to 106 m) per minute for common metals including: aluminum, brass, chrome, copper, iron, mild steel, and stainless steel. For accurate cuts this tool features dual-bearing blade guides, adjustable stopper plate, and a fluorescent job light. Included with the Saw is one each Band Saw Blade, Hex Wrench, Wrench Holder, and a Molded Carrying Case. Makita is a registered trademark of Makita Corporation.

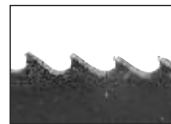

Bi-Metal Blade



CAT. NO.	DESCRIPTION
2107FK	Portable Band Saw
792556A	Replacement Bi-Metal Blade

Minimum order: 1 each.

## CRL T-Handle Tap Wrench

- Positive Grip Chuck
- Available in Three Sizes



**CAT. NO. TR1E**  
Wrench for #0 to 1/4" Taps



**CAT. NO. TR2E**  
Wrench for 1/4" to 1/2" Taps



**CAT. NO. TR112E**  
Wrench for #12 to 5/16" Taps

These CRL T-Handle Tap Wrenches have a sliding handle with spring tension stop, which can be extended to full length for more leverage. They have a positive grip knurled nut for tightening onto the tap. Three sizes are available to hold tap sizes from #0 to 1/2". Minimum order is one each.

## CRL Jobbers Length Fractional Size High Speed Steel Drill Bits

- Specific Drill Sizes for CRL Taps



These CRL Jobbers Length High Speed Steel Drill Bits are available in the most popular fractional sizes for general use in metal or wood. For a complete list of available sizes, see page 485K.

CAT. NO.	DRILL BIT SIZE
601316	3/16" for 1/4"-20NC Taps
60114	1/4" for 5/16"-18NC Taps
601516	5/16" for 3/8"-16NC Taps
601716	7/16" for 1/2"-13NC Taps
6012764	27/64" for 1/2"-13NC Taps

Minimum order: 1 each. Sizes can be combined for quantity pricing. Other sizes are available on page 485K.

## CRL Fractional Size Taps

- Five Different Fractional Sizes

- High Carbon Steel

Used for ordinary threading, these CRL High Carbon Steel Taps come in the most commonly used sizes. Minimum order is one each.

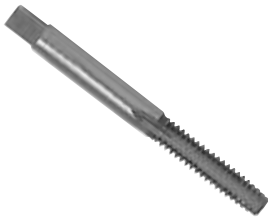

**CAT. NO. 151420**  
1/4"-20NC



**CAT. NO. 151428**  
1/4"-28NF



**CAT. NO. 155618**  
5/16"-18NC



**CAT. NO. 153816**  
3/8"-16NC



**CAT. NO. 151213**  
1/2"-13NC

## CRL Adjustable Click Torque Wrench

- Knurled Grip Handle
- 10-100 Foot-Pounds (16.9 to 132.2 Nm)

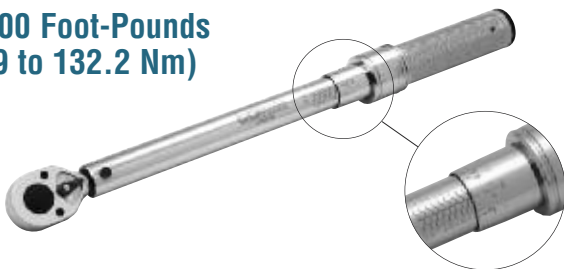

The CRL Adjustable Click Torque Wrench has a ratchet head and a 3/8" square drive, with 10-100 foot-pounds (16.9 to 132.2 Nm) worth of torque. The grip is knurled, and the overall length of the tool is 15-1/2" (394 mm). Minimum order is one each.

**CAT. NO. 85555A**

## CRL Impact Sockets and Accessories



**CAT. NO. 7175P**  
3/8" Drive Extension



**CAT. NO. 7714H**  
7/16" 6-Pt. Socket



**CAT. NO. 7716H**  
1/2" 6-Pt. Socket



**CAT. NO. 7718H**  
9/16" 6-Pt. Socket



**CAT. NO. 7719H**  
19 mm 6-Pt. Socket



**CAT. NO. 7290**  
3/8" Hex Bit

CAT. NO.	WORKS WITH	DESCRIPTION
7175P	All 3/8" Drives and Hex Bits	3/8" Drive - 3" (76.2 mm) Drive Extension
7714H	WBA14X3 Anchors	3/8" Drive - 7/16" Deep Socket 6-pt.
7716H	EBA334 Anchors	3/8" Drive - 1/2" Deep Socket 6-pt.
7718H	WBA38X4 Anchors	3/8" Drive - 9/16" Deep Socket 6-pt.
7719H	EBA335 Anchors	3/8" Drive - 19 mm Impact Socket 6-pt.
7290	All SHCS12 Cap Screws	3/8" Drive - 3/8" Hex Bit

Minimum order: 1 each.

## CRL P-Post Top Rail Installation Tool Kit

- Use for Installing Top Rails on P-Posts
- Works With Universal Pressure Drill

The Installation Kit is a valuable tool for drilling and tapping the underside of Schedule 40 Top Rail Tubing prior to attaching to P-Series Top Saddle Posts. Kit Includes: one Center Punch, one Drill Bit Holder, two TIN Coated Drill Bits, one Tube Wax, two TIN Coated High Speed 10-32 Machine Taps, one Tap Wrench, one Flat File, two Quick-Grip Clamps, and a set of instructions. Minimum order is one kit.



Tube Wax  
Cat. No. WS140



Tap Wrench  
Cat. No. TR1E



Center Punch  
Cat. No. G78



Drill Bit Holder  
Cat. No. DBH1

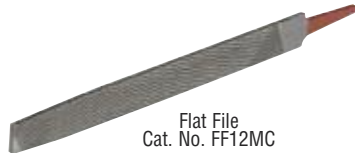

Flat File  
Cat. No. FF12MC



TIN Coated 10-32 Tap  
Cat. No. T1032TC



6" Quick-Grip Clamps  
Cat. No. 506QC



#21 TICN Coated Drill Bit  
Cat. No. SLD21

**CAT. NO. PS1K**

## CRL Universal Pressure Drill

- Drill 3/8" (9.5 mm) Steel in 45 Seconds
- Bits Last Up to 10 Times Longer
- Cuts Labor Costs by Up to 75%
- Pipe Adaptor Available for Drilling Up to 6" (152 mm) Diameter Pipe

The CRL Universal Pressure Drill is excellent for overhead drilling. Typical 1/2" (12.7 mm) drill bits usually take 210 pounds (95 kg) of pressure to get best results. With the CRL Universal Pressure Drill you'll only need 28 pounds (13 kg) of pressure to do the same job. Drill bit life can be extended up to 10 times when compared to hand drilling. Excellent results with self-drilling screws too.



Universal Pressure Drill **CAT. NO. UPD1**



**CAT. NO. UPDPA1**  
Pipe Adaptor



The CRL Pipe Adaptor for the Universal Pressure Drill allows you to easily field drill holes in steel pipe up to 6" (152 mm) in diameter. Each Pipe Adaptor is made from steel for added rigidity, and includes a Brace Foot with pivoting saddle and a 28" (711 mm) long Slide Rod. When combined with the Gear Box Drill Mounting Bracket from our Cat. No. UPD1 Universal Pressure Drill (sold separately) you create a portable drill press that will reduce your drilling labor costs by up to 75%. A typical 3/16" drill bit requires 100 pounds (45 kg) of pressure to properly drill into steel. With the Pipe Adaptor and the UPD1, you need exert only 8 pounds (3.6 kg) of pressure. Minimum order is one each.

## CRL 18-Volt Cordless Variable Speed Impact Driver/Drill Kit

- Reversible With Two Speed Ranges: 0 to 500, and 0 to 1150 RPM

The CRL 18-Volt Cordless Variable Speed Impact Driver/Drill is a lot of tool for a very conservative price. Put a drill bit or the included double-headed screwdriver bit into the keyless 3/8" (9.5 mm) chuck and pull the trigger for drilling/driving in two speed ranges: 0 to 500 RPM, and 0 to 1150 RPM. Twist the collar and you have an impact drill with an impact frequency of 6400 or 18000 strokes per minute.

CAT. NO.	DESCRIPTION
LD147	18-Volt Cordless Impact/Driver Kit
LD147B	18-Volt Battery Cartridge for LD147
LD147C	Charger for LD147B 18-Volt Battery
LD147AU	18-Volt Cordless Impact/Driver Kit w/AU Plug
LD147C240V	240-Volt Charger for LD147B Battery w/AU Plug
LD147EU	18-Volt Cordless Impact/Driver Kit w/EU Plug
LD147C220V	220-Volt Charger for LD147B Battery w/EU Plug

Kit Includes: Driver/Drill, Battery, Charger, Six Drill Bits, Magnetic Bit Holder, plus Molded Carrying Case. Minimum order: 1 each.

Hilti is a registered trademark of Hilti Aktiengesellschaft Corporation.



## Hilti® Hole Blow Out Pump

- For Cleaning Freshly Drilled Holes in Concrete and Masonry



The Hilti® Hole Blow Out Pump is an accessory used for cleaning out freshly drilled anchoring holes in concrete and masonry. Minimum order is one each.

**CAT. NO. EBADP1**

## Hilti® TE 2-S Deluxe Rotary Hammer Drill

- 110 Volt Tool Delivers 0 to 4,600 Blows Per Minute



- Fast and Efficient Drilling of 3/16" to 3/4" (4.8 to 19.1 mm) Diameter Holes Into Concrete and Masonry
- Sturdy Motor With High Load Rating

This Hilti® TE 2-S Deluxe Rotary Hammer Drill is mainly for drilling into concrete and masonry, however, its precision hammering feature allows for drilling into brittle materials like tile and stone as well. Includes: Tool with 13' (4 m) Power Cord, Side Handle, and Depth-Gauge, all in a molded Carrying Case. Minimum order is one each.

CAT. NO. HRHD1

## CRL Makita® 1" D-Handle Rotary Hammer Drill



Includes: Depth Gauge, Side Handle, and Carrying Case

- Variable Speed 0 to 1,100 RPM
- 110 Volt, 7 AMP Motor
- 0 to 4,500 Blows Per Minute
- Uses S.D.S. Drills

This Heavy-Duty Rotary Hammer with a variable speed and reversing motor is ideal for wedge-bolt drilling. It accepts SDS-PLUS bits while operating in 3-mode operation: "rotation only", "hammering with rotation" and "hammering only" for multiple applications. The ergonomic D-shaped handle with rubberized soft grip gives the user increased comfort and control. Minimum order is one each.

CAT. NO. HR2475

## Hilti® TE-C3X and TE-CX Masonry Drill Bits

- For Drilling Into Concrete and Masonry



CAT. NO. EBAD1  
TE-C3X Masonry Drill Bit



CAT. NO. EBAD2  
TE-C3X Masonry Drill Bit



CAT. NO. EBAD3  
TE-CX Masonry Drill Bit

Hilti® TE-C3X and TE-CX are the world's first Hammer Drill Bits with gradient technology, superior heat resistance and ruggedness – even when drilling into rebar. For use with EBA334 and EBA335 Hilti® HSL-3 Expansion Anchors.

CAT. NO.	DIAMETER	WORKS WITH	LENGTH
EBAD1	12 mm	EBA334 Expansion Anchor	170 mm
EBAD2	12 mm	EBA334 Expansion Anchor	270 mm
EBAD3	18 mm	EBA335 Expansion Anchor	470 mm

Minimum order: 1 each.

Hilti is a registered trademark of Hilti Aktiengesellschaft Corporation. Makita is a registered trademark of Makita Corporation.

## CRL S.D.S. Masonry Drills

- Work in Both Regular and Impact Drills
- ANSI Spec for Concrete Anchors

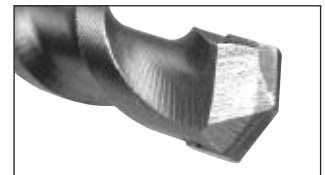

CAT. NO. SDSW12  
Drill for 1/2" Anchors



CAT. NO. SDSW38  
Drill for 3/8" Anchors



CAT. NO. SDSW14  
Drill for 1/4" Anchors

S.D.S. Masonry Drills are made to the ANSI Specifications required for the proper performance of concrete anchors. Life expectancy: 100-500 holes, depending on substrate and drill used. They work in both regular and impact drills, and can be used in a number of masonry materials.

CAT. NO.	DIAMETER	WORKS WITH	LENGTH
SDSW12	.495" (12.6 mm)	WBA12X4 Concrete Anchor	12" (305 mm)
SDSW38	.389" (9.9 mm)	WBA38X4 Concrete Anchor	12" (305 mm)
SDSW14	.259" (6.6 mm)	WBA14X3 Concrete Anchor	8" (203 mm)

Minimum order: 1 each. Sizes can be combined for quantity pricing.



## CRL Post Leveling Stand

- Quick Clamping Action Fits 1-1/2" Schedule 40 Pipe
- Rigid Steel Construction
- Folds Flat for Storage
- Simple Height and Plumb Adjustment



Perhaps one of the most time consuming portions of any post railing installation is the alignment of core mount posts. It takes countless hours of shimming, plumbing and adjusting, until now. The CRL Post Leveling Stand was originally designed for our CRS Railing System, but works with any 1-1/2" Schedule 40 core mounted post railing system.

Its quick clamping action allows you to easily adjust and set a post, and then move on to the next. The tripod legs of the CRL Post Leveling Stand have high ground clearance, allowing bottom horizontal rails to pass underneath without obstruction. The tripod legs also pivot for working in tight places and acute angle corners. The feet easily adjust up and down, taking the hassle out of the plumbing operation. They are also quickly convertible into an offset height configuration for use on stairs or curbs.

Rigid steel construction with corrosion resistant powder coated finish provides the strength and durability you require. It easily folds flat for storage, and can also be used as a stabilizer for flange mount post installations. Minimum order is one each.



CAT. NO. 1540PLS



## CRL Folding Post Level

- For Posts, Pipes, and Signs
- Opens to Any Angle
- Positive Lock Every 15 Degrees
- Hands-Free Design for Vertical and Horizontal Readings
- Large, Easy-to-Read Bubble Vials



The CRL Folding Post Level is the ideal tool to use when installing CRL Architectural Posts and Railings, both round and rectangular, or any other similar job that requires a plumb or level installation. This tool is "hands-free", and checks vertical or horizontal on both planes simultaneously. Sturdy high-impact molded plastic body with three large bubble vials. Minimum order is one each.

CAT. NO. 34008

## CRL Econ-O-Post Hole Form

- Creates Tapered Hole With Extra Space to Plumb Posts
- Sealed From the Bottom to Keep Out Concrete, Debris, and Water
- Lightweight and Sturdy
- Easy to Use

- Sizes for Large or Small Posts



CAT. NO. 3006  
Small Form

CAT. NO. 4012  
Large Form

Use the CRL Econ-O-Post Hole Form when setting concrete to allow posts to be set later. The Econ-O-Post Hole Form is sealed from the bottom to keep concrete, water, and debris from entering. The Econ-O-Post Hole Form's shape creates a tapered hole with extra space to plumb posts. Helical grooves allow the sleeve to be easily removed after the concrete is set, when you are ready to install the posts.



- Easy to Install and Remove

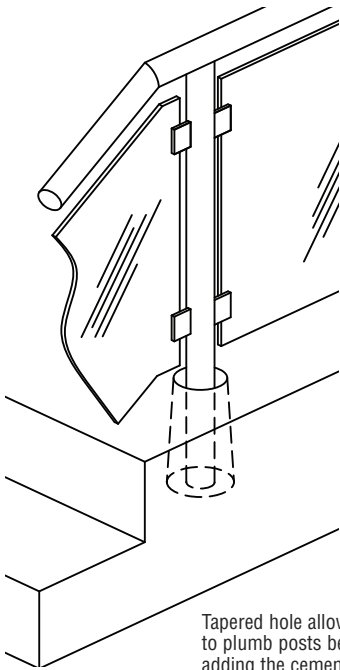

Tapered hole allows you to plumb posts before adding the cement

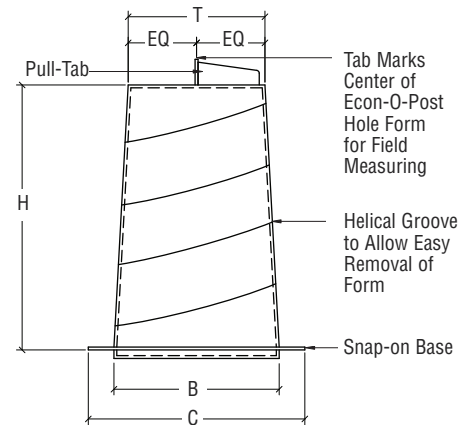

### SPECIFICATIONS

CAT. NO. SIZE	T	H	B	C	POST SIZE OF RAILING OR FENCE
3006 Small	3" (76 mm)	6" (152 mm)	3-1/2" (89 mm)	4-3/4" (121 mm)	Up to 2-3/8" (60 mm) O.D. Pipe; Up to 2" (51 mm) Square Post
4012 Large	4" (102 mm)	12" (305 mm)	5" (127 mm)	7" (178 mm)	Up to 3-1/2" (89 mm) O.D. Pipe; Up to 2-1/2" (64 mm) Square Post

Minimum order: 1 each. Sizes can be combined for quantity pricing.

## CRL Safety Guard Rail Base Systems

- Use Them With Your Own 2x4's to Create Temporary Guard Rails
- Cost Effective, Reusable, and Meets or Exceeds OSHA Requirements

These CRL Safety Guard Rail Base Systems are reusable bases for constructing freestanding temporary guard rail and stair rail systems that exceed OSHA standards. All you add are the fasteners and your own 2x4's. CRL Safety Guard Bases need no bracing, and anchor into most materials, including concrete. Two 2x4's are inserted into the center to form a strong, rigid post design. Toe boards need no fasteners, and drop directly into the channels on each Safety Guard Base. When permanent rails are ready to be installed, the Guards can be easily removed and reused in another location.

Safety Guard Bases are molded in one piece from a durable, high-impact, polymer, and have a one-year replacement guarantee. Minimum order is one each.



CAT. NO. SGR1

### SPECIFICATIONS:

**Base Dimensions:**  
5-5/8" x 8-5/8"  
(143 x 219 mm)  
**Height:** 5-1/8" (130 mm)  
**Weight:** 3 Pounds (1.36 kg)  
**Color:** Safety Orange

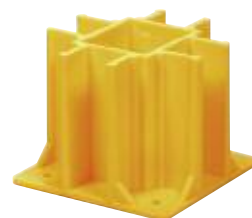

CAT. NO. SBG05

### SPECIFICATIONS:

**Base Dimensions:**  
7-1/2" (190 mm) Square  
**Height:** 6" (152 mm)  
**Weight:** 3 Pounds (1.36 kg)  
**Includes:** Four Metal Washers  
**Color:** Safety Yellow



## CRL UV Glass Bonding Kits

Starting a new opportunity segment for your business can cause concern about making the right decisions on equipment and supply selection. CRL UV Glass Bonding Kits have all of the choices made for you in advance to allow you to enter this field of technology easily at various levels based on your needs.

From our very basic CRL Small Project UV Glass Bonding Starter Kit suited for artists, hobbyists and small commercial requirements, to our Professional Kits with a wider variety of equipment and components, you will find just the right Kit to start creating finished projects in no time. Backed by our experienced in-house technicians and detailed instructions included with each Kit, you'll have everything you need at a great price without the tedious research usually required to start your new range of product offers.

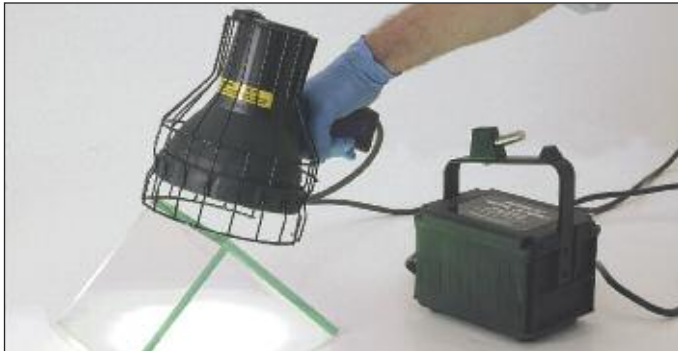

As you familiarize yourself with the various production techniques, you will quickly be able to expand the types of desired finished items produced by choice from our variety of specialty UV Pre-Treatment Supplies, Adhesives, Lamps, Fixation Devices, and Display and Furniture Hardware.

As work area safety is of the utmost importance, all CRL Curing Lamps are equipped with UV filter screens to prevent damage to eyes and skin, and we offer further protection with a selection of UV Spectacles, Goggles, and Face Masks.

C.R. Laurence will always be researching the newest developments in UV glass bonding to continually be positioned to offer the finest quality supplies, equipment, and hardware to the glass industry.

## CRL Small Project UV Glass Bonding Kit

- An Affordable Way to Learn UV Glass Bonding Techniques
- Low Viscosity UV Adhesive in Crystal Clear and Colors
- Ships With Easy-To-Follow Instructions

Modern technology has allowed development of UV Glass Bonding Adhesives and Equipment to become user friendly to a point that by following simple step-by-step instructions, beautiful small UV bonding projects can be created easily. Small display cases, crystal repairs and even art projects with the colorful UV Adhesives provided are easy to complete. Minimum order is one each.



CAT. NO. UVSK1

### CRL SMALL PROJECT UV GLASS BONDING KIT INCLUDES:

- 1 each Cat. No. UB80 DC UV Adhesive Curing Lamp
- 1 each Cat. No. UV701T10 Low Viscosity UV Adhesive
- 1 each Cat. No. UV90130 Red UV Adhesive
- 1 each Cat. No. UV90230 Yellow UV Adhesive
- 1 each Cat. No. UV90330 Blue UV Adhesive
- 5 each Cat. No. UVN35 Low Viscosity Applicator Needles
- 1 each Cat. No. UVS30 UV Spectacles
- 1 each Cat. No. UVA1 Application Needle Adapter
- 1 each Cat. No. RS65 Glass Scraper
- 12 pair Cat. No. 700512 Nitrile Gloves
- 1 pack Cat. No. Z100 Extra Fine Steel Wool
- 1 each Cat. No. T1408 Carrying Case

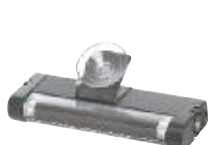

CAT. NO. UB80



CAT. NO. UV701T10



CAT. NO. UV90130



CAT. NO. UV90230



CAT. NO. UV90330



CAT. NO. UVN35



CAT. NO. UVS30



CAT. NO. UVA1



CAT. NO. RS65



CAT. NO. 700512



CAT. NO. Z100



CAT. NO. T1408

# CRL UV GLASS BONDING KITS

For Pricing Visit [crlaurence.com](http://crlaurence.com) or Call Us Toll Free at the Phone Numbers Shown on the Back Cover

## CRL Basic UV Glass Bonding Kit

- Complete Glass-to-Glass and Glass-to-Metal Projects
- Crystal Clear Medium-Bodied UV Adhesive
- Ships With Easy-to-Follow Instructions

Keep up with the growing trend of UV Glass Bonding with the CRL Basic UV Glass Bonding Kit. We provide you with the very versatile Medium Viscosity Glass-to-Glass and Glass-to-Metal UV Adhesive that allows you to UV bond our special selection of UV hardware to create displays, showcases, furniture, and more. Simple instructions included with the Kit will have you completing projects in no time. Minimum order is one each.



### CRL BASIC UV GLASS BONDING KIT INCLUDES:

- 1 each Cat. No. UV240 110 Volt UV Adhesive Curing Lamp
- 1 each Cat. No. UVS30 UV Protective Spectacles
- 1 each Cat. No. UV604L25 Medium Viscosity UV Adhesive
- 5 each Cat. No. UVN85 Medium Viscosity Applicator Needles
- 2 each Cat. No. UVA1 Application Needle Adapters
- 1 each Cat. No. RS65 Glass Scraper
- 100 each Cat. No. 51S Single Edge Razor Blades
- 12 pair Cat. No. 700512 Nitrile Gloves
- 1 pack Cat. No. Z100 Extra Fine Steel Wool
- 1 each Cat. No. CRL7528 Cleaner Degreaser
- 1 each Cat. No. T1418 Carrying Case



CAT. NO. UVSK2  
NO AIR FREIGHT



CAT. NO. UV240



CAT. NO. UVS30



CAT. NO. UV604L25



CAT. NO. UVN85



CAT. NO. UVA1



CAT. NO. RS65



CAT. NO. 51S



CAT. NO. 700512



CAT. NO. Z100



CAT. NO. CRL7528



CAT. NO. T1418

## CRL Professional UV Glass Bonding Kit With Tube Lamp

- Professional Quality Kit for UV Bonding
- Complete Larger Projects
- Ships With Easy-to-Follow Instructions

The CRL Professional UV Glass Bonding Kit With Tube Lamp provides you with all the basic equipment required to produce beautiful projects in your shop or on the job site. The Cat. No. UVBL15 UV Tube Lamp can be used to cure glass-to-metal hardware applications as well as longer bonding joints for furniture and display assemblies. Minimum order is one each.



NO AIR FREIGHT



### CRL PROFESSIONAL UV GLASS BONDING KIT WITH TUBE LAMP INCLUDES:

- 1 each Cat. No. UVBL15 110 Volt Adhesive Curing Tube Lamp
- 1 each Cat. No. UV604L25 Medium Viscosity UV Adhesive
- 1 each Cat. No. UV701T25 Low Viscosity UV Adhesive
- 5 each Cat. No. UVN85 Medium Viscosity Applicator Needles
- 5 each Cat. No. UVN35 Low Viscosity Applicator Needles
- 2 each Cat. No. UVA1 Application Needle Adapters
- 1 each Cat. No. RS65 Glass Scraper
- 100 each Cat. No. 51S Single Edge Razor Blades
- 12 pair Cat. No. 700512 Nitrile Gloves
- 1 pack Cat. No. Z100 Extra Fine Steel Wool
- 1 each Cat. No. CRL7528 Cleaner Degreaser
- 1 each Cat. No. UVS30 UV Protective Spectacles
- 1 each Cat. No. UV69962 Mini Clamp-It® 90 Degree Fixation Set
- 1 each Cat. No. UV69954 Clamp-It® 90 Degree Fixation Set
- 2 each Cat. No. UV282 Adjustable Angle Fixation Device
- 4 each Cat. No. UV285 Eccentric Height Adjustment Stops
- 1 each Cat. No. UVB1N1 Storage Container

CAT. NO. UVSK3



CAT. NO. UVBL15



CAT. NO. UV604L25  
CAT. NO. UV701T25



CAT. NO. UVN35  
CAT. NO. UVN85



CAT. NO. UVA1



CAT. NO. RS65  
CAT. NO. 51S



CAT. NO. 700512  
CAT. NO. Z100



CAT. NO. UVS30  
CAT. NO. CRL7528



CAT. NO. UV69962



CAT. NO. UV69954



CAT. NO. UV282



CAT. NO. UV285



CAT. NO. UVB1N1

Clamp-It is a registered trademark of Rockler Companies, Inc.



C.R. LAURENCE COMPANY

[crlaurence.com](http://crlaurence.com) | [usalum.com](http://usalum.com)

312K | [crlaurence.ca](http://crlaurence.ca) [crlaurence.com.au](http://crlaurence.com.au) [crlaurence.co.uk](http://crlaurence.co.uk) [crlaurence.de](http://crlaurence.de) [crlaurence.eu](http://crlaurence.eu)

## CRL Professional UV Glass Bonding Kit With High Intensity Lamp

- Perfectly Suited for the Fabrication of Showcases and Glass Furniture
- Supplied With CRL's Four Most Popular UV Bonding Adhesives for a Wide Variety of Applications
- Fixation Devices Securely Position Your Work Pieces for Precise Fabrication



CAT. NO. UVSK4

This CRL Professional UV Glass Bonding Kit features our powerful Z7596 High Intensity UV Lamp, designed to emit wave lengths of 365 nm, perfect for curing all CRL UV Bonding Adhesives. Projects will take less time to complete, with full curing achieved quickly.

Cat. No. UV703 High Viscosity UV Adhesive is included and is perfect for 'all-glass' showcases, shelves, furniture, towel bar installations, and standoff applications. The Cat. No. UV701T Low Viscosity Adhesive uses capillary action capabilities for the efficient production of glass furniture with crystal clear results. Use the Cat. No. UV604L Medium Viscosity Adhesive for your glass-to-metal hardware installations. Finally, Cat. No. UV602L Medium Viscosity Adhesive has special properties to be compatible with laminated glass bonding requirements.

The six Fixation Device configurations will enable you to position multitudes of glass arrangements securely during the UV Adhesive application and curing stages of your assemblies. These, combined with all of the other basic supplies and tools shown below, will set you apart from the competition and on your way to the growing popularity of finished UV bonded glass products. Minimum order is one each.

### CRL PROFESSIONAL UV GLASS BONDING KIT WITH HIGH INTENSITY LAMP INCLUDES:



- 1 each Cat. No. Z7596 110 Volt UV Adhesive Curing Lamp
- 1 each Cat. No. UV602L85 Medium Viscosity UV Adhesive
- 1 each Cat. No. UV604L25 Medium Viscosity UV Adhesive
- 1 each Cat. No. UV701T25 Low Viscosity UV Adhesive
- 1 each Cat. No. UV70310 High Viscosity UV Adhesive
- 2 each Cat. No. UV9SET Application Needle Sets
- 4 each Cat. No. UVA1 Application Needle Adapters
- 1 each Cat. No. RS65 Glass Scraper
- 100 each Cat. No. 51S Single Edge Razor Blades
- 12 pair Cat. No. 700512 Nitrile Gloves
- 1 pack Cat. No. Z100 Extra Fine Steel Wool
- 1 each Cat. No. CRL7528 Cleaner Degreaser
- 1 each Cat. No. UV1575 Non-Contact Laser Thermometer
- 1 each Cat. No. WH7080 Small 90 Degree Fixation Device
- 1 each Cat. No. UV280 Large 90 Degree Fixation Device
- 1 each Cat. No. UV69962 Mini Clamp-It® 90 Degree Fixation Set
- 1 each Cat. No. UV69954 Clamp-It® 90 Degree Fixation Set
- 2 each Cat. No. UV282 Adjustable Angle Fixation Device
- 4 each Cat. No. UV285 Eccentric Height Adjustment Stops
- 1 each Cat. No. UVB1N2 Storage Container



CAT. NO. Z7596



CAT. NO. UV604L25



CAT. NO. UV602L85



CAT. NO. UV701T25



CAT. NO. UV70310



CAT. NO. UV9SET



CAT. NO. UVA1



CAT. NO. RS65



CAT. NO. 51S



CAT. NO. 700512



CAT. NO. Z100



CAT. NO. CRL7528



CAT. NO. UV1575



CAT. NO. WH7080



CAT. NO. UV280



CAT. NO. UV69962



CAT. NO. UV69954



CAT. NO. UV282



CAT. NO. UV285



CAT. NO. UVB1N2

Clamp-It is a registered trademark of Rockler Companies, Inc.

## CRL Cleaner and Degreaser

- Cleans Up Uncured Adhesive
- Contains No Ozone Depleting Chemicals
- Evaporates Quickly



20 Oz. (567 g)

CRL Cleaner and Degreaser is a general-purpose cleaner/degreaser ideal for preparing surfaces prior to use of adhesives and sealants. It removes all traces of grease and oils, and leaves no residue. 12 cans per case. Minimum order is one each.

CAT. NO. CRL7528

## CRL S50 Sprayway® Glass Cleaner

- A Glass Industry Favorite for Years
- Ammonia Free Formula
- Fast Evaporation Rate
- Just Spray and Wipe Clean



19 Oz. (539 g)

CRL S50 is Sprayway's leading Glass Cleaner. The formula includes perfume-grade alcohols, which are the best cleaning agents you can use. It also has a fast evaporation rate, which keeps it from leaving a film and adversely interacting with other materials. 12 cans per case. Minimum order is one case.

CAT. NO. S50

## CRL Hot Air Gun Kit

- Dual Heat and Fan Settings

After cleaning the bonding surfaces an invisible moisture residue remains which can negatively affect the strength of the bond. Remove this moisture quickly and reliably with the CRL Hot Air Gun Kit. It has dual heat and fan settings: 1000 W - 375°C/700°F and 1500 W - 495°C/925°F. Also excellent for use in putty removal, paint removal, plastic pipe welding, and other jobs that require this type of tool.



CAT. NO.	DESCRIPTION
LD121	110V Hot Air Gun Kit
LD121AU	240V Hot Air Gun Kit w/AU Plug
LD121EU	220V Hot Air Gun Kit w/EU Plug

Minimum order: 1 each.

## CRL Milwaukee® Heat Gun

- Variable Temperature With Heat Adjustment Dial
- Ideal for Removing Residual Moisture After Cleaning



After cleaning the bonding surfaces an invisible moisture residue remains which can negatively affect the strength of the bond. Remove this moisture quickly and reliably with this variable temperature Heat Gun. It offers a range from 200 to 1050°F (93 to 565°C) that is controlled with a heat adjustment dial. The electrical heat control allows extra reduction of airflow for more accurate and concentrated heat location without damage to the heating element. Double insulated 110V AC tool features a unique impact resistant heating element. Minimum order is one each.

CAT. NO. UV8978

## CRL Non-Contact Thermometer

- Monitors Glass Temperature While Heating for Optimum Bond Results
- Built-In Laser Pointer
- Digital Display Switches Easily From Fahrenheit to Celsius

Now you can easily confirm the temperature of your bonding materials with the CRL Non-Contact Thermometer. No more guessing or risking burns with a touch test. This tool will tell you via digital display when your bonding components reach the 140 to 160°F (60 to 71°C) preheat stage required for a permanent bond. Easy one button control for switching between Fahrenheit and Celsius readings. Powered by two AAA batteries (included). Minimum order is one each.

Sprayway is a registered trademark of Claire-Sprayway, Inc.  
Milwaukee is a registered trademark of Milwaukee Electric Tool Corporation.



CAT. NO. UV1575

## CRL UV Glass Bonding Adhesives

The Benefits of UV Curing Adhesive Technology Are Many



### Join the Growing Trend of UV Glass Bonding

The use of glass combined with other materials continues to grow year after year. Store displays, showcases, and furniture designs are being produced without the usual mechanical fasteners and moving toward the clean, transparent look of UV bonded components.

The technological development of UV Glass Bonding over the years has enabled us to present a range of adhesives with a unique combination of performance, design, and processing benefits. You now have choices of adhesives with varying curing times that allow you to align parts precisely prior to curing.

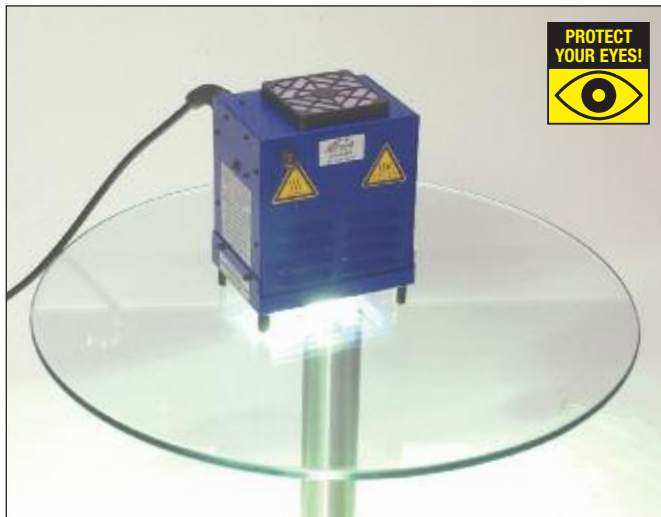

### UV Adhesive Technology for Common Use

These amazing materials have properties that allow them to remain in a liquid state during proper storage and are able to then cure with UV light exposure in a matter of seconds.

Using the properties of ultraviolet light, high curing speeds take the place of common slow evaporation methods for maximum processing production. Material construction combinations now include glass-to-glass, glass-to-metal, and glass-to-stone, further expanding the opportunities for creative designs more than ever.

Maximum strength developed between components is developed by keeping the gap between their surfaces as small as possible, optimally between 0.04 and 0.5 mm.



### It's Now Easier to Fabricate Than Ever Before

The best finished appearance for projects is achieved when glass edges are precisely ground and polished and when all other surfaces to be bonded are as smooth as possible.

Following the simple, step-by-step instructions provided to you for pre-treatment, proper fixation of the components, careful application of the adhesive, and the correct method for curing, can result in the production of unique, creative, and practical products.

CRL's staff of trained technicians is always available to provide you with the answers to your production questions and any other UV bonding requirements you may have as you familiarize yourself with this exciting new industry segment.

Contact CRL Customer Service Department at (800) 421-6144 in the U.S., (877) 421-6144 from Canada, or (323) 588-1281 International, and ask for Ext. 5275. You can also e-mail us through our web site, [crlaurence.com](http://crlaurence.com). From the home page click on Contact Us, and then click on Customer Service.

## CRL UV703 High Viscosity UV Adhesive

- Use to Adhere All-Glass Showcases, Shelves, Furniture, Towel Bars, and Standoff Bases
- Optically Clear
- Fast, High-Strength Bonds

CRL UV703 is a high viscosity, 100% solids, general purpose adhesive that forms resilient, high strength bonds between materials such as glass, steel, aluminum, stainless steel, and many plastics.

CRL UV703 is ideal for making all-glass showcases, glass shelves, and glass furniture. This adhesive does not have capillary properties; therefore it must be applied to the bonding surface prior to assembling the parts. It is ideal for bonding Glass Door Knobs or Metal Towel Bars in frameless shower door installations, as well as adhering metal Standoff Bases to glass.

Bonds prepared with CRL UV703 are optically clear as well as resistant to moisture and yellowing. The adhesive cures within seconds upon exposure to ultraviolet light. The speed of cure depends on the UV intensity as measured at the product surface, as well as the adhesive depth. CRL UV703 has outstanding ability to cure through large gaps, and cures to a hard surface that is transparent. Store adhesive away from sunlight.

CRL7528 Cleaner and Degreaser provides for optimum adhesion when used first to prepare the glass by removing any dirt and grease that is present.

**NOTE:** When bonding plastics, always test first, as not all plastics can be bonded properly. Do not bond any coated parts (powder coated or galvanized) with this adhesive.



CAT. NO.	DESCRIPTION	CONTENTS
UV70330	High Viscosity UV Adhesive	30g
UV70310	High Viscosity UV Adhesive	100g
UV70325	High Viscosity UV Adhesive	250g
UV7031K	High Viscosity UV Adhesive	1000g
CRL7528	Cleaner and Degreaser	20 Oz. (567g)

Minimum order: 1 each. \*CRL Cleaner and Degreaser cannot be shipped via air freight.

## CRL UV701T Low Viscosity UV Adhesive

- Ideal for Production of Glass Furniture
- Cures Within Seconds Upon Exposure to UV Light
- Capillary Action
- Optically Clear

CRL UV701T is a low viscosity, 100% solids, adhesive that forms resilient, high strength bonds coupled with good elasticity between materials such as glass, steel, aluminum, stainless steel, and many plastics.

Due to its excellent capillary action (low viscosity) it is ideal for glass-to-glass and tempered glass-to-tempered glass bonding, primarily in the construction of showcases and the efficient production of glass furniture. Reduced clean-up time means glass furniture production cycles are done quickly and efficiently.

Bonds prepared with CRL UV701T are optically clear as well as resistant to moisture and yellowing. The adhesive cures within seconds upon exposure to ultraviolet light. The speed of cure depends on the UV intensity as measured at the product surface, as well as the adhesive depth. Store adhesive away from sunlight.

CRL7528 Cleaner and Degreaser provides for optimum adhesion when used first to prepare the glass by removing any dirt and grease that is present.

**NOTE:** When bonding plastics, always test first, as not all plastics can be bonded properly. Do not bond any coated parts (powder coated or galvanized) with this adhesive.



CAT. NO.	DESCRIPTION	CONTENTS
UV701T30	Low Viscosity UV Adhesive	30g
UV701T10	Low Viscosity UV Adhesive	100g
UV701T25	Low Viscosity UV Adhesive	250g
UV701T1K	Low Viscosity UV Adhesive	1000g
CRL7528	Cleaner and Degreaser	20 Oz. (567g)

Minimum order: 1 each. \*CRL Cleaner and Degreaser cannot be shipped via air freight.



## CRL UV602L UV/Visible Light Adhesive

- Bonds Laminated Glass
- UV and Visible Light Cure
- Medium Viscosity With Capillary Action
- Optically Clear • Best Adhesion to Plastics

CRL UV602L is a medium viscosity, 100% solids, UV/visible light curable adhesive that bonds to a variety of substrates such as glass, laminated glass, metal, ceramic, and many plastics. It has good capillary action with glass up to 1/4" (6 mm) thick. For thicker glass apply to the bonding surface prior to assembly.

Of particular interest is its suitability for bonding laminated safety glass. The PVB film between laminated glass panes absorbs almost all of the UVA radiation, but because this adhesive has been made to also cure by daylight, it reacts with the remaining radiation (above 380 nm) and cures completely. Butt-edge bonding is also no problem, as the adhesive does not affect the PVB film.

Cured bonds of CRL UV602L are optically clear, extremely flexible, and demonstrate outstanding elongation, making this adhesive ideal for bonding different material combinations. Bonds are tough, durable, exhibit high vibration resistance, and are very resistant to moisture and yellowing. Store adhesive away from sunlight.

CRL7528 Cleaner and Degreaser provides for optimum adhesion when used first to prepare the glass by removing any dirt and grease that is present.

**NOTE:** When bonding plastics, always test first, as not all plastics can be bonded properly. Do not bond any coated parts (powder coated or galvanized) with this adhesive.

SPEC. DATA

MSDS



85g



1000g



CAT. NO. CRL7528\*  
Cleaner/Degreaser



Laminated Glass  
Butt-Edge Bond

CAT. NO.	DESCRIPTION	CONTENTS
UV602L85	UV/Visible Light Adhesive	85g
UV602L1K	UV/Visible Light Adhesive	1000g
CRL7528	Cleaner and Degreaser	20 Oz. (567g)

Minimum order: 1 each. \*CRL Cleaner and Degreaser cannot be shipped via air freight.

## CRL UV604L UV/Visible Light Adhesive

- Especially Strong Glass to Metal Bonds
- UV and Visible Light Cure
- Medium Viscosity
- Optically Clear

CRL UV604L is a medium viscosity, 100% solids, UV/visible light curable adhesive formulated to form high tensile shear and peel strength bonds to a variety of substrates such as glass, laminated glass, steel, stainless steel, aluminum, ceramic, stone, wood and some plastics. This adhesive does not have capillary properties; therefore it must be applied to the bonding surface prior to assembling the parts.

Of particular interest is its suitability of bonding laminated safety glass. The PVB film between laminated glass panes absorbs almost all of the UVA radiation, but because this adhesive has been made to also cure by daylight, it reacts with the remaining radiation (above 380 nm) and cures completely.

Cured bonds of CRL UV604L are optically clear, resistant to moisture and thermal cycling. Store adhesive away from sunlight.

CRL7528 Cleaner and Degreaser provides for optimum adhesion when used first to prepare the glass by removing any dirt and grease that is present.

**NOTE:** When bonding plastics, always test first, as not all plastics can be bonded properly. Do not bond any coated parts (powder coated or galvanized) with this adhesive.

SPEC. DATA

MSDS



30g



100g



250g



1000g



CAT. NO. CRL7528\*  
Cleaner/Degreaser



CAT. NO.	DESCRIPTION	CONTENTS
UV604L30	UV/Visible Light Adhesive	30g
UV604L10	UV/Visible Light Adhesive	100g
UV604L25	UV/Visible Light Adhesive	250g
UV604L1K	UV/Visible Light Adhesive	1000g
CRL7528	Cleaner and Degreaser	20 Oz. (567g)

Minimum order: 1 each. \*CRL Cleaner and Degreaser cannot be shipped via air freight.

## CRL UV601 Low Viscosity UV Adhesive

- Ideal for Glass-to-Glass Bonding
- Capillary Action
- Optically Clear

CRL UV601 is a low viscosity, 100% solids adhesive that forms resilient, high strength bonds between materials such as glass, metal, wood, and many plastics.

Due to its high purity UV601 is especially suited for bonding glass-to-glass where looks are paramount, making it suitable for bonding optical components. Because of its excellent capillary action (low viscosity) it is ideal for glass-to-glass and tempered glass-to-tempered glass bonding, primarily in the construction of showcases and the efficient production of glass furniture. Reduced clean-up time means glass furniture production cycles are done quickly and efficiently.

Bonds prepared with CRL UV601 are optically clear. The adhesive cures within seconds upon exposure to ultraviolet light. The speed of cure depends on the UV intensity as measured at the product surface, as well as the adhesive depth. Store adhesive away from sunlight.

CRL7528 Cleaner and Degreaser provides for optimum adhesion when used first to prepare the glass by removing any dirt and grease that is present.

**NOTE:** When bonding plastics, always test first, as not all plastics can be bonded properly. Do not bond any coated parts (powder coated or galvanized) with this adhesive.



CAT. NO.	DESCRIPTION	CONTENTS
UV60130	Low Viscosity UV Adhesive	30g
UV60110	Low Viscosity UV Adhesive	100g
UV60125	Low Viscosity UV Adhesive	250g
UV6011K	Low Viscosity UV Adhesive	1000g
CRL7528	Cleaner and Degreaser	20 oz. (567g)

Minimum order: 1 each. \*CRL Cleaner and Degreaser cannot be shipped via air freight.

## CRL UV603T Medium Viscosity UV Adhesive

- Extremely Flexible for Bonding Different Materials and Surface Bonding
- Capillary Action
- Optically Clear

CRL UV603T is a medium viscosity, 100% solids, general purpose adhesive that forms resilient, high strength bonds between materials such as glass, metal, ceramic, and many plastics.

CRL UV603T is extremely flexible, and demonstrates outstanding elongation, making it ideal for bonding different materials, as well as for surface bonding up to 1 m<sup>2</sup> (10.8 ft<sup>2</sup>). It shows good capillary action with glass up to 1/4" (6 mm) thick. For thicker glass apply to the bonding surface prior to assembly.

Bonds prepared with CRL UV603T are optically clear as well as resistant to moisture and yellowing. The adhesive cures within seconds upon exposure to ultraviolet light. The speed of cure depends on the UV intensity as measured at the product surface, as well as the adhesive depth. Store adhesive away from sunlight.

CRL7528 Cleaner and Degreaser provides for optimum adhesion when used first to prepare the glass by removing any dirt and grease that is present.

**NOTE:** When bonding plastics, always test first, as not all plastics can be bonded properly. Do not bond any coated parts (powder coated or galvanized) with this adhesive.



CAT. NO.	DESCRIPTION	CONTENTS
UV603T85	Medium Viscosity UV Adhesive	85g
UV603T1K	Medium Viscosity UV Adhesive	1000g
CRL7528	Cleaner and Degreaser	20 oz. (567g)

Minimum order: 1 each. \*CRL Cleaner and Degreaser cannot be shipped via air freight.

## CRL UV702 High Viscosity UV Adhesive

- Withstands High Static and Dynamic Forces
- Optically Clear
- Suitable for Universal Applications

CRL UV702 is a high viscosity, 100% solids, general purpose adhesive that forms resilient, high strength bonds between materials such as glass, metal, stone, wood, and many plastics.

CRL UV702 is ideal for making 'all-glass' showcases, glass shelves, and glass furniture. This adhesive does not have capillary properties, therefore it must be applied to the bonding surface prior to assembling the part. Ideal for bonding glass door knobs or metal towel bars in frameless shower door installations, as well as adhering metal standoff bases to glass.

Bonds prepared with CRL UV702 are optically clear as well as resistant to moisture and yellowing. The adhesive cures within seconds upon exposure to ultraviolet light. The speed of cure depends on the UV intensity as measured at the product surface, as well as the adhesive depth. CRL UV702 has outstanding ability to cure through large gaps and it cures to a hard surface that is transparent. Store adhesive away from sunlight.

CRL7528 Cleaner and Degreaser provides for optimum adhesion when used first to prepare the glass by removing any dirt and grease that is present.

**NOTE:** When bonding plastics, always test first, as not all plastics can be bonded properly. Do not bond any coated parts (powder coated or galvanized) with this adhesive.



SPEC. DATA

MSDS



CAT. NO. CRL7528\*  
Cleaner/Degreaser

CAT. NO.	DESCRIPTION	CONTENTS
UV70230	High Viscosity UV Adhesive	30g
UV70210	High Viscosity UV Adhesive	100g
UV70225	High Viscosity UV Adhesive	250g
UV7021K	High Viscosity UV Adhesive	1000g
CRL7528	Cleaner and Degreaser	20 Oz. (567g)

Minimum order: 1 each. \*CRL Cleaner and Degreaser cannot be shipped via air freight.

## CRL Colored UV Adhesives

- Five Colors Plus Clear for Surface Bonding of Glass Parts
- Brilliant, High Intensity Colors
- Bonds Bevels Onto Glass or Mirror
- Thin Viscosity



CAT. NO. CRL7528\*  
Cleaner/Degreaser

CRL Colored UV Adhesives are designed for bonding larger glass surfaces to make decorative colored pieces. An example would be a mirror with beveled clear glass bonded to the surface. The five different moisture-resistant colors can be used separately or mixed together for a wide range of color effects that are seen through the clear glass overlays. The Clear Base Adhesive is used to dilute the high intensity colors to produce a wide range of color options or to create separations between colors. This adhesive is intended for surface bonding only, and should never be used to bond edges (furniture construction). Due to the high color pigmentation the setting time is three to five times longer than typical clear UV adhesives and bonds are not as strong. Hands should be protected from the high color pigments by wearing our Disposable Nitrile Gloves (see page 270K).

CAT. NO.	DESCRIPTION	CONTENTS
UV90030	Clear Base UV Adhesive	30g
UV90010	Clear Base UV Adhesive	100g
UV90130	Red UV Adhesive	30g
UV90110	Red UV Adhesive	100g
UV90230	Yellow UV Adhesive	30g
UV90210	Yellow UV Adhesive	100g
UV90330	Blue UV Adhesive	30g
UV90310	Blue UV Adhesive	100g
UV90430	Green UV Adhesive	30g
UV90410	Green UV Adhesive	100g
UV90530	Black UV Adhesive	30g
UV90510	Black UV Adhesive	100g
UV900KT	Set of Six Colors	30g Each
CRL7528	Cleaner and Degreaser	20 Oz. (567g)

Minimum order: 1 each. \*CRL Cleaner and Degreaser cannot be shipped via air freight.

## CRL UV ADHESIVE PROPERTIES AT A GLANCE

UV ADHESIVE	VISCOSITY	FINAL CONSISTENCY	TENSILE/SHEAR STRENGTH*	BONDLINE GAP	MAX. ALLOWABLE CONTINUOUS TEMPERATURE**	TEMPERATURE RANGE-PEAK VALUES	COLOR
CRL UV601	20 - 100 cps at 25°C (77°F)	Very Hard Shore D 70 - 80	2460 psi	0.5 - 1 mil	50°C (122°F)	-40°C - 125°C (-40°F - 257°F)	Optically Clear
CRL UV701T	10 - 150 cps at 25°C (77°F)	Elastic Shore D 55 - 70	1737 psi	1 - 2 mils	70°C (158°F)	-40°C - 120°C (-40°F - 248°F)	Optically Clear
CRL UV602L	400 - 800 cps at 25°C (77°F)	Elastic Shore D 25 - 35	1450 psi	0.5 - 1 mil	50°C (122°F)	-50°C - 150°C (-58°F - 302°F)	Optically Clear
CRL UV603T	400 - 800 cps at 25°C (77°F)	Elastic Shore D 25 - 35	1450 psi	0.5 - 1 mil	50°C (122°F)	-50°C - 150°C (-58°F - 302°F)	Optically Clear
CRL UV604L	500 - 1000 cps at 25°C (77°F)	Very Hard Shore D 65 - 75	2968 psi	0.5 - 1 mil	50°C (122°F)	-40°C - 130°C (-40°F - 266°F)	Optically Clear
CRL UV702	1000 - 2000 cps at 25°C (77°F)	Hard Shore D 60 - 70	1625 psi	1 - 2 mils	70°C (158°F)	-40°C - 120°C (-40°F - 248°F)	Optically Clear
CRL UV703	3000 - 6000 cps at 25°C (77°F)	Very Hard Shore D 50 - 60	2046 psi	1 - 2 mils	70°C (158°F)	-40°C - 120°C (-40°F - 248°F)	Optically Clear
LOCTITE® IMPRUV™	6000 - 13500 mPas at 25°C (77°F)	Very Hard Shore D 70	2175 psi	N/A	N/A	-54°C - 150°C (-65°F - 302°F)	Optically Clear

\* When recommended minimum and maximum layer thicknesses are taken into consideration, the tensile/shear strengths listed in the table can be achieved.

\*\* The maximum allowable continuous temperature shows the maximum temperature at which the cured adhesive is not irreversibly damaged. With increasing temperatures the maximum strength steadily decreases.

THESE ARE TYPICAL PROPERTIES AND ARE NOT MEANT TO BE PRODUCT SPECIFICATIONS.

**NOTE:** The information contained in this chart and product pages are believed to be reliable. C.R. Laurence Co., Inc. makes no representation or warranties of any kind concerning this information. It is the user's responsibility to determine the suitability of this product for any intended use. The user assumes all risk and liability connected with the use of these products.

## CRL UV ADHESIVE PROPERTIES AT A GLANCE

UV ADHESIVE	PROPERTIES	APPLICATIONS	BONDING SUBSTRATES (BY PRIORITY)	STORAGE IN ORIGINAL CONTAINER
CRL UV601	Excellent capillary action, resistant to moisture.	Efficient production of glass furniture and showcases. Easy clean-up. Suitable for optical components.	Glass-to-glass, glass-to-metal, wood, many plastics.	Cool, dry, dark location (without UV radiation).
CRL UV701T	Excellent capillary action, resistant to moisture and yellowing.	Efficient production of glass furniture and showcases. Easy clean-up.	Glass-to-glass, tempered glass-to-tempered glass, glass-to-metal (steel, aluminum, stainless steel), glass to many plastics.	Cool, dry, dark location (without UV radiation).
CRL UV602L	Good capillary action, high vibration resistance, resistant to moisture and yellowing.	Especially for bonding laminated glass, ideal for bonding different material combinations.	Laminated glass to: glass, laminated glass, metal, ceramic, many plastics.	Cool, dry, dark location (without UV radiation).
CRL UV603T	Good capillary action, extremely flexible, high vibration resistance, resistant to moisture and yellowing.	Ideal for bonding different material combinations, surface bonding up to 1 m <sup>2</sup> .	Glass-to-glass, glass-to-metal, glass-to-ceramic, glass to many plastics.	Cool, dry, dark location (without UV radiation).
CRL UV604L	Apply prior to glass assembly, resistant to moisture and thermal cycling, high tensile shear and peel strength bonds.	Especially for glass-to-metal bonding in furniture production.	Glass-to-metal, glass-to-glass, tempered-glass-to-tempered glass, glass-to-metal (steel, aluminum, stainless steel), ceramic, stone, wood, and some plastics.	Cool, dry, dark location (without UV radiation).
CRL UV702	Apply prior to glass assembly, resistant to moisture and thermal cycling.	Constructions subject to high static loads, difficult climate conditions especially for glass/metal bonding in furniture production.	Glass-to-metal, glass-to-glass, tempered glass-to-tempered glass, glass-to-stone, glass-to-wood, glass to many plastics.	Cool, dry, dark location (without UV radiation).
CRL UV703	Apply prior to glass assembly, resistant to moisture and yellowing.	Shower enclosure glass knobs and metal towel bars, metal standoff bases, glass shelves, showcases, glass sculptures.	Glass-to-glass, glass-to-metal (steel, aluminum, stainless steel), glass to many plastics.	Cool, dry, dark location (without UV radiation).
LOCTITE® IMPRUV™	Apply prior to glass assembly.	Shower enclosure glass knobs and metal towel bars, metal standoff bases, glass shelves, showcases, glass sculptures.	Glass-to-glass, glass-to-metal.	Cool, dry, dark location (without UV radiation).



## CRL UV Glass Bonding System Catalog

### • Simplified Technology for Efficient and Safe Glass Bonding

CRL takes the mystery out of glass bonding with our complete line of UV and UV/Visible Light Adhesives, Fixation Devices, and UV Lamps. Everything you need with easy-to-understand instructions and guidelines to produce glass bonded work from functional glass furniture to beautiful glass artwork. There are hundreds of possible uses in glass construction with the Glass Bonding System from CRL.

New innovative Fixation Devices make construction faster and easier. Advanced UV Adhesives provide strong bonds to many different substrates including laminated glass, tempered glass, steel, aluminum, stainless steel, ceramic, stone, wood, and plastics. We have a wide selection of UV Lamps for fast bonding of all sizes of glass furniture. We even have basic UV Starter Kits for first time users and Professional Kits for full time users, plus all the right cleaners and accessories needed to make your job easier and more profitable. See them all in this full color catalog.

CAT. NO. GB10

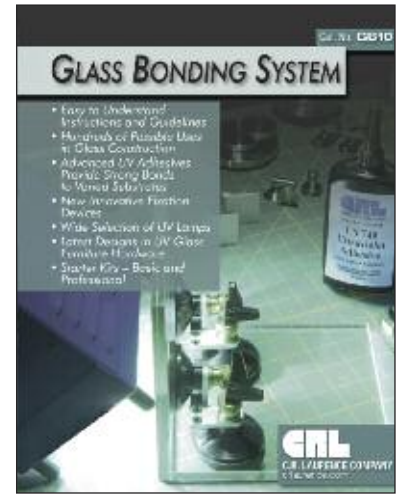

## CRL Fixation Devices

- Used When Curing UV Adhesives
- Prevents Bonding Parts From Moving While Curing
- Adjustable to Multiple Angles

It is absolutely critical that the bonded surfaces are kept stabilized and in a fixed position while UV Adhesives are curing. This is made possible by using these specially designed CRL Fixation Devices. From simple economical clamps to precision engineered, adjustable holders that are capable of placing the parts in precise angled positions, CRL offers a complete line of Fixation Devices designed for use when bonding UV Adhesives. These devices allow just one person to manage the steps involved when working with UV Adhesives. Using our CRL Fixation Devices properly will give professional results.



## CRL Adjustable Angle Suction Holder

- Adjustable Between 45 and 300 Degrees
- Precise Adjustment to Any Desired Position
- Suction Cups Hold Glass Firmly in Place While Adhesive Cures

This CRL Adjustable Angle Suction Holder grips glass from outside or inside surfaces. Position can be precisely adjusted by a knob. Glass is held firmly in place with 4-1/2" (114 mm) diameter rubber suction pads until the surfaces are firmly bonded. **NOTE:** Do not use to lift or carry glass or marble. Minimum order is one each.

**new**



CAT. NO. 3C024090  
4-1/2" Protective Pad Cover



CAT. NO. WH9602G

## CRL Adjustable Angle Suction Holder

- Holds Glass Pieces From Inside or Outside Surface While Adhesive Cures
- Adjustable Between 40 and 300 Degrees

This CRL Adjustable Angle Suction Holder grips glass from outside or inside surfaces, and can be fixed at a desired angle of 40 to 300 degrees. Height and position can be adjusted up to 11/16" (18 mm) by knobs located on each arm. Glass is held firmly in place with 4-3/4" (120 mm) diameter rubber suction pads until the surfaces are firmly bonded. Minimum order is one each.



CAT. NO. UV282

## CRL Inside 90 Degree Suction Holder

- Suction Cups Hold Glass Firmly in Place While Adhesive Cures
- Holds Glass Pieces at 90 Degrees
- Perfect for Frameless Shower Installations As Well

This CRL Inside 90 Degree Suction Holder grips glass on the inside surfaces at a fixed 90 degree angle. Height and position can be adjusted up to 11/16" (18 mm) by knobs located on each arm for precise UV adhesive application. Glass pieces are held firmly in place by rubber suction cups measuring 4-3/4" (120 mm) in diameter until they are bonded. Minimum order is one each.

**CAT. NO. UV280**

Inside Surface Suction Holder



## CRL Outside 90 Degree Suction Holder

- Suction Cups Hold Glass Firmly in Place While Adhesive Cures
- Holds Glass Pieces at 90 Degrees
- Perfect for Frameless Shower Installations As Well

This CRL Outside 90 Degree Suction Holder grips glass on the outside surfaces at a fixed 90 degree angle. Height and position can be adjusted up to 11/16" (18 mm) by knobs located on each arm for precise UV adhesive application. Glass pieces are held firmly in place by rubber suction cups measuring 4-3/4" (120 mm) in diameter until they are bonded. Minimum order is one each.

**CAT. NO. UV281**

Outside Surface Suction Holder



## CRL 90 Degree Clamp-It® Assembly Square Kits

- Holds Glass Pieces at Fixed 90 Degree Angle
- Cost-Effective Method for Holding Glass Surfaces in Place

These CRL 90 Degree Clamp-It® Assembly Square Kits allow you to align, hold, and clamp glass securely in place while bonding the glass pieces with UV adhesives. Both six-piece Kits come complete with two assembly squares and four steel bar clamps. The squares are manufactured from high-impact, rigid polycarbonate to ensure strength and accuracy. The steel bar clamps feature an ergonomic handle with a friction fit for quick and easy one-handed operation.



Mini Clamp-It® Clamps Shown



**CAT. NO. UV69954**

Clamp-It® Kit



**CAT. NO. UV69962**

Mini Clamp-It® Kit

CAT. NO.	DESCRIPTION	SQUARE SIZE	BAR CLAMP SIZE	BAR CLAMP THROAT DEPTH
UV69954	Clamp-It® Kit	8" x 8" x 1-1/2" (203 x 203 x 38 mm)	5" (127 mm)	3/4" (19 mm)
UV69962	Mini Clamp-It® Kit	4" x 4" x 1-1/4" (102 x 102 x 32 mm)	4" (122 mm)	3/4" (19 mm)

Minimum order: 1 each.

Clamp-It is a registered trademark of Rockler Companies, Inc.



## CRL Pump-Activated 90 Degree Suction Holder

- Holds Glass at 90 Degrees
- Superior Vacuum Stability
- Precise Positioning Every Time

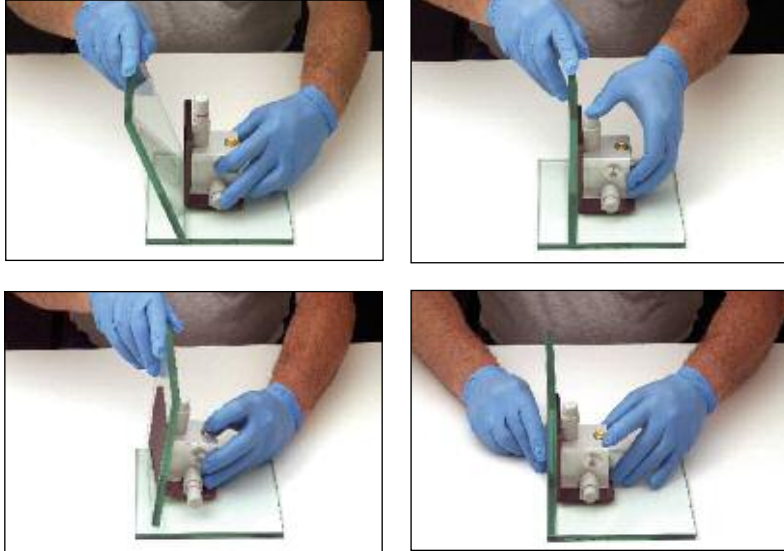

**CAT. NO. UV6380**  
Single Pump – Activated Holder



**CAT. NO. UV6389**  
Set of Two Pump – Activated Holders in Case

CRL Pump-Activated 90 Degree Suction Holders have a self-contained priming pump with excellent vacuum stability that holds glass pieces firmly at a fixed 90 degree angle. Excellent for fabricating glass cases, shelves, and showcases with horizontal and vertical partitions. Beveled corners prevent contact with the UV adhesive. Each unit has two built-in vacuum pumps, which can be quickly and individually vented to allow parts to be repositioned as needed.

The unique duranodic finish on the attachment plates provides a better grip on the glass, eliminates oxidation, and is resistant to adhesion of foreign materials. If a vacuum loss were to occur, a red indicator ring warns that the pump needs to be re-primed. Holders are easy to work with in limited space since the Holder surfaces measure only 2-7/8" x 3-15/16" and 3-15/16" x 3-15/16" (73 x 100 mm and 100 x 100 mm) and can be turned to suit the space available. This CRL Suction Holder is available as a single unit or in a convenient set of two packed in a sturdy carrying case. Minimum order is one each.

## CRL Magfix Fixed 90 Degree Magnetic Cube

- Holds Glass at 90 Degrees
- Cup Type Neodymium Magnet
- Holds Up to 3/8" (10 mm) Glass

The CRL Magfix Fixed 90 Degree Magnetic Cube securely holds smaller glass parts up to 3/8" (10 mm) thick at 90 degree angles. The cube is ideal for use in areas with limited space since it measures only 2-7/32" (56 mm) square. Plates measure 1-3/16" x 3-3/16" (30 x 81 mm). Cube and Counter Plates have beveled edges, and are lacquered to avoid scratches on glass surfaces and adhesion of UV Adhesives during application. Minimum order is one each.



**CAT. NO. UV6340**

**CAUTION:** Strong Magnetic Field. Keep Away from Cardiac Pacemakers.

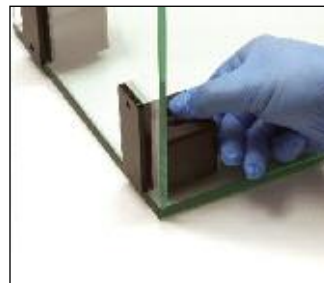

## CRL Adjustable Angle Suction Holder

- Holds Glass Pieces From Inside or Outside Surface
- Adjustable Between 60 and 240 Degrees

This CRL Adjustable Angle Suction Holder grips glass pieces from outside or inside surfaces, and can be fixed at desired angles of 60 to 240 degrees. Height and position can be adjusted up to 5/16" (8 mm) by knobs located on each arm. 2-3/8" (60 mm) diameter rubber suction pads hold glass panels firmly until they are bonded. Minimum order is one each.

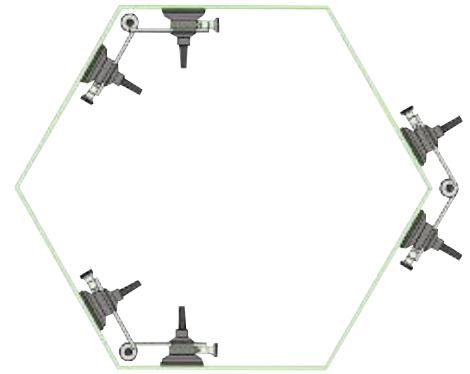

CAT. NO. UV2933

## CRL Eccentric Height Adjustment Stop

- Adheres to Glass With Suction Cup
- Used for Height Adjustment of Glass Pieces
- Shelf Leveling Made Easy

These CRL Eccentric Height Adjustment Stops can be used in pairs to make precision height adjustments of glass pieces before bonding with UV adhesives. Simply rotate the disk to the desired position. Minimum order is one each.

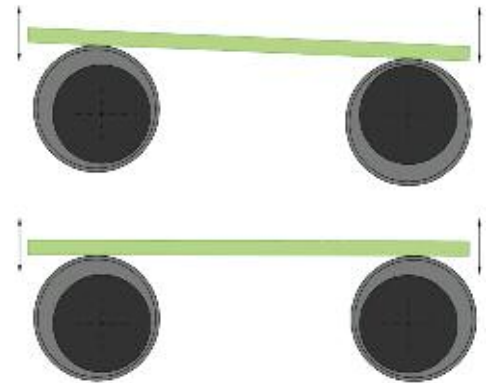

CAT. NO. UV285

## CRL Suction Stop and Holder

- Used to Hold Glass Panels in Place
- Can Be Adjusted With Great Precision

This handy CRL Suction Stop and Holder can be used in pairs to hold a glass shelf in place while bonding with UV adhesive. Just flip the cup lever for glass attachment, then loosen the knurled nut to allow the height adjustment bar to be moved as needed. Suction pad measures 2-1/4" (57 mm). A replacement vacuum cup unit is available, Cat. No. 5195. Minimum order is one each.



CAT. NO. RH670

## CRL UV Assembly Shim Set

- Precise Positioning Aids
- Alignment Shims Cushion and Center Doors and Hardware During Assembly

CRL UV Assembly Shims make precise positioning of glass doors and hardware simple and repeatable. Pre-assemble a cabinet door or any similar configuration and be assured that every clearance gap is precisely aligned top to bottom, side to side.



### CRL UV ASSEMBLY SHIM SET INCLUDES:

- 10 each 2" x 1/16" x 1/4" (51 x 1.6 x 6.3 mm)
- 10 each 2" x 1/8" x 1/4" (51 x 3.2 x 6.3 mm)
- 10 each 2" x 1/4" x 1/4" (51 x 6.3 x 6.3 mm)
- 10 each 2" x 3/8" x 1/4" (51 x 9.5 x 6.3 mm)
- 10 each 2" x 1/2" x 1/2" (51 x 12.7 x 12.7 mm)

Minimum order is one package.

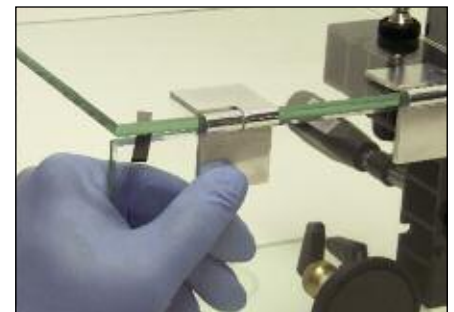

CAT. NO. UVSH1MS

## CRL Adjustable Inside 90 Degree Suction Holder

- Adjustable Height and Position
- Suction Cups Hold Glass Firmly in Place at 90 Degrees While Adhesive Cures

This CRL Adjustable Inside 90 Degree Suction Holder firmly grips glass from the inside surface at 90 degrees. Height and position can be adjusted up to 5/16" (8 mm) by knobs located on each arm for precise UV adhesive application. Glass pieces are held firmly in place by 2-1/8" (54 mm) diameter rubber suction pads until they are bonded. Minimum order is one each.



CAT. NO. WH7080

## CRL Adjustable Outside 90 Degree Suction Holder



- Adjustable Height and Position
- Suction Cups Hold Glass Firmly in Place at 90 Degrees While Adhesive Cures

This CRL Adjustable Outside 90 Degree Suction Holder firmly grips glass from the outside surface at 90 degrees. Height and position can be adjusted up to 5/16" (8 mm) by knobs located on each arm for precise UV adhesive application. Glass pieces are held firmly in place by 2-3/8" (60 mm) diameter rubber suction pads until they are bonded. Minimum order is one each.



CAT. NO. UV2932

## CRL Fixed Position Inside 90 Degree Suction Holder

- Suction Cups Hold Glass Firmly in Place While Adhesive Cures

This CRL Inside 90 Degree Suction Holder firmly grips glass from the inside surface at a fixed 90 degree angle. 2-3/8" (60 mm) diameter rubber suction pads hold the glass pieces firmly until they are bonded. Minimum order is one each.



CAT. NO. UV2921

## CRL Fixed Position Outside 90 Degree Suction Holder



- Suction Cups Hold Glass Firmly in Place While Adhesive Cures

This CRL Outside 90 Degree Suction Holder firmly grips glass from the outside surface at a fixed 90 degree angle. 2-3/8" (60 mm) diameter rubber suction pads hold the glass pieces in place until they are bonded. Minimum order is one each.



CAT. NO. UV2922

## CRL Adjustable 90 Degree Interior Corner Support



- Holds Glass at 90 Degrees

CRL Fixed 90 Degree Interior Corner Support holds glass pieces from inside surfaces at 90 degrees. Height and position can be adjusted up to 11/16" (17 mm) by knobs located on each arm for precise UV adhesive application. 4-3/4" (120 mm) diameter rubber suction pad holds glass pieces firmly until they are bonded. Minimum order is one each.

Shown in use with Cat. No. UV290 Fixed Interior Corner Clamp (Sold Separately)

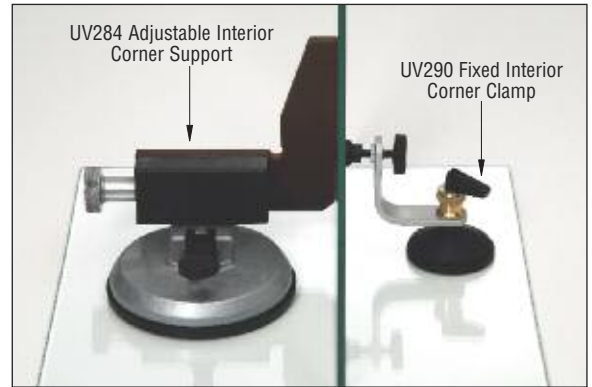

CAT. NO. UV284

## CRL Fixed 90 Degree Exterior Tall Arm Corner Clamp

- Holds Glass at 90 Degrees

The CRL Fixed 90 Degree Exterior Tall Arm Corner Clamp holds glass pieces from outside surfaces at 90 degrees. The outside arm is 4-5/8" (117 mm) tall with an adjustable thrust pad. This Clamp can be used with our Cat. No. UV284 Support to hold glass pieces while bonding. 2-3/8" (60 mm) diameter rubber suction pad holds glass pieces firmly until they are bonded. Minimum order is one each.



CAT. NO. UV289

## CRL Fixed 90 Degree Interior Corner Clamp

- Holds Glass at 90 Degrees

The CRL Fixed 90 Degree Interior Corner Clamp holds inside glass pieces at 90 degrees. Can be used with our Cat. No. UV284 Support to hold glass pieces while bonding. 2-3/8" (60 mm) diameter rubber suction pad holds glass pieces firmly until they are bonded. Minimum order is one each.

Shown in use with Cat. No. UV284 Adjustable Interior Corner Support (Sold Separately)

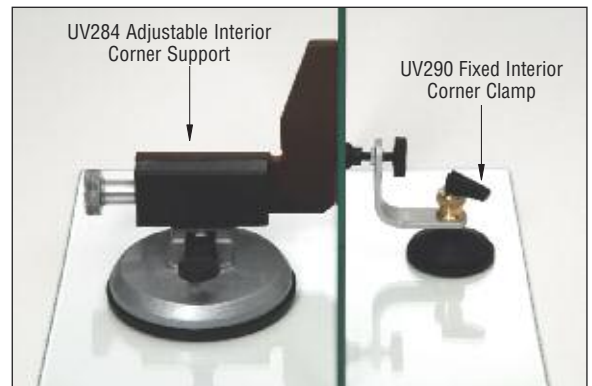

CAT. NO. UV290

## CRL Fixed 90 Degree Exterior Short Arm Corner Clamp

- Holds Glass at 90 Degrees

CRL Fixed 90 Degree Exterior Short Arm Corner Clamp holds glass pieces from outside surfaces at 90 degrees. The outside arm is 3-1/4" (83 mm) tall with an adjustable thrust pad. This Clamp can be used with our Cat. No. UV284 Support to hold glass pieces while bonding. 2-3/8" (60 mm) diameter rubber suction pad holds glass pieces firmly until they are bonded. Minimum order is one each.



CAT. NO. UV291

## CRL UV Hardware Positioning Device

- **Accurately Aligns Locks, Hinges, and Other Hardware**
- **Fast Set-Up**

Accurate positioning of UV bonding hardware is essential to producing high quality finished displays, showcases, and furniture. The CRL UV Hardware Positioning Device quickly attaches to the glass with a 2-1/8" (54 mm) suction cup, and features a pivoting arm to align hardware on two surfaces when required. Once in place, the initial adhesion set can be made, the Positioning Device removed, and the final cure can then be completed. Minimum order is one each.



CAT. NO. UV6335

## CRL UV Lay-Out Mat

- **Accurately Position Your UV Projects**
- **Easy to Read Grid Lines With 45, 90, and 135 Degree Calibrations**

CRL's UV Lay-Out Mat covers a large 24" x 36" (610 x 914 mm) work surface and lets you check your bonding project for square prior to adhesive application. The surface is self-healing should you also use it for razor cutting. Flip it over to the blank side and you have a durable, protective surface for your other work. Minimum order is one each.

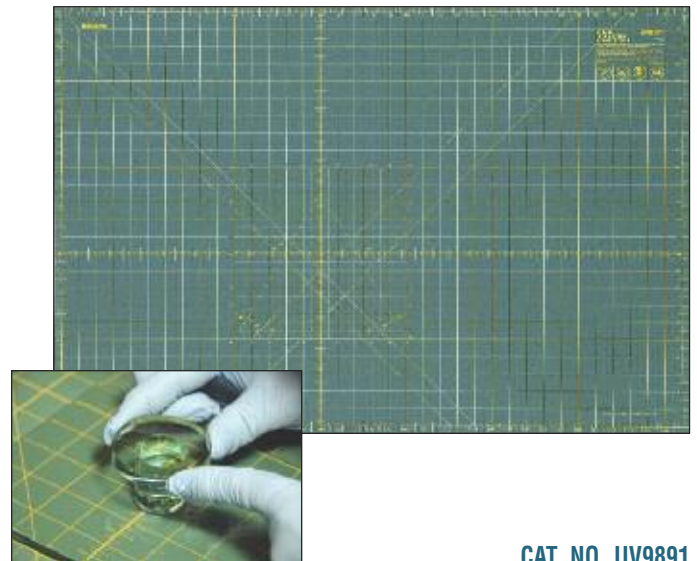

CAT. NO. UV9891

## CRL UV Bonding Work Surface Carpet

- **Dark Color Absorbs UV Light**
- **Special Long Wearing High Density Material**

This CRL UV Bonding Work Surface Carpet makes an ideal work area and protects against glass damage. It's light-absorbing material is appropriate when setting your UV bonding lamps aside. Note that you should never set your lamps face-down directly on this carpet as excessive heat build up will take place (always use a guard or other support). Carpet measures 36" x 72" (914 x 1829 mm). Minimum order is one each.



CAT. NO. UV3672

## CRL Third-Hand Power Clamp



- 4-1/2" (114 mm) Vacuum Cup
- 9" (229 mm) Long Clamping Bar

- Bar Adjusts 5-3/4" (146 mm) Side-to-Side
- Two Threaded Clamp Knobs

The CRL Third-Hand Power Clamp is perfect for holding parts in place during curing or bonding projects. Attach the pump-style vacuum cup to a clean, flat surface and swing the arm into position so one threaded finger centers over the part to be clamped. Screw the clamping finger down until contacting the part. Finally, screw down the finger on the opposite end of the bar to apply additional pressure straight down on the part being worked. This is the perfect solution to clamping shower door hardware into position while UV

adhesive cures. It also eliminates the possibility of parts shifting or twisting away from desired locations. It is also useful for holding automotive moldings, door and window trim, or any other object you would normally secure in place with masking tape.

The 4-1/2" (114 mm) diameter vacuum cup features a red safety indicator line to warn of vacuum loss. Finger tabs on the side of the cup allow quick release of vacuum pressure. Minimum order is one each.

**CAT. NO. UV91111**

## CRL Multi-Purpose SwasiClamp

- Use for Inside or Outside Angle Applications
- Shower Door Fixed Panel Assembly
- UV Assembly Bonding

The CRL Multi-Purpose SwasiClamp is a totally new clamp design intended to solve a variety of problems in fastening components together while bonding or sealing. This unique clamping device features a lever-actuated 4-3/4" (121 mm) vacuum cup connected to a three-piece articulated arm, which ends with a threaded plunger arm. SwasiClamp can be turned, twisted or reversed to solve virtually any clamping job ranging in length up to 13" (330 mm).

Add the CRL SwasiClamp Accessory Kit and double your range of options. Consisting of an additional 4-3/4" (121 mm) vacuum cup and another threaded plunger arm, this Kit allows clamping of additional angles and added force to original configurations. The Accessory Plunger Arm can clip onto the SwasiClamp articulated arm or into the Accessory Vacuum Cup. Whether your work scope involves shower doors or glass furniture bonding with UV Adhesives, the CRL SwasiClamp and SwasiClamp Accessory Kit are the installer's new best friend. Minimum order is one each.



**CAT. NO. UV2010**  
SwasiClamp



Shown With Optional UV2010A  
Accessory Kit



**CAT. NO. UV2010A**  
Optional Accessory Kit

## CRL UV Curing Lamps and Accessories

### Curing UV Adhesives

To cure the technologically advanced UV Adhesives offered by C.R. Laurence, UVA Lamps emitting wave lengths in the range of 315-400 nm are required. A comprehensive selection of models is available to meet all the requirements to construct beautifully finished showcase, display, furniture, and specialty projects.

Depending on the type of construction used, the choice of the proper UV Curing Lamps is essential. Depending on the choice of lamp used, prior testing is recommended to determine full cure time based on the lamp's strength and the age of the bulb. Our Cat. No. UV1365 UV Transmission and Power Meter (see page 335K) can provide precise ratings when needed.

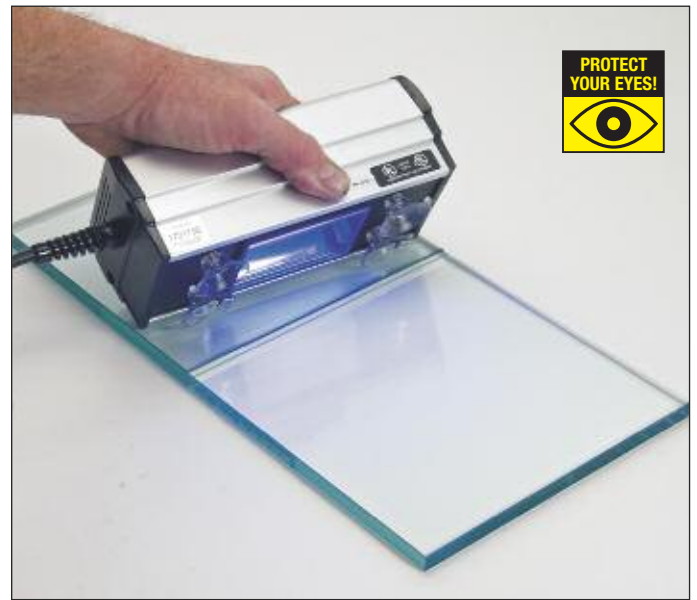
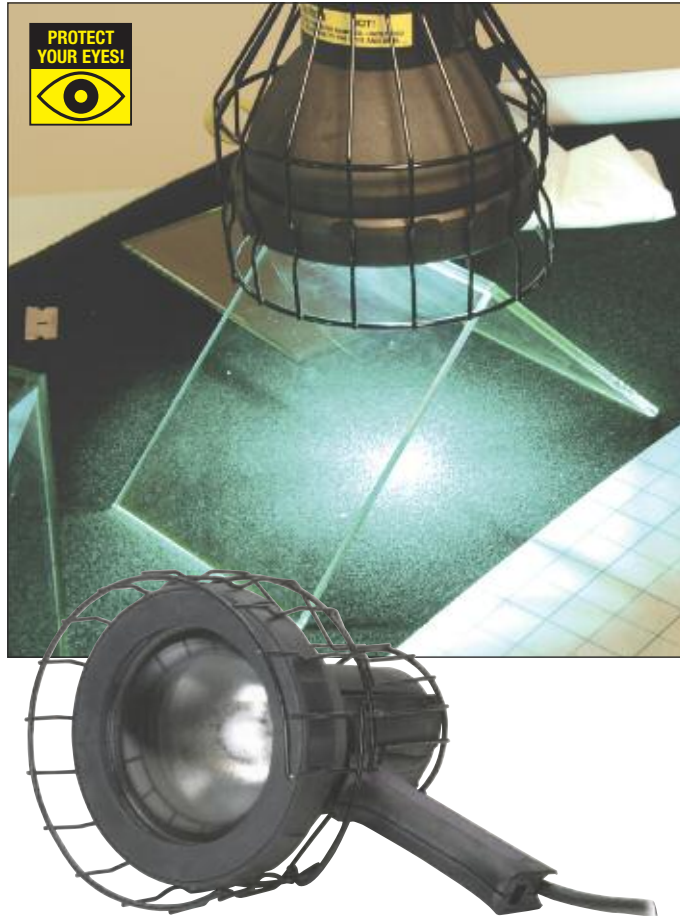

Bonding metal hardware to glass requires a smaller UV light area for the quickest cure times. Our Cat. Nos. UV255 and Z7596 Lamps are ideal choices. Only about 10 to 15 seconds are required for an initial set, and 90 to 120 seconds for full cure. Our Cat. No. UB80 Lamp takes longer for the initial set, approximately 60 to 90 seconds, and four to six minutes for final cure. Our Cat. No. UV240 Lamp provides an initial set of 25 to 30 seconds, and three to four minutes for full cure.

Longer lengths of glass in showcase and furniture construction should have the adhesive cured with Tube Lamps such as our Cat. Nos. XX40 or UVBL15 to assure tension-free results. Keep in mind that bond tension caused by curing shorter lengths at a time result in bond damage or glass breakage. UVA Tube Lamps take approximately 30 seconds for pre-curing, and three to five minutes for a full cure.



Safe lamp use must take into account the considerable heat developed by our high intensity bulb lamps. Always be sure to keep lamps away from combustible materials. Place them on a non-flammable surface when putting lamps aside. Lamps should never be positioned with the filter screen face down as this will cause excessive heat build-up that could destroy the lamp.

CRL UV Lamps are equipped with filter screens to reduce potential damage to eyes and skin. However, we strongly recommend the use of our Nitrile Gloves (see page 270K) to protect your skin, and the appropriate eye protection provided by our UV Spectacles, Goggles or Face Mask (see page 335K).

## CRL Hand-Held Spot Bulb UV Curing Lamp



- **Powerful 100 Watt Lamp Cures UV Adhesives in Seconds**
- **Lamp Head is Ergonomically Designed to Prevent Fatigue**
- **Impact Resistant Polymer Housing is Dent-Proof**



The CRL Hand-Held Spot Bulb UV Curing Lamp provides up to a 40mW/cm<sup>2</sup> of UV-A energy to cure all of our UV Adhesives in just seconds. Perfect for fabricating with our UV Bonded Hardware components, its unique filter provides maximum curing energy while minimizing the hazardous radiation inevitably produced by all high-intensity UV-A lamps.

Cat. Nos. Z7596 and AUZ7596 combine state-of-the-art design innovations with traditional proven features like the detachable lamp head with 96" (2.44 m) cord for lightweight hand-held use. Keep the lamp head mounted on the transformer and rotate it 360 degrees in either the horizontal or vertical positions for bench use. Included with each lamp is one pair of Cat. No. UVG50 Goggles, one pair of Cat. No. UVS30 Spectacles, and a Cat. No. UVG100 Heat Guard Stand to minimize the risk of accidental burn injury. Replacement bulbs and filters are available. Minimum order is one each.



CAT. NO.	DESCRIPTION
Z7596	Hand-Held Spot Bulb UV Curing Lamp 110V AC 60Hz
AUZ7596	Hand-Held Spot Bulb UV Curing Lamp 240V AC 50Hz
Z100SM	Replacement Bulb for Lamps with Serial Numbers 1567104 and Higher
Z100S	Replacement Bulb for Lamps with Serial Numbers 1567103 and Lower
Z2F100C	Replacement Filter for Z7596/AUZ7596
UVG100	Heat Guard Stand for Z7596/AUZ7596

Minimum order: 1 each.

## CRL High-Intensity Hand-Held UV Curing Lamp



- **High-Intensity Light Cures Fast**
- **Lightweight, Under 3 Lbs. (1.3 kg)**
- **13' (4 m) Electrical Cord**
- **Built-In Cooling Fan**

CRL's High-Intensity Hand-Held UV Adhesive Curing Lamp provides the best uniform UV adhesive curing with a 96 square inch (8" x 12"), 620 square centimeter (20 x 30 cm) curing area at a distance of 8" (20 cm) by use of its highly efficient 250 watt halide UV bulb. The uniform intensity distribution is guaranteed by its optimized reflector surface.

Designed to cure all CRL UV Bonding Adhesives, the Cat. No. UV255 features spacer spots near the lamp's lens to prevent overheating when the lamp unit is laid down. An hour counter integrated into the ballast box provides for operational monitoring and control over lamp life.

The high-strength aluminum and polycarbonate lamp housing makes this lamp a very durable UL 2422 Approved curing device.



CAT. NO.	DESCRIPTION
UV255	High-Intensity Hand-Held UV Curing Lamp 110V
UV255230	High-Intensity Hand-Held UV Curing Lamp 230V
UV255B	Replacement Bulb
UVH255F	Replacement Filter

Minimum order: 1 each.



## CRL Compact AC UV Curing Lamp



3" (76 mm)



- Lightweight and Durable
- Excellent for Smaller Projects
- Built-In Suction Cups for Positioning

The CRL Compact AC UV Curing Lamp is a great tool to assist you in the introduction to UV glass bonding. Although small in size, initial pre-cure and full cure bonding is assured with it's 3,500 micro watts/cm<sup>2</sup> light output. The built-in suction cups allow you to fix the lamp's position securely during the curing process.

CAT. NO.	DESCRIPTION
UV240	Compact Curing Lamp 110 Volts AC 60Hz
UV240230	Compact Curing Lamp 230 Volts AC 50Hz
UV240BULB	Replacement Bulb for UV240, UV240230 and UB80

Minimum order: 1 each.

## CRL Battery Operated UV Curing Lamp

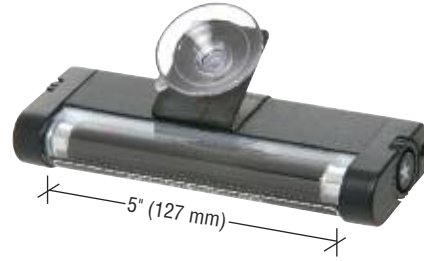

5" (127 mm)



- Cures All CRL UV Bonding Adhesives
- Built-In Suction Cup for Positioning

Our Battery Operated UV Curing Lamp may be small, but when allowed the appropriate initial pre-cure and final curing times, the resulting bonds will be high quality in strength and appearance. Power comes from the four "AA" batteries included with the Lamp, producing 1,000 micro watts/cm<sup>2</sup> of light output. This is the most affordable tool to use when starting out with UV bonding on a small scale.

CAT. NO.	DESCRIPTION
UB80	Battery Operated UV Adhesive Curing Lamp
UV240BULB	Replacement Bulb for UB80, UV240, and UV240230

Minimum order: 1 each.

## CRL High-Intensity LED UV Curing Lamp Kit

- Small in Size, Big in Energy Savings
- 30,000 Hour LED Bulb Life
- Perfect for Affixing UV Bonding Hardware
- Cures All CRL UV Bonding Adhesives

CRL's High-Intensity LED UV Curing Lamp provides ultra-high intensity up to 18,000 micro watts/cm<sup>2</sup> of light output to cure UV adhesives incredibly fast. Push the 'on' button and the lamp immediately reaches full power and is ready for use, eliminating the down time waiting for bulbs to warm up. Cordless operation lets you move around your work unencumbered, and the powerful NiMH battery will operate the lamp continuously for 90 minutes before a recharge is needed.

The 2" (51 mm) lamp diameter and 8" (203 mm) length of the lamp's body is encased in durable anodized aluminum. The LED bulb is made with an electronic intensity stabilizer to ensure consistent performance, which also means that the beam strength will not fade while operating between charges. Kit comes complete with smart AC and DC Chargers, UV Absorbing Spectacles, Belt Holster, and padded Carrying Case. Optional 240V AC Chargers are available and sold separately.



CAT. NO. OPX365



CAT. NO. RB3FA  
Optional 240V Charger with Australian Plug



CAT. NO. RB3FB  
Optional 240V Charger with European Plug



CAT. NO.	DESCRIPTION
OPX365	High-Intensity LED UV Curing Lamp Kit
RB3FA	Optional Australian Use 240V AC Charger
RB3FB	Optional European Use 240V AC Charger

Minimum order: 1 each.

## CRL Single Tube UV Curing Lamp

- Cures All CRL UV Bonding Adhesives
- Extra Long 30 Foot (9.1 m) Cord
- 17-1/2" (444 mm) Irradiation Length

The CRL Single Tube UV Curing Lamp is easily moved from position to position due to its lightweight and long 30' (9.1 m) electrical cord. The 365 nm output is ideal for curing all CRL UV Bonding Adhesives for glass-to-glass and glass-to-metal applications. The 17-1/2" (444 mm) irradiation length will cure seams up to that length. You can add more lamps end-to-end for longer lengths.

The on/off switch is conveniently located at the hand held end of the lamp. The fluorescent bulb is protected by a heavy-duty acrylic tube, and has a light shield around the back side. A hanging hook is built in for temporary mounting positions.



CAT. NO. UVBL15

CAT. NO.	DESCRIPTION
UVBL15	Single Tube 15 Watt UV Curing Lamp 110 Volts 60Hz
UVBL15BULB	Replacement Bulb for 15 Watt Single Tube UV Curing Lamp

Minimum order: 1 each.

## CRL Long Double Tube UV Curing Lamp

- 48" (1219 mm) Tubes for Long Seam UV Bonding
- Most Powerful Lamp of Its Type
- Mountable Fixture Housing

The CRL Long Double Tube UV Curing Lamp is perfect for use where high-intensity, wide-area UV coverage is needed. Specially filtered 40 watt bulbs make it the most powerful lamp of its type available. Suited to cure all CRL UV Bonding Adhesives, it features an enameled sheet metal housing that can be side mounted, hung overhead, or used as a portable lamp to accommodate many different requirements.

A corrosion-resistant, specular aluminum reflector ensures maximum UV irradiance. On/off switch is conveniently located on the lamp's housing. Lamps are U.L. listed.



CAT. NO. XX40  
Double Tube Lamp

CAT. NO.	DESCRIPTION
XX40	Double Tube UV Curing Lamp 110 Volts AC 60Hz
XX40230FA	Australian Use Double Tube UV Curing Lamp 230 Volts AC 50Hz
XX40230F	European Use Double Tube UV Curing Lamp 230 Volts AC 50Hz
XX40BULB	Replacement Bulb for Double Tube UV Curing Lamp

Minimum order: 1 each.



CAT. NO. XX40BULB  
Replacement Bulb

## CRL Double Tube UV Curing Lamp

- Cures All CRL UV Bonding Adhesives
- 17-1/2" (444 mm) Irradiation Length
- Fully Enclosed, Filtered Housing



Available Only in Europe



The CRL Double Tube UV Curing Lamp delivers 25 watts of curing power via two 18" (457 mm) fluorescent UV bulbs providing 17-1/2" (444 mm) of irradiation. This 230 volt lamp is fully enclosed and filtered to control and focus UVA radiation on the bonding joint. The 365 nm output is tuned to quickly cure all CRL UV Adhesives. Includes convenience of body mounted on/off switch and handle.

This powerful and durable tool with its 230 volt, 50 cycle wiring is CE approved for the European Market. **NOTE:** For sale in Europe only.



CAT. NO. UVBL25EU

CAT. NO.	DESCRIPTION
UVBL25EU	Double Tube 25 Watt UV Curing Lamp 230 Volts 50Hz
UVBL25BULB	Replacement Bulb for 25 Watt Twin Tube Curing Lamp

Minimum order: 1 each.

## CRL UV-Absorbing Spectacles

- Protects Against UV Exposure
- Fits Easily Over Regular Eyeglasses



Ultraviolet light is an invisible band of electromagnetic radiation just beyond the violet end of the visible spectrum. Although UV exposure is a natural part of our environment, prolonged and unprotected exposure to UV light can result in eye damage.

These CRL UV-Absorbing Spectacles are specially designed to protect the user against limited exposure to low intensity UV sources. Attractive and durable, these well proportioned frames fit easily over conventional eyeglasses. Minimum order is one each.

CAT. NO. UVS30

## CRL UV-Absorbing Goggles

- Protects Eyes From UV Sources
- Meets ANSI and OSHA Standards
- Fits Easily Over Regular Eyeglasses



Ultraviolet light is an invisible band of electromagnetic radiation just beyond the violet end of the visible spectrum. Although UV exposure is a natural part of our environment, prolonged and unprotected exposure to UV light can result in eye damage.

These CRL UV-Absorbing Goggles are recommended for extended or high intensity exposure to UV sources. They meet ANSI specification Z87.1 for safety eye wear, and OSHA standard 1910.133 for eye and face protection. These comfortable goggles easily fit over conventional eyeglasses. Minimum order is one each.

CAT. NO. UVG50

## CRL UV-Absorbing Face Shield

- Adjustable to Fit All Sizes
- Can Be Pivoted Off the Face



Ultraviolet light is an invisible band of electromagnetic radiation just beyond the violet end of the visible spectrum. Although UV exposure is a natural part of our environment, prolonged and unprotected exposure to UV light can result in eye damage.

The CRL UV-Absorbing Face Shield provides the recommended maximum protection for both eye and face from extended or high intensity UV sources. This Face Shield is adjustable to fit all sizes and has a visor that can be pivoted off the face. The shield meets ANSI specification Z87.1 for safety eye wear, and OSHA standard 1910.133 for eye and face protection. Minimum order is one each.

CAT. NO. UVF80

## CRL UV Transmission and Power Meter

- Checks Strength of UV Curing Lamps
- Displays UV Transmission % or Power Readings
- Measures Temperature in F° or C°



The CRL UV Transmission and Power Meter is the most versatile product available for measuring UV. It measures UV intensities (irradiance), or UV Transmission percentage. Perfect for checking the output of your UV curing lamps (must check new lamp or replacement bulb to set benchmark), you can even confirm the protection level of your UV spectacles, goggles and facemasks. An added feature allows you to also measure temperatures in Fahrenheit and Celsius.

Unlike other UV products on the market, this Meter is extremely simple to operate. The digital display is continually updated with real-time readings. Powered by a 9V battery (included). Minimum order is one each.

CAT. NO. UV1365

# CRL SHOWER DOOR TOOLS

For Pricing Visit [crlaurence.com](http://crlaurence.com) or Call Us Toll Free at the Phone Numbers Shown on the Back Cover

## CRL Plumb Perfect Level®

**new**

- Take "Out-of-Plumb" or Level Measurements Quick and Accurate
- No More Guessing With Standard Levels
- Stop Scraping Glass That Doesn't Fit
- Two Sizes Available

The CRL Plumb Perfect Level® was invented by a glazier who was looking for an easy method of establishing the distance a wall is "out-of-plumb" from top to bottom. This figure is necessary for many types of installations, especially when laying out storefront and shower projects. The end design is a simple, "one-person" tool that can be quickly extended to the correct height, trued to plumb, and then with a twist of the scale locking knob you can extend the scale to read the distance "out-of-plumb" the wall is from top to bottom.

The CRL Plumb Perfect Level® is an expandable aluminum frame with a built-in level, plus a calibrated steel scale which protrudes horizontally. Frames have a minimum height of 24" or 56" (610 or 1422 mm) and a maximum extended height of 42" or 98" (1066 or 2489 mm) to fit most common install jobs. These accurate and durable tools will save time and money during each installation.



PPL98 Shown



Vertical Bubble Vial Level



Horizontal Bubble Vial Level



Long Extension Lock and Horizontal Scale

CAT. NO.	DESCRIPTION
PPL42	Expands 24"- 42" (610-1066 mm)
PPL98	Expands 56"-98" (1422-2489 mm)

Minimum order: 1 each.

## CRL Electronic Level and Angle Locator With Digital Display

- Front Laser Beam for Quick Transference of Reference Points
- LCD Screen Automatically Inverts for Overhead Measurements
- LCD Displays Level or Angle
- Audible Indicator for Both 0 and 90 Degrees



CAT. NO. 406065

The CRL Electronic Level is the most advanced level and angle finder in the industry. The bright and clear LCD indicator shows both degrees of level or percent of level; at the same time when the pivot arm is lifted the indicator reads degrees of angle. When turned upside down to determine the level of a header or overhead beam, the LCD screen automatically inverts right-side-up for easy reading. There is a powerful built-in laser, which makes transference of level points a snap. It also features an audible tone when the unit is in perfect level or plumb. Unit is easily field calibrated for level, and the entire tool operates on just 3 "AA" batteries (included). Minimum order is one each.



**A Winning Combination**-Use your 406065 Electronic Level and Angle Locator with your CRL Cat. No. CM6 Construction Master® Pro Calculator to solve difficult "out-of-square" measurements. Complete detailed instructions can be found on the CRL web site. Just hit the "How To Do It" icon to view step-by-step instructions when you are viewing 406065 online.



CAT. NO. CM6

## CRL Plumb/Level Finder Gauges

- Use With Your Level to Determine "Out-of-Plumb"
- Five Individual Thickness Gauges

This handy set of CRL Plumb/Level Finder Gauges makes it simple to determine the amount or distance a wall or floor is "out-of-plumb" when using your bubble vial level. Set includes: 1/16", 1/8", 3/16", 1/4" and 3/8" (1.6, 3.2, 4.8, 6.4 and 9.5 mm) thick neoprene gauges. Simply hold the level tight against a horizontal or vertical surface. True the level and then use the thickness gauges to determine the amount out of level or plumb the surface is at that point. You can combine gauges when necessary for gaps exceeding 3/8" (9.5 mm). Minimum order is one each.

Plumb Perfect Level is a registered trademark of Brian Hale. Construction Master is a registered trademark of Calculated Industries, Inc.



CAT. NO. PLF1



C.R. LAURENCE COMPANY

[crlaurence.com](http://crlaurence.com) | [usalum.com](http://usalum.com)

336K | [crlaurence.ca](http://crlaurence.ca) [crlaurence.com.au](http://crlaurence.com.au) [crlaurence.co.uk](http://crlaurence.co.uk) [crlaurence.de](http://crlaurence.de) [crlaurence.eu](http://crlaurence.eu)

## CRL Cross-Line Self Leveling Laser Kit

- Self-Leveling Within 3 Degrees, 49' (15 meter) Range
- Vertical Line, Horizontal Line, or Both
- Locking Mechanism Blocks Self Leveling and Locks Display

The CRL LD200 Cross-Line Self Leveling Laser Kit allows you to cast a vertical or horizontal solid line, or both at the same time. When the device is tipped beyond 6 degrees, the laser will begin flashing and an audio alarm will sound. This kit also includes: three AA batteries, a 1/4-20 threaded mounting hole for use with tripods, a 360 degree swivel mount, a magnetic wall mount, a laser target (to extend useful range), and a rugged nylon storage bag. Minimum order is one each.



CAT. NO. LD200

## CRL Standard Spot Laser Tool

- Establishes Plumb and Level
- Projects Laser Beams 3 Ways

**PLS3 LASER SPECIFICATIONS:**  
**Working Range:** +/- 100 Feet  
**Accuracy:** 1/4" @ 100 Feet  
**Leveling:** Automatic  
**Leveling Range:** +/- 6°  
**Dimensions:** 1-1/2" x 4-1/2" x 3-1/8"



The CRL Standard Spot Laser Tool gives you the convenience of a torpedo level with the quality of information available only from a professional point-to-point laser. Three bright laser points allow the PLS3 to be used anywhere on the job site for level reference and point-to-point plumb from floor to ceiling, or from up to 50 feet (15.2 m) off the ground. Weighing only 12 ounces (.33 kg), this hand held unit operates on three AA batteries (not included) for up to 30 hours. It comes with a Leather Carrying Pouch, Operating Manual, and full one-year manufacturer's warranty. Minimum order is one each.

CAT. NO. PLS3

## CRL Deluxe Spot Laser Tool

- Establishes Plumb, Level, and Square
- Projects Laser Beams 5 Ways

**PLS5 LASER SPECIFICATIONS:**  
**Working Range:** +/- 100 Feet  
**Accuracy:** 1/8" @ 100 Feet  
**Leveling:** Automatic  
**Leveling Range:** +/- 8°  
**Dimensions:** 1-1/2" x 4-1/2" x 3-1/8"



The CRL Deluxe Spot Laser Tool provides simultaneous plumb, level, and square references in a compact, accurate, and affordable package. True point-to-point alignment information speeds layout and installation of curtainwalls, doors, windows, and skylights. Five bright reference points are easily seen indoors or out, and the unit is powered by three AA batteries (not included). It comes complete with Floor Mount, Magnetic Wall Mount, Layout Targets, Carrying Case, Operating Manual, and full one-year manufacturer's warranty. Minimum order is one each.

CAT. NO. PLS5

## CRL Granite, Marble, and Tile Drill Bits



- Groo-V Tip® Bit Makes Holes in Hard Materials
- Especially Suited for Marble and Granite

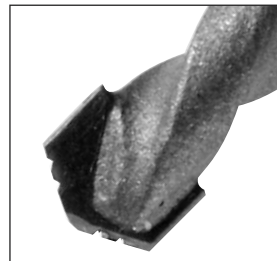

Engineered for drilling hard materials, these specialized Groo-V Tip® Marble and Granite Drills have a serrated carbide tip which penetrates up to 50% faster than ordinary masonry bits. Use with percussion and rotary drills only.

CAT. NO.	HOLE SIZE
GRT18	1/8" (3.2 mm)
GRT316	3/16" (4.8 mm)
GRT14	1/4" (6.3 mm)
GRT38	3/8" (9.5 mm)

Minimum order: 1 each.

Groo-V Tip is a registered trademark of Relton Corporation. Stanley and FatMax are registered trademarks of Stanley Logistics, LLC.

## CRL Stanley® Levels

- Professional Quality
- Aluminum Construction



All Stanley® Levels are constructed from heavy-duty aluminum. They all have a level accuracy of 0.0005" (.01 mm). The vials are made from a unique acrylic block design to greatly increase their impact resistance and ensure maximum accuracy. The "Torpedo" model has a powerful magnetic strip on the base which allows for "hands-free" operation, and holds the Level securely to all iron and steel surfaces.

CAT. NO.	DESCRIPTION	LENGTH
ST42465	Magnetic Torpedo Level	9" (229 mm)
ST43524	FatMax® Level	24" (609 mm)
ST43548	FatMax® Level	48" (1219 mm)
ST43572	FatMax® Level	72" (1829 mm)

Minimum order: 1 each.

## CRL Frameless Shower Super Kit

**new**

- **Convenient Kit Containing Everything Needed for a Professional Frameless Shower Door Installation**

The CRL Frameless Shower Super Kit provides the professional installer with a good selection of tools to assist with frameless shower door installs.



CAT. NO. FSSK1

FSSK1 FRAMELESS SHOWER SUPER KIT CONSISTS OF ONE EACH OF THE FOLLOWING UNLESS NOTED OTHERWISE:

CAT. NO.	DESCRIPTION
FA3W	Frameless Alignment Tool
GRT14	1/4" GROO-V Tip® Granite Drill Bit (5 Each)
GRT316	3/16" GROO-V Tip® Granite Drill Bit (5 Each)
MAT1	Magnetic Alignment Tool
PLF1	Plumb/Level Gauge Set
PR2S	Perfect Reveal Tool (1 Pair)
SS2L	Super Shim Leveler (1 Pair)
UV282	Adjustable Suction Clamp
T1418	Tool Box With Tray

Minimum order: 1 each.

## CRL Third Hand Fixture Device

- **4-1/2" (114 mm) Vacuum Cup**
- **Adjustable Clamp Bar**
- **Dual Threaded Screw Clamps**

The CRL Third Hand Fixture Device is the perfect solution for applying the pressure needed to bond UV and shower door hardware in place during heating and curing. The adjustable steel sliding bracket allows for precise positioning of clamp tips over your hardware. The clamp screws can accommodate knobs or bars exceeding 2" (51 mm) in height. Simply attach the 4-1/2" (114 mm) pump action vacuum cup within 2" or 3" (51 to 76 mm) of the hardware mounting point, adjust the clamp bar to center a clamp tip over the hardware, and screw one of the clamps down to secure the hardware in place. For added pressure when working with higher viscosity adhesives, lower the second clamp tip down onto the surface and tighten. Using the vacuum cup as a fulcrum in this way helps to force air bubbles out of adhesive and create the tightest possible gap to enhance adhesive performance. The CRL Third Hand Fixture Device can also be used to hold automotive trims and moldings in place while the adhesive cures. Minimum order is one each.



CAT. NO. UV91111

## CRL Multi-Purpose SwasiClamp

- **Use for Inside or Outside Angle Applications**
- **Shower Door Fixed Panel Assembly**
- **UV Assembly Bonding**
- **UV Hardware Clamping**

The CRL Multi-Purpose SwasiClamp is a totally new clamp design intended to solve a variety of problems in fastening components together while bonding or sealing. This unique clamping device features a lever-actuated 4-3/4" (121 mm) vacuum cup connected to a three-piece articulated arm, which ends with a threaded plunger arm. SwasiClamp can be turned, twisted, or reversed to solve virtually any clamping job ranging in length up to 13" (330 mm).

Add the CRL SwasiClamp Accessory Kit and double your range of options. Consisting of an additional 4-3/4" (121 mm) vacuum cup and another threaded plunger arm, this Kit allows clamping of additional angles and added force to original configurations. The Accessory Plunger Arm can clip onto the SwasiClamp articulated arm or into the Accessory Vacuum Cup. Whether your work scope involves shower doors or glass furniture bonding with UV Adhesives, the CRL SwasiClamp and SwasiClamp Accessory Kit are the installer's new best friend.

GROO-V Tip is a registered trademark of Relton Corporation.



CAT. NO. UV2010



Cat. No. UV2010 Shown With Cat. No. UV2010A



CAT. NO. UV2010A

CAT. NO.	DESCRIPTION
UV2010	SwasiClamp
UV2010A	SwasiClamp Accessory Kit

Minimum order: 1 each.

## CRL Adjustable Angle Suction Holder

- Holds Glass From Inside or Outside Surfaces While UV or Silicone Adhesive Cures
- Adjustable

CRL Adjustable Angle Suction Holder holds glass panels from the inside or outside surfaces. Glass panels can be fixed at desired angle and adhered by UV or silicone adhesives easily. Height and position can be adjusted 11/16" (18 mm) by knobs at each arm. The 4-3/4" (120 mm) rubber suction pad with lip holds the glass panels firmly until the adhesive cures and they stick to each other. It is adjustable between 40 and 300 degrees. Minimum order is one each.



CAT. NO. UV282



## CRL 90 Degree Outside Surface Tool

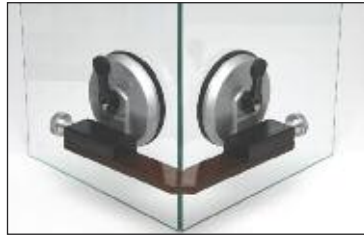

- Holds Glass From Outside Surfaces While UV or Silicone Adhesive Cures
- Adjustable

CRL 90 Degree Outside Surface Tool holds glass panels from the outside surfaces. Glass panels can be fixed at 90 degree angles and adhered by UV or silicone adhesives easily. Height and position can be adjusted 11/16" (18 mm) by knobs at each arm. The 4-3/4" (120 mm) rubber suction pad with lip holds the glass panels firmly until the adhesive cures and they stick to each other. Minimum order is one each.

CAT. NO. UV281

## CRL 90 Degree Inside Surface Tool



- Holds Glass From Inside Surfaces While UV or Silicone Adhesive Cures
- Adjustable

CRL 90 Degree Inside Surface Tool holds glass panels from the inside surfaces. Glass panels can be fixed at 90 degree angles and adhered by UV or silicone adhesives easily. Height and position can be adjusted 11/16" (18 mm) by knobs at each arm. The 4-3/4" (120 mm) rubber suction pad with lip holds the glass panels firmly until the adhesive cures and they stick to each other. Minimum order is one each.

CAT. NO. UV280

## CRL 90 Degree Clamp-It Square Tool Kit

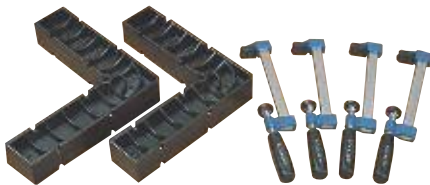

- Ideal For Drill-Press Jigs or Adding a Shelf
- Rigid Polycarbonate Construction

CRL 90 Degree Clamp-It Square Kit includes everything needed to clamp two corners at a time: two original Clamp-It Assembly Squares and four 5" (127 mm) Clamp-It Bar Clamps. The Bar Clamp is held in place on the Clamp-It Assembly Square with a friction fit to make operation quick, easy, and one-handed. Assembly Square measures 8" x 8" x 1-1/2" (203 x 203 x 38 mm). Minimum order is one each.

CAT. NO. UV69954

## CRL Angle Suction Holder Adjustable Between 45 and 300 Degree

- Adjustable Between 45 and 300 Degrees
- Precise Adjustment to Any Desired Position
- Suction Cups Hold Glass Firmly in Place While Adhesive Cures



This CRL Adjustable Angle Suction Holder grips glass from outside or inside surfaces. Position can be precisely adjusted by a knob. Glass is held firmly in place with 4-1/2" (114 mm) diameter rubber suction pads until the surfaces are firmly bonded.

**NOTE:** Do not use to lift or carry glass or marble. Minimum order is one each.

CAT. NO. WH9602G

## CRL Super Shim Shower Door Leveler

- Easy Adjustable Micro Leveling
- Eliminates Stacks of Wood or Plastic Shims
- Works With 3/8" or 1/2" (9.5 or 12.7 mm) Thick Tempered Glass Doors

The CRL Super Shim Shower Door Leveler is a remarkably simple device that every shower door installer will want in their tool box. The Super Shim is a micro adjustment device which will lift and level any shower door, ensuring a precise alignment every time.

The CRL Super Shim lifts the door panel by way of a threaded adjustment bolt: Turn the bolt clockwise and raise the panel. When used in conjunction with a level the CRL Super Shim will eliminate the phrase "close enough" from every shower door installer's vocabulary. Now every door installation will be a perfect fit.

The CRL Super Shim is manufactured with non-slip materials which prevent damage to tile or glass, while still allowing smooth movement where necessary. Ratchet wrench included. Minimum order is one pair.

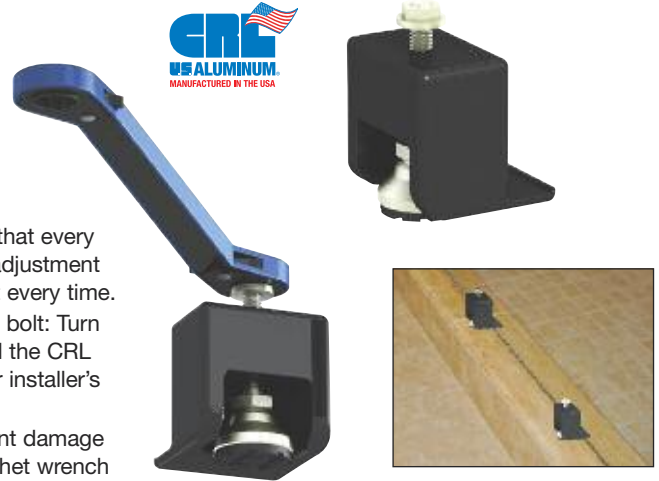

CAT. NO. SS2L

## CRL Frameless Blocks

- Use With 3/8" (10 mm) and 1/2" (12 mm) Thick Glass to Assist in Aligning and Leveling

CRL Frameless Blocks are used to help with the installation of 3/8" (10 mm) and 1/2" (12 mm) frameless shower doors and panels. You can set your door and panels in the blocks to assist in plumbing, aligning, and leveling your glass. Adjust your height by adding setting blocks in the rails. The base is 5/16" (8 mm) thick. The opening size for 3/8" (10 mm) glass is 7/16" (11 mm) wide, and for 1/2" (12 mm) glass the opening is 9/16" (14 mm).

Frameless Blocks help to avoid chipping, flaking, and breakage while helping to reduce installation time. Your installers will appreciate all of these features, as well as added safety. They can also be used to help with the installation of 3/8" (10 mm) and 1/2" (12 mm) commercial storefront doors and panels.



CAT. NO.	FOR USE WITH
FB38G	3/8" (10 mm) Glass
FB12G	1/2" (12 mm) Glass

Minimum order: 1 each.

## CRL Perfect Reveal Tool

- Establish and Maintain Perfect Reveal Depth
- Easy to Adjust
- Non-Marring Bottom Cushions
- Works For Doors and Fixed Panels

The CRL PR2S Perfect Reveal Tool is another glazier designed tool produced by CRL to further aid shower door craftsmen in perfecting their trade. The Perfect Reveal Tool allows the installer to preset and repeat the reveal depth for all panels in any frameless shower enclosure installation. Single knob allows vertical glass stop to be adjusted and set for correct depth. Dimensional scales are etched into the stainless steel body. Non-marring surface gripping cushions on bottom of tool protect the curb from the metal body of the PR2S, and prevents movement or slippage. Sold in pairs. Minimum order is one pair.

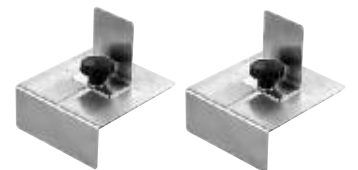

CAT. NO. PR2S

## CRL Frameless Hinge Jig

- Rapid Mounting of Wall Hinge Plates
- Accurately Mark Hole Locations Without Mounting Hinges on Glass
- Includes Templates for CRL Geneva, Pinnacle, Cologne, and Vienna Series Hinges

The Frameless Hinge Jig is the latest in a long line of "glazier inspired" tools that makes the installation of a wall mounted door more rapid and increases the accuracy of the hinge placement. The jig has been designed to accommodate many different wall mount hinge plate designs and, in doing so, acts as a template for marking the wall for drilling holes.

The Frameless Hinge Jig comes equipped with a folding straight edge that supports two adjustable hinge plates used for marking the wall. Minimum order is one each.



CAT. NO. FHJ1



## CRL Frameless Assist Shower Door Panel Clamp



- Holds Fixed Panels and Doors in Perfect Alignment
- Works With 3/8" to 1/2" (10 to 12 mm) Tempered Glass
- Clear Construction Keeps All Points Visible
- Adjustable for 90°, 180° or "T" Configurations

The CRL Frameless Assist Shower Door Panel Clamp is another in a long line of tools developed by, and for, professional glaziers. This ingenious tool was invented by a detail-oriented CRL customer with a perfectionist's eye. It helps you maintain precise, even spacing in door to fixed panel assemblies, whether in 180 or 90 degree installations.

Tool arrives configured for 3/8" (10 mm) glass. Simply loosen the four rear knobs, insert the 1/8" (3 mm) spacer plate to change over to 1/2" (12 mm) glass. Use in conjunction with Cat. No. MAT1 kit (shown below), for the most precise panel installation ever. Each kit is sold separately. Minimum order is one each.

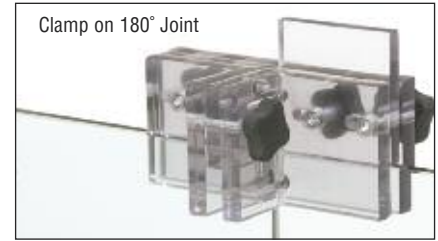

CAT. NO. FA3W

## CRL Magnetic Shower Installation Alignment Tool



- Provides Accurate, Consistent Gaps Between Doors and Panels
- Works With 3/8" to 1/2" (10 to 12 mm) Tempered Glass
- All Components are Re-Usable

Developed by a frameless shower door installer with exceptional concern for efficiency and detailed workmanship, the CRL Magnetic Shower Installation Alignment Tool can serve many other butt-glazed glass applications. The tool's two spacer assemblies, placed one at the top and one at the bottom, perform in two planes. First, it works vertically by use of the desired gap size running top to bottom. Secondly, it aligns the two panels horizontally. You can use it in conjunction with our new Frameless Assist Tool and our Super Shim Shower Door Levelers for even faster and more precise installations. Powerful neodymium rare earth magnets maintain the spacer's position. Kit includes a durable utility tool box that organizes all of the kit's components. Minimum order is one each.



CAT. NO. MAT1

## CRL "Best Friend" Shower Door Installation Assistant

- Replaces Second Person on Many Shower Door Installations
- Adjustable to Any Angle
- Works Inside or Outside of Enclosure

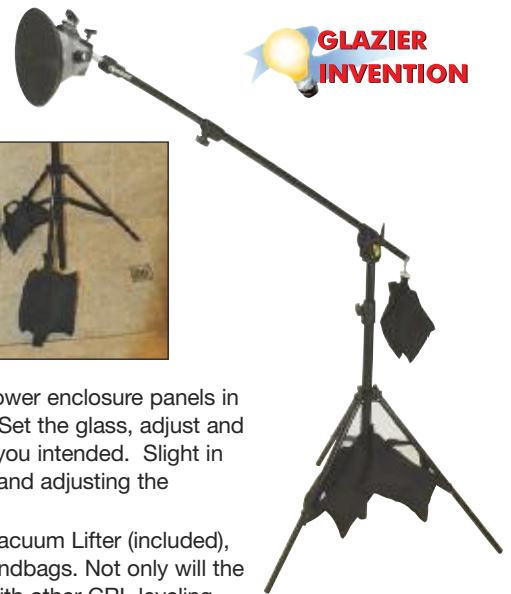

The CRL "Best Friend" Shower Door Installation Assistant works to stabilize and hold shower enclosure panels in place during set-up and installation, permitting a single glazier to perform the work of two. Set the glass, adjust and attach the "Best Friend", and you can be sure of the panel being held in the exact position you intended. Slight in and out adjustment can be accomplished by simply loosening the lock ring on the top arm and adjusting the extension tube.

The CRL "Best Friend" Clamp Head provides a firm grip on the CRL S338 8" (203 mm) Vacuum Lifter (included), and the stand base can be stabilized as needed with the two included 10 pound (4.5 kg) sandbags. Not only will the CRL "Best Friend" help with holding fixed panels and sidelights in place, when combined with other CRL leveling and alignment devices, it can also make hanging the door panel a one person operation. Minimum order is one each.

CAT. NO. SDBF1

## CRL Mirror Tools

- The Largest Selection of Glazing Tools Offered for Working With Mirrors and Glass
- Unmatched Service From Over 30 Worldwide Locations

Professionals who work with mirrors and glass know that C.R. Laurence can service their glazing tool needs quickly and affordably. Our network of over 30 service center locations on three continents allows us to get you the tools you want with little or no delay. And our selection is unmatched, with hand and power tools from many of the world's preeminent manufacturers, including our own CRL brand.

All of these can be found in this catalog, and in our Online Catalog at [crlaurence.com](http://crlaurence.com). Our pricing is competitive too! Plus we offer installation expertise through our Customer Service Department.

So if you work with mirrors and glass, look to the industry leader in this field, C.R. Laurence.



## CRL Glass Drills

- Precision Portable Glass Drilling Machines
- Glass Drills in Diameters Up to 6" (152 mm)

Mirrors must frequently be drilled for switch covers or electrical outlets. CRL supplies drilling machines and a host of drills for making holes in mirrors and glass. To see the entire selection, turn to pages 150K to 170K in this catalog or go to our web site, [crlaurence.com](http://crlaurence.com).



## CRL Glass Saws

- Models for Cutting Glass Up to 3/4" (19 mm)
- Battery Powered Saws for Full Portability

Many times a wall-mounted mirror must be notched to accommodate a counter top or other protrusion onto the wall's surface. CRL has portable glass saws to do the job efficiently and safely. Please see them on pages 174K to 176K in this catalog or visit our web site, [crlaurence.com](http://crlaurence.com).



## CRL Vacuum Lifters

- Pump-Up and Lever Style Vacuum Lifters for Small Mirror Panels to Wall-Sized Sheets
- All Built for Reliability and Safety

Safe lifting of mirrors can only be done with the right tools, and CRL has an entire selection of vacuum lifters designed for just that purpose, from small mirror tiles to wall-sized sheets. See pages 198K to 223K in this catalog or look online at [crlaurence.com](http://crlaurence.com).



## CRL Glass Jack

- A Simple and Affordable Tool That Makes Adjusting Large Glass Panels Easy
- Great for the Small Glass Shop



Vacuum Cup sold separately

The CRL Glass Jack makes adjusting (or lifting) large glass and mirror panels a simple, one person job. Used in conjunction with your metal handle pump-up vacuum cup (not included), this precision machined tool lets you adjust and set your glass, while getting a better view of what you are doing without any interference. At the same time, you reduce your risk of back injury.

The CRL Glass Jack is set on a solid surface while you position its cradle under your vacuum cup. Then by simply attaching your cup to the glass and turning the center adjustment bar by hand, the glass will raise or lower accordingly. The turnbuckle mechanism lets you move glass panels in the smallest of increments, without sudden movements. Made from the highest quality aluminum, the CRL Glass Jack is built for years of service. **NOTE:** Never exceed the recommended weight limit of your vacuum cup. Minimum order is one each.

CAT. NO. J1

## CRL Plate Glass Lifting Tool

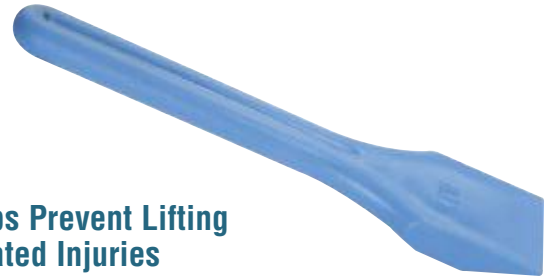

- Helps Prevent Lifting Related Injuries

This handy Plate Glass Lifting Tool is used to lift heavy plate glass and mirror while you insert setting blocks or shims. It helps reduce strain on your back. Also handy to scoop and spread mirror mastic. Minimum order is one each.

CAT. NO. PGL11

## CRL Quik-Draw Mirror Outlet Cut-Out Template Set

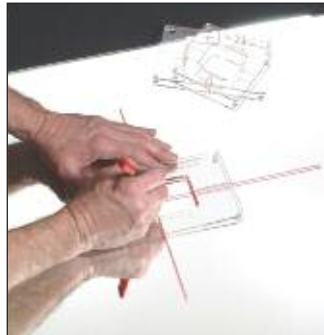

- Three Template Set Increases Your Accuracy
- Layout Time for Cut-Outs is Drastically Reduced
- Made From Durable Clear Acrylic

These clear, high-impact acrylic Templates were designed to simplify drilling cut-outs in glass and mirror. The non-skid bumpers adhered to the underside prevent slippage and scratches. The hole in the corner lets you hang the Templates in a convenient location near the cutting table. Select one of the three Templates in the set when drilling for switch, decora, duplex, TV cable, telephone cable, thermostat, and more. Minimum order is one set.

CAT. NO. QD1

## CRL Mirror Outlet and Switch Hole Nibbler



- Removes Small, Uneven Pieces of Mirror or Glass From Cut-Outs Without Removing the Mirror

CRL's Mirror Outlet and Switch Hole Nibbler was designed by a glazier to handle a problem that frequently happens when installing mirror walls. Sometimes when the ceiling line or seams are matched, the drilled outlet hole is slightly off. This tempered steel tool will "nibble" the hole with the mirror already in place, saving you the time and expense of removing the mirror. Minimum order is one each.

CAT. NO. MN1750

## CRL J-Channel Punch and Countersink Tool

- Cuts a Clean Screw Hole in J-Channel Back Leg

Our powerful J-Channel Punch cuts a clean screw hole in the J-Channel back leg and countersinks at the same time. A side gauge permits accurate throat depth adjustment. Extra dies may be purchased separately.

**NOTE:** Punched hole is .160" diameter; Countersink size is .284" diameter.



CAT. NO. JPD

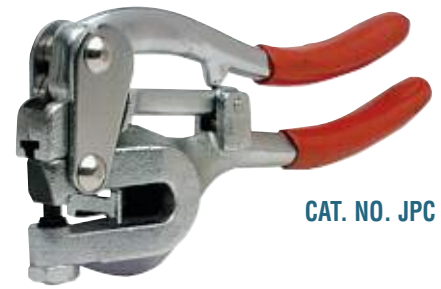
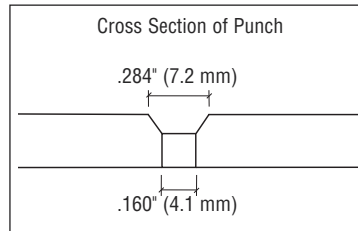

CAT. NO. JPC

CAT. NO.	DESCRIPTION
JPC	Punch with Die Set
JPD	Extra Die Set

Minimum order: 1 each.

## CRL Single Cut Miter Tool

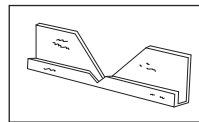

Sample Cut

- A Perfect Miter With the Close of a Hand

The CRL Single Cut Miter Tool is especially designed to make perfect miter cuts in stainless steel channels or other thin gauge metals. It is precision machined with tempered steel jaws which produce a clean cut without rough edges. **NOTE:** Not recommended for aluminum. Minimum order is one each.

CAT. NO. MT702

## CRL Palmer Mastic Stik™



- Applicator and Remover for Palmer Mirro-Mastic®
- Lightweight, Yet Extremely Durable

The Palmer Mastic Stik™ has a scoop end with a chiseled tip, making it the ideal tool for the application or removal of Palmer Mirro-Mastic®. The scoop end is just the right size for recommended "pats" or "gobs" of mastic, and its chiseled edge lets you remove mastic without scratching mirror backing. Made of lightweight and durable PVC, the Mastic Stik™ measures 16-1/2" (419 mm) long. Chiseled scoop edge is 1-1/2" (38 mm) wide. Minimum order is one each.



CAT. NO. MS97

## CRL Palmer Electric Mastic Applicator

- Heated Scoop Deposits Mastic Easier and in Uniform Size Pats
- Maximizes Yield per Can

Use the Palmer Mastic Applicator to scoop out regular Mirro-Mastic® in uniform size pats. The heated bowl scoops mastic directly from the can to apply either to the substrate or mirror panel. Applicator operates on 110V AC power, and is the most convenient way to apply CRL Palmer Mirro-Mastic®. When using this tool there are approximately 130-135 pats of mastic per gallon. Preferred application for proper spread of mastic is to apply pats in rows, spacing pats about 8" to 12" (203 to 305 mm) apart and 6" (152 mm) in from the edge of the mirror. Minimum order is one each.

Mirro-Mastic is a registered trademark of Palmer Products Corporation.

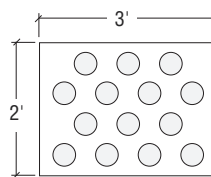

Typical Application of "Pats" on Mirror



CAT. NO. 1234PA

## CRL Screen and Spline Tools

The CRL Comfort Grip is the ultimate in roller tools. The handle is made from molded TPE plastic, softer than wood and ergonomically shaped to greatly increase your gripping power. The pressure point areas (shown in black) are 15% softer than the red areas to reduce user fatigue during extended use.

Our complete selection of Screen Roller Tools comes in sizes to accommodate most any screen frame and retainer spline. Some are multiple purpose combination tools with a pair of rollers, one of each type, screen insertion and spline insertion. Others include specialty rollers with "flat" or "step" contours. Whatever your needs, we have a Roller Tool that will satisfy your requirements.

### • Top Quality Tools for All Your Screen Fabricating Needs

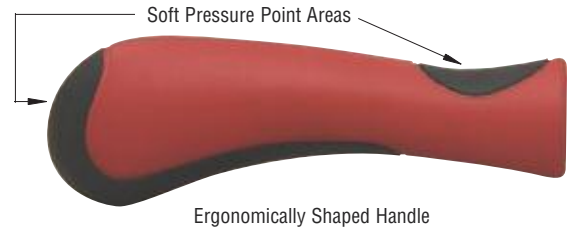

### CRL Comfort Grip Nylon Combination Roller Tools

#### • For Inserting Screen Cloth and Retainer Spline



**new**

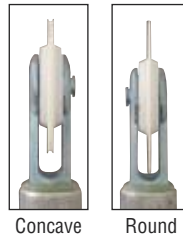

The CRL Nylon Combination Roller has a round edge nylon roller on one end for creasing the screen cloth into the spline groove, and a concave edge nylon roller on the opposite end for inserting the spline and screen into the screen frame spline groove. This tool is an excellent choice for rolling fiberglass screen.

CAT. NO.	CONCAVE EDGE ROLLER	ROUND EDGE ROLLER
<b>CGS5NK6N</b>	3/32" x 2" (2.4 x 50.8 mm)	1/16" x 2-1/2" (1.6 x 63.5 mm)
<b>CGS5NK7N</b>	1/8" x 2" (3.2 x 50.8 mm)	1/16" x 2-1/2" (1.6 x 63.5 mm)

Minimum order: 1 each. All Screen Roller Tools can be combined for quantity pricing.

### CRL Comfort Grip Steel Combination Roller Tools

#### • Ball Bearing Rollers for Smooth Operation



**new**



The CRL Steel Combination Roller has a round edge steel roller on one end and a concave steel roller on the other. All rollers have ball bearing inner races for smooth operation. This is a 'must have' tool whenever rolling aluminum or any other metal screen.

CAT. NO.	CONCAVE EDGE ROLLER	ROUND EDGE ROLLER
<b>CGS5K6</b>	3/32" x 2" (2.4 x 50.8 mm)	1/16" x 2-1/2" (1.6 x 63.5 mm)
<b>CGS5K7</b>	1/8" x 2" (3.2 x 50.8 mm)	1/16" x 2-1/2" (1.6 x 63.5 mm)

Minimum order: 1 each. All Screen Roller Tools can be combined for quantity pricing.

### CRL Comfort Grip Single Concave Edge Roller Tools

#### • Choice of Nylon or Steel Rollers



**new**

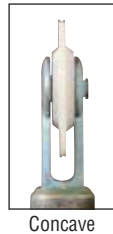

CRL Single Concave Edge Roller Tools are available with either a nylon or steel roller. They have ball bearing inner races to provide smooth operation.

CAT. NO.	ROLLER	ROLLER THICKNESS	ROLLER DIAMETER
<b>CG27K6N</b>	Nylon	3/32" (2.4 mm)	2" (50.8 mm)
<b>CG27K7N</b>	Nylon	1/8" (3.2 mm)	2" (50.8 mm)
<b>CG27K6</b>	Steel	3/32" (2.4 mm)	2" (50.8 mm)
<b>CG27K7</b>	Steel	1/8" (3.2 mm)	2" (50.8 mm)

Minimum order: 1 each. All Screen Roller Tools can be combined for quantity pricing.

### CRL Comfort Grip Combination Roller and Cutter Tools

#### • It's Two Tools in One



**new**

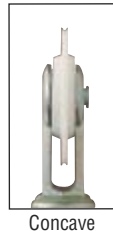

The CRL Combination Spline Roller and Cutter will increase your production speed. With one tool you can cut your screen cloth to size, then roll the screen into the spline channel and finish by cutting the spline to length.

CAT. NO.	ROLLER	ROLLER THICKNESS	ROLLER DIAMETER
<b>CGK6N96</b>	Nylon	3/32" (2.4 mm)	2" (50.8 mm)
<b>CGK7N96</b>	Nylon	1/8" (3.2 mm)	2" (50.8 mm)

Minimum order: 1 each. All Screen Roller Tools can be combined for quantity pricing.

## CRL Combination Spline and Flat Nylon Roller Tool

- Nylon Roller Tool Smooths Out Glazing Vinyl



**new**



Concave



Flat

The rollers on this combination CRL Nylon Flat Edge Roller and Spline Tool are riveted to a steel yoke, and mounted to a contour-grip, finished wood handle. Use it to smooth out flat spline or to insert glazing vinyl prior to insertion in the frame.

CAT. NO.	CONCAVE EDGE ROLLER (THICKNESS X DIAMETER)	FLAT ROLLER (WIDTH X DIAMETER)
<b>K7NFR40</b>	1/8" x 2" (3.2 x 50.8 mm)	1-3/4" x 2" (44.5 x 50.8 mm)

Minimum order: 1 each. All Roller Tools can be combined for quantity pricing.  
NOTE: Not available in Australia.

## CRL Single Concave Edge Nylon Wheel Spline Roller

- Three Models to Accommodate Different Spline Sizes

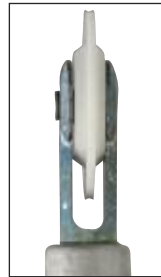

Concave

Concave Edge Nylon Roller Tools for retainer spline installation. Nylon ball bearing roller riveted to a steel yoke. Finished wood handle has a contoured grip. Choose from three roller thicknesses to accommodate different screen spline sizes.

CAT. NO.	ROLLER THICKNESS	ROLLER DIAMETER
<b>27K6N</b>	3/32" (2.4 mm)	2" (50.8 mm)
<b>27K7N</b>	1/8" (3.2 mm)	2" (50.8 mm)
<b>27K9N</b>	3/16" (4.8 mm)	2" (50.8 mm)

Minimum order: 1 each. All Roller Tools can be combined for quantity pricing.  
NOTE: Not available in Australia.

## CRL Single Concave Edge Steel Wheel Spline Roller

- Six Sizes to Choose From
- Finished Wood Handle With Contoured Grip

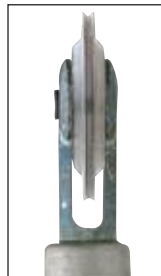

Concave

Steel Concave Edge Rollers for retainer spline installation. Steel ball bearing roller riveted to a steel yoke. Finished wood handle with contour grip. Different roller thicknesses accommodate varying spline diameters.

CAT. NO.	ROLLER THICKNESS	ROLLER DIAMETER
<b>27K1</b>	3/32" (2.4 mm)	1-1/2" (38.1 mm)
<b>27K6</b>	3/32" (2.4 mm)	2" (50.8 mm)
<b>27K2</b>	1/8" (3.2 mm)	1-1/2" (38.1 mm)
<b>27K7</b>	1/8" (3.2 mm)	2" (50.8 mm)
<b>27166</b>	1/8" (3.2 mm)	3" (76.2 mm)
<b>27K8</b>	5/32" (4.0 mm)	2" (50.8 mm)

Minimum order: 1 each. All Roller Tools can be combined for quantity pricing.  
NOTE: Not available in Australia.

## CRL Single Round Edge Nylon Wheel Screen Roller

- Most Popular for Fiberglass Screen Wire

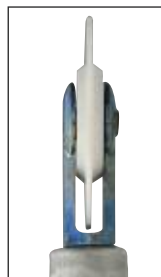

Round

Nylon Round Edge Roller for screen wire insertion into screen frame. Nylon ball bearing roller riveted to a steel yoke. Finished wood handle with contour grip.

CAT. NO.	ROLLER THICKNESS	ROLLER DIAMETER
<b>27S5N</b>	1/16" (1.6 mm)	2-1/2" (63.5 mm)

Minimum order: 1 each. All Roller Tools can be combined for quantity pricing.  
NOTE: Not available in Australia.

## CRL Single Round Edge Steel Wheel Screen Roller

- Five Size Combinations to Choose From
- Steel Ball Bearing Wheel

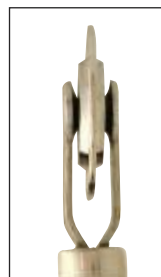

Round

Steel Round Edge Rollers for screen wire insertion into screen frame. Steel ball bearing roller riveted to a steel yoke. Finished wood handle with contour grip. Varying roller thicknesses to accommodate any size screen frame.

CAT. NO.	ROLLER THICKNESS	ROLLER DIAMETER
<b>27S1</b>	1/16" (1.6 mm)	2" (50.8 mm)
<b>27S5</b>	1/16" (1.6 mm)	2-1/2" (63.5 mm)
<b>27166RN</b>	1/16" (1.6 mm)	3" (76.2 mm)
<b>27S6</b>	3/32" (2.4 mm)	2-1/2" (63.5 mm)
<b>27S7</b>	1/8" (3.2 mm)	2-1/2" (63.5 mm)

Minimum order: 1 each. All Roller Tools can be combined for quantity pricing.  
NOTE: Not available in Australia.

## CRL Heavy-Duty Combination Nylon Wheel Screen and Spline Roller

- Our Most Popular Screening Tool



Get maximum efficiency with one of the most popular and widely used tools in the industry. One round edge and one concave nylon roller with steel ball bearings. The rollers are replaceable when worn. The contoured hardwood handle makes it comfortable to hold.

CAT. NO.	CONCAVE EDGE ROLLER (THICKNESS X DIAMETER)	ROUND EDGE ROLLER (THICKNESS X DIAMETER)
<b>S5NK7N</b>	1/8" x 2" (3.2 x 50.8 mm)	1/16" x 2-1/2" (1.6 x 63.5 mm)

Minimum order: 1 each. All Roller Tools can be combined for quantity pricing.  
NOTE: Not available in Australia.

## CRL Heavy-Duty Combination Steel Wheel Screen and Spline Roller

- Four Roller Combinations to Choose From
- Steel Ball Bearings on Both Rollers



Take your choice of four different roller size combinations. These rollers all have steel ball bearings, hardened and polished for smooth rolling. A contoured hardwood handle gives a comfortable grip, and the easy rolling rollers alleviate fatigue and facilitate finishing the job. Features one round edge and one concave edge roller.

CAT. NO.	CONCAVE EDGE ROLLER (THICKNESS X DIAMETER)	ROUND EDGE ROLLER (THICKNESS X DIAMETER)
<b>S5K7</b>	1/8" x 2" (3.2 x 50.8 mm)	1/16" x 2-1/2" (1.6 x 63.5 mm)
<b>166166RN</b>	1/8" x 3" (3.2 x 76.2 mm)	1/16" x 3" (1.6 x 76.2 mm)
<b>S5K3</b>	5/32" x 1-1/2" (4.0 x 38.1 mm)	1/16" x 2-1/2" (1.6 x 63.5 mm)
<b>S5K8</b>	5/32" x 2" (4.0 x 50.8 mm)	1/16" x 2-1/2" (1.6 x 63.5 mm)

Minimum order: 1 each. All Roller Tools can be combined for quantity pricing.  
NOTE: Not available in Australia.

## CRL Standard Combination Steel Wheel Screen and Spline Roller

- Popular Roller Diameters and Thicknesses

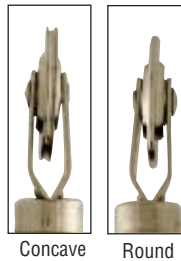

The concave edge and round edge steel rollers on this tool are mounted on ball bearings for smooth rolling operation. The contour grip handle is easy to hold, and hardened steel rollers give you long lasting use.

CAT. NO.	CONCAVE EDGE ROLLER (THICKNESS X DIAMETER)	ROUND EDGE ROLLER (THICKNESS X DIAMETER)
<b>PL7508</b>	3/32" x 1-1/2" (2.4 x 38.1 mm)	3/32" x 1-1/2" (2.4 x 38.1 mm)

Minimum order: 1 each. All Roller Tools can be combined for quantity pricing.  
NOTE: Not available in Australia.

## CRL Basic Combination Screen and Spline Roller

- Contoured Wood Handle

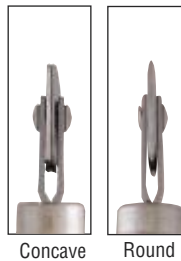

Two steel rollers, one round and one concave, are mounted on a contoured wood handle that makes handling easier. Packaged for over the counter sales, it's also a good tool for shop use.

CAT. NO.	CONCAVE EDGE ROLLER (THICKNESS X DIAMETER)	ROUND EDGE ROLLER (THICKNESS X DIAMETER)
<b>PL7505</b>	5/32" x 1-5/16" (4.0 x 33.3 mm)	3/32" x 1-5/16" (2.4 x 33.3 mm)

Minimum order: 1 each. All Roller Tools can be combined for quantity pricing.  
NOTE: Not available in Australia.

## CRL Basic Combination Nylon Wheel Screen and Spline Roller

- Lightweight Hollow Handle

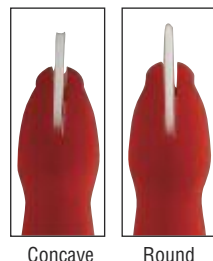

Featuring a round edge and concave edge nylon roller mounted in lightweight plastic handle, the CRL Combination Nylon Wheel Screen and Spline Roller is ideal for shop use or over the counter sales.

CAT. NO.	CONCAVE EDGE ROLLER (THICKNESS X DIAMETER)	ROUND EDGE ROLLER (THICKNESS X DIAMETER)
<b>PL7503</b>	5/32" x 1-5/8" (4.0 x 41.3 mm)	3/32" x 1-5/8" (2.4 x 41.3 mm)

Minimum order: 1 each. All Roller Tools can be combined for quantity pricing.

## CRL Steel Flat Edge Roller

- 2" (50.8 mm) Wide Roller for Smoothing Flat Spline



Flat

The 2" wide by 2" diameter steel ball bearing roller on our Flat Roller Tool is riveted to a steel yoke, and mounted to a contour-grip, finished wood handle. Use it to smooth out flat spline or glazing vinyl prior to insertion in the frame.

CAT. NO.	ROLLER THICKNESS	ROLLER DIAMETER
27FR5	2" (50.8 mm)	2" (50.8 mm)

Minimum order: 1 each. All Roller Tools can be combined for quantity pricing.  
NOTE: Not available in Australia.

## CRL Steel Step Roller

- Two Tools in One
- Hardwood Handle

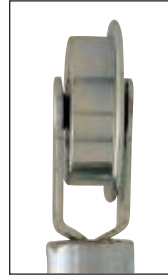

Step

You get two tools in one with this CRL Step Tool. It combines the uses of a Bevel Roller Tool and a Flat Roller Tool. The steel ball bearing roller is mounted to a contour grip hardwood handle.

CAT. NO.	ROLLER THICKNESS	ROLLER DIAMETER
27S3	1/16" (1.6 mm)	2" (50.8 mm)

Minimum order: 1 each. All Roller Tools can be combined for quantity pricing.  
NOTE: Not available in Australia.

## CRL Steel Bevel Roller

- Comfortable Contoured Grip Hardwood Handle



Bevel

Use the CRL Bevel Roller Tool to roll glazing vinyl into channels, and screen spline into the screen frame. The steel ball bearing roller is mounted to a contoured grip hardwood handle.

CAT. NO.	ROLLER THICKNESS	ROLLER DIAMETER
27S2	1/16" (1.6 mm)	2-1/4" (57.1 mm)

Minimum order: 1 each. All Roller Tools can be combined for quantity pricing.  
NOTE: Not available in Australia.

## CRL Combination Spline Roller and Screen Wire Cutter

- Designed for Speed and Efficiency
- Choose From Nylon or Steel Roller Models



Concave

Get two uses out of the CRL Combination Spline Roller and Screen Wire Cutter. Use one end to roll fiberglass screen into the frame, and the other to cut excess screen off as the spline is installed. Available with two roller sizes in either nylon or steel.

CAT. NO.	ROLLER	ROLLER THICKNESS	ROLLER DIAMETER
K6N96	Nylon	3/32" (2.4 mm)	2" (50.8 mm)
K7N96	Nylon	1/8" (3.2 mm)	2" (50.8 mm)
K696	Steel	3/32" (2.4 mm)	2" (50.8 mm)
K796	Steel	1/8" (3.2 mm)	2" (50.8 mm)

Minimum order: 1 each. All Roller Tools can be combined for quantity pricing.  
NOTE: Not available in Australia.

## CRL Combination Spline Roller and Shear Tool

- Steel Blade Cuts Screen Wire, Spline, and Glazing Vinyl

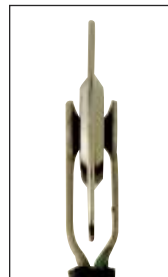

Round

Roll screen spline into your frame and cut it off at the correct length with the CRL Spline Roller and Shear Tool. You can also use the precision round steel blade to cut screen wire, glazing vinyl, etc.

CAT. NO.	ROLLER THICKNESS	ROLLER DIAMETER
P1S5	1/16" (1.6 mm)	2-1/2" (63.5 mm)

Minimum order: 1 each. All Roller Tools can be combined for quantity pricing.



## CRL Nylon Replacement Wheels for Spline Roller Tools

- Fully Raced Ball Bearing Inserted Into Nylon Wheel
- Includes Replacement Axle
- Two Hub Thicknesses

CRL Nylon Replacement Wheels are fitted with a fully raced ball bearing. Supplied with the wheel are both a Phillips head threaded shoulder bolt and press-fit solid axle rivet so the wheels of all styles of Screen and Spline Roller Tools can be replaced.



Narrow Fork

Wide Fork

Correct replacement wheel identification must be done by matching the wheel fork of your existing tool with the appropriate hub thickness.

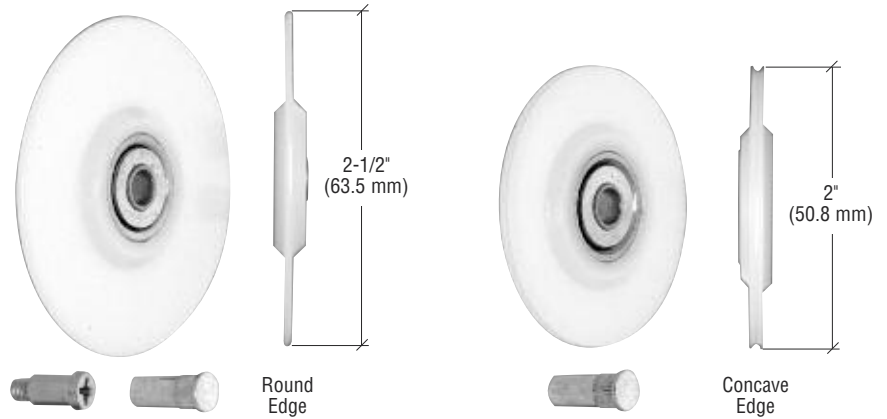

Round Edge

Concave Edge

NARROW FORK CAT. NO.	WIDE FORK CAT. NO.	WHEEL TYPE	WHEEL THICKNESS	WHEEL DIAMETER
REPS5N	WREPS5N	Round Edge	1/16" (1.6 mm)	2-1/2" (63.5 mm)
REPK6N	WREPK6N	Concave Edge	3/32" (2.4 mm)	2" (50.8 mm)
REPK7N	WREPK7N	Concave Edge	1/8" (3.2 mm)	2" (50.8 mm)
REPK9N	---	Concave Edge	3/16" (4.8 mm)	2" (50.8 mm)

Minimum order: 1 each.

## CRL Vinyl Roller Tools

- Knurl Diamond Grip and a Ball Bearing Wheel



VR17 Extra Long Vinyl Roller Tool

VR04 Standard Vinyl Roller Tool

VR10 Blue Handle Vinyl Roller Tool



CRL Vinyl Roller Tools aid in the insertion of Glazing Vinyls and Gaskets in window assemblies and heavy aluminum base shoe. Choose from three models, including our extra long Cat. No. VR17 with the two-handed grip.

CAT. NO.	DESCRIPTION
VR17	Extra Long 17" (432 mm) Vinyl Roller
VR04	Standard 11" (279 mm) Vinyl Roller
VR10	Blue Handle 11" (279 mm) Vinyl Roller
VR10RW	Replacement Wheel for VR10

Minimum order: 1 each.

## CRL Heavy-Duty Screen Shears

- For Fiberglass and Aluminum Screen Wire
- Comfortable, Balanced Grip

These Heavy-Duty Screen Shears speed the assembly time when fabricating screens. The comfortable grip and 10" (254 mm) blades cut aluminum and fiberglass screen easily. Minimum order is one each.



CAT. NO. P8062

## CRL Euro Screen Shears

- For Fiberglass and Aluminum Screen Wire **new**

European-made Shears have tempered stainless steel 10" (254 mm) blades to cut aluminum and fiberglass screen cloth. Non-handed, oversized, rubberized grips for maximum comfort and control. Minimum order is one each.



CAT. NO. P8377

## CRL Plunger Latch Step Drill



- Drills Proper Size Holes for Plunger Latches in a Single Operation

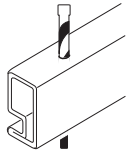

Drill hole from exterior edge of frame

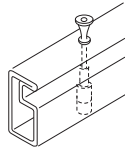

Insert plunger and spring, then bind knob from spline pocket edge of frame

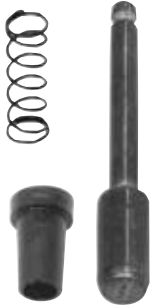

Typical Plunger Latch (Not Included)

CRL's Plunger Latch Step Drill is used to drill the proper size hole in screen frame for Plunger Latches, all in a single operation. The two-step, High Speed Steel Drill Bit has a 7/32" (5.6 mm) shank which "steps" down to 1/8" (3.2 mm). Minimum order is one each.

CAT. NO. WST905

## CRL Plunger Latch Jig

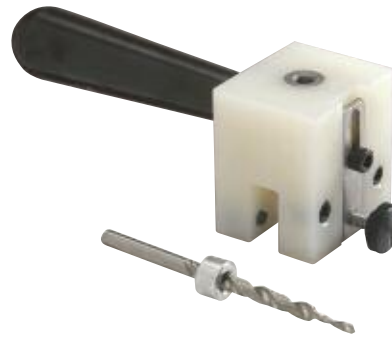

- Nylon Jig Provides for Quick Installation and Will Not Scratch Frame
- Makes Clean, Straight Holes Every Time

The CRL Plunger Latch Jig ensures that you get a perfect Plunger Latch hole every time. The nylon Jig is designed to accommodate 1/4" to 7/16" (6.3 to 11.1 mm) screen frame. Because it is nylon, it will not scratch the frame. It has a large, comfortable handle, which allows you to hold your frame steady. The accompanying Step Drill has a stop collar, which assures the correct depth for the Plunger Latch. Minimum order is one each.

CAT. NO. WST920

## CRL Screen Frame Punch

- Eliminates the Need to Drill for the Installation of Flat Springs

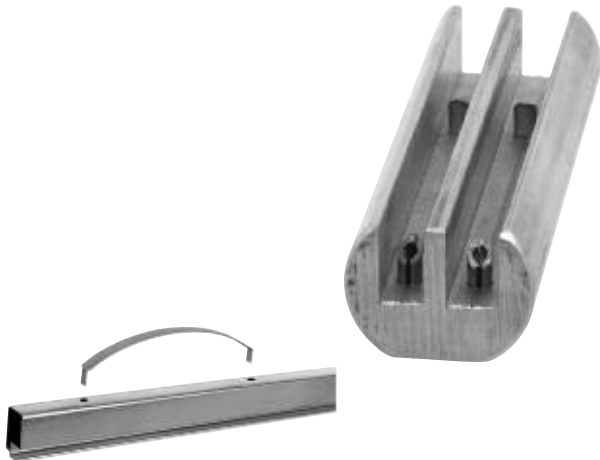

This CRL Screen Frame Punch for Flat Springs is a real time saver, making screen fabrication faster and easier. With one operation this tool punches both holes needed for the installation of our Cat. No. WSC410 Flat Screen Frame Tension Springs. The Punch works on 5/16" and 3/8" (7.9 and 9.5 mm) width screen frames. Minimum order is one each.

CAT. NO. WST930

## CRL Screen Frame Notching Jig and Tool

- For Quick, Easy Notching of Roll-Formed Screen Frame
- Not for Use With Extruded Screen Frame



Our Notching Jig and Tool notches roll-formed screen frame for the installation of Tension Springs, Slide Locks, and Knife Latches.

The grooved, wooden Jig holds 1/4", 5/16", 3/8", 7/16" and 1/2" (6.3, 7.9, 9.5, 11.1 and 12.7 mm) frame securely while you notch it with the Notching Tool, which is included with the Jig or available separately. **NOTE:** Not available in Australia.

CAT. NO.	HOLDS FRAME SIZES	DESCRIPTION
WST900	1/4" to 1/2" (6.3 to 12.7 mm)	Notching Jig and Tool Set
WST901	1/4" to 1/2" (6.3 to 12.7 mm)	

Minimum order: 1 each.

## CRL E-Z Slide Cut-Off Gauge

- Fast and Accurate Lineal Measuring
- Measures Stock Lengths from 6" (152 mm) to 108" (2.74 m)
- Easy-to-Read Measurement Indicator
- Made of Extruded Aluminum
- Choose From Left Hand or Right Hand Models

The CRL E-Z Slide Cut-Off Gauge provides accurate lineal cuts with fast length change capability. Simply lift and slide the bar clamp to the appropriate dimension and flip the slide bar clamp to secure the stop.

All measurements are read directly in front of the chop saw for maximum operator efficiency. The stop arm allows you to cut multiple same length pieces with one cut. Stock lengths from 6" (152 mm) to 108" (2.74 m) can be measured.

The CRL E-Z Slide Cut-Off Gauge mounts easily to your existing bench or our Cat. No. P8061R Miter Saw Table Kit shown at the bottom of this page. Full mounting instructions are included.



Left Hand E-Z Slide Cut-Off Gauge Cat. No. P7926 Shown.



Measurement Indicator

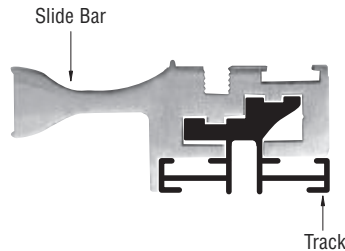

**NOTE:** Recommended gauge selection if the operator is left-handed, order a Cat. No. P7925 Right Hand Cut-Off Gauge. If the operator is right-handed, order a Cat. No. P7926 Left Hand Cut-Off Gauge.

CAT. NO.	DESCRIPTION
P7925	Right Hand E-Z Slide Cut-Off Gauge
P7926	Left Hand E-Z Slide Cut-Off Gauge
P7927	Right Hand Cut-Off Gauge Replacement Tape
P7928	Left Hand Cut-Off Gauge Replacement Tape

Minimum order: 1 each.

## CRL Miter Saw Table Kit

- Sturdy Painted Steel Framing Locks Into Place With the Tap of a Mallet – No Bolts Required!
- All You Supply is 1/2" or 3/4" (12 or 19 mm) Plywood or Particleboard and Your Miter Saw
- Work Surface Height is 36" (914 mm), Middle Shelf Height is Adjustable

Here is a quick, easy way to make the cutting area in your shop more efficient. The CRL Miter Saw Table Kit ships to you conveniently via U.P.S. oversized in three cartons. Once assembled the 18' (5.48 m) table can handle just about any cutting need. It has a comfortable 36" (914 mm) work height, and the 24" (610 mm) depth allows you plenty of table surface to work on. The additional cross members let you convert this space into usable storage for your supplies and tools. The only items you need to provide are the pieces of 1/2" or 3/4" (12 or 19 mm) particleboard or plywood and your miter saw.

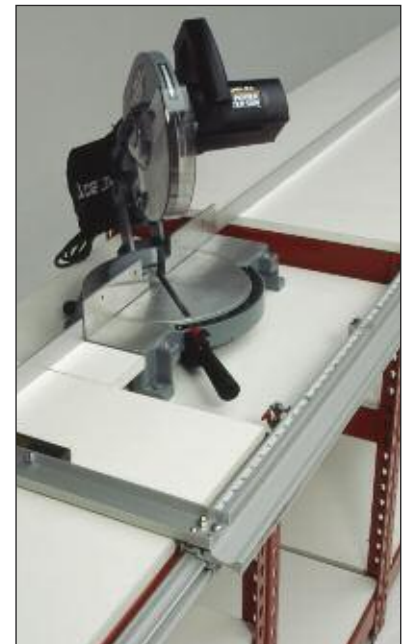

CAT. NO. P8061R

Shown with E-Z Slide Cut-Off Gauge, which must be ordered separately

## CRL Snow Cut-Off Gauge and Accessories

- Sets and Locks in a Single Operation
- Provides Precise Accuracy
- Cut Any Angle
- Made of Solid Steel



Measuring Tape



Indicator Plate

The Snow Cut-Off Gauge measures from 0" to 108" (2.75 m) with hairline accuracy without the operator changing position. Just raise operating bar, slide to desired length, drop bar and gauge is locked in position. It is installed on the front of your existing bench. Stop arms designed for easy removal, leaving the bench top clear and giving you a "straight edge" stop the full width of your bench, allow you to cut more than one piece at a time.

It speeds production because it's fast, accurate, and easy to use. Positive setting eliminates unnecessary set-up time, and a measuring scale is visible at all times. Gauge is set and secured in position by positive locking steel cams controlled by an operating bar directly in front of the operator. Can be easily installed on your existing bench whether on a solid or roller top. Just attach a 3/8" (9.5 mm) spacer, then a straight two by four along the face of the bench, install gauge on the top of the two by four, mount the gauge indicator at the cutting line, and you're ready to start cutting. The Snow Cut-Off Gauge features heavy steel construction for a long, rugged life and can be used indoors or out.



Snow Cut-Off Gauge in Installed Position

CAT. NO.	DESCRIPTION
M6ML	Left Hand 90 Degree Snow Cut-Off Gauge
M6MR	Right Hand 90 Degree Snow Cut-Off Gauge
AP63L	Left Hand Measuring Tape
AP63R	Right Hand Measuring Tape
AP69	Indicator Plate

Minimum order: 1 each.

## CRL Portable Miter Saw Table Kit

- 35-1/4" Wide x 16-1/2" Deep x 44-1/2" High (895 x 419 x 1130 mm) When Hinged Extensions are Folded
- 102" (2590 mm) Maximum Width With Extensions Open
- Left Side Fence Calibrated for Miter Cuts; Right Side for Square Cuts
- Built-In Adjustable Measuring Device for Extended Length Measuring
- Easy Rolling Lockable Casters

Want to be able to move your miter saw around the shop or use it efficiently on the job site? CRL has just what you need with our Portable Miter Saw Table Kit. The table has a fence clamp for accurate measurements. The built-in adjustable measuring device allows for extended length measuring. The table arrives at your shop partially assembled. All you need to add is your miter saw. Table height is adjustable to match several brands of miter saws. Minimum order is one each.

**NOTE:** Table Kit can ship via U.P.S. at 'oversize' rates.



Miter Saw Not Included

- Some Assembly Required

CAT. NO. P8077R

## CRL 10" High Speed Saw Blade

- 200 Teeth to Produce Burr-Free Cuts
- Long Lasting High Speed Steel

This 10" Hollow Ground High Speed Steel Saw Blade is designed for cutting thin-walled aluminum screen frame. The 200 teeth produce clean, burr-free cuts. Minimum order is one each.



CAT. NO. SHS10X200

## CRL Screen Table and Table Tower Kits

- Boltless Metal Framing Locks Into Place With the Tap of a Mallet
- Designed for Use With 3/4" Particleboard or Plywood (Not Included)
- Comfortable 36" (194 mm) Working Height
- Adjustable Shelf Height for Storing Screen Supplies
- Table or Tower Kits Ship U.P.S. in One Carton

You always wanted a table that would not just allow you to do your screening, but would also allow for storage of screen wire and other materials needed. You've seen them in other shops, but have put it off, thinking that you do not want to pay the freight on a fabricated table, or put up with the hassle of sending drawings and specs to a manufacturer to have one custom built.

Now with one call to CRL, we can ship our Screen Table Kit to you via U.P.S. oversized. The CRL Screen Table Kit, when assembled, will provide you with a table surface of 32 square feet (2.97 sq. mtrs.), and 64 square feet (5.95 sq. mtrs.) of storage area. Upon arrival all you have to do is tap the framework together, add 48" x 96" (1.2 x 2.4 m) pieces of particleboard or plywood, which you provide, and you are ready to go.

The Table Tower Kit (sold separately) is a perfect addition to your new Screen Table. The Tower keeps screen wire up to 48" (1.22 m) wide and spline (both sold separately) right at your fingertips. This easily installed kit ships in one carton which is sent via U.P.S. oversized.



CAT. NO.	DESCRIPTION
<b>P8060R</b>	Screen Table Kit
<b>P8076R</b>	Table Tower Kit

Minimum order: 1 each.

## CRL Screen Table Jig Set

- Allows Screen Frame to be Held Firmly and Squarely in Place While Installing Screen Wire

The CRL Screen Table Jig Set makes fabricating window screens easier because it keeps the screen frame square and prevents "Hour Glass" bow-in. The Set has six extruded aluminum Jig Bars. Three Bars are floaters, and three are stationary. One is 42" (1.06 m) for the short end of the table, and two are to be mounted end to end with a steel splice (included) for the 96" (2.44 m) long side of the table. This allows the Jig Set to ship standard U.P.S.

The Kit also includes 12 each 3/4" (19 mm) Jig Clips. Once the two Stationary Bars are mounted to the table, slip three Clips onto each side. Pick the appropriate floater bar lengths (depending on screen size), and slip three Clips onto each. Lay the frame onto the table so that the frame engages all 12 Clips. Arrange the Clips on each Bar so that one Clip is at the far end of the screen frame, and one Clip is in the middle of the frame. This center Clip does the work by holding the frame as straight as the Jig Bar and preventing bow in. Extra Jig Clips are available for either 3/4" (19 mm) or 1" (25 mm) frame.

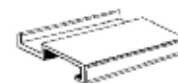
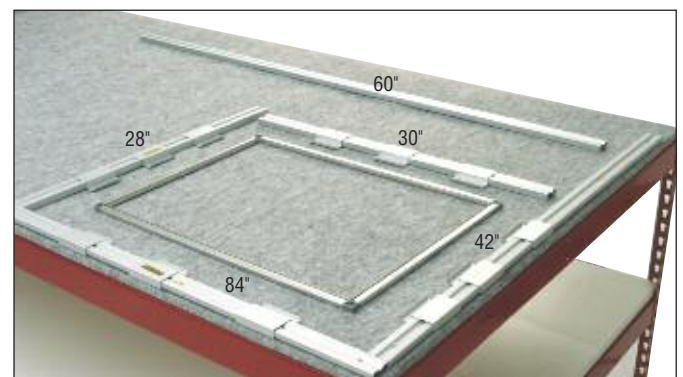

Additional Jig Clips are available for 3/4" (19 mm) or 1" (25 mm) Screen Frame.

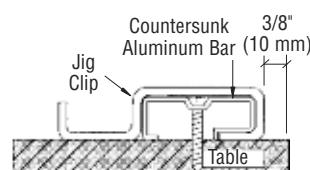

CAT. NO.	DESCRIPTION
<b>P7924</b>	Screen Table Jig Set
<b>P7932</b>	Set of Four 3/4" (19 mm) Jig Clips
<b>P7933</b>	Set of Four 1" (25 mm) Jig Clips

Minimum order: 1 each.

## CRL E.Z.D. Glazer De-Glazing Tool



- Aids in the De-Glazing of Glass Installed With Silicone, Foam Tapes, Butyl Tapes, and Other Flexible Materials
- Extremely Simple to Use

The EZ1010 goes to work when you lay the cutting blade flat on the glass surface and slide it into the glazing pocket. The glazing material is separated from the glass as you roll the tool along the entire length of the pocket. A built-in hand guard lets you work right next to the glass for good leverage and a deep cut when needed.

**NOTE:** Not recommended for use with glazing putty or other materials that harden over time.

CAT. NO.	DESCRIPTION
EZ1010	E.Z.D. Glazer De-Glazing Tool
EZ1022	Replacement Blade-Threaded
EZ10G	Replacement Hand Guard

Minimum order: 1 each.

## CRL Window De-Glazing Tool



- Provides Extra Leverage to Remove Window Units Safely and Easily
- Extremely Durable All-Aluminum Construction

The CRL WT2000 Window De-Glazing Tool is designed for the safe and easy removal of windows from their frames. This tool offers you advantages over manual methods because the large handle allows a positive two-hand grip for extra leverage, and the heat-treated blade cuts through the toughest of sealants. The WT2000 has a three-position handle for easy access to windows at almost any angle or height.

The replaceable blades are sharpened to a razor's edge, and heat-treated for strength and longevity. The WT2000 comes complete with a Handle and one each Left Hand and Right Hand Blades.

CAT. NO.	DESCRIPTION
WT2000	Window De-Glazing Tool
WT2001	Right Hand Replacement Blade
WT2002	Left Hand Replacement Blade
WT2003	Handle Only for WT2000

Minimum order: 1 each.

## CRL Aluminum and Steel Window Frame Extractor



- Removes Aluminum and Steel Window Frames in Minutes, Not Hours
- Reduces Clean Up Time

The CRL Window Frame Extractor pulls aluminum and steel frames from existing stucco, wood or siding structures. It can remove patio door frames as easily as window frames for installation of flush fin, block frame, and other retrofit window applications. Clean up time is reduced, and little or no stucco patching is required. Comes with nylon carry bag. Minimum order is one each.

CAT. NO. WFE

## CRL Stop Mold Puller

- Simple and Easy



- Reduces Your Chance of Breaking Glass While Pulling Stop Molds

The CRL Stop Mold Puller is used to remove stop molds or snap-on sash. It works on both door and tube stops, and makes removing window units easy. The rubber-lined pad will not damage metal extrusions. A reliable and inexpensive tool every glazier should own. Minimum order is one each.

CAT. NO. SMP200

## CRL Door Pressure Gauge



- Easy to Use, Pocket Sized Tool Helps to Determine if Amount of Force Required to Open Doors Meets A.D.A. Regulations



Our Door Pressure Gauge shows the amount of force (pounds or kilograms) required to open doors so you can determine if the door meets A.D.A. regulations. An absolutely vital tool if working on doors in facilities requiring full access to disabled persons. It can also be used to determine the amount of rolling force required to open or close patio doors. Range is from 0 to 35 pounds (0 to 15.9 kg). Minimum order is one each.

CAT. NO. HMC035

## CRL Tilt Balance Tool

- Split Head End Grasps Lower Pin on Balance Rod

This plated steel Tensioning Tool is designed for tilt window Spiral Sash Balances. The Tool grasps the lower pin on the balance rod to give the necessary counter balance adjustment. Minimum order is one each.

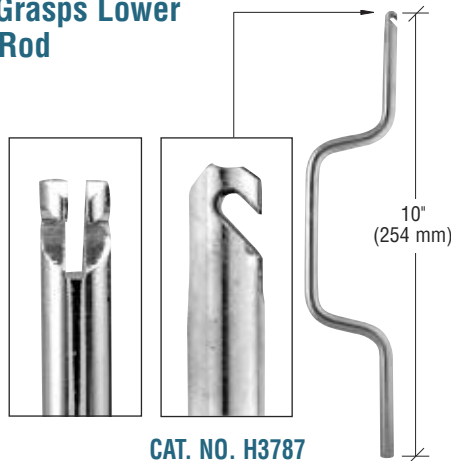

CAT. NO. H3787

## CRL Non-Tilt Balance Tool

- Wire Hook End Grasps Spiral Sash Balances

This plated steel Tensioning Tool is designed for non-tilt window Spiral Sash Balances. The Tool has a wire hook to grasp the balance rod to easily wind or unwind the rod to give the necessary counter balance adjustments. Minimum order is one each.

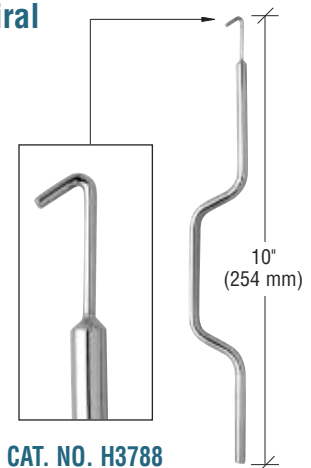

CAT. NO. H3788

## CRL Storm Sash Spreader Tool

- Used For Removal of Old Swivel or Corner Keys in Storm Sash



This CRL Storm Sash Spreader Tool quickly spreads the corners of frames for removal of old swivel or corner keys. Just insert the pointed jaws along side the old corner key and squeeze the handles. Minimum order is one each.

CAT. NO. 2114525

## CRL Crimping Tool for 1795 Zinc Corners

- For Installing 1795 Zinc Corners Into Miter Cut CRL-Sash



Zinc Corners Sold Separately

The projecting pins located in the jaws of the CRL Crimping Tool are designed to crimp the miter cut ends of Universal CRL-Sash into the dimples of Cat. No. 1795 Zinc Corners, securing both legs to the corner. Minimum order is one each.

CAT. NO. S1936

## CRL Auto Glass Tools

- Professional Quality
- Brand Names
- Constant Improvements
- The Industry's Largest Distribution Network

CRL maintains the industry's largest supply of tools for the automotive glass replacement market. Everything you need to successfully operate a shop and provide quality service to your customers by using the most technically advanced tools available.

Our commitment to providing these products is evident in the quality and thoroughness of our product lines. CRL stocks the major brand name tools you will recognize as the finest available, known for their durability and value.

CRL is constantly searching for new and improved automotive tools. We encourage inventors to present their new tool ideas for incorporation into the CRL family of tools. CRL has an attractive royalty program for ideas that become reality. See page 102K for information about submitting new tool ideas.



## Other CRL Catalogs of Interest to the Auto Glass Professional



### CRL03 Sealants, Adhesives, and Fasteners

- Automotive Sealants and Adhesives, Such as Urethanes, Gasket Sealers, and Weatherstrip Adhesives
- Tapes and Mechanical Fasteners, Such as Screws and Rivets
- Cleaning Products and Lubricants for Auto Maintenance

The CRL03 Master Catalog showcases our varieties of sealants, adhesives, cleaners, lubricants, and other maintenance products. Our full selection of tapes and mechanical fasteners for metals, glass, plastics, and the tools to apply them, can also be found in this all-encompassing, full color catalog.

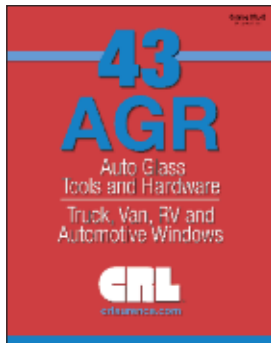

### CRL43 Auto Glass Tools and Hardware, Automotive Windows

- Auto Glass Adhesives, Sealants, Cleaners, and Lubricants
- Auto Glass Tools and Replacement Components
- Shop Tools and Safety Gear
- Truck Sliders, Sunroofs, Van and RV Windows, and Accessories

The CRL43 Master Catalog offers you our complete range of sealants, adhesives, cleaners, and lubricants for automotive use. All of the tools needed to successfully remove or replace auto glass are on hand, as well as safety gear. Our CRL brand of automotive windows completes the offering in this full color, informative catalog for the auto glass professional.



### TV12A Truck and Van Accents

- Pickup Truck Rear Sliders
- Van, Camper, and RV Windows
- Transit Bus and Shuttle Windows
- CRL/SFC Sunroofs



CRL has the largest selection of automotive accessory windows available to the aftermarket, as well as to fabricators of recreational vehicles, transit vehicles, long haul tractors, and farm equipment. You can see them all in this full color, easy to select from catalog.



## CRL Auto Glass Technician's Starter Kit

- Outfit a New Employee
- Spare Tools for Mobile Unit



CAT. NO. TSK01

The CRL Auto Glass Technician's Starter Kit provides the beginning technician with a good selection of tools to help get started in the trade. We provide basic tools to keep your cost low, and allow the new technician to grow into the tools that will be required as their knowledge and experience grows. This kit lets the technician tackle just about any job they would normally be assigned. The basic tool groups have been selected for windshield, back glass and door glass removal, replacement and clean up, as well as safety gear. Start your new employee off on the right foot with this professionally prepared kit.

### TSK01 AUTO GLASS TECHNICIAN'S STARTER KIT CONSISTS OF ONE EACH OF THE FOLLOWING:

CAT. NO.	DESCRIPTION	CAT. NO.	DESCRIPTION
<b>RK160</b>	Standard Cold Knife With RKB141 Blade	<b>CRL69</b>	Auto Vacuum Cup
<b>AN1001</b>	3/4" (19 mm) Ultra Thin Cold Knife Blade	<b>CP253</b>	Hook Tool
<b>AN1002</b>	1" (25 mm) Ultra Thin Cold Knife Blade	<b>RT752</b>	Rope-In Slider Tool
<b>AN1004</b>	1-1/2" (38 mm) Ultra Thin Cold Knife Blade	<b>CRL216</b>	Tapered Windshield Stick
<b>PK19</b>	Pipe Handle Long Knife	<b>CRL220</b>	Chisel Tip Windshield Stick
<b>K82</b>	Auto-loading Utility Knife	<b>CRL216H</b>	Windshield Stick Handle
<b>1993X10</b>	Pack of 10 Extra Long Utility Knife Blades	<b>CP26</b>	Door Handle Tool
<b>1996X10</b>	Pack of 10 Molding Removal Hook Blades	<b>516WT</b>	Pinch Weld Scraper
<b>21510T</b>	10 in 1 Trim Tool	<b>WG41004XT</b>	18 to 1 High Ratio Caulking Gun
<b>L47000</b>	Filler Strip Tool	<b>MR215</b>	Molding Removal Tool
<b>CRL761</b>	Razor Blade Scraper	<b>MB2</b>	5/64" and 3/32" Hex End Mirror Tool
<b>4050</b>	9-3/4" (248 mm) Scrape and Pry Bar	<b>MB2TX</b>	T15 and T20 Torx End Mirror Tool
<b>TW72</b>	Roll of Cut-Out Wire	<b>MB3</b>	Ford Mirror Release Tool
<b>LWH200</b>	Pair of Cut-Out Wire Handles	<b>MB4</b>	Chevy/GM Mirror Release Tool
<b>SH610</b>	Safety Glasses	<b>15568</b>	34 Piece Master Driver Set
<b>GR1PL</b>	Large Pair of GripPro Impact Gloves	<b>180312</b>	Tool Box With Tray

Minimum order: 1 each.

## CRL Glass Scratch Removal System

- Portable, Stand Alone System Works on All Types of Glass, Including Windshields, Side and Rear Glass
- One-Step Process Produces Distortion-Free Results
- Non-Abrasive Compound
- Integrated Water Feed System

The CRL Glass Scratch Removal System removes scratches from all types of glass including tempered, annealed, laminated, Low-e, mirrors, curved windshields, back and side windows. You can use this portable system to remove scratches, water scale, acid etching, paint over-spray, and other imperfections quickly and effectively.

This unique system combines thermal energy (heat), chemical reaction (polishing compound), and mechanical energy (force) to effectively eliminate scratches from glass without the use of fixed abrasives.

The CRL Glass Scratch Removal System can be integrated into your everyday operations. Whether you are a door and window manufacturer, a distributor, or an automotive glass shop, the CRL Glass Scratch Removal System can save you money, directly impacting your bottom line. These potential savings come from reduced down time for glass replacement thus keeping projects on schedule, and by reducing glass waste and scrap ratios.

Compare the CRL Glass Scratch Removal System to some of the other scratch removal systems you may have seen or tried in the past. This system is lightweight and compact: no buckets of coolant and compound to lug around. This system employs a one-step process: multiple abrasive and polishing pad changes are no longer required. This system delivers what others only promise: distortion-free surface restoration.

The CRL Glass Scratch Removal System features a unique pressurized water feed attachment with a push button activated nozzle mounted directly onto the polisher. This attachment can be secured directly to the work surface with built-in suction cups, or worn conveniently on your belt using the integral belt clip.

The 2", 3" and 4" (51, 76, and 102 mm) Polishing Pads attach to the appropriate Backer Pads using an aggressive hook-and-loop fastener system.

The complete SRS1 Glass Scratch Removal Kit includes: 110V AC 4500 RPM Polisher, .55 lbs (.250 kg) of Polishing Compound, one 2" (51 mm) Backer Pad, one package of 2" (51 mm) Polishing Disks, one 3" (76 mm) Backer Pad, one package of 3" (76 mm) Polishing Disks, one Pressurized Water Feed Attachment, one Inspection Light / IR Thermometer, Safety Glasses, two Respirator Masks, one Mixing Container, one Spatula, one Wrench, one Manual Spray Bottle, Ear Plugs, one Cleaning Brush, one detailed Training and Use Manual, and one foam padded lockable Carrying Case.



### COMPLETE KIT AND INDIVIDUAL COMPONENTS

CAT. NO.	DESCRIPTION
<b>SRS1</b>	Complete Scratch Removal Kit, 110 Volt AC
<b>SRS1PC</b>	Polishing Compound, 0.55 lbs (.250 kg), 2/pk
<b>SRSVPD2</b>	2" (51 mm) Hook-and-Loop Back Polishing Disks, 3/pkg
<b>SRSVPD3</b>	3" (76 mm) Hook-and-Loop Back Polishing Disks, 3/pkg
<b>SRSVPD4</b>	4" (102 mm) Hook-and-Loop Back Polishing Disks, 3/pkg
<b>SRSVPB2</b>	2" (51 mm) Hook-and-Loop Backer Pad
<b>SRSVPB3</b>	3" (76 mm) Hook-and-Loop Backer Pad
<b>SRSVPB4</b>	4" (102 mm) Hook-and-Loop Backer Pad

Minimum order: 1 each or 1 pack.

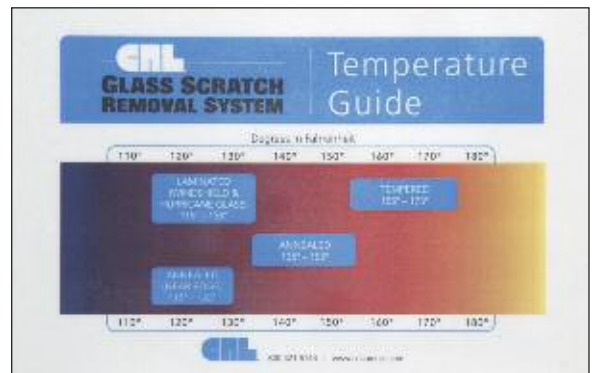

## CRL Heavy-Duty Scratch Polisher

- Polishes All Types of Glass, From Windshields to Watch Crystals
- Use it Hand Held or Bench Mounted for Added Stability



CAT. NO. YP85

Use the CRL Heavy-Duty Scratch Polisher as either a bench mounted or hand held polisher with excellent results. It is fitted with a high quality wool felt wheel that will polish virtually all types of glass, from windshields, sheet glass, edges, and bevels to watch crystals. It is powered by a heavy-duty, double-insulated 110V AC motor. Sure grip handles on each end of the tool assembly provide control.

### POLISHERS

CAT. NO.	DESCRIPTION
YP85	110V Scratch Polisher
1520	230V Scratch Polisher

Minimum order: 1 each.

### FELT WHEELS

CAT. NO.	YEARS	SIZE	ARBOR
YPF6X2N	1990 to Present	6" x 2" (152 x 51 mm)	2" (51 mm)
YPF6	Before 1990	6" x 1-1/2" (152 x 38 mm)	2-3/4" (70 mm)

Minimum order: 1 each.



CAT. NO. YPF6X2N  
for Current Model Polishers



CAT. NO. YPF6  
for Older Polishers

## CRL Scratch Polishing Kit

- Lightweight, So You Can Work on Windshields Right in the Car
- Remove Light Surface Scratches
- Polish Out Rubs, Fine Lines, Stains, and Discoloration on Mirrors or Glass of Any Kind
- Well Balanced for Smooth Action

The CRL Scratch Polishing Kit is designed to meet the demand for a low-priced, lightweight, portable tool capable of removing light surface scratches. It also can be used to polish out rubs, fine lines, stains, and discolorations on mirrors or glass of any kind. This tool can also be used as a sander by using a backup pad and sanding discs. Operates on 110V AC.

The CRL Scratch Polisher will remove light scratches and water deposits from glass. Generally, if you run your fingernail over the scratch and it catches, the scratch is too deep to be removed with this polisher. However, light scratches, windshield wiper rubs, and some water deposits can be removed by following these instructions. Minimum order is one each.



CAT. NO. CRL9257  
Complete Kit

### INCLUDED IN THE CRL9257 KIT:

- Cat. No. PV7001C Makita® 7" (178 mm) Vertical Polisher with Variable Speed (600 – 2,000 RPM)
- Rubber Back-Up Pad
- Spanner Wrench
- Side Handle
- Cat. No. 5702 Polishing Head 3" x 1-1/2" (76 x 38 mm) All Wool Felt Pad
- Cat. No. C0301 Cerium Oxide (One Pound / 454g)

## CRL Glass Polisher and Scratch Remover

- Excellent for Manual Bevel Finishing
- Large Felt Wheel is Suitable for Auto Glass Work
- Available for Purchase or Lease

CRL's Model No. 37 Glass Polisher is widely used in the glass industry for manual polishing and for the removal of scratches. A polishing compound such as cerium oxide, used on the felt wheel, will also produce a brilliant finish on edges, especially bevels, and will remove hairline scratches while maintaining the surface polish of the glass.

The machine is furnished with a solid quality felt wheel, 24" O.D. x 18" I.D. x 3" wide (610 x 457 x 76 mm), mounted on a wooden ring, which is V-belt driven by a 3/4 HP, single phase, 60 cycle, 110V AC motor. A motor starting switch, truing bar, and wooden support shelf are also provided. A 230 Volt model is also available.

Makita is a registered trademark of Makita Corporation.



### SPECIFICATIONS

**Width:** 20" (508 mm)  
**Depth:** 30" (762 mm)  
**Height:** 47" (1219 mm)  
**Shipping Weight:** Approx. 425 Lbs. (193 kg)

### REPLACEMENT FELT WHEEL

**CAT. NO. 2605244**  
**Diameter:** 24" (610 mm) O.D.  
**Width:** 3" (76 mm)

CAT. NO.	DESCRIPTION
SM37	110 Volt 60 Hz Polisher
SM37X230	230 Volt 50 Hz Polisher

Minimum order: 1 each.



## CRL Complete Polishing Head Assembly

- Used for Light Scratch Removal
- Can Be Used With a Cordless Drill

The CRL Polishing Head Assembly consists of a 1-1/2" (38 mm) thick by 3" (76 mm) diameter wool felt wheel, an aluminum adapter plate, and a 1/4" (6 mm) diameter shank. Use it with our Cat. No. PV7001C Polisher, or chuck it into your electric drill. Minimum order is one each.



Polisher Not Included

CAT. NO. 5703

## CRL All Wool Felt Wheel

- For Use With the 5701 Adapter

Made from the highest quality Spanish felt, this 3" (76 mm) diameter, 1-1/2" (38 mm) thick buffing wheel can remove scratches, stains, and discoloration from glass and mirrors. Used with the Cat. No. 5701 Aluminum Adapter, this economical wheel can work wonders in the smallest of spaces. Also replaces the felt wheel on the Cat. No. 5703 Polishing Head Assembly. Minimum order is one each.



CAT. NO. WFD03112

## CRL Aluminum Adapter

- Used With the WFD03112 Felt Wheel



The CRL Aluminum Adapter is machined to run smoothly while on the CRL9257 Scratch Polisher, or when used with the Cat. No. 5704 Shank Adapter. The Cat. No. WFD03112 All Wool Felt Wheel is adhered to the bottom surface of this Adapter by using Cat. No. 3M8001 Super Weatherstrip Adhesive or Cat. No. LN601 Construction Adhesive. Minimum order is one each.

CAT. NO. 5701

## CRL Aluminum Adapter and Felt Wheel

- Can Be Used With Your Hand Drill



The CRL Aluminum Adapter and Felt Wheel consists of one Cat. No. 5701 Aluminum Adapter and one Cat. No. WFD03112 All Wool Felt Wheel cemented together. Keep a spare on hand if you do a lot of scratch removal. Mate with Cat. No. 5704 to use it in your hand drill. Minimum order is one each.

CAT. NO. 5702

## CRL Shank Adapter

- 1/4" (6.4 mm) Diameter Shank Fits All Drill Motors



The CRL Shank Adapter is designed for use in any hand drill. The 5/8"-11 threads insert into popular disc pads such as Cat. No. 5702. Minimum order is one each.

CAT. NO. 5704

## CRL Cerium Oxide

- Used With the CRL9257 Scratch Polisher



CRL Cerium Oxide is a high grade optical polishing compound used to lessen and polish scratches from auto glass, mirror bevels, and table top edges. CRL Cerium Oxide is mixed with water to form a paste or slurry. This compound has excellent suspension qualities and will not harden. Contains no zinc oxide, and meets most local disposal ordinances.

CAT. NO.	CONTAINER CONTENTS
C0301	1 Pound (454 g)
C0305	5 Pounds (2.27 kg)
C0310	10 Pounds (4.54 kg)

Minimum order: 1 each.

Available in larger bulk packaging. See page 672K

## CRL 3M™ Super Weatherstrip Adhesive

- Exceptional Bonding Strength
- Waterproof and Flexible



CRL 3M™ Super Weatherstrip Adhesive is used for bonding and sealing weatherstripping to car trunks and doors. It also bonds WFD03112 Felt Wheels to 5701 Adapters with great adhesion. Easy to spread, extremely fast drying. Resists oil, grease, and solvents. Also a good general purpose cement. Contents: 5 Fl. Oz. (147 ml).

CAT. NO. 3M8001

## CRL Standard Cold Knife

- Our Best Selling Removal Tool
- Uses All CRL Cold Knife Blades



The CRL Standard Cold Knife comes complete with a strong tempered steel blade sharpened to a fine cutting edge. Large durable aluminum handle, combined with a steel cable pull handle, assures the easiest and fastest way of cutting the adhesive around the windshield. Comes with one Cat. No. RKB141 Standard Blade. Minimum order is one each.

**CAT. NO. RK160**

## CRL Short Handle Cold Knife

- Perfect for Tight Areas
- Uses All CRL Cold Knife Blades



The CRL Short Handle Cold Knife was designed for use on vehicles where the hood or fender comes up over the bottom edge of the windshield and rides so close that it is very difficult to get a cold knife under the hood to cut the urethane. Also useful on vans and RV's where the roof overhangs the top of the windshield. Comes with one Cat. No. RKB141 Standard Blade. Minimum order is one each.

**CAT. NO. RK160S**

## CRL Foam-Grip Push-Button Cold Knife

- Push-Button Blade Change
- Foam-Grip Handle
- Uses All 3/4" (19 mm) Shank CRL Cold Knife Blades



Our CRL Foam-Grip Push-Button Cold Knife has a convenient one step push-button blade release system. The textured foam grip adds handling stability, gripping action, and user comfort. Comes with one Cat. No. RKB10 Stainless Steel Cutting Blade. Minimum order is one each.

**CAT. NO. RK500**

## CRL Foam-Grip Push-Button Cold Knife Kit With 18 Blades

- Push-Button Blade Change
- Foam-Grip Handle

- Full Assortment of 18 Blades



**CAT. NO. AN5001**  
Six each

**CAT. NO. AN5002**  
Six each

**CAT. NO. AN5004**  
Six each

This CRL Foam-Grip Push-Button Cold Knife Kit provides you with the newest in cold knife convenience and innovation. You also get six each of these UltraWiz Ultra-Thin Cold Knife Blades: AN5001 3/4" (19 mm), AN5002 1" (25 mm), and AN5004 1-1/2" (38 mm) lengths. Minimum order is one each.

**CAT. NO. RZ5K1T**

Note: All CRL Cold Knife Blades fit the handles shown on this page. See pages 362K to 364K for blades.

## CRL Standard Cold Knife Blades

- One of Our Best Sellers
- Fits All 1/2" (12 mm) Shank Handles



These CRL Standard Cold Knife Blades are made of tempered steel for extra strength. The 7/8" (22 mm) size is our biggest seller. Please note these Blades have 1/2" (12 mm) wide shanks.

CAT. NO.	BLADE LENGTH (L)
RKB141	7/8" (22 mm)
RKB146	3/8" (9.5 mm)

Minimum order: 1 each. All Cold Knife Blades can be combined for quantity pricing.

## CRL Stainless Steel Cold Knife Blades

- Super Strong
- Use With All Handles



Our CRL Stainless Steel Blades are designed with extra strength for extended life. They fit standard cold knives, and have tips that can be re-sharpened. Three different tip lengths cover a variety of cut-out applications.

CAT. NO.	BLADE LENGTH (L)
RKB75	3/4" (19 mm)
RKB10	1" (25 mm)
RKB15	1-1/2" (37 mm)

Minimum order: 1 each. All Cold Knife Blades can be combined for quantity pricing.

## CRL Long Shank Stainless Steel Cold Knife Blades

- Gives Additional Clearance
- Use With All Handles

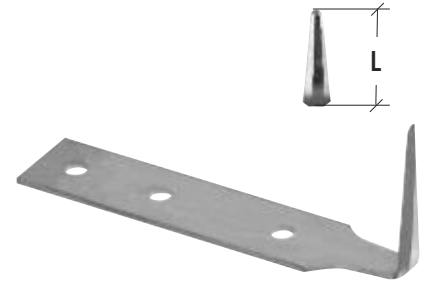

These CRL Long Shank Stainless Steel Blades provide good distance from the body during the cut-out. The two tip lengths give you the versatility to change to a longer length to cut wider beads of urethane along the bottom of the glass.

CAT. NO.	BLADE LENGTH (L)
RKB410	1" (25 mm)
RKB415	1-1/2" (37 mm)

Minimum order: 1 each. All Cold Knife Blades can be combined for quantity pricing.

## CRL Coated Cold Knife Blades

- Less Drag for Smoother Cutting
- Fits All 1/2" (12 mm) Shank Handles



CRL Coated Cold Knife Blades are specially sharpened, then coated to produce a Blade that is unsurpassed in performance when cutting through tough urethane. These Blades have 1/2" (12 mm) wide shanks.

CAT. NO.	BLADE LENGTH (L)
RKB142	1-3/8" (35 mm)
RKB143	7/8" (22 mm)

Minimum order: 1 each. All Cold Knife Blades can be combined for quantity pricing.

## CRL Cobra Stainless Steel Cold Knife Blades

- Unique Rounded Grind Produces Less Drag
- Use With All Handles



CRL Cobra Stainless Steel Cold Knife Blades remain flexible, stay sharp, and are made to last. The rounded blade face provides less flat surface for the adhesives to stick to during cut-out. This unique Blade design cuts better than other available blades.

CAT. NO.	BLADE LENGTH (L)
RCB175SS	3/4" (19 mm)
RCB110SS	1" (25 mm)

Minimum order: 1 each. All Cold Knife Blades can be combined for quantity pricing.

## CRL995 Knife Replacement Blade

- Narrow Width Blade for CRL995 Handle Only



Made with a 1/2" (12 mm) wide shank, the CRL995B Blade will only fit our CRL995 Cold Knife Handle, which is no longer manufactured. Many of our customers have used the CRL995 Knife for years, and only CRL offers this specially designed Blade to fit it.

CAT. NO.	BLADE LENGTH (L)
CRL995B	3/4" (19 mm)

Minimum order: 1 each. All Cold Knife Blades can be combined for quantity pricing.

## CRL UltraWiz® Cable Pull Cold Knife



See Page 364K for Replacement Blades



- Ergonomic, Contoured Handle With Cable Pull for Extra Power
- Uses All 3/4" (19 mm) Shank CRL Blades

The UltraWiz® Cable Pull Cold Knife is the perfect choice to accompany UltraWiz® Blades. All UltraWiz® Handles are shaped for comfort and gripping power, and have a single set screw that allows for quick blade changes. This knife comes with one Cat. No. AN1001 Standard Cut-Out Blade. Minimum order is one each.

CAT. NO. AN3001K

## CRL UltraWiz® Short and Long Handle Cold Knives



- Extruded, Contoured Handle
- Quick-Change Single Set Screw
- Uses All 3/4" (19 mm) Shank CRL Blades

These UltraWiz® Short and Long Handle Cold Knives provide the extra reach and power required to cut urethane. UltraWiz® Handles are shaped for comfort and gripping power. Both Handles feature a single set screw for quick blade changes. Comes with one Cat. No. AN1002 Cut-Out Blade.

CAT. NO.	DESCRIPTION
AN2001M	4-3/4" (121 mm) Short Handle
AN2002M	8-3/4" (222 mm) Long Handle

Minimum order: 1 each.

## CRL UltraWiz® Lever-Action Cold Knife



- Flip Lever to Adjust Blade Length
- Uses All 3/4" (19 mm) Shank CRL Blades

The UltraWiz® Lever-Action Cold Knife provides the extra power and adjustability needed for today's auto glass replacements. With a flip of the lever the blade can be adjusted in or out for better clearance on the body during the cut-out, or use the lever for quick blade changes. Solid aluminum handle is contoured for superior grip. Knife comes with one Cat. No. AN1001 Standard Cut-Out Blade. Minimum order is one each.

UltraWiz is a registered trademark of AN Designs, Inc.

CAT. NO. AN3007K

## CRL UltraWiz® UltraOne Cold Knife



- Single Screw for Quick Blade Change
- Uses All 3/4" (19 mm) Shank CRL Blades

This UltraWiz® UltraOne Cold Knife is the perfect choice to accompany UltraWiz® Blades. It features scratch resistant comfortable foam grips, and a single screw quick blade change feature. The single screw also allows for easy adjustment to the blade length for all applications. Order Cat. No. AN3005RK for Replacement Pull Handle. This knife comes with one Cat. No. AN1001 Standard Cut-Out Blade. Minimum order is one each.

CAT. NO. AN3005K

## CRL UltraWiz® Cold Knife Blades



- Ultra-Fast for Quick Glass Removal
- Use With All 3/4" (19 mm) Shank Handles

CRL UltraWiz® Cold Knife Blades are recognized as the industry standard for fast cutting. They fit all standard cold knife handles.

CAT. NO.	BLADE LENGTH (L)
AN1001	3/4" (19 mm)
AN1002	1" (25 mm)
AN1003	1-1/4" (32 mm)
AN1004	1-1/2" (37 mm)

Minimum order: 1 each. All Cold Knife Blades can be combined for quantity pricing.

## CRL UltraWiz® Ultra-Thin Cold Knife Blades



- Ultra-Thin for Easy Cutting Action
- Use With All 3/4" (19 mm) Shank Handles

CRL UltraWiz® Ultra-Thin Blades are 40% thinner to reduce drag. UltraWiz® Ultra-Thin Blades also have a double taper sharpened edge to further the quick cutting action.

CAT. NO.	BLADE LENGTH (L)
AN5001	3/4" (19 mm)
AN5002	1" (25 mm)
AN5003	1-1/4" (32 mm)
AN5004	1-1/2" (37 mm)

Minimum order: 1 each. All Cold Knife Blades can be combined for quantity pricing.

## CRL UltraWiz® Molding Blade

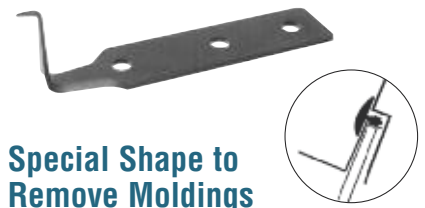

- Special Shape to Remove Moldings
- Use With All 3/4" (19 mm) Shank Handles

The CRL UltraWiz® Molding Removal Blade has a specially shaped tip that gets under the molding and over the glass edge, saving it for reinstallation. Minimum order is one each.

CAT. NO. AN1005

## CRL UltraWiz® Stainless Steel Cold Knife Blades

- Super-Strong, Longer Lasting Cutting Edge
- Use With All 3/4" (19 mm) Shank Handles

CRL UltraWiz® Stainless Steel Cold Knife Blades provide a longer lasting cutting edge than standard high carbon steel blades so they typically last longer.



CAT. NO.	BLADE LENGTH (L)
AN7001	3/4" (19 mm)
AN7002	1" (25 mm)
AN7004	1-1/2" (37 mm)

Minimum order: 1 each. All Cold Knife Blades can be combined for quantity pricing.

## CRL UltraWiz® Molding and Windshield Blade



- Removes Both Molding and Glass
- Use With All 3/4" (19 mm) Shank Handles

The CRL UltraWiz® Molding and Windshield Removal Blade cuts under the molding and the glass edge, saving the molding for reinstallation, and removing the windshield at the same time. Minimum order is one each.

CAT. NO. AN1022M

## CRL Sharpening Stone



- Use to Sharpen Your Cut-Out Blades

A couple of quick strokes with our Sharpening Stone are all you need to keep your cut-out blades sharp. Measures 4" by 3/8" (102 by 10 mm). Minimum order is one each.

CAT. NO. AKDS1

UltraWiz is a registered trademark of AN Designs, Inc.

## CRL 2" Custom Blue Blade



- Carbon Steel

The Custom Blue Blade is made of carbon steel, and has an extra long 2" (51 mm) cutting blade. This Blade has 1/2" (12 mm) wide shank.

CAT. NO.	BLADE LENGTH (L)
2011019	2" (51 mm)

Minimum order: 1 each. All Cold Knife Blades can be combined for quantity pricing.

## CRL950B Blade



- The Original 1/2" (12 mm) Shank Blade

The CRL950B Blade is a long time favorite of the trade, and should only be used on the following Cold Knife Handles: RK160 and RK160S.

CAT. NO.	BLADE LENGTH (L)
CRL950B	7/8" (22 mm)

Minimum order: 1 each. All Cold Knife Blades can be combined for quantity pricing.



## CRL Super-Hot Windshield Knife Cut-Out Blades

**NOTE:** Blades are only for use with the CRL Model SHK250 Super Hot Knife (Knife is no longer available).



### • 100% Copper in Five Models

These CRL Super-Hot Knife Blades offer fast cutting action, and are easy to change out. They are specifically designed for use with the CRL Model SHK250 Super-Hot Windshield Cut-Out Knife, which is no longer available. Minimum order for all blades is one each.



Our most popular, best selling, all-purpose blade

\* Sharpened Edge measures 1" (25 mm)

CAT. NO. SHKB149

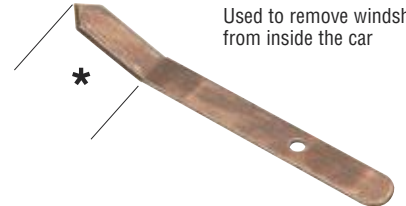

Used to remove windshields from inside the car

\* Sharpened Edge measures 1-1/8" (28 mm)

CAT. NO. SHKB150

Used to remove excess urethane from pinchweld



\* Sharpened Edge measures 1/2" (12 mm)

CAT. NO. SHKB151

Used to cut out lower edge of windshield where urethane is set back from edge of windshield



\* Sharpened Edge measures 1-1/8" (28 mm)

CAT. NO. SHKB152

Used around fenders and hoods where other blades won't allow access



\* Sharpened Edge measures 1" (25 mm)

CAT. NO. SHKB153

## CRL Persuader Chisel and Mallet

- Helps Cuts Urethane in Corners
- Simple But Effective

CRL Persuader Urethane Chisel is used to cut the urethane adhesive on the corners of windshields from the inside. Chisel is 15-3/4" (400 mm) long; blade width is 4" (102 mm). This CRL Three Pound Mallet is the perfect choice for use with the Persuader Urethane Chisel. Overall length is 10-1/2" (267 mm).



CAT. NO. RKP100



CAT. NO. ST56703

Mallet Not Available in Australia

CAT. NO.

DESCRIPTION

RKP100  
ST56703

Persuader Chisel  
Three Pound Mallet

Minimum order: 1 each.

## CRL Protect-A-Dash

- Prevents Costly Damage
- Non-Slip Foam Back - Tough Slick Nylon Front

Keep the "Oops" out of using Cut-Out Knives with our Protect-A-Dash. The slick nylon front lets you work quickly to cut away tough urethane, while the non-slip foam back keeps the Protect-A-Dash in position. Minimum order is one each.



CAT. NO. CU1077



## CRL Pull-Style U-Blade Knife

- Cuts Groove for Insert Molding
- Standard and Thin Blades

The CRL Pull-Style U-Blade Knife was designed for making re-insertion of push-in moldings easier. Use it to prepare a space between the glass edge and body opening for application of new urethane adhesive and insert molding replacement. Standard Blade cuts a 5/16" (8 mm) gap; Thin Blade cuts a 1/4" (6 mm) gap. Sold with one Standard Blade installed. Cable Pull Handle must be ordered separately.

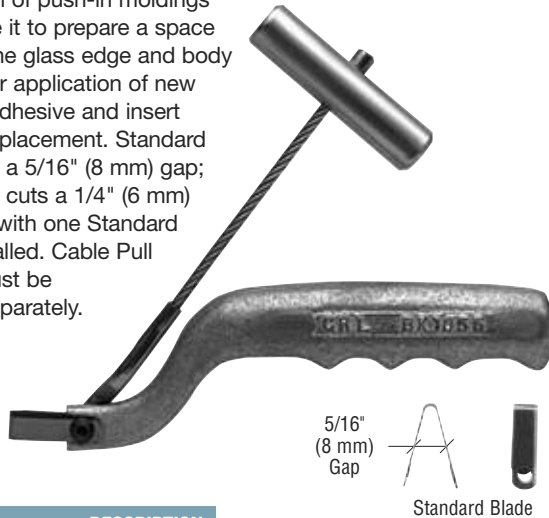

CAT. NO.	DESCRIPTION
<b>BK1055</b>	U-Blade Knife
<b>BK1056</b>	Standard Blade
<b>BK1057</b>	Thin Blade
<b>RK160CH</b>	Cable Pull Handle

Minimum order: 1 each.

## CRL Auto Glass Multi-Knife

- Three Tools in One
- Soft Fit Ergonomic Handle
- Single Screw Quick Change Feature



The CRL Multi-Knife has combined the three most common tools used for auto glass removal, and features a single set screw for quick blade changing. Can be used with all 3/4" (19 mm) shank cold knife blades. The ergonomic solid aluminum foam covered Handle comes complete with one Cat. No. AN1001 3/4" (19 mm) Cold Knife Blade, one Cat. No. RSB75 3/4" (19 mm) wide Scraper Blade, one Cat. No. H62750 6-1/2" (165 mm) long Curved Blade, and one Cat. No. AN3005RK T-Pull Handle.

CAT. NO.	DESCRIPTION
<b>1MK</b>	Complete Multi-Knife
<b>1MKH</b>	Contoured Grip Handle Only
<b>AN3005RK</b>	Replacement T-Pull Handle
<b>RSB75</b>	3/4" (19 mm) Wide Scraper Blade
<b>H62750</b>	6-1/2" (165 mm) Long Curved Blade

Minimum order: 1 each.

## CRL Push-Style U-Blade Knife

- Helps Make Reinstalling Plastic Reveal Molding Easy

Push this handy CRL Push-Style U-Blade Knife between the body panel and windshield edge to cleanly cut urethane and leave a 1/8" (3 mm) gap for reinstalling the reveal molding. Replacement U-Blades for this convenient body shop tool are quickly and easily changed.

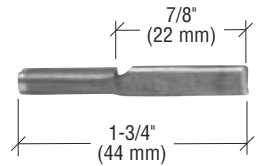

CAT. NO.	DESCRIPTION
<b>RK400</b>	U-Blade Knife
<b>RKB401</b>	Replacement U-Blade

Minimum order: 1 each.

## CRL Quickknife™ Quick Release Cold Knife Kit

- Quick Release for Fast Blade Changes
- Uses All 1/2" and 3/4" (12 and 19 mm) Shank Cold Knife Blades



The CRL Quickknife™ Quick Release Cold Knife Kit makes blade changing quick and easy. The cast aluminum handle pivots open for blade removal and replacement. The comfortable handle holds all brands of 1/2" (12 mm) and 3/4" (19 mm) shank cold knife blades. After the glass part is removed, you can quickly change the knife into a pinchweld scraper to complete the removal process. The Quickknife™ comes in a Molded Plastic Case with Cable Pull Handle, Long and Short Cut-Out Blades, and a Scraper Blade.

CAT. NO.	DESCRIPTION
<b>EQK425</b>	Complete Quickknife™ Kit
<b>EQR503</b>	Cable Pull Only
<b>RSB75</b>	3/4" (19 mm) Wide Scraper Blade Only

Minimum order: 1 each.

## CRL Pipe Handle Knives

- Our Most Popular Long Knives
- Available in Two Lengths
- Uses CRL Utility Knife Blades

The cast aluminum handles on our CRL Pipe Handle Cut-Out Knives give you extra reach to cut hardened urethane down below the dash. The round handle is easy to grip, and by adding a length of standard conduit pipe, can be extended for extra length. Three blades are stored in each handle. Both knives use CRL 1991, 1992, and 1993 Series Utility Knife Blades (see page 369K).



13" (330 mm) Standard Knife



18" (457 mm) Xtra Long Knife



Old Style Blade Plate

New Style Blade Plate

CAT. NO.	DESCRIPTION
PK19	Standard 13" (330 mm) Pipe Handle Knife
PK19XL	Xtra Long 18" (457 mm) Pipe Handle Knife
PK19PS	Old Style Blade Plate Replacement
PK19NS	New Style Blade Plate Replacement

Minimum order: 1 each.

## CRL Sur-Grip 18" Long Knife

- Foam Grip for Comfort
- Painted Steel Shaft



The CRL Sur-Grip 18" (457 mm) Long Knife offers you comfort with control. The 18" (457 mm) length is perfect to reach those below-the-dash urethane beads for easy cut-outs. The soft urethane foam grip provides a positive grasp of the tool. The Sur-Grip features powder-coated, baked-on black crinkle painted steel shaft attached to painted steel tubing with foam grip. **NOTE:** Roll pin must be removed to use the CRL Angled Blades shown below. Minimum order is one each.

CAT. NO. HT531

## CRL 24" Long Knife

- Extra Long Reach
- Fast Blade Change
- Black Crinkle Painted Aluminum Shaft



The CRL 24" (610 mm) Long Knife is long enough to get to those below-the-dash urethane beads that ordinary cut-out knives can't reach. The HT532 features rigid 1" (25.4 mm) flat stock aluminum construction. It's finished with a powder-coated, baked-on black crinkle paint that provides a better gripping surface than unfinished aluminum. Can be used with CRL Angled Blades shown below. Minimum order is one each.

CAT. NO. HT532

## CRL Angled Blades for All Long Knives on this Page

### Angled Straight Edge Blade

- Longest Reach
- Quick Set-Up



CRL Angled Long Knife Straight Edge Blade provides you with 4-1/2" (114 mm) of reach and cutting ability for any of your long knives. Quickly bolts to existing blade mounting locations. Minimum order is one each.

CAT. NO. RKB471

### Angled Serrated Edge Blade

- Faster Cutting
- Serrated Edge



For the ultimate in fast cutting, use our Angled Serrated Edge Blade. The serrations quickly cut through the toughest urethane. 4-1/2" (114 mm) long blade quickly bolts to existing blade mounting locations. Minimum order is one each.

CAT. NO. RKB472

## CRL Rigid Aluminum Long Knives

- Heavy-Duty Aluminum Shafts
- Excellent for Below-the-Dash Cut-Outs

These CRL Rigid Aluminum Long Knives use our 1992C and 1993X10 Heavy-Duty Utility Knife Blades see page 369K to cut through hardened urethane with ease. The long, thin shape of the knife works well for below-the-dash cut-outs. Order Cat. No. UKSCREW for Replacement Blade Screw.

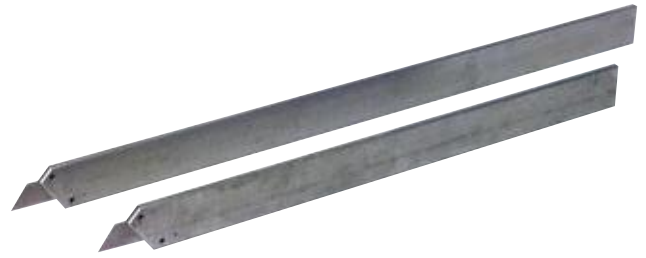

CAT. NO.	DESCRIPTION
UK18	18" (457 mm) Long Knife
UK24	24" (610 mm) Long Knife

Minimum order: 1 each.

## CRL Super-Grip Aluminum Long Knife

- Finger-Grip Handle for a Sure Grip
- Works Well in Tight Spaces

The CRL 9" (228 mm) Super-Grip Aluminum Long Knife has finger grooves for a sure grip. It uses our 1992C and 1993X10 Heavy-Duty Utility Knife Blades see page 369K to cut through hardened urethane, and works especially well in tight spaces between the dash and the glass.



CAT. NO.	DESCRIPTION
UK9	9" (228 mm) Super Grip Knife

Minimum order: 1 each.

## CRL Flexible Long Knife



- Flexes to Glass Curvature
- Rubber Grip

The CRL Flexible Long Knife has a 14" (355 mm) flexible metal shaft that provides especially long leverage for cutting out difficult urethane set windshields. This Knife uses our 1992C Heavy-Duty Utility Knife Blades or 1993X10 Extra-Long Utility Knife Blades see page 369K. Minimum order is one each.

CAT. NO. CRL1119

## CRL Adjustable Long Knife



- Adjustable 18"-24" (457 to 610 mm)

The CRL Adjustable Long Knife allows for quick adjustment from 18" to 24" (457 to 610 mm) with just a twist of the handle. This Knife uses our 1992C Heavy-Duty Utility Knife Blades or 1993X10 Extra-Long Utility Knife Blades see page 369K. Minimum order is one each.

CAT. NO. 2000226

## CRL Banana Knives

- Hardwood Handle
- Curved Sharp Cutting Edges



CAT. NO. BK125  
Standard Banana Knife



CAT. NO. BK150  
Scalloped Edge Banana Knife

CRL Banana Knives are handy tools for cutting out the hard-to-reach urethane below the dash. Made of quality tool steel with a curved, sharp cutting area. The hardwood handles are formed for comfort while providing a secure grip.

**NOTE:** Not Available in Australia.

CAT. NO.	OVERALL LENGTH	DESCRIPTION
BK125	9-1/2" (241 mm)	Standard Banana Knife
BK150	13-1/2" (343 mm)	Scalloped Edge Banana Knife

Minimum order: 1 each.

## CRL Standard Duty Utility Knife Blades

- Fit All Utility and Long Knives



CRL Standard Utility Knife Blades fit all standard, heavy-duty, and retractable blade utility knives and long knives.

CAT. NO.	DESCRIPTION
1991C	Standard Blades - Pack of 100

Minimum order: 1 pack.

## CRL Heavy-Duty Utility Knife Blades

- Our Best-Selling Utility Blades



CRL Heavy-Duty Utility Knife Blades fit all standard, heavy-duty, and retractable blade utility knives and long knives.

CAT. NO.	DESCRIPTION
1992C	Heavy-Duty Blades - Pack of 100
1992X10	Heavy-Duty Blades - Pack of 10

Minimum order: 1 pack.

## CRL Extra Long Utility Knife Blades

- Greater Reach
- Extra Sharp



CRL Extra Long Heavy-Duty Utility Knife Blades fit all urethane knives. They have an exposed cutting edge of 2-1/4" (57 mm), more than double the cutting edge of standard utility knife blades.

CAT. NO.	DESCRIPTION
1993X10	Extra Long Blades - Pack of 10

Minimum order: 1 pack.

## CRL Hook End Utility Blades

- Fit All Standard Utility Knives



When removing encapsulated windshields, this blade is perfect for cutting away the encapsulation. CRL Hook-End Utility Blades fit all standard utility knives.

CAT. NO.	DESCRIPTION
1996C	Hook End Blades - Pack of 100
1996X10	Hook End Blades - Pack of 10

Minimum order: 1 pack.  
Olfa is a registered trademark of Olfa Corporation.

## CRL Olfa® Long Reach Retractable Blade Knife



Solid Blade



Breakaway Blade

- Stainless Steel Housing With Rubber Grip
- Breakaway or Solid Blades

The CRL Olfa® Heavy-Duty Long Reach Retractable Knife was designed with hard-to-reach places in mind. Reaching along the bottom of windshields will no longer be a problem with our XL2 Long Reach Knife. It has a locking thumbscrew, a stainless steel housing, and a rubber grip that provide safety and extra comfort when using this knife.

CAT. NO.	DESCRIPTION
XL2	Olfa® Long Reach Knife
LS0L	Solid Blades - Pack of 10
LB10B	Breakaway Blades - Pack of 10
LB50B	Breakaway Blades - Pack of 50

Minimum order for Knife is one each; for Blades is one pack.

## CRL Extra Long Serrated Blades

- Faster Cutting
- Longer Length



CRL Extra Long Serrated Blades measure a full 4-3/16" (106 mm) long. One of the longest blades available and, with its serrated edge, one of the fastest cutting.

CAT. NO.	DESCRIPTION
SB418	Serrated Blades - Pack of 10

Minimum order: 1 pack.

## CRL Long Curved Blade

- For Use With 1MKH Handle
- 6-1/2" (165 mm) Long for Cutting Below the Dash Area



Handle Not Included



The CRL Long Curved Urethane Cut-Out Blade fits the CRL 1MKH Multi-Knife Handle (see 366K). At 6-1/2" (165 mm) long this Blade is perfect for cutting urethane deep below the dash area. Minimum order is one each.

CAT. NO. H62750

## CRL Standard Retractable Blade Utility Knife



Safety Overlap

- Three Position Heavy-Duty Slider Actuation
- Overlapping Nose for Safety

This CRL Standard Retractable Blade Utility Knife has a safety overlap that keeps the blade from slipping between the handle halves, an important safety consideration. It is supplied with four blades, and uses any of our CRL Utility Knife Blades (see page 369K), which must be purchased separately. Minimum order is one each.

CAT. NO. 97K

## CRL Stanley® Heavy-Duty Retractable Blade Utility Knife



- Industrial Quality
- Retractable Blade

This CRL Stanley® Heavy-Duty Retractable Blade Utility Knife features a five-position slide and heavy-duty metal body. It is supplied with three heavy-duty blades, and uses any of our CRL Utility Knife Blades (see page 369K), which must be purchased separately. Minimum order is one each.

CAT. NO. 99

## CRL Heavy-Duty Fixed Blade Utility Knife



- Industrial Quality Die Cast Handle
- Comes With Five Blades

This CRL Heavy-Duty Fixed Blade Utility Knife is an easy-to-use basic knife that has a fixed blade. For the shop that uses and or loses a lot of knives, this inexpensive model is an ideal purchase. It is supplied with five standard blades, and uses any of our CRL Utility Knife Blades (see page 369K), which must be purchased separately. Minimum order is one each.

CAT. NO. 199

## CRL Autoloading Utility Knife



- Easy, Quick Blade Replacement

The CRL Autoloading Utility Knife is ergonomically comfortable and easy to use. The spring-loaded blade housing lets you change blades without the need for tools. It's safety yellow color is easily visible wherever you might leave it. The rubber inserts in the handle give you an improved grip. It is supplied with five 1992C blades, and uses any of our CRL Utility Knife Blades (see page 369K), which must be purchased separately. Minimum order is one each.

CAT. NO. K82

## CRL Stanley® FatMax® Swivel-Lock Fixed Blade Utility Knife



- Quick Blade Change – No Tools Required
- Ergonomic Design

This CRL Stanley® FatMax® Swivel-Lock Fixed Blade Utility Knife swivels open so you can change the blade without using tools. The thumb dial locks the blade in place, and there is a magnet in the nose to hold the blade while the knife is open. It has a cast metal core with soft panels for a comfortable grip, and comes with three heavy-duty utility knife blades stored in the handle. It uses any of our CRL Utility Knife Blades (see page 369K), which must be purchased separately. Minimum order is one each.

CAT. NO. ST10799

Stanley and FatMax are registered trademarks of Stanley Logistics, LLC.

## CRL Heavy-Duty Retractable Blade Utility Knife



- Safety Orange Color
- Industrial Quality

This CRL Heavy-Duty Retractable Blade Utility Knife is a quality knife designed to better fit the hand with vertically recessed ribs for a more comfortable grip. The heavy-duty, die cast zinc handle features a safety nose with top and bottom over-lap, providing additional security by preventing the blade from slipping between each half of the handle. A zinc retractor makes for smoother operation and has three cutting positions. It is supplied with three heavy-duty blades, and uses any of our CRL Utility Knife Blades (see page 369K), which must be purchased separately. Minimum order is one each.

CAT. NO. 82L

## CRL Triple Strand Braided Cut-Out Wire

- Three Braided Strands for Strength
- Our Most Popular Cut-Out Wire



Our CRL Stainless Steel Triple Strand Braided Cut-Out Wire is made of three super strong, stainless steel strands braided to form a .022" (6 mm) diameter wire. 72' (21.95 m) per roll. Minimum order is one roll.

CAT. NO. TW72

## CRL Windshield Wire

- Fast-Cutting Heavy-Duty Wire Used for Many Years



CRL Windshield Wire is a one-pound coil of heavy-duty piano wire for removing windshields. Each roll has approximately 650' (198 m) of wire. For a good grip, try our TWH500 Tightwire Grips shown on page 372K. Minimum order is one roll.

CAT. NO. WW4

## CRL Stainless Steel Square Wire

- Super High Strength Wire Cuts Through Even the Toughest Urethanes



CRL's Stainless Steel Square Wire configuration cuts through even the toughest of urethanes with ease. The square edge of the wire rotates and cuts with amazing speed. Its super strength works to prevent breakage under tough loads. 72' (21.95 m) per roll. Minimum order is one roll.

CAT. NO. SSW508

## CRL Sidewinder Wire Cut-Out Tool

- Makes Wire Cut-Outs a Simple, One-Person Job



The CRL Sidewinder is the ideal tool for a one-man wire cut-out operation. Attach the powerful vacuum cup to the inside of the windshield. An aluminum swivel, riding on a ball bearing, allows the swivel to follow the wire. Attached to the swivel is a spring that acts as a second person; you pull the wire, make your cut, and the spring pulls the wire back so you can make another cut. Kit contains one Sidewinder Cut-Out Tool, one roll TW72 Triple Strand Wire, one WS782 Wire Starter Tool, and one set TWH500 Tightwire Grips. Minimum order is one each.

CAT. NO. VSR73

## CRL Windshield Removal Kit

- All-in-One Kit That Quickly Cuts Through Stubborn Urethane

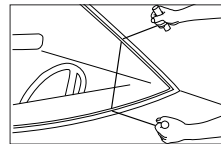

This CRL Windshield Removal Kit is designed to provide a quick, efficient, and economical method for removing stationary glass. The uniquely designed CRL Tightwire Grips hold on to CRL Windshield Wire securely. The vinyl grips allow you to tighten and loosen them quickly by hand. The CRL WireStarter™ is designed to make pushing the wire through the adhesive quicker and safer than conventional methods. After the wire is through the adhesive, it can be located and pulled out with a pair of needle nose pliers. Minimum order is one each.

CAT. NO. S21400

## CRL Tightwire Grips

- Solid Aluminum With Vinyl Grips
- Unique Wire Locking Feature

CRL Aluminum Tightwire Grips hold on to windshield wire securely. Vinyl-coated grips allow you to tighten and loosen them quickly by hand. Wire ends are contained within the body to prevent injury. Sold only by the pair. Minimum order is one pair.  
**NOTE:** Wire not included.



CAT. NO. TWH500

## CRL Grip-Tite Handles

- Positive Control
- Ergonomic Grip

CRL Grip-Tite Handles will give you a better grip on wire cut-out jobs. A hollowed out, wedged-shaped shaft is the secret to these unique wire grips. Grip-Tite's design keeps the wire away from your fingers at any angle. Contoured handle gives you a non-slip grip. Sold only by the pair.  
Minimum order is one pair.  
**NOTE:** Wire not included.



CAT. NO. LWH200

## CRL CenterStart™ Wire Starter Tool

- Long Reach for Starting Wire
- Tough Spring Steel



This CRL CenterStart™ Wire Starter helps get you started on those tough wire cut-outs. It is designed to push the wire far below the dash and through the urethane. Just place the end of the wire in the slot at the tip and push through the urethane bead.

CAT. NO. PK789

## CRL WireStarter™

- Hollow, Stainless Steel Tube Inserts Wire Quick and Easy

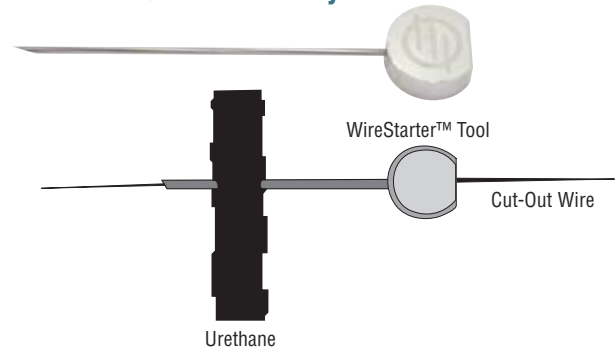

The CRL Wirestarter™ makes the task of pushing the cut-out wire through urethane simple. Just insert the wire through the center of the tool and push. Now you're ready for the cut-out. Minimum order is one each.

CAT. NO. WS782

## CRL Long Shaft Cut-Out Wire Guide

- Protects Dash From Damage
- Maintains Control of Wire



The CRL Long Shaft Windshield Cut-Out Wire Guide is long and narrow enough to protect the dash and interior moldings from being damaged. Run the wire through the hole at the end of the tool, attach the end of the wire in the hole midway, and lock it in place with the set screw. As the tool is moved inside the vehicle, the outside person follows and cuts. Minimum order is one each.

CAT. NO. DGE100

## CRL WireGuard

- Maintains Wire Close to Glass
- Prevents Damage to Dash and Moldings



The CRL WireGuard holds the cut-out wire tight to the glass and prevents damage to trim moldings and the dash. The metal bar provides easy movement of the wire. WireGuard is moved along the glass without removal by spraying water or glass cleaner on the glass as you go. Minimum order is one each.

CAT. NO. GWH366



## CRL FEIN® Cut-Out Knives

- 28% More Power Than Previous Models
- Adjustable Speed Control



CAT. NO. FK06  
Standard Kit

The FEIN® FK06 Standard Kit Contains:

One FEIN® Cut-Out Tool, one each FKB207, FKB208, and FKB209 Gator "L" Blades, one Spanner Wrench, one Sharpening Stone, and a Molded Carrying Case.

This CRL FEIN® Knife has 28% more power than previous models, enabling it to easily cut through the toughest materials. It's also slimmer for better clearance, and has an improved speed control that adjusts (7,000 to 23,000 oscillations per minute) to stay constant under light or heavy loads. All mechanical wear parts operate in an

- Use All Blades With Six and Twelve Sided Mounts
- 110 Volt AC



CAT. NO. FK6385  
Deluxe Kit

The FEIN® FK6385 Deluxe Kit Contains:

One FEIN® Cut-Out Tool, one each FKB118, FKB147, FKB081, FKB107, FKB111, FKB146, and FKB207 FEIN® Blades, one Spanner Wrench, one Sharpening Stone, and a Molded Carrying Case.

oil bath, and the tool is vented to run cooler and last longer. This knife uses blades that have six or twelve sided mounts, so you can adjust the blade angle as required for each specific vehicle. All this makes the FEIN® Knife the time and labor-saving way to remove auto glass on today's vehicles. Minimum order is one each.

## CRL FEIN® Straight Blades

- Fit All Six and Twelve Sided Blade Mounts

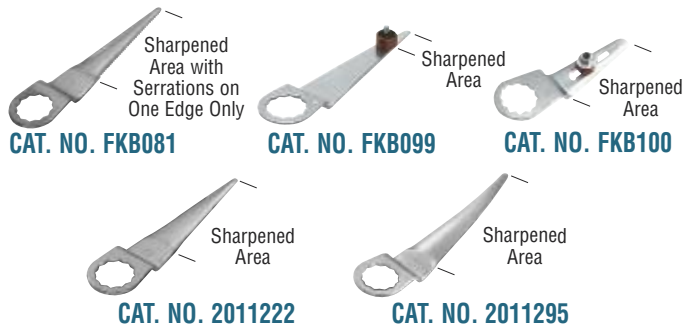

CAT. NO. FKB081

CAT. NO. FKB099

CAT. NO. FKB100

CAT. NO. 2011222

CAT. NO. 2011295

CRL FEIN® Straight Blades work well from the inside of the vehicle. If the sides of the exterior of the A-pillar urethane bead are exposed these blades make short work of cutting along this area. Both the FKB100 and the FKB099 have depth control stops built into the blade to minimize paint damage during the removal.

CAT. NO.	SHARPENED AREA/DESCRIPTION
FKB081	2-3/8" (68 mm) Straight Blade
FKB099	5/8" (16 mm) Straight Blade with Guide Wheel
FKB100	5/8" (16 mm) to 1-1/2" (38 mm) Adjustable Blade
2011222	2-1/2" (63.5 mm) Straight Blade - 2/pk
2011295	2-3/4" (70 mm) Straight with Curved Blade - 2/pk

Minimum order: 1 each. All Oscillating Blades can be combined for quantity pricing.

Blades shown on this page are not warranted against breakage. The blades are made from tempered steel that is strong but brittle, and will break if flexed to an extreme. FEIN is a registered trademark of C. & E. Fein GmbH LLC.

## CRL FEIN® Hook Blades

- Fit All Six and Twelve Sided Blade Mounts
- Long Reach for Cutting From the Exterior

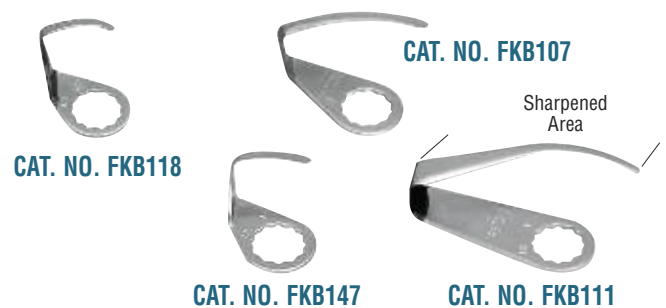

CAT. NO. FKB118

CAT. NO. FKB107

CAT. NO. FKB147

CAT. NO. FKB111

CRL FEIN® Hook Blades are used along the bottom of the windshield from the exterior, and work best when using the FEIN® Knife with a pull handle. **NOTE:** Care should be taken to prevent damage to the dash or moldings when using these blades because the cutting action is on the opposite side of the glass from the operator.

CAT. NO.	SHARPENED AREA/DESCRIPTION
FKB118	3/4" (19 mm) Hook Blade
FKB147	1-1/4" (32 mm) Hook Blade
FKB107	2-3/8" (60 mm) Hook Blade
FKB111	3-3/4" (95 mm) Hook Blade

Minimum order: 1 each. All Oscillating Blades can be combined for quantity pricing.

## CRL FEIN® Serrated Gator "L" Blades

- Fits All Six and Twelve Sided Blade Mounts
- Serrated for Faster Cutting



CAT. NO. FKB208

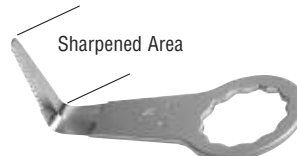

CAT. NO. FKB207

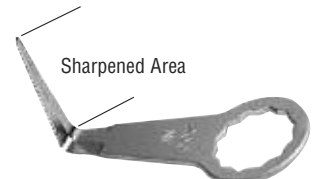

CAT. NO. FKB209

Use these CRL FEIN® Gator "L" Blades for exterior cutting along the A-Pillar and roof area. The serrated leading edge performs the cut faster and smoother than other oscillating blades. These blades have been engineered with outstanding durability, hardness, and flexibility to hold up to the toughest jobs. Sold only in packs of two blades.

CAT. NO.	BLADE LENGTH
FKB208	3/4" (19 mm)
FKB207	1" (25 mm)
FKB209	1-1/2" (38 mm)

Minimum order: 1 pack. All Oscillating Blades can be combined for quantity pricing.

## CRL FEIN® Serrated Gator "U" Blades

- Fits All Six and Twelve Sided Blade Mounts
- Serrated for Faster Cutting

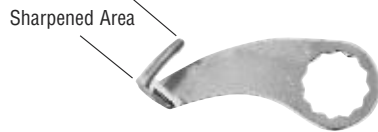

CAT. NO. FKB210



CAT. NO. FKB211



CAT. NO. FKB212

CRL FEIN® Gator "U" Blades will allow you to complete your toughest jobs faster. The serrated leading edge cuts faster and smoother than other oscillating blades. Engineered to work well from the exterior, with outstanding durability, hardness, and flexibility to hold up to the toughest jobs. Sold only in packs of two blades.

CAT. NO.	BLADE LENGTH
FKB210	3/4" (19 mm)
FKB211	1" (25 mm)
FKB212	1-1/2" (38 mm)

Minimum order: 1 pack. All Oscillating Blades can be combined for quantity pricing.

## CRL FEIN® Specialty Blades

- Curved and Bent Styles

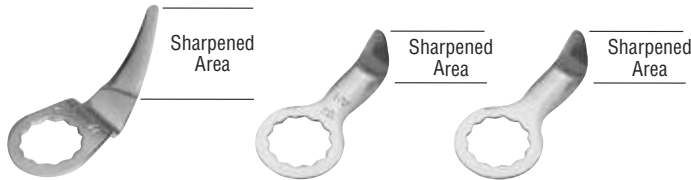

CAT. NO. FKB072    CAT. NO. FKB104    CAT. NO. FKB109

The FKB072 works very well for quarter glass removal with the slight curve and step bend in the blade used as a depth-stop, which helps prevent damage to the paint. The FKB104 and FKB109 are used for back glass and truck slider removal. The angled bend in the blade helps when inserting into the urethane around the encapsulation, and also acts as a depth controller to protect against paint damage.

CAT. NO.	SHARPENED AREA/DESCRIPTION
FKB072	1-3/16" (30 mm) Curved Blade
FKB104	3/4" (19 mm) 90 Degree Bent Up Blade
FKB109	1" (25 mm) 74 Degree Bent Up Blade

Minimum order: 1 each. All Oscillating Blades can be combined for quantity pricing.

## CRL FEIN® Scraper Blades

- Quickly Trims Urethane
- Fits Six and Twelve Sided Blade Mounts



CAT. NO. FKB146

CAT. NO. FKB113

These CRL FEIN® Scraper Blades are used to trim the urethane from the pinchweld once the glass has been removed. The FKB146 cuts from the end of the blade. The FKB113 Blade has a side-to-side cutting action. The "shoulders" on these blades protect against paint damage.

CAT. NO.	DESCRIPTION
FKB146	3/4" (19 mm) Scraper Blade (1/pk)
FKB113	2" (51 mm) Axe Style Scraper Blade (2/pk)

Minimum order: 1 pack. All Oscillating Blades can be combined for quantity pricing.

## CRL FEIN® Circular Saw Blade

- Perfect for Cutting Braces for Sunroof Installations
- Trims Bendover Tabs From Encapsulated Truck Sliders

If you install sunroofs, truck sliders, or van windows you really want this blade. The FEIN® Circular Saw Blade makes cutting braces a breeze. The blade does not spin but oscillates so if you touch it to your skin it won't cut you, but touch it to steel and it sinks in, cutting easily and quickly with full control. Use it to plunge cut the metal bendover tabs in factory sliders prior to cutting through the urethane. Blade diameter is 3-1/8" (79 mm). Minimum order is one each.



CAT. NO. FKB103

Blades shown on this page are not warranted against breakage. The blades are made from tempered steel that is strong but brittle, and will break if flexed to an extreme. FEIN® is a registered trademark of C. & E. Fein GmbH LLC.

## CRL FEIN® Cordless 18V Cut-Out Knife Kit

- Fast Charge 18 Volt Lithium-Ion Batteries With Built-In Power Gauge
- Patented QuickIN Rapid Blade Change
- Adjustable Speed Control



**new**

CAT. NO. FK18V

Finally, the power and technology of FEIN®, without miles of extension cords. The CRL FEIN® FK18V Cordless Sealant Cutter provides the power needed for hackout and windshield replacement jobs, and the portability of battery power. The FK18V features a variable speed control (11,000 to 18,500 oscillations per minute) and the patented QuickIN fast change accessory head which requires no wrenches to change blades. The 18V Li-ion battery packs are not subject to memory effect and can be charged regardless of discharge level. Each battery has a built-in charge indicator so you always know how much power is in your hand. Fully charged batteries deliver up to 25 minutes of continuous operation and the fast charger restores full power in 20 to 25 minutes. Kit includes AFSC18 Tool, two 18V 2.4Ah Li-Ion Batteries, a high-tech Charger, and a heavy-duty plastic Carrying Case. Minimum order is one each.

## CRL FEIN® Spanner Socket

- Fits 1/4" Drive Ratchet Wrench
- Offers Quick Change for Blades

Put this CRL FEIN® Tool Spanner Socket on any 1/4" drive ratchet wrench (not included) and use it to quickly and easily remove and reinstall the FEIN® Spanner Bolt. The all-metal socket is machined for a snug fit on the Spanner Bolt. Minimum order is one each.



CAT. NO. CRL6365

## CRL Spanner Wrench for FEIN® Auto Glass Removal Tools

- Machined Steel
- Fits All FEIN® Tool Spanner Bolts With Two Holes

The CRL FEIN® Spanner Wrench will fit FEIN® Spanner Bolts on FEIN® Tools that have the two-hole pattern, such as FK06, FK6385, FK6625, and FK23618. Minimum order is one each.



CAT. NO. FKSW

## CRL FEIN® Tool Replacement Spanner Bolt

- Machined Steel
- Fits Older FEIN® Knife Models FSN400 and ASTLXE638
- Use With FKSW and CRL6365 or FK0EW Spanner Wrenches



The CRL FEIN® Spanner Bolt will fit older FEIN® Cut-Out Knife Models FSN400 and ASTLXE638. Don't get caught without a replacement for this vital part. Minimum order is one each.

CAT. NO. FKS

## CRL FEIN® Tool Replacement Nut Assembly

- Fits Newer FEIN® Knife Models FSC1.6 and FSC2.0



The CRL FEIN® Nut Assembly will fit newer FEIN® Knife Models FSC1.6 and FSC2.0. Order a replacement to have on hand so you never have down time. Minimum order is one each.

CAT. NO. 6011039

## CRL FEIN® Knife Blade Clamp Bolt

- Fits New Style FEIN® Clamp Mechanism
- No Tools Required for Blade Change



The CRL FEIN® Blade Clamp Bolt is the blade attachment bolt for the newest generation of FEIN® super cutter tools. With the new pull down clamping mechanism, no wrenches are required to change blades on your FEIN® tool. Minimum order is one each.

CAT. NO. FKCB

FEIN is a registered trademark of C. & E. Fein GmbH.

# CRL AUTO GLASS CUT-OUT TOOLS

For Pricing Visit [crlaurence.com](http://crlaurence.com) or Call Us Toll Free at the Phone Numbers Shown on the Back Cover

## CRL Equalizer® Express 18 Volt Cordless Cut-Out Tool

- An Extremely Fast Cutting Tool
- Cordless for Full Control
- Flexible Blade Follows Contours



**CAT. NO. BFE1420**  
Finger Blade 10" (254 mm) Long



**CAT. NO. BFE1401**  
1-1/2" Blade 10" (254 mm) Long



**CAT. NO. BFE1400**  
3" Blade 10" (254 mm) Long



**CAT. NO. RLE1404**  
3" Blade 14" (355 mm) Long



**CAT. NO. DW9096**  
18V Battery Cartridge



**CAT. NO. DC9310**  
115V AC Charger



**CAT. NO. DC9319**  
12V DC Charger



**CAT. NO. DTE1000**  
Complete Kit

Fast is profitable, and the CRL Equalizer® Express is fast! Cutting urethane has never been easier. The Express Cut-Out Tool has a flexible blade that follows the contours of the windshield to provide perfect control during the cut-out.

The Express Kit contains: one Express Tool, one DW9096 18 Volt Battery Cartridge, one DC9310 115V AC Charger, one BFE1400 Standard Blade, and an instructional DVD, all packed in a molded Carrying Case.

CAT. NO.	DESCRIPTION
DTE1000	Express 18 Volt Cordless Tool Kit
BFE1420	Finger Blade
BFE1401	1-1/2" (39 mm) Narrow Blade
BFE1400	3" (76 mm) Standard Blade
RLE1404	3" (76 mm) Long Reach Blade
DW9096	DeWalt® 18 Volt Battery Cartridge
DC9310	DeWalt® 7.2 to 18 Volt Battery Charger (115V AC)
DC9319	DeWalt® 18 Volt Battery Charger (12V DC)

Minimum order: 1 each.

## CRL Equalizer® Express 360 Auto Glass Removal Kit

- 120 Volt, Powerful 2-1/2 HP Motor
- Eight Different Locking Head Positions
- Designed for Plunge and Angle Cuts
- Cuts Easily Through Wide Bands of Urethane

The CRL Equalizer® Express 360 is the most versatile tool ever manufactured by Equalizer®. The unique 360 degree rotating head can be locked in eight different positions, allowing you to get into hard to reach areas. The 120 Volt motor is a 2-1/2 horsepower workforce that drives the blade at 3,000 strokes per minute. A rotary switch allows you precise cutting power without varying up and down.

No matter how thick the urethane is, you will never need to worry about bogging this tool down. Kit includes: one Express 360 Tool, one BFE1400 Standard Blade, one instructional DVD, one pair of Safety Glasses, all packed in a molded Carrying Case. Minimum order is one each.



**CAT. NO. SR1418360**

## CRL Extractor® Pro Cut-Out Tool Replacement Blades

- Flexible Blades for Extractor® Pro Cut-Out Tool

These Replacement Blades are designed to fit only the CRL Extractor® Pro Cut-Out Tool. The flexible blade design allows the Extractor® to remove approximately 95% of windshields without damaging the glass.

Equalizer is a registered trademark of Equalizer Industries, Inc. Extractor is a registered trademark of Crystal Glass Canada, Ltd. DeWalt is a registered trademark of The Black and Decker Corporation.

Blades shown on this page are not warranted against breakage. The blades are made from tempered steel that is strong but brittle, and will break if flexed to an extreme.



**CAT. NO. EXTBL**  
4" Blade



**CAT. NO. EXTBLG**  
Extra Long 4" Blade



**CAT. NO. EXTBLN**  
1-1/2" Blade



**CAT. NO. EXTLS**  
Long Shaft Only



**CAT. NO. EXTSS**  
Short Shaft Only

CAT. NO.	DESCRIPTION
EXTBLG	Extra Long 4" (102 mm) Wide Blade
EXTBL	Standard Length 4" (102 mm) Wide Blade
EXTBLN	Narrow 1-1/2" (38 mm) Wide Blade
EXTLS	Long Shaft Only (No Blade)
EXTSS	Short Shaft Only (No Blade)

Minimum order: 1 each.



**C.R. LAURENCE COMPANY**

[crlaurence.com](http://crlaurence.com) | [usalum.com](http://usalum.com)

376K | [crlaurence.ca](http://crlaurence.ca) [crlaurence.com.au](http://crlaurence.com.au) [crlaurence.co.uk](http://crlaurence.co.uk) [crlaurence.de](http://crlaurence.de) [crlaurence.eu](http://crlaurence.eu)

## CRL Equalizer® Magnum

- Cuts at 4,000 Strokes per Minute
- Heavy-Duty One Horsepower Motor

The CRL Equalizer® Magnum was designed for shops that do a large volume of work, or have fleet accounts with auto dealers and car rental agencies. It has a heavy-duty, one horsepower 115V AC motor, ball bearings, counter-balanced drive, and a heavy-duty gear system. The blade-and-sheath system provides depth control for the cut-out, and vehicle interior protection during the removal process. The exposed blade length is fully adjustable for varying cut depths. Minimum order is one each.

### THE EQUALIZER® MAGNUM DELUXE KIT CONTAINS:

One Magnum Tool, one EQ4SS 4" (102 mm) Stainless Steel Sheath, one EQ8SS 8" (203 mm) Stainless Steel Sheath, one EQ12SS 12" (305 mm) Stainless Steel Sheath, two EQ4LB 4" (102 mm) Blades, two EQ8LB 8" (203 mm) Blades, two EQ12LB 12" (305 mm) Blades, and one pair of Safety Glasses, all in a molded carrying case.

**NOTE:** Blades and Sheaths are interchangeable with all other Equalizer® tools.



CAT. NO. EQM60D

## CRL Equalizer® Freedom

- Can Remove Three to Five Windshields on One Battery Charge
- Rechargeable Up to 1,200 Times

Freedom is certainly the operative word in describing this cut-out tool from Equalizer®. No longer are you limited by the lack of a power source or air compressor. The CRL Equalizer® Freedom features an 18 volt battery, which delivers enough power to remove up to five windshields on one charge (depending on how difficult the glass is to remove). A high-torque motor drives the blade at 4,000 strokes per minute.

The Equalizer® Freedom uses the latest in battery and motor technology, giving it extreme power for those tough cut-out jobs. The battery lasts 40% longer than standard batteries, never develops a "memory", and can be charged up to 1,200 times.



CAT. NO. EQF18

### THE EQUALIZER® FREEDOM KIT CONTAINS:

One EQF18 Equalizer Freedom Tool, one EQ4SS 4" (102 mm) Stainless Steel Sheath, one EQ8SS 8" (203 mm) Stainless Steel Sheath, one EQ12SS 12" (305 mm) Stainless Steel Sheath, two EQ4LB 4" (102 mm) Blades, two EQ8LB 8" (203 mm) Blades, two EQ12LB 12" (305 mm) Blades, one Pair of Safety Glasses, one DW9096 DeWalt® Nickel Cadmium Battery, one DC9310 115V AC one hour DeWalt® Battery Charger, all in a foam lined molded carrying case.

**NOTE:** Blades and Sheaths are interchangeable with all other Equalizer® tools.



CAT. NO. DW9096  
18V Battery Cartridge

CAT. NO. DC9310  
115V AC Charger

CAT. NO. DC9319  
12V DC Charger

Equalizer is a registered trademark of Equalizer Industries, Inc.  
DeWalt is a registered trademark of The Black and Decker Corporation.

CAT. NO.	DESCRIPTION
EQF18	Freedom Cordless Cut-Out Tool Kit
DW9096	DeWalt® 18 Volt Battery Cartridge
DC9310	DeWalt® 7.2 to 18 Volt Battery Charger (115V AC)
DC9319	DeWalt® 18 Volt Battery Charger (12V DC)

Minimum order: 1 each.

## CRL Equalizer® Standard Edge Reciprocal Blades

- Fast Cutting Reciprocal Action
- Fit All Equalizer® Reciprocal Tools

CRL Equalizer® Standard Edge Blades are made from quality steel that can be resharpened many times. They are used inside the Stainless Steel Sheaths shown below, and fit in all Equalizer® Reciprocating Tools, including Magnum, Freedom, and Excalibur.



• Super Sharp

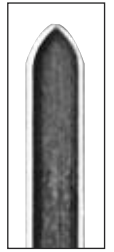

CAT. NO.	DESCRIPTION
EQ4LB	4" (102 mm) Standard Blade
EQ8LB	8" (203 mm) Standard Blade
EQ12LB	12" (305 mm) Standard Blade

Minimum order: 1 each. All Equalizer Blades can be combined for quantity pricing.

## CRL Equalizer® Serrated Edge Reciprocal Blades

- Double Serration for Faster Cutting
- Fit All Equalizer® Reciprocal Tools

These Equalizer® Blades have a double serrated edge for faster cutting. They fit in all Equalizer® Reciprocating Tools, including Magnum, Freedom, and Excalibur, and must be used inside the Stainless Steel Sheaths shown below.

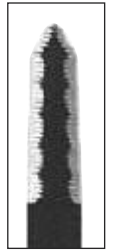

CAT. NO.	DESCRIPTION
ESB1304	4" (102 mm) Serrated Blade
ESB1308	8" (203 mm) Serrated Blade
ESB1312	12" (305 mm) Serrated Blade

Minimum order: 1 each. All Equalizer Blades can be combined for quantity pricing.

Blades shown on this page are not warranted against breakage. The blades are made from tempered steel that is strong but brittle, and will break if flexed to an extreme.

## CRL Equalizer® Reciprocal Blade Sheaths

- Adjustable for Cutting Depth
- Work With All Equalizer® Blades Above

These Equalizer® Sheaths are used with Equalizer® Standard Edge and Serrated Edge Reciprocal Blades. They help protect the dash and pillars from blade damage as the tips cut out the adhesive. You can adjust the exposed blade length to accommodate different widths of urethane bead.

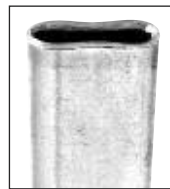

CAT. NO.	DESCRIPTION
EQ4SS	Sheath for 4" (102 mm) Blades
EQ8SS	Sheath for 8" (203 mm) Blades
EQ12SS	Sheath for 12" (305 mm) Blades

Minimum order: 1 each.

## CRL Equalizer® Sheath Cleaning Container

- Clean Sheaths Help Keep Your Equalizer® Tool Running Great
- Removes Build-Up

The CRL Equalizer® Sheath Cleaning Container will keep your Equalizer® Tool operating at top performance. Urethane and butyl should not be allowed to build up inside the sheaths of your CRL Equalizer® Tool. This build-up can put excess strain on the drive unit. We recommend using Cat. No. CRL2032 General Purpose Solvent and Adhesive Cleaner for soaking the sheaths. Minimum order is one each.



CAT. NO. ESC780

Equalizer is a registered trademark of Equalizer Industries, Inc.

## CRL General Purpose Solvent and Adhesive Cleaner

- Extra Strength for Removing Uncured Urethane Adhesive

CRL General Purpose Solvent and Adhesive Cleaner handles some of the toughest cleaning jobs your shop will encounter. Use CRL2032 to soften and remove uncured urethane adhesives, tar, grease, oil, body sealer, and undercoating. Apply to a rag and rub lightly over soiled areas, then wipe up with a clean, dry cloth. **NOTE:** Use only per printed instructions.

CAT. NO.	CONTENTS
CRL2032	32 Fl. Oz (946 ml)

Minimum order: 1 each.



## CRL POWR-Cat Oscillating Pneumatic Knife

- Industrial Grade Air Motor Oscillates Up to 20,000 Times Per Minute
- Longer Body for Better Control
- Hex Blade Mounting Collar Holds All Oscillating Cut-Out Blades

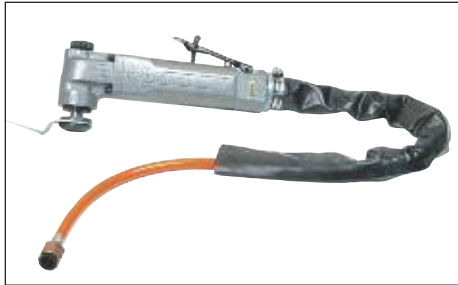

The CRL POWR-Cat Oscillating Pneumatic Cut-Out Knife features a large, industrial-grade air motor which delivers 20,000 oscillations per minute, plenty of power for your toughest cut-out needs. It operates at 90 psi and requires 4 cfm of air.

The long housing of the tool provides excellent balance and control while in use. The hex blade mounting collar gives the POWR-Cat the versatility of being able to use a wide range of blades, including all CRL Oscillating Blades, and Fine Cut-Out Blades. Blades must be ordered separately, see pages 374K and 381K. Minimum order is one each.

CAT. NO. AK60T00L

## CRL POWR-Cat Oscillating Pneumatic Knife Basic Kit



- Includes Four Popular Blades
- Industrial Grade Air Motor Oscillates at Over 20,000 RPM
- Hex Blade Mounting Collar Holds All Oscillating Cut-Out Blades

Our POWR-Cat Basic Knife Kit has our AK60T00L packaged with four of the most popular Oscillating Cut-Out Blades. Kit includes: the POWR-Cat Air Tool, and one each RD081 Straight Blade, RD105 Serrated Blade, RD111 Hook Blade, and RD115 Scraper Blade. It's a great starter kit, and you can add blades as required for different applications. Minimum order is one each.

CAT. NO. AK60K1T

## CRL POWR-Cat Oscillating Pneumatic Knife Deluxe Kit



- Complete Kit With POWR-Cat Tool, Four Blades, and Accessories
- Uses All Oscillating Cut-Out Blades With Six or Twelve Sided Mounts

The CRL POWR-Cat Deluxe Kit includes: POWR-Cat Air Tool, Four Cut-Out Blades, Sharpening Stone, Allen Wrench, Male Hose Coupler, Male Hose Plug, Female Hose Coupler, Female Hose Plug, Air Filter and Moisture Trap, In-Line Oiler, Pneumatic Tool Oil, 25' (7.6 m) Coiled Air Hose, 2" (51 mm) Duct Tape, 1" (25 mm) Blue Molding Tape, 2" (51 mm) Blue Molding Tape, all packed in an impact-resistant Carrying Case. Minimum order is one each.

CAT. NO. AK70

## CRL Wildcat Pneumatic Knife

- **Lightweight and Powerful**
- **Uses All Oscillating Cut-Out Blades**
- **Delivers Up to 20,000 Oscillations per Minute**

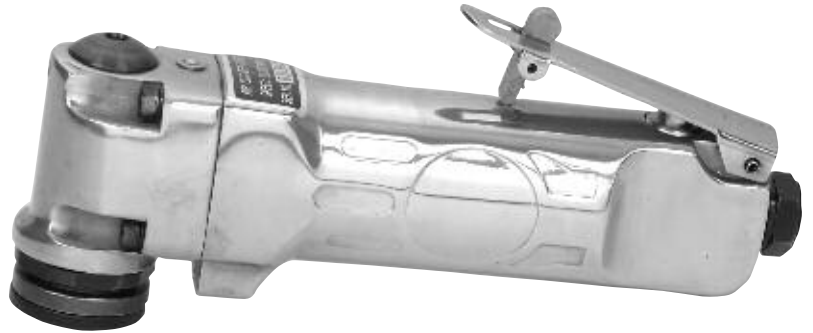

The CRL Wildcat Pneumatic Air Knife is a lightweight variable speed air tool that delivers up to 20,000 oscillations per minute and, when used with CRL Oscillating Cut-Out Blades, cuts through hardened urethane with ease. The compact design of the CRL Wildcat Tool makes it easy to operate in tight quarters, and the hex blade mounting collar allows for variable positioning of the blade. The speed control trigger is equipped with a safety stop to prevent accidental starts.

**NOTE:** The tool operates between 75 and 90 pounds per square inch maximum air pressure, so a regulated air supply is essential. An air supply or compressor with a 20 gallon tank that delivers 6.3 cubic feet per minute and 90 pounds per square inch is required for optimum performance. Tool comes with a Cat. No. 4MM 4mm Allen Wrench. Blades must be ordered separately, see pages 374K and 381K. Minimum order is one each.

**CAT. NO. AK20T00L**

## CRL Wildcat Pneumatic Knife Basic Kit



- **Basic Tool Kit to Get You Started**
- **Includes Two Wildcat Blades**
- **Uses All Oscillating Cut-Out Blades**

Our Wildcat Pneumatic Knife Basic Kit has the basics for getting started if you're not currently using a pneumatic cut-out tool. The Standard Blade is extremely versatile, and the Ram Blade works in special applications that require a longer cutting edge. You can add other blades as you become familiar with different cut-out situations because the Wildcat Tool will work with virtually all oscillating cut-out blades.

The AK10 CRL Wildcat Pneumatic Knife Basic Kit includes: Wildcat Pneumatic Tool, Wildcat Standard Blade, Wildcat Ram Blade, Sharpening Stone, and a Cat. No. 4MM 4 mm Allen Wrench, all packed in an impact-resistant Carrying Case. Minimum order is one each.

**CAT. NO. AK10**

## CRL Wildcat Pneumatic Knife Deluxe Kit



- **Complete Kit With Tool, Blades, and Accessories**
- **Uses All Oscillating Cut-Out Blades**

Our Wildcat Pneumatic Knife Deluxe Kit provides you with everything you need for cut-outs, except the compressed air. This kit has most items required to perform back glass and windshield removals, and still allows you to add on the specific blades you may require because the Wildcat Tool will work with virtually all oscillating cut-out blades.

The CRL Wildcat Pneumatic Knife Deluxe Kit includes: Wildcat Pneumatic Tool, Two Cut-Out Blades, Sharpening Stone, Allen Wrench, Air Filter and Moisture Trap, Pneumatic Tool Oil, In-Line Oiler, 2" (51 mm) Duct Tape, 1/2" (12 mm) Masking Tape, 2" (51 mm) Masking Tape, Magnetic Clip Insertion Tool, Four different CRL Quick Disconnects, 25' (7.6 m) Coiled Air Hose, and 24 CRL Slider Clips, all packed in a high-impact Carrying Case. Minimum order is one each.

**CAT. NO. AK50**



## CRL Encapsulated Back Glass Removal Blade

- Faster Slider Installations
- No Need to Remove Headliner
- Fits All Oscillating Knives With Six and Twelve Sided Blade Mounts



CAT. NO. RD924

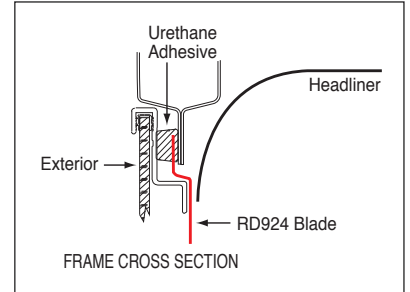

This CRL Encapsulated Back Glass Removal Blade for Wildcat, POWER-Cat or other oscillating cut-out knives has double machined edges, resulting in one of the thinnest and sharpest blades available. A special tempering process gives them more flexibility and reduces blade breakage. This blade allows the removal of OEM encapsulated rear sliding windows without removing the headliner. A real time saver, it's perfect for the Dodge Ram, Dakota, and other trucks with encapsulated back glass. Also useful on Ford Taurus, Mustang, Chevy Impala, and Cobalt. Overall blade length is 4-7/8" (124 mm); sharpened edge is 2" (51 mm). Minimum order is one each.

## CRL Oscillating Knife Blades



CAT. NO. RD115

CAT. NO. AKB300

CAT. NO. AKB200

- A Favorite With Truck Slider Installers
- Fit All Six and Twelve Sided Blade Mounts

CRL has developed these special Oscillating Knife Blades just for specific applications. The RD115 is the perfect blade to trim down the urethane bead after the glass has been removed. CRL's AKB300 Blade was made to speed the removal of the rear glass on Dodge Ram Trucks. The AKB200 Blade is used on most other trucks with encapsulated rear glass.

CAT. NO.	BLADE LENGTH AND DESCRIPTION
RD115	5/8" (16 mm) Scraper Blade
AKB300	1" (25 mm) Straight Blade for Dodge Ram
AKB200	1" (25 mm) Straight Standard Blade

Minimum order: 1 each. All Oscillating Blades can be combined for quantity pricing.

## CRL Oscillating "L" Blades



CAT. NO. V51847

CAT. NO. V51848

CAT. NO. V51849

- Fit All Six and Twelve Sided Blade Mounts
- Fast Cutting Action

CRL Oscillating Cold Knife "L" Blades for Wildcat, POWER-Cat and other oscillating cut-out knives have double-machined edges to produce the thinnest and sharpest blades available. A special tempering process gives them more flexibility and reduces blade breakage. These CRL Oscillating "L" Blades are designed to fit Wildcat, POWER-Cat, FEIN®, and other knives using six or twelve sided blade mounts.

CAT. NO.	BLADE LENGTH
V51847	3/4" (19 mm)
V51848	1" (25 mm)
V51849	1-1/2" (38 mm)

Minimum order: 1 each. All Oscillating Blades can be combined for quantity pricing.

## CRL Time Saver™ Blades

- Fit All Six and Twelve Sided Blade Mounts
- Tempered Steel



CAT. NO. TSB85

CAT. NO. TSB65

CAT. NO. TSB55

CAT. NO. TSB35

CRL Time Saver™ Blades give you the extra reach you need to cut out those difficult windshields with long cowls from inside the car. They can be used on Wildcat, POWER-Cat, and all other oscillating knives using six or twelve sided blade mounts.

CAT. NO.	OVERALL BLADE LENGTH
TSB35	5" (127 mm)
TSB55	5-1/2" (140 mm)
TSB65	6-5/8" (168 mm)
TSB85	8-5/8" (219 mm)

Minimum order: 1 each. All Oscillating Blades can be combined for quantity pricing.

FEIN is a registered trademark of C. & E. Fein GmbH LLC.

## CRL Straight Oscillating Cut-Out Blades

- Fit All Six and Twelve Sided Blade Mounts
- For Interior and A-Pillar Use

CRL Straight Oscillating Cut-Out Blades fit all oscillating cut-out knives using six or twelve sided blade mounts. These CRL Oscillating Blades have double-machined edges to produce the thinnest and sharpest blades available. Straight Blades are used primarily from the interior up the A-pillar and across the top of the windshield. **NOTE:** Never use the pinchweld as a stop for the blade penetration. Mark your blade at 1/2" and 3/4" (12 and 19 mm) so you know the depth of your blade. This reduces the chance of scratching the paint and creating rust.

CAT. NO.	OVERALL LENGTH	SHARPENED AREA
RD081	3-3/4" (95 mm)	2" (51 mm)
RD097	5" (127 mm)	2" (51 mm)
RD106	2-5/8" (67 mm)	1-3/8" (35 mm)
RD105	2-5/8" (67 mm)	1" (25 mm)
RD103	2-5/8" (67 mm)	7/8" (22 mm)

Minimum order: 1 each. All Oscillating Blades can be combined for quantity pricing.

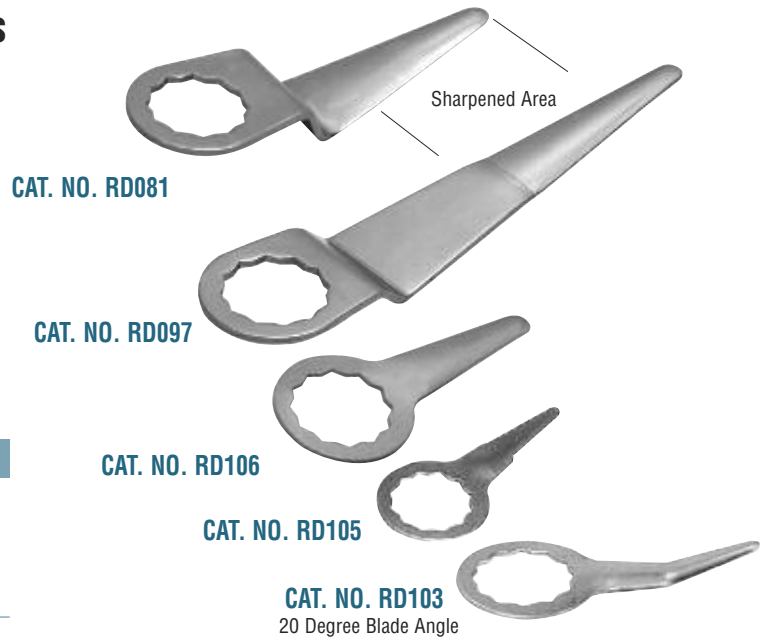

## CRL Hook Oscillating Cut-Out Blades

- Fit All Six and Twelve Sided Blade Mounts
- Extra Long Reach

CRL Hook Oscillating Cut-Out Blades fit all oscillating cut-out knives using six or twelve sided blade mounts. Hook Blades are normally used from the exterior of the vehicle, and provide you with the extra reach needed to cut the urethane bead along the bottom of the windshield. **NOTE:** Care should be used when using these blades as the cutting action is on the opposite side of the glass from the operator.

CAT. NO.	BLADE LENGTH
RD107	2-1/2" (64 mm)
RD111	2-3/4" (70 mm)
RD076	7/8" (22 mm)
RD079	1-1/2" (38 mm)

Minimum order: 1 each. All Oscillating Blades can be combined for quantity pricing.

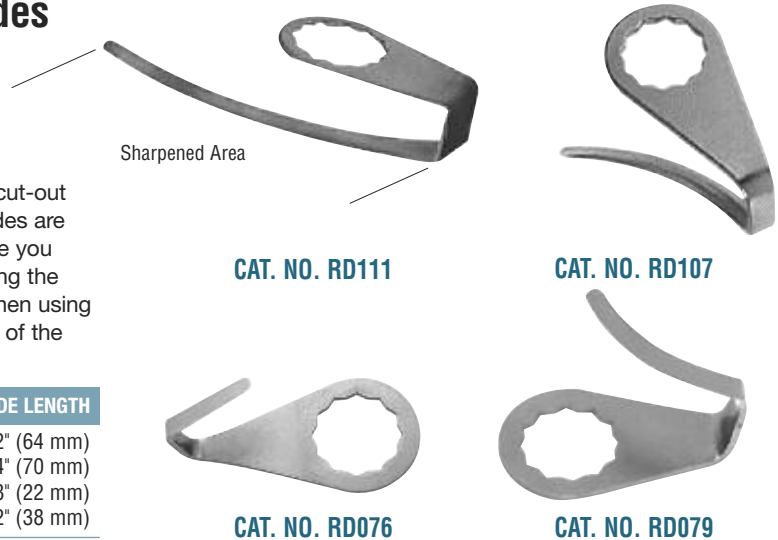

## CRL Curved Oscillating Cut-Out Blade

- Fits All Six and Twelve Sided Blade Mounts
- Interior and A-Pillar Use

This CRL Curved Oscillating Cut-Out Blade is used inside or outside the vehicle along the A-pillar post for quick cut-outs. Sharpened area is 2" (51 mm), overall length is 3-3/8" (86 mm). Minimum order is one each.

CAT. NO. RD072



## CRL Plastic Spray Bottle

- Use With Plain Water to Lubricate and Cool Blades as You Cut

No matter which power tool or blade selection you have made, using our Plastic Spray Bottle with plain water will speed your removal process. The water lubricates and cools the blade, reducing friction to speed removal. Water is best used as a lubricant since it will not contaminate the bonding area. Bottle capacity is 16 fluid ounces (.473 liters). Minimum order is one each.

CAT. NO. DB21



Blades shown on this page are not warranted against breakage. The blades are made from tempered steel that is strong but brittle, and will break if flexed to an extreme.

## CRL FEIN® Pneumatic Cut-Out Tool

- Robust Motor
- Ball Bearing Construction
- Uses All Oscillating Blades With Six or Twelve Sided Mounts



The economy and ease of a pneumatic cut-out tool can be found in this latest quality-crafted addition from FEIN® Power Tools. The CRL FEIN® Pneumatic Cut-Out Tool is compact, only weighing 2 pounds (.9 kg). With minimal regular maintenance, this tool will deliver constant, trouble free service. Requires 90 psi with 3 cfm air consumption.

The FK6625 Tool comes complete with a spanner wrench for blade changing, a maintenance manual, and instructions. No blades come with the FK6625, which accepts all oscillating cut-out blades with six and twelve sided mounts. Minimum order is one each.

CAT. NO. FK6625

## CRL FEIN® Serrated Gator "L" Blades

- Fit All Six and Twelve Sided Blade Mounts
- Serrated for Faster Cutting

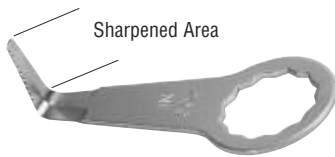
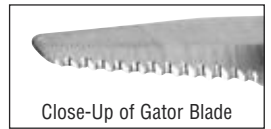

CAT. NO. FKB208

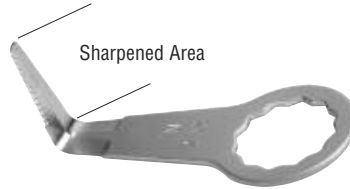

CAT. NO. FKB207

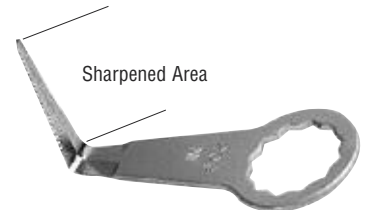

CAT. NO. FKB209

Use these CRL FEIN® Gator "L" Blades for exterior cutting along the A-Pillar and roof area, or on the interior A-Pillar. Serrated leading edge performs the cut faster and smoother than other oscillating blades. Engineered with outstanding durability, hardness, and flexibility to hold up to the toughest jobs. Sold only in packs of two blades.

CAT. NO.	SHARPENED AREA
FKB208	3/4" (19 mm)
FKB207	1" (25 mm)
FKB209	1-1/2" (38 mm)

Minimum order: 1 pack. All Oscillating Blades can be combined for quantity pricing.

## CRL FEIN® Serrated Gator "U" Blades

- Fit All Six and Twelve Sided Blade Mounts
- Serrated for Faster Cutting

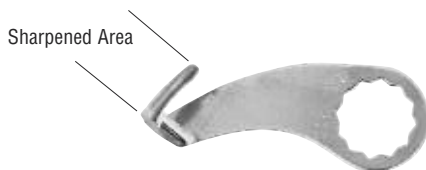

CAT. NO. FKB210

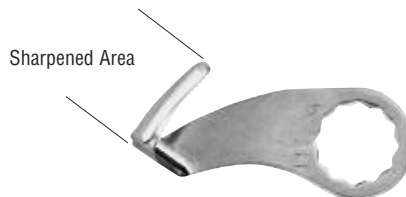

CAT. NO. FKB211

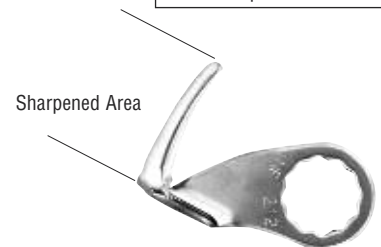

CAT. NO. FKB212

CRL FEIN® Gator "U" Blades will have you done with your toughest job faster. The serrated leading edge performs the cut faster and smoother than other oscillating blades. They have been engineered to work well from the exterior with outstanding durability, hardness, and flexibility to hold up to the toughest jobs. Sold only in packs of two blades.

CAT. NO.	SHARPENED AREA
FKB210	3/4" (19 mm)
FKB211	1" (25 mm)
FKB212	1-1/2" (38 mm)

Minimum order: 1 pack. All Oscillating Blades can be combined for quantity pricing.

Blades shown on this page are not warranted against breakage. The blades are made from tempered steel that is strong but brittle, and will break if flexed to an extreme. FEIN is a registered trademark of C. & E. Fein GmbH LLC.

## CRL FEIN® Straight Blades

- Fit All Six and Twelve Sided Blade Mounts

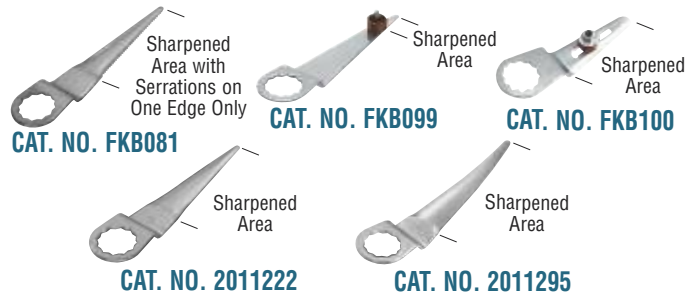

CRL FEIN® Straight Blades work well from the inside of the vehicle. If the sides of the exterior of the A-pillar urethane bead are exposed these blades make short work of cutting along this area. Both the FKB100 and the FKB099 have depth control stops built into the blade to minimize paint damage during the removal.

CAT. NO.	SHARPENED AREA/DESCRIPTION
FKB081	2-3/8" (68 mm) Straight Blade
FKB099	5/8" (16 mm) Straight Blade with Guide Wheel
FKB100	5/8" (16 mm) to 1-1/2" (38 mm) Adjustable Blade
2011222	2-1/2" (63.5 mm) Straight Blade - 2/pk
2011295	2-3/4" (70 mm) Straight with Curved Blade - 2/pk

Minimum order: 1 each. All Oscillating Blades can be combined for quantity pricing.

## CRL FEIN® Hook Blades

- Fit All Six and Twelve Sided Blade Mounts
- Long Reach for Cutting From the Exterior

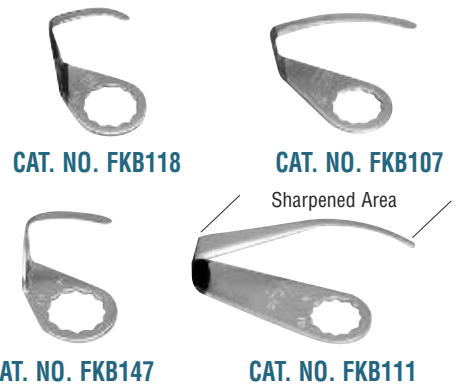

CRL FEIN® Hook Blades are used along the bottom of the windshield from the exterior, and work best when using the FEIN® Knife with a pull handle. **NOTE:** Care should be taken to prevent damage to the dash or moldings when using these blades because the cutting action is on the opposite side of the glass from the operator.

CAT. NO.	SHARPENED AREA/DESCRIPTION
FKB118	3/4" (19 mm) Hook Blade
FKB147	1-1/4" (32 mm) Hook Blade
FKB107	2-3/8" (60 mm) Hook Blade
FKB111	3-3/4" (95 mm) Hook Blade

Minimum order: 1 each. All Oscillating Blades can be combined for quantity pricing.

## CRL FEIN® Specialty Blades

- Curved and Bent Styles

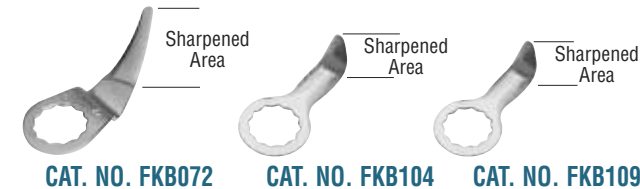

The FKB072 works very well for quarter glass removal with the slight curve and step bend in the blade used as a depth stop, which helps prevent damage to the paint. The FKB104 and FKB109 are used for back glass and truck slider removal. The bend in the blade helps when inserting into the urethane around the encapsulation, and also acts as a depth controller to prevent paint damage.

CAT. NO.	SHARPENED AREA/DESCRIPTION
FKB072	1-3/16" (30 mm) Curved Blade
FKB104	3/4" (19 mm) 90 Degree Bent Up Blade
FKB109	1" (25 mm) 74 Degree Bent Up Blade

Minimum order: 1 each. All Oscillating Blades can be combined for quantity pricing.

## CRL FEIN® Scraper Blades

- Quickly Trim Urethane
- Fit Six and Twelve Sided Blade Mounts



These CRL FEIN® Scraper Blades are used to trim the urethane from the pinchweld once the glass has been removed. The FKB146 cuts from the end of the blade. The FKB113 Blade has a side-to-side cutting action. Blades have "shoulders" to help prevent paint damage.

CAT. NO.	SHARPENED AREA/DESCRIPTION
FKB146	3/4" (19 mm) Scraper Blade (1/pk)
FKB113	2" (51 mm) Axe Style Scraper Blade (2/pk)

Minimum order: 1 each. All Oscillating Blades can be combined for quantity pricing.

## CRL FEIN® Circular Saw Blade

- Perfect for Cutting Braces for Sunroof Installations
- Trims Bendover Tabs From Encapsulated Truck Sliders

If you install sunroofs, truck sliders, or van windows you really want this blade. The FEIN® Circular Saw Blade makes cutting braces a breeze. The blade does not spin but oscillates so if you touch it to your skin it won't cut you, but touch it to steel and it sinks in, cutting easily and quickly with full control. Use it to plunge cut the metal bendover tabs in factory sliders prior to cutting through the urethane. Blade diameter is 3-1/8" (79 mm). Minimum order is one each.



CAT. NO. FKB103

Blades shown on this page are not warranted against breakage. The blades are made from tempered steel that is strong but brittle, and will break if flexed to an extreme. FEIN is a registered trademark of C. & E. Fein GmbH LLC.

## CRL Equalizer® Excalibur

- Fast Cutting Reciprocal Action
- Uses All Equalizer® Blades and Sheaths
- Speeds of Up to 3,200 Strokes Per Minute



The CRL Equalizer® Excalibur is a lightweight, air-powered version of the electric-powered CRL Equalizer®. The .020 inch (.5 mm) thick blade reciprocates inside a metal sheath, which protects the dash, garnish moldings, and headliner, and allows you to save encapsulated glass and bonded metal moldings. Excalibur has ball bearing construction, and runs at 0 to 3,200 strokes per minute. Best of all, it uses the same blades that are used by all CRL Equalizer® reciprocating tools.

The EX80D Deluxe Kit contains the following: an Excalibur Air Tool, two 4" (102 mm) Blades, two 8" (203 mm) Blades, two 12" (305 mm) Blades, one 4" (102 mm) Stainless Steel Sheath, one 8" (203 mm) Stainless Steel Sheath, one 12" (305 mm) Stainless Steel Sheath, one pair of Safety Glasses, all packed in a metal Carrying Case. The EX40S Standard Kit ships with the Excalibur Air Tool, one 8" (203 mm) Blade and one 8" (203 mm) Stainless Steel Sheath. Operates on 90 psi with 6 cfm air consumption.

CAT. NO.	DESCRIPTION
EX40S	Equalizer® Excalibur Standard Kit
EX80D	Equalizer® Excalibur Deluxe Kit

Minimum order: 1 each.

## CRL Equalizer® Sheath Cleaning Container

- Clean Sheaths Help Keep Your Equalizer® Tool Running Great
- Removes Build-Up

The CRL Equalizer® Sheath Cleaning Container will keep your Equalizer® Tool operating at top performance. Urethane and butyl should not be allowed to build up inside the sheaths of your CRL Equalizer® Tool. This build-up can put excess strain on the drive unit. We recommend using Cat. No. CRL2032 General Purpose Solvent and Adhesive Cleaner for soaking the sheaths (see page 378K). Minimum order is one each.



CAT. NO. ESC780

Equalizer is a registered trademark of Equalizer Industries, Inc.

## CRL Equalizer® Standard Edge Reciprocal Blades



- Fast Cutting Reciprocal Action
- Fit All Equalizer® Reciprocal Tools
- Super Sharp



CAT. NO.	DESCRIPTION
EQ4LB	4" (102 mm) Standard Blade
EQ8LB	8" (203 mm) Standard Blade
EQ12LB	12" (305 mm) Standard Blade

Minimum order: 1 each. All Equalizer Blades can be combined for quantity pricing.

## CRL Equalizer® Serrated Edge Reciprocal Blades



- Fastest Cutting Reciprocal Action
- Fit All Equalizer® Reciprocal Tools



CAT. NO.	DESCRIPTION
ESB1304	4" (102 mm) Serrated Blade
ESB1308	8" (203 mm) Serrated Blade
ESB1312	12" (305 mm) Serrated Blade

Minimum order: 1 each. All Equalizer Blades can be combined for quantity pricing.

## CRL Equalizer® Reciprocal Blade Sheaths

- Adjustable for Cutting Depth
- Work With All Equalizer® Blades Above

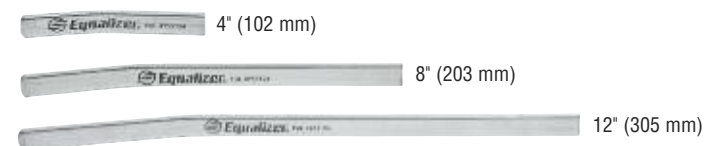

These Equalizer® Sheaths are used with Equalizer® Standard Edge and Serrated Edge Reciprocal Blades. They help protect the dash and paint from blade damage as the tips cut out the adhesive. You can adjust the exposed blade length to accommodate different widths of urethane bead.

CAT. NO.	DESCRIPTION
EQ4SS	Sheath for 4" (102 mm) Blades
EQ8SS	Sheath for 8" (203 mm) Blades
EQ12SS	Sheath for 12" (305 mm) Blades

Minimum order: 1 each. Sheaths can be combined for quantity pricing.



## CRL BTB Classic Auto Glass Cut-Out Tool Kit

- Removes Any Glass Part Without Breakage
- Saves Moldings
- Blades for Cut-Out Tool Can Also Be Used Manually

This CRL BTB Classic Auto Glass Cut-Out Tool Kit offers today's auto glass technician all of the tools required for any domestic or import glass removal. With the CRL BTB System the technician can use a variety of blades, either with the power tool or manually, using the handles provided with each kit. The power tool is small and compact, so you can use it in either hand. The air-powered tool provides a strong inline reciprocal stroke, enabling the blade to cut the urethane in hard-to-reach areas. The cut-out depth of the blades is regulated by the use of the depth controller arms provided with each kit.

Each BTB Classic Kit contains one each: Heavy-Duty Air Tool, Serrated Long Universal Flat Blade, General Purpose Bent Blade, Serrated Offset Blade for curved glass, Serrated Reverse Offset Blade for curved and encapsulated glass, Left and Right-Handed Power Cold Knife Blades, Pinchweld Scraper Blade, Manual Handle for BTB Blades, Sharpening Stone, Water Spray Bottle, Allen Wrench, Chuck Key, set of Spacer Tabs, and three Controller Arms, all packed in a Molded Carrying Case. Minimum order is one each.



Air Pressure: 90 psi (6.2 BAR) Maximum,  
Air Consumption: 6.6 cfm

CAT. NO. BTBCL

## CRL BTB Heavy-Duty Air Tool

Whether you already have a BTB Kit and need a back up tool, or you want to build your kit by purchasing the blades individually, starting with the BTB Heavy-Duty Air Tool is the first step. See specifications above. Minimum order is one each.

Blade and  
Controller Arm  
Not Included



CAT. NO. BTB10HD

## CRL BTB Long Blades



CAT. NO. BTB1



CAT. NO. BTB1SC

- Standard or Serrated Edges
- Tough Spring Steel

The CRL BTB Long Blade is used to cut urethane deep below the dash line. Unique to the BTB Tool is that you can perform the removal from the exterior of the vehicle and still reach to the bottom center of most windshields.

CAT. NO.	DESCRIPTION
BTB1	11-7/8" (302 mm) Standard Long Blade
BTB1SC	11-7/8" (302 mm) Serrated Long Blade

Minimum order: 1 each.

## CRL BTB Universal Blades



CAT. NO. BTB2



CAT. NO. BTB2SC

- Standard or Serrated Edges
- Tough Spring Steel

The CRL BTB Universal Blade provides additional benefits over the longer blade as it flexes and contours to the curved glass parts with ease. Great to use in the corners to relieve pressure on the glass when performing a removal while trying to save the part.

CAT. NO.	DESCRIPTION
BTB2	9-7/16" (240 mm) Standard Universal Blade
BTB2SC	9-7/16" (240 mm) Serrated Universal Blade

Minimum order: 1 each.

## CRL BTB General Purpose Blade



- Standard or Serrated Edges
- Tough Spring Steel

CRL BTB General Purpose Blade has become a favorite with BTB users because its flexibility and length work in several applications, removing the need to continually switch blades.

CAT. NO.	DESCRIPTION
<b>BTB3SC</b>	7-7/8" (200 mm) General Purpose Serrated Bent Blade

Minimum order: 1 each.

## CRL BTB Special Bent Blades



CAT. NO. BTB4



CAT. NO. BTB4SC

- Standard or Serrated Edges
- Tough Spring Steel

CRL BTB Special Bent Blades are the perfect size for A-Pillar cutting or quarter glass removal. This blade provides great control allowing you to work close to the body.

CAT. NO.	DESCRIPTION
<b>BTB4</b>	7-1/2" (191 mm) Standard Special Bent Blade
<b>BTB4SC</b>	7-1/2" (191 mm) Serrated Special Bent Blade

Minimum order: 1 each.

## CRL BTB Powered Cold Knife Blade Sets



CAT. NO. BTB27  
Standard



CAT. NO. BTB27R  
Reverse

- Left and Right Handed Blades
- Standard and Reverse Blades

These BTB Powered Cold Knife Blades allow you to use your BTB Knife on the exterior of the vehicle and quickly power around the windshield. Use the Reverse Blades for cutting out glass parts without damaging the moldings. One left hand and one right hand blade per package.

CAT. NO.	DESCRIPTION
<b>BTB27</b>	5" (127 mm) LH and RH Standard Cold Knife Blades
<b>BTB27R</b>	5" (127 mm) LH and RH Reverse Cold Knife Blades

Minimum order: 1 pair.

## CRL BTB Specialty Blades



CAT. NO. BTB24RS



CAT. NO. BTB24ZS and BTB24ZRS

This selection of BTB Specialty Blades provides additional options when using the BTB System. The BTB24RS is perfect for extreme curved glass removal. The BTB24ZS and BTB24ZRS are both suited for smaller encapsulated quarter glass removal.

CAT. NO.	DESCRIPTION
<b>BTB24RS</b>	Reverse 9-1/2" (241 mm) Serrated Curved Glass Blade
<b>BTB24ZS</b>	5-7/8" (149 mm) Serrated Quarter Glass Blade
<b>BTB24ZRS</b>	Reverse 5-7/8" (149 mm) Serrated Quarter Glass Blade

Minimum order: 1 each.

## CRL BTB Manual Handles

- Fit All BTB Blades

Insert BTB Blades into these Handles for those precise cut-outs that may be too delicate to cut with a power tool.



CAT. NO.	DESCRIPTION
<b>BTB7</b>	4" (102 mm) Two-Handed Manual Handle
<b>BTB7L</b>	7-1/4" (184 mm) Two-Handed Manual Handle

Minimum order: 1 each.

## CRL BTB Pinchweld Scraper Blade



The BTB6 Pinchweld Scraper Blade makes short work of trimming down the urethane for the installation of the new part.

CAT. NO.	DESCRIPTION
<b>BTB6</b>	5" (125 mm) Pinchweld Scraper Blade

Minimum order: 1 each.

## CRL Extractor® Pro Series

- Cuts Through the Toughest Urethane Adhesives
- Makes Difficult Cut-Outs Simple



Carrying Case Included

The CRL Extractor® Pro Series makes difficult urethane cut-outs simple, safe, and cost effective. Working either inside or outside the vehicle, removal time will be reduced dramatically with virtually no glass breakage. Used in conjunction with the heavy-duty air tool supplied with each kit, the hardened 4" (102 mm) wide steel blade of the Extractor® will easily cut the bottom bead on the most difficult urethane installations.

The EXT100L Kit contains an Extractor® Pneumatic Air Tool and EXTLS Long Shaft, a Cat. No. EXTBL Standard Extractor® Blade, a Cat. No. EXTBLLG Extra Long Extractor® Blade, Quick Release Coupler, Training DVD, and complete instructions. Optional blades and an instructional DVD are also available. 90 psi and 3.5 cfm is required. **NOTE:** Blades can only be used with CRL Extractor® Pro.



CAT. NO. EXT100L Pro Kit

CAT. NO.	DESCRIPTION
EXT100L	Extractor® Pro Kit with Long Shaft
EXTBL	Standard 4" (102 mm) Blade
EXTBLLG	Extra Long 4" (102 mm) Blade
EXTBLN	Narrow 1-1/2" (38 mm) Blade
EXTLS	Long Shaft
EXTSS	Short Shaft
EXTAPE	Extractor® Pro Instructional DVD

Minimum order: 1 each.

## CRL Equalizer® Ninja Air-Powered Oscillating Cold Knife

- The Look and Feel of a Cold Knife, but it Cuts With the Power of 22,000 Cutting Strokes Per Minute
- Uses Super Sharp Ninja Blades

The CRL Equalizer® Ninja is an auto glass removal tool that allows you to remove glass fast and effortlessly. It has the look and feel of a cold knife, but it cuts with the power of 22,000 cutting strokes per minute.

A unique feature is Ninja's ability to cut under hoods, trunk lids or anything that hangs over the glass and obstructs your ability to cut. You simply move the blade around so it sits at a 90 degree angle. This makes the tool short enough to go under these problem areas. 90 psi and 3.5 cfm is required. Minimum order is one each.



CAT. NO. ENK148

The Equalizer® Ninja Deluxe Kit consists of the Ninja with one blade in the tool, hex wrench, and two each 3/4", 1" and 1-1/2" (19, 25, and 38 mm) blades, all packaged in a foam-lined, plastic carrying case.

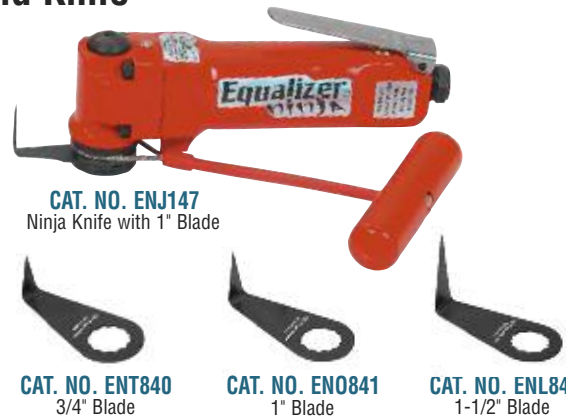

CAT. NO. ENJ147 Ninja Knife with 1" Blade

CAT. NO. ENT840 3/4" Blade

CAT. NO. ENO841 1" Blade

CAT. NO. ENL842 1-1/2" Blade

CAT. NO.	DESCRIPTION
ENJ147	Ninja Knife, One ENO841 1" Blade, Cable Pull Handle
ENK148	Ninja Deluxe Kit with Blades and Case
ENT840	3/4" (19 mm) Ninja Blade
ENO841	1" (25 mm) Ninja Blade
ENL842	1-1/2" (38 mm) Ninja Blade

Minimum order: 1 each. **NOTE:** Ninja Blades will only fit the Ninja Knife. They will not fit other tools.

## CRL Oscillating Power Tool Adapter

- Converts All Standard Cold Knife Blades to Powered Blades
- Fits All Six and Twelve Sided Blade Mounts

This CRL Oscillating Power Tool Adapter converts standard cold knife blades into powered cut-out blades that can be used with Wildcat, POWR-Cat, or other oscillating cut-out knives. Simply bolt your cold knife blade to this attachment and hit the trigger. Saves the cost of expensive oscillating blades. Long lasting tempered steel will provide years of use. Will work with any CRL 3/4" (19 mm) wide cold knife blade (blades not included). Minimum order is one each.

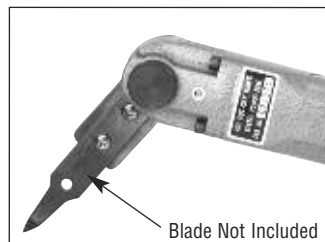

Blade Not Included



CAT. NO. AKB1A

Equalizer is a registered trademark of Equalizer Industries, Inc. Extractor is a registered trademark of Crystal Glass Canada, Ltd.



## CRL Pinchweld Scraper

- **Wide 15/16" (24 mm) Blade**

This CRL Pinchweld Scraper works well for trimming down adhesives on the pinchweld. The wide blade quickly removes the urethane with a single pass, while the comfortable grip provides complete control. Using the bevel side of the blade down prevents paint and e-coat damage, which can lead to rust development. Overall length is 10-7/8" (276 mm). Minimum order is one each. **CAT. NO. 516WT**



## CRL Heavy-Duty Scraper Chisel

- **Sturdy All Aluminum Handle**

Our CRL Heavy-Duty Scraper Chisel takes on the really tough jobs from urethane removal to hardened putty. The aluminum handle provides a secure grip in all conditions. Blade width is 11/16" (17.5 mm). Overall length is 11-3/4" (298 mm). Minimum order is one each. **CAT. NO. GL100**



## CRL 4-Piece Composite Scraper Set

**new**

- **Ideal for Removal of Old Adhesives**
- **Safe on Most Surfaces**

CRL Composite Scrapers remove material without marring or damaging aluminum and painted finishes. Polypropylene edges are ideal for removing residue from adhesives. Set includes four Scrapers, 3/4", 7/8", 1", and 1-1/2" (20, 23, 25, 38 mm) blade widths. 10-1/2" (267 mm) overall length. Minimum order is one set. **CAT. NO. PS2704**



## CRL Super Pinchweld Scraper

- **Easy-to-Change Surgically Sharp Blades Come in Three Widths**

The CRL Super Pinchweld Scraper saves you the time it takes to stop and sharpen your scraper blades. All Blades are surgically sharp, inexpensive to replace, and are available in three sizes: 1/2" (12 mm), 5/8" (16 mm), and 3/4" (19 mm). It features a lightweight shaft and comes with five 1/2" (12 mm) Blades stored in the flip-top handle. The blade cover only fits standard 1/2" (12 mm) blades. Minimum order is one each for the Scraper, and one pack for the Blades. **CAT. NO. SC300**

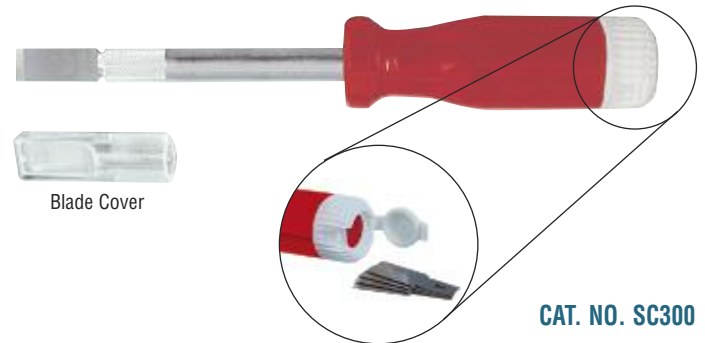

Super Scraper 1/2" Blade



**CAT. NO. SC301**  
5 Blades per Pack

Super Scraper 5/8" Blade



**CAT. NO. SC302**  
5 Blades per Pack

Super Scraper 3/4" Blade



**CAT. NO. SC303**  
5 Blades per Pack

## CRL Pinchweld Scraper Blade

- **Converts Cold Knife Handle Into a Scraper**

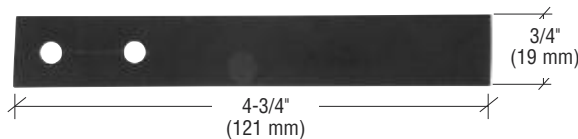

The CRL Pinchweld Scraper Blade, when used with the CRL 1MKH Multi-Knife Handle, offers you control and safety. Because this blade is shorter than most pinchweld scrapers, it is easier to control during the cutting process, making it much safer to use.

The RSB75 Blade will also fit most other cold knife handles, including: RK160, RK160S, AN2001M, AN2002M, AN3001K, AN3005K, AN3007K, RK500, and RZ500. Minimum order is one each. **CAT. NO. RSB75**



Handle Sold Separately

## CRL Scrape and Pry Bar

- **Our Most Popular Pry Tool is Ideal for Pulling Nails, Prying, Lifting, Scraping, and Much More**



The CRL Scrape and Pry Bar is a versatile tool made of the finest hardened, tempered tool steel. Both ends are chisel ground, 1-3/4" (44 mm) wide, for scraping or prying. One end has a 50 degree angle bend and nail puller hole. Our most popular model, just the right size for your tool box. Minimum order is one each. **CAT. NO. 4050**

## CRL Heavy-Duty Razor Scrapers

Overall length is 11" (279 mm). Comes with one steel and one plastic razor blade in the hollow handle. Blade is secured by a single set screw. Minimum order is one each.

Overall length is 11" (279 mm). Comes with one plastic and five steel razor blades in the hollow handle. Spring clamp holds blades securely and makes changing easy. Minimum order is one each.



CAT. NO. CRL761



CAT. NO. L52000

- Perfect for Scraping Rusted Pinchwelds
- Hold Both Metal and Plastic Razor Blades

## CRL Razor Blade Holder and Scraper



- Safely Holds Single-Edge Metal Razor Blades
- Comfortable Handle for a Sure Grip

This CRL Razor Blade Holder and Scraper is a safe and easy way to handle single-edge metal razor blades for all your scraping jobs. The blade end is molded into a plastic handle that provides a comfortable and sure grip, with a metal ferrule so you can hang it up. There is also a slip-on safety cover for the blade edge. Holds our 51S and KKB12 Single Edge Razor Blades. Overall length is 6-1/2" (165 mm). Minimum order is one each.

CAT. NO. RS65

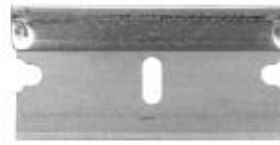

CAT. NO. 51S  
.009" Single Edge Metal  
Minimum order: 100 each.



CAT. NO. KKB12  
.012" Single Edge Metal  
Minimum order: 100 each.



CAT. NO. CP866088  
Single Edge Plastic  
Minimum order: 1 pack of 100 blades.



CAT. NO. CRL3000  
Double Edge Plastic  
Minimum order: 1 pack of 100 blades.

## CRL Safety Razor Blade Holder and Window Scraper

- Safely Holds All Single Edge Metal Razor Blades
- Buy Them Individually or in Bulk Cartons of 100

For a safe and simple way to hold single edge razor blades, try our Safety Razor Blade Holder and Window Scraper. Instantly expose or conceal the blade with a simple thumb lock. This metal tool will withstand lots of use, and has a hole in the end so you can hang it up. Overall length is 4-1/2" (114 mm). Scrapers are available individually, or in bulk boxes of 100 each.



CAT. NO.	DESCRIPTION
3223	#Individual Scraper
115000	*Box of 100 Scrapers

#Minimum order: 1 each. \*Minimum order: 100 each.

## CRL Plastic Mini Scraper With Razor Blade

- A Safe Way to Hold One Single Edge Razor Blade
- Two-Pack Blister Card Suitable for Resale

Our Mini Scraper holds one single edge razor blade for scraping or decal removal jobs. Two-pack blister card is suitable for resale, or to just throw in your tool box for whenever you need one. Each Scraper comes with one single edge metal razor blade. Minimum order is one pack.



CAT. NO. 20075  
Two Per Pack

## CRL Variable Speed Rotary Tool Kit

- Variable Speed 8,000 to 18,000 RPM's
- Includes 61-Piece Accessory Set



For versatility at a great price, you can't beat the CRL Variable Speed Rotary Tool Kit. The tool's comfortable grip and lightweight design make it easy to use in any position. Change accessories in just 20 seconds.

CAT. NO.	DESCRIPTION
LD111	110V Rotary Tool Kit
LD111AU	240V Rotary Tool Kit w/AU Plug
LD111EU	220V Rotary Tool Kit w/EU Plug

Minimum order: 1 each.

## CRL Cordless Rotary Tool Kit

**new**

- Super Bright LED Work Light
- Includes 40 Assorted Accessories



This CRL Cordless Rotary Tool is a compact, efficient 7.2 Volt rechargeable tool for fine sanding, grinding, cutting, sharpening, and engraving. Features two speeds: High at 16,000 rpm and low at 8,000 rpm. Includes two batteries.

CAT. NO.	DESCRIPTION
LD115	7.2 Volt Cordless Rotary Tool Kit
LD115AU	7.2 Volt Cordless Rotary Tool Kit w/AU Plug

Minimum order: 1 each.

## CRL Dremel® Mini-Mite Cordless Rotary Tool

- Small, Powerful, and Lightweight
- Runs at 5,000 and 10,000 RPM



This small yet powerful tool for the home and shop fits right into your hand, giving you the kind of maneuverability not usually found in a rotary tool. The D750 accepts Dremel® and other bits with shanks up to 1/8" (3 mm) diameter. Included are a Battery Pack, a Charger, and five Dremel® Bits. For replacement battery order Cat. No. D75501. Minimum order is one each.

CAT. NO. D750

## CRL Dremel® 300 Series Rotary Tool Kit

- Variable Speed (5,000-35,000 RPM)
- Includes Storage Case and 24 Accessories



The CRL Dremel® 300 Series Rotary Tool offers the precision and control required to complete a wide range of projects. Its variable speed control allows you to set the speed of the tool to match a particular accessory or the task at hand. Minimum order is one each.

CAT. NO. 300124

## CRL 3M® Radial and Roloc® Bristle Discs

When used for pinchweld rust repair work, 3M® Radial Bristle and Roloc® Bristle Discs are the fastest, cleanest, and most efficient way to prepare the surface for rebonding. Use Radial Disc 3M4094 for long straight areas, and Roloc® Bristle Discs 3M7524 and 3M7530 for corners and hard to get at edges. The patented abrasive-filled bristles apply a continuous, fresh supply of sharp 3M® Regalite® mineral to the work piece as the Disc wears away.

CAT. NO.	DESCRIPTION
3M4094	50 Grit 3" (76 mm) Radial Bristle Disc
3M7530	50 Grit 1" (25 mm) Roloc® Bristle Disc
3M5538	Holder for 1" and 3" (25 and 76 mm) Bristle Discs
3M7524	50 Grit 2" (51 mm) Roloc® Bristle Disc
3M5539	Holder for 2" (51 mm) Bristle Disc

Minimum order: 1 each.

Dremel is a registered trademark of Robert Bosch Tool Corporation. 3M, Roloc, and Regalite are registered trademarks of 3M Company Corporation.

- Perfect for Rust Repair on Pinchwelds
- Cleaner and Faster Than Wire Wheels
- Low Impact Sanding



CAT. NO. 3M4094  
3" (76 mm) Radial Bristle Disc



CAT. NO. 3M7524  
2" (51 mm) Roloc® Bristle Disc



CAT. NO. 3M5538  
Holder for 1" and 3" (25 and 76 mm) Discs



CAT. NO. 3M7530  
1" (25 mm) Roloc® Bristle Disc



CAT. NO. 3M5539  
Holder for 2" (51 mm) Disc

## CRL Humidity/Temperature Pen



- **A Must for Determining Urethane Cure Rates**

The CRL Humidity/Temperature Pen has fast response solid-state sensors which continuously and simultaneously display both Relative Humidity and Air Temperature (°F/°C) with a dual-recall memory. The large 1/2" (12 mm) LCD memory display registers the highest and lowest humidity/temperature achieved during any time period.

The pen reads a temperature range from 32.0 to 122.0°F (0.0 to 50.0°C), with a resolution of 0.1% and an accuracy of 1°C. It has a relative humidity range from 2 to 98%, with a resolution of 1% and an accuracy of 2% (mid-range) to 4% (end-of-range). The display shows changes in less than 30 seconds, and is updated every second. This is an indispensable tool for any windshield installer. Supplied with two silver-oxide batteries.

CAT. NO.	DESCRIPTION
HTP4093	Humidity/Temperature Pen
1039RB	1.5V DC Replacement Battery

Minimum order: 1 each.

## CRL Disposable Brush



- **Natural Horse Hair Bristles**
- **Perfect for Applying Pinchweld Primers**

The CRL Disposable Brush applies primers, acids, and flux. It is 6" (152 mm) long, with a 3/8" (9.5 mm) round rolled steel handle, and 3/4" (19 mm) stiff horsehair bristles. **NOTE:** Not available in Australia. Minimum order is 24 each.

CAT. NO. 1AB

## CRL 3" Brush

- **Great for Removing Heavy Dirt and Debris From Pinchweld Area**

You should always remove as much contamination from the pinchweld area as possible prior to cutting back the OEM urethane bead. Cutting the bead down to size without cleaning the road debris and dirt from this area allows this contamination to fall onto the freshly trimmed urethane bead. This brush's all-black pig bristles are chisel-shaped and perfect for reaching in between the urethane bead and the body of the vehicle for cleanup. The double-thick, flat, 3" (76 mm) wide brush has a panel-type handle for easy, flexible use. Minimum order is one each.



CAT. NO. LAB2634

## CRL Ultrasonic Leak Detector

- **Save Hours on Road Testing**
- **Simple and Effective Way to Locate Water, Air or Dust Leaks**
- **Set Includes Adjustable Headphones**

This CRL Wand Style Ultrasonic Leak Detector makes leak detection affordable and fast. This unit finds leaks accurately from inside or outside the vehicle. It is powered by two 9 Volt batteries that are included. Minimum order is one each.



CAT. NO. ALB3050

## CRL Paint Prep Pen

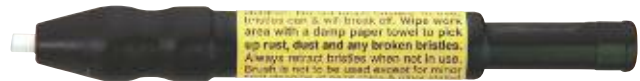

- **Thousands of Glass Fibers to Sand Away Rust on Pinchweld**
- **Small Tip for Easy Access Into Tight Spaces**

This CRL Paint Prep Pen has thousands of glass fibers bundled to form a sanding surface that can sand away rusted areas or bare metal scratches in preparation for pinchweld primer application. The small tip provides easy access to tight places. Two refill cartridges of glass fibers are contained in the handle so you are always prepared. Minimum order is one each.

CAT. NO. P3437

## CRL Cotton Swabs With Wooden Shafts

- **Perfect for Applying Pinchweld Primers**

CRL Cotton Swabs with Wooden Shafts make applying pinchweld primers to small scratches easier than using wool daubers. They can be used with all brands of pinchweld primers. 6" (152 mm) overall length. **NOTE:** Not available in Australia. Minimum order is 100 each.



CAT. NO. 1CS

## CRL Glass Handler Kit

- Allows One Person to Set Large Windshields
- Includes Two Pump-Actuated Vacuum Cups

The CRL Glass Handler Kit is the ultimate tool for setting auto glass. Ergonomic handle design allows for easier sets without strain on arms and back. The foam elbow pad rests on hood/cowl area as a pivot point reducing back strain. A step-by-step instruction DVD is included. Cat. No. 90111 Replacement Pump also available.



CAT. NO. K1T1710



The Glass Handler Kit contains: Two 6" (152 mm) diameter Pump-Actuated Vacuum Cups, Foam Block Elbow Pad, Suction Cup Lubrication, and an Instruction DVD, all packed in a sturdy plastic Carrying Case. Minimum order is one each.

## CRL Plastic Single Pad Vacuum Lifter

- Lightweight Yet Powerful Gripping Strength

Our Plastic Single Pad Vacuum Lifter is lightweight yet tough, and its 4-1/2" (114 mm) diameter rubber pad lifts up to 66 pounds (30 kg) when applied to smooth, non-porous surfaces. Place it firmly against the glass; flip up the handle actuator and lift. It's that quick and easy! Minimum order is one each.



CAT. NO. 05061P

## CRL Wood's Handi-Grip Vacuum Cup

- 3" by 6" (76 by 152 mm) Oval Shaped Cup for Long or Narrow Objects

The Wood's Handi-Grip Vacuum Cup is designed for handling small to moderate size loads of glass, sheet metal, and plastic. The 3" by 6" (76 by 152 mm) oval shape allows attachment to long, narrow objects. A finger grip aluminum "T" handle sits atop a reliable Wood's hand-actuated pump for sure holding power. Lift-tabs on edges of pad permit instant release. **NOTE:** Rated for a maximum safe load of 40 pounds (18 kg). Minimum order is one each.



CAT. NO. RF36HG

Wood's Powr-Grip is a registered trademark of Wood's Powr-Grip Co., Inc.

## CRL Aluminum Single Pad Vacuum Lifter

- Compact Design
- Large Capacity



Our lightweight Aluminum Single Pad Vacuum Lifter is easy to attach with its split handle design. The 4-1/2" (114 mm) diameter pad lifts up to 66 pounds (30 kg), making it, for its weight, one of the highest capacity lifters available. The pad will adhere to any smooth, non-porous surface such as glass, mirror, steel, aluminum, laminates, and plastics. Its durable metal construction and hard coating make it tough enough for everyday use. Replacement Rubber Pad and Lever, Cat. No. RR0506, and Replacement Lever with Pin, Cat. No. RR0506LVR are also available. Minimum order is one each.

CAT. NO. 05061

## CRL Glass Jack

- Adjustable for Perfect Alignment of Heavy Windshields



Although the CRL Glass Jack was developed for setting mirrors and float glass it also can be used for setting large windshields without stops. The Glass Jack's adjustability allows perfect alignment of the windshield with ease. **NOTE:** Requires CRL 8" Wood's Powr-Grip® Vacuum Cup, which must be ordered separately. Minimum order is one each.

CAT. NO. J1

## CRL Wood's Powr-Grip® 6" Vertical Handle Vacuum Cup

- All Metal Handle and Pump
- Handle Position is Ideal for Use With Windshields
- Red-Line Indicator Warns of Low Vacuum



Also available with the Low Vacuum Audio Alarm Plunger. See page 216K for Cat. No. W6100WBP



CAT. NO. W6100

The CRL Wood's Powr-Grip® 6" Vertical Handle Vacuum Cup has a semi-concave rubber cup which is excellent for handling curved surfaces such as windshields. The flexible cup conforms to the surface then flattens out, providing maximum gripping power. This 6" (152 mm) cup uses the same plunger as the Wood's W4950, which is respected worldwide in the flat glass industry. A plastic cover is included to protect the rubber pad. The W6100 is a must for anyone in the automotive windshield replacement business. **NOTE:** Not suggested for glass weighing in excess of 70 pounds (31 kg). Minimum order is one each.

## CRL Wood's Powr-Grip® 6" Rigid Handle Curved Surface Vacuum Cup

- Lightweight and Portable
- Makes Handling Glass Easier and Safer



This CRL Wood's Powr-Grip® 6" Rigid Handle Vacuum Cup has an all-aluminum casting which incorporates the pump housing and handle together for strength and protection for the pump. The 6" (152 mm) size makes this product easy to carry in a large tool pouch or small tool box. The rubber cup has a dual seal system to protect against vacuum loss. A plastic cover is included for protection against cuts and nicks. **NOTE:** Not suggested for pieces of glass weighing in excess of 70 pounds (31 kg). Minimum order is one each.

CAT. NO. W6200

## CRL Wood's Powr-Grip® 6" Flip Handle Vacuum Cup

- Compact, Lightweight, and Portable
- Famous Wood's Pump Reliability
- For Curved Glass



This CRL Wood's Powr-Grip® 6" (152 mm) Flip Handle Vacuum Cup has an all-aluminum casting which incorporates the pump housing, and serves as a base for the 'flip' handle. Its compact size is just right for your tool box. The rubber cup has a dual seal system to protect against vacuum loss. A plastic cover is included for protection against cuts and nicks. **NOTE:** Not suggested for pieces of glass weighing in excess of 70 pounds (31 kg). Minimum order is one each.

CAT. NO. W6350

## CRL All Rubber 6" Auto Vacuum Cup

- The Perfect Tool for Handling Curved Windshields and Backlites



The CRL All Rubber Auto Vacuum Cup provides the installer with the easiest way to handle windshields and backlites. They fit the contour of bent windshields and backlites to allow you to maneuver the glass into place, thus reducing the possibility of breakage by hitting the glass. Diameter of Cup is 6" (152 mm). Minimum order is one each.

CAT. NO. CRL69

## CRL Automotive Suction Cups

- Ideal for Dent Removal or Sheet Metal and Flat Panel Handling



CAT. NO. VC81810



CAT. NO. 77131

CRL Automotive Suction Cups are ideal for auto glass shops. You can use them for many jobs, such as pulling out panel dents and lifting sheet metal, glass or plastic. The steel bar handle swivels and flexes, and will permit pulling with a chain, jack or other similar methods. The thick rubber pad provides longevity and more powerful suction. **NOTE:** Not recommended for use on curved auto glass.

CAT. NO.	DESCRIPTION
VC81810	6" (152 mm) Automotive Suction Cup
77131	8" (203 mm) Automotive Suction Cup

Minimum order: 1 each.

Wood's Powr-Grip is a registered trademark of Wood's Powr-Grip Co., Inc.

## CRL 6" Vertical Handle Vacuum Lifter

- Pump-Type Cup Can Be Used on Both Flat and Curved Glass
- Tough ABS Polymer Handle
- Safe Lifting Weight Up to 55 Pounds (25 kg)



CAT. NO. S106VHP

This quality lifter is manufactured by CRL in Australia, and is used worldwide. Our 6" (152 mm) Vertical Handle Vacuum Lifter has a vacuum pad that can be used on both flat and curved glass surfaces. The ABS polymer handle houses a pump-up type vacuum mechanism that creates and maintains a vacuum strong enough to provide a safe lifting weight of up to 55 pounds (25 kg). A red-line indicator warns of pending vacuum loss so you can pump up the suction before losing a safe vacuum. A protective cover is supplied to keep the vacuum pad clean and safe between uses. Minimum order is one each.

## CRL Lil Buddy® Windshield Tools

- It's Like Having a Second Pair of Hands
- Easy to Set Up and Use On Almost Any Vehicle
- Reduces Call Backs Because the Glass is Precisely Set on the Urethane

The Lil Buddy® Pro 1 is a unique tool that allows one person to change windshields and back glass safely on cars, trucks, busses, and RV's. The glass is suspended on a swinging arm that acts as a second person to hold the glass above the opening until it can be fitted to the precise position required for a tight seal of the urethane adhesive. Lil Buddy® Pro 1 will more than pay for itself with the labor savings gained. It's made of stainless steel for strength and years of dependable service. Lil Buddy® Pro 1 comes in a molded case for easy transport on mobile installations, and includes two vacuum cups, an instruction manual, and training DVD. Minimum order is one each.

Lil Buddy® Junior Cups retain a secure grip on one side of the windshield so the technician can easily and accurately maneuver and position the replacement. Each set comes complete with two Lil Buddy® Junior Suction Cups and a carrying case. Minimum order is one pair.



CAT. NO. LBP1  
Lil Buddy® Pro 1 Windshield Tool



CAT. NO. LBJ2  
Lil Buddy® Junior Suction Cups Set

## CRL Auto Glass Setting Stick™ • Allows You to Set Windshields and Back Glasses by Yourself



There are times when you have to set a windshield by yourself because an extra set of hands is not available. Now one person can easily install a windshield. Developed by an auto glass technician, the Auto Glass Setting Stick™ sits over the windshield wiper post on the bottom. It can also be used when setting back glasses by placing its non-skid pad against the body. The pad is also useful when the wiper post is not in the right location. The top is held above the car with a non-skid rubber pad that keeps the Auto Glass Setting Stick™ elevated. Stick measures 48" (1219 mm) long to also accommodate large windshields. Minimum order is one each.



Set the glass on the peg at the bottom of the Auto Glass Setting Stick™. It is held in place while you put your side where you want it.

Lil Buddy is a registered trademark of Lilbuddy, LLC.



After setting your side, walk to the other side, lift the stick up a small amount and slide the Auto Glass Setting Stick™ out of the way.



Set the Auto Glass Setting Stick™ out of the way and you are now ready to place the glass in position.

CAT. NO. HST212

## CRL Plastic Handle Double Swivel Vacuum Lifter

- Plastic Handle and Double 4-1/2" (114 mm) Vacuum Pads
- Movable Pads Self-Adjust to Curved Glass

The CRL Double Swivel Vacuum Lifter is specially designed for lifting flat glass as well as the positioning and fitting of windshields or truck and bus glass. The strong, plastic body has double-swivel points to allow fast attachment to a wide variety of curved and flat surfaces. Lifting capacity is approximately 132 lbs. (60 kg). Replacement Rubber Pads Cat. No. RR911 are also available. Minimum order is one each.



Lifting Capacity  
132 lbs. (60 kg)

CAT. NO. 911VC

## CRL Aluminum Movable Double Pad Vacuum Lifter

- Movable Pads Self-Adjust to Curved Glass
- Suitable for Glass, Plastic, Metal, Coated Wood, Marble, and Any Other Smooth, Airtight Surface

Tested to high standards, the lightweight CRL Aluminum Movable Double Vacuum Lifter attaches quickly to curved glass during use. Tilting over the levers creates a vacuum suction to the substrate. Always check for resistance caused by the vacuum build-up while doing this to ensure proper attachment is made. The lifting capacity is 132 lbs. (60 kg). The pad diameter is 4-1/2" (114 mm). Replacement Rubber Pad and Lever Cat. No. RR0506, and replacement Lever with Pin Cat. No. RR0506LVR are also available. Minimum order is one each.



Lifting Capacity  
132 lbs. (60 kg)

CAT. NO. 05064

## CRL 7" Curved Glass Vacuum Cup

**new**

- Ideal For Use on Windshields
- Red-Line Indicator Warns User of Any Vacuum Loss
- Durable Metal Handle and Brass Plunger
- Concave Pad for Curved Surface



Lifting Capacity  
70 lbs. (32 kg)

The ideal tool for removing or installing windshields or custom bent glass, the CRL 7" Curved Glass Vacuum Cup provides comfortable and secure handling of glass with its unique style metal handle. Concave pad allows attachment to curved glass found on automobile windshields and can also be used on flat surfaces. Red-Line indicator on brass plunger warns user of any vacuum loss. Lift tab on the edge of the pad permits instant release. Minimum order is one each.

CAT. NO. WH9601HP7B

## CRL Windshield Hold-Down Vacuum Cup Set

- Secures Windshield and Molding



Slots for  
Tie-Down Strap

The CRL Windshield Hold-Down Vacuum Cup Set firmly secures both the windshield and the molding during the adhesive curing process. Once you use the Vacuum Cups to position the glass you thread the Tie-Down Strap through the slits in the handles. Then the strap is pulled around the "A" Pillars on each side of the vehicle, then back to the surface of the windshield. Then it is threaded into the ratchet mechanism and tightened, holding both the glass and molding in place. The set contains two Double Swivel Vacuum Cups and one 13' (4 m) Ratcheting Tie-Down Strap. Minimum order is one set.

CAT. NO. VCS2



## CRL Folding Windshield Stands

- These Easily Transportable and Very Sturdy Stands Are Now Available in Two Sizes, Large and Extra Large, to Handle Even the Biggest Windshields
- Made in the U.S.A. by CRL

Our Folding Windshield Stands come in two sizes: Large and Extra Large! They're big enough to handle even the largest windshields and backlites, yet easily transportable when you are called out to a mobile installation.

They're formed from 1-1/4" (32 mm) diameter steel tubing and have non-slip rubber feet to provide traction on smooth shop floors. The top liners are reinforced PVC to cushion the glass. Two 18" (457 mm) chains allow for quick adjustment for a comfortable working height.

Also available is our optional Carpeted Table Top that lets you convert either Stand to a portable work table. It measures 24-1/2" x 30-1/2" (622 x 775 mm), a full five square feet. Minimum order is one each.



**CAT. NO. 2011098**  
Large Size Windshield Stand  
Measures 30" (762 mm) Wide



**CAT. NO. FWST**  
Optional Carpeted Table Top  
Measures 24-1/2" x 30-1/2" (622 x 775 mm)



**CAT. NO. 2011099**  
Extra Large Size Windshield Stand  
Measures 41" (1041 mm) Wide

## CRL Portable Windshield Stand

- Easily Holds Up to 500 Pounds (226 kg)
- Lightweight at Only 16 Pounds (7 kg)
- Foam Padding Protects Glass
- Adjustable Height
- Assembles Easily in Minutes
- Folds to Just 4" (102 mm) Thick

Our WS85 Portable Windshield Stand will support even the largest windshield or backlite while you apply your urethane adhesive and primers. Constructed of steel tubing with 1/2" (12 mm) foam padding on top, this lightweight, yet strong stand will hold up to 500 pounds (226 kg). Ships economically via UPS, and is very easy to assemble. Also available is a 24-1/2" x 30-1/2" (622 x 775 mm) Carpeted Table Top to convert the Stand to a portable work table for your tools and supplies.



**CAT. NO. WS85**  
Portable Windshield Stand  
Measures 30" (762 mm) Wide



Shown with  
Optional Carpeted  
Table Top

CAT. NO.	DESCRIPTION
WS85	Portable Windshield Stand
FWST	Optional Carpeted Table Top

Minimum order: 1 each.

## CRL Mobile Auto Glass Racks

- Mounts in the Bed of Your Truck
- Standard 19" (483 mm) Masts Hold Larger Windshields
- Adjustable Grips for Safe, Secure Transport
- All Glass Areas Have Rubber Pads to Help Prevent Breakage During Transport
- Heavy Gauge Steel With Weather Resistant Black Powder-Coat Finish



Both WR5 5-Lite and WR9 9-Lite CRL Mobile Auto Glass Racks assemble easily for fast pickup truck bed installation. The heavy steel powder-coated base holds the sponge rubber protected masts firmly to keep your windshield load steady. Adjustable grips press against the glass to prevent movement, and the rubber protective strips on the base plate ensures against glass breakage. Black powder-coat finish gives all-weather resistance. Masts are 19" (483 mm) high. Mast Extensions are also available, Cat. No. EX21, see page 399K.



CAT. NO.	CAPACITY	LENGTH	WIDTH	HEIGHT
WR5	5 Lites	18" (457 mm)	30" (762 mm)	22-1/4" (565 mm)
WR9	9 Lites	30-1/2" (775 mm)	30" (762 mm)	22-1/4" (565 mm)

Minimum order: 1 each. All Racks are F.O.B. the nearest CRL warehouse.

## CRL Flat Rack Folding Glass Racks

- Provides Extra Room Quickly When Needed
- All Heavy-Duty Aluminum Construction

When you have the need to transport something large in your pickup bed, and still need a great windshield rack, the solution is the CRL Flat Rack Folding Glass Rack. Able to fold down in thirty seconds, this heavy-duty all aluminum rack is available in five and nine lite models. Four friction pins hold the masts in the vertical position, and when removed allow them to fold to the lowered position. Constructed with sturdy aluminum for long-lasting durability with no paint chipping or rusting. Masts are 18-1/2" (470 mm) high.



CAT. NO.	CAPACITY	LENGTH	WIDTH	HEIGHT
LRW5	5 Lites	20-3/4" (527 mm)	30" (762 mm)	21" (533 mm)
LRW9	9 Lites	32-3/4" (832 mm)	30" (762 mm)	21" (533 mm)

Minimum order: 1 each. All Racks are F.O.B. the nearest CRL warehouse.



## CRL Rubber Donuts

- Custom Build Your Own Glass Caddy or Repair Your Old One



CRL offers you a high-quality Rubber Donut for use in making your own glass caddy or rack. They fit snugly over rods or dowels with a 1" (25.4 mm) diameter. Custom build your own windshield transportation mechanism to fit your specific needs. With CRL Rubber Donuts, you can be sure of safety in glass transportation. Measures 3" (76.2 mm) in diameter by 7/8" (22 mm) thick. Minimum order is one each.

CAT. NO. 14779

## CRL Truck Rack Cushion

- Cushions Glass on Racks With Horizontal Slats

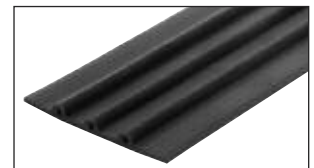

CRL Truck Rack Cushion is used on the horizontal slats of a glass rack. It cushions and prevents glass from slipping, and can be glued or tacked to glass racks. Must be ordered in increments of 12 feet.

CAT. NO.	COLOR	WIDTH	ROLL LENGTH
450TRC	Black	3-1/2" (89 mm)	12 Feet (3.66 m)

Minimum order: 12 feet.

## CRL Burco® Redi Racks®

- Constructed of Heavy Gauge Steel With Weather Resistant Black Powder-Coat Finish
- All Glass Contact Areas Have Rubber Pads to Help Prevent Breakage

These Burco® Redi Racks® offer the best ride for your glass because all glass contact areas are protected by rubber pads to help prevent breakage. They're constructed of heavy gauge steel with a highly durable, black powder-coat finish for all-weather protection and low maintenance. 5-Lite or 9-Lite models have 15" (381 mm) masts placed 3" (76 mm) on center, and each has the proprietary "Finger-Lock" to hold glass snugly. Both models come with a Slick Eddy Glass Slide to ease loading and unloading of glass. Mast Extensions (see below) are also available to extend the height of individual masts to 36" (914 mm). Replacement Top Caps, Cat. No. RCAP1, for masts are also available.

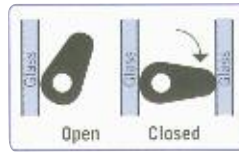

Burco's Exclusive "Finger-Lock" Design

Each mast is topped by a "Finger-Lock", which has an open/close position to secure the glass in place for a more dependable hold



CAT. NO. RCAP1  
Replacement Top Cap



The Slick Eddy Glass Slide that comes with every Redi Rack® makes loading and unloading windshields easier by reducing friction between the glass and the rubber base



CAT. NO.	CAPACITY	LENGTH	WIDTH	HEIGHT	DESCRIPTION
S05B	5 Lites	18" (457 mm)	30" (762 mm)	18" (457 mm)	5 Lite Redi Rack
S09B	9 Lites	30" (762 mm)	30" (762 mm)	18" (457 mm)	9 Lite Redi Rack
SE46					Slick Eddy Glass Slide

Minimum order: 1 each. Redi Racks® and accessories ship F.O.B. all CRL warehouses. Both sizes can ship UPS.

## CRL Burco® V-Rack

- Safe Transportation of Big Windshields
- "Finger-Locks" Keep Loads Secure
- Storage and Transportation of Glass in Enclosed Vehicles Reduces Chance of Breakage

The CRL Burco® V-Rack Carrier is designed with a step down base for upright transportation of windshields up to 47" (1194 mm) high in a full-size van or enclosed pickup. As with the CRL Burco® Redi Rack®, this rack incorporates "Finger-Locks" to hold the glass snugly. Heavy gauge steel with durable black powder-coat finish for long-life durability. Mast heights range from 21" (533 mm) to 23" (584 mm).



CAT. NO.	CAPACITY	LENGTH	WIDTH	HEIGHT
V0924	9 Lites	30" (762 mm)	30" (762 mm)	24-1/2" (622 mm)

Minimum order: 1 each. Ships F.O.B. nearest CRL warehouse. Can ship via UPS.

## Replacement Parts for CRL Burco® Redi Racks®

### Mast Extensions

- Extends Mast Height to 36" (914 mm)



CAT. NO. EX21  
Minimum order: 1 pair.

### Mast Tubing

- Easy Slip On Replacement



CAT. NO.	TUBING LENGTH
RCT01	13-3/4" (349 mm)
RCT02	19-1/2" (495 mm)
RCT03	21-1/4" (540 mm)
RCT04	22-3/4" (578 mm)

Minimum order: 1 each.

### Finger-Locks

- Replace Worn or Damaged Originals



CAT. NO. RFL01  
Minimum order: 1 each.

### Rubber Base Pads

- Maintains Glass Protection



CAT. NO.	FITS
RBR05	S05B Redi Rack
RBR09	S09B Redi Rack
RBR09V	V0924 V-Rack

Minimum order: 1 each.

Burco, and Redi Rack are all registered trademarks of Burco, Inc.

## CRL Freestanding Single-Sided Windshield Rack

- **Welded Steel Rack With Capacity for 25 Windshields or Backlites**

This CRL Single-Sided Windshield Rack is freestanding, making it easy to relocate if necessary. Designed to hold 25 windshields, the Rack is made out of welded steel, with a wide base to steady it under a full load. The steel pegs have durable, easy-to-clean polyethylene covers with plastic caps, and the enamel finish protects against rust. Neoprene glass stops are installed on uprights. Assembly requires no special tools, and all hardware is included. The support arms extend out 24" (610 mm), and the spacing between the arms is 1-3/4" (44 mm).

CAT. NO.	CAPACITY	DEPTH	WIDTH	HEIGHT
WSSR25	25 Lites	41" (1041 mm)	27" (686 mm)	72" (1829 mm)

Minimum order: 1 each. Racks are shipped F.O.B. Woodstock, Illinois



## CRL Freestanding Double-Sided Windshield Rack

- **Double the Capacity of Single-Sided Racks**

The CRL Double-Sided 90-Lite Windshield Rack absolutely provides the most windshield storage space possible. This Rack has twice the capacity of the Wall-Mount Single-Sided Racks, and occupies only slightly more floor space. The welded steel construction, corrosion resistant enamel finish, polyethylene covered arms, and sturdy base give you an economical and efficient storage system that's easy to assemble or move as necessary. The support arms extend out 24" (610 mm), the spacing between the arms is 1-3/4" (44 mm). Assembly requires no special tools, and all hardware and instructions are included.

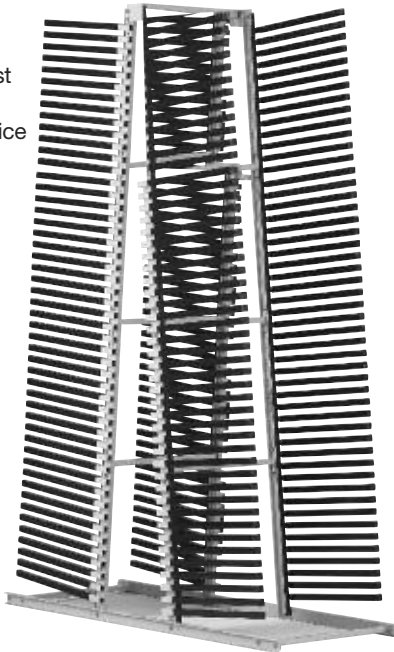

CAT. NO.	CAPACITY	DEPTH	WIDTH	HEIGHT
WDSR90	90 Lites	72" (1829 mm)	27" (686 mm)	128" (3251 mm)

Minimum order: 1 each. Racks are shipped F.O.B. Woodstock, Illinois

## CRL Wall Mount Windshield Rack

- **Holds Up to 45 Lites in a Minimum of Floor Space**

This CRL Wall Mounted Windshield Rack is the ultimate in peg rack-type storage systems. Polyethylene coated pegs and neoprene backstops protect the glass, while the Rack takes up an absolute minimum of floor space. Although Racks are anchored to the wall, the legs place most of the weight on the floor. The arms are firmly welded in place and require no assembly. The support arms extend out 24" (610 mm), the spacing between the arms is 1-3/4" (44 mm). A universal mounting kit is included.

**NOTE:** Consult a local building engineer and local building codes prior to installation.

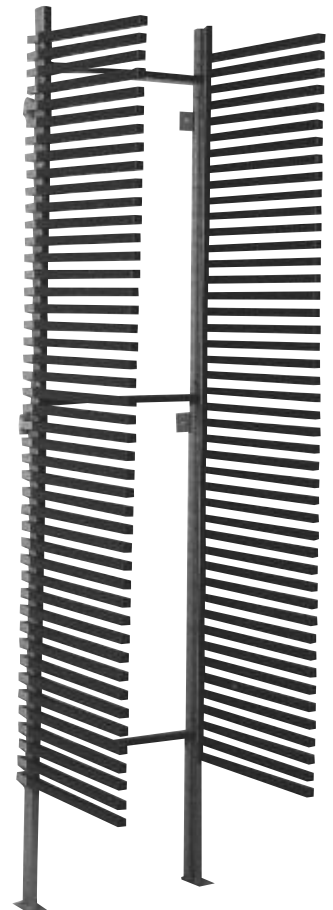

CAT. NO.	CAPACITY	DEPTH	WIDTH	HEIGHT
WR45	45 Lites	25" (635 mm)	27" (686 mm)	138" (3505 mm)

Minimum order: 1 each. Racks are shipped F.O.B. Woodstock, Illinois

## CRL Rolling Windshield Carts

- Holds 15 Lites
- Ball Bearing Casters
- Welded Steel Frames
- Coated Masts

This CRL Windshield Cart makes it easy for one person to move 15 windshields. It is built of welded steel, with polyethylene-coated masts and neoprene stops to protect the glass. This creates an elevated windshield setting area. Masts are 19-3/4" (502 mm) high. The cart rides on ball bearing casters with toe locks. Hardware and assembly instructions are included.



CAT. NO.	CAPACITY	DEPTH	WIDTH	HEIGHT
<b>WGC15</b>	15 Lites	51-1/4" (1302 mm)	27" (686 mm)	34-3/8" (873 mm)

Minimum order: 1 each. Ship F.O.B. all CRL warehouses.

## CRL Heavy-Duty Rolling Windshield Cart

- 3,000 Pound (1,360 kg) Capacity
- Holds Up to 15 Lites



The CRL Heavy-Duty Rolling Windshield Cart is built to withstand the rough handling sometimes encountered in the shop. The 40" (1016 mm) high push handle is ergonomically friendly for workers. Two casters lock for stability while loading lites, the other two casters swivel. Huge 5" (127 mm) roller bearing casters are non-marring and urethane coated, with built-in forklift slots, and 1-1/4" (31.8 mm) post spacing. This 200 lb. (90.7 kg) 15 lite cart is designed for years of dependable service. Shipped fully assembled.

CAT. NO.	CAPACITY	DEPTH	WIDTH	HEIGHT
<b>2101419</b>	15 Lites	43" (1092 mm)	32" (813 mm)	42" (107 mm)

Minimum order: 1 each. Cart is shipped F.O.B. Cicero, Illinois

## CRL Mini Windshield Inspection Stand



- Inspect and Clean Windshields Before Installation or Shipment



The CRL Mini Windshield Inspection Stand has three light fixtures containing two 48" (1219 mm), 25 watt Rapid Start T-12 Bulbs, which allows you to inspect or clean windshields in a highly illuminated workspace. The Stand is constructed with heavy 14 gauge, 2" (51 mm) diameter steel tubing, and welded for durability. The decking is also 14 gauge steel. Shipped fully assembled.

CAT. NO.	CAPACITY	DEPTH	WIDTH	HEIGHT
<b>2101510</b>	1 Lite	37" (940 mm)	52" (1321 mm)	64" (1626 mm)

Minimum order: 1 each. Stand is shipped F.O.B. Cicero, Illinois

## CRL Auto Glass Molding Release Tool

- For General Motors, Ford, and Other Vehicles
- Works Left and Right Handed

Made from tempered high carbon steel, the CRL Molding Release Tool is used to remove trim moldings from General Motors, Ford, and other vehicles. The easy-to-grip handle provides comfortable prying force. Minimum order is one each.



CAT. NO. KD2038

## CRL Window Molding Clip Tool

- For Molding Clips and Gasket Set Glass

One end of the CRL Window Molding Clip Tool spreads rubber zipper-type gaskets, the other end removes molding clips. Minimum order is one each.



CAT. NO. KD2037

## CRL Universal Auto Glass Molding Release Tool

- Angled for Easy Clip Release

Made from tempered high carbon steel, the CRL Universal Auto Glass Molding Release Tool is used to remove trim moldings. It is our most popular molding release tool. Available in standard and heavy-duty models. Minimum order is one each.



## CRL "Tree" Molding Removal Tool

- Coated Tip Won't Chip Glass
- Removes Insert Moldings

CRL "Tree" Molding Removal Tool makes a difficult job easier. The tool is thin enough to fit under moldings, and wide enough so the tool will not tear the molding. The wide tip is coated to protect against breaking the glass. Minimum order is one each.

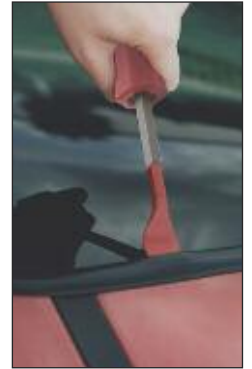

CAT. NO. RFN683

CAT. NO.	DESCRIPTION
MR215	Standard Release Tool
MR215EXP	Heavy-Duty Release Tool

Minimum order: 1 each.

## CRL Molding Release Tools for GM Vehicles

- Used to Release Moldings From Retainer Clips

### Right Handed Flat Tip Tool



CAT. NO. CP259  
Minimum order is one each

### Left Handed Flat Tip Tool



CAT. NO. CP261  
Minimum order is one each

### Double Ended Angled Tip Tool for Deep Aluminum Moldings



CAT. NO. CP295  
Minimum order is one each

All automotive hand tools can be combined for quantity pricing.

## CRL Import Car Clip Tool

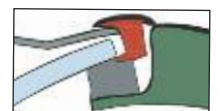
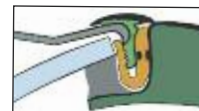

- Dual Purpose Tool

This handy tool serves two functions. It pries open difficult to remove molding retainers, and also depresses "butterfly" clips so they release from the pinchweld retainers. Minimum order is one each.

CAT. NO. TCR370

## CRL Clip-Zip Trim Fastener Tool



- Squeezes Trim Fasteners Out
- Helps Prevent Panel Fasteners From Tearing Interior Panels

The CRL Clip-Zip Tool makes the frustrating job of trim fastener removal simple. Slide the fork under the fastener head and squeeze the handles. Fastener pops out without damage to panel or trim molding. Use to remove hood insulation, door trim, wire harnesses, headliner fasteners and more. Made of high-carbon steel and heat treated for strength. Zinc coated for corrosion protection. The more you use it, the more uses you'll find for it. Minimum order is one each.

CAT. NO. CZ326

## CRL Door Panel Removal Tool



- Removes Plastic Door Panel Fasteners Without Breakage

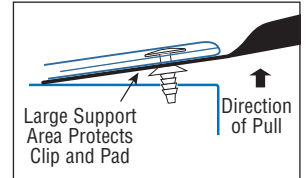

The CRL Door Panel Removal Tool makes access to the door glass easier. Place the tool under the edge of the door panel, insert tool under the fastener as far as possible, and then simply pry up. Rugged tool with a large comfortable handle. Minimum order is one each.

CAT. NO. L35400

## CRL 10-in-1 Universal Trim Tool



- 10 Tools in One Handy, Easy-to-Use Tool

The 10-in-1 Universal Trim Tool is a must for every auto glass installer. This handy tool does many of the jobs you normally have to do with a variety of other more expensive tools. It's made of tempered spring steel and is comfortable to hold. Why pay for an assortment of specialty tools, and then try to keep track of them, when the 10-in-1 Universal Trim Tool will do it all? Minimum order is one each.

CAT. NO. 21510T

## CRL Plastic Trim Fastener Removal Tool



- For Plastic Door Panel Trim Fasteners
- Sliding Button for Extra Leverage



The CRL Plastic Fastener Removal Tool quickly removes various types of plastic fasteners. The tool is equipped with a sliding urethane button for use when extra leverage is required. Minimum order is one each.

CAT. NO. L35260

All automotive hand tools can be combined for quantity pricing.

## CRL 5-Piece Door Panel Removal Set

- **Stainless Steel Blades**
- **Soft Ergonomic Handles**

Add this set to your tool box and be prepared for just about any door panel on the market. This complete set will provide you with the majority of tools required for this function. The stainless steel blades will offer years of use, and the soft ergonomic grips are comfortable to hold. From cowl vent push rivets to large door panel fasteners, this set will remove them all. Minimum order is one each.



CAT. NO. DT6200

## CRL 2-Piece Long Reach Door Panel Removal Kit

- **Stout 3/8" Steel Shafts Make it Possible to Get at Hard to Reach Fasteners**

Door panels always had the fasteners on the outside edges for easy access, but nowadays you can sometimes find them right in the middle of the door. This makes it difficult to pull free without worrying about buckling the panel or breaking the fastener. We offer our Long Reach Door Panel Removal Tool Kit with one each 20" (508 mm) and 10" (254 mm) long tool for those hard to reach fasteners. Both have 3/8" (10 mm) steel shafts for prying strength. Minimum order is one each.

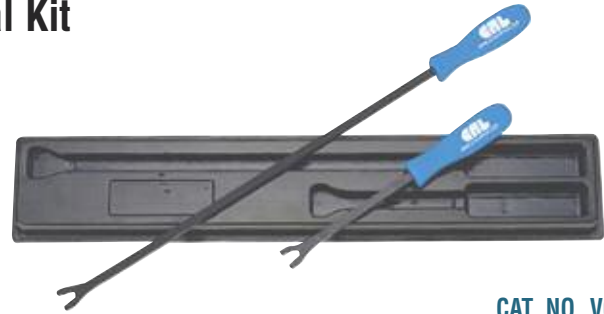

CAT. NO. V6132

## CRL 24" (610 mm) Flexible Shaft Magnetic Pick-Up Tool

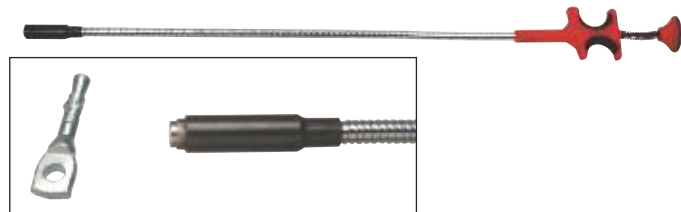

- **Sheath Prevents Magnet From Adhering**
- **Fingertip Controller Exposes Magnet**

Our 24" (610 mm) Flexible Magnetic Pick-Up Tool remains inactive until you depress the fingertip controller to expose the magnet. This prevents the magnet from becoming stuck to every metallic item around while trying to fish out that lost screw or bolt. The flexible shaft allows you to reach between and around areas not accessible to straight magnetic pick-up tools. Minimum order is one each.

CAT. NO. 13FM

## CRL 24" (610 mm) Flexible Shaft Four-Finger Claw Pick-Up Tool

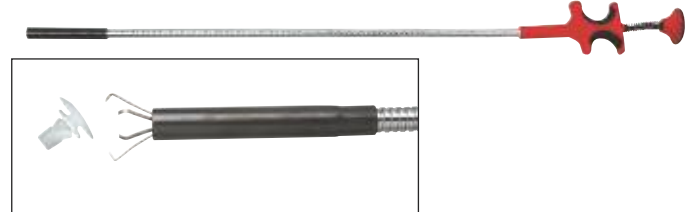

- **Excellent for Non-Magnetic Items**
- **Flexible Shaft Allows Easy Access**

If you drop a non-metallic part inside a door it can be a real problem, but we have the solution with our 24" (610 mm) Flexible Shaft 4-Finger Claw Pick-Up Tool. This tool operates the same as our Magnetic Pick-Up Tool with an easy-to-use finger controller. Pick up the pair and be prepared for any dropped item, metallic or not. Minimum order is one each.

CAT. NO. 24FC

## CRL Folding Work Seat

- **Heavy Canvas Seat and Tubular Legs**
- **Folds for Easy Storage**
- **Adjustable Carrying Strap**

This handy CRL Folding Work Seat is designed to go anywhere you need a seat, and is just the right height for working on door glass. Fold it up and put it in your tool chest or behind the seat of your truck. The seat stands 16" (406 mm) high when assembled, and comes with a convenient carrying strap. Minimum order is one each.



CAT. NO. CRL197

All automotive hand tools can be combined for quantity pricing.



## CRL Headliner Tools

- Stuffs Headliners Into Locking Channels
- Also Great for Landau Tops
- Two Models to Choose From

These CRL Headliner Tools are ideal for stuffing headlining in channels above car doors, or upholstery trim edges into hard-to-get-at places. Edges won't damage material, and work easily around corners. HT501 Tool also releases headliner clips.

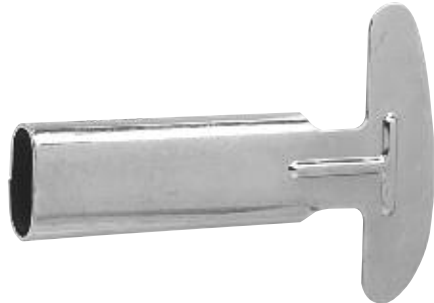

CAT. NO. AV7672

This all-steel tool has rounded edges that won't damage headliner materials. Overall length is 5-3/4" (146 mm). Minimum order is one each.



CAT. NO. HT501

Durable tempered stainless steel tool removes double or single prong headliner clips without breakage. Features tough vinyl grip. Overall length is 6-1/4" (159 mm). Minimum order is one each.

## CRL Underside Molding Installation Tool

- Quickly Installs Our 409T201 Underside Molding



The CRL Underside Molding Installation Tool takes the work out of installing our 409T201 Underside Molding. The tool holds the Molding in perfect position and quickly feeds it onto the glass at a consistent distance from the outside edge. Made from heavy-duty plastic material that will give you years of service. Minimum order is one each.

CAT. NO. 409TOOL

## CRL Door Handle and Window Crank Spring Tool

- Makes Clip Removal Easy



The most widely used tool for removal of inside handles is our CRL Door Handle and Window Crank Spring Tool. Fits GM, Ford, and most American Motors products from 1962-on. Spring remains on handle. Use reverse end of tool to remove door panels. Minimum order is one each.

CAT. NO. CP26

## CRL Windshield Molding and Door Clip Release Tool



- Releases Clips on Chrome Moldings
- Designed to Protect Against Molding Damage

This CRL Door Clip and Windshield Molding Release Tool releases clips on chrome windshield moldings. The offset handle allows for easy access. This tool also works on spring retention clips on door handles. Slips under door handle without damage to the door panel material. Minimum order is one each.

CAT. NO. L35200

## CRL Windshield Stick Setting Tools



CAT. NO. CRL216

Tapered on Both Ends

Overall Length: 7-7/8" (200 mm). Minimum order: 1 each.



CAT. NO. CRL220

Chisel Tip on One End, Tapered Tip on the Other

Overall Length: 7-7/8" (200 mm). Minimum order: 1 each.

## CRL Windshield Stick Holder

- Comfortable Grip for CRL216 and CRL220 Windshield Sticks



CAT. NO. CRL216HWS

Stick Handle with CRL220 Stick  
Minimum order: 1 each.

CAT. NO. CRL216H

Stick Handle Only  
Minimum order: 1 each.

All automotive hand tools can be combined for quantity pricing.

## CRL Window Roller Nut Removal Tool



- Fits 1/4" Drive Ratchet Wrench
- Steel Dowel Pins
- 1/2" (12 mm) Depth

The CRL Window Roller Nut Removal Tool fits window regulator roller nuts used on Chrysler, General Motors, Ford, and American Motors cars. The tool will hold nut in position for removing and replacing in blind operations. It is designed to work on any 1/4" drive ratchet wrench. Minimum order is one each. **CAT. NO. CRL830**

## CRL MultiSpanner Door Glass Retainer Tool

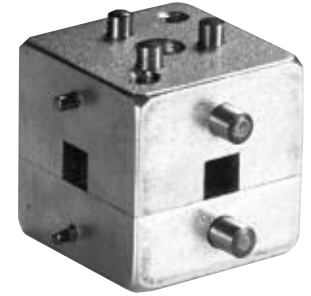

- Fits 95% of All Door Glass Retainers
- Uses 1/4" Drive Ratchet Wrench

Our CRL MultiSpanner fits up to 95% of all the door glass retainer nuts on the market. Made of steel with tempered steel pins. Use your 1/4" drive ratchet wrench to make short work out of a difficult job. Minimum order is one each. **CAT. NO. DZ623**

## CRL GM and Chrysler Roller Nut Wrench



- Removes Door Glass Nuts Easily

The CRL Roller Nut Removal Tool removes GM and Chrysler door glass retainer nuts quickly. The low profile makes it easier to use in tight places. Minimum order is one each. **CAT. NO. CP673115**

## CRL Saturn Roller Nut Wrench



- Removes Saturn Door Glass Nuts Easily

This CRL Roller Nut Removal Tool has a low profile design to make it easier to remove door glass retainer nuts from 1991+ Saturn vehicles. Minimum order is one each. **CAT. NO. CP937174**

## CRL Upholstery Nail Removers

- Gently Pry Without Damage

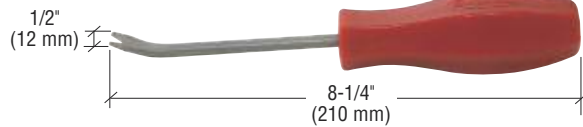

**CAT. NO. 2000657**



**CAT. NO. CP255**

These CRL Upholstery Remover Tools gently pry door panels off quickly and easily. Their heavy-duty shaft and prongs are durable and easy to use. Minimum order is one each.

## CRL Door Upholstery Remover

- Removes and Saves All Types of Upholstery Clips

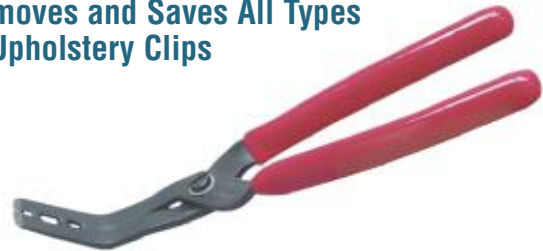

Our Door Upholstery Remover safely removes all types of clips without damaging them, so you can save them for re-installation. It's terrific for removing door panels. Many clips fit tightly into the hole, against the vehicle surface. The front of this tool is tapered so it will easily fit under a clip. Spread the jaws slightly so they go around and under the clip. Next, close the jaws and the tool will remove the clip without damaging it. Minimum order is one each. **CAT. NO. SCR696**

All automotive hand tools can be combined for quantity pricing.

## CRL Window Guide Pliers

### • Lets You Reuse Hard to Replace Window Guides

There are many different window guides on today's cars, but you never seem to have the right one to replace the one you just removed. These CRL Window Guide Pliers were developed by an auto glass technician to save the old window guide and assist in putting it back on the new glass. The jaws are made so they will go around the window guide without damaging it, and exert the pressure on the part that snaps together. The handle is made with a slotted area that can be used to pry the plastic snap loose so you can reuse the guide. Saves you both time and money. Minimum order is one each.

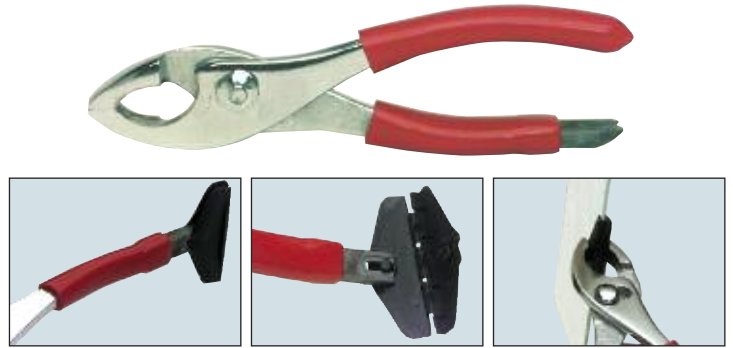

CAT. NO. JP685

## CRL Plastic Window Washer Holder/Separator

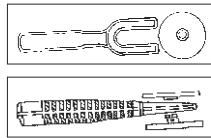

- Holds Plastic Washer While Drilling
- Separates Washers Without Breaking Them

This CRL Plastic Window Washer Holder/Separator works to solve two problems. Rivets often spin while being drilled out. The CRL Plastic Window Washer Holder prevents this from occurring. Wedge this tool in the plastic washer to hold it while drilling out the rivet. Then insert the tool between the plastic washers to separate them without breaking. Injected molded plastic will provide years of service. Minimum order is one each.

CAT. NO. CST522

## CRL Latch Pin Removal Pliers

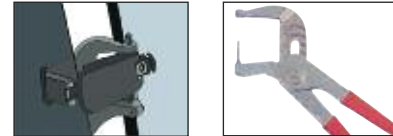

- Removes and Replaces Split Pins in Swing Out Window and Sunroof Latches
- Make a Tough Job Easy

CRL Latch Pin Removal Pliers have five adjustable settings that will fit any "swing out" window or sunroof latch. This tool not only removes these difficult to remove pins, but can also be used to reinstall them. Minimum order is one each.

CAT. NO. PRT305

## CRL Fiber Driving Wedge



- Can Be Used to Drive Glass On or Off of Channel
- Fiber Material Won't Scratch Glass

The CRL Fiber Driving Wedge is a great multi-purpose driving wedge primarily used for removing framework and channels from a piece of glass. Ideal for knocking door glass from the lower channel. Made of a tough, rigid fiber material. Minimum order is one each.

CAT. NO. F102

## CRL Rivet Stem Removal Tool



- Makes Drilling Out Door Glass Rivets Easier
- Spring-Loaded, Hardened Steel Tip



Removing door glass without breaking it usually requires you drill out the rivets. The first step in doing this involves removing the rivet's stem, typically a difficult task. Using the CRL Rivet Stem Removal Tool to force the stem out makes this a much easier job.

The concave end of the tool self-centers on the rivet to perfectly align the spring loaded hardened steel tip with the rivet stem. A few light taps with a hammer on the handle end of the tool will drive the rivet stem out. Minimum order is one each.

CAT. NO. RSR1

All automotive hand tools can be combined for quantity pricing.

## CRL Marson® "Big Daddy" Riveter



- Excellent for Window Regulator and Glass Stop Rivets

The CRL Marson® "Big Daddy" Riveter lets you work in hard-to-get-to areas. Use it to replace window regulator and glass stop rivets, plus door handle rivets. The special nosepiece provided with the tool must be used for these applications. 3/16" and 1/4" (4.8 and 6.4 mm) nosepieces for other rivet applications are stored in the body of the tool.

CAT. NO.	DESCRIPTION
39010	"Big Daddy" Riveter
39010JAWS	Replacement Jaws
39009	Long Nose Adapter

Minimum order: 1 each.

## CRL Rivet Tool Nosepieces

- Fit 39010 "Big Daddy" Riveter

These Replacement Rivet Tool Nosepieces are for Cat. No. 39010 Marson "Big Daddy" Riveter.



CAT. NO.	DESCRIPTION
96026	3/16" (4.8 mm) Nosepiece
96027	1/4" (6.4 mm) Nosepiece
96028	Klik-Split Rivet Nosepiece

Minimum order: 1 each.

## CRL Hydraulic Rivet Gun

- Develops Up to 3,500 Pounds of Pulling Power

The CRL Hydraulic Rivet Gun develops up to 3500 pounds (1587 kg) of rivet pulling power, capable of setting 1/4" (6.3 mm) diameter rivets. Includes four nosepieces for setting rivets of 1/8", 5/32", 3/16", and 1/4" (3.2, 4, 4.8, and 6.3 mm) diameter, plus a 1/4" (6.3 mm) split rivet nosepiece. Minimum order is one each.



CAT. NO. RG1105

Marson is a registered trademark of Alcoa, Inc.

## CRL Heavy-Duty Automotive Riveter



- Tremendous Power for Large Rivets
- Extra Heavy-Duty Tool Used in Auto Glass Shops
- Equipped With Three Long Nosepieces

This CRL Heavy-Duty Automotive Riveter allows riveting in areas where other tools won't reach. Exerts tremendous pulling power for large rivets. Shock resistant curved handles. Equipped with three nosepieces conveniently stored on the handle. Nosepieces set 5/32", 1/8", and 3/32" (4, 3.2, and 2.4 mm) rivets, plus there's a special nosepiece for inserting door handle rivets for the automotive industry.

CAT. NO.	DESCRIPTION
79034	Heavy-Duty Riveter with Nosepieces
96013	Replacement Jaws

Minimum order: 1 each.

## CRL Plastic Rivet Setter



- Available as a Complete Kit, or Just the Tool Only

The CRL Plastic Rivet Setting Tool Kit includes a selection of the four most popular plastic rivets. This all steel tool has full size handles to provide the extra pulling stroke needed to set plastic rivets.

CAT. NO.	DESCRIPTION
48001	Complete Rivet Setter Kit
48000	Rivet Setter Tool Only

Minimum order: 1 each.

## CRL Air Hydraulic Riveter

- Sets Rivet Diameters 1/8", 5/32", and 3/16"

The CRL Air Hydraulic Standard Duty Riveter is designed to set blind rivets from 1/8" to 3/16" (3.2 to 4.8 mm) diameter in all alloys. 1/8", 5/32", and 3/16" (3.2, 4, and 4.8 mm) nosepieces and servicing wrenches included. Requires 85 psi for optimum operation. Minimum order is one each.



CAT. NO. PHT3

## CRL Combination Rivet Tool

- Removes and Resets Rivets to Repair Vent Windows Without Removal

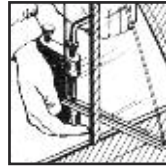

Use this CRL Combination Rivet Tool to replace and set rivets in lower vent pivots, vent handle brackets, and some division bars in many older cars. You can also replace vent handle brackets without removing the vent from the car. One side of the tool is for removing old rivets, and the other for setting new rivets. The rivets are rolled, not flattened, so it is quick and easy to operate. Comes complete with RT1200A Remover Screw and RT1200B Small Rivet Setting Screw. For larger rivets use Cat. No. RT1200C, which must be ordered separately. If you need a spare Allen Wrench order Cat. No. RT1200D separately. Minimum order is one each.

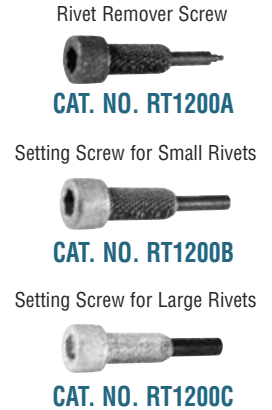

## CRL Rivet Head Removal Tool

- Cuts Heads Off Door Regulator Rivets
- Hollow Center Catches Rivet Stem



The CRL Rivet Head Removal Tool is perfect for the removal of rivets that hold door regulators in place. A hardened steel tip cuts off the rivet head, and the hollow center catches the rivet stem. 3" (76 mm) overall length with 1/4" (6.3 mm) shank to fit most electric drills. Minimum order is one each.

CAT. NO. 72181

## CRL Rivet Eater

- 6" Length for Hard-to-Reach Regulator Rivets in Vehicle Doors
- Removes Recessed Rivet Heads Fast



The CRL Rivet Eater, with its 6" (152 mm) length, easily removes the heads of recessed door regulator rivets in vehicle doors. It lets you get at rivets through small access holes, and has a hollow center so you can use the rivet stem as a guide. Sharpened tip with a 3/8" (9.5 mm) diameter shank removes rivet heads fast. Minimum order is one each.

CAT. NO. RE38

## CRL Rubber Gasket Cleaning Tool

- Cleans Glass Chips From Gasket Channel



Cleaning broken glass chips from rubber gaskets has never been easy, but now it can be with the CRL Rubber Gasket Cleaning Tool. As you pull the tool through the glass channel it cleans out old glass chips and sealant in one easy motion. The tip is specially shaped so it won't tear the gasket. The large handle assures a firm grip while keeping your hands clear of the glass. Minimum order is one each.

CAT. NO. RGC751

## CRL Door Glass Channel Cleaning Tool

- Extra Length Reaches Complete Channel Without Removing Panel



The extra long 24" (610 mm) reach of the CRL Door Glass Channel Cleaning Tool lets you get down into the door glass run channel to clean out broken bits and pieces of tempered glass. The hook shaped tip gets under channel lip and other places you can't normally reach and removes them without damage to the channel. Minimum order is one each.

CAT. NO. GCC506

## CRL Channel Chisel

- Removes Broken Glass and Adhesive From Channel



The CRL Channel Chisel is made of the best tool steel available, and set at the proper angle to easily remove broken pieces of glass from channels. This tool is 16" (406 mm) long. Minimum order is one each.

CAT. NO. 476

## CRL Channel and Vent Tool

- Cleans Broken Glass and Adhesive From Channel



The CRL Channel and Vent Tool is excellent for use as a regular channel chisel, and is also very handy for removing glass from vent frames. The overall length of the tool is 12-3/4" (324 mm). Minimum order is one each.

CAT. NO. CP214

All automotive hand tools can be combined for quantity pricing.

## CRL Hex End Mirror Wrench

- 5/64" and 3/32" Ends



The CRL Hex End Mirror Bracket Wrench is perfect for quick removal or reinstallation of mirrors held in place with hex screws. Pocket clip keeps it handy. Minimum order is one each.

CAT. NO. MB2

## CRL Torx® End Mirror Wrench

- TX15 and TX20 Ends



Our CRL Torx® Mirror Bracket Wrench is perfect to quickly remove or replace mirrors held in place with Torx® screws. The Torx® 15 tip is great for older Ford and GM models, while the Torx® 20 tip works on newer GM models. Minimum order is one each.

CAT. NO. MB2TX

## CRL Mirror Bracket Release Tools

- Quickly Release Rear View Mirrors



This CRL Mirror Bracket Spring Release Tool is designed for use with Ford rear view mirror brackets, allowing the mirror to be removed with a slight upward push on the handle of the tool. Minimum order is one each.

CAT. NO. MB3

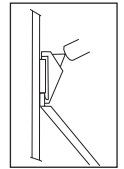

This CRL GM Mirror Release Tool is simple to use - just push tab under lip of clip that holds mirror to windshield bracket and pry up gently. Then grasp the mirror with your free hand and push up and off the bracket. Minimum order is one each.

CAT. NO. MB4

## CRL 6-in-1 Mirror Bracket Tool

- Torx®, Allen, Slotted, and Phillips Bits With Combined Driver Handle/Carrying Case

We have combined the most popular mirror bracket removal and replacement bits along with a driver handle/carrying case in our CRL Six-in-One Mirror Bracket Tool. Together they make up the most versatile mirror bracket tool ever. Minimum order is one each. Housed in this sturdy carrying case are one each:

Cat. Nos. 440TX15 and 440TX20 (TX15 and TX20) Torx® Bits;  
 Cat. Nos. 1851 and 1853 (3/32" and 5/64") Allen Bits;  
 Cat. No. 4453 #8 Slotted Insert Bit;  
 Cat. No. 4402 #2 Phillips Bit;  
 Cat. No. M490 Magnetic Insert Bit Holder



CAT. NO. MB6N1

## CRL Mirror Bracket Iron

- Safely Heats Mirror Brackets
- 10 Second Removal Time



The CRL Mirror Bracket Iron safely and easily removes most rear view mirror brackets from windshields within 10 seconds. The iron heats only the bracket, unlike other heat removal methods such as torches, which can break the glass or bubble the laminate. 110V AC. Minimum order is one each.

CAT. NO. 90MB1

Torx is a registered trademark of Acument Intellectual Properties, LLC.

## CRL Rear View Mirror Installer

- Installs Spring-Loaded Mirrors With Ease



Relieve the stress of mounting spring-loaded mirrors with our Rear View Mirror Installer. It solves this troublesome installation problem so you never have to worry about breaking the windshield or struggle with trying to ensure the mirror is correctly mounted. It's as simple as squeezing the handle and you're done. Minimum order is one each.

CAT. NO. RM1309

All automotive hand tools can be combined for quantity pricing.

## CRL Locking Strip Tools

Insert Eyes are Shown Approximately Actual Size

### CRL Swivel Tip Locking Strip Tool

- Comes With Two Double-Ended Tips That Swivel 90 Degrees

The unique design of our Swivel Tip Locking Strip Tool allows the tip to swivel 90 degrees in either direction to work where others will not. This feature provides the easiest way around corners and under roof overhangs. Just select the tip with the opening that most closely fits your locking strip and then feed into the eyelet. Minimum order is one each.

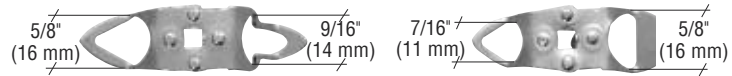

**CAT. NO. L47030**  
Replacement Dodge Tip

**CAT. NO. L47040**  
Replacement Standard Tip



**CAT. NO. L47000**  
Complete Swivel Tip Locking Strip Tool



### CRL Locking Strip Tools for Large Locking Strips



**CAT. NO. CP293**  
Straight Tip

**CAT. NO. CP303**  
Left Handed Tip

**CAT. NO. CP304**  
Right Handed Tip

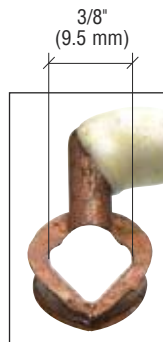

These Locking Strip Tools are used primarily for large windshield gasket locking strips found in trucks, buses, farm and off-road equipment. The tool is available in three models - straight, left, and right hand. Minimum order is one each.

### CRL General Purpose Locking Strip Tool



- Fits Our 713080 and AS789 Locking Strips

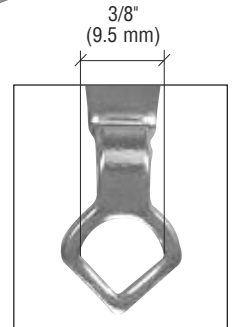

The CRL General Purpose Locking Strip Tool accommodates locking strips up to 7/16" (11 mm) in width at the widest point. All steel tool is bent for gripping comfort. Minimum order is one each.

**CAT. NO. DT110**

### CRL Locking Strip Tool for GM, Chrysler, and Many Imports

This popular Locking Strip Tool is used with the locking strips found in many General Motors, Chrysler, and import vehicles. Minimum order is one each.

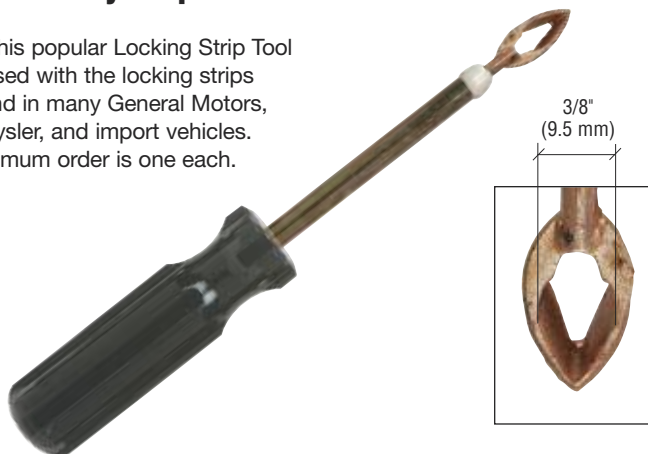

**CAT. NO. CP221**



### CRL Heavy-Duty Stainless Steel Locking Strip Tool

- Works Well With Wide Locking Strips

This CRL Heavy-Duty Locking Strip Tool was designed for use with the wide locking strips used on Dodge, Ford, GM, and other trucks and vans. The tool is constructed of stainless steel to provide years of service. Minimum order is one each.

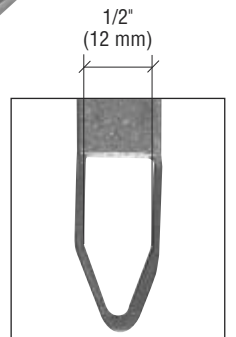
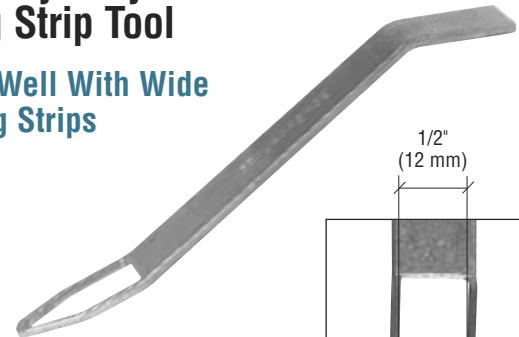

**CAT. NO. LT60**

All automotive hand tools can be combined for quantity pricing.

## CRL Locking Strip Tools

### CRL GM Large Eyed Locking Strip Tool

- Fits Our WLS848 and WLS466 Locking Strips

The CRL GM Large Eyed Locking Strip Tool is for use on all Chevy/GMC Trucks, full size Blazers, and Chevetttes that use an inlaid rubber type locking strip, such as our WLS848 or WLS466. Minimum order is one each.



CAT. NO. CP732085

Insert Eyes are Shown Approximately Actual Size

### CRL Large Eyed Locking Strip Tool

- Fits Cat. No. AS937 Locking Strip

This CRL Locking Strip Tool was designed for use on the locking strips used in Chevrolet trucks and vans, as well as various models of International Harvester vehicles. Minimum order is one each.



CAT. NO. CP772095

### CRL Small Eyed Locking Strip Tool

- Primarily Used on GMC and Chevy Trucks

The CRL Small Eyed Locking Strip Insert Tool works great for replacing gaskets on the door inspection panel on GMC and Chevrolet trucks. Minimum order is one each.



CAT. NO. CP663057

### CRL Chrysler Locking Strip Tool

- Fits Many Chrysler Cars and Trucks

Traditionally one of our top sellers, this CRL Chrysler Locking Strip Tool fits most Chrysler cars and trucks that use a locking strip. Minimum order is one each.

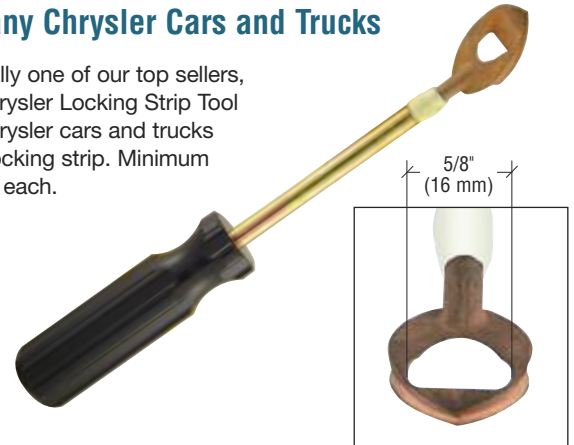

CAT. NO. CP294

### CRL Dodge Van Locking Strip Tool

- Fits Our WLS913 and WLS4165 Locking Strips

Specially shaped eye in tool installs our Cat. No. WLS913 T-Shaped Locking Strips used in full size Chrysler/Dodge vans, as well as our Cat. No. WLS4165 Chrome Locking Strip for Volkswagens. Minimum order is one each.



CAT. NO. CP842103

### CRL Dodge Van Locking Strip Tool

- Fits Our 14RD and WLS900 Locking Strips

This Locking Strip Tool is designed for use on the locking strips of 1969-1993 Dodge trucks and vans. Minimum order is one each.



CAT. NO. CP772100

All automotive hand tools can be combined for quantity pricing.



## CRL Hook and Pick Set

- Set of Four Different Tools



CRL Hook and Pick Set has four different configurations to help you get under and pry up the smallest object. Straight pick also works great when you are trying to align small holes. Minimum order is one set.

CAT. NO. 2000923

## CRL Dodge/Plymouth Locking Strip Tool

This CRL Locking Strip Tool was specifically developed and designed to make an easy job of installing the Mylar locking strip which is used in many full size Dodge and Plymouth vans, as well as Dodge Omni and Plymouth Horizon cars. It features a comfortable screwdriver type handle. Minimum order is one each.



Shown Approximately Actual Size

- Developed for Dodge and Plymouth

CAT. NO. RM730

## CRL Self-Sealing Weatherstrip Locking Tool



- Steel Roller Reduces Friction

This CRL Self-Sealing Weatherstrip Locking Tool is designed to speed closing of self-sealing windshield and back glass rubber. Steel roller rides along gasket edge to reduce friction. Minimum order is one each.

CAT. NO. CP228

## CRL General Purpose Gasket Installation Tool



- Also Commonly Known as a 'Hook' Tool

The CRL 'Hook' Tool is the most popular tool for working with gasket set glass. Most professionals wouldn't get caught without one because it is so versatile. Not only is it great for gasket work, but you can also use it for cleaning glass chips out of gasket and door glass channels, 'unlocking' one-piece weatherstrips, or for pulling cotter pins. Minimum order is one each.

CAT. NO. CP253

## CRL Bent Point Hook Tool



- Eases Installation of Gaskets

This CRL Bent Point Hook Tool is built without the traditional offset bend found in standard hook tools such as our CP253. Designed to ease the installation of rubber windshield and back glass gaskets over pinchweld in the body opening. Minimum order is one each.

CAT. NO. CP238

## CRL Self-Sealing Weatherstrip Locking Tool



- The Most Popular Tool for One-Piece Self-Sealing Weatherstrip

A special handle and insert tool for installing one-piece self-sealing weatherstrip. Also excellent for installing rubber channels with a lip. Insert tip between the locking lip and its groove. Then, by moving tip along the groove, the rubber lip locks in place. Tips and Handle can be ordered separately, or as the complete tool.

CAT. NO.	DESCRIPTION
LT112	Complete Locking Tool
H1	Handle Only
B1	Bent Tip Only
S1	Straight Tip Only

Minimum order: 1 each.

All automotive hand tools can be combined for quantity pricing.

## CRL 11 Piece Insert Kit

- Designed for Installing Rear Window Glass in Cabs, Coaches, Trailers, and Boats



CAT. NO.	DESCRIPTION	CAT. NO.	DESCRIPTION
2011021	11-Piece Complete Kit	2011026	3/8" (9 mm) Eye Inserter
2011022	Hollow Inserter Handle	2011028	5/16" (8 mm) Eye Inserter
2011023	Channel Spreader Handle	2011029	5/16" (8 mm) Collet
2011024	7/16" (11 mm) Eye Inserter	2011030	Large Channel Spreader Hook
2011025	7/16" (11 mm) Collet	2011031	Small Channel Spreader Hook

Minimum order: 1 each.

Minimum order: 1 each.

## CRL Chrysler-Boeing Insert Tool and Accessories

- For Installing Round Insert Strips

CRL Chrysler-Boeing insert tool is used for installing round insert strips in automotive, aeronautical, and marine applications. It has a reinforced eye bend and shank for added strength and durability. The hollow inserter handle provides the user with a secure and comfortable grip, as well as allow for quick inserter and collet change.



CAT. NO.	DESCRIPTION
CB1T1	3-Piece Complete Kit
2011022	Hollow Inserter Handle
2011024	7/16" (11 mm) Eye Inserter
2011025	7/16" (11 mm) Collet

Minimum order: 1 each.

## CRL Wiper Puller

- Removes Pressure-Fit Wiper Arms
- Eliminates Breakage or Damage



The CRL Wiper Puller eliminates wiper removal problems. Remove the wiper nut, slide the tool over the arm until the jaws touch the wiper post, and then turn the T-handle clockwise until the wiper arm pops from the wiper post. Minimum order is one each.

CAT. NO. L54150

## CRL Windshield Wiper Arm Removal Tool

- Makes Wiper Arm Removal an Easy Job
- Works With Most Wiper Arms



This CRL Windshield Wiper Arm Removal Tool removes wiper arms without damage to the automobile's finish. Simply place the "hook" under the arm base, lift the wiper arm and tool handle together. Wiper arm lifts right off. Minimum order is one each.

CAT. NO. 65750

## CRL Suck-N-Clamp

- "Hands-Free" Clamping of Windshield and Side Moldings, Emblems and More



The CRL Suck-N-Clamp provides "Hands-Free" clamping action for glue-on windshield and side moldings, body emblems and more. Suck-N-Clamp works by attaching the suction cup to any smooth, non-porous glass or metal surface. Then the arm is positioned over the item being bonded, and tightened to hold it in position while the adhesive cures. Available individually or in a six-pack.

CAT. NO.	DESCRIPTION
SC1	Suck-N-Clamp Single-Pack
SC6	Suck-N-Clamp Six-Pack

Minimum order: 1 each.

## CRL Door Glass Window Holders

- Holds Glass Up While You Work Inside the Door



Our Door Glass Window Holders are a simple to use tool that will hold side door glass up while you work inside the door. Press cups up against one side of glass, loop over door frame and apply cups to other side. Fast and simple to install or remove. Two per set. Minimum order is one set.

CAT. NO. WH745

## CRL POWR Urethanes and Primers

- The Best Adhesives for Installing Encapsulated Rear Sliders

Visit [crlaurence.com](http://crlaurence.com) for a complete listing of CRL Automotive Urethanes and Primers.



## CRL Rear Slider Installation Kit

- Contains All Necessary Tools for Gasket Mounted Sliders

CRL's Rear Slider Installation Kit contains all the tools necessary to successfully install most gasket mounted truck sliders. Minimum order is one each.



**Kit Includes:**  
20' (6.1 m) of 1.8" (3.2 mm) Nylon Rope;  
One HC140 Hand Cleaner/Lubricant;  
One CRL216 Windshield Stick;  
and One CP253 Hook Tool.

CAT. NO. DV1K

## CRL Series-E Clip Insertion Tool

- Use With CRL Installation Clips
- Makes Clip Installations Easy



The CRL Clip Insertion Tool, while simple in design, does the job beautifully. The jaws of the tool are machined with recesses so proper grip depth is assured. A handle is welded on the side of the tool so articulation of the tool can be accomplished without your hand pressing against the glass of the slider. This tool securely grips the Installation Clips so accurate placement can be made without deflection. Minimum order is one each.

CAT. NO. RC1T

## CRL Rope Insert Tool for Rubber Gaskets

- Makes "Roping-In" Easy
- Comfortable Grip



CRL's Rope Insert Tool inserts the rope into the groove of rubber gaskets to make the job easier than ever. The counter-grip plastic handle feeds rope through its stem as you pull it around the gasket, and has enough sturdy rope to fit around even the largest backlites or rear truck sliders. Extra handy for all installers. Minimum order is one each.

CAT. NO. RT752

## CRL Magnetic Clip Insertion Tool

- Used for the Quick Insertion of Installation Clips



Use our CRL Magnetic Clip Insertion Tool with the Installation Clips for fast installations. Magnet holds clip in position for easy insertion. Minimum order is one each.

CAT. NO. 88T00L

## CRL Slider Helper Installation Tool

- Speeds Installation Time
- Allows One Man Installations



CRL's Slider Helper Installation Tool will speed your installation time and cut your labor costs. CRL's Slider Helper saves from having a second installer hold the slider in place while the installer applies the retainer clips or bend over tabs on the interior. Easy to use, just insert between the cab and the bed of the truck, adjust the height to center the pads on the middle of the fixed panels, and then pump the handle until contact with the glass is made. Minimal pressure is required to hold the slider in place. Minimum order is one pair.



CAT. NO. BST1

# CRL VEHICLE AND PERSONAL PROTECTION

For Pricing Visit [crlaurence.com](http://crlaurence.com) or Call Us Toll Free at the Phone Numbers Shown on the Back Cover

## CRL Pumper

- Helps Prevent Neck Injuries
- Speeds Glass Removal



CRL Pumper is a tough, vinyl-encased bag that, when placed between the windshield and the body, prevents pushing out the glass with your head and shoulders, which can lead to injuries. Produces up to 200 pounds of constant pressure to push the glass out allowing you to easily cut through the urethane. The Pumper is best when used in pairs. Made in the U.S.A. Minimum order is one each.

CAT. NO. LB779

## CRL Neck Saver



- Holds Glass From Pillar to Speed Removal Process

Never use your head to push the windshield out. The CRL Neck Saver can prevent injuries by lifting the windshield as it is cut away. This not only exposes the urethane bead along the dash area, but also stresses the urethane for easier cutting. Neck Saver is sold only in pairs. Minimum order is one pair.

CAT. NO. 19NS

## CRL Tyvek® Shoe Covers



- Made of Lightweight Tyvek® Material With PVC Sole
- Protects Your Customers Floor Mats
- One Size Fits All

Our Shoe Covers are made of lightweight Tyvek® tops with PVC soles. Tyvek® is a durable tear and puncture-resistant material that remains strong, wet or dry, and will help protect your customer's floor mats from dirt and stains that your shoes might pick up from the shop floor. Interlocking seam construction gives maximum protection from liquid penetration. One size fits all. Extra large boot covers are available on special order.

CAT. NO.	CONTENTS/PACK
1SC	10 Pair

Minimum order: 1 pack.

## CRL Slip-N-Grip® Seat Covers

- Protect Your Customer's Seats for Pennies Each

These CRL Slip-N-Grip® Seat Covers can save you the cost of cleaning soiled or urethane stained seats. Disposable CRL Slip-N-Grip® Covers have a unique two-sided design that clings to the seat without slipping, protecting the interior of your customer's vehicle. The 33" by 56" (838 by 1422 mm) size fits virtually any seat. 250 large ready-to-use covers per dispenser box.

CAT. NO.	SIZE	QTY/BOX
600088	33" x 56" (838 x 1422 mm)	250

Minimum order: 1 box.



## CRL Slip-N-Grip® Value Floor Mats

- Made of Tough Plastic, Not Paper

CRL Slip-N-Grip® Floor Mats can save you the cost of cleaning soiled or urethane stained floor mats. Economical to use CRL Slip-N-Grip® Floor Mats have a two-ply design that stays put to protect the interior of your customer's vehicle. 500 mats per roll.

CAT. NO.	SIZE	QTY/ROLL
6000721	19" x 21" (482 x 533 mm)	500

Minimum order: 1 roll.



## CRL Slip-N-Grip® Steering Wheel Covers

- Protects Steering Wheels From Drips and Spills

CRL Slip-N-Grip® Steering Wheel Covers protects steering wheels from grease, dirt, and spills that are inevitable when installing glass. The universal-fit covers easily slip over the steering wheel with elastic which also keeps them in place. Keep your customers happy and show them you care with a professional job well done.

Tyvek is a registered trademark of E.I. du Pont de Nemours and Company. Slip-N-Grip is a registered trademark of Petoskey Plastics, Inc.

- Universal Fit

CAT. NO.	CONTENTS/PACK
600099	250

Minimum order: 1 box.



C.R. LAURENCE COMPANY

[crlaurence.com](http://crlaurence.com) | [usalum.com](http://usalum.com)

416K | [crlaurence.ca](http://crlaurence.ca) [crlaurence.com.au](http://crlaurence.com.au) [crlaurence.co.uk](http://crlaurence.co.uk) [crlaurence.de](http://crlaurence.de) [crlaurence.eu](http://crlaurence.eu)

## CRL Heavy-Duty Car Protectors

- High Grade Rubber Backing
- Protects Against Drips and Scratches

Protect your customer's vehicle while replacing windshields and backlites. Spread out our CRL Heavy-Duty Car Protectors on the hood or trunk to protect against drips, scratches, and scrapes from tools or supplies. All three sizes are made with a high grade rubber backing on the special fabric to keep it from slipping. A double-stitched hem all the way around protects it from fraying. Can be rolled up for storage.



CAT. NO.	DESCRIPTION	SIZE
306	Large Protector	90" x 27" (2286 x 686 mm)
307	Standard Protector	70" x 27" (1778 x 686 mm)
308	Small Protector	54" x 30" (1372 x 762 mm)

Minimum order: 1 each.

## CRL Radians® AV™ Glasses

- Scratch and Fog Resistant
- Complete With Neck Cord and Ear Plugs



**CAT. NO. AV1110**  
Radians® AV™ Glasses

CRL Radians® AV™ Glasses offer the best in eye and ear protection in one. Developed for the construction industry, these safety glasses employ the unique feature of having built-in earplugs. The lens has a hard anti-scratch coating, and a 99% UV protection rating that meets or exceeds ANSI standards. They also resist fogging in all types of weather and working conditions. Each pair of CRL Radians® AV™ Glasses come complete with a neck cord to hold them while not in use. The ear protectors are reusable, washable, and conveniently replaceable; Cat. No. JP2000. Minimum order is one each.

Radians is a registered trademark of Radians, Inc. Mechanix Wear, and M-Pact are registered trademarks of Mechanix Wear, Inc.

## CRL Vinyl Hood Protectors

- Washable, Non-Slip Vinyl
- Also Available With Your Company Logo

When you're working on a customer's vehicle, you don't want it damaged. These extra large 70" x 27" (1778 x 686 mm) Vinyl Hood Protectors give the hood and fender maximum protection against spills and scrapes. They are made with a rubber backing so they won't slip off while you're working. Washable vinyl material is also grease resistant. Minimum order is one each.



**CAT. NO. HP5470**

### CUSTOM IMPRINT AVAILABLE

CRL Vinyl Hood Protectors are also available with your custom imprint. We can put your logo, phone number, or web address on each protector, and our minimum order is only 144 pieces. Choose between black or blue color material, with a white ink imprint. Maximum imprint size is 18" wide x 12" high (457 x 305 mm), and a drawing will be required with the order. For more details and pricing, please contact CRL Customer Service.

## CRL Mechanix Wear® M-Pact® Gloves

- The Tool That Fits Like a Glove
- Reduces Injury From Vibrating Tools



CRL Mechanix Wear® M-Pact® Gloves have additional padding and gel-filled patches on the palm area to absorb the vibrations from power and impact tools. They fit your hands so well, it doesn't feel like you're wearing gloves at all. See our complete line of safety gloves on pages 264K through 271K.

CAT. NO.	DESCRIPTION
MPT010	Large M-Pact® Gloves
MPT011	X-Large M-Pact® Gloves
MPT012	XX Large M-Pact® Gloves

Minimum order: 1 pair.

## CRL Low Voltage Circuit Tester



- For Use on Any 6 to 12 Volt DC System
- Quickly Tests Circuits for Current
- Lighted Handle Detects Voltage

This CRL Low Voltage Circuit Tester is designed for use on all six to 12 Volt DC systems. To use, simply ground the clip to any metallic surface on the car, push the point through the insulation of the cable being tested until it makes contact with the copper conductor inside. The bulb in the handle will then light if the wire is "hot". Minimum order is one each.

CAT. NO. KD129

## CRL Digital Auto-Range Multimeter

- 1 Millivolt to 400 Volts AC/DC
- Large LCD Display
- Shirt Pocket Size - Only 3 Ounces
- Features an Audible Beep for Checking Continuity



The CRL Digital Auto-Range Multimeter is the perfect unit to test automotive electrical circuits (power windows, defoggers), electrical instrumentation and batteries. Saves money and time by solving problems and eliminating costly repairs. The unit ranges are from 1 millivolt to 400 volts AC/DC, and 0.1 to 2,000,000 ohms. Accuracy is 2 units or 2% of the reading. The Multimeter instantly displays the correct answer by automatically selecting the proper range. Four digit LCD display shows the exact resistance or voltage unit, and even indicates negative polarity with minus sign. Comes complete with case, batteries, probes and instructions. The Cat. No. 1039RB Replacement Battery is easily replaced. Minimum order is one each.

CAT. NO. CT3250

## CRL 3-Conductor Round Extension Cords



- UL Listed for Indoor/Outdoor Use
- Thermo-Vinyl Cord
- U-Blade Ground



This heavy-duty CRL 3-Conductor Round Extension Cord resists oil, grease, abrasion, and ozone to give long-term, reliable service. The standard copper wire stays completely flexible even in cold weather. Connectors are molded on.

CAT. NO.	WIRE SIZE	LENGTH	AMPS
EC2316025	16/3	25' (7.6 m)	13
EC2316050	16/3	50' (15.2 m)	13
EC4312050	12/3	50' (15.2 m)	15
EC4312100	12/3	100' (30.5 m)	15

Minimum order: 1 each. Sizes can be combined for quantity pricing.

## CRL 3-Conductor Twist-To-Lock Extension Cord



- UL Listed
- Remains Flexible in Cold Weather
- Molded-On Connector and Plug



This heavy-duty CRL 50' (15.2 m) 3-Conductor Twist-To-Lock Extension Cord stays flexible even in cold weather, and is built to give long-term, dependable service. Resists oil, grease, abrasion, and ozone. Copper strand conductors are completely flexible. 12/3 size cord is rated at 20 amp. Minimum order is one each.

CAT. NO. EC730830

## CRL Booster Cables

- 12' (3.6 m) Length
- Vinyl Grip Clamps

CRL Booster Cables are heavy ten gauge wire with vinyl grip clamps. 12 feet (3.6 m) long. Minimum order is one set.



CAT. NO. BC1210

## CRL Electrical Tape

- UL Listed • 3/4" (19 mm) Width

Designed to insulate wire, pipes, dissimilar metals, etc., CRL Electrical Tape is resistant to weather, water, acids, alkalines, and oils. It has superior conformability and high elongation to give a tight, solid wrap. A silicone spray additive gives it an 18 month shelf life. It practically never telescopes or bleeds. The glossy black tape is 7 mils thick. Roll length is 60 feet (18 m). Minimum order is one roll.



CAT. NO. 1ET314

## CRL Automotive Wire

- Heavy Automotive Gauge
- Great for Power Windows, Sunroofs, Dome Lights, and Accessories Wiring

CRL Heavy Gauge Auto Wire for rewiring power windows, dome lights, sunroofs and more. Comes in convenient 100 foot (30.5 m) spools.



CAT. NO.	SIZE
AW16	16 Gauge
AW18	18 Gauge

Minimum order: 1 roll.

## CRL Solderless Female Spade Connectors

- Pure Electronic Copper
- For 16-14 Gauge Wire

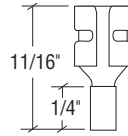

CRL Solderless Terminals are the quick and easy way to add wire terminals without soldering. Simply insert wire ends into the terminal, then crimp with catalog number 1963 tool or pliers. All terminals are packed 100 per box. Minimum order is one box.

CAT. NO. AV5068

## CRL Electrical Connector Crimping Tool

- Crimps, Cuts, Slices, Strips 22 to 8 Gauge Wire
- Cushioned Grip



This CRL Electrical Connector Crimping Tool cuts and strips 22 to 8 gauge wire, and crimps both insulated and non-insulated style terminals. The wire cutter is placed at the tip of the tool to facilitate cutting in cramped quarters. It has cushion grip handles for comfort. Minimum order is one each.

CAT. NO. AV7711

## CRL Heat Sink Forceps

- Use for Soldering, Testing, Heat Sinking
- Tempered Stainless Steel
- Self-Clamping



CAT. NO. 70296  
Straight Tips



CAT. NO. 70297  
Curved Tips

These CRL Heat Sink Forceps are self-clamping pincers to hold small parts or components, leaving both hands free for other tasks. These 6" (152 mm) tempered stainless steel precision-machined tools feature finely serrated jaws, box joint pivot, and three-position ratchet lock. Available with straight or curved tips. Minimum order is one each.

## CRL Nylon Cable Ties

- Convenient and Simple to Use
- Available in Four Lengths and Two Colors

CRL Nylon Cable Ties are convenient for bundling wires, cables, or other narrow components. They are especially useful for gathering and securing wires under dashboards or around computer equipment. They are simple to use, just insert the tapered end of the strap into the head slot and pull until the bundle is secure. 100 Nylon Ties per pack.



CAT. NO. NATURAL	CAT. NO. BLACK	STRAP LENGTH	MAXIMUM BUNDLE SIZE
NT40	NT40BL	4" (102 mm)	3/4" (19 mm)
NT56	NT56BL	5.6" (142 mm)	1-1/4" (31 mm)
NT75	NT75BL	7.5" (190 mm)	1-3/4" (44 mm)
NT111	NT111BL	11.1" (282 mm)	3" (76 mm)

Minimum order: 1 pack. Sizes and colors can be combined for quantity pricing.

## CRL Deluxe Drop Lite

- Delivers Light Where You Need It
- Operates on 110 Volts AC



This CRL Deluxe Drop Lite delivers light where you need it. Retractable 50 foot (15.2 m) cord for convenience. Handle has side outlet and switch. Bulb not included. Minimum order is one each.

CAT. NO. 2137530

## CRL Power Inverter

- Provides 115 Volts AC Power From 12 Volt DC Source
- Excellent for Field Use of Power Tools

The CRL PB12300 Power Inverter will provide 2300 watts of continuous power with a peak surge of 4600 watts. Use the two AC receptacles to power cut-out tools, a vacuum cleaner, or other power tools used by mobile glass operations. The compact design allows this unit to be mounted under the seat for security. A digital LED display shows input DC voltage or output wattage. The anodized aluminum case provides durability and maximum heat dissipation, and has a built-in cooling fan. Minimum order is one each.

**NOTE:** One Connector Cable Set is required for proper connection of the Inverter to the vehicle. Cable Set must be long enough to connect Inverter to vehicle battery. Be sure to order adequate length.



**Continuous Output:** 2300 Watts  
**Peak Load Rating:** 4600 Watts  
**Output Voltage:** 117V AC +/- 10%  
**Output Frequency:** 60Hz +/- 3Hz  
**Dimensions:** 13-15/16" x 10-5/16" x 3-1/8"  
 (354 x 262 x 79.4 mm)  
**Weight:** 12 lbs. (5.4 kg)

**CAT. NO. PB12300**

### CALCULATE WATTAGE REQUIREMENT

To calculate the Wattage required, multiply the AMPS by the Volts of the tool you want to use with the Inverter. Example: 4 AMP tool running on 120 Volts AC (4 x 120) = 480 Watts.

### WARNING

Do not exceed the capacity of the Inverter.

### CONNECTOR CABLE SETS

CAT. NO.	LENGTH OF CABLES
2AWG6	6' (1.83 m)
2AWG12	12' (3.66 m)

Minimum order: 1 each.



## CRL Master Defroster and Antenna Repair Kit

- Repairs Defroster and Antenna Grids
- Reattaches Connector Tabs
- Includes Common Connectors and Pins

This CRL Master Defroster and Antenna Repair Kit fixes the most common problems related to heated automotive glass. The kit includes: Test Lamp Kit; Two-Part Conductive Tab Repair Epoxy to bond the tabs onto the glass forming an electrical and structural connection; Grid Repair for scratched or broken defroster lines; 90 Degree Tab Connectors; Straight Tab Connectors; Replacement Power Tabs. This handy kit pays for itself after just a couple of repairs.



CAT. NO.	DESCRIPTION
P2700	Master Defroster Repair Kit

Minimum order: 1 each.



## CRL Rear Defroster Test Lamp Kit

- Inexpensive Way to Test Rear Window Defroster Lines
- Locates Small Hard to Find Breaks

The CRL Test Lamp Kit is an inexpensive way to test automotive rear window defrosters and identify broken defroster lines. Uses a 12 volt lamp with two long leads attached and marking tape. Move the leads over the defroster, then watch the lamp to verify defroster is working and to locate those small, hard to find breaks.

CAT. NO.	DESCRIPTION
P2400	Rear Defroster Test Lamp Kit

Minimum order: 1 each.







# 4

## General Hand and Shop Tools

- CLEANING TOOLS
- DRILLS AND BITS
- FASTENING TOOLS
- KNIVES AND BLADES
- MEASURING DEVICES
- PLIERS AND CLAMPS
- PUTTY TOOLS
- SAWS AND BLADES
- SCREWDRIVERS
- TOOL BOXES AND CARRIERS
- WRENCHES

See other side for Section Index.

# SECTION 4 INDEX

For a complete index to this catalog, turn to Section 7. To search for all CRL products, go to CRL Total Search at [crlaurence.com](http://crlaurence.com).

## A

Accufab Pro Curtain Wall Tool .....	468K-469K
Accu-Rule Measuring Rods .....	540K
Air Tools and Accessories .....	556K-559K
Aluminum Extrusion Notching Saw .....	462K
Angle Protractor .....	541K
Anglefix and Angletronic Tools .....	541K
Aprons .....	436K
Auto Glass Tools Technician's Starter Kit .....	426K

## B

Band Saw .....	454K
Battery Chargers .....	450K, 452K, 478K-479K, 512K
Belt Lubricants .....	558K
Bench Vise .....	531K
Bevel Square .....	541K
Bit Holders .....	514K
Blades, Knife .....	438K, 440K-441K, 444K-445K
Blades, Saw .....	449K-452K, 455K-458K, 470K
Blades, Shear .....	470K-471K
Blo-Guns .....	557K
Brushes .....	552K

## C

Cable Cutters .....	527K
Cable Ties .....	432K
Canvas Tool Bag .....	431K
Carbide Tipped Saw Blades .....	456K-457K
Carton Cutter .....	439K
Center Punch and Nail Set .....	493K
Chalk Lines .....	545K
Chamois .....	553K
Chisels .....	474K, 502K
Chucks, Drilling .....	492K
Circular Saw Blades .....	452K, 456K-458K, 470K
Circular Saws .....	452K-454K
Clamps .....	529K-531K
Combination Square .....	541K
Construction Master Calculator .....	539K
Contour Gauge .....	545K
Cordless Drills .....	478K-479K
Cordless Saws .....	450K, 452K
Cordless Screwdriver .....	512K
Countersinks .....	489K

## D

Diagonal Cutters .....	527K
Diamond Point Driver .....	509K
Diamond Tool Coolants .....	495K
Digital Auto-Range Multimeter .....	549K
Double End Window Tool .....	501K
Dremel Rotary Tools .....	494K
Drill Bits .....	482K-488K
Drill Jigs .....	462K-466K
Drills, Electric .....	477K-481K

## E

Electronic Levels and Angle Locaters .....	543K
End Cutting Nippers .....	526K
Extension Cords .....	550K

## F

Files .....	472K
Finder Gauges .....	545K
Fletcher-Terry Point Tool .....	509K
Flexible Putty Knives .....	498K-500K
Flooring Knife .....	443K
Folding Post Level .....	545K
Folding Wood Rule .....	539K
Framemaster Driver and Points .....	508K

## G

Glass Counter Pen .....	549K
Glass Frosting .....	562K
Glazier's Chisel .....	474K
Glazier's Tool Kits .....	424K-425K
Glazing Points .....	508K-509K
Glue Guns .....	535K
Ground Fault Circuit Interrupters .....	550K

## H

Hacking Knives .....	501K
Hacksaws and Blades .....	448K-449K
Hammer Drills .....	478K, 481K
Hammers and Mallets .....	475K-476K
Heat Guns and Propane .....	506K-507K
Hex Insert Bits .....	515K-518K
High Speed Steel Drills .....	484K-487K
High-Traction Anti-Slip Safety Tape .....	564K
Hole Saws .....	492K
Hot Air Gun Kit .....	506K
Humidity/Temperature Pen .....	549K
Hydrapunch Machine .....	467K
Hydraulic Rivet Gun .....	532K

## I

Insert Bits and Holders .....	514K-518K
-------------------------------	-----------

## J

Jig Saw .....	452K
Jigs, Drill .....	462K-466K

## K

Kett Power Shears .....	470K-471K
Kett Saws and Blades .....	470K-471K
Kik-Step .....	564K
Knives .....	439K-445K, 496K-501K

## L

Ladders .....	564K
Lamson® Knives .....	496K
Laser Tools .....	537K, 546K-548K
Levels .....	543K-547K
Low Voltage Circuit Tester .....	549K

## M

Machine Screw Taps .....	491K
Magnetic Insert Bit Holders .....	514K
Marking Pencils/Pens .....	542K
Marson Rivet Guns .....	532K-533K
Measuring and Marking Tools .....	536K-542K
Metal Snips .....	446K
Micro Fiber Wipes .....	553K
Miter Box .....	448K
Miter Saw Tables and Gauges .....	460K-461K
Miter Saws .....	453K-454K
Multi-Function Tool .....	505K

## N

Nail and Tool Bag .....	436K
Needle Nose Pliers .....	526K
Nibbler Cutting Tool .....	446K
Nut Drivers .....	523K

## O

Offset Screwdrivers .....	512K-513K
Omni Tight-Fit Drill Adapter .....	490K

## P

Padlocks .....	432K
Paint Spray Gun .....	556K
Painter's Tool .....	503K
Palm Laser .....	546K
Part Boxes and Cabinets .....	433K
Pencils .....	542K
Phillips Bits .....	516K, 518K
Phillips Screwdrivers .....	510K-511K
Plastic Cutters .....	445K
Pliers .....	526K-529K
Plumb Bobs .....	548K
Plumb/Level Finder Gauges .....	545K
Plumb Perfect Level Tool .....	544K
Pneumatic Tool Oiler .....	558K
Pocket Knives .....	444K
Pressure Regulator and Gauge .....	558K
Prexiso Distance Measurer .....	537K
Production Table .....	467K
Propane Torches and Cylinders .....	507K
Protractor/Angle Finder .....	541K
Pry and Ripping Bars .....	473K

Putty Chisels and Knives .....	496K-502K
--------------------------------	-----------

## Q

Quick-Grip Bar Clamp .....	530K
----------------------------	------

## R

Razor Blades, Holders and Scrapers .....	438K-439K, 443K
Reciprocating Saw .....	450K
Red Devil® Knives .....	496K-499K, 501K-502K
Retractable Blade Knives .....	444K
Rivet Tools .....	532K
Robo-Grip Pliers .....	528K
Roofing Knife .....	443K
Rotary Tools .....	494K
Rotating Head Rivet Gun .....	533K
Russell® Knives .....	496K-498K, 502K

## S

Sandblasters and Supplies .....	560K-563K
Saw Blades .....	449K-452K, 455K-458K, 470K
Saws .....	448K-454K
Scrapers .....	502K-503K
Screen Shears .....	447K
Screw Extractor Set .....	491K
Screwdrivers .....	510K-514K
Screwgun Bits .....	518K
Shears, Manual .....	446K-447K
Shears, Powered .....	470K-471K
Sheet Metal Clamps .....	529K
Shop-Vac Wet/Dry Vacs .....	551K
Single Edge Razor Blades .....	438K
Slip Joint Pliers .....	526K
Slotted Bits .....	516K, 518K
Slotted Screwdrivers .....	510K-511K
Snips .....	446K-447K
Snow Cut-Off Gauge and Accessories .....	461K
Socket Sets .....	520K
Soldering Irons and Supplies .....	554K-555K
Solo One-Handed Clamps .....	530K
Spanner Screwdriver .....	513K
Spanner Wrenches .....	522K
Spray Mist Coolant .....	459K
Staplers .....	534K
Straight Edges .....	539K
Stud Sensor .....	549K

## T

Tape Rules .....	536K-538K
Tape, Safety .....	564K
Taper Reamer .....	490K
Tapping Tools .....	490K-491K
Tarps .....	432K
Tele-Tape Measuring Stick .....	540K
Tool Boxes .....	427K
Torch Kits .....	507K
Torpedo Levels .....	544K
Torx Key Sets .....	524K
Torx Mirror Bracket Wrenches .....	525K
Tripods, Aluminum .....	548K
Tripple-Ripple Miniature Diamond Drills .....	495K
T-Handle Wrenches .....	491K, 525K
T-Squares .....	539K

## U

Unibit Step Drills .....	489K
Utility Knives and Blades .....	440K-444K

## V

Vacuum Cleaners .....	551K
Vacuum Cup Holster .....	437K
Vise Grips .....	529K

## W

Welding Clamp Locks .....	529K
Weldon Countersinks .....	489K
Wet/Dry Vacs .....	551K
Wildcat Sealant Cutter and Putty Remover .....	505K
Window Tools .....	501K-502K
Work Belts .....	437K
Wrenches .....	519K-525K, 556K



C.R. LAURENCE COMPANY

[crlaurence.com](http://crlaurence.com) | [usalum.com](http://usalum.com)

ALUMINUM

[crlaurence.ca](http://crlaurence.ca)

[crlaurence.com.au](http://crlaurence.com.au)

[crlaurence.co.uk](http://crlaurence.co.uk)

[crlaurence.de](http://crlaurence.de)

[crlaurence.eu](http://crlaurence.eu)

# SECTION 4 General Hand and Shop Tools

## QUICK INDEX

For a complete index to this catalog, turn to Section 7. To search for all CRL Products, go to CRL Total Search at [crlaurence.com](http://crlaurence.com).

### Tool Kits and Carriers – Pages 424K to 437K



### Cutting Tools– Pages 438K to 462K



### Drilling and Striking Tools – Pages 463K to 495K



### Putty Tools – Pages 496K to 509K



### Fastening and Gripping Tools – Pages 510K to 535K



### Measuring Tools – Pages 536K to 548K



### Miscellaneous Shop Tools – Pages 549K to 564K



## The Most Popular Hand and Power Tools Used in the Glass Industry

- Hand Tools
- Power Tools
- Measuring Tools
- Over 1,200 Items in this Section Alone

C.R. Laurence Company has decades of experience in supplying the glass industry, so we know the types and quality of tools needed by the professional glazier. CRL offers the highest quality tools at the most affordable prices. Our tools were chosen with the professional in mind, and will stand up under the most demanding conditions providing years of reliable service.

# new

Look for the "NEW" icon. It accompanies tools being introduced in this catalog. It also alerts you to improved designs or new options for existing tools.

### CRL Tool Boxes and Carriers

We offer a complete variety of quality Tool Boxes and Carriers for in-the-shop or on-the-job use. The Cat. No. 1022 is the glazier's favorite tool box, and is year-after-year our best seller. You can select light and handy tool tote boxes or bucket type carriers, and small parts boxes and cabinets to keep your shop organized. And we have lots of different leather carriers to keep your tools handy at your waist. Having your tools right at hand makes you more efficient, and CRL has lots of ways to do just that.



### CRL Power Saws, Shears, Cutters, Knives, and Blades

CRL maintains a large assortment of Power Saws in stock for your fabricating requirements. To support our selection of Power Saws we have a large variety of Blades for cutting steel, aluminum, wood or plastic.

Our hand saw selection includes Hacksaws, Miter Boxes and Specialty Saws. Saw Tables, Cut-Off Gauges, and Jackplanes are also available.

Utility and Razor Knives in addition to Replacement Blades complete our selection of quality cutting tools.

### CRL Electric and Cordless Drills, Power Screwdrivers, and Pneumatic Tools

We offer both CRL brand and name brand electric tools for both the domestic and overseas markets. We also stock replacement batteries and chargers for cordless tools, and a host of accessories for them. For those who prefer them, we offer a host of Pneumatic tools.



### CRL Hammer Drills and Masonry Bits

CRL is proud of its selection of one of the most versatile power tools ever made. Choose either a cordless or electric Rotary Hammer Drill, attach one of our several hammer or scraper attachments, and you are ready to tackle a tough demolition job.

Whether you are drilling concrete, granite or marble, CRL has the Hammer Drill Masonry Bit for your job. Our large selection of specialized Masonry Drill Bits will drill precise holes in concrete, granite or marble.

## CRL Putty Knives, Chisels, and Scrapers

The true glazing professional knows the right knife makes all the difference when glazing with putty. We have the widest assortment of quality Putty Knives, Chisels, and Scrapers available. We also offer many ways to remove putty safely and easily, whether by cutting or scraping. We also offer heat-producing tools to make softening of old, hardened putty easier.



## CRL Screwdrivers, Insert Bits, Hex and Allen Wrenches, and Nut Drivers

CRL offers Screwdrivers, Hex and Allen Wrenches, and Nut Drivers in assortments that contain the most popular sizes. You can also buy individual screwdrivers to complete your selection, or add popular specialty screwdrivers or wrenches for specific needs common to most installers. We also offer a vast assortment of Insert Bits for magnetic and cordless screwdrivers.

## CRL Socket Sets, Wrenches, Pliers, Metal Snips, Shears, and Files

CRL stocks both SAE and Metric Socket Sets and Wrenches, along with several Ratcheting and Spanner Wrenches, plus Sockets.

We have expanded our line of Pliers and Snips, both glazier's and general types. We also feature new tools with "compound-action" that doubles the strength of the tool.



## CRL Measuring Tools, Levels, and Lasers

CRL offers a complete selection of Tape Measures in several lengths and blade sizes, including fractional and metric. Telescoping Measuring Devices make taking vertical measurements easy, and our Adjustable Angle Tools are available for measuring angles or transferring angular patterns. There is a new electronic level/angle tool, which is very handy for the construction of hand rails and partitions.

Our Self-Leveling Laser selection includes Line Generating Lasers and 3 or 5 Point Lasers for laying out level and plumb.



## CRL Professional Glazier's Tool Kit



CAT. NO. GTB40

### • A Professional Glazier's Tool Package Complete With Our Most Popular Professional Tool Box

The professional glazier needs an assortment of quality tools to get every job done quickly and efficiently. CRL has assembled a package of our most popular Glazier's Tools, along with our large 22" (559 mm) CRL Cantilever Tool Box. The GTB40 Professional Glazier's Tool Kit is a special group of over 40 different, industry proven tools used through the years for glazing jobs big and small. The Kit contains cutters, pliers, clamps, gloves, hammers, drills, wrenches and much, much more. This Kit represents tremendous savings when compared to purchasing each tool separately. **NOTE:** Not available in Australia. Minimum order is one each.

#### GTB40 PROFESSIONAL GLAZIER'S TOOL KIT CONSISTS OF:

CAT. NO.	DESCRIPTION	QTY	CAT. NO.	DESCRIPTION	QTY	CAT. NO.	DESCRIPTION	QTY
1022	Cantilever Tool Chest	1	7WR	7" (178 mm) Wire Vise Grips	1	K7	7 Piece Nut Driver Kit	1
112020	Razor Blade Dispenser	1	91S	Hex Key Set	1	KS20	Plastic Cutter	1
11R	11" (279 mm) Vise Grip C-Clamp	1	97K	Utility Knife	1	M3R	Straight Aviation Snips	1
125100	100' (30.5 m) Chalkline	1	AC18	8" (203 mm) Crescent Wrench	1	P8B	Blue Chalk 8 oz. (277 g)	1
15568	34 Piece Screwdriver Set	1	CF10	10" (254 mm) Combination File	1	S13	13 Piece Drill Bit Set	1
202CUTTER	Glass Cutter	1	CS6S	#6 Countersink	1	S5403	Glass Cutter Pouch	1
2BE118	1-1/8" (29 mm) Putty Knife	1	CS8S	#8 Countersink	1	ST16900A	4 Piece Wood Chisel Set	1
3210	8" (203 mm) Drop Jaw Pliers	1	CS10S	#10 Countersink	1	ST46123	12" (305 mm) Combo Square	1
47467	22 Piece Wrench Set	1	CS18	#12-16 Countersink	1	ST51505	16 oz. (454 g) Curved Hammer	1
3MD	3/16" (4.8 mm) Masonry Drill	1	ES461	Safety Spectacles	1	ST57532	21 oz. (595 g) Power Hammer	1
4050	9-3/4" (248 mm) Scrape N' Pry Bar	1	G26	6" (152 mm) Slip Joint Pliers	1	ST69122	3/16" (4.8 mm) Scratch Awl	1
4MD	1/4" (6.4 mm) Masonry Drill	2	G78	5/8" (15.9 mm) Center Punch	1	ST1323ANB	23 Piece Socket Set	1
54819	16' x 3/4" (4.9 m x 19 mm) Tape Rule	1	GM44	Yellow Pencil	2	VR04	11" (279 mm) Vinyl Roller Tool	1
5427C	7" (178 mm) Cutting Pliers	1	HSF12	12" (305 mm) Hacksaw Frame	1			
63PNFW	Glass Handling Gloves (pair)	1	JC3202HT	6" (152 mm) Spring Clamp	2			

## CRL Professional Glazier's Starter Tool Kit



CAT. NO. STB20

- An Excellent Selection of Popular Glazier's Tools
- Perfect for a New Employee

CRL's Professional Glazier's Starter Tool Kit has an excellent selection of quality tools used by industry professionals everywhere. The Starter Kit has the essential tools used every day by glaziers, and comes packed in a high quality, durable cantilever tool box that has lots of room for other tools that you will add. The Starter Tool Kit consists of over 20 quality tools including a glass cutter, nut driver set, hex key, utility knife, cutting pliers, glass handling gloves, a drill bit set, and thirteen other tools. **NOTE:** Not available in Australia. Minimum order is one each.

### CRL'S STB20 PROFESSIONAL GLAZIER'S TOOL KIT CONSISTS OF:

CAT. NO.	DESCRIPTION	QTY	CAT. NO.	DESCRIPTION	QTY	CAT. NO.	DESCRIPTION	QTY
529	Cantilever Tool Chest	1	7WR	7" (178 mm) Wire Vise Grips	1	JC3202HT	6" (152 mm) Spring Clamp	2
202CUTTER	Glass Cutter	1	91S	Allen/Hex Key Set	1	K7	7 Piece Nut Driver Kit	1
3210	8" (203 mm) Drop Jaw Pliers	1	97K	Utility Knife	1	S13	13 Piece Drill Bit Set	1
4050	9-3/4" (248 mm) Scrape 'N Pry Bar	1	AC18	8" (203 mm) Crescent Wrench	1	ST46123	12" (305 mm) Combination Square	1
54819	16' x 3/4" (4.9 m x 19 mm) Tape Rule	1	G26	6" (152 mm) Slip Joint Pliers	1	ST51505	16 oz. (454 g) Claw Hammer	1
5427C	7" (178 mm) Diagonal Cutting Pliers	1	G78	5/8" (15.9 mm) Center Punch	1	ST69122	3/16" (4.8 mm) Scratch Awl	1
63PNFW	Glass Handling Gloves	1	GM44	Yellow Glass Marker Pencils	2	VR04	11" (279 mm) Vinyl Roller Tool	1

## CRL Auto Glass Technician's Starter Kit



- Outfit a New Employee
- Spare Tools for Mobile Unit

CAT. NO. TSK01

The CRL Auto Glass Technician's Starter Kit provides the beginning technician with a good selection of tools to help get started in the trade. We provide basic tools to keep your cost low, and allow the new technician to grow into the tools that will be required as their knowledge and experience grows. This kit lets the technician tackle just about any job they would normally be assigned. The basic tool groups have been selected for windshield, back glass and door glass removal, replacement and clean up, as well as safety gear. Start your new employee off on the right foot with this professionally prepared kit. Minimum order is one each.

### TSK01 AUTO GLASS TECHNICIAN'S STARTER KIT CONSISTS OF ONE EACH OF THE FOLLOWING:

CAT. NO.	DESCRIPTION	CAT. NO.	DESCRIPTION
RK160	Standard Cold Knife With RKB141 Blade	CRL69	Auto Vacuum Cup
AN1001	3/4" (19 mm) Ultra Thin Cold Knife Blade	CP253	Hook Tool
AN1002	1" (25 mm) Ultra Thin Cold Knife Blade	RT752	Rope-In Slider Tool
AN1004	1-1/2" (38 mm) Ultra Thin Cold Knife Blade	CRL216	Tapered Windshield Stick
PK19	Pipe Handle Long Knife	CRL220	Chisel Tip Windshield Stick
K82	Auto-loading Utility Knife	CRL216H	Windshield Stick Handle
1993X10	Pack of 10 Extra Long Utility Knife Blades	CP26	Door Handle Tool
1996X10	Pack of 10 Molding Removal Hook Blades	516WT	Pinchweld Scraper
21510T	10 in 1 Trim Tool	WG41004XT	18 to 1 High Ratio Caulking Gun
L47000	Filler Strip Tool	MR215	Molding Removal Tool
CRL761	Razor Blade Scraper	MB2	5/64" and 3/32" Hex End Mirror Tool
4050	9-3/4" (248 mm) Scrape and Pry Bar	MB2TX	T15 and T20 Torx End Mirror Tool
TW72	Roll of Cut-Out Wire	MB3	Ford Mirror Release Tool
LWH200	Pair of Cut-Out Wire Handles	MB4	Chevy/GM Mirror Release Tool
SH610	Safety Glasses	15568	34 Piece Master Driver Set
GR1PL	Large Pair of GripPro Impact Gloves	180312	Tool Box With Tray



## CRL 22" Glazier's Cantilever Tool Box

- Our Most Popular Large Tool Box
- Top-Quality Construction
- Plated Hardware for Longer Wear

CRL offers the Glazier's Cantilever Tool Box because we know hard-working professionals deserve the highest quality available. These Tool Boxes are made of sturdy steel, and are compartmentalized to organize tools, small parts, fasteners, fittings, and safety gear. Features include: extremely durable brown wrinkle finish; locking hardware and side catches plated for extra long wear; vinyl cushioned steel core handle; stair step enamel painted trays made of steel; and a divided lid for opening ease. Put it all together and you've got a Tool Box with quality construction throughout. Box measures 22-1/8" x 10-1/16" x 12-5/8" (562 x 255 x 320 mm). Minimum order is one each.



CAT. NO. 1022

## CRL 18" Cantilever Tool Box



- Our Most Popular Medium Size Tool Box
- Top Quality Construction With Plated Hardware for Longer Wear

These CRL Cantilever Tool Boxes are made of sturdy steel, and are compartmentalized to organize tools, small parts, fasteners, fittings, and safety gear. Features include: durable brown wrinkle finish; locking hardware and side catches plated for extra long wear; vinyl cushioned steel core handle; stair step enamel painted trays made of steel; and a divided lid for opening ease. This is truly a tool box with quality construction throughout. It measures 18-1/8" x 10-1/16" x 12-5/8" (460 x 255 x 320 mm). Minimum order is one each.

CAT. NO. 1018

## CRL 21" Cantilever Tool Box



- Durable Red Powder Coat Finish
- Excellent Construction

CRL's 21" (533 mm) Cantilever Tool Box is spacious, 21-1/4" x 8-3/4" x 12" (540 x 222 x 305 mm), convenient to carry, and has ample storage for your favorite glazing tools. The four trays are perfect for small tools, sockets, drill bits and other frequently used smaller hand tools. The Cantilever Style Box features durable long lasting construction, full-width piano hinges, a weather resistant watershed design, two side-mounted steel drawer latches, and center installed tabs for a padlock (not included). Minimum order is one each.

CAT. NO. 529

## CRL Kennedy® Top Till Eight Drawer Machinist's Chest

- Ruggedly Built With Large Capacity, Felt-Lined Drawers to Protect Your Valuable Tools



The eight drawers of the Kennedy® Machinist's Tool Chest are lined to keep your valuable tools clean and protected against corrosion. Standard features include: durable brown wrinkle finish; six adjustable drawer dividers; a cylinder lock with two keys; self-storing, drop front panel. In addition, the rugged side handles on each of these chests make them easy to carry. Measures 26-11/16" x 8-9/16" x 13-5/8" (678 x 217 x 346 mm). Minimum order is one each. **CAT. NO. 526**

## CRL Kennedy® Combination Tool Chest and Base

- Felt-Lined Drawers for Quality Tool Storage



**CAT. NO. MC28**



**CAT. NO. 526MC28**

Our CRL Combination Set consists of the CRL MC28 Tool Chest and the CRL 526 Tool Box to give you ample storage for many of your tools and small parts. This combo unit gives you ten drawers plus a king sized top till for a total of 2,912 cubic inches of tool storage. Our CRL Kennedy® MC28 2-Drawer Machinist Chest Base is designed to fit under our 526 Tool Box. The top drawer is felt-lined, and it comes with side handles, plus a cylinder lock and two keys for added security. Minimum order is one each.

## CRL Kennedy® Top Till Three Drawer Machinist's Chest

- Large Capacity Drawers
- Felt-Lined for Quality Tool Storage



You can carry this heavy-duty Kennedy® Top Till Three Drawer Machinist's Chest or just leave it on your workbench. It features three wool felt-lined drawers and a top compartment. It includes: four adjustable drawer dividers; cylinder lock with two keys; self-storing, drop front panel. Box measures 20-1/8" x 8-9/16" x 13-5/8" (511 x 217 x 346 mm). Minimum order is one each. **CAT. NO. 620**

## CRL Kennedy® Top Till Seven Drawer Tool Chest

- Felt-Lined for Quality Tool Storage



This sturdy, brown wrinkle finish Kennedy® Tool Chest has seven drawers with six adjustable dividers. Each drawer and the top compartment are wool felt-lined. The front panel conceals and locks the drawers when the lid closes, and stores in the base when not in use. Sturdy top handle and a cylinder lock with two keys round out the features of this quality built tool carrier. Measures 20-1/8" x 8-9/16" x 13-5/8" (511 x 217 x 346 mm). Minimum order is one each. **CAT. NO. 520**

## CRL Two Drawer Portable Tool Chest

- Popular New Style With Quality Construction
- Two Smooth Operating Drawers



Conveniently portable, this CRL Two Drawer Tool Box is constructed of the finest quality materials, and has the necessary storage space to hold both large and small tools. This good-looking tool box has a brown wrinkle finish, and smooth operating drawers that allow for organization of small parts or easily misplaced tools. Box measures 20-1/8" x 8-5/8" x 9-3/4" (511 x 219 x 248 mm). Minimum order is one each. **CAT. NO. 220K**

Kennedy is a registered trademark of KMC Holdings, LLC.

## CRL Kennedy® Three Drawer Rolling Tool Box

- Easy Rolling, Large Capacity Box
- Heavy-Duty Steel Construction



This Kennedy® Large Capacity Three Drawer Rolling Tool Box is a great place to store your large tools and supplies. It is made of heavy gauge steel, and has four 4" casters (two that lock in place), four dividers, and a cylinder lock with two keys. This durable brown wrinkle finish box measures 27" x 18" x 35" (686 x 457 x 889 mm). Minimum order is one each. **CAT. NO. 273**

## CRL 20" Tool Box and Toter Tray

- Removable Small Tool Carrying Tray
- Durable Construction



CRL's 20" Tool Box and Toter Tray is the practical way to store your small parts and tools for easy carrying. If you want an easy way to carry just a small assortment of tools that you want in order to complete that one job, just load up this tool tote and you are on your way. Features include: durable brown wrinkle finish; a folding polypropylene handle; and plated locking hardware. The Box measures 20-1/8" x 7-1/8" x 7-5/16" (511 x 181 x 186 mm). Minimum order is one each.

CAT. NO. 5220

## CRL 20" Tool Box and Lift Out Tray

- Spacious and Easy to Carry
- Tough, Red Powder Coated Finish



This convenient CRL 20" Tool Box is perfect for those smaller jobs where a specialized selection of tools is all you need to complete the job. If you are looking for an attractive, sturdy tool box, with an easy to remove tray for small tools or fasteners, this is it. The Box measures 20" x 7" x 8" (508 x 178 x 203 mm). Minimum order is one each.

CAT. NO. 725BX

## CRL Small Tote Box

- Lightweight and Lockable
- Convenient Size for Shop, Home or Truck

CRL's Small Tote Box is the perfect size for small tools and fasteners. Ideal for small installation or repair jobs, the Tote features a lift-out tray with center handle. The Tote is also rust-proof as well as scratch and chemical resistant. The water resistant rubber lid provides a tight seal against adverse weather conditions. Inside dimensions measure 13" x 6-3/4" x 7-1/4" (330 x 171 x 184 mm). Color is dark green. Minimum order is one each.



CAT. NO. T1408

## CRL Large Tote Box

- Heavy-Duty Handle
- Secure Latch

CRL's Large Tote Box is large enough to carry your favorite tools and still lightweight and rust-proof. The rubber lid has an easy-access heavy-duty latch to secure contents. The lift-out center tray has ample space for your frequently used small tools. The interior dimensions measure 17-1/2" x 10-1/2" x 12" (444 x 267 x 305 mm). Color is black. Minimum order is one each.



CAT. NO. T1418

## CRL Large Lightweight Tool Box

- Durable Plastic Construction
- Includes Tote Tray



This versatile CRL Large Lightweight Tool Box with Tote Tray can be used for a variety of needs. It is ideal for repair kits, sample cases, small power tools, specific job kits and other small items. The box is made of a rugged copolymer material that is lightweight, dent-proof, and rust-proof, along with being scratch resistant. Inside you'll find a handled tote tray for small parts and tools. This box measures 15" x 7" x 7-1/4" (381 x 178 x 184 mm). Color is black. Minimum order is one each.

CAT. NO. 180312

## CRL Small Lightweight Tool Box

- Durable Plastic Construction
- Includes Tote Tray



Our CRL Small Lightweight Tool Box with Tote Tray can be used for a variety of needs. It is ideal for repair kits, sample cases, small power tools, specific job kits and other small related items can be stored. It is made of rugged copolymer material that is very lightweight, dent-proof, and rust-proof, along with being scratch resistant. This box measures 13" x 5-1/2" x 5-1/4" (330 x 139 x 133 mm). Color is black. Minimum order is one each.

CAT. NO. 120312

## CRL Deluxe Bucket Boss® 35

- Fits Any Standard Five Gallon Bucket
- 35 Pockets: 24 Outside, 11 Inside
- Rugged 600 Denier Fabric

The CRL Deluxe Bucket Boss® 35 turns any ordinary five gallon bucket into an organized tool carrier. It is very convenient as a job site tool carrier and organizer. Minimum order is one each.



Bucket and Tools Shown With Bucket Boss® Not Included

CAT. NO. BC1001

## CRL Bucket Boss® 24

- Economic Alternative to the Bucket Boss® 35
- 24 Pockets: 17 Outside, 7 Inside
- Rugged 600 Denier Fabric

The CRL Bucket Boss® 24 is the economical alternative to the Deluxe Bucket Boss® 35, and features nearly the same storage space. Minimum order is one each.



Bucket and Tools Shown With Bucket Boss® Not Included

CAT. NO. BC1024

## CRL 28 Pocket Electrical and Maintenance Tool Pouch

- 7" x 5" (178 x 127 mm) Multi-Compartment Plastic Tray
- Box-Shaped Design Prevents Tipping
- Pockets for Drill Bits

This 28 Pocket Tool Pouch has a multi-compartment plastic tray that slides securely into the bottom of the pouch. It has pockets for your hand tools, tape rule, drill bits, and other small items. Its box-shaped design prevents tipping. Minimum order is one each.

Tools Not Included



CAT. NO. 1526

## CRL Bucket Seat Pro

- Fits All Standard Five Gallon Buckets, Even With a Bucket Caddy in Place
- Seat, Parts Tray, and Bucket Lid in One

The CRL Bucket Seat Pro is made of rugged polyethylene, and is equally useful as a cover, seat or parts tray. Simply place it on top of any five gallon plastic bucket so that it creates a great portable seat to work from. Six compartments organize fasteners, small tools and parts. Lid securely snaps closed. Minimum order is one each.

Bucket and Parts Not Included



CAT. NO. BS2002

## CRL Parachute Bag

- Separates and Organizes Small Parts
- Automatically Closes When Lifted
- Flat Bottom Design Prevents Tipping



Bucket and Items in Bag Not Included



Example of Bag and Items in a Bucket

The CRL Parachute Bag has six compartments to hold your screws, nuts, bolts, sockets, or any small parts. This Khaki tan 600 Denier polyester bag will stack up to four deep in any standard five gallon bucket. Strung with authentic military parachute cord, the Parachute Bag keeps those small parts in plain sight for easy access. Minimum order is one each.

CAT. NO. PB5001

Bucket Boss is a registered trademark of Pull'r Holding Company, Inc.

## CRL Bucket Stacker

- Convenient Grab Handle for Easy Carrying
- Molded Trays With Separators to Keep Small Parts Organized



Bucket and Items Shown With Bucket Stacker Not Included



Example of Bucket Stacker and Items in a Bucket

CRL Bucket Stackers are 2" (52 mm) deep injection molded trays divided into four separate compartments to hold fasteners, small parts, whatever. You can stack up to five stacker trays in your five gallon buckets to create an inexpensive and easy method of keeping your small items organized. They work great when paired with a Bucket Boss®. Minimum order is one each.

CAT. NO. BC15011

## CRL Sit/Stand/Tote With Caddy

- 3400 Cubic Inch Capacity
- Large Wheels For Easy Rolling

This CRL Sit/Stand/Tote With Caddy is sized to hold circular saws and other large items. The large tote tray will store drills, extension cords and other bulky supplies. Top tray has eight compartments for organizing hand tools, fasteners and supplies.

V-groove in lid holds pipes and dowels in place for sawing. Two large wheels for rolling over various indoor and outdoor surfaces. Plastic portables will not dent, rust or mar other surfaces. 26" W x 15-9/16" D x 16-7/8" H (660 x 395 x 429 mm). Minimum order is one each.



**new**

CAT. NO. HP5

## CRL Heavy-Duty Tool Carrying Bag

- Leather Bottom Panel With a Leather Handle and Billets
- Recessed Steel Frame



Our finest quality CRL Heavy-Duty Canvas Bag is light, strong, and has a recessed steel frame. It comes complete with a leather handle and billets that complete the top-grade construction. This is a very versatile bag used for carrying certain tools that you would use on specific jobs, yet is not as heavy as a metal tool box. Ideal for glaziers, electricians, mechanics, and masons, it measures 20" x 16" (508 x 406 mm). Minimum order is one each.

CAT. NO. M304

## CRL Pac-N-Roll

- Instant Rolling Tool Box



The CRL Pac-N-Roll appears to be a compact plastic briefcase until opened, when it becomes an instant rolling tool box. The RC9 is great for transporting tools from your vehicle to the job site, or use it for quick cleanup after the job is complete. Just undo the side latches, open, drop the bottom panel and you have an instant crate ready to hold 50 pounds (22 kg) of tools or supplies. Convenient handle extends for easy transport. Inside dimensions are 13-3/4" W x 11" D x 11-1/2" H (349 x 279 x 291 mm). Minimum order is one each.

CAT. NO. RC9

## CRL Commercial Shop Service Cart

- Large, Easy-Rolling 5" (127 mm) Casters
- 220 Pound (100 kg) Load Capacity
- Easy to Assemble
- Ships Economically Via UPS



Our Commercial Service Carts are useful in the shop, the warehouse, or anywhere a sturdy, highly functional cart is needed. The Cart is equipped with heavy-duty 5" (127 mm) solid rubber casters – two swivel and two stationary – for easy portability and a stable work surface. Convenient storage tray for your small tools. The working height is 32" (813 mm). The three trays measure 30" long (762 mm) by 16" wide (406 mm) by 3-1/2" deep (89 mm). Durable enamel finish. Easy to assemble. Minimum order is one each.

CAT. NO. TC4104

## CRL Tool Hook

- Hangs on Your Belt for Quick Access to Your Favorite Tools
- Fits Belts Up to 2" (51 mm) Wide

The CRL Tool Hook just slips over your belt so you can hang hammers, caulking guns, vacuum cups, and other tools within easy reach. The sturdy metal hook will hold heavier tools or even an extension cord close at hand. Fits belts up to 2" (51 mm) wide. Minimum order is one each.



CAT. NO. TH1000

## CRL Keyless Combination Padlock

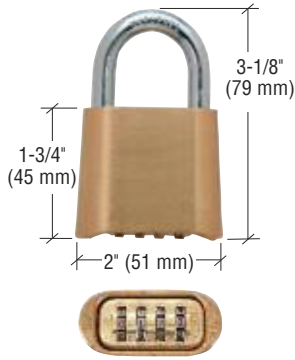

This rugged CRL Sesamee® Combination Padlock offers you extra security because you can change the combination at any time with 10,000 possible combinations. It has a solid brass body and mechanism, and the case-hardened steel shackle is zinc plated to resist corrosion. This strong yet simple Padlock gives full locking security indoors or out. Minimum order is one each.

CAT. NO. K436

## CRL Brite Nickel Plated Combination Padlock

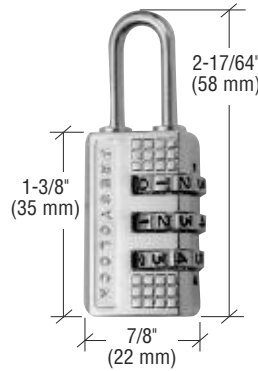

This CRL Combination Padlock can be easily "personalized" using 1,000 possible combinations, and can be changed whenever there is a need to do so. The die cast housing is strong and durable, while the steel shackle provides desired security. This very functional Padlock can be used on tool cases, luggage, golf bags, gym bags or lockers. Minimum order is one each.

CAT. NO. K3470BN

## CRL Keyed Steel Padlock

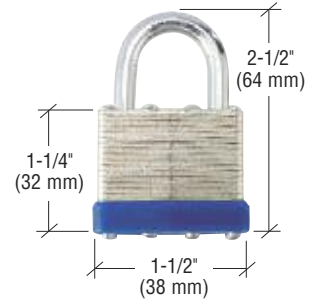

The CRL Chromatized Laminated Steel Padlock has a hardened steel shackle for added strength. It is an excellent Padlock for your tool box or locker at a good price. One Padlock and two keys per package. Minimum order is one each.

CAT. NO. APSJ30

All Locks shown above can be combined for quantity pricing.

## CRL Nylon Cable Ties

- Convenient and Simple to Use
- Available in Four Lengths and Two Colors

CRL Nylon Cable Ties are convenient for bundling wires, cables, or other narrow components. They are especially useful for gathering and securing wires under the dash or under a desk. Simple to use, just insert the tapered end of the strap into head slot and pull until the bundle is secure. 100 Nylon Ties per pack. Minimum order is one pack.



CAT. NO. NATURAL	CAT. NO. BLACK	STRAP LENGTH	MAXIMUM BUNDLE SIZE
NT40	NT40BL	4" (102 mm)	3/4" (19 mm)
NT56	NT56BL	5.6" (142 mm)	1-1/4" (31 mm)
NT75	NT75BL	7.5" (190 mm)	1-3/4" (44 mm)
NT111	NT111BL	11.1" (282 mm)	3" (76 mm)

Minimum order: 1 pack.



## CRL Blue Tarps

- Dozens of Uses
- Available in Four Different Sizes
- Washable, Mildew Resistant

CRL Blue Tarps are ideal for covering and protecting machinery, crated goods stored outdoors, truck beds, floors, outdoor furniture, and more. They are made of laminated woven polyurethane that is mildew-resistant and washable. Four sizes are available. Blue color Tarps are individually bagged for resale.

Sesamee is a registered trademark of The Eastern Company Corporation.



Protects Crated Materials While Stored Outdoors



CAT. NO.	TARP SIZE
620315	72" x 96" (1829 x 2438 mm)
620316	96" x 120" (2438 x 3048 mm)
620317	108" x 144" (2743 x 3658 mm)
620319	144" x 216" (3658 x 5486 mm)

Minimum order: 1 each.

## CRL 5 to 15 Compartment Plastic Parts Box

- Keeps Small Parts Organized
- Removable Dividers



This CRL Plastic Parts Box has removable dividers that you can configure to form 5 to 15 individual compartments. Very handy for storing small parts. Overall measurements are 8-1/2" (216 mm) wide by 4-3/4" (121 mm) deep by 1-1/2" (38 mm) high. Minimum order is one each.

CAT. NO. AM05805

## CRL 6 to 18 Compartment Plastic Parts Box

- Keeps Small Parts Organized
- Removable Dividers



This CRL Plastic Parts Box has removable dividers that you can set up to create anywhere from 6 to 18 individual compartments. Overall measurements are 8-5/8" (219 mm) wide by 5-1/8" (130 mm) deep by 1-5/8" (41 mm) high. Minimum order is one each.

CAT. NO. AM05705

## CRL 16 Drawer Small Parts Cabinet

- Economical Parts Cabinet
- 16 Drawers of Equal Size



This CRL Small Parts Cabinet has 16 equal size drawers for organizing and storing small parts. You can see through the fronts of the drawers for easy selection. Rugged polystyrene cabinet measures 10-9/16" (268 mm) wide by 6-3/8" (162 mm) deep by 8-1/2" (216 mm) high. Minimum order is one each.

CAT. NO. AM10116

## CRL 26 Drawer Small Parts Cabinet

- Economical Parts Cabinet
- 20 Small and 6 Large Drawers



This CRL Small Parts Cabinet has 26 drawers (20 small and six large) for organizing and storing small parts, keys, and hand tools. See through drawers make selection easy. Polystyrene cabinet is very sturdy, and measures 20" (508 mm) wide by 6-3/8" (162 mm) deep by 10-1/4" (260 mm) high. Minimum order is one each.

CAT. NO. AM10126

## CRL 44 Drawer Small Parts Cabinet

- Durable Plastic Construction
- 32 Small and 12 Large Drawers



This CRL Small Parts Cabinet has a total of 44 drawers (32 small and 12 large) for organizing and storing small parts, keys, and hand tools. Very sturdy polystyrene cabinet measures 20" (508 mm) wide by 6-3/8" (162 mm) deep by 15-13/16" (402 mm) high. Drawer fronts are see-through to make selection easy. Minimum order is one each.

## CRL Small Parts Cabinet

- With Four Drawers of 24 Equal Compartments
- Drawers Also Sold Separately



This CRL Four Drawer Small Parts Cabinet with all four drawers installed will have 96 small parts compartments in which to hold your items. The small parts drawers are on easy slide trays. This unit is made of heavy gauge steel, and is coated with a green enamel finish. It also features a pull handle and an index card holder for easy parts identification.

CAT. NO.

DESCRIPTION

AV196

24 Compartment Drawer

AV496

4 Drawer Cabinet

Minimum order: 1 each.

## CRL 14" Open-Top Soft-Sided Tool Carrier

- Large Interior to Carry a Variety of Tools
- Padded Bottom Will Not Scratch Counter Tops or Floors
- 21 Multi-Use Pockets

CRL's 14" (356 mm) Open-Top Soft-Sided Tool Carrier is absolutely the most convenient tool carrier and organizer you will find anywhere. The 21 pockets will provide a place for everything you will require on the job. The best feature is that everything is within eyesight and easily accessible; there is no digging around trying to locate your glass cutter, marker, or any of your small, hard to find tools. There are a variety of different pocket sizes for everything – even a special, plastic reinforced pocket for your utility knife. The adjustable, padded shoulder strap can be conveniently removed when not in use. Carrier measures 14" L x 11" W x 11" H (356 x 279 x 279 mm). Minimum order is one each.



Tools in Carrier are not included

CAT. NO. 1578CL

## CRL 20" Open-Top Soft-Sided Tool Carrier

- 27 Multi-Use Pockets
- Removable Internal Partition
- Sturdy Metal Bar Handle With Foam Grip

CRL's 20" (508 mm) Open-Top Soft-Sided Tool Carrier is just as convenient and accessible as our 14" (356 mm) version, only bigger and with more pockets. The large internal storage area will easily hold your hammers, drills, and other power tools. The many pocket sizes will accommodate tubes of silicone, cans of glass cleaner, water bottles, and even has a latched and zipped pocket for a wallet, keys, and other personal items. Carrier measures 20" L x 11" H x 11" D (508 x 279 x 279 mm). Minimum order is one each.



Tools in Carrier are not included

CAT. NO. 1579CL

## CRL Pocket Carry-All Tool Pouch

- Multi-Purpose Small Tool Carrier
- Durable Polyester Construction



Items in Pouch are not included

CRL's Pocket Carry-All has a belt loop and belt clip for quick and easy removal when you get back in the truck. There are two external and seven internal pockets, plus five web loops. There is also a carabiner for your keys or small tools. This Pouch is a great accessory to our Soft-Sided Tool Carriers. Minimum order is one each.

CAT. NO. 1504CL

## CRL 5-Pocket Cell Phone and Glass Cutter Holder

- Rugged and Water Resistant
- Clip to Your Belt, Web Suspenders or Work Apron



Items in Holder are not included

CRL's 5-Pocket Cell Phone and Glass Cutter Holder will hold most brands of compact cell phones. The Holder has a versatile 3-way attachment for belts, pants, web suspenders, and work aprons. It securely holds glass cutters, small tools or accessories, like pliers, mini-flashlights, screwdrivers, markers, punches, and more. This Holder is functional, convenient, and attractive. Minimum order is one each.

CAT. NO. 1105CL



## CRL Glass Cutter and Pencil Pouch

- Made From Top-Quality Leather
- Handy Accessory for Everyday Work
- Strap for Tape Measure or Pliers

This CRL Glass Cutter and Pencil Pouch, constructed from top-grain leather with heavy stitching, is one of our most popular items. Pouch has three molded pockets that retain their shape to hold your pens, pencils or glass cutters. In addition, a leather strap has been added to hold a measuring tape or pliers. The large belt loop will fit belts up to 1-1/2" (38 mm) wide. Minimum order is one each.



Items in Pouch not included

CAT. NO. S5403

## CRL Tool Holder

- Perfect for Small Tools
- Die Molded to Retain Shape

This CRL Leather Tool Pouch has a 4" (102 mm) wide x 4-1/2" (114 mm) high single pocket which is handy for calculators or cell phones, or just about any wide flat tools or note pads. There are two outer loops for screw drivers, cutters, or any tool with a long slender handle. Made from heavy-duty, top-grain leather with 2-3/4" (70 mm) extra wide belt slot. Minimum order is one each.



Items in Holder not included

CAT. NO. MN409

**new**

## CRL Utility Knife Sheath

- Designed for Standard Utility Knives

Designed to fit standard utility knives, this fiber-lined, saddle leather CRL Utility Knife Sheath features rivet reinforcing and an extra wide 2-3/4" (70 mm) belt slot. Minimum order is one each.



CAT. NO. MN453R

## CRL 16' to 25' Tape Rule Holder

- Extra Capacity to Hold Tape Rules 16 to 25 Feet

The CRL 16' to 25' (4.8 to 7.6 m) Tape Rule Holder holds most tape measures that have 3/4" (19 mm) wide blades. Extra wide 2-3/4" (70 mm) belt slots fit on all tool belts. The easy push-up pouch is molded from top-grain leather. Minimum order is one each.



Tape Measure not included

CAT. NO. TRP464

## CRL Plier Pocket

- Lined Pocket Allows Tools to Slide In and Out Freely

This CRL Plier Pocket is designed for use by glaziers or tradesmen. It holds pliers in a long, riveted pocket with lining to let the tool slide in and out freely. The perfect pocket for CRL's Drop Jaw Glass Pliers. Minimum order is one each.



Pliers not included

CAT. NO. MN901

## CRL Heavy-Duty Cordless Drill Holster

- Holds Most Name Brand Cordless Drills
- Extra Heavy-Duty Top-Grain Leather

The large main pocket on this CRL Heavy-Duty Cordless Drill Holster holds most name brand cordless drills and bits. The large main pocket has a safety strap plus a leather bit holder. It is rivet reinforced, and made of top-grain saddle leather featuring a 2" (51 mm) wide belt loop. Minimum order is one each.



CAT. NO. DRL91

## CRL 7-Pocket Tool Pouch

- Extra Heavy-Duty Top-Grain Leather
- Rivet Reinforced

This CRL 7-Pocket Tool Pouch has extra tool capacity with seven pockets for pliers, screwdrivers, etc. It features one large 6" (152 mm) main flared pocket, three pre-formed front pockets, two tapered side screwdriver holders, "T" chain tape holder, leather hammer holder, tape rule pocket, and a quick release spring metal clamp for wrenches. It is constructed from top grain leather with a 2" (51 mm) tunnel belt loop, and rivet reinforced for durability. Minimum order is one each.



CAT. NO. MN603

## CRL 5-Pocket Plier and Tool Holder

- Top-Grain Leather
- Quick Release Tool Snap

This CRL 5-Pocket Plier and Tool Holder has extra tool capacity with five pockets for pliers, screwdrivers, etc. It has one large main flared pocket, two vented front pockets, two tapered side screwdriver holders, "T" chain tape holder, and a quick release spring metal clamp for wrenches. It is constructed from top-grain leather with two, 2-3/4" (70 mm) belt slots. The overall size is 9" x 9-1/2" (229 x 241 mm). Joints are rivet reinforced for durability. Minimum order is one each.



CAT. NO. MN403

## CRL 8-Pocket Nail and Tool Bag

- Extra Rivet Reinforcement for Strength
- Rugged and Comfortable

This CRL 8-Pocket Nail and Tool Bag is popular with carpenters and tradesmen needing a functional and rugged tool bag. The 8-pocket design has two large pockets, six smaller tool pockets, two leather hammer loops, and a wide tunnel belt loop. Minimum order is one each.



CAT. NO. MN823

## CRL 12-Pocket Carpenters Apron



This CRL 12-pocket Carpenter's Apron is a professional-style apron made of heavy-duty, top-grain moccasin leather. It features two extra-large main nail pockets, two medium front pockets, six tool pockets, two hammer straps, and a leather tape rule pocket for 12' to 25' (3.6 to 7.2 m) tape rules. It is double-stitched and rivet reinforced for extra strength and durability, with a 2-1/4" (57 mm) wide, fully adjustable cotton web belt, that fits waist sizes up to 46" (1168 mm). Minimum order is one each.

CAT. NO. MN427

## CRL 11-Pocket Tool Apron



- Rivet Reinforced
- Web Belt

This CRL Leather Apron has four main pockets, six tool pockets, a leather tape rule pouch, a hammer loop on each side, and a 2-1/4" (57 mm) wide polypropylene web belt. Fits waist sizes up to 52" (1321 mm). Minimum order is one each.

CAT. NO. MN490X

## CRL Vacuum Cup Holster

- Finally a Way to Hold Your 8" (203 mm) Vacuum Cup When You're Not Using It
- Keeps Your Cup Ready to Use at Your Side

Developed by a glazier, the VCH1 Vacuum Cup Holster combines safety and convenience by keeping your vacuum cup readily available while in awkward positions, such as when working on a scaffold or ladder. This reduces the risk of injury by keeping your hands free, rather than having to hold the cup at all times.

Made from top-grain cowhide, the Vacuum Cup Holster is strong enough to withstand the daily abuse of a glazier's work, but soft enough to cradle your vacuum cup and protect it from sharp edges that often lead to cup damage and eventual failure. There is also a leather strap with a steel snap that holds the cup in place until ready for use. The Holster fits belts up to 2-1/4" (57 mm) wide. The VCH1 is available exclusively from CRL. **NOTE:** Do not use with larger than 8" (203 mm) diameter cups. Minimum order is one each.



Fits All 8" (203 mm) Vacuum Cups  
(Cup Not included)

CAT. NO. VCH1

## CRL Leather Work Belt

- Top-Grain Cowhide With Chrome Buckle



Made of top-grain cowhide with a chrome buckle, this 1-3/4" (45 mm) wide CRL Leather Work Belt fits tool pouches and bags. It can be trimmed to fit all waists from 29" to 46" (737 to 1169 mm). Minimum order is one each.

CAT. NO. MN416X

## CRL Poly Web Work Belt

**new**

- Made of Strong, Brown Webbing
- Heavy-Duty Steel Buckle



This CRL Polypropylene Web Work Belt is made of strong brown webbing with heavy belt hardware to easily hold your nail pouches, tool straps, etc. It has rust resistant rivets and buckle for strength and long wear. It adjusts to fit 29" to 46" (737 to 1169 mm) waists, and is 2" (51 mm) wide. Minimum order is one each.

CAT. NO. MN505

## CRL Tool Belt Suspenders

- Makes Heavy Tool Belts Easy to Wear All Day
- Adjusts to Fit Any Size
- Extra Heavy-Duty Materials



These extra-wide CRL Tool Belt Suspenders hold heavy tool bags and aprons off your hips and lower back, easing strain. They feature heavy-duty 2" (51 mm) wide, fully adjustable front straps, elastic rear straps, and nickel plated hardware. One size fits all. Minimum order is one each.

CAT. NO. MN110

## CRL ToolVest Tool Carrier

- Cool, Nylon Mesh Back
- Over 20 Pockets



This CRL ToolVest Tool Carrier is a practical vest that can be worn right to the jobsite to keep your tools within reach at all times. There are fourteen easy access pockets, six flap-covered pockets, and a large rear pocket with both left and right access. The nylon mesh backing allows cooling ventilation. A zippered neck opening provides comfort. Two buckles on each side of the vest allow adjusting for size. Minimum order is one each.

CAT. NO. 94350

## CRL Single Edge Razor Blades

- Our Most Popular Single Edge Blade
- Precision Honed, Surgical Steel Edges
- Each Blade is Individually Wrapped
- Multiple Uses

This CRL Single Edge Razor Blade is top quality, industrial grade, .009" (.23 mm) thick, Carbon C-1095 surgical steel, precision-honed for extra sharpness. It delivers durability along with the exacting, quality cut that professionals demand. Packed 100 each per box, there are 50 boxes per case. Each blade is individually wrapped to protect the edge until you are ready to use it. Also available in packs of ten, loaded in a handy, spring loaded plastic disposable pack. Minimum order is 100 each of the 51S blades and one each of 112020 dispenser.



**CAT. NO. 112020**  
Plastic Dispenser 10 Pack

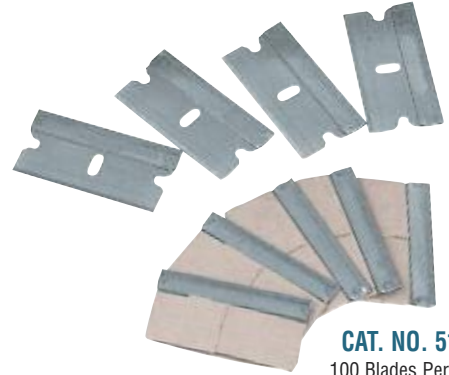

**CAT. NO. 51S**  
100 Blades Per Box



## CRL Heavy-Duty Industrial Single Edge Razor Blades

- Single Edge Blades With No Notch
- Heavy-Duty .012" Thick Carbon Steel
- For Use in Paint Scrapers and Mat Cutters

Our CRL Heavy-Duty Razor Blades are primarily used when the job requires a stronger blade. They are more rigid than our regular razor blades because of their .012" (.31 mm) thick steel construction and no side notches. Their extra rigidity also makes them great for tough scraping jobs. Packed 100 per box. Minimum order is 100 each.



**CAT. NO. KKB12**

## CRL Plastic Razor Blades

- Single or Double Edge Styles



**CAT. NO. CP866088**  
Single Edge Blades



**CAT. NO. CRL3000**  
Double Edge Blades

These CRL Plastic Razor Blades won't harm plastic coated windows or other hard surfaces that can be scratched or marred by metal razor blades. They are also useful for working on painted surfaces or chrome, and for removing decals, pin striping, or window tint film. The new Double Edge Blade has very thin, yet stiff edges for delicate scraping jobs. Choose from single edge or double edge versions to fit your razor blade scraper (see opposite page). Both are sold 100 per package. Minimum order is one package.



## CRL Heavy-Duty Razor Blade Scrapers



The overall length of this Scraper is 11" (279 mm). It comes with one steel and one plastic razor blade in the hollow handle. Blade is secured by a single set screw. Minimum order is one each.

CAT. NO. CRL761

- Perfect for Scraping or Sticker Removal
- Holds Both Metal and Plastic Razor Blades



The overall length is 11" (279 mm). It comes with one steel and one plastic razor blade in the hollow handle. Spring clamp holds blades securely and makes changing easy. Minimum order is one each.

CAT. NO. L52000

## CRL Safety Razor Blade Holder and Window Scraper

- Safely Holds All Single Edge Razor Blades

For a safe and simple way to hold single edge razor blades try our Safety Razor Blade Holder and Window Scraper. Instantly expose or conceal the blade with a simple thumb lock. All metal tool will withstand lots of use, and has a hole in the end so you can hang it up. Overall length is 4-1/2" (114 mm). Scrapers are available individually, or in bulk boxes of 100 each.



CAT. NO.	DESCRIPTION
3223	# Individual Scraper
115000	*Carton of 100 Scrapers

# Minimum order: 1 each. \*Minimum order: 100 each.

## CRL Razor Blade Holder and Scraper

The CRL Razor Blade Holder and Scraper is a safe and easy way to handle single edge metal razor blades for all your scraping jobs. The blade end is molded into a plastic handle that provides for a comfortable and sure grip, with a metal ferrule so you can hang it up. There is also a slip-on safety cover for the blade edge. Holds our 51S and KKB12 Single Edge Razor Blades (see page 438K). Overall length is 6-1/2" (165 mm). Minimum order is one each.



- Safely Hold Single Edge Metal Razor Blades
- Comfortable Handle for a Sure Grip

CAT. NO. RS65

## CRL Carton Cutter



- Uses CRL 51S Single Edge Razor Blades
- Safe and Economic Way to Hold Razor Blades

This CRL Razor Blade Carton Cutter Tool is a safe and economical way to handle single edge razor blades for cutting and scraping. Very commonly used for opening boxes or when scraping windows of paint and labels. It uses Cat. No. 51S Single Edge Razor Blades (see page 438K). Minimum order is one each.

CAT. NO. 183100

## CRL Razor Blade Knife



- Easy Way to Handle Single Edge Razor Blades

This CRL Razor Blade Knife is a safe and easy way to handle single edge razor blades for cutting and scraping. Very commonly used when scraping walls, windows, paint, and labels. This Knife is compatible with our Cat. No. 51S Single Edge Razor Blades (see page 438K). **NOTE:** Not available in Australia. Minimum order is one each.

CAT. NO. 117200

## CRL Heavy-Duty Utility Knife Blades

- Our Best Selling Utility Blades
- Heavy-Duty .025" Thickness
- Handy Slide-Out Dispenser of 100

CRL Heavy-Duty Utility Blades fit all standard and heavy-duty retractable blade utility knives. They are made to withstand heavy use and abuse. Available 10 per pack and in a bulk 100 pack supplied with a handy slide-out dispenser.

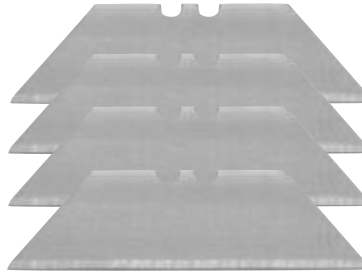

CAT. NO.	DESCRIPTION
<b>1992C</b>	Heavy-Duty Blades – Pack of 100
<b>1992X10</b>	Heavy-Duty Blades – Pack of 10

Minimum order: 1 pack.

## CRL Standard Utility Knife Blades

- Standard .018" Thickness
- Fit Virtually All Utility Knives
- 20 Packs of 5 Each

CRL Standard Utility Knife Blades fit virtually all standard and heavy-duty retractable blade utility knives. Standard .018" blade thickness. Available in a bulk pack of 100, packaged five blades per pack.



CAT. NO.	DESCRIPTION
<b>1991C</b>	Standard Blades – Pack of 100

Minimum order: 1 pack.

## CRL Extra Long Utility Knife Blades

- Extra Long Blade for Extra Reach
- Economy Packs of 10 for Easy Storage

CRL Extra Long Utility Knife Blades fit all Urethane Knives that use Utility Blades. They have an exposed cutting edge of 2-1/4" (57 mm), more than double the cutting edge of standard utility knife blades.

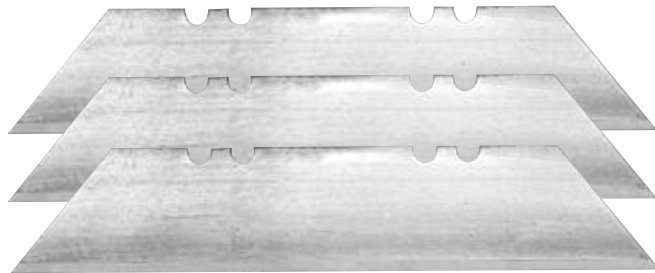

CAT. NO.	DESCRIPTION
<b>1993X10</b>	Extra Long Blades – Pack of 10

Minimum order: 1 pack.

## CRL Extra Long Serrated Blades

- Faster Cutting
- Longer Length

CRL Extra Long Serrated Blades are a full 4-3/16" (106 mm) in length; making them one of the longest blades available and, with the serrated edge, one of the fastest cutting. Fit all standard utility knives and long handle windshield cut-out knives.



CAT. NO.	DESCRIPTION
<b>SB418</b>	Serrated Blades – Pack of 10

Minimum order: 1 pack.

## CRL Swift Switch Utility Knife

- Easily Replaceable Blades
- Includes a Knife Holster



The CRL Swift Switch Utility Knife is ergonomically comfortable and easy to use. Its safety orange color is easily visible wherever you might leave it. It is supplied with a handy holster for safe storage. The CRL Swift Switch Utility Knife uses any of our CRL Utility Knife Blades (see page 440K), which must be purchased separately. Minimum order is one each.

CAT. NO. 03832

## CRL Stanley® SportUtility® Knife

- Two Knives in One
- 3-1/2" Cutlery Grade Stainless Blade
- 3-Position Retractable Utility Blade



This CRL Stanley® SportUtility® Knife features both a 3-1/2" (89 mm) cutlery grade stainless steel blade for durability and rust-resistance, and a three position retractable utility blade that works like a traditional utility knife. The Knife is supplied with a nylon storage sheath and a 10 pack blade dispenser. The SportUtility® Knife uses any of our CRL Utility Knife Blades (which must be purchased separately) shown on page 440K. Minimum order is one each.

CAT. NO. ST10804

## CRL Linoleum Utility Blade

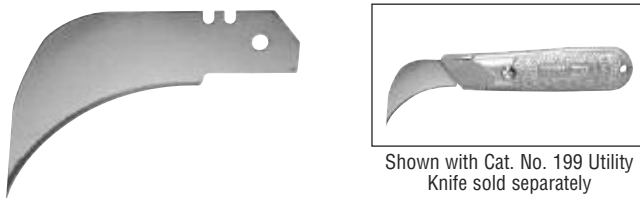

- Blade Fits in Most Non-Retractable Knives
- Used to Cut Linoleum, Ceiling Tile, Cartons, Wallboard, and More

Tempered high-carbon steel blade with keen edge for clean, true cuts in vinyl or linoleum floor covering, roofing and similar materials. For fixed non-retractable blade Utility Knives such as Cat. No. 199. Minimum order is one each.

CAT. NO. 3153

## CRL Hook End Utility Blades



- Heavy-Duty Hook End Blade
- Fits All Standard Utility Knives

When removing encapsulated windshields, this blade is perfect for cutting away the encapsulation. CRL Hook End Utility Blades fit all standard utility knives.

CAT. NO.	DESCRIPTION
1996C	Hook End Blades - Pack of 100
1996X10	Hook End Blades - Pack of 10

Minimum order: 1 package.

## CRL Craftsman Knife



- Ideal for Making Precision Cuts
- Supplied With Extra Blades

Craftsmen, artists, technicians, and all others who require small precision cuts will find this strong all aluminum CRL Craftsman Knife easy to work with. Uses for the Knife include: scribing, etching, cutting stencils, layout and paste up work, hobby cutting, as well as other types of intricate work. It is supplied with five extra blades. Minimum order is one each.

CAT. NO. 450001

Stanley and SportUtility are registered trademarks of Stanley Logistics, LLC.

## CRL Craftsman Replacement Blades



- Carded or Bulk
- Fits 450001 Craftsman Knife

CRL Craftsman Replacement Blades are used with the Cat. No. 450001 Craftsman Knife. They are ideal for hobbyists, craftsmen, artists, technicians, and anyone that needs to make intricate cuts.

CAT. NO.	DESCRIPTION
45111C	5 Blade Pack
45111P	100 Blade Box

Minimum order: 1 package.

## CRL Standard Retractable Blade Utility Knife



- Three Position Heavy-Duty Slider Actuation
- Overlapping Nose for Safety

This CRL Standard Retractable Blade Utility Knife has a safety overlap that keeps the blade from slipping between the handle halves, an important safety consideration. It is supplied with four blades, and uses any of our CRL Utility Knife Blades (see page 440K), which must be purchased separately. Minimum order is one each.

CAT. NO. 97K

## CRL Stanley® Heavy-Duty Retractable Blade Utility Knife



- Industrial Quality
- Retractable Blade

This CRL Stanley® Heavy-Duty Retractable Blade Utility Knife features a five-position slide and heavy-duty metal body. It is supplied with three heavy-duty blades, and uses any of our CRL Utility Knife Blades (see page 440K), which must be purchased separately. Minimum order is one each.

CAT. NO. 99

## CRL Heavy-Duty Fixed Blade Utility Knife



- Industrial Quality Die Cast Handle
- Comes With Five Blades

This CRL Heavy-Duty Fixed Blade Utility Knife is an easy-to-use basic knife that has a fixed blade. For the shop that uses and or loses a lot of knives, this inexpensive model is an ideal purchase. It is supplied with five standard blades, and uses any of our CRL Utility Knife Blades (see page 440K), which must be purchased separately. Minimum order is one each.

CAT. NO. 199

## CRL Autoloading Utility Knife

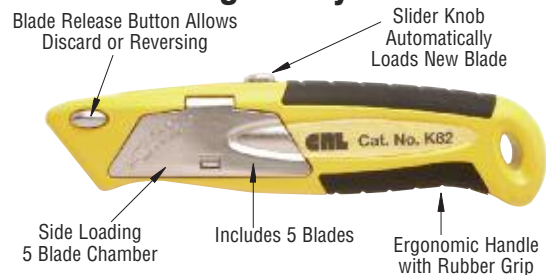

- Easy, Quick Blade Replacement

The CRL Autoloading Utility Knife is ergonomically comfortable and easy to use. The spring-loaded blade housing lets you change blades without the need for tools. It's safety yellow color is easily visible wherever you might leave it. The rubber inserts in the handle give you an improved grip. It is supplied with five 1992C blades, and uses any of our CRL Utility Knife Blades (see page 440K), which must be purchased separately. Minimum order is one each.

CAT. NO. K82

## CRL Stanley® FatMax® Swivel-Lock Fixed Blade Utility Knife



- Quick Blade Change – No Tools Required
- Ergonomic Design

This CRL Stanley® FatMax® Swivel-Lock Fixed Blade Utility Knife swivels open so you can change the blade without using tools. The thumb dial locks the blade in place, and there is a magnet in the nose to hold the blade while the knife is open. It has a cast metal core with soft panels for a comfortable grip, and comes with three heavy-duty utility knife blades stored in the handle. It uses any of our CRL Utility Knife Blades (see page 440K), which must be purchased separately. Minimum order is one each.

CAT. NO. ST10799

Stanley and FatMax are registered trademarks of Stanley Logistics, LLC.

## CRL Heavy-Duty Retractable Blade Utility Knife



- Safety Orange Color
- Industrial Quality

This CRL Heavy-Duty Retractable Blade Utility Knife is a quality knife designed to better fit the hand with vertically recessed ribs for a more comfortable grip. The heavy-duty, die cast zinc handle features a safety nose with top and bottom over-lap, providing additional security by preventing the blade from slipping between each half of the handle. A zinc retractor makes for smoother operation and has three cutting positions. It is supplied with three heavy-duty blades, and uses any of our CRL Utility Knife Blades (see page 440K), which must be purchased separately. Minimum order is one each.

CAT. NO. 82L



## CRL Ultra-Thin Combination Knife



### • Multiple Functions in Ultra-Thin Design

This CRL Ultra-Thin Combination Knife is compact and thin enough to fit comfortably in a pocket or on a work belt. The unique design enables the user to simply roll the tool in their hand to switch between utility and knife blade. It also easily converts to a screwdriver by inserting the included Phillips and slotted driver bits. Minimum order is one each.

CAT. NO. CK3N1

## CRL Safety Slitter



### • Safely Cuts Stretch Film, Plastic Straps and Sheets

The CRL Safety Slitter Knife is injection molded from indestructible glass-filled nylon material. Rotation of the high-quality carbon slitter blade provides four cutting edges per blade. The safety beak allows for easy hooking and guiding when slitting a variety of materials.

CAT. NO.	DESCRIPTION
20027	Safety Slitter Knife
20027B	Replacement Blades - 10 Pack

Minimum order: 1 each.

## CRL Roofing Knife



### • Ideal for Cutting Shingles, Linoleum, Tile, and Plastic

Our CRL Roofing Knife holds a specially designed Cat. No. 412100 blade with four ground cutting edges. The Knife is ideal for cutting linoleum, floor tile, shingles, plastic sheeting, and many other materials. The heavy gauge steel casing includes three heavy-duty blades that adjust to the exact depth required.

CAT. NO.	DESCRIPTION
777700	Roofing Knife
412100	Replacement Blades - 5 Pack

Minimum order: 1 each.

## CRL Red Devil® Flooring Knife



### • Tempered, High-Carbon Steel Blade • Large Easy Grip Handle

The CRL Red Devil Heavy-Duty Linoleum and Flooring Knife is the right tool for cutting linoleum and vinyl floor tiles. The tempered, high-carbon steel blade uses a tapered edge for free cutting and quick sharpening. Minimum order is one each.

CAT. NO. 4608

## CRL Utility Blade Scraper

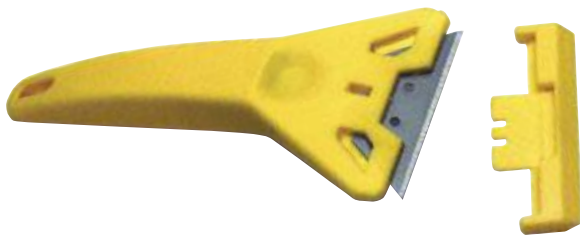

### • Safely Holds CRL 1992C Utility Knife Blade

This CRL Utility Blade Scraper is a safe and easy way to handle CRL 1992C Utility Knife Blades (see page 440K) for cutting and scraping. They are very commonly used when scraping walls, windows, paint, and labels. Minimum order is one each.

Red Devil is a registered trademark of Red Devil, Incorporated. CAT. NO. 337000

## CRL Utility Knife Sheath

### • Designed to Hold Most Standard Utility Knives

This CRL Utility Knife Sheath is designed to fit most standard utility knives. This fiber lined sheath features rivet reinforced saddle leather with an extra wide 2-3/4" (70 mm) belt slot. Minimum order is one each.



CAT. NO. MN453R

## CRL Olfa® Heavy-Duty Retractable Blade Knife

- Comfortable Rubber Grip
- All-Purpose Knife



This CRL Olfa® Heavy-Duty Retractable Point Knife features a high-impact plastic handle and stainless steel blade housing. The positive locking thumb screw allows the blade to be set to your desired length. Uses LB10B, LB50B and LS0L Replacement Blades shown below. Minimum order is one each.

CAT. NO. L2K

## CRL Olfa® Long Reach Retractable Blade Knife

- Designed for Hard-to-Reach Places
- Comfortable Rubber Grip

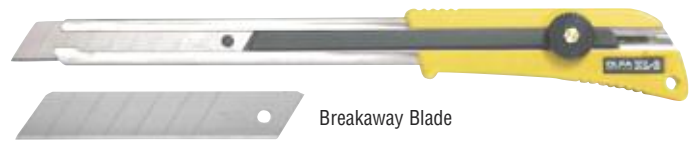

The CRL Olfa® Long Reach Retractable Point Knife was designed with hard-to-reach places in mind. It has a locking thumbscrew, stainless steel housing and rubber grip which provide safety and needed comfort. Uses LB10B, LB50B, and LS0L Replacement Blades shown below. Minimum order is one each.

CAT. NO. XL2

## CRL Olfa® Super Heavy-Duty Retractable Blade Knife

- Large 1" Wide Blade



This CRL Olfa® Super Heavy-Duty Knife was designed for the toughest of jobs with a .028" (.7 mm) thick blade that will extend a full 4" (102 mm). A rubber grip handle on the back side provides a non-slip surface for safety and comfort. The H1K uses the heavy-duty 1" (25 mm) wide HB5B Blade shown below. Minimum order is one each.

CAT. NO. H1K

## CRL Olfa® Stainless Steel Shirt Pocket Knife

- Fits Into Small Places



The CRL Olfa® Stainless Steel Shirt Pocket Knife is a slim, compact knife that is great for cutting urethane, silicone, boxes and more. Although this knife is compact, quality was not forgotten. The SVR1 housing is made of stainless steel. The pocket clip doubles as a device to snap away the used section of the blade. Cat. No. AB10S replacement blades are shown below. Minimum order is one each.

CAT. NO. SVR1

## CRL Stanley® Quick Point® Pocket Knife



This CRL Stanley® Quick Point® Pocket Knife has a retractable blade that snaps at scored intervals. Each time you snap off a prescored section you get a fresh, new sharp cutting surface. The reinforced plastic body is sturdy and lightweight with a pocket clip. Cat. No. ST11300 Replacement Blades are shown below. Minimum order is one each.

CAT. NO. ST10150

## CRL Stanley® Pocket Knife

This rugged, polished, chrome plated CRL Stanley® Pocket Knife with a cutlery stainless steel Blade and a safety lock feature. This ergonomically designed grip adds to the ease of use and performance. The Blade is easily replaceable. Knife and Replacement Blade come individually carded.



CAT. NO.	DESCRIPTION
ST10049	Pocket Knife
ST11041	Replacement Blade

Minimum order: 1 each.

Olfa is a registered trademark of Olfa Corporation. Stanley and Quick Point are registered trademarks of Stanley Logistics, LLC.

## CRL Replacement Blades

- Blades Fit CRL Retractable Knives and Other Similar Brands

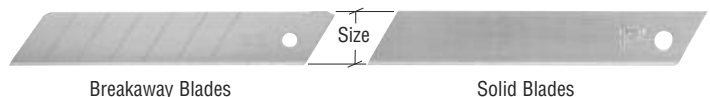

These CRL Replacement Blades are intended for use with the various Retractable Knives show on this page, as well as other similar brands. The breakaway feature allows the dull point to be snapped off to get a fresh, new sharp cutting surface.

CAT. NO.	BLADE TYPE	WIDTH	PACK QTY	FITS KNIFE
AB10S	Breakaway	3/8" (9.5 mm)	10	SVR1
HB5B	Breakaway	1" (25.4 mm)	5	H1K
LB10B	Breakaway	11/16" (18 mm)	10	L2K, XL2
LB50B	Breakaway	11/16" (18 mm)	50	L2K, XL2
LS0L	Solid	11/16" (18 mm)	10	L2K, XL2
ST11300	Breakaway	3/8" (9.5 mm)	3	ST10150

Minimum order: 1 pack.

## CRL Fletcher® Heavy-Duty Plastic Cutter



- Exclusive Replaceable Blades Feature
- Bio-Engineered for Production Cutting Comfort
- Design Delivers 55% More Pressure Power

The special grip on the CRL Fletcher® Plastic Cutting Tool was designed to give you fatigue-free, easy cutting of plastic and related products. It's exclusive shape produces 55% more pressure than light-duty disposable models. Comes with one APB121 Long Blade and complete instructions. Minimum order is one each.

CAT. NO. HDP11

## CRL Replacement Blades for HDP11 Plastic Cutter

- Standard and Long Lengths



CAT. NO.	DESCRIPTION
APB12	Standard Length Blade – 10 Pack
APB121	Long Length Blade – 10 Pack

CAT. NO. APB12 CAT. NO. APB121

Minimum order: 1 pack.

## CRL New Blade Retaining Clip

- Fits HDP11 Cutter

If the CRL HDP11 slot loses its snug grip after repeated blade replacing, this CRL New Blade Retaining Clip ensures that the blade will stay in its proper position. It becomes an integral part of the tool which guarantees problem-free scoring time after time. Minimum order is one each.



CAT. NO. BC11

## CRL Plastic-Plus Cutting Tool

- Available Carded or in Bulk
- Used to Cut Plastic, Vinyl Floor Tile, Thin Copper, Brass, and Aluminum

The CRL Plastic-Plus Cutting Tool allows easy and accurate cutting of acrylic sheets, plastic lighting panels, vinyl floor tile, and laminated plastics used for countertops, etc. The hardened steel cutting blade can be resharpened to keep scribing lines deep, and chipping to a minimum. The blade also folds into the compact plastic handle for safety while carrying.



CAT. NO.	PACKAGE	QUANTITY
KS20	Carded	1
KS20B	Bulk Pack	50

Minimum order: 1 each for the KS20; 50 each for the KS20B.

## CRL Plastic Cutting Knife



CAT. NO. PB800  
3 Plastic Cutter Blades



- Cuts .100 and .125 Plastic
- Easy Blade Changing

Cutting plastic is simple with our P800 Plastic Cutter Knife. For repairs using plastic, every installer should have our cutter in their tool box. Knife comes with two replacement blades which can be stored in the handle. A simple-to-remove thumb screw makes blade changes easy.

CAT. NO.	DESCRIPTION
P800	Plastic Cutter Knife
PB800	Plastic Cutter Blades – 3 Pack

Minimum order: 1 each.

Fletcher is a registered trademark of Fletcher-Terry Company, LLC.

## CRL Dexter Mat Cutter

The chrome plated CRL Dexter Mat Cutter will cut a straight or bevel edge with absolute accuracy. Blade adjustments can be done easily using the plastic knob on the tool. This knob secures the blade at any desired angle or depth. Minimum order is one each.



CAT. NO. MC119

## CRL Dexter Replacement Blades

- Five Blades Per Pack

The CRL Dexter Mat Cutter Replacement Blades will enable you to cut a straight or beveled edge cut, resulting in a professional look. Minimum order is one pack.



CAT. NO. DX3

## CRL Mat Cutter Replacement Blade

- Single Edge

CRL Mat Cutter Replacement Blades will work with C&H Series and other professional mat cutting machines. Blades have a .012 gauge thickness. Minimum order is 100 each.



CAT. NO. CH1200

## CRL Power Shift Metal Snips

- Dual Stage Snips Have 200% Greater Cutting Power Than Standard Metal Snips



Standard Mode



Power Mode

CRL Power Shift Dual Stage Snips have a unique double action power mode, which can easily be switched from standard cutting mode to the extra heavy-duty "Bulldog" mode. These Snips work like all common metal cutting snips when lighter gauge metals are being cut. However, simply spread the handles 180 degrees apart and the handle placement pins shift the fulcrum point, increasing the cutting strength by 200%. It's like having two Snips in one! The jaws have a light serration to prevent slippage, and the handles have a heavy rubberized coating for comfort.

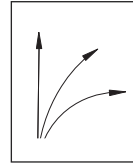

Right Cut

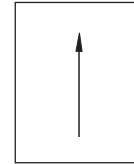

Straight Cut

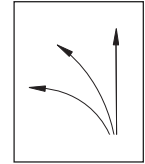

Left Cut

- Three Cut Patterns

CAT. NO.	DESCRIPTION	OVERALL LENGTH
ST1000	Straight Cut	10" (254 mm)
ST1001	Left Cut	10" (254 mm)
ST1002	Right Cut	10" (254 mm)

Minimum order: 1 each. Can be combined for quantity pricing.

## CRL Wiss® Metal Snips

- Three Cut Patterns
- Serrated Jaws to Prevent Slippage

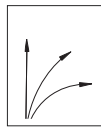

Right Cut

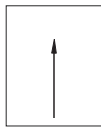

Straight Cut

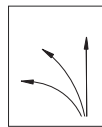

Left Cut

These Wiss® Snips are designed to cut 18-gauge (.049") or lighter sheet metal. The compound action of these Snips gives extra cutting power with less effort. The configuration of the jaws helps guide the user while making straight or curved cuts. The jaws are made from hardened molybdenum steel, and are serrated to prevent slipping. The handles have a non-slip textured plastic coating for superior control and comfort.



CAT. NO.	DESCRIPTION	OVERALL LENGTH
M3R	Straight Cut-Yellow Handle	10" (254 mm)
M1R	Left Cut-Red Handle	10" (254 mm)
M2R	Right Cut-Green Handle	10" (254 mm)

Minimum order: 1 each. Can be combined for quantity pricing.

## CRL Straight Pattern Snips



- Two Sizes

These heavy-duty forged Snips have a wide variety of uses. The jaws have a flat cutting edge to help guide the Snips when making straight cuts. They are recommended for cutting cold rolled steel up to 23-gauge (.025") or thinner.

CAT. NO.	OVERALL LENGTH	CUT LENGTH
A13	7" (178 mm)	1-3/4" (44 mm)
A11	10" (254 mm)	2-1/4" (57 mm)

Minimum order: 1 each.

Wiss is a registered trademark of Apex Brands, Inc. Prosnip is a registered trademark of Prosnip Corporation.

## CRL Prosnip® Offset Snips



- Cut Left or Right

These Snips are designed to cut either sheet metal or all types of screen cloths, including bronze and stainless steel. Models to cut either left or right are available. The curved handle design keeps your hand safely above the cutting surface.

CAT. NO.	DESCRIPTION
20SL	Left Cutting
20SR	Right Cutting

Minimum order: 1 each.

## CRL Nibbler Cutting Tool

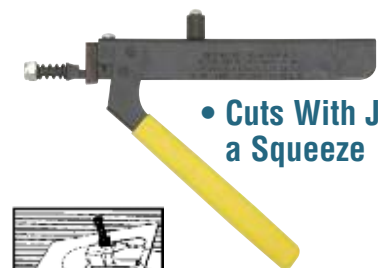

- Cuts With Just a Squeeze



This handy tool cuts either sheet metal or plastic with only a squeeze. The unique jaw configuration prevents bending or distortion of thin sheet metal often experienced with more conventional snips. Minimum order is one each.

CAT. NO. 70376

## CRL Plastic Trim Snips

- Replaceable Razor Sharp Blades



Plastic Trim Snips have a wide variety of uses. The 3-1/2" (89 mm) long razor sharp cutting blade is ideal for angle cutting plastic trim strips (not for cutting metal). The handle grip holds three additional replacement blades. Replacement blade pack includes three blades and one plastic anvil.

CAT. NO.	DESCRIPTION
PTS89	Trim Snips
PTS89B	Replacement Blade Pack

Minimum order: 1 each.

## CRL Adjustable Multi-Cutter

- Makes Precise Straight or Miter Cuts
- Comes With One Blade



The CRL Adjustable Multi-Cutter is great for cutting glazing vinyl and channel, rubber gaskets, PVC strips, trim molding, and weatherstrip. Simply adjust the guide with the desired angle line on the tool's platform and you have a perfect miter cut every time. Platform is marked at 135, 120, 105, 90, 75, 60 and 45 degrees. The Multi-Cutter is made of high quality steel with vinyl handgrips for comfort when cutting. Includes one blade.

CAT. NO.	DESCRIPTION
MC80N	Adjustable Multi-Cutter Tool
MC80RB	Replacement Blades (5/Pk)

Minimum order: MC80N is 1 each, MC80RB is 1 pack.

## CRL Plastic Cross-Cut Trim Snips

- Molded 90 Degree Cross Cut Base



Similar in design to the PTS89 Snips, these Cross-Cut Trim Snips have a high impact molded plastic base that gives an accurate 2" (51 mm) wide 90 degree cross-cut every time. Snips are perfect for cutting CRL Trim-Quick Moldings and other vinyl trim. Minimum order is one each.

CAT. NO. PTQS2

## CRL Universal Shears



Available Only in Australia



- High Quality Shears

These CRL Universal Shears are great for cutting PVC strips, rubber gaskets, molding and weatherstrip. The cutter is made of high quality steel with vinyl handgrips which allow for comfort when cutting. Includes one blade. Available in Australia only.

CAT. NO.	DESCRIPTION
1105	Universal Shears
1105B	Replacement Blade (1/Pk)

Minimum order: 1 each.

## CRL Euro Shears

- Micro Fine Serrated Edge Blades
- Non-Handed Grips

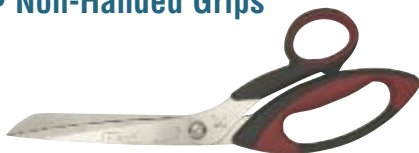

Our finest European made stainless steel Shears have a micro fine serrated edge and the blades have been ice tempered to stay sharp for years. Non-handed oversized grips offer the maximum comfort and control. Overall length is 11-3/8" (289 mm); cut length is 4-1/2" (114 mm). Minimum order is one each.

CAT. NO. P8377

## CRL Screen Shears

- Excellent for Cutting Aluminum and Fiberglass Screen
- 4" Cut Length



These Screen Shears are excellent for cutting aluminum or fiberglass screening, as well as light plastics. The overall 10" (254 mm) length produces a quick 4" (102 mm) cut. Minimum order is one each.

CAT. NO. P8062

## CRL Heavy-Duty Shears

- Designed to Cut Heavier Materials With Ease



These Heavy-Duty Shears are similar in appearance to the P8062, however, the blades are made from thicker steel, and the grips are wider to allow for stronger cutting force even through heavy materials that lighter weight shears would struggle through. The overall 10" (254 mm) length produces a 4-7/8" (124 mm) cut. Minimum order is one each.

CAT. NO. W20

## CRL Premium Hacksaw

- Our Finest Hacksaw Uses 12" (305 mm) Blades
- Vertical or Horizontal Blade Positioning
- Frame Holds Extra Blades

The CRL Premium Hacksaw is our finest model. The strong, yet lightweight tubular steel frame has a special blade tension device to hold the blades firmly to prevent flexing and breakage. The blade can also be mounted at 45 degrees for ease of making horizontal cuts. The tube provides storage for extra blades, and the heavy-duty construction will give you years of quality service. It uses 12" (305 mm) Hacksaw Blades shown on page 449K. Minimum order is one each.



CAT. NO. 24053

## CRL Heavy-Duty Hacksaw

- Strong Tubular Frame Holds 10" and 12" (254 and 305 mm) Blades



This CRL Heavy-Duty Hacksaw does everything a big hacksaw does and more. A durable molded handle offers maximum hand comfort. Uses regular 10" and 12" (254 and 305 mm) hacksaw blades, which can be stored in the tubular frame. Minimum order is one each.

CAT. NO. HSF12

## CRL Stanley® Tubular Frame Hacksaw

- Tubular Frame Holds Extra Blades
- Works With 10" and 12" (254 and 305 mm) Blades



The CRL Stanley® Tubular Frame Hacksaw has a heavy gauge, chromium plated, tubular steel frame with a rugged cast aluminum handle. The blade can be faced in four directions. It comes standard with a 10" (254 mm) flexible, hard edge blade. Minimum order is one each.

CAT. NO. ST15408

## CRL Stanley® Handyman® Hacksaw

- Frame Adjusts to Accept 8", 10", and 12" (203, 254, and 305 mm) Blades



The CRL Stanley® Handyman® Hacksaw features a D-shaped Guard to protect your hands and knuckles. It has a rigid steel frame and a virtually unbreakable vinyl handle. You can adjust the frame to accept an 8", 10" or 12" (203, 254 or 305 mm) blade. It comes with a 10" (254 mm) flexible, hard edge blade. Minimum order is one each.

CAT. NO. ST15265

Stanley and Handyman are registered trademarks of Stanley Logistics, LLC.

## CRL Dual Purpose Miter Box

- Cuts Wood and Plastic at Any Angle Between 45 Degrees Left and Right

The CRL Dual Purpose Miter Box was designed for the professional. This is one of the best wood and plastic cutting miter boxes on the market.

It comes with one wood and plastic combination blade. The hacksaw type blade for wood and plastic reduces saw kerf, for thin, fine cuts. The blade is mounted in tension and moves on a tubular shaft. Can be set at any angle between 45 degrees left and 45 degrees right.

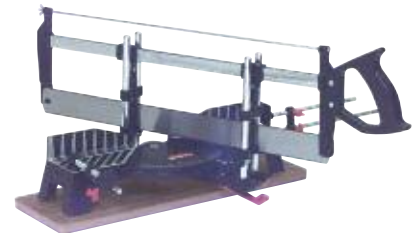

CAT. NO.	DESCRIPTION
H36191	Miter Box
H36192	Replacement Wood/Plastic Blades (2/PK)

Minimum order: 1 each.

## CRL High Speed Cobalt 12" Hacksaw Blades

- Highest Quality Blades With Specially Treated Cobalt Teeth
- Excellent for Cutting Steel

These CRL High Speed Cobalt Hacksaw Blades are made of the highest quality flexible steel. Specially treated cobalt teeth will cut almost any material, including tool and stainless steel. The flexibility of this Blade virtually eliminates breakage.



CAT. NO.	SIZE	TEETH PER INCH
<b>MB1218</b>	12" (305 mm)	18
<b>MB1224</b>	12" (305 mm)	24
<b>MB1232</b>	12" (305 mm)	32

Minimum order: 10 each. All Hacksaw Blades can be combined for quantity pricing.

## CRL Standard Alloy Steel 12" Hacksaw Blades

- Flexible Blade for Mild Steel, Cast Iron, Aluminum, Copper, Etc.
- Extremely Durable

CRL Standard Alloy Steel Hacksaw Blades can cut mild steel, cast iron, aluminum, copper, etc. Their flexibility reduces breakage and eliminates shattering. The Blade cuts easily and is extremely durable.

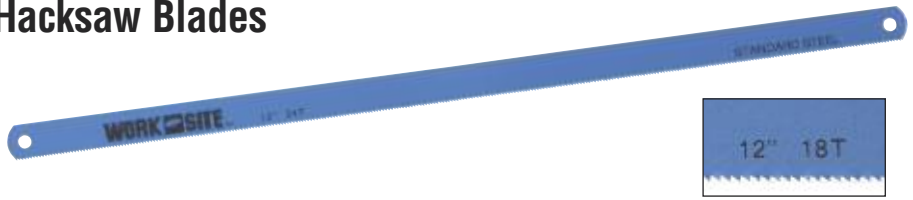

CAT. NO.	SIZE	TEETH PER INCH
<b>SL1214</b>	12" (305 mm)	14
<b>SL1218</b>	12" (305 mm)	18
<b>SL1224</b>	12" (305 mm)	24
<b>SL1232</b>	12" (305 mm)	32

Minimum order: 10 each. All Hacksaw Blades can be combined for quantity pricing.

## CRL Tungsten Carbide Hacksaw Blade

- Fits Standard 12" (305 mm) Hacksaw Frame
- Cuts Fast and Straight



The CRL Tungsten Carbide Hacksaw Blade is designed to make fast, straight, thin cuts in glass, plastic, steel cable, chain, masonry, tile or marble. It cuts both forward and reverse, and features the exclusive "grit edge" of tungsten carbide particles bonded to tough, alloy steel. Minimum order is one each.

CAT. NO. HS12CH

## CRL Stanley® 10" Mini Hacksaw

- Great for Those Hard-To-Get-At Cuts
- Individually Carded



This CRL Stanley® Mini Hacksaw tool does everything a big hacksaw does and more. A durable molded frame offers maximum hand comfort. Uses regular 10" (254 mm) hacksaw blades. Comes individually carded. Minimum order is one each.

CAT. NO. ST20807

## CRL Tungsten Carbide Rod Saw Blade

- Fits Standard 12" (305 mm) Hacksaw Frame
- Cuts Fast and Straight
- Virtually Unbreakable



The CRL Tungsten Carbide Rod Saw Blade cuts curves, contours, and patterns with both forward and reverse strokes. The exclusive "grit edge" of tungsten carbide particles is permanently bonded to tough, alloy steel. Cuts plastic, glass, fiberglass, marble, brick, etc. Minimum order is one each.

CAT. NO. RS12CH

Stanley is a registered trademark of Stanley Logistics, LLC.

## CRL Diamond Wire Form Saw

- Cuts Patterns in Glass, Stone, Quartz, Etc.
- Extremely Fine .75 mm Blade



Cut forms and shapes by hand with CRL's Diamond Wire Form Saw. Use it to cut patterns in glass, slabbed stone, agate, quartz, etc. Fits most clamp-style scroll saws with water drip systems for even faster cutting. Blade measures 5" (127 mm) long. Saw Frame and Blades sold separately. **NOTE:** Not available in Australia.

CAT. NO.	SIZE
<b>LC3104</b>	Diamond Wire Form Saw Frame
<b>LC3106</b>	.75 mm Diamond Wire Saw Blade

Minimum order: 1 each.

## CRL 750 Watt Variable Speed Reciprocating Saw With Rotating Head

- Head Rotates to Five Locked Positions
- 0-2500 SPM Variable Speed
- Tool-Less Blade Change



- 110V, 220V, and 240V Models Available



This CRL Variable Speed Reciprocating Saw cuts wood, lightweight concrete, mild steel, aluminum, plastics, drywall, stainless steel and more. Features a rotating head with five positive stops at 0, 45, 90, 135, and 180 degrees. Stroke length is 7/8" (22 mm).

CAT. NO.	DESCRIPTION
LD195	110V Reciprocating Saw
LD195AU	240V Reciprocating Saw - AU Plug
LD195EU	220V Reciprocating Saw - EU Plug
48005035	6" (152 mm) Blade – Wood and Composite Materials (6 Teeth/Inch) 5 Pack
48005037	12" (305 mm) Blade – Wood and Composite Materials (6 Teeth/Inch) 5 Pack
48001064	6" (152 mm) Blade – Wood and Composite Materials (10 Teeth/Inch) 10 Pack
48005282	6" (152 mm) Blade – Wood and Composite Materials (14 Teeth/Inch) 5 Pack
48005183	4" (102 mm) Blade – Wood and Composite Materials (18 Teeth/Inch) 5 Pack
48005284	6" (152 mm) Blade – Wood and Composite Materials (18 Teeth/Inch) 5 Pack
48005186	6" (152 mm) Blade – Wood and Composite Materials (24 Teeth/Inch) 5 Pack

Minimum order: 1 each or 1 pack.

## CRL Milwaukee 12 AMP Sawzall® Reciprocating Saw

- 0-2800 SPM Variable Speed Trigger
- Quick-Lok Blade Clamp
- Double Insulated



This CRL Milwaukee 12 AMP Sawzall® Reciprocating Saw is built with the professional in mind. It is powered by a big 12 AMP, 110V AC Milwaukee-built motor that is double-insulated and features a double bearing wobble plate mechanism for less vibration. The Quik-Lok Blade Clamp allows for faster blade changes, and the variable speed trigger operates the blade at between 0 and 2,800 strokes per minute with a 3/4" (19 mm) stroke. It uses all 1/2" (12.7 mm) shank Sawzall® Blades, and comes with two standard blades and a case to get you started.

CAT. NO.	DESCRIPTION
650931	110V Milwaukee Sawzall® Reciprocating Saw
48005035	6" (152 mm) Blade – Wood and Composite Materials (6 Teeth/Inch) 5 Pack
48005037	12" (305 mm) Blade – Wood and Composite Materials (6 Teeth/Inch) 5 Pack
48001064	6" (152 mm) Blade – Wood and Composite Materials (10 Teeth/Inch) 10 Pack
48005282	6" (152 mm) Blade – Wood and Composite Materials (14 Teeth/Inch) 5 Pack
48005183	4" (102 mm) Blade – Wood and Composite Materials (18 Teeth/Inch) 5 Pack
48005284	6" (152 mm) Blade – Wood and Composite Materials (18 Teeth/Inch) 5 Pack
48005186	6" (152 mm) Blade – Wood and Composite Materials (24 Teeth/Inch) 5 Pack

Minimum order: 1 each or 1 pack.

## CRL Makita® 12 Volt Cordless Reciprocating Saw Kit

- Compact and Lightweight for Easy, Cordless Handling
- Dual Power Control: Lever and Trigger
- Built-In L.E.D. Light Illuminates Work Area
- 0-3300 Strokes Per Minute
- Fast 110V Charge Lithium-Ion Batteries

This CRL Makita® Cordless Reciprocating Saw cuts wood, mild steel, drywall, and more with cordless convenience and versatility. Part of the Makita® 12V DC LI Tool System, it produces up to 3,300 SPM with a 1/2" (13 mm) stroke length for fast, smooth, and efficient cutting. Lock-off switch prevents accidental starts. "Tool-less" blade change system allows for faster blade installation and removal.

Milwaukee Sawzall are both registered trademarks of Milwaukee Electric Tool Corporation. Makita is a registered trademark of Makita Corporation.



CAT. NO.	DESCRIPTION
RJ01W	Cordless Reciprocating Saw, Two Batteries, Charger, Two Blades
BL1014	12V Lithium-Ion Battery Cartridge
DC10WB	110V Universal Lithium-Ion Charger
7925409	4" (102 mm) Blade – Mild Steel, Formica, Plastic (24 Teeth/Inch) 5 Pack

Minimum order: 1 each or 1 pack.



## CRL Reciprocating and Jig Saw Blades

Choosing the correct Reciprocating Saw Blade or Jig Saw Blade involves consideration of material and thickness, finished edge desired, and what kind of tool is being used. The following charts reflect the blade's teeth per inch (TPI), which dictates the quality or coarseness of the finished edge, as well as the hardness or density of the material being cut. Fewer teeth per inch usually implies heavy, coarse cutting such as opening wood cases that are nailed closed. More teeth per inch can imply finer pattern work or thin metal cutting where distortion is to be avoided. Whatever the application or tool, CRL has the most current selection of products to satisfy the requirements of your business.

### CRL Reciprocating Saw Blades



**CAT. NO. 48005035** (6 TPI) – Wood, composition materials with imbedded nails.



**CAT. NO. 48005282** (14 TPI) – Metals 1/8" (3.2 mm) or heavier, angles, bar stock.



**CAT. NO. 48005284** (18 TPI) – Heavy gauge metals, conduit, pipe, channels.



**CAT. NO. 48005186** (24 TPI) – Metal lighter than 18 gauge, trim, tubing.



**CAT. NO. 48001064**  
(10 TPI) Wood, composition materials with imbedded nails.

CAT. NO.	TPI	LENGTH	QTY/PKG
48005035	6	6" (152 mm)	5
48005037	6	12" (305 mm)	5
48001064	10	6" (152 mm)	5
48005282	14	6" (152 mm)	5
48005183	18	4" (102 mm)	5
48005284	18	6" (152 mm)	5
48005186	24	6" (152 mm)	5

Minimum order: 1 package.

### CRL Specialty Jig Saw Blades



**CAT. NO. 48420500** (6 TPI) – Fast wood finishing.



**CAT. NO. 48420540** (10 TPI) – Nail imbedded woods.



**CAT. NO. 48420101** (12 TPI) - Wood, composition materials with imbedded nails.



**CAT. NO. 48420120** (18 TPI) - Wood, composition materials with imbedded nails.



**CAT. NO. 48420140** (21 TPI) - Wood, composition materials with imbedded nails.



**CAT. NO. 7924306** T-Shank  
(8 TPI) - Wood, composition materials with imbedded nails.



**CAT. NO. 7924283** T-Shank  
(24 TPI) - Mild Steel

CAT. NO.	TPI	LENGTH	QTY/PKG
48420500	6	3-5/8" (92 mm)	5
48420540	10	3-5/8" (92 mm)	5
48420101	12	2-3/4" (70 mm)	5
48420120	18	2-3/4" (70 mm)	5
48420140	21	2-3/4" (70 mm)	5
7924306	8	4-1/8" (105 mm)	5
7924283	24	4-1/8" (105 mm)	5

Minimum order: 1 package.

### CRL Grit and Diamond Jig Saw Blades

CAT. NO.	TYPE	LENGTH	PKG
GJ1010	Grit	2-7/8" (73 mm)	1
DB20	Diamond	2-7/8" (73 mm)	1

Minimum order: 1 each.



**CAT. NO. GJ1010**  
Cuts composites, laminates, fiberglass, and tile.



**CAT. NO. DB20**  
Cuts glass and tile.

## CRL Jig Saw With LED Laser Light

- Powerful Variable Speed Motor
- Adjustable Cutting Modes
- LED or Laser Target Light

The CRL LD192 Jig Saw is packed with features to satisfy even the most demanding craftsman. This powerful double insulated tool provides a built-in LED light source to illuminate the work surface. At the flip of a switch you can change the LED light to a solid laser target line to assist in following your cut line. The motor is variable speed ranging from 500 to 3000 strokes per minute. A dust blower switch can be set to blow dust away from cutting path to keep cutting line visible. Quick change blade clamp accepts all T-shank jig saw blades (see page 451K).



**new**

CAT. NO.	DESCRIPTION
LD192	110V Jig Saw
LD192AU	240V Jig Saw w/AU Plug

Minimum order: 1 each.

## CRL Makita® 18 Volt Cordless Metal Cutting Saw

- Standard Kit and Stainless Steel Cutting Kit Available
- Uses 5-3/8" (136.5 mm) Carbide Saw Blades
- 18 Volt Lithium-Ion Batteries
- 3600 RPM No Load Speed
- 2" (51 mm) Maximum Cutting Depth
- 110 Volt Charger

The CRL Makita® 18 Volt Cordless Metal Cutting Saw is both powerful and portable. Using the latest in lithium-ion battery technology, the BCS550 represents the best of rapid charge and slow discharge cordless power tools from Makita®. The dry cutting BCS550 comes equipped with a 30 tooth 5-3/8" (136.5 mm) diameter carbide tipped saw blade engineered for mild steel or aluminum fabricating. Also included are two 18 volt 3.0Ah lithium-ion batteries and a 110 volt charger to make sure you are never out of power. Everything is packed in a sturdy plastic case.

The 56 tooth 5-3/8" (136.5 mm) A95794 Carbide Saw Blade is the first in its class designed to cut stainless steel material with a cordless saw. The ultra thin kerf (.043") provides smoother cuts with less drag on the motor and minimal material loss. Using this blade mounted on the new BCS550 cordless saw will mean more cuts per charge. **NOTE:** The A95794 is engineered for stainless steel cutting only and should not be used on aluminum.



**new**

CAT. NO.	DESCRIPTION
BCS550	18 Volt Cordless Metal Saw Kit
BCS550SS	18 Volt Cordless Metal Saw Kit with A95794 Blade for S.S.
BL1830	18V DC Lithium-Ion Battery Cartridge
DC18RA	18V Lithium-Ion Battery Charger - 110 Volt
A95794	5-3/8" (136.5 mm) 56 Tooth Carbide Blade for S.S.

Minimum order: 1 each.

## CRL Makita® 12 Volt Cordless Saw Kit

- Powerful 1400 RPM Motor
- 12 Volt Lithium-Ion Batteries
- 3-3/8" (86 mm) 20 Tooth Carbide Blade
- Ergonomic, Lightweight Design

The CRL Makita® 12 Volt Cordless Saw Kit features all new lithium-ion battery technology that allows for longer running and faster recharge cycles for almost non-stop operation. Powerful 1,400 RPM motor delivers fast cutting of plywood, MDF, particleboard, melamine, drywall, and more. Ergonomically designed handle and compact design at only 3.3 lbs. (1.5 kg) combine for reduced operator fatigue. Built-in dust blower helps keep the line-of-cut free of debris for increased accuracy. Adjustable cutting capacity from 1" (25 mm) at 90 degrees to 5/8" (16 mm) at 45 degrees. Tilting base allows for bevel cuts from 0 to 45 degrees. Each kit comes with saw, 3-3/8" (86 mm) 20 tooth carbide tipped blade, two lithium-ion 12 volt batteries, and one fast charge battery charger.

Makita is a registered trademark of Makita Corporation.

**new**



CAT. NO.	DESCRIPTION
SH01W	12V Cordless Saw Kit - 110 Volt
BL1014	12V Lithium-Ion Battery Cartridge
DC10WB	12V Lithium-Ion Battery Charger
7210038	3-3/8" Combination Blade
7922998	3-3/8" Fine Tooth Blade
NS3B	Optional Diamond Blade for Glass

Minimum order: 1 each.

## CRL Makita® 10" Compound Miter Saw

- **Powerful 15 AMP Motor Delivers 4,600 RPM**
- **Performs Bevel and Miter Cuts**
- **Performs Compound Cuts**

This CRL Makita® 10" (254 mm) Compound Miter Saw has a dual post compound-pivoting arm that bevel cuts up to 45 degrees to the left, makes miter cuts 0 to 45 degrees on the left, and 0 to 52 degrees on the right. This Saw has nine positive stops at 15, 22.5, 30, or 45 degrees right or left, and 0 degrees (90 degree cuts). Includes one 10" (254 mm) 40-tooth Carbide Tipped Blade, Socket Wrench, Dust Bag, Triangular Rule, and Vertical Vise. Arbor is 5/8" (16 mm). Minimum order is one each.



Blades for this saw can be found on pages 456K-457K.

CAT. NO. LS1040

## CRL Hitachi® 10" Sliding Dual Compound Miter Saw

- **Powerful 12 AMP Motor at 3,800 RPM (No Load) Speed**
- **Miter Cuts 57 Degrees Right and 45 Degrees Left**
- **45 Degree Bevel Angle Range to the Right and Left**
- **Linear Ball Bearing Slide System**

CRL Hitachi® 10" Sliding Dual Compound Miter Saw can perform slide cuts, precision bevel cuts up to 45 degrees left and right, and even compound cuts, as well as conventional miter cuts. This Saw has a linear ball bearing roller system for an extremely smooth slide action. The heavy-duty 12 AMP motor produces a no-load speed of 3,800 RPM's, and has an electric brake for fast stopping of blade once the power is turned off. Blade tilts 0 to 45 degrees for bevel and compound miter cutting, and has a miter range of 45 degrees left, 57 degrees right; there are 9 positive miter stops at 15, 22.5, 31.6, 45 degrees left or right and 0 degrees. Saw includes Carbide Tipped Blade, Socket Wrench, and Dust Bag. Arbor is 5/8" (16 mm). Minimum order is one each.



Blades for this saw can be found on pages 456K-457K.

CAT. NO. C10FSB

## CRL Hitachi® 15" Miter Saw

- **High Power 15 AMP Motor With Electronic Speed Control**
- **Cuts Up to 57 Degrees Right and Left**
- **Large Capacity Cutting Width**

This large capacity CRL Hitachi® 15" Miter Saw will make clean cuts up to 57 degrees left or right. The powerful 15 AMP motor develops a 3,400 RPM no load speed. The table has positive stops at nine settings, with a maximum cutting width capacity of 6-3/8" (162 mm) at 90 degrees, and 4-3/4" (121 mm) at 45 degrees. Includes 15" (381 mm) Combo Blade, Dust Bag, Vise Assembly, Extension Guide, and Wrench. Arbor is 1" (25.4 mm). Minimum order is one each.

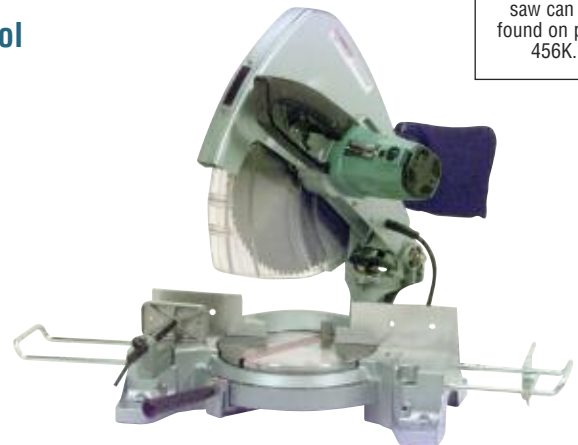

Blade for this saw can be found on page 456K.

CAT. NO. C15FB

Makita is a registered trademark of Makita Corporation.  
Hitachi is a registered trademark of Hitachi, Ltd.

## CRL Makita® 12" Cold Cut Metal Chop Saw

- Cuts Cool and Dry Mild Steel and Stainless Steel
- 12" (305 mm) Blade With 1" (25.4 mm) Arbor
- 4-1/2" (114.3 mm) Maximum Capacity at 90 Degrees

The CRL Makita® 12" (305 mm) Cold Cut Metal Chop Saw is designed to use special dry cutting carbide saw blades to cut mild steel and stainless steel with virtually no sparking, burring, or heat discoloring. Saw comes with a fixed angle head with adjustable fence/clamp stop to allow 0 - 45 degree cutting. A powerful 15 AMP, 1300 RPM motor will cut through mild steel with ease, yet cuts thin wall stainless cladding without distortion or flaring. This saw and blade combination requires no lubrication or coolant. Saw comes with one 60 tooth carbide blade, which should be used to cut mild steel and stainless steel only. Minimum order is one each.



**new**

Blades for this saw can be found on pages 456K-457K.

CAT. NO. LC1230

## CRL CTD 12" Professional Quick Index Miter Saw

- Extra Heavy-Duty Machine
- Balanced and Machined for Maximum Efficiency
- Can Be Used With Abrasive Blades

This CRL CTD 12" Professional Miter Saw is machined and balanced for maximum cutting efficiency on aluminum extrusions, non-ferrous metals, wood and other materials, including steel when an abrasive wheel is used. Will miter up to 45 degrees on each side, with positive pin stops at 90, 45, 30, 22.5, 15 and 0 degrees. The operator is protected by the enclosure around the blade and belt drive. The slotted key fences are adjustable, and always remain square to the blade. These professional Miter Saws are made of iron castings that are precision machined and ground to ensure long life and accurate cuts every time. Spindle and pivot shafts have pre-loaded, sealed ball bearings. The two horsepower, fan cooled, totally enclosed, one or three phase motor develops 3,700 RPM. These quality saws are the optimum in cutting performance and efficiency. Arbor is 1" (25.4 mm). Minimum order is one each.

\*Please specify voltage requirements at time of order:  
1/60/120 or 3/60/230.



Blades for this saw can be found on pages 456K-457K.

CAT. NO. M25R\*

## CRL Makita® Portable Band Saw

- Variable Speed Dial for Optimum Cutting Speed
- Powerful 6.5 AMP Motor for the Toughest Jobs
- Blade Tightening Lever for Fast and Easy Blade Installation

This Makita® Portable Band Saw cuts up to 4-3/4" (121 mm) material to handle most requirements, and uses standard 44-7/8" x 1/2" (1140 x 13 mm) metal cutting blades.

Cutting speeds range from 200 to 350 feet (61 to 106 m) per minute for common metals including: aluminum, brass, chrome, copper, iron, mild steel, and stainless steel. For accurate cuts this tool features dual-bearing blade guides, adjustable stopper plate, and a fluorescent job light. Included with the saw are one each Band Saw Blade, Hex Wrench, Wrench Holder, and Plastic Case. Cutting capacities for round materials: 4-3/4" (120 mm); for rectangular materials: 4-3/4" x 4-3/4" (120 x 120 mm). The Bi-Metal Blade lasts up to three times longer than carbon steel blades.

Makita is a registered trademark of Makita Corporation.



Bi-Metal Blade

CAT. NO.	DESCRIPTION
2107FK	Portable Band Saw
792556A	18 Teeth/Inch Replacement Bi-Metal Blade

Minimum order: 1 each.

## CRL Makita® General Purpose Specialty Saw Blade

- 4" (102 mm) Diameter
- 5/8" - 7/8" (16 - 22 mm) Arbor



CAT. NO. A94546

This CRL Makita® 4" (102 mm) General Purpose Specialty Saw Blade is a diamond rim blade with a 5/8" (16 mm) arbor diameter and a removable insert to accommodate 7/8" (22 mm) arbor saws. An excellent blade for cutting most masonry, except granite or ceramics. Can be used wet or dry. Minimum order is one each.

## CRL Makita® 12 Tooth Combination Wood Saw Blade

- 4-3/8" (111 mm) Diameter
- 20 mm Arbor



CAT. NO. A90093

The CRL Makita® 4-3/8" (111 mm) Combination Wood Saw Blade is carbide tipped and is an excellent choice for smaller battery powered circular saws. This general purpose blade works with both hard and soft woods, as well as particle board. Minimum order is one each.

## CRL 40 Tooth Combination Saw Blade

- 7-1/4" (184 mm) Diameter
- 1/2" - 5/8" (12.7 - 16 mm) Arbor



CAT. NO. F40714

This CRL Fire-Tooth Combination Saw Blade has 40 flame hardened steel teeth to stay sharp longer. This blade can be used for either cross-cutting or ripping. Minimum order is one each.

## CRL 60 Tooth Combination Saw Blade

- 7-1/4" (184 mm) Diameter
- 1/2" - 5/8" (12.7 - 16 mm) Arbor



CAT. NO. F37714

This CRL Fire-Tooth Combination Saw Blade has 60 flame hardened steel teeth to stay sharp longer. This blade can be used for either cross-cutting or ripping. Minimum order is one each.

## CRL Carbide Tipped Wood Saw Blade

- 7-1/4" (184 mm) Diameter
- 5/8" (16 mm) Arbor



CAT. NO. 721251A

This CRL 40 Tooth Carbide Tipped Saw Blade is an excellent choice for cutting all types of wood. Minimum order is one each.

## CRL Tungsten Carbide Saw Blade

- 7" (178 mm) Diameter
- 1/2" - 5/8" (12.7 - 16 mm) Arbor



CAT. NO. GC703

The CRL 7" (178 mm) Tungsten Carbide Saw Blade is good for cutting fiberglass, tempered hardwood, composite boards, and laminates. Minimum order is one each.

Makita is a registered trademark of Makita Corporation.

## CRL Cougar Carbide Tipped Saw Blades

- Superior Cutting of Aluminum, Copper, Brass and Magnesium
- Cuts Fast and Clean



- Available in Two Diameters

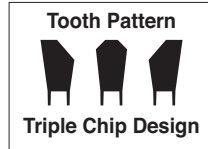

The CRL Cougar Carbide Tipped Saw Blade is perfect for cutting aluminum extrusions, copper, brass, and magnesium of all types. The triple chip tooth design on these blades gives fast, clean, smooth finish cuts. Blade lubricant is required during operation. The two diameters fit the most popular circular, chop and cutoff saws.

CAT. NO.	DIAMETER	ARBOR	NO. OF TEETH
<b>CT10X100</b>	10" (254 mm)	5/8" (16 mm)	100
<b>CT12X120</b>	12" (305 mm)	5/8" (16 mm)	120

Minimum order: 1 each.

## CRL Nordic Carbide Tipped Saw Blades

- Triple Chip Design for Aluminum Extrusions

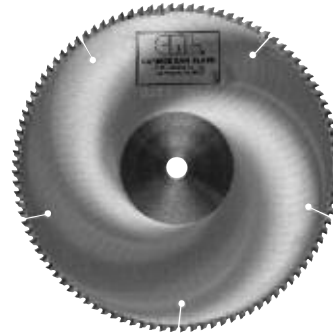

- Available in Five Diameters

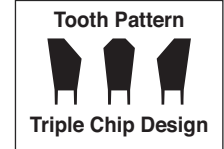

This CRL Nordic Blade is designed with the tip inserted into the blade for maximum strength. These Blades cut all types of aluminum, magnesium, copper, and brass – both hardcoat and standard finishes. They give clean cuts with a smooth finish.

**NOTE:** A lubricant should be used and the material must always be held down securely.

CAT. NO.	DIAMETER	ARBOR	NO. OF TEETH
<b>CSB9X90AX</b>	9" (209 mm)	5/8" (16 mm)	90
<b>CSB10X100AX</b>	10" (254 mm)	5/8" (16 mm)	100
<b>CSB12X120AX</b>	12" (305 mm)	5/8" (16 mm)	120
<b>CSB12X120X1AX</b>	12" (305 mm)	1" (25.4 mm)	120
<b>CSB14X120AX</b>	14" (356 mm)	1" (25.4 mm)	120
<b>CSB15X100AX</b>	15" (381 mm)	1" (25.4 mm)	100

Minimum order: 1 each.

## CRL High-Speed Saw Blades

- Thin Wall, Light Aluminum Extrusions
- Hollow Ground for Side Clearance



CRL high-speed, hollow ground steel Blades for cutting thin wall aluminum extrusions or rollformed shapes, brass, copper tubing, and other non-ferrous metals. Use on radial-arm saws, table saws, chop saws, and double miter saws. The Cat. No. SHS10X200 Blade is an excellent choice for thin wall, rollformed screen frame.

CAT. NO.	DIAMETER	ARBOR	NO. OF TEETH
<b>2303928</b>	9" (229 mm)	5/8" (16 mm)	120
<b>SHS10X200</b>	10" (254 mm)	5/8" (16 mm)	200

Minimum order: 1 each.

## CRL Nordic "ATX" Carbide Tipped Saw Blades

- For Thin Wall Aluminum Extrusions

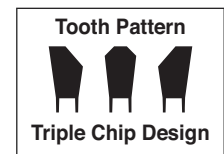

CRL Nordic "ATX" Saw Blades are built with a maximum number of teeth to give clean, burr-free cuts on thin-walled extrusions such as window screen frame. They are hollow ground to prevent kickback, and the teeth are inserted to give maximum tip strength.

**NOTE:** A lubricant must be used and the material must be held down securely while cutting. Exception is for insulating spacer and muntin bars, which should be dry cut.

CAT. NO.	DIAMETER	ARBOR	NO. OF TEETH
<b>CSB10X144ATX</b>	10" (254 mm)	5/8" (16 mm)	144
<b>CSB12X150ATX</b>	12" (305 mm)	5/8" (16 mm)	150

Minimum order: 1 each.

## CRL Semi-High Speed Aluminum Cutting Blades

### • For Aluminum, Brass, and Copper

CRL Semi-High Speed Aluminum Cutting Blades are constructed to withstand the excessive pressure encountered during metal cutting. They are particularly suited for cutting non-ferrous metals such as aluminum, brass and copper. All diameters have type "A" teeth grind for use with circular, radial arm, or chop saws.

CAT. NO.	DIAMETER	ARBOR	NO. OF TEETH
SHS9X150	9" (229 mm)	5/8" (16 mm)	150
SHS10X150	10" (254 mm)	5/8" (16 mm)	150
SHS12X150	12" (305 mm)	1" (25.4 mm)	150
SHS14X150	14" (355 mm)	1" (25.4 mm)	150

Minimum order: 1 each.

### • Available in Four Diameters



## CRL Nordic Carbide Tipped Saw Blades

### • For Plastics

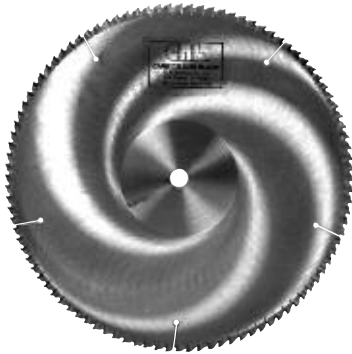

### • Available in Two Diameters

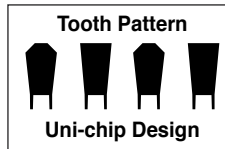

These CRL Nordic Blades are designed to give clean, chip-free cutting on formica, acrylics, plexiglas, heavy wall PVC pipe, and other hard plastics. Uni-chip design tooth pattern makes cutting smooth and fast.

CAT. NO.	DIAMETER	ARBOR	NO. OF TEETH
CSB10X80P	10" (254 mm)	5/8" (16 mm)	80
CSB10X100P	10" (254 mm)	5/8" (16 mm)	100
CSB12X100P	12" (305 mm)	5/8" (16 mm)	100

Minimum order: 1 each.

## CRL Nordic Carbide Tipped Saw Blade

### • For Picture Frame and Other Wood Moldings

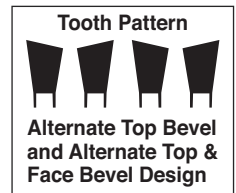

This crosscutting CRL Nordic Blade is designed with the alternate top bevel grind with face bevel to cut off lengths of trim wood with extreme smoothness and no splinters. Used for cutting moldings, picture frames and other wood cutting operations that require a quality cut.

CAT. NO.	DIAMETER	ARBOR	NO. OF TEETH
CSB10X80CCFB	10" (254 mm)	5/8" (16 mm)	80

Minimum order: 1 each.

## CRL Resinoid Metal Cutting Blades

### • Fast Cutting for a Variety of Metals

CRL Resinoid Metal Cutting Blades are fully reinforced with two layers of high-tensile strength fiberglass. They are specially designed for fast cutting of a variety of metals, including structural steel, stainless steel, and metal rod. Available in three popular saw blade diameters.



CAT. NO.	DIAMETER	ARBOR
MCB7	7" (178 mm)	Diamond or 5/8" (16 mm)
MCB10	10" (254 mm)	Diamond or 5/8" (16 mm)
MCB12	12" (305 mm)	1" (25.4 mm)

Minimum order: 1 each.

## CRL Resin Bond Diamond Blades

### • Exceptionally Smooth Cutting Action • Can Eliminate Secondary Grinding

This CRL Resin Bond Diamond Blade uses a softer bond to allow for the fine grit sizes recommended for use in chop saws and precision equipment. Resin Bond Diamond Blades offer the best finish, less chipping, and can eliminate secondary grinding applications. Designed for use with the TMB100 Diamond Miter Saw. Resin Bond Blades are more forgiving than other blades, so the finish is superior to metal bond blades.



CAT. NO.	DIAMETER	ARBOR	BOND
TMB110B	8" (203 mm)	3/8" (9.5 mm)	Resin
B10DB	10" (254 mm)	5/8" (16 mm)	Resin

Minimum order: 1 each.

## What is Carbide?

Carbide is an alloy composed of Cobalt and Tungsten. When used in the manufacture of saw blades this alloy produces longer lasting tips, sharper cutting edges, and greater impact resistance.

## What are the Advantages of Carbide Tips?

A Carbide tipped blade will stay sharp approximately 10 times longer than an ordinary steel blade. The reason is that Tungsten Carbide, a man-made substance, is one of the hardest materials on earth.

## Care of Carbide Blades:

How well you take care of your blades results in how well and accurately they cut. Here are a few simple rules:

1. Do not drop the blade. Even a short drop of 2 to 3 feet can ruin a blade.
2. Keep the blade clean. Whenever a build-up of resins is visible, use cleaners such as Simple Green® or 409® to remove the build-up before it becomes excessive.
3. When feed becomes difficult, have the blade sharpened by a professional saw sharpener.
4. Store blades flat on wood or cork surfaces. Do not stack blades on top of one another unless wood, cork or cardboard is between them. Carbide is very hard but is also brittle and will chip if carbide hits carbide.
5. Protect blades from rust. Spray with lubricants such as WD-40® or Top-Cote when not in regular use. When any of these substances are used, be sure to run blades through a couple feet of scrap before running project material.

## Available Types of Carbide Tipped Tooth Configurations:

### SQUARE TOP TOOTH

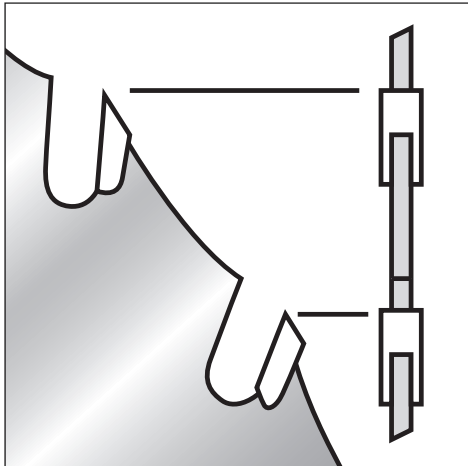

The top of each tooth is ground square, perpendicular to the sides of the blade. Square Top grinds are designed for heavy-duty cutting.

### ALTERNATE TOP BEVEL

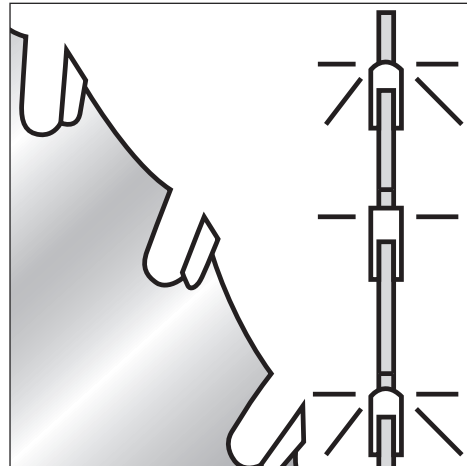

The first tooth has a double 45 degree angle corner bevel followed by a flat top raker tooth ground lower than the lead tooth. This type of tip combines balanced cutting and free chip flow. For use on hardwood, plastics, and plastic laminated to wood.

### TRIPLE CHIP

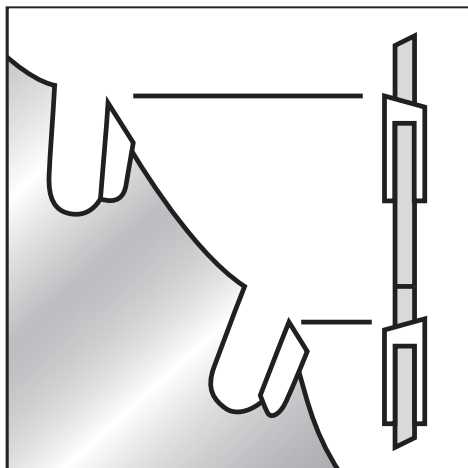

Tops of alternating teeth are beveled to one side of the blade or the other at 15 degrees. This type of tip provides a neat chipping action for very fine finishes. It is used on plywood, veneer, hardboard, fiberboard, and particle board.

### PLANER - COMBINATION

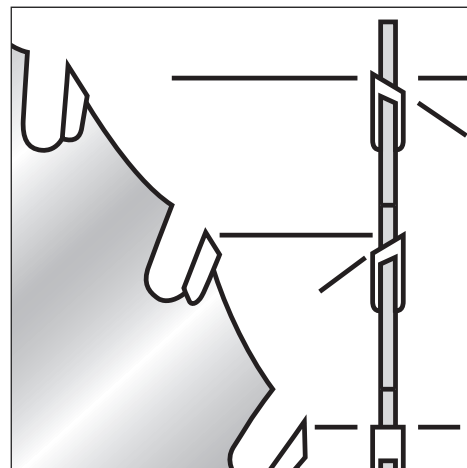

This tip combination provides four alternate top bevel teeth with one raker. The raker removes the v-shaped material left in the center of the cut by alternating top bevel teeth. This tooth configuration provides a very smooth cut.

Simple Green is a registered trademark of Sunshine Makers, Inc.  
409 is a registered trademark of The Clorox Company.  
WD-40 is a registered trademark of WD-40 Company.



## CRL Tube Wax Lubricant

- **Increases Tool Life**
- **Reduces Screw Breakage and Speeds the Installation By Lubricating the Threads**
- **Improves Finish and Performance**

CRL Tube Wax Lubricant is a special formulation of solid waxes that comes in a convenient, soft stick. Use it for all sawing, grinding, drilling, tapping, sanding, and fastening operations to increase production quality and extend tool life. The tube is easy to handle, neat, and requires no special storage. Net weight 15 ounces (425 g), 24 per case. Minimum order is one each.



CAT. NO. WS140

## CRL Spray Mist Coolant

- **For Use With Mist Coolant Unit**
- **Water Soluble, Easy Cleanup**
- **Increases Blade Life and Helps Produce Cleaner Cuts**



Use this water soluble CRL Spray Mist Coolant in machining and sawing all metals. It has a unique group of corrosion inhibitors, lubricants, and surface active materials blended to provide superior blade life and produce fine finishes. It is designed for dilution with water at a 40 to one ratio under normal use. Excellent for use with the CRL Spray Mist Coolant Unit.

CAT. NO.	ARBOR
SMC20001	1 Gallon (3.8 l)
SMC20005	5 Gallons (19 l)

Minimum order: 1 each.

## CRL Spray Mist Coolant Unit

- **Keeps Saw Blade Cool During Cutting Operations**
- **Fully Adjustable Swivel Spray Head**
- **Works With Standard Air Line**



The CRL Mist Coolant Unit has just about everything you need to lubricate your saw blade professionally. Just add an air supply, the liquid siphon tube can go into any open container. The magnetized base holds firmly, and the swivel spray head will adjust to any direction. It comes with separate adjustments for air and fluid. Minimum order is one each.

CAT. NO. MCU270

# CRL MITER SAW TABLES AND STANDS

For Pricing Visit [crlaurence.com](http://crlaurence.com) or Call Us Toll Free at the Phone Numbers Shown on the Back Cover

## CRL Miter Saw Table Kit

- **Sturdy Painted Steel Framing Locks Into Place With the Tap of a Mallet – No Bolts Required!**
- **All You Supply is 1/2" or 3/4" (12 or 19 mm) Plywood or Particleboard and Your Miter Saw**
- **Work Surface Height is 36" (914 mm), Middle Shelf Height is Adjustable**

Here is a quick, easy way to make the cutting area in your shop more efficient. The CRL Miter Saw Table Kit ships to you conveniently via U.P.S. oversized in three cartons. Once assembled the 18' (5.48 m) table can handle just about any cutting need. It has a comfortable 36" (914 mm) work height, and the 24" (610 mm) depth allows you plenty of table surface to work on. The additional cross members let you convert this space into usable storage for your supplies and tools. The only items you need to provide are the pieces of 1/2" or 3/4" (12 or 19 mm) particleboard or plywood and your miter saw.

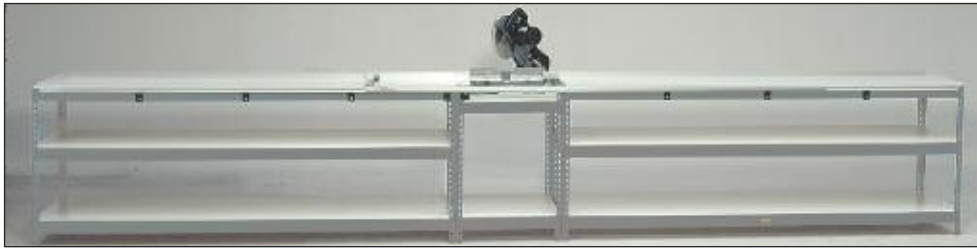

**CAT. NO. P8061R**

Shown with E-Z Slide Cut-Off Gauge, and Miter Saw which must be ordered separately

## CRL Portable Miter Saw Table Kit

- **35-1/4" Wide x 16-1/2" Deep x 44-1/2" High (895 x 419 x 1130 mm) When Hinged Extensions are Folded**
- **102" (2590 mm) Maximum Width With Extensions Open**
- **Left Side Fence Calibrated for Miter Cuts; Right Side for Square Cuts**
- **Built-In Adjustable Measuring Device for Extended Length Measuring**
- **Easy Rolling Lockable Casters**

Want to be able to move your miter saw around the shop or use it efficiently on the job site? CRL has just what you need with our Portable Miter Saw Table Kit. The table has a fence clamp for accurate measurements. The built-in adjustable measuring device allows for extended length measuring. The table arrives at your shop partially assembled. All you need to add is your miter saw. Table height is adjustable to match several brands of miter saws. Minimum order is one each.

**NOTE:** Table Kit can ship via U.P.S. at 'oversize' rates.



Miter Saw Not Included

- **Some Assembly Required**

**CAT. NO. P8077R**



Shown Fully Extended



**C.R. LAURENCE COMPANY**

[crlaurence.com](http://crlaurence.com) | [usalum.com](http://usalum.com)

**USA ALUMINUM 460K** | [crlaurence.ca](http://crlaurence.ca) [crlaurence.com.au](http://crlaurence.com.au) [crlaurence.co.uk](http://crlaurence.co.uk) [crlaurence.de](http://crlaurence.de) [crlaurence.eu](http://crlaurence.eu)

## CRL E-Z Slide Cut-Off Gauge

- Fast and Accurate Lineal Measuring
- Measures Stock Lengths From 6" (152 mm) to 108" (2.74 m)
- Easy-to-Read Measurement Indicator
- Made of Extruded Aluminum
- Choose From Left Hand or Right Hand Models

The CRL E-Z Slide Cut-Off Gauge provides accurate lineal cuts with fast length change capability. Simply lift and slide the bar clamp to the appropriate dimension and flip the slide bar clamp to secure the stop.

All measurements are read directly in front of the chop saw for maximum operator efficiency. The stop arm allows you to cut multiple same length pieces with one cut. Stock lengths from 6" (152 mm) to 108" (2.74 m) can be measured.

The CRL E-Z Slide Cut-Off Gauge mounts easily to your existing bench or our Cat. No. P8061R Miter Saw Table Kit shown at the bottom of this page. Full mounting instructions are included.



Left Hand E-Z Slide Cut-Off Gauge Cat. No. P7926 Shown.



Measurement Indicator

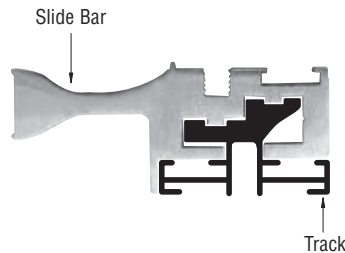

**NOTE:** Recommended gauge selection if the operator is left-handed, order a Cat. No. P7925 Right Hand Cut-Off Gauge. If the operator is right-handed, order a Cat. No. P7926 Left Hand Cut-Off Gauge.

CAT. NO.	DESCRIPTION
P7925	Right Hand E-Z Slide Cut-Off Gauge
P7926	Left Hand E-Z Slide Cut-Off Gauge
P7927	Right Hand Cut-Off Gauge Replacement Tape
P7928	Left Hand Cut-Off Gauge Replacement Tape

Minimum order: 1 each.

## CRL Snow Cut-Off Gauge and Accessories

- Sets and Locks in a Single Operation
- Provides Precise Accuracy
- Cut Any Angle
- Made of Solid Steel



Measuring Tape



Indicator Plate

The Snow Cut-Off Gauge measures from 0" to 108" (2.75 m) with hairline accuracy without the operator changing position. Just raise operating bar, slide to desired length, drop bar and gauge is locked in position. It is installed on the front of your existing bench. Stop arms designed for easy removal, leaving the bench top clear and giving you a "straight edge" stop the full width of your bench, allow you to cut more than one piece at a time.

It speeds production because it's fast, accurate, and easy to use. Positive setting eliminates unnecessary set-up time, and a measuring scale is visible at all times. Gauge is set and secured in position by positive locking steel cams controlled by an operating bar directly in front of the operator. Can be easily installed on your existing bench whether on a solid or roller top. Just attach a 3/8" (9.5 mm) spacer, then a straight two by four along the face of the bench, install gauge on the top of the two by four, mount the gauge indicator at the cutting line, and you're ready to start cutting. The Snow Cut-Off Gauge features heavy steel construction for a long, rugged life and can be used indoors or out.



Snow Cut-Off Gauge in Installed Position

CAT. NO.	DESCRIPTION
M6ML	Left Hand 90 Degree Snow Cut-Off Gauge
M6MR	Right Hand 90 Degree Snow Cut-Off Gauge
AP63L	Left Hand Measuring Tape
AP63R	Right Hand Measuring Tape
AP69	Indicator Plate

Minimum order: 1 each.

## CRL Aluminum Extrusion Notching Saw

- Cuts Storefront Extrusion With Accuracy
- Portable and Lightweight for On-the-Job Use
- Adjustable Cutting Height and Length
- Includes One Blade



CAT. NO. NS450  
Notching Saw



CAT. NO. 412  
Saw Blade  
1/8" x 5" x 1"  
(3.2 x 127 x 25 mm)

This is a new and improved model of our Aluminum Extrusion Notching Saw, which makes working with storefront metals safer and easier. The 115V AC 1/2 HP motor has a thermally protected circuit to avoid overheating. For safety, the momentary actuated switch doesn't let the machine operate without your hands being on it. All of the machine bearings are sealed and self-lubricating for low-maintenance operation. Heavy-duty machine table and legs support your work.

The NS450 is stronger and lighter than previous models, it weighs just 67 pounds (30 kg). Overall machine dimensions are 19"H by 18"W by 20"D (483 x 457 x 508 mm). Ships common carrier only. For Replacement Blades order Cat. No. 412. Minimum order is one each.

## CRL Universal Drill Jigs



CAT. NO. 40J  
Single Jig for Vertical Tubing

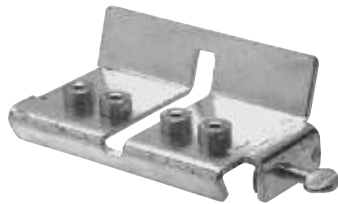

CAT. NO. 45J  
Single Jig for Horizontal Tubing

- Available for Either Vertical or Horizontal Storefront Tube Applications

These heavy-gauge steel drill jigs are designed to quickly and accurately position the mounting holes on 4" (102 mm) storefront tubes for mounting Cat. No. BPF4 Brackets. **NOTE:** These Jigs will not work with Vistawall, YKK, or Kawneer Brand Tubes. Minimum order is one each.

## CRL Storefront Brackets

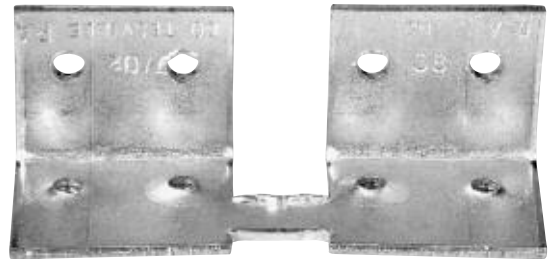

- Fits Plain or Fin Tube
- Can Be Used on 4", 4-1/2", and 5" (102, 114, and 127 mm) Tubes

CRL Storefront Brackets are made from heavy, 12-gauge cadmium plated steel. These Brackets are punched and dimpled where necessary. The dimpled holes have been tapped for #10-24 screws. Minimum order is one each.

CAT. NO. BPF4

## CRL Steel Reinforcement Backing Plates

- Used to Mount Door Hinges to Storefront Tubes
- Non-Handed, Can Be Used for Both Door and Frame Reinforcement

CRL Reinforcement Backing Plates are made from heavy-gauge plated steel. They are non-handed, and tapped for standard #12-24 machine screws to mount the plate to the frame or door.



CAT. NO. MHT4

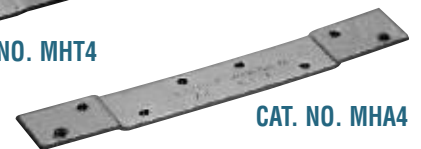

CAT. NO. MHA4



CAT. NO. 2302710



CAT. NO. 2302711

CAT. NO.	APPLICATION	LENGTH
MHT4	For Standard Weight 4-1/2" (114 mm) Butt Hinges	8" (203 mm)
MHA4	For Heavy Weight 4-1/2" (114 mm) Butt Hinges	8" (203 mm)
2302710	For Standard Weight 5" (127 mm) Butt Hinges	8-1/2" (216 mm)
2302711	For Standard Intermediate Pivots	9" (229 mm)

Minimum order: 1 each. All Backing Plates can be combined for quantity pricing.

## CRL Center Glazed Storefront Drill Jig

- For U.S. Aluminum 400-S and 450-S Series Storefronts

This CRL Drill Jig is designed for use on our U.S. Aluminum Center Glazed 400-S and 450-S Series storefront extrusions. The precision made steel Jig fits onto the vertical extrusion providing a template to accurately drill holes for the shear blocks. Minimum order is one each.



CAT. NO. DJ025

## CRL Center Glazed Storefront Drill Jig

- For U.S. Aluminum 451, 451-S, and IT451 Series Storefronts

This CRL Drill Jig is designed for use on our U.S. Aluminum Center Glazed 451, 451-S, and IT451 Series storefront extrusions. The precision made steel Jig fits onto the vertical extrusion providing a template to accurately drill holes for the screw spline and shear blocks. Minimum order is one each.



CAT. NO. DJ125

## CRL Center Glazed Storefront Drill Jig

- For U.S. Aluminum 400 and 450 Series Storefronts

This CRL Drill Jig is designed for use on our U.S. Aluminum Center Glazed 400 and 450 Series storefront extrusions. The precision made steel Jig fits onto the vertical extrusion providing a template to accurately drill holes for the screw spline. Minimum order is one each.

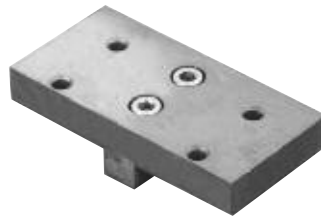

CAT. NO. DJ050

## CRL Center Glazed Storefront Drill Jig

- For U.S. Aluminum IT451 Series Storefronts

This CRL Drill Jig is designed for use on our U.S. Aluminum Center Glazed IT451 Series storefront extrusions. The precision made steel Jig fits onto the vertical extrusion providing a template to accurately drill holes for the shear blocks. Minimum order is one each.



CAT. NO. DJ150

## CRL Flush Front Storefront Drill Jig

- For U.S. Aluminum FF450 Series Storefronts

This CRL Drill Jig is designed for use on our U.S. Aluminum Flush Front FF450 Series storefront extrusions. The precision made steel Jig fits onto the vertical extrusion providing a template to accurately drill holes for the screw spline. Minimum order is one each.



CAT. NO. DJ452

## CRL Flush Front Storefront Drill Jig

- For U.S. Aluminum FF601 and FT601 Series Storefronts

This CRL Drill Jig is designed for use on our U.S. Aluminum Flush Front FF601 and FT601 Series storefront extrusions. The precision made steel Jig fits onto the vertical extrusion providing a template to accurately drill holes for the screw spline. Minimum order is one each.



CAT. NO. DJ752

## CRL Flush Front Storefront Drill Jig

- For U.S. Aluminum FF451 and FT451 Series Storefronts

This CRL Drill Jig is designed for use on our U.S. Aluminum FF451 and FT451 Series Storefront extrusions. The precision made steel Jig fits onto the vertical extrusion providing a template to accurately drill holes for the screw spline. Minimum order is one each.



CAT. NO. DJ552

## CRL Flush Front Storefront Drill Jig

- For U.S. Aluminum FF600 Series Storefronts

This CRL Drill Jig is designed for use on our U.S. Aluminum FF600 Series Storefront extrusions. The precision made steel Jig fits onto the vertical extrusion providing a template to accurately drill holes for the screw spline. Minimum order is one each.



CAT. NO. DJ652

## CRL Storm Front™ Storefront Drill Jig

- Reversible Jig for U.S. Aluminum IG500 and IG600 Series Storefronts

This CRL Drill Jig is reversible for use on our U.S. Aluminum IG500 and IG600 Series Storefront extrusions. The precision made steel Jig fits onto the vertical extrusion providing a template to accurately drill holes for the screw spline. Minimum order is one each.



CAT. NO. DJ801

## CRL Storm Front™ and Blast Storefront Drill Jig

- For U.S. Aluminum IT601, BT601, and BR606 Series Storefronts

This CRL Drill Jig is designed for use on our U.S. Aluminum IT601, BT601, and BR606 Series Storefront extrusions. The precision made steel Jig fits onto the vertical extrusion providing a template to accurately drill holes for the screw spline. Minimum order is one each.



CAT. NO. DJ601

## CRL Top Notch Window Wall Drill Jig

- For U.S. Aluminum TN451, TT451, TN601, and TT601 Series Window Walls

The CRL Drill Jig is designed for use on our U.S. Aluminum TN451, TT451, TN601, and TT601 Window Wall extrusions. The precision made steel Jig fits onto the head, sill, and vertical extrusions providing a template to accurately drill holes for the screw spline. Minimum order is one each.



CAT. NO. DJ456

## CRL Accufab Pro Curtain Wall and Storefront Tools

**new**

- Shear Block Positioning System
- Cuts Fabrication Times by 75% or More
- See Pages 468K - 469K for Information



## CRL OS-2 Window Wall Drill Jig

- For U.S. Aluminum OS450, OS450SG, OS451, and OS451SG Series Window Walls

This CRL Drill Jig is designed for use on our U.S. Aluminum OS450/OS450SG and OS451/OS451SG OS-2 Series window wall extrusions. The precision made steel Jig fits onto the vertical extrusion providing a template to accurately drill holes for the AP463 and AP563 Anchor Clips. Minimum order is one each.

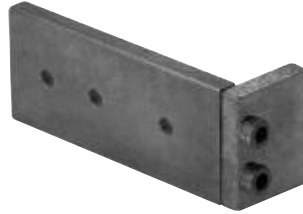

CAT. NO. DJ210

## CRL OS-2 Window Wall Drill Jig

- For U.S. Aluminum OS600, OS600SG, OS601, and OS601SG Series Window Walls

This CRL Drill Jig is designed for use on our U.S. Aluminum OS600/OS600SG and OS601/OS601SG OS-2 Series window wall extrusions. The precision made steel Jig fits onto the vertical extrusion providing a template to accurately drill holes for the AP664 and AP764 Anchor Clips. Minimum order is one each.



CAT. NO. DJ650

## CRL Window Wall Drill Jig

- For U.S. Aluminum BG450, BG525, and BT525 Series Window Walls

This CRL Drill Jig is designed for use on our U.S. Aluminum BG450, BG525, and BT525 Series window wall extrusions. The precision made steel Jig fits onto the vertical extrusion providing a template to accurately drill holes for the AP555 Anchor Clips. Minimum order is one each.



CAT. NO. DJ525

## CRL Curtain Wall Drill Jig

- For U.S. Aluminum 2100 Series Curtain Wall

This CRL Drill Jig is designed for use on our U.S. Aluminum 2100 Series curtain wall extrusions. The precision made steel Jig fits onto the vertical extrusion providing a template to accurately drill holes for the horizontal members and Anchor Clips. Minimum order is one each.

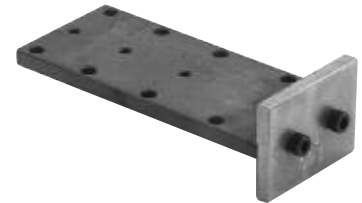

CAT. NO. DJ021

## CRL Curtain Wall Drill Jig

- For U.S. Aluminum 2200 Series Curtain Wall

This CRL Drill Jig is designed for use on our U.S. Aluminum 2200 Series curtain wall extrusions. The precision made steel Jig fits into the vertical extrusion providing a template to accurately drill holes for the horizontal members and Anchor Clips. Minimum order is one each.

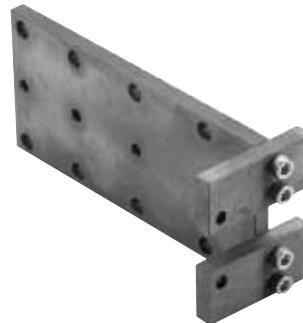

CAT. NO. DJ020

## CRL Curtain Wall Drill Jig

- For U.S. Aluminum 3150 and 3250 Series Curtain Wall

This CRL Drill Jig is designed for use on our U.S. Aluminum 3150 and 3250 Series curtain wall extrusions. The precision made steel Jig fits onto the extrusion providing a template to accurately drill holes in the vertical and horizontal members for the shear blocks. Minimum order is one each.



CAT. NO. DJ360

## CRL Curtain Wall Drill Jig

- For U.S. Aluminum 4250 Series Curtain Wall

This CRL Drill Jig is designed for use on our U.S. Aluminum 4250 Series curtain wall extrusions. The precision made steel Jig fits onto the vertical extrusion providing a template to accurately drill holes for the AP603 Anchor Clips. Minimum order is one each.



CAT. NO. DJ610

## CRL Curtain Wall Drill Jig

- For U.S. Aluminum 4250T Series Curtain Wall

This CRL Drill Jig is designed for use on our U.S. Aluminum 4250T Series curtain wall extrusions. The precision made steel Jig fits onto the intermediate horizontal extrusion providing a template to accurately drill holes for the AP603 Anchor Clips. Minimum order is one each.



CAT. NO. DJ620

## CRL Curtain Wall Drill Jig

- For U.S. Aluminum 4500 Series Curtain Wall

This CRL Drill Jig is designed for use on our U.S. Aluminum 4500 Series curtain wall extrusions. The precision made steel Jig fits onto the vertical extrusion providing a template to accurately drill holes for the shear blocks. Minimum order is one each.



CAT. NO. DJ750

## CRL Curtain Wall Drill Jig

- For U.S. Aluminum 4500SG Series Curtain Wall

This CRL Drill Jig is designed for use on our U.S. Aluminum 4500 Series curtain wall extrusions. The precision made steel Jig fits onto the vertical extrusion providing a template to accurately drill holes for the screw spline. Minimum order is one each.



CAT. NO. DJ751

## CRL Curtain Wall Drill Jig

- For U.S. Aluminum IW3250 Series Curtain Wall

This CRL Drill Jig is designed for use on our U.S. Aluminum IW3250 Series Impact Resistant curtain wall extrusions. The precision made steel Jig fits onto the vertical extrusion providing a template to accurately drill holes for the shear blocks. Minimum order is one each.



CAT. NO. DJ960

## CRL Curtain Wall Drill Jig

- For U.S. Aluminum BW3250 Series Curtain Wall

This CRL Drill Jig is designed for use on our U.S. Aluminum BW3250 Series blast resistant curtain wall extrusions. The precision made steel Jig fits onto the vertical extrusion providing a template to accurately drill holes in the vertical and horizontal members for the shear blocks. Minimum order is one each.



CAT. NO. DJ970



## CRL Hydrapunch™ Machine **new**

- Punches Four Holes at Once in Storefront or Curtain Wall Metal
- Reduces Shop Fabrication Time
- Hydraulic Operation - 110 Volts

The CRL Hydrapunch™ Machine is a multi-head machine with pre-set dies for quickly and accurately punching holes in the open back vertical mullion/filler of our popular center glazed systems - 1/4" and 1" infills. Simply insert the vertical mullion/filler into the die set, align against the pre-set flip stop, push the pedal and the Hydrapunch™ Machine punches four holes at one time.

No need to measure and drill each hole in CRL/U.S. Aluminum framing systems. Get a perfect fit every time and eliminate the most common fabrication errors. Minimum order is one each.

The Hydrapunch™ Machine comes with one die set which punches the following U.S. Aluminum Center Glazed Storefront Systems:

- Series 400 - 1/4" glazing
- Series 450 - 1/4" glazing
- Series 451 - 1" glazing
- Series IT451 - 1" glazing

Optional die sets for these popular U.S. Aluminum Systems are also available:

- Thermo-Set Systems
- Flush Front Systems
- Series 2200 Curtain Wall
- Series 3150 Curtain Wall
- Series 3250 Curtain Wall
- Series 4500 Curtain Wall

For additional information contact U.S. Aluminum Technical Sales at (800) 262-5151 and ask for Extension 5305.



CAT. NO. HM00100

## CRL Phillocraft® Pow-R-Pax® Production Table **new**

- 36" Wide by 96" Long Production Table
- Legs Adjust From 33" to 37" High
- Sturdy 12 Gauge Steel Frame
- Ships K.D.

The Phillocraft® Pow-R-Pax® Production Table is infinitely expandable to meet your current or future needs. Begin with a 96" (2438 mm) starter and expand with 48" (1219 mm) add-ons as your needs grow. The frame is made of heavy 12 gauge "C"-channel steel. The table top is 1" (25 mm) thick hardboard over a high-density flake core. Invisible steel spline clamping bars connect the tops to form a smooth, continuous surface. Adjustable legs allow for the table height to vary from 33" to 37" (838 to 940 mm). The table has a load rating of 100 lbs. (45 kg) per square foot. Frame color is putty. Table ships K.D. and requires some assembly. For additional information contact the CRL Customer Service Department at (800) 421-6144 and ask for Ext. 5275. Minimum order is one each.

Philocraft and Pow-R-Pax are registered trademarks of Manna Marketing & Development Group, Inc.



CAT. NO. WS3696

## CRL Accufab Pro Curtain Wall and Storefront Tools new



- **Accufab Pro Reduces Labor Time and Costs by 75% or More!**
- **Designed to Accurately and Quickly Locate Shear Block Connectors on U.S. Aluminum Curtain Wall or Storefront Verticals**
- **Three Sizes: 16', 24', and 32' (4.9, 7.3, and 9.8 m)**
- **Pneumatic Clamping System (Requires 75 PSI)**
- **U.S. Patent No. 8,176,610 B1**

CRL Accufab Pro Curtain Wall and Storefront Tools are designed to accurately and quickly locate Shear Block Connectors on the vertical members of U.S. Aluminum Curtain Wall, Storefront, and Window Wall Systems. Fabrication time on installing horizontal Shear Blocks to vertical mullions is cut by 75 percent or more. In your shop or on the job site, the new Accufab Pro Tool will eliminate misdrilled fasteners, out-of-level horizontal members, and costly measurement mistakes. The Storefront Tool is supplied with five AP403SBL Shear Block Locators for working with our 400/450 Series Storefront Verticals and AP403 Shear Blocks. The Curtain Wall Tools are supplied with seven AP955SBL Shear Block Locators for working with our 3150/3250 Series Curtain Wall Verticals and AP955 Shear Blocks. Additional Shear Block Locators to handle a variety of stock extrusion and Shear Block sizes can be easily changed out. The calibrated rear sliding bar allows quick setup and accurate repeatability. **NOTE:** Self-drilling screws must be used to fasten Shear Blocks to mullions when working with the Accufab Pro Tool. See [usalum.com](http://usalum.com) for specific self-drilling screws to use for each Shear Block. Setup and user instructions are included with every CRL Accufab Pro Tool.

For more information on these CRL Accufab Pro Curtain Wall and Storefront Tools, contact us toll free at (800) 262-5151 from anywhere in the United States and Canada. You can also contact us through our web site at [usalum.com](http://usalum.com).

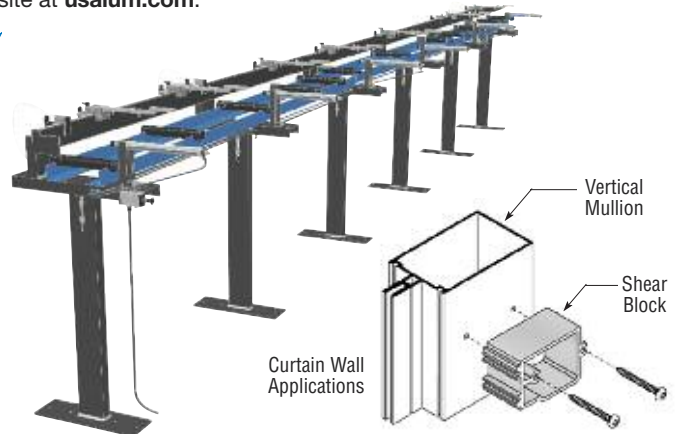
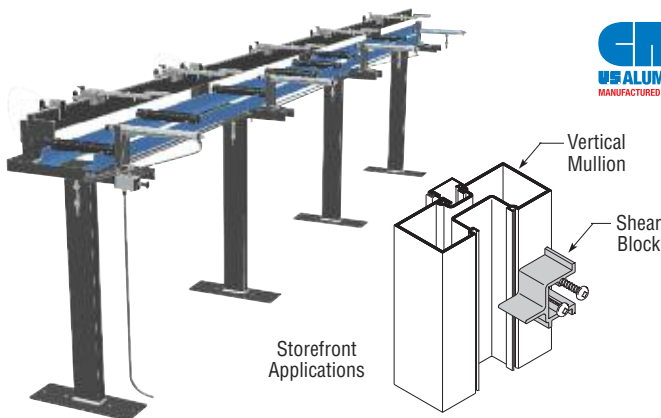

### ACCUFAB PRO STOREFRONT TOOL

CAT. NO.	DESCRIPTION
ACU16	16' (4.9 m) Accufab Pro Storefront Tool
ACUDVD	Accufab Pro Instructional DVD

Minimum order: 1 each.  
**NOTE:** Must specify U.S. Aluminum Curtain Wall, Storefront, or Window Wall Series used at time order is placed.

### ACCUFAB PRO CURTAIN WALL TOOL

CAT. NO.	DESCRIPTION
ACU24	24' (7.3 m) Accufab Pro Curtain Wall Tool
ACU32	32' (9.8 m) Accufab Pro Curtain Wall Tool
ACUDVD	Accufab Pro Instructional DVD

Minimum order: 1 each.  
**NOTE:** Must specify U.S. Aluminum Curtain Wall, Storefront, or Window Wall Series used at time order is placed.

Shear Block Locators for other types and sizes of Shear Blocks can be ordered separately. Locators are engineered to precisely position the Shear Blocks on the vertical members, and the use of improper locators may result in the incorrect positioning of the Shear Block, leaving your horizontal members with a less than desirable joining to the vertical members. For assistance in ordering Shear Block Locators, please consult with U.S. Aluminum Technical Sales or visit us online at [usalum.com](http://usalum.com).

### SHEAR BLOCK LOCATORS

CAT. NO.	FITS SHEAR BLOCK	FOR USE WITH USAL SYSTEM
AP403SBL*	AP403	400/450 Storefront Horizontal/Sill Anchor
AP202SBL	AP202	2100/2200 with 2-7/8" (73 mm) Back Member
AP204SBL	AP204	2100/2200 with 4" (102 mm) Back Member
AP954SBL	AP954	3150/3250 with 4" (102 mm) Back Member
AP955SBL△	AP955	3150/3250 with 5" (127 mm) Back Member
AP928SBL	AP928	3150/3250 with 8" (203 mm) Back Member

Minimum order: 1 each. \*Standard with ACU16. △ Standard with ACU24 and ACU32.

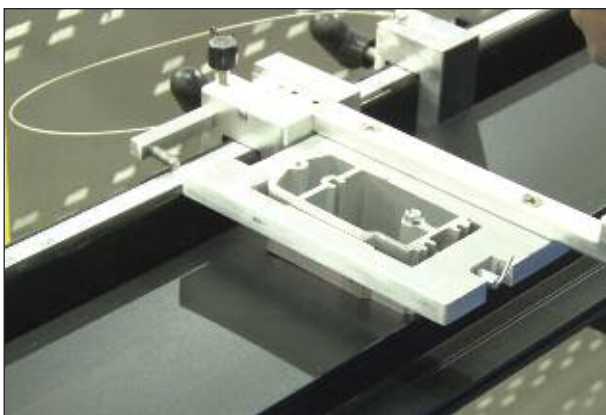

Shear Block Locator Shown with Shear Block which are purchased separately

## CRL Accufab Pro Curtain Wall and Storefront Tools

- Five Easy Steps to Precisely Install Shear Blocks

**new**



Watch the Accufab Pro Tool in Action!  
View the Video at [usalum.com](http://usalum.com)

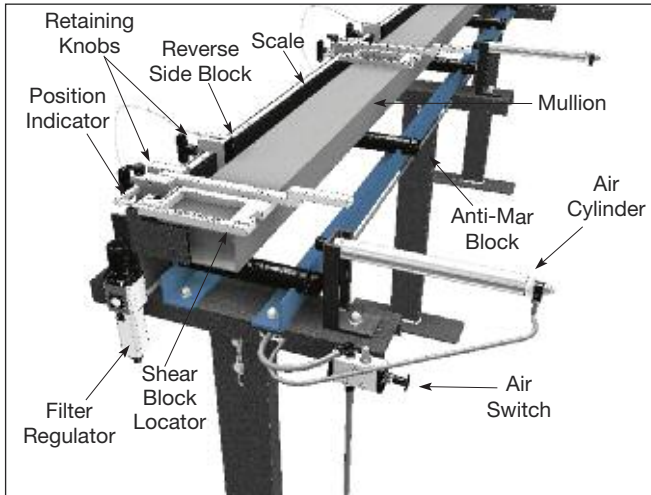

Accufab Pro Curtain Wall and Storefront Tool



1. With the pneumatic clamping system, set the Shear Block Locators to their proper locations and begin fastening Shear Blocks using self-drilling screws to one side of the Vertical Mullion. Proceed along the Vertical Mullion until all Shear Blocks are installed.



2. Release the pneumatic clamping system and lift up the Shear Block Locators.



3. Turn the Vertical Mullion on its opposite side.



4. Engage the pneumatic clamping system and pull down the Shear Block Locators to begin installing Shear Blocks on the reverse side.



5. Your Curtain Wall or Storefront Vertical Mullion is now fabricated and ready to receive the Horizontal Members.

## CRL Kett Panel Master Saw Kit

- Cuts Smoothly and Accurately; Milled Edges Are Finished With No Sanding Needed
- Start the Cut Where You Want and Cut With Ease
- Cuts Up to 16 Gauge Mild Steel, Aluminum, Fiberglass, Plastic, and Plastic Laminates

Get straight, smooth, and accurate cuts every time with the CRL Kett Panel Master Saw. It cuts up to 16 gauge mild steel, and zips through aluminum, fiberglass, plastic, and plastic laminates with minimum effort. Powerful industrial type 5.5 AMP, 1500 RPM motor. Includes two 2" (51 mm) and two 2-1/2" (63.5 mm) diameter Kett Blades. 110V AC.



CAT. NO.	DESCRIPTION
<b>KS23AM</b> <b>KSP750</b>	Kett Panel Master Saw Kit with Wrenches and Four Blades Carrying Case

Minimum order: 1 each.

## CRL Kett Saw Blades

- High-Speed Steel
- Black Oxide Finish

CRL Kett Saw Blades are made from the finest high-speed steel. These Blades are hardened to cut mild steel, plastics, aluminum, fiberglass and other sheet material. 3/32" (2.4 mm) thick with a staggered set tooth which cuts an approximate 3/64" (1 mm) kerf or slot. 7/16" (11 mm) bore. Black oxide finish on standard black blade.



CAT. NO.	DIAMETER	TEETH	CUT DEPTH
<b>15753</b>	2" (51 mm)	30	3/8" (10 mm)
<b>15754</b>	2" (51 mm)	44	3/8" (10 mm)
<b>15756</b>	2" (51 mm)	60	3/8" (10 mm)
<b>15758</b>	2" (51 mm)	80	3/8" (10 mm)
<b>15764</b>	2-1/2" (64 mm)	44	5/8" (16 mm)
<b>15766</b>	2-1/2" (64 mm)	60	5/8" (16 mm)
<b>15768</b>	2-1/2" (64 mm)	80	5/8" (16 mm)
<b>157610</b>	2-1/2" (64 mm)	100	5/8" (16 mm)
<b>15776</b>	3-3/8" (86 mm)	60	1" (25 mm)
<b>15778</b>	3-3/8" (86 mm)	80	1" (25 mm)
<b>157710</b>	3-3/8" (86 mm)	100	1" (25 mm)
<b>157713</b>	3-3/8" (86 mm)	136	1" (25 mm)

Minimum order: 1 each. All Kett Saw Blades can be combined for quantity pricing.

## CRL Kett Shear Plastic Saw Conversion Kit

- Turns Your Kett Shear Into a Plastic Saw
- Make the Conversion Quickly and Easily



This CRL Kett Plastic Saw Conversion Kit allows you to convert your Kett Power Shear into a versatile Plastic Cutting Saw. The Interchangeable Cutting Head lets you switch from shear to saw quickly and easily. It uses 3-3/8" (86 mm) diameter Cutting Blades shown above. Includes everything necessary to convert Model B100, K200, B180, K180, P300 or P500 Power Shears.

Minimum order is one each.

**CAT. NO. KS25724K**

## CRL Kett Replacement Parts and Tools

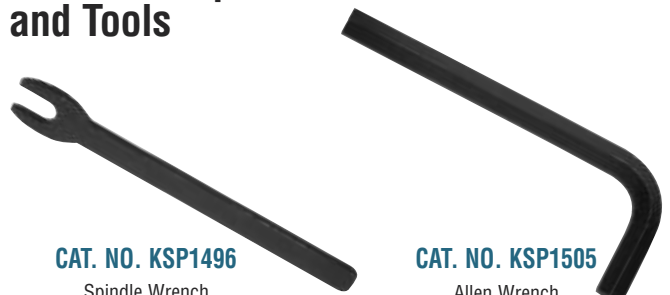

**CAT. NO. KSP1496**

Spindle Wrench  
(Open End)

**CAT. NO. KSP1505**

Allen Wrench  
(For Use on Spindle Bolt)



**CAT. NO. KSP17025**

Safety Shear Coupler  
(Hex Head Shank With Slot Dog)



**CAT. NO. KSP13316**

Spindle Bolt  
(Holds Blade On)

Minimum order: 1 each.

## CRL Kett Power Scissor Shears

- Ideal for Cutting Screen Wire
- Cut Neat and Fast

CRL Kett Power Scissor Shears are ideally suited for cutting a wide range of pliable sheet materials. A unique scissor action cuts light material without fouling or gouging. Even handles heavy foil, light insulated wire, hardware cloth and mesh screening with ease. The large, rabbit-ear blades funnel thick, soft materials into the scissor jaws for a clean, flowing cut. 120V AC.



**CAT. NO. B180**

CAT. NO.	DESCRIPTION
<b>KSP8021</b>	Top Blade
<b>KSP8022</b>	Bottom Blade

Minimum order: 1 each.

## CRL Kett® Power Shear

- Produces Smooth, Even Cuts Up to 180" (4.6 m) Per Minute
- Cuts Down on Production Times
- Ideal for Sunroof Installation or Duct Work

Save up to 90% on hand shearing time with this Kett® Double Cut Power Shear. The 7/32" (5.5 mm) waste curl leaves both sides of the cut straight and clean, with no distortion, and no need to deburr. This is the ideal tool for the tinner, roofer, and autobody shop worker. It is also excellent for duct work or installation of aluminum and steel siding.

**SPECIFICATIONS:** 2,500 RPM, 110V AC, 5 AMP Motor  
**CAPACITIES:** C.R. Mild Steel 18 Gauge; Stainless Steel 20 Gauge; 6" (152 mm) Minimum Radius



CAT. NO.	DESCRIPTION
<b>K200</b>	Electric Power Shear
<b>KSP6021</b>	Replacement Center Blade
<b>KSP6022L</b>	Replacement Left Side Blade
<b>KSP6022R</b>	Replacement Right Side Blade

Minimum order: 1 each.

## CRL Bosch® Unishear

- Cuts Up to 14 Gauge Aluminum at 5,000 Strokes Per Minute
- Cuts Aluminum and Stainless Steel Quickly and Efficiently

The CRL Bosch® Unishear Tool is a lightweight easy-to-maneuver electric shear for mild and stainless steel, and aluminum. Small in size and well balanced, it is designed to cut up to 14 gauge aluminum at up to 5,000 strokes per minute. The cutting head allows full visibility of the blade so that the intended cut-out can be made precisely on the template markings. Unishear is double-insulated for operator safety, and plugs into grounded 115V AC outlets. Minimum order is one each.



**CAT. NO. 3607010028**  
Replacement Blades Set



**CAT. NO. B1500**  
Unishear

## CRL Air Powered Heavy-Duty Sheet Metal Nibbler

- Cuts Up to 18 Gauge Metal
- Efficient and Powerful
- Easy to Operate and Control



**CAT. NO. AK80TOOL**

Get a bigger bite and better angle cuts with our Air Powered Heavy-Duty Nibbler. This tool actually "nibbles" aluminum, cold-rolled steel, plastic, and an assortment of other metals up to 18 gauge in thickness. It will not distort the edges of materials being cut, and you can start cuts in the center of a panel. Tool will hold a tight 1/4" (6 mm) radius with great accuracy. It operates using an air supply capable of 90 psi. **NOTE:** To order a replacement punch, specify Cat. No. AKRP1. For a replacement die, specify Cat. No. SM21341. Minimum order is one each.

Kett is a registered trademark of Kett Tool Company.  
 Bosch is a registered trademark of Robert Bosch GmbH Corp.  
 DRÄCO is a registered trademark of Max Draenert Apparatebau GmbH & Co. KG.

## CRL DRÄCO® Inline Metal Shear



**CAT. NO. SD5**  
Inline Metal Shear



**CAT. NO. SD5JW**  
Replacement Jaw Set

- Fast Cutting in Steel and Aluminum
- One-Handed Operation



**CAT. NO. SD5BL**  
Replacement Blades

This CRL DRÄCO® Inline Metal Shear provides fast cutting action (3,000 strokes per minute) for up to 19 gauge mild steel, 24 gauge stainless steel, and 18 gauge aluminum. It provides a minimum outside cutting radius of 2" (51 mm) for close right or left curve cuts with a smooth edge. It removes a continuous metal curl with no material distortion. Unit features a sliding on/off thumb switch for easy one-handed operation. Minimum order is one each.

## CRL Combination File



- Our Most Popular File Has One Rough Side, and One Smooth

Use this all-purpose Combination File anywhere. One side is rough for heavy jobs, while the other side is smooth for finish work. Our most popular File, this high-quality tool is affordable and will last for years.

CAT. NO.	SIZE
CF10	10" x 31/32" x 5/32" (254 x 24 x 4 mm)

Minimum order: 1 each. All Metal Files can be combined for quantity pricing.

## CRL Flat Aluminum File



- Fast-Cutting Teeth For Aluminum and Non-Ferrous Metals

These fast-cutting teeth are designed for use on aluminum and various non-ferrous metals. Double-cut and uniform in thickness, this File tapers in width toward the point.

CAT. NO.	SIZE
AF12F	12" x 1-5/32" x 9/32" (305 x 29 x 7 mm)

Minimum order: 1 each. All Metal Files can be combined for quantity pricing.

## CRL Round Files



- Tapers Toward the Point to Enlarge Circular Holes

CRL Round Files are designed to enlarge circular holes or rounded grooves too small for a half-round File. Another popular machinist's file, it tapers toward the point, so you can use it in different sized holes.

CAT. NO.	SIZE/DESCRIPTION
RF8MC	8" x 5/16" (203 x 8 mm) Second Cut
RF10MC	10" x 3/8" (254 x 9.5 mm) Second Cut
RF12BC	12" x 1/2" (305 x 13 mm) Bastard Cut

Minimum order: 1 each. All Metal Files can be combined for quantity pricing.

## CRL Combination File Card and Brush



- Keeps Metal Files Working Their Best

The Combination File Card and Brush removes fragments from Files. Its 1/4" (6 mm) long metal bristles and 5/8" (16 mm) nylon bristles are mounted on opposite sides of a wooden handle.

**NOTE:** Not available in Australia. Minimum order is one each.

CAT. NO. FC100

## CRL Flat Mill File



- All Purpose Flat Surface File for Rapid Stock Removal

Universally favored by technicians in many fields, this all-purpose tool is used for rapid stock removal. Double-cut with cut edges, it tapers in width toward the point.

CAT. NO.	SIZE/DESCRIPTION
FF12BC	12" x 1-5/32" x 9/32" (305 x 29 x 7 mm) Bastard Cut
FF12MC	12" x 1-5/32" x 9/32" (305 x 29 x 7 mm) Second Cut
FF12SC	12" x 1-5/32" x 9/32" (305 x 29 x 7 mm) Smooth Cut

Minimum order: 1 each. All Metal Files can be combined for quantity pricing.

## CRL Half-Round Aluminum File



- One Flat Side and One Convex Side for Aluminum and Soft Metals

Especially made to use on aluminum and soft metals, this File's half round shape lets you file on concave surfaces and round out holes. Has one double-cut flat side, which tapers to a point.

CAT. NO.	SIZE
AF12HR	12" x 1-1/8" x 11/32" (305 x 28 x 9 mm)

Minimum order: 1 each. All Metal Files can be combined for quantity pricing.

## CRL Square Files



- Four Equal Sides for Use on Slots, Keyways, Square and Rectangular Holes

These Files are handy for use on slots, keyways, square and rectangular holes, and also for surface work. Double cut, their four equal sides taper toward the point.

CAT. NO.	SIZE/DESCRIPTION
SF8MC	8" x 5/16" (203 x 8 mm) Second Cut
SF10MC	10" x 3/8" (254 x 9.5 mm) Second Cut
SF12BC	12" x 1/2" (305 x 13 mm) Bastard Cut

Minimum order: 1 each. All Metal Files can be combined for quantity pricing.

## CRL File Handles



- Used to Protect Hands and Improve Grip

Protect your hands and improve your grip with CRL's specially designed wooden File Handles. Each Handle is pre-drilled to accept the file tang. **NOTE:** Not available in Australia.

CAT. NO.	DESCRIPTION
FH108	5" (127 mm) for Files 6" to 10" (152 to 254 mm)
FH110	5-1/2" (140 mm) for Files 8" to 12" (203 to 305 mm)

Minimum order: 1 each. Sizes can be combined for quantity pricing.

# CRL PRY AND RIPPING BARS

For Pricing Visit [crlaurence.com](http://crlaurence.com) or Call Us Toll Free at the Phone Numbers Shown on the Back Cover

## CRL Scrape and Pry Bars

- Multi-Purpose Tools Made of Hardened, Tempered Steel
- Two Sizes With Chisel Ground Edges

CRL Scrape and Pry Bars are versatile tools made of the finest hardened, tempered tool steel. Both ends are chisel ground for scraping or prying. The 4050 is 1-3/4" (44.5 mm) wide, and the 3040 is 9/16" (14.3 mm) wide. One end has a 50 degree angle bend. Both tools have a nail puller hole. Our most popular model is 10" (254 mm) long – just the right size for your tool box. Minimum order is one each.

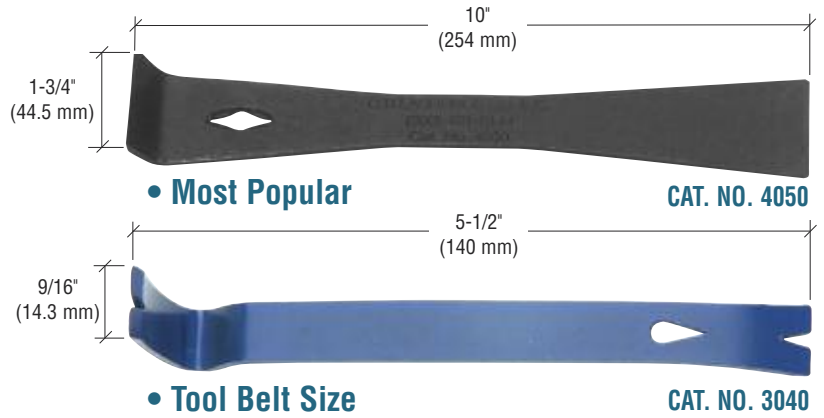

NOTE: Images not to scale.

## CRL 10" (254 mm) Pry Bar and Scraper

- Hardened, Tempered Tool Steel
- Ideal for Pulling Nails, Prying, Lifting, Scraping, and Much More



This CRL Pry Bar/Scraper is a versatile tool made of the finest hardened, tempered tool steel. It is typically used for scraping and prying. One end has a 90 degree angle bend and a nail puller hole. Both ends are chisel ground and 1-1/2" (38 mm) wide. Overall length is 10" (254 mm). Minimum order is one each. **CAT. NO. US10**

## CRL Stanley® 12-1/2" (318 mm) Pry Bar

- Contoured Pry Bar Ideal for Pulling Nails, Prying, Lifting, and Much More



This contoured CRL Stanley® 12-1/2" Pry Bar is ideal for pulling nails, prying, lifting, scraping and much more. Made of forged tool steel for extra strength, it has a bevelled nail slot at each end. Overall length is 12-1/2" (318 mm). Minimum order is one each.

**CAT. NO. ST55515**

## CRL Stanley® Offset Pattern Ripping Bar

- Extra Wide End

The CRL Stanley® Offset Pattern Ripping Bar has an extra wide, polished and slotted claw at one end, and has a bevelled nail slot at the other end. Overall length is 18" (457 mm). Minimum order is one each.



**CAT. NO. ST55818**

## CRL Stanley® 30" (762 mm) Ripping Bar

- Forged Hexagonal Steel

The CRL Stanley® 30" (762 mm) Ripping Bar has one polished end that has a slotted claw, while the other is bevelled chisel. Made of forged hexagonal steel for extra strength. This is a very handy tool with many uses. Overall length is 30" (762 mm). Minimum order is one each.



Stanley is a registered trademark of Stanley Logistics, LLC.

**CAT. NO. ST55130**

## CRL Multi-Wedge Pry and Level Tools

- Won't Damage Soft Materials

These CRL Multi-Wedge Pry and Level Tool sets are designed to be used in place of damaging, metal tools. The plastic material is perfect for when you need to protect the surface finish on delicate parts. Each set has three tools with a built-in handle. Designed for use with tougher materials like harder woods, soft metals, and similar materials; or soft materials such as soft woods, plastic, rubber, and others. Tools measure 5" to 6-3/4" (127 to 171 mm) in length.



**CAT. NO.**

**MW3100**  
**MW3400**

**DESCRIPTION**

For Tough Materials  
For Soft Materials

Minimum order: 1 each.

## CRL Stanley® 1-1/2" Glazier's Chisel

- High-Carbon Forged Steel Blade
- Longer Length for Easier Reach
- Thru-Tang™ Design for Superior Strength and Durability



The CRL Stanley® Glazier's Chisel has a thick, forged and tapered, high quality, high carbon steel blade that is 50% stronger than similar models. The "Thru-Tang" feature provides a solid one-piece metal shaft from chisel blade through the striking cap, allowing the Chisel to withstand continuous blows from a hammer. The large ergonomically designed handle provides superior grip and comfort. This Chisel easily removes putty and prepares sash for glazing. Blade width is 1-1/2" (38 mm), and the overall length is 9" (229 mm). Minimum order is one each.

CAT. NO. 1941

## CRL Stanley® Steel Wood Chisels

- Thru-Tang™ Design
- Steel Polished Finished Blade



These tough CRL Stanley® Wood Chisels can really take a hit! The strong handle is specially designed for balance and grip. Its crown shaped steel cap gives you a center for hammer blows. The 3" (76 mm) long, polished-finished blade and the tang are forged from one piece of high quality, cutlery grade steel, making this a sturdy, professional use tool. Minimum order is one each.

CAT. NO.	CHISEL SIZE
ST16973	1/4" (6 mm)
ST16974	3/8" (9.5 mm)
ST16975	1/2" (12 mm)
ST16976	5/8" (16 mm)
ST16977	3/4" (19 mm)
ST16978	1" (25 mm)
ST16979	1-1/4" (32 mm)
ST16980	1-1/2" (38 mm)
ST16981	2" (51 mm)

Minimum order: 1 each.

## CRL Stanley® 6-Piece Deluxe Steel Wood Chisel Set

- Six Piece Set From 1/4" to 1-1/2" (6 to 38 mm)
- Sturdy Carrying Case



This CRL Stanley® Wood Chisel Set is packed in a sturdy plastic tray and gives you six versatile sizes. This set includes one of each 1/4", 1/2", 3/4", 1", 1-1/4" and 1-1/2" (6, 12, 19, 25, 32, and 38 mm) sizes. Minimum order is one each set.

CAT. NO. ST16971

## CRL Stanley® 4-Piece Deluxe Steel Wood Chisel Set

- Four Piece Set From 1/4" to 1" (6 to 25 mm)
- Thru-Tang™ Design



This CRL Stanley® Wood Chisel Set gives you four sizes of strong, useful chisels. This set consists of one each 1/4", 1/2", 3/4", and 1" (6, 12, 19, and 25 mm) Chisels. Each made with a polished-finished blade and tang made of forged cutlery grade steel. Minimum order is one each set.

CAT. NO. ST16900A

## CRL Stanley® Floor Chisel

- Alloy Steel Tool With 3" (75 mm) Tapered Cutting Blade



This CRL Stanley® Floor Chisel has a tapered cutting blade for cutting, prying or ripping and trimming of hardwood flooring and nails. Overall length is 11" (280 mm). Minimum order is one each.

Stanley is a registered trademark of Stanley Logistics, LLC.

CAT. NO. ST16293

## CRL Stanley® 3-Piece Cold Chisel Set

- Three Piece Set of 3/8", 1/2", and 5/8" (10, 12, and 16 mm) Wide Alloy Steel Chisels



The CRL Stanley® Cold Chisel Set has a 3/8", 1/2", and 5/8" (10, 12, and 16 mm) wide sizes packed in a durable plastic pouch. These Chisels are forged from hardened and tempered alloy steel with a rust preventing, blasted finish. Minimum order is one each set.

CAT. NO. ST16298



## CRL Stanley® Curved Claw Graphite Hammer

- Epoxy Assembly
- Permanent Tapered Design Eliminates Head Fly-Off



The handle on the CRL Stanley® Graphite Hammer features the proper balance of graphite and continuously stranded fiberglass for a virtually unbreakable combination of strength and perfect balance. A precision-tempered, tool-steel head features an octagon pattern, crowned striking surface, and fine polish. The rim tempered face reduces chipping.

CAT. NO.	WEIGHT	LENGTH
ST51505	16 oz. (454 g)	13-1/4" (337 mm)

Minimum order: 1 each.

## CRL Stanley® Curved Claw Nail Hammer



- One of the Best General Purpose Hammers

This CRL Stanley® Nail Hammer has a high-carbon steel head with black finish, a polished bell face, stained wood handle, and curved nail head. **NOTE:** Not available in Australia.

CAT. NO.	WEIGHT	LENGTH
ST51613	7 oz. (198 g)	11-1/2" (292 mm)
ST51616	16 oz. (454 g)	13-1/4" (337 mm)

Minimum order: 1 each.

## CRL Stanley® FatMax® Anti-Vibe Framing Hammer



- Octagon Head Pattern
- All-Steel, Chrome Plated Tubular Handles

Get good driving and pulling power with this extra-tough CRL Stanley® FatMax® Anti-Vibe Framing Hammer. It has a large rim tempered striking face, tubular steel handle, and a ripping claw.

CAT. NO.	WEIGHT	LENGTH
ST51402	22 oz. (624 g)	18-1/4" (464 mm)

Minimum order: 1 each.

## CRL Stanley® Ball Pein Hammer



- Dead Blow, No Bounce Back
- Crowned Face for Greater Accuracy

CRL Stanley® Dead Blow Steel Face Ball Pein Hammer heads are manufactured with tempered alloy steel and crowned faces for more accuracy. The hammer uses steel shot for no bounce back, and a steel reinforced handle for added strength and safety.

CAT. NO.	WEIGHT	LENGTH
ST54516	16 oz. (454 g)	12-5/8" (321 mm)

Minimum order: 1 each.

## CRL Stanley® Sledge Hammers



CAT. NO. ST56703  
Not available in Australia.

- Quality Construction
- Superior Grip and Comfort

CRL Stanley® Sledge Hammers in either Compo-Cast® non-sparking urethane covered Sledge with steel reinforced handle, or our hardened, forged-steel head Sledge with lacquered hardwood handle. Both offer superior grip and comfort.

Stanley, FatMax, and Compo-Cast are registered trademarks of Stanley Logistics, LLC.



CAT. NO. ST57550

CAT. NO.	WEIGHT	LENGTH
ST56703	3 lbs. (1.4 kg)	10-1/2" (267 mm)
ST57550	5 lbs. (2.3 kg)	19-1/2" (495 mm)

Minimum order: 1 each.

# CRL HAMMERS AND MALLETS

For Pricing Visit [crlaurence.com](http://crlaurence.com) or Call Us Toll Free at the Phone Numbers Shown on the Back Cover

## CRL Stanley® No-Bounce Soft-Face Power Hitter

- Hundreds of Internal Metal-Shot Means No Rebound
- The Power Comes From Inside
- Non-Marring Surface

CRL Stanley® Power Hitters are designed for today's industry. With a solid reinforcing rod totally clad in hot cast urethane, these hammers beat all others for power, accuracy and endurance. The most important feature is "Dead Blow" power. Inside the head is a chamber containing hundreds of metal shot that combine to provide maximum controlled striking force without rebound. The entire force of the blow is spent in a striking action. The urethane surfaces allow the power hitter to be used in areas when sparks from an exposed metal hammer could cause trouble. The soft face is also non-marring and doesn't absorb liquids. Tests prove these hitters outperform and outlast other soft face materials.

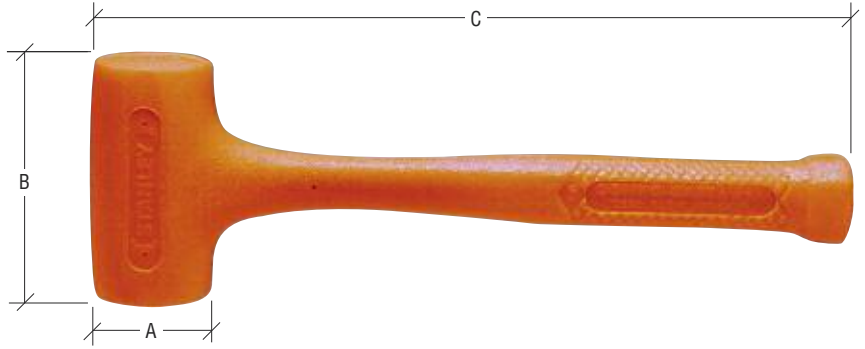

**Initial Force**  
On the downward stroke, the shot is forced to the top of the chamber, where it hangs in suspension until contact is made.



**Rebound Resistant**  
When contact is made, the shot follows through to sustain the blow, stop the rebound, and control the hammer.

CAT. NO.	WEIGHT	FACE (A) DIAMETER	HEAD (B) LENGTH	OVERALL (C) LENGTH
ST57541	14 oz. (397 g)	1-1/4" (32 mm)	4-1/8" (105 mm)	10-1/2" (267 mm)
ST57532	21 oz. (595 g)	2" (51 mm)	4-1/8" (105 mm)	12-3/4" (324 mm)
ST57534	52 oz. (1474 g)	2-1/2" (64 mm)	5-1/4" (133 mm)	15-3/4" (400 mm)

Minimum order: 1 each.

## CRL Stanley® Soft Face Hammer



- Tough Plastic Will Not Mar Surfaces
- Replaceable Tips Available

The CRL Stanley® Soft Face Hammer is used wherever you need a non-marring driving force. The replaceable tips are made of tough plastic. Heads are made of "Evertite" which are processed and securely locked in an oval-eye body. The handles are stained and lacquered hickory.

**NOTE:** Not available in Australia.

### SOFT-FACE HAMMERS

CAT. NO.	WEIGHT	HEAD DIAMETER
ST57594	8 oz. (227 g)	1-1/4" (32 mm)
ST57595	16 oz. (454 g)	1-3/8" (35 mm)

Minimum order: 1 each.

### REPLACEMENT TIPS

CAT. NO.	DIAMETER	FITS HAMMER
ST57584	1-1/4" (32 mm)	ST57594
ST57585	1-3/8" (35 mm)	ST57595

Minimum order: 1 each.

Stanley is a registered trademark of Stanley Logistics, LLC.

## CRL Rawhide Mallet



- Very Useful for Storefront Installation
- Prevents Surface Marring

These tough CRL Rawhide Face Mallets are the perfect and practical way of striking items that are subject to marring. Resilient rawhide heads are attached to sturdy wooden handles for durability.

**NOTE:** Not available in Australia.

CAT. NO.	LENGTH	HEAD DIAMETER
RHM2	9-1/2" (241 mm)	1-1/4" (32 mm)
RHM3	11-1/2" (292 mm)	1-3/4" (44 mm)
RHM4	11-1/2" (292 mm)	2" (51 mm)
RHM5	13-1/2" (343 mm)	2-3/4" (70 mm)

Minimum order: 1 each.

## CRL Rubber Mallet



- Ideal for Auto Channel Installations
- Available in 1 or 2 Pound Weights

CRL Rubber Mallets are perfect for use in setting auto channel. The rubber head is attached to a wood handle for balanced handling. A must for striking surfaces which are easily marred.

**NOTE:** Not available in Australia.

CAT. NO.	WEIGHT	HEAD DIAMETER
1M	1 Lb. (454 g)	2-1/8" (54 mm)
2M	2 Lb. (907 g)	3" (76 mm)

Minimum order: 1 each.

## CRL 3/8" Electric Drill

- 110V and 240V Models Available
- 4.2 AMP Motor
- Keyless Chuck
- 0 to 3000 RPM Variable Speed
- Reversible
- All Ball Bearing and Needle Bearing Construction for Long Life
- Convenient Molded Belt Clip



The CRL 3/8" (9.5 mm) Electric Drill has a powerful 4.2 AMP variable speed (0 to 3000 RPM) motor for greater speed control. Perfect for drilling wood, metal, or driving screws. This handy drill is lightweight and balanced for easy handling. The motor is reversible, and there is a large recessed "lock-on" button for continuous use. This drill motor has ball and needle bearing construction for long life and smooth operation.

CAT. NO.	DESCRIPTION
LD138	110 Volt 3/8" Electric Drill
LD138AU	240 Volt 3/8" Electric Drill

Minimum order: 1 each.

## CRL Makita® 1/2" Heavy-Duty Electric Drill

- 550 RPM, 6.3 AMP Motor
- Double Gear Reduction for Added Torque
- Heavy-Duty Industrial 1/2" (12 mm) Jacobs Chuck for Positive Bit Retention
- Multiple Handle Grips for Extra Control
- Chuck Key is Retained in Handle to Prevent Loss



This Makita® Heavy-Duty Reversible Drill has a large capacity industrial 1/2" (12.7 mm) Jacobs Chuck. The 550 RPM, 6.3 AMP motor has a double reduction gear for added torque, with ball and needle bearing construction for longevity and smooth operation. The 'D' shaped rear handle rotates 360 degrees for positive control in any drilling position. The additional cross brace handle increases the torque strength for the operator when drilling larger diameter holes. Conveniently located rocker-type reversing switch for easy one-handed operation. Double-insulated for operator safety. 120V AC powered. Includes: Top Handle and Chuck Key. Minimum order is one each.

CAT. NO. 6013BR

## CRL Makita® 12V Cordless 3/8" Angle Drill



- Variable Speed 0 to 800 RPM
- Reversible
- 3/8" Keyless Chuck

The CRL Makita® 12 Volt 3/8" (9.5 mm) Angle Drill Kit is ideal for drilling in narrow spaces where a conventional drill would be too large. It measures only 4-1/8" (105 mm) from the tip of the chuck to the widest portion of the body. The Drill weighs only 3.5 lbs. (1.6 kg), yet the powerful 0-800 RPM motor will last two times longer per charge than most 9 Volt drills. Kit includes: Drill, 12V Battery, Charger, Battery Cover, and Carrying Case. Minimum order is one each.

Makita is a registered trademark of Makita Corporation. CAT. NO. DA312DWD

## CRL 1/2 HP 3/8" Air Powered Drill

- Reversible
- Lightweight Design Only Three Pounds (1.4 kg)
- 1/2 HP Motor



This quality Air Drill has a powerful, stall-free 1800 RPM (Free Load) motor and a precision 3/8" (9.5 mm) Jacobs Chuck. Built-in air regulator controls pressure (rated at 90 psi). Lightweight and easy to maneuver, it weighs just three pounds (1.4 kg) and has a 7" (178 mm) overall length. Ball and needle bearing construction for longevity and smooth operation. Muffled handle exhaust for quiet operation. Minimum order is one each.

CAT. NO. SM725

## CRL Makita® 9.6V Cordless 3/8" Driver/Drill Kit

- Two Variable Speed Ranges: 0 to 350 or 0 to 1,200 RPM
- 16 Stage Torque Clutch
- 3/8" Keyless Chuck

This Makita® 9.6 Volt Cordless 3/8" (9.5 mm) Driver/Drill has two speed ranges: low speed 0 to 350 RPM, or high speed 0 to 1200 RPM which produces 200 in./lbs. of torque. There is an easy to adjust 16 stage torque clutch for a variety of fastening applications. The motor has an overload protector to guard against burnouts, and there is an electric brake, which stops the chuck fast.



CAT. NO.	DESCRIPTION
6226DWE	9.6 Volt 3/8" Driver/Drill Kit
1939793	9.6 Volt Battery Cartridge
1131032	110 Volt Universal Battery Charger

Minimum order: 1 each. Kit Includes: One Driver/Drill, Two Batteries, Charger, One Phillips/Slotted Bit, One Battery Protective Cover, plus a Molded Carrying Case.

## CRL Makita® 14.4V Cordless 3/8" Driver/Drill Kit

- Two Variable Speed Ranges: 0 to 400 or 0 to 1,300 RPM
- 16 Stage Torque Clutch
- Ergonomic Rubber Grip
- 3/8" Keyless Chuck

The Makita® 14.4 Volt Cordless 3/8" (9.5 mm) Driver Drill Kit has a reversible motor and features a 2-speed gear selection with variable speed in each range. The keyless chuck has 16 torque settings plus a drill mode. The powerful motor produces a 260 in./lbs. of torque, and is perfect for drilling wood or metal and driving screws. Lightweight and balanced with an ergonomic rubber grip handle.



CAT. NO.	DESCRIPTION
6281DWPE	14.4 Volt 3/8" Driver/Drill Kit
1941722	14.4 Volt Battery Cartridge
1131032	110 Volt Universal Battery Charger

Minimum order: 1 each. Kit Includes: One Driver/Drill, Two Batteries, Charger, One Phillips/Slotted Bit, One Battery Protective Cover, plus a Molded Carrying Case.

## CRL 18V Cordless Variable Speed Impact Driver/Drill Kit

- Reversible With Two Speed Ranges: 0 to 500, and 0 to 1150 RPM

The CRL 18 Volt Cordless Variable Speed Impact Driver/Drill is a lot of tool for a very conservative price. Put a drill bit or the included double-headed screwdriver bit into the keyless 3/8" (9.5 mm) chuck and pull the trigger for drilling/driving in two speed ranges: 0 to 500 RPM, and 0 to 1150 RPM. Twist the collar and you have an impact drill with an impact frequency of 6400 or 18000 strokes per minute.



CAT. NO.	DESCRIPTION
LD147	18 Volt Cordless Impact/Driver Kit
LD147B	18 Volt Battery Cartridge for LD147
LD147C	110 Volt Charger for LD147B 18 Volt Battery
LD147AU	18 Volt Cordless Impact/Driver Kit w/AU Plug
LD147C240V	240 Volt Charger for LD147B Battery w/AU Plug
LD147EU	18 Volt Cordless Impact/Driver Kit w/EU Plug
LD147C220V	220 Volt Charger for LD147B Battery w/EU Plug

Minimum order: 1 each. Kit Includes: Driver/Drill, Battery, Charger, Six Drill Bits, Magnetic Bit Holder, plus Molded Carrying Case.

## CRL Makita® 18V Cordless Lithium-Ion 1/2" Hammer-Driver-Drill Kit

- Three Modes: Hammer-Driver-Drill
- Three Speed Motor: 0 to 300, 0 to 600, 0 to 1700 RPM
- Two Powerful (3Ah) Lithium Batteries
- Built-In Depth Gauge
- Built-in LED Lights to Illuminate the Work Surface

This Makita® 18 Volt Cordless 1/2" (12.7 mm) Hammer-Driver-Drill is a three-mode tool providing hammer, driver, and drilling capabilities. The Shift-Lock™ Drive System quickly shifts between modes. This Drill features a powerful four-pole max-torque motor that delivers 560 in./lbs. (63 Nm) of torque. The three speed motor delivers 25% faster working speed with more efficiency than standard models. This Kit includes two Lithium-Ion batteries and the most advanced Rapid Charger that Makita® has ever made. The ergonomic shape fits like a glove, allowing delivery of even pressure and easy control. Two built-in LED lights illuminate the work.



CAT. NO.	DESCRIPTION
BHP454	18 Volt DC Cordless Hammer-Driver-Drill Kit
BL1830	18 Volt Battery Cartridge for BHP454
DC18RA	110 Volt Charger for BL1830 18 Volt Battery

Minimum order: 1 each. Kit Includes: Hammer/Driver/Drill, Two Batteries, Charger, One Phillips/Slotted Bit, One Battery Protective Cover, plus a Molded Carrying Case.

Makita is a registered trademark of Makita Corporation.

## CRL Makita® Universal Ni-MH and Ni-Cd Battery Charger

This Makita® Universal Battery Charger is designed to charge all 7.2V, 9.6V, 12V, 14.4V, and 18V Makita® brand batteries, both Stick and Pod types. Compatible for both Ni-MH and Ni-Cd type batteries. Minimum order is one each.



CAT. NO. 1131032

## CRL Makita® 7.2V and 9.6V Replacement Batteries

These Makita® Ni-Cd Stick-Type Batteries are offered in either 7.2V or 9.6V sizes to fit a large variety of Makita® tools. Both are rated at 1.3 AMP hours. Use with Cat. No. 1131032 Universal Battery Charger shown at left.



CAT. NO.	VOLTAGE
6320024	7.2 Volt
6320074	9.6 Volt

Minimum order: 1 each.

## CRL Makita® 9.6V and 12V Replacement Batteries

These Makita® Ni-Cd Pod-Type Batteries will work with most Makita® battery powered tools. The 9.6V battery is rated at 1.3 AMP hours and the 12V is rated at 2.0 AMP hours. Both batteries can be charged using the Cat. No. 1131032 Universal Battery Charger shown above.



CAT. NO.	VOLTAGE
1939793	9.6 Volt
1925982	12 Volt

Minimum order: 1 each.

## CRL Makita® 14.4V Replacement Battery

This Makita® brand 14.4V Ni-Cd Pod-Type Battery will work in any Makita® brand cordless power tool requiring 14.4V. This battery is rated at 1.3 AMP hours. Use with Cat. No. 1131032 Universal Battery Charger shown above. Minimum order is one each.



CAT. NO. 1941722

## CRL Makita® Lithium-Ion Battery Charger

This Makita® Lithium-Ion Battery Charger charges slide-on type batteries from 7.2V to 18V. The Charger uses an Advanced Rapid Charging Technology, which analyzes the battery condition based on current control and voltage control, then chooses the optimum rate of charge. When in use the Charger has a fan that blows cool air on the battery, extending it's life. Complete charging takes only 30 minutes. Minimum order is one each.



CAT. NO. DC18RA

Makita is a registered trademark of Makita Corporation.

## CRL Makita® 18V Lithium-Ion Replacement Battery

This Makita® brand 18V Lithium-Ion slide-on type Battery is rated at 3.0 AMP hours. Use only with Cat. No. DC18RA Lithium-Ion Battery Charger shown at left. Minimum order is one each.



CAT. NO. BL1830

## CRL Universal Pressure Drill

- Electric Drill Motor With 1/2" Chuck Included
- Cuts Labor Time by Up to 75%
- Bits Last Up to 10 Times Longer
- Works Either by Pushing or Pulling the Drill Bit Into the Work Surface

The CRL Universal Pressure Drill is like having a portable drill press that you can carry onto any work site, then set up and start drilling in just minutes. The entire Drill Press consists of four basic components (all included): an Electric Drill Motor with 1/2" (12.7 mm) Chuck, a Telescoping Extension Rod with Floor Base, a Gear Assisted Drill Motor Mounting Bracket, and a Sliding Foot Brace.

The Telescoping Rod has an extension range from 38" to 92" (965 to 2336 mm), and can be used to apply pressure to the drill whenever it has a solid surface to push against, making this an ideal tool for drilling vertically into a ceiling. The Sliding Foot Brace is used when there is a solid surface behind the work area. Slide the brace behind the material to be drilled then the unit operates similar to a C-Clamp pulling the drill into the work.

Typical 1/2" (12.7 mm) drill bits require 210 pounds of pressure to obtain best results. Thanks to the Universal Pressure Drill's gear driven mounting bracket, it only takes 28 pounds of force against the lever handle to generate the 210 pounds of force. Therefore, not only are your bits working at maximum efficiency, they are lasting up to 10 times longer and you are also finishing the job up to 75% faster, with less effort. Minimum order is one each.

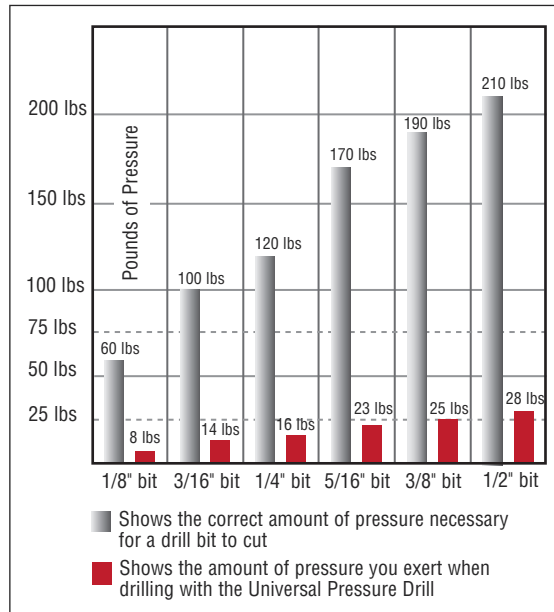

CAT. NO. UPD1

## CRL Pipe Adapter for Universal Pressure Drill

- Converts the CRL Universal Pressure Drill Into a Pipe Drill
- Produces Accurate and Straight Drilled Holes Every Time



The CRL Pipe Adapter for the Cat. No. UPD1 Universal Pressure Drill allows you to easily drill holes into steel pipe up to 6" (152 mm) in diameter, either in your shop or at the work site. Each steel Pipe Adapter includes a 28" (711 mm) long Rod with a Sliding Foot Brace which has a specialized cradle to center the drill onto the center of the pipe. Just slide the Gear Assisted Drill Motor Mounting Bracket with Drill off of the UPD1 Telescoping Rod and onto the Pipe Adapter Rod and you're ready to go. You now have all of the benefits of the Pressure Drill as outlined above, plus confidence that your drill is centered on the pipe. Minimum order is one each.

CAT. NO. UPDPA1

## CRL Makita® Power Hammer/Scraper

- Powerful Variable Speed 5 AMP Motor Produces Zero to 3,200 Air-Cushioned Blows Per Minute
- Excellent for Hackouts of Hardened Putty and Sealants
- Supplied Complete With Three Chisel Tips

The Makita® Power Hammer/Scraper has a powerful 5 AMP motor that will tackle even the toughest putty or sealant removal job, and is also ideal for cleaning out old mortar, removing tile, concrete scale, and weld splatter. It delivers from 0-3,200 blows per minute for light scraping, chiseling, and chipping. This tool is lightweight at 7 lbs. (3.2 kg) and easy to maneuver, with an air-cushioned design that will help reduce operator fatigue in use. The quick bit changeover system is designed for easy bit installation and positive bit retention. The automatic brush cut-out feature saves wear and tear on the commutator, and it is factory grease packed for reduced maintenance. Supplied with tool case and the three Chisel Tips shown. Chisel Tips can also be purchased separately.



CAT. NO. 7982645  
2" Scaling Chisel



CAT. NO. 7982653  
1-3/16" Scaling Chisel



CAT. NO. 7982661  
Ball Point Chisel

CAT. NO.	DESCRIPTION
HK1810	Makita® Power Scraper Hackout Gun
7982645	Replacement 2" (51 mm) Scaling Chisel*
7982653	Replacement 1-3/16" (30 mm) Scaling Chisel*
7982661	Replacement Bull Point Chisel*

Minimum order: 1 each. \*Included in kit.

## CRL Milwaukee® 1/2" Heavy-Duty Hammer Drill Kit

- 8.5 AMP 1800 RPM Motor Delivers 28,000 Blows Per Minute

The CRL Milwaukee® Hammer Drill Kit is especially built for percussion carbide bit drilling in concrete and masonry. It can also be used as a standard drill in wood and metal. It does not need daily oiling - just grease periodically. The powerfully built 8.5 AMP motor assures long, dependable life. It delivers 28,000 blows per minute at 1,800 RPM. Kit contains a Hammer Drill Depth Rod, Side Handle, a Chuck Key, and all are packaged in a heavy-duty Carrying Case. Minimum order is one each.

For a complete listing of Drills and Drill Bits, see pages 477K-489K.



CAT. NO. 5389

## CRL Makita® 1" Rotary Hammer Drill

- Variable Speed 7 AMP 0 to 1100 RPM Motor
- 0 to 4,500 Blows Per Minute
- Accepts SDS Plus Type Drill Bits

This CRL Makita® 1" Heavy-Duty Rotary Hammer Drill has a big 7 AMP motor for a high power-to-weight ratio, superior performance, and variable speed from 0 to 1,100 RPM with a speed control switch and reversing motor. Compact and lightweight 5.3 lbs. (2.4 kg) for easier operation, it is also double-insulated for operator safety. It also features a quick bit changeover system for positive bit retention, conveniently located reversing switch, and a multi-position side swivel handle for maneuverability. Readily accepts SDS Plus Type Masonry Bits (see page 483K). Minimum order is one each.

Makita is a registered trademark of Makita Corporation.  
Milwaukee is a registered trademark of Milwaukee Electric Tool Corporation.  
SDS Plus is a registered trademark of Robert Bosch GmbH.



CAT. NO. HR2475

## CRL Heavy-Duty Masonry Drill Bits

- Our Best Selling Masonry Drill Bits
- Available in Seven Sizes
- High Quality and Long Lasting



Our CRL Heavy-Duty Masonry Drill Bits are manufactured for drilling into several different materials including: concrete, cement, slate, brick, marble, stone, and others. They work in both regular and impact drills. These are quality, brite finish drill bits that drill faster and last longer.

CAT. NO.	DIAMETER	LENGTH	SHANK
2MD	1/8"	2-15/16" (75 mm)	7/64"
3MD	3/16"	3-7/8" (98 mm)	11/64"
4MD	1/4"	3-7/8" (98 mm)	15/64"
46MD	1/4"	6" (152 mm)	15/64"
5MD	5/16"	6" (152 mm)	1/4"
6MD	3/8"	6" (152 mm)	11/32"
8MD	1/2"	6" (152 mm)	3/8"

Minimum order: 1 each. All Masonry Drills can be combined for quantity pricing.



## CRL Rawl Slow Spiral Masonry Drill Bits

- Special Deep, Fast, Clear Flute
- Brazed-In Carbide Tips



Our CRL Rawl Deep Flute Slow Spiral Masonry Drill Bits are designed to give the best combination of strength and speed. CRL Rawl Slow Spiral Masonry Drill Bits are dependable and long lasting. They feature a brazed-in carbide tip that has maximum support against shock, and the specially designed spiral fluting clears cuttings rapidly.

Brazed-In Carbide Tip

CAT. NO.	DIAMETER	LENGTH	SHANK
8606RAWL	3/16"	3" (76 mm)	11/64"
8608RAWL	1/4"	4" (102 mm)	15/64"

Minimum order: 1 each. All Masonry Drills can be combined for quantity pricing.

## CRL Duo-Bit Masonry Drill Bits

- Made for Rotary and Hammer Drills
- Brazed-In Carbide Tips



A significant breakthrough in carbide tipped masonry bits, CRL's Duo-Bit Masonry Drill Bits work in two ways. They can be used in rotary drill or hammer drill applications. The carbide tip is brazed to the drill shaft for smooth turning and fast penetration in all masonry materials. Available in four diameters, and up to 12" (305 mm) in length.

Brazed-In Carbide Tip

CAT. NO.	DIAMETER	LENGTH	SHANK
06010	1/8"	3" (76 mm)	7/64"
06020	3/16"	3" (76 mm)	11/64"
06030	1/4"	4" (102 mm)	15/64"
06040	1/4"	6" (152 mm)	15/64"
06050	1/4"	12" (305 mm)	15/64"
06070	5/16"	4" (102 mm)	19/64"
06080	5/16"	6" (152 mm)	19/64"

Minimum order: 1 each. All Masonry Drills can be combined for quantity pricing.

## CRL Groo-V Tip® Granite, Marble, and Tile Drill Bits

- Very Popular Bits Especially Suited for Drilling Marble and Granite
- Made for Use With Rotary and Hammer Drills Only



These CRL Groo-V Tip® Granite, Marble, and Tile Drill Bits are especially suited for drilling small holes when used with percussion or rotary drill machines only. This straight shank Drill Bit is available in four sizes. Groo-V Tip is a registered trademark of Relton Corporation.

Carbide Groo-V Tip®

CAT. NO.	DIAMETER	LENGTH	SHANK
GRT18	1/8"	3" (76 mm)	7/64"
GRT316	3/16"	3" (76 mm)	11/64"
GRT14	1/4"	4" (102 mm)	15/64"
GRT38	3/8"	5" (127 mm)	11/32"

Minimum order: 1 each. All Masonry Drills can be combined for quantity pricing.



## CRL Heavy-Duty Cyclo-Impak® Drill Bits

- Brazed-In Carbide Tips

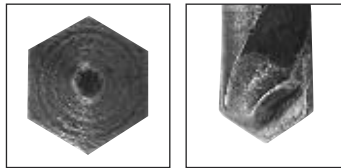

Hex Shank

Brazed-In Carbide Tip



CRL Heavy-Duty Cyclo-Impak® Drill Bits are made from a proven, impact-type alloy steel, allowing a long and productive drilling life. The special tip grind enables fast penetration into the toughest materials. Each Bit is treated to resist metal fatigue, and has a brazed-in carbide tip for superior drilling results on concrete, limestone, brick, marble, slate, structural tile, terra cotta, terrazzo, and more.

- Special Tip Grinding Enables Fast Penetration

CAT. NO.	DIAMETER	LENGTH	SHANK
12010	3/16"	3" (76 mm)	1/4"
12020	1/4"	4" (102 mm)	1/4"
12030	1/4"	6" (152 mm)	1/4"
12060	5/16"	4" (102 mm)	1/4"
12070	5/16"	6" (152 mm)	1/4"
12110	3/8"	6" (152 mm)	3/8"
12160	1/2"	6" (152 mm)	3/8"

Minimum order: 1 each. All Masonry Drills can be combined for quantity pricing.

## CRL Heavy-Duty Extra Length SDS Plus® Shank Masonry Drill Bits

- Extra Length Drill Bits For SDS Plus® Drills



SDS Plus® Shank

Carbide Tip



This CRL Heavy-Duty Extra Length SDS Plus® Shank Masonry Drill Bit is manufactured for drilling into several different materials: concrete, slate, brick, marble, stone, and others. They work in both regular and hammer drills with SDS Plus® drive systems. It is a high quality, brite finish bit that drills faster and lasts longer.

- High Quality and Long Lasting

CAT. NO.	DIAMETER	LENGTH
SDSW12	.495"	12" (305 mm)
SDSW38	.389"	12" (305 mm)
SDSW14	.259"	8" (203 mm)

Minimum order: 1 each. All Masonry Drills can be combined for quantity pricing.

## CRL Thundertwist™ SDS Plus® Shank Masonry Drill Bits



SDS Plus® Shank



Carbide Tip



These CRL Thundertwist™ SDS Plus® Shank Drill Bits are for pneumatic and electric hammer drills that require bits with SDS Plus® shanks. Bits are available in drill sizes 3/16" to 1/2", and are made to the highest engineering standards for performance and longevity. Excellent for drilling in marble, tile, brick, slate, limestone, concrete, and more.

- Fit All Hammer Drills Requiring SDS Plus® Shank Bits

CAT. NO.	DIAM.	LENGTH	MAX. DEPTH
25020	3/16"	6-3/8" (162 mm)	4" (102 mm)
25130	1/4"	6-3/8" (162 mm)	4" (102 mm)
25200	5/16"	6-5/8" (168 mm)	4" (102 mm)
25220	3/8"	6-5/8" (168 mm)	4" (102 mm)
25300	1/2"	6-5/8" (168 mm)	4" (102 mm)

Minimum order: 1 each. All Masonry Drills can be combined for quantity pricing.

## CRL Thundertwist™ "A" Taper Impak™ Drill Bits

- Fit "A" Taper Drill Tools or Adapters

- Top Quality



"A" Taper Shank

Carbide Tip



Thundertwist™ Drill Bit



SDS Plus® to "A" Taper Adapter



#1 Drift Key

CRL Thundertwist™ "A" Taper Impak™ Drills are best for electric and pneumatic hammer drills. The high-quality standards set for their manufacturing and testing assures you of long drilling life and top performance. They achieve superior drilling results when used on limestone, brick, marble, concrete, granite, tile, slate or cinder blocks. Optional "A" Taper Adapter allows you to use these Bits in hammer drills requiring SDS Plus®. The #1 Drift Key is a special tool required to remove the chuck from a drill press.

Cyclo-Impak is a registered trademark of Tru-Cut, Inc.

SDS Plus is a registered trademark of Robert Bosch GmbH.

### THUNDERTWIST™ "A" TAPER IMPAK™ DRILL BITS

CAT. NO.	DIAM.	LENGTH	MAX. DEPTH
19870	1/4"	6" (152 mm)	4" (102 mm)
19900	5/16"	6" (152 mm)	4" (102 mm)
19920	3/8"	9" (229 mm)	7" (178 mm)
19960	1/2"	9" (229 mm)	6-1/2" (165 mm)

Minimum order: 1 each. All Masonry Drills can be combined for quantity pricing.

### ACCESSORIES

CAT. NO.	DESCRIPTION
24105	Adapter for SDS Plus® to "A" Taper
24300	#1 Drift Key for Drill Press Chucks

Minimum order: 1 each.

## CRL Wire Gauge Jobber's Length Drill Bits

- Wire Gauge Sizes
- High Speed Steel
- 118 Degree Point Angle

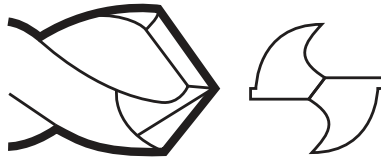

CRL High Speed Drill Bits in wire gauge sizes are available for when exact wire gauge diameters are required. These Jobber Length Bits have a high speed 118 degree point angle for a fast cut. Wire Gauge Bits are sold individually for a specific job or to complete an existing set.

CAT. NO.	WIRE GAUGE	INCHES
80101	No. 1	.2280"
80102	No. 2	.2210"
80103	No. 3	.2130"
80104	No. 4	.2090"
80105	No. 5	.2055"
80106	No. 6	.2040"
80107	No. 7	.2010"
80108	No. 8	.1990"
80109	No. 9	.1960"
80110	No. 10	.1935"
80111	No. 11	.1910"
80112	No. 12	.1890"
80113	No. 13	.1850"
80114	No. 14	.1820"

Minimum order: 1 each. All High Speed Drills can be combined for quantity pricing.

CAT. NO.	WIRE GAUGE	INCHES
80115	No. 15	.1800"
80116	No. 16	.1770"
80117	No. 17	.1730"
80118	No. 18	.1695"
80119	No. 19	.1660"
80120	No. 20	.1610"
80121	No. 21	.1590"
80122	No. 22	.1570"
80123	No. 23	.1540"
80124	No. 24	.1520"
80125	No. 25	.1495"
80126	No. 26	.1470"
80127	No. 27	.1440"
80128	No. 28	.1405"

Minimum order: 1 each. All High Speed Drills can be combined for quantity pricing.

CAT. NO.	WIRE GAUGE	INCHES
80129	No. 29	.1360"
80130	No. 30	.1285"
80131	No. 31	.1200"
80132	No. 32	.1160"
80133	No. 33	.1130"
80134	No. 34	.1110"
80135	No. 35	.1100"
80136	No. 36	.1065"
80137	No. 37	.1040"
80138	No. 38	.1015"
80139	No. 39	.0995"
80140	No. 40	.0980"

Minimum order: 1 each. All High Speed Drills can be combined for quantity pricing.

## CRL Wire Gauge "Stubby" Drill Bits

- Wire Gauge Sizes
- High Speed Steel



These surface treated short length Drill Bits are popularly known as "Stubbies." They have short flutes and a shorter overall length for maximum rigidity.

CAT. NO.	WIRE GAUGE	INCHES
20107	No. 7	.2010"
20109	No. 9	.1960"
20111	No. 11	.1910"
20119	No. 19	.1660"
20121	No. 21	.1590"
20125	No. 25	.1495"
20127	No. 27	.1440"
20128	No. 28	.1405"
31229	No. 29	.1360"
20130	No. 30	.1285"
20131	No. 31	.1200"
20132	No. 32	.1160"

Minimum order: 1 each. All High Speed Drills can be combined for quantity pricing.

## CRL Wire Gauge Drill Bit Set

- 60 Drill Bit Sizes
- 118 Degree Point Tip Angle

This CRL High Speed Drill Bit Set includes all wire gauge sizes from #60 to #1 (.0400" to .2280") in standard jobber length. It comes in a handy stamped steel Index Case. Minimum order is one each.

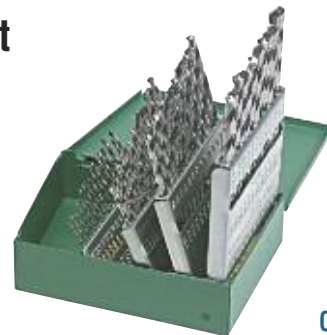

CAT. NO. S60W

## CRL 6" Long Wire Gauge Drill Bits

- Extra Long High Speed Steel



CAT. NO.	WIRE GAUGE	INCHES
666007	No. 7	.2010"
666009	No. 9	.1960"
666019	No. 19	.1660"
666020	No. 20	.1610"
666021	No. 21	.1590"
666025	No. 25	.1495"
666027	No. 27	.1440"
666028	No. 28	.1405"
666029	No. 29	.1360"
666030	No. 30	.1285"

Minimum order: 1 each. All High Speed Drills can be combined for quantity pricing.

## CRL Double End Wire Gauge Drill Bits

- Wire Gauge High Speed Steel



Double End High Speed Drill Bits come in a "stubby" length and have a 135 degree split point tip for fast drilling. Ideal for use on sheet metals and aluminum.

CAT. NO.	WIRE GAUGE	INCHES
61611	No. 11	.1910"
61620	No. 20	.1610"
61630	No. 30	.1285"

Minimum order: 1 each. All High Speed Drills can be combined for quantity pricing.

## CRL Fractional Sized 118 Degree Point Jobber's Length High Speed Drill Bits

- Fast Starting 118 Degree Point Tip
- Fractional Sizes
- Jobber's Length
- Bright Polished Finish

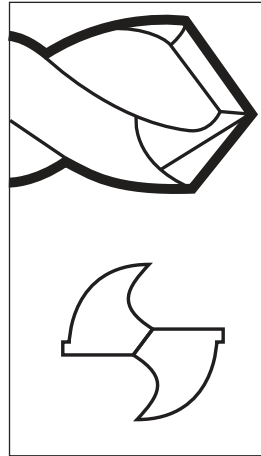
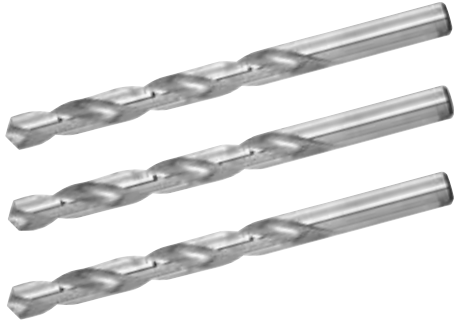

These High Speed Drill Bits are our most popular. The 118 Degree Point makes these Bits very fast-starting and drilling; making them an excellent choice as a general purpose Bit for drilling into metal, wood, and plastics. Each Bit is made with a hot, roll-formed flute, which is then heat-treated to give additional toughness and durability. Each Bit has a bright polished finish.

CAT. NO.	SIZE	LENGTH
601164	1/64"	3/4" (19 mm)
601132	1/32"	1-3/8" (34.9 mm)
601364	3/64"	1-3/4" (44.5 mm)
601116	1/16"	1-7/8" (47.6 mm)
601564	5/64"	2" (51 mm)
601332	3/32"	2-1/4" (57.2 mm)
601764	7/64"	2-5/8" (66.7 mm)
60118	1/8"	2-3/4" (69.9 mm)
601964	9/64"	2-7/8" (73 mm)
601532	5/32"	3-1/8" (79.4 mm)
6011164	11/64"	3-1/4" (82.6 mm)
601316	3/16"	3-1/2" (89 mm)
6011364	13/64"	3-5/8" (92 mm)
601732	7/32"	3-3/4" (95.3 mm)
6011564	15/64"	3-7/8" (98.4 mm)
60114	1/4"	4" (101.6 mm)
6011764	17/64"	4-1/8" (104.8 mm)
601932	9/32"	4-1/4" (108 mm)
6011964	19/64"	4-3/8" (111.1 mm)
601516	5/16"	4-1/2" (114.3 mm)
6012164	21/64"	4-5/8" (117.5 mm)
6011132	11/32"	4-3/4" (120.7 mm)
6012364	23/64"	4-7/8" (123.8 mm)
60138	3/8"	5" (127 mm)
6012564	25/64"	5-1/8" (130.2 mm)
6011332	13/32"	5-1/4" (133.3 mm)
6012764	27/64"	5-3/8" (136.5 mm)
601716	7/16"	5-1/2" (139.7 mm)
6012964	29/64"	5-5/8" (143 mm)
6011532	15/32"	5-3/4" (146 mm)
6013164	31/64"	5-7/8" (149.2 mm)
60112	1/2"	6" (152 mm)

Minimum order: 1 each. All High Speed Drills can be combined for quantity pricing.

## CRL Fractional Sized 135 Degree Split Point Jobber's Length High Speed Drill Bits

- 135 Degree Split Point Tip Prevents Walking or Skating
- Fractional Sizes
- Jobber's Length
- Black Oxide Finish

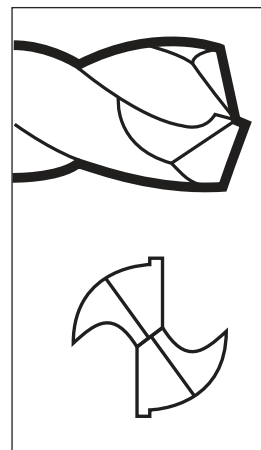

The CRL 135 Degree Split Point Tip Drill Bits don't walk or skate when you first start to drill. These Bits are excellent for general purpose drilling into metal, wood, and plastics. Each Bit is made with a hot, roll formed flute, which is then heat treated to give additional toughness and durability. All Bits have a black oxide finish to resist corrosion.

CAT. NO.	SIZE	LENGTH
40099104	1/16"	1-7/8" (47.6 mm)
40099105	5/64"	2" (51 mm)
40099106	3/32"	2-1/4" (57.2 mm)
40099107	7/64"	2-5/8" (66.7 mm)
40099108	1/8"	2-3/4" (69.9 mm)
40099109	9/64"	2-7/8" (73 mm)
40099110	5/32"	3-1/8" (79.4 mm)
40099111	11/64"	3-1/4" (82.6 mm)
40099112	3/16"	3-1/2" (89 mm)
40099113	13/64"	3-5/8" (92 mm)
40099114	7/32"	3-3/4" (95.3 mm)
40099115	15/64"	3-7/8" (98.4 mm)
40099116	1/4"	4" (101.6 mm)
40099117	17/64"	4-1/8" (104.8 mm)
40099118	9/32"	4-1/4" (108 mm)
40099119	19/64"	4-3/8" (111.1 mm)
40099120	5/16"	4-1/2" (114.3 mm)
40099121	21/64"	4-5/8" (117.5 mm)
40099122	11/32"	4-3/4" (120.7 mm)
40099123	23/64"	4-7/8" (123.8 mm)
40099124	3/8"	5" (127 mm)
40099126	13/32"	5-1/4" (133.3 mm)
40099128	7/16"	5-1/2" (136.5 mm)
40099130	15/32"	5-3/4" (146 mm)
40099132	1/2"	6" (152 mm)

Minimum order: 1 each. All High Speed Drills can be combined for quantity pricing.

## CRL Metric Sized Jobber's Length Drill Bits



- 118 Degree Point Tip
- Black Oxide Finish

These Jobber's Length Drill Bits come in the most popular Metric sizes for general purpose drilling into metal, wood, and plastic.

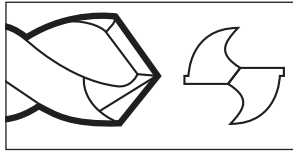

CAT. NO.	SIZE	LENGTH
D4120	2.0 mm	49 mm
D4125	2.5 mm	57 mm
D4130	3.0 mm	61 mm
D4132	3.2 mm	65 mm
D4135	3.5 mm	70 mm
D4140	4.0 mm	75 mm
D4142	4.2 mm	75 mm
D4145	4.5 mm	80 mm
D4150	5.0 mm	86 mm
D4155	5.5 mm	93 mm
D4160	6.0 mm	93 mm
D4165	6.5 mm	101 mm
D4170	7.0 mm	109 mm
D4175	7.5 mm	109 mm
D4180	8.0 mm	117 mm
D4190	9.0 mm	125 mm
D41100	10.0 mm	133 mm

Minimum order: 1 each. Sizes can be combined for quantity pricing.

## CRL Fractional Sized "Stubby" Drill Bits



- 135 Degree Split Point Tip

CRL "Stubby" Steel Drills are surface treated, short length Drills with short flutes and short overall length for maximum rigidity. All have 135 degree split points for easier starting in sheet metal.

CAT. NO.	SIZE	LENGTH
301116	1/16"	1-5/8" (41.3 mm)
301332	3/32"	1-3/4" (44.5 mm)
301764	7/64"	1-13/16" (46 mm)
301118	1/8"	1-7/8" (47.6 mm)
301964	9/64"	1-15/16" (49.2 mm)
301532	5/32"	2-1/16" (52.4 mm)
3011164	11/64"	2-1/8" (54 mm)
301316	3/16"	2-3/16" (55.6 mm)
3011364	13/64"	2-1/4" (57.2 mm)
301732	7/32"	2-3/8" (60.3 mm)
3011564	15/64"	2-7/16" (61.9 mm)
301114	1/4"	2-1/2" (63.5 mm)
301932	9/32"	2-11/16" (68.3 mm)

Minimum order: 1 each. Sizes can be combined for quantity pricing.

## CRL 6" Long Fractional Sized Drill Bits



- 135 Degree Split Point Tip
- Black Oxide Finish



These CRL 6" (152 mm) Long High Speed Steel Drills are ideal for use in hard to reach spaces or for making deeper holes.

CAT. NO.	SIZE	LENGTH
666116	1/16"	6" (152 mm)
666564	5/64"	6" (152 mm)
666332	3/32"	6" (152 mm)
666764	7/64"	6" (152 mm)
66618	1/8"	6" (152 mm)
666964	9/64"	6" (152 mm)
666532	5/32"	6" (152 mm)
6661164	11/64"	6" (152 mm)
666316	3/16"	6" (152 mm)
6661364	13/64"	6" (152 mm)
666732	7/32"	6" (152 mm)
6661564	15/64"	6" (152 mm)
66614	1/4"	6" (152 mm)

Minimum order: 1 each. Sizes can be combined for quantity pricing.

## CRL Double End Fractional Sized Drill Bits



- 135 Degree Split Point Tip

These CRL Double End Drills are popular for automotive body and sheet metal work. Drills are stub length and surface treated. They have flat, precision ground 135 degree split point tips for fast starting when drilling aluminum or sheet metal.

CAT. NO.	SIZE	LENGTH
60607	7/64"	1-13/16" (46 mm)
60608	1/8"	1-13/16" (46 mm)
60609	9/64"	2-1/16" (52.4 mm)
60610	5/32"	2-3/16" (55.6 mm)
60612	3/16"	2-5/16" (58.7 mm)
60614	7/32"	2-5/8" (66.7 mm)
60616	1/4"	2-7/8" (73 mm)

Minimum order: 1 each. Sizes can be combined for quantity pricing.

## CRL Drill Bits for Plastic Materials

- Special Extra Sharp Tip

These CRL Drill Bits are made especially for drilling plastic. The special sharp tapered point makes drilling fast and neat, while reducing the tendency of the plastic to crack and chip during drilling. **NOTE:** Not to be used on wood or metal.

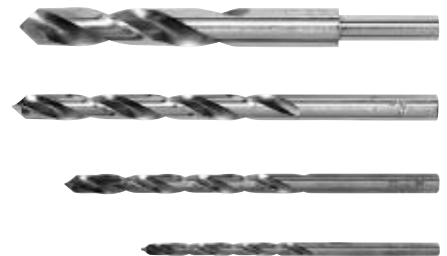

CAT. NO.	SIZE	LENGTH
61408	1/8"	2-3/4" (69.8 mm)
61412	3/16"	3" (76.2 mm)
61416	1/4"	4" (101.6 mm)
71124*	3/8"	4" (101.6 mm)

Minimum order: 1 each. \*Reduced shank to fit 1/4" (6.3 mm) chucks. Sizes can be combined for quantity pricing.

## CRL 29-Piece Drill Bit Set

- Fractional Sizes 1/16" through 1/2"
- All Bits Fit 1/4" Chucks
- 118 Degree Point Tip
- High Speed
- Bright Finish



29-Piece Drill Bit Set contains sizes from 1/16" to 1/2" in 1/64" increments. Diameters larger than 1/4" have reduced shanks to fit 1/4" or 3/8" chucks. All bits are standard jobber length, and come in a steel index case. Minimum order is one set.

CAT. NO. S2914

## CRL 15-Piece Drill Bit Set

- Fractional Sizes 1/16" Through 1/2"
- All Bits Fit 1/4" Chucks
- 118 Degree Point Tip
- High Speed
- Bright Finish



15-Piece Drill Bit set contains the following sizes: 1/16", 3/32", 1/8", 5/32", 3/16", 7/32", 1/4", 9/32", 5/16", 11/32", 3/8", 13/32", 7/16", 15/32", and 1/2". Diameters larger than 1/4" have reduced shanks to fit 1/4" or 3/8" chucks. All bits are standard jobber length, and come in a steel index case. Minimum order is one set.

CAT. NO. S1514

## CRL 13-Piece Drill Bit Set

- Fractional Sizes From 1/16" to 1/4"
- 118 Degree Point Tip
- High Speed
- Bright Finish



13-Piece Drill Bit Set contains the following sizes: 1/16", 5/64", 3/32", 7/64", 1/8", 9/64", 5/32", 11/64", 3/16", 13/64", 7/32", 15/64", and 1/4". All bits are standard jobber length, and come in a steel index case. Minimum order is one set.

CAT. NO. S13

## CRL Reduced Shank Drill Bits

- Reduced Shanks Fit Your 1/4" and 3/8" Drills



The reduced shanks of these Drill Bits extend the range of your 1/4" and 3/8" drill motor chucks, allowing you to drill holes up to 1/2" (12.7 mm) in diameter.

CAT. NO.	SIZE	LENGTH
71438	3/8" (9.5 mm)	5" (127 mm)
714716	7/16" (11.1 mm)	5-1/2" (140 mm)
71412	1/2" (12.7 mm)	6" (152 mm)

Minimum order: 1 each. Sizes can be combined for quantity pricing.

## CRL 7-Piece Drill Bit Set

- Fractional Sizes From 1/16" to 1/4"

7-Piece Drill Bit Set includes sizes 1/16", 3/32", 1/8", 5/32", 3/16", 7/32" and 1/4". All bits are standard jobber length, high speed drills. Comes in a re-sealable plastic case. Minimum order is one each.



CAT. NO. S107

## CRL 4-Piece Reduced Shank Drill Bit Set

- Fractional Sizes From 5/16" to 1/2"
- All Bits Fit 1/4" or 3/8" Chucks
- Bright Finish

4-Piece Drill Bit Set includes sizes 5/16", 3/8", 7/16", and 1/2". All bits are standard jobber length, and have reduced shanks to fit 1/4" or 3/8" chucks. Minimum order is one each.

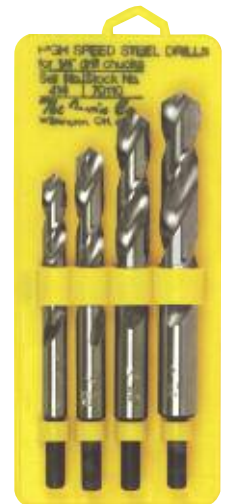

CAT. NO. S414

## CRL GROO-V Tip® Granite, Marble, and Tile Drill Bits

- Very Popular Bits Especially Suited for Drilling Marble and Granite
- For Use With Rotary and Hammer Drills Only



Carbide GROO-V Tip®

These CRL GROO-V Tip® Granite, Marble, and Tile Drill Bits are especially suited for drilling small holes when used with percussion or rotary drill machines only. This straight shank Drill Bit is available in four sizes.



CAT. NO.	DIAMETER	LENGTH	SHANK
GRT18	1/8"	3" (76 mm)	7/64"
GRT316	3/16"	3" (76 mm)	11/64"
GRT14	1/4"	4" (102 mm)	15/64"
GRT38	3/8"	5" (127 mm)	11/32"

Minimum order: 1 each. All Masonry Drills can be combined for quantity pricing.

## CRL Countersink Drill

- Double-End Drill Makes Proper Hole for Countersunk Rivets
- Drill and Countersink Holes in One Operation



Use this double-end CRL Countersink Drill to drill and countersink holes in one operation. Speeds up installation of 1/8" (3.2 mm) countersunk blind rivets. Overall length is 1-7/8" (48 mm). Minimum order is one each.

CAT. NO. D120

## CRL Plunger Latch Step Drill

- For Quick Installation of Screen Frame Plunger Latches



Drill hole from exterior edge of frame



Insert plunger and spring, then bind knob from spline pocket edge of frame

CRL's Plunger Latch Step Drill is used to drill the proper size holes in screen frame for Plunger Latches, all in one single operation. The two-step high speed Drill Bit has a 7/32" (5.5 mm) shank which steps down to 1/8" (3.2 mm). Minimum order is one each.

CAT. NO. WST905

## CRL High Speed Drill Bit

- 1/2" (13 mm) Shank, 6" (152 mm) Long



This High Speed Drill Bit is made of M-7 Steel for high resistance to abrasion during tough drilling applications. The three-flattened shank design provides better chuck grip and reduces slippage. Overall length is 6" (152 mm). Minimum order is one each.

CAT. NO. 91134

## CRL Drill Bit Holder

- Holds Cat. No. SLD21 Tin Coated #21 Drill Bit



The CRL Drill Bit Holder is ideal for holding 5/32" diameter drills or number-sized drills from #20-26. Originally designed to adapt drills for use with a quick disconnect chuck, CRL recommends using this Holder with our Cat. No. SLD21 Drill. Using this Holder greatly increases the gripping strength of the drill to the bit, making it ideal for drilling very hard metals. Minimum order is one each.

CAT. NO. DBH1

## CRL TiCN Coated #21 Drill Bit

- TiCN Coated, Sharp Tip for Drilling Into Stainless Steel
- #21 Size



The CRL #21 TiCN Coated Drill Bit can be used to drill the stainless steel tubing used with CRL Hand Rail Systems. This #21 Size Drill Bit is also ideal for use with the Cat. No. T1032TC Tap (see page 491K). CRL recommends using the Cat. No. DBH1 Bit Holder (at left) with this #21 Bit to greatly increase the gripping strength of the drill to the bit. Minimum order is one each.

CAT. NO. SLD21

## CRL Contractors Series Diamond Drills

- Ideal for Brick, Block and Concrete



Our Contractors Series Diamond Drills are excellent for brick, block, concrete, mortar, marble and other similar materials. 6" (152 mm) drilling depth with a removable center pilot. Use wet or dry in a 1/2" (127 mm) hand held drill.

CAT. NO.	DIAMETER
CSDD1	1"
CSDD118	1-1/8"
CSDD114	1-1/4"
CSDD138	1-3/8"
CSDD112	1-1/2"
CSDD2	2"
CSDD212	2-1/2"

Minimum order: 1 each.

Groo-V Tip is a registered trademark of Relton Corporation.

## CRL Countersinks

- Produce Smooth, Round Countersunk Holes Every Time
- Compare Our Low Prices Against Other Brands

CRL Countersinks are specifically designed to cut round countersunk holes in aluminum. They cut faster than standard countersinks, and leave a finished hole every time. Smooth drilling action from single cutting edge prevents chatter and fluted edges. The 1/4" (6.3 mm) shank diameter fits any 1/4" or 3/8" drill chuck.

CAT. NO.	DIAMETER	USES
<b>6SCS</b>	19/64" (7.5 mm)	For No. 6 Screws
<b>8SCS</b>	11/32" (8.7 mm)	For No. 8 Screws
<b>10SCS</b>	25/64" (9.9 mm)	For No. 10 Screws
<b>18SCS</b>	.486" (12.3 mm)	For No. 12 and 14 Screws
<b>18CS</b>	9/16" (14.3 mm)	For No. 12 and 16 Screws
<b>26ACS</b>	13/16" (20.6 mm)	For Large Holes
<b>18DB</b>	.560" (14.2 mm)	90 Degree Deburring Tool

Minimum order: 1 each. Sizes can be combined for quantity pricing.

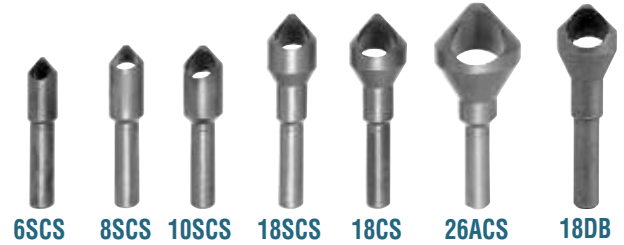

These four sizes are also available in a cost-saving set with a convenient case.



### 4 PIECE COUNTERSINK SET

CAT. NO.	SET INCLUDES
<b>CS4</b>	1 each 6SCS, 8SCS, 10SCS, and 18CS

Minimum order: 1 each.

## CRL Weldon® Countersinks



- Best Countersink Available for Aluminum
- Single Cutting Edge for Fast Removal of Stock

CAT. NO.	DIAMETER	USES
<b>CS6S</b>	19/64" (7.5 mm)	For No. 6 screws
<b>CS8S</b>	11/32" (8.7 mm)	For No. 8 screws
<b>CS10S</b>	25/64" (9.9 mm)	For No. 10 screws
<b>CS18S</b>	.486" (12.3 mm)	For Nos. 12 and 14 screws
<b>CS18</b>	9/16" (14.3 mm)	For Nos. 12 and 16 screws
<b>CS26A</b>	13/16" (20.6 mm)	For Large Holes
<b>DB18</b>	.556" (14.1 mm)	90 Degree Deburring Tool

Minimum order: 1 each. Sizes can be combined for quantity pricing.

CRL Weldon® Countersinks are known for their high quality unique designs and outstanding performance. They cut chatterless finished holes in aluminum every time. Smooth drilling action from a single cutting edge no matter what angle you cut at. The 1/4" (6.3 mm) shank diameter fits any 1/4" or 3/8" drill chuck.



The four most popular sizes are also available in a cost-saving set with a convenient wooden holder.

**NOTE:** 4 piece set not available in Australia.

### 4 PIECE COUNTERSINK SET

CAT. NO.	SET INCLUDES
<b>CS618S</b>	1 each CS6S, CS8S, CS10S, and CS18

Minimum order: 1 each.

## CRL Unibit® Step Drills

- Perfectly Round Holes in Thin Materials
- Drill Up to 13 Diameters With Just One Drill

The CRL Unibit® Step Drill uses a unique, single flute design to drill perfectly round holes in materials up to 1/8" (3.2 mm) thick. Cutting steps of progressively larger diameters make it possible to drill up to 13 different hole sizes with a single bit. Also, the hole is automatically deburred by the cutting edge of the next size up.

Hole starting is easy because it won't skid across the surface, even without center punching. Designed for use with steel, copper, brass, aluminum, and other thin metals, it can also be used on plastics without chipping or clogging.

CAT. NO.	STEPS	DIAMETERS
<b>UB1</b>	13	1/8" to 1/2" (3.2 to 12.7 mm)
<b>UB2</b>	6	3/16" to 1/2" (4.8 to 12.7 mm)
<b>UB3</b>	9	1/4" to 3/4" (6.3 to 19 mm)
<b>UB123</b>	-	Set of All 3

Minimum order: 1 each.

Weldon is a registered trademark of Dauphin Precision Tool, LLC.

Unibit is a registered trademark of Irwin Industrial Tool Company.



## CRL 3-in-1 Tapping Tool

- Taps Three Different Sizes All in One Tool



The CRL 3-in-1 Tapping Tool has a round shaft that steps down to three different diameters. Each size has a different tap thread, including 6-32, 8-32, and 10-24. This is a great tool for forming new threads or just cleaning existing threads in a variety of thin metals or plastics. Minimum order is one each.

CAT. NO. TT31

## CRL Taper Reamer

- Used to Ream, Deburr, Align, Enlarge, and Start Taps



Made of high-grade tempered tool steel, this 1/8" - 1/2" (3.2 - 12.7 mm) Taper Reamer has a sure-grip plastic handle. Use it to ream, deburr, align, enlarge, and start taps. Minimum order is one each.

CAT. NO. KD2043

## CRL Omni Tight-Fit Drill Adapter Kit

- Drill in a Space as Small as 2" (51 mm), or as Deep as 6" (152 mm)

The CRL Omni Tight-Fit Drill Adapter Kit allows you to drill in spaces as tight as only 2" (51 mm), so drilling can be done without disassembly of other components. The special right angle chuck is compatible with all 1/4" or larger drill motors, and has a knurled 7/8" (22 mm) diameter handle which is lightweight and easy to grasp. Kit includes a six piece assortment of Drills, a 6" (152 mm) long Extension, and an Adapter for using the specially designed Screw-In Drill Bits with any common drill motor. Also included is a Wrench for unscrewing the Drill Bits from either the special right-angle Chuck or the 6" (152 mm) Extension. Omni Drills included in the Kit are:



CAT. NO. 00101  
Complete Kit



- One: 9/16" Long x 1/8" Dia. (14.3 x 3.2 mm)
- One: 1-1/8" Long x 1/8" Dia. (28.6 x 3.2 mm)
- One: 1-1/8" Long x 5/32" Dia. (28.6 x 4 mm)
- One: 1-1/8" Long x 3/16" Dia. (28.6 x 4.8 mm)
- One: 2" Long x 3/32" Dia. (51 x 2.4 mm)
- One: 2" Long x 1/8" Dia. (51 x 3.2 mm)

The Kit comes in a plastic Carrying Pouch. Minimum order is one each.

### OPTIONAL ACCESSORIES

#### 9/16" (14.3 mm) SHORT DRILL SET



CAT. NO. 00134

Five Drills;  
3/32", 1/8", 5/32",  
3/16", and 1/4"  
(2.4, 3.2, 4,  
4.8, and 6.3 mm).

#### 1-1/8" (28.6 mm) MEDIUM DRILL SET



CAT. NO. 00133

Five Drills;  
3/32", 1/8", 5/32",  
3/16", and 1/4"  
(2.4, 3.2, 4, 4.8,  
and 6.3 mm).

#### 2" (51 mm) LONG DRILL SET



CAT. NO. 00132

Five Drills;  
3/32", 1/8", 5/32",  
3/16", and 1/4"  
(2.4, 3.2, 4, 4.8,  
and 6.3 mm).

#### EXTENSION SET



CAT. NO. 00120

Four Extensions, 1/2", 3", 6", and 9"  
(12, 76, 152, and 229 mm)  
can be combined for  
a work length of 18" (457 mm).

**NOTE:** Replacement drills and extensions shown to the right must be ordered in sets. Individual Drills and Extensions are not available.



## CRL Machine Screw Taps

- Five Sizes
- High-Carbon Steel



CRL Machine Screw Taps are made from high-carbon steel and will stay sharp for years.

CAT. NO.	THREAD SIZE	DRILL SIZE
106320	6-32NC	#36
108320	8-32NC	#29
101024	10-24NC	#25
101032	10-32NF	#21
101224	12-24NC	#16

Minimum order: 1 each. All Taps can be combined for quantity pricing.

## CRL Fractional Size Taps

- Five Sizes
- High-Carbon Steel



CRL Fractional Sized Taps are made from high-carbon steel and come in five common thread sizes.

CAT. NO.	THREAD SIZE	DRILL SIZE
151420	1/4"-20NC	#7
151428	1/4"-28NF	#3
155618	5/16"-18NC	F
153816	3/8"-16NC	5/16"
151213	1/2"-13NC	27/64"

Minimum order: 1 each. All Taps can be combined for quantity pricing.

## CRL Screw Extractor Set

- Use With 33682 Tap Wrench for Removing Broken Screws and Bolts
- Five Sizes

The CRL five-piece spiral-fluted Screw Extractor Set contains all of the most popular sized Screw Extractors. Refer to the chart below for screw and drill size.



CAT. NO. 35P

BIT NO.	DRILL SIZE	REMOVES BOLTS AND SCREWS
1	5/64"	3/32" to 5/32", No. 3 to No. 6, 2.5 to 4 mm
2	7/64"	5/32" to 7/32", No. 6 to No. 12, 4 to 6 mm
3	5/32"	7/32" to 9/32", No. 12, 6 to 8 mm
4	1/4"	9/32" to 3/8" and 1/8" NPT, 1/8" BSP, 8 to 10 mm
5	19/64"	3/8" to 5/8" and 1/4" NPT, 1/4" BSP, 10 to 16 mm

Minimum order: 1 set.

## CRL TIN Coated 10-32 Tap

- Works With Cat. No. TR1E Tap Wrench



This high-grade TIN Coated Tap is ideal for tapping stainless tubing. Recommended for use on our CRL Hand Rail Systems when using CRL Cat. No. PRS1032 Fasteners. Use the CRL Cat. No. SLD21 #21 TiCN Coated Drill Bit (see page 488K), which is the recommended size for this Tap. Minimum order is one each.

CAT. NO. T1032TC

## CRL T-Handle Tap Wrenches

- Positive-Grip Chuck
- Three Sizes

This CRL Tap Wrench has a sliding handle which can be extended to full length for more leverage. It has a knurled positive grip nut. Three sizes to choose from for holding tap sizes from #0 to 1/2".



CAT. NO.	HOLDS TAP SIZES
TR112E	#12 to 5/16"
TR1E	#0 to 1/4"
TR2E	1/4" to 1/2"

Minimum order: 1 each.

## CRL Drill and Threading Tap Set

- Has Six Drills and Six Taps



A convenient kit for workbench or truck, this set contains six wire gauge, high-speed, 135 degree split point, machine-length drill bits, sizes: #43, #35, #29, #25, #21, and #7. There are six threading taps, sizes: 4-40NC, 6-32NC, 8-32NC, 10-24NC, 10-32NF, and 1/4"-20NC. Also included is a Tap Wrench, which will accommodate all tap thread sizes from #0 to 1/4", and a handy vinyl carrying pouch. Minimum order is one each.

CAT. NO. S111C

# CRL DRILL ACCESSORIES

For Pricing Visit [crlaurence.com](http://crlaurence.com) or Call Us Toll Free at the Phone Numbers Shown on the Back Cover

## CRL High-Speed Hole Saws

- Available in Sizes 5/8" through 4" (16 to 102 mm)
- High-Speed Steel Cutting Edges

High-Speed Hole Saws are heavy-duty tools made to meet the demands of users in the automotive, electrical, and industrial trades. This professional quality line of Hole Saws is available in a complete range of sizes from 5/8" to 4" (16 to 102 mm). Special high-speed steel cutting edges are welded to alloy backs. Knock out holes provide easy core removal. Depth of cut: 1-1/8" (29 mm).

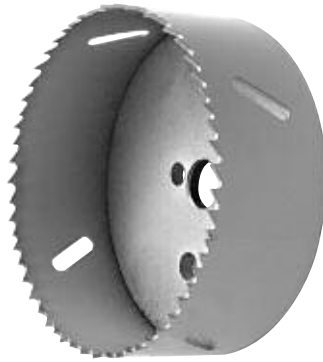

Hole Saw

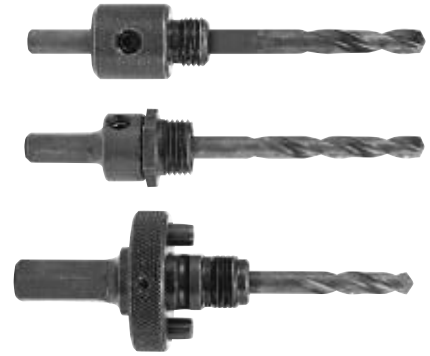

Mandrels with Pilot Drills

### HOLE SAWS

CAT. NO.	SIZE	USE MANDREL
HS8510	5/8" (16 mm)	HSM8501
HS8512	3/4" (19 mm)	HSM8501
HS8514	7/8" (22 mm)	HSM8501
HS8516	1" (25 mm)	HSM8501
HS8518	1-1/8" (29 mm)	HSM8501
HS8520	1-1/4" (32 mm)	HSM8502 or HSM8503
HS8522	1-3/8" (35 mm)	HSM8502 or HSM8503
HS8524	1-1/2" (38 mm)	HSM8502 or HSM8503

Minimum order: 1 each.

### HOLE SAWS

CAT. NO.	SIZE	USE MANDREL
HS8528	1-3/4" (44 mm)	HSM8502 or HSM8503
HS8532	2" (51 mm)	HSM8502 or HSM8503
HS8536	2-1/4" (57 mm)	HSM8502 or HSM8503
HS8540	2-1/2" (64 mm)	HSM8502 or HSM8503
HS8548	3" (76 mm)	HSM8502 or HSM8503
HS8556	3-1/2" (89 mm)	HSM8502 or HSM8503
HS8564	4" (102 mm)	HSM8502 or HSM8503

Minimum order: 1 each.

### MANDRELS WITH PILOT DRILLS

CAT. NO.	DESCRIPTION	SHANK
HSM8501	Fits Hole Saws 5/8" to 1-1/8"	1/4"
HSM8502	Fits Hole Saws 1-1/4" to 4"	5/16"
HSM8503	Fits Hole Saws 1-1/4" to 4"	7/16"

Minimum order: 1 each.

### PILOT DRILLS ONLY

CAT. NO.	DESCRIPTION
8501PD	Pilot Drill for HSM8501 or HSM8503
8502PD	Pilot Drill for HSM8502

Minimum order: 1 each.

## CRL Makita® Keyless Chuck

- Fits Bits From 1/16" to 3/8"



The CRL Makita® Keyless Chuck makes changing bits quick and easy. This Chuck accommodates bits from 1/16" to 3/8" (1.6 to 10 mm). Minimum order is one each.

CAT. NO. 7630838

## CRL Replacement Drill Chucks



Renowned quality Jacobs Chucks® made from hardened steel fit most popular 1/4" and 3/8" (6 and 10 mm) electric drills. 3/8" - 24 thread. Includes chuck key. Minimum order is one each.

CAT. NO. CDC4G61

## CRL Jacobs Chuck® Keys

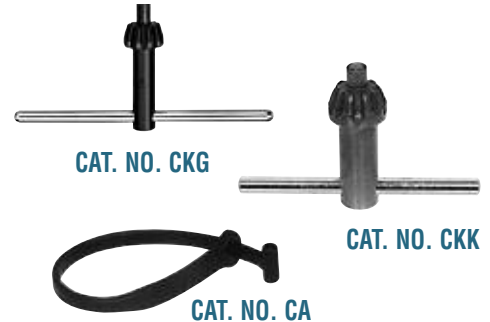

- T-Handle Models Fit Most Brands of Drills

Renowned quality Jacobs Chuck® Keys made from hardened steel fit most popular 1/4" and 3/8" (6 and 10 mm) electric drill motors. Minimum order is one each.

### FITS CHUCK MODELS

CAT. NO.	JACOBS	FITS PILOT HOLE SIZE
CKG	All Model Nos. Containing Letter "G"	1/4"
CKK	All Model Nos. Containing Letter "K"	9/32"
CA	Chuck Key Holder	---

Minimum order: 1 each.

## CRL Replacement Chuck Key

- Stainless Steel

Replacement Chuck Key for Cat. No. CRL2 Glass Drilling Machine. Minimum order is one each.



CAT. NO. DMP110

Makita is a registered trademark of Makita Corporation.

Jacobs Chuck is a registered trademark of Jacobs Chuck Manufacturing Company.



C.R. LAURENCE COMPANY

[crlaurence.com](http://crlaurence.com) | [usalum.com](http://usalum.com)

492K | [crlaurence.ca](http://crlaurence.ca) [crlaurence.com.au](http://crlaurence.com.au) [crlaurence.co.uk](http://crlaurence.co.uk) [crlaurence.de](http://crlaurence.de) [crlaurence.eu](http://crlaurence.eu)

## CRL General Automatic Center Punch

- Gives a Uniform Mark Each Time
- Automatically Sets and Releases

The CRL Automatic Center Punch has a hardened steel point that automatically sets and releases with each stroke. The spring tension within the tool gives a uniform impression that is adjustable for light, medium or heavy strokes. Knurled steel body for finger grip. All working parts are made of tool steel that is machined, heat-treated, and ground to give maximum performance.



CAT. NO.	DESCRIPTION
G78	5/8" (15.9 mm) Automatic Punch
G78P	5/8" (15.9 mm) Replacement Point
G79	1/2" (12.7 mm) Automatic Punch
G79P	1/2" (12.7 mm) Replacement Point

Minimum order: 1 each.

## CRL Noxon Center Punch and Nail Set

- No Hammer Needed
- Ringed Ends for Sure Grip



CAT. NO. NOX1  
Center Punch Only

CAT. NO. NOX2  
Center Punch/Nail Set



With the CRL Noxon Center Punch and Nail Set it is a snap to "mark the spot" in a great variety of materials. Simply locate the spot to be punched, place tip and press, lift plunger, and release. The heavy spring action produces quick results. Choose either the Two-end Snapper Center Punch and Nail Set, or the Center Punch only. Minimum order is one each.

## CRL General Pocket Automatic Center Punch

- Punches, Marks, Scribes and Starts Nail or Screw Holes



The CRL Pocket Automatic Center Punch is made of lightweight aluminum with an alloy steel point and convenient pocket clip. Ideal for marking, scribing, center punching, and more. Minimum order is one each.

CAT. NO. G87

## CRL Stanley® Pin Punch

- Hardened Material
- Designed for Industrial Use

**new**



This CRL Stanley® Pin Punch is used for punching holes. The one-piece construction is forged from tempered tool steel for strength and hardened for long life. Powder coated for increased visibility. Size is 3/16" (5 mm) and length 6" (152 mm). Minimum order is one each.

CAT. NO. ST16233

## CRL Stanley® Nail Sets

- Square Head/Round Knurled Shank



The CRL Stanley® Nail Sets have polished tips and are cupped and chamfered for durability. Made of hardened and tempered alloy steel, they have square heads to keep them from rolling. Available in three sizes: 1/32", 1/16", and 3/32".

CAT. NO.	SIZE	LENGTH
ST58111	1/32"	4" (102 mm)
ST58112	1/16"	4" (102 mm)
ST58113	3/32"	4" (102 mm)

Minimum order: 1 each.

## CRL Long Aligning Punch

- 16" Long Punch is Designed for Industrial Use



This CRL Long Aligning Punch is designed to line up holes in flanges, assemblies, and other mating parts. Can also be used for removing long pins and shafts. Size is 3/16" (5 mm), and length is 16" (406 mm). Minimum order is one each.

Stanley is a registered trademark of Stanley Logistics, LLC.

CAT. NO. 2114371

## CRL Metal Hand Punch Set

- Seven Die Sizes



This powerful CRL Metal Hand Punch makes accurate, round holes in metals up to 16 gauge. It is furnished with seven sizes of hardened punches and dies in a molded plastic box. All main parts are drop forged and heat treated. Contoured handles give a comfortable grip. A handy tool for anyone who needs a completely portable hole punch with plenty of power. Minimum order is one set.

CAT. NO. HP8500

# CRL ROTARY TOOLS

For Pricing Visit [crlaurence.com](http://crlaurence.com) or Call Us Toll Free at the Phone Numbers Shown on the Back Cover

## CRL Variable Speed Rotary Tool Kit

- Variable Speed 8,000 to 18,000 RPM
- Includes 61-Piece Accessory Set



For versatility at a great price, you can't beat the CRL Variable Speed Rotary Tool Kit. The tool's comfortable grip and lightweight design make it easy to use in any position. Change accessories in just 20 seconds.

CAT. NO.	DESCRIPTION
LD111	110V Rotary Tool Kit
LD111AU	240V Rotary Tool Kit w/AU Plug
LD111EU	220V Rotary Tool Kit w/EU Plug

Minimum order: 1 each.

## CRL Cordless Rotary Tool Kit

**new**

- Includes 40 Assorted Accessories
- Super Bright LED Work Light



This CRL Cordless Rotary Tool is a compact, efficient 7.2 Volt rechargeable tool for fine sanding, grinding, cutting, sharpening, and engraving. Features two speeds: High at 16,000 RPM, and low at 8,000 RPM. Includes two batteries.

CAT. NO.	DESCRIPTION
LD115	7.2 Volt Cordless Rotary Tool Kit
LD115AU	7.2 Volt Cordless Rotary Tool Kit w/AU Plug

Minimum order: 1 each.

## CRL Dremel® Mini-Mite Cordless Rotary Tool

- Small, Powerful and Lightweight
- Runs at 5,000 and 10,000 RPM



This small yet powerful tool for the home and shop fits right into your hand, giving you the kind of maneuverability not usually found in a rotary tool. The D750 accepts Dremel® and other bits with shanks up to 1/8" (3 mm) diameter. Included are a Battery Pack, a Charger, and five Dremel® Bits. For replacement battery order Cat. No. D75501. Minimum order is one each.

CAT. NO. D750

## CRL Dremel® 300 Series Rotary Tool Kit

- Variable Speed 5,000 to 35,000 RPM
- Includes Storage Case and 24 Accessories



The CRL Dremel® 300 Series Rotary Tool offers the precision and control required to complete a wide range of projects. Its variable speed control allows you to set the speed of the tool to match a particular accessory or the task at hand. Minimum order is one each.

CAT. NO. 300124

## CRL 1/16" Collet for Dremel® Mini-Mite Cordless Rotary Tool

- Holds Carbide Burr Drills and Diamond Ball Burr Bits

This CRL 1/16" (2 mm) Collet for the Dremel® Mini-Mite Rotary Tool accepts our Cat. No. DRL2021C Tapered Auger Carbide Bit and Cat. No. ADK3D Diamond Ball Bit. These Bits are used with the Aegis Windshield Repair Kits. Minimum order is one each.



CAT. NO. D482

Dremel is a registered trademark of Robert Bosch Tool Corporation.

## CRL Felt Polishing Tips for Dremel® Tools

- Used to Improve the Clarity of Glass Repairs

CRL Felt Polishing Tips will polish your glass repairs to the best possible clarity. Choose from three sizes. All use the Cat. No. M401 Mandrel, which must be ordered separately.



Mandrel  
CAT. NO. M401  
Minimum order is one each.



CAT. NO. DR422  
3/8" (10 mm) Diameter 1/pk



CAT. NO. DR414  
1/2" (13 mm) Diameter 6/pk



CAT. NO. DR429  
1" (25 mm) Diameter 1/pk  
Minimum order for Felt Tips is one pack.



C.R. LAURENCE COMPANY

[crlaurence.com](http://crlaurence.com) | [usalum.com](http://usalum.com)

494K | [crlaurence.ca](http://crlaurence.ca) [crlaurence.com.au](http://crlaurence.com.au) [crlaurence.co.uk](http://crlaurence.co.uk) [crlaurence.de](http://crlaurence.de) [crlaurence.eu](http://crlaurence.eu)

## CRL Tapered Auger Carbide Burr Drills

- Long Lasting Carbide Tip for Use in Dremel® or Other Rotary Tools



These CRL Tapered Auger Burr Drills for windshield repair quickly open the break area for quick resin flow. These burrs are virtually unbreakable as the tapered tip easily drills the glass and the tapered auger design brings the materials to the surface, keeping the drilling process cooler than when using a ball style burr. 10 Drills per package. Minimum order is one package.

**NOTE:** Requires Cat. No. D482 1/16" (1.6 mm) Collet when using in a CRL Dremel® Mini-Mite Cordless Rotary Tool or CRL Dremel® Moto Tool.

CAT. NO. DRL2021C

## CRL Diamond Ball Burr Bit

- Fast Drilling to Open Repair Areas for the Injection of Resin



This CRL Diamond Ball Burr Bit for windshield chip repair opens repair areas to create a pool for better resin flow. It increases potential for better results by gaining access to the start of the cracks in the center of the damaged area. Be sure never to drill deeper than the height of the ball burr to prevent damage to the inner layer of PVB. One per package. Minimum order is one each.

**NOTE:** Requires Cat. No. D482 1/16" (1.6 mm) Collet when using in a CRL Dremel® Mini-Mite Cordless Rotary Tool or CRL Dremel® Moto Tool.

CAT. NO. ADK3D

## CRL Tripple-Ripple™ and Flat-Tip Miniature Diamond Drills

- Music Wire Diamond Drills

Plated Diamond Flat-Tip Drills are to be used in hand-held Dremel®, Foredom or small precision drill presses. Diamond is plated on flexible music wire. Tripple-Ripple™ Drills have twice the life and cutting rate of our Flat-Tip Drills. The Tripple-Ripple™ Diamond Drill has three flutes to allow cuttings to flush away, and decrease frontal contact and drag. As the edges wear, fresh diamond in the flutes maintain the cutting action.

**NOTE:** Always submerge in CRL Diamond Tool Coolant Solution to prevent overheating and prolong tool life.



Shown in Dremel® Tool



Tripple-Ripple™ Drill



Flat-Tip Drill



### TRIPPLE-RIPPLE™ PLATED DIAMOND DRILLS

CAT. NO.	SIZE-U.S.	DESCRIPTION
TRD346	.0295"	.75 mm Tripple-Ripple™ Drill
TRD116	.0433"	1.1 mm Tripple-Ripple™ Drill
TRD146	.0551"	1.4 mm Tripple-Ripple™ Drill
TRD186	.0709"	1.8 mm Tripple-Ripple™ Drill
TRD216	.0827"	2.1 mm Tripple-Ripple™ Drill

Minimum order: Six Drills of one size. Can be combined for quantity pricing.

### MINIATURE PLATED DIAMOND FLAT-TIP DRILLS

CAT. NO.	SIZE-U.S.	DESCRIPTION
MD346	.0295"	.75 mm Flat-Tip Drill
MD16	.0394"	1 mm Flat-Tip Drill
MD1146	.0492"	1.25 mm Flat-Tip Drill
MD1126	.0590"	1.50 mm Flat-Tip Drill
MD26	.0787"	2 mm Flat-Tip Drill
MD2146	.0886"	2.25 mm Flat-Tip Drill
MD2126	.0985"	2.5 mm Flat-Tip Drill
MD36	.1182"	3 mm Flat-Tip Drill
MD3126	.1379"	3.5 mm Flat-Tip Drill
MD46	.1576"	4 mm Flat-Tip Drill

Minimum order: Six Drills of one size. Can be combined for quantity pricing.

## CRL Diamond Tool Coolant

- For Glass Drilling, Routing, and Sawing
- Now in Three Convenient Sizes

CRL Diamond Tool Coolant Concentrate is mixed with water to create an excellent coolant solution for drilling, routing, and sawing glass. CRL DTC80 is economical to use because a ratio of 50 parts water to one part concentrate is all that is needed for optimum cooling and lubricating performance. CRL Diamond Tool Coolant is biodegradable, which means it can be safely disposed of in your shop's drain without causing harm to the environment. Refer to page 166K for complete mixing instructions.

CAT. NO.	CONTENTS
DTC80Z	8 Ounces (236 ml)
DTC80QT	1 Quart (945 ml)
DTC80GL	1 Gallon (3.785 l)

Minimum order: 1 each.

Dremel is a registered trademark of Robert Bosch Tool Corporation.



## Types of Putty Knives

- Bent Stiff



- Stiff



- Flexible



## CRL Russell® 1-1/8" Bent Knife



- Our Best Seller

This knife's stiff, steel blade is riveted into the rosewood handle and held by a heavy-duty support. Preferred smooth 35 degree radius bend in the blade. The blade width is 1-1/8" (29 mm), and the overall length is 6-1/2" (165 mm). **NOTE:** Not available in Australia. Minimum order is one each.

CAT. NO. 2BE118

## CRL Lamson 3/4" Bent Knife



- Smooth 35 Degree Radius Bend in a Stiff Steel Blade

This knife's stiff steel blade is riveted into the wood handle and held by a heavy-duty support, with a preferred smooth 35 degree radius bend in the blade. The blade width is 3/4" (19 mm), and the overall length is 7-5/16" (186 mm). **NOTE:** Not available in Australia. Minimum order is one each.

CAT. NO. 900B34

## CRL Red Devil® 1-1/4" Bent Knife



- Solvent-Resistant Black Nylon Handle
- High Carbon Steel Blade

The high carbon, precision-ground steel blade on the CRL Red Devil® 1-1/4" (32 mm) Stiff Bent Putty Knife extends through the black nylon solvent-resistant handle, with a 30 degree angle bend in the blade. The brass-plated, solid steel nail setting head can be used for setting drywall nails and other hammering jobs. The overall length is 7-1/2" (191 mm). Minimum order is one each.

CAT. NO. 4243

## CRL Russell® 1-5/8" Bent Knife



- Best Size for Steel Sash Work

This knife's stiff steel blade is riveted into the rosewood handle and held by a heavy-duty support, with a preferred smooth 35 degree radius bend in the blade. The blade width is 1-5/8" (41 mm), and the overall length is 7-9/16" (192 mm). **NOTE:** Not available in Australia. Minimum order is one each.

Russell is a registered trademark of Dexter-Russell, Inc.  
Red Devil is a registered trademark of Red Devil, Inc.

CAT. NO. 416B

## CRL Glazing Putties

- For Glazing Wood, Metal, and Aluminum Sash
- Professional Quality
- Visit [crlaurence.com](http://crlaurence.com) for Information



## CRL Red Devil® 1-1/4" Stiff Knives



- Plastic Handle Knives are Great for Retail Sales
- 12 Per Box



The CRL Stiff Putty Knives in a Countertop Box are good quality putty knives with steel blades set into a plastic handle, ideal for use in the shop or over the counter sales. The blade width is 1-1/4" (32 mm) and the overall length is 7-3/8" (187 mm). Packed 12 per box. Minimum order is one box.

CAT. NO. 4701

## CRL Red Devil® 1-1/4" Stiff Knife



- Solvent-Resistant Black Nylon Handle
- High-Carbon Steel Blade

CRL Red Devil® Stiff Blade Knives feature a high-carbon, precision-ground steel blade that extends through the black nylon solvent-resistant handle. The brass-plated, solid steel nail setting head can be used for setting drywall nails and other hammering jobs. Blade width is 1-1/4" (32 mm). Overall length is 7-5/8" (194 mm). Minimum order is one each.

CAT. NO. 4201

## CRL Russell® 1-1/4" Stiff Knife



- High Grade Tool Steel Blade
- Rosewood Handle

High-grade tool steel blade make this CRL Russell® Stiff Blade Knife strong. The rosewood handle is riveted on. Blade width is 1-1/4" (32 mm). Overall length is 7-1/4" (184 mm). **NOTE:** Not available in Australia. Minimum order is one each.

CAT. NO. 3S114

## CRL Red Devil® 1-1/2" Stiff Knife



- Solvent-Resistant Black Nylon Handle
- High-Carbon Steel Blade

CRL Red Devil® Stiff Blade Knives feature a high-carbon, precision-ground steel blade that extends through the black nylon solvent-resistant handle. The brass-plated, solid steel nail setting head can be used for setting drywall nails and other hammering jobs. Blade width is 1-1/2" (38 mm). Overall length is 7-3/4" (197 mm). Minimum order is one each.

CAT. NO. 4203

## CRL Hyde® 1-1/2" Stiff Knife



- Soft Grip Ergonomic Handle
- Wide Hammer Head® End

This CRL Hyde® Stiff Blade Knife features a high-carbon steel blade set in a comfortable, professional grip with safety thumb bolster and a wide Hammer Head® end for setting nails. Blade width is 1-1/2" (38 mm). Overall length is 8-3/8" (213 mm). Minimum order is one each.

Russell is a registered trademark of Dexter-Russell, Inc.  
Red Devil is a registered trademark of Red Devil, Inc.  
Hyde and Hammer Head are registered trademarks of Hyde Tools, Inc.

CAT. NO. 06150

## CRL Red Devil® 2" Stiff Knife



- Solvent-Resistant Black Nylon Handle
- High-Carbon Steel Blade

CRL Red Devil® Stiff Blade Knives feature a high-carbon, precision-ground steel blade that extends through the black nylon solvent-resistant handle. The brass plated, solid steel nail setting head can be used for setting drywall nails and other hammering jobs. Blade width is 2" (51 mm). Overall length is 7-3/4" (197 mm). Minimum order is one each.

CAT. NO. 4205

## CRL Hyde® 2" Stiff Knife



- Soft-Grip Ergonomic Handle
- Wide Hammer Head® End

This CRL Hyde® Stiff Blade Knife features a high-carbon steel blade set in a comfortable, professional grip with safety thumb bolster and a wide Hammer Head® end for setting nails. Blade width is 2" (51 mm). Overall length is 8-1/2" (216 mm). Minimum order is one each.

CAT. NO. 06225

## CRL 3" Stiff Knife



- Large Handle With Soft Grip
- High-Carbon Steel Blade

This CRL Stiff Blade Knife features a high-carbon steel blade with a ground edge set in a large soft-grip handle. Blade width is 3" (76 mm). Overall length is 9" (229 mm). Minimum order is one each.

CAT. NO. HW039

## CRL Red Devil® 3" Stiff Knife



- Solvent-Resistant Black Nylon Handle
- High-Carbon Steel Blade

CRL Red Devil® Stiff Blade Knives feature a high-carbon, precision-ground steel blade that extends through the black nylon solvent-resistant handle. The brass-plated, solid steel nail-setting head can be used for setting drywall nails and other hammering jobs. Blade width is 3" (76 mm). Overall length is 8-1/4" (210 mm). Minimum order is one each.

CAT. NO. 4209

## CRL Russell® 1-1/4" Flexible Knife



- High-Carbon Tool Steel Blade
- Rosewood Handle

This CRL Russell® Flexible Putty Knife has a 1-1/4" (32 mm) wide, precision-ground and tempered, high-carbon tool steel blade. A metal bolster gives strength and protects the rosewood handle. Overall length is 7-1/4" (184 mm). **NOTE:** Not available in Australia. Minimum order is one each.

CAT. NO. 2F114

## CRL Red Devil® 1-1/4" Flexible Knife



- Polished Wood Handle
- Precision-Ground Steel Blade

CRL Red Devil® Flexible Blade Knives feature a precision-ground, rust-resistant lacquered steel blade that extends through the polished wood handle for flexibility and long life. The brass-plated, solid steel nail-setting head can be used for setting drywall nails and other hammering jobs. Blade width is 1-1/4" (32 mm). Overall length is 7-3/4" (197 mm). **NOTE:** Not available in Australia. Minimum order is one each.

Russell is a registered trademark of Dexter-Russell, Inc.

Red Devil is a registered trademark of Red Devil, Inc.

Hyde and Hammer Head are registered trademarks of Hyde Tools, Inc.

CAT. NO. 4102

## CRL Red Devil® 1-1/2" Flexible Knife



- Polished Wood Handle
- Precision-Ground Steel Blade

CRL Red Devil® Flexible Blade Knives feature a precision-ground, rust-resistant lacquered steel blade that extends through the polished wood handle for flexibility and long life. The brass-plated, solid steel nail-setting head can be used for setting drywall nails and other hammering jobs. Blade width is 1-1/2" (38 mm). Overall length is 7-5/8" (194 mm). **NOTE:** Not available in Australia. Minimum order is one each.

CAT. NO. 4104



## CRL 1-1/2" Flexible Knife



- High-Carbon Flexible Steel Blade
- Large Soft Grip Handle

Our CRL Flexible Blade Knife features a high-carbon steel blade set in a large soft grip handle. Blade width is 1-1/2" (38 mm). Overall length is 8-3/4" (222 mm). Minimum order is one each.

CAT. NO. HW033

## CRL 2" Flexible Knife



- High-Carbon Flexible Steel Blade
- Large Soft Grip Handle

Our CRL Flexible Blade Knife features a high-carbon steel blade set in a large soft grip handle. Blade width is 2" (51 mm). Overall length is 8-3/4" (222 mm). Minimum order is one each.

CAT. NO. HW034

## CRL Red Devil® 2" Flexible Knife



- Solvent-Resistant Black Nylon Handle
- High-Carbon Flexible Steel Blade

CRL Red Devil® Flexible Knives feature a high-carbon, precision-ground steel blade that extends through the black nylon solvent-resistant handle. The brass-plated, solid steel nail setting head can be used for setting drywall nails and other hammering jobs. Blade width is 2" (51 mm). Overall length is 7-5/8" (194 mm). Minimum order is one each.

CAT. NO. 4206

## CRL Red Devil® 2-1/2" Flexible Knife

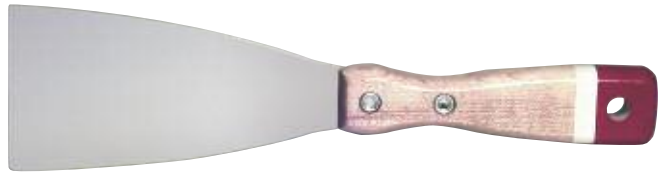

- Extra Long, Solid Hardwood Handle
- Super Flexible, Great for Spackling

This CRL Red Devil® Flexible Putty Knife is precision-ground with a high-carbon steel blade. It is polished, lacquered, and secured by brass eyelets in a solid hardwood handle. Blade width is 2-1/2" (64 mm). Overall length is 9-1/2" (241 mm). **NOTE:** Not available in Australia. Minimum order is one each.

CAT. NO. 4510

## CRL 3" Flexible Knife



- High-Carbon Flexible Steel Blade
- Large Soft Grip Handle

Our CRL Flexible Blade Knife features a high-carbon steel blade set in a large soft grip handle. Blade width is 3" (76 mm). Overall length is 9" (229 mm). Minimum order is one each.

Red Devil is a registered trademark of Red Devil, Inc.

CAT. NO. HW035

## CRL 4" Flexible Knife



- High-Carbon Flexible Steel Blade
- Large Soft Grip Handle

Our CRL Flexible Blade Knife features a high-carbon steel blade set in a large soft grip handle. Blade width is 4" (102 mm). Overall length is 9-3/16" (233 mm). Minimum order is one each.

CAT. NO. HW036

## CRL of Europe

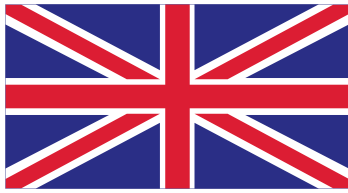

[crlaurence.co.uk](http://crlaurence.co.uk)



England



England



[crlaurence.de](http://crlaurence.de)



Germany



Germany

### CRL Ebor 1-1/2" 3110 Putty Knife Chisel



Available Only in Europe



- Carbon Steel
- Scale Tang Blade Handle
- Available Only in Europe

The CRL Ebor 3110 Putty Knife Chisel is made of high-grade carbon steel for strength and longevity. Its scale tang blade handle is extra strong and easy to grip. Blade width is 1-1/2" (38 mm). Overall length is 8-1/4" (210 mm). Minimum order is one each.

CAT. NO. 0704

### CRL Ebor 1-1/2" 3107 Skew Stiff Putty Knife



Available Only in Europe



- Carbon Steel
- Scale Tang Blade Handle
- Available Only in Europe

The CRL Ebor 3107 Skew is a high-grade carbon steel stiff Putty Knife with a scale tang blade handle for extra strength and ease during use. Stiff blade has skew end and a width of 1-1/2" (38 mm). Overall length is 8-3/8" (213 mm). Minimum order is one each.

CAT. NO. 0701

### CRL Ebor 1-1/4" 3130 Hacking Knife



Available Only in Europe



- Extra-Strong Carbon Steel Blade
- Heavy-Duty Triple Rivet Leather Handle
- Available Only in Europe

The CRL Ebor 3130 Hacking Knife features an extra-strong carbon steel blade with a heavy-duty triple rivet leather handle. Blade width is 1-1/4" (32 mm); length is 4-1/2" (114 mm). Overall length is 8-3/8" (213 mm). Minimum order is one each.

CAT. NO. 0705

### CRL Ebor 1-3/8" 3109 Clipt Flexible Putty Knife



Available Only in Europe



- Carbon Steel
- Scale Tang Handle
- Available Only in Europe

The CRL Ebor 3109 Clipt is a high-grade carbon steel Flexible Putty Knife with a scale tang blade handle for extra strength and ease during use. Flexible blade has clipt end and a width of 1-3/8" (35 mm). Overall length is 8-3/8" (213 mm). Minimum order is one each.

CAT. NO. 0703

## CRL Hyde® Hackout Knife



- High-Carbon Tool Steel Blade
- Comfortable Oak Leather Handle

The CRL Hyde® Hackout Knife has a blade made of high-carbon steel with a glaze finish. The broad-backed blade extends through the handle and is flanked with oak leather to provide a safe, comfortable grip. Three rivets secure the handle. Blade width is 1-1/4" (32 mm). Blade length is 4-1/2" (114 mm). Overall length is 8" (203 mm). Minimum order is one each.

CAT. NO. 40210

## CRL Heavy-Duty Hacking Knife



- Precision-Ground Blade Cuts Through the Hardest Putty
- Molded Plastic Handle

The Heavy-Duty CRL Hacking Knife is perfect for removing old putty. It features a precision-ground blade with a molded plastic handle. Blade width is 1-1/4" (32 mm). Blade length is 4" (102 mm). Overall length is 8-1/2" (216 mm). Minimum order is one each.

CAT. NO. HK1

## CRL "Don Carlos" Lead Putty Knife



- Traditional "Don Carlos" Knife With Forged Steel Blade and Black Wooden Handle

The CRL "Don Carlos" Lead Putty Knife has a forged steel blade set in a black wooden handle with lead inlay. The blade is almost 4" (100 mm) long. **NOTE:** Not available in Australia. Minimum order is one each.

CAT. NO. B05102403

## CRL Red Devil® Linoleum Knife



- Tempered High Carbon Steel Blade
- Large Easy Grip Handle

This CRL Red Devil® Heavy-Duty Linoleum Knife can be used to cut hardened putty and other glazing materials from window sashes. The tempered high-carbon steel blade uses a tapered edge for cutting and quick sharpening; and is attached to a comfortable, easy grip plastic handle. Minimum order is one each.

CAT. NO. 4608

## CRL Hyde® Window Zipper



- Stainless Steel Blade With Serrated Edge Cuts Through Dried Paint and Hardened Window Caulks
- Tubular Metal Handle

The CRL Hyde® Window Zipper Tool features a stainless steel blade set in a metal handle. It cuts through dried paint or other hardened materials that bind window sash. Overall length is 9-1/4" (235 mm). Minimum order is one each.

CAT. NO. 4046

Hyde is a registered trademark of Hyde Tools, Inc.  
Red Devil a registered trademark of Red Devil, Inc.

## CRL Red Devil® Double End Window Tool



- Putty Knife and Trimmer in One
- Stainless Steel Blades

The CRL Red Devil® Window Tool is a putty knife and trimmer in one. The V-shaped end packs, shapes and trims new putty, while the flat end removes old putty. This tool has two stainless steel blades mounted to a plastic handle with brass eyelets. Overall length is 7-1/2" (191 mm). Minimum order is one each.

CAT. NO. 4044

## CRL Heavy-Duty Scrapers and Chisels

- Steel Blades and Shafts
- Used for Removing Old Putty
- Also Great as Gasket Scrapers

These Heavy-Duty Scrapers and Chisels are used for removing old putty, as well as for many other jobs. They are sturdy enough for just about any application. Clear Handle model is our most popular; Solid Aluminum Handle model is extra durable.

CAT. NO.	OVERALL LENGTH (L)	BLADE WIDTH (W)
516WT	10-7/8" (276 mm)	15/16" (24 mm)
GL100	11-3/4" (298 mm)	11/16" (17.5 mm)

Minimum order: 1 each.



**CAT. NO. 516WT**  
Clear Plastic Handle



**CAT. NO. GL100**  
Solid Aluminum Handle

## CRL Russell® 1-1/4" Putty Chisel

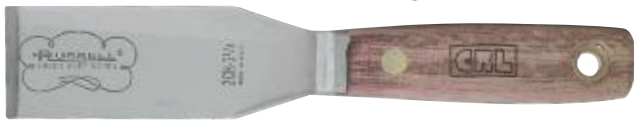

- Quality High Grade Steel Chisel
- Laminated Wood Handle

The CRL Russell® 1-1/4" (32 mm) Putty Chisel is a high grade steel chisel with clear protective coating and a laminated wood handle with brass rivets and hanging grommet. Blade width is 1-1/4" (32 mm). Overall length is 7-1/4" (184 mm). **NOTE:** Not available in Australia. Minimum order is one each.

**CAT. NO. 2CH114**

## CRL Red Devil® 1-1/4" Putty Chisel



- Precision Beveled Chisel Edge
- Heavy-Duty Steel Blade

The CRL Red Devil® Putty Chisel has a heavy-duty steel blade with a precision beveled chisel edge for removing old putty. The blade extends through the black nylon solvent-resistant handle and is riveted on for strength. The brass-plated, solid steel nail setting head can be used for setting drywall nails and other hammering jobs. Blade width is 1-1/4" (32 mm). Overall length is 7-3/4" (197 mm).

Minimum order is one each.

**CAT. NO. 4231**

## CRL Plastic Scraper

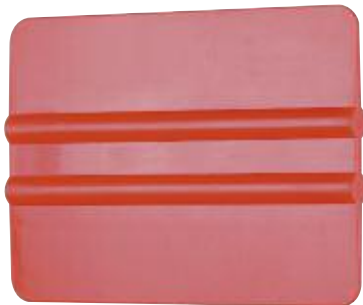

- Firm Double Edge Scraping Tool Won't Scratch Glass

This firm, double edge CRL Plastic Scraping Tool won't scratch glass surfaces. Use it to remove decals, stickers, labels, etc. from glass, or to apply window tint film. It's also handy for removing excess, uncured putty or caulking. Scraper measures 4" by 2-7/8" (102 mm by 73 mm).

**CAT. NO. 105**

## CRL Hyde® Contour Scraper



- Six Interchangeable Stainless Steel Blades of Various Shapes

This professional grade, stainless steel Hyde® Contour Scraper removes paint, varnish, putty, caulk or rust from virtually any surface. Six interchangeable blades fit into corners, curves, and small channels, and can be sharpened for repeated use.

Minimum order is one each.

**CAT. NO. 10450**

Russell is a registered trademark of Dexter-Russell, Inc.  
Stanley is a registered trademark of Stanley Logistics, LLC.

Red Devil is a registered trademark of Red Devil, Inc.  
Hyde is a registered trademark of Hyde Tools, Inc.

## CRL Scrape and Pry Bars

- Multi-Purpose Tools Made of Hardened, Tempered Steel
- Two Sizes With Chisel Ground Edges



• Most Popular

CAT. NO. 4050

CRL Scrape and Pry Bars are versatile tools made of the finest hardened, tempered tool steel. Both ends are chisel ground for scraping or prying. The 4050 is 1-3/4" (44.5 mm) wide, and the 3040 is 9/16" (14.3 mm) wide. One end has a 50 degree angle bend. Both tools have a nail puller hole. Our most popular model is 10" (254 mm) long – just the right size for your tool box. Minimum order is one each.

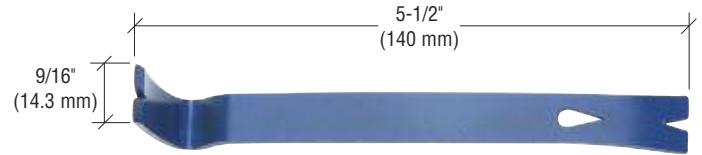

• Tool Belt Size

CAT. NO. 3040

NOTE: Images not to scale.

## CRL Pry Bar and Scraper

- Hardened, Tempered Tool Steel
- Ideal for Pulling Nails, Prying, Lifting, Scraping, and Much More

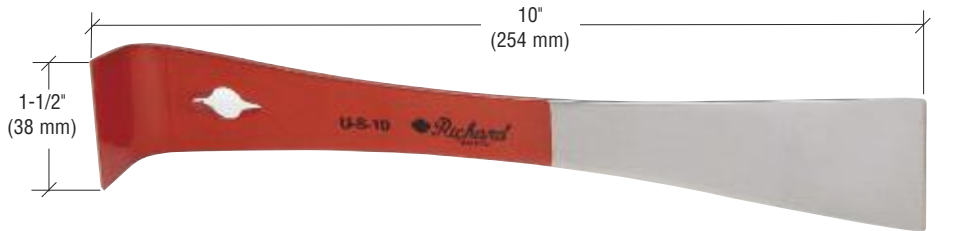

This CRL Pry Bar and Scraper is a versatile tool made of the finest hardened, tempered tool steel. It is typically used for scraping and prying. One end has a 90 degree angle bend and a nail puller hole. Both ends are chisel ground and 1-1/2" (38 mm) wide. Overall length is 10" (254 mm). Minimum order is one each.

CAT. NO. US10

## CRL 8-in-1 Painter's Tool



- Large Soft Grip Handle
- A Must for Any Tool Box

The CRL 8-in-1 Painter's Tool is a must in any tool box. Use it to scrape paint, remove putty, spread glazing compound, clean paint rollers, open cracks for patching, open lids, pull nails, and remove bottle caps. Blade width is 3" (76 mm). Overall length is 9-1/8" (232 mm). Minimum order is one each.

CAT. NO. HW048

Hyde is a registered trademark of Hyde Tools, Inc.

## CRL Hyde® 8-in-1 Painter's Tool



- Electrocoated Steel Blade
- Soft Grip Handle

This CRL Hyde® 8-in-1 Painter's Tool has eight handy functions: scrape paint, remove putty, spread glazing compounds, clean rollers, open cracks for patching, open lids, pull nails, and a die-cast metal nail setting end allows you to set drywall nails. Blade width is 3" (76 mm). Overall length is 8-5/8" (219 mm). Minimum order is one each.

CAT. NO. 06995

# CRL PUTTY REMOVAL TOOLS

For Pricing Visit [crlaurence.com](http://crlaurence.com) or Call Us Toll Free at the Phone Numbers Shown on the Back Cover

## CRL FEIN® SuperCut Sealant Cutter Knife Kit



- Removes Old, Hardened Putty Quickly and Easily
- Variable Speed Blade Oscillates 11,000 to 18,500 Times Per Minute
- Lightweight and Easy to Maneuver
- Powerful 120V AC 3.3 AMP Motor

CAT. NO. FK20618  
FEIN® SuperCut Sealant Cutter Knife Kit



The CRL FEIN® Cutter uses its oscillating blade to cut cured sealant and caulking quickly with a minimum of effort. This reliable electric tool is double-insulated for operator safety. The oscillation on this tool is simply a short back and forth stroke of the cutting blade, one degree to each side, at a frequency of up to 18,500 strokes per minute. Another important advantage is that the optional diamond-tipped blades can be used to cut through marble and mortar joints, while keeping dust formation to a minimum. The CRL FEIN® Sealant Cutter features an electronic speed control to keep cutting speed constant, even under load, so you can select the best cutting speed for every application. The gears are designed for continuous operation, and run in an oil bath. Thanks to a twelve-sided mount, cutting blades can be adjusted to any position. This kit includes a CRL FEIN® Cutter Tool, a set of blades for removing flexible sealants: five Cat. No. FKB17015 and one Cat. No. FKB16011, and a Blade Removal Tool, all packed in a metal Carrying Case. Minimum order is one each.

## Optional Blades for FEIN® SuperCut Knife



### Offset "T" Blade

Segment saw blade (offset), for removing insulating glass installed on a putty bed. Minimum order is one each.



CAT. NO. 2000166

### Diamond Blade

Diamond coated blade for cutting out marble and mortar joints, and making cuts in plaster walls. 3-1/8" (70 mm) diameter. Minimum order is one each.



CAT. NO. FKB10401

### Mushroom Blade

Mushroom shaped blade for separating panes of insulating glass. Also for cutting silicone, soft putty, and elastic joint sealants. Minimum order is one each.



CAT. NO. FKB128

### Caulking Blade

Flat blade for removing material while working on flush surfaces. Five each included in FK20618 Kit. Minimum order is one each.



CAT. NO. FKB17015

### Sealant Blade

Straight, elongated blade for removing flexible sealing compounds in extremely deep joints. One each included in FK20618 Kit. Minimum order is one each.



CAT. NO. FKB16011

## CRL Makita® Power Scraper Hackout Gun



- Excellent for Hackouts of Hardened Putty and Sealants
- Powerful Variable Speed 5 AMP Motor Produces 0 to 3,200 Air-Cushioned Blows Per Minute
- Complete With Three Chisel Tips

The Makita® Power Scraper Hackout Gun has a powerful 5 AMP motor that will tackle even the toughest putty or sealant removal job. Also ideal for cleaning out old mortar, removing tile, concrete scale, and weld splatter. Double insulated motor delivers from 0 to 3,200 blows per minute for light scraping, chiseling, and chipping. Excellent for hackouts of hardened putty and sealants.

FEIN is a registered trademark of C. & E. FEIN GmbH, LLC.  
Makita is a registered trademark of Makita Corporation.



CAT. NO.	DESCRIPTION
HK1810	Makita® Power Scraper Hackout Gun
7982645	Replacement 2" (51 mm) Scaling Chisel*
7982653	Replacement 1-3/16" (30 mm) Scaling Chisel*
7982661	Replacement Bull Point Chisel*

Minimum order: 1 each. \*Included in kit.



C.R. LAURENCE COMPANY

[crlaurence.com](http://crlaurence.com) | [usalum.com](http://usalum.com)

504K | [crlaurence.ca](http://crlaurence.ca) [crlaurence.com.au](http://crlaurence.com.au) [crlaurence.co.uk](http://crlaurence.co.uk) [crlaurence.de](http://crlaurence.de) [crlaurence.eu](http://crlaurence.eu)

# CRL PUTTY REMOVAL TOOLS

For Pricing Visit [crlaurence.com](http://crlaurence.com) or Call Us Toll Free at the Phone Numbers Shown on the Back Cover

## CRL Multi-Function Tool

- Multiple Use Tool With Variable Speed Oscillating Head
- Perfect for Hack-Outs, Glass Sanding, Edging, Sealant Cut-Outs and More
- Double Insulated and UL Approved

The CRL MFT1 Multi Function Tool is perfect for sealant removal and hack-out projects. Cuts insulating glass units apart with ease and even removes hardened glazing putty. The variable speed head oscillates at 11,000 to 22,000 oscillations per minute. Blades can be locked down at any angle to help with access to tight locations and to promote comfort during use. Switch to the hook-loop sanding backer pad and the MFT1 becomes a very effective glass edge seaming tool. The Kit comes complete with the double insulated Multi-Function Tool, a plastic storage case, five assorted blades, a triangle backer pad, and a blade wrench.

**NOTE:** Grinding Triangles are sold separately.



Grinding Triangles



**MFTFSB**  
Flexible Scraper  
Blade



**MFTHCB**  
1" (25 mm)  
Hi-Carbon Steel  
Saw Blade



**MFTHSB**  
3-1/8" (79 mm)  
Segmented Saw  
Blade



**MFTRCB**  
Carbide Coated  
Recess Saw Blade



**MFTSDB**  
Straight Saw  
Blade



**MFTTSD**  
Triangle Backer  
Pad

CAT. NO.	DESCRIPTION
MFT1	110V Multi Function Tool
MFT1AU	240V Multi Function Tool w/AU Plug
MFT1EU	220V Multi Function Tool w/EU Plug
MFTFSB	Flexible Scraper Blade
MFTHCB	1" (25 mm) Hi-Carbon Steel Saw Blade
MFTHSB	3-1/8" (79 mm) Segmented Saw Blade
MFTRCB	Carbide Coated Recess Saw Blade
MFTSDB	Straight Saw Blade
MFTTSD	Triangle Backer Pad
MFT180X	80X Glass Grinding Triangles 50/BX
MFT1120X	120X Glass Grinding Triangles 50/BX
MFT1220X	220X Glass Grinding Triangles 50/BX

Minimum order: 1 each for tool and accessories; 50 each for grinding triangles.

## CRL Wildcat Sealant Cutter and Putty Remover

- Cuts Out Old Sealants and Hardened Putties



The CRL Wildcat Pneumatic Sealant Cutter and Putty Remover quickly cuts out old sealant from expansion joints and chips away hardened putty from metal sash. The variable speed trigger allows the cutting blades to oscillate up to 20,000 times per minute for virtually effortless cutting and putty removal. The Kit includes the pneumatic tool, tool case, two each caulk cutting, sealant cutting and putty removal blades, sharpening stone, and blade wrench. Minimum order is one each.

CAT. NO. AK40

## CRL Putty Remover



- Removes Hardened Putty Without Damaging the Glass or Sash
- Fits Any 1/4" to 3/8" Electric Drill

The CRL Putty Remover is the newest and easiest way to remove hardened putty. No need to remove the glass from the frame because the Putty Remover's carbide blade is designed to clear the glazing points as it literally chews up the old putty. No more hand chipping, just insert the Putty Remover into your 1/4" or 3/8" (6 or 9.5 mm) electric drill. A notched, T-shaped sleeve guides it along the surface of the window sash. An adjustable collar controls the depth of the cut. The flexible plastic handle lets you pull the drill along steadily as the putty is being removed. Minimum order is one each.

CAT. NO. PR9000

# CRL PUTTY REMOVAL TOOLS

For Pricing Visit [crlaurence.com](http://crlaurence.com) or Call Us Toll Free at the Phone Numbers Shown on the Back Cover

## CRL Aluminum and Steel Window Frame Extractor

- Removes Aluminum and Steel Window Frames in Minutes, Not Hours
- Reduces Clean Up Time



The CRL Window Frame Extractor pulls aluminum and steel frames from existing stucco, wood or siding structures. It can remove patio door frames as easily as window frames for installation of flush fin, block frame, and other retrofit window applications. Clean up time is reduced, and little or no stucco patching is required. Comes with nylon carry bag. Minimum order is one each.

CAT. NO. WFE

## CRL Stop Mold Puller

- Reduces Your Chance of Breaking Glass While Pulling Stop Molds
- Solid Steel Construction
- Simple and Easy

The CRL Stop Mold Puller is used to remove stop molds or snap-on sash. It works on both door and tube stops, and makes removing window units easy. The rubber-lined pad will not damage metal extrusions. It's a reliable and inexpensive tool every glazier should own. Minimum order is one each.

**NOTE:** Always wear the proper protective eyewear when using this product.



CAT. NO. SMP200

## CRL Hot Air Gun Kit

- Dual Heat and Fan Settings
- Excellent for Use in Paint and Putty Removal, Plus Softening Caulking and Putty



This CRL Hot Air Gun Kit has dual heat and fan settings: 1000W and 375°C/700°F; 1500W and 495°C/925°F. This Hot Air Gun is excellent for use in putty removal, paint removal, plastic pipe welding, and other jobs that require this type of tool. Includes Five-Piece Paint Scraper Kit, Shavelock Scraper Handle with three Blades, plus Flat Paint Scraper.

CAT. NO.	DESCRIPTION
LD121	110V Hot Air Gun Kit
LD121AU	240V Hot Air Gun Kit w/AU Plug
LD121EU	220V Hot Air Gun Kit w/EU Plug

Minimum order: 1 each.

## CRL Milwaukee® Heat Gun

- Variable Temperature With Heat Adjustment Dial
- Ideal for Softening and Removal of Paint and Putty



CAT. NO. UV8978

This variable temperature Milwaukee® Heat Gun offers a range from 200 to 1050°F (93 to 565°C) that is controlled with a heat adjustment dial. This Heat Gun is ideal for use in putty removal, paint removal, and plastic pipe welding. The electrical heat control allows extra reduction of airflow for more accurate and concentrated heat location without damage to the heating element. Double insulated 110V AC tool features a unique impact resistant heating element. Minimum order is one each.

Milwaukee is a registered trademark of Milwaukee Electric Tool Corporation.



C.R. LAURENCE COMPANY

[crlaurence.com](http://crlaurence.com) | [usalum.com](http://usalum.com)

506K | [crlaurence.ca](http://crlaurence.ca) [crlaurence.com.au](http://crlaurence.com.au) [crlaurence.co.uk](http://crlaurence.co.uk) [crlaurence.de](http://crlaurence.de) [crlaurence.eu](http://crlaurence.eu)



## CRL Propane Torch With Pencil Point Burner

- Propane Fuel Cylinder
- Standard Pencil Point Burner
- Anti-Clog Filter

You get professional results and greater efficiency with this CRL Hand Held Torch. It comes complete with Propane Fuel Cylinder, Pencil Point Burner, and Burner Valve Assembly. The unit also includes an anti-clog filter which eliminates fuel flow interruptions. This is a good general purpose torch with many uses. **NOTE:** Item cannot ship via any small package carrier like UPS or Fed Ex Ground. Must ship via common carrier, or may be picked up at any CRL location.



CAT. NO.	DESCRIPTION
UL100	Complete Propane Torch Kit
LP1759	Propane Cylinder Only
UL2317	Pencil Point Burner Assembly Only

Minimum order: 1 each.

## CRL Self-Igniting Torch Kit

- Propylene Fuel Cylinder
- Adjustable Flame Settings
- Burn Tube Rotates 360 Degrees

This compact hand-held CRL Self-Igniting Torch Kit gives you instantly adaptable brazing and flame control. A push button ignitor activates the torch, and the solid brass regulator valve has an adjustable control knob. The torch comes with brazing-hot Propylene fuel and can also be used with LP1759 Propane. The stainless steel burn tube rotates 360 degrees for easy use. **NOTE:** Item cannot ship via any small package carrier like UPS or Fed Ex Ground. Must ship via common carrier, or may be picked up at any CRL location. Minimum order is one each.



CAT. NO. TS839Z

## CRL Solder-It® Micro-Jet™ Butane Torch

- Pocket Size Torch Reaches Temperatures to 2400° F (1315.5° C)

The pocket-size CRL Solder-It® Micro-Jet™ Butane Torch softens hardened putty to make removal easier. It also quickly clears moisture from cracks in concrete for preparation of sealant application, and can be used to accelerate curing. Includes refillable cell. Butane refills are easily found in retail stores. **NOTE:** Item cannot ship via any small package carrier like UPS or Fed Ex Ground. Must ship via common carrier, or may be picked up at any CRL location. Minimum order is one each.



Butane Cell

CAT. NO. 2002400

## CRL Self-Igniting Propane Torch Head

- Just Press Button to Start
- Excellent for Softening Hardened Putty
- Burn Tube Rotates 360 Degrees

The CRL Self-Igniting Propane Torch Head requires just the touch of a button to ignite. Use it with any standard propane fuel cylinder to produce a quick heating, high-energy flame for cutting and soldering applications, or for softening putty. Minimum order is one each.

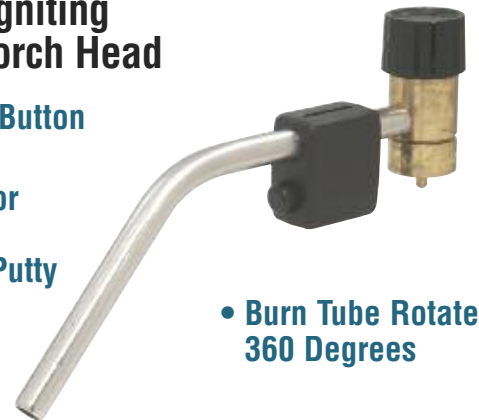

CAT. NO. HT802

## CRL Hose Torch Kit

- Fits Standard Propane Cylinders
- 60" (1524 mm) Hose
- Excellent for Softening Hardened Putty

CRL's Hose Torch Kit has an instant on/off igniter for simple, one-handed operation, and an adjustable flame control knob for ease in switching between different applications. The stainless steel burn tube provides durability, and the lock button keeps the Torch lit for finger-free use. The CRL Torch Kit includes: Trigger Start Hose Torch, Fuel Cylinder Holster with Burn Tube Holder, Quick Cylinder Release, Belt Clip and Carrying Handle. Fuel Cylinders must be ordered separately. Minimum order is one each.

Solder-It is a registered trademark of Solder-It, Inc.



Fuel Cylinder Not Included

CAT. NO. BZ8250HT

## CRL Fletcher® FrameMaster® Point Driver

- Quick Loading Reversible Point Magazine
- Uses 3/8" (9.5 mm) or 5/8" (16 mm) Points
- Adjustable Strike Force

Drive home Glazier's and Framers' Points with the CRL Fletcher® FrameMaster® Point Driver. It reliably drives wax-free stacked points straight and flat to the surface, one at a time, without double feeding or jamming. The easy-load magazine holds 100 points at a time. Unique design features a reversible magazine with a short nose for 3/8" (9.5 mm) Glazier's Points, or a long nose for the longer 5/8" (16 mm) Framers' Points.

A knurled adjustment screw allows easy tension adjustment: less force for soft woods and more force for hard woods. The 1/8" (3.2 mm) width of the point gives excellent holding power combined with a small profile for easy putty coverage of the Glazier's Points. The 5/8" (16 mm) Framers' Points are long enough to hold mat board and other picture frame backing materials securely in place while still being long enough for easy removal.

The lightweight yet durable plastic frame is designed to provide years of dependable service. Minimum order is one each.



CAT. NO. FM075



## CRL Fletcher® FrameMaster® Points

- Exclusively for the FrameMaster® Point Driver
- Wax-Free for a Strong Hold

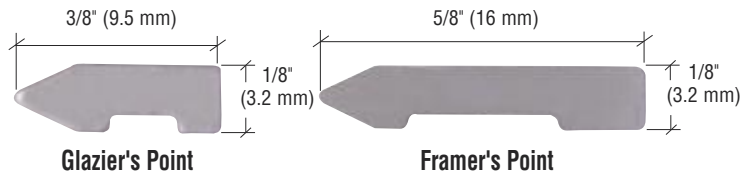

CAT. NO.	DESCRIPTION	QTY/PK
FT898	3/8" (9.5 mm) Glazier's Points	5,000
FT895	5/8" (16 mm) Framers' Points	3,000

Minimum order: 1 package. All Glazing Points can be combined for quantity pricing.

## CRL Fletcher® PullMate™ Point Removing Tool

- Removes Fletcher® FrameMaster® Points From Wood Frames



CAT. NO. 09517

The CRL Fletcher® PullMate™ Point Removing Tool is a high-quality finishing tool specifically designed to remove Fletcher® FrameMaster® Points from wood frames. It has a rubberized raised grip that provides added comfort and helps protect framing materials. Minimum order is one each.

Fletcher and FrameMaster are registered trademarks of The Fletcher-Terry Company, LLC.



## CRL PD9 Diamond Point Driver

- All Metal Design
- Drives 5/16" Diamond Points
- Adjustable Strike Force

The best and fastest way to glaze wood sash is to start off with a CRL PD9 Diamond Point Driver. Secure the glass in place with CRL No. 1 Diamond Points and warm up the putty. Adjustable strike force allows the user to drive the points deeply enough in hard or soft wood frames to hold the glass with 1/8" (3.2 mm) of exposure over the glass. This low profile is easily covered during putty application.

The CRL PD9 is built with small rubber cushions on the base to make sure tool is perfectly angled to properly set the points. Minimum order is one each.



CAT. NO. PD9

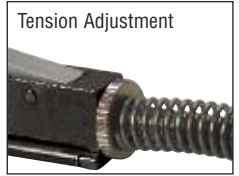

## CRL No. 1 Diamond Points

- Stacked Points Are Available in Two Package Quantities
- Works With Our PD9 Driver

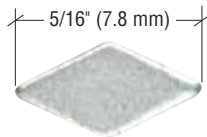

CAT. NO. 1P

Our No. 1 size Universal Diamond Points fit into our PD9 Point Driver, and also into older model point drivers. Stacked points slide into the magazine for quick and easy reloading. Get them in Packs of 5,000 each or in Bulk Boxes of 45,000 containing nine Packs.



CAT. NO.	DESCRIPTION	TOTAL POINTS
NW1P	Package of 5/16" (7.8 mm) Diamond Points	5,000
1P	Package of 5/16" (7.8 mm) Diamond Points	5,000
1B	Box (9 Packages) of 5/16" (7.8 mm) Diamond Points	45,000

Minimum order: 1 package or 1 box.

## CRL Points for Older Point Drivers and Manual Tools



Diamond Points



Triangle Points

We stock Diamond and Triangle Points for older model CRL and Fletcher brand Point Drivers. Stacked Diamond Points come in Packs of 4,000 each or in Boxes of 36,000 containing nine Packs.

**NOTE:** Triangle Points are not stacked, but shipped in bulk.

CAT. NO.	DESCRIPTION	SIZE	TOTAL POINTS
2P	Package of Stacked Diamond Points	1/2" (12.7 mm)	4,000
2B	Box (9 Packages) of Stacked Diamond Points	1/2" (12.7 mm)	36,000
NW5P	Package of Stacked No. 5 Triangle Points	3/8" (9.5 mm)	2,700
TP2	No. 2 Triangle Points Non-Stacked in Bulk	1/2" (12.7 mm)	1 lb. (.45 kg)
TP3	No. 3 Triangle Points Non-Stacked in Bulk	7/16" (11.1 mm)	1 lb. (.45 kg)

Minimum order: 1 package, 1 box, or 1 pound.

Fletcher is a registered trademark of The Fletcher-Terry Company, LLC.

## CRL Fletcher® Point Tool

- Perfect Choice for Inserting Push Points, Triangle Points, and Diamond Points Into Wood Frames and Window Sash

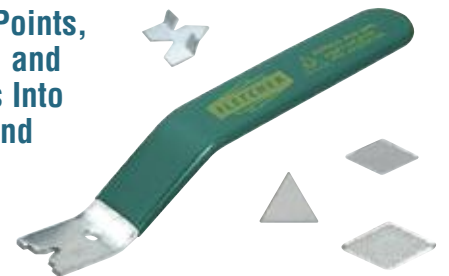

The CRL Fletcher® Point Tool is a high quality finishing tool that is the perfect choice for inserting Push Points, Triangle Points, and Diamond Points into wood frames and window sash. It has a rubberized raised grip that provides added comfort and helps prevent damage to the mat board and other backing material. Minimum order is one each.

CAT. NO. 09515

## CRL Vaco® Screwdrivers

- Professional Quality
- Heat Treated Nickel
- Chrome Plated

CRL Vaco® Screwdrivers have an exclusive handle that is larger and delivers more driving power. Designed for continuous comfortable use, it allows you to perform the toughest driving jobs without becoming fatigued. Each of our Screwdrivers features a professionally made tip that is manufactured with an extra-hard point. All of the Screwdrivers on this page can be combined for quantity pricing.

### CRL Slotted Screwdrivers

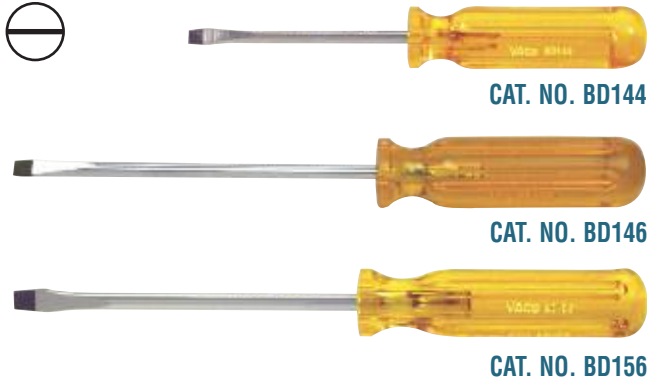

CAT. NO.	DESCRIPTION
<b>BD144</b>	1/4" x 4" (102 mm) Slotted Tip Screwdriver
<b>BD146</b>	1/4" x 6" (152 mm) Slotted Tip Screwdriver
<b>BD156</b>	5/16" x 6" (152 mm) Slotted Tip Screwdriver

Minimum order: 1 each.

### CRL Phillips Screwdrivers

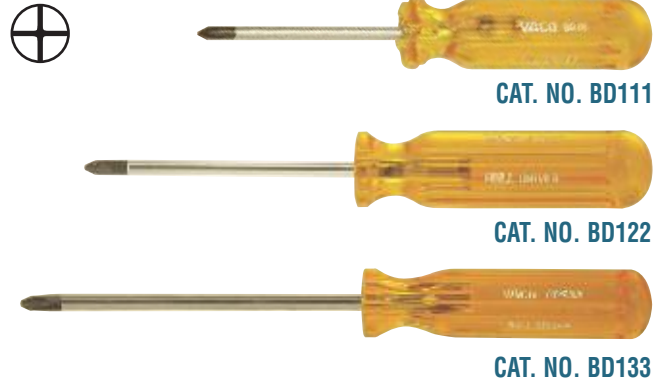

CAT. NO.	DESCRIPTION
<b>BD111</b>	6-5/8" (168 mm) Phillips Tip Screwdriver With No. 1 Point
<b>BD122</b>	8-1/2" (216 mm) Phillips Tip Screwdriver With No. 2 Point
<b>BD133</b>	11-1/4" (286 mm) Phillips Tip Screwdriver With No. 3 Point

Minimum order: 1 each.

### CRL Long-Shank Slotted Screwdrivers

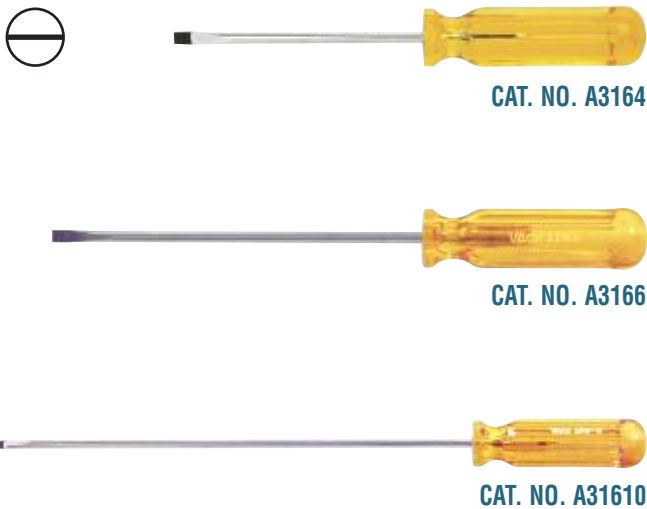

CAT. NO.	DESCRIPTION
<b>A3164</b>	Thin Blade 3/16" x 4" (102 mm) Slotted Tip Screwdriver
<b>A3166</b>	Thin Blade 3/16" x 6" (152 mm) Slotted Tip Screwdriver
<b>A31610</b>	Thin Blade 3/16" x 10" (254 mm) Slotted Tip Screwdriver

Minimum order: 1 each.

### CRL Long-Shank Phillips Screwdrivers

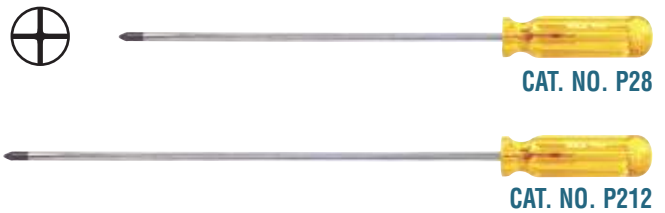

CAT. NO.	DESCRIPTION
<b>P28</b>	8" (203 mm) Long Phillips Tip Screwdriver No. 2 Point
<b>P212</b>	12" (305 mm) Long Phillips Tip Screwdriver No. 2 Point

Minimum order: 1 each.

### CRL Stubby Screwdrivers

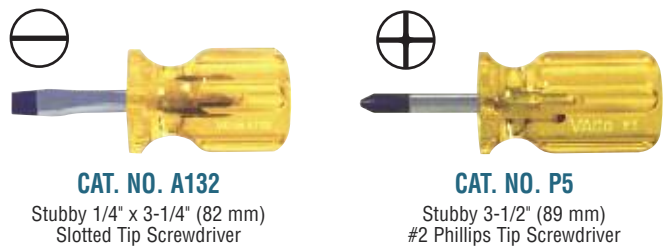

**CAT. NO. A132**  
Stubby 1/4" x 3-1/4" (82 mm)  
Slotted Tip Screwdriver

**CAT. NO. P5**  
Stubby 3-1/2" (89 mm)  
#2 Phillips Tip Screwdriver

Minimum order: 1 each.

Vaco is a registered trademark of Klein Tools, Inc.

## CRL Wera® Lasertip® 6-Piece Screwdriver Set

- Ergonomically Designed Handle
- Unique Laser Etched Gripping Surface

This CRL Wera® Lasertip® 6-Piece Screwdriver Set has an ergonomically designed handle which offers comfort and added grip strength. The driver shanks have hardened steel tips and a unique laser-etched gripping surface which "bites" into the head of the screw. This results in less slipping, less stripping of the screw head, and less thrust pressure to keep the tip engaged into the screw head. Holder is included. Minimum order is one each.

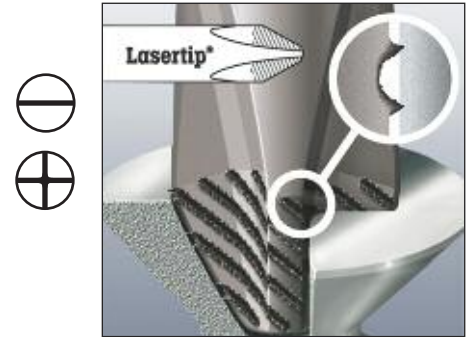
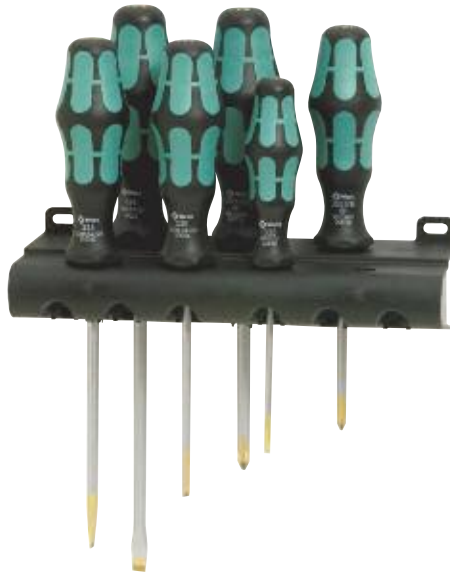

### 6-PIECE SCREWDRIVER SET INCLUDES:

TYPE	TIP	LENGTH
Phillips	#1	7" (178 mm)
Phillips	#2	8" (203 mm)
Slotted	1/8" (3.2 mm)	6-1/2" (165 mm)
Slotted	5/32" (4.0 mm)	7-3/4" (197 mm)
Slotted	7/32" (5.5 mm)	8-3/4" (222 mm)
Slotted	1/4" (6.4 mm)	10" (254 mm)

CAT. NO. 105650

## CRL Stanley® ProDriver 11-Piece Screwdriver Set

- High-Strength Tools That Provide 30% More Torque

CRL Stanley® ProDriver Screwdrivers are durable, high-strength tools that provide 30% more torque with minimum effort. A nylon core in the grip provides a virtually unbreakable bond with the handle. The tough polypropylene outer core is finished with a soft, solvent-resistant rubber grip, which has a textured surface for maximum comfort. The tips are hardened for maximum strength, and the tip dimensions, tip strength, and length all conform to strict ANSI standards. Minimum order is one each.



- Tips are Hardened for Maximum Strength

### 11-PIECE SCREWDRIVER SET INCLUDES:

TYPE	TIP	LENGTH
Phillips	#0	2-1/4" (57 mm)
Phillips	#1	3" (76 mm)
Stubby Phillips	#2	1-3/16" (30 mm)
Phillips	#2	4" (102 mm)
Phillips	#3	6" (152 mm)
Slotted	1/8" (3.2 mm)	3" (76 mm)
Slotted	3/16" (4.8 mm)	3" (76 mm)
Stubby Slotted	1/4" (6.4 mm)	1-1/2" (38 mm)
Slotted	1/4" (6.4 mm)	4" (102 mm)
Slotted	5/16" (7.9 mm)	6" (152 mm)
Offset	#2 x 1/4" (6.4 mm)	

CAT. NO. ST62502

## CRL 5-Piece Slotted Screwdriver Set



### 5-PIECE SCREWDRIVER SET INCLUDES:

TYPE	TIP	LENGTH
Stubby Slotted	1/4" (6.4 mm)	1-1/2" (38 mm)
Slotted	3/16" (4.8 mm)	4" (102 mm)
Slotted	3/16" (4.8 mm)	6" (152 mm)
Slotted	1/4" (6.4 mm)	6" (152 mm)
Slotted	5/16" (7.9 mm)	6" (152 mm)

Minimum order: 1 each.

CAT. NO. A52

Wera and Lasertip are registered trademarks of Wera Werk Hermann Werner GmbH & Co. Stanley is a registered trademark of Stanley Logistics, LLC.

## CRL Stanley® 5-Piece Phillips Screwdriver Set

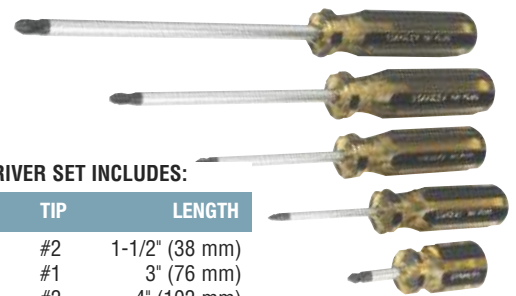

### 5-PIECE SCREWDRIVER SET INCLUDES:

TYPE	TIP	LENGTH
Stubby Phillips	#2	1-1/2" (38 mm)
Long Phillips	#1	3" (76 mm)
Long Phillips	#2	4" (102 mm)
Long Phillips	#3	6" (152 mm)
Long Phillips	#4	8" (203 mm)

Minimum order: 1 each.

CAT. NO. ST66156

## CRL 12-Volt Cordless Lithium-Ion Screwdriver Kit

- 12 Volt Fast Charge Lithium-Ion Power
- LED Work Light
- 23 Torque Settings Plus Non-Slip Drill Preset

The CRL 12 Volt Cordless Screwdriver incorporates the latest technology in Lithium-Ion fast charge power. This professional grade power tool is a variable speed screwdriver capable of speeds up to 500 RPM, and features an adjustable torque setting with 23 presets. A bright LED work light illuminates the work area when the trigger is depressed, and the Lithium-Ion battery packs feature a lighted visual charge gauge so you always know where you stand on reserve power.



CAT. NO.	DESCRIPTION
LD823	12-Volt Cordless Impact/Driver Kit
LD823B	12-Volt Battery Cartridge for LD823
LD823C	Charger for LD823 12-Volt Battery
LD823AU	12-Volt Cordless Impact/Driver Kit w/AU Plug
LD823CAU	240-Volt Charger/Adapter w/AU Plug
LD823EU	12-Volt Cordless Impact/Driver Kit w/EU Plug
LD823CEU	220-Volt Charger/Adapter w/EU Plug



CAT. NO. LD823

Kit Includes: Cordless Screwdriver, Two Batteries, 1-Hour Fast Charger, Molded Carrying Case and instructions. Minimum order: 1 each.

## CRL 3.6V Cordless Screwdriver

- Eight Auto-Stop Adjustable Torque Settings
- Comfortable Pistol Grip Handle
- 44-Piece Kit Includes Assorted Insert Bits, Screwgun Drivers, and Sockets

Powerful and compact, the CRL LD813 Cordless Screwdriver is designed to let you work productively and efficiently without fatigue. The long-lasting, 3.6 Volt battery powers through the toughest jobs with ease. Eight torque settings stop rotation at the precise force to prevent stripping screw heads with maximum torque at 2.5Nm. The Battery Charger and plastic Carrying Case are included.



CAT. NO.	DESCRIPTION
LD813	(New Style, Shown) 3.6V Screwdriver Kit Complete
LD813AU	(New Style, Shown) 3.6V Screwdriver Kit Complete w/AU Plug
LD813EU	(New Style, Shown) 3.6V Screwdriver Kit Complete w/EU Plug
LD813AC110	110-Volt (New Style) AC Adapter 3.6V
LD813AC240	240-Volt (New Style) AC Adapter 3.6V w/AU Plug
LD813AC220	220-Volt (New Style) AC Adapter 3.6V w/EU Plug
LD813B	Replacement Battery for Old Style LD813 (Not Shown)
LD813C	110-Volt Battery Charger for Old Style LD813 (Not Shown)
LD813C240V	240-Volt Battery Charger for Old Style LD813 (Not Shown)

Minimum order: 1 each.



CAT. NO. LD813

## CRL Offset Hex Bit Driver With Four Screwdriver Tips

- Removable Driver Head for Use With Electric Screwdrivers and Drills
- Holds All 1/4" (6.4 mm) Hex Insert Bits
- Low-Profile Angled Head



CAT. NO. M14895

#1, #2 Phillips, and 3/16", 1/4" Slotted Bits

The CRL Offset Bit Driver lets you fasten or remove screws located in channels, under wedges, or in areas where any regular screwdriver cannot fit. The low profile, angled head has hardened steel gears that are lubricated and sealed for a lifetime of service. The standard hex socket securely holds all types of 1/4" (6.4 mm) Hex Insert Bits. Minimum order is one each.

## CRL 34-Piece Multi-Bit Screwdriving Set

- Phillips, Slotted, Torx, Allen, Spanner, and Nut Driver Bits Included
- 34 Pieces With a Handy Carrying Case

This CRL 34-Piece Multi-Bit Screwdriving Set offers a complete range of insert bits to fit the ratcheting screwdriver. Comes in a molded case. Minimum order is one each.



CAT. NO. 15568

## CRL 6-in-1 Screwdriver With Bits

- Complete With Phillips and Slotted Bits



This CRL 6-in-1 Screwdriver has two replaceable #1 and #2 Slotted and Phillips Bits, which fit into an adapter tube. This tube slips into an easy-to-grasp plastic handle. When the Insert Bits are removed, the adapter tube and the handle can be used together as a 1/4" nut driver on one end and a 5/16" nut driver when reversed. Minimum order is one each.

CAT. NO. 6N1

## CRL 6-in-1 Pocket Drive Tool



- A Convenient 6-in-1 Screwdriver in a Compact Carrying Case



The CRL Pocket Drive Tool is a convenient and compact 6-in-1 screwdriver. It is in a small plastic case, 1-3/4" x 2-3/4" (44 x 70 mm), with a clip attached, allowing you to carry it on a belt, strap, or even on a car visor. Minimum order is one each.

CAT. NO. PD6N1

## CRL Square Drive Screwdrivers

- Designed for Robertson-Drive Screws
- Cushion Grip Handle
- Two Sizes Available



CRL Square Drive Screwdrivers are used with square-recessed drive screws, commonly referred to as Robertson drive. The cushion grip handle increases grip strength, and offers comfort for extended periods of use.

CAT. NO.	DESCRIPTION
KL661	7-1/2" (190 mm) Long Square Drive Screwdriver with No. 1 Point
KL662	8-1/4" (210 mm) Long Square Drive Screwdriver with No. 2 Point

Minimum order: 1 each.

## CRL Spanner Tip Screwdrivers

- For Installation or Removal of Spanner Head Screws
- Available in Three Sizes



Use CRL Spanner Tip Screwdrivers to remove spanner head tamper-proof screws. They come in three sizes to fit #6, #8, and #10 Spanner Screws. 1/4" Hex Insert Bits are also available to fit your magnetic screwdrivers (see pages 516K-517K). Bits are heat-treated for strength. **NOTE:** Spanner Drivers fit only Spanner Screws of the same size.

CAT. NO.	DESCRIPTION
SP6D	8-3/4" (222 mm) Long #6 Spanner Tip Screwdriver
SP8D	8-3/4" (222 mm) Long #8 Spanner Tip Screwdriver
SP10D	8-3/4" (222 mm) Long #10 Spanner Tip Screwdriver

Minimum order: 1 each.

## CRL Offset Phillips Tip Screwdriver

- #1 and #2 Phillips Tips



You can easily set Phillips screws in tight places with this CRL Offset Phillips Tip Blade Screwdriver. There is a different size tip on each end, and the crank type motion puts power into each turn. Minimum order is one each.

CAT. NO. P120

## CRL Offset Ratcheting Screwdrivers

- Phillips and Slotted Offset Styles Available
- Great for Tight Work Areas



CAT. NO. 807X  
#1 and #2 Phillips  
Offset Ratcheting Screwdriver



CAT. NO. 807SX

Slotted/Phillips Combination Offset Ratcheting Screwdriver

The CRL Offset Ratcheting Screwdrivers come in two types: all Phillips, and a combination of both Slotted and Phillips tips. They need only a minimum of clearance to work. A small, sliding latch changes the ratcheting directions. Hardened tips will ensure long service. Minimum order is one each.

## CRL Impact Screwdriver and 3/8" Socket Driver

- **Impact Action Loosens Screws and Bolts**
- **Individual Slotted and Phillips Replacement Tips Available**



Impact Drivers are used to free rusted or frozen screws or nuts. Hitting the back of the driver body with a hammer seats the Bit firmly into the screw head at the same time the spring-loaded, cam-action, internal (reversible) ratcheting mechanism turns the screw head to break it free. Many times this tool can eliminate the need to grind or drill out old screws or nuts. Kit comes complete with four heavy-duty "Impact Grade" Screwdriver Bits; one each slotted 9/32" and 5/16", and one each #2 and #3 Phillips. When the screwdriver bit holder is removed, the driver has a common spindle similar to any standard 3/8" socket wrench. Replacement Bits sold individually. Minimum order is one each.

## CRL Ratcheting Extension Screwdriver

- **Magnetic Tip Shaft Extends from 9-1/4" to 15" and Locks in Place**
- **Handle Ratchets Left or Right, or Works in Fixed Position**



This CRL Ratcheting Extension Screwdriver has a magnetic, tipped shaft that extends from 9-1/4" to 15" (235 to 381 mm) overall length. The shaft extends in 1/16" (1.6 mm) increments and locks into place automatically. You retract it by pushing up on the release collar that also holds the six Insert Bits: two each Phillips, Slotted, and Torx. The handle can be made to ratchet left, or right, or lock in place. It also features a soft, comfortable grip. Minimum order is one each.

**CAT. NO. H109**

## CRL Magnetic Insert Bit Holder for Yankee Screwdrivers

- **Designed Specifically for the Original Yankee Screwdriver**



Although the old Yankee Ratchet Type Screwdriver is no longer available, CRL still offers the replacement Magnetic Insert Bit Holder for the heavy-duty size original Yankee Screwdriver. Measure the shank diameter to confirm the Bit Holder is right for your Yankee Screwdriver. Fits all standard 1/4" (6 mm) Hex Insert Bits.

CAT. NO.	SHANK DIAMETER	LENGTH
<b>M460</b>	5/16" (7.9 mm)	3-3/8" (85.7 mm)

Minimum order: 1 each.

## CRL Magnetic Screwdrivers

- **Phillips and Slotted Bits Included in Storage Handle**
- **Also Drives 1/4" (6 mm) Hex Screws**



The CRL Magnetic Screwdriver is almost indispensable. The magnetic force holds Hex Insert Bits securely, yet are easily changed. The comfortable fluted plastic handle contains four bits: #1 and #2 Phillips, and #4 and #8 Slotted. It is available in three lengths.

CAT. NO.	OVERALL LENGTH
<b>3192</b>	3" (76 mm) Magnetic Screwdriver
<b>3195</b>	8" (203 mm) Magnetic Screwdriver
<b>3198</b>	10-1/2" (267 mm) Magnetic Screwdriver

Minimum order: 1 each.

## CRL #2 Phillips Bit for Yankee Driver

- **Designed Specifically for the Original Yankee Screwdriver**



Although the old Yankee Ratchet Type Screwdriver is no longer available, CRL still offers the most popular replacement #2 Phillips Screwdriver Bit. It is designed specifically for the original Yankee Screwdriver. **NOTE:** This Bit fits the medium sized driver having an extended length of 20-1/4" (514 mm) and a closed length of 15" (381 mm). The Shank diameter is 9/32" (7.1 mm). Minimum order is one each.

**CAT. NO. 452**



## CRL 1/4" Hex Insert Bits

- Fit Any 1/4" Hex Bit Holder
- Nine Types to Choose From: Phillips, Slotted, Clutch Head, Allen, Square Tip, Spanner, Torx, Tamper Torx, and PoziDrive

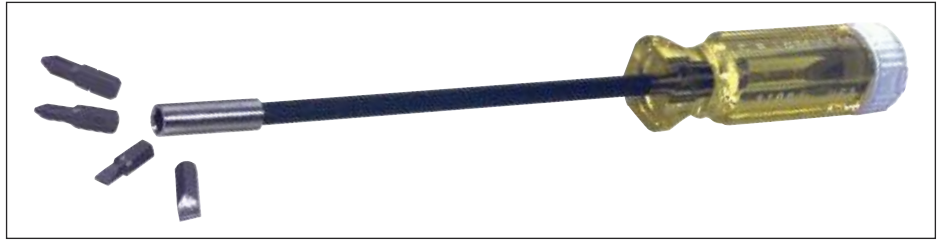

On the following pages you will find CRL's complete assortment of 1/4" Hex Insert Bits to fit any 1/4" Hex Bit Holder or Adapter. These Bits can be used with all magnetic drivers, Yankee Drivers with adapters, and screw guns with adapters. Nine different types of screws can be driven with our extensive selection. All Hex Insert Bits are hardened for durability and longevity, and can be combined for quantity pricing.

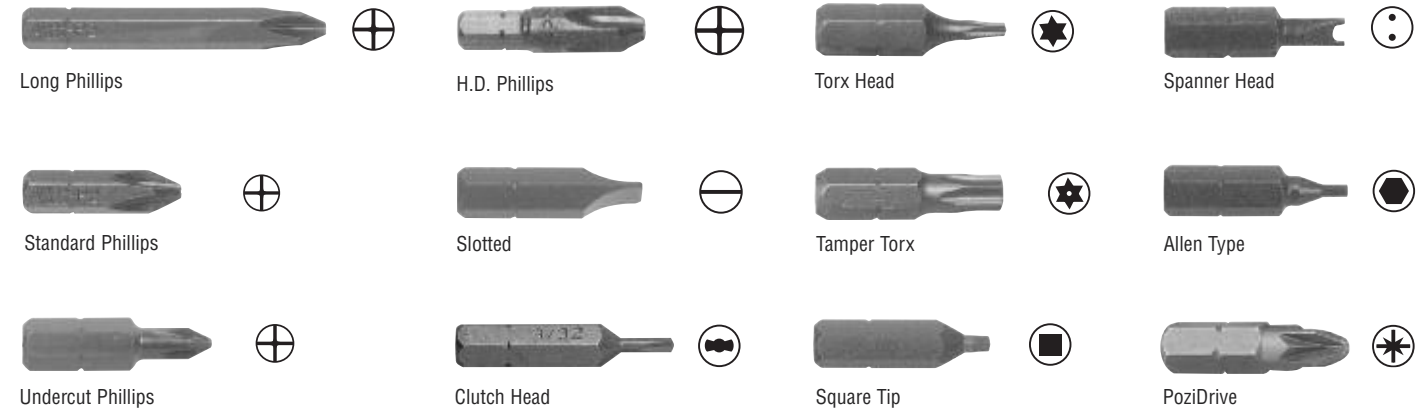

## CRL Makita® Screw Finder/Drivers

- Screw Holder Holds Screw in Correct Starting Position Without Wobbling or Disengaging From Bit

CRL Makita® Finder/Drivers have a retracting outer sleeve. When the screw is mounted onto the Bit the sleeve slides down to guide and prevent the screw from wobbling as it threads in. The sleeve pulls back as the screw threads in. Includes three 1/4" Insert Bits, one each Slotted, #1 and #2 Phillips Bits. These handy tools will hold all types of 1/4" Insert Bits.



CAT. NO.	DESCRIPTION	LENGTH
784811A	"Stubby" Finder/Driver	3" (76 mm)
784810A	Regular Finder/Driver	4-1/2" (114 mm)

Minimum order: 1 each.

## CRL Non-Magnetic Hex Insert Bit Holder



This Non-Magnetic Hex Insert Bit Holder can be chucked into your screwgun to hold all 1/4" Hex Insert Bits.

CAT. NO.	LENGTH
490	2" (51 mm)

Minimum order: 1 each.

Makita is a registered trademark of Makita Corporation.

## CRL Magnetic Hex Insert Bit Holders

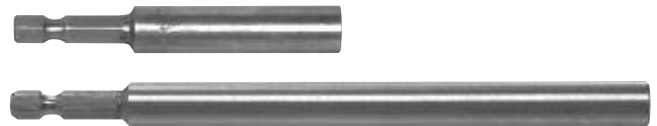

CRL Magnetic Hex Insert Bit Holders allow use of all 1/4" Hex Insert Bits in your screwgun.

CAT. NO.	LENGTH
M490	3" (76 mm)
M4906	6" (152 mm)

Minimum order: 1 each.

## CRL 1/4" Hex Phillips Insert Bits



CAT. NO. 4401



CAT. NO. 4402



CAT. NO. 4461



CAT. NO. 44022



CAT. NO. SD333



CAT. NO. 4462



CAT. NO. 346281



CRL 1/4" Hex Phillips Insert Bits come in six sizes and four styles: regular, undercut, long, and heavy-duty. We have Bits available for use with Phillips screws with #1, #2, and #3 point sizes.

Try our new "Drywall Screw Insert Bit". This undercut bit has a unique Phillips shape that is specifically designed to work with drywall screws, and is also an excellent bit for use on older, previously used #6 and #8 sized screws.

CAT. NO.	TYPE	POINT SIZE	SCREW SIZES	LENGTH
4401	Standard	1	2-3-4	1" (25 mm)
4402	Standard	2	5-6-7-8-10	1" (25 mm)
44022	Long	2	5-6-7-8-10	2" (51 mm)
4461	Undercut	1	2-3-4	1" (25 mm)
4462	Undercut	2	5-6-7-8-10	1" (25 mm)
SD333	Heavy-Duty	3	12-14	1-1/4" (32 mm)
346281	Drywall	2	6-8	1" (25 mm)

Minimum order: 1 each. All Hex Insert Bits can be combined for quantity pricing.

## CRL 1/4" Hex Slotted Insert Bits



CAT. NO. 4451



CAT. NO. 4453



CAT. NO. 4455



CAT. NO. 4452



CAT. NO. 4454



CAT. NO. 4456



CRL 1/4" Hex Slotted Insert Bits come in six sizes to fit slotted screw sizes from #4 to #16.

CAT. NO.	BLADE WIDTH X THICKNESS	SCREW SIZES	LENGTH
4451	3/16" x .034 (4.8 x .8 mm)	4-5	1" (25 mm)
4452	7/32" x .040 (5.6 x 1 mm)	6-8	1" (25 mm)
4453	1/4" x .042 (6.4 x 1 mm)	8-10	1" (25 mm)
4454	9/32" x .046 (7.1 x 1.2 mm)	10-12	1" (25 mm)
4455	5/16" x .050 (8 x 1.3 mm)	12-14	1-1/2" (38 mm)
4456	23/64" x .055 (9.1 x 1.4 mm)	14-16	1-1/2" (38 mm)

Minimum order: 1 each. All Hex Insert Bits can be combined for quantity pricing.

## CRL Nut Setter Insert Bits



• Available in Four Sizes



CRL Nut Setter Insert Bits fit all standard Bit Holders.



CAT. NO.	NUT SIZE
MNS3	3/16"
MNS4	1/4"
MNS5	5/16"
MNS6	3/8"



Minimum order: 1 each.

## CRL PoziDrive Insert Bits

• Come in Three Different Sizes



CRL PoziDrive Insert Bits are precision machined for the perfect fit. Designed to work exclusively with PoziDrive screws to prevent slip out and provide greater driving surface.

CAT. NO.	BIT SIZE
570101P	#1
570102P	#2
570103P	#3

Minimum order: 1 each. All Hex Insert Bits can be combined for quantity pricing.

## CRL Bit Caddy

- Holds Up to 37 Bits
- Center Slot Holds Magnetic Adapter

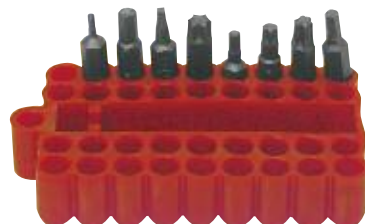

Bits shown not included

The CRL Bit Caddy will secure as many as 37 bits, and has a center slot to store a magnetic adapter, such as our Cat. No. M490. This soft, red plastic case is both practical and convenient. Minimum order is one each.

CAT. NO. APH037

## CRL Spanner Insert Bits

• Available in Three Sizes



CRL Hex Spanner Insert Bits come in three sizes. Use to set or replace Spanner Head Security Screws.

CAT. NO.	SCREW SIZE
SP6HB	#6
SP8HB	#8
SP10HB	#10

Minimum order: 1 each. All Hex Insert Bits can be combined for quantity pricing.

## CRL Hex Allen Insert Bits



- Available in Sizes From 1/16" to 1/4"

CRL 1/4" drive Hex Allen Insert Bits are available in ten sizes from 1/16" to 1/4" for cap screws and set screws.

CAT. NO.	HEX SIZE	LENGTH	CAP SCREW SIZE	SET SCREW SIZE
18500	1/16"	1" (25 mm)	1	5 and 6
1850	5/64"	1" (25 mm)	2 and 3	8
1851	3/32"	1" (25 mm)	4 and 5	10
1859	7/64"	1" (25 mm)	6	----
1852	1/8"	1" (25 mm)	8	1/4"
18510	9/64"	1" (25 mm)	8	----
1853	5/32"	1" (25 mm)	10	5/16"
1854	3/16"	1" (25 mm)	1/4"	3/8"
1855	7/32"	1" (25 mm)	----	7/16"
1856	1/4"	1" (25 mm)	5/16"	1/2" and 9/16"

Minimum order: 1 each. All Hex Insert Bits can be combined for quantity pricing.

## CRL Metric Hex Allen Insert Bits



- Available in Sizes From 3 to 6 mm

CRL 1/4" drive Metric Hex Allen Insert Bits are in four metric sizes from 3 to 6 mm.

CAT. NO.	HEX SIZE	LENGTH
HXB3M	3 mm	1" (25 mm)
HXB4M	4 mm	1" (25 mm)
HXB5M	5 mm	1" (25 mm)
HXB6M	6 mm	1" (25 mm)

Minimum order: 1 each. All Hex Insert Bits can be combined for quantity pricing.

## CRL Clutch Head Insert Bits

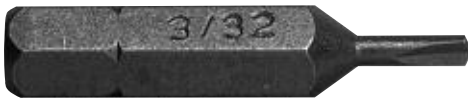

CRL Clutch Head Insert Bits come in five sizes from 3/32" to 1/4". Clutch head screws are found in GM truck window and body parts, as well as many other machine assemblies. These Clutch Head Insert Bits fit all standard 1/4" bit holders.

CAT. NO.	CLUTCH SIZE	LENGTH
1901G	3/32"	1-1/4" (32 mm)
1902G	1/8"	1-1/4" (32 mm)
1903G	5/32"	1-1/4" (32 mm)
1904G	3/16"	1-1/4" (32 mm)
1905G	1/4"	1-1/4" (32 mm)

Minimum order: 1 each. All Hex Insert Bits can be combined for quantity pricing.

## CRL Torx Insert Bits



- Available in Two Lengths

CRL 1/4" drive Standard Torx Insert Bits come in 11 sizes to fit the most common Torx screw sizes. **NOTE:** The T50 Bit only fits 5/16" hex drivers.

CAT. NO.	TORX SIZE	A (REF.)	LENGTH
440TX07	T7	.077	1" (25 mm)
440TX08	T8	.090	1" (25 mm)
440TX09	T9	.097	1" (25 mm)
440TX10	T10	.107	1" (25 mm)
440TX15	T15	.128	1" (25 mm)
440TX20	T20	.151	1" (25 mm)
440TX25	T25	.173	1" (25 mm)
440TX27	T27	.195	1" (25 mm)
440TX30	T30	.216	1" (25 mm)
440TX40	T40	.260	1" (25 mm)
440TX50	T50	.325	1-1/4" (32 mm)

Minimum order: 1 each. All Hex Insert Bits can be combined for quantity pricing.

## CRL Tamper-Proof Torx Insert Bits



CRL Tamper Torx Insert Bits come in ten sizes to fit all standard Torx head screws, as well as tamperproof type Torx head security screws.

CAT. NO.	TORX SIZE	A (REF.)	LENGTH
TTX07	T7	.077	1" (25 mm)
TTX08	T8	.090	1" (25 mm)
TTX09	T9	.097	1" (25 mm)
TTX10	T10	.107	1" (25 mm)
TTX15	T15	.128	1" (25 mm)
TTX20	T20	.151	1" (25 mm)
TTX25	T25	.173	1" (25 mm)
TTX27	T27	.195	1" (25 mm)
TTX30	T30	.216	1" (25 mm)
TTX40	T40	.260	1" (25 mm)

Minimum order: 1 each. All Hex Insert Bits can be combined for quantity pricing.

## CRL "Robertson" Square Drive Insert Bits



- Available in Four Sizes

CRL 1/4" hex Square Drive Insert Bits are often referred to as Robertson bits. They fit all standard 1/4" bit holders.

CAT. NO.	ROBERTSON SIZE	FRACTIONAL SIZE	LENGTH
9500	# 0	1/16"	1" (25 mm)
9501	# 1	3/32"	1" (25 mm)
9502	# 2	1/8"	1" (25 mm)
9503	# 3	9/64"	1" (25 mm)
SQ275S*	# 2	1/8"	3" (75 mm)

Minimum order: 1 each. All Hex Insert Bits can be combined for quantity pricing. \*Available in Australia only.

## CRL Phillips Screwgun Bits

CRL Phillips Screwgun Bits are available in #1, #2, and #3 Phillips point sizes. 1-15/16" (49 mm), 2-3/4" (70 mm), and 3-1/2" (90 mm) lengths fit all standard electric screwguns.



CAT. NO. 491



CAT. NO. 491A



CAT. NO. 492B

CAT. NO.	POINT SIZE	BODY DIAMETER	SCREW SIZES	LENGTH
491	1	3/16" (4.8 mm)	2-4	1-15/16" (49 mm)
492	2	1/4" (6.4 mm)	6-8-10	1-15/16" (49 mm)
493	3	5/16" (7.9 mm)	12-14	1-15/16" (49 mm)
491A	1	3/16" (4.8 mm)	2-4	2-3/4" (70 mm)
492A	2	1/4" (6.4 mm)	6-8-10	2-3/4" (70 mm)
493A	3	5/16" (7.9 mm)	12-14	2-3/4" (70 mm)
491B	1	3/16" (4.8 mm)	2-4	3-1/2" (90 mm)
492B	2	1/4" (6.4 mm)	6-8-10	3-1/2" (90 mm)
493B	3	5/16" (7.9 mm)	12-14	3-1/2" (90 mm)
PH2150S*	2	1/4" (6.4 mm)	6-8-10	6" (152 mm)

Minimum order: 1 each. All Screwgun Bits can be combined for quantity pricing. \*Available in Australia Only.

## CRL Slotted Screwgun Bits



CRL Slotted Screwgun Bits come in three blade widths and four thicknesses to fit most sizes of flat head and round head slotted screws. Length: 1-15/16" (49 mm).

CAT. NO.	BLADE WIDTH	BLADE THICKNESS	FITS SCREW SIZES
3202	.250" (6.4 mm)	.036" (.91 mm)	#5 flat, #6 round
3203	.250" (6.4 mm)	.038" (.97 mm)	#6 flat, #7 round
3204	.275" (6.8 mm)	.042" (1.1 mm)	#8 flat, #12 round
3205	.312" (8 mm)	.046" (1.2 mm)	#10 flat, #12 round

Minimum order: 1 each. All Screwgun Bits can be combined for quantity pricing.

## CRL Flex Hex Drive Adapter

**new**



The CRL Flex Hex Drive Adapter is an 8" (203 mm) steel spring with a 1/4" (6.4 mm) male drive on one end and a 1/4" (6.4 mm) hex bit holder on the other. This is a handy tool for driving hex bolts where a standard straight screwdriver cannot reach. Use with a standard hex drive screwdriver or your drill motor. Minimum order is one each.

CAT. NO. FE8

## CRL 1/4" Drive Socket Extensions



1/4" Drive Socket Extensions are designed to adapt the sockets shown at the right for use with all standard electric screwguns.

CAT. NO.	LENGTH
EX2502	2" (51 mm)
EX2504	4" (102 mm)

Minimum order: 1 each. All Screwgun Bits can be combined for quantity pricing.

## CRL 1/4" SAE Drive Sockets



1/4" Drive Sockets are for use with the extensions shown on the left or for any standard bit holder.

CAT. NO.	NUT SIZE
MX1108	1/4"
M1P10	5/16"
M1P12	3/8"
M1P14	7/16"

Minimum order: 1 each. All Screwgun Bits can be combined for quantity pricing.

## CRL One Way Screw Tool



Use this tool for installing one way screws. The outer sleeve prevents the screw from wobbling as it threads in.

CAT. NO.	LENGTH
50631250	4" (102 mm)

Minimum order: 1 each.

## CRL Screwgun Nut Setter Sockets



The CRL Screwgun Nut Setter Sockets are now available in two lengths and have a magnetic head to firmly hold the screw. CRL Nut Setter Sockets fit all standard screwguns.

- Nut Setters Have a Magnetic Head
- Fit All Standard Screwguns

CAT. NO.	NUT SIZE	LENGTH
MDB08	1/4"	1-3/4" (44 mm)
MDB10	5/16"	1-3/4" (44 mm)
MDB12	3/8"	1-3/4" (44 mm)
MDB14	7/16"	1-3/4" (44 mm)
MDB08L	1/4"	2-9/16" (65 mm)
MDB10L	5/16"	2-9/16" (65 mm)
MDB12L	3/8"	2-9/16" (65 mm)
MDB14L	7/16"	2-9/16" (65 mm)

Minimum order: 1 each. All Nut Setters can be combined for quantity pricing.

## CRL 7-Piece SAE Ratcheting Combination Wrench Set

- 5 Degree Micro Fine Ratchet

The CRL combination SAE open end/ratchet end Wrenches have a 72-tooth gear that ratchets with every 5 degree of wrench twist. These Wrenches are made from a drop forged steel alloy, and are triple chrome plated for superior corrosion resistance. The set includes sizes: 5/16", 3/8", 7/16", 1/2", 9/16", 5/8", and 3/4". Minimum order is one each.



CAT. NO. AT640990

## CRL 7-Piece Metric Ratcheting Combination Wrench Set

- 5 Degree Micro Fine Ratchet

The CRL combination Metric open end/ratchet end Wrenches have a 72 tooth gear that ratchets with every 5 degree wrench twist. These Wrenches are made from a drop forged steel alloy, and are triple chrome plated for superior corrosion resistance. The set includes sizes: 8, 10, 12, 13, 14, 15, and 19 mm. Minimum order is one each.



CAT. NO. AT640991

## CRL 3-Piece SAE Ratcheting Box End Wrench Set

- Reversible Ratcheting Design
- 25 Degree Offset for Added Clearance

The CRL SAE sized Double Box End Ratcheting Wrench Set includes sizes: 3/8", 7/16", 1/2", 9/16", 5/8", and 3/4". Minimum order is one each.



CAT. NO. AT640993

## CRL 3-Piece Metric Ratcheting Box End Wrench Set

- Reversible Ratcheting Design
- 25 Degree Offset for Added Clearance

The CRL Metric sized Double Box End Ratcheting Wrench Set includes sizes: 8, 10, 12, 14, and 17 mm. Minimum order is one each.



CAT. NO. AT640992

## CRL Adjustable Crescent Wrenches



- Heat Treated, Chrome Plated

All CRL Adjustable Crescent Wrenches are chrome plated for corrosion resistance, and heat treated for strength and durability.

CAT. NO.	LENGTH	GRIP
AC14	4" (102 mm)	1/2" (13 mm)
AC16	6" (152 mm)	15/16" (24 mm)
AC18	8" (203 mm)	1-1/8" (29 mm)
AC110	10" (254 mm)	1-5/16" (33 mm)
AC112	12" (305 mm)	1-1/2" (38 mm)

Minimum order: 1 each. Sizes can be combined for quantity pricing.

Stanley is a registered trademark of Stanley Logistics, LLC.

## CRL Stanley® MAXGRIP™ Locking Adjustable Wrench



- Combination Locking Pliers and Adjustable Wrench

The CRL Stanley® MAXGRIP™ Locking Adjustable Wrench has a patented design that combines the functions of locking pliers and an adjustable wrench. The 10" (254 mm) Wrench is forged and chrome plated, and exceeds ASME standards. Minimum order is one each.

CAT. NO. ST85610

## CRL 1/4" Drive SAE Socket Set

- 21-Piece Professional Grade
- 6 Point Sockets



Set includes: 1/4" Drive Ratchet; 1/4" Drive Spinner, 3" and 6" Extensions, 1/4" Universal Joint; 6 Pt. Standard Socket Sizes: 3/16", 7/32", 1/4", 9/32", 5/16", 11/32", 3/8", 7/16", and 1/2"; 6 Pt. Deep Socket Sizes: 1/4", 9/32", 5/16", 11/32", 3/8", 7/16", and 1/2". Minimum order is one each.

CAT. NO. ST1421NB

## CRL 1/4" and 3/8" Drive SAE Socket Set

- 23-Piece Professional Grade
- 6 and 12 Point Sockets



Set includes: 3/8" Drive Ratchet; 1/4" Drive Spinner; 3/8" Drive Extensions, 3" and 6"; 3/8" x 1/4" Adapter; 1/4" Drive 6 Pt. Socket sizes: 3/16", 7/32", 1/4", 9/32", 5/16", 11/32", 3/8", 7/16", and 1/2"; 3/8" Drive 12 Pt. Socket sizes: 7/16", 1/2", 9/16", 5/8", 11/16", 3/4", 13/16", and 7/8". Minimum order is one each.

CAT. NO. ST1323ANB

## CRL 3/8" Drive SAE Socket Set

- 21-Piece Professional Grade
- 6 and 12 Point Sockets



Set includes: Quick Release Ratchet, 3" Extension; 12 Pt. Socket Sizes: 3/8", 7/16", 1/2", 9/16", 5/8", 11/16", and 3/4"; 6 Pt. Socket Sizes: 3/8", 7/16", 1/2", 9/16", 5/8", 11/16", 3/4", 13/16", and 7/8". Also includes 5/8" and 13/16" Spark Plug Sockets. Minimum order is one each.

CAT. NO. PB0189

## CRL 3/8" Drive Metric Socket Set

- 21-Piece Professional Grade
- 6 and 12 Point Sockets



Set includes: Quick Release Ratchet, 3" extension; 12 Pt. Socket Sizes: 10, 12, 13, 14, 15, 16, 17, 18, and 19 mm; 6 Pt. Socket Sizes: 10, 11, 12, 13, 14, 15, 16, and 17 mm. Also includes a 16 mm Spark Plug Socket. Minimum order is one each.

CAT. NO. PB0190

## CRL 3/8" Drive SAE Deep Socket Set

- 7-Piece Professional Grade
- 6 Point Sockets



Socket sizes include: 3/8", 7/16", 1/2", 9/16", 5/8", 11/16", and 3/4". Minimum order is one each.

CAT. NO. PB0050

## CRL 3/8" Drive Metric Deep Socket Set

- 7-Piece Professional Grade
- 6 Point Sockets



Socket sizes include: 10, 11, 12, 13, 14, 15, and 17 mm. Minimum order is one each.

CAT. NO. PB0051

## CRL 5-Piece SAE Wrench Set



SAE sizes include: 3/8", 7/16", 1/2", 9/16", and 5/8". Minimum order is one each.

CAT. NO. 173C5

## CRL 11-Piece SAE Wrench Set



SAE sizes include: 1/4", 5/16", 3/8", 7/16", 1/2", 9/16", 5/8", 11/16", 3/4", 13/16", and 7/8". Minimum order is one each.

CAT. NO. 640377

## CRL 11-Piece Metric Wrench Set

- Includes Wall Mount Organizer

Metric sizes include: 6, 7, 8, 9, 10, 11, 12, 13, 14, 17, and 19 mm. Minimum order is one each.

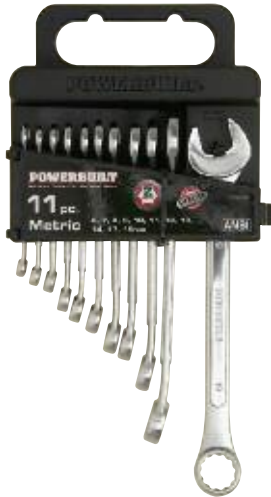

CAT. NO. AT640378

## CRL 22-Piece SAE and Metric Combo Wrench Set

- Handy Carrier/Stand

Set includes SAE sizes: 1/4", 5/16", 3/8", 7/16", 1/2", 9/16", 5/8", 11/16", 3/4", 13/16", and 7/8"; Metric sizes: 6, 7, 8, 10, 11, 12, 13, 14, 15, 17, and 19 mm. Minimum order is one each.



CAT. NO. 47467

## CRL 3/8" Drive Torque Wrench

- Accurate Between 10 and 100 Foot-Pounds

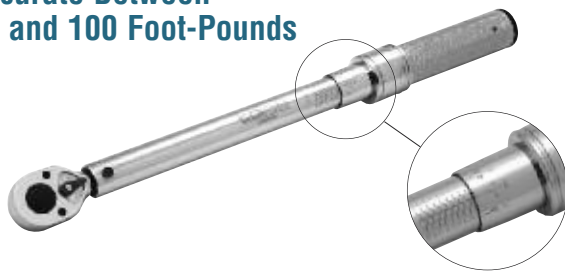

The CRL 3/8" Drive Torque Wrench will provide accurate torque values between 10 and 100 foot-pounds. The ratcheting 3/8" socket head is reversible. Simply set the micrometer adjustable handle to the torque value required and begin tightening. Once the handle clicks you have reached your desired strength. Minimum order is one each.

CAT. NO. 85555A

## CRL 15-Piece Squeeze Wrench Set

- Includes Nine Sockets



The CRL Squeeze Wrench lets you get into places your typical socket sets won't fit. Simply squeeze the handle and the ratchet head turns without having to twist the wrench. Set includes: One Squeeze Wrench, SAE Socket sizes: 5/16", 3/8", 7/16", and 1/2". Metric Socket sizes: 9, 10, 11, 12, and 13 mm. Also included are one Phillips and one slotted screwdriver bits and a compact Carrying Case. Minimum order is one each.

CAT. NO. SQW100R

## CRL Universal Spanner Wrench Kit

Use this CRL Universal Spanner Wrench as a quick and efficient method to secure and tighten CRL brand Laguna Series Brackets and Spider Fittings to glass.

**NOTE:** Minimum pin spread center-to-center is 1/4" (6 mm).



**Kit Includes:** One Adjustable Tool, five Metric (1.5, 2, 2.5, 3, and 4 mm) Spanner Pin Sets, and five Fractional (1/16", 3/32", 1/8", 5/32", and 3/16") Spanner Pin Sets. Comes complete with a Molded Carrying Case. Minimum order is one each.

CAT. NO. USW10

## CRL Adjustable Spanner Wrench



### • Adjustable Wrench Used to Install Laguna Series Top Roller on Glass Doors

Use this CRL Adjustable Spanner Wrench as a quick way to secure Laguna Series Brackets and Fittings to the glass. Use it to tighten the CRL Cat. No. LS300BS CRL Top Roller to the door panel. Minimum order is one each.

CAT. NO. SW19

## CRL Spanner Wrench for Stainless Standoffs

### • Designed to Work With SS30 Standoffs Only



This CRL Spanner Wrench for Stainless Steel Standoffs is designed to secure and tighten both the standoff cap and base. Notches are fabricated into the side of each component to attach the Wrench. Minimum order is one each.

CAT. NO. SW30

## CRL Laguna Series Socket Wrench Adapter



This CRL Spanner Socket Wrench is used with your 1/4" (6.4 mm) drive ratchet wrench to tighten or remove Laguna Series Brackets and Fittings to the glass. Ratchet wrench is not included. Minimum order is one each.

CAT. NO. LSSW1

## CRL Adjustable Strap Wrench

- Comfortable 4" (102 mm) Handle
- Durable Rubber Strap
- A "Must" for Standoff Installations



CRL's Adjustable Strap Wrench is the perfect tool for anyone installing Standoff Bases, plated shower door knobs or polished threaded tubing. The 7/16" (11 mm) wide x 1/8" (3.2 mm) thick rubber strap quickly tightens around any plated cylinder without damaging the surface's finish. The strap is easily adjustable from 3/4" to 4" (19 to 102 mm) diameter using a conveniently located thumb lever in the handle. Minimum order is one each.

CAT. NO. ASW12

## CRL Spanner Wrench for Round Standoff Cap Assemblies



The CRL Standoff Wrench provides a quick and efficient method of tightening and loosening the Cap Assembly of Round Standoffs from 3/4" (19 mm) to 1-1/4" (31.8 mm) in diameter. Minimum order is one each.

CAT. NO. SOW

## CRL Cap Assembly Spanner Wrench



The CRL Standoff Wrench for 1-1/2" and 2" (38.1 and 50.8 mm) Cap Assemblies was specifically designed to be used during installation of CRL Standoffs. The curved end of the Wrench fits around the Standoff Cap and into the slot in the edge, allowing the Cap to be easily tightened or loosened. Minimum order is one each.

CAT. NO. SSW12



# CRL NUT DRIVERS AND ALLEN WRENCHES

For Pricing Visit [crlaurence.com](http://crlaurence.com) or Call Us Toll Free at the Phone Numbers Shown on the Back Cover

## CRL SAE Hex Nut Drivers

- Sold Individually

Our Hex Nut Drivers are precision machined from cold-drawn, case hardened steel and have a plated finish for corrosion resistance. Large, easy-to-grip molded plastic handle.

- Six Different Fractional Sizes to Choose From

CAT. NO.	SIZE
S7	7/32"
S8	1/4"
S10	5/16"
S12	3/8"
S14	7/16"
S16	1/2"

Minimum order: 1 each.



## CRL SAE Hex Nut Driver Set

- Seven Different Fractional Sizes



This complete Hex Nut Driver Set includes seven of the most popular fractional SAE sizes: 3/16", 1/4", 5/16", 11/32", 3/8", 7/16", and 1/2" in a handy carrying pouch. Minimum order is one each.

CAT. NO. K7

## CRL Metric Hex Nut Driver Set

- Ten Different Metric Sizes

This complete Hex Driver Set includes ten of the most popular Metric sizes: 4, 4.5, 5, 5.5, 6, 7, 8, 9, 10, and 11 mm, in a handy metal base. Minimum order is one each.



CAT. NO. 70200

## CRL Large Allen Wrench Set

- Nine Different Fractional Sizes

The CRL Hex Allen Wrench Set has nine hex keys that fold out of the handy chrome plated holder. Sizes include: 5/64", 3/32", 7/64", 1/8", 9/64", 5/32", 3/16", 7/32", and 1/4". Minimum order is one each.



CAT. NO. 91

## CRL 10 mm Hex Nut Metric Driver

- Popular 10 MM Size
- Standard Length Works for Most Applications

CRL's 10 mm Hex Nut Driver is made from cold-drawn, case hardened steel, with a plated finish for corrosion resistance. Overall length is 7" (78 mm). Minimum order is one each.



CAT. NO. 2112909

## CRL Small Allen Wrench Set

- Nine Different Fractional Sizes

The CRL Hex Allen Wrench Set has nine hex keys that fold out of the handy chrome plated holder. Sizes include: .050, 1/16", 5/64", 3/32", 7/64", 1/8", 9/64", 5/32", and 3/16". Minimum order is one each.



CAT. NO. 91S

## CRL Metric Allen Wrench Set

- Seven Different Metric Sizes

The CRL Hex Allen Wrench Set has seven Metric Hex Keys that fold out of the handy chrome plated holder. Sizes include: 1.5, 2, 2.5, 3, 4, 5, and 6 mm. Minimum order is one each.



CAT. NO. M17

## CRL Ergo-Fold Hex and Torx® Key Sets

- Cushion-Grip Handle
- Hex, Torx® or Hex Ball-End Sets

CRL Ergo-Fold Key Sets feature a composite-grip handle shaped for superior ergonomics with a soft, cushion-grip insert providing comfort and slip resistance. Ergo-Fold Keys provide extra reach for safer clearance from your work. You can position the Ergo-Fold handle with the key at a right angle to generate maximum torque or it can be folded straight out and used like a screwdriver.



CAT. NO.	TYPE	KEYS	KEY SIZES	HANDLE LENGTH
EF919	Ball End Inch	9	5/64", 3/32", 7/64", 1/8", 9/64", 5/32", 3/16", 7/32", 1/4"	4-1/2" (114.3 mm)
EF169	Ball End Metric	6	2.0 mm, 2.5 mm, 3.0 mm, 4.0 mm, 5.0 mm, 6.0 mm	3-3/4" (95.3 mm)
EF912	Hex Inch	9	0.50", 1/16", 5/64", 3/32", 7/64", 1/8", 9/64", 5/32", 3/16"	3-3/4" (95.3 mm)
EF911	Hex Inch	9	5/64", 3/32", 7/64", 1/8", 9/64", 5/32", 3/16", 7/32", 1/4"	4-1/2" (114.3 mm)
EF171	Hex Metric	7	1.5 mm, 2.0 mm, 2.5 mm, 3.0 mm, 4.0 mm, 5.0 mm, 6.0 mm	3-3/4" (95.3 mm)
EF582	Torx®	8	T-6, T-7, T-8, T-9, T-10, T-15, T-20, T-25	3-3/4" (95.3 mm)

Minimum order: 1 each. All Ergo-Fold Key Sets can be combined for quantity pricing.

## CRL 6-in-1 Mirror Bracket Tool

- Torx®, Allen, Slotted, and Phillips Bits With Driver Handle/Carrying Case
- The Perfect "Must Have" Tool for the Mobile Installer



We have combined the most popular mirror bracket removal and replacement bits along with a driver handle/carrying case in our CRL 6-in-1 Mirror Bracket Tool. Together they make up the most versatile mirror bracket tool ever. Minimum order is one each. Housed in the sturdy case are one each of the following:

- CAT. NO'S. 440TX15 and 440TX20; (TX15 and TX20 Torx® Bits)
- CAT. NO'S. 1851 and 1853; (3/32" and 5/64" Allen Bits)
- CAT. NO. 4453; (#8 Slotted Insert Bit)
- CAT. NO. 4402; (#2 Phillips Bit)
- CAT. NO. M490 (Insert Bit Holder)

CAT. NO. MB6N1

## CRL Long Arm Torx® L-Key Set

- 14 Different Torx® L-Keys Ranging From T-6 to T-55
- Black Finish to Resist Rust

This handy CRL Torx® L-Key Set contains fourteen of the most used Torx® key sizes in a plastic case. L-Keys are top quality chrome nickel-alloy steel, precision machined and hardened for precise fit and long life. Torx® keys fit new Torx® type recessed screws. The fourteen tips on this tool are: T-6, T-7, T-8, T-9, T-10, T-15, T-20, T-25, T-27, T-30, T-40, T-45, T-50, and T-55. Minimum order is one each.



CAT. NO. 10914

## CRL 7-in-1 Fold Up Torx® Key Set

- Seven Different Torx® Bits Ranging From T-10 to T-40

This handy CRL 7-In-1 Fold Up Torx® Key Set contains seven of the most popular Torx® key sizes in one handle. Fold-out keys are top-quality chrome nickel-alloy steel, precision machined and hardened for precise fit and long life. Torx® keys fit Torx®-type recessed screws. The seven sizes of Torx® keys on this tool are: T-10, T-15, T-20, T-25, T-27, T-30, and T-40. Minimum order is one each.



CAT. NO. 22571

Torx is a registered trademark of Acument Intellectual Properties, LLC.

## CRL T-Handle Hex Wrench Set

- Sizes From 3/32" to 3/8"
- Indexed Stand

This CRL T-Handle Hex Wrench Set has 10 Wrenches and comes with a freestanding steel caddy. Sizes include: 3/32", 7/64", 1/8", 9/64", 5/32", 3/16", 7/32", 1/4", 5/16", and 3/8". Minimum order is one each.



CAT. NO. 1600369

## CRL Long Arm Allen Wrench Set

- 13-Piece Ball End Set
- Sizes From .050" to 3/8"
- Indexed Holder

This CRL Long Arm Allen Wrench Set has 13 pieces. Sizes include: .050", 1/16", 5/64", 3/32", 7/64", 1/8", 9/64", 5/32", 3/16", 7/32", 1/4", 5/16", and 3/8". Minimum order is one each.



CAT. NO. 13213

## CRL Specialty T-Handle Hex Wrenches

- Handy for Installing Door Rails
- Vinyl Tipped Soft Grip Loop Handle
- High Quality 8650 Chrome Nickel Alloy Steel

These T-Handle Hex Wrenches are very handy for installing CRL Door Rail Systems.

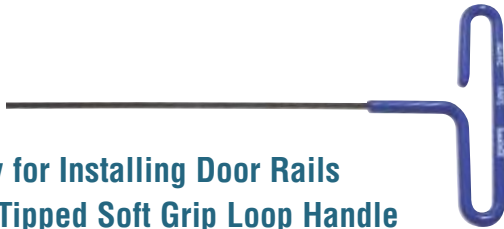

CAT. NO.	HEX SIZE	LENGTH
T620	2 mm	6" (152 mm)
T718	1/8"	6" (152 mm)
T912	3/16"	9" (229 mm)

Minimum order: 1 each.

## CRL Long Arm Metric Sized Allen Wrench Set

- 9-Piece Ball End Set
- Metric Sizes From 1.5 to 10 mm
- Indexed Holder

This CRL Long Arm Metric Sized Ball End Allen Wrench Set includes: 1.5, 2.0, 2.5, 3.0, 4.0, 5.0, 6.0, 8.0, and 10.0 millimeter sizes. Minimum order is one each.



CAT. NO. 13609

## CRL Specialty Allen Wrenches

- Commonly Used for Commercial Door Handle Installation
- Ball End Wrenches Can be Used at 25 Degree Angle

These four popular sizes of Allen Wrenches are commonly used when installing commercial door hardware.

CAT. NO.	TYPE	SIZE	LENGTH
18208	Ball End	1/8"	3-3/4" (95 mm)
18605	Ball End	2.5 mm	3-1/2" (88 mm)
18606	Ball End	3.0 mm	3-7/8" (98 mm)
4MM	Straight End	4.0 mm	2-7/8" (73 mm)

Minimum order: 1 each.

Torx is a registered trademark of Acument Intellectual Properties, LLC.

## CRL Hex and Torx® Mirror Bracket Wrenches



CAT. NO. MB2



CAT. NO. MB2TX



- MB2 Tool has 5/64" and 3/32" Hex Wrench Ends
- MB2TX Tool has TX15 and TX20 Torx® Wrench Ends

Two of our most popular and handy Automotive Rear View Mirror Bracket Wrenches. The MB2 Wrench has 5/64" and 3/32" Hex ends, and the MB2TX has TX15 and TX20 Torx® ends. The MB2TX Wrench fits newer models of GM and Chrysler cars. Both of these wrenches feature a handy clip for carrying around in your shirt pocket. These are vital tools for every automotive glass technician. Minimum order is one each.

## CRL Compound Long Nose Pliers



- **Compound Action for More Leverage**

Compound leverage action design produces 50% more gripping and cutting power than the more common single action design. Pliers are made from hardened vanadium steel. The molded ergonomically designed grips eliminate slipping and reduce fatigue. Overall length is 9" (229 mm). Nose length is 1-9/16" (40 mm). Minimum order is one each.

CAT. NO. CLN9

## CRL Long Needle Nose Pliers

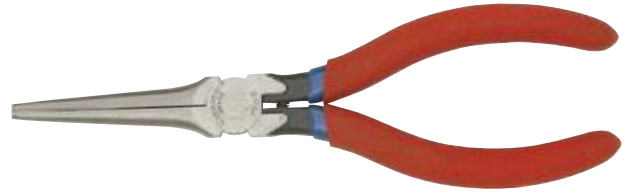

- **Precision Machined**
- **Serrated Jaws**

These single action Long Needle Nose Pliers are ideal for working inside of tight areas. The jaws have a 2" (51 mm) grip depth, and have a grip opening of 1-1/2" (38 mm) at the tips. Overall length is 6-1/2" (165 mm). Minimum order is one each.

CAT. NO. NN7776

## CRL Curved Needle Nose Pliers



- **For Working in Out-of-the-Way Confined Corners**

These 6" (152 mm) Curved Needle Nose Pliers make handy additions to any tool box. The curved nose allows objects to be grasped that would be out of reach for more common straight nosed pliers. Minimum order is one each.

CAT. NO. 8886C

## CRL Extra-Thin Needle Nose Pliers

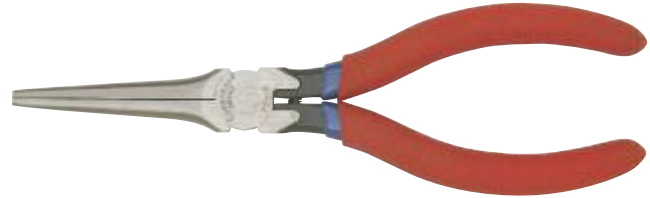

- **Ideal for Tight Places**

These single action Extra-Thin Needle Nose Pliers have very slender jaws. Originally designed for electricians, the jaws are spring-loaded causing them to stay open unless closed by squeezing the handles. Jaws have a 2" (51 mm) grip depth, and have a grip opening of 7/8" (22 mm) at the tips. Overall length is 6-3/4" (171 mm). Minimum order is one each.

CAT. NO. 7776SC

## CRL Slip Joint Pliers



- **Knurled Handles**
- **Built-In Wire Cutter**

Knurled handles allow for a good grip for these hardened steel Pliers. Chrome plated for maximum corrosion resistance. Pliers have handy built-in wire cutter.

CAT. NO.	SIZE
G26	6-1/2" (165 mm)
G28	8" (203 mm)

Minimum order: 1 each.

## CRL End Cutting Nippers



- **Precision Machined From Forged Alloy Tool Steel**

Our End Cutting Nippers are made of hardened, forged alloy tool steel with extra wide polished heads. These Nippers have extra thick handles with a thick non-slip coating. Overall length is 7-1/4" (184 mm). Minimum order is one each.

CAT. NO. 727C

## CRL Compound Diagonal Cutters



- 50% More Cutting Power
- Induction Hardened Edges for Years of Tough Cutting Service
- Molded Grips for Comfort



Hardened Vanadium Steel Blades With Compound Leverage

The compound leverage action design of these Diagonal Cutters produces 50% more cutting power than the more common single action type. Cutters are made from hardened vanadium steel. Molded, ergonomically designed grips eliminate slipping and reduce fatigue. Overall Cutter size is 9" (228 mm). Minimum order is one each.

CAT. NO. DC9

## CRL Diagonal Cutters



Standard Duty CAT. NO. 5427C



Heavy-Duty CAT. NO. 5428C

- Coated Grips
- Forged Alloy Tool Steel

Our general purpose Diagonal Cutters are made of hardened, forged alloy tool steel with polished heads. The handle has been coated to prevent slipping.

CAT. NO.	TYPE	SIZE
5427C	Standard Duty	7" (178 mm)
5428C	Heavy-Duty	8" (203 mm)

Minimum order: 1 each.

## CRL Ultra-Tec® Cable Cutter



- Top-Quality, Pocket-Size Cutter for Cable Up to 3/16" (5 mm) in Diameter



Shear-Cut Blades

These CRL Ultra-Tec® Cable Cutters will cut thin-strand stainless steel wire cable used in many glass shelf systems. Will work with cable up to 3/16" (5 mm) in diameter. Overall length is 7-1/2" (191 mm). Minimum order is one each.

CAT. NO. 0690TN

Ultra-Tec is a registered trademark of Ultra-Tec Corporation.

## CRL Ultra-Tec® Super-Duty Cable Cutter



- For Burr-Free Cutting of Cable Up to 3/8" (10 mm) in Diameter

The CRL Ultra-Tec® Super-Duty Cable Cutters have hardened steel jaws that will cut up to 3/8" (10 mm) diameter wire rope or 1/4" (6 mm) diameter steel wire with ease. These Cutters are great for cutting wire rope with large diameter strands, which might be too difficult for single-handed cutters. Overall length is 13" (330 mm). Minimum order is one each.

CAT. NO. CBLCTR1

# CRL PLIERS AND CUTTERS

For Pricing Visit [crlaurence.com](http://crlaurence.com) or Call Us Toll Free at the Phone Numbers Shown on the Back Cover

## CRL Robo-Grip® Pliers • Patented Design Adjusts Jaws Automatically

These Robo-Grip® Pliers are self-adjusting, allowing for quick one-handed operation. Laminated multi-ply construction adds strength, and their wide plastic handle grip allows for extra gripping strength while providing comfort for extended periods of use.

CRL Robo-Guards are heavy vinyl slip-on socks designed for the jaws of CRL Robo-Grip® Pliers. They protect fine surfaces, such as plated chrome or polished brass from being scratched. They come in packs of 10 each and are available for both plier sizes.



CAT. NO. RBGU7

Robo-Guards

### ROBO-GUARDS

CAT. NO.	FITS PLIER SIZE	PKG/QTY
RBGU7	7" (178 mm)	10
RBGU9	9" (228 mm)	10

Minimum order: 1 pack.



CAT. NO. RBG7

7" (178 mm) Robo-Grip® Pliers

CAT. NO. RBG9

9" (228 mm) Robo-Grip® Pliers

### ROBO-GRIP® PLIERS

CAT. NO.	LENGTH	JAW CONFIG.	MAX. GRIP
RBG7	7" (178 mm)	Curved	3/4" (19 mm)
RBG9	9" (228 mm)	"V" Jaw	1-1/2" (38 mm)

Minimum order: 1 each. Sizes can be combined for quantity pricing.

## CRL Cobra Adjustable Pliers



- Maintains Tight Gripping Pressure Without Squeezing

Our most powerful and universal pliers have a unique push-button channel lock feature that prevents the pliers from slipping out of adjustment. Features include a patented parallel jaw design, machine ground extra sharp jaw teeth, forged from high strength vanadium steel and then oil hardened, and extra long handles with non-slip plastic grips.

CAT. NO.	LENGTH
KN87017	7" (178 mm)
KN870110	10" (254 mm)

Minimum order: 1 each.

## CRL Multi-Function Tool

- 14 Tools in One
- Stainless Steel
- A Must for Every Tool Box



Fourteen tools in one, this all stainless steel tool unfolds into long nose pliers, regular pliers, wire cutters, two knife blades, three different sized slotted screw drivers as well as a #1 Phillips. Tool folds down and fits into a 1-1/2" x 4" (38 x 101 mm) case (included). Overall length is 7-1/4" (184 mm).

Minimum order is one each.

CAT. NO. 170197

## CRL Compound Action Linesman Pliers



- Comfortable Molded Grips
- 1/3 Lighter Than Standard Pliers

The compound leverage action design produces 50% more gripping and cutting power than single action pliers. Made from hardened vanadium steel, the molded, ergonomically designed grips eliminate slipping and reduce fatigue. Plier size is 9" (228 mm). Minimum order is one each.

CAT. NO. LMP9

Robo-Grip is a registered trademark of W Forge Holdings, Inc.

## CRL Linesman Pliers

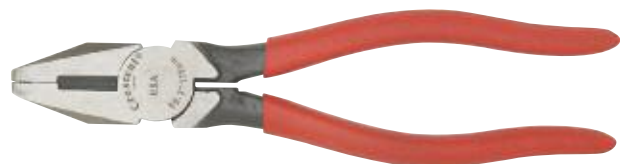

- Side Cutting Pliers With Honed Edges

General purpose Linesman Pliers are made of hardened, forged alloy tool steel with polished heads. The handle is coated to prevent slipping. Plier size is 7" (178 mm). Minimum order is one each.

CAT. NO. 507C



C.R. LAURENCE COMPANY

[crlaurence.com](http://crlaurence.com) | [usalum.com](http://usalum.com)

ALUMINUM 528K | [crlaurence.ca](http://crlaurence.ca) [crlaurence.com.au](http://crlaurence.com.au) [crlaurence.co.uk](http://crlaurence.co.uk) [crlaurence.de](http://crlaurence.de) [crlaurence.eu](http://crlaurence.eu)

## CRL Straight Jaw Locking Pliers



### • Straight Jaws for Maximum Contact

These compound action Locking Pliers are made to exceed all ASTM tool specifications. The unique angled jaw teeth provide exceptional gripping action in comparison to other locking pliers, and the durable nickel-plated finish will provide years of corrosion resistant life.

CAT. NO.	LENGTH	JAW CAPACITY
7R	7" (178 mm)	1-5/16" (33 mm)
10R	10" (254 mm)	1-3/4" (44 mm)

Minimum order: 1 each. All Vise Grips can be combined for quantity pricing.

## CRL Curved Jaw Locking Pliers



### • Curved Jaw Available With or Without Wire Cutter

CRL Curved Jaw Locking Pliers are made of special alloy steel and heat treated for toughness. The curved jaw gives tooth contact on four points of nuts, and increases tooth contact on round work. Thin tapered nose permits work in close quarters.

CAT. NO.	WIRE CUTTER	LENGTH	JAW CAPACITY
7CR	No	7" (177.8 mm)	1-1/8" (28.6 mm)
10CR	No	10" (254 mm)	1-1/2" (38.1 mm)
7WR	Yes	7" (177.8 mm)	1-1/8" (28.6 mm)
10WR	Yes	10" (254 mm)	1-1/2" (38.1 mm)

Minimum order: 1 each. All Vise Grips can be combined for quantity pricing.

## CRL Long Nose Locking Pliers



### • With Wire Cutter Feature

Possessing the same heavy-duty features as our Locking Pliers With Wire Cutters, these Locking Pliers have extra long jaws that taper at the end for gripping into tight areas where standard pliers would be too wide. Jaws are 2" (51 mm) long, 3/16" (5 mm) wide at the tip, and 3/8" (10 mm) wide near the wire cutter.

CAT. NO.	LENGTH	JAW CAPACITY
6LN	6" (152 mm)	2" (51 mm)

Minimum order: 1 each. All Vise Grips can be combined for quantity pricing.

## CRL "C" Clamp Locking Pliers

### • Classic Trigger Release Feature



CRL's compound action "C" Clamp Locking Pliers are faster and easier to use than standard "C" Clamps. Just a quick turn of the adjusting knob enables the Clamp to match the appropriate job thickness, and allows for increased or decreased clamping pressure.

CAT. NO.	LENGTH	JAW CAPACITY
11R	11" (279 mm)	3-3/8" (85 mm)
6R	6" (152 mm)	2-1/8" (54 mm)

Minimum order: 1 each. All Vise Grips can be combined for quantity pricing.

## CRL Welding Clamp Locks

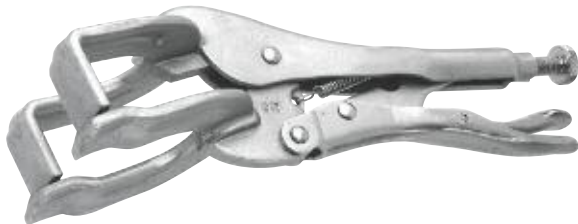

### • Great Tool for Welding or for Awkward Shapes

These handy Welding Clamps are a favorite among metal workers of all trades, especially welders. The compound lever action holds the clamp jaws tight to prevent slippage during assembly, drilling, or welding.

CAT. NO.	LENGTH	JAW CAPACITY
9R	9" (228 mm)	2-3/4" (70 mm)

Minimum order: 1 each. All Vise Grips can be combined for quantity pricing.

## CRL Sheet Metal Clamps



### • Designed to Hold Flat Sheet Metal

Originally designed for use in the sheet metal industry, these Clamps can be used anywhere flat stock needs to be held firmly together. They have no jaw teeth, making them especially useful in places where surfaces must be protected from scratches and marring.

CAT. NO.	LENGTH	JAW CAPACITY
8R	8" (203 mm)	3-1/8" (78 mm)

Minimum order: 1 each. All Vise Grips can be combined for quantity pricing.

## CRL Spring Clamps

- Bright Finish Resists Corrosion
- Available With or Without Vinyl Coated Grips and Tips
- Available in Three Sizes

CAT. NO.	DESCRIPTION	SIZE	MAX. JAW OPENING
JC3201HT	With Vinyl	4" (102 mm)	1" (25.4 mm)
JC3202HT	With Vinyl	6" (152 mm)	2" (50.8 mm)
JC3203HT	With Vinyl	9" (228 mm)	3" (76.2 mm)
JC3201	Without Vinyl	4" (102 mm)	1" (25.4 mm)
JC3202	Without Vinyl	6" (152 mm)	2" (50.8 mm)
JC3203	Without Vinyl	9" (228 mm)	3" (76.2 mm)

Minimum order: 1 each. All Spring Clamps can be combined for quantity pricing.



Vinyl Coated



Without Vinyl

CRL's Deluxe Spring Clamps are available with or without vinyl tips and grips. The vinyl-coated Clamps are ideal for clamping to glass or any surface that can easily be marred. The Clamps without vinyl are good for all of your common clamping needs, including work with any light metals.

## CRL Solo One-Handed Clamp

- Excellent Clamps for Holding Glass Tight During Insulated Glass Sealing
- Ideal for Holding Straight Edges and "L" Squares

The CRL Solo "G" Clamp has a patented design for use with only one hand. This Clamp is ideal for use in clamping glass for making insulated glass units, also great for holding any material for gluing, sawing, or drilling. Maximum jaw opening is 4" (102 mm). Minimum order is one each.



CAT. NO. 71004P

## CRL 6" Quick-Grip® Bar Clamp



- Takes Only One Hand to Operate
- High-Tech Resin Construction
- Up to 150 Pounds of Clamping Pressure

This 6" (152 mm) Quick-Grip® Bar Clamp is smaller in size than Cat. No. 506QC. This mini "Clamp Only" design with a jaw throat depth of 2-7/16" (62 mm) is handier for smaller jobs where the spreader feature is not required. Gripping jaws have vinyl pads. Minimum order is one each.

CAT. NO. 546QC

Quick-Grip is a registered trademark of Irwin Industrial Tool Company.

## CRL Quick-Grip® Bar Clamp/Spreader



- Quick Change Jaw Feature Converts From Clamp to Spreader
- Up to 300 Pounds of Clamping Force

The CRL Quick Grip® Bar Clamp/Spreader only takes one hand to operate and has a quick release trigger for fast positioning of the jaws. Jaw throat depth is 3-1/4" (83 mm). Large non-marring vinyl jaw pads offer maximum glass or finish protection and gripping strength.

CAT. NO.	MAX. JAW OPENING
506QC	6" (152 mm)
512QC	12" (305 mm)
524QC	24" (610 mm)

Minimum order: 1 each. Sizes can be combined for quantity pricing.



## CRL Mechanics Bench Vise

- Rugged Cast Iron Construction
- 360 Degree Swivel Base



These CRL Mechanics Bench Vises have a large anvil surface for shaping or forming, and rugged cast iron construction with replaceable jaws.

CAT. NO.	MAXIMUM JAW OPENING
BV4	4" (102 mm)
BV6	6" (152 mm)

Minimum order: 1 each.

## CRL Jorgensen® Wood Clamps

- Quick Twisting Operation

Jorgensen® Clamps distribute pressure evenly over the entire jaw surface. Jaws are made from the finest quality hard maple wood, and the threaded spindles are made from cold-drawn steel.

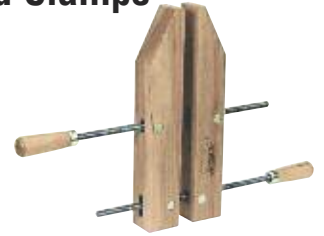

CAT. NO.	SIZE	MAXIMUM JAW OPENING
JC0	8" (203 mm)	4-1/2" (114 mm)
JC2	12" (305 mm)	8-1/2" (216 mm)
JC4	16" (406 mm)	12" (305 mm)

Minimum order: 1 each. Sizes can be combined for quantity pricing.

## CRL Framer's Corner Clamp

- 3" Width Capacity
- Fully Exposes Both Sides of the Joint

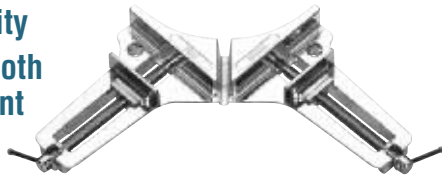

This handy Framer's Corner Clamp will hold any molding up to 3" (76 mm) wide at a perfect 90 degree angle for gluing, drilling or nailing. Made from high strength cast aluminum, this tool is ideal for fabricating picture frames. Minimum order is one each.

CAT. NO. ST83404

## Small Suction Cups With Clamp

- 1-1/8" (28.6 mm) Diameter Clear Suction Cup

The metal clamp will hold small signs, notes or advertisements in its spring-loaded jaws. This small diameter cup will hold up to 1 pound (.45 kg). Minimum order is one package of 25.



CAT. NO. ASC118MC

## CRL Glaziers Rule Holder

- Reduces Straight Edge Slip
- Suction Cup Base



The CRL Glaziers Rule Holder is a large 2" (51 mm) diameter rubber suction cup with an adjustable steel clamp attached.

CAT. NO.	DESCRIPTION
RH670	Glaziers Rule Holder
5195	Replacement Cup w/ Trigger

Minimum order: 1 each.

## CRL Suction Cup With Clamp

- 1-3/4" (44.5 mm) Diameter Clear Suction Cup

This Suction Cup has a spring loaded metal clamp that can be used to hold signs, work orders, or advertisements. The medium diameter suction cup will hold up to 3 pounds (1.4 kg). Minimum order is one package of 25.



CAT. NO. ASC134MC

## See CRL's Extensive Line of UV Bonding Clamps and Fixation Devices on Pages 322K to 330K

- Used While Curing UV Adhesives
- Prevent Bonded Parts From Moving While Curing
- Many Clamps Are Adjustable to Multiple Angles



Jorgensen is a registered trademark of Adjustable Clamp Company.

## CRL Marson® "Big Daddy" Riveter



- Excellent for Window Regulator and Glass Stop Rivets

The CRL Marson® "Big Daddy" Riveter lets you work in hard-to-get-to areas. Use it to replace window regulator and glass stop rivets, plus door handle rivets. The special nosepiece provided with the tool must be used for these applications. 3/16" and 1/4" (4.8 and 6.4 mm) nosepieces for other rivet applications are stored in the body of the tool.

CAT. NO.	DESCRIPTION
39010	"Big Daddy" Riveter
39010JAWS	Replacement Jaws
39009	Long Nose Adapter

Minimum order: 1 each.

## CRL Rivet Tool Nosepieces

- Fit 39010 "Big Daddy" Riveter

These Replacement Rivet Tool Nosepieces are for Cat. No. 39010 Marson "Big Daddy" Riveter.



CAT. NO.	DESCRIPTION
96026	3/16" (4.8 mm) Nosepiece
96027	1/4" (6.4 mm) Nosepiece
96028	Klik-Split Rivet Nosepiece

Minimum order: 1 each.

## CRL Hydraulic Rivet Gun

- Develops Up to 3,500 Pounds of Pulling Power

The CRL Hydraulic Rivet Gun develops up to 3500 pounds (1587 kg) of rivet pulling power, capable of setting 1/4" (6.3 mm) diameter rivets. Includes four nosepieces for setting rivets of 1/8", 5/32", 3/16", and 1/4" (3.2, 4, 4.8, and 6.3 mm) diameter, plus a 1/4" (6.3 mm) split rivet nosepiece. Minimum order is one each.



CAT. NO. RG1105

Marson is a registered trademark of Alcoa Inc.

## CRL Heavy-Duty Automotive Riveter



- Tremendous Power for Large Rivets
- Extra Heavy-Duty Tool Used in Auto Glass Shops
- Equipped With Three Long Nosepieces

This CRL Heavy-Duty Automotive Riveter allows riveting in areas where other tools won't reach. Exerts tremendous pulling power for large rivets. Shock resistant curved handles. Equipped with three nosepieces conveniently stored on the handle. Nosepieces set 5/32", 1/8", and 3/32" (4, 3.2, and 2.4 mm) rivets, plus there's a special nosepiece for inserting door handle rivets for the automotive industry.

CAT. NO.	DESCRIPTION
79034	Heavy-Duty Riveter with Nosepieces
96013	Replacement Jaws

Minimum order: 1 each.

## CRL Plastic Rivet Setter



- Available as a Complete Kit, or Just the Tool Only

The CRL Plastic Rivet Setting Tool Kit includes a selection of the four most popular plastic rivets. This all steel tool has full size handles to provide the extra pulling stroke needed to set plastic rivets.

CAT. NO.	DESCRIPTION
48001	Complete Rivet Setter Kit
48000	Rivet Setter Tool Only

Minimum order: 1 each.

## CRL Air Hydraulic Riveter

- Sets Rivet Diameters 1/8", 5/32", and 3/16"

The CRL Air Hydraulic Standard Duty Riveter is designed to set blind rivets from 1/8" to 3/16" (3.2 to 4.8 mm) diameter in all alloys. 1/8", 5/32", and 3/16" (3.2, 4, and 4.8 mm) nosepieces and servicing wrenches included. Requires 85 psi for optimum operation. Minimum order is one each.



CAT. NO. PHT3

## CRL Marson® Heavy-Duty Rivet Gun

- Includes Four Nosepieces



The CRL Marson® Heavy-Duty Rivet Gun includes four nosepieces that are housed in the tool's body. For use with 3/32", 1/8", 5/32", and 3/16" (2.4, 3.2, 4, and 4.8 mm) rivet sizes.

CAT. NO.	DESCRIPTION
HP2	Heavy-Duty Rivet Gun
HP23A	Replacement Jaws

Minimum order: 1 each.

## CRL Manual Rivet Gun

- Value Priced Manual Gun
- Includes Four Nosepieces



This CRL Manual Rivet Gun is smooth and fast. Interchangeable nosepieces attach to the base when not in use and will handle 3/32", 1/8", 5/32", and 3/16" (2.4, 3.2, 4, and 4.8 mm) rivet sizes. Minimum order is one each.

CAT. NO. RG110

## CRL Rivet Gun Kit



- Includes the HP2 Heavy-Duty Rivet Gun
- High Impact Carrying Case

The CRL Rivet Gun Kit includes the heavy-duty HP2 Rivet Gun, complete with its four nosepieces for 3/32", 1/8", 5/32", and 3/16" (2.4, 3.2, 4, and 4.8 mm) rivets. The rivet selection includes sizes to complete a diversity of job applications. Minimum order is one each.

CAT. NO. 39001

## CRL Rotating Head Rivet Gun

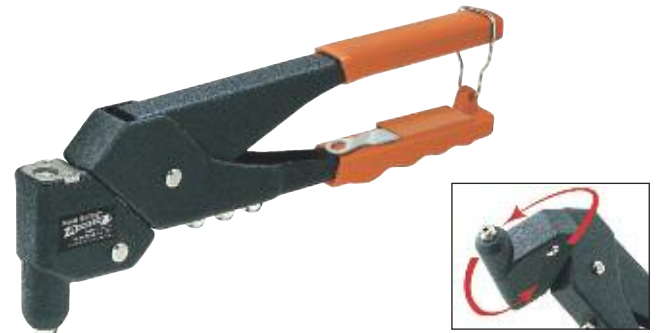

- Head Rotates a Full 360 Degrees

The Rotating Head Rivet Gun allows you to rivet at any angle because the head rotates a full 360 degrees. It's manufactured with all steel construction and vinyl grips for a more secure hold. Supplied with four nosepieces: 3/32", 1/8", 5/32", and 3/16" (2.4, 3.2, 4, and 4.8 mm). Minimum order is one each.

CAT. NO. RHT300

## CRL Electric Brad Nail Gun

- Shoots Four Sizes of Brads

CRL's Heavy-Duty Electric Brad Nail Gun has a powerful 110V AC 14 AMP motor to drive brads up to 1-1/4" (32 mm) long. This Gun features dual safety switches: surface contact and a trigger lock. Gun has a 10' (3 m) cord, and includes a handy carrying case.

CAT. NO.	DESCRIPTION	QTY/BOX
ET200	Electric Brad Nail Gun Kit	1
3130058	5/8" (16 mm) Brads	500
3130034	3/4" (19 mm) Brads	2000
3130001	1" (25.4 mm) Brads	2000
3130114	1-1/4" (32 mm) Brads	2000

Minimum order: 1 each or 1 box.

Marson is a registered trademark of Alcoa Inc.



Brads for ET200

CAT. NO. ET200

## CRL Arrow® Heavy-Duty Staple Gun

- Uses T50® Staples



This CRL Arrow® Heavy-Duty Stapler has an easy-to-squeeze double leverage mechanism. Chrome plated steel to resist corrosion. Minimum order is one each.

CAT. NO. T50

## CRL Arrow® Regular-Duty Staple Gun

- Uses T30™ Staples

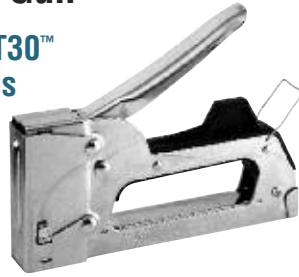

This CRL Arrow® Regular-Duty Staple Gun drives lighter gauge T30™ staples. Chrome plated steel construction.

CAT. NO.	DESCRIPTION	QTY/BOX
T32M	Stapler	1
T3214	1/4" (6.4 mm) T30™ Staples	5000
T32516	5/16" (7.9 mm) T30™ Staples	5000

Minimum order: 1 each or 1 box.

## CRL Arrow® Plier Type Stapler

- Uses P22™ Staples



The CRL Arrow® Heavy-Duty Plier Type Stapler has a 2-1/2" (63.5 mm) throat depth. Chrome plated steel construction.

CAT. NO.	DESCRIPTION	QTY/BOX
P22	Stapler	1
P2214	1/4" (6.4 mm) P22™ Staples	5040
P22516	5/16" (7.9 mm) P22™ Staples	5040

Minimum order: 1 each or 1 box.

## CRL Arrow® Hammer Tacker

- Uses T50® Staples
- Strikes Like a Hammer



The CRL Arrow® Hammer Tacker strikes like a hammer, automatically driving a staple. Made from chrome plated steel. Minimum order is one each.

CAT. NO. HT50A

## CRL Arrow® Professional Hammer Tacker

- Uses T50® Staples
- Ergonomic Grip



The CRL Arrow® Professional Hammer Tacker has an ergonomic rubber grip with knuckle guard. The body is made from chrome plated steel. Minimum order is one each.

CAT. NO. HTX50

## CRL Arrow® T50® Staples

- Available in Five Sizes



These heavy-duty wedge point T50® Staples fit the T50, HT50A, HTX50, and CT50K Staplers on this page.

CAT. NO.	LENGTH	QTY/BOX
T5014	1/4" (6.4 mm)	5000
T50516	5/16" (7.9 mm)	5000
T5038	3/8" (9.5 mm)	5000
T5012	1/2" (12.7 mm)	5000
T50916	9/16" (14.3 mm)	5000

Minimum order: 1 box.

## CRL Arrow® Cordless Staple Gun

- Uses T50® Staples
- LED Guide Light

This CRL Arrow® Cordless Staple Gun is powered by a 10.8V Lithium-ion Battery and comes with a 60-minute 110V AC Battery Charger. This Stapler has a "depth of drive" dial, an LED guide light, and a quick-release staple chamber release feature to remove clogged staples. Minimum order is one each.



CAT. NO. CT50K

Arrow and T50 are registered trademarks of Arrow Fastener Co., Inc.

## CRL Heavy-Duty Glue Gun

- Built for Professional Use
- Dependable Glue Temperature
- Fast Heat Up
- 120V AC

The CRL Heavy-Duty Glue Gun is for professional use. It provides hot glue in a molten form exceeding 380°F (193°C) for complete coverage of the bonding area. The solid-state circuitry of this gun provides fast heat up and dependable glue temperature for strong, consistent bonding. It comes with its own convenient fold down stand. Uses standard 4" (102 mm) long hot melt glue sticks, like those shown below. Minimum order is one each.



CAT. NO. GR20T

## CRL Dual Temperature Glue Gun

- One Gun for All Applications
- Temperature Setting Switch in Handle
- 120V AC

This CRL Dual Temperature Glue Gun is the perfect tool to meet all your hot melt needs. It's now simple to move from one temperature setting to another with the high-low switch located right in the handle. Use the high temperature setting for bonding wood, ceramics, and other non-porous materials. Switch to the low setting for use with foam, paper, and other heat sensitive materials. It comes with its own convenient fold down stand. Uses standard 4" (102 mm) long hot melt glue sticks. Minimum order is one each.



CAT. NO. GR25DT

## CRL All Purpose Glue Sticks

- High Strength
- 25 to 30 Second Set Up Time

These All Purpose Glue Sticks have a 25 to 30 second set up time. The high stress glue adheres to ceramic, rubber, leather, metal, acrylic, and fiberglass. Each pack contains six 4" (102 mm) long glue sticks. Minimum order is one pack.



CAT. NO. GS500

## CRL Slow Setting Glue Sticks

- Excellent for Woodworking Applications
- 60 to 70 Second Set Up Time

This Slow Setting Glue Stick, with its 60 to 70 second set up time, is the right choice for woodworking applications. Each pack contains thirty 4" (102 mm) long sticks in a handy container. Minimum order is one pack.



CAT. NO. GS264BT

# CRL MEASURING TOOLS

For Pricing Visit [crlaurence.com](http://crlaurence.com) or Call Us Toll Free at the Phone Numbers Shown on the Back Cover

## CRL Power Tape Rules

- Professional Quality
- Three Lengths and Two Blade Widths Available

These CRL Power Tape Rules have an ergonomic case design with a molded rubber grip that provides for both user comfort and durability. Nylon coated, two-color blades have 16" (406 mm) stud markings and feature a triple rivet hook connection. An active bumper protects both the blade and rivets from retraction shock, ensuring long blade life.



- Ultra Rigid Steel Blades With Two Color Markings
- Positive Lock Button

CAT. NO.	BLADE WIDTH	BLADE LENGTH
54112	5/8" (15.9 mm)	12' (3.6 m)
54125	1" (25.4 mm)	25' (7.6 m)
54133	1" (25.4 mm)	33' (10.1 m)

Minimum order: 1 each. All Tape Rules can be combined for quantity pricing.

## CRL 25 Foot Ultimate Tape Rule

This CRL Ultimate Tape Rule has an innovative inline gear which allows it to fit perfectly in your hand for exceptional comfort and a secure grip. The nylon coated, 25' (7.6 m) two-color blade has 16" (406 mm) stud markings and features a triple rivet hook connection. An active bumper protects both the blade and rivets from retraction shock, ensuring long blade life.



- Ergonomic Case for Exceptional Comfort and Secure Grip
- Ultra-Rigid 1" (25.4 mm) Wide Steel Blade With Large Easy-to-Read Numbers

CAT. NO.	BLADE WIDTH	BLADE LENGTH
54225	1" (25.4 mm)	25' (7.6 m)

Minimum order: 1 each. All Tape Rules can be combined for quantity pricing.

## CRL Fractional/Metric Tape Rules

- Tape Reads in Both Fractional and Metric
- Tape Reads in Vertical Orientation on Back Side of Blade

This handy Tape Rule reads in both fractional and metric sizes on top of the blade, however when measuring vertically, simply turn the blade over and the digits read horizontally (as shown in the inset to the right). The self-locking blade has a brake release on both the top and bottom of the case. The blade is nylon coated for durability and corrosion resistance.

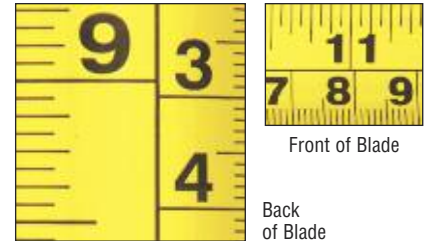

Front of Blade

Back of Blade

CAT. NO.	BLADE WIDTH	BLADE LENGTH
54819	3/4" (19 mm)	16' (4.9 m)
54829	1" (25.4 mm)	25' (7.6 m)

Minimum order: 1 each. All Tape Rules can be combined for quantity pricing.

## CRL Metric Tape Rule

- Easy to See Orange Case
- Easy to Read Yellow Blade

Our Metric Tape Rule has a fluorescent orange case that's easy to find on the job site. The yellow steel blade has large, easy-to-read numerals, and quick, smooth rewind. Thumb-lock button holds the blade in place during use. Belt clip included.



CAT. NO.	BLADE WIDTH	BLADE LENGTH
TR125M	1" (25.4 mm)	8 m (26'-3")

Minimum order: 1 each. All Tape Rules can be combined for quantity pricing.



C.R. LAURENCE COMPANY

[crlaurence.com](http://crlaurence.com) | [usalum.com](http://usalum.com)

US ALUMINUM

536K

| [crlaurence.ca](http://crlaurence.ca) [crlaurence.com.au](http://crlaurence.com.au) [crlaurence.co.uk](http://crlaurence.co.uk) [crlaurence.de](http://crlaurence.de) [crlaurence.eu](http://crlaurence.eu)

## CRL Stanley® FatMax® Tape Rules

- Massive New Bumper for Increased Hook Life
- 1-1/4" (31.8 mm) Blade Width
- 11' (3.3 m) Rigid Standout



1-1/4" Wide Blade for Extra Durability and Easy-to-Read Graphics



Hook Grabs on Side, Top, or Bottom



CRL Stanley® FatMax® Tape Rules have a cushion grip case for a comfortable, easy to use non-slip grip. These Tape Rules have a mylar coated blade with an oversized hook which grabs not only from the bottom but the sides as well. The blade stays rigid even when extended up to 11' (3.3 m).

CAT. NO.	BLADE WIDTH	BLADE LENGTH
ST33716	1-1/4" (31.8 mm)	16' (4.9 m)
ST33725	1-1/4" (31.8 mm)	25' (7.6 m)
ST33730	1-1/4" (31.8 mm)	30' (9.1 m)

Minimum order: 1 each. All Tape Rules can be combined for quantity pricing.

## CRL Stanley® PowerLock® II Tape Rules

CRL Stanley® PowerLock® II Tape Rules have a bright yellow blade with a mylar finish for better blade action and longer life. These Rules have easy to read numbers and 16" (406 mm) stud markings. All PowerLock® Tapes have a chrome plated metal case with a belt loop clip.



- Bright Yellow Blade With Mylar Finish
- Exclusive PowerLock® Feature

CAT. NO.	BLADE WIDTH	BLADE LENGTH
ST33312	3/4" (19 mm)	12' (3.6 m)
ST33316	3/4" (19 mm)	16' (4.9 m)
ST33425	1" (25.4 mm)	25' (7.6 m)

Minimum order: 1 each. All Tape Rules can be combined for quantity pricing.

## CRL Prexiso® X2 Laser Distance Measurer

- Accurate Measurements Up to 100' (30.5 m)



- Distance Measuring Accuracy of 1/8" (3.2 mm) at 100' (30.5 m)

- Ergonomic, Compact Design



The CRL Prexiso® X2 Laser Distance Measurer will measure distances in feet-inches, inches or meters from four inches to 100 feet (0.1 m to 30.5 m). It is accurate to 1/8" (3.2 mm) or better over entire range. This unit is designed for indoor and limited outdoor applications. The Prexiso® X2 is also able to measure and calculate areas and volumes. The bright laser beam and ergonomic, compact design make it easy to use. Minimum order is one each.

Stanley, FatMax, and PowerLock are all registered trademarks of Stanley Logistics, LLC. Prexiso is a registered trademark of Prexiso AG Corporation.

CAT. NO. 3350

# CRL MEASURING TOOLS

For Pricing Visit [crlaurence.com](http://crlaurence.com) or Call Us Toll Free at the Phone Numbers Shown on the Back Cover

## CRL Lufkin® 1/2" Mezurall Tape Rules

- Chrome Plated Case
- Yellow Blade With Two-Color Figures

This CRL Lufkin® Mezurall Tape Rule features a durable chrome plated Cicolac case with belt clip and easy-to-read, two-color figures on a yellow blade. Graduated feet and inches to 16ths on the top edge; consecutive inches to 16ths on the bottom edge; first 12 inches to 32nds. 16-inch centers are designated.



CAT. NO.	BLADE WIDTH	BLADE LENGTH
W928	1/2" (12.7 mm)	8' (2.44 m)
W9210	1/2" (12.7 mm)	10' (3.05 m)
W9212	1/2" (12.7 mm)	12' (3.66 m)

Minimum order: 1 each. All Tape Rules can be combined for quantity pricing.

## CRL Lufkin® 3/4" Tape Rules

- Two-Color Figures on a Yellow Blade
- Metric Model Y835S1 Available in Australia Only

These CRL Lufkin® Tape Rules feature durable cases with belt clips and easy-to-read, two-color figures on yellow blades.



Cat. No. W9312

Cat. No. Y835S1

CAT. NO.	BLADE WIDTH	BLADE LENGTH
W9312	3/4" (19 mm)	12' (3.66 m)
Y835S1*	19 mm	5 m

Minimum order: 1 each. All Tape Rules can be combined for quantity pricing. \*Available in Australia only.

## CRL Lufkin® 1" Mezurall Tape Rule

- Chrome Plated Cases
- Extra Wide Blade With Positive Lock Button

This CRL Lufkin® Mezurall Tape Rule has a 1" (25 mm) blade that stands straight at longer distances. Blade is graduated feet and inches to 16ths on the top edge, consecutive inches to 16ths on the bottom edge. 16-inch centers are designated.



CAT. NO.	BLADE WIDTH	BLADE LENGTH
Y125	1" (25.4 mm)	25' (7.62 m)

Minimum order: 1 each. All Tape Rules can be combined for quantity pricing.

## CRL Lufkin® 1" Hi-Viz® Tape Rules

- Extra Wide Blade With Rapid Rewind
- Bright Cases
- Metric Model FL418S1 Available in Australia Only

These Lufkin® Hi-Viz® Tape Rules have fluorescent cases that are easy to find on the job site. 1" (25 mm) wide yellow steel blade with large, easy-to-read numerals and smooth rewind. Thumb lock button holds blade in place. Belt clip included.

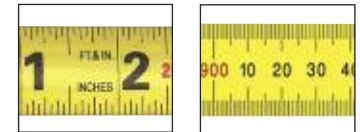

Cat. No. HV125

Cat. No. FL418S1

CAT. NO.	BLADE WIDTH	BLADE LENGTH
HV125	1" (25.4 mm)	25' (7.62 m)
FL418S1*	25 mm	8 m

Minimum order: 1 each. All Tape Rules can be combined for quantity pricing. \*Available in Australia only.

## CRL Lufkin® 100' Tape Rule

- Yellow Blade in a Vinyl Covered Steel Case
- Easy Action Winding

The CRL Lufkin® 100 Foot (30.5 m) Tape Rule is in a vinyl covered steel case with an easy re-winder built in. 3/8" (9.5 mm) wide yellow blade is graduated in feet, inches, and 8ths by bold black markings, and has 16" (406 mm) on-center stud markings.

Lufkin is a registered trademark of Apex Brands, Inc. Hi-Viz is a registered trademark of Cooper Brands, Inc.



CAT. NO.	BLADE WIDTH	BLADE LENGTH
HW100	3/8" (9.5 mm)	100' (30.5 m)

Minimum order: 1 each. All Tape Rules can be combined for quantity pricing.



C.R. LAURENCE COMPANY

[crlaurence.com](http://crlaurence.com) | [usalum.com](http://usalum.com)

538K | [crlaurence.ca](http://crlaurence.ca) [crlaurence.com.au](http://crlaurence.com.au) [crlaurence.co.uk](http://crlaurence.co.uk) [crlaurence.de](http://crlaurence.de) [crlaurence.eu](http://crlaurence.eu)



## CRL Construction Master® Pro Calculator

- Feet-Inch-Fraction Calculator
- Solutions in an Instant
- Includes Problem Solving for Stairs, Studs, Drywall, Siding, Panels, and More
- Includes CD-Rom With English and Spanish "How To" Video and User's Guide

The CRL Construction Master® Pro quickly finds solutions to challenging building and dimensional problems, and eliminates the need to remember complicated formulas. Enter the numbers just as you would say them and the solutions appear in an instant. It reduces the risk of expensive errors when estimating costs and materials, and it's perfect for completing layouts, plans, and bids on the job site or in the office. Battery included. Minimum order is one each.



**new**

Look up the CM6 on our web site for a full list of the operations this valuable tool can perform. Just enter CM6 in the Search Box to display its Online Catalog page.

CAT. NO. CM6

## CRL T-Squares



- 2" (51 mm) Wide Aluminum Blade
- Easy to Read Markings

This superior T-Square has markings that are clear and easy to read. One edge has markings graduated in 8ths of an inch, and the other edge is in 1/16ths. The body is 2" (51 mm) wide and .081" (2 mm) thick aluminum.

CAT. NO.	LENGTH
T36	36" (914 mm)
T48	48" (1219 mm)

Minimum order: 1 each.

## CRL Offset T-Square



- Wide Aluminum Blade
- Large Size for Greater Bearing Surface

This large Offset T-Square is made from flexible anodized aluminum and has four rivets holding the "T" perfectly square. The heavy-duty blade measures 2" (51 mm) wide by 3/16" (4.8 mm) thick and is 48" (1219 mm) long. The "T" measures 3/16" (4.8 mm) by 1-1/2" (38.1 mm) wide, and is 22-1/2" (571 mm) long. Minimum order is one each.

CAT. NO. GS48

## CRL Folding Wood Rules



- The Classic Folding Rule in Two Sizes

CRL's finest Folding Wood Rule is linked at each joint by a brass plated lock sleeve that protects each joint at the rivet. The top 6" (152 mm) section has a brass slide with graduations, which slides out from the edge, and is handy for measuring into narrow openings. Brass plated end caps protect the ends from wear. Graduations are in 16ths of an inch, and the entire rule is epoxy coated for long life.

CAT. NO.	LENGTH
X46	72" (1829 mm)
X48	96" (2438 mm)

Minimum order: 1 each.

Construction Master is a registered trademark of Calculated Industries, Inc.

## CRL Straight Edge Rules

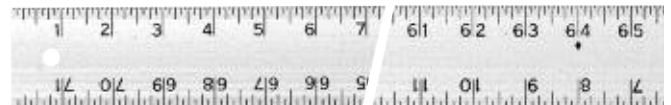

- Sturdy Aluminum Rule Lies Flat
- Easy to Read Markings

The smooth, square, and straight edges of this extremely accurate Aluminum Rule make measuring jobs easier and more exact. The 2" (51 mm) wide, flexible aluminum body is bend resistant and lies flat. The markings are in 8ths of an inch on one side and 16ths on the other. They are large and easy to read.

CAT. NO.	LENGTH
SE48	48" (1219 mm)
SE72	72" (1829 mm)

Minimum order: 1 each. Sizes can be combined for quantity pricing.

## CRL Tele-Tape Measuring Sticks



- Three Lengths Offered With a Measuring Range of Up to 197" (5004 mm)



Analog Display

The Tele-Tape Measuring Stick provides precise and reliable measurements whether used up or down, diagonally or flat. Simply extend the telescoping stick and read the measurement off an analog viewing window. The built-in measuring tape and the oversized roll-up device are very tough, and can withstand extreme strain. Anodized aluminum rectangular tubes slide between highly durable dust resistant plastic guides. The smallest telescoping section has a small end plate which makes it easier to pull out and, at the same time, serve as a contact surface when measuring. Three sizes are offered with retracted lengths as short as 28" (711 mm), and fully extended lengths as long as 197" (5004 mm).



CAT. NO.	RETRACTED/EXTENDED LENGTH
<b>TTE118</b>	28" (711 mm) to 118" (2997 mm)
<b>TTE158</b>	34" (864 mm) to 158" (4013 mm)
<b>TTE197</b>	42" (1067 mm) to 197" (5004 mm)

Minimum order: 1 each. Sizes can be combined for quantity pricing.

## CRL Electronic Measuring Rods

- Built-in Electronic Memory Allows Storage of Measurement Values
- Basic Unit Stores 10 Measurements
- Optional Memory Module Stores Up to 511 Measurements

The Electronic Measuring Rod is the easy, convenient, electronic measuring device that proves its worth in many ways, but most importantly by preventing human error. A built-in electronic memory will store 10 measurements, and an optional push-in memory module lets you store up to 511 measurements. Simply access your stored measurements and you have prevented the "double work" of writing down your figures, thus avoiding costly translation errors. Two sizes are available with a retracted length as short as 28" (711 mm), and a full extension length as long as 197" (5004 mm). Ask our Technical Sales Department about an optional interface to transfer stored data to an IBM compatible PC.

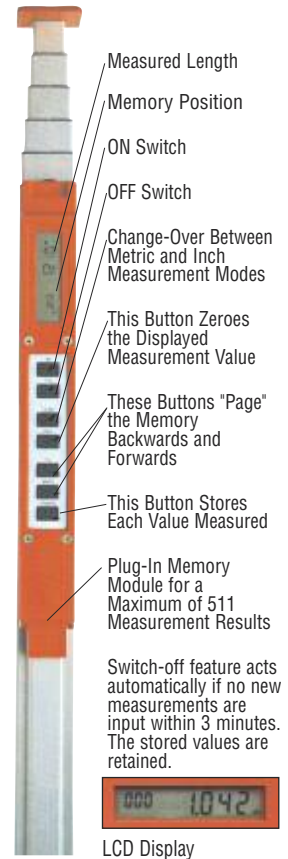

CAT. NO.	DESCRIPTION	RETRACTED/EXTENDED LENGTH
<b>TTM118</b>	Electronic Measuring Rod	28" (711 mm) to 118" (2997 mm)
<b>TTM197</b>	Electronic Measuring Rod	41" (1041 mm) to 197" (5004 mm)
<b>TTMM1</b>	Memory Module	---

Minimum order: 1 each. Sizes can be combined for quantity pricing.

## CRL Accu-Rule Measuring Rods

- Lightweight and Easy to Use
- Available in Three Lengths
- Narrow Frame is Ideal for Measuring Inside Window and Door Openings
- Marked to 1/16<sup>th</sup> of an Inch

Take quick, accurate window and door frame measurements with the CRL Accu-Rule Measuring Rod. Especially helpful for long or tall measurements, where common tape measures may bow or bend. The Accu-Rule is a two-piece heavy extruded aluminum telescoping slide with an accurate tape measure permanently affixed to the inner slide. What makes this tool exceptionally helpful for the window and door installer is the 3/8" (9.5 mm) thickness of the slide, which is thin enough to fit into most window and door frames. Both inner and outer slides are satin anodized to protect against corrosion, allowing the slide to operate freely for years. The larger size Cat. No. P8064 is an ideal tool for screen door installers.



CAT. NO.	MINIMUM/MAXIMUM MEASURING LENGTH
<b>P8066</b>	20" to 32" (508 to 813 mm)
<b>P8065</b>	30" to 60" (762 to 1524 mm)
<b>P8064</b>	60" to 119" (1524 to 3022 mm)

Minimum order: 1 each.

## CRL "Anglefix" Measuring Tool

- Measure Angles Quickly and Precisely
- Built-in Spirit Levels
- Easy to Read Analog Angle Display



The "Anglefix" Measuring Tool is a precision measuring device that works quickly and easily. Made from a sturdy extruded aluminum frame, there are two built-in spirit levels, one vertical and one horizontal. Simple to use, just loosen the clamping screw and open the Anglefix to your desired angle, you can then read the degrees on the clearly marked degrees tape, or tighten the clamp screw to transfer the exact angle to your cutting table. The Maxi Model is fitted with two steel points (both removable) for point-to-point distances, or you can remove one pin and insert a pencil. Your Anglefix can now be used as a compass for scribing circles and arcs.

CAT. NO.	MODEL	LEG LENGTH	MEASURING POINT
TT450	Mini	14-9/16" (370 mm)	No
TT500	Maxi	23-5/8" (600 mm)	Yes

Minimum order: 1 each. Sizes can be combined for quantity pricing.

## CRL "Angletronic" Measuring Tool

- An Electronic Version of the "Anglefix" Measuring Tool
- Stores Up to 56 Measurements
- Changeable Measuring Point
- Battery Saving Automatic Shut-Off Feature

The "Angletronic" Measuring Tool is an electronic device derived from the "Anglefix" Tool. Angles between 0 and 180 degrees can be measured quickly, precisely and reliably, and read off the digital display. "Angletronic" has a memory capacity of 56 measurement values. You can even take measurements in difficult positions, store the measurements and access them at a later time. The highly modern and easy-to-read opto-electronics provides accuracy and maintenance free service for years. An automatic "switch-off" feature turns the unit off after three minutes of non-use to extend the life of the battery. A pencil may be fitted in one of the measuring points to change the unit into a compass. A truly professional tool for glaziers and builders.



LCD Display

CAT. NO.	LEG LENGTH	MEASURING POINT
TT505	23-5/8" (600 mm)	Yes

Minimum order: 1 each. Can be combined with Anglefix Tools for quantity pricing.

## CRL Combination Square



Precision machined Combination Square has a hard chrome plated 12" (305 mm) steel blade graduated in 8ths, 16ths, and 32nds. Minimum order is one each.

CAT. NO. ST46123

## CRL Bevel Square



The CRL Bevel Square is a handy tool to accurately copy bevel angles. The convenient built-in blade locks firmly to hold the stainless steel blade at the desired angle. Blade is 8" (203 mm). Minimum order is one each.

CAT. NO. ST46825

## CRL Protractor/ Angle Finder

- Construction Angle Finder With Slide Pointer



The CRL Magnetic Protractor/Angle Finder's free-swinging pendulum measures any angle (0° to 90°) from horizontal. Minimum order is one each.

CAT. NO. 36MPP

## CRL Yellow Glass Marking Pencil

- Our Most Popular Marking Pencil
- Bright, Stand-Out Yellow Color



CRL Yellow Glass Marking Pencils are great for marking on glass, acrylics, marble, tile, etc. They sharpen to a precise point, and their bright yellow color makes them ideal for all marking purposes. Great for labeling stock and making measured cuts. Marks rub off easily with a dry cloth.

**NOTE:** Not available in Australia.

CAT. NO.	COLOR	QTY/BOX
GM44	Yellow	12

Minimum order: 1 each.

## CRL Stabilo® Glass Marking Pencils

- For Writing on Smooth Surfaces
- Holds a Point for Drawing Thin Lines



CRL Stabilo® Marking Pencils not only write on glass and paper, but also on metal, plastics, ceramics, porcelain, stone, film, painted or lacquered surfaces, and just about any other glossy surface. They are erasable from paper, and marks will wipe off of glossy surfaces with a damp cloth.

**NOTE:** Not available in Australia.

CAT. NO.	COLOR	QTY/BOX
8040	Red	12
8044	Yellow	12
8046	Black	12

Minimum order: 1 each. Colors can be combined for quantity pricing.

## CRL Dixon® China Markers

- Will Mark On All Glazed and Polished Surfaces, Such as Glass, Plastic, Metal, and Wood



The Dixon® China Marker's true, opaque pigment makes it one of the most versatile marking instruments available. Since it will mark on all glazed and polished surfaces, it is ideal for marking glass, plastic or lacquered wood. Its round shape makes writing comfortable for long periods, and to sharpen it, you merely pull the string.

CAT. NO.	COLOR	QTY/BOX
DX71	Red	1 Dozen
DX73	Yellow	1 Dozen
DX81	Black	1 Dozen

Minimum order: 1 dozen. Colors can be combined for quantity pricing.

## CRL Stabilo® Marking Pens

- Designed for Marking on Glass
- Quick-Drying Permanent Ink



CRL Stabilo® Marking Pens are designed expressly for marking on glass. They are quick-drying and easy to read because of the broader soft tip. Marks will not rub off under normal contact, but can be removed if necessary. Also great for marking cut lines or patterns on stained glass.



CAT. NO.	COLOR	QTY/BOX
76P40	Red	10
76P46	Black	10

Minimum order: 1 each. Colors can be combined for quantity pricing.

Stabilo is a registered trademark of Schwan-STABILO Schwanhaeusser GmbH & Co. KG LLC  
Dixon is a registered trademark of Dixon Ticonderoga Company.

## CRL Electronic Level and Angle Locator With Digital Display

- Front Laser Beam for Quick Transference of Reference Points
- LCD Displays Level or Angle
- Screen Automatically Inverts for Overhead Measurements
- Audible Indicator for Both 0 and 90 Degrees
- Push Button Calibration



Easy to Read Digital Display



Carrying Case Included

The CRL Electronic Level is the most advanced Level and Angle Finder in the industry. The bright and clear LCD indicator shows both degrees of level or percent of level; at the same time when the pivot arm is lifted the indicator reads degrees of angle. When this level is turned upside down to determine level of a header or overhead beam the LCD screen automatically inverts right side up for easy reading. There is a powerful built-in laser, which makes transference of level points a snap. There is also an audible tone when the unit is in perfect level or plumb. This unit is easily field calibrated for level, and the entire tool operates with just three "AA" batteries. Minimum order is one each.

## CRL Stanley® FatMax® Levels

- Professional Quality
- Aluminum Construction
- Block Vials on Each End

Shock Absorbing End Caps



All CRL Stanley® FatMax® Levels are constructed from a seamless one-piece aluminum extrusion to resist twisting or bending, and have a level accuracy of 0.0005" (.01 mm). The vials are made from a unique acrylic block design to greatly increase their impact resistance and assure maximum accuracy and durability. The MaxEdge™ center vial is magnified. The FatMax® Level also features non-marring side bumpers to prevent damage when working against finished surfaces.

Stanley and FatMax are registered trademarks of Stanley Logistics, LLC.

CAT. NO.	LENGTH
ST43524	24" (609 mm)
ST43548	48" (1219 mm)
ST43572	72" (1829 mm)

Minimum order: 1 each.

## CRL Plumb Perfect Level® Tool

- Take "Out-of-Plumb" Measurements Quickly and Accurately
- Two Models to Cover Lengths From 24" to 98" (610 to 2489 mm)
- Heavy-Duty Extruded Aluminum Frame
- Built-In Out of Plumb Gauges
- Combination Fractional and Metric Rule

The CRL Plumb Perfect Level® Tool was invented by a glazier who was looking for an easy method of establishing the distance a wall is "out-of-plumb" from top to bottom. This figure is necessary for many types of glazier installations; especially when laying out storefront and shower installations.

The design is a simple "one-person" tool which is both fast and easy to use. The tool is a heavy-duty expanding aluminum frame level available in two convenient sizes. The PPL42 expands from 24" to 42" (610 to 1067 mm) while the longer PPL98 expands from 56" to 98" (1422 to 2489 mm). Both units feature precision spirit levels for vertical and horizontal leveling as well as unique "out" gap scales. By dialing out the gap scale and centering the vertical spirit level, you get an exact read on the out-of-plumb dimension of the wall or other substrate. The sliding length adjustment function can be locked in place with the four knurled lock screws which fasten down onto a friction layer on the core of each tool. The CRL Plumb Perfect Level® is the perfect tool for glass estimators and installers, finish carpenters, cabinet installers, and framers.

CAT. NO.	RANGE
PPL42	24" - 42" (610 - 1067 mm)
PPL98	56" - 98" (1422 - 2489 mm)

Minimum order: 1 each.



**new**



Long Extension Lock and Horizontal Scale



Horizontal Bubble Vial Level

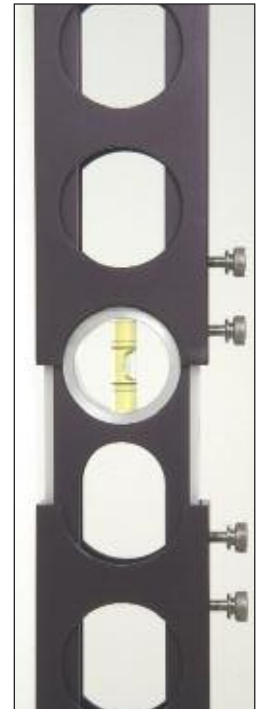

Vertical Bubble Vial Level

## CRL Stanley® 9" Torpedo Level

- Heavy-Duty Cast Aluminum Body
- Magnetic Base for Hands Free Use
- Three Bubble Vials



The CRL Stanley® 9" (229 mm) Torpedo Level has a heavy cast aluminum frame with easy-to-read top and side reading level bubbles and a 45 degree mitered level bubble. Its frame has a magnetic strip for hands free use on all steel and iron surfaces. Comes in a vinyl pouch. Minimum order is one each.

Plumb Perfect Level is a registered trademark of Brian Hale. Stanley is a registered trademark of Stanley Logistics, LLC.

CAT. NO. ST42465

## CRL 9" Torpedo Level

- Horizontal, Vertical, and Diagonal Level Bubbles
- Strong Magnetic Base
- Lightweight Yet Sturdy Polymer Body



The CRL 9" (229 mm) Torpedo Level has all of the features of larger levels in a handy, compact size perfect for a tool box. The strong magnetic base will firmly hold the Level to any steel or iron surface. Minimum order is one each.

CAT. NO. LEV9

## CRL Plumb/Level Finder Gauges

- Use With Your Level to Determine Out-of-Plumb
- Five Individual Thickness Gauges



Use this handy set of CRL Plumb/Level Finder Gauges to determine the amount or distance out-of-plumb a wall or floor is when using your bubble vial level. Set includes: 1/16", 1/8", 3/16", 1/4" and 3/8" thick neoprene gauges. Simply hold the level tight against a horizontal or vertical surface. True the level and use the Gauges to determine the amount out-of-level or plumb the surface is. Minimum order is one each.

CAT. NO. PLF1

## CRL Folding Post Level

- For Posts, Pipes, and Signs



The ideal tool to use when installing posts for signs, fences, and railings. Designed for both round and rectangular shapes, the Level opens to any position and locks at 15 degree increments. Bubble vials are large and easy to read for both vertical and horizontal levels. Level body is made from high impact molded plastic. Minimum order is one each.

CAT. NO. 34008

## CRL Strait-Line 100' Chalk Line

- Made of Aluminum Alloy
- 100' (30.5 m) Long Line

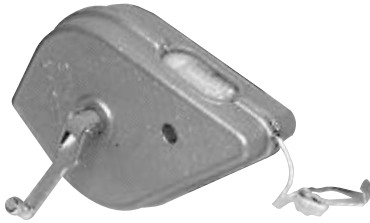

The CRL Strait-Line 100 foot (30.5 m) Chalk Line has a durable aluminum alloy box with an easy-to-fill side slide opening. It gives a sharp, clear line every time, and can also double as a plumb bob. Use Cat. Nos. P8R or P8B (below) to refill your chalk line. Minimum order is one each.

CAT. NO. 125100

## CRL Stanley® 100' Chalk Line

- Can Also Be Used as a Plumb Bob
- 100' (30.5 m) Long Line



The CRL Stanley® Chalk Line has a heavy, die-cast case with a rubber sealed screw cap, which minimizes chalk leakage. The cord is 100 feet (30.5 m) long and has a stainless steel hook. The handle folds flat against the case and locks into position, allowing the case to be used as a plumb bob. Minimum order is one each.

CAT. NO. ST47099

## CRL Chalk Refills

- Available in Two Colors, Blue or Red

CRL Chalk Refills contain a micro-fine chalk for a perfect line every time. Available in two colors, blue or red, and packaged in an unbreakable polyethylene bottle.

CAT. NO.	COLOR	SIZE
P8B	Blue	8 oz. (227 g)
P8R	Red	8 oz. (227 g)

Minimum order: 1 each.



Stanley is a registered trademark of Stanley Logistics, LLC.

## CRL Contour Gauge

- Duplicate Patterns or Shapes Exactly



The CRL Contour Gauge enables you to obtain an exact copy of any shape or contour. Extremely useful for duplicating patterns, fitting tile, linoleum, or measuring moldings. This sturdy steel gauge measures 5-3/4" (146 mm) long, and has graduated markings to 1/16th of an inch. Minimum order is one each.

CAT. NO. CG6

## CRL Cross-Line Self-Leveling Laser

- 110 Degrees Horizontal and Vertical Line Generating
- Plumb, Level, and Square
- Self-Leveling Mechanism

The CRL Brand Cross-Line Self-Leveling Laser has three separate modes of operation: a single horizontal line, a single vertical line, or both lines projected simultaneously forming cross hairs. All lines are projected from the front of the laser, and produce a line that is 110 degrees wide in both horizontal or vertical. This Laser is self-leveling when the base is within 5 degrees of level. Accuracy is within 5/64" (2 mm) at 16' (5 m). Three AAA batteries included. The case has a 1/4-20 threaded mounting hole for use with tripods, and comes with a handy belt-loop carrying pouch. Minimum order is one each.



CAT. NO. LD100

## CRL Cross-Line Self-Leveling Laser Kit

**new**

- Self Leveling Within 3 Degrees at 49' (15 m) Range
- Vertical Line, Horizontal Line, or Both
- Locking Mechanism Blocks Self Leveling and Locks Display



The CRL LD200 Cross-Line Self Leveling Laser Kit allows you to cast a vertical or horizontal solid line, or both at the same time. When the device is tipped beyond 6 degrees, the laser will begin flashing and an audio alarm will sound. This kit also includes: three AA batteries, a 1/4-20 threaded mounting hole for use with tripods, a 360 degree swivel mount, a magnetic wall mount, a laser target (to extend useful range), and a rugged nylon storage bag. Minimum order is one each.

CAT. NO. LD200

## CRL PLS180 Palm Laser

- 180 Degrees Horizontal and Vertical Line Generating
- Hand-Held Tool is Self-Leveling
- Plumb, Level, and Square

The fast, accurate and portable CRL PLS180 Palm Laser saves you time and money compared to old fashioned bubble vial levels, which are limited by their length. This line generating Laser will produce a level line 60' (18.3 m) long on a flat wall when the level is placed 30' (9.1 m) away from the wall. There are three separate modes of operation: a single horizontal line, a single vertical line, or both lines projected simultaneously forming cross hairs. Both lines are projected from the front of the Laser, and produce a line that is 180 degrees wide in both horizontal and vertical. This Laser is self-leveling when the base is within 6 degrees of level. Accuracy is within 1/8" (3.2 mm) at 30' (9.1 m). Three AA batteries included. Minimum order is one each.

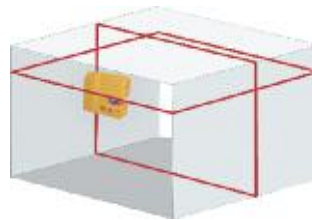

CAT. NO. PLS180

## CRL PLS3 Standard Spot Laser Tool

- Three Point Laser Establishes Plumb and Level
- Projects Laser Beams 3 Ways
- Self-Leveling Within 6 Degrees

The PLS3 Standard Spot Laser projects three bright, clear and accurate points on any surface. Once the base is within 6 degrees of horizontal just press the "On" button and three beams will project up to 100' (30.5 m). The two vertical beams are for plumb and the single horizontal beam is for level. The beams are accurate within 1/4" (6.4 mm) at 100' (30.5 m) and are bright enough to be clearly visible inside or out, even in bright sunlight. Weighing just 12 ounces (.33 kg), this compact laser is just a bit larger than a common tape measure which makes it convenient to carry around between job sites in its handy belt-loop pouch, which is included. This kit also includes: three AA batteries, a magnetic wall mount bracket, a floor bracket, a 1/4-20 threaded mounting hole for use with tripods, and a very detailed instruction booklet. Minimum order is one each.



CAT. NO. PLS3



## CRL Deluxe Spot Laser Level Kit

- Five Bright Reference Points
- Plumb, Level, and Square
- Clearly Visible Indoors or Outdoors
- Includes Pendulum Layout Target
- Weather Resistant and Durable

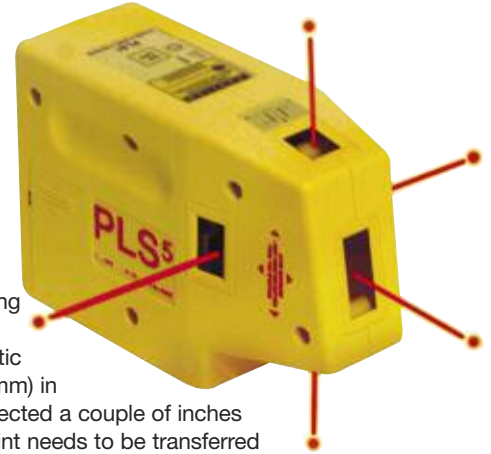

The PLS5 Deluxe Spot Laser Level projects five beams, which are necessary when measuring and checking for plumb, level, and square. Similar to our PLS3, the added design benefits of the PLS5 (besides the two horizontal side to side beams) include a greater range of automatic self-leveling from six degrees to eight degrees, and an increased accuracy to within 1/8" (3.2 mm) in 100' (30.5 m). This deluxe Kit also includes a Pendulum Layout Target. Since the beam is projected a couple of inches above the base, this Target is used when the unit is placed on a flat surface and the plumb point needs to be transferred to the same level surface as the base. This Kit also includes: a magnetic Wall Mounting Bracket, a Floor Bracket, a 1/4"-20 threaded mounting hole for use with tripods Cat. No. LD141 and LD142 (see page 548K), a very detailed, but easy-to-understand instruction booklet, three AA Batteries, and a sturdy Carrying Case. Minimum order is one each.

CAT. NO. PLS5

## CRL Bosch® 5-Point Laser Level

- Five Point Laser
- Plumb, Level, and Square
- Self Leveling Within  $\pm$  Five Degrees
- Weather Resistant

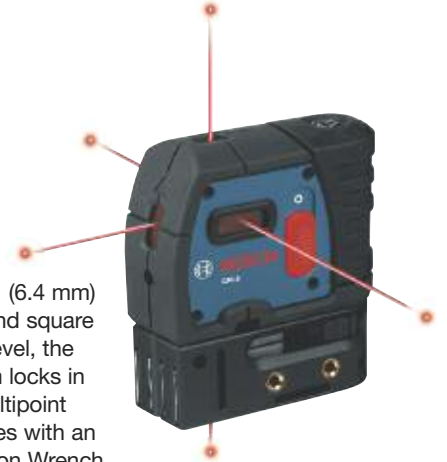

The CRL Bosch® 5-Point Laser Level eliminates set-up time and ensures accuracy to within 1/4" (6.4 mm) at 100' (30 m). The GPL5 transfers and aligns level points, as well as projects plumb, 90 degree, and square points. This Laser automatically levels itself when positioned within five degrees of level. If out of level, the beams will blink as a warning. When the unit is switched off, the internal pendulum leveling system locks in place to prevent damage during transportation. The housing is weather and dust resistant. The multipoint attachment base has a 1/4"-20 threaded mounting hole for tripods. It is also magnetized and comes with an attachment strap. The complete Kit includes: Laser Tool with multipoint attachment base, Calibration Wrench, Strap, three AA Batteries, and a Carrying Pouch with belt loop. Minimum order is one each.

CAT. NO. GPL5

## CRL Professional Laser Level Kit

- Two Vertical 360 Degree Lines and One Horizontal Line
- Self Leveling Within  $\pm$  Five Degrees
- Operating Range 100' (30 m)
- Accurate to 1/8" (3.2 m) Within 60' (18.3 m)
- Weather Resistant

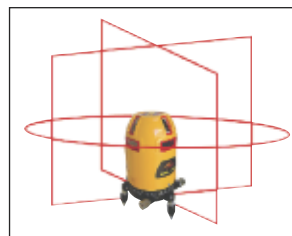

The CRL Professional Laser Level Kit is the most powerful laser we have ever offered. The HVL100 produces three 360 degree lines, which would divide a common room into eight quadrants. There are two vertical lines for plumb, and a single horizontal line for level. There is also a single point generated straight down for aligning the Laser over a specific reference point. Laser operating accuracy is 1/8" (3 mm) at 60' (18.3 M) with a working range of up to 100' (30 M). The self-leveling mechanism works when the base is within five degrees of level. If the Laser is outside of this range the beam will automatically shut off. The Laser base has a 5/8"-11 threaded mounting hole for use with the CRL Cat. No. LD142 Tripod (see page 548K). This Laser is powered by four AA batteries, and there is an additional battery pack and charger unit. Also included are two red magnetic Laser Targets, Two Floor Targets, and a Wall Mount Bracket. The entire Kit comes in a very sturdy plastic Carrying Case with an operations manual. Minimum order is one each.



Bosch is a registered trademark of Robert Bosch GmbH, Corporation.

CAT. NO. HVL100

## CRL 47" Aluminum Tripod

- 1/4"-20 Mounting Thread
- Perfect for Lasers
- Carrying Case Included



This CRL Aluminum Tripod provides a rigid, accurate base for mounting laser levels. Height adjustment ranges from 16" to 47" (406 to 1194 mm). The quick clamping feature on the legs makes adjustment faster and easier, and the mounting head is flat. For use with laser levels having a 1/4"-20 mounting thread. Minimum order is one each.

CAT. NO. LD141

## CRL 66" Aluminum Tripod

- Has Both 1/4"-20 and 5/8"-11 Mounting Threads
- Lightweight and Portable
- Includes Carrying Case



This CRL Aluminum Tripod fits both 5/8"-11 and 1/4"-20 threaded laser mounts, and has feet that are adjustable for indoor and outdoor use. Height adjustment ranges from 24" to 66" (610 to 1676 mm). Minimum order is one each.

CAT. NO. LD142

## CRL Bosch® Laser Mounting Pole

- Adjustable Laser Level Mounting Platform
- Telescoping Pole



The CRL Bosch® Laser Level Mounting Pole is a handy tool for quickly positioning your laser level. The extending pole comes with an adjustable height mounting platform so you can adjust the height of your level quickly and easily. To set up you simply extend the pole from floor to ceiling, locking it into place. The top of the pole has a ball-jointed head plate to conform to most sloping ceilings. Both the top and bottom of the pole have an anti-slip surface for secure placement. Next, mount your laser level onto the mounting platform and tighten the 1/4"-20 threaded locking stud. Loosen the clamp on the mounting platform and move up or down to the desired height. The telescopic pole adjustment range is from 54" to 138" (1372 to 3505 mm). Minimum order is one each.

CAT. NO. BP350

## CRL Brass Plumb Bobs

- Machined From Solid Brass
- Available in Two Sizes
- Hardened Steel Point

High quality Brass Plumb Bobs are machined from solid brass and are fully polished and lacquered. They feature a self-centering cord cap with a hardened steel point.



CAT. NO.	WEIGHT	LENGTH
80016	16 oz. (.45 kg)	5-3/4" (146 mm)
80032	32 oz. (.91 kg)	7-1/2" (191 mm)

Minimum order: 1 each.

Bosch is a registered trademark of Robert Bosch GmbH, Corporation.

## CRL Architectural Drawing Tube

- Durable Shatterproof Plastic
- Convenient Carry Strap



The CRL Architectural Drawing Tube is made from a pliable shatterproof see-through plastic, with slip on end caps, which will protect your valuable blue prints, vellums or other documents from damage due to the weather or rough handling while transporting from place to place. The Tube has a 2-3/4" (70 mm) diameter and measures 25" (635 mm) long. The handy nylon carry strap is 1-3/8" (35 mm) wide. Minimum order is one each.

CAT. NO. ADT255

## CRL Digital Auto-Range Multimeter

- Voltage and Resistance Measurements
- Audible Beep for Checking Continuity

The CRL Digital Multimeter is used for measuring either AC or DC voltage, resistance displayed in ohms, or continuity. Voltage range is from 2000mV's to 400 volts.



CAT. NO.	DESCRIPTION
CT3250 1039RB	Digital Auto-Range Multimeter Replacement Battery 1.5V DC

Minimum order: 1 each.

## CRL Glass Counter Pen

- Easy-to-Read LCD Screen
- Records Up to 99,999 Pieces

The CRL Glass Counter Pen is a unique counting aid that not only marks the edge of the glass with a felt tipped marker, it also beeps to acknowledge that the count has been recorded. This is a handy device for counting pallet loads or large stands of glass sheets. Just reset the counter to zero, and lightly tap the edge of each piece of glass. Each time a piece of glass is touched, an audible tone is heard, the felt tip marks the glass (so that it is not recounted), and the count is recorded and displayed on the LCD screen. Minimum order is one each.



CAT. NO. 3133

## CRL Zircon® Studsensor™

- Finds Wood and Metal Studs Behind Drywall Wall Up to 3/4" (19 mm) Deep



The CRL Zircon® Studsensor™ makes it easy to locate the edge of either wood or metal studs hidden behind up to 3/4" (19 mm) thick drywall. Operates with a single 9 Volt battery (not included). Minimum order is one each.

CAT. NO. 57953

Zircon, OneStep, and MultiScanner are all registered trademarks of Zircon Corporation.

## CRL Low Voltage Circuit Tester

- For Use on Any 6 to 12 Volt DC System
- Quickly Tests Circuits for Current
- Lighted Handle Detects Voltage



This CRL Low Voltage Circuit Tester is designed for use on all 6 to 12 Volt DC systems. To use, simply ground the clip to any metallic surface on the car, push the point through the insulation of the cable being tested until it makes contact with the copper conductor inside. The bulb in the handle will then light if the wire is "hot". Minimum order is one each.

CAT. NO. KD129

## CRL Humidity/Temperature Pen

- A Must for Determining Urethane Cure Rates



The CRL Humidity/Temperature Pen has a fast response solid-state sensor, which continuously and simultaneously displays both relative humidity and air temperature (°F/°C) on the 1/2" LCD screen. The Pen records the highest and lowest values in its memory, either overnight or for any duration of time to establish cure rates. Operates with one 1.5V battery.

CAT. NO.	DESCRIPTION
HTP4093 1039RB	Humidity/Temperature Pen Replacement Battery 1.5 V DC

Minimum order: 1 each.

## CRL Zircon® OneStep® MultiScanner®

- Finds Wood or Metal Stud Centers, Metal Pipes, and Live Electric Wires
- Automatically Calibrates



The CRL Zircon® OneStep® MultiScanner® can accurately locate wood or metal stud centers in walls up to 1-1/2" (38 mm) thick. This scanner will also trace live electrical wires, and will locate both copper and steel pipes within walls, floors, and ceilings. Minimum order is one each.

CAT. NO. 60576

## CRL Ground Fault Circuit Interrupter

- Connects Between Your Power Tool and 110 Volt AC Outlet to Prevent Electric Shocks
- A Must for Anyone Who Uses Wet-Working Sanders, Drills, Routers or Saws

Ground Fault Circuit Interrupters prevent the risk of electric shock by cutting the electricity off at any sign of a ground fault or short circuit. This takes place within 25/1,000's of a second; enough time to protect your body from injury. Minimum order is one each.



CAT. NO. GF1

## CRL Electrical Tape

- 3/4" (19 mm) Width
- UL Listed

Designed to insulate wire, pipes, dissimilar metals, etc., CRL Electrical Tape is resistant to weather, water, acids, alkalis, and oils. It has superior conformability and high elongation to give a tight, solid wrap. A silicone spray additive gives it an 18 month shelf life. The glossy black tape is 7 mils (.17 mm) thick. Roll length is 60' (18 m). Minimum order is one roll.



CAT. NO. 1ET314

## CRL 3-Conductor Round Extension Cords

- UL Listed for Indoor/Outdoor Use
- Thermo-Vinyl Cord
- U-Blade With Ground



This heavy-duty CRL 3-Conductor Round Extension Cord resists oil, grease, abrasion, and ozone to give long-term, dependable service. The standard copper wire stays completely flexible even in cold weather. Connectors are molded on.

CAT. NO.	WIRE SIZE	LENGTH	AMPS
EC2316025	16/3	25' (7.6 m)	13
EC2316050	16/3	50' (15.2 m)	13
EC4312050	12/3	50' (15.2 m)	15
EC4312100	12/3	100' (30.5 m)	15

Minimum order: 1 each. Sizes can be combined for quantity pricing.

## CRL 3-Conductor Twist-To-Lock Extension Cord

- UL Listed
- Remains Flexible in Cold Weather
- Molded-On Connector and Plug

This heavy-duty CRL 50' (15.2 m) 3-Conductor Twist-To-Lock Extension Cord stays flexible even in cold weather, and is built to give long-term, dependable service. Resists oil, grease, abrasion, and ozone. Copper strand conductors are completely flexible. 12/3 size cord is rated at 20 amp. Minimum order is one each.



CAT. NO. EC730830

## CRL Plug Adapters

- CE Approved

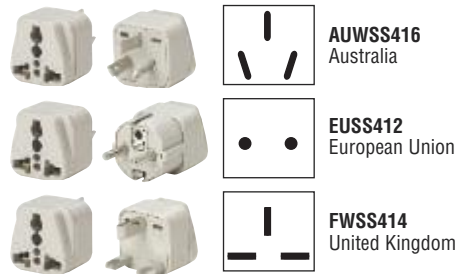

These CRL Plug Adapters convert virtually any 230 Volt grounded power tool plug to be used in Europe or Australia.

CAT. NO.	DESCRIPTION
AUWSS416	Australian 3 Prong Plug
EUSS412	European Union Plug
FWSS414	United Kingdom Plug

Minimum order: 1 each.

## CRL "Y" Electrical Adaptor



- Twist-To-Lock Type
- NEMA 5-20 Configuration
- 20 AMP – 125 Volt
- 12/3 Wire

This CRL "Y" Adapter is one twist-to-lock plug and two twist-to-lock connectors in NEMA 5-20 configuration.

CAT. NO.	DESCRIPTION
EC21040	Two Female to One Male

Minimum order: 1 each.

## CRL Combination Adapters

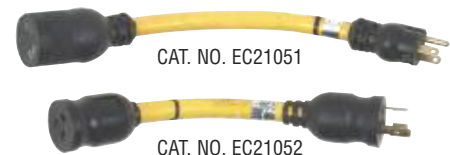

- Adapt Power Tools With a Twist-To-Lock Plug
- NEMA L5-20

These CRL Combination Adapters adapt power tools with a twist-to-lock plug to a common grounded 110 volt outlet, or vice versa.

CAT. NO.	DESCRIPTION
EC21051	15A Plug to 20A Twist-To-Lock Connector
EC21052	20A Twist-To-Lock Plug to 15A Connector

Minimum order: 1 each.

## CRL Shop-Vac® Industrial Wet/Dry Vacs

- Industrial Type Units
- Super Quiet, Longer Lasting Motor
- No Messy Filters to Change
- 120 Volt



**CAT. NO. 9254010**  
10 Gal. (37.85 l)

**CAT. NO. 9254210**  
16 Gal. (60.57 l)

Both of these Wet/Dry Vacs are industrial units equipped with longer lasting motors than what is found in consumer models. The high quality filter cartridge for wet or dry pick-up means no changing of messy filters. Both models also include a high quality drywall collection bag for fine dust pick-up, which ensures no blow-through when picking up drywall dust.

### ACCESSORIES INCLUDED:

- 72" x 2-1/2" (1829 x 63 mm) Heavy-Duty Hose
- Two Extension Wands
- 14" (356 mm) Floor Nozzle with Squeegee
- Oversized On-Board Tool Storage
- High-Quality Cartridge Filter
- 8" (203 mm) Utility Nozzle
- Crevice Tool
- Drywall Filter Bag

CAT. NO.	HORSEPOWER	TANK
9254010	4.0	10 Gallon (37.85 l)
9254210	6.25	16 Gallon (60.57 l)

Minimum order: 1 each.

## CRL Shop-Vac® All-Purpose Wet/Dry Vac

- Powerful Three Horsepower Motor
- 6 Gallon (22.7 l) Capacity
- 120 Volt



This CRL Shop-Vac® All-Purpose Wet/Dry Vacuum is a compact version of the 16 gallon unit. Because of its size, this small but powerful Vacuum is extremely portable. The narrow 1-1/4" (32 mm) diameter hose comes in handy when working in tight places.

### ACCESSORIES INCLUDED:

- 96" x 1-1/4" (2438 x 32 mm) Hose
- Two Extension Wands
- 10" (254 mm) Combination Wet/Dry Nozzle
- 10" (254 mm) Squeegee
- Foam Filter Sleeve
- Crevice Tool
- Reusable Dry Filter

CAT. NO.	DESCRIPTION
2117781	All Purpose 6 Gallon (22.7 l) Shop-Vac®
9051200	96" x 1-1/4" (2438 x 32 mm) Replacement Vacuum Hose
2119030	Vacuum Cartridge Filter
2119052	Vacuum Cloth Filter

Minimum order: 1 each.

## CRL FEIN® Mini-Turbo 6 Gallon Wet/Dry Vac

- Lightweight at 17-3/4 Pounds (8 kg)
- Quiet - Only 63 Decibels
- Small but Powerful
- 120 Volt



The FEIN® Mini-Turbo uses a unique dual fan motor, which prevents electrical damage and extends life. The cloth bladder utilizes the capacity of the vacuum tank and allows for maximum filtration. Minimum order is one each.

### ACCESSORIES INCLUDED:

- 16' x 1-1/4" (4.9 m x 32 mm) Hose
- Elbow Adapter with Suction Reducer
- Smooth Bottom Attachment
- Carpet Brush Attachment
- Upholstery Tool
- Two Hose Extenders
- Wide Floor Nozzle
- Rubber Lip Attachment
- Crevice Tool
- Cloth Bladder

Shop-Vac is a registered trademark of Shop Vac Corporation. **CAT. NO. 2095514**  
FEIN is a registered trademark of C. & E. Fein GmbH, LLC.

## CRL Shop-Vac® Quiet Series Wet/Dry Vac

- Compact 2.5 Gallon (9.46 l) Tank
- Powerful, Portable Hand Held and Wall Mountable Design
- Quickly Converts Into a Blower
- 120 Volt



This compact, yet powerful and quiet 2.5 gallon (9.46 l) Wet/Dry Vac is great for mobile van use or any small clean up jobs. Its compact design takes up very little room. With onboard accessory storage, cord storage and super lightweight, it travels effortlessly. Powerful 2.0 peak HP motor provides plenty of suction. Quickly converts into a blower for added versatility. Minimum order is one each.

### ACCESSORIES INCLUDED:

- 48" x 1-1/4" (1219 x 32 mm) Hose
- Gulper Nozzle
- Crevice Tool
- Foam Filter Sleeve
- Reusable Dry Filter Bag
- On-Board Tool Holder

**CAT. NO. 5860262**

## CRL Low-Cost Throw-Away Brushes

- Economical Utility Brushes
- Tapered Bristles

Many manufacturing procedures require a low-priced brush that can be discarded after one use. CRL Low-Cost Throw-Away Brushes are made with bristles that taper to a flagged point. They carry a heavy load of material and spread it evenly and efficiently.

**NOTE:** Not available in Australia.

CAT. NO.	WIDTH	QTY/BOX
LAB2256	1" (25 mm)	36
LAB2258	2" (51 mm)	36
LAB2260	3" (76 mm)	12
LAB2261	4" (102 mm)	12

Minimum order: 1 each. Sizes can be combined for quantity pricing.



## CRL 6" Disposable Acid Brush



- Natural Horse Hair Bristles
- Applies Acids, Primers, and Flux

This CRL Disposable Acid Brush is for applying primers, acids, and flux. They are 6" (152 mm) long, with a 3/8" (9.5 mm) round rolled steel handle and 3/4" (19 mm) long stiff horse hair bristles.

**NOTE:** Not available in Australia. Minimum order is 24 each.

CAT. NO. 1AB

## CRL Whisk Brush

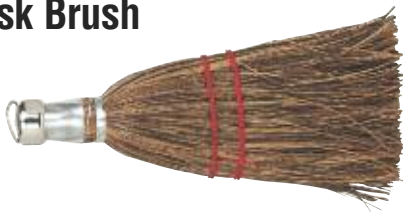

- 4" (102 mm) Width at Bristles

Use this stiff palmetto fiber Whisk Brush for general clean up or for brushing glass chips off your cutting table carpet. It has a complete wire-wrapped neck, topped with a sturdy metal cap and hanging ring.

**NOTE:** Not available in Australia. Minimum order is one each.

CAT. NO. LAB750

## CRL Wire Brush



- Hardwood Handle

This CRL Wire Brush cleans away rust and paint, or cleans parts after welding and soldering. It has tumble waxed smooth hardwood handle, with round spring steel wire bristles. Overall length is 13" (330 mm).

**NOTE:** Not available in Australia. Minimum order is one each.

CAT. NO. LAB450

## CRL 3" Paint and Varnish Brush



- Pure Black Pig Bristle

This double thick, flat CRL 3" (76 mm) Paint and Varnish Brush has a panel-type handle for easy, flexible use. Pure black pig bristle is chisel shaped for smooth, even flow.

Minimum order is one each.

CAT. NO. LAB2634

## CRL Horse Hair Dusting Brush



- Long Lasting Horse Hair Bristles

This top quality CRL Dusting Brush has many clean up uses in the shop or home. It has long wearing black horse hair bristles for sweeping sawdust, metal shavings, dirt, and dust. The molded plastic handle is comfortable to hold.

**NOTE:** Not available in Australia. Minimum order is one each.

CAT. NO. LAB40

## CRL Heavy-Duty Dust Pan



- Stamped From Heavy Gauge Steel

CRL Heavy-Duty 16" (406 mm) Dust Pan is a sturdy, one-piece, 20 gauge steel dust pan with corrugated ribs for rigidity and strength. It has a baked black enamel finish with a bevelled edge.

Minimum order is one each.

CAT. NO. 2131008

## CRL Mirror Wash Brush

- Excellent for Cleaning Glass Prior to Silvering



This CRL Mirror Wash Brush has a solid handle with 1" (25 mm) bristles, and is used with Pumice to clean glass prior to silvering. Approximate handle size is 8-1/4" x 2-7/8" (210 x 73 mm).

**NOTE:** Not available in Australia.

CAT. NO.	SIZE
175B	8-1/4" x 2-7/8" (210 x 73 mm)

Minimum order: 1 each.

## CRL Sponges

- Large and Easy to Handle



**CAT. NO. 1620**  
Natural Organic Sponge



**CAT. NO. 16A**  
Synthetic Cellulose Sponge

Choose either our Natural Organic Sponge or the Synthetic Cellulose Sponge for high-absorbency removal of water or other liquids. The Natural Sponge is recommended for the application of stannous chloride (tinning) to glass.

CAT. NO.	DESCRIPTION
1620	Natural Organic Sponge
16A	Synthetic Cellulose Sponge

Minimum order: 1 each.

## CRL Glass Chip Brush

- Mechanical Roller Brush Collects Glass Splinters
- A Safe Effective Way to Protect Your Hands



The glass splinters on cutting tables can not only cause scratches on the next glass pane you want to cut, but you get them stuck in your hands very easily. The solution is the CRL Glass Chip Brush. Simply brush over the surface and the little mechanical brush roller collects all splinters inside the plastic body. The body can then be opened and the glass chips thrown into the waste bin. It is an indispensable little helper for a proper work area. Minimum order is one each.

**CAT. NO. TG070**

## CRL Natural Full Skin Chamois

- Natural Full Skin Leather



The high quality, natural leather full skin CRL Chamois is ideal for cleaning, polishing, wiping, and dusting sensitive metal and glass surfaces. It is a superior product to clean excess water and residue from silvered mirror.

CAT. NO.	APPROXIMATE SIZE
BJ400	3.5 Sq. Ft. (.33 sq. m)

Minimum order: 1 each.

## CRL Box of Rags

- Convenient 4 Pound Boxes
- Cut in Usable-Sized Pieces
- Washable



CRL Recycled White Cloth Wipers are excellent all-purpose wiping, cleaning, and polishing cloths that are practically lint-free. White T-Shirts are good for cleaning metal and applying primers before applying sealants. White Thermals with their high cotton content and absorbency are good for cleaning up spills and removing heavy grease and oils.

CAT. NO.	DESCRIPTION
T10520	White T-Shirts - 4 Lb. (1.8 kg) Box
T10500	White Thermals - 4 Lb. (1.8 kg) Box

Minimum order: 1 box.

## CRL Micro Fiber Wipes

- Streak Free Cleaning on Windows and Mirrors
- Washable Up to 500 Times



CRL Micro Fiber Wipes have thousands of microscopic fibers that trap dirt and grime to increase cleaning effectiveness and reduce cleaning and drying times. Their large 16" x 16" (406 x 406 mm) size takes on big polishing, waxing, cleaning, and dusting jobs, and when you are done you can simply machine wash them (without fabric softener). They are packed two per poly bag with a hanger hook so you can also offer them for resale to your customers.

CAT. NO.	DESCRIPTION	QTY/PACK
MFW2	Micro Fiber Wipes	2

Minimum order: 1 pack.

## CRL 250 Watt Heavy-Duty Soldering Iron

### • Extra Heavy-Duty

This extra heavy-duty professional CRL Soldering Iron is rated at 250 watts. It uses 5/8" (16 mm) diameter tips, and has a long-lasting, high-heat element core. Designed for production use, comes with one 5/8" (16 mm) Chisel-Shaped Tip and a Stand. Minimum order is one each.



CAT. NO. P250T

### CRL Soldering Tips Used With Cat. No. P250T H.D. Soldering Iron



CAT. NO. HT256X

5/8" (16 mm) Shank Pyramid Tip



CAT. NO. HT499X

5/8" (16 mm) Shank Chisel Tip

## CRL 175 Watt Heavy-Duty Soldering Iron

A high heat element core designed for continuous duty gives this CRL Soldering Iron fast heat recovery, and excellent production line performance. The practically indestructible case houses a durable, dependable element. Comes with one 3/8" (9.5 mm) Chisel-Shaped Tip and a Stand. Minimum order is one each.

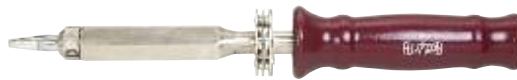

CAT. NO. P115

### CRL Soldering Tips for Cat. No. P115 and Cat. No. SPG80 Soldering Irons



CAT. NO. HT255X

3/8" (9.5 mm) Shank Pyramid Tip



CAT. NO. HT488X

3/8" (9.5 mm) Shank Chisel Tip

## CRL 80 Watt Medium-Duty Soldering Iron

This medium-duty 80 Watt CRL Soldering Iron is specifically designed for stained glass work. It develops a 900°F (482°C) tip temperature for precision soldering. Comes with 1/4" and 3/8" (6.4 and 9.5 mm) Chisel-Shaped Tips and a Stand. Minimum order is one each.



CAT. NO. SPG80



CAT. NO. HT266X

1/4" (6.4 mm) Shank Under Cut Tip

## CRL Weller® Pro Series Battery Powered Soldering Iron

### • Perfect for Field Service Repair

CRL's new Weller® Pro Series Battery Powered Soldering Iron is perfect for those small field repair jobs where an efficient, ergonomic soldering iron can complete the job quickly and effectively. This Iron heats up to working temperature range of 850 to 950°F (454 to 510°C) in under 15 seconds. Over 150 intermittent solder joints can be completed with fresh batteries. Requires 4 AA Batteries (not included). Minimum order is one each.

CAT. NO. P860M

Weller is a registered trademark of Cooper Brands, Inc.



## CRL Weller® Dual-Heat Soldering Gun Kit



- Dual-Heat (140/100) Watts
- Everything You Need In One Case



This convenient UL Listed CRL Weller® Dual-Heat Soldering Gun Kit includes a Dual-Heat Soldering Gun with Pre-Tinned Copper Tip; two extra Un-Tinned Copper Tips; Tip-Changing Wrench; Flux Brush; Soldering Aid Tool; Coil of 60/40 Rosin-Core Solder, and a sturdy plastic Carrying Case. Also comes with "Soldering Hints" booklet. Minimum order is one each.

CAT. NO. 8200PK



## CRL Disposable Acid Brush



- Natural Horse Hair Bristles
- Applies Acids, Primers and Flux

This CRL Disposable Acid Brush is for applying primers, acids, and flux. They are 6" (152 mm) long, with a 3/8" (9.5 mm) round rolled steel handle and 3/4" (19 mm) long stiff horse hair bristles.

**NOTE:** Not available in Australia. Minimum order is 24 each.

CAT. NO. 1AB

## CRL Solder

- Excellent Quality

This CRL Solder is sold in one-pound coils of 1/8" (3 mm) diameter material. Use soldering flux prior to soldering for the best results.



CAT. NO.	DESCRIPTION
2150	50/50 Solder
2160	60/40 Solder

Minimum order: 1 roll.

## CRL Oleic Acid

- Promotes Solder Flow and Adhesion
- Prevents Oxidation

This CRL Oleic Acid is a soldering flux that cleans the surface and promotes solder flow. Designed to be brushed on with the 1AB Acid Brush prior to soldering. This product makes solder adhere better and prevents oxidation.



CAT. NO.	DESCRIPTION
A777	Oleic Acid - 1 Gallon

Minimum order: 1 each.

## CRL LA-CO® Soldering Flux

- Non-Acid
- Formulated for Lead and Copper

This self-cleaning CRL Soldering Flux is formulated to use with lead or copper foil work. It is safe, and won't harm your skin.



CAT. NO.	DESCRIPTION
LRFL32	LA-CO® Soldering Flux - 1 Quart
LRFL4	LA-CO® Soldering Flux - 4 Ounce

Minimum order: 1 each.

## CRL Nokorode® Soldering Paste

- An Industry Standard for Over 50 Years

This CRL Soldering Paste is used to re-tin soldering iron tips. It provides a fast, safe, non-acid method of fluxing all common metals except aluminum. Packaged in a 1.7 oz. (48 g) plastic tub. Minimum order is one each.



CAT. NO. NSP2

## CRL Soldering Iron Temperature Control

- Solid State Circuitry

This CRL Soldering Iron Control allows you to adjust the tip temperatures of your soldering iron. It operates on a 115V AC, grounded outlet plug. Minimum order is one each.



CAT. NO. TC87G

## CRL Solder Removal Bulb

- Quick Response Bulb

This handy CRL Solder Removal Bulb quickly removes solder. It features an easy squeeze quick response bulb. Minimum order is one each.



CAT. NO. 882

LA-CO is a registered trademark of LA-CO Industries, Inc.  
Nokorode is a registered trademark of The Rectorseal Corporation.

## CRL Soldering Tip Cleaning Sponge and Tray

- Prevents Tip Contamination
- Pure Fine Pore Cellulose

This CRL Tip Cleaning Sponge and Tray accessory ensures reliability of soldered joints and extends tip life. Eliminates contamination caused by wiping rags. Minimum order is one each.

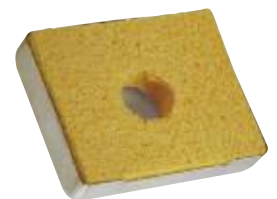

CAT. NO. 812

## CRL 3/8" (9.5 mm) Air Drill

- **Free Speed: 1,800 RPM**
- **Chuck Capacity: 3/8" (9.5 mm)**
- **1/2 HP Motor**

This lightweight, compact sized drill is easy to handle and provides full power in both forward and reverse. Chuck capacity is 3/8" (9.5 mm). The 1/2 hp motor requires 7 cfm (3304 cm/sec) at 90 to 120 psi (6.2 to 8.3 bars), which produces a free speed of 1800 RPM. Minimum order is one each.



CAT. NO. SM725

## CRL 1/4" (6.4 mm) Air Grinder

- **Long-Lasting Ball Bearing Drive**

The CRL Air Grinder has a 0.4 hp motor, which produces 22,000 RPM. This lightweight, 1-1/3 pound (.60 kg) Grinder is excellent for rounding sharp corners or removing burrs from sharp, saw-cut edges. Its overall length is 5-3/4" (146 mm), and the air requirement is 3 cfm (1415 cm/sec) at 90 to 120 psi (6.2 to 8.3 bars). Minimum order is one each.



CAT. NO. SM532S

## CRL 3/8" (9.5 mm) Air Impact Wrench

- **Produces 75 ft./lb. of Torque**



This compact CRL 3/8" (9.5 mm) Air Impact Wrench has a butterfly throttle control paddle, which controls the direction and speed of the wrench. Air requirement is 4 cfm (1888 cm/sec) at 90-120 psi (6.2 to 8.3 bars). Wrench has a free speed of 10,000 RPM. Minimum order is one each.

CAT. NO. SM401

## CRL Air Chisel Hammer

- **Includes Four Chisel Bits**



This CRL Air Chisel Hammer delivers 4,000 blows per minute and has a built-in power regulator. For continuous use, a 3 hp compressor or larger is required. Air consumption is 4 cfm (1888 cm/sec) at 90 psi (6.2 bars). Hammer stroke is 1-5/8" (41.3 mm). Minimum order is one each.

CAT. NO. SG0101RK

## CRL Paint Spray Gun

- **All-Purpose and Fully Adjustable**

The all-purpose CRL Paint Spray Gun has a fully adjustable fan pattern. The Gun weighs 2.3 lbs. (1.05 kg), and has a 1.8 mm nozzle. The reservoir cup is one quart (.946 ltrs). A minimum 3 hp air compressor is required. Air consumption is 7-12 cfm (3304 to 5663 cm/sec) at 50-65 psi (3.4-4.5 bars). Minimum order is one each.



CAT. NO. SG1010

## CRL Air Filter, Regulator, and Lubricator

- **Operates From 0-160 PSI**
- **Includes Oiler**
- **1/4" NPT Fittings**

The CRL Air Filter, Regulator, and Lubricator is a must for any shop that uses air-driven power tools. This unit will accurately control the pressure from 0-160 psi (0-11.0 bars). The filter removes impurities from the air including water, which can ruin a tool. Then the air passes through an oil reservoir to add lubrication. Minimum order is one each.



CAT. NO. SG70038

## CRL Coiled Air Hoses

- Nylon Hose Available in Two Lengths
- Heavy-Duty Rigid Brass Fittings



CRL Coiled Nylon Air Hoses have standard 1/4" (6.4 mm) male NPT fittings on each end. Each hose has spring guards for additional strain relief.

CAT. NO.	LENGTH
SA225	25' (7.6 m)
SA250	50' (15.2 m)

Minimum order: 1 each.

## CRL 3/8" Air Hoses

- Premium Quality Rubber Hose Available in Two Lengths



The CRL 3/8" (9.5 mm) diameter Premium Air Hose is made from genuine Goodyear Rubber with 1/4" (6.4 mm) male NPT brass fittings on both ends. One end has a special kink resistant sleeve. Rated for pressures up to 250 psi (17 bars).

CAT. NO.	LENGTH
AM1019	25' (7.6 m)
AM1020	50' (15.2 m)

Minimum order: 1 each.

## CRL Compressor Accessory Kit

- 17-Piece Kit



The CRL Compressor Accessory Kit includes everything you'll need to hook your compressor up to your hoses and tools. Kit includes two "M" style female couplers, three male plugs, two female plugs, one male nipple, one female coupling, a lever handled nozzle, assorted tube connectors and inflation devices. Minimum order is one each.

CAT. NO. S220

## CRL 5 Gallon Portable Air Tank

- Extra Capacity for Your Air Compressor



The CRL 5 Gallon Air Tank can be charged with your air compressor and carried onto a job site for small jobs requiring compressed air, or it can be attached to your compressor with the 36" (914 mm) air hose included to boost the capacity of your existing compressor tank. Minimum order is one each.

CAT. NO. 41712

## CRL Blo-Guns

- 150 PSI Maximum Operating Pressure
- 1/4" NPT Threaded Air Inlet
- OSHA Approved



CAT. NO. S148  
Standard Blo-Gun

CAT. NO. RJR03  
Ready Jet Inline

These CRL Blo-Guns have die cast bodies, and come with rubber nozzle tips as well as OSHA approved safety nozzle tips. Maximum recommended working pressure of 150 psi. (10 bars). Minimum order is one each.

## CRL 4-HP Gas Powered Compressor

- Small Footprint for Mobile Trucks
- Honda Powered



PRESSURE AND VOLUME REQUIREMENTS

PSI	CFM
125	4.0
100	4.4
40	5.1

This CRL 4-HP Gas Powered Compressor is the perfect size for mobile auto glass trucks and vans. Featuring a reliable Honda engine with overhead valves, dual element air cleaner, and electronic ignition. This heavy-duty single stage Compressor features ball bearings, splash lubrication, and metal air filter with exhaust silencer, stainless steel reed valves, plus fan cooling with fixed rotation speeds. The Compressor has a small footprint measuring 22" x 17" x 17" (558 x 432 x 432 mm). Minimum order is one each.

CAT. NO. GD4000

## CRL Inline Pneumatic Tool Oiler

- Automatically Lubricates Air Tool During Use
- Holds Three to Four Days Supply of Oil



The CRL Inline Pneumatic Tool Oiler automatically lubricates tools as you use them. Just fill the reservoir with CRL Cat. No. AK01L Tool Oil and you'll add years of life to your tools. Minimum order is one each. **CAT. NO. AP3000**

## CRL Pneumatic Tool Oil

- Keep Your Air Tools Working Right
- Everything You Need Between Your Compressor and Your Air Tools



CRL Pneumatic Tool Oil is the ideal lubricant for any automatic tool oiler. This oil can be used in either CRL Cat. No. SG70038 or Cat. No. AP3000. Keeping the air lubricated dramatically extends the life of your pneumatic tools. Sold in a 16 fl. oz. (472 ml) plastic bottle. Minimum order is one each. **CAT. NO. AK01L**

## CRL Male Quick Disconnect Coupler

- 1/4" (6.4 mm) NPT Threaded Fitting



The CRL Male Quick Disconnect Hose Coupler speeds the time it takes to change hoses or tools. Use these brass couplers with the Plug Couplers shown below. Just pull the slide collar back and insert the plug for an airtight seal. Minimum order is one each. **CAT. NO. AFMC1**

## CRL Female Quick Disconnect Coupler

- 1/4" (6.4 mm) NPT Threaded Fitting



The CRL Female Quick Disconnect Hose Coupler speeds the time it takes to change hoses or tools. Use these brass couplers with the Plug Couplers shown below. Just pull the slide collar back and insert the plug for an airtight seal. Minimum order is one each. **CAT. NO. AFFC3**

## CRL Male Hose Plug Coupler

- 1/4" (6.4 mm) NPT Threaded Fitting

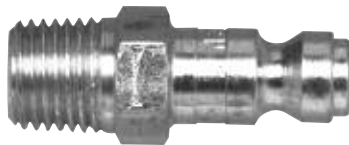

The CRL Male Hose Plug Coupler works with either of the Quick Disconnect Couplings shown above. Minimum order is one each. **CAT. NO. AFMP2**

## CRL Female Hose Plug Coupler

- 1/4" (6.4 mm) NPT Threaded Fitting



The CRL Female Hose Plug Coupler works with either of the Quick Disconnect Couplings shown above. Minimum order is one each. **CAT. NO. AFPP4**

## CRL Angle Swivel

- Helps Eliminate Twisted Air Lines



Solid brass 1/4" (6.4 mm) NPT threaded fitting has a male fitting on one side, and a female on the other. The female end swivels 360 degrees, allowing the user to move about the work area without the hose becoming kinked. Minimum order is one each. **CAT. NO. AP3SB10**

## CRL Pressure Regulator and Gauge

- Regulates Pressure to Protect Air Tools



The CRL Pressure Regulator and Gauge can handle air line pressures up to 250 psi, and regulate up to 160 psi. Primarily for inline use where pressure variances near the tool could be critical. Consists of pressure regulator, gauge, and 1/4" (6.4 mm) hose nipples. Minimum order is one each. **CAT. NO. AR1130**

## CRL Air Powered Cut-Out Tools

Our POWR-Cat and Wildcat Pneumatic Cut-Out Tools are just what you need to cut out hardened urethanes and remove old putty and sealants.



**CAT. NO. AK60K1T**  
POWR-Cat Oscillating  
Pneumatic Knife Basic Kit  
See page 379K



**CAT. NO. AK10**  
Wildcat Pneumatic  
Knife Basic Kit  
See page 380K



**CAT. NO. AK70**  
POWR-Cat Oscillating  
Pneumatic Knife Deluxe Kit  
See page 379K



**CAT. NO. AK40**  
Wildcat Sealant Cutter  
and Putty Remover Kit  
See page 505K

## CRL Air Powered Caulking Tools

Our selection of Air Powered Caulking Guns can dispense materials in cartridges, sausage packs, and in bulk form.



**CAT. NO. WG6100620**  
Cox Sausage Air  
Powered Gun  
See page 572K



**CAT. NO. WG61001**  
Cox Air Powered Gun  
See page 572K



**CAT. NO. WG61004**  
Cox Piston Rod Air  
Powered Gun  
See page 572K



**CAT. NO. PG100**  
Deluxe Air-Drive  
Caulking Gun  
See page 572K



**CAT. NO. PG150**  
Quart Size Air-Drive  
Caulking Gun  
See page 572K



**CAT. NO. 3021301**  
Air Power Cartridge  
Caulking Gun  
See page 572K

## CRL Pass-Thru Sandblasting Cabinet

- Open Sides and Top for Larger Lites
- Dual Side Opening Doors
- Extension Arms
- Large Tempered Glass Viewing Window
- 16 Gauge Welded Steel Construction
- Dust Collector Included

The CRL Pass-Thru Sandblasting Cabinet offers a generous internal working space of 36" (914 mm) wide by 29" (737 mm) deep. Exterior support arms increase width to 85" (2159 mm). Overall the cabinet measures 71" (1803 mm) tall, 37" (940 mm) wide, and 30" (762 mm) deep. Viewing the work in progress is easy with a 25" (635 mm) by 10" (254 mm) tempered glass observation window, and oversized arm openings allow for extended reach into the cabinet.

The included 90 CFM Dust Collector is a dual filtration system measuring 53" (1346 mm) tall and 16-1/2" (419 mm) in diameter. The unit runs on 110V AC power. The CRL Pass-Thru Sandblasting Cabinet ships F.O.B. the manufacturer. Minimum order is one each.



**CAT. NO. SL3730**  
Pass-Thru Sandblasting Cabinet and 90 CFM Dust Collector

## CRL Pressurized Sandblasting System

- Foot Operated Blast Action
- Holds 100 Lbs. (45.4 kg) of Blasting Medium
- Includes Regulator and Gauge
- ASME Coded Sealed Pressure Tank
- 96" (2438 mm), 3/8" (9.5 mm) ID Blast Hose

The CRL Pressurized Sandblasting System features a 12" (305 mm) diameter, 23" (584 mm) deep ASME coded pressure tank. The foot pedal actuated blasting system keeps hands free to work inside the cabinet.

The CRL Pressurized Sandblasting System delivers a more consistent flow rate than comparable siphon or gravity fed blasters. Minimum air requirement: 23 CFM @ 80-100 psi. Ships F.O.B. the manufacturer. Minimum order is one each.



Also available as a complete system with Sandblasting Cabinet, Dust Collector, and Pressure Tank. Minimum order is one each.

**CAT. NO. PT103730**



**CAT. NO. PT100SK**  
Pressurized Sandblasting System

## CRL Portable Pressure Blaster

- Cuts Faster Than Siphon Blasters
- Easy Loading ASME Certified Tank
- Includes Three Ceramic Nozzles



CAT. NO. SJ110DM

The CRL Portable Pressure Blaster has an impressive 90 to 110 pound (40.8 to 49.9 kg) abrasive capacity that will provide up to 50 minutes blasting time before refills. The large 12" (305 mm) diameter tank has an easy-loading recessed top, and the 8" (203 mm) diameter wheels make it easily portable. The tank has a pressure gauge and a pressure relief valve set at 125 PSI (8.6 bars).

The ASME Certified tank has a 1.1 cu. feet (31 l) volume capacity. Kit includes a 10' (3 m) abrasive hose, a blasting gun with an automatic shut-off if released or dropped, and two 1/8" (3.2 mm) and one 3/32" (2.4 mm) ceramic nozzles, and protective hood with hard hat. Requires a compressor that can deliver 15 CFM (7079 cm/sec) at 80 PSI (5.5 bars). Blasting Abrasive and Sandblasting Tape can be found on page 563K. Minimum order is one each.



CAT. NO. 40067 CAT. NO. 40068 CAT. NO. 40069 CAT. NO. 40164

### REPLACEMENT NOZZLES

CAT. NO.	DESCRIPTION	CFM @ 80 PSI (CM/SEC @ 5.5 BARS)
40067	Ceramic 3/32" (2.4 mm)	7 cfm (3303 cm/sec)
40068	Ceramic 1/8" (3.2 mm)	15 cfm (7079 cm/sec)
40069	Ceramic 5/32" (4.0 mm)	25 cfm (11799 cm/sec)
40164	Replacement Sealing Blocks (3/pk)	

Minimum order: 1 each.

## CRL Portable Vacuum Blaster

- Siphon-Type Blasting System
- Powerful Vacuum Recovery of Blasting Material
- Comes With Gun and Two Nozzles



CAT. NO. 36000

The CRL 36000 Portable Vacuum Blaster uses siphon technology with the addition of a powerful 115V AC electric vacuum. Pressurized air is fed through the blaster gun which siphons the abrasive into the gun via a separate hose. A third vacuum hose is attached to a hood surrounding the spray nozzle. This captures the abrasive into the hood and returns it to the tank. The hose length is 8-1/2' (2.6 m), and two 1/4" (6 mm) nozzles are included, (one ceramic and one carbide) delivering 8 CFM (3,776 cm/sec) at 80 PSI. Tank capacity is 40 pounds (18 kg). The Blaster requires a compressor that can deliver both 8 CFM (3,776 cm/sec) at 75 PSI (5.2 bars) or 22 CFM (10,382 cm/sec) at 160 PSI (11.0 bars). Blasting Abrasive and Sandblasting Tape can be found on page 563K. Minimum order is one each.



CAT. NO. 36455



CAT. NO. 36456

### REPLACEMENT NOZZLES

CAT. NO.	DESCRIPTION
36455	Ceramic 1/4" (6 mm)
36456	Carbide 1/4" (6 mm)

Minimum order: 1 each.

## CRL Abrasive Blaster Kit

- Portable Siphon Abrasive Blaster
- Includes Blasting Gun and Hose
- Comes With Three Steel Nozzles



CAT. NO. SJF30  
Blasting Gun also available separately. See page 562K

The CRL Abrasive Blaster Kit performs the same job as the larger Pressure Blasters shown above, however it operates by siphoning the abrasive material from the tank when pressurized air is passed through the blasting gun. The tank has a 90 pound (40.8 kg) capacity, and is supported by a strong tubular steel frame with 6" (152 mm) diameter wheels. The Blasting Gun, 10 feet (3 m) of Hose, and three Steel Nozzles are included. **NOTE:** For use with dry abrasives only. Requires a compressor, which can deliver 7 CFM (3303 cm/sec) at 80 PSI. (5.5 bars). Replacement Nozzles, Blasting Abrasive, and Sandblasting Tape can be found on page 563K. Minimum order is one each.



CAT. NO. SJF90

## CRL Abrasive Air Gun

- For Use With Several Types of Abrasive Mediums
- Carbide Tip Nozzle Included

This high-quality Abrasive Air Gun is ideal for etching designs, initials and figures on glass, stone, metal or plastics. The pistol-grip metal gun comes with a polyethylene abrasive medium reservoir bottle, and has an adjustable tip for use with a variety of abrasives, including aluminum oxide, pumice, starch, or any fine abrasive that will pass through a 30 to 100 mesh screen. The gun has a 1/4" NPT to connect to any compressor, which can supply between 20 and 80 psi (1.4 to 5.5 bars). Blasting Abrasive and Tape can be found on page 563K.



CAT. NO.	DESCRIPTION
LAC3	Complete Air Gun Kit
LAC3NOZ	Replacement Nozzle

Minimum order: 1 each.

## CRL Sandy Jet Abrasive Blaster Gun

- For Dry Abrasives or Liquid Blasting
- Includes Two Steel Nozzles

The Sandy Jet Abrasive Blaster Gun is a siphon type system which does not come with a tank. Instead, the 10' (3 m) long abrasive feeder hose with chrome plated pick-up tube can be lowered into any abrasive container, eliminating the need to refill bulky reservoir tanks. The Sandy Jet system requires a compressor, that can supply between 7 cfm's (3,303 cm/sec) @ 80 psi (5.5 bars). Three Steel Nozzles are supplied, two 1/4" (6 mm) and one 13/64" (5.2 mm). Two Air Jets are supplied, one 5/64" (2.0 mm) and one 1/8" (3.2 mm). The Sandy Jet can also be used with liquids for cleaning. Replacement Steel Nozzles, Ceramic Nozzles (for longer life), and Air Jets are available. See replacement nozzle chart on page 563K. Blasting Abrasive and Tape can be found on page 563K. Minimum order is one each.



## CRL Mini-Spot Glass Etcher Blaster

- Hand Held Unit
- Self-Recycling and Dust Free
- One Pound of Abrasive and Ceramic Nozzle Included
- Perfect for Small Jobs

The CRL Mini-Spot Glass Etcher Blaster is designed to spray abrasives for glass etching within the confines of the rubber boot. As the sprayer is used the abrasive is siphoned from the bag, shot against the glass, blasting an area approximately 1-1/4" (32 mm) diameter, and is then drawn back into the recovery bag for reuse. This Blaster is to be used only on vertical flat surfaces where the boot can make complete contact with the surface. Required air supply is 20 cfm (9439 cm/sec) @ 80 psi (5.5 bars). Blasting Abrasive and Tape can be found on page 563K. Minimum order is one each.

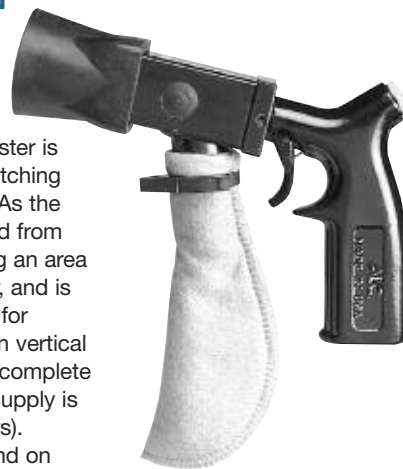

## CRL White Glass Frosting

- Sprays Uniformly
- Dries Fast

CRL White Glass Frosting gives a soft frosted effect on glass, plastic or other transparent material. It permits light to enter and obscures outside vision. It was developed for one or more coat applications with a fast drying time of five minutes or less between coats, and comes in a handy 11 ounce (312 g) aerosol can. Minimum order is one can.





## CRL Sandblast Tape

- Strong Vinyl Tape Available in Two Thicknesses
- Accepts Carbon, Pen or Pencil
- Holds Intricate Patterns



CRL has two thicknesses of Sandblast Tapes: 4 mil thick for light blasting or frosting of glass, and 8 mil thick for deep cutting and blasting. Both are durable, vinyl formulated tapes for stability and creep resistance. Sandblast Tape cuts cleanly and easily, and holds intricate patterns. The new, improved removable adhesive makes clean-up easier. The vinyl finish readily accepts pen, pencil or carbon marking of stencils for easy pattern transfer. The 8 mil thick tape can also be used as a stencil for screen etching on glass.

CAT. NO.	THICKNESS	WIDTH	COLOR	ROLL LENGTH
SB13006	4 mil	6" (152 mm)	White	60' (18.3 m)
470K062	4 mil	12" (305 mm)	White	60' (18.3 m)
SB131524	4 mil	24" (610 mm)	White	60' (18.3 m)
SB806	8 mil	6" (152 mm)	White	60' (18.3 m)
SB812	8 mil	12" (305 mm)	White	60' (18.3 m)
SB818	8 mil	18" (457 mm)	White	60' (18.3 m)
3491825	8 mil	24" (610 mm)	White	60' (18.3 m)
3493020	8 mil	30" (762 mm)	White	60' (18.3 m)
3493036	8 mil	36" (914 mm)	White	60' (18.3 m)

Minimum order: 1 roll. Sizes up to 54" wide available on special order. Sizes can be combined for quantity pricing.

## CRL Replacement Air Nozzles and Jets

CRL Replacement Nozzles and Jets are available for the Cat. No. SJF90 Abrasive Blaster Kit, and the Cat. No. SJF30 Sandy Jet Abrasive Blaster Gun.

**NOTE:** Always use 1/8" jets with 1/4" nozzles and 5/64" jets with 13/64" nozzles. For easy identification, 1/8" jets and 1/4" nozzles have a silver finish; 5/64" jets and 13/64" nozzles have a gold finish.



Ceramic Nozzle      Steel Nozzle      Steel Air Jet

CAT. NO.	DESCRIPTION	CFM (CM/SEC) @ 80 PSI (5.5 BARS)
BF16M	1/4" (6.3 mm) Ceramic Nozzle	15 (7079 cm/sec)
F16M	1/4" (6.3 mm) Steel Nozzle	15 (7079 cm/sec)
F16S	13/64" (5.1 mm) Steel Nozzle	7 (3303 cm/sec)
F15M	1/8" (3.2 mm) Steel Air Jet	15 (7079 cm/sec)
F15S	5/64" (2 mm) Steel Air Jet	7 (3303 cm/sec)

Minimum order: 1 each.

## CRL Aluminum Oxide Blasting Abrasive

- Available in Two Grits



CRL Aluminum Oxide will work in all CRL Sand Blasters and Etch Blasters. **NOTE:** 120 Grit Abrasive is more coarse than 180 Grit.

CAT. NO.	GRIT	QUANTITY
2643120	120	10 Lbs. (4.5 kg)
2643180	180	10 Lbs. (4.5 kg)

Minimum order: 1 each.

## CRL Heavy-Duty Aluminum Ladder

- ANSI Type 1 Heavy-Duty 300 Lb. (136 kg) Rating
- Extra Wide to Accept Planks
- Steps on Both Sides

This rugged CRL Aluminum Ladder has steps on both sides for convenience, and has an ANSI Type 1 heavy-duty 300 pound (136 kg) rating. Exceptionally strong riveted construction and extra bracing makes it rigid and steady. It is extra wide to accommodate scaffold type planks. Non-marking feet riveted to the legs keep them from shifting on smooth floors.



8 Foot Ladder is Shown Above

CAT. NO.	SIZE
7504	4' (1.22 m)
7506	6' (1.83 m)
7508	8' (2.44 m)

Minimum order: 1 each. Must ship common carrier.

## CRL Heavy-Duty Fiberglass Ladder

- ANSI Type 1A Extra Heavy-Duty 300 Lb. (136 kg) Rating
- Rugged Construction and Extra Bracing
- Steps on Both Sides



This rugged CRL Fiberglass Ladder has steps on both sides for convenience, and has an ANSI Type 1A rating for 300 pounds (136 kg). Each step is attached by six steel rivets. The heavy-duty top hinge uses 10 steel rivets on each side for long-lasting strength and durability. Structural PVC boots support the lower legs for durability and abrasion resistance.

CAT. NO.	SIZE
6204	4' (1.22 m)
6206	6' (1.83 m)
6208	8' (2.44 m)

Minimum order: 1 each. Must ship common carrier.

## CRL Kik-Step

- Rolling Step Stool

This CRL Kik-Step is a heavy-duty rolling step stool that no warehouse, factory or shop should be without. Made from a steel-formed base and a high impact plastic top, this stool has spring-loaded rollers, which retract when in use. This stool is rated at 500 lbs. (226 kg) and is 14" tall (356 mm). The large diameter at the base measures 15-3/4" (400 mm). Minimum order is one each.



CAT. NO. KSTEP

## CRL Aluminum Ladder Jacks



Lightweight and reversible, CRL Ladder Jacks let aluminum extension ladders support planks. They can be operated with one hand, and fold flat for storage. Minimum order is one pair.

- Support Planks Up to 19" (482 mm) Wide



CAT. NO. 22JACKS

## CRL Anti-Slip High Traction Safety Tape

- 60' (18.3 m) Roll in Two Widths

CRL Anti-Slip Safety Tape provides dependable, anti-slip protection on ladders, ramps, walkways, and loading areas. The tough, friction-textured material is covered with black, diamond-hard mineral particles, and has a pressure sensitive adhesive backing. Installation is fast and easy, while ensuring a secure, long lasting hold.



CAT. NO.	WIDTH
3102	2" (51 mm)
3104	4" (102 mm)

Minimum order: 1 roll. Sizes can be combined for quantity pricing.

## CRL SideRax Vehicle Side Racks

- Attaches to Door or Truck Box to Transport Ladders and Other Long Items
- Installs and Removes Quickly



Our CRL SideRax Vehicle Side Racks provide a convenient and easy way to transport long items, such as extrusions, ladders, lumber, and more. SideRax quickly mounts to an open window or truck bed side. Padded to prevent paint damage, SideRax fits most cars, trucks, vans, and SUV's without modifications.

**NOTE:** Not suitable for use with step side pickup trucks. Minimum order is one pair.

CAT. NO. 150SR



# SECTION 5 INDEX

For a complete index to this catalog, turn to Section 7. To search for all CRL products, go to CRL Total Search at [crlaurence.com](http://crlaurence.com).

## A

Acrylic Latex with Silicone .....	605K
Adhesive Guns .....	575K-576K
Adhesive Pumps .....	575K
Adsorbents, IG .....	609K
Air Powered Caulking Guns .....	572K, 608K
Air Powered Muntin Clip Punch .....	614K
Air Powered Muntin Notcher .....	613K
Auto-Mix Mixer Nozzles .....	573K
Aztech Hot Melt Dispensing System .....	603K

## B

Backer Rod Roller .....	579K
Barrel Transfer Pump .....	576K
Battery Chargers .....	570K-571K
Blades, Utility Knife .....	584K
Blades, Window De-Glazing Tool .....	581K
Brass Tip Nozzles .....	602K

## C

Caulking	
Accessories .....	577K-580K
Cut-Out Blades .....	581K-584K
Guns .....	566K-572K, 575K, 608K
Nozzles .....	573K-574K
Cordless Caulking Guns .....	570K-571K, 608K
Corner Caulker Nozzles .....	573K
Corners, IG Spacer .....	600K, 606K
Cox Sausage Air Caulking Gun .....	572K

## D

Deluxe	
Handy Clamps .....	607K
Insulating Glass Hot Melt Starter Kit .....	588K
Spacer Bender .....	614K
Super Spacer Starter Kit .....	590K
Desiccant Filling Machine .....	610K
Dispensers .....	575K-576K

## E

Edgetech Super Spacer .....	594K
European Glass Measuring Tools .....	624K
E.Z.D. Glazer De-Glazing Tool .....	581K

## F

Fein SuperCut Sealant Cutter Knife Kit .....	583K
Flexible Muntin Locator .....	612K
Flexible Nozzles .....	573K
Funnels .....	577K

## G

Glass	
CHEK Meters .....	615K-616K
Cleaners .....	599K
Thickness Gauges .....	617K, 624K
Thickness Laser .....	616K
Thickness Meters .....	615K-616K
Gun Fill Pump .....	576K
Gun, Hot Extruder .....	601K
Guns, Adhesive .....	575K-576K
Guns, Caulking .....	566K-572K, 575K, 608K

## H

Handi-Foam Dispensing Guns .....	575K
Hardman Gun .....	601K
Heat Lamp, Duralite .....	597K
Heat Strengthened Glass Detector .....	621K

Heater Ovens and Boxes .....	580K
Heavy-Duty Solar Series Glass Washers .....	628K
Hot Melt	
Butyl in Cakes .....	604K
Butyl in Cartridges .....	601K
Butyl in Chunks .....	604K
Butyl in Pails .....	604K
Butyl Rope .....	601K
Clamp Table .....	603K
Extruder Gun .....	601K
Extruder Systems .....	602K-603K
Hot Trim Knife .....	602K

## I

Insulating Glass	
Adsorbents .....	609K
Aluminum Spacers .....	600K, 606K
Caliper .....	617K
Corners .....	600K, 606K
Equipment .....	595K, 597K, 602K-603K, 610K, 613K-626K
Guides .....	598K
Molecular Sieve .....	609K
Muntin .....	611K-614K
Nozzles .....	602K
Sealants .....	598K, 601K, 605K, 608K
Silicone .....	598K, 605K, 608K
Spacers .....	594K, 596K, 600K, 606K
Starter Kits .....	588K-592K
Super Spacer .....	594K-595K
Thickness Gauge .....	617K
Trim Knife .....	602K
Internal Muntin Joiner .....	612K

## J

Jiffy Mixer .....	577K
-------------------	------

## K

Kit(s)	
Cordless Caulking Gun .....	570K, 608K
Fein Sealant Cut-Out .....	583K
Heat Strengthened Glass Detector .....	620K
IG Sales Demo .....	618K
IG Starter .....	588K-592K
Sealant Spatula .....	578K
Knives, Hot Trim .....	602K

## L

Laser, Glass Thickness .....	616K
Lint Free Nylon Gloves .....	606K
Low-e Nylon Contact Meter .....	623K
Low-e Coating Detectors .....	615K-616K, 622K-624K
Low-e Glass Edge Deletion Table .....	626K

## M

Makita® Power Scraper Hackout Gun .....	583K
Manual Muntin Bar Notcher and Die Sets .....	613K
Metric Glass Caliper .....	617K
Metric Glass Thickness Gauge .....	616K
Milwaukee Cordless Caulking Guns .....	571K
Multi-Function Tool .....	582K
Muntin Bars and Clips .....	611K-612K
Muntin Tools .....	613K-614K

## N

Neutral Cure Silicone .....	605K
Nozzle Cutter .....	574K
Nozzles, Caulking .....	573K-574K

## O

Oiler Can .....	576K
-----------------	------

## P

Paddle Mixer .....	577K
Peak Tool, Duralite .....	597K
Pistol Type Oiler Can .....	576K
Pocket Reference Book .....	622K
Polyethylene Sealant Guides .....	598K
Polyisobutylene Primary Seal .....	607K
Positioner Vacuum Cup Work Stand .....	625K
Power Ball Caster Tilt Tables .....	626K
Power Rotating Sealing Table .....	625K
Power Scraper .....	581K
Pro Tool, Duralite .....	597K
Problem Solver Nozzles .....	573K

## Q

Quartz Heat Lamp, Duralite .....	597K
----------------------------------	------

## R

Reusable Caulk Tips and Cap .....	574K
Rotary Work Table .....	625K
Rotating Sealing Table .....	625K

## S

Sealant Finishing Tools .....	579K
Sealant Removal Tools .....	581K-584K
Single Seal Spacer .....	600K
Solar Processing Equipment .....	627K-628K
Solar Transmission and BTU Power Meter .....	623K
Solar UV Sales Demo Kit .....	618K
Spatulas .....	578K
Spectrum Detective Energy Transmission Meter .....	619K
Strengthened Glass Detectors .....	620K
Sunburst Muntin Joiner .....	612K
Super Spacer® .....	594K-595K
Super Spacer® Sealant Starter Kits .....	589K-591K
SuperCut Sealant Cutter Knife Kit .....	583K
Surface Resist Meters .....	620K

## T

Tables	
Ball Caster .....	626K
Edge Deletion .....	626K
Hot Melt Clamp .....	603K
Inspection .....	626K
Rotary Work .....	625K
Sealing .....	625K
Tilting Transfer .....	626K
Tin Side Detectors .....	621K
Trim Knife .....	602K
TruSeal Duralite .....	596K
Two Part Insulating Glass Sealant .....	605K

## U

Universal Muntin Clips .....	611K
Utility Knives and Blades .....	584K

## W

Window De-Glazing Tool .....	581K
Window Energy Profiler .....	619K
Window Tools .....	583K
Wipes .....	602K



C.R. LAURENCE COMPANY

[crlaurence.com](http://crlaurence.com) | [usalum.com](http://usalum.com)

[crlaurence.ca](http://crlaurence.ca)

[crlaurence.com.au](http://crlaurence.com.au)

[crlaurence.co.uk](http://crlaurence.co.uk)

[crlaurence.de](http://crlaurence.de)

[crlaurence.eu](http://crlaurence.eu)

# SECTION 5 Caulking Tools and Insulating Glass

## QUICK INDEX

For a complete index to this catalog, turn to Section 7. To search for all CRL Products, go to CRL Total Search at [crlaurence.com](http://crlaurence.com).

### Caulking Guns – Pages 566K to 574K



### Dispensing and Application Tools – Pages 575K to 580K



### Sealant Removal Tools – Pages 581K to 584K



### Insulating Glass Supplies and Equipment – Pages 585K to 626K



## Caulking Gun Ratios - What Does It Mean? Extra Thrust!

Today's high viscosity sealants have brought about a new age of caulking guns. The question is, what does the term "ratio" really mean? Quite simply, for every pound of pressure being applied by the user, the ratio is a multiplier of pounds of pressure being exerted on the cartridge plunger. For example, the CRL 12:1 Ratio Caulking Gun would provide 12 times the amount of each pound of pressure being applied.

### CRL Cox® 12:1 Ratio Chilton Strap Frame Caulking Gun

- Our Most Popular Model
- Holds Standard Caulking Cartridges

CRL Cox® 12:1 Ratio Chilton Caulking Gun has the smooth operation of a friction rod, plus a large handle and trigger. Perfect for dispensing low to medium viscosity materials. Strap frame rotates to move the nozzle tip where needed.

The spring release plunger lets you load and dispense quickly and easily, and releases pressure on the plunger to prevent sealant run-on. A special feature of this gun is the Wear Compensating Device that minimizes wear on the applicator by automatically taking up the slack to provide total trigger action from first use to last. This device will approximately double the life of the gun.

Also features: die cast zinc alloy body, all component replaceable parts, patented catch plate (sintered steel), and built-in ladder hook. Holds all standard size caulking cartridges. Minimum order is one each.

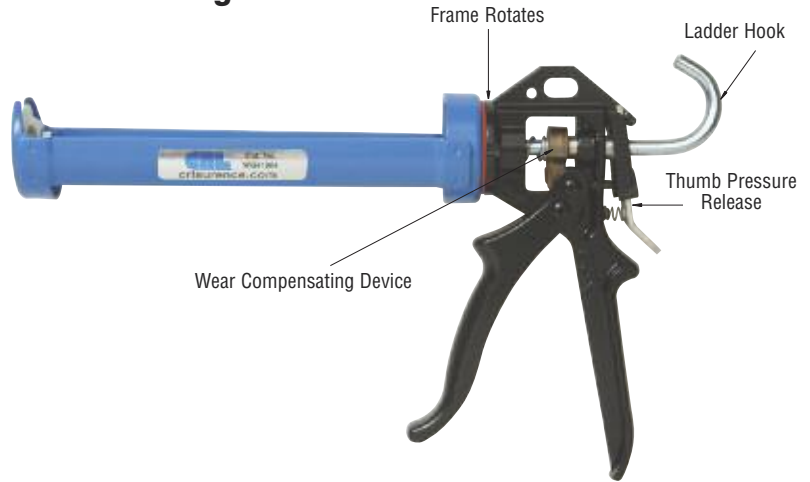

CAT. NO. WG41004

### CRL Cox® 18:1 Ratio Extra Thrust Strap Frame Caulking Gun

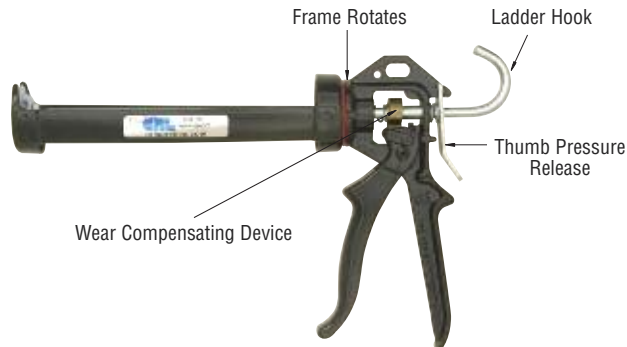

- Ideal for Cold Weather Use or With High Viscosity Sealants

This CRL Cox® 18:1 Ratio Extra Thrust Gun has the smooth operation of a friction rod, plus a large handle and trigger. Perfect for dispensing low to high viscosity materials. Strap frame rotates to move the nozzle tip where needed.

The spring release plunger lets you load and dispense quickly and easily, and releases pressure on the plunger to prevent sealant run-on. A special feature of this gun is the Wear Compensating Device that minimizes wear on the applicator by automatically taking up the slack to provide total trigger action from first use to last. This device will approximately double the life of the gun. Also features: die cast zinc alloy body, all component replaceable parts, patented catch plate (sintered steel), and built-in ladder hook. Holds all standard size caulking cartridges. Minimum order is one each.

CAT. NO. WG41004XT

### CRL Cox® 26:1 Ratio Ascot Strap Frame Caulking Gun

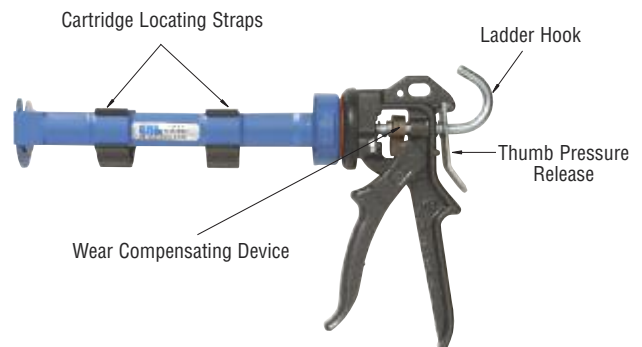

- Effortless Dispensing of High Viscosity Sealants

The CRL 26:1 Ratio Ascot Gun combines case-hardened working parts with a contoured handle and trigger design to make this gun the ultimate for dispensing high viscosity sealants. High-strength strap frame design features improved high-power bulkhead.

Includes new cartridge locating straps for holding slightly smaller diameter European cartridges. The spring release plunger lets you load and dispense quickly and easily, and releases pressure on the plunger to prevent sealant run-on. Same special Wear Compensating Device as WG41004 Gun. Also features: die cast zinc alloy body, all component replaceable parts, patented catch plate (sintered steel), and built-in ladder hook. Holds all standard size caulking cartridges. Minimum order is one each.

CAT. NO. WG410042T

Cox is a registered trademark of PC Cox Limited Corporation.

Caulking Guns can be combined for quantity pricing.

## CRL 26:1 Ratio Strap Frame Caulking Gun

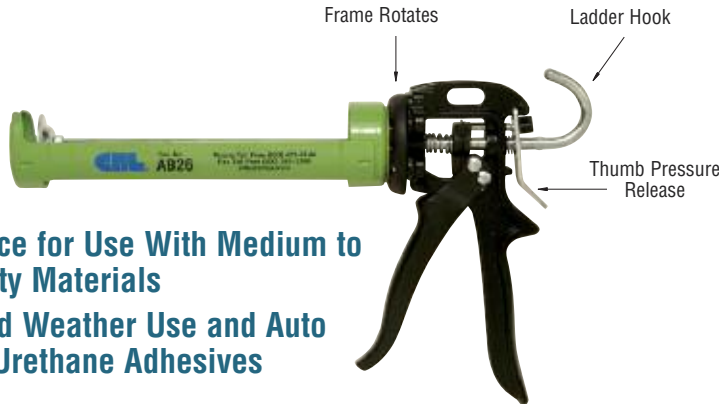

- A Good Choice for Use With Medium to High Viscosity Materials
- Ideal for Cold Weather Use and Auto Windshield Urethane Adhesives



This CRL Heavy Duty 26:1 Ratio Gun has the smooth operation of a friction rod and the mechanical advantage to dispense high viscosity sealants, such as auto urethanes or construction sealants, even during cold weather. The strap frame rotates to move the nozzle tip where needed. The spring release plunger lets you load and dispense quickly and easily. The thumb-activated instant pressure release button prevents sealant run-on. Includes a built-in ladder hook. Twelve guns per case. Minimum order is one each.

CAT. NO. AB26

## CRL 12:1 Ratio Strap Frame Caulking Gun

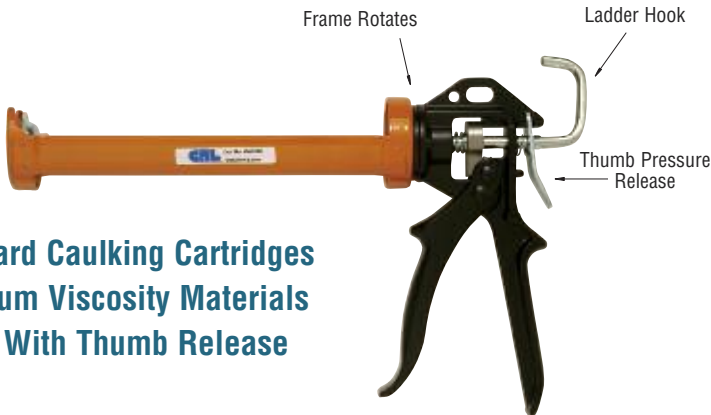

- Holds Standard Caulking Cartridges
- Low to Medium Viscosity Materials
- Smooth Rod With Thumb Release



This CRL 12:1 Ratio Caulking Gun has the smooth operation of a friction rod, plus a large handle and trigger. Perfect for dispensing low to medium viscosity materials, such as silicones and acrylic latex sealants. The strap frame rotates to move the nozzle tip where needed. The spring release plunger lets you load and dispense quickly and easily. The thumb-activated instant pressure release button prevents sealant run-on. Includes a built-in ladder hook. Twelve guns per case. Minimum order is one each.

CAT. NO. GA1203

## CRL Standard Smooth Rod Caulking Gun



- Thumb Pressure Release Button
- Our Best Seller is Also a Great Value
- Perfect for Low Viscosity Materials



Our CRL Standard Smooth Rod Caulking Gun is CRL's most popular caulking gun because it is quality constructed, and so easy and economical to use. Perfect for dispensing low viscosity materials. The spring release plunger lets you load and dispense quickly and easily, and releases pressure on the plunger to prevent sealant run-on. Minimum order is one each.

CAT. NO. ER3

Caulking Guns can be combined for quantity pricing.

# CRL CAULKING GUNS

For Pricing Visit [crlaurence.com](http://crlaurence.com) or Call Us Toll Free at the Phone Numbers Shown on the Back Cover

## CRL Metal Strap Frame Caulking Gun

- Popular Strap Frame Design
- Smooth Rod With Thumb Release

The strap frame design for caulking guns is becoming increasingly appealing, as witnessed in the fast-growing popularity of this quality gun. The CRL Metal Strap Frame Gun has a friction hex drive rod plunger, heavy die cast zinc alloy frame and trigger, and a thumb pressure release that lets you load and dispense quickly and easily, and releases pressure on the plunger to prevent sealant run-on. Includes built-in ladder hook, and handy seal piercer located in the handle of the sturdy steel skeleton type frame. Minimum order is one each.

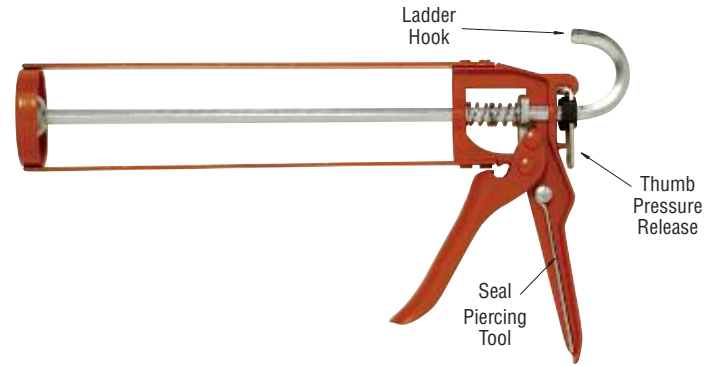

CAT. NO. GA1204

## CRL Nylon Strap Frame Caulking Gun

- Smooth Rod With Thumb Release
- Lightweight, Yet Durable

The CRL Nylon Strap Frame Caulking Gun has a pressure release device to reduce material flow after you release the trigger. This feature is ideal for precise application of your favorite sealant, and works with standard size plastic, metal or composite cartridges with integral or screw-on nozzles. Friction hex drive rod provides the thrust of a metal gun, and has a quick-release latch. Also includes belt or ladder hook. Minimum order is one each.

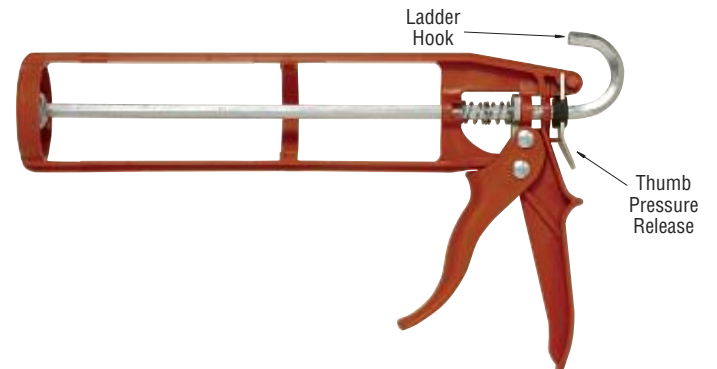

CAT. NO. GA1202

## CRL Albion Deluxe Strap Frame Caulking Gun

- Thumb Pressure Release Button
- Square Smooth Rod

This CRL Albion Deluxe Caulking Gun is made for the professional. Loading is quick and easy. Get superior caulking thrust with the 1-5/8" (41 mm) diameter ejector; speed and holding comfort with the no pinch finger guard. This easy-to-use gun also features a 1/4" (6 mm) square smooth piston rod that rotates for four times longer life. A handy seal piercing tool is located in the handle. Minimum order is one each.

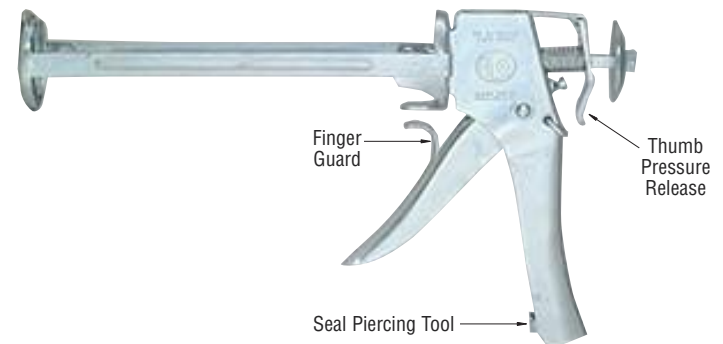

CAT. NO. AB1393

## CRL Newborn Ratchet Rod Caulking Gun

- Lightweight, Yet Durable
- Smooth Action Ratchet Rod

The CRL Newborn Ratchet Rod Gun is a professional model drop-in cartridge gun. The ratchet action rod pushes caulking material smoothly with double, heat-treated dog drives for even application. It's one of our most popular guns because it has a good combination of the following features at a very affordable price: seal piercing tool, nozzle spout cutter, ladder hook, adjustable wrist strap, and no pinch finger guard. Minimum order is one each.

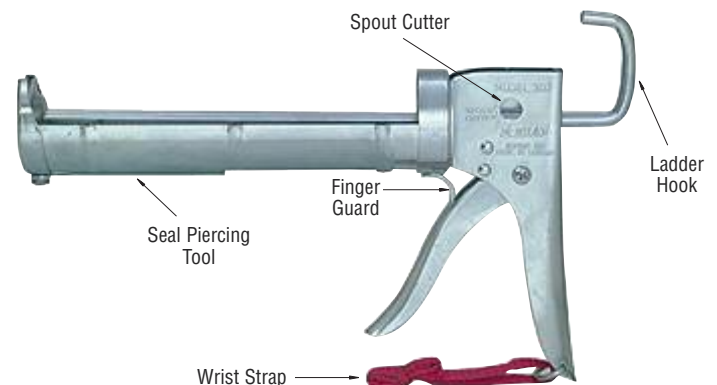

CAT. NO. KM27RD

Caulking Guns can be combined for quantity pricing.



C.R. LAURENCE COMPANY

[crlaurence.com](http://crlaurence.com) | [usalum.com](http://usalum.com)

568K | [crlaurence.ca](http://crlaurence.ca) [crlaurence.com.au](http://crlaurence.com.au) [crlaurence.co.uk](http://crlaurence.co.uk) [crlaurence.de](http://crlaurence.de) [crlaurence.eu](http://crlaurence.eu)



## CRL PowerGlide No-Drip Strap Frame Caulking Gun

- Stops Drips Automatically
- Smooth Rod
- Sturdy Steel Skeleton Type Frame

The CRL PowerGlide No-Drip Caulking Gun uses an exclusive automatic mechanism that creates a "vacuum" between the plunger and the caulking tube. When you release the trigger the material flow stops automatically. Features dual power settings: No Drip for most applications is perfect for interior and detail work with thumb release engaged; Power Thrust provides extra power for maximum application per trigger pull. Includes ladder hook; easy load clips to hold cartridge in barrel; and a handy seal piercer located in handle of the sturdy steel skeleton type frame. Minimum order is one each.

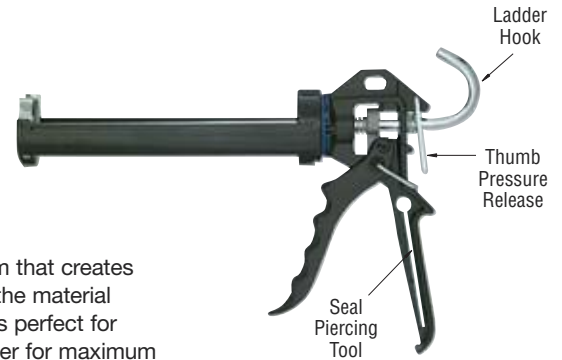

CAT. NO. Z349

## CRL Cox® Quart Size Strap Frame Caulking Gun

- Heavy-Duty Gun With Lightweight Handling
- Smooth Rod

The CRL Cox® Quart Size Strap Frame Caulking Gun incorporates the strap design for 29 fl. oz. (858 ml) quart size cartridges for lightweight handling. It has the smooth operation of a friction rod, plus a large handle and trigger. Perfect for dispensing low to medium viscosity materials. Strap frame rotates to move nozzle tip where needed. The spring release plunger lets you load and dispense quickly and easily, and releases pressure on the plunger to prevent sealant run-on. Same special Wear Compensating Device feature as other Cox® model guns. Minimum order is one each.

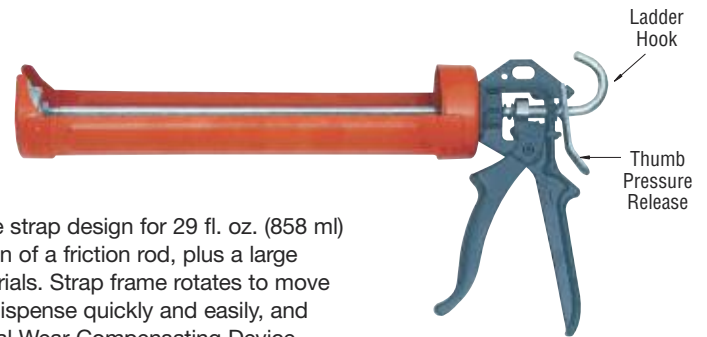

CAT. NO. WG41002

## CRL 15" Sausage and Cartridge Caulking Gun

- Converts for Gunning Sausage Packs or Cartridges
- Includes Plastic Cone Nozzle
- Lightweight Aluminum Barrel

The CRL 15" (381 mm) Sausage and Cartridge Caulking Gun is made of lightweight aluminum, and is ideal for waterproofing applications where wide beads of material are required. Cut the plastic cone type nozzle to deliver a bead from 1/8" (3 mm) up to 3/4" (19 mm) in diameter. Minimum order is one each.

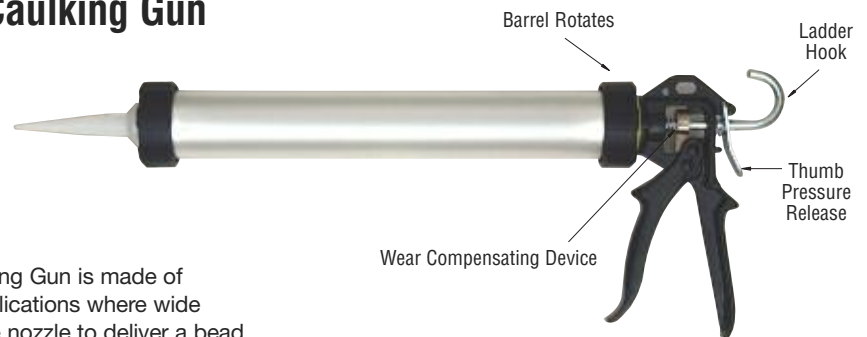

CAT. NO. GA1205

## CRL Cox® Avon 15" Sausage/Bulk Caulking Gun

- Converts for Gunning Sausage Packs, Cartridges or Bulk
- Supplied With Three Extra Nozzles
- Our Most Popular Sausage Gun

The CRL Cox® Avon 15" (381 mm) Sausage/Bulk Caulking Gun is made of lightweight aluminum, and is ideal for waterproofing applications where wide beads of material are required. Cut the plastic cone type nozzle to deliver a bead from 1/8" (3 mm) up to 1-5/16" (33 mm) in diameter. Minimum order is one each.

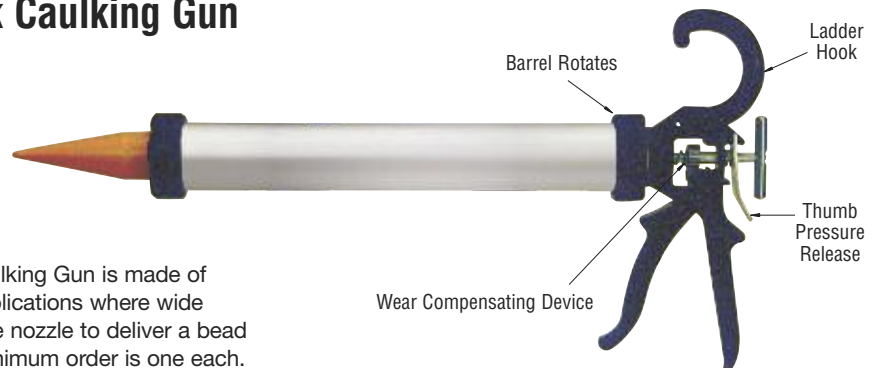

CAT. NO. WG51001

Cox is a registered trademark of PC Cox Limited Corporation.

Caulking Guns can be combined for quantity pricing.

# CRL CAULKING GUNS

For Pricing Visit [crlaurence.com](http://crlaurence.com) or Call Us Toll Free at the Phone Numbers Shown on the Back Cover

## CRL 12 Volt DC Variable Speed Cordless Cartridge Caulking Gun for Lightweight Sealants

- Variable Speed Trigger Controls Flow of Sealant
- Use to Dispense Lightweight Sealants Such as Silicones and Acrylic Latex
- Complete With 12 Volt Battery, One Hour Charger, and Molded Plastic Carrying Case

This CRL 12V DC Cordless Cartridge Caulking Gun operates on a 12 volt Rechargeable Battery and comes with a One Hour Charger. The variable speed control is in the trigger for easy adjustments in speed. It is ideal for glazing contractors, building contractors, roofers, cabinet makers, OEM fabricators, window manufacturers, or anyone who applies a lot of silicone or acrylic latex sealants and wants an easier, more professional way of getting the job done, without the restrictions of cords or hoses. Affordable and effective, this gun also comes with a 90 day warranty. For uninterrupted production, you can order additional LD188B 12 Volt Battery Packs.

**WARNING:** Not for use with high viscosity automotive urethane adhesives and construction polyurethane sealants. Use Only to dispense lightweight sealants such as silicone and acrylic latex.



CAT. NO.	DESCRIPTION
LD188	12 Volt Cordless Cartridge/Caulking Gun Kit
LD188B	12 Volt DC Battery Pack
LD188C	One Hour Battery Charger
LD188AU	240 Volt Caulking Gun Kit-Australia
LD188C240VAU	240 Volt Battery Charger-Australia
LD188EU	240 Volt Caulking Gun Kit-Europe
LD188C240VEU	240 Volt Battery Charger-Europe

Minimum order: 1 each.

## CRL Albion® Deluxe Professional Sausage/Bulk Caulking Gun

Instant Pressure Release



- Heavy-Duty Square Smooth Rod
- Rotating Swivel Handle

This CRL Albion® Deluxe Professional Bulk Caulking Gun holds 10.1 and 20.3 fl. oz. (300 and 600 ml) Sausage Packs with its large capacity barrel, or 24 fl. oz. (710 ml) of bulk loaded material. All-steel reinforced welded construction with a corrosion resistant, zinc plated body. An epoxy coated swivel handle rotates, allowing easy direction change and uninterrupted flow. Includes one 1/2" (13 mm) round metal nozzle. Minimum order is one each.

CAT. NO. DL45T04

## CRL Albion® Deluxe Professional 1-1/2 Pint Bulk Caulking Gun

Instant Pressure Release



- Heavy-Duty Square Smooth Rod
- Rotating Swivel Handle

This CRL Albion® Deluxe Professional Bulk Caulking Gun has a large capacity 24 fl. oz. (710 ml) barrel for bulk loading of caulking materials. All steel reinforced welded construction with a corrosion resistant, zinc plated body. An epoxy coated swivel handle rotates, allowing easy direction change and uninterrupted flow. Also features a quality screw-on conical cap with rolled threads for a tighter seal. Includes one 1/2" (13 mm) diameter metal nozzle. Minimum order is one each.

CAT. NO. DL45T03

## CRL Newborn® Professional Sausage/Bulk Caulking Gun

Built-In Spout Cutter

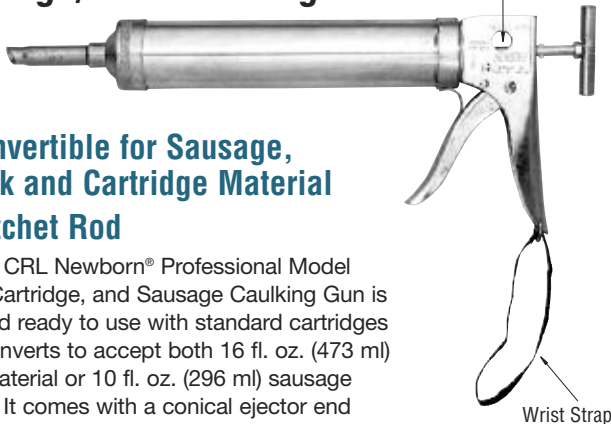

- Convertible for Sausage, Bulk and Cartridge Material
- Ratchet Rod

This CRL Newborn® Professional Model Bulk, Cartridge, and Sausage Caulking Gun is shipped ready to use with standard cartridges and converts to accept both 16 fl. oz. (473 ml) bulk material or 10 fl. oz. (296 ml) sausage packs. It comes with a conical ejector end cap with a 3/8" (9 mm) round metal nozzle, a ring cap that accepts wide tip cone nozzles, and is equipped with a built-in spout cutter and wrist strap. Minimum order is one each.

CAT. NO. KM32RCT

## CRL Albion® 2-1/2 Quart Big Capacity Bulk Caulking Gun

Instant Pressure Release



- Heavy-Duty Square Smooth Rod
- Rotating Swivel Handle

This CRL Albion® Bulk Caulking Gun has a 2-1/2 quart (80 fl. oz./2.4 l) capacity and is easy to handle. Made for bulk-loaded caulking materials only, it is supplied with a 3/4" (19 mm) diameter metal nozzle. All steel reinforced welded construction with a corrosion resistant zinc plated body. An epoxy coated swivel handle rotates, allowing easy direction change and uninterrupted flow. The best gun to use for that really big job where frequent gun refills may not be convenient. Minimum order is one each.

CAT. NO. KM145RCT

Albion is a registered trademark of Albion Engineering Company Corporation. Newborn is a registered trademark of Newborn Brothers & Co., Inc.

Caulking Guns can be combined for quantity pricing.

# CRL CAULKING GUNS

For Pricing Visit [crlaurence.com](http://crlaurence.com) or Call Us Toll Free at the Phone Numbers Shown on the Back Cover

## CRL Milwaukee® 18 Volt Variable Speed Cordless Caulking Guns

- Easily Dispenses High Viscosity Auto Urethanes
- Interchangeable Front Ends Work With Standard Cartridges, 29 Fl. Oz. Quart Cartridges, and 20.3 Fl. Oz. Sausage Packs
- Includes 18 Volt Battery and One Hour Charger

**new**



**CAT. NO. 264121CT**  
Standard Cartridge Gun



**CAT. NO. 264221CT**  
20 Fl. Oz. Sausage Pack

**CAT. NO. 48591801**  
One Hour M18 Charger



**CAT. NO. 48111815**  
M18 Compact Battery

**CAT. NO. 271020**  
18V DC Vehicle M18 Charger

This heavy-duty 18 Volt DC Cordless Caulking Gun makes manual caulking obsolete. A powerful pushing force of 950 pounds (431 kg) easily dispenses high viscosity materials such as automotive urethanes. Gun features include: variable speed trigger and remote speed dial control for optimized bead and steady flow rates; auto clutch release for rapid loading of material; anti-drip auto clutch (stops sealant flow when trigger is released); auto shut off at the end of plunger rod travel; 360 degree carriage rotation for easy work around corners and hard to reach areas.

Guns are ordered pre-configured for the type of packaging to be used: standard 10 fl. oz. (300 ml) cartridges, or 20 fl. oz. (600 ml) sausage packs. Additional front ends and plunger rods can be special ordered to convert the Gun to any configuration. All Gun Kits come standard with a 18V DC Battery Pack and One Hour Charger.

CAT. NO.	DESCRIPTION
<b>264121CT</b>	Standard Cartridge Gun, 18V Battery and One Hour Charger
<b>264221CT</b>	20 Fl. Oz. Sausage Gun, 18V Battery and One Hour Charger
<b>48111815</b>	18 Volt DC 1.4 Amp Hour Compact Battery Pack
<b>48591801</b>	One Hour M18 Battery Charger
<b>271020</b>	18V DC Vehicle Charger

Minimum order: 1 each.

## CRL Drill-Mate Portable Drill Powered Caulking Gun

- Costs Less Than Battery Operated Caulking Guns
- Two Year Limited Warranty
- Develops Up to 300 P.S.I. of Pressure

Combine the reliability of a cordless drill with the power of a high ratio caulking gun and you get the CRL Drill-Mate Portable Drill Powered Caulking Gun. With up to 300 pounds (136 kg) per square inch of pressure you can gun just about any material in a cartridge. A quick release clutch keeps the material from continuing to flow once you stop the drill. Made of strong high-impact plastics and backed by a two year warranty, this Gun accepts all standard cartridges. At over 50 percent less cost than a battery powered caulking gun, this is a hands down favorite for mobile operations. Minimum order is one each.



**CAT. NO. PR1000**

Milwaukee is a registered trademark of Milwaukee Electric Tool Corporation.

## CRL Cox® Air Power Sausage Gun

- Dispenses 10 to 20 Fl. Oz. Sausage Packs
- Air Regulator Pressure Adjuster



The CRL Cox® Air Power Sausage Caulking Gun dispenses even heavy materials, such as urethane, at a smooth, controlled rate of flow. It can be used with 10, 15.2 or 20.3 fl. oz. (296, 450 or 600 ml) sausage packs. The high flow trigger valve is responsive, with a built-in regulator to control flow, and an instant release valve with silencer to stop material flow. Can operate at up to 100 psi maximum. Minimum order is one each.

CAT. NO. WG6100620

## CRL Cox® Piston Rod Air Power Caulking Gun

- Dispenses Standard Cartridges and 10 Fl. Oz. Sausage Packs
- Quick Release End Cap



The CRL Cox® Piston Rod Air Power Caulking Gun dispenses even heavy materials, such as urethane, at a smooth, controlled rate of flow. The piston rod thrust prevents material contamination by compressed air, allowing use with standard 10.3 fl. oz. (305 ml) cartridges, or 10 fl. oz. (296 ml) sausage packs. The high-flow trigger valve is responsive, with a built-in regulator to control flow, and an instant release valve to stop material flow. Can operate at up to 100 psi maximum. Minimum order is one each.

CAT. NO. WG61004

## CRL Cox® Air Power Caulking Gun

- Holds Standard Cartridges
- Air Regulator Pressure Adjuster



This is a superb quality, lightweight air powered gun. The 2" x 10" (51 x 254 mm) drawn aluminum barrel holds all standard size cartridges. The Gun dispenses materials smoothly and uniformly with just a trigger squeeze, and connects to standard 1/4" (6 mm) NPT hose fittings. It has an instant release valve to stop material flow, a true air regulator, and can operate at up to 100 psi maximum. The body is made of lightweight drawn aluminum with a quick release end cap for fast change out of cartridges. A quick-disconnect fitting is included and replaceable parts are available for all components. Air action on cartridge plunger. Minimum order is one each.

CAT. NO. WG61001

## CRL Air Power Caulking Gun

- Holds Standard Cartridges
- Adjustable Air Flow 0-40 PSI
- Lightweight, High Density Plastic Body



This CRL Air Power Gun dispenses sealants packaged in standard caulking cartridges, up 10.5 fl. oz. (310 ml). Perfect for high volume users like window manufacturers, or anyone looking for fast dispensing of sealants with a uniform bead. This lightweight Gun weighs only 15 oz. (435 g). Maximum air pressure: 40 psi. Adjustable air flow: 0 - 40 psi. Accommodates an air hose diameter of 3/8" (ID) with an air inlet dimension of 1/4" - 18/19 NPT male nipple. Minimum order is one each. **NOTE:** May not dispense some high viscosity auto windshield urethanes.

CAT. NO. 3021301

## CRL Deluxe Air Drive Caulking Gun

- Twist-Lock Instant Loading Barrel
- Complete With Air Hose



This CRL Deluxe Air Drive Caulking Gun holds all standard size cartridges of sealants, adhesives, mastics or other caulking materials. It weighs less than one pound, so it is easy to handle. The trigger controls material flow, allowing you to dispense a smooth bead 2-3 times faster than a manual gun. It requires 5-70 psi air pressure. The gun comes standard with a 25' (7.6 m) air hose that connects to an optional compressor unit or your own compressed air supply.

CAT. NO.	DESCRIPTION
PG100	Air Caulking Gun
1002BARREL	Replacement Barrel

Minimum order: 1 each.

Cox is a registered trademark of PC Cox Limited Corporation.

## CRL Quart and Standard Size Air Drive Caulking Gun

- Includes Quart and Standard Size Barrels
- Lightweight and Fast Loading



The CRL Quart Size Air Drive Caulking Gun is made for those caulking materials in "jumbo" quart 30 fl. oz. (887 ml) size cartridges. It's fast loading, with a twist lock barrel. The precision air control valve makes applications smooth. It also comes with a 36" (914 mm) hose with standard 1/4" (6 mm) NPT hose fittings, and requires 5-65 psi. The barrel accepts all standard quart cartridges, and comes with a barrel for standard size caulking cartridges. Connects to an optional compressor unit or your own compressed air supply. Minimum order is one each.

CAT. NO. PG150

## CRL Yellow Plastic Cone Nozzles

- **Bead Sizes From 1/8" to 1-5/16" (3 to 33 mm)**
- **Easy to Clean After Use**



CRL Yellow Plastic Cone Nozzles are extra large for bulk and sausage caulking applications where wide beads of material are required. These are the same Cone Nozzles that come with the Cat. No. WG51001 Sausage Gun. The plastic cone-type Nozzle can be cut to deliver a bead from 1/8" to 1-5/16" (3 to 33 mm) in diameter. Fits most sausage and bulk guns with screw-on ring caps. Five Nozzles per pack. Minimum order is one pack. **CAT. NO. WGCN**

## CRL Screw-On Silicone Nozzles

- **Additional Nozzles for Screw-On Type Silicone Cartridges**

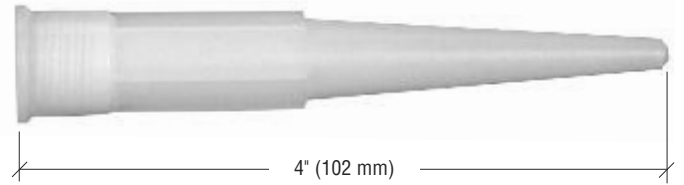

CRL Screw-On Silicone Nozzles are tapered so you can trim the nozzle to exactly the bead size you need. NOTE: These Nozzles will not fit auto glass urethane cartridges because of the different thread size. For auto glass urethane cartridges, use Cat. No. UNOZ. 24 Nozzles per pack. Minimum order is one pack. **CAT. NO. S1LN0Z**

## CRL Problem Solver Nozzles

- **Reaches Areas You Never Thought Possible**
- **Rigid, Flexible or Combo Pack**

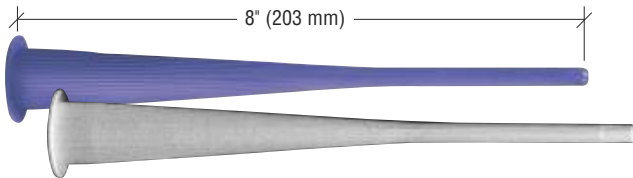

Problem Solver Nozzles fit virtually any caulking cartridge by sliding over the existing nozzle, or screwing onto the threaded nipple. Choose from either Rigid or Flexible Nozzles (four Nozzles per pack), or order the Combo Pack with two flexible and two rigid Nozzles per pack.

CAT. NO.	DESCRIPTION	COLOR
PSN2	Four Rigid Problem Solver Nozzles	Blue
PSN4	Four Flexible Problem Solver Nozzles	White
PSN6	Combo Pack of Four Problem Solver Nozzles	Mixed

Minimum order: 1 pack. Sizes can be combined for quantity pricing.

## CRL Corner Caulker Nozzles

- **Reusable and Easy to Clean**
- **90 Degree Bend**



CRL Corner Caulker Nozzles are durable polyethylene Nozzles with a 90 degree bend that allows application of sealants or caulks to places standard Nozzles can't reach. Firmly grips the Nozzle of both 1/10 gallon (300 ml) and 1 quart (946 ml) size cartridges. Reusable and easy to clean. 10 Nozzles per package. Minimum order is one pack. **CAT. NO. CC103**

## CRL Angle Shot Bent Nozzle

- **45 Degree Bent Spout for Use With Standard Cartridges, Sausage or Bulk Guns**
- **Extra Long 7-1/2" (190 mm) Overall Length**

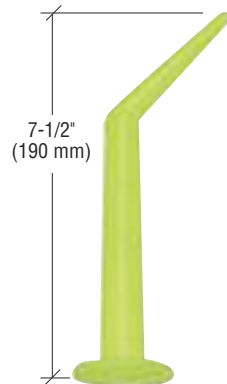

CRL Angle Shot Bent Nozzles fit virtually any caulking cartridge by sliding over the existing nozzle. They hold securely between the cartridge and the end of the caulking gun, and will also adapt for sausage or bulk guns. The 45 degree bend and extra long length make reaching into and around corners both easy and fast. Minimum order is one each. **CAT. NO. AB9351**

3M is a registered trademark of 3M Company Corporation.

## CRL 3M® Auto-Mix™ Mixer Nozzles

- **Replacement Nozzles for 3M® Auto-Mix Adhesive**

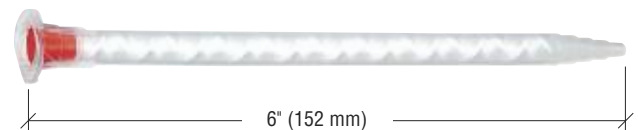

CRL 3M® Auto-Mix™ Mixer Nozzles are the key to 3M® Cat. No. 3M8641 Auto-Mix™ Adhesive. Inside each Nozzle is a series of blades to continually cut and mix the material ensuring that when it reaches the tip it is fully mixed. Each application usually requires a new tip (unless continual flow of material is maintained), so we suggest you stock up on extra Nozzles. Fits Cat. No. 3M8190 3M® Auto-Mix™ Applicator Gun (see page 576K). 12 Nozzles per package. Minimum order is one pack. **CAT. NO. 3M21791**

# CRL CAULKING NOZZLES

For Pricing Visit [crlaurence.com](http://crlaurence.com) or Call Us Toll Free at the Phone Numbers Shown on the Back Cover

## CRL Metal Caulking Gun Nozzles

- Variety of Diameters and Configurations to Fit Bulk Load Caulking Guns

These CRL Metal Nozzles fit most bulk caulking guns, such as KM32RCT, DL45T03, DL45T04, or others having a 3/8"-27 thread in the barrel cap.

CAT. NO.	DESCRIPTION	CAT. NO.	DESCRIPTION
KM1	1/8" (3 mm) Round	KM6	1/2" (13 mm) Triangular
KM2	3/16" (5 mm) Round	KM7	5/8" (16 mm) Oval
KM3	1/4" (6 mm) Round	KM13	3/32" x 7/8" (2.4 x 22 mm) Slot
KM8	3/8" (10 mm) Round	KM15	1/32" x 5/8" (0.8 x 16 mm) Slot
KM5	1/2" (13 mm) Round	KM17	1/8" x 9/16" (3 x 14 mm) Slot

Minimum order: 1 each. All nozzles can be combined for quantity pricing.



CAT. NO. KM1



CAT. NO. KM2



CAT. NO. KM8



CAT. NO. KM3



CAT. NO. KM6



CAT. NO. KM5



CAT. NO. KM7



CAT. NO. KM13



CAT. NO. KM15



CAT. NO. KM17

## CRL Little Red Nozzle Caps

- Economical and Reusable
- Reduces Sealant Waste



These CRL Little Red Nozzle Caps have an award winning design for capping tubes of sealant, caulk, wood glue, paint, or anything else on your shop shelf that needs to be sealed and reused after it has been opened. These economical, reusable Little Red Nozzle Caps cut sealant waste. Placed over the nozzle of partially used sealant cartridges, they seal out air and dirt to preserve the quality of the remainder of the sealant. Little Red Nozzle Caps also make a perfect Romex wire termination, air tool inlet, and felt pen cap. The possibilities are limitless. 35 Caps per package. Minimum order is one pack.

CAT. NO. LRC35

## CRL Reusable Caulk Tips and Cap

- Fit All Standard Cartridges

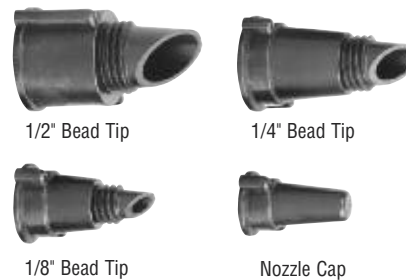

1/2" Bead Tip

1/4" Bead Tip

1/8" Bead Tip

Nozzle Cap



CRL Caulk Tips are reusable therefore they allow all the sealant to be used. 1/8", 1/4", and 1/2" (3, 6, and 12 mm) Tips are precut at a 45 degree angle. The Nozzle Cap can be used with all standard cartridges. Minimum order is one pack.

CAT. NO. CT45

## CRL Empty Plastic Cartridge

- Suitable for Most Cold Applied Sealants



This CRL Plastic Cartridge is made of a high density polyethylene, and is suitable for most cold applied sealants. The 1/10th gallon (310 ml) capacity, 2" (51 mm) diameter, and 8-1/2" (216 mm) length Cartridge fits all standard cartridge caulking guns. The Cartridge includes a tapered, non-removable nozzle and a plunger cap. Minimum order is one each.

CAT. NO. 103FL

## CRL Nozzle Cutter

- Use on All Plastic Cartridges to Cut Nozzle Tip and Threaded Tip



Our CRL Nozzle Cutter is used to cut off the plastic threaded tip of the cartridge and then cut the nozzle tip to the desired opening size at the proper angle. **NOTE:** Keep SAFELY AWAY from children! EXTREME DANGER to fingers if accidentally inserted in the cutter inlet! Minimum order is one each.

CAT. NO. NC594



C.R. LAURENCE COMPANY

[crlaurence.com](http://crlaurence.com) | [usalum.com](http://usalum.com)

ALUMINUM 574K | [crlaurence.ca](http://crlaurence.ca) [crlaurence.com.au](http://crlaurence.com.au) [crlaurence.co.uk](http://crlaurence.co.uk) [crlaurence.de](http://crlaurence.de) [crlaurence.eu](http://crlaurence.eu)

## CRL Adhesive Pump With 16 Fl. Oz. Can

- Used to Dispense a Variety of Liquid Adhesives, Sealers, and Primers



Use CRL Adhesive Pumps to dispense adhesives, sealers, primers or lubricants. The 195AG 16 fl. oz. (473 ml) can features a heavy-duty pump mechanism, 4" (102 mm) spout, and extra heavy-duty cap and spring. Can be easily disassembled for cleaning. Minimum order is one each.

**CAT. NO. 195AG**

## CRL Adhesive Pump Only for 16 Fl. Oz. Can

- Fits Most 6 to 16 Fl. Oz. Cans



The 181AG Adhesive Pump will fit most cans from 6 to 16 fl. oz. (177 or 473 ml). Use Cat. No. CRL 2032 Solvent and Adhesive Cleaner to properly clean guns and pumps. Minimum order is one each.

**CAT. NO. 181AG**

## CRL Handy-Foam® Dispensing Guns

- Dispenses Expanding Handy-Foam®
- Control Valve for Precise Flow

Our P10163 and P10290 Handy-Foam® can be applied using either the CRL Metal or Plastic Dispensing Guns. The trigger applicator has a control valve for precise flow, and a comfortable pistol grip for easy handling. The Handy-Foam® canister fits directly into a receptacle on the top of the gun. Just screw on the can, hold can and gun in both hands, shake vigorously for one minute and you're ready to go.



**CAT. NO. F61010**  
Metal Dispensing Gun



**CAT. NO. F61000**  
Plastic Dispensing Gun

**NOTE:** Cat. No. F61010 Metal Gun can be cleaned with Cat. No. FOM014 FomoClean Solvent. Cat. No. F61000 Plastic Gun cannot be cleaned with solvents.

CAT. NO.	DESCRIPTION
F61010	Metal Dispensing Gun
F61000	Plastic Dispensing Gun

Minimum order: 1 each.

Handi-Foam is a registered trademark of Fomo Products, Inc. Graco is a registered trademark of Graco Minnesota, Inc.

## CRL Graco® 5 Gallon Dispenser

- Air Powered 23:1 Ratio
- Completely Assembled and Ready to Use
- For Low to Medium Viscosity Materials

This economical CRL Graco® 5 Gallon Pumping System pumps silicone, grease, caulk, and sealant directly from 5 gallon (20 l) pails. Designed to pump low-to-medium viscosity one-part materials (30,000 + cps, Flow Rate 0-2.8 GPM). The 23:1 low maintenance carbon steel pump provides trouble-free operation, and is powered by a 3-1/4" (82.5 mm) air motor, including pressure gauge and regulator. It is easy to operate and ready to use. Minimum order is one each.

**NOTE:** Does not include Hose and Gun Assembly. Contact our Customer Service Department for options available for this system. Approximate shipping weight is 225 Lbs. (102 kg). Dispenser may vary slightly from image shown.



**CAT. NO. 50052**

## CRL 3M® Auto-Mix Adhesive Applicator Gun

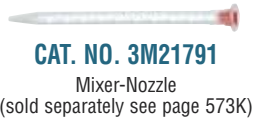

CAT. NO. 3M21791

Mixer-Nozzle  
(sold separately see page 573K)

- For Use With 3M8641 Auto-Mix Adhesive

The CRL 3M® Auto-Mix™ Applicator Gun is used with the Cat. No. 3M21791 Mixer Nozzle to quickly and neatly mix and dispense CRL 3M Auto-Mix Adhesive exactly where you want it. Minimum order is one each.

CAT. NO. 3M8190

## CRL Plastic Applicator Bottle With Needle

- For Precise Dispensing of Adhesives, Solvents or Lubricants
- 1-1/2" (38 mm) Long Stainless Steel Needle

The CRL Applicator Bottle is a 1.25 fl.oz. (37 ml) oval polyethylene squeeze-type applicator bottle with a 1-1/2" (38 mm) stainless steel needle. Ideal for precision cementing, solvent dispensing, and oiling. Minimum order is one each.



CAT. NO. AAB4

## CRL Small Tube Dispenser Handle

- Makes Small Tubes of Sealants or Adhesives Easy to Dispense



The Small Tube Dispenser Handle is the fast and easy way to dispense materials such as silicones and adhesives from squeeze tubes. It lets you apply just the right amount of pressure for the proper bead size, and since you apply just the right amount of material there is less mess and clean up. The open back design lets you draw the tube through the handle, so you can get virtually all of the material from the tube, reducing waste. Holds all flexible plastic or metal tubes up to 2-1/2" (63 mm) wide. Minimum order is one each.

CAT. NO. 710XX006

## CRL Pistol Type Oiler

- Made Especially for Dispensing Oil and Solvents
- High Quality Steel Can Comes With Two Nozzles



This heavy-duty CRL Pistol Type Oiler dispenses oil and solvents through either a 6" (152 mm) rigid metal, or flexible high density polyethylene spout. It has a 6 fl.oz. (177 ml) capacity and supporting base ring. Brass pump mechanism for smooth operation and a gasket on the lift rod to prevent leakage. Baked-on enamel finish on body resists rust. Minimum order is one each.

CAT. NO. KP500

## CRL Barrel Transfer Pump

- Delivers 10 Fl. Oz. (300 ml) Per Stroke
- Fits a Variety of Drums

This CRL Barrel Transfer Pump is an easy to operate suction lift pump that can be used on any 30 to 55 gallon (113 to 208 l) drum to dispense a wide variety of liquids. Delivery is 10 fl.oz. (300 ml) per stroke. Features telescoping suction pipe and pipe seal. Excellent for dispensing bulk oil based sealers or lubricants. **IMPORTANT NOTE:** Not for use with solvents, water-base fluids, weak acids, anti-freeze, or fuel. Minimum order is one each.



3M is a registered trademark of 3M Company Corporation.

CAT. NO. KP45485

## CRL Gun Fill Pump

- For Three and Five Gallon Straight Sided Pails
- Provides the Economy of Bulk in Small Containers

This CRL Gun Fill Pump is designed to transfer bulk sealants, adhesives or lubricants from three or five gallon (11 or 19 l) pails into convenient smaller containers. It is an 18" (457 mm) pump with a 12" (305 mm) follower plate. Minimum order is one each.



CAT. NO. GFD450



## CRL Paddle Mixer

- Zinc Plated Steel Mixer Fits Pails Up to Five Gallons



This CRL Paddle Mixer is zinc plated steel and used with larger containers of material, up to 5 gallons (18.9 l). Its opposing bent blades completely mix putties, mastics, paints, sealants, etc. It requires a drill with a 3/8" (9.5 mm) chuck and low RPM. Overall length is 15-3/8" (391 mm). Paddle head is 4-1/4" (108 mm) wide. Minimum order is one each.

CAT. NO. MX91

## CRL Follower Plates

- For Two Gallon Plastic or Metal Pails



CAT. NO. KM2P



CAT. NO. KM2M

CRL Follower Plates are designed for straight-sided two gallon (7.57 l) plastic or metal pails. Using a Follower Plate permits quick, clean loading of bulk guns, as well as helping to eliminate much of the wasted material normally left in the bottom of pails.

CAT. NO.	FITS
KM2P	Two Gallon Plastic Pail
KM2M	Two Gallon Metal Pail

Minimum order: 1 each.

## CRL Funnels

- Three Models Available



CAT. NO. UV5725



CAT. NO. KP64411



CAT. NO. KP64468

CRL Funnels are available in three types. Choose from plastic, galvanized steel, or nylon rapid-flow design.

CAT. NO.	DESCRIPTION
UV5725	Plastic Funnel - 8 Fl. Oz.
KP64411	Steel Funnel - 1 Quart
KP64468	Nylon Funnel - 1 Quart

Minimum order: 1 each.

## CRL Jiffy Mixer

- For Pails Up to Three Gallons
- Stainless Steel Construction

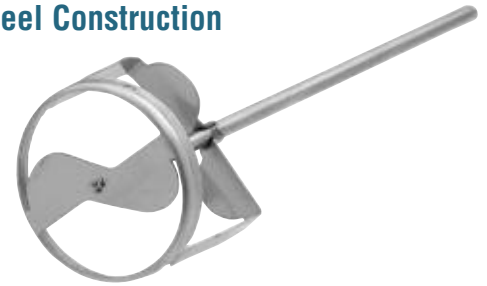

Operate this CRL Jiffy Mixer with any power tool at a recommended 450 to 750 RPM in an open container. Ideal for mixing two-part construction polyurethanes, and other two-component sealants. A true mixer, not a paddle-type stirrer, the two vertical blades confine the main mixing action within the mixer, and the horizontal opposed impellers force materials from the lower and upper areas of the container into the mixer. Thoroughly mixes paints, sealants, and putties to proper consistency, and blends in single and multi-component materials. Overall length is 10-1/4" (260 mm). Mixing head is 2-5/8" (67 mm) diameter. Minimum order is one each.

CAT. NO. MX40

## CRL Dual Hytel Cup

- Replaces Worn Leathers in Bulk Load Guns



The most commonly worn-out component part in bulk caulking guns are the leather cups. CRL Dual Hytel Cups replace the leather cups found in most 2" (51 mm) diameter barrels. Minimum order is one each.

CAT. NO. KM216L

## CRL Lid-Off Tool

- Eliminates Difficult Lock Cutting on Plastic Lids
- Opens Plastic Pails Quickly



This time-saving tool eliminates difficult lock cutting on plastic lids. The plastic CRL Lid-Off Tool provides enough leverage to cleanly lift off the lid without distortion so the pail can be resealed. Even the most tightly sealed lids surrender in no time to this one-piece professional tool. Minimum order is one each.

CAT. NO. LOT1

## CRL Wooden Handle Spatulas

- **Stainless Steel Blade With Rounded Tip for Recommended Tooled Sealant Profile**



CRL Spatulas are used to tool sealant joints, and to scrape out material from pails. They have a flat, flexible, heat treated stainless steel blade with a rounded tip for creating the recommended hourglass shape of sealant joints. Comfortable hardwood handle.

**NOTE:** Not available in Australia.

CAT. NO.	BLADE SIZE
AB2584	4" x 3/4" (102 x 19 mm)
AB2586	6" x 1" (152 x 25 mm)
AB2588	8" x 1-1/4" (203 x 32 mm)

Minimum order: 1 each.

## CRL All Stainless Steel Spatulas

- **Seven Different Sizes**
- **All Stainless Steel**
- **Easy to Clean**



Order the complete set or buy them individually

CRL All Stainless Steel Spatulas are used to tool sealant joints. Their length extends your reach and comes in handy for hard to reach areas. The flat, flexible, tempered spring stainless steel tooling blade is attached to a comfortable curved handle. They are also easy to clean. The complete set includes seven tools held together with a snap ring, or you can order individual Spatulas.

CAT. NO.	OVERALL SIZE
AB9583T	6-7/8" x 3/8" Tapered (175 x 9.5 mm)
AB9583	6-3/4" x 5/8" (171 x 16 mm)
AB9584	7-3/4" x 3/4" (197 x 19 mm)
AB9585	8-3/4" x 13/16" (222 x 20 mm)
AB9586	11" x 1" (279 x 25 mm)
AB9588	12-7/8" x 1-1/4" (327 x 32 mm)
AB95810	15" x 1-1/2" (381 x 38 mm)
AB958G	Complete Set of Seven Spatulas

Minimum order: 1 each. Individual Stainless Steel Spatulas can be combined for quantity pricing.

## CRL Plastic Caulking Applicator Tools

- **Unique Spline Radius Design**
- **Cured Sealant Easily Peels Off Tool**

CRL Plastic Caulking Applicator Tools will not scratch or damage glass, painted surfaces, metal, tile, porcelain, polished stone, etc. Lightweight high-quality copolymer material is strong yet will flex under pressure, and is easy to clean after use. Sold both individually and as a set of eight different styles to handle the most common joints. Overall length of each tool is 8-3/4" (222 mm).

CAT. NO.	BLADE WIDTH AND STYLE	CAT. NO.	BLADE WIDTH AND STYLE
P1000	1-1/4" (32 mm) - 10	P6000	7/8" (22 mm) - 60 P*
P2000	1-1/2" (38 mm) - 20	P7000	7/8" (22 mm) - 70 A*
P3000	1" (25 mm) - 30 A*	P8000	3/4" (19 mm) - 80 P*
P4000	1" (25 mm) - 40 P*	PC1080	Complete Set of Eight Applicators
P5000	3/4" (19 mm) - 50 A*		

Minimum order: 1 each. \*A (Aggressive) - more pointed radius. \*P (Passive) - more rounded radius. Individual Applicator Tools can be combined for quantity pricing.

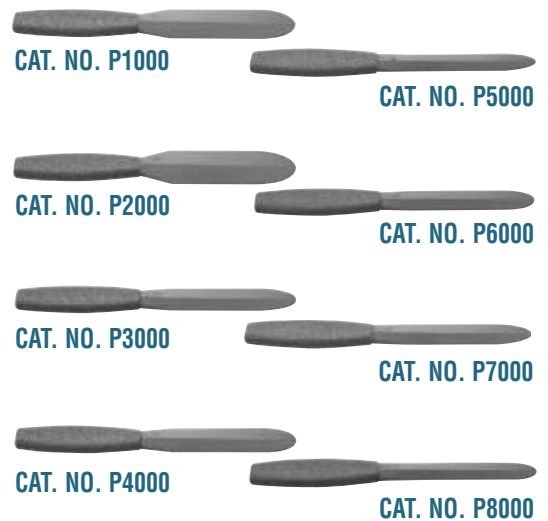

## CRL Sealant Spatula Set

- **Tools Six Different Joint Widths**
- **Easy to Clean After Use**

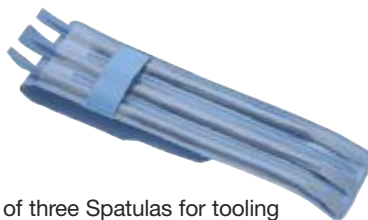

The CRL Sealant Spatula Set is a unique kit of three Spatulas for tooling applied sealants. They are tapered on each end for use in six different joint widths. The lightweight material is strong, will flex under pressure, and is easy to clean up after use. The overall length of each Spatula is 7-1/4" (184 mm), and each set comes in a divided vinyl pouch you can carry in your pocket or toolbox. Minimum order is one set.

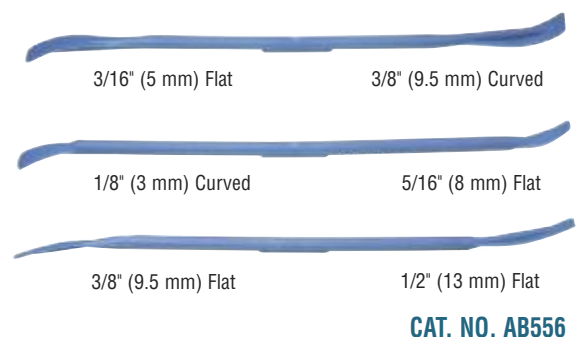

CAT. NO. AB556

## CRL Plastic Stick Tools

- A Very Popular Tool With Virtually Limitless Uses
- Tapered or Chisel End Tools

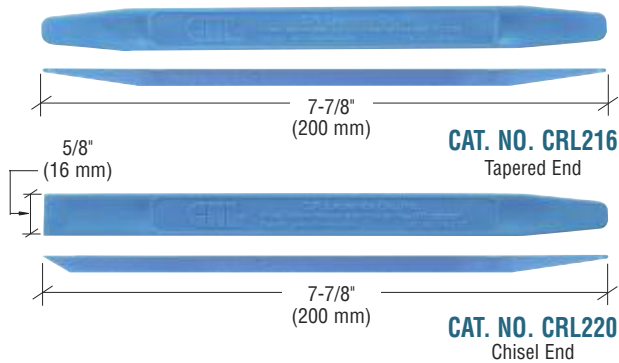

The CRL Plastic Stick Tool is one of our most popular items. Caulkers use them for tooling freshly applied sealants; glaziers find them useful for pushing vinyl into window channels; painters use them as mixing sticks; and auto glass installers use them for setting or removing glass from rubber gaskets. Stick Tools are made of a special high strength, flexible plastic formula that won't scratch adjoining glass or metal and makes them easy to clean.

CAT. NO.	DESCRIPTION
<b>CRL216</b>	Tapered End Stick Tool
<b>CRL220</b>	Chisel End Stick Tool

Minimum order: 1 each. Can be combined for quantity pricing.

## CRL Stick Tool Handle

- Comfortable Grip Handle Can Be Used With Either Tapered End or Chisel End Stick Tool
- Provides More Leverage for Scraping



The CRL Stick Tool Handle is an innovative tool that allows the user to simply slip in a popular CRL Stick Tool for a comfortable grip. This tool is indispensable to glaziers, caulkers, painters, and auto glass installers.

CAT. NO.	DESCRIPTION
<b>CRL216H</b>	Stick Handle Only
<b>CRL216HWS</b>	Stick Handle With Chisel End Stick Tool

Minimum order: 1 each.

## CRL Backer Rod Roller

- Installs Backer Rod in Joints From 1/4" to 1" (6 to 25 mm)
- Controls Proper Depth to Ensure Uniformity

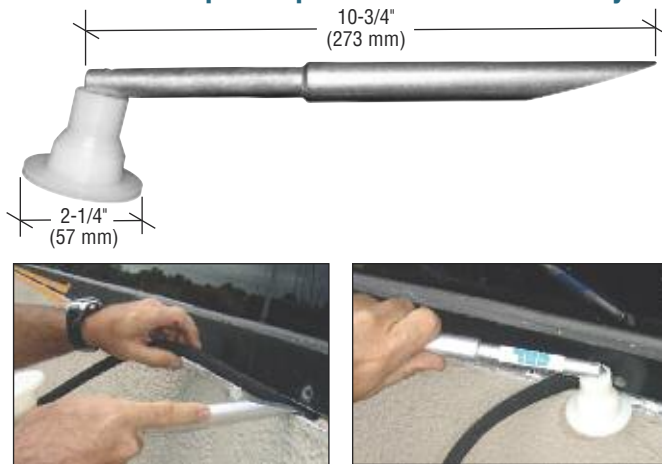

The CRL Backer Rod Roller greatly increases production with the unique roller design that allows fast and easy installation of backer rod with no more changing of wheels and making adjustments to get the proper depth. The pointed backside of the tool is used to insert the first few inches of the rod and to turn corners. Installs backer rod in joints ranging from 1/4" to 1" (6 to 25 mm) wide. Lightweight aluminum handle.

Minimum order is one each.

**CAT. NO. SBRR**

## CRL Sealant Finishing Tools

- Lightweight and Flexible, Simplifies Tooling of Sealants
- Titanium Catalyst Material Won't Stick to Silicone or Other Sealants

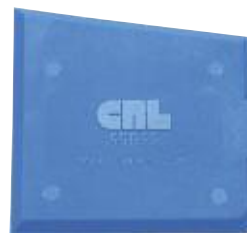

**CAT. NO. 55BSS**  
Available Worldwide



**CAT. NO. G2410**  
Available Only in Australia

These CRL Sealant Finishing Tools are made of a lightweight and flexible titanium catalyst material that will not stick to silicone and other sealants. This makes tooling fresh sealant joints easy, with smoother results and faster clean up. Tools are only 3/16" (5 mm) thick, and measure approximately 3-1/4" x 3-1/2" (83 x 89 mm). Minimum order is one each.

## CRL Urethane Heater Ovens

- Preheats Urethane to Desired Working Temperature in One Hour
- Available in 120V AC or 12V DC Models
- One Hour Heat Cycle
- Two or Six Cartridge Capacity

CRL Urethane Heater Ovens are designed to warm heated urethanes to the ideal application temperature of 185°F (85°C) within one hour. The two-hole or six-hole design allows you to heat a sufficient amount of material for a single or multiple windshield replacements.



Two Cartridge Oven



Six Cartridge Oven

CAT. NO.	DESCRIPTION	CAPACITY
E9007	12V DC Oven	2 Cartridges
E9006	120V AC Oven	2 Cartridges
E9011	120V AC Oven	6 Cartridges

Minimum order: 1 each.

## CRL Compact Heater Box

- Heats Caulking to 104°F (40°C)
- Holds Cartridges or Sausages
- Works On Your Vehicle's 12V DC Power or Optional 110V AC Adapter



This Compact Heater Box plugs into any 12V DC lighter outlet in your truck or car, or with the optional AC adapter (Cat. No. PAC15) plugs into any 110V AC power outlet. Factory set thermostat heats interior to 100° - 104°F (38° - 40°C). Use to keep caulking cartridges or sausages warm before gunning in cold temperatures. Warm sealants gun easier and cure faster than cold sealants. Lightweight and portable, this chest has a high impact polypropylene case and lid with smooth corners and edges, and is super insulated to stabilize interior temperatures with minimal (approximately 2.5 AMP) power drain.

External dimensions: 8-1/2" W x 16" H x 17-1/2" L (216 x 406 x 445 mm). Capacity: Holds 23 standard cartridges, or 18 sausages (20 Fl. Oz. [600 ml]). Includes one 10 foot (3 m) power cord.

## CRL Portable Heater Box

- Heats Caulking to 135°F (57°C)
- Holds Cartridges, Sausages or Pail
- Works On Your Vehicle's 12V DC Power or Optional 110V AC Adapter



This large capacity Portable Heater Box plugs into any 12V DC lighter outlet in your truck or car, or with the optional AC adapter (Cat. No. PAC15) plugs into any 110V AC power outlet. Factory set thermostat heats interior to approximately 135°F (57°C). Use to keep caulking cartridges, sausages or a two-gallon pail warm before gunning in cold temperatures. Warm sealants gun easier and cure faster than cold sealants. Lightweight and portable, this chest has a high impact polypropylene case and lid with smooth corners and edges and is super insulated to stabilize interior temperatures with minimal (approximately 2.5 AMP) power drain.

External dimensions: 16" D x 16" H x 21" L (406 x 406 x 533 mm). Capacity: Holds 34 standard cartridges, 42 sausages (20 Fl. Oz. [600ml]), or one pail (2 gal. [7.5l]). Includes one 10 foot (3 m) power cord.

CAT. NO.	DESCRIPTION
P20S	Compact Heater Box
PAC15	110V AC to 12V DC Converter

Minimum order: 1 each.



CAT. NO. PAC15

CAT. NO.	DESCRIPTION
P75	Portable Heater Box
PAC15	110V AC to 12V DC Converter

Minimum order: 1 each.

## CRL E.Z.D. Glazer De-Glazing Tool

- Aids in the De-Glazing of Glass Installed With Silicone, Foam Tapes, Butyl Tapes, and Other Flexible Materials
- Blade Lays Flat on the Glass and Slides Into the Glazing Pocket
- Extremely Simple to Use

The CRL E.Z.D. Glazer De-Glazing Tool is a real time-saver. This simple-to-use tool is designed to aid in the de-glazing of glass bedded into materials commonly used in the window industry, including silicone, foam or butyl tapes, and other materials engineered to remain flexible throughout their service life (not recommended for use with glazing putty or other materials that harden over time). The EZ1010 goes to work when you lay the cutting blade flat on the glass surface and slide it into the glazing pocket. The glazing material is separated from the glass as you roll the tool along the entire length of the pocket. For tight fits you can facilitate the cutting process by adding soapy water or a light lubricant (Cat. No. SLK4GL) to the blade. A built-in hand guard lets you work right next to the glass for good leverage and a deep cut when needed. The E.Z.D. Glazer is simple, effective and priced right.



CAT. NO.	DESCRIPTION
EZ1010	E.Z.D. Glazer De-Glazing Tool
EZ1022	Replacement Blade-Threaded
EZ10G	Replacement Hand Guard

Minimum order: 1 each.

## CRL Window De-Glazing Tool

- Provides Extra Leverage to Remove Glass Safely and Easily
- Extremely Durable All-Aluminum Construction



The CRL WT2000 Window Deglazing Tool is designed for the safe and easy removal of glass lites from their frames. This tool offers you advantages over manual methods because the large handle allows a positive two-hand grip for extra leverage, and the heat treated blade cuts through the toughest of sealants. The WT2000 has a three-position handle for easy access to windows at almost any angle or height.

All parts of the WT2000 are replaceable, including the heavy-duty aluminum handle. The blades are sharpened to a razor's edge, and heat treated for strength and longevity. The WT2000 comes complete with handle and one each left hand Cat. No. WT2002 and one each right hand Cat. No. WT2001 Blades.



CAT. NO. WT2000



CAT. NO. WT2001



CAT. NO. WT2002

CAT. NO.	DESCRIPTION
WT2000	Window De-Glazing Tool
WT2001	Right Replacement Blade
WT2002	Left Replacement Blade
WT2003	Handle Only for WT2000

Minimum order: 1 each.

# CRL SEALANT REMOVAL TOOLS

For Pricing Visit [crlaurence.com](http://crlaurence.com) or Call Us Toll Free at the Phone Numbers Shown on the Back Cover

## CRL Multi-Function Tool

- Multiple Use Tool With Variable Speed Oscillating Head
- Perfect for Hack-Outs, Glass Sanding, Edging, Sealant Cut-Outs, and More
- Double Insulated and UL Approved

The CRL MFT1 Multi-Function Tool is perfect for sealant removal and hack-out projects. Cuts insulating glass units apart with ease and even removes hardened glazing putty. The variable speed head oscillates at 11,000 to 22,000 oscillations per minute. Blades can be locked down at any angle to help with access to tight locations and to promote comfort during use. Switch to the hook-loop sanding backer pad and the MFT1 becomes a very effective glass edge seaming tool. The Kit comes complete with the double insulated Multi-Function Tool, a plastic storage case, five assorted blades, a triangle backer pad, and a blade wrench.

**NOTE:** Grinding Triangles are sold separately.

CAT. NO.	DESCRIPTION
<b>MFT1</b>	110V Multi Function Tool
<b>MFT1AU</b>	240V Multi Function Tool w/AU Plug
<b>MFT1EU</b>	220V Multi Function Tool w/EU Plug
<b>MFTFSB</b>	Flexible Scraper Blade
<b>MFTHCB</b>	1" (25 mm) Hi-Carbon Steel Saw Blade
<b>MFTHSB</b>	3-1/8" (79 mm) Segmented Saw Blade
<b>MFTRCB</b>	Carbide Coated Recess Saw Blade
<b>MFTSDB</b>	Straight Saw Blade
<b>MFTTSD</b>	Triangle Backer Pad
<b>MFT180X</b>	80X Glass Grinding Triangles 50/BX
<b>MFT1120X</b>	120X Glass Grinding Triangles 50/BX
<b>MFT1220X</b>	220X Glass Grinding Triangles 50/BX

Minimum order: 1 each for tool and accessories; 50 each for grinding triangles.



**new**



Grinding Triangles



**MFTFSB**  
Flexible Scraper  
Blade



**MFTHCB**  
1" (25 mm)  
Hi-Carbon Steel  
Saw Blade



**MFTHSB**  
3-1/8" (79 mm)  
Segmented Saw  
Blade



**MFTRCB**  
Carbide Coated  
Recess Saw Blade



**MFTSDB**  
Straight Saw  
Blade

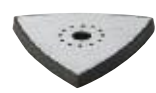

**MFTTSD**  
Triangle Backer  
Pad

## CRL Wildcat Sealant Cutter and Putty Remover



- Uses 6.3 cfm, 75-90 psi Air Supply
- Oscillates Up to 20,000 Times Per Minute

The CRL Wildcat Pneumatic Caulking-Sealant Cutter and Putty Remover quickly cuts out old sealant from expansion joints and chips away hardened putty from metal sash. The variable speed trigger allows the cutting blades to oscillate up to 20,000 times per minute for virtually effortless cutting and putty removal.

The Kit includes: the Wildcat Pneumatic Tool; two each Caulk Cutting, Sealant Cutting, and Putty Removal Blades; Sharpening Stone, Blade Wrench, and a molded Carrying Case with Tote Tray. The Wildcat Tool may also be used with our variety of automotive blades for cutting out windshields, sidelites, and backlites.

Minimum order is one each.

CAT. NO. AK40

## CRL Stop Mold Puller



- Simple and Easy



- Reduces Your Chance of Breaking Glass While Pulling Stop Molds

The CRL Stop Mold Puller is used to remove stop molds or snap-on sash. It works on both door and tube stops, and makes removing window units easy. The rubber-lined pad will not damage metal extrusions. A reliable and inexpensive tool every glazier should own. Minimum order is one each.

CAT. NO. SMP200



C.R. LAURENCE COMPANY

[crlaurence.com](http://crlaurence.com) | [usalum.com](http://usalum.com)

582K | [crlaurence.ca](http://crlaurence.ca) [crlaurence.com.au](http://crlaurence.com.au) [crlaurence.co.uk](http://crlaurence.co.uk) [crlaurence.de](http://crlaurence.de) [crlaurence.eu](http://crlaurence.eu)

## CRL FEIN® SuperCut Sealant Cutter Knife Kit



- Removes Old, Hardened Putty Quickly and Easily
- Variable Speed Blade Oscillates 11,000 to 18,500 Times Per Minute
- Lightweight and Easy to Maneuver
- Powerful 120V AC 3.3 AMP Motor



CAT. NO. FK20618  
FEIN® SuperCut Sealant Cutter Knife Kit

The CRL FEIN® Cutter uses its oscillating blade to cut cured sealant and caulking quickly with a minimum of effort. This reliable electric tool is double-insulated for operator safety. The oscillation on this tool is simply a short back and forth stroke of the cutting blade, one degree to each side, at a frequency of up to 18,500 strokes per minute. Another important advantage is that the optional diamond-tipped blades can be used to cut through marble and mortar joints, while keeping dust formation to a minimum. The CRL FEIN® Sealant Cutter features an electronic speed control to keep cutting speed constant, even under load, so you can select the best cutting speed for every application. The gears are designed for continuous operation, and run in an oil bath. Thanks to a twelve-sided mount, cutting blades can be adjusted to any position. This kit includes a CRL FEIN® Cutter Tool, a set of blades for removing flexible sealants: five Cat. No. FKB17015 and one Cat. No. FKB16011, and a Blade Removal Tool, all packed in a metal Carrying Case. Minimum order is one each.

## Optional Blades for FEIN® SuperCut Knife



### Offset "T" Blade

Segment saw blade (offset), for removing insulating glass installed on a putty bed. Minimum order is one each.



CAT. NO. 2000166

### Diamond Blade

Diamond coated blade for cutting out marble and mortar joints, and making cuts in plaster walls. 3-1/8" (70 mm) diameter. Minimum order is one each.



CAT. NO. FKB10401

### Mushroom Blade

Mushroom shaped blade for separating panes of insulating glass. Also for cutting silicone, soft putty, and elastic joint sealants. Minimum order is one each.



CAT. NO. FKB128

### Caulking Blade

Flat blade for removing material while working on flush surfaces. Five each included in FK20618 Kit. Minimum order is one each.



CAT. NO. FKB17015

### Sealant Blade

Straight, elongated blade for removing flexible sealing compounds in extremely deep joints. One each included in FK20618 Kit. Minimum order is one each.



CAT. NO. FKB16011

## CRL Makita® Power Scraper Hackout Gun



- Excellent for Hackouts of Hardened Putty and Sealants
- Powerful Variable Speed 5 AMP Motor Produces 0 to 3,200 Air-Cushioned Blows Per Minute
- Complete With Three Chisel Tips

The Makita® Power Scraper Hackout Gun has a powerful 5 AMP motor that will tackle even the toughest putty or sealant removal job. Also ideal for cleaning out old mortar, removing tile, concrete scale, and weld splatter. Double insulated motor delivers from 0 to 3,200 blows per minute for light scraping, chiseling, and chipping. Excellent for hackouts of hardened putty and sealants.

FEIN is a registered trademark of C. & E. FEIN GmbH, LLC.  
Makita is a registered trademark of Makita Corporation.



CAT. NO.	DESCRIPTION
HK1810	Makita® Power Scraper Hackout Gun
7982645	Replacement 2" (51 mm) Scaling Chisel*
7982653	Replacement 1-3/16" (30 mm) Scaling Chisel*
7982661	Replacement Bull Point Chisel*

Minimum order: 1 each. \*Included in kit.

# CRL SEALANT REMOVAL TOOLS

For Pricing Visit [crlaurence.com](http://crlaurence.com) or Call Us Toll Free at the Phone Numbers Shown on the Back Cover

## CRL Pipe Handle Cut-Out Knife



18" Xtra Long Knife

13" Standard Knife



Old Style Blade Plate

New Style Blade Plate

- Our Most Popular Knives
- Available in Two Lengths

The round, cast aluminum handle of our most popular Long Knife is easy to grip, and utility knife blades change out in just seconds. Tool length can be extended by adding a length of standard conduit pipe. Extra blades can be stored in the handle. Uses either 1992C or 1991C Utility Knife Blades, or 1993X10 Extra Long Utility Knife Blades. The blade plate and screw are also replaceable.

CAT. NO.	DESCRIPTION
PK19	Standard 13" (330 mm) Pipe Handle Knife
PK19XL	Xtra Long 18" (457 mm) Pipe Handle Knife
PK19PS	Old Style Blade Plate Replacement
PK19NS	New Style Blade Plate Replacement

Minimum order: 1 each.

## CRL Sur-Grip 18" Long Knife



- Foam Grip for Comfort
- Painted Steel Shaft

The CRL Sur-Grip 18" Long Knife offers you comfort with control. The 18" (457 mm) length is perfect for reaching those overhead areas for easy cut-outs. The soft, urethane foam grip provides a positive grasp of the tool, which relates to better control for safer cutting action. It features quality construction throughout, with a powder-coated, baked-on black crinkle painted steel shaft attached to painted steel tubing. Uses either 1992C or 1991C Utility Knife Blades or 1993X10 Extra Long Utility Knife Blades. Minimum order is one each.

CAT. NO. HT531

## CRL 24" Long Knife



- Rigid Flat Stock Aluminum With Molded Grip

The CRL 24" (610 mm) Long Knife features rigid 1" (25 mm) flat stock aluminum construction, and is finished with a powder-coated, baked-on black crinkle paint that provides a better gripping surface than unfinished aluminum. Uses either 1992C or 1991C Utility Knife Blades, or 1993X10 Extra Long Utility Knife Blades. Minimum order is one each.

CAT. NO. HT532

## CRL Utility Knife Blades • For Use in Virtually All Utility and Long Knives



Extra Long

Exposed cutting edge of 2-1/4" (57 mm), more than double regular utility knife blades

.025" (.64 MM) EXTRA LONG BLADE

CAT. NO.	DESCRIPTION
1993X10	10 Blade Pack

Minimum order: 1 pack.



Extra Long Serrated

Ideal for tough cutting applications, like automotive urethanes

.025" (.64 MM) EXTRA LONG SERRATED BLADE

CAT. NO.	DESCRIPTION
SB418	10 Blade Pack

Minimum order: 1 pack.



Standard Blade



100 Standard Blade Dispenser (20 5-Packs)

.018" (.46 MM) STANDARD BLADE

CAT. NO.	DESCRIPTION
1991C	100 Blade Dispenser

Minimum order: 1 box.



Heavy-Duty Blade



10 Blade Dispenser



100 Blade Slide-Out Dispenser

- Our Best Seller

.025" (.64 MM) HEAVY-DUTY BLADE

CAT. NO.	DESCRIPTION
1992C	100 Blade Dispenser
1992X10	10 Blade Dispenser

Minimum order: 1 box 1992C; 1 pack 1992X10.



C.R. LAURENCE COMPANY

584K

[crlaurence.ca](http://crlaurence.ca) [crlaurence.com.au](http://crlaurence.com.au) [crlaurence.co.uk](http://crlaurence.co.uk) [crlaurence.de](http://crlaurence.de) [crlaurence.eu](http://crlaurence.eu)

[crlaurence.com](http://crlaurence.com) | [usalum.com](http://usalum.com)



## CRL Basic Insulating Glass Manual

- Everything You Need to Know About Building Your Own Insulating Glass Units
- Explains What is Best for Your Application
- Easy to Follow Step-by-Step Instructions for First Time Fabricators

This CRL Basic Insulating Glass Manual is specifically designed to help glass professionals become more familiar with the materials necessary for Insulating Glass fabrication. It takes you step-by-step through all methods of Insulating Glass production: single seal, dual seal, silicone, butyl, and polysulfide. The GM15 shows you different glazing techniques, including glazing adapters for retrofit work. The Manual also describes testing procedures you can use in your shop, and there is a section on Insulating Glass terms and definitions.

Since rising energy costs have created a huge market for Insulating Glass, you can use the Manual to expand your knowledge, and help your customers get a better grasp of which of the many fine CRL Insulating Glass products would be best for their needs.

For any questions regarding Insulating Glass equipment, supplies, or even for a quote on setting up a whole new IG line, please contact CRL Door and Window Department at (800) 421-6144 in the U.S., (877) 421-6144 from Canada, or (323) 588-1281 International. Ask for Ext. 7520. You can send e-mail from the [crlaurence.com](http://crlaurence.com) home page. Click on Contact Us, then click on Technical Sales.



Minimum order is one each.

CAT. NO. GM15



- Easy to Read and Understand Format
- Includes Photographs, Diagrams, Terms and Definitions, Techniques, Procedures, and Products to Help Fabricate Top Quality Insulating Glass Units
- Lists and Explains Required Materials, Production Methods, Glazing Guidelines, and Ordering Information

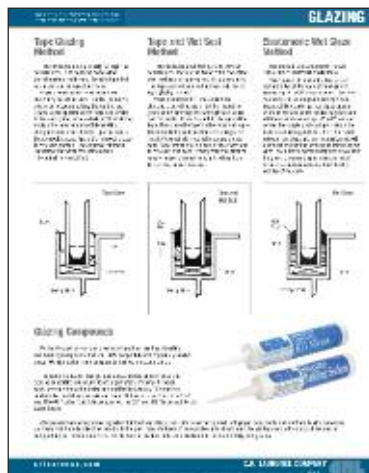
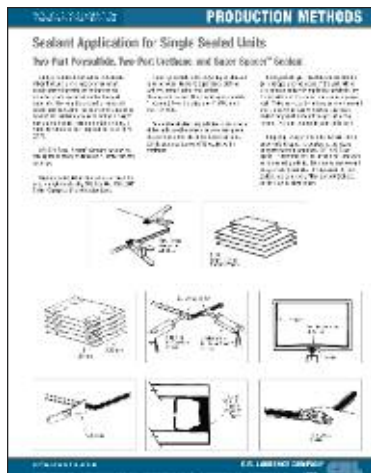

## Fabricating Quality Insulating Glass Units is Simple...If You Know How

The fabrication of quality Insulating Glass units is not a mysterious process that only a few fabricators can achieve. Over the years CRL has introduced hundreds of our accounts to the profitable business of installing new and retrofit Insulating Glass units.

Once you discover the simplicity of fabricating Insulating Glass units you will agree that this is a part of the energy conservation business that you can be part of with little prior experience and only a moderate investment in supplies and tools.

And CRL can help you at every step, from planning your workstations, stocking your supplies, and making sales presentations to prospective customers. We have a complete program to make Insulating Glass part of your successful business.

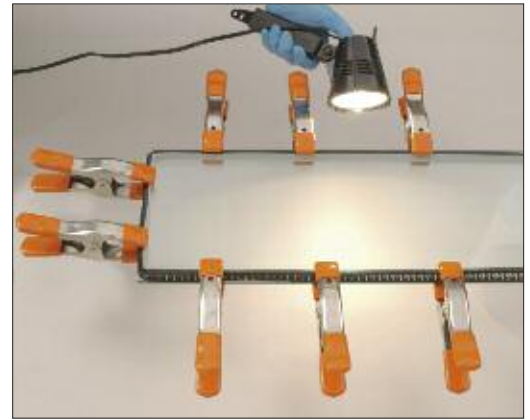

## Increased Energy Awareness Opens New Opportunities

The knowledgeable homeowner is now more aware than ever of the rising costs of heating and cooling their home. And they know that it's not likely to ever get any easier. What they probably don't know is that you can install energy-efficient Insulating Glass units in their home at a cost that will over time be recovered in energy savings.

Get the word out in your community that there's no need for your neighbors to go to a big national firm for Insulating Glass units when your local glass business can provide it at competitive costs. CRL can help you with promotional ad flyers with a space for your imprint. Talk to your CRL Sales Professional about this great way to reach prospective local customers.



## CRL's Insulating Glass Design and Fabrication Assistance

### • Insulating Glass Components and Sealants

The fabrication of quality Insulating Glass units is dependant upon the right materials, and CRL offers only the components and sealants that meet our strict standards. Be assured that the Insulating Glass materials we stock in our network of distribution facilities have been thoroughly tested, and will stand up to even the harshest of environmental conditions. Your reputation, and ours, depends on providing your customers with only the best Insulating Glass units, and that starts with the best materials.



### • Insulating Glass Production Line Design

To profitably fabricate Insulating Glass units in quantity you need the right tools and equipment. If you are planning to fabricate them in production-level quantities working with the right tools and shop equipment will make the difference between a profitable unit and one that costs more than you anticipated.

Contact Technical Sales to discuss your plans and we will work with you to design a new production line or upgrade your existing one. Call (800) 421-6144 in the U.S., (877) 421-6144 from Canada, or (323) 588-1281 International. Ask for the Door and Window Department at Ext. 7520.



### • Insulating Glass Consultation Service

The best part of gearing up to fabricate Insulating Glass units is that you don't have to go it alone. CRL has decades of experience in the field of Insulating Glass, and trained Technical Sales personnel to provide assistance in selecting the fabrication methods, supplies, and equipment that will best suit your needs and fit your budget.

Contact them at (800) 421-6144 in the U.S., (877) 421-6144 from Canada, or (323) 588-1281 International. Ask for the Door and Window Department at Ext. 7520. You can also send e-mail from the home page of [crlaurence.com](http://crlaurence.com). Click on Contact Us, and then click on Technical Sales.



## Selling the Benefits of Insulating Glass to Your Customers

### • Making a Persuasive Presentation

You know your Insulating Glass units are good, but how do you convince your customers? One way is to use precision test meters that show the quality of the units you can provide them, and the proven benefits of installing energy efficient Insulating Glass units. CRL has high tech yet easy to use and understand sales aids that you can use for showroom or in home demonstrations. See pages 618K to 624K.



## Selecting the Fabrication Method That's Right for You

### • Fabricating Within Your Capabilities

Now that you've made the decision to fabricate Insulating Glass units you must decide what type of units would be within your capabilities. Whether you start out using traditional single-seal or double-seal aluminum spacers or an alternative spacer system, such as Super Spacer or Duraseal, we offer the best selection, along with all of the accessories needed to build quality, ready-to-install units. There are even Starter Kits that feature a complete assortment of products you will need to build your first units. See pages 588K to 598K.



## Fabrication and Installation Supplies and Equipment

### • Investing to Assure Profitability

Just because you can make quality Insulating Glass units doesn't mean you're assured a profitable outcome. Assuring profitability often means investing in tools and equipment that will speed up the process, or make it less labor-intensive. We offer a full range of these items, from simple hand tools to large fabrication and inspection tables. All have been CRL tested for reliability and efficiency. See pages 602K to 603K, 626K. For additional information on our Insulating Glass Machinery visit [crlaurence.com](http://crlaurence.com).



## Fabricating Insulating Glass Units for Long Term Performance and Reliability

### • Assuring Your Units Will Perform for Years

Following precise directions and using good materials is the best way to assure that the Insulating Glass units you fabricate will be of lasting value to your customers. Our assortment of spacers, desiccants, sealants, glazing compounds, and cleaners can take you from start to finish, and make it easy for you to include the sale and installation of Insulating Glass a valued portion of your successful business. See pages 588K to 601K, 604K to 612K.



## We Make it Easy to Get Started With Our Insulating Glass Starter Kits

- Save Money and Time by Building Your Own Insulating Glass Units
- Eight Kits to Choose From - Basic to Deluxe
- Kits Available for Single Seal and Dual Seal Metal Spacers, Super Spacer®, and Duralite®
- Produce Units When Your Customers Need Them
- No Long Waits for Custom or Odd Shape Windows
- A Variety of Sealing Systems - Hot Melt Butyl, One-Part and Two-Part Polyurethanes, Two-Part Polysulfide, Silicone Sealant, and Duralite®

### CRL Deluxe Insulating Glass Hot Melt Starter Kit

- An Easy Way to Start Producing Quality Insulating Glass Units
- Kit Comes With Everything Needed for Production of Insulating Glass Units (Except the Glass)
- The SS96 is Our Most Popular Sealant Extruder



CAT. NO. D1GK7

#### KIT NO. D1GK7 INCLUDES:

CAT. NO.	DESCRIPTION	QUANTITY
SS96	Hot Melt Butyl Extruder Machine 110V AC	1 Each
CRL30703	Hot Melt Butyl Cakes	96 lbs (43.5 kg)
MSD50B	55 Pound (25 kg) Box Molecular Sieve	1 Box
3935	1/4" (6.3 mm) Single Seal Aluminum Spacer	50 each 12'8" Lengths
3937	3/8" (9.5 mm) Single Seal Aluminum Spacer	25 each 12'8" Lengths
3939	1/2" (12.7 mm) Single Seal Aluminum Spacer	50 each 12'8" Lengths
6265	1/4" (6.3 mm) Single Seal Spacer Corners	200 Each
6267	3/8" (9.5 mm) Single Seal Spacer Corners	100 Each
6269	1/2" (12.7 mm) Single Seal Spacer Corners	200 Each
1550	Lint Free Wipes	1 Case (900 Wipes)
695	Concentrated Glass Cleaner	1 Gallon (3.785 l)
DB21	Plastic Spray Bottles	2 Each
1BK990	Hot Melt Butyl Trim Knife 110V AC	1 Each
BN4	1/4" (6.3 mm) Brass Nozzle	1 Each
BN6	3/8" (9.5 mm) Brass Nozzle	1 Each
BN8	1/2" (12.7 mm) Brass Nozzle	1 Each
NG171	Lint Free Gloves (Large)	1 Dozen Pairs
321W	White Siliconized Acrylic Latex Glazing Sealant	10 Cartridges
321GRY	Gray Siliconized Acrylic Latex Glazing Sealant	10 Cartridges
JC3202HT	Plastic Tipped Handy Clamps	12 Each
GM15	Basic Insulating Glass Manual	1 Each

Minimum order: 1 each. Must ship common carrier only.

This CRL Deluxe Insulating Glass Hot Melt Starter Kit comes with everything needed (except the glass) to produce quality Insulating Glass units. This Kit is ideal for anything from limited production to job site fabrication. Using our Hot Melt Butyl Dispensing Machine with standard Aluminum Spacers and Corners, quality Insulating Glass units can be produced within minutes of warming up the machine.

Aluminum Spacers (see pages 600K and 606K) come in widths from 3/16" (4.8 mm) to 3/4" (19 mm), giving you the flexibility to fabricate Insulating Glass units in a variety of widths. This Kit comes with Spacers in the three popular widths, but others can be used.

The SS96 Hot Melt Butyl Extruder Machine is our best-selling hot melt gunning system. It dispenses our CRL30703 Hot Melt Butyl Cakes (see page 604K) to create a reliable edge seal. Brass Tip Nozzles apply the sealant evenly to assure uniformity and reduce waste. **NOTE:** For a 240V Australia only Hot Melt Butyl Extruder Machine order Cat. No. AU96.

For more information, contact our Door and Window Department, or go online at [crlaurence.com](http://crlaurence.com).

Super Spacer and Duralite are registered trademarks of Quanex Building Products Corporation.

## CRL Silicone Foam and Metal Spacer Insulating Glass Sealant Starter Kit With Super Spacer®

- Includes Everything Needed to Fabricate High Quality Insulating Glass Units
- Comes Complete With Over 300 Feet (91 m) of Super Spacer®
- Easily Adapts to All Shapes and Sizes of Glass



CAT. NO. S1GK877

KIT NO. S1GK877 INCLUDES:

CAT. NO.	DESCRIPTION	QUANTITY
877	Silicone Foam and Metal Spacer I.G. Sealant	12 Cartridges
SS1466	1/4" (6.3 mm) Super Spacer® 66' (20 m) roll	2 Rolls
SS3866	3/8" (9.5 mm) Super Spacer® 66' (20 m) roll	1 Roll
SS1266	1/2" (12.7 mm) Super Spacer® 66' (20 m) roll	2 Rolls
SSHN	Super Spacer® Hand Notcher	1 Each
1550	Lint Free Wipes	1 Case (900 Wipes)
695	Concentrated Glass Cleaner	1 Gallon (3.785 l)
DB21	Plastic Spray Bottles	2 Each
SGT14	1/4" (6.3 mm) Sealant Guide	1 Each
SGT38	3/8" (9.5 mm) Sealant Guide	1 Each
SGT12	1/2" (12.7 mm) Sealant Guide	1 Each
GM15	Basic Insulating Glass Manual	1 Each

Minimum order: 1 each.

### • Our Most Popular Starter Kit

This CRL Silicone Foam and Metal Spacer Insulating Glass Sealant Starter Kit with Super Spacer® contains everything needed to produce condensation-free perimeter edges which substantially reduces overall window heat loss. Super Spacer® allows you to build Insulating Glass units in shapes not permitted by metal spacers. The silicone foam contains a high quantity (40% by weight) of 3A molecular sieve desiccant, and the permeability of the foam allows for fast moisture pick up. Our 877 Sealant forms an airtight seal and is compatible with units fabricated with Super Spacer®.

## CRL Single Seal, Two-Part Polysulfide Insulating Glass Starter Kit



CAT. NO. S1GK550

This CRL Single Seal, Two-Part Polysulfide Insulating Glass Starter Kit is one of the most economical ways to start fabricating Insulating Glass units. Simply insert corners into the spacer, fill spacers with molecular sieve, add your glass, clamp together, apply the CRL Two-Part Polysulfide, let cure overnight and you're ready for installation. With this system any demand can be responded to immediately; simply measure, fabricate, allow the sealant to cure, and install the next day.

Super Spacer is a registered trademark of Quanex Building Products Corporation.

- Apply Two-Part Polysulfide With Brush, Gun, or Trowel
- Hardens as it Cures
- Easy to Assemble and Use



KIT NO. S1GK550 INCLUDES:

CAT. NO.	DESCRIPTION	QUANTITY
N400G15	Two-Part Polysulfide Sealant (1.5 Gallon Pail)	4 Pails
MSD5	5 Pound (2.2 kg) Can Molecular Sieve	2 Cans
3935	1/4" (6.3 mm) Single Seal Aluminum Spacer	50 Each 12'8" Lengths
3937	3/8" (9.5 mm) Single Seal Aluminum Spacer	25 Each 12'8" Lengths
3939	1/2" (12.7 mm) Single Seal Aluminum Spacer	50 Each 12'8" Lengths
6265	1/4" (6.3 mm) Single Seal Spacer Corners	200 Each
6267	3/8" (9.5 mm) Single Seal Spacer Corners	100 Each
6269	1/2" (12.7 mm) Single Seal Spacer Corners	200 Each
1550	Lint Free Wipes	1 Case (900 Wipes)
695	Concentrated Glass Cleaner	1 Gallon (3.785 l)
DB21	Plastic Spray Bottles	2 Each
NG171	Lint Free Gloves (Large)	1 Dozen Pairs
321W	White Siliconized Acrylic Latex Glazing Sealant	10 Cartridges
321GRY	Gray Siliconized Acrylic Latex Glazing Sealant	10 Cartridges
JC3202HT	Plastic Tipped Handy Clamps	12 Each
GM15	Basic Insulating Glass Manual	1 Each

Minimum order: 1 each. Must ship common carrier only.

## CRL Deluxe Super Spacer® Insulating Glass Starter Kit

- A Great Way to Get Started With "Warm Edge" Technology
- Easily Adapts to All Shapes and Sizes of Glass
- Great for Art Glass Panels

This state-of-the-art kit comes with everything you need (except the glass) to build Insulating Glass units, whether they are square, rectangular, or even circular, all without the use of a spacer bending machine.

Super Spacer® is one of the best materials to use in manufacturing Insulating Glass units because of its superior insulating foam. This foam essentially eliminates perimeter edge condensation and substantially reduces overall window heat loss. This flexible spacer also accommodates glass bowing and thermal movement. Excellent sound insulation properties add to the list of Super Spacer's attributes. Finally, there is no adsorbent to add because there is a high quantity of 3A molecular sieve already inside of Super Spacer's quality silicone foam.

The Kit also comes with a CRL SS96 Hot Melt Butyl Dispensing Machine, which is the fastest way to produce Insulating Glass units. We include 96 pounds of CRL30703 Butyl, which is the only butyl recommended for use in this machine. The SS96 features an all-mechanical system which doesn't use any air, so there is less down time and more production. The 8' (2.4 m) dispensing hose heats from 350-450°F (177-232°C), delivering the butyl at optimum temperature.

**NOTE:** For a 240V Australia only Hot Melt Butyl Extruder Machine order Cat. No. AU96.



### KIT NO. D1GK88 INCLUDES:

CAT. NO. D1GK88

CAT. NO.	DESCRIPTION	QUANTITY
SS96	Hot Melt Butyl Extruder Machine 110V AC	1 Each
CRL30703	Hot Melt Butyl Cakes	96 lbs. (43.5 kg)
SS1466	1/4" (6.3 mm) Super Spacer® 66' (20 m) roll	8 Rolls
SS3866	3/8" (9.5 mm) Super Spacer® 66' (20 m) roll	4 Rolls
SS1266	1/2" (12.7 mm) Super Spacer® 66' (20 m) roll	8 Rolls
SSHN	Super Spacer® Hand Notcher	1 Each
1550	Lint Free Wipes	1 Case (900 Wipes)
695	Concentrated Glass Cleaner	1 Gallon (3.785 l)
DB21	Plastic Spray Bottles	2 Each
1BK990	Hot Melt Butyl Trim Knife 110V AC	1 Each
BN4	1/4" (6.3 mm) Brass Nozzle	1 Each
BN6	3/8" (9.5 mm) Brass Nozzle	1 Each
BN8	1/2" (12.7 mm) Brass Nozzle	1 Each
NG171	Lint Free Gloves (Large)	1 Dozen Pairs
GM15	Basic Insulating Glass Manual	1 Each

Minimum order: 1 each. Must ship common carrier only.

## CRL "Hardman" Gun and Hot Melt Butyl Insulating Glass Starter Kit

- Hardman Hot Melt Butyl Gun is Portable, and Lets You Use Only What You Need

This Kit is perfect for the glass shop that needs to produce Insulating Glass units on an occasional "as needed" basis, or for someone who needs to do their work in different locations from time to time. The CRL "Hardman" Insulating Glass Hot Melt Butyl Starter Kit is also a great way to start a small production system for fabricating Insulating Glass units.



### SINGLE SEAL WITH HOT MELT BUTYL ROPE AND HARDMAN GUN

### KIT NO. D1GK913 INCLUDES:

CAT. NO. D1GK913

CAT. NO.	DESCRIPTION	QUANTITY	CAT. NO.	DESCRIPTION	QUANTITY
HEG522	"Hardman" Extruder Gun 110V AC	1 Each	695	Concentrated Glass Cleaner	1 Gallon (3.785 l)
N415	Hot Melt Butyl Rope	8 Rolls	DB21	Plastic Spray Bottles	2 Each
RH522	Hot Melt Butyl Rope Holder	1 Each	E9133	Brass Nipple	1 Each
MSD5	5 Pound (2.2 kg) Can Molecular Sieve	2 Cans	BN4	1/4" (6.3 mm) Brass Nozzle	1 Each
3935	1/4" (6.3 mm) Single Seal Aluminum Spacer	50 Each 12'8" Lengths	BN6	3/8" (9.5 mm) Brass Nozzle	1 Each
3937	3/8" (9.5 mm) Single Seal Aluminum Spacer	25 Each 12'8" Lengths	BN8	1/2" (12.7 mm) Brass Nozzle	1 Each
3939	1/2" (12.7 mm) Single Seal Aluminum Spacer	50 Each 12'8" Lengths	NG171	Lint-Free Gloves (Large)	1 Dozen Pairs
6265	1/4" (6.3 mm) Single Seal Spacer Corners	200 Each	321W	White Siliconized Acrylic Latex Glazing Sealant	10 Cartridges
6267	3/8" (9.5 mm) Single Seal Spacer Corners	100 Each	321GRY	Gray Siliconized Acrylic Latex Glazing Sealant	10 Cartridges
6269	1/2" (12.7 mm) Single Seal Spacer Corners	200 Each	JC320HT	Plastic Tipped Handy Clamps	12 Each
1550	Lint Free Wipes	1 Case (900 Wipes)	GM15	Basic Insulating Glass Manual	1 Each

Minimum order: 1 each. Must ship common carrier only.

Super Spacer is a registered trademark of Quanex Building Products Corporation.

## CRL Dual Seal Silicone With Polyisobutylene Insulating Glass Starter Kit



CAT. NO. S1GK344

This CRL Dual Seal Insulating Glass Starter Kit has all the components necessary to fabricate Dual Seal Insulating Glass units. Polyisobutylene, a one-part, non-drying, non-hardening ribbon material with exceptionally low vapor transmission and non-fogging characteristics, forms the primary seal. Insulating Glass Silicone (applied with a standard caulking gun), specifically formulated for bonding and sealing Insulating Glass units, makes the secondary seal. The Dual Seal Spacer is grooved on the shoulder, allowing it to accept the Polyisobutylene Tape, while the taper below the shoulder will accept the silicone secondary seal.

- Fabricate Units With Two High Performance Sealants
- Dual Seal Systems Withstand Intense Weather Conditions



### KIT NO. S1GK344 INCLUDES:

CAT. NO.	DESCRIPTION	QUANTITY
2132559	Polyisobutylene Tape	1 Case
9542	Insulating Glass Silicone	48 Cartridges
MSD5	5 Pound (2.2 kg) Can Molecular Sieve	2 Cans
99125	1/4" (6.3 mm) Dual Seal Aluminum Spacer	50 each 12'8" Lengths
99127	3/8" (9.5 mm) Dual Seal Aluminum Spacer	25 each 12'8" Lengths
99129	1/2" (12.7 mm) Dual Seal Aluminum Spacer	50 each 12'8" Lengths
92175	1/4" (6.3 mm) Dual Seal Spacer Corners	200 Each
92177	3/8" (9.5 mm) Dual Seal Spacer Corners	100 Each
92179	1/2" (12.7 mm) Dual Seal Spacer Corners	200 Each
1550	Lint Free Wipes	1 Case (900 Wipes)
695	Concentrated Glass Cleaner	1 Gallon (3.785 l)
DB21	Plastic Spray Bottles	2 Each
NG171	Lint Free Gloves (Large)	1 Dozen Pairs
321W	White Siliconized Acrylic Latex Glazing Sealant	10 Cartridges
321GRY	Gray Siliconized Acrylic Latex Glazing Sealant	10 Cartridges
JC3202HT	Plastic Tipped Handy Clamps	12 Each
GM15	Basic Insulating Glass Manual	1 Each

Minimum order: 1 each. Must ship common carrier only.

## CRL Polyurethane Sealant Insulating Glass Starter Kit With Super Spacer®

- Everything You Need to Fabricate Quality Insulating Glass Units Using Super Spacer®
- Comes Complete With Over 300 Feet (91 m) of Super Spacer®
- Uses Two-Part Polyurethane Sealant



### KIT NO. S1GK600 INCLUDES:

CAT. NO.	DESCRIPTION	QUANTITY
N600G15	Two-Part Polyurethane Sealant 1.5 Gallon Pail	1 Pail
SS1466	1/4" (6.3 mm) Super Spacer® 66' (20 m) roll	2 Rolls
SS3866	3/8" (9.5 mm) Super Spacer® 66' (20 m) roll	1 Rolls
SS1266	1/2" (12.7 mm) Super Spacer® 66' (20 m) roll	2 Rolls
SSHN	Super Spacer® Hand Notcher	1 Each
1550	Lint Free Wipes	1 Case (900 Wipes)
695	Concentrated Glass Cleaner	1 Gallon (3.785 l)
DB21	Plastic Spray Bottles	2 Each
MX40	Sealant Mixer	1 Each
4104	1-1/2" (38 mm) Putty Knife	1 Each
GM15	Basic Insulating Glass Manual	1 Each

Minimum order: 1 each.

Super Spacer is a registered trademark of Quanex Building Products Corporation.



CAT. NO. S1GK600

This CRL Insulating Glass Starter Kit features CRL Super Spacer®, the superior insulating foam that eliminates perimeter edge condensation and substantially reduces overall window heat loss. CRL Super Spacer® allows you to build Insulating Glass units in shapes not permitted by metal spacers. The silicone foam contains a high quantity of 3A molecular sieve desiccant, and the permeability of the foam allows for fast moisture pickup. Our Two-Part Polyurethane Sealant forms an airtight seal, and is compatible with units fabricated with Super Spacer®.

## CRL Insulating Glass Starter Kit With Duralite®

- Includes Everything Needed to Fabricate High Quality Insulating Glass Units
- Comes With 330 Feet (100 m) of Duralite®
- Easily Adapts to All Shapes and Sizes of Glass

This CRL Insulating Glass Starter Kit With Duralite® contains everything needed to produce condensation-free perimeter edges that substantially reduce overall window U-Value. It is a complete package that will get you into the business of producing high-quality Insulating Glass units to meet your customer's demands.

Duralite® allows you to build Insulating Glass units in shapes not permitted by metal spacers. The patented technology incorporates unique materials and a breakthrough in continuous composite manufacturing processes.

This advanced technology offers a higher performance spacer system at a competitive price. Duralite® takes optimum advantage of laminates and adhesives to reduce thermal conductivity while improving surface and corner appearance over other Insulating Glass spacers.



CAT. NO. S1GKDS66

### KIT NO. S1GKDS66 INCLUDES:

CAT. NO.	DESCRIPTION	QUANTITY
DS6614	1/4" (6.3 mm) Duralite® 66' (20.1 m) Roll	2 Rolls
DS6638	3/8" (9.5 mm) Duralite® 66' (20.1 m) Roll	1 Roll
DS6612	1/2" (12.7 mm) Duralite® 66' (20.1 m) Roll	2 Rolls
DSPT1	Duralite® Peak Tool Applicator	1 Each
TL2	Duralite® Quartz Heat Lamp 110V AC	1 Each
1550	Lint Free Shop Wipes (900 per Case)	1 Case
695	Concentrated Glass Cleaner	1 Gallon (3.785 l)
DB21	Plastic Spray Bottles	2 Each
NG171	Lint Free Gloves (Large)	1 Dozen Pairs
JC3202HT	Plastic-Tipped 6" Handy Clamps	24 Each
M3R	Straight Cut Snips	1 Each
GM15	Basic Insulating Glass Manual	1 Each

Minimum order: 1 each.



Apply Duralite® to clean glass surface with DSPT1 Applicator or by hand.

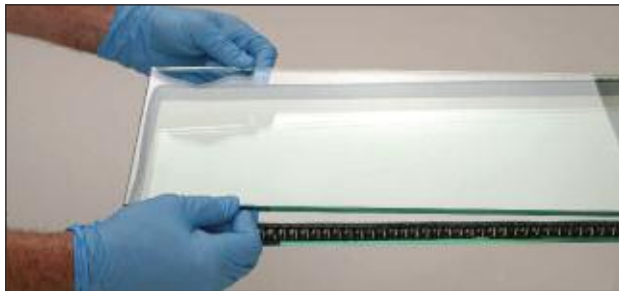

Index second piece of clean glass and press on to Duralite®.



Apply spring clamps or mechanical press with heat lamp to seal the unit.

Duralite is a registered trademark of Quanex Building Products Corporation.

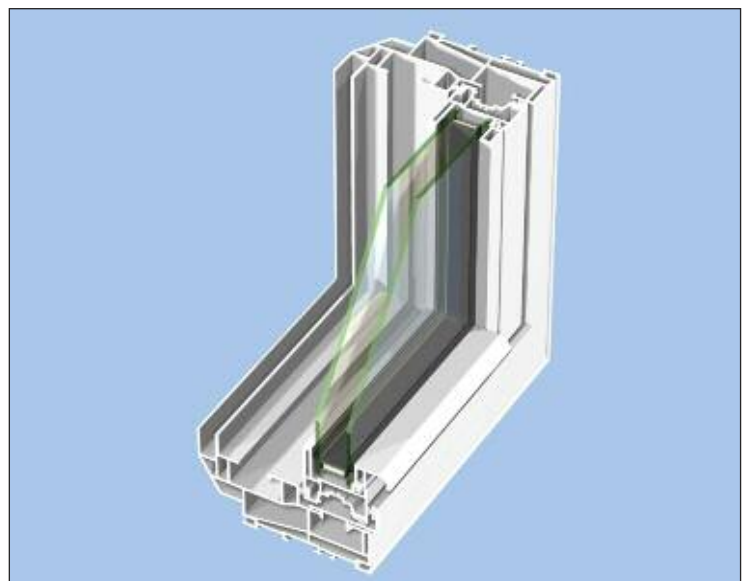



## Fabricating Insulating Glass Units With Alternatives to Aluminum Spacers

**Super Spacer® and Duralite® are the Latest Technology for High Performance Insulating Glass, Offering the Fabricator:**

- **Low Start-Up Costs Because No Special Tools Are Required to Begin Using Either System**
- **Reduced Assembly Times Because There are No Aluminum Spacers to Cut or Fill With Desiccant**
- **Reduced Storage Space Because There are No Long Stock Lengths, Just Convenient Rolls**
- **Flexibility of Design, Since Insulating Glass Units of Any Shape Can Now Be Fabricated**

As buildings become ever-more complex, with radical architecture and the intentions of owners to make their environments more energy-efficient, it's nice to know that you can meet their needs for high performance Insulating Glass units in places where traditional aluminum spacers can't be used. Windows with curved tops or corners that don't meet at 90 degrees are not a design problem when using a spacer system that is flexible, and capable of following their shape.

CRL offers two such spacer systems, Super Spacer® and Duralite®, and on the next few pages you'll discover how both of them can improve your Insulating Glass unit fabrication process, and the ability to accommodate your customer's needs.

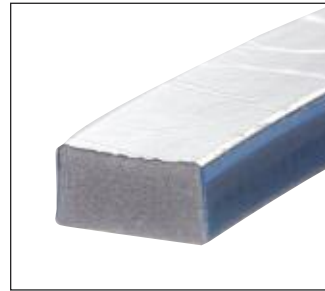

Super Spacer® is available in nine widths.



Duralite® is available in eight widths.

- **Super Spacer® and Duralite® are the Answer to the Problem of Fabricating Insulating Glass Units for Irregularly Shaped Windows**



Super Spacer and Duralite are registered trademarks of Quanex Building Products Corporation.

## CRL Edgetech Super Spacer®

- The Most Versatile Spacer Available
- Allows Simultaneous Production of Regular and Special Shaped Insulating Glass Units
- Save Production Time - No Desiccant Beads to Add or Corner Keys to Assemble
- No Metal Spacer – Dramatically Reduces Condensation
- No Heat Compression Required
- Low Profile Spacer is Only 1/4" (6 mm) Thick
- Multi-Layer Vapor Barrier is Continuous at Corners
- Available in Gray or Black

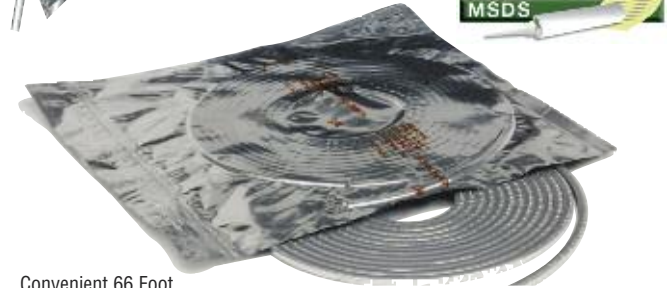
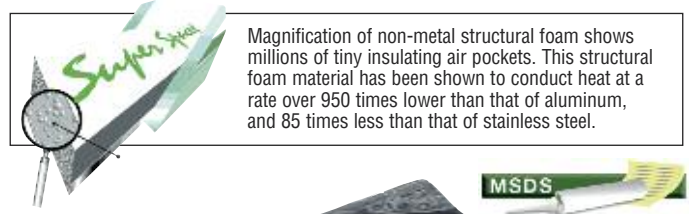

Convenient 66 Foot (20.1 m) Roll Package



1 Apply Super Spacer® to clean glass surface with SSHN Hand Notcher or SSAPA Shuttle Applicator as release liner is removed.

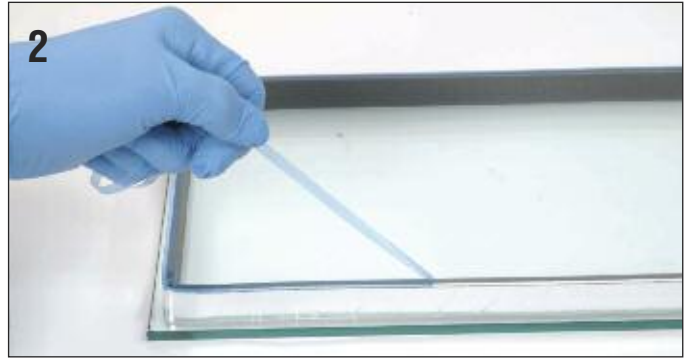

2 Remove second release liner.



3 Index second piece of clean glass and press on to Super Spacer®.



4 Apply CRL Hot Melt Butyl or Cat. No. 877 Sealant to seal the unit.

CRL Edgetech Super Spacer® is made from superior insulating silicone foam. The spacer essentially eliminates perimeter edge condensation and substantially reduces overall window heat loss. Because of the unique design features of Super Spacer® there are advantages in using this product for the fabrication of specialized insulating glass designs, including curved and odd shaped units, sound insulating, and triple-glazed units with art glass inserts.

For long-term durability, UV resistant silicone material is used to prevent spacer degradation. The flexible foam spacer accommodates glass bowing and thermal movement, and also helps ensure improved edge seal. The permeability of the foam allows for fast moisture pickup with the 40% desiccant composition. To reduce moisture vapor transmission and inert gas loss, the Super Spacer® is backed by a high performance, multi-layer barrier film.

Rolls are 66' (20.1 m) long. Other colors and bulk rolls are available on special order. **NOTE:** Super Spacer® cannot be used without an edge sealant. We recommend CRL Hot Melt Butyl or CRL 877 Sealant (see page 598K).

Super Spacer is a registered trademark of Quanex Building Products Corporation.

CAT. NO.	COLOR	WIDTH	ROLL LENGTH
<b>SS31666</b>	Gray	3/16" (4.8 mm)	66' (20.1 m)
<b>SS1466</b>	Gray	1/4" (6.3 mm)	66' (20.1 m)
<b>SS51666</b>	Gray	5/16" (7.9 mm)	66' (20.1 m)
<b>SS3866</b>	Gray	3/8" (9.5 mm)	66' (20.1 m)
<b>SS71666</b>	Gray	7/16" (11.1 mm)	66' (20.1 m)
<b>SS1266</b>	Gray	1/2" (12.7 mm)	66' (20.1 m)
<b>SS91666</b>	Gray	9/16" (14.3 mm)	66' (20.1 m)
<b>SS5866</b>	Gray	5/8" (15.9 mm)	66' (20.1 m)
<b>SS3466</b>	Gray	3/4" (19 mm)	66' (20.1 m)
<b>SS1466BL</b>	Black	1/4" (6.3 mm)	66' (20.1 m)
<b>SS3866BL</b>	Black	3/8" (9.5 mm)	66' (20.1 m)
<b>SS1266BL</b>	Black	1/2" (12.7 mm)	66' (20.1 m)
<b>SS91666BL</b>	Black	9/16" (14.3 mm)	66' (20.1 m)
<b>SS5866BL</b>	Black	5/8" (15.9 mm)	66' (20.1 m)
<b>SS3466BL</b>	Black	3/4" (19 mm)	66' (20.1 m)

Minimum order: 1 roll. Colors and sizes can be combined for quantity pricing.

## CRL Super Spacer® Hand Notcher

- Easy-to-Use Tool Simplifies Corner Notching
- Assures Consistent Placement of Super Spacer®

The CRL Super Spacer® Hand Notcher is designed to speed up the manual application of Super Spacer®. It simplifies corner notching and assures consistent placement of the foam Super Spacer® strip at a distance of 3/16" (4.8 mm) from the glass edge. Can be used with sizes ranging from 1/4" to 3/4" (6.3 to 19 mm) in width. Minimum order is one each.



CAT. NO. SSHN

## CRL Super Spacer® Super Shuttle™ Applicator

- Hand Held Pneumatic Tool Speeds Application of Super Spacer®

The hand held CRL Super Spacer® Super Shuttle™ Applicator makes precision laying, notching, cornering, and splicing a simple one-step process in the manufacture of Insulating Glass units. The Applicator glides on the Super Spacer®, eliminating contact with the glass, which prevents marking of the vision area.

The CRL Super Shuttle ensures straight sightlines, perpendicular to the glass, and is fully adjustable for Super Spacer® sizes of 3/16" to 15/16" (4.8 to 23.8 mm) and set back distances of either 3/16" (4.8 mm) or 1/4" (6.3 mm). Requires 100 cfm to operate. Minimum order is one each.



CAT. NO. SSAPA

## CRL Super Spacer® Groove Tool

- Cuts Groove in Super Spacer® for the Insertion of Leaded Glass Panels

The CRL Super Spacer® Groove Tool allows you to create your own grooved spacer for leaded and stained glass insert panels. By adjusting the centering guide to widths from 1/4" to 1" (6.3 to 25.4 mm) and pulling material across the blade, perfect grooves are quickly made. An adjustment screw on the bottom of the unit adjusts the blade for making either shallow or deep cuts. Two blades are included, and Cat. No. BK1056 Replacement Blades can be ordered separately. Minimum order is one each.



Uncut



Shallow Cut



Deep Cut



CAT. NO. LCSG1

## CRL Bulk Reel Super Spacer® Stand

- Positioned for Speed
- Accommodates Any Bulk Size of Super Spacer®

This CRL Super Spacer® Stand is designed to accommodate any size Super Spacer® in bulk reels. The Stand features a unique base and cover for totally enclosing the Super Spacer®, thereby preserving its quality by keeping it airtight during application. Minimum order is one each.

Optional items for use with the Stand include a two-roll lid and two-roll arm. Contact Technical Sales regarding special order Bulk Roll pricing.

**NOTE:** Not for use with standard 66' (20.1 m) rolls.



CAT. NO. LRS22

## CRL Super Spacer® Seminar DVD

- Demonstrates Proper Use of Super Spacer® and Accessories



This DVD demonstrates proper use of CRL Super Spacer®, showing how to make Insulating Glass units effectively using the product. It also shows different types of sealing methods to use with Super Spacer®. Minimum order is one each.

CAT. NO. DVDSS1

Super Spacer is a registered trademark of Quanex Building Products Corporation.

## CRL TruSeal® Duralite®

- Complete Spacer and Sealant in One Tape
- Contains No Metal for Improved Warm Edge Thermal Performance
- EnergySTAR® Labeled Technology
- Improved Condensation Resistance
- Reduced Total Window U-Value
- Superior Argon Gas Retention
- Same Spacer Used for Standard and Specialty Windows



SPEC. DATA

MSDS



### Spacer Sub-Assembly

A unique multi-component spacer that is bendable yet incompressible and stable

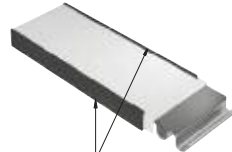

### Bondline Adhesive

Proprietary high performance adhesive providing exceptional resistance to gas and moisture vapor transmission



### Desiccated Topcoat

Desiccant concentrated in the top layer provides rapid dew point suppression



Apply Duralite® to clean glass surface with Applicator® or by hand

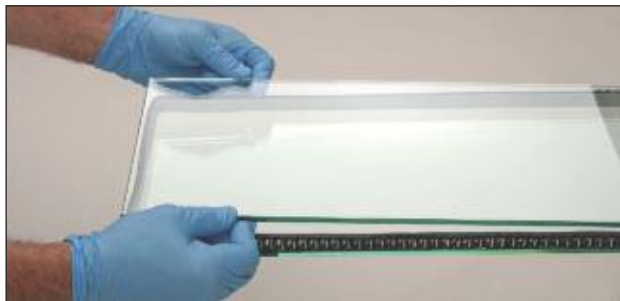

Index second piece of clean glass and press on to Duralite®



Apply Spring Clamps or Mechanical Press with Heat Lamp to seal the unit

Duralite® patented technology incorporates unique materials and a breakthrough in continuous composite manufacturing processes. This advanced technology offers a higher performance spacer system at a competitive price. Duralite® takes optimum advantage of laminates and adhesives to reduce thermal conductivity, while improving surface and corner appearance over other insulating glass unit spacers.

A single spacer system for both standard and special units has become an important factor in today's competitive marketplace where a high percentage of manufactured units are non-rectangular. Duralite® allows the window fabricator to produce Insulating Glass units with one spacer system. The fabricator can increase productivity and flexibility, while eliminating customer concerns over having dissimilar spacers in special versus standard windows.

Other colors and sizes of Duralite® are available on special order. Swiggle/Edgetherm DS and FS is available for our customers in Australia. Contact CRL Technical Sales or go to [crlaurence.com](http://crlaurence.com) for additional information.

### DURALITE® STANDARD ROLLS

CAT. NO.	COLOR	WIDTH	ROLL LENGTH
<b>DS6614</b>	Gray	1/4" (6.3 mm)	66' (20.1 m)
<b>DS66516</b>	Gray	5/16" (7.9 mm)	66' (20.1 m)
<b>DS6638</b>	Gray	3/8" (9.5 mm)	66' (20.1 m)
<b>DS66716</b>	Gray	7/16" (11.1 mm)	66' (20.1 m)
<b>DS6612</b>	Gray	1/2" (12.7 mm)	66' (20.1 m)
<b>DS66916</b>	Gray	9/16" (14.3 mm)	66' (20.1 m)
<b>DS6658</b>	Gray	5/8" (15.9 mm)	66' (20.1 m)
<b>DS6634</b>	Gray	3/4" (19 mm)	66' (20.1 m)

Minimum order: 1 roll. Sizes can be combined for quantity pricing.

### DURALITE® BULK ROLLS

CAT. NO.	COLOR	WIDTH	ROLL LENGTH
<b>BDS14</b>	Gray	1/4" (6.3 mm)	2640' (805 m)
<b>BDS516</b>	Gray	5/16" (7.9 mm)	2500' (762 m)
<b>BDS38</b>	Gray	3/8" (9.5 mm)	2240' (683 m)
<b>BDS716</b>	Gray	7/16" (11.1 mm)	2030' (619 m)
<b>BDS12</b>	Gray	1/2" (12.7 mm)	1750' (533 m)
<b>BDS916</b>	Gray	9/16" (14.3 mm)	1630' (497 m)
<b>BDS58</b>	Gray	5/8" (15.9 mm)	1520' (463 m)
<b>BDS34</b>	Gray	3/4" (19 mm)	1310' (399 m)

Minimum order: 1 roll. Sizes can be combined for quantity pricing.

TruSeal and Duralite are registered trademarks of Quanex Building Products Corporation.

EnergySTAR is a registered trademark of The United States Environmental Protection Agency.

## CRL Duralite® Quartz Heat Lamp

- Use With Deluxe Handy Clamps for Proper Compression of Duralite®
- Softens and Wets Out Adhesive

The CRL Duralite® Quartz Heat Lamp provides softening and wetting of the Duralite® adhesive. The powerful 600 watt Quartz Lamp provides plenty of heat. Hold at least 12" (305 mm) away from the glass edge to achieve approximately 120°F (49°C) of heat required which allows for adequate compression when used with Deluxe Handy Clamps. Requires 115V AC. Includes dark glasses to protect eyes from glare. For replacement bulbs, order Cat. No. TL2BULB. Minimum order is one each.

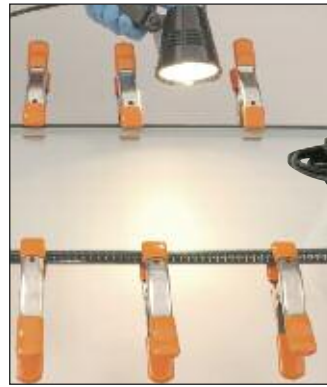

(Clamps not included)



CAT. NO. TL2

## CRL Duralite® Peak Tool

- Aids in Consistent Application of Duralite®
- Indexes Edge of Glass for Improved Sightlines

The CRL Duralite® Peak Tool is a hand tool that aids in the manual application of Duralite® for proper indexing of the material to the edge of the glass. It helps you make straighter sightlines, improving the overall appearance and quality of your Insulating Glass units. Rolls of Duralite® are fed through the Peak Tool by hand, which eases application. Training is minimal, and all widths of Duralite® can be used. Minimum order is one each.



CAT. NO. DSPT1

## CRL Duralite® Pro Tool

- Aids in Application of Duralite® on Air Flow Tables
- Eliminates Operator Contact With Glass Surfaces

The CRL Duralite® Pro Tool helps maintain consistent, high quality Insulating Glass unit production by eliminating all operator contact with glass surfaces. This helps to ensure a clear vision area and create an attractive, straight sightline. The precision-made Duralite® Pro Tool features a pivot pin enabling the applicator to form uniform 90 degree corners. Rubber protected guide wheels help to prevent chipping of the glass. Minimum order is one each.

**NOTE:** For information about air flow tables contact the CRL Customer Service Department.

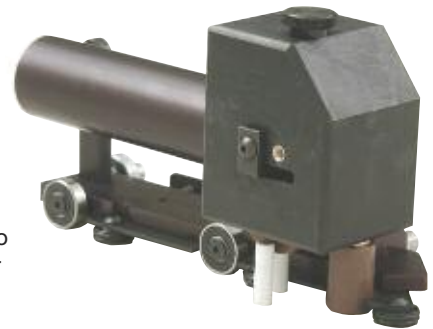

CAT. NO. SPT501

## CRL 6" Deluxe Handy Clamp

- Evenly Spreads Force Over Insulating Glass Unit

You can use these CRL 6" Deluxe Handy Clamps to apply the required compression for a proper seal while producing Duralite® Insulating Glass units. Position the Clamps every 6" (152 mm) around the unit's perimeter for even pressure and a uniform seal. Maximum jaw opening is 2" (51 mm). The minimum order is one each.



CAT. NO. JC3202HT

## CRL Straight Cut Snips

- Easily Cuts Duralite® Spacer



Use these Straight Cut Snips to cut and trim Duralite® during fabrication of Insulating Glass units. Maximum cut length is 1-3/8" (35 mm). Overall length is 9-3/4" (248 mm). Minimum order is one each.

CAT. NO. M3R

Duralite is a registered trademark of Quanex Building Products Corporation.

## CRL Silicone Foam and Metal Spacer I.G. Sealant

- One-Part Fast Cure Urethane With Low Solvent Formula Compatible With Super Spacer®
- Easy, Inexpensive Way to Make Low Production, High Quality Insulating Glass Units

Cat. No. 877 Silicone Foam and Metal Spacer I.G. Sealant is a single component urethane for the fabrication of quality single seal insulating glass units. Simply attach a SGT Polyethylene Sealant Guide to match your Super Spacer® width and backfill to the edge of the glass. Cat. No. 877 is a special low-solvent formulation that is made to be compatible with Super Spacer's adsorbent, and does not require a polyisobutylene primary seal. Cat. No. 877 may also be used with adsorbent filled aluminum spacers.

877 Silicone Foam and Metal Spacer I.G. Sealant works best for assembly of Insulating Glass units when temperature is over 40°F (5°C), and when humidity is more than 40%. Tack free time is 45-60 minutes at 77°F (25°C). Cure time is 3/16" (4.8 mm) per 24 hours. **NOTE:** Insulating Glass units should be totally sealed with Cat. No. 877 within one hour of exposing Super Spacer® adsorbent or adsorbent filled aluminum spacers to the atmosphere. Minimum order is one each. All cartridge sealants can be combined for quantity pricing.

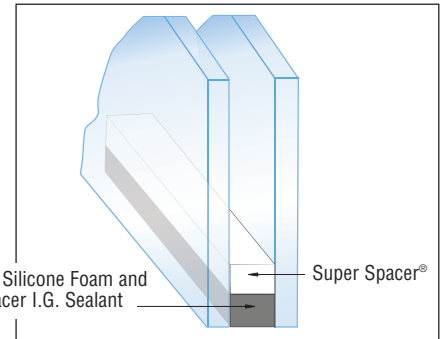

10.3 Fl. Oz. (304 ml);  
12 Cartridges per Case

**CAT. NO. 877**

## CRL Polyethylene Sealant Guides

- Fit on Tapered Nozzles for Insulating Glass Sealants
- Sizes From 3/16" to 3/4" (4.8 to 19 mm)

CRL Polyethylene Sealant Guides fit on the end of tapered cartridge nozzles for Insulating Glass sealants. The SGT Guide is designed to force sealant into the space between the two pieces of glass. Simply push the SGT Guide onto your nozzle and it is ready to use.



Polyethylene Adapter Nozzle **CAT. NO. 989**



SGT Polyethylene Sealant Guide

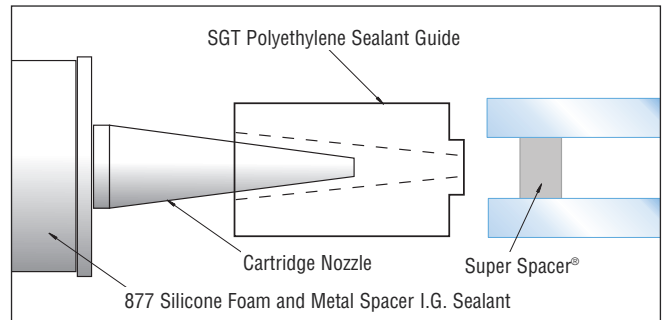

### POLYETHYLENE SEALANT GUIDES

CAT. NO.	SIZE
<b>SGT316</b>	3/16" (4.8 mm)
<b>SGT14</b>	1/4" (6.3 mm)
<b>SGT516</b>	5/16" (7.9 mm)
<b>SGT38</b>	3/8" (9.5 mm)
<b>SGT12</b>	1/2" (12.7 mm)
<b>SGT58</b>	5/8" (15.9 mm)
<b>SGT34</b>	3/4" (19 mm)

Minimum order: 1 each. Sizes can be combined for quantity pricing.

## CRL Super Spacer® Desiccant Activity Test Kit

- Ensure Quality of Units Made
- Test Previously Opened Packages

CRL Super Spacer® contains at least 40% of desiccant material by weight and, prior to unit fabrication, it is critical that this desiccant material is not pre-loaded with moisture before sealing the unit. Use this Test Kit to test the remainder of previously opened packages of Super Spacer®, and any unopened packages of Super Spacer® older than 36 months.

Any unused material can be repackaged in the flat roll bags with the foil packaging being heat-sealed or taped for desiccant protection. The unused, repackaged material must be stored elevated from the floor and away from any exterior walls. Minimum order is one each.

Super Spacer is a registered trademark of Quanex Building Products Corporation.



**CAT. NO. DTK1**

## The Importance of Working With Clean Glass

In the making of Insulating Glass units, it is imperative that the glass be clean. Many commercial cleansers on the market do an excellent job; however, some manufacturers incorporate a release agent to prevent future dirt buildup. These agents are good if you are cleaning windows, but if they are used in the area in which you expect adhesion with your sealant, problems will occur.

Sealants will not adhere to release agents, and you will have failures after the unit is out in the field. Be certain that the glass cleaner does not contain these additives, and do not use the product if a statement such as "leaves an invisible film on the glass" appears on the label. CRL Glass Cleaners 1973, 3371100, 695, and 895 for washing by hand, or CRL 155X, and 3379046 for automatic glass washers, have been tested and found to be ideal. **NOTE:** If washing the glass by hand, it must be cleaned with Lint Free Wipes such as CRL Cat. No. 1550 see page 105K, and all cleaned glass should only be handled with Cat. No. NG171 Lint Free Gloves see page 606K, to prevent oily fingerprints and/or contamination.

### CRL 1973 Glass Cleaner

- A Long Time Favorite of the Glass Industry
- Low-Ammoniated Formula
- Pleasant Aroma



CRL 1973 Glass Cleaner, a long time favorite of CRL customers, is a low ammoniated glass cleaner that is packaged in original 19 ounce (539 g) cans and new 4 ounce (113 g) Mini cans. 1973 features effective cleaning agents and a pleasant aroma, with the added feature of Sprayway's logo, so your customers will be able to identify the quality of this product. Minimum order is one case of 12 cans.

**NOTE:** Also available with your Logo or Private Label right on the can. Contact CRL Customer Service for details and pricing for this unique service.

SIZE **new**

MSDS

NO AIR FREIGHT



CAT. NO. 1973  
19 oz. (539 g)



Comfort-Use Finger Pad Nozzle



CAT. NO. 1973M  
4 oz. (113 g)



### CRL Hi-SHEEN® Glass Cleaner

- Industrial Strength Cleaner
- Lifts Residues From Non-Porous Surfaces
- Won't Leave Streaks, Blurs or Rainbows

CRL Hi-SHEEN® Glass Cleaner has been faithfully cleaning commercial and residential glass since 1970. It's dependable, no-nonsense aerosol formula is the reason, year after year, CRL Hi-SHEEN® is always a popular product! Having an effective, reliable glass cleaner is just as important today as it was 40 years ago. This is a great resale item for glass shops. Minimum order is one case of 12 cans.

**NOTE:** Also available with your Logo or Private Label right on the can. Contact CRL Customer Service for details and pricing for this unique service.

MSDS

NO AIR FREIGHT



Resale Display Carton



CAT. NO. 3371100  
19 oz. (539 g)

### CRL S50 Sprayway® Glass Cleaner

- Ammonia Free Formula
- Fast Evaporation Rate, Just Spray and Wipe Clean

CRL S50 is Sprayway's® leading glass cleaner. The formula includes perfume-grade alcohols, which are the best cleaning agents you can use. It also has a fast evaporation rate, which keeps it from leaving a film and adversely interacting with other materials. Large 19 ounce (539 g) cans are packed 12 per case. Minimum order is one case.

**NOTE:** Also available with your Logo or Private Label right on the can. Contact CRL Customer Service for details and pricing for this unique service.

MSDS

NO AIR FREIGHT



CAT. NO. S50  
19 oz. (539 g)

## The Aluminum Spacer Fabrication Method

Heat loss costs money and energy, but it can be prevented. Insulating glass is the most effective product that you can provide for your customers to save energy and cut their heating and cooling costs.

Traditional metal spacers for the fabrication of Insulating Glass units are available in both single and dual seal type. Single Seal Spacers have a single shoulder to accept the sealant deep enough to allow for adequate sealant penetration. Dual Seal Spacers accept a polyisobutylene primary seal while the exterior facing shoulders are designed to accept the secondary seal and allow for adequate sealant penetration. Both Single and Dual Seal Spacers utilize Spacer Corners to join them together to form frames.

**NOTE:** Corners must match spacer design.

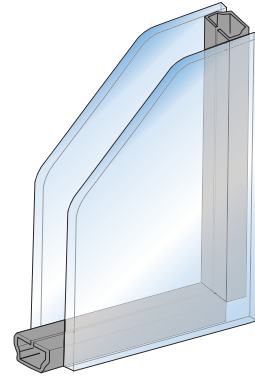

## CRL Single Seal Aluminum Spacers

- Laser Welded Spacers Are Available in Two Finishes
- Manufactured to Meet and Exceed Rigid Test Standards

CRL Single Seal Insulating Glass Spacers have a proven record for utility and satisfaction over many years of use. Single Seal Spacers have a single shoulder to accept the sealant, and this shoulder is deep enough to allow for excellent sealant penetration.



Clear Anodized

Bronze Anodized

### SINGLE SEAL SPACER

Universal Thickness for these Single Seal Spacers is .325" (8.3 mm)

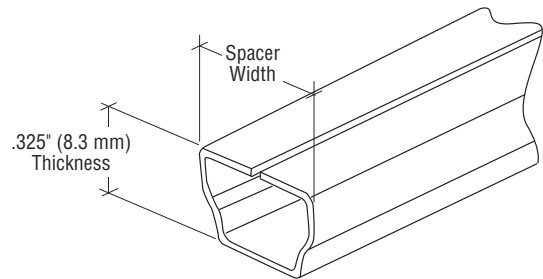

CLEAR ANODIZED CAT. NO.	BRONZE ANODIZED CAT. NO.	SPACER WIDTH	QTY/CASE
3934	3934BRZ	3/16" (4.8 mm)	500
3935	3935BRZ	1/4" (6.3 mm)	350
3936	3936BRZ	5/16" (7.9 mm)	250
3937	3937BRZ	3/8" (9.5 mm)	200
3938	3938BRZ	7/16" (11.1 mm)	175
3939	3939BRZ	1/2" (12.7 mm)	175
3940	3940BRZ	9/16" (14.3 mm)	170
3941	3941BRZ	5/8" (15.9 mm)	150
3941A	3941ABRZ	11/16" (17.5 mm)	150
3942	3942BRZ	3/4" (19 mm)	150

Minimum order: 20 stock lengths per size and color. Sizes can be combined for quantity pricing. Stock lengths are 12'8" (3.8 m). Must ship common carrier, unless you specify we cut them for U.P.S. A Cutting Charge will apply.

## CRL Corners for Single Seal Spacer

- Long Fin Design Holds Corners in Place
- Made From Durable Nylon

CRL Nylon Corners are designed to fit tightly into CRL Single Seal Spacers for a proper seal. High quality material resists cracking and aging. Quantity per case is 1000. Sold in increments of 100.

CAT. NO.	SIZE
6262	3/16" (4.8 mm)
6265	1/4" (6.3 mm)
6266	5/16" (7.9 mm)
6267	3/8" (9.5 mm)
6268	7/16" (11.1 mm)
6269	1/2" (12.7 mm)
6270	9/16" (14.3 mm)
6271	5/8" (15.9 mm)
6271A	11/16" (17.5 mm)
6272	3/4" (19 mm)



Minimum order 100 each. Must be ordered in increments of 100. Sizes can be combined for quantity pricing.

## CRL Flex Corners for Single Seal Spacer

- Used to Make Variable Angle Frames
- Made From Durable Nylon

CRL Flex Corner Keys for Single Seal Spacers are a low-cost, effective method of producing variable angle Insulating Glass unit frames. The long fin design ensures extra strength and a positive fit. Quantity per case is 1000. Sold in increments of 100.

CAT. NO.	SIZE
6222	3/16" (4.8 mm)
6225	1/4" (6.3 mm)
6226	5/16" (7.9 mm)
6227	3/8" (9.5 mm)
6228	7/16" (11.1 mm)
6229	1/2" (12.7 mm)
6230	9/16" (14.3 mm)
6231	5/8" (15.9 mm)
6231A	11/16" (17.5 mm)
6232	3/4" (19 mm)



Minimum order 100 each. Must be ordered in increments of 100. Sizes can be combined for quantity pricing.



## CRL Hot Melt Extruder Gun

- Variable Extrusion Rates to 1/2 Pound Per Minute
- Two to Four Minutes Start-Up Time
- Lightweight and Portable

This CRL Hot Melt Extruder Gun is a specially designed portable gun for applications requiring the use of hot flow materials, such as Hot Melt Butyl Sealant for the fabrication of Insulating Glass units. The Gun features a heated barrel with a trigger control, hydraulic pressure for constant uniform flow without pulsing or air gaps, and a quick-refilling capacity to reduce your down time.

The conical design within the sealant chamber allows trapped air to bleed backward to maintain a uniform material flow. By attaching the optional Cat. No. RH522 CRL Butyl Rope Holder (not included), this unit will hold one roll of CRL Hot Melt Butyl Rope.

Variable temperature setting from 200 to 400°F (93 to 204°C) with the 610 Watt heater. The Gun weighs only 11 pounds (5 kg) for easy maneuverability.



Hot Melt Extruder Gun  
CAT. NO. HEG522

Hot Melt Butyl Rope Holder  
CAT. NO. RH522

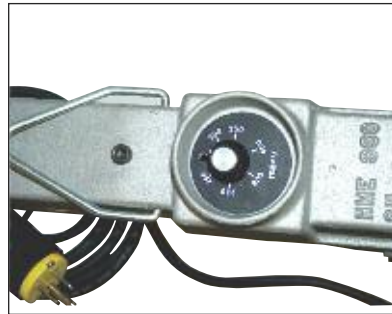

Variable Temperature Settings



Hot Melt Butyl Rope Holder (Optional Accessory)

CAT. NO.	DESCRIPTION
HEG522	Hot Melt Extruder Gun
RH522	Optional Butyl Rope Holder

Minimum order: 1 each.

## CRL Hot Melt Butyl Rope

- Rope Form for Use in CRL HEG522 Hot Melt Extruder Gun

CRL Hot Melt Butyl Rope is insulating glass sealant in rope form. It is made to use in our Cat. No. HEG522 Hot Melt Extruder Gun (sold separately see above).



For ease of use we suggest the optional RH522 Butyl Rope Holder (see above).

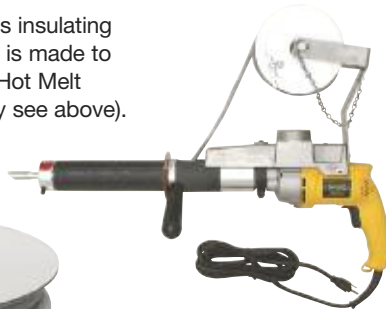

CAT. NO.	PACKAGING	ROLLS/CASE
N415	4.5 Lbs. (2 kg) Rolls, Approximately 551' (16.8 m) Long	8

Minimum order: 1 roll.

## CRL Hot Melt Butyl in Cartridges

- For Use With Thermal Extruder Guns



This is our one-part cross-link CRL Hot Melt Butyl Insulating Glass sealant in 11 ounce (325 ml) metal cartridges for use with thermal extruder guns. 100% solids content features low moisture vapor transfer rate, excellent adhesion to glass and metal, low shrinkage, high performance under all weather conditions. The sealant cools within five to 10 minutes to form a strong resilient seal. Cartridges require pre-heating prior to application.



CAT. NO.	CONTENTS	CTG/CASE
N415TU	11 Fl. Oz. (325 ml)	24

Minimum order: 1 each. All cartridge sealants can be combined for quantity pricing.

## CRL SS96 Hot Melt Butyl Gunning System

- An Efficient Machine for Insulating Glass Fabrication
- Dispenses CRL30703 Hot Melt Butyl Cakes
- Includes 8' Flexible Hose and Handgun
- Our Most Popular Model

The CRL Hot Melt Butyl Gunning System is compact and versatile. Its unique pumping action eliminates entrapped air in the sealant. The pump has a 10 pound (4.53 kg) tank capacity with a temperature range from 100°F to 425°F (37°C to 217°C). CRL Hot Melt Butyl can be added while gunning, and an adjustable flow control valve knob regulates the sealant output.

An 8' (2.4 m) Flexible Hose with variable 350°F to 450°F (177°C to 232°C) temperature control is coupled with a lightweight, heated handgun that features a swivel and trigger lock action. Two adjustable temperature controllers located inside the electrical enclosure regulate the temperature of the melting tank and the handgun/hose assembly. The SS96 does not use compressed air, and operates quietly. The mechanical and electrical systems contain few moving parts, resulting in less down time and low maintenance operation. Total shipping weight, including wood crate, is 120 pounds (54 kg).



Handgun Assembly (Included with SS96)

8' (2.4 m) Heated Hose (Included with SS96)

### SS96 SPECIFICATIONS

#### ELECTRICAL

Voltage - 115 VAC, 60 Hz with ground  
240V Models Available on Special Order  
Wattage - 1265 Watts  
Motor Rating - 1/6 hp, gearbox  
38 rpm output  
Warm-Up Time - 45-60 minutes

#### FUNCTIONAL

Melt Rate - 8 lbs. (3.6 kg)/hour  
Pump Output Rate (Maximum) - 40 lbs. (18.1 kg)/hour  
Tank Temperature Range - 100-425°F (37-217°C)  
Tank Capacity - 10 Lb. (4.5 kg)  
Gun/Hose Temperature Range - 350-450°F (177-232°C)

CAT. NO.	DESCRIPTION
SS96	Hot Melt Butyl Gunning System
SS26263N	8' (2.4 m) Replacement Heated Hose
SS75085000	Replacement Handgun Assembly

Minimum order: 1 each. SS96 must ship common carrier only.

## CRL Insulating Glass Hot Trim Knife

- Speeds Up I.G. Unit Production
- Works on Standard 110V AC Power

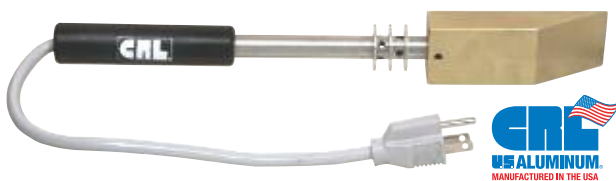

The CRL Insulating Glass Hot Trim Knife trims excess hot melt butyl from single or stacked units. It's the fast and efficient way to finish off single or dual sealed hot melt butyl units. This light, easy to handle Knife also can be used to cut up large slugs of hot melt butyl sealant for faster melting in a thermal extruder system.

Replacement Tips are available when the current Tip on your Hot Trim Knife becomes worn and caked with excess butyl. Made from solid brass, these Tips can be used for quite a long time before they need to be replaced.

CAT. NO.	DESCRIPTION
1BK990	Hot Trim Knife With Tip
RT90	Replacement Tip

Minimum order: 1 each.

## CRL Brass Tip Nozzles

- Speeds the Application of Insulating Glass Sealant
- Made From Solid Brass

CRL Brass Tip Nozzles may be used with almost all automated sealant dispensing systems. These Nozzles have a ridge that fits between the lites of glass to make the application of hot melt butyl much smoother. Nozzles may be used with our HEG522 or SS96, and all other hot melt extruders.



Brass Tip Nozzle



Brass Pipe Nipple  
CAT. NO. E9133

### BRASS TIP NOZZLES

CAT. NO.	SIZE
BN3	3/16" (4.8 mm)
BN4	1/4" (6.3 mm)
BN5	5/16" (7.9 mm)
BN6	3/8" (9.5 mm)
BN7	7/16" (11.1 mm)
BN8	1/2" (12.7 mm)
BN10	5/8" (15.9 mm)
BN12	3/4" (19 mm)

Minimum order: 1 each.

The CRL Brass Pipe Nipple works with the Cat. No. HEG522 Hot Extruder Gun and allows for the attachment of CRL Brass Tip Nozzles. Minimum order is one each.

## CRL Aztech Mini Hot Melt Butyl Dispensing System

- Fast Heat-Up Time; 200°F to 400°F Operating Range
- Used to Dispense CRL30703, CRL30706, and N420LB Chunk or Chip Form Hot Melt Butyl

The CRL Aztech Mini Hot Melt Butyl Dispensing System is a compact table-top hot melt gunning unit designed for production rates of up to 50 pounds (22.7 kg) of hot melt sealants or adhesives per day. The pot holds approximately 20 pounds (9 kg) of material. Additional material may be added to the pot at any time during production. A heavy-duty progressive cavity pump provides a uniform, pulse free adjustable flow rate for hand gunning or automatic dispensing. Operating range from 200 to 400° F (93 to 204° C). An 8' (2.4 m) heated gunning hose and a trigger actuated hand gun with a swivel coupling is supplied with the unit. A variety of nozzles and dispensing heads are available. Clean up is minimal. The power is simply turned off when the equipment is no longer needed, and reheated when required. Heat-up time is approximately one hour. Minimum order is one each. F.O.B. Somerville, New Jersey.



Stand with Casters Sold Separately. CAT. NO. ATXS

CAT. NO. ATXM1

### MEASUREMENTS

Width: 19" (482 mm), Height: 16" (406 mm)  
Length: 24" (609 mm), Weight: 90 Lbs. (40.8 kg)

## CRL Aztech II Hot Melt Butyl Dispensing System

- For Heating and Dispensing CRL30706 and N420LB Hot Melt Butyl in Chip, Chunk, or Slug Form
- Adjustable Temperature Control

This CRL Aztech II Hot Melt Butyl Dispensing System extrudes chunk, slug or chip-form hot melt butyl sealants from a heated hopper-type pot that also serves as the body of the positive displacement extruder pump. The extruder pump is driven by a 1/2 HP motor mounted on a direct drive gear reducer that is coupled to the pump drive shaft by a double-belt pulley. An internal screw auger moves material into the mouth of the pump. The pot holds approximately 30 pounds (14 kg) of material, and the system is designed for production rates of up to 200 pounds (90.7 kg) of hot melt sealants or adhesives per day. The heated 12' (3.7 m) hose is steel braided with a spring guard to prevent excessive flexing. Separate rheostats for hose and pot range up to 400°F (204°C). Operates on 220 Volts. Minimum order is one each. F.O.B. Somerville, New Jersey.



Stand with Casters Sold Separately. CAT. NO. ATXS

CAT. NO. ATX11

### MEASUREMENTS

Width: 30" (762 mm), Height: 19" (482 mm)  
Length: 31" (787 mm), Weight: 180 Lbs. (81.6 kg)

## CRL Hot Melt Clamp Table

- Clamp Units Up to 4" Thick
- Aids in the Assembly of Insulating Glass Units

The CRL Hot Melt Clamp Table has heavy-duty tubular steel construction. This tubular framed clamping unit consists of a stabilizer unit in the bottom, which is a horizontal bar powered by a 4" (102 mm) bore x 2" (51 mm) stroke pneumatic cylinder actuated by a hand lever on the frame. The clamping head has a horizontal bar lined with a 1" square (25 mm square) strip of closed cell, 40 durometer shore "A" neoprene rubber; powered by a 2" (51 mm) bore x 8" (203 mm) stroke pneumatic cylinder actuated by a foot pedal. The stabilizing bar comes up from the bottom and the clamp head comes down from the top to secure glass and spacer along one edge for sealant application. The clamping unit must be released and the unit rotated and re-clamped to seal each side. Requires 100 psi and seven cfm air supply. F.O.B. Red Oak, Texas. Minimum order is one each.

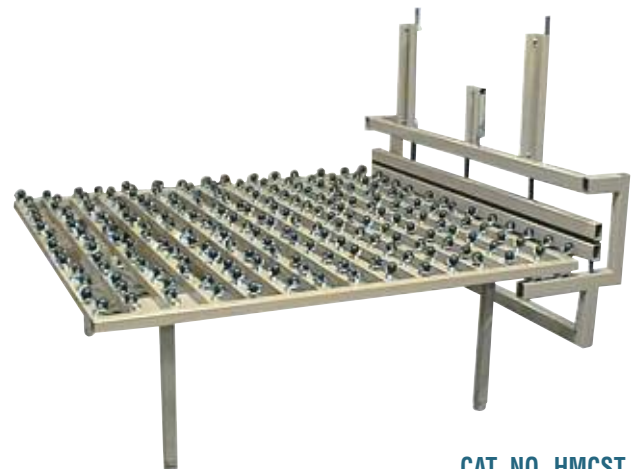

CAT. NO. HMCST

To see the complete selection of CRL Insulating Glass products, see our catalog CRL83R, pages 797W-852W or visit us at [crlaurence.com](http://crlaurence.com).

## CRL Hot Melt Butyl

CRL Hot Melt Butyl Insulating Glass Sealant is a 100% solids, hot applied butyl-based sealant designed to give tenacious adhesion to glass and aluminum for a moisture proof seal in Insulating Glass units. The product is a one-component sealant system with lower moisture vapor transmission rates than current polysulfide, silicone, or polyurethane systems. It has been formulated to support the operation of multiple application guns from a single pump station. This easy to apply sealant offers exceptional performance under environmental exposure to ultraviolet light, temperature extremes, and moisture. It exceeds ASTM E-773/E-774 specifications. Technical Data is available at [crlaurence.com](http://crlaurence.com).

- Hot Applied for Exceptional Flow
- Low Moisture Vapor Transmission Rate
- Excellent Adhesion to Glass and Metal
- Packaged in a Variety of Forms to Suit Your Application System

### TECH DATA FOR CRL307 SERIES HOT MELT BUTYL

Color.....	Black
Moisture Vapor Transmission Rate.....	0.35 g/m <sup>2</sup> /24 hr.
Suggested Application Temperature.....	350 to 400°F (175 to 204°C)
Brookfield Thermosel Viscosity at 374°F (190°C).....	275,000 cps
Shear Strength (Aluminum/Aluminum).....	50 psi cohesive failure
Average Setting Time...Window units may be moved after 3 minutes cooling time	
Weight per Gallon.....	9.91 lb (4.5 kg)

## CRL Hot Melt Butyl Cakes

- Convenient Cake Form is Easy to Use



CRL Hot Melt Butyl Cakes are easy to use in CRL SS96, Aztech ATXM1, and ATX11 dispensing systems.

CAT. NO.	APPROX. SIZE	WEIGHT/CASE
<b>CRL30703</b>	7-1/2" x 4" x 2-1/2" (190 x 102 x 63.5 mm)	48 lbs (22 kg)

Minimum order: 48 pounds. Must be ordered in increments of 48 pounds.

## CRL Hot Melt Butyl Chunks

- Fit All Large Hot Melt Butyl Dispensers



CRL Hot Melt Butyl in chunk packaging is for larger dispensers, such as CRL Aztech Mini (Cat. No. ATXM1) and Aztech II (Cat. No. ATX11). The Chunks are dropped into the melting pots whole.

**NOTE:** Hot Melt Butyl is dispensed at operating temperatures of 400°F (204°C). Wear the proper safety gear including gloves, arm guards and protective eyewear to avoid burns and other injuries.

CAT. NO.	APPROX. SIZE	WEIGHT/CASE
<b>CRL30706</b>	2-1/2" x 6" x 7-1/2" (63.5 x 152 x 190 mm)	48 lbs (22 kg)
<b>N420LB</b>	3" x 6" x 7-1/2" (76 x 152 x 190 mm)	50 lbs (23 kg)

Minimum order: 48 pounds for CRL30706 and 50 pounds for N420LB. Must be ordered in those increments.

## CRL Hot Melt Butyl in Pails



- For 5 Gallon Pail Hot Melt Butyl Dispensers

CRL Hot Melt Butyl in 5 gallon pails applies with any hot melt pumping system for 5 gallon pails.



CAT. NO.	CONTAINER	NET WEIGHT
<b>CRL30705</b>	5 gal. (19 l) Pail, net 4 gal. (15 l) Butyl	41 lbs (18.5 kg)

Minimum order: 1 pail.

## CRL Hot Melt Butyl in Drums



- For 55 Gallon Drum Hot Melt Butyl Dispensers

CRL Hot Melt Butyl in 55 gallon drums applies with any hot melt pumping system for 55 gallon drums.



CAT. NO.	CONTAINER	NET WEIGHT
<b>CRL52055GL</b>	55 gal. (208 l) Drum, net 48 gal. (182 l) Butyl	485 lbs (220 kg)

Minimum order: 1 drum.

## CRL Two-Part Polysulfide Insulating Glass Sealant

- Compatible With Aluminum Spacers
- Resistant to Weather, Ozone, Sunlight, Heat, and Cold
- Cures Rapidly to Permit Easy Cutting and Handling

CRL Two-Part Polysulfide Insulating Glass Sealant seals insulating glass units against moisture, cold, and heat. It out performs competitive polysulfide sealants in resistance to moisture, sunlight, aging, and weathering. CRL Two-Part Polysulfide Insulating Glass Sealant maintains outstanding adhesion to glass, aluminum, and other spacer and corner materials under the most severe weather conditions. Cures rapidly to permit easy cutting and handling within four to 12 hours at room temperature, or even less time at elevated temperatures. High strength and low cost make it attractive for single and dual seal units. Sealant passes SIGMA specifications for durability of Insulating Glass units.

CAT. NO.	COLOR	CONTENTS
N400G15	Black	1-1/2 Gallons (5.7 l)
N4005GL	Black	5 Gallons (18.9 l)
N40055GL	Black	55 Gallons (208.2 l)

Minimum order: 1 each. N40055GL ships via common carrier F.O.B. Delaware.

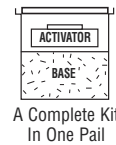

## CRL Two-Part Polyurethane Insulating Glass Sealant

- Compatible With Edgetech Super Spacer™
- Low Moisture Vapor Transfer Rate
- Can Be Used With Adsorbent Filled Aluminum Spacers

CRL Two-Part Polyurethane is an effective edge seal used for fabricating Insulating Glass units. Best when mixed by weight, using only as much as you need. Correct proportioning mixing ratio by weight is 14.8 to 1. Mix with a portable drill mixer and apply with a flexible blade putty knife. This Two-Part Polyurethane Sealant contains no solvents, allowing it to be used safely with Super Spacer™. Set time is three hours when properly mixed.



CAT. NO.	COLOR	CONTENTS
N600G15	Black	1-1/2 Gallons (5.7 l)
N60055GL	Black	55 Gallons (208.2 l)

Minimum order: 1 each. N60055GL ships via common carrier F.O.B. Delaware.

## Insulating Glass Compatible Sealants

### CRL RTV408 Neutral Cure Silicone

- Compatible for Insulating Glass Glazing
- Designed for Primerless Adhesion
- Low Odor, Non-Acetic Cure Formula
- AAMA Approved

CAT. NO.	COLOR
RTV408C	Clear
RTV408AL	Aluminum
RTV408BL	Black
RTV408BRZ	Bronze
RTV408BGE	Beige
RTV408DT	Dark Tan
RTV408T	Tan
RTV408W	White

Minimum order: 1 each. All cartridge sealants can be combined for quantity pricing.



### CRL 321 Acrylic Latex With Silicone

- Suitable for Glazing Insulating Glass Units in Wood Frames
- Paintable With Oil or Latex Based Paints
- Mildew Resistant

CAT. NO.	COLOR
321C	Clear
321W	White
321BRZ	Bronze
321GRY	Gray
321ALM	Almond

Minimum order: 1 each. All cartridge sealants can be combined for quantity pricing.



## CRL Low Profile Dual Seal Aluminum Spacers

- For the Fabricator Who Prefers a Dual Seal Insulating Glass Unit
- Laser Welded Spacers With Clear Anodized Finish

This CRL Low Profile Dual Seal Spacer was designed for fabricators of Insulating Glass who prefer a dual seal system. The groove on the shoulder is designed to accept the CRL Polyisobutylene Primary Seal (see page 607K), while the taper below the shoulder will accept the secondary seal. The uniform size and shape of this Spacer will assure you the close tolerances required for dual seal fabrication.

Clear Anodized

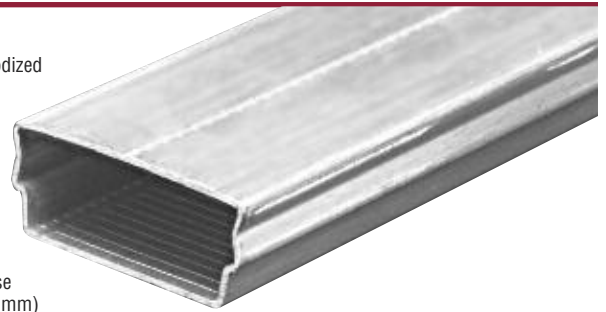

**DUAL SEAL SPACER**  
Universal Thickness for these Dual Seal Spacers is .250" (6.3 mm)

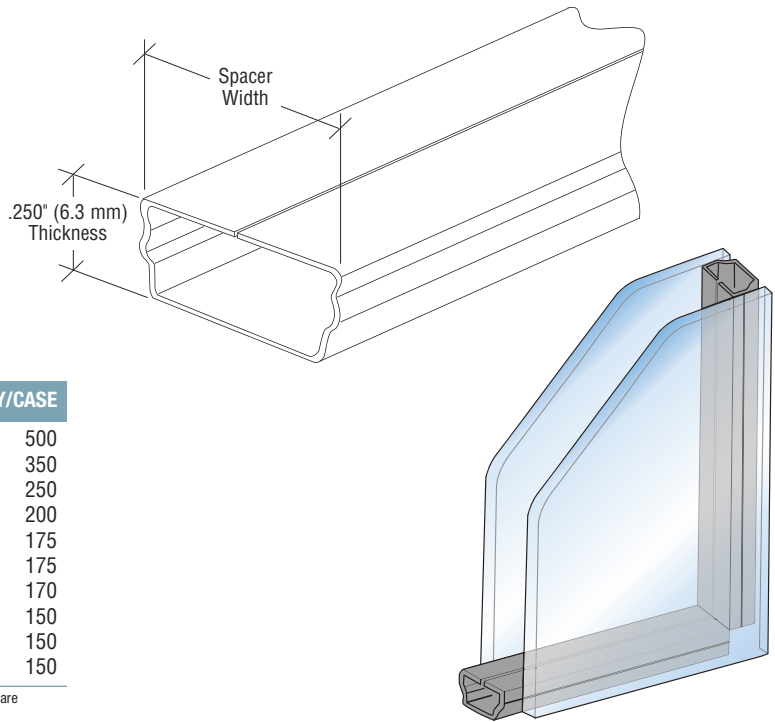

CAT. NO.	FINISH	SPACER WIDTH	QTY/CASE
99124	Clear Anodized	3/16" (4.8 mm)	500
99125	Clear Anodized	1/4" (6.3 mm)	350
99126	Clear Anodized	5/16" (7.9 mm)	250
99127	Clear Anodized	3/8" (9.5 mm)	200
99128	Clear Anodized	7/16" (11.1 mm)	175
99129	Clear Anodized	1/2" (12.7 mm)	175
99130	Clear Anodized	9/16" (14.3 mm)	170
99131	Clear Anodized	5/8" (15.9 mm)	150
99131A	Clear Anodized	11/16" (17.5 mm)	150
99132	Clear Anodized	3/4" (19 mm)	150

Minimum order: 20 stock lengths per size and color. Sizes can be combined for quantity pricing. Stock lengths are 12'8" (3.8 m). Must ship common carrier, unless you specify we cut them for U.P.S. A Cutting Charge will apply.

## CRL Corners for Dual Seal Spacer

- Used Exclusively With CRL Dual Seal Spacer
- Made From Durable Nylon

This CRL Nylon Corner for dual seal units has a patented design which allows it to lock tightly into the Spacer to assure a positive seal. Made from nylon, these Corners won't crack or deteriorate over time. Use with CRL Low Profile Dual Seal Spacer only (see above). Quantity per case is 1000. Sold in increments of 100.

CAT. NO.	SIZE
92174	3/16" (4.8 mm)
92175	1/4" (6.3 mm)
92176	5/16" (7.9 mm)
92177	3/8" (9.5 mm)
92178	7/16" (11.1 mm)
92179	1/2" (12.7 mm)
92180	9/16" (14.3 mm)
92181	5/8" (15.9 mm)
92181A	11/16" (17.5 mm)
92182	3/4" (19 mm)

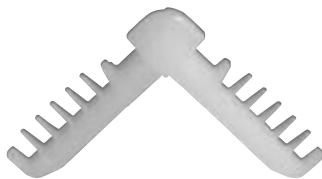

Minimum order 100 each. Must be ordered in increments of 100. Sizes can be combined for quantity pricing.

## CRL Lint Free Nylon Gloves

- A Must for Insulating Glass Fabrication
- Keeps Fingerprints Off Glass



CRL Lint Free Nylon Gloves are perfect for handling glass or mirrors without oily fingerprints or other contaminants. An absolute must for handling glass during Insulating Glass fabrication. Two sizes available to fit most anyone's hands.

CAT. NO.	SIZE
NG170	Small
NG171	Large

Minimum order: 1 dozen pairs.

## CRL Polyisobutylene Primary Seal

- Used to Manufacture Dual Seal Insulating Glass Units
- Exceptional Low Vapor Transmission
- Keeps Units From Fogging



CRL Polyisobutylene is used as the primary vapor seal in dual sealed Insulating Glass units. It is a one-part, non-drying, non-hardening material for dual seal fabrication in either tape or slug form. Primarily used in conjunction with CRL Insulating Glass Silicone, Polyisobutylene adheres to glass and metal, and resists water, ozone, and ultraviolet light.

The tape form is applied by hand to the sides of Dual Seal Spacer. Slugs are used in automated machines for application to the Spacer. CRL Polyisobutylene is made under the highest quality control conditions possible. With 100% solid content, it's compatible with any secondary seal.



Tape Form

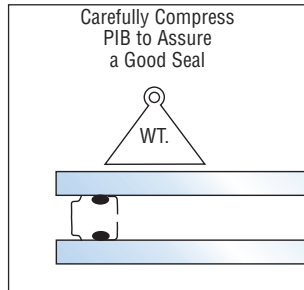

Slug Form

### POLYISOBUTYLENE TAPE

CAT. NO.	ROLL LENGTH	ROLLS/CASE	FEET/CASE
2132559	210' (64 m)	10	2100' (640 m)

Minimum order: 1 case.

### POLYISOBUTYLENE SLUGS

CAT. NO.	SIZE	WEIGHT	SLUGS/CASE
BK129	7-1/2" Dia. (190 mm) x 9" (229 mm)	15 lbs. (6.8 kg)	4

Minimum order: 1 case.

## CRL 3" Flexible Knife



- High-Carbon Flexible Steel Blade
- Large Soft Grip Handle

Our CRL Flexible Blade Knife features a high-carbon steel blade set in a large soft grip handle. Blade width is 3" (76 mm). Overall length is 9" (229 mm). Excellent for hand application of Two-Part Insulating Glass Sealants. Minimum order is one each.

CAT. NO. HW035

## CRL 6" Deluxe Handy Clamp

- Evenly Spreads Force Over Insulating Glass Unit
- Vinyl Tips and Grips

CRL Deluxe Handy Clamps hold Insulating Glass Spacers in place during the sealing process. The modern design of the Clamp minimizes the spread between handle ends, and makes the "grip" more comfortable for the user. Heavily plated steel Clamps have smooth, bright finish to resist corrosion. Maximum jaw opening is 2" (51 mm). Minimum order is one each.



CAT. NO. JC3202HT

## CRL 9542 Insulating Glass Silicone Sealant

- Specially Formulated for the Manufacture of Dual Seal Insulating Glass Units
- Excellent Glass-to-Glass Adhesion
- Resistance to UV Light and Weather Extremes

CRL 9542 Insulating Glass Silicone is a single component, neutral cure silicone glass sealant specifically designed for producing long lasting insulating glass units when used with a primary seal of polyisobutylene (page 607K). 9542 contains adhesion promoting additives for excellent glass-to-glass adhesion, and is resistant to ultraviolet light and weather extremes. CRL 9542 has a functional temperature range of -80°F to 400°F (-62°C to 204°C).

It is available in easy-to-use 10.3 fl. oz. (305 ml) cartridges or 52 gallon drums for bulk dispensing. This product is black in color. Tack-free time is 30 minutes; fully cures 1/8" (3 mm) thickness in 24 hours. Units may be cautiously moved after 24 hours. Full strength is obtained in seven days. See page 605K for Neutral Cure Silicone to be used as a compatible bedding sealant for I.G. units.



10.3 Fl. Oz. (305 ml);  
30 Cartridges per Case,  
1440 Cartridges Per Pallet;  
Screw-On Nozzle



Additional  
Nozzles  
Available  
Cat. No.  
S1LNOZ

**TECHNICAL DATA:** Meets or exceeds Federal Specifications TT-S-1543A, Class A (COM-NBS) for silicone building sealants; TT-S-00230C, Class A (COM-NBS) for one-component silicone sealants; ASTM C-920 for elastomer joint sealants, Type S, Grade NS, Class 25, Use NT, G, A; CGSB 19GP-13.

CAT. NO.	COLOR	CONTENTS
9542	Black	10.3 Fl. Oz. (305 ml)
954252GL	Black	52 Gallons (197 L)

Minimum order: 1 each. 954252GL must ship common carrier.

## CRL 12 Volt DC Variable Speed Cordless Cartridge Caulking Gun for Lightweight Sealants

- Variable Speed Trigger Controls Flow of Sealant
- Use to Dispense Lightweight Sealants Such as Silicones and Acrylic Latex
- Complete With 12 Volt Battery, One Hour Charger, and Molded Plastic Carrying Case

This CRL 12V DC Cordless Cartridge Caulking Gun operates on a 12 volt Rechargeable Battery and comes with a One Hour Charger. The variable speed control is in the trigger for easy adjustments in speed. It is ideal for glazing contractors, building contractors, roofers, cabinet makers, OEM fabricators, window manufacturers, or anyone who applies a lot of silicone or acrylic latex sealants and wants an easier, more professional way of getting the job done, without the restrictions of cords or hoses. Affordable and effective, this gun also comes with a 90 day warranty. For uninterrupted production, you can order additional LD188B 12 Volt Battery Packs.

**WARNING:** Not for use with high viscosity automotive urethane adhesives and construction polyurethane sealants. Use Only to dispense lightweight sealants such as silicone and acrylic latex.



CAT. NO.	DESCRIPTION
LD188	12 Volt Cordless Cartridge/Caulking Gun Kit
LD188B	12 Volt DC Battery Pack
LD188C	One Hour Battery Charger
LD188AU	240 Volt Caulking Gun Kit-Australia
LD188C240VAU	240 Volt Battery Charger-Australia
LD188EU	240 Volt Caulking Gun Kit-Europe
LD188C240VEU	240 Volt Battery Charger-Europe

Minimum order: 1 each.

## CRL 12 to 1 Ratio Strap Frame Caulking Gun

- Low to Medium Viscosity Materials
- Smooth Rod With Thumb Release



This CRL 12:1 Ratio Caulking Gun has the smooth operation of a friction rod, plus a large handle and trigger. Perfect for dispensing low to medium viscosity materials, such as silicones and acrylic latex sealants. The strap frame rotates to move the nozzle tip where needed. The spring release plunger lets you load and dispense quickly and easily. The thumb-activated instant pressure release button prevents sealant run-on. Includes a built-in ladder hook.

Minimum order is one each.

CAT. NO. GA1203

All Caulking Guns can be combined for quantity pricing.

## CRL Aluminum Air Powered Gun

- Holds Standard Cartridges
- Air Regulator Pressure Adjuster



A superb quality, lightweight aluminum air powered gun. The 2" x 10" (51 x 254 mm) drawn aluminum barrel holds all standard size cartridges. Gun dispenses materials smoothly and uniformly with just a trigger squeeze, and connects to standard 1/4" (6.4 mm) hose fittings. It has an instant release valve to stop material flow, true air regulator, and can operate at up to 100 psi maximum. Minimum order is one each.

CAT. NO. WG61001



## The Importance of Adsorbents

Molecular Sieve (MSD) has an excellent capacity for adsorbing water and chemical vapors, and is the most economical adsorbent on a cost-per-unit basis. MSD provides Insulated Glass fabricators with superior protection against fogging for a longer lasting unit. MSD is suitable for both cool and warm climates, and can be used for residential, architectural, and commercial applications.

MSD has a weight of 6.5 grams per foot in a 1/4" (6.3 mm) square channel. At 77°F (25°C) room temperature and a dew point of 60°F (16°C), 100 pounds (45 kg) of MSD would adsorb approximately 11-1/2 pounds (5.2 kg) of water. MSD is cost effective because it costs less per drop of water removed than any other adsorbent. This provides you with significant savings in unit production.

**NOTE:** It is only necessary to fill the two long legs of the spacer frame. Fill only one long and one short leg when the long side is greater than 2-1/2 times the length of the short side.

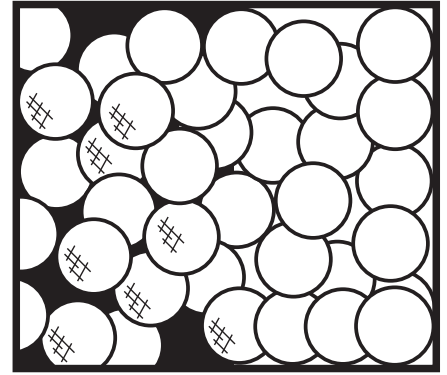

## CRL MSD Molecular Sieve Adsorbent

- Standard Formula Removes Moisture From I.G. Units
- Three Standard Packaging Sizes
- Ask About Our High Volume Special Pricing

This CRL MSD Type Molecular Sieve is an all-purpose adsorbent for use in the fabrication of Insulating Glass units. It has an excellent capacity for adsorption of water and chemical vapors. MSD provides Insulating Glass fabricators with superior protection against fogging for a longer lasting unit.

MSD is suitable for both cool and warm climates, and can be used for residential, architectural, and commercial applications. CRL Molecular Sieve Adsorbent is cost effective because it costs less per drop of water removed than any other adsorbent. This means significant savings in unit production. **NOTE:** Avoid prolonged skin contact when working with this product.



CAT. NO. MSD50B



CAT. NO. MSD5



CAT. NO. MSD325

CAT. NO.	CONTENTS	APPROXIMATE SHIPPING WEIGHT
MSD5	5 Pound (2.2 kg) Can	6 Pounds (2.7 kg)
MSD50B	55 Pound (25 kg) Box	57 Pounds (26 kg)
MSD325	325 Pound (147.4 kg) Drum	335 Pounds (152 kg)

Minimum order: 1 each. MSD325 must ship common carrier only.

## CRL Low Deflection Molecular Sieve Adsorbent

- Low Deflection Formula Removes Moisture from I.G. Units
- Ask About Our High Volume Special Pricing

This CRL Low Deflection Molecular Sieve Adsorbent is a uniform bead product with a high capacity for both moisture and solvent vapor. MSD LDA features low deflection characteristics and benefits in both economy and performance. Longer unit life results from the minimization of unit seal stress and deflection. Two convenient packages are available, both designed to protect the product during shipment and storage.

**NOTE:** Avoid prolonged skin contact when working with this product.



CAT. NO. MSD50BLDA



CAT. NO. MSD325LDA

CAT. NO.	CONTENTS	APPROXIMATE SHIPPING WEIGHT
MSD50BLDA	55 Pound (25 kg) Box	57 Pounds (26 kg)
MSD325LDA	325 Pound (147.4 kg) Drum	335 Pounds (152 kg)

Minimum order: 1 each. MSD325LDA must ship common carrier only.

## CRL Desiccant Filling Machine

- 12 Gallon Storage Container
- Fills Up to 35 Spacers at Once
- Visit [crlaurence.com](http://crlaurence.com) for Additional Insulating Glass Machinery

The CRL Desiccant Filling Machine is a fast, effective, and space-saving alternative for spacer bar filling. Fills up to 35 spacers at one time. The unit features all steel construction, and has a 12 gallon (45.4 l) storage capacity container for the desiccant. Its special spacer seal barrier and electric vibrator assure complete filling of the spacers. It can handle spacers of all sizes at the same time. Easy to operate and completely adjustable to a comfortable working height. Only one 110V AC source is required for the operation of the vibrator. Shipped knocked down F.O.B. Red Oak, TX. Minimum order is one each.



- Adjustable Working Height

### SPECIFICATIONS:

**Height:** 96" (2438 mm)  
**Length:** 48" (1219 mm)  
**Width:** 20-1/2" (520 mm)  
**Weight:** 255 lbs. (116 kg)

CAT. NO. EDFM

## CRL Aluminum Breather Tubes

- Equalizes Pressure in I.G. Units
- Larger Inside Diameter

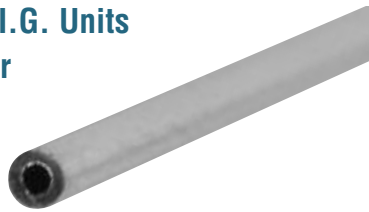
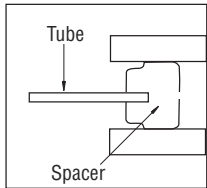

If your Insulating Glass units are transferred from low to high altitudes, or vice versa, install these CRL Breather Tubes into the spacer frame to equalize pressure. Upon arrival at the installation point, simply snip off the Tube below sealant surface, crimp the end and then seal. The larger inside diameter of the tube allows the unit to equalize the pressure faster. Available in two lengths.

CAT. NO.	LENGTH	I.D.	O.D.	QTY/PKG
3003	6" (152 mm)	.030" (.76 mm)	.050" (1.27 mm)	100

Minimum order: 100 each.

## CRL Stainless Steel Capillary Tubes

- Equalizes Pressure in I.G. Units
- Does Not Have to be Crimped

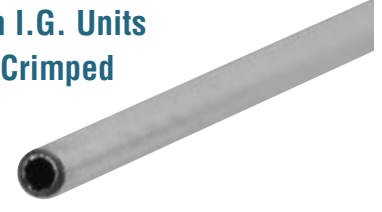
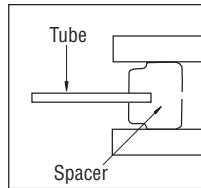

If you transport Insulating Glass units from low to high altitudes, or vice versa, install these CRL Capillary Tubes into the spacer frame to equalize pressure. The smaller inside diameter of the Tube and longer length does not allow as much moisture to travel up the Tube. At the destination point the Tube does not have to be crimped and sealed, just bent over along the frame at the top of the unit.

CAT. NO.	LENGTH	I.D.	O.D.	QTY/PKG
CT12C	12" (305 mm)	.021" (.533 mm)	.031" (.787 mm)	100
CT12M	12" (305 mm)	.021" (.533 mm)	.031" (.787 mm)	1000

Minimum order: 100 each for CT12C; 1000 each for CT12M

## CRL Test Kit for Molecular Sieve

- Used to Determine Freshness of MSD
- Easy to Use

Since the useful life of any adsorbent is reduced by excessive exposure to the atmosphere, daily testing of inventory with the CRL MSD Test Kit is recommended. The Kit lets you measure residual moisture quickly and easily. Kit contains two measuring glasses, one thermometer, one reference graph, and one instruction sheet. Minimum order is one each.

**NOTE:** Read instructions carefully and use caution when using this Test Kit. Work in an open area with good ventilation. A chemical reaction takes place when using.



CAT. NO. MSDTK

## Easy Steps to High Quality Insulating Glass Muntin Bar Fabrication

### • Muntin Bars Produce a Distinctive Divided Lite Appearance for Colonial Style Insulating Glass Units

For "Colonial" style Insulating Glass units, install CRL Muntin Bars cut to length using the inside measurements of the spacer frame. As with spacer frame fabrication, Muntin Bars should be cut with a fine 100 to 150 tooth saw blade (see page 456K) without oil or coolant. It is also recommended that Cat. No. NG171 Lint Free Gloves be worn while handling Muntin Bar lengths to reduce contamination (see page 606K).

Measure and mark the cross points of Muntin Bars. Notch each bar with Cat. No. MMBN1 Manual Muntin Bar Notcher with the appropriate die and punch (see page 613K).

After press fitting the Muntin Bar grid together, insert the appropriate Muntin Bar Clips. Larger Muntin Bar grids may require the use of internal Muntin Joiners. Drill or punch the spacer frames at the connecting points of spacer and Muntin Bar Clips. Use an electric hand drill, drill press or Cat. No. MBKP1 Muntin Bar Keeper Punch (see page 614K). Finished Muntin Bar grids then are assembled into the spacer frame.

**NOTE:** Clean Muntin Bars before sealing unit with 1973, 3371100, or S50 Glass Cleaner (see page 599K). Do not use MEK, alcohol, or similar chemicals.



## CRL Muntin Bars

- Fit Inside Spacer Frame to Create Colonial Style Insulating Glass Units
- Easy to Fabricate

CRL Muntin Bars add a distinctive flair to your Insulating Glass units. They are ideal for the fabrication of "Colonial" style windows. There are two finishes that will complement the trim of most any home. Muntin Bars are cut to size, and then assembled with CRL Muntin Bar Clips before being placed inside the unit.

For a professional 'crisscross' effect, use the CRL Manual Muntin Bar Notcher (see page 613K) and secure with the proper CRL Internal Muntin Joiners (see page 612K).

Stock lengths of Muntin Bars are 12' 8" (3.9 m).

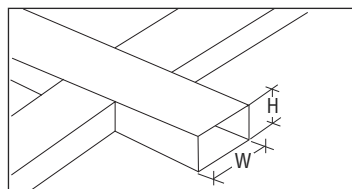

WHITE CAT. NO.	BRONZE CAT. NO.	SIZE HEIGHT X WIDTH	QTY/CASE
36006W	36006BRZ	3/16" x 13/16" (4.8 x 20.6 mm)	50
36009W	36009BRZ	3/16" x 9/16" (4.8 x 14.3 mm)	50
36012W	36012BRZ	3/16" x 5/8" (4.8 x 15.9 mm)	50
36004W	36004BRZ	3/16" x 3/4" (4.8 x 19 mm)	50

Minimum order: 1 stock length. A Packing Charge will be added to orders fewer than 20 combined lengths. Stock lengths longer than 98" (2.49 m) must ship common carrier, unless you specify we cut them for U.P.S. A Cutting Charge will apply. Sizes and colors can be combined for quantity pricing.

## CRL Universal Muntin Clips

- Fit Rectangular Spacer Widths 1/4" to 3/4" (6 to 19 mm)
- Flexible to Fit Any Angle
- Solid Centering Foot
- No Spacer Punching Required
- Works With Aluminum Spacers, Super Spacer®, and Duralite®

These CRL Universal Muntin Clips will fit all rectangular muntin bars up to 3/4" (19 mm) wide. The side fins help to center and lock the Clip inside the muntin bar, and the small nubs on the base keep the muntin from twisting when installed. Thin, flexible stem allows Clip to work with virtually any mitered angle. Clip base is slightly undersized so as not to interfere with the glass. Molded from grey resin to blend in with spacer color. No spacer punching required.

Super Spacer and Duralite are registered trademarks of Quanex Building Products Corporation.

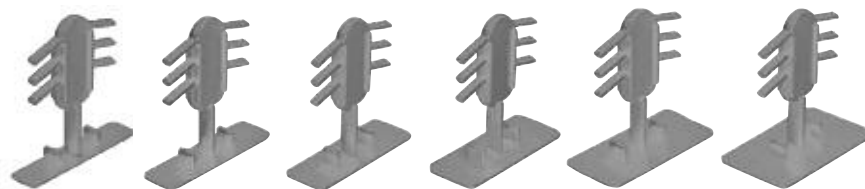

CAT. NO.	AIR SPACE	BASE DEPTH
UMC14	1/4" (6 mm)	.220" (5.6 mm)
UMC516	5/16" (7.9 mm)	.295" (7.5 mm)
UMC38	3/8" (9.5 mm)	.360" (9.1 mm)
UMC12	1/2" (12.7 mm)	.485" (12.3 mm)
UMC58	5/8" (15.9 mm)	.605" (15.4 mm)
UMC34	3/4" (19.1 mm)	.734" (18.6 mm)

Minimum order: 100 each. Must be ordered in increments of 100. All Muntin supplies can be combined for quantity pricing.

## CRL Muntin Clips

- Designed to Work With CRL Muntin Bars
- Made From Durable Nylon

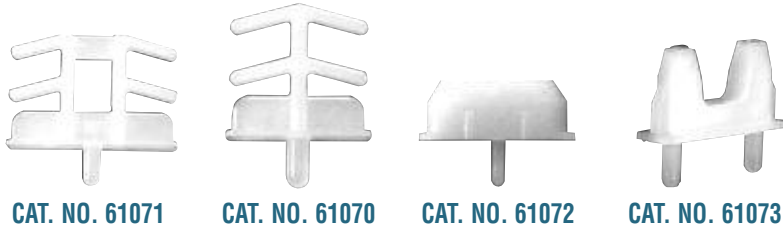
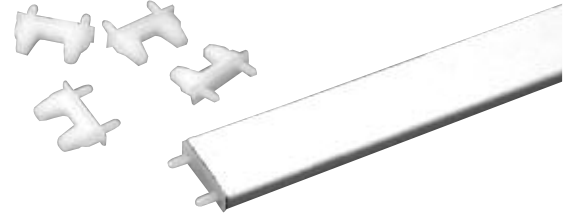

CAT. NO.	FITS BAR	PRONGS	QTY/BOX
61071	36006	1	100
61070	36009	1	100
61072	36012	1	100
61073	36004	2	100

CRL Muntin Clips are designed to fit tightly in CRL Muntin Bars to properly secure the Muntin Assembly within the air space of an Insulating Glass unit.

Minimum order: 100 each. Must be ordered in increments of 100. All Muntin supplies can be combined for quantity pricing.

## CRL Internal Muntin Joiner

- For Joining Notched Muntin Bars

The CRL Internal Muntin Joiner holds the notched bar intact during the grid and frame assembly. It makes assembling Muntin Bars easier and more manageable, especially for larger sized Insulating Glass units. Two sizes fit most applications.



CAT. NO.	FITS BAR	QTY/BOX
AM04	36004/36006	100
AM609	36009/36012	100

Minimum order: 100 each. Must be ordered in increments of 100. All Muntin supplies can be combined for quantity pricing.

## CRL Flexible Muntin Locator

- Secures Sunburst and Wagon-Wheel Windows

Use the CRL Flexible Muntin Locator to secure sunburst and wagon-wheel windows in their frames. The flexible end pin helps eliminate unsightly gaps. They are an excellent aid in the fabrication of Insulating Glass units.



CAT. NO.	FITS BAR	QTY/BOX
AM06	36004/36006	100
AM12	36009/36012	100

Minimum order: 100 each. Must be ordered in increments of 100. All Muntin supplies can be combined for quantity pricing.

## CRL Sunburst Muntin Joiner

- For Circle Top Windows
- Use With 36012 Muntin Bars Only

CRL Sunburst Muntin Joiners make half and full-circle windows easy to fabricate. The white, flexible nylon holds the muntin bar securely, producing great looking wagon-wheel windows. These Joiners are made for use with CRL 36012 Muntin Bars only.



CAT. NO.	FITS BAR	QTY/BOX
AM601	36012	100

Minimum order: 100 each. Must be ordered in increments of 100. All Muntin supplies can be combined for quantity pricing.



## CRL Manual Muntin Bar Notcher and Die Sets

- Each Precision Machined Unit is Made to Customer's Specifications
- Interchangeable Dies

This CRL Manual Muntin Bar Notcher will notch most Muntin Bars quickly and smoothly. Each Die Set is custom fabricated from hardened and ground tool steel. The Notcher comes with one Die Set. If you are using CRL Muntin Bar, no sample is required; simply provide the CRL Catalog Number of the Muntin being used. Otherwise, four sample pieces of your Muntin Bar, 24" (610 mm) long, are required in order to fabricate the Dies properly. Contact CRL Technical Sales for machine details and specifications.

Each CRL Die Set for the Muntin Bar Notcher is made from the finest heat-treated tool steel, and to your exact specifications. **NOTE:** To ensure a proper fit you must specify the distance between the mounting holes and the blade tip of your existing Die Set to match the new Blade and Die Set. Minimum order is one each.



**CAT. NO. MMBD1E**  
Die Set for Muntin Bar Notcher

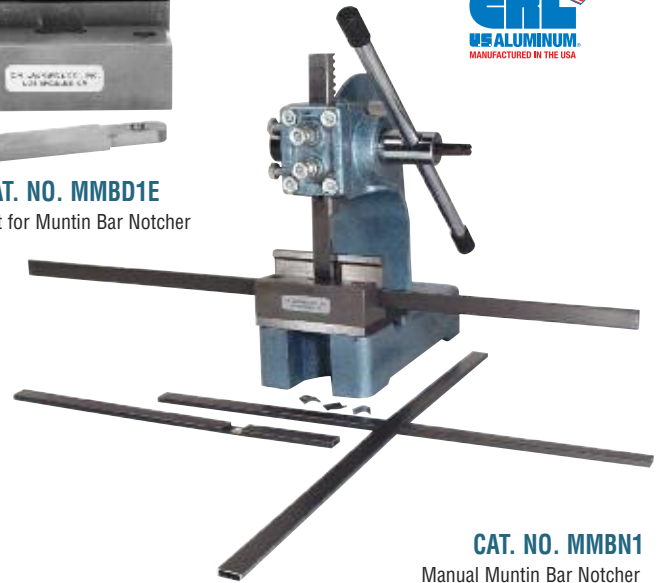

**CAT. NO. MMBN1**  
Manual Muntin Bar Notcher

## CRL Air Powered Muntin Bar Notcher and Punch and Die Sets

- For Fast Notching of Muntin Bars
- Excellent for Production Work

This CRL Air Powered Muntin Bar Notcher provides an accurate burr-free notch cut, and requires no hand cleaning. The guide bar has a graduated rule and a sliding stop for accurately spacing notches along the bar. All die sections are fabricated from hardened and ground tool steel.

The Notcher comes with a hand-operated Switch, Air Hose, Cutting Chart, and one Punch and Die Set. The machine requires 50 to 250 psi of air pressure for operation. A sample of the Muntin Bar to be used is required when ordering, and extra Punch and Die Sets are available. Also, Multiple Head Muntin Notchers (up to five heads) are available for larger production shops. Contact CRL Technical Sales for machine details and specifications. F.O.B. Canton, Michigan.



**CAT. NO. APMN1**  
Air Powered Muntin Bar Notcher



Punch and Die Set

CAT. NO.	DESCRIPTION
<b>APMN1</b>	Air Powered Muntin Notcher
<b>APDS916</b>	9/16" (14.3 mm) Punch and Die Set for CRL 36009 Muntin Bar
<b>APDS58</b>	5/8" (15.9 mm) Punch and Die Set for CRL 36012 Muntin Bar
<b>APDS34</b>	3/4" (19 mm) Punch and Die Set for CRL 36004 Muntin Bar
<b>APDS1316</b>	13/16" (20.6 mm) Punch and Die Set for CRL 36006 Muntin Bar

Minimum order: 1 each.

## CRL Muntin Bar Router

- Made Especially to Cut Notches in Muntin Bar Prior to Fabrication
- Air Operated Hold Down Clamp
- Adjustable Cut-Off Gauge

The CRL Muntin Bar Router makes notches in Muntin Bars prior to Insulating Glass unit fabrication. The welded steel constructed table has a 3/16" (4.8 mm) thick aluminum top measuring 18" x 120" (457 mm x 3.04 m). An adjustable cut-off gauge is mounted on the table to line up the Muntin Bars prior to routing. The Router is mounted on a linear slide plate and will route a groove in a 15" (381 mm) wide gang of Muntin Bars, which are held in place by a pneumatic-actuated bar assembly. It comes complete with 110V AC Router. Contact CRL Glass and Glazing Technical Sales for machine details and specifications. F.O.B. Red Oak, Texas. Shipping weight: 500 pounds (227 kg). Minimum order is one each.

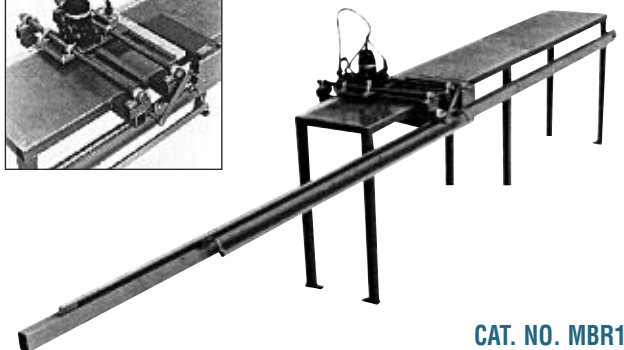
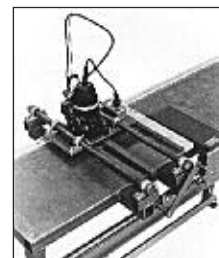

**CAT. NO. MBR1**  
Muntin Bar Router

## CRL Deluxe Spacer Bender

- Can Be Made to Accommodate Almost Any Size Spacer Bar
- Custom Manufactured by CRL



This machine is designed to bend Spacer Bars to any radius allowable by the design of the Spacer. Manually operated, the CRL Spacer Bender uses a pressure drive roller with two forming die rollers. As the Spacer is forced through the forming dies, the degree of bend is increased through higher pressure from the drive roller with each successive pass, until the desired radius is attained. Quick interchanging of the forming die rollers allows total versatility in bending of different size Spacers.

Unit includes Dies for 3/16", 1/4", 5/16", 3/8", and 1/2" (4.8, 6.4, 7.9, 9.5, and 12.7 mm) standard height CRL, All Metal, and Nichols Homeshield Spacer profiles. **NOTE:** Will not work with Slim Line/Narrow profiles. Different widths, other Spacer brands, and all Slim Line Narrow profiles require custom Die Sets. These Custom Dies are manufactured to customer samples. Contact CRL Glass and Glazing Technical Sales for machine details and specifications. F.O.B. Los Angeles, California. Minimum order is one each.



CAT. NO. DSBD1

## CRL Muntin Bar Bender

- For Fabricating Curved Insulating Glass Units
- Each Unit is Custom Made By CRL



The CRL Muntin Bar Bender easily bends Muntin Bar for Insulating Glass units with arched sunset patterns, as well as circular units. Any width of 3/16" (4.8 mm) thick Muntin Bar can be shaped with just a few quick passes. It has an easy-to-read indicator dial for quickly and accurately making repetitious bends.

The MMBD1 includes one set of Dies. If additional widths of muntins are going to need bending then an additional set of Dies will need to be ordered. If using Muntin Bars not sold by CRL then three each 36" (914 mm) samples of muntin must be sent to CRL. This is due to the tight machining tolerances needed to produce this precision piece of equipment. If you are using CRL brand Muntin Bar just specify the CRL catalog number that the Dies should be made to work with. Contact Glass and Glazing Technical Sales for machine details and specifications. F.O.B. Los Angeles, California. Minimum order is one each.



CAT. NO. MMBD1

## CRL Air Powered Muntin Clip Punch

- Accommodates 3/16" to 7/8" Aluminum Spacers
- For Single or Two-Prong Muntin Bar Clips

This CRL Air Powered Muntin Clip Punch is designed to accommodate 3/16" to 7/8" (4.8 to 22.2 mm) Spacers, and will punch holes for single or two-prong Muntin Bar Clips. It operates on air pressure from 50 to 250 PSI, and comes with a computer print-out Muntin Bar Spacing Chart. The chart shows machine stop settings for muntins up to 80" (2.03 m) long and up to six openings.

The Punch comes complete with a Stop Bar, one size Air Spacer Die, and one size Muntin Spacing Chart. When ordering, specify spacer and muntin sizes. Air Spacer Dies are available in all standard sizes. Specify centerline or off-center muntin clip holes when ordering Spacer Dies.

There are three available models to choose from, depending on what type of Muntin Bar Clip you are using. Customers ordering the MBKP1 will receive one Punch and Die with the unit. Spacer width and brand name must be designated. Additional widths of spacers require additional Dies. Customers must provide samples of their muntin clip (6 each) and spacer (4 each 6" [152 mm] long), unless they are using CRL components. Multiple Head Muntin Clip Punches (up to five heads) are available for larger production shops. Contact CRL Glass and Glazing Technical Sales for machine details and specifications.

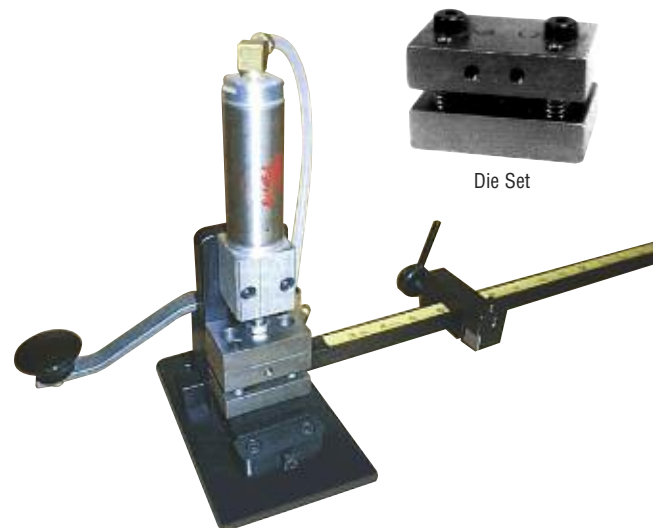

Air Powered Muntin Clip Punch

CAT. NO.	DESCRIPTION
MBKP1	Air Powered Muntin Clip Punch
MBKPD1E	Die Set for the MBKP1

Minimum order: 1 each. F.O.B. Canton, Michigan

## CRL Glass-Chek PRO Glass Thickness Meter and Low-e Coating Detector

- Triple Pane Thickness Measurement
- Full Low-e Detection Capabilities
- Enhanced Compatibility Means More Applications

GC3000 Glass-Chek PRO measures glass, air space and overall IG thickness of triple pane windows, all with a single test from one side of the window. It works with single and double pane applications as well.

The GC3000 is a fully equipped Low-e Coating Detector capable of locating a Low-e coating on any surface of a double pane window from a single side. This is a major time saver for testing multi-story buildings where you only have access to the inside of the window.

No other meter in the world can handle the same combination of applications. With an expanded thickness range to 1-1/2" (38 mm), the Glass-Chek PRO is compatible with residential and commercial glass. It is also compatible with new Low-e coatings, suspended film (i.e., Heat Mirror), tinted glass, laminated glass with Low-e against the laminate layer, and most commercial reflective glass. Minimum order is one each.

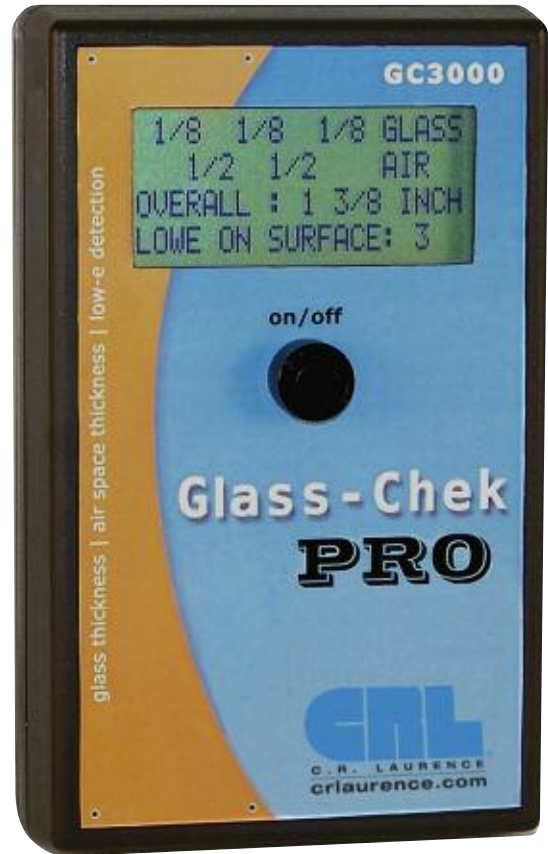

CAT. NO. GC3000

- Reduce Measurement Errors
- Measure Glass Deflection in Sealed IG Window Assemblies
- Uses a 9-Volt Battery – Common and Easily Replaceable
- Protective Carrying Case is Included
- Simple to Use Suitable for New or Experienced Window Installers, Production Personnel, Building Inspectors or Surveyors
- Made in the U.S.A.

### Choose from Multiple Display Formats

You can set up the Glass-Chek PRO to display measurement results in the format that works best for you. Choose from actual values or rounded (to ASTM Standards) in fractions of an inch, thousandths of an inch, decimals of an inch, millimeters, and more.

### Glass Thickness Capabilities Illustration

Measure the thickness of each pane, each air space, and the total IG thickness in single, double, and triple pane windows.

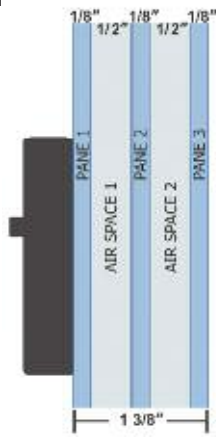

Total Thickness  
Triple Pane Window

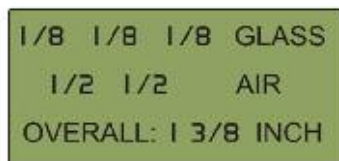

Display example outlining the glass, air space, and overall thickness of a triple pane window. Example shows readings in fractions of an inch, but the meter can be easily set up to display readings in other formats.

### Low-e Coating Detection Illustration

Detect the presence and location of Low-e coatings on any surface of the first two panes. The meter will specify whether the coating is on surface one, two, three/four or "CLEAR" if no coating is present.

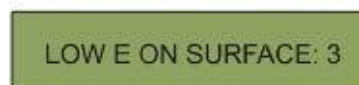

Display example indicates the Low-e coating is on surface 3 of the window. This means the coating is on the inside surface of the second pane. The GC3000 will detect coatings on any of the surfaces of a double pane window and most triple pane windows.

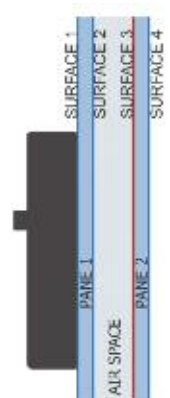

Double Pane Window

## CRL Glass Thickness Laser

- Measures Thickness of Air Space in Sealed Insulating Glass Units and Overall Unit Thickness
- Measures From Inside of the Building – No Glass Removal is Necessary
- Uses Laser Technology for Exact Measurements
- Calculates Thicknesses of Insulating, Laminated, Bullet Resistant, and Single Lite Float Glass
- Simple to Use – Just Press a Button and Read the Measurements

The CRL Glass Thickness Laser is a breakthrough in glass measuring devices. It will give you the same exacting readout as digital units costing hundreds more. Not only does the MG1500 measure standard Insulating Glass units, but it will also measure triple-glazed I.G. units, laminated glass, Low-e surfaces, and multi-layer bullet resistant glass. Best of all, the MG1500 is accurate from either side of the unit, so removal of the panel is not required. This is especially convenient in multiple-story buildings.

Designed for use in the field, glaziers and inspectors alike can easily carry it in their shirt pocket, on their belt, or just about anywhere the convenient carrying case will fit. The MG1500 is powered by two AAA batteries, which are included.

**IMPORTANT NOTE:** Avoid looking into laser beams at all times, as they can cause damage to your eyes.

- Fractional Inch and Metric Measurement Models



Overall Insulating Glass Thickness Scales

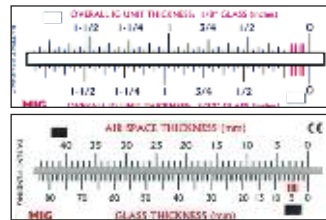

Fractional Inch and Metric Scale Sets are Interchangeable

CAT. NO.	DESCRIPTION
MG1500	Fractional Inch Laser
MG1500MM	Metric Laser
MG1500SS	Fractional/Metric Scale Set Only

Minimum order: 1 each.

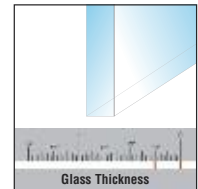

Float Glass and Mirror

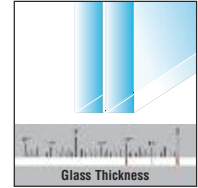

Laminated Glass (Any Thickness)

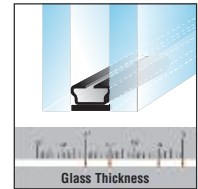

Double and Triple Glazed I.G. Units

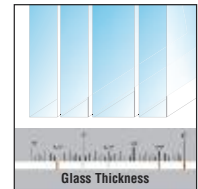

Bullet Resistant Glass (Any Combination of Thicknesses)

## CRL Glass-Chek+ Digital Glass Thickness Meter With Low-e

- Measures Insulating Glass Units – Thickness of Lite, Air Space, and Overall Thickness Up to 1-1/2" (38.1 mm)
- Detects Low-e Coating and Compatible With Tinted Glass
- Factory Calibrated, Needs No Field Adjustments
- Digital Readout in Decimal, Fractional, and Metric

The CRL Glass Chek+ Digital Glass Thickness Meter with Low-e Sensor is descended from the single pane Low-e coating detector, however the GC2001 is now able to differentiate whether the Low-e is on Surface 1 or Surface 2 of the glass. Another one of the biggest improvements is its ability to test tinted glass and the newest Low-e coatings that have been introduced in the past few years. This unit is capable of testing the thickness of single or double pane windows. Simply press the Glass-Chek Meter against a single lite of glass, or a dual lite window assembly, push the button and hold it until the measurements are digitally displayed. The thickness of each lite of glass, the air space, and the overall thickness of the unit will simultaneously appear on the two-line liquid crystal display. Unit can be read in decimal, fractional and metric. For best results, clean the window prior to testing. Uses one 9V DC battery (included). Minimum order is one each.



CAT. NO. GC2001  
Glass-Chek+

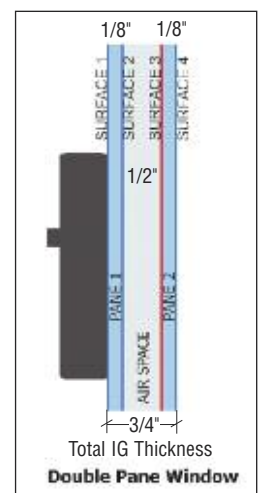



## CRL Insulating Glass Caliper

- Measures Insulating Glass Unit Thickness in Sliding Windows and Doors
- Quick and Easy to Use
- Fractional or Metric Scales on Both Sides



**CAT. NO. 1GCAL**  
Fractional Inch Caliper Shown

The CRL Insulating Glass Caliper makes it easy to measure the overall thickness of insulated glass panels in sliding windows and doors even when the panels have been glazed into a sash frame. This useful tool will measure up to 4" (102 mm) thick panels. The calibrated scale appears on both sides for quick and convenient measurements. Made of a high impact resistant composite material for durability.



CAT. NO.	DESCRIPTION
<b>1GCAL</b>	Fractional Inch Caliper
<b>1GCALMM</b>	Metric Caliper

Minimum order: 1 each.

## CRL Insulating Glass Thickness Gauge

- Works on Dual or Triple Glazed Units From 7/16" to 1-1/4" (11 to 32 mm) Thick
- No Opening or Disassembly of Windows Required
- Also Measures Thickness of Single Pane Windows

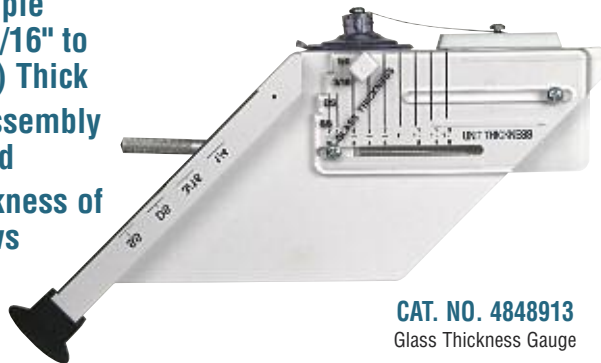

**CAT. NO. 4848913**  
Glass Thickness Gauge

The CRL Insulating Glass Thickness Gauge is a precise tool designed to accurately measure the glass thickness and overall unit thickness of multiple glazed windows in fractional increments. It works on any clear glass unit from 7/16" to 1-1/4" (11 to 32 mm) overall thickness. There is no need for exposed edges or openings, as the Gauge works by reflections, using a line-of-sight viewer that targets the exact thickness of the unit. The supplied reflector unit is held in place by a suction cup base. It is a time and money saver for anyone in the Insulating Glass field. Minimum order is one each.

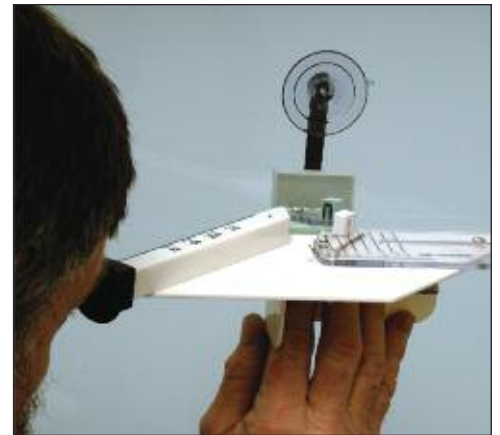

## CRL Glass Thickness Gauges

The CRL Glass Thickness Gauge measures single pane thickness even when it is not possible to measure the glass from the edge. Place the long edge of the Gauge against the glass and tilt the Gauge upward to a 45 degree angle to the glass surface. Look into the glass at the reflection of the Gauge and compare each short line with the long continuous line. Pick the one short line that is shown in the reflection within the same plane as the long line, and read the glass thickness measurement as indicated above that line. This is your glass thickness. Minimum order is one each.

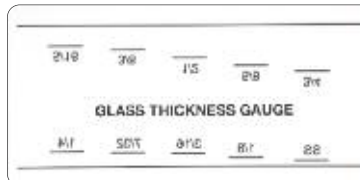

**CAT. NO. G1340**  
Fractional Gauge

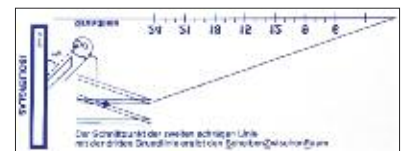

**CAT. NO. GTG1**  
Metric Gauge

## CRL Sales Demonstration Tools for Insulating Glass Units

- **High-Tech Aids to Show Your Customers the Benefits of Your Energy-Efficient Insulating Glass Units**

Convincing prospective customers to select your Insulating Glass units can be made easier with the proper demonstration aids. These new Meters help you show your customers that installing high performance Insulating Glass units will make a difference in the energy consumption costs and the comfort of their home.

Telling your customers how good your units are is one thing, but actually demonstrating it with the help of these precision meters will give you the edge over your competition. Choose our complete Sales Demo Kit (below) or individual meters (see opposite page). For additional information on these helpful sales tools go to [crlaurence.com](http://crlaurence.com).



## CRL Solar/UV Sales Demo Kit

- **Kit Includes Window Energy Profiler**

The CRL Solar/UV Sales Demo Kit can bring your Insulating Glass presentation to life, and help you convince prospective customers to select your energy efficient Insulating Glass units. This kit features the 4-in-1 Powerful Window Energy Profiler, which simultaneously reads the Solar Heat Gain Coefficient (SHGC), UV Transmission Percentage, Visible Light Transmission, and Infrared Transmission Values. This is the perfect sales tool to evaluate your customer's existing windows and compare them to your sales samples to confirm their need for new Insulating Glass units. The Kit comes with a Window Energy Profiler, an Infrared Heat Lamp, and Temperature Gun. The soft-sided Carrying Case has padded locations to hold your own insulating glass samples, and a set of factory glass samples for comparison. Additional details are available at [crlaurence.com](http://crlaurence.com). Minimum order is one each.



CAT. NO. SK1740

## CRL Window Energy Profiler

- Tests Windows in Frame Without Removal
- Simultaneously Displays Percentage of Allowable UV Transmission, Percentage of Visible Light, Percentage of Infrared Light Transmission, and Solar Heat Gain Coefficient

The CRL Window Energy Profiler is the latest in high-tech testing meters to determine the energy efficiency of dual glazed window and door glass. This meter simultaneously displays the four most important values to determine a glass panel's energy efficiency: UV Light Transmission, Visible Light Transmission, Infrared Light Transmission, and the "SHGC" (Solar Heat Gain Coefficient). Contractors and Building Inspectors can quickly tell if new windows and doors being installed meet code requirements.

This is a great tool to use during home sales demonstrations for potential homeowners to show the difference between their current windows and the newer types of energy efficient Low-e glass. One of the best features of the Energy Profiler is its design. The "U" shaped body allows a glass panel to be tested without having to remove it from the sash or frame. The Profiler calibrates itself automatically, and powers down automatically, prolonging the life of the single 9V DC Battery. The unit comes complete with a padded Carrying Case. Additional details are available at [crlaurence.com](http://crlaurence.com). Minimum order is one each.



CAT. NO. WP4500

## CRL Spectrum Detective Energy Transmission Meter

- Simultaneously Displays Three Measurements at Once: UV Transmission, Visible Light, and Percentage of Infrared Transmission Values
- Tests Single, Double, or Triple Panes

The CRL Spectrum Detective Energy Transmission Meter provides a convincing test to show the energy efficiency of your Insulating Glass units. Three performance values are displayed simultaneously: UV Energy, Visible Light, and Infrared Energy. Simple to operate and completely portable, it requires no additional light sources or power cords. Comes with a protective Carrying Case and 9V DC Battery. Additional details are available at [crlaurence.com](http://crlaurence.com). Minimum order is one each.

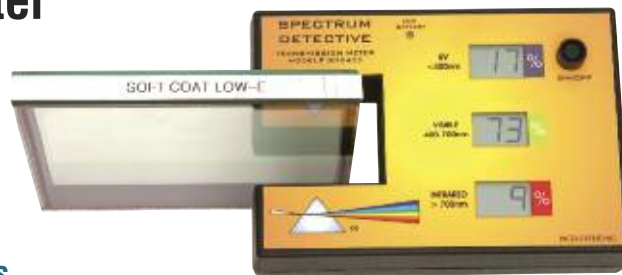

UV Transmission %



Visible Transmission %



Infrared Transmission %

CAT. NO. SD2400

## CRL Strengthened Glass Detector

- Identifies Glass That has Been Heat-Strengthened
- Tests Single or Double Panes
- Indicates Thickness of the First Pane of Glass



The Strengthened Glass Detector will allow users to confirm if glass has been heat strengthened. The Detector can test single panes of glass or multiple panes in a window at a single time, and from a single side. The glass can be tested in the factory, or after being installed in the field. This portable, battery-powered unit is convenient and simple to use. Simply slide the meter across the glass and conveniently watch the reflections from the glass head on. As the meter crosses stress lines in the glass (caused by the strengthening process), the resulting surface reflections from our wide array of light sources will change color.

The special optics of the SG2700 provides a robust change in color, and is great for applications where the stress lines are more difficult to view. The SG2700 Detector can even identify the thickness of the first piece of glass in the window. Conveniently portable size with a protective Carrying Case. Comes with a 9V DC Battery. Additional details are available at [crlaurence.com](http://crlaurence.com). Minimum order is one each.

CAT. NO. SG2700

## CRL Heat Strengthened Glass Detector Kit

- Instantly Determines Heat Strengthened Glass
- Illuminates Stress Areas
- Simple and Reliable



The CRL Heat Strengthened Glass Detector Kit provides a simple and reliable means of determining whether glass panels are heat treated by illuminating the stress zones created by the heat strengthened process. By shining the specially filtered, battery operated light source on the reverse side of the glass, and observing through the special glasses included with the kit, stress zones become rainbows of color. Annealed glass will remain clear when viewed using this technique.

Kit comes complete with Flashlight Light Source, Filtered Glasses, two "D" Cell Batteries, and a padded Carrying Case along with detailed instructions. You will want extra kits for your service department personnel and your quality control specialists. Minimum order is one each.

CAT. NO. HSGD1

## CRL Digital Surface Resist Meters

- Four Point Sheet Resistance Meters
- 9-Volt Battery Included

**new**



CAT. NO. RC2175



CAT. NO. RC3175

The resistance of a thin film coating is directly proportional to the resistivity and is an important quality control component of a coating. Therefore, resistivity may be the largest single item to determine the repeatability and function of a coating. Sheet resistance has the units of ohms, but it is convenient to refer to it in ohms per square since the sheet resistance produces the resistance of the coating within any square area. This parameter is therefore measured using the 4-point technique. Pocket Size Protection for Production, and Quality Assurance personnel who must know their products are "coated" properly.

CAT. NO.	RANGE	RESOLUTION
RC2175	0 - 20,000 ohms/sq.	0 - 2,000 = 1 ohm 2,000 - 20,000 = 10 ohms
RC3175	0 - 199.9 ohms/sq.	0.1 ohm

Minimum order: 1 each.

## CRL UV Transmission and Power Meter

- Checks Strength of UV Curing Lamps
- Displays UV Transmission Percent or Power Readings
- Measures Temperature in F° or C°



This CRL UV Transmission and Power Meter is the most versatile product available for measuring UV. You can measure UV intensities (irradiance), and UV Transmission percentage. Perfect for checking the output of your UV curing lamps to set benchmarks or you can even confirm the protection level of your UV spectacles, goggles, and facemasks. An added feature allows you to also measure temperatures in Fahrenheit and Celsius. Unlike other UV products on the market, this Meter is extremely simple to operate. The digital display is continually updated with real-time readings. Powered by a 9-volt battery (included). Minimum order is one each.

CAT. NO. UV1365

## CRL Digital Tin Side Detector

- Digital Technology
- Easy-to-Read Meter Identifies the Tin Side of Float Glass
- UV Lamp is Not Required



The CRL Digital Tin Side detector determines the tin side of float glass without the use of an ultraviolet bulb. There are several advantages to using digital technology to determine the tin side, such as being able to use this meter on either side of the glass. Just position up to the glass surface and depress the button, the large display clearly states if the meter is on the tin side, or if the tin is on the opposite side. With this new technology, the user no longer has to interpret the reflection of the UV light to make a subjective guess as to which surface is the tin side. There is no need to replace UV bulbs with this new Digital Meter, and the digital technology makes this meter very rugged, portable, and more energy efficient than other models. Operates on one 9V DC Battery. Minimum order is one each.

CAT. NO. TS2300

## CRL UV Lamp Tin Side Detector

- Battery Powered UV Lamp Identifies the Tin Side of Float Glass
- Includes UV Protective Spectacles



The CRL Tin Side Detector can identify the tin side of any piece of float glass by using short-wave ultraviolet light. This special lamp causes the tin to become visible in a milky white color. When the lamp is held to the air side, no color change takes place, just a dull image of the UV lamp is reflected. The short-wave UV light cannot transmit through the glass, therefore no change is noticed in the reflection and the milky color is not present. Some applications include auto glass fabrication, glass tempering, and the manufacture of mirror and other types of coated glass. The detection of the tin side is necessary in the processing of these types of glass. **NOTE:** Requires four "AA" Batteries, which are not included. Minimum order is one each.

CAT. NO. UVGA

## CRL Commercial Tin Side Detector

- The Solution Glass Processors Have Been Waiting for
- More Rugged Design
- Includes UV Protective Spectacles

**new**



The new Commercial Tin Side Detector has a momentary power switch which allows users to pulse the lamp, making it much easier to see the tin side glow. Also included is the patent-pending stencil insert that mounts behind the lamp. With the removable stencil in place, it is possible to read the words "TIN SIDE" on the edge of the glass when placed on the tin surface - even in well-lit environments. When placed on the tin side of glass, the fluorescent lamp image glows visibly. When placed on the non-tin side, the lamp image appears normal. Powered by three AA batteries (included). Minimum order is one each.

CAT. NO. TS1320

## CRL Tin Side Detector

- A Valuable Tool for Tempered Glass, Laminated Glass, Screen Printing, and Specialty Coating Applications
- Includes UV Protective Spectacles

**new**



The CRL Tin Side Detector allows you to determine the tin side of float glass. The instrument can test clear float glass or glass that has other specialty coatings applied to it in most applications. When the lamp is placed on the tin side of the glass, the fluorescent lamp image glows visibly. When placed on the non-tin side, the lamp image appears normal. This new design is powered by three AA batteries (included), however, it runs 50% longer than competing models. This new instrument is centered around a custom designed UV source that is more rugged and efficient than previous models. Minimum order is one each.

CAT. NO. TS1301

## CRL Conductive Coating Detector

- Red Indicator Lights Up On Contact With Low-e
- Edge Stop Restricts Use to Edge of Glass, Prevents Scratching
- Small Enough to Fit in Your Shirt Pocket

The CRL Conductive Coating Detector provides positive identification of the Low-e coated side of glass upon direct contact with the glass surface. This tool will prove itself invaluable to insulating glass fabricators who need to verify coatings and assure correct assembly procedures using Low-e glass. With edge stops designed into the housing, there is less chance of accidental scratching in the center viewing area. Window fabricators and quality control departments can verify that no Low-e surface is inadvertently exposed. Minimum order is one each.

**new**



CAT. NO. CD1

## CRL Non-Contact Detector

- Single Button Activation
- Visual Red LED Indicator and Audible Signal Announces Coating Found
- Helps Assure Manufacturers and Customers that Coating is Present
- Slips Comfortably into Shirt Pocket or Briefcase

The CRL Non-Contact Detector is a durable, dependable tool for use by fabricating, sales, and service personnel who need to verify the presence of Low-e glass coatings. Lay the CD2 against the glass surface and push the button to activate. A red LED indicator light and an audible signal will announce the presence of a Low-e coating on either surface one or two. Minimum order is one each.

**new**



CAT. NO. CD2

## CRL Dual Purpose Detector

- Switches Between Direct Contact and Non-Contact Modes
- Visual and Audible Signals Indicate Low-e Presence
- Maintains Calibration at all Times
- Compact, Reliable, and Efficient

The CRL Dual Purpose Detector combines the features of the CD1 and CD2 Low-e Detectors in one convenient, compact tool. The CD3 switches between direct contact mode and indirect presence mode to identify which side of the glass light has received the Low-e coating. It is ideal for in-shop quality assurance personnel, field service crews, sales people, building inspectors, and code enforcement staff. Minimum order is one each.

**new**



CAT. NO. CD3

## CRL Pocket Reference Book

- Tool and Construction Specs; Info on Paints, Finishes and Adhesives; Metric Conversions; and Lots of Useful Information

The CRL Pocket Reference Book is a wealth of information. Use it for tool and construction specs; get info on paints, adhesives and finishes; convert metric measurements; get electrical ratings and equivalents; solve math, geometry, and chemistry problems; look up area codes. It even has a 12 year perpetual calendar! There's a ton of useful data in this over 500 page reference that fits on your desk or in your glove compartment.

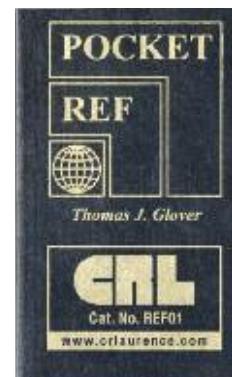

CAT. NO. REF01

## CRL Double-Pane Low-e Coating Detector

- Detects Invisible Low-e Coatings
- Ensures Windows are Installed Correctly
- Wide Temperature Stability
- Low-Battery Indicator

The CRL Low-e Glass Coating Detector senses the presence (or absence) and location of thermally resistant coatings (Low-e) used on single strength and double strength energy efficient glass from a single side. This helps to ensure windows are installed correctly.

This second generation tool offers enhanced reliability and temperature stability over its predecessor. Simple indicator lights check clear, near, or far surfaces. The unit requires one 9V DC Battery, which is included. The low-battery sensor causes the indicator lights to blink when the battery needs replacing. Minimum order is one each.



CAT. NO. AE1601

## CRL Low-e Coating Contact Meter

- Detects Hard or Soft-Coat Low-e Applications
- Reduces Costly Mistakes in Manufacturing
- Economically Priced

The CRL Low-e Coating Contact Meter is a simple instrument that detects any conductive surface, including Low-e coatings, on a single sheet of glass. The Meter has four non-scratch pads on the reverse side that you press against the glass to determine if that surface has any conductive Low-e coatings.

The CM1030 is the ideal tool to use during the manufacture of Low-e Insulating Glass units. You can easily check glass surfaces for coatings without any extensive training. If the Meter detects a coating on the surface an indicator lights up to signal its presence. One 9V DC Battery is included. Minimum order is one each.



CAT. NO. CM1030

## CRL Solar Transmission and BTU Power Meters

**new**

- Demonstrate Your Product's Solar Performance
- Displays Solar Transmission and BTU Power Readings



Lamp and Test I.G. Unit Not Included

These innovative CRL Solar Transmission and BTU Power Meters demonstrate both the solar transmission percentage of your window and, with the press of a button, the BTU values. The SP1065 reads radiant solar power in BTU's or watts. The SP2065 also can be switched to transmission mode to read solar transmission percentage. The SP2065 is included in the Cat. No. SK1740 Sales Demo Kit (shown on page 618K), or you can order it separately. Meters come with a 9V DC Battery. Additional details are available online at [crlaurence.com](http://crlaurence.com). Minimum order is one each.



CAT. NO. SP1065



CAT. NO. SP2065

## CRL Merlin Lazer Glass Measuring Gauge

- Quickly and Accurately Identify Laminated Glass
- No Glass Removal Necessary
- Available Only in Europe

Our CRL Merlin Lazer Glass Measurement Gauge is a very simple but effective precision measurement instrument that provides accurate measurement of single glass and air gap thickness in single, double, and triple glazed units. It is also able to identify laminate interlayers at a touch of a button. All readings can be taken from one side without the need to remove the glass. Minimum order is one each.



Available Only in Europe

CAT. NO. 0480

## CRL Pilkington® K Glass™ Detectors

- Identify Low Emissivity Low-e Coated Glass
- For Single and Double Glazed Glass
- Comprehensive Instructions Included

Our CRL Pilkington® K Glass™ Detectors have been developed to distinguish low emissivity coated glass from ordinary float glass. These units are available for single glazed or double glazed units.

- Available Only in Europe



Available Only in Europe

CAT. NO.	DESCRIPTION
0472S	Single Glazed Glass
0472D	Double Glazed Glass

Minimum order: 1 each.



CAT. NO. 0472S



CAT. NO. 0472D

## CRL Low-e Coating Detectors

- Reduce Costly Mistakes in Manufacturing
- Identify Low-e Coating in the Field Quickly
- Available Only in Europe



Available Only in Europe



The CRL Low-e Glass Detector senses the presence (or absence) and location of thermally resistant coatings used on single strength and double strength energy efficient glass (maximum air space of 1/2 inch (12.7 millimeters). This helps to ensure windows are manufactured correctly. Simple indicator lights check clear, near, or far surfaces. Minimum order is one each.

CAT. NO. AE3600

## CRL Merlin Lazer Low-e Coating Detector

- Easily Identify Low-e Glass at the Touch of a Button
- Ideal for Checking Document L Compliance
- Available Only in Europe



Available Only in Europe



The CRL Merlin Lazer Low-e Coating Detector is a dual-purpose tester designed to detect Pilkington® K Glass™ and all other low emissivity coatings on single and double glazed units, and to indicate on which surface it is present. Installers and inspectors can verify the presence of the coating and the correct orientation of the unit. Minimum order is one each.

CAT. NO. 0482

## CRL Merlin Lazer Toughened Glass Indicator

- Quickly Verify Whether Glass Has Been Toughened
- Identify From One Side Only
- Available Only in Europe

The CRL Merlin Lazer Toughened Glass Indicator is able to indicate toughened glass in single and multi-pane units from one side only at the touch of a button. This makes it an ideal solution to safely determine whether glass has been toughened or not. Minimum order is one each.

Pilkington is a registered trademark of Pilkington Group Limited Corp.



Available Only in Europe

CAT. NO. 0481





## CRL 360 Degree Rotary Work Table

- Speeds Production of Insulating Glass Units
- 2' x 3' (610 x 914 mm) Carpeted Surface
- Holds Units Up to 5' x 7' (1524 x 2134 mm)

The CRL Rotary Work Table speeds production of Insulating Glass units while creating a safer work place. The glass is held in position by a 6" (152 mm) vacuum cup on a 24" x 36" (610 x 914 mm) carpeted surface. Vacuum Cup system is powered by a continuous-flow vacuum generator which requires a 35 psi air supply (not supplied) regulated at the table. A 360 degree air driven braking system stops and holds the table-top in any rotational position. Both the vacuum hold-down and braking systems are controlled via tandem foot-pedal controls. Swing-out support arms expand the top surface to 60" x 84" (1524 x 2134 mm). Work surface height is 36" (914 mm). Shipping weight: 140 pounds (63.5 kg). Minimum order is one each.



CAT. NO. LCS3084

## CRL Power Rotating Sealing Table

- 360 Degree Rotating Table
- Extendable Arms Handle Large Insulating Glass Units

The CRL Power Rotating Sealing Table seals single or stacked Insulating Glass units weighing up to 400 pounds (181 kg). The tabletop is raised and lowered by a 5" (127 mm) bore x 8" (203 mm) stroke pneumatic cylinder. Vacuum cups are raised and lowered by two 1" (25 mm) bore x 1" (25 mm) stroke pneumatic cylinders. Table rotation is powered by a DC drive motor with speed control. The directional rotation switch and speed control are mounted on a control panel on the table frame. All other controls are actuated by a foot pedal. Table rotates only in raised position. F.O.B. Red Oak, Texas. Shipping weight: 900 pounds. (408 kg). Minimum order is one each.

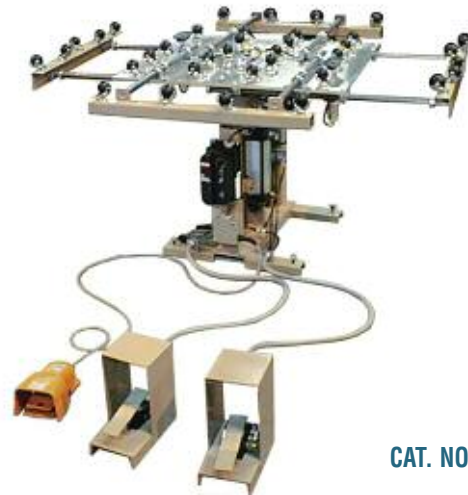

CAT. NO. PRST

## CRL Positioner Vacuum Cup Work Stand

- 360 Degree Rotation
- Safely Handles Work Loads to 150 Pounds (68 kg)

This CRL Positioner Vacuum Cup Work Stand is designed to hold glass or other non-porous materials up to 150 pounds (68 kg) in the position you set. The stand is great for window manufacturers when attaching hardware, assembling small I.G. units, or for anyone who needs to repetitively hold glass in a pre-determined position. It has full 360 degree edgewise rotation and a 90 degree forward tilt. A small, quiet 115V AC pump supplies constant vacuum to the 9" (228 mm) cup. Positioners feature adjustable pad height, foot valve vacuum release, 9" (228 mm) cup, vacuum pump, clamp and base. Shipping weight: 100 pounds (45 kg). Minimum order one each. F.O.B. Laurel, Montana.



CRL Positioner Vacuum Cup Work Stand with Table Mount Clamp

CAT. NO. POSB1P9AC



CRL Positioner Vacuum Cup Work Stand with Pedestal Base

CAT. NO. POSF1P9AC

To see the complete selection of CRL Insulating Glass products, see our catalog CRL83R, pages 797W-852W or visit us at [crlaurence.com](http://crlaurence.com).

## CRL Low-e Glass Edge Deletion Table

- Manual Table Easily Removes Glass Coatings
- Tubular Steel Construction With Adjustable Legs
- 2" (51 mm) Non-Marking Roller Balls Allow Glass to Move Easily

Glass lites with Low-e coatings must have the coating removed from the edge that will be sealed. The EDT60X84 Edge Deletion Table makes removing Low-e coating fast and easy. An operator moves one edge of the coated glass through the abrasive wheel, then runs the other three edges through the wheel and passes the finished sheet on to the next step. A HEPA Vacuum is included to collect particles from the edge wheel. Motor is 3/4 HP, single phase, 50/60 Hz, 220V AC. Made in the U.S.A.



CAT. NO.	TABLE TOP SIZE
EDT60X84	60" x 84" (1.5 x 2.13 m)

Minimum order: 1 each. F.O.B. Cicero, Illinois. Must ship via common carrier.

## CRL Power Ball Caster Tilt Tables

- Aids Transfer of Insulating Glass Units or Single Lites of Glass
- Raises and Lowers by Pneumatic Cylinder Action
- All Tubular Steel Construction With Adjustable Legs



For more information on Insulating Line Production Equipment and Services, call our Machinery Division at (866) 583-1377, or e-mail to [machinery@crlaurence.com](mailto:machinery@crlaurence.com).

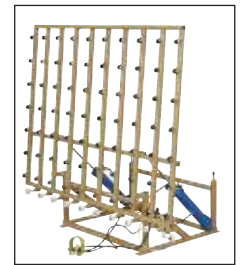

The CRL Power Ball Caster Tilt Table tilts to a vertical position for the lateral transfer of single sheets of glass or Insulating Glass units. Its heavy 2" (51 mm) square by 1/8" (3 mm) thick tubular steel construction supports any size load. The neoprene Casters are 2" (51 mm) in diameter, spherical balls that will not scratch the glass. The table height can be adjusted from 34" to 36" (863 to 914 mm). **NOTE:** 100 psi, seven cfm air supply is required for operation. Made in the U.S.A.

CAT. NO.	TABLE TOP SIZE
PBCTT84X120	84" x 120" (2.13 x 3.05 m)
PBCTT84X144	84" x 144" (2.13 x 3.66 m)
PBCTT84X156	84" x 156" (2.13 x 3.96 m)
PBCTT84X168	84" x 168" (2.13 x 4.27 m)
PBCTT84X192	84" x 192" (2.13 x 4.88 m)

Minimum order: 1 each. F.O.B. Cicero, Illinois. Must ship via common carrier.

## CRL Ball Caster Transfer and Inspection Tables

- Exclusive Neoprene Spherical Ball Casters
- Tubular Steel Construction With Adjustable Legs
- Available in 60" (1.52 m) Width on Special Order



Inspection Table



Transfer Table



These CRL Ball Caster Tables are for lateral transfer and inspection of single lites of glass and single or multiple Insulating Glass units. The legs and base are made from 2" x 3" (51 x 76 mm) tubular steel which can be adjusted for heights from 34" to 36" (864 to 914 mm). The table tops are constructed from 2" (51 mm) square tube steel. The 2" diameter neoprene Ball Casters won't scratch glass. Ball Casters are mounted on 12" (305 mm) centers. Custom 6" (152 mm) center mounts are available by special order. Inspection Tables are built with a cutout to allow an operator to get closer to the glass. All Tables are MIG welded and finished in industrial enamel to resist oxidation. Made in the U.S.A.

CAT. NO.	TABLE TYPE	TABLE TOP SIZE
BCT84X60	Transfer	84" x 60" (2.13 x 1.52 m)
BCT84X84	Transfer	84" x 84" (2.13 x 2.13 m)
BCT84X120	Transfer	84" x 120" (2.13 x 3.05 m)
BCT84X156	Transfer	84" x 156" (2.13 x 3.96 m)
BCT84X168	Transfer	84" x 168" (2.13 x 4.27 m)
BCT84X192	Transfer	84" x 192" (2.13 x 4.88 m)
B6212100	Inspection	84" x 60" (2.13 x 1.52 m)
BC1NPT84X156	Inspection	84" x 156" (2.13 x 3.96 m)
BC1NPT84X192	Inspection	84" x 192" (2.13 x 4.88 m)
BCT24XT12	26" x 31" (660 x 787 mm) Extensions for B6212100 - Set	

Minimum order: 1 each. Cat. No. BCT24XT12 is 1 set. F.O.B. Cicero, Illinois. Must ship via common carrier.

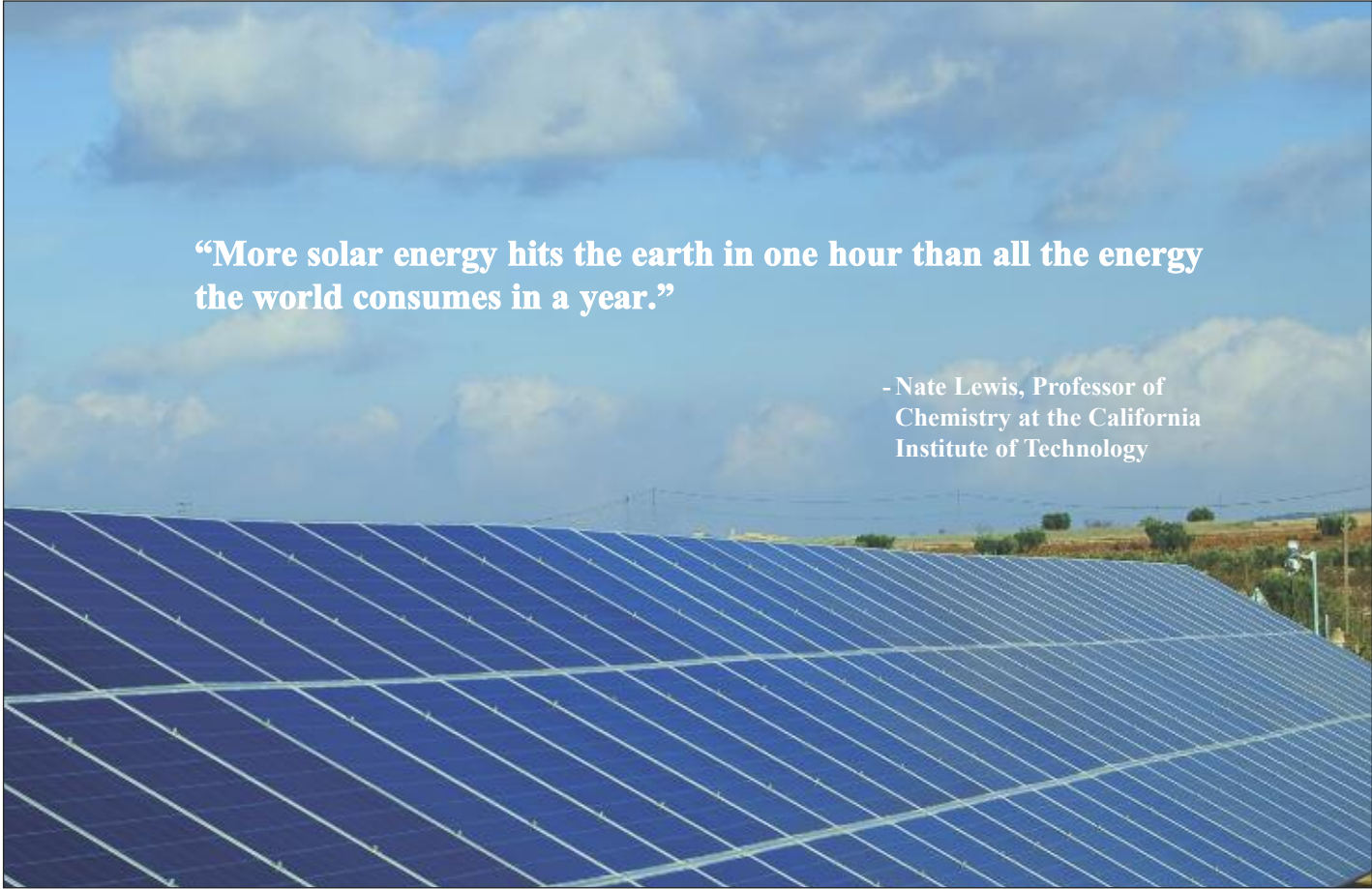

**“More solar energy hits the earth in one hour than all the energy the world consumes in a year.”**

- Nate Lewis, Professor of  
Chemistry at the California  
Institute of Technology

## **CRL Engineers Create Glass Washing and Handling Solutions That Allow Solar Panel Manufacturers to Increase Production and Efficiency**

The CRL Machinery Division is an industry leader in manufacturing glass cleaning, mirroring, edging, and handling equipment. Whether your need is to produce concentrators, thin film panels, or Crystalline Silicon components we have the solution.

Glass may not be the heart of the modern solar panel, but it is the medium on which the latest Photovoltaic Panels (PV) and Concentrating Solar Panels (CSP) are built. Glass remains the most economical base for utilizing these clean energy technologies. CRL Glass Processing Equipment is designed and built in our Cicero, Illinois manufacturing plant. If you have a unique process scenario, our in-house engineers can develop a custom solution to meet your application. Contact our Glass Machinery Division today for fast, reliable solutions to all your solar panel manufacturing process.

## **CRL Products for Solar Panel Fabricators**

- **Panel Wash, Rinse, and Dry Modules**
- **Oscillating Surface Scrubber Modules**
- **Connecting, Buffer, Oven, and Accumulator Conveyors**
- **Over-Spray Cleaning Modules**
- **Roller-Bed Conveyors and Belt-Edge Conveyors**
- **Glass Edging Machinery**

Contact our Glass Machinery Division at (866) 583-1377 or at [machinery@crlaurence.com](mailto:machinery@crlaurence.com)



## CRL Mirror Production Lines



Concentrated Solar Power (CSP) systems use mirrored panels to focus energy to a thermal collection point. Low-iron glass panels with one silver-plated mirror surface are best suited for these concentrators. CRL Machinery has the experience of building specialized sections and every component of these completely conveyorized Solar Mirror Production Lines. Contact our Glass Machinery Division at (866) 583-1377 or e-mail [machinery@crlaurence.com](mailto:machinery@crlaurence.com) for more information.

## CRL Heavy-Duty Solar Series Glass Washers

- Ideal for Photovoltaic Glass Cleaning
- Stainless Steel Construction
- 35' (10.7 m) Per Minute Standard Conveyor Speed
- Stainless Flowmeters and Flow Controls for All Compartments



HDSS Heavy-Duty Glass Washer



The Solar Series Washer can be built into any processing line or configuration where clean panels are needed. It can also be used as a stand-alone production section for component pieces. This Solar Series Washer splits open at the conveyor pass line to simplify service. A power-driven, safe lift-top is optional.

The CRL Heavy-Duty Solar Series Washer features a stainless steel cabin, covers, and pans. The cleaning sections include a pre-spray for removal of packing powders and loose contaminants. Next, washing and rinse sections with cylindrical brushes thoroughly clean the panel's surface. Then a high pressure turbine drying system removes all moisture from the panel. The roller journals, brush shafts, and recirculating coolant systems are all stainless steel. All panels and electrics are UL certified. Available options include filtration, conductivity monitoring, static elimination, and sound control.



# 6

## Glass Working Machinery and Lifting Equipment

- GLASS CUTTING TABLES
- GLASS EDGERS
- GLASS WASHERS
- PANEL AND MITER SAWS
- SURFACE RESTORATION
- UPRIGHT BELT SANDERS AND TWIN SEAMERS
- HAND SANDING EQUIPMENT
- WOOD'S VACUUM FRAMES FOR LIFTING, TILTING, AND ROTATING

See other side for Section Index.

**CRL**  
**U.S. ALUMINUM**  
crlaurence.com • usalum.com

# SECTION 6 INDEX

For a complete index to this catalog, turn to Section 7. To search for all CRL products, go to CRL Total Search at [crlaurence.com](http://crlaurence.com).

## A

Abrasive Belts for Upright Belt Sanders.....	647K-649K
Aluminum Storefront Tools .....	705K
Automatic Glass Edgers.....	657K-666K

## B

Ball Caster Tables .....	646K
Baume Scale and Vial.....	679K
Belt Guard Safety Shields.....	635K
Belt Sanders .....	634K-655K
Belts, Abrasive.....	634K, 637K, 639K, 642K, 647K-649K
Bench Model Wet Belt Sander.....	642K
Bevelling Wheels.....	667K
Brushes, Glass Washer.....	683K, 691K

## C

Cerium Oxide Polishing Compounds ..672K, 674K, 678K-679K	
Circle Edger and Polisher .....	671K
Cleaning Supplies .....	680K-682K
Coolant Pump.....	659K
Cork Polishing Belts .....	647K-648K
CRL	

Ball Caster Tables.....	646K
Belt Sanders.....	634K-643K, 646K
Counter Balance Cutting Tables.....	694K-695K
Edging Machinery.....	656K-667K
Finger Grip Machines.....	671K
Glass Washers.....	684K-691K
Grinding Mill.....	671K
Horizontal Sander.....	646K
Laminating Lines.....	693K
Machinery Leasing .....	633K
Portable Belt Sanders .....	651K-655K
Silvering Lines .....	692K
Single Spindle Edger .....	657K-659K
Smoothing Mill.....	671K
Tilt-Top Glass Cutting Tables .....	694K-696K
Twin Belt Seamers .....	644K-645K
Two Spindle Edger.....	660K-663K
Vertical Edgers.....	665K-666K
Cutting Tables and Accessories .....	694K-698K

## D

Defoaming Additives .....	669K
Diamond	
Edging Wheels.....	658K, 662K, 667K
Synthetic Tool Coolants.....	668K
Wheel Dressing Boards and Sticks.....	669K, 679K
Wheel Redress Program .....	668K
Double Miter Saw.....	704K
Dry Twin-Belt Seamer.....	644K

## E

Eazi Lifter® .....	713K
Edger Wheels and Parts .....	658K-659K, 662K-663K, 667K
Electric Winch for Glass Cutting Tables.....	697K
European Cutting Oils.....	670K
European Upright Wet Belt Sander.....	637K
Extendable Squeegee .....	681K

## F

Felt Wheels .....	673K-674K
Finger Grip Machine .....	671K
Fixed 45 Degree Double Miter Saw .....	704K
Flat Edgers .....	664K
Flex Wheel.....	707K
Forklift Boom.....	713K

## G

Glass	
Cutting Tables and Accessories.....	694K-698K

Edging Machinery.....	656K-667K
Laminating Lines.....	693K
Polishers.....	673K-676K
Scratch Removers .....	673K-678K
Surface Restoration .....	673K-678K
Washers.....	684K-691K
Grinders.....	706K-707K
Grinding Mill.....	671K
Grinding Wheels.....	707K
Ground Fault Circuit Interrupter .....	678K

## H

Hand Sanding Equipment and Abrasives .....	651K-655K
Heavy-Duty Router .....	705K
Heavy-Duty Scratch Polisher.....	673K
Heavy-Duty Vertical Glass Washers .....	686K
High Speed Spiral Bits .....	705K
Horizontal Glass Washers.....	687K-691K
Horizontal Wet Belt Sander .....	646K

## I

Industrial Glass Cleaners.....	682K
Industrial Paper Towels.....	682K
Insulating Glass Anti-Shear Supports .....	738K

## L

Ladder Lifter.....	712K
Lifting Frame Accessories.....	737K-740K
Lifting Frames.....	709K-736K
Low-e Washing Machine Detergent.....	683K

## M

Machines, Glass Edging.....	656K-667K
Machines, Glass Sanding.....	634K-646K
Makita® Angle Grinders.....	706K-707K
Metal Brake and Shear .....	708K
Metric Conglomerate Abrasive Belts .....	649K
Metric Sanding Belts.....	648K-649K
Mini Ball Caster Table Glass Rest.....	645K
Miter Saws .....	704K

## O

Oil, Polishing .....	650K
One Direction Glass Cutter.....	701K

## P

Panel Saw.....	703K
Paper Towels.....	682K
Particulate Respirators .....	650K
Peripheral Edging Machines.....	665K
Platen, Belt Sander.....	659K
Polishers.....	673K-676K
Polishing Oil.....	650K
Portable Belt Sanders .....	651K-655K
Powr-Grip® Lifting Frames.....	715K-740K
Production Miter Saws.....	704K

## R

Roller Track Kit for Twin-Belt Seamer.....	644K
Rotating/Tilting Hand Cup Lifting Frames .....	714K
Router Jig and Template .....	705K

## S

Safety Speed Cut Panel Saws.....	702K-703K
Sander Replacement Parts .....	636K, 638K, 640K-641K, 643K
Sanders, Portable Belt.....	651K-655K
Sanders, Wet Belt.....	634K-643K, 646K
Sanding Belts for Portable Sanders .....	651K-655K
Sanding Belts for Wet Belt Sanders.....	647K-649K
Scratch Removal Kits.....	673K, 675K-677K
Scratch-A-Way Polishing System.....	676K
Seamers, Twin-Belt.....	644K-645K

Silicon Carbide Abrasive Belts .....	647K-648K
Silvering Lines.....	692K
Single Spindle Glass Edgers .....	657K-659K
Slurry Bags .....	679K
Squeegees .....	680K-681K
Stab-In Glass Cutting Table Rollers.....	697K
Stalter Glass Cutting Machines .....	700K-701K
Stowaway Tilt Table.....	698K
Super Weatherstrip Adhesive .....	674K
Synthetic Blue Powder Coolant .....	662K
Synthetic Diamond Tool Coolants .....	668K

## T

Tables, Ball Caster .....	646K
Tables, Belt Sander Rolling .....	635K, 639K
Tables, Tilt-Top Glass Cutting .....	694K-698K
Template Guides for Router.....	705K
Tilt-Top Glass Cutting Tables .....	694K-698K
Tilt-Top Glass Washers.....	687K-690K
Tube Wax Lubricant.....	650K
Twin Seamer Glass Rest.....	646K
Twin-Belt Tempering Seamers .....	644K-645K
Two Direction Glass Cutter.....	700K
Two Spindle Edgers .....	660K-663K

## U

Universal Movable Glass Table.....	635K
Upright Wet Belt Sanders .....	634K-641K

## V

Vacuum	
Lifter Replacement Parts .....	737K-740K
Lifting Configurator .....	710K-711K
Lifting Frames.....	714K-740K
Loss Warning Buzzer .....	737K
Pads, Replacement .....	739K
Vapourmax Cutting Oils.....	670K
Vertical Glass Edgers .....	657K-666K
Vertical Glass Washers .....	685K-686K
Vitrolube Diamond Tool Coolants.....	679K

## W

Washer Brushes and Parts.....	683K, 691K
Washing Machine Detergents.....	683K
Washing Machines.....	684K-691K
Wax Lubricant .....	650K
Wet Abrasive Belts .....	634K, 637K, 639K, 642K, 647K
Wet Belt Sanders .....	634K-643K, 646K
Wet Twin-Belt Seamer .....	645K
Wheel	
Dressing Boards and Sticks .....	669K
Finger Grip .....	671K
Mounting Bolt Kit.....	659K
Position Dial Indicator.....	659K
Redress Program .....	668K
Wheels, Bevelling .....	667K
Wheels, Edging.....	658K-659K, 662K-663K, 667K
Wheels, Felt Polishing .....	673K-674K
Wood's™	
Channel Lifters .....	722K-725K
Custom Lifter Program .....	736K
Eazi Lifter®.....	713K
Equipment Leak Test Kit.....	740K
Heavy-Duty Transport Case.....	723K
Ladder Lifter.....	712K
Lifting Frame Options .....	737K-738K
Lifting Frames.....	715K-740K
Rental Program .....	718K-719K
Rotators.....	726K-734K
Tilters.....	727K-735K
Vacuum Lifting Frames.....	715K-740K
Wool Felt Wheel .....	674K



C.R. LAURENCE COMPANY

[crlaurence.com](http://crlaurence.com) | [usalum.com](http://usalum.com)

ALUMINUM

[crlaurence.ca](http://crlaurence.ca)

[crlaurence.com.au](http://crlaurence.com.au)

[crlaurence.co.uk](http://crlaurence.co.uk)

[crlaurence.de](http://crlaurence.de)

[crlaurence.eu](http://crlaurence.eu)

## Sommer & Maca Machinery Division of C.R. Laurence Company



The Spring of 2008 opened with the joining of two glass industry giants. The acquisition of Sommer & Maca by C.R. Laurence Company added the depth and scale of Sommer & Maca's machinery manufacturing base to the extensive worldwide sales and distribution network established by C.R. Laurence. The close working relationship between the two companies became formal as Sommer & Maca became the Machinery Division of C.R. Laurence Company. Today this powerhouse combination looks to the future of expanding technologies, such as solar production, as well as the ongoing industry need for glass fabrication of all sorts.



Committing to the continuation of the Sommer & Maca Machinery brand, the 90,000 square foot Sommer & Maca manufacturing facility in Cicero, Illinois, a suburb of Chicago, officially became CRL Branch 17, the second facility in the CRL group dedicated strictly to manufacturing. Along with the state-of-the-art engineering and manufacturing capability, the Cicero facility also acts as the Machine Parts and Technical Services Department for the company. With thousands upon thousands of Somaca machines built and sold around the world since 1921, the CRL commitment to support and service is dedicated and intense.



The most important and valuable asset in the joining of Sommer & Maca to C.R. Laurence is the core of dedicated, experienced professional personnel added to the already deep mix at CRL. Many of the administrative and technical personnel not only have 20 to 30 years or more working in their profession, but also working those years for one company. The combined talents of this group of skilled professionals will keep CRL moving forward to meet the challenges of the future.

## CRL Machinery Division History

### • Leadership Since 1920

What is now the C.R. Laurence Machinery Division began on February 23, 1920 as a machine shop specializing in flat glass processing equipment. The original partners, Ed Hansen, Kurt Sommer, and Paul Maca named the firm Hansen, Sommer and Maca Inc., or HSM for short. Hansen and Sommer, both immigrants, had machinist training in Sweden and Germany, respectively. Paul Maca was an engineering and business student in Chicago. All three had been previously employed by one of the premier glass machinery manufacturers in the Chicago area.



### • Original Location: Hansen, Sommer & Maca, 671-673 W. 16th Street, Chicago, Illinois.

The small company struggled for the first few years as it competed with larger, more entrenched machine companies. In 1923, Paul Maca designed a new style of upright grinding mill powered by a single electric motor. This was the first machine of its kind with self-contained power. Similar systems until then were being powered by centralized, stationary, and wide leather belt-and-pulley systems. The self-contained aspect allowed operators to move the machine as needed, which proved to be a big hit with auto glass replacement shops.

The new mill design caught the attention of Ford Motor Car Company. The HSM sales manager was dispatched to Detroit with photos and technical data for a full sales presentation. Ford was impressed but non-committal and gave no indication that they would purchase equipment. Six months after the Ford presentation, Ed Hansen moved to California and sold his interests in the company to Paul Maca and Kurt Sommer.

In October of 1924, an order arrived from Ford Motor Car Company for 200 grinding mills. Since HSM had only six employees, Ford's delivery schedule created a major headache. Information was discreetly supplied to Ford about the actual size and manufacturing capabilities of HSM. Surprisingly, Ford management was understanding. Ford said that if HSM would build and deliver 100 mills, Ford would build 100 and pay HSM a royalty on each machine.

The Ford order put HSM in a sound financial position and the performance of the new grinding mill set off a wave of new inquiries from glass companies across the country. The Ford success enabled HSM to expand and speed development of additional glass working equipment such as grinders, edgers, polishers, and miter machines.



## CRL Machinery Division History

In 1926, the company moved to larger quarters at 3600 S. Oakley in Chicago. Shortly after the move, Hansen's name was dropped and the company was renamed the Sommer & Maca Glass Machinery Corp. Somaca was adopted as a trade name.



### • Second Location: Sommer & Maca Corp., 3600 S. Oakley, Chicago, Illinois

During the years from 1939 to 1945, Somaca's machine shop performed work for the military and the war effort. Machinery sales and development slowed during these years as government orders for machined parts poured in. In 1941, these orders took precedence and Somaca soon became one of Chicago's major producers of cut gears needed for tanks, troop carriers, gun turrets, and a myriad of other applications. A new company was formed at the corporate headquarters named Gears and Transmissions, and continued operations until 1949. Although it was a fairly successful venture, Paul Maca and Kurt Sommer decided to concentrate on glass machinery, disbanded the company, and sold off the inventory.

By 1956, Sommer & Maca had outgrown its location on South Oakley Avenue and constructed a new 60,000 square foot building on Ogden Avenue in the Cicero Manufacturing District. The facility was later expanded to 90,000 square feet of manufacturing, distribution, and office space.

In March of 2008, Sommer & Maca Machinery became a division of the C.R. Laurence Company. Since then a significant amount of time and resources have been invested to modernize and upgrade the facility. Output capacity has more than doubled. The CRL Machinery Division also houses the engineering, support, installation, and parts departments.



### • Current Location: 5501 West Ogden Avenue, Cicero, Illinois

## CRL Machinery Division Parts and Technical Services Department

Phone (866) 583-1377  
(773) 242-2871

When investing, or even considering an investment in glass processing equipment, a major consideration has to be service quality, parts, and availability. What's available, how soon can I get it, and is it affordable?

The oldest recorded machine's serial number (12065) currently on file dates back to the 1940's. The Machinery Division is now entering serial numbers in the 68000 range. The original contract run of Flat Grinding Mills was produced in 1921. The first 4" x 106" (102 x 2692 mm) Upright Belt Machine was introduced in 1932. In addition to the thousands of Belt Machines and hundreds of specialized and unique processing machines built over the years, the Machinery Division has produced over 1200 Washing Machines in the last 50 years. Since 1984, the Machinery Division has built and sold over 750 Single Spindle Edgers and over 650 Two Spindle Edgers in various configurations. With thousands of pieces of equipment produced and sold, parts and technical expertise are crucial to customer support worldwide.

An extensive line of machinery requires an equally extensive inventory of parts, as well as a well trained experienced staff to match the correct parts to your machine. The CRL Machinery Division maintains an inventory of nearly 10,000 different parts. Our product line ranges from bolts to motors; casters to conveyor rollers; motor brushes to washing machine brushes, and if we don't have the part you need on the shelf, we will find or fabricate it for you. The CRL Machinery Division Parts and Service Department is backed up by our machine shop, where state-of-the-art equipment and highly trained personnel can quickly turn out any fabricated part. Plus, CRL's distribution system can get parts to you fast, anywhere in the world.



The CRL Machinery Division also maintains a staff of highly experienced expert technicians. Some of this trained group works out of our Cicero, Illinois machinery facility and stand ready to answer technical questions and troubleshoot problems over the phone. Others, located throughout the country, are available to travel to your facility to install, troubleshoot, or repair your CRL Machinery.



Need parts or service today? Have your machine model and serial number ready and call our experts toll free at (866) 583-1377. Ask for the Parts and Service Department, or fax your request to (866) 584-9722, attention Parts and Service.

Still trying to find the right machine for your needs? Visit [crlaurence.com](http://crlaurence.com) and click on **Glass Machinery** for a full listing of the latest models and used equipment, to request a quote, ask technical questions, or even request a manual for your current machine.

## CRL Machinery Quotation Request

- Request Quotations With Your Computer
- Call to Speak With a Machinery Specialist
- Huge Selection to Meet Your Needs

The CRL Machinery Division would be pleased to provide you with a quotation for your machinery purchase. Whether you are considering expansion or just budgeting for the next business cycle, we offer two methods of securing the needed information.

From the C.R. Laurence Home Page, click on **Quote Request** located on the upper tool bar. Then follow the steps until you reach the form shown here on the right. Fill in all the data you can and fax to (866) 584-9722.

The second method is a good, old-fashioned phone call to (866) 583-1377 to discuss your needs with one of our expert Machinery Specialists.



Equipment Quotation Request Form     Date: \_\_\_\_\_

For the equipment to:  RE-INSTALL      NEW INSTALLATION/REPAIR/REPLACE

Company: \_\_\_\_\_ Contact: \_\_\_\_\_

Name: \_\_\_\_\_ Title: \_\_\_\_\_

Address: \_\_\_\_\_

City/State/Zip: \_\_\_\_\_

Phone: ( ) \_\_\_\_\_ Fax: ( ) \_\_\_\_\_

Year of Purchase: \_\_\_\_\_

Model: \_\_\_\_\_

Make: \_\_\_\_\_

Capacity: \_\_\_\_\_

Power Source: \_\_\_\_\_

Voltage: \_\_\_\_\_

Weight: \_\_\_\_\_

Shipping/Handling: \_\_\_\_\_

Installation: \_\_\_\_\_

Warranty: \_\_\_\_\_

Notes: \_\_\_\_\_

## CRL Machinery Leasing

- Many Types Available
- Extended Financing
- Variable Terms

The CRL Machinery Division can connect you with one of the oldest and most respected Specialized Machinery Leasing companies in America to help you with the financing of your capital investment. Leasing is often a tax deductible way to handle your purchase without adversely affecting your bottom line. From Cutting Tables to complete Insulating Glass lines, leasing is available and often preferred to other types of financing. Leasing links are available for many popular CRL machines on our web site at [crlaurence.com](http://crlaurence.com).

Call our Machinery Sales office at (866) 583-1377 today to see how our Leasing Specialists can help you invest in the future while increasing your bottom line.



## CRL Used Machinery Connection

- Unique Web Based Posting Connects You With Other Glass Companies Interested in Upgrading
- Direct Connections – Buyer to Seller

By accessing the Glass Machinery web site at [crlaurence.com](http://crlaurence.com) you can open a posting site for "Used and Reconditioned" machinery. This listing is composed of machines for sale by companies wishing to upgrade to newer or larger machines from the CRL Machinery Division. There are no high pressure "used car" tactics, just one owner speaking to another. You will find here a mix of CRL Machinery as well as competitive machines. Call or e-mail us today to see how easy it is to grow into the realm of automated machinery.



## CRL 2200RP 4" x 106" (102 x 2690 mm) Wet Abrasive Belt Sander



- Durable Urethane Roller Platen and Front Rest Guide Bar
- Rugged Construction and Powerful 1 HP Direct Drive Motor
- Thick-Walled, Rust-Proof, High-Density Polyethylene Tank Extends Machine Life

- Uses Industry Standard 4" x 106" (102 x 2690 mm) Abrasive Belts
- Fast Abrasive Belt Changing Mechanism

Combine the rugged construction and innovative design of the Somaca 106" (2690 mm) Belt Machine and the streamlined CRL 2200 Belt Sander and you have the CRL 2200RP 4" x 106" (102 x 2690 mm) Wet Abrasive Belt Sander. More affordable and packed with solid engineering, the 2200RP Wet Belt Sander is ideal for use by glass fabricators and processors, and it's still designed to use industry standard 4" x 106" (102 x 2690 mm) belts.



### 2200RP SPECIFICATIONS:

**Height:**  
72" (1829 mm)

**Footprint:**  
30" x 24" (762 x 609 mm)

**Shipping Weight:**  
265 lbs. (120 kg)

See page 637K for European CE Compliant Model

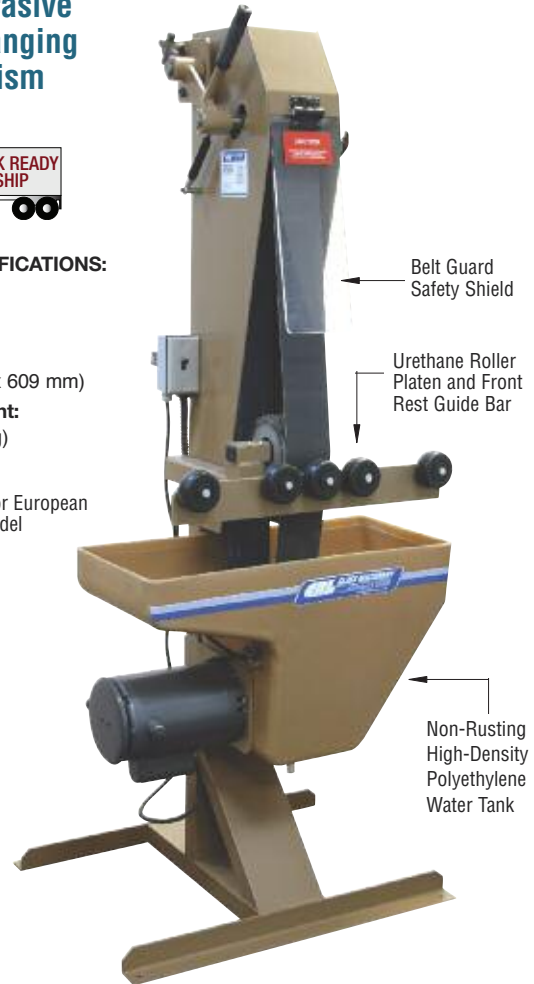

North American models include a direct drive, 1 HP, 60 cycle, 1725 RPM, 110 Volt AC Motor and a 5" (127 mm) diameter Drive Pulley. The Sander can be wired for 220 volts at an additional cost. An Electric Water Valve keeps the belts wet during sanding, and the Water Delivery System is designed for use with a standard city water supply. This machine now features a rustproof HDPE (High Density Polyethylene) Water Tank that won't chip or dent, and comes with a urethane covered Roller Platen and a Front Rest Guide Bar as standard equipment.

### IMPORTANT NOTES:

Always wear the proper safety gear when using any type of power tool. The Cat. No. GF1 Ground Fault Circuit Interrupt Device (see page 550K) should be used with any type of wet-working electric tool. Replacement parts can be found on pages 635K-636K, 638K or at [crlaurence.com](http://crlaurence.com).

CAT. NO.	DESCRIPTION
2200RP	Belt Sander With Roller Platen and Guide Bar - 110V AC
AU22	Belt Sander With Roller Platen and Guide Bar - 220V AC/50 Hz - Australia

Minimum order: 1 each. All Abrasive Belt Machines for export can be built to operate on Three Phase, 50/60 Hz power. Contact the Machinery Division with your power requirements.

## CRL 4" x 106" (102 x 2690 mm) Wet Abrasive Glass Grinding Belts

- Fast-Grinding 100% Polyester Backed Belts in 14 Grits From 36X to CORK
- Ask About Our Large User Program

CRL Wet Abrasive Glass Grinding Belts have 100 percent polyester backing, so you can use them wet or dry. They are available in grits from 36X (Super Coarse) to CORK (Polishing) to fit most upright belt sanders.



### MOST POPULAR GRITS FOR GLASS, AND EXAMPLES OF THEIR USE:

- 60X – Extra-Rough, Fast Glass Removal (Mitered Edge)
- 80X – Rough, Quick-Contouring (Auto Glass Edge)
- 120X – Smooth, Seaming and Polishing (Desk Top Edge)
- 220X – Extra-Smooth, Fine Frosted Finish (Glass Shelf Edge)
- 400X – Fine, Satin Finish (Opaque Edge)
- CORK – Polish, Smooth Luster Finish

CAT. NO.	GRIT	QTY/BOX	CAT. NO.	GRIT	QTY/BOX
CRL4X10636X	36X	5	CRL4X106150X	150X	5
CRL4X10640X	40X	5	CRL4X106180X	180X	5
CRL4X10650X	50X	5	CRL4X106220X	220X	5
CRL4X10660X	60X	5	CRL4X106320X	320X	5
CRL4X10680X	80X	5	CRL4X106400X	400X	5
CRL4X106100X	100X	5	CRL4X106600X	600X	5
CRL4X106120X	120X	5	CRL4X106CORK	CORK	2

Minimum order: 1 Box. All Glass Grinding Belts can be combined for quantity pricing. All Cork Belts can be combined for quantity pricing.

## CRL 2200RP 4" x 106" Upright Wet Abrasive Belt Sander



Belt Guard Safety Shield

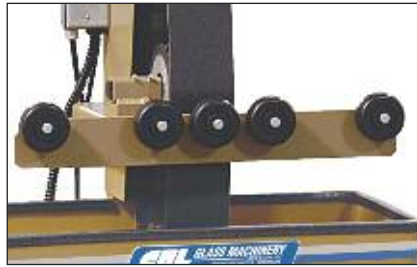

Urethane Covered Roller Platen and a Front Rest Guide Bar

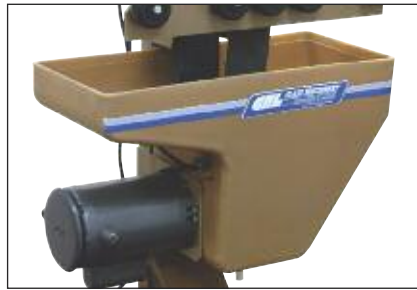

Non-Rusting High Density Polyethylene Water Tank

Our CRL 2200SS Belt Guard Safety Shield helps protect the operator in the event of accidental belt breakage. To solve the problem of water tank spray corrosion, we've replaced the steel tank with a Non-Rusting HDPE (High Density Polyethylene) Water Tank. Securely fastened with six mounting bolts, the tank is trimmed with rugged U-Channel and it's color is molded in so it won't scratch. The new Belt Tensioner uses an air cylinder to keep the belt at the correct tension. No more tension adjustments. The belt is kept wet by using a water solenoid that activates when the power is switched on. When you shut off the machine, the water stops flowing automatically. Upper Pulley and Roller Platen can be replaced as assemblies with bearings and shafts. This makes replacement of components fast and easy, needing no special tools.

When you consider all of these features, it's easy to see why glass shops of all sizes have made the 2200RP the glass industry's most popular Upright Belt Sander. For additional information, or machine specifications, contact CRL Customer Service Department at (800) 421-6144 in the U.S., (877) 421-6144 from Canada, or (323) 588-1281 International, and ask for Ext. 5275. You can also e-mail us through our web site, [crlaurence.com](http://crlaurence.com). From the home page click on Contact Us, and then click on Customer Service.



Easy-to-Use Belt Tensioner



Automatic Water Solenoid Valve



CAT. NO. BP2001

CAT. NO. FP2002

Optional Bar and Flat Platens fit in place of Standard Roller Platen



CAT. NO. 3MP2200

Optional 3M® Flat Platen bolts on in place of the Roller Platen



CAT. NO. 2200110VMTR

Strong, Reliable 1 HP Motor with Grease Fittings

## CRL Universal "One-Man" Movable Glass Table

### • Fits Upright Belt Sanders of Any Make



Legs Adjust to Fit Any Belt Machine



One person can sand large pieces of glass without having to support the weight of the glass by using this CRL Universal "One-Man" Movable Glass Table. It rolls on a support rail in front of the sander, so the operator controls the amount of pressure the glass applies to the belt. The table top is carpeted, and has four pop-up ball casters, allowing easy glass rotation. All sides can then be sanded without having to lift the glass. The legs are adjustable to allow use with any upright belt sander. Table Guide Rail is 156" (3962 mm) long; Table Top is 36" x 60" (914 x 1524 mm). F.O.B. Cicero, Illinois. Minimum order is one each.

Table Shown in Front of 2200RP Sander (each sold separately)

3M is a registered trademark of 3M Company Corporation.

CAT. NO. 3LTRT

## CRL Belt Guard Safety Shields

### • OSHA Recommended Form of Protection

The CRL Belt Guard Safety Shields for the 2200 and 3300 Series Upright Belt Sanders protect your face and eyes from flying debris, giving you an added degree of safety. The 2200SS is standard equipment on 2200 and older 2200RP Sanders. It can also be retro-fitted on 2200 and 2200RP Sanders that did not come with a safety shield. The 3300SS is standard on newer 2200RP, 3300RP, and BM132RP models. For safety, this is an attachment no shop should be without. Minimum order is one each.

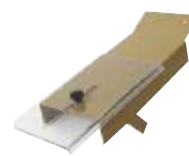

CAT. NO. 2200SS



CAT. NO. 3300SS



## CRL 2200RP and 3300RP Wet Abrasive Belt Sanders

The Glass Machinery Division of C.R. Laurence can provide replacement parts for all the machines we build. The parts listed below are the most common replacements for Cat. No. 2200RP and 3300RP Wet Abrasive Belt Sanders built from November 2009 to current. For older machines, turn to page 638K.

### SPECIFICATIONS:

Current Model . . . . .	2200RP/3300RP	Belt Size . . . . .	4" x 106" (102 x 2690 mm)
Years Built . . . . .	November 2009 to Current	Water Tank . . . . .	HDPE
Color . . . . .	Tan		

**Call our Machinery Division at (866) 583-1377 for help with ordering parts for any CRL machine**

### 1 HP 110V and 220V AC Motors

12.4 AMP, 1725 RPM, Single Phase/60 Hz, 110V AC, or 50 Hz, 220V AC.

CAT. NO.	DESCRIPTION
2200110VMTR	110V AC, 60 Hz
2200220VMTR	220V AC, 50 Hz

Minimum order: 1 each.



### Roller Platen Assembly

Roller Platen Assembly with Shaft and Bearings. Ready to install.

CAT. NO.	DESCRIPTION
CRP2000	Roller Platen Assembly

Minimum order: 1 each.



### 5" (127 mm) Lower Belt Pulley

5" (127 mm) Lower Sanding Belt Pulley. Also fits BM64B, AUBM64B, and 2622000 Belt Sanders.

CAT. NO.	DESCRIPTION
2622028	Lower Belt Pulley

Minimum order: 1 each.



### 5" (127 mm) Upper Belt Pulley

5" (127 mm) Upper Pulley Assembly (Pulley, Shaft, and Bearings). Avoid having to press bearings. Install this Assembly.

CAT. NO.	DESCRIPTION
330011	Upper Belt Pulley

Minimum order: 1 each.



### Belt Tensioner Assembly

This part comes assembled and ready for installation. Check the mounting parts and order Cat. No. 330014 Kit if the Spring Washers are flattened or weak.

CAT. NO.	DESCRIPTION
330013	Belt Tensioner Assembly

Minimum order: 1 each.



### Belt Tensioner Mounting Kit

Kit includes the Spring Washers and parts to keep the Tensioner working perfectly.

CAT. NO.	DESCRIPTION
330014	Belt Tensioner Mounting Kit

Minimum order: 1 each.



### Belt Tensioner Gas Cylinder

Replace this to maintain belt tension. Includes two swivel eye mount fittings.

CAT. NO.	DESCRIPTION
330012	Belt Tensioner Gas Cylinder

Minimum order: 1 each.



### Guide Roller Set With Bolts

Replace these if the old ones are sticking or corroded. Includes five Rollers with Sleeves, Nuts, and Bolts.

CAT. NO.	DESCRIPTION
2200762	Guide Roller Set

Minimum order: 1 each.



### Water Solenoid

Valve allows water to flow when machine is running. Works with 110V AC or 220V AC.

CAT. NO.	DESCRIPTION
41900630	Water Solenoid

Minimum order: 1 each.



### Water Spray Nozzle

Easier to change this Nozzle rather than try and clean out a damaged or corroded one.

CAT. NO.	DESCRIPTION
42201953	Water Spray Nozzle

Minimum order: 1 each.



# CRL ABRASIVE BELT SANDERS

For Pricing Visit [crlaurence.com](http://crlaurence.com) or Call Us Toll Free at the Phone Numbers Shown on the Back Cover

## CRL 3300RP 4" x 106" Wet Abrasive Belt Sander/CE Compliant



Available Only in Europe

- Uses Industry Standard 4" x 106" (102 x 2690 mm) Abrasive Belts
- Rugged Construction and Powerful 1 HP Direct Drive Motor
- Durable Urethane Roller Platen and Front Rest Guide Bar
- Thick-Walled, Rust-Proof, High Density Polyethylene Tank Extends Machine Life
- Fast Abrasive Belt Changing Mechanism

Increased production needed during the early 40's drove the evolution of our Wet Abrasive Belt Sander. This innovation, which ran the 4" (102 mm) wide belt through a water tray, greatly reduced glass dust and heat generated by grinding, resulting in a faster and safer machine. There can be little doubt that the CRL wet belt design made a good machine better and made the work environment around it safer.

Combine the rugged construction and innovative design of the CRL 106 inch (2690 mm) belt machine and the streamlined CRL 2200 Belt Sander, add the correct specifications to meet European Community CE standards, and you have the New 3300RP Wet Abrasive Belt Sander. More affordable and packed with solid engineering, the 3300RP Wet Abrasive Belt Sander is ideal for use by glass fabricators and processors, and it's still designed to use industry standard 4" x 106" (102 x 2690 mm) belts.

These export models include a direct drive, one H.P., 50 cycle, 1600 RPM, 240V AC Motor and a 5" (127 mm) diameter Drive Pulley. A manual Water Valve keeps the belts wet during sanding, and the Water Delivery System is designed for use with a standard city water supply. Additional safety features include E-Stop On/Off Control, Metal Belt Guards, and a Limit Switch on the Belt Door to shut off power when door is opened. This machine now features a rustproof HDPE (High Density Polyethylene) Water Tank that won't rust, chip or dent. The Model 3300RP also includes a urethane covered Roller Platen and a Front Rest Guide Bar as standard equipment.

### IMPORTANT NOTES:

Always wear the proper safety gear when using any type of power tool. Replacement parts are available at [crlaurence.com](http://crlaurence.com).



### 3300RP SPECIFICATIONS:

**Height:**  
72" (1829 mm)

**Footprint:**  
30" x 24"  
(762 x 609 mm)

**Shipping Weight:**  
265 lbs. (120 kg)

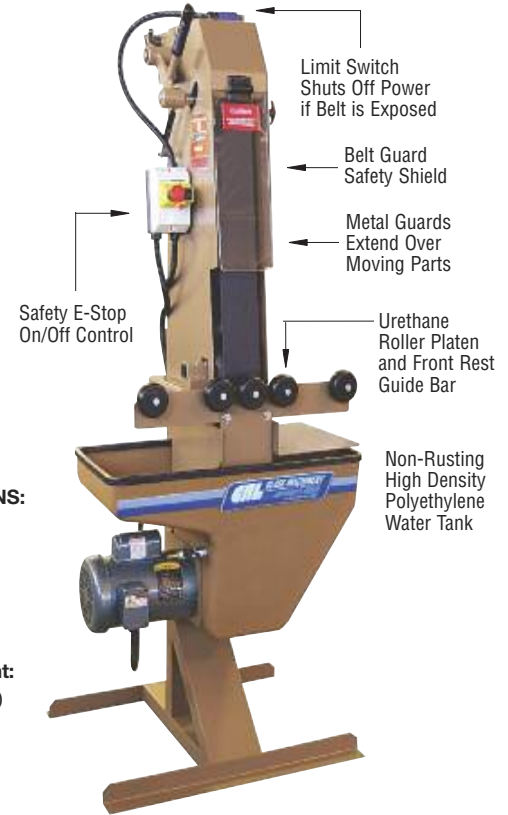

CAT. NO.	DESCRIPTION
3300RP	Belt Sander With Roller Platen and Guide Bar - 240V AC/50 Hz - Europe

Minimum order: 1 each.

## CRL 4" x 106" (102 x 2690 mm) Wet Abrasive Glass Grinding Belts

- Fast-Grinding 100% Polyester Backed Belts in 14 Grits From 36X to CORK
- Ask About Our Large User Program

CRL Wet Abrasive Glass Grinding Belts have 100 percent polyester backing, so you can use them wet or dry. They are available in grits from 36X (Super Coarse) to CORK (Polishing) to fit most belt sanders.

### MOST POPULAR GRITS FOR GLASS, AND EXAMPLES OF THEIR USE:

- 60X** - Extra-Rough, Fast Glass Removal (Mitered Edge)
- 80X** - Rough, Quick-Contouring (Auto Glass Edge)
- 120X** - Smooth, Seaming and Polishing (Desk Top Edge)
- 220X** - Extra-Smooth, Fine Frosted Finish (Glass Shelf Edge)
- 400X** - Fine, Satin Finish (Opaque Edge)
- CORK** - Polish, Smooth Luster Finish



CAT. NO.	GRIT	QTY/BOX	CAT. NO.	GRIT	QTY/BOX
CRL4X10636X	36X	5	CRL4X106150X	150X	5
CRL4X10640X	40X	5	CRL4X106180X	180X	5
CRL4X10650X	50X	5	CRL4X106220X	220X	5
CRL4X10660X	60X	5	CRL4X106320X	320X	5
CRL4X10680X	80X	5	CRL4X106400X	400X	5
CRL4X106100X	100X	5	CRL4X106600X	600X	5
CRL4X106120X	120X	5	CRL4X106CORK	CORK	2

Minimum order: 1 Box. All Glass Grinding Belts can be combined for quantity pricing. All Cork Belts can be combined for quantity pricing.





## CRL 2200RP Wet Abrasive Belt Sander

The Glass Machinery Division of C.R. Laurence can provide replacement parts for all the machines we build. The parts listed below are the most common replacements for Cat. No. 2200RP Wet Abrasive Belt Sanders built up to November 2009. For newer machines, see page 636K.

### SPECIFICATIONS:

Model . . . . .	2200RP	Belt Size . . . . .	4" x 106" (102 x 2690 mm)
Years Built . . . . .	Up to November 2009	Water Tank . . . . .	Fiberglass
Colors . . . . .	Blue or Tan		

**Call our Machinery Division at (866) 583-1377 for help with ordering parts for any CRL machine**

### 1 HP 110V AC Motor

12.4 AMP, 1725 RPM, Single Phase/60 Hz, 110V AC.



CAT. NO.	DESCRIPTION
2200110VMTR	1 HP Motor

Minimum order: 1 each.

### Roller Platen Assembly

New Roller Platen Assembly with Shaft and Bearings. Ready to install. This New Roller Platen design replaces the original design perfectly.



CAT. NO.	DESCRIPTION
CRP2000	Roller Platen Assembly

Minimum order: 1 each.

### Upper/Lower Belt Pulley

5" (127 mm) Upper or Lower Pulley. Includes the Hub and Outer Wheel.



CAT. NO.	DESCRIPTION
2200745	Upper/Lower Pulley

Minimum order: 1 each.

### Belt Tensioner Assembly

Includes Pulley, Bearings, and Shaft installed on the Tensioner Assembly. Simple installation can return an old machine to like-new condition.



CAT. NO.	DESCRIPTION
2200780	Belt Tensioner Assembly

Minimum order: 1 each.

### Water Solenoid

Easy to install. Works with 110V AC or 220V AC machines.



CAT. NO.	DESCRIPTION
2200725	Water Solenoid

Minimum order: 1 each.

### Platen Adapter Extension

This fixture mounts to the platen holder and allows the platen to be positioned higher, or allows a second platen to be mounted.



CAT. NO.	DESCRIPTION
PAE200	Platen Adapter Extension
PA100	Platen Adapter

Minimum order: 1 each.

### Guide Roller Bar and Mounting Plate

GRB102 includes the Rollers bolted to the bar, ready to install. GRA101 mounts the guide bar.

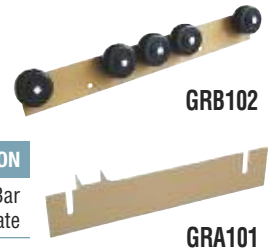

CAT. NO.	DESCRIPTION
GRB102	Guide Roller Bar
GRA101	Guide Roller Bar Mounting Plate

Minimum order: 1 each.

### Guide Roller Set With Bolts

Each Guide Roller Set with Bolts has steel sleeves installed.



CAT. NO.	DESCRIPTION
2200762	Guide Roller Set

Minimum order: 1 each.

### Water Spray Nozzle

Easier to change this Nozzle rather than try and clean out a damaged, corroded one. Two required.



CAT. NO.	DESCRIPTION
2200720	Spray Nozzle

Minimum order: 1 each.



## CRL 4" x 132" BM132RP Upright Wet Abrasive Belt Sander

- Built-In 24" (610 mm) Roller Platen
- Heavy-Gauge Steel Welded Frame

Our heavy-duty 4" x 132" (102 x 3353 mm) Upright Wet Abrasive Belt Sander is designed for continuous grinding, smoothing, and polishing of glass edges. It is similar in design to the 106" Model, but has larger diameter pulleys, and is twice the weight because of its heavy, reinforced construction.

You will be pleased with the superior performance of our 4" x 132" (102 x 3352 mm) Upright Wet Belt Sander, and the years of dependable service it will give you.

**CAUTION:** When grinding, always wear protective safety glasses and an approved glass dust respirator. One of each is provided with the machine.

### ABRASIVE BELTS

These machines use standard 4" x 132" (102 x 3352 mm) abrasive belts. One 120 grit belt, one pair of safety glasses, and one approved respirator are furnished with each machine. A safety shield is mounted to the hood.

### MOTOR AND STARTER

A 1 HP, 3450 RPM motor, with V-Belt drive, provides all the power for normal usage. The motor is three phase, 60 Hz, 220 or 440 Volts. It is wired to a manual push button starter. Please specify power requirements.

### PULLEYS

Both pulleys are 8" (203 mm) diameter, and made of machined and balanced cast iron.

### BELT TENSION DEVICE

Eccentric type with locking handle and control knob for tracking the belt.

### BEARINGS

Standard ball bearings are used throughout the drive system.

### COOLANT SYSTEM

A water supply line with an electrical solenoid control valve and a low water consumption spray nozzle (3.5 gph @ 30 psi) are included for wet grinding.

- Conveniently Converted From 220 to 440 Volts
- Available for Purchase or Lease

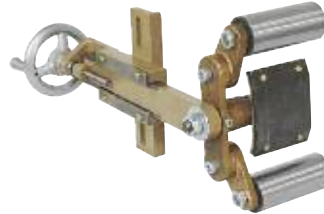

**CAT. NO. 2621320**  
Optional Double Roller Platen



24" (610 mm)  
Glass Rest and  
Roller Platen

**CAT. NO. BM132RP**  
4" x 132" (102 x 3353 mm)  
Upright Wet Abrasive Belt Sander



**CAT. NO. 3LTRT**  
Optional Universal Rolling Table for consistent edging of large or heavy glass lites. Height adjusts to any belt machine. Four swivel casters built into the table top raise the glass for ease of turning working edge. See page 635K.

## CRL 4" x 132" (102 x 3352 mm) Wet Abrasive Glass Grinding Belts

- Fast-Grinding 100% Polyester Backed Belts in Six Grits From 60X to CORK
- Ask About Our Large User Program

CRL Wet Abrasive Glass Grinding Belts have 100 percent polyester backing, so you can use them wet or dry. They are available in grits from 60X (Extra-Rough) to CORK (Polishing) to fit most belt sanders.

### MOST POPULAR GRITS FOR GLASS, AND EXAMPLES OF THEIR USE:

- 60X** – Extra-Rough, Fast Glass Removal (Mitered Edge)
- 80X** – Rough, Quick-Contouring (Auto Glass Edge)
- 120X** – Smooth, Seaming and Polishing (Desk Top Edge)
- 220X** – Extra-Smooth, Fine Frosted Finish (Glass Shelf Edge)
- 400X** – Fine, Satin Finish (Opaque Edge)
- CORK** – Polish, Smooth Luster Finish



CAT. NO.	GRIT	QTY/BOX
CRL4X13260X	60X	5
CRL4X13280X	80X	5
CRL4X132120X	120X	5
CRL4X132220X	220X	5
CRL4X132400X	400X	5
CRL4X132CORK	CORK	2

Minimum order: 1 Box. All Glass Grinding Belts can be combined for quantity pricing. All Cork Belts can be combined for quantity pricing.



## CRL BM132RP Wet Abrasive Belt Sander

The Glass Machinery Division of C.R. Laurence can provide replacement parts for all the machines we build. The parts listed below are the most common replacements for the Cat. No. BM132RP Upright Wet Abrasive Belt Sander.

### SPECIFICATIONS:

Current Model . . . . . BM132RP                      Colors . . . . . Orange or Tan  
 Years Built . . . . . 1987 to Current                Belt Size . . . . . 4" x 132" (102 x 3352 mm)

**Call our Machinery Division at (866) 583-1377 for help with ordering parts for any CRL machine**

### 1 HP 220V AC Motor

6.6 AMP, 3450 RPM, Three Phase/60 Hz, 220V AC. Can also be wired for Three Phase/60 Hz, 440V AC.



CAT. NO.	DESCRIPTION
41013260	1 HP Motor

Minimum order: 1 each.

### V-Drive Belt

This is the Drive Belt from the Motor to the Lower Pulley Shaft. Check belts often, and replace if cracked or contaminated.



CAT. NO.	DESCRIPTION
43314390	V-Drive Belt

Minimum order: 1 each.

### Contact Roller Platen

Current type with aluminum hub. 5-1/2" (140 mm) diameter.



CAT. NO.	DESCRIPTION
35585800	Contact Roller Platen

Minimum order: 1 each.

### 8" Lower Belt Pulley

8" (203 mm) Lower Sanding Belt Pulley. Mounts with two set screws.



CAT. NO.	DESCRIPTION
30024300	8" Lower Belt Pulley

Minimum order: 1 each.

### 8" Upper Belt Pulley

8" (203 mm) Upper Belt Pulley requires two bearings and shaft to be pressed in (Included in Cat. No. 37747600 on this page).



CAT. NO.	DESCRIPTION
30024400	8" Upper Belt Pulley Assembly

Minimum order: 1 each.

### Eccentric and Pulley Assembly

Includes Tensioner Eccentric, Upper Pulley, Shaft, and Bearings. Ready to install.



CAT. NO.	DESCRIPTION
37747600	Eccentric and Upper Pulley Assembly

Minimum order: 1 each.

### 3" Guide Roller

Guide Roller with Sleeve. Fits on Front Guide Bar with Cat. No. 36988803 Shoulder Screws (below). Also fits the 2622000 Sander.



CAT. NO.	DESCRIPTION
16300010	3" (76 mm) Guide Roller

Minimum order: 1 each.

### Shoulder Screw

Shoulder Screw with Grease Fitting for Cat. No. 16300010 Guide Roller (above). Also fits the 2622000 Sander.



CAT. NO.	DESCRIPTION
36988803	Shoulder Screw

Minimum order: 1 each.

### Water Solenoid

Valve allows water to flow when machine is running. This is a one-piece upgrade for the older style solenoid.



CAT. NO.	DESCRIPTION
41900630	Water Solenoid

Minimum order: 1 each.

### Water Spray Nozzle

Replaces clogged or damaged Nozzles perfectly. Also fits the 2622000 Sander.



CAT. NO.	DESCRIPTION
12203550	Water Spray Nozzle

Minimum order: 1 each.



## CRL 2622000 Wet Abrasive Belt Sander

The Glass Machinery Division of C.R. Laurence can provide replacement parts for all the machines we build. The parts listed below are the most common replacements for Cat. No. 2622000 Upright Wet Abrasive Belt Sander.

### SPECIFICATIONS:

Model ..... 2622000                      Belt Size ..... 4" x 106" (102 x 2690 mm)  
 Years Built ..... 1987 to 2009              Water Tank ..... Steel  
 Colors ..... Orange or Tan

**Call our Machinery Division at (866) 583-1377 for help with ordering parts for any CRL machine**

### 1 HP 110V AC Motor

6.4 AMP, 3450 RPM, Single Phase/60 Hz, 110V AC. Can also be wired for 220V AC.

CAT. NO.	DESCRIPTION
<b>41005031</b>	1 HP Motor

Minimum order: 1 each.



### V-Drive Belt

This is the Drive Belt from the Motor to the Lower Pulley Shaft. Check belts often.

CAT. NO.	DESCRIPTION
<b>13303080</b>	V-Drive Belt

Minimum order: 1 each.



### Contact Roller Platen

Current type with aluminum hub. 5-1/2" (140 mm) diameter.

CAT. NO.	DESCRIPTION
<b>35585800</b>	Contact Roller Platen

Minimum order: 1 each.



### Eccentric and Pulley Assembly

Complete with Upper Pulley, Bearings, and Shaft.

CAT. NO.	DESCRIPTION
<b>38124300</b>	Eccentric and Upper Pulley Assembly

Minimum order: 1 each.



### Contact Roller Bearing Assembly

Includes Housing, Shaft, Bearings and Cap.

CAT. NO.	DESCRIPTION
<b>39662400</b>	Contact Roller Bearing Assembly

Minimum order: 1 each.



### Bearing Housing Assembly

Includes Housing, Bearings and Shaft. Mounts the Drive Belt and Lower Pulley.

CAT. NO.	DESCRIPTION
<b>30066909</b>	Bearing Housing Assembly

Minimum order: 1 each.



### 5" Lower Belt Pulley

5" (127 mm) Lower Sanding Belt Pulley. Also fits Cat. Nos. 3300RP and BM64B Belt Sanders.

CAT. NO.	DESCRIPTION
<b>30016600</b>	5" Lower Belt Pulley

Minimum order: 1 each.



### Guide Roller and Shoulder Screw

3" (76 mm) Roller with Sleeve. Shoulder Screw with grease fitting for Roller.

CAT. NO.	DESCRIPTION
<b>16300010</b>	Guide Roller
<b>36988803</b>	Shoulder Screw

Rollers and Screws are sold separately. Minimum order: 1 each.



## CRL Models GL4W and CN4106 Wet Abrasive Belt Sanders

Listed below are the most common replacement parts stocked for the CRL Models GL4W and CN4106 Wet Abrasive Belt Sanders. If you have questions about the machines refer to [crlaurence.com](http://crlaurence.com), or call the Customer Service Department at (800) 421-6144, extension 5275 for assistance.



CAT. NO.	DESCRIPTION
<b>CN0025</b>	3" (76 mm) Front Rest Roller
<b>CN0026</b>	Front Rest Roller Axle
<b>CN0039</b>	Lower Pulley
<b>CN0034</b>	Upper Pulley with Bearings
<b>CN0012</b>	115V AC Motor

Minimum order: 1 each.

CAT. NO.	DESCRIPTION
<b>CN0035</b>	Top Pulley Shaft with Bearings
<b>CN0027</b>	Front Rest Roller Bar
<b>CN0017</b>	Top Wheel Bracket
<b>CN0038</b>	Bottom Bracket with Shaft and Bearings

Minimum order: 1 each.

## CRL 4" x 64" (102 x 1626 mm) Bench Model Wet Abrasive Belt Sander



- Extremely Mobile Unit is Ideal for Work Bench or Truck Bed
- Heavy-Duty, 1 HP, Single-Phase, 110V, 220V, and 240V Models
- Self-Contained Water Tank – No Water Hook-Up Needed

This CRL Bench Model Belt Sander uses all standard 4" x 64" (102 x 1626 mm) Wet or Dry Abrasive Belts, and is specially designed for use in the shop or on the job site. It's perfect for bench work where there is only a limited need for edge-work capacity. This Sander can also be mounted right onto a glass truck for rough grinding, smoothing, and polishing the edges of glass on a job site. Water for wet grinding sprays on the back of the belt from a built-in spray nozzle connected to a built-in water tank. Just pour water in the reservoir and you can wet grind anywhere.

### SPECIFICATIONS:

- Height:** 37-1/2" (952 mm)  
**Width (including motor):** 24" (610 mm)  
**Footprint:** 19" x 16" (483 x 406 mm)  
**Shipping Weight:** 150 Lbs. (68 kg)



### IMPORTANT NOTES:

Always wear the proper safety gear when using any type of power tool. A Cat. No. GF1 Ground Fault Circuit Interrupt Device (see page 550K) should be used with any type of wet-working electric tool. Replacement parts can be found on page 643K or at [crlaurence.com](http://crlaurence.com).

### Controls

All controls are built to OSHA requirements, utilizing CE, CSA and UL Certified components.

### Belts

Wet or Dry ..... 4" x 64" (102 x 1626 mm) belt, various grits

### Utilities – Standard

Electrical ..... One Motor, Total 1 HP  
 Voltage ..... Single Phase, 60 Cycle  
 Power ..... 15 AMP Service @ 110V AC, 240V AC, or 220V AC



EUBM64B Model

BM64B Model



CAT. NO.	DESCRIPTION
BM64B	Bench Model Belt Sander – 110V AC/60 Hz
AUBM64B	Bench Model Belt Sander – 240V AC/50 Hz – Australia
EUBM64B	Bench Model Belt Sander – 220V AC/50 Hz – Europe

Minimum order: 1 each.

## CRL 4" x 64" (102 x 1626 mm) Wet Abrasive Glass Grinding Belts

- Fast-Grinding 100% Polyester Backed Belts in Seven Grits From 40X to CORK
- Ask About Our Large User Program

CRL Wet Abrasive Glass Grinding Belts have 100 percent polyester backing, so you can use them wet or dry. They are available in grits from 40X (Super Coarse) to CORK (Polishing) to fit most upright belt sanders.



### MOST POPULAR GRITS FOR GLASS, AND EXAMPLES OF THEIR USE:

- 60X** – Extra-Rough, Fast Glass Removal (Mitered Edge)  
**80X** – Rough, Quick-Contouring (Auto Glass Edge)  
**120X** – Smooth, Seaming and Polishing (Desk Top Edge)  
**220X** – Extra-Smooth, Fine Frosted Finish (Glass Shelf Edge)  
**400X** – Fine, Satin Finish (Opaque Edge)  
**CORK** – Polish, Smooth Luster Finish

CAT. NO.	GRIT	QTY/BOX
CRL4X6440X	40X	5
CRL4X6460X	60X	5
CRL4X6480X	80X	5
CRL4X64120X	120X	5
CRL4X64220X	220X	5
CRL4X64400X	400X	5
CRL4X64CORK	CORK	2

Minimum order: 1 Box. All Glass Grinding Belts can be combined for quantity pricing. All Cork Belts can be combined for quantity pricing.





## CRL BM64B, AUBM64B, and EUBM64B Wet Abrasive Belt Sanders

The Glass Machinery Division of C.R. Laurence can provide replacement parts for all the machines we build. The parts listed below are the most common replacements for Cat. No. BM64B, AUBM64B, and EUBM64B Wet Abrasive Belt Sanders.

### SPECIFICATIONS:

Current Model . . . . . BM64B, AUBM64B, EUBM64B Color . . . . . Tan  
 Years Built . . . . . 1974 to Current Belt Size . . . . . 4" x 64" (102 x 1626 mm)

**Call our Machinery Division at (866) 583-1377 for help with ordering parts for any CRL machine**

### 1 HP 110V and 220V AC Motors

12.4 AMP, 1725 RPM, Single Phase/60 Hz, 110V AC, or 50 Hz, 220V AC.

CAT. NO.	DESCRIPTION
2200110VMTR	110V AC, 60 Hz
2200220VMTR	220V AC, 50 Hz



Minimum order: 1 each.

### V-Drive Belt

This is the Drive Belt from the motor to the Lower Pulley Shaft. Check Belts often, and replace if cracked or contaminated.

CAT. NO.	DESCRIPTION
43312070	V-Drive Belt



Minimum order: 1 each.

### 3M® Platen Replacement Pad

3M® Platen Replacement Pad. Includes Metal Plate, Rubber Backing Plate, Screws, Nuts, and Springs. Fits 3M® Platen Mount.

CAT. NO.	DESCRIPTION
2620099	3M® Platen Pad



Minimum order: 1 each.

### 5" Lower Belt Pulley

5" (127 mm) Lower Sanding Belt Pulley. Also fits Cat. Nos. 3300RP and 2622000 Belt Sanders.

CAT. NO.	DESCRIPTION
30016600	5" Lower Belt Pulley



Minimum order: 1 each.

### 5" Upper Belt Pulley

5" (127 mm) Upper Belt Pulley Assembly. (Pulley, Shaft, and Bearings). Avoid having to press Bearings by installing this assembly.

CAT. NO.	DESCRIPTION
30016900	5" Upper Belt Pulley Assembly



Minimum order: 1 each.

3M is a registered trademark of 3M Company.

### Motor Drive V-Pulley

Fits on Motor Shaft to drive the V-Belt.

CAT. NO.	DESCRIPTION
43200051	Motor Drive V-Pulley



Minimum order: 1 each.

### Lower Drive Shaft V-Pulley

Fits on Lower Sanding Belt Pulley Shaft.

CAT. NO.	DESCRIPTION
43207115	Lower Drive Shaft V-Pulley



Minimum order: 1 each.

### Pillow Block With Bearing

Greasable Pillow Block with Bearing. Lower Pulley Shaft rides in these Bearings. Two required.

CAT. NO.	DESCRIPTION
44103100	Pillow Block with Bearing



Minimum order: 1 each.

### 110V Power Cord With Switch

110V Power Cord with On/Off Switch to replace a frayed or damaged cord.

CAT. NO.	DESCRIPTION
41948070	Power Cord with Switch 110V
41427110	AU Power Cord with Switch 220V



Minimum order: 1 each.

### CRL Wet Abrasive Belts

- Fast-Grinding 100% Polyester Backed Belts
- Most Popular Grits for Glass



See pages 647K-648K

# CRL TWIN BELT SEAMERS

For Pricing Visit [crlaurence.com](http://crlaurence.com) or Call Us Toll Free at the Phone Numbers Shown on the Back Cover

## CRL 4" x 106" Dry Twin Belt Seamer



- Designed for Light Seaming or Swiping Edges
- Reduces Need to Clean Glass After Sanding
- Optional Dust Collector Unit Helps Keep Work Environment Cleaner and Safer
- Less Clean-Up Allows Savings in Production Time
- Gas Piston Belt Tensioners
- Available for Purchase or Lease



CAT. NO. DBS106  
Twin Belt Seamer



CAT. NO. DBS2DC  
Optional Dust Collection Unit

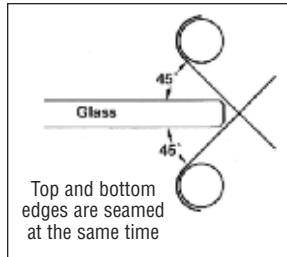

### Dry Belt Seamer Can Save Time and Money by Eliminating Glass Washing

The CRL Dry Twin Belt Seamer can make your shop cleaner and safer to work in. By using the optional Dust Collector Unit you can, in most cases, seam glass and skip the washing stage. This keeps glass grind out of the air and makes the work environment cleaner. A Glass Rest or Caster Table is recommended to keep the glass at a consistent level for even seam production. The belt nip working height is 36" (914 mm) above the floor. Belts are spaced 6-7/8" (175 mm) apart. Closer spacing is available. **Available Options Include: Glass Rest -** Five rubber 3" (76 mm) wheels on a 24" (610 mm) rest (see page 646K). **Mini Ball Caster Table Glass Rest -** Allows the operator to run smaller sheets of glass through the twin belts with consistent results (see page 645K). **Swivel Ball Caster Table -** Allows larger glass pieces to be easily moved into position and seamed at a consistent height (see page 646K). **Dust Collector Unit -** The CRL self-contained 2 HP Dust Collector is a strongly recommended option to accompany the DBS106 Twin Belt Seamer. All glass dust is pulled from the seamer into the lined collection bag for easy cleaning. Power requirements are the same as for the DBS106 machine (see above). **Roller Track With Brake -** Allows the Twin Belt Seamer to be rolled back, away from production line (see below).

#### Controls

All controls are built to OSHA requirements, utilizing CE, CSA, and UL Certified components. Wiring for three phase, 60 cycle, 230V AC power.

#### Belts (Two Included)

Abrasive Belts ..... Two - 4" x 106" (102 x 2690 mm) 120 grit belts  
..... (see page 647K for available belts)

#### Utilities

Electrical ..... Two Motors, Total 2 HP (1.48 kw)

Voltage ..... Three Phase, 60 Cycle, 230V AC

Power ..... 6.8 FLA @ 230V AC Converter available to  
..... operate on Single Phase, 60 Cycle, 230V AC

Minimum order: 1 each.

F.O.B. your local CRL warehouse. Must ship common carrier.



**CRL DBS106**  
**Three Phase, 50/60 Hz Export Model**



An export version of the DBS106 can be built to operate on Three Phase, 50/60 Hz power. Contact the Machinery Division with your power requirements.

### CRL Roller Track Kit for Double Belt Seamer

**new**

This CRL Roller Track Kit allows for the 488 pound CRL Twin Belt Seamer to roll easily in and out of a ball caster table inset and simplify the abrasive belt change over. A brake holds the machine firmly when set and releases easily. The 87" (2210 mm) Steel Track includes four rollers, one foot brake, and mounting hardware. Minimum order is one each.



CAT. NO. DBS1RT

#### SPECIFICATIONS:

**DBS106**  
Height: 64" (1626 mm)  
Footprint: 18" x 55" (457 x 1397 mm)  
Shipping Weight: 488 Lbs. (221 kg)  
Glass Working Height: Adjustable  
33" to 36" (838 to 914 mm)

#### SPECIFICATIONS:

**DBS2DC**  
Height: 76-1/2" (1943 mm)  
Footprint: 37" x 22" (940 x 559 mm)  
Shipping Weight: 165 Lbs. (75 kg)



**C.R. LAURENCE COMPANY**

[crlaurence.com](http://crlaurence.com) | [usalum.com](http://usalum.com)

**ALUMINUM 644K** | [crlaurence.ca](http://crlaurence.ca) [crlaurence.com.au](http://crlaurence.com.au) [crlaurence.co.uk](http://crlaurence.co.uk) [crlaurence.de](http://crlaurence.de) [crlaurence.eu](http://crlaurence.eu)

## CRL 4" x 106" Wet Twin Belt Seamer



- Wet Seaming Reduces Silica Dust in Atmosphere and the Burning or Chipping of Glass Edges
- Eliminates Need for Dust Collection Equipment
- Water Cools Glass for Easy Handling
- Available for Purchase or Lease

### Wet Twin Belt Seamer Makes Smooth Seams With Less Chipping

The CRL 106" (2690 mm) Wet Twin Belt Seamer can help you safely produce clean, smooth edges on all of your glass. Water is sprayed over the belts, cooling the belts and the glass, reducing any chipping of the edges. The water also reduces any silica dust that might become airborne. By using the optional Glass Rest or Caster Table you can keep your edge grinding smooth and consistent. The belt working height is 36" (914 mm) above the floor.

#### Available Options Include:

**Glass Rest** - Five rubber 3" (76 mm) wheels on a 24" (610 mm) rest. See page 646K.

**Mini Ball Caster Table Glass Rest** - Allows the operator to run smaller sheets of glass through the twin belts with consistent results. See below.

**Swivel Ball Caster Table** - Allows glass pieces to be easily moved into position and seamed at a consistent height. See page 646K.

**Roller Track With Brake** - Allows the Twin Belt Seamer to be rolled back away from production line. See page 644K.

#### Controls

All controls are built to OSHA requirements, utilizing CE, CSA, and UL Certified components. Wiring for three phase, 60 cycle, 230V AC power.

#### Belts (Two Included)

Abrasive Belts . . . . . Two - 4" x 106" (102 x 2690 mm) 120 grit belts (see page 647K for available belts)

#### Utilities

Electrical . . . . . Two Motors, Total 2 HP (1.48 kw)

Voltage . . . . . Three Phase, 60 Cycle, 230V AC

Power . . . . . 6.8 FLA @ 230V AC Converter available to operate on Single Phase, 60 Cycle, 230V AC

Minimum order: 1 each.

F.O.B. your local CRL service center. Must ship common carrier.



CAT. NO. DBS106W

### CRL Mini Ball Caster Table Glass Rest

This optional Mini Ball Caster Table Glass Rest bolts directly onto either DBS106 or DBS106W Seamer and allows the operator to run smaller sheets of glass through the twin belts with consistent results. Roller wheels and ball casters will not scratch glass. Ships knocked down via U.P.S. All hardware included. Minimum order is one each.



CAT. NO. DBSMCT



European Union

## CRL DBS106W

### Three Phase, 50/60 Hz Export Model



Australia

An export version of the DBS106W can be built to operate on Three Phase, 50/60 Hz power. Contact the Machinery Division with your power requirements.

#### SPECIFICATIONS:

**Height:** 64" (1626 mm)

**Footprint:** 18" x 55" (457 x 1397 mm)

**Shipping Weight:** 488 Lbs. (221 kg)

**Glass Working Height:** Adjustable 33" to 36" (838 mm to 914 mm)

# CRL SEAMER OPTIONS AND HORIZONTAL SANDER

For Pricing Visit [crlaurence.com](http://crlaurence.com) or Call Us Toll Free at the Phone Numbers Shown on the Back Cover

## CRL Twin Belt Seamer Glass Rest

- Bolts to Either DBS106 or DBS106W Twin-Belt Seamer
- Five Rubber Wheels Guide Glass as it is Moved Through the Seamer



The bolt-on Glass Rest allows workers to keep glass steady and at a consistent height when using the machine. Glass pieces can be run through the seamer faster and with better results using this simple guide.

The Guide Bar is 24" (610 mm) wide. The five wheels are on greased steel axles for long life. The complete Rest is easily removed if needed.

CAT. NO.	DESCRIPTION
<b>38192700</b>	Five Wheel Glass Rest for Twin Belt Seamers

Minimum order: 1 each. F.O.B. Cicero, Illinois.

## CRL Ball Caster Tables With Cut-Outs

- Allows Fast Glass Travel Through Seamers
- Two Styles Available
- Cut-Outs Allow Operators to Get Closer to the Machine With Small Pieces



CAT. NO. B6212100  
40 Caster Table Shown

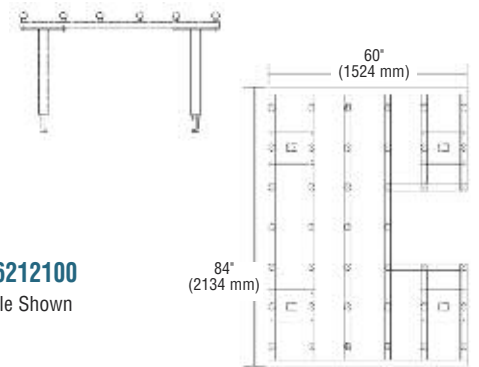

40 Caster Table B6212100

These CRL Ball Caster Tables allow one person to spin all four sides of glass lites through the Seamer with little effort. Both Tables measure 7' wide x 5' deep (2.13 x 1.52 m), and the height is adjustable.

The B6212100 Table has 40 casters located on 12" (305 mm) centers and has a 22" x 23" (559 x 584 mm) cut-out. The B6211500 Table has 140 casters on 6" (152 mm) centers and has a 34" x 29" (864 x 737 mm) cut-out.

**NOTE:** Optional Table Extensions are sold in sets (see chart).



CAT. NO. BCT24XT12  
Optional Table Extensions  
12" Centers Shown

CAT. NO.	DESCRIPTION
<b>B6212100</b>	Ball Caster Table with 40 Casters on 12" (305 mm) Centers
<b>B6211500</b>	Ball Caster Table with 140 Casters on 6" (152 mm) Centers
<b>BCT24XT12</b>	Optional Table Extensions for B6212100-Set
<b>BCT24XT6</b>	Optional Table Extensions for B6211500-Set

Minimum order: 1 each. Cat. Nos. BCT24XT12 and BCT24XT6 are 1 set. F.O.B. Cicero, Illinois. Must ship common carrier.

## CRL 4" x 106" Horizontal Wet Belt Sander

- Great for Surfacing the Bottom of Vases or Cast Freeform Shapes
- Direct Drive 1 HP, 110-220 Volt AC, Single Phase Motor
- Uses Industry Standard 4" x 106" (102 x 2690 mm) Abrasive Belts

The CRL Horizontal Wet Belt Sander is good for grinding vase bottoms or pottery. It uses standard 4" x 106" (102 x 2690 mm) wet/dry abrasive belts (see page 647K) that are driven directly by a one horsepower, single phase motor. The Steel Pulleys and Tightening Device are taken from the CRL Cat No. 2200RP Vertical 106" Machine design, as seen on page 634K. Water is sprayed onto the belt to keep heat and grinding dust down and there is a Flat Platen behind the belt.



See page 647K for belts to fit this Sander



CAT. NO.	DESCRIPTION
<b>H82</b>	Horizontal 4" x 106" (102 x 2690 mm) Wet Belt Sander

Minimum order: 1 each. F.O.B. Cicero, Illinois. Must ship common carrier.



C.R. LAURENCE COMPANY

[crlaurence.com](http://crlaurence.com) | [usalum.com](http://usalum.com)

ALUMINUM

646K

| [crlaurence.ca](http://crlaurence.ca) [crlaurence.com.au](http://crlaurence.com.au) [crlaurence.co.uk](http://crlaurence.co.uk) [crlaurence.de](http://crlaurence.de) [crlaurence.eu](http://crlaurence.eu)



## CRL Wet Abrasive Belts for Upright Belt Sanders

- Tough, Fast Grinding 100% Polyester Backed Belts are Long Lasting
- A Variety of Grits are Available, From 36X to 600X, Plus Cork
- Stock Sizes (Plus Other Sizes on Special Order) to Fit Virtually All Upright Belt Sanders
- Selected 3M® Brand Belts Also Available

CRL Wet Abrasive Belts have a 100 percent polyester backing, so you can use them wet or dry. Available in six standard sizes in grits from 36X (Extra Coarse) to 600X (Super Fine) to fit most any upright belt sanding machine. All Upright Sander Belts come five belts per box, unless otherwise marked. Cork Polishing belts are also available. If you don't see your belt size or grit here, contact CRL Customer Service Department at (800) 421-6144 in the U.S., (877) 421-6144 from Canada, or (323) 588-1281 International, and ask for Ext. 5275 for details and pricing on custom size and grit abrasives.



### MOST POPULAR GRITS FOR GLASS, AND EXAMPLES OF THEIR USE:

- 60X:** Extra-Rough, Fast Glass Removal (Mitered Edge)
- 80X:** Rough, Quick-Contouring (Auto Glass Edge)
- 120X:** Smooth, Seaming and Polishing (Desk Top Edge)
- 220X:** Extra-Smooth, Fine Frosted Finish (Glass Shelf Edge)
- 400X:** Fine, Satin Finish (Opaque Edge)
- CORK:** Polish, Smooth Luster Finish

### LARGE USER PROGRAM

If you use lots of sanding belts and discs, CRL has a bulk quantity program that can really cut your costs. All sizes and grits can be quoted, including any we don't normally stock. If you need them, CRL can supply them quickly at prices you'll find hard to beat. Please call CRL Customer Service Department at (800) 421-6144 in the U.S., (877) 421-6144 from Canada, or (323) 588-1281 International, and ask for Ext. 5275 for details.



For Upright Belt Sanders see pages 634K-643K

#### CRL 4" X 64" (102 X 1626 MM)

CAT. NO.	GRIT	QTY/BOX
CRL4X6440X	40X	5
CRL4X6460X	60X	5
CRL4X6480X	80X	5
CRL4X64120X	120X	5
CRL4X64220X	220X	5
CRL4X64400X	400X	5
CRL4X64CORK	CORK	2

#### CRL 4" X 82" (102 X 2083 MM)

CAT. NO.	GRIT	QTY/BOX
CRL4X8260X	60X	5
CRL4X8280X	80X	5
CRL4X82120X	120X	5
CRL4X82220X	220X	5
CRL4X82400X	400X	5

#### CRL 4" X 84" (102 X 2134 MM)

CAT. NO.	GRIT	QTY/BOX
CRL4X8460X	60X	5
CRL4X8480X	80X	5
CRL4X84100X	100X	5
CRL4X84120X	120X	5
CRL4X84220X	220X	5
CRL4X84400X	400X	5

#### CRL 4" X 106" (102 X 2690 MM)

CAT. NO.	GRIT	QTY/BOX
CRL4X10636X	36X	5
CRL4X10640X	40X	5
CRL4X10650X	50X	5
CRL4X10660X	60X	5
CRL4X10680X	80X	5
CRL4X106100X	100X	5
CRL4X106120X	120X	5
CRL4X106150X	150X	5
CRL4X106180X	180X	5
CRL4X106220X	220X	5
CRL4X106320X	320X	5
CRL4X106400X	400X	5
CRL4X106600X	600X	5
CRL4X106CORK	CORK	2

#### 3M® DUO-GLASS 4" X 106" (102 X 2690 MM)

CAT. NO.	GRIT	QTY/BOX
3M4X106120X	120X	5
3M4X106180X	180X	5
3M4X106220X	220X	5

#### CRL 4" X 118" (102 X 2997 MM)

CAT. NO.	GRIT	QTY/BOX
CRL4X11860X	60X	5
CRL4X11880X	80X	5
CRL4X118120X	120X	5
CRL4X118220X	220X	5
CRL4X118400X	400X	5
CRL4X118CORK	CORK	2

#### CRL 4" X 132" (102 X 3353 MM)

CAT. NO.	GRIT	QTY/BOX
CRL4X13260X	60X	5
CRL4X13280X	80X	5
CRL4X132120X	120X	5
CRL4X132220X	220X	5
CRL4X132400X	400X	5
CRL4X132CORK	CORK	2

#### 3M® DUO-GLASS 4" X 132" (102 X 3353 MM)

CAT. NO.	GRIT	QTY/BOX
3M4X13280X	80X	5

Minimum order: 1 box. All Glass Grinding Belts can be combined for quantity pricing. All Cork Belts can be combined for quantity pricing.

3M is a registered trademark of 3M Company Corporation.

## CRL Metric Size Silicon Carbide Abrasive Belts

- Popular Metric Sizes
- Polyester Wet-Dry Backing
- Non-Directional
- Available Only in Europe

Top-quality, long-lasting CRL Metric Size Silicon Carbide Abrasives provide the best in glass finishing. CRL Belts feature polyester wet-dry non-directional backing material. The sizes and grits shown here are stock, but most Abrasive Belt sizes are available in grits ranging 36X to 600X. These Belts are sold each unless otherwise noted.

**NOTE:** Imperial sizes shown in parentheses are nominal.



Available Only in Europe

### 50 X 1800 MM (2" X 71")

CAT. NO.	GRIT
1317GK	100X
1317FK	120X
1317F1K	180X

### 55 X 1000 MM (2-1/8" X 39-1/4")

CAT. NO.	GRIT
1373K	80X
1373AK	120X

### 100 X 1100 MM (4" X 43-1/4")

CAT. NO.	GRIT
1308K	180X

### 100 X 1524 MM (4" X 60")

CAT. NO.	GRIT
1314K	80X
1315K	180X
1315AK	220X
1316K	400X

### 100 X 2000 MM (4" X 78-3/4")

CAT. NO.	GRIT
13094K	80X
13094AK	100X
13095BK	120X
13095K	180X
13095AK	220X
13096K	400X

### 100 X 3310 MM (4" X 130-1/4")

CAT. NO.	GRIT
1318BK	100X

### 100 X 3350 MM (4" X 132")

CAT. NO.	GRIT
1319K	180X
1320K	400X

### 100 X 1800 MM (4" X 71")

CAT. NO.	GRIT
13309K	60X
13310K	80X
1327K	120X
1323K	150X
13143K	180X
1317HK	220X

### 100 X 1830 MM (4" X 72")

CAT. NO.	GRIT
1317BK	80X
1317DK	100X
1317B05K	120X
1317B1K	180X
1317B3K	220X
1317B2K	400X

### 100 X 3000 MM (4" X 118")

CAT. NO.	GRIT
1332AK	80X
1332BK	120X
1333K	180X
1334K	400X

### 100 X 2500 MM (4" X 98-1/2")

CAT. NO.	GRIT
1324K	80X
1325K	180X

### 100 X 2690 MM (4" X 106")

CAT. NO.	GRIT
1301K	80X
1301AK	120X
1302K	180X
1302AK	220X
1303K	400X

### 100 X 2400 MM (4" X 94-1/2")

CAT. NO.	GRIT
13038K	60X
1304K	80X
1304AK	120X
1305K	180X
1305AK	220X
1306K	400X

Minimum order: 1 each. All Metric Belts can be combined for quantity pricing.

## CRL Metric Size Cork Polishing Belts

- Top Quality Cork for Bright Finish Edgework
- Available Only in Europe

CRL Metric Size Cork Polishing Belts are manufactured using the highest quality material available. Cork Belts yield best results when used wet. Avoid letting belts dry out and overheat while running. All Cork Belts are sold one each.



Available Only in Europe



CAT. NO.	SIZE
1312K	100 x 1100 mm
1317K	100 x 1524 mm
1313K	100 x 1590 mm
1317AK	100 x 1800 mm
1317EK	100 x 1830 mm
13097K	100 x 2000 mm

CAT. NO.	SIZE
1311K	100 x 2400 mm
1325BK	100 x 2500 mm
1310K	100 x 2690 mm
1336K	100 x 3000 mm
1321K	100 x 3350 mm



Minimum order: 1 each. All Metric Belts can be combined for quantity pricing.

## CRL 3M™ Metric Size Flexible Diamond Grinding Belts

- Stocked in Five Sizes for Many Popular Brands of Belt Machines
- Consistent Edge Quality
- Longer Life Than Silicon Carbide
- Available Only in Europe

Traditional diamond belts have a cloth or paper backing, but 3M's Diamond Belts use metal bond technology to securely anchor micron-graded industrial diamonds to a premium, flexible film backing material. As a result, this unique system provides a superior, uniform surface to coat with micron-graded diamonds in a pattern that promotes both aggressive cutting action and reduced grinding loads.

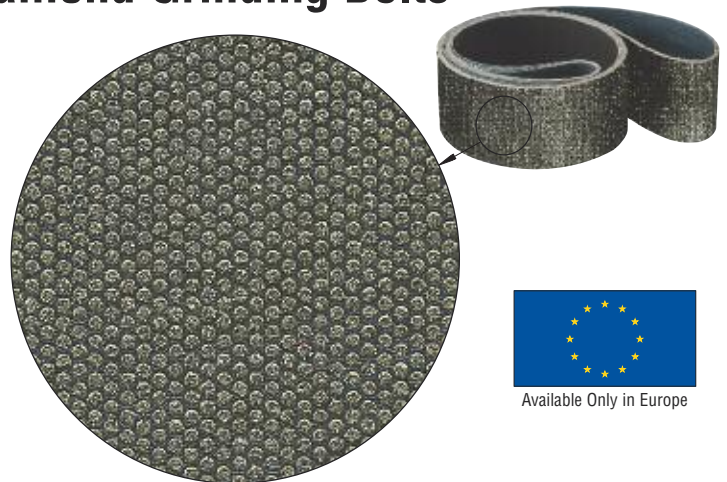

Available Only in Europe

### KEY BENEFITS OF A DIAMOND BELT

**Longer Life:** Diamonds are a much harder material than any other abrasive product. Diamonds wear but do not dull since they cut rather than scratch.

**Fewer Belt Changes:** The longer life span of a diamond belt means fewer changes and less downtime.

**Precise and Consistent:** Achieve the same speed and quality of cut from the first piece of glass to the last, regardless of glass thickness.

**Fast and Reliable:** Cutting rather than scratching removes more glass faster than conventional silicon carbide belts, and with much more consistent results.

**NOTE:** Imperial sizes shown in parentheses are nominal.

### DIAMOND BELT GRITS:

60 Grit	N250	Green
120 Grit	N125	Black
180 Grit	N74	Red
360 Grit	N40	Yellow

N74 180 Grit is standard but other grits and sizes are available on special order.

CAT. NO.	SIZE (WIDTH X LENGTH)	SUITABLE FOR	GRADE/GRIT
<b>13A6465JC</b>	57 x 1000 mm (2-1/4" x 40")	Willan	N74/180
<b>13A6405J</b>	70 x 1010 mm (2-3/4" x 40")	Simec	N74/180
<b>13A6465J3</b>	80 x 1180 mm (3" x 46")	Lisec	N74/180
<b>13C6465J</b>	100 x 1990 mm (4" x 78")	Metral	N74/180
<b>13F6465J</b>	100 x 3340 mm (4" x 132")	Ashton	N74/180

Minimum order: 1 each.

## CRL Metric Size Conglomerate Abrasive Belts

- Last Four Times Longer Than Standard Silicon Carbide
- Continuously Aggressive Grinding
- Four Popular Sizes
- Available Only in Europe

CRL Conglomerate Belts last four times longer than comparable silicon carbide belts. As each grade wears away, it continually exposes fresh sharp edges. This means the Belts continue their aggressive stock removal longer. The Conglomerate 120 Grit Belts perform like a conventional 80 grit, and a 240 Grit Conglomerate Belt performs more like 180 grit. All Conglomerate Abrasive Belts are sold one each.



Available Only in Europe

100 X 2000 MM (4" X 78-3/4")		100 X 2400 MM (4" X 94-1/2")	
CAT. NO.	GRIT	CAT. NO.	GRIT
<b>139030</b>	120	<b>139051</b>	120
<b>139032</b>	240	<b>139053</b>	240
<b>139034</b>	400	<b>139055</b>	400
		<b>139059</b>	600

Minimum order: 1 each.

Minimum order: 1 each.

100 X 2690 MM (4" X 106")	
CAT. NO.	GRIT
<b>139061</b>	120
<b>139063</b>	240
<b>139065</b>	400

Minimum order: 1 each.

100 X 3350 MM (4" X 132")	
CAT. NO.	GRIT
<b>139071</b>	120
<b>139075</b>	400

Minimum order: 1 each.

**NOTE:** Imperial sizes shown in parentheses are nominal.

## CRL Tube Wax Lubricant

- Improves Finish and Performance While Sanding and Grinding



CRL Tube Wax Lubricant is a special formulation of solid waxes that come in a convenient, soft stick. Use it for all sanding, grinding, drilling, tapping, sawing, and fastening operations to increase production quality and improve tool life. Neat and easy to use, it requires no special storage or handling. Net weight is 15 oz. (425 g). 24 per case. Minimum order is one each.

CAT. NO. WS140

## CRL Polishing Oil

- Spray on Belts and Discs for Faster, Brighter Polishing
- Promotes Longer Belt Life



Spray CRL Polishing Oil on your abrasive belts and discs to keep them soft and free cutting. CRL920 helps to reduce "loading" while it improves finish edges on metal and glass. Spray directly on belts, discs or abrasive wheel before starting, then re-apply lightly as needed. Gives you longer belt life and a brighter, faster polish. Net weight is 11 oz. (312 g). 12 per case. Minimum order is one each.

CAT. NO. CRL920

## CRL Safety Equipment for Sanding Operations

### CRL Safety Glasses

- Great Protection and Classic Design

The CRL Radians® Classic Glasses features a 100% polycarbonate lens that meets the ANSI Z87.1-1989 Standard, and is distortion-free with fog and scratch resistance built in. The adjustable temple and full 155 degree width provide increased protection. Minimum order is one each. For other safety eyewear, see pages 278K-279K.



CAT. NO. CL0210

### CRL Particulate Respirators

- Perfect for Glass Fabricators

CRL's new NIOSH approved Particulate Respirator is ideal for anyone in the glass industry who cuts, seams, drills, or edges glass. This is the perfect Respirator to filter out glass dust particles in the air caused by any glass fabrication process. Available in boxes of 20 each. Minimum order is one box. For other respiration safety items, see page 281K.



CAT. NO. G1002

## CRL 1/2" x 18" Detail Belt Sander



**new**

- Ideal for Intricate Finishing Work
- Includes Three Separate Belt Guide Arms
- Variable Speed

The CRL Detail Belt Sander is the ideal tool for getting into small or intricate areas for finishing detail work. Using 1/2" x 18" (13 x 457 mm) silicon carbide abrasive belts (sold separately), finishing the inside edges of circles or notches becomes simple and easy. The added bonus of this unique tool is the inclusion of two additional belt guide arms: One angled tip arm for the 1/2" x 18" belts that guides belts with a 45 degree sanding surface, and a mini belt guide arm that uses 5/16" x 18" (8 x 457 mm) abrasive belts for really intricate sanding jobs. All three arms are included with the sander in a black plastic storage and carrying case. Go to [crlaurence.com](http://crlaurence.com) for specifications.



Belt Guide Arms



CAT. NO.	DESCRIPTION
LD1218	110V Detail Belt Sander
LD1218AU	240V Detail Belt Sander w/AU Plug
LD1218EU	220V Detail Belt Sander w/EU Plug

Minimum order: 1 each.

CAT. NO. LD1218

## CRL 18" (457 mm) Glass Grinding Belts

**new**

- For Use With CRL Model LD1218 Detail Sander
- Available in Two Widths 5/16" and 1/2" (8 and 13 mm)

CRL Glass Grinding Belts for portable belt sanders have 100 percent polyester backing, so you can use them wet or dry. They are available in grits from 80X (Coarse) to 400X (Fine) to fit most portable belt sanders.



### MOST POPULAR GRITS FOR GLASS, AND EXAMPLES OF THEIR USE:

- 80X - Rough, Quick-Contouring
- 120X - Smooth, Seaming and Polishing
- 220X - Extra-Smooth, Fine Frosted Finish
- 400X - Fine, Satin Finish

#### 5/16" X 18" (8 X 457 MM) BELTS

CAT. NO.	GRIT	QTY/BOX
CRL516X1880X	80X	10
CRL516X18120X	120X	10
CRL516X18220X	220X	10
CRL516X18400X	400X	10

Minimum order: 1 box. All Glass Grinding Belts can be combined for quantity pricing.

#### 1/2" X 18" (13 X 457 MM) BELTS

CAT. NO.	GRIT	QTY/BOX
CRL12X1880X	80X	10
CRL12X18120X	120X	10
CRL12X18220X	220X	10
CRL12X18400X	400X	10

Minimum order: 1 box. All Glass Grinding Belts can be combined for quantity pricing.

# CRL HANDHELD SANDING EQUIPMENT

For Pricing Visit [crlaurence.com](http://crlaurence.com) or Call Us Toll Free at the Phone Numbers Shown on the Back Cover

## CRL 1-1/8" x 21" Portable Belt Sander



- Professional Quality Power Tool for Sanding Notches and Cut-Outs
- Side Handle for Easy Maneuverability
- Available in 110V, 220V, and 240V Models

The CRL 1-1/8" x 21" (29 x 533 mm) Belt Sander's design is compact and lightweight for close quarter work with excellent maneuverability, making it ideal for sanding irregular openings or shapes. 4.2 AMP motor provides excellent results at variable speeds.



CAT. NO.	DESCRIPTION
LD118	110V Portable Belt Sander
LD118AU	240V Belt Sander w/AU Plug
LD118EU	220V Belt Sander w/EU Plug
LD118BRSH	Replacement Brushes
LD118FR	Replacement Front Roller
LD118SW	Replacement Switch

### SPECIFICATIONS:

Belt Speed is 656' to 3,280' (200 to 1,000 m) Per Minute  
Belt Size to Use 1-1/8" x 21" (29 x 533 mm)

Minimum order: 1 each.

## CRL 1-1/8" x 21" (29 x 533 mm) Glass Grinding Belts

- Fast-Grinding 100% Polyester Backed Belts in 12 Grits From 40X to CORK
- Ask About Our Large User Program

CRL Glass Grinding Belts for portable belt sanders have 100 percent polyester backing, allowing them to be used wet or dry. They are available in grits from 40X (Super Coarse) to CORK (Polishing) to fit most portable belt sanders.



### MOST POPULAR GRITS FOR GLASS, AND EXAMPLES OF THEIR USE:

- 60X - Extra-Rough, Fast Glass Removal (Mitered Edge)
- 80X - Rough, Quick-Contouring (Auto Glass Edge)
- 120X - Smooth, Seaming and Polishing (Desk Top Edge)
- 220X - Extra-Smooth, Fine Frosted Finish (Glass Shelf Edge)
- 400X - Fine, Satin Finish (Opaque Edge)
- CORK - Polish, Smooth Luster Finish

CAT. NO.	GRIT	QTY/BOX
CRL118X2140X	40X	10
CRL118X2160X	60X	10
CRL118X2180X	80X	10
CRL118X21100X	100X	10
CRL118X21120X	120X	10
CRL118X21150X	150X	10

Minimum order: 1 box (except CORK). All Glass Grinding Belts can be combined for quantity pricing. Minimum order for Cork Belts is five each. All Cork Belts can be combined for quantity pricing.

CAT. NO.	GRIT	QTY/BOX
CRL118X21180X	180X	10
CRL118X21220X	220X	10
CRL118X21320X	320X	10
CRL118X21400X	400X	10
CRL118X21600X	600X	10
CRL118X21CORK	CORK	5

Minimum order: 1 box (except CORK). All Glass Grinding Belts can be combined for quantity pricing. Minimum order for Cork Belts is five each. All Cork Belts can be combined for quantity pricing.



C.R. LAURENCE COMPANY

[crlaurence.com](http://crlaurence.com) | [usalum.com](http://usalum.com)

ALUMINUM

652K | [crlaurence.ca](http://crlaurence.ca) [crlaurence.com.au](http://crlaurence.com.au) [crlaurence.co.uk](http://crlaurence.co.uk) [crlaurence.de](http://crlaurence.de) [crlaurence.eu](http://crlaurence.eu)

## CRL 3" x 18" Portable Belt Sander With Dust Bag

- Compact, Ergonomic Design
- 110V, 220V, and 240V Models
- Uses 3" x 18" (76 x 457 mm) Belts

CRL's 3" x 18" (76 x 457 mm) Portable Belt Sander is powered by a strong 7.0 AMP motor which drives the belt at 1,240' (380 m) per minute. Features include an efficient dust collection system, a belt tracking system, lock-on switch for continuous use, and external brush caps for easy brush changes.



CAT. NO.	DESCRIPTION
LD318	120V Portable Belt Sander With Dust Bag
LD318AU	240V Belt Sander With Dust Bag w/AU Plug
LD318EU	220V Belt Sander With Dust Bag w/EU Plug
LD318BRSH	Replacement Brushes for LD318 Belt Sander
LD318SW	Replacement Switch for LD318 Belt Sander

Minimum order: 1 each.

## CRL 3" x 18" (76 x 457 mm) Glass Grinding Belts

- Fast-Grinding 100% Polyester Backed Belts in Six Grits From 60X to CORK
- Ask About Our Large User Program

CRL 3" x 18" (76 x 457 mm) Glass Grinding Belts for portable belt sanders have 100 percent polyester backing, so you can use them wet or dry. They are available in grits from 60X (Extra-Rough) to CORK (Polishing) to fit most portable belt sanders.



### MOST POPULAR GRITS FOR GLASS, AND EXAMPLES OF THEIR USE:

- 60X** - Extra-Rough, Fast Glass Removal (Mitered Edge)
- 80X** - Rough, Quick-Contouring (Auto Glass Edge)
- 120X** - Smooth, Seaming and Polishing (Desk Top Edge)
- 220X** - Extra-Smooth, Fine Frosted Finish (Glass Shelf Edge)
- 400X** - Fine, Satin Finish (Opaque Edge)
- CORK** - Polish, Smooth Luster Finish

CAT. NO.	GRIT	QTY/BOX
CRL3X1860X	60X	10
CRL3X1880X	80X	10
CRL3X18120X	120X	10
CRL3X18220X	220X	10
CRL3X18400X	400X	10
CRL3X18CORK	CORK	5

Minimum order: 1 box. All Glass Grinding Belts can be combined for quantity pricing. All Cork Belts can be combined for quantity pricing.

## CRL 3" x 21" Portable Belt Sander With Dust Bag



- Professional Quality Power Tool Sands Cleanly With Dust Bag
- Available in 110V, 220V, and 240V Models
- Double-Insulated

This highly portable, 3" x 21" (76 x 533 mm) CRL Belt Sander with Dust Bag is lightweight and easy to maneuver. It features a powerful 7.8 AMP motor for fast and even belt tracking, an efficient dust collector bag, a lock-on switch, and an extra long power cord.



CAT. NO.	DESCRIPTION
LD321	110V Portable Belt Sander with Dust Bag
LD321AU	240V Belt Sander with Dust Bag w/AU Plug
LD321EU	220V Belt Sander With Dust Bag w/EU Plug
LD321BRSH	Replacement Brushes for LD321 Belt Sander
LD321SW	Replacement Switch for LD321 Belt Sander

Minimum order: 1 each.

## CRL 3" x 21" (76 x 533 mm) Glass Grinding Belts

- Fast-Grinding 100% Polyester Backed Belts in 12 Grits From 36X to CORK
- Ask About Our Large User Program

CRL 3" x 21" (76 x 533 mm) Glass Grinding Belts for portable belt sanders have 100 percent polyester backing, so you can use them wet or dry. They are available in grits from 36X (Super Coarse) to CORK (Polishing) to fit most portable belt sanders.



### MOST POPULAR GRITS FOR GLASS, AND EXAMPLES OF THEIR USE:

- 60X - Extra-Rough, Fast Glass Removal (Mitered Edge)
- 80X - Rough, Quick-Contouring (Auto Glass Edge)
- 120X - Smooth, Seaming and Polishing (Desk Top Edge)
- 220X - Extra-Smooth, Fine Frosted Finish (Glass Shelf Edge)
- 400X - Fine, Satin Finish (Opaque Edge)
- CORK - Polish, Smooth Luster Finish

CAT. NO.	GRIT	QTY/BOX
CRL3X2136X	36X	10
CRL3X2140X	40X	10
CRL3X2150X	50X	10
CRL3X2160X	60X	10
CRL3X2180X	80X	10
CRL3X21100X	100X	10

Minimum order: 1 box. All Glass Grinding Belts can be combined for quantity pricing. All Cork Belts can be combined for quantity pricing.

CAT. NO.	GRIT	QTY/BOX
CRL3X21120X	120X	10
CRL3X21180X	180X	10
CRL3X21220X	220X	10
CRL3X21400X	400X	10
CRL3X21600X	600X	10
CRL3X21CORK	CORK	5

Minimum order: 1 box. All Glass Grinding Belts can be combined for quantity pricing. All Cork Belts can be combined for quantity pricing.





## CRL 3" x 24" Portable Belt Sander With Dust Bag



- Professional Quality Power Tool Sands Cleanly
- Powerful 10 Amp Motor
- Double Insulated

The CRL LD324 Portable Belt Sander powers our most common abrasive belt: 3" x 24" (76 x 610 mm). This heavy-duty 10 AMP power sander comes with a Dust Bag and is ruggedly built to provide years of service. Belt tensioning lever and belt centering adjustment screw are simple to use and easily accessible.



CAT. NO.	DESCRIPTION
LD324	110V Portable Belt Sander with Dust Bag
LD324B	Replacement Drive Belt for LD324 Belt Sander
LD324BRSH	Replacement Brushes for LD324 Belt Sander
LD324SW	Replacement Switch for LD324 Belt Sander

Minimum order: 1 each.

## CRL 3" x 24" (76 x 610 mm) Glass Grinding Belts

- Fast-Grinding 100% Polyester Backed Belts in 14 Grits From 36X to CORK
- Ask About Our Large User Program

CRL 3" x 24" (76 x 610 mm) Glass Grinding Belts for portable belt sanders have 100 percent polyester backing, so you can use them wet or dry. They are available in grits from 36X (Super Coarse) to CORK (Polishing) to fit most portable belt sanders.



### MOST POPULAR GRITS FOR GLASS, AND EXAMPLES OF THEIR USE:

- 60X** - Extra-Rough, Fast Glass Removal (Mitered Edge)
- 80X** - Rough, Quick-Contouring (Auto Glass Edge)
- 120X** - Smooth, Seaming and Polishing (Desk Top Edge)
- 220X** - Extra-Smooth, Fine Frosted Finish (Glass Shelf Edge)
- 400X** - Fine, Satin Finish (Opaque Edge)
- CORK** - Polish, Smooth Luster Finish

CAT. NO.	GRIT	QTY/BOX
CRL3X2436X	36X	10
CRL3X2440X	40X	10
CRL3X2450X	50X	10
CRL3X2460X	60X	10
CRL3X2480X	80X	10
CRL3X24100X	100X	10
CRL3X24120X	120X	10

Minimum order: 1 box. All Glass Grinding Belts can be combined for quantity pricing. All Cork Belts can be combined for quantity pricing.

CAT. NO.	GRIT	QTY/BOX
CRL3X24150X	150X	10
CRL3X24180X	180X	10
CRL3X24220X	220X	10
CRL3X24320X	320X	10
CRL3X24400X	400X	10
CRL3X24600X	600X	10
CRL3X24CORK	CORK	5

Minimum order: 1 box. All Glass Grinding Belts can be combined for quantity pricing. All Cork Belts can be combined for quantity pricing.

## CRL Glass Edging Machinery

The Glass Edging process involves shaping only the glass edge employing either Peripheral or Cup Diamond Wheels. Edge processing by machine saves on abrasive belt expense, and provides a superior, consistent, and more competitive finished product.

CRL Glass Edging Machines employ Peripheral Wheels, Cup Wheels or a combination of both. Peripheral Wheels are profile specific since the diamond wheel cuts directly in line with the glass edge, and the profile is machined into the diamond wheel. This is what makes profiles like Pencil, Ogee, and Waterfall possible. Some Peripheral Wheel Machines, depending on the number of spindles and wheels doing the work, can produce these profiles, as well as Miter and Flat/Seam edges.

Our Cup Wheel Edgers are intended to produce Flat/Seam edges only. Cup Style Diamond Wheels cut across the edge of the glass and are capable of flat cutting only. For example, the smallest Cup Wheel Polishing Machine would be a four wheel machine: one wheel to grind the flat edge face, one wheel to grind the back arris or seam, one wheel to grind the front arris, and one wheel to polish the flat edge face.



All CRL Glass Edging Machines combine Diamond Wheels for removing stock and forming the basic profile desired, and Polishing Wheels made from a softer material to provide some degree of clarity to the ground edge. Peripheral Polishing Wheels have the diamond ground edge profile actually ground into the soft wheel surface so the polishing profile exactly matches the diamond profile. Since Cup Wheel Edging Machines are grinding and polishing flat surfaces only, there is no profile to be cut in the Polishing Wheels.

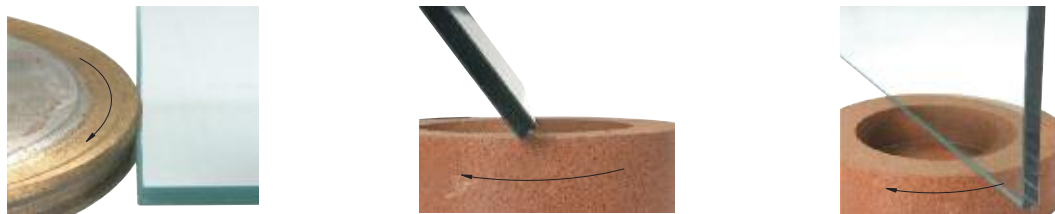

The clarity, speed, and profile selection of a CRL Edging Machine's capabilities will often depend on the number of spindles being offered on a specific frame or platform. Spindles are the precision machined bearing carriers connecting the motor to the wheel hub. More motors and spindles translates to greater speed and edge clarity. Two or three Diamond Wheels grinding a profile work more efficiently than one wheel doing the same profile. The same holds true for Polishing Wheels. Two or three polishing stations are capable of producing higher luster and clarity than one polisher on the same profile.

The CRL Machinery Division offers one spindle through five spindle Peripheral or Peripheral/Cup Combination Edgers, as well as four through eight spindle Cup Wheel Machines. These machines, depending on style and size, are capable of processing glass from 1/8" to 3/4" (3 to 19 mm) thick at speeds ranging as high as 376" (9.5 m) per minute. With this kind of selection, CRL offers enough choices to match any production requirement.

Whether you are considering buying edging equipment for the first time, or you're expanding existing fabrication capabilities, many things can influence the decision process: size of facility, market niche, competition, and capital for investment, to name a few.

When considering size of facility, floor space matters more than employee count. For a two man mirror shop a one or two spindle Edger becomes a third employee, edging instead of sanding as fast as the mirrors can be cut. If your local competitors have already invested in automated edging equipment, you may be working at a competitive disadvantage.

As to capital investment, how much are you spending monthly on finished custom edgework that you could be producing in-house? It's not unheard of for a company to be in the project bidding process and have new machine costs covered within the project margins. Leasing is a common option selected by our customers, allowing monthly payments to be written off as a business expense. And at any given time, the government may offer capital investment incentive programs to help with equipment acquisitions.

When considering the purchase of capital glass processing equipment, always remember, CRL Machinery Division has been in the forefront of design and innovation for over 90 years. The glass industry has always been able to rely on the engineering expertise and the manufactured quality of products offered by the CRL Machinery Division. Our highly trained and experienced installation and service technicians offer the finishing touch to any machinery purchase. This level of quality and pride in the products we produce continues to this day, and the wide scope and selection of CRL products continues to expand to meet your specific needs.

We encourage you to contact our staff of machinery experts at the CRL Machinery Division in Cicero, Illinois. Call toll free at (866) 583-1377 or fax us at (866) 584-9722 for more information regarding the selection of CRL Machinery. And don't forget to visit our web site at [crlaurence.com](http://crlaurence.com). If you are in the Los Angeles area we have a Machinery Showroom at our Corporate Headquarters. To schedule a visit please call us at (800) 421-6144.

## CRL Single Spindle Automatic Glass Edger



• Available for Purchase or Lease

- Up to Six Times Faster Than a Belt Machine
- The Easiest Glass Edger to Set Up and Run
- Produces Flat Edges With Seams, Pencil Edges (Round), and Miter Edges on Glass From 1/8" to 1/2" (3 to 12 mm) Thick
- Edges Glass Up to 66" (1676 mm) Per Minute
- Recirculating Coolant Eliminates Dust



One Polish Wheel and One Diamond Wheel Included



CAT. NO. VE1P

### One Diamond Wheel on the Single Spindle Edger Will Do the Work of Over 500 106" (2692 mm) Abrasive Belts

Our Single Spindle Automatic Glass Edger is designed and built to provide a simple, reliable method for edging and polishing a variety of thicknesses of glass and mirror for any size shop. This Edger will allow you to do quality edgework up to six times faster than a belt machine. Pencil edge, miter, and flat and seam edgework can all be performed on the machine.

Operation is very simple. The operator merely pushes the glass into the roller/belt conveyor and it is smoothly pulled over the wheel. You can process glass from 1/8" to 1/4" (3 to 6 mm) thick with just one wheel.

The VE1P is the ideal choice for an affordable Glass Edging Machine. Ask us about our Leasing Program. If you would like to see a sample of glass edged by the machine, or need additional information, please contact CRL Glass Machinery Division Sales at (866) 583-1377 in the U.S. and Canada.

#### Controls

All controls are built to OSHA requirements, utilizing CE, CSA and UL Certified components. Wired for single phase, 60 cycle, 110V AC power (Cat. No. VE1P). Also available configured for 220V AC, 50/60 Hz operation (Cat. No. AU11 and Cat. No. EU11).

#### Wheels (Included)

Diamond Wheel . . . . . One 7" (178 mm) for 1/8" to 1/4" (3 to 6 mm) Flat and Seam  
 Polish Wheel . . . . . One 7-1/4" x 3/4" (184 x 19 mm) Orange Polish Wheel

#### Utilities

Electrical . . . . . Three Motors, Total 1-1/6 HP (0.87 kw)  
 Voltage . . . . . Single Phase, 60 Cycle, 110V AC (220V AC available)  
 Power . . . . . 13.8 AMP @ 110V AC  
 6.4 AMP @ 220V AC

Minimum Glass Size: . . . . . 4" x 10" (102 x 254 mm). Edge side must be at least 10" (254 mm) long.

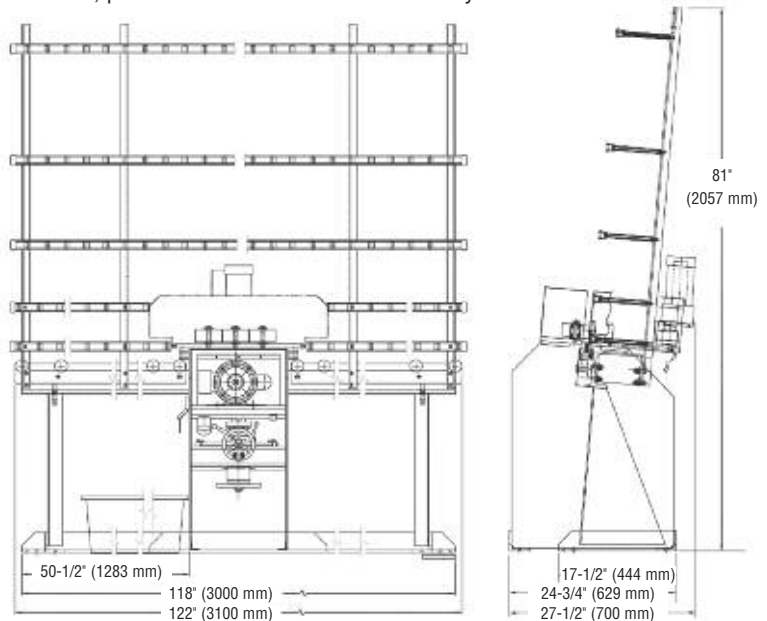

Elevation and Side View of Edger



## CRL Single Spindle Automatic Glass Edger

### Precision Wheel Position Indicators



Wheel Position Indicators are standard on every Edger. This feature allows you to spend less time on set-up, and makes wheel changes easier.

### Variable Speed Glass Conveyor



The Conveyor safely pulls the glass through at the desired speed. The operator only needs to push the glass into the Conveyor, the Edger does the rest.

- Fast and Easy One Person Set-Up
- Simple Design is Easy to Maintain
- Saves Labor Costs



Uncrating the Edger is an easy, one person job



Assemble Support Rack and plug in



Fill Coolant Tank and start edging glass

If you would like to see a sample of glass edged by the machine, or want additional information, please contact our Glass Machinery Sales Division at (866) 583-1377 in the U.S. and Canada. You can also e-mail us at [machinery@crlaurence.com](mailto:machinery@crlaurence.com). For a Demonstration Video on the Edger visit our web site, [crlaurence.com](http://crlaurence.com), and enter the machine's catalog number in the SEARCH box.



CAT. NO.	DESCRIPTION	DIAMETER	GRIT
VE1P	Single Spindle Edger (Single Phase/110V AC)	--	--
AU11	Single Spindle Edger (Single Phase/220V AC Australia)	--	--
EU11	Single Spindle Edger (Single Phase/220V AC Europe)	--	--
36443213	Pencil Edge Wheel for 1/8" to 1/4" (3 to 6 mm)	7" (178 mm)	140-170
36881012	Pencil Edge Wheel for 3/16" to 3/8" (5 to 10 mm)	7" (178 mm)	140-170
38404909	Pencil Edge Wheel for 1/4" to 1/2" (6 to 12 mm)	7" (178 mm)	140-170
38533510	Flat and Seam Wheel for 1/8" to 1/4" (3 to 6 mm)	7" (178 mm)	140-170
38386909	Flat and Seam Wheel for 3/16" to 3/8" (5 to 12 mm)	7" (178 mm)	140-170
38517503	Flat and Seam Wheel for 1/4" to 1/2" (6 to 12 mm)	7" (178 mm)	140-170
38677802	30 Degree Miter Wheel for 1/8" to 1/2" (3 to 12 mm)	7" (178 mm)	140
39666000	Polish Wheel for 1/8" to 1/2" (3 to 12 mm) Glass	7-1/4" (184 mm)	120
38430304	Grind Wheel Hub	--	--

Minimum order: 1 each. F.O.B. CRL service center. Edgers must ship common carrier.

**CRL AU11/EU11**  
**220V AC, 50/60 Hz Export Models**

Cat. Nos. AU11/EU11 are export versions of the Single Spindle Edger configured with 220V AC motors at 50/60 Hz. The EU11 is CE compliant for all of the European Union.

#### SPECIFICATIONS:

- Height:** 81" (2057 mm)
- Footprint:** 122" x 27-1/2" (3100 x 700 mm)
- Shipping Weight:** 900 lbs. (408 kg)
- Conveyor Height:** 28-1/2" (724 mm)

## CRL VE1P/AU11/EU11 Glass Edger Parts and Accessories

### Coolant Pumps

This is the correct Pump to maintain proper coolant circulation.



CAT. NO.	DESCRIPTION
42500170	110V AC Coolant Pump (for Cat. No. VE1P)
42500160	230V AC Coolant Pump (for Cat. No. AU11)
42500180	230V AC Coolant Pump (for Cat. No. EU11)

Minimum order: 1 each.

### Coolant Hose and Valve

12" (305 mm) Hose controls and directs coolant to the Diamond and Polish Wheels.



CAT. NO.	DESCRIPTION
42333006	12" Coolant Hose With Fittings (no valve)
42333008	Valve Only

Minimum order: 1 each.

### Wheel Mounting Bolt Kit

These are the correct stainless steel bolts for securing the Diamond and Polish Wheels. Set includes four flat washers, four lock washers, and four bolts each of five lengths: 1" (25 mm), 1-1/4" (32 mm), 1-1/2" (38 mm), 1-3/4" (44 mm), and 2" (51 mm).



CAT. NO.	DESCRIPTION
39528200	Kit of All 20 Bolts

Minimum order: 1 bolt kit.

Bolts should be 1/4" (6 mm) longer than the total thickness of the wheel(s) being used.

### Conveyor Roller and Shoulder Screw

The rubber Conveyor Roller that supports the glass as it enters and exits the Edger.

CAT. NO.	DESCRIPTION
16300160	Conveyor Roller
36988804	Roller Shoulder Screw

Minimum order: 1 each.



### Platen Belt

The rubber Platen Belt moves the glass through the Edger. Replace yours if it is stretched, cracked or contaminated.

CAT. NO.	DESCRIPTION
43313220	Platen Belt

Minimum order: 1 each.



### Rubber Wiper

This small Rubber "Wiper" keeps water inside of the Edger. Two are needed for each Edger.

CAT. NO.	DESCRIPTION
39021500	Rubber Wiper

Minimum order: 1 each.



### Wheel Position Dial Indicators

Dial Indicators allow precise positioning of Grind and Polish Wheels. Record settings for quick repositioning of Wheels during changeover.



CAT. NO.	DESCRIPTION
49000510	Replacement Dial Indicator (1 only)
39700000	Dial Indicator Kit, (2) Complete*
39700001	Dial Indicator Kit, (2) Complete**

Minimum order: 1 each. \* For machines built BEFORE April 1, 2003 (see serial no. on machine) \*\* For machines built AFTER April 1, 2003 (see serial no. on machine)

### Pressure Roller and Bearings

Pressure Rollers hold the glass against the Platen Belt. Bearings can wear and must be replaced for correct alignment. Three Rollers, three upper and three lower Bearings are needed per Edger.



CAT. NO.	DESCRIPTION
46300230	4" (102 mm) Pressure Roller
39663102	Lower Pressure Roller Bearings
39663101	Upper Pressure Roller Bearings

Minimum order: 1 each.

### Brush Shields

Brush Shields keep water inside the Edger and off of your work area. If yours are worn or contaminated, replace them with these parts. Two Main and two End Shields per Edger.



CAT. NO.	DESCRIPTION
39223200	Main Brush Shield
39021400	End Brush Shield

Minimum order: 1 each.

### Back Rails With Rollers

These Back Rails with Rollers replace worn or broken ones on your Edger. End Cap is sold separately.



CAT. NO.	DESCRIPTION
39983001	120-3/4" (3 m) Long
39983002	49-7/8" (1.2 m) Long
39983003	46" (1.1 m) Long
46300079	Back Rail End Cap Only

Minimum order: 1 each.

### Back Rail Roller and Axle

These parts replace the Rollers in each Back Rail. Have a few on hand to keep your glass rolling smoothly.



CAT. NO.	DESCRIPTION
4630007401	Back Rail Roller
4630007402	Back Rail Roller Axle

Minimum order: 1 each.



## CRL VE2PLUS2 Automatic Glass Edger

- Grind and Polish Glass in One Operation
- Save Time and Material Over Belt Machine Edging
- Produces Flat Edges With Seams, Pencil Edges (Round), and Miter Edges on Glass From 1/8" to 1/2" (3 to 12 mm) Thick
- Edges Glass Up to 100" (2540 mm) Per Minute
- Recirculating Coolant Eliminates Dust

• Available for Purchase or Lease

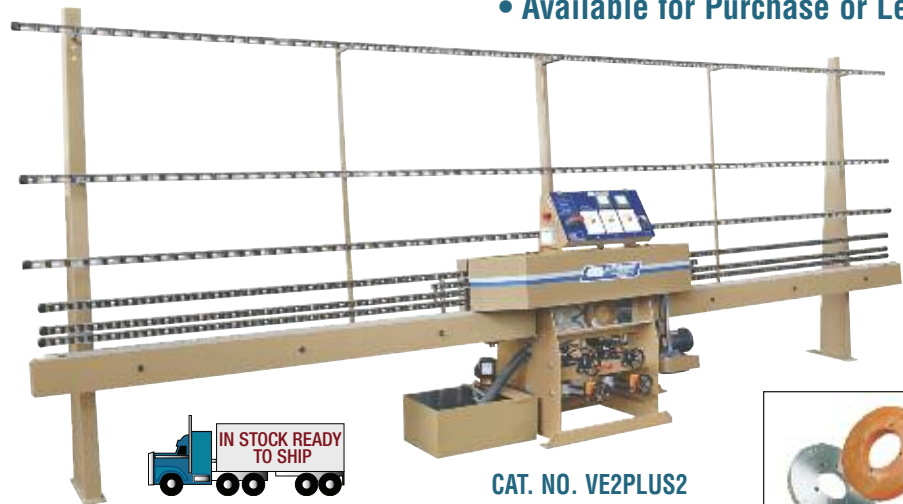

CAT. NO. VE2PLUS2



One Polish Wheel and One Diamond Wheel Included

**Our Most Popular Edging Machine. Over 600 in Use.  
Saves About 90% in Material Costs Over Abrasive Belts.**

Our VE2PLUS2 offers you added edging capacity not found elsewhere. You can place two wheels on each spindle, quickly repositioning them from 1/4" (6 mm) flat and seam, for example, to 1/2" (12 mm) pencil edge. You don't have to do a complete wheel changeover, saving you labor and production time. The new color coded Dial Indicator System allows exact wheel positioning every time and the fastest adjustments of any peripheral machine.

We've lowered the pass line to 28-1/2" (724 mm) making it even easier for the operator to load glass. Labor efficiency increases because of reduced fatigue. Processes 1/8" to 1/2" (3 to 12 mm) glass up to 100" (2540 mm) per minute. The VE2PLUS2 is designed to edge the most common range of glass thickness and sizes. Pencil, Miter or Flat and Seam profiles on a variety of thicknesses are possible.

Our VE2PLUS2 can be placed within one foot of the wall for minimum impact on floor space. To achieve this space savings, the coolant tank and all machine adjustments were moved to the front of the machine. This simplifies all machine adjustments and normal equipment maintenance. The VE2PLUS2 has the largest standard glass rack in the industry, so you'll appreciate the 7' (2134 mm) long conveyors. The VE2PLUS2 is the only U.L. approved two spindle machine on the market. It also meets or exceeds OSHA's requirements for machine safety.

### Controls

All controls are built to OSHA requirements, utilizing CE, CSA and UL Certified components. Wired for three phase, 60 cycle, 230V AC power.

### Wheels (Included)

- Diamond Wheel . . . . . One - 7" (178 mm) for 1/8" to 1/4" (3 to 6 mm) Flat and Seam
- Polish Wheel . . . . . One - 8" x 3/4" (203 x 19 mm) Orange Polish Wheel

### Utilities

- Electrical . . . . . Four Motors, Total 5.8 HP (4.32 kw)
- Voltage . . . . . Three Phase, 60 Cycle, 230V AC
- Power . . . . . 25 AMP @ 230V AC

Converter available to operate VE2PLUS2 at Single Phase, 60 Cycle, 220V AC

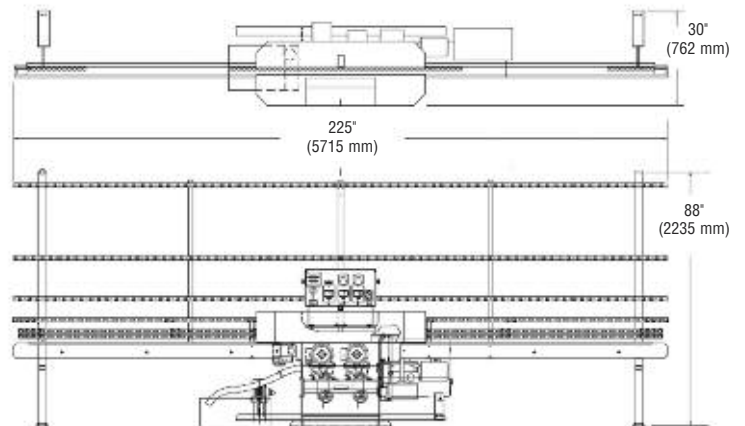



**CRL VE2PLUS2**  
**Three Phase, 50/60 Hz Export Model**



An export version of the VE2PLUS2 Edger can be built to operate on Three Phase, 50/60 Hz power. Contact the Machinery Division with your power requirements.

### SPECIFICATIONS:

- Height:** 88" (2235 mm)
- Footprint:** 225" x 30" (5715 x 762 mm)
- Shipping Weight:** 1800 lbs. (816 kg)
- Conveyor Height:** 28-1/2" (724 mm)
- Minimum glass size is 3.5" x 3.5" (89 x 89 mm)
- Glass strips from 2" x 24" (50 x 609 mm)

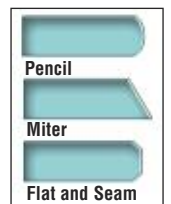

Optional installation and training by a CRL technician is recommended

## CRL VE2PLUS2 Automatic Glass Edging Machine



### Front-Mounted VE2PLUS2 Controls

The VE2PLUS2 Control Panel has all the controls needed to easily operate the machine. Ammeters indicate the load on each motor as the glass moves through the machine. The coolant pump, conveyor speed, and direction are also controlled from this panel. An hour meter is installed on the side of the panel for keeping track of maintenance scheduling. The spindle positions are controlled by the digital hand wheels, also at the front of the machine. Each Spindle has two position counters that allow you to record the wheel positions and easily reposition them when needed.

Mounting a grind wheel and a polish wheel for Pencil Edging 1/8" (3 mm) glass, and also mounting a grind wheel and a polish wheel to Flat and Seam 3/8" (10 mm) glass for example, will make your shop much more efficient. You will easily change from 1/8" to 3/8" (3 to 10 mm) glass without labor intensive wheel changing. Your set-up combinations are almost limitless.

### The Rugged VE2PLUS2 Design Has Been Continually Refined to Make it More Efficient



The unique VE2PLUS2 conveyor design allows glass from 1/8" to 1/2" (3 to 12 mm) thick to be processed. Only wheels or wheel positions needs to be changed. The conveyor is also easy to maintain with replaceable pads on front and rear.

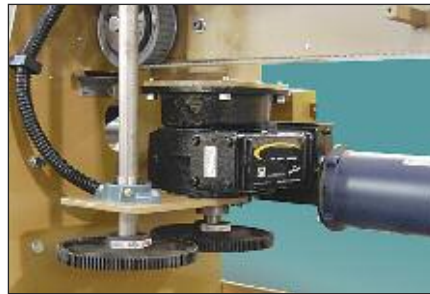

The CRL VE2PLUS2 is built with heavy-duty power transmission components not found on other two spindle edgers. It's no wonder that there are over 600 of these machines in use today.



Your VE2PLUS2 is backed by a full inventory of spare parts. If you ever need service advice or a replacement part, it's just a phone call or mouse click away at [crlaurence.com](http://crlaurence.com).



CRL Machinery Division Field Service Technicians can have your VE2PLUS2 up and running in as little as one day. With machines in stock at many locations, you could be edging glass faster and more efficiently than you might think. The Service Techs can also help with maintenance advice that will help extend the life of your machine.

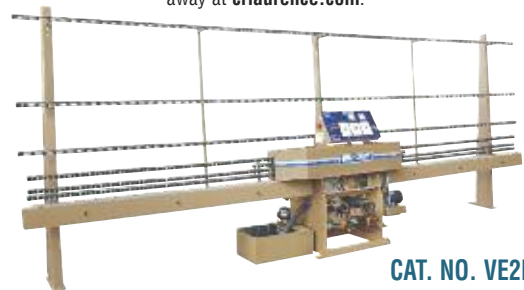

CAT. NO. VE2PLUS2

CAT. NO.	DESCRIPTION
VE2PLUS2	CRL Two Spindle Edger (Three Phase/230V AC)
EU2PLUS2	CRL Two Spindle Edger (Three Phase/50 Cycle/440V AC) - Europe
R3	Converter for Three Phase, 60 Cycle/220V AC
39173400	Vertical Extension Racks for 100" (2540 mm) Glass

Minimum order: 1 each. F.O.B. CRL Service Center. Must ship common carrier.

## CRL VE2PLUS2 Automatic Glass Edger Wheels and Accessories

**Call our Machinery Division at (866) 583-1377 for help with ordering parts for any CRL machine**

### Diamond Pencil Edge Wheels

7" (178 mm) diameter Diamond Wheel for Pencil Edge profiling.



CAT. NO.	GRIT	APPLICATION
<b>36443205</b>	170-200	For 1/8" to 1/4" (3 to 6 mm) Glass
<b>36881005</b>	170-200	For 3/16" to 3/8" (5 to 10 mm) Glass
<b>38404900</b>	170-200	For 1/4" to 1/2" (6 to 12 mm) Glass

Minimum order: 1 each.

### Diamond Flat and Seam Wheels

7" (178 mm) diameter Diamond Wheel for Flat and Seam profiling.



CAT. NO.	GRIT	APPLICATION
<b>38533500</b>	170-200	For 1/8" to 1/4" (3 to 6 mm) Glass
<b>38386900</b>	170-200	For 3/16" to 3/8" (5 to 10 mm) Glass
<b>38517504</b>	170-200	For 1/4" to 1/2" (6 to 12 mm) Glass

Minimum order: 1 each.

### Diamond 30 Degree Miter Wheel

7" (178 mm) diameter Diamond Wheel for 30 Degree Miter profiling.



CAT. NO.	GRIT	APPLICATION
<b>38677802</b>	140	For 1/8" to 1/2" (3 to 12 mm) Glass

Minimum order: 1 each.

### Orange Polish Wheels

Always use the original Orange Wheels for best results. Use Cat. No. 39579801 8" x 3/4" (203 x 19 mm) for 1/8" to 1/2" (3 to 12 mm) glass. Use the wider Cat. No. 39579802 8" x 1-3/16" (203 x 30 mm) for 1/8" to 3/4" (3 to 19 mm) glass.



CAT. NO.	GRIT	APPLICATION
<b>39579801</b>	120	For 1/8" to 1/2" (3 to 12 mm) Glass
<b>39579802</b>	120	For 1/8" to 3/4" (3 to 19 mm) Glass

Minimum order: 1 each.

### Grind Wheel Hub

Holds two wheels and fits the No. 1 spindle motor on the VE2PLUS2. Use it to mount extra set-ups.



CAT. NO.	APPLICATION
<b>38430302</b>	Grind Wheel Hub

Minimum order: 1 each.

### Polish Wheel Hub

Holds two wheels and fits the No. 2 spindle motor on the VE2PLUS2. Use it to mount extra set-ups.



CAT. NO.	APPLICATION
<b>38759900</b>	Polish Wheel Hub

Minimum order: 1 each.

### Wheel Dressing Boards and Sticks

8" x 6" (203 x 152 mm) Wheel Dressing Boards are used on the Polishing Wheel by running them through the machine like a piece of glass.



The 7" x 2" (178 x 51 mm) Dressing Stick is used to dress the Diamond Wheels by hand from the front of the machine.

CAT. NO.	DESCRIPTION	GRIT
<b>46205880</b>	1/4" (6 mm) Thick 8" x 6" (203 x 152 mm)	100X
<b>46205881</b>	3/8" (10 mm) Thick 8" x 6" (203 x 152 mm)	120X
<b>46205882</b>	1/2" (12 mm) Thick 8" x 6" (203 x 152 mm)	100X
<b>46205871</b>	1/4" (6 mm) Thick 7" x 2" (178 x 51 mm)	160X

Minimum order: 1 each.

### Blue Synthetic Coolant Powder



Biodegradable, anti-foaming Coolant Powder mixes with water for high lubricity. Inhibits rust and dissipates heat. Mix ratio is 100:1.

CAT. NO.	DESCRIPTION
<b>2651005</b>	1 lb. (.453 kg) Bag of Coolant Powder
<b>DRYCOOL40</b>	40 lb. (18 kg) Pail of Coolant Powder

Minimum order: 1 each.



## CRL VE2PLUS2 Automatic Glass Edger Parts

### Conveyor Pads

These front and rear Pads replace the ones on the machine perfectly to hold the glass firmly.

CAT. NO.	DESCRIPTION
<b>38864200</b>	Front Conveyor Pad
<b>38864100</b>	Rear Conveyor Pad

Minimum order: 1 each.



### Brush Shields and Wipers

The End Brush Shields and Wipers let glass slide in and out, keeping water in the machine. The Top Brush Shield keeps water from spraying on the conveyor.

CAT. NO.	DESCRIPTION
<b>38895200</b>	End Brush Shield
<b>38895400</b>	End Brush Shield Rubber Wiper
<b>38897200</b>	Top Brush Shield Assembly

Minimum order: 1 each.



### Coolant Pumps

This is the original heavy-duty Pump that is used in the VE2PLUS2.

CAT. NO.	DESCRIPTION
<b>42505610</b>	Single Phase Pump (S/N 67934 or lower)
<b>42505612</b>	Three Phase Pump (S/N 67935 or higher)

Minimum order: 1 each.



### Coolant Hose and Valve

12" (305 mm) Hose controls and directs coolant to the Diamond and Polish Wheels.

CAT. NO.	DESCRIPTION
<b>42333006</b>	12" Coolant Hose With Fittings (no valve)
<b>42333008</b>	Valve Only

Minimum order: 1 each.



### Wheel Mounting Bolt Kit

Stainless steel bolts for securing the Polish and Diamond Wheels. Set includes four flat washers, four lock washers, and four bolts each of five lengths: 1" (25 mm), 1-1/4" (32 mm), 1-1/2" (38 mm), 1-3/4" (44 mm), and 2" (51 mm).

CAT. NO.	DESCRIPTION
<b>39528200</b>	Kit of All 20 Bolts

Minimum order: 1 bolt kit.



Bolts should be 1/4" (6 mm) longer than the total thickness of the wheel(s) being used.

### Stainless Steel Coolant Tank

This Stainless Steel Coolant Tank replaces the painted steel tank that comes with the VE2PLUS2. It is the same size as the original and is easy to clean.

CAT. NO.	DESCRIPTION
<b>38861701</b>	Stainless Steel Coolant Tank

Minimum order: 1 each.



### Glass Feed Conveyor Belt

These are the Belts that bring the glass into and out of the main conveyor. Order by serial number on Edger.

CAT. NO.	DESCRIPTION
<b>43313022</b>	Conveyor Belt - S/N 55800 or higher
<b>43313001</b>	Conveyor Belt - S/N 55737 or lower

Minimum order: 1 each.



### Plastic Thumb Knob and Panel Screws

Original Plastic Knobs and Mounting Screws for panels and guards on the VE2PLUS2.

CAT. NO.	DESCRIPTION
<b>46980060</b>	Plastic Thumb Knob
<b>15005591</b>	3/4" Screw
<b>45007920</b>	5/8" Screw
<b>45007830</b>	1/2" Screw

Minimum order: 1 each.



Screws need to be pressed into plastic knob. This can be done with a bench vise or by driving screws in with a hammer.

### Conveyor Bumper

This is the original Bumper used on early VE2 machines. They should be glued to the springs.

CAT. NO.	DESCRIPTION
<b>46901050</b>	Rubber Conveyor Bumper

Minimum order: 1 each.



### Back Rail Roller and Axle

These parts replace the Rollers in each Back Rail. Have a few on hand to keep your glass rolling smoothly.

CAT. NO.	DESCRIPTION
<b>4630007401</b>	Back Rail Roller
<b>4630007402</b>	Back Rail Roller Axle

Minimum order: 1 each.



### Back Rails With Rollers

These Back Rails with Rollers replace worn or broken ones on your Glass Edger. End Cap is sold separately.

CAT. NO.	DESCRIPTION
<b>39983004</b>	112-7/8" (2.9 m) Long
<b>39983005</b>	61-11/16" (1.5 m) Long
<b>39983006</b>	26-1/4" (667 mm) Long
<b>39983007</b>	11-13/16" (300 mm) Long
<b>46300079</b>	Back Rail End Cap Only

Minimum order: 1 each.



### Wheel Position Digital Counters

Digital Counters allow precise positioning of Grind and Polish Wheels. Record settings for quick repositioning of Wheels during changeover.

CAT. NO.	DESCRIPTION
<b>46120253</b>	Black Horizontal Counter
<b>46120240</b>	Orange Vertical Counter

Minimum order: 1 each.



## CRL SM5C Five Cup Flat Edger



- High Polish, Quality Flat and Seam Edges on Glass Up to 1/2" (12 mm) Thick
- Grind and Polish 1/8" to 1/2" (3 to 12 mm) Glass
- Cerium Impregnated Polish Wheel Puts Final High Luster Finish on the Edge
- Available for Purchase or Lease

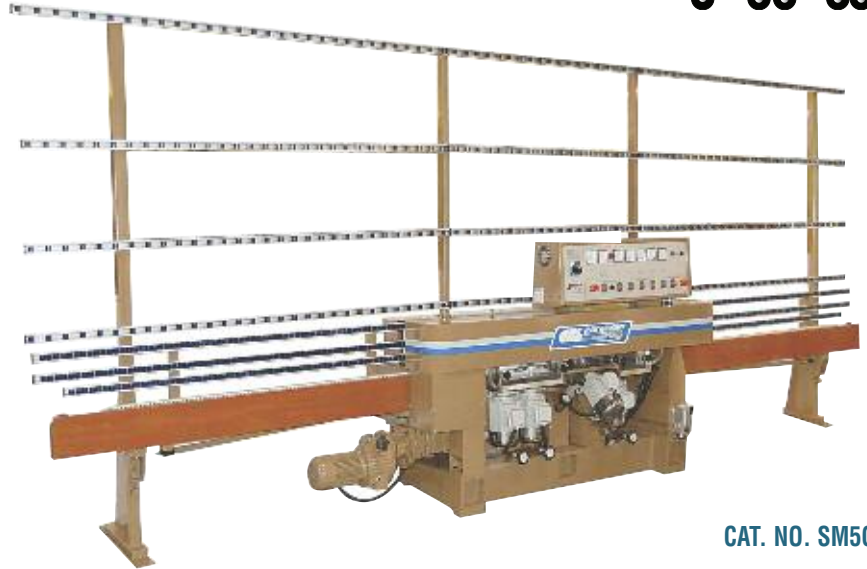

CAT. NO. SM5C

### Produces Polished Flat and Seam Edges on 1/8" to 1/2" (3 to 12 mm) Glass

This CRL SM5C Vertical Five Cup Flat Edger produces a polished flat and seam edge at an economical price. Five cup wheels grind, seam, and polish the glass as it runs through the machine. The two Polish Wheels ensure a smooth, high-quality finish. The last Polish Wheel is a Cerium Impregnated Wheel that gives the glass a clear polished finish. The conveyor speed is variable from 1.6 fpm to 9.8 fpm (0.5 to 3.0 mpm), and the machine has a large glass rack with the capacity to handle a 550 pound (250 kg) piece of glass up to 100" x 63" tall (2540 x 1600 mm). Thickness of glass can range from 1/8" to 1/2" (3 to 12 mm), and requires that only the arris wheel positions be changed for different thicknesses. Spindles have position indicators to make re-setting wheel positions easy. Glass pieces can be as small as 4" x 4" (102 x 102 mm). Compressed air is not required because all functions of the machine are set manually. Ammeters for each motor are mounted on the control panel with individual and main motor controls.

#### Wheels (Included)

- Cat. No. 39942002 Diamond Wheel .... One - 6" (152 mm) OD Cup Wheel-Position 1
- Cat. No. 39942101 Rear Seam Wheel .... One - 5" (127 mm) OD Cup Wheel-Position 2
- Cat. No. 39942101 Front Seam Wheel .... One - 5" (127 mm) OD Cup Wheel-Position 3
- Cat. No. 39942403 Polish Wheel .... One - 6" (152 mm) OD Cup Wheel-Position 4
- Cat. No. 39942402 Polish Wheel .... One - 6" (152 mm) OD Cup Wheel-Position 5  
Cerium Impregnated

#### Utilities

- Electrical ..... Seven Motors, Total 16 HP (12 kw)
- Voltage ..... Three Phase, 60 Cycle, 230V AC
- Power ..... 30 AMP @ 230V AC

Optional Converter available to operate the SM5C at Single Phase, 60 Cycle, 220V AC

#### SPECIFICATIONS:

- Height:** 98" (2489 mm)
- Footprint:** 236" x 47" (5994 x 1194 mm)
- Shipping Weight:** 4409 lbs. (2000 kg)
- Conveyor Height:** 33" (838 mm)
- Capacity:** Max. glass weight: 550 lbs. (250 kg)  
Min. glass size: 4" x 4" (102 x 102 mm), 1/8" to 1/2" (3 to 12 mm) thick

#### Controls

All controls are built to OSHA requirements, utilizing CE, CSA and UL Certified components. Wired for three phase, 60 cycle, 230V AC power.



Cat. No. 39942002    Cat. No. 39942101    Cat. No. 39942101    Cat. No. 39942403    Cat. No. 39942402

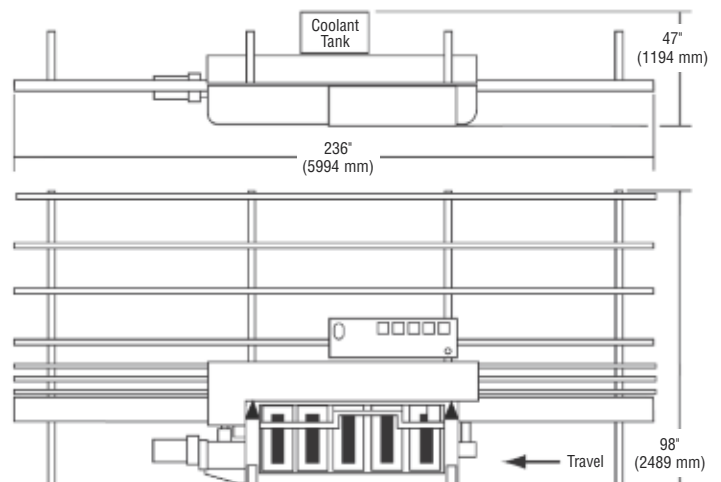



**CRL SM5C**  
**Three Phase, 50/60 Hz Export Model**



An export version of the SM5C Edger can be built to operate on Three Phase, 50/60 Hz power. Contact the Machinery Division with your power requirements.

Optional installation and training by a CRL Technician is recommended



## CRL Peripheral Edging Machines

The CRL Machinery Division is a world leader in Peripheral Edging Machines. When automated machine edging of glass was first introduced to the industry, it arrived in the form of peripheral machinery designed and built by the CRL Machinery Division. Peripheral Edgers shape the glass edge according to the profile milled or formed into the edge surface of a Diamond Wheel. As the glass passes over the Diamond Wheel, glass is removed according to the wheel profile. These machines can (depending on spindle count) produce Pencil, Flat and Seam, Miter, Ogee, or Waterfall profiles. The Peripheral Edgers listed below round out the line introduced previously by the VE1P and the VE2PLUS2. For more detailed information or to request a quote, contact CRL Machinery at (866) 583-1377 in the U.S. or Canada, or at [crlaurence.com](http://crlaurence.com).

- Available for Purchase or Lease

### VEA1 One Spindle Vertical Edger

- Virtually No Set-Up Required
- Processes Glass 51% Faster Than the VE1P Edger
- Process Glass From 1/8" to 1/2" (3 to 12 mm) at 100" (2540 mm) Per Minute

CRL's Heavy-Duty VEA1 Edger allows you to process glass 51% faster than the VE1P. The VEA1 uses the same heavy-duty glass gripper system as the larger VE2PLUS2 Two-Spindle Edger. The operator simply pushes the glass into the flexible gripper conveyor and it is smoothly pulled over the wheel. A digital ammeter easily lets you monitor the wheel pressure against the glass. With the VEA1 you can process glass from 1/8" to 1/2" (3 to 12 mm) thick at 100" (2.5 m) per minute. Pencil, miter, and flat and seam edges are all possible. **NOTE:** Wheels sold separately. See page 667K for available wheels.



CAT. NO. VEA1

### VE4 Four Spindle Vertical Edger

For years, CRL's VE4 Vertical Edger has been acclaimed the finest edger on the market - capable of producing the amazing Waterfall profile as well as a high quality Ogee edge in a single pass. Now, CRL has improved the VE4 Automatic Edger. One push of the button starts all machine functions. Another button automatically adjusts conveyor width for all glass thicknesses from 1/8" to 1" (3 to 25 mm). Conveyor height is only 29-1/2" (749 mm) for easy handling of heavy glass. All machine functions on the VE4 are now operated by a PLC control interface. At a glance the operator can read spindle amperage, conveyor load, and conveyor speed. To simplify wheel changeovers when necessary, the spindles and all adjustments are located in front of the machine. Digital position readouts at each spindle allow the operator to quickly set-up for the next production order without guesswork. **NOTE:** Wheels sold separately. See page 667K for available wheels.

- Conveyor Speeds Up to 376" (9.6 m) Per Minute
- Four Spindles Mounted With Two Wheels Each
- Cerium Oxide Option for Ultra-High Clarity



CAT. NO. VE4

### VE4PLUS1 Five Spindle Vertical Edger

CRL's Five-Spindle Vertical Edger produces premium edgework on 1/8" to 1" (3 to 25 mm) thick glass. There are four Peripheral Wheels that produce a highly polished edge at speeds to 376" (9.5 m) per minute. A Cup Wheel is used to create a flawless, high clarity, cerium polished "Flat and Seam" edge. When combining the two types of edging machines, a fabrication shop can offer the largest variety of premium quality edgework, while saving at least 100 sq. ft. of factory floor space. The re-circulated cerium polish system is standard equipment. No need to buy the expensive, fast wearing cerium-filled polish wheels. To simplify operation, the VE4PLUS1 has all machine adjustments on the front. The machine control center is designed as a Visual Operator Station. A large PLC interface displays the current control settings for the machine. With a touch of a button you can easily select which spindles to operate, glass thickness, conveyor speed, and the coolant systems. **NOTE:** Wheels sold separately. See page 667K for available wheels.

- Combines Four Peripheral Wheels With One Cup Wheel for Maximum Clarity on All Profiles
- Four Peripheral Spindles Carry Two Wheels Each
- Includes High Luster Cerium Oxide System

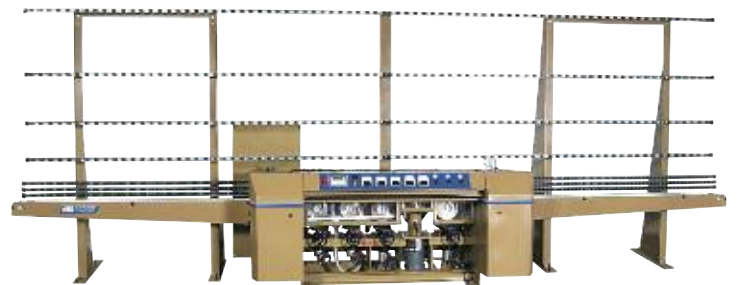

CAT. NO. VE4PLUS1

## CRL Vertical Cup Wheel Edgers

The CRL Machinery Division line of Vertical Cup Wheel Edgers produce one profile type: Flat and Seam. Cup Wheel Edgers differ from Peripheral Edgers in that Cup Wheels can only shape the glass edge into combinations of flat surfaces. The various sizes and spindle choices offer increased degrees of edge clarity. A four spindle machine can grind the front and back seams and the main flat edge, but can only polish the main flat edge. Larger, higher spindle count machines can add extra polish steps for the flat to increase clarity, or add polish to the front and back seams.

The CRL Cup Wheel Edgers shown here differ from the SM4C and the SM5C in that the VFE Series machines do not require adjustments for different thicknesses of glass. Any thickness, in any order, can be run through the machines with no operator involvement other than loading and unloading the conveyor. This saves money not only in operator training, but in the flexibility of quick reaction to customer needs.

For more information or to request a quote, please contact our Glass Machinery Sales Division at (866) 583-1377 in the U.S. and Canada. You can also e-mail us at [machinery@crlaurence.com](mailto:machinery@crlaurence.com).



- Available for Purchase or Lease

### CRL VFE4C Four Spindle Vertical Cup Edger

- Grind and Polish 1/8" to 1/2" (3 to 12 mm) Glass in Any Order
- Variable Speeds Up to 118" (3 m) Per Minute

CRL's VFE4C Four Cup Flat Edger allows you to run glass as it is cut - in real time. This means you can continually feed any size glass, any thickness, from 1/8" to 1/2" (3 to 12 mm), without stopping for machine adjustments. Pneumatically actuated Seaming and Polishing Wheels automatically adjust between each piece of glass. Various thicknesses of glass are continually kept in alignment during grinding with a solid rear vulcanized rubber registration conveyor. Since there are no adjustments to make, not only do you save time, the need for a highly trained operator is virtually eliminated. Further assisting the operator is a prominent, easy-to-operate control panel, with ammeter indicators on each spindle for fast monitoring of wheel condition.

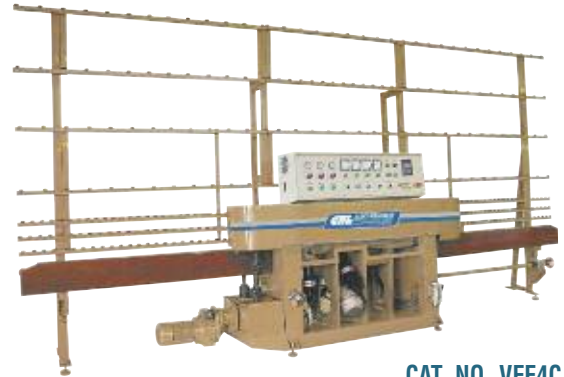

CAT. NO. VFE4C

### CRL VFE6C Six Spindle Vertical Cup Edger

- Grind and Polish 1/8" to 3/4" (3 to 19 mm) Glass in Any Order
- Variable Speeds Up to 118" (3 m) Per Minute
- Two Flat Grind Wheels, Two Seam Grind Wheels, and Two Flat Polish Wheels

Our VFE6C Six Cup Flat Edger allows you to continually feed any size of glass, in any thickness, from 1/8" to 3/4" (3 to 19 mm), without stopping for machine adjustments. The addition of one extra Flat Grinding Wheel and one extra Flat Polishing Wheel provides an even higher degree of optical clarity through the flat edge.



CAT. NO. VFE6C

### CRL VFE8C Eight Spindle Vertical Cup Edger

- Grind and Polish 1/8" to 3/4" (3 to 19 mm) Glass in Any Order
- Variable Speeds Up to 118" (3 m) Per Minute
- Two Flat Grind Wheels, Two Seam Grind Wheels, Two Flat Polish Wheels, and Two Front Seam Polish Wheels

Our VFE8C Eight Cup Flat Edger allows you to continually feed any size of glass, in any thickness, from 1/8" to 3/4" (3 to 19 mm), without stopping for machine adjustments. Adding two extra Front Seam Polishing Wheels provides optical clarity to the front or upper seam.



CAT. NO. VFE8C

## CRL VE4 and VE4PLUS1 Machine Wheels



Grinding Wheel



Smoothing Wheel



Polishing Wheel



Hi-Polish Felt Wheel

### GRINDING WHEELS FOR VE4 AND VE4PLUS1 MACHINES

CAT. NO.	TYPE	SPINDLE POS.	DIMENSIONS	GRIT
36443201	Pencil Edge for 1/8" to 1/4" (3 to 6 mm) Glass	1	7" (178 mm)	120 - 140
36443205	Pencil Edge for 1/8" to 1/4" (3 to 6 mm) Glass	2	7" (178 mm)	170 - 200
36881001	Pencil Edge for 3/16" to 3/8" (5 to 10 mm) Glass	1	7" (178 mm)	140 - 170
36881005	Pencil Edge for 3/16" to 3/8" (5 to 10 mm) Glass	2	7" (178 mm)	170 - 200
38404901	Pencil Edge for 1/4" to 1/2" (6 to 12 mm) Glass	1	7" (178 mm)	120 - 140
38404900	Pencil Edge for 1/4" to 1/2" (6 to 12 mm) Glass	2	7" (178 mm)	170 - 200
38533500	Flat and Seam for 1/8" to 1/4" (3 to 6 mm) Glass	1	7" (178 mm)	170 - 200
38533503	Flat and Seam for 1/8" to 1/4" (3 to 6 mm) Glass	2	7" (178 mm)	240 - 270
39617200	Flat and Small Seam for 1/4" (6 mm) Glass	2	7" (178 mm)	170 - 200
38386900	Flat and Seam for 3/16" to 3/8" (5 to 10 mm) Glass	1	7" (178 mm)	170 - 200
38386902	Flat and Seam for 3/16" to 3/8" (5 to 10 mm) Glass	2	7" (178 mm)	240 - 270
38517504	Flat and Small Seam for 1/2" (12 mm) Glass	1	7" (178 mm)	170 - 200
38517505	Flat and Small Seam for 1/2" (12 mm) Glass	2	7" (178 mm)	240 - 270
38748101	O.G. Edge for 3/8" to 1/2" (10 to 12 mm) Glass	1	7" (178 mm)	80
38748103	O.G. Edge for 3/8" to 1/2" (10 to 12 mm) Glass	2	7" (178 mm)	270
38677802	30 Degree Mitering	1 and 2	7" (178 mm)	140

Minimum order: 1 each.

### POLISHING WHEELS FOR VE4 AND VE4PLUS1 MACHINES

CAT. NO.	TYPE	SPINDLE POS.	DIMENSIONS	GRIT
39579801	Somaca Orange 1/8" to 1/2" (3 to 12 mm) Glass	3 and 4	8" x 3/4" (203 x 19 mm)	120
39579802	Somaca Orange 1/8" to 3/4" (3 to 19 mm) Glass	3 and 4	8" x 1-3/16" (203 x 30 mm)	120
38779401	1/4" to 3/4" (6 to 19 mm) Glass	3	8" (203 mm)	9R
38773904	3/8" to 3/4" (10 to 19 mm) Glass	3	8" (203 mm)	Red Clay
38805204	Felt Glass Polishing (Use with Cerium)	Last	8" x 1-1/4" (203 x 32 mm)	Felt

Minimum order: 1 each.

## CRL 4-Spindle Cup Machine Wheels



Diamond Cup Wheel Seam Cup Wheel Polishing Cup Wheel Polishing Cup Wheel

### WHEELS FOR VFE4C FOUR CUP FLAT EDGER

CAT. NO.	TYPE	SPINDLE POS.	DIMENSIONS	GRIT
39892300	Diamond Cup Wheel	1	6" (152 mm)	200 - 230
39892400	Seam Cup Wheel/Urethane	2 and 3	5" (127 mm)	120
39730003	Polishing Cup Wheel	4	6" (152 mm)	10S40
39730001	Polishing Cup Wheel (Optional Grit)	4	6" (152 mm)	10S60

Minimum order: 1 each.

## CRL 7-Spindle Edger/Beveller Machine Wheels



Diamond Bevel Grind Diamond Pencil Grind Edge Polish Bevel Smooth Bevel Polisher

### Let Our Experienced Staff Help You Choose the Right Wheels for Your Beveller

The 761 and 752 Bevellers have many wheel combinations that will produce the results you are looking for. Depending on the exact production edge or bevel you need, various wheels or combinations may be suggested. Please call the CRL Machinery Division at (866) 583-1377 to get the best set-up for your particular needs.

## CRL Diamond Tool Coolant Concentrate

- An Excellent Coolant for Glass Drilling, Cutting or Routing
- Extends the Life of the Tool
- Mixes With Plain Water

Mix CRL Diamond Tool Coolant Concentrate with water to create an excellent coolant solution for drilling, cutting, or routing glass. CRL DTC80 is economical to use because a ratio of 50 parts water to one part concentrate is all it takes for optimum cooling and lubricating performance. CRL Diamond Tool Coolant is biodegradable which means it can be safely disposed of in your shop's drain. Minimum order is one each.



**CAT. NO. DTC80Z**  
8 Fl. Oz. (236 ml)



**CAT. NO. DTC80QT**  
1 Quart (945 ml)



**CAT. NO. DTC80GL**  
1 Gallon (3.785 l)

## CRL Dry Synthetic Diamond Tool Coolant

- An Excellent Coolant for Glass Drilling, Cutting or Routing
- Extends the Life of the Tool
- Mixing Ratios: 100:1 for Wheels; 50:1 for Drills



**CAT. NO. 2651005**  
1 Pound (454 gm) Bag



**CAT. NO. DRYCOOL40**  
40 Pound (18.1 kg) Bucket



The function of coolant is to lubricate and cool the working points of contact while drilling. When used on production machinery, the coolant also provides faster operation, extends the life of diamond wheels, and inhibits rust build-up. This oil-based coolant is a best seller. Many customers have begun to use synthetic coolants to comply with local environmental regulations. The newest product in this assortment is synthetic powder. When mixed with water, this powder will yield up to 100 gallons of coolant per pound, and the synthetic powder is also inexpensive to ship. Dry Coolant Powder offers high lubricity, dissipates heat, and inhibits rust. It is also anti-foaming, anti-bacterial, and biodegradable. Small glass shops and new users will find the one pound bag ideal. Large fabricators will choose the 40 pound pail. The synthetic powder is excellent for edging and bevelling. Three ounces (85 gm) per gallon is ideal for drilling. Minimum order is one each.

## CRL Diamond Wheel Redress Program

- Send in Your Worn Diamond Wheels for Evaluation and Reconditioning
- Fraction of the Cost of a New Wheel
- Available Direct Through CRL Redress Department



Before



After

Your peripheral or cup wheel glass machine is a valuable and important company asset. And, just like your glass truck or any other capital equipment, it requires periodic maintenance. Part of that maintenance should be the reconditioning or redressing of your diamond wheels. Your machine may be drawing more and more amperage since worn wheels have to work harder to grind the glass. Your glass edge profile may seem less well defined. Or over time your glass edge profile may have changed completely. Our expert CRL Redress Department technicians will evaluate and, if possible, redress your used diamond wheel, returning it to "like new" condition for a fraction of the cost of a new wheel. Go to [crlaurence.com](http://crlaurence.com) to print out an order form or call our Customer Service Department for assistance at (800) 421-6144 in the U.S., (877) 421-6144 from Canada, or (323) 588-1281 International, and ask for Ext. 5275.

## CRL Diamond Machine Coolant

- High Performance Lubricant for Glass Edging and Beveling Machines
- Extends Tool Life
- Water Based

CRL Diamond Machine Coolant is a high performance, cost effective lubricant that is highly concentrated. The concentration on this product is usually within 50:1 to 100:1. With addition at tank side or by automated metering equipment, this product accommodates grinding bevels of up to 2" (51 mm). CRL DMC5 is considered a heavy-duty lubricant that can even extend the life of the sump. It is designed with long-lasting microbiological protection suited for heavy use situations experienced in even the largest of glass facilities. It also reduces the development of "popcorn" particles during grinding to keep the lines clear. CRL DMC5 is manufactured with the environment in mind, using a water-based formulation containing absolutely no oil. It is also pH-controlled at moderate levels to facilitate operator handling. Minimum order is one each.



CAT. NO. DMC5GL



CAT. NO. DMC55GL

## CRL Diamond Wheel Dressing Boards and Sticks

- Bring Back Life to Your Diamond Wheels
- Instantly Cut Profile in Polishing Wheels

CRL Dressing Boards are the answer to getting the most out of your diamond and polishing wheels. These medium grit oxide boards, when run through the conveyor of your edging or beveling machine, help to remove accumulated deposits of glass fines, bonding material, and worn diamonds. This combination action works to expose fresh diamonds so your wheels run cooler and your machinery runs more efficiently.

CRL Dressing Boards also provide the best method of quickly forming your diamond edge profile on new polishing wheels. Simply run the appropriate thickness of Board over the diamond wheel to cut the Board edge to match the diamond profile. Then while running the Board over the new polishing wheel, slowly raise the wheel so the abrasive stone actually cuts the profile into the softer polishing material.

The CRL Dressing Stick is used to periodically dress your diamond wheels in a more aggressive fashion. The Dressing Stick is held directly into the groove of the spinning diamond wheel through the wheel access window. By shutting down power to the wheel, the Stick serves as a brake to stop the wheel rotation. After the wheel comes to a complete stop, with the Stick still in place, turn the wheel several turns in reverse. This action completely refreshes the diamond surface of the wheel.

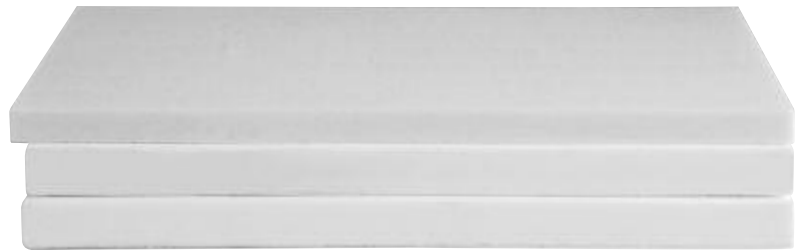

### DRESSING BOARDS

CAT. NO.	GRIT	SIZE
2612152	100X	8-1/2" x 6-1/8" x 1/4" (216 x 165 x 6 mm)
2612151	120X	8-1/4" x 6-1/4" x 3/8" (209.5 x 158.8 x 9.5 mm)
2612153	120X	8-1/4" x 6-1/4" x 1/2" (209.5 x 158.8 x 12.7 mm)
2612154	120X	8-1/4" x 6-1/4" x 3/4" (209.5 x 158.8 x 19 mm)

Minimum order: 1 each.



**WARNING:** Always soak boards and sticks in diamond coolant mixture before use. Never dress wheels dry.

### DRESSING STICKS

CAT. NO.	GRIT	SIZE
EMSS2	220X	8-1/2" x 6" x 1/4" (216 x 152 x 6 mm)
EMSS3	220X	2" x 7" x 1/4" (51 x 178 x 6 mm)

Minimum order: 1 each.

## CRL Zerofoam Defoaming Agent

- Reduces Foam in Diamond Tool Coolants

This CRL Zerofoam Defoaming Agent is a concentrated emulsion formulated to lower surface tension of coolant solution, thereby inhibiting the formation of foam. This is used by owners of edging and beveling machines because it is easy and economical to use. Minimum order is one pint.



CAT. NO. NS31F

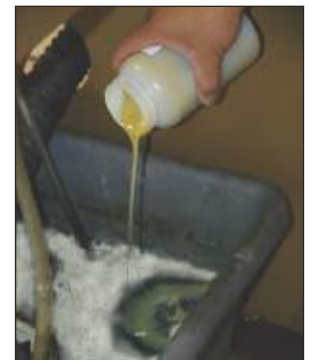

## CRL Green Coolant Fluid

- Fully Synthetic

CRL Green Coolant Fluid is a top quality, fully synthetic cutting fluid for improved finish and diamond wheel life. Recommended for use in straight line edging machines. Sold in one litre bottles. Minimum order is one litre.



CAT. NO. 1221

## CRL RD Anti-Foam Emulsion

- Concentrated

CRL RD Anti-Foam Emulsion is used when coolants and water conditions may cause foaming. Sold in five litre bottles. Minimum order is one each.



CAT. NO. 1229

## CRL Sof-Set 500

- Makes Tank Cleaning Easy

CRL Sof-Set 500 makes tank cleaning easy by soft-settling the glass powder. Dilution ratio 500 parts to 1. Sold in five litre bottles. Minimum order is one each.



Available Only in Europe



CAT. NO. 1225

## CRL Vapourmax Cutting Oil

- Non-Ozone Depleting
- Low Odour
- Residue Free Finish



CRL Vapourmax Cutting Oil is a water soluble evaporating cutting oil for use in automatic glass cutting tables.

## CRL Vapourmax 53 Cutting Oil

- For 2-15 mm Thick Glass and Mirror
- Residue Free Finish



CRL Vapourmax 53 Cutting Oil is a fast evaporating cutting fluid for 2-15 mm, soft-coated automotive and mirrored glass.

## CRL Vapourmax 60 Cutting Oil

- Excellent for Pattern and Shape Cutting
- Residue Free Finish



CRL Vapourmax 60 Cutting Oil is a washable, evaporating cutting fluid designed for pattern and shape glass cutting.

CAT. NO.	CONTENTS
EUW4101L	1 Litre
EUW4105L	5 Litres
EUW41025L	25 Litres

Minimum order: 1 each.

CAT. NO.	CONTENTS
EUW9531L	1 Litre
EUW9535L	5 Litres
EUW95325L	25 Litres

Minimum order: 1 each.

CAT. NO.	CONTENTS
EUW9601L	1 Litre
EUW9605L	5 Litres
EUW96025L	25 Litres

Minimum order: 1 each.

## CRL Glass Non-Evaporating Cutting Oils

- For Use With Hand Cutters and Automatic Tables
- Complies With Both the British and European Pharmacopoeia Monographs

For use in hand cutters and automatic tables. This Cutting Oil is a transparent, colourless, liquid free from fluorescence by daylight, almost odourless even when heated.



CAT. NO.	CONTENTS
EU12401L	1 Litre
EU12405L	5 Litres
EU124025L	25 Litres

Minimum order: 1 each.

## CRL Aquasol Cutting Oil

- Fully Water Soluble
- Designed for Production Cutting Lines

CRL Aquasol Cutting Oil is fully water soluble, for use in production cutting lines with automatic tables where glass is then going through a washing process. Sold in one litre bottles. Minimum order is one litre.



CAT. NO. 1241

## CRL Glass Cutting Tools

- Largest Selection of Quality Glass Cutters (See Pages 108K-120K)



CAT. NO. G100



CAT. NO. 02



CAT. NO. TC17B  
Straight Cutting Head



## CRL Circle Edger and Polisher

- An Affordable Alternative to Larger Grinding/Polishing Machines
- Set-Up is Fast, and Requires Very Little Operator Training
- Available in 110V AC or 220V AC



CAT. NO.	DESCRIPTION
EZE2000*	Circle Edger/Polisher Only 110V AC
EZE2001	Circle Edger/Polisher Only 220V AC
EZE3620*	Optional Coolant Pump and Tank 110V AC
EZE3640	Optional Coolant Pump and Tank 220V AC
EZE2K1T	Circle Edger/Polisher Kit w/ Pump and Wheels 110V AC
EZE2K1T220	Circle Edger/Polisher Kit w/ Pump and Wheels 220V AC
EZE2923M	3/16" (5 mm) Medium Grit Pencil Edge Wheel
EZE4922M	1/4" (6 mm) Medium Grit Pencil Edge Wheel
EZE4926F*	1/4" (6 mm) Fine Grit Pencil Edge Wheel
EZE6920M	3/8" (10 mm) Medium Grit Pencil Edge Wheel
EZE6921F	3/8" (10 mm) Fine Grit Pencil Edge Wheel
EZE7935F	1/2" (12 mm) Fine Grit Pencil Edge Wheel
EZE942A	1/8" (3 mm) Glass Polishing Wheel
EZE942C*	1/4" (6 mm) Glass Polishing Wheel
EZE942E	3/8" (10 mm) Glass Polishing Wheel
EZE942G	1/2" (12 mm) Glass Polishing Wheel

Minimum order: 1 each. Ships F.O.B. Cicero, Illinois.  
\*Included in EZE2K1T

CRL is pleased to present an affordable Edging Machine designed to produce satin-finished edges on glass up to 1/2" (12 mm) thick. The CRL Circle Edger and Polisher makes simple work of edging 10" to 60" (254 to 1524 mm) diameter glass and mirror up to 3/8" (10 mm) thick, and 10" to 44" (254 to 1118 mm) diameters for glass up to 1/2" (12 mm) thick. The machine features a 1/2 HP (0.3 kw) motor and adjustable coolant nozzles. It is equipped with a special two-wheel gang assembly for edge grinding and polishing without having to change wheels. The EZE2K1T comes complete with a 110V AC Edger, Pump, Tank, and set of 1/4" (6 mm) Fine Finish Wheels.

### EZE2000 and EZE2001 SPECIFICATIONS:

**Height:** 72" (1.82 m)  
**Footprint:** 19-1/2" x 30" (495 x 762 mm)  
**Shipping Weight:** 105 Lbs. (48 kg)

## CRL Grinding Mill and Smoothing Mill

- Best Machines for Custom or Hand-Roughing Edges

Certain glass grinding operations require a grinding plate used with wet abrasive grain. The GM24 is furnished with a carefully machined, high-grade Cast Iron Grinding Plate, which is especially selected for its grain retention property. The SM24 is shipped without a Smoothing Stone, which must be ordered separately.



### Spindle RPM - Plate RPM

SM24	176 - 1200
GM24	281 - 1750

**Utilities**  
Electrical: 1 Motor @ 3/4 HP (0.5 kw)  
Voltage: Single Phase, 60 Cycle, 110V AC  
Power: 15 AMP service @ 110V AC

CAT. NO.	DESCRIPTION
GM24	Grinding Mill / 110V AC
SM24	Smoothing Mill / 110V AC
SM24STN	24" (610 mm) Smoothing Stone
30018301	24" (610 mm) Cast Iron Grinding Plate
CG120X*	120 Grit Abrasive Grain / 10 Lbs. (4.5 kg)

Minimum order: 1 each. F.O.B. your local CRL Service Center. Must ship common carrier.  
\*Minimum order is 10 pounds (4.5 kg).

### GM24 and SM24 SPECIFICATIONS:

**Height:** 36" (914 mm)  
**Footprint:** 30" x 30" (762 x 762 mm)  
**Shipping Weights:** GM24 550 lbs (249 kg)  
SM24 425 lbs (193 kg)



## CRL Finger Grip Machine

- Cuts Smooth Finger Pulls Into Sliding Glass Windows in Minutes

The FG14BM is ruggedly built and designed for bench use. The machine is easy to use, and allows the operator to cut clean, 5/8" (16 mm) wide functional finger pulls in glass, quickly and with confidence. **NOTE:** BW14 Wheel included.



Finger Grip Cut Into Glass

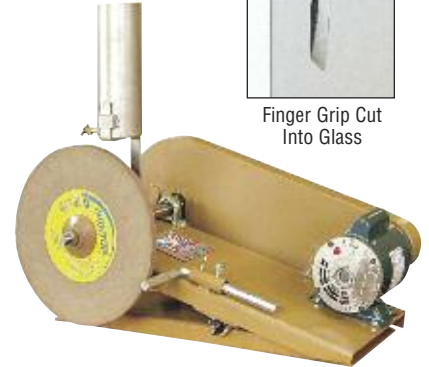

**Utilities**  
Electrical: 1 Motor @ 1/2 HP (0.3 kw)  
Voltage: Single Phase, 60 Cycle, 110V AC  
Power: 15 AMP service @ 110V AC

CAT. NO.	DESCRIPTION
FG14BM	Finger Grip Machine, 110V AC
AUFG14BM	Finger Grip Machine, 240V AC
BW14	14" (355 mm) Replacement Wheel - 3/4" (19 mm) Arbor

Minimum order: 1 each. F.O.B. your local CRL Service Center. Must ship common carrier. We recommend the use of a Ground Fault Interrupt Device with all wet-working tools. See Cat. No. GF1 on page 550K.

### FG14BM and AUFG14BM SPECIFICATIONS:

**Height:** 24" (610 mm)  
**Footprint:** 15" x 34" (381 x 864 mm)  
**Shipping Weight:** 135 Lbs. (61 kg)  
**Abrasive Wheel Shipping Weight:** 3 Lbs. (1.4 kg)



## CRL Cerium Oxide Polishing Compounds

- Premium Cerium Oxide for Fast Stock Removal
- Exceptional Suspension Qualities
- Ideal for Recirculating Slurry Systems
- Easily Cleaned From Glass and Equipment
- Contains No Zinc

All glass polishing and surface restoration systems that demand the highest degree of clarity in the finished product use some form of Cerium Oxide in the final process. To reach that high degree of clarity requires the best product combined with the correct methods to reach the final goal. CRL Cerium Oxide Compounds are refined from the highest quality rare earth minerals available. CRL Cerium Oxide Compounds can be used with a hand pad for light surface cleanup, powered hand devices for scratch and surface repair, mechanized scrubbers in mirror silvering lines, or as the final polishing step in multi-stage edging and bevelling equipment.

CRL Cerium Oxide Compounds maintain and deliver a uniform particle size, on average 2.9 micron, and a high concentration of rare earth oxides to provide the brightest possible finish in all applications. These compounds exhibit the exceptional suspension quality required for use in today's recirculating slurry systems. The added benefit of soft settling means glass and equipment are more easily cleaned and maintained.



**CAT. NO. C0301**  
Cerium Oxide – 1 lb.



**CAT. NO. C0453**  
Polishing Cerium Oxide – 44 lbs.



**CAT. NO. C0544**  
Machine Slurry – 44 lbs.

CAT. NO.	SIZE	RECOMMENDED USE	BAUME
<b>C0301</b>	1 lb. (454 g)	Scratch Repair	3-5
<b>C0305</b>	5 lbs. (2.27 kg)	Scratch Repair	3-5
<b>C0310</b>	10 lbs. (4.54 kg)	Scratch Repair or Machine Slurry	3-5
<b>C0453</b>	44 lbs. (20 kg)	Scratch Repair or Machine Slurry	3-5
<b>C0544</b>	44 lbs. (20 kg)	Machine Slurry	3-5

Minimum order: 1 each.

The efficiency of the Cerium Oxide polishing process depends on two important variables: concentration and temperature. Too much Cerium Oxide is a waste of resources while too little impairs the quality of the end product.

Cerium Oxide Compounds polish glass by a combination of mechanical and chemical action. The material must reach and maintain a certain temperature to stimulate the chemical reaction. The mechanical action employs felt pads or wheels. For surface restoration, the Cerium Oxide is mixed with water to form a thin paste that is applied directly to the glass surface. A damp felt pad or wheel is then used to agitate the paste. The friction of the wheel creates the heat needed to activate the polishing process. Too much heat will dry the paste, so care must be taken to keep the paste wet at all times.

For recirculating slurry systems, the concentration of Cerium Oxide in the water is based on the specific gravity of the slurry as measured in Degrees Baume, which is measured using a Hydrometer. Measure out the proper proportions of heated water (at least 80°F/30°C) and Cerium Oxide into a container and mix thoroughly. Place the Hydrometer into the mixture and take a reading at the surface line. For light surface cleaning such as pre-silvering, 1 degree Baume (1.6 oz. of Cerium per gallon of water or 11.8 grams per liter) is sufficient. For bevelling and edging, a 3 degree to 5 degree Baume (4 to 7.2 oz. per gallon, or 29.7 to 53.7 grams per liter) is recommended. Slurry temperature should be maintained between 90°F and 105°F (32°C and 40°C) for optimum performance. Our Cat. No. 2601065 Hydrometer will help you make these measurements. Minimum order is one each.



Scratch Repair



Beveller/Edger Slurry Tank



Mirror Line Scrubbers



**CAT. NO. 2601065**  
12" Shop  
Baume Gauge

Hydrometer

## CRL Heavy-Duty Scratch Polisher

- Polishes All Types of Glass, From Windshields to Watch Crystals
- Use it Hand Held or Bench Mounted for Added Stability

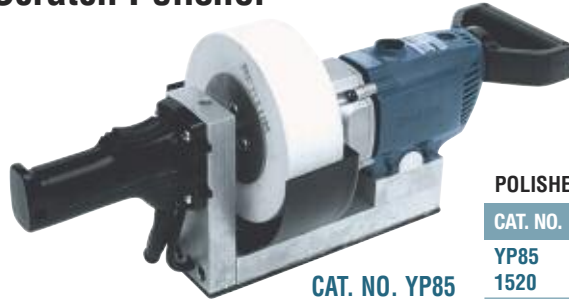

CAT. NO. YP85

Use the CRL Heavy-Duty Scratch Polisher as either a bench mounted or hand held polisher with excellent results. It is fitted with a high quality wool felt wheel that will polish virtually all types of glass, from windshields, sheet glass, edges, and bevels to watch crystals. It is powered by a heavy-duty, double-insulated 110V AC motor. Sure grip handles on each end of the tool assembly provide control.



CAT. NO. YPF6X2N  
for Current Model Polishers



CAT. NO. YPF6  
for Older Polishers

### POLISHERS

CAT. NO.	DESCRIPTION
YP85	110V AC Scratch Polisher
1520	230V AC Scratch Polisher-Europe

Minimum order: 1 each.

### FELT WHEELS

CAT. NO.	YEARS	SIZE	ARBOR
YPF6X2N	1990 to Present	6" x 2" (152 x 51 mm)	2" (51 mm)
YPF6	Before 1990	6" x 1-1/2" (152 x 38 mm)	2-3/4" (70 mm)

Minimum order: 1 each.

## CRL Glass Polisher and Scratch Remover

- Excellent for Manual Bevel Finishing
- Large Felt Wheel is Suitable for Auto Glass Work
- Available for Purchase or Lease

CRL's SM37 Glass Polisher is widely used in the glass industry for manual polishing and for the removal of scratches. A polishing compound such as cerium oxide, used on the felt wheel, will also produce a brilliant finish on edges, especially bevels, and will remove hairline scratches while maintaining the surface polish of the glass.

The machine is furnished with a high quality solid felt wheel, 24" O.D. x 18" I.D. x 3" wide (610 x 457 x 76 mm), mounted on a wooden ring, which is V-belt driven by a 3/4 HP, single phase, 60 cycle, 110V AC motor. A motor starting switch, truing bar, and wooden support shelf are also provided. A 230V AC model is also available.



### SPECIFICATIONS

**Width:** 20" (508 mm)  
**Depth:** 30" (762 mm)  
**Height:** 47" (1219 mm)  
**Shipping Weight:** Approx. 425 Lbs. (193 kg)

### REPLACEMENT FELT WHEEL

**CAT. NO. 2605244**  
**Diameter:** 24" (610 mm) O.D.  
**Width:** 3" (76 mm)



### CAT. NO. DESCRIPTION

SM37	110V AC 60 Hz Polisher
SM37X230	230V AC 50 Hz Polisher

Minimum order: 1 each. F.O.B. Your nearest CRL service center location. Must ship common carrier.

## CRL Scratch Polishing Kit

- Lightweight, So You Can Work on Windshields Right in the Car
- Remove Light Surface Scratches
- Polish Out Rubs, Fine Lines, Stains, and Discoloration on Mirrors or Glass of Any Kind
- Well Balanced for Smooth Action

The CRL Scratch Polishing Kit is designed to meet the demand for a low-priced, lightweight, portable tool capable of removing light surface scratches. It also can be used to polish out rubs, fine lines, stains, and discolorations on mirrors or glass of any kind. This tool can also be used as a sander by using a backup pad and sanding discs. Operates on 110V AC.

The CRL Scratch Polisher will remove light scratches and water deposits from glass. Generally, if you run your fingernail over the scratch and it catches, the scratch is too deep to be removed with this polisher. However, light scratches, windshield wiper rubs, and some water deposits can be removed by following these instructions. Minimum order is one each.



CAT. NO. CRL9257  
Complete Kit

### INCLUDED IN THE CRL9257 KIT:

- Cat. No. PV7001C Makita® 7" (178 mm) Vertical Polisher with Variable Speed (600 – 2,000 RPM)
- Rubber Back-Up Pad
- Spanner Wrench
- Side Handle
- Cat. No. 5702 Polishing Head 3" x 1-1/2" (76 x 38 mm) All Wool Felt Pad
- Cat. No. C0301 Cerium Oxide (One Pound / 454 g)

## CRL Complete Polishing Head Assembly

- Used for Light Scratch Removal
- Can Be Used With a Cordless Drill

The CRL Polishing Head Assembly consists of a 1-1/2" (38 mm) thick by 3" (76 mm) diameter all wool felt wheel, an aluminum adapter plate, and a 1/4" (6 mm) diameter shank. Use it with our Cat. No. PV7001C Polisher, or chuck it into your electric drill. Minimum order is one each.



## CRL All Wool Felt Wheel

- For Use With the 5701 Adapter

Made from the highest quality felt, this 3" (76 mm) diameter, 1-1/2" (38 mm) thick buffing wheel can remove scratches, stains, and discoloration from glass and mirrors. Used with the Cat. No. 5701 Aluminum Adapter, this all felt wheel can work wonders in the smallest of spaces. Also replaces the felt wheel on the Cat. No. 5703 Polishing Head Assembly. Minimum order is one each.



## CRL Aluminum Adapter

- For Use With the WFD03112 Felt Wheel



The CRL Aluminum Adapter is machined to run smoothly while on the CRL9257 Scratch Polisher, or when used with the Cat. No. 5704 Shank Adapter. The Cat. No. WFD03112 All Wool Felt Wheel is adhered to the bottom surface of this Adapter by using Cat. No. 3M8001 Super Weatherstrip Adhesive or Cat. No. LN601 Construction Adhesive. Minimum order is one each.

CAT. NO. 5701

## CRL Aluminum Adapter and Felt Wheel

- Can Be Used With Your Hand Drill



The CRL Aluminum Adapter and Felt Wheel consists of one Cat. No. 5701 Aluminum Adapter and one Cat. No. WFD03112 All Wool Felt Wheel cemented together. Keep a spare on hand if you do a lot of scratch removal. Mate with Cat. No. 5704 to use it in your hand drill. Minimum order is one each.

## CRL Shank Adapter

- 1/4" (6.4 mm) Diameter Shank Fits All Drill Motors



The CRL Shank Adapter is designed for use in any hand drill. The 5/8"-11 threads insert into popular disc pads such as Cat. No. 5702. Minimum order is one each.

## CRL Cerium Oxide

- For Use With the CRL9257 Scratch Polisher



CRL Cerium Oxide is a high grade optical polishing compound used to lessen and polish scratches from auto glass, mirror bevels, and table top edges. CRL Cerium Oxide is mixed with water to form a paste or slurry. This compound has excellent suspension qualities and will not harden. Contains no zinc oxide, and meets most local disposal ordinances.

CAT. NO.	CONTAINER CONTENTS
C0301	1 lb. (454 g)
C0305	5 lbs. (2.27 kg)
C0310	10 lbs. (4.54 kg)

Available in larger bulk containers. See page 672K.

Minimum order: 1 each.

3M is a registered trademark of 3M Company Corporation.

## CRL 3M® Super Weatherstrip Adhesive

- Exceptional Bonding Strength
- Waterproof and Flexible



CRL 3M® Super Weatherstrip Adhesive is used for bonding WFD03112 Felt Wheels to 5701 Adapters with great adhesion. Easy to spread, extremely fast drying. Also a good general purpose cement. Contents: 5 Fl. Oz. (147 ml). Minimum order is one each.

CAT. NO. 3M8001

## CRL Glass Scratch Removal System

- **Portable, Stand-Alone System Works On All Types of Glass**
- **One Step Process Produces Distortion-Free Results**
- **Integrated Water Feed System**
- **Non-Abrasive Compound**

The CRL Glass Scratch Removal System removes scratches from all types of glass including tempered, annealed, laminated, low-e, mirrors, and even curved glass. You can use this portable system to remove scratches, water scale, acid etching, paint over-spray, and other imperfections quickly and effectively.

This unique system combines thermal energy (heat), chemical reaction (polishing compound), and mechanical energy (force) to effectively eliminate scratches from glass without the use of fixed abrasives.

The CRL Glass Scratch Removal System can be integrated into your everyday operations. Whether you are a door and window manufacturer, a distributor, or an independent glass shop, the CRL Glass Scratch Removal System can save you money, directly impacting your bottom line. These potential savings come from reduced down time for glass replacement thus keeping projects on schedule, and by reducing glass waste and scrap ratios.

Compare the CRL Glass Scratch Removal System to some of the other scratch removal systems you may have seen or tried in the past. This system is lightweight and compact: no buckets of coolant and compound to lug around. This system employs a one step process: multiple abrasive and polishing pad changes are no longer required. This system delivers what others only promise: distortion-free surface restoration.

The CRL Glass Scratch Removal System features a unique pressurized water feed attachment with a push button activated nozzle mounted directly onto the polisher. This attachment can be secured directly to the work surface with built-in suction cups, or worn conveniently on your belt using the integral belt clip.

The 2", 3" and 4" (51, 76, and 102 mm) Polishing Pads attach to the appropriate Backer Pads using an aggressive hook-and-loop fastener system.

The complete SRS1 Glass Scratch Removal Kit includes: a 4500 RPM polisher, a .250 kg (.55 lbs.) jar of polishing compound, one 2" (51 mm) Backer Pad, one package of 2" (51 mm) Polishing Disks, one 3" (76 mm) Backer Pad, one package of 3" (76 mm) Polishing Disks, one Pressurized Water Feed Attachment, one Inspection Light/IR Thermometer, Safety Glasses, two Respirator Masks, one Mixing Container, one Spatula, one Wrench, one Manual Spray Bottle, Ear Plugs, one Cleaning Brush, one detailed Training and Use Manual, and one foam padded lockable Carrying Case.

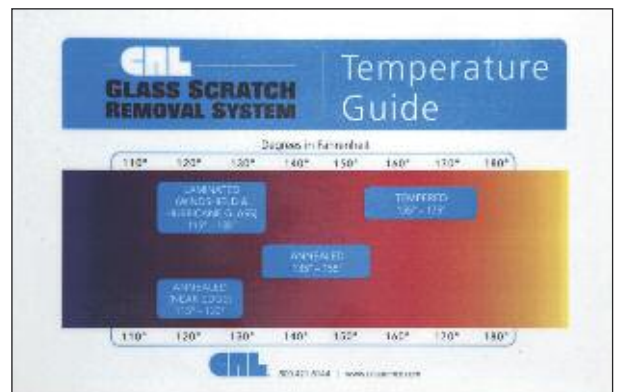

CAT. NO.	DESCRIPTION
SRS1	Complete Scratch Removal Kit, 110 volt
SRS1PC	Polishing Compound, .250 kg (0.55 lbs.) 2 jars/pkg.
SRSVPD2	2" (51 mm) Hook-and-Loop Back Polishing Disks, 3/pkg.
SRSVPD3	3" (76 mm) Hook-and-Loop Back Polishing Disks, 3/pkg.
SRSVPD4	4" (102 mm) Hook-and-Loop Back Polishing Disks, 3/pkg.
SRSVPB2	2" (51 mm) Hook-and-Loop Backer Pad
SRSVPB3	3" (76 mm) Hook-and-Loop Backer Pad
SRSVPB4	4" (102 mm) Hook-and-Loop Backer Pad

Minimum order: 1 each.

# CRL GLASS SURFACE RESTORATION

For Pricing Visit [crlaurence.com](http://crlaurence.com) or Call Us Toll Free at the Phone Numbers Shown on the Back Cover

## CRL Scratch-A-Way® Scratch Removal System

- Clean Working System for Light Scratches or Scuff Marks
- Flexible Rubber Shroud Keeps Slurry Contained – No Overspray!

## Auto Glass Applications

- Wholesalers – Remove Light Scratches Quickly
- Technicians – Provides Clean Removal of Light Scratches, Wiper Blade Marks, Stains, and Acid Spots, Etc.

## Flat Glass Applications

- Remove Light Scratches Quickly
- Polish Fabricated Bevelled Mirror Corners and Areas Needing Blending
- Insulating Glass – Fix In-Shop or On-Site Scratches

## Two Types of Scratches...



**LIGHT SURFACE or SCUFF MARK SCRATCH** – Over 95% of all scratches are light scratches or scuff marks. This magnified image above shows a light scratch. This scratch can be removed.



**HEAVY/DEEP SCRATCH** – Above is a magnified image of a heavy/deep scratch. It cannot be removed with this system.

## For Light Scratch and Scuff Mark Removal



After cleaning the glass thoroughly, inspect the area with the Diagnostic Inspection Tool. Mark the scratch area from the underside with the red marking pen. Attach the polishing disc to the polishing head. Then apply water to the surface of the scratch. Work the polishing head, very slowly, with consistent pressure, back and forth in the direction of the scratch. Work the area for 30 seconds, and then stop. Wipe the slurry away from the scratch with the edge of the red shroud so you can inspect the progress of your work. Repeat until scratch is removed.



Scratch-A-Way is a registered trademark of Duobond International b.v. Velcro is a registered trademark of Velcro Industries B.V. LLC.

## CRL Scratch-A-Way® Electric Powered Tool Kit



110V or 220V/150 Watts  
RPM: 5000 to 9500

**KIT CONTAINS:** Electrical Tool, Diagnostic Inspection Tool, Five Polishing Discs, Marking Pen, Red Chamois, Instructional CD with Manual, and Plastic Case.

CAT. NO.	DESCRIPTION
<b>S965020</b>	110 Volt Scratch-A-Way® Kit
<b>1523</b>	220 Volt Scratch-A-Way® Kit

Minimum order: 1 each.

## CRL Scratch-A-Way® Air Powered Tool Kit



**KIT CONTAINS:** Air Powered Tool, Diagnostic Inspection Tool, Ten Polishing Discs, Oil, Marking Pen, Red Chamois, Instructional CD with Manual, and Plastic Case. Minimum order is one each.

**Air Requirement:**  
8cfm 90 PSI

CAT. NO. 1523A

## CRL Scratch-A-Way® Accessories

### Diagnostic Inspection Tool

- Inspect Depth and Width of Scratches
- Inspect Bevels and Edgework in Post Fabrication Process

The Diagnostic Inspection Tool magnifies the surface image 30 times. The left section of the tool is illuminated so that the scratch can be viewed clearly. The rotary wheel adjusts the focus of the scratch area.



CAT. NO. S93085

### Cerium Oxide Discs

Cerium Oxide Polishing Discs are 2" (50 mm) in diameter, and have an estimated work life of approximately twenty scratches that are 2" (50 mm) long.



CAT. NO. S93054

CAT. NO.	DESCRIPTION
<b>S93085</b>	Diagnostic Inspection Tool
<b>S93054</b>	Cerium Oxide Polishing Disc
<b>S93075</b>	Back-Up Plate With Velcro®

Minimum order: 1 each.



CAT. NO. S93075



**C.R. LAURENCE COMPANY**

[crlaurence.com](http://crlaurence.com) | [usalum.com](http://usalum.com)

**ALUMINUM**

676K

| [crlaurence.ca](http://crlaurence.ca) [crlaurence.com.au](http://crlaurence.com.au) [crlaurence.co.uk](http://crlaurence.co.uk) [crlaurence.de](http://crlaurence.de) [crlaurence.eu](http://crlaurence.eu)

## CRL 3M® Trizact® Scratch Removal Starter Kits

- The Best Way to Start Using Trizact® Discs
- Uses Your Hand Held Electric Drill
- Includes Four 3" (76 mm) Disc Pads for Quick Change-Out of Discs

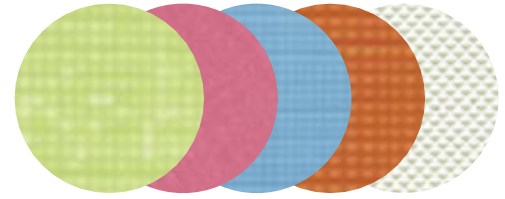

CRL 3M® Trizact® Scratch Removal Starter Kits are the most efficient way to start using CRL 3M® Trizact® products. Using your own hand-held cordless or 110V AC Electric Drill with a Ground Fault Circuit Interrupter (Cat. No. GF1), you can remove scratches ranging from very fine to very deep.

This amazing new material uses natural abrasives formed in the shape of small pyramids, and provides uniform layers of abrasive throughout the pyramid. As the abrasive particles are used, they get flushed away exposing new abrasive. So easy to use, almost anyone can start to remove scratches with this kit in a short time.

**NOTE:** The Flat Glass Kit comes with 3" (76 mm) Medium Disc Pads while the Curved Glass Kit is supplied with 3" (76 mm) Soft Disc Pads to accommodate the curvature of the glass. Replacement Disc Pads are available, Cat. No. ZDP3P58M for Medium; and Cat. No. ZDP3P58S for Soft.

### Trizact® Starter Kits Include:

- 20 Assorted 3" (76 mm) 3M® Trizact® Abrasive Discs
- Four 3" (76 mm) 3M® Disc Pads
- 1 Pound (454 g) of Cerium Oxide
- Spray Bottle for Water
- 1/4" (6 mm) Shank Drill Adapter
- Plastic Apron
- Full Instructions



Drill shown is not included

CAT. NO.	DESCRIPTION
ZSRPSSKM	3M® Trizact® Starter Kit for Flat Glass
ZSRPSSKS	3M® Trizact® Starter Kit for Curved Glass

Minimum order: 1 each.

## CRL 3M® Trizact® Professional Scratch Removal System

- Powerful Center Water Feed Polisher Works on Light to Heavy Scratches
- Developed for Professionals

The CRL 3M® Trizact® Professional Scratch Removal System is a breakthrough in scratch removal and glass or polycarbonate polishing. Now this once complicated and messy process is simple and clean without any slurries or compounds to mix. Our all-new, more powerful polisher has more power and torque than ever! With its on-demand water delivery system, constant water flow adjustments are a thing of the past. This system uses plain water, which is delivered through the center of the pad so very little is required.

The natural abrasives used in these discs are formed in the shape of small pyramids. The pyramids are then layered so as the disc wears, a new abrasive surface is exposed. Four grades of abrasive discs are included to remove the deepest of scratches. A cerium oxide pad is used to polish the glass during the final step. The results this system offers are nothing short of amazing.

**Please Note:** Scratch polishing is an abrasive process which, when certain factors are present, can affect your final polished product, such as one or more of the following examples: **Scratch Depth** - the deeper the scratch, the more difficult it will be to produce a clean and distortion-free surface; **Glass Temperature, Technique** - following instructions and keeping work surface clean between steps is crucial; **Glass Type** - float, tempered, textured, coated reflective, mirrored or tinted.

For additional information, visit the CRL web site, [crlaurence.com](http://crlaurence.com), or contact CRL Customer Service Department.

3M and Trizact are registered trademarks of 3M Company Corp.



CAT. NO.	DESCRIPTION
ZSRPSM	3M® Trizact® Professional System for Flat Glass

Minimum order: 1 each.

### The Trizact® Professional Kit Includes:

- 10 Each of the five different grades of 5" (127 mm) 3M® Trizact® Abrasive Discs
- Five Each 5" (127 mm) 3M® Medium Disc Pads
- 115V AC Center Water Feed Polisher With Built-In GFI
- Pressurized Water Delivery System
- 1 Pound (454 g) of Cerium Oxide
- Full Instructions and 3M® Application Guide

# CRL GLASS SURFACE RESTORATION

For Pricing Visit [crlaurence.com](http://crlaurence.com) or Call Us Toll Free at the Phone Numbers Shown on the Back Cover

## CRL 3M® Trizact® Discs

• **3M® Trizact® - A Cleaner, Long-Lasting Abrasive System for Glass Scratch Repair**

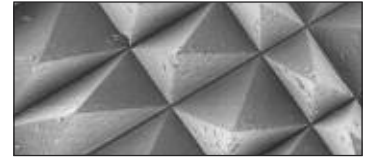

The precisely structured surface of Trizact® film is clearly visible under 50X magnification

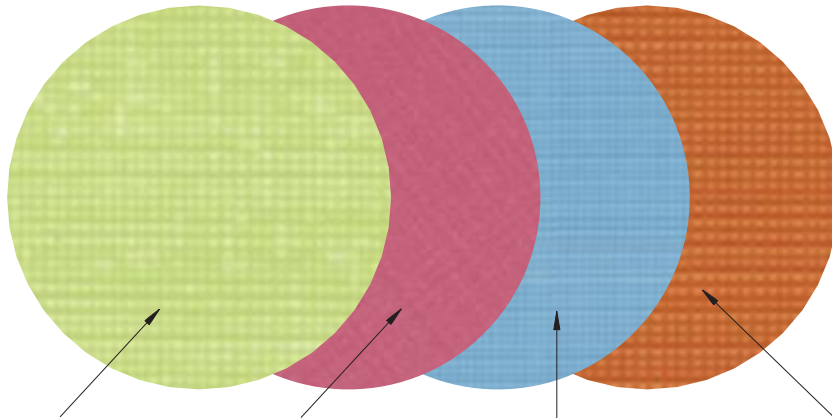

CAT. NO.	GRADE	DIAMETER
<b>TD335P</b>	A35	3" (76 mm)
<b>TD320P</b>	A20	3" (76 mm)
<b>TD310P</b>	A10	3" (76 mm)
<b>TD35P</b>	A5	3" (76 mm)
<b>TD3CP</b>	Cerium	3" (76 mm)
<b>TD535P</b>	A35	5" (127 mm)
<b>TD520P</b>	A20	5" (127 mm)
<b>TD510P</b>	A10	5" (127 mm)
<b>TD55P</b>	A5	5" (127 mm)
<b>TD5CP</b>	Cerium	5" (127 mm)

Minimum order: 1 each. All Trizact® Discs can be combined for quantity pricing.

TD335P and TD535P

### Removes Larger Scratches and Defects

Use the A35 Discs as the first step in removing larger scratches and defects. A small amount of water triggers the cutting action. Controlled water flow helps reduce heat and keeps the glass cooler.

TD320P and TD520P

### Removes Moderate Scratches and Defects

Use the A20 Discs when the scratches are significant, but not as deep as those requiring the A35 Discs. Very aggressive like the A35, the A20 requires adequate water flow to reduce heat and keep the glass cooler.

TD310P and TD510P

### Refines Scratches, Removes Scuffs and Acid Marks

Use the A10 Discs to refine the scratches left by the A35's, or start with A10 Discs to remove shallow scratches, scuffs, and acid marks. Apply a small amount of water to start the grinding action. Control the water flow to avoid generating too much heat.

TD35P and TD55P

### Refines Scratches, Removes Defective AR Coatings

Use the A5 Discs to further refine any scratches left by the A10's. As in previous steps, apply a small amount of water to start cutting action. Avoid extended dwell time to minimize heat build-up.

TD3CP and TD5CP

### Polishes and Leaves Glass Crystal Clear

Use this Cerium Oxide Disc for a final polish. To begin, wet the surface slightly with a small amount of water. As you polish, the pyramids will break down to form a slurry-like solution. The polishing action that occurs will remove scratches left by previous leveling steps.

Also available in other sizes. Visit our web site at [crlaurence.com](http://crlaurence.com).

## CRL 3M® Trizact® Disc Pads

• **Medium for Flat Glass, Soft for Curved Glass**



To get the most use out of your Trizact® Discs, and to achieve the best results, use a separate Disc Pad for each grade of disc.

CAT. NO.	DESCRIPTION
<b>02599</b>	5" Medium Density Disc Pad: 5/8"-11 Thread
<b>02598</b>	5" Medium Density Disc Pad: M14-2 Thread
<b>ZDP3P58M</b>	3" Medium Density Disc Pad
<b>ZDP3P58S</b>	3" Soft Disc Pad

Minimum order: 1 each.

## CRL Drill Adapter

• **Adapts Trizact® Disc Pads to Your Power Drill**



This high-quality CRL Drill Adapter, made from heavy-duty stainless steel, allows any of our 3M® Trizact® Disc Pads to be used with any power drill with a standard 3/8" (9.5 mm) or larger chuck. Minimum order is one each.

CAT. NO. 5704

## CRL Ground Fault Circuit Interrupter

• **A Must for Anyone Using Wet-Working Tools**



With the CRL GF1 Ground Fault Circuit Interrupter, you gain protection against possible shock or electrocution while using wet-working tools. For more information, see page 550K. Minimum order is one each.

CAT. NO. GF1

## CRL Cerium Oxide

• **Used for High-Grade Polishing**



This high-grade optical polishing compound is used as the final step with 3M® Trizact® Cerium Polishing Discs to produce a "water clear" finish. It contains no zinc oxide, and meets most local disposal ordinances. Contents: 1 pound (454 g). Minimum order is one each.

CAT. NO. C0301

3M and Trizact are registered trademarks of 3M Company Corp.



**C.R. LAURENCE COMPANY**

[crlaurence.com](http://crlaurence.com) | [usalum.com](http://usalum.com)

**678K** | [crlaurence.ca](http://crlaurence.ca) [crlaurence.com.au](http://crlaurence.com.au) [crlaurence.co.uk](http://crlaurence.co.uk) [crlaurence.de](http://crlaurence.de) [crlaurence.eu](http://crlaurence.eu)



## CRL Polishing Cerium Oxide

**new**

- Premium Quality Cerium Oxide for Fast Stock Removal
- Ideal for Beveling, Edging, and Scratch Polishing



CAT. NO. C0453W

CRL Polishing Cerium Oxide compounds are refined from the highest quality, rare earth minerals available. These compounds can be used with a hand pad for light surface clean-up, powered hand devices for scratch and surface repair, mechanized scrubbers in mirror silvering lines, or as the final polishing step in multi-stage edging and beveling equipment. Packaged in a 25 kg pail. Minimum order is one each.

## CRL Baume Scale and Vial Kit

This unit consists of a 390 mm (15") tall glass Vial and a glass Baume Hydrometer Scale with 50 graduations.



CAT. NO.	DESCRIPTION
1217	Baume Hydrometer Scale and Vial Kit
12172	Baume Hydrometer Scale Only

Minimum order: 1 each.

## CRL Dressing Tools



CAT. NO. 1205B  
Aluminum Oxide Slab

CAT. NO. 1205  
Aluminum Oxide Stick

CAT. NO. 1211B  
Carborundum Stick

CAT. NO. 1211  
Pumice Block

CRL Aluminum Oxide Dressing Slabs and Sticks dress peripheral and cup type diamonds. They are also used for dressing drill bits. Carborundum Dressing Sticks are used for dressing metal bond wheels on beveling machines. Pumice Dressing Blocks are for fine grit dressing of micro-diamonds on edging and beveling machines.

CAT. NO.	DESCRIPTION
1205B	Aluminum Oxide Dressing Slab 180 x 100 x 3 mm
1205	Aluminum Oxide Dressing Stick 150 x 13 x 13 mm Square
1211B	Carborundum Dressing Stick 150 x 12 mm Diameter
1211	Pumice Dressing Block 90 x 60 x 60 mm

Minimum order: 1 each.

## CRL Flocculent 7418 With Cooling

- Specifically for Use With Flat Glass
- Fast-Acting, Chloride-Free



Available Only in Europe



CAT. NO. 5993

CRL Flocculent 7418 With Cooling is used for the purification process of water. Packaged in a 25 litre container. Minimum order is one each.

## CRL Slurry Bags

CRL Slurry Bags are also known as "Filter Bags", and are available for both Clean 10 and Clean 20 Water Treatment Systems.



CAT. NO.	DESCRIPTION
5994A	For Clean 10 Machine
5994	For Clean 20 Machine 300 Kg, High Porosity

Minimum order: 1 each.

## CRL Vitrolube 4M Coolant Additive

- Environmentally Friendly
- Optimize Sump Pump Life

**new**

CRL Vitrolube 4M Coolant Additive is a high quality, high performance, multi-functional semi-synthetic low oil product. Enhanced corrosion protection makes it particularly suitable for machining and grinding operations on all ferrous and non ferrous materials. Packaged in a 25 litre container. Minimum order is one each.



CAT. NO. EU1218025L

## CRL Vitrolube Diamond Tool Coolants

- Fully Synthetic Water-Soluble Grinding Fluid for Edging and Beveling Machines

**new**

CRL Vitrolube Diamond Tool Coolant is a fully synthetic, water-soluble grinding fluid for edging and beveling machines. Reduces heat generated by the grinding process and improves wheel life. Supplied in either 1 litre, 5 litre or 25 litre containers.



CAT. NO.	DESCRIPTION
EUDTC801L	1 Litre Vitrolube Diamond Tool Coolant
EUDTC805L	5 Litre Vitrolube Diamond Tool Coolant
EUDTC8025L	25 Litre Vitrolube Diamond Tool Coolant
EUDTC80205L	205 Litre Vitrolube Diamond Tool Coolant
EUDTC1271L	1 Litre Vitrolube 127 Diamond Tool Coolant
EUDTC1275L	5 Litre Vitrolube 127 Diamond Tool Coolant
EUDTC12725L	25 Litre Vitrolube 127 Diamond Tool Coolant

Minimum order: 1 each.

# CRL GLASS CLEANING SUPPLIES

For Pricing Visit [crlaurence.com](http://crlaurence.com) or Call Us Toll Free at the Phone Numbers Shown on the Back Cover

## CRL Master Series Squeegees

- Available In Either Solid Brass or Stainless Steel
- Replacement Blades Available
- Can Be Used With REA-C-H Extension Poles

The Master Series Squeegee's rubber blade has a razor-sharp square edge, which leaves glass perfectly clean and streak free. The highly polished brass handle is designed for perfect balance and weight. The annealed stainless steel frame has the advantage of lightness, strength, corrosion resistance, as well as a comfortable soft rubber handle. Both Squeegees can be used with the REA-C-H Extension Pole.



### COMPLETE SQUEEGEES

CAT. NO.	DESCRIPTION
2132523	14" (356 mm) Solid Brass
2132524	18" (457 mm) Solid Brass
2132525	14" (356 mm) Stainless Steel
2132526	18" (457 mm) Stainless Steel

Minimum order: 1 each.

### REPLACEMENT CHANNELS AND RUBBER

CAT. NO.	DESCRIPTION
2132527	14" (356 mm) Brass
2132528	18" (457 mm) Brass
2132529	14" (356 mm) Stainless Steel
2132530	18" (457 mm) Stainless Steel

Minimum order: 1 each.

### REPLACEMENT HANDLES

CAT. NO.	DESCRIPTION
2132531	Brass
2132532	Brass/Rubber Quick Release
2132533	Stainless Steel
2132534	Stainless/Rubber Quick Release

Minimum order: 1 each.

## CRL Sleeve-Style Washers

These popular Sleeve-Style Washers are built to last with an extra-heavy-duty synthetic pile, double-twist fabric, and double seams at the sewn ends. Velcro® fasteners secure cover to lightweight plastic T-Bar frame. The heavy-duty Porcupine Scrubber Cover has interwoven flexible scrubber bristles that are tough on dirt, yet soft on glass. Easily slips on and off T-Bar Frame. Can be used with the REA-C-H Extension Pole.

- Lightweight T-Bar Frame
- Can Be Used With REA-C-H Extension Poles



### T-BAR FRAME WITH COVER

CAT. NO.	DESCRIPTION
2132513	14" (356 mm) T-Bar Frame With Cover
2132514	18" (457 mm) T-Bar Frame With Cover

Minimum order: 1 each.

### REPLACEMENT COVERS

CAT. NO.	DESCRIPTION
2132515	14" (356 mm) Synthetic Pile Cover
2132516	18" (457 mm) Synthetic Pile Cover
2132517	14" (356 mm) Porcupine Scrubber
2132518	18" (457 mm) Porcupine Scrubber

Minimum order: 1 each.

## CRL REA-C-H Extension Poles

- Universal Attachment Head
- 1/4 Turn Positive Twist Lock

CRL REA-C-H Extension Poles are made of fluted, gold anodized, industrial strength aluminum with high-impact plastic tips. The fluting resists twisting, and the gold anodized finish ensures years of corrosion-free use. Poles have a quarter turn positive lock and a comfortable rubber grip. The threaded tip is universal, so it fits most window cleaning tools, paint rollers, and brushes.

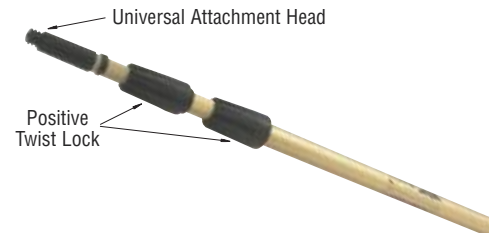

CAT. NO.	DESCRIPTION
2132519	8' (2.4 m) Two Section Pole
2132520	12' (3.6 m) Three Section Pole

Minimum order: 1 each.

## CRL Rubber Squeegees

- Thick Rubber Blade
- Sturdy Steel Handle



These heavy-duty CRL Squeegees have a thick rubber blade and steel handle. Available in 8" and 12" (203 and 305 mm) widths, these Squeegees will wipe away a lot of window cleaning solution quickly. Minimum order is one each.

## CRL Window Cleaning Soap

- Concentrated Formula
- Streak Free Results
- No Ammonia

CRL's bio-degradable formula Window Cleaning Soap makes squeegees slide easily across glass while instantly dissolving built-up grime, even grease. Concentrated formula; approximately two tablespoons of concentrate per gallon of water.



CAT. NO.	CONTENTS
2132521	16 Fl. Oz. (473 ml)

Minimum order: 1 each.



C.R. LAURENCE COMPANY

[crlaurence.com](http://crlaurence.com) | [usalum.com](http://usalum.com)

ALUMINUM 680K | [crlaurence.ca](http://crlaurence.ca) [crlaurence.com.au](http://crlaurence.com.au) [crlaurence.co.uk](http://crlaurence.co.uk) [crlaurence.de](http://crlaurence.de) [crlaurence.eu](http://crlaurence.eu)

## CRL Superior Squeegees

- Dual 10" Blades in an 8" Handle
- Two Colors With Chrome Caps



CRL Superior Squeegees have decorative end caps on white or black wiping blades and handles. This upscale combination of function and design makes it easy to wipe water spots from glass, tile, and marble surfaces. Dual 10" (254 mm) blades are held in an 8" (203 mm) handle.

CAT. NO.	HANDLE COLOR	CAP COLOR
<b>SQBC1</b>	Black	Chrome
<b>SQWC1</b>	White	Chrome

Minimum order: 1 each. Squeegees can be combined for quantity pricing.

## CRL Deluxe Shower Squeegee

- Suction Hook Holder Requires No Drilling
- Chrome Handle With Gray Blade
- Includes Vacuum Cup Hook



**CAT. NO. 17600**  
10" (254 mm)

**CAT. NO. RB17600**  
Replacement Blade

CRL's Deluxe Shower Squeegee has a chrome plated, zinc diecast handle that is rust and tarnish free. The polished stainless steel blade holder secures a 10" (254 mm) wide gray colored blade that effectively removes water spots and soap film. The blade is reversible to extend its service life. The Squeegee hangs on an attractively designed vacuum cup hook that installs easily without drilling. Minimum order is one each.

## CRL Crystal Clear Squeegee

**new**

- Crystal Clear Appearance Blends Beautifully With Glass
- Stainless Steel Blade Holder With 10" (254 mm) Rubber Blade
- Includes Strong Suction Cup Holder for Handy Storage



**CAT. NO. CCS1**

The new CRL Crystal Clear Squeegee can be used after each shower to quickly wipe glass to a spot-free finish. The stylish, ergonomically designed handle is made of durable acrylic, and the stainless steel blade holder has a gray 10" (254 mm) rubber blade. The CRL Crystal Clear Squeegee will be rust and tarnish free, and comes with a strong suction cup holder for convenient storage. Minimum order is one each.

## CRL Extendable Squeegee

**new**

- Durable Rust-Proof Aluminum With 10" (254 mm) Rubber Blade
- Handle Extends to 18" (457 mm)

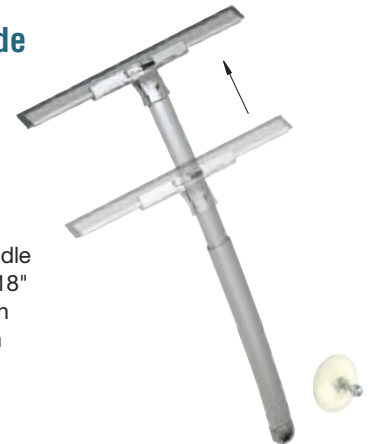

The new CRL Extendable Squeegee has a telescoping handle that goes from 12" (305 mm) to 18" (457 mm) in overall length. Finish is silver chrome, and comes with a strong suction cup holder for convenient storage. Minimum order is one each.

**CAT. NO. 17900**

## CRL Natural Chamois

- Natural Full Skin Leather
- Ideal for Cleaning, Polishing, Wiping



The high quality, natural full skin leather CRL Chamois is ideal for cleaning, polishing, wiping, and dusting sensitive metal and glass surfaces. A superior product to clean excess water and residue from silvered mirror.

CAT. NO.	DESCRIPTION
<b>BJ400</b>	3.5 Sq. Ft. Natural Chamois

Minimum order: 1 each.

## CRL Vacuum Squeegee

- Dripless, Streak Free Surface Clean-Up
- Rechargeable Power
- Save on Wipes and Towels



The CRL Vacuum Squeegee can be used on windows, shower enclosures, shower tile, counter tops, or any other smooth and flat vertical or horizontal surface. The Squeegee's rechargeable battery provides 20 minutes of service per charge, and its clear reservoir lets you keep track of the amount of liquid vacuumed.

CAT. NO.	DESCRIPTION
<b>VS20</b>	110V AC Vacuum Squeegee
<b>EUVS20</b>	240V AC Vacuum Squeegee

Minimum order: 1 each.

## CRL Industrial Glass Cleaners

- Quality Products for Any Application or Preference
- Seven Different Formulas
- Aerosol, Concentrate, and Pre-Mixed

CRL Glass Cleaners are available in four different time tested and industry approved foaming aerosol formulas. Choose from our All Purpose Cleaner, the original CRL 1973, the always popular CRL Sprayway S50, or longtime favorite Hi-SHEEN. CRL also offers the convenience of a pre-mixed product available in cases of four 1 gallon (3.8 l) bottles or single 5 gallon (19 l) boxes.

The ultimate in convenience and affordability, CRL Concentrate Glass Cleaner is mixed at the ratio of one part concentrate to 10 parts water. It is available in four 1 gallon (3.8 l) cases or 55 gallon (208 l) drums.

Visit [crlaurence.com](http://crlaurence.com) for full details on all CRL Industrial Glass Cleaners.



CAT. NO.	DESCRIPTION	UNIT
1973	19 oz. (539 g) Ammoniated Formula Foaming Aerosol Can – 12 Per Case	Case
1973M	4 oz. (113 g) Ammoniated Formula Foaming Aerosol Can – 24 Per Case	Case
3371100	19 oz. (539 g) Ammoniated Formula Foaming Aerosol Can – 12 Per Case	Case
S50	19 oz. (539 g) Ammonia Free Formula Foaming Aerosol Can – 12 Per Case	Case
CRL18X	19 oz. (539 g) Ammonia Free Formula Foaming Aerosol Can – 12 Per Case	Case
895GL	1 Gallon (3.8 l) Liquid Ammoniated Formula Bottles Ready Mix – 4 Per Case	Case
3377000	CRL Gunther Mirror and More Liquid Ammonia Free Pre-Mixed – 5 Gallon (19 l) Box	*5 Gallon
695	CRL Liquid Ammoniated Concentrate – 1 Gallon (3.8 l) Bottle	**Gallon
69555GL	CRL Liquid Ammoniated Concentrate – 55 Gallon (208 l) Drum	*Drum

Minimum order: 1 case. \* Minimum order: 1 each. \*\* Minimum order: 1 gallon.

## CRL Industrial Paper Towels and Lint Free Wipes

- 15 Different Options
- Rolls, Boxes, and Bundles
- General Cleaning
- Insulating Glass Washing

CRL offers a wide and varied range of cleaning wipes for glass, including 15 styles of towels and five different dispenser options. The chart below lists the four most popular catalog numbers.

Visit [crlaurence.com](http://crlaurence.com) and enter "paper towels" or "lint free wipes" in the search window to see our full line and review the details of each.



CAT. NO.	DESCRIPTION	UNIT
1550	Reinforced 4-Ply Pop-Up Lint Free Glass Wipes, 6 Boxes of 150 Per Case	Case
BX15	Single Box of 150 Reinforced 4-Ply Pop-Up Lint Free Glass Wipes	*Box
41482	General Use Rolled 2-Ply Paper Towels, 20 each 128 Towel Rolls Per Case	Case
2131300	Glass-EEZ 4-Ply Folded Lint Free Towels, 500 Per Case	Case

Minimum order: 1 case. \* Minimum order: 1 box.

## CRL "Low-e" Washing Machine Detergent and Brushes

### "Low-e" Washing Machine Detergent



- Self-Adjusting pH to Water Conditioners
- De-Limer to Help Keep the Machine Free of Dirt Build-Up
- Biodegradable and Approved for Use in All Drainage and Septic Systems

CRL "Low-e" is a specially formulated liquid detergent for use with all Glass Washing Machines. It has been field tested to yield better results when cleaning "Low-e" soft coat glass. One gallon of concentrate will treat over 1000 gallons of water. Listed on H.B. Fuller "Acceptable List" for sealant adhesion performance.

**NOTE:** Do not use on mirrors.

CAT. NO.	CONTENTS
3379046	1 Gallon (3.785 l) Bottle
3379048	55 Gallon (208 l) Drum*

Minimum order: 1 each. \*Must ship common carrier.



### "Low-e" Brushes

The wrong brush on soft coat "Low-e" glass can scratch the coating. Our special soft coat "Low-e" brushes can be installed on any old or new CRL Glass Washer. They retain more water, and become super-soft for a gentle, powerful cleaning action. Available for all Vertical and Horizontal Glass Washing Machines. Sizes from 36" to 96" (914 to 2438 mm). Ask our Machinery Service Department at (866) 583-1377 for more details.

CAT. NO.	DESCRIPTION	APPLICATION
39332702	Low-e Brush Assembly 3-1/2" x 37" (90 x 940 mm)	TTW364/366
39372202	Low-e Brush Assembly 5" x 61" (127 x 1549 mm)	TTW604/606
39707501	Low-e Brush Assembly 6" x 61" (152 x 1549 mm)	HDTTW606
39373202	Low-e Brush Assembly 6" x 96" (152 x 2438 mm)	TTW964/966
39188302	Low-e Brush Assembly 6" x 84" (152 x 2133 mm)	TTW844/846
38673611	Low-e Brush Assembly 8" x 85" (203 x 2159 mm)	HDTTW846
38673613	Low-e Brush Assembly 8" x 97" (203 x 2464 mm)	HDTTW966
39470404	Low-e Brush Assembly 6" x 70" (152 x 1778 mm)	VHDW60
4700000105	Small Low-e Brush Section	VEW60
4700000106	Large Low-e Brush Section	VEW60
4700115212	Low-e Brush Assembly 4" x 63" (102 x 1600 mm)	VW636

Minimum order: 1 each.

## CRL Glass Washing Machine Detergent

- Compatible With All Glass Washing Machines
- Will Not Leave a Film
- Biodegradable

Automatic glass washing machines require a special detergent for flat glass. CRL Glass Washing Machine Detergent mixes quickly, and is compatible with any brand of washer currently in use. It is composed of a unique combination of inhibitors with synthetic detergents to provide effective soil removal at low concentrations. This detergent is biodegradable, and does not contain additives (release agents), which will inhibit adhesion of sealants to the glass.

CAT. NO.	CONTENTS
155X	5 lbs. (2.2 kg)
155X40	40 lbs. (18.1 kg)
155X400	400 lbs. (181.4 kg)

Minimum order: 1 each. 400 pound drum must ship via common carrier.

## CRL Glass Washers for Every Application



- Vertical Washers Automatically Adjust for Glass Thickness
- Speeds From 18' (5.5 m) Per Minute With Electronic Speed Adjustment
- Uses Less Floor Space Than a Horizontal Washer
- Clean Glass Up to 3/4" (19 mm) Thick



- Over 60 Years of Experience and 1200 Machines Produced
- Horizontal Washers Have Tops That Tilt for Service
- Stainless Cabin Components Resist Corrosion
- Fastest Speed of Any Standard Four or Six Brush Washer - 35 FPM

## C.R. Laurence Offers a Complete Line of Horizontal Glass Washers From 12" (305 mm) to 144" (3658 mm) Wide and Vertical Glass Washers That Handle Glass From 4" x 16" (102 x 406 mm) to 120" (3048 mm) Tall\*

\* On Open Top Washers, in Two Passes

### HORIZONTAL WASHERS

Our line of Horizontal Glass Washers have the latest design features. Conveyor speed has been increased up to 35' (10.6 m) per minute, and we can fabricate machines to process glass at any speed you need. Horizontal Glass Washers have a tilt-top design, which can be supplied with an optional hydraulic lifting device. In fact, the top can be lifted straight off with an overhead crane. Easy access to the inside of the machine is important to perform proper maintenance. Glass fabricators will be interested in our patented rapid height adjustment system. This option allows the machine operator to raise the upper section from 1/4" to 1/2" (6 to 12 mm) glass in one second. To adjust 1/2" to 3/4" (12 to 19 mm) glass also takes only one second. Corrosion resistance of horizontal machines has been enhanced by adding stainless steel to the spray compartment walls and to the brush and roller journals. We also use non-corrosive recirculating pumps, and have located all bearings outside the wet area. To enhance the drying capability, the air blast drying system has been completely redesigned. As a result, glass can be loaded on the conveyor in a squared position and dried. Some competitive washers require the glass be loaded on the conveyor in a diagonal position so the trailing edge can be dried.

### VERTICAL WASHERS

Our Vertical Washers offer many options and configurations for a perfect fit into your operation. Whether you build ten units per day or operate three shifts, we have a Glass Washer that can do the job. Open Top 60" (1524 mm) Washers (VEW60 and VHDW60) can process up to 120" tall (3048 mm) glass in two passes. Frame components that come into contact with water are stainless steel. Standard features like recirculated heated detergent, recirculated miser rinse, and a fresh water solenoid valve can save water and make your Washer more efficient. The VEW60 Washer includes inspection lights on the outgoing conveyor, and all machines have brushes for cleaning Low-e and coated glass. Vertical Washers require less floor space than Horizontal Washers. Water naturally runs off of vertical glass panels, requiring less electrical power for drying. The interiors of our Vertical Washers are easily accessible for inspection or service.

## CRL VEW60 Open Top Vertical Glass Washer



- Open Top Runs Glass Up to 120" (3048 mm) Tall in Two Passes
- Standard Recirculating Detergent and Miser Rinse
- Standard Final Rinse Solenoid Water Saver
- Easy to Set Up and Maintain
- Easy to Use Operator Control Station
- Lighted Inspection Station on Outgoing Conveyor
- Available for Purchase or Lease



CAT. NO. VEW60

### Packed With All the Standard Features Needed for IG Manufacturing

The CRL 60" (1524 mm) Open Top Vertical Glass Washer can wash glass up to 60" (1524 mm) in one pass, and up to 120" (3048 mm) in two passes. The machine will operate from 4 to 18 feet per minute (1.2 x 5.5 mpm), and has a load capacity of 300 lbs. (136 kg). You can wash glass from single strength to 1/2" (12 mm) thick, and from a minimum size of 4" x 16" (102 x 406 mm). Frame components in contact with the washing areas are made of stainless steel. Recirculated heated detergent, recirculated miser rinse, and a fresh water electric solenoid valve are standard. Also included are glass inspection lights on the exit conveyor. The four brushes are Low-e compatible. Set-up and maintenance is easy, without a factory service technician.

CAT. NO.	BRUSHES	BRUSH MOTOR HP	MACHINE WEIGHT
VEW60	4	2 HP	2200 lbs. (998 kg)

Minimum order: 1 each. F.O.B. nearest CRL Service Center. Must ship common carrier.

#### Controls

All controls are built to OSHA requirements, utilizing CE, CSA and UL Certified components. Wired for three phase, 60 cycle, 230V AC power.

#### Utilities

Electrical . . . . . 5 Motors, Total 7 HP (8.7 kw\*)  
 \*includes Blower  
 Voltage . . . . . Three Phase, 60 Cycle, 230V AC  
 Power . . . . . 40 AMP @ 230V AC  
 Water. . . . . 1/2" NPT inlet thread connection

Converter available to operate the VEW60 Washer at Single Phase, 60 Cycle, 220V AC.

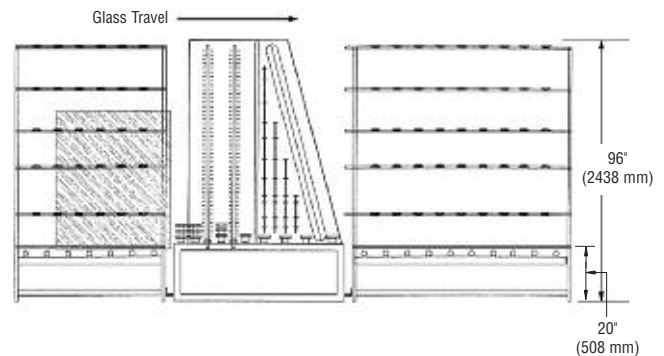
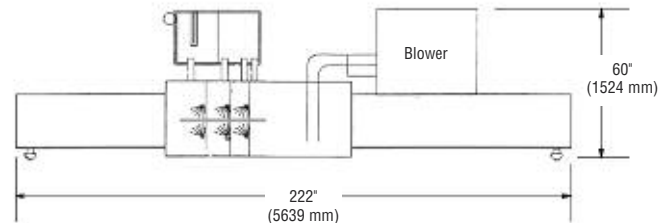

#### SPECIFICATIONS:

- Height: 96" (2438 mm)
- Footprint: 222" x 60" (5639 x 1524 mm)
- Roller Conveyor Height: 20" (508 mm)



**CRL VEW60**  
**Three Phase, 50/60 Hz Export Model**



An export version of the VEW60 can be built to operate on Three Phase, 50/60 Hz power. Contact the Machinery Division with your power requirements.

Optional installation and training by a CRL Technician is recommended



## CRL Heavy-Duty VHDW60 Open Top Vertical Glass Washer



- Open Top Runs Glass Up to 120" (3048 mm) Tall in Two Passes
- Standard Recirculating Detergent and Miser Rinse
- Standard Final Rinse Solenoid Water Saver
- Easy to Set Up and Maintain
- Includes Low-e Brushes
- Available for Purchase or Lease



CAT. NO. VHDW60

### Operator Friendly Vertical Washer Cleans 60" (1524 mm) Tall Glass in One Pass

This CRL Heavy-Duty Open Top Vertical Glass Washer can wash glass up to 60" (1524 mm) in one pass, and up to 120" (3048 mm) in two passes. If you are processing smaller pieces of glass, strips as small as 2" x 12" (51 x 305 mm) can be washed. As an option you can add motorized conveyors. Our Vertical Washer uses positive drive cog belts, and the roller drives are gear driven so you can forget about belt and chain adjustments. Processing speed is up to 18 feet per minute (5.5 mpm). CRL Vertical Washers require less energy to run because the glass being cleaned is vertical and water runs off it naturally. The blower for the air knives can be smaller and produce less volume of drying air. Full size 5" (127 mm) diameter nylon bristle brushes are safe for Low-e coatings. Maximum glass thickness is 3/4" (19 mm).

CAT. NO.	BRUSHES	BRUSH MOTOR HP	MACHINE WEIGHT
VHDW60	4	2 HP	3100 lbs. (1406 kg)

Minimum order: 1 each. F.O.B. Cicero, Illinois. Must ship common carrier.

#### POPULAR OPTIONS

CAT. NO.	DESCRIPTION
VHDWP1C	Power Inlet Conveyor
VHDWP0C	Power Outlet Conveyor

Minimum order: 1 each.

#### Controls

All controls are built to OSHA requirements, utilizing CE, CSA and UL Certified components. Wired for three phase, 60 cycle, 230V AC power.

#### Utilities

Electrical . . . . . 5 Motors, Total 8.25 HP (11.5 kw\*)  
 \*includes Blower  
 Voltage . . . . . Three Phase, 60 Cycle, 230V AC  
 Power . . . . . 50 AMP @ 230V AC  
 Water . . . . . 1/2" NPT inlet thread connection

Converter available to operate the VHDW60 Washer at Single Phase, 60 Cycle, 220V AC.

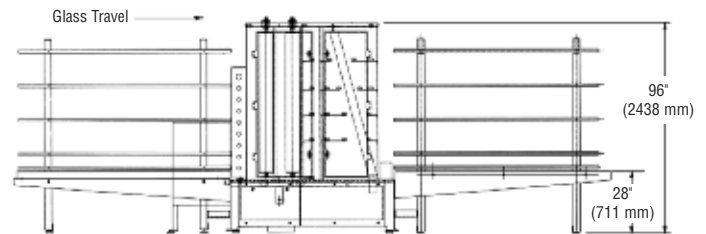
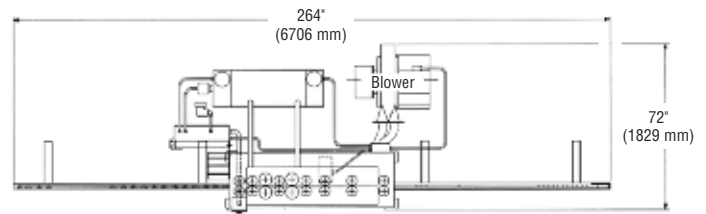

#### SPECIFICATIONS:

- Height: 96" (2438 mm)
- Footprint: 264" x 72" (6706 x 1829 mm)
- Roller Conveyor Height: 28" (711 mm)



**CRL VHDW60**  
**Three Phase, 50/60 Hz Export Model**



An export version of VHDW60 can be built to operate on Three Phase, 50/60 Hz power. Contact the Machinery Division with your power requirements.

Optional installation and training by a CRL Technician is recommended



## CRL Tilt-Top 36" Horizontal Glass Washers

- Fastest Standard Glass Washers Available
- Standard Heated Detergent Recirculation
- Standard Recirculating Miser Rinse
- Standard Final Rinse Solenoid Water Saver
- Tilt-Top for Easy Cleaning and Maintenance
- Optional De-Ionized Water Protection Package for Final Rinse Compartment



• Available for Purchase or Lease



CAT. NO. TTW364

## Compact 36" (914 mm) Washer With High Production Features

Our TTW364 Tilt-Top Glass Washer accepts glass in any shape with a single minimum dimension of 5-1/2" (140 mm) from single strength to 1/4" (6 mm). Variable line speed is 5' to 35' (1.52 to 10.6 m) per minute. Two models are available. The TTW364 has four brushes and the TTW366 has six. Brushes are 3-1/2" (89 mm) diameter by 37" (940 mm) long with spiral wound bristles. V-belt driven brushes are height adjustable. The Air Blast Drying System uses a 10HP (7.4 kw) pressure blower which pressurizes plant air and forces it through top and bottom blast tubes to dry both surfaces of the glass. The baffled enclosure covered drying system reduces noise. Solid rubber covered conveyor pinch rollers are featured throughout the machine. Brushes use heavy-duty ball bearing units to ensure long life, and are readily available for easy replacement.

Our Tilt-Top design allows for easy maintenance. One spray pipe per brush applies the detergent solution or water. Threaded pipe plug ends allow easy cleaning. Water consumption with Miser Rinse is about 2.2 GPM (8.3 LPM). Options available include a Hydraulic Power Tilt-Top, De-ionized Water Protection, and an Induction Static Eliminator.

CAT. NO.	BRUSHES	BRUSH MOTOR HP	MACHINE WEIGHT
TTW364	4	2 HP	1500 lbs. (680 kg)
TTW366	6	2 HP	1650 lbs. (748 kg)

Minimum order: 1 each. F.O.B. Cicero, Illinois. Must ship common carrier.

### POPULAR OPTIONS

CAT. NO.	DESCRIPTION
TTW36HP	Hydraulic Power Tilt-Top
TTW36D1R	De-Ionized Water Protection
TTW361SE	Induction Static Eliminator

Minimum order: 1 each.

### Controls

All controls are built to OSHA requirements, utilizing CE, CSA and UL Certified components. Wired for three phase, 60 cycle, 230V AC power.

### Utilities

Electrical . . . . . Both Models: 5 Motors, Total 13.5 HP (10 kw\*)  
\*includes Blower  
Voltage . . . . . Both Models: Three Phase, 60 Cycle, 230V AC  
Power . . . . . Both Models: 60 AMP @ 230V AC  
Water. . . . . Both Models: 1/2" NPT inlet thread connection

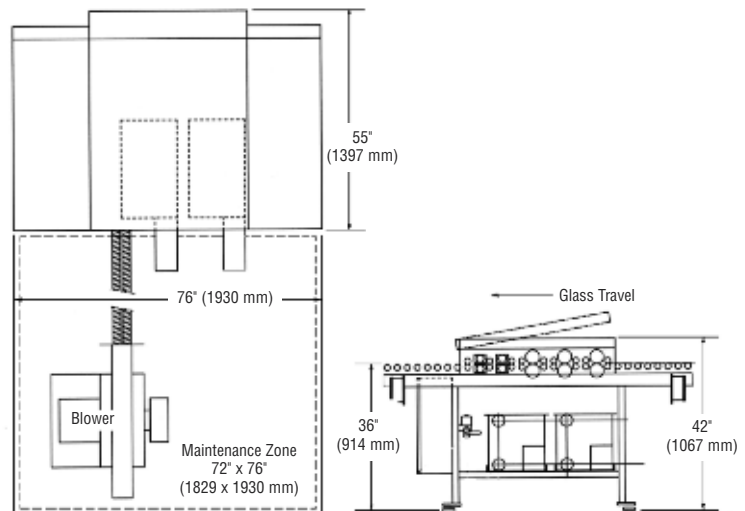

Converter available to operate the TTW364 or TTW366 at Single Phase, 60 Cycle, 220V AC.



### SPECIFICATIONS:

**Height:** 42" (1067 mm)  
**Footprint:** 55" x 76" (1397 x 1930 mm)  
**Roller Working Height:** 36" (914 mm)

Optional installation and training by a CRL Technician is recommended

## CRL 36" WASHER

### Three Phase, 50/60 Hz Export Model

An export version of either TTW364 OR TTW366 can be built to operate on Three Phase, 50/60 Hz power. Contact the Machinery Division with your power requirements.

## CRL Tilt-Top 60" Horizontal Glass Washers

- Fastest Standard Glass Washers Available
- Standard Heated Detergent Recirculation
- Standard Recirculating Miser Rinse
- Standard Final Rinse Solenoid Water Saver
- Tilt-Top for Easy Cleaning and Maintenance
- Optional De-ionized Water Protection Package for Final Rinse Compartment



Our Tilt-Top Washers Open From Either Side

Patented Rapid Height Adjustment Option

Enables operator to raise upper section of machine in one second from 1/4" to 1/2" (6 to 12 mm) glass.



- Available for Purchase or Lease

CAT. NO. TTW604

## 60" (1524 mm) Tilt-Top Washer With High Production Features

Our TTW606 Tilt-Top Glass Washer accepts 0.050 to 1/2" (1.27 to 12 mm) glass from a minimum 9-1/2" (241 mm) square to full width by 9-1/2" (241 mm) or longer lengths. TTW606 machine speed is up to 35' (10.6 m) per minute. The Low-e brushes are 5" (127 mm) in diameter by 61" (1550 mm) long, with spiral wound bristles and V-belt driven by a 2HP (1.5 kw) motor. The Air Blast Drying System dries both surfaces of the glass. The air knives are in a baffled enclosure covered drying system to reduce noise.

Solid rubber covered rollers are used in the main washing section. Load and unload conveyor rollers are ring type. One spray pipe per brush applies the detergent solution or water. Threaded pipe plug ends allow easy cleaning. Water consumption with Miser Rinse is about 4 GPM (15 LPM). Heavy-duty ball bearing units ensure long life, and are easy to replace. The wash compartment, pans, tanks, roller, and brush shafts are all stainless steel. The electrical cabinet on the machine is built to NEMA 12 specifications to meet OSHA requirements and is UL approved.

CAT. NO.	BRUSHES	BRUSH MOTOR HP	MACHINE WEIGHT
TTW604	4	2 HP	2550 lbs. (1157 kg)
TTW606	6	2 HP	2875 lbs. (1304 kg)

Minimum order: 1 each. F.O.B. Cicero, Illinois. Must ship common carrier.

### POPULAR OPTIONS

CAT. NO.	DESCRIPTION
TTW60HP	Hydraulic Power Tilt Top
TTW60D1R	De-ionized Water Protection
TTW601SE	Induction Static Eliminator
TTW60RH	Rapid Height Adjustment

### Controls

All controls are built to OSHA requirements, utilizing CE, CSA and UL Certified components. Wired for three phase, 60 cycle, 230V AC power.

### Utilities

Electrical . . . . . Both Models: Five Motors, Total 18 HP (23.4 kw\*)  
\*includes Blower

Voltage . . . . . Both Models: Three Phase, 60 Cycle, 230V AC

Power . . . . . Both Models: 100 AMP @ 230V AC

Water. . . . . Both Models: 1/2" NPT inlet thread connection

Converter available to operate the TTW604 or TTW606 at Single Phase, 60 Cycle, 220V AC.

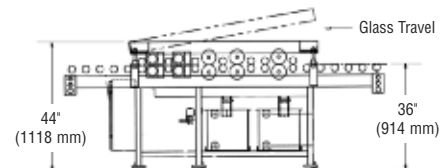
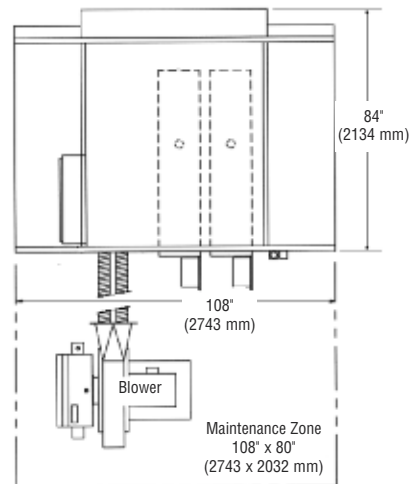

### SPECIFICATIONS:

Height: 44" (1118 mm)

Footprint: 108" x 84" (2743 x 2134 mm)

Roller Working Height: 36" (914 mm)

Optional installation and training by a CRL Technician is recommended



### CRL 60" WASHER

#### Three Phase, 50/60 Hz Export Model



An export version of either TTW604 or TTW606 can be built to operate on Three Phase, 50/60 Hz power. Contact the Machinery Division with your power requirements.



## CRL Heavy-Duty Tilt-Top 60" Horizontal Glass Washer

- Ideal for All Coated Glass, Including Pre-Temperable
- Stainless Steel Pumps
- Built-In Pre-Spray Cabin
- Flowmeters in Each Compartment
- Compatible With Aqua-Miser® Zero Water System
- Extra Rollers Prevent Water Contamination
- Available for Purchase or Lease



Operator Control Panel with Digital Detergent Temperature Read-out



CAT. NO. HDTTW606

### Patented Rapid Height Adjustment Option

Enables operator to raise upper section of machine in one second from 1/4" to 1/2" (6 to 12 mm) glass.

## High Production 60" (1524 mm) Washer for Coated Glass Saves Water

The HDTTW606 Heavy-Duty Tilt-Top Glass Washer features a stainless steel cabin, covers and pans for prespray, detergent, and rinse compartments. There are also stainless steel brush-and-roller journals in wet sections, plus slide-out stainless steel tanks, pitched for easy rinsing and cleaning. Floating upper rollers minimize scuffing of coated glass, while the upper roller pivot design eliminates thin glass breakage. Glass processing at 35' (10.7 m) per minute is standard.

Lubrication fittings on all brush and conveyor bearings make maintenance easy. Rollers in wet sections are Nitrile covered and precision ground. The brushes are 6" (152 mm) in diameter and are compatible with Low-e glass. 1/2 HP stainless steel pumps are used in recirculated detergent and rinse. All panels and electric equipment are UL certified. A convenient operator control station is on the loading conveyor and features sequential, one-button starting, a detergent temperature display, and low detergent level alarm.

Popular options include the Patented Rapid-Height One Second thickness changeover, Hydraulic Tilt-Top Lifters, and prep for Aqua-Miser® or similar Total Water Recirculation System.

CAT. NO.	BRUSHES	BRUSH MOTOR HP	MACHINE WEIGHT
HDTTW606	6	2 HP	4050 lbs. (1837 kg)

Minimum order: 1 each. F.O.B. Cicero, Illinois. Must ship common carrier.

### POPULAR OPTIONS

CAT. NO.	DESCRIPTION
TTW60HP	Hydraulic Power Tilt-Top
TTW60D1R	De-Ionized Water Protection
TTW60RH	Rapid Height Adjustment
TTW601SE	Induction Static Eliminator
TTW60AMP	Aqua-Miser® System Prep

Minimum order: 1 each.

### Controls

All controls are built to OSHA requirements, utilizing CE, CSA and UL Certified components. Wired for three phase, 60 cycle, 230V AC power.

### Utilities

Electrical . . . . . Six Motors, Total 19.25 HP (29.35 kw\*)  
\*includes Blower

Voltage . . . . . Three Phase, 60 Cycle, 230V AC

Power . . . . . 125 AMP @ 230V AC

Water. . . . . 1/2" NPT inlet thread connection

Converter also available to operate the HDTTW606 at Single Phase, 60 Cycle, 220V AC.

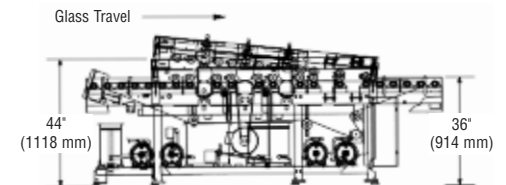
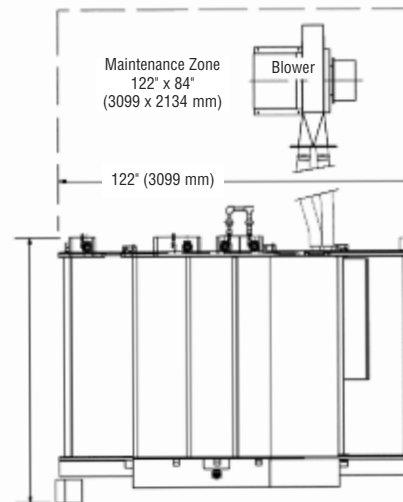

### SPECIFICATIONS:

- Height: 44" (1118 mm)
- Footprint: 122" x 92" (3099 x 2337 mm)
- Roller Working Height: 36" (914 mm)

Optional installation and training by a CRL Technician is recommended

### CRL HDTTW606

Three Phase, 50/60 Hz Export Model

An export version of either HDTTW606 can be built to operate on Three Phase, 50/60 Hz power. Contact the Machinery Division with your power requirements.

Aqua-Miser is a registered trademark of Carolina Equipment & Supply Company, Inc.



## CRL Tilt-Top 84" and 96" Horizontal Glass Washers



- Fastest Four and Six Brush Standard Washers Available
- Standard Heated Detergent Recirculation
- Standard Recirculating Miser Rinse
- Standard Final Rinse Solenoid Water Saver
- Tilt-Top for Easy Cleaning and Maintenance
- Optional De-Ionized Water Protection Package for Final Rinse Compartment
- Available for Purchase or Lease



**Patented Rapid Height Adjustment Option**  
Enables operator to raise upper section of machine in one second from 1/4" to 1/2" (6 to 12 mm) glass.

CAT. NO. TTW844

## 84" (2134 mm) and 96" (2438 mm) Tilt-Top Washers With High Production Features

Our 84" and 96" Horizontal Glass Washers accept 0.050 to 3/4" (1.27 to 19 mm) glass from a minimum 13" x 16" (330 x 406 mm) or longer lengths. Conveyor speed is 0 to 35 FPM. Brushes are 6" (152 mm) in diameter, with spiral wound Low-e bristles and V-belt driven by a five HP motor. The Air Blast Drying System dries both surfaces of the glass. The baffled enclosure covered drying system reduces noise.

Solid rubber covered pinch rollers are used in the main washing section. Load and unload rollers are ring type, with rubber rings cemented to the core. One spray pipe per brush applies the detergent solution or water. Threaded pipe plug ends allow easy cleaning. Water consumption with Miser Rinse is about 5-6 GPM (19 - 22.6 LPM). Heavy-duty ball bearing units ensure long life, and are readily available for easy replacement. The wash compartment pans, tanks, brush, and roller journals are all stainless steel. The electrical cabinet on the machine is built to NEMA 12 specifications to meet OSHA requirements. Every panel is UL approved.

CAT. NO.	SIZE	BRUSHES	MACHINE WEIGHT
TTW844	84" (2134 mm)	4	9280 lbs. (4209 kg)
TTW846	84" (2134 mm)	6	9500 lbs. (4309 kg)
TTW964	96" (2438 mm)	4	9480 lbs. (4300 kg)
TTW966	96" (2438 mm)	6	9700 lbs. (4400 kg)

Minimum order: 1 each. F.O.B. Cicero, Illinois. Must ship common carrier.

### POPULAR OPTIONS

CAT. NO.	DESCRIPTION
TTW84HP or TTW96HP	Hydraulic Power Tilt-Top
TTW84D1R or TTW96D1R	De-Ionized Water Protection
TTW841SE or TTW961SE	Induction Static Eliminator

Minimum order: 1 each.

### Controls

All controls are built to OSHA requirements, utilizing CE, CSA and UL Certified components. Wired for three phase, 60 cycle, 230V AC power.

### Utilities

Electrical . . . . . TTW844/6: Five Motors, Total 31 HP (33.1 kw\*)  
 . . . . . TTW964/6: Five Motors, Total 31 HP (35.1 kw\*)  
 \*includes Blower

Voltage . . . . . Both Models: Three Phase, 60 Cycle, 230V AC

Power . . . . . Both Models: 150 AMP @ 230V AC

Water. . . . . 1/2" NPT inlet thread connection

Converter available to operate TTW844 / TTW966 Series Washers at Single Phase, 60 Cycle, 220V AC.

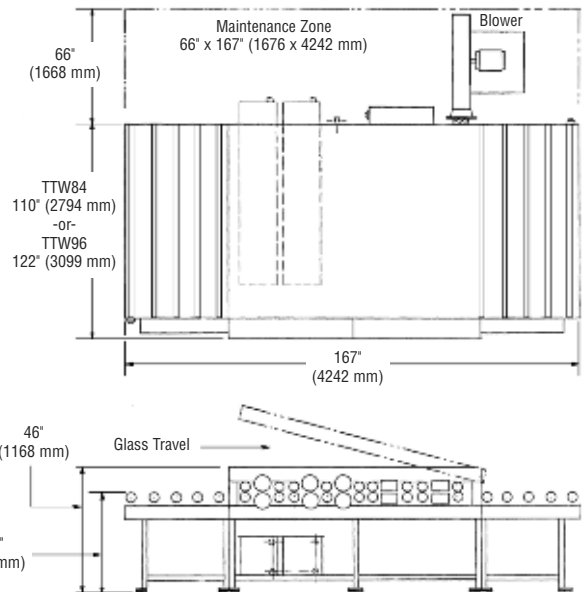

### SPECIFICATIONS:

- Height: 46" (1168 mm)
- 84" Footprint: 167" x 110" (4242 x 2794 mm)
- 96" Footprint: 167" x 122" (4242 x 3099 mm)
- Roller Working Height: 36" (914 mm)

Optional installation and training by a CRL Technician is recommended



**CRL WASHERS**  
Three Phase, 50/60 Hz Export Model



An export version of the TTW844/TTW966 Series Washers can be built to operate on Three Phase, 50/60 Hz power. Contact the Machinery Division with your power requirements.

## CRL Parts for Horizontal and Vertical Glass Washers



**CAT. NO. 16903500**  
Air Filter for Blower

**CAT. NO. 46903480**  
Air Filter for Blower

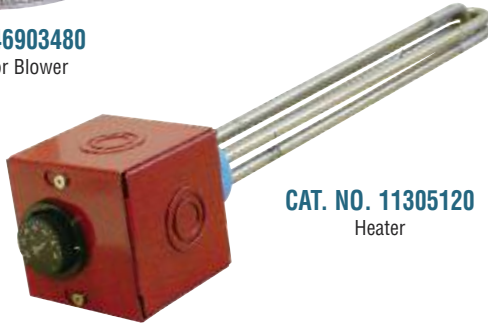

**CAT. NO. 11305120**  
Heater



**CAT. NO. 39470404**  
Brush Assembly

### PARTS FOR 36" (914 MM) HORIZONTAL WASHERS

CAT. NO.	DESCRIPTION	APPLICATION
46903480	Air Filter for Blower - Round Type	TTW364/366
43300951	V-Belt AX46 (1 req.)	TTW364/366
13303081	V-Belt AX31 (2 req.)	TTW364/366
42506047	Pump	TTW364/366
11305120	Heater, 5 kw, 3 Phase, 230V AC	TTW364/366
39332702	Low-e Brush Assembly, 3-1/2" x 37" (90 x 940 mm)	TTW364/366

Minimum order: 1 each.

### PARTS FOR 60" (1524 MM) HORIZONTAL WASHERS

CAT. NO.	DESCRIPTION	APPLICATION
46903480	Air Filter for Blower - Round Type	TTW604/606
43301151	V-Belt AX50 (3 req.)	TTW604/606
43301300	V-Belt AX41 (1 req.)	TTW604/606
42506047	Pump	TTW604/606
11305141	Heater, 10 kw, 3 Phase, 240V AC, SST	TTW604/606
39372202	Low-e Brush Assembly, 5" x 61" (127 x 1549 mm)	TTW604/606

Minimum order: 1 each.

### PARTS FOR 60" (1524 MM) HEAVY-DUTY HORIZONTAL WASHERS

CAT. NO.	DESCRIPTION	APPLICATION
46903480	Air Filter for Blower - Round Type	HDTTW606
43303320	V-Belt BX54 (3 req.)	HDTTW606
43303330	V-Belt BX51 (2 req.)	HDTTW606
42506090	Pump, 1/2 HP	HDTTW606
42506110	Pump, 1 HP	HDTTW606
41305211	Heater, 15 kw, 3 Phase, 240V AC	HDTTW606
39707501	Low-e Brush Assembly, 6" x 61" (152 x 1549 mm)	HDTTW606

Minimum order: 1 each.

### PARTS FOR 84" (2134 MM) AND 96" (2438 MM) HORIZONTAL WASHERS

CAT. NO.	DESCRIPTION	APPLICATION
16903500	Air Filter for Blower (2 req.)	TTW844/846/964/966
43301200	V-Belt AX51 (3 req.)	TTW844/846/964/966
43301250	V-Belt AX62 (1 req.)	TTW844/846/964/966
42506047	Pump	TTW844/846/964/966
11305141	Heater, 10 kw, 3 Phase, 240V AC, SST	TTW844/846
41305101	Heater, 12 kw, 3 Phase, 240V AC, SST	TTW964/966
39373202	Low-e Brush Assembly, 6" x 96" (152 x 2438 mm)	TTW964/966
39188302	Low-e Brush Assembly, 6" x 84" (152 x 2133 mm)	TTW844/846

Minimum order: 1 each.

### PARTS FOR 84" (2134 MM) AND 96" (2438 MM) HEAVY-DUTY HORIZONTAL WASHERS

CAT. NO.	DESCRIPTION	APPLICATION
16903500	Air Filter for Blower (2 req.)	HDTTW846/966
43301190	V-Belt AX56 (2 req.)	HDTTW846/966
43301330	V-Belt AX69 (3 req.)	HDTTW846/966
42506090	Pump, 1/2 HP	HDTTW846/966
42506110	Pump, 1 HP	HDTTW846/966
41305191	Heater, 20 kw, 3 Phase, 240V AC	HDTTW846/966
38673611	Low-e Brush Assembly, 8" x 85" (203 x 2159 mm)	HDTTW846
38673613	Low-e Brush Assembly, 8" x 97" (203 x 2464 mm)	HDTTW966

Minimum order: 1 each.

### PARTS FOR VEW60, VHDW60 AND VW636 SERIES VERTICAL WASHERS

CAT. NO.	DESCRIPTION	APPLICATION
46903480	Air Filter for Blower - Round Type	VHDW60
43314701	Timing Belt (2 req.)	VHDW60
42503003	Pump	VHDW60
11305120	Heater, 5 kw, 3 Phase, 230V AC, SST	VHDW60
39470404	Low-e Brush Assembly, 6" x 70" (152 x 1778 mm)	VHDW60
4700000105	Small Low-e Brush Section	VEW60
4700000106	Large Low-e Brush Section	VEW60
4700000201	Heater, 3 kw, 3 Phase, 230V AC	VEW60
4700000002	Pump	VEW60
4700000104	Air Filter for Blower	VEW60
4700115212	Low-e Brush Assembly, 4" x 63" (102 x 1600 mm)	VW636
4700115102	Heater, 3 kw, 3 Phase, 460V AC	VW636
4700115101	Pump, Stainless	VW636
4700000104	Air Filter for Blower	VW636

Minimum order: 1 each.

## CRL Automatic Silvering Lines



CRL Mirror Line Oven Sections are installed in the production line for testing before delivery.



- Highest-Efficiency Silvering System
- Pull-Out Scrubbers for Easy Servicing
- Curtain Coater for Cut or Stock Sizes
- Over-the-Line Exhausts
- Conveyor Speed to 30 FPM (9 mpm)
- Widths to 134" (3.4 m)
- Custom Designed to Your Needs
- Silver Saver Blowoff
- Rapid Fire™ IR Ceramic Ovens
- Efficient Face-Down Cleaner
- Electronic Controlled Servo-Traverses
- All Sections Can Be Ordered Separately

## Silvering Lines Designed to Meet International Demand

CRL continues its leadership in mirror production machinery by applying years of design and engineering experience to our customers' specific needs. The CRL Conveyorized Automatic Silvering Line is constructed in varying widths and modular sections to fit your facility and meet your production requirements.

Many features of the system are CRL originals, and have been designed and coordinated to provide unparalleled production capabilities. Engineering improvements have made CRL Conveyors the standard of the industry. Such innovations as Curtain-Coating Paint Systems and High Efficiency Ovens are standard features. In addition, CRL works closely with the leading suppliers of silvering chemistry and mirror backing paint to keep abreast of technical advances in these important areas.

Another major silvering line innovation by CRL is the utilization of Servo-Traverses, which offer vastly improved deposition control of silver during the coating process. Hi-torque motors provide high speed turning of silvering heads, minimizing the spray overlap and build-up that are traditional with slower gear motors, screw drives, and hydraulics. Other major line improvements include lower line costs through reduced use of chemicals, improved oven and cooling systems, and new designs to accommodate thinner glass.

**CRL Mirror Silvering Lines  
Have Produced Millions of Square  
Feet of Mirrors Worldwide!**

Australia - Canada - Chile - China - India - Italy - Jamaica - Japan  
Mexico - Singapore - South Africa - Taiwan - U.S.A. - Venezuela



Every Silvering Line section is built by hand and assembled into a coordinated production unit. Design and installation is planned and executed to keep down-time to a minimum.

**Call the CRL Machinery Division at  
(866) 583-1377 with your requirements**



**CRL Silvering Lines  
Three Phase, 50/60 Hz Export Model**



All Silvering Lines for export can be built to operate on Three Phase, 50/60 Hz power. Contact the Machinery Division with your power requirements.

## CRL Glass Laminating Lines

- Custom Options Available to Meet Customer Requirements

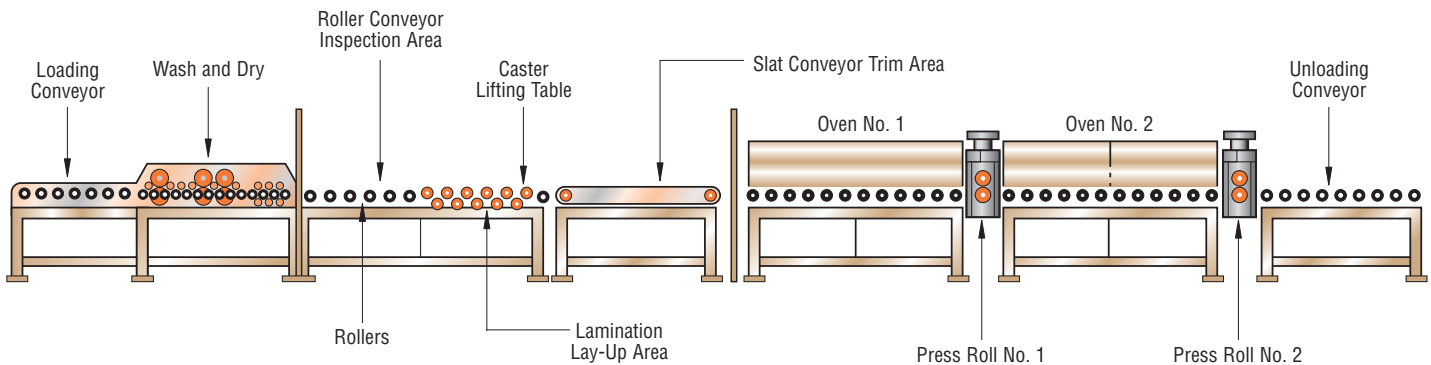
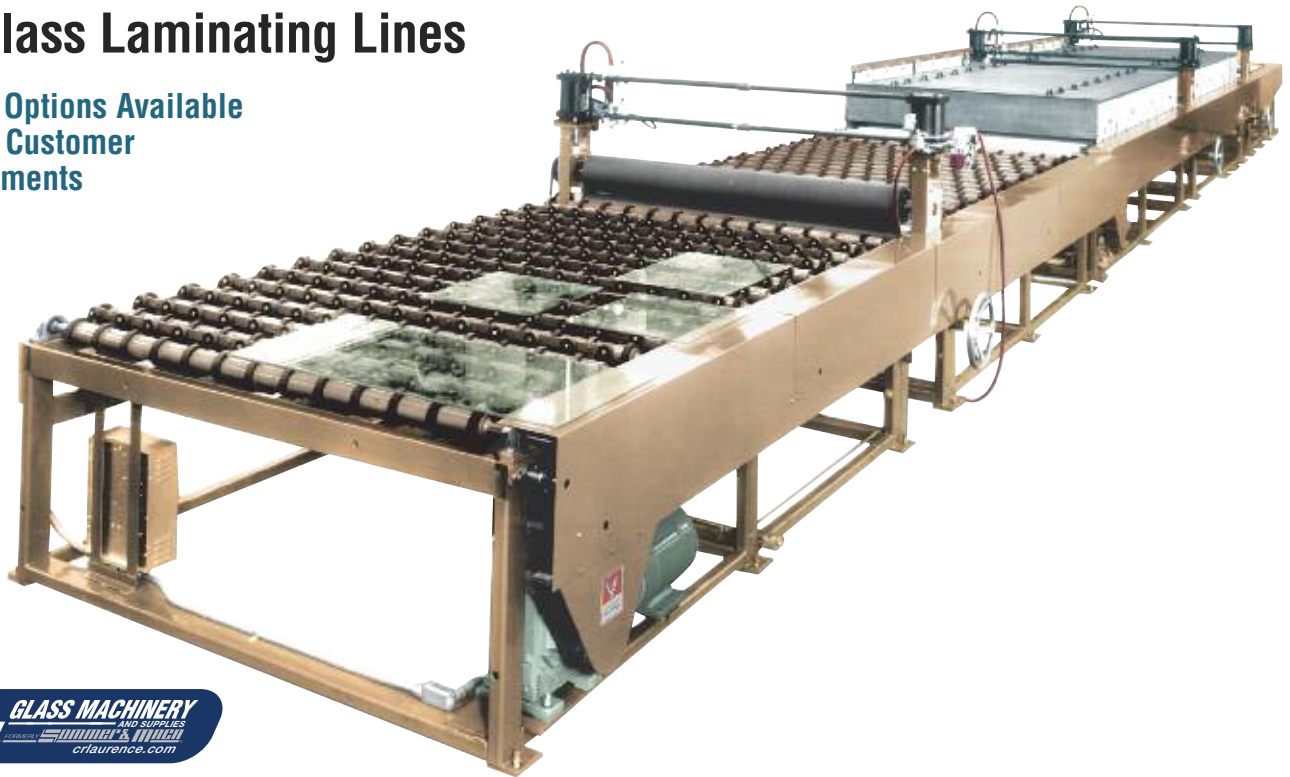

### Rugged, Hard Working Equipment for Quality Laminated Glass Production

The CRL Machinery Division has manufactured a number of Laminated Glass Lines. Pictured above is a typical dry laminating system made by CRL. Simplified, the line consists of Laminated Press Rolls, Ovens, and a Trim Area.

After the glass is washed, the vinyl sandwich is made up on the Laminating Conveyor. Units go to the Trim Area next, where excess vinyl is removed, and then to the first Oven. Units then pass through a Press Roller and the Second Oven. After the laminated units pass through a final Press Roller, they are ready to be unloaded and sent to an Autoclave. The Autoclave is necessary to completely bond the vinyl and glass.

Each line may vary as the customer's needs dictate. The illustration above is the same as the photo, but is provided for a clearer understanding of the equipment involved. Engineering and technical staff from CRL will work with you on your laminating needs, and will design a line that will meet your precise requirements.



European Union



Australia

### CRL Laminating Lines Three Phase, 50/60 Hz Export Model

All Laminating Lines for export can be built to operate on Three Phase, 50/60 Hz power. Contact the Machinery Division with your power requirements.

Call the CRL Machinery Division at (866) 583-1377 with your requirements

## CRL Counterbalanced Tilt-Top Glass Cutting Tables

- Our Most Popular Cutting Tables
- Counterbalanced for Easy Tilting
- Available in Four Standard Sizes
- Available With Air Float and/or Manual Breaker Bar
- Four Most Popular Models in Stock and Ready to Ship From Your Local CRL Warehouse
- Easy Assembly



CRL Counterbalanced Tilt-Top Glass Cutting Tables are constructed of heavy-gauge steel, electrically welded, and painted. A full 3/4" (19 mm) smooth particle board table top and carpet is included. All Tables are built with tops pre-fitted and drilled. Table frames are fully assembled and tested in our factory to assure the fit and free movement of every part. Tables are then knocked down and packed into a vertical shipping case, which takes up a minimum of truck space, assuring lower freight rates to your facility.

Assembly steps involve mounting the two table top sections onto the frame, filling the two counterbalance pans under the table top (normally loose bricks, bagged sand or cement provides sufficient weight), screwing on the particle board subsurface, and then applying the carpet over the particle board with the carpet adhesive included.

All Tables come with heavy Floor Casters, Floor Locks, and Retractable Wooden Toes. These wooden toes are located across the front edge of the Table, and are pulled up and slip-locked in place before the Table is tilted into the upright position. When tilted, the toes provide the shelf to support your stock sheet when loading the Table. After the Table is returned to its horizontal position, simply lift and drop the toes back into their pockets, keeping them out of the way of any glass movement.

These manually operated Tables are known for their simplicity and durability. The counterbalance mechanism is designed for single-person use and has proven itself to be reliable. A variety of available options can be ordered with your new Table. See the following pages.



Crated Table with plastic wrap removed. Forklift required for unloading at time of delivery.



Retractable Wooden Toes



Retractable Wooden Toes Support Glass in Vertical Position





\*Select Stock

## CRL Counterbalanced Tilt-Top Glass Cutting Tables



Carpet and Adhesive Supplied with Table



Counterbalance Pans on Base Frame and Under Top



Tilt-Top Pivot Pin



Heavy Casters

### STANDARD FEATURES INCLUDE:

- Indoor/Outdoor Carpet: Cushions Glass and Protects Against Scratches
- Counterbalance Pans: Fill with Cement, Bricks or Bagged Sand (not included)
- Retractable Wooden Toes: Support Glass in Vertical Position for Loading
- Heavy Casters and Floor Lock

### ACCESSORIES:

- Air Flotation: Creates Cushion of Air Under Glass to Aid Movement and Positioning
- Breaker Bars for Easy Glass Breaking
- Stab-In Roller Toes
- Electric Winch

CAT. NO.	TABLE TOP SIZE	MANUAL BREAKER BAR	AIR FLOAT/12 OUTLET (1 HP 1/60/120V)	AIR FLOAT/12 OUTLET (1 HP 1/50/230V)	AIR FLOAT/16 OUTLET (3 HP 3/60/220V)	AIR FLOAT/16 OUTLET (3 HP 3/50/400V)
2402500*	6' x 8' (1.8 x 2.4 m)	--	--	--	--	--
2402518	6' x 10' (1.8 x 3 m)	Included	--	--	--	--
2402510*	8' x 10' (2.4 x 3 m)	--	--	--	--	--
2402511	8' x 10' (2.4 x 3 m)	Included	--	--	--	--
2402512	8' x 10' (2.4 x 3 m)	--	Included	--	--	--
AU2402512	8' x 10' (2.4 x 3 m)	--	--	Included	--	--
EU2402512	8' x 10' (2.4 x 3 m)	--	--	Included	--	--
2402513	8' x 10' (2.4 x 3 m)	Included	Included	--	--	--
AU2402513	8' x 10' (2.4 x 3 m)	Included	--	Included	--	--
EU2402513	8' x 10' (2.4 x 3 m)	Included	--	Included	--	--
2402550	8' x 10' (2.4 x 3 m)	--	--	--	Included	--
EU2402550	8' x 10' (2.4 x 3 m)	--	--	--	--	Included
2402502*	8' x 12' (2.4 x 3.6 m)	--	--	--	--	--
2402503	8' x 12' (2.4 x 3.6 m)	Included	Included	--	--	--
EU2402503	8' x 12' (2.4 x 3.6 m)	Included	--	Included	--	--
2402504	8' x 12' (2.4 x 3.6 m)	Included	--	--	--	--
2402543	8' x 12' (2.4 x 3.6 m)	--	Included	--	--	--
EU2402543	8' x 12' (2.4 x 3.6 m)	--	--	Included	--	--
2402509*	9' x 12' (2.7 x 3.6 m)	--	--	--	--	--
2402524	9' x 12' (2.7 x 3.6 m)	Included	--	--	--	--
2402525	9' x 12' (2.7 x 3.6 m)	Included	--	--	Included	--
AU2402525	9' x 12' (2.7 x 3.6 m)	Included	--	--	--	Included
EU2402525	9' x 12' (2.7 x 3.6 m)	Included	--	--	--	Included
2402544	9' x 12' (2.7 x 3.6 m)	--	--	--	Included	--
EU2402544	9' x 12' (2.7 x 3.6 m)	--	--	--	--	Included
2402514	10' x 12' (3 x 3.6 m)	--	--	--	--	--

Minimum order: 1 each. \*Stocked and available from your local CRL Service Center. All other tables F.O.B. Cicero, Illinois. Other sizes and accessories available upon request.



## CRL Hydraulic "Easy-Tilt" Cutting Table

- Includes "Y" Breaker Bar and Air Flotation
- Retractable Wooden Toes
- Fully Carpeted Top Cushions Glass
- Ships Fully Assembled

The Hydraulic "Easy-Tilt" Glass Cutting Table has welded tubular steel construction. A full 3/4" (19 mm) smooth particle board table top and black carpet is furnished with each Table to cushion the glass and protect against scratches. The full plenum air flotation enables one person to move large or small lites of glass with ease. A built-in "Y" Breaker Bar is located in center position. The twin cylinder hydraulically operated Table enables the glazier to raise and lower the tilt-top with fingertip control.



Heavy Casters and Floor Lock



Air Flotation Tilt-Top at 36" Working Height

**NOTE:** Available options must be ordered with initial table order. Not intended for retrofit.

### 9' X 12' (2.7 X 3.6 M) HYDRAULIC "EASY-TILT" CUTTING TABLES

CAT. NO.	DESCRIPTION
2402555	Optional "X" Manual Breaker Bar
2402531	Optional Automatic Retractable Roller Toes
EW	Optional Electric Winch

CAT. NO.	DESCRIPTION	WEIGHT
2402522	3 Phase, 60 Cycle, 200 Volt	1560 lbs. (708 kg)
AU2402522	3 Phase, 50 Cycle, 400 Volt - Australia	1560 lbs. (708 kg)
EU2402522	3 Phase, 50 Cycle, 400 Volt - Europe	1560 lbs. (708 kg)

Minimum order: 1 each.

Minimum order: 1 each. F.O.B. Cicero, Illinois. Must ship common carrier.

## CRL Cutting Table Air Flotation Kit

- Two Versions Available, 12 and 16 Chambers
- Retrofit Any Standard Cutting Table

Air Flotation Kits improve your cutting table capabilities and relieve the strain of moving large or thick sheets of glass. Easy to install, these Kits allow one person to float, move, and turn glass on the table top. Kits feature self-contained blower units with multi-hose manifolds feeding either 12 or 16 check ball chambers.

For standard 8' x 10' (2.4 x 3.1 m) Tables and regular cutting, choose the 120 Volt, 12 chamber option. Larger Tables or the cutting of heavy plate glass may require the 230 Volt, 16 chamber option. Both Kits also available for 60 hertz and 50 hertz electrical supplies. Instructions are included.

**NOTE:** Cutting Table not included with Flotation Kit.

CAT. NO.	DESCRIPTION
2402562	12 Chamber, 120V/60Hz/1Hp
EU2402562	12 Chamber, 230V/50Hz/1Hp
2402563	16 Chamber, 230V/60Hz/3Hp
EU2402563	16 Chamber, 480V/50Hz/3Hp

Minimum order: 1 each. F.O.B. Cicero, Illinois.



## CRL Glass Cutting Table Stab-In Rollers

- Makes Glass Loading Easy When Table is in Upright Position
- Simple to Install and Remove



CRL Glass Cutting Table Stab-In Rollers make an efficient add-on to any Tilt-Top Glass Cutting Table. The set of four durable rubber rollers mount into steel collars that are recessed into the table's surface. Minimum order is one set.

CAT. NO. ERR1

## CRL Air Float Chamber With Ball for Cutting Tables

- Fits 2-7/16" (62 mm) Hole



Replace your worn or damaged ball float units on your Cutting Table with the CRL Air Float Chamber with Ball. This unit is an OEM part for all CRL Air Flotation Systems. **NOTE:** Fits hoses with an inside diameter of 1-1/2" (38 mm). Minimum order is one each.

CAT. NO. AFCB1

## CRL Electric Winch for Glass Cutting Tables

- Provides Safe, Effortless Loading
- Operates on 110 Volts AC



The CRL Electric Winch for Glass Cutting Tables takes the strain out of pulling large lites of glass from vertical storage racks onto Tilt-Top Cutting Tables when they are in the tilted position. Minimum order is one each.

CAT. NO. EW

## CRL Horse Hair Dusting Brush

- Great for Cutting Tables
- Comfortable Molded Handle



This top quality CRL Dusting Brush is used for many cleanup uses in the shop or home. It has long lasting black horse hair bristles for sweeping sawdust, metal shavings, dirt, and dust. A good way to remove glass chips from cutting table tops. The molded plastic handle is comfortable to hold. **NOTE:** Not available in Australia. Minimum order is one each.

CAT. NO. LAB40

## CRL FEIN® Mini-Turbo Portable 6 Gallon Wet/Dry Vacuum

- Very Practical for Cutting Table Clean-Up
- Small But Powerful
- Quiet – 63 Decibels
- 120 Volt AC

The FEIN® Mini-Turbo uses a unique dual fan motor. The cloth bladder utilizes the capacity of the vacuum tank and allows for maximum filtration. Minimum order is one each.

**ACCESSORIES INCLUDED:**  
Long 16' x 1-1/4" (4.9 m x 32 mm) hose, elbow adapter with suction reducer, crevice tool, and cloth bladder.

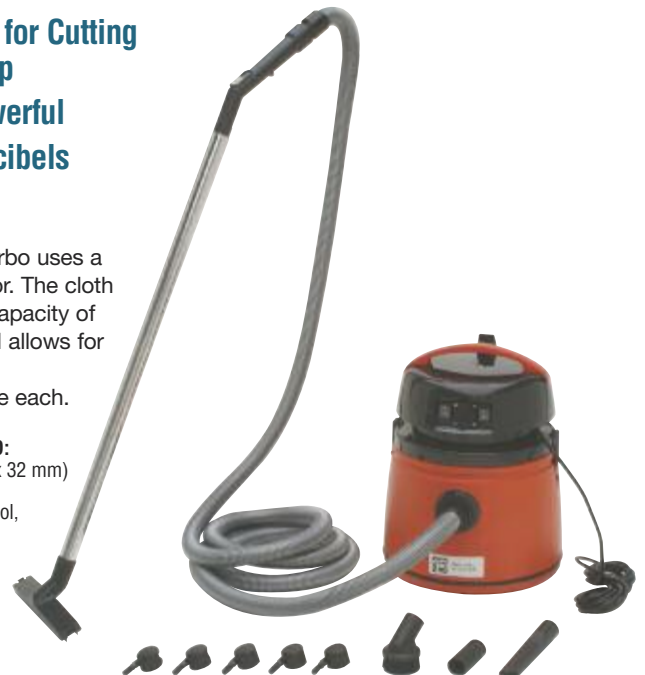

CAT. NO. 2095514

FEIN is registered trademark of C. & E. Fein GmbH.

## CRL Wood's Stowaway Tilt Table

- Great Space Saver in the Shop
- Great Time Saver on the Job Site
- From Cutting to Storage in Minutes

The CRL Wood's Stowaway Tilt Table transforms from a working full size 72-1/4" x 96-1/2" (1835 x 2451 mm) tilting glass cutting table, into it's compact 25-3/4" (654 mm) deep folded storage mode in only minutes. The 79-3/4" (2026 mm) folded height of this table makes it ideal for transport and use on the job site, as it fits easily through doors and hallways. Crossed support legs ensure a stable, 35" (889 mm) high working surface with a 500 lb. (225 kg) load capacity.

The CRL Wood's Stowaway Tilt Table is provided with a durable, long lasting felt work surface and rubber roller toes on the bottom edge to facilitate loading and unloading glass when table is tilted in the upright position. Table ships KD and some assembly is required. Shipping weight is 460 lbs. (209 kg). Minimum order is one each. F.O.B. Laurel, Montana.

**NOTE:** Available in a frame only version without the table top for export overseas.



Cutting

CAT. NO. STT1



Loading



Transport or Storage

## CRL Glass Cutting Carpet

- Special Long-Wearing, High-Density Material
- Black Color Exposes Small Fragments
- Abrasive Resistant

This specially designed Glass Cutting Carpet is manufactured exclusively for CRL. It is available in five complete one piece table top sizes, four sizes to accommodate center breaker bar configurations, and custom sizes based on lineal feet in the standard 12' (3.6 m) width.

This product is also good for use on work benches, shop tables, rolling carts, or anywhere you want a surface that is durable and protective. It makes an excellent surface for UV glass bonding work, as it is firm enough to provide a steady base for the application and curing of UV adhesives. The standard width is 12 feet (3.6 m), and you can order it in any length you require in even one foot increments.



CAT. NO.	DESCRIPTION
CPT6X8	6' x 8' (1.8 x 2.4 m) Cutting Carpet
CPT8X10	8' x 10' (2.4 x 3 m) Cutting Carpet
CPT8X12	8' x 12' (2.4 x 3.6 m) Cutting Carpet
CPT9X12	9' x 12' (2.7 x 3.6 m) Cutting Carpet
CPT10X12	10' x 12' (3 x 3.6 m) Cutting Carpet
CPT8X10BB	8' x 10' (2.4 x 3 m) Carpet Only for Cutting Table With Break Bar
CPT8X12BB	8' x 12' (2.4 x 3.6 m) Carpet Only for Cutting Table With Break Bar
CPT9X12BB	9' x 12' (2.7 x 3.6 m) Carpet Only for Cutting Table With Break Bar
CPT10X12BB	10' x 12' (3 x 3.6 m) Carpet Only for Cutting Table With Break Bar
CPTL1N	12' (3.6 m) Wide Cutting Carpet Sold by Lineal Foot

Minimum order: 1 each.

## CRL In-Shop Transport and Handling Devices

- Safely Move Sheets, Crates, or Finished Goods
- From Receiving to Shipping, Wheeled Handling Answers for Every Step

When moving raw or finished material inside your facility, the two most important considerations are personnel safety and protection of the production material, especially finished goods. The many forms of material transport are shown in Section 2 of this catalog beginning on page 224K. CRL can provide the tools for moving any glass product safely and efficiently. Flat case dollies and rolling pneumatic dollies for moving full cases, tilting carts for moving open cases, shop carts and transport carts for cases or loose lites, wood and steel dollies for single lites, and a variety of clamping dollies to help hold glass securely during movement are some of the many categories offered by CRL.

Some of these transport products are exceptionally versatile. The heavy-duty transport racks can serve as stationary shop storage A-frames without wheels, or with the addition of wheels can serve as 4000 pound (1814 kg) capacity shop carts. They can also be lifted onto the truck to deliver finished product to the customer or job site. This is one of the many innovative material handling solutions provided by CRL.

While some of the products shown in Section 2 will be new, others such as the AB Tilting Crate Handler have been industry standards for many years. A unique feature of the AB Handler is the ability it gives one man to retrieve cases, roll them to the cutting table, and after opening the front or end of the case, load glass lites directly onto the cutting table.

Another consideration when choosing in-house carts and mobile storage racks should be the amount of maneuvering space required where the racks will be used. Cart design falls into three general categories when it comes to casters. The first type is carts with four or more swivel casters. These carts require at least two people to move and control. The second and more common type will have two fixed casters on one end and two swivel casters on the other end. These tend to be more stable during movement, and can be controlled by one person depending on the weight. However, these carts need wider, uncluttered aisles for turning. The third style is represented by the CRL 6-Wheel Fabrication Carts that can turn 360 degrees on their oversized center casters. These high-capacity carts are ideal for heavy plate glass fabricators who move various lengths of material and need to turn tightly around shop obstacles.



**CAT. NO. 13065**  
See page 224K



**CAT. NO. GSD3**  
See page 226K



**CAT. NO. FC48**  
See page 229K



**CAT. NO. M4ROL**  
See page 228K

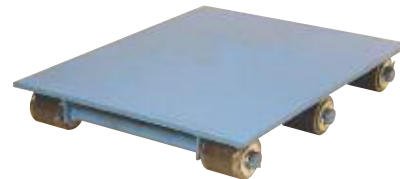

**CAT. NO. 253CD**  
See page 227K



**CAT. NO. AB**  
See page 232K



**CAT. NO. ATD1**  
See page 225K



**CAT. NO. ROW1**  
See page 233K



**CAT. NO. HDSC5448**  
See page 230K



**CAT. NO. 2401281**  
See page 225K

## CRL Stalter X-Y Two Direction Glass Cutting Machine

- High-Speed, High-Volume Square and Rectangular Glass Cutting
- Split-Head Design Allows Extra Cutter Heads to be Added or Removed Quickly
- Capable of Making Up to 3600 1" (25 mm) Square Glass Tiles in Less Than a Minute
- Available for Purchase or Lease

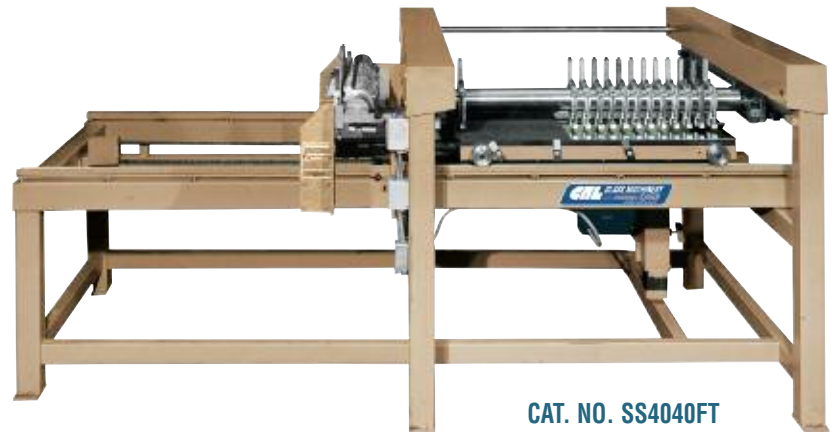

CAT. NO. SS4040FT  
Shown



### Produce Accurate Square and Rectangular Glass Pieces Quickly and Easily

CRL Stalter X-Y Glass Cutting Machines are designed for quick and accurate cross-cutting of glass lites of various sizes where squareness is important.

The machine is furnished with six Cutting Heads and six Carbide Wheels, with three on each bridge. The controls are simple directional switches for X and Y movement of the table and movable bridge. Electrical consists of two 1/4 HP motors wired for single phase, 110V AC power. The X-Y Machine is 47" (1194 mm) high, and the Pass Line is 37" (940 mm) tall.

Sizes other than those listed are available on special order. An Air Flotation Table Option is available for any size machine, as well as a Hard Surface Option for use with thin glass to replace the felt table top.

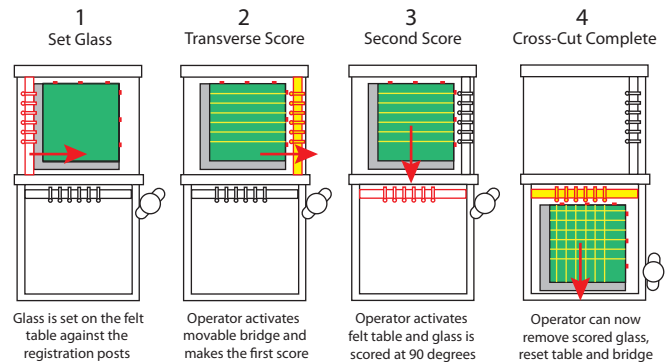

CAT. NO.	MAX. GLASS SIZE	MACHINE WEIGHT
SS4040FT	40" x 40" (1016 x 1016 mm)	1800 lbs. (816 kg)
SS5050FT	50" x 50" (1270 x 1270 mm)	2000 lbs. (907 kg)
SS6060FT	60" x 60" (1524 x 1524 mm)	2200 lbs. (998 kg)
35660000	Complete Cutting Head (Less Cutting Wheel)	

Minimum order: 1 each. F.O.B. Cicero, Illinois. Must ship common carrier.

#### Controls

All controls are built to OSHA requirements, utilizing CE, CSA and UL Certified components. Wiring for single phase, 60 cycle, 110V AC power.

#### Utilities

Electrical . . . . . Two Motors, Total .5 HP (.37 kw)  
Voltage . . . . . Single Phase, 60 Cycle, 110V AC  
Power . . . . . 20 AMP @ 110V AC

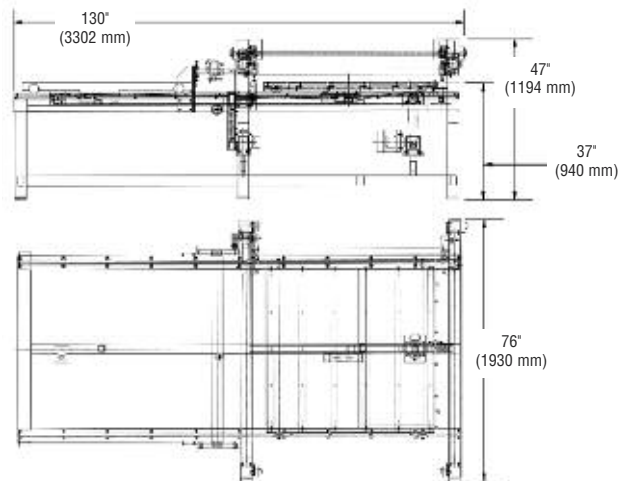

CAT. NO. SS5050FT  
Diagram

#### SPECIFICATIONS :

- Height: 47" (1194 mm)
- SS4040FT Footprint: 110" x 66" (2794 x 1676 mm)
- SS5050FT Footprint: 130" x 76" (3302 x 1930 mm)
- SS6060FT Footprint: 150" x 86" (3810 x 2184 mm)
- Table Pass Line Height: 37" (940 mm)



### CRL STALTERS

#### Three Phase, 50/60 Hz Export Model

An export version of any CRL Stalter can be built to operate on Three Phase, 50/60 Hz power. Contact the Machinery Division with your power requirements.



## CRL Stalter Glass Cutting Machine

- Includes Four Split Design Cutting Heads
- Standard 36" (914 mm) In-Feed and Out-Feed Tables
- Operates on Single Phase 110V AC Power
- Models From 60" to 108" (1.5 to 2.8 m) Capacity
- Available for Purchase or Lease

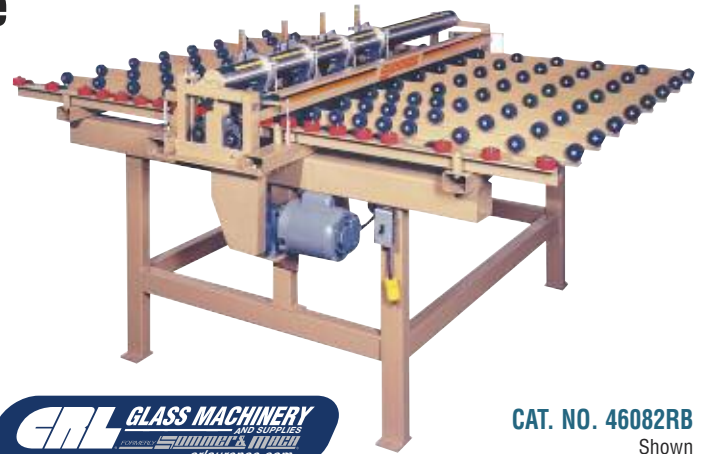

CAT. NO. 46082RB  
Shown

### Cutting Head Replacement Parts

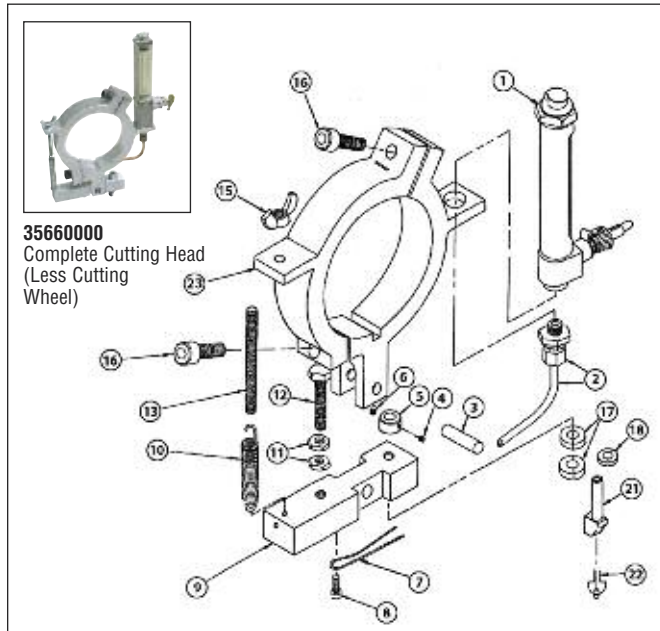

**35660000**  
Complete Cutting Head  
(Less Cutting Wheel)

### One Direction Glass Cutting Machines

Operation of the CRL Stalter Glass Cutting Machine is simple. The operator places the glass against the index wheels on the left side of the machine, and feeds it into the pinch rolls which power the glass under the cutter bar assembly. There are only two adjustments: one for the width of the cut, and the second for the glass thickness. Both adjustments are easily made.

#### Capacity:

Glass from single strength up to 1/4" (6 mm) thick, in sizes from 9" x 9" (229 x 229 mm) up to full width. The minimum distance between cuts is 1" (25 mm).

#### Options:

Additional Split-Type Cutting Heads may be added to the machine.

#### Controls:

All controls are built to OSHA requirements, utilizing CE, CSA and UL Certified components. Single phase, 60 cycle, 110V AC power. One 1/4 HP motor (.18 kw) at 15 AMP @ 110V AC.

#### CUTTING HEAD REPLACEMENT PARTS

CAT. NO.	DIAGRAM NO.	DESCRIPTION
<b>35660000</b>		Complete Cutting Head (Less Cutting Wheel)
<b>35660001</b>	1	Oiler Cylinders and Valve Assembly
<b>35660002</b>	2	Brass Fitting and Oil Tube
<b>35660003</b>	3	Pivot Pin
<b>35660004</b>	4	Set Screw
<b>35660005</b>	5	Collar
<b>35660006</b>	6	Set Screw
<b>35660007</b>	7	Retainer Spring
<b>35660008</b>	8	Cap Screw
<b>35660009</b>	9	Pivot Bar
<b>35660010</b>	10	Pressure Spring
<b>35660011</b>	11	Jam Nut
<b>35660012</b>	12	Stop Bolt
<b>35660013</b>	13	Adjusting Rod
<b>35660015</b>	15	Wing Nut
<b>35660016</b>	16	Cap Screw (2 required)
<b>35660017</b>	17	Bearing (2 required)
<b>35660018</b>	18	Spacer
<b>35660021</b>	21	Pillar Post
<b>2103224</b>	22	Carbide Cutting Wheel 124°
<b>35660022</b>	22	Carbide Cutting Wheel 114°
<b>35660025</b>	22	Steel Cutting Wheel 126°
<b>35660026</b>	22	Carbide Cutting Wheel 134°
<b>35660027</b>	22	Carbide Cutting Wheel 144°
<b>35660023</b>	23	Split Head Body Casting

Minimum order: 1 each. All parts come one per package.

#### STALTER GLASS CUTTING MACHINES

CAT. NO.	GLASS SIZE	DIMENSIONS	MACHINE WEIGHT
<b>46082RB</b>	60" (1.5 m)	75" x 82" (1.9 x 2.1 m)	1100 lbs. (499 kg)
<b>47282RB</b>	72" (1.8 m)	87" x 82" (2.2 x 2.1 m)	1250 lbs. (567 kg)
<b>48482RB</b>	84" (2.1 m)	99" x 82" (2.5 x 2.1 m)	1400 lbs. (635 kg)
<b>49682RB</b>	96" (2.4 m)	111" x 82" (2.8 x 2.1 m)	1550 lbs. (703 kg)
<b>410882RB</b>	108" (2.8 m)	123" x 82" (3.1 x 2.1 m)	1700 lbs. (771 kg)

Minimum order: 1 each. F.O.B. Middlebury, Indiana. Must ship common carrier.

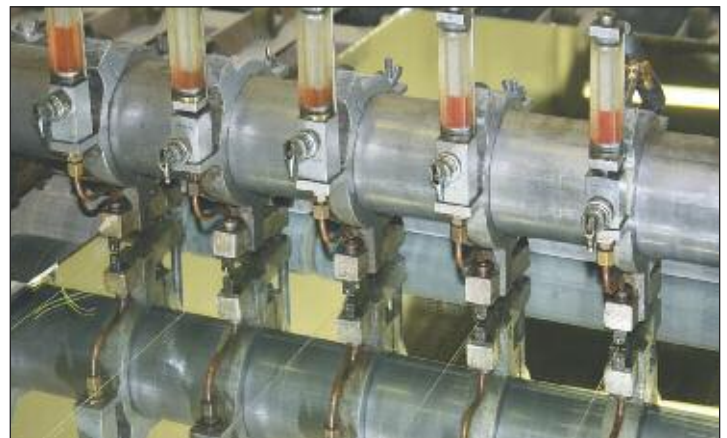

Cutting Heads on a CRL Stalter Machine in action, cutting mirror strips.

## CRL Safety Speed Cut Panel Saws

- Maximum Safety for One-Man Sawing Operations
- 64" and 76" (1625 and 1930 mm) Width Capacities
- Powerful 3-1/4 Horsepower Motor
- Operates on 110 Volts AC



Shown with Optional Dust Collection System and Bottom Wheels



For Blades to fit this saw see page 703K

Shown with Optional Bottom Wheels

Designed for one-man operation and maximum safety, this CRL Safety Speed Cut Panel Saw gives you the high quality and economical way to cut panels of plywood, particle board, masonite, acrylic plastic and plastic laminates. The many exclusive features offered by no other panel saw will convince you that this is the highest quality panel saw available today. To select the correct model, determine the widest crosscut capacity you need and then order the model that meets this requirement. This saw uses an 8" (203 mm) saw blade that is not included. See page 703K for blades to fit this saw.

### Standard and Exclusive Features Include:

- All steel frame, electrically welded square tubing can never warp or twist
- Thin material pressure guard provides chip and chatter-free cutting of thin material such as plastic laminates
- Heavy-duty counter balance with adjustable tension will provide years of trouble-free service
- Heavier-duty all ball and needle bearing power unit, 8" (203 mm), 13 AMP, 3-1/4 HP, 110V AC Motor
- Removable upper blade guard makes blade changing fast and easy
- Patented roller material carriage allows heavy material to roll through machine with no saw dust build-up
- Built-in vertical and horizontal rulers
- Material being ripped can move from either right or left
- Saw carriage moves up and down on graphite-impregnated nylon roller bearings which require no lubrication
- Cutting accuracy on all machines is guaranteed  $\pm 1/32"$  (.8 mm)
- Power unit can be turned from cross-cut position to either right or left hand ripping position by means of a single indexing pin control
- All panel saw motors can be greased externally, without disassembly or removal
- All safety speed cut panel saws are easily and completely adjustable
- All safety speed cut panel saws are shipped set up and pre-aligned, not knocked down

CAT. NO.	OVERALL HEIGHT	SAW FRAME LENGTH	CUTTING CAPACITY	FEATURES	SHIPPING WEIGHT
<b>SSCH5</b>	83" (2108 mm)	120" (3048 mm)	64" Wide (1625 mm) 1-3/4" (44.5 mm) Thick	Heavy-Duty 8" Milwaukee 6410 Power Unit, 13 AMP, 3-1/4 HP, 60 Cycle, 110V AC Motor Thin Material Pressure Guard	298 lbs. (135 kg)
<b>SSCH6</b>	95" (2413 mm)	120" (3048 mm)	76" Wide (1930 mm) 1-3/4" (44.5 mm) Thick		359 lbs. (163 kg)

Minimum order: 1 each. Ships F.O.B. Anoka, Minnesota.



## CRL Safety Speed Cut Panel Saw

- Compact and Portable 60" (1524 mm) Frame Length
- Quick Change From Vertical to Horizontal Cutting
- Adjustable Horizontal and Vertical Rulers
- Powerful 3-1/4 Horsepower 15 AMP Industrial Motor
- Operates on 120 Volts AC

This CRL Safety Speed Cut Panel Saw has been engineered to provide the small shop an accurate, dependable, heavy-duty panel saw that is truly portable and compact in size. It makes cutting large panels down to size easier, safer, and affordable. It has the same great features of our full size panel saws, but on a smaller, all-steel frame. In addition, it's shipped set up and pre-aligned, not knocked down. Cutting accuracy is guaranteed  $\pm 1/32"$  (.8 mm), and the power unit can be changed from cross-cut to ripping position quickly and simply. An 8" (203 mm) General Purpose Wood Saw Blade is required (Cat. No. 840ATB sold separately, see below). Additional options are available to enhance the performance and capability of your panel saw.



**CAT. NO. SSCC4**  
With Optional Wheels

### Standard and Exclusive Features Include:

- All-steel frame, electrically welded square tubing can never warp or twist
- Thin material pressure guard provides chip and chatter-free cutting of thin material such as plastic laminates
- Heavy-duty counter balance with adjustable tension will provide years of trouble-free service
- Heavier duty all ball and needle bearing power unit, 8" (203 mm), 15 AMP, 3-1/4 HP, 120V AC Motor
- Removable upper blade guard makes blade changing fast and easy
- Patented roller material carriage allows heavy material to roll through machine with no sawdust build-up
- Built-in vertical and horizontal rulers
- Material being ripped can move from either right or left
- Saw carriage moves up and down on graphite-impregnated nylon roller bearings which require no lubrication
- Cutting accuracy on all machines is guaranteed  $\pm 1/32"$  (.8 mm)
- Power unit can be turned from cross-cut position to either right or left hand ripping position by means of a single indexing pin control
- All panel saw motors can be greased externally, without disassembly or removal
- All Safety Speed Cut Panel Saws are easily and completely adjustable
- All Safety Speed Cut Panel Saws are shipped set up and pre-aligned, not knocked down
- 8" (203 mm) 40 Tooth Blade for general purpose wood sawing is sold separately.

CAT. NO.	OVERALL HEIGHT	SAW FRAME LENGTH	CUTTING CAPACITY	FEATURES	SHIPPING WEIGHT
<b>SSCC4</b>	70" (1778 mm)	60" (1524 mm)	50" (1270 mm) Cross-Cut 96" (2438 mm) Rip-Cut 1-3/4" (44.5 mm) Thick	Heavy-duty 8" Milwaukee 6410 Power Unit; 15 AMP, 3-1/4 HP, 60 Cycle, 120V AC Motor; Thin Material Pressure Guard	189 lbs. (86 kg)

Minimum order: 1 each. F.O.B. Anoka, Minnesota. Must ship common carrier.

## CRL 40 Tooth General Purpose Wood Saw Blade

- 8" (203 mm) Diameter
- 5/8" (16 mm) Arbor
- For Safety Speed Cut Panel Saws



This CRL 40 Tooth General Purpose Wood Saw Blade works with our Cat. No. SSCC4 Safety Speed Cut Panel Saw above. Minimum order is one each.

**CAT. NO. 840ATB**

## CRL Saw Blades

- Diameters From 7" to 15" (178 to 381 mm)
- Four Different Patterns of Carbide Teeth
- Five Different Styles of Blade
- Something for Nearly Every Application

CRL Saw Blades are stocked in carbide, high speed steel, semi high speed steel, resinoid, and resin bond diamond. Sizes ranging from 7" to 15" (178 to 381 mm) cover applications from glass sawing to storefront extrusion cutting. Refer to pages 455K-457K for full descriptions and selection.



## CRL CTD Fixed Double End 45 Degree Miter Saw

- World Renowned for Precision Engineering
- Makes Two Miter Cuts at One Time
- Precise Controls and Adjustments Minimize Scrap
- Offered With Most Popular Production Components

The CRL CTD D45AX Fixed 45 Degree Miter Saw represents the state-of-the-art in semi-automatic profile cutting. The saw arm, pivot brackets, and tabletop are precision-machined, ground-iron castings with milled slots for guide pivot brackets and fences.

The 34-1/2" (876 mm) tall table features a fully enclosed heavy gauge steel base with a 6" (152 mm) dust outlet and built-in scrap chute. The D45AX will accept 10" (254 mm), 12" (305 mm), or 14" (356 mm) Saw Blades. The individual saw heads are adjustable to compensate for blade variations resulting in minimized scrap. Another feature unique to the D45AX is the ability for adjustment of the blade position above the material to be cut and the precise length of the down stroke to cut that material. This allows minimal stroke time and maximum production. The D45AX is capable of cycling at one second intervals though actual cycle times, depending on material being cut.

The CRL D45AX comes fully equipped with the following components: Air Package with Filter, Regulator, and Lubricator with auto-drain, Pneumatic Foot Valve Actuator, two Vertical Air Clamps, two 60" (1524 mm) Work Table Extensions (left and right), Extended Fence Gauge with Manual Stop, Dual Magnetic Starters, Chip Breaker Support, and Blade Guard Interlock Switch. Factory configured for 12" (305 mm) Blades, (CRL Cat. No. CSB12X120AX sold separately). F.O.B. Los Angeles, CA. Must ship common carrier. Minimum order is one each.

### SPECIFICATIONS

**Electrical:** Three Phase, 230/460V AC, 60 Hz.

**Motors:** Two 1-1/2 HP, 3450 RPM With Fully Enclosed Fan Motors

**Air:** 75 PSI (5.4 kg/cm<sup>2</sup>), 1 cf per 10 Strokes at 75 PSI

**Shipping Weight:** 600 lbs. (272 kg)

**Blade Arbors:** 5/8" (16 mm) with 2-1/4" (57 mm) Blade Collars



CAT. NO. D45AX

## CRL CTD Double End Trim and Miter Saw

- Head Angle Accuracy Within .001"
- Capable of Up to 10 Strokes Per Minute
- Saw Heads Swivel From 90 to 45 Degrees
- Right Hand Head Travels for Long Miter or Square Cuts

The CRL CTD DM200R Double End Trim and Miter Saw is capable of cutting matching angles on each end of an extrusion whether they are 45 degree miters, 90 degree square cuts or any angle in between. The DM200R features precision-machined and ground-iron table castings. The floor stand is heavy gauge steel with maximum 96" (2438 mm) centers. The Right Hand Saw Head travels via rack and pinion gearing.

Safety Interlock System prevents heads from cycling until air clamps engage to hold material firmly in place. Units offered with blade coolant spray system. Configured for Cat. No. CSB12X120X1AX 12" (305 mm) Saw Blade (sold separately). F.O.B. Los Angeles, CA. Must ship common carrier. Minimum order is one each.



CAT. NO. DM200R

### SPECIFICATIONS

**Electrical:** Three Phase, 230/460V AC, 60 Hz.

**Motors:** 2 HP, 3450 RPM, Totally Enclosed Fan Cooled, With Starters and Voltage Protection

**Air:** 75 PSI (5.4 kg/cm<sup>2</sup>), 3 CFM at 75 PSI (.09 cubic meters at 5.2 kg/cm<sup>2</sup>)

**Blade:** 12" (305 mm), 1" (25.4 mm) Arbor With 2-1/2" (64 mm) Blade Collars

**Shipping Weight:** 1,050 lbs. (476 kg)

## CRL Heavy-Duty Router

- 1-3/4 HP 11 AMP Motor to Route Aluminum
- 1/4" and 1/2" (6.4 and 12.7 mm) Collets Included
- Double Insulated for Protection
- Calibrated Depth Gauge

The CRL 1-3/4 Horsepower D-Handle Router features an auto-release collet system which puts an end to "frozen" bits. This is a heavy-duty 11 AMP Router which operates at 27,500 rpm's. It has a precision machined aluminum motor housing and base, and has 100% sealed ball bearings. The base has a micrometer type depth-of-cut adjustment with an accuracy of up to .008" (.2 mm). Minimum order is one each.

### STANDARD EQUIPMENT:

- 1-3/4 Horsepower Motor
- D-Handle Base
- 1/4" (6.4 mm) Collet
- 1/2" (12.7 mm) Collet
- Collet Wrench
- Operating Manual



CAT. NO. PC691

## CRL High Speed Steel Spiral Bits

- 1/4" (6.4 mm) Shank High Speed (Aluminum Cutting) Spiral Bits



Single Flute Style



Double Flute Style

Use these CRL High Speed Steel Spiral Bits for routing aluminum storefront tubes. Bits are available in either a spiral up or spiral down configuration. Single fluted bits for faster cuts are available, as well as double spiraled bits for a smoother more precise cut. All bits are approximately 2-3/4" (70 mm) long.

CAT. NO.	FLUTES	FLUTE STYLE
J40007	Single	Up
J40008	Single	Down
J40107	Double	Up
J40108	Double	Down

Minimum order: 1 each. All Spiral Bits can be combined for quantity pricing.

## CRL Template Guides for PC691 Router

- Two Popular Sizes Available

CAT. NO. 42237

Locknut for Template Guides



CAT. NO. 42045

9/16" (14.3 mm) Template Guide

CAT. NO. 42046

7/32" (5.6 mm) Template Guide

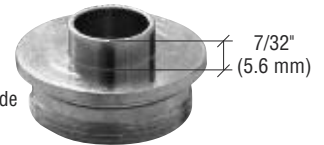

These two CRL Router Template Guides are the most popular sizes for routing storefront tubes for hinges. The Locknut is required to hold the Template Guides to the PC691 Router.

CAT. NO.	DESCRIPTION
42045	9/16" (14.3 mm) Template Guide for PC691 Router
42046	7/32" (5.6 mm) Template Guide for PC691 Router
42237	Locknut for Template Guides

Minimum order: 1 each.

## CRL Router Jig and Template

- Designed for Routing Storefront Tubes
- 1/8" (3.2 mm) Backset

This CRL Router Jig and Template is designed for routing storefront tubes for 4" or 4-1/2" (102 or 114.3 mm) butt hinges, and also for 1/8" (3.2 mm) hinge backsets. This Jig has a template for cutting tapered slots in tubes for Adams Rite® locks. Minimum order is one each.

Adams Rite is a registered trademark of Adams Rite Manufacturing Co.



CAT. NO. RJT4

## CRL Makita® 4-1/2" Angle Grinder

- Durable and Ergonomic 110V AC Tool
- Powerful 6.0 AMP Motor Delivers 11,000 RPM
- Small Circumference 2-1/4" (57 mm) Barrel Grip for Comfort
- Refined Design Weighing Only 3.1 Lbs. (1.4 kg) for Better Control



CAT. NO. GA4530

This CRL Makita® Angle Grinder is the perfect tool for cutting, notching, and edge finishing. The 6 AMP, 11,000 RPM motor delivers smooth continuous power for even the most demanding applications. The small circumference barrel grip and light weight assure increased control and added comfort. Motor brushes are externally accessible, and the all ball bearing design with a metal gear housing combine to make the GA4530 the ultimate in serviceability and durability.

The accessory control handle can be mounted on the left or right for added operator comfort, while the entire gear housing rotates to 90 degree stop-points to aid with cutting operations. Special 'Labyrinth' construction featuring protective zig-zag varnish seals help protect the motor from dust and debris, and will extend tool life. Minimum order is one each.

### Standard Equipment:

- 4-1/2" (114.3 mm) Grinding Wheel
- Wheel Guard
- Lock Nut
- Lock Nut Wrench
- Side Handle
- Inner Flange

## CRL Makita® Super Thin Cut-Off Wheel

- 4-1/2" (114.3 mm) Diameter Wheels Used for Cutting and Notching
- Fits GA4530 Grinder
- Just 3/64" (1.2 mm) Thick



Makita® Super Thin Cut-Off Wheels are just 3/64" (1.2 mm) thick for minimal stock removal and quick cutting when notching or cutting metal cladding. The fine grit edge cuts with a minimum of edge distortion. These stainless wheels are sold by the package of 25. **NOTE:** Center hole size: 7/8" (22 mm).

CAT. NO.	DESCRIPTION
7241112A25	25-Pack 4-1/2" (114.3 mm) Super Thin Wheel
1351032*	Wheel Guard
2243789*	Inner Flange

Minimum order: 1 package or 1 each. \*Wheel Flange and Wheel Guard are required to use Super Thin Wheels on the GA4530 Grinder.

Makita is a registered trademark of Makita Corporation.

## CRL Makita® Resin Fiber Finishing Discs

- 4-1/2" (114.3 mm) Diameter Discs Fit GA4530 Grinder
- Superior Stock Removal



Finishing Discs



CAT. NO. 7430363  
Rubber Backer Pad



CAT. NO. 1930480  
Lock Nut

These 4-1/2" (114.3 mm) Makita® Finishing Discs are great for wood or metal. Quickly finish freshly cut edges to remove burrs or rough surfaces. Choice of three grits.

**NOTE:** Center hole size: 7/8" (22 mm).

CAT. NO.	DESCRIPTION
794106A5	5-Pack 50 Grit Finishing Discs
794107A5	5-Pack 80 Grit Finishing Discs
794108A5	5-Pack 120 Grit Finishing Discs
7430363*	4-1/2" (114.3 mm) Rubber Backer Pad
1930480*	Lock Nut for Backer Pad

Minimum order: 1 package or 1 each. \*Backer Pad and Lock Nut are required to use Finishing Discs on GA4530 Grinder.

## CRL Makita® 7" Electronic Sander/Polisher

- Fast and Powerful Polishing for Clearcoat Finishes
- Variable Speed 600 to 3,000 RPM
- Easily Converts From Sander to Polisher



CAT. NO. PAD7



CAT. NO. 9227C

This CRL Makita® 7" (178 mm) Electronic Sander/Polisher maintains constant speed regardless of load variations, has a pre-set speed setting dial, and a lock-on button for continuous use at one speed. It is lightweight at 6.6 lbs. (3 kg), well balanced for easy handling, and double-insulated for operator safety. Standard 5/8" (16 mm) 11 UNC spindle. The 7" (178 mm) backup pad easily accepts all 7" (178 mm) sanding discs.

CAT. NO.	DESCRIPTION
9227C	Makita® Sander/Polisher
PAD7	7" (178 mm) Backup Pad

Minimum order: 1 each.

## CRL Makita® 4" Angle Grinder

- 4" (102 mm) Grinding Wheel
- 6.0 AMP Motor Design for High Output

The CRL Makita® GA4030 is a powerful, lightweight 4" (102 mm) Angle Grinder for polishing, sanding, or grinding. This 3.7 pound tool boasts a powerful 6 AMP motor, producing 11,000 RPM. The balanced ergonomic design features a 2-1/4" (57 mm) diameter body that measures just 10-1/4" (260 mm) long. The GA4030 comes with a 4" (102 mm) grinding wheel, wheel guard, lock-nut, lock-nut wrench, multi-position side handle, and inner flange. Minimum order is one each.



CAT. NO. GA4030

## CRL Bench Grinder

- Large 6" (152 mm) Diameter Wheels
- Operates on 110 Volts AC

This CRL Bench Grinder features a lubricated for life, shielded ball bearing, 1/2 HP, 4.2 AMP motor, assuring smooth grinder performance. The tool rest is adjustable for height and distance from the wheels. Dust exhausts are engineered to increase air flow. Minimum order is one each.



CAT. NO. B6G

## CRL 4" Flex Wheels



Flex Wheel

Plastic Backup Pad

The CRL 4" (102 mm) Flex Wheel is the most versatile wheel for light metal grinding, sanding, cutting, and weld blending. Must be used with Plastic Backup Pad.

CAT. NO.	DESCRIPTION
7414040BP	46 Grit 4" (102 mm) Wheel
7414040CP	60 Grit 4" (102 mm) Wheel
7414040DP	80 Grit 4" (102 mm) Wheel
7414040FP	120 Grit 4" (102 mm) Wheel
7430091A	Plastic Backup Pad

Minimum order: 1 each.

Makita is a registered trademark of Makita Corporation.

## CRL 4" Grinding Wheels



CRL 4" (102 mm) Grinding Wheels are for metal polishing and general flat grinding. Aluminum Oxide abrasive grains are evenly distributed to give a smooth surface.

CAT. NO.	DESCRIPTION
7414028	24 Grit 4" (102 mm) Wheel
7414052	36 Grit 4" (102 mm) Wheel

Minimum order: 1 each.

## CRL 4" Grinder Blades



CAT. NO. A94546

CAT. NO. A94580

CRL has two 4" (102 mm) Grinder Blades: Cat. No. A94546 is for concrete, block, and brick; Cat. No. A94580 is for granite and ceramic materials.

CAT. NO.	SPECIALTY USE
A94546	4" (102 mm) General Purpose
A94580	4" (102 mm) Granite and Ceramics

Minimum order: 1 each.

## CRL Metal Brake and Shear

- Ideal for Sheet Metal Fabricators and Solar Energy Panel Installers
- Unparalleled Bending Power
- Incorporates the Latest Technology

TrimCutter™ Shear (included)



Model MBS10 Shown

CRL's Metal Brake and Shear is designed for single user set-up and operation in the shop or on the job site. It will bend residential grade metals and most commercial metals used in roofing, siding, window, and gutter installations. The 14" (356 mm) throat allows for complex bending profiles and features a unique cam-locking system, along with new POWERslot™ technology for improved bending leverage. The stainless steel strip protects the bending edge and provides a superior guide for scoring material.

For cutting or shearing metal simply position your metal sheet into the brake and lock in place. Place the separate TrimCutter™ (included) onto the upper right side of the brake. Roll the TrimCutter™ along its track shearing the metal to size. The TrimCutter™ will cut painted steel sheet up to 24 gauge thick or .050 thick aluminum. A non-marring vinyl strip protects metal finishes, including clad, while leaving clean crisp bending lines and hems every time.

Each unit comes with a patented Xtreme™ shop stand that does not shake, rattle or loosen under any work load or job situation. With the longest service life of any portable brake of this class, you can depend on getting many years of reliable service.

CRL also has other Brakes and Shears available with different throat capacities, material thickness adjustments, and sizes which offer both shop and job site functions and features. For additional information contact the CRL Customer Service Department at (800) 421-6144 in the U.S., (877) 421-6144 from Canada, or (323) 588-1281 International. Ask for Extension 5275.

### MATERIAL CAPACITIES

	RECOMMENDED	MAXIMUM
Aluminum Coil	.040"	.063"
Gutter Coil	.032"	.032"
Galvanized Steel Grade D	24 ga.	20 ga.
Galvanized Steel Grade E	24 ga.	24 ga.
Copper	32 oz.	36 oz.

CAT. NO.	DESCRIPTION	WEIGHT
<b>MBS6</b>	78" (2 m) Metal Brake and Shear	119 lbs. (54 kg)
<b>MBS8</b>	102" (2.6 m) Metal Brake and Shear	148 lbs. (67 kg)
<b>MBS10</b>	126" (3.2 m) Metal Brake and Shear	176 lbs. (80 kg)
<b>MBS12</b>	150" (3.8 m) Metal Brake and Shear	206 lbs. (93 kg)
<b>MBS14</b>	168" (4.4 m) Metal Brake and Shear	235 lbs. (107 kg)
<b>BSV1V</b>	VHS Brake and Shear Video Tape	

Minimum order: 1 each. F.O.B. Farmington Hills, Michigan. Must ship common carrier.

## Technical Assistance for Choosing the Right Lifting Frame for Heavy Glass Handling

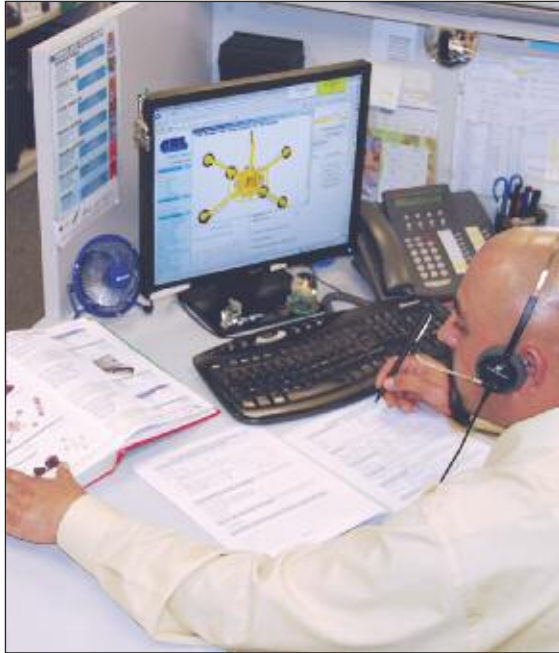

- CRL's Trained Staff is Ready to Provide Technical Assistance for All Your Glass Lifting and Handling Requirements
- Engineering Expertise is Available for Special Lifting Applications
- We Have the Answers to All Your Lifting Frame Questions Regarding Load Capacity, Power Requirements, and Load Manipulation

Vacuum Lifting Frames may become some of the most important tools used in your business and we have the technical support available to guide you in the proper selection to best suit your needs. Qualifying forms are used to determine which lifting frames will meet your needs.

If you already own a vacuum lifting frame and need technical assistance on maintenance, repair and/or replacement parts, we have all the troubleshooting guidance, part diagrams, and repair instructions for all CRL Wood's Powr-Grip® Vacuum Lifting Frames to get you back in business quickly and safely.

Contacting CRL for this information is easier than ever. Please call our Customer Service Department at (800) 421-6144 in the U.S., (877) 421-6144 from Canada, or (323) 588-1281 International. Ask for extension 5275. You can also send an e-mail by logging on to [crlaurence.com](http://crlaurence.com). From the home page click on Contact Us, then click on Customer Service.

## Engineering Expertise On-Hand, Available Direct from Wood's Powr-Grip®

- Custom Design Capability to Meet Special Lifting Requirements
- ASME Standard Guidelines Used for Custom Lifting on Below-the-Hook Lifting Devices
- Reliability, Safety, Ergonomics, and Affordability is Built Into Each Design

CRL teams up with the Wood's Powr-Grip® staff of highly skilled and specialized mechanical engineers to provide application designs that require special lifting and handling capabilities not offered from our selection of standard lifting devices.

These engineers use sophisticated design tools including math analysis software, computer aided design with 3-dimensional modeling, robust manufacturing software and finite element analysis technology to define and control every last screw on the machines they build. The result is a custom Vacuum Lifter made to fulfill your job requirements at the lowest possible cost and always with safety in mind first.



## CRL Provides Fast Access to Maintenance and Repair Instructions

- Troubleshooting and Repair Instructions Available for All Lifting Frames
- CRL Stocks the Most Common Replacement Parts for Your Equipment
- Assistance Available On-Line or By Phone

Easy to follow, step-by-step, plain language troubleshooting guides are available for every CRL Wood's Vacuum Lifter Frame. Each guide takes you through a sequence of checks to be made including the preliminary test, pad system tests, and the vacuum generating system test. Remember though, you always have the option to call or e-mail your question to our Customer Service Department to eliminate any doubt of the proper repair procedure. CRL will always be there to help you.

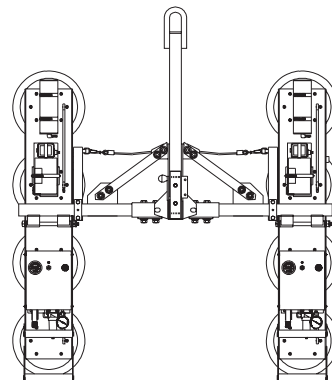

Wood's Powr-Grip is a registered trademark of Wood's Powr-Grip Co., Inc.

## CRL Online Vacuum Lifter Configurator Programs

- This Program Helps Determine Which Vacuum Lifting Equipment is Best Suited for Your Needs
- Access the Configurator Online at [crlaurence.com](http://crlaurence.com) for Below-the-Hook or Hand Held Vacuum Lifting Products



CRL has developed a web site "Vacuum Lifter Configurator" or product selection program for our line of Hand Held and Below-The-Hook Vacuum Lifting Devices. CRL offers so many Vacuum Lifting Devices that the selection process can become overwhelming. However, with our new Vacuum Lifter Configurator program there is now a way to quickly identify which Vacuum Cup or Lifting Frame is right for you!

By selecting a few basic qualifiers, the appropriate Vacuum Lifting Device is quickly narrowed down from our large selection. Find the right Vacuum Cup for use on glass, stone or metal; for use in glass fabrication, field installation or auto glass installation; for flat or curved pieces; smooth or textured surfaces; and based on the maximum weight (load) that needs to be lifted. Also choose how the load needs to be manipulated and/or tilted, tilt assisted, rotated, rotated and tilted, flat lifted or vertically lifted. To access the CRL Vacuum Lifter Configurator, simply go to [crlaurence.com](http://crlaurence.com) and click on Glass and Glazing, then Vacuum Lifter Configurator. See the next page for images and illustrations that demonstrate the easy selection process.



CAT. NO. 550



CAT. NO. 05063



CAT. NO. S338



CAT. NO. W4950



CAT. NO. S106VHP



CAT. NO. P11104DC



CAT. NO. PFHL69AC



CAT. NO. MRT411LDC

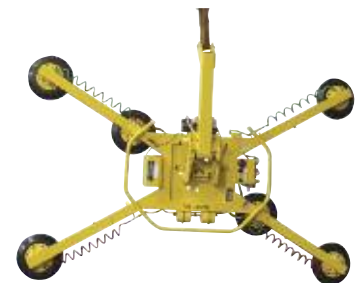

CAT. NO. MRTA611LDC



## CRL Online Vacuum Lifter Configurator Programs

- Choose From Either Below-the-Hook Vacuum Frames for Heavy Lifting or Hand Held Vacuum Lifters for Manual Lifting

### CRL Below-The-Hook Vacuum Lifting Frame Configurator (Example)

See the complete selection of Below-The-Hook Vacuum Lifting Frames on pages 714K-736K.

**CRL Configurator**

This online tool will help you select the most appropriate below-the-hook vacuum lifter to suit your particular requirement.

At any time you can place an order, click [here](#) to view your cart. You can also request an online quote, click [here](#) to request a quote. To speak with Customer Service simply call Toll Free at (800) 421-6144 ask for extension 6276, or to contact us via email, click [here](#).

• What type of material will you be handling?  
 ← Glass, Stone

• How will you be using the lifter?  
 ← Glass Fabrication, Installation, Auto Glass

• How does the load need to be manipulated?  
 ← Tilt Only, Rotate Only, Rotate and Tilt, Flat to Flat, Upright to Upright

• Do you prefer Manual or Power?  
 ← Manual

• What is the Maximum Load Weight in LBS/KGS?  
 ← ---Select---

23 Item(s) found!

PRODUCT	DESCRIPTION
• <a href="#">CFMR411LACS</a>	CRL Wood's™ Powr-Grip® AC Powered C-Frame Manual Rotator 4-Cup Vacuum Lifter 700 Series
• <a href="#">CFMR49ACS</a>	CRL Wood's™ Powr-Grip® AC Powered C-Frame Manual Rotator 4-Cup Vacuum Lifter 500 Series
• <a href="#">CFMT49ACS</a>	CRL Wood's™ Powr-Grip® AC Powered C-Frame Manual Tilting 4-Cup Vacuum Lifter 500 Series
• <a href="#">CFMT69ACS</a>	CRL Wood's™ Powr-Grip® AC Powered C-Frame Manual Tilting 6-Cup Vacuum Lifter 750 Series
• <a href="#">CFPT49AC</a>	CRL Wood's™ Powr-Grip® AC Powered C-Frame Power Tilter 4-Cup Vacuum Lifter 500 Series

### CRL Hand Held Vacuum Cup Configurator (Example)

See the complete selection of Hand Held Vacuum Cups on pages 202K-223K.

**CRL Configurator**

This online tool will help you select the most appropriate Hand Cup to suit your particular requirement.

At any time you can place an order, click [here](#) to view your cart. You can also request an online quote, click [here](#) to request a quote. To speak with Customer Service simply call Toll Free at (800) 421-6144 ask for extension 6276, or to contact us via email, click [here](#).

• What will the Hand Cup be used for?  
 ← Lifter, Mounting

• For Smooth or Textured Surfaces?  
 ← Smooth, Textured

• Flat, Curved Glass or Both?  
 ← Flat, Curved, Both

• What is the Maximum Load Weight in LBS/KGS?  
 ← 125 LBS (57 KG)

• Lever or Pump Type Activation or Pressure Applied?  
 ← ---Select---

8 Item(s) found!

PRODUCT	DESCRIPTION
• <a href="#">550</a>	CRL 5" Heavy-Duty Double Vacuum Cup
• <a href="#">H4900</a>	CRL Wood's Powr-Grip® Hybrid Handle 8" Vacuum Cup
• <a href="#">S338</a>	CRL Sure-Grip 8" Vacuum Lifter
• <a href="#">W4000</a>	CRL Wood's Powr-Grip® 8" ABS Handle Vacuum Cup
• <a href="#">W4000WBP</a>	CRL Wood's Powr-Grip® 8" Vacuum Cups With Low Vacuum Audio Alarm - ABS Handle

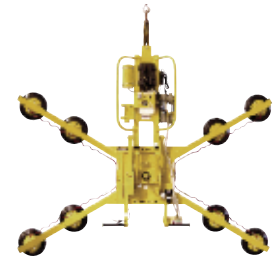
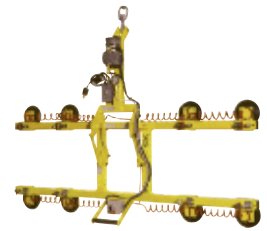
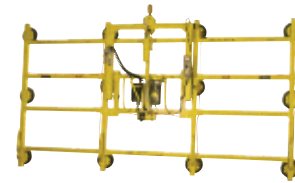

## CRL Wood's Powr-Grip® Ladder Lifter

- The Fastest, Safest, and Most Efficient Way to Install Above Grade Windows
- Reduces Installation Crew to Only Two People
- Eliminates Staging of Scaffolding
- Can Be Used From Interior or Exterior

Watch the Ladder Lifter in Action!  
View the Video at [crlaurence.com](http://crlaurence.com)



Developed by a high-volume remodeling contractor, the new CRL Wood's Powr-Grip® Ladder Lifter makes second story window installations safer and easier than ever. The Ladder Lifter quickly clamps onto the rungs of your ladder with the Pulley Assembly on top, and the Braking Winch Assembly near the bottom. Suspended from the galvanized steel cable is the adjustable width Hand Cup Lifter Bar that uses two Cat. No. W4950 Metal Handle 8" (203 mm) Powr-Grip® Vacuum Cups that you attach to the glass. Cups can be positioned along the bar to span exterior muntins when required.

You can easily lift up to 185 lbs. (84 kg) safely using the winch to precisely position the window unit. Using a second ladder the window can then be fitted and sealed into place. Because the Ladder Lifter uses a special "Braking" Winch there's no need to flip levers to lock the unit into place. Just release the winch handle and you are locked into position. To lower the Lifter Bar simply rotate the winch handle counterclockwise.

Typical installations require only a two-person crew and two hours to complete because there is no time lost staging and disassembling scaffolding, so payback for your Ladder Lifter is fast.

**NOTE:** Use only where the Vacuum Cups can be monitored and re-pumped if necessary. When Ladder Lifter is attached, the ladder may not be used to support workers. Ladders used in conjunction with the Ladder Lifter must have a minimum load capacity of 375 lbs. (170 kg).

CAT. NO.	DESCRIPTION
LL185	Wood's Ladder Lifter Without Vacuum Cups
LL185C	Wood's Ladder Lifter With Two W4950 8" (203 mm) Vacuum Cups

Minimum order: 1 each. CRL Wood's Ladder Lifters are shipped via U.P.S. from your nearest CRL regional warehouse.

## CRL Ladder Lifter Third Cup Accessories

Optional Third Vacuum Cup Accessories are available for additional load stabilization. The Adjustable Center Arm can be retrofitted on all Ladder Lifters produced after January 2007, and can be positioned in 2" (50.8 mm) increments vertically and 1/2" (12.7 mm) horizontally. The adjustable Horizontal Lift Bar Third Cup Holder is also available. It mounts and slides on the horizontal cross bar in a similar fashion to the two original cup mounts. Minimum order for either accessory is one each. Individual Cat. No. W4950 8" (203 mm) Powr-Grip® Vacuum Cups are sold separately (see page 212K).



CAT. NO. LL185CA

Horizontal Lift Bar  
Third Cup Holder



CAT. NO. LL185EXT

Center Arm for Addition of Third  
Powr-Grip® Cup (not included)

**NOTE:** The addition of a third vacuum cup does not add to the maximum lifting capacity of 185 lbs. (84 kg).

Wood's Powr-Grip is a registered trademark of Wood's Powr-Grip Co., Inc.

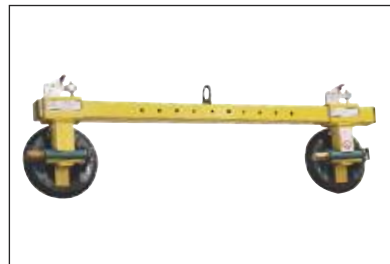

Hand Cup Lifter Bar Assembly



Top Pulley Assembly

### SPECIFICATIONS:

Adjustable Pad Spread With Two 8" (203 mm) Wood's Powr-Grip® Hand Vacuum Cups (to Outside Edge of Cups)  
**Minimum:** 8" x 16" (203 x 407 mm)  
**Maximum:** 8" x 39" (203 x 990 mm)  
**Load Capacity:** 185 lbs. (84 kg) with ANSI Type 1AA 375 lbs. (170 kg) capacity ladder (not included).



Bottom Braking Winch Assembly

## Easy Set Up and Operation



Position



Lift



Install

## CRL Wood's Eazi Lifter® Window Crane Kit

**new**

- Install Windows Above Ground Level Safely and Efficiently
- Eliminates Need for Scaffolding, Scissor Lifts, or Other Access Equipment
- 220 Pound (100 kg) Maximum Load Capacity

This CRL Wood's Eazi Lifter® Window Crane permits one person to safely lift windows up to three stories (30 feet) off the ground, and will hold the window in place during installation. The Crane can also be used for removing windows in multi-story buildings, when dealing with irregular terrain and landscaping. Avoid carrying windows up and down stairways, over obstacles, or through the home when doing retrofits. The unit features a boom that extends through the window opening while a winch raises or lowers the window, supporting the window's weight. The portable lifting device handles windows up to 220 pounds (100 kg), increasing productivity and worker safety.

Cat. No. EAZ1LK Eazi Lifter® Window Crane Kit comes complete with: extension tubes and mounts, allowing use in virtually any size window opening up to 103" (2.6 m) tall; shallow reveal head plate; raked angle head plate adapter; two guide straps for exterior control from the ground; chain mount with clamps for two vacuum cups (sold separately, see page 212K).

Cat. No. EAZ1LC is for the Eazi Lifter® Window Crane only. It has a maximum vertical clamping extension of 60" (1.5 m) within a window opening.

Cat. No. EAZ1EXT is the Crane Extension Kit that extends the clamping ability from 60" (1.5 m) to 103" (2.6 m) tall within window openings. The Crane Extension Kit includes extension tubes and plates, a raked angle header plate, and a shallow reveal header plate.

Cat. No. EAZ1L Eazi Lifter® Accessories Kit provides replacement parts for the EAZ1LK Complete Kit and additional parts for the EAZ1LC Crane Only Kit. Included are two guide straps for ground control of window, quick links, chain, attachment clasp, and vacuum cup collars. Vacuum Cups are sold separately, see page 212K.



**CAT. NO. EAZ1LK**

Complete Eazi Lifter® Window Crane Kit



**CAT. NO. EAZ1L**

Replacement Accessories Kit



**CAT. NO. EAZ1EXT**

Extension Kit for Openings up to 103" (2.6 m) Tall

CAT. NO.	DESCRIPTION
EAZ1LK	Complete Eazi Lifter® Window Crane Kit
EAZ1LC	Eazi Lifter® Window Crane Only
EAZ1EXT	Crane Extension Kit for Openings to 103" (2.6 m) Tall
EAZ1L	Replacement Accessories Kit

Minimum order: 1 each. F.O.B. Laurel, Montana.

Eazi Lifter is a registered trademark of Jeffrey Lee Crowder.

## CRL Forklift Boom

**new**

- For Use With 2 and 2-1/2 Ton (1814 and 2268 kg) Forklift Trucks
- Extends to 94-1/2" (2400 mm) Reach
- 1100 Pound (499 kg) Capacity at Maximum Extension
- 2200 Pound (998 kg) Capacity When Retracted



This CRL Forklift Boom is designed for use on 2 and 2-1/2 ton forklift trucks, and offers versatility with maximum visibility for the driver. Boom can be set in one of four positions, from 42-1/2" (1080 mm) to 94-1/2" (2400 mm). Slots for forks measure 6-1/2" by 2-1/2" (165 by 63 mm). Minimum order is one each. Must ship common carrier.

**CAT. NO. FLB1100**

# CRL MANUAL VACUUM LIFTING FRAMES

For Pricing Visit [crlaurence.com](http://crlaurence.com) or Call Us Toll Free at the Phone Numbers Shown on the Back Cover

## CRL Rotating Hand Cup Lifting Frames

- 4 Cup and 6 Cup Options Use Standard CRL Vacuum Lifters
- Edgewise Rotation
- Heavy-Duty Steel Construction



**CAT. NO. ROW40**  
500 Pound (227 kg)  
Capacity



**CAT. NO. ROW60**  
700 Pound (318 kg)  
Capacity



**CAT. NO. S110**  
10" (254 mm)  
Vacuum Lifter

These CRL 4 and 6 Cup Steel Rotating Hand Cup Lifting Frames offer an economical way to expand your lifting capabilities by providing an ideal method for moving glass quickly, either in the warehouse or on the jobsite, where rotation is required. The ROW40 and ROW60 work in conjunction with a crane, hoist or forklift to make the task of moving heavy glass up to 700 lbs. (318 kg), safe and efficient. Load movement takes place by manual rotation, 180 degrees edgewise, with locking in three positions. Minimum order is one each. Must ship common carrier.

The ROW40 holds four Vacuum Lifters, measures 36" x 24" (915 x 610 mm), and weighs 40 lbs. (18.1 kg). The ROW60 holds six Vacuum Lifters, measures 60" x 24" (1524 x 610 mm), and weighs 80 lbs. (36.3 kg). CRL Vacuum Lifters are sold separately. See Page 205K.

## CRL Rotating/Tilting Hand Cup Lifting Frames

- 4 Cup and 6 Cup Options Use Standard CRL Vacuum Lifters
- Edgewise Rotation and Tilt
- Heavy-Duty Steel Construction



**CAT. NO. ROW60T**  
700 Pound (318 kg)  
Capacity



**CAT. NO. ROW40T**  
500 Pound (227 kg)  
Capacity



**CAT. NO. S110**  
10" (254 mm)  
Vacuum Lifter

The CRL Rotating/Tilting Hand Cup Lifting Frames offer all the basic advantages as our Rotating Frames, plus more features and versatility. These Tilting Frames rotate nearly 360 degrees and tilt with a manual catch from full vertical to flat. These frames are ideal for skylight or canopy field glazing, as well as lifting large lites from fabrication tables onto A-frames or delivery trucks. Frames will accept 8" (203 mm) CRL Vacuum Lifters, but for the ultimate safety margin we recommend the CRL S110 10" (254 mm) Vacuum Lifter. See page 205K. Minimum order is one each. Must ship common carrier.

The ROW40T holds four Vacuum Lifters, measures 36" x 24" (915 x 610 mm), and weighs 50 lbs. (22.7 kg). The ROW60T holds six Vacuum Lifters, measures 60" x 24" (1524 x 610 mm), and weighs 90 lbs. (40.9 kg). CRL Vacuum Lifters are sold separately. See Page 205K.



**C.R. LAURENCE COMPANY**

[crlaurence.com](http://crlaurence.com) | [usalum.com](http://usalum.com)

**ALUMINUM** 714K | [crlaurence.ca](http://crlaurence.ca) [crlaurence.com.au](http://crlaurence.com.au) [crlaurence.co.uk](http://crlaurence.co.uk) [crlaurence.de](http://crlaurence.de) [crlaurence.eu](http://crlaurence.eu)

## CRL Wood's Powr-Grip® Rotate and Tilt Hand Cup Frames

### Standard Pad Spread\*:

(to outside edge of cups):  
46" x 57" (1169 x 1448 mm)

**Number/Size of Cups\*:** 6 / 9" (229 mm) diameter

**Lifting Capacity\*:** 700 lbs. (317 kg)

**Unit Weight\*:** 75 lbs. (34 kg)

**Load Movement:** Manual rotation, 180 degree edgewise with locking in three positions. Manual tilt, 90 degrees between upright and flat, with automatic latching in upright position.

**Units:** Available in Horizontal Configuration (HFH) or in Vertical Configuration (HFV)

### Standard Features:

Bolt-on Hand Cup Mounts

### Available Options:

- C-frame lift bar **CAT. NO. LB3CFL**
- Special sizes and capacities upon request
- \* With Wood's Powr-Grip® Hand-Held Vacuum Cups (Cat. No. W5450, sold separately)

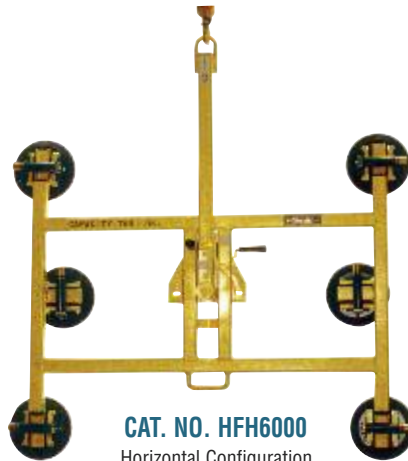

**CAT. NO. HFH6000**  
Horizontal Configuration  
46" x 57" (1169 x 1448 mm)



**CAT. NO. HFV6000**  
Vertical Configuration  
57" x 46" (1448 x 1169 mm)

**NOTE:** These Vacuum Lifters provide an inexpensive way to put Powr-Grips® Hand-Held Vacuum Cups to work on a crane, hoist or forklift. Units can be tilted ONLY when the lift bar is locked in the center position, as shown in photos. Uses your 9" (227 mm) W5450 Vacuum Cups. Use only where Cups can be monitored and re-pumped if necessary. Minimum order is one each. F.O.B. Laurel, Montana.

## CRL Wood's Powr-Grip® Vertical Lift Hand Cup Frames

### Standard Pad Spread\*:

(to outside edge of cups):  
**VL3000S:** 9" x 57" (229 x 1448 mm)  
**VL3000L:** 38" x 57" (966 x 1448 mm)

**Number/Size of Cups\*:**

3 / 9" (229 mm) diameter

**Lifting Capacity\*:** 330 lbs. (150 kg)

**Unit Weight\*:** 75 lbs. (34 kg)

**VL3000S:** 23 lbs. (11 kg)

**VL3000L:** 27 lbs. (13 kg)

**Load Movement:** Upright to upright.

### Standard Features:

Quick-detach Hand Cup Mounts

### Available Options:

- Special sizes and capacities upon request
- \* With Wood's Powr-Grip® Hand-Held Vacuum Cups (Cat. No. W5450, sold separately)



**CAT. NO. VL3000S**  
Short Center Cup Arm

**CAT. NO. VL3000L**  
Long Center Cup Arm

**NOTE:** These Vacuum Lifters provide an inexpensive way to put Powr-Grips® Hand-Held Vacuum Cups to work on a crane, hoist or forklift. Uses your 9" (227 mm) W5450 Vacuum Cups. Use only where Cups can be monitored and re-pumped if necessary. Minimum order is one each. F.O.B. Laurel, Montana.

## CRL Wood's Powr-Grip® Vertical Lift Hand Cup Frame 220

### Standard Pad Spread\*:

(to outside edge of cups):  
Minimum: 9-1/4" x 18-1/2" (232 x 473 mm)  
Maximum: 9-1/4" x 42-1/2" (232 x 1083 mm)

**Number/Size of Cups\*:** 2 / 9" (229 mm) diameter

**Lifting Capacity\*:** 220 lbs. (100 kg)

**Unit Weight\*:** 17 lbs. (8 kg)

**Load Movement:** Upright to upright.

### Standard Features:

Sliding Hand Cup Mounts

### Available Options:

- Adjustable center arm
- Special sizes and capacities upon request
- \* With Wood's Powr-Grip® Hand-Held Vacuum Cups (Cat. No. W5450, sold separately)



**NOTE:** These Vacuum Lifters provide an inexpensive way to put Powr-Grips® Hand-Held Vacuum Cups to work on a crane, hoist or forklift. Uses your 9" (227 mm) W5450 Vacuum Cups. Use only where Cups can be monitored and re-pumped if necessary. Minimum order is one each. F.O.B. Laurel, Montana.

**CAT. NO. VL2MAN**

Wood's Powr-Grip is a registered trademark of Wood's Powr-Grip Co., Inc.

## CRL Wood's Powr-Grip® Multipurpose Vacuum Lifters

Designed to be lightweight and rugged, Wood's Multipurpose Vacuum Lifters provide an efficient and economical approach to glass installation and low-volume fabrication. Multipurpose Rotator/Tilters incorporate rotation and tilt for quick and precise glass positioning. 12 Volt DC vacuum pumps are standard on most models, allowing cord-free operation of Vacuum Lifters at the job site or in various shop locations. Presented here are several selections of new CRL Wood's Powr-Grip® Vacuum Lifting Frames you will find on the following pages to assist you in your glass processing and installation requirements.



**Manual Rotator  
MRT Series**

Delivering manual 360 degree rotation and 90 degree tilt from any rotated position, these vacuum lifters provide economy and versatility in the shop or at the installation site. Movable vacuum pads and extension arms create three configurations of the vacuum pads, for handling materials of nearly any size. Cord-free DC power allows operation of the Vacuum Lifters from cranes, forklifts or floor hoists. When equipped with a Forklift Adapter (Cat. No. LB7FA0 option), a Vacuum Lifter mounts directly to the forks, for handling loads within the warehouse or installing exterior cladding under overhangs. Capacities to 700 lbs (318 kg). See page 727K for details.

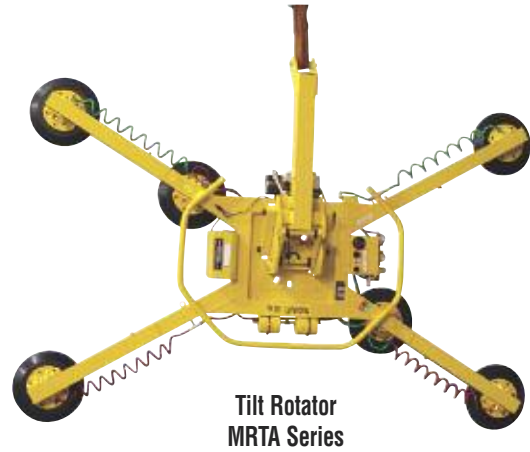

**Tilt Rotator  
MRTA Series**

A low-profile design makes these Vacuum Lifters ideal for installing construction materials between buildings and scaffolding or similar narrow locations. 180 degree manual rotation and 90 degree manual tilt provide ample load maneuverability, while a specially designed tilt mechanism significantly reduces operator effort. Adaptable pad frame frames supply the flexibility to handle various load dimensions, and on-board DC power allows for use at construction sites or any location lacking AC power. Wood's Dual Vacuum System also comes standard on these Vacuum Lifters, to reduce the risk of falling loads which might otherwise occur in an emergency. 1100 lbs (500 kg) maximum capacity. See pages 728K to 731K for details.



**Double Channel Lifter  
P2 Series**



**Channel Lifter  
P1 Series**



**CB1S  
Counter Balancer**

These modular Vacuum Lifters are expandable to meet a variety of materials handling needs. Interchangeable Lift Frames provide manual 180 degree rotation and 90 degree tilt. Pad Channels can be switched from one Lift Frame to another in minutes, for maximum versatility at the installation site. On-board DC power permits cord-free use of the Vacuum Lifter with cranes, forklifts or floor hoists. AC powered Vacuum Lifters are also available. When combined with the CB1S Counter-Balancer, Double-Channel Vacuum Lifters can be used to install windows and exterior surfacing materials under overhangs or in other low-clearance settings.

Wood's Powr-Grip is a registered trademark of Wood's Powr-Grip Co., Inc.

## CRL Wood's Powr-Grip® Rotators for Glass Production



**Air Power Rotator  
PR Series**



**AC Power Rotator  
PR Series**

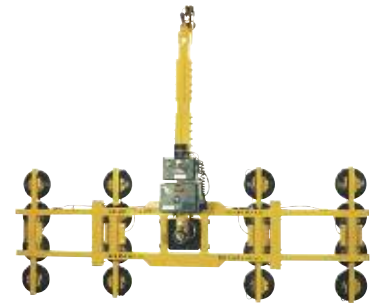

**Manual Rotator  
MR Series**

CRL Wood's Powr-Grip® Rotators allow glass to rotate edgewise along the vertical axis of the Vacuum Lifter, for loading and turning lites on vertical edgers, bevellers or similar production machinery. In most cases, these Vacuum Lifters provide 360 degrees of continuous rotation, to ensure quick and accurate glass positioning. Available with either manual or powered rotation, CRL Wood's Powr-Grip® Rotators are built for heavy-duty production line service. See pages 732K to 734K for details

## CRL Wood's Powr-Grip® Tilters for Glass Production



**Manual Tilter  
MT Series**

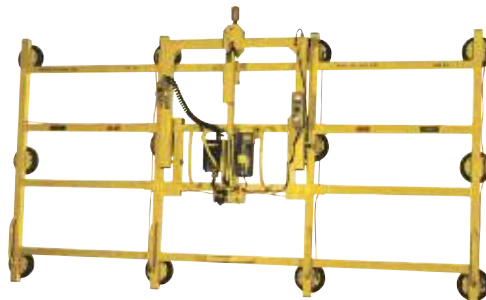

**Power Tilter  
PT Series**



**Mechanical Assist Tilter  
MTA Series**

When equipment requirements call for tilting glass 90 degrees between upright and flat positions, a tilter or "upender" is employed. CRL Wood's Powr-Grip® Tilters help to increase speed and mobility for glass transfers to and from cutting tables or production machinery, while providing sufficient glass support and rigidity to avoid breakage during the tilt. Factors such as glass size, thickness and stress placed on the glass due to jarring or bumping are considered in the design of these Vacuum Lifters. See page 735K for details.

## CRL Wood's Powr-Grip® Vertical, Flat, and C-Frame Lifters for Glass Production



**Vertical Lifter  
VLGG Series**



**Flat Lifter  
FL Series**



**C-Frame Lifter  
CF Series**

Vertical Lifters attach to vertically oriented glass surfaces, allowing movement of glass from place to place in the upright position. Overhead hoists or cranes provide the upward and downward movement of the vacuum lifter. A Vertical Lifter is used when rotation and tilt are not required for load positioning.

Flat Lifters are available in a wide variety of styles and capacities for handling horizontally oriented materials, including sheet metals, I-beams, modular construction panels, wood products and truck body panels. These Vacuum Lifters commonly feature adjustable pad frames, in order to handle irregularly shaped materials or to avoid holes and surface obstructions.

CRL Wood's Powr-Grip® unique C-shaped Vacuum Lifters help increase profits by quickly transferring glass directly into and out of the shipping case. Removal of the front of the case, as opposed to the end, keeps the case intact for reuse. This saves time, money and resources by reducing the time and manpower involved in rebuilding old cases or making new ones.

Wood's Powr-Grip is a registered trademark of Wood's Powr-Grip Co., Inc.

## CRL Wood's Powr-Grip® Vacuum Lifting Frame Rental Program

ALSO AVAILABLE FOR  
**rent**

- Not Enough Heavy Glass Lifting to Warrant a Purchase? Why Not Rent?
- Five Models to Choose From With Lifting Capacities of Up to 2,800 Pounds (1270 kg)
- Rent by the Week or Rent With an Option to Purchase

CRL offers large Wood's Powr-Grip® Vacuum Lifting Frames on a week-to-week rental basis from seven locations in North America, Europe, and Australia. Five styles of Lifting Frames are available to suit most heavy glass lifting requirements. Frames are shipped in enclosed, re-usable shipping crates (see opposite page).

Rental rate time is based on a one week minimum and begins on the day the Lifting Frame arrives at your destination. Rental rate billing ends on the day the Lifting Frame is shipped back to the originating CRL Service Center. Any portion of a week will be billed as a full week. Renting to CRL's open-account customers requires a current balance and available credit to secure the equipment during use. Renting for non-open account customers will require a security deposit. **Note:** Customers are responsible for outbound and return common carrier freight charges and any damage caused by improper packing or shipping.

Demand for renting CRL Wood's Vacuum Lifting Frames varies so it's best to contact us as far in advance as possible. For availability and rental rates please contact us at the toll free telephone numbers or emails listed below. At that time we will evaluate your lifting requirements and recommend the best and safest Vacuum Lifting Frame to suit your application based on material type, load weight, size, and lift movement.

## CRL Wood's Vacuum Lifting Frame Rental Locations

- Seven World Wide Rental Locations at Your Service

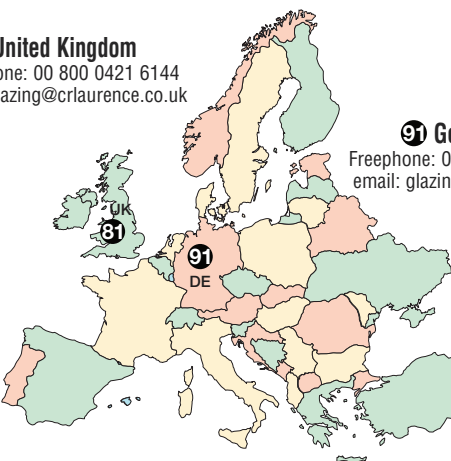

**81 United Kingdom**  
Freephone: 00 800 0421 6144  
email: [glazing@crlaurence.co.uk](mailto:glazing@crlaurence.co.uk)

**91 Germany**  
Freephone: 00 800 0421 6144  
email: [glazing@crlaurence.de](mailto:glazing@crlaurence.de)



**33 Canada**  
Toll Free: (877) 421-6144  
email: [glazing@crlaurence.ca](mailto:glazing@crlaurence.ca)

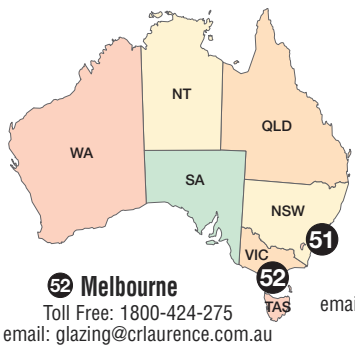

**51 Sydney**  
Toll Free: 1800-424-275  
email: [glazing@crlaurence.com.au](mailto:glazing@crlaurence.com.au)

**52 Melbourne**  
Toll Free: 1800-424-275  
email: [glazing@crlaurence.com.au](mailto:glazing@crlaurence.com.au)

**52 Perth**

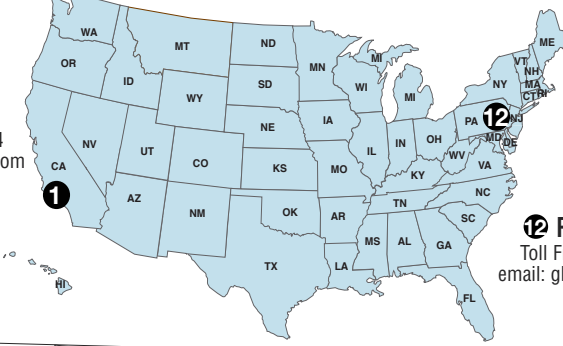

**1 Los Angeles**  
Toll Free: (800) 421-6144  
email: [glazing@crlaurence.com](mailto:glazing@crlaurence.com)

**12 Philadelphia**  
Toll Free: (800) 421-6144  
email: [glazing@crlaurence.com](mailto:glazing@crlaurence.com)



Wood's Powr-Grip is a registered trademark of Wood's Powr-Grip Co., Inc.



## CRL Wood's Powr-Grip® Vacuum Lifting Frames for Rent

- You Can Rent Models in Sizes and Capacities to Meet Almost Every Heavy Glass Lifting Requirement
- Inspected by Trained Technicians After Each Rental Return to Certify Reliability
- All Rental Models Can Tilt and Rotate 90 Degrees in Both Directions

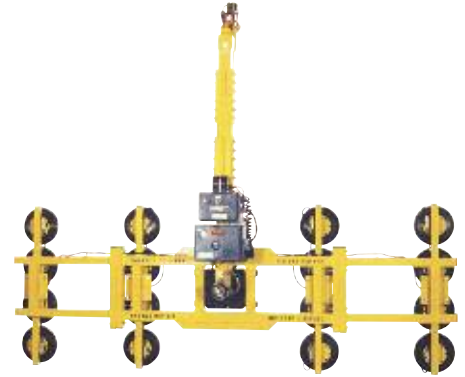

**CAT. NO. P11104DC** - North America  
**CAT. NO. AUP11104DC** - Australia Only  
**CAT. NO. EUP11104DCO** - Europe Only  
 Lifting Capacity:  
 700 lbs. (317 kg)  
 for Specifications  
 See Page 722K



**CAT. NO. MR1611LDC**  
 Lifting Capacity:  
 2,800 lbs. (1270 kg)  
 for Specifications  
 See Page 726K



**CAT. NO. MRT411LDC** - North America  
**CAT. NO. AUMRT411LDC** - Australia Only  
**CAT. NO. EUMRT411LDC** - Europe Only  
 Lifting Capacity: 700 lbs. (317 kg)  
 for Specifications See Page 727K

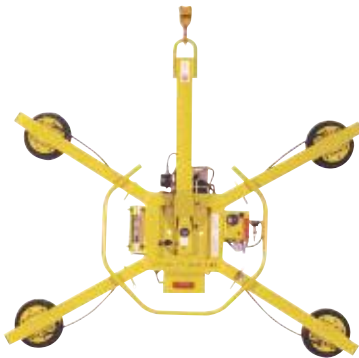

**CAT. NO. P2110445DC** - North America  
**CAT. NO. AUP2110445DC** - Australia Only  
**CAT. NO. EUP2110445DCO** - Europe Only  
 Lifting Capacity: 1,400 lbs. (635 kg)  
 for Specifications See Page 724K

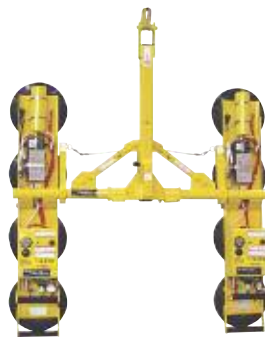

**CAT. NO. P211047DC** - North America  
**CAT. NO. AUP211047DC** - Australia Only  
**CAT. NO. EUP211047DCO** - Europe Only  
 Lifting Capacity: 1,400 lbs. (635 kg)  
 for Specifications See Page 725K



Wood's Powr-Grip is a registered trademark of Wood's Powr-Grip Co., Inc.

## CRL Wood's Powr-Grip® Horizontal Powr-Frames™ 700

- For Tilting and Rotating Horizontally Oriented Materials
- Battery Operation

Units can be tilted ONLY when the lift bar is locked in the center position, as shown on photos.

### Standard Pad Spread:

Small Frame: 37-1/4" x 46-1/4"  
(943 x 1172 mm)  
Large Frame: 46-1/4" x 57-1/4"  
(1172 x 1451 mm)

### Number/Size of Pads:

6 / 9" (229 mm) diameter

### Lifting Capacity:

6 pads - 700 lbs. (320 kg)

### Average Unit Weight:

80 lbs. (37 kg)

### Standard Operating Power:

12V DC, 8 AMP

### Load Movement:

Manual rotation, 180 degree edgewise, with locking in three positions. Manual tilt, 90 degrees between upright and flat, with automatic latching in upright position.

### Standard Features:

On-board Battery and Charger  
Battery Energy Gauge  
Low Vacuum Warning Light  
Vacuum Gauge  
Vacuum Line Filter  
Vacuum Reserve Tank  
Spring-mounted Pads

### Available Options

- Dual Vacuum System **CAT. NO. E010DVS**
- C-Frame Lift Bar **CAT. NO. LB3CFL**
- Vacuum Loss Warning Buzzer **CAT. NO. E03VLW**
- Individual Pad Shutoffs **CAT. NO. CM1COWB**
- Voltage Adaptation **CAT. NO. E06VA**
- Removable Control Pendant **CAT. NO. E09RP** (Available on DC units only).
- 10" (254 mm) Diameter Lipped Vacuum Pads **CAT. NO. HV11**
- Closed Cell Foam Pad Rings **CAT. NO. FRHV11** (available with **CAT. NO. HV11** pads only).

For special sizes and capacities, please contact our Customer Service Department at (800) 421-6144 in the U.S., (877) 421-6144 from Canada, or (323) 588-1281 International, and ask for Ext. 5275.



DC POWER CAT. NO.	AC POWER CAT. NO.	DESCRIPTION
<b>PFHS69DC</b>	<b>PFHS69AC</b>	120V AC Small Horizontal Powr-Frame™ 700
<b>PFHL69DC</b>	<b>PFHL69AC</b>	120V AC Large Horizontal Powr-Frame™ 700
<b>AUPFHS69DC</b>	<b>AUPFHS69AC</b>	240V AC Small Horizontal Powr-Frame™ 700 (Australia)
<b>AUPFHL69DC</b>	<b>AUPFHL69AC</b>	240V AC Large Horizontal Powr-Frame™ 700 (Australia)

Minimum order: 1 each. F.O.B. Laurel, Montana.

## CRL Wood's Powr-Grip® Vertical Powr-Frames™ 700

- For Tilting and Rotating Vertically Oriented Materials
- Battery Operation

Units can be tilted ONLY when the lift bar is locked in the center position, as shown on photos.

### Standard Pad Spread:

57-1/4" x 46" (1451 x 1172 mm)

### Number/Size of Pads:

6 / 9" (229 mm) diameter

### Lifting Capacity:

6 pads - 700 lbs. (320 kg)

### Average Unit Weight:

80 lbs. (37 kg)

### Standard Operating Power:

12V DC, 8 AMP

### Load Movement:

Manual rotation, 180 degree edgewise, with locking in three positions. Manual tilt, 90 degrees between upright and flat, with automatic latching in upright position.

### Standard Features:

On-board Battery and Charger  
Battery Energy Gauge  
Low Vacuum Warning Light  
Vacuum Gauge  
Vacuum Line Filter  
Vacuum Reserve Tank  
Spring-mounted Pads

### Available Options

- Dual Vacuum System **CAT. NO. E010DVS**
- C-Frame Lift Bar **CAT. NO. LB3CFL**
- Vacuum Loss Warning Buzzer **CAT. NO. E03VLW**
- Individual Pad Shutoffs **CAT. NO. CM1COWB**
- Voltage Adaptation **CAT. NO. E06VA**
- Removable Control Pendant **CAT. NO. E09RP** (Available on DC units only).
- 10" (254 mm) Diameter Lipped Vacuum Pads **CAT. NO. HV11**
- Closed Cell Foam Pad Rings **CAT. NO. FRHV11** (Available with **CAT. NO. HV11** Pads only).

For special sizes and capacities, please contact our Customer Service Department at (800) 421-6144 in the U.S., (877) 421-6144 from Canada, or (323) 588-1281 International, and ask for Ext. 5275.



DC POWER CAT. NO.	AC POWER CAT. NO.	DESCRIPTION
<b>PFV69DC</b>	<b>PFV69AC</b>	120V AC Small Vertical Powr-Frame™ 700
<b>AUPFV69DC</b>	<b>AUPFV69AC</b>	240V AC Small Vertical Powr-Frame™ 700 (Australia)

Minimum order: 1 each. F.O.B. Laurel, Montana.

Wood's Powr-Grip is a registered trademark of Wood's Powr-Grip Co., Inc.

## CRL Wood's Powr-Grip® Powr-Frame™ 1000

### Standard Pad Spread:

**CAT. NO. PFHS89DC:** Small Frame 39-1/4" x 47" (997 x 1194 mm)

**CAT. NO. PFHL89DC:** Large Frame 39-1/4" x 59-1/4" (997 x 1505 mm)

### Number/Size of Pads:

8 / 9" (229 mm) diameter

**Lifting Capacity:** 1000 lbs. (455 kg)

**Average Unit Weight:** 118 lbs. (54 kg)

### Standard Operating Power:

12V DC, 8 AMP

### Load Movement:

Manual Rotation, 180 Degree Edgewise,  
With Locking in Three Positions  
Manual Tilt, 90 Degree between Upright and Flat  
With Automatic Latching in Upright Position  
(Units can be tilted ONLY when the lift bar is locked in the center position, as shown on drawings).

### Standard Features:

On-board Battery and Charger  
Battery Energy Gauge  
Low Vacuum Warning Light  
Vacuum Gauge  
Vacuum Line Filter  
Vacuum Reserve Tank  
Spring-mounted Pads

### Alternative Power Systems

(Specification may not be as listed above. Please contact us for information.)

AC Power System **CAT. NO'S. PFHL89AC** and **PFHS89AC**  
with blow-off for quick release, 120V AC, 60 Hertz, 4 AMP

Air (Venturi) Power System

(**CAT. NO'S. PFHL89A1RS** and **PFHS89A1RS**)

**PFHL89DC** Available in 240V

For special sizes and capacities, please contact our Customer Service Department at (800) 421-6144 in the U.S., (877) 421-6144 from Canada, or (323) 588-1281 International, and ask for Ext. 5275.

For Tilting and Rotating Horizontally Oriented Materials



### CAT. NO.

### DESCRIPTION

**PFHS89DC**

Small Powr-Frame™ 1000

**PFHL89DC**

Large Powr-Frame™ 1000

**AUPFHL89DCO**

Large Powr-Frame™ 1000 (Australia)

Minimum order: 1 each. F.O.B. Laurel, Montana.

### Available Options:

- Dual Vacuum System **CAT. NO. E010DVS**
- Vacuum Loss Warning Buzzer **CAT. NO. E03VLU**
- Individual Pad Shutoffs **CAT. NO. CM1C0WB**
- Voltage Adaptation **CAT. NO. E06VA**
- Removable Control Pendant **CAT. NO. E09RP**
- 10" (254 mm) Diameter Lipped Vacuum Pads **CAT. NO. HV11**  
(Specifications not as listed above. Please contact us for information)
- Closed Cell Foam Pad Rings **CAT. NO. FRHV11**  
(available on **CAT. NO. HV11** pads only).
- See Pages 737K-738K for Details on Available Options.

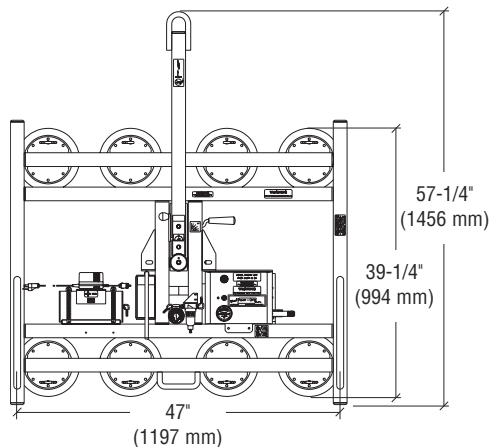

Small Frame  
PFHS89DC

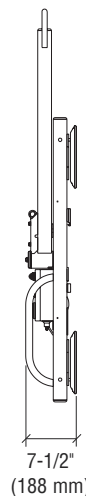

Large Frame  
PFHL89DC

Wood's Powr-Grip is a registered trademark of Wood's Powr-Grip Co., Inc.

## CRL Wood's Powr-Grip® Channel Lifters

Channel Lifters are comprised of one or more Pad Channels and interchangeable Lift Frames for manually rotating and tilting materials. These Vacuum Lifters may be ordered as complete units or as individual components to expand existing Channel Lifter systems. Lift Frames are available in single-channel or double-channel styles. Pad Channels can be switched from one frame to another in minutes.

### Standard Vacuum Pad Spread:

- CAT. NO'S. P11104DC, P11104AC, P11104A1RS - 51" x 12" (1295 x 305 mm)
- CAT. NO'S. P11004DC, P11004AC, P11004A1RS - 49" x 10" (1245 x 254 mm)
- CAT. NO'S. P1HV1104DC, P1HV1104AC, P1HV1104A1RS - 50" x 11" (1270 x 280 mm)

### Number/Size Of Vacuum Pads:

- CAT. NO'S. P11104DC, P11104AC, P11104A1RS - 4 / 11" (280 mm) diameter lipped vacuum pads
- CAT. NO'S. P11004DC, P11004AC, P11004A1RS - 4 / 10" (254 mm) diameter concave vacuum pads
- CAT. NO'S. P1HV1104DC, P1HV1104AC, P1HV1104A1RS - 4 / 10" (254 mm) diameter lipped vacuum pads

### Lifting Capacity\*:

- CAT. NO'S. P11104DC, P11104AC, P11104A1RS - 700 lbs. (317 kg)
  - CAT. NO'S. P11004DC, P11004AC, P11004A1RS - 600 lbs. (272 kg)
- (Capacity is reduced on curved surfaces. Call for capacity on curved surfaces)
- CAT. NO'S. P1HV1104DC, P1HV1104AC, P1HV1104A1RS - 600 lbs. (272 kg)
- (\*On smooth, non-porous surfaces. Call for recommendations on other surfaces)

Average Weight Of Vacuum Lifter: 70 lbs. (32 kg)

### Standard Operating Power:

- CAT. NO'S. P11104DC, P11004DC, P1HV1104DC: 12V DC, 10 AMP (for each Pad Channel)
- CAT. NO'S. P11104AC, P11004AC, P1HV1104AC: 120V AC, 60 Hz, 10 AMP
- CAT. NO'S. P11104A1RS, P11004A1RS, P1HV1104A1RS: Three SCFM (85 Liters/Min) Nominal Air Flow

### Load Movement:

Manual rotation, 180 degrees edgewise, with locking in three positions. Manual tilt, 90 degrees between upright and flat, with automatic latching in upright position.

### Standard Features:

- On-board Battery and Charger
- Battery Energy Gauge
- Low Vacuum Warning Light
- Vacuum Gauge
- Vacuum Line Filter
- Vacuum Reserve Tank (On Each Pad Channel)

### Available Options:

- Dual vacuum system **CAT. NO. E010DVS**
  - Removable control pendant **CAT. NO. E09RP**
  - Remote control system **CAT. NO. E08RC**
  - Closed cell foam vacuum pad rings  
**CAT. NO. FRHV11**  
(Available on P1HV1104 series lifters only)
  - ABS shipping case **CAT. NO. 53005**
- See pages 737K-738K for Details on Available Options.

Units can be tilted ONLY when the lift bar is locked in the center position, as shown in photos.



**CAT. NO. P11104DC**  
Shown



ALSO AVAILABLE FOR  
**rent**

FOR FLAT MATERIAL CAT. NO.	FOR CURVED MATERIAL CAT. NO.	FOR TEXTURED MATERIAL CAT. NO.	DESCRIPTION
P11104DC*	P11004DC	P1HV1104DC	12V DC Models
P11104AC	P11004AC	P1HV1104AC	120V AC Models
P11104A1RS	P11004A1RS	P1HV1104A1RS	Air (Venturi) Models
AUP11104DC	-----	-----	DC Model (Australia)

Minimum order: 1 each. \*F.O.B. CRL Service Center. All other Lifters F.O.B. Laurel, Montana.

### Components:

#### Pad Channels

Each channel features an independent, on-board vacuum generating system, including vacuum pump, vacuum controls, and all standard features listed above.

- CAT. NO. PC1104: 4 / 11" (280 mm) diameter lipped vacuum pads
- CAT. NO. PC1004: 4 / 10" (254 mm) diameter concave vacuum pads
- CAT. NO. PCHV1104: 4 / 10" (254 mm) diameter lipped vacuum pads

#### Lift Frames

- CAT. NO. PCFT1A1: 4 / 11" (280 mm) diameter lipped vacuum pads
- CAT. NO. PCFT2SA45: 4 / 10" (254 mm) diameter concave vacuum pads
- CAT. NO. PCFT2SA7: 4 / 10" (254 mm) diameter lipped vacuum pads

#### Interchangeable Arms

Vacuum pad spread can be changed if optional arms are purchased.

- CAT. NO. FA245: Optional arms convert PCFT2SA7 Lift Frame to PCFT2SA45 Lift Frame
- CAT. NO. FA27: Optional arms convert PCFT2SA45 Lift Frame to PCFT2SA7 Lift Frame

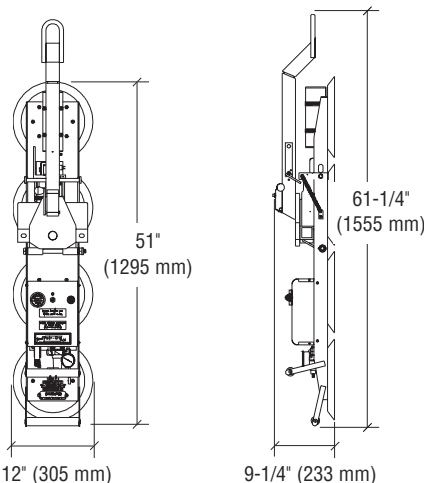

Wood's Powr-Grip is a registered trademark of Wood's Powr-Grip Co., Inc.

## CRL Wood's Powr-Grip® Low Profile Channel Lifters

The low-profile design of these Lifters allows a way to lift glass between scaffolding and buildings during high-rise window installations, and between tight vertical storage racks in the shop. Minimum order is one each. F.O.B. Laurel, Montana.

### Standard Pad Spread **CAT. NO. AUMRLPCH611LDC:**

With 6 vacuum pads in use - 77" x 12"  
(1956 x 305 mm)  
and with 4 vacuum pads in use - 52" x 12"  
(1321 x 305 mm)

### Standard Pad Spread **CAT. NO. MRTALPCH611LDC:**

With 6 vacuum pads in use - 79-1/4" x 12"  
(2013 x 305 mm)  
and with 4 vacuum pads in use - 54" x 12"  
(1371 x 305 mm)

### Lifting Capacity:

With 6 vacuum pads in use - 1100 lbs. (500 kg)  
and 4 vacuum pads in use - 736 lbs. (334 kg)  
(On smooth, nonporous surfaces. Please contact us for recommendations on other surfaces.)

### Average Weight Of Vacuum Lifter:

**CAT. NO. AUMRLPCH611LDC:** 110 lbs. (50 kg)  
**CAT. NO. MRTALPCH611LDC:** 125 lbs. (57 kg)

### Standard Operating Power:

**CAT. NO. AUMRLPCH611LDC:** 12V DC, 10 AMP  
**CAT. NO. MRTALPCH611LDC:** 12V DC, 10 AMP

### Load Movement:

**CAT. NO. AUMRLPCH611LDC:** Manual rotation, 180 degrees edgewise, with locking in three positions and **CAT. NO. MRTALPCH611LDC:** Manual rotation, 180 degrees edgewise, with locking in three positions. Assisted manual tilt, 90 degrees between upright and flat, with automatic latching in upright position.

### Profile:

**CAT. NO. AUMRLPCH611LDC:** 7-1/2" (191 mm) and  
**CAT. NO. MRTALPCH611LDC:** 7-3/4" (197 mm)  
(does not include load)

### Standard Features:

Removable Pad Frame Extensions  
Adjustable Length Lift Bar  
On-board Battery and Charger  
Battery Energy Gauge  
Low Vacuum Warning Light  
Vacuum Gauge  
Vacuum Line Filter  
Vacuum Reserve Tank  
Spring-mounted Vacuum Pads  
Dual Vacuum System (MRTA Frame only)  
Green Lift Light (MRTA Frame only)  
Blow-off for Quick Release (MRTA Frame only)

### Available Options For **AUMRLPCH611LDC:**

- Dual Vacuum System **CAT. NO. E010DVS**
- Remote Control System **CAT. NO. E08RC**
- Individual Vacuum Pad Shutoffs **CAT. NO. CM1C0WB**
- Alternative Vacuum Pads:  
10" (254 mm) Diameter Concave Vacuum Pads **CAT. NO. 49590TA**  
10" (254 mm) Diameter Flat Lipped Vacuum Pads **CAT. NO. 49614T**  
Closed Cell Foam Vacuum Pad Rings **CAT. NO. FRHV11**  
(Available on **CAT. NO. HV11** Pads only)

### Available Options For **MRTALPCH611LDC:**

- Alternative Vacuum Pads:
- 9" (229 mm) Diameter Vacuum Pad **CAT. NO. VPFS9**
  - 10" (254 mm) Diameter Concave Vacuum Pad **CAT. NO. 49590TA**
  - 10" (254 mm) Diameter Flat Lipped Vacuum Pad **CAT. NO. 49614T**
- For special sizes and capacities, please contact our Customer Service Department at (800) 421-6144 in the U.S., (877) 421-6144 from Canada, or (323) 588-1281 International, and ask for Ext. 5275.

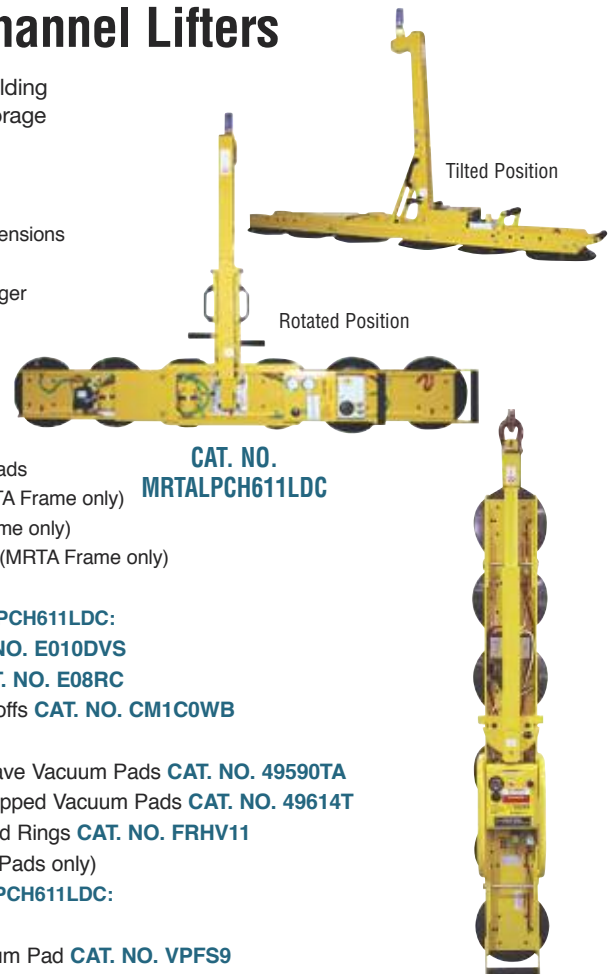

**CAT. NO. MRTALPCH611LDC**

**CAT. NO. AUMRLPCH611LDC**  
Australia Only

## CRL Wood's Powr-Grip® Heavy-Duty Transport Case

- Reliable Protection for Your CRL Wood's P1 and P2 Series Channel Lifters
- Made With High-Density Polyethylene for Durability

Protect your equipment investment by ordering our CRL Wood's Powr-Grip® Heavy-Duty Transport Case. Its weather resistance and high strength adds work life to your valuable lifting frame and, at the same time, protects the rubber pads and electrical system mounted on your lifting frame. Frames are secured inside the case with nylon straps and strong connectors to prevent movement of the frame within the case. Minimum order is one each.



**CAT. NO. 53005**

Wood's Powr-Grip is a registered trademark of Wood's Powr-Grip Co., Inc.

## CRL Wood's Powr-Grip® P2 Series Channel Lifters

Channel Lifters are comprised of one or more Pad Channels and interchangeable Lift Frames for manually rotating and tilting materials. They may be ordered as complete units or as individual components to expand existing Channel Lifter systems. Lift Frames are available in single-channel or double-channel styles. Pad Channels can be switched from one frame to another in minutes. Minimum order is one each. F.O.B. CRL Service Centers.

### Standard Pad Spread:

**CAT. NO. P2110445DC:** 51" x 54-1/4"

(1295 x 1378 mm)

**CAT. NO. P2HV110445DC:** 50" x 53-1/4"

(1270 x 1353 mm)

### Number/Size of Pads:

**CAT. NO. P2110445DC:** 8 / 11" (280 mm) diameter lipped

**CAT. NO. P2HV110445DC:** 8 / 10" (254 mm) diameter lipped

### Lifting Capacity:

**CAT. NO. P2110445DC:** 1400 lbs. (635 kg)

**CAT. NO. P2HV110445DC:** 1200 lbs. (545 kg)

(on smooth, non-porous surfaces.)

Call for recommendations on other surfaces.)

### Average Unit Weight:

171 lbs. (78 kg)

### Standard Operating Power:

12V DC, 10 AMP (for each Pad Channel).

### Load Movement:

Manual rotation, 180 degree edgewise, with locking in three positions. Manual tilt, 90 degree between upright and flat, with automatic latching in upright position. (Units can be tilted ONLY when the lift bar is locked in the center position, as shown in drawings.)

### Standard Features:

- On-Board Battery and Charger
- Battery Energy Gauge
- Low Vacuum Warning Light
- Vacuum Gauge
- Vacuum Line Filter
- Vacuum Reserve Tank

For special sizes and capacities, please contact our Customer Service Department at (800) 421-6144 in the U.S., (877) 421-6144 from Canada, or (323) 588-1281 International, and ask for Ext. 5275.

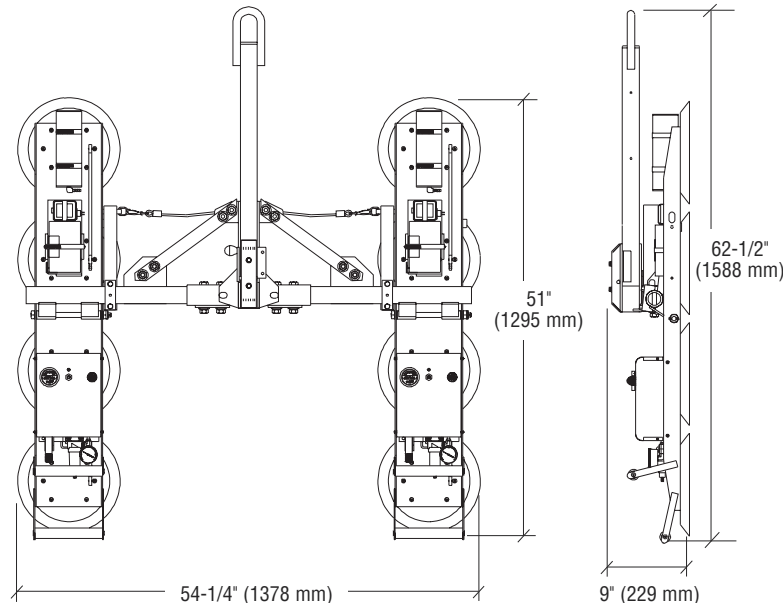

Wood's Powr-Grip is a registered trademark of Wood's Powr-Grip Co., Inc.

### Available Options

#### For All P2 Series Channel Lifters:

- AC Power System  
**CAT. NO. P2110445AC**  
**CAT. NO. P2HV110445AC**  
**CAT. NO. P211047AC**  
**CAT. NO. P2HV11047AC**
- Remote Control System  
**CAT. NO. E08RC**
- Removable Control Pendant  
**CAT. NO. E09RP**
- Dual Vacuum System  
**CAT. NO. E010DVS**
- Individual Pad Shutoffs  
**CAT. NO. CM1COWB**
- Closed Cell Foam Pad Rings  
**CAT. NO. FRHV11** (available on P2HV1104 units only.)
- Counter-Balancer  
**CAT. NO. CB1S**



**CAT. NO. P2110445DC** (For flat materials)

**CAT. NO. AUP2110445DC** - Australia Only

**CAT. NO. EUP2110445DCO** - Europe Only

**CAT. NO. P2HV110445DC** (For rough materials)



### Components

#### Pad Channels

Each channel features an independent, on-board vacuum generating system, including vacuum pump, vacuum controls and standard features as listed above.

- CAT. NO. PC1104** (for Flat Materials):  
4 / 11" (280 mm) Diameter Lipped Pads
- CAT. NO. PC1004** (for Curved Materials):  
4 / 10" (254 mm) Diameter Concaved Pads
- CAT. NO. PCHV1104** (for Rough Materials):  
4 / 10" (254 mm) Diameter Lipped Pads

#### Lift Frames

- CAT. NO. PCFT1A1:** for One Pad Channel
- CAT. NO. PCFT2SA45:** for Two Pad Channels,  
Approx. 4-1/2' (1.38 m) Pad Spread
- CAT. NO. PCFT2SA7:** for Two Pad Channels,  
Approx. 7' (2.14 m) Pad Spread

#### Interchangeable Arms

(Pad spread can be changed if optional arms are purchased.)

- CAT. NO. FA245:** Optional Arms Convert  
PCFT2SA7 Lift Frame to PCFT2SA45 Lift Frame
- CAT. NO. FA27:** Optional Arms Convert  
PCFT2SA45 Lift Frame to PCFT2SA7 Lift Frame

## CRL Wood's Powr-Grip® P2 Series Channel Lifters

ALSO AVAILABLE FOR  
**rent**

Channel Lifters are comprised of one or more Pad Channels and interchangeable Lift Frames for manually rotating and tilting materials. They may be ordered as complete units or as individual components to expand existing Channel Lifter systems. Lift Frames are available in single-channel or double-channel styles. Pad Channels can be switched from one frame to another in minutes. Minimum order is one each. F.O.B. Laurel, Montana.

### Standard Pad Spread:

**CAT. NO. P211047DC:** 51" x 84-1/4" (1295 x 2140 mm)

**CAT. NO. P2HV11047DC:** 50" x 83-1/4" (1270 x 2115 mm)

### Number/Size of Pads:

**CAT. NO. P211047DC:** 8 / 11" (280 mm) diameter lipped

**CAT. NO. P2HV11047DC:** 8 / 10" (254 mm) diameter lipped

### Load Capacity:

**CAT. NO. P211047DC:** 1400 lbs. (635 kg)

**CAT. NO. P2HV11047DC:** 1200 lbs. (545 kg)

(On smooth, non-porous surfaces.)

Call for recommendations on other surfaces.)

**Average Unit Weight:** 184 lbs. (84 kg)

### Standard Operating Power:

12V DC, 8 AMP (for each Pad Channel).

**Load Movement:** Manual rotation, 180 degree edgewise, with locking in three positions. Manual tilt, 90 degree between upright and flat, with automatic latching in upright position. (Units can be tilted ONLY when the lift bar is locked in the center position, as shown in drawings.)

### Standard Features:

- On-board Battery and Charger
- Battery Energy Gauge
- Low Vacuum Warning Light
- Vacuum Gauge
- Vacuum Line Filter
- Vacuum Reserve Tank

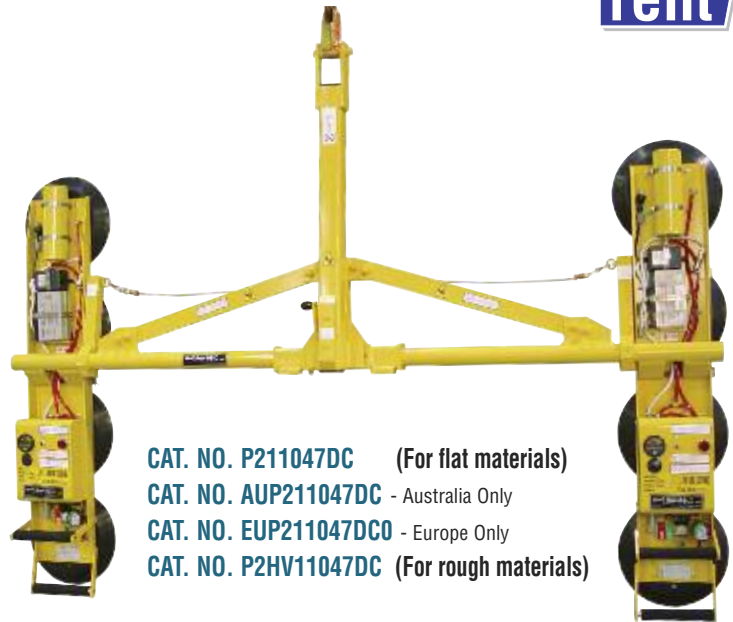

**CAT. NO. P211047DC** (For flat materials)

**CAT. NO. AUP211047DC** - Australia Only

**CAT. NO. EUP211047DCO** - Europe Only

**CAT. NO. P2HV11047DC** (For rough materials)

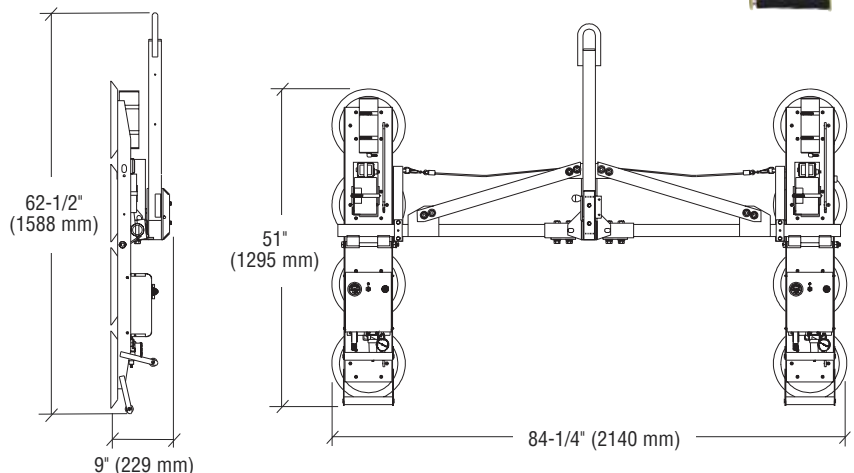

## CRL Wood's Powr-Grip® Counter-Balancer for P2 Channel Lifters

The Counter-Balancer is used in conjunction with Wood's Powr-Grip® P2 lifters. This vacuum lifter accessory allows loads to be positioned under overhangs by extending the lifter away from the lifting tackle. P2 lifters can also be inverted on the Counter-Balancer for reverse-angle installations, such as those in airport control towers. The Counter-Balancer is kept level using an adjustable counterweight arm, control lines and user-supplied ballast material. Minimum order is one each. F.O.B. Laurel, Montana.

### Counter-Balancer:

**Reach:** Minimum: 32-1/2" (825 mm)

Maximum: 62-1/4" (1581 mm)

**Length:** Fully Contracted: 156" (3962 mm)

Fully Expanded: 219-1/2" (5575 mm)

**Unit Weight (w/o ballast):** 470 lbs. (214 kg)

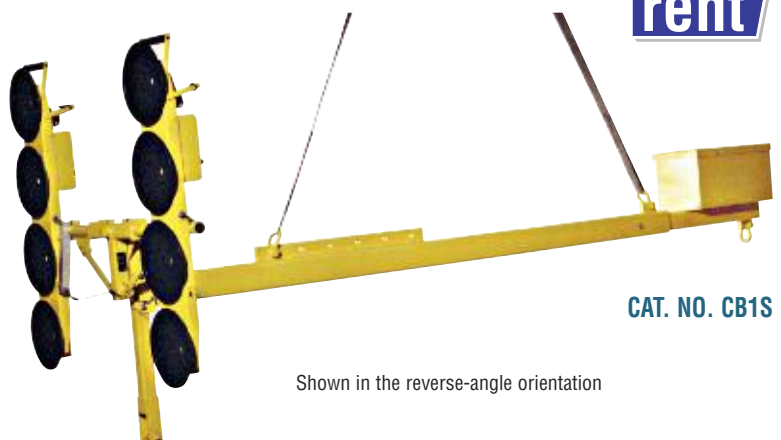

ALSO AVAILABLE FOR  
**rent**

**CAT. NO. CB1S**

Shown in the reverse-angle orientation

Wood's Powr-Grip is a registered trademark of Wood's Powr-Grip Co., Inc.

## CRL Wood's Powr-Grip® Manual Rotator 2800

### • Manual Rotation 360 Degree Edgewise

A high-capacity, 360 degree, DC-powered Rotator with multiple pad frame configurations for installation or fabrication applications. Minimum order is one each. F.O.B. Laurel, Montana.

**Standard Pad Spread:** Variable

(see Manual Rotator 2800 Pad Configurations online at [crlaurence.com](http://crlaurence.com))

**Number/Size of Pads:** Variable / 11" (280 mm) diameter lipped

(see Manual Rotator 2800 Pad Configurations)

**Lifting Capacity:** Variable (see Manual Rotator 2800 Pad Configurations online at [crlaurence.com](http://crlaurence.com))

**Unit Weight:** 685 lbs. (311 kg) maximum

**Standard Operating Power:** 12V DC, 26 AMP

**Standard Charger Input Voltage:** 120V AC  
(Other Voltages available)

**Load Movement:** Manual rotation, 360 degree edgewise, with locking at each quarter point.

**Standard Features:**

- On-board Battery and Charger
- Battery Energy Gauge
- Green Lift Light
- Removable Control Pendant
- Vacuum Gauge
- Vacuum Line Filter
- Vacuum Reserve Tank
- Removable Lift Bar Extension
- Removable Pad Frame Sections
- Removable Pad Arms
- Spring-mounted Pads
- Blow-off for Quick Release

ALSO AVAILABLE FOR  
**rent**

**Available Options**

- Dual Vacuum System  
**CAT. NO. E010DVS**
- Vacuum Loss Warning Buzzer  
**CAT. NO. E03VLW**
- Individual Pad Shutoffs  
**CAT. NO. CM1C0WB**

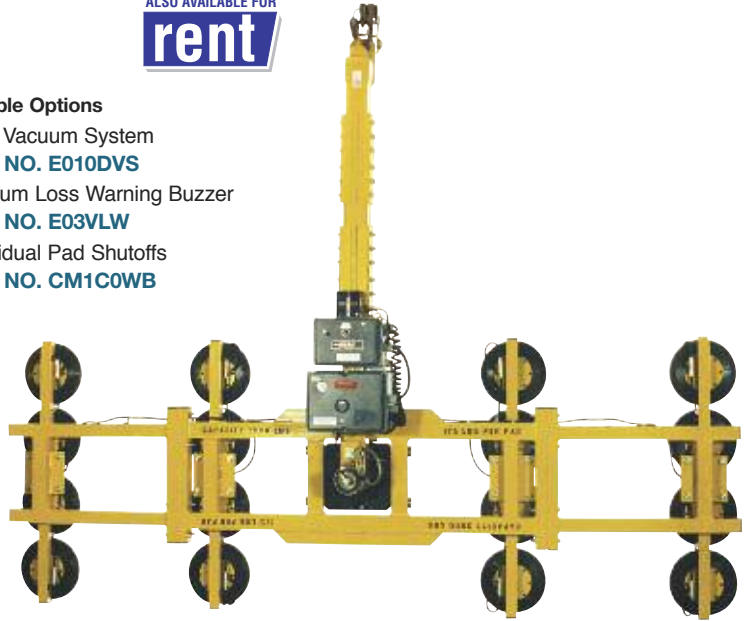

See all CRL Wood's Lifting Frame Options on pages 737K-738K.

**CAT. NO. MR1611LDC**

## Frame Configurations and Capacity Examples for MR1611LDC

To see all 19 configuration and capacity drawings, log on to [crlaurence.com](http://crlaurence.com)

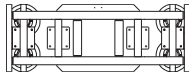

Pad Spread:  
24-1/2" x 66"  
(622 x 1676 mm)

Lifting Capacity:  
700 lbs. (320 kg)

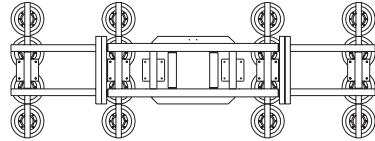

Pad Spread:  
49" x 132"  
(1245 x 3353 mm)

Lifting Capacity:  
2800 lbs. (1270 kg)

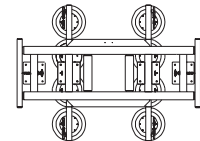

Pad Spread:  
49" x 40-3/4"  
(1245 x 1035 mm)

Lifting Capacity:  
1400 lbs. (635 kg)

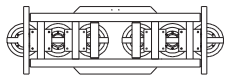

Pad Spread:  
12" x 78-1/2"  
(305 x 1994 mm)

Lifting Capacity:  
1050 lbs. (475 kg)

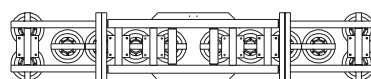

Pad Spread:  
24-1/2" x 132"  
(622 x 3353 mm)

Lifting Capacity:  
2100 lbs. (955 kg)

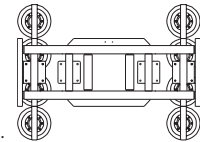

Pad Spread:  
49" x 66"  
(1245 x 1676 mm)

Lifting Capacity:  
1400 lbs. (635 kg)

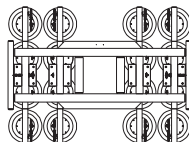

Pad Spread:  
49" x 66"  
(1245 x 1676 mm)

Lifting Capacity:  
2800 lbs. (1270 kg)

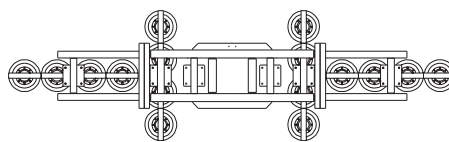

Pad Spread:  
49" x 169"  
(1245 x 4293 mm)

Lifting Capacity:  
2800 lbs. (1270 kg)

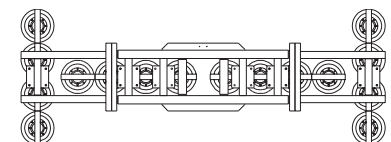

Pad Spread:  
49" x 132"  
(1245 x 3353 mm)

Lifting Capacity:  
2800 lbs. (1270 kg)

Wood's Powr-Grip is a registered trademark of Wood's Powr-Grip Co., Inc.



## CRL Wood's Powr-Grip® Manual Rotator/Tilter Lifters

- Manual Rotation 360 Degrees Edgewise
- Manual Tilt 90 Degrees Between Flat and Upright



(MRT49DC AND MRT411LDC)

ALSO AVAILABLE FOR  
**rent**  
(MRT411LDC)

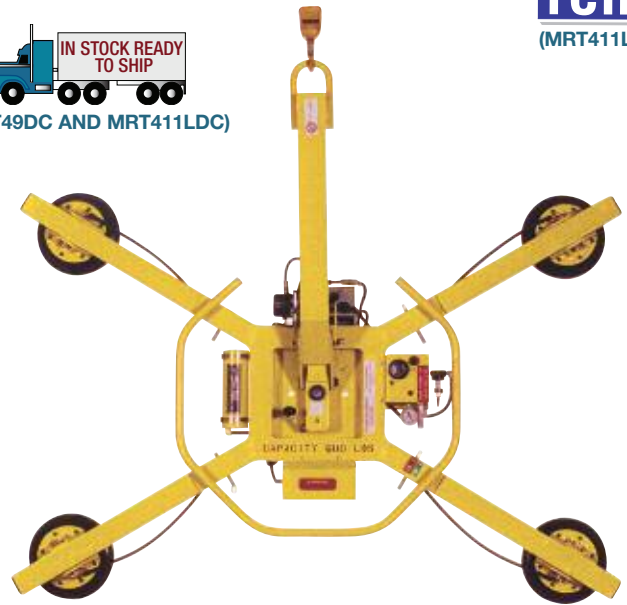

**Standard Pad Spread: CAT. NO. MRT49DC:**

- 25-1/4" x 30" (641 x 762 mm) (basic configuration)
- 45-1/4" x 64-3/4" (1149 x 1645 mm) (extended configuration)
- 75-1/4" x 12-3/4" (1911 x 324 mm) (linear configuration)

**Standard Pad Spread: CAT. NO. MRT411LDC:**

add 2-3/4" (70 mm) to Each Dimension Listed Above.

**Standard Pad Spread: CAT. NO. MRT4HV11DC:**

add 1-3/4" (45 mm) to Each Dimension Listed Above.

**Number/Size of Pads:**

- CAT. NO. MRT49DC:** 4 / 9" (229 mm) diameter
- CAT. NO. MRT411LDC:** 4 / 11" (280 mm) diameter lipped
- CAT. NO. MRT4HV11DC:** 4 / 10" (254 mm) diameter lipped

**Lifting Capacity:**

- CAT. NO. MRT49DC:** 500 lbs. (225 kg)
  - CAT. NO. MRT411LDC:** 700 lbs. (320 kg)
  - CAT. NO. MRT4HV11DC:** 600 lbs. (270 kg)
- (On smooth, non-porous surfaces. Please contact us for recommendations on other surfaces.)

**Average Unit Weight:** 122 lbs. (56 kg)

**Standard Operating Power:** 12V DC, 10 AMP

**Load Movement:** Manual rotation, 360 degree edgewise, with locking at each 1/4 point. Manual tilt, 90 degree between upright and flat, with automatic latching in upright position.

**Standard Features:**

- Low Vacuum Warning Light
- On-Board Battery and Charger
- Battery Energy Gauge
- Vacuum Gauge
- Vacuum Line Filter
- Vacuum Reserve Tank
- Spring-Mounted Pads
- (Re)Movable Pad Mounts
- Extension Arms

**Available Options:**

- Long Extension Arms **CAT. NO. CF5LEAO**
- Individual Pad Shutoffs **CAT. NO. CM1C0WB**
- Closed Cell Foam Pad Rings **CAT. NO. FRHV11** (available on **CAT. NO. MRT4HV11DC** only.)
- Dual Vacuum System **CAT. NO. E010DVS** (complies with CE Standard EN 13155 compliant)
- Adaptable Length Lift Bar **CAT. NO. LB6AL0**
- Forklift Adapter **CAT. NO. LB7FA0**
- Heavy-Duty Transport Case

CAT. NO.	DESCRIPTION
<b>MRT49DC</b>	500 lbs. (225 Kg) Load Capacity Manual Rotator/Tilter Lifter
<b>AUMRT49DC</b>	500 lbs. (225 Kg) Load Capacity Manual Rotator/Tilter Lifter (Australia)
<b>EUMRT49LDC</b>	500 lbs. (225 Kg) Load Capacity Manual Rotator/Tilter Lifter (Europe)
<b>MRT4HV11DC*</b>	600 lbs. (270 Kg) Load Capacity Manual Rotator/Tilter Lifter
<b>MRT411LDC</b>	700 lbs. (320 Kg) Load Capacity Manual Rotator/Tilter Lifter
<b>AUMRT411LDC</b>	700 lbs. (320 Kg) Load Capacity Manual Rotator/Tilter Lifter (Australia)
<b>EUMRT411LDC</b>	700 lbs. (320 Kg) Load Capacity Manual Rotator/Tilter Lifter (Europe)

Minimum order: 1 each. Lifters ship via common carrier from your local CRL Service Center. \*Ships F.O.B. Laurel, Montana.

For additional information, please contact our Customer Service Department at (800) 421-6144 in the U.S., (877) 421-6144 from Canada, or (323) 588-1281 International, and ask for Ext. 5275.

**Linear Configuration**

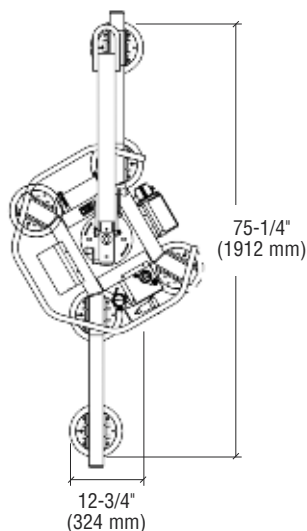

**Basic Configuration**

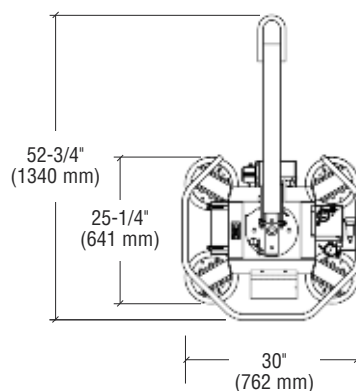

**Extended Configuration**

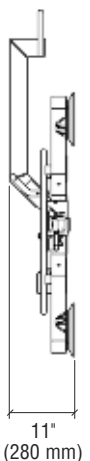
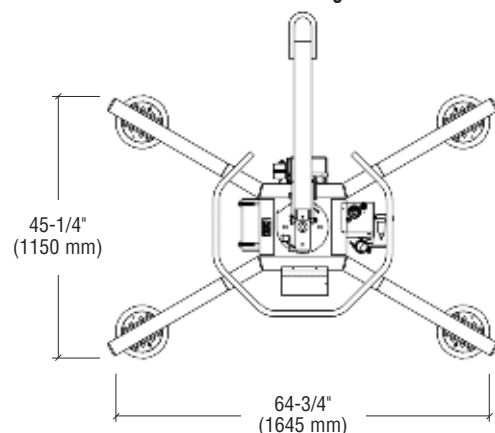

Wood's Powr-Grip is a registered trademark of Wood's Powr-Grip Co., Inc.

## CRL Wood's Powr-Grip® DC Quadra-Tilt Rotator 1100

- Manual Rotation 360 Degrees Edgewise
- Manual Tilt 90 Degrees Between Flat and Upright

### Standard Pad Spread:

- Minimum Width: 12-1/2" (318 mm)
- Maximum Width: 58-3/4" (1492 mm)
- Minimum Length: 46-3/4" (1188 mm)
- Maximum Length: 104-1/2" (2654 mm)

**Number/Size of Pads:** 6 / 11" (280 mm) diameter lipped

**Lifting Capacity\*:** 1100 lbs. (500 kg)

**Per-Pad Capacity\*:** 184 lbs. (84 kg)

(\*On Smooth, non-porous surfaces. Please contact us for recommendations on other surfaces.)

**Unit Weight:** 188 lbs. (86 kg)

**Standard Operating Power:** 12V DC, 10 AMP

**Load Movement:** Manual rotation, 360 degree edgewise, with automatic locking at each 1/4 revolution. Assisted manual tilt, 90 degree between upright and flat.

### Standard Features:

- Dual Vacuum System
- Low Vacuum Warning Light and Buzzer
- On-board Battery and Charger
- Battery Energy Gauge
- Vacuum Gauge
- Vacuum Line Filter
- Vacuum Reserve Tank
- Spring-mounted Pads
- (Re)movable Pad Mounts
- Extension Arms

### Available Options:

- Remote Control System **CAT. NO. E08RC**
- Tilt Locks **CAT. NO. LB8TLO**
- Heavy-Duty Transport Case



Quadra-Tilt Lifters feature a unique four-bar tilt mechanism that significantly reduces the effort of tilting heavy loads between flat and upright positions. This tilt mechanism also reduces hazards associated with lifting loads from upright racks. When a load is tilted to either the upright or the flat position, the lifter maintains the load position automatically without using latches, eliminating the tendency for a load to "kick back" at the operator's knees.

The Quadra-Tilt Rotator 1100 also features a dual vacuum system, 360 degree manual rotation, (re)movable pads and extension arms that accommodate a variety of load sizes and shapes (see Frame Configurations and Capacities below).

The Dual Vacuum System features two vacuum line circuits, allowing the lifter to maintain the vacuum level for one circuit even if an unexpected vacuum loss occurs in the other one. This system is designed to reduce the risk of falling loads, which could result from breakage or other accidents that compromise one area of the vacuum system. In addition, it features audible and visible alarms that warn the operator whenever the vacuum level is not sufficient for lifting the maximum load weight. Complies with CE Standard EN 13155.

For additional information contact CRL Customer Service Department at (800) 421-6144 in the U.S., (877) 421-6144 from Canada, or (323) 588-1281 International, and ask for Ext. 5275. You can also send e-mail from [crlaurence.com](http://crlaurence.com) home page. Click on Contact Us, and then click on Customer Service. Minimum order is one each. F.O.B. CRL Service Centers.

**CAT. NO. MRTA611LDC**  
**CAT. NO. AUMRTA611LDC** (Australia)  
**CAT. NO. EUMRTA611LDC** (Europe)

## Frame Configurations and Capacities for MRTA611LDC

<p>Pad Spread: 12-1/2" x 52-1/2" (318 x 1334 mm)</p> <p>Lifting Capacity: 368 lbs. (167 kg)</p>	<p>Pad Spread: 12-1/2" x 78-1/2" (318 x 1994 mm)</p> <p>Lifting Capacity: 736 lbs. (334 kg)</p>	<p>Pad Spread: 12-1/2" x 104-1/2" (318 x 2654 mm)</p> <p>Lifting Capacity: 1100 lbs. (500 kg)</p>
<p>Pad Spread: 32-3/4" x 46-3/4" (832 x 1188 mm)</p> <p>Lifting Capacity: 736 lbs. (334 kg)</p>	<p>Pad Spread: 47-1/4" x 78-1/2" (1200 x 1994 mm)</p> <p>Lifting Capacity: 1100 lbs. (500 kg)</p>	<p>Pad Spread: 47-1/4" x 104-1/2" (1200 x 2654 mm)</p> <p>Lifting Capacity: 1100 lbs. (500 kg)</p>
<p>Pad Spread: 45-3/4" x 69-1/2" (1162 x 1765 mm)</p> <p>Lifting Capacity: 1100 lbs. (500 kg)</p>	<p>Pad Spread: 58-3/4" x 92" (1492 x 2337 mm)</p> <p>Lifting Capacity: 1100 lbs. (500 kg)</p>	<p><b>Alternative Vacuum Pads:</b></p> <p>*Capacities are with 11" (280 mm) Diameter Pads only. Please contact us for more information regarding pads listed below.</p> <p>9" (229 mm) Diameter <b>CAT. NO. VPF59</b></p> <p>10" (254 mm) Diameter Concave <b>CAT. NO. 49590TA</b></p> <p>10" (254 mm) Diameter Lipped <b>CAT. NO. HV11</b></p>

Wood's Powr-Grip is a registered trademark of Wood's Powr-Grip Co., Inc.

## CRL Wood's Powr-Grip® DC Low-Profile Quadra-Tilt Rotator 1100

### Standard Vacuum Pad Spread:

- Minimum Width - 12" (305 mm)
- Maximum Width - 52-3/4" (1340 mm)
- Minimum Length - 35-1/2" (902 mm)
- Maximum Length - 102" (2591 mm)

### Number/Size of Pads:

6 / 11" (280 mm) diameter lipped vacuum pads

### Lifting Capacity\*: 1100 lbs. (500 kg)

### Per-Pad Capacity\*: 184 lbs. (84 kg)

(\*On Smooth, non-porous surfaces.

Please contact us for recommendations on other surfaces.)

### Unit Weight: 188 lbs. (86 kg)

### Standard Operating Power: 12V DC, 8 AMP

**Load Movement:** Manual rotation, 360 degree edgewise, with automatic locking at each 1/4 revolution. Assisted manual tilt, 90 degrees between upright and flat.

**Profile Thickness:** 8" (203 mm) does not include load.

### Standard Features:

- Dual Vacuum System
- Low Vacuum Warning Light and Buzzer
- Green Lift Light
- On-board Battery and Charger
- Battery Energy Gauge
- Vacuum Gauge
- Vacuum Line Filter
- Vacuum Reserve Tank
- Spring-mounted Pads
- (Re)movable Pad Mounts
- Vacuum Pad Extension Arms
- Blow-off for Quick Release

### Available Options

- Vertical lift bar  
**CAT NO. LB10VLB**
- Extensions for movable pad mounts  
**CAT NO. CM6MEVL**

In addition to DC power and a dual vacuum system, this Powr-Grip® Rotator/Tilter features a highly adaptable pad frame and a remarkably low profile, for maximum flexibility in handling loads between buildings and scaffolding or similar tight work locations. Minimum order is one each. F.O.B. Laurel, Montana.

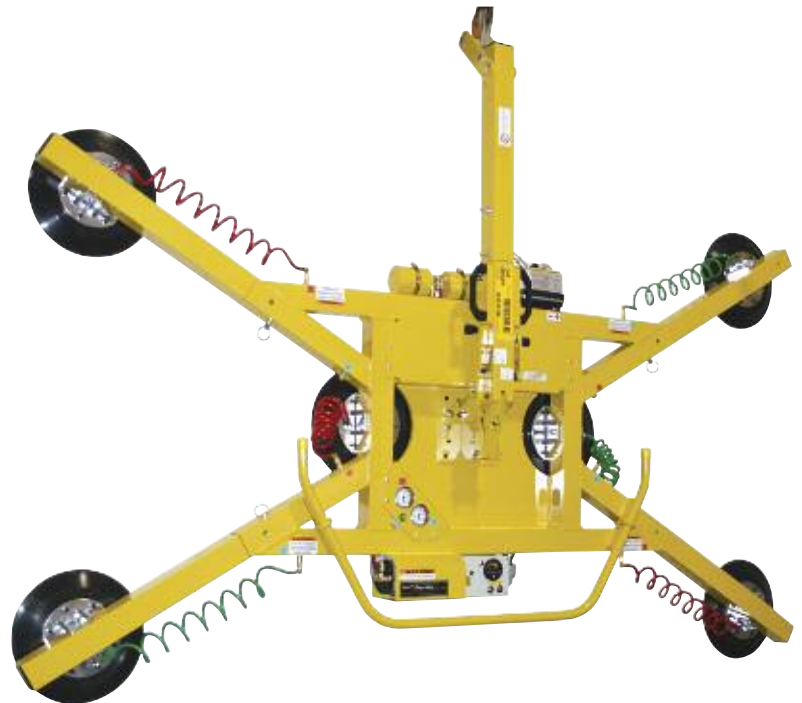

**CAT. NO. MRTALP611LDCS**

## Frame Configurations and Lifting Capacities for MRTALP611LDCS

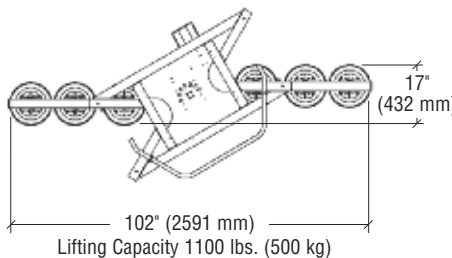
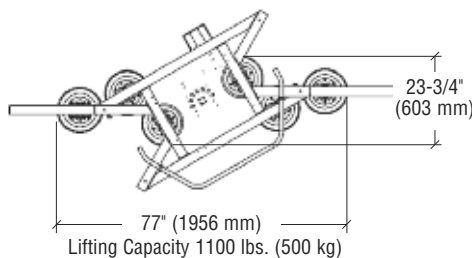
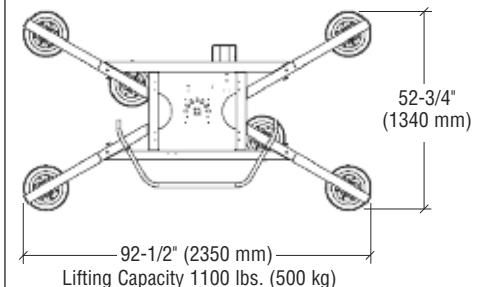
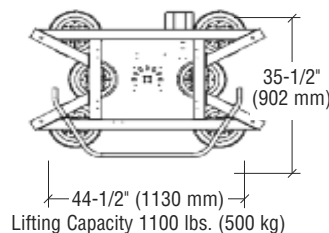
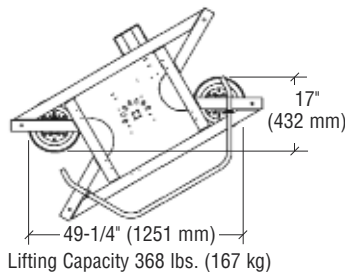

### Alternative Vacuum Pads:

- 9" (229 mm) Dia. **CAT NO. VPFS9**
- 10" (254 mm) Dia. Concave **CAT NO. 49590TA**
- 10" (254 mm) Dia. Flat Lipped **CAT NO. HV11**

For special sizes and capacities, please contact our Customer Service Department at (800) 421-6144 in the US., (877) 421-6144 from Canada, or (323) 588-1281 International, and ask for Ext. 5275.

Wood's Powr-Grip is a registered trademark of Wood's Powr-Grip Co., Inc.

## CRL Wood's Powr-Grip® High-Flow DC Quadra-Tilt Rotators 1200 and 1400

The Wood's Powr-Grip® High-Flow Quadra-Tilt Lifters feature an innovative Four-Bar Tilt Mechanism that significantly reduces the effort of tilting heavy loads between flat and upright positions. This tilt mechanism also reduces hazards associated with lifting loads from upright racks. When a load is tilted to either the upright or the flat position, the Lifter maintains the load position automatically without using latches, eliminating the tendency for a load to "kick back" at the operator's knees.

These units also feature 360 degree manual rotation, removable pads and extension arms (shown below) that accommodate a variety of load sizes and shapes.

### Standard Pad Spread: CAT. NO. MRTA8HV11DC

- 48" x 71-1/2" (1219 x 1816 mm basic configuration)
- 35-1/2" x 49-3/4" (902 x 1264 mm small configuration)\*
- 122" x 12-3/4" (3099 x 324 mm linear configuration)\*
- 68" x 106-1/4" (1727 x 2699 mm extended configuration)

### Standard Pad Spread: CAT. NO. MRTA811LDC, CAT. NO. AUMRTA811LDC, CAT. NO. EUMRTA811LDC add 1" (25 mm) to each dimension listed above

### Number/Size of pads:

- CAT. NO. MRTA8HV11DC: 8 / 10" (254 mm) diameter lipped
- CAT. NO. MRTA811LDC, CAT. NO. AUMRTA811LDC, CAT. NO. EUMRTA811LDC: 8 / 11" (280 mm) diameter lipped

### Lifting Capacity:

- CAT. NO. MRTA8HV11DC: 1200 lbs. (545 kg)
- CAT. NO. MRTA811LDC, CAT. NO. AUMRTA811LDC, CAT. NO. EUMRTA811LDC: 1400 lbs. (635 kg) (On smooth, non-porous surfaces. Please contact us for recommendations on other surfaces.)

\*Capacity reduced in this configuration

**Average Unit Weight:** 302 lbs. (137 kg)

**Standard Operating Power:** 12V DC, 26 AMP

**Load Movement:** Manual rotation, 360 degrees edgewise, with automatic locking at each 1/4 revolution. Assisted manual tilt, 90 degrees between upright and flat.

### Standard Features:

- Low Vacuum Warning Light
- On-board Battery and Charger
- Battery Energy Gauge
- Vacuum Gauge
- Vacuum Line Filter
- Vacuum Reserve Tank
- Spring-mounted Pads
- (Re)movable Pad Mounts
- Extension Arms
- Blow-off for Quick Release

### Available Options:

- Standard Flow DC Power System
- Dual Vacuum System **CAT. NO. E010DVS**
- AC and Air (Venturi) Power Systems
- Vacuum Loss Warning Buzzer **CAT. NO. E03VLW**
- Long Extension Arms **CAT. NO. CF5LEAO**
- Closed Cell Foam Pad Rings **CAT. NO. FRHV11** (Available on **CAT. NO. MRTA8HV11DC** only)
- Tilt Lock **CAT. NO. LB8TL0**

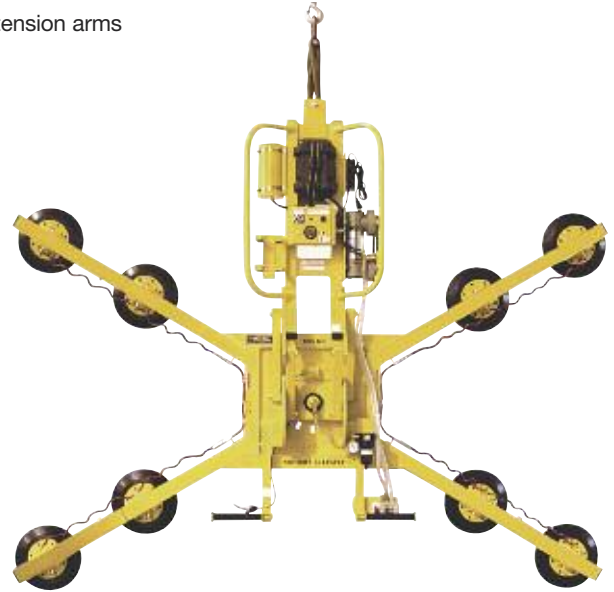

CAT. NO.	DESCRIPTION
<b>MRTA8HV11DC**</b>	1200 lbs. (545 Kg) Load Capacity 110 Volt Quadra-Tilt Rotator
<b>MRTA811LDC**</b>	1400 lbs. (635 Kg) Load Capacity 110 Volt Quadra-Tilt Rotator
<b>AUMRTA811LDC</b>	1400 lbs. (635 Kg) Load Capacity 220-240 Volt Quadra-Tilt Rotator (Australia)
<b>EUMRTA811LDC</b>	1400 lbs. (635 Kg) Load Capacity 220-240 Volt Quadra-Tilt Rotator (Europe)

Minimum order: 1 each. \*\*Ships F.O.B. Laurel, Montana.

For special sizes and capacities, please contact our Customer Service Department at (800) 421-6144 in the U.S., (877) 421-6144 from Canada, or (323) 588-1281 International, and ask for Ext. 5275.

### Basic/Small Configuration

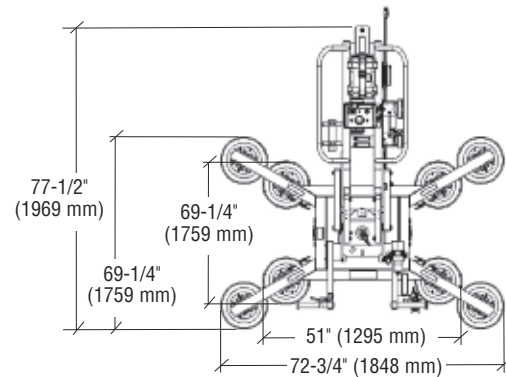

### Extended Configuration

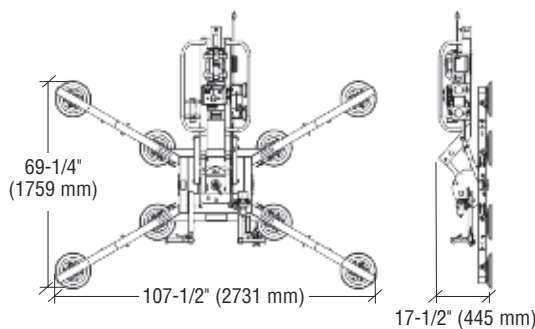

### Linear Configuration

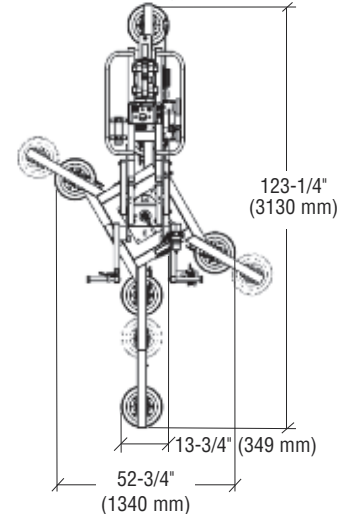

Wood's Powr-Grip is a registered trademark of Wood's Powr-Grip Co., Inc.

## CRL Wood's Manual Rotator/Tilter Lifter Options

### Adaptable Length Lift Bar

Designed for applications requiring increased horizontal reach at the hook point, or applications involving minimal clearance between the Lifter and the hoisting equipment, such as installations under eaves or similar handling situations.

**Overhead Clearance Reduction:** 11-3/4" (298 mm) with Shortened Configurations (C or D)

**Horizontal Reach Increase:** 7-5/8" (194 mm) with Reversed Bail Configurations (B or D)

**Maximum Load Capacity\*:**

- A) Standard Configuration: 700 lbs. (320 kg)
- B) Reversed Bail Configuration: 600 lbs. (270 kg)
- C) Shortened Configuration: 650 lbs. (295 kg)
- D) Shortened, Reversed Bail Configuration: 500 lbs. (225 kg)

\*Net capacity cannot exceed standard lifter capacity.

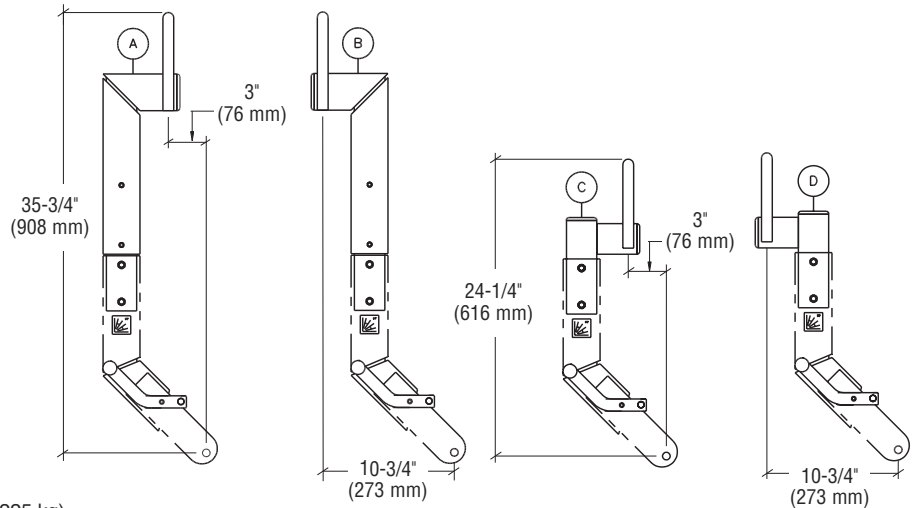

CAT. NO. LB6ALO

### Forklift Adapter

Designed for applications where a forklift is desired, such as installations under eaves and commercial, indoor applications, where using a crane is not possible.

**Compatible Fork Dimensions:** 1-1/2" to 2-1/4" (38 to 57 mm) thick and 4" to 6" (102 to 152 mm) wide

**Inside Fork Spread:** 4" (102 mm)

**Maximum Load Capacity:** 700 lbs. (320 kg) when used on **CAT. NO. MRT411LDC\***

**Maximum Load Thickness:** 1" (25 mm) at full capacity.

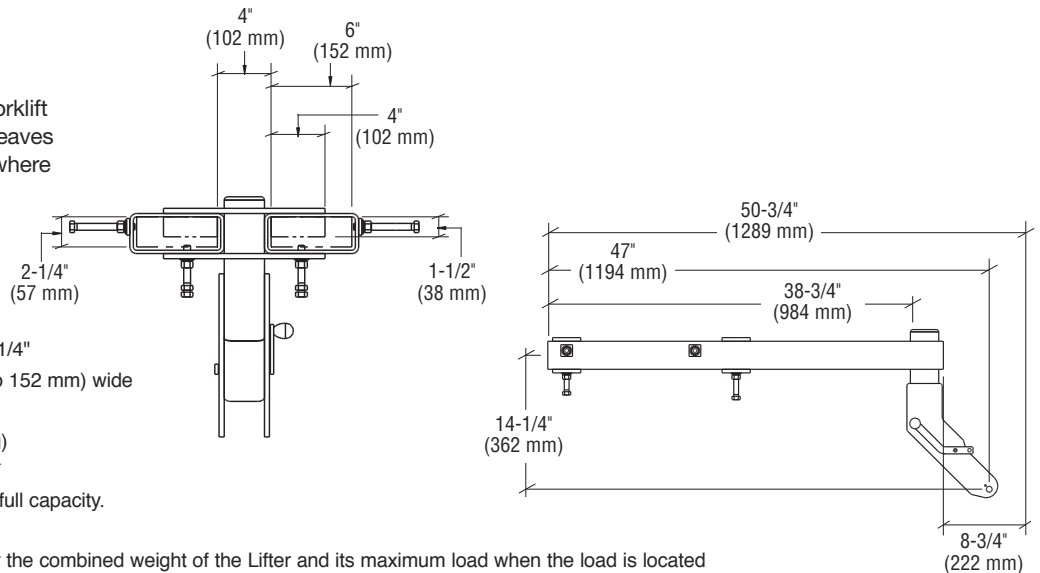

\*The forklift must have sufficient capacity for the combined weight of the Lifter and its maximum load when the load is located 8-3/4" (222 mm) outward from the fork tips, or 50-3/4" (1289 mm) outward from the fork stops, whichever places the load at a greater distance from the forklift's front wheels.

CAT. NO. LB7FAO

### Long Extension Arms

Designed for applications requiring a larger pad spread to reduce overhang on large loads.

**Maximum Load Capacity:** 500 lbs. (225 kg) (with long arms installed)

Pad Spread Dimensions provided are for **CAT. NO. MRT49DC**. For **CAT. NO. MRT4HV11DC**, add 1-3/4" (44 mm)

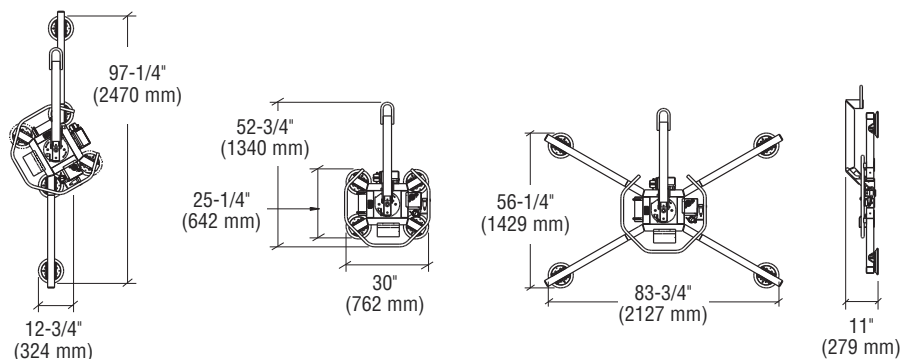

Minimum order: 1 each. F.O.B. Laurel Montana

CAT. NO. CF5LEAO

## CRL Wood's Powr-Grip® Manual Rotator/Power Tilter Lifters

With powered 90 degree tilt, continuous 360 degree rotation, and a high-flow vacuum system for fast attach and release times, these Powr-Grip® Vacuum Lifters provide reliable performance in heavy-duty installations. Available in both AC and DC models. Minimum order is one each. F.O.B. Laurel, Montana.

### DC Operating Power

**Standard Pad Spread:**

29-1/4" x 59-1/4" (743 x 1505 mm)

**Number/Size of Pads:** 8 / 9" (229 mm) diameter

**Lifting Capacity:** 1000 lbs. (455 kg)

**Unit Weight:** 306 lbs. (139 kg)

**Standard Operating Power:** 12V DC, 54 AMP

**Apply:** 5 sec. **Release:** 4 sec. (approx.)

**Load Movement:** Manual rotation, 360 degree edgewise, with locking at each 1/4 point.  
Power tilt, 90 degree between upright and flat.

**Time for 90 Degree Tilt:** 17 sec. (approx.)

**Tilt Duty:** 48 tilts per hour

**Standard Features:**

- Rechargeable 31 AMP-Hour Battery
- Battery Energy Gauge
- Battery Charger
- Green Lift Light
- Removable Control Pendant
- Vacuum Gauge
- Vacuum Reserve Tank
- Vacuum Line Filter
- Spring-Mounted Pads
- Blow-Off for Quick Release

### AC Operating Power

**Standard Pad Spread:**

29-1/4" x 59-1/4" (743 x 1505 mm)

**Number/Size of Pads:** 8 / 9" (229 mm) diameter

**Lifting Capacity:** 1000 lbs. (455 kg)

**Unit Weight:** 278 lbs. (126 kg)

**Standard Operating Power:**

120V AC, 60 hertz, 12 AMP

**Apply:** 4 sec. **Release:** 3 sec. (approx.)

**Load Movement:** Manual rotation, 360 degree edgewise, with locking at each 1/4 point.  
Power tilt, 90 degree between upright and flat.

**Time for 90 Degree Tilt:** 9 sec. (approx.)

**Tilt Duty:** 60 tilts per hour

**Standard Features:**

- Green Lift Light
- Removable Control Pendant
- Vacuum Gauge
- Vacuum Reserve Tank
- Vacuum Line Filter
- Spring-Mounted Pads
- Twist-lock Electrical Plug
- Blow-Off for Quick Release



Shown with optional Vacuum Loss Warning Buzzer, Pad Shutoffs and Telescoping Pad Arms

**CAT. NO. MRPT89DC**  
**CAT. NO. AUMRPT89DC** (Australia)

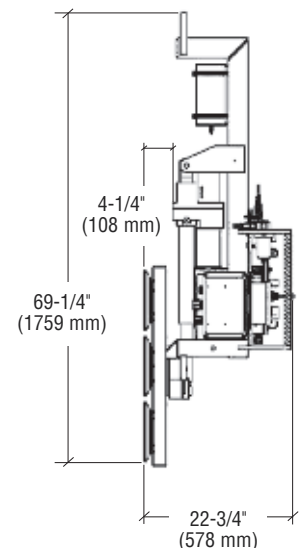

Wood's Powr-Grip is a registered trademark of Wood's Powr-Grip Co., Inc.

**CAT. NO. MRPT89AC**

## CRL Wood's Manual Rotator/Power Tilter Lifters

### Available Options for MRPT89DC and MRPT89AC Lifters

- High-duty tilt with speed control  
**CAT. NO. LB1ET0 (MRPT89AC only)**
- 12-Volt/DC Vacuum Back-up System  
**CAT. NO. E01DCB (MRPT89AC only)**
- Vacuum Loss Warning Buzzer **CAT. NO. E03VLW**
- Voltage Adaptation **CAT. NO. E06VA (MRPT89AC only)**
- Individual Pad Shutoffs **CAT. NO. CM1C0WB**
- Telescoping Pad Arms **CAT. NO. CF3TA0**
- Removable Pad Arms **CAT. NO. CF2EA0**
- Interchangeable Pad Frames **CAT. NO. CF11F0**
- Movable Pad Mounts **CAT. NO. CM2SCM**

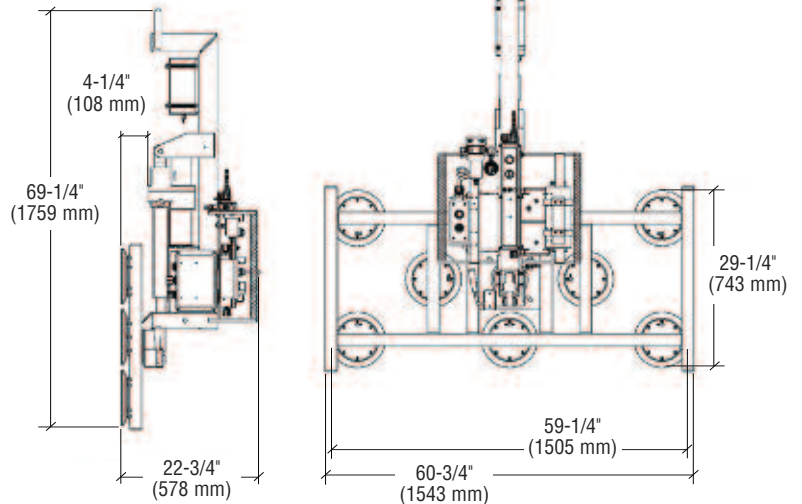

**CAT. NO. MRPT89AC** Shown

## Standard Interchangeable Pad Frames for MRPT89DC and MRPT89AC Lifters

### Telescoping Pad Arms

**CAT. NO. CF3TA0**

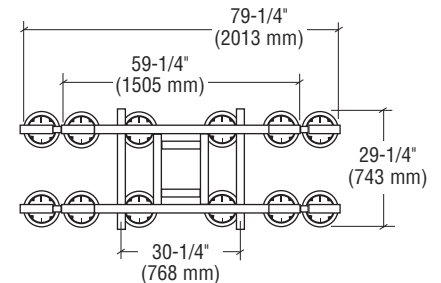
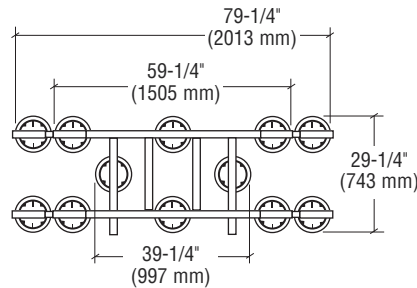
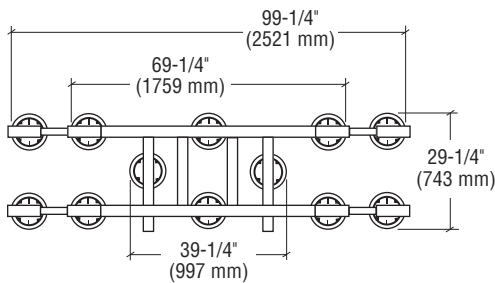

### Removable Pad Arms

**CAT. NO. CF2EA0**

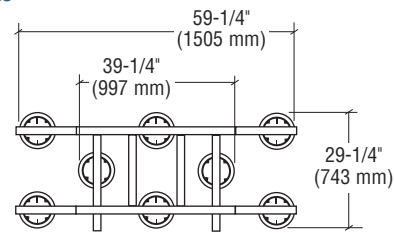
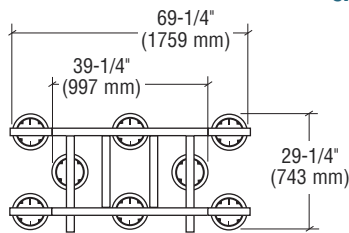

### Interchangeable Pad Frame

**CAT. NO. CF11F0**

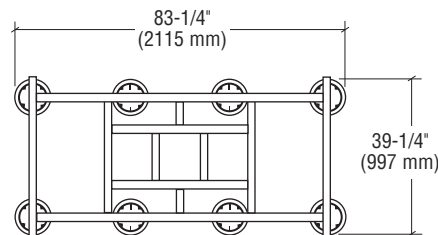

Minimum order: 1 each. F.O.B. Laurel, Montana.

## CRL Wood's Powr-Grip® Manual Rotators 500, 600 and 700

These Powr-Grip® Vacuum Lifters combine manual 360 degree rotation, and fast attach/release times, making them ideal on high-output production lines.

### Standard Pad Spread:

- CAT. NO. MR49AC:** 24" x 30" (610 x 762 mm)
- CAT. NO. MR411LAC:** 26" x 32" (661 x 813 mm)
- CAT. NO. MR4HV11AC:** 25" x 31" (636 x 788 mm)

### Number/Size of Pads:

- CAT. NO. MR49AC:** 4 / 9" (229 mm) diameter
- CAT. NO. MR411LAC:** 4 / 11" (280 mm) diameter lipped
- CAT. NO. MR4HV11AC:** 4 / 10" (254 mm) diameter lipped

### Lifting Capacity:

- CAT. NO. MR49AC:** 500 lbs. (227 kg)
  - CAT. NO. MR411LAC:** 700 lbs. (318 kg)
  - CAT. NO. MR4HV11AC:** 600 lbs. (272 kg)
- (On smooth, nonporous surfaces. Please contact us for recommendations on other surfaces.)

### Average Unit Weight:

**Standard Operating Power:** 120V AC, 60 Hz, 5 AMP (100V AC, 60 Hz, 3 AMP and 240V AC, 60 Hz, 2 AMP also available)

### Apply/Release Times:

- CAT. NO. MR49AC:** 1 sec./1 sec. (approx.)
- CAT. NO. MR411LAC:** 2 sec./2 sec. (approx.)

**Load Movement:** Manual rotation, 360 degrees edgewise with automatic locking at the quarter points.

### Standard Features:

- Vacuum Gauge
- Vacuum Reserve Tank
- Vacuum Line Filter
- Spring-mounted Pads
- Twist-lock Electrical Plug
- Blow-off for Quick Release

For special sizes and capacities, please contact our Customer Service Department at (800) 421-6144 in the U.S., (877) 421-6144 from Canada, or (323) 588-1281 International, and ask for Ext. 5275.

### Available Options:

- Air (Venturi) Power System  
**CAT. NO. MR49A1R**  
**CAT. NO. MR411LA1R**  
**CAT. NO. MR4HV11A1R**
- Individual Pad Shutoffs  
**CAT. NO. CM1C0WB**
- Green Lift Light  
**CAT. NO. E02GSL**
- Vacuum Loss Warning Buzzer  
**CAT. NO. E03VLW**
- Voltage Adaptation  
**CAT. NO. E06VA**
- Closed Cell Foam Pad Rings  
**CAT. NO. FRHV11**  
(Available only on **CAT. NO. MR4HV11AC**)
- Linear Pad Frame  
**CAT. NO. CF8LF0**



See Pages 737K-738K for Details on Available Options

CAT. NO.	DESCRIPTION
<b>MR49AC</b>	500 lbs. (225 kg) Load Capacity Manual Rotator
<b>AUMR49AC</b>	500 lbs. (225 kg) Load Capacity Manual Rotator (Australia)
<b>MR4HV11AC</b>	600 lbs. (270 kg) Load Capacity Manual Rotator
<b>MR411LAC</b>	700 lbs. (320 kg) Load Capacity Manual Rotator
<b>AUMR411LAC</b>	700 lbs. (320 kg) Load Capacity Manual Rotator (Australia)

Minimum order: 1 each. F.O.B. Laurel, Montana.

## CRL Wood's Powr-Grip® Manual Tilter 500

### Standard Pad Spread:

21-1/4" x 46-1/2" (540 x 1181 mm)

### Number/Size Of Pads:

4 / 9" (229 mm) diameter

**Lifting Capacity:** 500 lbs. (225 kg)

**Unit Weight:** 75 lbs. (35 kg)

### Standard Operating Power:

120V AC, 60 Hz, 3 AMP  
(120V AC, 60 Hz, 6 AMP for optional High-Flow Vacuum system)

**Apply:** 5 sec. **Release:** 4 sec. (approx.)

### Load Movement:

Manual tilt, 90 degree between upright and flat, with automatic latching in the upright position.

### Standard Features:

- Green Lift Light
- Vacuum Gauge
- Vacuum Reserve Tank
- Vacuum Line Filter
- Spring-mounted Pads
- Twist-lock Electrical Plug
- Blow-off for Quick Release

### Available Options:

- Vacuum Loss Warning Buzzer **CAT. NO. E03VLW**
- Voltage Adaptation **CAT. NO. E06VA**
- High-flow Vacuum System
- Alternative Frame Dimensions

Shown with Optional High-Flow Vacuum System and Optional Pad Frame



See Pages 737K-738K for Details on Available Options

**CAT. NO. MT49AC**

Minimum order is one each. F.O.B. Laurel, Montana

Wood's Powr-Grip is a registered trademark of Wood's Powr-Grip Co., Inc.



## CRL Wood's Powr-Grip® Manual Tilter 150

### Standard Vacuum Pad Spread:

11" x 11" (280 x 280 mm)

### Number/Size of Pads:

1 / 10" (254 mm) diameter lipped vacuum pad

### Lifting Capacity: 150 lbs. (68 kg)

(On smooth, non-porous surfaces.

Please contact us for recommendations on other surfaces.)

### Weight Of Vacuum Lifter: 36 lbs (17 kg)

### Standard Operating Power:

12V DC, 10 AMP (Other voltages available)

### Apply: 2 sec. Release: 3 sec. (approx.)

### Load Movement:

Manual tilt, 90 degrees between upright and flat

### Standard Features:

- On-Board Battery and Charger
- Battery Energy Gauge
- Low Vacuum Warning Light
- Vacuum Gauge
- Vacuum Line Filter
- Vacuum Reserve Tank



### CAT. NO. MT1HV11DC

Minimum order is one each.  
F.O.B. Laurel, Montana

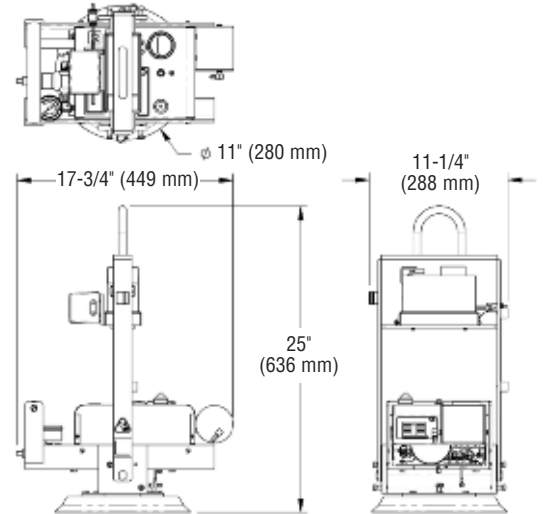

### Available Options:

- 175 lb. (79 kg) Flat Lift Model **CAT. NO. FL1HV11DCS**
  - Closed Cell Foam Pad Ring **CAT. NO. FRHV11**
  - Removable Control Pendant **CAT. NO. E09RP**
- See Pages 737K-738K for Details on Available Options.

## CRL Wood's Powr-Grip® Manual Tilter 300

### Standard Pad Spread:

11" x 23" (280 x 584 mm)

### Number/Size of Pads:

2 / 10" (254 mm) diameter lipped

### Lifting Capacity: 300 lbs. (135 kg)

(On smooth, non-porous surfaces. Please contact us for recommendations on other surfaces.)

### Unit Weight: 51 lbs (24 kg)

### Standard Operating Power:

12V DC, 10 AMP  
(Other voltages available)

### Apply: 5 sec.

### Release: 5 sec. (approx)

### Load Movement:

Manual tilt, 90 degrees between upright and flat

### Standard Features:

- Low Vacuum Warning Light
- Vacuum Gauge
- Vacuum Line Filter
- Vacuum Reserve Tank
- On-Board Battery and Charger
- Battery Energy Gauge

### Available Options:

- Dual Vacuum System **CAT. NO. E010DVS**
- Flat Lift Model **CAT. NO. FL2HV11DCS**
- Closed Cell Foam Pad Rings **CAT. NO. FRHV11**
- Removable Control Pendant **CAT. NO. E09RP**



### CAT. NO. MT2HV11DCS

### CAT. NO. AUMT2HV11DCO (Australia)

Minimum order is one each.  
F.O.B. Laurel, Montana

See Pages 737K-738K for Details on Available Options.

Wood's Powr-Grip is a registered trademark of Wood's Powr-Grip Co., Inc.

## CRL Wood's Powr-Grip® 2 Pad Quadra Tilt Lifter

### Standard Pad Spread:

11" x 24" (280 x 610 mm)

### Number/Size of Pads:

2 / 10" (254 mm) diameter lipped

### Lifting Capacity: 300 lbs. (135 kg)

(On smooth, non-porous surfaces. Please contact us for recommendations on other surfaces.)

### Unit Weight: 45 lbs (21 kg)

### Standard Operating Power:

120V AC, 60 hertz, 3 AMP  
(240V AC, 50/60 Hertz, 2 AMP also available)

### Apply: 2 sec. Release: 2 sec. (approx.)

### Load Movement:

Assisted manual tilt, 90 degrees between upright and flat

### Standard Features:

- Vacuum Gauge
- Vacuum Line Filter
- Twist-Lock Electrical Plug
- Blow-Off for Quick Release

### Alternative Power Systems:

- DC power system **CAT. NO. MTA2HV11DCS**
- Air (Venturi) power system **CAT. NO. MTA2HV11A1R**



### CAT. NO. MTA2HV11AC

### CAT. NO. AUMTA2HV11AC (Australia)

Minimum order is one each.  
F.O.B. Laurel, Montana

### Available Options:

- G-Force™ Hoist Control **CAT. NO. 1H0HGP**
- Vacuum Loss Warning Buzzer **CAT. NO. E03VLV**
- Closed Cell Foam Pad Rings **CAT. NO. FRHV11**
- Voltage Adaptation **CAT. NO. E06VA**

See Pages 737K-738K for Details on Available Options.

## CRL Wood's Powr-Grip® Custom Lifter Program

### A Solution for Virtually Any Lifting Requirement

Although Wood's Powr-Grip® offers an extensive line of standard lifter models for a variety of industries, you may not find a model that meets your specific job or process requirements. The crew at Wood's can design and fabricate a completely new and unique model, or modify one of their many existing models to meet your exact specifications.

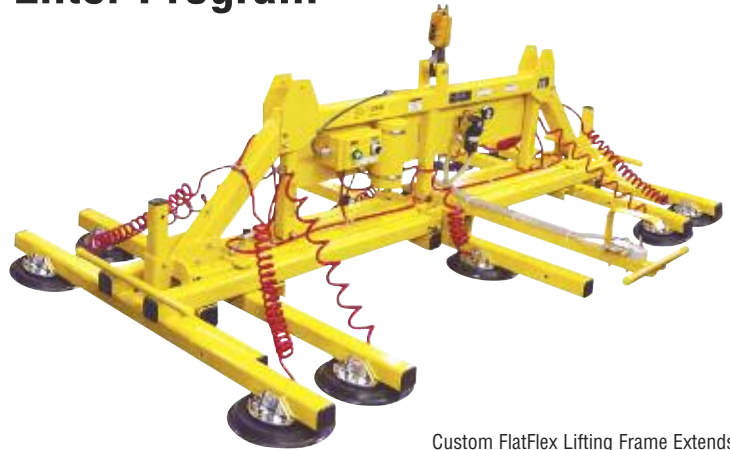

Custom FlatFlex Lifting Frame Extends to a Massive 14' (4.3 m) Length for Lifting Large Flat Sheets. Maximum Load Capacity 2500 lb. (1135 kg)

### Engineering

The process is done by a highly skilled, specialized and dedicated team of mechanical engineers. This group, with more than 40 years of experience in the design and manufacturing of vacuum equipment, has the right combination of talents to translate your ideas into reality.

### Design

Now combine talented staff with the most current, sophisticated design technology, including computer aided design, 3-D modeling, math analysis software, manufacturing software, and finite element analysis technology, and you have a system able to account for every inch of weld and every screw involved in the construction of your custom lifter.

### Fabrication

The final step in creation of your custom lifting device involves the latest in production machinery and technologies on the production floor. Skilled experienced machinists trained on the most up-to-date machinery, from manual mills and lathes to computer controlled CNC mills fabricate every component before it goes to the final states of welding and assembly.



Custom Power Tilt Lifting Frame was Built to Lift Textured Sheets. Maximum Load Capacity 1500 lb. (680 kg)

### Assembly

Wood's welding personnel are extensively trained and constantly tested to ensure the best possible welds, whether working in steel or aluminum. All systems including brazing, soldering, and hot bending are accomplished using only the best equipment available in the industry. Every type of structural weld is exhaustively tested and qualified through Wood's strict internal quality control requirements in accordance with the American Society of Mechanical Engineers (ASME) guidelines.

### Imagination

The images on this page represent a few of the many custom designed lifting devices required for industry specific applications. If you need a style of lifting device that you don't see in this catalog, please contact our Customer Service Department at (800) 421-6144 in the U.S., (877) 421-6144 from Canada, or (323) 588-1281 International. Ask for Extension 5275, and they will help create the device your job requires.



Custom 8-Cup Manual Rotating, Power Tilt Lifting Frame was Built to Place Armored Siding on Troop Transports. Maximum Load Capacity 1000 lb. (445 kg)

Wood's Powr-Grip is a registered trademark of Wood's Powr-Grip Co., Inc.

## CRL Wood's Individual Pad Shutoffs

- Allows You to Shut Off Airflow to Specific Vacuum Pads

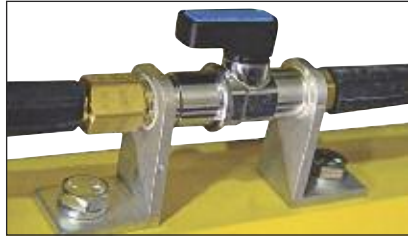

CRL Wood's Individual Pad Shutoffs are available for most of Wood's below-the-hook lifters, either at the time of lifter purchase, or installed later in the field. These manually operated valves shut off airflow at specific vacuum pads, allowing the lifter to attach to loads that are smaller than the pad frame. Minimum order is one each.

CAT. NO. CM1COWB

## CRL Wood's Dual Vacuum System

- Reduces the Risk of Dropping Loads



This Wood's Dual Vacuum System is available for many of Wood's below-the-hook vacuum lifters that are equipped with a DC-powered vacuum system. It features two vacuum line circuits, which allow the lifter to maintain the vacuum level for one circuit even if an unexpected vacuum loss occurs in the other one. The Dual Vacuum System features audible and visible alarms that warn the operator whenever the vacuum level is not sufficient for lifting the maximum load weight. **NOTE:** Must be ordered at time of lifter purchase (not retrofittable). Minimum order is one each.

CAT. NO. E010DVS

## CRL Wood's 12V DC Vacuum Back-Up

- Designed to Maintain Vacuum During Power Failures



Available for most Wood's AC and air powered below-the-hook vacuum lifters, this option consists of an auxiliary vacuum generating system with an independent power source that is designed to maintain vacuum in the event of a power failure. The Wood's DC Vacuum Back-Up System is ideal for use wherever AC or compressed air power is not reliable. **NOTE:** Must be ordered at time of lifter purchase (not retrofittable). Minimum order is one each.

CAT. NO. E01DCB

## CRL Wood's Vacuum Loss Warning Buzzer

- Warns Operator of Insufficient Vacuum for Safe Lifting



Powered independently by a long-lasting 9-volt battery, this Wood's Vacuum Loss Warning Buzzer is available for all Wood's below-the-hook vacuum lifters, either at the time of lifter purchase, or installed later in the field. This device automatically monitors the lifter's vacuum and sounds an alarm if the lifter does not reach or maintain a level that is sufficient for lifting. Unlike buzzers that sound whenever the lifter is not attached to a load, the Vacuum Loss Warning Buzzer uses advanced logic circuitry to warn the operator only when insufficient vacuum poses a hazard. Minimum order is one each.

CAT. NO. E03VLW

## CRL Wood's Movable Pad Mounts

- Lets You Change Overall Pad Spread in Minutes

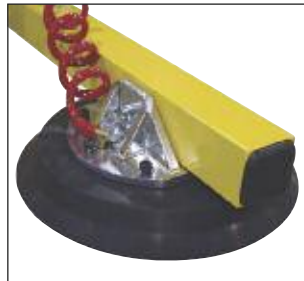

CRL Wood's Movable Pad Mounts allow vacuum pads to be removed and repositioned at various predetermined locations on the pad frame. By changing the overall pad spread in just moments, Movable Pad Mounts enable a single vacuum lifter to handle a wide variety of load dimensions. No tools are required because cotterless hitch pins make positioning the pad mounts fast and easy, while maintaining all necessary safety standards. **NOTE:** Must be ordered at the time of lifter purchase (not retrofittable). Minimum order is one each.

CAT. NO. CM2SCM

## CRL Wood's Closed Cell Foam Pad Rings

- For Lifting Materials With Textured Surfaces



These Closed Cell Foam Pad Rings are available for any of Wood's below-the-hook HV11 Vacuum Pad Lifters. This option is indispensable while lifting stone slabs or other materials with moderate surface texture; the rougher the surface, the more difficulty vacuum pads have sealing against it, which allows air to leak under the pads, eliminating any seal. Smooth surfaces, such as polished stone, generally seal well with standard vacuum pads. For rougher surfaces, such as flame-cut stone, foam rings are essential to attain a good seal. The flexible foam rubber in these rings helps vacuum pads conform to rough surfaces and reduces the vacuum flow needed to overcome leakage. Available at time of purchase or may be installed later in the field. Minimum order is one each.

CAT. NO. FRHV11

## CRL Wood's Counter-Balancer for P2 Series Channel Lifters

- Used in Conjunction With Wood's Powr-Grip® P2 Lifters
- P2 Lifters Can Also Be Inverted on the Counter-Balancer for Reverse-Angle Installations

The Counter-Balancer is used in conjunction with Wood's Powr-Grip® P2 Series Lifters. This accessory allows loads to be positioned under overhangs by extending the lifter away from the lifting tackle. P2 Lifters can also be inverted on the Counter-Balancer for reverse-angle installations, such as those in airport control towers. The Counter-Balancer is kept level using an adjustable counterweight arm, control lines, and user-supplied ballast materials. Minimum order is one each.



CAT. NO. CB1S

## CRL Wood's PT10HV11 Control Handle Extensions

- Enables Operator to Safely Maneuver the Load Without Being in Its Path

Available for Wood's PT10HV11 Vacuum Lifters, these Control Handle Extensions provide a way to move the control handle a distance of 36" (914 mm) outward from the standard operator position. This enables the operator to maneuver the load and to use the tilt control while remaining safely outside the path of tilting materials. In this way, the operator can handle a very wide load conveniently and efficiently without ever risking contact with the load itself. Minimum order is one each.



CAT. NO. LB9HE0

## CRL Wood's Insulating Glass Anti-Shear Supports

- A Must When Lifting Insulating Glass Units

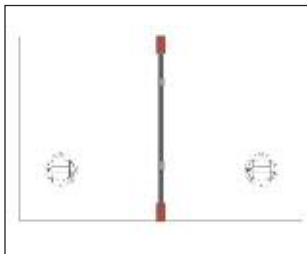
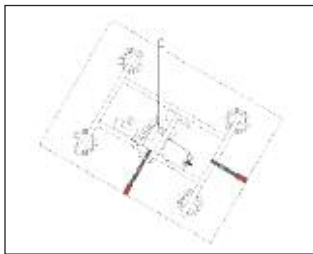

Lifting insulating glass units with vacuum cups on only one side of the unit means that the lite of glass on the other side is supported solely by the edge sealant used to produce the unit. To reduce the amount of shear force while lifting in this manner, simply employ a pair of CRL Wood's Insulating Glass Anti-Shear Supports. When used with vacuum lifting frames, attach a pair of the supports to the bottom of the unit for vertical lifts. If rotating the unit, attach at 90 degrees as shown in the diagram above for support in both directions.

CRL Wood's Insulating Glass Shear Supports can also be used when lifting I.G. units by hand to provide the same safety as when used with vacuum lifting frames. Just thread the straps of each support together so the insulating glass unit is held together, top and bottom as shown in the diagram above. Attach two or more vacuum cups to the front lite. The unit can then be lifted securely. Minimum order is one pair.

Wood's Powr-Grip is a registered trademark of Wood's Powr-Grip Co., Inc.

CAT. NO. TF007

## Keep Your CRL Wood's Powr-Grip® Lifting Frames in Good Working Order

CRL stocks the most commonly replaced Wood's Powr-Grip® Lifting Frame parts to keep your equipment in safe and ready-to-use condition. Wood's recommends that "All pads should be replaced on a regular basis, preferably after no more than two years to ensure the friction coefficient is not compromised". The friction coefficient represents the lifter's ability to resist load slippage when the load is oriented in any

position except horizontal. Contamination, wear, age, and exposure to sunlight, as well as the condition of the load's contact will affect the surface. Pads that exhibit wear, stiffness or glazed surfaces must be replaced. The Replacement Pads shown below, as well as the other parts shown here that are subject to damage and wear, are all genuine Wood's factory components that are easy to replace.

### CRL Wood's 10" Lifting Frame Vacuum Pad With Closed Cell Pad Ring



For lifting frames with 10" (254 mm) vacuum pads with closed cell foam pad rings. The flexible foam rubber conforms to rough surfaces. Minimum order is one each.

CAT. NO. FRHV11R

### CRL Wood's 9" Newer Model Lifting Frame Vacuum Pad



For lifting frames with 9" (229 mm) vacuum pads with the letter "L" in their model number. Minimum order is one each.

CAT. NO. VPFS9

### CRL Wood's 11" Lifting Frame Vacuum Pad



For all lifting frames with standard 11" (280 mm) vacuum pads. Minimum order is one each.

CAT. NO. G3370

### CRL Wood's Lifting Frame Battery



It makes good sense to have a back-up battery when you need it. For use with all 12V DC lifting frames. Minimum order is one each.

CAT. NO. 64664

### CRL Wood's Lifting Frame Battery Chargers



CAT. NO.	DESCRIPTION
64702AM	120V AC/12V DC Charger With Cinch Connector
64706AM	240V AC/12V DC Charger With Cinch Connector-Europe
64707AS	240V AC/12V DC Charger With Cinch Connector-Australia

Minimum order: 1 each.

Wood's Powr-Grip is a registered trademark of Wood's Powr-Grip Co., Inc.

### CRL Wood's Lifting Frame Battery Gauge

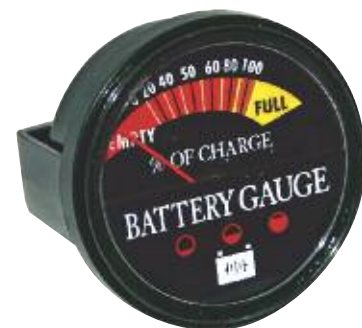

Replacement Battery Gauge includes a slide terminal. Minimum order is one each.

CAT. NO. W64590

# CRL VACUUM LIFTER REPLACEMENT PARTS

For Pricing Visit [crlaurence.com](http://crlaurence.com) or Call Us Toll Free at the Phone Numbers Shown on the Back Cover

## CRL Wood's Powr-Grip® Lifting Frame Dual Vacuum Gauge



This CRL Wood's Powr-Grip® Lifting Frame Vacuum Gauge has a 1-1/2" (38 mm) diameter dial with an 1/8" NPT fitting. Center back mount style. Minimum order is one each.

CAT. NO. W15911

## CRL Wood's Powr-Grip® Lifting Frame Filter Element



In-line air filters are designed to prevent water and airborne contaminants from entering the vacuum system. However, in order for a filter to function, liquid accumulating in the filter bowl must be removed before it contacts any portion of the Filter Element. In addition, the Filter Element must be replaced whenever it becomes too contaminated to work efficiently. This Filter Element is for 1 oz. bowl size mini air-line filter. Minimum order is one each.

CAT. NO. W16134

## CRL Wood's Powr-Grip® Lifting Frame Vacuum Pad Covers



Vacuum pads are the critical components to make a vacuum lifter function. They can become damaged by cutting or abrasion of the sealing edges. Beyond direct physical abuse, the biggest enemies of the rubber in vacuum pads are heat, ultraviolet rays, ozone, and harsh chemicals. Keeping pads clean and covered when not in use helps to avoid this. Minimum order is one each.

CAT. NO. 29353

## CRL Wood's Equipment Leak Test Kit

**new**

- Eliminate Costly Down Time
- Easy to Use In-Shop or the Jobsite



The CRL Wood's Equipment Leak Test Kit is necessary for protecting your valuable investment in glass lifting equipment. This Kit contains everything needed to accurately diagnose and repair vacuum leaks in all Wood's Below the Hook Lifting Equipment. Kit includes 25 feet (7.6 m) of vacuum hose, four plugs, eight test caps, one ball valve and gauge, and one set of special pliers for removing vacuum tubing from system fittings. Minimum order is one each.

CAT. NO. W66102

## CRL Wood's Vacuum Lifting Frame Rental Program

- Five Models to Choose From
- Rent by the Week or With an Option to Buy

CRL offers five different styles of Wood's Powr-Grip® Vacuum Lifting Frames on week-to-week rentals from locations worldwide. This is an ideal program for customers who have heavy glass lifting requirements, but not enough to justify a purchase. Please refer to pages 718K to 719K for complete rental program details.

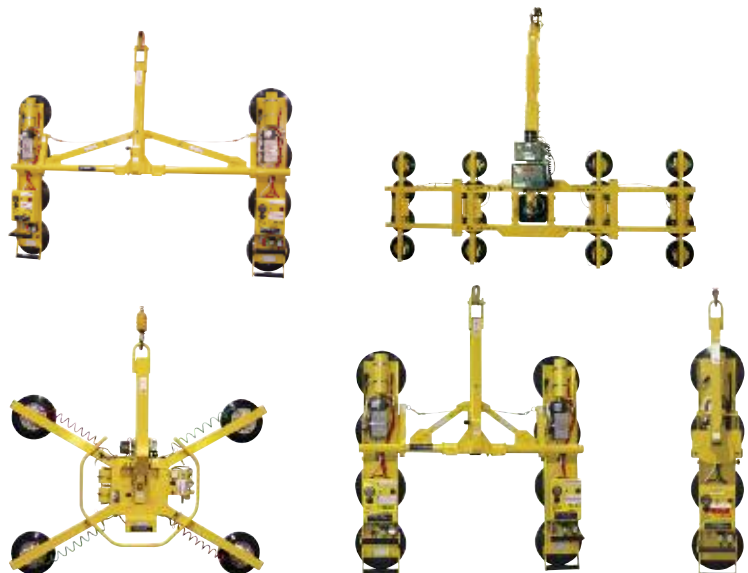

Wood's Powr-Grip is a registered trademark of Wood's Powr-Grip Co., Inc.



C.R. LAURENCE COMPANY

[crlaurence.com](http://crlaurence.com) | [usalum.com](http://usalum.com)

740K | [crlaurence.ca](http://crlaurence.ca) [crlaurence.com.au](http://crlaurence.com.au) [crlaurence.co.uk](http://crlaurence.co.uk) [crlaurence.de](http://crlaurence.de) [crlaurence.eu](http://crlaurence.eu)



**1** Glazier's Tools



**2** Glass Handling and Safety Gear



**3** Specialty Tools



**4** General Hand and Shop Tools



**5** Caulking Tools and Insulating Glass



**6** Glass Working Machinery and Lifting Equipment

# 7

## 73R TME Complete Product Index

- A TO Z INDEX FOR EVERY PRODUCT IN THIS CATALOG, WITH LISTINGS BY BRAND NAMES, GENERIC NAMES, AND COMMON NAMES
- PHONE, FAX AND EMAIL DIRECTORY
- CRL/U.S. ALUMINUM LOCATIONS
- CRL MANUFACTURING
- ARCHITECTURAL SYSTEMS

See other side for Section Index.

# ASSISTANCE IN FINDING PRODUCTS



Supplying the World With Glazing, Screen, Architectural, Railing, Construction, Industrial, and Automotive Supplies

C.R. Laurence Co., Inc. An ISO9001:2008 Company

## There Are Many Ways to Find Just the Right Product for Any Job, and We Are Here to Help

### C.R. Laurence Co., Inc.

2503 E. Vernon Ave.  
Los Angeles, California 90058-1897

Toll Free Phone (800) 421-6144  
Toll Free Fax (800) 262-3299  
International Phone (323) 588-1281  
International Fax (323) 581-6522



### Send An Email or Request to CRL's Online Support

You've looked through our catalog and tried the "CRL Total Search" on our web site, and still couldn't find what you were looking for? Don't give up, just ask us for assistance online. Go to the [crlaurence.com](http://crlaurence.com) home page and click on Contact Us. Then click on Online Support to tell us what it is you are looking for. Our Online Support Department will respond with an answer, usually within one hour if you contact us during normal business hours.

If you have a picture, drawing, or attachment you need to send along with your request, you can send a direct email by addressing it to [crl@crlaurence.com](mailto:crl@crlaurence.com). We will do our best to help you because your satisfaction is our goal.



### Call Us Toll Free At (800) 421-6144

There's a friendly and helpful voice to help with your product inquiries whenever you call us toll free at **(800) 421-6144** from anywhere in the United States or Canada. Please ask for Customer Service and let us know what you are looking for, how many you need, and when you need them. We're experts at searching available sources worldwide. The experience gained by decades of service affords us the ability to serve you in more ways than you might realize. In Australia our toll free number is 1800 424 275. In Europe our freephone number is 00 800 0421 6144.



### Fax Us Toll Free At (800) 262-3299

They say a picture is worth a thousand words, and when you send us a fax describing what you need it makes it that much easier to serve you. CRL offers toll free fax service from anywhere in the United States and Canada. Just dial **(800) 262-3299**, and address your request to CRL Customer Service. Make sure to include your name and return telephone number. We'll be in touch shortly with an answer. In Australia the toll free fax number is 1800 813 013. In Europe the freefax number is 00 800 0262 3299.



### Send Us A Sample

Need a special part but haven't been able to find it anywhere? We can usually help you by e-mail, phone or fax, but when that doesn't work, we offer a sample matching service that is determined to serve you. Every year hundreds of CRL customers send us samples of what they're looking for because they know that, quite often, CRL is their best chance of getting just what they need. You may send a sample of what you need to: CRL Customer Service, 2503 E. Vernon Avenue, Los Angeles, CA 90058-1897. Be sure to include your name and telephone number so we can call you with the results of our search. In Australia, 9 Shale Place, Eastern Creek, NSW 2766. In Europe, Charles Babbage Avenue, Kingsway Business Park, Rochdale OL16 4NW England.



C.R. LAURENCE COMPANY

[crlaurence.com](http://crlaurence.com) | [usalum.com](http://usalum.com)

[crlaurence.ca](http://crlaurence.ca)

[crlaurence.com.au](http://crlaurence.com.au)

[crlaurence.co.uk](http://crlaurence.co.uk)

[crlaurence.de](http://crlaurence.de)

[crlaurence.eu](http://crlaurence.eu)



## Customer Service Order Desk

Ask for Extension

# 5275

- Get Product Information
- Request Price Quotes
- Check Stock Availability
- Place or Trace Orders
- Check Your Account Status
- Request Catalogs

Customer Service Order Desk hours are 6 am to 5 pm (Pacific Time) Monday through Friday, and 7 am to 12 pm Saturday. If you wish to pick up your order at the Will Call Trade Counter of our regional warehouses the hours are 8 am to 5 pm Monday through Friday, and 8 am to 12 pm Saturday. For the fastest Will Call service be sure to place your order in advance so we can have it ready upon your arrival.

Direct Fax  
**(800) 262-3299**

Direct E-Mail  
**crl@crlaurence.com**

## Technical Sales Business Groups

### Glass and Glazing

Ask for Extension

# 5275

Direct Fax  
**(800) 262-3299**

Direct E-Mail  
**glazing@crlaurence.com**

- Glass Handling Equipment
- Glazier's Tools and Machinery
- Mirror and Glass Hardware
- Retail Display Hardware and Standoffs
- Safety Gear
- Sealants, Adhesives, and Fasteners
- UV Glass Bonding
- Vacuum Lifting Equipment
- Glass Cleaners
- Security Solutions for the Locksmith Industry



### Door and Window Control Hardware

Ask for Extension

# 7520

Direct Fax  
**(866) 921-0531**

Direct E-Mail  
**glazing@crlaurence.com**

- Door Closers and Hardware
- Commercial Door Hardware
- Insulating Glass Supplies
- Patio Door Hardware
- Residential Window Hardware
- Guarda™ Security Screens
- Screen Wire and Supplies
- Storm Door and Window Supplies
- Screen and Security Doors



## Technical Sales Business Groups

### Architectural Hardware

- Architectural Storefronts
- 'All-Glass' Entrance Systems
- Door and Sidelite Rails
- Glass Walls and Partitions
- Stacking and Sliding Glass Doors
- Structural Glass Fittings
- Bi-Folding Doors

Ask for Extension

# 7700

Direct Fax  
(800) 587-7501

Direct E-Mail  
[architectural@crlaurence.com](mailto:architectural@crlaurence.com)



### Blumcraft Architectural Metals

- Tubular Architectural Hardware
- Tempered Glass Door Hardware
- Panic Hardware
- Railing Systems
- Smoke Baffles
- Glass Gates
- Display Case Doors

Ask for Extension

# 7700

Direct Fax  
(800) 587-7501

Direct E-Mail  
[architectural@crlaurence.com](mailto:architectural@crlaurence.com)



### Architectural and Ornamental Metals

- Brake Shaped Metals
- Canopies and Sunshades
- Column Covers (Cladding)
- Custom Entrances and Storefronts
- Ornamental Hand and Guard Rails
- Wall Panel Systems
- Bollards
- Glass Awnings
- Balanced Doors

Ask for Extension

# 7770

Direct Fax  
(866) 921-0532

Direct E-Mail  
[archmetals@crlaurence.com](mailto:archmetals@crlaurence.com)



### U.S. Aluminum

- Storefronts and Entrance Doors
- Elephant Doors
- Curtain and Window Walls
- Sun Control Systems
- Windows
- Hurricane Resistant Systems
- Blast Mitigation Systems
- Glass Wall Office Systems

Ask for Extension

# 5305

Direct Fax  
(866) 262-3299

Direct E-Mail  
[usalum@crlaurence.com](mailto:usalum@crlaurence.com)



## Technical Sales Business Groups

### Frameless Shower Door

- Hinges and Clamps
- Knobs and Pull Handles
- Sliding Shower Enclosures
- Towel and Grab Bars
- Vanity and Wardrobe Mirrors
- 'All-Glass' Restroom Partitions
- Shower Installation Tools

Ask for Extension

# 7740

Direct Fax (800) 458-7496

Direct E-Mail [showers@crlaurence.com](mailto:showers@crlaurence.com)



### Architectural Railings

- TAPER-LOC® Railing System
- Aluminum Railing Systems
- Cap Railing Systems
- Hand Railing Systems
- Heavy Glass Base Shoe
- Post Railing Systems
- Windscreen and Gate Systems

Ask for Extension

# 7730

Direct Fax (800) 587-7501

Direct E-Mail [railings@crlaurence.com](mailto:railings@crlaurence.com)



### Transaction and Hospitality

- Bullet Resistant Exchange Windows
- Drive-Thru and Walk-Up Windows
- Food Service Sneeze Guards
- Partition Posts and Booth Dividers
- Safety and Security Mirrors
- Speak-Thru Devices
- Barrier Systems

Ask for Extension

# 7760

Direct Fax (800) 458-7496

Direct E-Mail [transaction@crlaurence.com](mailto:transaction@crlaurence.com)

Direct E-Mail [hospitality@crlaurence.com](mailto:hospitality@crlaurence.com)



### Automotive

- Auto Glass Shop Products
- Auto Glass Tools
- Pop-Up and Electric Sunroofs
- Truck Sliding Rear Windows
- Van and RV Windows

Ask for Extension

# 7780

Direct Fax (800) 587-7501

Direct E-Mail [automotive@crlaurence.com](mailto:automotive@crlaurence.com)

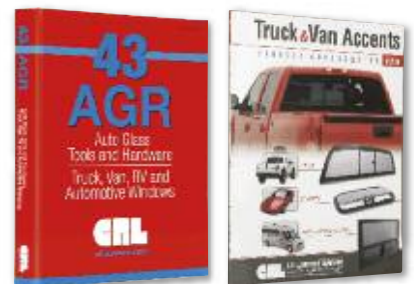

### Online Assistance by Telephone:

United States (800) 421-6144

Canada (877) 421-6144

International (323) 588-1281

Ask for Extension

# 6200

# CRL WORLDWIDE LOCATIONS

## C.R. Laurence/U.S. Aluminum in the United States crlaurence.com



C.R. Laurence Company has over 20 service centers in or near major metropolitan areas to serve our customers in the United States. Los Angeles, California is home to Corporate Headquarters and to CRL Manufacturing. It is from here that over 60,000 quality products are distributed to the regional CRL service center that serves your business.

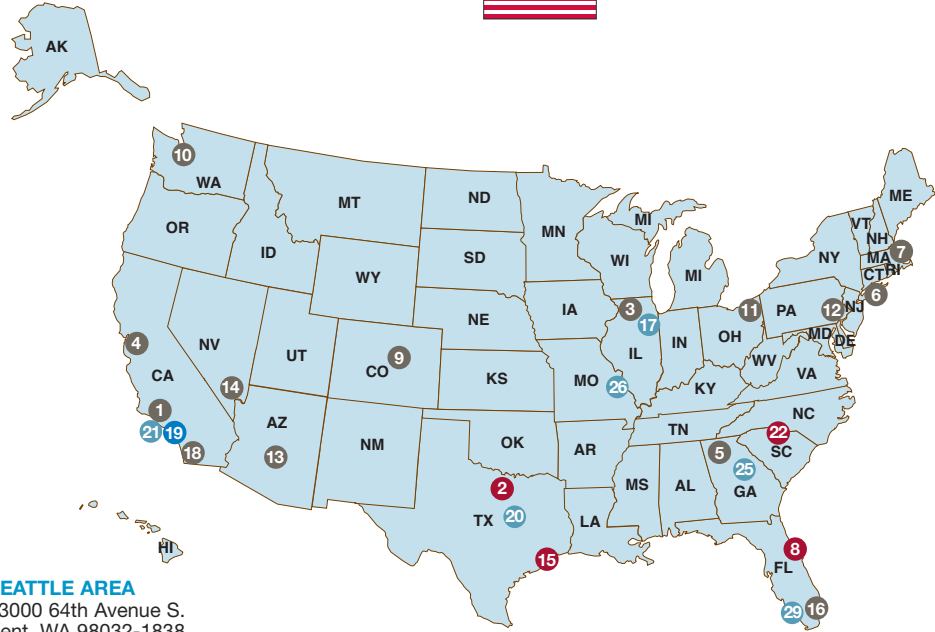

### C.R. LAURENCE

- 1 LOS ANGELES, CA**  
**CORPORATE HEADQUARTERS**  
2503 E. Vernon Avenue  
Los Angeles, CA 90058-1897  
Phone: (323) 588-1281  
Fax: (323) 581-6522
- 2 DALLAS, TX**  
2080 Lone Star Drive  
Dallas, TX 75212-6390  
Phone: (214) 634-7305  
Fax: (214) 631-6519
- 3 CHICAGO AREA**  
2765 Spectrum Drive  
Elgin, IL 60124-7841  
Phone: (847) 426-3800  
Fax: (847) 426-0111
- 4 S.F. / OAKLAND AREA**  
33200 Dowe Avenue  
Union City, CA 94587-2013  
Phone: (510) 475-1000  
Fax: (510) 475-1404
- 5 ATLANTA, GA**  
600 Wharton Drive  
Atlanta, GA 30336-4040  
Phone: (404) 696-3445  
Fax: (404) 696-3386
- 6 NEW YORK CITY AREA**  
211 County Avenue  
Secaucus, NJ 07094-2006  
Phone: (201) 770-1077  
Fax: (201) 770-1599
- 7 BOSTON AREA**  
97 Robert Treat Paine Drive  
Taunton, MA 02780-1267  
Phone: (508) 880-5600  
Fax: (508) 880-5775
- 8 ORLANDO, FL**  
6950 Presidents Drive  
Orlando, FL 32809-5668  
Phone: (407) 857-7900  
Fax: (407) 857-7766
- 9 DENVER, CO**  
4770 Joliet Street  
Denver, CO 80239-2513  
Phone: (303) 373-9988  
Fax: (303) 373-0884

- 10 SEATTLE AREA**  
23000 64th Avenue S.  
Kent, WA 98032-1838  
Phone: (253) 850-5800  
Fax: (253) 813-1818
- 11 CLEVELAND AREA**  
31600 Carter Street  
Solon, OH 44139-3551  
Phone: (440) 248-0003  
Fax: (440) 248-0120
- 12 PHILADELPHIA AREA**  
1511 Lancer Drive  
Moorestown, NJ 08057-4232  
Phone: (856) 727-1022  
Fax: (856) 727-3299
- 13 PHOENIX, AZ**  
640 S. 54th Avenue  
Phoenix, AZ 85043-4731  
Phone: (602) 269-7500  
Fax: (602) 269-7600
- 14 LAS VEGAS, NV**  
4120 Sobb Avenue  
Las Vegas, NV 89118-6857  
Phone: (702) 253-0211  
Fax: (702) 253-0311
- 15 HOUSTON, TX**  
4420 Windfern Road  
Houston, TX 77041-8918  
Phone: (713) 462-6300  
Fax: (713) 462-6306
- 16 MIAMI AREA**  
14290 N.W. 4th Street  
Sunrise, FL 33325-6226  
Phone: (954) 846-9233  
Fax: (954) 846-9277
- 18 SAN DIEGO, CA**  
10280 Camino Santa Fe  
San Diego, CA 92121-3105  
Phone: (858) 678-8984  
Fax: (858) 678-0486
- 22 CHARLOTTE AREA**  
780 Celriver Road  
Rock Hill, SC 29730-7419  
Phone: (803) 366-8326  
Fax: (803) 366-5776

### U.S. ALUMINUM

- 17 CHICAGO, IL**  
5501 West Ogden Avenue  
Cicero, IL 60804-3507  
Phone: (866) 583-1377  
Fax: (866) 584-9722
- 20 WAXAHACHIE, TX**  
200 Singleton Drive  
Waxahachie, TX 75165-5012  
Phone: (972) 937-9651  
Fax: (972) 937-0405
- 21 LOS ANGELES, CA**  
2450 E. Vernon Avenue  
Los Angeles, CA 90058-1802  
Phone: (323) 268-4230  
Fax: (866) 262-3299
- 25 ATLANTA, GA**  
5530 Westpark Drive SW  
Atlanta, GA 30336-2645  
Phone: (404) 344-3468  
Fax: (404) 344-3412
- 26 ST. LOUIS AREA**  
11621 Fairgrove Industrial Blvd.  
Maryland Heights, MO 63043-3437  
Phone: (314) 997-5112  
Fax: (314) 997-7504
- 29 MIAMI, FL**  
7500 N.W. 69th Avenue  
Miami, FL 33166-2524  
Phone: (305) 888-0077  
Fax: (305) 884-3111

### CRL MFG

- CRL MANUFACTURING**  
2200 E. 55th Street  
Los Angeles, Ca. 90058-3438  
Phone: (323) 588-1281  
Fax: (323) 581-6522
- CRL MANUFACTURING**  
2100 E. 38th Street  
Los Angeles, CA 90058-1617  
Phone: (323) 588-1281  
Fax: (323) 232-2240
- CRL MACHINERY**  
5501 West Ogden Avenue  
Cicero, IL 60804-3507  
Phone: (866) 583-1377  
Fax: (866) 584-9722
- 19 COLUMBIA MANUFACTURING**  
14400 S San Pedro Street  
Gardena, CA, 90248  
Phone: (310) 327-9300  
Fax: (310) 323-8220

= Combined CRL/U.S. Aluminum Service Center



**C.R. LAURENCE COMPANY**

[crlaurence.com](http://crlaurence.com) | [usalum.com](http://usalum.com)

744K | [crlaurence.ca](http://crlaurence.ca) [crlaurence.com.au](http://crlaurence.com.au) [crlaurence.co.uk](http://crlaurence.co.uk) [crlaurence.de](http://crlaurence.de) [crlaurence.eu](http://crlaurence.eu)

# CRL WORLDWIDE LOCATIONS

## C.R. Laurence/U.S. Aluminum Canada crlaurence.ca

C.R. Laurence/U.S. Aluminum Canada operates from five metropolitan service centers across Canada to bring our customers fast and efficient service coast-to-coast. We are an ISO-9001:2008 certified company that follows internationally recognized standards for service excellence.

All CRL/U.S. Aluminum Canada locations utilize modern materials handling technology, and inventories are refreshed weekly in all service centers. We do everything possible to assure that your orders can be shipped quickly and correctly.

Whenever you use our toll free telephone (800) 421-6144 and fax (800) 262-3299 numbers you are connected to the CRL Canada service centers that serves you, and not a centralized call center thousands of miles away. The people you talk to are also the people who process and ship your orders. Each location also offers Will Call Trade Counter service Monday through Saturday.

French speaking customers can use our multilingual Internet site to enjoy complete access to all CRL services. You can search in English, or computer-generated French, Spanish, and German.

## Five Locations to Serve All of Canada from Coast-to-Coast



All transactions between CRL/U.S. Aluminum Canada and our customers are conducted in Canadian Dollars. This includes all prices shown on our web site, on quotes, orders, and invoices, whether the product originates from one of our facilities, or is imported from a manufacturer in the United States or overseas. For current pricing, call us toll free at (800) 421-6144, or log on to the CRL Web Site at [crlaurence.ca](http://crlaurence.ca).

**31 VANCOUVER AREA**  
11920 Horseshoe Way  
Richmond, BC V7A 4V5  
Phone: (604) 448-9344  
Fax: (604) 448-9322

**35 VANCOUVER AREA**  
5377 272nd Street  
Langley, BC V4W 1P1  
Phone: (604) 857-7766  
Fax: (604) 857-1377

**34 CALGARY, ALBERTA**  
4200 116 Avenue SE  
Calgary, AB T2Z 4B5  
Phone: (403) 250-5783  
Fax: (403) 291-3260

**33 CANADA HEADQUARTERS  
TORONTO AREA**  
65 Tigi Court  
Concord, ON L4K 5E4  
Phone: (905) 303-7966  
Fax: (905) 303-7965

**32 MONTREAL AREA**  
8200, Rue Des Bâtisseurs  
Anjou, QC H1J 3B3  
Phone: (514) 352-3300  
Fax: (514) 352-1017

## C.R. Laurence Australia crlaurence.com.au

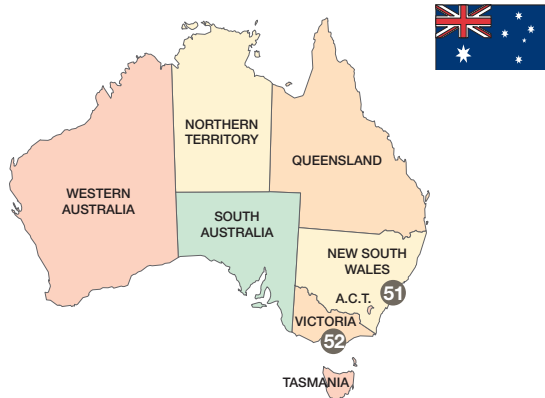

C.R. Laurence Australia serves Australia from coast-to-coast with quality CRL products and services.

All transactions between CRL of Australia and our customers are conducted in Australian Dollars. This includes all prices shown on our web site, on quotes, orders, and invoices, whether the product originates from an Australian manufacturer, or is imported from overseas. For current pricing, call us toll free at 1800 424 275, or log on to the CRL Web Site at [crlaurence.com.au](http://crlaurence.com.au).

**51 AUSTRALIA HEADQUARTERS  
SYDNEY AREA**  
9 Shale Place  
Eastern Creek, NSW 2766  
Phone: (02) 9851-3444  
Fax: (02) 9851-3445

**52 MELBOURNE AREA**  
42 Enterprise Drive  
Rowville, VIC 3178  
Phone: (03) 9764-8322  
Fax: (03) 9764-8378

## C.R. Laurence of Europe crlaurence.co.uk crlaurence.de crlaurence.dk

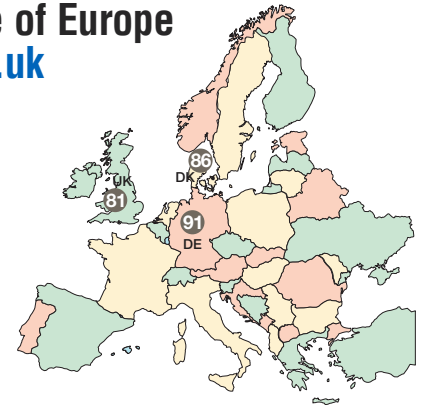

C.R. Laurence of Europe serves the European Union with quality products and services from three service centers.

All transactions between CRL of Europe and our customers are conducted in the local currency. For current pricing, please call our freephone number 00 800 0421 6144, or log on to the CRL Web Site at [crlaurence.co.uk](http://crlaurence.co.uk), [crlaurence.de](http://crlaurence.de), or [crlaurence.dk](http://crlaurence.dk).

**EUROPEAN HEADQUARTERS**  
**81 MANCHESTER AREA, ENGLAND**  
Charles Babbage Avenue  
Kingsway Business Park,  
Rochdale, OL16 4NW, England  
Phone: +44 (0)1706 863 600  
Fax: +44 (0)1706 869 860

**86 COPENHAGEN AREA, DENMARK**  
Stamholmen 70 Unit B  
DK-2650 Hvidovre, Denmark  
Phone: +45 (36) 72 09 00  
Fax: +45 (36) 70 33 35

**91 STUTTGART AREA, GERMANY**  
Boschstrasse 7  
D-74360  
Ilsfeld, Germany  
Phone: +49 (0)7062 915 93 15  
Fax: +49 (0)7062 915 93 16

# CRL73R CATALOG A TO Z PRODUCT INDEX

3-in-1 Tapping Tools.....	490K
3M	
Auto-Mix Mixer Nozzles.....	573K
Diamond Belts.....	192K
Duo-Glass Grinding Belts.....	185K
Flexible Diamond Hand Pads.....	196K
Metric Grinding Belts.....	649K
Radial and Roloc Bristle Discs.....	391K
Super Weatherstrip Adhesive.....	674K
Trizact Discs.....	678K
Trizact Scratch Removal Kits.....	677K
6-in-1 Mirror Bracket Tool.....	410K
6-in-1 Screwdriver with Bits.....	513K
90 Degree Clamp-it Square Kits.....	324K, 339K
90 Degree Corner Support.....	328K
90 Degree Suction Holders.....	324K, 327K
90 Degree Surface Tools.....	339K

## A

<b>Abrasive</b>	
Belts for Upright Belt Sanders.....	186K-189K, 191K-192K, 647K-649K
Blaster Kit.....	561K
Crystolon Rubbing Brick.....	196K
Diamond Belts.....	192K, 649K
Diamond Grinding Bits.....	196K
Diamond Hand Pads.....	196K
Glass Devil Sanding Tool Kit.....	193K
Glass Grinding Belts.....	179K-192K, 647K-649K
Guns.....	562K
Metric Size Silicon Carbide Belts.....	192K, 648K-649K
Sanding Bands.....	193K
Sanding Discs.....	195K
Sanding Drums.....	193K
Sanding Sticks.....	193K
Tools for Glass Working.....	177K
Accufab Pro Curtain Wall Tool.....	468K-469K
Accu-Rule Measuring Rods.....	540K
Acrylic Latex with Silicone.....	605K
Adapters, Electrical.....	550K
Additives, Defoaming.....	669K
<b>Adhesive</b>	
Bandages.....	291K
Guns.....	575K
Pumps.....	575K
Weatherstrip.....	360K
<b>Adjustable</b>	
90 Degree Interior Corner Support.....	328K
90 Degree Suction Holders.....	327K
Angle Clamp-It Tool Kit.....	323K, 339K
Angle Suction Holders.....	323K, 326K, 339K
Click Torque Wrench.....	306K
Lanyard.....	284K
Adjusting Angle Suction Holder.....	323K, 339K
Adsorbents, IG.....	609K
Aerosol Plastic Cleaner.....	149K
<b>Air</b>	
Chisel Hammer.....	556K
Filters.....	556K
Hoses.....	557K
Impact Wrench.....	556K
Powered Caulking Guns.....	572K, 608K
Powered Heavy-Duty Sheet Metal Nibbler.....	417K
Powered Muntin Clip Punch.....	614K
Powered Muntin Notcher.....	613K
Powered Tool Kit.....	676K
Tank.....	557K
Tools and Accessories.....	556K-559K
All Rubber Auto Vacuum Cup.....	221K, 394K
All Terrain Dolly.....	225K, 301K
All Wool Felt Wheel.....	360K, 674K
Allen Wrenches.....	523K, 525K
<b>Aluminum</b>	
Adapter and Felt Wheel.....	674K
Extrusion Notching Saw.....	462K
Glass Racks.....	248K-249K
Oxide Blasting Abrasive.....	563K
Side Slat.....	255K-256K, 259K
Single Pad Suction Lifter.....	393K
Storefront Tools.....	462K-465K, 705K
Vacuum Lifters.....	210K

Window Frame Extractor.....	354K
<b>Amazing Glazing</b>	
Diamond Countersinks.....	165K
Diamond Glass Saw.....	176K
Diamond Spot Facer.....	165K
Drill Adaptor.....	157K
Plated Diamond Drills.....	161K
Angle Locator, Electronic.....	543K
Angle Protractor.....	132K, 541K
Angle Swivel.....	558K
Angled Edge Blades.....	367K
Angleflex Measuring Tool.....	298K, 541K
Angletronic Measuring Tool.....	298K, 541K
Antiseptic Assortment.....	291K
Anti-Slip High Traction Safety Tape.....	564K
<b>Aprons</b>	
2-Pocket Split Leg.....	286K
5-Pocket Waist.....	287K
11-Pocket Tool.....	436K
12-Pocket Carpenters.....	436K
14-Pocket Bib.....	287K
Baler-Style Protective Leather.....	286K
Cargo Handler.....	287K
Leather.....	286K
Plastic.....	287K
Rubber.....	288K, 360K
Yellow Neoprene.....	288K
<b>Atlas</b>	
Fit Gloves.....	266K
Insulated Gloves.....	267K
Kevlar Cut Resistant Gloves.....	267K
Nitrile Gloves.....	271K
Textured Nitrile Coated Gloves.....	267K
Australian Vacuum Cups.....	202K, 204K-206K
<b>Auto Glass Tools</b>	
6-in-1 Mirror Bracket Tool.....	410K
10-in-1 Universal Trim Tool.....	403K
Channel and Vent Tool.....	409K
Channel Chisel.....	409K
Clip-Zip Trim Fastener Tool.....	403K
Combination Rivet Tool.....	409K
Cut-Out Tools.....	361K-388K
Door Glass Window Holders.....	414K
Door Handle and Window Crank Spring Tool.....	405K
Door Panel Remover.....	404K
Door Upholstery Remover.....	406K
Fiber Driving Wedge.....	407K
Flexible Shaft Pick-Up Tool.....	404K
Folding Work Seat.....	404K
Headliner Tools.....	405K
Hex End Mirror Wrench.....	410K
Hook Tool.....	413K
Import Car Clip Tool.....	402K
Latch Pin Removal Pliers.....	407K
Locking Strip Tools.....	41K-414K
Mirror Bracket Iron.....	410K
Mirror Bracket Release Tools.....	410K
Molding Release Tools.....	402K
Multi-Knife.....	366K
MultiSpanner Door Glass Retainer Tool.....	406K
Plastic Trim Fastener.....	403K
Plastic Window Washer Holder/Separator.....	407K
Rear View Mirror Installer.....	410K
Rivet Eater.....	409K
Rivet Head Removal Tool.....	409K
Rivet Stem Removal Tool.....	407K
Riveters.....	408K
Roller Nut Wrench.....	406K
Suck-N-Clamp.....	414K
Suction Cups.....	221K, 393K-396K
Technician's Starter Kit.....	426K
Torx® End Mirror Wrench.....	410K
"Tree" Molding Release Tool.....	402K
Underside Molding Installation Tool.....	405K
Universal Molding Release Tool.....	402K
Upholstery Nail Removers.....	406K
Vacuum Cups.....	221K, 393K-396K
Window Guide Pliers.....	407K
Window Molding Clip Tool.....	402K
Window Roller Nut Tool.....	406K
Windshield Hold-Down Vacuum Cup Set.....	414K

Windshield Molding and Door Clip Release Tool.....	405K
Windshield Stick Holder.....	405K
Windshield Stick Setting Tools.....	405K
Windshield Wiper Arm Removal Tool.....	414K
Automatic Glass Edgers.....	660K-663K
Automotive Suction Cups.....	221K, 393K-396K
Automotive Wire and Electrical Tools.....	418K-420K
Aztech Hot Melt Dispensing System.....	603K

## B

Back Belt.....	283K
Back Rail Roller and Axle.....	659K, 663K
Backer Rod Roller.....	579K
Baler-Style Protective Leather Apron.....	286K
Ball Caster Tables.....	626K, 646K
Banana Knives.....	368K
Band Mount Hearing Protectors.....	280K
Bandanas.....	291K
Barkleats.....	254K
Barpads.....	257K
Barrel Transfer Pump.....	576K
Base Rings.....	171K
Base Shoe Alignment Adapter.....	297K
Baseplate Pads.....	257K
Battery Chargers.....	175K-176K, 304K, 307K, 376K-377K, 452K, 478K-479K, 512K, 571K
Battery Operated UV Curing Lamp.....	333K
Baume Scale and Vial.....	679K
Below-the-Hook Lifters.....	198K
Belt Guard Safety Shields.....	635K
Belt Lubricants.....	180K, 650K
Belt Sanders.....	179K-189K, 634K-655K
Belts, Abrasive.....	186K-189K, 191K-192K, 647K-649K
Belts, Tool.....	436K-437K
Bench Model Wet Belt Sander.....	186K
Bench Vise.....	531K
Bent Point Hook Tool.....	413K
Bevel Square.....	541K
Bevelling Wheels.....	667K
Bit Caddy.....	516K
Bit Holders.....	514K-515K
Bits, Insert.....	515K-517K
Black Nitrile Gloves.....	270K
<b>Blades</b>	
Angled Edge.....	367K
Auto Glass Cut-Out.....	361K-362K, 364K-367K, 369K, 373K-374K, 376K, 378K, 381K-388K
Back Glass Removal.....	381K
Bosch Unishear.....	417K
Breakaway.....	444K
BTB Cut-Out.....	386K-387K
Carbide Tipped.....	456K-457K
Circular Saw.....	452K, 455K-458K, 470K
Cobra Stainless.....	362K
Cut-Out Knife.....	361K-362K, 364K-367K, 369K, 373K-374K, 376K, 378K, 381K-388K
Diamond Wire Form.....	449K
Equalizer Knife.....	376K, 378K, 385K, 388K
Fein Knife.....	373K-374K, 383K-384K
Hacksaw.....	449K
Hook End.....	369K, 441K
Inline Shear.....	471K
Jig Saw.....	451K
Kett Saw.....	470K
Kett Shear.....	470K-471K
Linoleum.....	441K
Mat Cutter.....	445K
Metal Bond Diamond.....	176K
Nordic Carbide Tipped.....	456K-457K
Oscillating Knife.....	373K-374K, 381K-384K, 388K
Pinch Weld Scraper.....	389K
Plastic Cutting.....	445K
Plated Diamond Saw.....	176K
Razor.....	390K, 438K
Reciprocating Saw.....	450K-451K
Resin Bond Diamond.....	176K, 457K
Resinoid Metal Cutting.....	457K
Rod Saw.....	449K
Roofing Knife.....	443K
Sealant Cut-Out.....	583K-584K
Semi-High Speed.....	457K

# CRL73R CATALOG A TO Z PRODUCT INDEX

Serrated Edge.....	369K, 440K	Clamp Bars with Gearboxes.....	259K	Two Spindle Edger.....	660K-663K
Super Hot Knife.....	365K	Clamps.....		Vertical Edgers.....	665K-666K
Time Saver Cut-Out.....	381K	Framer's Corner.....	531K	Cross-Line Leveling Laser.....	337K
U-Blade Knife.....	366K	Jorgensen Wood.....	531K	Crystolon Rubbing Brick.....	196K
UltraWiz.....	364K	Quick Grip® Bar Clamp/Spreader.....	530K	Cup Wheel Vertical Edgers.....	666K
Utility Knife.....	369K, 440K-441K, 444K, 584K	Sheet Metal.....	529K	Curing Lamps.....	331K-334K
Window De-Glazing Tool.....	354K, 581K	Solo One-Handed.....	530K	Curved Needle Nose Pliers.....	526K
Blo-Guns.....	557K	Spring.....	530K	Curved Oscillating Cut-Out Blade.....	382K
Blue Denim Protection Sleeves.....	274K	Cleaning and Polishing Products.....	104K-105K, 681K-683K	Cushion Grommets.....	259K
Blumcraft Access Control Handles.....	758K-759K	Clip-Zip Trim Fastener Tool.....	403K	Cut-Out Tools.....	361K-388K
Bonding Fixation Devices.....	322K-330K, 338K-339K	Closed Cell Foam Pad Rings.....	737K	Cut Protection.....	
Booster Cables.....	418K	Coated Cotton Work Gloves.....	269K	Cane Mesh Sleeves.....	273K
Bosch Laser Mounting Pole.....	548K	Cobra Stainless Steel Cold Knife Blades.....	362K	D-Flex Cut Resistant Gloves and Sleeves.....	267K, 276K
Bosch Unishear.....	471K	Coiled Air Hoses.....	557K	Glassworkers Protective Sleeves.....	272K-274K
Box of Rags.....	553K	Combination.....		Jackets.....	274K-275K
Brass Tip Nozzles.....	602K	Locks.....	432K	Kevlar® Apron.....	277K
Bristle Discs.....	391K	Rivet Tool.....	409K	Kevlar® Armor Wristlets.....	276K
Brush Shields.....	659K	Spline Rollers.....	345K-348K	Kevlar® Neck Protector.....	275K
Brushes.....		Square.....	541K	Leather Wrist Protectors.....	276K
3" Paint and Varnish.....	552K	Comfort-Grip Supercutter.....	116K	Nylon Mesh Wristlet.....	276K-277K
4" Whisk.....	552K	Compact T-Handle and Threaded Insert.....	491K	Ordering Custom Cane Mesh Sleeves.....	273K
6" Disposable.....	552K, 555K	Compact UV Curing Lamp.....	333K	Ordering Custom Protective Jackets.....	274K
Glass Chip.....	553K	Compressor Accessory Kit.....	557K	Ordering Custom Protective Sleeves.....	272K
Horsehair Dusting.....	552K	Concentrate Glass Cleaner.....	105K	Protective Leg Chaps.....	277K
Low-Cost Throw-Away.....	552K	Configurator.....	200K-201K, 710K-711K	Shin and Foot Protectors.....	275K
Mirror Wash.....	553K	Construction Master Calculator.....	539K	Shirts.....	275K
Wire.....	552K	Contour Gauge.....	545K	Wrist and Thumb Joint Protector.....	277K
BTB.....		Control Handle Extensions.....	738K	Wrist Protectors.....	276K-277K
Auto Glass Cut-Out Tool Kit.....	386K	Coolant.....		Cutter Oiling Stand.....	122K
General Purpose Blades.....	387K	Diamond Tool.....	167K, 495K	Cutters.....	
Heavy-Duty Air Tool.....	386K	Feeder.....	165K	Circle and Oval.....	127K-129K
Long Blades.....	386K	Hose and Valve.....	659K	Corner Radius.....	126K
Manual Handles.....	387K	Pump.....	659K	Diamond Glass.....	126K
Powered Cold Knife Blade Sets.....	387K	Cordless.....		Glass.....	108K-120K, 123K-129K
Specialty Blades.....	387K	Angle Drill.....	477K	Glass Tubing.....	126K
Universal Blades.....	386K	Auto Glass Cut-Out Tools.....	375K-377K	Plastic.....	146K-147K
Bungee Cord Assortment.....	261K	Caulking Guns.....	570K-571K, 608K	Production.....	123K-124K
Burco Glass Racks.....	399K	Drills.....	477K-478K	Self-Oiling.....	114K-120K
Butane Torches.....	507K	Glass Saws.....	175K-176K	Cutting.....	
		Hammer Drills.....	478K, 481K	Frame.....	132K
		Saws.....	450K, 452K	Guide.....	126K
		Screwdriver.....	512K	Head Replacement Parts.....	701K
		Core Drill Coolant Feeder.....	165K	Tables and Accessories.....	694K-698K
		Cork.....		Cutting Tools.....	
		Desk Buttons.....	245K	Cable Cutters.....	302K, 527K
		No-Adhesive Shipping Pads.....	243K	Diagonal Cutters.....	527K
		Polishing Belts.....	648K	Double Edge Plastic Cutters.....	147K
		Tabs on a Roll.....	244K	End Cutting Nippers.....	526K
		Transport Pads.....	246K	Euro Shears.....	447K
		Corner.....		Heavy-Duty Plastic Cutters.....	146K, 445K
		Caulker Nozzles.....	573K	Heavy-Duty Shears.....	447K
		Nipper Glass Pliers.....	141K	Machine for Glass and Plastic.....	125K
		Protectors.....	247K	Multi-Cutter.....	447K
		Radius Cutter.....	126K	Nibbler Cutting Tool.....	446K
		Corners, IG Spacer.....	600K, 606K	Pattern Snips.....	446K
		Cotton Swabs.....	392K	Plastic Cross-Cut Trim Snips.....	447K
		Counter Balancer for Channel Lifters.....	738K	Plastic Cutter Knife.....	147K, 445K
		Countersinks.....	489K	Plastic-Plus Cutting Tool.....	146K, 445K
		Cox Air Caulking Gun.....	572K	Plastic Trim Snips.....	447K
		Crimping Tool.....	355K	Power Shift Metal Snips.....	446K
		CRL.....		Prosnip Offset Snips.....	446K
		Ball Caster Tables.....	646K	Screen Shears.....	447K
		Belt Sanders.....	634K-646K	Wiss Metal Snips.....	446K
		Commercial Hardware.....	760K-763K		
		Counter Balance Cutting Tables.....	694K-696K	<b>D</b>	
		Finger Grip Machines.....	671K	Defoaming Additives.....	669K-670K
		Flat Edgers.....	664K	Deluxe.....	
		Glass Edging Machinery.....	656K-666K	Drop Lite.....	419K
		Glass Washers.....	684K-691K	Handy Clamps.....	530K, 597K
		Grinding Mill.....	671K	Insulating Glass Hot Melt Starter Kit.....	588K
		Horizontal Sander.....	646K	Laser Level Kit.....	547K
		Laminating Lines.....	693K	Laser Tool.....	299K, 337K
		Locations.....	744K-745K	Spacer Bender.....	614K
		Machinery Leasing.....	633K	Spring Clamps.....	135K
		Manufacturing.....	756K-757K	Super Spacer Starter Kit.....	590K
		Product Support.....	772K	Denim Protective Sleeves.....	274K
		Silvering Lines.....	692K	Desiccant Filling Machine.....	610K
		Single Spindle Edger.....	657K-659K	Dexter Mat Cutters.....	445K
		Smoothing Mill.....	671K	D-Flex Cut Resistant Gloves and Sleeves.....	267K, 276K
		Tilt-Top Glass Cutting Tables.....	694K-698K	Diagonal Cutters.....	527K
		Twin Belt Seamers.....	644K-645K	Diamantor Wooden Handle Glass Cutters.....	108K

# CRL73R CATALOG A TO Z PRODUCT INDEX

<b>Diamond</b>		<b>Drill</b>		<b>Electrical</b>	
Ball Burr Bit.....	495K	Accessories.....	480K, 492K	Adapters.....	550K
Belts.....	192K, 649K	Adapters.....	480K, 490K, 674K, 678K	Connector Crimping Tool.....	419K
Countersinks.....	165K	Bits.....	482K-488K	Cords.....	418K, 550K
Drills for Glass.....	160K-165K, 167K	Jigs.....	462K-466K, 705K	Plug Adapters.....	550K
Edging Wheels.....	658K, 662K, 667K	Threading Tap Set.....	491K	Supplies.....	550K
Electro-Formed Drills.....	162K	<b>Drilling Machines</b>		Tape.....	418K, 550K
Flat and Seam Wheels.....	658K, 662K	2-Speed Pro Vertical.....	154K	Electro-Formed Diamond Drills.....	162K
Flat-Tip Miniature Drills.....	495K	Glass Drilling Starter Kit.....	155K	Electronic Levels and Angle Locators.....	336K, 543K
Glass Drilling Machine.....	153K	Port-O-Holer Glass Drilling Tool.....	155K	Electronic Measuring Rod.....	540K
Grinding Bits.....	196K	Production Diamond Glass.....	153K	Elephant Doors.....	764K
Habit Fit Drills.....	164K	Swivel.....	154K	Encapsulated Back Glass Removal Blades.....	381K
Hand Pads.....	196K	TD25 Vertical Twin Drill.....	158K-159K	End Cutting Nippers.....	526K
Metal Bond Drills.....	163K	Tripod.....	152K	Engraver.....	137K
Mini Tripple Ripple Drills.....	167K	Vacuum Base Portable.....	156K	<b>Equalizer</b>	
Miter Wheels.....	658K, 662K	<b>Drills for Glass and Accessories</b>		Excalibur Cut-Out Tool.....	385K
Notch and Saw Machine.....	174K	Amazing Glazing Diamond Countersinks.....	165K	Express Cut-Out Tool.....	376K
Plated Drills.....	161K	Amazing Glazing Diamond Spot Facers.....	165K	Freedom Cut-Out Tool.....	377K
Point Driver.....	509K	Amazing Glazing Plated Diamond Drills.....	161K	Magnum Cut-Out Tool.....	377K
Resin Bond Blades.....	176K	Base Ring With Drain for AMZ1.....	171K	Ninja Oscillating Cold Knife.....	388K
Router Bits.....	172K-173K	Core Drill Coolant Feeder.....	165K	Reciprocal Blades and Sheaths.....	378K, 385K
Saw Blades.....	175K-176K	Diamond Tool Coolant Concentrate.....	167K, 495K	Sheath Cleaner.....	378K, 385K
Saws.....	174K-176K	Electro-Formed Diamond Drills.....	162K	Ergo-Fold Hex and Torx Key Sets.....	524K
Scribing Tools.....	137K	Glass Protecting Film Roll.....	171K	<b>European</b>	
Spot Facer.....	165K	Habit Fit Diamond Drills.....	164K	Abrasive Belts (Metric).....	192K, 648K-649K
Starlite Core Drills.....	165K	Metal Bond Diamond Drills.....	163K	Cutting Oils.....	670K
Tip Glass Cutters.....	126K	Metal Tube Drills.....	168K	Glass Measuring Tools.....	624K
Tool Coolants.....	167K, 495K, 662K, 668K, 670K, 679K	Miniature Flat-Tip Diamond Drills.....	167K	Putty Tools.....	500K
Wheel Dressing Boards and Sticks.....	662K, 669K, 679K	Portable Glass Router Kit.....	172K	Style L-Squares.....	132K-133K
Wheel Redress Program.....	668K	Prismatic Glass Drills.....	169K	Upright Wet Belt Sanders.....	186K, 188K
Digital Auto-Range Multimeter.....	549K	Sharpening Stones.....	167K	Evaporating Glass Cutting Oil.....	121K
Dispensers.....	576K	Small Diameter Glass Drills.....	170K	Evaporative Cooling Bandanas.....	291K
Dispensing Bottle for Expansion Cement.....	300K	Spearpoint Glass Drills.....	169K	Expansion Cement Dispensing Bottle.....	300K
<b>Disposable</b>		Standard Plated Diamond Drills.....	160K	Extendable Squeegee.....	681K
Brushes.....	392K, 552K, 555K	Starlite Diamond Core Drills.....	165K	Extension Cords.....	418K, 550K
Dust Mask.....	281K	Suction Base Drilling Rings.....	171K	Extra Long Cut-Out Blades.....	369K, 440K
Foam Ear Plugs.....	280K	Three-In-One Glass Drill.....	170K	Extractor Pro Tool.....	376K, 388K
Nitrile Gloves.....	270K	Tripple Ripple Diamond Drills.....	167K	Eyewash.....	291K
Dixon Lumber Crayon.....	137K	Tube Drills.....	168K	E.Z.D. Glazer De-Glazing Tool.....	354K, 581K
Dixon Markers.....	136K-137K	<b>Drills for Plastic Materials</b>		E-Z Slide Cut-Off Gauge.....	351K, 461K
Dodge Locking Strip Tools.....	412K-413K	Drills, Cordless.....	477K-478K	<b>F</b>	
<b>Dollies</b>		Drills, Electric.....	477K, 480K-481K	Fabricators Aprons.....	288K
All Terrain.....	225K	Drop Jaw Glass Pliers.....	138K	Fabricators Sleeves.....	288K
Camber Glass.....	226K	Dry Pressurized Fire Extinguishers.....	292K	Face Shield.....	282K
Four Wheel Glass.....	226K	Dry Twin-Belt Seamer.....	644K	FastCUT Glass and Metal Optimizing Software.....	144K
Framed Glass Handling.....	226K	<b>Dual</b>		FatMax Levels.....	543K
Heavy-Duty Glass.....	225K	Cartridge Organic Vapor Respirator.....	281K	FatMax Tape Measures.....	537K
Long Glass.....	226K	Hytrel Cup.....	577K	<b>Fein</b>	
Low Floor.....	227K	Purpose Miter Box.....	448K	Circular Saw Blade.....	374K, 384K
Low Profile Case.....	227K	Vacuum System.....	737K	Cut-Out Knives and Blades.....	373K-374K, 383K-384K
Plate Glass.....	224K	Dual-Flex Wrist Supports.....	283K	Hook Blades.....	373K, 384K
Pry.....	227K	Dust and Mist Respirator.....	281K	Mini-Turbo Vac.....	551K, 697K
Self-Locking.....	226K	Dust Masks.....	281K	Pneumatic Cut-Out Tool and Blades.....	383K-388K
Split-Case.....	228K	Dusting Brush.....	552K	Scraper Blades.....	374K, 384K
Two Wheel Adjustable Glass.....	226K, 301K	<b>E</b>		Sealant Cutter Knife Kit.....	583K
<b>Door</b>		Ear Plugs.....	280K	Serrated Blades.....	374K, 383K
Clip Release Tool.....	405K	Eazi Lifter®.....	713K	Spanner Socket and Wrench.....	375K
Glass Channel Cleaning Tool.....	409K	Ebor Knives.....	500K	Specialty Blades.....	374K, 384K
Glass Retainer Tool.....	406K	Eccentric Height Adjustment Stop.....	326K	Straight Blades.....	373K, 384K
Glass Window Holders.....	414K	Econ-O-Post Hole Form.....	310K	SuperCut Sealant Cutter Knife Kit.....	583K
Handle and Window Crank Spring Tools.....	405K	Edger Wheels and Parts.....	658K-659K, 662K-663K, 667K	Tool Accessories.....	375K
Jacks.....	241K	Edgetech Super Spacer.....	594K	<b>Felt</b>	
Lifter.....	241K	<b>Electric</b>		Desk Buttons.....	245K
Panel Removal Kits.....	403K-404K	Brad Nail Gun.....	533K	Glass Protectors.....	244K
Pressure Gauge.....	558K	Cut-Out Knives.....	373K, 376K-377K	Polishers for Dremel Tools.....	494K
Upholstery Remover.....	406K	Drilling Machines.....	150K-154K	Wheels.....	673K-674K
<b>Double</b>		Drills.....	477K, 480K-481K	Female Coupler.....	558K
Cup Vacuum Lifters.....	209K-211K, 222K	Edging Machines.....	656K-666K	Female Plug.....	558K
Edge Plastic Cutters.....	147K	Glass Router.....	172K	Fiber Driving Wedge.....	407K
Edge Razor Blades.....	147K	Glass Saws.....	174K-176K	Files.....	472K
End Trim and Miter Saw.....	704K	Glue Guns.....	535K	Finder Gauges.....	336K, 545K
End Window Tool.....	501K	Hammer Drills.....	308K, 481K	Finger Grip Machine.....	671K
Loop Case Slings.....	237K	Hot Air Gun.....	314K, 506K	Finger Locks.....	399K
Miter Saw.....	704K	Polishers.....	194K-195K	Fingerless Gloves.....	271K
Pane Low-E Coating Detectors.....	623K	Sanders.....	179K-189K, 634K-655K	Fire Extinguishers.....	292K
Swivel Vacuum Cups.....	211K, 396K	Saws.....	450K, 452K-454K, 462K, 470K, 704K	First Aid Kits.....	289K-291K
Tube UV Curing Lamp.....	334K	Shears.....	470K-471K	Five Cup Flat Edgers.....	664K
Draco Inline Metal Shear.....	471K	Soldering Irons.....	554K	Fixation Devices.....	322K-330K
Drawing Travel Tube.....	548K	Staple Gun.....	534K	Fixed 45 Degree Double Miter Saw.....	704K
Dremel Rotary Tools.....	391K, 494K	Winch for Glass Cutting Tables.....	697K	Fixed 90 Degree Corner Clamps.....	328K



# CRL73R CATALOG A TO Z PRODUCT INDEX

Fixed Position 90 Degree Suction Holder	327K
Flare Jaw Glass Pliers	138K
Flashlights	292K
Flat Rack Folding Glass Racks	398K
Fletcher-Terry	
Ball End Glass Cutter	109K-110K, 112K, 117K
Carbide Wheel Glass Cutters	112K
Circle and Oval Cutter	129K
CircleMate II Circle Cutters	127K
Circle Replacement Wheels	112K-113K, 120K
Double Edge Plastic Cutter	147K
Float Glass Cutters	110K, 112K
Glass Breaker Tool	142K
Glass Cutters	109K-110K, 112K, 117K, 120K, 125K
Glass Pliers	139K
Glass, Plastic and Matboard Cutting Machine	125K
Gold Tip Cutters	109K-110K, 112K, 117K, 120K
Lens Cutter	129K
Plastic Cutters	146K-148K
Plastic Cutting Machine	148K
Pliers	139K
Point Tool	509K
PullMate Point Removing Hand Tool	508K
Flex Wheel	707K
Flexible	
Diamond Hand Pads	196K
Long Knife	368K
Muntin Locator	612K
Nozzles	573K
Putty Knives	498K-500K
Shaft Pick-Up Tools	404K
Windshield Knife	368K
Flexx-Rap Protective Wrap	271K
Flooring Knife	443K
Foam Ear Plugs, Disposable	280K
Foam Grip Push Button Cold Knife	361K
Foam No-Adhesive Shipping Pads	244K
Folding	
Glass Racks	398K
Post Level	309K, 545K
Windshield Stands	397K
Wood Rule	539K
Work Seat	404K
Follower Plates	577K
Forklift Adapter	731K
Forklift Boom	713K
Four Wheel Glass Dolly	226K
Fractional Metric Tape Rules	536K
Fractional Size Taps	306K
Fractional Sized Drill Bits	485K-487K
Framed Glass Handling Dolly	226K
Frameless Blocks	340K
Framemaster Driver and Points	508K
Framer's Corner Clamps	531K
Freestanding Windshield Racks	400K
Freez-It Spray Propellant	143K
Full-Body Modular Safety Harness	284K
Funnels	577K
Fuzzy Duck PVC Gloves	267K

## G

Gasket Installation Tool	413K
Gauge Glass Cutter	126K
Gauntlet Gloves	264K
Gel Knee Pad	285K
General Purpose	
Adhesive Cleaner	378K
Glass Cutters	109K, 112K
Locking Strip Tool	411K
Solvents	378K
Glass	
Break-Out Tools	143K
Case Bracket	239K
CHEK Meters	615K-616K
Chip Brush	122K
Chipping Tool	130K
Cleaners	104K-105K, 599K, 682K-683K
Counter Pen	549K
Cutter and Pencil Pouch	110K, 121K
Cutter Oil	121K

Cutter Oiling Stand	122K
Cutter Wheels	111K-113K, 124K
Cutters	108K-120K, 123K-129K
Cutting Guide	126K
Cutting Introduction	106K-107K
Cutting Tables and Accessories	694K-698K
Devil Sanding Tool and Kit	193K
Dollies	224K-228K
Dust Respirator	281K
Edging Machinery	656K-667K
Frosting	562K
Gloves	264K-269K
Grinding Belts	179K-191K, 634K, 637K, 639K, 642K, 647K-649K
Grippers	528K-531K
Handler Kit	221K, 393K
Jacks	241K, 343K, 393K
Laminating Lines	693K
Lifting Sling and Hand Pad	240K
Pencils	136K, 542K
Polishers	359K, 676K
Protecting Film Roll	563K
Racks for Vans	249K, 252K-253K
Running Pliers	139K-140K
Sanders	179K-189K, 634K-655K
Scalloping Tool	130K
Scratch Removers	358K-359K, 675K
Slicker	122K
Sling Shot	143K
Slings	236K-237K
Surface Restoration	672K-678K
Tapper	122K
Tie Straps	228K, 261K
Tongs	239K
Transport Racks	258K
Truck Racks	248K-253K
Washers	684K-691K
Glass Cutters	
Ball End	109K-110K, 112K, 117K
Circle and Oval Cutting	127K-129K
Corner Radius Cutter	126K
Custom-Grip Supercutter®	115K
Deluxe Brass Oil Cutter	114K
Diamantor Wooden Handle	108K
Diamond Tip	126K
Fletcher® Carbide Wheel Gold-Tips®	112K
Fletcher® Circle and Oval Cutters	129K
Fletcher® CircleMate™ II Circle Cutters	127K
Fletcher® Float Glass	110K
Fletcher® Glass, Plastic, and Matboard Cutting Machine	125K
Fletcher® Gold-Tip Designer II	117K, 120K
Fletcher® Gold-Tip Metal Handle	109K
Fletcher® Hard Glass	110K
Fletcher® Heavy-Duty	120K
Heavy-Duty 6 Wheel	110K
Heavy-Duty Oil-Type	119K
Lens Cutter Circle Machine	129K
Metal Handle	109K
Oil-Type	114K-120K
Original Supercutter®	115K
Precision Circle Cutters	127K
Production Oil-T Cutters	123K
Production Speed Cutters	124K
Scalloping Tool and Positioners	130K
Segment Radius Cutters	126K
Self-Oiling	114K-120K
Self-Oiling Circle Supercutter	127K
Squeeze and Pop	126K
TOYO® Comfort-Grip Supercutter®	116K
TOYO® Custom-Grip Supercutter®	115K
TOYO® Dry Wheel Supercutter®	110K
TOYO® Original Supercutter®	115K
TOYO® Pistol-Grip Supercutter®	119K
TOYO® Tap Wheel™ Thick Glass	120K
TOYO® Thomas-Grip Supercutter®	116K
Wood Handle	108K
Glass Protectors and Shipping Pads	
Blue Transport Pads	246K
Cork and Neoprene Composition Pads	245K
Cork Glass Protectors	245K
Cork No-Adhesive Shipping Pads	243K

Cork Tabs on a Roll	244K
Cork Transport Pads	246K
Corner Protectors	247K
Felt Glass Protectors	244K-245K
Foam No-Adhesive Shipping Pads	243K
Green Transport Pads	246K
No-Adhesive Shipping Pads	244K
Pebbled No-Adhesive Shipping Pads	244K
Red Transport Pads	246K
Sponge Rubber Glass Protectors	245K
Sponge Rubber Shipping Pads	242K
Super-Duty Shipping Pads	242K
Glass Racks and Accessories	
Aluminum Side Slats	255K-256K, 259K
Barkleats®	254K
Barpads®	257K
Baseplate Pads	257K
Clamp Bars With Gear Boxes	259K
Cushion Grommets	259K
For Pickup Trucks	248K, 250K-251K
For Vans	249K, 252K-253K
Glass Ties	257K
Harp Racks	234K-235K
Heavy-Duty Truck Mount A-Frame	258K
Insulating Glass Storage Rack	235K
Interior Glass Rack for Vans	258K
Load Stopper	257K
Rolling Glass Racks	234K-235K
Slic-Rak Glass Rack Expander	257K
Top Hat Glass Rack Channels	259K
Truck Bed Racks	258K
Truck Rack Cushion	255K
Truck Rack Kleats	254K
Truck Rack Stakes	254K
Truck Strip Cushions	259K
Glass Thickness Gauges	617K
Glass Thickness Laser	616K, 624K
Glass Thickness Meters	615K-616K
Glassworker Cut Protection Gear	264K-269K, 271K-277K
Glazier's	
Chisel	474K
Gloves	264K-267K, 269K
Ladders	564K
Rule Holder	135K
Safety Gear	272K-292K
Tool Kits	424K-425K
Glazing Points	508K-509K
Glove Sizing Chart	265K
Gloves	
Atlas Fit	266K
Atlas Kevlar	267K
Atlas Nitrile	271K
Atlas Thermo-Fit	267K
Coated Cotton Work	269K
Cut Resistant Kevlar	267K
D-Flex Cut Resistant	267K
Disposable	270K
Fingerless	271K
Fuzzy Duck PVC	267K
Gauntlet Cuff	264K
GripPro Impact Performance	268K
Insulated	264K, 267K
Knit Fit	266K
Knit Wrist	265K, 269K
Leather	269K
Lint-Free Nylon	271K, 606K
Mechanix Brand	268K
Nitri-Flex	269K
Rubber Coated	264K-267K, 269K
Smooth Palm	264K-265K
Sure Grip	269K
Tear Resistant Black Latex	270K
Textured Nitrile	267K
Vinyl Coated Work	269K
Wrinkle Finish	264K-265K
Glue Guns and Sticks	535K
GM and Chrysler Roller Nut Wrench	406K
GM Large Eyed Locking Strip Tool	412K
Green Transport Pads	246K
Grifter Vacuum Lifter	223K
Grind Wheel Hub	658K, 662K

# CRL73R CATALOG A TO Z PRODUCT INDEX

Grinders .....	706K-707K
Grinding Mill .....	671K
Grinding Wheels .....	707K
Grip Strip .....	135K
Grip-Tite Handles .....	372K
GripPro Impact Performance Gloves .....	268K
Grommet Installation Tool Kit .....	303K
Ground Fault Circuit Interrupters .....	550K, 678K
Guarda Protective Security Screens .....	770K-771K
Guide, Glass Cutting .....	126K
Guides, Insulating Glass .....	598K
Gun Fill Pump .....	576K
Gun, Hot Extruded .....	601K
Guns, Adhesive .....	575K-576K
Guns, Caulking .....	566K-572K, 575K, 608K
Guns, Glue .....	535K

## H

Habit Fit Diamond Drills .....	164K
Habit Shank Drill Adapters .....	157K
Hacking Knives .....	501K
Hacksaws and Blades .....	448K-449K
Hammer Drills .....	478K, 481K
Hammers and Mallets .....	475K-476K
Hand	
Glass Seamer .....	196K
Held UV Curing Lamp .....	332K
Held Vacuum Lifters .....	202K-223K
Pads, Abrasive .....	196K
Sanding Equipment and Abrasives .....	651K-655K
Handi-Foam Dispensing Guns .....	575K
Hard Hat	
Chin Strap .....	282K
Head Lamp .....	282K
Hearing Protectors .....	280K
Winter Liner .....	282K
Hardman Gun .....	601K
Hardwood Slot Rack Flooring .....	239K
Harp Racks .....	234K-235K
Headliner Tools .....	405K
Hearing Protection .....	280K
Heat	
Guns and Propane .....	507K
Lamp, Duralite .....	597K
Sink Forceps .....	419K
Strengthened Glass Detector .....	620K
Heater Ovens and Boxes .....	580K
Heavy-Duty	
Automotive Riveter .....	408K, 532K
Car Protectors .....	417K
Cordless Drill Holster .....	436K
Dust Pan .....	552K
Fixed Blade Utility Knife .....	442K
Glass Cutter with Replaceable Wheel Units .....	120K
Glass Dolly .....	225K
Glass Nipper .....	141K
Glass Washers .....	689K
Hacking Knife .....	501K
Hacksaw .....	448K
Hook-End Blades .....	147K
Knee Pads .....	285K
Long Reach Retractable Knife .....	369K
Oil-Type Glass Cutters .....	119K
Plastic Cutter .....	146K
Razor Blades .....	438K
Razor Scrapers .....	390K, 439K
Retractable Blade Knives .....	441K-442K, 444K
Rivet Gun .....	408K, 532K
Rolling Windshield Cart .....	401K
Router .....	705K
Scraper Chisel .....	389K, 502K
Scratch Polisher .....	358K-359K, 673K
Screen and Spline Roller .....	347K
Screen Shears .....	349K
Shop Carts .....	229K-231K
Six Wheel Glass Cutter .....	110K
Solar Series Glass Washers .....	628K
Stainless Steel Locking Strip Tool .....	411K
Truck Mount A-Frame .....	258K
Utility Knife .....	370K
Utility Knife Blades .....	369K, 440K

Vacuum Cups .....	209K
Vertical Glass Washers .....	686K
Windshield Stands .....	397K
Hex Allen T-Wrench .....	525K
Hex End Mirror Wrench .....	410K
Hex Insert Bits .....	515K-517K
High Intensity Hand-Held UV Curing Lamp .....	332K
High Intensity LED UV Curing Lamp Kit .....	333K
High Speed Cobalt Hacksaw Blades .....	449K
High Speed Drill Bits .....	484K-487K
High Speed Hole Saws .....	492K
High Speed Saw Blades .....	352K, 457K
High Speed Spiral Bits .....	705K
High-Traction Anti-Slip Safety Tape .....	564K
Hilti Hole Blow Out Pump .....	307K
Hilti TE Drills and Bits .....	308K
Hi-SHEEN Glass Cleaner .....	104K, 599K
Hole Saws .....	492K
Hook End Utility Blades .....	369K, 441K
Hook Oscillating Cut-Out Blades .....	382K
Hook Tool .....	413K
Horizontal Glass Washers .....	687K-690K
Horizontal Wet Belt Sander .....	646K
Horse Hair Dusting Brush .....	697K
Hot Air Gun Kit .....	314K, 506K
Hot Melt	
Butyl .....	601K, 604K
Clamp Table .....	603K
Extruder Gun .....	601K
Extruder Systems .....	602K-603K
Hot Trim Knife .....	602K
Humidity/Temperature Pen .....	549K
Hyde® Knives .....	497K-498K, 501K-503K
Hydrapunch Machine .....	467K
Hydraulic Boom Manipulator .....	233K
Hydraulic Rivet Gun .....	408K, 532K

## I

Igloo® Water Cooler .....	261K
Impact Driver/Drill Kit .....	307K, 478K
Impact Performance Gloves .....	268K
Impact Sockets and Accessories .....	306K
Import Car Clip Tool .....	402K
Individual Pad Shutoffs .....	737K
Industrial Cutting Wheels .....	113K
Industrial Glass Cleaners .....	682K
Industrial Paper Towels .....	682K
Inline Pneumatic Tool Oiler .....	558K
Insert Bits .....	515K-517K
Insulating Glass	
Adsorbents .....	609K
Aluminum Spacers .....	600K, 606K
Anti-Shear Supports .....	738K
Caliper .....	617K
Corners .....	600K, 606K
Equipment .....	595K, 597K, 602K-603K, 610K, 613K-626K
Guides .....	598K
Molecular Sieve .....	609K
Muntin .....	611K-612K
Nozzles .....	602K
Sealants .....	598K, 601K, 605K, 608K
Silicone .....	598K, 605K, 608K
Spacers .....	594K, 596K, 600K, 606K
Starter Kits .....	588K-592K
Super Spacer .....	594K-595K
Thickness Gauge .....	617K
Trim Knife .....	602K
Interior Glass Rack for Cargo Vans .....	258K
Interior Office Front Systems .....	765K
Internal Muntin Joiner .....	612K

## J

J-Channel Punch and Countersink Tool .....	344K
Jackets, Cut Protection .....	274K-275K
Jiffy Mixer .....	577K
Jobbers Length High Speed Steel Drills .....	484K-486K

## K

Kett Power Shears .....	470K-471K
Kett Saws and Blades .....	470K

Kevbest Protective Sleeves .....	274K
Kevlar® Apron .....	277K
Kevlar® Armor Wristlets .....	276K
Kevlar® Gloves .....	267K
Kevlar® Neck Protector .....	275K
Kik-Step .....	564K
Kit(s)	
Air Hammer .....	556K
Angle Drill .....	477K
Auto Glass Technician's .....	357K
Cable Installation .....	303K
Cordless Caulking Gun .....	570K-571K, 608K
Cordless Saw .....	175K-176K, 304K, 450K, 452K
Cordless Screwdriver .....	512K
Dremel Tool .....	391K, 494K
Driver/Drill .....	478K
Equalizer Cut-Out Tool .....	376K-377K, 385K, 388K
Fall Protection .....	284K
Fein Sealant Cut-Out .....	583K
Fein Windshield Cut-Out .....	373K, 375K
First Aid .....	289K-291K
Glass Sling Shot .....	143K
Hammer-Drill .....	478K, 481K
Heat Strengthened Glass Detector .....	620K
Hot Air Gun .....	314K, 506K
Hydraulic Rivet Gun .....	408K
IG Sales Demo .....	618K
IG Starter .....	588K-592K
Kett Saw Conversion .....	470K
Laser Level .....	547K
Nut Driver .....	523K
Omni Drill .....	490K
Plumb/Angle/Locator .....	297K
Propane Torch .....	507K
Rear Defroster Test .....	420K
Reciprocating Saw .....	452K
Rivet Gun .....	533K
Rivet Setting .....	408K
Rotary Tool .....	391K, 494K
Scratch Removal .....	358K, 677K
Sealant Spatula .....	578K
Self-Igniting Torch .....	507K
Soldering Iron .....	554K
Staple Gun .....	534K
TAPER-LOC™ Installation Tool .....	294K
UV Starter .....	311K-313K
Vacuum Base Drill Press .....	156K
Windshield Removal .....	373K
Knee Pads .....	285K
Knit Fit Gloves .....	266K
Knit Wrist Gloves .....	265K-267K, 269K
Knives	
Autoloading Utility .....	442K
Banana .....	368K
Carton Cutter .....	439K
Craftsman .....	441K
Cut-Out .....	361K-363K, 366K-368K, 373K, 375K-377K, 379K-380K, 383K, 385K-386K, 388K
Equalizer .....	376K-377K, 385K, 388K
Fein .....	373K, 375K
Flooring .....	443K
Hackout .....	501K
Heavy-Duty Utility .....	442K
Hot Trim .....	602K
Lead .....	501K
Linoleum .....	501K
Long .....	367K
Olifa® Retractable Blade .....	444K
Pipe Handle .....	367K
Plastic Cutting .....	445K
POWR-Cat .....	379K
Putty .....	496K-500K
Razor Blade .....	439K
Roofing .....	443K
Safety Slitter .....	443K
Stanley® Pocket .....	444K
Stanley® Retractable Blade Utility .....	442K
Stanley® SportUtility™ .....	441K
Stanley® Swivel-Lock Utility .....	442K
Swift Switch Utility .....	441K
Ultra Wiz .....	363K

# CRL73R CATALOG A TO Z PRODUCT INDEX

Ultra-Thin Combination .....	443K
Utility.....	369K, 440K-442K, 444K, 584K
Wildcat.....	380K
Windshield Cut-Out.....	361K-363K, 366K-368K, 373K, 375K-377K, 379K-380K, 383K, 385K-386K, 388K
Knuckle and Fingertip Bandages.....	291K
Knuckle Saver Lifter.....	223K
Kraft Paper and Dispensers.....	262K
Kut Kit.....	290K

**L**

LA-CO Soldering Flux.....	555K
Ladder Lifter.....	712K
Ladders.....	564K
Laminated Glass Railing Setting Tool.....	296K
Lamps, UV Curing.....	331K-334K
Lamson® Knives.....	496K
Large Eyed Locking Strip Tool.....	412K
Laser	
Distance Measurer.....	299K, 537K
Glass Thickness.....	616K, 624K
Level Tools.....	297K, 299K, 546K-547K
Mounting Pole.....	548K
Target.....	297K
Latch Pin Removal Pliers.....	407K
Leather	
Apron.....	286K
Gloves.....	269K
Knee Pads.....	285K
Wrist Protectors.....	276K
LED Flashlight.....	292K
Lens Cutter Circle Machine.....	129K
Levels	
Electronic Level and Angle Locator.....	543K
Folding Post.....	309K, 545K
Laser.....	297K, 299K, 546K-547K
Plumb Perfect Tool.....	336K, 544K
Stanley®.....	298K, 337K, 543K-544K
Torpedo.....	298K, 544K
Lexan Vacuum Cup.....	211K
Lifter Accessories.....	737K-738K
Lifters, Sheet Metal.....	209K, 222K-223K
Lifters, Vacuum.....	198K-223K
Lifting Frames.....	714K-736K
Lightweight Glass Running Pliers.....	139K
Lightweight Visitor Spectacles.....	279K
Lil-Buddy Junior Suction Cups.....	221K
Lint-Free Nylon Gloves.....	271K, 606K
Lint-Free Wipes.....	105K, 553K
Listo Marking Pencils.....	137K
Little Grabber Lifter.....	223K
Load Stopper.....	257K
Locking Strip Tools.....	411K-414K
Long	
Aligning Punch.....	493K
Double Tube UV Curing Lamp.....	334K
Glass Dolly.....	226K
Knife.....	367K
Shaft Cut-Out Wire Guide.....	372K
Low Dollies.....	227K
Low Voltage Circuit Tester.....	418K, 549K
Low-e	
Coating Contact Meter.....	623K
Coating Detectors.....	615K, 623K
Glass Edge Deletion Table.....	626K
Washing Machine Detergent.....	683K
Lufkin Tape Rules.....	538K

**M**

Machine Screw Taps.....	491K
Machines, Glass Edging.....	656K-667K
Machines, Glass Sanding.....	179K-192K, 634K-655K
Magfix Fixed 90 Degree Magnetic Cube.....	325K
Magnetic Clip Insertion Tool.....	415K
Magnetic Insert Bit Holders.....	514K-515K
Makita®	
Angle Grinders.....	305K, 706K-707K
Batteries.....	479K
Belt Sanders.....	180K-185K
Circular Saws.....	304K, 452K-454K
Cordless Drills.....	477K-478K

Cordless Saws.....	175K, 304K, 450K, 452K
Disc Sanders/Polishers.....	194K
Electric Drills.....	477K, 481K
Electronic Grinders.....	707K
Keyless Chuck.....	492K
Metal Nibbler.....	471K
Portable Band Saw.....	305K, 454K
Power Hammer/Scraper.....	481K, 504K
Reciprocating Saw.....	450K
Resin Fiber Finishing Discs.....	305K, 706K
Rotary Hammer Drill.....	308K, 481K
Screw Finder/Driver.....	515K
Specialty Blades.....	707K
Super-Thin Cut-Off Wheels.....	305K, 706K
Universal Battery Charger.....	479K
Male Coupler.....	558K
Manual Handles, BTB Tool.....	387K
Manual Muntin Bar Notcher and Die Sets.....	613K
Marking Pencils/Pens	
Dixon China Markers.....	137K, 542K
Dixon Felt Tipped Markers.....	136K
Listo Marking Pencils.....	137K
Sharpie Blue Fine Point Pen.....	137K
Stabilo Glass Marking Pencils.....	136K, 542K
Stabilo Marking Pens.....	136K, 542K
Touch-Up Markers.....	137K
Yellow Glass Marking Pencils.....	136K, 542K
Marson "Big Daddy" Riveter.....	408K, 532K
Marson Heavy-Duty Rivet Guns.....	532K
Masonry Drills.....	308K
Mast Extensions and Tubing.....	399K
Measuring and Marking Tools	
Accu-Rule Measuring Rods.....	540K
Angle Protractor.....	132K
Angleflex Measuring Tools.....	298K, 541K
Angletronic Measuring Tools.....	298K, 541K
Bevel Square.....	541K
Carbide Point Scriber and Marker.....	137K
Combination Square.....	541K
Construction Master Calculator.....	539K
Diamond Scribing Tool.....	137K
Electronic Measuring Rod.....	540K
Euro Style L-Squares.....	132K-133K
Folding Wood Rule.....	539K
Fractional/Metric Tape Rules.....	536K
Lufkin Tape Rules.....	538K
Metric Tape Rules.....	536K, 538K
Offset T-Square.....	539K
Phenolic L-Squares.....	131K
Phenolic Straight Edges.....	134K
Power Tape Rules.....	536K-538K
Prexiso X2 Laser Distance Measurer.....	299K, 537K
Protractor/Angle Finder.....	298K, 541K
Stanley® Tape Rules.....	537K
Straight Edge Rule.....	135K, 539K
Suction Cup Straight Edges.....	134K
Tele-Tape Measuring Stick.....	540K
T-Squares.....	132K, 539K
Ultimate Tape Rule.....	536K
Mechanics Bench Vise.....	531K
Mechanix Gloves.....	268K
Mesh Sleeves.....	273K
Metal	
Bond Diamond Drills.....	163K
Bond Diamond Saw Blades.....	176K
Brake and Shear.....	708K
Cutting Blades.....	452K, 457K
Hand Punch Set.....	493K
Handle Ball End Glass Cutters.....	109K
Snips.....	446K
Tube Drills.....	168K
Metric	
Conglomerate Abrasive Belts.....	649K
Glass Caliper.....	617K
Glass Thickness Gauge.....	617K
Glass Thickness Laser.....	616K, 624K
Hex Insert Bits.....	517K
Hex Key Wrench Sets.....	523K-524K
High Speed Drill Bits.....	486K-487K
Nut Driver Set.....	523K
Ratchet Wrench Set.....	519K

Sanding Belts.....	648K-649K
Tape Rules.....	536K, 538K
Micro Fiber Wipes.....	105K, 553K
Milwaukee Cordless Caulking Guns.....	571K
Milwaukee Heavy-Duty Hammer/Drill Kit.....	481K
Milwaukee Sawzall Reciprocating Saw.....	450K
Mini	
Ball Caster Table Glass Rest.....	645K
Diamond Drills.....	167K
L-Square.....	132K
Spot Glass Etcher.....	562K
Stretch Film and Dispensers.....	262K
Water/Coolant Adapter.....	157K
Windshield Inspection Stand.....	401K
Mirror	
Bracket Tools.....	410K
Drilling Machines.....	152K-154K
Drills.....	160K-163K, 167K-170K
J-Channel Punch.....	344K
Mastic Applicator.....	344K
Mastic Stik™.....	344K
Notching Saw.....	175K
Outlet and Switch Hole Nibbler.....	343K
Outlet Cut-Out Template Set.....	343K
Silvering Lines.....	692K
Miter Saw Fences and Gauges.....	461K
Miter Saw Table Kits.....	351K-352K, 460K
Miter Saws.....	453K-454K, 704K
Mobile Auto Glass Racks.....	398K
Mobile Harp Racks.....	235K
Modular Full-Body Safety Harness.....	284K
Molding Release Tools.....	402K, 405K
Monolithic Glass Railing Setting Tool.....	296K
Monterey Bi-Folding Door and Wall System.....	766K-767K
Movable Pad Mounts.....	737K
M-Pact Mechanix Gloves.....	268K
Multi-	
Bit and Driver Set.....	512K
Function Tool.....	179K
Knife Handle.....	389K
Knife Scraper Blade.....	389K
Purpose Glass Storage System.....	238K
Purpose Swasi Clamp.....	330K, 338K
Spanner Door Glass Retainer Tool.....	406K
Wedge Pry and Level Tools.....	473K
Muntin Bars and Clips.....	611K-612K
Muntin Tools.....	613K-614K

**N**

Nail and Tool Bag.....	436K
Natural Full Skin Chamois.....	553K
Natural Sponge.....	553K
Neck Protector.....	275K
Neck Saver.....	416K
Needle Nose Pliers.....	526K
Neutral Cure Silicone.....	605K
Nibbler Cutting Tool.....	446K
Nitri-Flex Gloves.....	269K
Nitrile Gloves.....	269K-271K
No-Adhesive Shipping Pads.....	243K
Non-Contact Thermometer.....	314K
Non-Tilt Balance Tool.....	355K
Notching Jig and Tool.....	350K
Notching Saw.....	175K
Noxon Center Punch and Nail Set.....	493K
Nozzle Cutter.....	574K
Nozzles, Brass Tip.....	602K
Nut Drivers.....	523K
Nylon	
Cable Ties.....	419K, 432K
Combination Rollers.....	345K-347K
Gloves.....	271K
Mesh Wristlet.....	277K
Wheel Spline Rollers.....	346K
Wrist Protectors.....	276K

**O**

Octopus Suction Lifters.....	208K
Offset	
Glass Breakers.....	140K
Pliers.....	140K

# CRL73R CATALOG A TO Z PRODUCT INDEX

Screwdrivers.....	512K-513K
T-Square.....	539K
Oil	
Glass Cutter.....	121K
Pneumatic Tool.....	558K
Polishing.....	180K, 650K
T-Cutters.....	123K
Type Glass Cutters.....	114K-121K
Oiler Can.....	576K
Oiling Stand.....	122K
Oleic Acid.....	555K
Olfa Heavy-Duty Long Reach Retractable Knife.....	369K
Omni Tight-Fit Drill Adapter.....	490K
One Direction Glass Cutter.....	701K
Online Configurator.....	200K-201K, 710K-711K
Organic Vapor Respirator.....	281K
Original Mechanix Gloves.....	268K
Oscillating	
Cold Knife.....	388K
Cut-Out Knives.....	373K, 375K, 379K-380K, 383K, 388K
Knife Blades.....	373K-374K, 381K-384K, 388K
Power Tool Adapter.....	388K
Oversize Cane Mesh Sleeves.....	273K

## P

Paddle Mixer.....	577K
Padlocks.....	432K
Paint Markers.....	137K
Paint Prep Pen.....	392K
Paint Spray Gun.....	556K
Painter's Tool.....	503K
PAL Plumb/Angle/Level Laser Tool.....	297K
Palm Laser.....	546K
Palmer Mastic Applicator.....	344K
Panel Saw.....	703K
Paper Towels.....	105K, 682K
Part Boxes and Cabinets.....	433K
Particulate Respirators.....	281K, 650K
Pass-Thru Sandblasting Cabinet.....	560K
Patriot Safety Eyewear.....	279K
Peak Tool, Duralite.....	597K
Pebbled No-Adhesive Shipping Pads.....	244K
Pens, Glass Marking.....	136K-137K
Peripheral Edging Machines.....	665K
Persuader Chisel and Mallet.....	365K
Phenolic	
Cutting Frames.....	132K
L-Squares.....	131K-133K
Straight Edges.....	134K
T-Squares.....	132K
Phillips Bits.....	516K, 518K
Phillips Screwdrivers.....	510K-511K
Pickup Stick and Valve Grinder Cup.....	223K
Pickup Truck Glass Racks.....	248K, 250K-251K
Pinch Weld Prep Tools.....	389K-392K
Pinch Weld Scrapers.....	389K
Pipe Handle Knives.....	367K
Pistol Type Oiler Can.....	576K
Plastic	
Apron.....	287K
Cleaner.....	149K
Cutters.....	146K-148K, 445K
Double Pad Vacuum Lifter.....	211K
Handle Glass Cutters.....	115K-120K
Mini Scraper with Razor Blade.....	390K
Plus Cutter.....	146K
Polishes.....	149K
Rivet Setter.....	408K, 532K
Running Pliers.....	149K
Scraper.....	502K
Single Pad Vacuum Lifter.....	211K
Spray Bottles.....	170K, 382K
Trim Fastener Removal Tool.....	403K
Trim Snips.....	447K
Triple Pad Vacuum Lifter.....	211K
Window Washer Holder/Separator.....	407K
Plate Glass Dollys.....	224K-226K, 301K
Plate Glass Lifters.....	141K
Plated Diamond Saw Blades.....	176K
Platen, Belt Sander.....	659K

Pliers	
"C" Clamp Locking.....	529K
Cobra Adjustable.....	528K
Compound Long Nose.....	526K
Corner Nipper Glass.....	141K
Curved Needle Nose.....	526K
Drop Jaw Glass.....	138K
Extra-Thin Needle Nose.....	526K
Flare Jaw Glass.....	138K
Glass Running.....	139K-140K
Heavy Glass Breaking.....	142K
Lightweight Glass Running.....	139K
Linesman.....	528K
Locking.....	529K
Needle Nose.....	526K
Nipping.....	139K, 141K
Offset Glass.....	140K
PPG Glass Running.....	139K
Robo-Grip.....	528K
Running.....	139K-140K
Slip Joint.....	526K
Soft Nose Glass.....	138K
Straight Jaw Glass.....	138K
Straight Jaw Locking.....	529K
Thick Glass.....	142K
Plumb Bobs.....	548K
Plumb/Level Finder Gauges.....	336K, 545K
Plumb Perfect Level Tool.....	336K, 544K
Plunger Assembly with Low Vacuum Audio Alarm.....	214K
Plunger Latch Tools.....	350K
Plymouth Locking Strip Tool.....	413K
Pneumatic Tool Oil.....	558K
Pneumatic Tool Oiler.....	558K
Pocket Carry-All Tool Pouch.....	434K
Pocket Knives.....	444K
Pocket Reference Book.....	622K
Polishers.....	673K-676K
Polishing Oil.....	180K, 650K
Polo Shirts, Cut Protection.....	275K
Poly Truck Rope.....	260K
Polyethylene Sealant Guides.....	598K
Polyisobutylene Primary Seal.....	607K
Portable	
Air Tank.....	557K
Band Saw.....	305K, 454K
Belt Sanders.....	179K-185K, 651K-655K
Blasters.....	561K
Coolant Pressure Tank.....	157K
Disc Sanders.....	194K
Electric Polisher.....	195K
Glass Drilling Machines.....	152K-156K
Glass Router.....	172K
Glass Saws.....	174K-176K
Miter Saw Table Kit.....	352K
Vacuum Blaster.....	561K
Windshield Stands.....	397K
Positioner Vacuum Cup Work Stand.....	625K
Post Level, Folding.....	309K, 545K
Post Leveling Stand.....	309K
Pouring Ramp for Base Shoe.....	300K
Power	
Ball Caster Tilt Tables.....	626K
Breaker Set for Thick Glass.....	142K
Hitler Hammers.....	478K, 481K
Inverter.....	420K
Puller.....	260K
Rotating Sealing Table.....	625K
Scraper.....	504K, 583K
Shears.....	470K-471K
Tape Rules.....	536K-538K
Powered Cut-Out Knives.....	373K-388K
PowerLock Tape Measure.....	537K
PowerShift Metal Snips.....	446K
POWR	
Cat Oscillating Pneumatic Knife.....	379K
Grip Lifting Frames.....	715K-740K
Grip Rebuilt Vacuum Cup and Exchange Program.....	217K
Grip Vacuum Cups.....	212K-220K, 222K
Pozidrive Insert Bits.....	516K
PPG Glass Running Pliers.....	139K
Precision Circle Cutters.....	127K

Precision Cut Opener.....	142K
Pressure Regulator and Gauge.....	558K
Pressure Roller and Bushings.....	659K
Pre-Tensioner Locking Pliers.....	302K
Prexiso Distance Measurer.....	299K, 537K
Prismatic Glass Drills.....	169K
Pro Tool, Duralite.....	597K
Problem Solver Nozzles.....	573K

## Production

Diamond Glass Drilling Machine.....	153K
Miter Saws.....	704K
Oil T-Cutters.....	123K
Speed Cutters.....	124K

## Professional

Glass Cutter Oil.....	121K
Glazier's Tool Kit.....	424K-425K
Knee Pads.....	285K
Laser Level Kit.....	547K
Screwdriver Set.....	511K
Propane Torches and Cylinders.....	507K
Protect-A-Dash.....	365K

## Protective

Aprons.....	277K, 286K-288K
Earwear.....	280K
Eyewear.....	278K-279K
Gloves.....	264K-271K
Goggles.....	279K
Head Gear.....	282K
Jackets.....	274K-275K
Kneewear.....	285K
Leather Apron.....	277K, 286K-287K
Leg Chaps.....	277K
Masks and Respirators.....	281K
Neckwear.....	275K
Rain Suits and Boots.....	288K
Sleeves.....	272K-274K, 276K
Wristwear.....	276K-277K
Protractor/Angle Finder.....	132K, 525K
Pry and Ripping Bars.....	473K
Pry Dollys.....	227K
Pull-Style U-Blade Knife.....	366K
Pump Action Vacuum Lifters.....	202K-208K, 212K-223K
Pump-Activated Suction Holder.....	325K
Pump-Up Vacuum Cups.....	202K-208K, 212K-223K
Pumper Tool.....	416K
Pumps, Adhesive.....	575K
Punches, Metal.....	493K
Push-Style U-Blade Knife.....	366K
Putty	
Chisels.....	502K
Knives.....	496K-500K
Remover.....	506K-507K
Tools.....	496K-507K
PVC Slot Rack Flooring.....	239K
P-Post Top Rail Installation Tool Kit.....	307K

## Q

QR Powder.....	290K
Quartz Heat Lamp, Duralite.....	597K
Quickknife Quick Release Cold Knife Kit.....	366K
Quick-Grip Bar Clamp.....	530K
Quik-Draw Mirror Outlet Cut-Out Template Set.....	343K

## R

Radband Ear Protectors.....	280K
Radians Safety Glasses.....	278K-279K
Razor Blade Knife.....	439K
Razor Blade Scraper.....	390K, 439K
Razor Blades, Heavy-Duty.....	438K
Razor Blades, Single Edge.....	438K
Ready Jet Inline Blowgun.....	557K
Ready Mix Glass Cleaner.....	105K
Rear Slider Installation Kit.....	415K
Rear View Mirror Installer.....	410K
Reciprocal Blade Sheaths.....	378K, 385K
Reciprocating Cut-Out Tools.....	376K-378K, 385K-387K
Red Devil®	
Double End Window Tool.....	501K
Flexible Putty Knives.....	498K-499K

# CRL73R CATALOG A TO Z PRODUCT INDEX

Linoleum Knife.....	501K
Putty Chisel.....	502K
Stiff Putty Knives.....	497K
Window Zipper.....	501K
Refills for Chalk Lines.....	545K
Replacement	
Air Nozzles and Jets.....	563K
Blades, Olfa Knife.....	444K
Blades, Plastic Cutter.....	146K
Blades, Utility Knife.....	440K-441K
Bulbs for UV Lamps.....	332K-334K
Cutting Heads.....	110K, 113K-120K
E.Z.D. Glazer Blades.....	581K
Glass Cutting Turrets and Wheel.....	111K-113K, 123K-127K
Head, Speed Cutter.....	124K
Heads, Glass Cutter.....	110K, 113K-120K
Rollers for Belt Sanders.....	636K, 638K, 640K-641K
Rollers, Speed Cutter.....	124K
Rubber Pads for Lifters.....	209K-210K
Resin Bond Diamond Saw Blades.....	176K
Retractable Blade Knives.....	441K-442K, 444K
Reusable Caulk Tips and Cap.....	574K
Rigid Aluminum Long Knives.....	368K
Rivet	
Eater.....	409K
Head Removal Tool.....	409K
Stem Removal Tool.....	407K
Tools.....	409K, 532K-534K
Robo-Grip Pliers.....	528K
Rol-A-Lift Hydraulic Glass Crate Truck.....	228K
Rol-A-Lift Nylon Tie Straps.....	228K
Roller Blocks.....	240K
Roller Nut Wrench.....	406K
Roller Track Kit for Twin-Belt Seamer.....	644K
Rolling Glass Racks.....	234K-235K
Rolling Windshield Carts.....	401K
Roofing Knife.....	443K
Rope Insert Tool for Rubber Gaskets.....	415K
Rotary Sealing Table.....	625K
Rotary Tools.....	391K, 494K
Rotary Work Table.....	625K
Rotating Hand Cup Lifting Frames.....	714K
Rotating Head Rivet Gun.....	408K, 532K
Rotating/Tilting Hand Cup Lifting Frames.....	714K
Round Edge Screen Roller Tools.....	345K-349K
Round Edge Template Guide.....	130K
Router Bits.....	172K-173K
Router Jig and Template.....	705K
Rubber	
Aprons.....	287K-288K
Base Pads.....	399K
Base Rings.....	171K
Coated Gloves.....	264K-267K, 269K
Concave Edge Screen Roller Tools.....	345K-349K
Donuts.....	398K
Gasket Cleaning Tool.....	409K
Glass Protectors.....	242K
Strips for Glass Racks.....	399K
Wiper.....	659K, 663K
Rubbing Bricks.....	196K
Rules, Measuring.....	536K-539K
Russell® Knives.....	497K-498K, 502K

## S

S.D.S. Masonry Drills.....	308K
S50 Sprayway Glass Cleaner.....	104K, 599K
SAE Drive Sockets.....	518K
Safety Equipment and Gear	
Adhesive Bandage Strips.....	291K
Adjustable Lanyard.....	284K
Antiseptic Assortment.....	291K
Aprons.....	277K, 286K-288K
Back Support Belts.....	283K
Cane Mesh Sleeves.....	273K
Cargo Handlers Chaps.....	286K
Cut Protection Garments.....	272K-277K
Disposable Dust Mask.....	281K
Disposable Foam Ear Plugs.....	280K
Dry Pressurized Fire Extinguishers.....	292K
Dual Cartridge Organic Vapor Respirator.....	281K
Dual-Flex Wrist Support.....	283K

Dust Mask Respirators.....	281K
Ear Plugs.....	280K
Evaporative Cooling Bandanas.....	291K
Eyewash.....	291K
Eyewear.....	278K-279K
Face Shield.....	282K
Fall Protection Harness.....	284K
Fire Extinguishers.....	292K
First Aid Kits.....	289K-291K
Full-Body Modular Safety Harness.....	284K
Glass Dust Respirator.....	281K
Glasses.....	278K-279K
Glassworkers Sleeves.....	272K-274K
Gloves.....	264K-271K
Goggles.....	279K
Hard Hat Chin Strap.....	282K
Hard Hat Head Lamp.....	282K
Hard Hat Winter Liner.....	282K
Hard Hats.....	282K
Hearing Protectors.....	280K
Heavy-Duty LED Flashlight.....	292K
Jackets, Protective.....	274K-275K
Kevlar Garments.....	267K, 274K-277K
Knee Pads.....	285K
Knuckle and Fingertip Bandages.....	291K
Kut Kit.....	290K
Large Shop First Aid Kit.....	289K
Leg Chaps.....	277K
Neck Protector.....	275K
Particulate Respirator.....	281K
Protective Goggles.....	279K
Protective Leather Apron.....	286K
Protective Sleeves.....	272K-274K
QR Woundseal™ Powder.....	290K
Radband Hearing Protectors.....	280K
Radians Safety Glasses.....	278K-279K
Rain Suits and Boots.....	288K
Ratchet Suspension Hard Hat.....	282K
Respirators.....	281K
Safety Cones.....	292K
Safety Hard Hats.....	282K
Safety Tapes.....	292K
Safety Vests.....	292K
Shin and Foot Protectors.....	275K
Sleeves, Protective.....	272K-274K
UV Goggles.....	279K, 335K
Visitor Spectacles.....	279K
Water Resistant Flashlight.....	292K
Woven Bandage Assortment.....	291K
Wristlets.....	276K-277K
Safety Speed Cut Panel Saws.....	702K-703K
Sandblast Tape.....	563K
Sandblasters and Supplies.....	560K-563K
Sander Replacement Parts.....	636K, 638K, 640K-641K, 643K
Sanders	
CRL Portable Belt.....	179K-185K, 651K-655K
CRL Wet Belt.....	186K-189K, 634K-646K
Makita® Portable Belt.....	180K-185K
Porter-Cable Portable Belt.....	184K
Sanding	
Bands.....	193K
Belts for Wet Belt Sanders.....	186K-189K, 191K, 634K, 637K, 639K, 642K, 647K-649K
Discs.....	195K
Drums.....	193K
Sticks.....	193K
Saw Blades	
Carbide Tipped.....	456K-457K
Hacksaw.....	449K
High Speed Steel.....	456K
Metal Bond Diamond.....	176K
Nordic Carbide Tipped.....	456K-457K
Plated Diamond.....	176K
Reciprocating.....	450K-451K
Resin Bond Diamond.....	176K, 457K
Resinoid Metal Cutting.....	457K
Semi-High Speed Aluminum Cutting.....	457K
Specialty Circular.....	455K
Specialty Jig Saw.....	451K
Tungsten Carbide Rod Saw.....	449K

## Saws

Amazing Glazing Diamond Glass.....	176K
Cordless Compound Bevel and Miter.....	453K
Cordless Diamond Glass.....	175K-176K
CTD Professional Quick Index Miter.....	454K
Diamond Notch and Saw Machine.....	174K
Diamond Wire Form.....	449K
Dual Purpose Miter Box.....	448K
Heavy-Duty Hacksaw.....	448K
Hitachi® Sliding Dual Compound Miter.....	453K
Hitachi® Miter.....	453K
Makita® Compound Miter.....	453K
Makita® Circular.....	452K
Makita® Cordless Recipro.....	450K
Makita® Cordless Saw.....	452K
Makita® Variable Speed Reciprocating.....	450K
Milwaukee Sawzall® Reciprocating.....	450K
Mini Hacksaw.....	449K
Mirror and Glass Notching.....	174K-176K
Premium Hacksaw.....	448K
Stanley® Hacksaws.....	448K
Scrapers.....	502K-504K
Scratch Polishing Kit.....	673K
Scratch Removal Systems, Trizact.....	677K-678K
Scratch-A-Way Systems.....	676K
Screen	
Frame Notching Jig and Tool.....	350K
Frame Punch.....	350K
Jig Set for Pegboard.....	353K
Shears.....	447K
Spline Tools.....	345K-349K
Table and Table Tower Kits.....	353K
Screw Extractor Set.....	491K
Screwdrivers	
5-Piece Phillips Set.....	511K
5-Piece Slotted Set.....	511K
6-in-1 Pocket Drive Tool.....	513K
34-Piece Multi-Bit and Driver.....	512K
Cordless.....	512K
Impact Screwdriver and Socket Driver.....	514K
Offset.....	513K
Offset Hex Bit Driver.....	512K
Offset Ratcheting.....	513K
ProDriver 11-Piece Set.....	511K
Professional 6-Piece Set.....	511K
Ratcheting Extension.....	514K
Spanner.....	513K
Square Drive.....	513K
Vaco Long-Shank.....	510K
Vaco Phillips.....	510K
Vaco Slotted.....	510K
Vaco Stubby.....	510K
Screwgun Bits.....	518K
Screwgun Nut Setter Sockets.....	518K
Scribing Tool, Carbide Point.....	137K
Sealant Removal Tools.....	581K-584K
Seamers, Twin Belt.....	644K-645K
Segment Radius Cutter.....	126K
Self	
Igniting Torch Kit.....	507K
Locking Dolly.....	226K
Oiling Glass Cutters.....	114K-120K
Sealing Weatherstrip Locking Tool.....	413K
Series-E Clip Insertion Tool.....	415K
Shank Adapters.....	674K, 678K
Sharpening Stone.....	364K
Sharpie Blue Fine Point Pen.....	137K
Shears, Manual.....	447K
Shears, Powered.....	470K-471K
Sheet Metal Clamps.....	529K
Shipping Pads and Glass Protectors.....	242K-247K
Shirts, Cut Protection.....	275K
Shock Absorbing Lanyard for DuraFlex Harness.....	284K
Shop-Vac Wet/Dry Vacs.....	551K
Short Handle Cold Knife.....	361K
Shower Door Tools.....	341K
Side Slat, Truck Rack.....	255K-256K, 259K
SideRax Vehicle Side Rack.....	564K
Sidewinder Wire Cut-Out Tool.....	371K
Silicon Carbide Abrasive Belts.....	634K, 637K, 639K, 642K, 647K-648K, 651K-655K

# CRL73R CATALOG A TO Z PRODUCT INDEX

Silicon Carbide Grain.....	168K	Ripping Bars.....	473K	Template Guide, Round Edge.....	130K
Silicone, Neutral Cure.....	605K	Rubber Mallet.....	476K	Template Guides for Router.....	705K
Silvering Lines.....	692K	Screwdriver Sets.....	511K	Template Set for Outlets.....	343K
Single.....		Soft Face Hammers.....	476K	Tensioning Gauge.....	302K
Cup Vacuum Lifters.....	209K	Tape Measures.....	537K	Thick Glass Cut Opening Tapper.....	122K
Cut Miter Tool.....	344K	Torpedo Level.....	544K	Third Hand Fixation Device.....	330K, 338K
Edge Razor Blades.....	438K	Wood Chisel Sets.....	474K	Three-in-One Glass Drill.....	170K
Edge Spline Rollers.....	345K-346K, 348K	Staplers.....	534K	Tightwire Grips.....	372K
Seal Spacer.....	600K	Starlite Diamond Core Drills.....	165K	Tilt.....	
Sided Shop Cart.....	230K	Steel Wheel Screen Rollers.....	345K-348K	Back Table Truck.....	232K
Sided Transport Racks.....	231K	Stick-On Sanding Discs.....	195K	Balance Tool.....	355K
Spindle Glass Edgers.....	657K-659K	Sticks, Windshield.....	405K	Table, Ball Caster.....	626K
Slats, Truck Rack.....	255K-256K	Storefront Brackets.....	462K	Top Glass Cutting Tables.....	694K-698K
Sleeves, Cane Mesh.....	273K	Stowaway Tilt Table.....	698K	Top Glass Washers.....	687K-690K
Sleeves, Kevlar.....	274K	Straight.....		Tilting Crate Handler.....	232K
Sleeves, Protective.....	272K-274K	Cut Snips.....	597K	Tilting Transfer Tables.....	626K
Slic-Rak Glass Rack Expander.....	257K	Edges.....	134K, 539K	Time Saver Blades.....	381K
Slider Helper Installation Tool.....	415K	Fein Blades.....	373K	Tin Side Detectors.....	621K
Slings.....	236K-237K	Jaw Glass Pliers.....	138K-139K	Tool.....	
Slip Joint Pliers.....	526K	Jaw Locking Pliers.....	529K	Aprons.....	436K
Slip-N-Grip Mats and Covers.....	416K	Oscillating Cut-Out Blades.....	382K	Belt Suspenders.....	437K
Slotted Barpad.....	257K	Pattern Snips.....	446K	Boxes.....	427K-429K
Slotted Bits.....	516K, 518K	Strait-Line Chalk Line.....	545K	Carriers.....	430K-431K, 433K-437K
Slotted Screwdrivers.....	510K-511K	Strengthened Glass Detectors.....	620K	Chests.....	428K
Slurry Bags.....	679K	Stretch Wrap and Dispenser.....	262K	Holders.....	434K-437K
Small Diameter Glass Drills.....	160K-164K	Stud Sensor.....	549K	Hook.....	431K
Small Eyed Locking Strip Tool.....	412K	Suck-N-Clamp.....	414K	Kits.....	424K-426K
Snips.....	446K-447K	Suction.....		Top Hat Glass Rack Channels.....	259K
Snow Cut-Off Gauge and Accessories.....	352K, 461K	Base Drilling Rings.....	171K	Torch Kits.....	507K
Socket Sets.....	520K	Cup Straight Edges.....	134K	Torpedo Levels.....	544K
Soft Nose Glass Pliers.....	138K	Cups.....	221K-223K	Torx Key Sets.....	524K
Solar.....		Holders.....	323K-330K, 338K-339K	Torx Mirror Bracket Wrenches.....	410K, 525K
Energy Supplies and Equipment.....	628K	Sunburst Muntin Joiner.....	612K	Touch-Up Markers.....	137K
Processing Equipment.....	627K-628K	Super.....		TOYO.....	
Transmission and BTU Power Meter.....	623K	Duty Shipping Pads.....	252K	Carbide Wheel Oil Glass Cutters.....	115K-116K
UV Sales Demo Kit.....	618K	Grip Glass Gloves.....	269K	Circle Supercutter®.....	127K
Soldering Irons and Supplies.....	554K-555K	Grip Knives.....	367K-368K	Comfort-Grip Supercutter®.....	116K
Solder-It Butane Torch.....	507K	Hot Knife Cut-Out Blades.....	365K	Custom-Grip Supercutter®.....	115K-116K
Solo One-Handed Clamps.....	530K	Pinch Weld Scraper.....	389K	Dry Wheel Supercutter®.....	110K
Spanner Insert Bits.....	516K	Spacer.....	594K-595K	Pistol-Grip Supercutter®.....	119K
Spanner Screwdriver.....	513K	Spacer Sealant Starter Kits.....	589K-591K	Supercutter® Replacement Heads.....	116K
Spanner Wrenches.....	375K, 522K	Weatherstrip Adhesive.....	674K	Supercutters®.....	115K-116K, 119K-120K, 127K
Spatulas.....	578K	SuperCut Sealant Cutter Knife Kit.....	583K	Tap Wheel™ Thick Glass Cutter.....	120K
Spearpoint Glass Drills.....	169K	Supercutter® Circle Cutter.....	127K	Thick Glass Supercutter®.....	120K
Spectrum Detective Energy Transmission Meter.....	619K	Supercutter® Glass Cutters.....	115K-116K, 119K-120K, 127K	Thomas-Grip Supercutter®.....	116K
Speed Cutters.....	124K	Super-Thin Cut-Off Wheels.....	305K, 706K	TP2800 Deluxe Brass Oil Cutter.....	114K
Split Case Dolly.....	228K	Sure-Grip Vacuum Lifters.....	202K	Transport Pads.....	246K
Sponge Rubber Buttons and Pads.....	242K	Surface Resist Meters.....	620K	Transport Racks.....	231K
Sponges.....	553K	Swivel Drill Machine.....	154K	Tree Molding Removal Tool.....	402K
Spray Mist Coolant.....	459K	Swivel Tip Locking Strip Tool.....	411K	Trim Knife.....	602K
Spray Mist Coolant Unit.....	459K	Swivel Vacuum Cups.....	211K, 396K	Triple Strand Braided Cut-Out Wire.....	371K
Sprayway Glass Cleaner.....	104K, 599K	Swivel-Lock Utility Knife.....	442K	Tripod Glass Drilling Machine.....	152K
Spreader Bar and Sling System.....	236K	Synthetic Blue Powder Coolant.....	662K, 668K	Tripods, Aluminum.....	548K
Squeegees.....	680K-681K	Synthetic Diamond Tool Coolants.....	668K, 670K	Tripple-Ripple Miniature Diamond Drills.....	495K
Squeegee, Vacuum.....	681K	<b>T</b> .....		Trizact Scratch Removal System.....	677K-678K
Squeeze and Pop Glass Cutters.....	126K	Tables.....		Truck.....	
Stabilo Glass Marking Pencils and Pens.....	136K, 542K	Ball Caster.....	626K, 646K	Bed Glass Carriers.....	398K-399K
Stab-In Glass Cutting Table Rollers.....	697K	Belt Sander Rolling.....	635K, 639K	Bed Racks.....	258K, 398K-399K
Stainless Steel Cold Knife Blades.....	362K	Edge Deletion.....	626K	Mount A-Frame.....	258K
Stainless Steel Square Cut-Out Wire.....	371K	Glass Cutting.....	694K-698K	Rack Accessories.....	254K-259K
Stakes, Truck Rack.....	254K	Hot Melt Clamp.....	603K	Rack Cushion.....	255K, 259K, 398K
Stalter Glass Cutting Machines.....	700K-701K	Inspection.....	626K	Rack Kleats.....	254K
Standard.....		Miter Saw.....	351K	Rack Stakes.....	254K
Cold Knives and Blades.....	361K-362K	Rotary Work.....	625K	Racks for Pickups.....	248K, 250K-251K
Combination Screen and Spline Roller.....	347K	Screen Fabrication.....	353K	Racks for Vans.....	249K, 252K-253K
Duty Utility Knife Blades.....	369K, 440K	Sealing.....	625K	Rope.....	260K
Edge Reciprocal Blades.....	385K	Tilt-Top.....	694K-698K	Side Slats.....	255K-256K, 259K
Laser Tools.....	299K, 337K	Tape Rule Holder.....	435K	Strip Cushions.....	259K
Plated Diamond Drills.....	160K	Tape Rules.....	536K-538K	Truckers 4-Pocket Apron.....	287K
Wheels and Straight Axles.....	112K	Tape, Safety.....	292K, 564K	TruSeal Duralite.....	596K
Stanley®.....		Taper Reamer.....	490K	Tube.....	
Chalk Line.....	545K	Tapered Auger Carbide Burr Drills.....	495K	Drawing.....	548K
Floor Chisel.....	474K	TAPER-LOC® Dry Glaze Glass Railing System.....	768K-769K	Drills.....	168K
Hacksaws.....	448K	TAPER-LOC® Extraction Tool.....	295K	UV Curing Lamp.....	334K
Hammers.....	475K-476K	TAPER-LOC® Installation/Removal Tool Kit.....	294K	Wax Lubricant.....	180K, 459K, 650K
Levels.....	298K, 337K, 543K-544K	TAPER-LOC® Tool Replacement Blades.....	295K	Twin-Belt Tempering Seamers.....	644K-645K
Locking Adjustable Wrench.....	519K	Tapping Tools.....	490K-491K	Twin Seamer Glass Rest.....	645K-646K
Nail Set.....	493K	Tarps.....	432K	Two.....	
Pin Punch.....	493K	Tear Resistant Black Latex Gloves.....	270K	Direction Glass Cutter.....	700K
Pry Bar.....	473K	Tele-Tape Measuring Stick.....	540K	Part Insulating Glass Sealant.....	605K
Rawhide Mallet.....	476K			Spindle Edgers.....	660K-663K

# CRL73R CATALOG A TO Z PRODUCT INDEX

Wheel Adjustable Glass Dolly .....	301K
Ty Webbing .....	260K
Tyvek Shoe Cover .....	416K
T-Handle Wrenches .....	306K, 491K
T-Shirt, Cut Protection .....	275K
T-Squares .....	132K, 539K

## U

Ultimate Tape Rule .....	536K
Ultra Thin Combination Knife .....	443K
UltraWiz Blades and Knives .....	363K-364K
Underside Molding Installation Tool .....	405K
Unibit Step Drills .....	489K
Universal	
Auto Glass Molding Release Tool .....	402K
Battery Charger .....	479K
BTB Blades .....	386K
Diamond Points .....	509K
Drill Jigs .....	462K-466K, 705K
Drill Pipe Adapter .....	307K, 480K
Molding Release Tool .....	402K
Movable Glass Table .....	635K
Muntin Clips .....	611K
Pressure Drill .....	307K, 480K
Spanner Wrench .....	522K
Trim Tool .....	403K
Upgrade Kit for TLK5 Installation/Removal Tools .....	296K
Upholstery Nail Removers .....	406K
Upright Wet Belt Sanders .....	186K-189K, 634K-643K
Utility Knives and Blades .....	369K-370K, 440K-442K, 444K, 584K
UV	
Bonding Fixation Devices .....	322K-330K
Bonding Professional Kits .....	311K-313K
Bonding Starter Kits .....	311K-313K
Bonding Work Surface Carpet .....	329K
Curing Lamps and Accessories .....	331K-334K
Eye Protection .....	335K
Fixation Devices .....	322K-330K
Glass Bonding Catalog .....	322K
Lay-Out Mat .....	329K
Protective Goggles .....	279K, 335K

## V

Vaco Screwdrivers .....	510K
Vacuum	
Base Portable Drilling Machine .....	156K
Cleaners .....	551K
Cup Exchange Program .....	207K, 217K
Cup Holster .....	437K
Cups, Australian .....	202K, 204K-206K
Cups, Automotive .....	221K, 393K-396K
Cups, Heavy-Duty .....	209K
Cups, Wood's .....	212K-220K
Gauges .....	739K-740K
Lifter Replacement Parts .....	739K-740K
Lifters, Aluminum .....	210K
Lifters, Hand Held .....	202K-223K
Lifters, Pump-Up .....	202K-208K, 212K-223K
Lifting Configurator .....	200K-201K, 710K-711K
Lifting Equipment .....	198K-201K, 712K-740K
Lifting Frames .....	714K-740K
Loss Warning Buzzer .....	737K
Pads, Replacement .....	739K
Ratchet Tensioning Kit .....	204K
Squeegee .....	681K
Valved Particulate Respirator .....	281K
Vapourmax Cutting Oils .....	670K
Variable Speed Drilling Machine .....	154K
Variable Speed Rotary Tool Kit .....	391K, 494K
Vertical Glass Drill Machine .....	158K-159K
Vertical Glass Edgers .....	660K-666K
Vertical Glass Washers .....	684K-686K
Vests, Safety .....	292K
Vinyl Hood Protectors .....	417K
Vise Grips .....	529K
Visitor Spectacles .....	279K
Vitrolube Diamond Tool Coolants .....	679K

## W

Wall Mount Windshield Rack .....	400K
Wall Mounted First Aid Cabinet .....	290K

Washer Brushes and Parts .....	691K
Washing Machine Detergents .....	683K
Washing Machines .....	684K-690K
Water Cooler .....	261K
Water Resistant Flashlight .....	292K
Wax Lubricant .....	180K, 459K, 650K
Web Strap and Clamp .....	261K
Weight Belt Back Support .....	283K
Welding Clamp Locks .....	529K
Weldon Countersinks .....	489K

Wet Abrasive Belts .....	186K-192K, 634K, 637K, 639K, 642K, 647K-649K
Wet Belt Sanders .....	186K-189K, 634K-646K
Wet Glaze Pump and Accessories .....	300K
Wet Twin-Belt Seamer .....	645K
Wet/Dry Vacs .....	551K

## Wheel

Dressing Boards and Sticks .....	662K, 669K, 679K
Fabrication .....	360K
Finger Grip .....	671K
Mounting Bolt Kit .....	659K, 663K
Position Dial Indicator .....	659K, 663K
Redress Program .....	668K
Step .....	261K

## Wheels

Bevelling .....	667K
Edging .....	658K, 662K, 667K
Felt Polishing .....	673K-674K
Glass Cutter .....	111K-113K, 120K, 125K
Wool Felt .....	360K, 673K-674K
Wheeled Carts .....	229K-231K
Wheeled Dollies .....	224K-228K
Wheeled Storage Racks .....	234K-235K
Whisk Brush .....	552K
White Marking Pens .....	136K
Wildcat Sealant Cutter and Putty Remover .....	505K

## Window

Balance Tools .....	355K
Crank Spring Tool .....	405K
De-Glazing Tools .....	354K, 581K
Energy Profiler .....	619K
Frame Extractor .....	354K
Guide Pliers .....	407K
Hackout Tool .....	501K
Holders, Door Glass .....	414K
Molding Clip Tool .....	402K
Roller Nut Removal Tool .....	406K
Tools .....	501K-502K, 581K-582K
Washer Holder/Separator .....	407K

## Windshield

Carts .....	401K
Cut-Out Tools .....	361K-363K, 366K-368K, 373K, 375K-377K, 379K-380K, 383K, 385K-386K, 388K
Hold-Down Vacuum Cup Set .....	396K
Inspection Stand .....	401K
Molding and Door Clip Release Tool .....	405K
Racks .....	398K-401K
Removal Kit .....	371K
Stands .....	397K
Stick Holder .....	405K
Stick Setting Tools .....	405K
Wiper Arm Removal Tool .....	414K
Wire and Tools .....	371K-372K
Wiper Puller .....	414K
Wipes .....	105K, 553K
Wire Brush .....	552K
Wire Starter Tool .....	372K
Wire, Windshield .....	371K
Wood Chisel Set .....	474K
Wood Clamps .....	531K
Wood Handle Glass Cutters .....	108K
Wood Rule, Folding .....	539K
Wooden Handle Glass Cutters .....	108K
Wood's™	

ABS Handle Vacuum Cups .....	215K
Air-Powered Vacuum Cups .....	212K
Carrying Cases .....	213K
Channel Lifters .....	722K-725K
Custom Lifter Program .....	736K
Flip Handle Vacuum Cups .....	216K

Hand Held Vacuum Cups .....	212K-220K
Handi-Grip Vacuum Cups .....	218K
Heavy-Duty Transport Case .....	723K
Hybrid Handle Vacuum Cups .....	215K
Insulating Glass Anti-Shear Supports .....	738K
Ladder Lifter .....	712K
Lifting Frame Options .....	737K-738K
Lifting Frames .....	715K-740K
Low Vacuum Audio Alarm .....	214K
Powr-Grip® Vacuum Cups .....	212K-220K
Rental Program .....	718K-719K
Rigid Handle Vacuum Cups .....	216K
Rotators .....	726K-734K
Special Application Vacuum Cups .....	218K-220K
Textured Surface Vacuum Cups .....	215K
Tilters .....	727K-735K
T-Handle Vacuum Cups .....	220K
Vacuum Cups .....	212K-220K
Vacuum Lifting Frames .....	715K-740K
Vacuum Pads .....	739K
Vertical Handle Vacuum Cup .....	216K
Wool Felt Wheel .....	360K, 674K
Work Belts .....	437K
Wrenches	

Adjustable Click Torque .....	306K
Adjustable Crescent .....	519K
Adjustable Strap .....	522K
Allen .....	523K, 525K
Fein Spanner .....	375K
Hex Key Sets .....	523K-524K
Impact .....	556K
Laguna Top Roller Spanner .....	522K
Metric Ratcheting Box End Set .....	519K
Metric Ratcheting Combination Set .....	519K
Metric Set .....	521K
Mirror Bracket .....	410K
Roller Nut .....	406K
SAE Ratcheting Box End Set .....	519K
SAE Ratcheting Combination Set .....	519K
SAE Set .....	521K
Spanner .....	522K
Squeeze Wrench Set .....	521K
Stanley® Locking Adjustable .....	519K
Torque .....	521K
T-Handle .....	306K, 491K, 525K
Universal Spanner .....	522K
Wrist and Thumb Protectors .....	276K-277K
Wrist Supports .....	283K

## Y

Yellow Glass Marking Pencils .....	136K, 542K
Yellow Neoprene Apron .....	288K

# CRL MANUFACTURING



Los Angeles, California Headquarters of CRL Manufacturing

## CRL Manufacturing

- Making Quality Products for Over 50 Years
- User of Progressive ISO9001:2008 Manufacturing Processes
- Mechanical and Technical Expertise Available to Assist Your Manufacturing Processes



VIDEO



### Manufacturing Video Online

Go to the home page of [crl-arch.com](http://crl-arch.com) and click on Project Gallery, then Video Library. From there you can select a five-minute video presentation detailing CRL's product line and manufacturing capabilities.

You may know C.R. Laurence Company as the world's largest distributor of supplies to the glass industry. What you may not know is that we are also a manufacturer of over 10,000 products found in our Online Catalog. We make some of the best products available to customers worldwide. Our people use progressive ISO9001:2008 manufacturing processes to make products for the Glazing, Screen, Architectural, Railing, Construction, Industrial, and Automotive industries. These certified processes ensure that we give every product our full attention to detail.

Using strict manufacturing standards we produce the kind of quality products that has kept us at the head of this field for many years. That's your assurance that when you select a product made by CRL Manufacturing, you have made the best possible choice.

We're always looking for ways to make our products better, and along the way we've added experts from different fields to our staff of designers, engineers, and craftspeople. Our goal is to make our products a better value to you, whether it's time or labor savings, extended service life, increased versatility, or enhanced visual appeal.

Many of our products incorporate industry "firsts"; features offered by no other manufacturer because we feel that no product or process is so good that it can't be improved. We strive to make products of high quality and value. That's the goal we set for ourselves at the onset, and it's still our guiding influence. Some of the improvements we've made have originated from people who have used our products and generously contributed their opinions and suggestions. We welcome your comments, and invite you to contact us at any time regarding a C.R. Laurence product.

Expansion of our manufacturing capability has brought our total manufacturing floor space in California to roughly 650,000 square feet. CRL now has almost 1 million square feet of distribution and manufacturing capability in the local area to better serve our customers. We also have a 90,000 square foot machinery facility in Cicero, Illinois, and a facility in Melbourne, Australia for the manufacture of our Vacuum Lifters. It's all part of CRL's commitment to provide good quality products with short lead times to the industries we serve.



Manufacturers of Quality Vacuum Lifters in our State-of-the-Art Facility in Melbourne, Australia



**C.R. LAURENCE COMPANY**

[crlaurence.com](http://crlaurence.com) | [usalum.com](http://usalum.com)

756K | [crlaurence.ca](http://crlaurence.ca) [crlaurence.com.au](http://crlaurence.com.au) [crlaurence.co.uk](http://crlaurence.co.uk) [crlaurence.de](http://crlaurence.de) [crlaurence.eu](http://crlaurence.eu)



## CRL's Precision Design and Engineering is the Key to Quality



### • CRL is ISO9001:2008 Certified

It all starts with ISO9001:2008 certification. We produce over 7,000 items for the industries we serve in our ISO9001 Certified manufacturing facilities. Our adherence to the strictest of standards reflects the commitment of our employees to provide the highest quality products.

### • Innovation Makes Us a Leader

C.R. Laurence Manufacturing has provided new and innovative products for over 50 years. We know we can't just sit still, because if we do, others will pass us by, and that's not what being a leader is all about.

Many CRL manufactured products incorporate features offered by no one else because we feel that no product is so good that it can't be improved.



### • Award Winning Designs and Products

Just because we say our products are all top quality doesn't make it so. However, when those recognized as setting the standards for quality say we make the best, then that really means something. C.R. Laurence Manufacturing has earned some very prestigious awards for manufacturing excellence by organizations that set the standards for quality.



### • CRL Rapid Customization Program for Short Lead Times

The goal of CRL's Rapid Customization Program is to achieve the shortest possible lead time on all CRL Manufactured Products, from sketch to quote to fabrication to delivery. This is done several ways, and an important factor is keeping the entire process "in-house". Allowing CRL Manufacturing to control such processes as drafting, modeling, raw material procurement, cutting optimization, high-speed fabrication, finishing, powder coating, batch painting, packaging, and shipping makes for efficient and speedy delivery of products to you.



### • Engineers Available for Product Development, Testing, and Production Support

CRL's Engineering Department works with you to review designs and job plans to address feasibility, safety concerns, and possible alternate solutions in order to prepare a fair and accurate per unit or per job quote for our manufacturing services.



### • Experienced, Knowledgeable Team Dedicated From Start to Finish

Our staff has decades of experience in the various stages of manufacturing. Our people draw upon their resources to find innovation and efficiency in our manufacturing processes, allowing us to build top quality products at prices that are always competitive. From the procurement of raw materials to final shipment of finished goods, it's our experience that makes the difference.

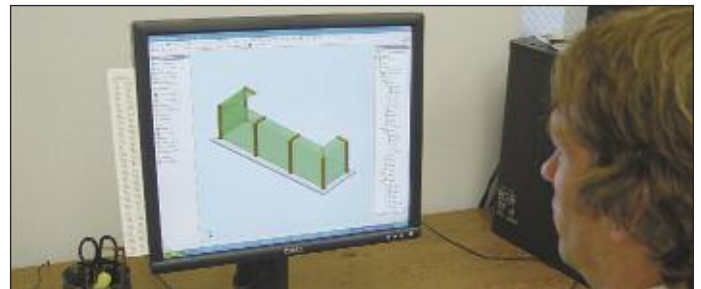

### • State-of-the-Art Computers and Software

CRL's trained staff uses up-to-date programs including Auto CAD, Auto Desk Inventor, and ANSYS Workbench to provide the best designs to send to our manufacturing plant. This software and our engineers provide workable, modern designs that can be simulated on our computers, saving you time and money down the road.

## Do You Have a New Product That Could be Made by CRL? Need Help With a Current Product? Contact Us

We welcome the opportunity to serve you, and are committed to providing your business with the services that produce quality products. To discuss the possibility of working with CRL Manufacturing we invite you to contact CRL Technical Sales at (800) 421-6144 in the U.S., (877) 421-6144 from Canada, or (323) 588-1281 International. Ask for Ext. 7520. To send e-mail go to [crlaurence.com](http://crlaurence.com), click on Contact Us, and then click on Product Management.

# CRL-BLUMCRAFT ACCESS CONTROL HANDLES

## CRL-Blumcraft Access Control Handles

# BLUMCRAFT®

A DIVISION OF C.R. LAURENCE CO., INC.

- Access Control Handles With a Large Selection of Exterior Fixed Pulls for Medium and Wide Stile Doors
- Available in Polished and Brushed Stainless, Satin and Polished Brass, and Oil Rubbed Bronze
- Custom Finishes Available By Special Order

CRL-Blumcraft manufactures a complete line of Access Control Handles for all your door needs. We have Panic Devices, Deadbolt Handles, and Electronic Egress Control Handles in a wide variety of configurations. We can also supply you with Dummy Handles to match these devices, allowing you to maintain the same appearance throughout the project, but without the added costs. Visit [crl-arch.com](http://crl-arch.com) for more information.



## Designer Series

PATENT PENDING



- Sharp Lines and Angles With a Smooth Round Gripping Surface
- Crisp Transitions at All Corners
- Available in Alloy 316 Brushed or Polished Stainless Steel

**new**



Contact CRL Technical Sales at (800) 421-6144 in the U.S., (877) 421-6144 from Canada, or (323) 588-1281 International, and ask for Ext. 7700. You can also send e-mail from the [crlaurence.com](http://crlaurence.com) home page. **NOTE:** All Access Control Handles on this page function as health and safety tools, and may only be purchased through CRL Authorized Glass Temperers and Door Manufacturers.



C.R. LAURENCE COMPANY

[crlaurence.com](http://crlaurence.com) | [usalum.com](http://usalum.com)

758K | [crlaurence.ca](http://crlaurence.ca) [crlaurence.com.au](http://crlaurence.com.au) [crlaurence.co.uk](http://crlaurence.co.uk) [crlaurence.de](http://crlaurence.de) [crlaurence.eu](http://crlaurence.eu)

# CRL-BLUMCRAFT ACCESS CONTROL HANDLES

## Standard Interior Configurations for CRL-Blumcraft Access Control Handles

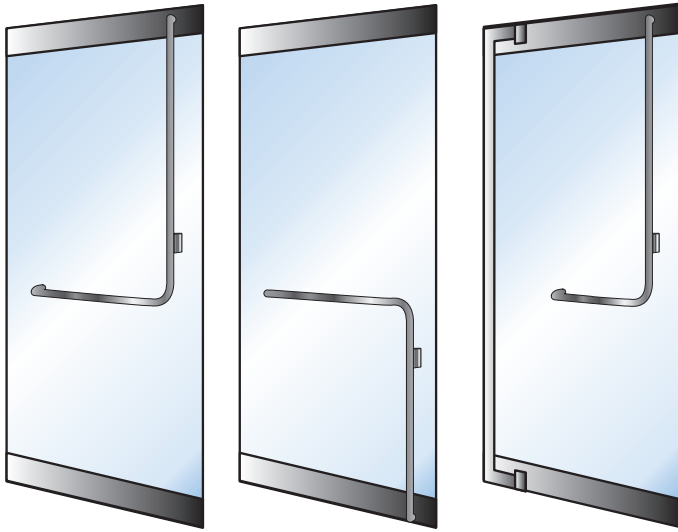

**PA100, DB100, AND EG100 SERIES**

**PA110, DB110, AND EG110 SERIES**

**BP100 SERIES**  
For Balanced Doors

Available with or without  
Keyed Access Device



## Exterior Handle Combinations for Doors with CRL-Blumcraft Access Control Handles

**NOTE:** All Exterior Fixed Handles below can be used in combination with any Panic, Deadbolt or Electronic Egress Handle.  
Contact CRL Technical Sales at (800) 421-6144 in the U.S., (877) 421-6144 from Canada, or (323) 588-1281 International. Ask for Ext. 7700. You can also send e-mail from the [crlaurence.com](http://crlaurence.com) home page. Click on Contact Us, and then click on Technical Sales for Commercial Products.

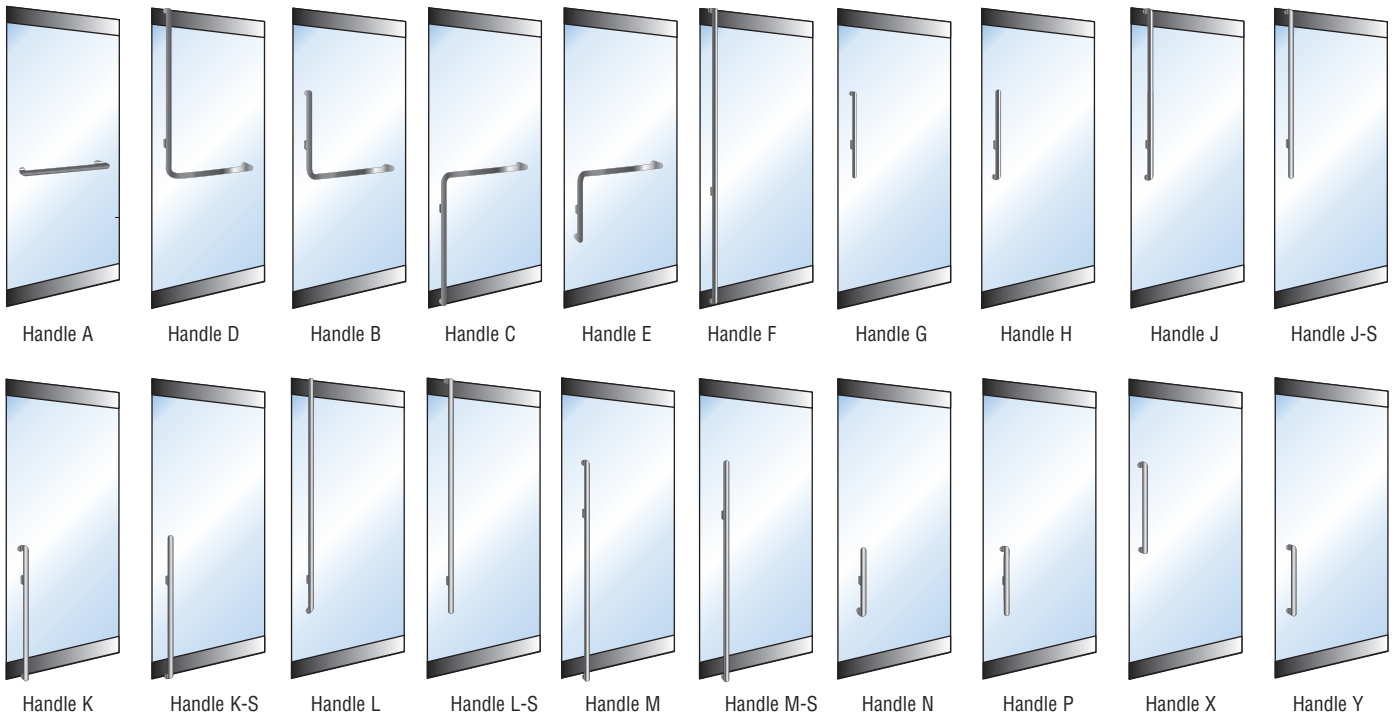

**NOTE:** All Access Control Handles on this page function as health and safety tools, and may only be purchased through CRL Authorized Glass Temperers and Door Manufacturers.



## CRL-Blumcraft Head Channels



- Channels for 1/2" or 3/4" (12 or 19 mm) Tempered Glass
- Accepts Glazing Gaskets, Top Pivots, and Snap-In Filler Strips
- Available in Five Architectural Finishes
- Custom Finishes, Including Oil Rubbed Bronze, Are Available on Special Order



## CRL-Blumcraft Wet Glaze U-Channels

- Channels for 1/2" or 3/4" (12 or 19 mm) Tempered Glass
- Available in Five Architectural Finishes
- Custom Finishes, Including Oil Rubbed Bronze, Are Available on Special Order



## CRL-Blumcraft Floating Transom System

- Suspended Stainless Steel Rods
- No Holes or Notches in Transom or Sidelites
- For 1/2" or 3/4" (12 or 19 mm) Tempered Glass
- Available in Five Architectural Finishes
- Custom Finishes, Including Oil Rubbed Bronze, Are Available on Special Order



## CRL-Blumcraft Catalogs



**CAT. NO. B2010**  
Tempered Glass Doors, Panic, Deadbolt, and Dummy Hardware



**CAT. NO. D2010**  
Display Case Door Series 1301



**CAT. NO. HW2010**  
Tubular Architectural Hardware



**CAT. NO. M2010**  
Railings, Smoke Baffles, Glass Gates

## CRL Wedge-Lock™ Door Rails and Accessories

- Adjustable Door Alignment System Allows Jamb Line Adjustment Without Removing Door
- Solid Aluminum Rail, Rigid Single Component Housing Will Not Shift and Fall Out of Alignment Over Time Because the Housing is Not Made of Two Halves
- Door Rails Come Completely Fabricated So Door Assembly Can Be Ready for Installation in Less Than 10 Minutes
- Dry Glazing Allows Easy Field Glass Replacement
- Glass Securing Pads Designed for Longevity in Extreme Environments
- Available With or Without a Lock
- Up to Nine Standard Architectural Finishes
- Custom Finishes, Lengths and Heights Available
- Stocked for 3/8", 1/2", and 3/4" (10, 12, and 19 mm) Tempered Glass



### Patented Wedge-Lock™ Glass Securing System

The patented Wedge-Lock® Glass Securing System is a totally new concept for securing the glass in the Door Rail. It works by applying pressure from the bottom of the Door Rail, using two glass retaining aluminum extrusions via a flat stainless steel bar. As this bar is pulled down with socket head cap bolts, over 100 pounds per inch of pressure is applied to the glass retaining aluminum extrusions. The bottom of the extrusions are at an angle and fit into an angled groove in the Door Rail. As the glass retaining extrusions are being pulled down, the angled wedge in the Door Rail also pulls the glass retaining extrusions together. This action, along with our specially designed door retaining gasket, creates a tremendous amount of force.

### Laboratory Test

National Technical Systems, a certified laboratory, tested the Wedge-Lock™ Door Rail System at a temperature range from -10°F to 150°F (-23°C to 65.5°C), with 1000 pounds (454 kg) of tension load applied. No evidence of movement was detected at any temperature. At an ambient temperature of 73°F (22.8°C), in a "Pull to Failure Test", 6900 pounds (3130 kg) of tension was required before any creep (not failure) was detected.

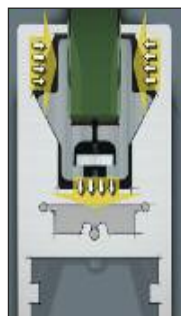

- Full Length Door Rails for Single or Double Doors in 2-5/16" Low Profile, 4" Tapered and 4", 6", and 10" Square
- Pull Tested to Nearly 7,000 Pounds (3175 Kg)

Made under the following: U.S. Patents 6,434,905 and 6,912,818 B2.

Foreign Patents Pending



Door centering is easily achieved by turning the two hex head bolts

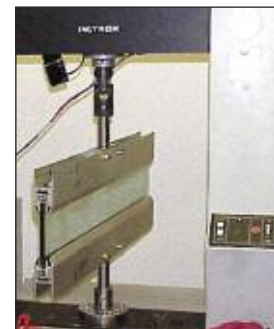

## CRL Sidelite Rails and U-Channel

### CRL Sidelite Rails With Top Load Roll-In Gasket



- Five Styles in Up to 11 Architectural Finishes
- Sidelite Rails Match Our Door Rails for an Even Sightline

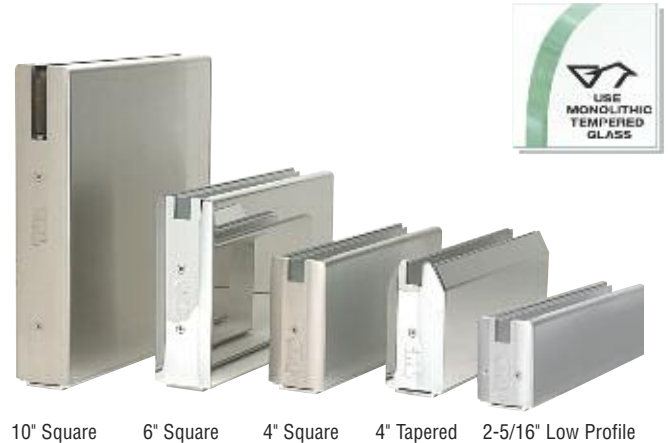

## CRL Combination Wide U-Channel and Narrow Header

- Available in Stock Lengths, Fabricated Headers, or Headers With Side Pockets for "Lift and Drop" Panel Glazing
- Matches the Width of Our Door and Sidelite Rails
- Accepts Roll-In Gasket, Top Pivot Block, and Flush Snap-In Insert
- Accepts 3/8", 1/2", 5/8", and 3/4" (10 to 19 mm) Tempered Glass
- 11 Architectural Finishes
- Custom Sizes and Finishes Available



Combination Wide U-Channel and Narrow Header

Regular U-Channel with Aluminum/Neoprene Setting Block

Shallow U-Channel

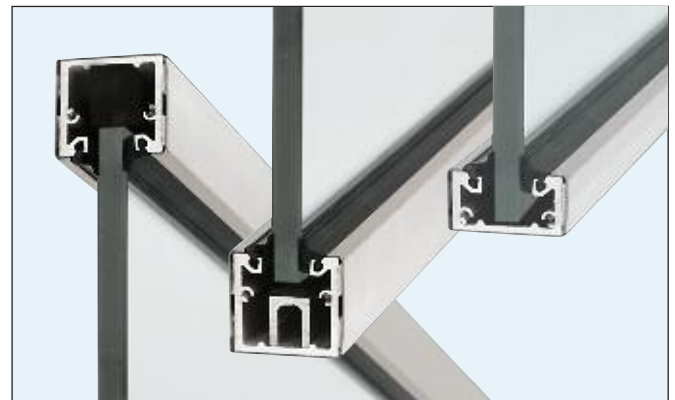

## CRL Regular and Shallow U-Channels With Top Load Roll-In Gasket

- Accepts 3/8" (10 mm) or 1/2" (12 mm) Glass
- Both Depths Available in Six Standard Architectural Finishes

## CRL Wet/Dry Glaze U-Channels

- Accepts 3/8" (10 mm) or 1/2" (12 mm) Glass
- Offered in Three Standard Heights
- 120" (3.05 m) and 240" (6.1 m) Stock Lengths Available in Six Finishes
- Custom Finishes Available

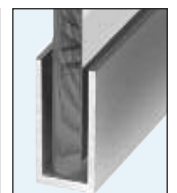
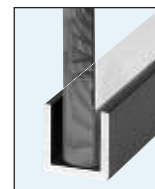

## CRL Commercial Glass Door Accessories

### CRL Stock Size Headers for Overhead Concealed Door Closers

- Five Stock Architectural Finishes
- Includes Snap-In Cover Plates
- 4" and 4-1/2" (102 and 114 mm) Widths



Typical Installation Showing Exposed Spindle of Overhead Closer

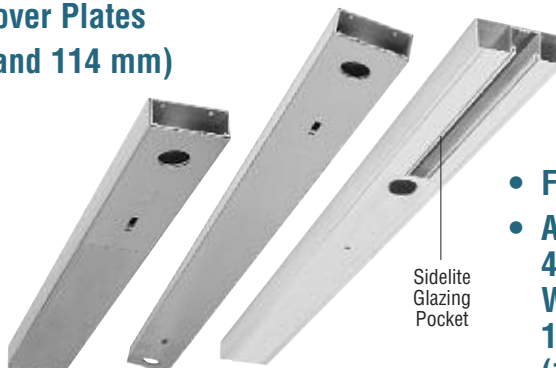

36" (914 mm) Single Door    72" (1829 mm) Double Door    Custom Lengths

- Five Stock Finishes
- Available in 4" or 4-1/2" (102 or 114 mm) Widths for 3/8", 1/2", 5/8", and 3/4" (10 to 19 mm) Glass

Sidelite Glazing Pocket

### CRL Custom Length Door Headers With Glazing Pocket



Fixed Panel Section With Glazing Gasket



Header Section

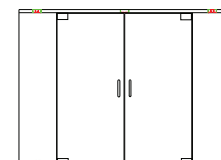

Typical Double Glass Doors with Sidelites

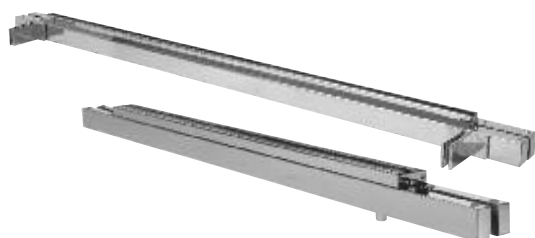

### CRL Floating Header for Overhead Concealed Door Closers

- Available for 1/2" (12 mm) Glass-to-Glass or Glass-to-Wall Installations With or Without Overhead Concealed Door Closers
- Stock 36" (914 mm) Single and 72" (1829 mm) Double Headers, With Custom Sizes Available
- Available in Five Stock Architectural Finishes



### CRL Hat Channel Door Closer Header for Single and Double Doors

- Surrounded by "L" Angle to Support Ceiling Tiles
- White Finish to Match Ceiling "T" Bar
- Provides an Almost Invisible Look

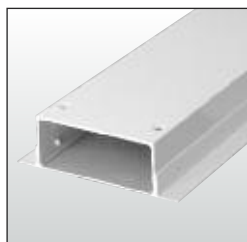

### CRL Hat Channel for Fixed Glazing

- White Finish to Match Ceiling "T" Bar
- Accepts 3/8" or 1/2" (10 or 12 mm) Glass
- Glass Secured With Silicone Sealant or Roll-in Glazing Vinyl

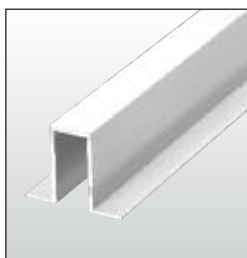

### Complete Line of Commercial Door Pulls

- Beautiful Accessories for Frameless 'All-Glass' Entrance Doors and Sidelites
- Custom Finishes and Sizes Available
- New Selection of Locking Ladder Pulls



# CRL ELEPHANT DOORS SLIDING STOREFRONTS

## CRL Series E1200 Elephant Doors

**new**



- "Elephant Size" Opening Sliding Storefront
- Recessed Floor Track
- Interlocking Panels
- For 1/4" or 1" (6 or 25 mm) Glazing
- Up to 6' (1.8 m) Wide by 14' (4.2 m) Tall Operable Bays
- Available in Clear, Dark Bronze, or Black Anodized Finishes

CRL-U.S. Aluminum Series E1200 Elephant Doors are the first of their kind! The Elephant Door System is easily suitable for 6' (1.8 m) wide x 14' (4.2 m) tall bays, and can meet code requirements with 30 psf windloads. Its rugged overall construction coupled with heavy wall stiles and interlocks, heavy-duty tandem rollers, and a concealed floor track, offers smooth operation and durability. Available in clear, bronze or black anodized and a wide range of standard U.S. Aluminum Fluoropolymer painted finishes. Doors are available in offset pivot or center hung configurations with a wide variety of locking hardware and overhead concealed closers to meet your specific requirements.

The CRL-U.S. Aluminum Elephant Door System is ideal for renovation projects as no wall pockets are needed to facilitate the horizontal movement of the system. The operable storefront sections easily slide behind the fixed sections, creating monumental openings for the passage of large items such as cars, trucks, boats, works of art, furniture, or mass pedestrian traffic for sporting venues. Various configurations are available to meet your design needs. The E1200 is intended for installations that have soffit overhangs greater than the overall entrance frame height. Local codes should be checked for compliance.

For additional information, contact CRL-U.S. Aluminum Technical Sales at (800) 262-5151 in the U.S. and Canada, or (323) 588-1281 International, and ask for Ext. 5305. You can also email us through our web site at [usalum.com](http://usalum.com).



In the closed position it's business as usual with pairs of swinging entrance doors



With the sliding doors open, the "Elephant Size" opening allows for larger objects to be moved in or out



**C.R. LAURENCE COMPANY**

[crlaurence.com](http://crlaurence.com) | [usalum.com](http://usalum.com)

764K | [crlaurence.ca](http://crlaurence.ca) [crlaurence.com.au](http://crlaurence.com.au) [crlaurence.co.uk](http://crlaurence.co.uk) [crlaurence.de](http://crlaurence.de) [crlaurence.eu](http://crlaurence.eu)



## CRL Interior Office Front Systems

- Create Contemporary Office Space in a Wide Range of Architectural Finishes
- Designed to Accommodate Aluminum and Wood Doors
- Accommodates Glazing Thickness Range of 1/4" to 3/8" (6 to 10 mm)
- Screw Spline or Clip Joinery Available
- Fabricate On or Off Site
- Wrap Walls in Various Depths
- Doors and Sidelites Available



View our GWOS15 Brochure at the Catalog Library at [usalum.com](http://usalum.com)

As part of our ever-expanding architectural hardware line, CRL-U.S. Aluminum is proud to introduce our latest addition, Interior Office Front Systems.

We have involved all our resources to develop a product line that our customers, architects, and designers will come to trust as a viable solution to their interior office design needs. Use our door and window frames for sidelites to doors, clerestory lites, borrowed lites, or continuous glass walls. A great way to divide interior office space and provide acoustical privacy, all while allowing desirable light to enter the indoor spaces.

CRL-U.S. Aluminum offers a variety of Interior Office Front Hardware to make state-of-the-art glazing systems available to the glazing industry. Our commitment to our customers is to carry sufficient inventories of popular stock items, and short lead times for special orders. It is a total program that will allow your entry into the Interior Office Front Systems market.

For additional information, contact CRL-U.S. Aluminum Technical Sales at (800) 262-5151 in the U.S. and Canada, and ask for Ext. 5305. You can also email us through our web site at [usalum.com](http://usalum.com).



Interior Offices



Conference Room Walls



Office Wall Dividers



Office Entrances

# CRL BI-FOLDING DOOR AND WALL SYSTEMS

## Bring the Outdoors Inside With the NEW Monterey Bi-Folding Door and Wall Systems from CRL

**new**



See our New CRL14D Doors and Entrance Systems Catalog for more information at [crlaurence.com](http://crlaurence.com)

**MONTEREY**  
Bi-Folding Door and Wall System  
Interior and Exterior By C.R. Laurence Co., Inc. / U.S. Aluminum

- Weather Resistant, Designed for Interior/Exterior Use
- New Construction or Retrofit, Commercial and Residential
- Fully Assembled, Ready for Glazing
- Simple to Operate Panels Open or Close Easily
- Several Configurations With Inward or Outward Opening Options Available
- Wood Grain, White, and Black Powder Coat, Satin and Black/Bronze Anodized. Custom Colors Available on Special Order

CRL's long awaited and much anticipated venture into the great outdoors is finally here! We are excited to introduce the Monterey Bi-Folding Door and Wall System! The Monterey Series allows you to bring the outdoors inside while providing resistance to undesirable weather conditions. Countless options are available to create large living spaces that seamlessly transition outdoors to indoors.

Our precision engineered components provide a system that slides smoothly with minimal effort. Design options are virtually limitless. The sturdy, yet slim frame construction allows for more glass and less metal. A thermally broken frame option offers improved acoustics and energy savings.

The Monterey Series is designed for use with 1/4" to 1-1/4" (6 to 32 mm) glazing. Standard finishes are Wood Grain, White, and Black Powder Coat; Satin and Black/Bronze Anodized. Custom colors are available on special order.

Contact CRL Technical Sales Department for available options at (800) 421-6144 in the U.S., (877) 421-6144 from Canada, or (323) 588-1281 International and ask for Ext. 7700.

### • Virtually Limitless Design Options

Complete design flexibility allows the system to support any number of sliding and pivoting panels in a single opening, with both inward and outward opening options.

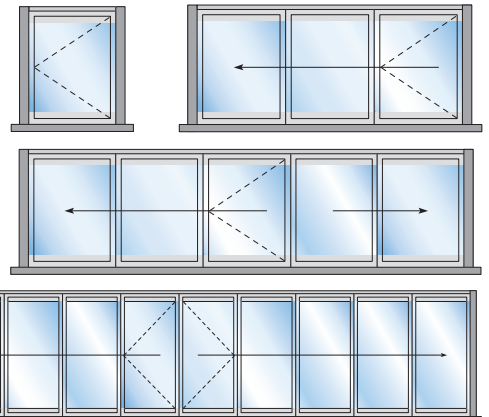

The versatile Pivoting Panel Option gives you the flexibility to fully or partially open the Monterey Bi-Folding Wall.



**C.R. LAURENCE COMPANY**

[crlaurence.com](http://crlaurence.com) | [usalum.com](http://usalum.com)

766K | [crlaurence.ca](http://crlaurence.ca) [crlaurence.com.au](http://crlaurence.com.au) [crlaurence.co.uk](http://crlaurence.co.uk) [crlaurence.de](http://crlaurence.de) [crlaurence.eu](http://crlaurence.eu)

## CRL Monterey Bi-Folding Glass Wall Systems

**new**

### Monterey S55 and S55R Series

- Top Hung Panels Glide Smoothly and Easily With Minimal Effort
- Versatile Pivoting Panel Option
- Weather Resistant, Designed for Interior/Exterior Use
- Inward or Outward Stacking Positions Available
- Certain Models Available With Three Point Keyed Locking System
- Flush Mount or Raised Sill Options

A contemporary way to maximize the available space in residential or commercial properties without limiting design options. The Monterey can be installed for interior or exterior use, opening either inwards or outwards. Interior applications come standard with flush mount sills whereas raised sills are supplied standard for exterior use. Flush sill option at exterior requires additional water management such as a trench drain (supplied by others) in front of the entire opening.

All systems are top hung and include a compensating frame and adjustable spacers to help overcome openings that are not level or plumb. Available in five standard colors and in custom finishes upon request.

Taller openings are easily handled by our **S55R** Series that incorporates a vertical mullion at each roller joint, allowing for additional rollers to help carry the weight of the door.



Monterey S55 Series in a residential setting

### Monterey S80 and S80R Series

- Thermally Broken, Constructed for Extreme Weather Conditions
- Top Hung Panels Glide Smoothly and Easily With Minimal Effort
- Inward or Outward Stacking Positions Available
- Certain Models Available With Three Point Keyed Locking System

All the same great features as the S55 plus thermally broken for extreme weather conditions and long term performance. Specifically engineered to satisfy the increasing demands for energy conservation. The high quality materials used and precision manufacturing of the system provides smooth operation of the panels with minimal effort.

All systems are top hung, and have a comprehensive seal configuration creating an exceptional weather-sealed system. Available in five standard colors and in custom finishes upon request.

Taller openings are easily handled by our **S80R** Series that incorporates a vertical mullion at each roller joint, allowing for additional rollers to help carry the weight of the door.



Monterey S80 Series in a commercial setting



# CRL TAPER-LOC® DRY GLAZE GLASS RAILING

## CRL TAPER-LOC® Dry Glaze Glass Railing System

- Designed for Commercial and Residential Applications
- Reduces Installation Time By 50%
- Clean (No Messy Wet Cement)
- Miami-Dade County Approved



ICC-ES Approval ESR-3269  
-ICC Evaluation Service

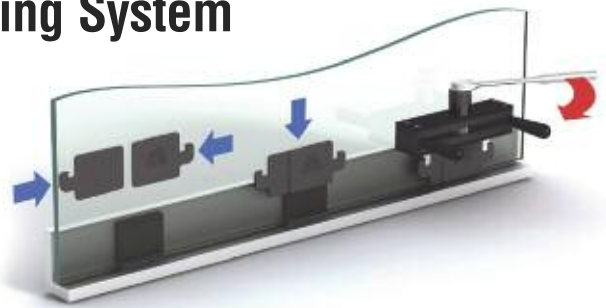

Winner of Glass Magazine's 2009 Crystal Achievement Award for "Most Innovative Commercial Hardware Product"

## We Offer a Choice of Taper Sets to Suit the Glass Being Used for Your Project

U.S. Patent Numbers 8,122,654 and 8,201,366;  
Commonwealth of Australia Patent No. 2008207524



**CAT. NO. TL5X10**  
for 1/2" (12 mm), 5/8" (15 mm) or 3/4" (19 mm) Thick Monolithic Glass



**CAT. NO. LTL10X**  
for 27/32" (21.52 mm) and 1-1/16" (25.52 mm) Thick Laminated Glass



**CAT. NO. LTL96X**  
for 9/16" (13.52 mm) Thick Laminated Glass



**CAT. NO. TL3X10**  
for 3/8" (10 mm) Thick Monolithic Glass Used in Windscreens

## We Offer a Choice of Aluminum Base Shoe to Suit the Glass Being Used for Your Project

- Available 10 and 20 Foot Lengths
- Cladding Available in Many Finishes

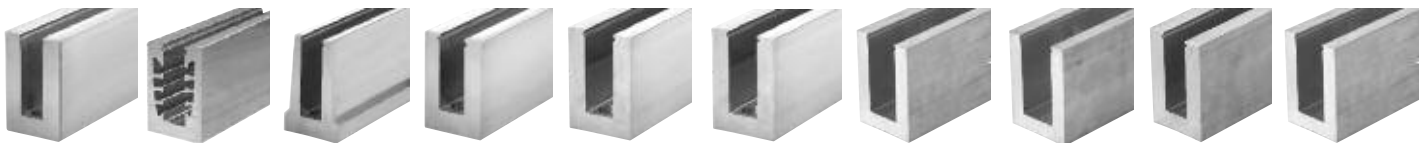

B5S Series

B5G Series

B5T Series

B5L Series

B6S Series

B7S Series

L21S Series

L25S Series

L56S Series

L68S Series

## TAPER-LOC® Installation Tools

- Expressly Designed for the Easy and Secure Installation and Removal of All TAPER-LOC® Taper Sets
- Your Time and Labor Savings Will More Than Pay for These Tools

## TAPER-LOC® Tool Kit for Installation and Removal of Taper Sets

- Newly Improved Tool Will Install and Remove All Sizes of Taper Sets for Both Monolithic Tempered and Laminated Tempered Glazing
- Integrated Torque Wrench Provides Precise Lock-Up Force
- Reduces Installation Time by 50%



**CAT. NO. TLK12**  
Installation/Removal Tool With Integrated Torque Wrench

MODEL **new**

## PAL Plumb/Angle/Level Locator Kit

- A Must for Installing Base Shoe Plumb and Level



**CAT. NO. PAL1K**- Kit With Laser Level  
**CAT. NO. PAL0K**- Kit Without Laser Level



C.R. LAURENCE COMPANY

crlaurence.com | usalum.com

768K | crlaurence.ca crlaurence.com.au crlaurence.co.uk crlaurence.de crlaurence.eu

# CRL TAPER-LOC® DRY GLAZE GLASS RAILING

Announcing the

**TAPER-LOC® XA**  
DRY GLAZE RAILING SYSTEM

## Good Just Got Better

- TAPER-LOC® XA Lets You Compensate for Uneven Surfaces So Glass Panels Can Be Perfectly Plumb
- Next Generation Taper Sets Install Easily Using Our TLK12 Installation/Removal Tool and New TLXAAT Angle Adjustment Tool
- Taper Sets for Monolithic and Laminated Glass Work With Our Most Commonly Used Aluminum Base Shoes

When job site conditions aren't perfect it's good to know you can rely on a product that will help you achieve results that are. That's what you get with TAPER-LOC®XA.

The 'A' stands for Adjustable and TAPER-LOC®XA is especially designed to allow vertical adjustment of the glass panels to perfect plumb, no matter how uneven the floor beneath the base shoe. Glass setting strips adhered to the lower edges of the panel rest on a setting base that allows you to adjust the glass panel to plumb, even if the base shoe segments do not align perfectly.

Unlike the original TAPER-LOC® System, the 'XA' Taper Sets are placed on both sides of the glass panel. That gives you the flexibility to perfectly align and plumb the glass panels in every segment. The addition of our TLXAAT Angle Adjustment Tool even lets you make adjustments to panels that are already installed on balconies or elevated concourses, without the need for scaffolding or inconveniently leaning over the railing.

The new TAPER-LOC®XA is a good thing made better, and is another product from the innovative engineers at C.R. Laurence Manufacturing. 'XA' Taper Sets and tools are made in California, and available from all C.R. Laurence Service Centers worldwide.

For more information, contact CRL Architectural Railing Technical Sales at (800) 421-6144 in the U.S., (877) 421-6144 from Canada, or (323) 588-1281 from outside the U.S. and Canada. For email go to the home page of [crlaurence.com](http://crlaurence.com) and click on Contact Us, and then click on Technical Sales for Railing Products.

End view of glass panel with 'XA' Taper Sets installed in our B5S Aluminum Base Shoe for 1/2" (12mm) glass. The glass has setting strips adhered to both lower edges, and rests on the setting base installed within the base shoe. Roll-in top gasket completes the installation after the Taper Sets have been tightened to lock the panel in place.

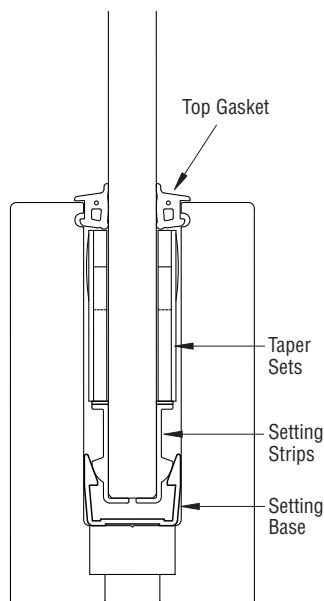

**new**



**CAT. NO. TLXATSM**

Taper Set for Monolithic Glass



**CAT. NO. TLXATSL**

Taper Set for Laminated Glass



**CAT. NO. TLK12**

Installation/Removal Tool

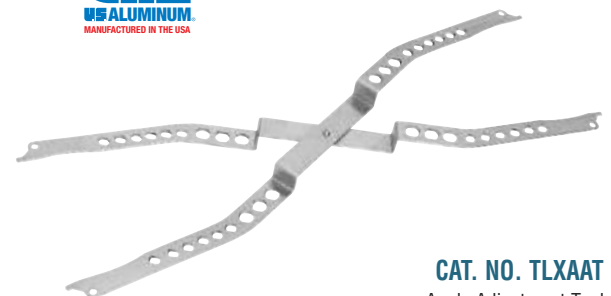

**CAT. NO. TLXAAT**

Angle Adjustment Tool

## CRL Security Doors and Windows

**new**

**GUARDA™**  
PROTECTIVE SECURITY SCREENS



- Internationally Patented Security Screen System With High Resistance to Forced Entry
- Exclusively Made With Certified 316 Marine Grade High-Tensile Stainless Steel Black Powder Coated Meshtec Security Mesh
- Provides Protection and Ventilation With Unobstructed Clear Views
- Perfect Replacement for Old Style Steel Bar Type Security Doors and Window Guards
- Incorporates Specially Designed Multi-Point Lock Systems
- Nine Standard Aluminum Frame Colors to Complement Virtually Any Exterior Decor



CRL Security Screens are nearly indestructible. They are available in a wide variety of styles to suit both commercial and residential architectural designs. These Security Screens are easily incorporated into new or existing properties with metal, vinyl, or wooden framed doors and windows.

Genuine Meshtec Security Mesh provides energy savings from the reduced need for air conditioning because it allows the free free-flow and circulation of air, and as an added benefit, blocks an average of 60% of harmful UV rays.

CRL offers two levels of protection, and units are available in standard and custom sizes to meet your security needs:

CRL Premium Security Screens feature our maximum strength frames that take protection "to the max" and are perfect for residential properties, military installations, prisons, commercial properties, and other structures that require the ultimate in security. The heavy extruded aluminum frame size is 1-1/8" by 2-13/16" (28.6 by 71.4 mm). Sliding and swinging screen doors come with strong three-point latching systems, delivering the ultimate in protection against forced entry.

CRL Slimline Security Screens are popular products for both residential and commercial applications. The slimline design is aesthetically pleasing. When used by businesses in commercial applications, Slimline Frames help ensure protection of property and inventory in the same manner they would protect your home and belongings. The extruded aluminum frame size is 13/16" by 2-13/16" (20.6 by 71.4 mm). As with the Premium Security Screens, all Slimline Screens feature a three-point latching system to provide increased protection against forced entry.

Visit the CRL web site at [crlaurence.com](http://crlaurence.com) to learn more about Guarda™. To speak with a CRL Guarda™ Security Systems Technician please call (800) 421-6144 in the U.S., (877) 421-6144 from Canada, or (323) 588-1281 International. Ask for Ext. 7520.

Go to [crlaurence.com](http://crlaurence.com)

to view the



## CRL Security Doors and Windows



**new**

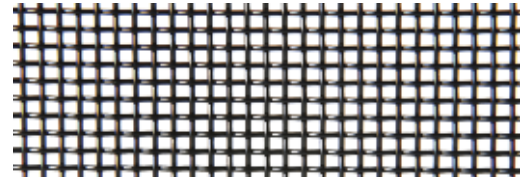

Mesh Shown Actual Size



Clear Vision



Impact Resistance



Protection from Insects



Energy Savings



No Bars



Air Flow and Circulation



Appealing Design



Standard Sizes and Custom Made



60% UV Blockage



Quick Exit



## Product Testing

### Dynamic Impact Test

Compliance test applied to ensure impact resistance to the patented fabrication system of components. The test comprises a heavy bag (92.5 lbs.) swung to impact the mesh and repeated five times, in varying directions. Guarda™ easily passes and exceeds AS 5041-2003.

### Knife Shear Test

Compliance test for protective security screens: A knife is used to simulate an attack on the mesh, repeated three times, in a constant directional force [vertical force 33 lbs. (147 N); horizontal force 77 lbs. (342 N); at a velocity of .236" second]. Guarda™ successfully passes and exceeds AS 5041-2003.

### Jimmy Test

Strength test designed to simulate attempted forced entry by burglars and intruders using an implement to pry open doors and windows or break locks and hinges by applying leverage forces. Guarda™ easily passes and exceeds AS 5041-2003.

### Salt Spray Test

Corrosion resistance test for all metal components. An accelerated climate machine (1,000 hours is the equivalency to 10 years) produces a corrosive attack on coated samples, measuring suitability and resistance of the protective finish to corrosive agents such as weather conditions. Guarda™ easily exceeds ASTM B117.

## Guarda Meshtec Warranties



• Powder Coating Color Warranty\* for a period of 10 years from the date of original installation on mesh and sash panels.



• Hardware Warranty\* for a period of one year from the date of original installation on all hardware (hinges, door closers, locks, and rollers).

\* Terms and conditions apply.



Dynamic Impact Test

## CRL Product Showcases

- Four Times a Year We Publish Our Product Showcase Featuring New Products and Promotions on Our Most Popular Items
- Save 10, 15, 20, 25% or More
- Qualifying Orders Placed Online Get an Extra Bonus

CRL customers who receive our Product Showcase Flyer get extra special savings on our newest and most popular products. Four times a year (quarterly), we offer some of the products you use most at discounts of up to 25%. You get three whole months to take advantage of these special savings and offers, and all you need to do to get them is place your qualifying order. The CRL Computer System automatically gives you the sale prices, whether you place your order by toll free phone, toll free fax or over the Internet. You can also get details on our Product Showcase promotions when you log onto [crlaurence.com](http://crlaurence.com).



## CRL Product Support to Boost Your Sales

- Our In-House Advertising Division Can Supply You With Banners, Posters, Brochures, Flyers, Magazine Advertising, Private Labeling, and More
- Ad Layouts and Copy Writing to Boost Your Sales Effort and Your Company's Image

CRL Advertising makes available to you professional quality ad materials that can help boost your sales and give your business a higher profile. We can help put your name out there where potential customers can see it, and let them know of the products and services you have to offer in local, regional, and national markets. For information, contact CRL's National Sales Manager at (800) 421-6144. Ask for Ext. 5262.



## New Product Submissions

### Do You Have an Idea for a New Product?

- Engineers Available for Product Development, Testing, and Production Support
- Award Winning Designs and Products
- State-of-the-Art Computers and Software

No one knows better what tools he or she would like to see in a catalog than the people who use them. We make an effort to make our catalogs as thorough as possible, but it never fails that as soon as we introduce a catalog one or more of our customers will come up with an item or a suggestion that makes us say "Why didn't we think of that?" We've received lots of useful suggestions, and are always pleased when someone takes the time to tell us their ideas on what they would have liked us to include.

We welcome the opportunity to serve you, and are committed to providing your business with the services that produce quality products. To discuss the possibility of working with CRL Manufacturing we invite you to contact CRL Product Management at (800) 421-6144 in the U.S., (877) 421-6144 from Canada, or (323) 588-1281 International. To send e-mail go to [crlaurence.com](http://crlaurence.com), click on Contact Us, and then click on Product Management.

### Need Help With a Current Product?

- Experienced, Knowledgeable Team Dedicated From Start to Finish
- CRL is ISO9001-2008 Certified

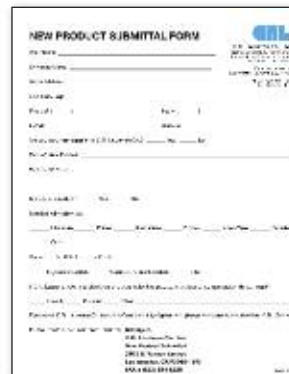

Online "New Product Submittal Form" can be found at [crlaurence.com](http://crlaurence.com)





[crlaurence.com](http://crlaurence.com)

[crl-arch.com](http://crl-arch.com)

[usalum.com](http://usalum.com)

### Glazier's Tools Pages 101K to 196K

1



### Glass Handling and Safety Gear Pages 197K to 292K

2



### Specialty Tools Pages 293K to 420K

3



### General Hand and Shop Tools Pages 421K to 564K

4



### Caulking Tools and Insulating Glass Pages 565K to 628K

5



### Glass Working Machinery and Lifting Equipment Pages 629K to 740K

6



## LANGUAGES

Information about the products in this CRL Catalog is available in these languages when you visit our supplementary web sites:

[crlaurence.com.mx](http://crlaurence.com.mx) or  
[crlaurence.es](http://crlaurence.es) : Spanish

[crlaurence.de](http://crlaurence.de) : German  
[crlaurence.qc.ca](http://crlaurence.qc.ca) or [crlaurence.fr](http://crlaurence.fr) : French

[crlaurence.it](http://crlaurence.it) : Italian  
[crlaurence.dk](http://crlaurence.dk) : English

Enter the product number into the Search Box and information about the item will be in that language.

### C.R. LAURENCE CO., INC.

Corporate Headquarters  
Post Office Box 58923, Los Angeles, CA 90058-0923  
International Phone: (323) 588-1281 • International Fax: (323) 581-6522

### TOOLS, MACHINERY AND EQUIPMENT

Phone: (800) 421-6144 or (323) 588-1281 Ext. 5275  
Direct Fax: (800) 262-3299 or (323) 581-6522  
Direct E-Mail: [glazing@crlaurence.com](mailto:glazing@crlaurence.com)

© Copyright 2013, C.R. Laurence Co., Inc.