

03 SAF

Sealants, Adhesives, and Fasteners

■ Sealants and Glazing Products

■ Glass Bonding Tools and
Supplies

■ Cleaning Products, Lubricants,
and Touch-Up Paints

■ Adhesives, Tapes, and
Fasteners

■ Application and Removal Tools

■ Insulating Glass Products and
Auto Glass Sealants

CRL®

crlaurence.com

Page Intentionally Left Blank

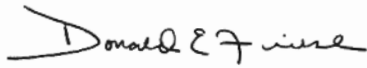

Donald E. Friese
Chairman and C.E.O.



Lloyd W. Talbert
President and C.O.O.

Thanking You for Your Continued Support as C.R. Laurence Goes Global

We would like to say "Thank You" to all of our customers and employees. Your help and encouragement has made it possible for C.R. Laurence Company to grow into the industry leader, and we plan to continue growing. Our goal is to listen, and challenge ourselves to better serve our customers.

Because of you we set our standards for innovation, service, and selection of quality products at the highest level. We consider it our responsibility to bring new technology to our industry so that we can all prosper.

Access to all CRL products and services is available to you through our "self-service" web site, crlaurence.com, the most comprehensive and convenient information source we can offer our customers. The CRL web site is a powerful communications device between your business and the CRL people who serve you. It also allows us to empower you to have more flexibility and control of your orders, making it possible for you to contribute in the process of our providing you with excellent service.

We believe the Internet has become the tool of modern business, and C.R. Laurence Company is making a major commitment to the development of our global web sites so they can be your source for information and technical support, and to make crlaurence.com an even more valuable and convenient resource.

This catalog is the latest evidence of our commitment to bringing the glass and aluminum industries this extensive line of sealants, adhesives, and fasteners. CRL has searched the world to gather the products that glaziers and tradesmen can use to make their jobs easier and more efficient. CRL03 has over 3,000 items that will help you do a better job for your clients.

CRL's success has been made possible through our transition into manufacturing. We are producing a growing number of products to fill all of your requirements, and we will continue to listen to your ideas for products to manufacture for our industry. As always, we plan to expand our product line to be a continuing source for the glass industry. We are also adding to the number of distribution and manufacturing facilities we use to serve you, with plans for more to come in North America and Australia, and a major commitment into Europe.

Again, we thank you for your continued support. Without your ideas for better service, new products, and generally high expectations, we would not have enjoyed our growth and success. Let's continue our success together.

C.R. Laurence Co., Inc.

C.R. Laurence Company has 16 distribution locations in or near major metropolitan areas to serve our customers in the United States. Los Angeles, California is home to Corporate Headquarters and to CRL Manufacturing. It is from here that over 50,000 quality products are distributed to the regional CRL warehouse that serves your business.

C.R. Laurence Worldwide

C.R. Laurence of Canada has four locations to serve all of Canada from coast-to-coast. C.R. Laurence of Europe has locations in the United Kingdom and Germany. C.R. Laurence of Australia serves that continent and the Pacific from locations in Sydney and Melbourne. Plans are under way to expand our service network in the near future.





CRL Serves the World From Three Continents With Ever-Improving Service Capabilities

- North America • Europe • Australia

C.R. Laurence has been a supplier to customers worldwide for decades, and can now offer our unmatched range of products and services from CRL locations on three continents: North America, Europe, and Australia.

Communicating

In our history we have prospered as a company because we've followed a path of innovation and growth, always seeking new ways to use the latest technology to expand our service capabilities. Major advancements in the world of communications have made much of this possible. We've always been among the first to introduce new ways of reaching our customers, and in return, have made it easier for them to do business with us.

C.R. Laurence was the first in our industry to offer toll free telephone ordering. For over thirty years our customers have been able to call our 1-800 number to place orders, ask questions about products, get prices, and communicate with us without it costing them a cent. Our recent expansion into Europe lets us offer the same free phone and free fax service to our customers on that continent.

In the early '80's we added toll free fax ordering, making it possible for our customers to fax their purchase orders, parts lists, shop drawings and other documents directly to our Customer Service Department at CRL Corporate Headquarters. It was during this time that we also introduced CRL FastFax, providing customers instant notification that their orders had been shipped.

One of our most important advances was the installation of the CRL Computer System in 1978. The power of our abilities multiplied many times when we went 'online' because we were better able to track inventory levels throughout our distribution network, and better able to process your orders quickly and more accurately. The ongoing evolution of the CRL Computer System now includes our Internet and fax servers, which empowers us to offer our customers in every corner of the world ever-improving service at every step in the process, from order entry through shipping and billing.

Some say our most important communications advancement was our entry into the business of Electronic Commerce with the introduction of the CRL web site in 1997. What was once a fledgling effort has blossomed into a full service web site featuring information regarding all of the products and services CRL has to offer. Customers who use crlaurence.com find an enlightening and comprehensive web site that is constantly improving with the addition of new features that make it quicker and easier to use. And now we have web sites especially tailored to the countries with which we do business.

C.R. Laurence makes a serious effort to promote ever-improving service by making the investments required to improve communications at every level. We want your business dealings with CRL to be simple, clear, and convenient. If you feel that we can improve communications at any level, we would like to hear from you. To submit comments, go to crlaurence.com and click on Contact Us, then click on Web Comments.



Building A Network

Providing the ever-improving service level we strive for means bringing CRL to our customers. From a single Los Angeles, California location we have grown to a network of distribution warehouses in five countries on three continents.

Each of our distribution warehouses is connected to Corporate Headquarters through our computer system, which monitors and updates inventory levels with the arrival of each new delivery truck and the shipment of each customer order. Every warehouse receives fresh inventory each week through our Inter-Branch Transfer System so stock levels can remain high. This improves the percentage of your orders we can ship complete, and usually on the same day we receive them.

Another advantage of having regionally located warehouses in or near major metropolitan areas is the opportunity to serve our customers in person. Each CRL location has a Will Call Trade Counter open six days a week. For directions to CRL locations go to crlaurence.com and click on About CRL under the General Information menu to the left of your screen. The pop-up menu will give you a selection for Distribution Locations.

And in order to provide ever-improving service the CRL network of distribution warehouses will continue to grow. In recent years CRL service has come to Australia and Europe with the opening of locations to serve customers on these continents. New or enlarged locations are planned for metropolitan areas throughout the U.S. With the opening of each new facility, we make getting what you want from CRL faster and easier.

Investing In People To Serve You

The best way we can serve you is to have capable people available to answer your questions, take and expedite your orders, suggest solutions to problems you may be having with a job, or to assist you in any manner we can. We maintain ongoing training programs so that the CRL people who serve you will have at their command the resources to make your business transactions with us a pleasant experience.



CRL CUSTOMER SERVICES



CRL Serves the World With Local and International Brands of Your Favorite Products

• North America

• Europe

• Australia



CRL's Global Headquarters in the Los Angeles, California area

Brand Names

Product branding is the identification of a product by a specific name, and it is present in just about everything you buy. Whether it's groceries, garments, appliances, electronics or vehicles, we all have our favorite brands. We get to know and trust certain brands for their reputation of quality, good or bad, and we make buying decisions in part based on our familiarity and trust in a brand name.

The same is true for the products we use. Every professional has favorite brands that they trust for quality, service life, and value. Some of these names are familiar worldwide, and can be found in shops in virtually every country. Others are more local in scope, marketed only in certain countries or on certain continents.

As for quality, in many cases the "local" brands are just as good as the "international" brands, and provide equal value. They have their particular markets, and have excelled in them by producing top quality products at affordable prices.

CRL Brings The Best To You

Operating on three continents allows us to bring brands to you that you may not otherwise have local access to. Our purchasing agents select quality products from vendors across the globe, and because we have a global distribution network these products can be made available through any of our warehouses.

When you review our catalogs, both in print and online, you'll see many familiar brand names and some that will be new to you. Be assured that these new brands, including those products bearing the CRL brand name, are tested products that will deliver both quality and value.

As both a manufacturer and a distributor CRL can bring you the best products at value prices. We're a brand name that you can trust.

Need It But Don't See It? Just Ask CRL

Our access to suppliers worldwide gives us the ability to deliver products from any of the brand names we advertise. If you need a certain product from a specific brand name don't hesitate to ask us for a price and delivery time. We're experts at getting you what you want when you need it. Just ask us and we'll do our best to serve you.



CRL's Canadian Headquarters in the Toronto, Ontario area



CRL's European Headquarters in the Manchester, England area



CRL's Australian Headquarters in the Sydney, New South Wales area



CRL CUSTOMER SERVICES

CRL Provides Global Service With Regionally Oriented Web Sites

- Access to All CRL Products and Services is Available 24 Hours a Day, Seven Days a Week When You Visit Us Online
- Our Sites are Updated Continually to Bring You Our Newest Products and Special Offers
- The Entry Port for 'All-Glass' Storefronts Online®, Showers Online, Hand Rails Online, and Our Other Web-Based Services



As a global supplier to the industries we serve CRL recognizes that the power of electronic commerce strengthens our ability to serve you locally, as well as our other customers worldwide. And while the Internet had created a virtual "global village", it's important to also have the capability to tailor our web sites to the specific needs and business conditions of the continents on which we are based. That said, it became apparent that our web site, crlaurence.com, had to at the same time be global in appeal, but still local enough to be relevant.

Thus the creation of our Global Web Site Directory. When you visit our web site you are directed to the home page of the individual site designated to host your home country.

You can also move from one site to another simply by clicking on the directory icon at the top of the home page. From here you have access to all of our sites, giving you the opportunity to explore the entire scope of CRL's online world.

As we progress in this global strategy, look for us to include new language options, and translation of our Online Catalog into many more of the major languages. We are committed to bringing the virtual world of C.R. Laurence to the world, and making your online shopping experience at crlaurence.com pleasant and easy to understand. We want you to be comfortable with CRL, and will work hard to make that possible.

Welcome to the C.R. Laurence Global Web Site Directory

Please select from one of these web sites to begin your visit

 UNITED STATES and INTERNATIONAL <i>English Language</i> crlaurence.com	 CANADA <i>English Language</i> crlaurence.ca	 EUROPE – UK <i>English Language</i> crlaurence.co.uk	 EUROPE – DE <i>Deutsche Sprache</i> crlaurence.de
 UNITED STATES and INTERNATIONAL <i>MX idioma español</i> crlaurence.com.mx	 CANADA <i>FR en français</i> crlaurence.qc.ca	 EUROPE <i>FR en français</i> crlaurence.fr	 EUROPE <i>English Language</i> crlaurence.eu
 A Division of C.R. Laurence Co., Inc. somaca.com	 AUSTRALIA crlaurence.com.au	 EUROPE <i>Spanish Language</i> crlaurence.es	 A Division C.R. Laurence of Europe LTD crlaurence.co.uk

TRANSLATIONS

This CRL Catalog can be translated into the following languages by going to these specific web sites:
 GERMAN: crlaurence.de
 FRENCH: crlaurence.qc.ca or crlaurence.fr
 SPANISH: crlaurence.com.mx or crlaurence.es
 Enter the product number into the Search Box and all information about the item will be in that language.

Pour visualiser ce catalogue CRL en français, visitez le site Web:
crlaurence.qc.ca ou crlaurence.fr

Saisissez le numéro d'article dans la case de recherche pour recevoir les informations traduites en langue française.

TRADUCTIONS

ÜBERSETZUNGEN

Dieser CRL-Katalog kann in die deutsche Sprache übersetzt werden, indem Sie auf die Webseite: crlaurence.de gehen.

Geben Sie die Artikelnummer in das Suchfeld ein und alle Produktinformationen sind in deutscher Sprache.

Para ver éste catálogo de CRL en español, diríjase a éste sitio Web:
crlaurence.com.mx o crlaurence.es

Ingrese el número de producto en la casilla de Búsqueda y toda la información del producto estará en español.

TRADUCCIONES



C.R. LAURENCE COMPANY

crlaurence.com

IV | crlaurence.ca crlaurence.com.au crlaurence.co.uk crlaurence.de crlaurence.eu

CRL CUSTOMER SERVICES



Methods of Ordering

Online at crlaurence.com

- **crlaurence.com Never Closes!**
- **It's the Home of Our Online Catalog**

Many of our customers have found the most convenient method of ordering from CRL is through our "self-service" web site. When you use crlaurence.com to place your orders you have many options that other methods don't provide. You set the schedule and the pace because you can sign on 24 hours a day, seven days a week. You can build a personal catalog; even make changes or additions to your orders online. There's no easier way! See pages VI and VII for more information about the benefits of ordering at crlaurence.com.



Toll Free Fax Service

- **This Convenient Way of Ordering is Used Over 1,000 Times Every Day**

When we introduced toll free fax service in the '80's we had no idea how popular it would become, but now our customers send us over 1,000 orders or quote requests every business day! Fax ordering is very convenient because you can fill out your own purchase orders and then just fax them to us. You can be specific about shipping instructions or other details that will help us serve you. To send your orders or quote requests by toll free fax from anywhere in the U.S. or Canada, just dial **(800) 262-3299**. In Australia the number is **1800 813 013**. In Europe the number is **00 800 0262 3299**.

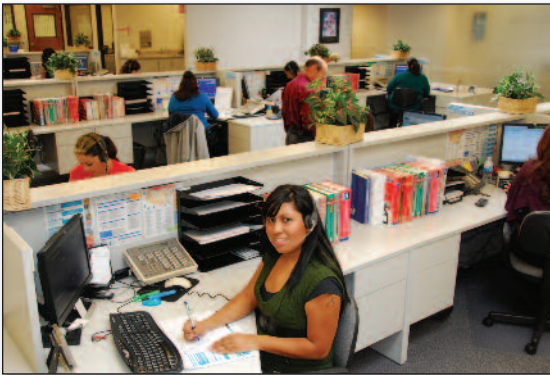

Toll Free Customer Service Order Desk

- **Our Friendly, Trained Staff is Always Happy to Hear From You**

For almost 40 years CRL has provided toll free ordering at **(800) 421-6144**. When you call our Customer Service Order Desk you'll find CRL staff who are trained to provide assistance with CRL products and services. They have instant access to pricing, stock availability, and the status of your account, plus they can connect you to CRL Technical Sales personnel if you need specialized product assistance. Order Desk hours are 6 am to 5 pm (Pacific Time) Monday through Friday, and 7 am to 12 pm Saturdays. In Australia our number is **1800 424 275**. In Europe our number is **00 800 0421 6144**.



Will Call Trade Counter

- **When You Need It Today, Our Will Call Trade Counter is Your Fastest Option**
- **Come In and Visit Us at All CRL Distribution Locations**

Every CRL distribution location has a Will Call Trade Counter where you can place and pick up your orders in person. And when you place your order in advance by phone, fax, or over the Internet we can have it ready and waiting for you, which can save you a lot of time. Will Call Trade Counter hours are 8 am to 5 pm Monday through Friday, and 8 am to 12 pm Saturdays. Some of our most experienced people staff our Will Call Trade Counter, and they are always happy to see you. Remember, to save time just place your order in advance.

Who May Buy

C.R. Laurence is a manufacturer and wholesale distributor. Possession of this catalog, or any other CRL sales literature, does not constitute an offer to sell. Orders from individuals (except professional tradesmen) may not be accepted.

QUICK INDEX TO CRL03

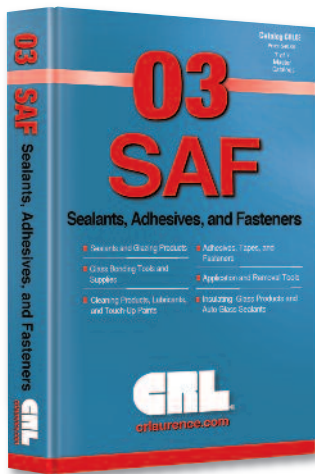

The CRL03 Sealants, Adhesives, and Fasteners Catalog

- A Very Useful Catalog for Glaziers, Installers, Fabricators, and Trademen
- Thousands of Items for the Successful Business

CRL03 is a very useful catalog for glaziers, installers, fabricators, and business professionals in the glazing, railing, architectural, construction, and automotive industries. From basic sealants, adhesives, and tapes to common and specialty mechanical fasteners, this catalog has thousands of items to help you get a job done right. We feature sealants and adhesives from recognized manufacturers worldwide, as well as our own extensive line of CRL brand products. Our line of adhesive and specialty tapes has applications in virtually all forms of fabrication, installation, and repair. It's a selection that is unsurpassed in this industry. Best of all, our products are available for shipment to anywhere in the world from our 25 distribution facilities on three continents. We're competitive with our pricing, and have the experience and capability to supply your sealant, adhesive, tape, and fastener needs. Here's a quick look at the selection within these pages. For a more precise and thorough index of all products, turn to the back section, or go to our web site, crlaurence.com.



Sealants and Glazing Products

Pages N101 to N204

- Acrylic Sealants
- Backer Rod
- Butyl Sealants
- Glazing Gaskets
- Glazing Tapes
- Polyurethane Sealants
- Putties
- Setting Blocks
- Shims
- Silicone Sealants



Application and Removal Tools

Pages N205 to N252

- Adhesives and Dispensers
- Caulking Guns and Tools
- Glazing Clips and Points
- Knives and Blades
- Putty Knives and Tools
- Sealant Removal Tools



Adhesives, Tapes, and Fasteners

Pages N253 to N332

- Adhesive Tapes
- Adhesives and Cements
- Anchors
- Insert Fasteners
- Mirror Mastics
- Railing Fasteners
- Rivets
- Screws, Washers, Nuts, and Bolts
- Specialty Tapes



C.R. LAURENCE COMPANY

crlaurence.com

VI | crlaurence.ca crlaurence.com.au crlaurence.co.uk crlaurence.de crlaurence.eu

QUICK INDEX TO CRL03



Cleaning Products, Lubricants, and Touch-Up Paints Pages N333 to N388

- **Cleaning Tools and Supplies**
- **Glass, Plastic, and Metal Cleaners**
- **Lubricants**
- **Safety Wear**
- **Surface Protection and Restoration**
- **Touch-Up Paints**
- **Towels and Wipes**



Glass Bonding Tools and Supplies Pages N389 to N444

- **Basic and Professional Starter Kits**
- **Curing Lamps**
- **Fixation Devices**
- **Glass Furniture Hardware**
- **Glass Prep Tools and Supplies**
- **Ultraviolet Cure Adhesives**



Insulating Glass Products and Auto Glass Sealants Pages N445 to N492

- **Auto Glass Sealants**
- **IG Adsorbents**
- **IG Fabrication Equipment and Tools**
- **IG Sealants and Dispensers**
- **IG Spacers and Accessories**
- **IG Starter Kits**
- **IG Testing Tools**



Complete Product Index Pages N493 to N524

- **A to Z Index for Every Product in This Catalog, With Listings by Brand Names, Generic Names, and Common Names**
- **Information on Searching the CRL Web Site**
- **User's Guide to CRL Online Services**
- **Other CRL Catalogs**

Welcome to the C.R. Laurence Online Catalog

- Thousands of Pages of Quality Products and Helpful Information are Just Clicks Away, Anytime, and at Your Convenience
- It's the Best Way to Shop at CRL

What's the best way to shop at C.R. Laurence? Visit the Online Catalog at crlaurence.com. Our Online Catalog brings you thousands of pages from our many printed catalogs. All of them in full color, and linked to our ordering module so you can browse and shop at any time it's convenient. You can check prices, review stock levels, and get the most complete and up-to-date details on the products we offer. And you can do it all from any PC.

Our "self-service" web site and Online Catalog are the most comprehensive and convenient up-to-date information sources we can offer. Explore some of our most popular product lines or review individual products. CRL has over 50,000 of them organized by specific product categories.

The convenience of having all CRL catalogs combined into one Online Catalog is the quick and easy way to find just what you need, available at your convenience, whenever you're ready. And if you ever need assistance, just contact us over the Internet or by toll free phone. We'll be glad to help.

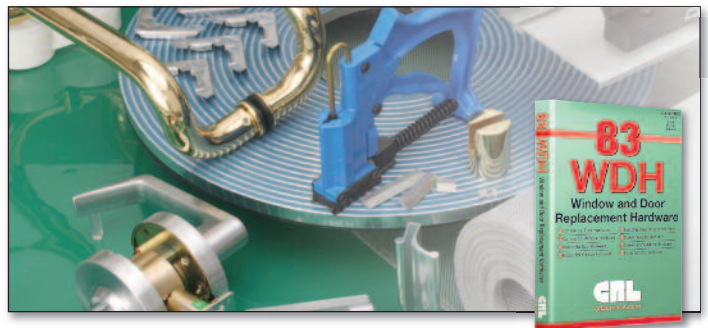

We know that the most efficient way for our customers to shop at CRL is by using this carefully planned and thoroughly prepared Online Catalog that makes it easy for you to find the CRL products and services that will best meet your needs. C.R. Laurence Company is committed to making our Online Catalog your best source for information and technical support.

What you will find at crlaurence.com is a link to who we are, what we do, and what we have to offer our customers. The CRL "self-service" web site allows us to use the powers of Electronic Commerce to bring you closer to all of the products and services that we offer.

We take a Business-to-Business approach of conducting business over the Internet because it gives us so many ways to connect with you. Methods of searching for and ordering products that just a few years ago would have been impossible were it not for the versatility of this powerful tool.

Empowerment is what a good web site is all about. We let you make the decisions that will best serve you. You can build your orders and submit them 24 hours a day, seven days a week, at your convenience. You can review over 50,000 products which we make available, including pricing and current stock availability.

All of this and more is available to CRL customers who have signed on to our web site and become part of the world of crlaurence.com.

User's Guide to the CRL Online Catalog and Web Site Features

- How to Create a User Name and Password
- How to Sign On and Recover Your Information
- How to Search for Products
- How to Check Prices
- How to Check Stock
- How to Place an Order
- How to Request a Quote
- How to Request Product Data
- How to Pay Your Statement Online
- How to Contact Us
- How to See What's on Sale



User's Guide
CAT. NO. UG11

The User's Guide to our web site shows you quick ways to learn how to locate necessary information. We've written step-by-step instructions to help you through our Online Catalog. Ask for your free copy today!

crlaurence.com ONLINE SERVICES

Our Home Page has buttons you can click on to link directly to the most popular areas of **crlaurence.com**. With one click you can get phone and fax numbers for CRL Departments; directions to all CRL locations; access our Customer Support Center or our Document Library; review our Product of the Month Sale; view and check out your Online Orders; navigate Product Groups by catalog type. All of this is just a click away.

The Navigation Menu is also where you'll find our all-important 'Enter your search words here' box. This powerful option lets you locate CRL products by entering their catalog number, key words, or the names of products. Navigating a web site with over 50,000 products doesn't need to be difficult, just make sure to take advantage of this helpful feature.



Near the top of our Customer Menu is your link to **Express Ordering**, an easy to learn and quick to complete method of placing orders online whenever it's convenient for you. You set the schedule and the pace because you are in control. You can also build your Personal Catalog by matching your part numbers to our Catalog Numbers.



With **crlaurence.com** it's easy for you to contact us online 24 hours a day for **Online Support**. With just a click or two you can send e-mail to a number of CRL Departments. You can also get addresses, phone and fax numbers, even driving directions for all CRL locations in the United States, Canada, Europe, and Australia.



The new **CRL Power Search** is simple! Search all CRL Brands or, to reduce your initial results, select a specific Brand by clicking the drop down and making a selection. Then type in a catalog number, a word or a combination of words into the Search Box. Now press ENTER or click on the magnifying glass icon. Within seconds you will see results from your search. It's that easy!



When you click into our **Help** screen you are presented with a selection that includes information about CRL's Business Policies, ways to contact us, our distribution locations, and how to sign in. There's also a link to our Document Library of Comparison, Cross-Reference, and Specification Charts, Application Guides, New Product Submittal Forms, and more.



C.R. LAURENCE COMPANY

X | crlaurence.ca crlaurence.com.au crlaurence.co.uk crlaurence.de crlaurence.eu

crlaurence.com

CRL Showers Online

- New 3-D View Brings Dynamic Color Images to Your Quote Page
- Now Supports Hydroslide and Cottage Series Sliding Enclosures, and Bi-Fold Doors
- Hardware Packages Can Be Assembled to Use Your Most Popular Items as Default Lists - One Button and Your Hardware is Complete!
- New Branding Feature Lets You Add Your Logo and Company Information to Reports

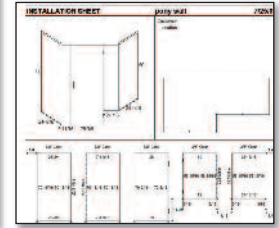
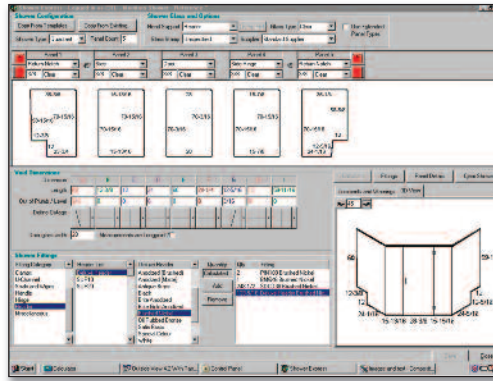

CRL Showers Online is a glass size program that lets you enter a list of products used for a particular shower enclosure, and the rough opening dimensions. Showers Online then calculates final glass sizes and displays detailed information, including hinge and handle locations, miters and much more. Showers Online is tailored to work with most any shower enclosure configuration. This program eliminates the weakest link in your ability to compete and increase your shower door business. Showers Online issues warnings about possible problems with the shower design. It also builds a library of your most common showers, which you can use to start a new job by copying from the most similar design in the library. Online access means availability to the program anytime, anywhere... from the office, shop or field. The sophisticated CAD processing takes place on our web servers. Any Windows-based PC running Windows 2000 or newer with a minimum of 56K modem can be used. **Go to crlaurence.com and sign up for our Webinar and a 30-day FREE trial.**

CRL 'All-Glass' Storefronts Online®

- Request Quotes and Order Directly From Program
- You Can Create a Job Template Library or Clone Any Saved Project
- New Branding Features Add Your Company Logo to Documents
- Direct Link to CRL Web Site From Program
- CRL Training Webinars to Get You Started

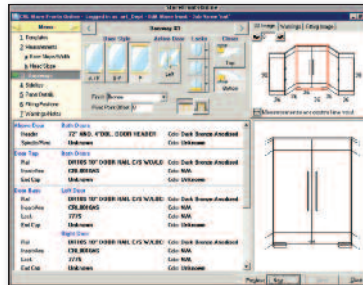

Designers of 'all-glass' storefronts will find our web based 'All-Glass' Storefronts Online® program to be a real time and money saver. It is tailored for use in most any 'all-glass' storefront application using 3/8", 1/2", or 3/4" (10, 12, or 19 mm) glass, including doors, sidelites, transoms, and fin supports with full top and bottom rails or patch fittings. Our program will create a hardware list, print glass sizes, and create a quote sheet in minutes. This includes warnings regarding any issues that may conflict with a complete and sound entrance. You can simply log on from any computer that is connected to the Internet. All the processing takes place on our computers so you do not need any special hardware to run it. Any Windows-based PC running Windows 2000 or newer with a minimum of 56K modem can be used.

Go to crlaurence.com and sign up for our Webinar and a 30-day FREE trial.

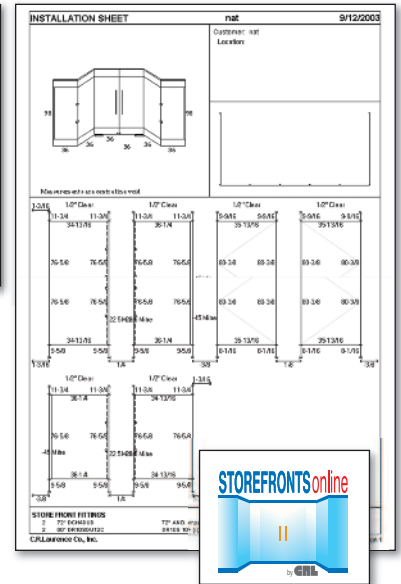

CRL Hand Rails Online for Glass Railings

- Produces a Complete Quote Package Instantly From Your Desk Top
- Produces a Full Color 3-D Rendering and Dimensional Plan View for Field Installation
- Allows You to Order Material Directly From Your Computer
- Determines All Material Quantities Needed for Each Project
- Generates Quotes / Orders in Minutes

CRL Hand Rails Online is a software package designed to work for you. You now have the power to become a professional estimator and installer of glass railing and windscreens systems. This innovative program will automatically generate material lists, glass sizes, and fabrication details for your project. You can create a quote and order from your own computer. You will easily save up to half the time in estimating and ordering hand rails and windscreens systems. **Go to crlaurence.com and sign up for our Webinar and a 30-day FREE trial.**

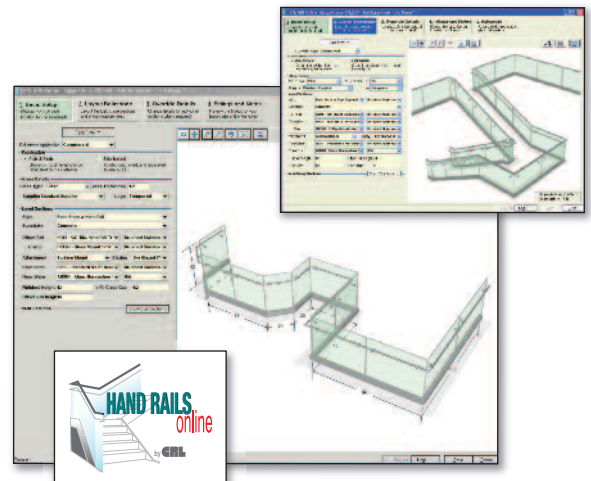

NEW CRL BRANDS

We Welcome Blumcraft of Pittsburgh Into the CRL Family of Companies



CRL happily announces the acquisition of Blumcraft of Pittsburgh, an icon in the architectural metal and glass industry. Blumcraft has been designing, manufacturing, and delivering high quality products to the architectural metal and glass industry for over 95 years. The company's tempered glass doors, panic hardware, hand rails, and display doors are well known to architects, contractors, and installers in their building trades. Blumcraft has close ties to many architectural firms, customizing products to their specifications.

Blumcraft metalwork elements have been installed in more than 77,000 buildings throughout the world, including the White House, the Smithsonian Institute, the Metropolitan Museum of Art, the Louvre in Paris, and many other prestigious buildings overseas.

The acquisition of Blumcraft will benefit CRL customers and provide you with even more choices of high quality architectural hardware products. We value the experience, reputation, and technical expertise of the Blumcraft staff, and welcome them to the CRL team.

For more information about the Blumcraft line, please contact CRL Technical Sales for Architectural Products or visit our web site at crlaurence.com.

Jackson Corporation is Now a Member of CRL Manufacturing



Jackson Corporation is now a member of CRL Manufacturing. Jackson has been a leading manufacturer of door hardware for the aluminum and tempered glass door industry for over 50 years. In 1995 they became the first U.S. hardware manufacturer to be certified to ISO 9001 quality standards. The manufacturing operations will be housed in our new 62,000 sq. ft. facility in Los Angeles, and Jackson products will be distributed through CRL's worldwide network.

This joining provides CRL customers more choices than ever of traditionally high quality Jackson architectural hardware. Jackson's very popular Transom Closer was originally developed and patented over 35 years ago. The innovative features of today's versions continue to make the Jackson Transom Closer a top choice. The company's Panic Exit Hardware is universally recognized as the standard for the aluminum storefront market.

The experience gained through this move is invaluable, and we welcome the Jackson staff into our Technical Sales and Manufacturing efforts. For more information, to place an order or request a quote, contact CRL Jackson Technical Sales or visit our web site at crlaurence.com.

NEW CRL BRANDS

Tajima Becomes Part of the Future of C.R. Laurence



Tajima Corporation USA is a well-known firm in the Architectural Metals industry. Based in Los Angeles, Tajima has been supplying design, engineering, and manufacturing services to this industry in the United States for over 20 years. The employees of Tajima have joined CRL as Tajima's operations have consolidated with our existing Los Angeles Architectural Metals and Manufacturing operations.

Tajima Corporation USA has extensive experience in the architectural metals industry. The company's product expertise includes: curtain walls, entrances, storefronts, metal wall panels, column covers, cladding, canopies, sunscreens, handrails, and custom ornamental metals. CRL also announced an agreement with Pacific Door Closer to become the exclusive manufacturer and distributor of Balanced Doors developed by Wikk Industries, whose balanced door hardware has been tested and proven commercially in thousands of installations. CRL will continue to produce and distribute this well-known line of Balanced Doors.

The people, products, machinery and know-how acquired in these two transactions are tremendous complements to our growing Architectural Metals and Architectural Hardware capabilities, and represent our strong commitment to these important growth industries.

CRL's extensive line of Architectural Metals is showcased in the CRL AM09 Architectural Metals Catalog and the TAJ11 CRL Tajima Architectural Metals Catalog. Both are available for viewing or download at crlaurence.com.

Vitrododi Supply is Welcomed to Our Expanding Family



Exclusive Distributor for Toyo in Europe, the Middle East, and North Africa



C.R. Laurence Company announces the acquisition of the Supply Division of the Italian Vitrododi International Company. For three generations Vitrododi has been operating in the glass field supplying machines and tools. The Milan-based company serves several markets, predominantly across Europe, the Middle East, and North Africa.

With more than an 80-year long history, Vitrododi has devoted itself to exporting Italian made machines and tools around the world. It is the supply business that has been acquired by C.R. Laurence, along with the exclusive distribution rights to the entire Toyo product line. Toyo is best known for its glass cutters, including the famous "Supercutters", "Pistol" and "Thomas" Grip Hand Cutters, and Glass Cutting Wheels for automatic machines – such as the innovative "Tap Wheel", plus all of Toyo's associated glass working and breaking tools.

We are proud to welcome the Vitrododi Supply business into the expanding CRL family. This move both underscores our commitment to developing the European, Middle East, and North African markets, and ensures our customers have great choice and availability of proven and well-respected products.

The business will operate from our 75,000 sq ft (7,000 m2) sales and distribution facility near Manchester, in the United Kingdom. For more information, contact CRL Technical Sales for Glass and Glazing, or visit our web site at crlaurence.com.



CRL MANUFACTURING



CRL Manufacturing

- **Making Quality Products for Over 40 Years**
- **User of Progressive ISO9001:2008 Manufacturing Processes**
- **Mechanical and Technical Expertise Available to Assist Your Manufacturing Processes**

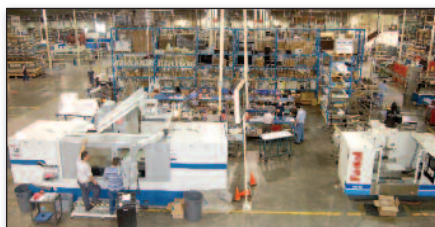

Manufacturing Video Online

Go to the home page of crlaurence.com and click on Video Library. From there you can select a seven-minute video presentation detailing CRL's product line and manufacturing capabilities.

You may know C.R. Laurence Company as the world's largest distributor of supplies to the glass industry. What you may not know is that we are also a manufacturer of over 5,000 products found in our Online Catalog. We make some of the best products available to customers worldwide. Our people use progressive ISO9001:2008 manufacturing processes to make products for the Glazing, Railing, Architectural, Construction, Industrial, and Automotive industries. These certified processes ensure that we give every product our full attention to detail.

There are many industries served by the products manufactured in our California plants. We make architectural hardware for new and retrofit building construction, railing systems and windscreens for balconies and decks, security transaction windows and devices, display hardware for the retail trade, specialty tools for the glazing trade, hinges and other products for frameless shower doors, and automotive windows for trucks, vans, and RV's.

Using strict manufacturing standards we produce the kind of quality products that has kept us at the head of this field for many years.

That's your assurance that when you select a product made by CRL Manufacturing you have made the best possible choice.

We're always looking for ways to make our products better, and along the way we've added experts from different fields to our staff of designers, engineers, and craftspeople. Our goal is to make our products a better value to you, whether it's time or labor savings, extended service life, increased versatility or enhanced visual appeal.

Many of our products incorporate industry "firsts"; features offered by no other manufacturer because we feel that no product or process is so good that it can't be improved. We strive to make products of high quality and value. That's the goal we set for ourselves at the onset, and it's still our guiding influence.

Some of the improvements we've made have originated from people who have used our products and generously contributed their opinions and suggestions. We welcome your comments, and invite you to contact us at any time regarding a C.R. Laurence product.

Manufacturing Expansion

- **The New Homes of Many Popular CRL Brands**

Expansion of our manufacturing capability continues in Los Angeles. Two new facilities, one recently opened, and one scheduled for completion in 2011, will bring our total manufacturing floor space in California to roughly 650,000 square feet. Upon completion CRL will have almost 1 million square feet of distribution and manufacturing capability in the local area to better serve our customers.

We also have a 90,000 square foot machinery facility in Cicero, Illinois, and are planning a new facility in Melbourne, Australia for the manufacture of our Vacuum Lifters. It's all part of CRL's commitment to provide good quality products with short lead times to the industries we serve.



C.R. LAURENCE COMPANY

crlaurence.com

XIV | crlaurence.ca | crlaurence.com.au | crlaurence.co.uk | crlaurence.de | crlaurence.eu

CRL MANUFACTURING

CRL's Precision Design and Engineering is the Key to Quality



DNV Certification, Inc.

ISO 9002 REGISTERED FIRM



• CRL is ISO9001-2008 Certified

It all starts with ISO9001-2008 certification. We produce over 5,000 items for the industries we serve in our ISO9001-2008 Certified manufacturing facilities. Our adherence to the strictest of standards reflects the commitment of our employees to provide the highest quality products.

• Innovation Makes Us a Leader

C.R. Laurence Manufacturing has provided new and innovative products for over 40 years. We know we can't just sit still, because if we do, others will pass us by, and that's not what being a leader is all about.

Many CRL manufactured products incorporate features offered by no one else because we feel that no product is so good that it can't be improved.



• Award Winning Designs and Products

Just because we say our products are all top quality doesn't make it so. However, when those recognized as setting the standards for quality say we make the best, then that really means something. C.R. Laurence Manufacturing has earned some very prestigious awards for manufacturing excellence by organizations that set the standards for quality.



• CRL Rapid Customization Program for Short Lead Times

The goal of CRL's Rapid Customization Program is to achieve the shortest possible lead time on all CRL Manufactured Products, from sketch to quote to fabrication to delivery. This is done several ways, and an important factor is keeping the entire process "in-house". Allowing CRL Manufacturing to control such processes as drafting, modeling, raw material procurement, cutting optimization, high-speed fabrication, finishing, powder coating, batch painting, packaging, and shipping makes for efficient and speedy delivery of products to you.

• Engineers Available for Product Development, Testing, and Production Support

CRL's Engineering Department works with you to review designs and job plans to address feasibility, safety concerns, and possible alternate solutions in order to prepare a fair and accurate per unit or per job quote for our Manufacturing services.



• Experienced, Knowledgeable Team Dedicated From Start to Finish

Our staff has decades of experience in the various stages of manufacturing. Our people draw upon their resources to find innovation and efficiency in our manufacturing processes, allowing us to build top quality products at prices that are always competitive. From the procurement of raw materials to final shipment of finished goods, it's our experience that makes the difference.

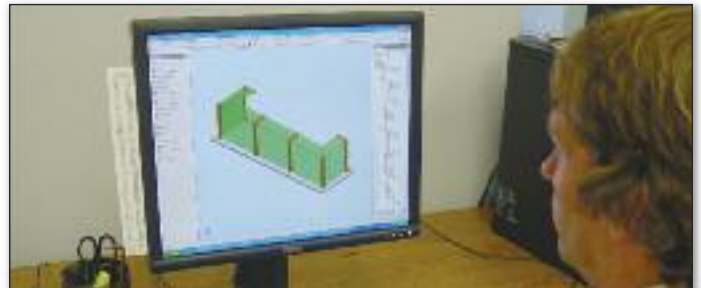

• State-of-the-Art Computers and Software

CRL's trained staff uses up-to-date programs including Auto CAD, Auto Desk Inventor, and ANSYS Workbench to provide the best designs to send to our manufacturing plant. This software and our engineers provide workable, modern designs that can be simulated on our computers, saving you time and money down the road.

Do You Have a New Product That Could be Made by CRL? Turn to Page N524 in this Catalog.

We welcome the opportunity to serve you, and are committed to providing your business with the services that produce quality products. To discuss the possibility of working with CRL Manufacturing we invite you to contact CRL Technical Sales at (800) 421-6144 in the U.S., (877) 421-6144 from Canada, or (323) 588-1281 International. Ask for Ext. 7720.

CRL MANUFACTURING

Sommer and Maca Machinery Division of C.R. Laurence Company

Parts and Technical Services Department

Phone (866) 583-1377
(773) 242-2871



The Spring of 2008 opened with the joining of two glass industry giants. The acquisition of Sommer & Maca by C.R. Laurence Company added the depth and scale of Sommer & Maca's machinery manufacturing base to the extensive worldwide sales and distribution network established by C.R. Laurence. The close working relationship between the two companies became formal as Sommer & Maca became the Machinery Division of C.R. Laurence Company. Today this powerhouse combination looks to the future of expanding technologies, such as solar production, as well as the ongoing industry need for glass fabrication of all sorts.

Committing to the continuation of the Sommer & Maca Machinery brand, the 90,000 square foot Sommer & Maca manufacturing facility in Cicero, Illinois, a suburb of Chicago, officially became CRL Branch 17, the second facility in the CRL group dedicated strictly to manufacturing. Along with the state-of-the-art engineering and manufacturing capability, the Cicero facility also acts as the Machine Parts and Technical Services Department for the company. With thousands upon thousands of Somaca machines built and sold around the world since 1921, the CRL commitment to support and service is dedicated and intense.

C.R. Laurence of Australia Pty Ltd.

- **Manufacturers of Quality Vacuum Lifters**
- **State-of-the-Art Machinery in a 54,000 Square Foot Facility in Melbourne, Australia**
- **Lifters Meet CE Conformance**

Quality assurance at the highest level is maintained during all phases of CRL Manufactured Vacuum Lifters. Based on the independent laboratory testing at Advanced Technology Testing and Research in Springvale, Victoria, Australia.

Under stringent conditions, our Vacuum Lifters were set up in an Instron Tensile Test Machine using a specially designed rig to secure the Vacuum Lifter and a glass plate. Load was then applied at a constant rate until a failure took place well above our noted lifting capacities.

During the past 18 years over 300,000 units have been manufactured and sold worldwide. Parts refinement of the major components continues today to ensure that the highest level of quality is achieved.



Third party
independent lab tests



Manufactured in Australia by
C.R. Laurence Co.



For information on
CRL Vacuum Lifters
please see Catalog CRL73
pages K198 to K214
or visit our web site,
crlaurence.com.



C.R. LAURENCE COMPANY

XVI |

crlaurence.ca crlaurence.com.au crlaurence.co.uk crlaurence.de crlaurence.eu

crlaurence.com

Introduction to Sealants



In any glazing, waterproofing or sealing project, being fully informed is a major part of being prepared. This usually means a time and labor intensive struggle to gather material from manufacturers of competing products, only then to be faced with too many options.

C.R. Laurence Co. recognizes this, having been heavily involved in the sealants industry for many years, and has brought together the most complete and comprehensive sealant information you will find.

Here you will find information from the major sealant suppliers including; Dow Corning®, General Electric®, Tremco®, and our own **CRL Brand**. We cover a full range of technologies from the original patent silicone to the modern neutral cure system; from high performance polyurethanes to acrylics, butyl and latex caulking compounds, as well as other sealant and adhesive products. You will also find excellent information on dispensing systems and related accessories.

We believe you will appreciate our basic knowledge approach. For example, our coverage of Good Glazing Guidelines, or our Sealant Basic Uses and Limitations section is something you can give to your newer employees for their training (see pages N146 to N161).

CRL service is more than this. We also offer expert technical assistance. If you need more information, just call or go to our web site crlaurence.com. In an era when the major manufacturers are cutting back on customer service, CRL is expanding service! This is just our way of saying "Thank You" to our customers for your ongoing support.

Expert Sealant Assistance



Choosing the right sealant for the job calls for technical knowledge and professional experience. With so many different sealant applications, specifications, and products, choosing the best sealant involves balancing cost, performance, and suitability.

CRL is here to help. We employ full time sealant specialists who keep up to date with the ever-changing sealant market. Their job is to answer your questions, discuss all the options available, and help you make the right decisions about selecting and applying the sealants for your jobs. They are at your service all the way through the job for help with those tricky questions that inevitably come up on even the most thoroughly planned projects.

CRL's sealant assistance also includes our full line of sealants and related products. You can choose from such major brand names as **CRL**, Dow Corning®, General Electric®, Tremco®, and Dap. We stock silicones, polyurethanes, acrylics, butyls, and latex sealants in common construction colors.

Whether your project calls for 55 gallon drums, five gallon pails, two gallon pails, sausages, or standard cartridges, CRL can fill the need. Dispensing needs from hand-operated caulking guns to bulk dispensing pumps and accessories, solvents and cleaners, backer rods, and everything else you need to do the job right from start to finish are available from CRL.

Whatever your question, from selection to dispensing systems, from preparation to clean up, from MSDS to spec data sheets, CRL's sealant experts are as close as a toll free phone call (800) 421-6144, toll free fax (800) 262-3299, or visit us on the web at crlaurence.com.

Limitations of Warranties

All C.R. Laurence Company products and materials are sold subject to the terms and conditions set forth in our publications. All recommendations regarding such products are based on tests and examinations believed to be reliable, but C.R. Laurence Company neither guarantees nor warrants their accuracy or completeness.

It shall be the sole responsibility of the user to determine the suitability of the C.R. Laurence product or material for each intended use, and the user shall assume all

risks and liability in connection with the use, or inability to use, the product or material.

To the exclusion of all other remedies, C.R. Laurence Company warrants and agrees to replace, or at its sole option, to refund the purchase price of that portion of any material or product supplied by C.R. Laurence Company, which is proven upon inspection within thirty (30) days of the date of receipt of such product or material, to be defective in material or workmanship. No salesperson, agent, employee or representative of

C.R. Laurence Company has any authority to enlarge or change the terms of the warranty. In no event shall C.R. Laurence Company be responsible for any special, indirect, consequential or incidental damages or loss, including, without limitation, loss of profits or revenues, economic losses and loss of use, whether statutory or based on theories of contract or tort. There are no other agreements, express or implied (including any regarding merchantability or fitness for a particular purpose) not specified herein.

CRL Sealant Basic Uses and Limitations

The following is a summary of each of our CRL Construction Sealants with the basic uses and limitations for each. Unfortunately, no single glazing or construction sealant is right for every application. For example, some sealants can be painted while other sealants cannot. However, the sealant that cannot be painted usually has longer life expectancy than the sealant that can be painted. Some sealants are better suited for interior applications, while other sealants are able to perform in more demanding exterior applications. The exterior sealant costs considerably more than the sealant that is suitable for interior applications, however. How do you choose? Many times it comes down to trial and error, and your experience with different sealants over the years. The next few pages will help you select the CRL Sealants that fit the specific applications you have, and help you determine if the sealants you are using now are appropriate and comparable to our sealants.



33S
Silicone Sealant
(See page N108 for additional information)

Comparable Sealants

Dow Corning®: 999-A; 786; 732; 700; Trademate Glazing; General Purpose; Commercial Grade 100%; Tub, Tile & Ceramic, HVAC/R.
GE®: 1200 Construction, 1000 Contractors, 1700 Sanitary.
Tremco®: Proglaze, Tremsil 200, TremPro 644. **Pecora®:** 860, 863.
Sonneborn®: OmniPlus.

CRL 33S Silicone

Description

This is an acetic cure, 100% high modulus, silicone sealant that delivers the performance you demand at a competitive price. Certified by NSF for food grade applications, UL Recognized, 24 month shelf life, and 10 year limited warranty. Qualifies for the **LEED®** (Leadership in Energy and Environmental Design) Green Building Rating System™ credit. **Our most popular sealant!**

Basic Uses

Glass, aluminum, metal alloys, stainless steel, wood, and plastics. Seals curtainwall joints, steel and aluminum windows, and skylights. Indoor uses include bathtubs, showers, and sanitary installations. Capable of ± 25% joint movement in a well-designed joint. Can be applied at outdoor temperatures as low as -35°F (-37°C) to +140°F (60°C), and withstands extreme temperatures after full cure from -80°F (-62°C) to +400°F (204°C).

Limitations

Not suitable for painting. Paint films bridge the sealant, but do not adhere to the silicone. Not recommended for structural glazing or insulating glass glazing, concrete and stone expansion joints, horizontal decks, patios, driveway or terrace joints where abrasion is possible, potable water applications or mirrors. Not recommended for surfaces with special protective or cosmetic coatings such as mirrors, reflective glass, polyethylene or polypropylene surfaces. Check cartridge label and Specification Data Sheet for additional limitations.

CRL RTV408 Industrial and Construction Silicone



RTV408
Silicone Sealant
(See page N118 for additional information)

Comparable Sealants

Dow Corning®: 799; Trademate Vinyl Window, Siding & Door.
GE®: 2800 SilGlaze II. **Tremco®:** Tremsil 600, TremPro 645.
Pecora®: 896. **Novagard®:** Novaflex.

Description

Non-acetic neutral cure, low odor, 100% medium modulus silicone sealant that cures to a tough, flexible rubber. AAMA Approved, 12 month shelf life, and 20 year limited warranty. Qualifies for the **LEED®** (Leadership in Energy and Environmental Design) Green Building Rating System™ credit. Non-corrosive in contact with metals, and glazing I.G. units.

Basic Uses

Designed for joining most building materials including a variety of structural materials: glass, aluminum, stainless steel, ceramic, most reflective-coated glass, wood, and plastics. Seals curtainwall joints; vinyl, steel and aluminum windows; and skylights. Ideal for many in-house production applications. Suitable for alkaline materials such as mortar and cement. Non-corrosive to most building materials including insulating glass. Indoor uses include bathtubs, showers, and sanitary installations. Capable of ± 25% joint movement in a well-designed joint. Can be applied at outdoor temperatures as low as -20°F (-29°C) to +100°F (38°C), and withstands extreme temperatures after full cure from -65°F (-54°C) to +400°F (204°C).

Limitations

Not suitable for painting. Paint films bridge the sealant, but do not adhere to the silicone. Not recommended for structural glazing, concrete and stone expansion joints, horizontal decks, patios, driveway or terrace joints where abrasion is possible, food contact, potable water applications or mirrors. Neutral cure sealant cure byproducts may cause stress cracking or surface crazing of polycarbonate sheet under certain conditions. Check cartridge label and Specification Data Sheet for additional limitations.

CRL Sealant Basic Uses and Limitations



WCS1

Water Clear Silicone Sealant
(See page N113 for additional information)

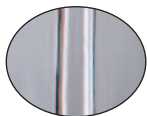
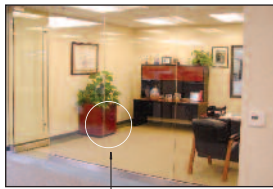

CRL
Water Clear

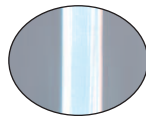
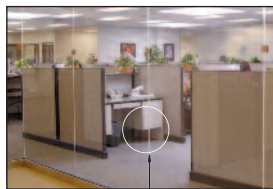

Typical Clear
(Translucent) Silicone

CRL Water Clear Silicone

Description

An optically clear, acetic cure 100% high modulus silicone sealant that cures in the presence of atmospheric moisture to produce a durable and flexible silicone rubber. It features a 12 month shelf life and 25 year limited warranty. It also qualifies for **LEED®** (Leadership in Energy and Environmental Design) Green Building Rating System™ credit (see page N159). By far, one of the clearest silicone available to the industry!

Basic Uses

Particularly effective for glazing butt and lap shear joints, sealing curtainwall projections and other glass, plastic, and metal assemblies. Its exceptional clarity makes it the ideal sealant to use in frameless shower enclosures, glass entries and partitions, specialty glass assemblies, and glass block installations. It adheres to clean metal, glass, most types of wood, silicone resin, ceramic, natural and synthetic fiber, and most painted surfaces. It is also appropriate for general construction and industrial applications.

Limitations

The exceptional clarity of this product will not hide application or tooling errors. A small amount of bubbles may form during the curing process of the sealant, so considerations should be made before use regarding standards of appearance and subsequent repairs (e.g., limited to sight lines). It is not recommended for use in the following applications: glazing or edge sealing of insulating glass; copper, brass, magnesium, zinc, galvanized surfaces. WCS1 is not mildew resistant. Check cartridge label and Specification Data Sheet for additional limitations.



95C

Silicone Building Sealant
(See page N120 for additional information)

CRL 95C Silicone Building Sealant

Description

Non-acetic neutral cure 100% low modulus silicone sealant that cures to a durable, flexible silicone rubber building joint seal. It features a 12 month shelf life with a 20 year limited warranty. It also qualifies for **LEED®** (Leadership in Energy and Environmental Design) Green Building Rating System™ credit (see page N159).

Basic Uses

It is designed for sealing expansion and control joints in precast concrete panels and metal curtainwalls; non-structural glazing of glass, metal, and plastic, as well as waterproofing applications, including perimeter sealing of doors and windows. Bonds with most building materials in any combination of glass, ceramics, plastics, stone, masonry, wood, steel, anodized and mill-finished aluminum, and painted surfaces. Compatible with all laminated glass, insulating glass units, and acrylic or polycarbonate glazing sheets. Capable of ± 50% joint movement in a well-designed joint. Can be applied at outdoor temperatures as low as -20°F (-29°C) to +130°F (54°C), and withstands extreme temperatures after full cure from -40°F (-40°C) to +350°F (177°C).

Limitations

Not suitable for painting. Paint films bridge the sealant, but do not adhere to the silicone. It is not recommended for structural glazing, sealing horizontal decks, patios, driveway or terrace joints where abrasion is possible, food contact, potable water applications, sealing below the waterline in marine applications, or mirrors. The cure byproducts of neutral cure sealants may cause stress cracking or surface crazing of the polycarbonate sheet under certain conditions. Check cartridge label and Specification Data Sheet for additional limitations.

Comparable Sealants

Dow Corning®: 795, 790, 791. **GE®:** SilPruf 2000, UltraPruf II 2900, SilPruf LM 2700. **Tremco®:** Spectrem 1, Spectrem II, Spectrem 3. **Pecora®:** 864, 895. **Sonneborn:** OmniSeal.

CRL Sealant Basic Uses and Limitations

CRL M64 Smooth and M66 Textured Polyurethanes

Description

Polyurethane sealant that cures in the presence of atmospheric moisture to produce a durable, flexible sealant for moving joints. Cures to either a smooth finish (M64) or light grainy textured finish (M66). AAMA approved, 12 month shelf life and five year limited warranty. Qualifies for the **LEED®** (Leadership in Energy and Environmental Design) Green Building Rating System™ credit.

Basic Uses

Developed for sealing dynamically moving joints, such as expansion and control joints, precast concrete panel joints, curtainwall joints, window and door frame perimeters, and similar types of construction joints. Adheres to common substrates such as brick, concrete, aluminum, vinyl, wood, and granite. Compatible with I.G. sealants when glazing units and applied as a toe or heel bead. Suitable for continual immersion in water with the use of the appropriate primer. Withstands temperatures after full cure from -40°F (-40°C) to +180°F (82°C). Paintable after full cure, minimum 72 hours. It is also appropriate for general construction and industrial applications.

Limitations

Do not apply over damp or contaminated surfaces. Use with adequate ventilation. Not recommended for surfaces with special protective or cosmetic coatings without prior consultation of the manufacturer. Should not be applied to unpredictably absorptive surfaces such as marble, limestone or granite unless a standard of appearance has been agreed on as a result of testing for stain and/or discoloration. Check cartridge label and Specification Data Sheet for additional limitations.



M64
Smooth Formula
Polyurethane



M66
Textured Formula
Polyurethane

(See pages N128-N129 for additional information)

Comparable Sealants

Dap: Premium Polyurethane. **Tremco®:** Vulkem 921, Vulkem 116, Dymonic, TremGlaze U1400, TremPro 626. **Sika:** 1A, 15LM, Sikaflex®-201 US, Sikaflex®-201 Textured, Sikaflex®-219 LM. **Sonneborn:** NP1. **Pecora:** Dynatrol 1-XL. **OSI:** PR-255. **Schnee Moorehead:** 7100. **Bostik:** Chem-Calk 900.

CRL M65W PermaWhite Polythane

Description

Modified polyurethane sealant with advanced non-yellowing formula and a smooth finish appearance. Low VOC and low odor; contains no isocyanates. Fast cure time allows painting in just two hours. 12 month shelf life and five year limited warranty. Qualifies for the **LEED®** (Leadership in Energy and Environmental Design) Green Building Rating System™ credit.

Basic Uses

Ideal for door and window frame perimeters. Specifically developed for sealing dynamically moving joints, such as: expansion and control joints, precast concrete panel joints, curtainwall joints, perimeter caulking (masonry, windows, doors, skylights, panels), bedding of mullions, panels, and frames. It is compatible with I.G. sealants when glazing units and applied as a toe or heel bead. Reduced fluid migration, or exudation, allows applications with new self-cleaning glass. Exhibits tenacious adhesion, which will not dissipate with time, to prepainted metals, plywood, glass, aluminum, steel, fiber cement, SMC, RIM, FRP, vinyl, and many plastics and composites. Capable of ± 25% joint movement in a well-designed joint. Withstands extreme temperatures after full cure from -30°F (-34°C) to +200°F (93°C).

Limitations

CRL M65W PermaWhite Polythane is not recommended for structural glazing, sealing horizontal decks, patios, driveway or terrace joints where abrasion is possible, food contact, potable water applications, sealing below the waterline in marine applications or mirrors. Do not apply over damp or contaminated surfaces. Not recommended for surfaces with special protective or cosmetic coatings without prior consultation of the manufacturer. Testing prior to painting with oil-based paints is recommended. Check cartridge label and Specification Data Sheet for additional limitations.



M65W
PermaWhite Polythane
(See page N127 for additional information)

Standard White Polyurethane

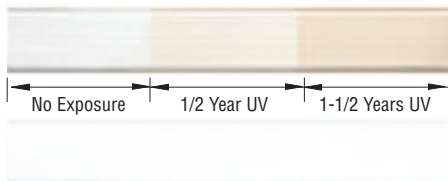

M65W PermaWhite Polythane

Comparable Sealants

Pecora: Pro-Sil1. **Tremco®:** Dymonic FC TremGlaze U1600. **Sonneborn:** Sonolastic 150. **Dap:** SIDE WINDER®.

CRL Sealant Basic Uses and Limitations



777

Butyl Rubber Sealant
(See page N136 for
additional information)

CRL 777 Butyl Rubber

Description

Butyl based sealant is specially formulated using a blend of age resistant polymers to give excellent weathering properties at various temperature extremes. USDA Certified, AAMA 808.3 approved. It has a twelve month shelf life.

Basic Uses

CRL 777 Butyl Rubber is recommended for exterior applications and hidden areas, such as under sill cans, thresholds, and around screw heads. Other areas, such as between metal building panels, wall-mounted air conditioning units, under aluminum siding and gutters are all good applications for this proven butyl sealant. It has excellent adhesion to wood, masonry, glass, and metal surfaces, and is capable of $\pm 10\%$ joint movement in a well-designed joint. It can be applied at outdoor temperatures as low as 0°F (-18°C) to +120°F (49°C), and withstands extreme temperatures after full cure from -20°F (-29°C) to +200°F (93°C). Paint time is 24 hours.

Limitations

CRL 777 Butyl Rubber is not recommended for use in sealing horizontal decks, patios, driveways or terrace joints where abrasion or physical abuse is encountered. Not recommended for surfaces with special protective or cosmetic coatings, and should not be applied with wet tooling techniques using solvents, water or detergent/soap solutions. CRL 777 has a solvent based curing system. A slight odor of mineral spirits will be detected during application, which is normal. Do not use where this odor may be objectionable, such as refrigeration units that will be stocked soon after construction. Check the cartridge label and Specification Data Sheet for additional limitations.

Comparable Sealants

CRL: 888. **Adco:** B-100, AP-77. **Dap:** BUTYL-FLEX®. **OSI:** SBR-100. **PTI:** 757. **Pecora:** BC-158. **Tremco®:** Butyl Sealant.



888

Butyl Rubber Sealant
(See page N137 for
additional information)

CRL 888 Butyl Rubber

Description

A general purpose butyl-based sealant suitable for use in joints where economical, maintenance-free and watertight seals are desired. Non-stringy during application, and will not harden or crack with aging. AAMA 808.3 approved. It has a twelve month shelf life.

Basic Uses

It is recommended for caulking exterior and interior construction units, under thresholds and aluminum siding, between metal building panels and truck body joints, and many other areas. It is designed for use in joints of 3/8" (9.5 mm) or less in metal, glass, wood, plastic, and concrete. It can be applied at outdoor temperatures from 40°F (4°C) to +120°F (49°C), and withstands extreme temperatures after full cure from -20°F (-29°C) to +200°F (93°C). Paint time is 24 hours.

Limitations

CRL 888 Butyl Rubber is not recommended for use in sealing horizontal decks, patios, driveways or terrace joints where abrasion or physical abuse is encountered. It is also not recommended for surfaces with special protective or cosmetic coatings, and should not be applied with wet tooling techniques using solvents, water or detergent/soap solutions. Check the cartridge label and Specification Data Sheet for additional limitations.

Comparable Sealants

CRL: 777. **Adco:** AP-77, B-100. **Dap:** BUTYL-FLEX®. **OSI:** SBR-100. **PTI:** 757. **Pecora:** BC-158. **Tremco®:** Butyl Sealant.

CRL Sealant Basic Uses and Limitations



321
Siliconized Acrylic Latex
(See page N133 for additional information)



800
Acrylic Latex Caulk With Silicone
(See page N134 for additional information)

Comparable Sealants

Pecora®: AC-20. **Dap**®: Alex-Plus, Alex Fast Dry™, Dynaflex 230®.
OSI®: Polyseamseal Acrylic Caulk with Silicone, SA-167, Pro-Stik,
Sonneborn®: Sonolac. **Tremco**®: 834, TremGlaze SA1100, TremPro 655.

CRL 321 and 800 Acrylic Latex With Silicone

Description

These are premium quality acrylic latex caulks with silicone, featuring outstanding properties including adhesion, weather resistance, low shrinkage, water clean up, and more. The acrylic base offers outstanding adhesion and resistance to oxidation and ultraviolet rays. The siliconized feature improves the flexibility, and adhesion to ceramic and glass substrates. Both have a 12 month shelf life and 35 year limited warranty. Qualifies for **LEED**® (Leadership in Energy and Environmental Design) Green Building Rating System™ credit (see page N159).

Basic Uses

These can be used in areas with high moisture, such as showers, bathrooms, sinks, and kitchens, since it is mildew resistant and waterproof. Both offer excellent adhesion to aluminum, wood, concrete, glass, ceramic tiles, etc. They can be used for interior or exterior applications since it is odor free and offers superior weatherability, and are capable of ± 10% joint movement in a well-designed joint. They can be applied at outdoor temperatures as low as 40°F (4°C) to +120°F (49°C), and withstand extreme temperatures after full cure from 0°F (-17°C) to +180°F (82°C). Both can be painted with latex or oil-based paints.

Limitations

Neither should be used in applications that will be immersed in water. Should not be exposed to water or rain for at least 24 hours. Always apply when temperatures are above 40°F (4°C). Protect from freezing until fully cured. Check cartridge label and Specification Data Sheet for additional limitations.

CRL15W Acrylic Latex Caulk

Description

CRL15W Acrylic Latex Caulk is a superior quality acrylic latex caulk that guns with a creamy consistency. It is formulated to meet the needs of the professional or the do-it-yourselfer. It is easily cleaned with soap and water, and possesses a 12 month shelf life with a 25 year life expectancy. It also qualifies for **LEED**® (Leadership in Energy and Environmental Design) Green Building Rating System™ credit (see page N159).

Basic Uses

CRL15W Acrylic Latex Caulk is specially formulated for interior sealing around window frames, door frames, baseboards, moldings, plaster walls, etc. It adheres to plaster, drywall, painted and unpainted wood, masonry, and aluminum. It can be applied at outdoor temperatures as low as 40°F (5°C) to +90°F (32°C), and withstands extreme temperatures after full cure from 0°F (-18°C) to +200°F (94°C). It may be painted when a skin has formed, usually after two hours of application for latex paint or 24 hours if using oil-based paint.

Limitations

Maximum joint dimension is 1/2" x 1/2" (13 x 13 mm). Check cartridge label and Specification Data Sheet for additional limitations.



CRL15W
Acrylic Latex Caulk
(See page N135 for additional information)

Comparable Sealants

Red Devil®: Interior Wall & Wood.
Dap®: Alex® Painters, RELY-ON®. **OSI**®: LC-160.

Silicone Sealants are used in a wide variety of applications. Silicones have excellent resistance to the sun (UV) and weather. They are easy to apply in all temperatures, -35° to 130°F (-37° to 54.4°C), and exhibit very high heat as well as very low temperature stability, -80° to 400°F (-62° to 204°C); provide good adhesion to many substrates, especially glass; have very good joint movement capabilities from ± 25% to ± 50%; come with 10 to 20 year warranties and life expectancy of over 25 years; and good shelf life from one to two years. **NOTE:** Silicone sealants cannot be painted because paint typically beads up when applied to cured silicone.

CRL Special Properties of Silicones

- Excellent UV and Weather Resistance
- Long Life Reliability - 10 to 20 Year Warranty
- Stable Product - 1 to 2 Year Shelf Life
- Excellent Adhesion to Glass
- Remains Flexible and Easy to Apply Over a Wide Temperature Range

CRL Typical Applications of Silicones

Glazing



Conventional glazing of glass (cap, toe and heel beads); curtainwall sealing (projections, metal-to-metal joints); butt and lap shear joints; solar panels; replacement glazing.

Sealing Glass Butt Joints



Glass butt joints; specialty glass assemblies.

Structural Glazing



Adheres glass, metal panels, or other cladding components to the building

Shower Enclosures and Tubs



Mildew-resistant silicone for sealing glass-to-glass, glass-to-metal, metal-to-fiberglass joints in frameless showers; tubs; sinks; ceramic tile, cultured marble top to back splash; spas.

Fabricating I.G. Units

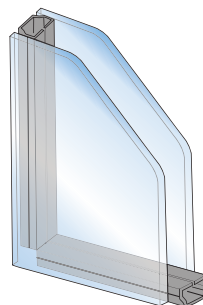

Fabricating Insulating Glass units with one or two-component silicone.

Manufacturing



Numerous applications when used as an adhesive.

CRL 33S Silicone Sealant

SPEC. DATA

MSDS

- Our Most Popular Sealant
- Plastic Cartridges With Screw-On Nozzles
- Available in Eight Colors
- 24 Month Shelf Life
- 10 Year Limited Warranty

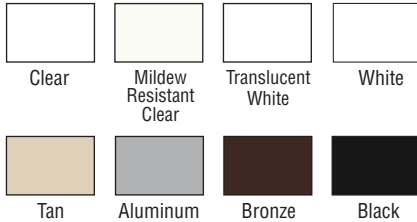

Colors shown are approximate.
Custom colors are available (see page N110).



10.3 Fl. Oz. (305 ml);
30 Cartridges Per Case;
1440 Cartridges Per Pallet

Additional
Screw-On Nozzles Available
CAT. NO. S1LNOZ



Description

This is our most popular sealant! CRL 33S Silicone is a high quality sealant that delivers the performance you demand at a competitive price. It is a one component, room temperature curing, acetic cure, 100% silicone elastomer that does not require the addition of activators, stabilizers, or catalysts to achieve optimum performance.

Basic Uses

CRL 33S Silicone is especially designed for joining and sealing most non-porous building materials including a variety of structural materials: glass, aluminum, metal alloys, stainless steel, wood, and plastics. It has a wide operating temperature range of -80° to 400°F (-62° to 204°C), and can be applied at outdoor temperatures as low as -35° to 140°F (-37° to 60°C). 33S exhibits strong physical properties: 350 psi Tensile Strength; 120 psi Lap Shear at 1/8" (3 mm) thickness and Tear Strength of 25 ppi. It will seal curtainwall joints, steel and aluminum windows, and skylights. Indoor uses include bathtubs, showers, and sanitary installations (Mildew Resistant Clear, White, Translucent White, and Tan contain a fungicide for cured beads that are mildew resistant).

Limitations

It is not recommended for structural glazing or insulating glass glazing, concrete and stone expansion joints, horizontal decks, patios, driveway or terrace joints where abrasion is possible. Not recommended for use on concrete, marble, limestone, lead coated surfaces, submerged joints (swimming pools and aquariums), plazas, decks, pavements, etc. Not suitable for painting. Check cartridge label and Specification Data Sheet for additional limitations.

Comparable Sealants

Dow Corning®: 999-A; 786; 732; 700; Glazing Silicone; General Purpose; Commercial Grade 100%; Tub, Tile and Ceramic, HVAC/R.
Dap®: 100% Silicone. **GE®:** 1200 Construction, 1000 Contractors, 1700 Sanitary. **Tremco®:** Proglaze, Tremsil 200, TremPro 644. **OSI®:** HM-270.
Pecora®: 860, 863. **Sika®:** SikaSil® GP. **Sonneborn®:** OmniPlus.



Certified by NSF to Standard 51 - Plastic Materials and Components used in Food Equipment



UL Recognized Component

Technical Data

Meets or exceeds Federal Specifications: TT-S-001543A (COM-NBS) Class A, for silicone building sealants; TT-S-00230C (COM-NBS) Class A, for one-component building sealants; ASTM C-920 for elastomer joint sealants, Type S, Grade NS, Class 25, Use NT, G, A; CAN/CGSB 19.13-M87. CRL 33S meets the requirements of FDA Regulation Number 21 CFR 177.2600 for use in food-related applications, such as walk-in freezers and refrigerated trucks. CRL 33S is Certified by NSF to Standard 51 - Plastic Materials and Components used in Food Equipment. CRL 33S is a "UL Recognized Component". Meets California Air Resources Board 2003 requirements for Volatile Organic Compound (VOC) content. Qualifies for **LEED®** (Leadership in Energy and Environmental Design) Green Building Rating System™ credit.

10.3 FL. OZ. (305 ML) CARTRIDGES

CAT. NO.	COLOR
33SC	Clear
33SAL	Aluminum
33SBL	Black
33SBRZ	Bronze
33ST	*Tan
33SW	*White
33STW	*Translucent White
33SMRC	*Mildew Resistant Clear

Minimum order: 1 each. All cartridge sealants can be combined for quantity pricing. *Mildew Resistant Color.



CRL 33S Packaging Features



Screw-On Nozzles

All CRL Silicone Sealant cartridges are packed with innovative Screw-On Nozzles, offering you a greater yield per tube. They are 4" (102 mm) long, and tapered so you can trim the nozzle to exactly the bead size you need. To order additional nozzles, specify Cat. No. S1LN0Z (see page N220).

Cartridges Packed 30 Per Case

All CRL Silicone Sealant cartridges are packed 30 per case to match industry standards. Inventory and product tracking is easier because CRL Sealants are packed to match other manufacturers in the industry.

"WHMIS" Safety Info Shown on Cartridges and Cartons

Each CRL Silicone Sealant cartridge and carton contains important "WHMIS" (Workplace Hazardous Material Information System) safety data. It is shown in English, French, and Spanish to comply with shipping regulations in the U.S., Canada, and Mexico.

Press-In-Hand Holes
Make Lifting Easier



Press-In Hand Holes Make Lifting Easier

By pushing in a perforation on each end of our silicone cartons, you will have an easier time lifting and moving these products where you need them.

1440 Cartridges (48 Cases) Per Pallet

This convenient way of packing pallets reduces load-shifting during freight transport because the cartons stack together tightly.

Pallet Quantity Buyers Can Save More

By purchasing silicone in pallet quantities of 1440 in one color you can save even more. Contact CRL now for current pricing for larger quantity buyers.

<p>33S SILICONE SEALANT (ACETOXY CURE) CAUTION: Skin and eye irritant. Vapors may irritate respiratory tract. PRECAUTIONS: Store in a cool, dry, well-ventilated area in a tightly closed container. Avoid direct contact with skin and eyes. Avoid breathing vapors. FIRST AID: EYES: Immediately flush eyes with plenty of water for at least 15 minutes. Get immediate medical attention. SKIN: Immediately wash with soap and plenty of water. INHALATION: Remove from area of exposure to fresh air. Get medical attention.</p>		<p>AVERTISSEMENT: Irritant pour les yeux et la peau. Le vapeur pourrait irriter le tract respiratoire. MISE EN GARDE: Entreposer dans un endroit sec, frais et bien aéré dans des contenants soigneusement fermés. Éviter tout contact direct avec la peau ou les yeux. Éviter d'inhaler les vapeurs. PREMIERS SOINS: YEUX: Rincer les yeux immédiatement avec beaucoup d'eau durant au moins 15 minutes. Consulter un médecin immédiatement. PEAU: Laver immédiatement avec une grande quantité d'eau et de savon. Consulter un médecin si une irritation se développe ou persiste. EN CAS D'INHALATION: Éloigner la victime à l'air libre. Consulter un médecin.</p>	<p>ADVERTENCIA: Irritante a la piel y los ojos. Sus vapores pueden irritar las vías respiratorias. PRECAUCION: Almacenar en área bien ventilada, fresca y seca en contenedores bien cerrados. Evitar el contacto directo con la piel y los ojos. Evitar la inhalación de vapores. PRIMERA AUXILIOS: OJOS: Inmediatamente lavar bien los ojos con mucha agua por lo menos 15 minutos. Recibir atención médica inmediata. PIEL: Lavarse con bastante agua y jabón inmediatamente. Recibir atención médica inmediata, si la piel desarrolla irritación persistente. INHALACION: Retirarse del área expuesta y respire aire fresco. Recibir atención médica inmediata. C. R. LAURENCE CO., INC.</p>
---	--	---	--

CRL 33S Silicone Sealant in Bulk Packaging

- Top Quality Silicone Sealants in Money-Saving Pails or Drums
- Available in Eight Standard Colors
- Also Available in Custom Colors

High performance sealants for bulk users are our specialty. We can supply our 33S Silicone in 4.5 gallon (17 l) pails and 52 gallon (197 l) drums. CRL can supply any of eight standard colors in bulk.

If you're looking for custom colors, we can do that for you too! See page N110 for more information.



4.5 Gallon Pail
(17 Liters)



52 Gallon Drum
(197 Liters)

4.5 GALLON (17 L) PAILS

CAT. NO.	COLOR
33SC5GL	Clear
33SAL5GL	Aluminum
33SBL5GL	Black
33SBRZ5GL	Bronze
33ST5GL	*Tan
33SW5GL	*White
33STW5GL	*Translucent White
33SMRC5GL	*Mildew Resistant Clear

Minimum order: 1 each. 4.5 gallon pails can be combined for quantity pricing. *Mildew Resistant Color.

52 GALLON (197 L) DRUMS

CAT. NO.	COLOR
33SC52GL	Clear
33SAL52GL	Aluminum
33SBL52GL	Black
33SBRZ52GL	Bronze
33ST52GL	*Tan
33SW52GL	*White
33STW52GL	*Translucent White
33SMRC52GL	*Mildew Resistant Clear

Minimum order: 1 each. *Mildew Resistant Color. Drums must ship common carrier.

Call us for a price quotation on special order bulk pumping systems for dispensing sealants from pails and drums. See pages N208-N209 for bulk load caulking guns and accessories.

CRL Computerized Custom Color Matching Program for Silicones

EASY AS
1 - 2 - 3

- 33S Acetic Cure, RTV408, and 95C Neutral Cure are Available in Custom Colors
- Minimum Order As Low As Only 300 Cartridges
- Sample Matches Can Be Ready in 5 to 10 Working Days

STEP 1

Send us a sample.



STEP 2

We'll computer analyze your sample and send your Custom Color Samples out in about 5 to 10 working days!

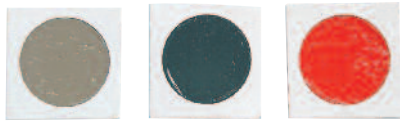

STEP 3

After your approval of the sample, just place your order and your Custom Color is on its way in the packaging of your choice.



C.R. Laurence can match almost any color imaginable with our computerized color matching system. We offer the perfect match for your substrate, plus the unmatched performance of the highest quality silicones available.

From black and white to contemporary colors that complement your designs, CRL's Custom Color Program gives you a color that specifically meets your sealant performance requirements. You can always design with CRL Brand Silicone in mind.

Our computerized color matching system can create a custom color match with your substrate samples or color swatches. Just send them to the attention of our Product Manager for Construction

Sealants in Los Angeles, and we will provide you with dry sealant samples in one to two weeks for your approval.

Order 50 gallons (minimum order for 33S) or more in the packaging that works best for you: 600 cartridges; 12 each 4.5 gallon (17 l) pails; or one each 52 gallon (197 l) drum ($\pm 10\%$). Order 100 gallons (378 l) (minimum order for RTV408 and 95C) or more in the packaging that works best for you: 1200 cartridges; 44 each 2 gallon (7.5 l) pails (95C); 22 each 4.5 gallon (17 l) pails; or 2 each 52 gallon (197 l) drums ($\pm 10\%$). Total lead time is five to six weeks for color matching and to get product shipped.

CRL Private Label Silicone Program

- You Can Get Your Own Name (Private Label) on 33S Acetic Cure or RTV408 Neutral Cure Silicone

Create your company's own private label sealant program and become more recognized to your customers. Requirements: A minimum purchase of 8000 cartridges per label, per year, with a minimum run of 2880 cartridges per label; 1440 cartridges per color for 33S; 2000 cartridges per color for RTV408.



CRL Silicone in 3 Fl. Oz. Squeeze Tubes

- Same Professional Formula as Our 33S Silicone
- Great for Small Jobs or Over-the-Counter Sales
- Retail Display Also Available (See Below)

SPEC. DATA

MSDS



Color deposits shown here are approximate.



CAT. NO. 22C



CAT. NO. 22AL



CAT. NO. 22BL



CAT. NO. 22W



CAT. NO. 55RED

Description

CRL professional quality Silicone Sealant is available for small jobs or over-the-counter retail sales. It has the same professional acetic cure formula as our 33S Silicone, and it meets the same exacting standards and specifications, so it is a proven product you can use or sell with complete confidence. The tubes are blister carded in an attractive retail package that includes a screw-on tapered nozzle.

CAT. NO.	COLOR	CONTENTS	QTY/CASE
22C	Clear	3 Fl. Oz. (90 ml)	12
22AL	Aluminum	3 Fl. Oz. (90 ml)	12
22BL	Black	3 Fl. Oz. (90 ml)	12
22W	White	3 Fl. Oz. (90 ml)	12
55RED	Red	3 Fl. Oz. (90 ml)	12

Minimum order: 1 each. Colors can be combined for quantity pricing.

Basic Uses

22C Clear: Use as either an adhesive or sealant. High tensile strength withstands the effects of even the harshest weather. Repairs household items. **22AL Aluminum:** Use this to repair rain gutters, storm windows, patio doors, and metal awnings. It is an excellent seam sealer for aluminum window joints and mobile home panels. **22BL Black:** Seals and repairs many rubber items in autos. Stops leaks in doors and windows, or trunk lid gaskets. **22W White:** Our mildew-resistant formula caulks bathtubs, sinks, tile, and shower stalls. **55RED:** High-Temp up to 600°F (315°C) Silicone Gasket sealant for resisting high temperature applications and makes in-place seals for so many automotive uses. Resists the effects of heat, regular and synthetic oils, grease, antifreeze, and transmission fluid.

CRL Small Tube Dispenser Handle

- Makes Small Tubes of Sealant or Adhesive Easy to Dispense



The Small Tube Dispenser Handle is the fast and easy way to dispense materials (such as silicones and adhesives) from squeeze tubes. It lets you apply just the right amount of pressure for the proper bead size, and since you apply just the right amount of material, there is less mess and clean up. The open back design lets you draw the tube through the handle, so you can get virtually all of the material from the tube, so waste is reduced. Holds all flexible plastic or metal tubes up to 2-1/2" (63.5 mm) wide. Minimum order is one each.

CAT. NO. 710XX006

CRL Silicone Counter Display

- Includes 48 Retail Carded Tubes: 12 Each of Clear, Aluminum, Black, and White
- Each Blister Card Contains One Tube With a Reusable Screw-On Nozzle
- A Sure Profit Center for Your Business



The entire set-up, including the sturdy wire rack and header sign in three languages (English, French and Spanish), requires only 8" by 23" (203 x 584 mm) of counter space, and is easy to re-stock. Minimum order is one each.

CAT. NO. POP10

CRL SILICONE – ACETIC CURE

For Pricing Visit Our Web Site or Call Us Toll Free at the Phone Numbers Shown on the Back Cover

CRL Silicones for Sanitary Applications

SPEC. DATA

MSDS

- Mildew Resistant Formulations Make These Silicones Excellent for Bathrooms, Spas, Kitchens, and Other Sanitary Applications

Description

These high quality CRL Silicone Sealants contain a fungicide in their formulas, making them resistant to mildew. 33S is an acetic cure silicone that is also Certified by NSF to Standard 51 – Plastic Materials and Components used in Food Equipment. They meet the requirements of FDA Regulation Number 21 CFR 177.2600 for use in food-related applications. RTV408 is a neutral cure silicone with better adhesion to stone, masonry, and plastics.

Basic Uses

Tub and shower enclosures, sinks, kitchens, spas, hot tubs, glass blocks, and other sanitary applications.

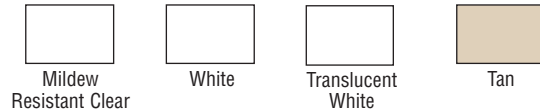

Colors shown are approximate

10.3 FL. OZ. (305 ML) CARTRIDGES

CAT. NO.	CURE TYPE	COLOR
33SMRC	Acetic	Mildew Resistant Clear
33SW	Acetic	White
33STW	Acetic	Translucent White
33ST	Acetic	Tan
RTV408W	Neutral	White
RTV408T	Neutral	Tan

Minimum order: 1 each. All cartridge sealants can be combined for quantity pricing.

CRL Mildew Resistant Clear Silicone Sealant

- Excellent Choice for 'All-Glass' Shower Enclosures
- Color Blends Well With Porcelain Fixtures

Description

Mildew Resistant Clear color makes it ideal for use with porcelain fixtures, as well as glass, tile, and marble surfaces. Also blends well with highly polished metal shower enclosures and fixtures.

Basic Uses

33SMRC adheres to most clean surfaces, including ceramic tile, glass, porcelain, marble, stainless steel, and aluminum. It's a terrific choice for use in 'all-glass' tub and shower enclosures, around sinks, in pools and spas, and with glass blocks.

SPEC. DATA

MSDS



Additional Screw-On Nozzles Available
CAT. NO. S1LN0Z



Mildew Resistant Clear
Color shown is approximate

CAT. NO.	CONTENTS
33SMRC	10.3 Fl. Oz. (305 ml) Cartridge
33SMRC5GL	4.5 Gallon (17 l) Pail
33SMRC52GL	52 Gallon (197 l) Drum

Minimum order: 1 each. All cartridge sealants can be combined for quantity pricing. Drums must ship common carrier.

CRL Translucent White Silicone Sealant

- Color Blends Great With Marble and Tile

Description

Unique Translucent White color blends in with tile and marble better than bright white silicones. Contains mildew resistant additives that provide durable, long-lasting seals that withstand repeated exposure to humidity and high temperature conditions (400°F / 204°C).

Basic Uses

33STW adheres to most clean surfaces, including ceramic tile, solid decorative surfaces, glass, porcelain, marble, stainless steel, and aluminum. Excellent for use around tubs, sinks, showers, as well as laminates and solid surface countertops.

SPEC. DATA

MSDS



Additional Screw-On Nozzles Available
CAT. NO. S1LN0Z



Translucent White
Color shown is approximate



Installation Using Translucent White Silicone Sealant



Installation Using White Silicone Sealant

CAT. NO.	CONTENTS
33STW	10.3 Fl. Oz. (305 ml) Cartridge
33STW5GL	4.5 Gallon (17 l) Pail
33STW52GL	52 Gallon (197 l) Drum

Minimum order: 1 each. All cartridge sealants can be combined for quantity pricing. Drums must ship common carrier.



C.R. LAURENCE COMPANY

N112 |

crlaurence.ca

crlaurence.com.au

crlaurence.co.uk

crlaurence.de

crlaurence.eu

crlaurence.com

CRL Water Clear Silicone Sealant

SPEC. DATA

MSDS

- **Optically Clear When Cured**
- **Applications Include Glass Butt Joints, Shower Enclosures, and Specialty Glass Assemblies**
- **Water Clear Formulation for Sealing Glass-to-Glass, Glass-to-Tile, and Glass to U-Channel**

Description

CRL Water Clear Silicone Sealant is an optically clear acetic cure, 100% silicone sealant that cures in the presence of atmospheric moisture to produce a durable and flexible silicone rubber. Its unique weatherability enables it to retain its original properties, even after years of exposure.



Water Clear

Color shown is approximate



10.3 and 5.0 Fl. Oz.
(305 and 148 ml) Cartridges
30 Cartridges Per Case

Removable, reusable, resealable
screw-on nozzles with a screw-on cap

Basic Uses

Water Clear Silicone Sealant is intended for building construction applications, and is particularly effective for glazing butt and lap shear joints and sealing curtainwall projections and other glass, plastic, and metal assemblies. Its exceptional clarity makes it the ideal sealant to use in frameless shower enclosures. It is also appropriate for general construction and industrial applications. Water Clear Silicone is packaged in two sizes of heavy plastic cartridges that feature removable, reusable, resealable screw-on nozzles with a screw-on cap for convenience and product savings. Water Clear Silicone cures quickly with a tack-free time of 10 minutes. It adheres to clean metal, glass, most types of wood, silicone resin, ceramic, natural and synthetic fiber, and most painted surfaces. For single use applications you'll find the five fluid ounce size meets your needs exactly!

Important Note

Exceptional clarity of product will not hide application or tooling errors. A small amount of bubbles may form during the curing process of the sealant, so considerations should be made up front regarding standards of appearance and subsequent repairs (e.g., limited to sight lines). Not recommended for use in the following applications: Glazing or edge sealing of insulating glass; copper, brass, magnesium, zinc, galvanized surfaces. Water Clear Silicone is not mildew resistant. Check cartridge label and Specification Data Sheet for additional limitations.

CLARITY COMPARISONS

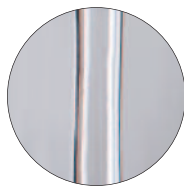
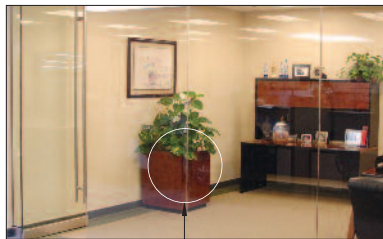

CRL
Water Clear

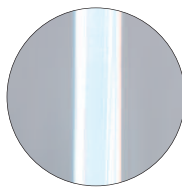
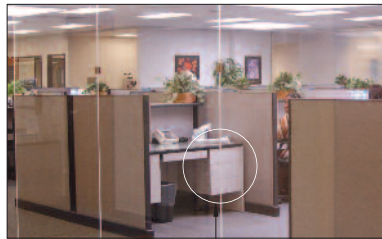

Typical Clear
(Translucent) Silicone

Technical Data

Meets or exceeds the test requirements of Federal Specification TT-S-001543A (COM-NBS) Class A for silicone building sealants; TT-S-230C (COM-NBS) Class A, Non-Sag for one-component building sealants; ASTM C-920 Standard Specifications for Elastomeric Joint Sealants as Type S, Grade NS, Class 25, Use NT, G and A; CAN/CGSB-19.13-M97. Meets California Air Resources Board 2003 requirements for Volatile Organic Compound (VOC) content. Qualifies for LEED® (Leadership in Energy and Environmental Design) Green Building Rating System™ credit.

CAT. NO.	CONTENTS	QTY/CASE
WCS1	10.3 Fl. Oz. (305 ml)	30
WCS5	5 Fl. Oz. (148 ml)	30

Minimum order: 1 each. All cartridge sealants can be combined for quantity pricing.

CRL EZ GLAZE Soundstrip

new

- Creates a Seal Between Glass Panels
- Simple to Install - No Adhesives
- Available in Clear or Black in Sizes for 1/4", 3/8", and 1/2" (6, 10, and 12 mm) Thick Glass



CRL EZ GLAZE Soundstrip is an extruded silicone gasket designed to reduce sound, smoke, and odors through glass-to-glass (butt) joints. It's most commonly used in interior office spaces where tenants wish to utilize partial and full-height glass partitions to reduce sound transmission. Unlike wet glazing with silicone sealants, EZ GLAZE Soundstrip is easy to apply, saving the labor required to mask and apply silicone, plus the clean-up afterward. It can be installed from one side of the glass with simple roller tools, it cuts easily, and will not bubble like silicone sealants. It will not adversely affect laminated glass. EZ GLAZE is available in clear or black for 1/4" (6 mm), 3/8" (10 mm), and 1/2" (12 mm) thick glass. Recommended gap between the lites of glass is 1/4" (6 mm). Rolls are 100' (30.5 m) in length.

CLEAR EZ GLAZE SOUNDSTRIP

CAT. NO.	COLOR	FITS GLASS THICKNESS
EZ14C	Clear	1/4" (6 mm)
EZ38C	Clear	3/8" (10 mm)
EZ12C	Clear	1/2" (12 mm)

BLACK EZ GLAZE SOUNDSTRIP

CAT. NO.	COLOR	FITS GLASS THICKNESS
EZ14BL	Black	1/4" (6 mm)
EZ38BL	Black	3/8" (10 mm)
EZ12BL	Black	1/2" (12 mm)

Minimum order: 1 Roll. Sizes and colors can be combined for quantity pricing.

Minimum order: 1 Roll. Sizes and colors can be combined for quantity pricing.

CRL Primer for Silicone Sealants

- Promotes Adhesion to Metal, Masonry, and Plastics



CRL S1L2100 Primer promotes adhesion of certain one-part CRL Silicone Sealants to a variety of construction materials such as coated glass, metal, stone, masonry, and plastics. A coverage rate of about 25 square feet (2.3 m²) per container is recommended on rough or porous substrates. On smooth metal surfaces a coverage rate of 50 square feet (4.6 m²) per container is possible. Allow the primer to dry for 15 to 60 minutes depending on substrate and weather conditions, and apply the silicone sealant within 8 hours. Check Spec Data for complete application instructions.



CAT. NO.	COLOR	CONTENTS
S1L2100	Clear	8 Fl. Oz (240 ml)

Minimum order: 1 each.

CRL Insulating Glass Silicone Sealant

- Specially Formulated for the Manufacture of Dual Seal Insulating Glass Units
- Excellent Glass-to-Glass Adhesion and Resistance to UV Light and Temperature Extremes

Description

CRL 9542 Insulating Glass Silicone is a single component acetic cure silicone glass sealant specifically designed for producing long lasting insulating glass units when used with a primary seal of Polyisobutylene (PIB) Tape (see page N456). 9542 contains adhesion promoting additives for excellent glass-to-glass adhesion, and is resistant to ultraviolet light and weather extremes.

Basic Uses

Recommended as a secondary seal for dual seal units only. CRL 9542 has a functional temperature range of -80°F to 400°F (-62°C to 204°C). Tack-free time is 30 minutes; fully cures 1/8" (3 mm) thickness in 24 hours. Units may be cautiously moved after 24 hours. Full strength is obtained in seven days.

Technical Data

It meets or exceeds the test requirements of Federal Specification TT-S-001543A (COM-NBS) Class A for silicone building sealants; TT-S-230C (COM-NBS) Class A for one component building sealants; ASTM C-920 for elastomer joint sealants as Type S, Grade NS, Class 25, Use NT, G and A; CAN/CGSB-19.13-M97.



Additional Screw-On Nozzles Available

CAT. NO. S1LNOZ

10.3 Fl. Oz. Cartridges
30 Cartridges Per Case
1440 Cartridges Per Pallet



Color shown is approximate



52 Gallon Drum

Limitations

Recommended for dual seal units only with Polyisobutylene (PIB) Tape as the primary seal. Check cartridge label and Specification Data Sheet for additional limitations.

CAT. NO.	COLOR	CONTENTS
9542	Black	10.3 Fl. Oz. (305 ml)
954252GL	Black	52 Gallons (197 l)

Minimum order: 1 each. All cartridge sealants can be combined for quantity pricing. Drums must ship common carrier.



C.R. LAURENCE COMPANY

N114

crlaurence.ca | crlaurence.com.au | crlaurence.co.uk | crlaurence.de | crlaurence.eu

crlaurence.com

CRL Dow Corning® 999-A Silicone Building and Glazing Sealant

- General Purpose Silicone Glazing Sealant
- Easily Applied One-Part, High Modulus Formula

Description

Dow Corning 999-A is a one-part acetic cure silicone sealant that cures in the presence of atmospheric moisture to produce a durable and flexible wet glazing and curtainwall seal. It is designed for conventional glazing of glass and plastic, curtainwall sealing, solar panels, and replacement glazing.

Basic Uses

Dow Corning 999-A is intended for building construction applications, and is particularly effective for glazing butt and lap shear joints, sealing curtainwall projections, glass, plastic, and metal assemblies. It is also appropriate for general construction applications.

Technical Data

It meets or exceeds the following specification standards: Federal Specifications TT-S-001543A (COM-NBS) Class A for silicone building sealants, and TT-S-00230C (COM-NBS) Class A for one component building sealants; ASTM C-920; Canadian Specification CAN2-19.13-M82.

Limitations

Dow Corning 999-A Building and Glazing Sealant is not intended for structural glazing, or for use on masonry. Check cartridge label and Specification Data Sheet for additional limitations.



10.3 Fl. Oz. (305 ml);
12 Cartridges Per Case;
1296 Cartridges Per Pallet

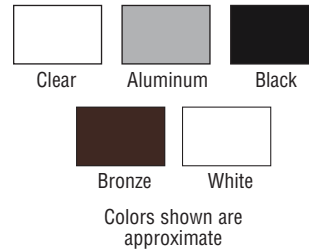

Colors shown are approximate



Comparable Sealants

CRL: 33S. **Dap:** 100% Silicone. **Dow Corning®:** 786; 732; 700; Glazing Silicone; General Purpose; Commercial Grade 100%; Tub, Tile and Ceramic, HVAC/R. **GE®:** 1200 Construction, 1000 Contractors, 1700 Sanitary. **Tremco®:** Proglaze, Tremsil 200, TremPro 644. **OSI:** HM-270. **Pecora:** 860, 863. **Sonneborn:** OmniPlus. **Sika:** SikaSil®-GP.

10.3 FL. OZ. (305 ML) CARTRIDGES

CAT. NO.	COLOR
999AC	Clear
999AAL	Aluminum
999ABL	Black
999ABRZ	Bronze
999AW	White

Minimum order: 1 each. All cartridge sealants can be combined for quantity pricing.

CRL Dow Corning® Glazing Silicone Sealant

- Excellent Adhesion to Most Common Building Substrates
- Excellent Weatherability and UV Resistance

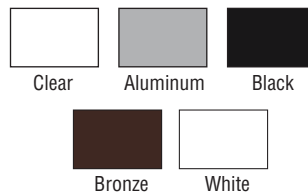

Colors shown are approximate

Description

Dow Corning® Glazing Silicone Sealant is a professional quality acetic cure silicone sealant specifically formulated to meet glass shop glazing needs. It forms a long-lasting, water resistant seal with ±25 percent movement capability when properly applied.

Basic Uses

It can be used in general glazing applications, backlite replacement, and skylight installations. It may also be used to repair weatherstripping and gaskets. It's unique adhesion-promoted formulation ensures adhesion to many building substrates, and longer working time means a professional appearance for the finished job. Glazing Silicone Sealant can be used on most glass, plastics, metal, repainted surfaces, fiberglass, ceramics, and aluminum.

Technical Data

It meets or exceeds the following specification standards: Federal Specifications TT-S-001543A (COM-NBS) Class A for silicone building sealants, and TT-S-00230C (COM-NBS) Class A for one component building sealants; ASTM C-920; Canadian Specification CAN2-19.13-M82.



10.3 Fl. Oz. (305 ml);
12 Cartridges Per Case;
1296 Cartridges Per Pallet

Limitations

Dow Corning Glazing Silicone Sealant is not intended for structural glazing, or for use on masonry. Check cartridge label and Specification Data Sheet for additional limitations.

Comparable Sealants

CRL: 33S. **Dap:** 100% Silicone. **Dow Corning®:** 999-A; 786; 732; 700; General Purpose; Commercial Grade 100%; Tub, Tile and Ceramic; HVAC/R. **GE®:** 1200 Construction, 1000 Contractors, 1700 Sanitary. **Tremco®:** Proglaze, Tremsil 200, TremPro 644. **OSI:** HM-270. **Pecora:** 860, 863. **Sonneborn:** OmniPlus. **Sika:** SikaSil®-GP.

10.3 FL. OZ. (305 ML) CARTRIDGES

CAT. NO.	COLOR
DC1C	Clear
DC1AL	Aluminum
DC1BL	Black
DC1BRZ	Bronze
DC1W	White

Minimum order: 1 each. All cartridge sealants can be combined for quantity pricing.



CRL GE® 1200 Construction Silicone Sealant

- High Modulus, High Strength Silicone
- Wide Temperature Use Range
- Creates Permanent Watertight Bonds

Description

GE® 1200 is a one-part building and glazing acetic cure silicone sealant that cures to a tough, flexible rubber through the moisture cure process.

Basic Uses

Used to seal building joints to prevent the penetration of rain, air, and noise. It effectively weatherproofs junctions of building materials and can also be used for sealing curtainwall, mullion, and other building construction joints, and for glazing steel and aluminum windows, painted and plastic coated wood windows, interior glass partitions, and skylights. Permanent watertight bonds are made with this sealant, in combination with glass, ceramic, steel, plastics, and painted surfaces. In addition, many maintenance applications are possible where long life, reliability, and sealing properties are required.

Technical Data

It meets or exceeds the following specification standards: Federal Specifications TT-S-001543A Class A (COM-NBS) for silicone building sealants, and TT-S-00230C Class A (COM-NBS) for one component building sealants; ASTM C-920, Type S, Grade NS, Class 25, Use NT, G, A and O; CAN/CGSB-19.13-M87. USDA, FDA, NSF Status.



10.1 Fl. Oz. (300 ml);
24 Cartridges Per Case;
1080 Cartridges Per Pallet

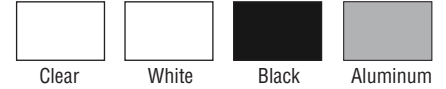

Colors shown are approximate

Limitations

GE® 1200 Construction Silicone Sealant is not intended for structural glazing, or for use on masonry. Check cartridge label and Specification Data Sheet for additional limitations.

Comparable Sealants

CRL: 33S. **Dap:** 100% Silicone. **Dow Corning®:** 999-A; 786; 732; 700; Glazing Silicone; General Purpose; Commercial Grade 100%; Tub, Tile and Ceramic; HVAC/R. **GE®:** 1000 Contractors, 1700 Sanitary. **Tremco®:** Proglaze, Tremsil 200, TremPro 644. **OSI:** HM-270. **Pecora:** 860, 863. **Sonneborn:** OmniPlus. **Sika:** SikaSil®-GP.

10.1 FL. OZ. (300 ML) CARTRIDGES

CAT. NO.	COLOR
SCS1201	Clear
SCS1202	White
SCS1203	Black
SCS1209	Aluminum

Minimum order: 1 each. All cartridge sealants can be combined for quantity pricing.

CRL GE® 1000 Contractors Silicone Sealant

- Easy to Use for General Purpose Glazing
- ± 25% Joint Movement Capability

Description

GE® 1000 is a one-part acetic cure silicone sealant designed for general purpose glazing and curtainwall sealing applications where long-term reliability is required.

Basic Uses

Well suited for general sealing applications such as sheet metal, skylights, ventilators, air conditioning systems, metal or plastic signs, glass block structures, and as a bedding for marine hardware. GE® 1000 retains its cured properties from -40° to 400°F (-40° to 204°C). It can be applied at outdoor temperatures as low as -35°F (-37°C) provided only that surfaces are clean, dry, and frost-free.

Technical Data

It meets or exceeds the following specification standards: Federal Specifications TT-S-001543A (COM-NBS) Class A for silicone building sealants, and TT-S-00230C (COM-NBS) Class A for one component building sealants; ASTM C-920, Type S, Grade NS, Class 25, Use NT, G, A and O; CAN/CGSB-19.13-M87. USDA, FDA, NSF Status.



10.1 Fl. Oz. (300 ml);
24 Cartridges Per Case;
1080 Cartridges Per Pallet



Colors shown are approximate

Limitations

GE® 1000 Contractors Silicone Sealant is not intended for structural glazing, or for use on masonry. Check cartridge label and Specification Data Sheet for additional limitations.

Comparable Sealants

CRL: 33S. **Dap:** 100% Silicone. **Dow Corning®:** 999-A; 786; 732; 700; Glazing Silicone; General Purpose; Commercial Grade 100%; Tub, Tile & Ceramic; HVAC/R. **GE®:** 1200 Construction, 1700 Sanitary. **Tremco®:** Proglaze, Tremsil 200, TremPro 644. **OSI:** HM-270. **Pecora:** 860, 863. **Sonneborn:** OmniPlus. **Sika:** SikaSil®-GP.

10.1 FL. OZ. (300 ML) CARTRIDGES

CAT. NO.	COLOR
SCS1001	Clear
SCS1002	White
SCS1003	Black
SCS1009	Aluminum

Minimum order: 1 each. All cartridge sealants can be combined for quantity pricing.

CRL Tremco® Proglaze® Silicone Sealant

- Fast Curing to a Durable, Flexible Seal
- Excellent Resistance to Ultraviolet, Ozone, and Temperature

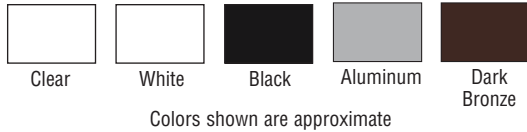

SPEC. DATA

MSDS

Description

Tremco® Proglaze® is a one-part, moisture curing, acetic cure silicone sealant, easily gunned under all types of weather conditions. It rapidly cures to produce a durable, flexible seal.

Basic Uses

It provides a high performance seal for a wide variety of glazing applications such as cap bead, toe bead, heel bead, butt glazing, and metal-to-metal joints. Clear, white, aluminum, and black are acceptable for indirect contact of edible products under U.S.D.A. requirements for use in federally inspected meat and poultry plants.

Technical Data

It meets or exceeds the following specification standards: Federal Specifications TT-S-001543A Class A (COM-NBS) for silicone building sealants, and TT-S-00230C (COM-NBS) Class A for one-component building sealants; ASTM C-920, Type S, Grade NS, Class 25, Use NT, G, A and O; CAN/CGSB-19.13-M87, MG-2-25-A-L.

Limitations

Tremco® Proglaze® is not intended for structural glazing, or for use on masonry. Check cartridge label and Specification Data Sheet for additional limitations.

Comparable Sealants

CRL: 33S. **Dap:** 100% Silicone. **Dow Corning®:** 999-A; 786; 732; 700; Glazing Silicone; General Purpose; Commercial Grade 100%; Tub, Tile and Ceramic; HVAC/R. **GE®:** 1000 Contractors, 1700 Sanitary. **Tremco®:** Tremsil 200, TremPro 644. **OSI:** HM-270. **Pecora:** 860, 863. **Sonneborn:** OmniPlus. **Sika:** SikaSil®-GP.

10.1 FL. OZ. (300 ML) CARTRIDGES

CAT. NO.	COLOR
942800	Clear
942806	White
942802	Black
942810	Aluminum
942857	Dark Bronze

Minimum order: 1 each. All cartridge sealants can be combined for quantity pricing.

CRL Tremco® Tremsil® 200 Silicone Sealant

- Produces a Long-Life, Weathertight Seal
- Contains a Fungicide for Mildew Resistance

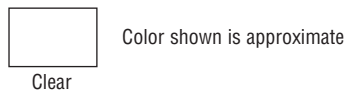

SPEC. DATA

MSDS

Description

Tremco® Tremsil® 200 is a one-part, acetic cure silicone sealant. Tremsil® 200 cures to a flexible rubber when exposed to moisture present in the air.

Basic Uses

It produces a weathertight seal to glass, metal, porcelain, ceramic, and most painted surfaces. Contains a fungicide making the sealant suitable for use in bathrooms, spas, and similar applications where joints need protection against fungi and bacteria.

Technical Data

It meets or exceeds the following specification standards: Federal Specifications TT-S-001543A (COM-NBS) Class A for silicone building sealants, and TT-S-00230C (COM-NBS) Class A for one-component sealants; ASTM C-920, Type S, Grade NS, Class 25, Use NT, G, A and O; CAN/CGSB-19.13-M87.

Limitations

Tremco® Tremsil® 200 is not intended for structural glazing, or for use on masonry. Check cartridge label and Specification Data Sheet for additional limitations.

Comparable Sealants

CRL: 33S. **Dap:** 100% Silicone. **Dow Corning®:** 999-A; 786; 732; 700; Glazing Silicone; General Purpose; Commercial Grade 100%; Tub, Tile and Ceramic; HVAC/R. **GE®:** 1000 Contractors, 1700 Sanitary. **Tremco®:** Proglaze, TremPro 644. **OSI:** HM-270. **Pecora:** 860, 863. **Sonneborn:** OmniPlus. **Sika:** SikaSil®-GP.

10.1 FL. OZ. (300 ML) CARTRIDGES

CAT. NO.	COLOR
9718004	Clear

Minimum order: 1 each. All cartridge sealants can be combined for quantity pricing.

CRL RTV408 Industrial and Construction Silicone

SPEC. DATA

MSDS

- Low Odor, Non-Acetic Cure Formula
- Excellent Adhesion to Most Surfaces
- Easy Gunnability and Tooling
- AAMA Approved
- 20 Year Limited Warranty



10.3 Fl. Oz. (305 ml);
30 Cartridges Per Case;
1440 Cartridges Per Pallet

Additional Screw-On
Nozzles Available

CAT. NO. S1LN0Z

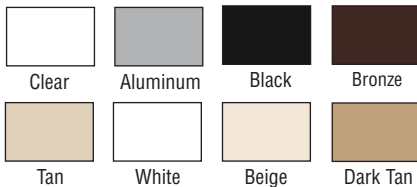

Colors shown are approximate
Custom colors are available (see pages N110).



Description

CRL RTV408 Silicone is a neutral cure, medium modulus, 100% Silicone Sealant that cures to a tough, flexible rubber when exposed to moisture. RTV408 features primerless adhesion to: aluminum, stainless steel, chromium, tin, iron, plastics, rigid PVC, phenolic resin, glass, ceramic, and most reflective-coated glasses.

Basic Uses

Its fast cure time and easy tooling make it ideal for many in-house production applications; and it is non-corrosive to most building materials such as glass (including insulating glass), tiles, and sanitary equipment. CRL RTV408 seals curtainwall joints; vinyl, steel and aluminum windows; and skylights. It is also used in vehicles, ships, aircraft, as well as for electrical insulation. CRL RTV408 does not cause corrosion in contact with metals. It is suitable for alkaline materials such as mortar and cement, and other applications where metal corrosion could be a problem. CRL RTV408 stays flexible and is resistant to cracking or becoming brittle in a wide range of temperatures approximately -65° to 400°F (-54° to 204°C). It can be applied at outdoor temperatures as low as -20°F (-29°C), provided that surfaces are clean, dry and frost-free, or on surfaces as high as 100°F (38°C). RTV408W and RTV408T contain a fungicide, and the cured sealant is mildew resistant.

Limitations

It is not recommended for concrete and stone expansion joints; horizontal decks, patios, driveway or terrace joints where abrasion or physical abuse is encountered; sealing submerged joints, particularly where porous surfaces permit water infiltration to the bond surface; interior or exterior structural sealing below the waterline in marine applications; structural glazing; food contact or potable water applications; mirrors. Check cartridge label and Specification Data Sheet for additional limitations.

Comparable Sealants

Dap: Titanium®. **Dow Corning®:** 799 Contractors Weatherproofing, Vinyl Window, Siding & Door. **GE®:** 2800 Silglaze II Contractors-N 1800. **Tremco®:** Tremsil 600, TremPro 645. **OSI:** VP-275. **Pecora®:** 896. **Novagard®:** Novaflex. **Sika:** SikaSil®-N Plus.

Technical Data

Meets or exceeds Federal Specifications: TT-S-001543A (COM-NBS) Class A, for silicone building sealants; TT-S-00230C (COM-NBS) Class A, for one-component silicone sealants; ASTM C-920 for elastomeric joint sealants, Type S, Grade NS, Class 25, Use NT, G, A and O; CAN/CGSB 19.13-M87. AAMA 802.3-92 Type 1, 802.3-92 Type 2, 805.2-94 and 808.3-92. Meets California Air Resources Board 2003 requirements for Volatile Organic Compound (VOC) content. Qualifies for **LEED®** (Leadership in Energy and Environmental Design) Green Building Rating System™ credit.

10.3 FL. OZ. (305 ML) CARTRIDGES

CAT. NO.	COLOR
RTV408C	Clear
RTV408AL	Aluminum
RTV408BL	Black
RTV408BRZ	Bronze
RTV408T	*Tan
RTV408W	*White
RTV408BGE	Beige (Almond)
RTV408DT	Dark Tan

Minimum order: 1 each. All cartridge sealants can be combined for quantity pricing. *Mildew Resistant Color.

CRL RTV408 Packaging Features



Additional Screw-On Nozzles Available
CAT. NO. S1LNOZ

Screw-On Nozzles

All CRL Silicone Sealant cartridges are packed with innovative Screw-On Nozzles, offering you a greater yield per tube. They are 4" (102 mm) long, and tapered so you can trim the nozzle to exactly the bead size you need. To order additional nozzles, specify Cat. No. S1LNOZ (see page N220).

Cartridges Packed 30 Per Case

All CRL Silicone Sealant cartridges are packed 30 per case to match industry standards. Inventory and product tracking is easier because CRL Sealants are packed to match other manufacturers in the industry.

"WHMIS" Safety Info Shown on Cartridges and Cartons

Each CRL Silicone Sealant cartridge and carton contains important "WHMIS" (Workplace Hazardous Material Information System) safety data. It is shown in English, French, and Spanish to comply with shipping regulations in the U.S., Canada, and Mexico.

Press-in-Hand Holes Make Lifting Easier



Press-In Hand Holes Make Lifting Easier

By pushing in a perforation on each end of our silicone cartons, you will have an easier time lifting and moving these products where you need them.

1440 Cartridges (48 Cases) Per Pallet

This convenient way of packing pallets reduces load-shifting during freight transport because the cartons stack together tightly.

Pallet Quantity Buyers Can Save More

By purchasing silicone in pallet quantities of 1440 in one color you can save even more. Contact CRL now for current pricing for larger quantity buyers.

RTV408 INDUSTRIAL AND CONSTRUCTION SILICONE

WARNING: May cause allergic skin reaction or eye irritation. Repeated vapor exposure may cause injury to blood and liver and may cause drowsiness.

PRECAUTIONS: Store in a cool, dry, well-ventilated area in a tightly closed container. Avoid direct contact with skin and eyes. Avoid breathing vapors.

FIRST AID:

EYES: Immediately flush eyes with plenty of water for at least 15 minutes. Get immediate medical attention.

SKIN: Immediately wash with soap and plenty of water. Get medical attention if irritation develops or persists.

INHALATION: Remove from area of exposure to fresh air. Get medical attention.

AVERTISSEMENT: Le contact avec la peau peut causer une réaction allergique ou peut irriter les yeux. Surexposition aux vapeurs peut causer des maladies du sang ou du foie. Les vapeurs peuvent provoquer des somnolences.

MISE EN GARDE: Entreposer dans un endroit sec, frais et bien aéré dans des contenants soigneusement fermés. Éviter tout contact direct avec la peau ou les yeux. Éviter d'inhaler les vapeurs.

PREMIERS SOINS:

YEUX: Rincer les yeux abondamment avec beaucoup d'eau durant au moins 15 minutes. Consulter un médecin immédiatement.

PEAU: Laver immédiatement avec une grande quantité d'eau et de savon. Consulter un médecin si une irritation se développe ou persiste.

EN CAS D'INHALATION: Emmener la victime à l'air libre. Consulter un médecin.

ADVERTENCIA: Puede causar reacción alérgica a la piel o irritación a los ojos. Sobre exposición repetidamente al vapor puede causar daño a la sangre y al hígado y también puede causar somnolencia.

PRECAUCION: Almacenar en zona bien ventilada, fresca y seca, en contenedores cerrados. Evite contacto directo con la piel y ojos. Evite la inhalación de vapores.

PRIMERA AUXILIO:

OJOS: Inmediatamente echar bastante agua a los ojos por lo menos 15 minutos. Recibir atención médica inmediata.

PIEL: Lavarse con bastante agua y jabón inmediatamente. Recibir atención médica inmediata, si la piel desarrolla irritación persistente.

INHALACION: Retirarse del área expuesta y respirar aire fresco. Recibir atención médica inmediata.

C. R. LAURENCE CO., INC.

CRL RTV408 Silicone Sealant in Bulk Packaging

- Top Quality Silicone Sealants in Money-Saving Pails or Drums
- Available in Seven Standard Colors
- Also Available in Custom Colors

High performance sealants for bulk users are our specialty. We can supply our RTV408 Silicone in 4.5 gallon (17 l) pails and 48 gallon (181 l) drums. CRL can supply any of seven standard colors in bulk.

If you're looking for custom colors, we can do that for you too! See page N110 for more information.

Call us for a price quotation on special order bulk pumping systems for dispensing sealants from pails and drums. See pages N208-N209 for bulk load caulking guns and accessories.



4.5 Gallon Pail
(17 Liters)

4.5 GALLON (17 L) PAILS

CAT. NO.	COLOR
RTV408C5GL	Clear
RTV408AL5GL	Aluminum
RTV408BL5GL	Black
RTV408BRZ5GL	Bronze
RTV408T5GL	*Tan
RTV408W5GL	*White
RTV408BGE5GL	Beige (Almond)

Minimum order: 1 each. 4.5 gallon pails can be combined for quantity pricing. *Mildew Resistant Color.



48 Gallon Drum
(181 Liters)

48 GALLON (181 L) DRUMS

CAT. NO.	COLOR
RTV408C48GL	Clear
RTV408AL48GL	Aluminum
RTV408BL48GL	Black
RTV408BRZ48GL	Bronze
RTV408T48GL	*Tan
RTV408W48GL	*White
RTV408BGE48GL	Beige (Almond)

Minimum order: 1 each. *Mildew Resistant Color. Drums must ship via common carrier.

CRL 95C Silicone Building Sealant

SPEC. DATA

MSDS

Additional Screw-On Nozzles Available
CAT. NO. S1LNOZ



10.3 Fl. Oz. (305 ml);
30 Cartridges Per Case;
1440 Cartridges Per Pallet

- Excellent Primerless Adhesion to Most Common Construction Substrates
- ± 50% Joint Width Movement
- AAMA Approved
- Approved for the Florida Hurricane Impact Glazing Code*
- 20 Year Limited Warranty

Colors shown are approximate
Custom colors also available (see page N110).

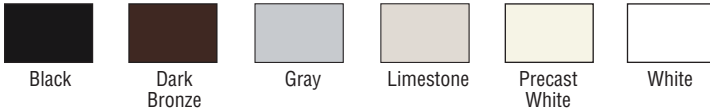

Description

CRL 95C Silicone is a one-part, medium modulus, neutral cure, 100% silicone formulation that cures to a durable and flexible silicone rubber building joint seal. It can accommodate ± 50% joint movement in properly designed joints.

Basic Uses

It is designed for sealing expansion and control joints in precast concrete panels and metal curtainwalls; non-structural glazing of glass, metal, and plastic, as well as waterproofing applications, including perimeter sealing of doors and windows. CRL 95C forms a durable, flexible watertight bond with most building materials in any combination of glass, ceramics, plastics, stone, masonry, wood, steel, anodized and mill-finished aluminum, and painted surfaces. In most cases no primer is required. CRL 95C is compatible with all laminated glass, insulating glass units, and acrylic or polycarbonate glazing sheets. CRL 95C can be used as a weather seal for insulating glass units produced with any type of sealant, including two-part silicones, polysulfides, polyurethanes, and butyls. CRL 95C can be applied at outdoor temperatures as low as -20°F (-29°C), provided that surfaces are clean, dry and frost-free, or on surfaces as high as 130°F (54°C). Cured sealant will perform at cold temperatures down to -80°F (-62°C) or at high temperatures up to 350°F (177°C).

*Successfully tested by manufacturers with systems approved for the Florida Hurricane Impact Glazing Code and recommended as an installation sealant. **NOTE:** Each manufacturer must test for use in their systems and have the results independently verified.

Comparable Sealants

Dow Corning®: 795, 791. **GE®:** SilPruf® 2000. **Tremco®:** Spectrem® 2, Spectrem® 3. **Pecora®:** 864, 895. **Sonneborn®:** OmniSeal. **Sika:** SikaSil®-WS95.

Limitations

CRL 95C should not be used for structural glazing; sealing horizontal decks, patios, driveways or terrace joints where abrasion or physical abuse is encountered; sealing submerged joints; or for exterior or interior sealing below the waterline in marine applications. Do not use CRL 95C in totally confined or air-free spaces, or in designs that will be painted after application of the sealant. Paint film does not stretch with extension of the sealant, and adhesion of paint to the sealant is not adequate. The sealant should be applied after painting is completed. Neutral cure sealant curing by-products may cause stress cracking or surface crazing of polycarbonate sheet under certain conditions. Test application before use. Check cartridge label and Specification Data Sheet for additional limitations.

Technical Data

It meets or exceeds Federal Specifications: TT-S-001543A (COM-NBS) for silicone building sealants Class A; TT-S-00230C (COM-NBS) for one-component building sealants as Class A, Type II; ASTM C-920 Standard Specification for Elastomer Joint Sealants as Type S, Grade NS, Class 50, Use NT, G, A, M and O; CAN/CGSB 19.13-M87. 95CBL (black) meets all of AAMA 802.3-92 (Type I and II), 805.2-94 (Group C), and 808.3-92. Meets California Air Resources Board 2003 requirements for Volatile Organic Compound (VOC) content. Qualifies for **LEED®** (Leadership in Energy and Environmental Design) Green Building Rating System™ credit (see page N159).

10.3 FL. OZ. (305 ML) CARTRIDGES

CAT. NO.	COLOR
95CBL	Black
95CDBRZ	Dark Bronze
95CGRY	Gray
95CL	Limestone
95CW	Precast White
95CWH	White

Minimum order: 1 each. All cartridge sealants can be combined for quantity pricing.

CRL 95C Packaging Features



Additional Screw-On Nozzles Available
CAT. NO. S1LN0Z

Screw-On Nozzles

All CRL Silicone Sealant cartridges are packed with innovative Screw-On Nozzles, offering you a greater yield per tube. They are 4" (102 mm) long, and tapered so you can trim the nozzle to exactly the bead size you need. To order additional nozzles, specify Cat. No. S1LN0Z (see page N220).

Cartridges Packed 30 Per Case

All CRL Silicone Sealant cartridges are packed 30 per case to match industry standards. Inventory and product tracking is easier because CRL Sealants are packed to match other manufacturers in the industry.

"WHMIS" Safety Info Shown on Cartridges and Cartons

Each CRL Silicone Sealant cartridge and carton contains important "WHMIS" (Workplace Hazardous Material Information System) safety data. It is shown in English, French, and Spanish to comply with shipping regulations in the U.S., Canada, and Mexico.

Press-in Hand Holes
Make Lifting Easier



Press-In Hand Holes Make Lifting Easier

By pushing in a perforation on each end of our silicone cartons, you will have an easier time lifting and moving these products where you need them.

1440 Cartridges (48 Cases) Per Pallet

This convenient way of packing pallets reduces load-shifting during freight transport because the cartons stack together tightly.

Pallet Quantity Buyers Can Save More

By purchasing silicone in pallet quantities of 1440 in one color you can save even more. Contact CRL now for current pricing for larger quantity buyers.

<p>95C SILICONE BUILDING SEALANT (NEUTRAL CURE) CAUTION: MAY BE HARMFUL IF INHALED. Do not breathe vapor. Keep container closed. Use with adequate ventilation. IF INHALED, remove to fresh air.</p> <p>KEEP OUT OF THE REACH OF CHILDREN.</p> <p>PRECAUTIONS: Store in a cool, dry, well-ventilated area in a tightly closed container. Avoid direct contact with skin and eyes. Avoid breathing vapors.</p> <p>FIRST AID:</p> <p>EYES: Immediately flush eyes with plenty of water for at least 15 minutes. Get immediate medical attention.</p> <p>SKIN: Immediately wash with soap and plenty of water.</p> <p>Get medical attention if irritation develops or persists.</p> <p>INHALATION: Remove from area of exposure to fresh air. Get medical attention.</p>		<p>PRECAUTION: STAGE NOCIIF EN CAS D'INHALATION. Ne respirez pas la vapeur. Le récipient doit être toujours fermé. Utilisez avec beaucoup d'aération. En cas d'inhalation entrez en air frais. Gardez loin des enfants.</p> <p>MINI EN GARDE: Entreposer dans un endroit sec, frais et bien aéré dans des contenants solidement fermés. Éviter tout contact direct avec la peau ou les yeux. Éviter d'inhaler les vapeurs.</p> <p>PREMIERS SOINS:</p> <p>YEUX: Rincer les yeux immédiatement avec beaucoup d'eau durant au moins 15 minutes. Consulter un médecin immédiatement.</p> <p>PEAU: Laver immédiatement avec une grande quantité d'eau et du savon.</p> <p>Consulter un médecin si une irritation se développe ou persiste.</p> <p>EN CAS D'INHALATION: Éloigner la victime à l'air libre. Consulter un médecin.</p>	<p>ADVERTENCIA: VAPORES NOCIIVOS A LA SALUD. Evite respirar los vapores. Mantenga el envase herméticamente cerrado. Usar únicamente en áreas con ventilación adecuada. En caso de problemas respiratorios respire aire fresco. Manténgalo fuera del alcance de los niños.</p> <p>PRECAUTION: Almacene en área bien ventilada, fresca y seca, en contenedores herméticamente cerrados. Evite el contacto directo con la piel y los ojos. Evite la inhalación de vapores.</p> <p>PRIMEROS AUXILIOS: OJOS: Enjuáguese inmediatamente con agua en abundancia por al menos 15 minutos. Reciba atención médica inmediata.</p> <p>PIEL: Lavarse inmediatamente con agua y jabón en abundancia y recibir atención médica inmediata si la piel desarrolla irritación persistente.</p> <p>INHALACION: Retírese del área expuesta y respire aire fresco. Reciba atención médica inmediata.</p> <p style="text-align: right;">C. R. LAURENCE CO., INC.</p>
--	---	---	--

CRL 95C Silicone Sealant in Bulk Packaging

- Top Quality Silicone Sealants in Money-Saving Pails
- Available in Six Standard Colors
- Also Available in Custom Colors

High performance sealants for bulk users are our specialty. We can supply our 95C Silicone in 2 and 4.5 gallon (7.5 and 17 l) pails. CRL can supply any of six standard colors in bulk.

If you're looking for custom colors, we can do that for you too! See page N110 for more information.

Call us for a price quotation on special order bulk pumping systems for dispensing sealants from pails and drums. See pages N208-N209 for bulk load caulking guns and accessories.



2 Gallon Pail
(7.5 Liters)

2 GALLON (7.5 L) PAILS

CAT. NO.	COLOR
95C2GLWHT	White
95C2GLW	Precast White
95C2GLBL	Black
95C2GLDBRZ	Dark Bronze
95C2GLGRY	Gray
95C2GLL	Limestone

Minimum order: 1 each. 2 gallon pails can be combined for quantity pricing.



4.5 Gallon Pail
(17 Liters)

4.5 GALLON (17 L) PAILS

CAT. NO.	COLOR
95C5GLWHT	White
95C5GLW	Precast White
95C5GLBL	Black

Minimum order: 1 each. 4.5 gallon pails can be combined for quantity pricing.

CRL Dow Corning® 795 Silicone Building Sealant

- ± 50% Joint Width Movement
- Medium Modulus Building Sealant for Expansion Joints
- Structural and Non-Structural Glazing of Glass, Metals, and Plastics



10.3 Fl. Oz. (305 ml);
12 Cartridges Per Case;
1296 Cartridges Per Pallet

Description

Dow Corning® 795 is a one-part, medium modulus, neutral cure silicone formulation. Dow Corning® 795 cures to a durable and flexible silicone rubber building joint seal, and can accommodate ± 50% joint movement in a properly designed joint.

Basic Uses

Structural and non-structural glazing of glass, metal, and plastic; adhering stiffeners to building panels; weatherproofing applications, including perimeter sealing of doors and windows. Dow Corning® 795 is virtually unaffected by sunlight, rain, sleet, snow, ultraviolet radiation, atmospheric contamination, ozone, and temperature extremes. Joint performance does not change significantly with aging or exposure to weather.

Comparable Sealants

CRL: 95C. **Dow Corning®:** 995, 791. **GE®:** SilPruf 2000, UltraGlaze® SSG 4000. **Tremco:** Spectrem 2, Spectrem 3. **Pecora:** 864, 895. **Sonneborn:** OmniSeal. **Sika:** SikaSil®-WS95.

Limitations

Should not be applied to building materials that bleed oils, plasticizers or solvents, or in totally confined spaces. Do not apply to frost-laden or wet surfaces, or to surfaces that are in direct contact with food. Check cartridge label and Specification Data Sheet for additional limitations.

Technical Data

It meets or exceeds the following specification standards: Federal Specifications TT-S-001543A (COM-NBS) Class A for silicone building sealants, and TT-S-00230C (COM-NBS) Class A for one-component building sealants; ASTM C-920 Type S, Grade NS, Class 50, Use NT, G, A and O; ASTM Specification C 1184 for structural silicone sealants; Canadian Specification CAN2-19.13-M82.

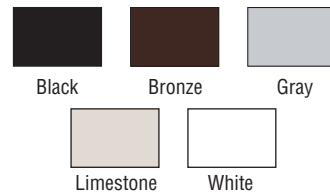

Colors shown are approximate

10.3 FL. OZ. (305 ML)	
CAT. NO.	COLOR
795BL	Black
795BRZ	Bronze
795GRY	Gray
795L	Limestone
795W	White

Minimum order: 1 each. All cartridge sealants can be combined for quantity pricing.

CRL Dow Corning® 995 Silicone Structural Adhesive

- Designed Specifically for Structural and Protective Glazing
- Self-Priming to Most Common Building Substrates, Including Most Fluoropolymer-Based Paints



10.3 Fl. Oz. (305 ml);
12 Cartridges Per Case;
1296 Cartridges Per Pallet

Description

Dow Corning® 995 is a one-component, self-priming, shelf stable, neutral cure, elastomeric adhesive specifically formulated for silicone structural glazing.



Colors shown are approximate

Basic Uses

CRL Dow Corning® 995 Silicone Structural Adhesive features excellent unprimed adhesion to most common building substrates, including glass, reflective glass, anodized aluminum, granite, and paints, including most fluoropolymer-based paints; non-corrosive by products; 20-year performance warranty available. Cures to an extremely tough elastomeric rubber, with movement capability of ± 50%. Structural applications require prior testing and written print review by Dow Corning®. Dow 995 is also the approved adhesive component of the unique 3M® Ultraflex Window System which incorporates 3M® Scotchshield Ultra Safety and Security Window Film as a new dimension in window film technology for property and personal protection against crime, violent weather, explosions, earthquakes, and accidents.

Limitations

Structural glazing applications for Dow Corning® 995 must be reviewed by the Technical Service staff, Dow Corning Corporation, Construction Sealants Technical Service and Development. Check cartridge label and Specification Data Sheet for additional limitations.

Technical Data

It meets or exceeds the following specification standards: Federal Specifications TT-S-001543A (COM-NBS) Class A for silicone building sealants, and TT-S-00230C (COM-NBS) Class A for one-component building sealants; ASTM C-920, Type S, Grade NS, Class 50, Use NT, G, and O; ASTM C1184 Standard Specification for Structural Silicone Sealant; Chinese specification GB 16776 for structural glazing.

Comparable Sealants

Dow Corning®: 795. **GE®:** UltraGlaze® SSG 4000. **Tremco®:** Proglaze SSG. **Pecora:** 895.

10.3 FL. OZ. (305 ML)	
CAT. NO.	COLOR
995BL	Black
995W	White

Minimum order: 1 each. All cartridge sealants can be combined for quantity pricing.

CRL GE® SilPruf® Silicone Sealant

- ± 50% Dynamic Joint Movement Capability
- Weatherproofing Sealant for Building Joints
- Primerless Adhesion to Most Substrates



Description

GE® SilPruf® Silicone Sealant is a one-part, neutral cure sealant for use in most common weatherproofing applications on a wide variety of materials.

Basic Uses

After application, the sealant reacts with atmospheric moisture to produce a low-modulus, long-lasting, formed-in-place silicone rubber building joint and glazing sealant. It seals assemblies of metals, masonry, concrete, coated surfaces, plastics, wood, and other common building materials. SilPruf® is specially designed for use in butt joints or lap shear joints in weatherproofing and glazing applications subject to movement.

Comparable Sealants

CRL: 95C. **Dow Corning®:** 791, 795. **Tremco®:** Spectrem® 2, Spectrem® 3. **Pecora:** 864, 895. **Sonneborn:** Omniseal. **Sika:** SikaSil®-WS95.



10.1 Fl. Oz. (299 ml);
24 Cartridges Per Case;
1080 Cartridges Per Pallet

Limitations

Structural glazing applications require that GE® Silicones give written approval of the use of GE® SilPruf® Silicone Sealant for each building project. Check cartridge label and Specification Data Sheet for additional limitations.

Technical Data

It meets or exceeds Federal Specifications TT-S-001543A (COM-NBS) Class A, for silicone building sealants; ASTM C 1184-95 and ASTM C-920 for elastomeric joint sealants, Type S, Grade NS, Class 25, Use NT, G, A and O.

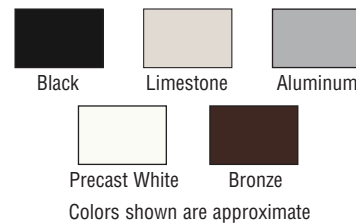

10.1 FL. OZ. (299 ML)	
CAT. NO.	COLOR
SCS2003	Black
SCS2004	Limestone
SCS2009	Aluminum
SCS2020	Precast White
SCS2097	Bronze

Minimum order: 1 each. All cartridge sealants can be combined for quantity pricing.

CRL GE® SilGlaze® II Silicone Sealant

- Ideal for Window Perimeter Weathersealing
- One-Part, Neutral Cure/Low Odor, Fast Cure



Description

GE® SilGlaze® II Silicone Sealant is a one-part, neutral curing, medium modulus sealant that can be used for field glazing, window installations, and general purpose sealing applications.

Basic Uses

SilGlaze® II may be used for in-shop window fabrication as a bedding sealant, as well as for cap, toe, and heel bead applications. GE® SilGlaze® II Silicone Sealant is also recommended for use as a saw kerf sealant for the setting of dimensional stone panels. It has excellent adhesion to wood, vinyl, aluminum, and glass. May also be used as a perimeter weatherseal for field glazing and window installations.

Comparable Sealants

CRL: RTV408. **Dap:** Titanium®. **Dow Corning®:** 799 Contractors Weatherproofing, Vinyl Window, Siding & Door. **Tremco®:** Tremsil 600, TremPro 645. **OSI:** VP-275. **Pecora:** 896. **Novagard®:** Novaflex. **Sika:** SikaSil®-N Plus.



10.1 Fl. Oz. (299 ml);
24 Cartridges Per Case;
1080 Cartridges Per Pallet

Limitations

It should not be used for the following applications: structural glazing applications; aquariums; continuous water immersion applications; for applications where FDA or USDA compliance is required; in glass butt joints or other glazing applications where small bubbles which can develop during cure may be objectionable. Check cartridge label and Specification Data Sheet for additional limitations.

Technical Data

It meets or exceeds Federal Specifications TT-S-001543A (COM-NBS); TT-S-00230C (COM-NBS); ASTM C-920, Type S, Grade NS, Class 25, Use NT, G, A & O. AAMA 802.3-92, 805.2-92, 808.3-92, 803.3-92 (Type I).

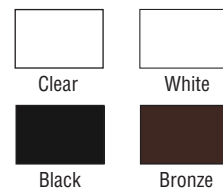

10.1 FL. OZ. (299 ML)	
CAT. NO.	COLOR
SCS2801	Clear
SCS2802	White
SCS2803	Black
SCS2897	Bronze

Colors shown are approximate

Minimum order: 1 each. All cartridge sealants can be combined for quantity pricing.

CRL GE® UltraGlaze® Silicone Structural Glazing Sealant

- High Strength Neutral Cure Sealant for Use in Structural Glazing
- Primerless Adhesion to Most Substrates



Black

Color shown is approximate

Description

GE® UltraGlaze® is a one-component, high strength neutral cure sealant specially designed and tested for structurally glazed curtainwall applications.

Basic Uses

UltraGlaze® features include primerless adhesion to many building substrates. Specific substrate testing is required on all structurally glazed projects. UltraGlaze® is compatible with insulating glass sealants, has low odor, a long tooling time, and is non-corrosive. This material can also be used as the weatherseal in glass-to-glass butt joints.

Comparable Sealants

Dow Corning®: 795, 995. **Tremco®:** Proglaze® SSG, Spectrem® 2. **Pecora:** 895.

SPEC. DATA

MSDS



10.1 Fl. Oz. (299 ml);
24 Cartridges Per Case;
1080 Cartridges Per Pallet

Limitations

Structural glazing applications require that GE® Silicones give written approval of the use of UltraGlaze® SSG4000 sealant for each building project. No blanket approval is given by GE® Silicones for structural glazing applications. Check cartridge label and Specification Data Sheet for additional limitations.

Technical Data

Meets or exceeds Federal Specifications TT-S-001543A (COM-NBS) Class A for silicone building sealants; TT-S-00230C (COM-NBS) Class A for one-component silicone sealants; ASTM C-920 for elastomeric joint sealants.

10.1 FL. OZ. (299 ML) CARTRIDGES

CAT. NO.	COLOR
SSG4000	Black

Minimum order: 1 each. All cartridge sealants can be combined for quantity pricing.

CRL Tremco® Proglaze® SSG Structural Glazing Silicone Sealant

- High Modulus Sealant for Two or Four Sided Structural Glazing Applications
- Impact/Hurricane Tested Including Miami/Dade Protocol



Black

Color shown is approximate

Description

CRL Tremco® Proglaze® SSG is a one-part, high modulus, neutral cure silicone sealant ideal for a wide variety of glazing applications. Proglaze® SSG provides high performance capabilities, as well as an exceptionally fast cure.

Basic Uses

Proglaze® SSG is designed to meet the stringent performance needs for both structural and protective glazing. Whether it is a unitized curtainwall manufactured in plant or a field glazed project, Proglaze® SSG offers fast thorough curing and exceptional tensile strength to meet the most stringent building codes.

Comparable Sealants

Dow Corning®: 795, 995. **GE®:** UltraGlaze®. **Pecora:** 895

SPEC. DATA

MSDS



10.1 Fl. Oz. (300 ml);
30 Cartridges Per Case;
1800 Cartridges Per Pallet

Limitations

All structural glazing applications must be reviewed and approved by Tremco® Technical Service prior to the application of Proglaze® SSG. Do not apply to damp or contaminated surfaces. Use with adequate ventilation. Check cartridge label and Specification Data Sheet for additional limitations.

Technical Data

Conforms to ASTM C920 Type S, Grade NS, Class 25, Use NT, M, G, A and O; CAN/CGSB-19. 13-M87; U.S. Federal Specification TT-S 00001543A (COM-NBS) Class A, and U.S. Federal Specification TT-S-00230C (COM-NBS) Class A, Class II.

10.1 FL. OZ. (299 ML) CARTRIDGES

CAT. NO.	COLOR
954802	Black

Minimum order: 1 each. All cartridge sealants can be combined for quantity pricing.

CRL Tremco® Spectrem® 2 High Performance Silicone Sealant

- High Performance in Demanding Applications
- Tools Easily, Cures Quickly

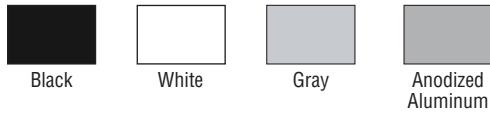

Colors shown are approximate

Description

Tremco® Spectrem® 2 Silicone Sealant is a medium modulus, one-part, high performance, neutral cure sealant ideal for a variety of caulking and glazing applications.

Basic Uses

CRL Tremco® Spectrem® 2 is suitable for both caulking and glazing applications, including cap beads, toe beads, heel beads, and other typical air seals. It is particularly appropriate as a weather seal and tensile bead in two-sided structural glazing systems, and ideal for sealing joints within the curtain/window wall systems.

Comparable Sealants

CRL: 95C. **Dow Corning®:** 795, 995, 791. **GE®:** SilPruf® 2000, UltraGlaze® SSG 4000. **Tremco:** Spectrem® 3. **Pecora:** 864, 895. **Sonneborn:** OmniSeal. **Sika:** SikaSil®-WS95.

SPEC. DATA

MSDS



10.1 Fl. Oz. (300 ml);
30 Cartridges Per Case;
1800 Cartridges Per Pallet

Limitations

All structural glazing applications must be reviewed and approved by Tremco Technical Service prior to the application of Spectrem® 2. Do not apply to damp or contaminated surfaces. Check cartridge label and Specification Data Sheet for additional limitations.

Technical Data

It meets or exceeds the test requirements of TT-S-001543A (COM-NBS) Class A; TT-S-00230C (COM-NBS) Class A, Type II; ASTM C-920 Type S, Grade NS, Class 50, Use NT, M, G, A, O.; CAN/CGSB-19.13-M87; AAMA 802.3-92 (Type I and II), 805.2-94 (Grade C), and 808.3-92.

10.1 FL. OZ. (300 ML) CARTRIDGES

CAT. NO.	COLOR
947802	Black
947806	White
947852	Gray
947878	Anodized Aluminum

Minimum order: 1 each. All cartridge sealants can be combined for quantity pricing.

CRL Tremco® Tremsil 600 Silicone Sealant

- Excellent Primerless Adhesion to Metal, Glass, Plastic, Rigid PVC, and Painted Surfaces
- Easy Gunning and Tooling Over a Wide Temperature Range
- Fast Cure

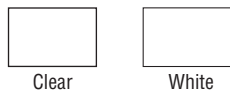

Colors shown are approximate

Description

CRL Tremco® Tremsil 600 Silicone Sealant is a one-part, medium modulus, neutral cure sealant. The sealant cures to a flexible rubber when exposed to moisture present in the air.

Basic Uses

Tremsil 600 is compatible to most common, non-porous building component surfaces making it an excellent sealant for glazing of low rise residential windows. Tremsil 600 has excellent adhesion to aluminum, stainless steel, metals, glass, plastics, rigid P.V.C.'s, wood, brick, concrete, and painted surfaces.

Comparable Sealants

CRL: RTV408 Silicone. **Dap:** Titanium®. **Dow Corning®:** 799 Silicone Contractors Weatherproofing, Vinyl Window, Siding and Door. **GE®:** 2800 SilGlaze II Silicone Contractors-N1800. **Pecora®:** 896 Silicone. **OSI:** VP-275. **Novagard®:** Novaflex Silicone. **Sika:** SikaSil®-N Plus.

SPEC. DATA

MSDS



10.1 Fl. Oz. (300 ml);
30 Cartridges Per Case;
1800 Cartridges Per Pallet

Limitations

Do not apply to damp or contaminated surfaces. Use with adequate ventilation. Check cartridge label and Specification Data Sheet for additional limitations.

Technical Data

It conforms to ASTM C920 Type S, Grade NS, Class 25, Use NT, G, A and O; CAN/CGSB-19.13-M87; U.S. Federal Specification TT-S-0001543A (COM-NBS) Class A; U.S. Federal Specification TT-S-00230C (COM-NBS) Class A; AAMA 800-92 (802.3 - 92, 808.3-92).

10.1 FL. OZ. (300 ML) CARTRIDGES

CAT. NO.	COLOR
944800	Clear
944806	White

Minimum order: 1 each. All cartridge sealants can be combined for quantity pricing.

CRL Special Properties of Construction Sealants

- Excellent Adhesion to Many Surfaces
- Lower Cost Than Construction Silicones
- Paintable
- Water-Based Available for Easy Clean Up
- Not Used for Structural Glazing

CRL Construction Sealants include Polyurethanes, Acrylic Latex with Silicone, and Butyl Rubber sealants. Polyurethanes are high performance sealants because of their joint movement capability of $\pm 25\%$ and higher. Because of their higher joint movement capability they can be used in many of the same applications as silicones (perimeter caulking around windows and doors, but not to glass), and typically at less cost. Polyurethanes offer excellent bonding to many surfaces and are paintable.

Acrylic Latex with Silicone caulks are water-based, making them easy to clean up. They are used mainly in residential and light commercial construction applications for both interior and exterior work because of their lower movement capability. They typically are paintable after only a short time.

Butyl Rubber Sealants have excellent adhesion to most substrates and exhibit excellent weathering, but because of their limited movement capability they are used in many low movement applications, like lap seams of metal panels, and concealed window frame joints. Butyl Rubber Sealants are also paintable after full cure.

CRL Typical Applications of Construction Sealants

Perimeter Caulking



Construction Polyurethanes for metal-to-concrete/brick storefronts, and residential vinyl window perimeter sealing.

Weatherproofing



Construction Polyurethanes for concrete-to-concrete expansion joints in tilt-ups, and other masonry joints.

Interior Caulking



Acrylic Latex Caulk with Silicone for interior gaps around window frames and baseboards; seals around tubs, sinks, back splashes, and toilets.

Metal Panels



Butyl Rubber Caulk for between metal building panels, aluminum siding, flashing, gutters, and other hidden areas.

CRL M65W PermaWhite Polythane Construction Sealant

SPEC. DATA

MSDS

- **Advanced, Non-Yellowing, One-Part Smooth Finish Formula**
- **Primerless Adhesion on Most Common Construction Surfaces**
- **Low Odor**
- **No Isocyanates and Low VOC's**

Description

CRL M65W is a high performance, medium modulus, fast curing, paintable, one-component, moisture curing modified polyurethane sealant with advanced non-yellowing formula and a smooth finish appearance. Contains no isocyanates and low VOC. Low odor for interior or exterior applications. M65's fast cure time allows painting in just two hours.



10.1 Fl. Oz. (300 ml);
30 Cartridges Per Case;
1440 Cartridges Per Pallet

Basic Uses

CRL M65W is ideal for door and window frame perimeters. Specifically developed for sealing dynamically moving joints, such as expansion and control joints, precast concrete panel joints, curtainwall joints, perimeter caulking (masonry, windows, doors, skylights, panels), bedding of mullions, panels, and frames. It is compatible with insulating glass sealants when glazing units and applied as a toe or heel bead. Reduced fluid migration, or exudation, allows applications with new self-cleaning glass. M65W exhibits tenacious adhesion, which will not dissipate with time, to pre-painted metals, plywood, glass, aluminum, steel, fiber cement, SMC, RIM, FRP, vinyl, and many plastics and composites. Capable of $\pm 25\%$ joint movement in a well-designed joint. This unique weather-resistant formulation possesses a balanced adhesive strength, medium modulus, and high recovery, making it ideal to withstand the following adverse conditions common to such installations: moisture, movement, shear, and deflection. Best of all, it is non-yellowing and non-staining.

Technical Data

Conforms to U.S. Federal Specification TT-S-00230C, Type II, Class A; ASTM C 920-98, Type S, Grade NS, Class 25, Use NT, M, A, G, and O; CAN/CGSB 19.13-M87; USDA Approved. Meets California Air Resources Board 2003 requirements for Volatile Organic Compound (VOC) content. Qualifies for **LEED®** (Leadership in Energy and Environmental Design) Green Building Rating System™ credit.

Comparable Sealants

CRL: M66 Polyurethane Sealant, M64 Polyurethane Sealant.
Tremco®: Vulkem 921, Vulkem® 116, DyMonic, Dymonic® FC, TremGlaze U1400, TremPro 626. **Sika:** 1A, 15LM.
Sonneborn: NP1, Sonolastic 150. **Pecora:** Dynatrol 1-XL.
OSI: PR-255. **Schnee Moorehead:** 7100. **Bostik:** Chem-Calk 900.
DAP: Side Winder.



White

Color shown is approximate

UV EXPOSURE COMPARISON

Standard White Polyurethane

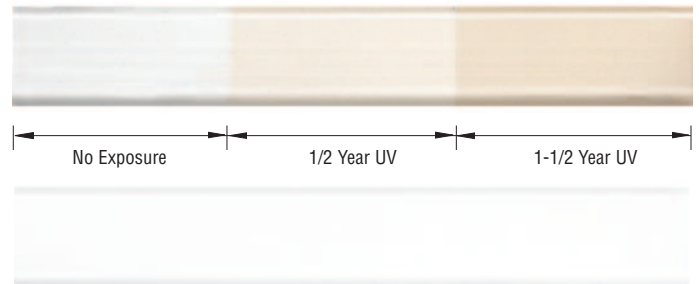

M65W PermaWhite Polythane

Limitations

Not recommended for structural glazing, sealing horizontal decks, patios, driveway or terrace joints where abrasion is possible, food contact, potable water applications, sealing below the waterline in marine applications, or mirrors. Do not apply over damp or contaminated surfaces. Use with adequate ventilation. Not recommended for surfaces with special protective or cosmetic coatings without prior consultation of the manufacturer. Should not be applied to unpredictably absorptive surfaces such as marble, limestone or granite unless a standard of appearance has been agreed on as a result of testing for stain and/or discoloration. Testing prior to painting with oil-based paints is recommended. Check cartridge label and Specification Data Sheet for additional limitations.

10.1 FL. OZ. (300 ML) CARTRIDGES

CAT. NO.	COLOR
M65W	White

Minimum order: 1 each. All cartridge sealants can be combined for quantity pricing.

CRL M66 Polyurethane Construction Sealant

SPEC. DATA

MSDS

- One-Part Grainy **Textured** Finish Formula With Primerless Adhesion on Most Common Construction Surfaces
- Excellent Sealant for Interior or Exterior Use
- Durable and Flexible Performance in Moving Joints

Description

CRL M66 Polyurethane is a one-part, moisture curing, gun grade polyurethane sealant. It does not require a primer on most common construction surfaces. CRL M66 is durable, flexible, and offers excellent performance in moving joints.

Basic Uses

CRL M66 is an excellent general purpose sealant designed for sealing dynamically moving joints, such as expansion and control joints, precast concrete panel joints, curtainwall joints, window and door frame perimeters, and similar types of masonry and construction joints. Adheres to common substrates such as brick, concrete, aluminum, vinyl, wood, and granite. The light grainy texture has proven very popular for matching textured substrates like stucco and masonry, and for smooth metal storefront joints where the light texture blends and hides tooling marks and the wavy effect that is inevitable when tooling sealants.

CRL M66 is compatible with insulating glass sealants when glazing units and applied as a toe or heel bead. It is suitable for continual immersion in water with the appropriate primer. CRL M66 is designed for exterior and interior use. Withstands temperatures after full cure from -40°F to 180°F (-40 to 82°C). Paintable after full cure (minimum 72 hours). It is also suitable for varied manufacturing uses, such as the production of travel trailers and mobile homes, and in the assembly of galvanized air conditioning ductwork.

Technical Data

Conforms to U.S. Federal Specification TT-S-00230C, Type II, Class A; ASTM C920-98, Type S, Grade NS, Class 25, Use NT, M, T, A, G, and O. CAN/CGSB 19.13-M87, Type MCG-225-A-N with QPL #81050; USDA Approved. Meets California Air Resources Board 2003 requirements for Volatile Organic Compound (VOC) content. Qualifies for **LEED**® (Leadership in Energy and Environmental Design) Green Building Rating System™ credit.

Limitations

Do not apply over damp or contaminated surfaces. Use with adequate ventilation. Not recommended for surfaces with special protective or cosmetic coatings without prior consultation of the manufacturer. Should not be applied to mirrors or unpredictable absorptive surfaces such as marble, limestone or granite unless a standard of appearance has been agreed on as a result of testing for stain and/or discoloration. Check cartridge label and Specification Data Sheet for additional limitations.

Comparable Sealants

CRL: M64 Polyurethane Sealant, M65W PermaWhite. **Tremco**®: Vulkem® 116, Vulkem 921, DyMonic, Dymonic® FC, TremGlaze U1400, TremPro 626. **Sika**®: 1A, 15LM. **Sonneborn**®: NP1. **Pecora**®: Dynatrol 1. **OSI**®: PR-255. **Schnee Moorehead**: 7100 Sealant. **Bostik**: Chem-Caulk 900.



10.1 Fl. Oz. (300 ml);
30 Cartridges Per Case;
1440 Cartridges Per Pallet

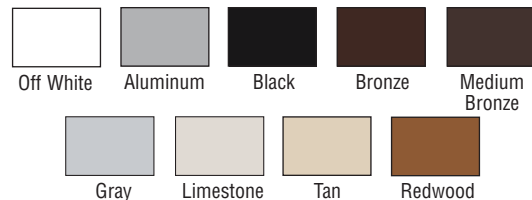

Colors shown are approximate

• Cost-Saving Sausage Packs

20.3 Fl. Oz. (600 ml);
15 Sausages Per Case;
990 Sausages Per Pallet



CRL M66 is also available in cost-saving sausage packs for sausage loading guns, such as our GA1205 (manual), LD717 (cordless) or WG6100620 (air). Bulk sausage packing means less waste and better economy per use, so you get the same great quality with less expense.

10.1 FL. OZ. (300 ML) CARTRIDGES

30 PER CASE

CAT. NO.	COLOR
M660FW	Off White
M66AL	Aluminum
M66BL	Black
M66BRZ	Bronze
M66MBRZ	Medium Bronze
M66GRY	Gray
M66L	Limestone
M66T	Tan
M66RW	Redwood

Minimum order: 1 each. Cartridges and sausages can be combined for quantity pricing.

20.3 FL. OZ. (600 ML) SAUSAGES

15 PER CASE

CAT. NO.	COLOR
M66S0FW	Off White
M66SBRZ	Bronze
M66SGRY	Gray

Minimum order: 15 each. Cartridges and sausages can be combined for quantity pricing.

CRL M64 Polyurethane Construction Sealant

SPEC. DATA

MSDS

- One-Part **Smooth** Finish Formula With Primerless Adhesion on Most Common Construction Surfaces
- AAMA Approved
- Excellent Performance in Moving Joints

Description

CRL M64 is a high performance, low modulus, one-component, moisture curing, modified polyurethane sealant. It has a smooth, even consistency and surface when cured. M64 requires no priming for common substrates such as brick, concrete, aluminum, wood, and granite. It applies with any standard cartridge size caulking gun to clean, dry surfaces.

Basic Uses

CRL M64 was specifically developed for sealing dynamically moving joints, such as: expansion and control joints, precast concrete panel joints, curtainwall joints, perimeter caulking (masonry, windows, doors, panels), bedding of mullions, panels, and frames. Adheres to common substrates such as brick, concrete, aluminum, vinyl, wood, and granite.

CRL M64 is compatible with I.G. sealants when glazing units and applied as a toe or heel bead. M64 exhibits tenacious adhesion that will not dissipate with time. This unique weather-resistant formulation possesses a balanced adhesive strength, low modulus, and high recovery, making it ideal to withstand the following adverse conditions common to such installations: moisture, movement, shear, and deflection. Withstands temperatures after full cure from -40°F to 180°F (-40 to 82°C). M64 is suitable for continual immersion in water with the use of the appropriate primer. It is paintable after full cure (minimum 72 hours).

Technical Data

Conforms to U.S. Federal Specification TT-S-00230C, Type II, Class A; ASTM C 920-98, Type S, Grade NS, Class 25, Use NT, M, A, G, and O; CAN/CGSB 19.13-M87, Type MCG-225-A-N with QPL #81050; AAMA 802.3-92 Type 1, 802.3-92 Type 2, and 808.3-92. USDA Approved. Meets California Air Resources Board 2003 requirements for Volatile Organic Compound (VOC) content. Qualifies for **LEED**® (Leadership in Energy and Environmental Design) Green Building Rating System™ credit.

Limitations

Do not apply over damp or contaminated surfaces. Use with adequate ventilation. Not recommended for surfaces with special protective or cosmetic coatings without prior consultation of the manufacturer. Should not be applied to mirrors or unpredictably absorptive surfaces such as marble, limestone or granite unless a standard of appearance has been agreed on as a result of testing for stain and/or discoloration. Check cartridge label and Specification Data Sheet for additional limitations.

Comparable Sealants

CRL: M66 Polyurethane Sealant, M65W PermaWhite. **Tremco**®: Vulkem 921, Vulkem® 116, DyMonic, Dymonic® FC, TremGlaze U1400, TremPro 626. **Sika**®: 1A, 15LM. **Sonneborn**®: NP1. **Pecora**®: Dynatrol 1. **OSI**®: PR-255. **Schnee Moorehead**: 7100. **Bostik**: Chem-Calk 900.



10.1 Fl. Oz. (300 ml);
30 Cartridges Per Case;
1440 Cartridges Per Pallet

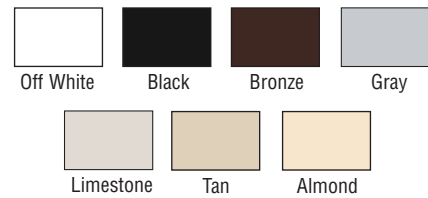

Colors shown are approximate

• Cost-Saving Sausage Packs

20.3 Fl. Oz. (600 ml);
15 Sausages Per Case;
990 Sausages Per Pallet



CRL M64 is also available in cost-saving sausage packs for sausage loading guns, such as our GA1205 (manual), LD717 (cordless) or WG6100620 (air). Bulk sausage packing means less waste and better economy per use, so you get the same great quality with less expense.

10.1 FL. OZ. (300 ML) CARTRIDGES

30 PER CASE

CAT. NO.	COLOR
M640FW	Off White
M64BL	Black
M64BRZ	Bronze
M64GRY	Gray
M64L	Limestone
M64T	Tan

Minimum order: 1 each. Cartridges and sausages can be combined for quantity pricing.

20.3 FL. OZ. (600 ML) SAUSAGES

15 PER CASE

CAT. NO.	COLOR
M64S0FW	Off White
M64SBRZ	Bronze
M64SGRY	Gray
M64SALM	Almond

Minimum order: 15 each. Cartridges and sausages can be combined for quantity pricing.

CRL POLYURETHANE CONSTRUCTION SEALANTS

For Pricing Visit Our Web Site or Call Us Toll Free at the Phone Numbers Shown on the Back Cover

CRL Vulkem® 116 Polyurethane Sealant

SPEC. DATA

MSDS

- Primerless Adhesion on Most Common Construction Surfaces

- One-Part Grainy Textured Finish

Description

CRL Vulkem® 116 Sealant is a one-part moisture curing, gun grade polyurethane sealant. Vulkem® 116 is durable, flexible, and offers excellent performance in moving joints. No primer is required on most construction materials, and it applies with conventional caulking guns.

Basic Uses

Vulkem® 116 is an excellent general purpose sealant designed for use in precast masonry, glazing, window frame perimeters, and similar types of construction joints. Suitable for continual immersion in water with the appropriate primer. Designed for exterior and interior use, the light, grainy texture has proven very popular for matching textured substrates like stucco and masonry, and for smooth metal storefront joints. The light texture blends and hides tooling marks, and the wavy effect that is inevitable when tooling Sealants.

Technical Data

Conforms to U.S. Federal Specification TT-S-00230C, Type II, Class A; ASTM C920, Type S, Grade NS, Class 25, Use NT, M, T, A, I (Class 2), and O. USDA approved. CAN/CGSB 19.13-M87. Canadian Food Inspection Agency. City of Los Angeles (COLA) approval standards.

Limitations

Do not apply to damp or contaminated surfaces. Not recommended for surfaces with special protective or cosmetic coatings without prior consultation of the manufacturer. Use with adequate ventilation. Check cartridge label and Specification Data Sheet for additional limitations.



10.1 Fl. Oz. (300 ml);
30 Cartridges Per Case;
1800 Cartridges Per Pallet



Colors shown are approximate

Comparable Sealants

CRL: M66 Polyurethane Sealant, M64 Polyurethane Sealant, M65W PermaWhite. **Dap:** Premium Polyurethane. **Tremco®:** Vulkem 921, DyMonic, TremGlaze U1400, TremPro 626. **Sika:** 1A, 15LM, Sikaflex®-201 US, Sikaflex®-201 Textured, Sikaflex®-219 LM. **Sonneborn:** NP1. **Pecora:** Dynatrol 1-XL. **OSI:** PR-255. **Schnee Moorehead:** 7100. **Bostik:** Chem-Calk 900.

10.1 FL. OZ. (300 ML) CARTRIDGES

CAT. NO.	COLOR
V116W	White
V116BL	Black
V116BRZ	Bronze
V116GRY	Gray
V116L	Limestone
V116T	Tan

Minimum order: 1 each. All cartridge sealants can be combined for quantity pricing.

CRL Vulkem® 45 SSL One-Part Semi Self-Leveling Polyurethane

SPEC. DATA

MSDS

NO AIR FREIGHT

- Suitable for Slopes Up to Six Percent
- Exceptional Wear and Tear Resistance

Description

CRL Vulkem® 45 SSL Polyurethane is a one-part moisture curing, low modulus polyurethane sealant especially developed for sealing joints in level and/or slightly sloped surfaces. Exceptional wear and tear resistance in high traffic areas.

Basic Uses

Vulkem® 45 SSL's high adhesive strength to common construction materials makes this the material of choice for a wide variety of applications. Use 45 SSL in expansion joints in sidewalks, parking decks, plazas, floors and other horizontal surfaces with slopes of up to six percent. Light tooling can be done immediately after application if necessary. Suitable for use in continuous immersion in non-chlorinated water, and can be applied to green concrete.

Technical Data

Meets or exceeds the following specifications: ASTM C920, Type S, Grade P, Class 50, Use M, T, A, I (Class 2) and O. CAN/CGSB 19.13-M87, MC-1-25-B-N.



30 Fl. Oz. (890 ml)
12 Cartridges Per Case



Colors shown are approximate

Limitations

Do not apply to damp or contaminated surfaces. Use with adequate ventilation. Check cartridge label and Specification Data Sheet for additional limitations.

Comparable Sealants

Sika: 1CSL. **Sonneborn:** SL 1.

30 FL. OZ. (890 ML) CARTRIDGES

CAT. NO.	COLOR
445707	Buff
445805	Limestone
445806	White

Minimum order: 1 each. All cartridge sealants can be combined for quantity pricing.

CRL POLYURETHANE CONSTRUCTION SEALANTS

For Pricing Visit Our Web Site or Call Us Toll Free at the Phone Numbers SHOWN on the Back Cover

CRL Tremco® Dymonic® FC Polyurethane Sealant

SPEC. DATA

MSDS

- Fast Skin Time, Less Dirt Pick Up
- Primerless Adhesion on Most Common Construction Substrates
- Regular DyMonic Also Available in Sausage Packs

Description

CRL Tremco® Dymonic® FC is a fast skinning, high performance, low modulus, one-component, moisture curing, polyurethane sealant. Dymonic® FC features a smooth, consistent surface when cured. It requires no priming when used on most common substrates, provided surfaces are dry, clean, and free from contaminants. It is supplied in a non-sag consistency which will gun easily with conventional caulking equipment. Because it skins in only one hour at 70°F (21°C) there is less dirt pick up compared to other polyurethane sealants. Regular DyMonic typical skin time is 16 hours at 70°F (21°C).



10.1 Fl. Oz. (300 ml);
30 Cartridges Per Case;
1800 Cartridges Per Pallet

Basic Uses

Dymonic® FC can be used to seal dynamic moving joints in precast concrete panels, curtainwall, and tilt-up panels. Also for expansion and control joints, perimeter caulking of windows and doors, bedding of mullions, frames, and panels. It develops a strong adhesive bond that will not deteriorate, and exhibits excellent weather resistance. Its balance of properties (high strength, low modulus, high recovery) makes it able to withstand moisture, shear, and deflection movement. Dymonic® FC exhibits a tenacious adhesion which will not diminish over product life.

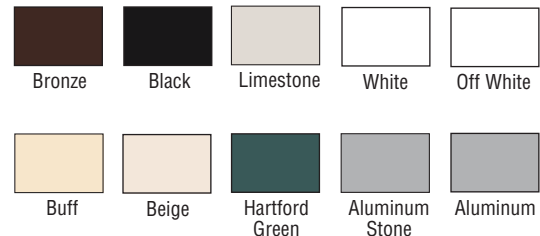

Colors shown are approximate

Technical Data

Meets U.S. Federal Specification TT-S-00230C, Type II, Class A; Canadian standard CAN/CGSB-19.13-M87; and ASTM C 920, Type S, Grade NS, Class 50 (Dymonic® FC) Class 25 (DyMonic), Use NT, M, A and O.

Limitations

Do not apply to damp or contaminated surfaces. Some substrates may require priming, such as certain high performance paints and architectural finishes. Painting over DyMonic is not a recommended practice since paint may crack and peel when joint movement occurs. Check cartridge label and Specification Data Sheet for additional limitations.

Comparable Sealants

CRL: M66 Polyurethane Sealant, M64 Polyurethane Sealant, M65W PermaWhite. **Tremco®:** Vulkem® 116, Vulkem 921, TremGlaze U1400, TremPro 626. **Sika:** 1A, 15LM. **Sonneborn:** NP1. **Pecora:** Dynatrol 1. **OSI:** PR-255. **Schnee Moorehead:** 7100. **Bostik:** Chem-Calk 900.

• Cost-Saving Sausage Packs

20.3 Fl. Oz. (600 ml);
15 Sausages Per Case;
990 Sausages Per Pallet



CRL DyMonic is also available in cost-saving sausage packs for sausage loading guns, such as our GA1205 (manual), LD717 (cordless) or WG6100620 (air). Bulk sausage packing means less waste and better economy per use, so you get the same great quality with less expense.

10.1 FL. OZ. (300 ML) CARTRIDGES – DYMONIC® FC 30 PER CASE

CAT. NO.	COLOR
960801323	Bronze
960802323	Black
960805323	Limestone
960806323	White
960807323	Buff
960808323	Beige
960824323	Hartford Green
960851323	Aluminum Stone
960878323	Aluminum

Minimum order: 1 each. Cartridges and sausages can be combined for quantity pricing.

20.3 FL. OZ. (600 ML) SAUSAGES – DYMONIC 15 PER CASE

CAT. NO.	COLOR
9503564	Bronze
9503485	Black
9503584	Limestone
9503574	Off White
9503504	Aluminum Stone

Minimum order: 15 each. Sausages and cartridges can be combined for quantity pricing.

CRL Backer Rod

See pages N186-N189 for CRL Backer Rod

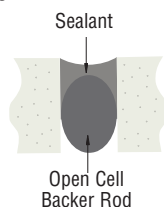

CRL POLYURETHANE CONSTRUCTION SEALANTS

For Pricing Visit Our Web Site or Call Us Toll Free at the Phone Numbers Shown on the Back Cover

CRL Tremco® Dymeric® 240FC Polyurethane Sealant

- Multi-Component, Chemically Curing
- Gun Grade Consistency

Description

CRL Tremco® Dymeric® 240FC is a patented, multi-component, chemically curing, polyurethane sealant specifically formulated for dynamically moving building joints.

Basic Uses

Dymeric® 240FC provides non-sag, flexible, durable, weathertight seals in such areas as: expansion joints in masonry and metal curtainwall; perimeter joints of sash, panels and doors; exterior insulated finish systems; severe outdoor applications with ultraviolet exposure. Dymeric® 240FC has a gun grade consistency and is easily workable in hot and cold climates producing a smooth, attractive bead. It adheres without primer in most applications (concrete, wood, brick, and masonry). **NOTE:** Requires one Color Pak Pouch per 1-1/2 gallon (5.7 l) pail (not included).

Technical Data

Meets U.S. Federal Specification TT-S-00227E, Class A, Type II; ASTM C 920, Type M, Grade NS, Class 50, Use NT, T, M, A, and O; Canadian Standard CAN/CGSB-19.24-M90, Type II Class B.



1.5 Gal. (5.7 l) in 2 Gal. (7.6 l) Pail; 96 Pails Per Pallet

SPEC. DATA

MSDS



Requires One Color Pack Pouch Per 1-1/2 Gallon (5.7 l) Pail (Sold Separately)

Limitations

Do not apply to damp or contaminated surfaces. Not recommended for glazing of acrylic or polycarbonate sheets; vehicular traffic joints, applications on glass, anodized aluminum and other special architectural finishes without prior adhesion testing; some marble and natural stone substrates without additional surface preparation. Check pail label and Specification Data Sheet for additional limitations.

Comparable Sealants

Sika: 2C NS. **Sonneborn:** NP2. **Pecora:** Dynatrol II.

CAT. NO.	DESCRIPTION
DYM240FC	Dymeric 240FC Tint Base

Minimum order: 1 each. Can be combined with THC-900 for quantity pricing.

CRL Tremco® THC-900 Horizontal Joint Sealant

- Self-Leveling Expansion Joint Sealant for Slopes of 5% or Less
- Multi-Component, Chemically Curing



1.5 Gal. (5.7 l) in 2 Gal. (7.6 l) Pail; 96 Pails Per Pallet

SPEC. DATA

MSDS



Requires One Color Pack Pouch Per 1-1/2 Gallon (5.7 l) Pail (Sold Separately)

Basic Uses

Weatherproofs horizontal expansion and control joints with a 5% slope or less. THC-900 forms a flexible, watertight seal designed to withstand cyclical movement and heavy traffic wear in horizontal joints, such as those found in plazas, sidewalks, driveways, garages, and concrete floors.

Technical Data

Meets the requirements of U.S. Federal Specification TT-S-00227E, Type I, Class A; ASTM C920, Type M, Grade P, Class 25, Use T, M, O. USDA approved.

CAT. NO.	DESCRIPTION
THC900	THC-900 Tint Base

Minimum order: 1 each. Can be combined with DYM240FC for quantity pricing.

CRL Tremco® Color Pak System

- For Use with Dymeric® 240FC and THC-900
- One Easy to Open Color Pak Mixes with One 1-1/2 Gallon (5.7 l) Base

MSDS



Basic Uses

CRL Tremco® Color Pak additives for Tremco® multi-component polyurethanes provide excellent uniformity and a visual index of proper mixing. Required for use with Dymeric® 240FC and THC-900. One pouch mixes with a 1-1/2 gallon (5.7 l) tint base unit. Available in six standard colors, custom color matching is also available on a special order basis. Packed six pouches per case.

CAT. NO.	COLOR
105511	Precast White
105501	Bronze
105502	Black
105503	Off White
105505	Limestone
105551	Aluminum Stone

See pages N208-N209, and N218 for Mixing Paddles and Bulk Load Caulking Guns



CAT. NO. MX91

Minimum order: 1 each. Colors can be combined for quantity pricing.

CRL 321 Acrylic Latex With Silicone

- Paintable and Easily Cleaned Up With Soap and Water
- Can Be Used on Exterior or Interior Surfaces
- Mildew Resistant
- 35 Year Warranty

Description

A premium quality acrylic caulk with silicone, featuring outstanding properties including adhesion, weather resistance, low shrinkage, water clean up, and more. The acrylic base offers outstanding adhesion and resistance to oxidation and ultraviolet rays. The siliconized feature improves the flexibility and adhesion to ceramic and glass substrates.

Basic Uses

CRL 321 Acrylic Latex with Silicone is truly a versatile caulk featuring easy tooling and water clean up. A special blend of silicone and acrylic latex that provides superior primerless adhesion to building materials such as wood, brick, glass, plastic, vinyl, plaster, drywall, metal, and ceramics. The silicone gives it flexibility, the acrylic promotes long life expectancy. Together they form an excellent sealant that can be used around window and door frames, for siding and trim work, caulking tubs and sink tops, thresholds and baseboards. It may be used to grout marble and ceramic tile, repair mortar joints, and, under controlled conditions, to bed insulating glass units and storm windows.

CRL 321 can be used for interior or exterior applications since it is odor free and offers superior weatherability. Capable of $\pm 10\%$ joint movement in a well-designed joint. Can be applied at outdoor temperatures as low as 40°F to 120°F (4° to 49°C), and withstands extreme temperatures after full cure from 0°F to 180°F (-17° to 82°C). CRL 321 can be used in areas with high moisture, such as showers, bathrooms, sinks and kitchens, since it is mold and mildew resistant, and is paintable with oil or latex based paint. CRL 321 can be tooled for approximately 30 minutes, and can be painted over after two hours with oil or latex based paints.

Comparable Sealants

CRL: 800. **Pecora**®: AC-20. **DAP**®: Alex-Plus®, Alex Fast Dry™, Dynaflex 230®. **OSI**®: Polyseamseal Acrylic Caulk with Silicone, SA-167, Pro-Stik. **Sonneborn**®: Sonolac. **Tremco**®: 834, TremGlaze SA1100, TremPro 655.



Screw-On Additional
CAT. NO. S1LNOZ
Nozzles Available

10.1 Fl. Oz. (300 ml);
30 Cartridges Per Case;
1440 Cartridges Per Pallet



Colors shown are approximate

Technical Data

Exceeds the requirements of ASTM C-834-00 Standard Specification for Latex Sealing Compounds, ASTM C-920 and TT-S00230C Meets California Air Resources Board 2003 requirements for Volatile Organic Compound (VOC) content. Qualifies for **LEED**® (Leadership in Energy and Environmental Design) Green Building Rating System™ credit.

Limitations

Should not be used in applications that will be immersed in water. Should not be exposed to water or rain for at least 24 hours. Always apply when temperatures are above 40°F (4°C). Protect from freezing until fully cured. Check cartridge label and Specification Data Sheet for additional limitations.

10.1 FL. OZ. (300 ML) CARTRIDGES

CAT. NO.	COLOR
321W	White
321C	Clear
321ALM	Almond
321BRZ	Bronze
321GRY	Gray

Minimum order: 1 each. All cartridge sealants can be combined for quantity pricing.

CRL Caulking Guns

CRL offers an extensive selection of Caulking Guns. (see pages N205-N212). The LD188 Cordless Caulking Gun shown here works great with Acrylic Latex Caulks.



CAT. NO. LD188



CRL 800 Acrylic Latex With Silicone

- Paintable and Easily Cleaned Up With Soap and Water
- Can Be Used on Exterior or Interior Surfaces
- Mildew Resistant

Description

A premium quality acrylic caulk with silicone, featuring outstanding properties including adhesion, weather resistance, low shrinkage, water clean up, and more. The acrylic base offers outstanding adhesion and resistance to oxidation and ultraviolet rays. The siliconized feature improves the flexibility where slight to moderate movement is anticipated, and adhesion to ceramic and glass substrates.

Basic Uses

CRL 800 Acrylic Latex with Silicone is a pure acrylic latex sealant featuring easy tooling and water clean up. A special blend of silicone and acrylic latex that provides superior primerless adhesion to building materials such as wood, brick, glass, plastic, vinyl, plaster, drywall, metal, and ceramics. The silicone gives it flexibility; the acrylic promotes long life expectancy. Together they form an excellent sealant that can be used around window and door frames, for siding and trim work, caulking tubs and sink tops, thresholds and baseboards. It may be used to grout marble and ceramic tile, repair mortar joints, and, under controlled conditions, to bed insulating glass units and storm windows.

CRL 800 can be used for interior or exterior applications since it is odor free and offers superior weatherability. Capable of $\pm 10\%$ joint movement in a well-designed joint. Can be applied at outdoor temperatures as low as 40°F to 120°F (4° to 49°C), and withstands extreme temperatures after full cure from 0°F to 180°F (-17° to 82°C). CRL 800 can be used in areas with high moisture, such as showers, bathrooms, sinks and kitchens, since it is mold and mildew resistant, and is paintable with oil or latex-based paint. CRL 800 can be tooled for approximately 30 minutes, and can be painted over after two hours with oil or latex-based paints.

Comparable Sealants

CRL: 321. **Pecora®:** AC-20. **DAP®:** Alex-Plus®, Alex Fast Dry™, Dynaflex 230®. **OSI®:** Polyseamseal Acrylic Caulk with Silicone, SA-167, Pro-Stik. **Sonneborn®:** Sonolac. **Tremco®:** 834, TremGlaze SA1100, TremPro 655.

CRL Tapered Wood Shims

See page N196 for the complete selection.



White Wood Shims

Cedar Wood Shims

Wood Composite Shims



Bulk Shims

SPEC DATA

MSDS



10.5 Fl. Oz. (310 ml);
30 Cartridges Per Case;
1440 Cartridges Per Pallet

Screw-On Additional
Nozzles Available
CAT. NO. S1LNOZ



White Bronze Gray

Colors shown are approximate

Technical Data

Exceeds the requirements of ASTM C-834-95 Standard Specification for Latex Sealants. Qualifies for LEED® (Leadership in Energy and Environmental Design) Green Building Rating System™ Credit.

Limitations

The sealant must be protected from water for 24 hours after application; do not caulk on the exterior when rain is imminent. For insulating glass units and storm windows, the windows must be properly weeped or entrapped water could cause reversion. Sealant must be given additional time to fully cure before windows are installed because of the closed-in conditions. Protect from freezing before fully cured. Check cartridge label and Specification Data Sheet for additional limitations.

10.5 FL. OZ. (310 ML) CARTRIDGES

30 PER CASE

CAT. NO.	COLOR
800W	White
800BRZ	Bronze
800GRY	Gray

Minimum order: 1 each. All cartridge sealants can be combined for quantity pricing.

CRL15W Premium Grade Acrylic Latex Caulk

- Paintable and Easily Cleaned With Soap and Water
- Odorless and Adheres to All Common Interior Substrates
- 25 Year Life Expectancy

Description

A superior quality Acrylic Latex Caulk formulated to meet the needs of the professional or the do-it-yourselfer. CRL15W guns with a creamy consistency, and is easily cleaned with soap and water.

Basic Uses

CRL15W is specially formulated for interior sealing around window frames, door frames, baseboards, moldings, plaster walls, etc. It adheres to plaster, drywall, painted and unpainted wood, masonry, and aluminum. It can be applied at outdoor temperatures as low as 40°F (5°C) to +90°F (32°C), and withstands extreme temperatures after full cure from 0°F (-18°C) to +200°F (94°C). May be painted when a skin has formed, usually after two hours of application for latex paint or 24 hours if using an oil-based paint.

Limitations

Maximum joint dimension is 1/2" x 1/2" (13 x 13 mm). Check cartridge label and Specification Data Sheet for additional limitations.



10.1 Fl. Oz. (300 ml);
24 Cartridges Per Case;
1920 Cartridges Per Pallet



Technical Data

Meets or exceeds the requirements of ASTM C-834. Meets California Air Resources Board 2003 requirements for Volatile Organic Compound (VOC) contents. Qualifies for **LEED®** (Leadership in Energy and Environmental Design) credit.

Comparable Sealants

Red Devil®: Interior Wall & Wood. **DAP®**: Alex® Painters, **RELY-ON®**. **OSI®**: LC-160.

10.1 FL. OZ. (300 ML) CARTRIDGES

CAT. NO.	COLOR
CRL15W	White

Minimum order: 1 each. All cartridge sealants can be combined for quantity pricing.

CRL DAP Kwik-Seal Tub and Tile Caulk

- Dries Tack Free in 15 Minutes
- Mildew Resistant and Paintable
- Water Clean-Up
- Low VOC Content

Description

CRL DAP Kwik-Seal Tub and Tile Caulk makes a neat, white, watertight seal around tubs, sinks and shower stalls. It also resets loose tile, and caulks indoor window and door frames. It adheres to ceramic and plastic tile, wood, metal, plaster, glass, porcelain, and fiberglass.

Basic Uses

DAP Kwik-Seal can be used to seal tubs, sinks, fixtures, back splashes, shower stalls, and loose tiles. Dap Kwik-Seal dries fast, yet stays flexible and resists mildew. Kwik-Seal is paintable and easy to apply. It is easy to clean just using water.



5.5 Fl. Oz. (162 ml);
12 Tubes Per Case

CAT. NO.	COLOR
DAP18001	White

Minimum order: 1 each. All cartridge sealants can be combined for quantity pricing.



CRL DAP Vinyl Spackling Compound

- Use Interior or Exterior
- Can Be Painted
- Easy to Sand
- Spreads Smoothly

Description

CRL DAP Vinyl Spackling is a ready-mixed compound for easy interior or exterior patching.

Basic Uses

DAP Vinyl Spackling may be used to fill holes and cracks in surfaces such as drywall, plaster, wood, brick, stone, and concrete. Will not crack, crumble, or flake yet dries hard, sands easily, and can be painted.



32 Fl. Oz. (946 ml);
6 Quarts Per Case

CAT. NO.	COLOR
DAP12132	White

Minimum order: 1 each.



CRL BUTYL RUBBER SEALANTS

For Pricing Visit Our Web Site or Call Us Toll Free at the Phone Numbers Shown on the Back Cover

CRL 777 Butyl Rubber Sealant

SPEC. DATA

MSDS

NO AIR FREIGHT



- Excellent Adhesion to a Variety of Clean Surfaces
- Superior Exterior Weathering Properties
- Easy to Apply and Tool

Description

CRL 777 Butyl Rubber is a unique, butyl-based sealant specially formulated using a blend of age resistant polymers to give excellent weathering properties at various temperature extremes. CRL 777 offers excellent adhesion to most clean surfaces, and will withstand joint movement of $\pm 10\%$ without affecting its water-tightness. It also has a special ultraviolet fighting agent for exceptional service life.

Basic Uses

Recommended for exterior applications, CRL 777 Butyl Rubber Sealant features excellent adhesion to wood, masonry, glass, concrete, some plastics, and metal surfaces. Hidden areas, such as under sill cans, thresholds, and around screw heads are excellent applications. Other areas, such as between metal building panels, wall-mounted air conditioning units, under aluminum siding and gutters are all good applications for proven butyl sealants. Application temperature range is 40° to 120°F (4° to 49°C). Service temperature range is -20° to 200°F (-29° to 93°C). Paint time is 24 hours.

Comparable Sealants

CRL: 888. **Adco:** B-100, AP-77. **DAP®:** Butyl Flex. **OSI®:** SBR-100. **Pecora®:** BC-158. **PTI:** 757. **PSI:** 301. **Tremco®:** Butyl Sealant.

Technical Data

Meets Federal Specifications TT-S-001657, Type 1, TT-C-1796A, ASTM C 1311, and AAMA 808.3-05; USDA Certified.

Limitations

Not recommended for use in sealing horizontal decks, patios, driveways or terrace joints where abrasion or physical abuse is encountered. Not recommended for use in window glazing applications or hidden joint details, which require a non-skinning, non-hardening sealant. CRL 777 has a solvent based curing system. A slight odor of mineral spirits will be detected during application, which is normal. Do not use where this odor may be objectionable, such as refrigeration units that will be stocked soon after construction. Check cartridge label and Specification Data Sheet for additional limitations.

NOTE: All colors are available in bulk packaging.

11 FL. OZ. (326 ML) CARTRIDGES

CAT. NO.	COLOR
777W	White
777BL	Black
777BRZ	Bronze
777GRY	Gray

Minimum order: 1 each. All cartridge sealants can be combined for quantity pricing.

CRL Sealant Spatulas and Putty Knives

CRL offers a complete line of Sealant Spatulas and Putty Knives to assist in tooling sealants. See pages N216-N217 and N228 to N232.

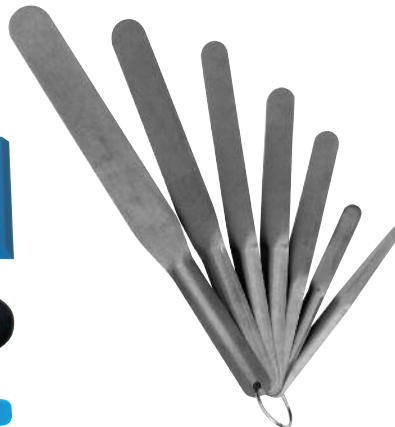

C.R. LAURENCE COMPANY

N136 |

crlaurence.ca

crlaurence.com.au

crlaurence.co.uk

crlaurence.de

crlaurence.eu

crlaurence.com

CRL 888 Premium Grade Caulking Compound

- Multi-Functional, All Weather Caulk
- Economical Air and Watertight Seal
- Non-Stringy and Easy to Apply and Tool

Description

CRL 888 Premium Grade Caulking is a general purpose butyl-based sealant suitable for use in joints where economical, maintenance-free, and watertight seals are required.

Basic Uses

CRL 888 is designed for use in joints measuring 3/8" (9.5 mm) or less in metal, glass, wood, plastic, and concrete. This sealing compound is easy to apply with standard manual caulking guns. CRL 888 Premium Grade Caulking is non-stringy during application, and contains no asbestos minerals. When fully cured it forms an elastic, all-weather resistant seal which bonds to many surfaces. Application temperature range is 40° to 120°F (4° to 49°C). It also withstands temperature changes from -20° to 200°F (-29° to 93°C). It is recommended for caulking exterior and interior construction units, under thresholds and aluminum siding, between metal building panels and truck body joints, and many other areas. CRL 888 Premium Grade Caulking will not harden or crack with age, and its color is stable to ultraviolet exposure. It features a non-staining, solvent release formula that bonds to a variety of surfaces. Two hour tack free time, it is 90% cured in 21 days. Paint time is 24 hours.

Comparable Sealants

CRL: 777. **Adco:** B-100, AP-77. **DAP®:** Butyl-Flex. **OSI®:** SBR-100. **Pecora®:** BC-158. **PSI:** 301. **PTI:** 757. **Tremco®:** Butyl Sealant.



11 Fl. Oz. (326 ml);
30 Cartridges Per Case;
1440 Cartridges Per Pallet



Technical Data

Meets Federal Specifications TT-S-001657, TT-C00598C, TT-C-1796A, ASTM C 1085, ASTM C1311, and AAMA 808.3.

Limitations

Not recommended for use in sealing horizontal decks, patios, driveways or terrace joints where abrasion or physical abuse is encountered. Not recommended for use in window glazing applications or hidden joint details, which require a non-skinning, non-hardening sealant. CRL 888 has a solvent based curing system. A slight odor of mineral spirits will be detected during application, which is normal. Do not use where this odor may be objectionable, such as refrigeration units that will be stocked soon after construction. Check cartridge label and Specification Data Sheet for additional limitations.

11 FL. OZ. (326 ML) CARTRIDGES

30 PER CASE

CAT. NO.	COLOR
888W	White
888BLBRZ	Black/Bronze
888GRY	Gray

Minimum order: 1 each. All cartridge sealants can be combined for quantity pricing.

CRL Setting Blocks

CRL has a vast selection of Setting Blocks. Choose from Neoprene, Silicone Rubber, EPDM Rubber, Plastic, and Vinyl. See pages N197 to N203.

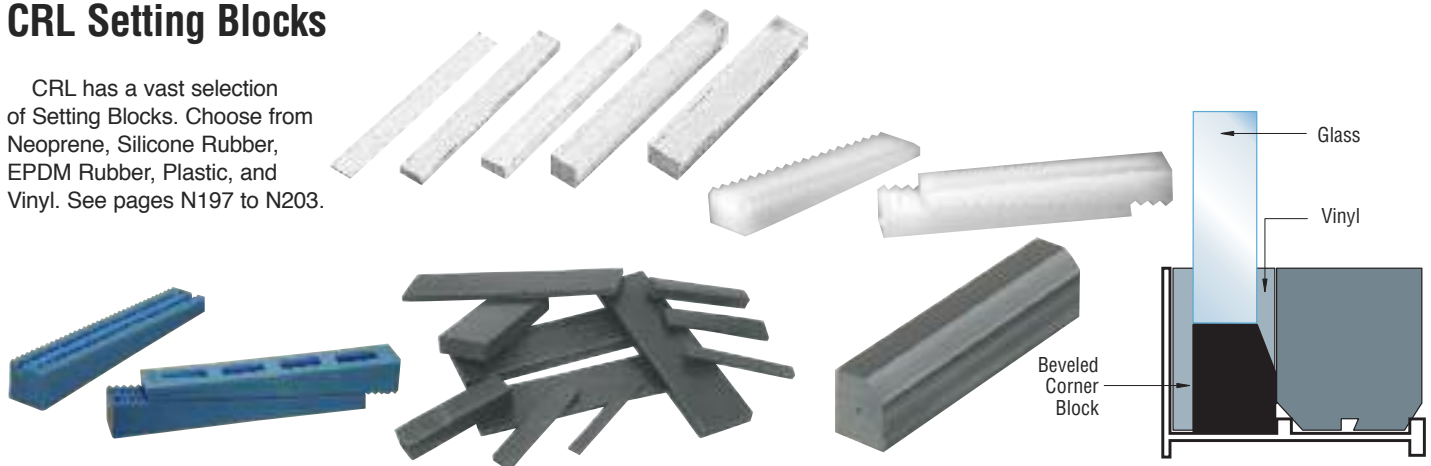

CRL BUTYL RUBBER SEALANTS

For Pricing Visit Our Web Site or Call Us Toll Free at the Phone Numbers Shown on the Back Cover

CRL PTI 707 Butyl Rubber Sealant

- Non-Skinning, Gunnable Sealant
- Will Not Harden or Lose Flexibility



11 Fl. Oz. (325 ml);
30 Cartridges Per Case

Technical Data

Meets Federal Specifications TT-S-001657, ASTM C-1085, AAMA 808.3 and Canadian Specification 19GPN.

Basic Uses

PTI 707 does not harden or lose flexibility, adhesion, or elongation after prolonged exposure to high or low temperatures and ultraviolet light. Joint movement of up to $\pm 12\%$ will not affect the water-tightness of PTI 707. Recommended for glazing of glass, heel and toe beading, and complete channel bedding. Also recommended for use in metal-to-metal panel seals, perimeter seal around doors, windows and masonry intersections, bedding for mullions, framed openings and coping areas, curtainwall sealants, end dams and splice joints. PTI 707 has excellent adhesion to wood, metal, glass, concrete, and masonry surfaces.

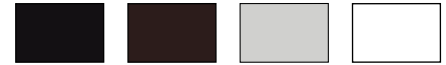

Black Bronze Gray White

Colors shown are approximate

11 FL. OZ. (325 ML) CARTRIDGES

CAT. NO.	COLOR
PT1707BL	Black
PT1707BRZ	Bronze
PT1707GRY	Gray
PT1707W	White

Minimum order: 1 each. All cartridge sealants can be combined for quantity pricing.

CRL Adco BP-300 Curtainwall and Bedding Sealant

- Non-Hardening, Non-Skinning, Permanently Pliable Formula
- Also Used as an Acoustical Sealant



10.3 Fl. Oz. (305 ml);
30 Cartridges Per Case

Technical Data

Meets AAMA 809.2. Effectively increases the Sound Transmission Class (STC) value by as much as 65% by properly sealing partition openings.

Basic Uses

Use BP-300 to seal metal-to-metal concealed curtainwall joints to exclude air and moisture infiltration. It is also good for use in acoustical sealing applications, or for bedding frames or thresholds. Its permanently pliable formula will not harden, and has excellent resistance to adverse weather conditions.



10.3 FL. OZ. (305 ML) CARTRIDGES

CAT. NO.	COLOR
BP300BL	Black

Minimum order: 1 each. All cartridge sealants can be combined for quantity pricing.

CRL 3M™ Fire Barrier Caulk

- Most Recognized Brand in Firestopping
- Water-Based and Intumescent (Expands When Heated)
- UL Listed and Meets Building Codes
- Tested Systems Up to Four Hours



10.1 Fl. Oz. (298 ml);
12 Cartridges Per Case

Technical Data

Approved for use by all three model building codes (Basic/National Building Code-BOCA, Uniform Building Code-ICBO, Standard Building Code-SSBCCI) as reported in the National Research Board Report No. NER-243. ASTM E-119 Fire Tests of Building Construction and Materials, ASTM E-814 Fire Tests of Through-Penetration Fire Stops, UL 1479 Firestops, and Fire Tests of Through Penetration. Both tested and classified by Underwriters Laboratories.

Basic Uses

CRL 3M™ Fire Barrier Caulk is a water-based, premium, intumescent, latex-based sealant offering outstanding fire performance plus a non-halogen formula. In addition, the unique intumescent property (expanding when heated) means that as cable and pipe insulation is consumed by fire, 3M™ Fire Barrier Caulk expands to fill and hold the penetration closed. As little as 1/2" (13 mm) can effectively firestop the opening. Bonds to concrete, metals, wood and cable jacketing. No mixing required. Dries tack-free in approximately 10 to 15 minutes, and is paintable after a 72 hour cure. Only minimal amounts necessary to fill the void.



Red
Color shown is approximate

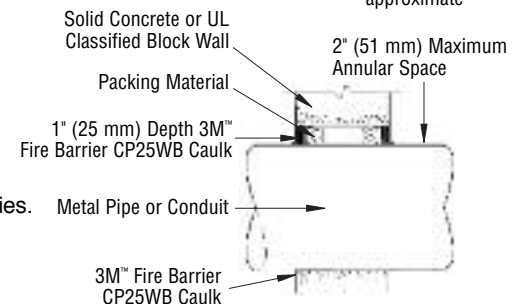

10.1 FL. OZ. (298 ML) CARTRIDGES

CAT. NO.	COLOR
CP25WB	Red

Minimum order: 1 each. All cartridge sealants can be combined for quantity pricing.



C.R. LAURENCE COMPANY

N138

crlaurence.ca | crlaurence.com.au | crlaurence.co.uk | crlaurence.de | crlaurence.eu

crlaurence.com

CRL Australia

crlaurence.com.au

C.R. Laurence Australia is headquartered in the Sydney area, and serves the continent from distribution warehouses in metropolitan Sydney and Melbourne. Manufacturing operations are also located in our Melbourne facility.



Sydney



Melbourne



Sydney



Melbourne

CRL Roof-N-Gutter Silicone Sealant



new

- Neutral Cure Silicone With Excellent Adhesion to Glass, Most Metals, and Plastics
- Available in Australia Only



CRL Roof-N-Gutter Silicone is a one component silicone sealant which cures to a high modulus silicone rubber on exposure to atmospheric moisture at room temperature. This product is a neutral cure sealant that skins and cures fast. In addition to the unique features of silicone rubber, such as superior high and low temperatures resistance, water resistance, and outstanding weatherability, CRL Roof-N-Gutter also provides excellent adhesion to glass, metal, and numerous construction materials. **SUITABLE FOR:** All types of roofing, guttering, weatherproofing, sheet metal, Zinalume®, aluminium, wall cladding, ceramics, painted surfaces, concrete, zinc, and galvanized surfaces.

CAT. NO.	COLOUR	CONTENTS	QTY/CTN
PRG10C	Clear	300 g	20
PRG10G	Grey	300 g	20

Minimum order: 1 each. All cartridge sealants can be combined for quantity pricing.

CRL General Purpose Silicone Sealant



new

- Neutral Cure Silicone With Excellent Weathering and UV Resistance
- Available in Australia Only



CRL General Purpose Silicone is a one component moisture curing neutral silicone sealant that is easy to use. Designed for general purpose glazing and sealing applications where long term reliability is required, its excellent weathering and UV resistance is important in glazing applications where most organic sealants fail. **SUITABLE FOR:** Zinalume®, Galvabond®, Colorbond®, Marviplate®, glass, aluminium, ceramics, masonry, concrete, stone, most metals, and most painted and plastic surfaces.

CAT. NO.	COLOUR	CONTENTS	QTY/CTN
GPS10C	Clear	300 g	20
GPS10B	Black	300 g	20
GPS10G	Grey	300 g	20
GPS10W	White	300 g	20

Minimum order: 1 each. All cartridge sealants can be combined for quantity pricing.

CRL GE® 2600 Series Neutral Cure Sanitary Silicone

- Mildew Resistant, Fast Curing, and Outstanding Weatherability
- Has Excellent Adhesion to Glass, Ceramics, Aluminium, Masonry, Stone, Concrete, Most Metals, and Many Plastics
- Available in Australia Only

CRL GE® 2600 Series Sanitary Silicone is a one-part, high modulus, fast cure and long skin time neutral cure sanitary silicone sealant. It resists mildew even when exposed to prolonged hot and humid environments. The sealant does not provide or maintain a nutrient surface for fungus. This sealant effectively seals around bathtubs, shower stalls, wall fixtures, rimless sinks, kitchen and bathroom fixtures.

SPEC. DATA

MSDS



CAT. NO.	COLOUR	CONTENTS	QTY/CTN
SCS2601	Clear	300 g	20
SCS2602	White	300 g	20

Minimum order: 1 each. All cartridge sealants can be combined for quantity pricing.

CRL GE® 1700 Series Sanitary Silicone

- Use in Bathrooms and Kitchens
- Mildew Resistant Acetic Cure Formula
- Available in Australia Only

CRL GE® 1700 Series Sanitary Silicone is a one-part acetic cure silicone sealant especially designed to resist mildew even when exposed to prolonged hot and humid environments, such as bathrooms and kitchens. The sealant does not allow a surface environment for unsightly fungus to grow, and forms watertight bonds in combination with glass, ceramic, steel, aluminium, and many plastics.

SPEC. DATA

MSDS



CAT. NO.	COLOUR	CONTENTS	QTY/CTN
SCS1701	Clear	300 g	20
SCS1702	White	300 g	20

Minimum order: 1 each. All cartridge sealants can be combined for quantity pricing.

CRL GE® Plumbers Mate Silicone

- Neutral Cure Formula for Roofing and Plumbing Markets
- Available in Australia Only

CRL GE® Plumbers Mate Silicone is a 100% silicone sealant designed for plumbers and roofers to seal roofing, spouting, guttering, flashing, wall cladding, and rainwater products. The neutral cure formula is unaffected by high and low temperatures, and its superior physical properties are retained after many years of exposure. Recommended for use with Zincolume®, Galvabond®, Colourbond®, and Marviplat®, and also has potable water approval.

SPEC. DATA

MSDS



CAT. NO.	COLOUR	CONTENTS	QTY/CTN
SCS4001	Clear	300 g	20

Minimum order: 1 each. All cartridge sealants can be combined for quantity pricing.

CRL GE® Silglaze N-10 Silicone

- Excellent Weathering and UV Resistance
- One-Part, Neutral Oxime Cure Sealant
- Great for General Purpose Sealing Applications
- Available in Australia Only

CRL GE® Silglaze N-10 is a neutral oxime curing silicone sealant that can be used for general glazing and sealing applications where long term reliability is required. CRL GE® Silglaze N-10 Silicone Sealant has excellent adhesion to glass, aluminium, concrete, ceramics, zinc coated steel, wood, and many plastics. Silglaze N-10 is excellent for sealing butt or lap shear joints with low or similar coefficients of thermal expansion. It may also be applied in-plant to glass, plastic, and metals as the primary weather seal in finished products.

SPEC. DATA

MSDS



CAT. NO.	COLOUR	CONTENTS	QTY/CTN
SCS2701	Clear	300 g	20
SCS2702	White	300 g	20
SCS2703	Black	300 g	20
SCS2709	Dark Gray	300 g	20
SCS2729	Light Gray	300 g	20
SCS2797	Brown	300 g	20

Minimum order: 1 each. All cartridge sealants can be combined for quantity pricing.

CRL GE® Acrylic Gap-Seal

- A General Purpose Acrylic Polymer Sealant
- Water Based and Paintable
- For Use on Interior or Exterior Joints
- Available in Australia Only



CRL GE® Acrylic Gap-Seal is a flexible, one component acrylic latex caulk for interior and exterior gaps and joints. It displays excellent adhesion to concrete, masonry, wood, brick, glass, ceramic tiles, and plasterboard. It is not designed for joints subjected to significant joint movement or pooling water. Do not apply below 5°C (41°F) or when rain is expected.

CAT. NO.	COLOUR	CONTENTS	QTY/CTN
91AW	White	450 g	20

Minimum order: 1 each. All cartridge sealants can be combined for quantity pricing.

CRL GE® Bond-Fast Construction Adhesive

- Fast-Drying High-Strength Sealant
- Available in Australia Only



CRL GE® Bond-Fast Construction Adhesive is a high-strength contact adhesive that will not slump on vertical surfaces. It has been formulated for use as either a one way liquid adhesive or a two way contact adhesive. It offers adhesion to many common surfaces.



CAT. NO.	COLOUR	CONTENTS	QTY/CTN
GE320G	Beige	320 g	20

Minimum order: 1 each. All cartridge sealants can be combined for quantity pricing.

CRL Brand Sealants

- CRL Brand Sealants are Stocked in Both Sydney and Melbourne Locations



CAT. NO. M64

CAT. NO. M66

CAT. NO. M65W

Polyurethanes

see pages N127-N129



CAT. NO. 777

CAT. NO. 888

Butyl Rubbers

see pages N136-N137



CAT. NO. WCS1

CAT. NO. 95C

CAT. NO. RTV408

CAT. NO. 33S

Silicones

see pages N108-N113 and N118-N121



CAT. NO. 321

CAT. NO. 800

CAT. NO. CRL15W

Acrylic Latexes

see pages N133-N135

CRL Bostik Rhodorsil® V60 Neutral Cure Silicone

- High-Performance Glazing Sealant
- Low-Odour, Neutral Cure Formula
- Available in Australia Only



CRL Bostik Rhodorsil® V60 is a premium grade neutral cure glazing weatherproofing silicone sealant with superior adhesion to painted and anodized aluminium and glass. With excellent UV stability typical uses include: two-sided structural glazing (colours only on to aluminium substrate); structurally glazed systems (subject to Bostik approval and review of design first); fin glazing; sealing of laminated and reflective glass; general glazing applications; weather sealing in curtain wall and building facades including composite metal panels. It meets the requirement of Australian Standard AS 4020-1994.



CAT. NO.	COLOUR	CONTENTS	QTY/CTN
28001	Clear	300 g	15
28002	Black	300 g	15
28003	Grey	300 g	15
28004	Silver	300 g	15
28005	White	300 g	15

Minimum order: 1 each. All cartridge sealants can be combined for quantity pricing.

CRL Bostik Z Bond® 616 Neutral Cure Silicone

- Multi-Purpose Sealant for Glass, Metal, Masonry, and Glazed Ceramic Tiles
- Low-Odour, Neutral Cure Formula
- Available in Australia Only



CRL Bostik Z Bond® 616 Silicone is a one component, non-flowing, neutral cure, medium modulus, RTV silicone that cures to a tough, flexible rubber when exposed to moisture. Developed for use in glazing weatherseals it offers good adhesion to glass, coated aluminium, and masonry. Typical uses include weatherseals between glass and aluminium; back glazing between timber and glass; perimeter seals between aluminium window frames and brick and masonry; air seals in concrete panels.



CAT. NO.	COLOUR	CONTENTS	QTY/CTN
28022	Translucent	300 g	15
28023	Black	300 g	15
28024	White	300 g	15
28025	Grey	300 g	15
28026	Primrose	300 g	15
28027	Off White	300 g	15
28039	Stone Beige	300 g	15

Minimum order: 1 each. All cartridge sealants can be combined for quantity pricing.

CRL Bostik Rhodorsil® V70 Structural Glazing Silicone

- Neutral Cure
- High Modulus, High Strength
- Available in Australia Only



CRL Bostik Rhodorsil® V70 is a neutral cure, high modulus silicone sealant that meets the currently accepted engineering standards for structural glazing. This high-strength silicone has very good unprimed adhesion properties to a broad range of building substrates.

NOTE: Bostik must always carry out substrate testing first.



CAT. NO.	COLOUR	CONTENTS	QTY/CTN
28066	Black	400 g	15

Minimum order: 1 each. All cartridge sealants can be combined for quantity pricing.

CRL Bostik Rhodorsil® V2 Acetic Cure Silicone

- High Modulus, High Strength
- Structural Applications
- Available in Australia Only



CRL Bostik Rhodorsil® V2 Silicone Sealant combines high strength with excellent adhesive properties making this product a very reliable structural adhesive sealant. Typical uses include: frameless shower screens; structural glazing (glass to glass applications); fin glazing; butt glazing; general glazing applications, toughened glass and fiberglass application.



CAT. NO.	COLOUR	CONTENTS	QTY/CTN
28008	Clear	300 g	15
28009	White	300 g	15
28010	Black	300 g	15

Minimum order: 1 each. All cartridge sealants can be combined for quantity pricing.

CRL Bostik Z Bond® V4 Metal & Masonry Silicone

- Low Modulus, Neutral Cure Sealant
- Excellent Adhesion
- Available in Australia Only



CRL Bostik Z Bond® V4 Metal and Masonry Silicone Sealant is a low modulus neutral cure sealant that imparts the minimum stress on the adhesion bond for a ±35% joint movement capability. Z Bond V4 has excellent natural aging stability and will maintain its elastomeric joint sealant properties permanently, even under harsh conditions and temperature extremes. Typical applications include: precast panels, concrete panels, anodized aluminum, coated copper and brass plaques, sealing of polycarbonate sheeting, splashbacks, expansion joints on pavers, and general purpose building and construction applications.



CAT. NO.	COLOUR	CONTENTS	QTY/CTN
28011	White	370 g	15
28012	Grey	370 g	15
28014	Beige	370 g	15

Minimum order: 1 each. All cartridge sealants can be combined for quantity pricing.

CRL Bostik Rhodorsil® 5CLM Low Modulus Silicone

- Low Modulus, Neutral Cure Sealant
- High Joint Movement Capability
- Available in Australia Only



CRL Bostik Rhodorsil® 5CLM is a low modulus, neutral cure silicone sealant that exhibits excellent joint movement capabilities of +100%/-50%, making it ideal for high joint movement applications. The 5CLM places minimum stress on the adhesion bond during extreme movement. Typical applications include: all types of building facades, restoration, weatherproofing; curtainwall joints; marble and granite joints (stain testing must be carried out first); precast/concrete panels; weatherproofing of coated metal and aluminium composite panels; anodized aluminium; coated copper and brass plaques; and sealing of polycarbonate sheeting.



CAT. NO.	COLOUR	CONTENTS	QTY/CTN
28015	White	370 g	15
28017	Charcoal	370 g	15

Minimum order: 1 each. All cartridge sealants can be combined for quantity pricing.

CRL Bostik Z Bond® 6S Shower & Tile Silicone

- UV Stable Sealant Perfect for Showers and Tubs
- Available in Australia Only



CRL 6S Shower and Tile Silicone is specially formulated to resist mildew despite prolonged exposure to hot and humid environments. The sealant does not provide or maintain a nutrient surface for fungus. It effectively seals glass, coated enamel, and most laminated surfaces. It's also ideal for sealing around bathtubs, shower stalls, wall fixtures, rimless sinks, kitchen and bathroom fixtures; and may be used for ceramic tile grouting. Food Grade Approval (NZ).



CAT. NO.	COLOUR	CONTENTS	QTY/CTN
28035	Clear	300 g	15
28036	White	300 g	15
28037	Ivory	300 g	15

Minimum order: 1 each. All cartridge sealants can be combined for quantity pricing.

CRL Bostik Z Bond® 8S Bathroom & Kitchen Silicone

- Mid Modulus, Mildew Resistant Sealant
- Available in Australia Only



CRL 8S Bathroom & Kitchen Silicone is a one-component acetic cure sealant. It contains an effective fungicide to reduce growth of mould and mildew. It is a fast curing system that offers very good adhesion to glazed ceramic and enamel surfaces. It is an excellent seal for wet surroundings like kitchens, baths, showers, fiberglass spas, etc.



CAT. NO.	COLOUR	CONTENTS	QTY/CTN
28020	Clear	300 g	15
28021	White	300 g	15

Minimum order: 1 each. All cartridge sealants can be combined for quantity pricing.

CRL Bostik Rhodorsil® Multi-Purpose Paintable Silicone

- 100% Water-Based Silicone
- Easy Tooling and Finishing
- Available in Australia Only



CRL Bostik Rhodorsil® Multi-Purpose Paintable Silicone is a 100% water-based silicone that is easy to tool and finish. It has superior adhesion to many surfaces and can be cleaned up with water.

Painting: Use either oil-based or acrylic paints. Apply paint between 12 and 72 hours after sealant application. When one coat has been successfully applied, additional coats can be applied later at a convenient time.



CAT. NO.	COLOUR	CONTENTS	QTY/CTN
28070	White	390 g	15

Minimum order: 1 each. All cartridge sealants can be combined for quantity pricing.

CRL Fuller Max Bond™ Construction Adhesive

- High-Bond-Strength, Multi-Purpose Adhesive
- Fast Adhesion
- Available in Australia Only



CRL Fuller Max Bond™ Construction Adhesive is ideal for bonding timber and most common construction materials, including particle board, MDF board, brick, concrete, gypsum board, galvanized metal, and aluminium. Max Bond™ is a synthetic rubber-based adhesive designed primarily for installation of flooring and wall panels. Max Bond™ has also found use in many general household applications as well.

Compliance: Max Bond™ Construction Adhesive has been formulated to comply with the requirements of AS2329-1999 "Mastic Adhesives for Fixing Wallboards."



CAT. NO.	COLOUR	CONTENTS	QTY/CTN
28993	Tan	320 g	20

Minimum order: 1 each. All cartridge sealants can be combined for quantity pricing.

CRL Bostik Seal 'N' Flex 1



- One Part, Low Modulus Construction Polyurethane Sealant
- Available in Australia Only



CRL Bostik Seal 'N' Flex 1 is a low modulus, one-component, Class A Polyurethane Sealant. When cured it will form a tough, flexible seal capable of cyclic expansion and compression movement of +50%, -25% of the original joint width. Seal 'N' Flex 1 is virtually unaffected by normal weathering conditions such as rain, sunlight, snow, ultra violet radiation, ozone, atmospheric contamination, and pollution. Its excellent weatherability enables it to retain its original properties after years of exposure.

CAT. NO.	COLOUR	CONTENTS	QTY/CTN
216267	White	600 ml	20
216275	Grey	600 ml	20
217751	Beige	600 ml	20
217808	Black	600 ml	20
217824	Limestone	600 ml	20
226203	Sandstone	600 ml	20
242322	Classic Bone	600 ml	20

Minimum order: 1 each. All cartridge and sausage sealants can be combined for quantity pricing.

CRL Megapoxy® Self-Leveling Sealant



- Sag Resistant, Multi-Purpose Adhesive Paste
- Superior Tensile and Compressive Strength
- Available in Australia Only



CRL Megapoxy® Self-Leveling Sealants are two-component high strength assembly adhesives that exceed all existing international standards. They are manufactured under a quality management system that is certified by the National Association of Testing Authorities (NATA) Australia as conforming to International Standard ISO 9002. Megapoxy is simple, clean, and easier to use than other conventional concrete and mortar systems.

CAT. NO.	COLOUR	CONTENTS
8105	Beige	300 g

Minimum order: 1 each.

CRL Dow Corning® 795 Silicone Building Sealant

- ±50% Joint Width Movement
- Medium Modulus Building Sealant for Expansion Joints
- Structural and Non-Structural Glazing of Glass, Metals, and Plastics
- Available in Australia Only



CRL Dow Corning® 795 is a one-part, medium modulus, neutral cure silicone formulation. Dow Corning® 795 cures to a durable and flexible silicone rubber building joint seal, and can accommodate ± 50% joint movement in a properly designed joint. Basic uses include structural and nonstructural glazing of glass, metal, and plastic, adhering stiffeners to building panels, and weatherproofing applications, including perimeter sealing of doors and windows. Dow Corning® 795 is virtually unaffected by sunlight, rain, sleet, snow, ultraviolet radiation, atmospheric contamination, ozone, and temperature extremes. Joint performance does not change significantly with aging or exposure to weather. Seals remain watertight and weatherproof.

CAT. NO.	COLOUR	CONTENTS	QTY/CTN
795B	Black	305 ml Cartridge	12
795BSG	Black	600 ml Sausage	16

Minimum order: 1 each. All cartridge and sausage sealants can be combined for quantity pricing.

CRL Dow Corning® 791 Silicone Weatherproofing Sealant

- A One-Part, Medium Modulus, Elastomeric Sealant
- Available in Australia Only



Dow Corning® 791 Silicone Weatherproofing Sealant is a one-part, medium modulus, neutral cure, elastomeric sealant designed for general weather sealing. It is a silicone formulation that cures to a flexible and curable silicone rubber building joint seal, with extension/compression movement capability of up to ± 50% of the original joint width. Excellent unprimed adhesion to a wide variety of construction materials and building components. Suitable for use on coated glass, galvanized steel, masonry and other porous and non-porous substrates.

CAT. NO.	COLOUR	CONTENTS	QTY/CTN
791B	Black	300 ml Cartridge	24
791BSG	Black	600 ml Sausage	12
791G	Grey	300 ml Cartridge	24
791GSG	Grey	600 ml Sausage	12

Minimum order: 1 each. All cartridge and sausage sealants can be combined for quantity pricing.

CRL Selleys® Adseal SL

- Seals Joints in Window Frames
- Seals Seams or Openings of 1/8" (3.2 mm) or Smaller
- Available in Australia Only



Our fast-drying CRL Selleys Adseal Joint Sealer is formulated to seal seams in metal window frames, storm windows, miter cut screens, etc. It is highly adhesive and self-leveling for a smooth, inconspicuous appearance. For best adhesion, application should be made by brush or adhesive gun to clean and dry surfaces.

CAT. NO.	COLOUR	CONTENTS
3995	Grey	20 l

Minimum order: 1 each.

CRL Bostik R40 Cleaning Solvent

- General Purpose Cleaner Removes Uncured Adhesives
- Available in Australia Only



CRL Cleaning Solvent handles some of the toughest cleaning jobs your shop can encounter. Use to soften and remove uncured urethane, adhesive, tar, grease, oil, body sealer and undercoating. Apply to a rag and rub lightly over soiled areas, then wipe up with a clean, dry cloth. Available in 500 ml (17 fl. oz.) cans.

CAT. NO.	CONTENTS
R40	500 ml

Minimum order: 1 each.

The Full Service Sealant Source Selection

C.R. Laurence Company is a full service distributor of quality sealants. That means we stock dozens of sealants for use in the building, glazing, weatherization, and waterproofing trades. You can choose from our own quality CRL brands or from other major manufacturers' brands to get the right product for your application. We can also help you select the proper sealant. Our sealant experts can supply you with specifications and compatibility data on the full range of sealant products we stock.

Pricing

Full service also means sealant affordability. Volume distribution lets us keep our costs down, so you also benefit from our volume buying power. We know that you must be competitive in your market, and CRL's volume buying power helps you stay competitive. Sealant affordability, selection and availability, all from the CRL full service sealant source.

Availability

Full service means you can order the sealants you need, in the quantities you require, and get them expediently from your supplier. CRL offers sealants in drums, pails, cartridges, sausage packs, and squeeze tubes, along with dispensing equipment and tools to suit the application requirements of your job. Inventories are stocked in our regional warehouses for immediate pickup and shipment. Ordering is as simple as dialing our toll free fax or telephone numbers, or buying through our web site, crlaurence.com. Only CRL, the full service sealant supplier, offers you all of this.



Types and Movements of Sealants Most Commonly Used by Glazing Contractors

The following is a listing of all commonly used generic and non-generic sealant types. These listings cross-reference the sealants to their movement capability and to the architectural specification standard to which they conform.

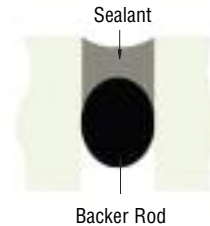

PRODUCTS	EXTENSION / COMPRESSION	ASTM / FEDERAL TEST
One-Part Silicone High Modulus Medium Modulus Low Modulus	25% / 25% 50% / 50% 100% / 50%	TT-S 001543 (COM-NBS) Class A, TT-S-00230C (COM-NBS) Class A, ASTM C-920 Type S, Grade NS, Class 25, Use NT, G, A; CAN/CGSB 19.13-M87.
One-Part Polyurethane	25% / 25%	TT-S-00230C, Type I and II, Class A; ASTM C-920-98, Type S, Grade NS or P, Class 25, Use NT, M, A, and O; CAN/CGSB 19.13-M87.
Two-Part Polyurethane	25% / 25%	TT-S-00227E, Class A, Type I and II; ASTM C-920, Type M, Grade NS or P, Class 25, Use NT, M, A, and O; CAN/CGSB 19.24-M90, Type I or II, Class B.
Acrylic Latex	10% / 10%	ASTM C-834
Butyl Rubber	10% / 10%	TT-S-001657, Type 1, TT-C00598C, TT-C-1796A, ASTM C-1311.

Class A ± 25% Joint Movement	Type S Single Component	Grade NS Non-Sag Material	Use G Glass
Class B ± 12.5% Joint Movement	Type I Non-Sag Material	Use NT Non-Traffic	Use A Aluminum
Class 25 ± 25% Joint Movement	Type II Self-Leveling Material	Use M Masonry	Use O Other

Guidelines to Good Glazing



Below are important guidelines to good glazing. By following these basic guidelines, you can be assured that every project will be completed with a good sealant installation. If you should have any questions regarding any of these general guidelines, please feel free to contact our Glass and Glazing Technical Sales at (800) 421-6144 in the U.S., (877) 421-6144 from Canada, or (323) 588-1281 International, and ask for Ext. 7720.

Glaze Above 40°F (4.4°C)

It is always a good practice to glaze above 40°F (4.4°C). Below this temperature condensation and frost can contaminate the surface and interfere with adhesion. If you must glaze in cold temperatures wipe all surfaces first with a recommended solvent, then wipe dry. Isopropyl alcohol and Methyl Ethyl Ketone (see page N251), are soluble in water and may be more appropriate for winter cleaning as they help remove condensation and frost. Xylene and Toluene are not soluble in water and may be better suited for warm weather cleaning. (See our Technical Article "Cold Weather Caulking" on page N149 for additional information.)

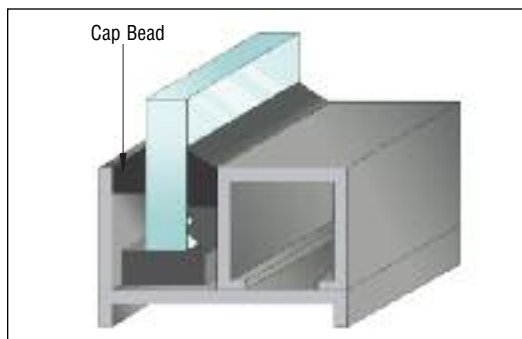

Form a Watershed

Gunnable sealants, when applied as a cap bead, should form a bevel or watershed away from the glass. When tape is used to the sightline, it should form a watershed when compressed. Do not undercut a sealant, compound, or tape below the sightline. Minimum cap bead depth should be from 1/4" to 3/8" (6 to 9.5 mm). For banded insulating units, a minimum of 1/8" (3 mm) sealant contact above the band is recommended. Tool and finish the sealant with a Tooling Spatula or Stick Tool as required. Do not use liquid tooling aids such as water, soap, or alcohol (such as IPA). These materials may interfere with sealant cure and adhesion, and may create aesthetic issues. (See our Technical Article "Surface Preparation and Proper Application" on pages N153-N155 for additional information.)

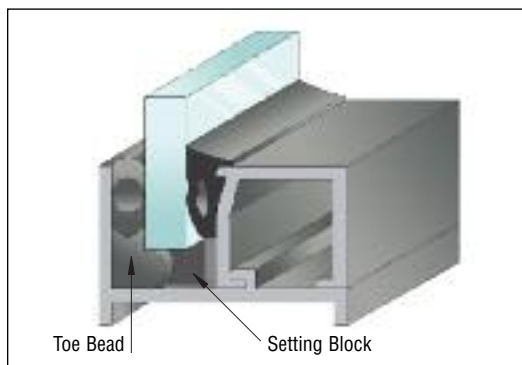

Achieve Positive Contact

When applying a heel bead, lap onto the glass a minimum of 3/16" (5 mm), and make certain of positive contact with the sash. When applying a toe bead, whether continuous or a corner seal, make certain it is large enough to contact both the glass and sash. The proper sequence is to install the sealant prior to glass placement.

Setting Blocks

Setting blocks should generally be made of Neoprene, EPDM or Silicone with a Shore "A" durometer from 80 to 90. When used in combination with heel and toe beads, they should be first buttered with sealant, then placed before installing the glass. This ensures an uninterrupted seal between glass and sash member.

As a general rule, setting blocks should be centered at quarter points. However, they can also be moved out to eighth points, or to a point 6" (152 mm) from the edge of the glass to the end of the setting block, whichever is greater.

Setting block widths should be 1/16" (1.6 mm) less than the full rabbet width, and high enough to provide the recommended minimum bite and minimum edge clearance for the glass. Length of setting blocks should not be less than 2" (51 mm).

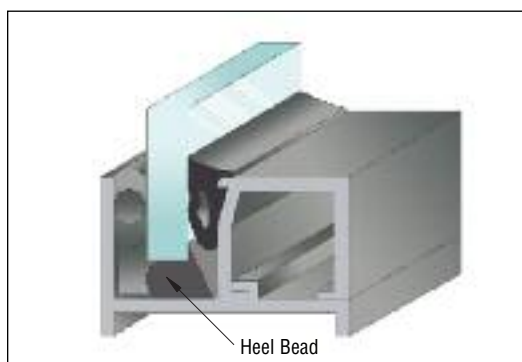

Surface Preparation

The key to good sealant adhesion is a clean surface. Clean the sash surface and glass edge just prior to glazing with proper cleaning solvents. Non-porous surfaces must be cleaned with a solvent before the sealant is applied. The solvent used will depend on the type of dirt or oil to be removed and the substrate to be cleaned. To avoid damaging the substrate, make sure that the cleaning procedures and solvents you are using are compatible with the substrate. Non-oily dirt and dust can usually be removed with a 50% solution of isopropyl alcohol (IPA) and water, a 70% solution of IPA and water (rubbing alcohol) or pure IPA. Oily dirt or films generally require a degreasing solvent such as Xylene or Methyl Ethyl Ketone (see page N251).

Guidelines to Good Glazing (Continued)



Be sure to use the "two-cloth" cleaning method, meaning a solvent wipe followed by a dry cloth wipe such as our Cat. No. 10522. Allowing solvent to dry on the surface without wiping with a second cloth negates the entire cleaning procedure, because the contaminants are re-deposited as the solvent dries. See our Technical Article "Surface Preparation and Proper Application" on pages N153-N155 for additional information. As work progresses, remove all excess sealant and smears with Cat. No. SR200 Silicone Remover and Surface Prep (see page N249).

Avoid Glass Damage

Glass should be carefully handled and glazed to avoid edge damage which can occur when units are rotated or "pitched" during positioning. One recommendation is the use of roller blocks (Cat. No. RB200) to rotate the glass unit. This minimizes possible corner damage by evenly distributing the glass weight along the edges, rather than at the corners.



RB200
Roller Blocks

Shims and Setting Blocks/Spacers

Shims and setting blocks/spacers should be used, and are generally made from Neoprene or EPDM (Glazing Wedge Gasket), with a Shore "A" durometer hardness as recommended by the appropriate glass manufacturer. They can be either individually inserted shims, or preferably a continuous rod or wedge. Porous materials such as polyethylene and polyurethane foam are not suitable as shims.



Cross Section of Tape
Showing Shim

Tape Compression

Glazing tapes must be kept under proper compression. Depending upon the tape selected, this will vary from 10 to 50%.

Air Seal

When glazing a pressure-equalized system, it is necessary to install an interior air seal, or vapor barrier, around the perimeter of the glass unit. This equalizes pressure in the void around the edge of the unit with that of the building exterior. A heel bead of gunnable sealant accomplishes this best, since it readily bridges the space between the interior face of the glass unit and the sash.

Clearances

Observe minimum face clearance, edge clearance, and glass bite as recommended by the appropriate glass and sealant manufacturers. This allows the glass to freely float in the opening without undue restriction by the framing members, allowing the sealant to perform within its designed capabilities.

Weep Holes

When glazing insulating and laminated glass, the sill member must be wept to the exterior. A minimum of three weeps per sill, separated by the setting blocks, is recommended. Refer to the appropriate glass manufacturer for their recommended size and placement.

Tape Installation

Do not install glazing tapes more than one day ahead of glass placement. This helps avoid potential damage to the tapes by the other trades. Remove the release paper from the tape only when the lite is ready to be installed. Do not stretch the tape to make it fit. Do not overlap the ends of the tape. Instead, butt ends together, and when corners are butted together, dab with sealant to assure a positive seal.

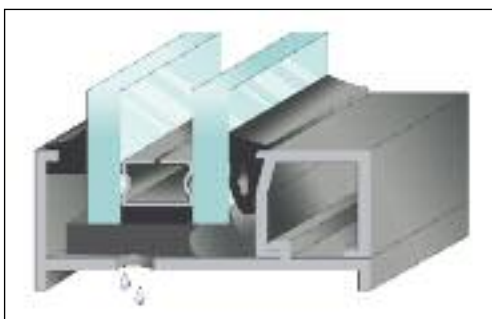

Guidelines to Good Glazing (Continued)

Insulating Units

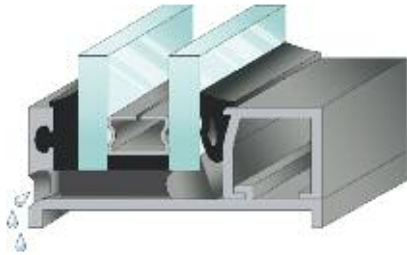

When Glazing Insulating Units:

- (1) Prevent water from standing in contact with the edge of the insulating unit, accomplished by incorporating weep holes in the sash design.
- (2) Provide a long-lasting cushion and seal between the insulating unit and the sash.
- (3) Glazing sealants must be fully compatible with sealants used in the fabrication of the insulating glass assembly. Deviation from these guidelines may ultimately lead to insulating glass failure.



The Glass Association of North America (GANA) has published a sealant manual for the glass and glazing community. The manual shows not only the types of sealants and their properties, but also illustrates details of joint types, has photos that guide you through compatibility and stain conditions, and explains the importance of sealants in restoration and protective glazing. The manual is for the use and guidance of commercial glazing contractors and architects in the commercial fenestration market. For copies of this manual email gana@glasswebsite.com or visit glasswebsite.com.



Follow Manufacturer's Specifications

Apply glazing sealants to the manufacturer's specifications. Use qualified installers who specialize in glazing and glass installation. Always report any unsatisfactory conditions, as soon as possible, to the general contractor for resolution before continuing.

Glazing Mock-up

Conduct an on-site glazing mock-up with the specified glazing components. Use the mock-up area as the "standard" for workmanship. It is recommended that the glazing system supplier be present during installation and testing.

If you have any questions or comments please contact the CRL Sealant Specialist.

Technical Article Cold Weather Caulking

The problem of low temperature work is related to three general situations, which may cause either difficulty in work or bad bonds, and these are:

- #1. The substrate may be covered with a film of ice – possibly too thin to be easily visible.
- #2. The sealant may be too cold to properly "wet down" to the substrate.
- #3. The sealant may be too stiff to gun or tool.

Of these, only the first is a real problem. The last two are solved simply by keeping the sealant at the suggested temperature range of 40° to 80°F (4° to 27°C) prior to use. We suggest that 60° to 80°F (16° to 27°C) is an ideal storage range. There are many mechanical means available for storage and maintenance of temperature.

The placement of a curing type sealant at a substrate temperature below 32°F (0°C) is always subject to the problem described in #1 above. If the sealant is cool it may not melt the ice film. Even if it does, the pressure may be gone and the resultant water film may remain intact and act as a barrier until it freezes again. In any event the application of curing sealants to wet substrates is not recommended.

Caulking can be done at low temperatures if proper care is taken to avoid the problems above. Necessary for good adhesion is that the substrate be clean and dry. This is easily accomplished by one of two methods:

- a) Flame dry the substrate and apply the "warm" sealant before the surface freezes again.
- b) Wipe the substrate clean of ice, (see pg. thx.) Wire brush the surface immediately before application. It should be noted that the curing time of sealants at 20°F (-7°C) is slowed to about one-third the normal rate.



Why Sealants Fail

Substrate Movement and Joint Design

To achieve proper joint design, two factors must be considered: the movement of the substrates, and the movement capabilities of the sealant. The information below is provided to help you determine these movements and select an adequate joint width for your application.

Substrate expansion of a 10 foot (3 m) length over a 100°F (55°C) temperature range:

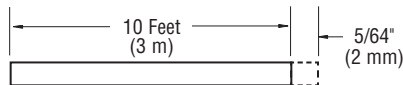

Glass, Limestone and Granite

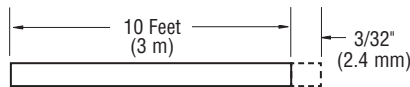

Concrete and Steel

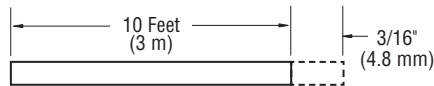

Aluminum

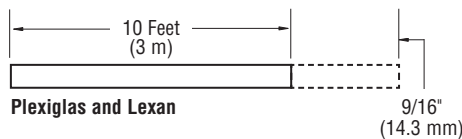

Plexiglas and Lexan

Movement to Joint Width Guideline:

10% Movement Materials – Butyl Rubbers and Acrylic Latex sealants. Movement x 10 = Joint Width.

25% Movement Materials – Polyurethanes and Silicones. Movement x 4 = Joint Width.

50% Movement Materials – Polyurethanes and Silicones. Movement x 2 = Joint Width

In Addition, the Following Should Also be Taken Into Consideration:

A minimum of 1/4" (6 mm) sealant substrate bond is necessary to ensure adequate adhesion.

One-part sealants require atmospheric moisture to fully cure. The sealant joint must be designed to ensure that the sealant is not isolated from the air.

A minimum 1/4" (6 mm) joint width is recommended. Wider joints accommodate more movement than narrow joints. As the sealant joint width becomes larger than 1" (25 mm), the depth should be held to approximately 3/8" (9.5 mm).

Three-sided adhesion limits the amount of movement that a joint can accept before failing. Three-sided adhesion can be eliminated by the addition of a bond breaker tape or backer rod.

A thin bead of sealant [1/4" ± 1/8" (6 ± 3 mm) depth] will accommodate more movement than a thick bead.

Optimum performance is also delivered when the sealant bead is shaped like an hourglass formed from round backer rod at the bottom and tooling the top with a rounded spatula tool.

Based on the above information, sometimes you will encounter a bad joint design in which no sealant will function properly. In these instances, contact the architect or general contractor to advise them of the poor joint design so they can take positive actions to resolve the design problems.

Substrate Movement During Cure:

One-part sealants cure by reacting with atmospheric moisture. Joint movement during cure can cause unsightly aesthetics due to joint wrinkling, and in some severe cases, cohesive failure of the sealant. Premature adhesion loss can also occur because the adhesive characteristics of the sealant are obtained after the sealant has cured. Adhesion loss due to movement during cure can be minimized by the use of a primer. Primers can decrease the adhesion cure time lag.

Minimize Wrinkling by Following These Suggestions:

Use open-cell polyurethane backer rod in vertical applications to allow air to the sealant from the back side to speed up curing time.

Apply sealant when the joint surface is cool and will experience minimum temperature changes, typically in the late afternoon or early evening.

Improper Surface Preparation:

All surfaces must be clean, dry, dust free and frost free prior to sealant application. This means removal of all dirt, dust, oils, and all other forms of surface contaminants prior to the application of any sealant materials.

Remove All Surface Contaminants:

- Sacking and dust from concrete.
- Concrete form-release agents, water repellents, surface treatments, protective coatings.
- Old sealants
- Oil from metals
- Surface protectors from metal or glass
- Dust from all surfaces



Improper Cleaning Solvents:

- Oil based solvents that leave a residue
- Soaps or detergents that leave a film
- Contaminated rags or wipes

Proper Cleaning Solvents:

50% solution of isopropyl alcohol (IPA) and water, 70% solution of IPA and water (rubbing alcohol) or pure IPA for non-oily dirt and dust.

Methylethylketone (MEK), Xylene or Toluene for oil and grease.

IPA and MEK are soluble in water and may be more appropriate for winter cleaning as they help in removing condensation and frost.

Use Primer When Required:

Certain substrates that chalk or oxidize require primer (see manufacturer's spec sheet).

Joints subject to water submersion. Surface condition at time of application: sealing to wet or frosty surfaces will cause sealant failure. See the Technical Article "Surface Preparation and Proper Application" on our web site for additional information.

Wrong Sealant Selection:

Incorrect sealant selection can and will lead to many sealant failures. Consult CRL's Product Manager for Construction Sealants to ensure the proper sealant is selected for your project. Listed below are some of the wrong applications.

Applications That are Sure to Cause Problems:

- Low performance sealants in high movement joints
- Using silicone sealant if surface is to be painted
- Butyl sealants on wide precast panel joints
- Urethane sealants on structural glazing
- Sealants in underwater applications
- Solvent based sealants to certain paints, plastics, and foams
- Silicone sealants to marble and natural stone (staining)
- Urethane or acrylic sealants as a glazing cap bead (UV breakdown)

Why Sealants Fail (Continued)

Incompatible Materials

Sealants may react with materials that are deemed to be incompatible with that sealant. If you're not sure of the compatibility of your sealant to a substrate, contact CRL's Sealant Specialist for clarification.

Some Incompatible Applications:

- Acetoxy silicone to copper
- Latex to bare steel
- All silicones to neoprene rubber
- Acetoxy silicone to most insulating glass sealants
- Solvent based sealants to plastic and rubber (test)

Poor Weather and/or UV Resistance

UV, ozone, and weather conditions are major factors in selecting the proper sealant. Jobs in large metropolitan areas are subject to smog and other airborne contaminants; jobs in rural areas are subject to temperature ranges that may exceed the manufacturer's suggested application range. If you need help in this area, feel free to call us, or you may reference the Specification Data Sheets for our sealants from the web site offer page for each sealant.

Applications to be Aware of:

- Low performance caulks have poor UV resistance
- Never apply caulks above/below the manufacturer's suggested application temperature range
- UV and ozone attack butyls, acrylics, and urethanes (chalking and crazing)

Using Material Beyond Its Shelf Life

All sealants have a published shelf life. A sealant that has exceeded the published shelf life may cause sealant failure if used without testing.

General Guidelines on Shelf Life:

- Oil based caulks and butyls - 12 months
- Acrylics and construction urethanes - 12 months
- Silicone (acetoxy) - 24 months
- Silicone (neutral cure) - 12 months
- Automotive urethanes - 9 months

Three Basic Types of Sealant Failure

Adhesive



"Loss of Adhesion" is failure of the sealant to adhere along the bond line of the surface to which it is attached, causing it to break away. Some possible causes are: joint movement exceeding the sealant capability, improper surface preparation, or improper bead configuration.

Cohesive



"Cohesive Failure" occurs when the sealant fails to hold together. Cohesive failure can take the form of splits and tears in both transverse and longitudinal directions. Usual causes include; improper sealant selection, poor mixing of multi-component sealants, possible air entrapment in the sealant from mixing, or improper bead configuration.

Substrate



"Substrate Failure" is not a failure of the sealant itself, but of the surface or substrate to which it is supposed to adhere. Substrate failure results from improper surface preparation. The weak interface depicted here should have been saw cut back to prevent loose pieces of the surface material from breaking away from the joint interface.

Other Factors That Cause Sealant Failures: Poor Joint Design or Application

Failures occur when the design of the joint exceeds the ability of the sealant to function properly, or when the material is applied incorrectly or carelessly. Below is a guideline for basic **Do's** and **Don'ts**.

General Guidelines for Joint Designs

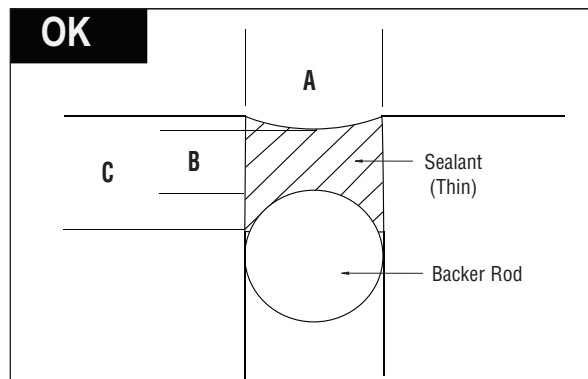

1. Dimensions C and A must be at least 1/4" (6 mm).
2. Ratio of A:B should be 2:1 minimum.
3. Joint surface tooled concave.
4. Dimension B suggested maximum is 3/8" (9.5 mm).

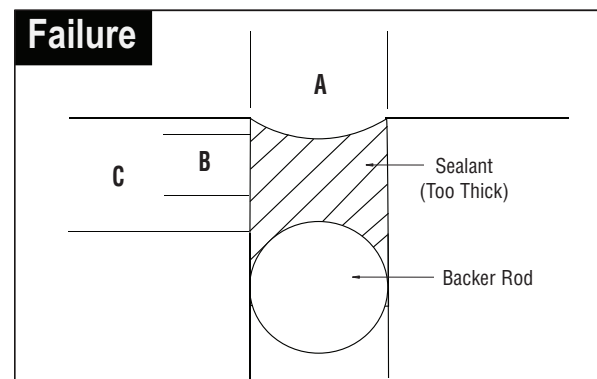

1. Deep sealant bead will not have same movement capability as properly designed thinner bead.
2. Slower cure time due to excessive sealant depth.

Why Sealants Fail (Continued)

Butt Joint Glazing

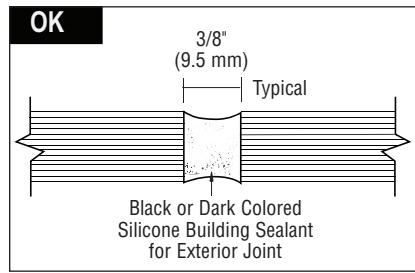

(1) Minimum 1/4" (6 mm) joint width; (2) Minimum 1/4" (6 mm) glass thickness; (3) Joint tooled into hourglass shape; (4) Dark-colored silicone building sealant is recommended (exterior).

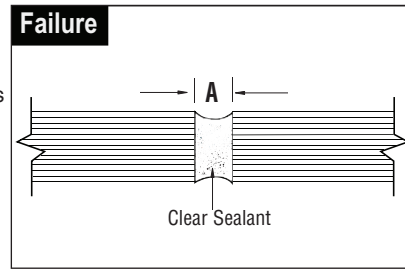

(1) Dimension A less than 1/4" (6 mm) resulting in inconsistent joint fill and very limited movement capabilities; (2) Clear sealants susceptible to yellowing from window cleaning chemicals, intersecting organic gaskets, and tobacco smoke; shows glass defects and bubbles.

Horizontal to Vertical Joint

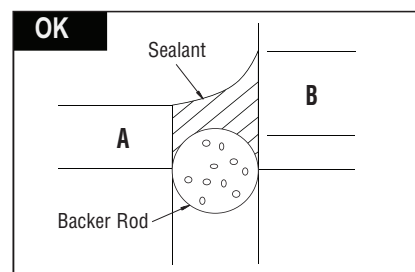

(1) Dimensions A and B are both greater than 1/4" (6 mm); (2) Sealant tooled to ensure positive runoff of water.

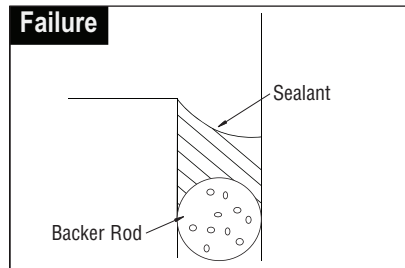

(1) Water could accumulate on top of the improperly tooled joint, increasing the chance of "pooling" and the probability of joint failure.

Moving Corner Joint

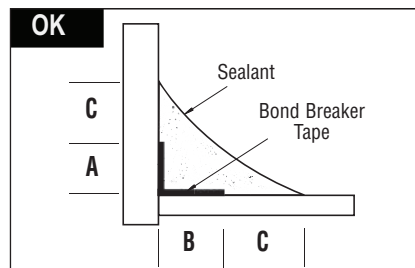

(1) Dimension A, B, and C must be at least 1/4" (6 mm); (2) A bond breaker tape or backer rod must be present if joint movement is anticipated; (3) Joint must be tooled into a concave surface; (4) Minimum sealant thickness of 1/8" (3 mm).

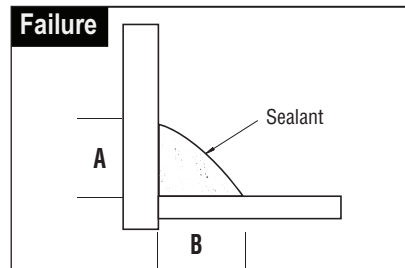

(1) Dimension A or B less than 1/4" (6 mm); (2) Joint not properly tooled into a concave surface; (3) No bond breaker material; therefore the joint will not accept movement.

Remedial Joints

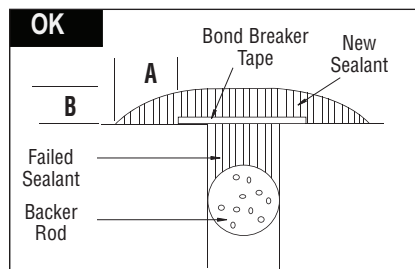

(1) Dimension A must be at least 1/4" (6 mm); (2) Dimension B must be at least 1/8" (3 mm) to a 3/8" (9.5 mm) maximum; (3) Bond breaker tape must be used to isolate fresh sealant from failed sealant.

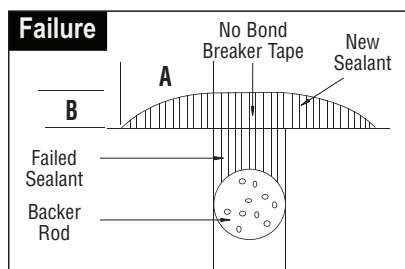

(1) Dimension A less than 1/4" (6 mm): difficulty in obtaining adhesion and increases the likelihood for gaps; (2) Dimension B less than 1/8" (3 mm): increases the likelihood of pinholes or voids in tooling; poor cohesive integrity. (3) No bond breaker tape: increases the chance that the sealant will tear when the underlying substrates move.

CRL Surface Preparation and Proper Application



The Correct method is to pour on the cleaner. Dipping the rag into the solvent is incorrect, as this will contaminate the cleaning agent.

"Call backs" cost money. They also undermine customer satisfaction and complicate scheduling. When working with sealants, the most common cause of "call backs" is sealant failure due to improper surface preparation and sealant application.

There are **five basic steps** for proper joint preparation and sealant application. Care must be taken during each of these steps to ensure sealant success. In fact, most manufacturers require that these procedures are followed in order to be warranty eligible. Let's look at each of these steps in depth:

1. Clean Surface



Check cloth for dirt and wipe again if necessary.

The key to good sealant adhesion is a clean bonding surface. Non-porous surfaces must be cleaned with a solvent before the sealant is applied. The solvent used will depend on the type of dirt or oil to be removed and the substrate to be cleaned. To avoid damaging the substrate, make sure that the cleaning procedures and solvents you are using are compatible with the substrate. Non-oily dirt and dust can usually be removed with a 50% solution of isopropyl alcohol (IPA) and water, a 70% solution of IPA and water (rubbing alcohol), or pure IPA. Oily dirt or films generally require a degreasing solvent such as Xylene. **NOTE:** Be sure to use the "two-cloth" cleaning method, meaning a solvent wipe followed by a dry, clean cloth wipe. Allowing solvent to dry on the surface without wiping with a second cloth negates the entire cleaning procedure, because the contaminants are re-deposited as the solvent dries.



"Two-cloth" method - final wipe before solvent evaporates.

When utilizing the "two-cloth" cleaning method, be sure to use clean, soft, absorbent, lint-free cloths, and do not dip the cloth into the solvent container. This will contaminate the cleaning agent. Instead, it is best to use a plastic, solvent-resistant squeeze bottle. Keep rotating the cloth to clean areas and re-wipe until no additional dirt is picked up. Then, immediately wipe the solvent-cleaned area with a separate clean, dry cloth. Isopropyl alcohol (IPA) is soluble in water, and may be more appropriate for winter cleaning as they help remove condensation and frost. Xylene and Toluene are not soluble in water, and may be better suited for warm weather cleaning.

CRL Surface Preparation and Proper Application

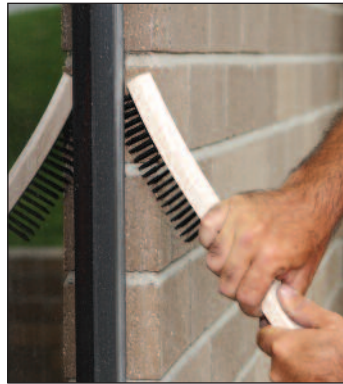

Mechanical Abrasion with Cat. No. 9553NB and LAB450



Cat. No. S1L2100 Silicone Primer

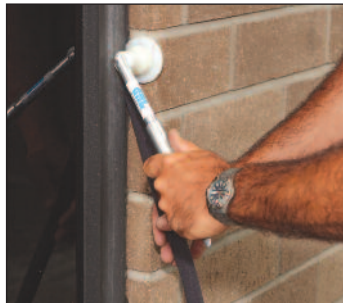
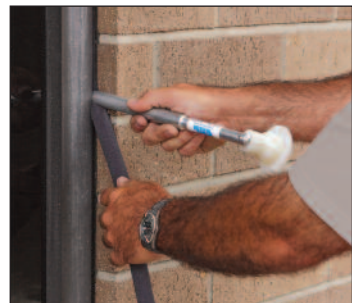

Pack Joint with Backer Rod Using Cat. No. SBRR Roller Tool

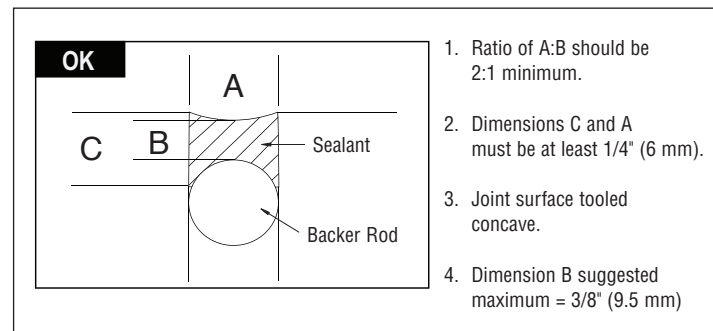

1. Clean Surface (Continued)

Porous substrates absorb liquid and include such building materials as EIFS, cement board panels, concrete, granite, limestone, and other stone or cementitious materials. Dusting alone may be sufficient, however, depending on the condition of the surface, abrasion cleaning, solvent cleaning, or both may be necessary. Laitance and surface dirt must be completely removed. Concrete form-release agents, water repellents, surface treatments, protective coatings, and old sealant all affect sealant adhesion. For proper removal, abrasion cleaning may be required to obtain acceptable adhesion.

Abrasion cleaning involves grinding, saw cutting, sand or water blasting, mechanical abrading, or a combination of these methods. Remaining dust and loose particles should be removed by dusting the surface with a stiff brush, vacuuming, or blowing the joints with oil-free compressed air. Once the abraded surface is clean and dry, the sealant can be applied. If the surface is dirty, the "two-cloth" cleaning method is again recommended. Some porous materials will trap solvents after cleaning or priming. Allow this solvent to evaporate before sealant is applied.

Most primers and sealants cannot be removed with organic solvents. Where aesthetics are important, be sure that uncured primers and sealants do not contact non-abradable surfaces in areas where the sealant is not intended. Mask these surfaces or use extreme care to prevent any contact with the surface during priming and sealant application.

2. Primer

Many sealants do not require a primer on properly cleaned substrates. Generally, priming will improve adhesion to any substrate, and is inexpensive insurance. When priming is recommended by the sealant manufacturer for specific substrates, use the following guideline.

Before applying the primer, be sure that the joint surfaces are clean and dry and that the proper surfaces are masked. Two different methods of primer application may then be used, depending on the substrate and job conditions. The preferred application is to dip a clean, dry, lint-free cloth into the primer and gently wipe a thin film onto the surface. A thin film of primer, applied with a clean brush is best for "hard-to-get-to" areas and rough surfaces such as EIFS. Be careful not to overprime, because this can cause adhesion loss between the sealant and the primer. Allow the primer to dry until all of the solvent evaporates. The surface is then ready for application of the backer rod and sealant. Sealant must be applied the same day the surfaces are primed. Any surfaces primed but not sealed on that same day must be re-cleaned and re-primed before applying the sealant.

3. Pack

When designing moving joints, a minimum 1/4" (6 mm) joint width is recommended. Wider joints accommodate more movement than narrow joints. Three-sided adhesion limits the amount of movement that a joint can accept without inducing a tear. (The rule of thumb is that no more than $\pm 15\%$ movement can be accommodated.)

Three-sided adhesion can be eliminated by adding a Backer Rod or a Bond Breaker Tape (see page N190).

CRL Surface Preparation and Proper Application



No Skin on Open Cell Backer Rod



Backer Rod Roller – Cat. No. SBRR



3. Pack (Continued)

Backer Rod is an integral part of the joint in which it is installed, and is available in a variety of diameters to accommodate different size joints. This backup material eliminates the need for a bond breaker, and helps control the depth of the sealant. Because the sealant does not bond to the rod, it can stretch and recover with joint movement, while minimal stress is put at the points of adhesion to the substrate. Bond Breaker Tape is usually used on joints too shallow for Backer Rods. It creates a two-sided adhesion, thereby allowing more joint movement.

A thin sealant joint [$1/4" \pm 1/8"$ (6 ± 3 mm) depth] will absorb more movement than a thick joint. Sealants are designed to deliver optimum performance when the joints are shaped like an hourglass. In this configuration, the sealant is gunned and tooled to be thinner in the middle and wider at the bonded sides, providing more stretching and recovery with joint movement. As a practical matter, as the sealant joint width becomes larger than 1" (25 mm), the depth should be held at approximately $3/8"$ (9.5 mm). There is no need to increase the depth beyond $3/8"$ (9.5 mm).

One-part sealants cure by taking moisture out of ambient air. Joint movement during cure can cause unsightly aesthetics due to joint wrinkling. Premature adhesion loss can also occur because the adhesive characteristics of the sealant are obtained after the sealant has cured. Adhesion loss due to movement during cure can be minimized by the use of a primer. Primers can decrease the adhesion cure time lag.

Minimize wrinkling by using Open Cell Polyurethane Backer Rod in vertical applications or non-exterior insulation finishing systems. This allows air and moisture to the back side of the one-part sealant. It is best to seal when the joint surface is cool and will experience minimum temperature changes, typically in the late afternoon or early evening.

Two-part sealants cure with the aid of a catalyst. Cure times are typically shorter, and wrinkling is usually not an issue.

4. Apply Sealant

It is critical that the sealant fills the entire joint or cavity and firmly contacts all surfaces intended to receive sealant. If the joint is improperly filled, good adhesion will not be achieved, and sealant performance will be weakened. To obtain full adhesion, sealants require a clean, dry, frost-free surface. Because frost formation can begin to occur below 4°C (40°F), it is best not to apply sealant at temperatures below that mark unless the frost is first removed using solvent when cleaning the surface. To assist in the drying of a frost-containing joint, a water-soluble solvent such as methyl ethyl ketone (MEK) or isopropyl alcohol (IPA) should be used.

Apply the sealant in a continuous operation, using a caulking gun or pump. Positive application pressure, adequate to fill the entire joint width, should be used. This can be accomplished by "pushing" the sealant ahead of the application nozzle. Be sure to completely fill the sealant cavity.

5. Tooling Sealant

Before a skin begins to form on the sealant, it must be tooled. There are several different types of tools available for this step, including Spatulas of different sizes and shapes and Stick Tools. Tooling forces the sealant against the back-up material and the joint surfaces. Tool the sealant with light pressure. At this point a concave configuration can be shaped at the top of the sealant, creating the recommended hourglass shape. Do not use liquid tooling aids such as water, soap, or isopropyl alcohol. These materials may interfere with sealant cure and adhesion, and may create aesthetic issues. Remove the masking tape before the sealant skins over.

CRL Sealant Requirement Estimator Chart

Spec Data, Material Safety Data Sheets and complete
Selector Charts are available at crlaurence.com

JOINT SIZE Depth x Width	APPROXIMATE LINEAR FEET (METERS) SEALED				
	Per 1 Gallon Container	Per 10.3 Fl. Oz. Cartridge	Per 20 Fl. Oz. Sausage	Per 2 Gallon Pail	Per 4.5 Gallon Pail
3/16" x 1/4" (4.8 x 6.3 mm)	411' (125 m)	33' (10 m)	64' (20 m)	821' (250 m)	1848' (563 m)
3/16" x 3/8" (4.8 x 9.5 mm)	274' (83 m)	22' (7 m)	43' (13 m)	548' (167 m)	1232' (376 m)
3/16" x 1/2" (4.8 x 12.7 mm)	205' (62 m)	16' (5 m)	32' (9.8 m)	411' (125 m)	924' (282 m)
3/16" x 5/8" (4.8 x 16 mm)	164' (50 m)	13' (4 m)	26' (8 m)	329' (100 m)	739' (225 m)
3/16" x 3/4" (4.8 x 19 mm)	137' (41 m)	11' (3.3 m)	21' (6 m)	274' (84 m)	616' (188 m)
1/4" x 1/4" (6.3 x 6.3 mm)	308' (94 m)	25' (8 m)	48' (15 m)	616' (188 m)	1386' (422 m)
1/4" x 3/8" (6.3 x 9.5 mm)	205' (62 m)	16' (4.9 m)	32' (9.8 m)	411' (125 m)	924' (282 m)
1/4" x 1/2" (6.3 x 12.7 mm)	154' (47 m)	12' (4 m)	24' (7.3 m)	308' (94 m)	693' (211 m)
1/4" x 5/8" (6.3 x 16 mm)	123' (37 m)	10' (3 m)	19' (5.8 m)	246' (75 m)	554' (169 m)
1/4" x 3/4" (6.3 x 19 mm)	103' (31 m)	8.3' (2.5 m)	16' (5 m)	205' (62 m)	462' (141 m)
1/4" x 1" (6.3 x 25 mm)	77' (23 m)	6.2' (1.9 m)	12' (3.6 m)	154' (47 m)	346' (105 m)
3/8" x 3/8" (9.5 x 9.5 mm)	137' (41 m)	11' (3.3 m)	21' (6 m)	274' (84 m)	616' (188 m)
3/8" x 1/2" (9.5 x 12.7 mm)	103' (31 m)	8.3' (2.5 m)	16' (4.9 m)	205' (62 m)	462' (141 m)
3/8" x 5/8" (9.5 x 16 mm)	82' (25 m)	6.6' (2 m)	13' (4 m)	164' (50 m)	370' (113 m)
3/8" x 3/4" (9.5 x 19 mm)	68' (21 m)	5.5' (1.7 m)	11' (3.3 m)	137' (41 m)	308' (94 m)
3/8" x 1" (9.5 x 25 mm)	51' (15.5 m)	4.1' (1.2 m)	7.9' (2.4 m)	103' (31 m)	231' (70 m)
3/8" x 1.5" (9.5 x 38 mm)	34' (10 m)	2.7' (.8 m)	5.3' (1.6 m)	68' (21 m)	154' (47 m)
3/8" x 2" (9.5 x 51 mm)	25' (8 m)	2' (.6 m)	3.9' (1.2 m)	51' (15.5 m)	115' (35 m)
3/8" x 3" (9.5 x 76 mm)	17' (5.1 m)	1.4' (.4 m)	2.6' (.8 m)	34' (10 m)	77' (23 m)
1/2" x 1/2" (12.7 x 12.7 mm)	77' (23 m)	6.2' (1.9 m)	12' (4 m)	154' (47 m)	346' (105 m)
1/2" x 5/8" (12.7 x 16 mm)	62' (19 m)	5' (1.5 m)	9.7' (2.9 m)	123' (37 m)	277' (84 m)
1/2" x 3/4" (12.7 x 19 mm)	51' (15.5 m)	4.1' (1.2 m)	8' (2.4 m)	103' (31 m)	231' (70 m)
1/2" x 1" (12.7 x 25 mm)	39' (12 m)	3.1' (.9 m)	6.1' (1.8 m)	77' (23 m)	173' (53 m)
1/2" x 1.5" (12.7 x 38 mm)	25' (8 m)	2' (.6 m)	3.9' (1.2 m)	52' (15.8 m)	115' (35 m)
1/2" x 2" (12.7 x 51 mm)	19' (5.8 m)	1.5' (.5 m)	3' (.9 m)	38' (11.5 m)	86' (26 m)
1/2" x 3" (12.7 x 76 mm)	12' (3.6 m)	1' (.3 m)	1.9' (.5 m)	26' (7.9 m)	58' (18 m)

Volume Equivalents:

25 Cartridges = one 2 gallon (7.6 liter) pail
 56 Cartridges = one 4.5 gallon (17 liter) pail
 Six 20 ounce Sausages = 1 gallon (less 8 ounces)

NOTE: Actual volume of sealant used will depend on factors such as joint design, backer rod placement, viscosity differences of various caulking materials, the tooling and rate at the job site.



CRL Construction Sealant Selector Chart

Spec Data, Material Safety Data Sheets and complete Selector Charts are available at crlaurence.com.

SEALANT	Primerless Adhesion to These Substrates	Dynamic Joint Movement	Hardness (Shore A)	Tack-Free Time	Tooling Time	Cure Time 1/4" (6 mm) Bead	Performance Temperature Range	Application Temperature Range	Conformance to ASTM and Federal Specification
CRL 33S Acetic Cure Silicone Sealant	Glass, Fiberglass, Plastics, Glazed Ceramic Tile, Porcelain, Painted Surfaces	± 25%	25	10 – 20 Minutes	5 – 8 Minutes	48 Hours	-80° to 400°F -62° to 204°C	-35° to 140°F -37° to 60°C	TT-S-001543A Class A; TT-S-00230C Class A; ASTM C-920; FDA; NSF, UL Recognized; Qualifies for LEED ®.
CRL WCS1 and WCS5 Water Clear Silicone Sealant	Glass, Fiberglass, Glazed Ceramic Tile, Porcelain, Painted Surfaces	± 25%	30	10 – 20 Minutes	5 – 8 Minutes	48 Hours	-80° to 400°F -62° to 204°C	-35° to 140°F -37° to 60°C	TT-S-001543A Class A; ASTM C-920; Qualifies for LEED ®.
CRL RTV408 Neutral Cure Silicone Sealant	Glass, Aluminum, Steel, Plastics, Glazed Ceramic Tile, Porcelain, Painted and Fluoropolymer Surfaces	± 25%	23	18 – 25 Minutes	10 – 15 Minutes	48 Hours	-80° to 400°F -62° to 204°C	-35° to 140°F -37° to 60°C	TT-S-001543A Class A; TT-S-00230C Class A; ASTM C-920; AAMA 802.3, 805.2, 808.3; Qualifies for LEED ®.
CRL 95C Neutral Cure Silicone Building Sealant	Glass, Aluminum, Steel, Plastics, Glazed Ceramic Tile, Porcelain, Painted and Fluoropolymer Surfaces	± 50%	25	30 – 35 Minutes	25 – 30 Minutes	48 Hours	-80° to 350°F -62° to 177°C	-20° to 140°F -29° to 60°C	TT-S-001543A Class A; TT-S-00230C Class A; ASTM C-920; Qualifies for LEED ®.
CRL M66 Polyurethane Construction Sealant	Concrete, Brick, Aluminum, Steel, Vinyl, Painted Metals, Natural Stones	± 25%	30	3 Hours	2.5 Hours	36 Hours	-40° to 200°F -40° to 93°C	-35° to 120°F -37° to 49°C	TT-S-00230C Class A; ASTM C-920; CAN/CGSB-19.13-M87 Qualifies for LEED ®.
CRL M64 Polyurethane Construction Sealant	Concrete, Brick, Aluminum, Steel, Vinyl, Painted Metals, Natural Stones	± 25%	25	3 Hours	2.5 Hours	36 Hours	-40° to 200°F -40° to 93°C	-35° to 120°F -37° to 49°C	TT-S-00230C Class A; ASTM C-920; AAMA 808.3; CAN/CGSB-19.13-M87; Qualifies for LEED ®.
CRL M65W Polyurethane Construction Sealant	Glass, Concrete, Brick, Aluminum, Steel, Vinyl, Painted Metals, Natural Stones, Many Plastics	± 25%	25	2 Hours	1 Hour	36 Hours	-40° to 200°F -40° to 93°C	-35° to 120°F -37° to 49°C	TT-S-00230C Class A; ASTM C-920; CAN/CGSB-19.13-M87; Qualifies for LEED ®.
CRL 777 Butyl Rubber Sealant	Glass, Metal, Concrete, Wood, Masonry, Some Plastics	± 7.5%	40	2 Hours	1 Hour	21 Days	-20° to 200°F -29° to 93°C	0° to 120°F -18° to 49°C	TT-S-001657 Type I; TT-C-1796A; ASTM C 1311; AAMA 808.3-05; USDA.
CRL 888 Butyl Rubber Sealant	Glass, Metal, Concrete, Wood, Masonry, Some Plastics	± 7.5%	40	2 Hours	1 Hour	21 Days	-20° to 200°F -29° to 93°C	0° to 120°F -18° to 49°C	TT-S-001657 Type I; TT-C-1796A; ASTM C 1311; AAMA 808.3-05; USDA.
CRL 321 Acrylic Latex with Silicone	Glass, Vinyl, Metal, Brick, Wood, Plastic, Ceramics, Drywall, Plaster	± 10%	45	15 Minutes	5-10 Minutes	72 Hours	40° to 120°F 4° to 49°C	0° to 180°F -18° to 82°C	ASTM C-834-00; ASTM C-920; TT-S-00230C; Qualifies for LEED ®.
CRL 800 Acrylic Latex with Silicone	Glass, Vinyl, Metal, Brick, Wood, Plastic, Ceramics, Drywall, Plaster	± 7.5%	40	15 Minutes	5-10 Minutes	72 Hours	40° to 120°F 4° to 49°C	0° to 180°F -18° to 82°C	ASTM C-834; Qualifies for LEED ®.
CRL15W Acrylic Latex Caulk	Aluminum, Masonry, Painted and Unpainted Wood, Drywall, Plaster	± 7.5%	50	15 Minutes	5-10 Minutes	72 Hours	40° to 120°F 4° to 32°C	-35° to 140°F -37° to 60°C	ASTM C-834; Qualifies for LEED ®.

CRL Comparable Sealant Brands Chart

Spec Data, Material Safety Data Sheets and complete
Selector Charts are available at crlaurence.com.

CRL	DAP	DOW CORNING	GE (MOMENTIVE)	OSI
SILICONES				
CRL 33S	100% Silicone	999-A 732 700 Glazing General Purpose	1000 Contractors 1200 Construction	HM-270
CRL 33SMRC		786 Tub, Tile and Ceramic	1700 Sanitary	
CRL RTV408	TITANIUM®	799 Contractors Weatherproofing Vinyl Window, Siding & Door	Silglaze II 2800 Contractors-N 1800	VP-275
CRL 95C		791, 795	Silpruf	
POLYURETHANES				
CRL M64	Premium Polyurethane			PR-255
CRL M65W	SIDE WINDER®			
ACRYLIC LATEX				
CRL 321 or CRL 800	ALEX PLUS® ALEX Fast Dry™			SA-167 Polyseamseal
CRL 321	DYNAFLEX 230®			Pro-Stik
CRL15W	ALEX® Painters RELY-ON®			LC-160
BUTYL RUBBERS				
CRL 888 or CRL 777	BUTYL-FLEX®			SBR-100
CRL	PECORA	SIKA	SONNEBORN	TREMCO
SILICONES				
CRL 33S	860 863	SikaSil®-GP	OmniPlus	Proglaze Tremsil 200 TremPro 644
CRL RTV408	896	SikaSil®-N Plus		Tremsil 600 TremPro 645
CRL 95C	864 895	SikaSil®-WS95	OmniSeal	Spectrem 2 Spectrem 3
POLYURETHANES				
CRL M64	Dynatrol® 1-XL	Sikaflex® 1A Sikaflex®-201 US Sikaflex® 15LM Sikaflex®-219 LM	NP1	Dymonic Vulkem 921 TremGlaze U1400
CRL M66		Sikaflex®-201 Textured		Vulkem 116 TremPro 626
CRL M65W	Pro-Sil 1		Sonolastic 150	TremGlaze 41600
ACRYLIC LATEX				
CRL 321 or CRL 800	AC-20+		Sonolac	834 TremGlaze SA1100 TremPro 655
BUTYL RUBBERS				
CRL 888 or CRL 777	BC-158			Butyl Sealant

LEED® (Leadership in Energy and Environmental Design) Statement for CRL Sealants, Adhesives, and Glazing Tapes

More and more new building projects are classified as "Green" or "Environmentally Friendly", and provide **LEED®** credits for reducing air contaminants.

What is LEED®?

LEED® is a third party certification program and the nationally accepted benchmark for the design, construction, and operation of high performance "green" buildings. Developed by the U.S. Green Building Council in 2000 through a consensus based process, **LEED®** serves as a tool for buildings of all types and sizes. **LEED®** certification offers third party validation of a project's "green" features, and verifies that the building is operating exactly the way it was designed to.

How does LEED® work?

LEED® is a point-based system where building projects earn **LEED®** points for satisfying specific "green" building criteria. Within each of the **LEED®** credit categories, projects must satisfy particular prerequisites and earn points. The five categories include Sustainable Sites (SS), Water Efficiency (WE), Energy and Atmosphere (EA), Materials and Resources (MR), and Indoor Environmental Quality (IEQ). An additional category, Innovation in Design (ID), addresses sustainable building expertise as well as design measures not covered under the five environmental categories. The number of points the project earns determines the level of **LEED®** Certification the project receives.

Credit 4.1 Indoor Environmental Quality (IEQ) is given for using Low-Emitting Materials, Adhesives, and Sealants. The intent is to reduce the quantity of indoor air contaminants that are odorous, potentially irritating, and/or harmful to the comfort and well-being of installers and occupants. The Volatile Organic Compounds (VOC) content of adhesives and sealants used must be less than the current VOC content limits of South Coast Air Quality Management District (SCAQMD) Rule # 1168 requirements, and the Bay Area Air Quality Management District Regulation 9 (BAAQMD) Rule 51 requirements. CRL Sealant VOC values fall below the applicable VOC limit listed within this credit, which is 250 g/L (grams/liter). In addition, all of our Polyurethane Sealants and Adhesives (M64, M66, and M65W) are TDI free compared to most competitors' products. Our Polyurethanes are formulated from the safer, less toxic MDI based polymer.

Credit 5.1 Materials and Resources (MR) is given for using Local/Regional Materials. The intent is to increase demand for building products that are manufactured locally, thereby reducing the environmental impacts resulting from their transportation and supporting the local economy. Credit is given to products manufactured within 500 miles of the building site location. The manufacturing site for our sealants listed below (except if otherwise noted) is Lakewood, NJ 08701. Confirm your site is within a 500 mile radius of the manufacturing site.

CRL Sealants

33S Silicone	<39 g/L
RTV408 Industrial and Construction Silicone	<39 g/L
95C Silicone Building Sealant	<25 g/L
WCS1 Water Clear Silicone	<36 g/L
M64 Polyurethane Construction Sealant	<33 g/L
M66 Polyurethane Construction Sealant	<33 g/L
M65W PermaWhite Sealant	<23 g/L
321 Acrylic Latex with Silicone (Mfg. site is Pryor, OK 74361)	<19 g/L
CRL15W Acrylic Latex Caulk (Mfg. site is Pryor, OK 74361)	30-40 g/L
800 Acrylic Latex with Silicone (Mfg. site is Dallas, TX 75243)	31 g/L

VOC Value

CRL Adhesives

UV770, UV740, UV678, UV682, UV665, UV690, UV760, and Colored UV Adhesives (Mfg. site is Winsted, CT 06098)	0 g/L
---	-------

CRL Mastics

600GL Heavy Bodied Mirror Mastic (Mfg. site is Louisville, KY 40207)	230 g/L
---	---------

CRL Tapes

980 Series Vinyl Foam Glazing Tape – Adhesive Two Sides	<5 g/L
740 Series Vinyl Foam Glazing Tape – Adhesive One Side (Mfg. site is San Antonio, TX 78218)	<5 g/L
V2100 Thermalbond™ Structural Glazing Spacer Tape (Mfg. site is Granville, NY 12832)	<6.5 g/L
GT Series Butyl Architectural Tape (Mfg. site is Evansville, IN 47711)	0 g/L

Additional **LEED®** information is available on the U.S. Green Building Council web site at usgbc.org

LEED® is a registered trademark of the U.S. Green Building Council.

Surface Preparation Guide for CRL Silicone Sealants *Non-Structural Use Only



Optimum performance of CRL Sealants depends on proper surface preparation and often the use of a primer. As in all cases, the chosen substrate should be tested for adhesion and compatibility prior to sealant application.

SUBSTRATE	Surface Preparation	CRL 33S		CRL RTV408		CRL 95C	
		Recommendation	Primer	Recommendation	Primer	Recommendation	Primer
GLASS							
Insulating	Solvent Wipe ³	Do not use		OK	None Req.	OK	None Req.
Float, Plate, Sheet	Solvent Wipe	OK	None Req.	OK	None Req.	OK	None Req.
Laminated ⁴	Solvent Wipe	OK	None Req.	OK	None Req.	OK	None Req.
Tinted	Solvent Wipe	OK	None Req.	OK	None Req.	OK	None Req.
Porcelain-Coated Material	Solvent Wipe	OK	None Req.	OK	None Req.	OK	None Req.
Ceramic Tile, Glazed	Solvent Wipe	OK	None Req.	OK	None Req.	OK	None Req.
Vitrified Surfaces	Solvent Wipe	OK	None Req.	OK	None Req.	OK	None Req.
Reflective Glass	Solvent Wipe	Call CRL		OK	None Req.	OK	None Req.
Low (E) High (T) Glass	Solvent Wipe	Call CRL		OK	None Req.	OK	None Req.
CONCRETE & MASONRY¹							
Brick	Abrade ²	Do not use		OK	S1L2100	OK	None Req.
Concrete Block	Abrade	Do not use		OK	S1L2100	OK	S1L2100
Poured Concrete	Abrade	Do not use		OK	S1L2100	OK	S1L2100
Precast Concrete	Abrade	Do not use		OK	S1L2100	OK	S1L2100
Tilt-Up Concrete	Abrade	Do not use		OK	S1L2100	OK	S1L2100
Mortar	Abrade	Do not use		OK	S1L2100	OK	S1L2100
Grout	Abrade	Do not use		OK	S1L2100	OK	S1L2100
Plaster	Abrade	Do not use		OK	S1L2100	OK	S1L2100
STONE¹							
Travertine	Abrade/Solvent Wipe	Do not use		OK	S1L2100	OK	S1L2100
Granite	Abrade/Solvent Wipe	Do not use		OK	S1L2100	OK	None Req.
Marble	Abrade/Solvent Wipe	Do not use		OK	S1L2100	OK	S1L2100
Limestone	Abrade/Solvent Wipe	Do not use		OK	S1L2100	OK	S1L2100
Sandstone	Abrade/Solvent Wipe	Do not use		OK	S1L2100	OK	S1L2100
PAINTS							
Acrylic Latex	Solvent Wipe	OK	S1L2100	OK	None Req.	OK	None Req.
Acrylic Thermoset	Solvent Wipe	OK	S1L2100	OK	None Req.	OK	None Req.
Silicone Alkyd	Solvent Wipe	OK	None Req.	OK	None Req.	OK	None Req.
Silicone Acrylic	Solvent Wipe	OK	None Req.	OK	None Req.	OK	None Req.
Polyurethane	Solvent Wipe	OK	None Req.	OK	None Req.	OK	None Req.
Polyvinyl Chloride (PVC)	Solvent Wipe	OK	S1L2100	OK	S1L2100	OK	None Req.
Silicone Polyester	Solvent Wipe	OK	None Req.	OK	None Req.	OK	None Req.
FLOUROPOLYMER							
KYNAR [®]	Solvent Wipe	OK	S1L2100	OK	None Req.	OK	None Req.
DURANAR [®]	Solvent Wipe	OK	S1L2100	OK	None Req.	OK	None Req.
FLUOROPON [®]	Solvent Wipe	OK	S1L2100	OK	None Req.	OK	None Req.
DURANAR XL [®]	Solvent Wipe	OK	S1L2100	OK	None Req.	OK	None Req.
PLASTICS							
Acrylic Sheet	Solvent Wipe	OK	S1L2100	OK	S1L2100	OK	None Req.
Polyester/Fiberglass	Solvent Wipe	OK	None Req.	OK	None Req.	OK	None Req.
Epoxy Aggregate Panels	Solvent Wipe	OK	None Req.	OK	None Req.	OK	None Req.
Polycarbonate Sheet	Solvent Wipe	OK	S1L2100	OK	S1L2100	OK	None Req.
Polystyrene	Solvent Wipe	OK	None Req.	OK	None Req.	OK	None Req.
Polyvinyl Chloride	Solvent Wipe	OK	S1L2100	OK	S1L2100	OK	None Req.
Polyester Aggregate Panel	Solvent Wipe	OK	None Req.	OK	None Req.	OK	None Req.

Surface Preparation Guide for CRL Silicone Sealants *Non-Structural Use Only



Optimum performance of CRL Sealants depends on proper surface preparation and often the use of a primer. As in all cases, the chosen substrate should be tested for adhesion and compatibility prior to sealant application.

SUBSTRATE	Surface Preparation	CRL 33S		CRL RTV408		CRL 95C	
		Recommendation	Primer	Recommendation	Primer	Recommendation	Primer
RUBBER							
Butyl	Solvent Wipe	Test	None Req.	Test	None Req.	OK	None Req.
EPDM	Solvent Wipe	Test	None Req.	Test	None Req.	OK	None Req.
Neoprene	Solvent Wipe	Test	None Req.	Test	None Req.	OK	None Req.
Polyurethane	Solvent Wipe	Test	None Req.	Test	None Req.	OK	None Req.
Acrylic	Solvent Wipe	Test	None Req.	Test	None Req.	OK	None Req.
Vinyl	Solvent Wipe	Test	None Req.	Test	None Req.	OK	None Req.
Silicone Rubber	Solvent Wipe	OK	None Req.	OK	None Req.	OK	None Req.
METALS							
Aluminum – Alodine	Solvent Wipe	OK	S1L2100	OK	None Req.	OK	None Req.
Aluminum – Mill Finish	Abrade/Solvent Wipe	OK	S1L2100	OK	S1L2100	OK	None Req.
Aluminum – Anodized	Solvent Wipe	OK	S1L2100	OK	None Req.	OK	None Req.
Copper	Abrade/Solvent Wipe	Do not use		Do not use		OK	S1L2100
Lead	Abrade/Solvent Wipe	Do not use		OK	None Req.	OK	None Req.
STEEL							
Red Lead Primer	Solvent Wipe	OK	S1L2100	OK	None Req.	OK	None Req.
Weathered	Abrade/Solvent Wipe	OK	S1L2100	OK	None Req.	OK	None Req.
Stainless	Solvent Wipe	OK	S1L2100	OK	None Req.	OK	None Req.
Galvanized	Solvent Wipe	OK	S1L2100	OK	None Req.	OK	None Req.
Cold Rolled	Solvent Wipe	OK	S1L2100	OK	None Req.	OK	None Req.
WOODS							
Unfinished	Solvent Wipe	OK	S1L2100	OK	None Req.	OK	None Req.
Finished	Solvent Wipe	Refer to PAINTS Section		Refer to PAINTS Section		Refer to PAINTS Section	

*These recommendations apply for weatherseal applications only, and are NOT intended for structural glazing applications.

¹Job specific stain testing should be done for both sealant or primer because masonry and stone porosity varies.

²Abrade = Mechanical surface preparation such as wire brush or sand blast. Should always be followed by residual dust removal.

³Solvent wipe = Wipe with clean, oil-free rag; wet with industrial solvent such as mineral spirits, naphtha, isopropyl alcohol (IPA), or ketones (MEK or MIBK). Test small sample to ensure solvent does not affect finish. Allow surface to thoroughly dry before applying sealant.

CAUTION: When using solvents or primers always provide adequate ventilation and keep away from heat, sparks, and open flames. Follow all precautions given on the solvent container label and Material Safety Data Sheet. Additionally, always check compatibility of substrate with cleaning solvent or primer before full-scale use. Follow local, state, and federal regulations for solvent use.

⁴Laminated glass with polyvinyl butrol (PVB) interlayers may delaminate up to 1/4" (6 mm) when in contact with a sealant.

SPECIAL NOTE: We no longer carry Cat. No. 99AS Aquarium Silicone Sealant due to circumstances beyond our control. In addition, it is not our intent to carry any aquarium sealant in the future. We apologize for any inconvenience this may cause any of our customers.

Types of CRL Glazing Tapes and Gaskets

Glazing Tapes are designed to be either primary or secondary seals in a variety of glazing systems. They are used by themselves or combined with sealants to minimize and prevent infiltration of air and water into a building envelope.

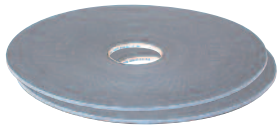

Foam Glazing Tape
(Adhesive One Side)

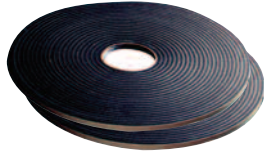

Foam Glazing Tape
(Adhesive Two Sides)

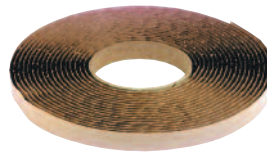

Butyl Architectural Tape



Shimmed Butyl Tape

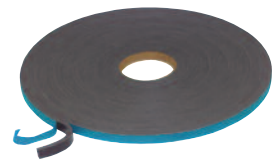

Thermalbond Structural/
Glazing Spacer Tape



Wedge Gasket Glazing Spline



VISIONstrip® Glazing Seal



Roll-In Glazing Gasket

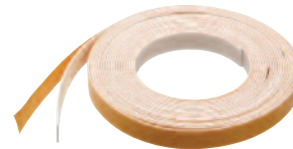

Fire Glazing Tape



Putty Tape

In all **Conventional Glazing** the glass is mechanically retained by the framing system. The glass is separated from contact with the inner and outer framing by either wet (sealants) or dry (tapes and gaskets) resilient glazing materials that are used to isolate the glass from the frame and provide a seal against air and water.

Wet Glazing refers to the use of gunnable sealants or mastic tapes that rely on adhesion to the glass to effectively seal against air and water infiltration. A cap bead of gunnable sealant may be applied over shimmed mastic tapes for even greater protection against leakage.

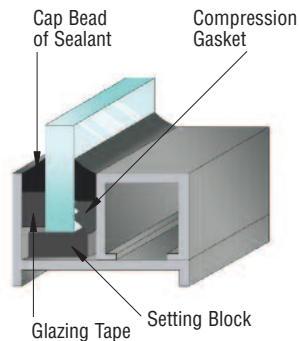

Dry Glazing refers to the use of synthetic rubber and other elastomeric gaskets or tapes which require compressive force to effectively seal against air and water infiltration.

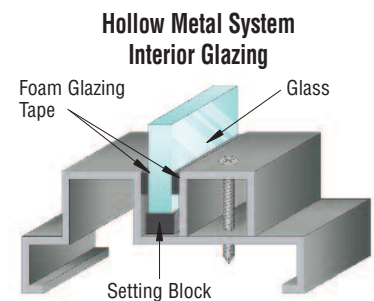

Wet-Dry Glazing combines the watertight integrity of wet systems with the ease of installation and attractive appearance of dry glazing. Typically, a pre-shimmed mastic tape is used for the wet seal, and an elastomeric gasket is used for the dry seal.

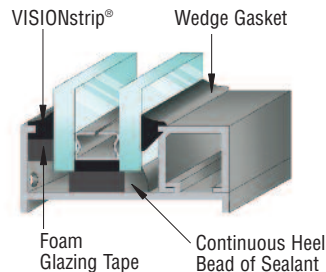

Structural Sealant Glazing relies on the adhesive properties of silicone sealants to adhere glass to the framing system. Thermalbond Structural Glazing Spacer Tape is used in conjunction with the structural silicone sealant as a spacer for joint dimension control.

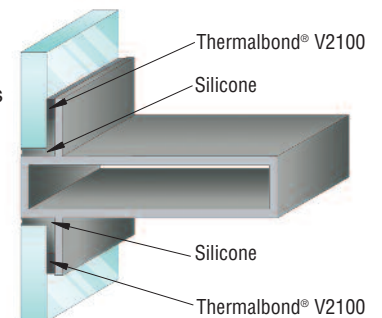

CRL Saint-Gobain/Norton V2100 Thermalbond® Structural Glazing Spacer Tape



- Structural Glazing Spacer for Field and Shop Glazing
- Superb Spacer for Two and Four Sided Structural Silicone Glazing Systems
- Chemically Compatible With All Silicones Tested
- Black Color

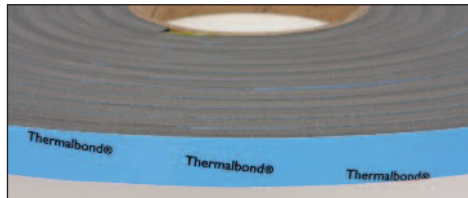
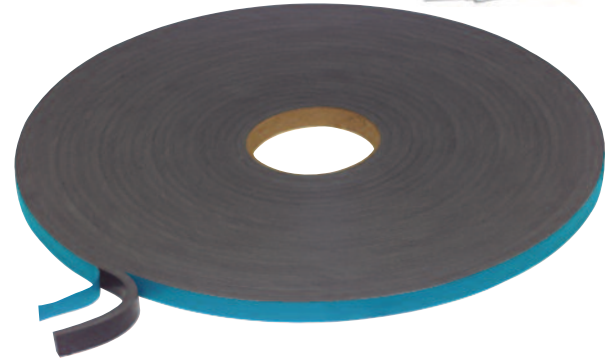

Printed Liner Verifies Specified Product is Used

Description

CRL Saint-Gobain/Norton V2100 Thermalbond® Tape is a semi-rigid foam tape with an aggressive pressure-sensitive adhesive. This high density tape has a specially formulated cellular substrate, and is used as a spacer for joint dimension control in structural silicone glazing systems. It is the most widely used spacer tape for structural silicone systems.

V2100 has proven to be compatible with all commercial silicone sealants used for structural glazing. It has a highly aggressive adhesive on both sides, and a semi-rigid, open cell structure that maintains the required spacing, and allows air and moisture to reach the silicone to allow optimum curing. Its low conductivity reduces heat transfer and inhibits condensation on windows, doors, and metal systems.

V2100 Tape is designed as a spacer for glass, metal, stone, mineral cement, and plastic panels in structural silicone glazing systems. This includes: two and four sided structural silicone glazing of curtain walls, storefronts, skylights and windows; to temporarily secure glazing or panels to framework in shop fabrication of unitized structural silicone glazing and cladding systems; to temporarily secure lightweight veneers to substrates while permanent structural silicone adhesives are curing; as a thermal break to reduce the conduction of heat; to provide an even sight line in vision areas. It is stocked only in an architectural black finish (other colors available on special order), and in nine stock sizes. Other sizes are also available on special order.

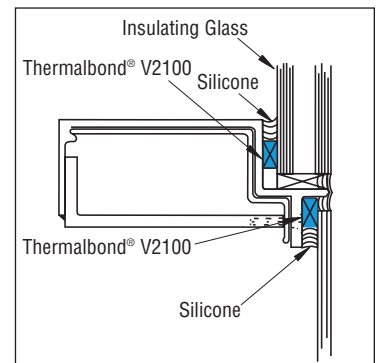
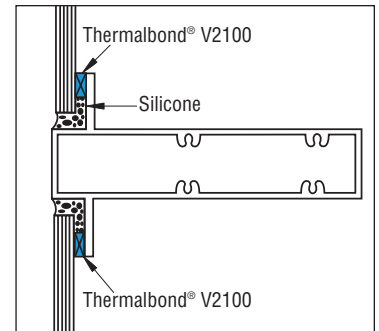

Limitations

NOTE: Thermalbond® V2100 is a SPACER material and not intended to be a structural component. The adhesive properties cannot be used as part of the permanent fastening system or in any way to reduce the amount of silicone adhesive recommended by the silicone manufacturer. Contact surfaces must be thoroughly cleaned. Position V2100 carefully, as it cannot be repositioned after initial contact. With some surfaces, it may be necessary to prime the surface with Norton Tite-R-Bond Adhesion Promoter (see page N173).

Typical Properties

Density: 31 lbs./cu.ft. (497 kg/m³); Hardness: 35 durometer Shore A; Force to Compress 10%: 31 psi (214 kPa); Tensile Strength: 180 psi (1241 kPa); Elongation: 125%; Temperature Range: Application 60°F (16°C) to 125°F (52°C); Service -40°F (-40°C) to 180°F (82°C).

CAT. NO.	THICKNESS	WIDTH	LENGTH	ROLLS/CASE	LENGTH/CASE
V210438	1/8" (3.2 mm)	3/8" (9.5 mm)	50' (15.2 m)	20	1,000' (305 m)
V210412	1/8" (3.2 mm)	1/2" (12.7 mm)	50' (15.2 m)	20	1,000' (305 m)
V210638	3/16" (4.7 mm)	3/8" (9.5 mm)	50' (15.2 m)	20	1,000' (305 m)
V210814	1/4" (6.3 mm)	1/4" (6.3 mm)	50' (15.2 m)	40	2,000' (610 m)
V210838	1/4" (6.3 mm)	3/8" (9.5 mm)	50' (15.2 m)	40	2,000' (610 m)
V210812	1/4" (6.3 mm)	1/2" (12.7 mm)	50' (15.2 m)	20	1,000' (305 m)
V21081	1/4" (6.3 mm)	1" (25.4 mm)	50' (15.2 m)	10	500' (152.4 m)
V211238	3/8" (9.5 mm)	3/8" (9.5 mm)	25' (7.6 m)	20	500' (152.4 m)
V211212	3/8" (9.5 mm)	1/2" (12.7 mm)	25' (7.6 m)	20	500' (152.4 m)

Minimum order: 1 roll. Sizes can be combined for quantity pricing.

CRL Foam Glazing Tapes – Adhesive On Two Sides

SPEC. DATA

MSDS

- **Excellent Adhesion to Wood, Vinyl (Rigid PVC), Aluminum, and Glass**
- **Superior Resistance to Weathering, Oxidation, and UV Exposure**
- **Meets AAMA 810.1 Certification**
- **Aggressive Adhesive**
- **Service Temperature Range From – 40°F to 180°F (-40°C to 82°C)**

ENERGY STAR®– CRL is an **ENERGY STAR®** partner, and our fenestration foam glazing tapes carry the **ENERGY STAR®** seal. **ENERGY STAR®** is a government backed program helping businesses and individuals protect the environment through superior energy efficiency.



- **Available in Gray and Black**

CRL Foam Glazing Tape is a closed-cell polyethylene foam sealant in tape form. The aggressive acrylic adhesive is formulated to position the foam on curved or irregular surfaces with the slightest pressure. Adheres to wood, vinyl, aluminum, and glass. It can be used as an exterior glazing sealant - particularly where glass repositioning is important before the final setting.

CRL Foam Glazing Tape is specifically designed to be a primary or secondary seal in a variety of glazing systems. It is self-shimming, so you don't need shims or spacers. The tape is constructed with a patented cellular structured foam that is particularly resistant to weathering and water-absorption, while providing a superior long-lived seal.



Easy-peel paper liner prevents tape from stretching during installation.

Closed-cell foam substrate seals effectively without requiring a shim.

Aggressive double-faced adhesive keeps tape in place.

CRL FOAM GLAZING TAPE WITH ADHESIVE ON TWO SIDES HAS THE FOLLOWING FEATURES:

- **Simplicity:** Requires no clean-up, easy to handle, no waste, requires no mixing or special application equipment.
- **Remains flexible** at low temperatures and dimensionally stable at high temperatures.
- **Superior resistance** to weathering, oxidation, and ultraviolet exposure.
- **Preformed tape** provides consistent and accurate application. No shim is required.
- **Special non-yellowing, non-staining water-white adhesives** provide a clean, aesthetic appearance.
- **Seals effectively** against water, dust, and light.
- **Variety of available sizes**

A minimum of 30% compression must be maintained to provide an effective moisture seal. In small lites, this may be achieved by applying pressure directly to the glazing tape when installing glazing stops. However, in most lites, the use of a compression wedge gasket is recommended. Apply with firm, uniform pressure to a clean, dry surface without stretching (the paper liner indicates if the tape has been stretched). Tape corners should be cut and butted together, rather than overlapped or radiused, and a thin bead of an approved seal sealant should be applied at the intersection after the liner has been removed. In-service temperature range is –40° to 180°F (-40° to 82°C). CRL Foam Glazing Tape is compatible with other sealing and glazing compounds.

CRL Foam Glazing Tapes – Adhesive On Two Sides

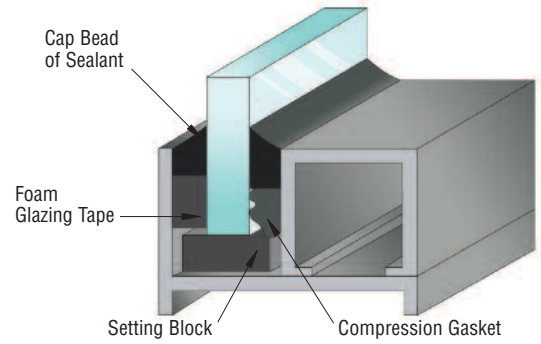
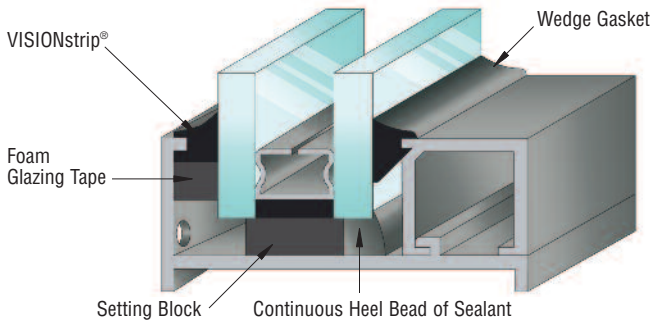

Curtain Wall System

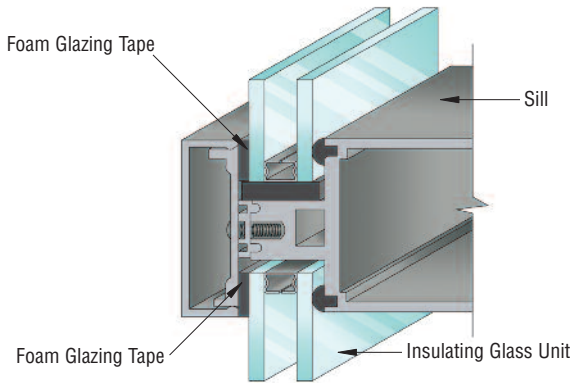

Interior Set System

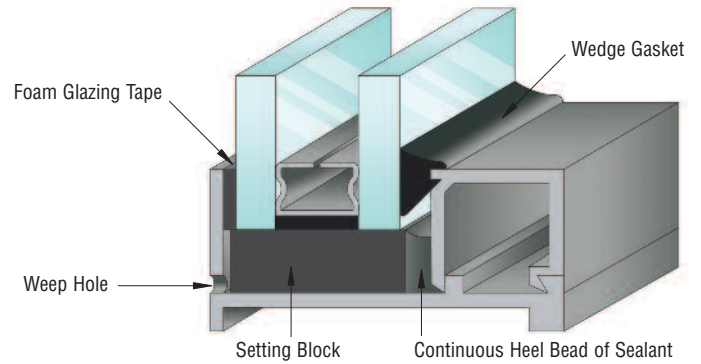

Black

BLACK TWO-SIDED ADHESIVE FOAM GLAZING TAPE

CAT. NO.	THICKNESS	WIDTH	ROLL LENGTH	ROLLS/CASE	LENGTH/CASE
982116X14BL	1/16" (1.6 mm)	1/4" (6.3 mm)	200' (61 m)	20	4,000' (1219 m)
982116X38BL	1/16" (1.6 mm)	3/8" (9.5 mm)	200' (61 m)	20	4,000' (1219 m)
982116X12BL	1/16" (1.6 mm)	1/2" (12.7 mm)	200' (61 m)	20	4,000' (1219 m)
982116X34BL	1/16" (1.6 mm)	3/4" (19 mm)	200' (61 m)	20	4,000' (1219 m)
98418X38BL	1/8" (3.2 mm)	3/8" (9.5 mm)	100' (30.5 m)	40	4,000' (1219 m)
98418X12BL	1/8" (3.2 mm)	1/2" (12.7 mm)	100' (30.5 m)	40	4,000' (1219 m)
98418X34BL	1/8" (3.2 mm)	3/4" (19 mm)	100' (30.5 m)	20	2,000' (610 m)
98418X1BL	1/8" (3.2 mm)	1" (25.4 mm)	100' (30.5 m)	20	2,000' (610 m)
98814X38BL	1/4" (6.3 mm)	3/8" (9.5 mm)	50' (15.2 m)	40	2,000' (610 m)
98814X12BL	1/4" (6.3 mm)	1/2" (12.7 mm)	50' (15.2 m)	40	2,000' (610 m)
98814X34BL	1/4" (6.3 mm)	3/4" (19 mm)	50' (15.2 m)	20	1,000' (305 m)

GRAY TWO-SIDED ADHESIVE FOAM GLAZING TAPE

CAT. NO.	THICKNESS	WIDTH	ROLL LENGTH	ROLLS/CASE	LENGTH/CASE
982116X14GRY	1/16" (1.6 mm)	1/4" (6.3 mm)	200' (61 m)	20	4,000' (1219 m)
982116X38GRY	1/16" (1.6 mm)	3/8" (9.5 mm)	200' (61 m)	20	4,000' (1219 m)
982116X12GRY	1/16" (1.6 mm)	1/2" (12.7 mm)	200' (61 m)	20	4,000' (1219 m)
982116X34GRY	1/16" (1.6 mm)	3/4" (19 mm)	200' (61 m)	20	4,000' (1219 m)
98418X38GRY	1/8" (3.2 mm)	3/8" (9.5 mm)	100' (30.5 m)	40	4,000' (1219 m)
98418X12GRY	1/8" (3.2 mm)	1/2" (12.7 mm)	100' (30.5 m)	40	4,000' (1219 m)
98418X34GRY	1/8" (3.2 mm)	3/4" (19 mm)	100' (30.5 m)	20	2,000' (610 m)
98418X1GRY	1/8" (3.2 mm)	1" (25.4 mm)	100' (30.5 m)	20	2,000' (610 m)
98814X38GRY	1/4" (6.3 mm)	3/8" (9.5 mm)	50' (15.2 m)	40	2,000' (610 m)
98814X12GRY	1/4" (6.3 mm)	1/2" (12.7 mm)	50' (15.2 m)	40	2,000' (610 m)
98814X34GRY	1/4" (6.3 mm)	3/4" (19 mm)	50' (15.2 m)	20	1,000' (305 m)

Minimum order: 1 roll. Sizes and colors can be combined for quantity pricing.

TWO-SIDED ADHESIVE TAPE WITH POLYLINER

WHITE CAT. NO.	BLACK CAT. NO.	THICKNESS	WIDTH	ROLL LENGTH	ROLLS/CASE	LENGTH/CASE
982116X38W	V992116X38BL	1/16" (1.6 mm)	3/8" (9.5 mm)	200' (61 m)	20	4,000' (1219 m)
98418X38W	--	1/8" (3.2 mm)	3/8" (9.5 mm)	100' (30.5 m)	40	4,000' (1219 m)

Minimum order: 1 roll. Sizes and colors can be combined for quantity pricing.

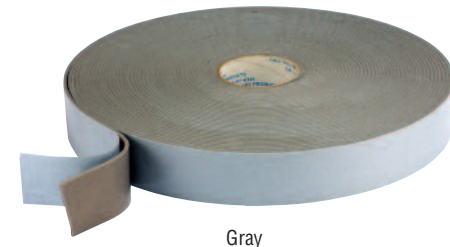

Gray

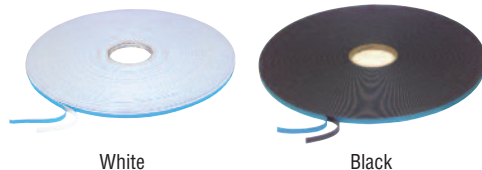

White

Black

CRL Foam Glazing Tapes – Adhesive On One Side



- Excellent Adhesion to Wood, Vinyl (Rigid PVC), Aluminum, and Glass
- Superior Resistance to Weathering, Oxidation, and UV Exposure
- Meets AAMA 810.1 Certification
- Aggressive Adhesive
- Non-Adhesive Face Releases Cleanly From Most Surfaces
- Service Temperature Range From -40°F to 180°F (-40°C to 82°C)

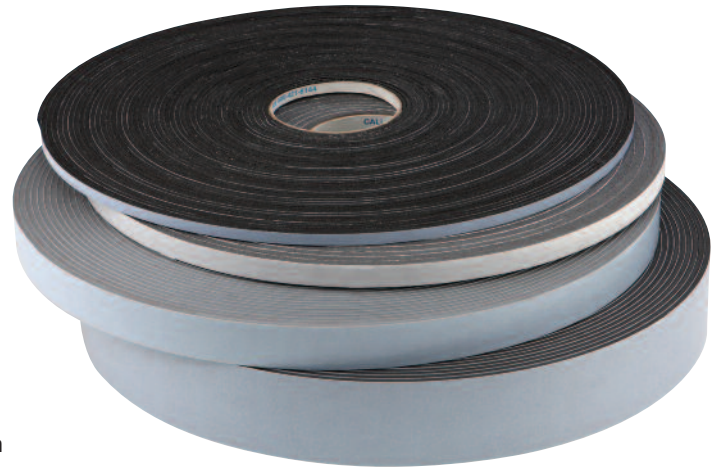

CRL Foam Glazing Tape is a closed-cell polyethylene foam sealant in tape form. The aggressive acrylic adhesive is formulated to position the foam on curved or irregular surfaces with the slightest pressure. Adheres to wood, vinyl, aluminum, and glass. It can be used as an exterior glazing sealant - particularly where glass repositioning is important before the final setting.

CRL Foam Glazing Tape is specifically designed to be a primary or secondary seal in a variety of glazing systems. It is self-shimming, so you don't need shims or spacers. The tape is constructed with a patented cellular structured foam that is particularly resistant to weathering and water-absorption, while providing a superior long-lived seal.

• Available in Gray and Black

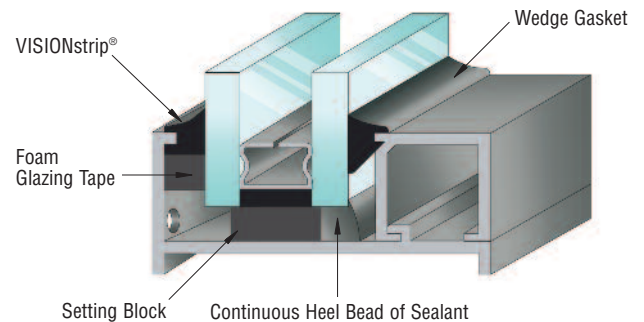
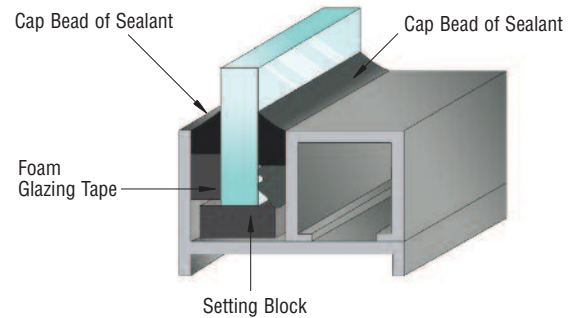

ENERGY STAR®- CRL is an **ENERGY STAR**® partner, and our fenestration foam tapes carry the **ENERGY STAR**® seal. **ENERGY STAR**® is a government backed program helping businesses and individuals protect the environment through superior energy efficiency.



Joints sealed with CRL Foam Glazing Tape with Adhesive on One Side can be opened and closed, repositioned, and used without the sticky mess associated with sealants. Use this tape in demountable partitions, louvers, formwork, access panels, doors, and other operable or temporary joints.

The non-adhesive face will release cleanly from most surfaces. When a joint is opened the tape recovers most of its original uncompressed thickness and is ready to be used again.

CRL FOAM GLAZING TAPE WITH ADHESIVE ON ONE SIDE HAS THE FOLLOWING FEATURES:

- Simplicity: Requires no clean-up, easy to handle, no waste, requires no mixing or special application equipment.
- Remains flexible at low temperatures and dimensionally stable at high temperatures.
- Superior resistance to weathering, oxidation, and ultraviolet exposure.
- Preformed tape provides consistent and accurate application. No shim is required.
- Special non-yellowing, non-staining water-white adhesives provide a clean, aesthetic appearance.
- Seals effectively against water, dust, and light.
- Variety of available sizes.

A minimum of 15% compression must be maintained to provide an effective moisture seal. In small lites, this may be achieved by applying pressure directly to the glazing tape when installing glazing stops. However, in most lites, the use of a compression wedge gasket is recommended. Apply with firm, uniform pressure to a clean, dry surface without stretching (the paper liner indicates if the tape has been stretched). Tape corners should be cut and butted together, rather than overlapped or radiused, and a thin bead of an approved sealant should be applied at the intersection after the liner has been removed. In-service temperature range is -40° to 180°F (-40° to 82°C). CRL Foam Glazing Tape is compatible with other sealing and glazing compounds.

CRL Foam Glazing Tapes – Adhesive On One Side

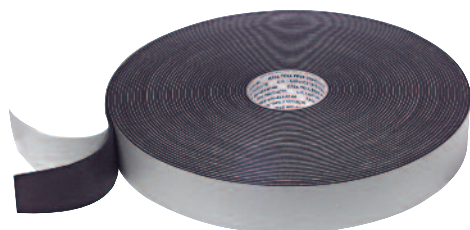
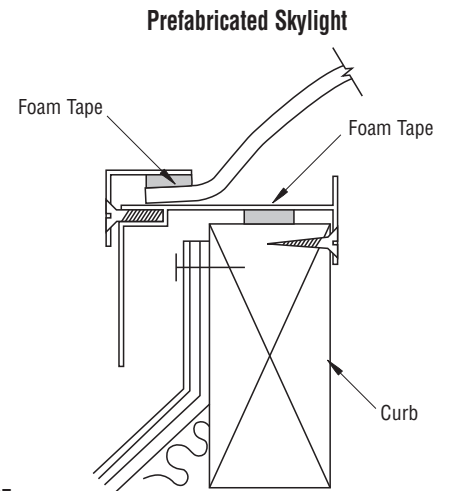
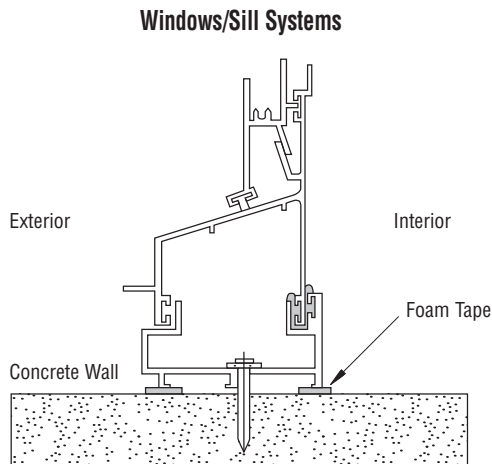
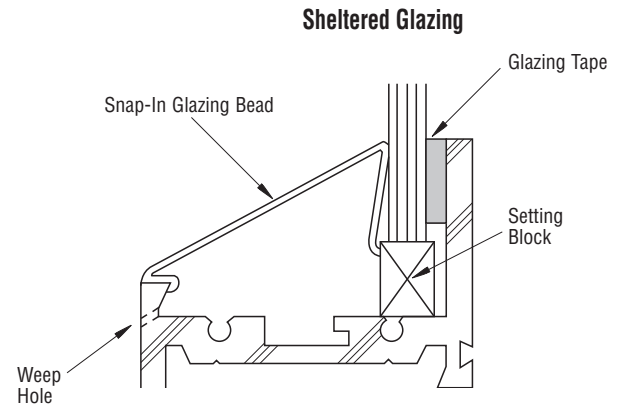
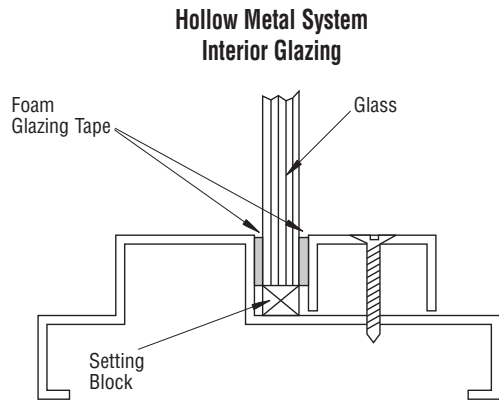

Black

BLACK ONE-SIDED ADHESIVE FOAM GLAZING TAPE

CAT. NO.	THICKNESS	WIDTH	ROLL LENGTH	ROLLS/CASE	LENGTH/CASE
74418X14BL	1/8" (3.2 mm)	1/4" (6.3 mm)	100' (30.5 m)	40	4,000' (1,219 m)
74418X38BL	1/8" (3.2 mm)	3/8" (9.5 mm)	100' (30.5 m)	40	4,000' (1,219 m)
74418X12BL	1/8" (3.2 mm)	1/2" (12.7 mm)	100' (30.5 m)	40	4,000' (1,219 m)
74418X34BL	1/8" (3.2 mm)	3/4" (19 mm)	100' (30.5 m)	20	2,000' (610 m)
74418X1BL	1/8" (3.2 mm)	1" (25.4 mm)	100' (30.5 m)	20	2,000' (610 m)
74418X112BL	1/8" (3.2 mm)	1-1/2" (38 mm)	100' (30.5 m)	5	500' (152 m)
74418X2BL	1/8" (3.2 mm)	2" (51 mm)	100' (30.5 m)	5	500' (152 m)
74814X12BL	1/4" (6.3 mm)	1/2" (12.7 mm)	50' (15.2 m)	20	1,000' (305 m)
74814X34BL	1/4" (6.3 mm)	3/4" (19 mm)	50' (15.2 m)	20	1,000' (305 m)
74814X1BL	1/4" (6.3 mm)	1" (25.4 mm)	50' (15.2 m)	20	1,000' (305 m)
74814X112BL	1/4" (6.3 mm)	1-1/2" (38 mm)	50' (15.2 m)	5	250' (76 m)
74814X2BL	1/4" (6.3 mm)	2" (51 mm)	50' (15.2 m)	5	250' (76 m)

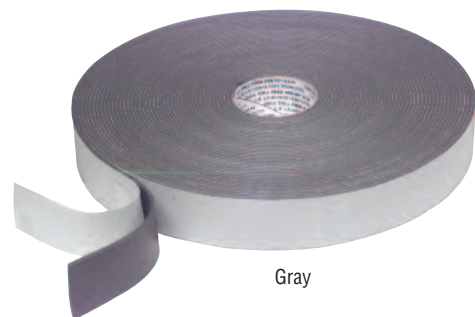

Gray

GRAY ONE-SIDED ADHESIVE FOAM GLAZING TAPE

CAT. NO.	THICKNESS	WIDTH	ROLL LENGTH	ROLLS/CASE	LENGTH/CASE
74418X14GRY	1/8" (3.2 mm)	1/4" (6.3 mm)	100' (30.5 m)	40	4,000' (1,219 m)
74418X38GRY	1/8" (3.2 mm)	3/8" (9.5 mm)	100' (30.5 m)	40	4,000' (1,219 m)
74418X12GRY	1/8" (3.2 mm)	1/2" (12.7 mm)	100' (30.5 m)	40	4,000' (1,219 m)
74418X34GRY	1/8" (3.2 mm)	3/4" (19 mm)	100' (30.5 m)	20	2,000' (610 m)
74418X1GRY	1/8" (3.2 mm)	1" (25.4 mm)	100' (30.5 m)	20	2,000' (610 m)
74418X112GRY	1/8" (3.2 mm)	1-1/2" (38 mm)	100' (30.5 m)	5	500' (152 m)
74418X2GRY	1/8" (3.2 mm)	2" (51 mm)	100' (30.5 m)	5	500' (152 m)
74814X12GRY	1/4" (6.3 mm)	1/2" (12.7 mm)	50' (15.2 m)	20	1,000' (305 m)
74814X34GRY	1/4" (6.3 mm)	3/4" (19 mm)	50' (15.2 m)	20	1,000' (305 m)
74814X1GRY	1/4" (6.3 mm)	1" (25.4 mm)	50' (15.2 m)	20	1,000' (305 m)
74814X112GRY	1/4" (6.3 mm)	1-1/2" (38 mm)	50' (15.2 m)	5	250' (76 m)
74814X2GRY	1/4" (6.3 mm)	2" (51 mm)	50' (15.2 m)	5	250' (76 m)

Minimum order: 1 roll. Sizes and colors can be combined for quantity pricing.

CRL Butyl Architectural Glazing Tape

SPEC. DATA

MSDS

- Age and Weather Resistant Butyl Rubber Formula
- 100% Solids Content
- Meets AAMA Certification
- Used as an Exterior Primary Spacing and Glazing Seal
- Available in Gray and Black

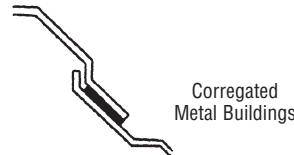
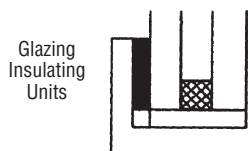
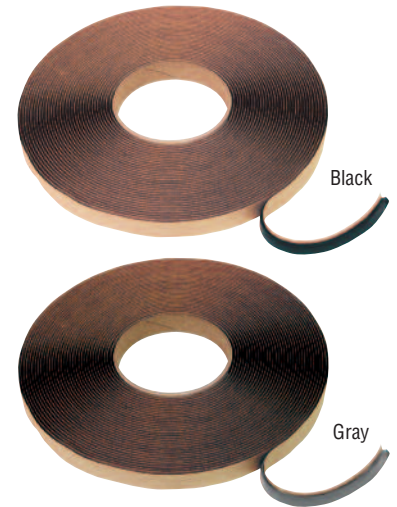

Description

CRL Butyl Architectural Glazing Tape is an extruded, preformed tape furnished on release paper rolls. Based on a butyl rubber formulation with proven age and weather resistant properties, it is designed to create a long lasting, flexible weather seal between two surfaces that will be subjected to normal expansion/contraction and wind loading forces. It is used as an exterior primary spacing and glazing seal when glazing glass into a window sash; also used to seal other architectural surfaces such as metal to metal joints, wood to glass, metal to plastic, etc. The thickness is designed to be compressed approximately 10 percent at installation to accommodate surface alignments.

Typical Properties

Base Polymer: butyl rubber (polyisobutylene); Solids Content: 100% solids (no asbestos); Cure Time: fully cured before application; Hardness: 20 durometer Shore "A" @ 77°F (25°C); Temperature Range: Application 20°F (-7°C) to 120°F (49°C); Service -40°F (-40°C) to 190°F (88°C); VOC Content: 0%; Joint Movement: ±15% of joint width; Service Life: 20 year minimum.

Limitations

For applications above two floors use a spacer, shim, or a structural cap bead (such as silicone) to prevent over compression or use CRL 100+ Load Bearing Glazing Tape. (see page N169).

Applicable Standards

AAMA 804.3, 806.3, and 807.3. ASTM C1281

Good Glazing Practices

The following "Good Glazing Practices" are recommended when using CRL Glazing Tapes. Surfaces to be adhered should be free of frost or standing water, brushed clean, solvent washed (MEK, Toluene or Naptha) and wiped dry. At installation, positive contact and approximately 10 percent compression is recommended to fully marry surfaces to be joined. Glazing tapes kept under compression with clips or wedges provide the best seals.

Always use setting blocks (80 durometer Shore "A" hardness) placed at the sill quarter points. Spacing shims are recommended to accommodate wind loading when glass lite is over 100 united inches (50 durometer Shore "A" hardness). Tape placement on the sill rabbet is not to be below the sight line unless a cap bead is specified, then tape is placed 3/16" (4.8 mm) below the sight line to allow for the cap bead. Do not overlap tape to join; always butt ends without stretching. To keep the tape surface clean, leave the release paper in place until ready to set the glass.

BLACK CAT. NO.	GRAY CAT. NO.	THICKNESS	WIDTH	ROLL LENGTH	ROLLS/ CASE	LENGTH/ CASE
GT104	GT105	1/16" (1.6 mm)	3/8" (9.5 mm)	50' (15.2 m)	24	1,200' (366 m)
GT106	GT107	1/16" (1.6 mm)	1/2" (12.7 mm)	50' (15.2 m)	20	1,000' (305 m)
GT204	GT205	1/8" (3.2 mm)	3/8" (9.5 mm)	25' (7.6 m)	24	600' (183 m)
GT206	GT207	1/8" (3.2 mm)	1/2" (12.7 mm)	25' (7.6 m)	20	500' (152.4 m)
GT304	GT305	3/16" (4.8 mm)	3/8" (9.5 mm)	25' (7.6 m)	24	600' (183 m)
GT406	GT407	1/4" (6.3 mm)	1/2" (12.7 mm)	20' (6.1 m)	20	400' (122 m)

Minimum order is case quantity. Must be ordered in full case increments. Sizes and colors can be combined for quantity pricing.



C.R. LAURENCE COMPANY

N168

crlaurence.ca | crlaurence.com.au | crlaurence.co.uk | crlaurence.de | crlaurence.eu

crlaurence.com

CRL 100+ Load Bearing Butyl Architectural Glazing Tape

SPEC. DATA

MSDS

- For High Performance Glazing of Large Lites of Glass Exceeding 100 United Inches* Without the Need for Spacer Shims
- 100% Solids Content
- Accommodates High Windloading Even at Elevated Temperatures
- Black Color



DESCRIPTION

CRL 100+ Load Bearing Butyl Architectural Glazing Tape is made from a blend of rubber polymers. It is designed for glazing large lites of glass exceeding 100 united inches* without the need for spacer shims. 100+ Tape transfers high wind loads evenly, from the glass to the window frame, and will accommodate high wind loading at elevated temperatures. It enables the project to be glazed from the inside. The 100 percent solids content formula will not shrink or absorb moisture, but will compress to accommodate variances in pocket width. It comes on release paper rolls and is positioned for quick alignment during installation. Application temperature range is 20° to 120°F (-7° to 49°C), and life expectancy if properly applied is 20 years.

APPLICABLE STANDARDS

AAMA 804.3, 806.3, and 807.3, ASTM C1281.

TYPICAL PROPERTIES

CRL Base Polymer: butyl rubber (polyisobutylene); Solids Content: 100% solids (no asbestos). Cure Time: fully cured before application. Hardness: 20 durometer Shore "A" @ 77°F (25°C). Temperature Range: Application 20°F (-7°C) to 120°F (49°C); Service -40°F (-40°C) to 190°F (88°C). VOC Content: 0%. Joint Movement: ±15% of joint width. Service Life: 20 year minimum.

CAT. NO.	THICKNESS	WIDTH	LENGTH/ROLL	ROLLS/CASE	LENGTH/CASE
GT804	1/8" (3.2 mm)	3/8" (9.5 mm)	40' (12.2 m)	24	960' (293 m)
GT808	1/8" (3.2 mm)	1/2" (12.7 mm)	40' (12.2 m)	20	800' (244 m)
GT805	3/16" (4.7 mm)	3/8" (9.5 mm)	26' (7.9 m)	24	624' (190 m)
GT810	1/4" (6.3 mm)	3/8" (9.5 mm)	20' (6.1 m)	24	480' (146 m)

Minimum order: 1 case. Sizes can be combined for quantity pricing. *United inches = width + height.

CRL Sealant Tape

MSDS

- Fabric Reinforced Synthetic Rubber Tape
- Dozens of Applications and Uses

CRL Sealant Tape is a high-quality, black color, synthetic rubber sealant tape reinforced with lightweight polyester cloth to eliminate stretching and prevent creeping or sagging in service. It holds well to most surfaces - even when applied in vertical or overhead positions, and forms a watertight, gasket-like seal that has outstanding resistance to weathering. Accelerated weather testing showed no loss of flexibility or resiliency, and no surface cracking after 1300 hours of weathering exposure. Can also withstand sub-zero temperatures of -70°F (-56.7°C). Aggressive tack permits application at temperatures as low as 40°F (4°C). Application is as easy as peel and stick, yet you can reposition it without damage to the tape or surface.

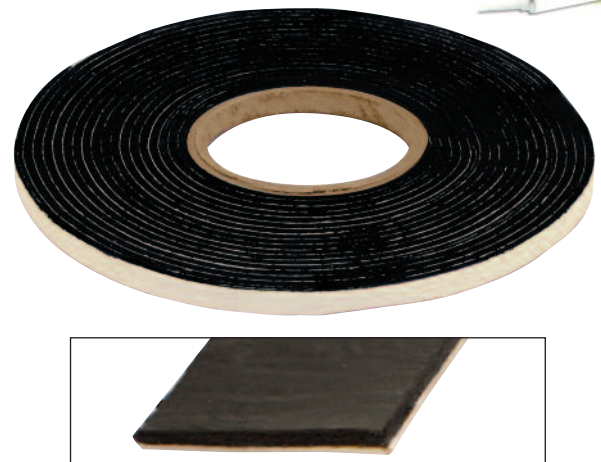

CAT. NO.	THICKNESS	WIDTH	LENGTH/ROLL	ROLLS/CASE	LENGTH/CASE
ST132X14	1/32" (.8 mm)	1/4" (6.4 mm)	100' (30.5 m)	36	3,600' (1098 m)
ST132X38	1/32" (.8 mm)	3/8" (9.5 mm)	100' (30.5 m)	25	2,500' (762 m)
ST132X12	1/32" (.8 mm)	1/2" (12.7 mm)	100' (30.5 m)	18	1,800' (547 m)
ST116X14	1/16" (1.6 mm)	1/4" (6.4 mm)	50' (15.2 m)	36	1,800' (547 m)
ST116X38	1/16" (1.6 mm)	3/8" (9.5 mm)	50' (15.2 m)	25	1,250' (381 m)
ST116X12	1/16" (1.6 mm)	1/2" (12.7 mm)	50' (15.2 m)	18	900' (274 m)
ST18X38	1/8" (3.2 mm)	3/8" (9.5 mm)	25' (7.6 m)	25	625' (190 m)
ST18X12	1/8" (3.2 mm)	1/2" (12.7 mm)	25' (7.6 m)	18	450' (137 m)
ST18X34	1/8" (3.2 mm)	3/4" (19 mm)	50' (15.2 m)	12	600' (183 m)
ST18X1	1/8" (3.2 mm)	1" (25.4 mm)	50' (15.2 m)	9	450' (137 m)

Minimum order: 1 roll. Sizes can be combined for quantity pricing.

CRL Tremco® 440 Butyl Architectural Tape

SPEC. DATA

MSDS

- Superior Weather Resistance
- 100% Solids Content
- Available in Aluminum and Black Colors

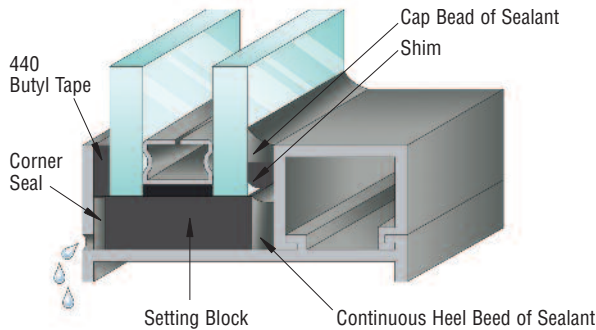
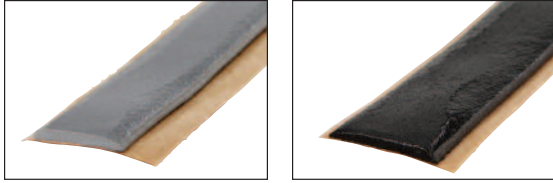

Typical Properties

Base Polymer: cross-linked butyl rubber (polyisobutylene); Solids Content: 100% by weight; Cure Time: fully cured before application; Hardness: 65 durometer Shore "00"; Temperature Range: Application 20°F (-7°C) to 120°F (49°C); Service -40°F (-40°C) to 158°F (70°C); Weathering: Unaffected by ultra violet through glass. Remains flexible at low temperatures.

Limitations

Not for use in joints subjected to continuous water immersion or temperatures exceeding 158°F (70°C). Not for use with lites of glass over 75 united inches (1905 mm). As the size of the lite approaches this maximum a higher performance glazing system, such as CRL Tremco® Pre-Shimmed Butyl Tape (see opposite page) should be considered.

Applicable Standards

AAMA 800-92, 804.3, and 807.3.

Description

CRL Tremco® 440 Butyl Architectural Tape is a pre-formed butyl sealant in tape form. The 100 percent solids compound of butyl and polyisobutylene contains no solvents or other volatiles that could escape on exposure, causing shrinkage and sealant failure. Tremco® 440 forms a watertight seal to prevent water infiltration, and has superior weather resistance. Highly adhesive, it remains permanently elastic, even at low temperatures, and is adaptable to many different types of glazing systems. Use Tremco® 440 for non-compression glazing of vision lites and spandrel panels in metal and wood frames in low rise building construction. It can also be used for lap sealing between panels such as steel, aluminum and porcelain, as well as a variety of other joints in shear between similar and dissimilar materials.

Good Glazing Practices

The following "Good Glazing Practices" are recommended when using CRL Glazing Tapes. Surfaces to be adhered should be free of frost or standing water, brushed clean, solvent washed (MEK, Toluene or Naptha) and wiped dry. At installation, positive contact and approximately 10 percent compression is recommended to fully marry surfaces to be joined. Glazing tapes kept under compression with clips or wedges provide the best seals.

Always use setting blocks (80 durometer Shore "A" hardness) placed at the sill quarter points. Spacing shims are recommended to accommodate wind loading when glass lite is over 100 united inches (50 durometer Shore "A" hardness). Tape placement on the sill rabbet is not to be below the sight line unless a cap bead is specified, then tape is placed 3/16" (4.76 mm) below the sight line to allow for the cap bead. Do not overlap tape to join; always butt ends without stretching. To keep tape surface clean, leave release paper in place until ready to set the glass.

ALUMINUM CAT. NO.	BLACK CAT. NO.	THICKNESS	WIDTH	ROLL LENGTH	ROLLS/CASE	LENGTH/CASE
71009F1	----	1/16" (1.6 mm)	1/4" (6.3 mm)	50' (15.2 m)	22	1,100' (335 m)
----	710CAH5	1/16" (1.6 mm)	1/4" (6.3 mm)	50' (15.2 m)	26	1,300' (396 m)
71049N1	71049Q1	1/16" (1.6 mm)	3/8" (9.5 mm)	50' (15.2 m)	20	1,000' (305 m)
71010W1	71010B1	1/16" (1.6 mm)	1/2" (12.7 mm)	50' (15.2 m)	20	1,000' (305 m)
71016U1	71016W1	1/8" (3.2 mm)	3/8" (9.5 mm)	25' (7.6 m)	20	500' (152.4 m)
71017F1	71017H1	1/8" (3.2 mm)	1/2" (12.7 mm)	25' (7.6 m)	20	500' (152.4 m)
71024R1	71024G1	3/16" (4.7 mm)	1/2" (12.7 mm)	25' (7.6 m)	20	500' (152.4 m)
71029G1	71029D1	1/4" (6.3 mm)	1/2" (12.7 mm)	20' (6 m)	20	400' (122 m)

Minimum order: 1 case. Must be ordered in case quantities. Sizes can be combined for quantity pricing.

CRL Tremco® POLYshim™ II Butyl Architectural Tape

SPEC. DATA

MSDS

- Continuous Integral EPDM Shim
- 100% Solids Content
- Used in Compression Glazing Systems
- Meets AAMA 800-92, 804.3, 806.3, and 807.3
- Black Color

Description

CRL Tremco® POLYshim™ II Tape is a 100 percent solids, highly adhesive and elastic, cross linked preformed butyl tape. Use it in compression glazing systems wherever the design calls for high performance glazing of curtain wall, unitized curtain walls, punched and ribbon window systems, and sloped glazing applications.

The continuous rubber shim works to prevent sealant squeeze-out because it is resilient to pressure exerted by building and glass expansion or contraction. It also helps prevent glass breakage by eliminating pressure points created by improper shimming. The continuous shim eliminates the need for preshimming the lite before installing the tape. Tremco® Pre-Shimmed tape has good adhesion, heat resistance, sealant compatibility, and resistance to weathering. It can be used in conjunction with many glazing systems.



Cross Section of Tape Showing Shim

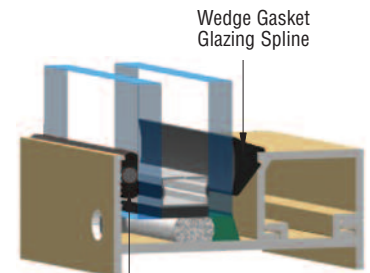

POLYshim™ II Tape

Applicable Standards

POLYshim™ II Tape meets the requirements of AAMA 800-92 Specifications 804.3, 806.3, and 807.3.

Limitations

Not for use in joints subjected to continuous water immersion or temperatures exceeding 200°F (93°C). Do not compression glaze glass with POLYshim™ II Tape having less than an 1/8" (3 mm) shim.

Typical Physical Properties

Base Polymer: cross linked butyl rubber (polyisobutylene); Solids Content: 100% by weight. Hardness: 57 durometer Shore "00". Temperature Range: Application 20°F (-7°C) to 120°F (49°C); Service -65°F (-54°C) to 200°F (93°C). Weathering: Unaffected by Ultraviolet through glass. Remains flexible at low temperatures.

CAT. NO.	THICKNESS OF TAPE	FACE CLEARANCE (SHIM DIAMETER)	WIDTH	ROLL LENGTH	ROLLS/CASE	LENGTH/CASE
7242YA3	.090" (2.3 mm)	1/16" (1.6 mm)	3/8" (9.5 mm)	50' (15.2 m)	20	1000' (305 m)
7241XC3	.150" (3.8 mm)	1/8" (3.2 mm)	3/8" (9.5 mm)	40' (12 m)	20	800' (244 m)
7241YP3	.215" (5.5 mm)	3/16" (4.8 mm)	3/8" (9.5 mm)	25' (7.6 m)	20	500' (152 m)
7244SB3	.280" (7.1 mm)	1/4" (6.3 mm)	3/8" (9.5 mm)	20' (6 m)	20	400' (122 m)

Minimum order: 20 rolls. Must be ordered in increments of 20. Sizes can be combined for quantity pricing.

CRL Rubber Flashing Tape

- Conforms to Uneven Surfaces to Seal Out Air and Moisture
- Remains Flexible for Years

This CRL Flashing Tape is uncured EPDM rubber membrane laminated with a self-adhering sealant adhesive. It molds and conforms to unevenly shaped surfaces to seal out air and moisture. No special preparation is required when applied to clean and dry surfaces. The availability of material widths up to 12" (305 mm) makes this Tape suitable for many applications. Leaky roofs, chimney or vent openings, duct work, truck or rail car bodies, etc., can all be patched easily with minimum prep work. Just stick, press and remove the release paper as you roll the Tape into place. Minimum clean up is required. It will remain flexible for years through a range of temperature variations.

MSDS



CAT. NO.	THICKNESS	WIDTH	ROLL LENGTH
ET5506	1/16" (1.6 mm)	6" (152 mm)	100' (30.5 m)
ET55012	1/16" (1.6 mm)	12" (305 mm)	50' (15.2 m)

Minimum order: 2 rolls of ET5506; 1 roll of ET55012.

CRL Dor-Tite Sponge Rubber Strip

- Weatherproofs and Cushions Against Vibrations, Rattles, and Drafts
- Open Cell Foam With Adhesive On One Side
- Available in a Variety of Sizes

CRL Dor-Tite Sponge Rubber Strip is a black, open cell, adhesive on one side tape that can be used in a variety of applications: cushioning, insulating, dustproofing, weatherproofing, sealing, rattle proofing, and more. Dor-Tite is used by the manufacturers of campers, trailers, freezer boxes, metal buildings, electrical control panel boxes, office furniture, and mobile homes. It makes an effective weather seal around air conditioning and heater units. It can also be used as a jamb seal for sliding doors and windows. Available in different widths and thicknesses to fit most any size joint, Dor-Tite is easy to use - just remove the adhesive cover and apply. No clean up is required. The strip's exposed surface has a very fine satin finish and is non-stretchable.

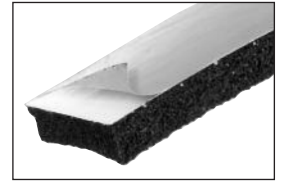

CAT. NO.	THICKNESS	WIDTH	ROLL LENGTH	ROLLS/ CASE
D3450	3/16" (4.8 mm)	1/2" (12.7 mm)	50' (15.2 m)	20
D3850	3/16" (4.8 mm)	1" (25.4 mm)	50' (15.2 m)	10
D4450	1/4" (6.3 mm)	1/2" (12.7 mm)	50' (15.2 m)	20
D4650	1/4" (6.3 mm)	3/4" (19 mm)	50' (15.2 m)	15
D4850	1/4" (6.3 mm)	1" (25.4 mm)	50' (15.2 m)	10
D9425	9/16" (14.3 mm)	1/2" (12.7 mm)	25' (7.6 m)	10
D9625	9/16" (14.3 mm)	3/4" (19 mm)	25' (7.6 m)	15
D9825	9/16" (14.3 mm)	1" (25.4 mm)	25' (7.6 m)	10

Minimum order: 1 roll. Sizes can be combined for quantity pricing.

CRL Putty Tape



- Gray Color Extruded Caulking Tape
- Seals Between Aluminum Window Frames
- Great for Van and RV Windows

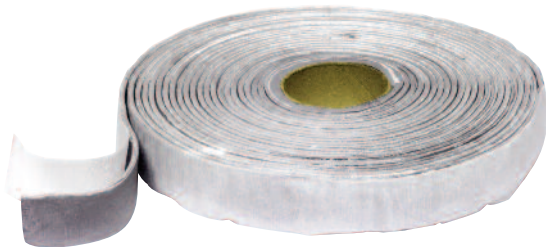

Use CRL Putty Tape to seal between the vehicle body and frames of aluminum windows. Originally designed for manufacturers of mobile homes, campers and RVs, the material stays soft and pliable, so it installs easily and conforms well to corners. It comes rolled on specially treated release paper for easy handling, and is easy to clean up.

CAT. NO.	THICKNESS	WIDTH	ROLL LENGTH	ROLLS/ CASE
PT34X18	1/8" (3 mm)	3/4" (19 mm)	30' (9 m)	20
PT1X18	1/8" (3 mm)	1" (25.4 mm)	30' (9 m)	16

Minimum order: 1 case. Sizes can be combined for quantity pricing.

CRL Sticker-Tite



- Self-Sealing Closed Cell Sponge Rubber With Adhesive On One Side
- Available in a Variety of Thicknesses and Widths



CRL Sticker-Tite is a closed cell black sponge rubber tape with an adhesive back for quick and simple installation. This tape has many uses such as a weatherseal, or as a rattle eliminator when used as a cushion between two surfaces.

CAT. NO.	THICKNESS	WIDTH	ROLL LENGTH
1044017	3/16" (4.8 mm)	3/8" (9.5 mm)	50' (15.2 m)
1044018	1/4" (6.3 mm)	3/8" (9.5 mm)	50' (15.2 m)
1044021	7/16" (11.1 mm)	1/2" (12.7 mm)	50' (15.2 m)
1044022	5/16" (7.9 mm)	1/2" (12.7 mm)	50' (15.2 m)
1044025	5/16" (7.9 mm)	1" (25.4 mm)	50' (15.2 m)
1044026	3/4" (19 mm)	1" (25.4 mm)	12' (3.7 m)

Minimum order: 1 roll. Sizes can be combined for quantity pricing.

CRL Norton Tite-R-Bond® Adhesion Promoter

- Enhances Adhesion of Pressure Sensitive Adhesives to Most Plastics and Paints
- Improves Quick-Stick and Bonding Strength



CRL Norton Tite-R-Bond® actually helps pressure sensitive adhesive tapes bond better to substrates that might normally resist adhesion. It enhances the adhesion of pressure sensitive adhesives to most plastics (rigid PVC, ABS Plastic, Polycarbonate, Rigid Polyurethane), metals, or painted surfaces, and helps it cling to irregular, rough or curved surfaces. The free flowing liquid formula can be wiped or brushed on.

WARNING: It is the user's responsibility to test painted surfaces prior to application.

CAT. NO.	CONTENTS
2287PT	1 Pint (473 ml)
2287GL	1 Gallon (3.785 l)

Minimum order: 1 each.

CRL Norseal® Acoustical Sealant Tape

- Reduces Sound Transmission Through Walls and Partitions
- Improves Energy Efficiency by Reducing Heat Loss
- Adhesive On One Side
- Closed Cell Structure

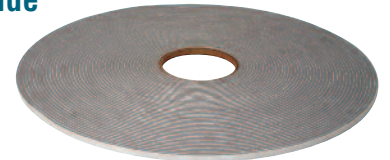

CRL Norseal® Acoustical Sealant Tape is specially designed and formulated to effectively stop perimeter sound transmission through walls and partitions. It also helps control vibration in wall partition systems. Its low density aids in maintaining the desired STC rating of wall systems to irregular surfaces, which allows it to function as an effective seal against light and dust infiltration. V730 is compatible as a gasket to panel material, and its low thermal conductivity improves energy efficiency of the structure by reducing heated or cooled air loss around wall perimeters.

CAT. NO.	THICKNESS	WIDTH	ROLL LENGTH	ROLLS/ CASE
V73418X14	1/8" (3 mm)	1/4" (6.3 mm)	100' (30.5 m)	40
V73418X38	1/8" (3 mm)	3/8" (9.5 mm)	100' (30.5 m)	40
V73814X38	1/4" (6.3 mm)	3/8" (9.5 mm)	50' (15.2 m)	40
V73814X12	1/4" (6.3 mm)	1/2" (12.7 mm)	50' (15.2 m)	40
V73814X112	1/4" (6.3 mm)	1-1/2" (38 mm)	50' (15.2 m)	20

Minimum order: 1 roll. Sizes can be combined for quantity pricing.

CRL Norseal® Campermount® Tape

- Sealant and Vibration Cushioning Tape for Camper Tops and Caps
- Closed Cell Structure
- Positive Compression Seal Resists Dust and Moisture Penetration
- Adhesive On One Side



The ideal way to seal camper tops and pickup truck caps. Each foam cell acts like a tiny shock absorber to reduce vibration and eliminate metal-to-metal contact. CRL Norseal® Campermount® Tape is also easy to apply. It has a pressure-sensitive acrylic adhesive on one side and a paper liner that ensures simple non-stretch installation.

CAT. NO.	THICKNESS	WIDTH	ROLL LENGTH	ROLLS/ CASE
V666316	3/16" (4.8 mm)	1" (25.4 mm)	50' (15.2 m)	20
V66614	1/4" (6.3 mm)	1" (25.4 mm)	50' (15.2 m)	20

Minimum order: 1 roll. Sizes can be combined for quantity pricing.

CRL Truck Cap Foam Seal Tape

- Truck Cap to Truck Bed Seal
- Silicone Based Closed Cell Structure With Excellent Memory
- Adhesive On One Side

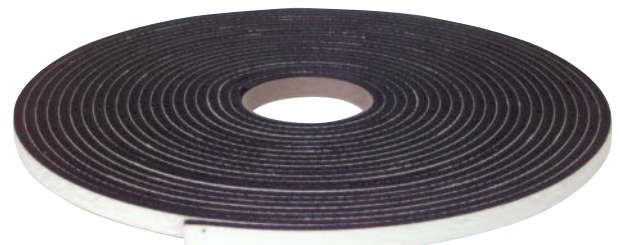
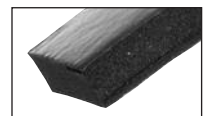

This CRL Truck Cap Foam Seal Tape is a closed cell silicone base, automotive grade weather seal material. This Foam Seal Tape has excellent memory, and will keep drafts and water out of the truck bed when used to install truck caps.

CAT. NO.	THICKNESS	WIDTH	ROLL LENGTH	ROLLS/ CASE
60701	1/4" (6.3 mm)	1/2" (12.7 mm)	50' (15.2 m)	60

Minimum order: 1 roll.

CRL SPECIALTY GLAZING TAPES

For Pricing Visit Our Web Site or Call Us Toll Free at the Phone Numbers Shown on the Back Cover

CRL Fire Glazing Tape



new

- Specially Formulated High Performance Intumescent Glazing Tape
- Positive Pressure Tested and Listed
- Use With Wire Glass and Firelite™
- White Color

CRL FG3000 Fire Glazing Tapes are specially formulated high performance intumescent glazing tapes with adhesive backing on one side, that allow for much larger vision lites in 20, 45, 60 and 90 minute rated wood and hollow metal doors with metal vision frames. In 20 and 45 minute rated hollow metal screens the use of FG3000 allows for much larger side lites, borrowed lites and glass transoms. Successfully passed 20 minutes (with hose stream) and 45 minutes on wood and metal doors with vision lites installed.

Maximum Wood Door Size:

48" x 96" (1219 x 2438 mm) single and/or pairs approved.

Maximum Hollow Metal Door Size:

48" x 120" (1219 x 3048 mm) single and/or pairs approved.

Listed glazing products include:

(Wire Glazing) Pilkington, Asahi, and Central Glass;

(Non-Wire Glazing) Firelite™.

Verify all applications with your door and/or frame manufacturer.



CAT. NO. FG3000S45

45 Minute Fire Glazing Tape



CAT. NO. FG3000S90

90 Minute Fire Glazing Tape

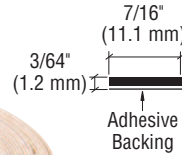

TYPICAL APPLICATIONS

Apply FG3000S45 to both sides of the frame

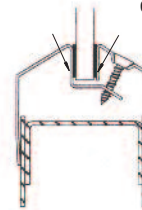

FG3000S45 in 20 Minute and 45 Minute Hollow Metal Doors



FG3000S45 in 20 Minute and 45 Minute Wood Doors

TYPICAL APPLICATION

Apply FG3000S90 to both sides of the frame

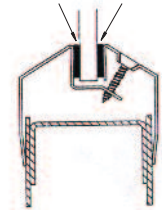

FG3000S90 in 90 Minute Hollow Metal Doors

CAT. NO.	THICKNESS	WIDTH	ROLL LENGTH
FG3000S45	3/64" (1.2 mm)	7/16" (11.1 mm)	16' (4.9 m)
FG3000S90	5/64" (2 mm)	7/16" (11.1 mm)	16' (4.9 m)

Minimum order: 1 roll. Sizes can be combined for quantity pricing.

CRL Norex® Butyl Coated PVC Foam



- Compressible PVC Foam Inner Core – High Tack 100% Solids Butyl Coating
- Available in Tape or Rod Form

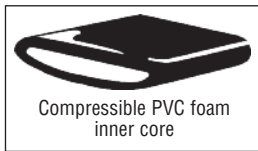
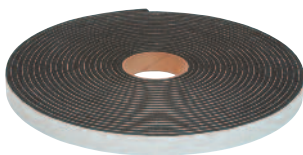

CRL Norex® Butyl Coated PVC Foam extrusions come in both tape and rod form, and are highly flexible, conforming readily to corners and irregular contours. These versatile foam extrusions seal effectively against water penetration to prevent corrosion or moisture damage. They are ideal for sealing joints in RV's, motor homes, trailers, and boats, where joints are subject to the stress of movement and the effects of constant exposure to the elements.

TAPE FORM CAT. NO.	THICKNESS	WIDTH	ROLL LENGTH	ROLLS/CASE
KB31638	1/8" (3 mm)	3/8" (9.5 mm)	79' (24 m)	24

Minimum order: 24 rolls. Must be ordered in case quantity only.

ROD FORM CAT. NO.	DIAMETER	ROLL LENGTH	ROLLS/CASE
K3A204	1/4" (6.3 mm)	56' (17 m)	24

Minimum order: 24 rolls. Must be ordered in case quantity only.

CRL FSK Facing Tape



- Vapor Seal for Spandrel Insulation Panels
- Low Temperature Performance
- UL Listed



This UL-listed CRL FSK Facing Tape has a 2x3 fiberglass scrim to reinforce it against tearing and stretching. Used primarily as a vapor seal for spandrel insulation panels, it has a special cold weather acrylic adhesive for low temperature performance. It is also used by insulation contractors as a vapor seal for reinforced fiberglass or mineral wool thermal insulation.

CAT. NO.	THICKNESS	WIDTH	ROLL LENGTH	ROLLS/CASE
1525CWSB	.0075" (.2 mm)	5" (127 mm)	150' (46 m)	8

Minimum order: 1 roll.



C.R. LAURENCE COMPANY

crlaurence.com

N174

| crlaurence.ca crlaurence.com.au crlaurence.co.uk crlaurence.de crlaurence.eu

CRL Sealstrip Glass Setting Tape

- Fiber Impregnated for Strength
- Won't Stretch Out of Shape
- Clings to Glass



CRL Sealstrip holds glass firmly and permanently, and also seals against dirt, moisture, and weather. Sealstrip Glass Setting Tape insulates against sound and vibration, and won't stretch out of shape. It's thin enough so it doesn't crowd the glass and cause cracking or breaking. Just fold it over the glass edge, insert glass in the metal frame or channel, and trim with a knife or razor blade. Technical Specifications: Specific Gravity - 1.24; Tensile Strength - 275; Elongation % - 100; Durometer - 60

CAT. NO.	THICKNESS	WIDTH	ROLL LENGTH	ROLLS/CASE
A4264	1/32" (0.8 mm)	1-1/2" (38 mm)	100' (30.5 m)	10
A4263	3/64" (1.2 mm)	1-1/2" (38 mm)	100' (30.5 m)	10
A4262	1/16" (1.6 mm)	1-1/2" (38 mm)	100' (30.5 m)	10
A46142	5/64" (2.0 mm)	1-1/2" (38 mm)	100' (30.5 m)	10
A4261	3/32" (2.4 mm)	1-1/2" (38 mm)	100' (30.5 m)	10

Minimum order: 1 roll. Sizes can be combined for quantity pricing.

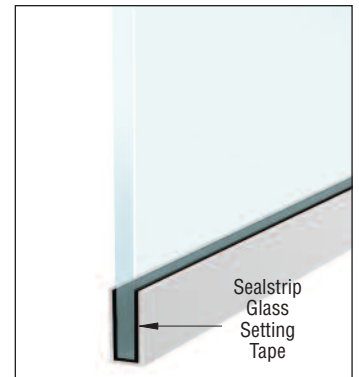

CRL Tuff-Pak Cork and Rubber Glass Setting Tape

- Accepted Standard of the Auto Glass Industry
- High Cork Content Cushions Glass
- Compresses for a Tight Seal
- Better Grip on Glass



The cork content in CRL Tuff-Pak Glass Setting Tape makes it compressible, for a strong setting that is both a cushion and a tight seal. Tuff-Pak has the right proportion of cork and rubber to provide an all-purpose tape with these specific advantages: flexibility, better grip on glass, high cork content, superior cloth backing, and versatility. Tuff-Pak Tape is the accepted standard of the auto glass industry for door and vent glass channels.

CAT. NO.	THICKNESS	WIDTH	ROLL LENGTH	ROLLS/CASE
690	1/32" (0.8 mm)	1-1/2" (38 mm)	100' (30.5 m)	8
770	3/64" (1.2 mm)	1-1/2" (38 mm)	100' (30.5 m)	8
720	1/16" (1.6 mm)	1-1/2" (38 mm)	100' (30.5 m)	8
760	5/64" (2.0 mm)	1-1/2" (38 mm)	50' (15.2 m)	8
820	3/32" (2.4 mm)	1-1/2" (38 mm)	50' (15.2 m)	8

Minimum order: 1 roll. Sizes can be combined for quantity pricing.

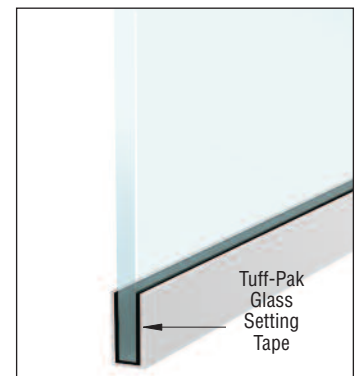

CRL FLASHING PRODUCTS

For Pricing Visit Our Web Site or Call Us Toll Free at the Phone Numbers Shown on the Back Cover

CRL Fortifiber Moistop PF® Flashing

new

- Mechanically Attached
- Cost Effective

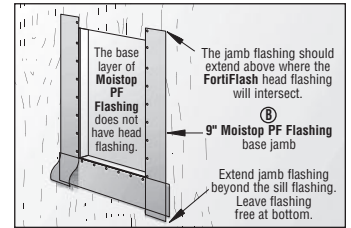

Cut a strip of **Moistop PF Flashing** long enough to extend beyond sill flashing already in place, and above where the **FortiFlash** head flashing will intersect. Next attach the jamb flashing **(B)** flush to the edge of the rough opening leaving the bottom free. Repeat above steps for the remaining jamb.

CRL Fortifiber Moistop PF® Flashing is a superior, mechanically attached, flexible flashing product engineered to offer the perfect balance between extraordinary durability and cost-effectiveness. It is manufactured from a multi-layer composite employing heavy-duty polypropylene fabric, and coated on both sides with UV resistant polypropylene to resist cracking and curling. Ideal for installation over OSB or plywood, it can be used on all types of windows, including wood, vinyl, aluminum, and doors. It installs easily with a utility knife and hammer. Thickness is 6 mils. For optimum performance Moistop PF should be installed in conjunction with Moistop Sealant (see below).

CAT. NO.	WIDTH	LENGTH	QTY/CASE
S033009	9" (229 mm)	300' (91.4 m)	6
S033012	12" (305 mm)	300' (91.4 m)	6

Minimum order: 1 roll. Can be combined with other rolls of flashing for quantity pricing.

CRL Fortifiber FortiFlash® Waterproof Flashing

new

- Self-Adhesive Waterproof Membrane
- 25 and 40 mil Thicknesses

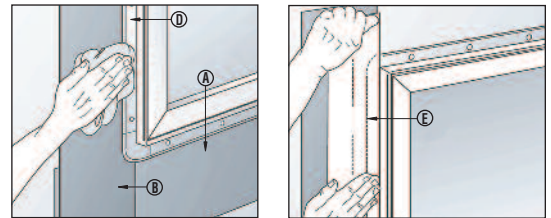

Wipe the window flange **(D)** and base **Moistop PF Flashing (B)** layer clean before applying **Fortifiber FortiFlash**. Cut the desired length of **Fortifiber FortiFlash** with a sharp knife. Pull off the release paper and place the **Fortifiber FortiFlash (E)** on top of the window flange. Apply firm pressure along the entire length to ensure a continuous seal.

CRL Fortifiber FortiFlash® Waterproof Flashing is a premium, self-adhesive, waterproof flashing membrane for windows. It is also ideally suited for flashing non-roofing horizontal surfaces such as pot shelves, parapets, sill pans and recessed windows. This product is reinforced by incredibly strong, cross-laminated, high-density polyethylene film. This self-sealing, rubberized, asphalt core membrane is perfect for sealing around common through-wall penetrations. The 25 mil thick flashing makes it the preferred product for working in tight corners, while the 40 mil flashing is best suited for those applications where a thicker product is desired.

CAT. NO.	THICKNESS	WIDTH	LENGTH	QTY/CASE
M705030	25 mil	9" (229 mm)	75' (23 m)	4
M705040	25 mil	12" (305 mm)	75' (23 m)	4
M706030	40 mil	9" (229 mm)	75' (23 m)	3
M706040	40 mil	12" (305 mm)	75' (23 m)	3

Minimum order: 1 roll. Can be combined with other rolls of flashing for quantity pricing.

CRL Fortifiber Moistop® Sealant

new

- Compatible With Fortifiber Flashing Products

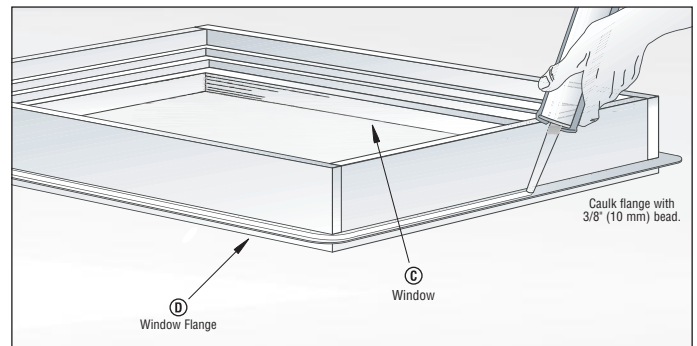

Before installing the window **(C)**, Apply a continuous bead of **Moistop Sealant** to the perimeter of the rough opening **(C)** and to the backside of the mounting flange **(D)** of the window. Install the window according to the window manufacturer's instructions.

CRL Fortifiber Moistop® Sealant is an integral component of Fortifiber's moisture control system for walls. It is compatible with all of Fortifiber's products and a wide range of building materials. A continuous bead on the window nail flange gives long lasting protection against moisture infiltration. It is the ideal choice for use in window and door installations.

CAT. NO.	CONTENTS	QTY/CASE
M704015	10.1 Fl. Oz. (300 ml)	30

Minimum order: 1 each. All cartridge sealants can be combined for quantity pricing.



C.R. LAURENCE COMPANY

N176 |

crlaurence.ca

crlaurence.com.au

crlaurence.co.uk

crlaurence.de

crlaurence.eu

crlaurence.com

CRL Tremco® Wedge Gasket Glazing Spline

new

- Used in Compression Glazing Systems With Tremco POLYshim II Glazing Tape
- 70 Durometer Extruded EPDM



SPEC. DATA

MSDS

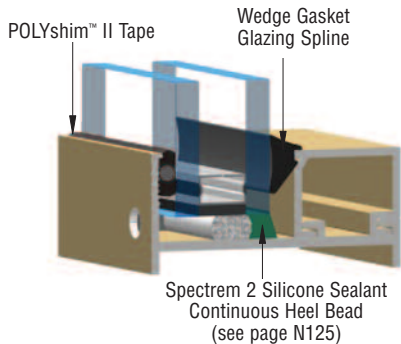

This CRL Tremco® Wedge Gasket Glazing Spline profile is made of extruded 70 durometer dense EPDM. The wedge profile is designed for use in compression glazing systems with Tremco® POLYshim™ II Glazing Tapes. Glazing Spline profiles require a .090" x .062" (2.3 x 1.6 mm) metal nib for proper engagement. **NOTE:** A mock-up is recommended by Tremco® to verify acceptable mating between both the Glazing Spline and the metal nib.

CAT. NO.	FACE CLEARANCE	LENGTH/CASE
1768011	.120" (3 mm)	500' (152 m)
1768012	.160" (4 mm)	500' (152 m)
1768013	.200" (5 mm)	500' (152 m)

Minimum order: 1 case. Sizes can be combined for quantity pricing.

CRL Tremco® VISIONstrip® Glazing Seal

new

- Clean Gasket Appearance with Positive Wet-Seal
- EPDM Rubber and 100% Cross-Linked Butyl



SPEC. DATA

MSDS

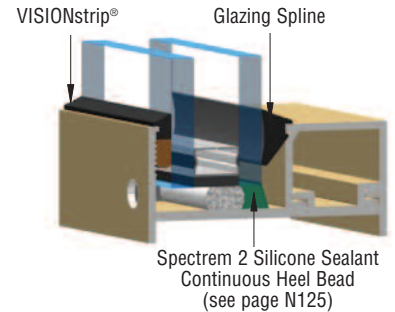
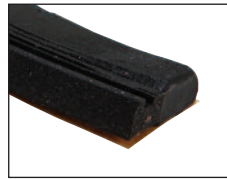

CRL Tremco® VISIONstrip® is a precision extruded glazing medium consisting of an EPDM rubber extrusion positioned at the sightline with a 100% solids, highly adhesive and elastic, cross-linked butyl preformed sealant bonded below. A single component profile achieving a positive wet-seal between the metal and glass surfaces while providing a clean gasket appearance at the sightline.

VISIONstrip® is used in compression glazing systems wherever the design calls for high performance glazing of curtain wall, unitized curtain walls, punched and ribbon window systems and sloped glazing applications. VISIONstrip® needs to be installed on a special metal nib, .050" x .060" (1.3 x 1.5 mm). **NOTE:** A mock-up is recommended by Tremco® to verify acceptable mating between both VISIONstrip® and metal nib.

CAT. NO.	FACE CLEARANCE	ROLL LENGTH	ROLLS/CASE
733T74	.125" (3.2 mm)	40' (12.2 m)	11
733V25	.187" (4.8 mm)	35' (10.6 m)	10

Minimum order: 11 rolls 733T74; 10 rolls 733V25. Must order in case quantities. Sizes can be combined for quantity pricing.

CRL Vinyl Roller Tools

- Knurl Diamond Grip and a Ball Bearing Wheel



VR17 Extra Long Vinyl Roller Tool



VR04 Standard Vinyl Roller Tool

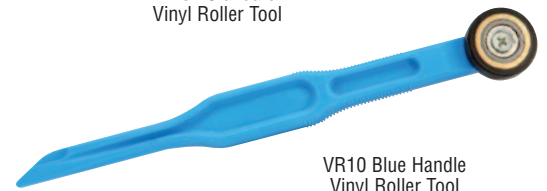

VR10 Blue Handle Vinyl Roller Tool



CRL Vinyl Roller Tools aid in the insertion of Glazing Vinyls and Gaskets in window assemblies and heavy aluminum base shoe. Choose from three models, including our extra long Cat. No. VR17 with the two-handed grip.

CAT. NO.	DESCRIPTION
VR17	Extra Long 17" (432 mm) Vinyl Roller
VR04	Standard 11" (279 mm) Vinyl Roller
VR10	Blue Handle 11" (279 mm) Vinyl Roller

Minimum order: 1 each.

CRL Universal Roll-In Vinyl

- Non-Stretch Black Vinyl Fits Most Pocket Storefront Systems

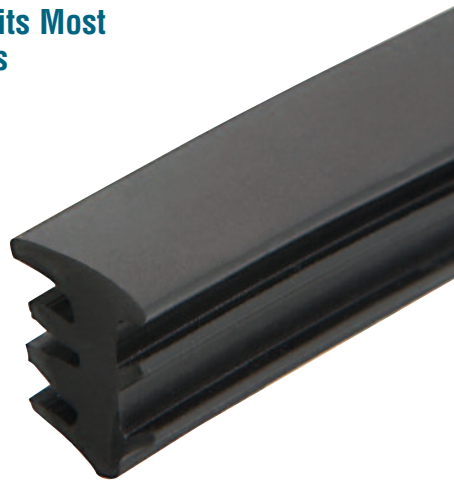
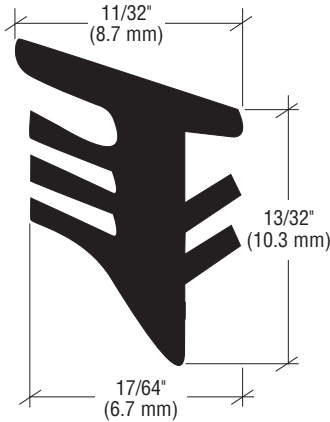

CRL Universal Roll-In Storefront Vinyl is a non-stretch black polyvinyl chloride which was developed to work in most storefront pocket glazed extrusions. The security legs were designed to grip tightly in many different manufacturer's extrusions, allowing the glass shop to stock only one vinyl. Even though this Vinyl will fit most applications, we suggest that the user test for his particular need. For easy installation we recommend our VR04 and VR17 Vinyl Roller Tools (see page N177).

CAT. NO.	ROLL LENGTH
SFV335C	100' (30.5 m)
SFV335M	1000' (305 m)

Minimum order: 1 roll.

CRL Roll-In Glazing Gaskets

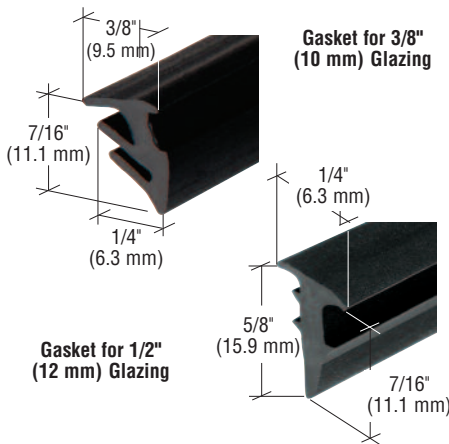

CRL Roll-In Glazing Gasket for 3/8" (10 mm) and 1/2" (12 mm) glass provides an easy way of glazing glass. It eliminates using messy silicone sealant and the clean up that follows. Black color material can be used with all finishes of glazing channels.

CAT. NO.	GLASS THICKNESS	ROLL LENGTH
RG38100	3/8" (10 mm)	100' (30.5 m)
RG38500	3/8" (10 mm)	500' (152.4 m)
RG12100	1/2" (12 mm)	100' (30.5 m)
RG12500	1/2" (12 mm)	500' (152.4 m)

Minimum order: 1 roll.

CRL Roll-In EPDM Gasket for Sidelite Rails

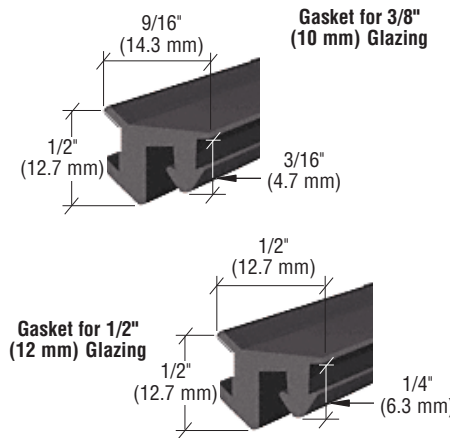

This CRL Glazing Gasket is used to dry glaze 3/8" (10 mm) and 1/2" (12 mm) glass in CRL Sidelite Rails and CRL U-Channel with Roll-In Top Load Gasket materials.

CAT. NO.	GLASS THICKNESS	ROLL LENGTH
GG38100	3/8" (10 mm)	100' (30.5 m)
GG38500	3/8" (10 mm)	500' (152.4 m)
GG12100	1/2" (12 mm)	100' (30.5 m)
GG12500	1/2" (12 mm)	500' (152.4 m)

Minimum order: 1 roll.

CRL Roll-In EPDM Gasket for Tapered Sidelite Rails

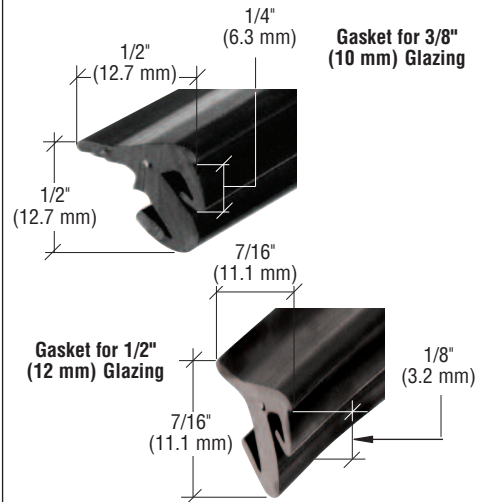

This CRL Glazing Gasket is used to dry glaze 3/8" (10 mm) and 1/2" (12 mm) thick glass in CRL Tapered Sidelite Rails and CRL U-Channels.

CAT. NO.	GLASS THICKNESS	ROLL LENGTH
GGT38100	3/8" (10 mm)	100' (30.5 m)
GGT38500	3/8" (10 mm)	500' (152.4 m)
GGT12100	1/2" (12 mm)	100' (30.5 m)
GGT12500	1/2" (12 mm)	500' (152.4 m)

Minimum order: 1 roll.

CRL Top Rubber Gasket for Monolithic Tempered Glass Base Shoe

- Rubber Gasket Locks in Place Quickly and Easily When Used With CRL's B5S, B5A, B5L, B5T, B6S, and B7S Glass Railing Base Shoes

CRL Top Rubber Gasket finishes off the top of the Base Shoe pocket after glass has been set. Made of black EPDM rubber, it rolls in easily with the CRL Vinyl Roller Tool. An alternate method of finishing off the top pocket is to use CRL Open Cell Backer Rod (see page N187) and 95CBL Black Silicone (see page N120).



Used for Monolithic Glass Base Shoe

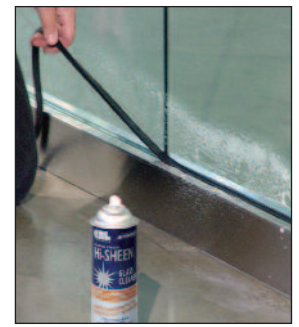

CAT. NO.	COLOR	GLASS THICKNESS	ROLL LENGTH
BSG100	Black	1/2" to 3/4" (12 to 19 mm)	100' (30.5 m)
BSG500	Black	1/2" to 3/4" (12 to 19 mm)	500' (152.4 m)

Minimum order: 1 roll.

CRL Top Rubber Gasket for Laminated Tempered Glass Base Shoe

new

- Rubber Gasket Locks in Place Quickly and Easily When Used With CRL's L56S, L21S, and L25S Glass Railing Base Shoe

CRL Top Rubber Gasket finishes off the top of the Base Shoe pocket after glass has been set. Made of black EPDM rubber, it rolls in easily with the CRL Vinyl Roller Tool. An alternate method of finishing off the top pocket is to use CRL Open Cell Backer Rod (see page N187) and 95CBL Black Silicone (see page N120).

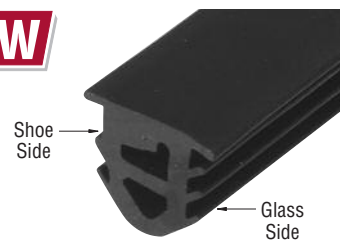

Used for Laminated Glass Base Shoe

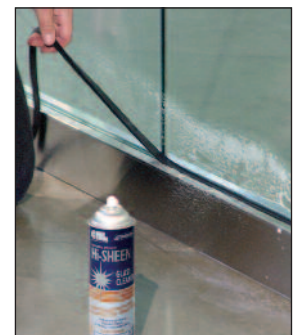

CAT. NO.	COLOR	GLASS THICKNESS	ROLL LENGTH
LBSG100	Black	9/16", 27/32", or 1-1/16" (13.52, 21.52, or 25.52 mm)	100' (30.5 m)
LBSG200	Black	9/16", 27/32", or 1-1/16" (13.52, 21.52, or 25.52 mm)	200' (61 m)

Minimum order: 1 roll.

CRL Fast-Seal Top Rubber Gasket for Base Shoe

- EPDM Rubber Gasket for Railing Base Shoe
- Locks in Place Quickly and Easily When Used With CRL Base Shoe

Use CRL's BSG250 Fast Seal Top Rubber Gasket for glass railing applications where there is no access to the outside shoe edge. It's designed to be installed to the outside cladding edge before the glass is set in place, eliminating the difficulty and risk of reaching over the guard rail for seal installation. Use CRL's BSG100 or LBSG100 Top Rubber Gasket to finish off top inside edge of the base shoe pocket.

new

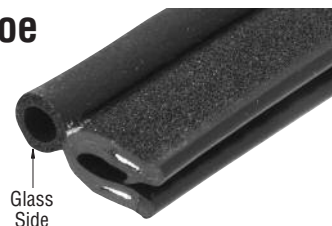

CAT. NO.	COLOR	ROLL LENGTH
BSG250	Black	250' (76.2 m)

Minimum order: 1 roll.

CRL All Purpose Putty

- Glazes Wood, Metal, and Aluminum Sash
- Ideal for Over-The-Counter Sales
- Available in Two Colors

Apply CRL All Purpose Putty in most any glazing application to wood, steel, and aluminum sash. Its special formulation adheres firmly to sash and glass, and outlasts ordinary putties.

Surfaces should be clean, dry, and free of frost. When re-glazing, remove all old putty and bedding. If necessary, place glazing in hands and roll into coils to warm and soften. Smooth glazing to an angle that sheets water. Typical dry time before painting is four to six weeks, depending on temperature and humidity. Putty must be painted after it has

skinned over and attained a firm set. For best results, use a high quality oil-based paint. Both gray and off-white colors come in factory sealed plastic containers that preserve freshness and shelf life. CRL All Purpose Putty is attractively labeled for over-the-counter retail sales in your choice of five sizes.

Technical Data: Meets the requirements of Federal Specification TT-G-410E; ASTM C 669-75, C669, D2249, D2376, C797.

Important Note: Do not thin putty. Check spec data for additional limitations.



Colors shown are approximate

OFF-WHITE CAT. NO.	GRAY CAT. NO.	SIZE	QTY/CASE
533HPW	533HPGRY	Half Pint (237 ml)	24
533QTW	533QTGRY	Quart (946 ml)	6
533GLW	533GLGRY	Gallon (3.785 l)	2
5333GLW	5333GLGRY	3 Gallon (11.35 l)	1
5335GLW	5335GLGRY	5 Gallon (19 l)	1

Minimum order: 1 each. Can be combined with similarly sized putties for quantity pricing

CRL Wood Sash Putty

- High Quality Formulation for Face Glazing of Wood Sash
- Goes On Smooth and Evenly

CRL Wood Sash Putty is formulated for application to wood. It goes on smooth and evenly, and its off-white color blends with most unfinished wood surfaces.

Surfaces should be clean, dry, and free of frost. For best results, prime wood first with an oil-based primer. When re-glazing, remove all old putty and bedding. If necessary, place glazing in hands and roll into coils to warm and soften. Smooth glazing to an angle that sheets water. Typical dry time before painting is four to six weeks, depending on temperature and humidity. Putty must be painted after it has skinned over and attained

a firm set. For best results, use a high quality oil-based paint. Off-white color comes in factory sealed plastic containers that preserve freshness and shelf life. CRL Wood Sash Putty is attractively labeled for over-the-counter retail sales in your choice of five sizes.

Technical Data: Meets the requirements of Federal Specification TT-G-410E; ASTM C 669-75, C669, D2249, D2376, C797.

Important Note: Do not thin putty. Check spec data for additional limitations.



Color shown is approximate

CAT. NO.	COLOR	SIZE	QTY/CASE
500HP	Off-White	Half Pint (237 ml)	24
500QT	Off-White	Quart (946 ml)	6
500GL	Off-White	Gallon (3.785 l)	2
5003GL	Off-White	3 Gallon (11.35 l)	1
5005GL	Off-White	5 Gallon (19 l)	1

Minimum order: 1 each. Can be combined with similarly sized putties for quantity pricing.

CRL Metal Sash Putty

- Use for Steel, Aluminum, or Galvanized Window Sash
- Applies Smoothly Without Priming

Made expressly for glazing in steel, aluminum or galvanized window sash. CRL Metal Sash Putty is made to apply smoothly, without priming. The gray color blends with the metal finish.

Surfaces should be clean, dry, and free of frost. When re-glazing, remove all old putty and bedding. If necessary, place glazing in hands and roll into coils to warm and soften. Smooth glazing to an angle that sheets water. Typical dry time before painting is four to six weeks, depending on temperature and humidity. Putty must be painted after it has skinned over and attained a firm set. For best results, use a high quality oil-based paint.

Technical Data: Meets the requirements of Federal Specification TT-G-410E; ASTM C 669-75, C669, D2249, D2376, C797.

Important Note: Do not thin putty. Check spec data for additional limitations.

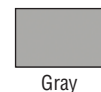

Color shown is approximate

CAT. NO.	COLOR	SIZE	QTY/CASE
528HP	Gray	Half Pint (237 ml)	24
528QT	Gray	Quart (946 ml)	6
528GL	Gray	Gallon (3.785 l)	2
5283GL	Gray	3 Gallon (11.35 l)	1
5285GL	Gray	5 Gallon (19 l)	1

Minimum order: 1 each. Can be combined with similarly sized putties for quantity pricing.

CRL DAP® '33'® Glazing Compound

- Ready to Use for Wood and Metal Sash
- Smooth Creamy Consistency
- Must Be Painted

CRL DAP® '33'® Glazing Compound is smooth and flexible, and comes ready to use for face glazing wood and metal window frames. Its adhesion to both glass and sash is excellent, forming a dependable air and watertight seal that resists sagging, shrinking, chalking, and cracking.

Surfaces should be clean, dry, and free of frost. Wood sash that is not primed or painted must be primed first with an oil-based primer and allowed to dry. When re-glazing, remove all old putty and bedding. If any separation has occurred in glazing, mix entire contents of container until uniform. Do not thin glazing compound. If necessary, place glazing in hands and roll into coils to warm and soften. Smooth glazing to an angle that sheets water with a putty knife. Typical dry time before painting is one to two weeks, depending on temperature and humidity. Putty must be painted after it has skinned over and attained a firm set. For best results, use a high quality oil-based paint, or if using a latex paint, prime first with a high quality oil-based primer.

Important Note: Do not thin glazing compound. Do not apply when air or sash temperatures are below 40° F (4° C). Do not use on plastic window panes, insulating glass units with an organic seal, any window pane over 48" (1219 mm) in length, or metal sash with rabbets over 1-1/4" (32 mm) wide. Also not recommended for stained/leaded glass projects. Clean tools immediately after use with mineral spirits.



White

Color shown is approximate

SPEC. DATA

MSDS



CAT. NO. 33HPW
Half Pint



CAT. NO. 33PTW
Pint



CAT. NO. 33QTW
Quart



CAT. NO. 33GLW
1 Gallon



CAT. NO. DAP12124
3.5 Gallon

CAT. NO.	COLOR	SIZE	QTY/CASE
33HPW	White	Half Pint (237 ml)	12
33PTW	White	Pint (473 ml)	12
33QTW	White	Quart (946 ml)	6
33GLW	White	Gallon (3.785 l)	2
DAP12124	White	3.5 Gallon (13 l)	1

Minimum order: 1 each. Can be combined with other like size putties for quantity pricing.

CRL DAP® '1012'® Glazing Metal Sash Putty

- Professional Quality for Face Glazing Metal Sash
- Does Not Have To Be Painted
- Meets Federal Specification ASTM C-669



Gray

Color shown is approximate

SPEC. DATA

MSDS



CAT. NO. 1012GL
1 Gallon



CAT. NO. DAP12056
3.5 Gallon

CRL DAP® 1012 Metal Sash Putty is formulated for face glazing interior or exterior aluminum, primed steel, stainless steel, and galvanized steel sash. It applies and sets quickly and smoothly without priming, and is colored to match metal finishes. Glazing may be painted with oil or latex-based paint after it has skinned over and attained a firm set (two to three weeks, depending on temperature and humidity).

Surfaces should be clean, dry, and free of frost. When re-glazing, remove all old putty and bedding. If any separation has occurred in glazing, mix entire contents of container until uniform. If the compound is too stiff, the addition of a minimum amount of VM and P Naphtha Spirits (not to exceed 1-1/2 fl. oz. [44 ml] for each 1 gl. [3.785 l] of compound) will reduce the consistency. Do not add any type of oil or pigment to the compound. Preferably store compound in a warm place prior to use. Press glazing onto sash filling height and width of L-shaped recess completely. Smooth glazing with a putty knife to an angle that sheets water. Typical dry time before painting is two to three weeks, depending on temperature and humidity. Putty may be painted after it has skinned over and attained a firm set. For best results, use a high quality oil-based paint.

Important Note: Do not apply when air or sash temperatures are below 40° F (4° C). Do not use for channel glazing, inside face glazing of plastic window panes, plastic window panes over 24" (610 mm) in any dimension, any window pane over 48" (1219 mm) in any dimension, or insulated glass units with an organic seal. DAP® '1012' Glazing is not recommended for glazing porcelainized steel insulating panels, for any composite or composition panels or for stained/leaded glass projects. Clean tools immediately after use with mineral spirits. Be sure container lid is closed and tightly sealed. Store in a cool, dry place.

CAT. NO.	COLOR	SIZE	QTY/CASE
1012GL	Gray	Gallon (3.785 l)	2
DAP12056	Gray	3.5 Gallon (13 l)	1

Minimum order: 1 each. Can be combined with other like size putties for quantity pricing.

CRL DAP® Latex Window Glazing Compound

- Ready to Use for Face Glazing Wood, Metal or Aluminum Window Frames
- Easy Application From Cartridge
- Must Be Painted



White

Color shown is approximate



SPEC. DATA

MSDS

CRL DAP® Latex Glazing is an easy-working compound for back-bedding and face-glazing window sash. It adheres well to wood, aluminum, steel and galvanized sash for a weathertight seal. Its smooth, consistent texture can be applied directly from the cartridge, requires no kneading, and resists shrinking and cracking. The 10.1 fl. oz. (300 ml) tube features a unique, rectangular shaped nozzle for uniform beads. Excess glazing can be removed with soap and water before it sets. Dries to touch in two hours. Typical dry time required before painting is three to seven days depending on temperature and relative humidity. The white color compound can be painted with latex paint after three days. Oil-based paint may be applied after one week. Surfaces should be clean, dry, and free of frost. When re-glazing, remove all old putty and bedding. Smooth glazing to an angle that sheets water.

SPECIFICATIONS:

Coverage: 33 linear feet (10 m) at 3/8" x 1/4" (9.5 mm x 6 mm) triangular cross section per cartridge. Meets ASTM Spec C-669-95.

LIMITATIONS:

Do not thin glazing compound. Do not apply when air or sash temperatures are below 40° F (4° C). Do not use on plastic windowpanes, insulating glass units with an organic seal, any windowpane over 48" (1219 mm) in length, or metal sash with rabbets over 1-1/4" (32 mm) wide. Also not recommended for stained/leaded glass projects.

CAT. NO.	COLOR	SIZE	QTY/CASE
DAP13TU	White	10.1 Fl. Oz. (300 ml)	12

Minimum order: 1 each. All cartridge sealants can be combined for quantity pricing.

CRL DAP® Vinyl Spackling Compound

- Use for Interior or Exterior Patching
- Can Be Painted
- Easy to Sand



Off-White

Color shown is approximate



MSDS

CRL DAP® Vinyl Spackling is a ready-mixed compound for easy interior or exterior patching. DAP® Vinyl Spackling may be used to fill holes and cracks in surfaces such as drywall, plaster, wood, brick, stone, and concrete. It will not crack, crumble or flake yet dries hard, sands easily, and can be painted.

CAT. NO.	COLOR	SIZE	QTY/CASE
DAP12132	Off-White	32 Fl. Oz. (946 ml)	6

Minimum order: 1 quart.

CRL Putty Tools

- Flexible and Stiff Blades
- Straight and Bent Knives in All Sizes
- Manual and Electric Tools to Choose From

CRL offers a wide assortment of Putty Tools to choose from. From simple high carbon, precision ground, steel bladed stiff and flexible Putty Knives, to power driven specialty removal tools, we have the the right tool available to help make the installation and removal of putty easier, and less time consuming.



For a complete line of CRL Putty Application and Removal Tools, see pages N228 through N248, or visit our web site at crlaurence.com.

CRL SEAM SEALERS AND DISPENSERS

For Pricing Visit Our Web Site or Call Us Toll Free at the Phone Numbers Shown on the Back Cover

CRL Small Joint Seam Sealer

- Seals Seams or Openings of 1/8" (3 mm) or Smaller
- Seals Mechanically Fixed Joints in Window Frames
- Self-Leveling With Controlled Flow

Our fast-drying Small Joint Seam Sealers are formulated to seal seams in metal window frames, storm windows, miter cut screens, etc. They are highly adhesive, and self-leveling for a smooth, inconspicuous appearance. Meets AAMA Specification 803.3-92 Type II Reference Standards ANSI/AAMA 101-85 and 1002.10-83. Available in four colors: clear, white, bronze, and aluminum. For best adhesion, application should be made by brush or adhesive gun to clean and dry surfaces.



CAT. NO. 5504
Pint Can



CAT. NO. SJ88TU
Cartridge



CAT. NO. SJ88GL
Gallon Can



CAT. NO. SJ885GL
5 Gallon Pail

CAT. NO.	CONTENTS	COLOR	QTY/CASE
5504AL	Pint - 16 Fl. Oz. (473 ml)	Aluminum	24
5504BRZ	Pint - 16 Fl. Oz. (473 ml)	Bronze	24
5504C	Pint - 16 Fl. Oz. (473 ml)	Clear	24
5504W	Pint - 16 Fl. Oz. (473 ml)	White	24
SJ88TUAL	Cartridge - 10.3 Fl. Oz. (305 ml)	Aluminum	12
SJ88TUC	Cartridge - 10.3 Fl. Oz. (305 ml)	Clear	12

Minimum order: 1 each. Sizes can be combined for quantity pricing.

CAT. NO.	CONTENTS	COLOR	QTY/CASE
SJ88GLAL	1 Gallon - 128 Fl. Oz. (3.785 l)	Aluminum	4
SJ88GLBRZ	1 Gallon - 128 Fl. Oz. (3.785 l)	Bronze	4
SJ88GLC	1 Gallon - 128 Fl. Oz. (3.785 l)	Clear	4
SJ88GLW	1 Gallon - 128 Fl. Oz. (3.785 l)	White	4
SJ885GLAL	5 Gallon - 640 Fl. Oz. (19 l)	Aluminum	1
SJ885GLBRZ	5 Gallon - 640 Fl. Oz. (19 l)	Bronze	1
SJ885GLC	5 Gallon - 640 Fl. Oz. (19 l)	Clear	1
SJ885GLW	5 Gallon - 640 Fl. Oz. (19 l)	White	1

Minimum order: 1 each. Sizes can be combined for quantity pricing.

CRL Adhesive Pump Guns



CRL Adhesive Guns and Pumps can be used with a variety of liquid adhesives, sealers, and primers. Screw the pump top directly into 6 or 16 fl. oz. (177 or 473 ml) cone top cans, or pour from larger containers into the adhesive gun can. All guns and pumps feature a heavy-duty pump spring and cap for long-lasting durability. The CRL Adhesive Gun Brush Tip attaches to our Adhesive Guns and Pumps. Use it to spread sealant over wider joints.



CAT. NO.	DESCRIPTION
181AG	16 Fl. Oz. Pump Only
195AG	16 Fl. Oz. Pump and Can
KP3298	Brush Tip

Minimum order: 1 each. Can be combined for quantity pricing.

CRL Gun Fill Pump

- For Three and Five Gallon Straight Sided Cans
- The Economy of Bulk in Small Containers



This CRL Gun Fill Pump is designed to transfer bulk sealants, adhesives or lubricants from three or five gallon (11 or 19 liter) pails to convenient smaller containers. It is an 18" (457 mm) pump with 12" (305 ml) cover.

CAT. NO. GFD450

CRL Handi-Seal® Window and Door Sealant

- Exceptionally Low Pressure and Minimal Expansion Sealing Foam
- Virtually Eliminates Bowing of Window Frames
- Complies With AAMA Document #812-04

SPEC. DATA

MSDS

NO AIR FREIGHT



CAT. NO. P10163
31 Oz. (880 g) Can

CRL Handi-Seal® Window and Door Sealant is a one-component, closed cell polyurethane foam in a pressurized can specially formulated for window and door applications. Its unique low pressure and minimal expansion properties virtually eliminate the chance of bowing that can lead to customer callbacks. Complies with AAMA (American Architectural Manufacturers Association) Document #812-04 Industry Specification for proper installation of windows and doors. It extrudes the size of your pinky finger and expands to the size of your thumb.

Use for gaps less than 3" (76 mm) and in bead applications. Requires moisture to cure and becomes tack-free within five minutes, reaching full cure in 12 to 24 hours. A 1" (25 mm) bead at room temperature can be cut within one hour. Easily dispensed with either our Plastic or Metal Dispensing Guns (see next page). 12 cans per case. Minimum order is one each.

CRL Handi-Foam®

- Minimal Expansion, Only 20 to 25 Percent
- Insulates and Soundproofs
- Seals Around Window and Door Frames, Air Ducts, and Pipes

SPEC. DATA

MSDS

NO AIR FREIGHT



CAT. NO. P10290
31 Oz. (880 g) Can

This CRL Handi-Foam® for Gun Dispensing is a one-component polyurethane foam in a pressurized can that expands to only 20 to 25 percent of its original volume. It extrudes the size of your pinky finger and expands to the size of your thumb. Use for gaps less than 3" (76 mm) and in bead applications. Requires moisture to cure, becoming tack-free in 10 minutes, and curing in 12 to 24 hours.

Use Handi-Foam® as a fill to stop air infiltration from cracks, gaps, holes, and more. It adheres to everything except silicone, and polyethylene. Easily dispensed with either our Plastic or Metal Dispensing Guns (see next page). 12 cans per case. Minimum order is one each.

CRL Handi-Foam® Metal Gun

- Heavy-Duty Model for Production Use



- Control Valve for Precise Flow

Either Handi-Foam® canister fits directly into a receptacle on the top of the gun. Just screw on the can, hold can and gun in both hands, shake vigorously for one minute and you're ready to go. Can be cleaned with Cat. No. FOM014 FomoClean Solvent. Minimum order is one each.

CAT. NO. F61010

CRL Handi-Foam® Plastic Gun

- Lightweight Model for Occasional Use



- Pull the Trigger to Dispense Foam

Either Handi-Foam® canister fits directly into a receptacle on the top of the gun. Just screw on the can, hold can and gun in both hands, shake vigorously for one minute and you're ready to go. **NOTE:** Cannot be cleaned with Cat. No. FOM014 FomoClean Solvent. Minimum order is one each.

CAT. NO. F61000

CRL FomoClean Solvent



- Dissolves Freshly Sprayed Foams for Easy Clean-Up

This CRL FomoClean Solvent dissolves freshly sprayed polyurethane foams, making clean-up easy. FomoClean evaporates rapidly, and takes the foam with it when wiped away, without leaving a residue. Use to keep F61010 Metal Dispensing Gun internally clean. **NOTE:** FomoClean will not clean up foam that has already cured. Not recommended for use on the Cat. No. F61000 Plastic Gun. Minimum order is one each.

CAT. NO. FOM014

CRL Handi-Foam® Triple Expanding

- Insulates and Soundproofs
- Seals Around Window and Door Frames, Air Ducts, and Pipes



CRL Handi-Foam® Triple Expanding is a one-component polyurethane foam in a pressurized can that expands up to three times its original volume. Use Handi-Foam® as a fill to stop air infiltration from cracks, gaps, holes, etc. Use for gaps less than 3" (76 mm) and in bead applications. Requires moisture to cure, becomes tack-free in 10 minutes, and cures in 12 to 24 hours. Net weight: 29 oz. (822 g). Minimum order is one each. 12 per case.



CAT. NO. FOM03

CRL Handi-Foam® II Kit

- Yields 1 Cubic Foot
- One Time Use Per Kit
- Portable and Self-Contained



CRL Handi-Foam® II is a totally portable system used for the application of polyurethane foam for sealing and insulation jobs. Portable kit includes the dispensing hose and nozzles. The dispensing guns all have a metering system to control the flow and spray, reducing waste and over spray. Yield: 1 cubic foot (12 board feet). Minimum order is one each.



CAT. NO. FOM012

CRL Handi-Foam® II Kit

- Polyurethane Foam
- Reduces Vibration and Noise
- Yields 8.75 Cubic Feet



CRL Handi-Foam® II is a totally portable system used for the application of polyurethane foam for sealing and insulation jobs. Each portable kit includes the dispensing hose and nozzles. The dispensing guns all have a metering system to control the flow and spray, reducing waste and over spray. Yield: 8.75 cubic feet (105 board feet). Minimum order is one each.

CAT. NO. FOM0875

CRL Handi-Foam® II Kit

- Yields 50 Cubic Feet
- Insulates and Soundproofs



CRL Handi-Foam® II is a totally portable system used for the application of polyurethane foam for sealing and insulation jobs. Portable kit includes the dispensing hose and nozzles. The dispensing guns all have a metering system to control the flow and spray, reducing waste and over spray. Yield: 50 cubic feet (605 board feet). Minimum order is one each.

CAT. NO. FOM0605

CRL Backer Rod Basics for Dynamically Moving Joints

• Prevents Three-Sided Adhesion

The sealant will not adhere to the bottom of the joint, allowing more movement of the sealant (Figure 1).

• Controls Depth of Sealant Bead

The sealant bead will be the design recommended by the sealant manufacturer to maximize sealant movement capability. Round rod configuration also creates less sealant in the middle for greater movement capability of the sealant (Figure 2).

Creates less stress at the bond line which means less sealant failures.

• Provides Resistance to Tool Against

The sealant is pushed against the backer rod during tooling thus forcing the sealant against the side walls of the joint for maximum adhesion (Figure 3). Backer rod must be oversized to hold tightly in the joint (Figure 4).

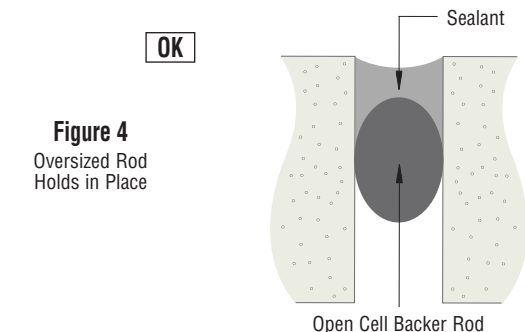
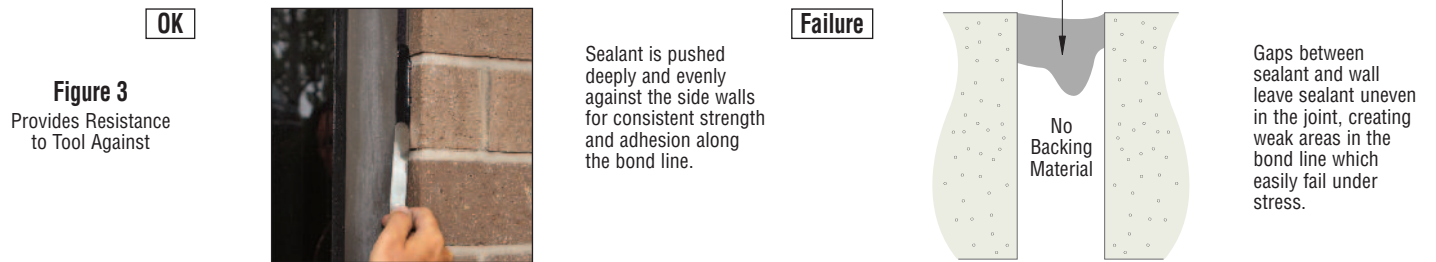
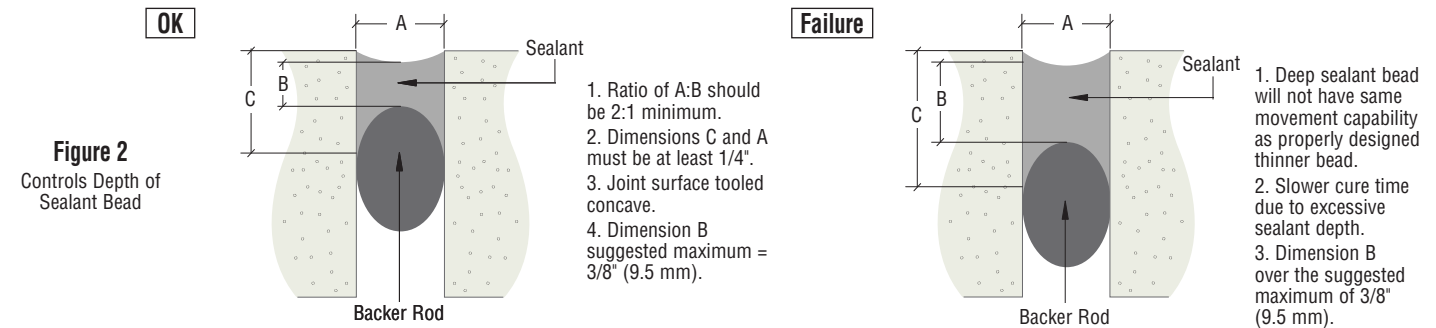
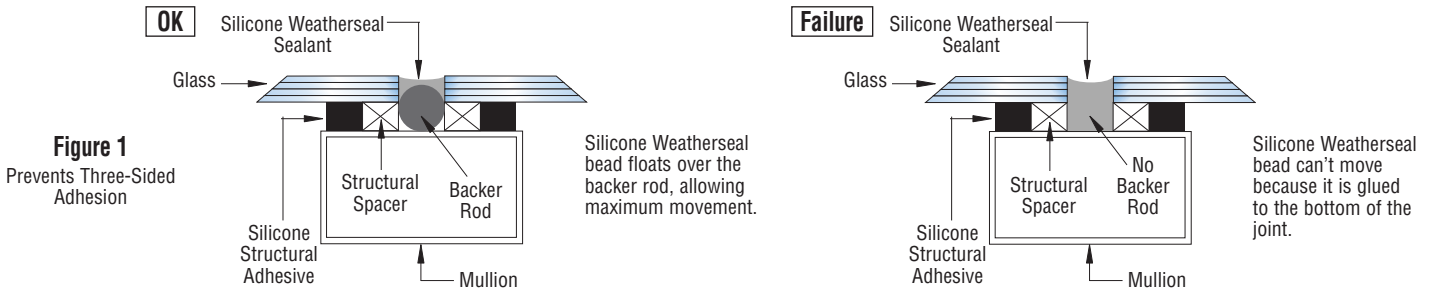

RECOMMENDED BACKER ROD SIZES

JOINT WIDTH	CRL CLOSED CELL BACKER ROD DIAMETER	CRL OPEN CELL BACKER ROD DIAMETER
3/16" (5 mm)	1/4" (6 mm)	---
1/4" (6 mm)	3/8" (10 mm)	---
3/8" (10 mm)	1/2" (12 mm)	5/8" (16 mm)
1/2" (12 mm)	5/8" (16 mm)	7/8" (22 mm)
5/8" (16 mm)	3/4" (19 mm)	1-1/8" (29 mm)
3/4" (19 mm)	1" (25 mm)	1-1/8" (29 mm)
1" (25 mm)	1-1/4" (32 mm)	1-1/2" (38 mm)
1-1/4" (32 mm)	1-1/2" (38 mm)	2" (51 mm)
1-1/2" (38 mm)	2" (51 mm)	---

CRL Open Cell Backer Rod

SPEC. DATA

MSDS

- Open Cell, No Skin, Non-Gassing Rod is Compatible With All Cold-Applied Sealants
- Controls Depth of Sealant and Acts as a Bond Breaker
- Soft, Compresses Easily

new

CRL Open Cell Backer Rod is a soft, round, and easily compressible open cell polyurethane foam. Open Cell Backer Rod is not adversely affected by dynamic joint movement, and its inherent flexibility applies itself to joint variations very easily. The open cell structure and no "skin" on the rod allows air to get to the sealant from the back side, which cures the sealant faster. This also eliminates potential sealant failures due to out-gassing that occurs when the "skin" of Closed Cell Backer Rod is punctured. CRL Open Cell Backer Rod can be used in temperatures from -65° to 400°F (-54° to 204°C). It is highly recommended for use with high performance sealants such as silicones and urethanes. CRL Open Cell Backer Rod should be used only in vertical wall joints. It is not suitable for horizontal traffic joint surfaces.

Proper size selection of CRL Open Cell Backer Rod is important as it controls the depth of the sealant bead. It must be approximately 50% wider than the joint to fit tightly, and function as a bond breaker to prevent bottom-side adhesion of the sealant.

New joints must be cleaned thoroughly, removing any concrete form-release agents, curing compound residue, or any other foreign materials. To ensure a good sealant bond, joints must be clean and dry when the sealant is installed. If old joints are being repaired, all old sealant or filler must be removed. Wire brushing and air blasting are very effective in removing residue from old materials. If an air compressor is used, it must be equipped with traps for the removal of oil and moisture.

After measuring the joint size and choosing the applicable Backer Rod, install the Backer Rod at the depth recommended by the sealant manufacturer. The depth that the rod is inserted into the joint should allow the sealant to form a "hourglass" shape. This is the optimum shape factor for prolonging the service life of the sealant. The Backer Rod must be installed with a blunt tool or roller. The CRL Backer Rod Insert Tool Set, Cat. No. T607CU605, or the CRL Backer Rod Roller, Cat. No. SBRR, are designed specifically for the smooth installation of backer rod.

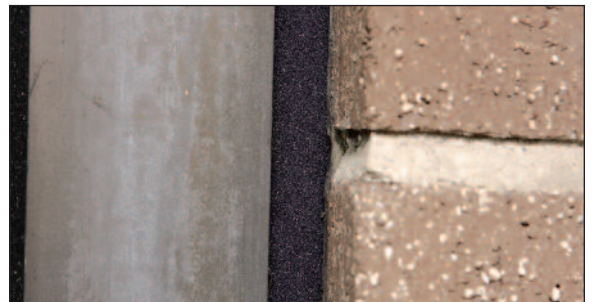

100' (30.5 M) ROLLS

CAT. NO.	ROD DIAMETER	ROLL LENGTH
BOCBR58C	5/8" (16 mm)	100' (30.5 m)
BOCBR78C	7/8" (22 mm)	100' (30.5 m)
BOCBR118C	1-1/8" (28 mm)	100' (30.5 m)
BOCBR112C	1-1/2" (38 mm)	100' (30.5 m)

Minimum order: 1 roll. Sizes can be combined for quantity pricing.

BULK CASES

CAT. NO.	ROD DIAMETER	CASE LENGTH
BOCBR58	5/8" (16 mm)	1400' (426 m)
BOCBR78	7/8" (22 mm)	900' (274 m)
BOCBR118	1-1/8" (28 mm)	350' (107 m)
BOCBR112	1-1/2" (38 mm)	200' (61 m)
BOCBR2	2" (51 mm)	100' (30.5 m)

Minimum order: 1 case. Sizes can be combined for quantity pricing.

CRL Closed Cell Backer Rod

SPEC. DATA

MSDS

- Allows Easy Control of Sealant Application Thickness
- Won't Adhere to Sealants; No Bond Breaker Needed
- Compatible With All Cold-Applied Sealants

CRL Closed Cell Backer Rod is a round, flexible, closed cell polyethylene foam with an exterior "skin" used as a backing and thickness control device for elastomeric and other cold-applied sealants. The Backer Rod becomes an integral part of the joint into which it is installed, and therefore is available in a range of diameters to accommodate joints from 3/16" to 1-5/8" (5 to 41 mm). It limits the depth of the sealant, thereby preventing excessive use of the sealant, which promotes proper joint design. Because the sealant will not bond to the "skin" of the rod, it can stretch and recover with joint movement, with minimal stress being put on the points of adhesion to the substrate.

CRL Closed Cell Backer Rod will not absorb water or wick water to joint walls, which could cause adhesive failure. It is compatible with cold-applied sealants, and its round shape promotes the preferred "hourglass" shape for joint sealants. It withstands hot and cold temperature extremes from -45° to 160°F (-43° to 71°C).

CRL Closed Cell Backer Rod is chemically inert, and resistant to oils, gasoline, and solvents. It will not stain or "bleed" into sealant material. Backer Rod is typically used in expansion/control joints where cold-applied sealants are used. These joints would normally be found in curtain walls, construction partitions, precast panels, parking decks, door and window frame perimeters, coping, floor and deck joints, horizontal traffic joints, and building rehabilitation projects.

Proper size selection of CRL Closed Cell Backer Rod is important as it controls the depth of the sealant bead. It must be approximately 25% wider than the joint to fit tightly, and function as a bond breaker to prevent bottom-side adhesion of the sealant. Always install using a blunt tool or roller. Cat. No. SBRR Backer Rod Roller is designed specifically for the smooth installation of all types of backer rods. **NOTE:** Do not tear, puncture, crease, over compress or stretch during insertion. Always use the correct size Backer Rod for the particular application. Refer to the size selection chart (see page N186). Do not use with hot-applied sealants or hot melt adhesives where their surface temperature is over 160°F (71°C).



Cat. No. SBRR Roller Tool will not tear "skin" of Backer Rod.



Insertion with sharp putty knife will tear "skin".



Out-gassing through torn "skin" will form bubbles in sealant!

100' (30.5 M) ROLLS

CAT. NO.	ROD DIAMETER	ROLL LENGTH
EF14C	1/4" (6 mm)	100' (30.5 m)
EF38C	3/8" (10 mm)	100' (30.5 m)
EF12C	1/2" (12 mm)	100' (30.5 m)
EF58C	5/8" (16 mm)	100' (30.5 m)
EF34C	3/4" (19 mm)	100' (30.5 m)
EF1C	1" (25 mm)	100' (30.5 m)
EF114C	1-1/4" (32 mm)	100' (30.5 m)
EF112C*	1-1/2" (38 mm)	102' (31.1 m)
EF2C*	2" (51 mm)	102' (31.1 m)

Minimum order: 1 roll. Sizes can be combined for quantity pricing. *This size is shipped in 84" (2.13 m) cut lengths.

BULK CASES

CAT. NO.	ROD DIAMETER	CASE LENGTH
EF14B	1/4" (6 mm)	6400' (1951 m)
EF38B	3/8" (10 mm)	3600' (1097 m)
EF12B	1/2" (12 mm)	2500' (762 m)
EF58B	5/8" (16 mm)	1550' (472 m)
EF34B	3/4" (19 mm)	1100' (335 m)
EF1B	1" (25 mm)	550' (168 m)
EF114B	1-1/4" (32 mm)	400' (122 m)
EF112B*	1-1/2" (38 mm)	552' (168 m)
EF2B*	2" (51 mm)	360' (110 m)

Minimum order: 1 case. Sizes can be combined for quantity pricing. *This size is shipped in 84" (2.13 m) cut lengths.

CRL Sof[®] Rod

SPEC. DATA

MSDS

- Easily Conforms to Joint Irregularities
- Non-Gassing if Damaged
- No Moisture Absorption

CRL Sof[®] Rod is a state-of-the-art sealant backing material combining the best properties of both open and closed cell backer rods in a single, trouble-free product. Sof[®] Rod is a continuous length of extruded polyolefin foam made with a non-absorbent outer "skin" and a highly resilient interior network of open and closed cells. Sof[®] Rod will not out-gas if ruptured. It can be used in temperatures ranging from -45° to 160°F (-43° to 71°C).

CRL Sof[®] Rod is basically an inert material, and therefore compatible both physically and chemically with virtually all known cold-applied sealants, including self-leveling types like our CRL Vulkem 45 SSL and CRL Tremco THC900. It provides superior performance for a wide range of expansion and contraction joint applications such as EIFS, glazing, curtainwalls, and parking decks. Sof[®] Rod fills the same joint dimensions as Closed Cell Backer Rod.

Proper installation includes the following: Verify that the joint is clean, moisture-free, and clear of obstructions. Use Sof[®] Rod in a diameter approximately 25% larger than the joint. Always install using a blunt tool or roller. The Cat. No. T607CU605 Backer Rod Insert Tool Set or Cat. No. SBRR Backer Rod Roller are designed specifically for the smooth installation of all types of backer rods. **NOTE:** Do not tear, puncture, crease, over compress or stretch during insertion. Always use the correct size Backer Rod for the particular application. Do not use with hot-applied sealants or hot melt adhesives where their surface temperature is over 160°F (71°C).

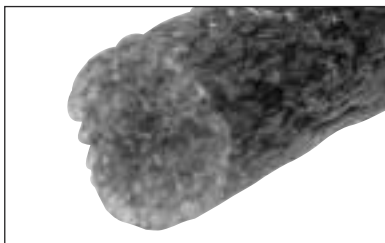

100' (30.5 M) ROLLS

CAT. NO.	ROD DIAMETER	ROLL LENGTH
SR38C	3/8" (10 mm)	100' (30.5 m)
SR58C	5/8" (16 mm)	100' (30.5 m)
SR78C	7/8" (22 mm)	100' (30.5 m)
SR118C	1-1/8" (28 mm)	100' (30.5 m)
SR112C**	1-1/2" (38 mm)	102' (31.1 m)
SR2C**	2" (51 mm)	102' (31.1 m)

Minimum order: 1 roll. **Minimum order: 1 box of seventeen 6 foot lengths. Sizes can be combined for quantity pricing.

BULK CASES

CAT. NO.	ROD DIAMETER	CASE LENGTH
SR38B	3/8" (10 mm)	3600' (1097 m)
SR58B	5/8" (16 mm)	1550' (472 m)
SR78B	7/8" (22 mm)	850' (259 m)
SR118B	1-1/8" (28 mm)	500' (152 m)
SR112B*	1-1/2" (38 mm)	552' (168 m)
SR2B*	2" (51 mm)	360' (110 m)

Minimum order: 1 roll. *Minimum order: 1 case of 72" (1.83 m) cut lengths. Sizes can be combined for quantity pricing.

CRL Bond Breaker Tape

- Used to Create Proper Two-Way Sealant Bond
- Use in Shallow Joints and Metal Butt Joints

Use CRL Bond Breaker Tape to create proper two-way sealant bonds. This clear, tough plastic tape with a clear polyethylene adhesive backing is eight mils (.2 mm) thick, and has high adhesion to steel or other structural metals. It is important for the sealant to bond to joints in two places so it can expand properly. If the sealant bonds in the wrong areas, it may tear or stretch to the point of failure. For sealing shallow joints Bond Breaker Tape is applied to the bottom of the joint so the sealant will bond only to the walls. For metal butt joints Bond Breaker Tape is applied to metal edges so the sealant can be "buttered" over the joint and can properly expand or contract.

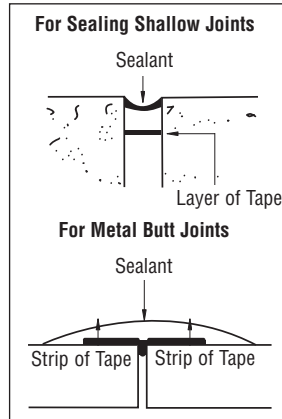

CAT. NO.	WIDTH	LENGTH/ROLL
827T14	1/4" (6.3 mm)	108' (33 m)
827T38	3/8" (9.5 mm)	108' (33 m)
827T12	1/2" (12.7 mm)	108' (33 m)
827T34	3/4" (19 mm)	108' (33 m)
827T1	1" (25.4 mm)	108' (33 m)
827T2	2" (50.8 mm)	108' (33 m)

Minimum order: 1 roll. Sizes can be combined for quantity pricing.

CRL Backer Rod Insert Tool Set

- Works Easily With Both Closed and Open Cell Backer Rod
- Controls Proper Depth to Ensure Uniformity

CRL Backer Rod Insert Tool Set is the quickest, easiest, and safest way to install backer rod. The proper insertion of backer rod into the joint is imperative to proper joint sealing. The assortment of rollers allow insertion of backer rod diameters of 1/8" (3 mm) and larger. The tool allows you to set the desired depth to ensure uniformity. The nylon wheels won't damage the backer rod, or scratch adjacent channel walls.

Complete set includes a Standard Backer Rod Insertion Tool and the Backer Rod Insertion Tool for Close Quarters. The Standard Backer Rod Insertion Tool is designed for the following applications: masonry expansion wall joints, precast panel wall joints, pavement/floor joints, EIFS/stucco joints. The main frame will accommodate a standard threaded broom handle if desired. The Backer Rod Insertion tool for Close Quarters is designed for the following applications: window perimeters, steps, curtainwalls, and corners. Minimum order is one each.



Backer Rod Insert Tool Set Includes:

- Two Roller Frame Units
- Insertion Wheels of 1/8" (3 mm), 1/4" (6 mm), 3/8" (9.5 mm), 1/2" (12 mm)
- One Handle Knife Adapter
- Complete Instructions



CAT. NO. T607CU605

CRL Backer Rod Roller

- Installs Backer Rod in Joints From 1/4" to 1" (6 to 25 mm)
- Controls Proper Depth to Ensure Uniformity

The CRL Backer Rod Roller greatly increases production with the unique roller design that allows fast and easy installation of backer rod with no more changing of wheels and making adjustments to get the proper depth. The pointed backside of the tool is used to insert the first few inches of the rod and to turn corners. Installs backer rod in joints ranging from 1/4" to 1" (6 to 25 mm) wide. Lightweight aluminum handle. Overall length is 11-1/2" (292 mm). Minimum order is one each.

new



CAT. NO. SBRR



CRL Stepped Roller Tool

- For 3/8" (9.5 mm) Foam Backer Rod When Used in Heavy Aluminum Base Shoe
- Controls Proper Depth to Ensure Uniformity

An alternate method to finish off the top opening of Aluminum Base Shoe is to roll in 3/8" (9.5 mm) Foam Backer Rod and run a cap bead of our Cat. No. 95CBL Neutral Cure Silicone (see page N120) over it. This method is preferred in exterior installations where a more positive seal is required. Overall length of tool is 11" (279 mm).



CAT. NO.	DESCRIPTION
GWFR38	Stepped Roller Tool for 3/8" (9.5 mm) Foam Backer Rod
EF38C	100' (30.5 m) Roll 3/8" (9.5 mm) Foam Backer Rod
EF38B	3600' (1097 m) Roll 3/8" (9.5 mm) Foam Backer Rod

Minimum order 1 each GWFR38; 1 roll EF38C; 1 case EF38B.

CRL Canvas Tool Pouch

- Perfect for Holding Backer Rod Rollers, Tooling Spatulas, and Caulking Accessories
- Strong, Lightweight Canvas
- Measures 11" (279 mm) By 9" (229 mm)

This handy Canvas Tool Pouch holds the tools and supplies you need for caulking while up on a ladder, boom lift or swing stage. Eight inside loops and pockets are perfect for holding your backer rod rollers, tooling spatulas, cut-out knife, setting blocks, shims, tape measure, masking tape, utility knife, etc.. Tunnel belt loop is rivet reinforced for durability. Measures 11" (279 mm) wide by 9" (229 mm) deep. Minimum order is one each.



CAT. NO. 4TP

Tools Shown Sold Separately

new

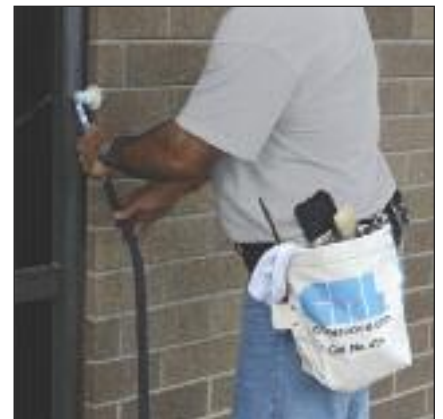



CRL Shimstack Shims

- Adjustable in Thickness and Length With Just a Snap
- Choose the Desired Thickness From 1/16" to 1" (1.6 to 25.4 mm)
- Installation Tab Makes Insertion Easy

CRL Shimstack Shims give you fast, low cost leveling. 16 heat-sealed pieces make up each one-inch stack. Simply snap off individual shims to get the thickness you need. With so many available sizes, Shimstack Shims can be used to align windows, doors, curtainwalls, storefront tubing and other architectural components.

The convenient installation tab allows the shim to be easily inserted completely within the gap, and can be easily broken off after insertion.

Shimstacks are made of black fire resistant, non-staining, high-impact plastic with an ASTM rating of 5000 p.s.i. compressive strength. There are two sizes available, regular and extra long.

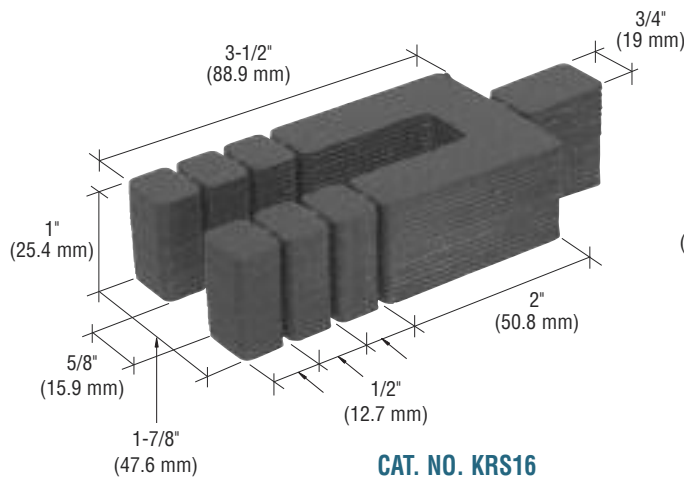

CAT. NO. KRS16
Regular

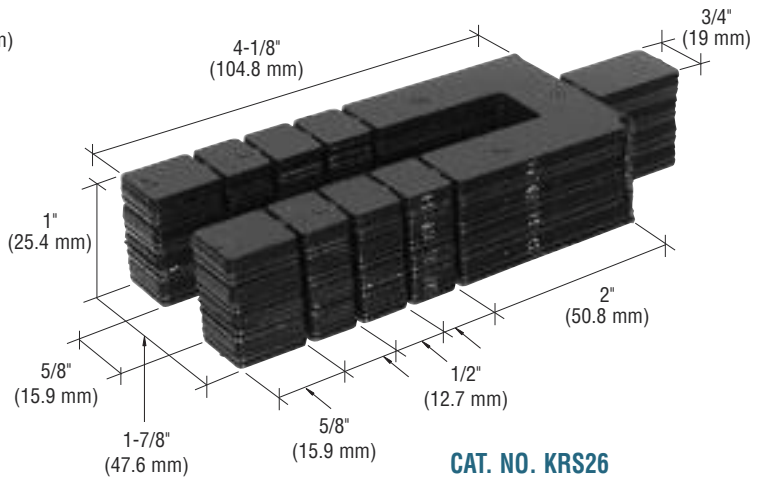

CAT. NO. KRS26
Extra Long



Snap off sections to get the length you need



Separate Shims to get the thickness you need

CAT. NO.	COLOR	THICKNESS	LENGTH	WIDTH	SLOT	QTY/CASE
KRS16	Black	1/16" (1.6 mm)	3-1/2" (88.9 mm)	1-7/8" (47.6 mm)	5/8" (15.9 mm)	1,000
KRS26	Black	1/16" (1.6 mm)	4-1/8" (104.8 mm)	1-7/8" (47.6 mm)	5/8" (15.9 mm)	1,000

Minimum order: 1,000 shims. Must be ordered in increments of 1,000. Sizes can be combined for quantity pricing.

CRL Plastic Horseshoe Shims

- Color Coded for Convenience
- Simplifies All Leveling Requirements
- Packed in Convenient Sleeves and Tubs
- Economical
- Three Standard Lengths

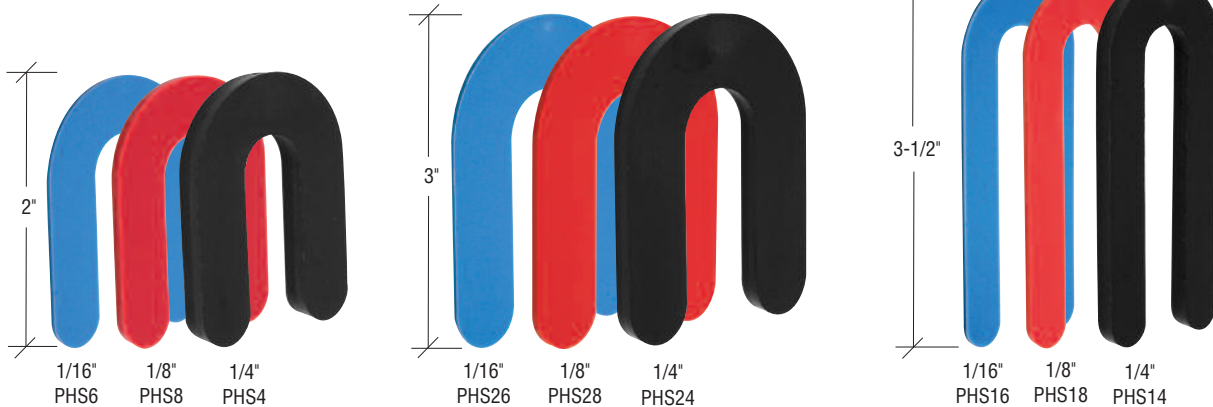

CRL Plastic Horseshoe Shims are made to simplify leveling problems wherever they occur, and have been approved by architects for use in the installation of windows, doors, curtainwalls, storefronts, and insulating glass units. They are adaptable for use in the appliance, automotive, aviation, and mobile home industries as well. They help cut labor and material costs wherever used.

CRL Horseshoe Shims are made of high-impact styrene plastic, properly designed and balanced for vertical or horizontal use. They are available in three thicknesses 1/16", 1/8", and 1/4" (1.6, 3.2, and 6.4 mm), and three lengths 2", 3", and 3-1/2" (51, 76, and 89 mm).

The 3-1/2" (89 mm) length is extremely popular for installing storefront aluminum since most major storefront fabricators use 4" (101.6 mm) tubing. You will find these valuable aids in your building requirements.

New innovative packaging makes it easier to bring shims to the job site, or store them in the shop. Convenient 100 count sleeves in each box of 1,000 allow for easy dispensing and accounting of shims to your field crew at the beginning of the day. 100 count sleeves are packed in our CRL tubs when ordered by the hundred for easy and secure storage in the shop.

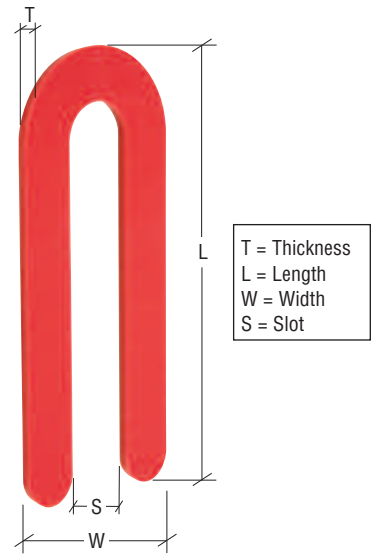

T = Thickness
L = Length
W = Width
S = Slot

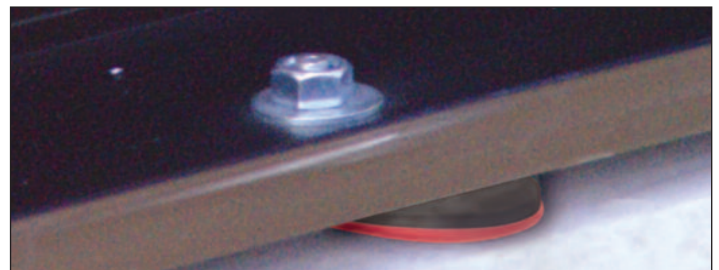

Horseshoe Shims are stackable for required leveling

CAT. NO.	COLOR	THICKNESS (T)	LENGTH (L)	WIDTH (W)	SLOT (S)	QTY/CONTAINER
PHS6	Blue	1/16" (1.6 mm)	2" (51 mm)	1-1/2" (38 mm)	9/16" (14 mm)	100 or 1,000
PHS8	Red	1/8" (3.2 mm)	2" (51 mm)	1-1/2" (38 mm)	9/16" (14 mm)	100 or 1,000
PHS4	Black	1/4" (6.4 mm)	2" (51 mm)	1-1/2" (38 mm)	9/16" (14 mm)	100 or 1,000
PHS26	Blue	1/16" (1.6 mm)	3" (76 mm)	2-5/16" (59 mm)	7/8" (22 mm)	100 or 1,000
PHS28	Red	1/8" (3.2 mm)	3" (76 mm)	2-5/16" (59 mm)	7/8" (22 mm)	100 or 1,000
PHS24	Black	1/4" (6.4 mm)	3" (76 mm)	2-5/16" (59 mm)	7/8" (22 mm)	100 or 1,000
PHS16	Blue	1/16" (1.6 mm)	3-1/2" (89 mm)	1-1/2" (38 mm)	9/16" (14 mm)	100 or 1,000
PHS18	Red	1/8" (3.2 mm)	3-1/2" (89 mm)	1-1/2" (38 mm)	9/16" (14 mm)	100 or 1,000
PHS14	Black	1/4" (6.4 mm)	3-1/2" (89 mm)	1-1/2" (38 mm)	9/16" (14 mm)	100 or 1,000

Minimum order: 100 shims. Must order in increments of 100. Sizes can be combined for quantity pricing.

CRL Jumbo Size Plastic Horseshoe Shims



- Larger 3" x 4" (76 x 102 mm) Size
- Available in Three Thicknesses
- Color Coded for Convenience

CRL Jumbo Size Plastic Horseshoe Shims are preferred for use in curtainwall construction and other installations requiring the leveling of larger members. These high-impact styrene shims are molded to a jumbo 3" x 4" (76 x 102 mm) size in standard thicknesses of 1/16", 1/8", and 1/4" (1.6, 3.2, and 6.3 mm). Precisely sized and balanced for vertical and horizontal installation.



CAT. NO.	COLOR	THICKNESS (T)	LENGTH (L)	WIDTH (W)	SLOT (S)	QTY/CONTAINER
PHS36	Blue	1/16" (1.6 mm)	4" (102 mm)	3" (76 mm)	13/16" (20.6 mm)	100 or 500
PHS38	Red	1/8" (3.2 mm)	4" (102 mm)	3" (76 mm)	13/16" (20.6 mm)	100 or 500
PHS34	Black	1/4" (6.3 mm)	4" (102 mm)	3" (76 mm)	13/16" (20.6 mm)	250

PHS36 and PHS38 Minimum order: 100 each. Must order in increments of 100. PHS34 Minimum order: 250 each. Must order in increments of 250. Sizes can be combined for quantity pricing.

CRL Clear Plastic Horseshoe Shims

- Clear Color Hides Shim
- Available in Three Thicknesses



CRL Clear Plastic Horseshoe Shims are made to simplify leveling problems wherever they occur, and have been approved by architects for use in the installation of windows, doors, curtainwalls, storefronts, and insulating glass units. These shims are made of a clear, high-impact styrene plastic, properly designed and balanced for vertical or horizontal use. They are adaptable for use in the appliance, automotive, aviation, and mobile home industries as well. They help cut labor and material costs wherever used.

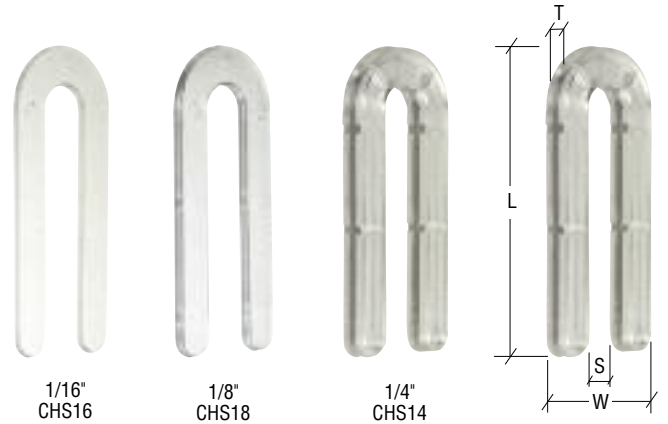

CAT. NO.	COLOR	THICKNESS (T)	LENGTH (L)	WIDTH (W)	SLOT (S)	QTY/CONTAINER
CHS16	Clear	1/16" (1.6 mm)	3-1/2" (89 mm)	1-1/2" (38 mm)	9/16" (14 mm)	100 or 1,000
CHS18	Clear	1/8" (3.2 mm)	3-1/2" (89 mm)	1-1/2" (38 mm)	9/16" (14 mm)	100 or 1,000
CHS14	Clear	1/4" (6.3 mm)	3-1/2" (89 mm)	1-1/2" (38 mm)	9/16" (14 mm)	100 or 1,000

Minimum order: 100 each. Must order in increments of 100. Sizes can be combined for quantity pricing.

CRL Aluminum Horseshoe Shims

- For Use When the Installation of Plastic Shims is Restricted By Building Codes
- Won't Compress Under Heavy Aluminum Base Shoe
- Available in Three Thicknesses

These CRL Aluminum Horseshoe Shims solve the problem on construction projects where the use of plastic horseshoe shims is restricted. They are fireproof in accordance with regulations and building codes. CRL Aluminum Horseshoe Shims are ideal for Base Shoe installations. They will not compress or project beyond the Base Shoe. They are also the same base metal as the Base Shoe, so corrosion is minimized.

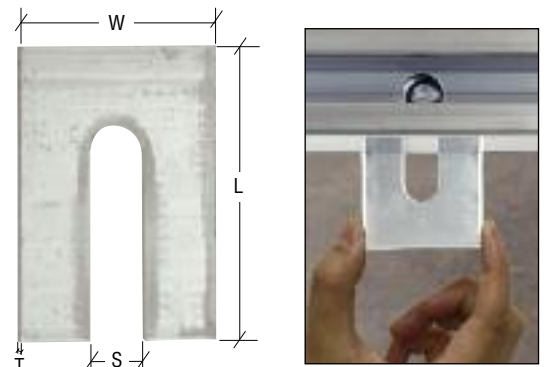

CAT. NO.	THICKNESS (T)	LENGTH (L)	WIDTH (W)	SLOT (S)	QTY/CONTAINER
AHS66	1/16" (1.6 mm)	3" (76 mm)	2" (51 mm)	9/16" (14 mm)	100
AHS68	1/8" (3.2 mm)	3" (76 mm)	2" (51 mm)	9/16" (14 mm)	100
AHS64	1/4" (6.3 mm)	3" (76 mm)	2" (51 mm)	9/16" (14 mm)	100

Minimum order: 100 each. Must order in increments of 100. Sizes can be combined for quantity pricing.

CRL Plastic Bearing Shimstrips

- High Compressive Strength Maintains Uniform Thickness
- Water, Chemical, and Alkali Resistant
- Color Coded for Convenience
- Easy Snap Off



These CRL Plastic Bearing Shimstrips are intended for use in placing and leveling curtainwall and storefront metal in concrete openings. They are made of an extremely strong multipolymer plastic that withstands tremendous loads without compressing or deteriorating due to chemicals, moisture or rust. These solid shims can be drilled in the center to allow placement over the bolt which prevents the shim from possibly moving, as can happen with horseshoe shims with slots. The 4" x 2" (102 x 51 mm) shims snap from the factory strip, and are available in thicknesses of 1/4", 1/8", and 1/16" (6.3, 3.2, and 1.6 mm).

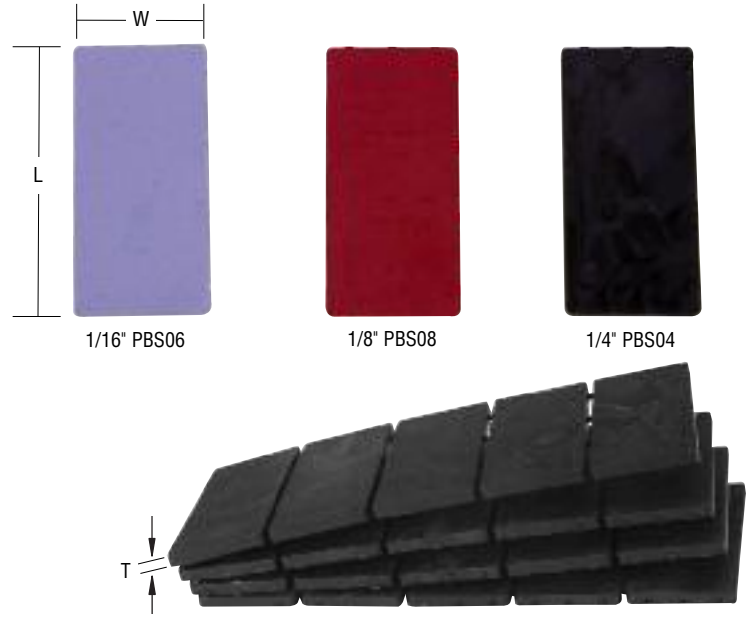

CAT. NO.	COLOR	THICKNESS (T)	LENGTH (L)	WIDTH (W)	QTY/CONTAINER
PBS06	Blue	1/16" (1.6 mm)	4" (102 mm)	2" (51 mm)	100
PBS08	Red	1/8" (3.2 mm)	4" (102 mm)	2" (51 mm)	100
PBS04	Black	1/4" (6.3 mm)	4" (102 mm)	2" (51 mm)	100

Minimum order: 100 each. Must order in increments of 100. Sizes can be combined for quantity pricing.

CRL Aluminum Shim Strips

- Available in Three Thicknesses: to Adjust Aluminum Base Shoe to Plumb Position



CRL Aluminum Shim Strips are used under one side of Heavy Aluminum Base Shoe to adjust it into a plumb position before securing it with the fasteners. The length can be trimmed as required for an exact fit.



CAT. NO.	THICKNESS	WIDTH	LENGTH	QTY/PKG
BSS164	1/64" (.4 mm)	3/4" (19 mm)	24" (610 mm)	10
BSS132	1/32" (.8 mm)	3/4" (19 mm)	24" (610 mm)	10
BSS116	1/16" (1.6 mm)	3/4" (19 mm)	24" (610 mm)	10

Minimum order: 1 package. Sizes can be combined for quantity pricing.



CRL Aluminum Drain Blocks

- Placed Under Aluminum Base Shoe to Provide Drainage Space
- Great for Balconies and Decks

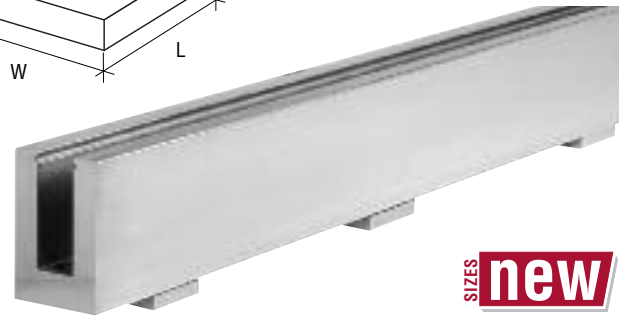
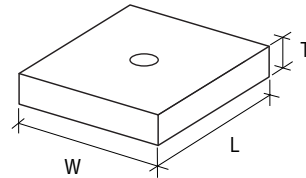

Place CRL Aluminum Drain Blocks under exterior installed Base Shoes to provide drainage space for water run-off. This is especially important where Base Shoe will be installed on balconies or decks where water could pool unless proper drainage is available. One Drain Block should be placed under each mounting hole. Blocks can be rotated to fit different width Base Shoes.

CAT. NO.	THICKNESS (T)	WIDTH (W)	LENGTH (L)	QTY/PKG
BSDB38	3/8" (9.5 mm)	2-1/4" (57 mm)	2-1/2" (63 mm)	10
BSDB58	3/8" (9.5 mm)	2-1/4" (57 mm)	2-5/8" (67 mm)	10
BSDB34	3/8" (9.5 mm)	2-1/4" (57 mm)	2-3/4" (70 mm)	10
LSDB21	3/8" (9.5 mm)	2-1/4" (57 mm)	3-3/16" (81 mm)	10

Minimum order: 1 package. Sizes can be combined for quantity pricing.

CRL Tapered Wood Shims

- Made From Northern White Wood or Kiln Dried Western Cedar
- Handy for Builders, Plumbers, Carpenters, Masons, and Glaziers



CRL White Wood Shims are made from northern white woods, and bundled conveniently for on-the-job use. CRL Cedar Shims are made from kiln dried western red cedar or white cedar. Most other cedar shims are made from inland cedar which tends to rot, but CRL Cedar Shims are better because they snap cleaner, making them especially suited for outdoor applications, such as between a concrete pad and a treated plate. CRL Cedar Shims are resistant to termites, and are specified in climates where termites are a problem. Wood Shims are also used for leveling door and window frames, cabinets and large appliances; and can also be used for stirring paints and stains or spreading mastics and adhesives.

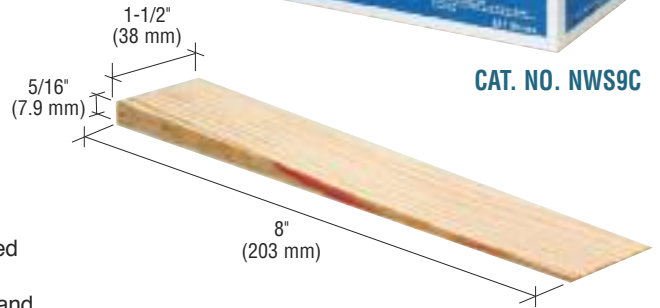

CAT. NO. NWS9C

CAT. NO.	TYPE	SHIMS/CARTON
NWS9	White Wood	420 Shims
NWS9C	Cedar	432 Shims

Minimum order: 1 carton. Can be combined with other shims for quantity pricing.

CRL Tapered Wood Composite Shims

- New Technology in Wood Shims
- Snaps Four Times Easier and Cleaner Than Traditional Wood
- 35% Better Load Support Than Traditional Wood

These CRL Wood Composite Shims are made from a composite of wood and plastic providing both building and environmental advantages. They are engineered to high performance standards with reduced material at natural breakpoints (perforations). This allows clean snaps at breakpoints calculated according to common usage, resulting in less waste and greater strength. Wood Composite Shims have the following building advantages: 35% better load support than traditional wood; snap four times easier than traditional wood; snap off cleaner; no waste; waterproof; impervious to insects; will not mildew or rot; and resist splitting, splintering, swelling and warping. Environmental advantages include: no wood from the rain forests; no wood from endangered tree species; 100% wood waste encourages recycling; promotes sound wood waste recovery; and reduces volatile pricing from the wood industry.

So versatile, they can be used in many ways including: leveling door and window frames, cabinets, and large appliances; stirring paints and stains; spreading mastics and adhesives. They are very easy to use - no more mess of breaking or cutting shingles, and handy to keep around - one 32 count carton easily fits under the seat of your vehicle. Bulk carton of 288 shims contains 12 shims per bundle, 24 bundles per carton.



CAT. NO. NWCS8



CAT. NO. BWCS8

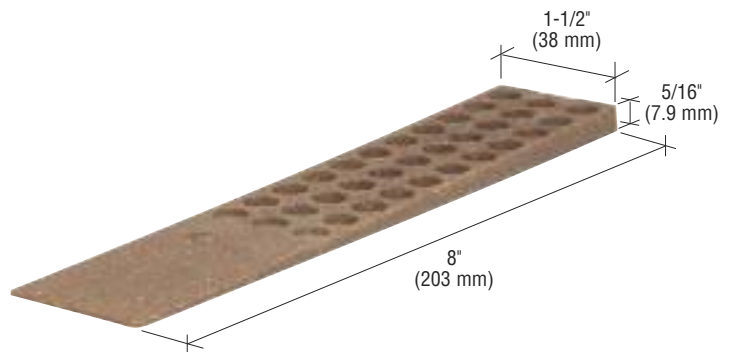

CAT. NO.	TYPE	SHIMS/CARTON
NWCS8	Wood Composite	32
BWCS8	Bulk Wood Composite	288

Minimum order: 1 carton. Can be combined with other shims for quantity pricing.

CRL SETTING BLOCKS

For Pricing Visit Our Web Site or Call Us Toll Free at the Phone Numbers Shown on the Back Cover

CRL Neoprene Setting Blocks

- The Preferred Method for Centering and Cushioning Glass
- 80 Durometer Hardness
- Special Sizes and Hardnesses Available

SIZES **new**

CRL Neoprene Setting Blocks cushion and support glass, and act as a centering device for glass installed in channels. The neoprene composition of the blocks makes them resilient, so that glass cushioned by them can withstand vibration, shock, and heavy wind loads. A variety of sizes are available from stock. Custom sizes and hardnesses are also available on special order. **NOTE:** May discolor clear and light colored silicones.

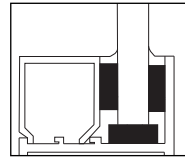

Setting Blocks used to cushion and/or center glass in a typical installation

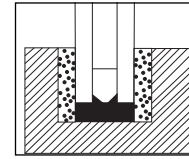

Setting Blocks used as a cushion for insulating glass units

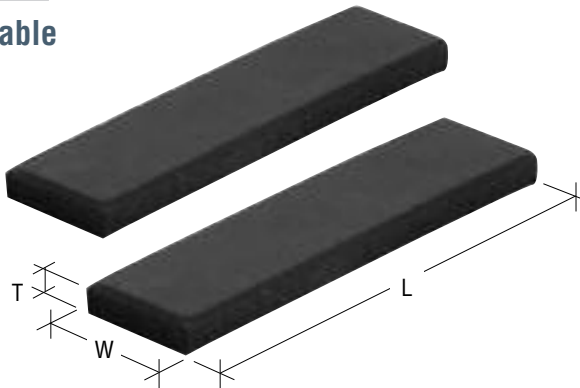

TECHNICAL INFORMATION:

Polymer: Neoprene; Temperature Range: -30 to +200°F (-34 to +93°C); Hardness, Shore A: 80±5; Tensile, PSI: 750; Elongation, %: 250.

CAT. NO.	THICKNESS (T)	WIDTH (W)	LENGTH (L)
SB569	1/16" (1.6 mm)	1/4" (6.3 mm)	2" (50.8 mm)
SB561	1/16" (1.6 mm)	1/2" (12.7 mm)	2" (50.8 mm)
SB587	1/16" (1.6 mm)	1" (25.4 mm)	2" (50.8 mm)
SB568	1/8" (3.2 mm)	1/4" (6.3 mm)	2" (50.8 mm)
SB560	1/8" (3.2 mm)	3/8" (9.5 mm)	2" (50.8 mm)
SB562	1/8" (3.2 mm)	1/2" (12.7 mm)	2" (50.8 mm)
SB583	1/8" (3.2 mm)	1" (25.4 mm)	2" (50.8 mm)
SB559	3/16" (4.8 mm)	3/8" (9.5 mm)	2" (50.8 mm)
SB582	3/16" (4.8 mm)	7/8" (22.2 mm)	2" (50.8 mm)
SB567	1/4" (6.3 mm)	1/4" (6.3 mm)	2" (50.8 mm)
SB566	1/4" (6.3 mm)	3/8" (9.5 mm)	2" (50.8 mm)
SB563	1/4" (6.3 mm)	1/2" (12.7 mm)	2" (50.8 mm)
SB584	1/4" (6.3 mm)	1" (25.4 mm)	2" (50.8 mm)
SB586	3/8" (9.5 mm)	1/2" (12.7 mm)	1" (25.4 mm)
SB564	3/8" (9.5 mm)	1/2" (12.7 mm)	2" (50.8 mm)
SB585	3/8" (9.5 mm)	1" (25.4 mm)	2" (50.8 mm)
SB565	1/2" (12.7 mm)	1/2" (12.7 mm)	2" (50.8 mm)

Minimum order: 100 each. Must be ordered in increments of 100. Sizes can be combined for quantity pricing.

CAT. NO.	THICKNESS (T)	WIDTH (W)	LENGTH (L)
SB596	1/16" (1.6 mm)	1/4" (6.3 mm)	4" (101.6 mm)
SB578	1/16" (1.6 mm)	1/2" (12.7 mm)	4" (101.6 mm)
SB570	1/8" (3.2 mm)	1/4" (6.3 mm)	4" (101.6 mm)
SB579	1/8" (3.2 mm)	1/2" (12.7 mm)	4" (101.6 mm)
SB574	1/8" (3.2 mm)	3/4" (19 mm)	4" (101.6 mm)
SB576	1/8" (3.2 mm)	1" (25.4 mm)	4" (101.6 mm)
SB571	3/16" (4.8 mm)	7/16" (11.1 mm)	4" (101.6 mm)
SB589	3/16" (4.8 mm)	7/8" (22.2 mm)	4" (101.6 mm)
SB572	1/4" (6.3 mm)	3/8" (9.5 mm)	4" (101.6 mm)
SB580	1/4" (6.3 mm)	1/2" (12.7 mm)	4" (101.6 mm)
SB573	1/4" (6.3 mm)	5/8" (15.9 mm)	4" (101.6 mm)
SB575	1/4" (6.3 mm)	3/4" (19 mm)	4" (101.6 mm)
SB577	1/4" (6.3 mm)	1" (25.4 mm)	4" (101.6 mm)
SB588	1/4" (6.3 mm)	7/8" (22.2 mm)	4" (101.6 mm)
SB581	1/2" (12.7 mm)	1/2" (12.7 mm)	4" (101.6 mm)
SB590	1/16" (1.6 mm)	1-1/8" (28.5 mm)	4" (101.6 mm)
SB591	1/8" (3.2 mm)	1-1/8" (28.5 mm)	4" (101.6 mm)
SB592	1/4" (6.3 mm)	1-1/8" (28.5 mm)	4" (101.6 mm)
SB593	3/8" (9.5 mm)	1-1/8" (28.5 mm)	4" (101.6 mm)
SB594	1/2" (12.7 mm)	1-1/8" (28.5 mm)	4" (101.6 mm)
SB595	5/8" (15.9 mm)	1-1/8" (28.5 mm)	4" (101.6 mm)

Minimum order: 100 each. Must be ordered in increments of 100. Sizes can be combined for quantity pricing.

CRL Bulk Rolled Setting Block Material

- 80 Durometer Hardness in Rolls That You Cut to Length as Needed to Reduce Waste

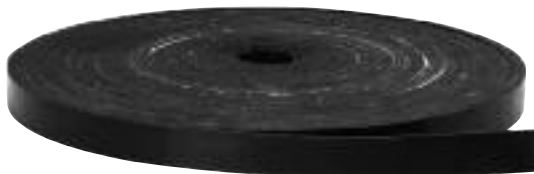

CRL Bulk Rolled Setting Block Material cushions and supports glass, and acts as a centering device for glass installed in channels. The 80 durometer neoprene or PVC composition makes it resilient, so that glass cushioned by the materials can withstand vibration, shock, and heavy wind loads. These economical bulk rolls can be cut to any length for each application, and are available in a variety of stock sizes. Custom sizes and durometers can be quoted upon request.

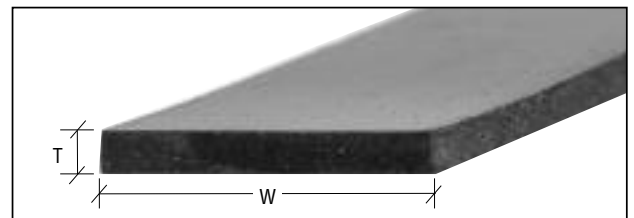

CAT. NO.	MATERIAL	THICKNESS (T)	WIDTH (W)	LENGTH (L)
SBRL6	PVC	1/16" (1.6 mm)	1" (25.4 mm)	100' (30.5 m)
SBRL6B	PVC	1/16" (1.6 mm)	1" (25.4 mm)	1000' (305 m)
SBRL2	Neoprene	1/8" (3.2 mm)	3/4" (19 mm)	100' (30.5 m)
SBRL4	Neoprene	1/8" (3.2 mm)	1" (25.4 mm)	100' (30.5 m)
SBRL4B	PVC	1/8" (3.2 mm)	1" (25.4 mm)	500' (152.4 m)
SBRL7	PVC	3/16" (4.8 mm)	1" (25.4 mm)	100' (30.5 m)
SBRL7B	PVC	3/16" (4.8 mm)	1" (25.4 mm)	500' (152.4 m)
SBRL1	Neoprene	1/4" (6.3 mm)	5/8" (15.9 mm)	100' (30.5 m)
SBRL3	Neoprene	1/4" (6.3 mm)	3/4" (19 mm)	100' (30.5 m)
SBRL5	Neoprene	1/4" (6.3 mm)	1" (25.4 mm)	100' (30.5 m)
SBRL5B	PVC	1/4" (6.3 mm)	1" (25.4 mm)	350' (106.7 m)

Minimum order: 1 roll. Sizes can be combined for quantity pricing.

CRL Neoprene Setting Blocks in Custom Sizes

- Strips, Blocks, or Rolls of Neoprene Custom-Cut to Your Specifications
- Different Durometers Available

We can custom cut blocks, strips, or rolls of neoprene rubber to the exact specifications for your job. Every order is made to your specs, and getting the right material is easy. To order, we need the following information:

1. Exact size and shape of the material required. Specify length, width, and thickness of each different size.
2. Durometer (hardness) required of the material.
3. The quantities of each size you want.
4. Any special packaging or shipping instructions.

We require the above information, plus two to three weeks lead time to ship your order. All custom size orders for neoprene are non-returnable, so be sure of your exact requirements before ordering.



CRL Thermoplastic Rubber (TPR) Setting Blocks

- Compatible With Silicone, Butyl, Polyurethane, and Polysulfide Sealants
- UV Stabilized

CRL Thermoplastic Rubber (TPR) Setting Blocks are compatible with almost anything, meaning you can use them in designs calling for the use of modern structural glazing sealants. They are formed of a 90 durometer shore hardness thermoplastic rubber that performs as well as traditional neoprene setting blocks. They are available in the most popular sizes of neoprene blocks. They have excellent chemical resistance, and do not mar or stain surfaces. Job specific testing prior to start up is recommended with each silicone sealant manufacturer.

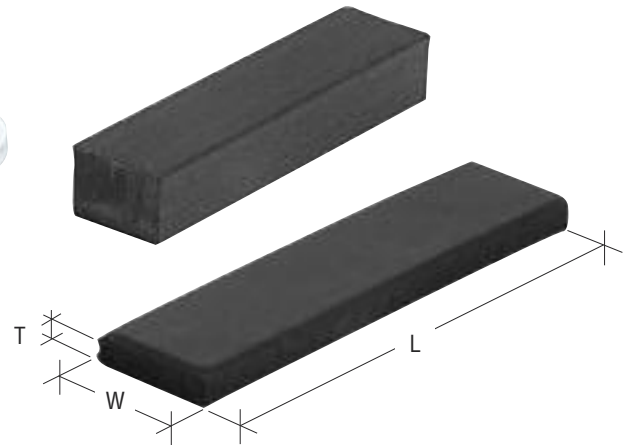

Typical installation in metal window frame.



TPR Blocks will not discolor applied sealants like neoprene blocks can.

CAT. NO.	"T" THICKNESS	"W" WIDTH	"L" LENGTH
TPR569	1/16" (1.6 mm)	1/4" (6.3 mm)	2" (50.8 mm)
TPR561	1/16" (1.6 mm)	1/2" (12.7 mm)	2" (50.8 mm)
TPR560	1/8" (3.2 mm)	3/8" (9.5 mm)	2" (50.8 mm)
TPR568	1/8" (3.2 mm)	1/4" (6.3 mm)	2" (50.8 mm)
TPR562	1/8" (3.2 mm)	1/2" (12.7 mm)	2" (50.8 mm)
TPR576	1/8" (3.2 mm)	1" (25.4 mm)	4" (101.6 mm)
TPR559	3/16" (4.8 mm)	3/8" (9.5 mm)	2" (50.8 mm)

Minimum order: 100 each. Must be ordered in increments of 100. Sizes can be combined for quantity pricing.

CAT. NO.	"T" THICKNESS	"W" WIDTH	"L" LENGTH
TPR567	1/4" (6.3 mm)	1/4" (6.3 mm)	2" (50.8 mm)
TPR566	1/4" (6.3 mm)	3/8" (9.5 mm)	2" (50.8 mm)
TPR563	1/4" (6.3 mm)	1/2" (12.7 mm)	2" (50.8 mm)
TPR577	1/4" (6.3 mm)	1" (25.4 mm)	4" (101.6 mm)
TPR564	3/8" (9.5 mm)	1/2" (12.7 mm)	2" (50.8 mm)
TPR565	1/2" (12.7 mm)	1/2" (12.7 mm)	2" (50.8 mm)
TPR578	5/8" (15.9 mm)	1" (25.4 mm)	4" (101.6 mm)

Minimum order: 100 each. Must be ordered in increments of 100. Sizes can be combined for quantity pricing.

CRL EPDM Rubber Setting Blocks

- **Stable EPDM Rubber Has Better Resistance to the Effects of Weather and Ultraviolet Rays**
- **80 Durometer Hardness**

CRL EPDM Rubber Setting Blocks are more durable than Silicone Rubber Setting Blocks, and have better resistance to the effects of weather and ultraviolet rays. CRL EPDM Rubber Blocks are preferred for use in places where there is potential for contact with fuels and/or ozone. The composition of the blocks makes them resilient, so that glass cushioned by them can withstand vibration, shock, high and low temperatures, and heavy wind loads. A variety of sizes are available from stock, and special sizes can also be ordered.

NOTE: Do not use them with silicone sealants, as there is a potential for bleed-through of color.



CAT. NO.	"T" THICKNESS	"W" WIDTH	"L" LENGTH
SBEP1	1/16" (1.6 mm)	1-1/8" (28.5 mm)	4" (101.6 mm)
SBEP2	1/8" (3.2 mm)	1-1/8" (28.5 mm)	4" (101.6 mm)
SBEP3	3/16" (4.8 mm)	1-1/8" (28.5 mm)	4" (101.6 mm)
SBEP4	1/4" (6.3 mm)	1-1/8" (28.5 mm)	4" (101.6 mm)
SBEP5	3/8" (9.5 mm)	1-1/8" (28.5 mm)	4" (101.6 mm)
SBEP6	1/2" (12.7 mm)	1-1/8" (28.5 mm)	4" (101.6 mm)
SBEP7	1/2" (12.7 mm)	7/16" (11.1 mm)	4" (101.6 mm)
SBEP8	1-1/8" (28.5 mm)	1-1/8" (28.5 mm)	4" (101.6 mm)
SBEP9	5/8" (15.9 mm)	1-1/8" (28.5 mm)	4" (101.6 mm)

Minimum order: 100 each. Must be ordered in increments of 100. Sizes can be combined for quantity pricing.

CRL Silicone Rubber Setting Blocks

- **Compatible With, and Will Not Discolor Most Silicone Sealants**
- **Can Be Used for Food and Computer Related Applications**
- **80 Durometer Hardness**

These CRL Silicone Rubber Setting Blocks have superior durability, are U.V. resistant, and are compatible with most silicone sealants. They will not discolor the silicone should the two come in contact with each other. The composition of the blocks makes them resilient, so that glass cushioned by them can withstand vibration, shock, high and low temperatures, and heavy wind loads. A variety of sizes are available from stock, and special sizes can also be ordered.

To ensure sealant to block compatibility, the manufacturer of the silicone sealant can test the compatibility of job site representative accessory materials with their silicone sealants using ASTM C1087-87. Results of the compatibility test will be forwarded in writing. Testing takes approximately four weeks from receipt of samples.



CAT. NO.	"T" THICKNESS	"W" WIDTH	"L" LENGTH
SBSN1	1/16" (1.6 mm)	1-1/8" (28.5 mm)	4" (101.6 mm)
SBSN2	1/8" (3.2 mm)	1-1/8" (28.5 mm)	4" (101.6 mm)
SBSN3	3/16" (4.8 mm)	1-1/8" (28.5 mm)	4" (101.6 mm)
SBSN4	1/4" (6.3 mm)	1-1/8" (28.5 mm)	4" (101.6 mm)
SBSN5	3/8" (9.5 mm)	1-1/8" (28.5 mm)	4" (101.6 mm)
SBSN6	1/2" (12.7 mm)	1-1/8" (28.5 mm)	4" (101.6 mm)
SBSN7	1/2" (12.7 mm)	7/16" (11.1 mm)	4" (101.6 mm)
SBSN8	1-1/8" (28.5 mm)	1-1/8" (28.5 mm)	4" (101.6 mm)

Minimum order: 100 each. Must be ordered in increments of 100. Sizes can be combined for quantity pricing.

CRL "Vinyl Set" Bevelled Corner Setting Blocks

- **Helps Eliminate "Waves" in Vinyl**
- **Compatible With Silicone, Polyurethane, and Polysulfide Sealants**
- **90 Durometer Hardness**

Our "Vinyl Set" Bevelled Corner Setting Blocks are sure to save you time. You will not need to notch the vinyl, and this will also eliminate the waves in the vinyl that you normally get with standard setting blocks. Vinyl Set Bevelled Corner Blocks are made of a 90 durometer material compatible with Silicone, Polyurethane, and Polysulfide. Two lengths are available.

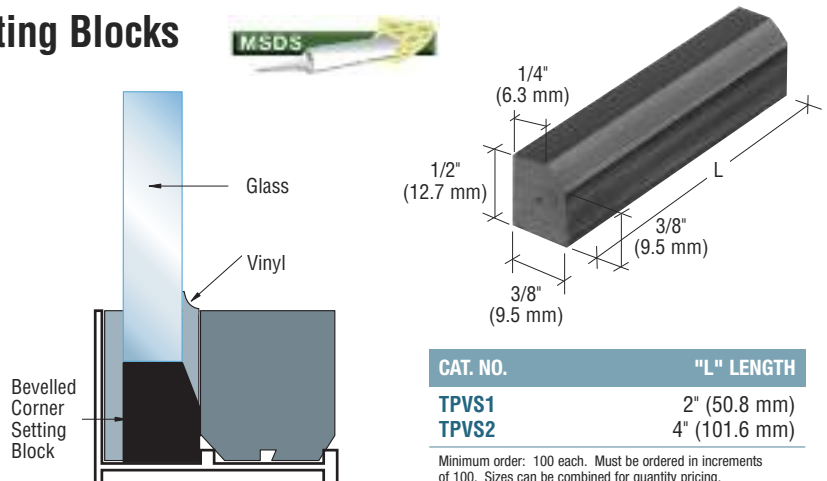

CAT. NO.	"L" LENGTH
TPVS1	2" (50.8 mm)
TPVS2	4" (101.6 mm)

Minimum order: 100 each. Must be ordered in increments of 100. Sizes can be combined for quantity pricing.

CRL Clear Plastic Setting Blocks

- Barely Visible Blocks Are Great for Use in Mirror and Frameless Shower Installations
- 80 ±5 Durometer Hardness



.040" Thick (1 mm) PSB040
 1/8" Thick (3.2 mm) PSB125
 5/32" Thick (4 mm) PSB156
 1/4" Thick (6.4 mm) PSB250
 3/8" Thick (9.5 mm) PSB375

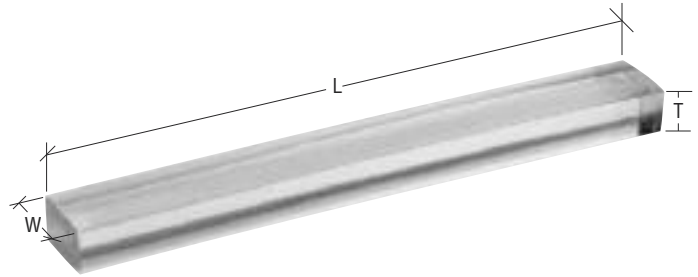

CRL Clear Plastic Setting Blocks are especially suited for use where black neoprene or thermoplastic rubber setting blocks are undesirable, such as mirror or 'all-glass' frameless shower door installations. They are barely visible in the bottoms of Mirror J-Channel, or on the bottom of sliding track H-Bar. CRL Clear Plastic Setting Blocks make glass leveling very simple in shower enclosures, and are available in five different thicknesses.

CAT. NO.	"T" THICKNESS	"W" WIDTH	"L" LENGTH
PSB040	.040" (1 mm)	1/4" (6.4 mm)	2" (50.8 mm)
PSB125	1/8" (3.2 mm)	1/4" (6.4 mm)	2" (50.8 mm)
PSB156	5/32" (4 mm)	1/4" (6.4 mm)	2" (50.8 mm)
PSB250	1/4" (6.4 mm)	1/4" (6.4 mm)	2" (50.8 mm)
PSB375	3/8" (9.5 mm)	1/4" (6.4 mm)	2" (50.8 mm)

Minimum order: 100 each. Must be ordered in increments of 100. Sizes can be combined for quantity pricing.

CRL Self Aligning Adjustable Setting Blocks

- Molded Fin and Slot Assures Proper Alignment
- Adjustable Thicknesses From 3/8" to 11/16" (9.5 to 17.5 mm)

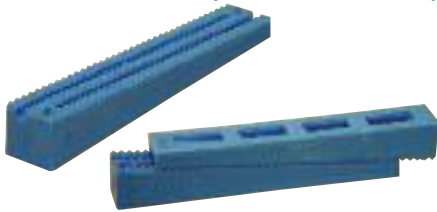

CRL Self-Aligning Adjustable Setting Blocks have a unique molded fin and slot that ensures proper alignment without slippage. The fine teeth allow for thickness adjustments from 3/8" to 11/16" (9.5 to 17.5 mm). These high impact plastic blocks will not chip glass edges and will not deteriorate under extreme temperature variances. Mating them is also easy because every one is the same, and any two fit together.

CAT. NO.	WIDTH	LENGTH	QTY/PKG
ASB38	3/8" (9.5 mm)	2-3/8" (60 mm)	100 Pair

Minimum order: 100 pair. Must be ordered in increments of 100.

CRL Adjustable Setting Blocks

- Available in Two Widths
- Adjustable Thicknesses From 3/8" to 11/16" (9.5 to 17.5 mm)

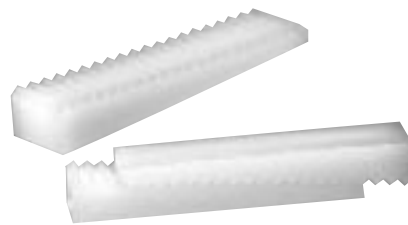

Adjust the thickness of these CRL Adjustable Setting Blocks by mating the stepped surfaces to the precise requirement for your installation. Available in 3/8" and 1/2" (9.5 and 12.7 mm) widths, the thickness can vary between 3/8" and 11/16" (9.5 and 17.5 mm). They are made of a high impact plastic that won't chip glass, and resist the deteriorating effects of weather and age.

CAT. NO.	WIDTH	LENGTH	QTY/PKG
44338	3/8" (9.5 mm)	2-3/8" (60 mm)	100 Pair
44412	1/2" (12.7 mm)	2-3/8" (60 mm)	100 Pair

Minimum order: 100 pair. Must be ordered in increments of 100.

CRL Strip Lead

- Cut Your Own Setting Blocks
- Soft Lead Won't Chip Glass Edges



This CRL Strip Lead is ideal for use in making your own custom length setting blocks because the lead is soft and malleable. It will not chip the glass edges, and it can be doubled up for extra thickness if necessary. The 1/2" and 1/4" (12.7 and 6.4 mm) widths come in 1/8" (3.2 mm) thicknesses, in continuous strips wound on 25 pound (11.3 kg) spools.

CAT. NO.	THICKNESS	WIDTH	PKG
SL1814	1/8" (3 mm)	1/4" (6.4 mm)	Spool
SL1812	1/8" (3 mm)	1/2" (12.7 mm)	Spool

Minimum order: 1 roll. Sizes can be combined for quantity pricing.

new

CRL Rigid Rubber Spacing Blocks With Adhesive

- Adhesive Back Holds Spacing Block in Place
- Maintains Even Spacing on Slant Installations

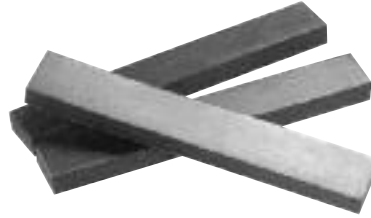

CRL Rigid Rubber Spacing Blocks With Adhesive provide even spacing between glass panels. They are always necessary on slant stair installations to prevent the glass panels from sliding down. They are easily installed and perfectly aligned every time using the CRL Rubber Spacing Block Installation Tool (see below). Adhesive back holds the Spacing Blocks in position.

NOTE: You must cut 5/8" (16 mm) off of the length of the Spacing Block when used with our B5L Series Low Profile Base Shoe.

CAT. NO.	FITS BASE SHOE SERIES	WIDTH	THICKNESS	LENGTH	QTY/PKG
GR5ASB	B5S, B5T, B5A, B6S, L56S, and B5L	1/2" (12 mm)	1/4" (6.3 mm)	3-5/16" (84 mm)	100
GR7ASB	B7S	3/4" (19 mm)	1/4" (6.3 mm)	3-5/16" (84 mm)	100
LGR21SB	L21S	7/8" (22 mm)	1/4" (6.3 mm)	3-5/16" (84 mm)	100
LGR25SB	L25S	1" (25 mm)	1/4" (6.3 mm)	3-5/16" (84 mm)	100

Minimum order: 100 each. Blocks must be ordered in increments of 100. Sizes can be combined for quantity pricing.



CRL High Density Foam Spacing and Sealing Pads

- Die Cut Foam Pad With Adhesive on One Side
- Fast and Accurate Spacing and Sealing of Glass Panels
- Can Be Adhered Together to Increase the Gap Between the Glass Panels in 1/4" (6 mm) Increments



These High Density Foam Pads not only act as spacers between panels of glass, they also create a seal at the end of selected panels, acting as a dam for your desired pour area. They are easily installed and perfectly aligned every time using the CRL Rubber Spacing Block and Sealing Pad Installation Tool (see below). The adhesive on one side allows the pads to be adhered together so spacing can be

increased in 1/4" (6 mm) increments to meet your needs. Use with Rigid Rubber Spacing Blocks on slant pours to prevent glass movement during installation. **NOTE:** You must cut 5/8" (16 mm) off of the length of the Spacing and Sealing Pad when used with our B5L Series Low Profile Base Shoe.

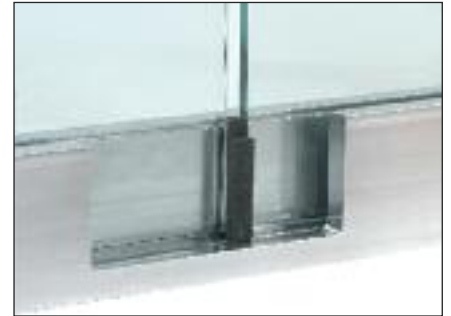

CAT. NO.	FITS BASE SHOE SERIES	GLASS THICKNESS	PAD WIDTH	PAD THICKNESS	PAD LENGTH	QTY/PKG
GR5NSB	B5S, B5T, B5A, and B5L	1/2" (12 mm)	1-1/16" (27 mm)	1/4" (6.3 mm)	3-7/16" (87 mm)	20
GR7NSB	B7S	3/4" (19 mm)	1-5/16" (33 mm)	1/4" (6.3 mm)	3-7/16" (87 mm)	20

Minimum order: 20 each. Pads must be ordered in increments of 20.

CRL Rubber Spacing Block and Sealing Pad Installation Tool

- Makes Positioning of Spacing Blocks or Sealing Pads Fast and Easy

Simply push the CRL Rubber Spacing Block, with the adhesive side out, into the notch at the end of the Installation Tool, and then remove the release paper. Slip the Tool into Base Shoe pocket and slide it toward the edge of the glass panel. When contact is made push firmly, and then slide the Tool back. The Spacing Block is now in the proper location. To install Sealing Pads, place them in the Base Shoe pocket, and then push into place with the Tool.

CAT. NO.	DESCRIPTION
RSB1T	Rubber Spacing Block and Sealing Pad Installation Tool

Minimum order: 1 each.

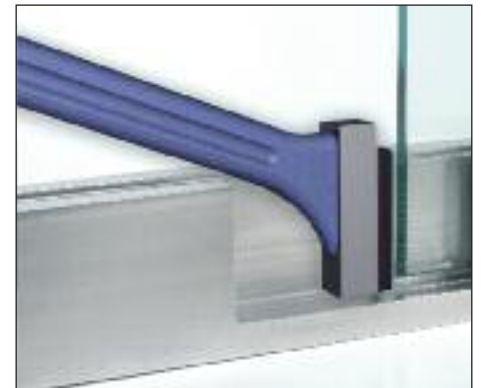
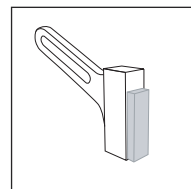
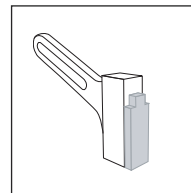

CRL Glass Railing Setting and Centering Blocks

- Easily Center Glass Panels in Hand Rail Base Shoe
- Supports Glass Panels for Expanding Cement Installations
- Available in 4" (102 mm) Cut Pieces or 25' (7.6 m) Bulk Rolls

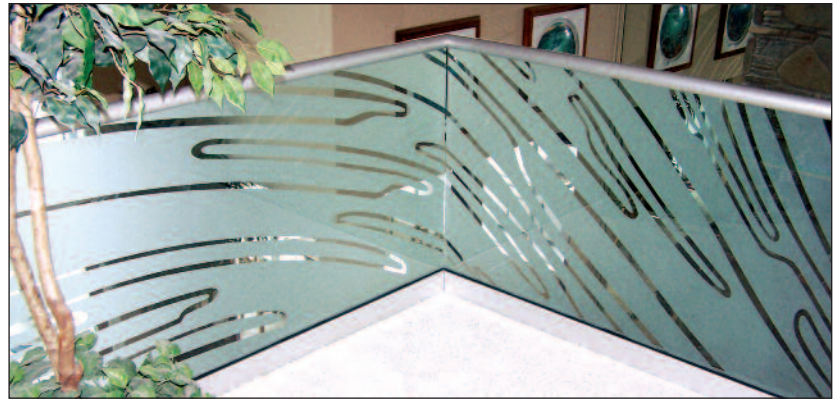
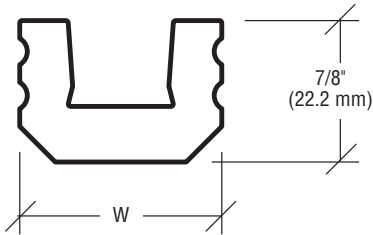

CRL Setting and Centering Blocks are available for use with our B5L, B5S, B5T, B6S, B7S, L56S, L21S, and L25S Series Base Shoe. Stocked in pre-cut 4" (102 mm) pieces, they are made of black EPDM rubber for durability and longevity. **NOTE:** Three are available in 25' (7.6 m) rolls that can be cut to any length. CRL recommends two 4" (102 mm) pieces located at quarter points along the bottom edge of each glass panel.

CAT. NO.	GLASS THICKNESS	BASE SHOE SERIES	WIDTH (W)	PACKAGING
GR4UB4	15 mm •	B6S	1-1/4" (31.7 mm)	*20 each 4" (102 mm) per Pack
GR5UB4	1/2" (12 mm) •	B5S, B5T, B5L	1" (25.4 mm)	*20 each 4" (102 mm) per Pack
GR6UB4	5/8" (16 mm) •	B7S	1-1/4" (31.7 mm)	*20 each 4" (102 mm) per Pack
GR7UB4	3/4" (19 mm) •	B7S	1-1/4" (31.7 mm)	*20 each 4" (102 mm) per Pack
LGR56UB4	9/16" (13.52 mm)**	L56S	1-1/4" (31.7 mm)	*20 each 4" (102 mm) per Pack
LGR8UB4	27/32" (21.52 mm)**	L21S	1-5/8" (41.3 mm)	*20 each 4" (102 mm) per Pack
LGR10UB4	1-1/16" (25.52 mm)**	L25S	1-3/4" (44.5 mm)	*20 each 4" (102 mm) per Pack
GR5UB25	1/2" (12 mm) •	B5S, B5T, B5L	1" (25.4 mm)	.25' (7.6 m) per Roll
GR6UB25	5/8" (16 mm) •	B7S	1-1/4" (31.7 mm)	.25' (7.6 m) per Roll
GR7UB25	3/4" (19 mm) •	B7S	1-1/4" (31.7 mm)	.25' (7.6 m) per Roll

*Minimum order for 4" (102 mm) pieces is 20 each. Must be ordered in increments of 20. †Minimum order: 1 roll. • Monolithic Glass. ** Laminated Glass.

CRL SurfaceMate Angle Adjust Curved Blocks



SurfaceMate Angle Adjust Curved Blocks (Cat. No. AACs1) are placed directly beneath the SurfaceMate Base Shoe at each bolt hole location. They are slotted to allow for minor adjustments to the placement of the block so that the base shoe can be adjusted to perfect plumb. There is also an Angle Adjust Curved Block (Cat. No. AACs2) that can be used in fascia mount application of SurfaceMate Base Shoe. See our website, crlaurence.com, for detailed diagrams of mounting methods.

CAT. NO.	DESCRIPTION
AACs1	One-Piece Curved Block for Bottom Mount Installations
AACs2	Two-Piece Curved Block for Fascia Mount Installations

Minimum order: 10 each. Must be ordered in increments of 10.

CRL SurfaceMate Horseshoe Shims



Aluminum Horseshoe Shims are available in three thicknesses for use with SurfaceMate Base Shoe. Shims are slotted to allow for minor adjustment, and can be stacked in various sizes to accommodate irregular surfaces below the base shoe and curved block. They can also be used in fascia mount applications of SurfaceMate Base Shoe.

CAT. NO.	THICKNESS	SIZE
ALSS32	1/32" (.8 mm)	2-1/8" x 2-1/4" (54 x 57 mm)
ALSS16	1/16" (1.6 mm)	2-1/8" x 2-1/4" (54 x 57 mm)
ALSS08	1/8" (3.2 mm)	2-1/8" x 2-1/4" (54 x 57 mm)

Minimum order: 100 each. Must be ordered in increments of 100. Sizes can be combined for quantity pricing.

CRL Aluminum/Neoprene Setting Blocks for Glass

- Protects Glass Edge While Providing Rigid Glass Support in Sidelite Rails and U-Channel
- Provides Proper Height for Recommended Glass Coverage

CRL Aluminum Setting Blocks with Neoprene are used to provide a rigid glass support for the bottom of our Sidelite Rails and our U-Channel with Roll-In Top Load Gasket. They are the proper height to provide 9/16" (14.3 mm) glass coverage in both the Top and Bottom Channels when glazed with the "lift and drop" method. Minimum order is one each.

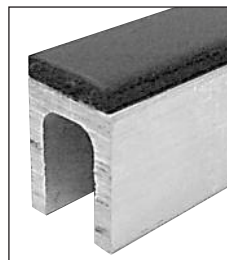

Length 4" (102 mm)
Width 5/8" (16 mm)
Height 7/8" (22 mm)

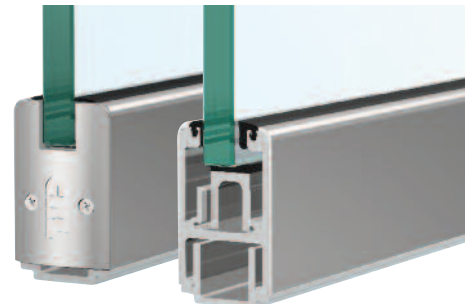

CAT. NO. UCSB4

CRL Wedgit Glass Centering Springs

- Keeps Glass Centered in Channel Prior to Sealant Application
- Won't Slip, Slide or Lose Tension
- Three Convenient Sizes

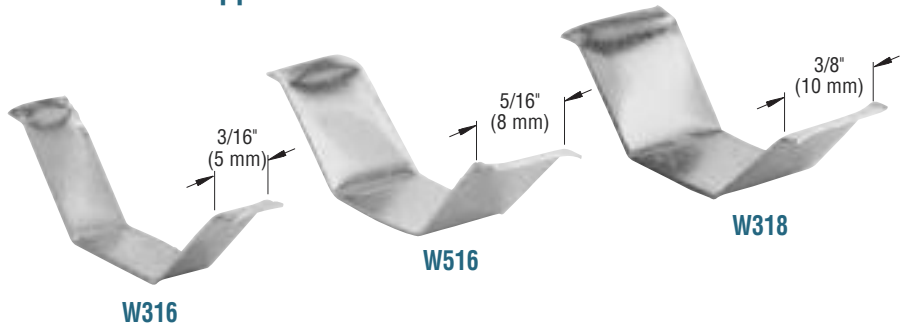

CRL Wedgits are steel springs available in three widths. They are used for filling up the space and preventing rattles when using glass or plastic that is thinner than the channel it is being used in, or to center glass panels in wood or metal channels prior to sealant application. By placing Wedgits directly opposite each other at regular intervals, the glass will maintain a uniformly spaced position in the center of the channel, promoting a more even distribution of sealant on both sides.

CAT. NO.	WIDTH	BOX WEIGHT	APPROX. QTY/BOX
W316	3/16" (5 mm)	1 lb (454 g)	1500
W516	5/16" (8 mm)	1 lb (454 g)	1000
W318	3/8" (10 mm)	1 lb (454 g)	1000

Minimum order: 1 lb. Sizes can be combined for quantity pricing.

CRL Anti-Walk Blocks

- Coiled Rubber Blocks
- Snaps Back Into Coiled Position

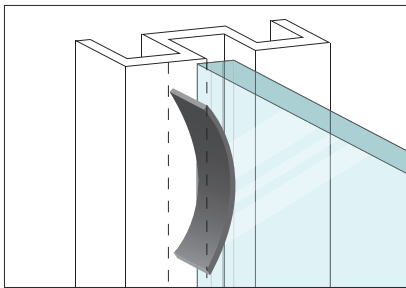

These CRL Anti-Walk Blocks are designed to prevent the glass from "walking" out of the glazing pocket by providing a positive stop in each vertical tube. The coiled rubber blocks can be spread out and inserted into the storefront tube glazing pocket, after which they snap back into their coiled position and stay in place. The AWBT Insert Tool is designed to insert the last Anti-Walk Blocks after the glass has been centered in the opening.

CAT. NO.	WIDTH	LENGTH	THICKNESS	QTY/BOX
AWB38	3/8" (10 mm)	3-7/16" (87 mm)	1/8" (3 mm)	500
AWB716	7/16" (11 mm)	3-7/16" (87 mm)	1/8" (3 mm)	500
AWB12	1/2" (13 mm)	3-7/16" (87 mm)	1/8" (3 mm)	500
AWB916	9/16" (14 mm)	3-7/16" (87 mm)	1/8" (3 mm)	500
AWB58	5/8" (16 mm)	3-7/16" (87 mm)	1/8" (3 mm)	500
AWBT	Plastic Insert Tool			1

Minimum order: 1 box of 500 each for the Blocks. 1 each AWBT. Sizes can be combined for quantity pricing.

CRL Glass Pocket Setting Block for Windscreen Posts

- Can Be Easily Cut to Any Length
- Will Not Compress Under Glass Weight



This Windscreen Post Setting Block fits into the glass pocket to support the glass panel at the height you determine. It is made of a rigid UHMW plastic composite that won't compress under the weight of the glass, helping to maintain an even sight line. You can trim it to any length you require.

CAT. NO.	THICKNESS	WIDTH	LENGTH
WPSB1	1/2" (13 mm)	3/4" (19 mm)	24" (610 mm)

Minimum order: 1 each.

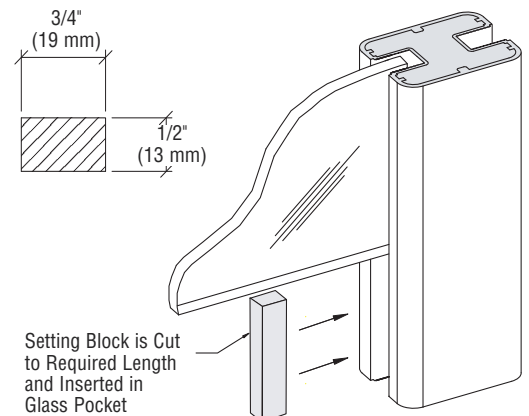

Setting Block is Cut to Required Length and Inserted in Glass Pocket

CRL Super Shim Shower Door Leveler

- Easily Adjustable Micro Leveling
- Eliminates Stacks of Wood or Plastic Shims
- Works With 3/8" or 1/2" (10 or 12 mm) Thick Tempered Glass Doors

The CRL Super Shim Shower Door Leveler is a remarkably simple device that every shower door installer will want in their tool box. The Super Shim is a micro adjustment device which will lift and level any shower door, ensuring a precise alignment every time.

The CRL Super Shim lifts the door panel by way of a threaded adjustment bolt: Turn the bolt clockwise and raise the panel. When used in conjunction with a level the CRL Super Shim will eliminate the phrase "close enough" from every shower door installer's vocabulary. Now every door installation will be a perfect fit.

The CRL Super Shim is manufactured with non-slip materials which prevent damage to tile or glass, while still allowing smooth movement where necessary. Ratchet wrench included. Minimum order is one pair.



CRL Frameless Blocks

- Use With 3/8" (10 mm) and 1/2" (12 mm) Thick Glass to Assist in Aligning and Leveling

CRL Frameless Blocks are used to help with the installation of 3/8" (10 mm) and 1/2" (12 mm) frameless shower doors and panels. You can set your door and panels in the blocks to assist in plumbing, aligning, and leveling your glass. Adjust your height by adding setting blocks in the rails. The base is 5/16" (8 mm) thick. The opening size for 3/8" (10 mm) glass is 7/16" (11 mm) wide, and for 1/2" (12 mm) glass the opening is 9/16" (14 mm).

Frameless Blocks help to avoid chipping, flaking, and breakage while helping to reduce installation time. Your installers will appreciate all of these features, besides the added safety. They can also be used to help with the installation of 3/8" (10 mm) and 1/2" (12 mm) commercial storefront doors and panels.



CAT. NO.	FOR USE WITH
FB38G	3/8" (10 mm) Glass
FB12G	1/2" (12 mm) Glass

Minimum order: 1 set.

CRL Shower Door Tools

- Innovative Tools for Shower Door Installations
- Designed by Glazing Professionals
- Save Time and Money

CRL offers professional quality Shower Door Installation Tools that can help make your frameless shower door installs easier and less time consuming. Less time spent on a job equates to larger profits.

The tools we produce and distribute are often the ideas of experienced glazing professionals. C.R. Laurence recognizes that no one knows better what is needed in a tool than the individuals who use those tools each and every day.

For more information on these innovative Shower Door Installation Tools, please see pages K328 to K332 in our CRL73 Master Catalog, or visit us online at crlaurence.com.



Caulking Gun Ratios - What Does It Mean? Extra Thrust!

Today's high viscosity sealants have brought about a new age of caulking guns. The question is, what does the term "ratio" really mean? Quite simply, for every pound of pressure being applied by the user, the ratio is a multiplier of pounds of pressure being exerted on the cartridge plunger. For example, the CRL 12:1 Ratio Caulking Gun would provide 12 times the amount of each pound of pressure being applied.

CRL Cox 12:1 Ratio Chilton Strap Frame Caulking Gun

- Our Most Popular Model
- Holds Standard Caulking Cartridges

CRL Cox 12:1 Ratio Chilton Caulking Gun has the smooth operation of a friction rod, plus a large handle and trigger. Perfect for dispensing low to medium viscosity materials. Strap frame rotates to move the nozzle tip where needed.

The spring release plunger lets you load and dispense quickly and easily, and releases pressure on the plunger to prevent sealant run-on. A special feature of this gun is the Wear Compensating Device that minimizes wear on the applicator by automatically taking up the slack to provide total trigger action from first use to last. This device will approximately double the life of the gun.

Also features: die cast zinc alloy body, all component replaceable parts, patented catch plate (sintered steel), and built-in ladder hook. Holds all standard size caulking cartridges. Minimum order is one each.

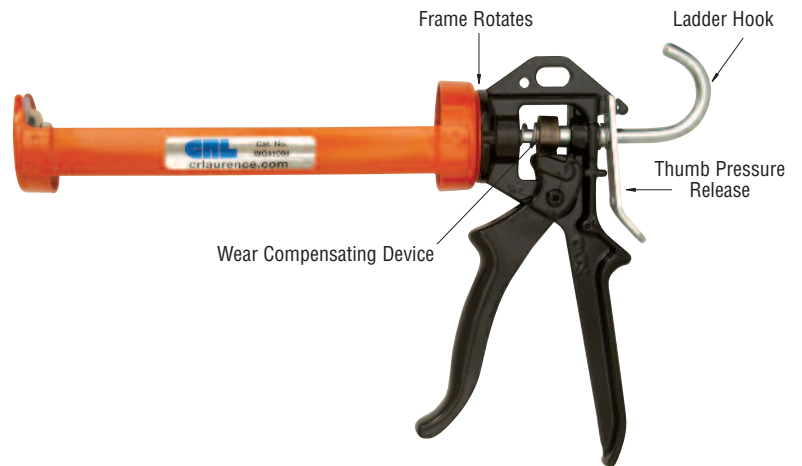

CAT. NO. WG41004

CRL Cox 18:1 Ratio Extra Thrust Strap Frame Caulking Gun

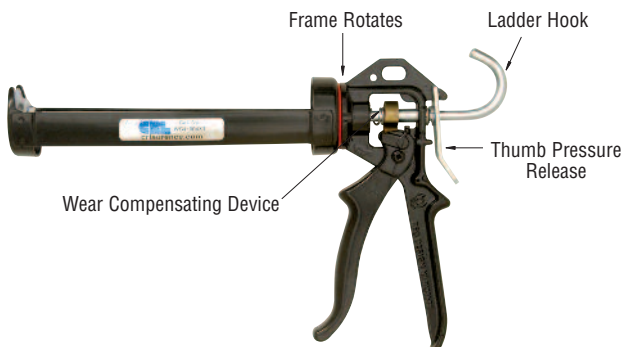

- Ideal for Cold Weather Use or With High Viscosity Sealants

This CRL Cox 18:1 Ratio Extra Thrust Gun has the smooth operation of a friction rod, plus a large handle and trigger. Perfect for dispensing low to high viscosity materials. Strap frame rotates to move the nozzle tip where needed.

The spring release plunger lets you load and dispense quickly and easily, and releases pressure on the plunger to prevent sealant run-on. A special feature of this gun is the Wear Compensating Device that minimizes wear on the applicator by automatically taking up the slack to provide total trigger action from first use to last. This device will approximately double the life of the gun. Also features: die cast zinc alloy body, all component replaceable parts, patented catch plate (sintered steel), and built-in ladder hook. Holds all standard size caulking cartridges. Minimum order is one each.

CAT. NO. WG41004XT

CRL Cox 26:1 Ratio Ascot Strap Frame Caulking Gun

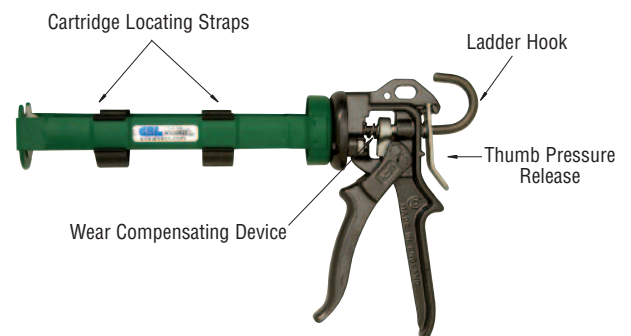

- Effortless Dispensing of High Viscosity Sealants

The CRL 26:1 Ratio Ascot Gun combines case-hardened working parts with a contoured handle and trigger design to make this gun the ultimate for dispensing high viscosity sealants. High-strength strap frame design features improved high-power bulkhead.

Includes new cartridge locating straps for holding slightly smaller diameter European cartridges. The spring release plunger lets you load and dispense quickly and easily, and releases pressure on the plunger to prevent sealant run-on. Same special Wear Compensating Device as WG41004 Gun. Also features: die cast zinc alloy body, all component replaceable parts, patented catch plate (sintered steel), and built-in ladder hook. Holds all standard size caulking cartridges. Minimum order is one each.

CAT. NO. WG410042T

Caulking Guns can be combined for quantity pricing.

CRL Standard Smooth Rod Caulking Gun



- Thumb Pressure Release Button
- Our Best Seller is Also a Great Value
- Perfect for Low Viscosity Materials



Our CRL Standard Smooth Rod Caulking Gun is CRL's most popular caulking gun because it is quality constructed, and so easy and economical to use. Perfect for dispensing low viscosity materials. The spring release plunger lets you load and dispense quickly and easily, and releases pressure on the plunger to prevent sealant run-on. Minimum order is one each.

Caulking Guns can be combined for quantity pricing.

CAT. NO. ER3

CRL 12:1 Ratio Strap Frame Caulking Gun

new

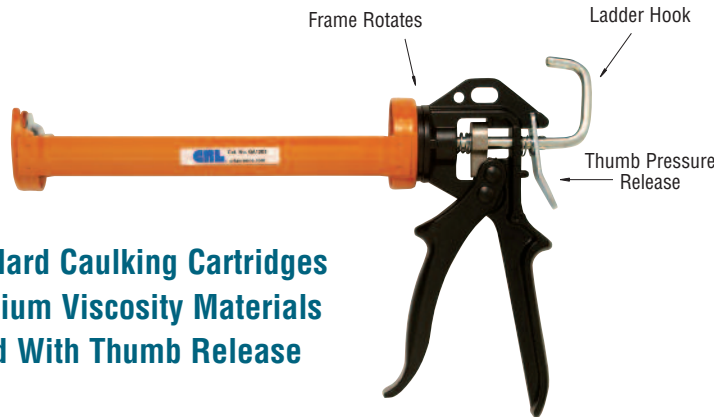

- Holds Standard Caulking Cartridges
- Low to Medium Viscosity Materials
- Smooth Rod With Thumb Release



This CRL 12:1 Ratio Caulking Gun has the smooth operation of a friction rod, plus a large handle and trigger. Perfect for dispensing low to medium viscosity materials, such as silicones and acrylic latex sealants. The strap frame rotates to move the nozzle tip where needed. The spring release plunger lets you load and dispense quickly and easily. The thumb-activated instant pressure release button prevents sealant run-on. Includes a built-in ladder hook. Twelve guns per case. Minimum order is one each.

CAT. NO. GA1203

CRL 26:1 Ratio Strap Frame Caulking Gun

new

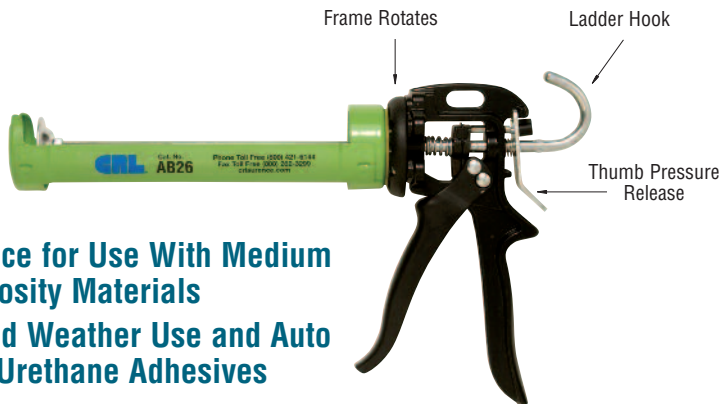

- A Good Choice for Use With Medium to High Viscosity Materials
- Ideal for Cold Weather Use and Auto Windshield Urethane Adhesives



This CRL Heavy Duty 26:1 Ratio Gun has the smooth operation of a friction rod and the mechanical advantage to dispense high viscosity sealants, such as auto urethanes or construction sealants, even during cold weather. The strap frame rotates to move the nozzle tip where needed. The spring release plunger lets you load and dispense quickly and easily. The thumb-activated instant pressure release button prevents sealant run-on. Includes a built-in ladder hook. Twelve guns per case. Minimum order is one each.

CAT. NO. AB26

CRL Albion Deluxe Strap Frame Caulking Gun

- Thumb Pressure Release Button
- Square Smooth Rod

This CRL Albion Deluxe Caulking Gun is made for the professional. Loading is quick and easy. Get superior caulking thrust with the 1-5/8" (41 mm) diameter ejector; speed and holding comfort with the no pinch finger guard. This easy-to-use gun also features a 1/4" (6 mm) square smooth piston rod that rotates for four times longer life. A handy seal piercing tool is located in the handle. Minimum order is one each.

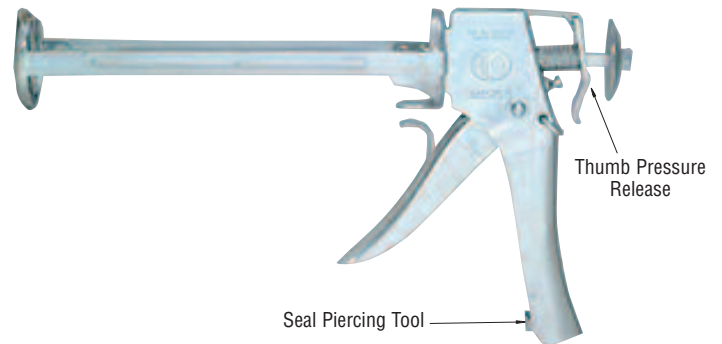

CAT. NO. AB1393

CRL Newborn Ratchet Rod Caulking Gun

- Lightweight, Yet Durable
- Smooth Action Ratchet Rod

The CRL Newborn Ratchet Rod Gun is a professional model drop-in cartridge gun. The ratchet action rod pushes caulking material smoothly with double, heat-treated dog drives for even application. It's one of our most popular guns because it has a good combination of the following features at a very affordable price: seal piercing tool, nozzle spout cutter, ladder hook, adjustable wrist strap, and no pinch finger guard. Minimum order is one each.

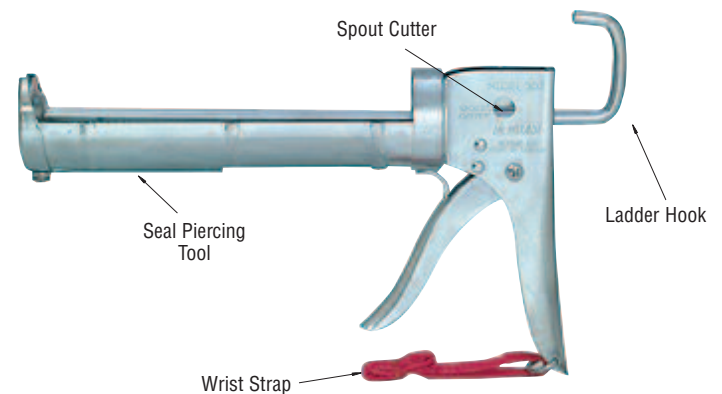

CAT. NO. KM27RD

CRL Vacuum Action No-Drip Caulking Gun

- Smooth Rod With Thumb Release
- Stops Drips Automatically

This CRL Vacuum Action No-Drip Caulking Gun is a heavy-duty, cradle-type caulking gun that features an exclusive Vacuum Action Mechanism for no-drip caulking. Dual power settings allow the operator to set the gun for No-Drip, which is perfect for most interior and detail work applications, or Power Thrust, which provides extra power for maximum application per trigger pull. The Z341 features a ladder hook, nozzle cutter, and a piercing tool on the gun. Minimum order is one each.

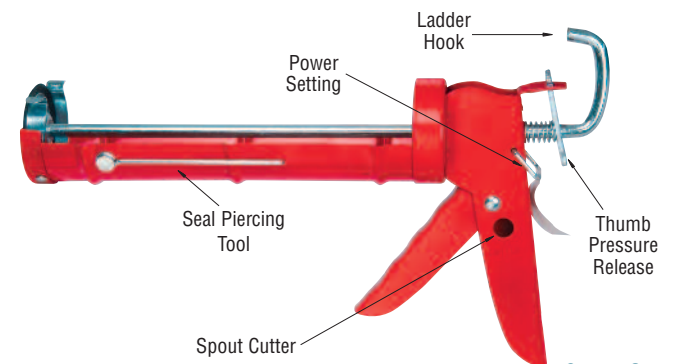

CAT. NO. Z341

CRL Albion Utility Caulking Gun

- Tradesman Quality
- Round Smooth Rod With Thumb Release

The CRL Albion Utility Caulking Gun is a quality tool for the handyman. Built for moderate use, this gun is also a good value in many industrial applications. The smooth friction drive rod and large trigger with finger guard combine to make it a reliable tool. The spring release plunger lets you load and dispense quickly and easily, and releases pressure on the plunger to prevent sealant run-on. Minimum order is one each.



Caulking Guns can be combined for quantity pricing.

CAT. NO. AB3703

CRL Metal Strap Frame Caulking Gun

- Popular Strap Frame Design
- Smooth Rod With Thumb Release

new

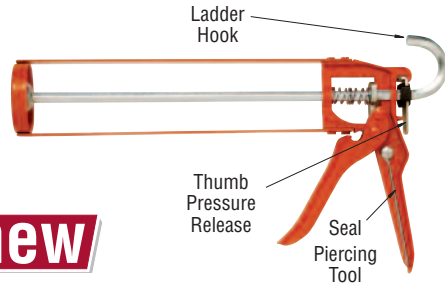

The strap frame design for caulking guns is becoming increasingly appealing, as witnessed in the fast-growing popularity of this quality gun. The CRL Metal Strap Frame Gun has a friction hex drive rod plunger, heavy die cast zinc alloy frame and trigger, and a thumb pressure release that lets you load and dispense quickly and easily, and releases pressure on the plunger to prevent sealant run-on. Includes built-in ladder hook, and handy seal piercer located in the handle of the sturdy steel skeleton type frame. Minimum order is one each.

CAT. NO. GA1204

CRL Nylon Strap Frame Caulking Gun

- Smooth Rod
- Lightweight, Yet Durable

new

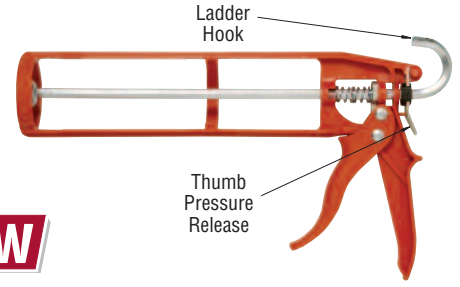

The CRL Nylon Strap Frame Caulking Gun has a pressure release device to reduce material flow after you release the trigger. This feature is ideal for precise application of your favorite sealant, and works with standard size plastic, metal or composite cartridges with integral or screw-on nozzles. Friction hex drive rod provides the thrust of a metal gun, and has a quick-release latch. Also includes belt or ladder hook. Minimum order is one each.

CAT. NO. GA1202

CRL PowerGlide No-Drip Strap Frame Caulking Gun

- Smooth Rod
- Stops Drips Automatically
- Sturdy Steel Skeleton Type Frame

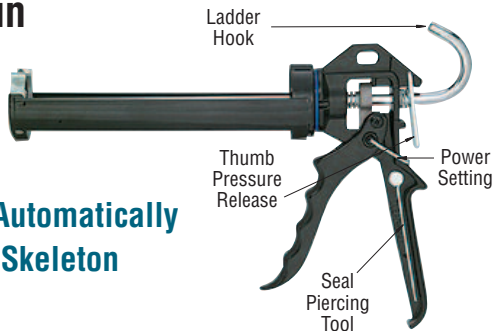

The CRL PowerGlide No-Drip Caulking Gun uses an exclusive automatic mechanism that creates a "vacuum" between the plunger and the caulking tube. When you release the trigger the material flow stops automatically. Features dual power settings: No Drip for most applications is perfect for interior and detail work with thumb release engaged; Power Thrust provides extra power for maximum application per trigger pull. Includes ladder hook; easy load clips to hold cartridge in barrel; handy seal piercer located in handle of the sturdy steel skeleton type frame. Minimum order is one each.

CAT. NO. Z349

CRL Cox Quart Size Strap Frame Caulking Gun

- Heavy-Duty Gun With Lightweight Handling
- Smooth Rod

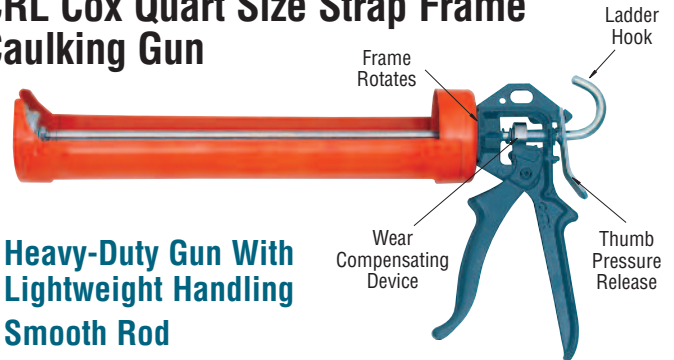

The CRL Cox Quart Size Strap Frame Caulking Gun incorporates the strap design for quart 29 fl. oz. (858 ml) size cartridges for lightweight handling. It has the smooth operation of a friction rod, plus a large handle and trigger. Perfect for dispensing low to medium viscosity materials. Strap frame rotates to move nozzle tip where needed. The spring release plunger lets you load and dispense quickly and easily, and releases pressure on the plunger to prevent sealant run-on. Same special Wear Compensating Device feature as other Cox model guns. Minimum order is one each.

CAT. NO. WG41002

CRL 15" Sausage and Cartridge Caulking Gun

- Converts for Gunning Sausage Packs or Cartridges
- Includes Plastic Cone Nozzle
- Lightweight Aluminum Barrel



new

The CRL 15" Sausage and Cartridge Caulking Gun is made of lightweight aluminum, and is ideal for waterproofing applications where wide beads of material are required. Cut the plastic cone type nozzle to deliver a bead from 1/8" (3 mm) up to 3/4" (19 mm) in diameter. Minimum order is one each.

CAT. NO. GA1205

Caulking Guns can be combined for quantity pricing.

CRL Cox Avon 15" Sausage/Bulk Caulking Gun

- Converts for Gunning Sausage Packs, Cartridges or Bulk
- Supplied With Three Nozzles
- Our Most Popular Sausage Gun

The CRL Cox Avon 15" (381 mm) Sausage/Bulk Caulking Gun is made of lightweight aluminum, and is ideal for waterproofing applications where wide beads of material are required. Cut the plastic cone type nozzle to deliver a bead from 1/8" (3 mm) up to 1-5/16" (33 mm) in diameter. Minimum order is one each.

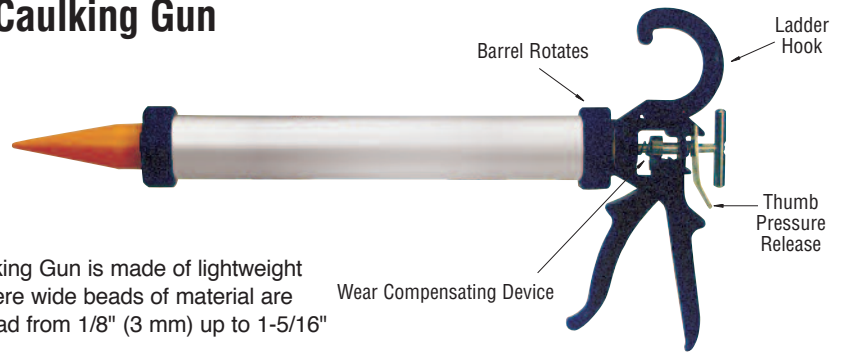

CAT. NO. WG51001

CRL Albion Deluxe Professional Sausage/Bulk Caulking Gun



- Heavy-Duty Square Smooth Rod
- Rotating Swivel Handle

This CRL Albion Deluxe Professional Bulk Caulking Gun holds 10.1 and 20.3 fl. oz. (300 and 600 ml) Sausage Packs with its large capacity barrel, or 24 fl. oz. (710 ml) of bulk loaded material. Extra thick 5/16" (8 mm) square smooth piston rod with T-pull allows maximum gunning pressure on even stiff materials, and an instant pressure release button stops material flow. All-steel reinforced welded construction with a corrosion resistant, zinc plated body. An epoxy coated swivel handle rotates, allowing easy direction change and uninterrupted flow. Includes one 1/2" (13 mm) round metal nozzle. Minimum order is one each.

CAT. NO. DL45T04

CRL Albion Deluxe Professional 1-1/2 Pint Bulk Caulking Gun

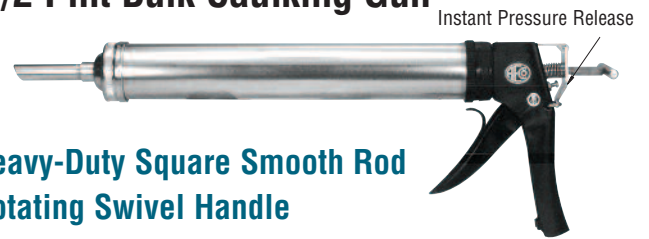

- Heavy-Duty Square Smooth Rod
- Rotating Swivel Handle

This CRL Albion Deluxe Professional Bulk Caulking Gun has a large capacity 24 fl. oz. (710 ml) barrel for bulk loading of caulking materials. An extra thick 5/16" (8 mm) square smooth piston rod with T-pull allows maximum gunning pressure on even stiff materials, and an instant pressure release button stops material flow. All steel reinforced welded construction with a corrosion resistant, zinc plated body. An epoxy coated swivel handle rotates, allowing easy direction change and uninterrupted flow. Also features a quality screw-on conical cap with rolled threads for a tighter seal. Includes one 1/2" (13 mm) diameter metal nozzle. Minimum order is one each.

CAT. NO. DL45T03

CRL Newborn Professional Sausage/Bulk Caulking Gun



- Convertible for Sausage, Bulk and Cartridge Material
- Ratchet Rod

This CRL Newborn Professional Model Bulk, Cartridge, and Sausage Caulking Gun is shipped ready to use with standard cartridges and converts to accept both 16 fl. oz. (473 ml) bulk material or 10 fl. oz. (296 ml) sausage packs. The heavy-duty plunger and cap allow the use of the stiffest materials. It comes with a conical ejector end cap with a 3/8" (9 mm) round metal nozzle, a ring cap that accepts wide tip cone nozzles, and is equipped with a built-in spout cutter and wrist strap. Minimum order is one each.

CAT. NO. KM32RCT

CRL Albion 2-1/2 Quart Big Capacity Bulk Caulking Gun



- Heavy-Duty Square Smooth Rod
- Rotating Swivel Handle

This CRL Albion Bulk Caulking Gun has a 2-1/2 quart [80 fl. oz. (2.4 l)] capacity and is easy to handle. Made for bulk-loaded caulking materials only, it is supplied with a 3/4" (19 mm) diameter metal nozzle. The extra thick 5/16" (8 mm) square smooth piston rod with T-pull allows maximum gunning pressure even on stiff materials, and an instant pressure release button stops material flow. All steel reinforced welded construction with a corrosion resistant zinc plated body. An epoxy coated swivel handle rotates, allowing easy direction change and uninterrupted flow. The best gun to use for that really big job where frequent gun refills may not be convenient. Minimum order is one each.

CAT. NO. KM145RCT

For Bulk Caulking Gun Filler Cat. No. 52GF see page N218. Caulking Guns can be combined for quantity pricing.

CRL 12 Volt DC Variable Speed Cordless Cartridge Caulking Gun for Lightweight Sealants

- Variable Speed Trigger Controls Flow of Sealant
- Use to Dispense Only Lightweight Sealants Such as Silicones and Acrylic Latex
- Complete With 12 Volt Battery, One Hour Charger, and Molded Carrying Case

This CRL 12V DC Cordless Cartridge Caulking Gun operates on a 12 Volt DC Rechargeable Battery and comes with a One Hour Charger. The variable speed control is in the trigger for easy adjustments. It is ideal for glazing contractors, building contractors, roofers, cabinet makers, OEM fabricators, window manufacturers and installers, or anyone who applies a lot of silicone or acrylic latex sealant and wants an easier, more professional way of getting the job done without the restrictions of cords or hoses. Affordable and effective, this gun also comes with a 90 day warranty. **NOTICE: Not for use with high viscosity automotive urethane adhesives and construction polyurethane sealants. Use Only to dispense lightweight sealants such as silicone and acrylic latex.** For uninterrupted production, you can order additional Cat. No. LD188B 12 Volt DC Batteries.



CAT. NO.	DESCRIPTION
LD188	12 Volt Cordless Cartridge Caulking Gun Kit
LD188B	12 Volt DC Battery Pack
LD188C	One Hour Battery Charger
LD717C240V	240 Volt Charger

Minimum order: 1 each.

CRL 12 Volt DC Variable Speed Cordless Cartridge and Sausage Caulking Gun for Heavyweight Sealants

- Dispenses Standard Cartridges or 20.3 Fl. Oz. (600 ml) Sausage Packs
- Use to Dispense Heavyweight Sealants, Such as Construction Polyurethanes and Automotive Urethane Adhesives
- Complete With 12 Volt Battery, One Hour Charger, and Molded Carrying Case

This heavy-duty Cordless Caulking Gun operates on a 12V DC Rechargeable Battery and comes with a One Hour Charger. The variable speed control is in the trigger for easy adjustments. A powerful pushing force of 485 lbs. (220 kg) easily dispenses high viscosity materials such as construction polyurethanes and automotive urethane adhesives.

The kit includes a longer shaft and barrel with a special plastic plunger disc for sausage pack applications. Barrels and shafts are easily changed to switch from standard 10.3 fl. oz. (305 ml) cartridges to up to 20.3 fl. oz. (600 ml) sausage packs. It is ideal for glazing contractors, building contractors, roofers, cabinet makers, OEM fabricators, window manufacturers and installers, or anyone who applies a lot of sealant and wants an easier, more professional way of getting the job done without the restrictions of cords or hoses. Affordable and effective, this gun also comes with a 90 day warranty. For uninterrupted production, you can order additional Cat. No. LD717B 12 Volt DC Batteries.



Shown With Sausage Barrel and Nozzles (All Included)

CAT. NO.	DESCRIPTION
LD717	12 Volt Cordless Cartridge/Sausage Caulking Gun Kit
LD717B	12 Volt DC Battery Pack
LD717C	One Hour Battery Charger
LD717C240V	240 Volt Charger

Minimum order: 1 each.

CRL Milwaukee® 14.4 Volt Variable Speed Cordless Caulking Guns

- Easily Dispenses High Viscosity Auto Urethanes
- Interchangeable Front Ends Work With Standard Cartridges, 29 Fl. Oz. Quart Cartridges, and 20.3 Fl. Oz. Sausage Packs
- Includes 14.4 Volt Battery and One Hour Charger



CAT. NO. 48111024
14.4 Volt Battery



CAT. NO. 48590245
One Hour Charger



CAT. NO. 48590184
One Hour Vehicle Charger

This heavy-duty 14.4 Volt DC Cordless Caulking Gun makes manual caulking obsolete. A powerful pushing force of 620 pounds (281 kg) easily dispenses high viscosity materials such as automotive urethanes. Gun features include: variable speed trigger for smooth start up and reduced fatigue; manual clutch release for rapid loading of material; auto reverse (stops sealant flow when trigger is released); auto shut off at the end of plunger rod travel; 360 degree carriage rotation for easy work around corners and hard to reach areas.

Guns are ordered pre-configured for the type of packaging to be used: standard 10 fl. oz. (300 ml) cartridges, 29 fl. oz. (850 ml) quart cartridges, 20 fl. oz. (600 ml) sausage packs. Additional front ends and plunger rods can be special ordered to convert the Gun to any configuration. All Gun Kits come standard with a 14.4V DC Battery Pack and One Hour Charger. Charge the Battery with the Power-Plus Universal One Hour Charger or One Hour Vehicle Charger. European and Australian plug adapters are included in all 240V Kits.



CAT. NO. 656221
Standard Cartridge Gun



CAT. NO. 656223
Quart Cartridge Gun



CAT. NO. 656224
20 Fl. Oz. Sausage Pack

CAT. NO.	DESCRIPTION
656221	Standard Cartridge Gun, 14.4V Battery and One Hour Charger
656223	Quart Cartridge Gun, 14.4V Battery and One Hour Charger
656224	20 Fl. Oz. Sausage Gun, 14.4V Battery and One Hour Charger
48111024	14.4 Volt DC 2.4 Amp Hour Power-Plus Battery Pack
48590245	Power-Plus Universal One Hour Charger
48590184	Power-Plus Universal One Hour Vehicle Charger
AU656221	Standard Cartridge Gun, 14.4V Battery and 240 Volt Charger
AU656223	Quart Cartridge Gun, 14.4V Battery and 240 Volt Charger
AU656224	600 ml Sausage Gun, 14.4V Battery and 240 Volt Charger
AU656240V	240 Volt Charger

Minimum order: 1 each.

CRL Drill-Mate Portable Drill Powered Caulking Gun

- Costs Less Than Battery Operated Caulking Guns
- Two Year Limited Warranty
- Develops Up to 300 P.S.I. of Pressure

Combine the reliability of a cordless drill with the power of a high ratio caulking gun and you get the CRL Drill-Mate Portable Drill Powered Caulking Gun. With up to 300 pounds (136 kg) per square inch of pressure you can gun just about any material in a cartridge. A quick release clutch keeps the material from continuing to flow once you stop the drill. Made of strong high-impact plastics and backed by a two year warranty, this Gun accepts all standard cartridges. At over 50 percent less cost than a battery powered caulking gun, this is a hands down favorite for mobile operations. Portable Drill not included. Minimum order is one each.

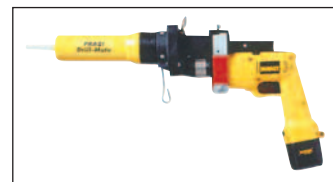

CAT. NO. PR1000

CRL Cox Air Power Sausage Gun

- Dispenses 10 to 20 Fl. Oz. Sausage Packs
- Air Regulator Pressure Adjuster



The CRL Cox Air Power Sausage Caulking Gun dispenses even heavy materials, such as urethane, at a smooth, controlled rate of flow. It can be used with 10, 15.2 or 20.3 fl. oz. (296, 450 or 600 ml) sausage packs. The high flow trigger valve is responsive, with a built-in regulator to control flow, and an instant release valve with silencer to stop material flow. Can operate at up to 100 psi maximum. Minimum order is one each.

CAT. NO. WG6100620

CRL Cox Piston Rod Air Power Caulking Gun

- Dispenses Standard Cartridges and 10 Fl. Oz. Sausage Packs
- Quick Release End Cap



The CRL Cox Piston Rod Air Power Caulking Gun dispenses even heavy materials, such as urethane, at a smooth, controlled rate of flow. The piston rod thrust prevents material contamination by compressed air, allowing use with standard 10.3 fl. oz. (305 ml) cartridges, or 10 fl. oz. (296 ml) sausage packs. The high-flow trigger valve is responsive, with a built-in regulator to control flow, and an instant release valve to stop material flow. Can operate at up to 100 psi maximum. Minimum order is one each.

CAT. NO. WG61004

CRL Cox Air Power Caulking Gun

- Holds Standard Cartridges
- Air Regulator Pressure Adjuster



This is a superb quality, lightweight air powered gun. The 2" x 10" (51 x 254 mm) drawn aluminum barrel holds all standard size cartridges. The Gun dispenses materials smoothly and uniformly with just a trigger squeeze, and connects to standard 1/4" (6 mm) NPT hose fittings. It has an instant release valve to stop material flow, a true air regulator, and can operate at up to 100 psi maximum. The body is made of lightweight drawn aluminum with a quick release end cap for fast change out of cartridges. A quick-disconnect fitting is included and replaceable parts are available for all components. Air action on cartridge plunger. Minimum order is one each.

CAT. NO. WG61001

CRL Air Power Caulking Gun

- Holds Standard Cartridges
- Adjustable Air Flow 0-40 PSI
- Lightweight, High Density Plastic Body



new

This CRL Air Power Gun dispenses sealants packaged in standard caulking cartridges, up to 10.5 fl. oz. (310 ml). Perfect for high volume users like window manufacturers, or anyone looking for fast dispensing of sealants with a uniform bead. This lightweight Gun weighs only 15 oz. (435 g). Maximum air pressure: 40 psi. Adjustable air flow: 0 – 40 psi. Accommodates an air hose diameter of 3/8" (ID) with an air inlet dimension of 1/4" - 18/19 NPT male nipple. Minimum order is one each. **NOTE:** May not dispense some high viscosity auto windshield urethanes.

CAT. NO. 3021301

CRL Deluxe Air Drive Caulking Gun

- Twist-Lock Instant Loading Barrel
- Complete With Air Hose

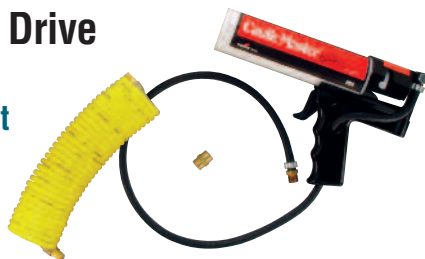

This CRL Deluxe Air Drive Caulking Gun holds all standard size cartridges of sealants, adhesives, mastics or other caulking materials. It weighs less than one pound, so it is easy to handle. The trigger controls material flow, allowing you to dispense a smooth bead 2-3 times faster than a manual gun. It requires 5-70 psi air pressure. The gun comes standard with a 25' (7.6 m) air hose that connects to an optional compressor unit or your own compressed air supply.

CAT. NO.	DESCRIPTION
PG100	Air Caulking Gun
1002BARREL	Replacement Barrel

Minimum order: 1 each.

CRL Quart and Standard Size Air Drive Caulking Gun

- Includes Quart and Standard Size Barrels
- Lightweight and Fast Loading



The CRL Quart Size Air Drive Caulking Gun is made for those caulking materials in "jumbo" quart 30 fl. oz. (887 ml) size cartridges. It's fast loading, with a twist lock barrel. The precision air control valve makes applications smooth. It also comes with a 36" (914 mm) hose with standard 1/4" (6 mm) NPT hose fittings, and requires 5-65 psi. The barrel accepts all standard quart cartridges, and comes with a barrel for standard size caulking cartridges. Connects to an optional compressor unit or your own compressed air supply. Minimum order is one each.

CAT. NO. PG150

CRL Graco® 5 Gallon Dispenser

- Air Powered 23:1 Ratio
- Completely Assembled and Ready to Use
- For Low to Medium Viscosity Materials



NOTE: Does not include Hose and Gun Assembly. Contact our Glass and Glazing Technical Sales for options available for this system. Approximate shipping weight is 225 Lbs. (102 kg). Dispenser may vary slightly from images shown.

This economical CRL Graco® 5 Gallon Pumping System pumps silicone, grease, caulk, and sealant directly from 5 gallon (20 l) pails. Designed to pump low-to-medium viscosity one-part materials (30,000 + cps, Flow Rate 0-2.8 GPM). The heavy-duty single post elevator provides down pressure to maintain pump prime, and up pressure to assist in quick pail changing. The 23:1 low maintenance carbon steel pump provides trouble-free operation, and is powered by a 3-1/4" (82.5 mm) air motor, including pressure gauge and regulator. The dispenser combo plate wipes the straight-sided or tapered pail clean as the material is being pumped and prevents contamination. It is easy to operate and ready to use. Minimum order is one each.

CAT. NO. 50052

CRL 4-hp Gas Powered Compressor

- Small Footprint for Mobile Trucks
- Honda Powered

PRESSURE AND VOLUME REQUIREMENTS

PSI	CFM
125	4.0
100	4.4
40	5.1



This CRL 4-hp Gas Powered Compressor is the perfect size for mobile auto glass trucks and vans. It features a reliable 4-hp Honda engine with overhead valves, dual element air cleaner, and electronic ignition. This heavy-duty single stage Compressor features ball bearings, splash lubrication, and metal air filter with exhaust silencer, stainless steel reed valves, plus fan cooling with fixed rotation speeds. The Compressor has a small footprint measuring 22" x 17" x 17" (558 x 432 x 432 mm). Minimum order is one each.

CAT. NO. GD4000

CRL 2-hp Electric Powered Compressor

- Excellent Choice for Mobile Trucks

PRESSURE AND VOLUME REQUIREMENTS

PSI	CFM
125	3.6
100	4.1
40	5.1



The CRL 2-hp Electric Powered Compressor is sized right for mobile auto glass trucks and vans. It comes with a 2-hp 3,400 RPM electric motor that features overload protection with manual reset. This Compressor is a single stage, ball bearing design to provide years of reliable service. The Compressor's footprint is only 16" x 16" x 16" (406 x 406 x 406 mm). Minimum order is one each.

CAT. NO. GD1500

CRL Coiled Air Hoses

new

- Nylon Hose Available in Two Lengths
- Heavy-Duty Rigid Brass Fittings



CRL Coiled Nylon Air Hoses have standard 1/4" (6.4 mm) male NPT fittings on each end. Each hose has spring guards for additional strain relief.

CAT. NO.	LENGTH
SA225	25' (7.6 m)
SA250	50' (15.2 m)

Minimum order: 1 each.

CRL 3/8" Air Hoses

new

- Premium Quality Rubber Hose Available in Two Lengths



The CRL 3/8" (9.5 mm) diameter Premium Air Hose is made from genuine Goodyear Rubber with 1/4" (6.4 mm) male NPT brass fittings on both ends. One end has a special kink resistant sleeve. Rated for pressures up to 250 psi (17 bars).

CAT. NO.	LENGTH
AM1019	25' (7.6 m)
AM1020	50' (15.2 m)

Minimum order: 1 each.

CRL Compressor Accessory Kit

new

- 17-Piece Kit



The CRL Compressor Accessory Kit includes everything you'll need to hook your compressor up to your hoses and tools. Kit includes two "M" style female couplers, three male plugs, two female plugs, one male nipple, one female coupling, a lever handled nozzle, assorted tube connectors and inflation devices. Minimum order is one each.

CAT. NO. S220

CRL 5 Gallon Portable Air Tank

new

- Extra Capacity for Your Air Compressor

The CRL 5 Gallon Air Tank can be charged with your air compressor and carried onto a job site for small jobs requiring compressed air, or it can be attached to your compressor with the 36" (914 mm) air hose included to boost the capacity of your existing compressor tank. Minimum order is one each.



CAT. NO. 41712

CRL Ready Jet Inline Blo-Gun

- One Button Operation
- Die Cast Body

The Ready Jet Inline Blo-Gun has 1/4" female NPT threads on both ends of the housing, and is designed to be installed mid-stream on any hose line. This is a handy device which can be mounted on the hose close to your air drill or other pneumatic tool, allowing the operator to quickly blow his work clear without the need to disconnect tools. Minimum order is one each.



CAT. NO. RJR03

CRL Blo-Guns

new

- 150 PSI Maximum Operating Pressure
- 1/4" NPT Threaded Air Inlet
- OSHA Approved



CAT. NO. S148



CAT. NO. S158

These CRL Blo-Guns have a die cast body, and come with a rubber nozzle tip as well as an OSHA approved safety nozzle tip. The Cat. No. S158 is a 24" (610 mm) Extended Reach Blo-Gun with an extra long bent nozzle tube which is good for accessing hard to reach areas. Both Blo-Guns have a maximum recommended working pressure of 150 psi. (10 bars). Minimum order is one each.

CRL Inline Pneumatic Tool Oiler

new

- Automatically Lubricates Air Tool During Use
- Holds Three to Four Days Supply of Oil



The CRL Inline Pneumatic Tool Oiler automatically lubricates tools as you use them. Just fill the reservoir with CRL Cat. No. AK01L Tool Oil and you'll add years of life to your tools. Minimum order is one each.

CAT. NO. AP3000

CRL Pneumatic Tool Oil

- Keep Your Air Tools Working Right
- Everything You Need Between Your Compressor and Your Air Tools



CRL Pneumatic Tool Oil is the ideal lubricant for any automatic tool oiler. This oil can be used in either CRL Cat. No. SG70038 or Cat. No. AP3000. Keeping the air lubricated dramatically extends the life of your pneumatic tools. Sold in a 16 fl. oz. (472 ml) plastic bottle. Minimum order is one each.

CAT. NO. AK01L

CRL Male Quick Disconnect Coupler

- 1/4" (6.4 mm) NPT Threaded Fitting



The CRL Male Quick Disconnect Hose Coupler speeds the time it takes to change hoses or tools. Use these brass couplers with the Plug Couplers shown below. Just pull the slide collar back and insert the plug for an airtight seal.

Minimum order is one each.

CAT. NO. AFMC1

CRL Female Quick Disconnect Coupler

- 1/4" (6.4 mm) NPT Threaded Fitting



The CRL Female Quick Disconnect Hose Coupler speeds the time it takes to change hoses or tools. Use these brass couplers with the Plug Couplers shown below. Just pull the slide collar back and insert the plug for an airtight seal.

Minimum order is one each.

CAT. NO. AFFC3

CRL Male Hose Plug Coupler

- 1/4" (6.4 mm) NPT Threaded Fitting



The CRL Male Hose Plug Coupler works with either of the Quick Disconnect Couplings shown above.

Minimum order is one each.

CAT. NO. AFMP2

CRL Female Hose Plug Coupler

- 1/4" (6.4 mm) NPT Threaded Fitting

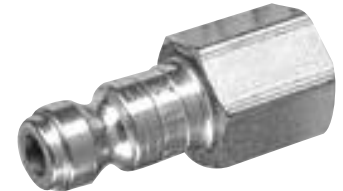

The CRL Female Hose Plug Coupler works with either of the Quick Disconnect Couplings shown above.

Minimum order is one each.

CAT. NO. AFFP4

CRL Angle Swivel

- Helps Eliminate Twisted Air Lines

Solid brass 1/4" (6.4 mm) NPT threaded fitting has a male fitting on one side, and a female on the other. The female end swivels 360 degrees, allowing the user to move about the work area without the hose becoming kinked.

Minimum order is one each.



CAT. NO. AP3SB10

CRL Pressure Regulator and Gauge

- Regulates Pressure to Protect Air Tools

The CRL Pressure Regulator and Gauge can handle air line pressures up to 250 psi, and regulate up to 160 psi. Primarily for inline use where pressure variances near the tool could be critical. Consists of pressure regulator, gauge, and 1/4" (6.4 mm) hose nipples.

Minimum order is one each.



CAT. NO. AR1130

CRL Wooden Handle Spatulas

- **Stainless Steel Blade With Rounded Tip for Recommended Tooled Sealant Profile**



CRL Spatulas are used to tool sealant joints, and to scrape out material from pails. They have a flat, flexible, heat treated stainless steel blade with a rounded tip for creating the recommended hourglass shape of sealant joints. Comfortable hardwood handle.

CAT. NO.	BLADE SIZE
AB2584	4" x 3/4" (102 x 19 mm)
AB2586	6" x 1" (152 x 25 mm)
AB2588	8" x 1-1/4" (203 x 32 mm)

Minimum order: 1 each.

CRL All Stainless Steel Spatulas

- **Seven Different Sizes**
- **All Stainless Steel**
- **Easy to Clean**

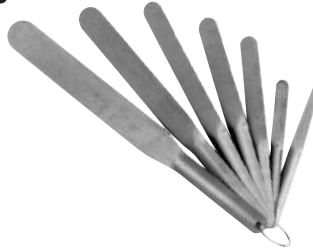

CRL All Stainless Steel Spatulas are used to tool sealant joints. Their length extends your reach and comes in handy for hard to reach areas. The flat, flexible, tempered spring stainless steel tooling blade is attached to a comfortable curved handle. They are also easy to clean. The complete set includes seven tools held together with a snap ring, or you can order individual Spatulas.



Order the complete set or buy them individually

CAT. NO.	OVERALL SIZE
AB958G	Complete Set of Seven Spatulas
AB9583T	6-7/8" x 3/8" Tapered (175 x 9.5 mm)
AB9583	6-3/4" x 5/8" (171 x 16 mm)
AB9584	7-3/4" x 3/4" (197 x 19 mm)
AB9585	8-3/4" x 13/16" (222 x 20 mm)
AB9586	11" x 1" (279 x 25 mm)
AB9588	12-7/8" x 1-1/4" (327 x 32 mm)
AB95810	15" x 1-1/2" (381 x 38 mm)

Minimum order: 1 each. Individual Stainless Steel Spatulas can be combined for quantity pricing.

CRL Plastic Caulking Applicator Tools

- **Unique Spline Radius Design**
- **Cured Sealant Easily Peels Off Tool**

CRL Plastic Caulking Applicator Tools will not scratch or damage glass, painted surfaces, metal, tile, porcelain, polished stone, etc. Lightweight high-quality copolymer material is strong yet will flex under pressure, and is easy to clean after use. Sold both individually and as a set of eight different styles to handle the most common joints. Overall length of each tool is 8-3/4" (222 mm).

CAT. NO.	BLADE WIDTH AND STYLE	CAT. NO.	BLADE WIDTH AND STYLE
P1000	1-1/4" (32 mm) - 10	P6000	7/8" (22 mm) - 60 P*
P2000	1-1/2" (38 mm) - 20	P7000	7/8" (22 mm) - 70 A*
P3000	1" (25 mm) - 30 A*	P8000	3/4" (19 mm) - 80 P*
P4000	1" (25 mm) - 40 P*	PC1080	Complete Set of Eight Applicator Tools
P5000	3/4" (19 mm) - 50 A*		

Minimum order: 1 each. *A (Aggressive) - more pointed radius. *P (Passive) - more rounded radius. Individual Applicator Tools can be combined for quantity pricing.

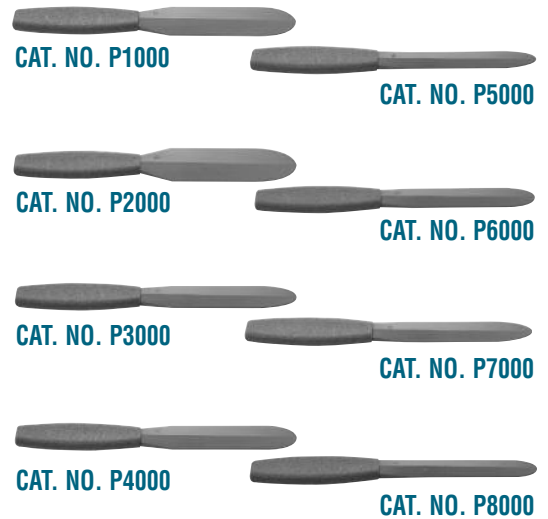

CRL Sealant Spatula Set

- **Tools Six Different Joint Widths**
- **Easy to Clean After Use**



The CRL Sealant Spatula Set is a unique kit of three Spatulas for tooling applied sealants. They are tapered on each end for use in six different joint widths. The lightweight material is strong, will flex under pressure, and is easy to clean up after use. The overall length of each Spatula is 7-1/4" (184 mm), and each set comes in a divided vinyl pouch you can carry in your pocket or toolbox. Minimum order is one set.

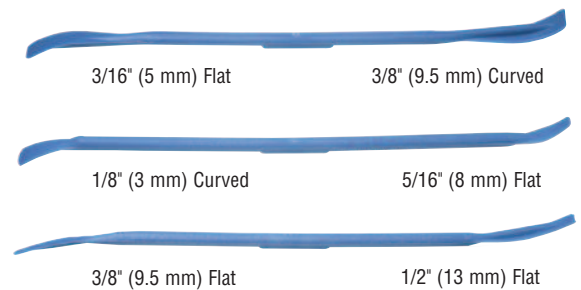

CAT. NO. AB556

CRL Stick Tools

- A Very Popular Tool With Virtually Limitless Uses
- Terrific for Tooling Freshly Applied Sealants
- Tapered on Both Ends or With One Chisel End
- Stick Handle Available (See Below)

For years the CRL Stick Tool has been one of our most popular items. Caulkers use them for tooling freshly applied sealants; glaziers find them useful for pushing vinyl into window channels; painters use them as mixing sticks; and auto glass installers use them for setting or removing glass from rubber gaskets. The Stick Tool is made of a special, high-strength, flexible plastic formula that's non-corrosive, non-conducting, and won't scratch adjoining glass or metal. It's composition won't absorb liquids, which makes it easy to clean.

Tapered End Stick Tool



The tapered tips on either end fit into tight crevices for prying. Overall length is 7-7/8" (200 mm). Minimum order is one each.

CAT. NO. CRL216

Chisel End Stick Tool



The tapered and chisel tips on either end fit into tight crevices for prying. Chisel tip end is 5/8" (16 mm) wide. The overall length is 7-7/8" (200 mm). Minimum order is one each.

Stick Tools can be combined for quantity pricing.

CAT. NO. CRL220

CRL Stick Tool Handle

- Comfortable Grip Handle Can Be Used With Either Tapered End or Chisel End Stick Tool
- Provides More Leverage for Scraping



CAT. NO. CRL216H



CAT. NO. CRL216HWS

The CRL Stick Tool Handle is an innovative tool that allows the user to simply slip in a popular CRL Stick Tool for a comfortable grip. This tool will become indispensable to glaziers, caulkers, painters, and auto glass installers.

CAT. NO.	DESCRIPTION
CRL216H	Stick Handle Only
CRL216HWS	Stick Handle With Chisel End Stick Tool

Minimum order: 1 each.

CRL Sealant Finishing Tool

- Lightweight and Flexible, Simplifies Tooling of Sealants
- Titanium Catalyst Material Won't Stick to Silicone or Other Sealants

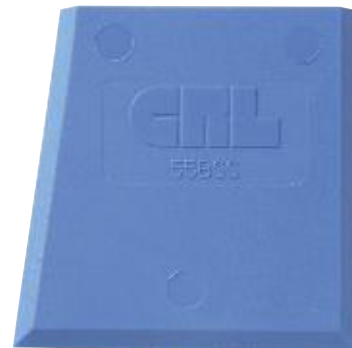

The CRL Sealant Finishing Tool is made of a lightweight and flexible Titanium Catalyst material that will not stick to silicone and other sealants. This makes tooling fresh sealant joints easy, with smoother results and faster clean up. This lightweight and flexible tool is only 3/16" (5 mm) thick, and measures approximately 3-1/4" x 3-1/2" (83 x 89 mm). Minimum order is one each.

CAT. NO. 55BSS

CRL Paddle Mixer

- For Pails Up to Five Gallons
- Zinc Plated Steel



This CRL Paddle Mixer is zinc plated steel and used with larger containers of material, up to 5 gallons (18.9 l). Its opposing bent blades completely mix putties, mastics, paints, sealants, etc. It requires a drill with a 3/8" (9.5 mm) chuck and low RPM. Overall length is 15-3/8" (391 mm). Paddle head is 4-1/4" (108 mm) wide. Minimum order is one each.

CAT. NO. MX91

CRL Follower Plates

- For Plastic or Metal Pails



CAT. NO. KM2P



CAT. NO. KM2M

CRL Follower Plates are designed for straight-sided two gallon (7.57 l) plastic or metal pails. Using a Follower Plate permits quick, clean loading of bulk guns, as well as helping to eliminate much of the wasted material normally left in the bottom of pails.

CAT. NO.	FITS
KM2P	Two Gallon Plastic Pail
KM2M	Two Gallon Metal Pail

Minimum order: 1 each.

CRL Bulk Caulking Gun Filler

- Fits Standard Straight Sided Five Gallon Pails
- Fills Bulk Guns Quickly and Easily
- Economical - Allows Use of All Material

This CRL Gun Filler fits standard straight-sided five gallon containers and fills bulk-type guns quickly and cleanly. Simply place the open barrel end into the receptacle and "pump" handle. The material is forced into the barrel of the gun. This is an essential tool for caulking professionals because it fits all popular bulk guns. Minimum order is one each.



CAT. NO. 52GF

CRL Jiffy Mixer

- For Pails Up to Three Gallons
- Stainless Steel Construction

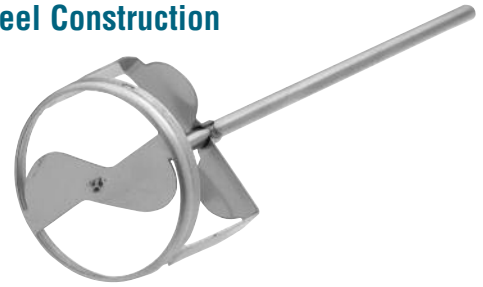

Operate this CRL Jiffy Mixer with any power tool at a recommended 450 to 750 RPM in an open container. Ideal for mixing two-part construction polyurethanes, and other two-component sealants. A true mixer, not a paddle-type stirrer, the two vertical blades confine the main mixing action within the mixer, and the horizontal opposed impellers force materials from the lower and upper areas of the container into the mixer. Thoroughly mixes paints, sealants, and putties to proper consistency, and blends in single and multi-component materials. Overall length is 10-1/4" (260 mm). Mixing head is 2-5/8" (67 mm) diameter. Minimum order is one each.

CAT. NO. MX40

CRL Dual Hytrel Cup

- Replaces Worn Leathers in Bulk Load Guns



The most commonly worn-out component part in bulk caulking guns are the leather cups. CRL Dual Hytrel Cups replace the leather cups found in most 2" (51 mm) diameter barrels. Minimum order is one each.

CAT. NO. KM216L

CRL Lid-Off Tool

- Eliminates Dangerous Lock Cutting on Plastic Lids
- Opens Plastic Pails Quickly



This time-saving tool eliminates dangerous lock cutting on plastic lids. The plastic CRL Lid-Off Tool provides enough leverage to cleanly lift off the lid without distortion so the pail can be resealed. Even the most tightly sealed lids surrender in no time to this one-piece professional tool. Minimum order is one each.

CAT. NO. LOT1

CRL Urethane Heater Ovens

- Preheats Urethane to Desired Working Temperature in One Hour
- Available in 120V AC or 12V DC Models
- One Hour Heat Cycle
- Two or Six Cartridge Capacity

CRL Urethane Heater Ovens are designed to warm heated urethanes to the ideal application temperature of 185°F (85°C) within one hour. The two-hole or six-hole design allows you to heat a sufficient amount of material for a single or multiple windshield replacements.

CAT. NO.	DESCRIPTION	CAPACITY
E9007	12V DC Oven	2 Cartridges
E9006	120V AC Oven	2 Cartridges
E9011	120V AC Oven	6 Cartridges

Minimum order: 1 each.



Two Cartridge Oven



Six Cartridge Oven

CRL Compact Heater Box

- Heats Caulking to 104°F (40°C)
- Holds Cartridges or Sausages
- Works On Your Vehicle's 12V DC Power or Optional 110V AC Adapter



This Compact Heater Box plugs into any 12V DC lighter outlet in your truck or car, or with the optional AC adapter (Cat. No. PAC15) plugs into any 110V AC power outlet. Factory set thermostat heats interior to 100° - 104°F (38° - 40°C). Use to keep caulking cartridges or sausages warm before gunning in cold temperatures. Warm sealants gun easier and cure faster than cold sealants. Lightweight and portable, this chest has a high impact polypropylene case and lid with smooth corners and edges, and is super insulated to stabilize interior temperatures with minimal (approximately 2.5 AMP) power drain.

External dimensions: 8-1/2" W x 16" H x 17-1/2" L (216 x 406 x 445 mm). Capacity: Holds 23 standard cartridges, or 18 sausages (20 Fl. Oz. [600 ml]). Includes one 10 foot (3 m) power cord.

CAT. NO.	DESCRIPTION
P20S	Compact Heater Box
PAC15	110V AC to 12V DC Converter

Minimum order: 1 each.

CRL Portable Heater Box

new

- Heats Caulking to 135°F (57°C)
- Holds Cartridges, Sausages or Pail
- Works On Your Vehicle's 12V DC Power or Optional 110V AC Adapter



This large capacity Portable Heater Box plugs into any 12V DC lighter outlet in your truck or car, or with the optional AC adapter (Cat. No. PAC15) plugs into any 110V AC power outlet. Factory set thermostat heats interior to approximately 135°F (57°C). Use to keep caulking cartridges, sausages or a two-gallon pail warm before gunning in cold temperatures. Warm sealants gun easier and cure faster than cold sealants. Lightweight and portable, this chest has a high impact polypropylene case and lid with smooth corners and edges and is super insulated to stabilize interior temperatures with minimal (approximately 2.5 AMP) power drain.

External dimensions: 16" D x 16" H x 21" L (406 x 406 x 533 mm). Capacity: Holds 34 standard cartridges, 42 sausages (20 Fl. Oz. [600ml]), or one pail (2 gal. [7.5l]). Includes one 10 foot (3 m) power cord.



CAT. NO. PAC15

CAT. NO.	DESCRIPTION
P75	Portable Heater Box
PAC15	110V AC to 12V DC Converter

Minimum order: 1 each.

CRL Yellow Plastic Cone Nozzles

- **Bead Sizes From 1/8" to 1-5/16" (3 to 33 mm)**
- **Easy to Clean After Use**



CRL Yellow Plastic Cone Nozzles are extra large for bulk and sausage caulking applications where wide beads of material are required. These are the same Cone Nozzles that come with the Cat. No. WG51001 Sausage Gun. The plastic cone-type Nozzle can be cut to deliver a bead from 1/8" to 1-5/16" (3 to 33 mm) in diameter. Fits most sausage and bulk guns with screw-on ring caps. Five Nozzles per pack. Minimum order is one pack.

CAT. NO. WGCN

CRL Screw-On Silicone Nozzles

- **Additional Nozzles for Screw-On Type Silicone Cartridges**

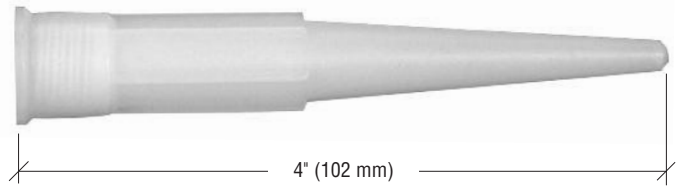

CRL Screw-On Silicone Nozzles are tapered so you can trim it to exactly the bead size you need. **NOTE:** These Nozzles will not fit auto glass urethane cartridges because of the different thread size. For auto glass urethane cartridges, use Cat. No. UNOZ. 24 Nozzles per pack. Minimum order is one pack.

CAT. NO. S1LN0Z

CRL Problem Solver Nozzles

- **Reaches Areas You Never Thought Possible**
- **Rigid, Flexible or Combo Pack**

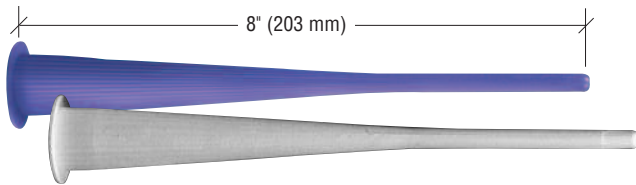

Problem Solver Nozzles fit virtually any caulking cartridge by sliding over the existing nozzle, or screwing onto the threaded nipple. Choose from either Rigid or Flexible Nozzles (four Nozzles per pack), or order the Combo Pack with two flexible and two rigid Nozzles per pack.

CAT. NO.	DESCRIPTION	COLOR
PSN2	Four Rigid Problem Solver Nozzles	Blue
PSN4	Four Flexible Problem Solver Nozzles	White
PSN6	Combo Pack of Four Problem Solver Nozzles	Mixed

Minimum order: 1 pack. Sizes can be combined for quantity pricing.

CRL Corner Caulker Nozzles

- **Reusable and Easy to Clean**
- **90 Degree Bend**

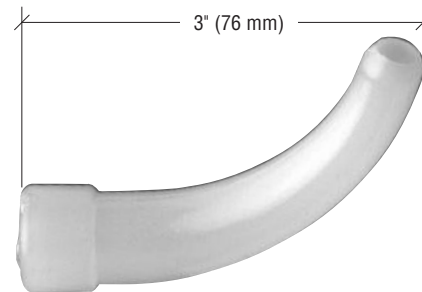

CRL Corner Caulker Nozzles are durable polyethylene Nozzles with a 90 degree bend that allows application of sealants or caulks to places standard Nozzles can't reach. Firmly grips the nozzle of both 1/10 gallon (300 ml) and 1 quart (946 ml) size cartridges. Reusable and easy to clean. 10 Nozzles per pack. Minimum order is one pack.

CAT. NO. CC103

CRL Angle Shot Bent Nozzles

- **45 Degree Bent Spout for Use With Standard Cartridges, Sausage or Bulk Guns**
- **Extra Long 7-1/2" (190 mm) Overall Length**

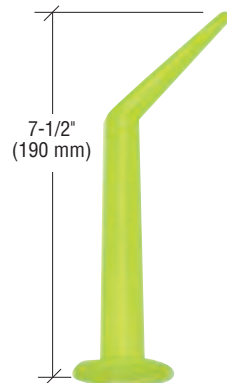

CAT. NO. AB9351

CRL Angle Shot Bent Nozzles fit virtually any caulking cartridge by sliding over the existing nozzle. They hold securely between the cartridge and the end of the caulking gun, and will also adapt for sausage or bulk guns. The 45 degree bend and extra length make reaching into and around corners both easy and fast. Minimum order is one each.

new

CRL 3M® Auto-Mix™ Mixer Nozzles

- **Replacement Nozzles for 3M® Auto-Mix Adhesive**

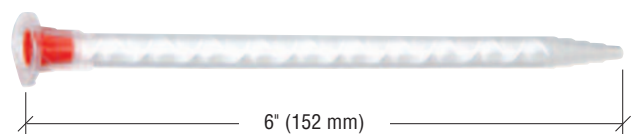

CRL 3M® Auto-Mix™ Mixer Nozzles are the key to 3M® Cat. No. 3M8641 Auto-Mix™ Adhesive. Inside each Nozzle is a series of blades to continually cut and mix the material ensuring that when it reaches the tip it is fully mixed. Each application usually requires a new tip (unless continual flow of material is maintained), so we suggest you stock up on extra Nozzles. Fits Cat. No. 3M8190 3M® Auto-Mix™ Applicator Gun (see page N222). 12 Nozzles per package. Minimum order is one pack.

CAT. NO. 3M21791

CRL Metal Caulking Gun Nozzles

- Variety of Diameters and Configurations to Fit Bulk Load Caulking Guns

These CRL Metal Nozzles fit most bulk caulking guns, such as KM32RCT, DL45T03, DL45T04, or others having a 3/8"-27 thread in the barrel cap.

CAT. NO.	DESCRIPTION	CAT. NO.	DESCRIPTION
KM1	1/8" (3 mm) Round	KM6	1/2" (13 mm) Triangular
KM2	3/16" (5 mm) Round	KM7	5/8" (16 mm) Oval
KM3	1/4" (6 mm) Round	KM13	3/32" x 7/8" (2.4 x 22 mm) Slot
KM8	3/8" (10 mm) Round	KM15	1/32" x 5/8" (0.8 x 16 mm) Slot
KM5	1/2" (13 mm) Round	KM17	1/8" x 9/16" (3 x 14 mm) Slot

Minimum order: 1 each. All nozzles can be combined for quantity pricing.



CAT. NO. KM1



CAT. NO. KM2



CAT. NO. KM8



CAT. NO. KM3



CAT. NO. KM6



CAT. NO. KM5



CAT. NO. KM7



CAT. NO. KM13



CAT. NO. KM15



CAT. NO. KM17

CRL Little Red Nozzle Caps

- Economical and Reusable
- Reduces Sealant Waste



These CRL Little Red Nozzle Caps have an award winning design for capping tubes of sealant, caulk, wood glue, paint, or anything else on your shop shelf that needs to be sealed and reused after it has been opened. These economical, reusable Little Red Nozzle Caps cut sealant waste. Placed over the nozzle of partially used sealant cartridges, they seal out air and dirt to preserve the quality of the remainder of the sealant. Little Red Nozzle Caps also make a perfect Romex wire termination, air tool inlet, and felt pen cap. The possibilities are limitless. 35 Caps per package. Minimum order is one pack.

CAT. NO. LRC35

CRL Reusable Caulk Tips and Cap

- Fit All Standard Cartridges

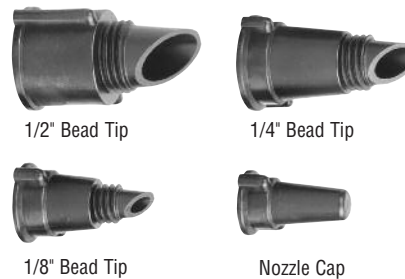

1/2" Bead Tip

1/4" Bead Tip

1/8" Bead Tip

Nozzle Cap



CRL Caulk Tips are reusable therefore they allow all the sealant to be used. 1/8", 1/4", and 1/2" (3, 6, and 12 mm) Tips are precut at a 45 degree angle. The Nozzle Cap can be used with all standard cartridges. Minimum order is one pack.

CAT. NO. CT45

CRL Empty Plastic Cartridge

- Suitable for Most Cold Applied Sealants



This CRL Plastic Cartridge is made of a high density polyethylene, and is suitable for most cold applied sealants. The 1/10th gallon (310 ml) capacity, 2" (51 mm) diameter, and 8-1/2" (216 mm) length Cartridge fits all standard cartridge caulking guns. The Cartridge includes a tapered, non-removable nozzle and a plunger cap. Minimum order is one each.

CAT. NO. 103FL

CRL Nozzle Cutter

- Use on All Plastic Cartridges to Cut Nozzle Tip and Threaded Tip



Our CRL Nozzle Cutter is used to cut off the plastic threaded tip of the cartridge and then cut the nozzle tip to the desired opening size at the proper angle. **NOTE:** Keep SAFELY AWAY from children! EXTREME DANGER to fingers if accidentally inserted in the cutter inlet! Minimum order is one each.

CAT. NO. NC594

CRL 3M® Auto-Mix Adhesive Applicator Gun

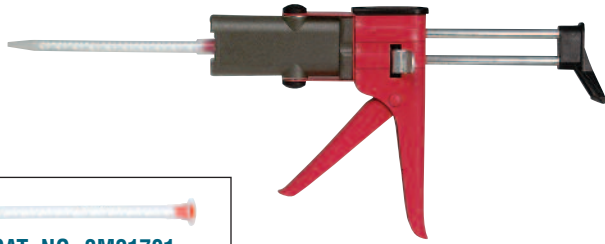

CAT. NO. 3M21791

Mixer-Nozzle
(sold separately)

- For Use With 3M8641 Auto-Mix Adhesive

The CRL 3M® Auto-Mix™ Applicator Gun is used with the Cat. No. 3M21791 Mixer Nozzle to quickly and neatly mix and dispense CRL 3M Auto-Mix Adhesive (see page N281) exactly where you want it. Minimum order is one each.

CAT. NO. 3M8190

CRL Plastic Applicator Bottle With Needle

- For Precise Dispensing of Adhesives, Solvents or Lubricants
- 1-1/2" (38 mm) Long Stainless Steel Needle

The CRL Applicator Bottle is a 1.25 fl. oz. (37 ml) oval polyethylene squeeze-type applicator bottle with a 1-1/2" (38 mm) stainless steel needle. Ideal for precision cementing, solvent dispensing, and oiling. Minimum order is one each.



CAT. NO. AAB4

CRL Small Tube Dispenser Handle

- Makes Small Tubes of Sealants or Adhesives Easy to Dispense



The Small Tube Dispenser Handle is the fast and easy way to dispense materials such as silicones and adhesives from squeeze tubes. It lets you apply just the right amount of pressure for the proper bead size, and since you apply just the right amount of material there is less mess to clean up. The open back design lets you draw the tube through the handle, so you can get virtually all of the material from the tube, reducing waste. Holds all flexible plastic or metal tubes up to 2-1/2" (63 mm) wide.

Minimum order is one each.

CAT. NO. 710XX006

CRL Pistol Type Oiler

- Made Especially for Dispensing Oil and Solvents
- High Quality Steel Can Comes With Two Nozzles

This heavy-duty CRL Pistol Type Oiler dispenses oil and solvents through either a 6" (152 mm) rigid metal, or flexible high density polyethylene spout. It has a 6 fl. oz. (177 ml) capacity and supporting base ring. This oiler also features a brass pump mechanism for smooth operation and a gasket on the lift rod to prevent leakage. Baked-on enamel finish on the body resists rust.

Minimum order is one each.



CAT. NO. KP500

CRL Barrel Transfer Pump

- Delivers 10 Fl. Oz. (300 ml) Per Stroke
- Fits a Variety of Drums

This CRL Barrel Transfer Pump is an easy to operate suction lift pump that can be used on any 30 to 55 gallon (113 to 208 l) drum to dispense a wide variety of liquids. Delivery is 10 fl. oz. (300 ml) per stroke. Features telescoping suction pipe and pipe seal. Excellent for dispensing bulk oil-based sealers or lubricants. **IMPORTANT NOTE:** Not for use with solvents, water-base fluids, weak acids, anti-freeze, or fuel. Minimum order is one each.



CAT. NO. KP45485

CRL Gun Fill Pump

- For Three and Five Gallon Straight Sided Pails
- Provides the Economy of Bulk in Small Containers

This CRL Gun Fill Pump is designed to transfer bulk sealants, adhesives or lubricants from three or five gallon (11 or 19 l) pails into convenient smaller containers. It is an 18" (457 mm) pump with a 12" (305 mm) follower plate. Minimum order is one each.



CAT. NO. GFD450

CRL Cord-Free Glue Gun

- Excellent for Hard to Reach Spots
- Use With or Without Cord

The CRL Cord-Free Glue Gun is a truly versatile tool that allows you to get into those extra tight areas where a cord hampers your work. Simply plug the gun into an electrical outlet, wait 3 to 6 minutes for the gun and glue to heat up, disconnect the cord and begin applying hot glue. You can use the gun for 12 minutes before needing to reheat. Then simply re-insert the cord, allow to heat for 3 minutes, and go back to work. Uses standard 4" (102 mm) long hot melt glue sticks. Minimum order is one each.



CAT. NO. GR90C

CRL Heavy-Duty Glue Gun

- Built for Professional Use
- Dependable Glue Temperature
- Fast Heat Up

The CRL Heavy-Duty Glue Gun is for professional use. It provides hot glue in a molten form exceeding 380°F (193°C) for complete coverage of the bonding area. The solid-state circuitry of this gun provides fast heat up and dependable glue temperature for strong, consistent bonding. Uses standard 4" (102 mm) long hot melt glue sticks. Minimum order is one each.



CAT. NO. GR20T

CRL Dual Temperature Glue Gun

- One Gun for All Applications
- Temperature Setting Switch in Handle

This CRL Dual Temperature Glue Gun is the perfect tool to meet all your hot melt needs. It's now simple to move from one temperature setting to another with the high-low switch located right in the handle. Use the high temperature setting for bonding wood, ceramics, and other non-porous materials. Switch to the low setting for use with foam, paper, and other heat sensitive materials. It comes with its own handy wire stand. Uses standard 4" (102 mm) long hot melt glue sticks. Minimum order is one each.



CAT. NO. GR25DT

CRL All Purpose Glue Sticks

- High Strength
- 25 to 30 Second Set Up Time

These All Purpose, High Strength Glue Sticks have a 25 to 30 second set up time. The glue adheres with high strength to ceramic, rubber, leather, metal, acrylic, and fiberglass. Each pack contains six 4" (102 mm) long glue sticks. Minimum order is one pack.



CAT. NO. GS500

new

CRL Slow Setting Glue Sticks

- Excellent for Woodworking Applications
- 60 to 70 Second Set Up Time

This Slower Setting Glue Stick, with its 60 to 70 second set up time, is the right choice for woodworking applications. Each pack contains thirty 4" (102 mm) long sticks in a handy container. Minimum order is one pack.



CAT. NO. GS264BK

CRL PD9 Diamond Point Driver

new

- All Metal Design
- Drives 3/8" Diamond Points
- Adjustable Strike Force

The best and fastest way to glaze wood sash is to start off with a CRL PD9 Diamond Point Driver. Secure the glass in place with CRL Universal Diamond Points and warm up the putty. Adjustable strike force allows the user to drive the points deeply enough in hard or soft wood frames to hold the glass with 1/8" (3.2 mm) of exposure over the glass. This low profile is easily covered during putty application.

The CRL PD9 is built with small rubber cushions on the base to make sure tool is perfectly angled to properly set the points. Minimum order is one each.



CAT. NO. PD9

CRL Universal Diamond Points

- Stacked Points for Quick and Easy Loading
- Works With Our PD9 Point Driver

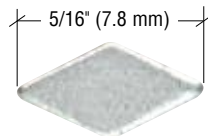

CAT. NO. NW1P

Our No. 1 size Universal Diamond Points fit into our PD9 Point Driver, and also into older model point drivers. Stacked points slide into the magazine for quick and easy reloading.



CAT. NO.	DESCRIPTION	TOTAL POINTS
NW1P	Package of 5/16" (7.8 mm) Stacked Diamond Points	5,000

Minimum order: 1 package.

CRL Points for Older Point Drivers and Manual Tools

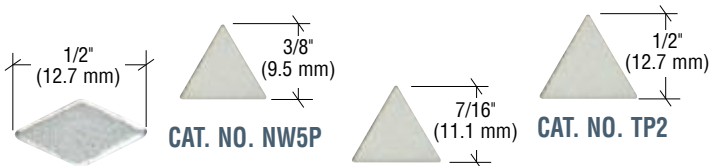

CAT. NO. NW2P

CAT. NO. TP3

We stock Diamond and Triangle Points for older model CRL and Fletcher brand Point Drivers. **NOTE:** TP2 and TP3 Triangle Points are not stacked, but shipped in bulk.

CAT. NO.	DESCRIPTION	TOTAL POINTS
NW2P	Package of 1/2" (12.7 mm) Stacked Diamond Points	4,000
NW5P	Package of 3/8" (9.5 mm) Stacked No. 5 Triangle Points	2,700
TP3	No. 3 Triangle Point 7/16" (11.1 mm) Non-Stacked in Bulk	1 lb. (.45 kg)
TP2	No. 2 Triangle Point 1/2" (12.7 mm) Non-Stacked in Bulk	1 lb. (.45 kg)

Minimum order: 1 package or 1 pound.

CRL Fletcher Point Tool

- Perfect Choice for Inserting Push Points, Triangle Points, and Diamond Points Into Wood Frames and Window Sash



The CRL Fletcher Point Tool is a high quality finishing tool that is the perfect choice for inserting Push Points, Triangle Points, and Diamond Points into wood frames and window sash. It has a rubberized raised grip that provides added comfort and helps prevent damage to the mat board and other backing material. Minimum order is one each.

CAT. NO. 09515

CRL Fletcher FrameMaster® Point Driver

- Quick Loading Reversible Point Magazine
- Uses 3/8" (9.5 mm) or 5/8" (16 mm) Points
- Adjustable Strike Force

Drive home Glazier's and Framer's Points with the CRL Fletcher FrameMaster® Point Driver. It reliably drives wax-free stacked points straight and flat to the surface, one at a time, without double feeding or jamming. The easy-load magazine holds 100 points at a time. Unique design features a reversible magazine with a short nose for 3/8" (9.5 mm) Glazier's Points, or a long nose for the longer 5/8" (16 mm) Framer's Points.

A knurled adjustment screw allows easy tension adjustment: less force for soft woods and more force for hard woods. The 1/8" (3.2 mm) width of the point gives excellent holding power combined with a small profile for easy putty coverage of the Glazier's Points. The 5/8" (16 mm) Framer's Points are long enough to hold mat board and other picture frame backing materials securely in place while still being long enough for easy removal.

The lightweight yet durable plastic frame is designed to provide years of dependable service. Minimum order is one each.



CAT. NO. FM075



CRL Fletcher FrameMaster® Points

- Exclusively for the FrameMaster® Point Driver
- Wax-Free for a Strong Hold

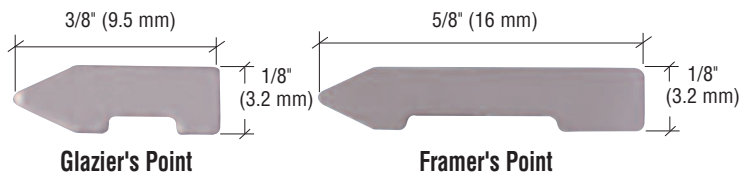

CAT. NO.	DESCRIPTION	QTY/PK
FT898	3/8" (9.5 mm) Glazier's Points	5,000
FT895	5/8" (16 mm) Framer's Points	3,000

Minimum order: 1 package. All Glazing Points can be combined for quantity pricing.

CRL Fletcher PullMate™ Point Removing Tool

- Removes Fletcher FrameMaster® Points From Wood Frames



The CRL Fletcher PullMate™ Point Removing Tool is a high-quality finishing tool specifically designed to remove Fletcher FrameMaster® Points from wood frames. It has a rubberized raised grip that provides added comfort and helps protect framing materials. Minimum order is one each.

CAT. NO. 09517



CRL Easy Push Points

- Our Most Popular Push Points
- Packaged in Convenient Display Boxes for Over-the-Counter Sales
- Also Available in Bulk One Pound Containers

CRL Push Points install without the use of special tools, making them a favorite of glaziers and consumers. Just push them into place with a putty knife, chisel or slotted screwdriver. Use Push Points for wood sash glazing, greenhouses, picture frames, mirror frames, and more. They are zinc coated to resist corrosion, and available in two types of packaging; retail counter display containing twelve small packages, and one pound bulk containers for professional use.

NOTE: Cat. No. 30 Points consist of one retail display with 12 small packages containing approximately 50 push points (600 points total). One Cat. No. 31B bulk container holds approximately 1500 points.



CAT. NO. 30
Retail Display Push Points

CAT. NO. 31B
Bulk Push Points

CAT. NO.	PACKAGING
30	Retail Display of 12 Packages
31B	One Pound Bulk Container

Minimum order: 1 each. All Glazing Points can be combined for quantity pricing.

CRL Push Points

- Packaged in Attractive Blister Cards for Retail Display

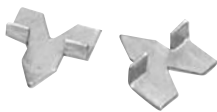

Popular CRL Push Points are available on attractive blister cards for retail display. Use them for fast, easy glazing of wood sash, picture frames, and more. Packaged for pegboard or wire rack display. Approximately 50 Push Points per card. 12 blister cards per carton. Minimum order is one carton.



CAT. NO. 30C

CRL Wire Brads

- Used in the Assembly of Finished Wood Picture Frames or Cabinetry
- Sharp Points Aid Insertion With Hammer or Brad Pusher

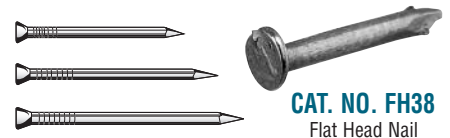

CAT. NO. FH38
Flat Head Nail



CRL Wire Brads are used in the assembly of finished wood picture frames or cabinetry. Sharp points aid their insertion using a hammer or brad-setting pusher. All sizes are packed one pound (.45 kg) per box.

Wire Brad Gauges

#16		●
#17		●
#18		●
#19		●

CAT. NO.	SIZE
16X1BRAD	#16 x 1" (25 mm)
16X1 1/2BRAD	#16 x 1-1/2" (38 mm)
17X3/4BRAD	#17 x 3/4" (19 mm)
17X1BRAD	#17 x 1" (25 mm)
18X3/4BRAD	#18 x 3/4" (19 mm)
18X1BRAD	#18 x 1" (25 mm)
19X1 1/2BRAD	#19 x 1 1/2" (12 mm)
19X3/4BRAD	#19 x 3/4" (19 mm)
FH38	#18 x 3/8" (10 mm)*

Minimum order: 1 box. All Wire Brads can be combined for quantity pricing. *Quantity 2000 per box.

CRL Professional Electric Brad Nail Gun

- Shoots Four Sizes of Brad Nails
- A Great Tool for Business or Home Projects

CRL's Professional Electric Brad Nail Gun is perfect for installing any type of trim, moulding or general woodworking projects. This Brad Nail Gun has a powerful 14 amp motor along with a 10 foot (3 m) cord, and utilizes 5/8" (15 mm) to 1-1/4" (32 mm) Brad Nails. The specially designed nail channel prevents jamming. The Brad Nail Gun also features dual safety switches: surface contact and trigger lock. The non-marring bumper protects the trim surfaces. Includes carrying case. Minimum order is one each.



CAT. NO. ET200



Brad Nails for ET200 Gun

BRAD NAILS

CAT. NO.	LENGTH	QTY/BOX
3130058	5/8" (16 mm)	500
3130034	3/4" (19 mm)	2000
3130001	1" (25 mm)	2000
3130114	1-1/4" (32 mm)	2000

Minimum order: 1 box.

CRL Sash Glazing Clips

- Available in High Tensile Spring Steel and Aluminum
- Keep Glass in Place Prior to Applying Putty

CRL Sash Glazing Clips are made to keep glass in place in aluminum and steel sash windows prior to application of putty. Lightweight high tensile spring clips hold glass securely in place, and are easy to install.

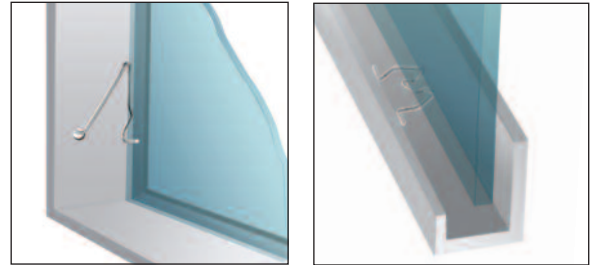

Typical Applications

For Residential Use



This 18 gauge residential Steel Sash Clip is used for both single or double thickness glass. It's our most widely used glazing clip. Both legs have a small bend at the end.

CAT. NO.	QTY/BOX
1800	1000
1800BULK	25000

Minimum order: 1 box. All clips on this page can be combined for quantity pricing.



This lightweight Aluminum Sash Clip is for double or single thickness glass in residential windows. Cannot be used for steel sash glazing. One leg has a small bend at the end.

CAT. NO.	QTY/BOX
AL18	1000

Minimum order: 1 box. All clips on this page can be combined for quantity pricing.

For Commercial Use



These heavyweight Steel Sash Clips are designed for use on 1/4" (6 mm) plate or rough glass in commercial installations. Each of the two legs has a small bend at the end.

CAT. NO.	QTY/BOX
1675	1000
1675BULK	25000

Minimum order: 1 box. All clips on this page can be combined for quantity pricing.



This commercial Aluminum Sash Clip is designed for heavyweight use on 1/4" (6 mm) plate or rough glass. Only one of the two legs has a small bend at the end.

CAT. NO.	QTY/BOX
AL16	1000

Minimum order: 1 box. All clips on this page can be combined for quantity pricing.

For Industrial Use



These Steel Sash Clips are used in glazing Truscon, Creco, Fenestra, Vento, Mesko and other well-known industrial steel sash.

CAT. NO.	QTY/BOX
S625C	1000

Minimum order: 1 box. All clips on this page can be combined for quantity pricing.



Aluminum butterfly style Sash Clip is designed for use on aluminum channel sash.

CAT. NO.	QTY/BOX
W26	1000

Minimum order: 1 box. All clips on this page can be combined for quantity pricing.



Butterfly style Sash Clip intended for use on aluminum channel sash.

CAT. NO.	QTY/BOX
W19	1000

Minimum order: 1 box. All clips on this page can be combined for quantity pricing.

Types of Putty Knives

- Bent Stiff



- Stiff



- Flexible



CRL Russell 1-1/8" Bent Knife



- Our Best Seller

This knife's stiff, steel blade is riveted into the rosewood handle and held by a heavy-duty support. Preferred smooth 35 degree radius bend in the blade. The blade width is 1-1/8" (29 mm), and the overall length is 6-1/2" (165 mm). Minimum order is one each.

CAT. NO. 2BE118

CRL Lamson 3/4" Bent Knife



- Smooth 35 Degree Radius Bend in a Stiff Steel Blade

This knife's stiff steel blade is riveted into the wood handle and held by a heavy-duty support, with a preferred smooth 35 degree radius bend in the blade. The blade width is 3/4" (19 mm), and the overall length is 7-5/16" (186 mm). Minimum order is one each.

CAT. NO. 900B34

CRL Red Devil 1-1/4" Bent Knife



- Solvent-Resistant Black Nylon Handle
- High Carbon Steel Blade

The high carbon, precision-ground steel blade on the CRL Red Devil 1-1/4" (32 mm) Stiff Bent Putty Knife extends through the black nylon solvent-resistant handle, with a 30 degree angle bend in the blade. The brass-plated, solid steel nail setting head can be used for setting drywall nails and other hammering jobs. The overall length is 7-1/2" (191 mm). Minimum order is one each.

CAT. NO. 4243

CRL Russell 1-5/8" Bent Knife



- Best Size for Steel Sash Work

This knife's stiff steel blade is riveted into the rosewood handle and held by a heavy-duty support, with a preferred smooth 35 degree radius bend in the blade. The blade width is 1-5/8" (41 mm), and the overall length is 7-9/16" (192 mm). Minimum order is one each.

CAT. NO. 416B

CRL Lamson 2" Bent Knife



- Smooth 35 Degree Radius Bend in Blade

The CRL Lamson Bent Stiff Putty Knife has a 2" (51 mm) wide blade with a smooth, 35 degree radius bend. The blade is riveted to the wood handle resulting in an overall length of 7-7/16" (189 mm). Minimum order is one each.

CAT. NO. 900E2

CRL Red Devil 1-1/4" Stiff Knives



- Plastic Handle Knives are Great for Retail Sales
- 12 Per Box



The CRL Stiff Putty Knives in a Countertop Box are good quality putty knives with steel blades set into a plastic handle, ideal for use in the shop or over the counter sales. The blade width is 1-1/4" (32 mm) and the overall length is 7-3/8" (187 mm). Packed 12 per box. Minimum order is one box.

CAT. NO. 4701

CRL Red Devil 1-1/4" Stiff Knife

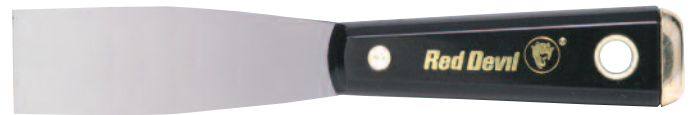

- Solvent-Resistant Black Nylon Handle
- High-Carbon Steel Blade

CRL Red Devil Stiff Blade Knives feature a high-carbon, precision-ground steel blade that extends through the black nylon solvent-resistant handle. The brass-plated, solid steel nail setting head can be used for setting drywall nails and other hammering jobs. Blade width is 1-1/4" (32 mm). Overall length is 7-5/8" (194 mm). Minimum order is one each.

CAT. NO. 4201

CRL Russell 1-1/4" Stiff Knife



- High Grade Tool Steel Blade
- Rosewood Handle

High-grade tool steel blade make this CRL Russell Stiff Blade Knife strong. The rosewood handle is riveted on. Blade width is 1-1/4" (32 mm). Overall length is 7-1/4" (184 mm). Minimum order is one each.

CAT. NO. 3S114

CRL Red Devil 1-1/2" Stiff Knife



- Solvent-Resistant Black Nylon Handle
- High-Carbon Steel Blade

CRL Red Devil Stiff Blade Knives feature a high-carbon, precision-ground steel blade that extends through the black nylon solvent-resistant handle. The brass-plated, solid steel nail setting head can be used for setting drywall nails and other hammering jobs. Blade width is 1-1/2" (38 mm). Overall length is 7-3/4" (197 mm). Minimum order is one each.

CAT. NO. 4203

CRL Hyde 1-1/2" Stiff Knife **new**



- Soft Grip Ergonomic Handle
- Wide Hammer Head® End

This CRL Hyde Stiff Blade Knife features a high-carbon steel blade set in a comfortable, professional grip with safety thumb bolster and a wide Hammer Head® end for setting nails. Blade width is 1-1/2" (38 mm). Overall length is 8-3/8" (213 mm). Minimum order is one each.

CAT. NO. 06150

CRL Red Devil 2" Stiff Knife **new**



- Solvent-Resistant Black Nylon Handle
- High-Carbon Steel Blade

CRL Red Devil Stiff Blade Knives feature a high-carbon, precision-ground steel blade that extends through the black nylon solvent-resistant handle. The brass plated, solid steel nail setting head can be used for setting drywall nails and other hammering jobs. Blade width is 2" (51 mm). Overall length is 7-3/4" (197 mm). Minimum order is one each.

CAT. NO. 4205

CRL Hyde 2" Stiff Knife

new



- Soft-Grip Ergonomic Handle
- Wide Hammer Head® End

This CRL Hyde Stiff Blade Knife features a high-carbon steel blade set in a comfortable, professional grip with safety thumb bolster and a wide Hammer Head® end for setting nails. Blade width is 2" (51 mm). Overall length is 8-1/2" (216 mm). Minimum order is one each.

CAT. NO. 06225

CRL 3" Stiff Knife

new



- Large Handle With Soft Grip
- High-Carbon Steel Blade

This CRL Stiff Blade Knife features a high-carbon steel blade with a ground edge set in a large soft-grip handle. Blade width is 3" (76 mm). Overall length is 9" (229 mm). Minimum order is one each.

CAT. NO. HW039

CRL Red Devil 3" Stiff Knife

new



- Solvent-Resistant Black Nylon Handle
- High-Carbon Steel Blade

CRL Red Devil Stiff Blade Knives feature a high-carbon, precision-ground steel blade that extends through the black nylon solvent-resistant handle. The brass-plated, solid steel nail-setting head can be used for setting drywall nails and other hammering jobs. Blade width is 3" (76 mm). Overall length is 8-1/4" (210 mm). Minimum order is one each.

CAT. NO. 4209

CRL Russell 1-1/4" Flexible Knife



- High-Carbon Tool Steel Blade
- Rosewood Handle

This CRL Russell Flexible Putty Knife has a 1-1/4" (32 mm) wide, precision-ground and tempered, high-carbon tool steel blade. A metal bolster gives strength and protects the rosewood handle. Overall length is 7-1/4" (184 mm). Minimum order is one each.

CAT. NO. 2F114

CRL Red Devil 1-1/4" Flexible Knife



- Polished Wood Handle
- Precision-Ground Steel Blade

CRL Red Devil Flexible Blade Knives feature a precision-ground, rust-resistant lacquered steel blade that extends through the polished wood handle for flexibility and long life. The brass-plated, solid steel nail-setting head can be used for setting drywall nails and other hammering jobs. Blade width is 1-1/4" (32 mm). Overall length is 7-3/4" (197 mm). Minimum order is one each.

CAT. NO. 4102

CRL Red Devil 1-1/2" Flexible Knife



- Polished Wood Handle
- Precision-Ground Steel Blade

CRL Red Devil Flexible Blade Knives feature a precision-ground, rust-resistant lacquered steel blade that extends through the polished wood handle for flexibility and long life. The brass-plated, solid steel nail-setting head can be used for setting drywall nails and other hammering jobs. Blade width is 1-1/2" (38 mm). Overall length is 7-5/8" (194 mm). Minimum order is one each.

CAT. NO. 4104

CRL 1-1/2" Flexible Knife

new



- High-Carbon Flexible Steel Blade
- Large Soft Grip Handle

Our CRL Flexible Blade Knife features a high-carbon steel blade set in a large soft grip handle. Blade width is 1-1/2" (38 mm). Overall length is 8-3/4" (222 mm). Minimum order is one each.

CAT. NO. HW033

CRL 2" Flexible Knife

new



- High-Carbon Flexible Steel Blade
- Large Soft Grip Handle

Our CRL Flexible Blade Knife features a high-carbon steel blade in a large soft grip handle. Blade width is 2" (51 mm). Overall length is 8-3/4" (222 mm). Minimum order is one each.

CAT. NO. HW034

CRL Red Devil 2" Flexible Knife

new



- Solvent-Resistant Black Nylon Handle
- High-Carbon Flexible Steel Blade

CRL Red Devil Flexible Knives feature a high-carbon, precision-ground steel blade that extends through the black nylon solvent-resistant handle. The brass-plated, solid steel nail setting head can be used for setting drywall nails and other hammering jobs. Blade width is 2" (51 mm). Overall length is 7-5/8" (194 mm). Minimum order is one each.

CAT. NO. 4206

CRL Red Devil 2-1/2" Flexible Knife

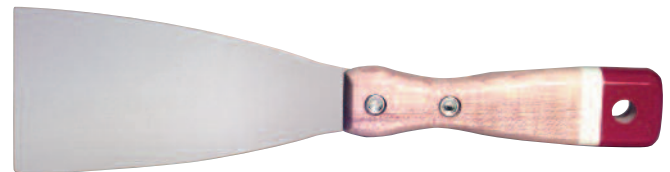

- Extra Long, Solid Hardwood Handle
- Super Flexible, Great for Spackling

This CRL Red Devil Flexible Putty Knife is precision-ground with a high-carbon steel blade. It is polished, lacquered, and secured by brass eyelets in a solid hardwood handle. Blade width is 2-1/2" (64 mm). Overall length is 9-1/2" (241 mm). Minimum order is one each.

CAT. NO. 4510

CRL 3" Flexible Knife

new



- High-Carbon Flexible Steel Blade
- Large Soft Grip Handle

Our CRL Flexible Blade Knife features a high-carbon steel blade set in a large soft grip handle. Blade width is 3" (76 mm). Overall length is 9" (229 mm). Minimum order is one each.

CAT. NO. HW035

CRL 4" Flexible Knife

new



- High-Carbon Flexible Steel Blade
- Large Soft Grip Handle

Our CRL Flexible Blade Knife features a high-carbon steel blade set in a large soft grip handle. Blade width is 4" (102 mm). Overall length is 9-3/16" (233 mm). Minimum order is one each.

CAT. NO. HW036

CRL of Europe

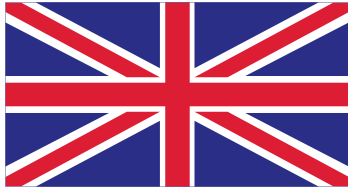

crlaurence.co.uk



England



England



crlaurence.de



Germany



Germany

CRL Ebor 1-1/2" 3110 Putty Knife Chisel



- Carbon Steel
- Scale Tang Blade Handle
- Available in Europe Only

The CRL Ebor 3110 Putty Knife Chisel is made of high-grade carbon steel for strength and longevity. Its scale tang blade handle is extra strong and easy to grip. Blade width is 1-1/2" (38 mm). Overall length is 8-1/4" (210 mm). Minimum order is one each.

CAT. NO. 0704

CRL Ebor 1-1/2" 3107 Skew Stiff Putty Knife



- Carbon Steel
- Scale Tang Blade Handle
- Available in Europe Only

The CRL Ebor 3107 Skew is a high-grade carbon steel stiff Putty Knife with a scale tang blade handle for extra strength and ease during use. Stiff blade has skew end and a width of 1-1/2" (38 mm). Overall length is 8-3/8" (213 mm). Minimum order is one each.

CAT. NO. 0701

CRL Ebor 1-1/4" 3130 Hacking Knife



- Extra-Strong Carbon Steel Blade
- Heavy-Duty Triple Rivet Leather Handle
- Available in Europe Only

The CRL Ebor 3130 Hacking Knife features an extra-strong carbon steel blade with a heavy-duty triple rivet leather handle. Blade width is 1-1/4" (32 mm); length is 4-1/2" (114 mm). Overall length is 8-3/8" (213 mm). Minimum order is one each.

CAT. NO. 0705

CRL Ebor 1-3/8" 3109 Clipt Flexible Putty Knife



- Carbon Steel
- Scale Tang Handle
- Available in Europe Only

The CRL Ebor 3109 Clipt is a high-grade carbon steel Flexible Putty Knife with a scale tang blade handle for extra strength and ease during use. Flexible blade has clipt end and a width of 1-3/8" (35 mm). Overall length is 8-3/8" (213 mm). Minimum order is one each.

CAT. NO. 0703

CRL Heavy-Duty Scrapers and Chisels

- Steel Blades and Shafts
- Used for Removing Old Putty
- Also Great as Gasket Scrapers

These Heavy-Duty Scrapers and Chisels are used for removing old putty, as well as for many other jobs. They are sturdy enough for just about any application. Clear Handle model is our most popular; Solid Aluminum Handle model is extra durable.

CAT. NO.	OVERALL LENGTH (L)	BLADE WIDTH (W)
516WT	10-7/8" (276 mm)	15/16" (24 mm)
GL100	11-3/4" (298 mm)	11/16" (17.5 mm)
KD485	10-1/2" (267 mm)	7/8" (22 mm)

Minimum order: 1 each.

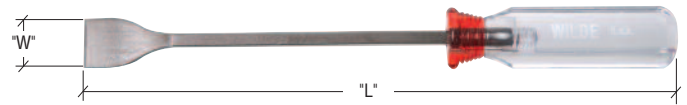

CAT. NO. 516WT
Clear Plastic Handle



CAT. NO. GL100
Solid Aluminum Handle



CAT. NO. KD485
Red Plastic Handle

CRL Russell® 1-1/4" Putty Chisel



- Quality High Grade Steel Chisel
- Laminated Wood Handle

The CRL Russell® 1-1/4" (32 mm) Putty Chisel is a high grade steel chisel with clear protective coating and a laminated wood handle with brass rivets and hanging grommet. Blade width is 1-1/4" (32 mm). Overall length is 7-1/4" (184 mm). Minimum order is one each.

CAT. NO. 2CH114

CRL Red Devil® 1-1/4" Putty Chisel

new



- Precision Beveled Chisel Edge
- Heavy-Duty Steel Blade

The CRL Red Devil® Putty Chisel has a heavy-duty steel blade with a precision beveled chisel edge for removing old putty. The blade extends through the black nylon solvent-resistant handle and is riveted on for strength. The brass-plated, solid steel nail setting head can be used for setting drywall nails and other hammering jobs. Blade width is 1-1/4" (32 mm). Overall length is 7-3/4" (197 mm).

Minimum order is one each.

CAT. NO. 4231

CRL Stanley® 1-1/2" Glazier's Chisel



- High-Carbon Forged Steel Blade
- Longer Length for Easier Reach
- Thru-Tang™ Design for Superior Strength and Durability

The CRL Stanley® Glazier's Chisel has a thick, forged and tapered, high quality, high carbon steel blade that is 50% stronger than similar models. The Thru-Tang™ feature provides a solid one-piece metal shaft from chisel blade through the striking cap, allowing the Chisel to withstand continuous blows from a hammer. The large ergonomically designed handle provides superior grip and comfort. This Chisel easily removes putty and prepares sash for glazing. Blade width is 1-1/2" (38 mm), and the overall length is 9" (229 mm). Minimum order is one each.

CAT. NO. 1941

CRL Hyde® Contour Scraper

new



- Six Interchangeable Stainless Steel Blades of Various Shapes

This professional grade, stainless steel Hyde® Contour Scraper removes paint, varnish, putty, caulk or rust from virtually any surface. Six interchangeable blades fit into corners, curves, and small channels, and can be sharpened for repeated use.

Minimum order is one each.

CAT. NO. 10450

CRL Hyde Hackout Knife



- High-Carbon Tool Steel Blade
- Comfortable Oak Leather Handle

The CRL Hyde Hackout Knife has a blade made of high-carbon steel with a glaze finish. The broad-backed blade extends through the handle and is flanked with oak leather to provide a safe, comfortable grip. Three rivets secure the handle. Blade width is 1-1/4" (32 mm). Blade length is 4-1/2" (114 mm). Overall length is 8" (203 mm). Minimum order is one each.

CAT. NO. 40210

CRL Heavy-Duty Hacking Knife



- Precision-Ground Blade Cuts Through the Hardest Putty
- Molded Plastic Handle

The Heavy-Duty CRL Hacking Knife is perfect for removing old putty. It features a precision-ground blade with a molded plastic handle. Blade width is 1-1/4" (32 mm). Blade length is 4" (102 mm). Overall length is 8-1/2" (216 mm). Minimum order is one each.

CAT. NO. HK1

CRL "Don Carlos" Lead Putty Knife



- Traditional "Don Carlos" Knife With Forged Steel Blade and Black Wooden Handle

The CRL "Don Carlos" Lead Putty Knife has a forged steel blade set in a black wooden handle with lead inlay. The blade is almost 4" (100 mm) long. Minimum order is one each.

CAT. NO. B05102403

CRL Red Devil Linoleum Knife



- Tempered High Carbon Steel Blade
- Polished Wood Handle

This CRL Red Devil Heavy-Duty Linoleum Knife can be used to cut hardened putty and other glazing materials from window sashes. The tempered high-carbon steel blade uses a tapered edge for cutting and quick sharpening; and is attached to a comfortable, polished wood handle with metal bolster. Minimum order is one each.

CAT. NO. 4608

CRL Window Zipper



- Stainless Steel Blade With Serrated Edge Cuts Through Dried Paint and Hardened Window Caulks

The CRL Window Zipper Tool features a stainless steel blade set in a metal handle. It cuts through dried paint or other hardened materials that bind window sash. Overall length is 9-1/4" (235 mm). Minimum order is one each.

CAT. NO. 4046

CRL Window Hackout Tool



- Great for Window Replacement
- Super Tough Steel Blade

This CRL Window Hackout Tool was designed to remove putty and other materials from a window groove in a safe and efficient manner. The special shape of this tool helps to minimize the risk of injury to the hand that sometimes occurs when improvising with a chisel or screwdriver. Overall length is 11" (279 mm). Blade thickness is 1/8" (3.2 mm). Minimum order is one each.

CAT. NO. WHT1

CRL 8-in-1 Painter's Tool

new



- Large Soft Grip Handle
- A Must For Any Toolbox

The CRL 8-in-1 Painter's Tool is a must in any tool box. Use it to scrape paint, remove putty, spread compound, clean paint rollers, open cracks for patching, open lids, pull nails, and remove bottle caps. Blade width is 3" (76 mm). Overall length is 9-1/8" (232 mm). Minimum order is one each.

CAT. NO. HW048

CRL Hyde 8-in-1 Painter's Tool

new



- Electrocoated Steel Blade
- Soft Grip Handle

This CRL Hyde 8-in-1 Painter's Tool has eight handy functions: scrape paint, remove putty, spread compound, clean rollers, open cracks for patching, open lids, pull nails, and a die-cast metal nail setting end allows you to set drywall nails. Blade width is 3" (76 mm). Overall length is 8-5/8" (219 mm). Minimum order is one each.

CAT. NO. 06995

CRL Red Devil Double End Window Tool



- Putty Knife and Trimmer in One
- Stainless Steel Blades

The CRL Red Devil Window Tool is a putty knife and trimmer in one. The V-shaped end packs, shapes and trims new putty, while the flat end removes old putty. This tool has two stainless steel blades mounted to a plastic handle with brass eyelets. Overall length is 7-1/2" (191 mm). Minimum order is one each.

CAT. NO. 4044

CRL 10" (254 mm) Pry Bar and Scraper

new



- Hardened, Tempered Tool Steel
- Ideal for Pulling Nails, Prying, Lifting, Scraping, and Much More

This CRL Pry Bar and Scraper is a versatile tool made of the finest hardened, tempered tool steel. It is typically used for scraping and prying. One end has a 50 degree angle bend and a nail puller hole. Both ends are chisel ground and 1-1/2" (38 mm) wide. Overall length is 10" (254 mm). Minimum order is one each.

CAT. NO. US10

CRL Scrape and Pry Bars

- Multi-Purpose Tools Made of Hardened, Tempered Steel
- Two Sizes With Chisel Ground Edges

CRL Scrape and Pry Bars are versatile tools made of the finest hardened, tempered tool steel. Both ends are chisel ground for scraping or prying. The 4050 is 1-3/4" (44.5 mm) wide, and the 3040 is 9/16" (14.3 mm) wide. One end has a 50 degree angle bend. Both tools have a nail puller hole. Our most popular model is 10" (254 mm) long – just the right size for your tool box. Minimum order is one each.

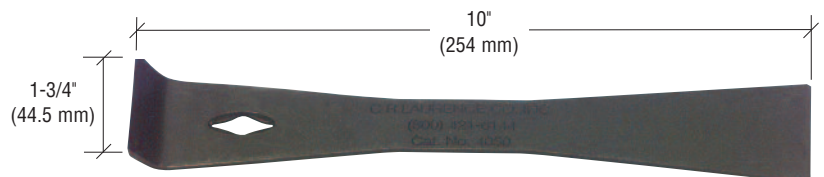

- Most Popular

CAT. NO. 4050

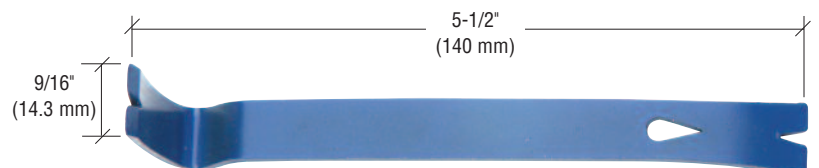

- Tool Belt Size

CAT. NO. 3040

NOTE: Images not to scale.

CRL Fein® SuperCut Sealant Cutter Knife Kit



- Removes Old, Hardened Putty Quickly and Easily
- Variable Speed Blade Oscillates 11,000 to 18,500 Times Per Minute
- Lightweight and Easy to Maneuver
- Powerful 120V AC 3.3 AMP Motor



CAT. NO. FK20618
Fein® SuperCut Sealant Cutter Knife Kit

The CRL Fein® Cutter uses its oscillating blade to cut cured sealant and caulking quickly with a minimum of effort. This reliable electric tool is double-insulated for operator safety. The oscillation on this tool is simply a short back and forth stroke of the cutting blade, one degree to each side, at a frequency of up to 18,500 strokes per minute. Another important advantage is that the optional diamond-tipped blades can be used to cut through marble and mortar joints, while keeping dust formation to a minimum. The CRL Fein® Sealant Cutter features an electronic speed control to keep cutting speed constant, even under load, so you can select the best cutting speed for every application. The gears are designed for continuous operation, and run in an oil bath. Thanks to a twelve-sided mount, cutting blades can be adjusted to any position. This kit includes a CRL Fein® Cutter Tool, a set of blades for removing flexible sealants: five Cat. No. FKB17015 and one Cat. No. FKB16011, and a Blade Removal Tool, all packed in a metal Carrying Case. Minimum order is one each.

Optional Blades for Fein® SuperCut Knife



Offset "T" Blade

Segment saw blade (offset), for removing insulating glass installed on a putty bed. Minimum order is one each.



CAT. NO. 2000166

Diamond Blade

Diamond coated blade for cutting out marble and mortar joints, and making cuts in plaster walls. 3-1/8" (70 mm) diameter. Minimum order is one each.



CAT. NO. FKB10401

Mushroom Blade

Mushroom shaped blade for separating panes of insulating glass. Also for cutting silicone, soft putty, and elastic joint sealants. Minimum order is one each.



CAT. NO. FKB128

Caulking Blade

Flat blade for removing material while working on flush surfaces. Five each included in FK20618 Kit. Minimum order is one each.



CAT. NO. FKB17015

Sealant Blade

Straight, elongated blade for removing flexible sealing compounds in extremely deep joints. One each included in FK20618 Kit. Minimum order is one each.



CAT. NO. FKB16011

CRL Makita® Power Scraper Hackout Gun



- Excellent for Hackouts of Hardened Putty and Sealants
- Powerful Variable Speed 5 AMP Motor Produces 0 to 3,200 Air-Cushioned Blows Per Minute
- Complete With Three Chisel Tips

The Makita® Power Scraper Hackout Gun has a powerful 5 AMP motor that will tackle even the toughest putty or sealant removal job. Also ideal for cleaning out old mortar, removing tile, concrete scale, and weld splatter. Double insulated motor delivers from 0 to 3,200 blows per minute for light scraping, chiseling, and chipping. Excellent for hackouts of hardened putty and sealants.



CAT. NO.	DESCRIPTION
HK1810	Makita® Power Scraper Hackout Gun
7982645	Replacement 2" (51 mm) Scaling Chisel*
7982653	Replacement 1-3/16" (30 mm) Scaling Chisel*
7982661	Replacement Bull Point Chisel*

Minimum order: 1 each. *Included in kit.

CRL Wildcat Sealant Cutter and Putty Remover



- Uses 6.3 cfm, 75-90 psi Air Supply
- Oscillates Up to 20,000 Times Per Minute

The CRL Wildcat Pneumatic Caulking-Sealant Cutter and Putty Remover quickly cuts out old sealant from expansion joints and chips away hardened putty from metal sash. The variable speed trigger allows the cutting blades to oscillate up to 20,000 times per minute for virtually effortless cutting and putty removal.

The Kit includes: the Wildcat Pneumatic Tool; two each Caulk Cutting, Sealant Cutting, and Putty Removal Blades; Sharpening Stone, Blade Wrench, and a molded Carrying Case with Tote Tray. The Wildcat Tool may also be used with our variety of automotive blades for cutting out windshields, sidelites, and backlites. Minimum order is one each.

CAT. NO. AK40

CRL Putty Remover



- Removes Hardened Putty Without Damaging the Glass or Sash
- Fits Any 1/4" to 3/8" Electric Drill

Our CRL Putty Remover is the newest and easiest way to remove hardened putty. No need to remove the glass from the frame because the Putty Remover's carbide blade is designed to clear the glazing points as it literally chews up the old putty. No more hand chipping, just insert the Putty Remover into your 1/4" or 3/8" (6 or 9.5 mm) electric drill. A notched, T-shaped sleeve guides it along the surface of the window sash. An adjustable collar controls the depth of the cut. The Putty Remover's handle lets you pull the drill along steadily as the putty is being removed. Minimum order is one each.

CAT. NO. PR9000

CRL Aluminum and Steel Window Frame Extractor

- Removes Aluminum and Steel Window Frames in Minutes, Not Hours
- Reduces Clean Up Time



The CRL Window Frame Extractor pulls aluminum and steel frames from existing stucco, wood or siding structures. It can remove patio door frames as easily as window frames for installation of flush fin, block frame, and other retrofit window applications. Clean up time is reduced, and little or no stucco patching is required. Comes with nylon carry bag. Minimum order is one each.

CAT. NO. WFE

CRL Stop Mold Puller

- Reduces Your Chance of Breaking Glass While Pulling Stop Molds
- Solid Steel Construction
- Simple and Easy

The CRL Stop Mold Puller is used to remove stop molds or snap-on sash. It works on both door and tube stops, and makes removing window units easy. The rubber-lined pad will not damage metal extrusions. It's a reliable and inexpensive tool every glazier should own. Minimum order is one each.

NOTE: Always wear the proper protective eyewear when using this product.



CAT. NO. SMP200

CRL Hot Air Gun Kit

- Dual Heat and Fan Settings
- Excellent for Use in Putty Removal
- Five-Piece Paint Scraper Kit – Shavehook Scraper Handle With Three Blades, Plus Flat Paint Scraper

This CRL Hot Air Gun Kit has dual heat and fan settings: 1000 W - 375°C/700°F and 1500 W - 495°C/925°F. This 110V AC Hot Air Gun is excellent for use in putty removal, paint removal, plastic pipe welding, and other jobs that require concentrated hot air. 240 Volt model (Cat. No. LD121AU) also available. Minimum order is one each.



CAT. NO. LD121

CRL Milwaukee® Heat Gun

- Variable Temperature Range With Heat Adjustment Dial
- Ideal for Removing Residual Moisture After Cleaning
- Excellent for Use in Putty Removal

Soften old putty quickly and reliably with this variable temperature Heat Gun. It offers a range from 200° to 1050°F (93° to 565°C) that is controlled with a heat adjustment dial. The electrical heat control allows extra reduction of airflow for more accurate and concentrated heat location without damage to the heating element. Gun is also excellent for use in paint removal, plastic pipe welding, and other jobs that require this type of tool. Double insulated 110V AC tool features a unique impact resistant heating element. Minimum order is one each.



CAT. NO. UV8978

CRL Propane Torch With Pencil Point Burner

- Propane Fuel Cylinder
- Standard Pencil Point Burner
- Anti-Clog Filter

You get professional results and greater efficiency with this CRL Hand Held Torch. It comes complete with Propane Fuel Cylinder, Pencil Point Burner, and Burner Valve Assembly. The unit also includes an anti-clog filter which eliminates fuel flow interruptions. This is a good general purpose torch with many uses. **NOTE:** Item cannot ship via any small package carrier like UPS or Fed Ex Ground. Must ship via common carrier, or may be picked up at any CRL location.



CAT. NO.	DESCRIPTION
UL100	Complete Propane Torch Kit
LP1759	Propane Cylinder Only
UL2317	Pencil Point Burner Assembly Only

Minimum order: 1 each.

CRL Self-Igniting Torch Kit

- Propylene Fuel Cylinder
- Adjustable Flame Settings
- Burn Tube Rotates 360 Degrees

new



This compact hand-held CRL Self-Igniting Torch Kit gives you instantly adaptable brazing and flame control. A push button ignitor activates the torch, and the solid brass regulator valve has an adjustable control knob. The torch comes with brazing-hot Propylene fuel and can also be used with LP1759 Propane. The stainless steel burn tube rotates 360 degrees for easy use.

NOTE: Item cannot ship via any small package carrier like UPS or Fed Ex Ground. Must ship via common carrier, or may be picked up at any CRL location. Minimum order is one each.



CAT. NO. TS839Z

CRL Solder-It™ Micro-Jet™ Butane Torch

- Pocket Size Torch Reaches Temperatures to 2400° F (1315.5° C)



new

The pocket-size CRL Solder-It™ Micro-Jet™ Butane Torch softens hardened putty to make removal easier. It also quickly clears moisture from cracks in concrete for preparation of sealant application, and can be used to accelerate curing. Includes refillable cell. Butane refills are easily found in retail stores. **NOTE:** Item cannot ship via any small package carrier like UPS or Fed Ex Ground. Must ship via common carrier, or may be picked up at any CRL location. Minimum order is one each.



Butane Cell

CAT. NO. 2002400

CRL Self-Igniting Propane Torch Head

- Just Press Button to Start
- Excellent for Softening Hardened Putty

- Burn Tube Rotates 360 Degrees

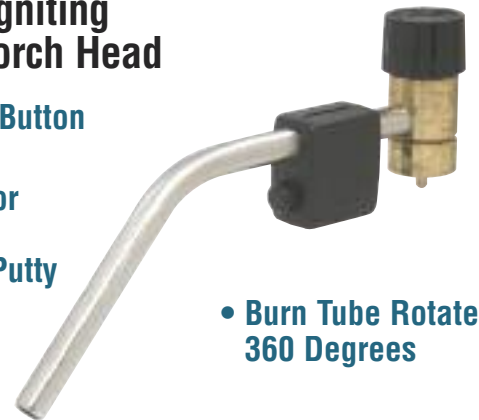

The CRL Self-Igniting Propane Torch Head requires just the touch of a button to ignite. Use it with any standard propane fuel cylinder to produce a quick heating, high-energy flame for cutting and soldering applications, or for softening putty. Minimum order is one each.

CAT. NO. HT802

CRL Hose Torch Kit

- Fits Standard Propane Cylinders
- 60" (1524 mm) Hose
- Excellent for Softening Hardened Putty

CRL's Hose Torch Kit has an instant on/off igniter for simple, one-handed operation, and an adjustable flame control knob for ease in switching between different applications. The stainless steel burn tube provides durability, and the lock button keeps the Torch lit for finger-free use. The CRL Torch Kit includes: Trigger Start Hose Torch, Fuel Cylinder Holster with Burn Tube Holder, Quick Cylinder Release, Belt Clip and Carrying Handle. Fuel Cylinders must be ordered separately. Minimum order is one each.

new



Fuel Cylinder Not Included

CAT. NO. BZ8250HT

CRL E.Z.D. Glazer De-Glazing Tool

- Aids in the De-Glazing of Glass Installed With Silicone, Foam Tapes, Butyl Tapes, and Other Flexible Materials
- Blade Lays Flat on the Glass and Slides Into the Glazing Pocket
- Extremely Simple to Use

The CRL E.Z.D. Glazer De-Glazing Tool is a real time-saver. This simple-to-use tool is designed to aid in the de-glazing of glass bedded into materials commonly used in the window industry, including silicone, foam or butyl tapes, and other materials engineered to remain flexible throughout their service life (not recommended for use with glazing putty or other materials that harden over time). The EZ1010 goes to work when you lay the cutting blade flat on the glass surface and slide it into the glazing pocket. The glazing material is separated from the glass as you roll the tool along the entire length of the pocket. For tight fits you can facilitate the cutting process by adding soapy water or a light lubricant (Cat. No. SLK1QT) to the blade. A built-in hand guard lets you work right next to the glass for good leverage and a deep cut when needed. The E.Z.D. Glazer is simple, effective and priced right.

For newer models (screw-on blade) use Cat. No. EZ1022 for the correct replacement blade. For older style (weld-on) blades use Cat. No. EZ1011 replacement blade. The plastic hand guard is also replaceable by ordering Cat. No. EZ10G.



CAT. NO.	DESCRIPTION
EZ1010	E.Z.D. Glazer De-Glazing Tool
EZ1011	Replacement Blade (Old Style – Welded)
EZ1022	Replacement Blade (New Style – Threaded)
EZ10G	Replacement Hand Guard

Minimum order: 1 each.

CRL Window De-Glazing Tool

- Provides Extra Leverage to Remove Glass Safely and Easily
- Extremely Durable All-Aluminum Construction



The CRL WT2000 Window De-Glazing Tool is designed for the safe and easy removal of glass lites from their frames. This tool offers you advantages over manual methods because the large handle allows a positive two-hand grip for extra leverage while the heat treated blade cuts through the toughest of sealants. The WT2000 has a three-position handle for easy access to windows at almost any angle or height.

All parts of the WT2000 are replaceable, including the heavy-duty aluminum handle. The blades are sharpened to a razor's edge, and heat treated for strength and longevity. The WT2000 comes complete with handle and one each left hand Cat. No. WT2002 and one each right hand Cat. No. WT2001 Blades.



CAT. NO. WT2000



CAT. NO. WT2001



CAT. NO. WT2002

CAT. NO.	DESCRIPTION
WT2000	Window De-Glazing Tool
WT2001	Right Replacement Blade
WT2002	Left Replacement Blade
WT2003	Handle Only for WT2000

Minimum order: 1 each.

CRL Pipe Handle Cut-Out Knife



18" Xtra Long Knife

13" Standard Knife

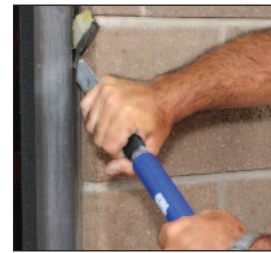

Old Style Blade Plate

New Style Blade Plate

• Our Most Popular Long Knives Are Available in Two Lengths

The round, cast aluminum handle of our most popular Long Knife is easy to grip, and utility knife blades change out in just seconds. Tool length can be extended by adding a length of standard conduit pipe. Extra blades can be stored in the handle. Uses either 1992C or 1991C Utility Knife Blades, or 1993X10 Extra Long Utility Knife Blades (see page N243). The Blade Plate and Screw are also replaceable.

CAT. NO.	DESCRIPTION
PK19	Standard 13" (330 mm) Pipe Handle Knife
PK19XL	Xtra Long 18" (457 mm) Pipe Handle Knife
PK19PS	Old Style Blade Plate Replacement
PK19NS	New Style Blade Plate Replacement

Minimum order: 1 each.

CRL Rigid Aluminum Long Knives

- Heavy-Duty Aluminum Shafts
- Uses Utility Knife Blades

These CRL Rigid Aluminum Long Knives use our 1992C and 1993X10 Heavy-Duty Utility Knife Blades (see page N243) to cut through hardened sealants with ease. Order Cat. No. UKSCREW for the Replacement Blade Screw.

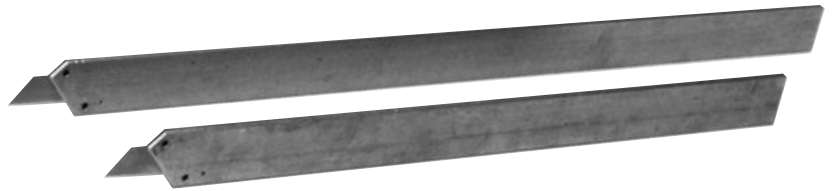

CAT. NO.	DESCRIPTION
UK18	18" (457 mm) Long Knife
UK24	24" (610 mm) Long Knife

Minimum order: 1 each.

CRL Sur-Grip 18" Long Knife



- Foam Grip for Comfort
- Painted Steel Shaft

The CRL Sur-Grip 18" Long Knife offers you comfort with control. The 18" (457 mm) length is perfect for reaching those overhead areas for easy cut-outs. The soft, urethane foam grip provides a positive grasp of the tool, which relates to better control for safer cutting action. It features quality construction throughout, with a powder-coated, baked-on black crinkle painted steel shaft attached to painted steel tubing. Uses either 1992C or 1991C Utility Knife Blades or 1993X10 Extra Long Utility Knife Blades (see page N243). Minimum order is one each.

CAT. NO. HT531

CRL 24" Long Knife



- Rigid Flat Stock Aluminum With Molded Grip

The CRL 24" (610 mm) Long Knife features rigid 1" (25 mm) flat stock aluminum construction, and is finished with a powder-coated, baked-on black crinkle paint that provides a better gripping surface than unfinished aluminum. Uses either 1992C or 1991C Utility Knife Blades, or 1993X10 Extra Long Utility Knife Blades (see page N243). Minimum order is one each.

CAT. NO. HT532

CRL Flexible Long Knife



- Flexes to Glass Curvature
- Rubber Grip

The CRL Flexible Long Knife has a 14" (355 mm) flexible metal shaft that provides extra leverage for difficult cut-outs. Uses our 1992C Heavy-Duty Utility Knife Blades or 1993X10 Extra-Long Utility Knife Blades (see page N243). Minimum order is one each.

CAT. NO. CRL1119

CRL Super-Grip Aluminum Long Knife



- Finger-Grip Handle for a Sure Grip
- Works Well in Tight Spaces

The CRL 9" (228 mm) Super-Grip Aluminum Long Knife has finger grooves for a sure grip. It uses our 1992C and 1993X10 Heavy-Duty Utility Knife Blades (see page N243) to cut through hardened sealants, and works especially well in tight spaces. Minimum order is one each.

CAT. NO. UK9

CRL Standard Retractable Blade Utility Knife



- Three Position Heavy-Duty Slider Actuation
- Overlapping Nose for Safety

This CRL Standard Retractable Blade Utility Knife has a safety overlap that keeps the blade from slipping between the handle halves, an important safety consideration. It is supplied with four blades, and uses any of our CRL Utility Knife Blades (see page N243), which must be purchased separately. Minimum order is one each.

CAT. NO. 97K

CRL Stanley® Heavy-Duty Retractable Blade Utility Knife



- Industrial Quality
- Retractable Blade

This CRL Stanley® Heavy-Duty Retractable Blade Utility Knife features a five-position slide and heavy-duty metal body. It is supplied with three heavy-duty blades, and uses any of our CRL Utility Knife Blades (see page N243), which must be purchased separately. Minimum order is one each.

CAT. NO. 99

CRL Heavy-Duty Fixed Blade Utility Knife



- Industrial Quality Die Cast Handle
- Comes With Five Blades

This CRL Heavy-Duty Fixed Blade Utility Knife is a basic, easy-to-use knife with a fixed blade. For the shop that uses and loses a lot of knives, this inexpensive model is an ideal purchase. It is supplied with five standard blades, and uses any of our CRL Utility Knife Blades (see page N243), which must be purchased separately. Minimum order is one each.

CAT. NO. 199

CRL Autoloading Utility Knife

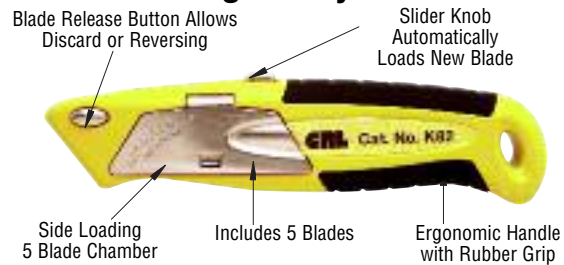

- Easy, Quick Blade Replacement

The CRL Autoloading Utility Knife is ergonomically designed and easy to use. The spring-loaded blade housing lets you change blades without the need for tools. Its safety yellow color is easily visible wherever you might leave it. The rubber inserts in the handle give you an improved grip. It is supplied with five 1992C blades, and uses any of our CRL Utility Knife Blades (see page N243), which must be purchased separately. Minimum order is one each.

CAT. NO. K82

CRL Stanley® FatMax™ Swivel-Lock Fixed Blade Utility Knife



- Quick Blade Change – No Tools Required
- Ergonomic Design

This CRL Stanley® FatMax™ Swivel-Lock Fixed Blade Utility Knife swivels open so you can change the blade without using tools. The thumb dial locks the blade in place, and there is a magnet in the nose to hold the blade while the knife is open. It has a cast metal core with soft panels for a comfortable grip, and comes with three heavy-duty utility knife blades stored in the handle. It uses any of our CRL Utility Knife Blades (see page N243), which must be purchased separately. Minimum order is one each.

CAT. NO. ST10799

CRL Heavy-Duty Retractable Blade Utility Knife



- Safety Orange Color
- Industrial Quality

This CRL Heavy-Duty Retractable Blade Utility Knife is a quality knife designed to better fit the hand with vertically recessed ribs for a more comfortable grip. The heavy-duty, die cast zinc handle features a safety nose with top and bottom over-lap, providing additional security by preventing the blade from slipping between each half of the handle. A zinc retractor makes for smoother operation and has three cutting positions. It is supplied with three heavy-duty blades, and uses any of our CRL Utility Knife Blades (see page N243), which must be purchased separately. Minimum order is one each.

CAT. NO. 82L

CRL Heavy-Duty Utility Knife Blades

- Our Best Selling Utility Blade
- Heavy-Duty .025" Thick Blade

CRL Heavy-Duty Utility Knife Blades fit all standard, heavy-duty, and retractable blade utility knives. These .025" (.64 mm) thickness blades are made to withstand heavy use and abuse. Available in 10 and 100 Blade Dispensers.

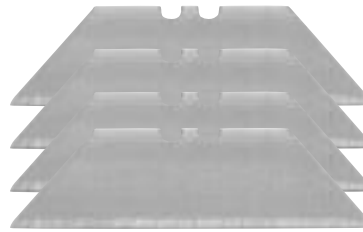

1992X10
10 Blade Dispenser



1992C
100 Blade Slide-Out Dispenser

CAT. NO.	DESCRIPTION
1992C	100 Blade Dispenser
1992X10	10 Blade Dispenser

Minimum order: 1 box 1992C; 1 pack 1992X10.

CRL Standard Utility Knife Blades

- Fits Virtually All Utility Knives
- .018" Thick Standard Blade

CRL Standard Utility Knife Blades fit virtually all standard and heavy-duty retractable blade utility knives. They are available in 100 blade dispensers with a standard .018" (.46 mm) blade thickness.



1991C
100 Blade Dispenser
(20 5-Packs)

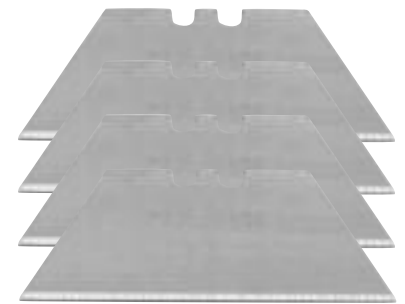

CAT. NO.	DESCRIPTION
1991C	100 Blade Dispenser

Minimum order: 1 box.

CRL Extra Long Utility Knife Blades

- Extra Long Blade Ideal for Long Handle Knives
- Heavy Thickness Blade for Cut-Outs

CRL Extra Long Utility Knife Blades fit all Long Handle Knives that use Utility Blades. They have an exposed cutting edge of 3-3/4" (95 mm), more than double the cutting edge of standard utility knife blades. Available in .025" (.04 mm) blade thickness.



CAT. NO.	DESCRIPTION
1993X10	10 Blade Pack

Minimum order: 1 pack.

CRL Extra Long Serrated Blades

- Faster Cutting of Hardened Sealants and Putties
- Extra Long Blade Ideal for Long-Handle Knives

CRL Extra Long Serrated Blades measure a full 4-1/8" (105 mm) long with a .025" (.04 mm) blade thickness. One of the longest blades available and, with the serrated edge, one of the fastest cutting.



CAT. NO.	DESCRIPTION
SB418	10 Blade Pack

Minimum order: 1 pack.

CRL Olfa® Heavy-Duty Retractable Blade Knife

- Comfortable Rubber Grip
- All-Purpose Knife

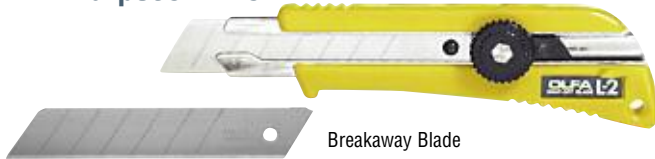

Breakaway Blade

This CRL Olfa® Heavy-Duty Retractable Point Knife features a high-impact plastic handle and stainless steel blade housing. The positive locking thumb screw allows the blade to be set to your desired length. Uses LB10B, LB50B and LS0L Replacement Blades shown below. Minimum order is one each.

CAT. NO. L2K

CRL Olfa® Long Reach Retractable Blade Knife

- Designed for Hard-to-Reach Places
- Comfortable Rubber Grip

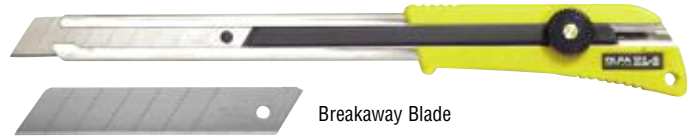

Breakaway Blade

The CRL Olfa® Long Reach Retractable Point Knife was designed with hard-to-reach places in mind. It has a locking thumbscrew, stainless steel housing and rubber grip which provide safety and needed comfort. Uses LB10B, LB50B, and LS0L Replacement Blades shown below. Minimum order is one each.

CAT. NO. XL2

CRL Olfa® Super Heavy-Duty Retractable Blade Knife

- Large 1" Wide Blade



Breakaway Blade

This CRL Olfa® Super Heavy-Duty Knife was designed for the toughest of jobs with a .028" (.7 mm) thick blade that will extend a full 4" (102 mm). A rubber grip handle on the back side provides a non-slip surface for safety and comfort. The H1K uses the heavy-duty 1" (25 mm) wide HB5B Blade shown below. Minimum order is one each.

CAT. NO. H1K

CRL Olfa® Stainless Steel Shirt Pocket Knife

- Fits Into Small Places



Breakaway Blade

The CRL Olfa® Stainless Steel Shirt Pocket Knife is a slim, compact knife that is great for cutting urethane, silicone, boxes and more. Although this knife is compact, quality was not forgotten. The SVR1 housing is made of stainless steel. The pocket clip doubles as a device to snap away the used section of the blade. Cat. No. AB10S replacement blades are shown below. Minimum order is one each.

CAT. NO. SVR1

CRL Stanley® Quick-Point™ Pocket Knife



This CRL Stanley® Quick-Point™ Pocket Knife has a retractable blade that snaps at scored intervals. Each time you snap off a prescored section you get a fresh, new sharp cutting surface. The reinforced plastic body is sturdy and lightweight with a pocket clip. Cat. No. ST11300 Replacement Blades are shown below. Minimum order is one each.

CAT. NO. ST10150

CRL Stanley® Pocket Knife

This rugged, polished, chrome plated CRL Stanley® Pocket Knife with a cutlery stainless steel Blade and a safety lock feature. This ergonomically designed grip adds to the ease of use and performance. The Blade is easily replaceable. Knife and Replacement Blade come individually carded.



CAT. NO.	DESCRIPTION
ST10049	Pocket Knife
ST11041	Replacement Blade

Minimum order: 1 each.

CRL Replacement Blades

- Blades Fit CRL Retractable Knives and Other Similar Brands

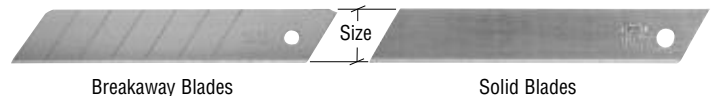

Breakaway Blades

Solid Blades

These CRL Replacement Blades are intended for use with the various Retractable Knives show on this page, as well as other similar brands. The breakaway feature allows the dull point to be snapped off to get a fresh, new sharp cutting surface.

CAT. NO.	BLADE TYPE	WIDTH	PACK QTY	FITS KNIFE
AB10S	Breakaway	3/8" (9.5 mm)	10	SVR1
HB5B	Breakaway	1" (25.4 mm)	5	H1K
LB10B	Breakaway	3/4" (18 mm)	10	L2K, XL2
LB50B	Breakaway	3/4" (18 mm)	50	L2K, XL2
LS0L	Solid	3/4" (18 mm)	10	L2K, XL2
ST11300	Breakaway	3/8" (9.5 mm)	3	ST10150

Minimum order: 1 pack.

CRL Swift Switch Utility Knife

- Easily Replaceable Blades
- Includes a Knife Holster



The CRL Swift Switch Utility Knife is ergonomically comfortable and easy to use. Its safety orange color is easily visible wherever you might leave it. It is supplied with a handy holster for safe storage. The CRL Swift Switch Utility Knife uses any of our CRL Utility Knife Blades (see page N243), which must be purchased separately. Minimum order is one each.

CAT. NO. 03832

CRL Stanley® SportUtility™ Knife **new**

- Two Knives in One
- 3-1/2" Cutlery Grade Stainless Blade
- 3-Position Retractable Utility Blade

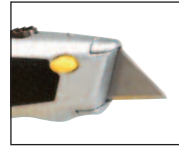

This CRL Stanley® SportUtility™ Knife features both a 3-1/2" (89 mm) cutlery grade stainless steel blade for durability and rust-resistance, and a three position retractable utility blade that works like a traditional utility knife. The Knife is supplied with a nylon storage sheath and a 10 pack blade dispenser. The SportUtility™ Knife uses any of our CRL Utility Knife Blades (which must be purchased separately) shown on page N243. Minimum order is one each.

CAT. NO. ST10804

CRL Linoleum Utility Blade

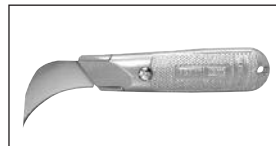

Shown with Cat. No. 199 Utility Knife (sold separately)

- Blade Fits in Most Non-Retractable Knives
- Used to Cut Linoleum, Ceiling Tile, Cartons, Wallboard, and More

Tempered high-carbon steel blade with keen edge for clean, true cuts in vinyl or linoleum floor covering, roofing and similar materials. For fixed non-retractable blade Utility Knives such as Cat. No. 199 (see page N242). Minimum order is one each.

CAT. NO. 3153

CRL Hook End Utility Blades

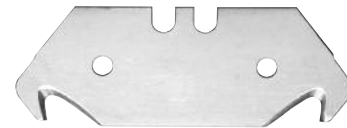

- Heavy-Duty Hook End Blade
- Fits All Standard Utility Knives

When removing encapsulated windshields, this blade is perfect for cutting away the encapsulation. CRL Hook End Utility Blades fit all standard utility knives (see page N242).

CAT. NO.	DESCRIPTION
1996C	Hook End Blades - Pack of 100
1996X10	Hook End Blades - Pack of 10

Minimum order: 1 package.

CRL Craftsman Knife



- Ideal for Making Precision Cuts
- Supplied With Extra Blades

Craftsmen, artists, technicians, and all others who require small precision cuts will find this strong all aluminum CRL Craftsman Knife easy to work with. Uses for the Knife include: scribing, etching, cutting stencils, layout and paste up work, hobby cutting, as well as other types of intricate work. It is supplied with five extra blades. Minimum order is one each.

CAT. NO. 450001

CRL Craftsman Replacement Blades

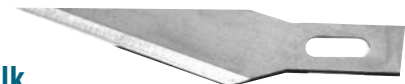

- Carded or Bulk
- Fits 450001 Craftsman Knife

CRL Craftsman Replacement Blades are used with the Cat. No. 450001 Craftsman Knife. They are ideal for hobbyists, craftsmen, artists, technicians, and anyone that needs to make intricate cuts.

CAT. NO.	DESCRIPTION
45111C	5 Blade Pack
45111P	100 Blade Box

Minimum order: 1 package.

CRL Single Edge Razor Blades

- Our Most Popular Single Edge Blade
- Precision Honed, Surgical Steel Edges
- Each Blade is Individually Wrapped
- Multiple Uses

This CRL Single Edge Razor Blade is top quality, industrial grade, .009" (.23 mm) thick, Carbon C-1095 surgical steel, precision-honed for extra sharpness. It delivers durability along with the exacting, quality cut that professionals demand. Packed 100 each per box, there are 50 boxes per case. Each blade is individually wrapped to protect the edge until you are ready to use it. Also available in packs of ten, loaded in a handy, spring loaded plastic disposable pack. Minimum order is 100 each of the 51S blades and one each of 112020 dispenser.



CAT. NO. 112020
Plastic Dispenser 10 Pack

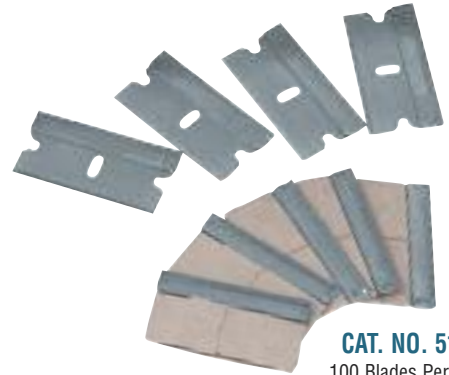

CAT. NO. 51S
100 Blades Per Box



CRL Heavy-Duty Industrial Single Edge Razor Blades

- Single Edge Blades With No Notch
- Heavy-Duty .012" Thick Carbon Steel
- For Use in Paint Scrapers and Mat Cutters

Our CRL Heavy-Duty Razor Blades are primarily used when the job requires a stronger blade. They are more rigid than our regular razor blades because of their .012" (.31 mm) thick steel construction and no side notches. Their extra rigidity also makes them great for tough scraping jobs. Packed 100 per box. Minimum order is 100 each.



CAT. NO. KKB12

CRL Plastic Razor Blades

- Single or Double Edge Styles



CAT. NO. CP866088
Single Edge Blades



CAT. NO. CRL3000
Double Edge Blades

These CRL Plastic Razor Blades won't harm plastic coated windows or other hard surfaces that can be scratched or marred by metal razor blades. They are also useful for working on painted surfaces or chrome, and for removing decals, pin stripping, or window tint film. The new Double Edge Blade has very thin, yet stiff edges for delicate scraping jobs. Choose from single edge or double edge versions to fit your razor blade scraper (see opposite page). Both are sold 100 per package. Minimum order is one package.



CRL Heavy-Duty Razor Blade Scrapers

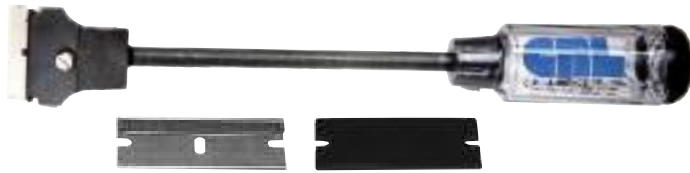

The overall length of this Scraper is 11" (279 mm). It comes with one steel and one plastic razor blade in the hollow handle. Blade is secured by a single set screw. Minimum order is one each.

CAT. NO. CRL761

- Perfect for Scraping or Sticker Removal
- Holds Both Metal and Plastic Razor Blades



The overall length is 11" (279 mm). It comes with one steel and one plastic razor blade in the hollow handle. Spring clamp holds blades securely and makes changing easy. Minimum order is one each.

CAT. NO. L52000

CRL Safety Razor Blade Holder and Window Scraper

- Safely Holds All Single Edge Razor Blades

For a safe and simple way to hold single edge razor blades try our Safety Razor Blade Holder and Window Scraper. Instantly expose or conceal the blade with a simple thumb lock. All metal tool will withstand lots of use, and has a hole in the end so you can hang it up. Overall length is 4-1/2" (114 mm). Scrapers are available individually, or in bulk boxes of 100 each.



CAT. NO.	DESCRIPTION
3223	# Individual Scraper
115000	*Carton of 100 Scrapers

Minimum order: 1 each. *Minimum order: 100 each.

CRL Razor Blade Holder and Scraper

The CRL Razor Blade Holder and Scraper is a safe and easy way to handle single edge metal razor blades for all your scraping jobs. The blade end is molded into a plastic handle that provides a comfortable and sure grip, with a metal ferrule so you can hang it up. There is also a slip-on safety cover for the blade edge. Holds our 51S and KKB12 Single Edge Razor Blades (see page N246). Overall length is 6-1/2" (165 mm). Minimum order is one each.



- Safely Hold Single Edge Metal Razor Blades
- Comfortable Handle for a Sure Grip

CAT. NO. RS65

CRL Carton Cutter



- Uses CRL 51S Single Edge Razor Blades
- Safe and Economic Way to Hold Razor Blades

This CRL Razor Blade Carton Cutter Tool is a safe and economical way to handle single edge razor blades for cutting and scraping. Very commonly used for opening boxes or when scraping windows of paint and labels. It uses Cat. No. 51S Single Edge Razor Blades (see page N246). Minimum order is one each.

CAT. NO. 183100

CRL Razor Blade Knife



- Easy Way to Handle Single Edge Razor Blades

This CRL Razor Blade Knife is a safe and easy way to handle single edge razor blades for cutting and scraping. Very commonly used when scraping walls, windows, paint, and labels. This Knife is compatible with our Cat. No. 51S Single Edge Razor Blades (see page N246). Minimum order is one each.

CAT. NO. 117200

CRL Ultra-Thin Combination Knife

new



• Multiple Functions in Ultra-Thin Design

This CRL Ultra-Thin Combination Knife is compact and thin enough to fit comfortably in a pocket or on a work belt. The unique design enables the user to simply roll the tool in their hand to switch between utility and knife blade. It also easily converts to a screwdriver by inserting the included Phillips and slotted driver bits. Minimum order is one each.

CAT. NO. CK3N1

CRL Safety Slitter



• Safely Cuts Stretch Film, Plastic Straps, and Sheets

The CRL Safety Slitter Knife is injection molded from indestructible glass-filled nylon material. Rotation of the high-quality carbon slitter blade provides four cutting edges per blade. The safety beak allows for easy hooking and guiding when slitting a variety of materials.

CAT. NO.	DESCRIPTION
20027	Safety Slitter Knife
20027B	Replacement Blades - 10 Pack
Minimum order: 1 each.	

CRL Roofing Knife



• Ideal for Cutting Shingles, Linoleum, Tile, and Plastic

Our CRL Roofing Knife holds a specially designed Cat. No. 412100 blade with four ground cutting edges. The Knife is ideal for cutting linoleum, floor tile, shingles, plastic sheeting, and many other materials. The heavy gauge steel casing includes three heavy-duty blades that adjust to the exact depth required.

CAT. NO.	DESCRIPTION
777700	Roofing Knife
412100	Replacement Blades - 5 Pack
Minimum order: 1 each.	

CRL Super Scraper Tool



• Surgically Sharp Replaceable Blades Are Available in Three Widths

The CRL Super Scraper saves you the time it takes to stop and sharpen your scraper blades. Our Blades are surgically sharp and inexpensive to replace. The built-in quick blade release lets you change the Blade in seconds. The CRL Super Scraper has a lightweight aluminum shaft with a flip-top handle that stores extra Blades. It comes with five 1/2" (13 mm) wide Blades and a blade cover for safety.

CAT. NO.	DESCRIPTION
SC300	Super Scraper Tool with Five Blades
SC301	5-Pack of 1/2" (13 mm) Wide Blades
SC302	5-Pack of 5/8" (16 mm) Wide Blades
SC303	5-Pack of 3/4" (19 mm) Wide Blades
Minimum order: 1 each.	

CRL Utility Blade Scraper



• Safely Holds CRL 1992C Utility Knife Blade

This CRL Utility Blade Scraper is a safe and easy way to handle CRL 1992C Utility Knife Blades (see page N243) for cutting and scraping. They are very commonly used when scraping walls, windows, paint, and labels. Minimum order is one each.

CAT. NO. 337000

CRL Multi-Knife Scraper Blade and Handle

CAT. NO. RSB75
Tempered Steel Blade



CAT. NO. 1MKH

Blade Shown in 1MKH Handle
(Each Sold Separately)



• Blade Fits Multi-Knife Handle and Most Standard Cold Knife Handles

The CRL Multi-Knife Scraper Blade, when used with the CRL 1MKH Multi-Knife Handle, offers you control and safety. This Blade will also fit most other standard cold knife handles. Made of tempered steel to maintain its cutting edge. Blade measures 3/4" x 4-3/4" (19 x 120 mm). The CRL Multi-Knife Handle is ergonomically designed with a strong aluminum body, wrapped in a neoprene rubber grip for comfort and control. Minimum order is one each.

CRL Silicone Remover and Surface Prep

- Ideal for Removing Uncured and Many Cured Silicones
- Prepares Surfaces to Be Sealed, Painted or Bonded
- VOC Exempt

CRL Silicone Remover and Surface Prep is the long-needed answer to uncured silicone clean up. This spray works simply and easily. Spray on and it instantly dissolves silicone film! Just wipe the surface clean with a lint free wipe, or for tough jobs use our NP48 Open Cell Pads. SR200 is also a degreaser that removes uncured silicone residue, grease and most oils without leaving any residue when prepping for painting, sealing, and bonding applications. It is safe on plastic, paint, glass, and is noncorrosive to metals. Contains no VOC, and does not deplete the ozone layer.

SR200 is low in toxicity and essentially odorless. Dries as fast as isopropyl alcohol. Also softens and removes many cured silicones. Spray or wipe it on, let soak, then scrape before the material dries; reapply and wipe with a clean cloth. Typical applications include cleaning plastics and fiberglass; pre-cleaning surfaces prior to painting, sealing, and bonding; removing silicone-based car wax and protectants; and pressure sensitive adhesives (labels). Minimum order is one each.



CAT. NO. SR200

CAT. NO. CK1T3
Silicone Clean Up Kit

KIT INCLUDES: One bottle of Cat. No. SR200 Silicone Remover; one box of 150 Cat. No. BX15 Wipes; and one pack of 20 Cat. No. NP48 Open Cell Pads

CRL Quick Release Agent

- Quick Release of Most Adhesives
- Softens Butyl and Other Sealants

CRL Quick Release Agent is a solvent blend designed to loosen or dissolve most adhesives. It softens or undercuts butyl, oil-based, and polyurethane sealants.



CAT. NO.	NET WEIGHT	QTY/CASE
CRL958	14 Oz. (397 g)	12

Minimum order: 1 each.

CRL Dow Corning® Silicone Cleaner and Surface Prep

- Ideal for Removing Uncured Silicone and Many Cured Silicones

CRL Dow Corning® Cleaner and Surface Prep Solvent is based on a unique blend of siloxanes that can dissolve silicone oils, soften and swell silicone residue, and undercut dirt and greases. It is also used as a cleaning solvent for painting, sealing, and bonding operations.

Remove cured silicone by scraping away as much as possible, then apply OS2, let soak for two minutes minimum, and then remove with a clean cloth. OS2 is VOC exempt.



CAT. NO.	NET WEIGHT	QTY/CASE
OS2	10 Oz. (283 g)	12

Minimum order: 1 each.

CRL Pure Gum Turpentine

- 100% Pure Gum
- Dissolves and Removes Oil, Grease, Tar, and Wax

This CRL Pure Gum Turpentine is used for thinning oil-based paints, and will dissolve and remove oil, grease, tar, and wax. Softens many adhesives and sealants to aid in their removal.



CAT. NO.	CONTENTS	QTY/CASE
PGT1	1 Gal. (3.785 l)	4

Minimum order: 1 gallon.

CRL Solvent Cleaner and Degreaser

- Excellent Spray Cleaner for Uncured Sealants, Grease, Tar, Crayon, and Ink

CRL Solvent Cleaner and De-Greaser removes uncured sealants, grease, tar, adhesive marks, crayon, lipstick, ink, and fresh paint along with many other types of dirt and grime. CRL60 is also excellent for removing spots from fabrics, rugs and clothing.



CAT. NO.	NET WEIGHT	QTY/CASE
CRL60	20 Oz. (567 g)	12

Minimum order: 1 each.

CRL Molsenbocker's Lift Off® Removers

- Stain Removal Made Easy With Specialized Formulas for the Toughest Stains
- Excellent Results on the Job, in the Shop, or in the Home



Lift Off® 2 for Grease, Oils, and Adhesive

CRL Lift Off® 2 is a petroleum-based, commercially proven formula that effectively removes such items as adhesives, grease, tar, motor oil, gum, sap, and oil-based foods. The 22 fluid ounce (650 ml) pistol-grip bottles are attractive for over-the-counter sales. Minimum order is one each.



CAT. NO. LF2

Lift Off® 3 for Pen, Ink, and Marker

CRL Lift Off® 3 is a biodegradable and water-based product designed to remove most inks including: permanent markers, indelible inks, ball point pens, hi-liters, stamp pads, and fountain inks. The 22 fluid ounce (650 ml) pistol-grip bottles are attractive for over-the-counter sales. Minimum order is one each.



CAT. NO. LF3

Lift Off® 4 for Spray Paint Graffiti

CRL Lift Off® 4 is the first biodegradable, water-based spray paint graffiti remover. It actually breaks the molecular bond between the paint and hard, soft, or porous surfaces without damaging them. The 22 fluid ounce (650 ml) pistol-grip bottles are attractive for over-the-counter sales. Minimum order is one each.



CAT. NO. LF4

CRL Adhesive Solvent

- Cleans Up Storm Window Adhesives

CRL Adhesive Solvent is used to clean up or thin Cat. No. C205GL CRL Storm Window Adhesive, as well as many other adhesives. **NOTE:** Always use care and caution when working with solvents.



CAT. NO.	CONTENTS	QTY/CASE
C215GL	1 Gallon (3.785 l)	6

Minimum order: 1 gallon.

CRL Disposable Nitrile Gloves

- Provides Resistance Against Solvents
- Powder Free



CRL 100% Nitrile Gloves provide better protection against solvents, resists a broad range of chemicals, gives greater puncture resistance than comparable natural rubber and vinyl disposable gloves, and reduces hand pressure and fatigue caused by elastomeric stress (making them almost therapeutic for your hands).

CAT. NO.	SIZE	QTY/BOX
7005SM	Small	100
7005MD	Medium	100
7005NG	Large	100
7005XL	X-Large	100

Minimum order: 1 box. All gloves on this page can be combined for quantity pricing.

CRL Black Nitrile Gloves

- 100% Latex Free With No Powder
- Textured Surface for Superior Grip
- Excellent Puncture and Tear Resistance
- Resistant to Solvents

new



CRL's Black Nitrile Gloves are the alternative for those who are allergic to natural rubber latex. The textured surface makes them an excellent choice for the glass fabrication industry in both wet and dry applications. These gloves provide puncture, tear, and chemical resistance while allowing excellent dexterity.

CAT. NO.	SIZE	QTY/BOX
5005SM	Small	100
5005MD	Medium	100
5005LG	Large	100
5005XL	X-Large	100

Minimum order: 1 box. All gloves on this page can be combined for quantity pricing.

CRL Powder Free Disposable Latex Gloves

- Fully-Textured Surface
- Can Be Worn on Either Hand
- Available in Four Sizes
- Powder Free

new



These CRL Powder Free Disposable Latex Gloves minimize the risk of allergic reaction to protein or chemical residue. They are made of natural rubber and molded to be worn on either hand. The fully-textured surface provides superior grip in wet or dry applications.

CAT. NO.	SIZE	QTY/BOX
262SM	Small	100
265MD	Medium	100
266LG	Large	100
268XL	X-Large	100

Minimum order: 1 box. All gloves on this page can be combined for quantity pricing.

CRL General Purpose Solvent and Adhesive Cleaner

- Removes Uncured Adhesives, Paints, Greases, and Oils
- The Perfect Clean Up Companion for Urethane Users

CRL General Purpose Solvent and Adhesive Cleaner handles some of the toughest cleaning jobs your shop can encounter. Use CRL2032 to soften and remove uncured urethane, adhesive, tar, grease, oil, body sealer, and undercoating. Apply to a rag and rub lightly over soiled areas, then wipe up with a clean, dry cloth.

NOTE: Be sure to observe all safety recommendations during use of this powerful cleaner.

CAT. NO.	CONTENTS	QTY/CASE
CRL2032	32 Fl. Oz. (946 ml)	12

Minimum order: 1 each.



CRL Cleaner and Degreaser

- Cleans Up Uncured Adhesive
- Contains No Ozone Depleting Chemicals
- Evaporates Quickly

CRL Cleaner and Degreaser is a general-purpose cleaner/degreaser ideal for preparing surfaces prior to use of adhesives and sealants. It removes all traces of grease and oils, and leaves no residue.

CAT. NO.	CONTENTS	QTY/CASE
CRL7528	20 Oz. (567 g)	12

Minimum order: 1 each.



CRL Funnels

- One Quart Capacity

These quart capacity CRL Funnels are available in two types. Choose from galvanized steel, or the deluxe rapid-flow design made of durable nylon.

CAT. NO.	DESCRIPTION
KP64411	Steel Funnel
KP64468	Nylon Funnel

Minimum order: 1 each.



CAT. NO. KP64411

CAT. NO. KP64468

CRL WET/DRY VACUUM CLEANERS

For Pricing Visit Our Web Site or Call Us Toll Free at the Phone Numbers Shown on the Back Cover

CRL Shop-Vac® Industrial Wet/Dry Vacs

- Industrial Type Units
- Super Quiet, Longer Lasting Motor
- No Messy Filters to Change



CAT. NO. 9254010
10 Gal. (37.85 l)

CAT. NO. 9254210
16 Gal. (60.57 l)

Both of these Wet/Dry Vacs are industrial units equipped with longer lasting motors than what is found in consumer models. The high quality filter cartridge for wet or dry pick-up means no changing of messy filters. Both models also include a high quality drywall collection bag for fine dust pick-up, which ensures no blow-through when picking up drywall dust.

ACCESSORIES INCLUDED:

- 72" x 2-1/2" (1829 x 63 mm) Heavy-Duty Hose
- Two Extension Wands
- 14" (356 mm) Floor Nozzle with Squeegee
- Oversized On-Board Tool Storage
- High-Quality Cartridge Filter
- 8" (203 mm) Utility Nozzle
- Crevice Tool
- Drywall Filter Bag

CAT. NO.	HORSEPOWER	TANK
9254010	4.0	10 Gallon (37.85 l)
9254210	6.25	16 Gallon (60.57 l)

Minimum order: 1 each.

CRL Shop-Vac® All-Purpose Wet/Dry Vac

- Powerful Three Horsepower Motor
- 6 Gallon (22.7 l) Capacity



This CRL Shop-Vac® All-Purpose Wet/Dry Vacuum is a compact version of the 16 gallon unit. Because of its size, this small but powerful Vacuum is extremely portable. The narrow 1-1/4" (32 mm) diameter hose comes in handy when working in tight places.

ACCESSORIES INCLUDED:

- 96" x 1-1/4" (2438 x 32 mm) Hose
- Two Extension Wands
- 10" (254 mm) Combination Wet/Dry Nozzle
- 10" (254 mm) Squeegee
- Foam Filter Sleeve
- Crevice Tool
- Reusable Dry Filter

CAT. NO.	DESCRIPTION
2117781	All Purpose 6 Gallon (22.7 l) Shop-Vac®
9051200	96" x 1-1/4" (2438 x 32 mm) Replacement Vacuum Hose
2119030	Vacuum Cartridge Filter
2119052	Vacuum Cloth Filter

Minimum order: 1 each.

CRL Fein® Mini-Turbo 6 Gallon Wet/Dry Vac

- Lightweight at 17-3/4 Pounds (8 kg)
- Quiet - Only 63 Decibels
- Small but Powerful



The Fein® Mini-Turbo uses a unique dual fan motor, which prevents electrical damage and extends life. The cloth bladder utilizes the capacity of the vacuum tank and allows for maximum filtration. Minimum order is one each.

ACCESSORIES INCLUDED:

- 16' x 1-1/4" (4.9 m x 32 mm) Hose
- Elbow Adapter with Suction Reducer
- Smooth Bottom Attachment
- Carpet Brush Attachment
- Upholstery Tool
- Two Hose Extenders
- Wide Floor Nozzle
- Rubber Lip Attachment
- Crevice Tool
- Cloth Bladder

CAT. NO. 2095514

CRL Shop-Vac® Quiet Series Wet/Dry Vac

- Compact 2.5 Gallon (9.46 l) Tank
- Powerful, Portable Hand Held and Wall Mountable Design
- Quickly Converts Into a Blower



This compact, yet powerful and quiet 2.5 gallon (9.46 l) Wet/Dry Vac is great for mobile van use or any small clean up jobs. Its compact design takes up very little room. With onboard accessory storage, cord storage and super lightweight, it travels effortlessly. Powerful 2.0 peak HP motor provides plenty of suction. Quickly converts into a blower for added versatility. Minimum order is one each.

ACCESSORIES INCLUDED:

- 48" x 1-1/4" (1219 x 32 mm) Hose
- Gulper Nozzle
- Crevice Tool
- Foam Filter Sleeve
- Reusable Dry Filter Bag
- On-Board Tool Holder

CAT. NO. 5860262



C.R. LAURENCE COMPANY

crlaurence.com

N252 | crlaurence.ca crlaurence.com.au crlaurence.co.uk crlaurence.de crlaurence.eu

CRL Transparent and Translucent Very Hi-Bond Acrylic Adhesive Tapes

SPEC. DATA

MSDS

- Water Clear
Transparent Color
- Instant Pressure
Sensitive Bonding
- Excellent for Use With
Glass or Clear
Polycarbonates,
Seals, and Wipes Used
in Frameless Shower
Installations
- Foldable, Moldable,
and Compressible
- Will Not Harden or
Become Brittle with Age
- Moisture Resistant –
Excellent Weathering
Properties
- Maintains Adhesion at
Sub-Zero Temperatures

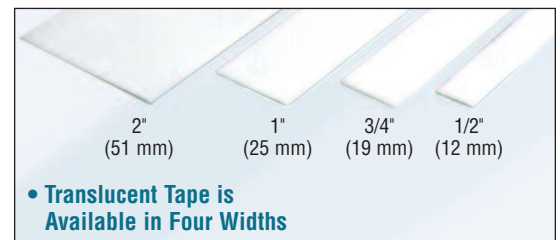
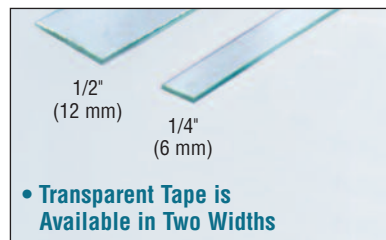

- Excellent for Applying Wipes and Seals to Frameless Glass Shower Doors

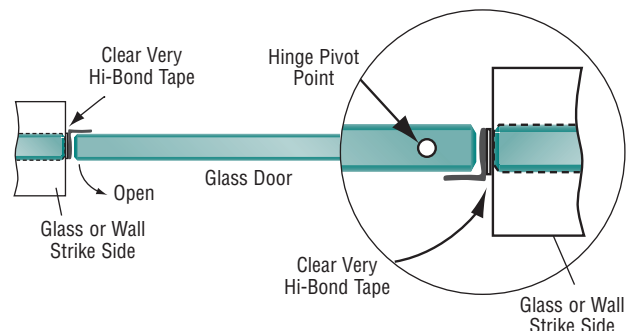
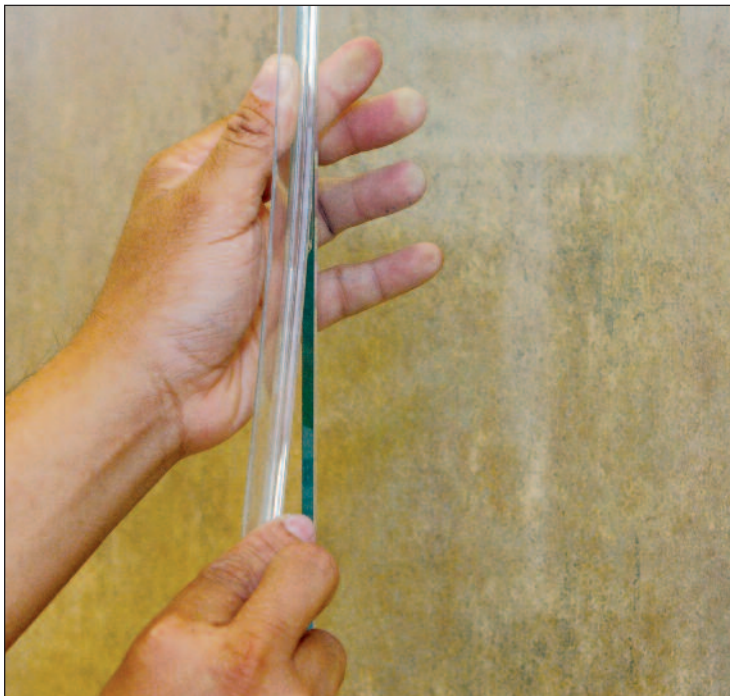

CRL Transparent and Translucent Acrylic Very Hi-Bond Adhesive Tapes

CRL Transparent Acrylic Very Hi-Bond Tape is used in adhesive applications involving glass or other clear materials, making it ideal for adhering clear polycarbonates, edge wipes, and seals used in frameless shower installations. Other applications include skin-to-frame assemblies, furniture, appliances, auto trim attachment, window grids, signs, graphics, construction uses to replace mechanical fasteners and welds, and whenever a waterproof bond in a wide range of temperature conditions exists. A new application utilizes the clear acrylic tape for perimeter bonding of resin-filled laminated glass.

This tape possesses a uniform high-tack acrylic adhesive on both surfaces, and will bond to most clean, dry, oil-free substrates. It is non-staining after aged contact, has a solid composition for clean cutting, and is flexible, moldable, and compressible, so it can conform to intricate shapes.

CRL Very Hi-Bond Adhesive Tapes can be applied at 50° - 100°F (10° - 38°C), and will maintain adhesion at sub-zero temperatures. After application, the bond strength will increase as the adhesive flows onto the surface. At room temperature, approximately 50 percent of the ultimate strength will be achieved after 20 minutes, 90 percent after 24 hours, and 100 percent after 72 hours. The speed can be increased by raising the temperature to 150°F (65.5°C) for a period of one hour. Its solid acrylic core gives it superior strength, and allows for clean cuts.

Translucent Double-Sided Tape is an economical alternative to higher priced Transparent Tapes. It's a good choice for adhering edge wipes and seals in frameless shower enclosures.

Attachment of Muntin Profiles to Glass



Tape Application

Colonial style divided lites are a popular and attractive architectural design element for windows and doors. Modern fabrication methods use "simulated" divided lites, in which a grill assembly is attached on a single large glass surface to create the appearance of individual sections, but without the labor and extra costs required of a "true" divided lite.

Muntin bar grills can be clipped to the window perimeter or permanently bonded with tape. Clipped systems can be removed for cleaning, but may rattle in place or have a less than pleasing appearance. Bonding muntin bar grills permanently with high-performance, all-weather CRL Transparent Very Hi-Bond Tape gives a divided lite window a rugged bond and pleasing visual appearance, while improving production efficiency.

Perimeter Bonding of Resin-Filled Laminated Glass

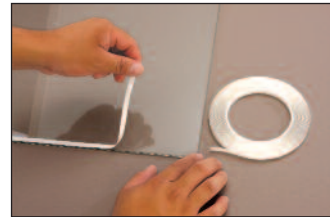

Resin Injection

The new preferred method for producing laminated glass is the resin-fill process. A liquid polymer resin is injected between the glass sheets and cured with UV lights or catalysts, depending on the resin formulation. This alternative method allows for variations in resin thickness as opposed to the traditional method, which employs a polyvinyl butyral (PVB) film that is bonded between two layers of glass. The disadvantage of the traditional method includes the high cost for the manufacturing equipment and the limitations for different thicknesses.

CRL Transparent Very Hi-Bond Tape is a solid acrylic tape for use with the resin-fill system. Placed around the glass perimeter, it secures the glass in position while creating a seal prior to the liquid resin injection. The transparent tape is virtually invisible, and often eliminates edge trimming to reduce waste and improve manufacturing efficiency.

CAT. NO.	TYPE	THICKNESS	WIDTH	ROLL LENGTH	ROLLS/CASE
AT0201436	Transparent	.020" (.5 mm)	1/4" (6.3 mm)	36' (11 m)	36
AT02014	Transparent	.020" (.5 mm)	1/4" (6.3 mm)	216' (66 m)	24
AT0401436	Transparent	.040" (1 mm)	1/4" (6.3 mm)	36' (11 m)	36
AT04014	Transparent	.040" (1 mm)	1/4" (6.3 mm)	108' (33 m)	24
AT0401236	Transparent	.040" (1 mm)	1/2" (12.7 mm)	36' (11 m)	36
AT04012	Transparent	.040" (1 mm)	1/2" (12.7 mm)	108' (33 m)	24
AT04512	Translucent	.045" (1.1 mm)	1/2" (12.7 mm)	108' (33 m)	24
AT04534	Translucent	.045" (1.1 mm)	3/4" (19 mm)	108' (33 m)	14
AT0451	Translucent	.045" (1.1 mm)	1" (25.4 mm)	108' (33 m)	14
AT0452	Translucent	.045" (1.1 mm)	2" (50.8 mm)	108' (33 m)	8

Minimum order: 1 roll. All tapes on this page can be combined for quantity pricing.

CRL 3M™ Transparent and Translucent Adhesive Tapes

SPEC. DATA

- Bonds to Most Clean, Dry Surfaces Instantly
- Replaces Mechanical Fasteners in Many Applications
- Full Strength Attained in 72 Hours
- Widely Used by Frameless Shower Door Installers



SIZES **new**

Transparent 3M™ VHB™ Double-Sided Adhesive Tape

Clear 3M™ VHB™ (Very High Bond) Tape is a high strength, double-sided adhesive that features instant bonding, with full strength attained within 72 hours. It is ideal for adhering Clear Polycarbonates, Edge Wipes, and Seals. You will find VHB™ Tape can be the clear replacement for mechanical fasteners in many instances. Available in 1/4" (6.3 mm), 1/2" (12.7 mm) or 3/4" (19 mm) widths.

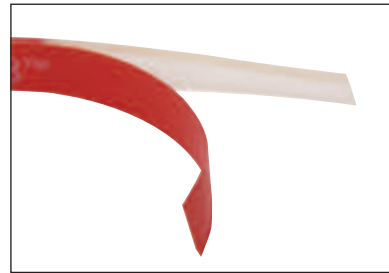

Mini Roll

Translucent 3M™ Double-Sided Adhesive Tape

This tape provides a translucent appearance and can be used to adhere Edge Wipes and Seals.



Transparent 3M™ Polyurethane Single-Sided Adhesive Protective Tape

Many installations may require a buffer to protect glass-to-glass contact when a double opposed miter on the strike side is required. This transparent 6 mil thick tape adheres to the miter, and acts as a cushion to protect against chipping.

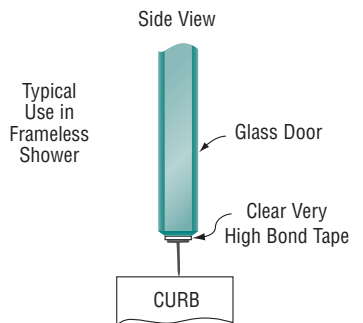
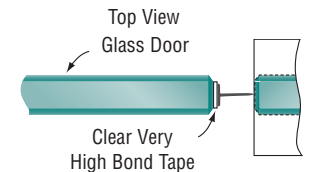

CAT. NO.	TYPE	WIDTH	THICKNESS	ROLL LENGTH	ROLLS/CASE
490514	Transparent, VHB™ Double-Sided	1/4" (6.3 mm)	.020" (.5 mm)	216' (66 m)	36
491014	Transparent, VHB™ Double-Sided	1/4" (6.3 mm)	.040" (1 mm)	108' (33 m)	36
491012	Transparent, VHB™ Double-Sided	1/2" (12.7 mm)	.040" (1 mm)	108' (33 m)	18
491034	Transparent, VHB™ Double-Sided	3/4" (19 mm)	.040" (1 mm)	45' (14 m)	12
SDT51660	Translucent, Double-Sided	5/16" (7.9 mm)	.005" (.13 mm)	180' (55 m)	16
867238	Transparent, Single-Sided	3/8" (9.5 mm)	.006" (.15 mm)	108' (33 m)	24

Minimum order: 1 roll. All tapes on this page can be combined for quantity pricing.

CRL Clear Double-Sided PVC Tape

- A Good Choice for Adhering Polycarbonate Wipes and Seals to Frameless Shower Doors
- Easy-to-Peel Off Liner, Tape Does Not Stretch

This CRL Double-Sided PVC Tape adheres to rubber, plastic, glass, metal, and wood substrates. Great for adhering polycarbonate seals to frameless shower doors. Excellent temperature, UV, aging, and water vapor resistance.



CAT. NO.	WIDTH	THICKNESS	ROLL LENGTH	ROLLS/CASE
4420C	23/64" (9 mm)	.009" (.23 mm)	180' (55 m)	24

Minimum order: 1 roll. Can be combined for quantity pricing with adhesive bond tapes.

CRL 3M™ Very High Bond Manufacturing Tapes

SPEC. DATA

- Super Adhesive, High Bonding Strength Tape Can Replace Rivets, Screws, Spot Welds, and Liquid Adhesives
- Can be Used for Interior or Exterior Industrial Applications
- Bonds to Many Substrates

3M™ VHB™ Tape can replace mechanical fasteners such as rivets, spot welds, screws, and liquid adhesives. VHB™ Tape has successfully replaced all these and other fasteners in various manufacturing uses. It bonds to many substrates, and can be used for interior or exterior industrial applications. VHB™ Tape eliminates drilling for mechanical fasteners, and mixing of liquid adhesives. It applies neatly and easily, conforms to irregular surfaces, and allows concealment during use. It also features excellent resistance to ultraviolet light, solvents, moisture, and plasticizer migration.

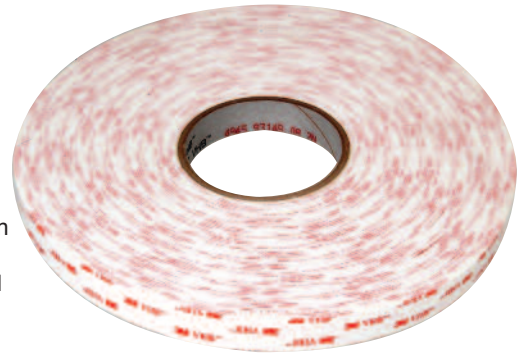

CAT. NO.	WIDTH	THICKNESS	ROLL LENGTH	ROLLS/CASE
494512	1/2" (12.7 mm)	.045" (1.1 mm)	108' (33 m)	18
3M462412	1/2" (12.7 mm)	.062" (1.6 mm)	108' (33 m)	18
494534	3/4" (19 mm)	.045" (1.1 mm)	108' (33 m)	12
49451	1" (25.4 mm)	.045" (1.1 mm)	108' (33 m)	9
3M4622112	1-1/2" (38 mm)	.045" (1.1 mm)	108' (33 m)	9
49452	2" (50.8 mm)	.045" (1.1 mm)	108' (33 m)	6

Specifications: Foam: Closed cell acrylic. Color: White. Thickness: .045" (1.1 mm). Peel adhesion: Excellent. Tensile adhesion: Very good. Dynamic shear adhesion: Good. Static shear adhesion: Room temperature – very good; 200°F (93°C) – good. UV resistance: Excellent. Shelf life: 12 months in original carton at 70°F (21°C) and 50% relative humidity.

Minimum order: 1 roll. All tapes on this page can be combined for quantity pricing.

CRL Acrylic Foam Very Hi-Bond Adhesive Tape

SPEC. DATA

MSDS

- Solid Acrylic Core for Superior Strength
- Bonds to Most Clean, Dry Surfaces Instantly
- Used to Adhere Cladding to Base Shoe in CRL Railing Systems

This CRL Acrylic Foam Very Hi-Bond Tape is designed to replace mechanical fasteners and welds for a variety of applications including: cladding, auto trim attachment, window grids, signs, graphics, and construction use. This tape possesses a uniform, high-tack, acrylic adhesive on both surfaces, and will bond to most clean, dry, oil-free substrates. It's solid acrylic core gives it superior strength, and allows for clean cuts. It is flexible, moldable, and compressible, so you can conform it to intricate shapes. Best adhesion when applied at temperatures above 50°F (10°C) to 100°F (38°C). Full strength is attained in 72 hours.

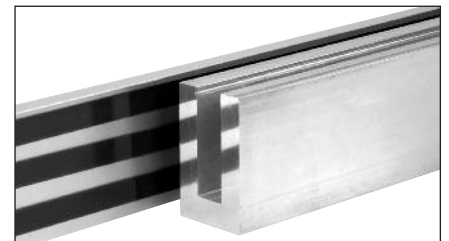
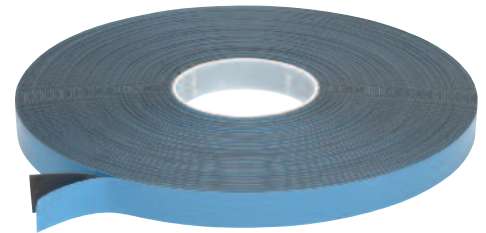

CAT. NO.	WIDTH	THICKNESS	ROLL LENGTH	ROLLS/CASE
AT234	3/4" (19 mm)	.045" (1.1 mm)	108' (33 m)	12

Minimum order: 1 roll. All tapes on this page can be combined for quantity pricing.

CRL Very High Adhesion Foam Tape

- Double-Sided Self-Adhesive Tape
- Secure Bonds Even on Rough Surfaces
- Especially Resistant to Plasticizers

CRL Very High Adhesion Foam Tape is a universal double-sided adhesive tape used for all demanding applications. This tape combines a PVC backing with outstanding acrylic adhesive for secure, reliable mounting of many different materials. Typical applications include: mounting of plastic and wooden trims; mounting of heavy decorative materials and displays; mounting of signs and scales.

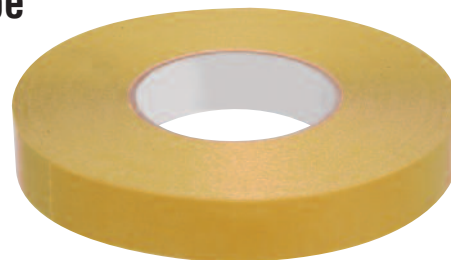

new



CAT. NO.	WIDTH	THICKNESS	ROLL LENGTH	ROLLS/CASE
4970	1" (25.4 mm)	.009" (.23 mm)	180' (55 m)	36

Minimum order: 1 roll. All tapes on this page can be combined for quantity pricing.

CRL 3M™ Scotch Mount Foam Tape

- Strong, Sticky, Double-Sided Self-Adhesive Tape
- Conforms to All Surfaces
- Ideal for Mounting Mirror Tiles, Mirrors, Plaques or Frames Directly to the Wall

The strong, pressure sensitive adhesive of 3M™ Scotch Mount Foam Tape is bonded to a high density foam. Because this foam conforms to any surface, you will find it ideal to use for mounting mirror squares, small plaques or frames directly to walls. A favorite in the glass industry, it is available in three widths, and gives you neat, clean, and easy mounting.



CAT. NO.	WIDTH	THICKNESS	ROLL LENGTH	ROLLS/CASE
403212	1/2" (12.7 mm)	1/32" (.8 mm)	216' (66 m)	18
40321	1" (25.4 mm)	1/32" (.8 mm)	216' (66 m)	9
401612	1/2" (12.7 mm)	1/16" (1.6 mm)	108' (33 m)	18
401634	3/4" (19 mm)	1/16" (1.6 mm)	108' (33 m)	12
40163445	3/4" (19 mm)	1/16" (1.6 mm)	45' (13.7 m)	12
40161	1" (25.4 mm)	1/16" (1.6 mm)	108' (33 m)	9
400812	1/2" (12.7 mm)	1/8" (3.2 mm)	108' (33 m)	18
400834	3/4" (19 mm)	1/8" (3.2 mm)	108' (33 m)	12
40083421	3/4" (19 mm)	1/8" (3.2 mm)	21' (6.4 m)	12
40081	1" (25.4 mm)	1/8" (3.2 mm)	108' (33 m)	9

Minimum order: 1 roll. Sizes can be combined for quantity pricing.

new

DOUBLE-COATED FOAM CONSTRUCTION

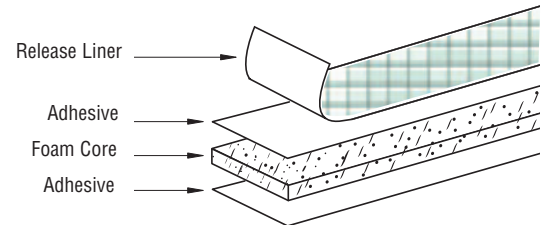

Paper Backing Peels Off Easily and Exposes the High Quality Foam Core and Adhesive

CRL 3M™ Removable Double Coated Clear Acrylic Foam Tape

- Excellent for Removable P.O.P. Displays, Signs, Exhibitions, Name Plates, Etc.
- Can Be Cleanly Removed From Many Substrates

This clear foam tape offers removability from a variety of substrates. Double coated acrylic foam removes cleanly from many surfaces, yet offers high ultimate bond strength, good temperature resistance, solvent resistance, and static shear holding power.

Ideal tape application temperature is 70° to 100°F (21° to 38°C). Initial tape application to surfaces at temperatures below 50°F (10°C) is not recommended because the adhesive may become too firm to adhere readily. However, once properly applied, low temperature holding is generally satisfactory.

CAT. NO.	WIDTH	THICKNESS	ROLL LENGTH	ROLLS/CASE
4658F12	1/2" (12.7 mm)	1/32" (.8 mm)	81' (24.6 m)	4
4658F34	3/4" (19 mm)	1/32" (.8 mm)	81' (24.6 m)	2
4658F1	1" (25.4 mm)	1/32" (.8 mm)	81' (24.6 m)	2

Minimum order: 1 roll. Sizes can be combined for quantity pricing.



CRL Foam Tape Squares

- 3/4" (19 mm) Squares of Neat, Strong Holding Power
- Neat, Clean and Easy to Apply
- Ideal for Hanging Frames, Plaques, Posters, Mirror Squares or Tiles

CRL Foam Tape Squares take the hang-ups out of a sticky business. These pre-cut foam tape squares are easy to use – simply peel and stick! No messy glues or epoxies, no holes to drill, no screws, nails, nuts or bolts.

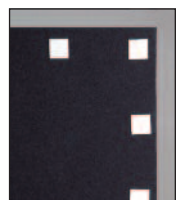
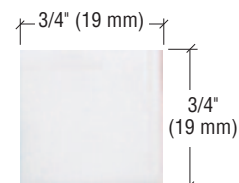

CAT. NO.	SIZE	THICKNESS	SQUARES/BOX
CRL4022	3/4" x 3/4" (19 x 19 mm)	1/32" (.8 mm)	1,000
CRL4026	3/4" x 3/4" (19 x 19 mm)	1/16" (1.6 mm)	1,000

Minimum order: 1 box. Sizes can be combined for quantity pricing.

CRL All Purpose Mirror Mounting Foam Tape

SPEC. DATA

- Double-Sided Self-Adhesive Tape
- Excellent Shear Strength
- Conforms to All Surfaces
- Ideal for Mounting Mirror Tiles, Mirrors, Glass, Metals, Plastics, and Other Surfaces
- White and Black Colors Available

DOUBLE-COATED FOAM CONSTRUCTION

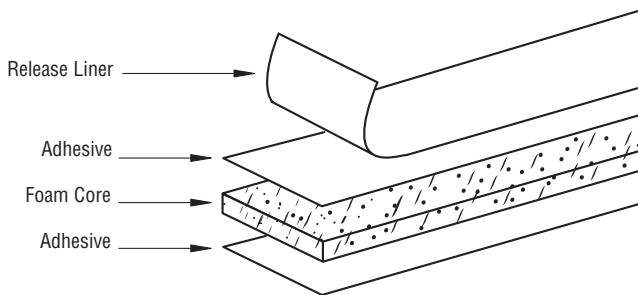

Paper Backing Peels Off Easily and Exposes the High Quality Foam Core and Adhesive

Specifications:

Adhesion: 1.875 lbs/in

Shear Strength: 10,000+ minutes

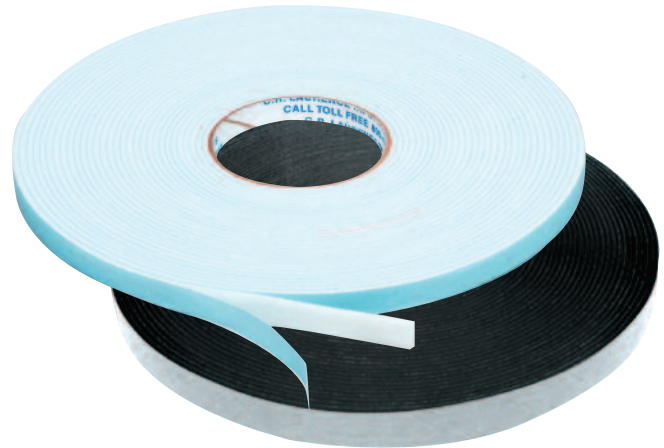

CRL All Purpose Foam Mounting Tape has a high-strength adhesive with tenacious holding power. A flexible closed cell polyethylene foam core is double-coated with a high-tack, rubber-based, pressure sensitive adhesive that makes a strong tape which will conform to irregular shapes and surfaces. The soft density of the foam core also lets you apply it to smooth and textured surfaces with the confidence that it will adhere to both equally. Just peel off the paper release liner and apply to glass, metal, plastic, masonite, cardboard, wallboard - any dry, clean, and dust-free surface. Applications include mounting small mirrors and mirror tiles; mounting metal or plastic signs; mounting posters or pictures; adhering edge moldings.



Mirror Tiles

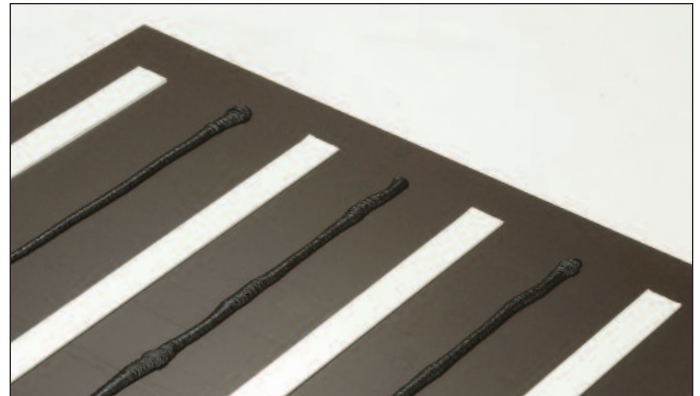

Mirror Walls - Use With Mastics for Immediate Adhesion

CRL All Purpose Mirror Mounting Foam Tape

• Works Great On Other Mounting Jobs Too!



Metal and Plastic Signs

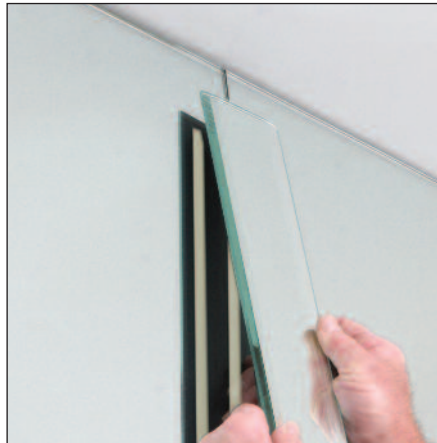

Mirror Bevels



Posters or Pictures

Application Techniques

1. Pressure-sensitive adhesives require clean and dry surfaces for bonding. Typical surface cleaning solvents are isopropyl alcohol/water mixture (rubbing alcohol) or heptane. **NOTE:** Be sure to follow solvent manufacturer's precautions and directions for use when using solvents.

2. Position and attach the tape using firm pressure, making sure the adhesive makes good contact along the entire length. Bond strength is dependent upon the amount of adhesive-to-surface contact developed. Squeegees and rollers make good application tools.

3. After application the bond strength will increase as the adhesive flows onto the surface. At room temperature approximately 50% of the ultimate strength will be achieved after 20 minutes, 90% after 24 hours and 100% after 72 hours.

4. Ideal tape application temperature range is 70° to 100°F (21 to 38°C). Minimum suggested application temperature is 50°F (10°C). **NOTE:** Initial tape application to surfaces at temperatures below these suggested minimums is not recommended, because the adhesive becomes too firm to adhere. However, once properly applied, low temperature holding is generally satisfactory.

5. It may be necessary to seal or prime some substrates prior to bonding. Consult CRL Technical Services for more information.



CAT. NO.	COLOR	THICKNESS	WIDTH	ROLL LENGTH	ROLLS/CASE
CRL213212	White	1/32" (.8 mm)	1/2" (12.7 mm)	216' (65.8 m)	23
CRL21321	White	1/32" (.8 mm)	1" (25.4 mm)	216' (65.8 m)	12
CRL211612	White	1/16" (1.6 mm)	1/2" (12.7 mm)	108' (33 m)	23
CRL211634	White	1/16" (1.6 mm)	3/4" (19 mm)	108' (33 m)	16
CRL21161	White	1/16" (1.6 mm)	1" (25.4 mm)	108' (33 m)	12
CRL210812	White	1/8" (3.2 mm)	1/2" (12.7 mm)	50' (15.2 m)	23
CRL210834	White	1/8" (3.2 mm)	3/4" (19 mm)	50' (15.2 m)	16
CRL21081	White	1/8" (3.2 mm)	1" (25.4 mm)	50' (15.2 m)	12
CRL423212	Black	1/32" (.8 mm)	1/2" (12.7 mm)	216' (65.8 m)	23
CRL421612	Black	1/16" (1.6 mm)	1/2" (12.7 mm)	108' (33 m)	23
CRL421634	Black	1/16" (1.6 mm)	3/4" (19 mm)	108' (33 m)	16
CRL420812	Black	1/8" (3.2 mm)	1/2" (12.7 mm)	50' (15.2 m)	23

Minimum order : 1 roll. All sizes and colors can be combined for quantity pricing.

CRL Blue Masking and Securing Tape

- Leaves No Adhesive Residue for Up to Seven Days
- Ideal for Masking Tooled Silicone Joints
- Holds Moldings While Windshield Urethane Cures
- Available in Four Widths

CRL Blue Masking and Securing Tape is a blue crepe paper tape with built-in UV stability and adhesive transfer resistance for up to seven days. Ideal for holding in moldings on urethane-set windshields, also as a masking tape for tooled silicone joints in frameless shower door installations, or any exterior sealing applications such as storefronts, where the metal needs to be protected.



CAT. NO.	WIDTH	ROLL LENGTH	ROLLS/CASE
BL9934	3/4" (19 mm)	180' (54.8 m)	48
BL991	1" (25.4 mm)	180' (54.8 m)	36
BL99112	1-1/2" (38.1 mm)	180' (54.8 m)	24
BL992	2" (50.8 mm)	180' (54.8 m)	24

Minimum order: 1 roll. All Masking Tape can be combined for quantity pricing.

CRL 3M™ Blue Windshield and Trim Securing Tape

- Leaves No Adhesive Residue for Up to 14 Days
- Can Also Be Used as a Mask for Tooled Silicone Joints

CRL 3M™ Blue Windshield and Trim Securing Tape is most commonly used for holding the trim around newly installed windshields while the urethane sets. It has UV stability and resists adhesive transfer for up to 14 days after application. It can also be used in frameless shower door installations as a mask for tooled silicone joints and for any exterior sealing application such as storefronts, where the metal needs to be protected.

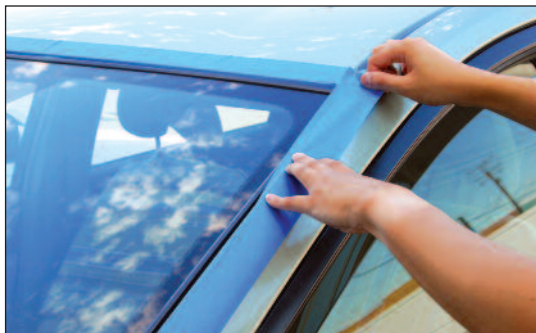

CAT. NO.	WIDTH	ROLL LENGTH	ROLLS/CASE
3M6817	3/4" (19 mm)	180' (54.8 m)	48
3M6818	1" (25.4 mm)	180' (54.8 m)	36
3M6819	1-1/2" (38.1 mm)	180' (54.8 m)	24
3M6820	2" (50.8 mm)	180' (54.8 m)	24

Minimum order: 1 roll. All Masking Tape can be combined for quantity pricing.

CRL Multi-Purpose Masking Tape

- Hundreds of Uses
- Six Convenient Widths
- High Quality Adhesive



Use CRL Multi-Purpose Masking Tape for masking, packaging, bundling, sealing, "X"-ing window glass, or for many other jobs. Designed to stick to all surfaces, smooth or rough, it easily conforms to irregular shapes. This high quality, low-priced tape is packed in plastic sleeves to keep it fresh for a long shelf life.

CAT. NO.	WIDTH	ROLL LENGTH	ROLLS/CASE
40312	1/2" (12.7 mm)	180' (54.8 m)	72
40334	3/4" (19 mm)	180' (54.8 m)	48
4031	1" (25.4 mm)	180' (54.8 m)	36
403112	1-1/2" (38.1 mm)	180' (54.8 m)	24
4032	2" (50.8 mm)	180' (54.8 m)	24
4033	3" (76.2 mm)	180' (54.8 m)	16

Minimum order: 1 roll. All Masking Tape can be combined for quantity pricing.

CRL Black Masking Tape

- For General Purpose Mirror and Automotive Use
- Three Convenient Widths



CRL Black Masking Tape is used in between and behind joints of mirror walls to leave a clean black line. This tape also acts as a shock-absorbing cushion when applied to the edge of the mirror, eliminating "clam shell" caused by mirror edges striking each other.

CAT. NO.	WIDTH	ROLL LENGTH	ROLLS/CASE
23534	3/4" (19 mm)	180' (54.8 m)	48
2351	1" (25.4 mm)	180' (54.8 m)	36
632W	2" (50.8 mm)	180' (54.8 m)	24

Minimum order: 1 roll. All Masking Tape can be combined for quantity pricing.

CRL Automotive Masking Tape

- Adheres Evenly and Strips Clean
- Excellent for Refinish Painting



Professional auto body shops use CRL Automotive Masking Tape for refinish painting. Its excellent conformability and stain-resistant curing adhesive let you do it right the first time. Eliminates paint build-up along the tape line, and strips clean.

CAT. NO.	WIDTH	ROLL LENGTH	ROLLS/CASE
13934	3/4" (19 mm)	180' (54.8 m)	48
1392	2" (50.8 mm)	180' (54.8 m)	24

Minimum order: 1 roll. All Masking Tape can be combined for quantity pricing.

CRL 3M™ Automotive Masking Tape

- Expressly for the Professional Auto Paint Refinisher
- Solvent Resistant
- Good Holding Power



Made expressly for the professional auto paint refinisher, 3M™ Automotive Masking Tape features good holding power, conformability, instant adhesion, solvent resistance, and smooth texture. It unwinds easily from the roll, and stretches around moldings, handles, etc., without pulling away.

CAT. NO.	WIDTH	ROLL LENGTH	ROLLS/CASE
3M26334	3/4" (19 mm)	180' (54.8 m)	48
3M26336	1" (25.4 mm)	180' (54.8 m)	36
3M26340	2" (50.8 mm)	180' (54.8 m)	24

Minimum order: 1 roll. All Masking Tape can be combined for quantity pricing.

CRL Duct Tape

- Flexible and Versatile
- Highly Aggressive Adhesive



CRL Duct Tape is a bonding of highly aggressive natural adhesive to a strong cloth tape with a coating of polyethylene. It is resistant to moisture and heat extremes, and conforms well to corners and sharp edges.

Typical uses include: Sealing duct work in exhaust and dryer vents, air conditioning and heating systems; as a pipe insulation wrap; temporary repair for fractured fiberglass or plastic panels; to bundle electrical cords; as a general adhesive tape when securing large sheets of protective cloth or plastic.

CAT. NO.	COLOR	WIDTH	ROLL LENGTH	ROLLS/CASE
C5192	Gray	2" (50.8 mm)	180' (54.8 m)	24
C5193	Gray	3" (76.2 mm)	180' (54.8 m)	16
C5292	Black	2" (50.8 mm)	180' (54.8 m)	24

- Gray or Black Color

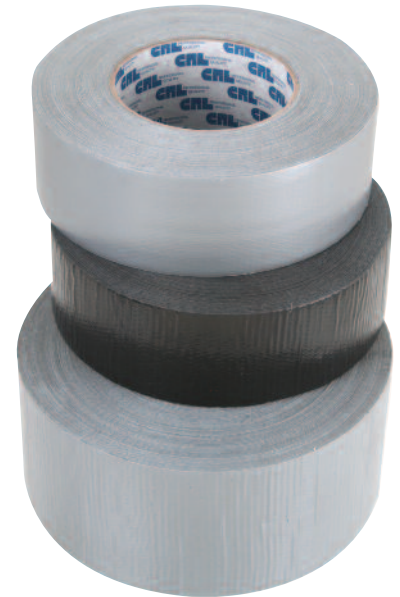

Minimum order: 1 roll. Sizes and colors can be combined for quantity pricing.

CRL Filament Tape

- Perfect for Sealing, Reinforcing, Holding, Strapping, Bundling, Securing, Shipping, Etc.
- Available in Three Widths
- Use Any Width of This Tape in Our TD901 Filament Tape Dispenser



CRL Filament Tape is a reinforced strapping tape that firmly grabs without cutting into cartons or edges of soft materials. It is a high tensile strength tape that readily conforms to irregular shapes, and is quickly and easily dispensed by hand or with dispenser. Unidirectional filaments reinforce the tape for strong tear resistance. It also resists curling, and adheres excellently to corrugated and other surfaces.

CAT. NO.	WIDTH	ROLL LENGTH	ROLLS/CASE
898T12	1/2" (12.7 mm)	180' (54.8 m)	72
898T34	3/4" (19 mm)	180' (54.8 m)	48
898T1	1" (25.4 mm)	180' (54.8 m)	36

Minimum order: 1 roll. Sizes can be combined for quantity pricing.

CRL Carton Sealing Tapes

- Extra Sticky for Easy Application
- Easily Dispensed With Our TD902 Carton Sealing Tape Dispenser (see page N268)
- Available in Clear or Tan

CRL Carton Sealing Tapes are pressure-sensitive, premium grade clear or tan polypropylene films that are used for sealing cartons, packages, etc. The tapes are extremely sticky, giving strong holding power to corrugated and other materials. It is very clear when applied, and both are good for sealing labels on shipping cartons. The high tensile strength will help keep packages together when subjected to even the most abusive handling.



CAT. NO.	COLOR	WIDTH	ROLL LENGTH	ROLLS/CASE
3802	Clear	2" Nominal (48 mm)	165' (50.3 m)	36
4264	Tan	2" Nominal (48 mm)	165' (50.3 m)	36

Minimum order: 1 roll.

CRL 3M™ Adhesive Transfer Tape for ATG Dispenser Guns

- High Performance Adhesive
- Available in Individual Boxes or in Economical Bulk Cartons
- For Use With ATG751 Adhesive Transfer Gun

This acrylic film 3M™ Adhesive Transfer Tape will mount papers, film, foil, photos, etc. onto almost any smooth surface with the aid of the ATG751 Adhesive Transfer Gun (see below). It transfers easily from the liner with a high initial adhesion. Two mil (.05 mm) thick, it's available in 1/2" or 3/4" (12.7 or 19 mm) widths. Comes individually boxed or in economical bulk cartons.



CAT. NO.	PACK	WIDTH	ROLL LENGTH	ROLLS/CASE
92412BULK	Bulk	1/2" (12.7 mm)	108' (33 m)	72
92434BULK	Bulk	3/4" (19 mm)	108' (33 m)	48
92412BX	Box	1/2" (12.7 mm)	108' (33 m)	12
92434BX	Box	3/4" (19 mm)	108' (33 m)	12

Minimum order: Bulk Tape = 12 Rolls; Boxed Tape = 1 Roll. Sizes can be combined for quantity pricing.

CRL 3M™ ATG Dispenser Gun for 3M™ Adhesive Transfer Tape

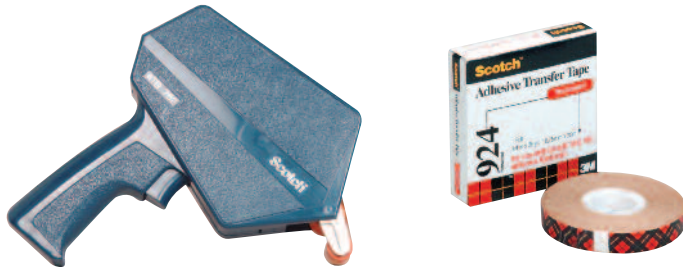

Tape must be ordered separately

- ATG Dispenser Gun Uses 3M™ 924 Series Adhesive Transfer Tapes

Use the 3M™ Adhesive Transfer Gun to dispense 3M™ 924 Series Adhesive Transfer Tape (see above). This one hand, trigger-actuated dispenser easily applies the adhesive to the bond surface while removing the release paper, all in one smooth operation. Easy to load, and lightweight for operator comfort and maneuverability. Minimum order is one each.

CAT. NO. ATG751

CRL 3M™ Adhesive Transfer Tape

- A High Performance Tape That Bonds Metal, Wood, Glass, and Some Plastics



3M™ Adhesive Transfer Tape is the choice of many fabricators who require a high performance adhesive that provides excellent bond strength that actually improves with age. Use 467 Tape to bond dissimilar materials such as metals, wood, glass, and some plastics. Apply tape to bond area, peel the release liner, and you have a thin strip of adhesive with excellent resistance to moisture and solvents. Typical applications include door signs or name plates, pulls and knobs, serial number or name plates on equipment. This translucent tape is two mils (.05 mm) thick.

CAT. NO.	WIDTH	ROLL LENGTH	ROLLS/CASE
46712	1/2" (12.7 mm)	180' (54.8 m)	72
4671	1" (25.4 mm)	180' (54.8 m)	36

Minimum order: 1 roll. Sizes can be combined for quantity pricing.

CRL 3M™ Double Coated Masking Tape

- Adhesive on Both Sides

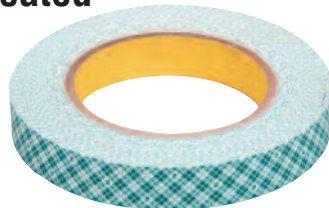

3M™ Double Coated Masking Tape is used to mount light objects. It has a high shear adhesive on both sides that bonds to almost any surface and is easy to apply.

CAT. NO.	WIDTH	ROLL LENGTH	ROLLS/CASE
3M40034	3/4" (19 mm)	180' (54.8 m)	48
3M4001	1" (25.4 mm)	180' (54.8 m)	36

Minimum order: 1 roll. Sizes can be combined for quantity pricing.

CRL 3M™ Transparent Tape

- Dispenses Easily
- Resists Yellowing

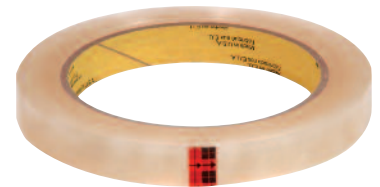

This 3M™ Transparent Tape dispenses easily, and can be used for many sealing, packing, and shipping applications. It resists yellowing, and is a good general purpose tape.

CAT. NO.	WIDTH	ROLL LENGTH	ROLLS/CASE
60012	1/2" (12.7 mm)	216' (65.8 m)	12
60034	3/4" (19 mm)	216' (65.8 m)	12

Minimum order: 1 roll. Sizes can be combined for quantity pricing.

CRL Deluxe Windshield and Trim Securing Tape*

- Works in Temperatures From 30° to 200°F
- Contains Special UV Inhibitors
- Never Leaves a Residue

CRL Deluxe Windshield and Trim Securing Tape is a high strength, nine mils thick, white polyethylene tape with special UV inhibitors and adhesive. It will work in temperatures from 30° to 200°F (-1 to 93°C) and will never leave a residue, even when left on for days. You can feel confident that cleanup is minimal when securing the windshield and trim with this tape.



CAT. NO.	WIDTH	ROLL LENGTH	ROLLS/CASE
921W	1" (25.4 mm)	108 Ft. (33 m)	48
922W	2" (51 mm)	108 Ft. (33 m)	24

Minimum order: 1 roll. All tapes on this page can be combined for quantity pricing.

***Warning:** These products are not recommended for use on poorly repainted or lacquered surfaces. Purchaser shall be solely responsible for determining the adequacy of these products for any and all uses to which the purchaser shall apply these products, and the application of these products by the purchaser shall not be subject to any implied warranty of fitness for that purpose. Statements or descriptions of these products are for information only, and not made or given as a warranty of these products in any way.

CRL Vinyl Molding Retention Tape*

- Temporarily Holds Moldings
- Perforated Every 6" for Easy Tearing
- Orange or Clear Color, With or Without Printed 24 Hour Warning

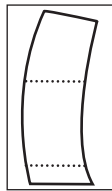

Perforations

CRL's Vinyl Molding Retention Tape is designed to temporarily hold moldings while auto urethane adhesives cure. Vinyl tape repels water better than masking tapes. Perforations every 6" (152 mm) throughout the roll make it easy to tear off perfectly sized strips to hold down corners. 108 feet (33 m) per roll.

ORANGE CAT. NO.	CLEAR CAT. NO.	24 HOUR IMPRINT	WIDTH	ROLLS/CASE
MT112	MT112C	NO	1-1/2" (38 mm)	32
MT112W	MT112CW	YES	1-1/2" (38 mm)	32
MT2	MT2C	NO	2" (51 mm)	24
MT2W	MT2CW	YES	2" (51 mm)	24

Minimum order: 1 roll. All tapes on this page can be combined for quantity pricing.



Clear with Imprint



Clear without Imprint



Orange with Imprint



Orange without Imprint

***Warning:** Do not use with or on lacquers, wallpapers, unpainted wallboard, or poorly bonded re-painted finishes. Purchaser shall be solely responsible for determining the adequacy of these products for any and all uses to which the purchaser shall apply these products, and the application of these products by the purchaser shall not be subject to any implied warranty of fitness for that purpose. Statements or descriptions of these products are for information only, and not made or given as a warranty of these products in any way.

CRL Silver Molding Retention Tape*

- Paper-Backed
- Easily Torn to Desired Length

Our Silver Molding Retention Tape is designed to temporarily hold moldings while auto urethane adhesives cure. Paper-backed Tape is easily torn to required length.

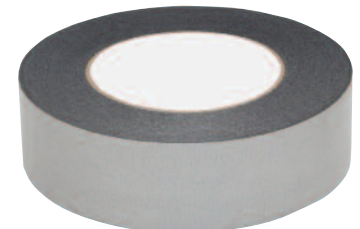
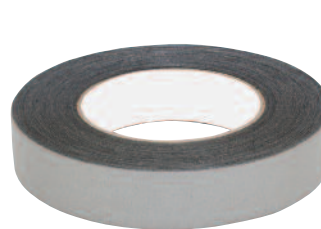

CAT. NO.	WIDTH	ROLLS/CASE	ROLL LENGTH
2130006	1" (25.4 mm)	36	180 Ft. (54.8 m)
2130007	1-1/2" (38 mm)	24	180 Ft. (54.8 m)

Minimum order: 1 roll. All tapes on this page can be combined for quantity pricing.

***Warning:** These products are not recommended for use on poorly repainted or lacquered surfaces. Purchaser shall be solely responsible for determining the adequacy of these products for any and all uses to which the purchaser shall apply these products, and the application of these products by the purchaser shall not be subject to any implied warranty of fitness for that purpose. Statements or descriptions of these products are for information only, and not made or given as a warranty of these products in any way.

CRL Scotchmate® Fastening Tape

- Positive Closure Can Be Engaged and Disengaged Hundreds of Times
- Adhesive Back Sticks to Any Clean Surface

Scotchmate® Fastener is a dense pattern of 400 stems per square inch on a fabric backing. When coupled with itself, it forms a positive closure that can be engaged and disengaged hundreds of times. Adhesive back sticks to any clean dry surface.

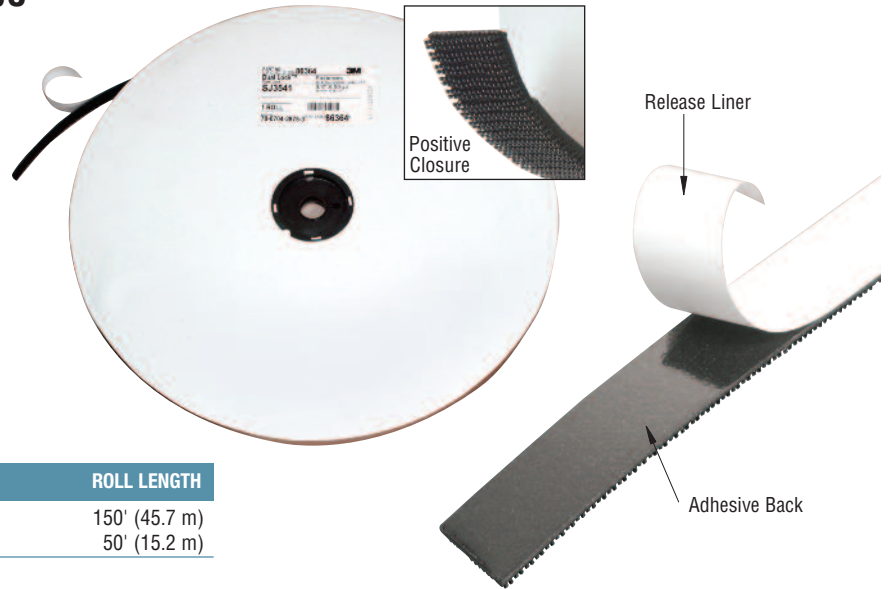

CAT. NO.	WIDTH	TYPE	ROLL LENGTH
SJ3541	3/4" (19 mm)	Adhesive Backing	150' (45.7 m)
SJ354150	3/4" (19 mm)	Adhesive Backing	50' (15.2 m)

Minimum order: 1 roll.

CRL Velcro® Fastening Tape

- 3/4" Wide Genuine Hook and Loop Velcro®
- Adhesive Back has Superior Bond Strength

The CRL Velcro® Fastening Tape consists of two mating Hook and Loop components. The woven Hook Tape consists of tiny, flexible hooks which engage with a mating Loop Tape comprised of small, soft loops. When pressed together, the resulting closure is adjustable, highly secure, and jam proof. To reopen, simply peel apart. Adhesive back has superior bond strength to any clean dry surface for attaching signs, graphics on P.O.P. displays, computer components, etc. Hook and Loop components are sold separately. Black color.



CAT. NO.	WIDTH	TYPE	ROLL LENGTH
90916	3/4" (19 mm)	Hook Tape	75' (22.9 m)
90917	3/4" (19 mm)	Loop Tape	75' (22.9 m)

Minimum order: 1 roll.

CRL Velcro® Fastening Coins

- 3/4" Diameter Pre-Cut Hook and Loop Coins With Adhesive Backing

The CRL Velcro® Fastening Coins are great for small or large fastening jobs on smooth surfaces. Perfect for hanging decorations where nails aren't desirable, these pre-cut 3/4" (19 mm) diameter coins are available in a black color with adhesive backing. They can be invisibly attached and disengaged hundreds of times. Use to attach posters, signs, display components, etc. Hook and Loop components are sold separately.

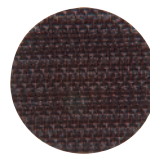

Black



CAT. NO.	WIDTH	TYPE	COINS/ROLL
192318	3/4" (19 mm)	Hook Coins	1028
192302	3/4" (19 mm)	Loop Coins	1028

Minimum order: 1 roll.

CRL Magnetic Tape

- A Great Way to Secure Metal Signs or Steel Storm Windows
- Adhesive on One Side

Use CRL Magnetic Tape to hold metal signs or placards; to hold steel frame storm window panels; to trap metal particles near sensitive equipment. It has adhesive on one side that will adhere to virtually any clean, dry, smooth surface. Just cut to length, peel liner, and stick in place.

CAT. NO.	WIDTH	THICKNESS	ROLL LENGTH
M11598	1/2" (12.7 mm)	1/16" (1.6 mm)	10' (3 m)
M115103	1" (25.4 mm)	1/16" (1.6 mm)	10' (3 m)

Minimum order: 1 roll. Sizes can be combined for quantity pricing.



CRL Electrical Tape

- UL Listed
- 18-Month Shelf Life



Designed to insulate wire, pipes, dissimilar metals, etc., CRL Electrical Tape is resistant to weather, water, acids, alkalis, and oils. It has superior conformability and high elongation to give a tight, solid wrap. A silicone spray additive gives it an 18-month shelf life. It practically never telescopes or bleeds. The glossy black tape is 7 mils (.18 mm) thick.

CAT. NO.	WIDTH	ROLL LENGTH	ROLLS/CASE
1ET314	3/4" (19 mm)	60' (18.3 m)	100

Minimum order: 1 roll.

CRL Friction Tape

- Shop Favorite for Setting Vent and Door Glass
- Tacky Adhesive on Both Sides



CRL Friction Tape is a heavy fabric tape with a tacky adhesive on both sides. A long time favorite in auto glass shops for setting vent and door glass in channels, you will find it has many industrial and manufacturing uses. Each roll is individually wrapped to preserve shelf life.

CAT. NO.	WIDTH	ROLL LENGTH	ROLLS/CASE
FT34	3/4" (19 mm)	60' (18.3 m)	50
FT112	1-1/2" (38 mm)	60' (18.3 m)	50

Minimum order: 1 roll. Sizes can be combined for quantity pricing.

CRL Glass-Strip Masking Liquid

- Protective Coating for Glass, Porcelain, and Polished Stone
- Brush-On, Peel-Off, Water-Based Formula
- Tack Free in One Hour at Three Mils

This CRL Glass-Strip Masking Liquid is a transparent blue protective coating for glass, porcelain, and polished stone. Simply brush it onto surfaces you want to keep clean and undamaged. Glass-Strip forms a tough, elastic, clear seal that protects surfaces against rubs, scratches, paint or stucco overspray while still allowing light through the windows. When you're finished working, it is easy to remove, just peel off the film. Excellent as a mask for caulking, it also makes it easier to clean up plaster spray from non-metal surfaces.

Application: Glass with deposits of dirt, mortar, stucco or label adhesive must be washed prior to coating. Use soft bristle brush, apply a generous coat, up and down; wait 30 minutes and apply a second cross coat. A dry film thickness of three mils [0.003 in. (0.076 mm)] is needed.

Coverage: Approximately 180 sq. ft. per gallon at 3 mils.

Dry Time: One hour at 3 mils, depending on weather conditions.

Exterior Exposure: Maximum of 90 days at minimum 3 mils.



CAT. NO.	CONTENTS
W2503	1 Gallon (3.785 l)

Minimum order: 1 gallon

CRL Glass Bandage

- Provides Highly Visible Warning of Broken Glass Hazards
- Transparent – Does Not Block Vision or Light
- Self-Adhesive – Remains In Place



Broken glass panes represent a significant safety hazard in factories, retail stores, office buildings, schools, hotels, and homes. CRL Glass Bandage offers a "quick-fix" until the glass can be replaced. Installation takes just minutes. Prevents air leakage while covering sharp edges and also seals in broken glass shards. Glass Bandage's brilliant red danger warning helps prevent harm to the public, reduce accident insurance claims, and possible legal suits. Glass Bandage is transparent, so it does not block vision and light - another safety plus! Roll size is 18" x 120" (457 x 3048 mm). Minimum order is one roll.

CAT. NO. 7100

CRL Window and Door Mask

- Protects From Paint Overspray and Stucco Application
- Economical 1200 Square Foot Roll
- Applies Quickly, Just Peel, Apply to Glass, and Trim
- Removal is Fast and Easy



Avoid costly clean up of paint overspray and misapplied stucco during construction with CRL Window and Door Mask. Window and Door Mask has no release liner to remove, so you simply peel from the roll, apply to glass, and then trim. This clear 3-mil polyethylene film stays where you put it because of its strong, water-based acrylic adhesive. Removal is fast and easy. 24" x 600' (610 mm x 183 m) long rolls are easy to handle and economical too, costing only pennies per square foot. Minimum order is one roll.

CAT. NO. MF304

CRL Surface Protection Film

- Protects Surfaces of Finished Pieces During Storage, Handling, and Transit
- Prevents Scratching of Glass During Routing or Sawing
- Low-Tack Adhesive for Easy Removal

CRL Surface Protection Film is a clear sheet of flexible plastic that prevents scratching and marring of your glass while routing or sawing. The film is backed by a low-tack adhesive that can easily be removed later and won't "gum" up the glass after it is removed. Also works well with CRL Steel or Brass Tube Drills because the abrasive grain can easily scratch your glass when removing it. Use it to protect the surface of finished pieces during storage, handling, and transit. Recommended for glass, wood, or metal which has been polished or brushed.



- Available in Three Sizes

CAT. NO.	WIDTH	ROLL LENGTH
GPF25	12" (305 mm)	25' (7.6 m)
GPF50	12" (305 mm)	50' (15.2 m)
99118	18" (457 mm)	50' (15.2 m)

Minimum order: 1 roll.

CRL Lead Foil Tape

- Ideal for Creating Imitation Diamond Window Effects
- Gives "Leaded" Window Look



- Available in Three Widths

CRL Lead Foil Tape is ideal for use in creating imitation diamond or square windows. The tape, with its clear adhesive backing, gives windows a distinctive "leaded" look. It is also good for decorative borders in leaded glass designs. Rolls are 108 feet (33 m) in length. Tape is 5 mils (.127 mm) thick.



CAT. NO.	WIDTH
42238	3/8" (9.5 mm)
42212	1/2" (12.7 mm)
42234	3/4" (19 mm)

Minimum order: 1 roll. Sizes can be combined for quantity pricing.

WARNING: Lead is a known carcinogen, use extreme caution when handling lead foils. Use either latex or nitrile gloves whenever handling. Wash all areas that come in contact with lead foil especially before eating, drinking/smoking.

CRL 3M® Aluminum Foil Tape

- Long Term Indoor and Outdoor Aging Characteristics



- Available in Three Widths

CRL 3M® Aluminum Foil Tape is perfect for making decorative patterns and designs on windows since it provides excellent radiation for both heat and light, and has indoor and outdoor long aging characteristics. Rolls are 180 feet (54.8 m) in length. Tape is 4.5 mils (.114 mm) thick.

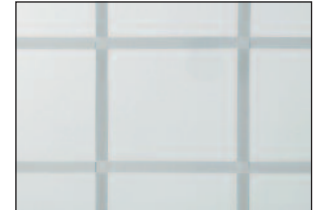

CAT. NO.	WIDTH
3M42538	3/8" (9.5 mm)
3M42512	1/2" (12.7 mm)
3M425112	1-1/2" (38.1 mm)

Minimum order: 1 roll. Sizes can be combined for quantity pricing.

CRL Copper Foil Tape

- Ideal for Tiffany Lamps and Stained Glass Items

The stained glass industry uses CRL Copper Foil Tape to make Tiffany style lamps. The shiny, copper-finish foil readily accepts solder when first treated with solder flux. It is conveniently dispensed from rolls and comes in two popular widths. It is attractive, and lends a unique look to stained glass patterns.

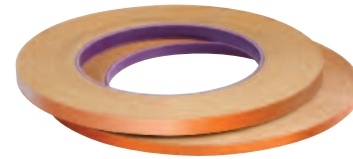

CAT. NO.	WIDTH	ROLL LENGTH
7420316	3/16" (4.8 mm)	108' (33 m)
742014	1/4" (6.4 mm)	108' (33 m)

Minimum order: 1 roll. Sizes can be combined for quantity pricing.

CRL Carton Sealing Tape Dispenser

- Made Especially for Dispensing 2" (48 mm) Width Carton Sealing Tape

Lightweight and compact, this CRL Carton Sealing Tape Dispenser is built to dispense our carton sealing tape quickly and efficiently. It comes with an adjustable brake to ensure smooth application. **NOTE:** Tape not included. Minimum order is one each.



CAT. NO. TD902

CRL Filament and Masking Tape Dispenser

- Holds Filament and Masking Tapes in Widths Up to 1" (25.4 mm)

This CRL Filament and Masking Tape Dispenser speeds the dispensing of tape for most applications. Made of heavy gauge, bright finish steel, it has a high efficiency hand brake to regulate tape tension quickly and effectively. A sharp, serrated steel cutting blade cuts off the tape easily. **NOTE:** Tape not included. Minimum order is one each.



CAT. NO. TD901

CRL Glass Cushioning Felt Tape

- Gray Felt With Adhesive Back Available in Seven Widths
- Cushions Glass Showcase and Desk Tops



CRL Glass Cushioning Felt Tape has an adhesive backing protected by a release paper liner. Simple peel and stick application to clean and dry surfaces. You can also use it as a protective cushion between desk tops and glass covers.



CAT. NO.	WIDTH	THICKNESS	ROLL LENGTH
FS2238	3/8" (9.5 mm)	1/16" (1.6 mm)	100' (30.5 m)
FS2212	1/2" (12.7 mm)	1/16" (1.6 mm)	100' (30.5 m)
FS2258	5/8" (15.9 mm)	1/16" (1.6 mm)	100' (30.5 m)
FS2234	3/4" (19 mm)	1/16" (1.6 mm)	100' (30.5 m)
FS221	1" (25.4 mm)	1/16" (1.6 mm)	100' (30.5 m)
FS22112	1-1/2" (38 mm)	1/16" (1.6 mm)	100' (30.5 m)
FS222	2" (51 mm)	1/16" (1.6 mm)	100' (30.5 m)

Minimum order: 1 roll. Sizes can be combined for quantity pricing.

CRL Plastic Reflective Tape

- Two Mirror-Like Finishes
- Adhesive Backed
- Conforms to Irregular Surfaces

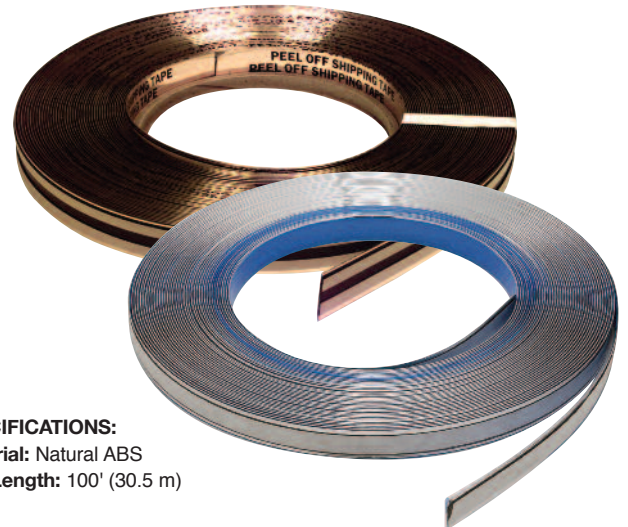
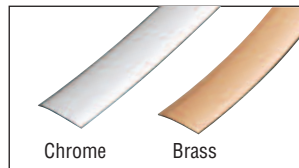

Adhesive Backing

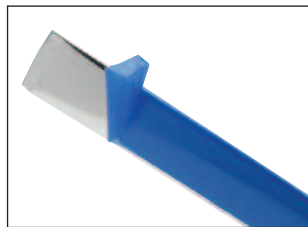

Protective Plastic Film

SPECIFICATIONS:
Material: Natural ABS
Roll Length: 100' (30.5 m)

CRL Plastic Reflective Tape has a mirror-like finish that blends easily to hide butt joints and rough edges on mirrored walls. It is flexible to conform well to curves and irregularities. Can be cleanly cut with a standard utility knife. Backed with a pressure sensitive adhesive, it is easy to apply and holds firmly in place.

CAT. NO.	FINISH	WIDTH	THICKNESS
PRT400CH	Chrome	1/2" (12.7 mm)	.040" (1.02 mm)
PRT400BR	Brass	1/2" (12.7 mm)	.040" (1.02 mm)
PRT475CH	Chrome	3/4" (19 mm)	.040" (1.02 mm)
PRT475BR	Brass	3/4" (19 mm)	.040" (1.02 mm)
PRT490CH	Chrome	1" (25.4 mm)	.030" (.762 mm)
PRT490BR	Brass	1" (25.4 mm)	.030" (.762 mm)

Minimum order: 1 roll. Sizes can be combined for quantity pricing.



CRL Cork and Neoprene Desk Stripping

- Provides Cushioned Protection Between Glass Top and Surface
- Easy to Apply and Remove

CRL's Cork and Neoprene Composition Desk Stripping has adhesive on one side with a cloth backing. Apply by peeling off backing and pressing in place. 100' (30.5 m) of brown color stripping per roll. 1" (25.4 mm) wide x 1/16" (1.6 mm) thick.

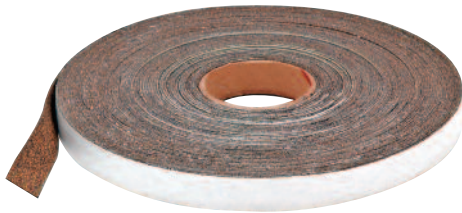

CAT. NO.	WIDTH	ROLL LENGTH
CN11	1" (25.4 mm)	100' (30.5 m)

Minimum order: 1 roll.



CRL Sponge Rubber Desk Stripping

- Provides an Excellent Protective Cushion Between Glass Top and Desk or Table Surface
- Very Easy to Apply and Remove

CRL Sponge Rubber Desk Stripping has adhesive on one side with a paper backing. This Sponge Rubber Stripping is very easy to apply and remove. It provides an excellent protective cushion between any glass top and table surface. 50' (15.2 m) of black color stripping per roll. 3/4" (19 mm) wide x 1/16" (1.6 mm) thick.



CAT. NO.	WIDTH	ROLL LENGTH
SRS33	3/4" (19 mm)	50' (15.2 m)

Minimum order: 1 roll.

CRL Adjustable Multi-Cutter Tool

- Makes Straight or Precise Miter Cuts in Many Kinds of Tape
- Adjustable Guide



CAT. NO. MC80N



CAT. NO. MC80RB

The CRL Adjustable Multi-Cutter Tool is great for cutting PVC strips, rubber gaskets, molding and weatherstrip. Simply adjust the guide with the desired angle line on the tool's platform and you have a perfect 135, 120, 105, 90, 75, 60 or 45 degree miter cut every time. The cutter is made of high-quality steel with vinyl handgrips that allow for comfort when cutting. Includes one blade.

CAT. NO.	DESCRIPTION
MC80N	Adjustable Multi-Cutter Tool
MC80RB	

Minimum order: MC80A is 1 each, MC80RB is 1 pack.

CRL Grip Strip

- Self Adhesive Black Tape Grips Glass But Does Not Stick to It

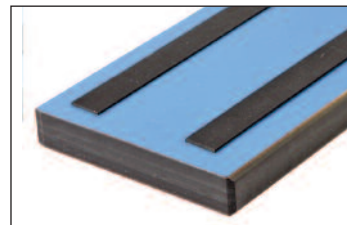

CRL Grip Strip is a unique, self-adhesive tape you apply to your straight edges and L-Squares to keep them from slipping on glass while cutting. It grips the glass but will not stick to it or leave a messy residue. This good quality tape is quick and easy to apply, and comes on release paper rolls. Tape measures 1/2" x 25' (12.7 mm x 7.6 m). Minimum order is one roll.

CAT. NO. GG1225

CRL Heavy-Bodied Mirror Mastic

- **Reliable, Top-Quality Formula Comes Ready to Use**

CRL Heavy-Bodied Mirror Mastic is an adhesive mastic formulated for adhering plate glass mirror and acrylic mirror to various substrates, such as drywall, wood, glass, metal or tile. Ideal for large mirrored walls, columns, and vanities. May be used with CRL Category Two Safety Tape Film that has been washed with a 70% solution of isopropyl alcohol (IPA). All applications must have permanent bottom support and mechanical fasteners. Qualifies for **LEED®** (Leadership in Energy and Environmental Design) Green Building Rating System™ credit. **NOTE:** Use Mirror Mastic® Bond to seal porous substrates (see page N273).



CAT. NO.	CONTENTS	QTY/CASE
600GL	1 Gallon (3.785 l)	4

Minimum order: 1 gallon.

CRL Light-Bodied Mirror Mastic

- **Top-Quality Adhesive for Lightweight Mirrors or Mirror Tiles**

CRL Light-Bodied Mirror Mastic is a top quality adhesive. Use it to coat an entire mirror backing to hold pieces together in case of breakage. Use with Double Sided Mirror Mounting Foam Tape (see pages N258-N259) for small mirror installations, or for J-Channel and Mirror Clip installations. It is not recommended for installations of heavy mirror panels or in overhead installations. All applications must have permanent bottom support and mechanical fasteners.



CAT. NO.	CONTENTS	QTY/CASE
300GL	1 Gallon (3.785 l)	4

Minimum order: 1 gallon.

CRL Mirror-Tite Mastic Dots

- **Easy to Use With No Mess or Waste**
- **Instant Grab With No Curing Time Before Hanging Mirror**
- **Perfect for Small Mirror Installations Such as Bathroom Vanity Mirrors**



CRL Mirror-Tite Mastic Dots are a new and innovative adhesive system for mirror installations. Easy-to-use, simply remove the dots from the box, apply to the wall, remove the release paper and install the mirror. Mirror-Tite Mastic Dots immediately grab the mirror and substrate. There is no need to wait for the curing times of typical mastics. Mirror-Tite Mastic Dots are primarily designed for bathroom vanity mirrors that do not exceed 36" (914 mm) in height.

CRL Mirror-Tite Mastic Dots should be applied one dot per square foot of wall. If extra thickness is needed to bridge irregularities, simply stack dots to the desired height. A mechanical support system is needed and pressure must be used when setting the mirror. Mastic Dots are black in color. **NOTE:** Do not apply on wallpaper or treated woods. Not intended for exterior use. Not for large mirrored walls.



CAT. NO.	THICKNESS	DIAMETER	QTY/CASE
MD150	3/16" (4.8 mm)	3" (76 mm)	150

Minimum order: 1 case.

CRL Palmer Mirro-Mastic® in Cans

- The Industry Standard for High Quality Mastic
- Cures to Form a Strong, Permanent Bond
- Does Not Become Hard or Brittle With Age
- Palmer Application Guidelines Available

Palmer Mirro-Mastic® is an adhesive mastic formulated for adhering plate glass mirror and acrylic mirror to various substrates, such as drywall, wood, glass, metal or tile. Mirro-Mastic® is ideal for large mirrored walls, columns, and vanities. Mirro-Mastic® does not become hard or brittle with age. Unopened cans have a two-year shelf life. Mirro-Mastic® may be used with CRL Category Two Safety Tape that has been washed with a 70% solution of isopropyl alcohol (IPA). All applications must have permanent bottom support and mechanical fasteners. Palmer Mirro-Mastic® also qualifies for **LEED®** (Leadership in Energy and Environmental Design) Green Building Rating System™ credit.

MASTIC COVERAGE: With minimum coverage, one gallon will install approximately 130 square feet (12 square meters) of mirror. 130 to 135 golf ball size pats per gallon.

NOTE: Use Mirro-Mastic® Bond (see page N273) to seal porous substrates.

SPEC. DATA

MSDS

NO AIR FREIGHT

VIDEO



CAT. NO. PM201GL
1 Gallon

CAT. NO. PM205
5 Gallons

CAT. NO.	CONTENTS	QTY/CASE
PM201GL	1 Gallon (3.785 l)	4
PM205	5 Gallons (18.927 l)	1

Minimum order: 1 each.

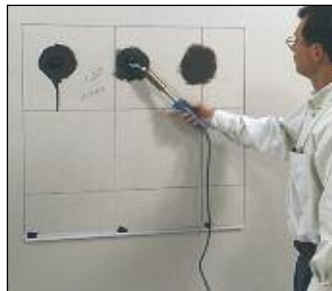

CRL Palmer Mirro-Mastic® in Cartridges

- Same Formula as Above in the Convenience of a Cartridge
- Ideal for Large Mirrored Walls

Palmer Mirro-Mastic® in cartridges is the same high quality adhesive mastic that is in the can, but with the added convenience of a cartridge. It is formulated for adhering plate glass mirror and acrylic mirror to various substrates, such as drywall, wood, glass, metal, and tile. Mirro-Mastic® is ideal for large mirrored walls, columns, and vanities. It has a one-year shelf life. Mirro-Mastic® may be used with CRL Category Two Safety Tape that has been washed with a 70% solution of isopropyl alcohol (IPA).

All applications must have permanent bottom support and mechanical fasteners. This product also qualifies for **LEED®** (Leadership in Energy and Environmental Design) Green Building Rating System™ credit. **MASTIC COVERAGE:** With minimum coverage, one 29 ounce (857 ml) cartridge will install approximately 30 square feet (2.8 square meters) of mirror, and one 11 ounce (325 ml) cartridge will install approximately 12 square feet (1.1 square meters) of mirror.

NOTE: Use Mirro-Mastic® Bond (see page N273) to seal porous substrates.

SPEC. DATA

MSDS

NO AIR FREIGHT

VIDEO



CAT. NO. PM601T
11 Ounces



CAT. NO. PM601QT
29 Ounces

CAT. NO.	CONTENTS	QTY/CASE
PM601T	11 Fl. Oz. (325 ml)	24
PM601QT	29 Fl. Oz. (857 ml)	12

Minimum order: 1 each. Cartridges can be combined for quantity pricing.

CRL Palmer QwikSet™ Mirro-Mastic®

- Fast Cure Time
- Ideal for Overlays and Beveled Strips

Palmer QwikSet™ Mirro-Mastic® is a fast curing adhesive mastic formulated for adhering plate glass mirror to various substrates, such as drywall, wood, glass, metal, or tile. QwikSet™ is ideal for mirror-to-mirror overlays, beveled strips, and mirrored furniture. At room temperature (72°F / 22°C), QwikSet™ will cure to 80 percent strength in 48 hours. It has a one-year shelf life from the date on the end of the cartridge. Use sealer or primer on porous substrates, but not Palmer Mirro-Mastic® Bond. **NOTE:** Do not use on acrylic mirror, safety tapes or backings.



CAT. NO.	CONTENTS	QTY/CASE
PM711N	10.1 Fl. Oz. (298 ml)	24

Minimum order: 1 each. Can be combined with all cartridge mastics for quantity pricing.

CRL Palmer Mastic Stik™

- Applicator and Remover for Palmer Mirro-Mastic®
- Lightweight, Yet Extremely Durable

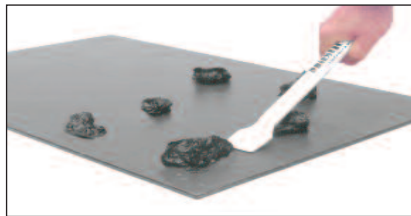

Mastic Stik™ makes it easy to apply or remove mastic



The Palmer Mastic Stik™ has a scoop end with a chiseled tip, making it the ideal tool for the application or removal of Palmer Mirro-Mastic®. Scoop end is just the right size for recommended "pats" or "gobs" of mastic, and its chiseled edge lets you remove mastic without scratching mirror backing. Made of lightweight and durable PVC, the Mastic Stik™ measures 16-1/2" (419 mm) long. Chiseled scoop edge is 1-1/2" (38 mm) wide. Minimum order is one each.

CAT. NO. MS97

CRL Palmer Mirro-Mastic® Bond

- Made for Priming Wall Surfaces
- Apply With a Brush or Roller



Palmer Mirro-Mastic® Bond is made specifically to seal porous wall surfaces prior to application of CRL Palmer Mirro-Mastic®. Use it to prime walls of wood, concrete, drywall, concrete block or brick before you apply Mirro-Mastic®. Apply with a brush or roller. It penetrates and seals walls, giving the best possible surface for mirror installations.

NOTE: Mirro-Mastic® Bond is not required for glazed porcelain or tile surfaces, nor for mirror-to-mirror installations. Use only with regular Palmer Mirro-Mastic®. Never use Mirro-Mastic® Bond with Palmer QwikSet™. Coverage: Approximately 400 square feet (37 square meters) per gallon.



CAT. NO.	CONTENTS	QTY/CASE
PMB401GL	1 Gallon (3.785 l)	4

Minimum order: 1 gallon.

CRL Palmer Electric Mastic Applicator

- Heated Scoop Deposits Mastic Easier and in Uniform Size Pats
- Maximizes Yield per Can

Use the Palmer Electric Mastic Applicator to scoop out regular Mirro-Mastic® in uniform size pats. The heated bowl scoops mastic directly from the can to apply either to the substrate or mirror panel. Applicator operates on 110V AC power, and is the most convenient way to apply CRL Palmer Mirro-Mastic®. When using this tool there are approximately 130-135 pats of mastic per gallon. Preferred application for proper spread of mastic is to apply pats in rows, spacing pats about 8" to 12" (203 to 305 mm) apart and 6" (152 mm) in from the edge of the mirror. Minimum order is one each.

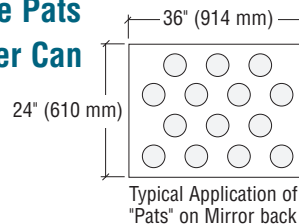

CAT. NO. 1234PA

CRL Gunther Mirror Mastics

- Two High Strength Formulas
- Extra/Build™ Provides Build Out for Large Mirrored Walls
- Ultra/Bond™ Compresses for Tight Tolerances Such as Overlays

Gunther Ultra/Bond™ and Extra/Build™ Mirror Mastics are high-quality adhesives formulated to provide a strong, permanent bond between electro-copper-plated glass mirror and various substrates. Both have been field tested for compatibility with silver, copper, and mirror backing. Both have an easy working consistency year round, and will adhere to a wide variety of substrates including drywall, wood, metal, glass, marble, and tile.

NOTE: Not for use on acrylic mirror. Use Cat. No. GN6 Gunther Prime-N-Seal™ Primer (see page N275) on all porous substrates. Application guidelines are available online for all Gunther products. Mechanical support systems are recommended for all mirror applications.

SPEC. DATA

MSDS

NO AIR FREIGHT

VIDEO



Gunther Ultra/Bond's viscosity provides for a build out of 3/4" (19 mm), and can be compressed to 1/32" (.8 mm) for mirror installations requiring close tolerances, such as overlays, mirrored furniture, and medicine cabinets. At 72°F (22°C) it achieves approximately 30% strength in 24 hours, full cure up to 605 psi in 30 days. It comes in 10.1 Fl. Oz. cartridges and one gallon cans.

Gunther Extra/Build's viscosity provides for a build out of 2-1/2" (63.5 mm) without sag for custom mirrored walls or vanities, where construction is such that there are gaps of over 3/4" (19 mm) between the mirror and the substrate. At 72°F (22°C) it achieves approximately 20% strength in 48 hours, full cure up to 300 psi in 30 days. It comes in 10.1 Fl. Oz. cartridges and one gallon cans.

10.1 FL. OZ. (299 ML) CARTRIDGES

CAT. NO.	TYPE	COLOR	QTY/CASE
GN100A	Ultra/Bond™	Cream	24
GN200A	Extra/Build™	Black	24

Minimum order: 1 each. Can be combined with all cartridge mastics for quantity pricing.

ONE GALLON (3.785 L) CANS

CAT. NO.	TYPE	COLOR	QTY/CASE
GN101B	Ultra/Bond™	Cream	4
GN201B	Extra/Build™	Black	4

Minimum order: 1 each. Gallons can be combined for quantity pricing.

CRL Gunther Premier™ Plus Mirror Mastic

new

- Bonds to Porous and Non-Porous, Primed and Unprimed Surfaces
- Fast Permanent Bond, Yet Remains Very Flexible
- Will Compress to 1/16" for Mirror Overlays
- Ultra Low VOC (10 g/l)

Gunther Premier™ Plus Mirror Mastic is a high-quality, urethane based adhesive formulated to provide a strong, permanent bond between electro-copper-plated glass mirror or acrylic mirror and various substrates, including CRL Brand Category II Safety Tape. It is a very versatile product that is ideal for high-traffic areas, such as gyms, dance studios, and commercial projects. It holds firm, yet absorbs movement, vibrations, and allows for thermal expansion and contraction. It can be built out to 2" (51 mm) for large mirrors or uneven wall jobs, or compressed to 1/16" (1.6 mm) for mirror installations requiring close tolerances, such as overlays, mirrored furniture, and medicine cabinets. Mechanical support systems are recommended for all mirror applications. This product also qualifies for the LEED® (Leadership in Energy and Environmental Design) Green Building Rating System™ credit.

SPEC. DATA

MSDS

VIDEO



Gunther Premier™ Plus at 72°F (22°C) achieves approximately 30 percent strength in 24 hours, full cure in 7 days. Gunther Premier™ Plus should be applied in 3/8" (9.5 mm) vertical beads, 5 to 6" (127 to 152 mm) apart and away from the edge to prevent squeeze out. Approximate coverage is 7 sq. ft. per cartridge.



Gunther Premier™ Plus may be used with CRL Brand Category II Mirror Safety Tape.

CAT. NO.	COLOR	CONTENTS	QTY/CASE
GN105P	Gray	10.3 Fl. Oz. (304 ml)	12

Minimum order: 1 each. Can be combined with all cartridge mastics for quantity pricing.

CRL Gunther Prime-N-Seal™ Primer

- Enhances Adhesion of Gunther Mastics
- Quick Drying



Gunther Prime-N-Seal™ is a superior, quick drying acrylic primer and sealer designed to help eliminate mirror installation failure. It enhances the adhesion of Gunther Mastics while protecting the mirror from substrate contaminants. Prime-N-Seal™ promotes exceptional adhesion to drywall, greenboard, concrete, plaster, plywood, brick, and other substrates. It does not become brittle with age, is non-flammable, and does not contain environmentally damaging ingredients. Gunther Prime-N-Seal™ Primer is easy to apply by brush, roller or spray, and has a flat white appearance when dry.



CAT. NO.	CONTENTS	QTY/CASE
GN6	32 Fl. Oz. (946 ml)	6

Minimum order: 1 quart.

CRL Gunther Seal-Kwik™ Mirror Edge Sealant

- Protects Mirror Edges From "Black Edge"
- Dries Clear
- Built-In Applicator Top



Easy Application with Sponge-Dauber Top

CRL Gunther Seal-Kwik™ has a safe, proven formula for protecting mirror edges from "black edge". Seal-Kwik™ goes on fast and easy, with no running, spilling or wasteful overspray, using a sponge-dauber top. Seal-Kwik™ dries clear, and will not yellow or crack with age.



CAT. NO.	CONTENTS	QTY/CASE
GN4	4 Fl. Oz. (118 ml)	6

Minimum order: 1 each.

CRL Aerosol Mirror Edge Sealant

- Sprays On Clear to Seal Mirror Edges After Sanding and Beveling
- Prevents Cut Mirror Edges From Turning Black as They React to Moisture



Aerosol Spray for Faster Application



CRL Aerosol Mirror Edge Sealant sprays on clear to seal mirror edges after cutting, seaming or polishing. Edge Sealant protects the edges from turning black, which occurs when the silver backing is exposed to humidity. The sealant provides long lasting protection against moisture and other harmful conditions.

CAT. NO.	NET WEIGHT	QTY/CASE
S209	10.5 Oz. (298 g)	12

Minimum order: 1 each.

CRL Mirror Edge Sealant

- Prevents Mirror Edges From Turning Black
- Sponge Applicator Included



Easy, Brush-on Application



CRL Mirror Edge Sealant protects the silver on seamed or finished edges from turning black. Black edges occur when the silver is exposed to humidity or acidity. This easy-to-use brush on product has no wasteful overspray, and will guard edges against harmful conditions. 1" (25 mm) wide Sponge Applicator included with every can.

CAT. NO.	NET WEIGHT	QTY/CASE
MES16	16 Fl. Oz. (473 ml)	6

Minimum order: 1 pint.

CRL Category II Safety Backing Tape for Mirrors

SPEC. DATA

MSDS

- **Makes Mirrors Shatter Resistant**
- **Keeps Glass Fragments From Causing Serious Bodily Damage Should Mirror Be Accidentally Broken**
- **Ready to Use and Easy to Apply**

Category II Safety Backing Tape for Mirrors keeps glass fragments together should mirrors be accidentally broken. Comes in 600 foot (183 m) rolls, individually boxed for shipment by U.P.S., except for 60" (1524 mm) width, which must ship via common carrier. You can combine widths for quantity pricing. For specifications, go to our web site crlaurence.com.

This pressure-sensitive, adhesive coated film tape is primarily recommended for mirrored wardrobe doors that require a Category II Mirror Safety Backing. The woven scrim embedded in the film for high tensile and impact strength also prevents moisture entrapment and scrim delamination. The high performance adhesive allows for easy roll unwind, yet promotes high bond to a wide variety of mirror backings. Complies with ANSI Z97.1-1984 and 16CFR1201 for impact resistance.



Category II Safety Tape with Woven Scrim

- **Available in Four Widths**

CAT. NO.	WIDTH	ROLL LENGTH
2MT24	24" (610 mm)	600' (183 m)
2MT36	36" (914 mm)	600' (183 m)
2MT48	48" (1219 mm)	600' (183 m)
2MT60	60" (1524 mm)	600' (183 m)

Minimum order: 1 roll. Widths can be combined for quantity pricing.



Mastic Application:

Only regular Palmer Mirro-Mastic® (Cat. No.'s PM201GL, PM205, PM601T, and PM601QT); CRL Heavy Bodied Mirror Mastic (Cat. No. 600GL) and Gunther Premier Plus Mastic may be used with Category II Safety Tape* that has been washed with 70 percent isopropyl alcohol (Rubbing Alcohol). Palmer Qwikset Mirro-Mastic®, Gunther Extra/Build, or Gunther Ultra/Bond are **NOT** to be used with any Safety Tape unless holes are cut out prior to applying mastic (see image at right). *Gunther Premier Plus has only been tested and approved for CRL Brand Category II Safety Tape.



Applying mastic to mirror with Category II Tape applied to back with no holes cut out

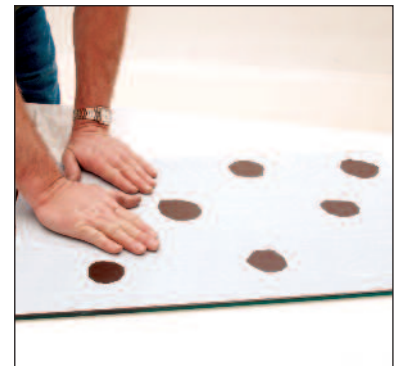

Tape applied to back with holes cut out for application of mastic. Application temperature range is 60 to 100°F (15 to 37°C).

CRL Loctite® Minute Bond Adhesive and Primer

- Clear Color Makes it an Excellent All Purpose Adhesive
- Superior Holding Power Up to 3000 psi
- Joins Glass to Metal Permanently in Just Seconds
- Four Kit Sizes Including Single Application

CRL Loctite® Minute Bond Adhesive permanently bonds non-porous materials such as glass, metal, tile, coated wood, plastics, and nylon with superior strength holding power up to 3,000 psi. The combined Primer and Adhesive two-step application offers handling strength in 10 seconds, 60% full strength in two minutes, and a full cure in 24 hours. Kits contain both Adhesive and Primer.



CAT. NO. 0144
1.69 Fl. Oz. Kit



CAT. NO. 3325
0.8 Fl. Oz. Kit



CAT. NO. 37438
0.2 Fl. Oz. Kit



CAT. NO. 37438
Single Applicator Kits



CAT. NO. 73656
Minute Bond Primer

NOTE: Minute Bond Adhesive is only recommended for use on non-porous flat surfaces that are to be mated together with a gap of .004" maximum. Where bond gaps are large, up to a maximum of .02", or faster cure speed is required, primer should be applied to both surfaces. Primer should be 72°F (22°C) or warmer.

CAT. NO.	CONTENTS	MINIMUM ORDER
0144	1.69 Fl. Oz. (50 ml) Adhesive/6 Oz. (170 g) Primer	1 Kit
3325	0.8 Fl. Oz. (24 ml) Adhesive/6 Oz. (170 g) Primer	1 Kit
3346	0.2 Fl. Oz. (6 ml) Adhesive/1.33 Oz. (38 g) Primer	1 Kit
37438	0.01 Fl. Oz. (0.3 ml) Adhesive/0.02 Fl. Oz. (0.6 ml) Primer	1 Box (12/bx)
73656	6 Oz. (170 g) Minute Bond Primer	1 Can

Minimum order: 1 each.

CRL Loctite® Superbonder® Adhesive

- Bonds Instantly
- No Mixing
- No Mess



CAT. NO. 49504
0.1 Oz. (3 g)



CAT. NO. 49550
1 Oz. (28.4 g)

CRL Loctite® Superbonder® Adhesive sets in seconds to form a permanent transparent bond. It's effective on metal, rubber, aluminum, ceramics, vinyl, alloys, plastics, and other non-porous surfaces. Comes ready to use, with no mixing required.

CAT. NO.	NET WEIGHT	QTY/CASE
49504	0.1 Oz. (3 g)	10
49550	1 Oz. (28.4 g)	10

Minimum order: 1 each.

CRL Loctite® Prism® Instant Adhesives

- Fast Curing Gel Bonds Non-Porous and Porous Surfaces
- Highly Resistant to Solvents, Weathering, and Temperature Extremes



CAT. NO. 45404
High Viscosity



CAT. NO. 40104
Medium Viscosity



CAT. NO. 40140
Medium Viscosity

Use CRL Loctite® Prism® in places where you could never use instant adhesives before. Prism® goes beyond typical cyanoacrylate adhesives to perform on wood, leather, ceramic, paper, foam, rubber, fabric, metal, plastic or elastomeric materials. Prism® also works on acidic surfaces, such as freshly plated or coated metal parts.

CAT. NO.	NET WEIGHT	DESCRIPTION	QTY/CASE
45404	0.1 Oz. (3 g)	High Viscosity Gel	30
40104	0.1 Oz. (3 g)	Medium Viscosity Gel	30
40140	0.7 Oz. (20 g)	Medium Viscosity Gel	10

Minimum order: 1 each.

CRL Loctite® Metal Contact Cement

- The Strength of an Epoxy and the Speed of an Instant Adhesive
- Permanently Bonds Cap Rails, Hand Rails, and Their Accessories With Superior Strength for Holding Power Up to 2,700 psi
- Offers Handling Strength in 60 Seconds, Full Cure in 24 Hours

To permanently bond Metal Rails and their accessories we suggest this strong adhesive system from Loctite®, with two different Primers to best suit your assembly time frame.

Use Cat. No. 7649 Primer to activate in 60 seconds, 60% of full strength in two minutes, and a full cure in 24 hours. When a longer curing time is needed use Cat. No. 7075 Primer to activate in five minutes, 60% of full strength in ten minutes, and a full cure in 24 hours.

For best performance surfaces should be clean and free of grease. Simply apply a generous amount of Primer to both of the bond surfaces and apply Adhesive to one of the surfaces. Position parts quickly and exactly as Adhesive begins to work immediately. Excess Adhesive outside joined surfaces can be wiped away with an organic solvent.



CAT. NO.	DESCRIPTION	ACTIVATION	CONTENTS
32629	Metal Contact Cement	---	1.69 Fl. Oz. (50 ml)
7649	Primer for Metal Contact Cement	60 Seconds	1.75 Fl. Oz. (52 ml)
7075	Primer for Metal Contact Cement	5 Minutes	4.5 Oz. (128 g)

Minimum order: 1 each. *Cat. No. 7075 cannot be shipped via air freight.



CAT. NO. 32629
Cement



CAT. NO. 7649
60 Second Primer



CAT. NO. 7075*
5 Minute Primer

CRL Loctite® Fast Cure Epoxy

- Bonds Virtually Any Material in as Little as 10 Minutes
- Pre-Measured Individual Mixer Cups Assure Consistent Results

CRL Loctite® Fast Cure Epoxy bonds, seals, and repairs almost anything in as little as ten minutes. The convenient no mess, no guess, no waste mixer cup packaging assures consistent results. Zip off the protective film, pop the mixer cup, and mix the pre-measured parts thoroughly. The resulting gray-colored mixture gives a strong and confident bond to glass, metal, plastic, wood, ceramic, marble, brick, concrete, and many more surfaces.

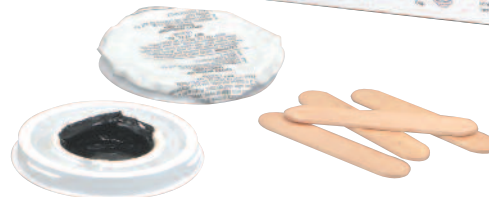

CAT. NO.	CUP CONTENTS	QTY/BOX
44581X10	.12 Fl. Oz. (3.5 ml)	10 Cups
44583X10	1 Oz. (28 g)	10 Cups
44583X50	1 Oz. (28 g)	50 Cups

Minimum order: 1 box.



Zip Off the Protective Film



Pop the Mixer Cup

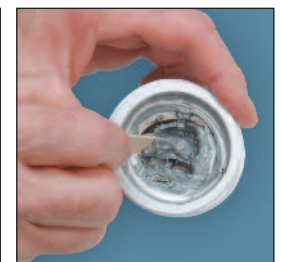

Mix Contents Thoroughly

CRL Loctite® Poxy-Pak™ Clear Two-Part Epoxy



- Pre-Measured Resin and Hardener for Easy Application, Consistent Strength
- Resealable - No Waste
- Bonds Virtually Any Material

CRL Loctite® Poxy-Pak™ Clear Adhesive is a rapid cure two-part epoxy that reaches handling strength in about five minutes, and fully cures in 45 to 60 minutes. Poxy-Pak™ is easily dispensed from the two-cylinder syringe in any amount you need. It bonds metals, ceramics, concrete, wood, glass, and most plastics. It's inexpensive to use, as the unused portion can be re-sealed and saved. May be drilled, tapped, sanded, machined, and painted after it cures. Poxy-Pak™ cures at room temperature, and can withstand temperatures up to 300°F (149°C).



CAT. NO.	CONTENTS	QTY/CASE
81120	1 Fl. Oz. (29 ml)	12

Minimum order: 1 each.

CRL Loctite® Contact Adhesives



- Fast Curing, High Strength
- Bonds to Rubber, Metal, Wood, and Fabric
- Choice of Black or Yellow Color Formulas

Loctite® Contact Adhesive is a viscous liquid contact cement for general purpose bonding. It bonds rubber, weatherstripping, insulation, wood, metal, and fabric. After completely curing it is water and chemical resistant. Choice of black or yellow colors.



Yellow

Black

CAT. NO.	COLOR	CONTENTS	QTY/CASE
30537	Yellow	5 Fl. Oz. (147 ml)	12
30540	Black	5 Fl. Oz. (147 ml)	12

Minimum order: 1 each.

CRL Loctite® Threadlocker



- Locks and Seals Against Loosening
- Protects Threads Against Corrosion

Loctite® Threadlocker eliminates the need for stocking costly lock nuts and lock washers. This blue-colored sealer locks standard nuts in place and keeps them from loosening due to vibration. The medium strength formula allows nuts to be removed for disassembly using normal hand tools, and also helps protect threads from corrosion.



- New Semi-Solid Stick



CAT. NO.	CONTENTS	QTY/CASE
24221	.34 Fl. Oz. (10 ml) Liquid	10
24231	1.69 Fl. Oz. (50 ml) Liquid	10
37684	.32 Oz. (9 g) Stick	10
37087	.67 Oz. (19 g) Stick	10

Minimum order: 1 each.

CRL Loctite® Form-A-Thread®



- Repairs Threads in Less Than One Hour

CRL Loctite® Form-A-Thread® repairs almost all fastener sizes and thread grades. It maintains the thread size, so you can re-use the original fastener. Other thread repair methods are now obsolete! Makes fastener repair easy for both do-it-yourselfers and professionals.



Just Spread Form-A-Thread® In the Hole

Forms New Reusable Threads Fast



CAT. NO.	CONTENTS	QTY/CASE
28654	.32 Fl. Oz. (9.5 ml)	6

Minimum order: 1 each.

CRL 3M™ Super Weatherstrip Adhesive (Black Color)



- Strong and Flexible
- Rapid Setting
- Withstands Extreme Temperatures

3M™ Super Weatherstrip Adhesive is a strong, flexible, rubbery adhesive that withstands vibration and extreme temperature variations. Primarily designed for use on T-Tops and Sunroofs to provide the strength and rapid setting needed to hold weatherstripping and gaskets in place. Because of its black color, clean-up is virtually eliminated because it blends in with the rubber.

CAT. NO.	CONTENTS	QTY/CASE
3M8008	5 Fl. Oz. (147 ml)	12

Minimum order: 1 each. All Adhesives on this page can be combined for quantity pricing.

CRL 3M™ Super Weatherstrip Adhesive (Yellow Color)



- Exceptional Bonding Strength
- Waterproof and Flexible
- Extremely Fast Drying

This 3M™ Super Weatherstrip Adhesive is primarily used for bonding and sealing weatherstripping to car trunks and doors. Easy to brush on and spread, it's also extremely fast drying. 3M™ Super Weatherstrip Adhesive resists oil, grease, and solvents. A good general purpose cement for the auto shop.

CAT. NO.	CONTENTS	QTY/CASE
3M8001	5 Fl. Oz. (147 ml)	12

Minimum order: 1 each. All Adhesives on this page can be combined for quantity pricing.

CRL 3M™ Weatherstrip Adhesive



- Fast Drying Adhesive That Can Be Used for Sealing Between Rubber and Glass
- Excellent Adhesion to EPDM Weatherstripping
- Remains Flexible

This 3M™ Weatherstrip Adhesive is used for bonding and sealing weatherstripping, as well as sealing between rubber and glass. The black color matches most weatherstripping. It is easy to apply, remains flexible, and is waterproof.

CAT. NO.	CONTENTS	QTY/CASE
3M8011	5 Fl. Oz. (147 ml)	12

Minimum order: 1 each. All Adhesives on this page can be combined for quantity pricing.

CRL 3M™ Plastic and Emblem Adhesive



- Clear Color Adhesive for Plastic Repair and Emblem Application
- Great for Taillight Lenses and Vinyl Trim Strips
- Quick Drying

3M™ Plastic and Emblem Adhesive is used for plastic repair and emblem applications. Because it is clear, strong, and quick drying it can be used for both interior and exterior bonding.

CAT. NO.	CONTENTS	QTY/CASE
3M8061	5 Fl. Oz. (147 ml)	12

Minimum order: 1 each. All Adhesives on this page can be combined for quantity pricing.

CRL 3M™ Fast Tack Trim Adhesive

- Fast Drying With Long Tack
- Transparent and Non-Staining
- Permits Repositioning

3M™ Fast Tack Trim Adhesive is a transparent, extremely fast drying, non-staining adhesive with long tack for attaching various auto trim such as upholstery cloth, floor mats, carpeting, kick pads, and silencer pads to painted, primed or bare metal, wood, K.B. board or other fabrics. **NOTE:** For attaching vinyl trim, we suggest you use 3M™ Super Trim Adhesive Spray, Cat. No. 3M8090 (see page N283).



CAT. NO.	CONTENTS	QTY/CASE
3M8031	5 Fl. Oz. (147 ml)	12

Minimum order: 1 each. All Adhesives on this page can be combined for quantity pricing.

CRL 3M™ Auto-Mix™ Adhesive System

- Black Color Adhesive is Extremely Fast-Setting
- Side Glass Bonding is Easier, Goes Faster



CAT. NO. 3M8641
3M™ Auto-Mix™ Adhesive



CAT. NO. 3M21791
3M™ Auto-Mix™ Adhesive Mixer



CAT. NO. 3M8190
3M™ Auto-Mix™ Adhesive Applicator Gun



CRL 3M™ Auto-Mix™ Adhesive is a fast-curing, two-part epoxy that is extremely flexible when cured. Use it with the assurance that it will hold the bonded glass in the side channel, and resist vibration and shock. The CRL 3M™ Auto-Mix™ Adhesive Applicator Gun with the special Mixer Nozzle (12 per pack) quickly and neatly mixes and dispenses the adhesive exactly where you want it. Handling strength is achieved in about 15 minutes, with full cure in one hour. Net content of both tubes of adhesive is 1.6 fl. oz. (47 ml). Minimum order is one each for the Adhesive and Applicator Gun and one package of 12 for the Mixer Nozzles.

CRL 3M™ Structural Adhesive

- Powerful Bonding Strength
- Bonds Steel, Glass, Rubber, Plastic, and Fiberglass



CAT. NO. 3M8101



CRL 3M™ Structural Adhesive is a two-part general purpose adhesive that may be used for many structural and auto repair jobs. It may be used for bonding auto glass to metal retainers and also for trim ornaments and miscellaneous fiberglass repairs. The two components come in separate tubes, you mix an equal amount from each tube as needed for each repair. This powerful bonding system bonds steel, glass, rubber, plastic, and fiberglass. Achieves handling strength in one hour and full cure in eight hours. Each Kit contains two tubes, one 2 fl. oz. (59 ml) tube of each part per package. Minimum order is one each.

CRL #33 Acrylic Cement

new

- Clear-Thickened Acrylic Cement
- Joins Acrylic Sheet, Plexiglas®, Lucite®, and Acrylite®

Used to adhere acrylic to acrylic. Apply this cement and allow it to wet both surfaces. Hold or clamp firmly until set. Joint will be fully cured in 24 hours. This high-viscosity cement is perfect to apply to exterior edges of acrylic hinges for added strength. Tube contents is 1.5 fl. oz. (44 ml). Minimum order is one each.



CAT. NO. 3352133



CRL Titebond® III Wood Glue

new

- Waterproof Formula
- Designed for Interior and Exterior Applications
- Assembly Time: 10 Minutes; Set Time: 24 Hours; Clamping Time: 30 Minutes

Use CRL Titebond® III Wood Glue when joining Wood Cap Rails, mitered Wood Hand Rail Corners, and installing Wood End Caps. This waterproof, water-based formula passes Type 1 water-resistance specifications and conforms to ASTM D-4236. Unaffected by finishes, this Glue will fully set up within 24 hours, and is designed for interior and exterior applications. Content is 8 fl. oz. (237 ml). Minimum order is one each.



CAT. NO. CRLWG1



CRL Elmer's® Glue-All®

- The Versatile Glue That Dries Clear and Fast
- Holds Strong on Most Porous Surfaces
- Non-Flammable and Non-Toxic

CRL Elmer's® Glue-All® is the strong, versatile glue that dries to a clear, strong bond on paper, wood, cardboard, cloth, and almost any porous material. It's easy to clean up and work with.

Elmer's® Glue-All® is non-toxic, non-flammable, and produces no harmful fumes. Available in one gallon (3.785 l) plastic bottles and 50 gallon (189 l) drums.

CAT. NO.	CONTENTS	QTY/CASE
E395	1 Gallon (3.78 l)	4
E39555GL	50 Gallons (189 l)	1

Minimum order: 1 each. Drums must ship common carrier.



1 Gallon Bottle



50 Gallon Drum

CRL Double/Bubble® Extra Fast Setting Epoxy

- Clear Color

new

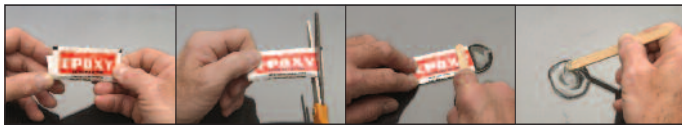

Fold Snip Squeeze Mix/Apply

This extra fast setting, two-component, room temperature curing Epoxy is clear in color, and provides handling strength in only 15 to 30 minutes. Bonds to most substrates including: glass, metal (carbon steel, stainless steel, aluminum), wood, concrete, stone, ceramics, leather, china, and many plastics. Cures in temperatures as low as 0°F (-18°C). Cured epoxy withstands temperatures to 180°F (82°C). Net weight per pouch is 3.5 grams (.12 oz.). Minimum order is five each.



CAT. NO. DB04001

CRL QuikSteel Epoxy Putty

- Permanent Repairs to All Metals, Glass, PVC, Plastic, Ceramics, Wood, and More
- Mixes Like Putty So It's Easy to Use
- Can Be Drilled, Tapped, Sanded, and Painted

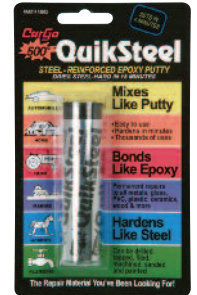

CRL QuikSteel Epoxy Putty is a steel-reinforced material that sets in four minutes, dries steel-hard in 15 minutes, and fully cures in 60 minutes. QuikSteel permanently bonds to aluminum, brass, copper, steel, PVC, fiberglass, plastics, glass, ceramics, wood, and more. It's easy to use. Cut off amount needed for repair and knead QuikSteel to one uniform color. QuikSteel can be drilled, tapped, machined, sanded, and painted. Will also set up under water, is resistant to 500°F (260°C) temperatures, is impervious to chemicals, and holds bonds to -90°F (-68°C).

CAT. NO.	NET WEIGHT	QTY/CASE
16002	2 Oz. (57 g)	6

Minimum order: 1 each.

CRL Double/Bubble® Epoxy

- Very High-Peel Strength

CRL Double/Bubble® Epoxy is a flexible, tough, and durable vibration resistant adhesive that is easily mixed and applied the same way as our Double/Bubble® Extra Fast Setting Epoxy (shown above). High peel and shear strengths make this Epoxy the only choice for Key Control Specialists Slide Guard Series Showcase Locks. It bonds to glass, metal, acrylic, polycarbonate, polystyrene, ABS nylon, wood, masonry, and rubber. It is gray in color, with a handling strength in 18 hours. Net weight per pouch is 3.5 grams (.12 oz.). Minimum order is five each.

- Used Exclusively on Key Control Specialists Security Locks

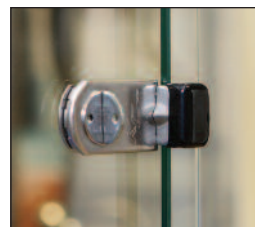

new



CAT. NO. SLGLA

CRL Spray Adhesive

- For Permanent or Temporary Bonds to Cardboard, Paper, Glass, Wood, Cloth, Metal, Plastic and Foam Rubber

- Quick Tack and Water Resistant

CRL Spray Adhesive is an easy-to-use industrial strength cement for installing insulation, attaching gaskets, joining foam rubber, applying labels, mounting sanding discs, tacking cloth, and dozens of other uses in the shop, factory or home. CRL66 makes a permanent or temporary bond that will not wrinkle, and is water resistant.

CAT. NO.	NET WEIGHT	QTY/CASE
CRL66	13 Oz. (369 g)	12

Minimum order: 1 each.



CRL 3M™ 77 Spray Adhesive

- Fast Drying
- Heat and Water Resistant
- Uniform Spray Application

3M™ 77 Spray Adhesive is a strong, translucent, fast-drying, multi-purpose adhesive for permanently attaching foils, cloth, carpeting, foams, paper, cardboard, felt, etc. to metal, wood, hardboard, and other base materials. Aggressive, high initial tack allows sufficient "positioning" time. It's an extremely versatile adhesive for the shop or home.

CAT. NO.	NET WEIGHT	QTY/CASE
3M77	16.75 Oz. (475 g)	12

Minimum order: 1 each.



CRL 3M™ Spray Trim Adhesive

- Bonds Lightweight Automotive Trim
- Fast Drying, Clear Color
- Convenient, Easy-to-Use Spray

Use 3M™ Spray Trim Adhesive for attaching various auto trim such as upholstery cloth, floor mats, carpeting, kick pads, and silencer pads to painted or bare metal, wood, K.B. board or other trim materials.

NOTE: Not recommended for use on vinyl materials or automotive headliners. For attaching vinyl use 3M™ Super Trim Adhesive, Cat. No. 3M8090 (shown below).

CAT. NO.	NET WEIGHT	QTY/CASE
3M8074	16.5 Oz. (467 g)	6

Minimum order: 1 each.



CRL 3M™ Super Trim Adhesive

- Bonds Vinyl Tops, Heavyweight Headliners
- Convenient, Easy-to-Use Spray
- Long Bonding Range

3M™ Super Trim Adhesive is a contact adhesive designed for bonding vinyl tops, heavy weight headliners, and hood silencer pads where high strength and heat resistance is needed. Provides high immediate bond strength and is repositionable during assembly. Excellent heat, water, and plasticizer resistance.

NOTE: Not recommended for polyethylene, polypropylene or foamed polystyrene.

CAT. NO.	NET WEIGHT	QTY/CASE
3M8090	19 Oz. (539 g)	6

Minimum order: 1 each.



CRL 3M™ Underseal™ Undercoating

- Rubberized Formula Helps Protect Underside of Vehicle
- Deadens Sound
- Paintable

new

3M™ Underseal™ Undercoating is a totally new, rapid drying, rubberized undercoating material in an aerosol container. Designed for rustproofing and sound deadening; also for sealing fenders, quarter panels, door panels, repaired sections, welded joints, hoods, and decks. Easy to apply, and won't plug nozzle.

CAT. NO.	NET WEIGHT	QTY/CASE
3M8882	17 Oz. (481 g)	12

Minimum order: 1 each.



CRL Liquid Nails® Adhesive

- Bonds to All Common Building Materials
- Durable Bond That Stays Flexible



CRL Liquid Nails® is a fast-bonding, superior quality, waterproof, rubber-based interior grade adhesive recommended for bonding plywood, hardboard, furring strips and molding, paneling, brick veneer, drywall, and cork board. **NOTE:** Liquid Nails® is not recommended for styrofoam, foam, plastic, marble, or mirrors.

Liquid Nails® has a strong initial grab, and a working time of up to 10 minutes on clean and dry surfaces. One of the surfaces to be bonded must be porous. Applies with a standard caulking gun, and cleans up with mineral spirits.

CAT. NO.	CONTENTS	QTY/CASE
LN601	10 Fl. Oz. (296 ml)	24

Minimum order: 1 each. Can be combined with all cartridge sealants for quantity pricing.



CRL Titebond® Heavy-Duty Construction Adhesive

- Designed for a Wide Range of Construction Applications



The Titebond® Heavy-Duty Construction Adhesive is a versatile, professional-strength adhesive that exceeds the American Plywood Associations AFG-01 specification. It is specifically designed for a wide range of construction applications including wet, frozen, and treated lumber. It is also ideal for metal, brick, concrete, ceramic, fiberglass, and most large panel-type substrates. **NOTE:** Not available for sale in California.

CAT. NO.	CONTENTS	QTY/CASE
F5261	10.5 Fl. Oz. (311 ml)	12

Minimum order: 1 each. Can be combined with all cartridge sealants for quantity pricing.



CRL Storm Window and Door Frame Adhesive and Solvent

- For New and Remedial Glazing of Aluminum Storm Windows and Doors
- Fast Drying, Firm Bond



CRL Storm Window Adhesive is an extremely strong bonding adhesive used for gluing glass into aluminum frame storm windows and doors. Flexible and fast drying, it has high resistance to heat and water. Seals glass, vinyl, steel, wood, and aluminum. Off-white neutral color. CRL Storm Window and Door Adhesive Solvent is used to clean up or thin CRL Storm Window Adhesive.

NOTE: Always use care and caution when working with solvents.



CAT. NO. C205GL



CAT. NO. C215GL

CAT. NO.	DESCRIPTION	CONTENTS	QTY/CASE
C205GL	Adhesive	1 Gallon (3.785 l)	6
C215GL	Adhesive Solvent	1 Gallon (3.785 l)	6

Minimum order: 1 gallon.

CRL Miracle All-Purpose Adhesive

- Fast Setting - Quick Tack
- Waterproof - May Be Used Indoors or Outdoors



CRL Miracle® All-Purpose Adhesive will adhere to most rigid materials, such as iron, steel, wood, concrete, brick, tile, hard plastics, plaster, gypsum board, etc. Recommended applications include: paneling, hardboard, expanded polyurethane foam board, semi-rigid fiberglass insulation, decorative wood strips, metal tracks (shower enclosure), slate/composition blackboards, and F.R.P. board. **NOTE:** Not available for sale in California.

CAT. NO.	CONTENTS	QTY/CASE
BL293	1 Gallon (3.785 l)	4

Minimum order: 1 gallon.

CRL Vinyl Weld

new



- Bonds PVC to PVC
- Fills Gaps and Gouges

Use CRL Vinyl Weld when bonding PVC to PVC. This gives you the ability to weld any part of a vinyl window or door in the field because it cures and becomes rigid PVC. 1/2 oz. (15 ml) tubes have a fine nozzle for precise sealing.



CAT. NO.	COLOR
VW1W	White
VW1ALM	Almond
VW1T	Tan

Minimum order: 1 each.

CRL Kwixset® and Rockite® Expanding Cements

- Kwixset® for Exterior Applications
- Rockite® for Interior Applications
- Great for Setting Core Mount Stanchions for Vertical Posts
- Fast Setting, They Will Not Shrink or Crack When Used as Directed



Exterior Applications

KWIXSET® CEMENT

CAT. NO.	CONTENTS
KWX25	25 Pounds (11.3 kg)
KWX50	50 Pounds (22.7 kg)

Minimum order: 1 each. **NOTE:** Kwixset® can be used in temperatures as low as 40F (4°C).

MIXING GUIDELINES

BASE SHOE RUNNING FEET	CEMENT POUNDS	IN MIXING PITCHER	WATER PINTS	FLUID OZ.	MILLILITERS
4 (1.2 m)	5 (2.27 kg)	2000 ml (2 l)	1-1/4	20	591.5
8 (2.4 m)	10 (4.54 kg)	4000 ml (4 l)	2-1/2	40	1183
12 (3.6 m)	15 (6.80 kg)	6000 ml (6 l)	3-3/4	60	1774.5

These mixing proportions are guidelines based on what we feel is the best way to mix and apply cement, and we make no guarantee or warranty as to its performance. We suggest you make a sample batch for testing purposes to determine the exact formula that is right for your application before beginning any job.

- Recommended on All Wet Glaze HRS Installations

CRL Kwixset® and Rockite® are gray, hydraulic type cements that expand as they set, and are specially formulated to produce unequalled strength and bonding qualities. When mixed with water they pour into place smoothly. Both set within 15 to 20 minutes, and when fully cured develop compression strengths in excess of 8,000 pounds per square inch.

Kwixset® is not affected by standing water, making it the right cement for exterior use, while the more economical Rockite® is great for any interior application. Use either product to set railings, posts, and other fixtures because they will not shrink, crack or dry out.



Interior Applications

ROCKITE® CEMENT

CAT. NO.	CONTENTS
ROCK01	1 Pound (.453 kg)
ROCK05	5 Pounds (2.27 kg)
ROCK10	10 Pounds (4.54 kg)
ROCK50	50 Pounds (22.7 kg)

Minimum order: 1 each. **NOTE:** Rockite® can be used in temperatures as low as 25F (-4°C).

EXAMPLE: #1 For 8 feet (2.4 m) of Base Shoe you need 10 pounds of cement and 40 ounces of water for the correct mix.

EXAMPLE: #2 For 12 feet (3.6 m) of Base Shoe you need 6000 milliliters of cement and 1774.5 milliliters of water for the correct mix.

CRL X-Pandotite Cement



- White Color Cement Expands As It Sets
- Dozens of Adhesive and Repair Uses

CRL X-Pandotite is a white, mortar-like cement that expands as it sets, creating an excellent bonding material that forces its way into every crack and crevice of the fill area. Use it to set railings, brackets, and other fixtures because it will not shrink, crack or dry out. It has excellent durability to weather extremes and chemicals, so it can be used to set and grout tiles and mosaic pieces. It is also used to fasten terminal wires and posts in electronic assemblies and insulators. X-Pandotite is a versatile adhesive cement with dozens of uses.

IMPORTANT NOTE: Will discolor aluminum unless anodized.

CAT. NO.	CONTENTS
EXP25510	10 Pounds (4.54 kg)
EXP25525	25 Pounds (11.3 kg)
EXP25550	50 Pounds (22.7 kg)
EXP255100	100 Pounds (45.4 kg)

Minimum order: 1 each.



CAT. NO. EXP25510
10 Pounds



CAT. NO. EXP25525
25 Pounds



CAT. NO. EXP25550
50 Pounds



CAT. NO. EXP255100
100 Pounds

CRL Wet Glaze Pump and Accessories

- **Portable, Lightweight, Compact Delivery System for Expanding Cement**
- **Dramatically Increases Speed of Application**
- **On/Off Control at Point of Delivery**
- **Quick and Easy Hose Replacement**



CAT. NO. GRP1

Pump Kit Includes: One Pump with Hoses, One Nozzle, One Momentary ON/OFF Switch, Two 5 Gallon Buckets, Two Measuring Pitchers, One Plastic Scoop, One Mixing Spoon, One GFC1 15A Ground Fault Interrupt Device, and One GRP2 Replacement Hose Kit.

NOTE: Clamp and Alignment Fixture not included. Visit crlaurence.com for information. Minimum order is one each.

CAT. NO. GRP2

Replacement Hose Kit Includes: Hoses, One Nozzle, and Clamps (No ON/OFF Switch). Minimum order is one each.

Details on Kit components are available from CRL Technical Sales or the CRL web site at crlaurence.com.

When CRL decided to enter the Glass Rail market, we went at it in typical CRL fashion and asked the question, "How can we improve on the antiquated processes and equipment currently being used to benefit our customers?" So when it came time to look at the way that the expanding cement was being delivered to the Base Shoe, we knew we had to find a better way. We did just that by developing our Wet Glaze Pump and Accessories.

The Wet Glaze Pump has been designed to reduce the labor associated with the application of expanding cement to Hand Rail Base Shoe, and to improve the quality, efficiency, and effectiveness of the final assembly of the Base Shoe and glass. The Wet Glaze Pump not only increases speed of application dramatically, it also offers superior control over the flow rate and delivery location than that of manual applicators.

This unique delivery system utilizes a pair of rollers fixed to a rotating disk that squeezes the cement through flexible tubing. Since the tubing is the only thing to come in contact with the cement, there are no seals to leak, giving you a virtually maintenance free pump.

Simply mix your cement in the mixing bucket, insert the end of the Inlet Hose into the mixture, and depress the handy ON/OFF Switch located on the Delivery Nozzle. The Pump will immediately start to move the cement through the hose. Purge any excess water from the hose and release the ON/OFF Switch. You are now ready to start pumping cement into the Base Shoe at a rate of 11 feet (3.3 m) per minute.



CRL Cement Mixing Kit and Mixing Accessories

- **Everything Needed to Accurately Measure and Mix Expanding Cement**
- **Buy the Kit or Order Items Individually**

We have developed a kit with a combination of accessories that makes it easier to get the proper mixture of water and expanding cement. Simply mix two 3000 ml pitchers, approximately 15 lbs. (6.8 kg) of expanding cement with almost two full 1000 ml pitchers, approximately 60 fl. oz. (1774.5 ml) of water and you have the correct mixture for 12 ft (3.6 m) of Base Shoe. The handy 3.5 gallon (13.25 l) Pouring Pail has a spout and handle for easy delivery of the mixture. The Plastic Scoop and Mixing Spoon complete the kit. Use our Cat. No. GRP35 Cement Pouring Ramp (see page N287) for a neat and effective method of directing the mixture just where you want it.

CAT. NO. GRP32

CAT. NO. GRP31



CAT. NO. GRP33

CAT. NO. GRP34

CAT. NO.	DESCRIPTION
GRP30	Cement Mixing Kit with one of each: 1000 ml Pitcher (Water); 3000 ml Pitcher (Dry Cement), 3.5 Gallon Pouring Pail, Plastic Scoop, Mixing Spoon
GRP31	Set of Mixing Pitchers: 1000 ml (Water), 3000 ml (Dry Cement)
GRP32	3.5 Gallon Pouring Pail
GRP33	Plastic Scoop
GRP34	Mixing Spoon

Minimum order: 1 each.

CRL Pouring Ramp for Base Shoe Applications Using Expanding Cement

- Neat and Effective Manual Delivery of Expanding Cement
- Shields Gasket Retention Groove in Base Shoe
- Wide Delivery Area

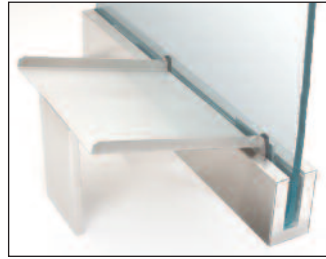

The CRL Pouring Ramp provides a wide delivery area for mess-free pouring of expanding cement into Base Shoe. It shields the gasket retention groove area in the Base Shoe, thereby eliminating further clean up. You will find the Pouring Ramp to be a neat and effective method to manually deliver the expanding cement used in our Wet Glaze System. Minimum order is one each.



CAT. NO. GRP35

CRL Dispensing Bottle for Expanding Cement

- Ideal for Small, Hard to Pour Areas
- 32 Ounce Capacity



This is a durable plastic squeeze bottle that ideally applies the expanding cement to small, hard to pour areas. This clean and neat Dispensing Bottle saves you clean up time on the job, and makes spot pours easy. Bottle capacity is 32 fluid ounces (946 ml). Minimum order is one each.

CAT. NO. GRP36

CRL Bituminous Paint

- Creates a Barrier Between Railing Hardware and Wet Concrete
- Prevents Electrolysis and Corrosion
- Available in Aerosol or 5 Gal. Pails



new

CRL Bituminous Black Paint is used as a barrier to protect CRL Base Shoe, Posts, Railings, and Stanchions from electrolysis and corrosion when embedded in concrete. Simply brush on a clean and dry surface and allow to dry before embedding in concrete. Coverage: Approx. 100 to 200 sq. ft. per gallon, 33 sq. ft. per aerosol can. For clean up use Cat. No. MEK1GL (see page N364).



CAT. NO. BC17A



CAT. NO. BC5GL

CAT. NO.	CONTENTS
BC17A	15 Oz. (425 g)
BC5GL	Net 4.7 Gallons (17.8 l)

Minimum order: 1 can or pail.

CRL Roof Coating

- Smooth or Textured Finishes
- Thick Bright White Coating
- Can Be Applied by Brush, Spray Equipment, or by Roller



CRL Roof Coating is a thick, bright white roof coating that cures to a tough, yet flexible membrane. It is specially formulated with high quality polymer resins to ensure its resistance to mildew and weather as well as ultraviolet. Keeps roofs free of leaks, and helps cut down on noise.

Easy to apply, it resists sagging. Available in smooth or textured surface appearance formulas. Roof Coating can be applied by brush, spray equipment or by roller. Approximate coverage is 100 square feet (9.3 sq. m) per gallon (3.785 l).



CAT. NO.	DESCRIPTION	CONTENTS
RCS5GL	Smooth Roof Coating	5 Gallons (19 l)
RCT5GL	Textured Roof Coating	5 Gallons (19 l)

Minimum order: 1 each. Can be combined for quantity pricing.

CRL FASTENERS – ANCHORS

For Pricing Visit Our Web Site or Call Us Toll Free at the Phone Numbers Shown on the Back Cover

CRL ITW Buildex E-Z Ancor®

- Our Best Selling Anchors
- Self-Drilling, One Piece Anchors for Mounting to 3/8", 1/2" or 5/8" (10, 13 or 16 mm) Thick Gypsum Wallboard
- Secure and Removable

These original CRL ITW Buildex E-Z Ancors are our best selling anchors because they are: fast (no predrilling or hole preparation necessary); easy (installs with only a #2 Phillips screwdriver or bit); neat (single point self-drills a clean, small hole); secure (deep threads provide strong hold in gypsum wallboard); removable (can be easily backed out). They are available in zinc and plastic to replace plastic plugs, toggle bolts, or "Molly" type anchors for dozens of different mounting applications. Maximum fixture thickness is 3/4" (19 mm).

HOLDING VALUES (ULTIMATE LOADS) – TENSILE (PULLOUT)

ANCHOR	WALLBOARD THICKNESS		
	3/8" (10 MM)	1/2" (13 MM)	5/8" (16 MM)
E-Z Plastic Lite	25 Lbs. (11.3 kg)	30 Lbs. (13.6 kg)	40 Lbs. (18 kg)
E-Z Plastic Plus	40 Lbs. (18 kg)	50 Lbs. (22.7 kg)	75 Lbs. (34 kg)
E-Z Zinc	40 Lbs. (18 kg)	50 Lbs. (22.7 kg)	75 Lbs. (34 kg)

These performance values are averages obtained under laboratory conditions. **NOTE:** These values will change depending on age, moisture, content, and surface treatment of the drywall (gypsum material). Appropriate safety factors should be applied to these values for design purposes.

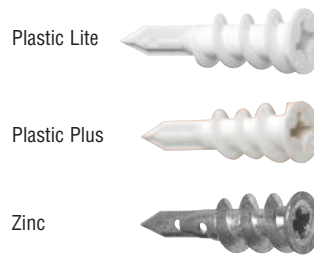

STEP 1: Place #2 Phillips driver or bit into recess of E-Z Ancor



STEP 2: Press into gypsum wallboard while turning clockwise until seated flush with wall.



STEP 3: Place fixture into position over E-Z Ancor, insert screw and tighten.

CAT. NO.	TYPE	SCREW SIZE
5006902	E-Z Plastic Lite	#5 – 6
5006902S	E-Z Plastic Lite with Screws	#6 x 1-1/4" Pan Head Phillips
5035902	E-Z Plastic Plus	#6 – 8
5035902S	E-Z Plastic Plus with Screws	#8 x 1-1/2" Pan Head Phillips
5000902	E-Z Zinc	#6 – 8
5000902S	E-Z Zinc with Screws	#8 x 1-1/2" Pan Head Phillips

Minimum order is 100 each. Order in increments of 100. Sizes can be combined for quantity pricing.

CRL Toggler® SnapSkrü® Self-Drilling Drywall Anchors

- More Holding Power
- Works in 3/8", 1/2" or 5/8" (10, 13 or 16 mm) Thick Drywall and Ceilings
- Audible "Pop" Indicates Correct Install

CRL Toggler® SnapSkrü® Self-Drilling Anchors are designed to preserve drywall integrity at installation as well as when the item and screw are removed. These Anchors work with a range of screw sizes – MINI: #6 (recommended) to #8, and Regular: #6 to #10, #8 (recommended). Screws can be backed out and changed if needed without the Anchor coming out of the wall!

When activated with the minimum proper length screw: 1-1/4" (32 mm) for MINI and 1-1/2" (38 mm) for Regular, the Anchors open with an audible "pop", locking them in place in the wall or ceiling. They are easily installed with No. 2 Phillips screwdriver or bit, and resist vibration and shock. Maximum fixture thickness: 1/2" (13 mm) for MINI with 1-1/4" (32 mm) screw, and 3/4" (19 mm) for Regular with 1-1/2" (38 mm) screw. For thicker fixtures use longer screws.

HOLDING VALUES (ULTIMATE LOADS) – TENSILE (PULLOUT)

ANCHOR	WALLBOARD THICKNESS		
	3/8" (10 MM)	1/2" (13 MM)	5/8" (16 MM)
SnapSkrü® MINI	57 Lbs. (25.8 kg)	65 Lbs. (29.5 kg)	95 Lbs. (43 kg)
SnapSkrü® Regular	57 Lbs. (25.8 kg)	79 Lbs. (35.8 kg)	135 Lbs. (61.2 kg)

Holding values are per anchor with #6 x 1-1/4" screw for MINI and #8 x 1-1/2" screw for Regular. Industry standard safe holding = 1/4 of ultimate load.

new



STEP 1: Place #2 Phillips driver or bit into recess of SnapSkrü®

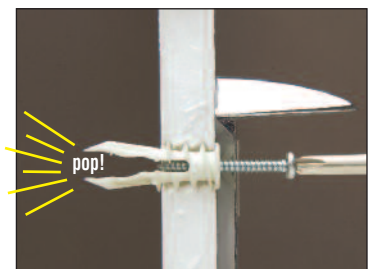

STEP 2: Place fixture into position over SnapSkrü®, insert screw and tighten.

CAT. NO.	TYPE	SCREW SIZE
TA3003	SnapSkrü® MINI	#6 – 8
TA3003S	SnapSkrü® MINI with Screws	#6 x 1-1/4" Pan Head Phillips
TA3001	SnapSkrü® Regular	#6 – 10
TA3001S	SnapSkrü® Regular with Screws	#8 x 1-1/2" Pan Head Phillips

Minimum order is 100 each. Order in increments of 100. Sizes can be combined for quantity pricing.

CRL Plastic Screw Anchors

- Our Best Selling Plastic Anchors
- Use in Concrete, Block, Brick, Wallboard
- Use With Wood or Sheet Metal Screws
- Available With or Without Shoulders

CRL Plastic Screw Anchors are designed to be used with wood or sheet metal screws. Their multiple-ribbed construction ensures secure holding power in hard or soft materials, from concrete to plaster. They are available in two styles. The Shoulderless Anchors will fit flush to the surface; while the type with shoulders keeps the Anchor from slipping through the hole. Both the 3/16" and 1/4" (5 and 6 mm) sizes accommodate screw sizes from #4 through #10.

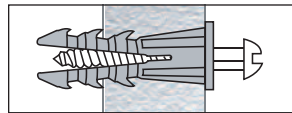

ANCHORS WITH SHOULDERS

CAT. NO.	SCREW SIZE	DRILL HOLE	QTY/PACK
1329	4 – 5 – 6	3/16" (5 mm)	1000
P1329C	4 – 5 – 6	3/16" (5 mm)	100
1339	8 – 10	1/4" (6 mm)	500
P1339C	8 – 10	1/4" (6 mm)	100

Minimum order: 100 each on packs of 100. 1 pack on Bulk Packs of 500 and 1000. Sizes can be combined for quantity pricing.

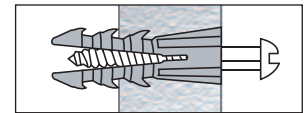

ANCHORS WITHOUT SHOULDERS

CAT. NO.	SCREW SIZE	DRILL HOLE	QTY/PACK
1319	4 – 5 – 6	3/16" (5 mm)	1000
P1319C	4 – 5 – 6	3/16" (5 mm)	100
1349	8 – 10	1/4" (6 mm)	500
P1349C	8 – 10	1/4" (6 mm)	100

Minimum order: 100 each on packs of 100. 1 pack on Bulk Packs of 500 and 1000. Sizes can be combined for quantity pricing.

CRL Red Cap Plastic Anchors

- Not Affected By Moisture or Corrosion
- Use in Concrete, Block, Brick, Wallboard
- Use With Wood or Sheet Metal Screws



CRL Red Cap Anchors have a collar that keeps the Anchor from falling into over-drilled holes or hollow walls, and fins in the body keep it from turning in the hole. A tapered end allows easy insertion. It is not affected by moisture or corrosion.

CAT. NO.	SCREW SIZE	DRILL HOLE	LENGTH
8C	6 – 7 – 8	3/16" (5 mm)	7/8" (22.2 mm)
12C	9 – 10 – 12	1/4" (6 mm)	1" (25.4 mm)
16C	14 – 16	5/16" (8 mm)	1-3/8" (35 mm)

Minimum order: 100 each. Must order in increments of 100. Sizes can be combined for quantity pricing.

CRL Diamond Plastic Anchors

- Use in Concrete, Block, Brick, and Wallboard
- Use With Either Wood or Sheet Metal Screws
- Available in Three Sizes



Use these CRL Diamond Plastic Screw Anchors with either wood or sheet metal screws. Their flat, concentric ribs resist turning and give a greater bearing surface for stronger holding power. An open slot permits inner end compression for easy insertion and expansion.

CAT. NO.	SCREW SIZE	DRILL HOLE	LENGTH
08210	8 – 10	3/16" (5 mm)	7/8" (22.2 mm)
08220	10 – 12	1/4" (6 mm)	1" (25.4 mm)
08230	14 – 16	5/16" (8 mm)	1-3/8" (35 mm)

Minimum order: 100 each. Must order in increments of 100. Sizes can be combined for quantity pricing.

CRL Conical Plastic Anchors

- Use in Concrete, Block, Brick, and Wallboard
- Use With Wood or Sheet Metal Screws
- Made From Extremely Durable Plastic

Our CRL Conical Plastic Anchors, available in three sizes, are made from an extremely durable plastic that has good weatherability and will hold securely in a variety of building substrates. Their shape makes them easy to insert into drilled holes. The wide shoulders will keep them from slipping through the hole. The wide fins will keep them from turning during fastener insertion.

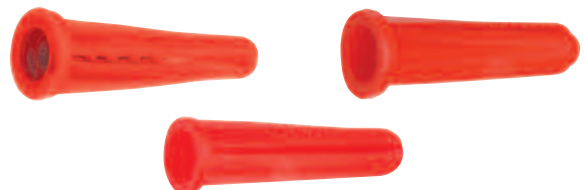

CAT. NO.	SCREW SIZE	DRILL HOLE	LENGTH
CPA316	8 – 10	3/16" (5 mm)	7/8" (22.2 mm)
CPA14	10 – 12	1/4" (6 mm)	1" (25.4 mm)
CPA516	14 – 16	3/16" (8 mm)	1-3/8" (35 mm)

Minimum order: 100 each. Must order in increments of 100. Sizes can be combined for quantity pricing.

CRL Hi-Red Plastic Anchors

- Use in Concrete, Block, Brick, and Stone
- Use With Wood or Sheet Metal Screws
- Superior Design-Won't Slip or Turn in Drilled Hole
- Unaffected By Corrosion, Moisture or Weather
- Available in Four Sizes

These CRL Hi-Red Plastic Anchors outperform most anchors, holding screws or nails in any drillable material. They are dependable, easy to use, and offer many advantages that assure better installations. They take a smaller hole, and the screw cuts its own perfect threads. They will not slip or turn as the screw is inserted, and are unaffected by corrosion, moisture or weather. They're usable indoors or out, and are available in four standard sizes. Other sizes of Hi-Red Anchors are available on special order.



CAT. NO. HR12X1



CAT. NO. HR12X112



CAT. NO. HR16X1



CAT. NO. HR16X112

CAT. NO.	SCREW SIZE	DRILL HOLE	LENGTH
HR12X1	8 – 10 – 12	1/4" (6 mm)	1" (25.4 mm)
HR12X112	8 – 10 – 12	1/4" (6 mm)	1-1/2" (38.1 mm)
HR16X1	12 – 14 – 16	5/16" (8 mm)	1" (25.4 mm)
HR16X112	12 – 14 – 16	5/16" (8 mm)	1-1/2" (38.1 mm)

Minimum order: 100 each. Must be ordered in increments of 100. Sizes can be combined for quantity pricing.

CRL Expanding Plastic Anchors

- Use in Concrete, Block, Brick, and Stone
- Use With Wood or Sheet Metal Screws
- Size Color Coding
- Nine Different Sizes for Screws From #4 to #16

These popular CRL Expanding Plastic Anchors give you tremendous performance in many building materials. Nine different size options give you just the right anchor for fastening versatility, and screw applications from #4 to #16. Their color-coding makes picking the right size easy. Good weatherability and resistance to chemicals give these Anchors lasting durability.



Screw Sizes: 4-5-6



Screw Sizes: 7-8-9



Screw Sizes: 10-12



Screw Sizes: 14-16

CAT. NO.	SCREW SIZE	DRILL HOLE	LENGTH	COLOR
EXP2002	4 – 5 – 6	3/16" (5 mm)	1" (25.4 mm)	White
EXP2003	7 – 8 – 9	15/64" (6 mm)	1" (25.4 mm)	Red
EXP2004	7 – 8 – 9	15/64" (6 mm)	1-1/2" (38.1 mm)	Red
EXP2005	10 – 12	1/4" (6 mm)	1" (25.4 mm)	Green
EXP2006	10 – 12	1/4" (6 mm)	1-1/4" (31.8 mm)	Green
EXP2007	10 – 12	1/4" (6 mm)	1-1/2" (38.1 mm)	Green
EXP2008	10 – 12	1/4" (6 mm)	2" (50.8 mm)	Green
EXP2009	14 – 16	5/16" (8 mm)	1" (25.4 mm)	Blue
EXP2010	14 – 16	5/16" (8 mm)	1-1/2" (38.1 mm)	Blue

Minimum order: 100 each. Must be ordered in increments of 100. Sizes can be combined for quantity pricing.

CRL Straight Line Plastic Anchors

- For Concrete, Block, Brick, or Stone
- Use With Wood or Sheet Metal Screws

Use our CRL Straight Line Plastic Anchors in almost any drillable material - indoors or outdoors. They were designed to be consistent in size, so they slip easily into a drilled hole for fast installation. The tough plastic material won't split or fray, or turn in the hole during fastener installation. The two popular sizes accommodate screw sizes from #4 to #12.

- No Fraying or Splitting

- Secure and Cost Effective



CAT. NO.	SCREW SIZE	DRILL HOLE	LENGTH	COLOR
CRL10X1	4 – 6	3/16" (5 mm)	1" (25.4 mm)	Blue
CRL12X1	8 – 10 – 12	1/4" (6 mm)	1" (25.4 mm)	Red

Minimum order: 100 each. Must be ordered in increments of 100. Sizes can be combined for quantity pricing.

CRL Plastic Toggle Screw Anchors



CAT. NO. PTA1258
1/2" (12.7 mm)



CAT. NO. PTA5834
5/8" (15.9 mm)

- Easy to Install With Dependable Holding Power

Our CRL Plastic Toggle Anchors are easy to install, and deliver dependable holding power in hollow walls. Two wall thickness sizes are available; use PTA1258 for 1/2" (12.7 mm) thick walls and PTA5834 for 5/8" (15.9 mm) thick walls. Both Anchors require a 5/16" (8 mm) drilled hole, and both work with screw sizes from #6 to #12. Minimum order is 100 each. Must be ordered in increments of 100. Sizes can be combined for quantity pricing.

CRL Nylon Cable Ties

- Convenient and Simple to Use
- Available in Natural or Black

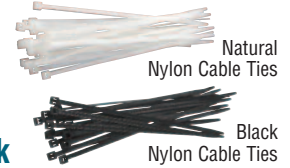

CRL Nylon Ties are convenient for bundling wires or other narrow components. Simple to use, just insert the tapered end of the strap into head and pull until bundle is secure. 100 ties per package.

NATURAL CAT. NO.	BLACK CAT. NO.	LENGTH
NT40	NT40BL	4" (102 mm)
NT56	NT56BL	5.6" (142 mm)
NT75	NT75BL	7.5" (190 mm)
NT111	NT111BL	11.1" (282 mm)

Minimum order: 1 pack. Sizes and colors can be combined for quantity pricing.

CRL Rawl Scru-Lead Anchors

- For Concrete, Block, or Brick
- Use With Wood, Sheet Metal or Lag Screws



Use CRL Rawl Scru-Leads with wood, sheet metal or lag screws. They are made of Rawloy, an exclusive lead alloy soft enough for easy installation, yet hard enough to give sure holding power. The Scru-Lead design permits complete circular expansion, while the flange lets you use them in hollow materials.

CAT. NO.	SCREW SIZE	DRILL HOLE	LENGTH
9414	6 – 8	1/4" (6 mm)	1" (25.4 mm)
9419	6 – 8	1/4" (6 mm)	1-1/2" (38.1 mm)
9429	10 – 12 – 14	5/16" (8 mm)	1" (25.4 mm)
9439	10 – 12 – 14	5/16" (8 mm)	1-1/2" (38.1 mm)

Minimum order: 100 each. Must be ordered in increments of 100. Sizes can be combined for quantity pricing.

CRL Rawl "Nailins" Expansion Anchors

- Used Strictly for Brick, Concrete, Stone, Marble, and Terrazzo



CRL Rawl "Nailins" are a fast and easy to use Expansion Anchor. Developed for resistance to corrosion and high tensile strength, "Nailins" develop substantial holding power, so you use smaller holes, requiring less drilling with lower cost.

CAT. NO.	DRILL HOLE	LENGTH
2802	3/16" (5 mm)	7/8" (22.2 mm)
2808	1/4" (6 mm)	1" (25.4 mm)
2820	1/4" (6 mm)	1-1/2" (38.1 mm)

Minimum order: 100 each. Must be ordered in increments of 100. Sizes can be combined for quantity pricing.

CRL Wall Grabber Anchors

- Two Sizes for Drywall, Hollow Core Doors, Pegboards, Plaster, and Masonry
- One Size for Concrete or Cinder Blocks
- Easy Removal Design

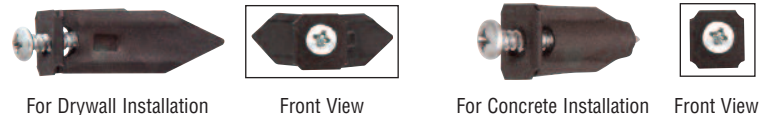

Patented CRL Wall Grabber Anchors work like no others in drywall, pegboard, hollow core doors, plaster walls, masonry, wood paneling, concrete, and cinder blocks. For drywall, pegboard, hollow core doors or plaster walls simply drive these spring steel Anchors into the wall with a hammer, then drive in a screw or nail. The Anchor will automatically expand to provide instant gripping tension. The unique design of the Anchor keeps it from rotating in the hole while the screw is being turned. To use in concrete or cinder block drill a 1/4" (6 mm) starting hole approximately 1-1/4" (32 mm) deep. Hammer the Anchor straight into the hole point first. Insert either a hardened nail or a #8 screw through the object to be held and hammer or screw the fastener into the Grabber. Some applications such as concrete walls may require a 3/8" (10 mm) hole. Once inserted into the hole, the Grabber will not rotate.



Easy to Install

1. Squeeze anchor legs together. Hammer point straight into wall.
2. Insert screw through object to be held on wall and thread into anchor. Tighten screw; anchor locks in place.



Easy to Remove

1. Untighten the screw until 75% is out of wall. The anchor automatically contracts.
2. Grip the screw with pliers and pull out of wall; anchor slides right out.

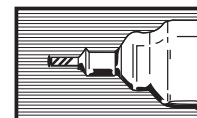
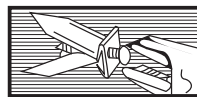

To Use in Concrete

1. Drill 1/4" (6 mm) starting hole approximately 1-1/4" (32 mm) deep.

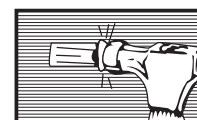

2. Hammer anchor straight into hole point first.

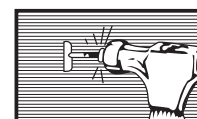

3. Hammer nail directly into anchor; or first through object to be mounted and then into anchor. Anchor locks in place. #8 screw can also be used.

CAT. NO.	APPLICATION	SCREW SIZE
TR106W	Drywall, Hollow Core Doors, Plaster, Masonry	Holds #8 Screw
TR107W	Drywall, Hollow Core Doors, Plaster, Masonry	Holds #10 Screw
TR108W	Concrete, Cinder Blocks	Holds #8 Screw or Hardened Nail

Minimum order: 100 each. Must be ordered in increments of 100. Sizes can be combined for quantity pricing.

CRL Hollow Wall Fasteners

- Strong and Easy to Install



Ideal for any hollow type of wall, floor or ceiling construction of wallboard, plywood, concrete block, and more. Once applied, they stay in the wall, even if the screw is removed, reliably bearing the weight over a large surface. Expand with Phillips head screwdriver.

CAT. NO.	GRIP RANGE	DRILL HOLE	QTY/BOX
4S	1/8" to 1/2" (3.2 to 12.7 mm)	5/16" (8 mm)	100
4L	5/8" to 7/8" (15.8 to 22.2 mm)	5/16" (8 mm)	100
4XL	1-1/4" to 1-1/2" (31.8 to 38.1 mm)	5/16" (8 mm)	100
6S	1/8" to 5/8" (3.2 to 15.9 mm)	3/8" (10 mm)	50
6L	5/8" to 1-3/16" (15.9 to 30.1 mm)	3/8" (10 mm)	50
8S	1/8" to 5/8" (3.2 to 15.9 mm)	1/2" (12 mm)	50
8L	5/8" to 1-3/16" (15.9 to 30.1 mm)	1/2" (12 mm)	50

Minimum order: 100 each for the #4 Sizes and 50 each for the #6 and #8 Sizes. All sizes and types can be combined for quantity pricing.

CRL Flat Head Hollow Wall Fasteners

- Excellent for Use With Plastic Mirror Clips



Use these CRL Flat Head Hollow Wall Fasteners wherever you want a flush, smooth surface. Expand with Phillips head screwdriver.

CAT. NO.	GRIP RANGE	DRILL HOLE	QTY/BOX
4SFH	1/8" to 1/2" (3.2 to 12.7 mm)	1/4" (6 mm)	100

Minimum order: 100 each. Must be ordered in increments of 100. All sizes and types can be combined for quantity pricing.

CRL Drive Fasteners

- Drive Fasteners Install Fast



These CRL Drive Fasteners install without drilling. Use a hammer to drive into hollow walls, then a screwdriver to tighten. The tapered tip screw makes driving easy and clean.

CAT. NO.	GRIP RANGE	QTY/BOX
4SD	1/8" to 1/2" (3.2 to 12.7 mm)	100
4SLD	5/8" to 7/8" (15.9 to 22.2 mm)	100

Minimum order: 100 each. Must be ordered in increments of 100. All sizes and types can be combined for quantity pricing.

CRL Hollow Door Fasteners

- Prong Type for Wood Doors



These CRL Hollow Door Fasteners are designed to fasten fixtures where expansion space is too small to accommodate Screw Anchors, such as hollow construction flush doors. Needs only 3/8" (9.5 mm) expansion space. Prongs grip firmly, yet won't split thin materials.

CAT. NO.	GRIP RANGE	DRILL HOLE	QTY/BOX
4XS	0 to 3/16" (0 to 4.8 mm)	5/16" (8 mm)	100
4MS	3/16" to 3/8" (4.8 to 9.5 mm)	5/16" (8 mm)	100

Minimum order: 100 each. Must be ordered in increments of 100. All sizes and types can be combined for quantity pricing.

CRL High Speed Installer

- Quickly and Securely Installs Any Size Screw Anchor on This Page



This tool is an excellent choice for the professional - it's a real time and labor saver. Just slip the nose over the anchor's head, give the handle one pull, and it's set. Minimum order is one each.

CAT. NO. SAT1980U

CRL Jacknut Anchors

- Flush Type for Metal Doors Up to 1/8" (3.2 mm) Thick

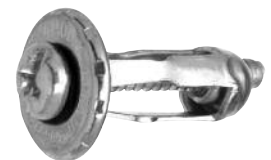

These CRL Jacknut Anchors are a regular type hollow door fastener without prongs. They will hold fixtures securely on hollow core flush doors. They even work in as small an expansion space as 3/8" (9.5 mm).

CAT. NO.	GRIP RANGE	DRILL HOLE	QTY/BOX
4SJNWS	0 to 3/16" (0 to 4.8 mm)	5/16" (8 mm)	100

Minimum order: 100 each. Must be ordered in increments of 100. All sizes and types can be combined for quantity pricing.

CRL Toggle Anchors

- Heavy Steel Spring Toggle Wings
- Available in Round or Flat Head Styles

Use CRL Toggle Anchors in hollow walls of concrete, wallboard, wood or steel up to 2-1/2" (63.5 mm) thick. The bolt and wing are corrosion-resistant, and have heavy steel springs. The flat head style allows flush set for maximum clearance; round heads are for surface mount installations.

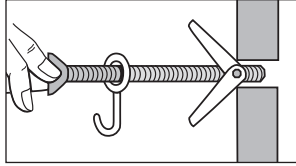

1. Position threaded bolt in drilled hole, with toggle wings toward wall.

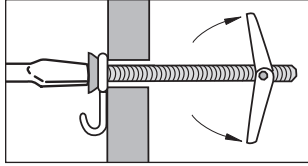

2. Push compressed wings through hole until they open.

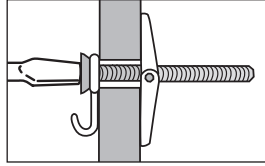

3. After wings open, tighten the screw. It's that easy!

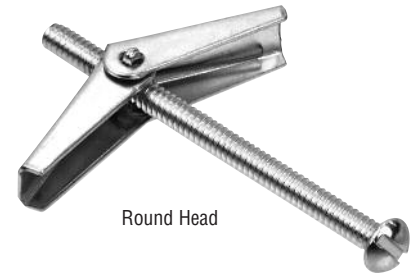

Round Head

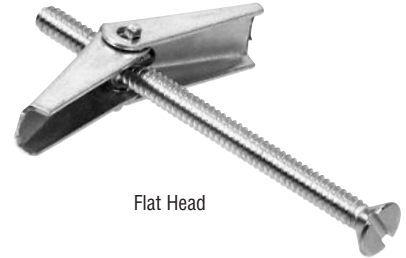

Flat Head

ROUND HEAD TOGGLE ANCHORS

CAT. NO.	TOGGLE SIZE	DRILL HOLE	MAXIMUM THICKNESS
70223	1/8" (3.2 mm) x 2" (50.8 mm)	3/8" (10 mm)	1-1/2" (38.1 mm)
70233	1/8" (3.2 mm) x 3" (76.2 mm)	3/8" (10 mm)	2-1/2" (63.5 mm)
70333	3/16" (4.8 mm) x 3" (76.2 mm)	1/2" (12 mm)	2-1/2" (63.5 mm)

Minimum order: 50 each. Must be ordered in increments of 50. Sizes can be combined for quantity pricing.

FLAT HEAD TOGGLE ANCHORS

CAT. NO.	TOGGLE SIZE	DRILL HOLE	MAXIMUM THICKNESS
70221	1/8" (3.2 mm) x 2" (50.8 mm)	3/8" (10 mm)	1-1/2" (38.1 mm)
70231	1/8" (3.2 mm) x 3" (76.2 mm)	3/8" (10 mm)	2-1/2" (63.5 mm)
70331	3/16" (4.8 mm) x 3" (76.2 mm)	1/2" (12 mm)	2-1/2" (63.5 mm)

Minimum order: 50 each. Must be ordered in increments of 50. Sizes can be combined for quantity pricing.

CRL SNAPTOGGLE® Toggle Anchors

- Secure Installation in Seconds
- Pre-Installs Without Bolt
- Maximum Strength
- Several Sizes Available

CRL SNAPTOGGLE® Toggle Anchors pre-install without a bolt and can be installed using a screw gun because the anchor won't spin in the hole. They also allow for bolt or fixture removal without the anchor falling behind the wall. SNAPTOGGLE® can be used in drywall, plaster, cement board, hollow walls of block, brick, stucco, fiberglass, and wood. **NOTE:** Bolts sold separately.

CAT. NO.	BOLT THREAD	DRILL HOLE	GRIP RANGE
TB1024	#10 - 24	1/2" (13 mm)	3/8" - 3-5/8" (9.5 - 92 mm)
TB1420	1/4" - 20	1/2" (13 mm)	3/8" - 3-5/8" (9.5 - 92 mm)
TB51618	5/16" - 18	3/4" (19 mm)	3/8" - 2-1/2" (9.5 - 63.5 mm)
TB3816	3/8" - 16	3/4" (19 mm)	3/8" - 2-1/2" (9.5 - 63.5 mm)
TB1213	1/2" - 13	3/4" (19 mm)	3/8" - 2-1/2" (9.5 - 63.5 mm)

Minimum order: 10 each. Sizes can be combined for quantity pricing.



CAT. NO. TB1420
Accepts 1/4"-20 Bolt

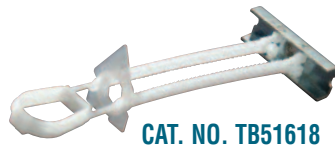

CAT. NO. TB51618
Accepts 5/16"-18 Bolt



CAT. NO. TB3816
Accepts 3/8"-16 Bolt

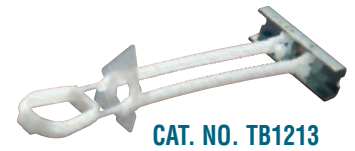

CAT. NO. TB1213
Accepts 1/2"-13 Bolt

INSTALLATION INSTRUCTIONS

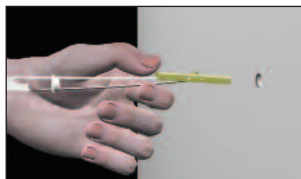

Drill appropriate size hole. Hold metal channel flat alongside plastic straps and slide channel through the hole. Minimum clearance behind wall is only 1-7/8" (48 mm).

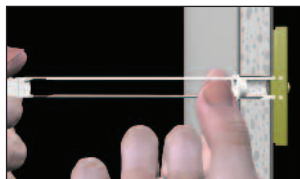

Hold ends of straps together between thumb and forefinger and pull toward you until channel rests behind wall. Ratchet cap along straps with other hand until flange of cap is flush with wall.

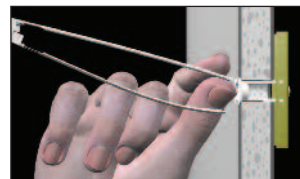

Place thumb between straps at wall. Push thumb side to side, snapping off straps level with flange of cap.

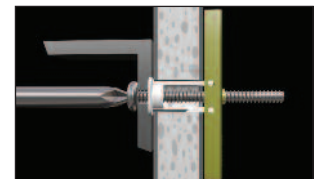

Place item over flange. Insert bolt and tighten until snug against item, then stop. Use machine screw or bolt to match thread in metal channel.

SNAPTOGGLE® is a Worldwide registered trademark of Mechanical Plastics Corp.

CRL FASTENERS – ANCHORS

For Pricing Visit Our Web Site or Call Us Toll Free at the Phone Numbers Shown on the Back Cover

CRL Toggler® Hollow-Wall Anchors

- Install Quickly and Securely
- Maximum, Reliable Holding Power in Concrete, Sheet Metal, Plywood, Paneling, Drywall, Hollow or Plaster Walls, and in Hollow Core Doors
- Use With Wood or Sheet Metal Screws From #6 Through #14



Three Push-In Setting Keys Included in Every Pack of 100 Each

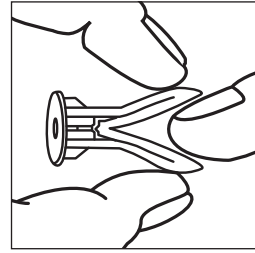

1. Drill 5/16" (8 mm) hole. Fold Anchor in middle.

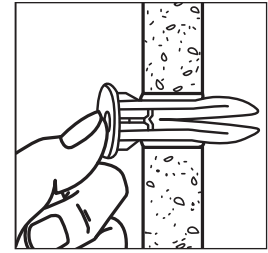

2. Insert Anchor in hole and tap flush with wall.

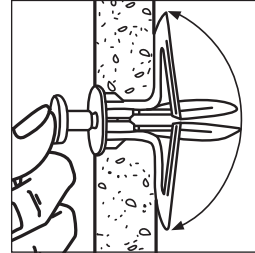

3. Insert Setting Key to pop Anchor open behind hollow wall (not necessary for thick or solid walls). Do not force or hammer Setting Key.

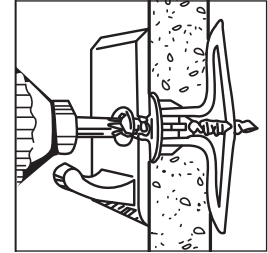

4. Place item over Anchor. Insert screw and tighten until screw is flush with fixture.



T11009

Grip Range
1/8" - 1/4"
(3.2 - 6.3 mm)

T11010

Grip Range
3/8" - 1/2"
(9.5 - 12.7 mm)

T11011

Grip Range
5/8" - 3/4"
(15.9 - 19 mm)

The CRL Toggler® Hollow-Wall Anchors provide secure holding power for light and medium loads. They are safe and reliable, absorb vibration and shock, and won't damage walls. Also, corrosion-proof, highly acid and base resistant, and rustproof. Anchors pre-install in a small 5/16" (8 mm) diameter hole without screws. Can be used with a screw gun. Protect walls from spalling and breakthrough. Translucent color so they blend into wall color and texture.

CAT. NO.	GRIP RANGE	QTY/PKG
T11009	1/8" to 1/4" (3.2 to 6.3 mm)	100
T11010	3/8" to 1/2" (9.5 to 12.7 mm)	100
T11011	5/8" to 3/4" (15.9 to 19 mm)	100

Minimum order: 100 each. All Toggles can be combined for quantity pricing.

CRL Toggler® Shelving Anchors

- Ensure Accurate Alignment
- Prevent Anchor From Being Pulled Out of the Wall



Three Push-In Setting Keys Included in Every Pack of 100 Each

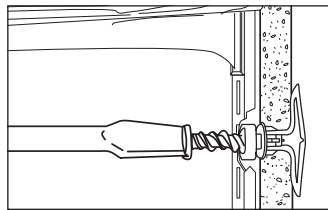

No more fumbling with shelving standards when using CRL Toggler® Shelving Anchors. The built-in spacer is made to fit flush with shelving standards to ensure accurate alignment and prevent the Anchor from being pulled out of the wall during installation. There is no need to find a stud. These Anchors work in hollow, thick, and solid walls, and may be used as a standoff for installing equipment on warm or wet walls when ventilation is needed behind the installed object.

CAT. NO.	GRIP RANGE	QTY/PKG
T11023	3/8" to 1/2" (9.5 to 12.7 mm)	100

Minimum order: 100 each. All Toggles can be combined for quantity pricing.

CRL Toggler® Picture Hook Anchors

- Hang Wall Décor Quickly, Easily, and Securely
- Includes Built-in Hook for Hanging



Three Push-In Setting Keys Included in Every Pack of 100 Each

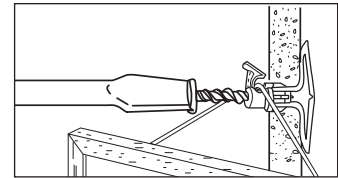

Hang wall décor quickly, easily, and securely when using CRL Toggler® Picture Hook Anchors. These Anchors have a built-in hook for hanging paintings, prints, mirrors, and anything framed. Also used for telephone cable, house electrical wire or TV/audio cable. When used with a screw in hollow walls, this Anchor holds three times more than old-fashioned nail-in metal picture hooks. The weight of the picture rests on the screw, close to the wall, preventing pullout. Corrosion-proof for hanging fixtures in humid areas. Works in hollow, thick or solid walls.

CAT. NO.	GRIP RANGE	QTY/PKG
T11012	3/8" to 1/2" (9.5 to 12.7 mm)	100

Minimum order: 100 each. All Toggles can be combined for quantity pricing.



C.R. LAURENCE COMPANY

N294 |

crlaurence.ca | crlaurence.com.au | crlaurence.co.uk | crlaurence.de | crlaurence.eu

crlaurence.com

CRL's Common Sense Packaging

- We Make Handling Screws Simple
- See Through Tubs and Bags are Easier to Stock, and Easier to Inventory



100 quantities are packaged in plastic tubs



1,000 quantities are packaged in poly bags



Bulk cartons have all screws packed in poly bags: 1,000 screws each

Some of the major problems incurred with small items such as screws and anchors is handling, stocking, counting, and maintaining a neat and clean inventory. We at CRL, being a large volume distributor, had the same problems as our customers with large, hard-to-handle kegs weighing up to 200 pounds (90 kg), small cardboard boxes breaking, mixed screw inventories, and hard-to-read labeling.

Instead of continuing with the same problems, we made a decision that if we solved our problems, we would also solve our customers' problems. Thus came about CRL's Common Sense Packaging: 100 counts in translucent plastic tubs. What's inside can be seen, along with easy-access lids and easy-to-read computer-generated labels. 1,000 counts are packed in see-through heavy gauge poly bags with easy-to-read labels. Heavy-duty master cartons are small enough to be easily handled, but as an added benefit, we also decided to put all the screws in the master cartons in 1,000 count poly bags for easier distribution and inventory. We hope you like our packaging idea, and that it will help you control your fastener inventory.

How to Identify Screws

Head Types

Flat Pan Oval

Round Drywall Hex Washer

Thread Types

Sheet Metal Sharp Point Drywall Machine Masonry

Wood Self-Drilling Sheet Metal Self-Tapping Machine

Drive Styles

Phillips Slotted Hex

Spanner Tamperproof Square Drive

How to Measure Screw Lengths

Flat Oval Round Pan Drywall Hex Washer

Ordering Language for Screws

1st	2nd	3rd	4th	5th		
Diameter Size	By	Length	Head Type	Drive Style	Thread Type	
6	X	1-1/4"	Flat Head	Phillips	Sheet Metal	=

CAT. NO. 6X114FHPSMS

CRL Sheet Metal - Screws

- Super Sharp Points
- Bright Zinc Plated
- Easier to Inventory
- Order in Bulk for Additional Savings



Quantities of 100 are packed in resealable plastic tubs. Bulk packages of 1000 are packaged in poly bags. Both feature easy-to-read labels and see-through packaging.

Flat Head Phillips



BRIGHT ZINC PLATED



Flat



Phillips

CAT. NO.	SIZE
AV5646*	4 x 1/4" (6 mm)
AV5647*	4 x 3/8" (10 mm)
AV5648*	4 x 1/2" (13 mm)
AV2736*	6 x 5/16" (8 mm) - 4 Hd.
6X38FHPSMS	6 x 3/8" (10 mm)
6X12FHPSMS	6 x 1/2" (13 mm)
6X12FHP4HDSMS	6 x 1/2" (13 mm) - 4 Hd.
6X58FHPSMS	6 x 5/8" (16 mm)
6X34FHPSMS	6 x 3/4" (19 mm)
6X1FHPSMS	6 x 1" (25 mm)
6X114FHPSMS	6 x 1-1/4" (32 mm)
6X112FHPSMS	6 x 1-1/2" (38 mm)
6X2FHPSMS	6 x 2" (51 mm)
8X38FHPSMS	8 x 3/8" (10 mm)
AV1479*	8 x 7/16" (11 mm) - 6 Hd.
AV1711*	8 x 1/2" (13 mm) - 5 Hd.
8X12FHPSMS	8 x 1/2" (13 mm)
8X58FHPSMS	8 x 5/8" (16 mm)
AV1712*	8 x 3/4" (19 mm) - 6 Hd.
8X34FHPSMS	8 x 3/4" (19 mm)
8X1FHPSMS	8 x 1" (25 mm)
8X114FHPSMS	8 x 1-1/4" (32 mm)
8X112FHPSMS	8 x 1-1/2" (38 mm)
8X2FHPSMS	8 x 2" (51 mm)
8X212FHPSMS	8 x 2-1/2" (64 mm)
8X3FHPSMS	8 x 3" (76 mm)
10X12FHPSMS	10 x 1/2" (13 mm)
10X12FHPUCSMS	10 x 1/2" (13 mm) Undercut
10X58FHPSMS	10 x 5/8" (16 mm)
10X34FHPSMS	10 x 3/4" (19 mm)
10X34FHPUCSMS	10 x 3/4" (19 mm) Undercut
10X1FHPSMS	10 x 1" (25 mm)
10X114FHPSMS	10 x 1-1/4" (32 mm)
10X112FHPSMS	10 x 1-1/2" (38 mm)
10X2FHPSMS	10 x 2" (51 mm)
10X212FHPSMS	10 x 2-1/2" (64 mm)
10X3FHPSMS	10 x 3" (76 mm)
12X12FHPSMS	12 x 1/2" (13 mm)
12X34FHPSMS	12 x 3/4" (19 mm)
12X1FHPSMS	12 x 1" (25 mm)
12X112FHPSMS	12 x 1-1/2" (38 mm)
12X2FHPSMS	12 x 2" (51 mm)

Minimum order: 100 each. Must order in increments of 100.
*Minimum order: 1 box. All bulk screws can be combined for quantity pricing.

Pan Head Phillips



BRIGHT ZINC PLATED



Pan



Phillips

CAT. NO.	SIZE
AV3071*	4 x 1/4" (6 mm)
AV3072*	4 x 3/8" (10 mm)
AV3073*	4 x 1/2" (13 mm)
D175	5 x 3/4" (19 mm)
6X14PHPSMS	6 x 1/4" (6 mm)
6X38PHPSMS	6 x 3/8" (10 mm)
6X12PHPSMS	6 x 1/2" (13 mm)
6X58PHPSMS	6 x 5/8" (16 mm)
6X34PHPSMS	6 x 3/4" (19 mm)
6X1PHPSMS	6 x 1" (25 mm)
6X114PHPSMS	6 x 1-1/4" (32 mm)
6X112PHPSMS	6 x 1-1/2" (38 mm)
8X38PHPSMS	8 x 3/8" (10 mm)
8X12PHPSMS	8 x 1/2" (13 mm)
8X58PHPSMS	8 x 5/8" (16 mm)
8X34PHPSMS	8 x 3/4" (19 mm)
8X1PHPSMS	8 x 1" (25 mm)
8X114PHPSMS	8 x 1-1/4" (32 mm)
8X112PHPSMS	8 x 1-1/2" (38 mm)
8X1-3/4" (44 mm)	8 x 1-3/4" (44 mm)
8X2PHPSMS	8 x 2" (51 mm)
8X212PHPSMS	8 x 2-1/2" (64 mm)
8X3PHPSMS	8 x 3" (76 mm)
10X12PHPSMS	10 x 1/2" (13 mm)
10X58PHPSMS	10 x 5/8" (16 mm)
10X34PHPSMS	10 x 3/4" (19 mm)
10X1PHPSMS	10 x 1" (25 mm)
10X114PHPSMS	10 x 1-1/4" (32 mm)
10X112PHPSMS	10 x 1-1/2" (38 mm)
10X2PHPSMS	10 x 2" (51 mm)
10X212PHPSMS	10 x 2-1/2" (64 mm)
10X3PHPSMS	10 x 3" (76 mm)
12X12PHPSMS	12 x 1/2" (13 mm)
12X34PHPSMS	12 x 3/4" (19 mm)
12X1PHPSMS	12 x 1" (25 mm)
12X112PHPSMS	12 x 1-1/2" (38 mm)
12X2PHPSMS	12 x 2" (51 mm)
AV2371*	14 x 2-1/4" (57 mm)

Minimum order: 100 each. Must order in increments of 100.
*Minimum order: 1 box. All bulk screws can be combined for quantity pricing.

Oval Head Phillips



BRIGHT ZINC PLATED



Oval



Phillips

CAT. NO.	SIZE
6X120HPSMS	6 x 1/2" (13 mm)
AV2698 (Chrome)*	6 x 1/2" (13 mm)
6X340HPSMS	6 x 3/4" (19 mm)
6X10HPSMS	6 x 1" (25 mm)
6X1140HPSMS	6 x 1-1/4" (32 mm)
6X1120HPSMS	6 x 1-1/2" (38 mm)
AV3485 (Chrome)*	8 x 3/8" (10 mm)
AV2707 (Chrome)*	8 x 1/2" (13 mm)
AV2710 (Chrome)*	8 x 3/4" (19 mm)
AV2713 (Chrome)*	8 x 1" (25 mm)
AV1423 (Chrome)*	8 x 1-1/4" (32 mm) - 6 Hd.
AV2716 (Chrome)*	8 x 1-1/4" (32 mm)
AV2718 (Chrome)*	8 x 1-1/2" (38 mm)
AV2631*	8 x 1-3/4" (44 mm)
AV2632*	8 x 2" (51 mm) - 6 Hd.
AV2633*	8 x 2" (51 mm)
AV2722 (Chrome)*	10 x 1/2" (13 mm)
AV2666*	10 x 2" (51 mm)

Minimum order: 100 each. Must order in increments of 100.
*Minimum order: 1 box. All bulk screws can be combined for quantity pricing.

Hex Washer Head



BRIGHT ZINC PLATED



Hex Washer



Hex

CAT. NO.	SOCKET SIZE	SIZE
6X38HWSMS	3/16"	6 x 3/8" (10 mm)
6X12HWSMS	3/16"	6 x 1/2" (13 mm)
6X34HWSMS	3/16"	6 x 3/4" (19 mm)
6X1HWSMS	3/16"	6 x 1" (25 mm)

Minimum order: 100 each. Must order in increments of 100.
All bulk screws can be combined for quantity pricing.

CAT. NO.	SOCKET SIZE	SIZE
8X12HWSMS	1/4"	8 x 1/2" (13 mm)
8X34HWSMS	1/4"	8 x 3/4" (19 mm)
8X1HWSMS	1/4"	8 x 1" (25 mm)
8X114HWSMS	1/4"	8 x 1-1/4" (32 mm)
8X112HWSMS	1/4"	8 x 1-1/2" (38 mm)
8X2HWSMS	1/4"	8 x 2" (51 mm)

Minimum order: 100 each. Must order in increments of 100.
All bulk screws can be combined for quantity pricing.

CAT. NO.	SOCKET SIZE	SIZE
10X58HWSMS	5/16"	10 x 5/8" (16 mm)
10X34HWSMS	5/16"	10 x 3/4" (19 mm)
10X1HWSMS	5/16"	10 x 1" (25 mm)
10X114HWSMS	5/16"	10 x 1-1/4" (32 mm)
10X112HWSMS	5/16"	10 x 1-1/2" (38 mm)
10X2HWSMS	5/16"	10 x 2" (51 mm)

Minimum order: 100 each. Must order in increments of 100.
All bulk screws can be combined for quantity pricing.

CRL Square Drive (Robertson) Sheet Metal Screws

- Excellent Driving Power
- Resists Driver Slippage
- Available in Flat Head and Pan Head

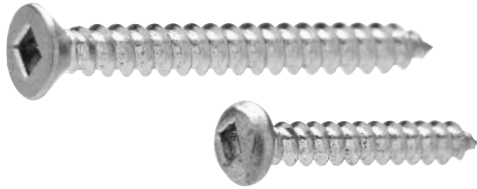

These CRL Square Drive Sheet Metal Screws are also known as Robertson and Scrulox Drive. The Square Drive head configuration offers excellent driving power and resists driver slippage. These Type "A" Sheet Metal Screws have a bright zinc plated finish. Sold in quantities of 100 packed in resealable plastic tubs, and bulk packages of 1000 in poly bags.

FLAT HEAD

CAT. NO.	SIZE
6X12FSD	6 x 1/2" (13 mm)
6X34FSD	6 x 3/4" (19 mm)
6X1FSD	6 x 1" (25 mm)
6X114FSD	6 x 1-1/4" (32 mm)
6X112FSD	6 x 1-1/2" (38 mm)
6X2FSD	6 x 2" (51 mm)
8X1FSD	8 x 1" (25 mm)
8X114FSD	8 x 1-1/4" (32 mm)
8X112FSD	8 x 1-1/2" (38 mm)
8X2FSD	8 x 2" (51 mm)
8X212FSD	8 x 2-1/2" (64 mm)
8X3FSD	8 x 3" (76 mm)
10X112FSD	10 x 1-1/2" (38 mm)
10X2FSD	10 x 2" (51 mm)

Minimum order: 100 each. Must order in increments of 100. All bulk screws can be combined for quantity pricing.

PAN HEAD

CAT. NO.	SIZE
6X12PSD	6 x 1/2" (13 mm)
6X34PSD	6 x 3/4" (19 mm)
6X112PSD	6 x 1-1/2" (38 mm)
8X1PSD	8 x 1" (25 mm)
8X114PSD	8 x 1-1/4" (32 mm)
8X112PSD	8 x 1-1/2" (38 mm)
8X2PSD	8 x 2" (51 mm)
8X3PSD	8 x 3" (76 mm)
10X1PSD	10 x 1" (25 mm)
10X2PSD	10 x 2" (51 mm)

Minimum order: 100 each. Must order in increments of 100. All bulk screws can be combined for quantity pricing.

CRL Self-Drilling Screws

- Cut Their Own Holes in a Variety of Metals
- Speed Manufacturing and Fabricating



CRL Self-Drilling Screws combine a drill and screw into a single efficient unit to save time and labor costs. They are designed to drill their own hole, cut or form mating threads, and make a complete fastening in a single operation. Each is precision machined and heat treated under exacting standards to ensure quality performance.

Self-Drilling Screws work well in a variety of metals, including carbon steel, aluminum, brass, bronze, stainless steel, fiberglass, as well as some thin plastics. The special design eliminates the need to pre-drill or pre-punch pilot holes, as well as eliminating the problem of hole alignment. Their unique fastening qualities mean you can fasten materials of dissimilar thicknesses easily, and will probably use fewer screws on many applications.

CRL Self-Drilling Screws bring new speed, mobility, and economy to on-site assembly installations. Used in curtainwall and storefront installations, metal roofing and siding, metal window frame and door installations, emergency board-ups, heating and air conditioning ducts, interior partitions, decking and subfloor assemblies, electrical circuit boxes and conduit fastening, and many other applications. Sold in quantities of 100 packed in resealable plastic tubs, and bulk packages of 1000 in poly bags.

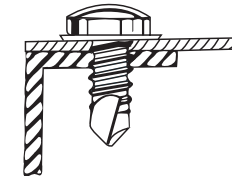

Sheet to Structure

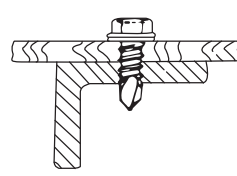

Wood to Structure

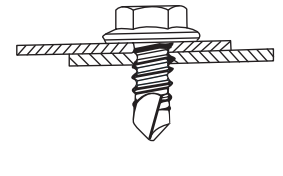

Sheet to Sheet



PAN HEAD PHILLIPS

CAT. NO.	SIZE
20061201	6-20 x 3/8" (10 mm)
AV9604*	8-18 x 7/16" (11 mm)
20061601	6-20 x 1/2" (13 mm)
20081601	8-18 x 1/2" (13 mm)
20082401	8-18 x 3/4" (19 mm)
20083201	8-18 x 1" (25 mm)
20084801	8-18 x 1-1/2" (38 mm)
20092004	10-16 x 5/8" (16 mm)
20092404	10-16 x 3/4" (19 mm)
AV9609*	10-16 x 1" (25 mm)

Minimum order: 100 each. Must order in increments of 100. *Minimum order: 1 box. All bulk screws can be combined for quantity pricing.

HEX WASHER HEAD

CAT. NO.	SIZE
20081602	8-18 x 1/2" (13 mm)
20082402	8-18 x 3/4" (19 mm)
20083202	8-18 x 1" (25 mm)
20091603	10-16 x 1/2" (13 mm)
20092003	10-16 x 5/8" (16 mm)
20092403	10-16 x 3/4" (19 mm)
20093203	10-16 x 1" (25 mm)
20094003	10-16 x 1-1/4" (32 mm)
20152403	1/4-20 x 3/4" (19 mm)
20153203	1/4-20 x 1" (25 mm)

Minimum order: 100 each. Must order in increments of 100. All bulk screws can be combined for quantity pricing.

CRL Wood Framing Screws

- Super Sharp Points
- Bright Zinc Plated Finish
- Flat Head Phillips

CRL Wood Framing Screws are preferred by fabricators for attaching storefront tubing to substrates. Their extra long length assures a dependable grip when installed properly, and the bright zinc plating helps to prevent corrosion. Three popular sizes in a variety of lengths provide a good selection. Quantities of 100 are packed in plastic resealable tubs, and bulk packages of 1000 are packaged in poly bags.



Flat



Phillips



Wood

FLAT HEAD

CAT. NO.	SIZE
D150	8 x 1" (25 mm)
10X312FHPWS	10 x 3-1/2" (89 mm)
12X212FHPWS	12 x 2-1/2" (64 mm)
12X3FHPWS	12 x 3" (76 mm)
12X312FHPWS	12 x 3-1/2" (89 mm)
12X4FHPWS	12 x 4" (102 mm)
14X3FHPWS	14 x 3" (76 mm)
14X312FHPWS	14 x 3-1/2" (89 mm)
14X4FHPWS	14 x 4" (102 mm)
14X412FHPWS	14 x 4-1/2" (114 mm)

Minimum order: 100 each. Must order in increments of 100. Sizes can be combined for quantity pricing.

CRL Nickel Plated Wood Screws

- Super Sharp Points
- Bright Nickel Plated Finish

CRL Nickel Plated Wood Screws are made especially for use with mirror clips, rosettes, and metal mirror hangers. All have slotted heads in your choice of oval, flat, and round head styles. They have a bright nickel plated finish that will help resist corrosion. Quantities of 100 are packed in resealable plastic tubs, and bulk packages of 1000 are packaged in poly bags.



Oval



Slotted



Wood

OVAL HEAD

CAT. NO.	SIZE
6X340HNPWS	6 x 3/4" (19 mm)
6X10HNPWS	6 x 1" (25 mm)
6X1140HNPWS	6 x 1-1/4" (32 mm)
6X1120HNPWS	6 x 1-1/2" (38 mm)
6X20HNPWS	6 x 2" (51 mm)
7X1140HNPWS	7 x 1-1/4" (32 mm)

Minimum order: 100 each. Must order in increments of 100. Sizes can be combined for quantity pricing.



Flat



Slotted



Wood

FLAT HEAD

CAT. NO.	SIZE
6X1FHPWS	6 x 1" (25 mm)
6X114FHPWS	6 x 1-1/4" (32 mm)
6X112FHPWS	6 x 1-1/2" (38 mm)

Minimum order: 100 each. Must order in increments of 100. Sizes can be combined for quantity pricing.



Round



Slotted



Wood

ROUND HEAD

CAT. NO.	SIZE
6X34RHPWS	6 x 3/4" (19 mm)
6X1RHPWS	6 x 1" (25 mm)
6X114RHPWS	6 x 1-1/4" (32 mm)
6X112RHPWS	6 x 1-1/2" (38 mm)

Minimum order: 100 each. Must order in increments of 100. Sizes can be combined for quantity pricing.

CRL Tapped Head Wood Screws

- For Mirror Installations Using Tapped Rosettes or Buds
- 3-48 Machine Thread
- Installs With Slotted Screwdriver
- Four Lengths Available



CRL Tapped Head Wood Screws are tapped with a 3-48 machine thread hole to accept CRL Clear Plastic Buds and Threaded Shank Rosettes (online at crlaurence.com). Protect the drilled holes in the mirror by using Vinyl Protective Sleeves (online at crlaurence.com). Screws can be installed with a slotted screwdriver.



Flat



Tapped and Slotted



Wood

CAT. NO.	SIZE
TH34	8 x 3/4" (19 mm)
TH35	8 x 1" (25 mm)
TH36	8 x 1-1/4" (32 mm)
TH37	8 x 1-1/2" (38 mm)

Minimum order: 100 each. Must order in increments of 100. Sizes can be combined for quantity pricing.

CRL FASTENERS – SCREWS

For Pricing Visit Our Web Site or Call Us Toll Free at the Phone Numbers Shown on the Back Cover

CRL Masonry Screws

- Each Box Complete With Masonry Drill Bit
- Available in 3/16" and 1/4" (5 and 6 mm) Diameters in Lengths Up to 4" (102 mm)

CRL Masonry Screws actually cut into masonry! They hold strong in concrete, brick or hollow block, eliminating the need for expansion anchors, plugs with screws, or power-actuated fasteners. Common applications in masonry include: electrical junction boxes and conduit clips; wall partition brackets; roof flashing; awning brackets; ceiling tie wire brackets; 3/4" (19 mm) plywood backer boards; 2 x 4 wood nailers. Each screw has a corrosion resistant coating. Packaged 100 each per box. A "close tolerance" masonry drill bit is included in every box of 100.

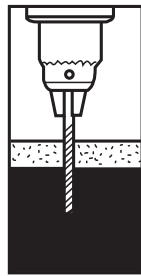

Drill masonry hole a minimum of 1/4" deeper than screw is to be embedded

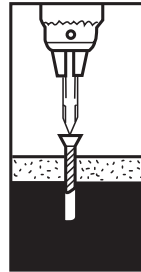

Drive screw into predrilled hole until sealed



CAT. NO.	SIZE	DRILL BIT SIZE
3169407	3/16" x 1-1/4" (32 mm)	5/32" x 3-1/2" (89 mm)
3171407	3/16" x 1-3/4" (44 mm)	5/32" x 3-1/2" (89 mm)
3173407	3/16" x 2-1/4" (57 mm)	5/32" x 4-1/2" (114 mm)
3175407	3/16" x 2-3/4" (70 mm)	5/32" x 4-1/2" (114 mm)
3177407	3/16" x 3-1/4" (82.5 mm)	5/32" x 5-1/2" (140 mm)
3181407	3/16" x 4" (102 mm)	5/32" x 5-1/2" (140 mm)
3183407	1/4" x 1-1/4" (32 mm)	3/16" x 3-1/2" (89 mm)
3185407	1/4" x 1-3/4" (44 mm)	3/16" x 3-1/2" (89 mm)
3187407	1/4" x 2-1/4" (57 mm)	3/16" x 4-1/2" (114 mm)
3189407	1/4" x 2-3/4" (70 mm)	3/16" x 4-1/2" (114 mm)
3191407	1/4" x 3-1/4" (82.5 mm)	3/16" x 5-1/2" (140 mm)
3195407	1/4" x 4" (102 mm)	3/16" x 5-1/2" (140 mm)

Minimum order: 100 each. Must be ordered in increments of 100. Sizes can be combined for quantity pricing.

CRL Drywall Screws

- Sharp Point and Self-Drilling Types in Industry-Preferred Sizes and Lengths
- Phillips Type Flat Heads

Drywall installations are much easier when using the right fasteners. CRL Drywall Screws feature a steel black finish, with Phillips type flat heads and extremely sharp threads. Choose from Sharp Point or Self-Drilling types. Drive CRL Drywall Screws with our Cat. No. 346281 Drywall Bit. (See page N305.)

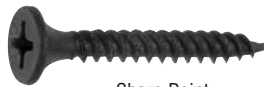

Sharp Point



Self-Drilling Point

SHARP POINT SCREWS

CAT. NO.	SIZE
6X118DW	6 x 1-1/8" (29 mm)
6X114DW	6 x 1-1/4" (32 mm)
6X158DW	6 x 1-5/8" (41 mm)
6X2DW	6 x 2" (51 mm)
8X212DW	8 x 2-1/2" (64 mm)
8X3DW	8 x 3" (76 mm)

Minimum order: 100 each. Must be ordered in increments of 100. Sizes can be combined for quantity pricing.

SELF-DRILLING POINT SCREWS

CAT. NO.	SIZE
6X114DWSD	6 x 1-1/4" (32 mm)
6X158DWSD	6 x 1-5/8" (41 mm)
6X178DWSD	6 x 1-7/8" (48 mm)

Minimum order: 100 each. Must be ordered in increments of 100. Sizes can be combined for quantity pricing.

CRL Machine Screws

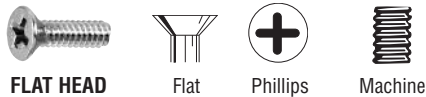

CAT. NO.	SIZE
632X12FMS	6-32 x 1/2" (13 mm)
632X34FMS	6-32 x 3/4" (19 mm)
632X1FMS	6-32 x 1" (25 mm)
632X112FMS	6-32 x 1-1/2" (38 mm)
832X12FMS	8-32 x 1/2" (13 mm)
832X34FMS	8-32 x 3/4" (19 mm)
832X1FMS	8-32 x 1" (25 mm)
832X112FMS	8-32 x 1-1/2" (38 mm)
1024X14FSS	S.S. 10-24 x 1/4" (6 mm)
1024X516FSS	S.S. 10-24 x 5/16" (8 mm)
1024X58FMS	10-24 x 5/8" (16 mm)
1224X12FMS	12-24 x 1/2" (13 mm)
1224X112FMS	12-24 x 1-1/2" (38 mm)
1420X34FMS	1/4-20 x 3/4" (19 mm)
1420X1FMS	1/4-20 x 1" (25 mm)
1420X112FMS	1/4-20 x 1-1/2" (38 mm)
1420X2FMS	1/4-20 x 2" (51 mm)

Minimum order: 100 each. Must be ordered in increments of 100. Sizes can be combined for quantity pricing.

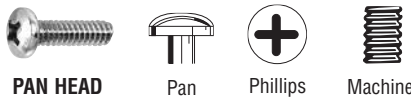

CAT. NO.	SIZE
632X12PMS	6-32 x 1/2" (13 mm)
632X34PMS	6-32 x 3/4" (19 mm)
632X1PMS	6-32 x 1" (25 mm)
632X112PMS	6-32 x 1-1/2" (38 mm)
832X12PMS	8-32 x 1/2" (13 mm)
832X34PMS	8-32 x 3/4" (19 mm)
832X1PMS	8-32 x 1" (25 mm)
1024X58PMS	10-24 x 5/8" (16 mm)

Minimum order: 100 each. Must be ordered in increments of 100. Sizes can be combined for quantity pricing.

CRL Mirror Plate Screws



CAT. NO. 632X120HS

Oval Head Screw, 6-32 x 1/2" (13 mm)
Minimum order is 10 each.

CRL Self-Tapping Machine Screws

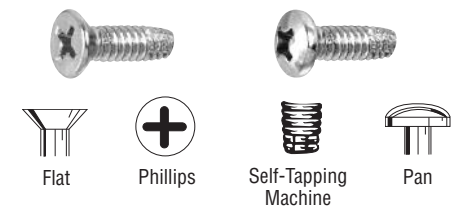

CRL Self-Tapping Machine Screws have special cross-cuts which allow them to tap their own threads in metal. They attach thin materials to substrates with pre-drilled holes.

CAT. NO.	HEAD	SIZE
F1024X58STMS	Flat	10-24 x 5/8" (16 mm)
1024X58PHPTS	Pan	10-24 x 5/8" (16 mm)
1024X34PHPTS	Pan	10-24 x 3/4" (19 mm)
1024X114PHPTS	Pan	10-24 x 1-1/4" (32 mm)
1024X158PHPTS	Pan	10-24 x 1-5/8" (41 mm)

Minimum order: 100 each. Must be ordered in increments of 100. Sizes can be combined for quantity pricing.

CRL Spanner Head Tamperproof Security Screws

- Made of Corrosion Resistant 8-18 Stainless Steel
- Protect Valuable Fixtures From Vandalism and Pilferage

These CRL Spanner Head Tamperproof Security Screws protect valuable fixtures and equipment from theft and vandalism because they are virtually impossible to remove without the matching Spanner Head Screwdrivers. Flat or Pan Head screws are available in Machine or Sheet Metal Type "A" styles. A regular screwdriver will not work with these screws; you must use a Spanner Head Driver or Hex Insert Bit (see below).



SHEET METAL SCREWS

CAT. NO.	HEAD	SIZE
TP6X1FHSMS	Flat	6 x 1" (25 mm)
TP8X12FHSMS	Flat	8 x 1/2" (13 mm)
TP8X1FHSMS	Flat	8 x 1" (25 mm)
TP8X112FHSMS	Flat	8 x 1-1/2" (38 mm)
TP10X12FHSMS	Flat	10 x 1/2" (13 mm)
TP10X1FHSMS	Flat	10 x 1" (25 mm)
TP10X112FHSMS	Flat	10 x 1-1/2" (38 mm)
TP6X12PHSMS	Pan	6 x 1/2" (13 mm)
TP6X1PHSMS	Pan	6 x 1" (25 mm)
TP8X12PHSMS	Pan	8 x 1/2" (13 mm)
TP8X1PHSMS	Pan	8 x 1" (25 mm)
TP8X112PHSMS	Pan	8 x 1-1/2" (38 mm)
TP10X12PHSMS	Pan	10 x 1/2" (13 mm)
TP10X1PHSMS	Pan	10 x 1" (25 mm)
TP10X112PHSMS	Pan	10 x 1-1/2" (38 mm)

Minimum order: 100 each. Must order in increments of 100. All Bulk Screws can be combined for quantity pricing.

MACHINE SCREWS

CAT. NO.	HEAD	SIZE
TP632X12FMS	Flat	6-32 x 1/2" (13 mm)
TP632X34FMS	Flat	6-32 x 3/4" (19 mm)
TP832X12FMS	Flat	8-32 x 1/2" (13 mm)
TP832X1FMS	Flat	8-32 x 1" (25 mm)
TP1024X1FMS	Flat	10-24 x 1" (25 mm)
TP1032X1FMS	Flat	10-32 x 1" (25 mm)
TP832X12PMS	Pan	8-32 x 1/2" (13 mm)
TP832X1PMS	Pan	8-32 x 1" (25 mm)
TP1024X12PMS	Pan	10-24 x 1/2" (13 mm)
TP1024X1PMS	Pan	10-24 x 1" (25 mm)
TP1032X1PMS	Pan	10-32 x 1" (25 mm)

Minimum order: 100 each. Must order in increments of 100. All Bulk Screws can be combined for quantity pricing.

CRL Spanner Head Screwdrivers and Hex Insert Bits

- Specially Made to Install or Remove Spanner Head Screws
- Sizes to Fit All Spanner Head Tamperproof Security Screws From #6 to #10
- Hex Insert Bits Also Available for Your Magnetic Screwdrivers or Bit Holders

Spanner Head Screwdrivers come in three sizes to fit #6, #8, and #10 Spanner Screws. **NOTE:** Spanner Drivers fit only Spanner Screws of the same size.

1/4" (6 mm) Spanner Head Hex Insert Bits are also available to fit your magnetic screwdrivers or bit holders. Hex bits are heat-treated for strength, and measure 1" (25 mm) in length.



SPANNER HEAD DRIVERS

CAT. NO.	APPLICATION
SP6D	Fits #6 Spanner Screws
SP8D	Fits #8 Spanner Screws
SP10D	Fits #10 Spanner Screws

Minimum order: 1 each. Can be combined with all other Hand Screwdrivers for quantity pricing.

1/4" HEX BITS FOR MAGNETIC DRIVERS

CAT. NO.	FITS SCREW SIZES
SP6HB	Fits #6 Spanner Screws
SP8HB	Fits #8 Spanner Screws
SP10HB	Fits #10 Spanner Screws

Minimum order: 1 each. Can be combined with all other Hex Insert Bits for quantity pricing.

CRL Tamperproof Security Screw Kit

The CRL Tamperproof Security Screw Kit contains 20 of the most asked for sizes of Machine and Sheet Metal Spanner Head Tamperproof Screws. It includes three matching Spanner Drivers and a total of 1000 stainless steel screws in sizes #6, #8, and #10. Lengths are from 1/2" to 1" (13 to 25 mm). It comes in a sturdy steel storage box. An ideal kit for institutions, schools, hospitals, etc. with security-type fixtures. Minimum order is one each.



- Contains Three Spanner Head Drivers and 1000 Assorted Spanner Head Screws



CAT. NO. SP1000K

CRL Oval Head Phillips Tapping Screw "Fix-Kit"

- 24 Varieties
- 540 Pieces
- Metal Case



Phillips



CAT. NO. AV6003

This CRL "Fix-Kit" contains 24 sizes of commonly used Oval Head Phillips Tapping Screws. The sturdy, compartmented metal case is indexed for picking the fastener you need quickly and easily. Minimum order is one each.

ORDER REFILLS FROM THE CATALOG NUMBERS LISTED BELOW

CAT. NO.	SIZE	TYPE	CAT. NO.	SIZE	TYPE
AV3069	4 x 3/4" (19 mm)	Oval Head	AV1802	8 x 1-1/8" (29 mm)	Oval Head
AV1793	6 x 5/8" (16 mm)	Oval Head	AV2361	8 x 1-1/4" (32 mm)	Oval Head
AV1794	6 x 3/4" (19 mm)	Oval Head	AV1803	8 x 1-1/4" (32 mm)	Oval Head
AV1796	6 x 1" (25 mm)	Oval Head	AV2362	8 x 1-1/2" (38 mm)	Oval Head
AV1797	6 x 1-1/4" (32 mm)	Oval Head	AV1932	8 x 1-1/2" (38 mm)	Oval Head
AV2024	8 x 3/8" (10 mm)	#6 Head	AV1933	8 x 1-3/4" (44 mm)	#6 Head
AV2358	8 x 1/2" (13 mm)	Oval Head	AV1717	10 x 3/4" (19 mm)	Oval Head
AV2027	8 x 1/2" (13 mm)	#6 Head	AV2728	10 x 3/4" (19 mm)	#6 Head
AV1421	8 x 5/8" (16 mm)	#6 Head	AV1804	10 x 1" (25 mm)	#6 Head
AV1799	8 x 3/4" (19 mm)	#6 Head	AV1807	10 x 1-1/8" (29 mm)	#6 Head
AV2359	8 x 3/4" (19 mm)	Oval Head	AV2046	10 x 1-1/2" (38 mm)	Oval Head
AV1801	8 x 1" (25 mm)	#6 Head			

CRL Specialty Tapping Screw "Fix-Kit"

- 24 Varieties
- 795 Pieces
- Metal Case



Phillips



CAT. NO. AV6004

This CRL "Fix-Kit" contains 24 sizes of commonly used Specialty Tapping Screws. The sturdy, compartmented metal case is indexed for picking the fastener you need quickly and easily. Minimum order is one each.

ORDER REFILLS FROM THE CATALOG NUMBERS LISTED BELOW

CAT. NO.	SIZE	TYPE	CAT. NO.	SIZE	TYPE
AV1936	6 x 3/8" (10 mm)	Pan Head	AV2365	8 x 3/4" (19 mm)	Pan Head
AV1937	6 x 1/2" (13 mm)	Pan Head	AV3079	8 x 1" (25 mm)	Pan Head
AV2364	6 x 3/4" (19 mm)	Pan Head	AV2178	10 x 3/8" (10 mm)	Rnd Wshr Hd
AV1939	8 x 3/8" (10 mm)	Pan Head	AV1943	10 x 1/2" (13 mm)	Pan Head
AV10642	8 x 3/8" (10 mm)	Oval Wshr Hd	AV2808	10 x 5/8" (16 mm)	Pan Head
AV2805	8 x 7/16" (11 mm)	Pan Wshr Hd	AV13709Δ	10 x 3/4" (19 mm)	Rnd Wshr Hd
AV1940	8 x 1/2" (13 mm)	Pan Head	AV2366	10 x 3/4" (19 mm)	Pan Head
AV12095Δ	8 x 1/2" (13 mm)	Pan Wshr Hd	AV3082	10 x 1" (25 mm)	Pan Head
AV14859	8 x 1/2" (13 mm)	Flat Wshr Hd	AV2367	12 x 3/4" (19 mm)	Pan Head
AV15171	8 x 1/2" (13 mm)	Rnd Wshr Tek	AV3086	12 x 1" (25 mm)	Pan Head
AV15172	8 x 1/2" (13 mm)	Flat Wshr Tek	AV3089	14 x 1/2" (13 mm)	Pan Head
AV1712	8 x 3/4" (19 mm)	#6 Flat Head	AV3090	14 x 3/4" (19 mm)	Pan Head

CRL Tek® Self-Drilling Screw "Fix-Kit"

- 16 Varieties
- 365 Pieces
- Metal Case



Hex



Phillips



CAT. NO. AV6144

This CRL "Fix-Kit" contains a complete assortment of Tek® Self-Drilling Screws with Phillips Pan and Hex Washer heads. All are zinc plated. Minimum order is one each.

ORDER REFILLS FROM THE CATALOG NUMBERS LISTED BELOW

CAT. NO.	SIZE	TYPE	CAT. NO.	SIZE	TYPE
AV9605	8 x 1/2" (13 mm)	Pan Head	20092003	10 x 5/8" (16 mm)	Hex Head
AV9606	8 x 3/4" (19 mm)	Pan Head	AV9615	10 x 3/4" (19 mm)	Hex Head
AV9607	10 x 1/2" (13 mm)	Pan Head	AV9616	10 x 1" (25 mm)	Hex Head
AV9608	10 x 3/4" (19 mm)	Pan Head	AV11911*	12 x 1" (25 mm)	Hex Head
AV11905Δ	12 x 1" (25 mm)	Pan Head	AV9620	14 x 3/4" (19 mm)	Hex Head
AV9611	8 x 1/2" (13 mm)	Hex Head	AV11914*	14 x 1" (25 mm)	Hex Head
AV9612	8 x 3/4" (19 mm)	Hex Head	AV11915*	14 x 1-1/4" (32 mm)	Hex Head
AV9613	10 x 1/2" (13 mm)	Hex Head	AV11916*	14 x 1-1/2" (38 mm)	Hex Head

Minimum order for refills: 1 box. All refills contain 100 screws, except where noted *25 per box or Δ 50 per box. All Refill Screw Kits can be combined for quantity pricing.

CRL Countersunk Washer Head Screw "Fix-Kit"

- 12 Varieties
- 460 Pieces
- Metal Case



Phillips



CAT. NO. AV6049

This CRL "Fix-Kit" contains a complete assortment of chrome plated, Phillips Countersunk Washer Head Screws. Minimum order is one each.

ORDER REFILLS FROM THE CATALOG NUMBERS LISTED BELOW

CAT. NO.	SIZE	TYPE	CAT. NO.	SIZE	TYPE
AV3537	6 x 5/8" (16 mm)	#6 Head	AV2773	8 x 1-1/4" (32 mm)	#6 Head
AV3538	6 x 3/4" (19 mm)	#6 Head	AV14970Δ	8 x 1-1/2" (38 mm)	#6 Head
AV3539	6 x 1" (25 mm)	#6 Head	AV3465	10 x 5/8" (16 mm)	#8 Head
AV2771	8 x 5/8" (16 mm)	#6 Head	AV3466	10 x 3/4" (19 mm)	#8 Head
AV2751	8 x 3/4" (19 mm)	#6 Head	AV3467	10 x 1" (25 mm)	#8 Head
AV2772	8 x 1" (25 mm)	#6 Head	AV3468	10 x 1-1/4" (32 mm)	#8 Head

CRL Countersunk Self-Drilling Screws With Washers

- Available in Black and Chrome
- Several Lengths Offered



Chrome Flush



Black Countersunk



Phillips



Oval



Self-Drilling

These CRL Oval Head Phillips Self-Drilling Screws come with matching flush or countersunk washers for finish work. They are available in either a chrome plated or black phosphate finish.

CAT. NO.	SCREW SIZE	FINISH/WASHER TYPE	QTY/BOX
AV11448	8 x 5/8" (16 mm)	Chrome Flush Countersunk	100
AV11449	8 x 5/8" (16 mm)	Chrome Countersunk	100
AV11450	8 x 3/4" (19 mm)	Chrome Countersunk	100
AV11451	8 x 1" (25 mm)	Chrome Countersunk	50
AV11452	8 x 1-1/4" (32 mm)	Chrome Countersunk	50
AV11453	8 x 5/8" (16 mm)	Black Flush Countersunk	100
AV11454	8 x 5/8" (16 mm)	Black Countersunk	100
AV11455	8 x 3/4" (19 mm)	Black Countersunk	100
AV11456	8 x 1" (25 mm)	Black Countersunk	50
AV11457	8 x 1-1/4" (32 mm)	Black Countersunk	50

Minimum order: 1 box. Sizes can be combined for quantity pricing.

CRL Sheet Metal Screws With Countersunk Washers

- Available in Black and Chrome



Phillips



Oval



Sheet Metal

These CRL Oval Head Phillips Sheet Metal Screws with Countersunk Washers come in chrome plated or black phosphate finishes.

CAT. NO.	SCREW SIZE	FINISH	QTY/BOX
AV11784	6 x 5/8" (16 mm)	Black	100
AV3537	6 x 5/8" (16 mm)	Chrome	100
AV11785	6 x 3/4" (19 mm)	Black	100
AV3538	6 x 3/4" (19 mm)	Chrome	100
AV11786	6 x 1" (25 mm)	Black	100
AV3539	6 x 1" (25 mm)	Chrome	100
CP906819	8 x 9/16" (14 mm)	Black	100
AV11787	8 x 5/8" (16 mm)	Black	100
AV2771	8 x 5/8" (16 mm)	Chrome	100
AV11788	8 x 3/4" (19 mm)	Black	100
AV2751	8 x 3/4" (19 mm)	Chrome	100
AV11789	8 x 1" (25 mm) #6 Head	Black	100
AV2772	8 x 1" (25 mm) #6 Head	Chrome	100
AV11790	8 x 1-1/4" (32 mm) #6 Head	Black	100
AV2773	8 x 1-1/4" (32 mm) #6 Head	Chrome	100
AV14970	8 x 1-1/2" (38 mm) Oval Head	Chrome	100
AV3465	10 x 5/8" (16 mm) #8 Head	Chrome	100
AV11791	10 x 3/4" (19 mm) #8 Head	Black	100
AV3466	10 x 3/4" (19 mm) #8 Head	Chrome	100
AV3467	10 x 1" (25 mm) #8 Head	Chrome	100
AV3468	10 x 1-1/4" (32 mm) #8 Head	Chrome	100

Minimum order: 1 box. Sizes can be combined for quantity pricing.

CRL Standard Countersunk Washers

- Nickel Plated Brass



The CRL Standard Countersunk Washers are available in boxes of 100 each for screw sizes #6 to #12.

CAT. NO.	WASHER TYPE	QTY/BOX
AV614	Standard #6 Countersunk	100
AV616	Standard #8 Countersunk	100
AV618	Standard #10 Countersunk	100
AV619	Standard #12 Countersunk	100

Minimum order: 1 box. All Countersunk Washer can be combined for quantity pricing.

CRL Flanged Countersunk Washers

- Nickel Plated Brass



The CRL Flanged Countersunk Washers are available in boxes of 100 each for screw sizes #6 to #10.

CAT. NO.	WASHER TYPE	QTY/BOX
AV3469	Flanged #6 Countersunk	100
AV2515	Flanged #8 Countersunk	100
AV3471	Flanged #10 Countersunk	100

Minimum order: 1 box. All Countersunk Washer can be combined for quantity pricing.

CRL Flush Countersunk Washers

- Nickel Plated Brass



CRL Flush Countersunk Washers are available in boxes of 100 each for screw sizes #6 to #8.

CAT. NO.	WASHER TYPE	QTY/BOX
AV602	Flush #6 Countersunk	100
AV604	Flush #8 Countersunk	100

Minimum order: 1 box. All Countersunk Washer can be combined for quantity pricing.

CRL Metal Flat Washers

- Available in Zinc and Stainless Steel
- For Shimming, Bolt, and Rivet Support



CAT. NO. AV2333



CAT. NO. FW14S



CAT. NO. AV2227

CAT. NO.	SCREW SIZE	DIAMETER	FINISH	QTY/PKG
AV2007*	3/16"	1/2" (13 mm)	Zinc	100
AV2008*	1/4"	5/8" (16 mm)	Zinc	100
AV2333*	1/4"	1-1/4" (32 mm)	Zinc	100
AV1376*	5/16"	3/4" (19 mm)	Zinc	100
AV2227*	3/8"	1-1/2" (38 mm)	Zinc	100
FW10SΔ	#10	7/16" (11 mm)	Stainless	10
FW14SΔ	1/4"	11/16" (17 mm)	Stainless	10
FW14ZΔ	1/4"	11/16" (17 mm)	Zinc	10
FW516SΔ	5/16"	3/4" (19 mm)	Stainless	10
FW516ZΔ	5/16"	3/4" (19 mm)	Zinc	10
FW38SΔ	3/8"	7/8" (22 mm)	Stainless	10
FW38ZΔ	3/8"	7/8" (22 mm)	Zinc	10

*Minimum order: 1 box. Δ Minimum order: 10 each. Must be ordered in increments of 10.

CRL Plastic Flat Washers

- Provides Protection to Glass Surface
- Several Sizes Available



CAT. NO. SW114S



CAT. NO. SW114L



CAT. NO. SW012S

CAT. NO.	SCREW SIZE	DIAMETER	QTY/PKG
SW012S	#8	1/2" (13 mm)	10
SW012L	1/4"	1/2" (13 mm)	10
HW058	1/4"	3/4" (19 mm)	10
SBP1PW	5/16"	1" (25 mm)	10
DH114GASK	#10	1-1/8" (29 mm)	10
SW1S	1/4"	1" (25 mm)	10
SW114S	1/4"	1-1/4" (32 mm)	10
SW114L	3/8"	1-1/4" (32 mm)	10
SW112S	1/4"	1-1/2" (38 mm)	10
SW2S	1/4"	2" (51 mm)	10

Minimum order: 10 each. Must be ordered in increments of 10.

CRL Felt Washers

- For Use Behind Mirror Rosettes
- Black Color for Low Visibility



CAT. NO. 7358



CAT. NO. 7334

CAT. NO.	SCREW SIZE	DIAMETER	QTY/PKG
7358	#6	5/8" (16 mm)	100
7334	#6	3/4" (19 mm)	100

Minimum order: 100 each. Sizes can be combined for quantity pricing.

CRL Lock Washers

- Spring Lock Type Available in Zinc and Stainless Steel
- Won't Loosen Under Shock or Vibration



CAT. NO. AV5720



CAT. NO. LW14S

CAT. NO.	SCREW SIZE	DIAMETER	FINISH	QTY/PKG
AV5720*	#14, 1/4" Bolt	1/2" (13 mm)	Zinc	200
LW10SΔ	#10	7/16" (11 mm)	Stainless	10
LW14SΔ	1/4"	1/2" (13 mm)	Stainless	10
LW14ZΔ	1/4"	1/2" (13 mm)	Zinc	10
LW516SΔ	5/16"	9/16" (14 mm)	Stainless	10
LW516ZΔ	5/16"	9/16" (14 mm)	Zinc	10
LW38SΔ	3/8"	11/16" (17 mm)	Stainless	10
LW38ZΔ	3/8"	11/16" (17 mm)	Zinc	10

*Minimum order: 1 box. Δ Minimum order: 10 each. Must be ordered in increments of 10.

CRL offers a complete selection of Screwdrivers, including Cordless Drivers, and Screwdriver Sets. Our selection also covers a vast assortment of Insert Bits along with Bit Holders. We have many specialty screwdrivers for all of your job requirements.

CRL thinks that there is a "right tool" for every job, and we have the tool to fit your needs. Below and on the next page you will find our most popular and newest selection of Screwdrivers and Insert Bits. For a complete listing with descriptions please review our CRL73 Tools, Machinery, and Equipment Catalog. You can also view our Online Catalog by visiting our web site, crlaurence.com.



CRL Ratcheting Extension Screwdriver

- **Magnetic Tip Shaft Extends From 9-1/4" to 15" and Locks in Place**
- **Handle Ratchets Left or Right, or Works in Fixed Position**



This CRL Ratcheting Extension Screwdriver has a magnetic tipped shaft that extends from 9-1/4" to 15" (235 to 381 mm) overall length. The shaft extends in 1/16" (1.6 mm) increments and locks into place automatically. You retract it by pushing up on the release collar that also holds the six Insert Bits: two each Phillips, Slotted, and Torx. The handle can be made to ratchet left, right, or lock in place. It also features a soft, comfortable grip. Minimum order is one each.

CAT. NO. H109

CRL Magnetic Screwdrivers

- **Phillips and Slotted Bits Included in Storage Handle**
- **Also Drives 1/4" (6 mm) Hex Screws**



The CRL Magnetic Screwdriver is almost indispensable. The magnetic force holds Hex Insert Bits securely, yet are easily changed. The comfortable fluted plastic handle contains four bits: #1 and #2 Phillips, and #4 and #8 Slotted. It is available in three lengths.

CAT. NO.	OVERALL LENGTH
3192	3" (76 mm)
3195	8" (203 mm)
3198	10" (254 mm)

Minimum order: 1 each.

CRL Wera Lasertip® 6-Piece Screwdriver Set

- **Ergonomically Designed Handle**
- **Unique Laser Etched Gripping Surface**

This CRL Wera Lasertip® 6-Piece Screwdriver Set has an ergonomically designed handle which offers comfort and added grip strength. The driver shanks have hardened steel tips and a unique laser-etched gripping surface which "bites" into the head of the screw. This results in less slipping, less stripping of the screw head, and less thrust pressure to keep the tip engaged into the screw head. Holder is included. Minimum order is one each.

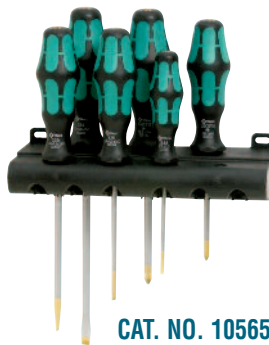

new

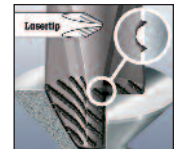

6-PIECE SCREWDRIVER SET INCLUDES:

TYPE	TIP	LENGTH
Phillips	#1	7" (178 mm)
Phillips	#2	8" (203 mm)
Slotted	1/8" (3.2 mm)	6-1/2" (165 mm)
Slotted	5/32" (4.0 mm)	7-3/4" (197 mm)
Slotted	7/32" (5.5 mm)	8-3/4" (222 mm)
Slotted	1/4" (6.4 mm)	10" (254 mm)

CRL Offset Hex Bit Driver With Four Screwdriver Tips

- **Removable Driver Head for Use With Electric Screwdrivers and Drills**
- **Holds All 1/4" (6.4 mm) Hex Insert Bits**
- **Low-Profile Angled Head**



Removable Driver Head can be used with electric screwdrivers



Extra Bits are stored in handle

The CRL Offset Hex Bit Driver lets you fasten or remove screws located in channels, under wedges, or in areas where any regular screwdriver cannot fit. The low profile, angled head has hardened steel gears that are lubricated and sealed for a lifetime of service. The standard hex socket securely holds all types of 1/4" (6.4 mm) Hex Insert Bits. Tool includes #1 and #2 Phillips Bits, and 3/16" and 1/4" Slotted Bits. Minimum order is one each.

CAT. NO. M14895

CRL 1/4" Hex Phillips Insert Bits



CAT. NO. 4401



CAT. NO. 4402



CAT. NO. SD333



CAT. NO. 44022



CAT. NO. 4461



CAT. NO. 4462



CAT. NO. 346281



CRL 1/4" Hex Phillips Insert Bits come in six sizes and four styles: regular, undercut, long, and heavy-duty. We have Bits available for use with Phillips screws with #1, #2, and #3 Phillips point sizes.

Try our new "Drywall Screw Insert Bit". This undercut bit has a unique Phillips shape that is specifically designed to work with drywall screws, and is also an excellent bit for use on older, previously used #6 and #8 sized screws.

CAT. NO.	TYPE	POINT SIZE	SCREW SIZES	LENGTH
4401	Standard	#1	2-3-4	1" (25 mm)
4402	Standard	#2	5-6-7-8-10	1" (25 mm)
44022	Long	#2	5-6-7-8-10	2" (51 mm)
4461	Undercut	#1	2-3-4	1" (25 mm)
4462	Undercut	#2	5-6-7-8-10	1" (25 mm)
SD333	Heavy-Duty	#3	12-14	1-1/4" (32 mm)
346281	Drywall	#2	6-8	1" (25 mm)

Minimum order: 1 each. All Hex Insert Bits can be combined for quantity pricing.

CRL Phillips Screwgun Bits

CRL Phillips Screwgun Bits are available in #1, #2, and #3 Phillips point sizes. 1-15/16" (49 mm), 2-3/4" (70 mm), and 3-1/2" (90 mm) lengths fit all standard electric screwguns.



CAT. NO. 491



CAT. NO. 491A



CAT. NO. 492B

CAT. NO.	POINT SIZE	SCREW SIZES	LENGTH
491	#1	2-4	1-15/16" (49 mm)
492	#2	6-8-10	1-15/16" (49 mm)
493	#3	12-14	1-15/16" (49 mm)
491A	#1	2-4	2-3/4" (70 mm)
492A	#2	6-8-10	2-3/4" (70 mm)
493A	#3	12-14	2-3/4" (70 mm)
491B	#1	2-4	3-1/2" (90 mm)
492B	#2	6-8-10	3-1/2" (90 mm)
493B	#3	12-14	3-1/2" (90 mm)

Minimum order: 1 each. All Screwgun Bits can be combined for quantity pricing.

CRL Makita® Screw Finder/Driver



Includes three 1/4" Insert Bits: one each Slotted, #1 and #2 Phillips Bits. This handy tool will also hold all other types of 1/4" Insert Bits.

CAT. NO.	DESCRIPTION	LENGTH
784811A	"Stubby" Finder/Driver	3" (76 mm)
784810A	Regular Finder/Driver	4-1/2" (114 mm)

Minimum order: 1 each.

CRL Magnetic Hex Insert Bit Holders



CRL Magnetic Hex Insert Bit Holders allow use of all 1/4" Hex Insert Bits in your screwgun. Available in two lengths.

CAT. NO.	LENGTH
M490	3" (76 mm)
M4906	6" (152 mm)

Minimum order: 1 each.

CRL Screwgun Nut Setter Sockets



The CRL Screwgun Nut Setter Sockets have a magnetic head to firmly hold the screw and are now available in two lengths. CRL Nut Setter Sockets fit all standard screwguns.

- Nut Setters Have a Magnetic Head
- Fit All Standard Screwguns



CAT. NO.	NUT SIZE	LENGTH
MDB08	1/4"	1-3/4" (44 mm)
MDB10	5/16"	1-3/4" (44 mm)
MDB12	3/8"	1-3/4" (44 mm)
MDB14	7/16"	1-3/4" (44 mm)
MDB08L	1/4"	2-9/16" (65 mm)
MDB10L	5/16"	2-9/16" (65 mm)
MDB12L	3/8"	2-9/16" (65 mm)
MDB14L	7/16"	2-9/16" (65 mm)

Minimum order: 1 each. All Nut Setters can be combined for quantity pricing.

CRL Replacement Screw Packs for Hand Rail Brackets

• Five Finishes



RSP1 Pack
Each pack contains: Two each 8-18 x 3/4" (19 mm) Self-Drilling Phillips Pan Head Screws and One each 3/8" -16 x 3" (76.2 mm) Hanger Bolt.

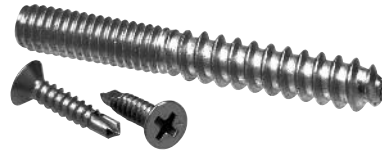

RSP3 Pack
Each pack contains: Two each 8-18 x 3/4" (19 mm) Self-Drilling Phillips Pan Head Screws and One each 5/16" -18 x 2-1/2" (63.5 mm) Hanger Bolt.



RSP2 Pack
Each pack contains: Two each 8-18 x 3/4" (19 mm) Self-Drilling Phillips Pan Head Screws and One each 3/8" -16 x 1-1/4" (31.8 mm) Allen Screw.

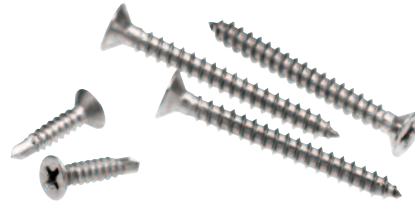

RSP5 Pack
Each pack contains: Two each 8-18 x 3/4" (19 mm) Self-Drilling Phillips Flat Head Screws and Three each 12 x 2" (50.8 mm) Phillips Flat Head Screws.

BRUSHED STAINLESS CAT. NO.	POLISHED STAINLESS CAT. NO.	BRASS PLATED CAT. NO.	SATIN ANODIZED CAT. NO.	DARK BRONZE CAT. NO.	FITS CRL HAND RAIL SERIES
RSP1BS	RSP1PS	RSP1PB	RSP1SA	RSP1DU	HR2SW and HR2DW
RSP2BS	RSP2PS	RSP2PB	RSP2SA	RSP2DU	HR2SP
RSP3BS	RSP3PS	RSP3PB	-----	-----	HR15T, HR20T, HR15B3, and HR20B3
RSP5BS	RSP5PS	RSP5PB	-----	-----	HR15B4, HR20B4, HR15WA, and HR20WA



Minimum order: 1 pack.

CRL Replacement Screw Packs for Bar Mount Foot Railing Brackets

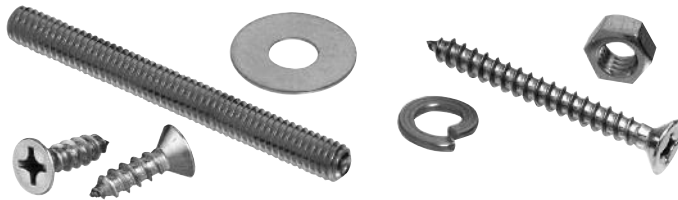

CRL Replacement Screw Packs for Bar Mount Foot Railing Brackets come in finishes to match the Brackets. Packs include:

- 1 Each 5/16" - 18 x 3" (76.2 mm) Allen Screw
- 1 Each 12 x 2" (50.8 mm) Flat Head Phillips Screw
- 2 Each 12 x 3/4" (19 mm) Flat Head Phillips Screw
- 1 Each 7/8" (22.2 mm) Diameter Flat Washer
- 1 Each Spring Lock Washer
- 1 Each 5/16"-18 Hex Nut

CAT. NO.	FINISH
RSP4BS	Brushed Stainless
RSP4PS	Polished Stainless
RSP4PB	Brass Plated

Minimum order: 1 pack.

CRL Screws for Aluminum Railings

• Stainless Steel



These Stainless Steel Screws are used with CRL Aluminum Railing Systems.

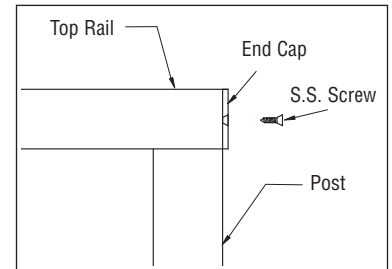

CAT. NO.	DESCRIPTION	SIZE
TEK1	Pan Head Square Drive Self Drilling	#8 x 3/4" (19 mm)
RCBS	Pan Head Square Drive Self Drilling	#10 x 2" (50.8 mm)
ECS1	Flat Head Phillips Sheet Metal	#12 x 3/4" (19 mm)
CBS1	Pan Head Phillips Sheet Metal	#14 x 3/4" (19 mm)
PRS1032	Flat Head Phillips Undercut Machine	#10-32 x 5/8" (16 mm)

Minimum order: 50 each. Must order in increments of 50. All Railing Screws can be combined for quantity pricing.

CRL Flat Head Phillips Screws

- For Use With CRL Hand Rail Brackets and Fittings
- Three Architectural Finishes

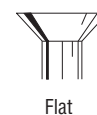

CAT. NO.	SIZE	FINISH
10X112FHPBS	#10 x 1-1/2" (38.1 mm)	Brushed Stainless
10X112FHPPS	#10 x 1-1/2" (38.1 mm)	Polished Stainless
10X112FHPPB	#10 x 1-1/2" (38.1 mm)	Brass Plated
12X2FHPBS	#12 x 2" (50.8 mm)	Brushed Stainless
12X2FHPPS	#12 x 2" (50.8 mm)	Polished Stainless
12X2FHPPB	#12 x 2" (50.8 mm)	Brass Plated

Minimum order: 100 each. Must order in increments of 100. All bulk screws can be combined for quantity pricing.

CRL Z-Clamp Replacement Screws

- Three Finishes to Match Our Z-Series Clamps



CAT. NO.	FINISH	QTY/PACK
ZCS5X15BR	Brass	8
ZCS5X15CH	Chrome	8
ZCS5X15SS	Stainless Steel	8

Minimum order: 1 pack.

CRL Z-Clamp Attachment Screws

- Stainless Screws for Use With CRL's Z-Series Clamps



CAT. NO. ZLAG
For Wood Attachments

CAT. NO. SHCS10X34
For Metal Attachments

CAT. NO.	DESCRIPTION
ZLAG	5/16" x 2" (51 mm) 316 Grade Stainless Steel Lag Bolt
SHCS10X34	10-24 x 3/4" (19 mm) 304 Grade Stainless Steel Socket Head Cap Screw

Minimum order: 10 each. Must order in increments of 10.

CRL Glass Extension Bolts

new

- Threaded Studs for Thicker Glass Panel Applications
- For Use With RB50 and RB51 Glass Fittings
- 316 Alloy 3/8"-16 Threaded Studs

CRL's Glass Extension Bolts were designed for projects that require thicker panel connections. Made from 316 Alloy Stainless Steel, these component parts are designed to work with CRL's RB50 and RB51 Double Arm Glass Fittings.

BRUSHED STAINLESS CAT. NO.	POLISHED STAINLESS CAT. NO.	DESCRIPTION
RBEB2BS	RBEB2PS	2" (51 mm) Bolt for 1/2" (12 mm) Thick Panels
RBEB214BS	RBEB214PS	2-1/4" (57 mm) Bolt for 3/4" (19 mm) Thick Panels
RBEB212BS	RBEB212PS	2-1/2" (63 mm) Bolt for 1" (25 mm) Thick Panels

Minimum order: 1 each. Sizes and finishes can be combined for quantity pricing.



CAT. NO. RBEB2
2" (51 mm)



CAT. NO. RBEB214
2-1/4" (57 mm)



CAT. NO. RBEB212
2-1/2" (63 mm)

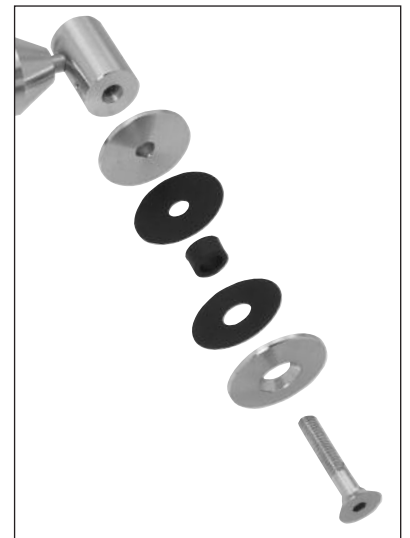

CRL Standoff Connector Bolt

- For Securing Modular Crossbar Standoffs
- Stainless Steel 1/4"-20 x 1" Flat Head Phillips Bolt



CRL Standoff Connector Bolts are used to secure Standoff Connectors to drilled and tapped posts. Flat Phillips head bolt has 1/4"-20 thread.

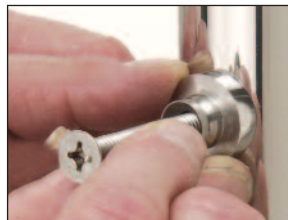

CAT. NO.	SIZE	QTY/PACK
SRBOLT	1/4"-20 x 1" (25 mm)	50

Minimum order: 50 each. Must be ordered in increments of 50.

CRL Rail Connecting Block Screws

- For 200, 300, 350, and 400 Series Railings
- Self-Tapping
- Stainless Steel

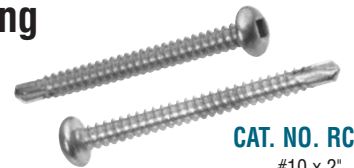

CAT. NO. RCBS
#10 x 2"
Rail Connecting Block Screw



CAT. NO. 9502
Square Insert Bit

Use CRL Rail Connecting Block Screws when installing 200, 300, 350, and 400 Series Rail Connecting Blocks. RCB Screws are stainless steel #10 x 2", and have special crosscuts which allow them to tap their own threads in aluminum. Screws require Cat. No. 9502 1/8" (3 mm) size Square Insert Bit to install.

CAT. NO.	DESCRIPTION	SIZE
RCBS	Rail Connecting Block Screw	#10 x 2" (50.8 mm) ▲
9502	Square Insert Bit for Screws	1/8" (3 mm) #

▲ Minimum order: 50 each. Must be ordered in increments of 50. # Minimum order: 1 each.

CRL Concrete Screw Anchors

• Heat Treated Carbon Steel

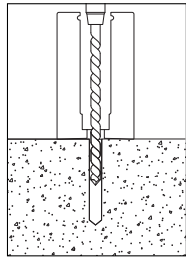

Using the proper diameter ANSI Grade drill bit, drill a hole into the concrete to a depth of at least 1/2" (12.7 mm), or one anchor diameter deeper than the embedment required. Blow the hole clean of dust and other material.

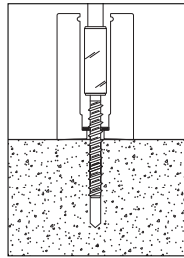

Insert the Concrete Screw Anchor through the Washer and Base Shoe into the drilled hole. Begin tightening the Concrete Screw Anchor by rotating clockwise and applying downward pressure. This will engage the first few threads as the Anchor begins to advance.

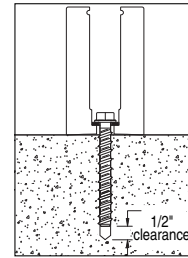

Continue tightening the Anchor until the Anchor and Washer are firmly seated against the Base Shoe while achieving the required embedment depth. In extremely dense materials, use of an impact wrench is recommended.

CRL Concrete Screw Anchors are made of heat-treated carbon steel, and are ideal for use with all CRL Aluminum Railings to attach Vertical Posts and CRL Heavy Aluminum Base Shoes to the substrate. Concrete Screw Anchors achieve their load capacity by the thread undercutting the base material. Up to 40 ft/lbs of torque can be applied in 4000 psi concrete to achieve maximum clamping torque. Concrete Screw Anchors are manufactured from heat treated carbon steel, and are bright zinc plated with a chromate treatment.

CAT. NO.	DESCRIPTION
WBA14X3	1/4" x 3" (6.3 x 76.2 mm) Concrete Screw Anchor
WBAW14*	Washer for WBA14X3 Screw
WBA38X4	3/8" x 4" (9.5 x 101.6 mm) Concrete Screw Anchor
WBAW38*	Washer for WBA38X4 Screw
WBA12X4	1/2" x 4" (12.7 x 101.6 mm) Concrete Screw Anchor

Minimum order: 50 each. Must be ordered in increments of 50. *Must be used with Concrete Screw Anchors to achieve the required attachment strength of the Base Shoe to the concrete.

CRL Lag Bolts

• Stainless Steel

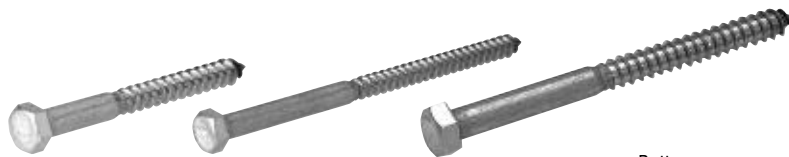

CRL Stainless Steel Lag Bolts are perfect for attaching Post Railings to a wooden deck.

CAT. NO.	THREAD SIZE	LENGTH
LB350	3/8" (9.5 mm)	3-1/2" (89 mm)
LB600	3/8" (9.5 mm)	6" (152.4 mm)
LB12X6	1/2" (12.7 mm)	6" (152.4 mm)

Minimum order: 20 each. Must be ordered in increments of 20. Can be combined for quantity pricing.

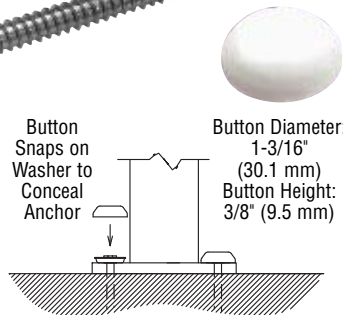

Use BTN1 Buttons and WSHR1 Washers for a finished look. See page N312.



CRL Stainless Steel Concrete Anchors

• All Stainless Steel



CRL Stainless Steel Concrete Anchors are ideal for attaching partition posts or hand railing brackets for non-structural applications to a concrete substrate.

CAT. NO.	THREAD SIZE	LENGTH
CA325	1/4" – 20	3-1/4" (82.5 mm)
CA3817	5/16" – 18	1-7/8" (47.6 mm)
CA1222	3/8" – 16	2-1/4" (57.1 mm)

Minimum order: 1 each for CA3817 and CA1222; 20 each for CA325. Can be combined for quantity pricing.

CRL Concrete Anchors

• For Standoff Bases and Cable Display Systems



CRL Concrete Anchors are ideal for attaching Standoff Bases and Cable Display Systems for non-structural applications to a concrete substrate.

CAT. NO.	SIZE	DESCRIPTION
CA1420	1/4" – 20	Anchor for 3/4" Standoff Base
CA51618	5/16" – 18	Anchor for 1-1/4" Standoff Base
CA3816	3/8" – 16	Anchor for 1-1/2" and 2" Standoff Bases
Y12CA	M6	Anchor for 1/2" Cable System
Y38CA	M8	Anchor for 3/8" Cable System

Minimum order: 1 each. Can be combined for quantity pricing.

Hilti® HSL-3 Expansion Anchors

- Approved for Use With CRL's Aluminum Railing Systems
- Optimized Design Provides Reliable Performance in a Wide Range of Applications
- Delivers Optimum Performance in Cracked Concrete in the Tension Zone, Resulting in Excellent Load Values



These Hilti® HSL-3 Anchors are 2003 and 2006 IBC Compliant, torque controlled, heavy-duty expansion bolts designed for high performance in static and dynamic load applications. Hilti® TE-C3X Masonry Drills designed to drill holes for the HSL-3 Expansion Anchors are available. Visit crlaurence.com for details.

CAT. NO.	BOLT DIAMETER	OVERALL LENGTH
EBA334	5/16" (8 mm)	3-3/4" (95 mm)
EBA335	1/2" (12 mm)	6-9/64" (156 mm)

Minimum order: 10 each. Must be ordered in increments of 10. Sizes can be combined for quantity pricing.

CRL Carbon Steel Wedge Anchors

- Provide 360 Degree Contact With Substrate
- Anchor Size Equals Hole Size



These CRL Carbon Steel Wedge Anchors are easy to use. Heavy-duty and versatile, the Wedge Anchor is non-bottom bearing, so precise hole depth or clean-out is not always required. A one-piece carbon steel expanding clip assures full expansion for rugged, dependable holding strength. It is ideal for fastening electrical, heating, ventilating, air conditioning, and plumbing equipment to concrete. Comes complete with washers and nuts. The drill bit diameter needed for proper installation is the same as the anchor diameter.

CAT. NO.	SIZE	QTY/BOX
RHWS1416	1/4"-20 x 1-3/4" (44.5 mm)	100
RHWS3822	3/8"-16 x 2-1/4" (57 mm)	50
RHWS3830	3/8"-16 x 3" (76 mm)	50
RHWS3836	3/8"-16 x 3-3/4" (95 mm)	50

Minimum order: 1 box. Sizes can be combined for quantity pricing.

CRL Sunshade Bolt Assembly

- Bolt Assembly for Aluminum Sunshades
- Stainless Steel



This CRL Bolt Assembly for Aluminum Sunshades come complete with: (1) 3/8"-16 x 2" (51 mm) Stainless Steel Hex Bolt, (2) 3/8" Stainless Steel Flat Washers, (1) 3/8" Stainless Steel Lock Washer, (1) 3/8"-16 Hex Lock Nut.

Minimum order is one package.

CAT. NO. AWS38BA

CRL Socket Head Cap Screws

- For Use With CRL Aluminum Base Shoes
- Stainless Steel



CRL Socket Head Cap Screws are used to secure Aluminum Base Shoes to approved 1/2" (12.7mm) steel embedment plates with a minimum 1/2" (12.7mm) of thread engagement. Also works with CRL Weld Blocks. Visit crlaurence.com for more details.

CAT. NO.	SIZE
SHCS14X1	1/4"-20 x 1" (25 mm)
SHCS38X34	3/8"-16 x 3/4" (19 mm)
SHCS12X34	1/2"-13 x 3/4" (19 mm)
SHCS12X1	1/2"-13 x 1" (25 mm)
SHCS12X112	1/2"-13 x 1-1/2" (38 mm)

Minimum order: 10 each. Must be ordered in increments of 10. Sizes can be combined for quantity pricing.

CRL Red Head Sleeve Anchors

- Holds in Cement Block, Brick, Stone, Thin Wall or Solid Concrete

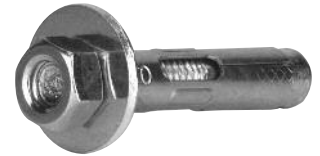

The CRL Red Head Sleeve Anchor is a heavy-duty expansion Sleeve Anchor whose six-rib design assures holding power in cement block, thin wall or solid concrete, brick or stone. Hex nut head allows fastening of numerous fixtures for industrial and commercial applications. Anchor can be installed through objects to be fastened. Maximum work thickness is 1/4" (6 mm).

CAT. NO.	THREAD SIZE	SLEEVE SIZE	QTY/BOX
RHHN1614	1/4"-20	5/16" x 1-1/2" (38 mm)	100
RHHN3817	5/16"-18	3/8" x 1-7/8" (48 mm)	50
RHHN1240	3/8"-16	1/2" x 4" (102 mm)	25

Minimum order: 1 box. Sizes can be combined for quantity pricing.

CRL Hex Head Cap Screws and Washers

- For Use With CRL Laminated Base Shoe



CRL M14-2.0 x 20mm Long Hex Head Cap Screws are Stainless Steel Din Rated and used for attaching Laminated Glass Base Shoe to steel. CRL Stainless Flat Washers are used with M14-2.0 Hex Head Screws when attaching to substrates. Minimum order is 10 each.

CAT. NO. HHCS14X34
Hex Head Screw With Washer

CAT. NO. SHCSM14X34
Hex Head Screw Only



CAT. NO. SHCSW14X34
Washers Only

Hilti® Self-Drilling Hex Washer Head #3 Screws

- For Aluminum and Steel
- Self-Drilling for Labor Savings
- Immune to Embrittlement Failure

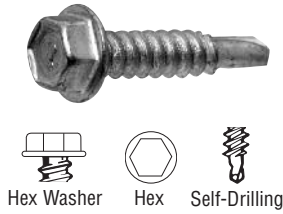

CAT. NO.	SIZE
12X1HWSD	12-14 x 1" (25.4 mm)
12X2HWSD	12-14 x 2" (50.8 mm)
14X1HWSD	1/4-14 x 1" (25.4 mm)
14X2HWSD	1/4-14 x 2" (50.8 mm)

Minimum order: 50 each. Must order in increments of 50. All bulk screws can be combined for quantity pricing.

Hilti® 1/4-14 x 7/8" Self-Drilling Hex Washer Head Screw

- For Exterior Overlapping Sheets and Corner Sheets
- Side Lap: Steel to Steel
- Self-Drilling for Labor Savings
- Rubber Washer



CAT. NO.	SIZE
14X78HWSD	1/4-14 x 7/8" (22.2 mm)

Minimum order: 50 each. Must order in increments of 50. All bulk screws can be combined for quantity pricing.

CRL 8-18 x 3/4" Self-Drilling Pan Head Phillips Screw

- Five Architectural Finishes

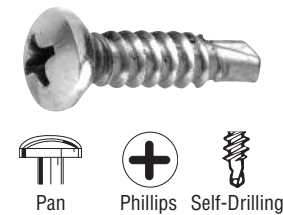

CAT. NO.	FINISH
8X34PHPSDBS	Brushed Stainless
8X34PHPSDPS	Polished Stainless
8X34PHSPDPB	Brass Plated
8X34PHPSDSA	Satin Anodized
8X34PHPSDDU	Dark Bronze

Minimum order: 100 each. Must order in increments of 100. All bulk screws can be combined for quantity pricing.

CRL 8-18 x 3/4" Self-Drilling Flat Head Phillips Screw

- Cut Their Own Holes in a Variety of Metals
- Stainless Steel

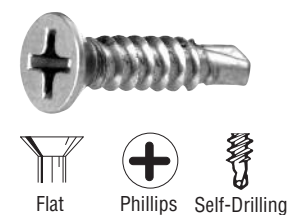

CAT. NO.	FINISH
8X34SFPTS	Stainless Steel

Minimum order: 100 each. Must order in increments of 100. All bulk screws can be combined for quantity pricing.

CRL 10 x 5/8" Stainless Steel Pan Head Phillips Screw

- For CRL Round or Square Aluminum Pickets

Stainless Steel Pan Head Phillips Screw fits in the screw race of both our Round and Square Aluminum Pickets used in our aluminum railings.

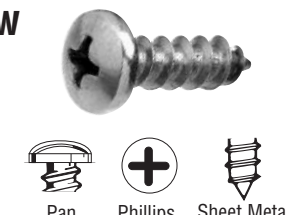

CAT. NO.	SIZE
PKTS2	#10 x 5/8" (15.9 mm)

Minimum order: 50 each. Must order in increments of 50.

CRL Self-Tapping Flat Head Phillips Screws

- Stainless Steel

This Flat Head Phillips Self-Tapping Screw taps its own thread to fasten materials together all in one single operation.



CAT. NO.	SIZE
8X34FHSTMSS	8-18 x 3/4" (19 mm)**
1032X34FHPSS	10-32 x 3/4" (19 mm)*

* Minimum order: 50 each. Must order in increments of 50.
** Minimum order: 100 each. Must order in increments of 100.
All bulk screws can be combined for quantity pricing.

CRL Stainless Steel Sheet Metal Screws

- Perfect for Shower Door Hardware and Railing Applications
- Flat Head Phillips

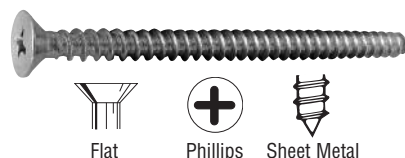

CAT. NO.	SIZE	QTY/PK
P815SS	#8 x 1-1/2" (38 mm)	10
S8X15MF	#8 x 1-1/2" (38 mm)	500/Bulk
BPS112	#14 x 1-1/2" (38 mm)	50

Minimum order: P815SS 1 package; S8X15MF 1 bag; BPS112 50 each.

CRL Allen Screws and Hanger Bolts

• Used With CRL Standoff Systems

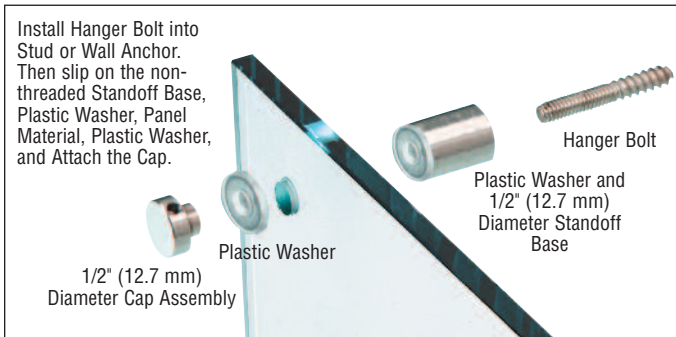

CRL Stainless Steel Allen Screws

- Stainless Steel
- Four Available Thread Sizes

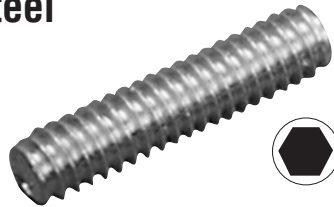

The top of the screw has an Allen hex for tightening into substrate or loosening

CAT. NO.	FINISH	THREAD SIZE	LENGTH
AS102434	Stainless	10 – 24	3/4" (19 mm)
AS10241	Stainless	10 – 24	1" (25.4 mm)
AS1032316	Stainless	10 – 32	3/16" (4.8 mm)
AS142014	Stainless	1/4" – 20	1/4" (6.3 mm)
AS1434	Stainless	1/4" – 20	3/4" (19 mm)
AS141	Stainless	1/4" – 20	1" (25.4 mm)
AS14114	Stainless	1/4" – 20	1-1/4" (31.7 mm)
AS14112	Stainless	1/4" – 20	1-1/2" (38.1 mm)
AS14134	Stainless	1/4" – 20	1-3/4" (44.4 mm)
AS142	Stainless	1/4" – 20	2" (50.8 mm)
AS51634	Stainless	5/16" – 18	3/4" (19 mm)
AS5161	Stainless	5/16" – 18	1" (25.4 mm)
AS516114	Stainless	5/16" – 18	1-1/4" (31.7 mm)
AS516112	Stainless	5/16" – 18	1-1/2" (38.1 mm)
AS516134	Stainless	5/16" – 18	1-3/4" (44.4 mm)
AS5162	Stainless	5/16" – 18	2" (50.8 mm)
AS5163	Stainless	5/16" – 18	3" (76.2 mm)
AS381	Stainless	3/8" – 16	1" (25.4 mm)
AS38114	Stainless	3/8" – 16	1-1/4" (31.7 mm)
AS38112	Stainless	3/8" – 16	1-1/2" (38.1 mm)
AS38134	Stainless	3/8" – 16	1-3/4" (44.4 mm)
AS382	Stainless	3/8" – 16	2" (50.8 mm)

Minimum order: 10 each. Sizes can be combined for quantity pricing.

• Used With CRL Hand Rail and Foot Rail Brackets

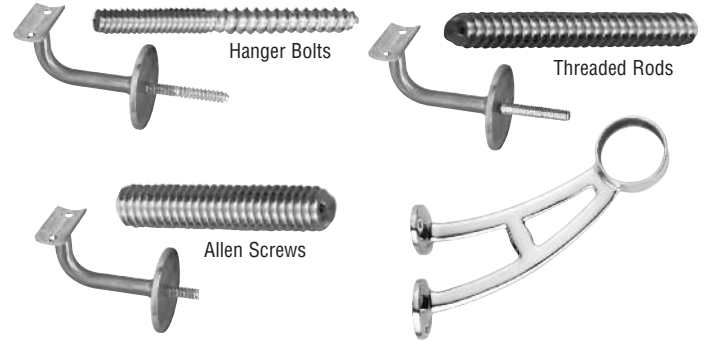

CRL Threaded Rods

- Stainless Steel or Zinc
- Cut to Desired Length

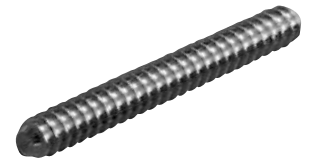

Full 36" (914 mm) lengths of Threaded Rod permits you to cut rod down to desired length.

CAT. NO.	FINISH	THREAD SIZE	LENGTH
TR1024X36S	Stainless	10 – 24	36" (914 mm)
TR1420X36S	Stainless	1/4" – 20	36" (914 mm)
TR1420X36Z	Zinc	1/4" – 20	36" (914 mm)
TR51618X36S	Stainless	5/16" – 18	36" (914 mm)
TR51618X36Z	Zinc	5/16" – 18	36" (914 mm)
TR3816X36S	Stainless	3/8" – 16	36" (914 mm)
TR3816X36Z	Zinc	3/8" – 16	36" (914 mm)

Minimum order: 1 each. Sizes can be combined for quantity pricing.

CRL Hanger Bolts

- Stainless Steel or Zinc
- Four Available Thread Sizes

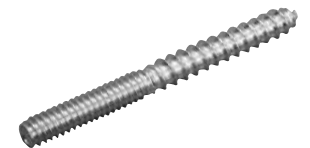

Hanger Bolts can be used in wood or with plastic anchors.

CAT. NO.	FINISH	THREAD SIZE	LENGTH
HB10241Z	Zinc	10 – 24	1" (25.4 mm)
HB1024112Z	Zinc	10 – 24	1-1/2" (38.1 mm)
HB10242Z	Zinc	10 – 24	2" (50.8 mm)
HB1024212Z	Zinc	10 – 24	2-1/2" (63.5 mm)
HB14112S	Stainless	1/4" – 20	1-1/2" (38.1 mm)
HB14112Z	Zinc	1/4" – 20	1-1/2" (38.1 mm)
HB14212S	Stainless	1/4" – 20	2-1/2" (63.5 mm)
HB14212Z	Zinc	1/4" – 20	2-1/2" (63.5 mm)
HB516112S	Stainless	5/16" – 18	1-1/2" (38.1 mm)
HB516112Z	Zinc	5/16" – 18	1-1/2" (38.1 mm)
HB516212S	Stainless	5/16" – 18	2-1/2" (63.5 mm)
HB516212Z	Zinc	5/16" – 18	2-1/2" (63.5 mm)
HB38112S	Stainless	3/8" – 16	1-1/2" (38.1 mm)
HB38112Z	Zinc	3/8" – 16	1-1/2" (38.1 mm)
HB38212S	Stainless	3/8" – 16	2-1/2" (63.5 mm)
HB38212Z	Zinc	3/8" – 16	2-1/2" (63.5 mm)
HB383S	Stainless	3/8" – 16	3" (76.2 mm)

Minimum order: 1 each for Stainless; 10 each for Zinc. Sizes can be combined for quantity pricing.

CRL Nuts

- Used for Various Fastener Installations
- Stainless, Zinc, and Nickel Finishes

HEX NUTS

CAT. NO.	FINISH	SIZE
N632*	Zinc	6 – 32
N832*	Zinc	8 – 32
N1024*	Zinc	10 – 24
HN1024S	Stainless	10 – 24
N1420*	Zinc	1/4" – 20
HN1420S	Stainless	1/4" – 20
HN1420Z	Zinc	1/4" – 20
HN51618S	Stainless	5/16" – 18
HN51618Z	Zinc	5/16" – 18
HN3816S	Stainless	3/8" – 16
HN3816Z	Zinc	3/8" – 16

Minimum order: 10 each. *Minimum order: 100 each.

TEE NUTS

CAT. NO.	FINISH	SIZE
TN1024Z	Zinc	10 – 24
TN1420Z	Zinc	1/4" – 20
TN51618Z	Zinc	5/16" – 18
TN3816Z	Zinc	3/8" – 16

Minimum order: 10 each.

ACORN NUTS

CAT. NO.	FINISH	SIZE
ACN1420	Nickel	1/4" – 20
ACN51618	Nickel	5/16" – 18
ACN3816S	Stainless	3/8" – 16
ACN3816Z	Zinc	3/8" – 16

Minimum order: 10 each.



Hex Nut



Tee Nut

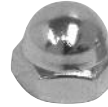

Acorn Nut



Nylock Hex Nut

NYLOCK HEX NUTS

CAT. NO.	FINISH	SIZE
NLN1024S	Stainless	10 – 24
NLN1420S	Stainless	1/4" – 20
NLN1420Z	Zinc	1/4" – 20
NLN51618S	Stainless	5/16" – 18
NLN51618Z	Zinc	5/16" – 18
NLN3816S	Stainless	3/8" – 16
NLN3816Z	Zinc	3/8" – 16

Minimum order: 10 each.

CRL Snap Cap Screw Covers

- Hide Screw Heads, Rivets, and Nails
- Choose From Three Colors and Two Styles

CRL Snap Caps are designed for protecting, decorating, and concealing screws and other fasteners. There are two types available: Countersunk for countersunk screws, and Flat for pan head screws, rivets, and nails. Snap Caps are used in the RV, boat, appliance, furniture, and construction industries. They can also be used to finish off just about any fastening job. Packed 100 Washers and Caps per box.

Other colors are available on special order by contacting CRL Technical Sales at (800) 421-6144 in the U.S., (877) 421-6144 from Canada, or (323) 588-1281 International, ask for Ext. 7720. You can e-mail us through our web site at crlaurence.com. From the home page click on Contact Us, and then click on Technical Sales for Glass and Glazing Products.



Countersunk Type for Countersunk Screws



Flat Type for Pan Head Screws, Rivets or Nails

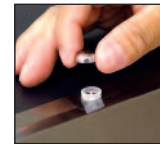

COUNTERSUNK TYPE COVERS

CHROME CAT. NO.	WHITE CAT. NO.	BLACK CAT. NO.	FASTENER SIZE/TYPE
SC80C50	SC81C50	SC82C50	6-8 Screws, 1/8"-5/32" Rivets
SC90C40	SC91C40	SC92C40	10-12-1/4" Screws, 3/16"-1/4" Rivets

Minimum order: 100 each. All Snap Caps can be combined for quantity pricing.

FLAT TYPE COVERS

CHROME CAT. NO.	WHITE CAT. NO.	BLACK CAT. NO.	FASTENER SIZE/TYPE
SC80F50	SC81F50	SC82F50	6-8 Screws, 1/8"-5/32" Rivets
SC90F40	SC91F40	SC92F40	10-12-1/4" Screws, 3/16"-1/4" Rivets

Minimum order: 100 each. All Snap Caps can be combined for quantity pricing.

CRL Color Match Bolt Cover Buttons

- Snap-On Fit
- Eight Standard Colors

CRL Color Match Bolt Cover Buttons are designed to cover up exposed Concrete Anchors and Lag Bolts on Vertical Post Base Plates. Plastic Buttons snap over Cat. No. WSHR1 Stainless Steel Washers to create a finished look (see right).



CAT. NO.	COLOR
BTN1W	Sky White
BTN10W	Oyster White
BTN1AGY	Agate Gray
BTN1BGY	Beige Gray
BTN1BL	Matte Black
BTN1BRZ	Matte Bronze
BTN1DS	Dark Silver
BTN1GRN	Forest Green

Minimum order: 50 each. Must be ordered in increments of 50.

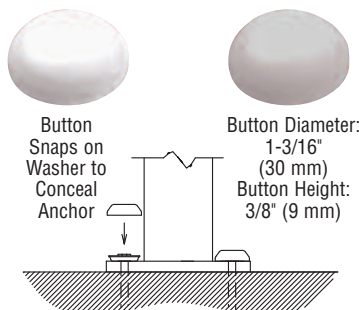

CRL Stainless Steel Button Washer

- Sleek Design Allows Bolt Cover Buttons to Snap Over the Stainless Steel Washer

1" (25 mm) diameter Stainless Steel Washer with a 7/16" (11 mm) hole. Designed to accept CRL Color Match Bolt Cover Buttons (see left).

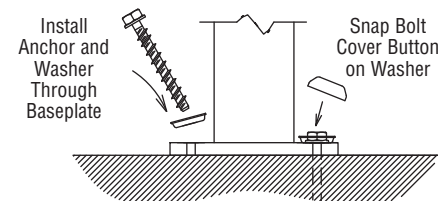

CAT. NO.	DIAMETER	HOLE	THICKNESS
WSHR1	1" (25 mm)	7/16" (11 mm)	1/8" (3 mm)

Minimum order: 50 each. Must be ordered in increments of 50.

CRL Mirror Grommets With Chrome Caps

- Chrome Cap Hides Screw Heads When Hanging Mirrors
- Sold in Packs of 100 Sets

CRL Mirror Grommets With Chrome Caps hold mirrors fastened to substrates in any position – even overhead. The grommet base fits into the drilled 5/16" (8 mm) hole in the mirror, the screw is inserted and tightened into the anchor, and the chrome colored cap is snapped on to finish the job. 100 sets (grommet and cap) per package. **NOTE:** Screws are sold separately (see page N296-N300).

CAT. NO.	CAP DIAMETER	CAP HEIGHT	QTY/PKG
MG40	5/8" (16 mm)	1/4" (6.3 mm)	100 Sets

Minimum order: 1 pack.

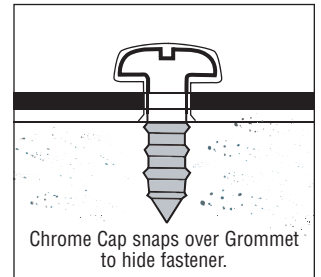

CRL QuickBit and QuickCaps

new

- Drills Two Holes at the Same Time
- Saves Time and Labor



The CRL QuickBit is a Countersink/Driver Bit that creates a 1/8" (3.2 mm) pilot hole for your screw and at the same time forms a 3/8" (9.5 mm) countersink for QuickCaps that are easily pressed into place. It works great with our TrimQuick Vinyl Trim. QuickCaps include 50 each 3" (76 mm) screws and 50 each white hole covers.

CAT. NO.	DESCRIPTION
QU1CKBIT	1 Each QuickBit Drill Kit
QC5050	50 Each QuickCaps Hole Covers and Screws

Minimum order QU1CKBIT: 1 each; QC5050: 1 pack.

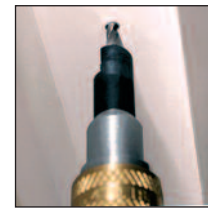

QuickBit starts the hole with an 1/8" Drill Bit...

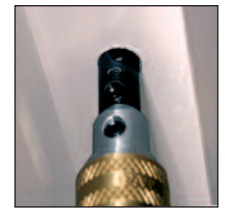

and finishes the hole with the 3/8" Countersink



Install the Screw



Snap on the QuickCap

CRL Caps for Hinge Cover Plate Screws

- Fits 5 mm and 6 mm Flat Head Phillips Screws (Eight per Pack)

Apply a small dab of silicone sealant into the Phillips recess in the screw, then press the metal Cap in place. A great finishing touch for frameless shower door hinges.

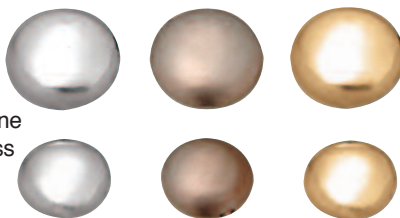

5 MM HEAD CAPS CAT. NO.	6 MM HEAD CAPS CAT. NO.	FINISH
CAP5CH	CAP6CH	Polished Chrome
CAP5BN	CAP6BN	Brushed Nickel
CAP5BR	CAP6BR	Polished Brass

Minimum order: 1 pack. Caps can be combined for quantity pricing. Other Finishes are available on special order.

CRL Screw and Wire Gauge

- Measures Screws in Either American Standard or Metric Sizes

The CRL Screw and Wire Gauge measures screws in either American standard or Metric sizes, also wire diameters from #0 to #30. It is made out of stainless steel, and has a 3" (76 mm) rule on one edge for screw lengths. Minimum order is one each.

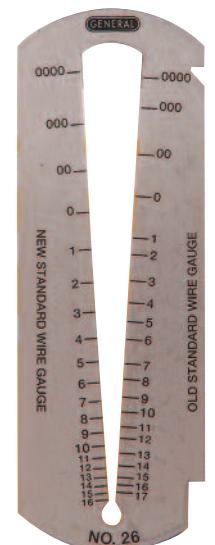

CAT. NO. SG26

CRL Shower Hinge Cover Plate Screws

- CRL Has a Full Range of Frameless Shower Door Hardware Replacement Screws
- Available in Up to 21 Finishes

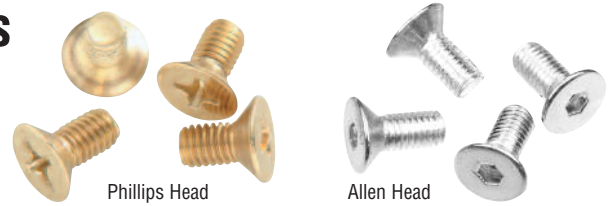

CRL carries an extensive inventory of Replacement Screws for all of our frameless shower door hinge cover plates. Three sizes are available; 5 mm x 12 mm, 6 mm x 12 mm, and 6 mm x 15 mm. Phillips or Allen heads are offered to meet your needs.



5 mm X 12 mm Flat Head Screws (8 per pack)

FOR: JUNIOR CATHEDRAL, JUNIOR GENEVA, JUNIOR PRIMA, MILANO, TRIANON, AND ZURICH HINGES

PHILLIPS HEAD CAT. NO.	ALLEN HEAD CAT. NO.	FINISH
P512CH	A512CH	Polished Chrome
P512SC	A512SC	Satin Chrome (Matte)
P512BN	A512BN	Brushed Nickel
P512PN	A512PN	Polished Nickel
P512SN	A512SN	Satin Nickel
P512BR	A512BR	Polished Brass
P512SB	A512SB	Satin Brass
P512ORB	A512ORB	Oil Rubbed Bronze
P512GM	A512GM	Gun Metal
P512GP	A512GP	Gold Plated
P512W	A512W	White
P512BL	A512BL	Black

Minimum order: 1 pack. Packs can be combined for quantity pricing. Other finishes are available on special order.

6 mm X 15 mm Flat Head Screws (8 per pack)

FOR: ELITE, SENIOR PRIMA, REGAL, COLOGNE, AND VIENNA HINGES

PHILLIPS HEAD CAT. NO.	ALLEN HEAD CAT. NO.	FINISH
P615CH	A615CH	Polished Chrome
P615SC	A615SC	Satin Chrome (Matte)
P615BN	A615BN	Brushed Nickel
P615PN	A615PN	Polished Nickel
P615BR	A615BR	Polished Brass
P615SB	A615SB	Satin Brass
P615ABR	A615ABR	Antique Brass
P615ORB	A615ORB	Oil Rubbed Bronze
P615BBRZ	A615BBRZ	Brushed Bronze
P615GP	A615GP	Gold Plated
P615W	A615W	White

Minimum order: 1 pack. Packs can be combined for quantity pricing. Other finishes are available on special order.

Shown Actual Size



6 mm X 12 mm Flat Head Screws (8 per pack)

FOR: BERLIN, CARDIFF, CATHEDRAL, CLASSIQUE, CONCORD, ESTATE, GENEVA, GRANDE, MONACO, PETITE, PINNACLE, PRIMA, ROMAN, RONDO, SHELL, AND ULTIMATE HINGES

PHILLIPS HEAD CAT. NO.	ALLEN HEAD CAT. NO.	FINISH
P612CH	A612CH	Polished Chrome
P612SC	A612SC	Satin Chrome (Matte)
P612BSC	A612BSC	Brushed Satin Chrome
P612BN	A612BN	Brushed Nickel
P612PN	A612PN	Polished Nickel
P612SN	A612SN	Satin Nickel
P612ABN	A612ABN	Antique Brushed Nickel
P612BR	A612BR	Polished Brass
P612SB	A612SB	Satin Brass
P612ABR	A612ABR	Antique Brass
P612UBR	A612UBR	Ultra Brass
P612ORB	A612ORB	Oil Rubbed Bronze
P612ABRZ	A612ABRZ	Antique Bronze
P612BBRZ	A612BBRZ	Brushed Bronze
P612ABCO	A612ABCO	Antique Brushed Copper
P612BCO	A612BCO	Brushed Copper
P612PCO	A612PCO	Polished Copper
P612GM	A612GM	Gun Metal
P612GP	A612GP	Gold Plated
P612W	A612W	White
P612BL	A612BL	Black

Minimum order: 1 pack. Packs can be combined for quantity pricing. Other finishes are available on special order.

CRL Shower Hinge Back Plate Mounting Screws

- CRL Has a Full Range of Shower Door Hinge Replacement Screws
- Available in Up to 21 Finishes

#10 X 2" (51 MM) Flat Head Phillips Sheet Metal Screws (10 Per Pack and 50 Per Pack)

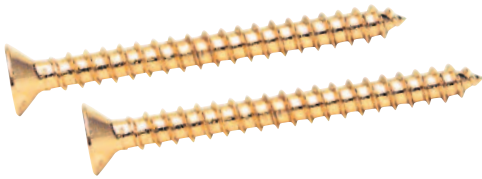

FITS: BERLIN, CARDIFF, CATHEDRAL, CLASSIQUE, COLOGNE, CONCORD, ESTATE, GENEVA, GRANDE, JUNIOR CATHEDRAL, JUNIOR GENEVA, JUNIOR PRIMA, MILANO, MONACO, PETITE, PINNACLE, PRIMA, ROMAN, RONDO, SHELL, ULTIMATE, VIENNA, AND ZURICH HINGES.

10 PACK CAT. NO.	50 PACK CAT. NO.	FINISH
P102CH	P102CH50	Polished Chrome
P102SC	---	Satin Chrome
P102BSC	---	Brushed Satin Chrome
P102BN	---	Brushed Nickel
P102PN	---	Polished Nickel
P102SN	---	Satin Nickel
P102ABN	---	Antique Brushed Nickel
P102BR	P102BR50	Polished Brass
P102SB	---	Satin Brass
P102ABR	---	Antique Brass
P102UBR	---	Ultra Brass
P102ORB	---	Oil Rubbed Bronze
P102ABRZ	---	Antique Bronze
P102BBRZ	---	Brushed Bronze
P102ABCO	---	Antique Brushed Copper
P102BCO	---	Brushed Copper
P102PCO	---	Polished Copper
P102GM	---	Gun Metal
P102GP	---	Gold Plated
P102W	---	White
P102BL	---	Black

Minimum order: 1 pack. Packs can be combined for quantity pricing. Other finishes are available on special order.



CRL carries a full range of Replacement Screws for frameless shower door hinge mounting plates. Two sizes of Screws are available, #10 x 2" (51 mm) and #10 x 3" (76 mm). Up to 21 stock finishes, with custom finishes available on special order.

#10 X 3" (76 MM) Flat Head Phillips Sheet Metal Screws (10 Per Pack)

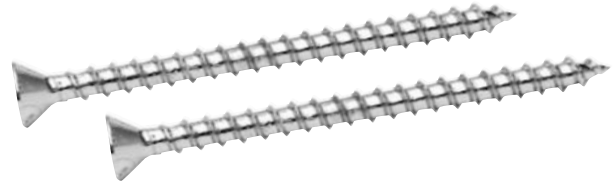

FITS: BERLIN, CARDIFF, CATHEDRAL, CLASSIQUE, COLOGNE, CONCORD, ESTATE, GENEVA, GRANDE, JUNIOR CATHEDRAL, JUNIOR GENEVA, JUNIOR PRIMA, MILANO, MONACO, PETITE, PINNACLE, PRIMA, ROMAN, RONDO, SHELL, ULTIMATE, VIENNA, AND ZURICH HINGES.

10 PACK CAT. NO.	FINISH
P103CH	Polished Chrome
P103SC	Satin Chrome
P103BSC	Brushed Satin Chrome
P103BN	Brushed Nickel
P103PN	Polished Nickel
P103BR	Polished Brass
P103ABR	Antique Brass
P103ORB	Oil Rubbed Bronze
P103ABRZ	Antique Bronze
P103BBRZ	Brushed Bronze
P103GP	Gold Plated
P103W	White

Minimum order: 1 pack. Packs can be combined for quantity pricing. Other finishes are available on special order.



CRL Sex Bolts

- Available in Four Finishes
- Four Sex Bolts Per Pack

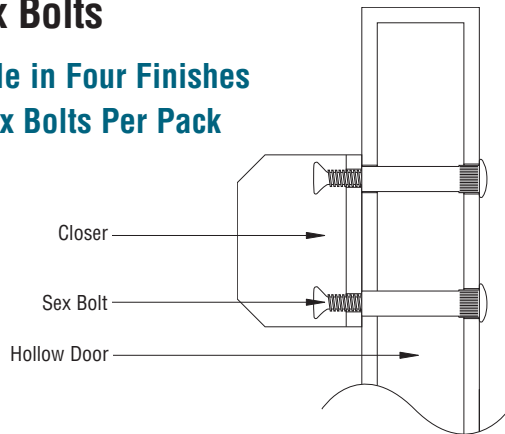
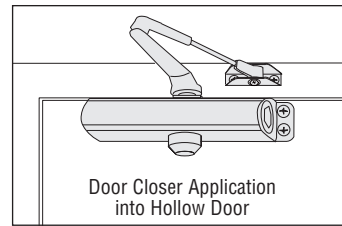
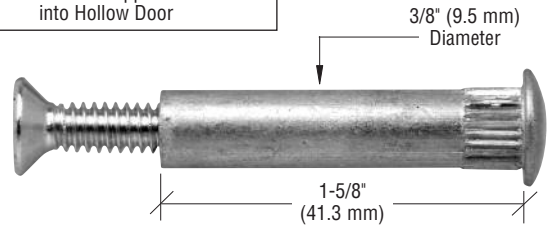

Illustration of Sex Bolt being used to mount door closer

Used for securing Push Bars, Surface Mounted Door Closers, and other fixtures to 1-3/4" (44.5 mm) doors. Knurled barrel fits a 3/8" (9.5 mm) diameter hole. Available in aluminum, bronze, bright gold, and bright chrome finishes. Four bolts per package.



Door Closer Application into Hollow Door



CAT. NO.	THREAD SIZE	FINISH
8025	1/4" – 20	Satin Aluminum
8025BRZ	1/4" – 20	Bronze Anodized
DCSBBG	1/4" – 20	Bright Gold
DCSBCH	1/4" – 20	Bright Chrome

Minimum order: 1 pack. All Sex Bolts can be combined for quantity pricing.

CRL Door Closer Replacement Screw Packages

- For Use With CRL Surface Mounted Door Closers

CRL Replacement Screw Packages are available for all CRL Surface Mounted Door Closers. Four different packs in both aluminum and dark bronze finishes. Each pack contains all the screws required to install the Door Closer Series shown in the chart below.

CAT. NO.	FINISH	DOOR CLOSER SERIES
DCSA	Aluminum	DC52-DC55, PR80, PR70
DCSBRZ	Dark Bronze	DC52-DC55, PR80, PR70
PR40SA	Aluminum	PR40
PR40SDU	Dark Bronze	PR40
PR50SA	Aluminum	PR50
PR50SDU	Dark Bronze	PR50
PR90SA	Aluminum	PR90
PR90SDU	Dark Bronze	PR90

Minimum order: 1 pack.



CAT. NO. DCSA



CAT. NO. PR40SDU



CAT. NO. PR50SDU



CAT. NO. PR90SA

CRL Through-Bolts for Door Pulls

- For 3/8" and 1/2" (10 and 12 mm) Glass or 1-3/4" (45 mm) Wood or Metal Doors

CRL Cat. No. TB2CH Through-Bolts will allow mounting of standard door pulls on 3/8" and 1/2" (10 and 12 mm) thick glass doors. Cat. No. TB4CH allows for mounting of standard door pulls on 1-3/4" (45 mm) thick wood or metal-framed doors. Minimum order is one pair (two screws).



Replacement Through-Bolts work with Cat. No. CD10X10PS and other CRL Commercial Door Pulls



CAT. NO. TB2CH



CAT. NO. TB4CH

CRL Premium Industrial Blind Rivets

- CRL Has One of the Largest Selections of Blind Rivets in the Industry at Competitive Prices
- Convenient Packs of 1000 or Money-Saving Factory Cases



Ordering Information

All Blind Rivets are shipped in standard cases. Quantities per standard cases vary depending on the size of the Rivet. The Catalog Number is used to specify the type and size of Rivet. This simple key assures you that the Rivets you order will meet your specifications for material type, head type, rivet diameter, and grip range.

Example: Cat. No. ABA44L

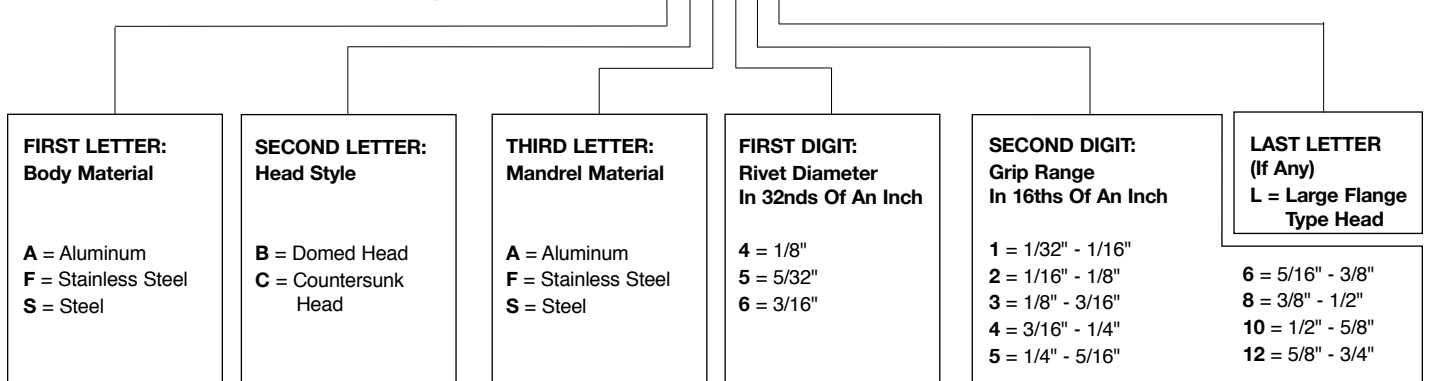

Rivet Sleeve

Begin with the one piece, all metal tubular sleeve with flared end.



Rivet Mandrel

Add the solid, all metal mandrel, crimped near the head.



Complete Rivet

The assembly of the sleeve and mandrel result in the finished Blind Rivet.

Domed Head Rivets

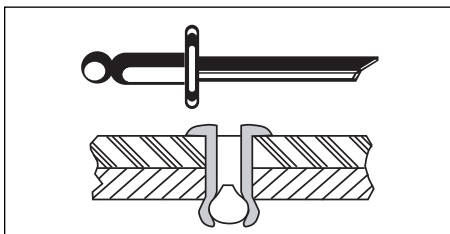

The Domed Head Rivet is the most commonly used style. With twice the diameter of the rivet body, the dome head has enough bearing surface to retain all but extremely soft or brittle materials.

Large Flange Rivets

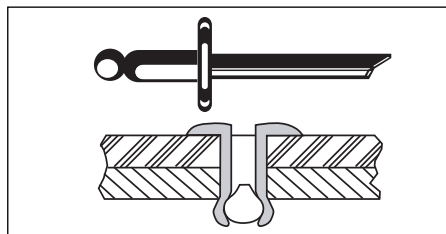

Large Flange Rivets have twice the underhead bearing surface of comparable Dome Head Rivets. This makes them ideal for applications where soft or brittle materials are joined to a rigid backing.

Countersunk Head Rivets

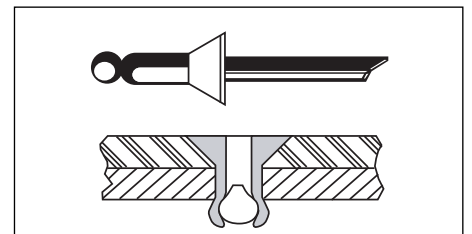

Countersunk Rivets are used where a flush surface is desired. To drill a proper hole for Countersunk Rivets, use our Cat. No. D120 Rivet Drill.

Grip Range



The grip range is the effective capacity of the Rivet to fasten materials together. All Rivet bodies are longer than their grip range to allow for tip expansion.

Rivet Diameter

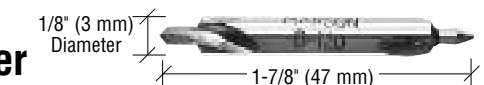

Relative strength capacity of the Rivet against shear or tensile strength forces is dictated by the diameter (size) of the Rivet.

CRL Actual Size Rivet Chart Use to Determine the Required Size

Place your rivets up against this drawing to match the sizes you're using to our Catalog Numbers. The first digit indicates the rivet diameter in 32nds of an inch; the second digit indicates the grip range in 16ths of an inch.

Actual Size Rivet Identification Chart

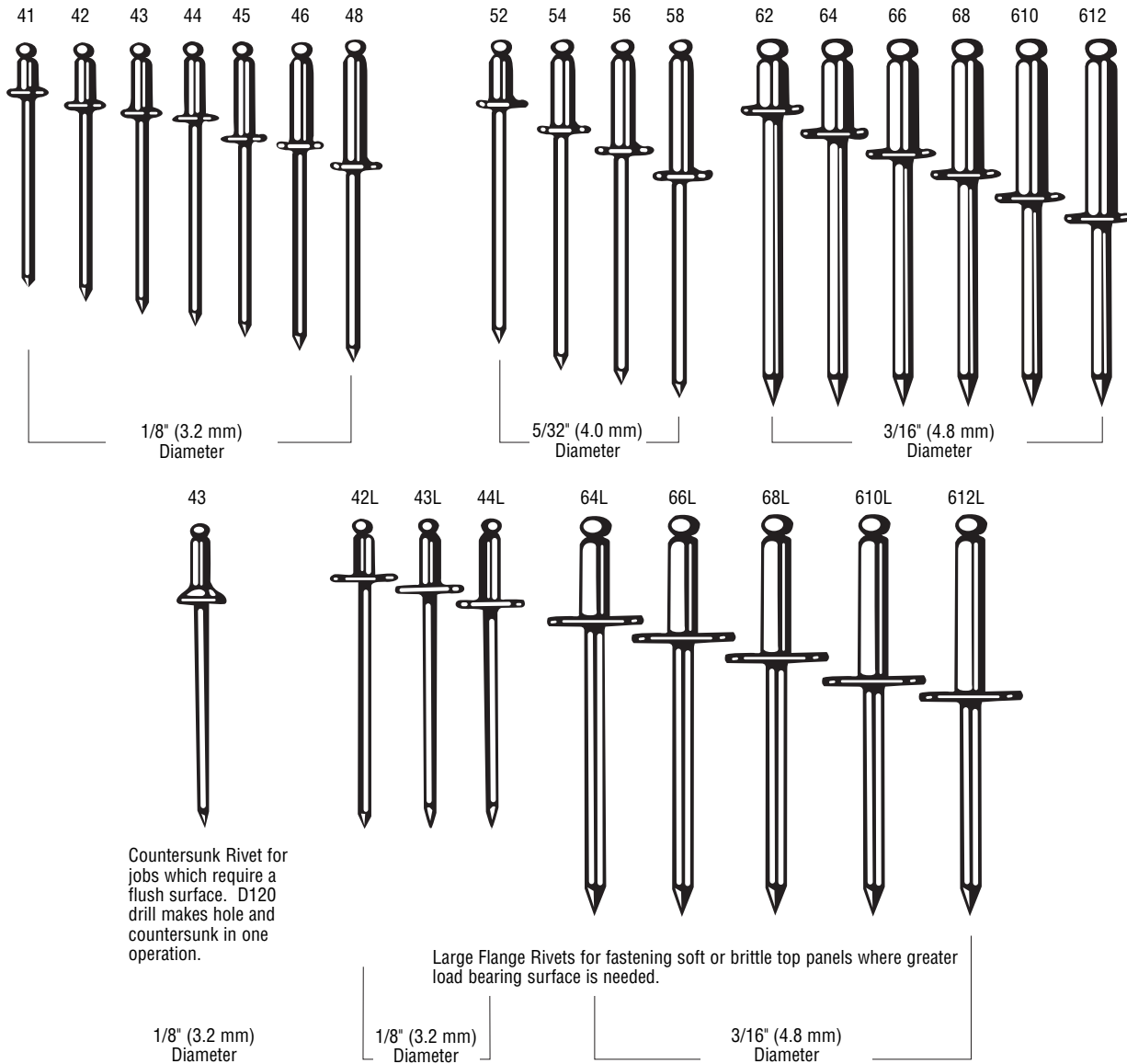

CRL Rivet Ordering Tips

• Joint Strength • Joint Thickness • Materials to Be Joined

When searching for the proper Blind Rivet to meet your requirements, take into account the joint strength, joint thickness, and nature of materials to be joined. Also consider the type of head that best suits the intended rivet application. The diameter of Rivet you select will depend on the desired joint strength. Blind Rivets develop joint strength in two ways: by clinch of the counterhead and by compression of the rivet body against the walls of the hole. Rivet grip is the combined thickness of the materials being fastened. Select the rivet length by choosing a grip range that includes the thickness of the materials to be joined. One rivet length can be used for a range of material thicknesses. It is better to choose a rivet that is too long than one that is too short. You should consider also the materials to be joined. If using a soft material, you may need to use a Rivet Spacer, thereby increasing the requirement for the grip range slightly.

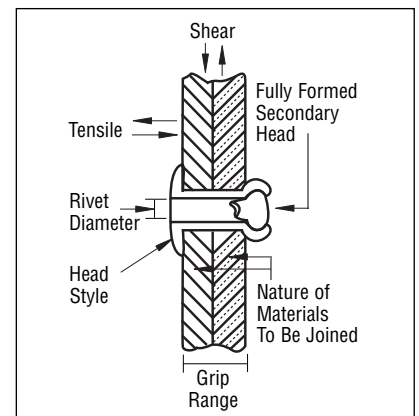

CRL Premium Industrial Blind Rivets in Cases

- Full Factory Cases Cut Your Costs
- Available in All Aluminum, Aluminum/Steel, All Steel, and All Stainless
- Standard and Large Flange Head Styles



Easy Installation Steps



1. Insert rivet mandrel in rivet setting tool.



2. Using tool as a guide, insert rivet into prepared hole.



3. The tool grips the mandrel and exerts a strong pull, forcing the head of the mandrel into the rivet's hollow core. The protruding tail portion of the rivet expands, forming the counterhead.



4. At maximum pull, the mandrel breaks (at the pre-cripped section) and is withdrawn. The mandrel head remains locked in the rivet, closing the rivet bore.

CRL Premium Industrial Blind Rivets feature a low profile head with minimum back-up space; join thin gauge or dissimilar materials; are vibration-proof - won't back out or shake loose; provide positive fastening of painted or finished components without possibility of surface marring; conform to Industrial Fasteners Institute and appropriate Government Standards and Specifications. Add to these advantages their ease of use, and you may begin to realize how using CRL Blind Rivets could benefit your profit picture.

CRL Blind Rivets in Cases are standard pack quantities as supplied from the factory. To find the proper catalog number, check the diameter and grip range columns in the chart below. Once you have found the required range and diameter for the Rivet you need, then select the Catalog Number under the column heading showing the Rivet and mandrel type specified for your application or use. You can also refer to the Actual Size Rivet Chart to determine the size you need, and ordering information on pages N317-N318.

For our complete line of CRL Premium Industrial Blind Rivets, go to crlaurence.com.

CAT. NO.	CAT. NO.	CAT. NO.	CAT. NO.	DIAMETER	RIVET GRIP RANGE		HOLE SIZE AND DRILL NO.	QTY/CASE
					FRACTIONAL	METRIC		
ABA41	-	-	-	1/8" (3.2 mm)	1/32"-1/16"	(.8-1.6 mm)	.129 - .133, #30	10000
ABA42	ABS42	SBS42	FBF42	1/8" (3.2 mm)	1/16"-1/8"	(1.6-3.2 mm)	.129 - .133, #30	10000
ABA43	ABS43	SBS43	FBF43	1/8" (3.2 mm)	1/8"-3/16"	(3.2-4.8 mm)	.129 - .133, #30	10000
ABA44	ABS44	SBS44	FBF44	1/8" (3.2 mm)	3/16"-1/4"	(4.8-6.3 mm)	.129 - .133, #30	10000
ABA45	ABS45	SBS45	-	1/8" (3.2 mm)	1/4"-5/16"	(6.3-7.9 mm)	.129 - .133, #30	10000
ABA46	ABS46	SBS46	FBF46	1/8" (3.2 mm)	5/16"-3/8"	(7.9-9.5 mm)	.129 - .133, #30	10000
ABA48	ABS48	-	-	1/8" (3.2 mm)	3/8"-1/2"	(9.5-12.7 mm)	.129 - .133, #30	10000
-	ABS42L Δ	SBS42L Δ	FBF42L Δ	1/8" (3.2 mm)	1/32"-1/8"	(.8-3.2 mm)	.129 - .133, #30	10000
ABA43L Δ	-	-	-	1/8" (3.2 mm)	1/8"-3/16"	(3.2-4.8 mm)	.129 - .133, #30	10000
ABA44L Δ	ABS44L Δ	-	-	1/8" (3.2 mm)	3/16"-1/4"	(4.8-6.3 mm)	.129 - .133, #30	10000
ACA43	-	-	-	1/8" (3.2 mm)	1/8"-3/16"	(3.2-4.8 mm)	.129 - .133, #30	10000
ABA52	-	-	-	5/32" (4 mm)	1/16"-1/8"	(1.6-3.2 mm)	.160 - .164, #20	8000
ABA54	-	-	-	5/32" (4 mm)	3/16"-1/4"	(4.8-6.3 mm)	.160 - .164, #20	8000
ABA56	-	-	FBF56	5/32" (4 mm)	1/4"-3/8"	(6.3-9.5 mm)	.160 - .164, #20	6000
ABA58	-	-	-	5/32" (4 mm)	3/8"-1/2"	(9.5-12.7 mm)	.129 - .133, #30	6000
ABA62	ABS62	-	-	3/16" (4.8 mm)	1/32"-1/8"	(.8-3.2 mm)	.192 - .196, #11	5000
ABA64	ABS64	SBS64	FBF64	3/16" (4.8 mm)	1/8"-1/4"	(3.2-6.3 mm)	.192 - .196, #11	5000
ABA66	ABS66	SBS66	-	3/16" (4.8 mm)	1/4"-3/8"	(6.3-9.5 mm)	.192 - .196, #11	5000
ABA68	ABS68	SBS68	-	3/16" (4.8 mm)	3/8"-1/2"	(9.5-12.7 mm)	.192 - .196, #11	4000
ABA610	-	-	-	3/16" (4.8 mm)	1/2"-5/8"	(12.7-15.9 mm)	.192 - .196, #11	4000
ABA612	ABS612	-	-	3/16" (4.8 mm)	5/8"-3/4"	(15.9-19 mm)	.192 - .196, #11	4000
ABA64L Δ	-	-	FBF64L Δ	3/16" (4.8 mm)	1/16"-1/4"	(1.6-6.3 mm)	.192 - .196, #11	3000
ABA66L Δ	ABS66L Δ	-	-	3/16" (4.8 mm)	1/4"-3/8"	(6.3-9.5 mm)	.192 - .196, #11	3000
ABA68L Δ	-	-	-	3/16" (4.8 mm)	3/8"-1/2"	(9.5-12.7 mm)	.192 - .196, #11	3000
ABA610L Δ	ABS610L Δ	-	-	3/16" (4.8 mm)	1/2"-5/8"	(12.7-15.9 mm)	.192 - .196, #11	2000
ABA612L Δ	ABS612L Δ	-	-	3/16" (4.8 mm)	5/8"-3/4"	(15.9-19 mm)	.192 - .196, #11	2000

Δ = Large Flange Rivets. All others have conventional domed heads. See page N317.

Minimum order: 1 case. All cases of Rivets can be combined for quantity pricing.

CRL Blind Rivets in Packs of 1000

ALUMINUM RIVETS WITH ALUMINUM MANDRELS

CAT. NO.	DIAMETER	GRIP RANGE
ABA41PK	1/8" (3.2 mm)	1/32"-1/16" (.8-1.6 mm)
ABA42PK	1/8" (3.2 mm)	1/16"-1/8" (1.6-3.2 mm)
ABA43PK	1/8" (3.2 mm)	1/8"-3/16" (3.2-4.8 mm)
ABA44PK	1/8" (3.2 mm)	3/16"-1/4" (4.8-6.3 mm)
ABA45PK	1/8" (3.2 mm)	1/4"-5/16" (6.3-7.9 mm)
ABA46PK	1/8" (3.2 mm)	5/16"-3/8" (7.9-9.5 mm)
ABA48PK	1/8" (3.2 mm)	3/8"-1/2" (9.5-12.7 mm)
ABA52PK	5/32" (4 mm)	1/32"-1/8" (.8-3.2 mm)
ABA54PK	5/32" (4 mm)	3/16"-1/4" (4.8-6.3 mm)
ABA56PK	5/32" (4 mm)	1/4"-3/8" (6.3-9.5 mm)
ABA58PK	5/32" (4 mm)	3/8"-1/2" (9.5-12.7 mm)
ABA62PK	3/16" (4.8 mm)	1/32"-1/8" (.8-3.2 mm)
ABA64PK	3/16" (4.8 mm)	1/8"-1/4" (3.2-6.3 mm)
ABA66PK	3/16" (4.8 mm)	1/4"-3/8" (6.3-9.5 mm)
ABA68PK	3/16" (4.8 mm)	3/8"-1/2" (9.5-12.7 mm)
ABA610PK	3/16" (4.8 mm)	1/2"-5/8" (12.7-15.9 mm)

Minimum order: 1 pack.

STEEL RIVETS WITH STEEL MANDRELS

CAT. NO.	DIAMETER	GRIP RANGE
SBS42PK	1/8" (3.2 mm)	1/16"-1/8" (1.6-3.2 mm)
SBS44PK	1/8" (3.2 mm)	3/16"-1/4" (4.8-6.3 mm)
SBS48PK	1/8" (3.2 mm)	3/8"-1/2" (9.5-12.7 mm)

Minimum order: 1 pack.



Our more popular sizes of CRL Blind Rivets are available in packages of 1000 each. This is an economical alternative to ordering factory cases for sizes that you may use infrequently or in limited amounts.

- Our More Popular Sizes Conveniently Packed
- Economic Alternative to Ordering Factory Cases

ALUMINUM RIVETS WITH STEEL MANDRELS

CAT. NO.	DIAMETER	GRIP RANGE
ABS42PK	1/8" (3.2 mm)	1/16"-1/8" (1.6-3.2 mm)
ABS43PK	1/8" (3.2 mm)	1/8"-3/16" (3.2-4.8 mm)
ABS44PK	1/8" (3.2 mm)	3/16"-1/4" (4.8-6.3 mm)
ABS45PK	1/8" (3.2 mm)	1/4"-5/16" (6.3-7.9 mm)
ABS46PK	1/8" (3.2 mm)	5/16"-3/8" (7.9-9.5 mm)
ABS48PK	1/8" (3.2 mm)	3/8"-1/2" (9.5-12.7 mm)
ABS64PK	3/16" (4.8 mm)	1/8"-1/4" (3.2-6.3 mm)
ABS66PK	3/16" (4.8 mm)	1/4"-3/8" (6.3-9.5 mm)
ABS68PK	3/16" (4.8 mm)	3/8"-1/2" (9.5-12.7 mm)

Minimum order: 1 pack.

ALL STAINLESS STEEL RIVETS

CAT. NO.	DIAMETER	GRIP RANGE
FBF42PK	1/8" (3.2 mm)	1/16"-1/8" (1.6-3.2 mm)
FBF43PK	1/8" (3.2 mm)	1/8"-3/16" (3.2-4.8 mm)
FBF44PK	1/8" (3.2 mm)	3/16"-1/4" (4.8-6.3 mm)
FBF46PK	1/8" (3.2 mm)	5/16"-3/8" (7.9-9.5 mm)
FBF48PK	1/8" (3.2 mm)	3/8"-1/2" (9.5-12.7 mm)
FBF56PK	5/32" (4 mm)	1/4"-3/8" (6.3-9.5 mm)
FBF64PK	3/16" (4.8 mm)	1/8"-1/4" (3.2-6.3 mm)

Minimum order: 1 pack.

CRL Blind Rivets In Color

These Aluminum Rivets with aluminum mandrels are available in three different colors: black, brown, and white. They come in cases of 10,000 and packs of 1,000 each. You can also special order custom CRL Blind Rivets in any color necessary to meet the job requirements. The minimum order on special order color rivets is 100,000 each.

COLOR RIVETS IN PACKS OF 1,000

CAT. NO.	COLOR	DIAMETER	GRIP RANGE
ABA42BLPK	Black	1/8" (3.2 mm)	1/16"-1/8" (1.6-3.2 mm)
ABA42RBP	Brown	1/8" (3.2 mm)	1/16"-1/8" (1.6-3.2 mm)
ABA42WPK	White	1/8" (3.2 mm)	1/16"-1/8" (1.6-3.2 mm)
ABA44BLPK	Black	1/8" (3.2 mm)	3/16"-1/4" (4.8-6.3 mm)
ABA44RBP	Brown	1/8" (3.2 mm)	3/16"-1/4" (4.8-6.3 mm)
ABA44WPK	White	1/8" (3.2 mm)	3/16"-1/4" (4.8-6.3 mm)

Minimum order: 1 pack.

- Most Popular Sizes Available in Three Colors
- Custom Colors Available by Special Order



COLOR RIVETS IN BULK CASES OF 10,000

CAT. NO.	COLOR	DIAMETER	GRIP RANGE
ABA42BL	Black	1/8" (3.2 mm)	1/16"-1/8" (1.6-3.2 mm)
ABA42RB	Brown	1/8" (3.2 mm)	1/16"-1/8" (1.6-3.2 mm)
ABA42W	White	1/8" (3.2 mm)	1/16"-1/8" (1.6-3.2 mm)
ABA44BL	Black	1/8" (3.2 mm)	3/16"-1/4" (4.8-6.3 mm)
ABA44RB	Brown	1/8" (3.2 mm)	3/16"-1/4" (4.8-6.3 mm)
ABA44W	White	1/8" (3.2 mm)	3/16"-1/4" (4.8-6.3 mm)

Minimum order: 1 case. Can be combined with all other Blind Rivet cases for quantity pricing.

CRL Rivet Head Removal Tool

- 1/4" Shank Fits All Drills
- Hollow Center Catches Rivet Stem



CAT. NO. 72181

The CRL Rivet Head Removal Tool is perfect for the removal of blind rivets. The hardened steel tip cuts off the rivet head, and the hollow center catches the rivet stem. 3" (76 mm) overall length. 1/4" (6.3 mm) shank fits most electric drills. Minimum order is one each.

CRL Square Steel Spacers

- Gives Extra Support On Soft Surfaces

CRL Square Steel Spacers are for use as back-up washers when rivets are used to fasten soft materials. Access to both sides of material is necessary for proper performance. Spacers are 1/16" (1.6 mm) thick, and have an overall size of 1/2" x 1/2" (12.7 mm x 12.7 mm).



CAT. NO.	HOLE SIZE	QTY/BOX
SS4	1/8" (3.2 mm)	500
SS6	3/16" (4.8 mm)	500

Minimum order: 1 box.

CRL Marson Heavy-Duty Rivet Gun

- Heavy-Duty Construction
- Includes Four Nosepieces



The CRL Marson Heavy-Duty Rivet Gun features heavy-duty construction and includes four nosepieces that are housed in the tool body. Will set 3/32", 1/8", 5/32", and 3/16" (2.4, 3.2, 4, and 4.8 mm) rivet sizes.

CAT. NO.	DESCRIPTION	QTY/PKG
HP2	Heavy-Duty Rivet Gun	1 each
HP23A	Replacement Jaws	1 pair

Minimum order: 1 each for the Rivet Gun and 1 pair for the Replacement Jaws.

CRL Manual Rivet Gun

- Value Priced Manual Gun
- Includes Four Nosepieces



This CRL Manual Rivet Gun is smooth and fast. Interchangeable nosepieces attach to the base when not in use and will set 3/32", 1/8", 5/32" and 3/16" (2.4, 3.2, 4, and 4.8 mm) rivet sizes. Minimum order is one each.

CAT. NO. RG110

CRL Rotating Head Rivet Gun

- Head Rotates a Full 360 Degrees
- Includes Four Nosepieces



The CRL Rotating Head Rivet Gun allows you to rivet at any angle because the head rotates a full 360 degrees. All steel construction with vinyl grips, and supplied with four nosepieces for 3/32", 1/8", 5/32", and 3/16" (2.4, 3.2, 4, and 4.8 mm) rivet sizes. Minimum order is one each.

CAT. NO. RHT300

CRL Hydraulic Rivet Gun

- Develops Up to 3500 Pounds of Pulling Power
- One Hand Operation Gives Access to Tight Areas

The CRL Hydraulic Rivet Gun develops up to 3500 pounds (1587 kg) of rivet pulling power, capable of setting 1/4" (6.3 mm) diameter rivets. Its compact yet lightweight design easily fits in the palm of your hand for hard to reach areas. Ergonomic design eliminates overworking of arms and backs associated with other riveters. Includes four nosepieces for setting rivets of 1/8", 5/32", 3/16", and 1/4" (3.2, 4, 4.8, and 6.3 mm) diameter, plus a 1/4" (6.3 mm) split rivet nosepiece, all in a high impact plastic carrying case. Minimum order is one each.



CAT. NO. RG1105

CRL Rivet Gun Kit

- Includes the HP2 Heavy-Duty Rivet Gun
- High Impact Carrying Case



The CRL Rivet Gun Kit includes the heavy-duty HP2 Rivet Gun, complete with its four nosepieces for 3/32", 1/8", 5/32", and 3/16" (2.4, 3.2, 4, and 4.8 mm) rivets. Elongated, contour-grip handles for positive setting action. This kit includes an assortment of five common sized rivets to complete a diversity of job applications. All are housed in a high impact plastic carrying case with a positive snap lock closure. An excellent all-around Rivet Gun Kit for every tool chest. Minimum order is one each.

CAT. NO. 39001

CRL Air Hydraulic Standard Duty Riveter

- Excellent for Production Work
- Sets Rivet Diameters 1/8", 5/32", and 3/16"
- Lightweight and Easy to Handle

The CRL Air Hydraulic Standard Duty Riveter is designed for use in production applications requiring a pneumatically actuated Rivet Gun. The PHT3 is lightweight and easy to handle, and will set Blind Rivets from 1/8" to 3/16" (3.2 to 4.8 mm) diameter in all alloys. 1/8", 5/32", and 3/16" (3.2, 4, and 4.8 mm) nosepieces and servicing wrenches included. Requires 85 psi for optimum operation. Minimum order is one each.



CAT. NO. PHT3

CRL Auto Glass Rivets



Important Information About Automobile Rivets: Automotive Rivets used for regulator and door handle applications are the split rivet type. The stem is part of the structural strength of the rivet, and must remain in the rivet after application. Two important factors make this happen: Using the proper grip range rivet, and being sure to use the special automotive nosepiece in your rivet gun. The rivet stem has serrations on it that are crimped tightly at the rivet head by the special automotive nosepiece. If you use a rivet that does not fall in the proper grip range, the serrations will be below the crimping area, and when the rivet stem breaks, the stem will be propelled into the outer door panel, causing a "dimple" dent. Use caution when selecting the proper rivet for your application.

CRL Glass Stop Rivets

These rivets are used to secure the glass stop to the window glass.

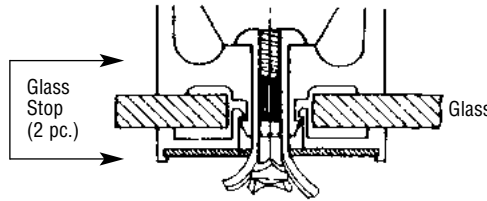

Glass Grip Range: .520" to .620"
 Pack of 50 **CAT. NO. 42376** Bulk Case of 2,000 **CAT. NO. 52376**

CRL Window Regulator Rivets

These rivets are used to connect the regulator to the door or body panel.

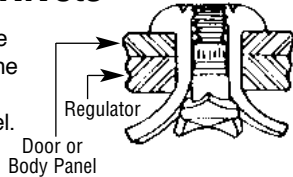

Grip Range: .032" to .140"

Pack of 50 **CAT. NO. 42371** Bulk Case of 3,000 **CAT. NO. 52371**



Grip Range: .140" to .187"

Pack of 50 **CAT. NO. 42374** Bulk Case of 2,000 **CAT. NO. 52374**

CRL Door Handle Rivets

These rivets are used to mount recessed door handles to the door panel.

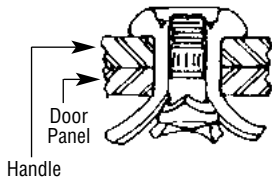

Grip Range: .090" to .115"

Pack of 50 **CAT. NO. 42372** Bulk Case of 3,000 **CAT. NO. 52372**



Grip Range: .110" to .177"

Pack of 50 **CAT. NO. 42373** Bulk Case of 2,000 **CAT. NO. 52373**

CRL Multi-Purpose Large Flange Rivet



Fits Various GM Car Trim, Accessories, etc.
 Matches: GM 9432552

Qty/Pkg 500
CAT. NO. 40324R

CRL Windshield Side Rail Rivet



Fits T-Bird and Cougar Windshield Side Rails
 Matches: Ford N805759-S100

Qty/Pkg 50
CAT. NO. CP896631



Rivet, Peel Type, Door Window Attachment
 Rivet: M6.3, Flange: 16 mm,
 Grip Range: 10-16.5 mm;
 Fits Lincoln Continental,
 Ford Taurus and Windstar '95+

Qty/Pkg 25
CAT. NO. CP997999

CRL Screw Fastener for Molding Clip



Replaces Rivet for Attaching Stud Style Molding Clips to Panels.

Qty/Pkg 100
CAT. NO. AV9877



Rivet, Peel Type, Front and Rear Door Glass
 Hole Dia.: 5 mm, Head Dia.: 9.8 mm,
 Grip Range: 11-13 mm
 Fits GM V, W, and Y Bodies '88+

Qty/Pkg 25
CAT. NO. CP967599



Rivet, Peel Type, Window Regulator
 Rivet: 1/4", Flange: 1/2",
 Grip Range: .100-.200 mm;
 Ford Mustang and Lincoln Continental '94+

Qty/Pkg 25
CAT. NO. CP987908

CRL Auto Glass Rivets



Blind Rivet, Super Tough Nylon, Window Regulator Attachments; M5 Hole, 3-4 mm Panel Range, 9 mm Head Dia.; GM and Cadillac

Qty/Pkg 25
CAT. NO. CP876311



Blind Rivet, Super Tough Nylon, General Purpose; 4.75 mm Hole, 1.5-3.5 mm Panel Range, 9.5 mm Head Dia.; GM 'A' and 'C' Bodies, Various Ford

Qty/Pkg 25
CAT. NO. CP998058



Blind Rivet, Aluminum with Steel Mandrel (Zinc); 1/8" Rivet w/ 5/16" Flange, .125-.187 Grip Range; GM Rear Window Gasket Various Models

Qty/Pkg 50
CAT. NO. CP947237



Aluminum Rivet w/ Aluminum Mandrel for Glass Stop/Roller; 3/16" Rivet w/ 5/8" Flange, .501-.625 Grip Range; Chrysler Products, Not Supplied by O.E.M.

Qty/Pkg 25
CAT. NO. CP906792



Blind Rivet, Peel Style, for Outside Door Handle; Black Aluminum Rivet w/ Steel Mandrel; 1/4" Dia., 1/2" Flange, Grip Range .520-.620; Ford Products '88+

Qty/Pkg 25
CAT. NO. CP906793



Steel Rivet w/ Steel Zinc Mandrel; 1/4" Rivet, 1/2" Flange, .062-.125 Grip Range; GM and Saturn '91+

Qty/Pkg 25
CAT. NO. CP947239



Steel Rivet w/ Steel Mandrel, Window Regulator; 1/4" Rivet, 1/2" Flange, .086-.129 Grip Range; GM 'N' Bodies '91+

Qty/Pkg 15
CAT. NO. CP947240



Steel Rivet w/ Steel Mandrel, Window Channel; 1/4" Rivet, 3/4" Flange, .060-.083 Grip Range; GM 'E' Bodies and Cadillac 'C' Body '93+

Qty/Pkg 15
CAT. NO. CP947241



Blind Rivet, Nylon, Door Weatherstrip Retainer; M4 Hole, Panel Range 2.5-5.5 mm, 15 mm x 8 mm Rectangle Head; Saturn '91+

Qty/Pkg 50
CAT. NO. CP927041



Upper Vent Pivot Shoulder Rivet; Chevrolet, Pontiac, Olds '61-'72

Qty/Pkg 50
CAT. NO. B7722

Rivet Tools



Having the right rivet is only half the solution. Install them properly with our selection of Automotive Rivet Tools (see page N325).

CRL Window Things

- Eliminates the Need for Door Regulator Rivets in Most Vehicles
- Installs With a Phillips Screwdriver



CAT. NO. WT50

Window Things come 50 to a package, along with 50 screws and 12 washers for installations where a spacer is required.

Install door glass the easy way with CRL Window Things. This handy item will virtually eliminate the need for most auto glass rivets now in use. Window Things fit Ford, GM, and Chrysler products, and replace traditional snap-through or screw type retainers. Simply snap the Window Thing through hole in glass, line up carrier and insert the screw. They install with just a Phillips screwdriver. Glass breakage is almost impossible because Window Things are made of Zytel ST801 by Dupont.

CRL Plastic Auto Glass Rivets

- Precision-Molded Nylon
- Dozens of Applications

CRL Plastic Rivets are made from precision-molded nylon, and designed as original equipment part numbers for Ford, Chrysler, and General Motors vehicles. Each year, car makers use millions of Plastic Rivets to attach bumper fascia strips, secure inner fenders, and mount dozens of subassemblies and parts. To assure appropriate appearance and structural balance, replace OEM parts with CRL Plastic Rivets. In addition to the automotive applications listed, many fastening situations call for Plastic Rivets.







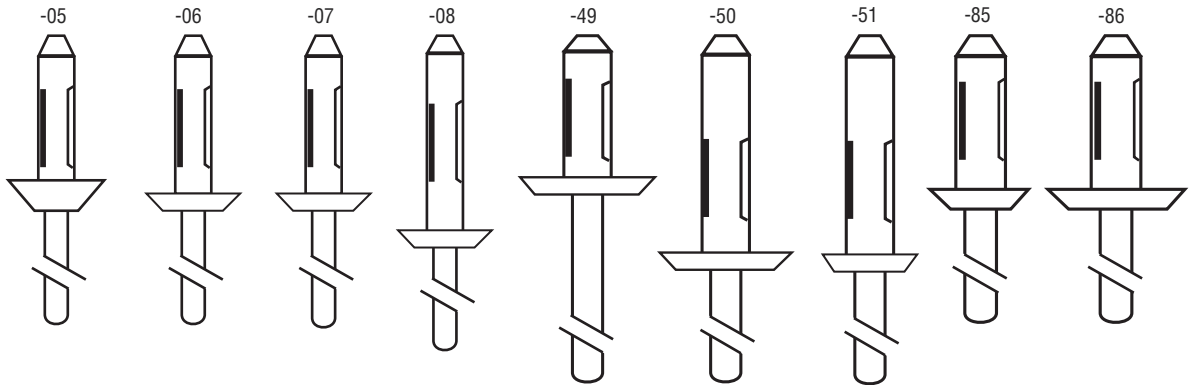

For instance, properly selected, the Plastic Rivets below are ideal for use in non-conductive and non-corrosive environments. When a Plastic Rivet is set, it forms three "legs" that compress against the blind side of the work, securely locking components in place. It is unlikely that you'd get a better grip from any other plastic rivet fastener. For trouble-free installation, use the CRL Cat. No. 48000 Plastic Rivet Setter (see page N325).



Actual Size Plastic Rivet Guide

Compare your Plastic Rivets up to this drawing to match the sizes you are using to our catalog numbers. All Plastic Rivets are available in packages of 100.



 <p>Grip Range .059-.177" (1.5-4.5 mm) Rivet Dia. .195" (5 mm) Flange Dia. .472" (12 mm) Drill Hole Dia. .197" (5 mm) OEM Ref: GM 20423647</p> <p>Qty/Pkg 100 CAT. NO. 48305</p>	 <p>Grip Range .118-.236" (3-6 mm) Rivet Dia. .195" (5 mm) Flange Dia. .472" (12 mm) Drill Hole Dia. .197" (5 mm) OEM Ref: GM 20432975, Chrysler 6500899, VW 175-853-577</p> <p>Qty/Pkg 100 CAT. NO. 48306</p>	 <p>Grip Range .118-.177" (3-4.5 mm) Rivet Dia. .195" (5 mm) Flange Dia. .472" (12 mm) Drill Hole Dia. .197" (5 mm) OEM Ref: Chrysler 6500859</p> <p>Qty/Pkg 100 CAT. NO. 48307</p>
 <p>Grip Range .236-.394" (6-10 mm) Rivet Dia. .195" (5 mm) Flange Dia. .472" (12 mm) Drill Hole Dia. .197" (5 mm) OEM Ref: Chrysler 6500898</p> <p>Qty/Pkg 100 CAT. NO. 48308</p>	 <p>Grip Range .157-.236" (4-6 mm) Rivet Dia. .246" (6.3 mm) Flange Dia. .669" (17 mm) Drill Hole Dia. .248" (6.3 mm) OEM Ref: GM 14070914</p> <p>Qty/Pkg 100 CAT. NO. 48349</p>	 <p>Grip Range .157-.394" (4-10 mm) Rivet Dia. .246" (6.3 mm) Flange Dia. .669" (17 mm) Drill Hole Dia. .248" (6.3 mm) OEM Ref: GM14063981, Chrysler 6500911, AMC 8934-201-631, Ford N803043S</p> <p>Qty/Pkg 100 CAT. NO. 48350</p>
 <p>Grip Range .098-.197" (2.5-5 mm) Rivet Dia. .258" (6.5 mm) Flange Dia. .512" (13 mm) Drill Hole Dia. .260" (6.6 mm) OEM Ref: GM 20421672</p> <p>Qty/Pkg 100 CAT. NO. 48385</p>	 <p>Grip Range .098-.197" (2.5-5 mm) Rivet Dia. .258" (6.5 mm) Flange Dia. .709" (18 mm) Drill Hole Dia. .260" (6.6 mm) OEM Ref: GM 20433026, VW 175-853-577A</p> <p>Qty/Pkg 100 CAT. NO. 48386</p>	

CRL Marson "Big Daddy" Riveter



- Excellent for Automotive Window Regulator and Glass Stop Rivets

The CRL Marson "Big Daddy" Riveter lets you work in hard-to-get-to areas. Use it to replace automotive window regulator and glass stop rivets, plus door handle rivets. The special nosepiece provided with the tool must be used for these applications. 3/16" and 1/4" (4.8 and 6.4 mm) nosepieces for other rivet applications are stored in the body of the tool.

CAT. NO.	DESCRIPTION
39010	"Big Daddy" Riveter
39010JAWS	Replacement Jaws
39009	Long Nose Adapter

Minimum order: 1 each.

CRL Heavy-Duty Automotive Riveter



- Tremendous Power for Large Rivets
- Extra Heavy-Duty Tool Used in Auto Glass Shops
- Equipped With Three Long Nosepieces

This CRL Heavy-Duty Automotive Riveter allows riveting in areas where other tools won't reach. Exerts tremendous pulling power for large rivets. Shock resistant handles. Equipped with three nosepieces conveniently stored on the handle. Nosepieces set 5/32", 1/8", and 3/32" (4, 3.2, and 2.4 mm) rivets, plus there's a special nosepiece for inserting door handle rivets for the automotive industry.

CAT. NO.	DESCRIPTION
79034	Heavy-Duty Riveter with Nosepieces
96013	Replacement Jaws

Minimum order: 1 each.

CRL Rivet Tool Nosepieces



CAT. NO. 96026



CAT. NO. 96027



CAT. NO. 96028

- Fit 39010 "Big Daddy" Riveter

These Rivet Tool Replacement Nosepieces are for use in the Cat. No. 39010 Marson "Big Daddy" Riveter (see above).

CAT. NO.	DESCRIPTION
96026	3/16" (4.8 mm) Nosepiece
96027	1/4" (6.4 mm) Nosepiece
96028	Klik-Split Rivet Nosepiece

Minimum order: 1 each.

CRL Plastic Rivet Setter



- Available as a Complete Kit, or Just the Tool Only

The CRL Plastic Rivet Setter Tool Kit includes 20 each of the four most popular plastic rivets, Cat. Nos. 48306, 48308, 48349, and 48350. This all steel tool has full size handles to provide the extra pulling stroke needed to set plastic rivets.

CAT. NO.	DESCRIPTION
48001	Complete Rivet Setter Kit
48000	Rivet Setter Tool Only

Minimum order: 1 each.

CRL Deluxe Clinch-Fast Kit

- Cost Effective Repair System Converts Vise Grip Pliers Into a Snap Fastener Installation Tool
- A Must for Every Upholstery Shop

The CRL Deluxe Clinch-Fast Kit provides an easy remedy to broken or missing snap fasteners by converting the included 10" Vise Grip Pliers into a snap fastener repair tool. The Clincher and Anvil slide over the jaws of the pliers and provide the base to hold and flare the eyelet stems.

This Kit includes a special 3-piece hole punch set, over 330 assorted fasteners, and 10" Vise Grip Pliers in a plastic carrying case. It has everything you need to clinch snaps, buttons, grommets, rivets, center punch, countersink and clamp soft, fragile plated or painted materials.



CAT. NO. T54HD

CRL Button and Socket Fastening Kit



CAT. NO. TS11K

This CRL Button and Socket Fastening Kit provides an easy remedy to broken or missing snap fasteners. The CRL Button and Socket Fastening Kit converts your Vise Grip Pliers into a snap fastener repair tool. The Clincher and Anvil slide over the jaws of the pliers and provide the base to hold and flare the eyelet stems. The Kit contains the following pieces: six AV7677 Buttons, six AV7678 Snap Sockets, one Anvil, and one Clincher. Vise Grips not included.

CRL Stud and Eyelet Fastening Kit



CAT. NO. TS12K

This CRL Stud and Eyelet Fastening Kit provides an easy remedy to broken or missing snap fasteners. The CRL Stud and Eyelet Fastening Kit converts your Vise Grip Pliers into a snap fastener repair tool. The Clincher and Anvil slide over the jaws of the pliers and provide the base to hold and flare the eyelet stems. The Kit contains the following pieces: six AV7679 Eyelet Studs, six AV7682 Eyelets, one Anvil, and one Clincher. Vise Grips not included.

CRL Upholstery Fasteners

- For Use With Our TS11K or TS12K CRL Upholstery Fastening Kits

All boxes of Upholstery Fasteners can be combined for quantity pricing.

CRL Nickel on Brass Socket



Qty/Box 100
CAT. NO. AV7678 9/16" (14.3 mm) Diameter

CRL Nickel on Brass Stud (Clinch Type)



Qty/Box 100
CAT. NO. AV7679 9/16" (14.3 mm) Diameter

CRL 10" Vise Grip Pliers

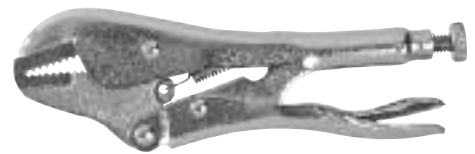

CAT. NO. 10R
Minimum order: 1 each.

CRL Nickel on Brass Button



Qty/Box 100
CAT. NO. AV7677 5/8" (15.9 mm) Diameter

CRL Nickel on Brass Eyelet

1/4" Barrel



Qty/Box 100
CAT. NO. AV7682 9/16" (14.3 mm) Diameter

CRL Nickel on Brass Clinch With Phillips Head Wood Screw

3/8" Stud Length

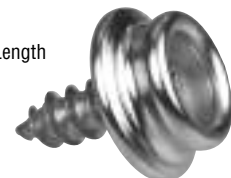

Qty/Box 100
CAT. NO. AV9814 1/2" (12.7 mm) Diameter;
3/8" (9.5 mm) Thread Length

CRL Rivet-Nut Kit

- Saves You Time, Labor, and Expense
- Can Blind Fasten in Virtually Any Material

new

Threaded Rivet-Nuts and Rivet Inserts provide a cost-effective method of placing permanent threads in thin materials. Installed from one side, these fasteners are perfect for use in metal, fiberglass, and rigid plastic. The special 39300 CRL Rivet-Nut Setter™ Installation Tool installs vibration-proof, compression fit threaded inserts with a nearly flush head, ready to accept machine bolts and screws in thread sizes from #6-32 to 3/8"-16.

Each Kit contains one 39300 Rivet-Nut Setter™ Tool with mandrels and nosepieces for 6-32, 8-32, 10-24, and 1/4"-20 thread sizes. Also included are 103 assorted Flat Head Rivet-Nuts, Klik® Poly-Nuts, instructions, a Nosepiece Wrench, and a plastic Carrying Case. Tool, Mandrels, Nosepieces, and Fasteners are also available separately (see below). Minimum order is one each.



CAT. NO. M39301

COMPLETE KIT INCLUDES:

1 Each 39300 Rivet-Nut Setter™; 1 each 6-32 Mandrel; 1 each 6-32 Nosepiece; 1 each 8-32 Mandrel; 1 each 8-32 Nosepiece; 1 each 10-24 Mandrel; 1 each 10-24 Nosepiece; 1 each 1/4"-20 Mandrel; 1 each 1/4"-20 Nosepiece; 25 each 6-32 Aluminum Rivet-Nuts; 25 each 8-32 Steel Klik® Poly-Nuts; 25 each 10-24 Steel Rivet Nuts; 20 each 1/4"-20 Aluminum Rivet-Nuts; 8 each 1/4"-20 Steel Poly-Nut; 1 each Nosepiece Wrench; 1 each Plastic Carrying Case.

CRL Rivet-Nut Setter™ RN-1 Tool

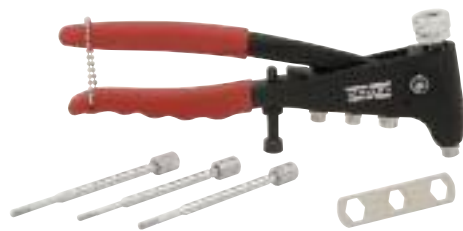

new

CAT. NO. 39300

This quality CRL Rivet-Nut Setter™ RN-1 Tool features a patented fulcrum design and comfortable, vinyl coated, oversize hand grips. This tool installs all fractional and metric sizes of Rivet-Nuts, Klik® Poly-Nuts, and Klik® Thread-Serts into steel, aluminum, fiberglass, and rigid plastic.

The upper handle is made from forged steel; the body is precision cast aluminum alloy; the mandrels and nosepieces are made from hardened steel. This newly redesigned Rivet-Nut Setter™ RN-1 has an adjustable stroke bolt to provide consistent nut and insert compression during installation.

This tool includes three mandrels and four nosepieces, a nosepiece wrench, and comes in a heavy-duty vinyl storage pouch.

- Installs: Rivet-Nuts, Klik® Poly-Nuts, and Thread-Serts
- Includes: Three Mandrels: 8-32, 10-24, and 10-32
- Includes: Four Nosepieces: #6, #8, #10, and 1/4"

CAT. NO.	SIZE	DESCRIPTION
39300		Rivet-Nut Setter™
M39354	6-32	Mandrel for 39300
M39355	8-32	Replacement Mandrel for 39300
M39356	10-24	Replacement Mandrel for 39300
M39357	10-32	Replacement Mandrel for 39300
M39358	1/4"-20	Mandrel for 39300
M39359	5/16"-18	Mandrel for 39300
M39360	3/8"-16	Mandrel for 39300
M39361	6-32	Replacement Nosepiece for 39300
M39362	8-32	Replacement Nosepiece for 39300
M39363	10-24 & 10-32	Replacement Nosepiece for 39300
M39379	1/4"-20	Replacement Nosepiece for 39300

Minimum order: 1 each. Replacement pieces are not compatible with all older models. Please contact a CRL sales assistant.

CRL Aluminum Threaded Klik® Poly-Nuts

- Provide Permanent Threads in Thin Material Down to .010" or .020" (.25 or .51 mm)

CRL Aluminum Threaded Klik® Poly-Nuts are designed to provide a very efficient and cost-effective method of placing permanent threads in materials as thin as .010" or .020" (.25 or .51 mm). Perfect for use in metal, fiberglass, and rigid plastic previously too thin for tapped threads. Provide a vibration-proof, nearly flush installation with an excellent fit to application materials. Accept machine bolts and screws in thread sizes from 6-32 to 3/8"-16. Installation is made easy with the Cat. No. 39300 Rivet-Nut Setter™ Installation Tool.



CAT. NO.	SIZE	QTY/PKG
131VB	6-32	100
132VB	8-32	100
133VB	10-32	100
134VB	10-24	100
135VB	1/4"-20	50
322VB	5/16"-18	25
323VB	3/8"-16	25

Minimum order: 1 pack.

CRL Aluminum Klik® Thread-Serts

- Unlimited Grip Range From 3/32" (2.4 mm) and Up

CRL Aluminum Klik® Thread-Serts can be used with sheet metal, plastic, castings, fiberglass or rigid material. One size fits all grip ranges from 3/32" (2.4 mm) to infinity. No special preparation is needed. A drilled or punched hole is all that is required. The threaded, mechanical hold prevents the fastener from twisting, vibrating loose or falling out. Thread-Serts install almost flush with the application surface. Installation is made easy with Cat. No. 39300 Rivet-Nut Setter™.



CAT. NO.	SIZE	QTY/PKG
136VB	6-32	100
137VB	8-32	100
138VB	10-32	100
139VB	10-24	100
140VB	1/4"-20	50
141VB	5/16"-18	25
142VB	3/8"-16	25

Minimum order: 1 pack.

CRL A-T Series Steel Insert Fasteners

- **Blind Installation (Installs From One Side of Work) for Light to Medium Duty Fastening**
- **The Unique Method of Installing Load Threads in Virtually Any Material: Aluminum, Magnesium, Steel, Cast Iron, Plastics, Fiberglass, or Hardboard**
- **Reduces Inventory Because One Insert Works in Any Thickness Above .030" (.76 mm)**
- **Vibration Proof**



A-T Series Steel Insert Fastener installed in Square Tubing



A-T Series Steel Insert Fastener Installation

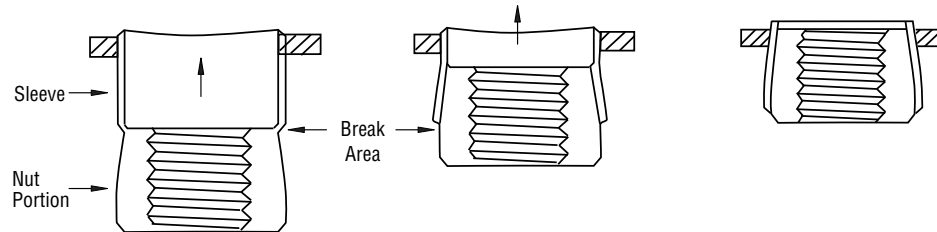

A-T Series Insert Fasteners are a one-piece design consisting of a nut portion and a sleeve portion.

A rotating tool mandrel exerts a pull and "breaks" the nut portion from the sleeve, drawing it into the sleeve.

The nut portion expands the sleeve, exerting a 360 degree swage fit against the parent material.

Features:

- Wear resistant threads due to unique mechanical properties of installation
- No special skills are required – installation can be learned in minutes
- Ideal for high-speed production. Can be installed at rates up to 500 pieces per hour
- Steel Insert Fasteners self-tighten with repeated use
- Use in standard drilled or punched holes
- No deburring necessary
- Can be installed at any point of the assembly operation with portable tools
- Can be installed after painting or plating
- Metric and other sizes, aluminum, brass or stainless steel available on special order

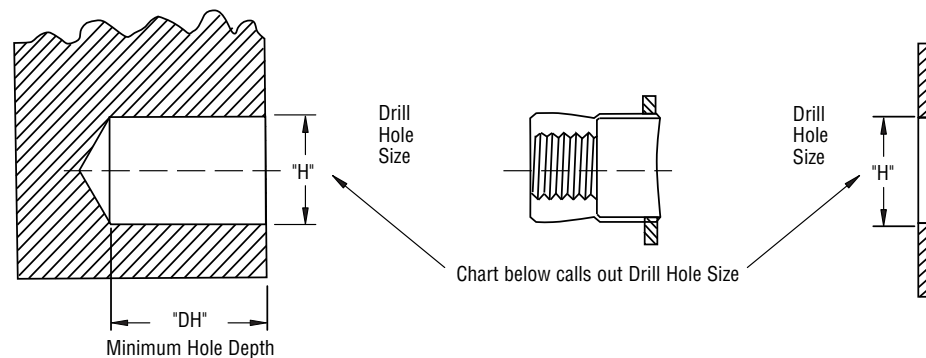

CRL A-T Series Steel Insert Fasteners can be used in light and medium duty fastening applications. They can be installed into thinner materials with greater ease than can be accomplished with weld nuts, pierce nuts, clinch nuts, thread tapping, and thread forming screws. They are "non-grip sensitive", one Steel Insert Fastener part number per thread size accommodates any grip over .030" (.76 mm), eliminating the need for various grip ranges.

The unique feature of CRL A-T Series Steel Insert Fasteners is the axial knurl under the flange of the insert. The expansion of the sleeve causes the knurl to bite into the parent material, providing greater torque resistance. Use CRL A-T Series Steel Insert Fasteners to improve your product and speed up production. They're ideal for high-speed installations, as well as low volume applications using manual tools.

CAT. NO.	THREAD SIZE	QTY/BOX	"DH"		"H" - MATCH METAL THICKNESS BELOW AND USE DRILL SIZE LISTED			
			MIN. HOLE DEPTH		.030-.090	.091-.124	.125-.186	.187-OVER
ATS2440	#4 (.112) – 40	100	.390 (9.9 mm)		3/16"	#10	#10	#9
ATS2632	#6 (.138) – 32	100	.390 (9.9 mm)		7/32"	#2	#1	#1
ATS2832	#8 (.164) – 32	100	.390 (9.9 mm)		1/4"	1/4"	17/64"	17/64"
ATS21032	#10 (.190) – 32	100	.390 (9.9 mm)		9/32"	19/64"	19/64"	19/64"
ATS2420	1/4" (.250) – 20	100	.535 (13.6 mm)		3/8"	3/8"	25/64"	25/64"
ATS2518	5/16" (.312) – 18	100	.635 (16.1 mm)		1/2"	1/2"	33/64"	33/64"

Minimum order: 100 each. Must be ordered in increments of 100. Sizes can be combined for quantity pricing.



CRL A-T Series Master Assortment Kit

- A Complete Kit With Six Sizes of Steel Insert Fasteners, Deluxe Hi-Torquer Hand Tool, and Adapter Heads

Use the CRL A-T Series Master Assortment Kit to install load bearing threads in virtually any material. It is ideal for production and maintenance repair applications.

The Kit contains: one AA112 A-T Series Deluxe Hi-Torquer Hand Tool, 50 each of six different sizes of A-T Series Steel Insert Fasteners, and one Conversion Kit for each thread size with complete installation instructions.

All of this comes in a rugged polyethylene case ready for use under the harshest of conditions, in the plant or in the field.



COMPLETE KIT INCLUDES:

50 each of these A-T Series Steel Insert Fasteners:

ATS2440 #4-40
ATS2632 #6-32
ATS2832 #8-32
ATS21032 #10-32
ATS2420 1/4"-20
ATS2518 5/16"-18

One of each of these A-T Series Conversion Adapters:

AAT202440 #4-40
AAT202632 #6-32
AAT202832 #8-32
AAT2021032 #10-32
AAT202420 1/4"-20
AAT202518 5/16"-18

One AA112 Hi-Torquer Hand Tool.

CAT. NO.	DESCRIPTION
AAT312A	A-T Series Master Assortment Kit

Minimum order: 1 each.

CRL A-T Series Deluxe Hi-Torquer Hand Tool

- Can Be Used to Set All Sizes of A-T Series Steel Insert Fasteners

The CRL A-T Series Deluxe Hi-Torquer Hand Tool is used to set all sizes of A-T Series Steel Insert Fasteners simply by using the appropriate Adapter to change from one thread size to another.

The Tool features a patented Quick Change thread size nose assembly. There is a recess to accept a 1/4" (6.3 mm) socket drive. **NOTE:** Be sure to order an Adapter Kit for each Insert Fastener size you plan to use. Minimum order is one each.

INSTALLATION:

- Thread insert fully onto mandrel.
- Place into hole.
- Hold grip bar while turning the "T" handle clockwise until insert is installed.
- Turn "T" handle counter-clockwise to remove from insert.



CAT. NO. AA112

CRL A-T Series Adapters for Hand Tool

- Order One for Each Steel Insert Fastener Size You Use

Use these CRL A-T Series Adapters to set all sizes of A-T Series Steel Insert Fasteners with Cat. No. AA112 Hand Tool (see above). They feature quick and easy conversions from one thread size to another.

CAT. NO.	FITS THRESH SIZE
AAT202440	#4-40
AAT202632	#6-32
AAT202832	#8-32
AAT2021032	#10-32
AAT202420	1/4"-20
AAT202518	5/16"-18

Minimum order: 1 each.



Hand Tool Sold Separately (See Above)

How Rivet-Nuts Work

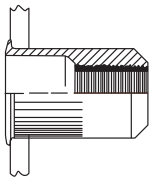

Inserted

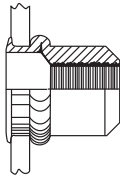

Compressed

CRL Rivet-Nuts enable you to fasten Glass Clamps, Clips or any other fastener requiring threads into a hollow metal round post or square tube which may be too thin for tapped threads. After installation, CRL Rivet-Nuts provide a permanent, captive thread that resists high loads, and will not rotate when a screw or bolt is inserted. No special preparation aside from a drilled or punched hole is required. Installation is made easy with the CRL Cat. No. 34604 Heavy-Duty Thread Insert Tool shown below. The appropriate sized Mandrel is required to set each Rivet-Nut size.



First, drill the appropriate size hole for the Rivet-Nut into your round post or square tube



Second, insert the Rivet-Nut into your round post or square tube until the collar on the Rivet-Nut is against the post or tube wall



Third, compress the Rivet-Nut by using the CRL Cat. No. 34604 Heavy-Duty Thread Insert Tool



Lastly, insert the screw or bolt into the Rivet-Nut and tighten

CRL Rivet-Nuts and Stainless Steel Socket Head Cap Bolts

CRL Rivet-Nuts can be used to secure Fixed Glass and Swivel Hinge Fittings in Partition Post and Sneeze Guard Tubing. Simply drill the appropriate size hole, insert Rivet-Nut and compress it. Stainless Steel Socket Head Cap Bolts provide durability in exterior applications.

CAT. NO.	DESCRIPTION	REQUIRED HOLE
RN1420	1/4"-20 Rivet-Nut	25/64" (10 mm)
ZRNUT	5/16"-18 Rivet-Nut	25/64" (10 mm)
ZBOLT14	1/4"-20 x 1" S.S. Socket Head Cap Bolt	—
ZBOLT	5/16"-18 x 1" S.S. Socket Head Cap Bolt	—

Minimum order: 10 each.



CAT. NO. RN1420



CAT. NO. ZRNUT



CAT. NO. ZBOLT14



CAT. NO. ZBOLT



CRL Heavy-Duty Thread Insert Tool and Drill Bit

- For Installing Larger Size Rivet-Nuts and Thread Inserts
- Comes With 1/4"-20 Mandrel and Nosepiece

The CRL Heavy-Duty Thread Insert Tool is supplied with a 1/4"-20 Mandrel and Nosepiece. It will install aluminum or steel Rivet-Nuts and Poly-Nuts. A 5/16"-18 Mandrel and Nosepiece are sold separately. Works well with our Cat. No. RN1420 and Cat. No. ZRNUT Rivet-Nuts (see above). High Speed 25/64" Drill Bit is made of steel for tough drilling applications. Overall length is 5-1/8" (130 mm)

CAT. NO.	DESCRIPTION
34604	Heavy-Duty Thread Insert Tool
34618	5/16"-18 Mandrel and Nosepiece
6012564	25/64" Drill Bit for 5/16" -18 Rivet-Nuts

Minimum order: 1 each.



CRL Screw Eyes

- Plated to Resist Corrosion
- Available in Eight Sizes



CRL's Screw Eyes come in an assortment of sizes to accommodate light to heavy hanger wire. All are plated to resist corrosion, and have sharp threaded points for easy tapping into wood frames.

CAT. NO.	EYELET I.D.	LENGTH	QTY/BOX
21712	1/8" (3.2 mm)	15/32" (12 mm)	200
21612	9/64" (3.6 mm)	1/2" (13 mm)	200
21512	9/64" (3.6 mm)	5/8" (16 mm)	200
21412	5/32" (4 mm)	5/8" (16 mm)	200
21312	11/64" (4.4 mm)	11/16" (17 mm)	200
21212	3/16" (4.8 mm)	3/4" (19 mm)	200
21112	13/64" (5.2 mm)	15/16" (24 mm)	200
21012	7/32" (5.6 mm)	1" (25 mm)	200

Minimum order: 200 each. Must order in increments of 200. All Screw Eyes can be combined for quantity pricing.

CRL Wire Brads

- Used in the Assembly of Finished Wood Picture Frames or Cabinetry
- Sharp Points Aid Insertion With Hammer or Brad Pusher

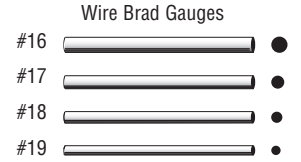
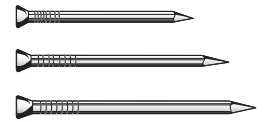

CRL Wire Brads are used in the assembly of finished wood picture frames or cabinetry. Sharp points aid their insertion using a hammer or brad-setting pusher. All sizes are packed one pound (.45 kg) per box.

CAT. NO.	SIZE
16X1BRAD	#16 x 1" (25 mm)
16X112BRAD	#16 x 1-1/2" (38 mm)
17X34BRAD	#17 x 3/4" (19 mm)
17X1BRAD	#17 x 1" (25 mm)
18X34BRAD	#18 x 3/4" (19 mm)
18X1BRAD	#18 x 1" (25 mm)
19X12BRAD	#19 x 1/2" (12 mm)
19X34BRAD	#19 x 3/4" (19 mm)
FH38	#18 x 3/8" (10 mm)*

Minimum order: 1 box. All Wire Brads can be combined for quantity pricing. *Quantity 2000 per box.

CRL Brad Pusher

- Used to Insert Brads Into Wood Frame Molding

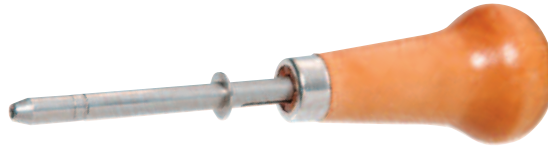

The CRL Brad Pusher is used to insert Wire Brads into wood frame molding. Simply position Brad, then push! It is inserted neatly and easily. Can also be used with a hammer for installing Brads into extra hard wood. Minimum order is one each.

CAT. NO. 74



CRL Hanger Wire

- Braided Wire Ideal for Hanging Framed Items
- High Quality Steel Wire

The CRL Hanger Wire is made from braided strands of high quality steel wire available in a variety of diameters that will support up to a maximum of 153 pounds (69.4 kg) before breaking. CRL's Hanger Wire is the perfect product for hanging framed pictures, paintings, mirrors, bulletin boards, and signs when using metal hangers or screw eyes. Approximately five pounds (2.3 kg) of wire comes on the metal spools, which can be mounted on a rod for convenient dispensing.

CAT. NO.	SPOOL LENGTH	NO. OF STRANDS	BREAK STRENGTH
PW1	2250' (686 m)	8	34 lbs. (15.4 kg)
PW2	1500' (457 m)	12	51 lbs. (23 kg)
PW3	1125' (343 m)	16	68 lbs. (30.8 kg)
PW4	850' (259 m)	20	85 lbs. (38.6 kg)
PW6	625' (190 m)	28	119 lbs. (54 kg)
PW8	500' (152 m)	36	153 lbs. (69.4 kg)
PW822	575' (175 m)	Patented*	100 lbs. (45.4 kg)

Minimum order: 1 roll. All Picture Wire can be combined for quantity pricing. Heavy wire braid recommended for mirror hanging. *Patent No. 2801565.



CAT. NO PW1



CAT. NO. PW4



CAT. NO. PW2



CAT. NO PW6



CAT. NO. PW8



CAT. NO. PW3



CAT. NO PW822

CRL FASTENERS – STAPLING

For Pricing Visit Our Web Site or Call Us Toll Free at the Phone Numbers Shown on the Back Cover

CRL Arrow Heavy-Duty Staple Gun

- Uses T50® Staples



This CRL Arrow Heavy-Duty Stapler has an easy-to-squeeze double leverage mechanism. Chrome plated steel to resist corrosion. Minimum order is one each.

CAT. NO. T50

CRL Arrow Regular-Duty Staple Gun

- Uses T30™ Staples

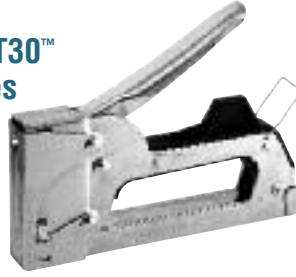

This CRL Arrow Regular-Duty Staple Gun drives lighter gauge T30™ staples. Chrome plated steel construction.

CAT. NO.	DESCRIPTION	QTY/BOX
T32M	Stapler	1
T3214	1/4" (6.4 mm) T30™ Staples	5000
T32516	5/16" (7.9 mm) T30™ Staples	5000

Minimum order: 1 each or 1 box.

CRL Arrow Plier Type Stapler

- Uses P22™ Staples



The CRL Arrow Heavy-Duty Plier Type Stapler has a 2-1/2" (63.5 mm) throat depth. Chrome plated steel construction.

CAT. NO.	DESCRIPTION	QTY/BOX
P22	Stapler	1
P2214	1/4" (6.4 mm) P22™ Staples	5040
P22516	5/16" (7.9 mm) P22™ Staples	5040

Minimum order: 1 each or 1 box.

CRL Arrow Hammer Tacker

- Uses T50® Staples



The CRL Arrow Hammer Tacker strikes like a hammer, automatically driving a staple. Made from chrome plated steel. Minimum order is one each.

CAT. NO. HT50A

CRL Arrow Professional Hammer Tacker

new

- Uses T50® Staples



The CRL Arrow Professional Hammer Tacker has an ergonomic rubber grip with knuckle guard. The body is made from chrome plated steel. Minimum order is one each.

CAT. NO. HTX50

CRL Arrow T50® Staples

- Available in Five Sizes



These heavy-duty wedge point T50® Staples come 5,000 per box.

CAT. NO.	LENGTH	QTY/BOX
T5014	1/4" (6.4 mm)	5000
T50516	5/16" (7.9 mm)	5000
T5038	3/8" (9.5 mm)	5000
T5012	1/2" (12.7 mm)	5000
T50916	9/16" (14.3 mm)	5000

Minimum order: 1 box.

CRL Arrow Cordless Staple Gun **new**

- Uses T50® Staples



This CRL Arrow Cordless Staple Gun is powered by a 10.8V lithium-ion battery and comes with a 60-minute (110V AC) battery charger. This Stapler has a "depth of drive" dial, an LED guide light, and a quick-release staple chamber release feature to remove clogged staples. Minimum order is one each.

CAT. NO. CT50K

CRL Arrow Electric Staple Gun

- Uses T50® Staples

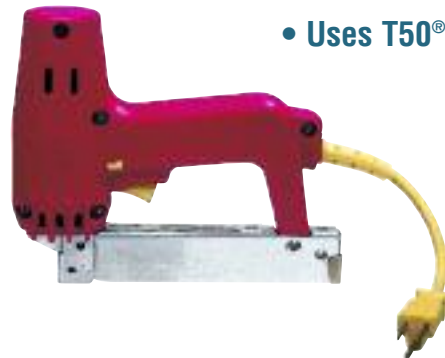

The CRL Arrow Electric Staple Gun has solid-state electronic circuitry, and operates on 110V AC current. Powerful enough to penetrate even the hardest of woods, this stapler has a precision jam-proof mechanism to prevent staple clogs. Minimum order is one each.

CAT. NO. ET50

CRL Cleaning Products and Supplies

One of the fastest growing product lines at CRL has been our Cleaning Products. We have always specialized in glass cleaning products with the industry favorite being our 1973 Glass Cleaner. And because of our alliance with Sprayway, we are able to offer you even more high quality glass cleaning products, as well as other specialty products for all types of cleaning needs. Available in aerosol and liquid forms, they tackle your toughest applications from cleaning glass, plastics, and metal, to removing graffiti, greases, oils, sealants, adhesives, and even cleaning your hands.



CRL Glass Cleaners

- Ammoniated Aerosol Formulas
- Non-Ammoniated Aerosol Formulas
- Private and Logo Labels
- Glass Washing Machine Detergents



CRL Concentrated Glass Cleaners, Stain Removers, and Protectants

- Concentrated Liquid Glass Cleaner
- Ready-Mix Glass and Mirror Cleaners
- Stain Removers
- Surface Protectors



CRL Plastic Cleaners

- Aerosol Plastic Cleaners
- Liquid Plastic Cleaners



CRL All Purpose Cleaners

- Multi-Surface Cleaners
- Stone Countertop Cleaners
- Anti-Fog Spray and Dust Remover
- Solvent Adhesive Removers and Cleaners



CRL Metal and General Purpose Cleaners

- Stainless Steel Polish and Cleaners
- Armor All® Protectant
- Metal Cleaners
- Rust Treatment



CRL Wipes, Towels, and Rags

- Lint Free Shop Wipes
- Scott Paper Towel Rolls
- Kimberly-Clark® Towels
- Micro-Fiber Wipes
- Box of Rags



CRL Hand Cleaners

- Organic Formula
- Orange Formula With Grit
- Wipes in a Bucket With Urethane and Grease Removers



CRL Cleaning Accessories

- Razor Blades and Scrapers
- Coveralls and Shoe Covers
- Steel Wool and Scotch Brite® Pads
- Vehicle Interior Protection



CRL Window Washing Tools

- Squeegees
- Extension Poles
- Window Cleaning Soaps

CRL and Sprayway, an Alliance of Two Industry Leaders Bringing You the Best in Glass Cleaners

- CRL is Sprayway's Master Distributor to the Glass Industry
- CRL's Glass Cleaners are Manufactured Exclusively for Distribution Through the Glass Industry
- Available in Cases of Twelve Big 19 Ounce (539 g) Cans or Twenty Four Mini 4 Ounce (113 g) Cans



All Are Also Available With Your Logo or Private Label

Ammoniated Formula

CRL 1973 Glass Cleaner



12 Cans Per Case

CAT. NO. 1973
19 Ounces (539 g)

- Our Most Popular Aerosol Glass Cleaner
- A Long-Time Favorite of the Glass Industry
- Low-Ammoniated Formula
- Also Available With Your Logo or in Your Own Private Labeled Cans

Clean glass is not only attractive and sanitary, but also vitally important in the fabrication of sealed insulating glass units. Why risk smudges or dust on the interior surfaces of sealed units? Make sure they are clean before sealing the unit by using this proven cleaner and our Lint Free Shop Wipes (see page N342).



new



24 Cans Per Case

CAT. NO. 1973M
4 Ounces (113 g)

- Convenient Mini Sized Cans are Great for Promotional Giveaways
- Easily Fits in Tool or Glove Box

CRL 1973 Glass Cleaner, a long time favorite of CRL customers, is a low ammoniated glass cleaner that is packaged in the traditional easy-to-handle 19 ounce (539 gram) can, and now in new 4 ounce (113 gram) mini can. CRL Glass Cleaner has effective cleaning agents that leave glass sparkling clean. It also has a pleasant aroma, so you can use it indoors and out with equal effectiveness.

Our new mini cans are a great way to promote repeated sales of this fine cleaner. Leave one with your business card when you finish up an installation or repair. Once your customers try it they'll be back for more.

CAT. NO.	NET WEIGHT	QTY/CASE
1973	19 Oz. (539 g)	12
1973M	4 Oz. (113 g)	24

Minimum order: 1 case. All aerosol glass cleaners can be combined for quantity pricing.

CRL/Somaca Hi-SHEEN® Glass Cleaner

- Industrial Strength Cleaner
- Lifts Residues From Non-Porous Surfaces
- Won't Leave Streaks, Blurs, or Rainbows



12 Cans Per Case

- Also Available With Your Logo or In Your Own Private Labeled Cans

CRL Hi-SHEEN® Glass Cleaner has been faithfully cleaning commercial and residential glass since 1970. It's dependable, no-nonsense aerosol formula is the reason year after year. Hi-SHEEN® is always a popular product!

Having an effective, reliable glass cleaner is just as important today as it was 40 years ago. This industrial strength cleaner is specially formulated to dissolve the toughest problems a professional will face: dirt, fingerprints, grime, grease, salts, saps and smudges. Hi-SHEEN® lifts residues from nonporous surfaces. It will not run when applying, or evaporate quickly like many other cleaners on the market. And it won't leave streaks, blurs, or rainbows.

Hi-SHEEN® can clean glass, tile, formica, metal panels, vinyl and much more, leaving a pure, clean, "perfume-free" scent. This is a great resale item for glass shops. We are always receiving inquiries from homeowners asking where they can purchase Hi-SHEEN® in their area. Some of the most popular uses are for cleaning film and soot from glass fireplace panels, and lifting ocean salts from windows. This product is never sold to national home centers, which offers you, the glass shop owner, an exclusive product to sell to your customers.



Ammoniated Formula



CAT. NO.	NET WEIGHT	QTY/CASE
3371100	19 Oz. (538 g)	12

Minimum order: 1 case. All aerosol glass cleaners can be combined for quantity pricing.

CRL POWR Cleaner

- Formulated for Use With All Automotive Urethanes to Enhance Bonding of Urethane Adhesive
- Removes Contamination and Release Agents
- LYNX Approved

CRL POWR Cleaner has been tested by CRL labs to offer the same cleaning qualities as most automotive urethane glass conditioners. This allows you to use a glass cleaner as a prep for primer applications instead of the costly glass conditioners. Large 19 fl. oz. (539 g) cans will provide you with significant cost savings.



CAT. NO.	NET WEIGHT	QTY/CASE
PWR22	19 Oz. (539 g)	12

Minimum order: 1 case. All aerosol glass cleaners can be combined for quantity pricing.



Ammoniated Formula



12 Cans Per Case

CRL S50 Glass Cleaner

- Fast Evaporation Rate, Just Spray and Wipe Clean
- Also Available With Your Logo or in Your Own Private Labeled Cans (See Page N337)



Year after year, S50 is one of our most popular cleaners. The formula includes perfume-grade alcohols, which are the best cleaning agents you can use. It also has a fast evaporation rate, which keeps it from leaving a film and adversely interacting with other materials. Also available with your logo or private label (see page N337).



Ammonia Free Formula



12 Cans Per Case

CAT. NO.	NET WEIGHT	QTY/CASE
S50	19 Oz. (539 g)	12

Minimum order: 1 case. All aerosol glass cleaners can be combined for quantity pricing.

CRL18X Glass and All Purpose Cleaner

- Our Best All Purpose Glass Cleaner for Around the House
- Ammonia Free Formula is Extra Strong for Really Tough Cleaning Jobs
- Available With Your Logo or in Your Own Private Labeled Cans (See Page N337)

Use this extra strong, ammonia free CRL18X Cleaner on glass, mirrors, porcelain, enamel surfaces, ceramic tile, aluminum, brass, and chrome. Excellent for really tough cleaning problems around the house or on the job site. Large 19 oz.(539 g) can includes the CRL and Sprayway names known throughout the industry for quality cleaning performance. Also available with your logo or private label (see page N337).



Ammonia Free Formula



12 Cans Per Case

CAT. NO.	NET WEIGHT	QTY/CASE
CRL18X	19 Oz. (539 g)	12

Minimum order: 1 case. All aerosol glass cleaners can be combined for quantity pricing.

CRL Logo Label and Private Label Aerosols

- You Can Now Get Any of the CRL-Sprayway Glass Cleaners and Other Quality Aerosol Products With Your Company's Name and Logo Right on the Can
- A Minimum 40 Case Order is All it Takes to Get Started



CRL Logo Label Program

- 40 Case Minimum Order (12 Cans Per Case)
- Choose From Many of Our Most Popular Formulations, Including S50, 1973, Hi-SHEEN®, and CRL18X Glass Cleaners
- Freight Paid to Any Location in the Continental U.S.

The CRL Logo Label Program uses our label templates with designated areas for your company's name or logo, address, and product name. Packaged in one to four color UV coated labeled cans and shipped in white custom stenciled boxes. We offer the same fine quality glass cleaners and lubricants that you are accustomed to using. We can manufacture and ship your first order in approximately four to six weeks from the date your input is received at the packaging plant. Call CRL Glass and Glazing Department at (800) 421-6144, Ext. 7720, for details and pricing for this unique service.



CRL Private Label Program

- 60 Case Minimum Order (12 Cans Per Case)
- Choose From Many of Our Fine Formulations, Including S50, 1973, Hi-SHEEN®, and CRL18X Glass Cleaners
- Freight Paid to Any Location in the Continental U.S.

CRL's Private Label Program lets you choose from one to four color UV coated labeled cans. Design your labels within our guidelines for that custom look. Your aerosols will ship to you in oyster white custom stenciled boxes. First orders take approximately four to six weeks.



Color Chart for Labels

Primrose Yellow #91S-110	Yellow #31068	Light Pumpkin #31062	Gold #31031	Brilliant Orange #91S-120
Warm Red #32113	Fire Red #91S-122	Bright Red #91S-128	Perm. Red #91M-125	Lime Green #35054
Emerald Green #91S-142	Perm. Green #91M-149	Glenn Blue #34034	Sky Blue #91S-158	Perm. Blue #91S-159
Ultra Blue #91S-150	Turquoise #35077	Deep Turquoise #34039	Cerise #33045	Purple #33057
Magenta #91M-183	Brown #37056	Gray #36010	Black #91S-170	White

Ordering Information

For either Logo Label or Private Label request an Order Form to provide us with the information you want on the bottom back of the can label. Federal regulations require a minimum amount of information: your company name, city, state, and phone number. You may also include any additional information like web and e-mail addresses, fax number, etc., but please understand the more information, the smaller the type (font) will be.

For the front of the can you may either place your camera-ready artwork on the order form, or send a disc or e-mail in a Mac format.

There are five lines with 27 letters per line for the stenciling on the outside of your carton.

This Color Chart shows all of the existing Sprayway colors available, or you may choose any PMS color for printing. Almost any color is acceptable for paper labels.

***NOTE:** This Color chart is computer generated – colors may vary slightly from actual can colors produced.

CRL GLASS CLEANERS

For Pricing Visit Our Web Site or Call Us Toll Free at the Phone Numbers Shown on the Back Cover

CRL Concentrate Glass Cleaner

- One Gallon Concentrate Makes 10 Gallons of Strong Cleaning Fluid
- Leaves No Film, Wipes Clean With No Rinsing
- Ammoniated for Strength



See page N340 for Dispenser Bottles



4 Gallons Per Case

CAT. NO. 695
1 Gallon (3.785 l)



CAT. NO. 69555GL
55 Gallon (208 l)

CRL Concentrate Glass Cleaner is the most popular bulk glass cleaner for in-shop and on-the-job use. It's easy to use and leaves no film or smears on glass. Does not harm paint. Used for cleaning glass by insulating glass unit manufacturers, and also used by the auto glass industry for windshields. It's easy to mix - one gallon (3.785 liters) makes ten gallons (37.85 liters) of strong, safe cleaning fluid. For extra hard cleaning jobs, use it with less water. We recommend the use of CRL Lint Free Glass Wipes (see page N342) with any glass cleaner.

CAT. NO.	CONTAINER
695	1 Gallon (3.785 l) Bottle
69555GL*	55 Gallon (208 l) Drum

Minimum order: 1 each. *Must ship common carrier.

CRL Mirror and Glass Cleaner

- Non-Streaking, Environmentally Safe Formula
- Contains No Ammonia or Vinegar



new



5 Gallons (18.9 l)



CRL Mirror and Glass Cleaner is an all-purpose cleaner that contains no ammonia or vinegar to harm mirror backing. Non-streaking, environmentally safe formula. Sold in a five gallon boxed container with an easy-pour spout included. Minimum order is one each.

CAT. NO. 3377000

CRL Ready-Mix Glass Cleaner

- Ready-Mixed Bulk Liquid
- Also Available in Private Label for Your Resale



1 Gallon (3.785 l)

Our professional strength CRL Bulk Glass Cleaner is available in these ready-mixed gallons for bulk filling of your spray dispensers. It's precisely formulated to give great glass cleaning results without the effort of mixing it yourself. Also available for resale in containers with your private label. Four one gallon bottles per case. Minimum order is one case.

CAT. NO. 895GL



C.R. LAURENCE COMPANY

crlaurence.com

N338

crlaurence.ca

crlaurence.com.au

crlaurence.co.uk

crlaurence.de

crlaurence.eu

CRL Mirror Cleaner and Polish

- Makes Mirrors and Glass Sparkle
- Strong Foaming Action
- Ammonia-Free Formula Won't Harm Mirrors
- Available With Your Logo or in Your Own Private Labeled Cans



12 Cans Per Case

CRL Mirror Cleaner and Polish is formulated especially for cleaning mirrors. It has a strong working foaming action that leaves mirrors sparkling clean, with no streaking or smearing. Ammonia-free formula will not attack mirror edges or contribute to "black edge." Also good for cleaning chrome, tile, porcelain, formica, appliance surfaces and stainless steel. 15 oz. (425 g) cans are attractively labeled for retail sale.

CAT. NO.	NET WEIGHT	QTY/CASE
1982	15 Oz. (425 g)	12

Minimum order: 1 case. All aerosol glass cleaners can be combined for quantity pricing.

CRL Automated Glass Washing Machinery

- Best Known and Most Popular Line of Glass Washing Equipment in the World
- Options for Low, Mid, or High Production Levels
- Vertical Capacities to 120" (3048 mm)
- Horizontal Capacities to 96" (2438 mm)

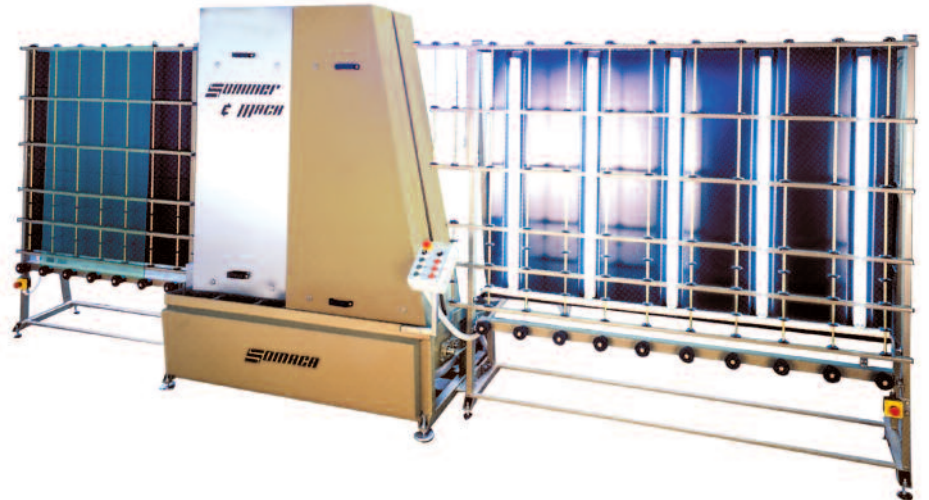

CAT. NO. VEW60

The Somaca Machinery Division of CRL has been designing and producing innovative glass washing equipment for over 70 years. Somaca/CRL Washers have been included in every conceivable glass fabrication format: mirror silvering, tempering, insulating, art framing and window manufacturing. Somaca/CRL Washers offer two brush, four brush, or six brush options, all compatible with today's most sensitive surface coatings.

For more information call our Glass Machinery Division at (866) 583-1377. You can also send an e-mail to somaca@crlaurence.com.



CAT. NO. HDTTW606

CRL GLASS CLEANERS

For Pricing Visit Our Web Site or Call Us Toll Free at the Phone Numbers Shown on the Back Cover

CRL Low-e Washing Machine Detergent



- Self-Adjusting pH to Water Conditions
- De-Limer to Help Keep Machine Free of Dirt Build-Up
- Biodegradable



CAT. NO. 3379046
1 Gallon (3.785 l)



CAT. NO. 3379048
55 Gallon (208 l)

This CRL Low-e Glass Washing Machine Detergent is for use with all glass washing machines. One gallon of super concentrated detergent treats over 1000 gallons (3785 liters) of water. Field tested to yield best results in "Low-e" soft coat production runs. Listed on H.B. Fuller "Acceptable List." **NOTE:** Not for use on mirrors.

CAT. NO.	CONTAINER	QTY/CASE
3379046	1 Gallon (3.785 l) Bottle	4
3379048*	55 Gallon (208 l) Drum	1

Minimum order: 1 each. *Must ship common carrier.

CRL Plastic Spray Dispenser Bottles

- Ideal for Use With CRL Concentrate Glass Cleaner
- Oversized Trigger for Powerful Pumping Action
- High-Volume Output
- Lasts Longer Than Regular Sprayers



CAT. NO. DB21
16 Ounce Size
(473 ml)

CAT. NO. 3371032
32 Ounce Size
(946 ml)

These CRL Plastic Dispenser Bottles provide the easiest and most economical way to use Concentrate Glass Cleaner. The easy trigger operation sprays a large, fine mist pattern for best coverage of glass area. Easily cleaned valve and intake strainer. These Dispensers will replace and outlast expensive, high-pressure aerosol containers.

CAT. NO.	DESCRIPTION
DB21	16 Oz. (473 ml) Plastic Spray Dispenser Bottle
3371032	32 Oz. (946 ml) SprayMaster® Trigger Sprayer

Minimum order: 1 each.

CRL Glass Washing Machine Detergent



- Compatible With All Glass Washing Machines
- Biodegradable
- Will Not Leave a Film



CAT. NO. 155X
5 Pounds (2.2 kg)



CAT. NO. 155X40
40 Pounds (18.1 kg)



CAT. NO. 155X400
400 Pounds (181.4 kg)

Automatic glass washing machines require a special detergent for flat glass. CRL Glass Washing Machine Detergent mixes quickly, and is compatible with any brand of washer currently in use. It is composed of a unique combination of inhibitors with synthetic detergents to provide effective soil removal at low concentrations. Starting ratio for mixing is one tablespoon per ten gallons of water. Complete instructions are on the container label. This detergent is biodegradable, and does not contain additives (release agents), which will inhibit adhesion of sealants to the glass.

CAT. NO.	CONTENTS
155X	5 Pounds (2.2 kg)
155X40	40 Pounds (18.1 kg)
155X400*	400 Pounds (181.4 kg)

Minimum order: 1 each. *Must ship common carrier.



C.R. LAURENCE COMPANY

N340

crlaurence.ca | crlaurence.com | crlaurence.com.au | crlaurence.co.uk | crlaurence.de | crlaurence.eu

crlaurence.com

CRL TPC Surface Protector



- Transparent Polymer Coating
- Water, Soil, and Stain Repellant
- Protects Glass and Many Other Surfaces

CRL TPC Surface Protector will actually seal the pores of glass, porcelain, ceramic, plastics, polished metals, fiberglass, and marble to make the surface water, soil, and stain resistant. The clear coating guards against the adhesion and build-up of dirt, grime, mold, mildew, rust, and mineral deposits. Environmentally friendly and non-toxic, CRL TPC Surface Protector permits the practice of preventive cleaning and maintenance, reducing costly cleaning, repairs, and replacement. One fluid ounce protects approximately 15 square feet (1.4 meters square) of glass. Also available in 55 gallon (208 l) drums on special order.

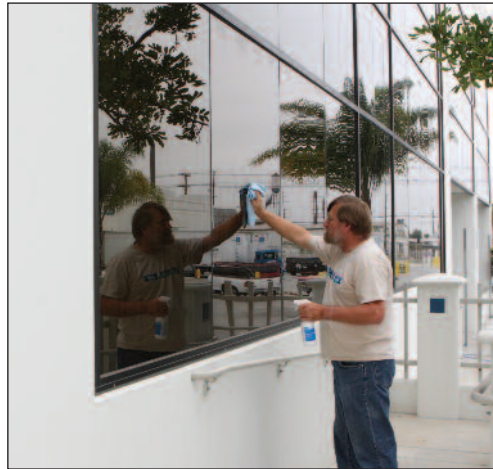

Visit our web site, crlaurence.com, for Application Tips and Most Common Uses. Also Protects Sand-Blasted Glass



CAT. NO. TPC16



UNTREATED GLASS

Water does not "bead" on glass. Dirt sticks to water that dries on the glass and leaves stains.



TREATED GLASS

Water "beads" up on sealed, polished glass and easily runs off, taking any dirt with it.

CRL TPC Surface Protector Towelettes

new

- Sample Pouches
- Five Towelettes Per Pack

CRL TPC Surface Protector Towelettes keep your customers coming back. Leave one or two with your customer after each beautiful frameless shower door installation. Once they see how well CRL TPC Surface Protector keeps their new glass clean, they will be ordering 16 fl. oz. (473 ml) bottles from you. Works well in combination with CRL Bio-Clean Water Stain Remover (see page N350).



CAT. NO. TPC16P

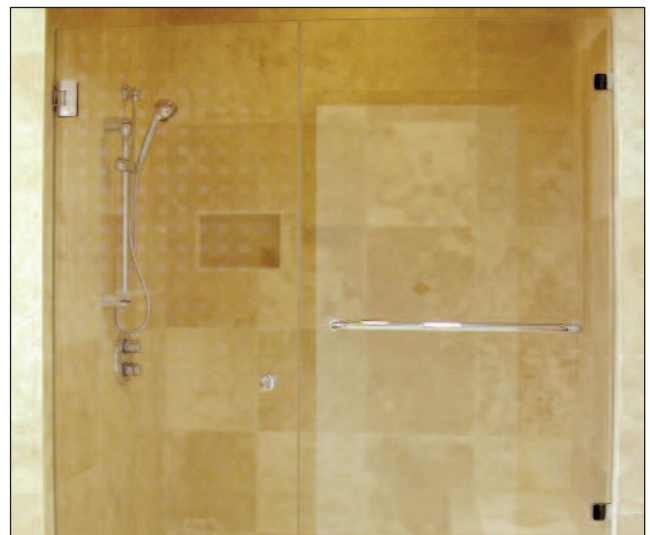

CAT. NO.	CONTENTS	QTY/CASE
TPC16	16 Fl. Oz. (473 ml)	12
TPC5GL	5 Gallons (18.9 l)	1
TPC16P	5 Towelettes	1

Minimum order: 1 each.

CRL Lint Free Glass Wipes



CAT. NO. 1550
900 Wipes Per Case

Extra-tough CRL Lint Free Glass Wipes bring the absorbing power you need in a lighter weight material that's reinforced with a nylon scrim for extra strength. The ripple texture makes them easy to hold during use, and provides just the right amount of surface area for cleaning solutions to do their work.

CRL Lint Free Glass Wipes have no adhesives or binders so they leave nothing behind except clean, lint free surfaces. Besides glass, they are ideal for your most demanding shop clean up tasks.

CRL Lint Free Glass Wipes measure a big 16-1/2" x 9-3/4" (419 x 248 mm). Each case has six pop-up boxes containing 150 wipes each for a total of 900 wipes per case.

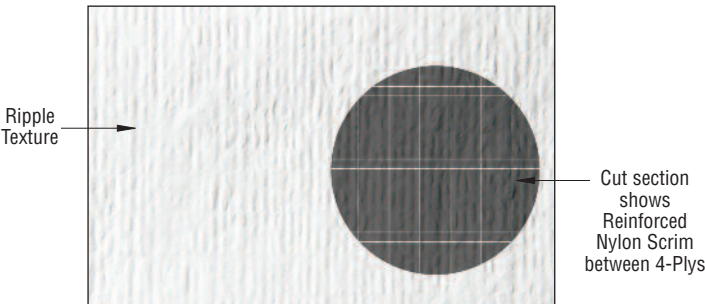

- New, Convenient Pop-Up Dispenser Box
- Strong, Four-Ply White Paper Wipes are Virtually Lint Free
- Reinforced Nylon Scrim in Both Directions So They Work Great Wet or Dry
- Six Pop-Up Boxes In Each Case



CAT. NO. BX15
150 Wipes Per Box

4-PLY



CAT. NO.	DESCRIPTION
1550 BX15	Case of 900 Wipes Box of 150 Wipes

Minimum order: 1550 1 case; BX15 1 box.

CRL Lint Free Glass Wipes Dispenser Bracket

- Positions Pop-Up Boxes of 1550 and BX15 Wipes Right Where You Need Them
- Include Screws, Anchors, and Double-Face Tape

Mount the CRL Dispenser Bracket to walls or work benches for quick and easy pull-down dispensing of our 1550 and BX15 Lint Free Glass Wipes. Mounting screws, wall anchors, and double-face tape patches are included. After attaching the bracket, simply press the perforated edge of the BX15 Wipe box against the two forks to mount. Minimum order is one each.



CAT. NO. K73900

CRL Paper Towels in Rolls

- Strong and Extra Absorbent
- Two Plies Thick

2-PLY



CRL Paper Towels are two plies of strong white paper with extra absorbent qualities. Each 8-3/4" x 8-3/4" (223 x 223 mm) sheet wipes up spills quickly, and you get 128 sheets per roll. You'll find CRL Paper Towels economical to use. They're great on the job, in the shop, and around the house. Sold only in cases of 20 rolls. Each individually wrapped roll has 128 towels.

CAT. NO.	SHEET SIZE	QTY/CASE
41482	8-3/4" x 8-3/4" (223 x 223 mm)	20 Rolls

Minimum order: 1 case.

CRL Micro Fiber Wipes

- Streak Free Cleaning on Windows and Mirrors
- Washable Up to 500 Times



CRL Micro Fiber Wipes have thousands of microscopic fibers that trap dirt and grime to increase cleaning effectiveness and reduce cleaning and drying times. Our large 16" x 16" (406 x 406 mm) Wipe takes on big polishing, waxing, cleaning, and dusting jobs. When you're done you can simply machine wash them (without fabric softener). They are packed two per poly bag with a hanger hook for resale to your customers.

CAT. NO.	WIPE SIZE	QTY/PACK
MFW2	16" x 16" (406 x 406 mm)	2

Minimum order: 1 pack.

CRL Wypall Utility Wipes

2-PLY

- A Bestseller
- Two-Ply Construction
- Pop-Up Box

new



Ideal for cleaning glass, this tough wipe's two-ply construction provides superior strength and fast absorption at an economical cost per wipe. Contains 18 boxes per case, with 125 utility wipes per box.

CAT. NO.	SHEET SIZE	WIPES/CASE
2130003	10-1/2" x 12" (266 x 305 mm)	2250

Minimum order: 1 case.

CRL Kimtowels

4-PLY

- Tough, Strong Multiple Plies
- Highly Absorbent
- Durable and Reusable



These CRL Kimtowels have multiple plies bonded together to form tough, durable wipes for hands and equipment. Extra absorbent inner plies soak up oil, water, and solvents fast. Kimtowels will clean up more and last longer than ordinary paper towels. Kimtowels measure a big 12-1/2" x 14-7/16" (317 x 365 mm).

CAT. NO.	TOWELS/PACK	TOWELS/CASE
K47011	68 per Band Wrap	816
K47033	100 per Pop-Up Box	800

Minimum order: 1 case.

CRL Kimberly-Clark® WypAll® Workhorse® X80 Shop Towels

- Feel Like Cloth and Work Even Better
- Made With Hydroknit® Fast Absorbing Material



CRL Kimberly-Clark® WypAll® Workhorse® X80 Shop Towels feel like cloth and work even better. They are made with Hydroknit® fast absorbing material that has outstanding tear resistance. Absorbs water and oil faster than laundered shop Towels, with no holes, strings, metal chips or residues to worry about. Sold in cases containing five pop-up boxes of 80 white Towels for convenient dispensing. Towels measure 9-1/8" x 16-3/4" (232 x 425 mm). The box also has a perforated edge so it can be wall mounted with our optional Wall Mount Bracket.

CAT. NO.	DESCRIPTION	QTY/CASE
K41048	Workhorse® X80 Towels	5 Boxes
K73900	Dispenser Bracket	1 Each

Minimum order: K41048 1 case; K73900 1 each.

CRL Kimberly-Clark® WypAll® Workhorse® X70 Rags

- High Tech Performance at a Value Price
- Made With Hydroknit® Fast Absorbing Material



These big rolls of CRL Kimberly-Clark® WypAll® Workhorse® X70 Manufactured Rags will give you long lasting performance for extended usage and minimal waste. Made with Hydroknit® fast absorbing material that has outstanding tear resistance, they tackle those heavy-duty industrial jobs usually handled by cloth Rags. Each roll contains 275, 10" x 13-3/8" (254 x 340 mm) manufactured Rags. There are three rolls per case.

The K09025 Center-Pull Dispenser is available for fast delivery of Workhorse® X70 Manufactured Rags, and can be mounted permanently or temporarily with the included hardware.

CAT. NO.	DESCRIPTION	QTY/CASE
K41702	Workhorse® X70 Towels	3 Rolls
K09025	Center Pull Dispenser	1 Each

Minimum order: K41702 1 case; K09025 1 each.

CRL Kimtex® Shop Towels

- Super Absorbent, Remarkably Soft
- Poly Fiber Towels are More Durable Than Paper

Soft and super absorbent CRL Kimtex® Shop Towels are made in a special, patented process using melt-blown polypropylene fibers to create the first non-woven wipe durable enough to replace shop rags. A low-lint wipe with the soft texture of cloth and the disposability of paper towels, Kimtex® Towels are more durable than paper and outlast disposable towels. Towels measure 12" x 14.4" (305 x 366 mm), and there are 528 Towels per case. Minimum order is one case.

NOTE: Kimtex® Towels are made with a special process that contains harmless chemicals that may leave a film if used to clean glass. For cleaning glass, we suggest you use CRL 1550 Lint Free Glass Wipes (see page N342).



CAT. NO. 33560

CRL Tork® Advanced Hand Towel

- Super Absorbent 2-Ply Rolls
- Center-Pull Dispenser



These 100% cellulose Tork® Hand Towels are able to absorb up to four times their own weight in liquids, requiring fewer wipes per job. If you are making insulating glass units, they will leave your glass lint and streak-free every time. The big, 600 sheet roll can be kept clean and contamination-free by using the sealed, consumption control Center-Pull Dispenser. Towels measure 9" x 11-3/4" (229 x 300 mm).



CAT. NO.	DESCRIPTION	CONTENTS
121201	Tork® Advanced	1 Roll
2001234	Tork® Advanced	6 Rolls
559028A	Center-Pull Dispenser	1 Each

Minimum order: 121201 1 roll; 2001234 1 case; 559028A 1 each.

Center Pull Dispenser

CRL Kimberly-Clark® WypAll® X50 Jumbo Paper Towels

new

- Made With Hydroknit® Fast Absorbing Material
- 1,100 Sheets Per Roll
- Perforated for Easy Tear-Off

These WypAll® Paper Towels are perfect for cleaning glass as well as for general clean-up around the shop. They are made with Hydroknit® fast absorbing material that has outstanding tear resistance. The perforated sheets makes removal easy when used with our Paper Towel Dispensers. Largest and most economical towel we sell.



Packed one roll per case. Each roll contains 1,100 Towels. Each Towel measures 9-3/4" x 13-3/8" (248 x 340 mm). Minimum order is one roll.

CAT. NO. K35015

CRL Paper Towel Dispenser

new

- Holds Jumbo Rolls
- Perfect for Workbench, Floor, or Wall



Shown with Cat. No. K35015 Paper Towels (sold separately)

The 80595 floor model Dispenser has detachable legs so it can also be used on a workbench. Use the wall mount model to mount your jumbo rolls of paper towels right next to your work station.

CAT. NO.	DESCRIPTION
80595	Floor/Bench Dispenser
80579	Wall Mount Dispenser

Minimum order: 1 each.

CRL Glass-EEZ Cleaning Towels

4-PLY

- Lint-Free, 4-Ply Towels
- 500 Towels With Two Dispenser Boxes



These CRL Glass-EEZ Cleaning Towels are high quality paper towels that are the most versatile wiping product available to the glass industry. They are lint-free and combine softness, strength and absorbency to successfully fulfill all glass cleaning requirements. Sheet size is 13-1/2" x 17-5/8" (343 x 448 mm).

CAT. NO.	DESCRIPTION
2131300	Case of 500 Towels

Minimum order: 1 case.

CRL Box of Rags

new

- Convenient Five Pound Boxes
- White T-Shirts and White Thermals
- Cut in Usable Sized Pieces

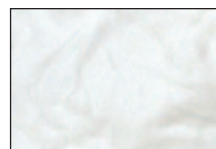

White T-Shirt Material



White Thermal Material



CRL Box of Rags are recycled white cloth wipers that are excellent for all purpose wiping, cleaning, and polishing because they are practically lint-free. White T-Shirts are good for cleaning metal and applying primers before applying sealants. White Thermals are good for cleaning up spills and removing heavy grease and oils with their high cotton content and absorbency. More durable than paper and also washable.

CAT. NO.	DESCRIPTION
10522	White T-Shirts – 5 Lb. Box
10502	White Thermals – 5 Lb. Box

Minimum order: 1 box.

CRL Wipes in a Bucket

- Quickly Removes Urethane, Tough Soils, Adhesives, Grease, Etc.
- No Rinsing, No Drying, No Residue
- Effective, Portable, and Convenient

CRL99W Wipes in a Bucket are a patented, waterless hand cleaning system combining both a high quality liquid hand cleaner formula, and a heavy-duty, non-scratching, abrasive hand-cleaning towel. Unique patented towel construction is comprised of a polymeric non-woven soft layer, to which thousands of polymeric deep cleaning scrubbers are permanently bonded to one side of the surface. Then, a special micro-perforation pattern is added to hold effective, yet mild, liquid contaminant-dissolving agents and soil lifters that dry quickly after use. Use Wipes in a Bucket to clean up spills, drips, and spatters from most non-porous surfaces like shop tools, equipment, counter tops, and more. Large 10-1/2" x 12-1/4" (267 x 311 mm) Wipes dispense easily from their own pop-up container.



CAT. NO. CRL99W



CAT. NO. CRL99WB

Optional Wall Mount Bracket keeps Wipes in a Bucket handy, and allows for extra space on your work bench.



CAT. NO.	DESCRIPTION	QTY/CASE
CRL99W	Bucket of 72 Wipes	6
CRL99WB	Wall Mount Bracket	---

Minimum order: 1 each.

CRL Scrubs-In-A-Bucket®

- Pop-Up Towels Impregnated With Waterless Hand Cleaner
- Recyclable and U.S.D.A. Authorized

- Cleans Urethane, Adhesives, Grease, Oils, Tar, and More

Use CRL Scrubs-In-A-Bucket® for fast and easy hand cleaning. These pre-moistened towels clean hands of urethane, adhesives, ink, tar, and oil with a gentle-to-the-skin formula that gives pumice performance without the grit. They also feature a natural citrus fragrance.

CRL Scrubs-In-A-Bucket® contain a germ fighting agent, and leave hands clean without residue or drying. They are great for cleaning tools, work surfaces, and spills; as well as recyclable, U.S.D.A. authorized, and carry an E-4 rating. Large 10-1/2" x 12-1/4" (267 x 311 mm) wipes dispense easily from their own pop-up bucket. Optional Cat. No. CRL99WB Wall Mount Bracket keeps Scrubs-In-A-Bucket® handy, and allows for additional space on your work bench.

CAT. NO.	DESCRIPTION	QTY/CASE
C422	Bucket of 72 Wipes	6
CRL99WB	Wall Mount Bracket	---

Minimum order: 1 each.



CAT. NO. CRL99WB
Optional Wall Mount Bracket

CAT. NO. C422

CRL Hand Cleaner



- 100% Organic Formula is Safe for Skin
- Cleans Dried Urethane and Other Tough Stains Such as Grease, Oil, Ink, and Carbon Smudges
- Also an Excellent Lubricant for Rubber Gasket and Glass Installations

CRL Hand Cleaner has a 100 percent organic formula that dissolves grease, oil, ink, carbon smudges, dried urethane, and other sealants. It cleans urethane stains from auto glass, paint, and vinyl upholstery. It is also excellent as a lubricant for rubber gasket and glass installation. It contains absolutely no petroleum products that will be harmful to your skin, and has lanolin to condition your skin. Non-polluting, non-toxic, non-caustic, non-irritating, non-flammable, water soluble, completely organic and biodegradable. It has an unlimited shelf life if kept closed between uses. The pleasant citrus scent leaves a clean smell.



CAT. NO. HC140
16 Oz. Tub



CAT. NO. HC720
4.5 lb. Tub



CAT. NO. HC2145
Dispenser for HC720

CAT. NO.	CONTENTS	QTY/CASE
HC140	16 Oz. (454 g) Tub	12
HC720	4.5 lb. (2.14 kg) Tub	6
HC2145	Dispenser for HC720 Tub	1

Minimum order: 1 each.

CRL Kimberly-Clark® Kimcare NTO Hand Cleaner With Grit



- Works Effectively, Even Without Water
- Formulated for Tougher Grime

CRL Kimberly-Clark® Kimcare NTO Hand Cleaner with Grit is designed to remove tougher hand soil without water. It contains polymer beads for scrubbing without the abrasion associated with other grits using pumice or walnut shells. Each rugged one gallon container comes with its own dispensing pump.



CAT. NO.	CONTENTS
K91035GL	1 Gallon (3.785 l)

Minimum order: 1 each.

CRL Rez-Guard Barrier Cream



- Helps Protect Hands Against Problems Associated With the Handling of Industrial Adhesives, Solvents, Sealants, and Coatings

CRL Rez-Guard Barrier Cream helps protect hands against dermatitis, skin irritation, dryness, and cracking. Prevents fingers from sticking together when using cyanoacrylates (super glue). Rez-Guard contains glycerine to promote healing, but contains no silicone, so it's clean and washes off with water.



CAT. NO.	CONTENTS	QTY/CASE
REZ4	4 Fl. Oz. (118 ml)	24

Minimum order: 1 each.

CRL Grime Scrub Brush

- Gentle and Effective Cleaning Action Quickly Removes Grime
- Special Row of Stiff Bristles Cleans Under Fingernails
- Contoured Handle for Firm Gripping
- Durable and Lightweight



CAT. NO. 17050

The CRL Grime Scrub Brush effectively cleans out the grime from the crevices in one's hand, and has a special row of bristles to clean under fingernails. The contoured handle gives even wet hands a firm grip. Durable and lightweight, with molded-in-place bristles for long service life. Minimum order is one each.



CRL Master Series Squeegees

- Available In Either Solid Brass or Stainless Steel
- Replacement Blades Available
- Can Be Used With REA-C-H Extension Poles

The Master Series Squeegee's rubber blade has a razor-sharp square edge, which leaves glass perfectly clean and streak free. The highly polished brass handle is designed for perfect balance and weight. The annealed stainless steel frame has the advantage of lightness, strength, corrosion resistance, and it has a soft rubber handle. Both Squeegees can be used with the REA-C-H Extension Pole.



COMPLETE SQUEEGEES

CAT. NO.	DESCRIPTION
2132523	14" (356 mm) Solid Brass
2132524	18" (457 mm) Solid Brass
2132525	14" (356 mm) Stainless Steel
2132526	18" (457 mm) Stainless Steel

Minimum order: 1 each.

REPLACEMENT CHANNELS AND RUBBER

CAT. NO.	DESCRIPTION
2132527	14" (356 mm) Brass
2132528	18" (457 mm) Brass
2132529	14" (356 mm) Stainless Steel
2132530	18" (457 mm) Stainless Steel

Minimum order: 1 each.

REPLACEMENT HANDLES

CAT. NO.	DESCRIPTION
2132531	Brass
2132532	Brass/Rubber Quick Release
2132533	Stainless Steel
2132534	Stainless/Rubber Quick Release

Minimum order: 1 each.

CRL Sleeve-Style Washers

These popular Sleeve-Style Washers are built to last with an extra-heavy-duty synthetic pile, double-twist fabric, and double seams at the sewn ends. Velcro® fasteners secure cover to lightweight plastic T-Bar frame. The heavy-duty Porcupine Scrubber Cover has interwoven flexible scrubber bristles that are tough on dirt, yet soft on glass. Easily slips on and off T-Bar frame. Can be used with the REA-C-H Extension Pole.

- Lightweight T-Bar Frame
- Can Be Used With REA-C-H Extension Poles



T-BAR FRAME WITH COVER

CAT. NO.	DESCRIPTION
2132513	14" (356 mm) T-Bar Frame With Cover
2132514	18" (457 mm) T-Bar Frame With Cover

Minimum order: 1 each.

REPLACEMENT COVERS

CAT. NO.	DESCRIPTION
2132515	14" (356 mm) Synthetic Pile Cover
2132516	18" (457 mm) Synthetic Pile Cover
2132517	14" (356 mm) Porcupine Scrubber
2132518	18" (457 mm) Porcupine Scrubber

Minimum order: 1 each.

CRL REA-C-H Extension Poles

- Universal Attachment Head
- 1/4 Turn Positive Twist Lock

CRL REA-C-H Extension Poles are 40% thicker than other poles, made of fluted, gold anodized, industrial strength aluminum with high-impact plastic tips. The fluting resists twisting, and the gold anodized finish ensures years of corrosion-free use. Poles have a quarter turn positive lock and a comfortable rubber grip. The threaded tip is universal, so it fits most window cleaning tools, paint rollers, and brushes.

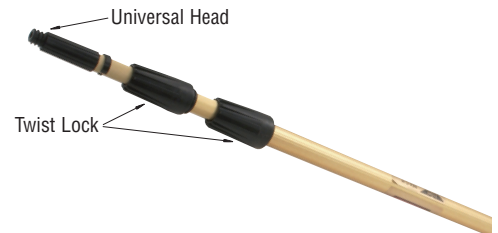

CAT. NO.	DESCRIPTION
2132519	8' (2.4 m) Two Section Pole
2132520	12' (3.6 m) Three Section Pole

Minimum order: 1 each.

CRL Natural Chamois

- Natural Full Skin Leather

The high quality, natural full skin leather CRL Chamois is ideal for cleaning, polishing, wiping, and dusting sensitive metal and glass surfaces. A superior product to clean excess water and residue from silvered mirror.



CAT. NO.	DESCRIPTION
BJ400	3.5 Sq. Ft. Natural Chamois

Minimum order: 1 each.

CRL Window Cleaning Soap

- Concentrated Formula
- Streak Free Results
- No Ammonia

CRL's bio-degradable formula Window Cleaning Soap makes squeegees slide easily across glass while instantly dissolving built-up grime, even grease. Concentrated formula; approximately 2 tablespoons of concentrate per gallon of water.



CAT. NO.	CONTENTS
2132521	16 Fl. Oz. (473 ml)

Minimum order: 1 each.

CRL Rubber Squeegees

- Thick Rubber Blade
- Sturdy Steel Handle



CAT. NO. SP408
8" (203 mm)

CAT. NO. SP412
12" (305 mm)

These heavy-duty CRL Squeegees have a thick rubber blade and steel handle. Available in 8" and 12" (203 and 305 mm) widths, these Squeegees will wipe away a lot of window cleaning solution quickly. Minimum order is one each.

CRL Deluxe Shower Squeegee

- Suction Hook Holder Requires No Drilling
- Chrome Handle With Gray Blade

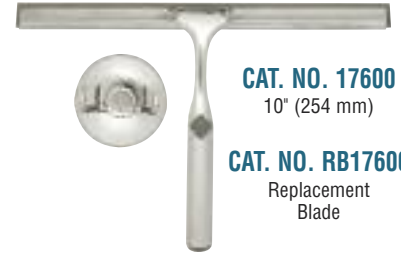

CAT. NO. 17600
10" (254 mm)

CAT. NO. RB17600
Replacement Blade

CRL's Deluxe Shower Squeegee has a chrome plated, zinc diecast handle that is rust and tarnish free. The polished stainless steel blade holder secures a 10" (254 mm) wide gray colored blade that effectively removes water spots and soap film from all types of bathroom surfaces. The blade is reversible to extend its service life. The Squeegee hangs on an attractively designed vacuum cup hook that installs easily without drilling into the shower wall. Minimum order is one each.

CRL Vacuum Squeegee new

- Dripless, Streakfree Surface Clean-Up
- Rechargeable Power
- Save on Wipes and Towels



The CRL Vacuum Squeegee can be used on windows, shower enclosures, shower tile, counter tops, or any other smooth and flat vertical or horizontal surface. The Squeegee's rechargeable battery provides 20 minutes of service per charge, and its clear reservoir lets you keep track of the amount of liquid previously vacuumed.

CAT. NO.	DESCRIPTION
VS20	110V Vacuum Squeegee
EUVS20	240V Vacuum Squeegee

Minimum order: 1 each.

CRL Cleret Elite Squeegees

- Dual 10" Wide Blades Wipe Water Spots From Enclosure Door and Walls



CRL Cleret Elite Bath Squeegees have decorative end caps on white or black wiping blades and handles. This upscale combination of function and design makes it easy to wipe water spots from shower doors, tile and marble surfaces. Dual 10" (254 mm) blades are held in an 8" (203 mm) handle.

CAT. NO.	HANDLE COLOR	CAP COLOR
EBCB1	Black	Chrome
EBGB1	Black	Gold
EWCW1	White	Chrome
EWGW1	White	Gold
2360101	White	White

Minimum order: 1 each. Squeegees can be combined for quantity pricing.

CRL Sponges

- Large and Easy to Handle
- Choose Organic or Synthetic



CAT. NO. 1620
Natural Organic Sponge



CAT. NO. 16A
Synthetic Cellulose Sponge

Choose either our Natural Organic Sponge or the Synthetic Cellulose Sponge for high absorbency removal of water or other liquids. Minimum order is one each.

CRL Wash Brush and Felt Hand Block

- High Quality and Long Lasting Glass Cleaning Tools

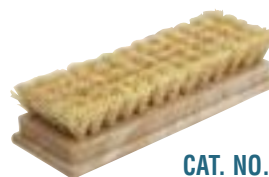

CAT. NO. 175B



CAT. NO. 633

This CRL Wash Brush has a solid handle with 1" (25 mm) bristles, and is used with Pumice to clean glass. Approximate handle size is 8-1/4" x 2-7/8" (210 x 73 mm). Minimum order is one each.

Use this CRL Felt Hand Block with CRL Cerium Oxide to clean glass. See page N352 for Cerium Oxide. Approximate block size is 6" x 3" x 2" (152 x 76 x 51 mm). Minimum order is one each.

CRL Bio-Clean Water Stain Remover



- Effectively Removes Water and Mineral Stains, Rust, Tree Sap, Paint Overspray, Soap Scum, and Mildew From Glass and Other Surfaces
- Works Great On: Shower Doors, Windows, Glass Surfaces, Tile, Fiberglass, Windshields, Chrome, Porcelain, Corian®, Anodized Brass and Aluminum, Stainless Steel, and Hard Vinyl

CRL Bio-Clean is a professional strength cleaner recommended by both glazing contractors and professional window cleaning companies. It is successfully used in hospitals, nursing homes, manufacturing plants, hotels, supermarkets, and other public facilities with difficult to clean surfaces. **NOTE:** Do not use on surfaces that can be harmed by the use of a mild abrasive.

Apply CRL Bio-Clean directly onto surface or on a cloth, sponge, brush or electric buffer. Press firmly to loosen stain with a rubbing action, and then just rinse with water until residue free. Dry with cloth or paper towel. It can be reapplied as needed until surface is sparkling clean. On severely stained shower doors use a non-scratch pad. On tile and porcelain use a Cat. No. SB7447F Scotch Brite Pad (see page N368).



• Removes Stage One Corrosion Quickly

Stage One Corrosion is defined as glass with light corrosion, and little or no damage to the glass. Stage Two Corrosion occurs when the deposits are no longer on the surface of the glass, but have started to break down the molecular structure of the glass, leaving an etched or white haze on the glass after the stain has been removed. CRL Bio-Clean Water Stain Remover will not repair glass with Stage Two Corrosion.



CAT. NO. WSR1
16 Fl. Oz. (473 ml)

CRL Bio-Clean Water Stain Remover Pouches

new

• Five Sample Pouches Per Pack

CRL Bio-Clean Water Stain Remover Pouches keep your customers coming back. Leave one or two pouches with your customer after each beautiful frameless shower door installation. Once they see how well CRL Bio-Clean removes soap scum and water stains, they will be ordering 16 fluid ounce (473 ml) bottles from you. Works well in combination with CRL TPC16 Surface Protector (see page N341).



CAT. NO. WSR1P

CAT. NO.	CONTENTS	QTY/CASE
WSR1	16 Fl. Oz. (473 ml)	12
WSR1P	5 Pouches	1

Minimum order: 1 each of WSR1 and 1 pack of WSR1P.

CRL A-Maz Water Stain Remover

- Removes the Toughest Stains
- Contains No Acids, Bleach, or Chlorides
- Includes Nylon Scrub Pad

CRL A-Maz Water Stain Remover removes the toughest stains on glass, chrome, porcelain, fiberglass, metal, tile - water stains, mineral deposits, and sealant stains. It can also be used on all types of bathroom surfaces to remove lime scale, oxidation, and soap scum. A nylon pad is provided with product. Pad measures approximately 6" x 3-1/2" x 1" (152 x 89 x 25 mm) Net Weight: 14 oz. (396 grams). Minimum order is one each. **NOTE:** Do not use on surfaces that can be harmed by the use of a mild abrasive.

new



CAT. NO. 3379520
14 Fl. Oz. (396 g)

CRL Water Spot Remover

- Solves the Problem of Water Spotting From Sprinklers, Hard Water Sources, and Exposure to Acid Rain
- Removes Alkaline Residue, Chemical and Mineral Deposits From Uncoated Clear and Float Glass Surfaces (Typical Stage One Corrosion)

CRL Water Spot Remover is specifically formulated for use by professional window cleaning contractors and glazing professionals. It is designed to remove any residue left on glass which may alter the optical clarity, and cannot be cleaned using standard methods. CRL Water Spot Remover will make clear again glass that has turned hazy due to caustic and corrosive air pollution, acid rain, auto exhaust, hard water deposits, corrosive cleaning materials, dust and dirt residues. It works by dissolving mineral deposits from the surface of the glass, and prevents their redeposit later. Because CRL Water Spot Remover is an acid-based product, it has the ability to dissolve deposits found in the rough pits and ridges of the glass surface, leaving it looking almost like new.

Stage One Corrosion is defined as glass with light corrosion, and little or no damage to the glass. Stage Two Corrosion occurs when the deposits are no longer on the surface of the glass, but have started to break down the molecular structure of the glass, leaving an etched or white haze on the glass after the stain has been removed. CRL Water Spot Remover will not repair glass with Stage Two Corrosion.



This product is for use only by glazing professionals. It is not intended or recommended for consumer use, for use on automotive glass, or for use on the coated sides of chemically-treated glass. Protective gloves and glasses are recommended when using CRL Water Spot Remover.

CAT. NO.	CONTENTS	QTY/CASE
C2020	1 Gallon (3.785 l)	4
C2030	1 Quart (946 ml)	12

Minimum order: 1 each.

CRL "Sparkle" Cleaner and Stain Remover

- Cleans Light Water Stains From Glass
- Removes Soap Scum From Shower Doors
- A Longtime Favorite

CRL "Sparkle" Cleaner does those glass cleaning jobs too tough for spray-on cleaners. It removes light water spots and stains in glass caused by weather, sea air, or pollution; also removes soap scum from shower doors and ceramic tile. Wipe on with a damp cloth or paper towel, rub stained areas, then wipe off.



8 Fl. Oz. (236 ml)

CAT. NO.	CONTENTS	QTY/CASE
SP101	8 Fl. Oz. (236 ml)	12

Minimum order: 1 each.

CRL Complete Polishing Head Assembly

- Used for Light Scratch Removal
- Can Be Used With a Cordless Drill

The CRL Polishing Head Assembly consists of a 1-1/2" (38 mm) thick by 3" (76 mm) diameter wool felt wheel, an aluminum adapter plate, and a 1/4" (6 mm) diameter shank. Use it with our Cat. No. PV7001C Polisher, or chuck it into your electric drill. Minimum order is one each.



CAT. NO. 5703



Polisher Not Included

CRL All Wool Felt Wheel

- For Use With the 5701 Adapter

Made from the highest quality Spanish felt, this 3" (76 mm) diameter, 1-1/2" (38 mm) thick buffing wheel can remove scratches, stains, and discoloration from glass and mirrors. Used with the Cat. No. 5701 Aluminum Adapter, this economical wheel can work wonders in the smallest of spaces. Also replaces the felt wheel on the Cat. No. 5703 Polishing Head Assembly. Minimum order is one each.



CAT. NO. WFD03112

CRL Aluminum Adapter

- Used With the WFD03112 Felt Wheel



The CRL Aluminum Adapter is machined to run smoothly while on the CRL9257 Scratch Polisher, or when used with the Cat. No. 5704 Shank Adapter. The Cat. No. WFD03112 All Wool Felt Wheel is adhered to the bottom surface of this Adapter by using Cat. No. 3M8001 Super Weatherstrip Adhesive or Cat. No. LN601 Construction Adhesive. Minimum order is one each.

CAT. NO. 5701

CRL Aluminum Adapter and Felt Wheel

- Can Be Used With Your Hand Drill



The CRL Aluminum Adapter and Felt Wheel consists of one Cat. No. 5701 Aluminum Adapter and one Cat. No. WFD03112 All Wool Felt Wheel cemented together. Keep a spare on hand if you do a lot of scratch removal. Mate with Cat. No. 5704 to use it in your hand drill. Minimum order is one each.

CAT. NO. 5702

CRL Shank Adapter

- 1/4" (6.4 mm) Diameter Shank Fits All Drill Motors



The CRL Shank Adapter is designed for use in any hand drill. The 5/8"-11 threads insert into popular disc pads such as Cat. No. 5702. Minimum order is one each.

CAT. NO. 5704

CRL Cerium Oxide

- Used With the CRL9257 Scratch Polisher



CRL Cerium Oxide is a high grade optical polishing compound used to lessen and polish scratches from auto glass, mirror bevels, and table top edges. CRL Cerium Oxide is mixed with water to form a paste or slurry. This compound has excellent suspension qualities and will not harden. Contains no zinc oxide, and meets most local disposal ordinances.

CAT. NO.	CONTAINER CONTENTS
C0301	1 Pound (454 g)
C0305	5 Pounds (2.27 kg)
C0310	10 Pounds (4.54 kg)

Minimum order: 1 each.

Available in larger bulk packaging. Visit crlaurence.com

CRL 3M™ Super Weatherstrip Adhesive

- Exceptional Bonding Strength
- Waterproof and Flexible



CRL 3M™ Super Weatherstrip Adhesive is used for bonding and sealing weatherstripping to car trunks and doors. It also bonds WFD03112 Felt Wheels to 5701 Adapters with great adhesion. Easy to spread, extremely fast drying. Resists oil, grease, and solvents. Also a good general purpose cement. Contents: 5 Fl. Oz. (147 ml).

CAT. NO. 3M8001



CRL GLASS SURFACE RESTORATION

For Pricing Visit Our Web Site or Call Us Toll Free at the Phone Numbers Shown on the Back Cover

CRL Heavy-Duty Scratch Polisher

- Polishes All Types of Glass, From Windshields to Watch Crystals
- Use it Hand Held or Bench Mounted for Added Stability



CAT. NO. YP85

Use the CRL Heavy-Duty Scratch Polisher as either a bench mounted or hand held polisher with excellent results. It is fitted with a high quality wool felt wheel that will polish virtually all types of glass, from windshields, sheet glass, edges, and bevels to watch crystals. It is powered by a heavy-duty, double-insulated 110V AC motor. Sure grip handles on each end of the tool assembly provide control.

POLISHERS

CAT. NO.	DESCRIPTION
YP85	110V Scratch Polisher
1520	230V Scratch Polisher

Minimum order: 1 each.

FELT WHEELS

CAT. NO.	YEARS	SIZE	ARBOR
YPF6X2N	1990 to Present	6" x 2" (152 x 51 mm)	2" (51 mm)
YPF6	Before 1990	6" x 1-1/2" (152 x 38 mm)	2-3/4" (70 mm)

Minimum order: 1 each.



CAT. NO. YPF6X2N
for Current Model Polishers



CAT. NO. YPF6
for Older Polishers

CRL Scratch Polishing Kit

- Lightweight, So You Can Work on Windshields Right in the Car
- Remove Light Surface Scratches
- Polish Out Rubs, Fine Lines, Stains, and Discoloration on Mirrors or Glass of Any Kind
- Well Balanced for Smooth Action

The CRL Scratch Polishing Kit is designed to meet the demand for a low-priced, lightweight, portable tool capable of removing light surface scratches. It also can be used to polish out rubs, fine lines, stains, and discolorations on mirrors or glass of any kind. This tool can also be used as a sander by using a backup pad and sanding discs. Operates on 110V AC.

The CRL Scratch Polisher will remove light scratches and water deposits from glass. Generally, if you run your fingernail over the scratch and it catches, the scratch is too deep to be removed with this polisher. However, light scratches, windshield wiper rubs, and some water deposits can be removed by following these instructions. Minimum order is one each.



CAT. NO. CRL9257
Complete Kit

INCLUDED IN THE CRL9257 KIT:

- Cat. No. PV7001C Makita® 7" (178 mm) Vertical Polisher with Variable Speed (600 – 2,000 RPM)
- Rubber Back-Up Pad
- Spanner Wrench
- Side Handle
- Cat. No. 5702 Polishing Head 3" x 1-1/2" (76 x 38 mm) All Wool Felt Pad
- Cat. No. C0301 Cerium Oxide (One Pound / 454g)

Somaca/CRL Glass Polisher and Scratch Remover

- Excellent for Manual Bevel Finishing
- Large Felt Wheel is Suitable for Auto Glass Work
- Available for Purchase or Lease

Somaca/CRL's Model No. 37 Glass Polisher is widely used in the glass industry for manual polishing and for the removal of scratches. A polishing compound such as cerium oxide, used on the felt wheel, will also produce a brilliant finish on edges, especially bevels, and will remove hairline scratches while maintaining the surface polish of the glass.

The machine is furnished with a solid quality felt wheel, 24" O.D. x 18" I.D. x 3" wide (610 x 457 x 76 mm), mounted on a wooden ring, which is V-belt driven by a 3/4 HP, single phase, 60 cycle, 110V AC motor. A motor starting switch, truing bar, and wooden support shelf are also provided. A 230 Volt model is also available.



SPECIFICATIONS

Width: 20" (508 mm)
Depth: 30" (762 mm)
Height: 47" (1219 mm)
Shipping Weight: Approx. 425 Lbs. (193 kg)

REPLACEMENT FELT WHEEL

CAT. NO. 2605244
Diameter: 24" (610 mm) O.D.
Width: 3" (76 mm)

CAT. NO.	DESCRIPTION
SM37	110 Volt 60 Hz Polisher
SM37X230	230 Volt 50 Hz Polisher

Minimum order: 1 each.

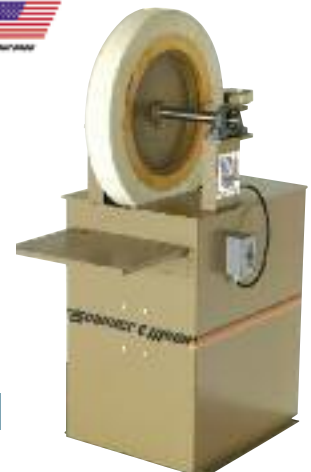

CRL Glass Scratch Removal System

new

- Portable, Stand Alone System Works on All Types of Glass, Including Windshields, Side and Rear Glass
- One-Step Process Produces Distortion-Free Results
- Non-Abrasive Compound
- Integrated Water Feed System

The CRL Glass Scratch Removal System removes scratches from all types of glass including tempered, annealed, laminated, Low-e, mirrors, curved windshields, back and side windows. You can use this portable system to remove scratches, water scale, acid etching, paint over-spray, and other imperfections quickly and effectively.

This unique system combines thermal energy (heat), chemical reaction (polishing compound), and mechanical energy (force) to effectively eliminate scratches from glass without the use of fixed abrasives.

The CRL Glass Scratch Removal System can be integrated into your everyday operations. Whether you are a door and window manufacturer, a distributor, or an automotive glass shop, the CRL Glass Scratch Removal System can save you money, directly impacting your bottom line. These potential savings come from reduced down time for glass replacement thus keeping projects on schedule, and by reducing glass waste and scrap ratios.

Compare the CRL Glass Scratch Removal System to some of the other scratch removal systems you may have seen or tried in the past. This system is lightweight and compact: no buckets of coolant and compound to lug around. This system employs a one-step process: multiple abrasive and polishing pad changes are no longer required. This system delivers what others only promise: distortion-free surface restoration.

The CRL Glass Scratch Removal System features a unique pressurized water feed attachment with a push button activated nozzle mounted directly onto the polisher. This attachment can be secured directly to the work surface with built-in suction cups, or worn conveniently on your belt using the integral belt clip.

The 2", 3" and 4" (51, 76, and 102 mm) Polishing Pads attach to the appropriate Backer Pads using an aggressive Velcro fastener system, while the 6" (152 mm) Pads attach using a Pressure Sensitive Adhesive system.

The complete SRS1 Glass Scratch Removal Kit includes: 110V AC 4500 RPM Polisher, .55 lbs (.250 kg) of Polishing Compound, one 2" (51 mm) Backer Pad, one package of 2" (51 mm) Polishing Disks, one 3" (76 mm) Backer Pad, one package of 3" (76 mm) Polishing Disks, one Pressurized Water Feed Attachment, one Inspection Light / IR Thermometer, Safety Glasses, two Respirator Masks, one Mixing Container, one Spatula, one Wrench, one Manual Spray Bottle, Ear Plugs, one Cleaning Brush, one detailed Training and Use Manual, and one foam padded lockable Carrying Case.



COMPLETE KIT AND INDIVIDUAL COMPONENTS

CAT. NO.	DESCRIPTION
SRS1	Complete Scratch Removal Kit, 110 Volt AC
EUSRS1	Complete Scratch Removal Kit, 220 Volt AC, 50Hz
SRS1PC	Polishing Compound, 0.55 lbs (.250 kg), 2/pk
SRSVPD2	2" (51 mm) Velcro Back Polishing Disks, 3/pkg
SRSVPD3	3" (76 mm) Velcro Back Polishing Disks, 3/pkg
SRSVPD4	4" (102 mm) Velcro Back Polishing Disks, 3/pkg
SRSPSA6	6" (152 mm) PSA Back Polishing Disks, 3/pkg
SRSVPB2	2" (51 mm) Velcro Backer Pad
SRSVPB3	3" (76 mm) Velcro Backer Pad
SRSVPB4	4" (102 mm) Velcro Backer Pad
SRSPSB6	6" (152 mm) PSA Backer Pad

Minimum order: 1 each or 1 pack.



CRL Scratch-A-Way® Scratch Removal System

- Clean Working System for Light Scratches or Scuff Marks
- Flexible Rubber Shroud Keeps Slurry Contained – No Overspray!

Auto Glass Applications

- Wholesalers – Remove Light Scratches Quickly
- Technicians – Provides Clean Removal of Light Scratches, Wiper Blade Marks, Stains, and Acid Spots, Etc.

Flat Glass Applications

- Remove Light Scratches Quickly
- Polish Fabricated Bevelled Mirror Corners and Areas Needing Blending
- Insulating Glass – Fix In-Shop or On-Site Scratches

Two Types of Scratches...



LIGHT SURFACE or SCUFF MARK SCRATCH – Over 95% of all scratches are light scratches or scuff marks. This magnified image above shows a light scratch. This scratch can be removed.



HEAVY/DEEP SCRATCH – Above is a magnified image of a heavy/deep scratch. It cannot be removed with this system.

For Light Scratch and Scuff Mark Removal



After cleaning the glass thoroughly, inspect the area with the Diagnostic Inspection Tool. Mark the scratch area from the underside with the red marking pen. Attach the polishing disc to the polishing head. Then apply water to the surface of the scratch. Work the polishing head, **very slowly**, with consistent pressure, back and forth in the direction of the scratch. Work the area for 30 seconds, and then stop. Wipe the slurry away from the scratch with the edge of the red shroud so you can inspect the progress of your work. Repeat until scratch is removed.

CRL Scratch-A-Way® Electric Powered Tool Kit



110V or 220V/150 Watts
RPM: 5000 to 9500

KIT CONTAINS: Electrical Tool, Diagnostic Inspection Tool, Five Polishing Discs, Marking Pen, Red Chamois, Instructional CD with Manual, and Plastic Case.

CAT. NO.	DESCRIPTION
S965020	110 Volt Scratch-A-Way® Kit
1523	220 Volt Scratch-A-Way® Kit

Minimum order: 1 each.

CRL Scratch-A-Way® Air Powered Tool Kit



KIT CONTAINS: Air Powered Tool, Diagnostic Inspection Tool, Ten Polishing Discs, Oil, Marking Pen, Red Chamois, Instructional CD with Manual, and Plastic Case. Minimum order is one each.

Air Requirement:
8cfm 90 PSI

CAT. NO. 1523A

CRL Scratch-A-Way® Accessories

Diagnostic Inspection Tool

- Inspect Depth and Width of Scratches
- Inspect Bevels and Edgework in Post Fabrication Process

The Diagnostic Inspection Tool magnifies the surface image 30 times. The left section of the tool is illuminated so that the scratch can be viewed clearly. The rotary wheel adjusts the focus of the scratch area.



CAT. NO. S93085

Cerium Oxide Discs

Cerium Oxide Polishing Discs are 2" (50 mm) in diameter, and have an estimated work life of approximately twenty scratches that are 2" (50 mm) long.



CAT. NO. S93054

CAT. NO.	DESCRIPTION
S93085	Diagnostic Inspection Tool
S93054	Cerium Oxide Polishing Disc
S93075	Back-Up Plate With Velcro®

Minimum order: 1 each.



CAT. NO. S93075

CRL 3M™ Trizact™ Scratch Removal Starter Kits

- The Best Way to Start Using Trizact™ Discs
- Uses Your Hand Held Electric Drill
- Includes Four 3" (76 mm) Disc Pads for Quick Change-Out of Discs

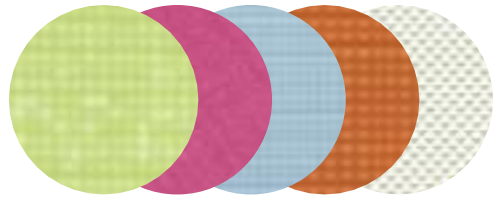

CRL 3M™ Trizact™ Scratch Removal Starter Kits are the most efficient way to start using CRL 3M™ Trizact™ products. Using your own hand-held cordless or 110V AC Electric Drill with a Ground Fault Circuit Interrupter (Cat. No. GF1), you can remove scratches ranging from very fine to very deep.

This amazing new material uses natural abrasives formed in the shape of small pyramids, and provides uniform layers of abrasive throughout the pyramid. As the abrasive particles are used, they get flushed away exposing new abrasive. So easy to use, almost anyone can start to remove scratches with this kit in a short time.

NOTE: The Flat Glass Kit comes with 3" (76 mm) Medium Disc Pads while the Curved Glass Kit is supplied with 3" (76 mm) Soft Disc Pads to accommodate the curvature of the glass. Replacement Disc Pads are available, Cat. No. ZDP3P58M for Medium; and Cat. No. ZDP3P58S for Soft.

Trizact™ Starter Kits Include:

- 20 Assorted 3" (76 mm) 3M™ Trizact™ Abrasive Discs
- Four 3" (76 mm) 3M™ Disc Pads
- 1 Pound (454 g) of Cerium Oxide
- Spray Bottle for Water
- 1/4" (6 mm) Shank Drill Adapter
- Plastic Apron
- Full Instructions



Drill shown is not included

CAT. NO.	DESCRIPTION
ZSRPSSKM	3M™ Trizact™ Starter Kit for Flat Glass
ZSRPSSKS	3M™ Trizact™ Starter Kit for Curved Glass

Minimum order: 1 each.

CRL 3M™ Trizact™ Professional Scratch Removal System

- Developed for Professionals
- Powerful Center Water Feed Polisher Works on Light to Heavy Scratches

The CRL 3M™ Trizact™ Professional Scratch Removal System is a breakthrough in scratch removal and glass or polycarbonate polishing. Now this once complicated and messy process is simple and clean without any slurries or compounds to mix. Our all-new, more powerful polisher has more power and torque than ever! With its on-demand water delivery system, constant water flow adjustments are a thing of the past. This system uses plain water, which is delivered through the center of the pad so very little is required.

The natural abrasives used in these discs are formed in the shape of small pyramids. The pyramids are then layered so as the disc wears, a new abrasive surface is exposed. Four grades of abrasive discs are included to remove the deepest of scratches. A cerium oxide pad is used to polish the glass during the final step. The results this system offers are nothing short of amazing.

PLEASE NOTE: Scratch polishing is an abrasive process which when certain factors are present, can affect your final polished product, such as one or more of the following examples: **Scratch Depth** - the deeper the scratch, the more difficult it will be to produce a clean and distortion-free surface; **Glass Temperature, Technique** - following instructions and keeping work surface clean between steps is crucial; **Glass Type** - float, tempered, textured, coated reflective, mirrored or tinted.



CAT. NO.	DESCRIPTION
ZSRPSM	3M™ Trizact™ Professional System for Flat Glass

Minimum order: 1 each.

The Trizact™ Professional Kit Includes:

- 10 Each of the five different grades of 5" (127 mm) 3M™ Trizact™ Abrasive Discs
- Five Each 5" (127 mm) 3M™ Medium Disc Pads
- 115V AC Center Water Feed Polisher With Built-In GFI
- Pressurized Water Delivery System
- 1 Pound (454 g) of Cerium Oxide
- Full Instructions and 3M Application Guide

For additional information, visit the CRL web site, crlaurence.com, or contact CRL Technical Sales.

CRL GLASS SURFACE RESTORATION

For Pricing Visit Our Web Site or Call Us Toll Free at the Phone Numbers Shown on the Back Cover

CRL 3M™ Trizact™ Discs

- 3M™ Trizact™ - A Cleaner, Long-Lasting Abrasive System for Glass Scratch Repair

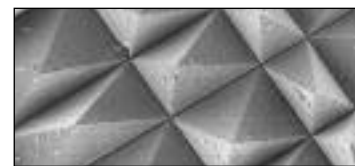

The precisely structured surface of Trizact™ film is clearly visible under 50X magnification

CAT. NO.	GRADE	DIAMETER
TD335P	A35	3" (76 mm)
TD320P	A20	3" (76 mm)
TD310P	A10	3" (76 mm)
TD35P	A5	3" (76 mm)
TD3CP	Cerium	3" (76 mm)
TD535P	A35	5" (127 mm)
TD520P	A20	5" (127 mm)
TD510P	A10	5" (127 mm)
TD55P	A5	5" (127 mm)
TD5CP	Cerium	5" (127 mm)

Minimum order: 1 each. All Trizact™ Discs can be combined for quantity pricing.

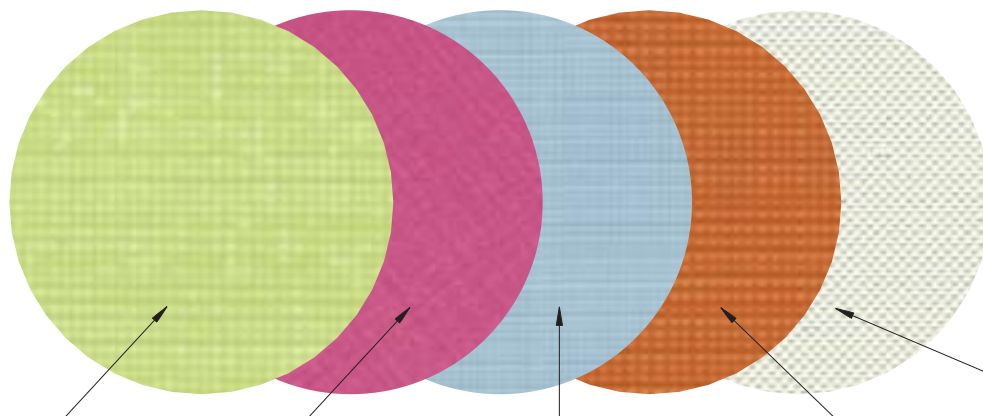

TD335P and TD535P

Removes Larger Scratches and Defects

Use the A35 Discs as the first step in removing larger scratches and defects. A small amount of water triggers the cutting action. Controlled water flow helps reduce heat and keeps the glass cooler.

TD320P and TD520P

Removes Moderate Scratches and Defects

Use the A20 Discs when the scratches are significant, but not as deep as those requiring the A35 Discs. Very aggressive like the A35, the A20 requires adequate water flow to reduce heat and keep the glass cooler.

TD310P and TD510P

Refines Scratches, Removes Scuffs and Acid Marks

Use the A10 Discs to refine the scratches left by the A35's, or start with A10 Discs to remove shallow scratches, scuffs, and acid marks. Apply a small amount of water to start the grinding action. Control the water flow to avoid generating too much heat.

TD35P and TD55P

Refines Scratches, Removes Defective AR Coatings

Use the A5 Discs to further refine any scratches left by the A10's. As in previous steps, apply a small amount of water to start cutting action. Avoid extended dwell time to minimize heat build-up.

TD3CP and TD5CP

Polishes and Leaves Glass Crystal Clear

Use this Cerium Oxide Disc for a final polish. To begin, wet the surface slightly with a small amount of water. As you polish, the pyramids will break down to form a slurry-like solution. The polishing action that occurs will remove scratches left by previous leveling steps.

Also available in other sizes. Visit our web site at crlaurence.com.

CRL 3M™ Trizact™ Disc Pads

- Medium for Flat Glass, Soft for Curved Glass



3" (76 mm) Disc Pad

5" (127 mm) Disc Pad

To get the most use out of your Trizact™ Discs, and to achieve the best results, use a separate Disc Pad for each grade of disc. Cat. No. 02599 Pad requires Cat. No. 02814 Adapter.

CAT. NO.	DESCRIPTION
02599	5" Medium Density Disc Pad
02814	Adapter for 02599 Pad
ZDP3P58M	3" Medium Density Disc Pad
ZDP3P58S	3" Soft Disc Pad

Minimum order: 1 each.

CRL Drill Adapter

- Adapts Trizact™ Disc Pads to Your Drill



This high-quality CRL Drill Adapter, made from heavy-duty stainless steel, allows any of our 3M™ Trizact™ Disc Pads to be used with any power drill with a standard 3/8" (9.5 mm) or larger chuck. Minimum order is one each.

CAT. NO. DPAS58

CRL Ground Fault Circuit Interrupter

- A Must for Anyone Using Wet-Working Tools



With the CRL GF1 Ground Fault Circuit Interrupter, you are always protected against possible shock or electrocution. Minimum order is one each.

CAT. NO. GF1

CRL Cerium Oxide

- Used for High-Grade Polishing



This high-grade optical polishing compound is used as the final step with 3M™ Trizact™ Cerium Polishing Discs to produce a "water clear" finish. It contains no zinc oxide, and meets most local disposal ordinances. Contents: 1 pound (454 g). Minimum order is one each.

CAT. NO. C0301

CRL Hi-GLOSS Stone Countertop Cleaner

- Cleans, Polishes, and Protects
- Invisible When Buffed
- Safe for All Stone Surfaces
- Fresh Citrus Scent
- Large 17 Ounce (481 g) Can



new



CRL Hi-GLOSS Stone Countertop Cleaner is safe for all sealed and unsealed stone surfaces. It is deep cleaning and contains no wax. It protects your stone surfaces from water stains and household spills. The new SprayAnyWay™ valve allows easy application, even with can upside down. Hi-GLOSS is three products in one. It's a stone surface cleaner, polish, and protectant. It works just as well on engineered stone countertops. There is no buildup with Hi-GLOSS so you can use it without fear of creating a heavy film. After an installation, leave a can with your customer and they will become a customer for life. Makes a great showroom merchandiser too. Available in cases of twelve 17 ounce (481 g) cans.



CAT. NO.	NET WEIGHT	QTY/CASE
3371149	17 Oz. (481 g)	12

Minimum order: 1 each.

CRL Sprayway Crazy Clean® All Purpose Cleaner



- Great on Smooth Finishes
- Contains No Ozone Depleting Chemicals
- Cleans and Deodorizes

CRL Sprayway Crazy Clean All Purpose Cleaner is great for all washable, painted surfaces, window sills, venetian blinds, and all porcelain and tile surfaces. Excellent for removing dirty hand prints from walls and doors, scuff marks on floors, crayon and grease spots, soot and smoke film. Also suitable for bathtubs, washbowls, toilet bowls, kitchen sinks, cabinets, stoves, and refrigerators. Twelve 19 ounce (539 g) Cans per case. Minimum order is one case.



CAT. NO. SW31

CRL Anti-Fog Spray and Cleaner

- Eliminates Fog From Any Glass Surface Including Mirrors
- Convenient and Easy-to-Use Spray Bottle



This CRL Anti-Fog Spray is the perfect solution and cleaner to keep bathroom mirrors, auto glass, safety goggles, or sun glasses fog-free. The spray is effective until the glass or mirror surface needs to be cleaned again, at which time the Anti-Fog and Cleaner solution is reapplied. The easy-to-use spray bottle contains 4 fluid ounces (118 ml). Minimum order is one each.



CAT. NO. ZSP2

CRL Can Handler



- Snaps on Any Standard Spray Can
- Eliminates Finger Fatigue

The CRL Can Handler snaps on any standard spray can to give professional spray gun convenience. Controls direction of spray, and keeps your hands clean and away from spray. Eliminates finger fatigue for a steady and controlled application. Safety trigger lock prevents accidental dispensing. Made in U.S.A. Minimum order is one each.

CAT. NO. CH49

CRL Aerosol Plastic Cleaner

- Anti-Static, Anti-Fog, Non-Streaking Formula
- Fast Drying and Economical to Use



CRL Aerosol Plastic Cleaner is an anti-static, anti-fog, non-streaking formula that is fast drying and economical to use. Apply it to a variety of plastic materials: acrylic, Plexiglas, polycarbonates, and safety glazing panels. CRL848 wipes away without streaking, and leaves a sparkling clean surface. This large 19 ounce aerosol will clean a lot of plastic.



CAT. NO.	NET WEIGHT	QTY/CASE
CRL848	19 Oz. (539 g)	12

Minimum order: 1 each.

CRL Plastic Cleaner and Polish

- Contains No Abrasives
- Non-Static/Non-Glare
- Great for Removing Tiny Scratches



Developed especially for the glass industry, CRL Plastic Cleaner and Polish cleans and polishes virtually everything made of plastic. It's great for removing tiny scratches from acrylic windows in boats, campers, RV's, airplanes, or any other vehicle. It can polish the plastic on boat surfaces, seat covers, shower doors, Formica tops, etc. Handy and attractive squeeze bottles make it easy to carry, easy to apply, and a fast mover in over-the-counter sales.



- Two Easy to Use Formulas With Excellent Cleaning Results
- Can Be Used on Virtually All Plastics

CAT. NO.	CONTENTS	QTY/CASE
CRL10	8 Fl. Oz. (236 ml)	12

Minimum order: 1 each.

CRL Novus Plastic Polishes

- No. 2 for Fine Scratches
- No. 3 for Heavy Scratches



CRL offers two Novus Plastic Polishes in convenient eight fluid ounce bottles. CRL Novus No. 2 removes fine scratches, haziness, and abrasion from most plastic surfaces. It is not just a surface cover up, but will restore and protect. CRL Novus No. 3 removes heavy scratches and abrasions from most acrylic surfaces. Both polishes contain a light abrasive and are not for use on eyeglasses, polycarbonates, or coated plastics. Novus No. 2 should be used as a follow-up to Novus No. 3 for best results.



CAT. NO. PN7030



CAT. NO. PN7080

CAT. NO.	DESCRIPTION	CONTENTS
PN7030	Novus Polish No. 2 (Fine)	8 Fl. Oz. (237 ml)
PN7080	Novus Polish No. 3 (Heavy)	8 Fl. Oz. (237 ml)

Minimum order: 1 each.

CRL Scratch-B-Gone Professional Brushed Stainless Steel Restoration Kits

new



- Removes Scuffs, Fine Scratches, Light and Deep Scratches
- Removes Chemical Discoloration Caused by Cleaning Products, Bleach, and Acids
- Removes Oxidation and Black, Blue, Gold Colors From Heat Scorching / Welding
- Easy, Fast, and Simple to Use



CAT. NO. SBG1



CAT. NO. US8

CRL's new Scratch-B-Gone provides a complete solution to common problems associated with brushed stainless steel surfaces, including scratches and gouges, rust, heat scorching, and chemical stains. If you are working with architectural surfaces such as these, you now have a time and money saving alternative to replacing damaged metal components.

Choose our Cat. No. SBG1 Basic Professional Kit or the larger Cat. No. SBG2 Master Professional Kit to get started. Kits contain coarse burgundy pads for deep scratches, brown pads for reconditioning, and gray pads for removing light scratches, rust, and chemical stains. The Ultra Shine™ Cutting Lubricant and Surface Oxidant used with the pads lifts particulates created during the re-graining process. Its proprietary formula speeds the return of the "warm look" by chemically oxidizing the "new" restored surface to quickly blend and match surrounding areas.

To ensure successful results, each Kit includes both written instructions and a demonstration DVD that will take you through the easy restoration process. The complete list of components for the Basic Professional Kit and the Master Professional Kit can be found online at crlaurence.com.

For new stainless steel installations and for surfaces restored with the CRL Scratch-B-Gone Kits, we recommend Cat. No. ARM32 CRL EZ Armor Acrylic Surface Protector. It offers protection for aluminum, stainless steel, brass, and copper against harsh chemicals and acids, rust stains, salt spray, pitting, weathering, and corrosion.



CAT. NO. SBG2



CAT. NO. ARM32

CAT. NO.	DESCRIPTION
SBG1	CRL Scratch-B-Gone Basic Professional Kit
SBG2	CRL Scratch-B-Gone Master Professional Kit
US2	CRL Ultra Shine™ 2 oz. (59 ml) Bottle
US8	CRL Ultra Shine™ 8 oz. (237 ml) Bottle
ARM32	CRL EZ Armor Acrylic Surface Protector

Minimum order: 1 each. Other consumables available. Contact us for pricing.



Door Hardware Repair



Aggressive Nick Repair



Blending Overall Finish

CRL Alumin-Nu Metal Cleaner

- For Use On Aluminum, Brass, Copper, Nickel, Chromium, Stainless Steel, and All Bright Metals
- Ideal for Removing Heavy Oxidation
- Leaves No Residue

This concentrated liquid restores metal to its original finish. It is a proven metal cleaner and polish for aluminum, copper, brass, bronze, nickel, chromium, and stainless steel. CRL Alumin-Nu not only cleans flat or extruded sections of metal, it is also used to clean metal plaques and relief work because it does not leave any residue in crevices. It dissolves accumulations of abrasives and grime that have been deposited by ordinary metal polishes. After the surface has been cleaned, a protective film remains which retards discoloration. Alumin-Nu applies easily with a soft cloth, and a little goes a long way.



CAT. NO. 95060QT



CAT. NO. 95060GL

CAT. NO.	CONTENTS	QTY/CASE
95060QT	32 Fl. Oz. (946 ml)	12
95060GL	128 Fl. Oz. (3.785 l)	4

Minimum order: 1 each.

CRL Autosol Shine Metal Cleaner



- Cleans and Conditions in a Single Treatment
- Produces a Brilliant Gloss

CRL Autosol Shine Metal Cleaner is ideal for chrome, aluminum, stainless steel, brass, copper, gold, pewter, platinum, silver, tin, fiberglass, ceramic, and certain painted surfaces. Mild abrasives help to remove built-up tarnish, oxidation, and even rust, leaving behind a protective coating providing a longer lasting shine. 2.5 fl. oz. (75 ml). Quantity per case is 24. Minimum order is one each. **NOTE:** Not suitable for anodized aluminum and fine silver.

CAT. NO. 1188AS

CRL Metal Polish and Tarnish Remover



- Non-Abrasive
- Fast Acting and Easy-To-Use

CRL Metal Polish and Tarnish Remover was originally developed to remove tarnish from bathtub enclosures and shower door frames, but it can also be used to restore bright, shiny finishes on brass, bronze, silver aluminum, stainless steel, and chrome surfaces.

After restoration CRL14 leaves a residual coating to protect against future tarnish without chlorinated solvents or petroleum distillates.



CAT. NO.	NET WEIGHT	QTY/CASE
CRL14	14 Oz. (396 g)	12

Minimum order: 1 each.

CRL Stainless Steel Polish and Cleaner

- Cleans, Polishes, and Protects
- Resists Fingerprints, Grease, and Water Spatter
- Preserves the Factory Finish of Stainless Steel



CRL Stainless Steel Polish and Cleaner cleans, polishes, and protects stainless steel without hard rubbing and polishing. Resists fingerprints, grease, and water spatter. Helps preserve the factory finish. Stainless Steel Polish and Cleaner can be used on all types of stainless steel window frames, trims, doors, corridor guards, kick plates, dishwashers, refrigerators, freezers, sterilizers, etc. Also excellent for Formica, porcelain, ceramic tile, and chrome.



CAT. NO.	NET WEIGHT	QTY/CASE
CRL841	15 Oz. (425 g)	12

Minimum order: 1 each.

CRL Loctite® Extend® Rust Treatment

- Quality Rust Protection After Only One Coat
- Can Be Painted Over
- Requires No Primer



CRL Loctite® Extend® Rust Treatment can be used on any surface that is susceptible to rust. This professional treatment gives quality protection against rust for three to five years, after only one coat. Simply clean the surface with a wire brush and apply the treatment with a brush or roller, even to damp surfaces. Extend® can be painted over in 48 hours, in most cases without a primer. Unpainted Extend® has a gray/black matte finish when dry.



CAT. NO.	NET WEIGHT	QTY/CASE
75430	32 Fl. Oz. (946 ml)	10

Minimum order: 1 quart.

CRL Molsenbocker's Lift Off® Removers

- Stain Removal Made Easy With Specialized Formulas for the Toughest Stains
- Excellent Results on the Job, in the Shop, or in the Home

Lift Off® 2 for Grease, Oils, and Adhesive

CRL Lift Off® 2 is a petroleum-based, commercially proven formula that effectively removes such items as adhesives, grease, tar, motor oil, gum, sap, and oil-based foods. The 22 fluid ounce (650 ml) pistol-grip bottles are attractive for over-the-counter sales. Minimum order is one each.



CAT. NO. LF2

Lift Off® 3 for Pen, Ink, and Marker

CRL Lift Off® 3 is a biodegradable and water-based product designed to remove most inks including: permanent markers, indelible inks, ball point pens, hi-liters, stamp pads, and fountain inks. The 22 fluid ounce (650 ml) pistol-grip bottles are attractive for over-the-counter sales. Minimum order is one each.



CAT. NO. LF3

Lift Off® 4 for Spray Paint Graffiti

CRL Lift Off® 4 is the first biodegradable, water-based spray paint graffiti remover. It actually breaks the molecular bond between the paint and hard, soft, or porous surfaces without damaging them. The 22 fluid ounce (650 ml) pistol-grip bottles are attractive for over-the-counter sales. Minimum order is one each.



CAT. NO. LF4



CRL Sprayway® Clean Jet 100

- Non-Flammable Dust Remover
- Strong Air Blasts for Non-Moisture Cleaning of Parts and Equipment

CRL Sprayway® Clean Jet 100 is a compact portable source of ultra-clean gas for precision removal of dirt, dust, lint, and particulates. Use Clean Jet 100 for cleaning and dusting office and computer equipment such as: keyboards, circuits, electronic devices, audio/visual recording equipment, and photographic, X-ray film, clean rooms, and laboratories. There are twelve 10 ounce (284 g) cans per case. Minimum order is one each.



CAT. NO. SW805



CRL Armor All® Cleaner

- Leaves a Clean Finish That is Ready for Armor All® Protectant
- Cleans Rubber, Vinyl, Plastic, Finished Leather, and Sealed Wood

Use CRL Armor All® Cleaner to wipe away grime, dirty fingerprints, smudges on dashboard, door panels, or other vinyl surfaces. Leaves a clean finish that is ready to protect with Armor All® Protectant. There are twelve 20 fluid ounce (590 ml) bottles per case. Minimum order is one each.



CAT. NO. 30200



CRL Industrial Instant Spray Release Agent

- Get a Beautifully Renewed Surface
- Contains No Ozone Depleting Chemicals

CRL Industrial Instant Spray Release Agent is a great final detail product for metal, rubber, and plastic. Works on tires, vinyl interiors, bumpers, bumper guards, body moldings, door jambs, engine compartments, even hard to reach air conditioner ducts.



CAT. NO.	NET WEIGHT	QTY/CASE
SW936	11 Oz. (312 g)	12

Minimum order: 1 each.

CRL Armor All® Protectant

- Gives Long Lasting Protection and Guards Against Ozone, Oxygen, and Ultraviolet Rays

CRL Armor-All® Protectant makes surfaces look like new. Simply apply Armor-All® with a cloth or sponge, or spray directly on the surface, wipe off to leave a shiny, protected finish. It is also anti-static to repel dust and dirt. To prepare the surface before application of Armor-All® Protectant, use Armor-All® Cleaner (see above).



Quart

Gallon

CAT. NO.	CONTENTS	QTY/CASE
10320	1 Quart (946 ml)	6 Quarts
10710	1 Gallon (3.785 l)	4 Gallons

Minimum order: 1 each.

CRL Silicone Remover and Surface Prep

- Ideal for Removing Uncured and Many Cured Silicones
- Prepares Surfaces to be Sealed, Painted or Bonded
- VOC Exempt

CRL Silicone Remover and Surface Prep is the long needed answer to uncured silicone clean up. This spray works simply and easily. Spray on and it instantly dissolves silicone film! Just wipe the surface clean with a wipe, or for tough jobs use the NP48 Open Cell Pads. It's also a degreaser that removes uncured silicone residue, grease and most oils without leaving any residue when prepping for painting, sealing, and bonding applications. As paint prep it reduces fisheye. It is safe on plastic, paint, glass, and is noncorrosive to metals. Contains no VOC and does not deplete the ozone layer. SR200 is low in toxicity and essentially odorless. Dries as fast as isopropyl alcohol.

SR200 also softens and removes many cured silicones. Spray or wipe it on, let soak, then scrape before the material dries; reapply and wipe with a clean cloth. Typical applications include: cleaning plastics and fiberglass; pre-cleaning surfaces prior to painting, sealing, and bonding; removing silicone-based car wax and protectants; and pressure sensitive adhesives (labels). SR200 is odorless, low in toxicity, and evaporates completely at room temperature. Minimum order is one each.



CAT. NO. SR200

CAT. NO. CK13
Silicone Clean Up Kit

KIT INCLUDES: One bottle 16 Fl. Oz. (473 ml) of Cat. No. SR200 Silicone Remover; one box of 150 Cat. No. BX15 Wipes; and one pack of 20 Cat. No. NP48 Open Cell Pads

CRL Solvent Cleaner and Degreaser

- Can Be Used on Electrical Motors
- An Excellent Spot Remover

CRL Solvent Cleaner and De-Greaser removes: grease, tar, adhesive marks, crayon, lipstick, ink, and fresh paint, along with many other types of dirt and grime. CRL60 is also excellent for removing spots from fabrics, rugs and clothing.



CAT. NO.	NET WEIGHT	QTY/CASE
CRL60	20 Oz. (568 g)	12

Minimum order: 1 each.

CRL Quick Release Agent

- Quick Release of Most Adhesives
- Softens Butyl and Other Sealants

CRL Quick Release Agent is a solvent blend designed to loosen or dissolve most adhesives. It softens or undercuts butyl, oil-based, and polyurethane sealants.



CAT. NO.	NET WEIGHT	QTY/CASE
CRL958	14 Oz. (397 g)	12

Minimum order: 1 each.

CRL Dow Corning® Silicone Cleaner and Surface Prep

- Ideal for Removing Uncured Silicones and Many Cured Silicones

CRL Dow Corning® Cleaner and Surface Prep Solvent is based on a unique blend of siloxanes that can dissolve silicone oils, soften and swell silicone residue, and undercut dirt and greases. It is also used as a cleaning solvent for painting, sealing, and bonding operations.

Remove cured silicone by scraping away as much as possible, then apply OS2, let soak for two minutes minimum, and then remove with a clean cloth. OS2 is VOC exempt.



CAT. NO.	NET WEIGHT	QTY/CASE
OS2	10 Oz. (283 g)	12

Minimum order: 1 each.

CRL General Purpose Solvent and Adhesive Cleaner



- Removes Uncured Adhesives
- The Perfect Clean-Up Companion for Urethane Users
- Handles Some of the Toughest Cleaning Jobs

CRL General Purpose Solvent and Adhesive Cleaner handles the toughest cleaning jobs your shop may encounter. Use CRL2032 to soften and remove uncured urethane, adhesive, tar, grease, oil, body sealer, and undercoating. Apply to a rag and rub lightly over soiled areas, then wipe up with a clean, dry cloth.

NOTE: Be sure to observe all safety recommendations while using this extra strong cleaner.



CAT. NO.	CONTENTS	QTY/CASE
CRL2032	32 Fl. Oz. (946 ml)	12

Minimum order: 1 each.

CRL Solvent Degreaser

- Contains No Ozone Depleting Chemicals



- Cleans Glass and Metal Before Application of UV Adhesive
- Removes Grease and Oil
- Use for Preparing Surfaces

CRL Solvent Degreaser can be used to remove oil, dirt, grease, and other contaminants. It dries quickly and leaves no residue. Use this product with UV Adhesives for a secure bond.

NOTE: Protect all rubber, plastic, and painted surfaces from over-spray.



CAT. NO.	NET WEIGHT	QTY/CASE
CRL7528	20 Oz. (567 g)	12

Minimum order: 1 each.

CRL Loctite® ODC-Free Cleaner and Degreaser



- Prepares Surfaces for UV Adhesives
- Cleans Uncured UV Adhesives
- Contains No Ozone Depleting Chemicals
- Non-Aerosol Pump Spray Container

Loctite® ODC-Free Cleaner and Degreaser is a general purpose cleaner/degreaser, ideal for preparing surfaces prior to use of all Loctite® adhesives and sealants. Removes all traces of grease and oils, and leaves no residue. It is nonflammable and low in toxicity. 10 pump spray cans per case. Minimum order is one each.



CAT. NO.	NET WEIGHT	QTY/CASE
20162	16 Oz. (473 ml)	10

Minimum order: 1 each.

CRL Tyvek® Shoe Covers

- Use to Protect Your Customer's Carpets
- Made of Lightweight Tyvek® Material
- One Size Fits All



CRL Tyvek® Shoe Covers are made of lightweight Tyvek® tops, with PVC soles. Tyvek® is a durable tear and puncture resistant material that will not absorb liquids. It is not paper, so it remains strong, wet or dry. Interlocking closed seam construction gives maximum protection from liquid penetration, spills, and splashes. Extra large boot covers are a must for residential glass installers. They are available on special order by contacting CRL Technical Sales, and are sold ten pairs per package. Minimum order is one package.

CAT. NO. 1SC

CRL All Purpose Coverall

- Zips Up and Can Be Washed
- Extremely Lightweight



The CRL All Purpose Coverall is easy to slip on over your clothing. It protects your clothes from grease, dirt, oil, paint, wax, etc, and is made from DuPont™ Tyvek®, a durable, washable, tear and puncture resistant material that won't absorb liquids. It is not a paper, so it remains strong, wet or dry. Extremely lightweight, it weighs only 5 oz. (142 g). This is inexpensive protection for your clothing. Keep one in your trunk, in the shop, in your home. One size fits all. Minimum order is one each.

CAT. NO. CA104

CRL Slip-N-Grip® Seat Covers

- Protects Your Customer's Seats for Pennies Each
- Ideal for Auto Glass Installers
- Inexpensive Compared to Cleaning Cost

CRL Slip-N-Grip® Covers can save you the cost of cleaning soiled or urethane stained interiors. Innovative and economical to use, these disposable CRL Slip-N-Grip® Covers have a unique two-sided design that clings to the seat without slipping, protecting the interior of your customer's vehicle. Large 33" x 56" (838 x 1422 mm) covers fit virtually any seat, and are sold 250 ready-to-use seat covers per dispenser box. Minimum order is one box.



CAT. NO. 600088

CRL Slip-N-Grip® Floor Mats

- Protects Your Customer's Vehicle Interior
- Improves Customer Confidence
- Inexpensive Compared to Cleaning Cost

These CRL Slip-N-Grip® Floor Mats can save you the cost of cleaning soiled or urethane stained interiors. Innovative and economical to use, these disposable CRL Slip-N-Grip® Floor Mats have a unique two-ply design that stays put, without slipping, to protect the interior of your customer's vehicle. The 19" x 21" (482 x 533 mm) size covers virtually any floor area, and are sold 500 ready-to-use Floor Mats per dispenser roll. Minimum order is one roll.



CAT. NO. 6000721

CRL Slip-N-Grip® Steering Wheel Covers

- Protects Steering Wheels From Grease and Stains
- Universal Fit

CRL Slip-N-Grip® Steering Wheel Covers protect steering wheels from grease, dirt, and drips that are inevitable when installing glass. The universal-fit covers easily slip over the steering wheel with elastic which also keeps them in place. Keep your customers happy and show them you care with a professional job well done. There are 250 ready-to-use Steering Wheel Covers per box. Minimum order is one box.



CAT. NO. 600099

CRL Heavy-Duty Razor Blade Scrapers

- Holds Both Metal and Plastic Razor Blades
- Perfect for Scraping or Sticker Removal



CAT. NO. CRL761

Overall length is 11" (279 mm). Comes with one steel and one plastic razor blade in the hollow handle. Blade is secured by a single set screw. Minimum order is one each.



CAT. NO. L52000

Overall length is 11" (279 mm). Comes with one plastic and five steel razor blades in the hollow handle. Spring clamp holds blades securely and makes changing easy. Minimum order is one each.

CRL Razor Blade Holder and Scraper

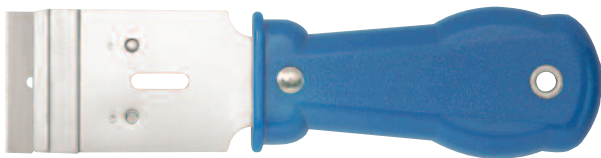

- Safely Holds Single Edge Metal Razor Blades
- Comfortable Handle for a Sure Grip

This CRL Razor Blade Holder and Scraper is a safe and easy way to handle single edge metal razor blades for all your scraping jobs. The blade end is molded into a plastic handle that provides a comfortable and sure grip, with a metal ferrule so you can hang it up. There is also a slip-on safety cover for the blade edge. Holds our 51S and KKB12 Single Edge Razor Blades. Overall length is 6-1/2" (165 mm). Minimum order is one each.

CAT. NO. RS65

Our Scrapers Hold Any of These Blades

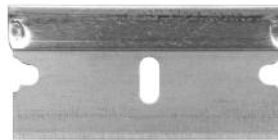

CAT. NO. 51S
.009" Single Edge Metal
Minimum order: 100 each.



CAT. NO. KKB12
.012" Single Edge Metal
Minimum order: 100 each.



CAT. NO. CP866088
Single Edge Plastic
Minimum order: 1 pack of 100 blades.



CAT. NO. CRL3000
Double Edge Plastic
Minimum order: 1 pack of 100 blades.

CRL Safety Razor Blade Holder and Window Scraper

- Safely Holds All Single Edge Metal Razor Blades
- Buy Them Individually or in Bulk Cartons of 100

For a safe and simple way to hold single edge razor blades, try our Safety Razor Blade Holder and Window Scraper. Instantly expose or conceal the blade with a simple thumb lock. This metal tool will withstand lots of use, and has a hole in the end so you can hang it up. Overall length is 4-1/2" (114 mm). Scrapers are available individually, or in bulk boxes of 100 each.



CAT. NO.	DESCRIPTION
3223	Individual Scraper#
115000	Box of 100 Scrapers*

#Minimum order: 1 each. *Minimum order: 100 each.

CRL Plastic Mini Scraper With Razor Blade

- A Safe Way to Hold One Single Edge Razor Blade
- Two-Pack Blister Card Suitable for Resale

Our Mini Scraper holds one single edge razor blade for scraping or decal removal jobs. Two-pack blister card is suitable for resale, or to just throw in your tool box for whenever you need one. Each Scraper comes with one single edge metal razor blade. Minimum order is one pack.



CAT. NO. 20075
Two Per Pack

CRL Single Edge Razor Blades

- Our Most Popular Single Edge Blade
- Precision Honed, Surgical Steel Edges
- Each Blade is Individually Wrapped
- Multiple Uses

This CRL Single Edge Razor Blade is top quality, industrial grade, .009" (.23 mm) thick, Carbon C-1095 surgical steel, precision-honed for extra sharpness. It delivers durability along with the exacting, quality cut that professionals demand. Packed 100 each per box, there are 50 boxes per case. Each blade is individually wrapped to protect the edge until you are ready to use it. Also available in packs of ten, loaded in a handy, spring loaded plastic disposable pack. Minimum order is 100 each of the 51S blades and one each of 112020 dispenser.

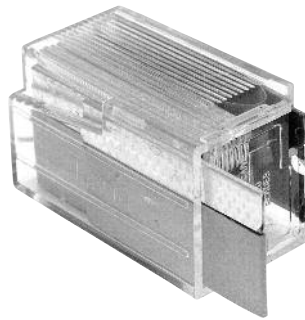

CAT. NO. 112020
Plastic Dispenser 10 Pack

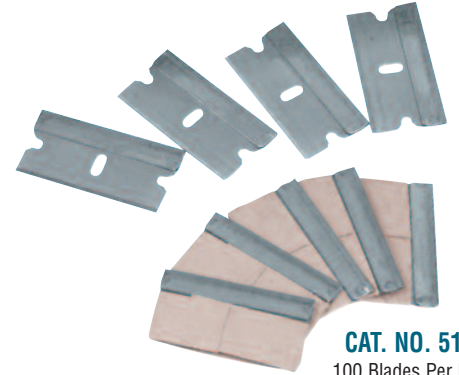

CAT. NO. 51S
100 Blades Per Box

CRL Heavy-Duty Industrial Single Edge Razor Blades

- Single Edge Blades With No Notch
- Heavy-Duty .012" Thick Carbon Steel
- For Use in Paint Scrapers and Mat Cutters

Our CRL Heavy-Duty Razor Blades are primarily used when the job requires a stronger blade. They are more rigid than our regular razor blades because of their .012" (.31 mm) thick steel construction and no side notches. Their extra rigidity also makes them great for tough scraping jobs. Packed 100 per box. Minimum order is 100 each.



CAT. NO. KKB12

CRL Plastic Razor Blades

- Single or Double Edge Styles



CAT. NO. CP866088
Single Edge Blades



CAT. NO. CRL3000
Double Edge Blades

These CRL Plastic Razor Blades won't harm plastic coated windows or other hard surfaces that can be scratched or marred by metal razor blades. They are also useful for working on painted surfaces or chrome, and for removing decals, pin striping, or window tint film. The new Double Edge Blade has very thin, yet stiff edges for delicate scraping jobs. Choose from single edge or double edge versions to fit your razor blade scraper (see opposite page). Both are sold 100 per package. Minimum order is one package.



CRL Steel Wool

- Comes in Four High Quality Grades
- Super Fine to Coarse

CRL Steel Wool comes in four high-quality grades from super fine to coarse. Packed in economical sleeve packs (16 pads per pack) with a handy chart to show which grade is best for every cleaning job.



CAT. NO.	GRADES
Z100	Super Fine
Z200	Fine
Z300	Medium
Z400	Coarse

Minimum order: 1 pack. Grades can be combined for quantity pricing.

CRL 3M Scotch-Brite™ Hand Pads

- Cleans, Finishes, Blends, and Deburrs Metal
- Two Grades Available, Fine and Coarse



CAT. NO. SB7447F
Scotch-Brite Fine Hand Pad



CAT. NO. SB7440C
Scotch-Brite Coarse Hand Pad

CRL 3M Scotch-Brite™ Commercial Hand Pads are for general purpose cleaning and scouring. High-quality synthetic fiber will not rust or corrode. Large 6" x 9" (152 x 229 mm), 1/4" (6.3 mm) thick Pads. Our Cat. No. SB7447F Pad is for surface conditioning. Perfect for cleaning, finishing, blending, and deburring for railing applications. Our Cat. No. SB7440C Pad is for heavy-duty work. A high mineral content makes these pads cut fast to remove contaminants and oxides in your most demanding jobs. One pad per pack. Minimum order is one pack.

CRL Open Cell Nylon Clean Up Pads

- Used With Sealant Removal Products on Tough Jobs
- Ideal for Use With Our PWR22 Cleaner to Remove Windshield Contamination



CRL Open Cell Clean Up Pads are made of nylon, and used for the tough cleaning jobs because of their aggressive open cell design. These pads measure approximately 4" x 8" (102 x 203 mm). Minimum order is 50 pads. Must order in increments of 50.

CAT. NO. NP48

CRL Dusting Brush and Pan



CAT. NO. 2131008
Heavy-Duty Dust Pan

CRL Heavy-Duty 16" (406 mm) Dust Pan is a sturdy, one-piece, 20 gauge steel dust pan with corrugated ribs for rigidity and strength. It has a baked black enamel finish with a bevelled edge. Minimum order is one each.



CAT. NO. LAB40
Horse Hair Dusting Brush

This top quality CRL Dusting Brush has many clean up uses in the shop or home. It has long wearing black horse hair bristles for sweeping sawdust, metal shavings, dirt, and dust. The molded plastic handle is comfortable to hold. Minimum order is one each.

CRL Wire Brush

- Hardwood Handle
- Spring Steel Bristles



This CRL Wire Brush cleans away rust and paint, or cleans parts after welding and soldering. It has tumble waxed smooth hardwood handle, with round spring steel wire bristles. Overall length is 13" (330 mm). Minimum order is one each.

CAT. NO. LAB450

CRL Whisk Brush

- 4" (102 mm) Width at Bristles



Use this stiff palmetto fiber CRL Whisk Brush for general clean up or for brushing glass chips off your cutting table carpet. It has a complete wire-wrapped neck, topped with a sturdy metal cap and hanging ring. Minimum order is one each.

Not available in Australia.

CAT. NO. LAB750

CRL Disposable Nitrile Gloves

100% Nitrile Gloves provide better protection against solvents, and resist a broad range of chemicals where more splash protection is required than you can get with latex gloves. Nitrile compound gives greater puncture resistance than comparable natural rubber and vinyl disposable gloves. They also provide greater comfort by reducing hand pressure and fatigue caused by elastomeric stress.



new

- Textured Surface for Grip
- Provide Resistance Against Solvents and Other Chemical
- Powder Free
- Available in Four Sizes

CAT. NO.	SIZE	QTY/BOX
7005SM	Small	100
7005MD	Medium	100
7005NG	Large	100
7005XL	X-Large	100

Minimum order: 1 box. All gloves on this page can be combined for quantity pricing.

CRL Powder Free Disposable Latex Gloves

These CRL Powder Free Disposable Latex Gloves minimize the risk of allergic reaction to protein or chemical residue. They are made of natural rubber and molded to be worn on either hand. The fully-textured surface provides superior grip in wet or dry applications. Each box contains 100 gloves.



new

- Fully-Textured Surface
- Can Be Worn on Either Hand
- Available in Four Sizes
- Powder Free

CAT. NO.	SIZE	QTY/BOX
262SM	Small	100
265MD	Medium	100
266LG	Large	100
268XL	X-Large	100

Minimum order: 1 box. All gloves on this page can be combined for quantity pricing.

CRL Tear Resistant Black Latex Gloves

CRL's new Tear Resistant Black Latex Gloves are designed to provide extra protection and stronger resistance to wear and tear on the job. The thickness of the fingers is almost double that of regular latex gloves. The added thickness provides confidence for manufacturing professionals during glass fabrication.



new

- 10 Mil Thickness for Extra Protection
- Textured Surface for Superior Grip
- Powder Free

CAT. NO.	SIZE	QTY/BOX
2005SM	Small	100
2005MD	Medium	100
2005LG	Large	100
2005XL	X-Large	100

Minimum order: 1 box. All gloves on this page can be combined for quantity pricing.

CRL Black Nitrile Gloves

CRL's new Black Nitrile Gloves are the alternative for those who are allergic to natural rubber latex. The textured surface makes them an excellent choice for the glass fabrication industry in both wet and dry applications. These gloves provide puncture, tear, and chemical resistance while allowing excellent dexterity.



new

- 100% Latex Free With No Powder
- Textured Surface for Superior Grip
- Excellent Puncture and Tear Resistance
- Resistant to Solvents

CAT. NO.	SIZE	QTY/BOX
5005SM	Small	100
5005MD	Medium	100
5005LG	Large	100
5005XL	X-Large	100

Minimum order: 1 box. All gloves on this page can be combined for quantity pricing.

CRL Brand Knit Nitrile Gloves

- Our Most Affordable Knit/Nitrile Coated Gloves
- Machine Washable and Dryable

new

These affordable Knit Gloves have a nitrile coating on the palms and fingers which makes them ideal for handling glass. A seamless polyester knit liner makes them form fitting, while the well ventilated back allows your hand to breathe. These lightweight gloves provide a high level of dexterity and sensitivity, and can be used around oils, greases, and paints. Machine washable.

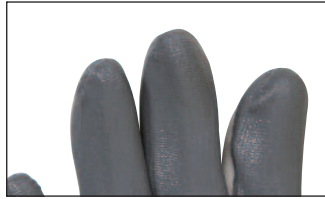

CAT. NO.	SIZE
NF1TS	Small
NF1TM	Medium
NF1TL	Large
NF1TXL	X-Large

Minimum order: 1 dozen pair. Sold only by the dozen.
All CRL Gloves can be combined for quantity pricing.

CRL Brand Knit Fit Gloves

- Grip Securely on All Surfaces
- Machine Washable and Dryable

CRL Brand Knit Fit Gloves have wrinkled finish latex coated palms that are ideal for handling all smooth surfaces, even wet glass. The seamless knit liner makes them form-fitting for increased comfort, and the uncoated back section allows your hand to breath. Machine washable CRL Brand Knit Fit Gloves will provide you with the gripping power, dexterity, durability, and protection you need on the job.



CAT. NO.	SIZE
KF1TS	Small
KF1TM	Medium
KF1TL	Large
KF1TXL	X-Large

Minimum order: 1 pair. Sold only by the pair.
All CRL Gloves can be combined for quantity pricing.

CRL Atlas Textured Nitrile Coated Gloves

new

- Ideal for Handling Glass
- Comfortable Fit and Exceptional Grip

This durable, flat-dipped, dark green colored Nitrile Coated Glove features exceptional grip, dexterity, and durability with oil resistant Nitrile coating. The cotton/polyester lining provides an extremely comfortable fit. An elastic knit wrist secures the glove above the wrist for comfort, and prevents debris from entering the glove. Machine washable.



CAT. NO.	SIZE
350S	Small
350M	Medium
350L	Large
350XL	X-Large

Minimum order: 1 pair. Sold only by the pair.
All CRL Gloves can be combined for quantity pricing.

CRL Atlas Fit Gloves

- Excellent Choice for Glass Handling
- Flexible, Form-Fitting, and Ventilated
- A Great Glove for Shop or Job Site Chores

The CRL Atlas Fit Glove is perfect for light lifting situations where hand protection is needed. The poly/cotton knit glove is latex covered for maximum durability, and protects your hands while providing ventilation through the back and wrists. Specially formulated latex palm provides maximum wet gripping power while it guards against punctures and abrasions. Both versatile and economical, the CRL Atlas Fit Glove is a sure winner in hand protection. Four sizes available for the perfect fit. Machine washable.



CAT. NO.	SIZE
300AFS	Small
300AFM	Medium
300AFL	Large
300AFXL	X-Large

Minimum order: 1 pair. Sold only by the pair.
All CRL Gloves can be combined for quantity pricing.

CRL Nitri-Flex Lite Gloves

- Popular With Auto Glass Professionals
- Smooth Finish



CRL's Nitri-Flex Lite Gloves are the choice of auto glass professionals. This very comfortable glove has a nitrile coated palm with smooth finish. The seamless nylon knit liner provides moisture absorption and all weather comfort.

CAT. NO.	SIZE
2404130	Medium
2404264	Large
2404131	X-Large

Minimum order: 1 pair.

CRL Nitri-Flex Plus Gloves

- The Auto Glass Professionals Glove
- Textured Finish



Used extensively by auto glass professionals, the Nitri-Flex Plus provides all day comfort as well as excellent gripping power. This nitrile coated glove with textured finish provides an alternative to cotton and lightweight leather gloves. The seamless cotton poly-knit liner allows your hands to breathe in all weather conditions.

CAT. NO.	SIZE
2404132	Medium
2404133	Large
2404265	X-Large

Minimum order: 1 pair.

CRL Sure Grip Glass Gloves

- Knit Wrist
- Coated Palm
- Thread-Rubber Finish



These Sure Grip Glass Gloves are comfortable, pliable gloves that provide the user with an extremely aggressive grip. Vulcanized rubber coated fingers and palm on a cotton knit base makes this glove safe, durable, and flexible. Minimum order is one pair.

CAT. NO. 2404065

CRL Leather Gloves

- All-Leather Palm, Thumb, Forefinger, and Fingertips
- Gauntlet Cuff With Elastic Wrist Band



These heavy-duty CRL Leather Gloves feature an all-leather palm, thumb, forefinger, and fingertips. The rubberized, waterproof safety cuff, leather knuckle strap, and elastic wrist band make them comfortable to wear. They offer strong, rugged protection. Minimum order is one pair.

CAT. NO. LG5231

CRL Knit Wrist Cotton Gloves

- White 100% Cotton for Light Duty Work
- Washable



These CRL 100% Cotton Gloves are excellent for light-duty shop work or clean up. Knitted wrist bands for easy removal. Also ideal for home and garden use. They offer only minimal protection against cuts or abrasions. Minimum order is one pair.

CAT. NO. 8K

CRL Vinyl Coated Cotton Work Gloves

- Flexible and Durable
- Washable



CRL's Vinyl Coated Cotton Work Gloves have a grainy, vinyl finish that is both flexible and durable. These gloves provide a firm grip on metal, wood, or glass surfaces. The cotton material breathes so that hands feel more comfortable. They remain pliable after washing and drying. Minimum order is one pair.

CAT. NO. 2404105

All CRL Gloves can be combined for quantity pricing.

CRL Atlas Kevlar® Cut Resistant Gloves

new

- The Perfect Glove for Glass Fabricators

CRL's new Atlas Kevlar® Cut Resistant Gloves are used by glass fabricators to protect against cuts, punctures, and slashes. The 10-gauge 100% Kevlar® fiber seamless knit liner provides an ergonomic fit. The latex coated palms deliver an outstanding grip.

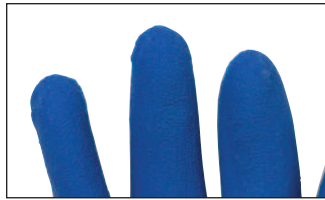

CAT. NO.	SIZE
300KVS	Small
300KVM	Medium
300KVL	Large
300KVXL	X-Large

Minimum order: 1 pair. All CRL Gloves can be combined for quantity pricing.

CRL Atlas Thermo-Fit Insulated Gloves

new

- Flexible, Form-Fitting and Ventilated

CRL Atlas Thermo-Fit Insulated Glass Gloves are fully insulated with a liner that is ideal for working outside in cold climates. The gloves offer maximum durability and protect your hands while providing ventilation through the back and wrists. Their specially formulated latex palms provide maximum wet gripping power while they guard against punctures and abrasions.



CAT. NO.	SIZE
451S	Small
451M	Medium
451L	Large
451XL	X-Large

Minimum order: 1 pair. All CRL Gloves can be combined for quantity pricing.

CRL Fuzzy Duck® PVC Gloves

- Two-Piece Jersey Liner for Comfort
- Excellent Gripping on Glass

CRL Fuzzy Duck® PVC Gloves have a breathable PVC coating on a soft, cool, comfortable, two-piece jersey liner. Their textured coating provides an excellent grip on glass, and minimizes absorption of water, oil, and grease. Although not a true anti-vibration glove, they tend to absorb and minimize shock. Fuzzy Duck® Gloves outlast and replace cotton, light-to-medium weight leather, and goatskin gloves in a wide variety of applications.



CAT. NO.	SIZE
962FDS	Small
962FDM	Medium
962FDL	Large
962FDXL	X-Large

Minimum order: 1 pair. All CRL Gloves can be combined for quantity pricing.

CRL D-Flex® Cut Resistant Glass Handling Gloves

- Natural Rubber Dots Provide a Secure Grip
- Two Popular Sizes and Material Weights

CRL's line of D-Flex® Cut Resistant Glass Handling Gloves raises the safety level for you and your crew. Made from tough Dyneema® or Spectra® fibers, these gloves are more cut resistant and more comfortable than other products of their kind. They can be laundered and bleached over and over without losing their protective qualities. We offer D-Flex® Cut Resistant Glass Gloves in the two most popular sizes and material weights.



CAT. NO.	TYPE	SIZE
910CM	Light Weight	Medium
910CL	Light Weight	Large
917CM	Medium Weight	Medium
917CL	Medium Weight	Large

Minimum order: 1 pair. All CRL Gloves can be combined for quantity pricing.

CRL Lint Free Nylon Gloves

- A Must for Insulating Glass Fabrication
- Keeps Fingerprints Off Glass



CRL Lint Free Nylon Gloves are perfect for handling glass or mirrors without leaving oily fingerprints or other contaminations. An absolute must for handling glass during insulated glass fabrication. Gloves are available in two sizes to fit most hands.

CAT. NO.	SIZE
NG170	Small
NG171	Large

Minimum order: 1 dozen pairs. Sizes can be combined for quantity pricing.

CRL Atlas Nitrile Gloves

- Tough Nitrile Coating
- Resists Many Chemicals



These CRL Atlas Nitrile Gloves have a coating that makes them extra resistant to punctures and abrasions. That's good news for glaziers with heavy jobs to do! The patented Atlas dipping process and seamless knit liner give hands comfortable protection. Machine washable. Sold only by the pair.

CAT. NO.	SIZE
PR0720	X-Large

Minimum order: 1 pair.

CRL Fingerless Gloves

- Made of Top Grain Cowhide
- Stitched With Kevlar® Thread
- Hook-and-Loop Closure Around Wrist



These CRL Fingerless Gloves will help protect your palms and lower finger areas while handling glass or other sharp objects. Your finger tips remain exposed enough to allow dexterity and handling. Sold only by the pair.

CAT. NO.	SIZE
FGS	Small
FGL	Large

Minimum order: 1 pair. Sizes can be combined for quantity pricing.

CRL Flexx-Rap Protective Wrap for Hands and Fingers

- Waterproof, Flexible, and Porous
- Self-Adhesive Without Leaving Residue



CRL Flexx-Rap is an innovative tape that protects fingers from cuts and blisters. It also improves your grip when wrapped around fingers, tools, or sporting equipment. Flexx-Rap is waterproof, flexible, porous, hypoallergenic, and self-adhesive. Flexx-Rap goes on easily and won't come loose with movement, even when wet. If you work with your hands, protect them with Flexx-Rap. Roll size is 1" x 15' (25 mm x 4.6 m). Minimum order is one roll.

CAT. NO. FR51

CRL Glove Sizing

All glove sizes vary depending upon their style. Nitrile gloves for instance, require a skin tight fit, however, general purpose work gloves or glass handling gloves need not fit too tight or too loose. Measure around the palm of your hand, and use the chart to the right to get the correct fit.

- What Size Glove Should You Order?
- Use the Chart Below to Determine the Correct Size

SIZE	PALM MEASUREMENT
Small	7" to 8" (178 to 203 mm)
Medium	8" to 9" (203 to 229 mm)
Large	9" to 10" (229 to 254 mm)
X-Large	10" to 11" (254 to 279 mm)



Measure around your palm

CRL Brand GripPro Impact Performance Gloves

- Shock Absorbing Impact-X Padding
- Heavy-Duty Elastic Velcro Closure
- Lightweight and Durable RhinoTex Synthetic Leather Palm

CRL Brand GripPro Impact Performance Gloves provide superior protection against injury-causing shock and impact. Made with the finest materials available, they are designed to endure demanding environments while providing wearer comfort. They are also machine washable.



CAT. NO.	SIZE
GR1PS	Small
GR1PM	Medium
GR1PL	Large
GR1PXL	X-Large
GR1P2X	XX-Large

Minimum order: 1 pair. Sold only by the pair. Sizes can be combined for quantity pricing.

CRL Mechanix Wear® M-Pact® Gloves

- No Other Glove Compares for Superior Comfort and Feel
- CRL is the Exclusive Distributor to the Glass Industry

CRL Mechanix Wear® M-Pact® Gloves offer the same quality construction and materials as the Original® Mechanix Gloves, but have additional padding and foam-filled patches on the palm area to absorb the vibrations from power tools and impact tools like hammers or air tools. This helps to eliminate the potential for injuries. Easy on-off fit with hook-and-loop wrist closures.



CAT. NO.	DESCRIPTION	SIZE
MP010	Black M-Pact® Gloves	Large
MP011	Black M-Pact® Gloves	X-Large
MP012	Black M-Pact® Gloves	XX-Large

Minimum order: 1 pair. Sold only by the pair.

CRL Mechanix Wear® FastFit® Gloves

- Easy-Entry, Wide Opening, Elastic Cuff
- Soft, Durable Clarino® Synthetic Leather Palm
- Reinforced Thumb and Fingertips
- Available in Blue and Black

CRL's Mechanix Wear® FastFit® Gloves give you great comfort, flexibility, and protection. You'll work with more confidence when wearing these gloves. You get uncompromising comfort and protection from abrasion without losing dexterity when performing even the most difficult task.



CAT. NO.	DESCRIPTION	SIZE
MFF03010	Blue FastFit® Gloves	Large
MFF05010	Black FastFit® Gloves	Large
MFF03011	Blue FastFit® Gloves	X-Large
MFF05011	Black FastFit® Gloves	X-Large

Minimum order: 1 pair. Sold only by the pair.

CRL Mechanix Wear® Original® Gloves

- The Tool That Fits Like a Glove
- Ergonomically and Anatomically Designed
- Machine Washable
- Available in Blue and Black

CRL Mechanix Wear® Original® Glove, the glove that started it all, introduced to the racing industry, and has since been a mainstay in just about every industrial work setting.



CAT. NO.	DESCRIPTION	SIZE
MG03010	Blue Mechanix Wear® Gloves	Large
MG05010	Black Mechanix Wear® Gloves	Large
MG03011	Blue Mechanix Wear® Gloves	X-Large
MG05011	Black Mechanix Wear® Gloves	X-Large

Minimum order: 1 pair. Sold only by the pair.

CRL Dual Cartridge Organic Vapor Respirator

- Protects Against Dust, Tiny Particles, and Fumes



Requires Two Cartridges

This CRL Dual Cartridge Respirator comes with NIOSH approved Cartridges for organic vapors. Common applications include degreasing, adhesive use, working with other airborne contaminants. The elastomeric face piece is soft on the face. Low breathing resistance lessens fatigue, resulting in higher productivity. Protection is also offered against highly toxic dusts, including asbestos, mists, and fumes.

CAT. NO.	DESCRIPTION
ES285X MD8100	Respirator and Cartridges Replacement Cartridges (Pair)

Minimum order: Respirator is 1 each. Cartridges are 1 pair. Respirators can be combined for quantity pricing.

CRL Glass Dust Respirator

- Soft, Durable Face Piece Designed for Safety and Comfort



Requires Two Filters

The CRL Glass Dust Respirator comes complete with Filter Disks certified under NIOSH 42 CFR 84 to have a filter efficiency of 99.97% or greater against oil, non-oil aerosols, and silica (glass) dust. It also conforms to requirements for contaminants falling under OSHA substance specific standards of High Efficiency Particulate Air (HEPA) Filters.

CAT. NO.	DESCRIPTION
ES287X MD8940	Respirator and Filter Disks Replacement Filter Disks (Pair)

Minimum order: Respirator is 1 each. Filter Disks are 1 pair. Respirators can be combined for quantity pricing.

CRL Disposable Dust Mask

- Ideal Protection Against Dust When Sanding, Grinding and Cutting



NOTE: This mask is not suitable for use against toxic or hazardous air contaminants.

These CRL Disposable Dust Masks protect against nuisance and non-toxic dusts, powders, pollen, and other common airborne irritants. Comfortable and lightweight, they are designed to be worn with or without eyeglasses or goggles without interfering with your maximum field of vision.

CAT. NO.	QTY/BOX
G1001	50

Minimum order: 1 box. All Dust Masks can be combined for quantity pricing.

CRL Dust and Mist Respirator

- NIOSH/MSHA Approved for Dust and Mists With PEL
- Meets OSHA Up to 10X PEL



For excellent balance of performance and cost, choose the CRL Dust/Mist Respirator, the first maintenance-free respirator to be approved. The ES8710 is used throughout general industry in a wide variety of applications. Protects against coal, cadmium, chromium, lead, cotton, dust, silica, and other substances. NIOSH/OSHA approved for dusts and mists with PEL not less than 0.05 mg/m³. Meets OSHA Standards for use up to 10X PEL.

CAT. NO.	QTY/BOX
ES8710	20

Minimum order: 1 box. All Dust Masks can be combined for quantity pricing.

CRL Particulate Respirator

new

- Perfect for Glass Fabricators

CRL's Particulate Respirator is ideal for anyone in the glass industry who cuts, seams, drills or edges glass. This is the perfect Respirator to filter out glass dust particles in the air caused by any glass fabrication process. The Particulate Respirator is designed with inner foam which provides a custom seal, and a dual head strap for optimum fit. NIOSH approved.



CAT. NO.	QTY/BOX
G1002	20

Minimum order: 1 box. All Dust Masks can be combined for quantity pricing.

CRL Valved Particulate Respirator

new

- Valve Permits Easy Respiration

CRL's Valved Particulate Respirator has the same features and benefits as our Cat. No. G1002 Particulate Respirator, except it permits the person wearing the mask to exhale comfortably through a valve which automatically closes after exhalation. NIOSH approved.



CAT. NO.	QTY/BOX
G1003	10

Minimum order: 1 box. All Dust Masks can be combined for quantity pricing.

CRL Radians® Vector™ Safety Glasses

- Great Protection
- Classic Style



CAT. NO. CL0220
Gray Lens



CAT. NO. CL0210
Clear Lens

CRL Radians® Vector™ Safety Glasses feature a 100% polycarbonate lens that meets the ANSI Z87.1-1989 Standard, and is distortion-free with fog and scratch resistance built in. The adjustable temple and full 155 degree width provide increased protection. Minimum order is one pair.

CRL Radians® AV™ Safety Glasses

- 99 Percent UV Protection
- Anti-Scratch Coating



CAT. NO. JP2000



CAT. NO. AV1110

CRL Radians® AV™ Safety Glasses employ the best in eye and ear protection that meets or exceeds ANSI Standards. The lens has a hard anti-scratch coating and is 99% UV protected. They also resist fogging in all types of weather and working conditions. Each pair comes with a neck cord to hold them while not in use. JP2000 Ear Protectors are reusable, washable, and conveniently replaceable. Made in the U.S.A. Minimum order is one pair.

CRL Radians® Rad-Apocalypse™ Safety Glasses **new**

- Available in Three Lens Colors
- Great Style

CRL's Radians® Rad-Apocalypse™ Safety Glasses not only provide excellent eye protection, but have great style. Features include soft rubber temples and a nosepiece which allows all-day comfort, coated scratch-resistant lenses, and a convenient neck cord. The polycarbonate lenses meet the ANSI Z87.1 rating and have 99.9 percent UV protection.



CAT. NO.	LENS COLOR
RAP1C	Clear
RAP1S	Smoke
RAP1O	Indoor/Outdoor

Minimum order: 1 pair.

CRL Radians® Rad-Infinity™ Safety Glasses **new**

- Excellent Features
- Superior Protection

CRL's Radians® Rad-Infinity™ Safety Glasses are uniquely styled and offer superior eye protection. They are available in clear, smoke, and indoor/outdoor lenses. Rad-Infinity™ Glasses have cushioned rubber temple pads which provide outstanding comfort, a gel non-slip nosepiece, coated scratch-resistant lenses, and a neck cord for convenient on/off situations. The lenses conform to ANSI Z87.1 standards and provide 99.9 percent UV protection.



CAT. NO.	LENS COLOR
R1N1C	Clear
R1N1S	Smoke
R1N1O	Indoor/Outdoor

Minimum order: 1 pair.

CRL Radians® Rad-Sequel™ Safety Glasses **new**

- Meets ANSI Z87.1 Standards
- Comfortable Fit

CRL's Radians® Rad-Sequel™ Series Safety Glasses provide wrap-around eye protection in a lightweight design. Choose either clear, smoke or indoor/outdoor polycarbonate, impact-resistant lenses. The rubber tipped temples offer a secure, comfortable fit. The hard coated lenses are also 99.9 percent UV effective.



CAT. NO.	LENS COLOR
RDS1C	Clear
RDS1S	Smoke
RDS1O	Indoor/Outdoor

Minimum order: 1 pair.

CRL Radians® Mirage™ Safety Glasses **new**

- Made in USA
- Sleek, Lightweight Design

CRL's Radians® Mirage™ Series Safety Glasses offer a comfortable fit for both men and women. The snap-fit temples provide a secure fit and the optically correct lenses give distortion-free viewing. The wrap-around lens design provides impact resistance and a nearly perfect orbital seal. They are ANSI approved, 99.9 percent UV effective, and available in clear, smoke and indoor/outdoor lenses.



CAT. NO.	LENS COLOR
MR01C	Clear
MR01S	Smoke
MR01O	Indoor/Outdoor

Minimum order: 1 pair.

All Safety Glasses on this page can be combined for quantity pricing.

CRL Patriot Safety Eyewear

- Red, White, and Blue Frame
- Integrated Side Guards



CRL Patriot Safety Eyewear provides wrap-around protection in an attractive, lightweight, colorful frame with adjustable temples. The single-lens style with nosepiece and brow guard provides a comfortable fit and also meets ANSI A87.1 Spec. The clear, hard coated lenses are scratch resistant. Minimum order is one pair.

CAT. NO. 2404443

CRL Deluxe Safety Spectacles

- Designer Styling
- 99% UV Protection



CRL Deluxe Safety Spectacles have designer styling that makes them attractive as well as functional. The clear lenses provide 99% protection from UV Sources. The soft, brown plastic frames have side shields for added protection, wire-reinforced temples, and sturdy metal hinges. Certified ANSI Z87.1-1979. Minimum order is one pair.

CAT. NO. ES384

CRL Radians® Coveralls™ Safety Glasses

- Safety and Comfort
- Can Be Worn Over Eyeglasses



Traditionally styled Radians® Coveralls™ give you protection at an economic price. They can be worn over prescription glasses. They're an excellent choice for use as "visitor" glasses. Minimum order is one pair.

CAT. NO. VS0010

CRL Lightweight Visitor Spectacles

- Wrap-Around Shields
- Distortion-Free Lens



Extremely comfortable CRL Lightweight Spectacles can be worn with or without prescription glasses. They feature wrap-around side shields, and an anti-glare brow guard. The distortion-free clear lenses are .080" (2 mm) thick for added protection. Minimum order is one pair.

CAT. NO. ES461

CRL Protective Goggles

- Soft Vinyl Frame
- Distortion Free Lens



CRL Protective Goggles offer comfort as well as protection against flying particles, dust and splash. Injection molded from soft, pliable, non-irritating vinyl, these Goggles fit all sizes and shapes. They even fit comfortably over large prescription glasses. They have a soft vinyl frame with perforations for maximum ventilation. They also feature a high-optical quality, distortion-free, replaceable polycarbonate lens. Minimum order is one pair.

CAT. NO. ES432

CRL UV Goggles

- Provides Maximum Protection From Exposure to Extended or High-Intensity Ultraviolet Sources



CRL UV Goggles protect the user against most ultraviolet light sources. These Goggles specifically provide maximum protection from exposure to extended or high-intensity UV sources. Meet ANSI specification Z87.1 for safety eye-wear and OSHA standard 1910.133 for eye and face protection. They fit easily over regular eyeglasses. Minimum order is one each.

CAT. NO. UVG50

CRL Eyeglass Holder Strap

- Holds Firmly in Place Without Binding
- Perfect for Safety Glasses

NOTE:
Eyeglasses not included.



These CRL Eyeglass Holders feature fully adjustable, patented temple grips. Ideal for all activities, they fit comfortably, holding your glasses firmly in place without binding. Minimum order is one each.

CAT. NO. ES027

CRL PR02 Silicone Spray

- Our Best Selling Lube
- Seals Out Moisture
- Waterproofs and Lubricates

Use our versatile CRL Silicone Spray Lubricant for almost any lubricating need. An effective squeak squelcher, its non-conducting, non-gumming formula repels water. Use it to damp-proof auto and marine electrical systems, and for many other applications.



Lubricates screen door rollers

CAT. NO.	NET WEIGHT	QTY/CASE
PR02	10.75 Oz. (305 g)	12

Minimum order: 1 each. All Aerosol Lubricants can be combined for quantity pricing.



CRL Metal Lube

- Cleans as it Lubricates
- Preserves Metal Finish
- Frees Sticky Hinges, Rollers, Guides, Tool Parts

Developed for the professional to handle all metal lubricating needs, CRL Metal Lube unsticks hinges, latches, locks, and rollers. It can also be used on power tools, saws, trunk lids, and car door hinges. Preserves metal from rust and corrosion. You'll find many uses for this popular lubricant.



Eliminates automobile door hinge squeaks

CAT. NO.	NET WEIGHT	QTY/CASE
1200	11 Oz. (312 g)	12

Minimum order: 1 each. All Aerosol Lubricants can be combined for quantity pricing.



CRL White Grease Lubricant

- Heavy-Bodied Spray Lube
- Excellent for Metal-to-Metal Moving Parts

CRL White Grease Lubricant is a heavy-bodied aerosol spray lube that frees metal moving parts in locks, gears, chains, cables, pulleys, and more. Clings to sprayed areas to give good lubricating performance and keep things working right.

CAT. NO.	NET WEIGHT	QTY/CASE
CRL715	11 Oz. (312 g)	12

Minimum order: 1 each. All Aerosol Lubricants can be combined for quantity pricing.



CRL Lock Lubricant

- Lubricates and Penetrates
- Displaces Moisture and Retards Rust
- Contains No Ozone Depleting Chemicals



new

CRL Lock Lubricant is formulated to drive out moisture, retard corrosion, lubricate and penetrate rust on all metal lock parts as well as hinges, bolt threads, cables, and chains. This aerosol spray is harmless to paints, plastics, and fabrics. CRL90 is a non-conductor and does not contain silicones.

Save maintenance time and money by freeing sticky mechanisms with a quick spray through the applicator extension straw (included). Apply periodically for continuing protection against corrosion caused by humidity, electrolysis, salt water deposits, and industrial residues.



CAT. NO.	NET WEIGHT	QTY/CASE
CRL90	10.75 Oz. (305 g)	12

Minimum order: 1 each. All Aerosol Lubricants can be combined for quantity pricing.

CRL Spray Penetrant

- Penetrates Fast to Unstick Frozen Nuts, Bolts, and Machine Parts
- An Excellent Corrosion Preventative



CRL Penetrating Oil works fast to unstick frozen parts. It lubricates parts and displaces moisture. An excellent corrosion preventative for tool and die steels and tool room equipment. Can be totally removed, if necessary, using common petroleum-based solvents.



CAT. NO.	NET WEIGHT	QTY/CASE
CRL960	12 Oz. (340 g)	12

Minimum order: 1 each. All Aerosol Lubricants can be combined for quantity pricing.

CRL Sprayway® Dry Silicone Lubricant and Release Agent

- Lubricates Dry Without Picking Up Debris
- Excellent for Sliders and Window Channels
- Many Automotive Uses



CRL Sprayway® Dry Silicone Lubricant and Release Agent lubricates window channels, doors, weatherstripping, trunk seals, car seat adjustment mechanisms, and more. It also acts like a release agent for plastic moldings. Use it to waterproof ignition system hinges, springs and casters, or to eliminate squeaks from fan belts.



CAT. NO.	NET WEIGHT	QTY/CASE
SW77	12 Oz. (340 g)	12

Minimum order: 1 each. All Aerosol Lubricants can be combined for quantity pricing.

CRL 3M™ Silicone Lubricant

- Dry Type Silicone Lubricant
- Seals Out Moisture
- Prevents Squeaks and Sticking



CRL 3M™ Silicone Lubricant seals out moisture from a vehicle's distributor, ignition, spark plugs, and all auto electrical wiring. It eliminates the squeaks and sticking caused by friction between moving parts, and fights corrosion on metals. You can also use it to preserve leather and rubber.



CAT. NO.	NET WEIGHT	QTY/CASE
3M8897	8 Oz. (228 g)	12

Minimum order: 1 each. All Aerosol Lubricants can be combined for quantity pricing.

CRL Polishing Oil

- Spray On Belts and Discs for Faster, Brighter Polishing
- Promotes Longer Belt Life

Spray CRL Polishing Oil on your abrasive belts and discs to keep them soft and free cutting. Helps to reduce "loading" while it improves finish edges on metal and glass. Spray directly on belt or abrasive wheel before starting, then re-apply lightly as needed. Gives you longer belt life and a brighter, faster polish.



CAT. NO.	CONTENTS	QTY/CASE
CRL920	11 Oz. (312 g)	12

Minimum order: 1 each. All Lubricants can be combined for quantity pricing.

CRL Glas-Slip

- Rubber Lubricant for Easier Installation of Gaskets
- Helps With Installation and Centering of Gasket Set Glass



CAT. NO. GS32
Quart Can



CAT. NO. GS128
Gallon Can

CRL Glas-Slip is a specially formulated lubricant that makes working with glass and rubber gaskets easy. It's extra slippery and stays wet, so you can spread it on the entire gasket before you install the glass. Also makes the installation of filler strips quick and easy. Apply it with a brush or rag, or spread it on with your fingers. Glas-Slip comes in one gallon cans or handy quart size cans.

CAT. NO.	CONTENTS	QTY/CASE
GS32	32 Fl. Oz. (.945 l)	12
GS128	128 Fl. Oz. (3.785 l)	4

Minimum order: 1 each.

CRL Krytox High-Performance Lubricant

- Excellent for Stopping Persistent Squeaks in Automobiles, Machinery, Fixtures or Tools
- Insoluble in Common Solvents
- High Temperature Stability Up to 650°F (344°C)



CRL Krytox High-Performance Lubricant is excellent for windshield molding and interior trim squeaks, and is compatible with plastics, rubber, ceramics, and metals. Krytox Lubricant is also ideal for use on machinery, tools, bearings or virtually any area where lubrication is required. Since GPL205 Lubricant is fluorinated, it can be used around chemicals, and is non-flammable. It is safe to work with in almost any application.

CAT. NO.	CONTENTS	QTY/CASE
GPL205	1/2 Fl. Oz. (14.7 ml)	12

Minimum order: 1 each.

CRL Dry Graphite

- Greaseless and Dripless
- Highly Refined Fine Powder

CRL Dry Graphite is highly refined into a finely powdered texture which provides superior dry lubrication. Use to unstick locks, doors, and windows; or to keep tools working easily. The puffer bottle is refillable from the 1/2 pound (225 g) bulk bottle. Minimum order is one each.



CAT. NO. MZ25
1/2 Pound (225 g)
Bulk Bottle



CAT. NO. MZ21
1.76 Ounce (50 g)
Puffer Bottle

CRL Tube Wax Lubricant

- Increases Production and Improves Tool Life
- Reduces Screw Breakage and Speeds the Installation by Lubricating the Threads
- Excellent for Use With CRL Sanding Belts and Discs
- Improves Finish and Performance

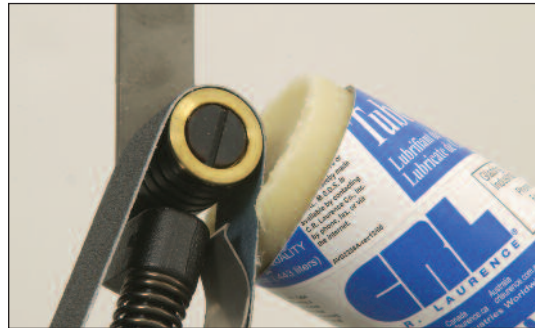

CRL Tube Wax Lubricant is a special formulation of solid waxes that comes in a convenient, soft stick. Use it for all sawing, grinding, drilling, tapping, sanding, and fastening operations to increase production quality and improve tool life. Easy and neat to handle, requiring no special storage or handling.

CAT. NO.	CONTENTS	QTY/CASE
WS140	15 Oz. (425 g)	24

Minimum order: 1 each.

CRL Lith-Ease White Lithium Grease



- Long Lasting Lubricant With Many Automotive, Marine, and Shop Uses
- Excellent Water and Heat Resistance
- Easy to Use Sealed Cartridge



The CRL Lith-Ease Grease Cartridge is a high quality white grease with superior resistance to heat and water. This cartridge fits our Cat. No. C1080 Grease Gun.

CAT. NO.	CONTENTS	QTY/CASE
WL14	14.5 Oz. (411 g)	10

Minimum order: 1 each.

CRL Grease Gun

- Uses Standard 14 Ounce (397 g) Grease Cartridges
- Also Dispenses Bulk Loaded Grease



This CRL Grease Gun is a precision-made, heavy-duty constructed gun built to give years of reliable use under rugged conditions. It is designed for multiple reloading, using cartridges of Cat. No. WL14 or bulk material. Develops pressures of up to 10,000 psi. It is well balanced for easy handling, with a natural-shaped handle. It loads three ways, and a positive action plunger sizes automatically for cartridge or bulk. E-Z Air Vent safety lock cap prevents accidental plunger release while loading. Minimum order is one each.

CAT. NO. C1080

CRL Spray Mist Coolant

- Water Soluble, Easy Cleanup
- Increases Blade Life and Helps Produce Cleaner Cuts

Use this water soluble CRL Spray Mist Coolant in machining and sawing all metals. It has a unique group of corrosion inhibitors, lubricants, and surface active materials blended to provide good saw life and give fine finishes. It is designed for dilution with water at a 40 to one ratio under normal use. Use with Cat. No. MCU270 Spray Mist Coolant Unit.



CAT. NO. SMC2001



CAT. NO. SMC2005

CAT. NO.	CONTENTS	QTY/CASE
SMC20001	1 Gallon (3.785 l)	6
SMC20005	5 Gallons (18.9 l)	1

Minimum order: 1 each.

CRL 3M™ Silicone Lubricant Plus

- Wet Type
- Seals Out Moisture
- Prevents Sticking

CRL 3M™ Silicone Spray Lubricant is designed to aid in the installation of rubber gasket-set windshields and backlights. Seals out moisture from a vehicle's distributor, ignition, spark plugs, and all auto electrical wiring. May also be applied to metal, glass, vinyl, wood, and painted surfaces.



CAT. NO.	CONTENTS	QTY/CASE
3M8877	9 Oz. (255 g)	12

Minimum order: 1 each. All Aerosol Lubricants can be combined for quantity pricing.

CRL WD-40® Lubricant

- Heavy-Bodied Spray Lube Clings to Sprayed Areas, Giving Good Lubricating Performance
- Penetrates and Loosens Frozen Nuts, Bolts, Etc.
- Three Convenient Sizes

One of the most popular lubricants used in home, auto, and industrial applications, WD-40® lubricates and leaves an invisible film of protection against rust and corrosion. It penetrates to free frozen nuts, bolts, and more. It's clear, clean, and non-staining.



8 Oz. Aerosol With Smart Straw



16 Oz. Aerosol



Gallon Liquid

CAT. NO.	CONTENTS	QTY/CASE
WD40	8 Oz. (226 g) Aerosol with Smart Straw	12
WD4018	16 Oz. (453 g) Aerosol	12
WD401	1 Gallon (3.785 l) Liquid	4

Minimum order: 1 each. All Aerosol Lubricants can be combined for quantity pricing.

CRL 3-IN-ONE® Oil

new

- Multi-Purpose Oil Cleans and Prevents Rust
- Telescoping Spout

CRL 3-IN-ONE® Oil lubricates, cleans, and prevents rust. Its easy-to-use drip spout enables precise lubrication, with no overspray or splatter. The new Telescoping Spout provides an extra 5" (127 mm) for those difficult to reach areas.



CAT. NO.	CONTENTS	QTY/CASE
3N1	4 Fl. Oz. (118 ml)	12

Minimum order: 1 each.

CRL Pneumatic Tool Oil

- Helps to Keep Your Air Tools Working Right

CRL Pneumatic Tool Oil can be used with most common pneumatic tools, and makes the job of maintaining optimum tool condition easy.

Comes in a 16 fl. oz. (472 ml) plastic bottle with a flip up lid for quick application.



CAT. NO.	CONTENTS	QTY/CASE
AK01L	16 Fl. Oz. (472 ml)	10

Minimum order: 1 each.

CRL Professional Glass Cutter Oil

- For Automatic or Hand-Held Glass Cutters
- Saves You Money by Increasing the Life of the Cutter Wheel
- No Mixing - Ready to Use
- Easy Clean-Up



CAT. NO. W4104

4 Oz. (118 ml)

Quantity Per Case is 20



CAT. NO. W410QT

1 Quart (945 ml)

Quantity Per Case is 12



CAT. NO. W410GL

1 Gallon (3.78 l)

Quantity Per Case is 4



CAT. NO. W4105GL

5 Gallons (18.9 l)



CAT. NO. W41055GL

55 Gallons (208.2 l)

CRL Professional Glass Cutter Oil was originally developed for use in production type glass cutting bridges and X-Y glass cutting machines. Because it worked so well and cleaned up easily, it is now being used in all phases of glass cutting from hand glass cutters to computer controlled glass cutting machines. CRL Professional Glass Cutter Oil produces cleaner cuts and increases the life of the cutter wheel dramatically. Minimum order is one each.

CRL Evaporating Glass Cutting Oil

- 100% Evaporation Within One Hour When Exposed to Air
- Lubricant for Cutting Heads
- Leaves No Residue

new



CRL Evaporating Glass Cutting Oil is an excellent glass cutting lubricant that is widely used throughout the glazing industry. The viscosity is perfect for precision feed-automated oiling systems, and today's modern oil-feed hand cutters. Fast evaporation makes it ideal for the insulating glass industry. It lowers the chance of contamination in washing machines, and no residue is left to interfere with edge adhesion. Minimum order is one each.



CAT. NO. V020

20 Liter (5.3 gal.) Pail



CAT. NO. V024

4 kg. (1.1 gal.) Bottle

CRL Thick Glass Cutting Oil

- Recommended for Thick Glass
- Splintered Glass is Bound

new



CRL Thick Glass Cutting Oil is the only fluid recommended for lubricating your cutter when cutting glass that is 1/2" (12 mm) or thicker. This professional cutting fluid lubricates the cutting wheel and binds the glass dust created by scoring. Due to its low viscosity, it creeps into the cut to delay the "healing process" of the glass. Packed in a convenient 4 kg (1.1 gal) bottle. Minimum order is one each.



CAT. NO. TGC04

CRL Can Organizer

- Keeps Loose Cans Organized in Vehicles
- Aluminum Bracket for Easy Mounting
- Design Allows Visibility of Cans in Holder



CAT. NO. RX1394

The CRL Can Organizer is a great way to organize loose cans, and keep them from rolling around in your vehicle. Use it for your aerosol lubricants, coatings, or cleaners. The special design of the Can Organizer allows the labels of each can to be easily visible for quick identification of what you need in an instant. Sturdy aluminum bracket makes mounting a breeze. Minimum order is one each.

CRL Match-Up Paint

- Aerosol Cans or Quart Containers
- Used to Match-Up or to Cover Defects on Aluminum Finishes
- Colors to Match Most Popular Finishes

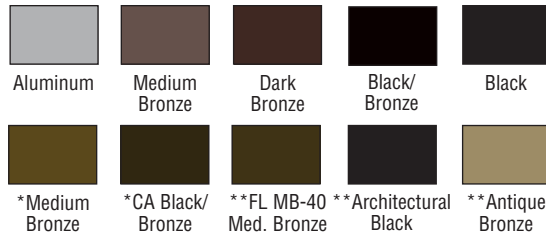

Colors shown are approximate



32 fl oz (946 ml) Quart Containers



12 Oz. (340g) Aerosol Cans

Use CRL Match-Up Paint to touch up scratches or defects in duranodic or anodized aluminum finishes. Although it is not intended to replace those hard anodic architectural finishes, it is designed to correct or cover up coloring defects, scratches, or bare metal ends.

CRL Match-Up Paint can be applied at the job site, thus eliminating the need for costly dismantling and reassembling of the affected parts. The paint is highly durable, and will not crack, peel or discolor with age. The aerosol can is pre-filtered to prevent clogging in the spray nozzle. Quart size containers can be applied by brush, dauber or powered sprayers (see page N388 for our Cat. No. SG1010 Air Paint Spray Gun).



12 OZ. (340 G) AEROSOL CANS

CAT. NO.	COLOR	QTY/CASE
L4527	Aluminum	12
L6515	Medium Bronze	12
L4485	Dark Bronze	12
L5800	Black/Bronze	12
L3900	Black	12
3368521	*Medium Bronze	12
3368528	*California Black/Bronze	12
3368527	**Florida MB-40 Medium Bronze	12
3368533	**Architectural Black	12
3368538	**Antique Bronze	12

Minimum order: 1 each. Colors can be combined for quantity pricing.
 * Former Sommac AlumaColor Finishes for Anodized Aluminum
 ** Former Sommac AlumaColor Finishes for Coated Aluminum

32 FL. OZ. (946 ML) QUART CONTAINERS

CAT. NO.	COLOR	QTY/CASE
L4527QT	Aluminum	6
L6515QT	Medium Bronze	6
L4485QT	Dark Bronze	6
L5800QT	Black/Bronze	6
L3900QT	Black	6

Minimum order: 1 quart. Colors can be combined for quantity pricing.

CRL Touch-Up Markers

- High Gloss Paint
- Covers Up Scratches
- Great for Covering Screw Heads

CRL Touch-Up Markers will cover scratches on metal beautifully, and can be a real time saver to the glazier. They replace paint brushes or standard black felt tip markers better because they are actual high gloss paint. Positive-seal cap prevents the Markers from drying out. Minimum order is one each. Colors can be combined for quantity pricing.



CAT. NO. TUM8
Medium Bronze



CAT. NO. TUM9
Black

CRL Krylon® Spray Paint

- Fast Drying and Dust-Free in Less Than 5 Minutes
- Fast Dry to Handle in Less Than 30 Minutes
- Excellent Appearance
- Good Leveling (Avoids "Orange Peel" Effect)

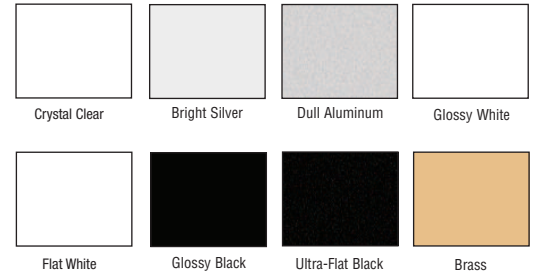

Colors shown are approximate

CAT. NO.	COLOR	CAT. NO.	COLOR
KP1301	Crystal Clear	KP1502	Flat White
KP1401	Bright Silver	KP1601	Glossy Black
KP1403	Dull Aluminum	KP1602	Ultra-Flat Black
KP1501	Glossy White	KP2202	Brass

Minimum order: 1 each. Colors can be combined for quantity pricing.

Made with the user in mind, CRL Krylon® Spray Paint is easy to use. You need less skill to get a beautiful, smooth job without runs and drips than with other spray paints. It dries dust-free in five minutes, and can be handled in half an hour. You also can re-coat Krylon® any time - it will never self-lift like many other paints. It offers these advantages: no brush to buy and clean (or discard); no mixing; no mixer to clean. Use what you need, store the rest, no evaporation, no skin to remove, will not thicken in the can. No lost time, because it's always ready-just shake it and spray. You get professional results every time - no brush marks. 12 oz. (340 g) cans.

CRL Krylon® Primers

- Primes Surfaces for Application of Krylon® Paint
- Dries to Touch in Only Five Minutes



Ruddy Brown

Color shown is approximate



CAT. NO. KP1317
Rust Primer

CAT. NO. KP1314
All Purpose Primer

This aerosol-applied CRL Krylon® All-Purpose Primer builds up surfaces, smooths out irregularities, seals out moisture, and provides a uniform base for Krylon® paint and other coatings. Use on unrusted metal, wood, ceramics, etc., to ensure a good finish. Performs satisfactorily up to 300°F (149°C). 12 oz. (340 g) cans. Minimum order is one each.

CRL Glass Frosting

- Dries Fast
- Sprays Uniformly

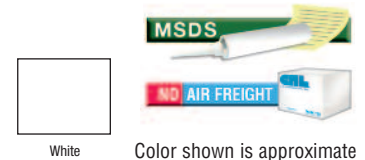

White

Color shown is approximate

CRL Glass Frosting gives a soft frosted effect on glass, plastic or other transparent materials. Permits light to enter and obscures outside vision; developed for one or more coat application and fast (15 minutes or less) drying time between coats. It is a decorative and useful coating on bathroom windows, lamps, shades, skylights, glass partitions, transoms, mirrors, table tops, greenhouses, shower doors, bottles, and bulbs, just leave it to your imagination. Allows glass to take pencil or crayon marks for tracing or artwork. Recommended for store, office, home, or factory. Coverage: Approx. 20 sq. ft. per can. 12 oz. (340 g) can. Minimum order is one each.



CAT. NO. GF816W

CRL Bituminous Paint

- Creates a Barrier Between Railing Hardware and Wet Concrete

new

- Prevents Electrolysis and Corrosion



CAT. NO. BC17A

CAT. NO. BC5GL

CAT. NO.	SIZE
BC17A	15 oz. (425 g)
BC5GL	Net 4.7 gallons (17.8 l)

Minimum order: 1 each.

CRL Bituminous Black Paint is used as a barrier to protect CRL Base Shoe, Posts, Railings, and Stanchions from electrolysis and corrosion when embedded in concrete. Simply brush on a clean and dry surface and allow to dry before embedding in concrete. Coverage: Approx. 100 to 200 sq. ft. per gallon, 33 sq. ft. per aerosol can.

CRL Loctite® Color Guard

- Makes Non-Slip Grips on Hand Tools

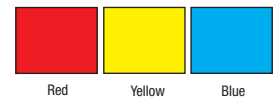

Colors shown are approximate

Our CRL Loctite® Color Guard dries to a tough rubber coating that prevents slipping and protects against corrosion, noise and shock. It can be applied to almost any material to provide a tough rubber coating that will not crack, chip or peel. It is great for making non-slip handle grips on hand tools; simply dip and let dry. Contents: 14.5 fl. oz. (428.7 ml).

CAT. NO.	COLOR
81811	Red
81813	Yellow
81814	Blue

Minimum order: 1 each. Colors can be combined for quantity pricing.



CRL Professional Touch-Up Paint

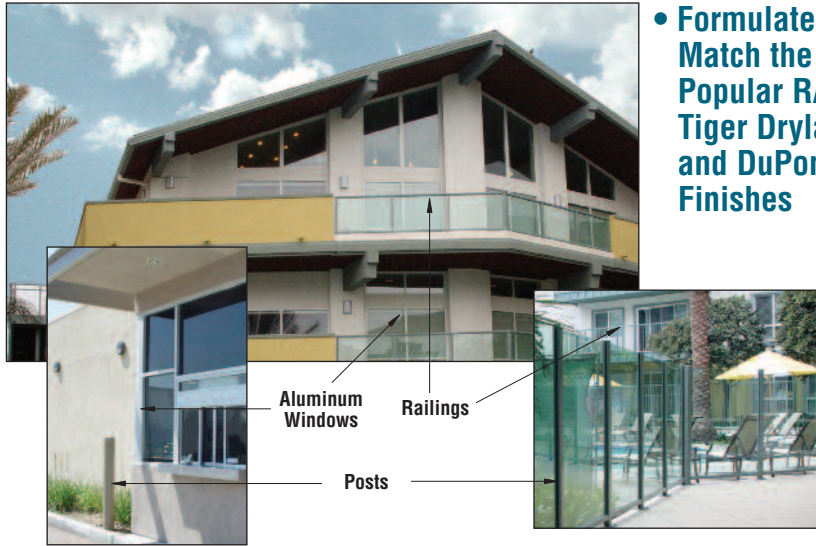

• Formulated to Match the Most Popular RAL®, Tiger Drylac®, and DuPont® Finishes



CRL Professional Touch-Up Paint is ideally suited for the repair of minor chips and scratches. Formulated to match RAL®, Tiger Drylac®, and DuPont® finishes, these acrylic enamel paints come in 12 ounce (340 g) cans that are packed 12 per case. 28 different colors can be combined for quantity pricing. Minimum order is one can.

PLEASE NOTE: Colors shown here are approximate. For a Color Chart order **CAT. NO. RAL**

RAL-9010 Pure White CAT. NO. RAL9010	RAL-1013 Oyster White CAT. NO. RAL1013	RAL-9016 Traffic White CAT. NO. RAL9016	RAL-9003 Signal White CAT. NO. RAL9003	DuPont PFW-510S9 Sky White CAT. NO. D510	Tiger Drylac 249/11111 Bengal White CAT. NO. T249	DuPont PFB-401-S6 Vulcan Black CAT. NO. D401	
RAL-1015 Light Ivory CAT. NO. RAL1015	RAL-1001 Beige CAT. NO. RAL1001	RAL-9001 Cream CAT. NO. RAL9001	RAL-8017 Chocolate Brown CAT. NO. RAL8017	RAL-8019 Gray Brown CAT. NO. RAL8019	DuPont PFJ-407-A5 Statuary Bronze CAT. NO. D407	RAL-7006 Beige Gray CAT. NO. RAL7006	
RAL-7035 Light Gray CAT. NO. RAL7035	RAL-7032 Pebble Gray CAT. NO. RAL7032	RAL-7040 Window Gray CAT. NO. RAL7040	RAL-5002 Ultramarine Blue CAT. NO. RAL5002	RAL-5005 Signal Blue CAT. NO. RAL5005	RAL-6005 Moss Green CAT. NO. RAL6005	RAL-6021 Pale Green CAT. NO. RAL6021	
Sky White CAT. NO. SP8W*	Oyster White CAT. NO. SP8OW*	Agate Gray CAT. NO. SP8AGY*	Beige Gray CAT. NO. SP8BGY*	Matte Black CAT. NO. SP8BL*	Matte Bronze CAT. NO. SP8BRZ*	Forest Green CAT. NO. SP8GRN*	Silver Metallic CAT. NO. SP8S*

*These colors match the finishes of our Aluminum Railing System.

CRL Professional Touch-Up Paint For Australia

- Stocked at Both CRL Sydney and Melbourne Locations
- Formulated to Match Colorbond® and Powder-Coated Finishes

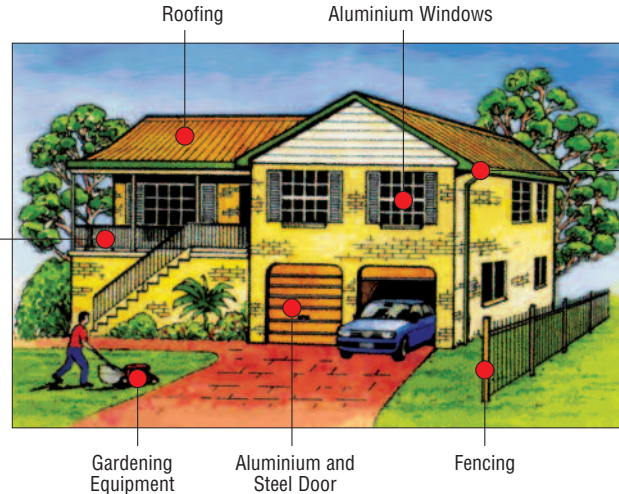
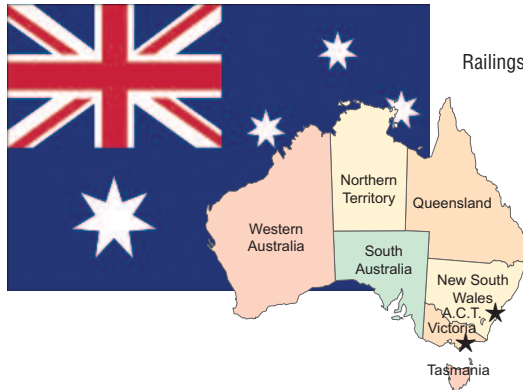

Guttering and Downspouts



CRL Professional Touch-Up Paint has become the industry standard for the repair of minor chips and scratches. Formulated to match Colorbond® and Powder Coated finishes, Professional Touch-Up Paint comes in an ever increasing range of over 130 stock colours. For a colour chart of all of the available colours, contact Customer Service. 5.3 ounce (150 g) cans are packed 12 per case. Colours can be combined for quantity pricing. Minimum order is one can. Available from CRL locations in Sydney and Melbourne, Australia. For more information, visit us at crlaurence.com.au.

CAT. NO.	COLOUR	CAT. NO.	COLOUR	CAT. NO.	COLOUR	CAT. NO.	COLOUR
PC890	A.P.O. Grey	JN126	Cotta Sand	JN158	Loft	JN100	Satin Black
PC44	Admiralty Grey	JN151	Cottage Green	PC450	Magnolia	JN700	Shadow Grey
PC21	Almond Ivory	PC612	Cream	JN143	Manor Red	JN152	Shale Grey
JN30	Aluminium	JN139	Deep Ocean	PC297	Marine Outdoor	PC98	Shoji White
PC570	Anodic Bronze	PC64	Dem. Electric Orange	PC32	Matte Black	PC980	Signal Red
PC66	Anodic Natural Matte	PC350	Doeskin	PC118	Matte Tan	PC133	Silver Glo Pearl
PC390	Anodic Off White	PC94	Dove Grey Texture	JN7	Medium Bronze	PC112	Smokey Glass
PC49	Anotec Dark Grey	JN50	Dover White	PC38	Merino White	JN340	Smooth Cream
PC71	Anotec Off White	JN148	Dune	PC540	Met Bronze Pearl	PC480	Space Blue
PC61	Anotec Silver Grey	PC25	Electric Orange	PC24	Metallic Charcoal	JN300	Stone
JN740	Appliance White	PC122	Eternity Steel	JN157	Monument	PC470	Stone Beige Satin
PC710	Arch. White	JN156	Evening Haze	JN140	Mossvale Sand	PC780	Stone Grey
PC34	Arrowhead	PC54	Federation Green	PC29	Navy	PC810	Stone White
PC120	Aust. Brown	PC41	Federation Red	JN142	Nightsky Ebony	PC99	Storm Front Pearl
PC56	Azure Grey	PC610	Ferndell Blue	PC580	Notre Dame	PC490	Stromboli
PC114	Bac Beige	PC180	Flame Red	PC550	Old Pewter Grey	JN149	Surfmist
PC101	Barley	PC750	French Blue	PC190	Oyster	JN132	Tea Tree
PC204	Barrister White	PC990	Gloss Black	JN141	Pale Eucalypt	JN122	Torres Blue
PC611	Beige	PC16	Gloss White	JN125	Pale Terracotta	PC310	Townsend Silver
PC65	Black Onyx	PC970	Golden Yellow	JN138	Paperbark	PC770	Transformer Grey
PC299	Black Outdoor	PC93	Graphite Ripple	PC250	Pearl White	PC95	Ultra Silver Gloss
PC170	Blaze Blue	PC45	Grey Nurse	PC15	Periwinkle	JN121	Vincent Brown
JN136	Blueridge	JN154	Gun Metal Grey	JN940	Picton Green	PC614	Violettone White
JN90	Bowral Brown	PC18	Gypsum White	JN131	Plantation	JN60	Weather Copper
PC47	Bright Silver	PC150	Hammersley Brown	PC950	Pottery	PC23	Wedgewood
PC51	Bright White Gloss	PC670	Hawthorn Green	PC420	Precious Bronze Pearl	JN113	Wheat
JN200	Bronze Olive	JN146	Headland	PC380	Precious Nickel Pearl	PC690	White Birch
PC33	Brunswick Green	PC790	Heritage Green	PC260	Precious Pewter Pearl	PC1	White Lustre
PC86	Cabana Green	PC870	Horizon Blue	PC96	Precious Silver Pearl	PC83	White Satin
PC35	Charcoal Gloss	JN220	Hunter Red	PC320	Precious Steel Pearl	PC500	White Steel
JN155	Charcoal Grey	JN117	Iron Bark	PC850	Primrose	PC840	Wild Oats
PC39	Charcoal Satin	JN134	Ironstone	JN127	Quartz	JN144	Wilderness
JN400	Citi Low Sheen	PC2	Jason Metallic	PC590	Rivergum Beige	JN147	Windspray
PC111	Citi Pearl	JN137	Jasper	PC75	Roseberry Grey	PC22	Wizard
PC290	Claret	PC650	Lawn Green	PC520	Safety Yellow	PC110	X15 Orange
PC760	Claypot	PC298	Leather Green Outdoor	PC53	Sand	PC615	Yellowtone White
PC52	Clear Gloss	PC27	Lemon Yellow	JN135	Sandbank		
PC68	Coffee	PC36	Light Grey	PC296	Sandstone Outdoor		

CRL Throw-Away Brushes

- Good Quality Brushes for Painting Trim
- Tapered Bristles

These economical Throw-Away Brushes are made with bristles that taper to a flagged point. They carry a heavy load of material and spread it evenly and efficiently.

CAT. NO.	WIDTH	QTY/BOX
LAB2256	1" (25 mm)	36
LAB2258	2" (51 mm)	36
LAB2260	3" (76 mm)	12
LAB2261	4" (102 mm)	12

Minimum order: 1 each. Sizes can be combined for quantity pricing.



CRL Paint and Varnish Brush



- Pure Black Pig Bristles

This double thick, flat CRL 3" (76 mm) Paint and Varnish Brush has a panel-type handle for easy, flexible use. Pure black pig bristle is chisel shaped for smooth, even flow. Minimum order is one each.

CAT. NO. LAB2634

CRL Disposable Acid Brush



- Natural Horse Hair Bristles
- Applies Acids, Primers, and Flux

The CRL 6" Disposable Acid Brush is for applying primers, acids and flux, they are 6" (152 mm) long, with a 3/8" (9.5 mm) round rolled steel handle and 3/4" (19 mm) long stiff horse hair bristles. Minimum order is one each.

CAT. NO. 1AB

CRL Paint Prep Pen

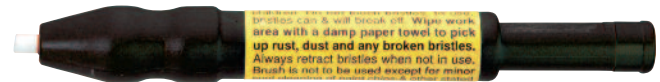

- Thousands of Glass Fibers to Sand Away Rust on Pinch Weld
- Small Tip Provides Easy Access Into Tight Spaces

This CRL Paint Prep Pen has thousands of glass fibers bundled to form a sanding surface that can sand away rusted areas or bare metal scratches in preparation for pinch weld primer application. The small tip provides easy access to tight places. Two refill cartridges of glass fibers are contained in the handle so you are always prepared. Minimum order is one each.

CAT. NO. P3437

CRL Paint Spray Gun

- All-Purpose and Fully Adjustable

The all-purpose CRL Paint Spray Gun has a fully adjustable fan pattern. The Gun weighs 2.3 lbs. (1.05 kg), and has a 1.8 mm nozzle. The reservoir cup is one quart (.946 ltrs). A minimum 3 hp air compressor is required. Air consumption is 7-12 cfm (3304 to 5663 cm/sec) at 50-65 psi (3.4-4.5 bars). Minimum order is one each.



CAT. NO. SG1010

new

CRL Can Handler

- Snaps on Any Standard Spray Can
- Eliminates Finger Fatigue



The CRL Can Handler snaps on any standard spray can to give professional spray gun convenience. Controls direction of spray, and keeps your hands clean, away from spray. Eliminates finger fatigue for a steady and controlled application. Safety trigger lock prevents accidental dispensing. Made in U.S.A. Minimum order is one each.

CAT. NO. CH49

The Easy Solution For All Your Glass Bonding Needs

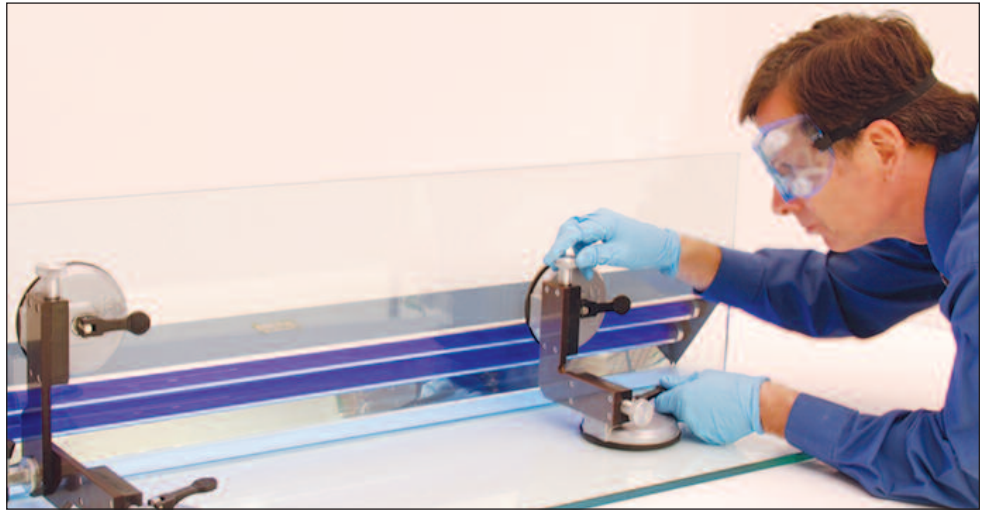

Simplified Technology for Efficient and Safe Glass Bonding

CRL takes the mystery out of glass bonding with our complete line of UV and UV/Visible Light Adhesives, Fixation Devices, UV Lamps, and Glass Furniture Hardware.

Everything you need with easy-to-understand instructions and guidelines to produce glass bonded work from functional glass furniture to beautiful glass artwork. There are hundreds of possible uses in glass construction with the Glass Bonding System from CRL.

New innovative Fixation Devices make construction faster and easier. Advanced UV Adhesives provide strong bonds to many different substrates including laminated glass, tempered glass, steel, aluminum, stainless steel, ceramic, stone, wood, and plastics. We have a wide selection for UV Lamps for fast bonding of all sizes of glass furniture. We even have basic UV Starter Kits for first time users and professional kits for full time users, plus all the right cleaners and accessories needed to make your job easier and more profitable.

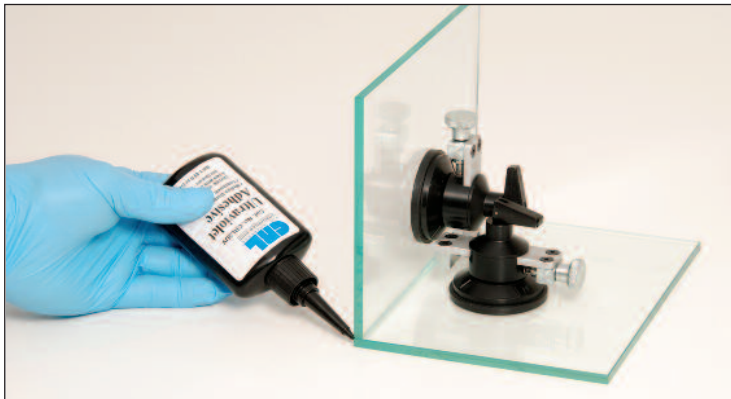

Advantages of CRL's Glass Bonding System

- Easy to Understand Instructions and Guidelines
- Hundreds of Possible Uses in Glass Construction
- Advanced UV Adhesives Provide Strong Bonds to Varied Substrates
- New Innovative Fixation Devices
- Wide Selection of UV Lamps
- Latest Designs in Glass Furniture Hardware
- Starter Kits – Basic and Professional

FOR TECHNICAL ASSISTANCE CONTACT GLASS AND GLAZING TECH SALES

Phone: (800) 421-6144 or (323) 588-1281 Ext. 7720
Direct Fax: (866) 921-0532 or (323) 584-5226
Direct E-Mail: glassglazing@crlaurence.com



CRL Has the Right UV Adhesive for Any Application

- High, Medium, and Low Viscosity Formulas
- Strong Bond to Many Substrates, Even Laminated Glass
- See Pages N413-N417

CRL UV/Visible Light Cure Adhesives handle any glass bonding application you may encounter. Choose from seven different formulations plus colored adhesives for your projects. Typical applications include: glass knobs and metal towel bars to frameless glass shower doors; glass shelves on mirrors; glass showcases; glass sculptures; glass artwork; and efficient production of glass furniture.

Our different formulations adhere to many substrates, including metal, ceramic, stone, plastic, wood, and laminated glass, which normally does not lend itself to UV adhesives, because the PVB inner layer absorbs almost all of the UVA radiation.



CRL Fixation Devices

- Wide Selection to Choose From
- Precisely Positions and Holds Glass in Place While Adhesive Cures
- See Pages N404-N411

For optimum curing of UV Adhesives it is imperative to keep the glass parts from sliding out of place. In the past, a second person was often needed to hold the glass parts in position. Now, with CRL Fixation Devices, one person can easily manage all the work steps alone. Many of the Fixation Devices have adjustment screws to raise and lower the glass parts for proper application of high and low viscosity (capillary action) UV Adhesives. Other devices have marked dimensions for fixing glass parts in virtually any angle.



CRL UV Curing Lamps

- Provides Correct UV Wavelength for Proper Curing of UV Adhesives
- Numerous Models to Choose From
- See Pages N422-N425

Maximum bond strengths of UV Adhesives are achieved with the appropriate UV Curing Lamp. CRL Lamps emit the correct UV wavelength of 365 nm for curing adhesives, and different intensity lamps are available to cure the adhesive at a faster rate if desired. **NOTE:** Always wear special UV safety glasses, goggles, or face shield when using UV Curing Lamps.



CRL Glass Furniture Hardware

- Latest Designs for Unique Glass Furniture
- Eliminates Cut-Outs, Notches or Drilling Holes in Glass
- See Pages N428-N444

Glass has long been the choice for unique furniture designs and display products due to the many alternatives available for glass thickness and colors. Glass is also unique in that glass shops or glass fabricators can produce custom furniture designs for homes or businesses, no matter how large or small. CRL Glass Furniture Hardware provides the latest in design and function. Combined with our different formulas of UV Adhesives, our many Fixation Devices, and UV Curing Lamps, your possibilities are almost limitless.



Using UV Adhesives

Bonding glass with UV Curing Adhesives can easily be achieved by taking your time and carefully following these basic steps:

1. Material Selection

Glass choice and adhesive selection is critical since both predetermine the results. A different mix of glass and adhesives will result in varying bond strengths. Clear float glass, mirrored, tempered glass, and smooth, flat wired glass can be bonded without problems. Structured glass like patterned, sandblasted, or wired glass can cause lower bond strengths or cannot be bonded at all. The UVA light permeability depends on the glass thickness and color intensity of the glass. Glass with high UV absorption such as laminated glass or colored glass cannot be bonded with common UV adhesives and require a highly sensitive adhesive such as our UV678 (page N414). Bonding metal-to-glass requires a suitable adhesive such as our UV682 (page N414).



2. Surface Preparation

All bonding surfaces must be absolutely clean, free of grease, and dry. When UV bonding use appropriate cleaners such as CRL7528 (page N399) that are free of surfactants (soap) or other contaminants. Common glass and general purpose cleaners are not suitable in most cases. In order to obtain a stable and durable bond, the adhesive and all parts to be bonded must be at room temperature. Heating all surfaces to 155°F (68°C) prior to bonding will remove any condensation that could adversely affect the bond strength.



CRL7528 Cleaner

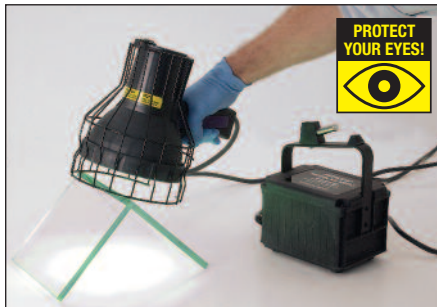

UV665 Glass-to-Glass Bonding

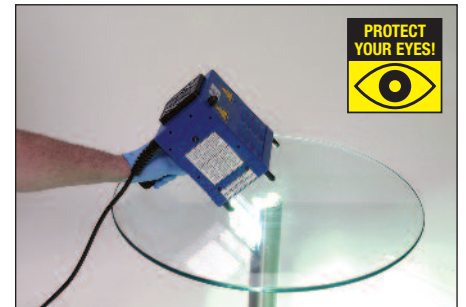

UV682 Glass-to-Metal Bonding

3. Adhesive Selection

The correct UV Adhesive depends on the bonding materials, application of the finished product, and the resulting stress load.

- For glass-to-glass bonds, self-supported "closed" construction is recommended to obtain the highest possible stability. Adhesives such as our UV678 and UV690 (pages N414-N415) are best suited for this type of "closed" construction. When self-supported "closed" construction isn't possible, use UV740, UV665, UV770, UV760 or UV682 Adhesives for non-self-supported "open" construction (pages N413-N416).
- For glass-to-metal bonds, use our UV682 Adhesive (page N414).



Self-Supported "Closed" Construction



Non-Self-Supported "Open" Construction

4. Applying UV Adhesive

Before applying the adhesive it is recommended to check if the bonding parts will fit in their intended position. This is best done by first assembling the project without bonding by using the CRL Fixation Devices shown on pages N404 to N411 to securely hold the surfaces in position.

- The adhesive should be applied within five minutes after the parts have been heated. Should a longer time period have passed, the parts should be re-heated.
- Bonding surfaces should preferably be in a horizontal position when the adhesive is applied.
- Precise and economic application of the adhesive can be achieved by using CRL Dispensing Systems and Application Needles shown on page N420.



An important fact to always remember is that the smoother the bonding surface and the thinner the layer of adhesive, the stronger and more resilient the bond will be. A layer of too much adhesive reduces the strength of the bond, and increases the workload of removing excess adhesive.

Applying the adhesive BEFORE joining the parts:

With medium/high viscosity adhesives, such as UV770 (page N413), the adhesive should be applied in a wiggly pattern before the parts are joined.

- When bonding horizontally, the bonding parts should be evenly and carefully joined to avoid trapping any air bubbles.
- The weight of the bonding parts should be sufficient to evenly spread the adhesive over the entire bonding surface.
- When bonding metal-to-glass, apply a liberal amount of the adhesive to the center of the part and gently squeeze or clamp to eliminate any air bubbles.
- Air bubbles appearing in adhesive may be removed by carefully moving parts in a circular motion until bubble moves to the edge and is released.

Applying the adhesive AFTER joining the parts:

With low viscosity adhesive, such as UV740 (page N413), the adhesive seeps into the bondline gap by itself. Therefore, the bonding parts can be joined in their final position before the adhesive is applied.

- Do not work on several parts at the same time, instead build the project one step at a time.
- To achieve an optimum distribution of adhesive over the entire bonding surface, the parts should be slightly lifted and lowered to increase coverage before curing. Care should be exercised as to not create air bubbles in adhesive.

5. Structural Stability

It is absolutely critical that the bonded surfaces are kept stable and in a fixed position. This is made possible by using the CRL Fixation Devices shown on pages N404 to N411.

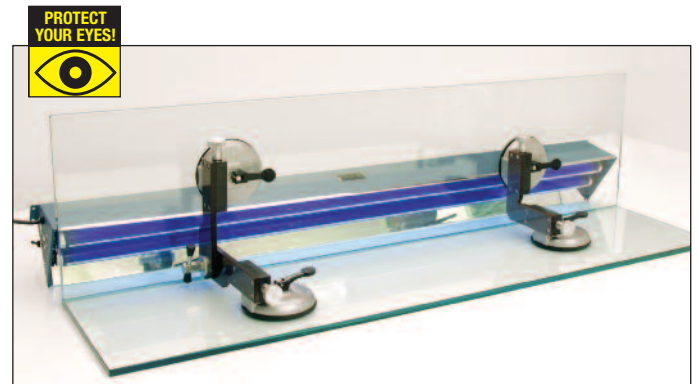

6. Curing UV Adhesive

CRL UV Lamps are equipped with UV filters that reduce potential damage to eyes and skin. For your own safety, however, you should use additional suitable protection, such as UVS30 Safety Glasses with UV filtering (page N426), and 700512 Disposable Gloves (page N426).

- Use a suitable size CRL UV Lamp (page N422). The Lamp should not be shorter than the bonding edge to avoid tension build-up due to uneven curing.
- Position Lamp as close as possible to the bonding surface during curing.
- Never move parts during the curing process, and do not expose the project to vibrations.

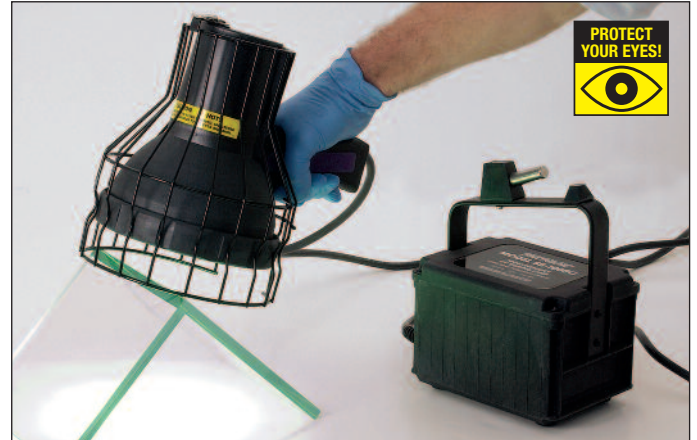

The Exposure to UV Light is Done in Two Steps: Pre-Cure and Finish-Cure

- **Pre-Cure** the bond by exposing to UV light from at least 10 seconds to approximately two minutes, depending on the type of Curing Lamp used and glass thickness. By pre-curing, a working strength (approximately 30% of the final strength) is achieved. This allows excess adhesive outside the bonding surface to be removed easily.
 - Remove any Fixation Devices and clean the object of any adhesive residue.
CRL Loctite Chisel® Paint Stripper: 79040 (page N402)
CRL Glass Scraper: RS65 (page N402)
CRL Extra Fine Steel Wool: Z100 (page N402)
 - **Finish-Cure** the bond by exposing to UV light for at least 60 seconds to approximately five minutes, depending on the type of UV Curing Lamp used and glass thickness.
- NOTE:** Exposing the bond for a longer time has no negative or positive effects on the bond.
- After final curing (approximately 24 hours), the bond is fully functional, and can be put under load.

7. Bond Test

- Test strength of bond by subjecting it to stresses exceeding those it would normally incur by impacts, tilting, sudden movements, etc.
IMPORTANT NOTE: Protect yourself from future liability claims by advising your customers in writing that no construction performed solely with adhesives is 100 percent fail safe. Conditions outside of your control, such as excessive loads, whether accidentally or intentionally placed on the completed project, can cause a bond to fail, and that you are by no means responsible in those situations.
- For technical assistance, contact CRL Technical Sales at (800) 421-6144 in the U.S., (877) 421-6144 from Canada, or (323) 588-1281 International. Ask for Ext. 7720. You can also e-mail us through our web site at crlaurence.com. From the home page click on Contact Us, and then click on Technical Sales for Glass and Glazing Products.

Limited Warranty: CRL guarantees the satisfactory quality of the products and the materials supplied by us. The preceding information as well as any technical recommendation given in writing, verbally or based on tests, is provided to the best of our knowledge. They are non-binding recommendations only, and do not affect your responsibility to determine the suitability of the product for your particular processes and purposes. The quality of the bond depends on conditions which are outside of our control. We therefore have to reject any liability which exceeds the replacement of faulty material. This refers especially to any indirect or consequential loss, damages or expenses.

CRL Glass Bonding Training

- In-House Training Seminars
- Training and Instructional Videos
- Online Webinars



Let us help you get started with UV Glass Bonding, or answer your questions if you have already experimented with producing glass construction using UV adhesives. We have the easy solutions for all your glass bonding needs, and can provide them to you with a Training and Instructional Video, an In-House Training Seminar, and Online Webinars.

The Training and Instruction Video can be ordered in DVD format (Cat. No. DVDUV101). Log on to crlaurence.com for information on CRL Webinars and to register for the next scheduled one, or call us for the date of our next in-house Training Seminar at our Los Angeles, California headquarters.



CRL Glass Bonding 101 Training Will Provide the Following:

- Features and Advantages of Different CRL UV Adhesives, Including Properties of Each and Their Best Use
- Instructions and Techniques on Proper Surface Preparation
- Explanations and Demonstrations of CRL Fixation Devices
- Information on Different UV Bonding Lamps to Help You to Choose the Right One
- Proper Selection and Installation of CRL's Wide Variety of Glass Furniture Hardware



CRL UV Glass Bonding Basics DVD

- Step-By-Step Instructions
- Video Demonstrations

- Available in English, German, and French



This CRL UV Glass Bonding Basics DVD provides a detailed step-by-step video of the seven basic procedures for proper application of UV adhesives for glass bonding projects.

The easy way to learn how to:

1. Provide Proper Surface Preparation
2. Apply Fixtures and Align Joints
3. Heat Bonding Surfaces
4. Select and Apply Appropriate Adhesive
5. Illuminate Short for Precure
6. Remove Fixtures and Clean Off Excess Adhesive
7. Illuminate Long for Final Cure



1. Provide Proper Surface Preparation

CAT. NO.	DESCRIPTION
DVDUV101	English DVD
DVDUVDE	German DVD
DVDUVFR	French DVD

Minimum order: 1 each.



2. Apply Fixtures and Align Joints



3. Heat Bonding Surfaces

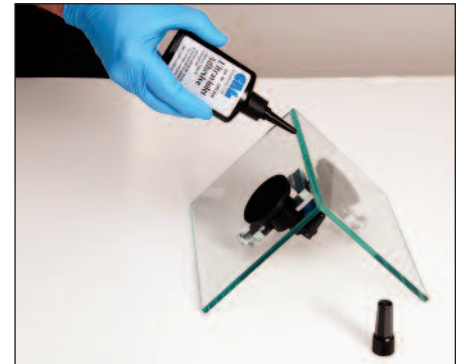

4. Select and Apply Appropriate Adhesive



5. Illuminate Short - For Precure



6. Remove Fixtures and Clean Off Excess Adhesive



7. Illuminate Long - For Final Cure

CRL UV Glass Bonding Kits

Starting a new opportunity segment for your business can cause concern about making the right decisions on equipment and supply selection. CRL UV Glass Bonding Kits have all of the choices made for you in advance to allow you to enter this field of technology easily at various levels based on your needs.

From our very basic CRL Small Project UV Glass Bonding Starter Kit suited for artists, hobbyists and small commercial requirements, to our Professional Kits with a wider variety of equipment and components, you will find just the right Kit to start creating finished projects in no time. Backed by our experienced in-house technicians and detailed instructions included with each Kit, you'll have everything you need at a great price without the tedious research usually required to start your new range of product offers.

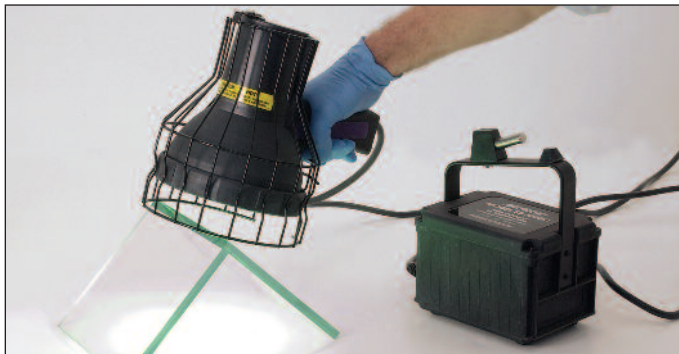

As you familiarize yourself with the various production techniques you will quickly be able to expand the types of desired finished items produced by choice from our variety of specialty UV Pre-Treatment Supplies, Adhesives, Lamps, Fixation Devices, and Display and Furniture Hardware.

As work area safety is of the utmost importance, all CRL Curing Lamps are equipped with UV filter screens to prevent damage to eyes and skin, and we offer further protection with a selection of UV Spectacles, Goggles, and Face Masks.

C.R. Laurence will always be researching the newest developments in UV glass bonding to continually be positioned to offer the finest quality supplies, equipment, and hardware to the glass industry.

CRL Small Project UV Glass Bonding Starter Kit

- An Affordable Way to Learn UV Glass Bonding Techniques
- Low Viscosity UV Adhesive in Crystal Clear and Colors
- Ships With Easy-To-Follow Instructions

Modern technology has allowed development of UV Glass Bonding Adhesives and Equipment to become user friendly to a point that by following simple step-by-step instructions beautiful small UV bonding projects can be created easily. Small display cases, crystal repairs and even art projects with the colorful UV Adhesives provided are easy to complete. Minimum order is one each.

CRL SMALL PROJECT UV GLASS BONDING STARTER KIT INCLUDES:



CAT. NO. UVSK1

new

- 1 each Cat. No. UB80 DC UV Adhesive Curing Lamp
- 1 each Cat. No. UV74010 Low Viscosity UV Adhesive
- 1 each Cat. No. UV19332 Red UV Adhesive
- 1 each Cat. No. UV19333 Yellow UV Adhesive
- 1 each Cat. No. UV19334 Blue UV Adhesive
- 5 each Cat. No. UVN35 Low Viscosity Applicator Needles

- 1 each Cat. No. UVA1 Application Needle Adapter
- 1 each Cat. No. RS65 Glass Scraper
- 12 pair Cat. No. 700512 Nitrile Gloves
- 1 pack Cat. No. Z100 Extra Fine Steel Wool
- 1 each Cat. No. UVS30 UV Spectacles
- 1 each Cat. No. 180312 Carrying Case

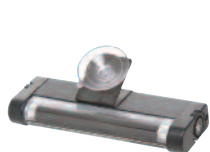

CAT. NO. UB80



CAT. NO. UV74010



CAT. NO. UV19332



CAT. NO. UV19333



CAT. NO. UV19334

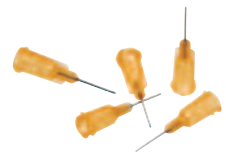

CAT. NO. UVN35



CAT. NO. UVS30



CAT. NO. UVA1



CAT. NO. RS65



CAT. NO. 700512



CAT. NO. Z100



CAT. NO. 180312

CRL UV GLASS BONDING KITS

For Pricing Visit Our Web Site or Call Us Toll Free at the Phone Numbers Shown on the Back Cover

CRL Basic UV Glass Bonding Starter Kit

- Complete Glass-to-Glass and Glass-to-Metal Projects
- Crystal Clear Medium-Bodied UV Adhesive **new**
- Ships With Easy-to-Follow Instructions

Keep up with the growing trend of UV Glass Bonding usage with the CRL Basic UV Glass Bonding Starter Kit. We provide you with the very versatile Medium Viscosity Glass-to-Glass and Glass-to-Metal UV Adhesive that allows you to UV bond our special selection of UV hardware to create displays, showcases, furniture, and more. Simple instructions included with the Kit will have you completing projects in no time. Minimum order is one each.

CRL BASIC UV GLASS BONDING STARTER KIT INCLUDES:

- 1 each Cat. No. UV240 110 Volts UV Adhesive Curing Lamp
- 1 each Cat. No. UVS30 UV Protective Spectacles
- 1 each Cat. No. UV68225 Medium Viscosity UV Adhesive
- 5 each Cat. No. UVN85 Medium Viscosity Applicator Needles
- 2 each Cat. No. UVA1 Application Needle Adapters
- 1 each Cat. No. RS65 Glass Scraper



CAT. NO. UVSK2

- 100 each Cat. No. 51S Single Edge Razor Blades
- 12 pair Cat. No. 700512 Nitrile Gloves
- 1 pack Cat. No. Z100 Extra Fine Steel Wool
- 1 each Cat. No. CRL7528 Cleaner Degreaser
- 1 each Cat. No. T1418 Carrying Case



CAT. NO. UV240



CAT. NO. UVS30



CAT. NO. UV68225



CAT. NO. UVN85



CAT. NO. UVA1



CAT. NO. RS65



CAT. NO. 51S



CAT. NO. 700512



CAT. NO. Z100



CAT. NO. CRL7528



CAT. NO. T1418

CRL Professional UV Glass Bonding Kit With Tube Lamp

- Professional Quality Kit for UV Bonding
- Complete Larger Projects
- Ships With Easy-to-Follow Instructions

The CRL Professional UV Glass Bonding Kit With Tube Lamp provides you with all the basic equipment required to produce beautiful projects in your shop or on the job site. The Cat. No. UVBL15 UV Tube Lamp can be used to cure glass-to-metal hardware applications as well as longer bonding joints for furniture and display assemblies. Minimum order is one each.

CRL PROFESSIONAL UV GLASS BONDING KIT WITH TUBE LAMP INCLUDES:

- 1 each Cat. No. UVBL15 110 Volt Adhesive Curing Tube Lamp
- 1 each Cat. No. UV68225 Medium Viscosity UV Adhesive
- 1 each Cat. No. UV74025 Low Viscosity UV Adhesive
- 5 each Cat. No. UVN85 Medium Viscosity Applicator Needles
- 5 each Cat. No. UVN35 Low Viscosity Applicator Needles
- 2 each Cat. No. UVA1 Application Needle Adapters
- 1 each Cat. No. RS65 Glass Scraper
- 100 each Cat. No. 51S Single Edge Razor Blades
- 12 pair Cat. No. 700512 Nitrile Gloves



CAT. NO. UVSK3

- 1 pack Cat. No. Z100 Extra Fine Steel Wool
- 1 each Cat. No. CRL7528 Cleaner Degreaser
- 1 each Cat. No. UVS30 UV Protective Spectacles
- 1 each Cat. No. UV69962 Mini Clamp-It® 90 Degree Fixation Set
- 1 each Cat. No. UV69954 Clamp-It® 90 Degree Fixation Set
- 2 each Cat. No. UV282 Adjustable Angle Fixation Device
- 4 each Cat. No. UV285 Eccentric Height Adjustment Stops
- 1 each Cat. No. UVB1N1 Storage Container



CAT. NO. UVBL15



CAT. NO. UV68225
CAT. NO. UV74025

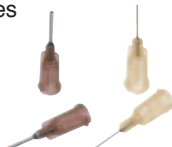

CAT. NO. UVN35
CAT. NO. UVN85



CAT. NO. UVA1

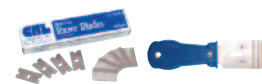

CAT. NO. RS65
CAT. NO. 51S



CAT. NO. 700512
CAT. NO. Z100



CAT. NO. UVS30
CAT. NO. CRL7528



CAT. NO. UV69962



CAT. NO. UV69954



CAT. NO. UV282



CAT. NO. UV285



CAT. NO. UVB1N1

CRL Professional UV Glass Bonding Kit With High Intensity Lamp

new

- Perfectly Suited for the Fabrication of Showcases and Glass Furniture
- Supplied With CRL's Four Most Popular UV Bonding Adhesives for a Wide Variety of Applications
- Fixation Devices Securely Position Your Work Pieces for Precise Fabrication



CAT. NO. UVSK4

This CRL Professional UV Glass Bonding Kit features our powerful Z7596 High Intensity UV Lamp, designed to emit wave lengths of 365 nm, perfect for curing all CRL UV Bonding Adhesives. That means your projects will take less time to complete with full curing achieved quickly.

Cat. No. UV770 High Viscosity UV Adhesive is included and is perfect for 'all-glass' showcases, shelves, furniture, towel bar installations, and standoff applications. The Cat. No. UV740 Low Viscosity Adhesive uses capillary action capabilities for the efficient production of glass furniture with crystal clear results. Use the Cat. No. UV682 Medium Viscosity Adhesive for your glass-to-metal hardware installations. Finally, Cat. No. UV678 Medium Viscosity Adhesive has special properties to be compatible with laminated glass bonding requirements.

The six Fixation Device configurations will enable you to position multitudes of glass arrangements securely during the UV Adhesive application and curing stages of your assemblies. These, combined with all of the other basic supplies and tools shown below, will set you apart from the competition and on your way to the growing popularity of finished UV bonded glass products. Minimum order is one each.

CRL PROFESSIONAL UV GLASS BONDING KIT WITH HIGH INTENSITY LAMP INCLUDES:

- 1 each Cat. No. Z7596 110 Volt UV Adhesive Curing Lamp
- 1 each Cat. No. UV67885 Medium Viscosity UV Adhesive
- 1 each Cat. No. UV68225 Medium Viscosity UV Adhesive
- 1 each Cat. No. UV74025 Low Viscosity UV Adhesive
- 1 each Cat. No. UV77010 High Viscosity UV Adhesive
- 2 each Cat. No. UV9SET Application Needle Sets
- 4 each Cat. No. UVA1 Application Needle Adapters
- 1 each Cat. No. RS65 Glass Scraper
- 100 each Cat. No. 51S Single Edge Razor Blades
- 12 pair Cat. No. 700512 Nitrile Gloves
- 1 pack Cat. No. Z100 Extra Fine Steel Wool
- 1 each Cat. No. CRL7528 Cleaner Degreaser
- 1 each Cat. No. UV1575 Non-Contact Laser Thermometer
- 1 each Cat. No. UV2931 Small 90 Degree Fixation Device
- 1 each Cat. No. UV280 Large 90 Degree Fixation Device
- 1 each Cat. No. UV69962 Mini Clamp-It® 90 Degree Fixation Set
- 1 each Cat. No. UV69954 Clamp-It® 90 Degree Fixation Set
- 2 each Cat. No. UV282 Adjustable Angle Fixation Device
- 4 each Cat. No. UV285 Eccentric Height Adjustment Stops
- 1 each Cat. No. UVB1N2 Storage Container



CAT. NO. Z7596



CAT. NO. UV68225



CAT. NO. UV67885



CAT. NO. UV74025



CAT. NO. UV77010



CAT. NO. UV9SET



CAT. NO. UVA1



CAT. NO. RS65



CAT. NO. 51S



CAT. NO. 700512



CAT. NO. Z100



CAT. NO. CRL7528



CAT. NO. UV1575



CAT. NO. UV2931



CAT. NO. UV280



CAT. NO. UV69962



CAT. NO. UV69954



CAT. NO. UV282



CAT. NO. UV285



CAT. NO. UVB1N2

Proper Surface Preparation – Crucial for Optimal Bonding

Just like in the application of construction sealants or automotive windshield urethanes, proper cleaning of all surfaces prior to applying the bonding adhesive is essential for good results. Only with an absolutely clean surface is it possible to achieve optimal bonding results with UV Adhesives. Therefore, a complete pre-cleaning procedure of the glass and hardware is very important. All bonding surfaces must be **clean** and free of grease and oil, and **completely dry** as well. By following our application instructions, and by using the cleaning products and accessories on the following pages you will achieve optimal bonds.



First, clean the edges to be bonded with Cat. No. CRL7528 Cleaner and Degreaser and Cat. No. 1550 Lint Free Glass Wipes



Second, clean entire glass piece with Cat. No. S50 Glass Cleaner and Cat. No. 1550 Lint Free Glass Wipes



Third, completely dry edges to be bonded with Hot Air Heat Gun Cat. No's LD121 or UV8978

CRL Cleaner and Degreaser



- Prepares Surfaces for UV Adhesives
- Cleans Up Uncured UV Adhesive
- Contains No Ozone Depleting Chemicals
- Evaporates Quickly



CRL Cleaner and Degreaser is a general-purpose cleaner/degreaser ideal for preparing surfaces prior to use of all ultraviolet adhesives and sealants. It removes all traces of grease and oils, and leaves no residue. 12 per case. Minimum order is one each.

20 Oz. (567 g)

CAT. NO. CRL7528

CRL Loctite® ODC-Free Cleaner and Degreaser

- Prepares Surfaces for UV Adhesives
- Cleans Uncured UV Adhesives
- Contains No Ozone Depleting Chemicals
- Non-Aerosol Pump Spray Container



16 Fl. Oz. (473 ml)



Loctite® ODC-Free Cleaner and Degreaser is a general purpose cleaner/degreaser, ideal for preparing surfaces prior to use of all Loctite® adhesives and sealants. Removes all traces of grease and oils, and leaves no residue. It is nonflammable and low in toxicity. 12 pump spray cans per case. Minimum order is one each.

CAT. NO. 20162

CRL S50 Sprayway Glass Cleaner

- A Glass Industry Favorite for Years
- Ammonia Free Formula
- Fast Evaporation Rate
- Just Spray and Wipe Clean



19 Oz. (539 g)



CRL S50 is Sprayway's leading Glass Cleaner. The formula includes perfume-grade alcohols, which are the best cleaning agents you can use. It also has a fast evaporation rate, which keeps it from leaving a film and adversely interacting with other materials. 12 cans per case. Minimum order is one case.

CAT. NO. S50

CRL Hot Air Gun Kit

- Dual Heat and Fan Settings
- Ideal for Removing Residual Moisture After Cleaning



After cleaning the bonding surfaces an invisible moisture residue remains which can negatively affect the strength of the bond. Remove this moisture quickly and reliably with the CRL Hot Air Gun Kit. It has dual heat and fan settings: 1000 W - 375°C/700°F and 1500 W - 495°C/925°F. This 110V AC Hot Air Gun is also excellent for use in putty removal, paint removal, plastic pipe welding, and other jobs that require this type of tool. 240 Volt model also available. Minimum order is one each.

CAT. NO. LD121

CRL Milwaukee® Heat Gun

new

- Variable Temperature With Heat Adjustment Dial
- Ideal for Removing Residual Moisture After Cleaning



After cleaning the bonding surfaces an invisible moisture residue remains which can negatively affect the strength of the bond. Remove this moisture quickly and reliably with this variable temperature Heat Gun. It offers a range from 200 to 1050°F (93 to 565°C) that is controlled with a heat adjustment dial. The electrical heat control allows extra reduction of airflow for more accurate and concentrated heat location without damage to the heating element. Double insulated 110V AC tool features a unique impact resistant heating element. Minimum order is one each.

CAT. NO. UV8978

CRL Non-Contact Thermometer

- Monitors Glass Temperature While Heating for Optimum Bond Results
- Built-In Laser Pointer
- Digital Display Switches Easily From Fahrenheit to Celsius

new

Now you can easily confirm the temperature of your bonding materials with the CRL Non-Contact Thermometer. No more guessing or risking burns with a touch test. This tool will tell you via digital display when your bonding components reach the 140 to 160°F (60 to 71°C) preheat stage required for a permanent bond. Easy one button control for switching between Fahrenheit and Celsius readings. Powered by two AAA batteries (included). Minimum order is one each.



CAT. NO. UV1575

CRL Kimberly-Clark® WypAll® X50 Paper Towels

new

- 1100 Sheets Per Roll
- Perforated for Easy Tear-Off



These WypAll® X50 Paper Towels are perfect for cleaning glass prior to UV adhesive application, as well as for cleaning up excess adhesive that has oozed out around parts being bonded. The perforated sheets make removal easy with only one hand when used with our Paper Towel Dispensers, keeping your other hand free to hold the glass parts you are working on.

Largest and most economical towel we sell. Packed one roll per case. Each roll contains 1100 each 9-3/4" x 13-3/8" (248 x 340 mm) towels. Minimum order is one roll.

CAT. NO. K35015

CRL Paper Towel Dispenser

new

- Holds Wypall® K35015 Jumbo Rolls
- Perfect for Workbench, Floor, or Wall



Shown with Cat. No. K35015 X50 Paper Towels (sold separately).

Cleaning glass prior to applying UV adhesives or cleaning up excess adhesive means you need plenty of paper towels close at hand. The 80595 Floor/Bench Dispenser has detachable legs so it can also be used on a table top or work bench. Use the wall mount model to mount jumbo rolls of paper towels right next to your work station.

CAT. NO.	DESCRIPTION
80595	Floor/Bench Dispenser
80579	Wall Mount Dispenser

Minimum order: 1 each.

CRL Micro Fiber Wipes

- Super-Soft, Large 16" x 16" (406 x 406 mm) Size Wipes
- Can Be Used Hundreds of Times



CRL Micro Fiber Wipes have thousands of microscopic fibers that trap dirt and grime to increase cleaning effectiveness and reduce cleaning and drying times. Our large 16" x 16" (406 x 406 mm) size takes on big cleaning jobs, and when you're done you can simply machine-wash them (without fabric softener). Packed two wipes per poly bag with a hanger hook so you can also offer them for resale to your customers. Minimum order is one pack.

CAT. NO. MFW2

CRL Lint Free Glass Wipes

- Use for Cleaning and Removing Excess Adhesive
- Strong, 4-Ply White Paper Wipes

4-PLY



CAT. NO. BX15
Box of 150 Wipes



CAT. NO. 1550
Case of 900 Wipes
(Six BX15 Boxes)



CAT. NO. K73900

Extra-tough CRL Lint Free Glass Wipes bring the absorbing power you need in a lighter weight material that's reinforced with a nylon scrim for extra strength. The ripple texture makes them easy to hold during use, and provides just the right amount of surface area for cleaning solutions to do their work. BX15 also has a perforated edge so it can be wall mounted with our optional Cat. No. K73900 Wall Mount Bracket.

CAT. NO.	DESCRIPTION
BX15	Box of 150 Wipes
1550	Case of 900 Wipes
K73900	Dispenser Bracket

Minimum order: 1 box BX15; 1 case 1550; 1 each K73900.



CRL Loctite Chisel® Paint Stripper

- **Foaming Action Softens Cured UV Adhesive**



If excess UV adhesive is allowed to cure it is almost impossible to remove. The strong foaming action of this aerosol solvent softens cured UV adhesives to aid in removal with steel wool, scraping tools, and blades. Minimum order is one each.

CAT. NO. 79040

CRL Single Edge Razor Blades

- **Our Most Popular Single Edge Blade**
- **Individually Wrapped to Protect the Edge**



This CRL Single Edge Razor Blade is top quality, industrial grade, .009" thick surgical steel precision-honed for extra sharpness. It delivers durability along with the exacting quality cut that professionals demand. Packed 100 each per box, there are 50 boxes per case. Each blade is individually wrapped to protect the edge until you are ready to use it. Minimum order is 100 each.

CAT. NO. 51S

CRL Extra Fine Steel Wool

- **Extra Fine Steel Wool #0000**
- **Use to Clean Excess Adhesive**

CRL Extra Fine Steel Wool is used to remove excess cured adhesive that has oozed out around parts being sealed. Use in conjunction with Loctite Chisel® Paint Stripper (Cat. No. 79040). 16 pads per package. Minimum order is one pack.



CAT. NO. Z100

CRL Heavy-Duty Industrial Razor Blades

- **Extra Rigid Single Edge Blades Without Notch**
- **For Use in Paint Scrapers**



Our CRL Heavy-Duty Razor Blades are more rigid than our regular razor blades because of their .012" thick steel construction, and because they have no side notches. Their extra rigidity makes them great for really tough scraping jobs. Packed 100 per box, 50 boxes per case. Minimum order is 100 each.

CAT. NO. KKB12

CRL Cotton Swabs With Wooden Shafts

- **Use to Remove Excess Adhesive**

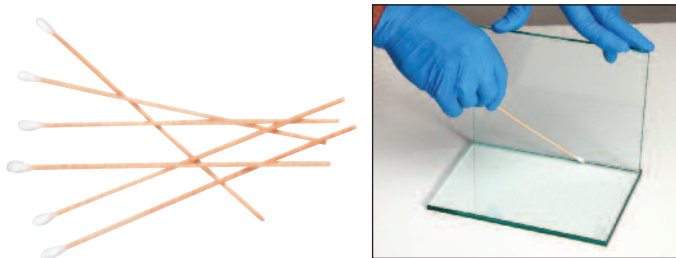

CRL Cotton Swabs with Wooden Shafts make removing excess adhesives in corners and hard to reach areas easier. Minimum order is 100 each.

CAT. NO. 1CS

CRL Razor Blade Holder and Scraper

- **Safely Holds Single Edge Metal Razor Blades**
- **Comfortable Handle for a Sure Grip**



The CRL Razor Blade Holder and Scraper is a safe and easy way to handle single edge metal razor blades for all your scraping jobs. The blade end is molded into a plastic handle that provides for a comfortable and sure grip, with a metal ferrule so you can hang it up. There is also a slip-on safety cover for the blade edge. Holds our 51S and KKB12 Single Edge Razor Blades. Overall length is 6-1/2" (165 mm). Minimum order is one each.

CAT. NO. RS65

CRL UV Glass Bonding System Catalog

• Simplified Technology for Efficient and Safe Glass Bonding

CRL takes the mystery out of glass bonding with our complete line of UV and UV/Visible Light Adhesives, Fixation Devices, and UV Lamps. Everything you need with easy-to-understand instructions and guidelines to produce glass bonded work from functional glass furniture to beautiful glass artwork. There are hundreds of possible uses in glass construction with the Glass Bonding System from CRL.

New innovative Fixation Devices make construction faster and easier. Advanced UV Adhesives provide strong bonds to many different substrates including laminated glass, tempered glass, steel, aluminum, stainless steel, ceramic, stone, wood, and plastics. We have a wide selection of UV Lamps for fast bonding of all sizes of glass furniture. We even have basic UV Starter Kits for first time users and Professional Kits for full time users, plus all the right cleaners and accessories needed to make your job easier and more profitable. See them all in this full color catalog.

CAT. NO. GB10

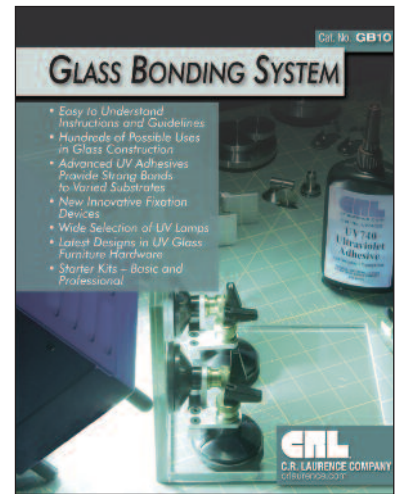

CRL Fixation Devices

- Used When Curing UV Adhesives
- Prevents Bonding Parts From Moving While Curing
- Adjustable to Multiple Angles

It is absolutely critical that the bonded surfaces are kept stabilized and in a fixed position while UV Adhesives are curing. This is made possible by using these specially designed CRL Fixation Devices. From simple economical clamps to precision engineered, adjustable holders that are capable of placing the parts in precise angled positions, CRL offers a complete line of Fixation Devices designed for use when bonding UV Adhesives. These devices allow just one person to manage the steps involved when working with UV Adhesives. Using our CRL Fixation Devices properly will give professional results.

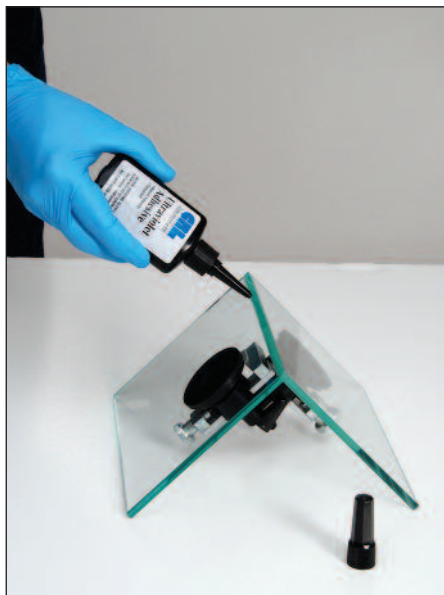

CRL Adjustable Angle Suction Holder

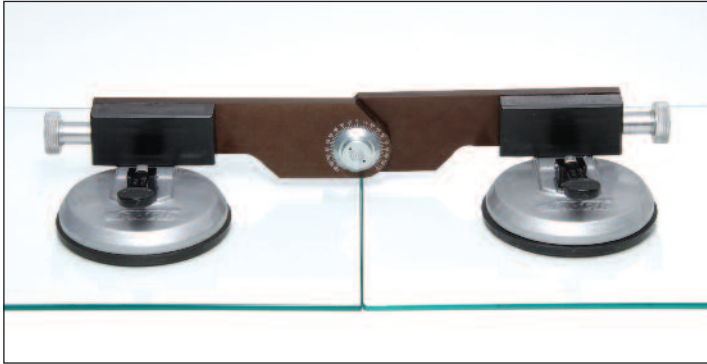

- Holds Glass Pieces From Inside or Outside Surface While Adhesive Cures
- Adjustable Between 40 and 300 Degrees

This CRL Adjustable Angle Suction Holder grips glass from outside or inside surfaces, and can be fixed at a desired angle of 40 to 300 degrees. Height and position can be adjusted up to 11/16" (18 mm) by knobs located on each arm. Glass is held firmly in place with 4-3/4" (120 mm) diameter rubber suction pads until the surfaces are firmly bonded. Minimum order is one each.

CAT. NO. UV282

CRL Adjustable Angle Clamp-It® Assembly Tool Kit

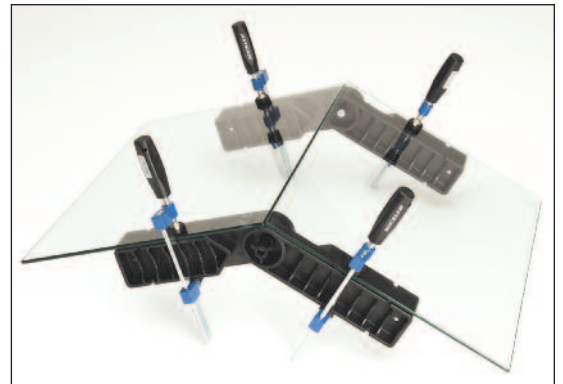

- Adjusts to Multiple Angles From 45 to 315 Degrees
- Economical Method for Holding Glass Surfaces in Place

This CRL Adjustable Angle Clamp-It® Assembly Tool Kit allows you to align it, hold it, and clamp it at multiple angles in five degree increments from 45 to 315 degrees. This handy and economical kit allows one to hold glass surfaces at odd angles while bonding with UV adhesives. Kit comes complete with two adjustable assembly squares and four 5" (127 mm) steel bar clamps. The adjustable squares are manufactured from high-impact, rigid polycarbonate to ensure strength and accuracy. The angle is held in place by interlocking teeth that can be adjusted by simply loosening a center knob. The bar clamps feature a 3/4" (19 mm) deep throat to clamp the center of the assembly square, and a 5" (127 mm) bar to accommodate panel thicknesses up to 2-1/2" (64 mm). Minimum order is one kit.



CAT. NO. UV28843

CRL 90 Degree Inside Suction Holder

- Suction Cups Hold Glass Firmly in Place While Adhesive Cures
- Holds Glass Pieces at 90 Degrees
- Perfect for Frameless Shower Installations As Well

This CRL 90 Degree Inside Suction Holder grips glass on the inside surfaces at a fixed 90 degree angle. Height and position can be adjusted up to 11/16" (18 mm) by knobs located on each arm for precise UV adhesive application. Glass pieces are held firmly in place by rubber suction cups measuring 4-3/4" (120 mm) in diameter until they are bonded. Minimum order is one each.

CAT. NO. UV280

Inside Surface Suction Holder



CRL 90 Degree Outside Suction Holder

- Suction Cups Hold Glass Firmly in Place While Adhesive Cures
- Holds Glass Pieces at 90 Degrees
- Perfect for Frameless Shower Installations As Well

This CRL 90 Degree Outside Suction Holder grips glass on the outside surfaces at a fixed 90 degree angle. Height and position can be adjusted up to 11/16" (18 mm) by knobs located on each arm for precise UV adhesive application. Glass pieces are held firmly in place by rubber suction cups measuring 4-3/4" (120 mm) in diameter until they are bonded. Minimum order is one each.

CAT. NO. UV281

Outside Surface Suction Holder



CRL 90 Degree Clamp-It® Assembly Square Kits

- Holds Glass Pieces at Fixed 90 Degree Angle
- Cost-Effective Method for Holding Glass Surfaces in Place

These CRL 90 Degree Clamp-It® Assembly Square Kits allow you to align, hold, and clamp glass securely in place while bonding the glass pieces with UV adhesives. Both six-piece Kits come complete with two assembly squares and four steel bar clamps. The squares are manufactured from high-impact, rigid polycarbonate to ensure strength and accuracy. The steel bar clamps feature an ergonomic handle with a friction fit for quick and easy one-handed operation.



Mini Clamp-It® Clamps Shown



CAT. NO. UV69954

Clamp-It® Kit



CAT. NO. UV69962

Mini Clamp-It® Kit

CAT. NO.	DESCRIPTION	SQUARE SIZE	BAR CLAMP SIZE	BAR CLAMP THROAT DEPTH
UV69954	Clamp-It® Kit	8" x 8" x 1-1/2" (203 x 203 x 38 mm)	5" (127 mm)	3/4" (19 mm)
UV69962	Mini Clamp-It® Kit	4" x 4" x 1-1/4" (102 x 102 x 32 mm)	4" (122 mm)	3/4" (19 mm)

Minimum order: 1 each.

CRL Multi-Purpose SwasiClamp

new

- Use for Inside or Outside Angle Applications
- Shower Door Fixed Panel Assembly
- UV Assembly Bonding

The CRL Multi-Purpose SwasiClamp is a totally new clamp design intended to solve a variety of problems in fastening components together while bonding or sealing. This unique clamping device features a lever-actuated 4-3/4" (121 mm) vacuum cup connected to a three-piece articulated arm, which ends with a threaded plunger arm. SwasiClamp can be turned, twisted or reversed to solve virtually any clamping job ranging in length up to 13" (330 mm).

Add the CRL SwasiClamp Accessory Kit and double your range of options. Consisting of an additional 4-3/4" (121 mm) vacuum cup and another threaded plunger arm, this Kit allows clamping of additional angles and added force to original configurations. The Accessory Plunger Arm can clip onto the SwasiClamp articulated arm or into the Accessory Vacuum Cup. Whether your work scope involves shower doors or glass furniture bonding with UV Adhesives, the CRL SwasiClamp and SwasiClamp Accessory Kit are the installer's new best friend. Minimum order is one each.

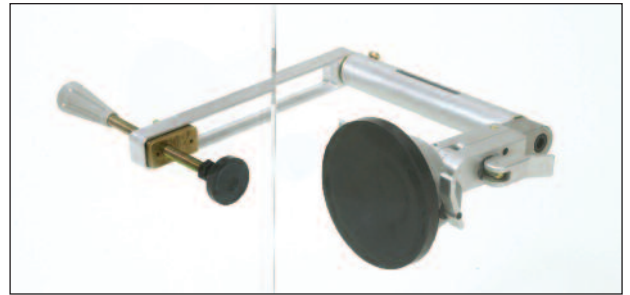

CAT. NO. UV2010
SwasiClamp



Shown With Optional UV2010A
Accessory Kit

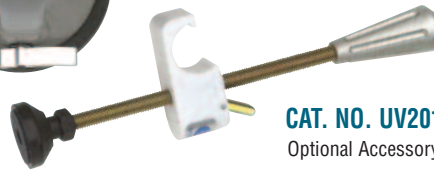

CAT. NO. UV2010A
Optional Accessory Kit

CRL Third-Hand Power Clamp

new

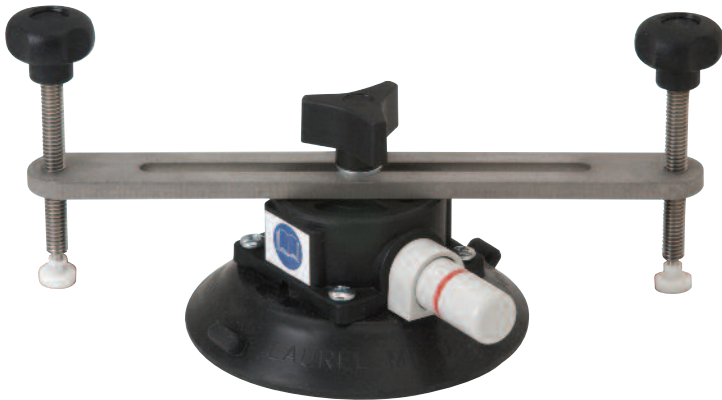

- 4-1/2" (114 mm) Vacuum Cup
- 9" (229 mm) Long Clamping Bar

The CRL Third-Hand Power Clamp is perfect for holding parts in place during curing or bonding projects. Attach the pump-style vacuum cup to a clean, flat surface and swing the arm into position so one threaded finger centers over the part to be clamped. Screw the clamping finger down until contacting the part. Finally, screw down the finger on the opposite end of the bar to apply additional pressure straight down on the part being worked. This is the perfect solution to clamping shower door hardware into position



- Bar Adjusts 5-3/4" (146 mm) Side-to-Side
- Two Threaded Clamp Knobs

while UV adhesive cures. It also eliminates the possibility of parts shifting or twisting away from desired locations. It is also useful for holding automotive moldings, door and window trim, or any other object you would normally secure in place with masking tape.

The 4-1/2" (114 mm) diameter vacuum cup features a red safety indicator line to warn of vacuum loss. Finger tabs on the side of the cup allow quick release of vacuum pressure. Minimum order is one each.

CAT. NO. UV91111

CRL Pump-Activated 90 Degree Suction Holder

- Holds Glass at 90 Degrees
- Superior Vacuum Stability
- Precise Positioning Every Time

new

CAT. NO. UV6380
Single Pump – Activated Holder

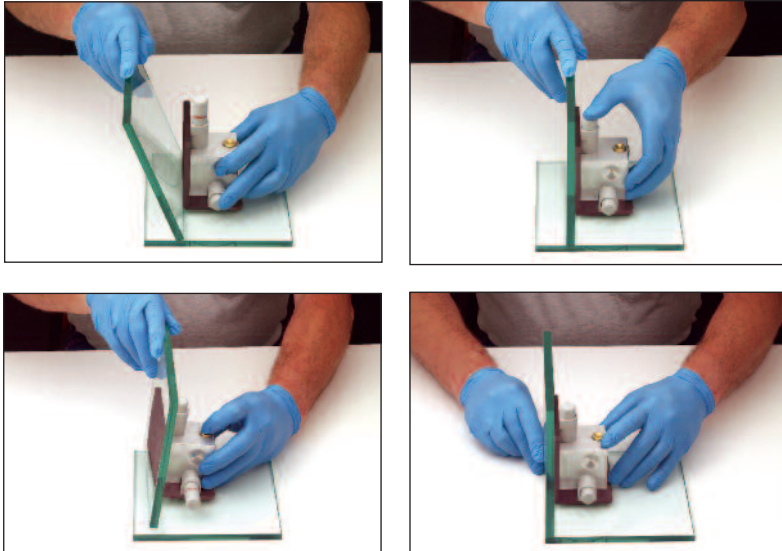

CAT. NO. UV6389
Set of Two Pump – Activated Holders in Case

CRL Pump-Activated 90 Degree Suction Holders have a self-contained priming pump with excellent vacuum stability that holds glass pieces firmly at a fixed 90 degree angle. Excellent for fabricating glass cases, shelves, and showcases with horizontal and vertical partitions. Beveled corners prevent contact with the UV adhesive. Each unit has two built-in vacuum pumps, which can be quickly and individually vented to allow parts to be repositioned as needed.

The unique duranodic finish on the attachment plates provides a better grip on the glass, eliminates oxidation, and is resistant to adhesion of foreign materials. If a vacuum loss were to occur, a red indicator ring warns that the pump needs to be re-primed. Holders are easy to work with in limited space since the Holder surfaces measure only 2-7/8" x 3-15/16" and 3-15/16" x 3-15/16" (73 x 100 mm and 100 x 100 mm) and can be turned to suit the space available. This CRL Suction Holder is available as a single unit or in a convenient set of two packed in a sturdy carrying case. Minimum order is one each.

CRL Magfix Fixed 90 Degree Magnetic Cube

- Holds Glass at 90 Degrees
- Cup Type Neodymium Magnet
- Holds Up to 3/8" (10 mm) Glass

new



CAT. NO. UV6340

The CRL Magfix Fixed 90 Degree Magnetic Cube securely holds smaller glass parts up to 3/8" (10 mm) thick at 90 degree angles. The cube is ideal for use in areas with limited space since it measures only 2-7/32" (56 mm) square. Plates measure 1-3/16" x 3-3/16" (30 x 81 mm). Cube and Counter Plates have beveled edges, and are lacquered to avoid scratches on glass surfaces and adhesion of UV Adhesives during application. Minimum order is one each.

CAUTION: Strong Magnetic Field. Keep Away from Cardiac Pacemakers.

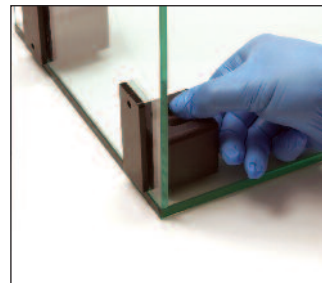

CRL Adjustable Angle Suction Holder

- Holds Glass Pieces From Inside or Outside Surface
- Adjustable Between 60 and 240 Degrees

This CRL Adjustable Angle Suction Holder grips glass pieces from outside or inside surfaces, and can be fixed at desired angles of 60 to 240 degrees. Height and position can be adjusted up to 5/16" (8 mm) by knobs located on each arm. 2-3/8" (60 mm) diameter rubber suction pads hold glass panels firmly until they are bonded. Minimum order is one each.

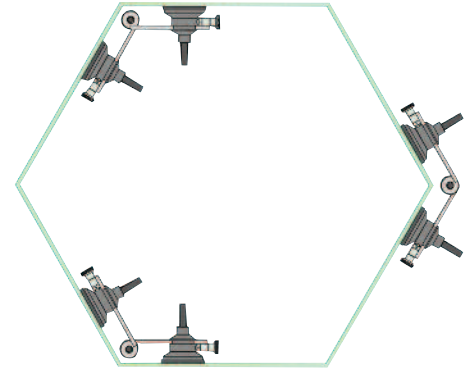

CAT. NO. UV2933

CRL Eccentric Height Adjustment Stop

- Adheres to Glass With Suction Cup
- Used for Height Adjustment of Glass Pieces
- Shelf Leveling Made Easy

These CRL Eccentric Height Adjustment Stops can be used in pairs to make precision height adjustments of glass pieces before bonding with UV adhesives. Simply rotate the disk to the desired position. Minimum order is one each.

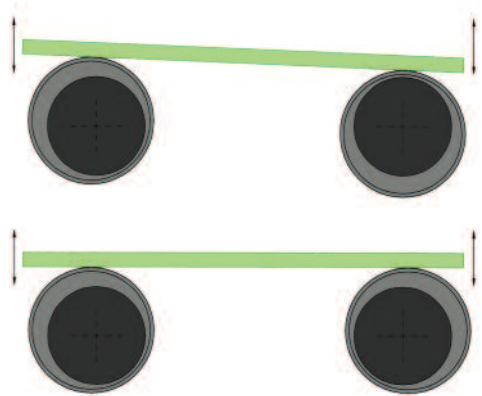

CAT. NO. UV285

CRL Suction Stop and Holder

- Used to Hold Glass Panels in Place
- Can Be Adjusted With Great Precision

This handy CRL Suction Stop and Holder can be used in pairs to hold a glass shelf in place while bonding with UV adhesive. Just flip the cup lever for glass attachment, then loosen the knurled nut to allow the height adjustment bar to be moved as needed. Suction pad measures 2-1/4" (57 mm). A replacement vacuum cup unit is available, Cat. No. 5195. Minimum order is one each.



CAT. NO. RH670

CRL UV Assembly Shim Set

- Precise Positioning Aids
- Alignment Shims Cushion and Center Doors and Hardware During Assembly

CRL UV Assembly Shims make precise positioning of glass doors and hardware simple and repeatable. Pre-assemble a cabinet door or any similar configuration and be assured that every clearance gap is precisely aligned top to bottom, side to side.



CRL UV ASSEMBLY SHIM SET INCLUDES:

- 10 each 2" x 1/16" x 1/4" (51 x 1.6 x 6.3 mm)
- 10 each 2" x 1/8" x 1/4" (51 x 3.2 x 6.3 mm)
- 10 each 2" x 1/4" x 1/4" (51 x 6.3 x 6.3 mm)
- 10 each 2" x 3/8" x 1/4" (51 x 9.5 x 6.3 mm)
- 10 each 2" x 1/2" x 1/2" (51 x 12.7 x 12.7 mm)

Minimum order is one package.

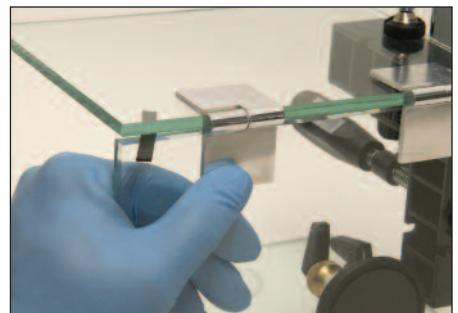

CAT. NO. UVSH1MS

CRL Fixed Position 90 Degree Inside Suction Holder

new

- Suction Cups Hold Glass Firmly in Place While Adhesive Cures
- Inside 90 Degree Holder

This CRL 90 Degree Inside Suction Holder firmly grips glass from the inside surface at a fixed 90 degree angle. 2-3/8" (60 mm) diameter rubber suction pads hold the glass pieces firmly until they are bonded. Minimum order is one each.



CAT. NO. UV2921

CRL Fixed Position 90 Degree Outside Suction Holder

new



- Suction Cups Hold Glass Firmly in Place While Adhesive Cures
- Outside 90 Degree Holders

This CRL 90 Degree Outside Suction Holder firmly grips glass from the outside surface at a fixed 90 degree angle. 2-3/8" (60 mm) diameter rubber suction pads hold the glass pieces in place until they are bonded. Minimum order is one each.



CAT. NO. UV2922

CRL Adjustable 90 Degree Inside Suction Holder

new

- Adjustable Height and Position
- Suction Cups Hold Glass Firmly in Place at 90 Degrees While Adhesive Cures

This CRL Adjustable 90 Degree Inside Suction Holder firmly grips glass from the inside surface at 90 degrees. Height and position can be adjusted up to 5/16" (8 mm) by knobs located on each arm for precise UV adhesive application. Glass pieces are held firmly in place by 2-3/8" (60 mm) diameter rubber suction pads until they are bonded. Minimum order is one each.

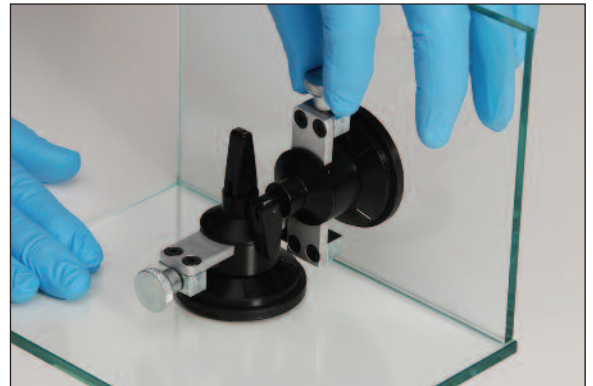

CAT. NO. UV2931

CRL Adjustable 90 Degree Outside Suction Holder

new



- Adjustable Height and Position
- Suction Cups Hold Glass Firmly in Place at 90 Degrees While Adhesive Cures

This CRL Adjustable 90 Degree Outside Suction Holder firmly grips glass from the outside surface at 90 degrees. Height and position can be adjusted up to 5/16" (8 mm) by knobs located on each arm for precise UV adhesive application. Glass pieces are held firmly in place by 2-3/8" (60 mm) diameter rubber suction pads until they are bonded. Minimum order is one each.



CAT. NO. UV2932

CRL Adjustable 90 Degree Interior Corner Support

new



- Holds Glass at 90 Degrees

CRL Fixed 90 Degree Interior Corner Support holds glass pieces from inside surfaces at 90 degrees. Height and position can be adjusted up to 11/16" (17 mm) by knobs located on each arm for precise UV adhesive application. 4-3/4" (120 mm) diameter rubber suction pad holds glass pieces firmly until they are bonded. Minimum order is one each.

Shown in use with Cat. No. UV290 Fixed Interior Corner Clamp (Sold Separately)

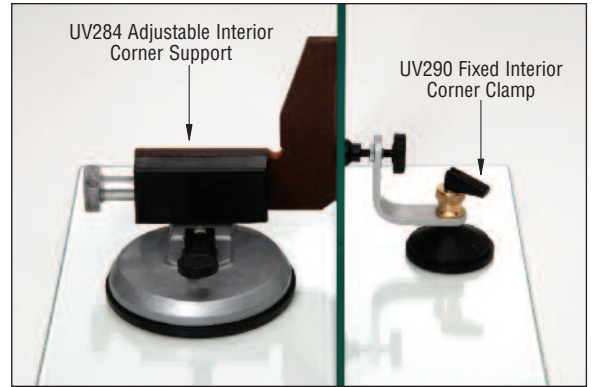

CAT. NO. UV284

CRL Fixed 90 Degree Exterior Tall Arm Corner Clamp

new

- Holds Glass at 90 Degrees

The CRL Fixed 90 Degree Exterior Tall Arm Corner Clamp holds glass pieces from outside surfaces at 90 degrees. The outside arm is 4-5/8" (117 mm) tall with an adjustable thrust pad. This Clamp can be used with our Cat. No. UV284 Support to hold glass pieces while bonding. 2-3/8" (60 mm) diameter rubber suction pad holds glass pieces firmly until they are bonded. Minimum order is one each.



CAT. NO. UV289

CRL Fixed 90 Degree Interior Corner Clamp

new

- Holds Glass at 90 Degrees

The CRL Fixed 90 Degree Interior Corner Clamp holds inside glass pieces at 90 degrees. Can be used with our Cat. No. UV284 Support to hold glass pieces while bonding. 2-3/8" (60 mm) diameter rubber suction pad holds glass pieces firmly until they are bonded. Minimum order is one each.

Shown in use with Cat. No. UV284 Adjustable Interior Corner Support (Sold Separately)

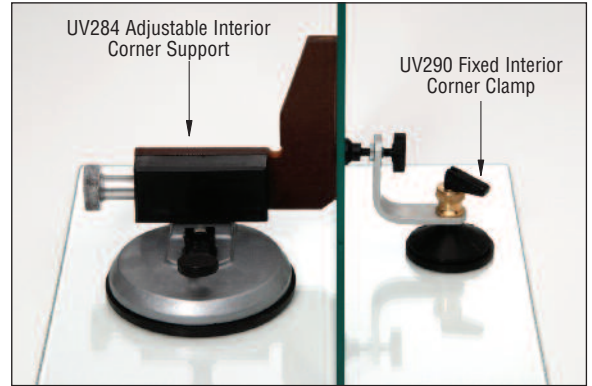

CAT. NO. UV290

CRL Fixed 90 Degree Exterior Short Arm Corner Clamp

new

- Holds Glass at 90 Degrees

CRL Fixed 90 Degree Exterior Short Arm Corner Clamp holds glass pieces from outside surfaces at 90 degrees. The outside arm is 3-1/4" (83 mm) tall with an adjustable thrust pad. This Clamp can be used with our Cat. No. UV284 Support to hold glass pieces while bonding. 2-3/8" (60 mm) diameter rubber suction pad holds glass pieces firmly until they are bonded. Minimum order is one each.



CAT. NO. UV291

CRL UV Hardware Positioning Device

new

- **Accurately Aligns Locks, Hinges, and Other Hardware**
- **Fast Set-Up**

Accurate positioning of UV bonding hardware is essential to producing high quality finished displays, showcases, and furniture. The CRL UV Hardware Positioning Device quickly attaches to the glass with a 2-1/8" (54 mm) suction cup, and features a pivoting arm to align hardware on two surfaces when required. Once in place, the initial adhesion set can be made, the Positioning Device removed, and the final cure can then be completed. Minimum order is one each.



CAT. NO. UV6335

CRL UV Lay-Out Mat

new



- **Accurately Position Your UV Projects**
- **Easy to Read Grid Lines With 45, 90, and 135 Degree Calibrations**

CRL's UV Lay-Out Mat covers a large 24" x 36" (610 x 914 mm) work surface and lets you check your bonding project for square prior to adhesive application. The surface is self-healing should you also use it for razor cutting. Flip it over to the blank side and you have a durable, protective surface for your other work. Minimum order is one each.

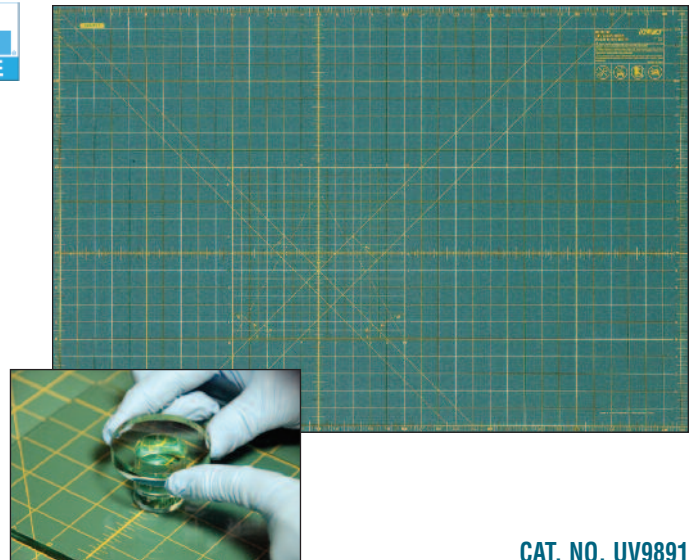

CAT. NO. UV9891

CRL UV Bonding Work Surface Carpet

new



- **Dark Color Absorbs UV Light**
- **Special Long Wearing High Density Material**

This CRL UV Bonding Work Surface Carpet makes an ideal work area and protects against glass damage. It's light-absorbing material is appropriate when setting your UV bonding lamps aside. Note that you should never set your lamps face-down directly on this carpet as excessive heat build up will take place (always use a guard or other support). Carpet measures 36" x 72" (914 x 1829 mm). Minimum order is one each.



CAT. NO. UV3672

CRL UV Glass Bonding Adhesives

The Benefits of UV Curing Adhesive Technology Are Many



Join the Growing Trend of UV Glass Bonding

The use of glass combined with other materials continues to grow year after year. Store displays, showcases, and furniture designs are being produced without the usual mechanical fasteners and moving toward the clean, transparent look of UV bonded components.

The technological development of UV Glass Bonding over the years has enabled us to present a range of adhesives with a unique combination of performance, design, and processing benefits. You now have choices of adhesives with varying curing times that allow you to align parts precisely prior to curing.

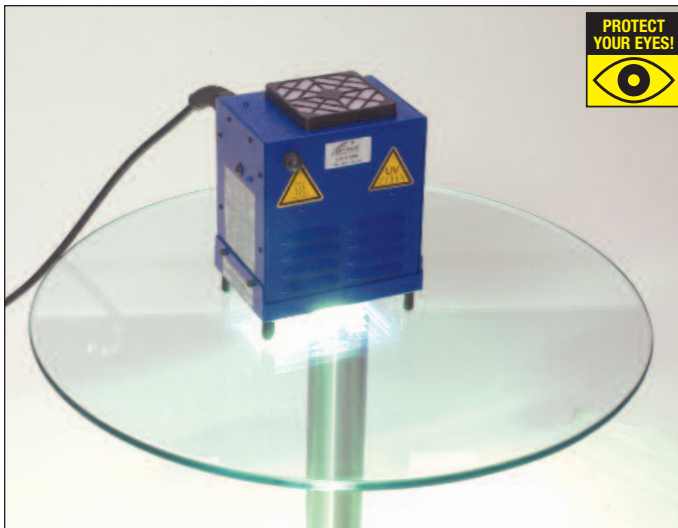

UV Adhesive Technology for Common Use

These amazing materials have properties that allow them to remain in a liquid state during proper storage and are able to then cure with UV light exposure in a matter of seconds.

Using the properties of ultraviolet light, high curing speeds take the place of common slow evaporation methods for maximum processing production. Material construction combinations now include glass-to-glass, glass-to-metal, and glass-to-stone, further expanding the opportunities for creative designs more than ever.

Maximum strength developed between components is developed by keeping the gap between their surfaces as small as possible, optimally between 0.04 and 0.5 mm.



It's Now Easier to Fabricate Than Ever Before

The best finished appearance for projects is achieved when glass edges are precisely ground and polished and when all other surfaces to be bonded are as smooth as possible.

Following the simple, step-by-step instructions provided to you for pre-treatment, proper fixation of the components, careful application of the adhesive, and the correct method for curing, can result in the production of unique, creative and practical products.

CRL's staff of trained technicians is always available to provide you with the answers to your production questions and any other UV bonding requirements you may have as you familiarize yourself with this exciting new industry segment.

Contact CRL Technical Sales at (800) 421-6144 in the U.S., (877) 421-6144 from Canada, or (323) 588-1281 International, and ask for Ext. 7720. You can also e-mail us through our web site, crlaurence.com. From the home page click on Contact Us, and then click on Technical Sales for Glass and Glazing Products.

CRL UV770 High Viscosity UV Adhesive

- Use to Adhere All-Glass Showcases, Shelves, Furniture, Towel Bars, and Standoff Bases
- Optically Clear
- Fast, High-Strength Bonds

CRL UV770 is a high viscosity, 100% solids, general purpose adhesive that forms resilient, high strength bonds between materials such as glass, steel, aluminum, stainless steel, and many plastics.

CRL UV770 is ideal for making all-glass showcases, glass shelves, and glass furniture. This adhesive does not have capillary properties; therefore it must be applied to the bonding surface prior to assembling the parts. It is ideal for bonding Glass Door Knobs or Metal Towel Bars in frameless shower door installations, as well as adhering metal Standoff Bases to glass.

Bonds prepared with CRL UV770 are optically clear as well as resistant to moisture and yellowing. The adhesive cures within seconds upon exposure to ultraviolet light. The speed of cure depends on the UV intensity as measured at the product surface, as well as the adhesive depth. CRL UV770 has outstanding ability to cure through large gaps, and cures to a hard surface that is transparent. Store adhesive away from sunlight.

CRL7528 Cleaner and Degreaser provides for optimum adhesion when used first to prepare the glass by removing any dirt and grease that is present.

NOTE: When bonding plastics, always test first, as not all plastics can be bonded properly. Do not bond any coated parts (powder coated or galvanized) with this adhesive.

new

SPEC. DATA

MSDS

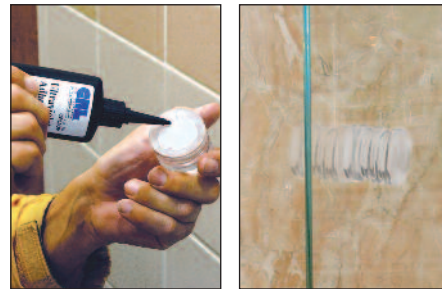

CAT. NO. CRL7528*
Cleaner/Degreaser

CAT. NO.	DESCRIPTION	CONTENTS
UV77030	High Viscosity UV Adhesive	30g
UV77010	High Viscosity UV Adhesive	100g
UV77025	High Viscosity UV Adhesive	250g
UV7701K	High Viscosity UV Adhesive	1000g
CRL7528	Cleaner and Degreaser	20 Oz. (567g)

Minimum order: 1 each. *CRL Cleaner and Degreaser cannot be shipped via air freight.

CRL UV740 Low Viscosity UV Adhesive

- Ideal for Production of Glass Furniture
- Cures Within Seconds Upon Exposure to UV Light
- Capillary Action
- Optically Clear

CRL UV740 is a low viscosity, 100% solids, adhesive that forms resilient, high strength bonds coupled with good elasticity between materials such as glass, steel, aluminum, stainless steel, and many plastics.

Due to its excellent capillary action (low viscosity) it is ideal for glass-to-glass and tempered glass-to-tempered glass bonding, primarily in the construction of showcases and the efficient production of glass furniture. Reduced clean-up time means glass furniture production cycles are done quickly and efficiently.

Bonds prepared with CRL UV740 are optically clear as well as resistant to moisture and yellowing. The adhesive cures within seconds upon exposure to ultraviolet light. The speed of cure depends on the UV intensity as measured at the product surface, as well as the adhesive depth. Store adhesive away from sunlight.

CRL7528 Cleaner and Degreaser provides for optimum adhesion when used first to prepare the glass by removing any dirt and grease that is present.

NOTE: When bonding plastics, always test first, as not all plastics can be bonded properly. Do not bond any coated parts (powder coated or galvanized) with this adhesive.

new

SPEC. DATA

MSDS



CAT. NO. CRL7528*
Cleaner/Degreaser

CAT. NO.	DESCRIPTION	CONTENTS
UV74030	Low Viscosity UV Adhesive	30g
UV74010	Low Viscosity UV Adhesive	100g
UV74025	Low Viscosity UV Adhesive	250g
UV7401K	Low Viscosity UV Adhesive	1000g
CRL7528	Cleaner and Degreaser	20 Oz. (567g)

Minimum order: 1 each. *CRL Cleaner and Degreaser cannot be shipped via air freight.

CRL UV678 UV/Visible Light Adhesive

- Bonds Laminated Glass
- UV and Visible Light Cure
- Medium Viscosity With Capillary Action
- Optically Clear
- Best Adhesion to Plastics

CRL UV678 is a medium viscosity, 100% solids, UV/visible light curable adhesive that bonds to a variety of substrates such as glass, laminated glass, metal, ceramic, and many plastics. It has good capillary action with glass up to 1/4" (6 mm) thick. For thicker glass apply to the bonding surface prior to assembly.

Of particular interest is its suitability for bonding laminated safety glass. The PVB film between laminated glass panes absorbs almost all of the UVA radiation, but because this adhesive has been made to also cure by daylight, it reacts with the remaining radiation (above 380 nm) and cures completely. Butt-edge bonding is also no problem, as the adhesive does not affect the PVB film.

Cured bonds of CRL UV678 are optically clear, extremely flexible, and demonstrate outstanding elongation, making this adhesive ideal for bonding different material combinations. Bonds are tough, durable, exhibit high vibration resistance, and are very resistant to moisture and yellowing. Store adhesive away from sunlight.

CRL7528 Cleaner and Degreaser provides for optimum adhesion when used first to prepare the glass by removing any dirt and grease that is present.

NOTE: When bonding plastics, always test first, as not all plastics can be bonded properly. Do not bond any coated parts (powder coated or galvanized) with this adhesive.

new

SPEC. DATA

MSDS



85g



1000g



CAT. NO. CRL7528*
Cleaner/Degreaser

CAT. NO.	DESCRIPTION	CONTENTS
UV67885	UV/Visible Light Adhesive	85g
UV6781K	UV/Visible Light Adhesive	1000g
CRL7528	Cleaner and Degreaser	20 Oz. (567g)

Minimum order: 1 each. *CRL Cleaner and Degreaser cannot be shipped via air freight.

CRL UV682 UV/Visible Light Adhesive

- Especially Strong Glass to Metal Bonds
- UV and Visible Light Cure
- Medium Viscosity
- Optically Clear

CRL UV682 is a medium viscosity, 100% solids, UV/visible light curable adhesive formulated to form high tensile shear and peel strength bonds to a variety of substrates such as glass, laminated glass, steel, stainless steel, aluminum, ceramic, stone, wood and some plastics. This adhesive does not have capillary properties; therefore it must be applied to the bonding surface prior to assembling the parts.

Of particular interest is its suitability of bonding laminated safety glass. The PVB film between laminated glass panes absorbs almost all of the UVA radiation, but because this adhesive has been made to also cure by daylight, it reacts with the remaining radiation (above 380 nm) and cures completely.

Cured bonds of CRL UV682 are optically clear, resistant to moisture and thermal cycling. Store adhesive away from sunlight.

CRL7528 Cleaner and Degreaser provides for optimum adhesion when used first to prepare the glass by removing any dirt and grease that is present.

NOTE: When bonding plastics, always test first, as not all plastics can be bonded properly. Do not bond any coated parts (powder coated or galvanized) with this adhesive.

new

SPEC. DATA

MSDS



30g



100g



250g



1000g



CAT. NO. CRL7528*
Cleaner/Degreaser

CAT. NO.	DESCRIPTION	CONTENTS
UV68230	UV/Visible Light Adhesive	30g
UV68210	UV/Visible Light Adhesive	100g
UV68225	UV/Visible Light Adhesive	250g
UV6821K	UV/Visible Light Adhesive	1000g
CRL7528	Cleaner and Degreaser	20 Oz. (567g)

Minimum order: 1 each. *CRL Cleaner and Degreaser cannot be shipped via air freight.

CRL UV665 Low Viscosity UV Adhesive

- Ideal for Glass-to-Glass Bonding
- Capillary Action
- Optically Clear

CRL UV665 is a low viscosity, 100% solids adhesive that forms resilient, high strength bonds between materials such as glass, metal, wood, and many plastics.

Due to its high purity UV665 is especially suited for bonding glass-to-glass where looks are paramount, making it suitable for bonding optical components. Because of its excellent capillary action (low viscosity) it is ideal for glass-to-glass and tempered glass-to-tempered glass bonding, primarily in the construction of showcases and the efficient production of glass furniture. Reduced clean-up time means glass furniture production cycles are done quickly and efficiently.

Bonds prepared with CRL UV665 are optically clear. The adhesive cures within seconds upon exposure to ultraviolet light. The speed of cure depends on the UV intensity as measured at the product surface, as well as the adhesive depth. Store adhesive away from sunlight.

CRL7528 Cleaner and Degreaser provides for optimum adhesion when used first to prepare the glass by removing any dirt and grease that is present.

NOTE: When bonding plastics, always test first, as not all plastics can be bonded properly. Do not bond any coated parts (powder coated or galvanized) with this adhesive.



CAT. NO.	DESCRIPTION	CONTENTS
UV66530	Low Viscosity UV Adhesive	30g
UV66510	Low Viscosity UV Adhesive	100g
UV66525	Low Viscosity UV Adhesive	250g
UV6651K	Low Viscosity UV Adhesive	1000g
CRL7528	Cleaner and Degreaser	20 oz. (567g)

Minimum order: 1 each. *CRL Cleaner and Degreaser cannot be shipped via air freight.

CRL UV690 Medium Viscosity UV Adhesive

- Extremely Flexible for Bonding Different Materials and Surface Bonding
- Capillary Action
- Optically Clear

CRL UV690 is a medium viscosity, 100% solids, general purpose adhesive that forms resilient, high strength bonds between materials such as glass, metal, ceramic, and many plastics.

CRL UV690 is extremely flexible, and demonstrates outstanding elongation, making it ideal for bonding different materials, as well as for surface bonding up to 1 m² (10.8 ft²). It shows good capillary action with glass up to 1/4" (6 mm) thick. For thicker glass apply to the bonding surface prior to assembly.

Bonds prepared with CRL UV690 are optically clear as well as resistant to moisture and yellowing. The adhesive cures within seconds upon exposure to ultraviolet light. The speed of cure depends on the UV intensity as measured at the product surface, as well as the adhesive depth. Store adhesive away from sunlight.

CRL7528 Cleaner and Degreaser provides for optimum adhesion when used first to prepare the glass by removing any dirt and grease that is present.

NOTE: When bonding plastics, always test first, as not all plastics can be bonded properly. Do not bond any coated parts (powder coated or galvanized) with this adhesive.



CAT. NO.	DESCRIPTION	CONTENTS
UV69085	Medium Viscosity UV Adhesive	85g
UV6901K	Medium Viscosity UV Adhesive	1000g
CRL7528	Cleaner and Degreaser	20 oz. (567g)

Minimum order: 1 each. *CRL Cleaner and Degreaser cannot be shipped via air freight.

CRL UV760 High Viscosity UV Adhesive

- Withstands High Static and Dynamic Forces
- Optically Clear
- Suitable for Universal Applications

CRL UV760 is a high viscosity, 100% solids, general purpose adhesive that forms resilient, high strength bonds between materials such as glass, metal, stone, wood, and many plastics. When bonding plastics, always test first, as not all plastics can be bonded properly. Do not bond any coated parts (powder coated or galvanized) with this adhesive.

CRL UV760 is ideal for making 'all-glass' showcases, glass shelves, and glass furniture. This adhesive does not have capillary properties, therefore it must be applied to the bonding surface prior to assembling the part. Ideal for bonding glass door knobs or metal towel bars in frameless shower door installations, as well as adhering metal standoff bases to glass.

Bonds prepared with CRL UV760 are optically clear as well as resistant to moisture and yellowing. The adhesive cures within seconds upon exposure to ultraviolet light. The speed of cure depends on the UV intensity as measured at the product surface, as well as the adhesive depth. CRL UV760 has outstanding ability to cure through large gaps and it cures to a hard surface that is transparent. Store adhesive away from sunlight.

CRL7528 Cleaner and Degreaser provides for optimum adhesion when used first to prepare the glass by removing any dirt and grease that is present.

new

SPEC. DATA

MSDS



30g

100g

250g

1000g



CAT. NO. CRL7528*
Cleaner/Degreaser

CAT. NO.	DESCRIPTION	CONTENTS
UV76030	High Viscosity UV Adhesive	30g
UV76010	High Viscosity UV Adhesive	100g
UV76025	High Viscosity UV Adhesive	250g
UV7601K	High Viscosity UV Adhesive	1000g
CRL7528	Cleaner and Degreaser	20 Oz. (567g)

Minimum order: 1 each. *CRL Cleaner and Degreaser cannot be shipped via air freight.

CRL Colored UV Adhesive

- Five Colors Plus Clear for Surface Bonding of Glass Parts
- Brilliant, High Intensity Colors
- Bonds Bevels Onto Glass or Mirror
- Thin Viscosity



new

SPEC. DATA

MSDS



30g

100g



CAT. NO. CRL7528*
Cleaner/Degreaser

CRL Colored UV Adhesives are designed for bonding larger glass surfaces to make decorative colored pieces. An example would be a mirror with beveled clear glass bonded to the surface. The five different moisture-resistant colors can be used separately or mixed together for a wide range of color effects that are seen through the clear glass overlays. The Clear Base Adhesive is used to dilute the high intensity colors to produce a wide range of color options or to create separations between colors. This adhesive is intended for surface bonding only, and should never be used to bond edges (furniture construction). Due to the high color pigmentation the setting time is three to five times longer than typical clear UV adhesives and bonds are not as strong. Hands should be protected from the high color pigments by wearing our Disposable Nitrile Gloves (see page N426).

CAT. NO.	DESCRIPTION	CONTENTS
UV19331	Clear Base UV Adhesive	30g
UV1933110	Clear Base UV Adhesive	100g
UV19332	Red UV Adhesive	30g
UV1933210	Red UV Adhesive	100g
UV19333	Yellow UV Adhesive	30g
UV1933310	Yellow UV Adhesive	100g
UV19334	Blue UV Adhesive	30g
UV1933410	Blue UV Adhesive	100g
UV19335	Green UV Adhesive	30g
UV1933510	Green UV Adhesive	100g
UV19336	Black UV Adhesive	30g
UV1933610	Black UV Adhesive	100g
UV19337	Set of Six Colors	30g Each
CRL7528	Cleaner and Degreaser	20 Oz. (567g)

Minimum order: 1 each. *CRL Cleaner and Degreaser cannot be shipped via air freight.

CRL Loctite® Impruv™ UV Adhesive

- Bonds and Seals Glass-to-Glass, or Glass-to-Metal Components
- Optically Clear UV Adhesive
- Cures Within Seconds

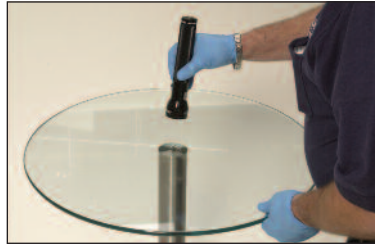

CRL Loctite® UV Adhesive is a one-part, high viscosity adhesive with an ultraviolet cure system. Tough, durable bonds can be formed with excellent adhesion to glass, metal and some thermoplastics. Ideal for making all glass showcases, glass shelves, furniture, etc. The adhesive cures within seconds upon exposure to UV light from a curing lamp to form a transparent bond. This product is cured when exposed to UV radiation of 365nm. The speed of cure will depend on the UV intensity as measured at the product surface, as well as the coating depth. UV349 has an outstanding ability to cure through large gaps and to cure to a hard, dry surface that is water clear. CRL Loctite® 20162 Cleaner and Degreaser is offered for optimum glass preparation, and removal of dirt and grease.

COVERAGE:

Approximate coverage of a 1.69 fl. oz. bottle:
 1/16" (1.6 mm) bead - 1,000 linear inches (25 m)
 1/8" (3 mm) bead - 250 linear inches (6.3 m).

SPEC. DATA

MSDS

NO AIR FREIGHT



CAT. NO. UV349
UV Adhesive



CAT. NO. 20162*
Cleaner/Degreaser

CAT. NO.	DESCRIPTION	CONTENTS
UV349	UV Clear Adhesive	1.69 Fl. Oz. (50 ml)
UV34990	UV Clear Adhesive	33.8 Fl. Oz. (1 l)
20162	Cleaner and Degreaser	16 Fl. Oz. (473 ml)

Minimum order: 1 each. *Loctite Cleaner and Degreaser cannot be shipped via air freight.

CRL Loctite Minute Bond Adhesive and Primer

- Joins Glass-to-Metal Without a UV Lamp
- Clear Color Makes it an Excellent All Purpose Adhesive
- Superior Holding Strength Up to 3000 psi
- Four Kit Sizes Including Single Application Size

SPEC. DATA

MSDS

NO AIR FREIGHT

CRL Loctite® Minute Bond Adhesive permanently bonds non-porous materials such as glass, metal, tile, coated wood, plastics, and nylon with superior strength holding power up to 3,000 psi. The combined Primer and Adhesive two-step application offers handling strength in 10 seconds, 60% full strength in two minutes, and a full cure in 24 hours. Kits contain both Adhesive and Primer.



CAT. NO. 0144
1.69 Fl. Oz. Kit



CAT. NO. 3325
0.8 Fl. Oz. Kit



CAT. NO. 3346
0.2 Fl. Oz. Kit



CAT. NO. 37438
Single Application Kit



CAT. NO. 73656
Primer Improves Bond Strength

NOTE: Minute Bond Adhesive is only recommended for use on non-porous flat surfaces that are to be mated together with a gap of .004" maximum. Where bond gaps are large, up to a maximum of .02", or faster cure speed is required, primer should be applied to both surfaces. Primer should be 72°F (22°C) or warmer.

CAT. NO.	DESCRIPTION	MIN. ORDER
0144	1.69 Fl. Oz. (50 ml) Adhesive/6 Oz. (170 g) Primer	1 Kit
3325	0.8 Fl. Oz. (24 ml) Adhesive/6 Oz. (170 g) Primer	1 Kit
3346	0.2 Fl. Oz. (6 ml) Adhesive/1.33 Oz. (38 g) Primer	1 Kit
37438	0.01 Fl. Oz. (0.3 ml) Adhesive/0.02 Fl. Oz. (0.6 ml) Primer	1 Box (12/Bx)
73656	6 Oz. (170 g) Minute Bond Primer	1 Can

Minimum order: 1 each.

CRL UV ADHESIVE PROPERTIES AT A GLANCE

UV ADHESIVE	VISCOSITY	FINAL CONSISTENCY	TENSILE/SHEAR STRENGTH*	BONDLINE GAP	MAX. ALLOWABLE CONTINUOUS TEMPERATURE**	TEMPERATURE RANGE-PEAK VALUES	COLOR
CRL UV665	20 - 100 cps at 25°C (77°F)	Very Hard Shore D 70 - 80	24 N/mm ² 3480 psi	0.5 - 1 mil	50°C (122°F)	-40°C - 125°C (-40°F - 257°F)	Optically Clear
CRL UV740	10 - 150 cps at 25°C (77°F)	Very Hard Shore D 55 - 70	18 N/mm ² 2610 psi	1 - 2 mils	70°C (158°F)	-40°C - 120°C (-40°F - 248°F)	Optically Clear
CRL UV678	400 - 800 cps at 25°C (77°F)	Elastic Shore D 25 - 35	10 N/mm ² 1450 psi	0.5 - 1 mil	50°C (122°F)	-50°C - 150°C (-58°F - 302°F)	Optically Clear
CRL UV690	400 - 800 cps at 25°C (77°F)	Elastic Shore D 25 - 35	10 N/mm ² 1450 psi	0.5 - 1 mil	50°C (122°F)	-50°C - 150°C (-58°F - 302°F)	Optically Clear
CRL UV682	500 - 1000 cps at 25°C (77°F)	Very Hard Shore D 65 - 75	27 N/mm ² 3915 psi	0.5 - 1 mil	50°C (122°F)	-40°C - 130°C (-40°F - 266°F)	Optically Clear
CRL UV760	1000 - 2000 cps at 25°C (77°F)	Hard Shore D 60 - 70	26 N/mm ² 3770 psi	1 - 2 mils	70°C (158°F)	-40°C - 120°C (-40°F - 248°F)	Optically Clear
CRL UV770	3000 - 6000 cps at 25°C (77°F)	Very Hard Shore D 50 - 60	20 N/mm ² 2990 psi	1 - 2 mils	70°C (158°F)	-40°C - 120°C (-40°F - 248°F)	Optically Clear
LOCTITE® IMPRUV™	6000 - 13500 mPas at 25°C (77°F)	Very Hard Shore D 70	15 N/mm ² 2175 psi	N/A	N/A	-54°C - 150°C (-65°F - 302°F)	Optically Clear

* When recommended minimum and maximum layer thicknesses are taken into consideration, the tensile/shear strengths listed in the table can be achieved. N/mm² = Newtons per square millimeter.

** The maximum allowable continuous temperature shows the maximum temperature at which the cured adhesive is not irreversibly damaged. With increasing temperatures the maximum strength steadily decreases.

THESE ARE TYPICAL PROPERTIES AND ARE NOT MEANT TO BE PRODUCT SPECIFICATIONS.

NOTE: The information contained in this chart and product pages are believed to be reliable. C.R. Laurence Co., Inc. makes no representation or warranties of any kind concerning this information. It is the user's responsibility to determine the suitability of this product for any intended use. The user assumes all risk and liability connected with the use of these products.

CRL UV ADHESIVE PROPERTIES AT A GLANCE

UV ADHESIVE	PROPERTIES	APPLICATIONS	BONDING SUBSTRATES (BY PRIORITY)	STORAGE IN ORIGINAL CONTAINER
CRL UV665	Excellent capillary action, resistant to moisture.	Efficient production of glass furniture and showcases. Easy clean-up. Suitable for optical components.	Glass-to-glass, glass-to-metal, wood, many plastics.	Cool, dry, dark location (without UV radiation).
CRL UV740	Excellent capillary action, resistant to moisture and yellowing.	Efficient production of glass furniture and showcases. Easy clean-up.	Glass-to-glass, tempered glass-to-tempered glass, glass-to-metal (steel, aluminum, stainless steel), glass to many plastics.	Cool, dry, dark location (without UV radiation).
CRL UV678	Good capillary action, high vibration resistance, resistant to moisture and yellowing.	Especially for bonding laminated glass, ideal for bonding different material combinations.	Laminated glass to: glass, laminated glass, metal, ceramic, many plastics.	Cool, dry, dark location (without UV radiation).
CRL UV690	Good capillary action, extremely flexible, high vibration resistance, resistant to moisture and yellowing.	Ideal for bonding different material combinations, surface bonding up to 1 m ² .	Glass-to-glass, glass-to-metal, glass-to-ceramic, glass to many plastics.	Cool, dry, dark location (without UV radiation).
CRL UV682	Apply prior to glass assembly, resistant to moisture and thermal cycling, high tensile shear and peel strength bonds.	Especially for glass-to-metal bonding in furniture production.	Glass-to-metal, glass-to-glass, tempered-glass-to-tempered glass, glass-to-metal (steel, aluminum, stainless steel), ceramic, stone, wood, and some plastics.	Cool, dry, dark location (without UV radiation).
CRL UV760	Apply prior to glass assembly, resistant to moisture and thermal cycling.	Constructions subject to high static loads, difficult climate conditions especially for glass/metal bonding in furniture production.	Glass-to-metal, glass-to-glass, tempered glass-to-tempered glass, glass-to-stone, glass-to-wood, glass to many plastics.	Cool, dry, dark location (without UV radiation).
CRL UV770	Apply prior to glass assembly, resistant to moisture and yellowing.	Shower enclosure glass knobs and metal towel bars, metal standoff bases, glass shelves, showcases, glass sculptures.	Glass-to-glass, glass-to-metal (steel, aluminum, stainless steel), glass to many plastics.	Cool, dry, dark location (without UV radiation).
LOCTITE® IMPRUV™	Apply prior to glass assembly.	Shower enclosure glass knobs and metal towel bars, metal standoff bases, glass shelves, showcases, glass sculptures.	Glass-to-glass, glass-to-metal.	Cool, dry, dark location (without UV radiation).



CRL UV Adhesive Dispensing Needles

- Eight Needle Sizes to Fit All UV Adhesive Applications
- Color Coded for Quick, Accurate Selection
- Sold Individually or in a Cost-Saving Set

new

Working with UV adhesives requires precise control of the volume used for each application. CRL's choice of eight different orifice diameters will help you select just the right size Dispensing Needle for the job. Cat. No. UVA1 Needle Adapters fit all our standard size bottles (except 1 liter). Bottle caps stay clean and may be re-used to seal the bottle for storage. Use Cat. No. UV100G Empty Bottle when buying bulk size 1000g bottles for easier handling and dispensing.



100g Empty Bottle

CAT. NO. UV9SET Complete Set



CAT. NO.	COLOR	DIAMETER	FOR ADHESIVES
UVN25	Red	0.25 mm	UV740
UVN35	Orange	0.35 mm	UV740
UVN40	Blue	0.40 mm	UV740 & UV678
UVN50	Dark Blue	0.50 mm	UV678 & UV682
UVN60	Violet	0.60 mm	UV678 & UV682
UVN85	Green	0.85 mm	UV678 & UV682
UVN140	Dark Red	1.40 mm	UV682
UVN155	Dark Green	1.55 mm	UV770 & UV349
UVA1	Orange	-	Dispensing Needle Adapter
UV9SET	-	-	Complete 8 Needle Set with Adapter
UV100G	-	-	Empty Bottle with Tip

Minimum order: 5 each. (Except UVA1 and UV9SET, 1 each.)

CRL Timed Air Dispenser System for UV Adhesives

new

- Wide Range of Applications
- Barrel Suck-Back Assures No Dripping
- Low Cost System With High Reliability
- 110 Volts AC

The CRL Analog Timed Air Dispenser for UV Adhesives is an economical, versatile, and simple-to-use general purpose dispenser. It is designed for operator or automatic use in manual or automatic modes for timed air deposits, dots, beads or potting. It features easy to read gauges as the timed air pushes fluid out in doses.

Operation is easy, just hook up the barrel adapter (included), then connect the air and electric cords. Timed air is sent into the syringe to push the material out in measured doses. Requires an air supply of 70 to 100 psi (5.0 – 7.0 bar). The CRL Timed Air Dispenser comes complete with a starter kit of supplies, ready to use. Minimum order is one each.

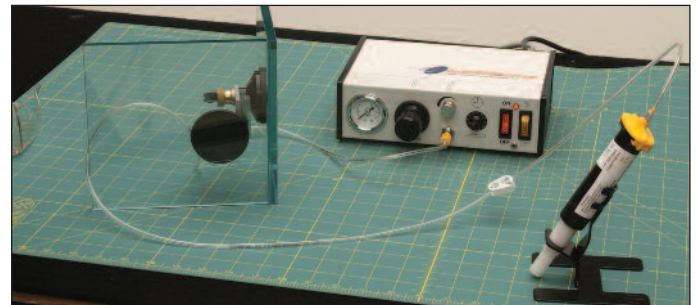

SYSTEM INCLUDES:

- 1 each Cat. No. UV1284 CRL Analog Timed Air UV Adhesive Metering Unit With Foot Pedal Control
- 4 each 30 cc/ml Cat. No. UV0322 Syringe Packages (1 Per Pack)
- 1 set of Needles Cat. No. UV9SET
- 1 each Lab Stand

CAT. NO. UV510

CRL UV Transmission and Power Meter

new

- Checks Strength of UV Curing Lamps
- Displays UV Transmission % or Power Readings
- Measures Temperature in F° or C°

The CRL UV Transmission and Power Meter is the most versatile product available for measuring UV. It measures UV intensities (irradiance), or UV Transmission percentage. Perfect for checking the output of your UV curing lamps (must check **new** lamp or replacement bulb to set benchmark), you can even confirm the protection level of your UV spectacles, goggles and facemasks. An added feature allows you to also measure temperatures in Fahrenheit and Celsius.

Unlike other UV products on the market, this Meter is extremely simple to operate. The digital display is continually updated with real-time readings. Powered by a 9V battery (included). Minimum order is one each.

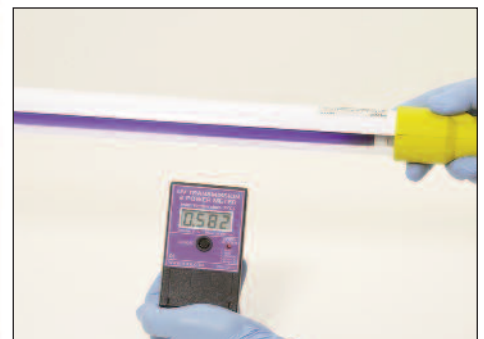

CAT. NO. UV1365

CRL Loctite® Poxy-Pak™ Clear Two-Part Epoxy

- Pre-Measured Resin and Hardener for Easy Applications, Consistent Strength
- Resealable – No Waste
- Bonds Virtually Any Material

CRL Loctite® Poxy-Pak™ Clear Adhesive is a rapid cure two-part epoxy that reaches handling strength in about five minutes, and fully cures in 45 to 60 minutes. Poxy-Pak™ is easily dispensed from the two-cylinder syringe in any amount you need. It bonds metals, ceramics, concrete, wood, glass, and most plastics. It's inexpensive to use, as the unused portion can be re-sealed and saved. May be drilled, tapped, sanded, machined and painted after it cures. Poxy-Pak™ cures at room temperature, and can withstand temperatures up to 300°F (149°C).



CAT. NO.	CONTENTS	QTY/CASE
81120	1 Fl. Oz. (29 ml)	12

Minimum order: 1 each.

CRL Water Clear Silicone Sealant



- Optically Clear When Cured
- Water Clear Formulation for Sealing Glass-to-Glass, Glass-to-Tile and Glass-to-U-Channel
- Applications Include Glass Butt Joints, Showcases, and Specialty Glass Assemblies

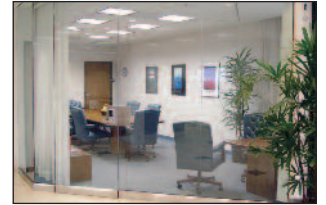

CRL Water Clear Silicone Sealant is an optically clear one-part silicone sealant that cures in the presence of atmospheric moisture (acetic cure) to produce a durable and flexible silicone rubber. Its unique weatherability enables it to retain original design properties, even after years of exposure.

CAT. NO.	CONTENTS	QTY/CASE
WCS1	10.3 Fl. Oz. (305 ml)	30
WCS5	5 Fl. Oz. (148 ml)	30

Minimum order: 1 each. Can be combined with all cartridge sealants for quantity pricing.

CRL Metal Contact Cement

- Strength of an Epoxy and the Speed of an Instant Adhesive
- Permanently Bonds Metal to Metal Without a UV Lamp, With Superior Strength Holding Power Up to 2,700 psi

To permanently bond metal to metal we suggest this strong adhesive system from Loctite®, with two different Primers to best suit your assembly time frame. Use Cat. No. 7649 Primer to activate in 60 seconds, 60% of full strength in two minutes, and a full cure in 24 hours. When a longer curing time is needed use Cat. No. 7075 Primer to activate in five minutes, 60% of full strength in ten minutes, and a full cure in 24 hours. For best performance surfaces should be clean and free of grease. Simply apply a generous amount of Primer to both of the bond surfaces and apply Adhesive to one of the surfaces. Position parts quickly and exactly as Adhesive begins to work immediately. Excess Adhesive outside joined surfaces can be wiped away with an organic solvent.



CAT. NO. 32629
Contact Cement



CAT. NO. 7075*
5 Minute Primer



CAT. NO. 7649
60 Second Primer

CAT. NO.	DESCRIPTION	ACTIVATION	CONTENTS
32629	Metal Contact Cement	--	1.69 Fl. Oz. (50 ml)
7649	Primer for Metal Contact Cement	60 Seconds	1.75 Fl. Oz. (52 ml)
7075	Primer for Metal Contact Cement	5 Minutes	4.5 Oz. (128 g)

Minimum order: 1 each. *Cat. No. 7075 cannot be shipped via air freight.

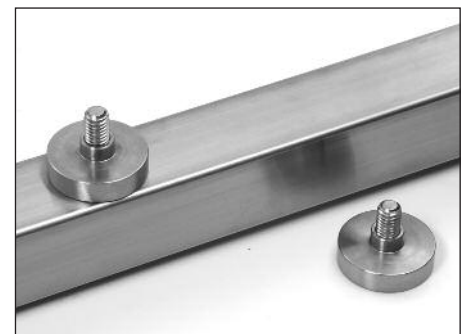

CRL UV Curing Lamps and Accessories

Curing UV Adhesives

To cure the technologically advanced UV Adhesives offered by C.R. Laurence, UVA Lamps emitting wave lengths in the range of 315-400 nm are required. A comprehensive selection of models is available to meet all the requirements to construct beautifully finished showcase, display, furniture, and specialty projects.

Depending on the type of construction used, the choice of the proper UV Curing Lamps is essential. Depending on the choice of lamp used, prior testing is recommended to determine full cure time based on the lamp's strength and the age of the bulb. Our Cat. No. UV1365 UV Transmission and Power Meter can provide precise ratings when needed.

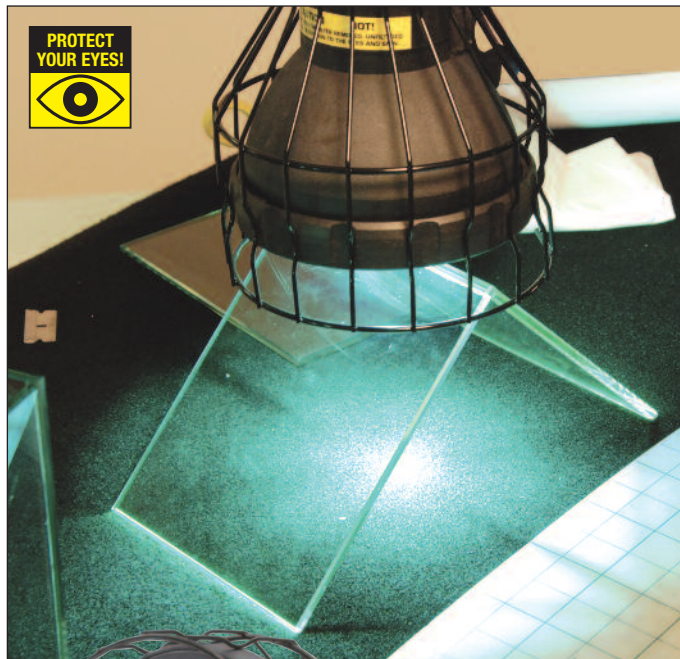

Safe lamp use must take into account the considerable heat developed by our high intensity bulb lamps. Always be sure to keep lamps away from combustible materials. Place them on a non-flammable surface when putting lamps aside. Lamps should never be positioned with the filter screen face down as this will cause excessive heat build-up that could destroy the lamp.

CRL UV Lamps are equipped with filter screens to reduce potential damage to eyes and skin. However, we strongly recommend the use of our Nitrile Gloves to protect your skin, and the appropriate eye protection provided by our UV Spectacles, Goggles or Face Mask (see page N426).

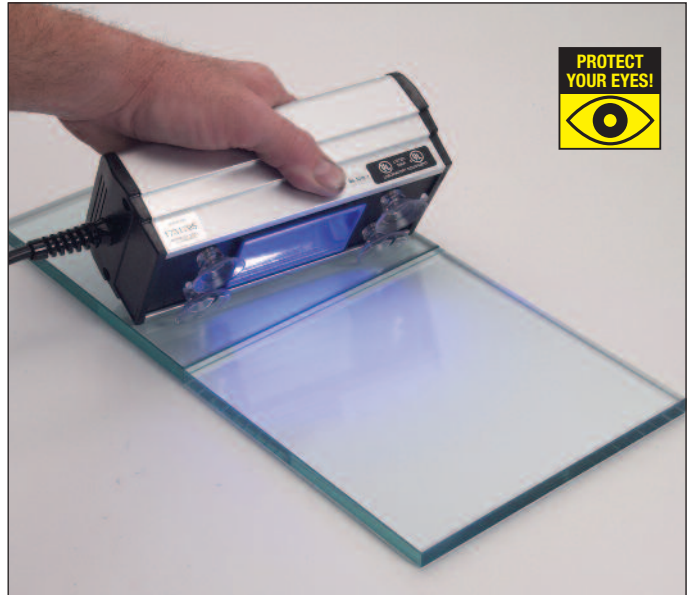

Bonding metal hardware to glass requires a smaller UV light area for the quickest cure times. Our Cat. Nos. UV255 and Z7596 Lamps are ideal choices. Only about 10 to 15 seconds are required for an initial set, and 90 to 120 seconds for full cure. Our Cat. No. UB80 Lamp takes longer for the initial set, approximately 60 to 90 seconds, and four to six minutes for final cure. Our Cat. No. UV240 Lamp provides an initial set of 25 to 30 seconds, and three to four minutes for full cure.

Longer lengths of glass in showcase and furniture construction should have the adhesive cured with Tube Lamps such as our Cat. Nos. XX40 or UVBL15 to assure tension-free results. Keep in mind that bond tension caused by curing shorter lengths at a time result in bond damage or glass breakage. UVA Tube Lamps take approximately 30 seconds for pre-curing, and three to five minutes for a full cure.

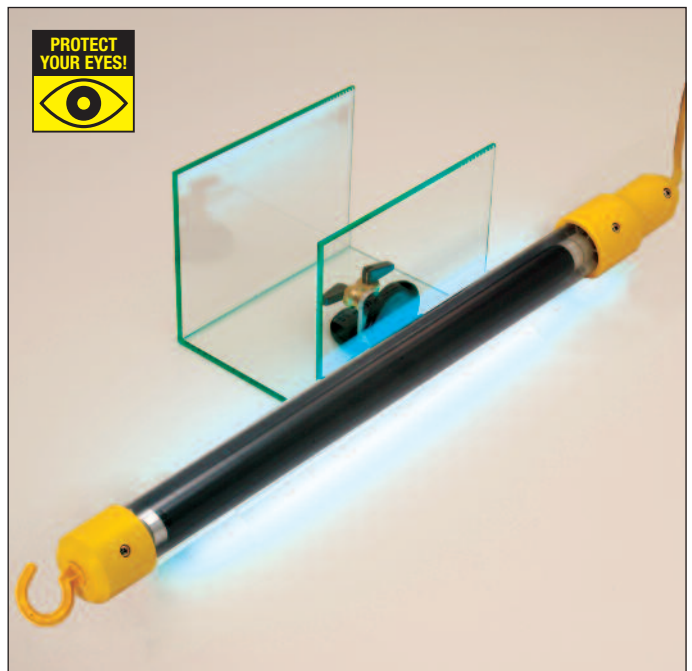

CRL High-Intensity Hand-Held UV Curing Lamp



- High-Intensity Light Cures Fast
- Lightweight, Under 3 Lbs. (1.3 kg)
- 13' (4 m) Electrical Cord
- Built-In Cooling Fan

CRL's High-Intensity Hand-Held UV Adhesive Curing Lamp provides the best uniform UV adhesive curing with a 96 square inch (8" x 12"), 620 square centimeter (20 x 30 cm) curing area at a distance of 8" (20 cm) by use of its highly efficient 250 watt halide UV bulb. The uniform intensity distribution is guaranteed by its optimized reflector surface.

Designed to cure all CRL UV Bonding Adhesives, the Cat. No. UV255 features spacer spots near the lamp's lens to prevent overheating when the lamp unit is laid down. An hour counter integrated into the ballast box provides for operational monitoring and control over lamp life.

The high-strength aluminum and polycarbonate lamp housing makes this lamp a very durable UL 2422 Approved curing device.

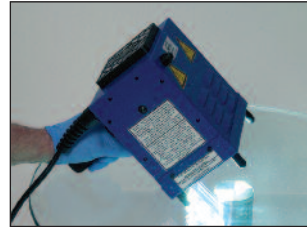

CAT. NO.

DESCRIPTION

UV255
UV255230
UV255B
UVH255F

High-Intensity Hand-Held UV Curing Lamp 110V
High-Intensity Hand-Held UV Curing Lamp 230V
Replacement Bulb
Replacement Filter

Minimum order: 1 each.

CRL Hand-Held Spot Bulb UV Curing Lamp



- Powerful 100 Watt Lamp Cures UV Adhesives in Seconds
- Lamp Head is Ergonomically Designed to Prevent Fatigue
- Impact Resistant Polymer Housing is Dent-Proof

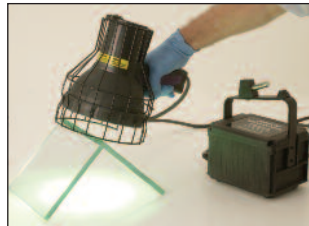

The CRL Hand-Held Spot Bulb UV Curing Lamp provides up to a 40mW/cm² of UV-A energy to cure all of our UV Adhesives in just seconds. Perfect for fabricating with our UV Bonded Hardware components, its unique filter provides maximum curing energy while minimizing the hazardous radiation inevitably produced by all high-intensity UV-A lamps.

Cat. Nos. Z7596 and AUZ7596 combine state-of-the-art design innovations with traditional proven features like the detachable lamp head with 96" (2.44 m) cord for lightweight hand-held use. Keep the lamp head mounted on the transformer and rotate it 360 degrees in either the horizontal or vertical positions for bench use. Included with each lamp is one pair of Cat. No. UVG50 Goggles, one pair of Cat. No. UVS30 Spectacles, and a Cat. No. UVG100 Heat Guard Stand to minimize the risk of accidental burn injury. Replacement bulbs and filters are available. Minimum order is one each.



CAT. NO.

DESCRIPTION

Z7596
AUZ7596
Z100SM

Hand-Held Spot Bulb UV Curing Lamp 110V AC 60Hz
Hand-Held Spot Bulb UV Curing Lamp 240V AC 50Hz
Replacement Bulb for Lamps with Serial Numbers 1567104 and Higher

Z100S

Replacement Bulb for Lamps with Serial Numbers 1567103 and Lower

Z2F100C
UVG100

Replacement Filter for Z7596/AUZ7596
Heat Guard Stand for Z7596/AUZ7596

Minimum order: 1 each.

CRL Compact AC UV Curing Lamp



3" (76 mm)



- Lightweight and Durable
- Excellent for Smaller Projects
- Built-In Suction Cups for Positioning

The CRL Compact AC UV Curing Lamp is a great tool to assist you in the introduction to UV glass bonding. Although small in size, initial pre-cure and full cure bonding is assured with it's 3,500 watts/cm² light output. The built-in suction cups allow you to fix the lamp's position securely during the curing process.

CAT. NO.	DESCRIPTION
UV240	Compact Curing Lamp 110 Volts AC 60Hz
UV240230	Compact Curing Lamp 230 Volts AC 50Hz
UV240BULB	Replacement Bulb for UV240, UV240230 and UB80

Minimum order: 1 each.

CRL Battery Operated UV Curing Lamp

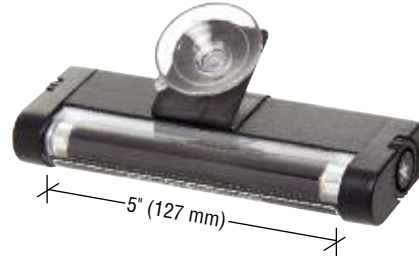

5" (127 mm)



- Cures All CRL UV Bonding Adhesives
- Built-In Suction Cup for Positioning

Our Battery Operated UV Curing Lamp may be small, but when allowed the appropriate initial pre-cure and final curing times, the resulting bonds will be high quality in strength and appearance. Power comes from the four "AA" batteries included with the Lamp, producing 1,000 watts/cm² of light output. This is the most affordable tool to use when starting out with UV bonding on a small scale.

CAT. NO.	DESCRIPTION
UB80	Battery Operated UV Adhesive Curing Lamp
UV240BULB	Replacement Bulb for UB80, UV240, and UV240230

Minimum order: 1 each.

CRL High-Intensity LED UV Curing Lamp Kit

- Small in Size, Big in Energy Savings
- 30,000 Hour LED Bulb Life
- Perfect for Affixing UV Bonding Hardware
- Cures All CRL UV Bonding Adhesives

CRL's High-Intensity LED UV Curing Lamp provides ultra-high intensity up to 18,000 watts/cm² of true UV-A, 365 nm radiation to cure UV adhesives incredibly fast. Push the 'on' button and the lamp immediately reaches full power and is ready for use, eliminating the down time waiting for bulbs to warm up. Cordless operation lets you move around your work unencumbered, and the powerful NiMH battery will operate the lamp continuously for 90 minutes before a recharge is needed.

The 2" (51 mm) lamp diameter and 8" (203 mm) length of the lamp's body is encased in durable anodized aluminum. The LED bulb is made with an electronic intensity stabilizer to ensure consistent performance, which also means that the beam strength will not fade while operating between charges. Kit comes complete with smart AC and DC Chargers, UV Absorbing Spectacles, Belt Holster, and padded Carrying Case. Optional 240V AC Chargers are available and sold separately.



CAT. NO. OPX365



CAT. NO. RB3FA
Optional 240V AC Charger
with Australian Plug



CAT. NO. RB3FB
Optional 240V AC Charger
with European Plug



CAT. NO.	DESCRIPTION
OPX365	High-Intensity LED UV Curing Lamp Kit
RB3FA	Optional Australian Use 240V AC Charger
RB3FB	Optional European Use 240V AC Charger

Minimum order: 1 each.

CRL Long Double Tube UV Curing Lamp

- 48" (1219 mm) Tubes for Long Seam UV Bonding
- Most Powerful Lamp of It's Type
- Mountable Fixture Housing

The CRL Long Double Tube UV Curing Lamp is perfect for use where high-intensity, wide-area UV coverage is needed. Specially filtered 40 watt bulbs make it the most powerful lamp of it's type available. Suited to cure all CRL UV Bonding Adhesives, it features an enameled sheet metal housing that can be side mounted, hung overhead, or used as a portable lamp to accommodate many different requirements.

A corrosion-resistant, specular aluminum reflector ensures maximum UV irradiance. On/off switch is conveniently located on the lamp's housing. Lamps are U.L. listed.



CAT. NO. XX40
Double Tube Lamp

CAT. NO.	DESCRIPTION
XX40	Double Tube UV Curing Lamp 110 Volts AC 60Hz
XX40230FA	Australian Use Double Tube UV Curing Lamp 230 Volts AC 50Hz
XX40230F	European Use Double Tube UV Curing Lamp 230 Volts AC 50Hz
XX40BULB	Replacement Bulb for Double Tube UV Curing Lamp

Minimum order: 1 each.



CAT. NO. XX40BULB
Replacement Bulb

CRL Single Tube UV Curing Lamp

- Cures All CRL UV Bonding Adhesives
- Extra Long 30 Foot (9.1 m) Cord
- 17-1/2" (444 mm) Irradiation Length

The CRL Single Tube UV Curing Lamp is easily moved from position to position due to its lightweight and long 30' (9.1 m) electrical cord. The 365 nm output is ideal for curing all CRL UV Bonding Adhesives for glass-to-glass and glass-to-metal applications. The 17-1/2" (444 mm) irradiation length will cure seams up to that length. You can add more lamps end-to-end for longer lengths.

The on/off switch is conveniently located at the hand held end of the lamp. The fluorescent bulb is protected by a heavy-duty acrylic tube, and has a light shield around the back side. A hanging hook is built in for temporary mounting positions.

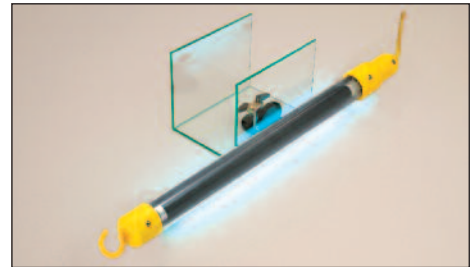

CAT. NO.	DESCRIPTION
UVBL15	Single Tube 15 Watt UV Curing Lamp 110 Volts 60Hz
UVBL15BULB	Replacement Bulb for 15 Watt Single Tube UV Curing Lamp

Minimum order: 1 each.

CAT. NO. UVBL15

CRL Double Tube UV Curing Lamp

- Cures All CRL UV Bonding Adhesives
- 17-1/2" (444 mm) Irradiation Length
- Fully Enclosed, Filtered Housing

The CRL Double Tube UV Curing Lamp delivers 25 watts of curing power via two 18" (457 mm) fluorescent UV bulbs providing 17-1/2" (444 mm) of irradiation. This 230 volt lamp is fully enclosed and filtered to control and focus UVA radiation on the bonding joint. The 365 nm output is tuned to quickly cure all CRL UV Adhesives. Includes convenience of body mounted on/off switch and handle.

This powerful and durable tool with its 230 volt, 50 cycle wiring is CE approved for the European Market. **NOTE:** For sale in Europe only.



CAT. NO. UVBL25EU

CAT. NO.	DESCRIPTION
UVBL25EU	Double Tube 25 Watt UV Curing Lamp 230 Volts 50Hz
UVBL25BULB	Replacement Bulb for 25 Watt Twin Tube Curing Lamp

Minimum order: 1 each.

CRL UV-Absorbing Spectacles

- Protects Against UV Exposure
- Fits Easily Over Regular Eyeglasses



Ultraviolet light is an invisible band of electromagnetic radiation just beyond the violet end of the visible spectrum. Although UV exposure is a natural part of our environment, prolonged and unprotected exposure to UV light can result in eye damage.

These CRL UV-Absorbing Spectacles are specially designed to protect the user against limited exposure to low intensity UV sources. Attractive and durable, these well proportioned frames fit easily over conventional eyeglasses. Minimum order is one each.

CAT. NO. UVS30

CRL UV-Absorbing Goggles

- Protects Eyes From UV Sources
- Meets ANSI and OSHA Standards
- Fits Easily Over Regular Eyeglasses



Ultraviolet light is an invisible band of electromagnetic radiation just beyond the violet end of the visible spectrum. Although UV exposure is a natural part of our environment, prolonged and unprotected exposure to UV light can result in eye damage.

These CRL UV-Absorbing Goggles are recommended for extended or high intensity exposure to UV sources. They meet ANSI specification Z87.1 for safety eye wear, and OSHA standard 1910.133 for eye and face protection. These comfortable goggles easily fit over conventional eyeglasses. Minimum order is one each.

CAT. NO. UVG50

CRL UV-Absorbing Face Shield

- Adjustable to Fit All Sizes
- Can Be Pivoted Off the Face



Ultraviolet light is an invisible band of electromagnetic radiation just beyond the violet end of the visible spectrum. Although UV exposure is a natural part of our environment, prolonged and unprotected exposure to UV light can result in eye damage.

The CRL UV-Absorbing Face Shield provides the recommended maximum protection for both eye and face from extended or high intensity UV sources. This Face Shield is adjustable to fit all sizes and has a visor that can be pivoted off the face. The shield meets ANSI specification Z87.1 for safety eye wear, and OSHA standard 1910.133 for eye and face protection. Minimum order is one each.

CAT. NO. UVF80

CRL Disposable Nitrile Gloves SIZES **new**

- Provides Resistance Against Solvents
- Powder Free
- Now in Four Sizes



Our 100% Nitrile Gloves provide better protection against solvents where more splash protection is required than you can get with latex gloves. The Nitrile compound gives greater puncture resistance than natural rubber and vinyl disposable gloves, and reduces hand pressure and fatigue caused by elastomeric stress.

CAT. NO.	SIZE	QTY/BOX
7005SM	Small	100
7005MD	Medium	100
7005NG	Large	100
7005XL	X-Large	100

Minimum order: 1 box. Can be combined with all other disposable gloves for quantity pricing.

CRL UV Glass Bonding Hardware for Furniture and Display Products



- Create Custom Designs
- A New Business Opportunity Awaits
- 'All-Glass' Look is the Choice of Many Interior Designers

Glass has long been the choice for unique furniture designs and display products due to the many alternatives available for glass thicknesses and colors. Glass furniture and displays, due to the clarity, also creates the illusion of being in a much larger environment. Glass is unique in that custom designs, no matter the size or the intended use, can be produced by glass fabricators using your drawings to construct almost anything for your home or business.

Until recently, the only method of connecting glass panels was by using various types of connectors that require cut-outs, notches or drilling holes in the glass. Through the development of UV glass bonding adhesives and specialty hardware like hinges, locks, pulls, shelf supports, handles, and counter top supports, glass bonding has developed into a whole new world of glass product design and fabrication.

C.R. Laurence Co. has all the glass bonding cleaners, UV adhesives, fixation devices, clamps, and a selection of UV glass hardware you will need to create truly original glass furniture or displays. Also important is that C.R. Laurence has the technical resources and expertise to answer any glass bonding questions you may have. For additional information on CRL's Glass Bonding Products, contact CRL Technical Sales at (800) 421-6144 in the U.S., (877) 421-6144 from Canada, or (323) 588-1281 International. Ask for ext. 7720. You can also e-mail us through our web site, crlaurence.com. From the home page click on Contact Us, and then click on Technical Sales for Glass and Glazing Products.



CRL UV Glass-to-Glass Swing Hinges

- Designed for Inset Doors

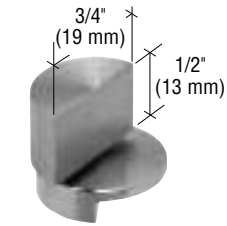

CAT. NO. UV6260

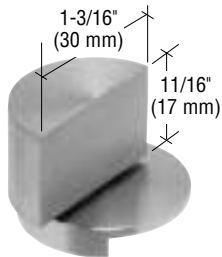

CAT. NO. UV6261

CRL's UV Glass-to-Glass Hinges are designed for 'all-glass' showcase applications. This unique two-part Top and Bottom Hinge is fabricated from stainless steel material that comes in a brushed finish, and is bonded to inset doors with a glass thickness up to 1/2" (12 mm). A threaded pin in the Bottom Hinge allows the door to be easily installed or removed after bonding. Minimum order is one pair (top and bottom).

CAT. NO.	DESCRIPTION	WEIGHT CAPACITY
UV6260	Small Glass-to-Glass Hinge	22 Lbs. (10 kg)
UV6261	Large Glass-to-Glass Hinge	44 Lbs. (20 kg)

Minimum order: 1 pair. All UV Hinges can be combined for quantity pricing.

CRL UV Glass-to-Wood Swing Hinges

- For Inset Glass Doors in a Wood Cabinet

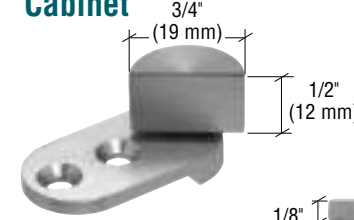

CAT. NO. UV6262

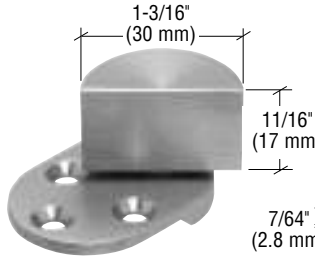

CAT. NO. UV6263

CRL's UV Glass-to-Wood Hinges provide the perfect solution for bonded glass cabinet doors installed into a wood surround frame. These brushed stainless hinges can be bonded to glass up to a 1/2" (12 mm) thick per pair of hinges. A threaded pin in the Bottom Hinge permits easy installation and removal after glass bonding. Minimum order is one pair (top and bottom).

CAT. NO.	DESCRIPTION	WEIGHT CAPACITY
UV6262	Small Glass-to-Wood Hinge	22 Lbs. (10 kg)
UV6263	Large Glass-to-Wood Hinge	44 Lbs. (20 kg)

Minimum order: 1 pair. All UV Hinges can be combined for quantity pricing.

CRL UV Glass-to-Glass Cone Hinges

- For Overlay Doors
- Available in Two Sizes

new

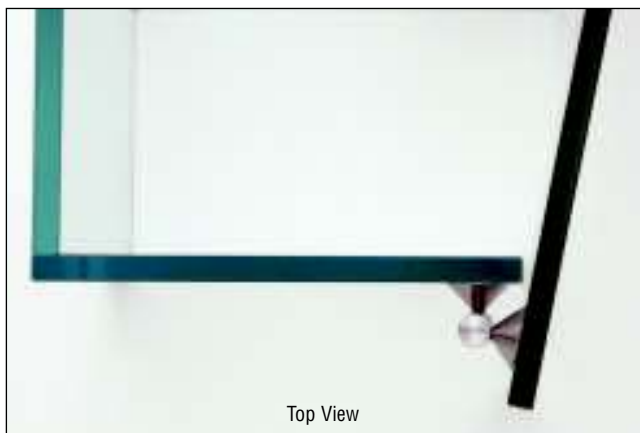

CRL's UV Cone Glass-to-Glass Hinges are designed for 'all-glass' showcases with overlay doors. The doors must overlap the end of the glass side panels by 1" to 2" (25 to 50 mm), depending on which Hinge is being used. The Hinges are bonded on exterior end panels and the overlap portion of the glass door. The Hinges open to a maximum of 180 degrees. Fabricated in brushed stainless steel, the minimum order for Cone Hinges is one each.

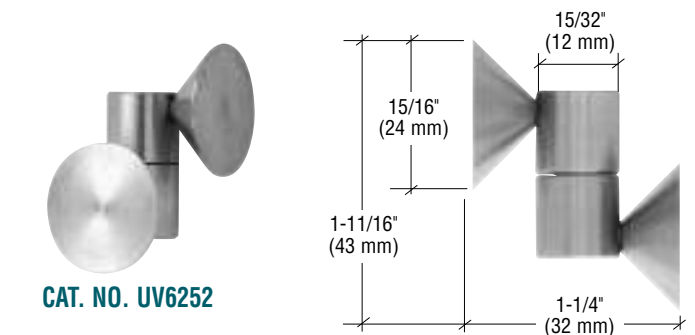

CAT. NO. UV6252

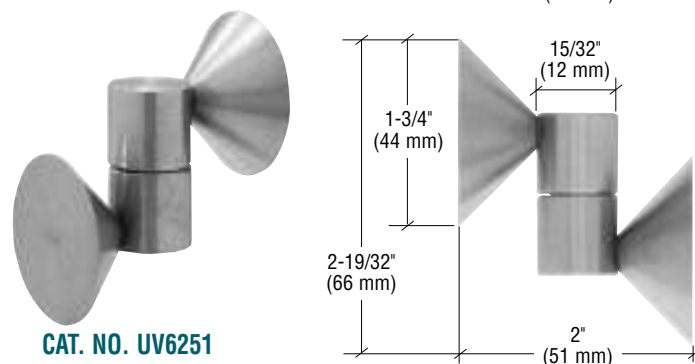

CAT. NO. UV6251

CAT. NO.	CONE DIAMETER	MAX. GLASS THICKNESS	WEIGHT CAPACITY
UV6252	15/16" (24 mm)	3/8" (10 mm)	22 Lbs. (10 kg)
UV6251	1-3/4" (44 mm)	1/2" (12 mm)	44 Lbs. (20 kg)

Minimum order: 1 each. All UV Hinges can be combined for quantity pricing.

CRL UV Designer Series Hinges, Locks, and Door Pull

- Matching Design for All Bonded Hardware
- Brushed Stainless Finish
- Hinges for 'All-Glass' and Glass-to-Wood Doors



CRL's Designer Series UV Hardware for glass showcases or cabinets is elegantly designed, and provides a coordinated appearance from Hinges to Locks to Pulls. This hardware design brings something unique to what could be very plain. The Designer Series collection of UV Hardware gives you the opportunity to create an attractive and functional display or piece of furniture.

CRL UV Designer Glass-to-Glass and Glass-to-Wood Hinges

new

- For Inset Glass Doors

UV Designer Series Hinges can be used on either 'all-glass' cabinets or attached to wood side panels. Easily installed, these Hinges have a maximum recommended glass thickness of 1/4" (6 mm). The Glass-to-Wood Hinge has an internal wood mounting plate that slides into the Hinge housing to securely hold it in place. The maximum weight per pair of Hinges is 33 lbs. (15 kg). Hinges are available for both right hand and left hand doors.

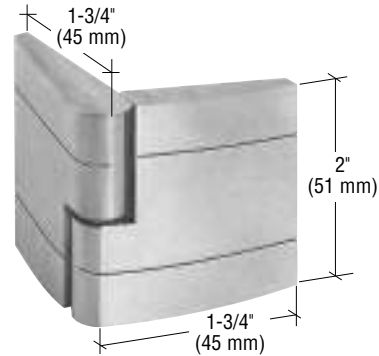

Right Hand Shown

CAT. NO.	DESCRIPTION	JAMB
UV0264	Glass-to-Glass	Right Hand
UV0263	Glass-to-Glass	Left Hand
UV0274	Glass-to-Wood	Right Hand
UV0273	Glass-to-Wood	Left Hand

Minimum order: 1 each. All UV Hinges can be combined for quantity pricing.

CRL UV Designer Single and Double Door Locks

new

- For Inset or Overlay Doors
- Locks Keyed Differently

Simply bond the Keeper to the glass side panel and bond the Single Door Lock to the door. Turn the key and the cam slides into the Keeper and your showcase is secure. Minimum order is one each.

CRL's UV Designer Lock for double doors provides an easy and trouble free method to secure your glass door showcase or cabinet. The matching Lock and Keeper can be used with our Designer Series Glass-To-Glass or Glass-To-Wood Hinges to create an attractive, unique appearance. Minimum order is one each.

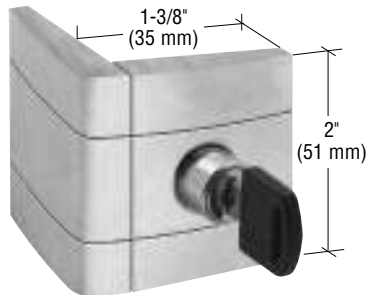

Single Door
CAT. NO. UV0268

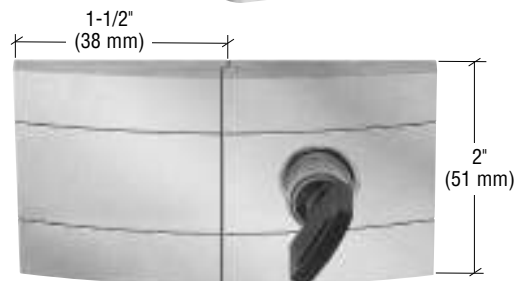

Double Door
CAT. NO. UV0266

CRL UV Designer Pull

new

- For Inset or Overlay Glass Doors

Install your Designer Pull anywhere along the edge of your door overlapping the cabinet sidewall to provide a convenient handle. The Pull and Single Door Lock can be used together, and will present a coordinated look with the Glass-To-Glass or Glass-To-Wood Hinges. Minimum order is one each.

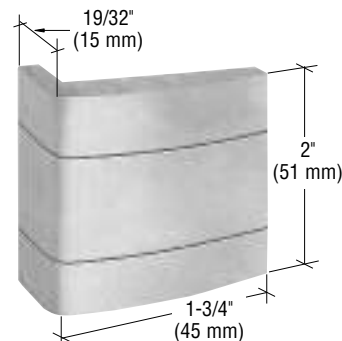

CAT. NO. UV0276

CRL UV GLASS BONDING HARDWARE

For Pricing Visit Our Web Site or Call Us Toll Free at the Phone Numbers Shown on the Back Cover

CRL UV Curved Glass-to-Glass Hinge

- For Overlay Glass Doors
- Available in Two Finishes

new

CRL EXCLUSIVE



CRL's UV Curved Glass-to-Glass Hinges have a unique and contemporary design that will enhance the look of any 'all-glass' cabinet or showcase. These Hinges are easy to install and the polished or satin nickel finish will match other showcase hardware. The maximum glass thickness is 1/4" (6 mm), and maximum weight per pair of Hinges is 33 lbs. (15 kg). Hinges are available for left hand or right hand doors.

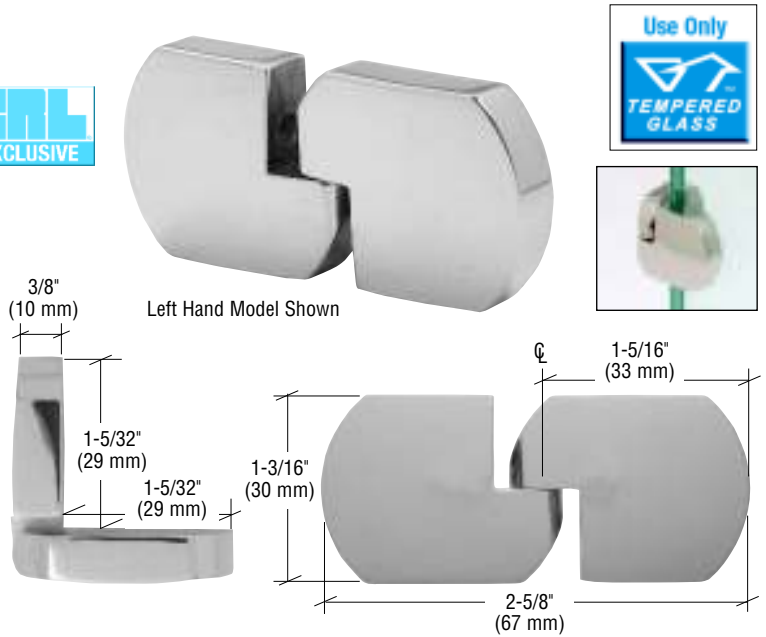

CAT. NO.	JAMB	FINISH
UVCK12PN	Left Hand	Polished Nickel
UVCK11PN	Right Hand	Polished Nickel
UVCK12SN	Left Hand	Satin Nickel
UVCK11SN	Right Hand	Satin Nickel

Minimum order: 1 each. Finishes can be combined for quantity pricing.

CRL UV Stainless Steel Glass-to-Glass Hinge

- For Inset or Overlay Doors
- Self-Centering at 90 and 180 Degrees

CRL's UV Stainless Steel Glass-to-Glass Hinges are designed for 'all-glass' cabinets, and are available in brushed or polished stainless. The Hinge plate is 1-3/4" (44 mm) long by 1-1/2" (38 mm) wide. For overlay doors, use of UV0235 or UV0236 Dampers (see page N438) is recommended. The maximum recommended door weight per pair of Hinges is 40 lbs. (18 kg).

CAT. NO.	FINISH
UVHG1BS	Brushed Stainless
UVHG1PS	Polished Stainless

Minimum order: 1 each. Finishes can be combined for quantity pricing.

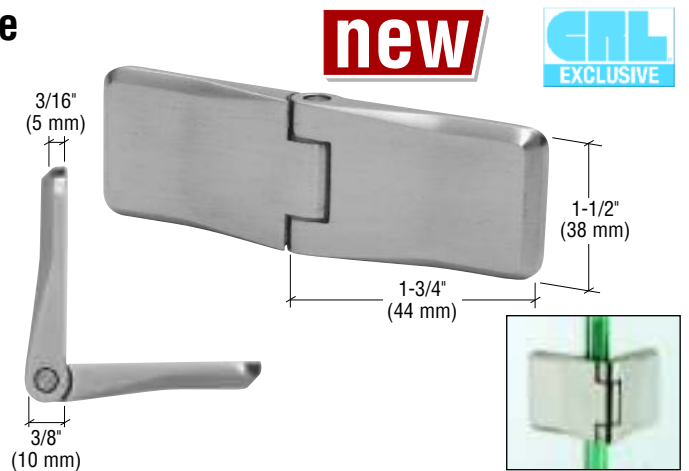

CRL UV Circular Glass-to-Glass Hinge

- Available in Brushed or Polished Stainless

CRL's UV Circular Glass-to-Glass Hinges are fabricated from stainless steel, and are designed for inset glass doors. The overall length of each side is 1-15/16" (49 mm), and the diameter of the bonding disk is 1-3/16" (30 mm). The maximum recommended weight per pair of Hinges is 28 lbs. (13 kg).

CAT. NO.	FINISH
UV3010BS	Brushed Stainless
UV3010PS	Polished Stainless

Minimum order: 1 each. Finishes can be combined for quantity pricing.

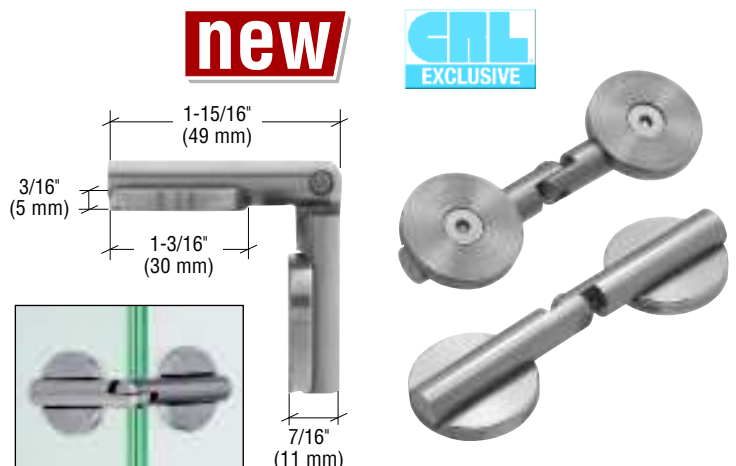

C.R. LAURENCE COMPANY

N430 |

crlaurence.ca

crlaurence.com.au

crlaurence.co.uk

crlaurence.de

crlaurence.eu

crlaurence.com

CRL UV Large Flat Glass-to-Glass Hinge

new

- For Inset or Overlay Doors
- Chrome Plated Brass

CRL's UV Large Flat Glass-to-Glass Hinge is free-swinging and designed for 'all-glass' showcases or cabinets. The maximum glass thickness for these chrome plated Hinges is 1/4" (6 mm). The maximum recommended door width is 19" (483 mm). The maximum weight per pair of Hinges is 16-1/2 lbs. (7.5 kg).

NOTE: Lightly scuff (do not scratch) bonding surface prior to applying adhesive.

CAT. NO.	FINISH
UV0090	Chrome

Minimum order: 1 each. All UV Hinges can be combined for quantity pricing.

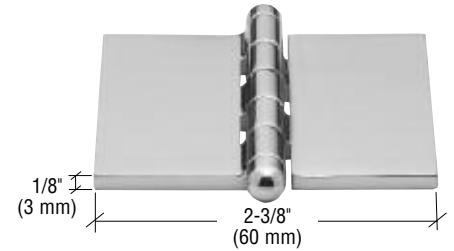
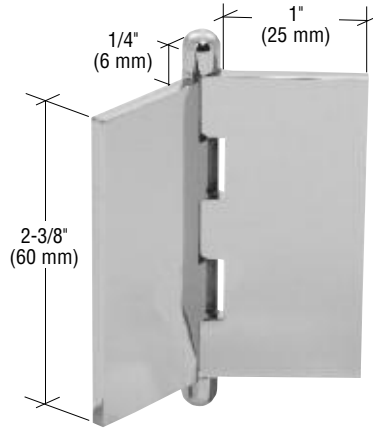

CRL UV Flat Glass-to-Glass Hinge

new

- Ideal for Smaller 'All-Glass' Cabinets

These free-swinging polished stainless steel Glass-to-Glass Hinges are designed for smaller 'all-glass' cabinets with inset doors. The maximum recommended glass thickness is 1/4" (6 mm). The maximum weight per pair of Hinges is 22 lbs. (10 kg). The minimum order is one each.

CAT. NO.	JAMB
UV6265	Right Hand
UV6267	Left Hand

Minimum order: 1 each. All UV Hinges can be combined for quantity pricing.

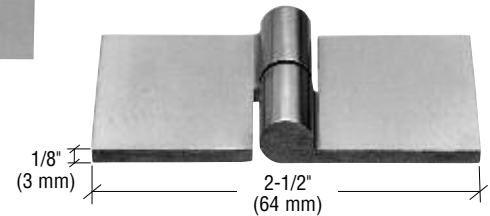
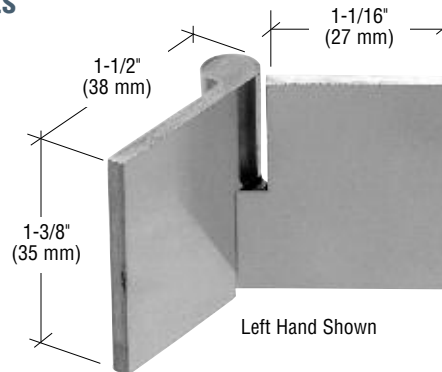

CRL UV Flat Glass-to-Wood Hinge

new

- Designed for Wood Cabinets With Glass Doors

CRL's free-swinging polished stainless steel Glass-to-Wall Hinges are designed for smaller size cabinets with wood side panels and inset glass doors. The maximum recommended glass thickness is 1/4" (6 mm). The maximum weight per pair of Hinges is 22 lbs. (10 kg). Minimum order is one each.

CAT. NO.	JAMB
UV6266	Right Hand
UV6268	Left Hand

Minimum order: 1 each. All UV Hinges can be combined for quantity pricing.

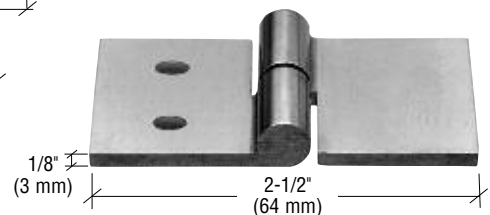
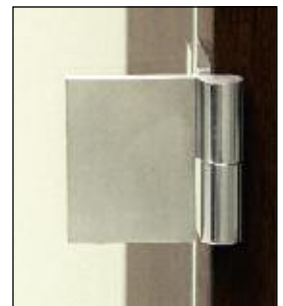
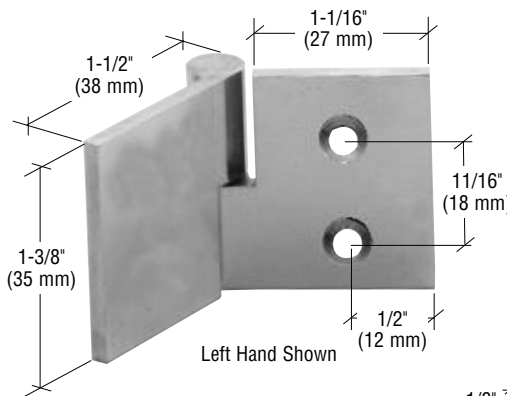

CRL UV Round Glass-to-Glass Door Hinge

- For Inset Glass-to-Glass Doors
- Gives Cabinets an 'All-Glass' Look

new

CRL's UV Round Glass-to-Glass Door Hinge is popular in the furniture industry due to its clean, efficient design and ease of assembly. The door moves to the inside of the cabinet by 1-3/16" (30 mm) when opening. After installation, minor adjustments to the door can be made by simply turning a screw.

The maximum glass thickness is 5/16" (8 mm), and the maximum door weight should not exceed 18 lbs. (8 kg) using two Hinges. Minimum order is one each.

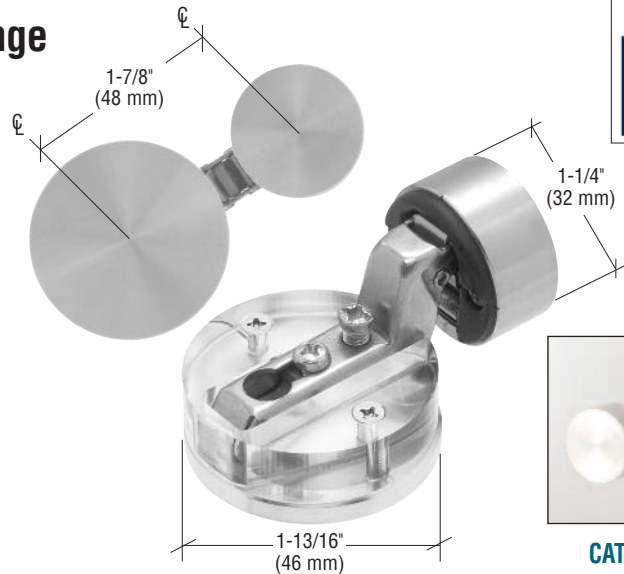

CAT. NO. UV6200

CRL UV Square Glass-to-Glass Door Hinge

- For Inset Glass-to-Glass Doors
- Gives Cabinets an 'All-Glass' Look

new



CRL's UV Square Glass-to-Glass Door Hinge uses the same clean, efficient design as the Round UV6200 Hinge shown above, but with all new square bonding plates. The fixed sidewall plate measures 1-13/16" (46 mm) square, while the door plate measures 1-1/4" (32 mm) square.

The maximum glass thickness is 5/16" (8 mm), and the maximum door weight should not exceed 18 lbs. (8 kg) using two Hinges. Minimum order is one each.

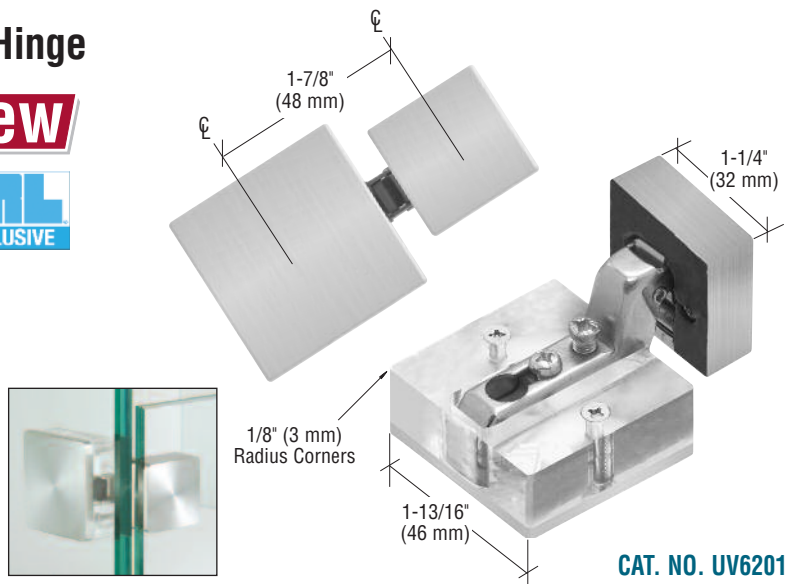

CAT. NO. UV6201

CRL UV European Style Glass-to-Wood Hinge

- For Inset or Overlay Glass-to-Wood Doors

new

CRL's UV Glass-to-Wood Hinge features a nickel plated finish and a positive action close. Made popular on kitchen cabinets and stereo furniture, this side wall mounted Hinge comes with a plate that is UV bonded to the glass door. The face of the Hinge snaps into the mounting plate which connects the door to the Hinge.

Maximum recommended door size using two Hinges is 24" (610 mm) wide and 36" (914 mm) high, with a maximum weight of 20 lbs. (9 kg). Using three Hinges increases the maximum door height to 60" (1524 mm) and weight to 40 lbs. (18 kg). However, the maximum door width remains 24" (610 mm). Minimum order is one each.

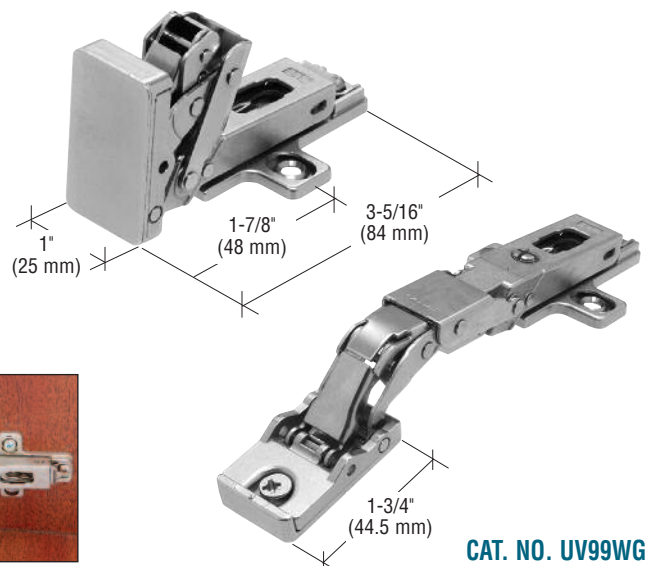

CAT. NO. UV99WG

CRL UV Classic Series Glass Door Locks and Keepers

- For Overlay and Inset Glass Doors
- Available in Chrome and Brushed Nickel



CRL's UV Glass Door Locks for Inset and Overlay Doors are attractively designed and easily installed. Available in chrome and brushed nickel, the lock set includes a UV Lock and Keeper. The recommended glass thickness is 1/4" (6 mm). The 1-1/4" (32 mm) tall design of this lock is very versatile in that it can be installed anywhere along the vertical length on right or left hand doors or at the top of the door. Use with CRL's Classic Series Hinges to provide your customer with matching UV hardware. Bolt throw for each style is 3/8" (9.5 mm).

CAT. NO.	DESCRIPTION	FINISH
UV4070CH	Overlay Doors	Chrome
UV4070BN	Overlay Doors	Brushed Nickel
UV4071CH	Inset Doors	Chrome
UV4071BN	Inset Doors	Brushed Nickel

Minimum order: 1 each. Finishes can be combined for quantity pricing.

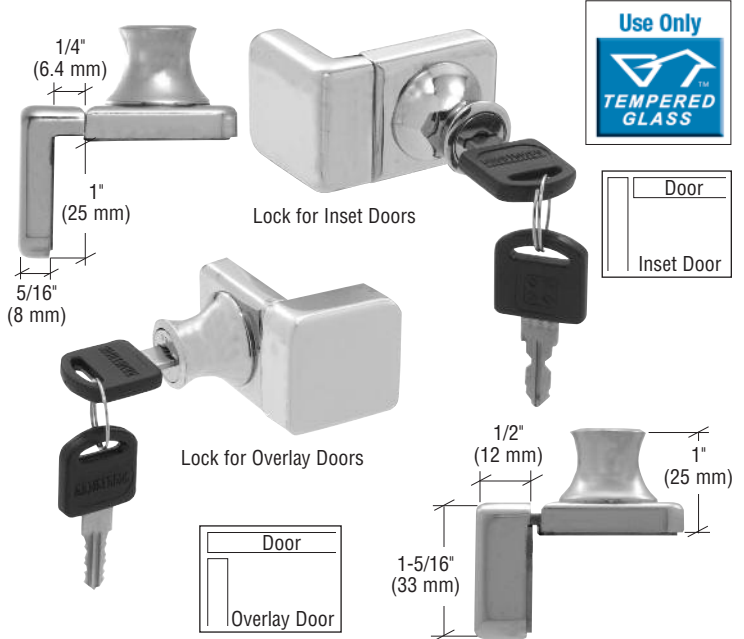

CRL UV Classic Series Glass Door Lock and Keeper for Double Doors

- Available in Chrome and Brushed Nickel

This UV Lock for double glass doors can be bonded at any convenient door height. The Lock cylinder functions as a door pull. See below for matching chrome or brushed nickel UV Hinges.

CAT. NO.	DESCRIPTION	FINISH
UV417CH	Double Doors	Chrome
UV417BN	Double Doors	Brushed Nickel

Minimum order: 1 each. Finishes can be combined for quantity pricing.

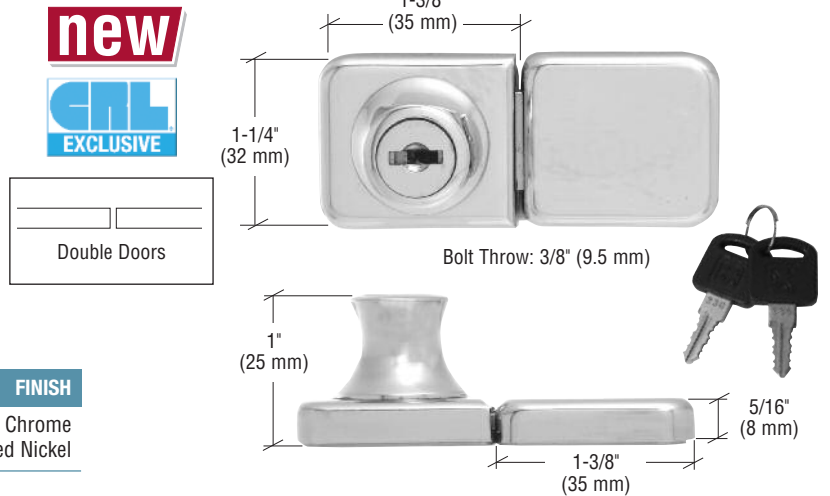

CRL UV Classic Series Glass Door Hinge

- Matches Design of Single and Double Door Locks
- Available in Chrome and Brush Nickel

CRL's UV Classic Series Hinges match the configuration of the Classic Series Locks, and are available in chrome or brushed nickel. Recommended for 1/4" (6 mm) thick glass, the recommended weight capacity is 22 lbs. (10 kg). Two Hinges per pack.

CAT. NO.	FINISH
UVHG3CH	Chrome
UVHG3BN	Brushed Nickel

Minimum order: 1 pack. Finishes can be combined for quantity pricing.

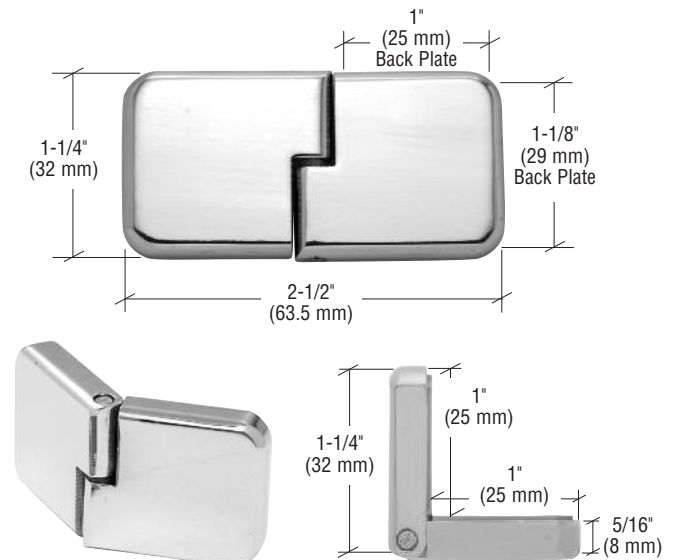

CRL UV Tube Locks

- For Inset, Overlay, and Double Doors

new

CRL's UV Tube Locks are extremely versatile due to the side mounted design. Easy to install, these Locks can be installed on glass doors up to a maximum thickness of 1/2" (12 mm). All three key tubes measure 1-3/32" (28 mm) in diameter and 1-13/16" (46 mm) in length. These tubes are flat on one long side for bonding. The 3/8" (10 mm) thick x 1-3/16" (30 mm) high receiver plates vary in size according to application. Minimum order is one each.



UV Receiver Plates

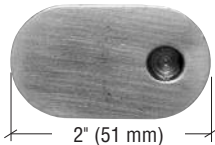

For Single Inset Doors

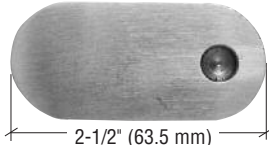

For Single Overlay Door Lock



For Double Door Lock

CAT. NO.	DESCRIPTION	FINISH
UV6278BS	Single Inset Door Lock	Brushed Stainless
UV6278PS	Single Inset Door Lock	Polished Stainless
UV6279BS	Single Overlay Door Lock	Brushed Stainless
UV6279PS	Single Overlay Door Lock	Polished Stainless
UV6280BS	Double Door Lock	Brushed Stainless
UV6280PS	Double Door Lock	Polished Stainless

Minimum order: 1 each. Finishes can be combined for quantity pricing.

CRL UV Bolt Locks for Double Doors

- For Large and Small Double Glass Doors

new

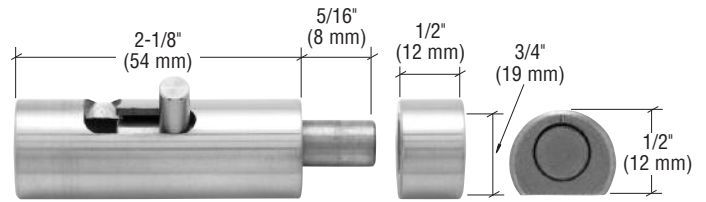

CAT. NO. UV6259

3/4" (19 mm) Diameter Bolt Lock

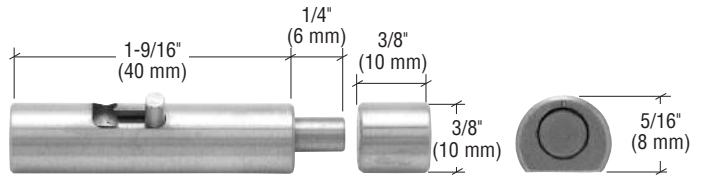

CAT. NO. UV6258

3/8" (10 mm) Diameter Bolt Lock

CRL's stainless steel UV Bolt Locks for double glass doors are easily installed and keep the doors of your glass cabinet or showcase closed without requiring a key for access. The lock is UV glued to one door, while the Receiver is glued to adjoining door. It is available in two sizes to accommodate both large and small doors. Minimum order is one each.

CRL UV Lock for Single Inset or Overlay Doors

new



- Available in Brushed and Polished Stainless Steel



CRL's versatile UV Lock can be used for both single inset or overlay glass doors. Requires drilling a 1" (25 mm) diameter hole in the glass door with adhesive applied to rear surface of cover plate, and bonding the latch to the glass side panel. Each lock includes 1-7/8" (48 mm) short cam for overlay doors and a 2-3/8" (60 mm) long cam for inset door. Each is also designed for 'all-glass' cabinets with a maximum glass thickness of 3/8" (10 mm).

CAT. NO.	DESCRIPTION	FINISH
UV4101BS	Single Inset or Overlay Lock	Brushed Stainless
UV4101PS	Single Inset or Overlay Lock	Polished Stainless

Minimum order: 1 each. Finishes can be combined for quantity pricing.

CRL UV Lock for Double Glass Doors

new



- For Inset or Overlay Doors

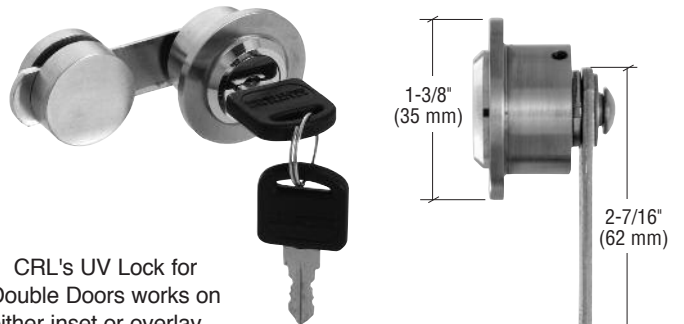

CRL's UV Lock for Double Doors works on either inset or overlay glass doors. Installation requires drilling a 1" (25 mm) diameter hole in one door with adhesive applied to rear surface of the lock cover plate, and bonding the receiver hook latch to the inside of the other door. This lock is easy to install in 1/4" (6 mm) or 3/8" (10 mm) glass.

CAT. NO.	DESCRIPTION	FINISH
UV4102BS	Double Door Lock	Brushed Stainless
UV4102PS	Double Door Lock	Polished Stainless

Minimum order: 1 each. Finishes can be combined for quantity pricing.

CRL UV Stainless Steel Handle

- Versatile Design for Single or Double Doors

This universally designed UV glass door Handle can be bonded to single or double glass doors vertically or horizontally. The brushed stainless steel Handle is 7/16" (11 mm) wide and 8-5/8" (216 mm) long. Minimum order is one each.

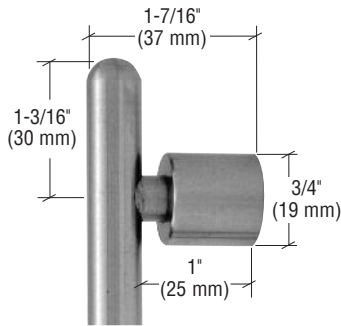

CAT. NO. UV0241

CRL UV Stainless Steel Knob

- Ideal for Small Glass Doors or Kitchen Cabinets

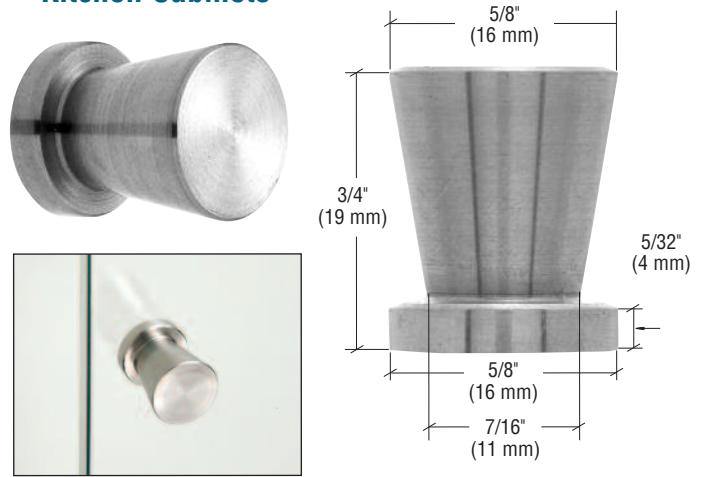

CRL's UV Stainless Steel Knobs are perfect for small cabinets or showcases with glass doors. The tapered knob design is easy to grip and provides a contemporary appearance. The base of the Knob measures 5/8" (16 mm), and extends 3/4" (19 mm) from the door's surface. Minimum order is one each.

CAT. NO. UV6256

CRL UV Door Knob

- Stainless Steel Material
- Use as a Knob or Shelf Support
- Neoprene Grip Rings

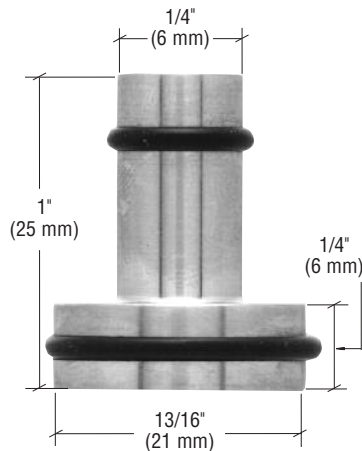
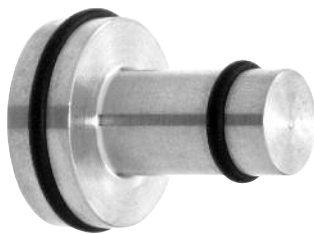

CRL's UV Door Knob has a high-tech style and the versatile design is perfect for both knob or shelf support. The bonding surface measures 13/16" (21 mm), and extends 1" (25 mm) from the glass surface. Minimum order is one each.

CAT. NO. UV6170

CRL UV Glass Knobs



- Knobs Blend With 'All-Glass' Doors



CAT. NO. UV367

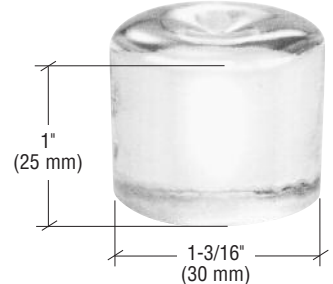

CAT. NO. UVK01

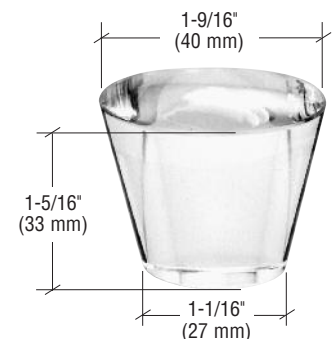

CRL's UV Glass Knobs are perfect for your 'all-glass' cabinet or showcase doors. The clean, simple lines make for a great appearance and create a total see-through look. Minimum order is one each.

CRL UV Pivot Pull



- Fabricated From Type 304 Stainless Steel
- Matches Design of Cat. No. 12PVH Hinges

CRL's UV Pivot Pull is perfect for a contemporary, high tech design. The narrow, 1/2" (12 mm) diameter, 3" (76 mm) long solid tube looks great on glass cabinet doors. Choose matching CRL Cat. No. 12PVH Hinges which are designed for 1/4" (6 mm) thick glass and require drilling holes in the glass, or select UV Hinges from selections shown on pages N428 to N431. Minimum order is one each.

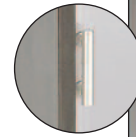
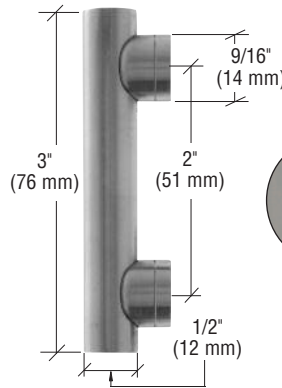

CAT. NO. UV12PVP

CRL UV Silhouette Pull



- Brushed Stainless Finish
- Petite Design

Our UV Silhouette Pull is ideal for small showcase or kitchen cabinet doors. The design is clean and simple. The Pull can be bonded at the most convenient location on the door. Minimum order is one each.

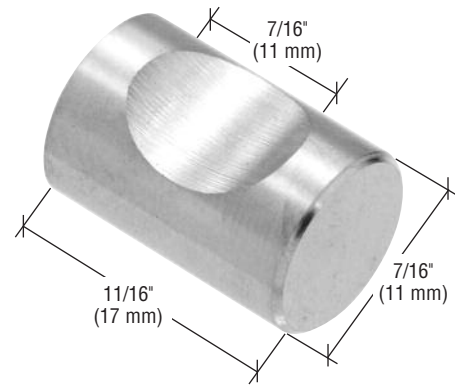

CAT. NO. UVCK37

CRL UV Traditional Crystal Knob

- All Crystal Design

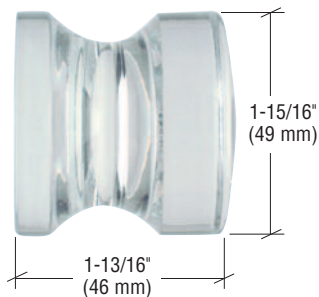

The Traditional Style UV Crystal Knob provides a clean and transparent look. Use UV760 UV Adhesive for bonding glass-to-glass (see page N416). Minimum order is one each.

CAT. NO. SDK400CR

CRL UV Contemporary Crystal Knob

- Transparent and Elegant

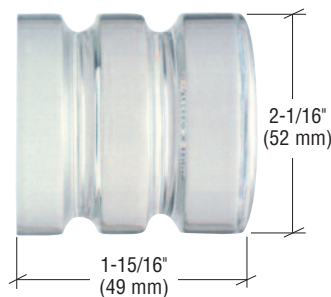

The Contemporary Style UV Crystal Knob and a glass door blend together for a see-through appearance. Use UV760 UV Adhesive for bonding glass-to-glass (see page N416). Minimum order is one each.

CAT. NO. SDK406CR

CRL UV Solid Glass Knob

- Beautifully Styled and Versatile

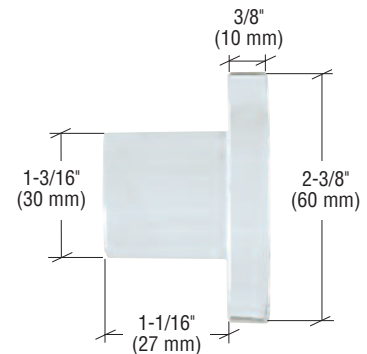

CRL's Solid Glass UV Knob is beautifully styled and can provide several applications: Door Knob, Foot for Glass Showcase, or Robe Hook on a Shower Door. Knob extends 1-1/2" (38 mm) from the glass surface. Use UV760 UV Adhesive for bonding glass-to-glass (see page N416). Minimum order is one each.

CAT. NO. SDK061

CRL UV Threaded Adapters

- Available in Three Popular Thread Sizes
- UV Glue Standoffs, Knobs, Pulls, Towel Bars to Glass Without Drilling Holes
- Fabricated From 316 Stainless Steel

new



CRL's new UV Threaded Adapters will not only substantially expand your UV business and glass hardware opportunities, but will also save glass fabrication time and expense. Use the Adapters to install glass signage using standoff bases, knobs for glass door cabinets or showers, towel bars or handles without drilling holes. Quickly and easily mount hardware in either new construction or existing installations using CRL's large selection of compatible hardware and UV adhesives, curing lamps, fixation devices, and cleaning supplies.

UV Adapters are available in six different diameters and three thread sizes to accommodate almost any requirement. UV Adapters have a bonding plate thickness of 1/16" (1.6 mm). For additional information regarding hardware that can be used with our UV Adapter, contact CRL Glass and Glazing Technical Sales.

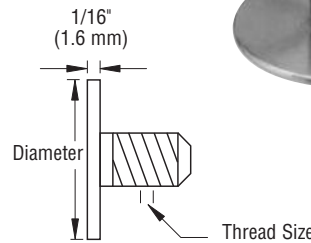

Standoffs with an adapter on either end for building glass shelving units without drilling.

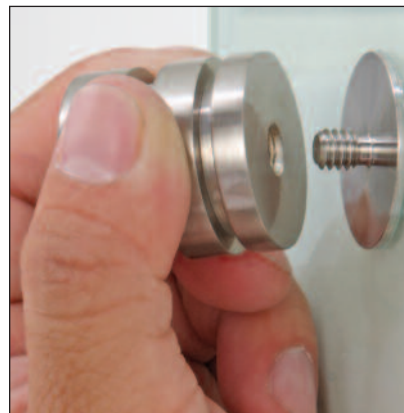

Affix knobs and handles to glass doors without drilling.



CAT. NO.	DIAMETER	THREAD SIZE
UV34ADP	3/4" (19 mm)	1/4"-20 UNC
UV1ADP	1" (25.4 mm)	1/4"-20 UNC
UV1316ADP	1-3/16" (30.2 mm)	1/4"-20 UNC
UV114ADP	1-1/4" (31.8 mm)	5/16"-18 UNC
UV112ADP	1-1/2" (38.1 mm)	3/8"-16 UNC
UV2ADP	2" (50.8 mm)	3/8"-16 UNC

Minimum order: 1 each. Sizes can be combined for quantity pricing.

CRL UV Magnetic Latches for 'All-Glass' Cabinets

new

- Designed for 'All-Glass' Cabinets
- Available for Single and Double Glass Doors

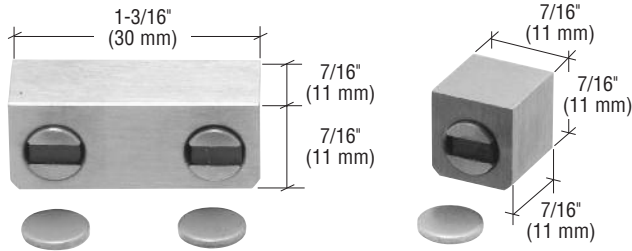

CAT. NO. UV6255
For Double Doors

CAT. NO. UV6254
For Single Doors

CRL's UV Magnetic Latches are perfect for keeping glass cabinet doors closed if there is no door lock. The Latches are fabricated from stainless steel, and are designed so they can be bonded at the top or bottom of your 'all-glass' cabinet. Each Latch comes with 5/16" (8 mm) Round Disks that need to be UV bonded to the glass door. Latches are available for both single and double doors. Minimum order quantity is one each.

CRL UV Magnetic Latches for Wood Cabinets

new



- Available for Single and Double Glass Doors

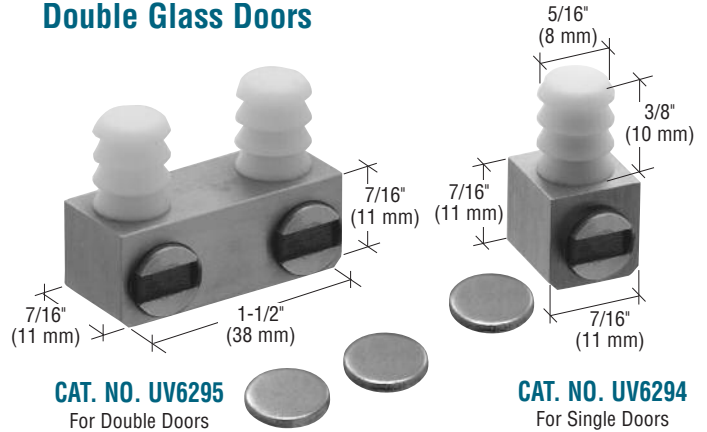

CAT. NO. UV6295
For Double Doors

CAT. NO. UV6294
For Single Doors

CRL's UV Magnetic Latches for wood cabinets with glass doors are fabricated from stainless steel. They come with pre-installed anchors to mount the Latch to either the wood top or base. Requires 9/32" (7 mm) diameter hole for installation. Each Latch comes with 5/16" (8 mm) Round Disks that need to be UV bonded to the door. The minimum order quantity is one each.

CRL UV Pushbutton Magnetic Latches

- Round and Square Designs

new

The UV Pushbutton Magnetic Latch can be UV bonded to either the top or bottom of your 'all-glass' cabinet or showcase. The internal pushbutton spring mechanism retracts and releases. Each Latch comes with 5/16" (8 mm) Round Disks that need to be UV bonded to the glass door. Minimum order is one each.

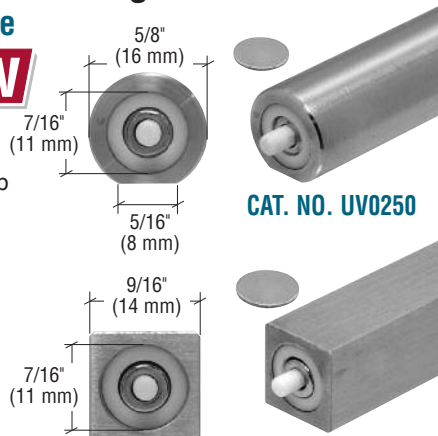

CAT. NO. UV0250

CAT. NO. UV0251

CRL UV Magnetic Holder

new

- Designed for 'All-Glass' Doors



CAT. NO. UVCK28

CRL's UV stainless steel Magnetic Holder is designed to be bonded to either the top or bottom of an 'all-glass' cabinet. Each Holder comes with a 7/16" (11 mm) diameter Disk that is UV bonded to the door. The Holder measures 1-1/8" (28 mm) in overall length and 5/8" (16 mm) in diameter. Minimum order is one each.

CRL UV Dampers for Glass Doors

new

- Available With Two Dampening Strengths

CRL's UV Dampers are designed for glass doors with self-closing hinges. It is available with soft or strong damping force. Easy to install on 'all-glass' cabinets. Minimum order is one each.

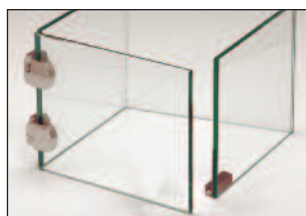
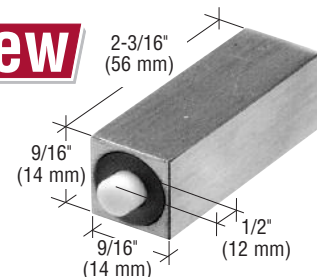

CAT. NO.	DESCRIPTION
UV0235	Soft Damper
UV0236	Strong Damper

Minimum order: 1 each.

CRL UV Rotation Support

new

- "Lazy-Susan" for Glass Table Tops

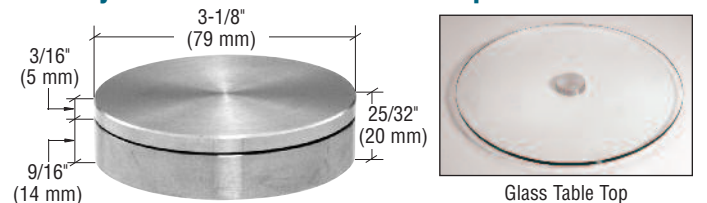

CRL's UV Rotation Support requires a 1-3/16" (30 mm) diameter hole in glass top. The Rotation Support is installed onto the middle of the glass table and then the glass "lazy-susan" is UV bonded to the stainless steel support. The maximum glass size is 24" (610 mm) in diameter. The maximum recommended weight capacity is 130 lbs. (60 kg). Minimum order is one each.

CAT. NO. UVCK20

CRL Fixed Shelf Supports

- For Glass or Wood Shelves

CRL offers two styles of Fixed Shelf Supports. One can be attached to glass by UV bonding, the other to wood side panels using a screw. Both Supports can hold glass up to 3/8" (10 mm) thick. The rubber ring protects the glass from both movement and scratches.

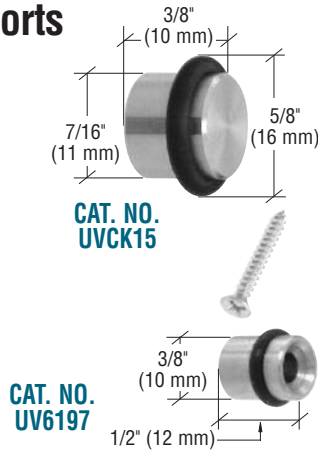

CAT. NO. UVCK15

CAT. NO. UV6197

CAT. NO.	DESCRIPTION	WEIGHT CAPACITY
UVCK15	UV Support for Glass	11 lbs. (5 kg)
UV6197	Support for Wood Panels	22 lbs. (10 kg)

Minimum order: 1 each.

CRL UV Adjustable Shelf Support

- Permits Shelf Adjustment After Bonding

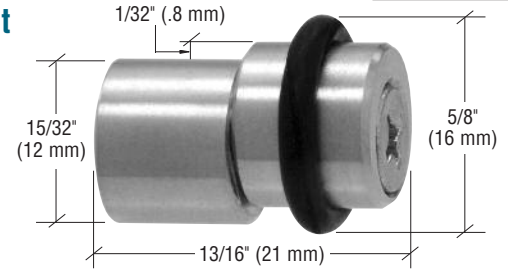

CRL's stainless steel UV Adjustable Shelf Support is used in 'all-glass' cabinets or showcases to support shelves. Bonded to glass side panels, the Adjustable Support, once installed, can be rotated to make minor 1/32" (.8 mm) height adjustments so that glass shelves are level. The weight capacity per Support is 11 lbs. (5 kg) each. Minimum order is one each.

CAT. NO. UVCK16

CRL UV Large Fixed Shelf Support

- Stainless Steel Material



CRL's UV Large Fixed Shelf Support is designed to be bonded to the vertical side panels in 'all-glass' cabinets to support shelving. The Support has a rubber ring surrounding the cylinder which prevents glass movement and scratches. Maximum weight capacity is 44 lbs. (20 kg) each. Minimum order is four each.

CAT. NO. UV6192

CRL UV Large Adjustable Shelf Support

- Adjustable So You Can Level Shelves After Installation

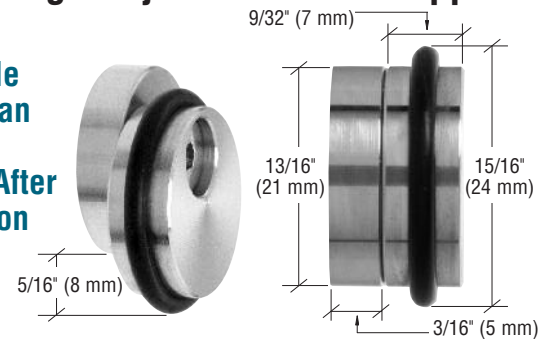

These UV Large Adjustable Shelf Supports have a weight capacity of 44 lbs. (20 kg) each. After being bonded to the glass side panel, adjustments of up to 5/16" (8 mm) per Support are possible to ensure the shelf is perfectly level. The Support is 1/2" (12 mm) thick overall, and has a rubber ring, which cushions the glass and prevents slippage. Minimum order is four each.

CAT. NO. UV6194

CRL UV Fixed Shelf Support

- Bond Vertically or Horizontally

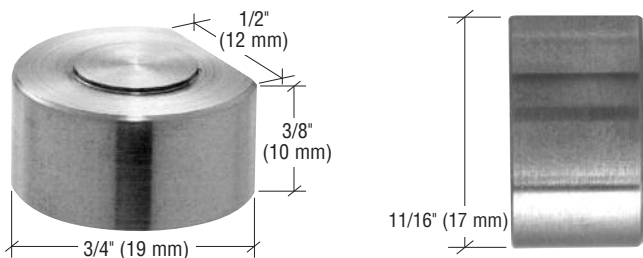

CRL's stainless steel UV Fixed Shelf Support is 3/4" (19 mm) in diameter. The flat or shelf rest area is 1/2" (12 mm). This Support can be bonded to the glass side panel either vertically or horizontally. The maximum load capacity is 44 lbs. (20 kg) per four Supports. Included is one round and one square adhesive cushion to protect the glass shelf. Minimum order is four each.

CAT. NO. UV6191

CRL UV Adjustable Shelf Support

- Allows 1/8" (3.2 mm) Height Adjustment

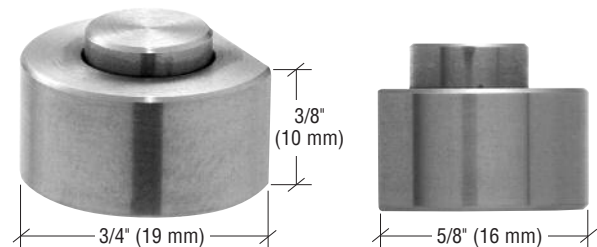

CRL's UV Adjustable Shelf Support has a height adjustment of 1/8" (3 mm) after bonding. Adjustment is accomplished by turning a set screw. The maximum recommended weight capacity is 44 lbs. (20 kg) per four Supports. Included is one round and one square adhesive cushion to protect the glass shelf. Minimum order is four each.

CAT. NO. UV6193

CRL UV Shelf Supports

- Plastic Cushion Helps Prevent Glass Contact With Metal

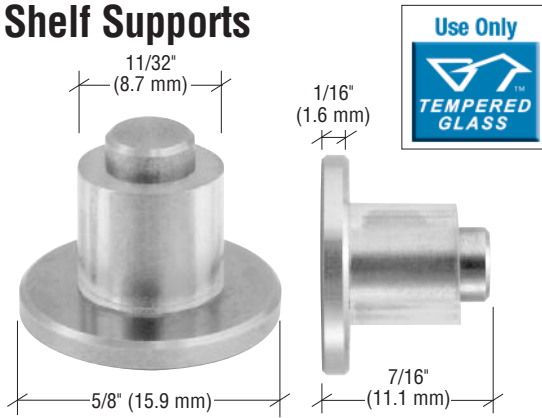

CRL's stainless steel UV Shelf Supports have a 5/8" (16 mm) diameter bonding surface and come with a clear plastic cushion to ensure there's no glass to metal contact. Maximum weight capacity is 88 lbs. (40 kg) per four Supports. Minimum order quantity is one pack of four.

CAT. NO. UV6198

CRL UV Round and Square Crystal Shelf Supports

- Crystal Clear Transparency
- Use as Shelf Support or Foot in 'All-Glass' Cabinets or Showcases

CRL's Crystal Shelf Supports provide a unique and attractive method of supporting shelves in 'all-glass' cabinets or showcases. Both Round and Square Supports have a recommended weight capacity of 44 lbs. (20 kg) per four Supports. Minimum order is four each.

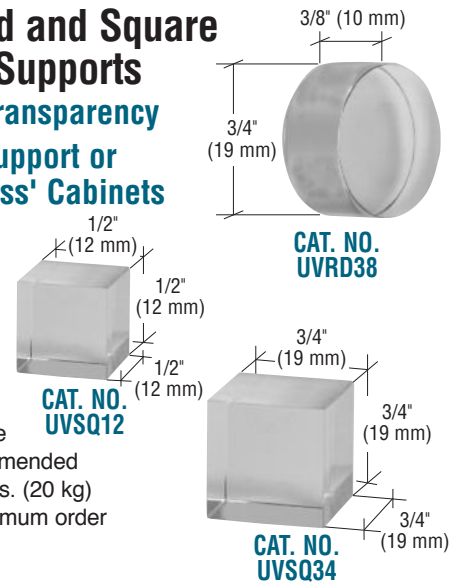

CRL UV Stainless Steel Furniture Foot

- Nylon Tip to Protect Floor's Surface
- Brushed Stainless Steel Finish

This CRL UV Stainless Steel Foot for glass furniture or display cases, provides a nylon cushion to protect your floor. The foot can support up to 55 lbs. (25 kg) each, and is fabricated from stainless steel for strength and corrosion resistance. Minimum order is one each.

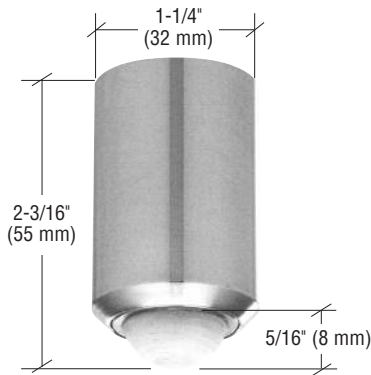

CAT. NO. UV6120

CRL UV Stainless Steel Furniture Foot With Glide

- With Plastic Floor Glide
- Brushed Stainless Steel Finish

CRL's UV Furniture Foot is ideal for 'all-glass' cabinets, showcases or bookcases. The stainless steel Foot includes a plastic glide which protects the floor's surface when the fixture is relocated or moved. Minimum order is one each.

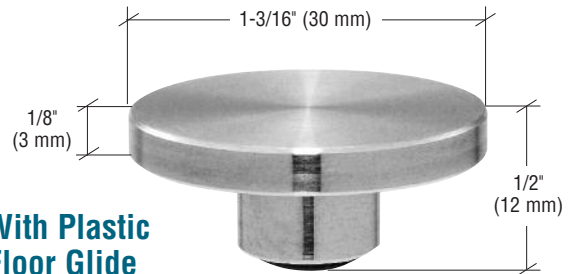

CAT. NO. UV0280

CRL UV Glass Support

- Used to Protect Glass and Counter Surfaces

CRL's UV Glass Support is designed to be used underneath glass cabinets or fixtures to protect the glass or countertop from getting scratched. They also keep the cabinet from sliding. The overall height is 3/16" (5 mm), including the cushion. Minimum order is one each.

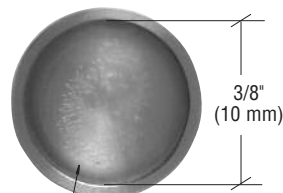
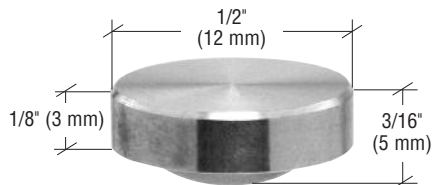

Nylon Cushion

CAT. NO. UVCK27

CRL UV Adjustable Support

- Designed to Function as Cabinet or Showcase Leg

CRL's UV Adjustable Support is designed to be bonded to the underside of a glass cabinet or showcase. The maximum height adjustment is 3/16" (5 mm), and the recommended maximum weight capacity is 88 lbs. (40 kg) per Support. Minimum order is one each.



CAT. NO. UVCK33

CRL UV Vertical Countertop Support

new

- Base Easily Mounts Mechanically to the Countertop
- Choose From Three Beautiful Finishes to Match Decor
- Easy to Install and Maintain

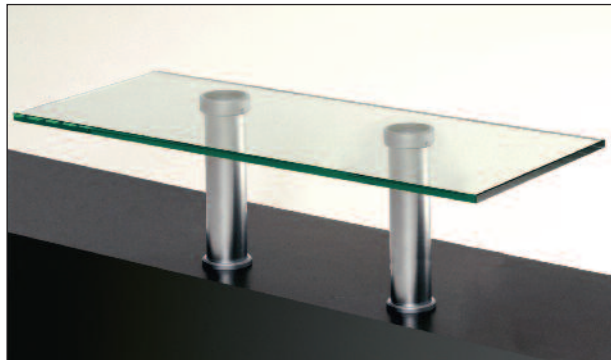

The trend towards added counter space in kitchens and baths is growing quickly and provides the opportunity for you to offer more choices to your customers looking to enhance new and re-model projects. CRL UV Vertical Countertop Supports can be used to add both glass and solid counter tops to granite, Corian, wood, tile, concrete, and stone surfaces. Custom sneeze guards are another possibility.

Three popular finishes are available, and simple-to-follow instructions are provided for easy installation. The Supports are designed to allow precise final height adjustments to compensate for slightly uneven surfaces. Lower counter mounting bolts are included with each Support. A finely machined disk for UV bonding provides the perfect surface for strong contact to glass using Cat. No. UV682 UV Bonding Adhesive (see page N414). **NOTE:** Maximum recommended span between Supports is 23-1/2" (597 mm). Maximum overhang from post center is 7-7/8" (200 mm). Maximum load capacity is 33 lbs. (15 kg) per Support.

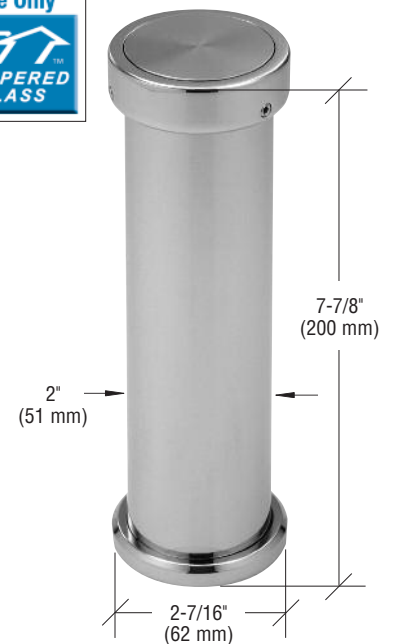

CAT. NO.	FINISH
UV0130	Chrome
UV0131	Satin Chrome
UV0132	Satin Nickel

Minimum order: 1 each.

CRL UV Angled Countertop Support

new

- Projects the Surface Outward for Extra Clearance
- Allows Precise Adjustment After UV Bonding for a Perfect Fit
- Finishes to Match Our Vertical Countertop Supports

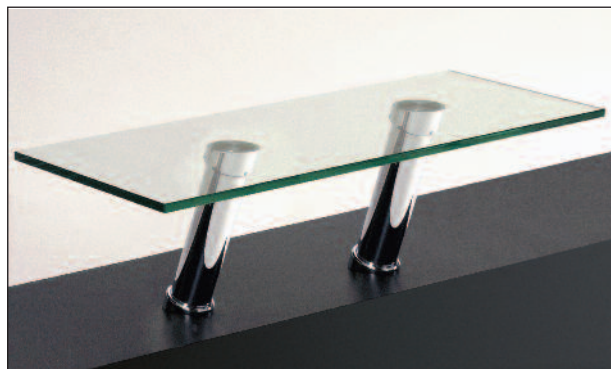

CRL UV Angled Countertop Supports are 20 degrees off vertical to assist positioning the upper countertop off the lower for additional space requirements in residential and commercial applications. Installed height matches our Vertical Countertop Supports. Use a combination of Vertical and Angled Countertop Supports to create unique installation designs for your customer's shelf riser, sneeze guard, or glass breakfast bar applications.

You can use our UV682 UV Bonding Adhesive (see page N414) for the flat insert, glass-to-metal portion of the installation. Everything required for the mechanical portion of the installation is provided with each Support, including the lower counter mounting bolts. **NOTE:** Maximum recommended span between Supports is 23-1/2" (597 mm). Maximum overhang from post center is 7-7/8" (200 mm). Maximum load capacity is 33 lbs. (15 kg) per Support.

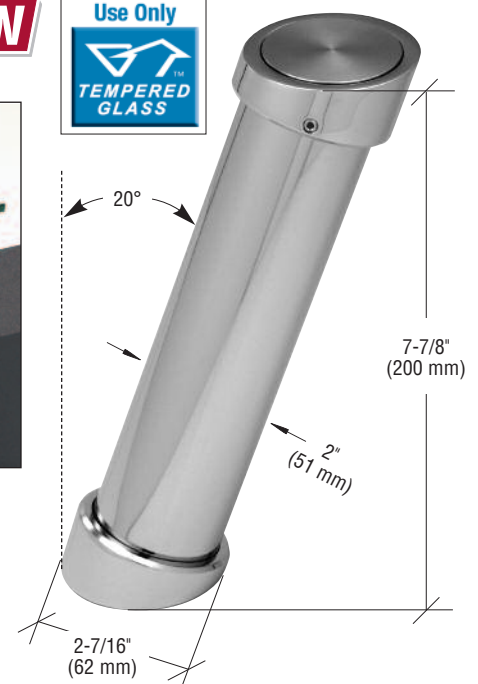

CAT. NO.	FINISH
UV0135	Chrome
UV0136	Satin Chrome
UV0137	Satin Nickel

Minimum order: 1 each.

CRL UV Glass Shelf Supports

• Stainless Steel in Four Sizes

Perfect for 'all-glass' bookcases, etageres or cabinets, these CRL Glass Shelf Supports are fabricated from 1-9/16" (40 mm) diameter stainless steel tubing for strength and corrosion resistance. Available in four lengths, they are supplied complete with two 2" (51 mm) bonding plates and threaded rod. Minimum order is one each.

CAT. NO.	LENGTH
UV6111	4-3/4" (120 mm)
UV6112	8-5/8" (220 mm)
UV6113	12-5/8" (320 mm)
UV6114	16-1/2" (420 mm)

Minimum order: 1 each. Sizes can be combined for quantity pricing.

new

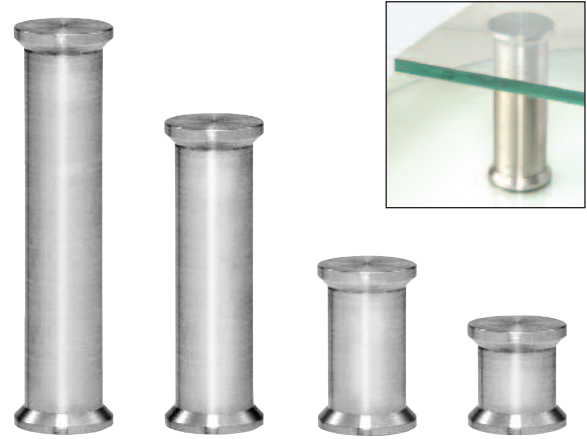

CRL UV Pole Support

• Used to Mount Flat Glass Shelves or Counters Above Wood or Granite Surfaces

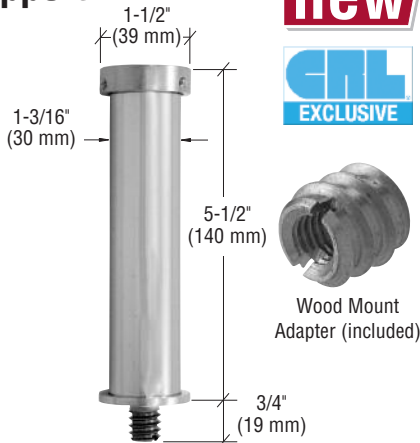

new

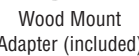

CRL UV Pole Supports can be used to support a flat glass shelf, bar, or table top at 5-1/2" (140 mm) above the bottom surface. Fabricated from stainless steel for strength and corrosion resistance, these vertical Supports can be installed into wood bases by drilling a 7/16" (11 mm) hole, or into granite or stone by drilling 5/8" (16 mm) diameter holes. Minimum order is one each.

CAT. NO. UVCD30

CRL UV Wall Mount Shelf Support Brackets

new



• Available in Two Sizes

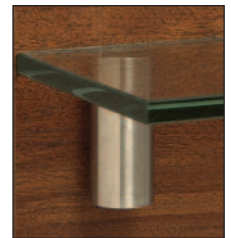

CRL's stainless steel UV Wall Mount Brackets are intended to be installed into concrete, brick, stone or wall studs. These uniquely designed Wall Brackets will support glass shelving to hold books, collectibles, speakers, etc. These 2-1/2" (63.5 mm) tall Brackets are available in two diameters. Minimum order is one each.

CAT. NO.	DIAMETER	MAX. SHELF DEPTH	WEIGHT CAPACITY
UVCK38	13/16" (21 mm)	5" (127 mm)	13 Lbs. (6 kg) Pair
UVCK39	1-1/8" (29 mm)	8" (203 mm)	22 Lbs. (10 kg) Pair

Minimum order: 1 each. Sizes can be combined for quantity pricing.

CRL UV Glass-to-Wall Support

new

• Stainless Steel Material

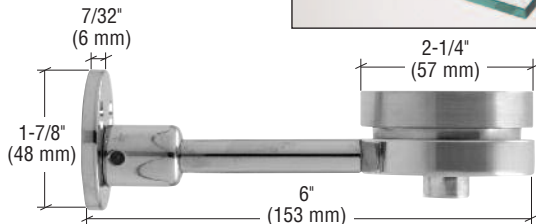
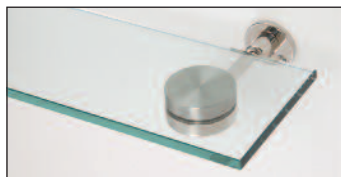

CRL's UV Glass-to-Wall Support is designed to install into wall studs, wood blocking, concrete, stone or brick to support glass shelves. The Supports can accommodate a shelf with a maximum width of 8" (203 mm). The distance from the wall to the center line of the bonding puck is 5" (127 mm). Maximum recommended weight capacity per Support is 44 lbs. (20 kg). Minimum order is one each.

CAT. NO. UVCK29

CRL Glass Protectors

• Protects Against Scratches and Abrasions • Easy to Use and Remove



CAT. NO. CB1PK
Clear Protective Bumpads



CAT. NO. SR3
Black Sponge Rubber Desk Buttons



CAT. NO. CP8
Clear Plastic Desk Buttons

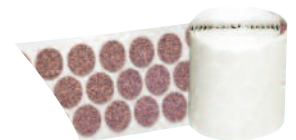

CAT. NO. CN1B
Cork and Neoprene Desk Buttons

CRL offers a complete selection of Glass Protectors in plastic, vinyl, cork, and sponge rubber. They cushion glass on furniture tops and prevent slamming, scuffing, sliding or vibration. Some are available with or without adhesive backing. See the full selection in our Online Catalog at crlaurence.com.

CRL UV Table Legs • Powder Coated • Standard Table Heights • Adjustable Foot

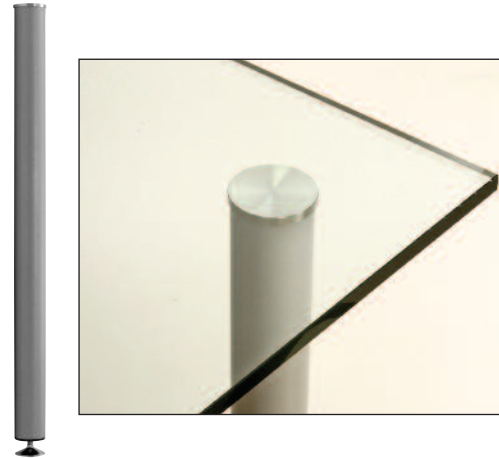
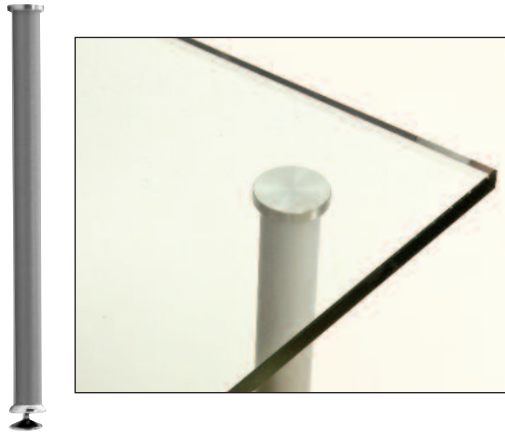

Available in silver, black or chrome, CRL's 1-3/16" diameter (30 mm) UV Legs for coffee tables come in 17" (432 mm) heights. Fabricated from 1 mm thick wall aluminum, these attractively designed Legs are perfect for any style of "occasional" table. The UV adapter can be quickly and easily bonded to any glass table top. Adjustable foot included.

1-3/16" (30 MM) DIAMETER UV TABLE LEGS

CAT. NO.	LENGTH	FINISH
UVD30430S	17" (432 mm)	Silver
UVD30430BL	17" (432 mm)	Black
UVD30430CH	17" (432 mm)	Chrome

Minimum order: 1 each.

CRL's 2" diameter (50 mm) UV Legs for dining and coffee tables are available in 17" (432 mm) and 28" (711 mm) heights. Fabricated from 1.50 mm thick wall aluminum tubing for superior strength, these attractively designed Legs are available in beautiful and durable powder coated finishes. The UV adapter can be easily bonded to any thickness of glass. Adjustable foot included.

2" (50 MM) DIAMETER UV TABLE LEGS

CAT. NO.	LENGTH	FINISH
UVD50430S	17" (432 mm)	Silver
UVD50430BL	17" (432 mm)	Black
UVD50710S	28" (711 mm)	Silver
UVD50710BL	28" (711 mm)	Black

Minimum order: 1 each.

CRL UV 40 mm Bonding Plate

• Used With 30 mm Coffee Table Legs

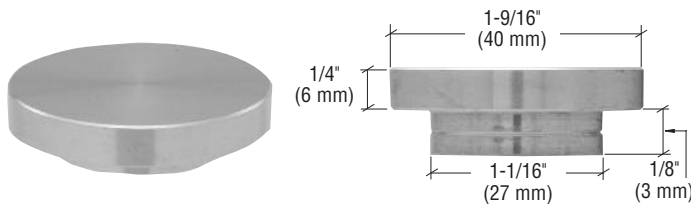

CRL 40 mm Table Leg Bonding Plates are used for attaching 30 mm diameter table legs to glass tops with UV adhesives. Made from stainless steel for superior durability and corrosion resistance. These Bonding Plates can be used with CRL's UVD30430 Series table legs above. Requires M8 threaded stud. Minimum order is one each.

CAT. NO. UVCK22

CRL UV 55 mm Bonding Plate

• Used With 50 mm Diameter Table Legs

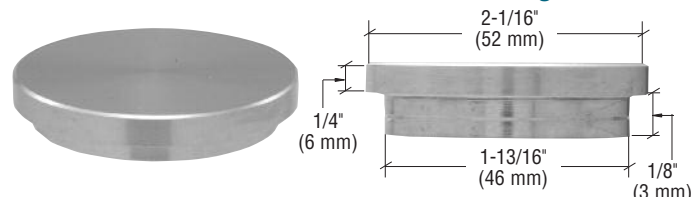

CRL 55 mm Table Leg Bonding Plates are used for attaching 50 mm diameter table legs to glass tops with UV adhesives. Made from stainless steel for superior durability and corrosion resistance. These Bonding Plates can be used with CRL's UVD50430 and UVD50710 Series table legs above. Requires M10 threaded stud. Minimum order is one each.

CAT. NO. UVCK23

CRL UV 70 mm Bonding Plate

• Used With 60 mm Diameter Table Legs

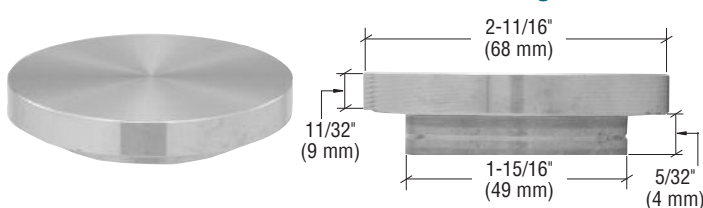

CRL 70 mm Table Leg Bonding Plates are used for attaching 60 mm diameter table legs to glass tops with UV adhesives. Made from stainless steel for superior durability and corrosion resistance. Requires M10 threaded stud. Minimum order is one each.

CAT. NO. UVCK24

CRL UV 90 mm Bonding Plate

• Used With 80 mm Diameter Table Legs

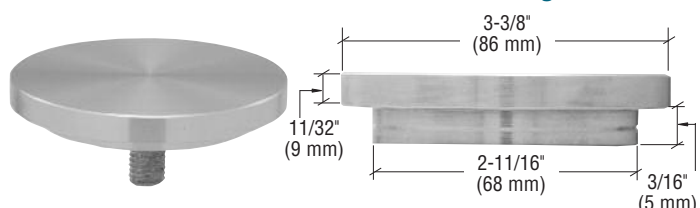

CRL 90 mm Table Leg Bonding Plates with a M12 threaded stud are used for attaching 80 mm diameter table legs to glass tops with UV adhesives. Made from stainless steel for superior durability and corrosion resistance. Minimum order is one each.

CAT. NO. UVCK25

CRL UV Table Posts and Base Plates

- Design and Build Beautiful Glass Tables With These Posts and Bases

Posts are available in three sizes. All are pre-drilled and threaded to match Base Plates. Brushed stainless steel finish.



new

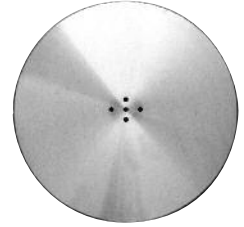

These stainless steel clad Base Plates provide stability for your table. Pre-drilled to match holes in posts. Fasteners are included.

CRL has the components for you to design and build beautiful glass tables with these Posts and Base Plates. Maximum recommended glass table top diameter is 1-1/2 times the diameter of the base.

POSTS

CAT. NO.	DIAMETER	HEIGHT
UV0156	2-3/8" (60 mm)	17-13/16" (452 mm)
UV0158	3-3/16" (81 mm)	26-1/2" (673 mm)
UV0159	4-5/16" (110 mm)	42-1/2" (1080 mm)

Minimum order: 1 each.

BASE PLATES

CAT. NO.	DIAMETER
UV0154	15-3/4" (400 mm)
UV0155	19-11/16" (500 mm)

Minimum order: 1 each.

CRL UV Casters With Stainless Steel Bonding Plates

new

CRL UV Support With Roller

- Easy Movement for Glass Showcases

CRL's UV Support with Roller is bonded to the bottom panel of glass cabinets or showcases to allow the unit to be easily moved or relocated. The 1-1/2" (38 mm) diameter stainless steel puck and 1-3/8" (35 mm) plastic roller has a maximum weight capacity of 33 lbs. (15 kg) each. The overall height of the Support with Roller is 3-5/16" (84 mm). Minimum order is one each.



CAT. NO. UVCK19

CRL Metal Shield UV Caster

- Chrome Shield for Attractive Appearance

CRL's Metal Shield UV Caster comes with a 2" (51 mm) diameter polyurethane roller. The chrome shield provides an attractive appearance. Includes a 2" (51 mm) diameter stainless steel bonding adapter. Weight capacity for this 3-3/8" (86 mm) tall Caster is 60 lbs. (27 kg). Minimum order is one each.



CAT. NO. UVC1CASTER

CRL Hooded Twin-Wheel UV Casters

- BIFMA* Compliant

CRL's Hooded Twin-Wheel UV Casters are available with or without a brake. Both come with a 2" (51 mm) diameter stainless steel bonding adapter to bond to glass. Weight capacity per Caster is 75 lbs. (34 kg). Overall height is 3-1/4" (82 mm). Wheel diameter is 1-9/16" (40 mm). They are easy to install and smooth rolling. Minimum order is one each.



*Business and Institutional Furniture Manufacturer's Association

CAT. NO.	DESCRIPTION
UVC2CASTER	Caster Without Brake
UVC3CASTER	Caster With Brake

Minimum order: 1 each.

CRL Twin-Wheel UV Caster

- High Weight Capacity With European Styling

CRL's Twin-Wheel UV Caster comes with a 2" (51 mm) diameter hard wheel. Includes a 2" (51 mm) diameter stainless steel bonding adapter to bond to glass. Weight capacity per Caster is 75 lbs. (34 kg). Overall height is 3-1/8" (79 mm). Minimum order is one each.



CAT. NO. UVC4CASTER

CRL Basic Insulating Glass Manual

- Everything You Need to Know About Building Your Own Insulating Glass Units
- Explains What is Best for Your Application
- Easy to Follow Step-by-Step Instructions for First Time Fabricators

This CRL Basic Insulating Glass Manual is specifically designed to help glass professionals become more familiar with the materials necessary for Insulating Glass fabrication. It takes you step-by-step through all methods of Insulating Glass production: single seal, dual seal, silicone, butyl, and polysulfide. The GM11 shows you different glazing techniques, including glazing adapters for retrofit work. The Manual also describes testing procedures you can use in your shop, and there is a section on Insulating Glass terms and definitions.

Since rising energy costs have created a huge market for Insulating Glass, you can use the Manual to expand your knowledge, and help your customers get a better grasp of which of the many fine CRL Insulating Glass products would be best for their needs.

For any questions regarding Insulating Glass equipment, supplies, or even for a quote on setting up a whole new IG line, please contact CRL Technical Sales at (800) 421-6144 in the U.S., (877) 421-6144 from Canada, or (323) 588-1281 International. Ask for Ext. 7720. You can send e-mail from the crlaurence.com home page. Click on Contact Us, then click on Technical Sales for Glass and Glazing Products.

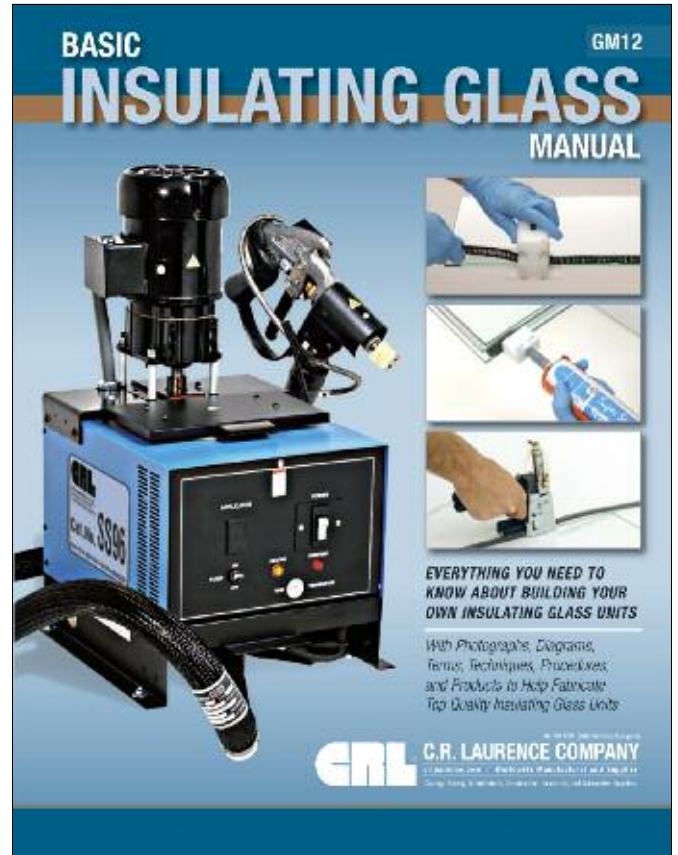

Minimum order is one each.

CAT. NO. GM12



- Easy to Read and Understand Format
- Includes Photographs, Diagrams, Terms and Definitions, Techniques, Procedures, and Products to Help Fabricate Top Quality Insulating Glass Units
- Lists and Explains Required Materials, Production Methods, Glazing Guidelines, and Ordering Information

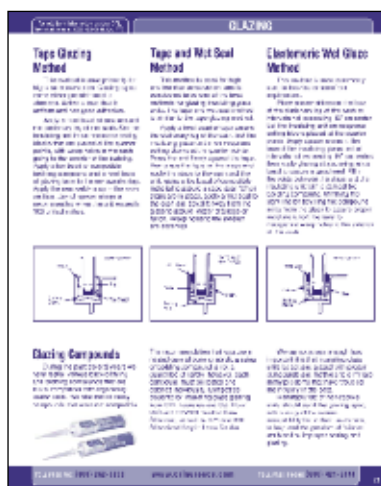
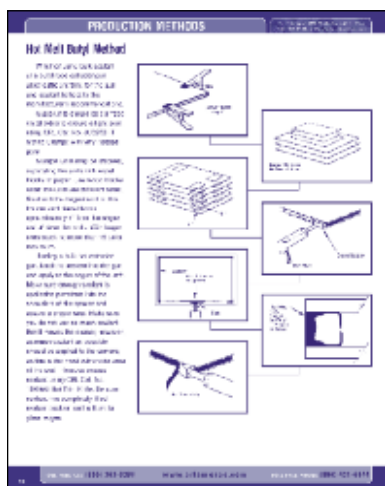

We Make it Easy to Get Started With Our Insulating Glass Starter Kits

- Save Money and Time by Building Your Own Insulating Glass Units
- Eight Kits to Choose From - Basic to Deluxe
- Kits Available for Single Seal and Dual Seal Metal Spacers, Super Spacer®, and Duralite®
- A Variety of Sealing Systems - Hot Melt Butyl, One-Part and Two-Part Polyurethanes, Two-Part Polysulfide, Silicone Sealant, and Duralite®
- Produce Units When Your Customers Need Them
- No Long Waits for Custom or Odd Shape Windows

CRL Deluxe Insulating Glass Hot Melt Starter Kit

- An Easy Way to Start Producing Quality Insulating Glass Units
- Kit Comes With Everything Needed for Production of Insulating Glass Units
- The SS96 is Our Most Popular Sealant Extruder



CAT. NO. D1GK7

KIT NO. D1GK7 INCLUDES:

CAT. NO.	DESCRIPTION	QUANTITY
SS96	Hot Melt Butyl Extruder Machine	1 Each
CRL520LB	Hot Melt Butyl Slabs	96 lbs (43.5 kg)
MSD50B	55 Pound (25 kg) Box Molecular Sieve	1 Box
3935	1/4" (6.3 mm) Single Seal Aluminum Spacer	50 each 12'8" Lengths
3937	3/8" (9.5 mm) Single Seal Aluminum Spacer	25 each 12'8" Lengths
3939	1/2" (12.7 mm) Single Seal Aluminum Spacer	50 each 12'8" Lengths
6265	1/4" (6.3 mm) Single Seal Spacer Corners	200 Each
6267	3/8" (9.5 mm) Single Seal Spacer Corners	100 Each
6269	1/2" (12.7 mm) Single Seal Spacer Corners	200 Each
1550	Lint Free Wipes	1 Case (900 Wipes)
695	Concentrated Glass Cleaner	1 Gallon (3.785 l)
DB21	Plastic Spray Bottles	2 Each
1BK990	Hot Melt Butyl Trim Knife	1 Each
BN4	1/4" (6.3 mm) Brass Nozzle	1 Each
BN6	3/8" (9.5 mm) Brass Nozzle	1 Each
BN8	1/2" (12.7 mm) Brass Nozzle	1 Each
NG171	Lint Free Gloves (Large)	1 Dozen Pairs
800W	White Acrylic Latex Glazing Sealant	10 Cartridges
800GRY	Gray Acrylic Latex Glazing Sealant	10 Cartridges
JC3202HT	Plastic Tipped Handy Clamps	12 Each
GM12	Basic Insulating Glass Manual	1 Each

Minimum order: 1 each. Must ship common carrier only.

This CRL Deluxe Insulating Glass Hot Melt Starter Kit comes with everything needed (except the glass) to produce quality Insulating Glass units. This Kit is ideal for anything from limited production to job site fabrication. Using our Hot Melt Butyl Dispensing Machine with standard Aluminum Spacers and Corners, quality Insulating Glass units can be produced within minutes of warming up the machine.

Aluminum Spacers (see pages N468 and N469) come in widths from 3/16" (4.8 mm) to 3/4" (19 mm), giving you the flexibility to fabricate Insulating Glass units in a variety of widths. This Kit comes with Spacers in the three popular widths, but others can be used.

The SS96 Hot Melt Butyl Extruder Machine is our best-selling hot melt gunning system. It dispenses our CRL520LB Hot Melt Butyl Slabs (see page N453) to create a reliable edge seal. Brass Tip Nozzles apply the sealant evenly to assure uniformity and reduce waste.

For more information, contact our Technical Sales Glass and Glazing Specialists, or go online at crlaurence.com.

CRL Deluxe Super Spacer® Starter Kit

- A Great Way to Get Started With "Warm Edge" Technology
- Easily Adapts to All Shapes and Sizes of Glass
- Great for Art Glass Panels

This state-of-the-art kit comes with everything you need (except the glass) to build Insulating Glass units, whether they are square, rectangular, or even circular, all without the use of a spacer bending machine.

Super Spacer® is one of the best materials to use in manufacturing Insulating Glass units because of its superior insulating foam. This foam essentially eliminates perimeter edge condensation and substantially reduces overall window heat loss. This flexible spacer also accommodates glass bowing and thermal movement. Excellent sound insulation properties add to the list of Super Spacer's attributes. Finally, there is no adsorbent to add because there is a high quantity of 3A molecular sieve already inside of Super Spacer's quality silicone foam.

The Kit also comes with a CRL SS96 Hot Melt Butyl Dispensing Machine, which is the fastest way to produce Insulating Glass units. We include 96 pounds of CRL520LB Butyl, which is the only butyl recommended for use in this machine. The SS96 features an all-mechanical system which doesn't use any air, so there is less down time and more production. The 8' (2.4 m) dispensing hose heats from 350°-450°F (177°-232°C), delivering the butyl at optimum temperature.



KIT NO. D1GK88 INCLUDES:

CAT. NO.	DESCRIPTION	QUANTITY
SS96	Hot Melt Butyl Extruder Machine	1 Each
CRL520LB	Hot Melt Butyl Slabs	96 lbs. (43.5 kg)
SS1466	1/4" (6.3 mm) Super Spacer® 66' (20 m) roll	8 Rolls
SS3866	3/8" (9.5 mm) Super Spacer® 66' (20 m) roll	4 Rolls
SS1266	1/2" (12.7 mm) Super Spacer® 66' (20 m) roll	8 Rolls
SSHN	Super Spacer® Hand Notcher	1 Each
1550	Lint Free Wipes	1 Case (900 Wipes)
695	Concentrated Glass Cleaner	1 Gallon (3.785 l)
DB21	Plastic Spray Bottles	2 Each
1BK990	Hot Melt Butyl Trim Knife	1 Each
BN4	1/4" (6.3 mm) Brass Nozzle	1 Each
BN6	3/8" (9.5 mm) Brass Nozzle	1 Each
BN8	1/2" (12.7 mm) Brass Nozzle	1 Each
NG171	Lint Free Gloves (Large)	1 Dozen Pairs
GM12	Basic Insulating Glass Manual	1 Each

CAT. NO. D1GK88

Minimum order: 1 each. Must ship common carrier only.

CRL "Hardman" Gun and Hot Melt Butyl Starter Kit

- Hardman Hot Melt Butyl Gun is Portable, and Lets You Use Only What You Need

This Kit is perfect for the glass shop that needs to produce Insulating Glass units on an occasional "as needed" basis, or for someone who needs to do their work in different locations from time to time. The CRL "Hardman" Insulating Glass Hot Melt Butyl Starter Kit is also a great way to start a small production system for fabricating Insulating Glass units.

KIT NO. D1GK913 INCLUDES:

CAT. NO.	DESCRIPTION	QUANTITY
HEG522	"Hardman" Extruder Gun	1 Each
N415	Hot Melt Butyl Rope	8 Rolls
RH522	Hot Melt Butyl Rope Holder	1 Each
MSD5	5 Pound (2.2 kg) Can Molecular Sieve	2 Cans
3935	1/4" (6.3 mm) Single Seal Aluminum Spacer	50 Each 12'8" Lengths
3937	3/8" (9.5 mm) Single Seal Aluminum Spacer	25 Each 12'8" Lengths
3939	1/2" (12.7 mm) Single Seal Aluminum Spacer	50 Each 12'8" Lengths
6265	1/4" (6.3 mm) Single Seal Spacer Corners	200 Each
6267	3/8" (9.5 mm) Single Seal Spacer Corners	100 Each
6269	1/2" (12.7 mm) Single Seal Spacer Corners	200 Each
1550	Lint Free Wipes	1 Case (900 Wipes)

SINGLE SEAL WITH HOT MELT BUTYL ROPE AND HARDMAN GUN



CAT. NO. D1GK913

CAT. NO.	DESCRIPTION	QUANTITY
695	Concentrated Glass Cleaner	1 Gallon (3.785 l)
DB21	Plastic Spray Bottles	2 Each
E9133	Brass Nipple	1 Each
BN4	1/4" (6.3 mm) Brass Nozzle	1 Each
BN6	3/8" (9.5 mm) Brass Nozzle	1 Each
BN8	1/2" (12.7 mm) Brass Nozzle	1 Each
NG171	Lint-Free Gloves (Large)	1 Dozen Pairs
800W	White Acrylic Latex Glazing Sealant	10 Cartridges
800GRY	Gray Acrylic Latex Glazing Sealant	10 Cartridges
JC3202HT	Plastic Tipped Handy Clamps	12 Each
GM12	Basic Insulating Glass Manual	1 Each

Minimum order: 1 each. Must ship common carrier only.

CRL Insulating Glass Super Spacer Sealant Starter Kit With Super Spacer®

- Includes Everything Needed to Fabricate High Quality Insulating Glass Units
- Comes Complete With Over 300 Feet (91 m) of Super Spacer®
- Easily Adapts to All Shapes and Sizes of Glass



KIT NO. S1GK877 INCLUDES:

CAT. NO.	DESCRIPTION	QUANTITY
877	Super Spacer Sealant	12 Cartridges
SS1466	1/4" (6.3 mm) Super Spacer® 66' (20 m) roll	2 Rolls
SS3866	3/8" (9.5 mm) Super Spacer® 66' (20 m) roll	1 Rolls
SS1266	1/2" (12.7 mm) Super Spacer® 66' (20 m) roll	2 Rolls
SSHN	Super Spacer® Hand Notcher	1 Each
1550	Lint Free Wipes	1 Case (900 Wipes)
695	Concentrated Glass Cleaner	1 Gallon (3.785 l)
DB21	Plastic Spray Bottles	2 Each
SGT14	1/4" (6.3 mm) Sealant Guide	1 Each
SGT38	3/8" (9.5 mm) Sealant Guide	1 Each
SGT12	1/2" (12.7 mm) Sealant Guide	1 Each
GM12	Basic Insulating Glass Manual	1 Each

Minimum order: 1 each.

CAT. NO. S1GK877

• Our Most Popular Starter Kit

This CRL Insulating Glass Super Spacer® Starter Kit contains everything needed to produce condensation-free perimeter edges which substantially reduces overall window heat loss. Super Spacer® allows you to build Insulating Glass units in shapes not permitted by metal spacers. The silicone foam contains a high quantity of 3A molecular sieve desiccant, and the permeability of the foam allows for fast moisture pickup. Our Super Spacer Sealant is compatible with units fabricated with Super Spacer® and forms an airtight seal.

CRL Insulating Glass Polyurethane Starter Kit With Super Spacer®

- Everything You Need to Fabricate Quality Insulating Glass Units Using Super Spacer®
- Comes Complete With Over 300 Feet (91 m) of Super Spacer®
- Uses Two-Part Polyurethane Sealant



KIT NO. S1GK600 INCLUDES:

CAT. NO.	DESCRIPTION	QUANTITY
N600G15	Two-Part Polyurethane Sealant 1.5 Gallon Pail	1 Pail
SS1466	1/4" (6.3 mm) Super Spacer® 66' (20 m) roll	2 Rolls
SS3866	3/8" (9.5 mm) Super Spacer® 66' (20 m) roll	1 Rolls
SS1266	1/2" (12.7 mm) Super Spacer® 66' (20 m) roll	2 Rolls
SSHN	Super Spacer® Hand Notcher	1 Each
1550	Lint Free Wipes	1 Case (900 Wipes)
695	Concentrated Glass Cleaner	1 Gallon (3.785 l)
DB21	Plastic Spray Bottles	2 Each
MX40	Sealant Mixer	1 Each
4104	1-1/2" (38 mm) Putty Knife	1 Each
GM12	Basic Insulating Glass Manual	1 Each

Minimum order: 1 each.

CAT. NO. S1GK600

This CRL Insulating Glass Starter Kit features CRL Super Spacer®, the superior insulating foam that eliminates perimeter edge condensation and substantially reduces overall window heat loss. CRL Super Spacer® allows you to build Insulating Glass units in shapes not permitted by metal spacers. The silicone foam contains a high quantity of 3A molecular sieve desiccant, and the permeability of the foam allows for fast moisture pickup. Our Two-Part Polyurethane Sealant forms an airtight seal, and is compatible with units fabricated with Super Spacer®.

CRL Dual Seal Silicone With Polyisobutylene Insulating Glass Starter Kit



CAT. NO. S1GK344

This CRL Dual Seal Insulating Glass Starter Kit has all the components necessary to fabricate Dual Seal Insulating Glass units. Polyisobutylene, a one-part, non-drying, non-hardening ribbon material with exceptionally low vapor transmission and non-fogging characteristics, forms the primary seal. Insulating Glass Silicone (applied with a standard caulking gun), specifically formulated for bonding and sealing Insulating Glass units, makes the secondary seal. The Dual Seal Spacer is grooved on the shoulder, allowing it to accept the Polyisobutylene Tape, while the taper below the shoulder will accept the Silicone secondary seal.

- Fabricate Units With Two High Performance Sealants
- Dual Seal Systems Withstand Intense Weather Conditions



KIT NO. S1GK344 INCLUDES:

CAT. NO.	DESCRIPTION	QUANTITY
2132559	Polyisobutylene Tape	1 Case
9542	Insulating Glass Silicone	48 Cartridges
MSD5	5 Pound (2.2 kg) Can Molecular Sieve	2 Cans
99125	1/4" (6.3 mm) Dual Seal Aluminum Spacer	50 each 12'8" Lengths
99127	3/8" (9.5 mm) Dual Seal Aluminum Spacer	25 each 12'8" Lengths
99129	1/2" (12.7 mm) Dual Seal Aluminum Spacer	50 each 12'8" Lengths
92175	1/4" (6.3 mm) Dual Seal Spacer Corners	200 Each
92177	3/8" (9.5 mm) Dual Seal Spacer Corners	100 Each
92179	1/2" (12.7 mm) Dual Seal Spacer Corners	200 Each
1550	Lint Free Wipes	1 Case (900 Wipes)
695	Concentrated Glass Cleaner	1 Gallon (3.785 l)
DB21	Plastic Spray Bottles	2 Each
NG171	Lint Free Gloves (Large)	1 Dozen Pairs
800W	White Acrylic Latex Glazing Sealant	10 Cartridges
800GRY	Gray Acrylic Latex Glazing Sealant	10 Cartridges
JC3202HT	Plastic Tipped Handy Clamps	12 Each
GM12	Basic Insulating Glass Manual	1 Each

Minimum order: 1 each. Must ship common carrier only.

CRL Single Seal, Two-Part Polysulfide Insulating Glass Starter Kit



CAT. NO. S1GK550

This CRL Single Seal, Two-Part Polysulfide Insulating Glass Starter Kit is one of the most economical ways to start fabricating Insulating Glass units. Simply insert corners into the spacer, fill spacers with molecular sieve, add your glass, clamp together, apply the CRL Two-Part Polysulfide, let cure overnight and you're ready for installation. With this system any demand can be responded to immediately; simply measure, fabricate, allow the sealant to cure, and install the next day.

- Apply Two-Part Polysulfide With Brush, Gun, or Trowel
- Hardens as it Cures
- Easy to Assemble and Use



KIT NO. S1GK550 INCLUDES:

CAT. NO.	DESCRIPTION	QUANTITY
N400G15	Two-Part Polysulfide Sealant (1.5 Gallon Pail)	4 Pails
MSD5	5 Pound (2.2 kg) Can Molecular Sieve	2 Cans
3935	1/4" (6.3 mm) Single Seal Aluminum Spacer	50 Each 12'8" Lengths
3937	3/8" (9.5 mm) Single Seal Aluminum Spacer	25 Each 12'8" Lengths
3939	1/2" (12.7 mm) Single Seal Aluminum Spacer	50 Each 12'8" Lengths
6265	1/4" (6.3 mm) Single Seal Spacer Corners	200 Each
6267	3/8" (9.5 mm) Single Seal Spacer Corners	100 Each
6269	1/2" (12.7 mm) Single Seal Spacer Corners	200 Each
1550	Lint Free Wipes	1 Case (900 Wipes)
695	Concentrated Glass Cleaner	1 Gallon (3.785 l)
DB21	Plastic Spray Bottles	2 Each
NG171	Lint Free Gloves (Large)	1 Dozen Pairs
800W	White Acrylic Latex Glazing Sealant	10 Cartridges
800GRY	Gray Acrylic Latex Glazing Sealant	10 Cartridges
JC3202HT	Plastic Tipped Handy Clamps	12 Each
GM12	Basic Insulating Glass Manual	1 Each

Minimum order: 1 each. Must ship common carrier only.

CRL SS96 Hot Melt Butyl Gunning System

- An Efficient Machine for Insulating Glass Fabrication
- Dispenses CRL520LB Hot Melt Butyl Slabs
- Includes 8' (2.4 m) Flexible Hose and Handgun
- Our Most Popular Model

The CRL Hot Melt Butyl Gunning System is compact and versatile. Its unique pumping action eliminates entrapped air in the sealant. The pump has a 10 pound (4.53 kg) tank capacity with a temperature range from 100° to 425°F (37° to 217°C). CRL Hot Melt Butyl can be added while gunning, and an adjustable flow control valve knob regulates the sealant output.

An 8' (2.4 m) Flexible Hose with variable 350° to 450°F (177° to 232°C) temperature control is coupled with a lightweight, heated handgun that features a swivel and trigger lock action. Two adjustable temperature controllers located inside the electrical enclosure regulate the temperature of the melting tank and the handgun/hose assembly.

The SS96 does not use compressed air, and operates quietly. The mechanical and electrical systems contain few moving parts, resulting in less down time and low maintenance operation. Total shipping weight, including wood crate, is 120 pounds (54 kg).



- Available for Purchase or Lease

SS96 SPECIFICATIONS

ELECTRICAL

Voltage - 115V AC, 60 Hz with ground
 240V Models Available on Special Order
 Wattage - 1265 Watts
 Motor Rating - 1/6 hp, gearbox
 38 rpm output
 Warm-Up Time - 45-60 minutes

FUNCTIONAL

Melt Rate - 8 lbs. (3.6 kg)/hour
 Pump Output Rate (Maximum) - 40 lbs. (18.1 kg)/hour
 Tank Temperature Range - 100°-425°F (37°-217°C)
 Tank Capacity - 10 lb. (4.5 kg)
 Gun/Hose Temperature Range - 350°-450°F (177°-232°C)

CAT. NO.	DESCRIPTION
SS96	Hot Melt Butyl Gunning System
SS26263N	Replacement 8' (2.4 m) Heated Hose
SS75085000	Replacement Handgun Assembly

Minimum order: 1 each. SS96 must ship common carrier only.

CRL Insulating Glass Hot Trim Knife

- Speeds Up I.G. Unit Production
- Works on Standard 110V AC Power



The CRL Insulating Glass Hot Trim Knife trims excess hot melt butyl from single or stacked units. It's the fast and efficient way to finish off single or dual sealed hot melt butyl units. This light, easy to handle Knife can also be used to cut up large slugs of hot melt butyl sealant for faster melting in a thermal extruder system.

Replacement Tips are available when the current Tip on your Hot Trim Knife becomes worn and caked with excess butyl. These solid brass Tips can be used for a long time before they need to be replaced.

CAT. NO.	DESCRIPTION
1BK990	110V AC Hot Trim Knife With Tip
RT90	Replacement Tip

Minimum order: 1 each.

CRL Brass Tip Nozzles

- Speeds the Application of Insulating Glass Sealant
- Made From Solid Brass

CRL Brass Tip Nozzles may be used with almost all automated sealant dispensing systems. These Nozzles have a ridge that fits between the lites of glass to make the application of hot melt butyl much smoother. Nozzles may be used with our HEG522, SS96, BM615, BM650, and all other hot melt extruders.



Brass Tip Nozzle



Brass Pipe Nipple
 CAT. NO. E9133

BRASS TIP NOZZLES

CAT. NO.	SIZE
BN3	3/16" (4.8 mm)
BN4	1/4" (6.3 mm)
BN5	5/16" (7.9 mm)
BN6	3/8" (9.5 mm)
BN7	7/16" (11.1 mm)
BN8	1/2" (12.7 mm)
BN10	5/8" (15.9 mm)
BN12	3/4" (19 mm)

Minimum order: 1 each.

The CRL Brass Pipe Nipple works with the Cat. No. HEG522 Hot Extruder Gun, and allows for the attachment of CRL Brass Tip Nozzles. Minimum order is one each.

CRL BM600 Series Hot Melt Extruder Systems

new

- Two and Five Gallon Options
- Digital Programming and Control Functions
- Melt Rates of 4 to 35 Pounds (1.8 to 15.9 kg) Per Hour
- Gunning Rate of One to Two Pounds (0.45 to 0.91 kg) Per Minute

The BM615 and BM650 Hot Melt Extruders are state-of-the-art digital machines with nearly every function programmable by the user. Preset timers can be programmed to shut down and turn on the pump either overnight or over the weekend. Each temperature zone (pot, hose, and gun) can be set individually, and each zone has its own over-temp alarm. An alarm in one zone shuts down all three zones and an indicator light will flash next to the problem area.

The BM615 is a 120 volt, low-volume system with a 15 pound (6.8 kg) tank, 1000 watt cartridge style replaceable tank heater, and a 59 RPM high-torque, fractional horsepower motor.

The BM650 is a 220 volt, mid to high-volume system with a 50 pound (22.7 kg) tank, 3000 watt cartridge style replaceable tank heater, and a 113 RPM high-torque, fractional horsepower motor.

Both systems come equipped with a 96" (2438 mm) hose precisely constructed to assure accuracy, durability, and the longest possible service life under the harshest of industrial applications. A No. 8 core is standard for the BM615 hose while the BM650 hose is provided with a larger diameter No.10 core for higher volume and a faster delivery rate. Both systems have 360-Plus ball swivel bottom feed handguns. These Guns have a historically proven superior service life in today's industrial environments. They are designed for superior ergonomics and movement, which translates to less operator fatigue in high production situations. Contact Glass and Glazing Technical Sales for additional details and available options. Both systems ship common carrier, F.O.B. Rochester Hills, Michigan. Minimum order is one each.



CAT. NO. BM615

BM615 SPECIFICATIONS

ELECTRICAL

Voltage: 120V AC, Single Phase, 50/60 Hz
Wattage: 1000 Watts
Motor Rating: 59 RPM
Warm Up: 45 to 60 Minutes

FUNCTIONAL

Melt Rate: 4 to 8 Pounds (1.8 to 3.6 kg) Per Hour
Pump Output (maximum): 1 Pound (0.45 kg) Per Minute
Tank Temperature Range: 100° to 475°F (38° to 246°C) +/- 1°F
Tank Capacity: 15 Pounds (6.8 kg)
Gun/Hose Temperature Range: Same as Tank



CAT. NO. BM650

BM650 SPECIFICATIONS

ELECTRICAL

Voltage: 220V AC, Single Phase, 50/60 Hz
Wattage: 3000 Watts
Motor Rating: 113 RPM
Warm Up: 45 to 60 Minutes

FUNCTIONAL

Melt Rate: 25 to 35 Pounds (11.3 to 15 kg) Per Hour
Pump Output (maximum): 2 Pounds (0.91 kg) Per Minute
Tank Temperature Range: 100° to 475°F (38° to 246°C) +/- 1°F
Tank Capacity: 50 Pounds (22.7 kg)
Gun/Hose Temperature Range: Same as Tank

OPTIONS

CAT. NO. 2308010 Optional Boom Kit fits either Pump to support and protect Hose.

CAT. NO. BM600C Optional Cart with Locking Casters supports either Pump.

CRL Aztech Mini Hot Melt Butyl Dispensing System

- Fast Heat-Up Time; 200° to 400°F Operating Range
- Used to Dispense CRL520LB, CRL520LB45 and N420LB Chunk or Chip Form Hot Melt Butyl

The CRL Aztech Mini Hot Melt Butyl Dispensing System is a compact table-top hot melt gunning unit designed for production rates of up to 50 pounds (22.7 kg) of hot melt sealants or adhesives per day. The pot holds approximately 20 pounds (9 kg) of material. Additional material may be added to the pot at any time during production. A heavy-duty progressive cavity pump provides a uniform, pulse free adjustable flow rate for hand gunning or automatic dispensing. Operating range from 200° to 400° F (93° to 204° C). An 8' (2.4 m) heated gunning hose and a trigger actuated hand gun with a swivel coupling is supplied with the unit. A variety of nozzles and dispensing heads are available. Clean up is minimal. The power is simply turned off when the equipment is no longer needed, and reheated when required. Heat-up time is approximately one hour. Minimum order is one each. F.O.B. Somerville, New Jersey.



CAT. NO. ATXM1

MEASUREMENTS

Width: 19" (482 mm), Height: 16" (406 mm)
Length: 24" (609 mm), Weight: 90 Lbs. (40.8 kg)

CRL Aztech II Hot Melt Butyl Dispensing System

- For Heating and Dispensing CRL520LB45 and N420LB Hot Melt Butyl in Chip, Chunk, or Slug Form
- Adjustable Temperature Control

This CRL Aztech II Hot Melt Butyl Dispensing System extrudes chunk, slug or chip-form hot melt butyl sealants from a heated hopper-type pot that also serves as the body of the positive displacement extruder pump. The extruder pump is driven by a 1/2 HP motor mounted on a direct drive gear reducer that is coupled to the pump drive shaft by a double-belt pulley. An internal screw auger moves material into the mouth of the pump. The pot holds approximately 30 pounds (14 kg) of material, and the system is designed for production rates of up to 200 pounds (90.7 kg) of hot melt sealants or adhesives per day. The heated 12' (3.7 m) hose is steel braided with a spring guard to prevent excessive flexing. Separate rheostats for hose and pot range up to 400°F (204°C). Operates on 220 Volts. Minimum order is one each. F.O.B. Somerville, New Jersey.



CAT. NO. ATX11

MEASUREMENTS

Width: 30" (762 mm), Height: 19" (482 mm)
Length: 31" (787 mm), Weight: 180 Lbs. (81.6 kg)

CRL Hot Melt Clamp Table

- Clamp Units Up to 4" Thick
- Aids in the Assembly of Insulating Glass Units

The CRL Hot Melt Clamp Table has heavy-duty tubular steel construction. This tubular framed clamping unit consists of a stabilizer unit in the bottom, which is a horizontal bar powered by a 4" (102 mm) bore x 2" (51 mm) stroke pneumatic cylinder actuated by a hand lever on the frame. The clamping head has a horizontal bar lined with a 1" square (25 mm square) strip of closed cell, 40 durometer shore "A" neoprene rubber; powered by a 2" (51 mm) bore x 8" (203 mm) stroke pneumatic cylinder actuated by a foot pedal. The stabilizing bar comes up from the bottom and the clamp head comes down from the top to secure glass and spacer along one edge for sealant application. The clamping unit must be released and the unit rotated and re-clamped to seal each side. Requires 100 psi and seven cfm air supply. F.O.B. Red Oak, Texas. Minimum order is one each.

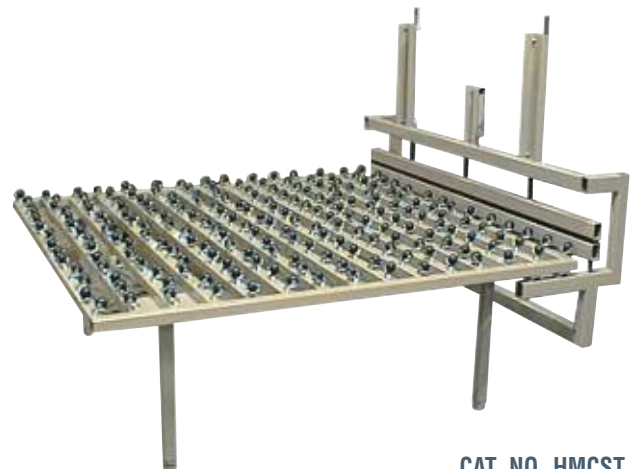

CAT. NO. HMCST

To see the complete selection of CRL Insulating Glass products, see our catalog CRLB3, pages W640-W685 or visit us at crlaurence.com.

CRL Hot Melt Butyl

CRL Hot Melt Butyl Insulating Glass Sealant is a 100% solids, hot-applied butyl-based sealant designed to give tenacious adhesion to glass and aluminum for a moisture proof seal in Insulating Glass units. The product is a one-component sealant system with lower moisture vapor transmission rates than current polysulfide, silicone, or polyurethane systems. It has been formulated to support the operation of multiple application guns from a single pump station. This easy-to-apply sealant offers exceptional performance under environmental exposure to ultraviolet light, temperature extremes, and moisture. It exceeds ASTM E-773/E-774 specifications. Technical Data is available at crlaurence.com.

- Hot Applied for Exceptional Flow
- Low Moisture Vapor Transmission Rate
- Excellent Adhesion to Glass and Metal
- Packaged in a Variety of Forms to Suit Your Application System

TECH DATA FOR CRL520 SERIES HOT MELT BUTYL

Color.....	Black
Moisture Vapor Transmission Rate.....	0.2 g/m ² /24 hr.
Suggested Application Temperature.....	365° to 400°F (185° to 204°C)
Brookfield Thermosel Viscosity at 374°F (190°C).....	275,000 cps
Shear Strength (Aluminum/Aluminum).....	35 psi cohesive failure
Average Setting Time.....	Window units may be moved after 3 minutes cooling time
Weight per Gallon.....	10.1 Lbs. (4.6 kg)

CRL Hot Melt Butyl Slabs

- Convenient Slab Form is Easy to Use



CRL Hot Melt Butyl Slabs are easy to use in CRL SS96, SS88, BM615, BM650, Aztech ATXM1, and ATX11 dispensing systems. It is packaged on coated release sheets, and can be easily rolled up or folded for inserting into dispensers with smaller melting pots. **NOTE:** Hot Melt Butyl is dispensed at operating temperatures of 400°F (204°C). Wear the proper safety gear including gloves, arm guards, and protective eyewear to avoid burns and other injuries.

CAT. NO.	APPROX. SIZE	WEIGHT/CASE
CRL520LB	3/8" x 6" x 17" (9.5 x 152 x 431 mm)	48 Lbs. (22 kg)

Minimum order: 48 pounds. Must be ordered in increments of 48 pounds.

CRL Hot Melt Butyl in Chunks

- Fit All Large Hot Melt Butyl Dispensers



CRL Hot Melt Butyl in chunk packaging is for larger dispensers, such as the BM615, BM650, ATX11, and ATXM1. The Chunks are dropped into the melting pots whole. **NOTE:** Hot Melt Butyl is dispensed at operating temperatures of 400°F (204°C). Wear the proper safety gear including gloves, arm guards, and protective eyewear to avoid burns and other injuries.

CAT. NO.	APPROX. SIZE	WEIGHT/CASE
CRL520LB45	3" x 6" x 7-1/2" (76 x 152 x 190 mm)	48 Lbs. (22 kg)
N420LB	3" x 6" x 7-1/2" (76 x 152 x 190 mm)	50 Lbs. (23 kg)

Minimum order: 48 pounds for CRL520LB45 and 50 pounds for N420LB. Must be ordered in those increments.

CRL Hot Melt Butyl in Pails



- For 5 Gallon Pail Hot Melt Butyl Dispensers

CRL Hot Melt Butyl in 5 gallon pails applies with any hot melt pumping system for 5 gallon pails.



CAT. NO.	CONTAINER	NET WEIGHT
CRL5205GL	5 Gal. (19 l) Pail, Net 4 Gal. (15 l) Butyl	41 Lbs. (18.5 kg)

Minimum order: 1 pail.

CRL Hot Melt Butyl in Drums



- For 55 Gallon Drum Hot Melt Butyl Dispensers

CRL Hot Melt Butyl in 55 gallon drums applies with any hot melt pumping system for 55 gallon drums.



CAT. NO.	CONTAINER	NET WEIGHT
CRL52055GL	55 Gal. (208 l) Drum, Net 48 Gal. (182 l) Butyl	485 Lbs. (220 kg)

Minimum order: 1 drum.

CRL INSULATING GLASS SEALANTS

For Pricing Visit Our Web Site or Call Us Toll Free at the Phone Numbers Shown on the Back Cover

CRL Hot Melt Extruder Gun

- Variable Extrusion Rates to 1/2 Pound Per Minute
- Two to Four Minutes Start-Up Time
- Lightweight and Portable

This CRL Hot Melt Extruder Gun is a specially designed portable gun for applications requiring the use of hot flow materials, such as Hot Melt Butyl Sealant for the fabrication of Insulating Glass units. The Gun features a heated barrel with a trigger control, hydraulic pressure for constant uniform flow without pulsing or air gaps, and a quick-refilling capacity to reduce your down time.

The conical design within the sealant chamber allows trapped air to bleed backward to maintain a uniform material flow. By attaching the optional Cat. No. RH522 CRL Butyl Rope Holder (not included), this unit will hold one roll of CRL Hot Melt Butyl Rope.

Variable temperature setting from 200° to 400°F (93° to 204°C) with the 610 Watt heater. The Gun weighs only 11 pounds (5 kg) for easy maneuverability.



Hot Melt Extruder Gun
CAT. NO. HEG522



Hot Melt Butyl Rope Holder
CAT. NO. RH522

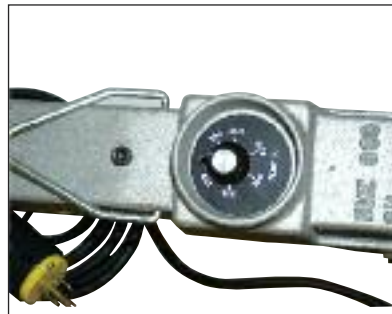

Variable Temperature Settings



Hot Melt Butyl Rope Holder (Optional Accessory)

CAT. NO.	DESCRIPTION
HEG522	Hot Melt Extruder Gun
RH522	Optional Butyl Rope Holder

Minimum order: 1 each.

CRL Hot Melt Butyl Rope

- Rope Form for Use in CRL HEG522 Hot Melt Extruder Gun

CRL Hot Melt Butyl Rope is insulating glass sealant in rope form. It is made to use in our Cat. No. HEG522 Hot Melt Extruder Gun (sold separately see above).



For ease of use we suggest the optional RH522 Butyl Rope Holder (see above).

CAT. NO.	PACKAGING	ROLLS/CASE
N415	4.5 lbs. (2 kg) Rolls, Approximately 551' (16.8 m) Long	8

Minimum order: 1 roll.

CRL Hot Melt Butyl in Cartridges

- For Use With Thermal Extruder Guns



This is our one-part cross-link CRL Hot Melt Butyl Insulating Glass sealant in 11 ounce (325 ml) metal cartridges for use with thermal extruder guns. 100% solids content features low moisture vapor transfer rate, excellent adhesion to glass and metal, low shrinkage, high performance under all weather conditions. The sealant cools within five to 10 minutes to form a strong resilient seal. Cartridges require pre-heating prior to application.



CAT. NO.	CONTENTS	CTG/CASE
N415TU	11 Fl. Oz. (325 ml)	24

Minimum order: 1 each. All cartridge sealants can be combined for quantity pricing.

CRL INSULATING GLASS SEALANTS

For Pricing Visit Our Web Site or Call Us Toll Free at the Phone Numbers Shown on the Back Cover

CRL Two-Part Polysulfide Insulating Glass Sealant

- Compatible With Aluminum Spacers
- Resistant to Weather, Ozone, Sunlight, Heat, and Cold
- Cures Rapidly to Permit Easy Cutting and Handling

CRL Two-Part Polysulfide Insulating Glass Sealant seals insulating glass units against moisture, cold, and heat. It outperforms competitive polysulfide sealants in resistance to moisture, sunlight, aging, and weathering. CRL Two-Part Polysulfide Insulating Glass Sealant maintains outstanding adhesion to glass, aluminum, and other spacer and corner materials under the most severe weather conditions. Cures rapidly to permit easy cutting and handling within four to 12 hours at room temperature, or even less time at elevated temperatures. High strength and low cost make it attractive for single and dual seal units. Sealant passes SIGMA specifications for durability of Insulating Glass units.

CAT. NO.	COLOR	CONTENTS
N400G15	Black	1-1/2 Gallons (5.7 l)
N4005GL	Black	5 Gallons (18.9 l)
N40055GL	Black	55 Gallons (208.2 l)

Minimum order: 1 each. N40055GL ships via common carrier F.O.B. Delaware.

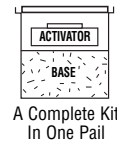

CRL Two-Part Polyurethane Insulating Glass Sealant

- Compatible With Edgetech Super Spacer™
- Low Moisture Vapor Transfer Rate
- Can Be Used With Adsorbent Filled Aluminum Spacers

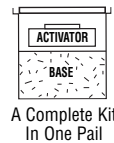

CAT. NO. N600G15

CAT. NO. N60055GL

CRL Two-Part Polyurethane is an effective edge seal used for fabricating Insulating Glass units. Best when mixed by weight, using only as much as you need. Correct proportioning mixing ratio by weight is 14.8 to 1. Mix with a portable drill mixer and apply with a flexible blade putty knife. This Two-Part Polyurethane Sealant contains no solvents, allowing it to be used safely with Super Spacer™. Set time is three hours when properly mixed.

CAT. NO.	COLOR	CONTENTS
N600G15	Black	1-1/2 Gallons (5.7 l)
N60055GL	Black	55 Gallons (208.2 l)

Minimum order: 1 each. N60055GL ships via common carrier F.O.B. Delaware.

Insulating Glass Compatible Sealants

CRL RTV408 Neutral Cure Silicone

- Compatible for Insulating Glass Glazing
- Designed for Primerless Adhesion
- Low Odor, Non-Acetic Cure Formula
- AAMA Approved

CAT. NO.	COLOR
RTV408C	Clear
RTV408AL	Aluminum
RTV408BL	Black
RTV408BRZ	Bronze
RTV408BGE	Beige
RTV408DT	Dark Tan
RTV408T	Tan
RTV408W	White

Minimum order: 1 each. All cartridge sealants can be combined for quantity pricing.



For more information, see page N118.

CRL 321 Acrylic Latex With Silicone

- Suitable for Glazing Insulating Glass Units in Wood Frames
- Paintable With Oil or Latex Based Paints
- Mildew Resistant

CAT. NO.	COLOR
321C	Clear
321W	White
321BRZ	Bronze
321GRY	Gray
321ALM	Almond

Minimum order: 1 each. All cartridge sealants can be combined for quantity pricing.



For more information, see page N133.

CRL 9542 Insulating Glass Silicone

- Specially Formulated for the Manufacture of Dual Seal Insulating Glass Units
- Excellent Glass-to-Glass Adhesion
- Resistance to UV Light and Weather Extremes

CRL 9542 Insulating Glass Silicone is a single component, acetic cure, silicone glass sealant specifically designed for producing long lasting Insulating Glass units when used with a primary seal of polyisobutylene. CRL 9542 contains adhesion promoting additives for excellent glass-to-glass adhesion, and is resistant to ultraviolet light and weather extremes. CRL 9542 has a functional temperature range of -80°F to 400°F (-62°C to 204°C).

Tack-free time is 30 minutes; fully cures 1/8" (3 mm) thickness in 24 hours. Units may be cautiously moved after 24 hours. Full strength is obtained in seven days. See page N120 for Neutral Cure Silicone to be used as a compatible bedding sealant for I.G. units.

CAT. NO.	COLOR	CONTENTS
9542	Black	10.3 Fl. Oz. (305 ml)
954252GL	Black	52 Gallons (197 l)

Minimum order: 1 each. All cartridge sealants can be combined for quantity pricing. Drums must be shipped via common carrier.



Additional Nozzles Available
Cat. No. S1LN0Z



10.3 Fl. Oz. (305 ml);
30 Cartridges per Case;
1440 Cartridges Per Pallet;
Screw-On Nozzle

TECHNICAL DATA:

Meets or exceeds Federal Specifications TT-S-1543A, Class A (COM-NBS) for silicone building sealants; TT-S-00230C, Class A (COM-NBS) for one-component silicone sealants; ASTM-C-920 for elastomer joint sealants, Type S, Grade NS, Class 25, Use NT, G, A; CGSB 19GP-13.

CRL Polyisobutylene Primary Seal

- Used to Manufacture Dual Seal Insulating Glass Units
- Exceptional Low Vapor Transmission
- Keeps Units From Fogging

CRL Polyisobutylene is used as the primary vapor seal in dual sealed Insulating Glass units. It is a one-part, non-drying, non-hardening material for dual seal fabrication in either tape or slug form. Primarily used in conjunction with CRL 9542 Insulating Glass Silicone, Polyisobutylene Primary Seal adheres to glass and metal, and resists water, ozone, and ultraviolet light.

Tape form is hand applied to the sides of Dual Seal Spacer. Slugs are used in automated machines for application to the spacer. CRL Polyisobutylene is made under the highest quality control conditions possible. With 100% solids content, it's compatible with any secondary seal.



Tape Form



Slug Form

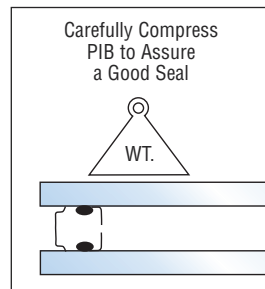

POLYISOBUTYLENE TAPE

CAT. NO.	ROLL LENGTH	ROLLS/CASE	LENGTH/CASE
2132559	210' (64 m)	10	2100' (640 m)

Minimum order: 1 case.

POLYISOBUTYLENE SLUGS

CAT. NO.	SIZE	WEIGHT	SLUGS/CASE
BK156	4-1/2" Dia. (114 mm) x 7" (177 mm)	4.5 lbs. (2 kg)	9
BK129	7-1/2" Dia. (190 mm) x 8-1/4" (209 mm)	15 lbs. (6.8 kg)	4

Minimum order: 1 case.

CRL Two-Part Insulating Glass Silicone

SPEC. DATA

MSDS

- Specially Formulated for the Manufacture of Dual Seal Insulating Glass Units
- For Residential Commercial, and Structurally Glazed Applications
- Formerly PRC® 4400

CRL Bondaflex Sil 4400IGS Insulating Glass Sealant is a two-part silicone sealing compound specifically developed for sealing insulating glass units against the penetration of moisture when used with a primary seal of Polyisobutylene (page N456). Cat. No. S1L4400 is designed to provide excellent bonding and sealing characteristics when used in the manufacture of insulating glass units. It has excellent adhesion to glass, even after exposure to ultraviolet radiation through glass.

Standard units are furnished with a premeasured quantity of base compound and accelerator individually packaged and assembled for mixing by the customer. The proper ratio for mixing is 100:10.0 by volume (100:7.9 by weight). Cure properties are such that units can be handled three hours after fabrication when cured at room temperature of 75°F (24°C).

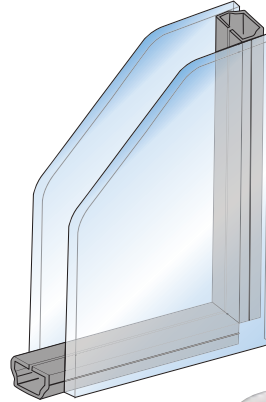

new

TECHNICAL DATA: Meets or exceeds the requirements of ASTM E-774 and CAN/CGSB 12.8.

CAT. NO.	COLOR	CONTENTS
S1L4400	Black	55 gal. (208 l) unit

Minimum order: 1 drum. F.O.B. CRL warehouses. Must ship common carrier.

CRL Hydra-Mate Two-Component Dispensing Unit

- Used to Dispense Two-Part Insulating Glass Sealants
- Provides Accurate Proportioning
- High Output Applicator Gun

The CRL Hydra-Mate System dispenses and applies small to large beads of sealants. It provides accurate proportioning, reliability, and a continuous, uniform application. This package uses a valve that requires no flushing, and is powered by a reliable Bulldog® Proportioning Pump. The CRL Ultra-Lite™ 2K Manual Applicator combines a light trigger pull with rugged durability. Comes with Mixer Nozzles to perfectly blend the two components. Applicator must be ordered separately.

TECHNICAL SPECIFICATIONS:

Max. Working Pressure: 3000 psi (20.7 Mpa)
Fluid Inlet Base: 55 gal. (208 l) ram plate/priming piston pump
Air Inlet: 3/4 npt (m) 10 ft (3.05 m) hose
Height (raised): 102" (2591 mm)
Height (lowered): 63" (1600 mm)
Weight: 1100 lbs. (499 kg)
Width x Depth: 50" x 40" (1270 mm x 1016 mm)
Typical Size: 62" x 50" x 77" (1575 x 1270 x 1956 mm) OD
Wetted Part: Zinc-plated carbon steel, aluminum ram plate, nitrile rubber wipers chrome, stainless steel, UHMW polyethylene PTFE, nylon, Buna-N

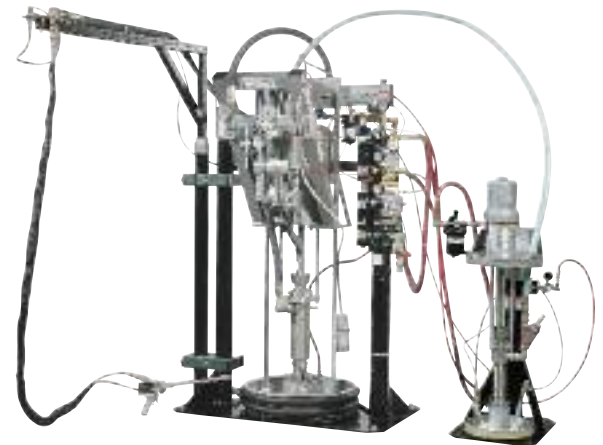

Shown with Applicator Gun (ordered separately)

CAT. NO. VRHME3
Hydra-Mate Two-Component Dispensing Unit



CAT. NO. UL2K
Applicator Gun

CRL MSD Molecular Sieve Adsorbent

- Standard Formula Removes Moisture From I.G. Units
- Three Standard Packaging Sizes
- Ask About Our High Volume Special Pricing

This CRL MSD Type Molecular Sieve is an all-purpose adsorbent for use in the fabrication of Insulating Glass units. It has an excellent capacity for adsorption of water and chemical vapors. MSD provides Insulating Glass fabricators with superior protection against fogging for a longer lasting unit.

MSD is suitable for both cool and warm climates, and can be used for residential, architectural, and commercial applications. CRL Molecular Sieve Adsorbent is cost-effective because it costs less per drop of water removed than any other adsorbent. This means significant savings in unit production.

NOTE: Avoid prolonged skin contact when working with this product.



CAT. NO. MSD50B



CAT. NO. MSD5



CAT. NO. MSD325

CAT. NO.	CONTENTS	APPROXIMATE SHIPPING WEIGHT
MSD5	5 Pound (2.2 kg) Can	6 Pounds (2.7 kg)
MSD50B	55 Pound (25 kg) Box	57 Pounds (26 kg)
MSD325	325 Pound (147.4 kg) Drum	335 Pounds (152 kg)

Minimum order: 1 each. MSD325 must ship common carrier only.

CRL Low Deflection Molecular Sieve Adsorbent

- Low Deflection Formula Removes Moisture From I.G. Units
- Ask About Our High Volume Special Pricing

This CRL Low Deflection Molecular Sieve Adsorbent is a uniform bead product with a high capacity for both moisture and solvent vapor. MSD LDA features low deflection characteristics and benefits in both economy and performance. Longer unit life results from the minimization of unit seal stress and deflection. Two convenient packages are available, both designed to protect the product during shipment and storage.

NOTE: Avoid prolonged skin contact when working with this product.



CAT. NO. MSD50BLDA



CAT. NO. MSD325LDA

CAT. NO.	CONTENTS	APPROXIMATE SHIPPING WEIGHT
MSD50BLDA	55 Pound (25 kg) Box	57 Pounds (26 kg)
MSD325LDA	325 Pound (147.4 kg) Drum	335 Pounds (152 kg)

Minimum order: 1 each. MSD325LDA must ship common carrier only.

CRL Test Kit for Molecular Sieve

- Used to Determine Freshness of MSD
- Easy to Use

Since the useful life of any adsorbent is reduced by excessive exposure to the atmosphere, daily testing of inventory with the CRL MSD Test Kit is recommended. The Kit lets you measure residual moisture quickly and easily. Kit contains two measuring beakers, one thermometer, one reference graph, and one instruction sheet. Minimum order is one each.

NOTE: Read instructions carefully and use caution when using this Test Kit. Work in an open area with good ventilation. A chemical reaction takes place when using.



CAT. NO. MSDTK

CRL Desiccant Filling Machine

- 12 Gallon Storage Container
- Fills Up to 35 Spacers at Once
- Adjustable Working Height

The CRL Desiccant Filling Machine is a fast, effective, and space-saving alternative for spacer bar filling. Fills up to 35 spacers at one time. The unit features all steel construction, and has a 12 gallon (45.4 l) capacity storage container for the desiccant. Its special Spacer Seal Barrier and Electric Vibrator assure complete filling of the spacers. It can handle spacers of all sizes at the same time. Easy to operate and completely adjustable to a comfortable working height. Only one 110V AC source is required for the operation of the Vibrator. Shipped knocked down F.O.B. Red Oak, Texas. Must ship via common carrier. Minimum order is one each.



SPECIFICATIONS:
Height: 96" (2438 mm)
Length: 48" (1219 mm)
Width: 20-1/2" (520 mm)
Weight: 255 lbs. (116 kg)

CAT. NO. EDFM

Somaca/CRL Spacer Bar Cutting Machine

- Safe, Foot Actuated Cutting of Single or Multiple Profiles
- Fast, Accurate Set-Up on Large Support Table

The Somaca/CRL Spacer Bar Cutting Machine has a digital display with a foot-activated Pneumatic Clamp and Saw. Minimum order is one each.

SPECIFICATIONS:

- 287" x 20" x 36" (7290 x 508 x 914 mm)
- Includes Spacer Supports
- Air Requirement: 90 psi (6 atm)
- Power: 230V AC/60 cycle, 500 watts.
Export power configurations available
- F.O.B. Cicero, Illinois. Must ship common carrier.



For more information on Insulating Line Production Equipment and Services, call our Machinery Division at (866) 583-1377, or e-mail to somaca@crlaurence.com.

CAT. NO. 47001610

Somaca/CRL PIB (Polyisobutylene) Extruders

Somaca/CRL PIB (Polyisobutylene) Extruders are completely automatic, and can be used manually for round and oval profiles. Cat. No. 47001500 has a capacity of 5.5 lbs. (2.5 kg); Cat. No. 47001510 has a capacity of 15.5 lbs. (7 kg). Both models have a working speed of 98' (30 m) per minute.

SPECIFICATIONS:

- Cat. No. 47001500 Butyl Cartridge Dimension: 4.5" dia. x 7" (114 mm dia. x 177 mm)
- Cat. No. 47001510 Butyl Cartridge Dimension: 7.6" dia. x 9" (195 mm dia. x 230 mm)
- Dimensions - Cat. No. 47001500: 98" x 21" x 48" high (2489 x 533 x 1219 mm)
Cat. No. 47001510: 118" x 29" x 45" high (2997 x 736 x 1143 mm)
- Voltage: 230V AC, 60 Hz, Three Phase
Export power configurations available
- Power: Cat. No. 47001500 - 2.5 kw
Cat. No. 47001510 - 3.8 kw
- Air Requirements: 90 psi (6 atm)

- Easy to Operate
- Manual Operation for Round or Oval Profiles



CAT. NO.	DESCRIPTION
47001500	5.5 lb. (2.5 kg) Capacity Extruder
47001510	15.5 lb. (7 kg) Capacity Extruder

Minimum order: 1 each. F.O.B. Cicero, Illinois. Must ship via common carrier.

Fabricating Insulating Glass Units With Alternatives to Aluminum Spacers

**Super Spacer® and Duralite® are Two of the
Most Versatile Spacer Systems You Can
Choose for the Fabrication of Quality
Insulating Glass Units**

**So How Do You Choose Which System is Right
for You?**

• Build a Trial Unit for Display

You can assemble a complete Insulating Glass unit with either Super Spacer® or Duralite® and keep your total investment to the cost of the spacer itself. There are no special tools needed to work with either of these systems, so building a trial unit is the best way to familiarize yourself with the simplicity of these systems. As they used to say, "Try it, you'll like it".

• Ask Our Insulating Glass Tech Experts

If you're unsure of what you need to start working with Super Spacer® or Duralite® we can help. Our Glass and Glazing Technical Sales personnel can help you make the choice. Tell us about the Insulating Glass project you are bidding and we can suggest just the right system, with materials and tools, to make your bid competitive in your market. And if your bid has special conditions, such as irregular shaped units, or units to be installed in difficult locations, we can help there too.

You can reach CRL Technical Sales at (800) 421-6144 in the U.S., (877) 421-6144 from Canada, or (323) 588-1281 International. Ask for Ext. 7720. You can also send e-mail from the home page of crlaurence.com. Click on Contact Us, and then click on Technical Sales for Glass and Glazing Products.

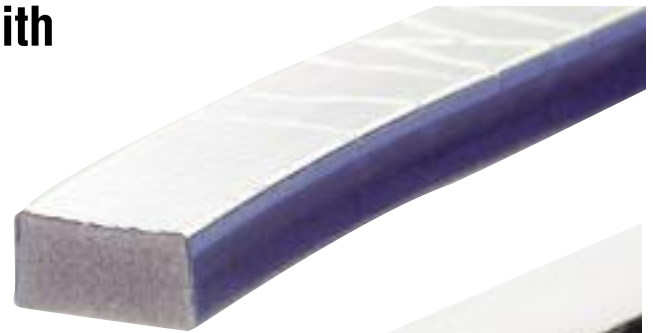

Super Spacer®

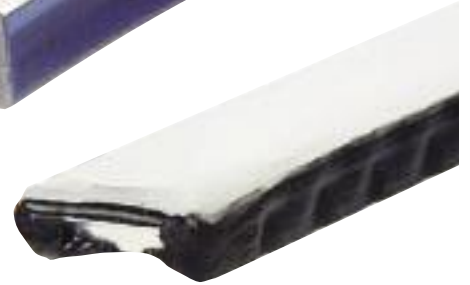

Duralite®



CRL Super Spacer®

- Easy to Work With Spacer Available in Two Colors: Black and Gray
- Widths Ranging From 3/16" to 3/4" (4.8 to 19 mm)
- Convenient 66 Foot (20.1 Meter) Rolls Individually Sealed in an Airtight Foil Bag
- Can Be Used to Fabricate Both Rectangular and Non-Rectangular Shaped Units



CRL Duralite®

- Gray Color Spacer Available in Widths Ranging From 1/4" to 3/4" (6.3 to 19 mm)
- Convenient 66 Foot (20.1 Meter) Rolls and Money-Saving Bulk Rolls
- Packaged in Individually Sealed Airtight Foil Bags
- Can Be Used to Fabricate Both Rectangular and Non-Rectangular Shaped Units

CRL Insulating Glass Starter Kit With Duralite®

- Includes Everything Needed to Fabricate High Quality Insulating Glass Units
- Comes With 330 Feet (100 m) of Duralite®
- Easily Adapts to All Shapes and Sizes of Glass

Duralite® allows you to build Insulating Glass units in shapes not permitted by metal spacers. The patented technology incorporates unique materials and a breakthrough in continuous composite manufacturing processes.

This advance technology offers a higher performance spacer system at a competitive price. Duralite® takes optimum advantage of laminates and adhesives to reduce thermal conductivity while improving surface and corner appearance over other Insulating Glass spacers.

This CRL Insulating Glass Starter Kit With Duralite® contains everything needed to produce condensation-free perimeter edges that substantially reduces overall window U-Value. It is a complete package that will get you into the business of producing high-quality Insulating Glass units to meet your customer's demands.



CAT. NO. S1GKDS66



Apply Duralite® to clean glass surface with Applicator or by hand

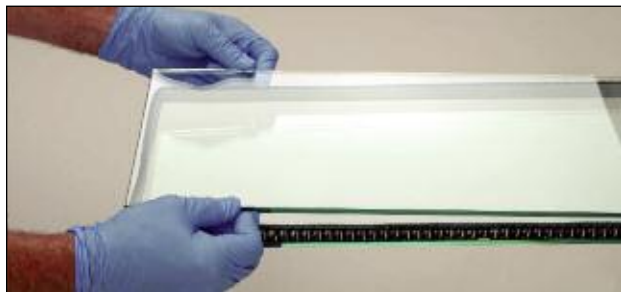

Index second piece of clean glass and press on to Duralite®



Apply Spring Clamps or Mechanical Press with Heat Lamp to seal the unit

KIT NO. S1GKDS66 INCLUDES:

CAT. NO.	DESCRIPTION	QUANTITY
DS6614	1/4" (6.3 mm) Duralite® 66' (20.1 m) Roll	2 Rolls
DS6638	3/8" (9.5 mm) Duralite® 66' (20.1 m) Roll	1 Roll
DS6612	1/2" (12.7 mm) Duralite® 66' (20.1 m) Roll	2 Rolls
DSPT1	Duralite® Peak Tool Applicator	1 Each
TL2	Duralite® Quartz Heat Lamp	1 Each
1550	Lint Free Shop Wipes (900 per Case)	1 Case
695	Concentrated Glass Cleaner	1 Gallon (3.785 l)
DB21	Plastic Spray Bottles	2 Each
NG171	Lint Free Gloves (Large)	1 Dozen Pairs
JC3202HT	Plastic-Tipped 6" Handy Clamps	24 Each
M3R	Straight Cut Snips	1 Each
GM12	Basic Insulating Glass Manual	1 Each

Minimum order: 1 each.

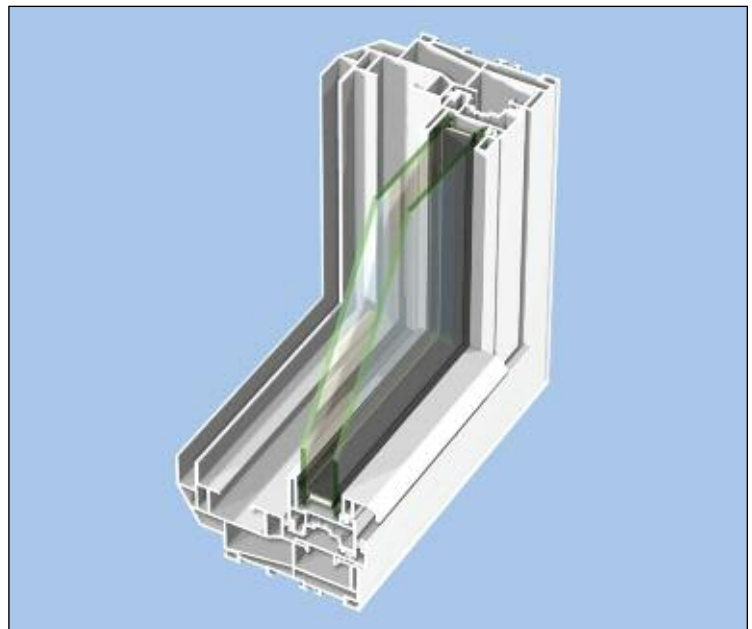

CRL TruSeal® Duralite®

- Complete Spacer and Sealant in One Tape
- Contains No Metal for Improved Warm Edge Thermal Performance
- EnergySTAR® Labeled Technology
- Improved Condensation Resistance
- Reduced Total Window U-Value
- Superior Argon Gas Retention
- Same Spacer Used for Standard and Specialty Windows



SPEC. DATA

MSDS



Spacer Sub-Assembly

A unique multi-component spacer that is bendable yet incompressible and stable

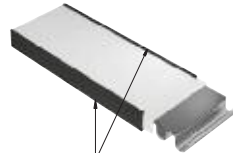

Bondline Adhesive

Proprietary high performance adhesive providing exceptional resistance to gas and moisture vapor transmission

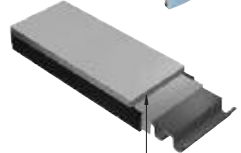

Desiccated Topcoat

Desiccant concentrated in the top layer provides rapid dew point suppression

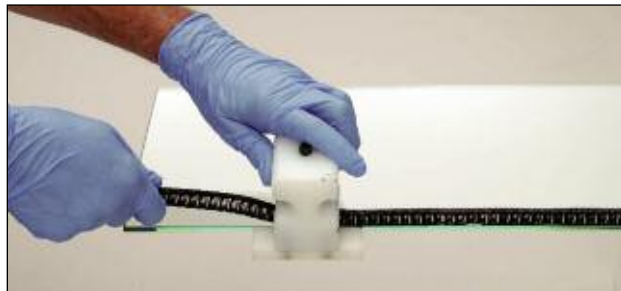

Apply Duralite® to clean glass surface with Applicator or by hand

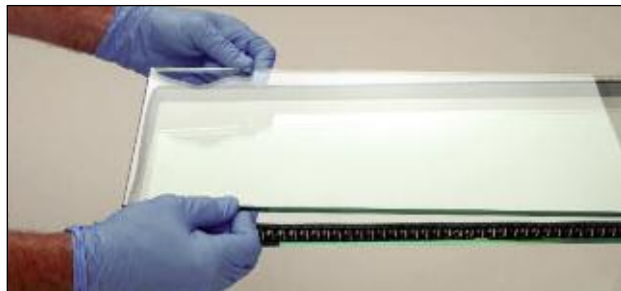

Index second piece of clean glass and press on to Duralite®



Apply Spring Clamps or Mechanical Press with Heat Lamp to seal the unit

Duralite's® patented technology incorporates unique materials and a breakthrough in continuous composite manufacturing processes. This advanced technology offers a higher performance spacer system at a competitive price. Duralite® takes optimum advantage of laminates and adhesives to reduce thermal conductivity, while improving surface and corner appearance over other Insulating Glass unit spacers.

A single spacer system for both standard and special units has become an important factor in today's competitive marketplace where a high percentage of manufactured units are non-rectangular. Duralite® allows the window fabricator to produce Insulating Glass units with one spacer system. The fabricator can increase productivity and flexibility, while eliminating customer concerns over having dissimilar spacers in special versus standard windows.

Other colors and sizes of Duralite® are available on special order. Swiggle/Edgetherm DS and FS is available for our customers in Australia. Contact CRL Technical Sales or go to crlaurence.com for additional information.

DURALITE® STANDARD ROLLS

CAT. NO.	COLOR	WIDTH	ROLL LENGTH
DS6614	Gray	1/4" (6.3 mm)	66' (20.1 m)
DS66516	Gray	5/16" (7.9 mm)	66' (20.1 m)
DS6638	Gray	3/8" (9.5 mm)	66' (20.1 m)
DS66716	Gray	7/16" (11.1 mm)	66' (20.1 m)
DS6612	Gray	1/2" (12.7 mm)	66' (20.1 m)
DS66916	Gray	9/16" (14.3 mm)	66' (20.1 m)
DS6658	Gray	5/8" (15.9 mm)	66' (20.1 m)
DS6634	Gray	3/4" (19 mm)	66' (20.1 m)

Minimum order: 1 roll. Sizes can be combined for quantity pricing.

DURALITE® BULK ROLLS

CAT. NO.	COLOR	WIDTH	ROLL LENGTH
BDS14	Gray	1/4" (6.3 mm)	2640' (805 m)
BDS516	Gray	5/16" (7.9 mm)	2500' (762 m)
BDS38	Gray	3/8" (9.5 mm)	2240' (683 m)
BDS716	Gray	7/16" (11.1 mm)	2030' (619 m)
BDS12	Gray	1/2" (12.7 mm)	1750' (533 m)
BDS916	Gray	9/16" (14.3 mm)	1630' (497 m)
BDS58	Gray	5/8" (15.9 mm)	1520' (463 m)
BDS34	Gray	3/4" (19 mm)	1310' (399 m)

Minimum order: 1 roll. Sizes can be combined for quantity pricing.

CRL Duralite® Quartz Heat Lamp

- Use With Deluxe Handy Clamps for Proper Compression of Duralite®
- Softens and Wets Out Adhesive

The CRL Duralite® Quartz Heat Lamp provides softening and wetting of the Duralite® adhesive. The powerful 600 watt Quartz Lamp provides plenty of heat. Hold at least 12" (305 mm) away from the glass edge to achieve approximately 120°F (49°C) of heat required which allows for adequate compression when used with Deluxe Handy Clamps. Requires 115V AC. Includes dark glasses to protect eyes from glare. For replacement bulbs, order Cat. No. TL2BULB. Minimum order is one each.

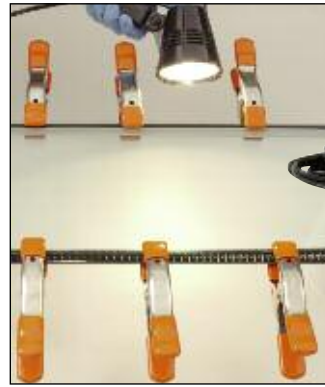

(Clamps not included)



CAT. NO. TL2

CRL Duralite® Peak Tool

- Aids in Consistent Application of Duralite®
- Indexes Edge of Glass for Improved Sightlines

The CRL Duralite® Peak Tool is a hand tool that aids in the manual application of Duralite® for proper indexing of the material to the edge of the glass. It helps you make straighter sightlines, improving the overall appearance and quality of your Insulating Glass units. Rolls of Duralite® are fed through the Peak Tool by hand, which eases application. Training is minimal, and all widths of Duralite® can be used. Minimum order is one each.



CAT. NO. DSPT1

CRL Duralite® Pro Tool

- Aids in Application of Duralite® on Air Flow Tables
- Eliminates Operator Contact With Glass Surfaces

The CRL Duralite® Pro Tool helps maintain consistent, high quality Insulating Glass unit production by eliminating all operator contact with glass surfaces. This helps to ensure a clear vision area and create an attractive, straight sightline. The precision-made Duralite® Pro Tool features a pivot pin enabling the applicator to form uniform 90 degree corners. Rubber protected guide wheels help to prevent chipping of the glass. Minimum order is one each.

NOTE: For information about air flow tables contact Glass and Glazing Technical Sales.

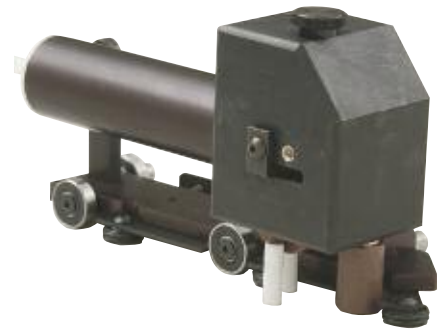

CAT. NO. SPT501

CRL 6" (152 mm) Deluxe Handy Clamp

- Evenly Spreads Force Over Insulating Glass Unit

You can use these CRL 6" Deluxe Handy Clamps to apply the required compression for a proper seal while producing Duralite® Insulating Glass units. Position the Clamps every 6" (152 mm) around the unit's perimeter for even pressure and a uniform seal. Maximum jaw opening is 1" (25 mm). The minimum order is one each.



CAT. NO. JC3202HT

CRL Straight Cut Snips

- Easily Cuts Duralite® Spacer



Use these Straight Cut Snips to cut and trim Duralite® during fabrication of Insulating Glass units. Maximum cut length is 1-3/8" (35 mm). Overall length is 9-3/4" (248 mm). Minimum order is one each.

CAT. NO. M3R

SOMACA/CRL Tilting Hot Press Production Table

- Halogen Heating Unit
- Reel Stand, Pro Tool, and Infrared Thermometer Included
- Press Adjusts for Units From 3/8" to 2" (10 to 51 mm) Thick
- Safety Switch Shuts Off Heat if Glass Stops
- Work Table Tilts for Easy Loading
- Eight Roller Pairs Pull Glass Unit Through Machine
- Available for Purchase or Lease



CAT. NO. HPT57

Affordable Hot Press System Rolls Units Through Under Pressure

The Hot Press Production System combines two work stations to save space and tilts for easy loading. The Work Table holds the glass against the registration guides with a vacuum port while the seal is applied by hand. Once the seal is applied and the top glass is placed, the unit can be floated to the hot press on the full plenum air flotation system built into the table's surface. There is no need to lift or carry the assembled unit. Each side of the unit is run through the press rollers. The Work Table area is 74" x 86" (1.88 x 2.18 m), and is 35" (900 mm) high. Large units can be loaded easily by using the power tilt feature.

The temperature and motor speed is monitored and easily controlled with a digital operators panel. The halogen heating unit keeps the heat source in a concentrated area. Cooling fans are built in at the end of the conveyor. Glass moves from right to left at 78 to 140 inches (1.2 to 3.5 meters) per minute depending on ambient air temperature. A safety switch automatically shuts off the heat unit if the glass stops moving. The eight roller pairs are made of a soft composite to prevent scratching the glass. Units from 3/8" to 2" (10 to 51 mm) thick can be processed.

CAT. NO.	DIMENSIONS	MACHINE WEIGHT
HPT57	74" x 86" (1.88 x 2.18 m)	800 lbs. (363 kg)

See pages N462-N463 for Duralite® Spacer and accessories.

Controls:

All controls are built to OSHA requirements, utilizing CE, CSA and UL Certified components. Wiring for three phase, 60 cycle, 230V AC power.

Utilities:

Electrical 2 Motors, Total 4.8 HP (3.6 kw*).

Voltage 3 Phase, 60 Cycle, 230V AC.

Power 50 AMP @ 230V AC.

Air Requirements . . .90 PSI (6 atm)



Easy to Use Operator Control Station



Simple Height Adjustment



Infrared Thermometer and Pro Tool Seal Applicator Included



SOMACA/CRL HPT57
Three Phase, 50/60 Hz Export Model



An export version of the HPT57 can be built to operate on Three Phase, 50/60 Hz power. Contact the Machinery Division with your power requirements.

SPECIFICATIONS:

- Table Height:** 35" (900 mm)
- Footprint:** 74" x 86" (1.88 x 2.18 m)
- Shipping Weight:** 1100 lbs. (499 kg)

CRL Edgetech Super Spacer®

- The Most Versatile Spacer Available
- Allows Simultaneous Production of Regular and Special Shaped Insulating Glass Units
- Save Production Time - No Desiccant Beads to Add or Corner Keys to Assemble
- No Metal Spacer – Dramatically Reduces Condensation
- No Heat Compression Required
- Low Profile Spacer is Only 1/4" (6 mm) Thick
- Multi-Layer Vapor Barrier is Continuous at Corners
- Available in Gray or Black

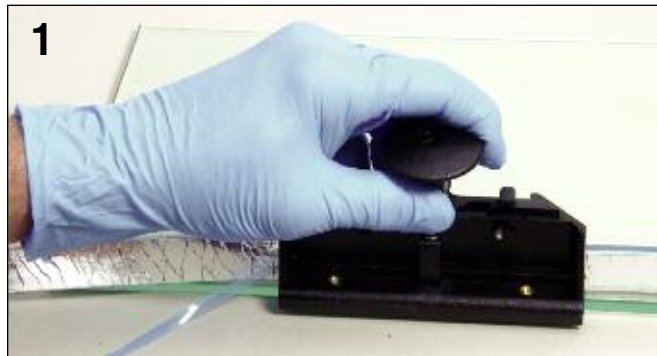
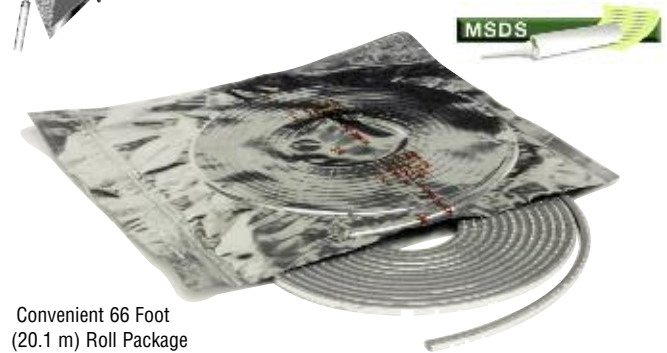
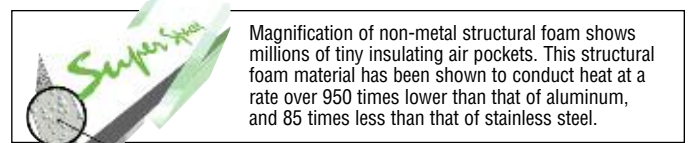

1 Apply Super Spacer® to clean glass surface with SSHN Hand Notcher or SSAPA Shuttle Applicator as release liner is removed

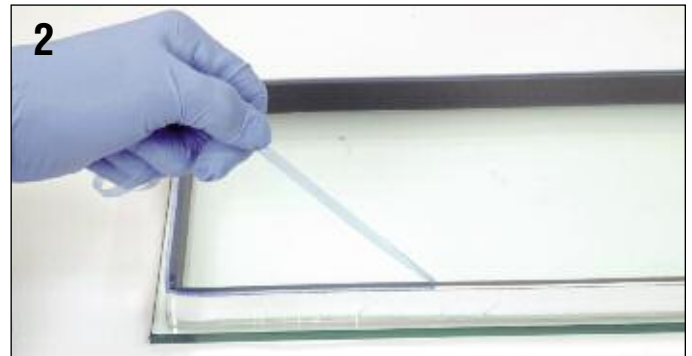

2 Remove second release liner

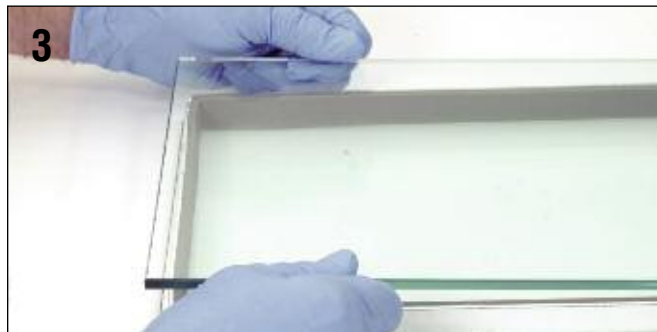

3 Index second piece of clean glass and press on to Super Spacer®



4 Apply CRL Hot Melt Butyl or Cat. No. 877 Super Spacer Sealant to seal the unit

CRL Edgetech Super Spacer® is made from superior insulating silicone foam. The spacer essentially eliminates perimeter edge condensation and substantially reduces overall window heat loss. Because of the unique design features of Super Spacer® there are advantages in using this product for the fabrication of specialized insulating glass designs, including curved and odd shaped units, sound insulating, and triple-glazed units with art glass inserts.

For long-term durability, UV resistant silicone material is used to prevent spacer degradation. The flexible foam spacer provides friendly accommodation of glass bowing and thermal movement, and also helps ensure improved edge seal desiccant, and the permeability of the foam allows for fast moisture pickup. To reduce moisture vapor transmission and inert gas loss, the Super Spacer® is backed by a high performance, multi-layer barrier film.

Rolls are 66' (20.1 m) long. Other colors and bulk rolls are available on special order. **NOTE:** Super Spacer® cannot be used without an edge sealant. We recommend CRL Hot Melt Butyl or CRL 877 Super Spacer Sealant (see page N467).

CAT. NO.	COLOR	WIDTH	ROLL LENGTH
SS31666	Gray	3/16" (4.8 mm)	66' (20.1 m)
SS1466	Gray	1/4" (6.3 mm)	66' (20.1 m)
SS51666	Gray	5/16" (7.9 mm)	66' (20.1 m)
SS3866	Gray	3/8" (9.5 mm)	66' (20.1 m)
SS71666	Gray	7/16" (11.1 mm)	66' (20.1 m)
SS1266	Gray	1/2" (12.7 mm)	66' (20.1 m)
SS91666	Gray	9/16" (14.3 mm)	66' (20.1 m)
SS5866	Gray	5/8" (15.9 mm)	66' (20.1 m)
SS3466	Gray	3/4" (19 mm)	66' (20.1 m)
SS1466BL	Black	1/4" (6.3 mm)	66' (20.1 m)
SS3866BL	Black	3/8" (9.5 mm)	66' (20.1 m)
SS1266BL	Black	1/2" (12.7 mm)	66' (20.1 m)
SS91666BL	Black	9/16" (14.3 mm)	66' (20.1 m)
SS5866BL	Black	5/8" (15.9 mm)	66' (20.1 m)
SS3466BL	Black	3/4" (19 mm)	66' (20.1 m)

Minimum order: 1 roll. Colors and sizes can be combined for quantity pricing.

CRL Super Spacer® Hand Notcher

- Easy-to-Use Tool Simplifies Corner Notching
- Assures Consistent Placement of Super Spacer®

The CRL Super Spacer® Hand Notcher is designed to speed up the manual application of Super Spacer®. It simplifies corner notching and assures consistent placement of the foam Super Spacer® strip at a distance of 3/16" (4.8 mm) from the glass edge. Can be used with sizes ranging from 1/4" to 3/4" (6.3 to 19 mm) in width. Minimum order is one each.



CAT. NO. SSHN

CRL Super Spacer® Super Shuttle™ Applicator

- Hand Held Pneumatic Tool Speeds Application of Super Spacer®

The hand held CRL Super Spacer® Super Shuttle™ Applicator makes precision laying, notching, cornering, and splicing a simple one-step process in the manufacture of Insulating Glass units. The Applicator glides on the Super Spacer®, eliminating contact with the glass, which prevents marking of the vision area.

The CRL Super Shuttle ensures straight sightlines, perpendicular to the glass, and is fully adjustable for Super Spacer® sizes of 3/16" to 15/16" (4.8 to 23.8 mm) and set back distances of either 3/16" (4.8 mm) or 1/4" (6.3 mm). Requires 100 cfm to operate. Minimum order is one each.



CAT. NO. SSAPA

CRL Super Spacer® Groove Tool

- Cuts Groove in Super Spacer® for the Insertion of Leaded Glass Panels

The CRL Super Spacer® Groove Tool allows you to create your own grooved spacer for leaded and stained glass insert panels. By adjusting the centering guide to widths from 1/4" to 1" (6.3 to 25.4 mm) and pulling material across the blade, perfect grooves are quickly made. An adjustment screw on the bottom of the unit adjusts the blade for making either shallow or deep cuts. Two blades are included, and Cat. No. BK1056 Replacement Blades can be ordered separately. Minimum order is one each.



Uncut



Shallow Cut



Deep Cut



CAT. NO. LCSG1

CRL Bulk Reel Super Spacer® Stand

- Positioned for Speed
- Accommodates Any Size Bulk Reel of Super Spacer®

This CRL Super Spacer® Stand is designed to accommodate any size Super Spacer® in bulk reels. The Stand features a unique base and cover for totally enclosing the Super Spacer®, thereby preserving its quality by keeping it airtight during application. Minimum order is one each.

Optional items for use with the Stand include a two-roll lid and two-roll arm. Contact Technical Sales regarding special order Bulk Roll pricing.

NOTE: Not for use within standard 66' (20.1 m) rolls.



CAT. NO. LRS22

CRL Super Spacer® Seminar DVD

- Demonstrates Proper Use of Super Spacer® and Accessories



This DVD demonstrates proper use of CRL Super Spacer®, showing how to make Insulating Glass units effectively using the product. It also shows different types of sealing methods to use with Super Spacer®. Minimum order is one each.

CAT. NO. DVSS1

CRL Super Spacer® Sealant

- One-Part Fast Cure Urethane With Low Solvent Formula Compatible With Super Spacer®
- Easy, Inexpensive Way to Make Low Production, High Quality Insulating Glass Units

Cat. No. 877 Super Spacer® Sealant is a single component urethane for the fabrication of quality single seal Insulating Glass units. Simply attach a SGT Polyethylene Sealant Guide to match your Super Spacer® width and backfill to the edge of the glass. Cat. No. 877 is a special low-solvent formulation that is made to be compatible with Super Spacer's adsorbent, and does not require a polyisobutylene primary seal. Cat. No. 877 may also be used with adsorbent filled aluminum spacers.

Super Spacer® Sealant works best for assembly of Insulating Glass units when temperature is over 40°F (5°C), and when humidity is more than 40%. Tack free time is 45-60 minutes at 77°F (25°C). Cure time is 3/16" (4.8 mm) per 24 hours. **NOTE:** Insulating Glass units should be totally sealed with Cat. No. 877 within one hour of exposing Super Spacer® adsorbent or adsorbent filled aluminum spacers to the atmosphere. Minimum order is one each. All cartridge sealants can be combined for quantity pricing.

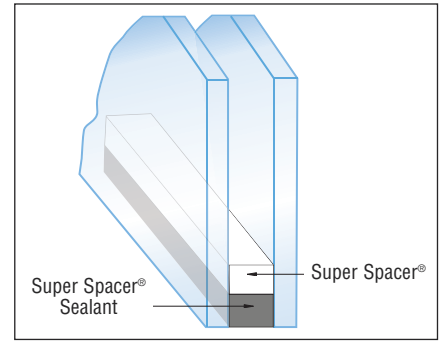

10.3 Fl. Oz. (304 ml);
12 Cartridges per Case

CAT. NO. 877

CRL Polyethylene Sealant Guides

- Fit on Tapered Nozzles for Insulating Glass Sealants
- Sizes From 3/16" to 3/4" (4.8 to 19 mm)

CRL Polyethylene Sealant Guides fit on the end of tapered cartridge nozzles for Insulating Glass sealants. The SGT Guide is designed to force sealant into the space between the two pieces of glass. Simply push the SGT Guide onto your nozzle and they are ready to use.



Polyethylene Adapter Nozzle CAT. NO. 989

The CRL Polyethylene Adapter Nozzle allows you to use SGT Sealant Guides with many different bulk sealant dispenser systems. Minimum order is one each.

Polyethylene Sealant Guides and Adapter Nozzles never need cleaning, because sealants will peel off when dry.

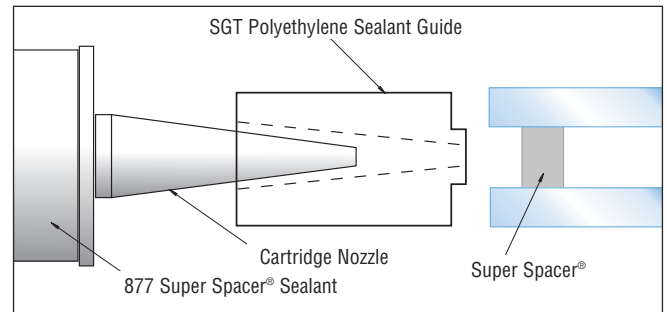

SGT Polyethylene Sealant Guide

POLYETHYLENE SEALANT GUIDES

CAT. NO.	SIZE
SGT316	3/16" (4.8 mm)
SGT14	1/4" (6.3 mm)
SGT516	5/16" (7.9 mm)
SGT38	3/8" (9.5 mm)
SGT12	1/2" (12.7 mm)
SGT58	5/8" (15.9 mm)
SGT34	3/4" (19 mm)

Minimum order: 1 each. Sizes can be combined for quantity pricing.

CRL Super Spacer® Desiccant Activity Test Kit

- Ensure Quality of Units Made
- Test Previously Opened Packages

CRL Super Spacer® contains at least 40% of desiccant material by weight and, prior to unit fabrication, it is critical that this desiccant material is not pre-loaded with moisture before sealing the unit. Use this Test Kit to test the remainder of previously opened packages of Super Spacer®, and any unopened packages of Super Spacer® older than 36 months.

Any unused material can be repackaged in the flat roll bags with the foil packaging being heat-sealed or taped for desiccant protection. The unused, repackaged material must be stored elevated from the floor and away from any exterior walls. Minimum order is one each.



CAT. NO. DTK1

The Aluminum Spacer Fabrication Method

Heat loss costs money and energy, but it can be prevented. Insulating glass is the most effective product that you can provide for your customers to save energy and cut their heating and cooling costs.

Traditional metal spacers for the fabrication of Insulating Glass units are available in both single and dual seal type. Single Seal Spacers have a single shoulder to accept the sealant deep enough to allow for adequate sealant penetration. Dual Seal Spacers accept a polyisobutylene primary seal while the exterior facing shoulders are designed to accept the secondary seal and allow for adequate sealant penetration. Both Single and Dual Seal Spacers utilize Spacer Corners to join them together to form frames.

NOTE: Corners must match spacer design.

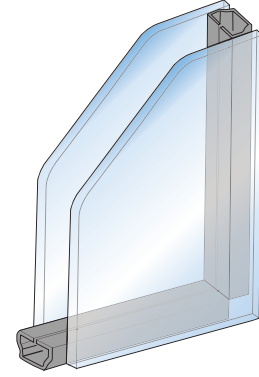

CRL Single Seal Aluminum Spacers

- Laser Welded Spacers Are Available in Two Finishes
- Manufactured to Meet and Exceed Rigid Test Standards

CRL Single Seal Insulating Glass Spacers have a proven record for utility and satisfaction over many years of use. Single Seal Spacers have a single shoulder to accept the sealant, and this shoulder is deep enough to allow for excellent sealant penetration.



Clear Anodized

Bronze Anodized

SINGLE SEAL SPACER

Universal Thickness for these Single Seal Spacers is .325 (8.3 mm)

CLEAR ANODIZED CAT. NO.	BRONZE ANODIZED CAT. NO.	SPACER WIDTH	QTY/CASE
3934	3934BRZ	3/16" (4.8 mm)	500
3935	3935BRZ	1/4" (6.3 mm)	350
3936	3936BRZ	5/16" (7.9 mm)	250
3937	3937BRZ	3/8" (9.5 mm)	200
3938	3938BRZ	7/16" (11.1 mm)	175
3939	3939BRZ	1/2" (12.7 mm)	175
3940	3940BRZ	9/16" (14.3 mm)	170
3941	3941BRZ	5/8" (15.9 mm)	150
3941A	3941ABRZ	11/16" (17.5 mm)	150
3942	3942BRZ	3/4" (19 mm)	150

Minimum order: 20 stock lengths per size and color. Sizes can be combined for quantity pricing. Stock lengths are 12'8" (3.8 m). Must ship common carrier, unless you specify we cut them for U.P.S. A Cutting Charge will apply.

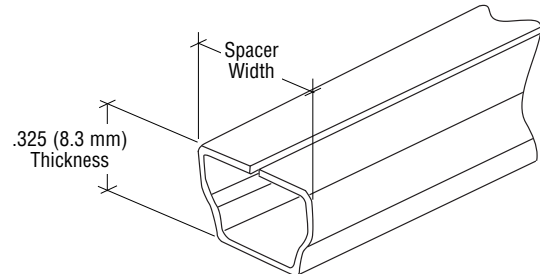

CRL Corners for Single Seal Spacer

- Long Fin Design Holds Corners in Place
- Made From Durable Nylon

CRL Nylon Corners are designed to fit tightly into CRL Single Seal Spacers for a proper seal. High quality material resists cracking and aging. Quantity per case is 1000. Sold in increments of 100.

CAT. NO.	SIZE
6262	3/16" (4.8 mm)
6265	1/4" (6.3 mm)
6266	5/16" (7.9 mm)
6267	3/8" (9.5 mm)
6268	7/16" (11.1 mm)
6269	1/2" (12.7 mm)
6270	9/16" (14.3 mm)
6271	5/8" (15.9 mm)
6271A	11/16" (17.5 mm)
6272	3/4" (19 mm)



Minimum order 100 each. Must be ordered in increments of 100. Sizes can be combined for quantity pricing.

CRL Flex Corners for Single Seal Spacer

- Used to Make Variable Angle Frames
- Made From Durable Nylon

CRL Flex Corner Keys for Single Seal Spacers are a low-cost, effective method of producing variable angle Insulating Glass unit frames. The long fin design ensures extra strength and a positive fit. Quantity per case is 1000. Sold in increments of 100.

CAT. NO.	SIZE
6222	3/16" (4.8 mm)
6225	1/4" (6.3 mm)
6226	5/16" (7.9 mm)
6227	3/8" (9.5 mm)
6228	7/16" (11.1 mm)
6229	1/2" (12.7 mm)
6230	9/16" (14.3 mm)
6231	5/8" (15.9 mm)
6231A	11/16" (17.5 mm)
6232	3/4" (19 mm)



Minimum order 100 each. Must be ordered in increments of 100. Sizes can be combined for quantity pricing.

CRL Low-Profile Dual Seal Aluminum Spacers

- For the Fabricator Who Prefers a Dual Seal Insulating Glass Unit
- Laser Welded Spacers With Clear Anodized Finish

This CRL Low Profile Dual Seal Spacer was designed for fabricators of Insulating Glass who prefer a dual seal system. The groove on the shoulder is designed to accept the CRL Polyisobutylene Primary Seal (see page N456), while the taper below the shoulder will accept the secondary seal. The uniform size and shape of this Spacer will assure you the close tolerances required for dual seal fabrication.

Clear Anodized

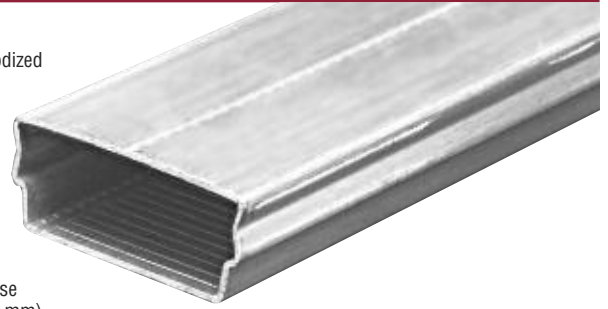

DUAL SEAL SPACER
Universal Thickness for these Dual Seal Spacers is .250 (6.3 mm)

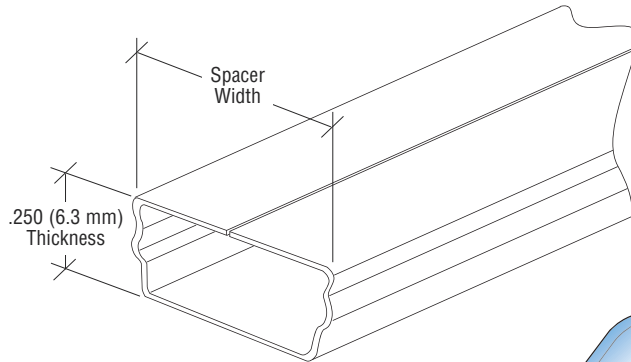

CAT. NO.	FINISH	SPACER WIDTH	QTY/CASE
99124	Clear Anodized	3/16" (4.8 mm)	500
99125	Clear Anodized	1/4" (6.3 mm)	350
99126	Clear Anodized	5/16" (7.9 mm)	250
99127	Clear Anodized	3/8" (9.5 mm)	200
99128	Clear Anodized	7/16" (11.1 mm)	175
99129	Clear Anodized	1/2" (12.7 mm)	175
99130	Clear Anodized	9/16" (14.3 mm)	170
99131	Clear Anodized	5/8" (15.9 mm)	150
99131A	Clear Anodized	11/16" (17.5 mm)	150
99132	Clear Anodized	3/4" (19 mm)	150

Minimum order: 20 stock lengths per size and color. Sizes can be combined for quantity pricing. Stock lengths are 12'8" (3.8 m). Must ship common carrier, unless you specify we cut them for U.P.S. A Cutting Charge will apply.

new

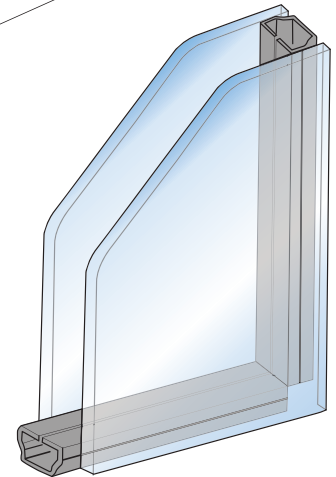

CRL Corners for Dual Seal Spacer

- Used Exclusively With CRL Dual Seal Spacer
- Made From Durable Nylon

This CRL Nylon Corner for dual seal units has a patented design which allows it to lock tightly into the Spacer to assure a positive seal. Made from nylon, these Corners won't crack or deteriorate over time. Use with CRL Low Profile Dual Seal Spacer only (see above). Quantity per case is 1000. Sold in increments of 100.

CAT. NO.	SIZE
92174	3/16" (4.8 mm)
92175	1/4" (6.3 mm)
92176	5/16" (7.9 mm)
92177	3/8" (9.5 mm)
92178	7/16" (11.1 mm)
92179	1/2" (12.7 mm)
92180	9/16" (14.3 mm)
92181	5/8" (15.9 mm)
92181A	11/16" (17.5 mm)
92182	3/4" (19 mm)

Minimum order 100 each. Must be ordered in increments of 100. Sizes can be combined for quantity pricing.

new

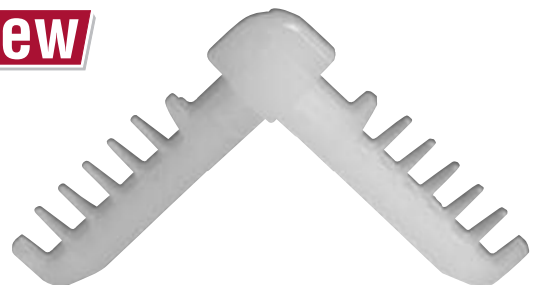

CRL Muntin Bars

- Fit Inside Spacer Frame to Create Colonial-Style Insulating Glass Units
- Easy to Fabricate

CRL Muntin Bars add a distinctive flair to your Insulating Glass units. They are ideal for the fabrication of Colonial-style windows. Muntin Bars are cut to size, and then assembled with CRL Muntin Bar Clips before being placed inside the unit.

For a professional 'crisscross' effect, use the CRL Manual Muntin Bar Notcher or the CRL Air Powered Muntin Bar Notcher (see page N472) and secure with the proper CRL Internal Muntin Joiners (see page N471).

Stock lengths of Muntin Bars are 12' 8" (3.9 m). There are two available finishes that will complement the trim of almost any home.

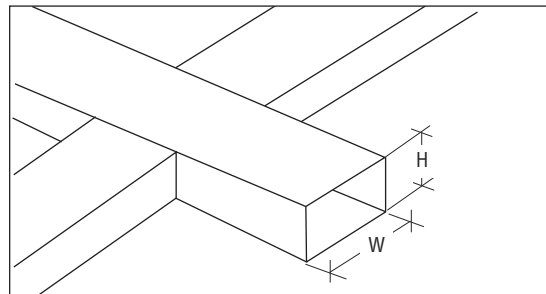

CAT. NO. 36006BRZ



CAT. NO. 36009BRZ



CAT. NO. 36012W



CAT. NO. 36004W

WHITE CAT. NO.	BRONZE CAT. NO.	SIZE HEIGHT X WIDTH	QTY/CASE
36006W	36006BRZ	3/16" x 13/16" (4.8 x 20.6 mm)	50
36009W	36009BRZ	3/16" x 9/16" (4.8 x 14.3 mm)	50
36012W	36012BRZ	3/16" x 5/8" (4.8 x 15.9 mm)	50
36004W	36004BRZ	3/16" x 3/4" (4.8 x 19 mm)	50

Minimum order: 1 stock length. A Packing Charge will be added to orders fewer than 20 combined lengths. Stock lengths longer than 98" (2.49 m) must ship common carrier, unless you specify we cut them for U.P.S. A Cutting Charge will apply. Sizes and colors can be combined for quantity pricing.

Easy Steps to High Quality Insulating Glass Muntin Bar Fabrication

- Muntin Bars Produce a Distinctive, Divided Lite Appearance for Colonial-Style Insulating Glass Units

For Colonial-style Insulating Glass units, install CRL Muntin Bars cut to length using the inside measurements of the spacer frame. As with spacer frame fabrication, Muntin Bars should be cut with a fine 100 to 150 tooth saw blade without oil or coolant. It is also recommended that Cat. No. NG171 Lint Free Gloves be worn while handling Muntin Bar lengths to reduce contamination (see page N373).

Measure and mark the cross points of Muntin Bars. Notch each bar with Cat. No. MMBN1 Manual Muntin Bar Notcher or Cat. No. APMN1 Air Powered Muntin Bar Notcher with the appropriate die and punch (see page N472).

After press fitting the Muntin Bar grid together, insert the appropriate Muntin Bar Clips. Larger Muntin Bar grids may require the use of internal Muntin Joiners. Drill or punch the spacer frames at the connecting points of spacer and Muntin Bar Clips. Use an electric hand drill, drill press or Cat. No. MBKP1 Muntin Bar Keeper Punch (see page N473). Finished Muntin Bar grids then are assembled into the spacer frame.

NOTE: Clean Muntin Bars before sealing unit with 1973 Glass Cleaner (see page N334). Do not use MEK, alcohol, or similar chemicals.



CRL Muntin Clips

- Designed to Work With CRL Muntin Bars
- Made From Durable Nylon



CAT. NO. 61071

CAT. NO. 61070

CAT. NO. 61072

CAT. NO. 61073

CRL Muntin Clips are designed to fit tightly in CRL Muntin Bars to properly secure the Muntin Assembly within the air space of an Insulating Glass unit.

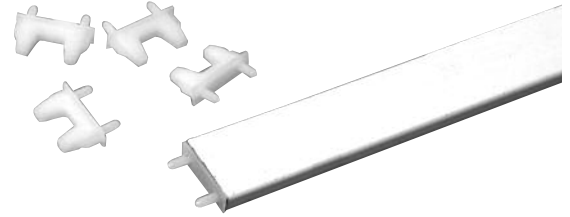

CAT. NO.	FITS BAR	PRONGS	QTY/BOX
61071	36006	1	100
61070	36009	1	100
61072	36012	1	100
61073	36004	2	100

Minimum order: 100 each. Must be ordered in increments of 100. All Muntin supplies can be combined for quantity pricing.

CRL Internal Muntin Joiner

- For Joining Notched Muntin Bars

The CRL Internal Muntin Joiner holds the notched bar intact during the grid and frame assembly. It makes assembling Muntin Bars easier and more manageable, especially for larger sized Insulating Glass units. Two sizes fit most applications.



CAT. NO.	FITS BAR	QTY/BOX
AM04	36004/36006	100
AM609	36009/36012	100

Minimum order: 100 each. Must be ordered in increments of 100. All Muntin supplies can be combined for quantity pricing.

CRL Flexible Muntin Locator

- Secures Sunburst and Wagon-Wheel Windows

Use the CRL Flexible Muntin Locator to secure sunburst and wagon-wheel windows in their frames. The flexible end pin helps eliminate unsightly gaps. They are an excellent aid in the fabrication of Insulating Glass units.



CAT. NO.	FITS BAR	QTY/BOX
AM06	36004/36006	100
AM12	36009/36012	100

Minimum order: 100 each. Must be ordered in increments of 100. All Muntin supplies can be combined for quantity pricing.

CRL Sunburst Muntin Joiner

- For Circle Top Windows
- Use With 36012 Muntin Bars Only

CRL Sunburst Muntin Joiners make half and full-circle windows easy to fabricate. The white, flexible nylon holds the muntin bar securely, producing great looking wagon-wheel windows. These Joiners are made for use with CRL 36012 Muntin Bars only.

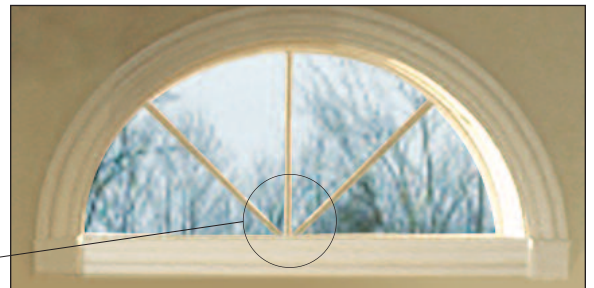

CAT. NO.	FITS BAR	QTY/BOX
AM601	36012	100

Minimum order: 100 each. Must be ordered in increments of 100. All Muntin supplies can be combined for quantity pricing.

CRL Manual Muntin Bar Notcher and Die Sets

- Each Precision Machined Unit is Made to Customer's Specifications
- Interchangeable Dies

This CRL Manual Muntin Bar Notcher will notch most Muntin Bars quickly and smoothly. Each Die Set is custom fabricated from hardened and ground tool steel. The Notcher comes with one Die Set. If you are using CRL Muntin Bar, no sample is required; simply provide the CRL Catalog Number of the Muntin being used. Otherwise, four sample pieces of your Muntin Bar, 24" (610 mm) long, are required in order to fabricate the Dies properly. Contact CRL Technical Sales for machine details and specifications.

Each CRL Die Set for the Muntin Bar Notcher is made from the finest heat-treated tool steel, and to your exact specifications. **NOTE:** To ensure a proper fit you must specify the distance between the mounting holes and the blade tip of your existing Die Set to match the new Blade and Die Set. Minimum order is one each.



CAT. NO. MMBD1E
Die Set for Muntin Bar Notcher

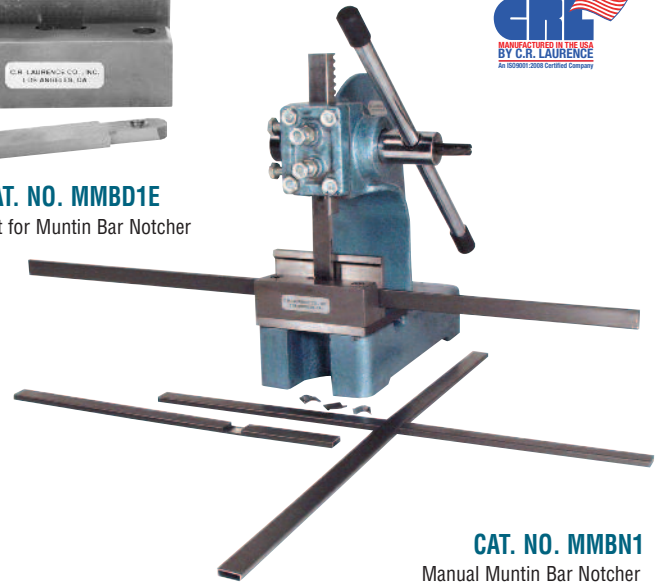

CAT. NO. MMBN1
Manual Muntin Bar Notcher

CRL Air Powered Muntin Bar Notcher and Punch and Die Sets

- For Fast Notching of Muntin Bars
- Excellent for Production Work

This CRL Air Powered Muntin Bar Notcher provides an accurate burr-free notch cut, and requires no hand cleaning. The guide bar has a graduated rule and a sliding stop for accurately spacing notches along the bar. All die sections are fabricated from hardened and ground tool steel.

The Notcher comes with a hand-operated Switch, Air Hose, Cutting Chart, and one Punch and Die Set. The machine requires 50 to 250 psi of air pressure for operation. A sample of the Muntin Bar to be used is required when ordering, and extra Punch and Die Sets are available. Also, Multiple Head Muntin Notchers (up to five heads) are available for larger production shops. Contact CRL Technical Sales for machine details and specifications. F.O.B. Canton, Michigan.



CAT. NO. APMN1
Air Powered Muntin Bar Notcher

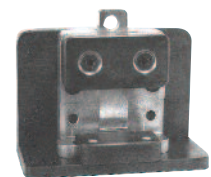

Punch and Die Set

CAT. NO.	DESCRIPTION
APMN1	Air Powered Muntin Notcher
APDS916	9/16" (14.3 mm) Punch and Die Set for CRL 36009 Muntin Bar
APDS58	5/8" (15.9 mm) Punch and Die Set for CRL 36012 Muntin Bar
APDS34	3/4" (19 mm) Punch and Die Set for CRL 36004 Muntin Bar
APDS1316	13/16" (20.6 mm) Punch and Die Set for CRL 36006 Muntin Bar

Minimum order: 1 each.

CRL Muntin Bar Router

- Made Especially to Cut Notches in Muntin Bar Prior to Fabrication
- Air Operated Hold Down Clamp
- Adjustable Cut-Off Gauge

The CRL Muntin Bar Router makes notches in Muntin Bars prior to Insulating Glass unit fabrication. The welded steel constructed table has a 3/16" (4.8 mm) thick aluminum top measuring 18" x 120" (457 mm x 3.04 m). An adjustable cut-off gauge is mounted on the table to line up the Muntin Bars prior to routing. The Router is mounted on a linear slide plate and will route a groove in a 15" (381 mm) wide gang of Muntin Bars, which are held in place by a pneumatic-actuated bar assembly. It comes complete with 110V AC Router. Contact CRL Glass and Glazing Technical Sales for machine details and specifications. F.O.B. Red Oak, Texas. Shipping weight: 500 pounds (227 kg). Minimum order is one each.

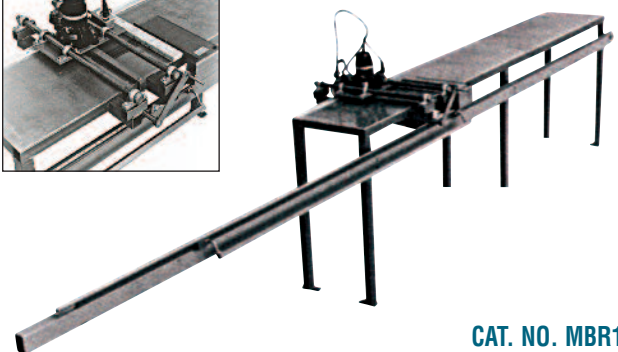
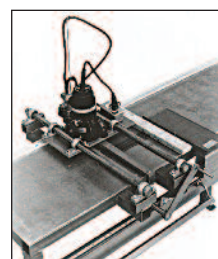

CAT. NO. MBR1
Muntin Bar Router

CRL Deluxe Spacer Bender

- Can Be Made to Accommodate Almost Any Size Spacer Bar
- Custom Manufactured by CRL

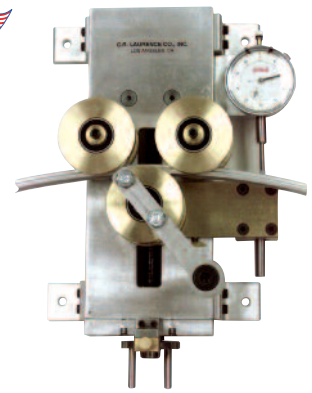

CAT. NO. DSBD1

This machine is designed to bend Spacer Bars to any radius allowable by the design of the Spacer. Manually operated, the CRL Spacer Bender uses a pressure drive roller with two forming die rollers. As the Spacer is forced through the forming dies, the degree of bend is increased through higher pressure from the drive roller with each successive pass, until the desired radius is attained. Quick interchanging of the forming die rollers allows total versatility in bending of different size Spacers.

Unit includes Dies for 3/16", 1/4", 5/16", 3/8", and 1/2" (4.8, 6.4, 7.9, 9.5, and 12.7 mm) standard height CRL, All Metal, and Nichols Homeshield Spacer profiles. **NOTE:** Will not work with Slim Line/Narrow profiles. Different widths, other Spacer brands, and all Slim Line Narrow profiles require custom Die Sets. These Custom Dies are manufactured to customer samples. Contact CRL Glass and Glazing Technical Sales for machine details and specifications. F.O.B. Los Angeles, California. Minimum order is one each.

CRL Muntin Bar Bender

- For Fabricating Curved Insulating Glass Units
- Each Unit is Custom Made By CRL

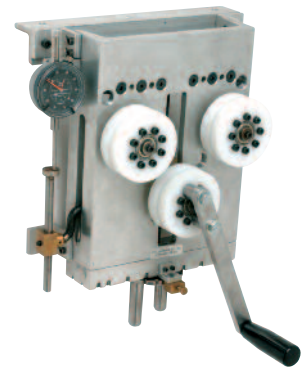

CAT. NO. MMBD1

The CRL Muntin Bar Bender easily bends Muntin Bar for Insulating Glass units with arched sunset patterns, as well as circular units. Any width of 3/16" (4.8 mm) thick Muntin Bar can be shaped with just a few quick passes. It has an easy-to-read indicator dial for quickly and accurately making repetitious bends.

The MMBD1 includes one set of Dies. If additional widths of muntins are going to need bending then an additional set of Dies will need to be ordered. If using Muntin Bars not sold by CRL then three each 36" (914 mm) samples of muntin must be sent to CRL. This is due to the tight machining tolerances needed to produce this precision piece of equipment. If you are using CRL brand Muntin Bar just specify the CRL catalog number that the Dies should be made to work with. Contact Glass and Glazing Technical Sales for machine details and specifications. F.O.B. Los Angeles, California. Minimum order is one each.

CRL Air Powered Muntin Clip Punch

- Accommodates 3/16" to 7/8" Aluminum Spacers
- For Single or Two-Prong Muntin Bar Clips

This CRL Air Powered Muntin Clip Punch is designed to accommodate 3/16" to 7/8" (4.8 to 22.2 mm) Spacers, and will punch holes for single or two-prong Muntin Bar Clips. It operates on air pressure from 50 to 250 PSI, and comes with a computer print-out Muntin Bar Spacing Chart. The chart shows machine stop settings for muntins up to 80" (2.03 m) long and up to six openings.

The Punch comes complete with a Stop Bar, one size Air Spacer Die, and one size Muntin Spacing Chart. When ordering, specify spacer and muntin sizes. Air Spacer Dies and Muntin Spacing Charts are available in all standard sizes. Specify centerline or off-center muntin clip holes when ordering Spacer Dies.

There are three available models to choose from, depending on what type of Muntin Bar Clip you are using. Customers ordering the MBKP1 will receive one Punch and Die with the unit. Spacer width and brand name must be designated. Additional widths of spacers require additional Dies. Customers must provide samples of their muntin clip (6 each) and spacer (4 each 6" [152 mm] long), unless they are using CRL components. Multiple Head Muntin Clip Punches (up to five heads) are available for larger production shops. Contact CRL Glass and Glazing Technical Sales for machine details and specifications.

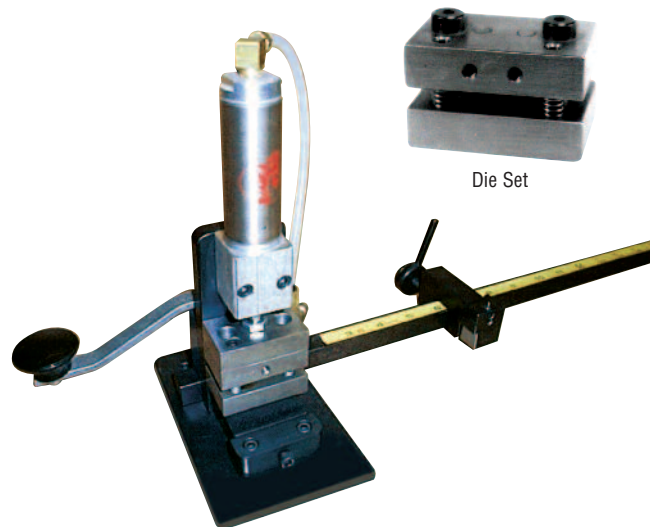

Air Powered Muntin Clip Punch

CAT. NO.	DESCRIPTION
MBKP1	Air Powered Muntin Clip Punch
MBKPD1E	Die Set for the MBKP1
MBKCH5	Spacing Chart for the MBKP1

Minimum order: 1 each. F.O.B. Canton, Michigan

CRL Rotary Sealant and Ball Caster Transfer Tables

- Sealant Application Tables to Fit Any Budget or Production Level
- Ball Caster Tables Sized to Fit Your Production Flow

CRL Rotary Work and Sealing Tables are available in five versions with varying levels of automation and capacity. All five are designed with on-board vacuum cup systems to firmly hold glass in place. The smallest options are floor pedestal and bench mount and have 9" (229 mm) vacuum cups and a 150 pound (68 kg) capacity. The largest option has an expandable ball caster top, adjustable height and 400 pound (182 kg) capacity, allowing for multiple unit stacking. All five Tables are controlled via convenient foot pedals. For full details and options on CRL Rotary Work and Sealing Tables refer to the Online Catalog at crlaurence.com.

CRL Ball Caster Tables are a must for any horizontal production line. CRL Ball Caster Tables are designed for material transfer from one production stage to the next, tilting for loading and unloading of product and inspection station for quality control. Tables range in size from 84" x 60" (2134 x 1524 mm) to 84" x 192" (2134 x 4877 mm), and are adjustable from 34" to 36" (864 to 914 mm) in height. All CRL Ball Caster Tables are fabricated with welded 2" (51 mm) tubular steel frames and are shipped KD (knocked down) for lower freight charges. For details refer to the CRL73 Master Catalog or the Online Catalog at crlaurence.com.

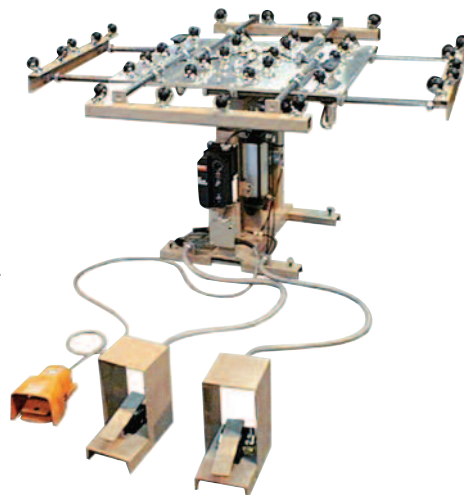

CAT. NO. PRST

CRL Glass Cutting Tables

- Wide Variety of Sizes
- Manual, Hydraulic and Spring Operated
- All Options Include Carpet
- Several In-Stock Options



CAT. NO. 2402500



CAT. NO. 2402522

CRL Cutting Tables are the first step in Insulating Glass production. Every custom insulating glass fabricator must be able to cut glass lites to size from stock sheets. CRL Cutting Tables range in size from the 6' x 8' (1829 x 2438 mm) portable folding table (Cat. No. STT1) to the 9' x 12' (2438 x 3658 mm) Hydraulic Tilting Table with Air Float and Breaker Bar (Cat. No. 2402522). The most common style, counter-balanced tilt top, is stocked by CRL in four popular sizes, ready for shipment from your local CRL warehouse.

Available options include Air Floatation to aid in moving sheets across the table surface, X and Y Breaker Bars to aid in running cuts in stock sheets, and Stab In or Roller Toes. These CRL Cutting Tables are proudly manufactured in the U.S.A. and all but one are fabricated at the Somaca/CRL Machinery Division in Cicero, Illinois. Get full details in our CRL73 Tools, Machinery, and Equipment Catalog, or online at crlaurence.com.

CRL Insulating Glass Storage and Handling Equipment

- Mobile Harp Racks and A-Frame Carts
- Various Sizes for Components and Finished Units

CRL Insulating Glass Storage and Handling Equipment include various sizes of Mobile Harp Racks that are designed either for organizing individual glass lites before assembly, or for staging completed units post assembly. The CRL A-Frame Carts are fabricated with true 90 degree deck angles to eliminate shearing problems that can occur with some Insulating Glass sealant systems. These Carts are ideal for staging product prior to pick-up or delivery. Most have locking casters and pull bars to facilitate loading and unloading, as well as movement from production to storage. Get full details in our CRL73 Tools, Machinery, and Equipment Catalog, or online at crlaurence.com.



CAT. NO. R55RACK

CRL Vertical Glass Washing Machines

- Closed or Open Top Models
- Four or Six Brush Options

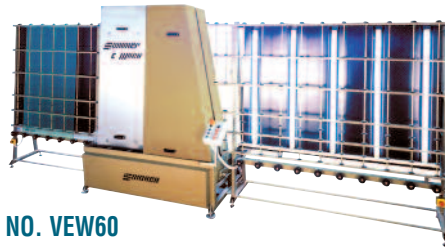

CAT. NO. VEW60



CAT. NO. SM70V

The Vertical Washing Machines offered by the Somaca/CRL Machinery Division come in two distinctly different styles: Open Top, which allows glass processing sizes twice the height of the brush length, and Closed Top, which restricts the glass size to the brush length. The two Open Top models feature four Low-e compatible brushes while the Closed Top are all six brush machines. All brush and air-knife compartments are easily accessible from front and rear for easy cleaning and maintenance.

The most popular feature of the Somaca/CRL Vertical Washing Machine line is the extremely small footprint when compared to horizontal washing machines. Companies with floor space or expansion issues will appreciate the relatively small amount of space these rugged machines occupy. The VEW60 measures just 222" x 60" (5639 x 1524 mm).

Small space, rugged design and feature loaded, Somaca/CRL Vertical Washing Machines are the first choice for growing insulating glass manufacturers. See our CRL73 Master Catalog or the Online Catalog at crlaurence.com for details on the full line of quality Vertical Washing Machines from the Somaca/CRL Machinery Division of CRL.

CRL TTW Horizontal Glass Washing Machines

- High Production Capability
- Two, Four or Six Brush Options
- Available in Four Standard Widths



CAT. NO. TTW606



CAT. NO. TTW966

The Somaca/CRL Machinery Division has been producing Horizontal Glass Washing Machinery for over 70 years. Long the industry leader and popular worldwide, Somaca/CRL Horizontal Glass Washing Machines have been included in glass manufacturing processes that include: insulating, tempering, laminating, mirror silvering, art framing, and window manufacturing.

What is TTW? Tilt Top Washer. The Somaca/CRL Horizontal Washing Machines are designed so the top roller assembly can be tilted up from either end, or lifted off entirely with an overhead crane for easy maintenance of the internal brush area. With a variety of options, you can order a custom washing machine detailed to your exact specifications, or choose from a more standardized selection loaded with the most commonly selected features. Brush selection (2, 4, or 6) depends on the finished level of cleanliness your product demands, combined with the type of debris needing to be removed. A six brush Horizontal Washing Machine will produce insulating glass quality with its 3 up, 3 down configuration.

Somaca/CRL Horizontal Washing Machines are offered in four standard frame widths: 36", 60", 84", and 96" (915, 1524, 2134, and 2438 mm), but can be custom built to any size. Somaca/CRL Horizontal Glass Washing Machines are capable of line speeds of up to 35 feet (10.7 m) per minute. Insulating glass production centering around a TTW966 Washer running at 35 feet per minute will be limited only by the speed of the crew to load and unload the washer conveyors.

See the full line of Somaca/CRL Horizontal Washing Machines in our CRL73 Master Catalog or the Online Catalog at crlaurence.com.

CRL Dual Seal High Capacity Insulating Glass Production Lines

- Available in Automatic or Semi-Automatic Configurations
- Closed Top Washer Heights From 63" to 98" (1600 to 2489 mm)
- Maximum Glass Lengths From 78" to 140" (1981 to 3556 mm)

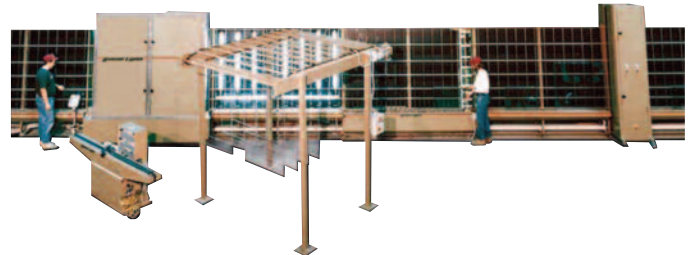

The function of Somaca/CRL Insulating Glass Production Lines is to thoroughly wash both lites of glass, stage the second lite over the dual seal spacer and first lite (either automatically or manually in the semi-auto versions), press both lites evenly to thoroughly spread the polyisobutylene primary sealant, and then tilt the units down for movement to the secondary sealant area.

These Somaca/CRL Insulating Glass Lines are available in five sizes to fit your production requirements, with each size offered in Automatic or Semi-Automatic Configurations. See our CRL73 Master Catalog or the Online Catalog at crlaurence.com to find the equipment to fit your production needs.

CRL Glass-Chek PRO Glass Thickness Meter and Low-e Coating Detector

new

- Triple Pane Thickness Measurement
- Full Low-e Detection Capabilities
- Enhanced Compatibility Means More Applications

GC3000 Glass-Chek PRO measures glass, air space and overall IG thickness of triple pane windows, all with a single test from one side of the window. It works with single and double pane applications as well.

The GC3000 is a fully equipped Low-e Coating Detector capable of locating a Low-e coating on any surface of a double pane window from a single side. This is a major time saver for testing multi-story buildings where you only have access to the inside of the window.

No other meter in the world can handle the same combination of applications. With an expanded thickness range to 1-1/2" (38 mm), the Glass-Chek PRO is compatible with residential and commercial glass. It is also compatible with new Low-e coatings, suspended film (i.e., Heat Mirror), tinted glass, laminated glass with Low-e against the laminate layer, and most commercial reflective glass. Minimum order is one each.



CAT. NO. GC3000

- Reduce Measurement Errors
- Measure Glass Deflection in Sealed IG Window Assemblies
- Uses a 9-Volt Battery – Common and Easily Replaceable
- Protective Carrying Case is Included
- Simple to Use Suitable for New or Experienced Window Installers, Production Personnel, Building Inspectors or Surveyors
- Made in the U.S.A.

Choose from Multiple Display Formats

You can set up the Glass-Chek PRO to display measurement results in the format that works best for you. Choose from actual values or rounded (to ASTM Standards) in fractions of an inch, thousandths of an inch, decimals of an inch, millimeters, and more.

Glass Thickness Capabilities Illustration

Measure the thickness of each pane, each air space, and the total IG thickness in single, double, and triple pane windows

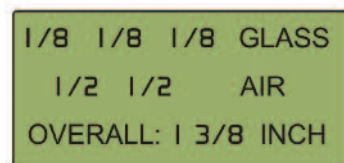

Display example outlining the glass, air space, and overall thickness of a triple pane window. Example shows readings in fractions of an inch, but the meter can be easily set up to display readings in other formats.

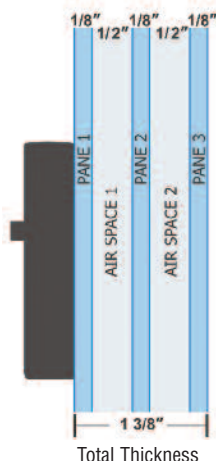

Triple Pane Window

Low-e Coating Detection Illustration

Detect the presence and location of Low-e coatings on any surface of the first two panes. The meter will specify whether the coating is on surface one, two, three/four or "CLEAR" if no coating is present.



Display example indicates the Low-e coating is on surface 3 of the window. This means the coating is on the inside surface of the second pane. The GC3000 will detect coatings on any of the surfaces of a double pane window and most triple pane windows.

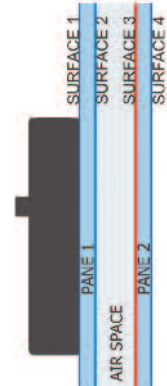

Double Pane Window

CRL Glass Thickness Laser

- Measures Thickness of Air Space in Sealed Insulating Glass Units and Overall Unit Thickness
- Measures From Inside of the Building – No Glass Removal is Necessary
- Uses Laser Technology for Exact Measurements
- Calculates Thicknesses of Insulating Glass, Laminated, Bullet Resistant, and Single Lite Float Glass
- Simple to Use – Just Press a Button and Read the Measurements

- Fractional Inch and Metric Measurement Models

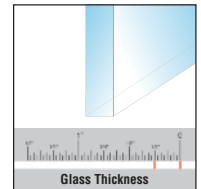

Float Glass and Mirror

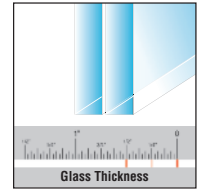

Laminated Glass (Any Thickness)

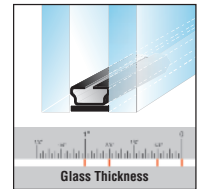

Double and Triple Glazed I.G. Units

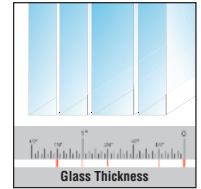

Bullet Resistant Glass (Any Combination of Thicknesses)

The CRL Glass Thickness Laser is a breakthrough in glass measuring devices. It will give you the same exacting readout as digital units costing hundreds more. Not only does the MG1500 measure standard Insulating Glass units, but it will also measure triple-glazed I.G. units, laminated glass, Low-e surfaces, and multi-layer bullet resistant glass. Best of all, the MG1500 is accurate from either side of the unit, so removal of the panel is not required. This is especially convenient in multiple-story buildings.

Designed for use in the field, glaziers and inspectors alike can easily carry it in their shirt pocket, on their belt, or just about anywhere the convenient carrying case will fit. The MG1500 is powered by two AAA batteries, which are included.

IMPORTANT NOTE: Avoid looking into laser beams at all times, as they can cause damage to your eyes.

Overall Insulating Glass Thickness Scales

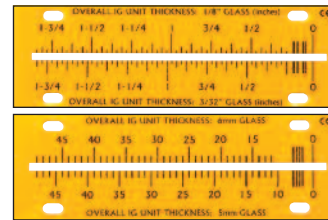

Fractional Inch and Metric Scale Sets are Interchangeable

CAT. NO.	DESCRIPTION
MG1500	Fractional Inch Laser
MG1500MM	Metric Laser
MG1500FS	Fractional Scale Set Only
MG1500MS	Metric Scale Set Only

Minimum order: 1 each.

CRL Glass-Chek+ Digital Glass Thickness Meter With Low-e

new

- Measures Insulating Glass Units – Thickness of Lite, Air Space, and Overall Thickness Up to 1-1/2" (38.1 mm)
- Also Detects Low-e Coating and Compatible With Tinted Glass
- Factory Calibrated, Needs No Field Adjustments
- Digital Readout in Decimal, Fractional, and Metric

The new CRL Glass Chek+ Digital Glass Thickness Meter with Low-e Sensor is descended from the single pane Low-e coating detector, however the GC2001 is now able to differentiate whether the Low-e is on Surface 1 or Surface 2 of the glass. Another one of the biggest improvements is its ability to test tinted glass and the newest Low-e coatings that have been introduced in the past few years. This unit is capable of testing the thickness of single or double pane windows. Simply press the Glass-Chek Meter against a single lite of glass, or a dual lite window assembly, push the button and hold it until the measurements are digitally displayed. The thickness of each lite of glass, the air space, and the overall thickness of the unit will simultaneously appear on the two-line liquid crystal display. Unit can be read in decimal, fractional and metric. For best results, clean the window prior to testing. Uses one 9V DC battery (included). Minimum order is one each.



CAT. NO. GC2001
Glass-Chek+

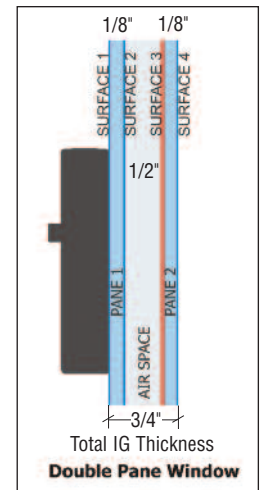

CRL Insulating Glass Caliper

- Measures Insulating Glass Unit Thickness in Sliding Windows and Doors
- Quick and Easy to Use
- Fractional or Metric Scales on Both Sides

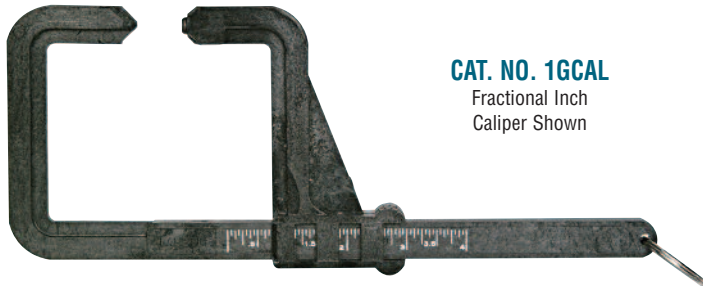

CAT. NO. 1GICAL
Fractional Inch
Caliper Shown



The CRL Insulating Glass Caliper makes it easy to measure the overall thickness of insulated glass panels in sliding windows and doors even when the panels have been glazed into a sash frame. This useful tool will measure up to 4" (102 mm) thick panels. The calibrated scale appears on both sides for quick and convenient measurements. Made of a high impact resistant composite material for durability.

CAT. NO.	DESCRIPTION
1GICAL	Fractional Inch Caliper
1GICALMM	Metric Caliper

Minimum order: 1 each.

CRL Insulating Glass Thickness Gauge

- Works on Dual or Triple Glazed Units From 7/16" to 1-1/4" (11 to 32 mm) Thick
- No Opening or Disassembly of Windows Required
- Also Measures Thickness of Single Pane Windows

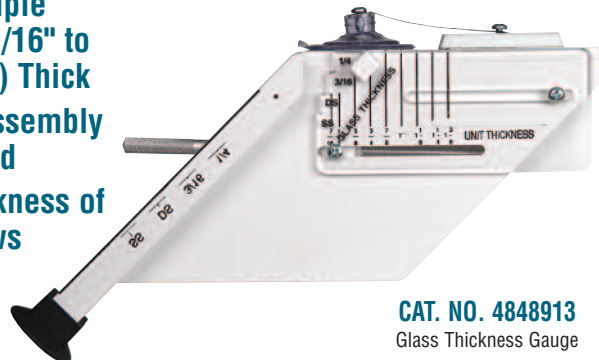

CAT. NO. 4848913
Glass Thickness Gauge



The CRL Insulating Glass Thickness Gauge is a precise tool designed to accurately measure the glass thickness and overall unit thickness of multiple glazed windows in fractional increments. It works on any clear glass unit from 7/16" to 1-1/4" (11 to 32 mm) overall thickness. There is no need for exposed edges or openings, as the Gauge works by reflections, using a line-of-sight viewer that targets the exact thickness of the unit. The supplied reflector unit is held in place by a suction cup base. It is a time and money saver for anyone in the Insulating Glass field. Minimum order is one each.

CRL Glass Thickness Gauges

The CRL Glass Thickness Gauge measures single pane thickness even when it is not possible to measure the glass from the edge. Place the long edge of the Gauge against the glass and tilt the Gauge upward to a 45 degree angle to the glass surface. Look into the glass at the reflection of the Gauge and compare each short line with the long continuous line. Pick the one short line that is shown in the reflection within the same plane as the long line, and read the glass thickness measurement as indicated above that line. This is your glass thickness. Minimum order is one each.

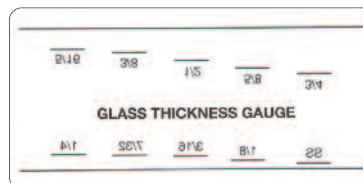
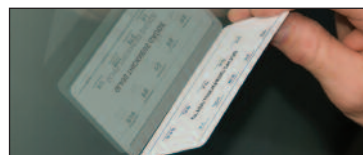

CAT. NO. G1340
Fractional Gauge

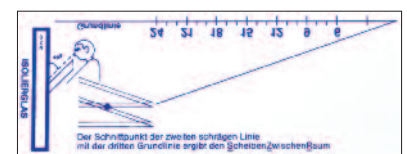

CAT. NO. GTG1
Metric Gauge

CRL Pilkington® K Glass™ Detectors

• Available in Europe Only

new

- Identify Low Emissivity Low-e Coated Glass
- For Single and Double Glazed Glass
- Comprehensive Instructions Included

Our CRL Pilkington® K Glass™ Detectors have been developed to distinguish low emissivity coated glass from ordinary float glass. These units are available for single glazed or double glazed units, as well as a combination detector.

CAT. NO.	DESCRIPTION
0472S	Single Glazed Glass
0472D	Double Glazed Glass
0472C	Combined Single and Double Glazed

Minimum order: 1 each.



CAT. NO. 0472S

CAT. NO. 0472D

CAT. NO. 0472C

CRL Merlin Lazer Low-e Coating Detector

- Easily Identify Low-e Glass at the Touch of a Button
- Ideal for Checking Document L Compliance
- Available in Europe Only

The CRL Merlin Lazer Low-e Coating Detector is a dual-purpose tester designed to detect Pilkington® K Glass™ and all other low emissivity coatings on single and double glazed units, and to indicate on which surface it is present. Installers and inspectors can verify the presence of the coating and the correct orientation of the unit. Minimum order is one each.



new

CAT. NO. 0482

CRL Merlin Lazer Glass Measuring Gauge

- Quickly and Accurately Identify Laminated Glass
- No Glass Removal Necessary
- Available in Europe Only

Our CRL Merlin Lazer Glass Measurement Gauge is a very simple but effective precision measurement instrument that provides accurate measurement of single glass and air gap thickness in single, double, and triple glazed units. It is also able to identify laminate interlayers at a touch of a button. All readings can be taken from one side without the need to remove the glass.

Minimum order is one each.



new

CAT. NO. 0480

CRL Merlin Lazer Toughened Glass Indicator

- Quickly Verify Whether Glass Has Been Toughened
- Identify From One Side Only
- Available in Europe Only

The CRL Merlin Lazer Toughened Glass Indicator is able to indicate toughened glass in single and multi-pane units from one side only at the touch of a button. This makes it an ideal solution to safely determine whether glass has been toughened or not. Minimum order is one each.



new

CAT. NO. 0481

CRL Double-Pane Low-e Coating Detector

- Detects Invisible Low-e Coatings
- Ensures Windows are Installed Correctly
- Wide Temperature Stability
- Low-Battery Indicator

The CRL Low-e Glass Coating Detector senses the presence (or absence) and location of thermally resistant coatings (Low-e) used on single strength and double strength energy efficient glass from a single side. This helps to ensure windows are installed correctly.

This second generation tool offers enhanced reliability and temperature stability over its predecessor. Simple indicator lights check clear, near, or far surfaces. The unit requires one 9V DC Battery, which is included. The low-battery sensor causes the indicator lights to blink when the battery needs replacing. Minimum order is one each.



new



CAT. NO. AE1601

CRL Low-e Coating Contact Meter

- Detects Hard or Soft-Coat Low-e Applications
- Reduces Costly Mistakes in Manufacturing
- Economically Priced

The CRL Low-e Coating Contact Meter is a simple instrument that detects any conductive surface, including Low-e coatings, on a single sheet of glass. The Meter has four non-scratch pads on the reverse side that you press against the glass to determine if that surface has any conductive Low-e coatings.

The CM1030 is the ideal tool to use during the manufacture of Low-e Insulating Glass units. You can easily check glass surfaces for coatings without any extensive training. If the Meter detects a coating on the surface an indicator lights up to signal its presence. One 9V DC Battery is included. Minimum order is one each.



CAT. NO. CM1030

CRL Solar Transmission and BTU Power Meter

- Demonstrate Your Product's Solar Performance
- Displays Solar Transmission and BTU Power Readings
- Easily Switches to BTU Measurements

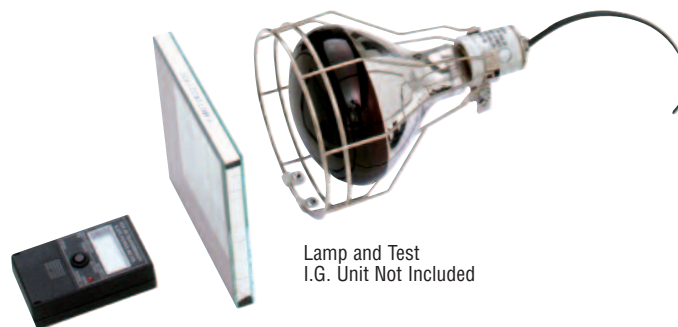

Lamp and Test I.G. Unit Not Included



CAT. NO. SP2065

The innovative CRL Solar Transmission and BTU Power Meter demonstrates both the solar transmission percentage of your window and, with the press of a button, the BTU values. It's two meters in one! Can also be used to measure the approximate solar heat gain co-efficient value for windows. The SP2065 is included in the Cat. No. SK1740 Sales Demo Kit, or you can order it separately. Meter comes with a 9V DC Battery. Additional details are available online at crlaurence.com. Minimum order is one each.

CRL Urethane Systems



- Complete Adhesive Systems That Meet or Exceed U.S. Federal Motor Vehicle Safety Standards 208, 212, and 216
- POWR BOND or POWR Primerless, Both Brands Provide High Performance at Cost-Efficient Pricing
- High and Medium Viscosity Formulas Offer You a Choice of Price Points
- Low or Non-Conductive Formulas for Special Vehicle Applications
- A Full Complement of Pinchweld Primer and UV Blockers

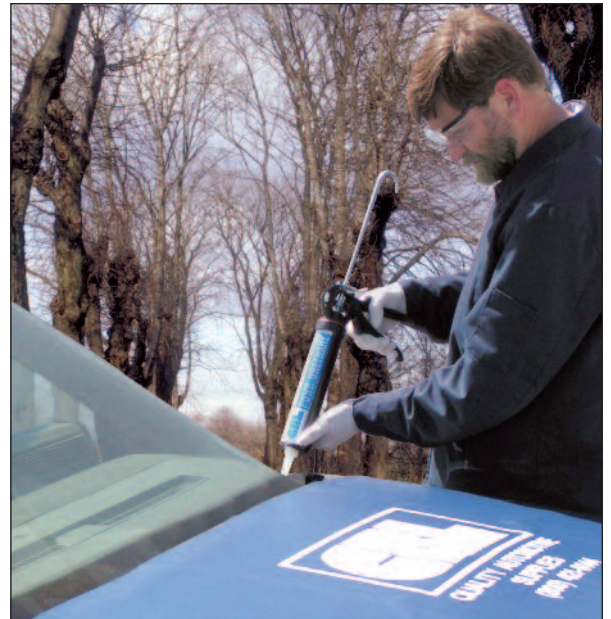

POWR BOND

Three Formulas:

1. High Viscosity
 2. One-Hour Cure
 3. Heat Accelerated
- Plus a One Step Primer



See pages N482-N483

POWR PRIMERLESS

Three Formulas:

1. High Viscosity
 2. Medium Viscosity
 3. High Modulus/Low-Conductive
- Plus a Pinchweld Primer and EPDM/PVC Primer With UV Blocker



See pages N484-N485

Certification Testing



- All CRL Urethane Systems Are Part of the LYNX Services Quality Adhesive Program
- Certification Testing Online Via the CRL Web Site

Certification testing for auto glass professionals using CRL Automotive Urethanes is available online at crlaurence.com. Visit our web site for information about and access to our online test. After submitting and passing the test, a certificate suitable for mounting will be sent to you via certified mail.



CRL POWR BOND High-Viscosity Auto Glass Urethane Adhesive

new

SPEC. DATA

MSDS



- Meets or Exceeds U.S. Federal Motor Vehicle Safety Standards 208 and 212
- Value Priced, Fast Curing, Cold Applied
- Part of the LYNX Services Program

CRL POWR BOND High-Viscosity Auto Glass Urethane Adhesive is a fast curing adhesive that passes or exceeds U.S. Federal Motor Vehicle Safety Standards FMVSS212 (Barrier Crash Test) and FMVSS208 (Occupant Crash Protection) in its most severe interpretation with dual air

bags and unrestrained dummies. The fast curing formula is tack free in only 50 ±10 minutes and offers safe drive away time in as little as 1-1/2 hours when used on vehicles without a passenger side air bag, 3 hours with passenger air bag at 73°F (23°C) and 45% RH (relative humidity).

Cleaning and Primers - CRL Urethanes are supported by a One Step Primer, Cat. No. 1214006, and an aerosol cleaner, Cat. No. PWR22, formulated for use in all aspects of glass bonding, including the glass frit, pinchweld, and EPDM/PVC moldings. (1) After removing all of the old urethane to within 1/16" (1.6 mm) of the pinchweld, prepare the pinchweld following the procedures outlined in the CRL Technicians Training Manual. Prime these areas with Cat. No. 1214006 One Step Primer; (2) Clean the inside of the windshield with a lint-free towel, Cat. No. BX15, nylon pad, Cat. No. NP48, and Cat. No. PWR22 Automotive Glass Cleaner; (3) Apply Cat. No. 1214006 One Step Primer to the frit area with a dauber and allow to dry for a minimum of 10 minutes, but no more than 8 hours before installing the adhesive. This procedure must be performed above 40°F (4°C). **NOTE:** POWR BOND One Step Primer must be used prior to any adhesive application to prevent glass displacement. Failure to do so may result in personal injury or property damage; (4) Apply Cat. No. 1214006 One Step Primer to encapsulated moldings if they are part of the bonding area.

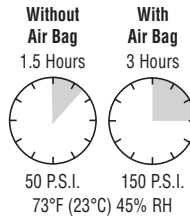

10.5 Fl. Oz. (310 ml);
12 Cartridges Per Case; 1488 Cartridges Per Pallet

CAT. NO.	CONTENTS	QTY/CASE
1217349	10.5 Fl. Oz. (310 ml)	12

Minimum order: 1 each. All automotive sealants can be combined for quantity pricing.

CRL POWR BOND One Hour Auto Glass Urethane Adhesive

new

SPEC. DATA

MSDS



- Safe Driveaway in Only One Hour
- Meets or Exceeds U.S. Federal Motor Vehicle Safety Standards 208 and 212
- Part of the LYNX Services Program

CRL One Hour Auto Glass Urethane Adhesive is a high-viscosity, non-conductive, super-fast curing adhesive with excellent decking that passes or exceeds U.S. Federal Motor Vehicle Safety Standards FMVSS212 (Barrier Crash Test) and FMVSS208 (Occupant Crash Protection) in its most severe interpretation with dual air bags and unrestrained dummies. The fast curing formula is tack free in 10 minutes, and offers safe drive-away time in only one hour at 0°F (-17.8°C). It is normally cold applied, however, it can be heated in a Urethane Oven to help gun the high viscosity formula.

Cleaning and Primers - CRL Urethanes are supported by a One Step Primer, Cat. No. 1214006, and an aerosol cleaner, Cat. No. PWR22 formulated for use in all aspects of glass bonding, including the glass frit, pinchweld, and EPDM/PVC moldings. (1) After removing all of the old urethane to within 1/16" (1.6 mm) of the pinchweld, prepare the pinchweld following the procedures outlined in the CRL Technicians Training Manual. Prime these areas with Cat. No. 1214006 One Step Primer; (2) Clean the inside of the windshield with a lint-free towel, Cat. No. BX15, nylon pad, Cat. No. NP48, and Cat. No. PWR22 Automotive Glass Cleaner; (3) Apply Cat. No. 1214006 One Step Primer to the frit area with a dauber and allow to dry for a minimum of 10 minutes, but no more than 8 hours before installing the adhesive. This procedure must be performed above 40°F (4°C). **NOTE:** POWR BOND One Step Primer must be used prior to any adhesive application to prevent glass displacement. Failure to do so may result in personal injury or property damage; (4) Apply Cat. No. 1214006 One Step Primer to encapsulated moldings if they are part of the bonding area.

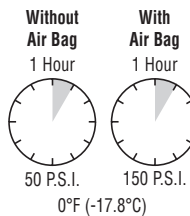

10.5 Fl. Oz. (310 ml);
12 Cartridges Per Case; 1488 Cartridges Per Pallet

CAT. NO.	CONTENTS	QTY/CASE
1214002	10.5 Fl. Oz. (310 ml)	12

Minimum order: 1 each. All automotive sealants can be combined for quantity pricing.

CRL AUTO GLASS SEALANTS

For Pricing Visit Our Web Site or Call Us Toll Free at the Phone Numbers Shown on the Back Cover

CRL POWR BOND Heated High Modulus Auto Glass Urethane Adhesive

new

SPEC. DATA MSDS

- Heat Accelerated Curing Provides Fast, Safe, Drive Away Times
- Meets or Exceeds U.S. Federal Motor Vehicle Safety Standards 208 and 212
- Part of the LYNX Services Program



10.5 Fl. Oz. (310 ml);
12 Cartridges Per Case; 1488 Cartridges Per Pallet

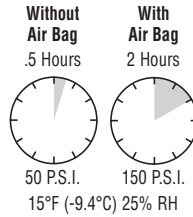

CRL Heated Auto Glass Urethane Adhesive is specially formulated as a safe, fast alternative to room-temperature-applied, one-component urethanes. CRL Heated Urethane Adhesive accelerates the curing of the material when heated

first in a Urethane Oven to provide you with fast, safe, driving release times for customers who demand their vehicle back quickly. CRL Heated Urethane Adhesive passes or exceeds U.S. Federal Motor Vehicle Safety Standards FMVSS212 (Barrier Crash Test) and FMVSS208 (Occupant Crash Protection) in its most severe interpretation with dual air bags and unrestrained dummies. The fast curing formula offers safe drive away time in as little as 30 minutes when used on vehicles without a passenger side air bag, or two hours with passenger air bag at 15°F (-9.4°C) and 25% RH (relative humidity).

Cleaning and Primer - CRL Urethanes are supported by a One Step Primer, Cat. No. 1214006, and an aerosol cleaner, Cat. No. PWR22, formulated for use in all aspects of glass bonding, including the glass frit, pinchweld, and EPDM/PVC moldings. (1) After removing all of the old urethane to within 1/16" (1.6 mm) of the pinchweld, prepare the pinchweld following the procedures outlined in the CRL Technicians Training Manual. Prime these areas with Cat. No. 1214006 One Step Primer; (2) Clean the inside of the windshield with a lint-free wipe, Cat. No. BX15, nylon pad, Cat. No. NP48, and PWR22 Automotive Glass Cleaner; (3) Apply the same One Step Primer to the frit area with a dauber and allow to dry for a minimum of 10 minutes, but no more than 8 hours before installing the adhesive. This procedure must be performed above 40°F (4°C). **NOTE:** POWR BOND One Step Primer must be used prior to any adhesive application to prevent glass displacement. Failure to do so may result in personal injury or property damage; (4) Apply Cat. No. 1214006 One Step Primer to encapsulated moldings if they are part of the bonding area.

CAT. NO.	CONTENTS	QTY/CASE
1214001	10.5 Fl. Oz. (310 ml)	12

Minimum order: 1 each. All automotive sealants can be combined for quantity pricing.

CRL POWR BOND One Step Primer

- Universal Primer Required for a Secure Bond
- Use on Glass, Pinchweld, Bare Metal, and EPDM/PVC Moldings
- Part of the LYNX Services Program

SPEC. DATA
MSDS
NO AIR FREIGHT



NOTE: One Step Primer must be used prior to any adhesive application to prevent glass displacement. Failure to do so may result in personal injury or property damage.

CAT. NO. 1214006
4 Fl. Oz. (125 ml)

CRL One Step Primer chemically reacts with the glass frit and urethane to provide a secure bond. Clean new glass first with PWR22 Automotive Glass Cleaner, and then apply One Step Primer to the frit with a dauber. Allow the primer to dry for a minimum of 10 minutes, but no more than 8 hours before installing adhesive. This procedure must be performed above 40°F (4°C). One Step Primer may also be used on glass supplied without black ceramic frit to improve adhesion. You can also apply it to bare pinchweld metal scratches or rust areas that have been properly repaired prior to priming. Minimum order is one each.

CRL Urethane Heater Ovens

- Preheats Urethane to Desired Working Temperature in One Hour
- Available in 120V AC or 12V DC Models

CRL Urethane Heater Ovens are designed to warm CRL POWR BOND Heated Urethane and other manufacturers' heated urethanes to the ideal application temperature of 185°F (85°C) within one hour.



CAT. NO.	DESCRIPTION	CAPACITY
E9006	120V AC Oven	2 Cartridges
E9007	12V DC Oven	2 Cartridges
E9011	120V AC Oven	6 Cartridges

Minimum order: 1 each.

crlaurence.com

crlaurence.ca crlaurence.com.au crlaurence.co.uk crlaurence.de crlaurence.eu | N483

C.R. LAURENCE COMPANY



CRL POWR Primerless 301HV High Viscosity Urethane Adhesive

- Primerless to Auto Glass Frit
- Rates Non-Conductive, High Modulus
- Accelerated Cure
- Part of the LYNX Services Program
- Wide Mouth Nozzles Included

This primerless to auto glass frit High Viscosity Urethane is a high quality adhesive that passes or exceeds the requirements of U.S. Federal Motor Vehicle Safety Standards 208, 212, and 216, as well as OEM specifications. With over 1,000 psi of tensile strength and 550 psi lap shear at ultimate cure, PP301HV is one of the safest and strongest urethanes offered for the aftermarket. This urethane has a new Aggressive Adhesion Formula that has proven itself to aggressively bond to all automotive glass frits without the need for a glass primer. Designed to support auto glass without the use of dam tape. Long term exposure testing confirms that the new formula stands up to the harshest environmental conditions.

POWR 300 Series is formulated without isocyanates. As a result, this new formulation produces a by-product of moisture in the curing process, accelerating the curing process and providing faster safe drive away times.

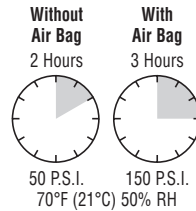

10.1 Fl. Oz. (300 ml); 24 Cartridges Per Case, 1440 Cartridges Per Pallet

In addition to these features, POWR 300 Series Urethane has a new wide mouth cartridge that provides a 60% larger nozzle opening than standard cartridges, enabling an increased flow of the material with less force. Re-engineered nozzles supplied with POWR 300 Series Urethane are designed for easy trimming to accommodate back filling operations. They can also be trimmed further to produce a full round bead. The V-Notch indentation can be used for trimming the nozzle for the proper urethane bead dispensing height.

CAT. NO.	CONTENTS	QTY/CASE
PP301HV	10.1 Fl. Oz. (300 ml)	24

Minimum order: 1 each. All automotive sealants can be combined for quantity pricing.

CRL POWR Primerless 302MV Medium Viscosity Urethane Adhesive

- Primerless to Auto Glass Frit
- Medium Modulus
- Accelerated Cure
- Part of the LYNX Services Program
- Wide Mouth Nozzles Included

This primerless to auto glass frit Medium Viscosity Urethane is a high quality adhesive that passes or exceeds the requirements of U.S. Federal Motor Vehicle Safety Standards 208, 212, and 216, as well as OEM specifications. PP302MV has over 1,000 psi of tensile strength and 550 psi lap shear at ultimate cure. This urethane has a new Aggressive Adhesion Formula that has proven itself to aggressively bond to all automotive glass frits without the need for a glass primer. The easy gunning viscosity is great for back filling gasket set glass or, if used with foam sound tapes, saves the cost of using a high viscosity product. Long term exposure testing confirms that the new formula stands up to the harshest environmental conditions.

POWR 300 Series is formulated without isocyanates. As a result, this new formulation produces a by-product of moisture in the curing process, accelerating the curing process and providing faster safe drive away times.

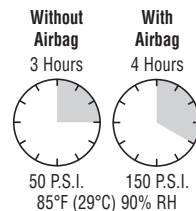

10.1 Fl. Oz. (300 ml); 24 Cartridges Per Case, 1440 Cartridges Per Pallet

POWR 300 Series Urethane has a new wide mouth cartridge that provides a 60% larger nozzle opening than standard cartridges, making possible an increased flow of the material with less force. The V-Notch indentation can be used for trimming the nozzle for the proper urethane bead dispensing height. Nozzles are designed for easy trimming to accommodate back filling operations, or to be trimmed further to produce a full round bead. The V-Notch indentation can be used for trimming the nozzle for the proper urethane bead dispensing height.

CAT. NO.	CONTENTS	QTY/CASE
PP302MV	10.1 Fl. Oz. (300 ml)	24

Minimum order: 1 each. All automotive sealants can be combined for quantity pricing.

CRL POWR Primerless 303HL High Modulus/Low-Conductive Urethane Adhesive

- Primerless to Auto Glass Frit
- High Modulus, Low-Conductive
- Accelerated Cure
- Part of the LYNX Services Program
- Wide Mouth Nozzles Included



10.1 Fl. Oz. (300 ml); 24 Cartridges Per Case, 1440 Cartridges Per Pallet

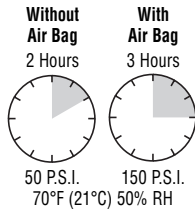

This primerless to auto glass frit High Modulus/Low-Conductive Urethane is a high quality adhesive that passes or exceeds the requirements of U.S. Federal Motor Vehicle Safety Standards 208, 212, and 216, as well as OEM specifications. With over 1,000 psi of tensile strength, and 550 psi lap shear at ultimate cure, PP303HL is one of the safest and strongest urethanes available.

Virtually all European vehicles have specifications for High Modulus Urethane to be used when replacement glass is required. Additionally, aluminum bodied vehicles require low conductive urethane to prevent electrical current from passing from the glass to the body and creating corrosion. The Low-Conductive aspect of the formula is also required for glass with embedded electronic devices.

High Modulus is completely different from High Viscosity because the High Modulus specification is the physical property of the material after it has cured (stiffness), where the High Viscosity specification is the physical property of the material in the liquid state (thickness). In the circumstance where this material is required for rigidity, it is very important, as the driving characteristics of the vehicle could be altered by not using a High Modulus Urethane.

PP303HL has a new Aggressive Adhesion Formula that has proven itself to aggressively bond to all automotive glass frits without needing a glass primer. Long term exposure testing confirms that the new formula stands up to the harshest environmental conditions. POWR 300 Series is also formulated without isocyanates. As a result, this new formulation produces a by-product of moisture in the curing process, accelerating the curing process and providing faster safe drive away times.

POWR 300 Series Urethane comes in a new wide mouth cartridge that provides a 60% larger nozzle opening than standard cartridges, enabling improved flow with less force. Nozzles supplied with POWR 300 Series Urethane are designed for easy trimming to accommodate back filling operations. They can also be trimmed further to produce a full round bead. The V-Notch indentation can be used for trimming the nozzle for the proper urethane bead dispensing height.

CAT. NO.	CONTENTS	QTY/CASE
PP303HL	10.1 Fl. Oz. (300 ml)	24

Minimum order: 1 each. All automotive sealants can be combined for quantity pricing.

CRL POWR 300 Series Pinchweld Primer

- Improves Adhesion of POWR 300 Series Urethanes



To improve adhesion to repaired rust areas and repainted pinchwelds, or to touch up bare metal scratches, use our PP3MP Pinchweld Primer.

CAT. NO.	CONTENTS	QTY/CASE
PP3MP	3.8 Fl. Oz. (100 ml)	6

Minimum order: 1 each. Pinchweld Primer and UV Blocker can be combined for quantity pricing.



CRL POWR 300 Series Primer and UV Blocker

- Protects Against UV



Use our PP3UV Primer and UV Blocker if the glass does not have a black frit to protect against UV rays. Also promotes adhesion if bonding to EPDM/PVC moldings.

CAT. NO.	CONTENTS	QTY/CASE
PP3UV	3.8 Fl. Oz. (100 ml)	6

Minimum order: 1 each. Pinchweld Primer and UV Blocker can be combined for quantity pricing.



CRL 44NC Neutral Cure Automotive Silicone Sealant

SPEC. DATA

MSDS

- Low Odor, Non-Acetic Cure Formula is Non-Corrosive and Sets Up Fast
- Seals Van Windows, Sunroofs, Roof Vents



CRL 44NC Neutral Cure Automotive Silicone Sealant is a fast curing, neutral cure silicone with special adhesion additives for use in vehicles to seal and weatherproof. It stops leaks while cushioning the glass against shock and vibration. Easy to dispense, this one-part formula features primerless adhesion to aluminum, stainless steel, chromium, tin, iron, plastics, silicone gaskets, rigid PVC, phenolic resin, glass, ceramic, and most reflective-coated glasses.

Non-acetic formula does not cause corrosion in contact with metal, making it perfect for installations of sunroofs to sheet metal roofs. Vinyl top installers know that it is the best silicone to use for vinyl and simulated convertible top installations because the curing process does not emit gases that will bubble the top. Its fast cure time and easy tooling make it ideal for many in-house production applications as well. 44NC Silicone Sealant will stay flexible for at least 20 years when properly applied and used under normal conditions.

CAT. NO.	COLOR	CONTENTS	QTY/CASE
44NC	Black	10.3 Fl. Oz. (305 ml)	30

Minimum order: 1 each. All cartridge sealants can be combined for quantity pricing.



CRL 877A Auto Polyurethane Adhesive/Sealant

SPEC. DATA

MSDS

- Fast Cure, One-Component, Low-Solvent Formula
- Stays Permanently Flexible
- Comparable to Sika 221, 227, and 252



CRL 877A is a one-component, fast cure, low solvent, permanently flexible polyurethane adhesive/sealant that has been specifically developed for use in the fabrication and repair of trailers, trucks, buses, trains, RV utility bodies, van conversions, and specialty vehicles. Applications include: vehicle bodies and cab construction including panels, underbody components, roofing, front and rear spoilers, auto trim, molding in truck trailers, RV and auto body repair. CRL 877A can also be used to seal body-to-cab joints, underside joints (floor and wheel well), bonding rubber door gaskets and profiles, and sealing and covering rivets/fastener heads. CRL 877A Auto Polyurethane is paintable, sandable, remains permanently elastic, and is non-staining. It has excellent resistance to weathering and road salts.

CAT. NO.	COLOR	CONTENTS	QTY/CASE
877A	Black	10.3 Fl. Oz. (304 ml)	12

Minimum order: 1 each. All cartridge sealants can be combined for quantity pricing.



CRL Red RTV High-Temp Silicone Gasket

- Temperature Operating Range: Continuous Exposure to 450°F (232°C), Intermittent Exposure to 500°F (260°C)
- Makes In-Place Seals for Many Automotive Uses
- Packaged With Screw-On Nozzle for Retail Sales

Easy to apply, CRL Red RTV High-Temp Silicone Gasket lets you make any size or shape gasket or seal in minutes. This acetic cure silicone's special formula resists the effects of heat, regular and synthetic oils, grease, anti-freeze, and transmission fluid. CRL 55RED bonds, waterproofs, and insulates most materials. It replaces most cork, asbestos, felt, rubber, paper or metal gaskets in minutes. It bonds to metal, plastics, glass, vinyl, rubber, leather, fabrics, wood, tile, and ceramic. Low volatility formula makes it acceptable for OEM requirements for safe usage on automotive oxygen sensing devices. Quantity per case is 12. Minimum order is one each.

MSDS



Red

Color shown is approximate

CAT. NO. 55RED
3 Fl. Oz. (90 ml)



CRL Windshield Sealant

- Can Be Water Tested Immediately
- Cures to a Butyl Tape Consistency
- Applies Easily and Quickly

CRL Windshield Sealant is a one-part, ready-to-use sealant for resealing windshields and backlites. Also useful for sealing drip rails and pinchwelds after installation of vinyl hardtops. Cures to a tough, flexible, rubbery bead with powerful adhesion to glass, butyl tape, and all metal surfaces.

CAT. NO.	COLOR	CONTENTS	QTY/CASE
CRL7711	Black	11 Fl. Oz. (326 ml)	10

Minimum order: 1 each. All automotive sealants can be combined for quantity pricing.

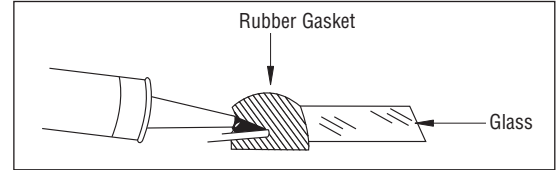

CRL Windshield and Body Sealant

- Non-Curing Flow Grade Butyl in Cartridges
- Remains Tacky Throughout Life, Does Not Skin Over
- Can Be Water Tested Immediately

CRL Windshield and Body Sealant is an economical, non-hardening, water resistant sealing product formulated for use as a sealant and bedding compound for windshields installed in rubber gaskets. It locks out moisture, dust, and cold air instantly. CRL7708 remains flexible and resilient, and can also be used to seal weatherstripping and concealed body joints.

CAT. NO.	COLOR	CONTENTS	QTY/CASE
CRL7708	Black	11 Fl. Oz. (326 ml)	10

Minimum order: 1 each. All automotive sealants can be combined for quantity pricing.

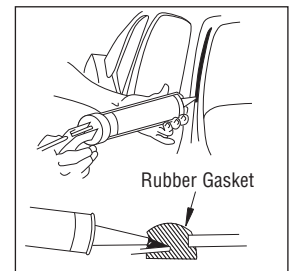

CRL Windshield and Repair Sealant

- Flow Grade Butyl Sealant Used to Fix Leaks in Both Gasket and Gasketless Installations
- Adheres Well to Glass and Metal
- Can Be Used With Any Standard Adhesive Gun

CRL Professional Windshield and Repair Sealant is a flow grade liquid rubber polymer compound for auto glass installations and repair work. It remains elastic, adheres well to glass, metal, and rubber surfaces, and sets up as a permanent, flexible sealant. Apply with a Cat. No. 181AG Adhesive Gun (see page N183), or with a 1AB Brush (see page N388) to fill any openings around clips, in corners, or around setting blocks and backfilling operations on new gaskets.

CAT. NO.	COLOR	CONTENTS	QTY/CASE
CRL1716	Black	16 Fl. Oz. (473 ml)	12

Minimum order: 1 each. All automotive sealants can be combined for quantity pricing.

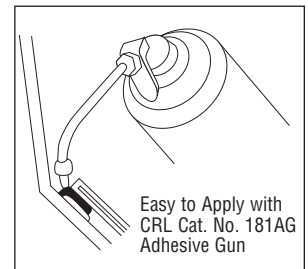

How To Use Flow Grade Butyl

Use CRL's Flow Grade Butyl to ensure your gasket set glass does not leak. Even when using a new gasket, it is always a good idea to backfill sealant around the glass side of the gasket prior to installing the gasket on the glass. After the glass has been installed, use Cat. No. CRL216 Windshield Stick (see page N191) to lift the lip of the gasket off the body of the vehicle and gun a small 1/16" to 1/8" (1.6 to 3.2 mm) bead onto the body a 1/4" (6.3 mm) back from the edge of the gasket with Cat. No. 181AG Adhesive Gun (see page N183). This needs to only be done across the top and down the sides. You will have a leak free installation following these guidelines.

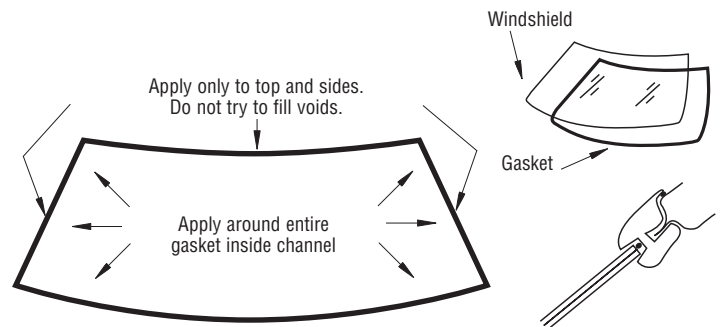

CRL Butyl Autoglass Tape

- Positive Bond on Contact
- Won't Flow Out of the Pinch Weld
- Unlimited Shelf Life
- No Damage to Interior Trim



SPEC. DATA

MSDS

CRL Butyl Autoglass Tape has been developed for installers to meet specific needs. It is easily compressible and tacky, but won't flow out of the pinch weld. This means an easy installation with no clean up. It's the one tape that gives you the support, sealing, and strength you need for leak-proof installations and no call-backs. Controlled rebound allows proper molding fit. CRL Butyl Autoglass Tape has been proven to be one of the finest tapes on the market. That is why we can guarantee your complete satisfaction. Try it on your next installation and you'll see that you can still get quality at an economical price.

NOTE: Butyl tapes should not be used where OEM has installed the automotive glass with urethane. Please consult the OEM guidelines for your installation.

ROUND TAPE

CAT. NO.	SIZE	ROLL LENGTH	ROLLS/CASE
CRL1401	1/4" (6.3 mm)	15' (4.6 m)	12
CRL1403	5/16" (7.9 mm)	15' (4.6 m)	12
CRL1405	3/8" (9.5 mm)	15' (4.6 m)	12

SQUARE TAPE

CAT. NO.	SIZE	ROLL LENGTH	ROLLS/CASE
CRL1303	5/16" x 5/16" (7.9 mm x 7.9 mm)	15' (4.6 m)	12
CRL1305	3/8" x 3/8" (9.5 mm x 9.5 mm)	15' (4.6 m)	12

RECTANGULAR TAPE

CAT. NO.	SIZE	ROLL LENGTH	ROLLS/CASE
CRL1309	1/8" x 1/4" (3.2 mm x 6.3 mm)	30' (9.1 m)	12
CRL1504	1/4" x 5/16" (6.3 mm x 7.9 mm)	15' (4.6 m)	12
CRL1502	1/4" x 3/8" (6.3 mm x 9.5 mm)	15' (4.6 m)	12

Minimum order: 12 rolls. All sizes of Butyl Autoglass Tape can be combined for quantity pricing.

CRL Pinch Weld Primer for Butyl Tape

- Designed to Enhance the Adhesion of Butyl Autoglass Tape
- Quick Drying
- Easy to Apply



CRL Professional Pinch Weld Primer for Butyl Tape is an adhesive primer designed for coated metal or glass. Quick drying compound goes on quickly and evenly with the built-in brush-top applicator. CRL1106 improves the adhesion of butyl tapes to metal or glass surfaces.

NOTE: Not for use with urethane set glass.



Includes Brush-Top Applicator



CAT. NO.	CONTENTS	QTY/CASE
CRL1106	16 Fl. Oz. (473 ml)	12

Minimum order: 1 pint.

CRL Foam Core Butyl Tape

- Compressible PVC Foam Inner Core – High Tack 100% Solids Butyl Coating
- Particularly Suited to Vehicle Fabrication

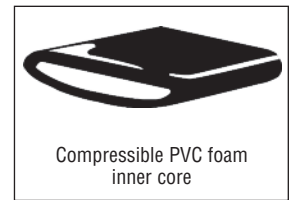

CRL Foam Core Butyl Tape is required on quarter windows of various vehicles and back glass installations. It is also ideal for sealing joints in RVs, motor homes, trailers, and boats, places where joints are subject to the stress of movement and the effects of constant exposure to the elements. The soft inner core responds to body movement, expansion, and contraction. These versatile foam extrusions seal effectively against water penetration to prevent corrosion or moisture damage. Foam Core Butyl Tape controls sound better than standard butyl tape.

CAT. NO.	SIZE	ROLL LENGTH	ROLLS/CASE
CRL1600	3/16" (4.8 mm) Round	15' (4.6 m)	24
CRL1601	1/4" (6.3 mm) Round	15' (4.6 m)	24

Minimum order: 24 rolls. All sizes of Butyl Autoglass Tape can be combined for quantity pricing.

CRL 3M™ Window-Weld™ Ribbon Sealer (Butyl Autoglass Tape)



BULK CASES

CAT. NO.	SIZE	ROLL LENGTH	ROLLS/CASE
3M8620	1/4" (6.3 mm) Round	15' (4.6 m)	24
3M8621	5/16" (7.9 mm) Round	15' (4.6 m)	24
3M8622	3/8" (9.5 mm) Round	15' (4.6 m)	24
3M8625	1/8" x 1/4" (3.2 x 6.3 mm)	30' (9.1 m)	24

Minimum order: 24 rolls (one case). All sizes of Butyl Autoglass Tape can be combined for quantity pricing.

- Supports Glass and Seals on Contact

3M™ Window-Weld™ Ribbon Sealer is a tape-type sealer used in the replacement of windshields and backlites on all butyl set car and truck models. It supports the glass and seals on contact. Forms a water tight seal when used with Cat. No. CRL1106 Pinchweld Primer.

INDIVIDUAL KITS

CAT. NO.	SIZE	ROLL LENGTH	ROLLS/CASE
3M8611	5/16" (7.9 mm) Round	15' (4.6 m)	1
3M8612	3/8" (9.5 mm) Round	15' (4.6 m)	1

Minimum order: 1 roll. All sizes of Butyl Autoglass Tape can be combined for quantity pricing.

CRL 3M™ Strip-Calk Bedding and Glazing Compound

- Easily Thumbed Into Place and Smoothed With Finger
- May Be Painted Immediately
- Will Not Crack or Dry Out
- Unlimited Shelf Life

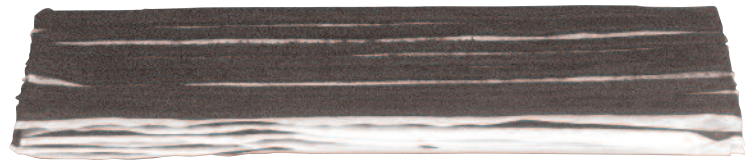

3M™ Strip-Calk Bedding and Glazing Compound is a soft, non-hardening caulking material in one foot lengths for use in all types of seams, joints, and openings. Adheres well to metal, paint, glass, and rubber. 3M™ Strip-Calk is easy to apply, and can be painted immediately. Excellent for sealing retaining clip holes for interior or exterior trim. Black color material comes 60 each 12" (305 mm) lengths per box, 12 boxes per case.

CAT. NO.	STRIP SIZE	STRIP LENGTH	STRIPS/BOX
3M8578	1/8" x 1/4" (3.2 mm x 6.3 mm)	12" (305 mm)	60

Minimum order: 1 box. Can be combined with Butyl Autoglass Tape for quantity pricing.

CRL 3M™ Clear Auto Sealer

- Flow Grade Liquid Rubber With Numerous Auto Body Applications



3M™ Clear Auto Sealer is used for sealing leaks around windshields, in tail lights, reveal moldings, trunk ornaments, and other small seams on the auto body. Up to 1/8" (3.2 mm) bead can be applied easily. Excellent adhesion to metal, glass, and rubber. Will not harden or become brittle.

CAT. NO.	CONTENTS	QTY/CASE
3M8551	5 Fl. Oz. (147 ml)	12

Minimum order: 1 each.

CRL 3M™ Heavy Drip-Chek Sealer

- Heavier Bodied Formula is Excellent for Use on Vertical Seams



3M™ Heavy Drip-Chek Sealer is a light colored, paintable, heavy based sealer especially designed for use on vertical seams. Minimum 1/16" (1.6 mm) thick bead can be applied easily. Excellent adhesion to metal, glass, and rubber. Outstanding weather resistance.

CAT. NO.	CONTENTS	QTY/CASE
3M8531	5 Fl. Oz. (147 ml)	12

Minimum order: 1 each.

CRL SikaFlex® 220+ Fast Curing Urethane Adhesive

- Fast Curing Windshield Adhesive
- Non-Corrosive One-Part High Viscosity Formula

CRL SikaFlex® 220+ is a fast curing, flexible, high performance, polyurethane-based adhesive for bonding windshields to vehicle body shells (direct glazing). Its initial strength is derived from its high viscosity upon application. The excellent non-sag properties grab and hold the glass while the material cures. In order to ensure that manufacturer's standards are met S1KA206GP Pinchweld Primer must be used as needed. S1KA21530 Primer must be used in PVC and EPDM applications. Prep glass with Sika® Aktivator PRO (see below).

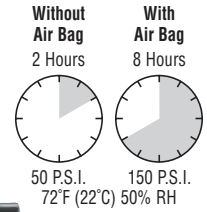

CAT. NO.	CONTENTS	QTY/CASE
S1KA220	10.1 Fl. Oz. (300 ml) Cartridge	24

Minimum order: 1 each. All automotive sealants can be combined for quantity pricing

CRL Sika® Primer-206 G+P Pinchweld Primer



- For Use With Sika® Urethane Adhesives

A one-component, fast drying, moisture sensitive black liquid used to cover all bare metal prior to bonding with Sika® Urethane Adhesives. Apply to pinchweld with Cat. No. 1AB Disposable Brush, or Cat. No. 1CS Cotton Swabs with Wooden Shafts.



CAT. NO.	CONTENTS	QTY/CASE
S1KA206GP	8.3 Fl. Oz. (250 ml)	6

Minimum order: 1 each.



CRL Sika® Aktivator PRO



- Fast Drying Glass Prep for Use With Sika® Urethane Adhesives

CRL Sika® Aktivator is a moisture sensitive liquid that must be used to pre-treat glass prior to application of Sika® Adhesives. One-component formula enhances the adhesive bond, is fast drying, and applies easily with wool daubers, such as Cat. No. PT1U409.



CAT. NO.	CONTENTS	QTY/CASE
60D960	8.3 Fl. Oz. (250 ml)	6

Minimum order: 1 each.



CRL Sika® Primer-206 Pinchweld Primer Stix

- For Use With Sika® Urethane Adhesives
- Built-In Applicator

Sika® Primer-206 Stix are used for pinchweld treatment of all fresh scratches or bright metal rubs and scrapes prior to bonding with Sika® Urethane Adhesives. Unique packaging provides primer and applicator all in one! Contains 15 individual 1.4 ml applicators per box.

CAT. NO.	CONTENTS	QTY/BOX
S1KA060	.01 Fl. Oz. (1.4 ml)	15 Stix

Minimum order: 1 box.



CRL Sika® Aktivator Pads

- For Use With Sika® Urethane Adhesives
- Fast Drying Single Use Size Means Less Waste



Our Sika® Aktivator Pads are the easiest and neatest way to apply Sika® Aktivator to glass. They resemble a small paint pad. A quick squeeze of the handle dispenses the Aktivator solution into the drip-free pad, evenly applying it to the targeted surface to clean and prepare the glass for Sika® Urethane Adhesives. Available in packages of five, or cartons of 15, which is the recommended number of pads for one case of Sika® Urethanes.

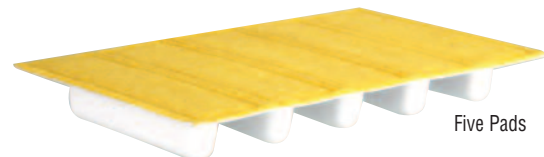

CAT. NO.	CONTENTS	PACKAGING
6H12SPK	.037 Fl. Oz. (1.1 ml)	5 Pads/Pack
6H12S	.037 Fl. Oz. (1.1 ml)	15 Pads/Ctn.

Minimum order: 1 pack 6H12SPK. 15 each 6H12S.

CRL Sika® Primer-215

- For Use With Rigid and Semi-Rigid PVC and EPDM Encapsulated Parts

New encapsulated parts require new primers for OEM bonding strength when urethane is being bonded to the encapsulation rather than to the glass. PVC and EPDM encapsulated parts can not be bonded to the body using normal primers. Select this primer for a sure bond in these cases.

CAT. NO.	CONTENTS	QTY/CASE
S1KA21530	1 Fl. Oz. (30 ml)	6

Minimum order: 1 each.



CRL 3M™ Windo-Weld™ Super Fast Urethane

- 15 Minute Tack Free Time
- Fast Cure
- Exceeds OEM Strength Requirements
- Officially Licensed by NASCAR™

Without Air Bag 3 Hours With Air Bag 8 Hours

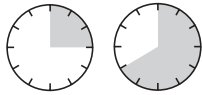

50 P.S.I. 70°F (21°C) 150 P.S.I. 50% RH



3M™ Windo-Weld™ Super Fast Urethane is a fast curing windshield adhesive with high green strength. It meets FMVSS 212 strength requirements in as little as four hours, depending upon temperature and humidity. 3M™ Super Fast Urethane is a one-component polyurethane-based adhesive formulated for bonding automotive glass. It will develop up to 1,200 psi in tensile strength at full cure to provide your customer with a safe installation.

CAT. NO.	CONTENTS	QTY/CASE
3M8609	10.5 Fl. Oz. (310 ml)	12

Minimum order: 12 each. Must order in increments of 12. All automotive sealants can be combined for quantity pricing.

CRL 3M™ Fast Cure Auto Glass Urethane (High Viscosity)

- Passed FMVSS 212 @ Four Hours
- Meets OEM Strength Requirements
- Carlite™ by Visteon™ Approved
- Officially Licensed by NASCAR™

Without Air Bag 5 Hours With Air Bag 7 Hours

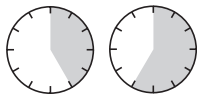

100 P.S.I. 70°F (21°C) 150 P.S.I. 50% RH



3M™ Fast Cure Auto Glass Urethane is a one-part, moisture curing urethane providing rapid strength build-up. This high strength, high viscosity adhesive is designed for use in full cut-out installations without dam tape. Passes FMVSS 212 at four hours at 70°F / 50% RH with dual airbags.

CAT. NO.	CONTENTS	QTY/CASE
3M8690	10.5 Fl. Oz. (310 ml)	12

Minimum order: 12 each. Must order in increments of 12. All automotive sealants can be combined for quantity pricing.



CRL 3M™ Single Step Primer

- One Primer for Both Glass and Pinch Weld
- Also Promotes Adhesion to PVC Encapsulated Parts
- Does Not Need an Activator

3M™ Single Step Primer is a polyurethane-based primer that promotes adhesion of polyurethane adhesives to glass, painted pinchweld metal, and PVC encapsulated parts. It is also a black-out primer to block out the sun's ultraviolet rays.

CAT. NO.	CONTENTS	QTY/CASE
3M8681	4.2 Fl. Oz. (125 ml)	6

Minimum order: 1 each.

CRL Essex™ U418 Quick Cure Primerless Regular Viscosity Urethane Adhesive

- Meets All OEM Standards
- Fast Installations – No Windshield Prep or Glass Primer Needed



Essex™ U418 Quick Cure Primerless Regular Viscosity Urethane Adhesive meets all OEM standards. It eliminates steps and speeds installations by incorporating the glass primer into the urethane adhesive. It does require you use Cat. No. U5404 Betaprime Primer on the pinchweld if the metal is scratched during glass removal.

CAT. NO.	CONTENTS	QTY/CASE
U418	10.5 Fl. Oz. (310 ml)	10

Minimum order: 10 each. Must order in increments of 10. All automotive sealants can be combined for quality pricing.

CRL Essex™ Betaprime U5404 Urethane Pinchweld and Encapsulation Primer

- One Primer for Pinchweld, PAAS, RIM, and PVC
- Reduces Need to Carry Multiple Primers
- Compatible With All Essex™ Urethane Adhesives

Apply Betaprime U5404 to small areas of bare metal scratches or unpainted areas on cleaned pinchweld to promote adhesion. Also reactivates the pre-applied adhesive system (PAAS) bead found on windshields installed on several vehicle models manufactured by BMW, Volkswagen, Saab, Porsche, Fiat, and others. Promotes adhesion between Essex™ Urethane Adhesives and OEM PVC (polyvinyl chloride) substrates, and bonds to RIM (reaction injection molding) encapsulation.



CAT. NO.	CONTENTS	QTY/CASE
U5404	3.4 Fl. Oz. (100 ml)	5

Minimum order: 1 each.

CRL Essex™ Betaprime U5500N One-Step Glass/Frit Primer

- Preps and Primes Windshield in One Pass
- Meets All OEM Requirements

Use Essex™ U5500N with all Essex™ Urethane Adhesives that require auto glass primers. The black color provides protection against ultraviolet rays. Easy to use and meets all OEM requirements, including long-term durability.



CAT. NO.	CONTENTS	QTY/CASE
U5500N	1.4 Fl. Oz. (40 ml)	5

Minimum order: 1 each.

CRL POWR Clean Frit Kit

- Removes Windshield Contamination
- Will Not Scratch Glass or Black Frit

This kit was developed for removing bond inhibiting contaminants. It combines PWR22 POWR Cleaner, special 4" x 8" (102 x 203 mm) Open Cell Nylon Pads, and durable nylon reinforced BX15 Shop Wipes.

Simply spray POWR Cleaner on the glass. When the cleaner "beads up" you have contaminants. Scrub the suspect contaminants with the Open Cell Nylon Pads, then clean again with POWR Cleaner and BX15 Shop Wipes. If "beading" is still present, the glass should be returned to the vendor. Pads will not scratch glass or black frit. Kit includes: 20 Open Cell Nylon Pads, one can of PWR22 POWR Cleaner and one box of BX15 Shop Wipes.



CAT. NO.	DESCRIPTION
FK1T2*	POWR Clean Frit Kit (Cleaner, Pads, Wipes)
PWR22*	POWR Cleaner 19 Oz. (539 g) Cans (12 per case)
NP48	4" x 8" (102 x 203 mm) Open Cell Pads (50/Pack)
BX15	Lint-Free Shop Wipes (150 Wipes per box)

Minimum order: 1 each. * Product cannot ship via any kind of air transport.

CRL Essex™ Betaprime U5201 Bare Metal Etch Primer

- Primes Base Metal in One Easy Step
- Dries in 30 Minutes

Essex™ Betaprime primes bare metal in one quick, easy step. U5201 etches the exact degree of roughness necessary to prepare the metal for proper bonding. It cures approximately 50 times faster than conventional two-part mixes, and may be used with all CRL Essex™ Urethane Adhesives. Must be used on bare metal areas larger than 1/2" (12 mm) square.



CAT. NO.	CONTENTS	QTY/CASE
U5201	.5 Fl. Oz. (15 ml)	5

Minimum order: 1 each.

HOW TO SEARCH FOR INFORMATION

First, go to crlaurence.com

- 1 Locate the **Search Box** at the top right of the page
- 2 Enter a CRL Catalog Number or keywords then click **Search**
- 3 If your search does not return the results you are looking for, try using a different word, or more words to help limit the results
- 4 You can also click on **CRL Total Search**, located under "Searching on CRL". You will be taken to the CRL Power Search Option



- 5 When viewing a product page, you can find similar or related products by clicking on **More Choices** located next to the pricing table

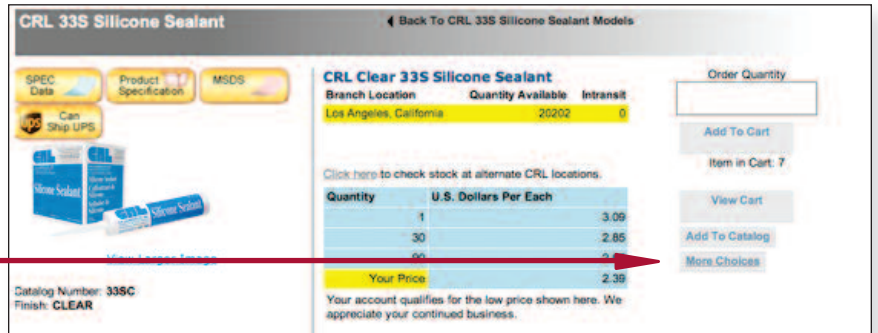

- 6 You can also view all products that are in any of our printed catalogs by clicking on **Catalog Library** under "General Information"

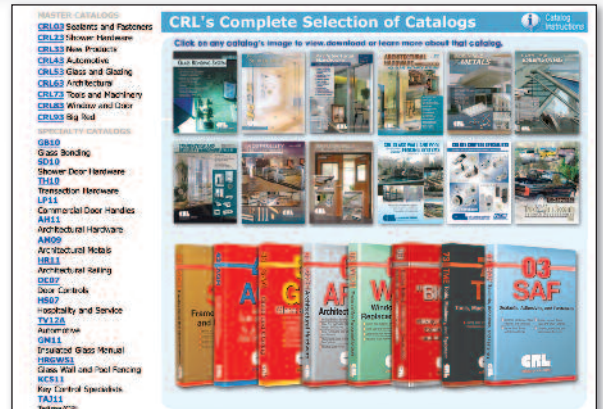
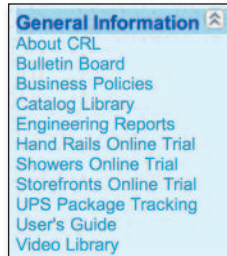

03SAF CATALOG A TO Z PRODUCT INDEX

1000 GE Contractors Silicone Sealant	N116	Impruv UV	N417	Architectural Tapes	N162-N171
116 Vulkem Polyurethane Sealant.....	N130	Liquid Nails.....	N284	Armor All Cleaner.....	N362
1200 GE Construction Silicone Sealant.....	N116	Low Viscosity UV	N413, N415	Armor All Protectant.....	N362
15W CRL Acrylic Latex Caulk.....	N135	Medium Viscosity UV.....	N415	Arrow Staples.....	N332
1700 GE Sanitary Silicone Sealant.....	N140	Metal Contact Cement.....	N278, N421	ATG Tape and Dispenser Gun.....	N263
200 Tremsil Silicone Sealant.....	N117	Minute Bond.....	N277, N417	Atlas Gloves.....	N370, N372-N373
2000 GE Silpruf Silicone Sealant.....	N123	Miracle All-Purpose.....	N284	A-T Series.....	
2600 GE Sanitary Silicone Sealant.....	N140	Plastic and Emblem.....	N280	Adapters.....	N329
2700 GE SilGlaze N-10 Silicone Sealant.....	N140	Prism Instant.....	N277	Hi-Torquer Hand Tool.....	N329
2800 GE SilGlaze II Silicone Sealant.....	N123	Properties at a Glance Chart.....	N418-N419	Master Assortment Kit.....	N329
321 CRL Acrylic Latex With Silicone.....	N133	Pumps.....	N183	Steel Insert Fasteners.....	N328
33S CRL Silicone Sealant.....	N108-N109	Remover.....	N250-N251	Australian Sealants.....	N139-N145
3-IN-ONE Oil.....	N382	Solvent.....	N250	Auto Glass Butyl Tape.....	N488
3M.....		Spray.....	N283	Auto Glass Rivets.....	N322-N324
Adhesive Transfer Tape.....	N263	Storm Window and Door.....	N284	Auto Glass Sealants.....	N481-N492
Aluminum Foil Tape.....	N268	Structural.....	N281	Autoloading Utility Knife.....	N242
ATG Tape and Dispenser Gun.....	N263	Superbonder.....	N277	Automotive.....	
Auto-Mix Adhesive and Applicator Gun.....	N281	Tapes.....	N253-N266	Glass Cleaner.....	N335
Clear Auto Sealer.....	N489	Titebond Construction.....	N284	Glass Urethanes.....	N482-N485, N490-N492
Double Coated Masking Tape.....	N263	Transfer Tape.....	N263	Polyurethane Adhesive/Sealant.....	N486
Fast Cure Auto Glass Urethane.....	N491	Trim.....	N280, N283	Primers.....	N483, N485, N488, N490-N492
Fast Tack Trim Adhesive.....	N280	Vinyl Weld.....	N284	Riveters.....	N325
Fire Barrier Caulk.....	N138	Visible Light UV.....	N414	Silicone Sealant.....	N486
Heavy Drip-Chek Sealer.....	N489	Weatherstrip.....	N280, N352	Windshield and Trim Securing Tape.....	N260
Mixer Nozzles.....	N220	White Glue.....	N282	Autosol Shine Metal Cleaner.....	N361
Plastic and Emblem Adhesive.....	N280	Wood Glue.....	N281	Aztech Hot Melt Dispensing Systems.....	N452
Removable Double Coated Foam Tape.....	N257	Adjustable.....			
Scotch Mount Foam Tape.....	N257	90 Degree Interior Corner Support.....	N410		
Scotch-Brite Hand Pads.....	N368	90 Degree Suction Holders.....	N409		
Silicone Lubricant Plus.....	N382	Angle Clamp-It Assembly Tool Kit.....	N404		
Single Step Primer.....	N491	Angle Suction Holders.....	N404, N408		
Spray Adhesive.....	N283	Multi-Cutter Tool.....	N270		
Strip-Calk Glazing and Bedding Compound.....	N489	Setting Blocks.....	N200		
Structural Adhesive.....	N281	Shelf Supports.....	N439		
Super Trim Adhesive.....	N283	Stop, Eccentric Height.....	N408		
Super Weatherstrip Adhesive.....	N352	Support, UV.....	N440		
Transparent Tape.....	N263	Adsorbents, Insulating Glass.....	N458		
Trizact Discs and Accessories.....	N357	Aerosol.....			
Trizact Scratch Removal Kits.....	N356	Glass Cleaner.....	N334-N338, N400		
Underseal Undercoating.....	N283	Mirror Edge Sealant.....	N275		
VHB Tapes.....	N255-N256	Paints.....	N385-N387		
Weatherstrip Adhesive.....	N280	Plastic Cleaner.....	N359		
Windo-Weld Super Fast Urethane.....	N491	Air.....			
Window-Weld Ribbon Sealer.....	N489	Compressors.....	N213		
Windshield and Trim Securing Tape.....	N260	Hydraulic Riveter.....	N321		
4000 GE UltraGlaze Silicone Sealant.....	N124	Power Caulking Guns.....	N212		
440 Tremco Butyl Tape.....	N170	Powered Muntin Bar Notcher.....	N472		
45 SSL Vulkem Polyurethane.....	N130	Powered Muntin Clip Punch.....	N473		
600 Tremsil Silicone Sealant.....	N125	Powered Scratch-A-Way Tool Kit.....	N355		
707 PTI Butyl Rubber Sealant.....	N138	Tool Accessories.....	N214-N215		
777 CRL Butyl Rubber Sealant.....	N136	Albion Caulking Guns.....	N207, N209		
791 Dow Silicone Weatherproofing Sealant.....	N145	All Purpose.....			
795 Dow Silicone Building Sealant.....	N122, N145	Cleaner.....	N336		
800 CRL Acrylic Latex With Silicone.....	N134	Foam Mounting Tape.....	N258-N259		
888 CRL Premium Grade Caulking Compound.....	N137	Glue Sticks.....	N223		
8-in-1 Painter's Tool.....	N235	Putty.....	N180		
90 Degree.....		Wet/Dry Vac.....	N252		
Clamp-It Square Kits.....	N405	All Wool Felt Wheel.....	N352		
Corner Clamps.....	N410	Allen Screws.....	N311		
Inside Suction Holders.....	N405, N409	Aluminum.....			
Interior Corner Support.....	N410	Adapter and Felt Wheel.....	N352		
Outside Suction Holders.....	N405, N409	Air Powered Caulking Gun.....	N212		
Suction Holder, Magnetic.....	N407	Drain Blocks.....	N195		
Suction Holder, Pump-Activated.....	N407	Foil Tape.....	N268		
95C CRL Silicone Building Sealant.....	N120-N121	Horseshoe Shims.....	N194, N202		
995 Dow Silicone Structural Adhesive.....	N122	Long Knives.....	N241		
999-A Dow Silicone Building Sealant.....	N115	Rivets.....	N319-N320		
		Sash Clips.....	N227		
A		Setting Block.....	N202		
Acetic Cure Silicones.....	N108-N117	Shim Strips.....	N195		
Acorn Nuts.....	N312	Spacers.....	N468-N469		
Acoustical Sealant Tape.....	N173	Threaded Poly-Nuts.....	N327		
Acrylic.....		Thread-Serts.....	N327		
Cement.....	N281	Window Frame Extractor.....	N237		
Foam Very Hi-Bond Adhesive Tape.....	N256	Alumin-Nu Metal Cleaner.....	N361		
Gap-Seal Latex Caulk.....	N141	A-Maz Water Stain Remover.....	N350		
Latex Caulk.....	N135	Ammonia-Free Glass Cleaners.....	N336, N339		
Latex With Silicone.....	N133-N134	Anchors.....			
Very Hi-Bond Tapes.....	N253-N254	Concrete.....	N289-N291		
Adapters, Threaded UV.....	N437	Drywall.....	N288, N291-N292		
Adco BP-300 Curtainwall and Bedding Sealant.....	N138	Hilti Expansion.....	N309		
Adhesion Promoter.....	N173	Hollow Wall.....	N292		
Adhesive(s).....		Lead.....	N291		
Auto-Mix.....	N281	Plastic.....	N289-N291		
Cleaners.....	N250-N251	Railing.....	N308-N309		
Clear Two-Part Epoxy.....	N279, N421	Stainless Steel.....	N308		
Colored UV.....	N416	Toggle.....	N288, N294		
Contact.....	N279	Wedge-Bolt.....	N308-N309		
Curing Lamps.....	N422-N425	Angle Swivel.....	N215		
Dispenser System.....	N420	Angled Countertop Support.....	N441		
Dispensing Needles.....	N420	Anti-Fog Spray and Cleaner.....	N358		
Epoxy Mixer Cups.....	N278	Anti-Walk Blocks.....	N203		
Guns.....	N183, N222	Applicator Gun, Hydra-Mate.....	N457		
High Viscosity UV.....	N413, N416	Applicator Tool, Super Spacer.....	N466		

B

Backer Pads, Scratch Removal.....	N354
Backer Rod.....	N186-N189
Backer Rod Tools.....	N190-N191
Ball Caster Tables.....	N474
Barrel Transfer Pump.....	N222
Bars, Scrape and Pry.....	N235
Base Plates, Table.....	N444
Base Shoe Glazing Gaskets.....	N179
Basic Insulating Glass Manual.....	N445
Basic Sealant Uses and Limitations.....	N102-N106
Battery Operated UV Curing Lamp.....	N424
Battery Powered Caulking Guns.....	N210-N211
Belt Lubricants.....	N381
Benders, Spacer and Muntin.....	N473
Bent Nozzles.....	N220
Bent Putty Knives.....	N228
Bevelled Corner Setting Blocks.....	N199
Bio-Clean Water Stain Remover.....	N350
Bits, Hex Insert.....	N300, N305
Bituminous Paint.....	N287, N385
Black Latex and Nitrile Gloves.....	N250, N369
Blades.....	
Breakaway.....	N244
Hook End.....	N245
Razor.....	N246, N367, N402
Sealant Cut-Out, Fein.....	N236
Serrated Edge Utility.....	N243
Utility Knife.....	N243
Blind Rivets.....	N317-N320
Blocks, Setting.....	N197-N200
Blocks, Spacing.....	N201-N202
Blo-Guns.....	N214
Blue Masking Tape.....	N260
Bolt Cover Buttons.....	N312
Bolt Locks.....	N434
Bolts, Sex.....	N316
Bond Breaker Tape.....	N190
Bonding.....	
Adhesives, Ultraviolet.....	N412-N421
Curing Lamps.....	N422-N425
Fixation Devices.....	N403-N411
Furniture Hardware.....	N427-N444
Plates, UV.....	N443
Starter Kits, Glass.....	N396-N398
System Catalog.....	N403, N509
Work Surface Carpet.....	N411
Bond-Fast Construction Adhesive.....	N141
Bostik R40 Cleaning Solvent.....	N145
Bostik Rhodorsil Silicones.....	
5CLM Low Modulus.....	N143
616 Neutral Cure.....	N142
6S Shower and Tile.....	N143
8S Bathroom and Kitchen.....	N143
Multi-Purpose Paintable.....	N144
V2 Acetic Cure.....	N142
V4 Metal and Masonry.....	N143
V60 Neutral Cure.....	N142
V70 Structural Glazing.....	N142
Bostik Seal 'N' Flex 1 Polyurethane Sealant.....	N144
Bottles, Plastic Spray.....	N340
Box of Rags.....	N345
BP300 Curtainwall and Bedding Sealant.....	N138
Bracket, Glass Wipes Dispenser.....	N342
Brad Nail Gun.....	N226
Brad Pusher.....	N331
Brads.....	N226, N331



O3SAF CATALOG A TO Z PRODUCT INDEX

Brass Tip Nozzles.....	N450
Breakaway Knife Blades.....	N244
Brushes.....	
Disposable Acid.....	N388
Dusting.....	N368
Low-Cost Throw-Away.....	N388
Paint and Varnish.....	N388
Scrub.....	N347
Whisk.....	N368
Wire.....	N368
Building Sealant, Silicone.....	N120-N121
Bulk.....	
Caulking Gun Filler.....	N218
Loaded Caulking Guns.....	N209
Packaged Silicone Sealant.....	N109, N119, N121
Reel Super Spacer Stand.....	N466
Rolled Setting Block Material.....	N197
Sealant Dispenser.....	N213
Butane Torches.....	N239
Buttons, Upholstery.....	N326
Butyl.....	
Architectural Glazing Tape.....	N168-N171
Auto Glass Tape.....	N488-N489
Coated PVC Foam Tape.....	N174
Dispensing Systems.....	N450-N452
Hot Melt.....	N453-N454
Rope.....	N454
Rubber Sealants.....	N136-N138
Tape Primer.....	N488

C	
Cable Ties.....	N290
Caliper, Insulating Glass.....	N478
Campermount Tape.....	N173
Can Handler.....	N358, N388
Can Organizer.....	N383
Canvas Tool Pouch.....	N191
Cap Screws.....	N309
Carpet, UV Bonding.....	N411
Carton Cutter.....	N247
Carton Sealing Tape.....	N262
Carton Sealing Tape Dispenser.....	N268
Cartridge Heater Ovens.....	N219
Cartridges, Empty.....	N221
Casters.....	N444
Category II Safety Backing Tape for Mirrors.....	N276
Caulk, Acrylic Latex.....	N135
Caulk, Butyl Rubber.....	N137
Caulk, Fire Barrier.....	N138
Caulking.....	
Applicator Tools.....	N216
Cut-Out Blades.....	N236
Guns.....	N205-N212
Nozzles.....	N220-N221
Spatulas.....	N216
Cement Mixing Kit.....	N286
Cement, Contact.....	N278, N421
Cements, Expanding.....	N285
Centering Springs, Wedgit.....	N203
Cerium Oxide Polish.....	N352
Certification Testing for Auto Glass Technicians.....	N481
Chamois.....	N348
Chart, UV Adhesive At A Glance.....	N418-N419
Chilton Caulking Gun.....	N205
Chisel Paint Stripper.....	N402
Chisels, Putty.....	N233
Clamp Table, Hot Melt.....	N452
Clamps, Corner.....	N410
Clamps, Spring-Type.....	N463
Clamp-It Assembly Tool Kit.....	N404
Cleaner(s).....	
Adhesives.....	N250-N251
Armor All.....	N362
Degreasers.....	N251, N399-N400
Glass.....	N334-N338, N400
Hand.....	N347
Metal.....	N361
Plastic.....	N359
Sparkle.....	N351
Sprayway Glass.....	N336, N400
Stainless Steel.....	N361
Stone Countertop.....	N358
Clear.....	
Acrylic Foam Tape.....	N257
Auto Sealer, 3M.....	N489
Double-Sided PVC Tape.....	N255
Plastic Horseshoe Shims.....	N194
Plastic Setting Blocks.....	N200
Two-Part Epoxy.....	N421
Washers.....	N303
Cleret Elite Squeegees.....	N349
Clips, Muntin.....	N471
Clips, Sash Glazing.....	N227
Closed Cell Backer Rod.....	N188

Coating Contact Meters.....	N480
Coiled Air Hoses.....	N214
Color Guard.....	N385
Conical Rivets.....	N320
Colored UV Adhesive.....	N416
Compact A.C. Curing Lamp.....	N424
Compact Heater Box.....	N219
Complete Polishing Head Assembly.....	N352
Composite Wood Shims.....	N196
Compressors, Air.....	N213
Concentrate Glass Cleaner.....	N338
Concrete Anchors.....	N308-N309
Cone Nozzles.....	N220
Conical Plastic Anchors.....	N289
Construction Sealants.....	N108-N132
Construction Shims.....	N192-N196
Contact Adhesives.....	N279
Contact Cement, Metal.....	N278, N421
Contour Scraper.....	N233
Coolant, Spray Mist.....	N381
Copper Foil Tape.....	N268
Cordless Caulking Guns.....	N210-N211
Cordless Glue Gun.....	N223
Cordless Staple Gun.....	N332
Cork and Neoprene Desk Stripping.....	N270
Corner Caulker Nozzles.....	N220
Corner Support, Interior.....	N410
Corners, Aluminum IG Spacer.....	N468-N469
Cotton Gloves.....	N371
Cotton Swabs.....	N402
Countersunk Self-Drilling Screws.....	N302
Countersunk Washer Head Screws.....	N301
Countersunk Washers.....	N302
Countertop Cleaner.....	N358
Countertop Supports.....	N441
Couplers, Air Hose.....	N215
Cox Caulking Guns.....	N205, N208-N209, N212
Craftsman Knife and Blades.....	N245
Crazy Clean All Purpose Cleaner.....	N358
Curing Lamps and Accessories.....	N422-N425
Curtainwall and Bedding Sealant.....	N138
Custom Color Silicones.....	N110
Cut Resistant Glass Handling Gloves.....	N372
Cutting Oil.....	N383
Cutting Tool, Multi-Cutter.....	N270
Cut-Out Knives.....	N241
Crystal Shelf Supports.....	N440

D	
Damper for Glass Doors.....	N438
Dap.....	
Glazing Compounds.....	N181-N182
Kwik-Seal Tub and Tile Caulk.....	N135
Latex Window Glazing Compound.....	N182
Metal Sash Putty.....	N181
Vinyl Spackling Compound.....	N135, N182
Degreaser and Solvent Cleaner.....	N251, N364, N399
Deluxe.....	
Clinch-Fast Kit.....	N326
Handy Clamps.....	N463
Insulating Glass Hot Melt Starter Kit.....	N446
Safety Spectacles.....	N377
Spacer Bender.....	N473
Super Spacer Starter Kit.....	N447
Windshield and Trim Securing Tape.....	N264
Desiccant Activity Kit.....	N467
Desiccant Filling Machine.....	N459
Desiccant, Molecular Sieve.....	N458
Designer Hinges, Locks and Pulls.....	N429
Desk Stripping.....	N270
Detergent, Glass Washing Machine.....	N340
Devices, Fixation.....	N403-N411
De-Glazing Tools.....	N240
D-Flex Cut Resistant Glass Handling Gloves.....	N372
Diagnostic Inspection Tool.....	N355
Diamond Plastic Anchors.....	N289
Diamond Point Driver and Points.....	N224
Discs, Trizact.....	N357
Dispenser(s).....	
5-Gallon.....	N213
Bottles.....	N340
Bracket.....	N342
Guns, Handi-Foam.....	N185
Handle, Small Tube.....	N111, N222
Hot Melt Butyl.....	N450-N452
Hydra-Mate Two-Component.....	N457
Paper Towel.....	N344-N345, N401
System, Timed Air UV Adhesive.....	N420
Tape.....	N268
Dispensing Bottle for Expanding Cement.....	N287
Dispensing Needles.....	N420
Display, Silicone.....	N111
Disposable.....	
Acid Brushes.....	N388

Dust Masks.....	N375
Latex Gloves.....	N250, N369
Nitrile Gloves.....	N250, N369, N426
Paint Brushes.....	N388
Don Carlos Lead Putty Knife.....	N234
Door Closer Screw Packages.....	N316
Door Knobs.....	N435-N436
Door Locks and Keepers.....	N433-N434
Door Pulls.....	N435-N436
Dor-Tite Sponge Rubber Strip.....	N172
Double.....	
Coated Masking Tape.....	N263
Door Locks.....	N429
End Window Tool.....	N235
Pane Low-e Coating Detectors.....	N476, N480
Sided PVC Clear Tape.....	N255
Tube UV Curing Lamp.....	N425
Double/Bubble Epoxies.....	N282
Dow Corning.....	
791 Silicone Weatherproofing Sealant.....	N145
795 Silicone Building Sealant.....	N122, N145
995 Silicone Structural Adhesive.....	N122
999-A Silicone Building Sealant.....	N115
Glazing Silicone Sealant.....	N115
Silicone Cleaner and Surface Prep.....	N249, N363
Drain Blocks.....	N195
Drill Bit for Rivet-Nuts.....	N330
Drill-Mate Caulking Gun.....	N211
Drip-Chek Sealer.....	N489
Drive Fasteners.....	N292
Dry Graphite.....	N380
Drywall Screws.....	N299
Dual.....	
Cartridge Organic Vapor Respirator.....	N375
Hytrex Cup.....	N218
Seal Aluminum IG Spacer.....	N469
Temperature Glue Gun.....	N223
Duct Tape.....	N261
Duralite Spacer IG Starter Kit.....	N461
Duralite Spacer, Truseal.....	N462
Duralite Tools.....	N463
Dust Masks and Respirators.....	N375
Dust Pan.....	N368
Dusting Brush.....	N368
Dymerc 240FC Polyurethane Sealant.....	N132
Dymonic FC Polyurethane Sealant.....	N131

E	
Easy Push Points.....	N226
Ebor Glazing Knives.....	N232
Eccentric Height Adjustment Stop.....	N408
Edge Sealant, Mirror.....	N275
Edgetech Super Spacer.....	N465
Electric.....	
Brad Nail Gun.....	N226
Glue Guns.....	N223
Hot Air Gun.....	N400
Mastic Applicator.....	N273
Powered Scratch-A-Way Tool Kit.....	N355
Staple Gun.....	N332
Electrical Tape.....	N266
Elmer's Glue-All.....	N282
Empty Plastic Cartridges.....	N221
EPDM Gaskets.....	N178
EPDM Rubber Setting Blocks.....	N199
EPDM/PVC Primer and UV Blocker.....	N485
Epoxy Mixer Cups.....	N278
Epoxy Putty, QuikSteel.....	N282
Epoxy, Clear Two-Part.....	N421
Epoxy, Double/Bubble.....	N282
Essex Auto Glass Primers.....	N492
Essex Quick Cure Urethane Adhesive.....	N492
European Putty Tools.....	N232
Evaporating Glass Cutting Oil.....	N383
Expanding.....	
Cements Dispensing Bottle.....	N287
Cements.....	N285
Foam Sealants.....	N184-N185
Plastic Anchors.....	N290
Expert Sealant Assistance.....	N101
Extend Rust Treatment.....	N361
Extension Poles.....	N348
Exterior Corner Clamp.....	N410
Extra Fine Steel Wool.....	N402
Extra Thrust Caulking Gun.....	N205
Extractor, Window Frame.....	N237
Extruder Gun, Hot Melt.....	N454
Extruder Systems, Hot Melt.....	N451
Extruder, Polyisobutylene.....	N459
Eyeglass Holder Strap.....	N377
EZ GLAZER Soundstrip.....	N114
E.Z.D. Glazer De-Glazing Tool.....	N240
E-Z Ancors.....	N288

O3SAF CATALOG A TO Z PRODUCT INDEX

F

Face Shield, UV Absorbing.....	N426
Fast Cure Epoxy Mixer Cups.....	N278
Fast Tack Trim Adhesive.....	N280
Fasteners, Upholstery.....	N326
Fastening Tape.....	N265
Felt	
Circular Cut-Out Blade.....	N236
Mini-Turbo Vac.....	N252
Scraper Blades.....	N236
Sealant Cutter Knife Kit.....	N236
Felt	
Hand Block.....	N349
Tape.....	N269
Washers.....	N303
Wheel.....	N352
Female Couplers.....	N215
Filament and Masking Tape Dispenser.....	N268
Filament Tape.....	N262
Film, Surface Protection.....	N267
Fingerless Gloves.....	N373
Fire Barrier Caulk.....	N138
Fire Glazing Tape.....	N174
Fixation Devices.....	N403-N411
Fixed 90 Degree Corner Clamps.....	N410
Fixed Shelf Supports.....	N439
Fix-Kits of Screws.....	N301
Flashing Products.....	N176
Flashing Tape.....	N171
Flat Head Phillips Screws.....	N296
Flat Washers.....	N303
Fletcher FrameMaster and Points.....	N225
Fletcher Glazing Point Tools.....	N224-N225
Flex Corners for Aluminum Spacers.....	N468
Flexible	
Long Knife.....	N241
Muntin Locator.....	N471
Nozzles.....	N220
Putty Knives.....	N230-N231
Flexx-Rap Protective Wrap.....	N373
Floor Mats.....	N365
Foam	
Backer Rod.....	N186-N189
Core Butyl Tape.....	N488
Sealants.....	N184-N185
Spacing and Sealing Pads.....	N201
Foam Tape(s)	
Glazing.....	N164-N167
Mirror Mounting.....	N258-N259
Removable Double Coated Clear Acrylic.....	N257
Scotch Mount.....	N257
Squares.....	N257
Very High Adhesion.....	N256
Very Hi-Bond Adhesive.....	N256
Foil Tapes.....	N268
Follower Plates.....	N218
FomoClean Solvent.....	N185
Form-A-Thread.....	N279
Fortifiber Flashing.....	N176
Frameless Blocks.....	N204
Framemaster Point Driver and Points.....	N225
Friction Tape.....	N266
FSK Facing Tape.....	N174
Fuller Max Bond Construction Adhesive.....	N144
Funnels.....	N251
Furniture Hardware, UV.....	N427-N444
Fuzzy Duck PVC Gloves.....	N372

G

Gasket Remover, Chisel.....	N402
Gasket Silicone.....	N486
Gaskets for Base Shoe.....	N179
Gauges, Glass Thickness.....	N478
GE Acrylic Gap-Seal.....	N141
GE Bond-Fast Construction Adhesive.....	N141
GE Silicones	
1000 Contractors.....	N116
1200 Construction.....	N116
1700 Sanitary.....	N140
2000 Silpruf.....	N123
2600 Sanitary.....	N140
2700 SilGlaze N-10.....	N140
2800 SilGlaze II.....	N123
4000 UltraGlaze.....	N124
Plumbers Mate.....	N140
General Purpose Silicone Sealant.....	N139
General Purpose Solvent and Adhesive Cleaner.....	N251, N364
Glass	
Bandage.....	N267
Centering Springs.....	N203
Cleaners.....	N334-N338, N400
Concentrated Cleaner.....	N338
Cutting Oil.....	N383
Cutting Tables.....	N474

Door Damper.....	N438
Door Locks and Keepers.....	N433-N434
Dust Respirator.....	N375
Extension Bolts.....	N307
Frosting.....	N385
Furniture Hardware.....	N428-N444
Gloves.....	N372
Knobs.....	N435-N436
Protecting Film Roll.....	N267
Protectors.....	N442
Railing Setting Blocks.....	N202
Scratch Removers.....	N353-N355
Setting Tapes.....	N175
Shelf Supports.....	N442
Surface Restoration.....	N352-N357
Thickness Gauges.....	N478
Thickness Lasers.....	N477
Thickness Meters.....	N476-N478
Washing Machine Detergent.....	N340
Washing Machinery.....	N339, N475
Wipes, Lint Free.....	N342, N401
Glass Bonding	
Adhesives.....	N412-N421
Catalog.....	N403, N509
Curing Lamps.....	N422-N425
Fixation Devices.....	N403-N411
Hardware.....	N427-N444
Introduction.....	N389-N395
Lay-Out Mat.....	N411
Professional Kits.....	N397-N398
Protective Eyewear.....	N426
Starter Kits.....	N396-N397
Glass-Chek Thickness Meters.....	N476-N477
Glass-EEZ Cleaning Towels.....	N345
Glass-Strip Masking Liquid.....	N266
Glass-to-Glass Hinges.....	N428-N433
Glass-to-Wood Hinges.....	N428-N429, N431-N432
Glas-Slip.....	N380
Glazier's Chisel.....	N233
Glazier's Gloves.....	N370-N372
Glazier's Safety Gear.....	N370-N377
Glazing	
Clips.....	N227
Compounds.....	N181-N182
Gaskets.....	N177-N179
Points.....	N224
Putty.....	N180-N181
Spline.....	N177
Tape, Butyl Architectural.....	N168-N171
Tape, Vinyl Foam.....	N164-N167
Tapes.....	N162-N175
Gloves	
Atlas Fit.....	N370
Atlas Kevlar.....	N372
Atlas Nitrile.....	N373
Atlas Thermo-Fit.....	N372
Cotton Work.....	N371
Cut Resistant.....	N372
Disposable.....	N250, N369, N426
Fingerless.....	N373
Fuzzy Duck PVC.....	N372
GripPro Impact Performance.....	N374
Insulated.....	N372
Knit Nitrile.....	N370
Knit Wrist.....	N370-N371
Leather.....	N371
Lint-Free Nylon.....	N373
Mechanix Brand.....	N374
Nitril-Flex.....	N371
Nitrile.....	N250, N369, N426
Rubber Coated.....	N372
Sure Grip.....	N371
Textured Nitrile.....	N370
Vinyl Coated Work.....	N371
Glue Guns and Sticks.....	N223
Glues.....	N281-N282
Goggles, UV Absorbing.....	N377, N426
Graco 5-Gallon Dispenser.....	N213
Graffiti Remover.....	N250, N362
Graphite Lubricant.....	N380
Grease Gun.....	N381
Grease Lubricants.....	N378, N381
Grease Remover.....	N250, N362
Grime Scrub Brush.....	N347
Grip Strip.....	N270
GripPro Impact Performance Gloves.....	N374
Grommets, Mirror.....	N313
Ground Fault Interrupt Device.....	N357
Groove Tool, Super Spacer.....	N466
Guidelines to Good Glazing.....	N147-N149
Guides, Sealant.....	N467
Gun Fill Pump.....	N183, N222
Guns	
Adhesive.....	N183, N222

Brad Nail.....	N226
Caulking.....	N205-N212
Glue.....	N223
Grease.....	N381
Handi-Foam.....	N185
Heat.....	N400
Hot Air.....	N400
Hot Extruder.....	N454
Hydra-Mate Applicator.....	N457
Paint Spray.....	N388
Rivet.....	N321
Staple.....	N332
Gunther	
Extra Build Mirror Mastic.....	N274
Mirror and More Glass Cleaner.....	N338
Premier Plus Mirror Mastic.....	N274
Prime-N-Seal Primer.....	N275
Seal-Kwik Mirror Edge Sealant.....	N275
Ultra/Bond Mirror Mastic.....	N274

H

Hacking Knife.....	N234
Hackout Tools, Window.....	N234, N236
Hammer Tacker.....	N332
Hand	
Cleaners.....	N347
Held Spot Bulb UV Curing Lamp.....	N423
Notcher, Super Spacer.....	N466
Tool, A-T Series Fasteners.....	N329
Towels.....	N344
Handi-Foam Dispenser Guns.....	N185
Handi-Foam Polyurethane Foam.....	N184-N185
Handi-Seal Window and Door Sealant.....	N184
Handy Clamps.....	N463
Hanger Bolts.....	N311
Hanger Wire.....	N331
Hardman Gun.....	N454
Hardware Positioning Device.....	N411
Hardware, Glass Furniture.....	N427-N444
Heat Guns.....	N238, N400
Heat Lamp, Duralite.....	N463
Heated Auto Glass Urethane.....	N483
Heater Boxes.....	N219
Heater Ovens.....	N219, N483
Heavy-Bodied Mirror Mastic.....	N271
Heavy-Duty	
Automotive Riveter.....	N325
Fixed Blade Utility Knife.....	N242
Glue Gun.....	N223
Hacking Knife.....	N234
Hook-End Blades.....	N245
Razor Blades and Scrapers.....	N247, N366, N402
Retractable Blade Knives.....	N242, N244
Rivet Gun.....	N321
Scrapers and Chisels.....	N233
Scratch Polisher.....	N353
Thread Insert Tool.....	N330
Utility Knife and Blades.....	N242-N243
Hex	
Head Cap Screws.....	N309
Insert Bits.....	N300, N305
Nuts.....	N312
Washer Head Screws.....	N296, N310
High	
Intensity Hand Held UV Curing Lamp.....	N423
Intensity LED UV Adhesive Curing Lamp Kit.....	N424
Modulus Urethane Adhesive.....	N485
Ratio Caulking Guns.....	N205-N206
Speed Installer for Anchors.....	N292
Temp Silicone Gasket.....	N486
Viscosity Auto Glass Urethanes.....	N482, N484, N490-N491
Viscosity UV Adhesives.....	N413, N416
Hilti Expansion Anchors.....	N309
Hinge Cover Plate Screw Caps.....	N313
Hinge Cover Plate Screws.....	N314
Hinges, Glass Furniture.....	N428-N433
Hi-GLOSS Stone Countertop Cleaner.....	N358
Hi-Red Plastic Anchors.....	N290
Hi-SHEEN Glass Cleaner.....	N335
Hi-Torquer Hand Tool.....	N329
Holder, Magnetic.....	N438
Holder, Razor Blade.....	N247, N402
Holders, Suction.....	N404-N405, N407-N409
Hollow Door and Wall Fasteners.....	N292
Hollow Wall Anchors, Toggle.....	N294
Hooded Twin-Wheel Casters.....	N444
Hook End Utility Blades.....	N245
Horizontal Joint Sealant.....	N132
Horse Hair Dusting Brush.....	N368
Horseshoe Shims, Aluminum.....	N194, N202
Horseshoe Shims, Jumbo.....	N194
Horseshoe Shims, Plastic.....	N193
Hose Torch Kit.....	N239
Hot Air Gun Kit.....	N238, N400



03SAF CATALOG A TO Z PRODUCT INDEX

Hot Melt	
Butyl.....	N453-N454
Butyl Dispensing Systems	N450-N452
Butyl Insulating Glass Starter Kits	N447
Butyl Rope	N454
Clamp Table	N452
Extruder Gun.....	N454
Trim Knife	N450
Hot Press Production Table.....	N464
How to Identify Screws.....	N295
Hyde	
Contour Scraper.....	N233
Hackout Knife.....	N234
Painter's Tool.....	N235
Putty Knives	N229-N230
Hydraulic Rivet Guns	N321
Hydra-Mate Dispensing Unit	N457

I	
Impact Performance Gloves.....	N374
Impruv UV Adhesive	N417
Industrial	
and Construction Silicone	N118-N119
Blind Rivets	N317-N320
Glass Cleaners	N334-N338
Paper Towels	N343-N345
Razor Blades	N402
Release Agent	N362
Wet/Dry Vacs	N252
Inline Bio-Gun	N215
Inline Pneumatic Tool Oiler	N300, N305
Insert Bits	N405, N409
Inside Suction Holders	N372
Insulating Glass	
Adsorbents.....	N458
Aluminum Spacers.....	N468-N469
Butyl Sealants	N453-N454
Caliper.....	N478
Compatible Sealants	N455
Corners	N468-N469
Duralite Spacer	N462
Equipment.....	N450-N452, N457, N459, N464, N472-N475
Gauges.....	N478
Guides.....	N467
Hot Melt Pumps.....	N450-N452
Manual.....	N445
Molecular Sieve	N458
Muntin Bars and Clips.....	N470-N471
Nozzles.....	N450
Polyisobutylene Primary Seal	N456
Polysulfide Sealant	N455
Polyurethane Sealant	N455
Production Lines.....	N475
Sealant Dispensers.....	N450-N452
Silicone.....	N114, N456-N457
Spacers.....	N468-N469
Starter Kits	N446-N449, N461
Storage and Handling Equipment	N474
Super Spacer	N465-N466
Thickness Gauges	N478
Trim Knife	N450
Internal Muntin Joiner.....	N471
Interior Corner Clamp	N410
Interior Corner Support.....	N410
Introduction to Sealants	N101
ITW Buildex E-Z Ancors	N288

J	
Jacknut Anchors	N292
Jiffy Mixer	N218
Joiners, Muntin	N471
Joint Tooling Spatulas	N216
Jumbo Horseshoe Shims.....	N194
Jumbo Paper Towels.....	N345

K	
KD Scraper and Chisel	N235
Kevlar Cut-Resistant Gloves.....	N372
Kimberly-Clark Hand Cleaner	N347
Kimberly-Clark Paper Towels.....	N343-N345, N401
Kimtex Shop Towels.....	N344
Kit(s)	
Adjustable Angle Clamp-It Assembly Tool	N404
A-T Series Fasteners	N329
Cement Mixing	N286
Clamp-It Assembly Square	N405
Cordless Caulking Gun	N210-N211
Fein Sealant Cut-Out	N236
Viscosity Bonding Starter.....	N396-N398
Hot Air Gun	N400
Insulating Glass Starter	N446-N449, N461
Molecular Sieve Testing	N458
Propane Torch.....	N239

Rivet Gun	N321
Rivet-Nut/Poly-Nut.....	N327
Scratch Polishing	N353-N356
Sealant Cutter	N236
Stainless Steel Restoration	N360
Staple Gun	N332
Super Spacer Desiccant Activity	N467
Tamperproof Security Screws.....	N300
UV Curing Lamp	N424
UV Starter	N396-N398
Klik Poly-Nuts and Thread-Serts	N327
Knit Wrist Gloves	N370-N371
Knives	
Carton Cutter	N247
Craftsman	N245
Fein Sealant Cut-Out.....	N236
Hackout.....	N234
Hot Melt Trim.....	N450
Lead	N234
Linoleum	N234
Long Handle Cut-Out	N241
Olfa	N244
Pipe Handle.....	N241
Pocket.....	N244
Putty.....	N228-N232
Razor	N247
Roofing	N248
Utility	N242
Wildcat Sealant Cutting.....	N237
Knobs, Glass Furniture.....	N435
Krylon Primers	N385
Krylon Spray Paint	N385
Krytox Lubricant	N380
Kwik-Seal, Dap	N135
Kwikset Cement	N285

L	
Lag Bolts.....	N308
Lamp, Quartz Heat	N463
Lamps, UV Curing	N422-N425
Lamson Bent Knives	N228
LaserTip Screwdriver Set.....	N304
Laser, Glass Thickness	N477
Latches, Magnetic	N438
Latex Caulks	N133-N135, N141
Latex Gloves	N250, N369
Latex Window Glazing Compound	N182
Lay-Out Mat, UV	N411
Lead Anchors	N291
Lead Foil Tape	N268
Lead Knife	N234
Leather Gloves	N371
LEED Statement	N159
Lid-Off Tool	N218
Lift-Off Removers.....	N250, N362
Light-Bodied Mirror Mastic.....	N271
Limitations of Warranties	N101
Linoleum Knife	N234
Lint Free Glass Wipes.....	N342, N401
Lint Free Nylon Gloves	N373
Liquid Nails Adhesive	N284
Lith-Ease White Lithium Grease.....	N381
Lock Lubricant	N379
Lock Washers	N303
Locks for Glass Furniture	N429, N434
Loctite	
Chisel Paint Stripper	N402
Color Guard	N385
Contact Adhesives	N279
Fast Cure Epoxy Mixer Cups	N278
Form-A-Thread.....	N279
Impruv UV Adhesive	N417
Metal Contact Cement	N278, N421
Minute Bond Adhesive and Primer.....	N277, N417
ODC-Free Cleaner and Degreaser	N364, N400
Poxy-Pak Clear Two-Part Epoxy	N279, N421
Primers	N277, N417, N421
Prism Instant Adhesive	N277
Rust Treatment	N361
Superbonder Adhesive.....	N277
Threadlocker	N279
Logo Label Glass Cleaner	N337
Long Double Tube UV Curing Lamp.....	N425
Long Knives	N241
Long Reach Knife, Olfa	N244
Low	
Conductive Urethane Adhesive	N485
Deflection Molecular Sieve	N458
Profile Dual Seal Aluminum Spacers	N469
Viscosity UV Adhesive	N413, N415
Low-e Coating Contact Meter.....	N480
Low-e Coating Detectors.....	N476-N477, N479-N480
Low-e Washing Machine Detergent	N340
Lubricants	N378-N383

M	
M64 CRL Polyurethane Construction Sealant	N129
M65 CRL Polythane Construction Sealant	N127
M66 CRL Polyurethane Construction Sealant	N128
Machine Screws.....	N299
Magnetic	
Cube, Fixed 90 Degree	N407
Fixation Device.....	N407
Insert Bit Holders.....	N305
Latches	N438
Screwdrivers.....	N304
Suction Holder.....	N407
Tape	N266
Makita Power Scraper Hackout Gun	N236
Makita Screw Finder/Driver	N305
Male Couplers	N215
Marson Rivet Guns	N321, N325
Masking Liquid.....	N266
Masking Tape.....	N260, N263
Masks, Dust.....	N375
Masonry Screws	N299
Master Assortment Kit, A-T Series.....	N329
Mastics	N271-N274
Match-Up Paint	N384
Mat, UV Lay-Out	N411
Mechanic Gloves	N374
Medium Viscosity Auto Glass Urethanes.....	N484, N492
Medium Viscosity UV Adhesive	N415
Megapoxy Self-Leveling Sealant	N144
Merlin Lazers	N479
Metal	
Cleaners and Polishes.....	N361
Contact Cement	N278, N421
Lubricants	N378-N379
Sash Putty.....	N180-N181
Shield Casters.....	N444
Meters, Glass Coating	N480
Meters, Glass Thickness	N476-N478
Methyl Ethyl Ketone	N251, N364, N469
Metric Glass Thickness Caliper	N478
Metric Glass Thickness Gauge.....	N478
Metric Glass Thickness Laser	N477
Micro Fiber Wipes	N343, N401
Mildew Resistant Silicone Sealant	N112
Milwaukee Cordless Caulking Guns	N211
Milwaukee Heat Gun	N238, N400
Minute Bond Adhesive and Primer	N277, N417
Miracle All-Purpose Adhesive	N284
Mirror	
Backing Tape.....	N276
Cleaner and Polish	N339
Edge Sealants	N275
Grommets	N313
Mastic Applicator Stik.....	N273
Mastics, CRL.....	N271
Mastics, Gunther.....	N274
Mastics, Palmer	N272-N273
Plate Screws	N299
Mirror-Tite Mastic Dots.....	N271
Mixer Cups of Epoxy	N278
Mixers for Two-Part Sealants	N218
Moistop Sealant	N176
Molding Retention Tape	N264
Molecular Sieve Adsorbent	N458
Molly Type Anchors	N292
Motsenbocker's Lift-Off Removers.....	N250, N362
Multi-Cutter Tool	N270
Multi-Knife Scraper Blade and Handle	N248
Multi-Purpose Swasi Clamp.....	N406
Muntin Bars and Clips	N470-N471
Muntin Tools	N472-N473

N	
Natural Chamois.....	N348
Natural Organic Sponge	N349
Needles, UV Dispensing	N420
Neoprene Setting Blocks	N197-N198
Neutral Cure Automotive Silicone Sealant.....	N486
Neutral Cure Silicones	N118-N125, N140, N142
Newborn Caulking Guns	N207, N209
Nickel Plated Wood Screws	N298
Nitrile Coated Gloves	N370, N373
Nitrile Disposable Gloves	N250, N369, N426
Nitri-Flex Gloves.....	N371
No-Drip Caulking Guns.....	N207-N208
Non-Contact Thermometer.....	N400
Norseal Tapes.....	N173
Norton Tape	N163
Norton Tite-R-Bond Adhesion Promoter	N173
Notchers, Muntin Bar	N472
Novus Plastic Polishes.....	N359
Nozzle Caps.....	N221
Nozzle Cutter	N221
Nozzles, Brass Tip.....	N450

O3SAF CATALOG A TO Z PRODUCT INDEX

Nozzles, CaulkingN220-N221
 Nozzles, Polyethylene.....N220
 Nut Setter SocketsN305
 Nylock Hex Nuts.....N312
 Nylon Cable TiesN290
 Nylon Gloves, Lint Free.....N373

O

ODC-Free Cleaner and DegreaserN364, N400
 Offset Hex Bit DriverN304
 Oil, Glass CuttingN383
 Oil, Pneumatic ToolN382
 Olfa Knives and Blades.....N244
 Open Cell Backer RodN187
 Open Cell Nylon Clean Up PadsN368
 Organic Vapor Respirator.....N375
 Oval Suction Holders.....N405, N409
 Oval Head Phillips ScrewsN296, N301
 Ovens, Cartridge Heater.....N219, N483

P

Paddle MixerN218
 Pads, Open Cell Nylon.....N368
 Paint
 and Varnish BrushN388
 BituminousN287, N385
 Match-UpN384
 Prep PenN388
 Spray Gun.....N388
 Touch-Up.....N386-N387
 Painter's ToolN235
 Palmer
 Electric Mastic ApplicatorN273
 Mastic Stik.....N273
 Mirro-Mastic.....N272
 Mirro-Mastic Bond.....N273
 QwikSet Mirro-Mastic.....N273
 Pan Head Phillips ScrewsN296
 Paper Towels and DispensersN343-N345, N401
 Particulate Respirators.....N375
 Peak Tool, Duralite.....N463
 PermaWhite Polythane Construction SealantN127
 Phillips Insert Bits.....N305
 PIB Extruder.....N459
 Picture Hook Anchors.....N294
 Pilkington K Glass Detectors.....N479
 Pinchweild Primer.....N485, N488
 Pipe Handle Cut-Out Knives.....N241
 Pistol Type Oiler Can.....N222
 Plastic
 and Emblem AdhesiveN280
 Auto Glass Rivets.....N324
 Applicator Bottle.....N222
 Bearing ShimstripsN195
 Caulking Applicator ToolsN216
 Cleaners.....N359
 Horseshoe Shims.....N193-N194
 Mini Scraper With Razor Blade.....N366
 Polishes.....N359
 Razor Blades.....N246, N367
 Reflective Tape.....N269
 Rivet Setter.....N325
 Screw Anchors.....N289-N291
 Setting Blocks, Clear.....N200
 Spray Bottles.....N340
 Toggle Screw Anchors.....N290
 Washers.....N303
 Plier Type Stapler.....N332
 Plumbers Mate Silicone Sealant.....N140
 Pneumatic Tool Oil.....N215, N382
 Pneumatic Tool Oiler.....N215
 Pocket Knives.....N244
 Point Drivers.....N224-N225
 Points
 Diamond.....N224
 Framemaster.....N225
 Glazing.....N224-N225
 Push.....N226
 Triangle.....N224
 Polish, Stainless Steel.....N361
 Polishes, Plastic.....N359
 Polishing Disks, Scratch Removal.....N354
 Polishing Head Assembly.....N352
 Polishing Oil.....N380
 Polyester Surface Protection Tape.....N267
 Polyethylene Backer Rod.....N188
 Polyethylene Sealant Guides and Nozzle.....N467
 Polyisobutylene Insulating Glass Starter Kit.....N449
 Polyisobutylene Primary Seal.....N456
 Polysulfide Sealant Insulating Glass Starter Kit.....N449
 Polysulfide Sealant, Two-Part.....N455
 Polythane Construction Sealant.....N127
 Polyurethane
 Automotive Adhesive/Sealant.....N486

Backer RodN187
 Construction Sealants.....N128-N132, N144
 Sealant Insulating Glass Starter Kit.....N448
 Sealant, Two-Part.....N455
 Poly-Nuts.....N327
 Portable Air Tank.....N214
 Portable Heater Box.....N219
 Positioning Device, UV Hardware.....N411
 Posts, Table.....N444
 Pouring Ramp.....N287
 PowerGlide Caulking Gun.....N208
 Power Meter, UV Transmission.....N420
 Power Rotating Sealing Table.....N474
 Power Scraper, Makita.....N236
 POWR
 Bond Auto Glass Urethanes.....N482-N483
 Bond One Step Primer.....N483
 Clean Frit Kit.....N492
 Cleaner.....N335
 Primerless Auto Glass Urethanes.....N484-N485
 Poxy-Pak Clear Two-Part Epoxy.....N279, N421
 Premium Grade Caulking Compound.....N137
 Pre-Shimmed Architectural Tape.....N171
 Pressure Regulator and Gauge.....N215
 Primer(s)
 3M Single Step.....N491
 Automotive.....N483, N485, N488, N490-N492
 Butyl Tape.....N488
 Essex Auto Glass.....N492
 Loctite Contact Cement.....N421
 Loctite Minute Bond Adhesive.....N277, N417
 POWR Bond One Step.....N483
 Sika Auto Glass.....N490
 Silicone Sealant.....N114
 Prism Instant Adhesive.....N277
 Private Label Glass Cleaner.....N337
 Private Label Silicone Program.....N110
 Pro Tool, Duralite.....N463
 Problem Solver Nozzles.....N220
 Production Table, IG Hot Press.....N464
 Professional Glass Cutter Oil.....N383
 Professional Kits, Glass Bonding.....N397-N398
 Professional Touch-Up Paint.....N386-N387
 Proglaze Silicone Sealants.....N117, N124
 Propane Torches and Cylinders.....N239
 Protective
 Eyewear.....N376-N377, N426
 Films and Tapes.....N267
 Gloves.....N370-N374
 Masks and Respirators.....N375
 Protectors, Glass.....N341, N442
 Pro-2 Silicone Spray.....N378
 Pry Bars.....N235
 PTI 707.....N138
 Pullmate Point Removing Tool.....N225
 Pulls, Glass Furniture.....N429, N436
 Pump-Activated 90 Degree Suction Holder.....N407
 Pumps, Adhesive.....N183
 Pumps, Bulk Transfer.....N222
 Pure Gum Turpentine.....N249
 Push Points Display.....N226
 Pushbutton Magnetic Latches.....N438
 Pushmate Point Setting Tool.....N224
 Putty
 All-Purpose.....N180-N181
 Chisels.....N233
 Knives.....N228-N232
 Metal Sash.....N180-N181
 Removal Tools.....N233-N237
 Tape.....N172
 Wood Sash.....N180
 PVC Clear Tape.....N255

Q

Quart Size Caulking Guns.....N208-N209, N212
 Quartz Heat Lamp, Duralite.....N463
 Quick Disconnect Air Hose Couplers.....N215
 Quick Release Agent.....N249, N363
 QuickBit and QuickCaps.....N313
 QuickSteel Epoxy Putty.....N282
 QwikSet Mirro-Mastic.....N273

R

Radians Safety Glasses.....N376-N377
 Rags, Cleaning.....N345
 Railing Anchors.....N308
 Railing Screws.....N306-N307, N310
 Ratchet Rod Caulking Gun.....N207
 Ratcheting Extension Screwdriver.....N304
 Rawl Nails Expansion Anchors.....N291
 Rawl Scru-Lead Anchors.....N291
 Razor Blade Holder and Scraper.....N247, N366, N402
 Razor Blades.....N246, N367, N402
 Razor Knives.....N247

Ready Jet Inline Blo-Gun.....N215
 Ready Mix Glass Cleaner.....N338
 Red Cap Plastic Anchors.....N289
 Red Devil
 Double End Window Tool.....N235
 Linoleum Knife.....N234
 Putty Knives and Chisels.....N228-N231, N233
 Window Zipper.....N234
 Red Head Sleeve Anchors.....N309
 Red RTV High-Temp Silicone Gasket.....N486
 Release Agent Spray.....N362, N379
 Remover, Water Spot.....N351
 Remover, Water Stain.....N350
 Replacement Blades, Utility Knife.....N243-N244
 Replacement Bulbs, UV Curing Lamp.....N423-N425
 Respirators.....N375
 Retractable Blade Utility Knives.....N242
 Reusable Caulk Tips and Cap.....N221
 Rez-Guard Barrier Cream.....N347
 Rigid Aluminum Long Knives.....N241
 Rigid Rubber Spacing Blocks.....N201
 Rivet
 Guns.....N321
 Head Removal Tool.....N320
 Ordering Information.....N317-N318
 Spacers.....N320
 Tool Nosepieces.....N325
 Rivets
 Aluminum.....N319-N320
 Auto Glass.....N322-N324
 Colored.....N320
 Steel.....N319-N320
 Stainless Steel.....N319-N320
 Rivet-Nuts.....N330
 Rivet-Nut/Poly-Nut Kit.....N327
 Rockite Cement.....N285
 Rod, Backer.....N186-N189
 Rod, Threaded.....N311
 Rolled Setting Block Material.....N197
 Roller Tools, Backer Rod.....N190-N191
 Roller Tools, Vinyl.....N177
 Roll-In Glazing Gaskets.....N178
 Roof and Gutter Silicone Sealant.....N139
 Roof Coating.....N287
 Roofing Knife.....N248
 Rotary Sealing Table.....N474
 Rotating Head Rivet Gun.....N321
 Rotation Support.....N438
 Router, Muntin Bar.....N472
 RTV408 CRL Silicone.....N118-N119
 Rubber
 Flashing Tape.....N171
 Setting Blocks.....N197-N199
 Spacing Block and Sealing Pad Tool.....N201
 Spacing Blocks.....N202
 Squeegees.....N349
 Russell Putty Knives and Chisels.....N228-N230, N233
 Rust Treatment.....N361

S

S50 Sprayway Glass Cleaner.....N336, N400
 Safety Backing Tape for Mirrors.....N276
 Safety Slitter.....N248
 Safety Wear
 Dust Masks.....N375
 Glasses and Goggles.....N376-N377, N426
 Gloves.....N370-N374
 Respirators.....N375
 UV Goggles and Spectacles.....N426
 Sanitary Silicones.....N112, N140
 Sash Glazing Clips.....N227
 Sausage Caulking Guns.....N208-N212
 Scotchmate Fastening Tape.....N265
 Scotch-Brite Hand Pads.....N368
 Scrape and Pry Bars.....N235
 Scrapers, Razor Blade.....N247, N402
 Scratch Polishing Kit.....N353
 Scratch Removal Systems.....N354-N356
 Scratch-A-Way Scratch Removal System.....N355
 Scratch-B-Gone Stainless Steel Restoration Kits.....N360
 Screw
 Anchors.....N289
 and Wire Gauge.....N313
 Covers.....N312
 Eyes.....N331
 Screwdrivers.....N304-N305
 Screwgun Bits and Sockets.....N305
 Screws
 Door Closer.....N316
 Drywall.....N299
 How to Identify.....N295
 Machine.....N299
 Masonry.....N299
 Railing.....N306-N307, N310



C.R. LAURENCE COMPANY

N498 | crlaurence.ca crlaurence.com.au crlaurence.co.uk crlaurence.de crlaurence.eu

crlaurence.com

O3SAF CATALOG A TO Z PRODUCT INDEX

Self-Drilling.....	N297, N301	Dow Corning.....	N115, N122, N145	Squeeze Tubes of Silicone.....	N111
Self-Tapping Machine.....	N299	Gasket.....	N486	SS96 Hot Melt Gunning System.....	N450
Sheet Metal.....	N296-N297	GE.....	N116, N123-N124, N140-N141	Stain Remover.....	N350
Shower Hinge.....	N314-N315	General Purpose.....	N139	Stainless Steel	
Spanner Head.....	N300	Insulating Glass.....	N114, N456-N457	Allen Screws.....	N311
Stainless Steel.....	N306	Lubricants.....	N378-N379	Anchors.....	N308
Tapped Head.....	N298	Mildew Resistant.....	N112	Cleaner.....	N361
Wood Framing.....	N298	Neutral Cure.....	N118-N125, N140, N142, N486	Furniture Foot.....	N440
Scrub Brush.....	N347	Nozzles.....	N220	Handles.....	N435
Scrubs-in-a-Bucket.....	N346	Plumbers Mate.....	N140	Hinges.....	N428-N431
Sealant(s)		Primer.....	N114	Knobs.....	N435
Acrylic Latex.....	N133-N135	Private Label.....	N110	Pocket Knife.....	N244
Assistance.....	N101	Remove and Surface Prep.....	N249, N363	Restoration Kits.....	N360
Basic Uses and Limitations.....	N102-N106	Roof and Gutter.....	N139	Rivets.....	N319-N320
Butyl Rubber.....	N136-N138	RTV408.....	N118-N119	Screws.....	N306, N310
Comparable Brands Chart.....	N158	Rubber Setting Blocks.....	N199	Socket Head Cap Bolts.....	N330
Construction.....	N126	Sealants.....	N107-N125, N139-N145	Spatulas.....	N216
Cutter Knife Kit.....	N236	Spray Lubricants.....	N378, N382	Threaded Rods.....	N311
for Australia.....	N139-N145	Structural Adhesive.....	N122	Washers.....	N303, N312
Finishing Tool.....	N217	Tremco.....	N117, N124-N125	Standard Duty Utility Knife Blades.....	N243
Guidelines.....	N146-N161	Typical Applications.....	N107	Stanley Glazier's Chisel.....	N233
Guides, Polyethylene.....	N467	Water Clear.....	N113, N421	Stanley Pocket Knife.....	N244
Mirror Edge.....	N275	Siliconized Acrylic Latex Sealants.....	N133-N134	Stanley Utility Knives.....	N242, N244-N245
Polysulfide.....	N455	SilPruf Silicone Sealant.....	N123	Standoff Connector Bolt.....	N307
Polythane.....	N127	Single		Staples and Staplers.....	N332
Polyurethane.....	N127-N132	Door Locks.....	N429	Starter Kits, Glass Bonding.....	N396-N398
Removal Tools.....	N236-N241	Edge Razor Blades.....	N246, N367	Starter Kits, Insulating Glass.....	N446-N449, N461
Requirement Estimator Chart.....	N156	Seal Aluminum IG Spacer.....	N468	Steel	
Roof and Gutter.....	N139	Tube UV Curing Lamp.....	N425	Insert Fasteners.....	N328
Selector Chart.....	N157	Sleeve-Style Window Washers.....	N348	Rivets.....	N319-N320
Silicone.....	N107-N125	Slip-N-Grip Floor Mats.....	N365	Sash Clips.....	N227
Spatulas.....	N216	Slip-N-Grip Seat Covers.....	N365	Window Frame Extractor.....	N237
Super Spacer.....	N465	Slip-N-Grip Steering Wheel Covers.....	N365	Wool.....	N368, N402
Surface Preparation Guide.....	N160-N161	Slotted Insert Bits.....	N305	Steering Wheel Covers.....	N365
Table, Rotary.....	N474	Slugs, Polyisobutylene.....	N456	Stepped Roller Tool.....	N191
Windshield.....	N487	Small Joint Seam Sealer.....	N183	Stick Tools.....	N217
Sealstrip Glass Setting Tape.....	N175	Small Tube Dispenser Handle.....	N111, N222	Sticker-Tite.....	N172
Seam Sealer.....	N183	Smooth Finish Polyurethane Sealant.....	N129	Stiff Putty Knives.....	N228-N230
Seat Covers.....	N365	Smooth Rod Caulking Gun.....	N206	Stop Mold Puller.....	N238
Self-Aligning Setting Blocks.....	N200	Snap Cap Screw Covers.....	N312	Storm Window and Door Adhesive.....	N284
Self-Drilling Anchors.....	N288	Snaptoggle Toggle Bolts.....	N293	Straight Cut Snips.....	N463
Self-Drilling Screws.....	N297, N301, N310	Snips, Metal Cutting.....	N463	Straight Line Plastic Anchors.....	N291
Self-Igniting Torch Kit.....	N239	Soap, Window Cleaning.....	N348	Strap Frame Caulking Guns.....	N205-N208
Self-Tapping Machine Screws.....	N299, N310	Socket Head Cap Bolts.....	N330	Strip Lead.....	N200
Selleys Adseal SL.....	N145	Socket Head Cap Screws.....	N309	Strip-Calk Bedding and Glazing Compound.....	N489
Setting Blocks		Sof Rod Backer Rod.....	N189	Structural Adhesive, 3M.....	N281
Adjustable.....	N200	Solar Transmission and BTU Power Meter.....	N480	Structural Glazing Tape.....	N163
Aluminum/Neoprene.....	N202	Solder-It Butane Torch.....	N239	Suction Holders.....	N404-N405, N407-N409
Beveled Corner.....	N199	Solvent Cleaner and Degreaser.....	N249, N363, N399	Sunburst Muntin Joiners.....	N471
Clear Plastic.....	N200	Solvent, Foam Sealant.....	N185	Sunshade Bolt Assembly.....	N309
EPDM Rubber.....	N199	Solvents, Adhesive.....	N250-N251, N364	Super	
Glass Railing.....	N202	Somaca/CRL		Scraper Tool.....	N248
Neoprene.....	N197-N198	Glass Polisher and Scratch Remover.....	N353	Shim Shower Door Leveler.....	N204
Rolled.....	N197	Glass Washers.....	N339	Trim Adhesive.....	N283
Silicone Rubber.....	N199	Polyisobutylene Extruders.....	N459	Weatherstrip Adhesive.....	N280
Thermoplastic Rubber.....	N198	Tilting Hot Press Production Table.....	N464	Super Spacer	
Vinyl Set.....	N199	Soundstrip.....	N114	Bulk Reel Stand.....	N466
Windscreen Post.....	N203	Spacer		Desiccant Activity Kit.....	N467
Sex Bolts.....	N316	Aluminum IG.....	N468-N469	Groove Tool.....	N466
Sheet Metal Screws.....	N296-N297	Bar Cutting Machine.....	N459	Hand Tool.....	N466
Sheet Metal Washer Head Screws.....	N302	Bender.....	N473	IG Sealant.....	N465
Shelf Supports.....	N439-N440, N442	Corners.....	N468-N469	Sealant Starter Kits.....	N447-N448
Shelving Anchors.....	N294	Edgetech Super.....	N465	Seminar DVD.....	N466
Shims		TruSeal Duralite.....	N462	Super Shuttle Applicator.....	N466
Aluminum.....	N194, N202	Spacing and Sealing Pads.....	N201	Urethane Sealant.....	N467
Clear Plastic.....	N200	Spacing Blocks, Rubber.....	N201	Superbonder Adhesive.....	N277
Horseshoe.....	N193	Spackling Compound.....	N135, N182	SuperCut Aluminum Cutter Knife Kit.....	N236
Jumbo.....	N194	Spanner Head Screws.....	N300	Super-Grip Sealant Long Knife.....	N241
SurfaceMate.....	N202	Spanner Insert Bits and Driver.....	N300	Support	
Wood.....	N196	Sparkle Cleaner and Stain Remover.....	N351	Countertop.....	N441
Shimstacks.....	N192	Spatulas, Sealant.....	N216	Glass-To-Wall.....	N442
Shimstrips.....	N195	Spectacles, UV Absorbing.....	N426	Pole.....	N442
Shoe Covers.....	N365	Sponge Rubber Desk Stripping.....	N270	Rotation.....	N438
Shop Towels.....	N343-N345	Sponge Rubber Tape.....	N172	Shelf.....	N439-N440, N442
Shop-Vac Wet-Dry Vac.....	N252	Sponges.....	N349	Sure Grip Glass Gloves.....	N371
Shower Door Leveler, Super Shim.....	N204	Spot Remover.....	N351	Surface	
Shower Hinge Screws.....	N314-N315	Spray		Carpet, Bonding Work.....	N411
Shower Squeegee.....	N349	Adhesive.....	N283	Preparation and Application.....	N153-N155
Shuttle Applicator, Super Spacer.....	N466	Dispenser Bottles.....	N340	Preparation Guide for CRL Sealants.....	N160-N161
Sika Primers.....	N490	Glass Cleaners.....	N334-N337, N400	Protection Film.....	N267
SikaFlex Urethane Adhesive.....	N490	Mirror Edge Sealant.....	N275	Protector.....	N341
SilGlaze Silicone Sealant.....	N123, N140	Mist Coolant.....	N381	Restoration.....	N352-N357
Silicone		Paint.....	N385-N387	SurfaceMate Angle Adjust Curved Blocks.....	N202
33S.....	N108-N109	Paint Remover.....	N362	SurfaceMate Horseshoe Shims.....	N202
Acetic Cure.....	N108-N117	Penetrant.....	N379	Sur-Grip Long Knife.....	N241
Australian.....	N139-N140, N142-N145	Trim Adhesive.....	N283	Swabs, Cotton.....	N402
Automotive.....	N486	Sprayway		SwasiClamp.....	N406
Bostik Rhodorsil.....	N142-N144	Clean Jet 100.....	N362	Swivel-Lock Utility Knife.....	N242
Building Sealant.....	N120-N121	Crazy Clean All Purpose Cleaner.....	N358	Synthetic Cellulose Sponge.....	N349
Bulk Packaged.....	N109, N119, N121	Dry Silicone Lubricant.....	N379		
Carded Tubes.....	N111	Glass Cleaners.....	N336, N400		
Clean Up Kit.....	N363	Square Drive Sheet Metal Screws.....	N297		
Counter Display.....	N111	Square Steel Spacers.....	N320		
Custom Colors.....	N110	Squeegees.....	N348-N349		

03SAF CATALOG A TO Z PRODUCT INDEX

T

Table Legs, UV	N443
Table Posts and Base Plates, UV	N444
Tables	
Ball Caster	N474
Duralite Production	N464
Glass Cutting	N474
Hot Melt Clamp	N452
Rotary Work	N474
Tamperproof Security Screws	N300
Tape	
Acoustical	N173
Adhesive Transfer	N263
Aluminum Foil	N268
Bond Breaker	N190
Butyl Architectural	N168-N171
Butyl Automotive	N488-N489
Campermount	N173
Carton Sealing	N262
Copper Foil	N268
Dispensers	N268
Dor-Tite	N172
Double-Sided Clear PVC	N255
Duct	N261
Electrical	N266
Fastening	N265
Felt	N269
Filament	N262
Fire Glazing	N174
Flashing	N171
Foam Core Butyl	N488
Foam Glazing	N164-N167
Foam Mounting	N257
Foam Very Hi-Bond Adhesive	N256
Friction	N266
FSK Facing	N174
Glass Cushioning	N268
Glass Setting	N175
Glazing	N162-N175
Lead Foil	N268
Load Bearing	N169
Magnetic	N266
Masking	N260
Mirror Backing	N276
Mirror Mounting	N258-N259
Molding Retention	N264
Norton Thermalbond	N163
Polyisobutylene	N456
Putty	N172
PVC Foam	N174
Reflective	N269
Sealstrip	N175
Squares	N257
Sticker-Tite	N172
Translucent	N253-N255
Transparent	N253-N255, N263
Truck Cap Foam Seal	N173
Tuff-Pak	N175
Very Hi-Bond	N253-N254
VHB	N255-N256
Windshield and Trim Securing	N260, N264
Tapered Wood Shims	N196
Tapped Head Wood Screws	N298
Tapping Screws Fix-Kit	N301
Tarnish Remover	N361
Tee Nuts	N312
Tek Self-Drilling Screw Fix-Kit	N301
Test Kit for Molecular Sieve	N458
Textured Finish Polyurethane Sealant	N128
Thermalbond Structural Glazing Spacer Tape	N163
Thermometer, Non-Contact	N400
Thermoplastic Rubber Setting Blocks	N198
Thick Glass Cutting Oil	N383
Thickness Calipers and Gauges	N478
Thickness Lasers	N477
Third-Hand Power Clamp	N406
Thread Insert Tool	N330
Threaded Adapters for Knobs	N437
Threaded Rods	N311
Threadlocker	N279
Thread-Serts	N327
Through-Bolts for Door Pulls	N316
Throw-Away Brushes	N388
Timed Air UV Adhesive Dispenser System	N420
Titebond III Wood Glue	N281
Titebond Heavy-Duty Construction Adhesive	N284
Tite-R-Bond Adhesion Promoter	N173
Toggle Bolts	N293
Toggle Screw Anchors	N290
Toggle	
Drywall Anchors	N288
Hollow-Wall Anchors	N294
Picture Hook Anchors	N294
Shelving Anchors	N294

Tool Kit, Adjustable Angle Clamp-It	N404
Tool Pouch	N191
Top Rubber Gaskets	N179
Torch Kits	N239
Tork Advanced Hand Towels	N344
Toughened Glass Indicator	N479
Touch-Up Markers	N384
Touch-Up Paint	N386-N387
Towel Dispensers	N344-N345, N401
Towels, Paper	N343-N345, N401
TPC Surface Protector	N341
Transfer Tables	N474
Translucent Very Hi-Bond Tape	N253-N254
Translucent White Silicone Sealant	N112
Transparent Tapes	N253-N254, N263
Tremco	
Butyl Architectural Tape	N170-N171
Color Pak System	N132
Dymeric 240FC Polyurethane Sealant	N132
Dymonic FC Polyurethane Sealant	N131
POLYshim II Tape	N171
Proglaze Silicone Sealant	N117
Proglaze SSG Silicone Sealant	N124
Spectrum 2 Silicone Sealant	N125
THC-900 Horizontal Joint Sealant	N132
Tremsil 200 Silicone Sealant	N117
Tremsil 600 Silicone Sealant	N125
VISIONstrip Glazing Seal	N177
Wedge Gasket Glazing Spline	N177
Triangle Points	N224
Trizact Discs and Accessories	N357
Trizact Scratch Removal Kits	N356
TruSeal Duralite	N462
Tub and Tile Caulk	N135
Tube Locks	N434
Tube Wax Lubricant	N381
Tuff-Pak Glass Setting Tape	N175
Turpentine	N249
Twin-Wheel Casters	N444
Two-Part	
Epoxy	N421
Insulating Glass Silicone	N457
Polysulfide Sealant	N455
Polyurethane Sealant	N455
Tyvek Shoe Covers	N365

U

UltraGlaze Silicone Structural Glazing Sealant	N124
Ultra-Thin Combination Knife	N248
Underseal Undercoating	N283
Universal Diamond Points	N224
Universal Roll-In Vinyl	N178
Upholstery Fasteners	N326
Urethane Auto Glass Adhesives	N482-N485, N490-N492
Urethane Heater Ovens	N219, N483
Utility Blade Scraper	N248
Utility Knives and Blades	N242-N245
UV	
Adhesive Dispensing Needles	N420
Adhesive Properties Chart	N418-N419
Adhesives	N412-N417
Assembly Shim Set	N408
Bonding Fixation Devices	N403-N411
Bonding Plates	N443
Bonding Professional Kits	N397-N398
Bonding Starter Kits	N396-N397
Bonding Work Surface Carpet	N411
Casters	N444
Curing Lamps and Accessories	N422-N425
Dispensing Tools	N420
Eye Protection	N426
Glass Bonding Catalog	N403, N509
Glass Furniture Hardware	N427-N444
Hardware Positioning Device	N411
Lay-Out Mat	N411
Shelf Supports	N439
Table Legs	N443
Transmission and Power Meter	N420

V

Vacuum Cleaners	N252
Vacuum Squeegee	N349
Valved Particulate Respirator	N375
Velcro Back Polishing Disks	N354
Velcro Fastening Tape	N265
Vertical Countertop Support	N441
Very Hi-Bond Tapes	N253-N254
VHB Tapes	N255-N256
Vinyl	
Coated Cotton Work Gloves	N371
Foam Glazing Tape	N164-N167
Molding Retention Tape	N264
Roller Tools	N177
Set Setting Blocks	N199

Spackling Compound	N135, N182
Weld	N284
Vise Grip Pliers	N326
Visible Light UV Adhesives	N414
VISIONstrip Glazing Seal	N177
Visitor Spectacles	N377
Vulkem 116 Polyurethane Sealant	N130
Vulkem 45 SSL Polyurethane Sealant	N130

W

Wall Grabber Anchors	N291
Wall Mount Back Plate Screws	N315
Warranties, Limitations of	N101
Wash Brush	N349
Washer Head Screws	N301-N302
Washers	
Clear Plastic	N303
Countersunk	N302
Felt	N303
Lock	N303
Stainless Steel	N303, N312
Zinc	N303
Washing Machine Detergent	N340
Washing Machines	N339, N475
Water Clear Silicone Sealant	N113, N421
Water Spot Remover	N351
Water Stain Remover	N350
Wax Lubricant	N381
WD-40 Lubricant	N382
Weatherstrip Adhesive	N280
Wedge Gasket Glazing Spline	N177
Wedge-Bolt Anchors	N308
Wedgit Glass Centering Springs	N203
Wet Glaze Pump and Accessories	N286
Wet/Dry Vacs	N252
Wheel, Felt Polishing	N352
Whisk Brush	N368
White Grease Lubricant	N378, N381
Why Sealants Fail	N150-N152
Wildcat Sealant Cutter and Putty Remover	N237
Window and Door Mask	N267
Window	
Cleaning Soap	N348
De-Glazing Tools	N240
Frame Extractor	N237
Glazing Compound	N182
Hackout Tools	N234
Scraper	N366
Things	N323
Washing Tools	N348
Zipper Tool	N234
Windo-Weld Super Fast Urethane	N491
Window-Weld Ribbon Sealer	N489
Windscreen Post Setting Block	N203
Windshield and Body Sealant	N487
Windshield and Repair Sealant	N487
Windshield Retention Tapes	N260, N264
Wipes in a Bucket	N346
Wipes, Lint Free	N342, N401
Wipes, Micro Fiber	N343, N401
Wire Brads	N226, N331
Wire Brush	N368
Wood	
Framing Screws	N298
Glue	N281
Sash Putty	N180
Shims	N196
Wooden Handle Spatulas	N216
Wood-to-Glass Hinges	N428-N429, N431-N432
Wool Felt Wheel	N352
Wool, Steel	N368, N402
Work Surface Carpet	N411
WypAll Paper Towels	N343-N344, N401

X

X-Pandotite Cement	N285
--------------------	------

Z

Zinc Threaded Rods	N311
Zinc Washers	N303



FINDING PRICES ON OUR WEB SITE

First, go to crlaurence.com

1 Click **Sign On**



2

Enter your user name and password, then **Click Here to Sign On**



How to Check Prices

3 On the **Product Page**:

- Enter a CRL Catalog Number in the search box located at the top right of page, then click **Search**

- If you are signed on, pricing will automatically appear on the right hand side



To get the full benefits of our web site we suggest you review our UG11 User's Guide, available for viewing or download at crlaurence.com.

4 On the **Quick Pricing Page**:

- Click on **Quick Pricing** under "Customer Menu Bar" located on the top left (see above image)



- Enter the CRL Catalog Number then click **Look Up**

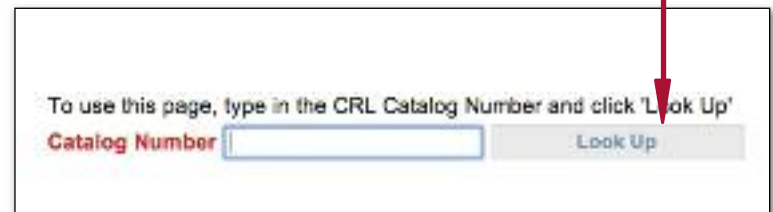

5 On the **Shopping Cart Page**:

- Click on **View Cart** located at the top right of the page



- Enter the quantity and CRL Catalog Number then click **Add to Cart**



- If you decide not to order this item, click **Remove Item**

HOW TO CONTACT US

How to Contact CRL

1 Click on **Contact Us**

2 Click on the **department you want to contact** via e-mail or fax

The screenshot shows the CRL website with the 'Contact Us' link highlighted in the top navigation bar. A table lists various departments and their contact details:

DEPARTMENT	FAX
Online Support	
Discuss any Web Site Issues	(800) 921-0530
Crash!	
Contact the CRL Department, Agency or Office	(800) 921-0530

How to Find Addresses for CRL Locations

1 Click on **Contact Us**

2 Click on **View All CRL Locations**

3 Click on **home country**

4 Click on the **CRL Location nearest you**

5 View and/or print map directions

The sequence of screenshots illustrates the steps:
 1. From the main website, clicking 'Contact Us' leads to a page with a 'View All CRL Locations' button.
 2. Clicking 'View All CRL Locations' leads to a world map where a home country (e.g., USA) is selected.
 3. This leads to a detailed page for the USA with a list of regional locations.
 4. Clicking on a specific location (e.g., 'CRL of Southern California') leads to a page with a detailed map and directions for that location.

PHONE, FAX AND E-MAIL DIRECTORY

Customer Service Order Desk

Ask for Extension

5275

- Get Product Information
- Request Price Quotes
- Check Stock Availability
- Place or Trace Orders
- Check Your Account Status
- Request Catalogs

Customer Service Order Desk hours are 6 am to 5 pm (Pacific Time) Monday through Friday, and 7 am to 12 pm Saturday. If you wish to pick up your order at the Will Call Trade Counter of our regional warehouses the hours are 8 am to 5 pm Monday through Friday, and 8 am to 12 pm Saturday. For the fastest Will Call service be sure to place your order in advance so we can have it ready upon your arrival.

Direct Fax
(800) 262-3299

Direct E-Mail
crl@crlaurence.com



CRL03

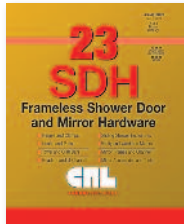

CRL23



CRL43



CRL53



CRL63



CRL73



CRL83



CRL93

Technical Sales Business Groups

Glass and Glazing

Ask for Extension

7720

Direct Fax
(866) 921-0531

Direct E-Mail
glazing@crlaurence.com

- Door and Window Hardware
- Door Controls
- Glass Handling Equipment
- Glazier's Tools and Machinery
- Insulating Glass
- Mirror and Glass Hardware
- Retail Display Hardware and Standoffs
- Safety Gear
- Sealants, Adhesives, and Fasteners
- UV Glass Bonding
- Vacuum Lifting Equipment
- Weatherization Supplies

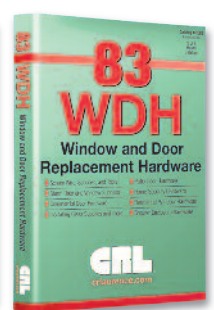
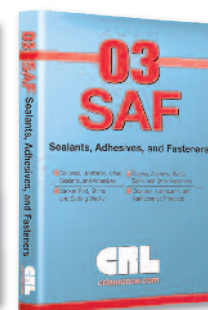
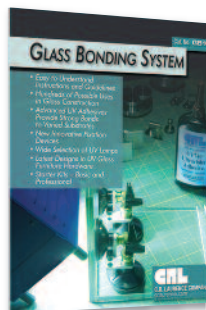
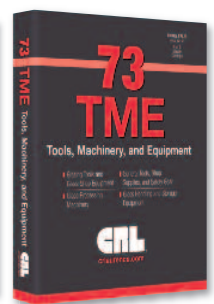
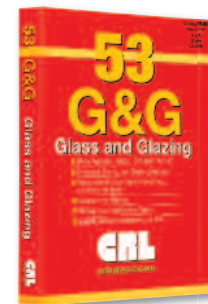

Online Assistance by Telephone:

United States **(800) 421-6144**

Canada **(877) 421-6144**

International **(323) 588-1281**

Ask for Extension

6200

Technical Sales Business Groups

Architectural Hardware

- Architectural Storefronts
- 'All-Glass' Entrance Systems
- Door and Sidelite Rails
- Glass Walls and Partitions
- Stacking and Sliding Glass Doors
- Structural Glass Fittings

Ask for Extension

7700

Direct Fax
(800) 587-7501

Direct E-Mail
architectural@crlaurence.com



Blumcraft Architectural Metals

- Tubular Architectural Hardware
- Tempered Glass Door Hardware
- Panic Hardware
- Railing Systems
- Smoke Baffles
- Glass Gates
- Display Case Doors

Ask for Extension

7700

Direct Fax
(800) 587-7501

Direct E-Mail
architectural@crlaurence.com



Jackson Door Control Hardware

- Overhead Concealed Door Closers
- Door Controls
- Panic Exit Devices
- Door Mounting Accessories
- Door Pivots

Ask for Extension

7520

Direct Fax
(800) 888-6855

Direct E-Mail
jacksonexit@crlaurence.com



Architectural and Ornamental Metals

- Brake Shaped Metals
- Canopies and Sunshades
- Column Covers (Cladding)
- Custom Entrances and Storefronts
- Ornamental Hand and Guard Rails
- Wall Panel Systems

Ask for Extension

7770

Direct Fax
(866) 921-0532

Direct E-Mail
archmetals@crlaurence.com



Europe and Australia – See the rear cover for toll free service numbers



C.R. LAURENCE COMPANY

crlaurence.com

N504 | crlaurence.ca | crlaurence.com.au | crlaurence.co.uk | crlaurence.de | crlaurence.eu

Technical Sales Business Groups

Frameless Shower Door

- Hinges and Clamps
- Knobs and Pull Handles
- Sliding Shower Enclosures
- Towel and Grab Bars
- Vanity and Wardrobe Mirrors

Ask for Extension

7740

Direct Fax (800) 458-7496

Direct E-Mail showers@crlaurence.com

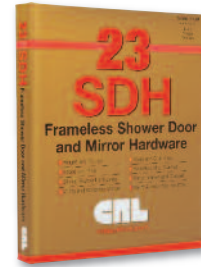

Architectural Railings

- Aluminum Railing Systems
- Cap Railing Systems
- Hand Railing Systems
- Heavy Glass Base Shoe
- Post Railing Systems
- Windscreen and Gate Systems

Ask for Extension

7730

Direct Fax (800) 587-7501

Direct E-Mail railings@crlaurence.com



Transaction and Hospitality

- Bullet Resistant Exchange Windows
- Drive-Thru and Walk-Up Windows
- Food Service Sneeze Guards
- Partition Posts and Booth Dividers
- Safety and Security Mirrors
- Speak-Thru Devices

Ask for Extension

7760

Direct Fax (800) 458-7496

Direct E-Mail transaction@crlaurence.com

Direct E-Mail hospitality@crlaurence.com



Automotive

- Auto Glass Shop Products
- Auto Glass Tools
- Pop-Up and Electric Sunroofs
- Truck Sliding Rear Windows
- Van and RV Windows

Ask for Extension

7780

Direct Fax (800) 587-7501

Direct E-Mail automotive@crlaurence.com



Europe and Australia – See the rear cover for toll free service numbers

CRL CATALOGS AND LITERATURE

C.R. Laurence is a Catalog Company

- Master and Specialty Catalogs in Print and Online
- Thousands of Products Presented in an Organized Manner
- Color Photos and Detailed Illustrations
- Easy to Understand Ordering Information



Of all the products we bring you, our catalogs may be the most important. C.R. Laurence is in the business of making catalogs because we know that our customers find it convenient and informative to use these carefully planned and thoroughly prepared catalogs that make it easy for them to find exactly what they need.

Part of our catalog philosophy is to bring more of the information you need, and not overburden you with excess catalog literature. That is why we make our Master Catalogs that usually contain all of the products we offer to certain industries, as well as our Specialty Catalogs that focus on particular product groups. You can select CRL Catalogs for only the areas that pertain to your business, or choose to shop from our Master Catalogs because you like the convenience of finding such a wide variety of products all under one cover.

Our Catalog Library continues to grow with the publication of new Specialty Catalogs on a regular basis. Visit our Catalog Library online at crlaurence.com to see our latest editions.

Master Catalog Selection

- **03** SEALANTS, ADHESIVES, AND FASTENERS
- **23** FRAMELESS SHOWER DOOR HARDWARE
- **43** AUTO GLASS TOOLS AND WINDOWS
- **53** GLASS AND GLAZING HARDWARE
- **63** ARCHITECTURAL HARDWARE
- **73** TOOLS, MACHINERY, AND EQUIPMENT
- **83** WINDOW AND DOOR REPLACEMENT HARDWARE
- **93** BIG RED MASTER CATALOG

Free CRL Catalogs Online

You can also view or download CRL Catalogs free of charge any time at crlaurence.com. Go to the Home Page and click on the link for the CRL Catalog Library.

Catalog
Library



Once you open the page you'll be able to view full PDF versions of each catalog simply by clicking on the image of that catalog's cover. Browse through them page by page at your convenience. When you find a product that you want more information about, or would like to order, just click on its Catalog Number and you'll go directly to that product's Offer Page. It's another convenient way for you to shop at crlaurence.com.

MASTER CATALOGS

- [CRL03](#) Sealants and Fasteners
- [CRL23](#) Shower Hardware
- [CRL33](#) New Products
- [CRL43](#) Automotive
- [CRL53](#) Glass and Glazing
- [CRL63](#) Architectural
- [CRL73](#) Tools and Machinery
- [CRL83](#) Window and Door
- [CRL93](#) Big Red

SPECIALTY CATALOGS

- [GB10](#) Glass Bonding
- [SD10](#) Shower Door Hardware
- [TH10](#) Transaction Hardware
- [LP11](#) Commercial Door Handles
- [AH11](#) Architectural Hardware
- [AM09](#) Architectural Metals
- [HR11](#) Architectural Railing
- [DC07](#) Door Controls
- [HS07](#) Hospitality and Service
- [TV12A](#) Automotive
- [GM11](#) Insulated Glass Manual
- [HRGWS1](#) Glass Wall and Pool Fencing
- [KCS11](#) Key Control Specialists
- [TAJ11](#) Tajima/CRL

CRL's Complete Selection of Catalogues

Click on any catalogue's image to view, download, or learn more about that catalogue.



C.R. LAURENCE COMPANY

crlaurence.com

N506 |

crlaurence.ca

crlaurence.com.au

crlaurence.co.uk

crlaurence.de

crlaurence.eu

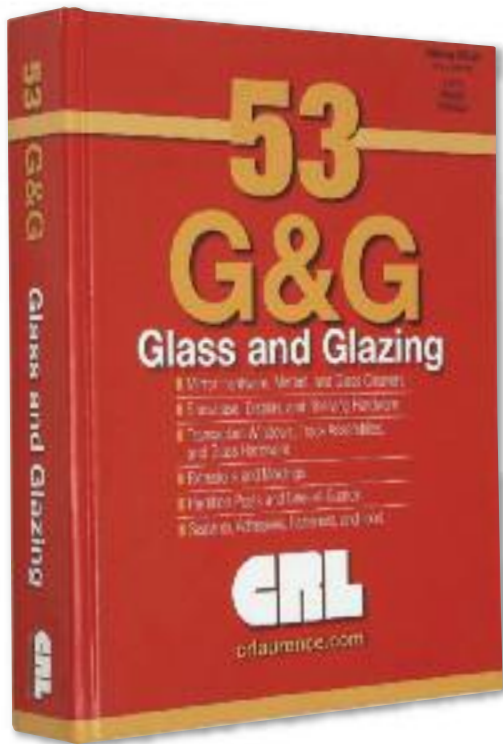

CAT. NO. CRL53

744 full-color pages, including an extensive A to Z Product Index for quick look-up of products

Glass and Glazing Master Catalog CRL53

- Mirror Hardware, Mirrors, and Glass Cleaner
- Showcase, Display, and Shelving Hardware
- Transaction Windows, Track Assemblies, and Glass Hardware
- Extrusions and Moldings
- Partition Posts and Sneeze Guards
- Sealants, Adhesives, and Fasteners
- Glazier's Tools and Equipment

CRL53 Glass and Glazing Catalog is an absolute must for glass shops and glazing contractors. It showcases almost 8,000 products, featuring the finest and most comprehensive line of glass and glazing hardware. CRL53 is separated into six sections for fast and easy product reference, and organized to make ordering primary and related products simple. It's the second in CRL's series of seven Master Catalogs that serve the glass industry and related businesses, each focusing on one of our core business groups.



View Any Page of the CRL53 Online at crlaurence.com

View the CRL53 Catalog online. Simply start from our home page, crlaurence.com, and click on CRL Catalog Library.



Technical Assistance for Glass and Glazing

Ask for Extension

7720

Live consultation by phone is available from 6:00 am to 5:00 pm (Pacific Time) Monday through Friday, and 7:00 am to 12:00 pm on Saturday.

Direct Fax
(866) 921-0531

Direct E-Mail
glazing@crlaurence.com



Tools, Machinery, and Equipment Master Catalog CRL73

- Glaziers' Tools
- Glass Handling Tools
- Safety Gear
- Specialty Tools
- General Hand and Shop Tools
- Caulking Tools
- Insulating Glass
- Glass Storage Equipment
- Glass Working Machinery
- Lifting Equipment

CRL73 is where you will find our extensive line of Tools, Machinery, and Equipment specifically designed for the glazing industry. This catalog contains the most complete list found in the industry of every essential tool the glazing professional needs from abrasives to truck racks and safety glasses; from auto glass tools to cut protection garments; from caulking guns to UV bonding tools and solar energy equipment. CRL73 Master Catalog is organized into six sections for fast and easy product reference. It is the sixth in CRL's series of seven Master Catalogs that serve the glass industry and related businesses, each focusing on one of our core business groups.

CAT. NO. CRL73

Over 600 full-color pages, including an extensive A to Z Product Index for quick look-up of products



View Any Page of the CRL73 Online at crlaurence.com

Viewing the CRL73 Catalog online is as easy as 1-2-3. Simply start from our home page, crlaurence.com, and click on CRL Catalog Library.

1



2



Then choose a viewing option. It's that easy!

3



C.R. LAURENCE COMPANY

N508 |

crlaurence.ca

crlaurence.com.au

crlaurence.co.uk

crlaurence.de

crlaurence.eu

crlaurence.com

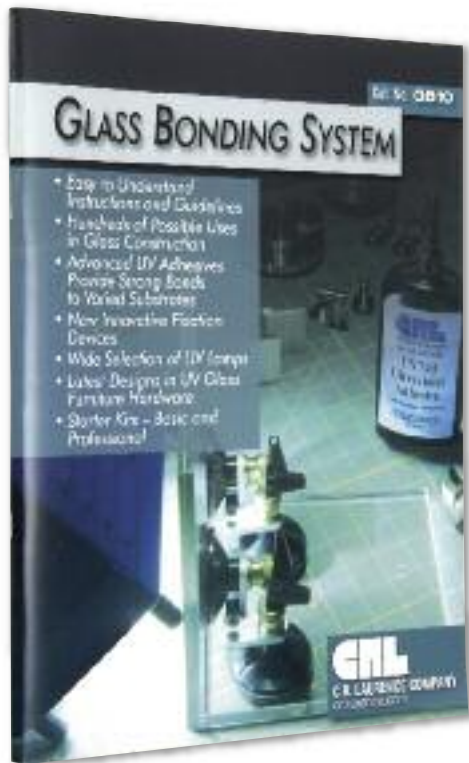

CAT. NO. GB10

64 full-color pages, including an A to Z Product Index for quick look-up of products

Glass Bonding System Specialty Catalog GB10

- Easy to Understand Instructions and Guidelines
- Hundreds of Possible Uses in Glass Construction
- Advanced UV Adhesives Provide Strong Bonds to Varied Substrates
- New Innovative Fixation Devices
- Wide Selection of UV Lamps
- Latest Designs in UV Glass Furniture Hardware
- Starter Kits - Basic and Professional

CRL takes the mystery out of glass bonding with our complete line of UV and UV/Visible Light Adhesives, Fixation Devices, UV Curing Lamps, and Glass Furniture Hardware. The GB10 Specialty Catalog brings you everything you need with easy-to-understand instructions and guidelines to produce glass bonded work, from functional glass furniture and display cases, to beautiful glass artwork. We even include basic UV Starter Kits for first time users and Professional Kits for full time users, plus all the right cleaners and accessories needed to make your job easier and more profitable.



Technical Assistance for Glass and Glazing

Live consultation by phone is available from 6:00 am to 5:00 pm (Pacific Time) Monday through Friday, and 7:00 am to 12:00 pm on Saturday.

Ask for Extension

7720

Direct Fax
(866) 921-0531

Direct E-Mail
glazing@crlaurence.com



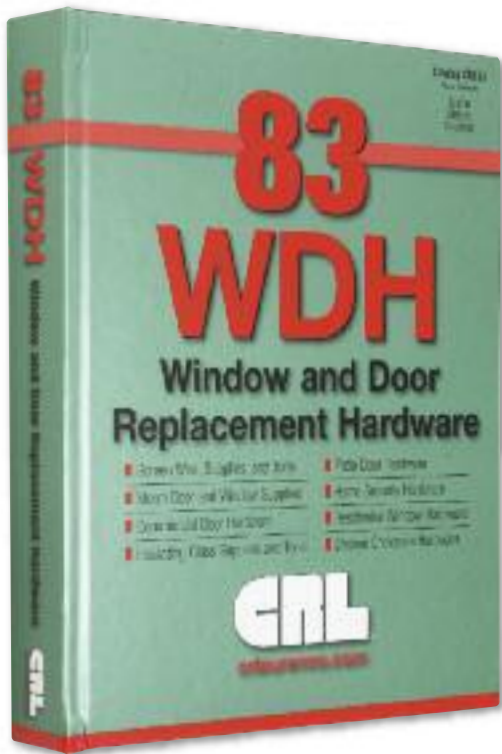

CAT. NO. CRL83

688 full-color pages, including an extensive A to Z Product Index for quick look-up of products

Window and Door Replacement Hardware Master Catalog CRL83

- Screen Wire, Supplies, and Tools
- Patio Door Hardware
- Storm Door and Window Supplies
- Home Security Hardware
- Commercial Door Hardware
- Residential Window Hardware
- Insulating Glass Supplies and Tools
- Shower Enclosure Hardware

CRL83 features our comprehensive selection of door and window replacement parts for residential, commercial, and institutional use. There is also a full selection of hardware for use in shower enclosures, and our full program for the fabrication and installation of energy saving insulating glass units. The CRL83 Master Catalog is separated into five sections for fast and easy product reference. It's the fifth in CRL's series of seven Master Catalogs that serve the glass industry and related businesses, each focusing on one of our core business groups.



View Any Page of the CRL83 Online at crlaurence.com

Viewing the CRL83 Catalog online is as easy as 1-2-3. Simply start from our home page, crlaurence.com, and click on CRL Catalog Library.

1



2



Then choose a viewing option. It's that easy!

3



WINDOW AND DOOR CATALOGS



CAT. NO. DC07

128 full-color pages, including an A to Z Product Index for quick look-up of products

Door Controls Specialty Catalog DC07

- Surface Mounted Door Closers
- Overhead Concealed Door Closers
- Floor Mounted Door Closers
- Access Control Handles
- Locking Ladder Pulls
- Door Pulls and Hinges
- Glass Door Center Locks
- Door Thresholds and Weatherization

The DC07 Door Controls Catalog is intended to help simplify the selection of the proper hardware for the closing and securing of commercial and institutional doors. Our CRL brand Door Closers and related hinge hardware are reliable and durable, and the variety of mounting options assures you will find just the right door hardware for every installation. Our Access Control Handles and Panic Exit Devices are all built to code requirements for the safe egress from buildings. You'll also find a good assortment of door security items in the DC07 Catalog.



A.D.A. Compliance Models Available



Is now a CRL brand



Is now a CRL brand

Technical Assistance for Door and Window Hardware, Including Our Blumcraft and Jackson Brands

Live consultation by phone is available from 6:00 am to 5:00 pm (Pacific Time) Monday through Friday, and 7:00 am to 12:00 pm on Saturday.

Ask for Extension

7720

Direct Fax (866) 921-0531

Direct E-Mail glazing@crlaurence.com



crlaurence.com

C.R. LAURENCE COMPANY



crlaurence.ca crlaurence.com.au crlaurence.co.uk crlaurence.de crlaurence.eu | N511

CRL Frameless Shower Door and Mirror Hardware Master Catalog CRL23

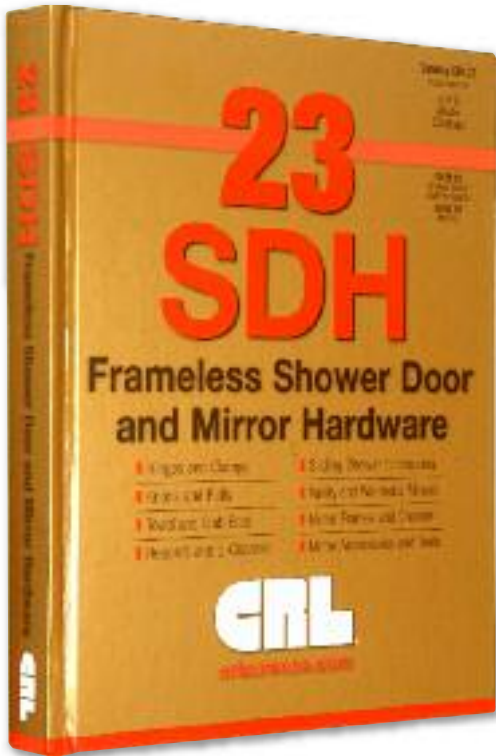

CAT. NO. CRL23

432 full-color pages, including an extensive A to Z Product Index for quick look-up of products

- Hinges and Clamps
- Knobs and Pulls
- Towel and Grab Bars
- Headers and U-Channel
- Sliding Shower Enclosures
- Vanity and Wardrobe Mirrors
- Mirror Frames and Channels
- Mirror Accessories and Tools

CRL23 is the catalog you need when you are looking for hardware specifically for frameless shower and mirror hardware. CRL23 features thousands of products, including hundreds of new products selected for their appeal to your customers. The CRL23 Frameless Shower Door and Mirror Hardware Master Catalog is separated into four sections for fast and easy product reference. It's the fourth in CRL's series of seven Master Catalogs that serve the glass industry and related businesses, each focusing on one of our core business groups.



View Any Page of the CRL23 Online at crlaurence.com

Viewing the CRL23 Catalog online is as easy as 1-2-3. Simply start from our home page, crlaurence.com, and click on CRL Catalog Library.

1



2



Then choose a viewing option. It's that easy!

3



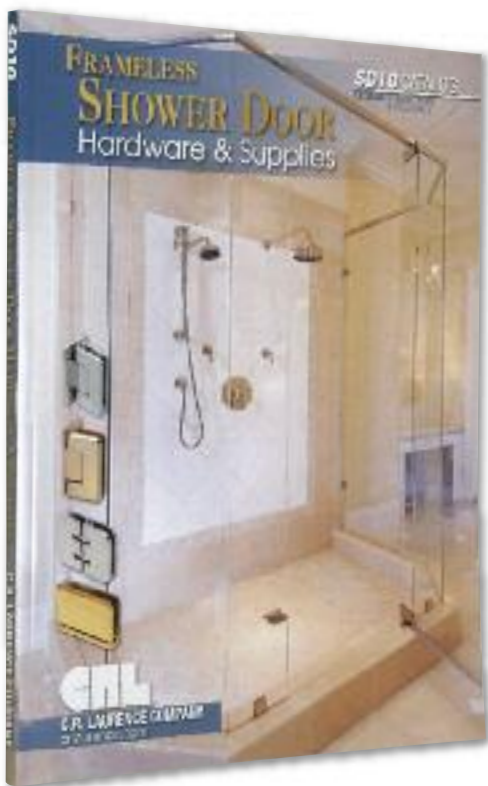

CAT. NO. SD10

160 full-color pages, including an A-Z Product Index for quick look-up of products

CRL Frameless Shower Door Hardware and Supplies Specialty Catalog SD10

- Beautiful Architectural Finishes
- Unequaled Selection of Styles
- Dozens of Finished Installation Photos to Show Your Customers
- New and Innovative Solutions for Installers

C.R. Laurence offers the largest variety of Frameless Shower Door Hardware in the glass industry. Our initial offering of the basic Wall Mount Hinge in just two finishes has evolved over the years to over 25 series of Shower Door Hinges in various configurations and beautiful finishes, plus Door Pulls and Knobs, Towel Bars, Glass Clamps, Headers, U-Channels, Thresholds, Frameless Door Kits, Wipes and Seals, Sliding Shower Door Kits, Bathroom Mirrors, and Decorator Accessories.

Reacting to the "wish list" of designers and installers has brought about many of the new products that are now part of our extensive selection. Unsurpassed quality combined with technical expertise, full inventories, and the willingness to listen has contributed to create our complete package of quality hardware backed by excellent service.

You can see all of this in our Frameless Shower Door Hardware and Supplies Catalog. Copies are available for order, viewing or download online at our web site, crlaurence.com.



CAT. NO. FF4SD

Shower Door Flyers for Your Retail Sales Counter



CAT. NO. SDT21

Frameless Shower Door Guide With Installation Instructions and Cut-Out Templates



Ask about a FREE 30-Day Trial of Showers Online, our Web-based glass sizing and estimating program

Technical Assistance for Frameless Shower Hardware

Live consultation by phone is available from 6:00 am to 5:00 pm (Pacific Time) Monday through Friday, and 7:00 am to 12:00 pm on Saturday.

Direct E-Mail showers@crlaurence.com

Ask for Extension

7740

Direct Fax
(800) 458-7496

Direct E-Mail





CRL Architectural Hardware Master Catalog CRL63

- All-Glass Entrance Systems
- Glass Door and Sidelite Rails, Headers and Channels
- Panic Exit Devices, Door Controls and Hardware
- Stacking and Sliding All-Glass Door Systems
- Structural Glass Fittings
- Aluminum Railings, Windscreens, and Gate Systems
- Hand Rail and Guard Rail Systems
- Aluminum and Stainless Component Post Railings
- Custom Ornamental Metalwork and Awnings

The CRL63 Architectural Hardware Master Catalog features the most comprehensive line of heavy glass and architectural hardware. CRL63 is separated into six sections for fast and easy product reference. It's the third in CRL's series of seven Master Catalogs that serve the glass industry and related businesses, each focusing on one of our core business groups.

CAT. NO. CRL63

Over 700 full-color pages, including an extensive A to Z Product Index for quick look-up of products



View Any Page of the CRL63 Online at crlaurence.com

Viewing the CRL63 Catalog online is as easy as 1-2-3. Simply start from our home page, crlaurence.com, and click on CRL Catalog Library.

1



2



Then choose a viewing option. It's that easy!

3



C.R. LAURENCE COMPANY

N514 |

crlaurence.ca

crlaurence.com.au

crlaurence.co.uk

crlaurence.de

crlaurence.eu

crlaurence.com



CAT. NO. AH11

Over 350 full-color pages, including an extensive A to Z Product Index for quick look-up of products

CRL Architectural Hardware 'All-Glass' Entrance Systems Specialty Catalog AH11

- Door and Sidelite Rails
- Headers and Channels
- Access Control Handles
- Ladder Pulls and Locking Hardware
- Push/Pull Handles
- Center Locks and Keepers
- Sliding and Stacking Glass Door Systems
- Pivot Door Systems
- Glass Clamps and Patch Hardware
- Spider Fittings
- Standoff Systems
- Door Closers and Hinges
- Architectural Metals

The AH11 Architectural Hardware Catalog features our expanded selection of architectural metal and glass hardware for the construction of 'all-glass' entrances in commercial office buildings and storefronts. There are photos of finished projects, as well as helpful technical data.



Ask about a FREE 30-Day Trial of 'All-Glass' Storefronts Online®, our Web-based glass sizing and estimating program

Technical Assistance for Architectural Hardware

Live consultation by phone is available from 6:00 am to 5:00 pm (Pacific Time) Monday through Friday, and 7:00 am to 12:00 pm on Saturday.

Ask for Extension

7700

Direct Fax
(800) 587-7501

Direct E-Mail
architectural@crlaurence.com





CAT. NO. HR11

Over 450 full-color pages, including an extensive A to Z Product Index for quick look-up of products

CRL Architectural Railing Systems Specialty Catalog HR11

- Glass Railings/Balustrades
- TAPER-LOC™ Railing Systems
- Cap Railing Systems
- Aluminum Railing Systems
- Hand Railing Systems
- Welded Railing Systems
- Post Railing Systems
- Swinging Gate Systems
- Glass Walls/Windcreens
- Tools/Accessories

The HR11 Architectural Railing Systems Catalog offers an extensive selection of architectural railing systems and related hardware for the construction of beautiful, code compliant railings and balustrades, including our very popular Aluminum Railing Systems, and our impressive line of Windcreens. We've expanded our complete line of Glass Railing Hardware, from Base Shoe to Cap Rails, simplifying your hardware selection process for balustrades, hand rails, and guard rails. We have also included our Stainless Steel Post Railing Kits, Wood Cap Rails and Hand Rails, as well as our line of Swinging Gates.

And now, for the first time, our Railing Catalog features TAPER-LOC™, the dry glazing system for Glass Railings. TAPER-LOC™ Tapers can be used with monolithic and laminated tempered glass. This innovative system reduces the installation time and mess associated with wet glaze systems, and is what railing installers have been waiting for.



Ask about a FREE 30-Day Trial of Hand Rails Online, our Web-based glass sizing and estimating program

Technical Assistance for Architectural Railings

Live consultation by phone is available from 6:00 am to 5:00 pm (Pacific Time) Monday through Friday, and 7:00 am to 12:00 pm on Saturday.

Ask for Extension

7730

Direct Fax
(800) 587-7501

Direct E-Mail
railings@crlaurence.com



C.R. LAURENCE COMPANY

crlaurence.com

N516 | crlaurence.ca crlaurence.com.au crlaurence.co.uk crlaurence.de crlaurence.eu



CAT. NO. AM09

Over 200 full-color pages, including an extensive A to Z Product Index for quick look-up of products

CRL Architectural Metals Specialty Catalog AM09

- Column Covers (Cladding)
- Canopies and Sunshades
- Wall Panel Systems
- Perforated Panel Systems
- 'All-Glass' Entrances and Spider Fittings
- Custom Ornamental Metalwork
- Custom Cladding and Brake Metal
- Architectural Wire Cloth

The AM09 Architectural Metals Catalog offers an extensive selection of architectural systems and related hardware for the construction of beautiful, code compliant building façades, including our very popular 'All-Glass' Systems, with our impressive line of stock Spider Fittings. We've expanded our complete line of Glass Awnings, from Tension Rods to Universal Brackets, simplifying your hardware selection process for wall mount, storefront mount, and curtainwall mount applications. We have also included our newest product lines, the CRL Wall Panel Systems, Ceiling Systems, Column Cladding, and Perforated Panel Systems, as well as our rapidly growing line of Sunshades and Canopies.



Technical Assistance for Architectural and Ornamental Metals

Live consultation by phone is available from 6:00 am to 5:00 pm (Pacific Time) Monday through Friday, and 7:00 am to 12:00 pm on Saturday.

Ask for Extension

7770

Direct Fax
(866) 921-0532

Direct E-Mail
archmetals@crlaurence.com





CAT. NO. TH10

208 full-color pages, including an A to Z Product Index for quick look-up of products

CRL Transaction and Security Hardware Specialty Catalog TH10

- Service and Pass-Thru Windows
- Ticket and Cashier Windows
- Mail Slots and Package Receivers
- Deal Trays and Shelves
- Electronic Communicators and Speak-Thrus
- Transaction Drawers and Receivers
- Bullet Resistant Windows, Doors, and Barriers
- Safety and Security Mirrors
- Commercial Door Handles and Security Hardware

The CRL Transaction and Security Hardware Catalog showcases our complete selection of products for the secure transfer of cash and merchandise. The TH10 features a full array of products for commercial use in retail stores, banks, check cashing counters, theatres, arenas, ball parks, stadiums, concert halls, and other venues where the cash and card transactions are processed face-to-face, and security concerns for both merchant and customer are at a premium.



View Any Page of the TH10 or HS07 Online at crlaurence.com

Viewing the TH10 or HS07 Catalogs online is as easy as 1-2-3. Simply start from our home page, crlaurence.com, and click on CRL Catalog Library.

1



2



Then choose a viewing option. It's that easy!

3



C.R. LAURENCE COMPANY

N518 |

crlaurence.ca crlaurence.com.au crlaurence.co.uk crlaurence.de crlaurence.eu

crlaurence.com



CAT. NO. HS07

196 full-color pages, including an A-Z Product Index for quick look-up of products

CRL Hospitality and Service Hardware Specialty Catalog HS07

- Systems for Food Service and Display Counters, Booth Dividers, Glass Barriers, and More
- Partition Posts and Sneeze Guards, Fully Assembled or Build Your Own
- Tray Slide Shelves and Service Rails
- Standoffs and Glass Fittings
- Menu and Bulletin Boards

The HS07 Hospitality and Service Catalog offers a full line of products for use in the food industry – Self Service Buffet and Cafeteria Posts, Sandwich Shop and Salad Bar Sneeze Guards, Booth Partition Posts, Tray Slide Shelves, Bar and Foot Rails, and Heavy-Duty Area Separation Posts. Most are available fully assembled and ready to install, or as components so you can build your own. We also feature Menu Boards and our full line of Standoff Hardware for use in creating visual point-of-purchase photos or advertising.



Partition Posts Fully Assembled or Build Your Own

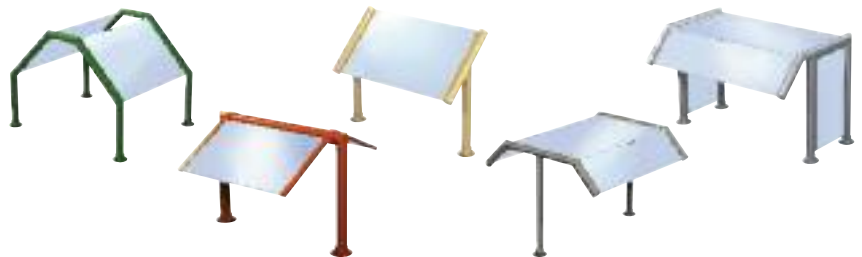

Sneeze Guards in Hundreds of Configurations and Finishes



Technical Assistance for Transaction and Hospitality Hardware

Live consultation by phone is available from 6:00 am to 5:00 pm (Pacific Time) Monday through Friday, and 7:00 am to 12:00 pm on Saturday.

Direct E-Mail transaction@crlaurence.com
Direct E-Mail hospitality@crlaurence.com

Ask for Extension

7760

Direct Fax
(800) 458-7496



AUTOMOTIVE CATALOGS

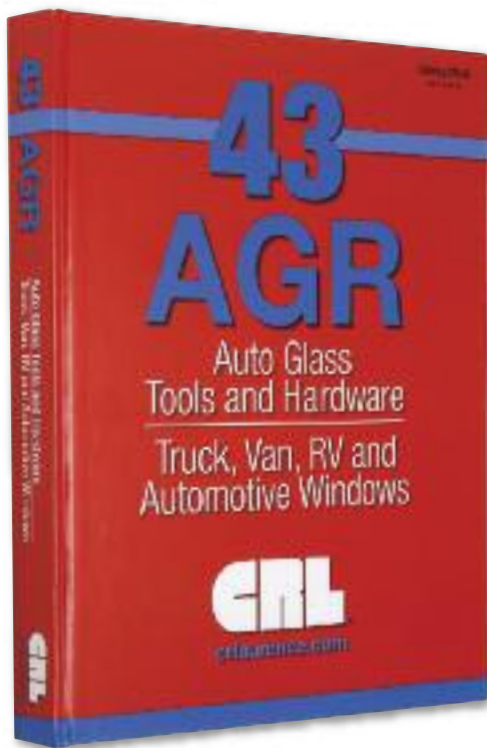

CRL Auto Glass Tools and Hardware Master Catalog CRL43

- Truck, Van, RV, and Automotive Windows
- Auto Glass Adhesives and Sealants
- Auto Glass Shop Tools and Equipment
- Cleaning Supplies and Lubricants
- Automotive Weatherstrips, Moldings, and Replacement Gaskets
- Auto Glass Clips and Fasteners
- Safety Gear and First Aid Kits

CAT. NO. CRL43

Over 400 full-color pages, including an extensive A to Z Product Index for quick look-up of products

The CRL43 Auto Glass Catalog focuses on tools, equipment, supplies, safety gear, and accessories used by the auto glass industry. The CRL 43 Auto Glass Master Catalog is separated into five sections for fast and easy product reference. It's the first in CRL's series of seven Master Catalogs that serve the glass industry and related businesses, each focusing on one of our core business groups.



View Any Page of the CRL43 Online at crlaurence.com

Viewing the CRL43 Catalog online is as easy as 1-2-3. Simply start from our home page, crlaurence.com, and click on CRL Catalog Library.

1



2



Then choose a viewing option. It's that easy!

3



C.R. LAURENCE COMPANY

crlaurence.com

N520 |

crlaurence.ca

crlaurence.com.au

crlaurence.co.uk

crlaurence.de

crlaurence.eu

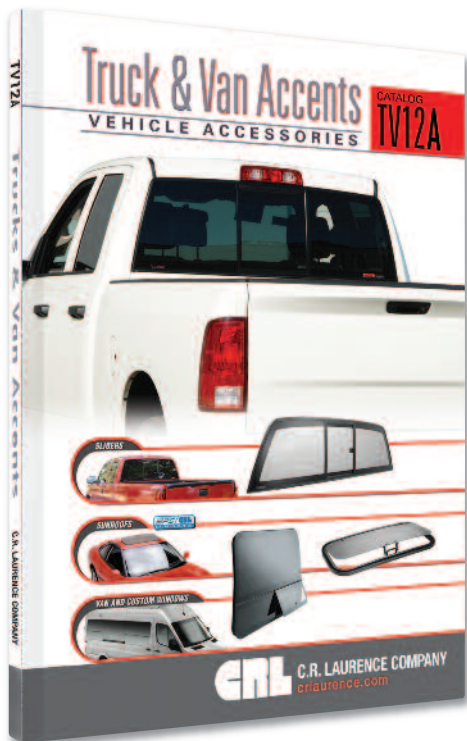

CAT. NO. TV12A

Over 100 full-color pages, including an A to Z Product Index for quick look-up of products

CRL Truck & Van Accents Vehicle Accessories Specialty Catalog TV12A

- Pickup Truck Sliders for Trucks Back to 1948
- Truck Slider Installation Tools
- "All Glass Look" Van Windows
- Fully Framed Van Conversion Windows
- RV, Camper, Motorhome, and Trailer Windows
- Commuter Bus and Shuttle Van Windows
- Sunroofs for Cars, Trucks, and Vans

The TV12A Truck and Van Accents Specialty Catalog details the full selection of CRL automotive aftermarket windows. See our variety of quality Sunroofs, Truck Sliders, and Windows for Vans, RV's, Campers, Trailers, Busses, Big Rigs, Tractors and more in this comprehensive edition. A selection of tools and supplies for the installer are also featured.



Technical Assistance for Automotive Accessories

Live consultation by phone is available from 6:00 am to 5:00 pm (Pacific Time) Monday through Friday, and 7:00 am to 12:00 pm on Saturday.

Ask for Extension

7780

Direct Fax
(800) 587-7501

Direct E-Mail
automotive@crlaurence.com



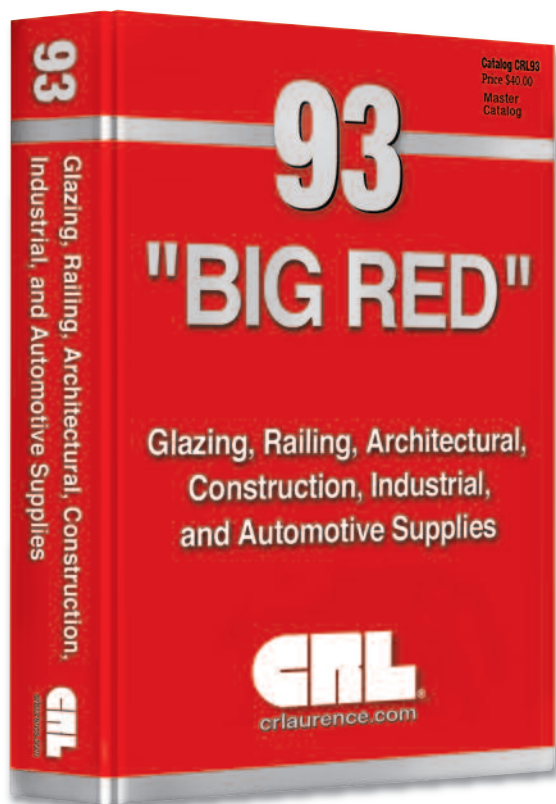

"BIG RED" CAT. NO. CRL93

This massive full-color volume will feature an extensive A to Z Product Index for quick look-up of products

The CRL93 Master Catalog

- **The Return of "Big Red", Our Original Master Catalog**
- **Our Most Popular Catalog Ever Features Our Best Selling Product Lines in One Comprehensive Volume**
- **The Most Asked for Everyday Glazing Tools and Supplies for the Successful Glass Business**
- **A Full Selection of Our Most Popular General Tools, Plus Safety and Maintenance Supplies That Can Be Used By Most Any Business**

For many years we offered all of our products in just one catalog. CRL93, or "Big Red" as it was called, was the single resource for our entire selection of tools and supplies for the glazing industry. It was so popular that we eventually made four reprints, and over the years distributed over 200,000 copies.

As CRL expanded to serve many more industries it became apparent that we just couldn't get everything under one cover any longer. And so was born our seven volume Master Catalog set, with individualized catalogs that focus on core product lines for the industries we serve. We've printed and distributed many thousands of these volumes as well, and they have spawned our popular Specialty Catalogs for individual product lines.

But for many years our customers have commented that they would still like to have one resource catalog for the everyday supplies they use the most, one catalog of the most popular every day items. At CRL we strive to oblige the customers we value so dearly, and because so many have asked, "Big Red" is about to make its return.

The new CRL93 "Big Red" will bring our customers just what they asked for; the best of CRL's product line under one cover. It will feature the top quality items that most any business can use for their day-to-day needs. Products will be organized for easy selection and ordering, and we'll list the details you need to know in order to make an informed selection.

Look for "Big Red" in early 2011. In the meantime, all other CRL Master and Specialty Catalogs are available for order, download, or viewing online at crlaurence.com. Click into our Catalog Library to see our full selection of informative and colorful product catalogs for your successful business.

- **Hardware for Glass and Mirrors, Doors and Windows and Screens, Frameless Showers, Retail Displays**
- **Glazing Tools and Machinery**
- **Glass Handling Equipment**
- **Auto Glass Shop Tools and Supplies**
- **Sealants, Adhesives, Mastics**

CRL Catalog Organizers

- **Keeps Your CRL Catalogs Organized and Standing Upright for Quick and Easy Reference**
- **Fits Both Hard and Soft Cover CRL Catalogs**

CRL Catalog Organizers are perfect for keeping your CRL Catalogs neat and organized. Available in 3" and 6" (76 and 152 mm) widths, the Organizers work with both CRL soft cover Specialty Catalogs as well as CRL hard cover Master Catalogs. These sturdy, black color Organizers are packed six per carton.



CAT. NO. CH3
3" (76 mm)



CAT. NO. CH6
6" (152 mm)



CRL Blumcraft Architectural Metals Catalogs

- Tubular Architectural Hardware
- Tempered Glass Door Hardware
- Panic Hardware
- Railing Systems
- Smoke Baffles
- Glass Gates
- Display Case Doors

For over 100 years Blumcraft of Pittsburgh, an icon in the architectural metal and glass industry, has continued to exhibit elegance in design and craftsmanship, assuring the quality expected by customers around the world.

Beginning with the finest base materials, then adding hand and mechanical skills as well as expert finishing to the mix, Blumcraft's tempered glass doors, hardware, handrails, and display doors are an expression of excellence. Recognized by architects, contractors, and installers in the building trade, we take pride in every product that is shipped to our customers.

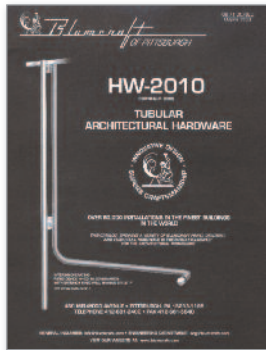

CAT. NO. HW2010
Tubular Architectural Hardware



CAT. NO. B2010
Tempered Glass Doors, Panic, Deadbolt and Dummy Hardware



CAT. NO. M2010
Railings
Smoke Baffles
Glass Gates

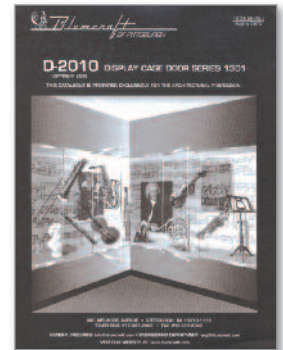

CAT. NO. D2010
Display Case Door Series 1301

CRL Jackson Door Control Hardware Catalog



The JK11 Jackson Door Control Hardware Catalog offers a complete line of Door Closers and related Door Control Hardware, such as the Jackson line of Panic Exit Devices. Included are U. L. Approved Overhead Concealed Door Closers, plus related mounting accessories.

CAT. NO. JK11

CRL Commercial Door Handles Catalog



The LP11 Architectural Hardware Commercial Door Handles Catalog offers an extensive selection of Commercial Door Handles, including Ladder Pulls, Locking Ladder Pulls, Center Locks, Deadbolt, Panic, and Electronic Egress Handles. There are photos of finished projects as well as helpful technical data.

CAT. NO. LP11

CRL Key Control Specialists Catalog



The KCS11 Key Control Specialists Catalog has a complete selection of quality security hardware for retail displays and door control applications. Key Control Specialist locks are now manufactured by C.R. Laurence in our Los Angeles facility using ISO9001:2008 manufacturing processes.

CAT. NO. KCS11

PRODUCT SUPPORT

CRL Product Showcases

- Four Times a Year We Publish Our Product Showcase Featuring New Products and Promotions on Our Most Popular Items
- Save 10, 15, 20, 25% or More
- Qualifying Orders Placed Online Get an Extra Bonus

CRL customers who receive our Product Showcase Flyer get extra special savings on our newest and most popular products. Four times a year (quarterly), we offer some of the products you use most at discounts of up to 25%. You get three whole months to take advantage of these special savings and offers, and all you need to do to get them is place your qualifying order. The CRL Computer System automatically gives you the sale prices, whether you place your order by toll free phone, toll free fax or over the Internet. You can also get details on our Product Showcase promotions when you log onto crlaurence.com.



CRL Product Support to Boost Your Sales

- Our In-House Advertising Division Can Supply You With Banners, Posters, Brochures, Flyers, Magazine Advertising, Private Labeling, and More
- Ad Layouts and Copy Writing to Boost Your Sales Effort and Your Company's Image

CRL Advertising makes available to you professional quality ad materials that can help boost your sales and give your business a higher profile. We can help put your name out there where potential customers can see it, and let them know of the products and services you have to offer in local, regional, and national markets. For information, contact CRL's National Sales Manager at (800) 421-6144. Ask for Ext. 5262.



New Product Submissions

Do You Have an Idea for a New Product?

- Engineers Available for Product Development, Testing, and Production Support
- Award Winning Designs and Products
- State-of-the-Art Computers and Software

No one knows better what tools he or she would like to see in a catalog than the people who use them. We make an effort to make our catalogs as thorough as possible, but it never fails that as soon as we introduce a catalog one or more of our customers will come up with an item or a suggestion that makes us say "Why didn't we think of that?" We've received lots of useful suggestions, and are always pleased when someone takes the time to tell us their ideas on what they would have liked us to include.

We welcome the opportunity to serve you, and are committed to providing your business with the services that produce quality products. To discuss the possibility of working with CRL Manufacturing we invite you to contact CRL Glass and Glazing at (800) 421-6144 in the U.S., (877) 421-6144 from Canada, or (323) 588-1281 International. Ask for Ext. 7720. To send e-mail go to crlaurence.com, click on Contact Us, and then click on Technical Sales for Glass and Glazing Products.

Need Help With a Current Product?

- Experienced, Knowledgeable Team Dedicated From Start to Finish
- CRL is ISO9001-2008 Certified



Online "New Product Submittal Form" can be found at crlaurence.com



C.R. LAURENCE COMPANY

N524 |

crlaurence.ca

crlaurence.com.au

crlaurence.co.uk

crlaurence.de

crlaurence.eu

crlaurence.com



C.R. LAURENCE COMPANY

An ISO9001:2008 Certified Company

03 SAF



UNITED STATES

 Visit Our Web Site: crlaurence.com

Corporate Headquarters

LOS ANGELES, CALIFORNIA

Phone: (323) 588-1281 Fax: (323) 581-6522

Toll Free Phone: (800) 421-6144

Toll Free Fax: (800) 262-3299

ATLANTA, GEORGIA

Phone: (404) 696-3445 Fax: (404) 696-3386

BOSTON AREA, MASSACHUSETTS

Phone: (508) 880-5600 Fax: (508) 880-5775

CHICAGO AREA, ILLINOIS

Phone: (847) 426-3800 Fax: (847) 426-0111

CLEVELAND AREA, OHIO

Phone: (440) 248-0003 Fax: (440) 248-0120

DALLAS, TEXAS

Phone: (214) 634-7305 Fax: (214) 631-6519

DENVER, COLORADO

Phone: (303) 373-9988 Fax: (303) 373-0884

HOUSTON, TEXAS

Phone: (713) 462-6300 Fax: (713) 462-6306

LAS VEGAS, NEVADA

Phone: (702) 253-0211 Fax: (702) 253-0311

MIAMI AREA, FLORIDA

Phone: (954) 846-9233 Fax: (954) 846-9277

NEW YORK CITY AREA

Phone: (201) 770-1077 Fax: (201) 770-1599

ORLANDO, FLORIDA

Phone: (407) 857-7900 Fax: (407) 857-7766

PHILADELPHIA AREA

Phone: (856) 727-1022 Fax: (856) 727-3299

PHOENIX, ARIZONA

Phone: (602) 269-7500 Fax: (602) 269-7600

SAN FRANCISCO / OAKLAND AREA

Phone: (510) 475-1000 Fax: (510) 475-1404

SEATTLE AREA, WASHINGTON

Phone: (253) 850-5800 Fax: (253) 813-1818

BLUMCRAFT OF PITTSBURGH

PITTSBURGH, PENNSYLVANIA

Phone: (412) 681-2400 Fax: (412) 681-6840

SOMMER AND MACA

GLASS MACHINERY DIVISION

CICERO, ILLINOIS

Phone: (773) 242-2871 Fax: (708) 863-5462



CRL CANADA

crlaurence.ca

Corporate Headquarters

TORONTO AREA, ONTARIO

Phone: (905) 303-7966

Fax: (905) 303-7965

MONTREAL AREA, QUEBEC

Phone: (514) 352-3300

Fax: (514) 352-1017

CALGARY, ALBERTA

Phone: (403) 250-5783

Fax: (403) 291-3260

VANCOUVER AREA, B.C.

Phone: (604) 448-9344

Fax: (604) 448-9322

Toll Free Phone: (800) 421-6144

Toll Free Fax: (800) 262-3299



CRL AUSTRALIA

crlaurence.com.au

Toll Free Phone: 1800 424 275

Toll Free Fax: 1800 813 013

**SYDNEY AREA,
NEW SOUTH WALES**

Phone: (02) 9851-3444

Fax: (02) 9851-3445

**MELBOURNE AREA,
VICTORIA**

Phone: (03) 9764-8322

Fax: (03) 9764-8378



CRL EUROPE

Freephone: 00 800 0421 6144

Freefax: 00 800 0262 3299

**MANCHESTER AREA,
ENGLAND**

Phone: +44 (0)1706 863 600

Fax: +44 (0)1706 869 860

crlaurence.co.uk

crlaurence.eu

**STUTTGART AREA,
GERMANY**

Phone: +49 (0)7062 915 93 15

Fax: +49 (0)7062 915 93 16

crlaurence.de

TRANSLATIONS

TRADUCTIONS

This CRL Catalog can be translated into the following languages by going to these specific web sites:

GERMAN: crlaurence.de

FRENCH: crlaurence.qc.ca or crlaurence.fr

SPANISH: crlaurence.com.mx or crlaurence.es

Enter the product number into the Search Box and all information about the item will be in that language.

Pour visualiser ce catalogue CRL en français, visitez le site

Web: crlaurence.qc.ca ou crlaurence.fr

Saisissez le numéro d'article dans la case de recherche pour recevoir les informations traduites en langue française.

ÜBERSETZUNGEN

TRADUCCIONES

Dieser CRL-Katalog kann in die deutsche Sprache übersetzt werden, indem Sie auf die Webseite: crlaurence.de gehen.

Geben Sie die Artikelnummer in das Suchfeld ein und alle Produktinformationen sind in deutscher Sprache.

Para ver este catálogo de CRL en español, diríjase a este sitio Web: crlaurence.com.mx o crlaurence.es

Ingrese el número de producto en la casilla de Búsqueda y toda la información del producto estará en español.

C.R. LAURENCE CO., INC.

Corporate Headquarters

Post Office Box 58923, Los Angeles, CA 90058-0923

International Phone: (323) 588-1281 • International Fax: (323) 581-6522

GLASS AND GLAZING

Phone: (800) 421-6144 or (323) 588-1281 Ext. 7720

Direct Fax: (800) 262-3299 or (323) 581-6522

Direct E-Mail: glazing@crlaurence.com